

USB IO-Link Master, CDSU-1

FESTO



Key features

General information

The USB IO-Link Master CDSU-1 allows Festo IO-Link products to be commissioned quickly and intuitively.

For commissioning IO-Link devices with a higher output, a standardised 24 V industrial input port is available on the master (up to 2.5 A).

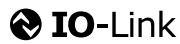

It is connected to a PC via a mini USB port. The M12 IO-Link connection and the USB interface are galvanically isolated to ensure safe and reliable operation.

Port Class B IO-Link devices up to 3.5 A (e.g. valve terminals) can be operated using the new NEDU distributor.

The USB IO-Link Master Tool software acts as the user interface for visualising and editing the parameters of IO-Link devices.

This software can be downloaded for free from the Support Portal.

IO-Link devices with a low current demand can be operated directly from the USB port of a PC via an integrated DC/DC converter (up to 80 mA).

Key features / highlights

- Universal solution for the parameterisation and visualisation of IO-Link devices
- For all Festo IO-Link devices (sensors and actuators)
- Universal connections
- Galvanic isolation
- For port class A and port class B (with accessories)
- Connecting cables available as accessories for nearly all Festo IO-Link devices
- For IO-Link devices with protocol version 1.1 and 1.0
- Supports data storage
- IODD Finder Interface
- Future-proof: new functions, e.g. firmware updates via IO-Link, will be available regularly
- Compact, cost-effective and powerful

CDSU-1



Peripherals overview

Connection example up to 80 mA:

Devices with a low current demand can be operated directly from the USB port of a PC via an integrated DC/DC converter.

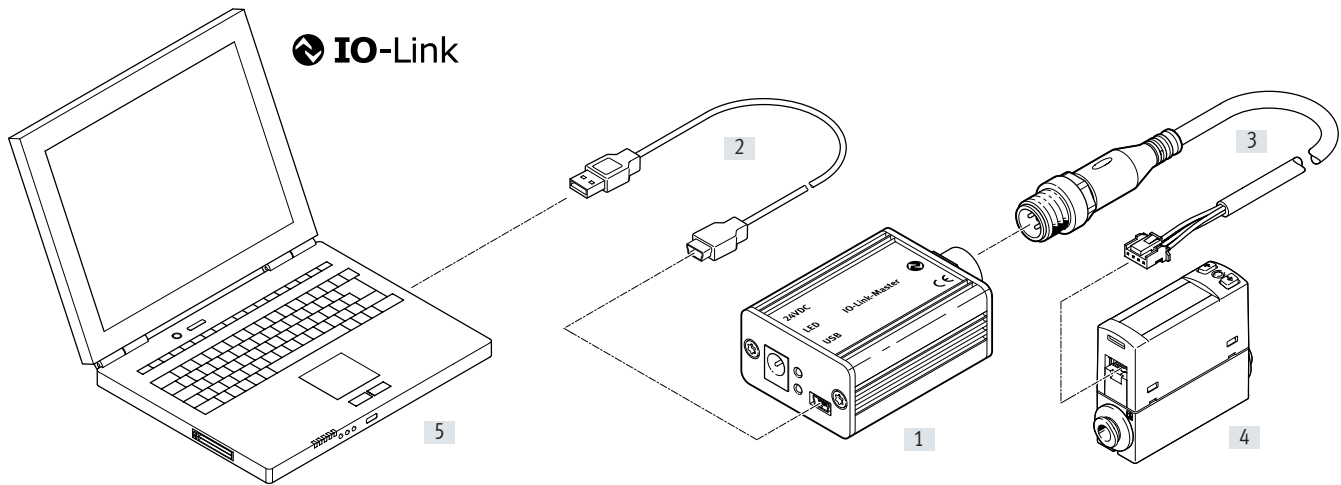

Product overview		Brief description	→ Page/Internet
[1]	Controller CDSU-1	For quick and intuitive commissioning of products with IO-Link	6
[2]	Connecting cable ¹⁾	Mini USB cable type A	-
[3]	Connecting cable NEBS-L1G4-K-1-N-M12G4	4 x 0.25 mm ² , M12x1, A-coded, to EN 61076-2-101	11
[4]	Flow sensors SFAH-...	For monitoring compressed air and non-corrosive gases.	sfah
[5]	Laptop	-	-

1) Mini USB cable is included in the scope of delivery of the CDSU-1

Peripherals overview

Connection example up to 2.5 A:

For commissioning IO-Link devices with a higher output, a standardised 24 V industrial input port is available on the master for connecting an external power supply unit.

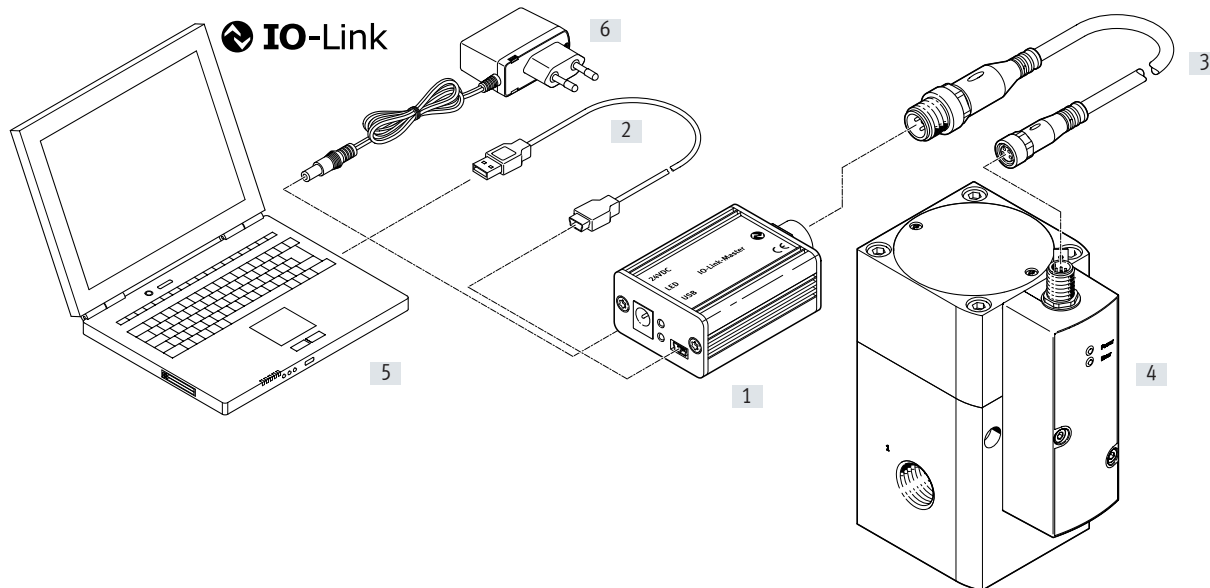

Product overview		Brief description	→ Page/Internet
[1]	Controller CDSU-1	For quick and intuitive commissioning of products with IO-Link	6
[2]	Connecting cable ¹⁾	Mini USB cable type A	–
[3]	Connecting cable NEBU-M8G4-K-1-N-M12G4	4 x 0.25 mm ² , M8x1, A-coded, to EN 61076-2-104	12
[4]	Proportional valves VPPM	Proportional-pressure regulators	vppm
[5]	Laptop	–	–
[6]	Power supply unit ²⁾	For supplying power	–

1) Mini USB cable is included in the scope of delivery of the CDSU-1

2) Power supply plug is not included in the scope of delivery of the CDSU-1

Peripherals overview

Connection example up to 3.5 A:

Port Class B IO-Link devices can be operated using the new distributor.

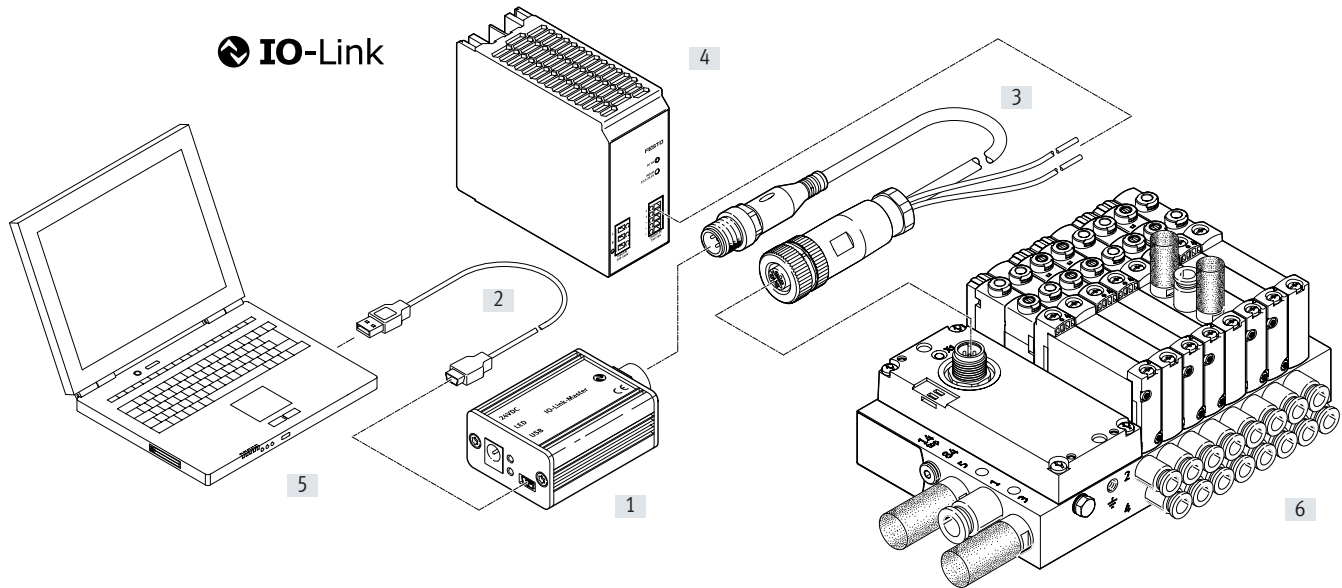

Product overview		Brief description	→ Page/Internet
[1]	Controller CDSU-1	For quick and intuitive commissioning of products with IO-Link	6
[2]	Connecting cable ¹⁾	Mini USB cable type A	–
[3]	Distributor NEDU-L1R2-M12G5-M12LE-1R	3 x 0.25 mm ² , 2 x 0.5 mm ²	9
[4]	Power supply unit ²⁾ CACN	For supplying power	–
[5]	Laptop	–	–
[6]	Valve terminal VTUG-...	Valve terminal with IO-Link interface	vtug

1) Mini USB cable is included in the scope of delivery of the CDSU-1

2) Power supply unit is not included in the scope of delivery of the CDSU-1

Data sheet



General technical data	
Type	CDSU-1
Conforms to standard	EN 61131-9
Certification	RCM compliance mark
CE marking (see declaration of conformity)	To EU EMC Directive To EU RoHS Directive
Note regarding use	For use with the USB IO-Link Master Tool software (available from the Support Portal) for Windows version 7 or higher (32/64-bit)

Electronics	
Input voltage	5 V DC at the USB connection
	24 V DC \pm 6 V via external supply
Input current	Max. 600 mA at the USB connection
	Max. 2.5 A via external supply
Output voltage	24 V DC \pm 10% with USB operation
	24 V DC \pm 6 V with external supply (max. input voltage)
IO-Link, output current	80 mA with USB operation
	Max. input current with external supply
Reverse polarity protection	For operating voltage connections
Short circuit protection	Yes
Overload protection	Not present

Ambient conditions	
Ambient temperature	[°C] 0 ... 55
Storage temperature	[°C] -10 ... 75
Degree of protection	IP20
Note on materials	RoHS-compliant

Mechanical components	
Product weight	[g] 106
Housing material	Anodised wrought aluminium alloy

Data sheet

Communication interface for IO-Link	
Protocol	IO-Link
Protocol version	Master V 1.0 Master V 1.1
Communication mode	COM1 (4.8 kBd) COM2 (38.4 kBd) COM3 (230.4 kBd)
Port class	A B with accessories
Number of ports	1
Process data width OUT	Can be parameterised 0 - 32 bytes
Process data width IN	Can be parameterised 0 - 32 bytes
Minimum cycle time [ms]	1.5
Data memory available	2 kB/port

Power supply	
Function	Additional power supply
Connection technology	Coaxial
Number of pins/wires	2
Note on connection technology	For plugs with an O.D. of 5.5 mm For plugs with an I.D. of 2.1 mm
USB interface	
Connection type	Socket
Connection technology	USB 2.0 type B mini
Galvanic isolation	Yes

Electrical connection of IO-Link	
Number of pins/wires	5
Assigned pins/wires	3
Connection technology	M12x1, A-coded, to EN 61076-2-101

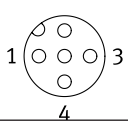
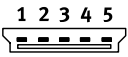
Pin allocation		
	Pin	Meaning
	1	+ 24 V
	2	Not assigned
	3	GND
	4	IO-Link (C/Q)
	5	Not assigned
	1	+ 5 V
	2	D-
	3	D+
	4	Not assigned
	5	GND

Data sheet

Dimensions

Download CAD data → www.festo.com

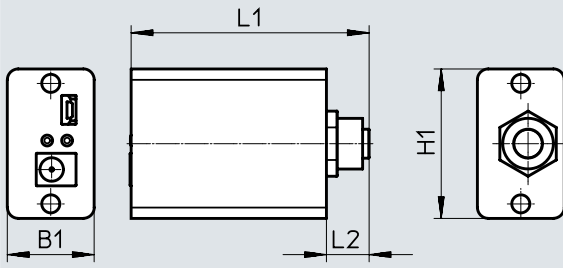

Type	B1	H1	L1	L2
CDSU-1	24	41.3	65.8	11.8

Ordering data

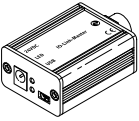
Controllers	Brief description	Part no.	Type
	The USB IO-Link Master CDSU-1 allows products with IO-Link to be commissioned quickly and intuitively ¹⁾	8091509	CDSU-1

1) Power supply plug is not included in the scope of delivery of the CDSU-1

Accessories

Distributor NEDU

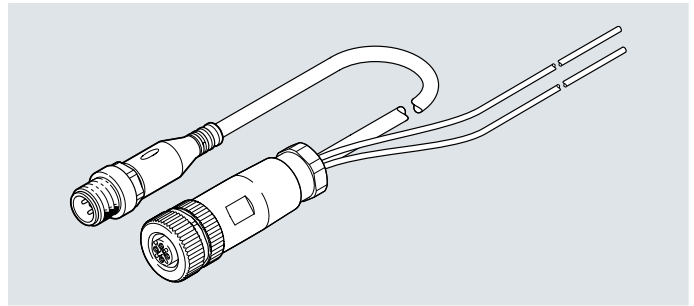

General technical data		Electrical connection 1	Electrical connection 2	Electrical connection 3
Connecting cable 4x 0.25 mm ²				
Design	Y distributor with cable on controller side			
Distributor type	1 to 2			
Based on standard	EN 61076-2-101			
Function	Field device side	Communication, IO-Link	Additional supply	
Design type	Round	Round	-	
Connection type	Socket	Plug	2x single wires	
Cable outlet	Straight	Straight	-	
Connection technology	M12x1, A-coded, to EN 61076-2-101	M12x1, A-coded, to EN 61076-2-101	Open end	
Number of pins/wires	5	3	2	
Assigned pins/wires	5	3	2	
Cable characteristic	For static applications			
Cable length [m]	1			
Cable composition [mm ²]	3 x 0.25	3 x 0.25	2 x 0.5	
Conductor nominal cross section [mm ²]	0.25	0.25	0.5	
Bending radius, fixed cable installation	≥ 13.5 mm			
Bending radius, flexible cable installation	≥ 6 mm			
Cable diameter [mm]	4.5 and 1.75	4.5	1.75	
Type of mounting	Screw-type lock with 18 mm hexagon and longitudinal knurl	Screw-type lock with hexagon A/F 13 mm and longitudinal knurl	-	
Plug pattern			-	

Accessories

Operating and environmental conditions

Ambient temperature	[°C]	-30 ... 80
Nominal operating voltage DC	[V]	24
Operating voltage range DC	[V]	0 ... 30
Current rating at 40°C	[A]	4
Surge resistance	[kV]	0.8
Degree of protection		IP65, IP68, IP69K
Note on degree of protection		When mounted IP40 for M12 socket
Pollution degree		3
Corrosion resistance class CRC ¹⁾		1

1) Corrosion resistance class CRC 1 to Festo standard FN 940070

Low corrosion stress. Dry indoor application or transport and storage protection. Also applies to parts behind coverings, in the non-visible interior area, and parts which are covered in the application (e.g. drive trunnions).

Materials

Housing material	TPE-U(PUR), PA
Housing colour	Black
Cable sheath material	TPE-U(PUR)
Cable sheath colour	Grey
Material of screw-type lock	Nickel-plated brass, nickel-plated die-cast zinc
Material of pin contacts	Nickel-plated and gold-plated bronze
Insulating sheath material	PVC
Note on materials	RoHS-compliant

Dimensions

Download CAD data → www.festo.com

Distributor

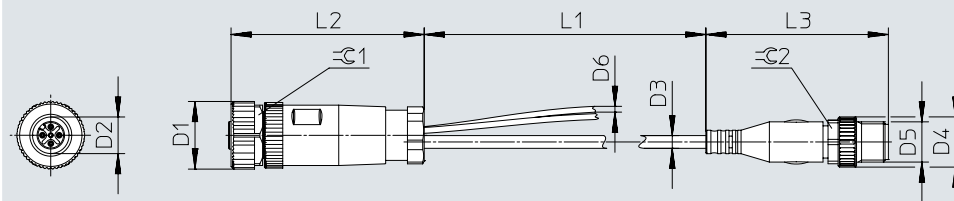

Type	D1	D2	D3	D4	D5
NEDU-L1R2-M12G5-M12LE-1R	20.2 ∅	M12x1	4.5 ∅	15 ∅	M12x1

Type	L1	L2	L3	ϕ 1	ϕ 2
NEDU-L1R2-M12G5-M12LE-1R	1000	54	54.5	18	13

Ordering data – Connecting cables

Data sheets → Internet: nebs

	Electrical connection 1 [mm ²]	Electrical connection 2 [mm ²]	Electrical connection 3 [mm ²]	Length [m]	Weight [g]	Part no.	Type
	3 x 0.25	3 x 0.25	3 x 0.5	1	78	8091516	NEDU-L1R2-M12G5-M12LE-1R

Accessories

Connecting cables NEBS

e.g. for SPAN, SCDN and SFAH

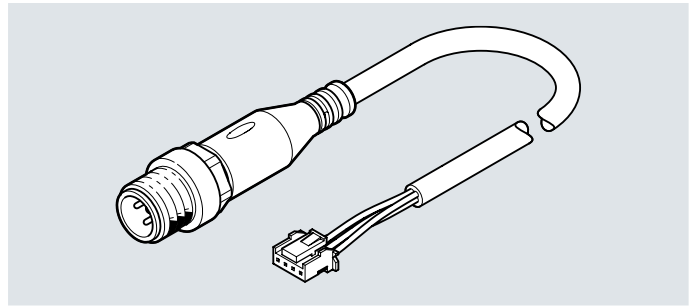

General technical data		
Connecting cable 4x 0.25 mm ²	Electrical connection 1	Electrical connection 2
Function	Field device side	Controller side
Design type	Rectangular	Round
Connection type	Socket	Plug
Cable outlet	Straight	Straight
Connection technology	Plug pattern L1]	M12x1, A-coded, to EN 61076-2-101
Number of pins/wires	4	4
Assigned pins/wires	4	4
Cable characteristic	Standard	
Bending radius, fixed cable installation	≥ 14 mm	
Bending radius, flexible cable installation	≥ 46 mm	
Cable diameter [mm]	4.5	
Conductor nominal cross section [mm ²]	0.25	
Type of mounting	Snap-locking	Screw-type lock with hexagon A/F 13 mm and longitudinal knurl
Plug pattern	<p>4 3 2 1</p>	

Operating and environmental conditions		
Ambient temperature [°C]	-20 ... 60	
Ambient temperature with flexible cable installation [°C]	-5 ... 60	
Storage temperature [°C]	-20 ... 60	
Operating voltage range DC [V]	0 ... 30	
Current rating at 40°C [A]	1	
Surge resistance [kV]	0.8	
Degree of protection	IP65, IP67, IP69K	
Note on degree of protection	When mounted IP40 for plug pattern L1]	
Pollution degree	2	
Corrosion resistance class CRC ¹⁾	2	

1) Corrosion resistance class CRC 2 to Festo standard FN 940070
Moderate corrosion stress. Indoor applications in which condensation can occur. External visible parts with primarily decorative surface requirements which are in direct contact with a normal industrial environment.

Accessories

Materials	
Housing material	PA, TPE-U(PUR)
Housing colour	Black, white
Cable sheath material	TPE-U(PUR)
Material of screw-type lock	Nickel-plated brass
Material of pin contacts	Tin-plated bronze, gold-plated brass
Insulating sheath material	PP
Cable sheath colour	Grey
Note on materials	RoHS-compliant, halogen-free

Dimensions

Plug

Scale 2:1

Download CAD data → www.festo.com

Type	B1	B3	B4	D1 ∅	D2 ∅
NEBS-L1G4-K-1-N-M12G4	10	6	2	4.5	15

Type	D3	H1	L1	L2	L3	⌀ 1
NEBS-L1G4-K-1-N-M12G4	M12x1	5.8	1000	25	54.5	13

Ordering data – Connecting cable Data sheets → Internet: nebs

	Electrical connection 1	Electrical connection 2	Length [m]	Cable composition [mm ²]	Weight [g]	Part no.	Type
	Plug pattern L1J	M12x1, A-coded, to EN 61076-2-101	1	4 x 0.25	40	8091514	NEBS-L1G4-K-1-N-M12G4

Ordering data

	Cable composition	Electrical connection	Part no.	Type
	3 x 0.25 mm ²	M12x1, A-coded, to EN 61076-2-101	8091511	NEBU-M12G5-K-1-N-M12G3
		M8x1, A-coded, to EN 61076-2-104	8091512	NEBU-M8G3-K-1-N-M12G3
		Open end	8091515	NEBU-LE3-K-1-N-M12G3
	4 x 0.25 mm ²	M8x1, A-coded, to EN 61076-2-104	8091513	NEBU-M8G4-K-1-N-M12G4

Festo - Your Partner in Automation



1 Festo Inc.
5300 Explorer Drive
Mississauga, ON L4W 5G4
Canada

Festo Customer Interaction Center
Tel: 1 877 463 3786
Fax: 1 877 393 3786
Email: customer.service.ca@festo.com



2 Festo Pneumatic
Av. Ceylán 3,
Col. Tequesquináhuac
54020 Tlalnepantla,
Estado de México

Multinational Contact Center
01 800 337 8669
ventas.mexico@festo.com



3 Festo Corporation
1377 Motor Parkway
Suite 310
Islandia, NY 11749

Festo Customer Interaction Center
1 800 993 3786
1 800 963 3786
customer.service.us@festo.com



4 Regional Service Center
7777 Columbia Road
Mason, OH 45040

Connect with us



www.festo.com/socialmedia



www.festo.com

Subject to change