

Branching module MS4-FRM

FESTO



Characteristics

At a glance

- Grid dimension: 40 mm
- Outlet at top and bottom
- Support for additional modules
- Optionally with integrated non-return function and pressure switch
- Can be used as an intermediate distributor for varying air qualities
- Optional pressure sensor

Product segmentation



Festo Core Range

Solves the majority of your automation tasks

With the Festo Core Range, we have selected the most important products and functions from our broad product catalogue, and added the quickest delivery. the Core Range offers you the best value with the expected high Festo quality.

- Quickest delivery, worldwide – wherever, whenever
- Expected high Festo quality
- Easy and fast to select

Ordering data - modular system

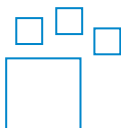

Configurable product

This product and all its product options can be ordered online via the configurator.

Function

Air distributor with 4 connections

Pneumatic connection

Depending on the size, different connection types can be selected:

- Individual fittings that are fastened via a female thread
- Connecting plates with female thread

Additional function

None

With integrated non-return function

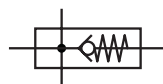
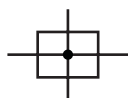

prevents backflow, e.g. of lubricated compressed air

Pressure gauge alternatives

Two pressure gauge connections for variable installation

Alternative pressure gauge scale

The scaling of the built-in pressure gauge can be selected. The unit options available are [MPa], [bar] / [psi].

Pressure switch

Optionally available with different pressure switches.

Characteristics

EU certification

Optional device variant EX4 for use in potentially explosive areas of zones 1, 2, 21 and 22

UL certification

Optional device variant UL1, which meets the safety requirements for the Canadian and US markets.

Flow direction

Available with flow in the opposite direction.

Type code

001		Series
MS4	MS series, size 4	
002		Size
4	Grid dimension 40 mm	
003		Function
FRM	Branching module	
004		Pneumatic connection
1/8	Female thread G1/8	
1/4	Female thread G1/4	
AGA	Sub-base G1/8	
AGB	Sub-base G1/4	
AGC	Sub-base G3/8	
005		Additional function
	None	
I	With integrated non-return function	
006		Pressure gauge alternatives
	None	
A4	Adapter for EN pressure gauge 1/4, without pressure gauge	
A8	Adapter for EN pressure gauge 1/8, without pressure gauge	
AD7	Pressure sensor with switching display, M8 plug, threshold value comparator, PNP, N/O	
AD8	Pressure sensor with switching display, M8 plug, threshold value comparator, PNP, N/C	
AD9	Pressure sensor with switching display, M8 plug, window comparator, PNP, N/O	
AD10	Pressure sensor with operational status indicator, M8 plug, window comparator, PNP, N/C	
AD11	Pressure sensor with LCD display, M12 plug, 4-pin, IO-Link®, PNP, NPN, 0...10 V, 1...5 V, 4...20 mA	
AD12	Pressure sensor with LCD display, M8 plug, 4-pin, IO-Link®, PNP, NPN, 0...10 V, 1...5 V, 4...20 mA	
AG	MS pressure gauge	
RG	Integrated pressure gauge, red/green scale	

007		Alternative pressure gauge scale
	MS pressure gauge	
PSI	psi	
MPA	MPa	
008		Pressure switch
	None	
X	Pressure switch PEV with display, plug socket, EN 175301, type A, cube	
Y	Pressure switch PEV without display, plug socket, EN 175301, type A, cube	
M12	Pressure switch PEV without display, plug socket, round, M12, 4-pin	
009		Type of mounting
	Without mounting bracket	
WP	Mounting bracket basic design	
WPM	Mounting bracket for hooking in service unit components	
WB	Mounting centrally at rear (wall mounting top and bottom), connecting plates not required	
WBM	Mounting centrally at rear (wall mounting top), connecting plates not required	
010		EU certification
	None	
EX4	II 2GD	
011		UL certification
	None	
UL1	cULus ordinary location for Canada and USA	
012		Flow direction
	Flow direction from left to right	
Z	Flow direction from right to left	
013		Special material properties
	None	
F1A	Recommended for production plants for manufacturing lithium-ion batteries, F1A	

Datasheet

General technical data

Pneumatic connection, port 1	G1/8, G1/4
Pneumatic connection, port 2	G1/8, G1/4
Pneumatic connection, port 3	G1/4
Pneumatic connection, port 4	G1/4
Design	Branching module, With non-return function
Mounting position	optional

Standard nominal flow rate

Pneumatic connection, port 1	G1/8, G1/4
Standard nominal flow rate in main flow direction 1->2	1,200 ... 4,600 l/min
Standard nominal flow rate, outlet upwards	500 ... 1,600 l/min
Standard nominal flow rate, outlet downwards	500 ... 1,700 l/min

Electrical data

Operational voltage range AC ¹⁾	0 ... 250 V
Operational voltage range DC ²⁾	0 ... 125 V

1) Only in combination with pressure switch

2) Only in combination with pressure switch

Operating and environmental conditions

Operating pressure	0 ... 14 bar
Operating medium	Compressed air to ISO 8573-1:2010 [7:4:4], Inert gases
Note on operating and pilot medium	Lubricated operation possible (in which case lubricated operation will always be required)
Ambient temperature	-10 ... 60°C
Media temperature	-10 ... 60°C
Storage temperature	-10 ... 60°C
Corrosion resistance class CRC ¹⁾	2 - Moderate corrosion stress
Suitable for use with food ²⁾	See supplementary material information
Approval ³⁾	c UL us - Recognized (OL)
Instructions on use ⁴⁾	Foreign particles can adhere to the product or form during installation. Depending on the application, it may be necessary to purge the product with clean compressed air, to clean it after installation and operate it with ducted exhaust air.

1) Further information www.festo.com/x/topic/crc

2) Further information www.festo.com/catalogue/ms-firm → Support/Downloads.

3) Further information www.festo.com/catalogue/ms-firm → Support/Downloads.

4) Applies to products for battery production (F1A)

ATEX

ATEX category gas	II 2G
Explosion ignition protection type for gas	Ex h IIC T6 Gb X
ATEX category dust	II 2D
Explosion ignition protection type for dust	Ex h IIIC T60°C Db X
Explosion ambient temperature	-10°C ≤ Ta ≤ +60°C
CE mark (see declaration of conformity) ¹⁾	To EU Explosion Protection Directive (ATEX)

1) Further information www.festo.com/sp/Certificates.

Materials

Material housing	Die-cast aluminium
Note on materials	RoHS-compliant
LABS (PWIS) conformity	VDMA24364-B1/B2-L

Datasheet

Additional material properties – products for battery production (F1A)

Suitability for the production of Li-ion batteries	Metals with more than 1% by mass of copper, zinc or nickel by mass are excluded from use. Exceptions are nickel in steel, chemically nickel-plated surfaces, printed circuit boards, cables, electrical plug connectors and coils
--	---

Dimensions

Dimensions – Basic type with female thread, with cover plate

Download CAD data → www.festo.com

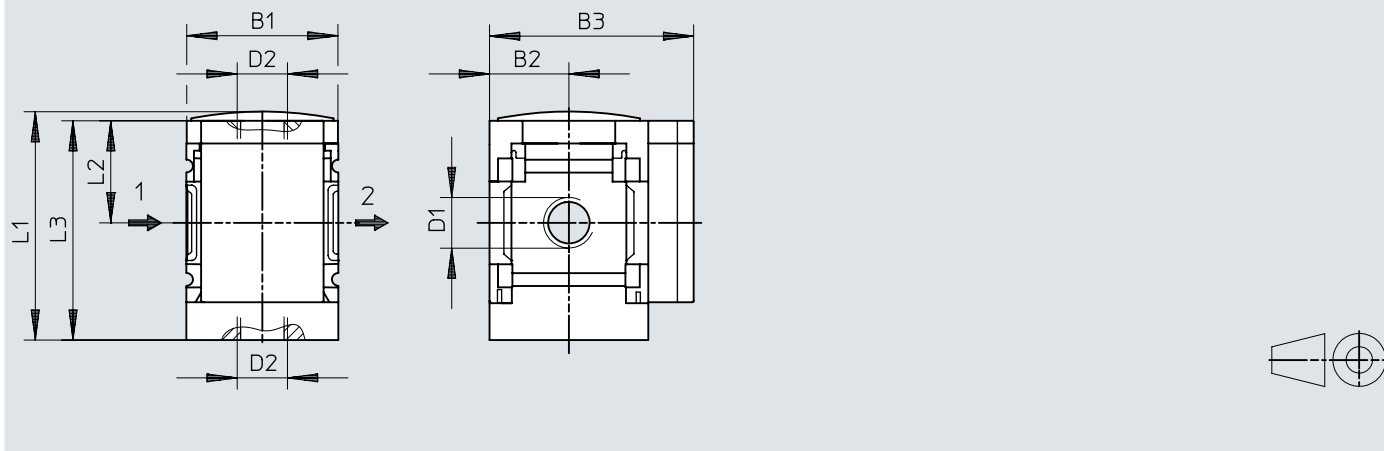

	B1	B2	B3	D1	D2	L1	L2	L3
MS4-FRM-1/8	40	21	54	G1/8	G1/4	60,4	27	58
MS4-FRM-1/4				G1/4				

Dimensions

Dimensions – AG Integrated MS pressure gauge with standard scale, RG Integrated MS pressure gauge with red-green scale

Download CAD data → www.festo.com

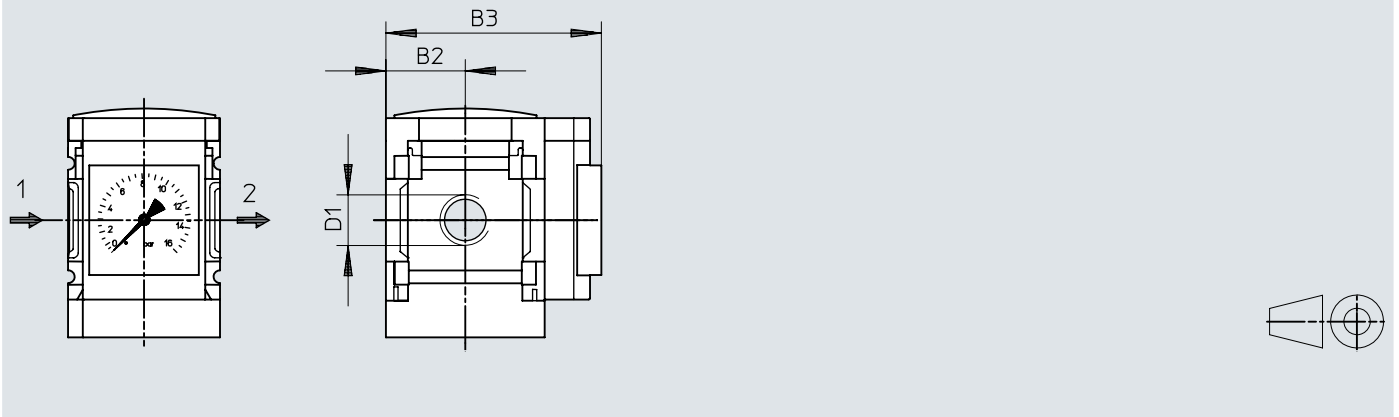

	B2	B3		D1
		1)	l	
MS4-FRM-1/8-...-AG	21	65		G1/8
MS4-FRM-1/4-...-AG				G1/4
MS4-FRM-1/8-...-RG	21	66,5		G1/8
MS4-FRM-1/4-...-RG				G1/4

1) Standard

Dimensions

Dimensions – A8 adapter for EN pressure gauge 1/8, without pressure gauge,
 A4 adapter for EN pressure gauge 1/4, without pressure gauge

Download CAD data → www.festo.com

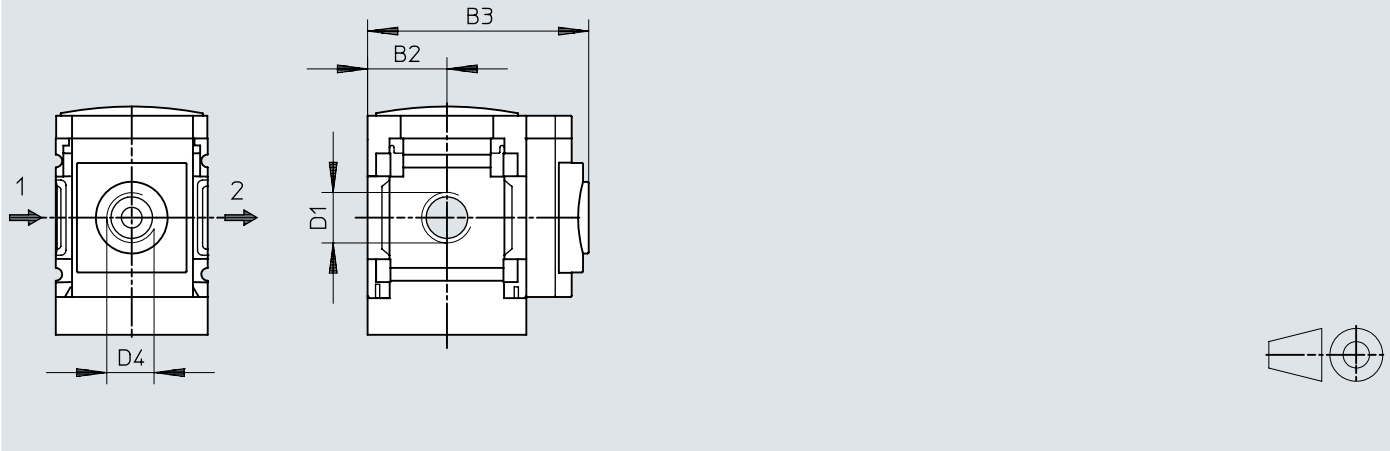

	B2	B3		D1	D4
		1)	l		
MS4-FRM-1/8-...-A8	21	58,5		G1/8	G1/8
MS4-FRM-1/4-...-A8				G1/4	
MS4-FRM-1/8-...-A4	21	58,5		G1/8	G1/4
MS4-FRM-1/4-...-A4				G1/4	

1) Standard

Dimensions

Dimensions – AD7/AD8/AD9/AD10 Pressure sensor with switching indicator

Download CAD data → www.festo.com

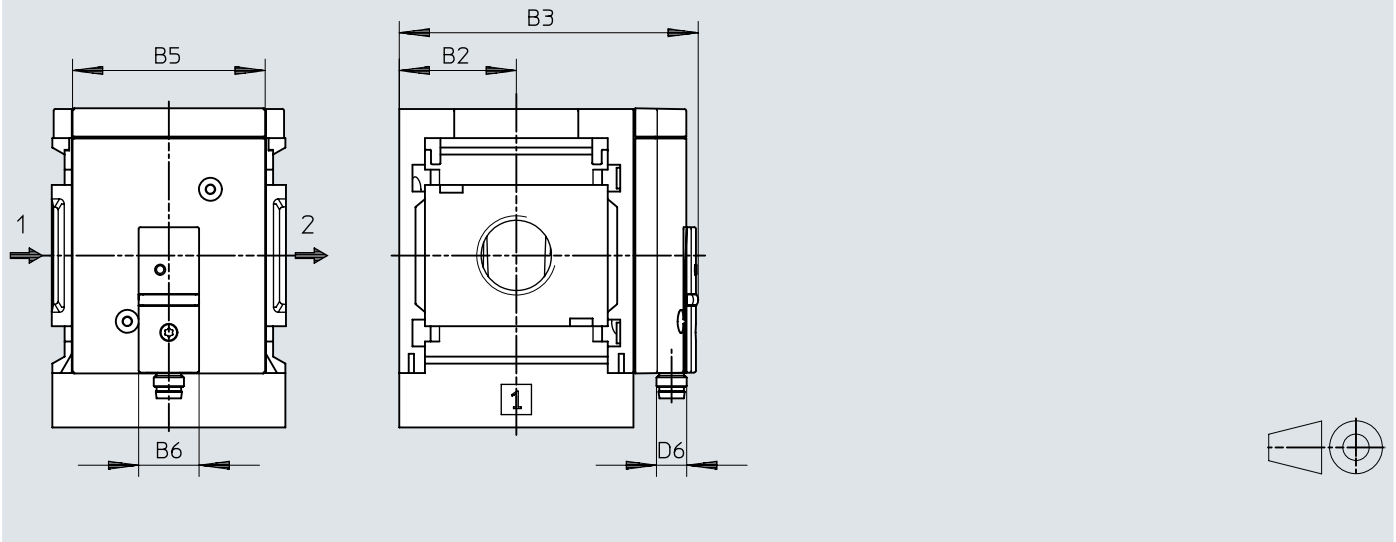

	B2	B3	B5	B6	D6
MS4-FRM-....AD7/AD8/AD9/AD10	21	59,1	~32	16	M8x1

Dimensions

Dimensions – AD11, AD12 pressure sensor with LCD display

Download CAD data → www.festo.com

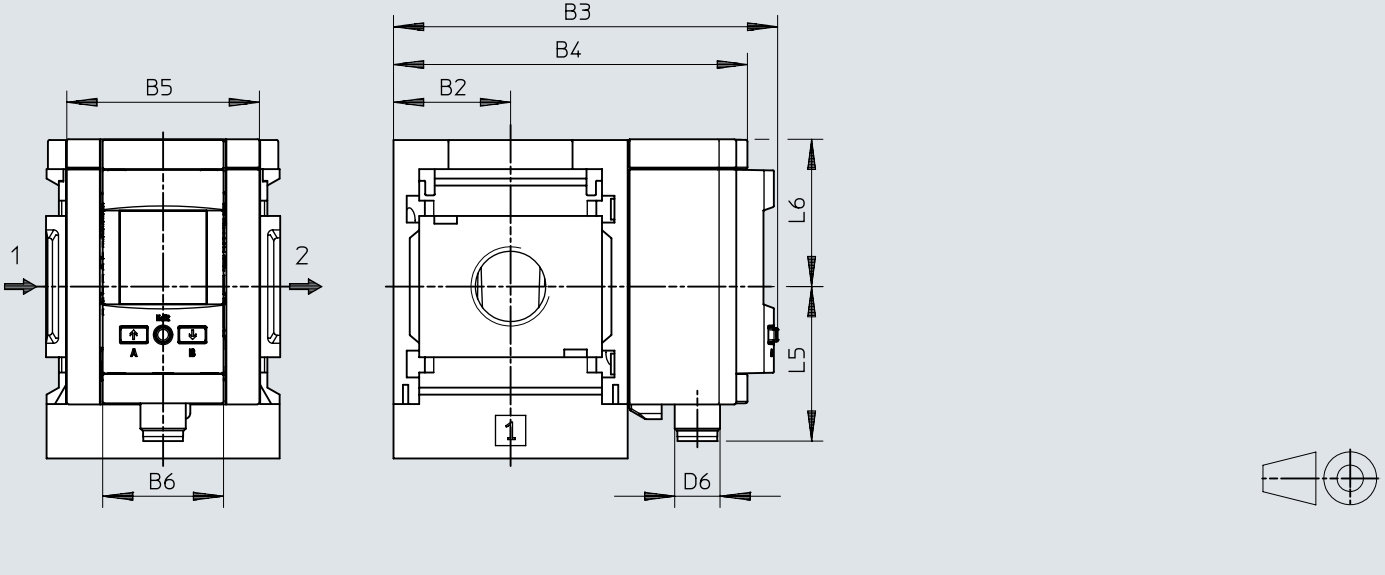

	B2	B3	B4	B5	B6	D6	L5	L6
MS4-...-AD11	21	81,2	73,3	32	32	M12x1	41,2	39
MS4-...-AD12						M8x1	37,9	

Dimensions

Dimensions – X/Y pressure switch with adjustable pressure switching point

Download CAD data → www.festo.com

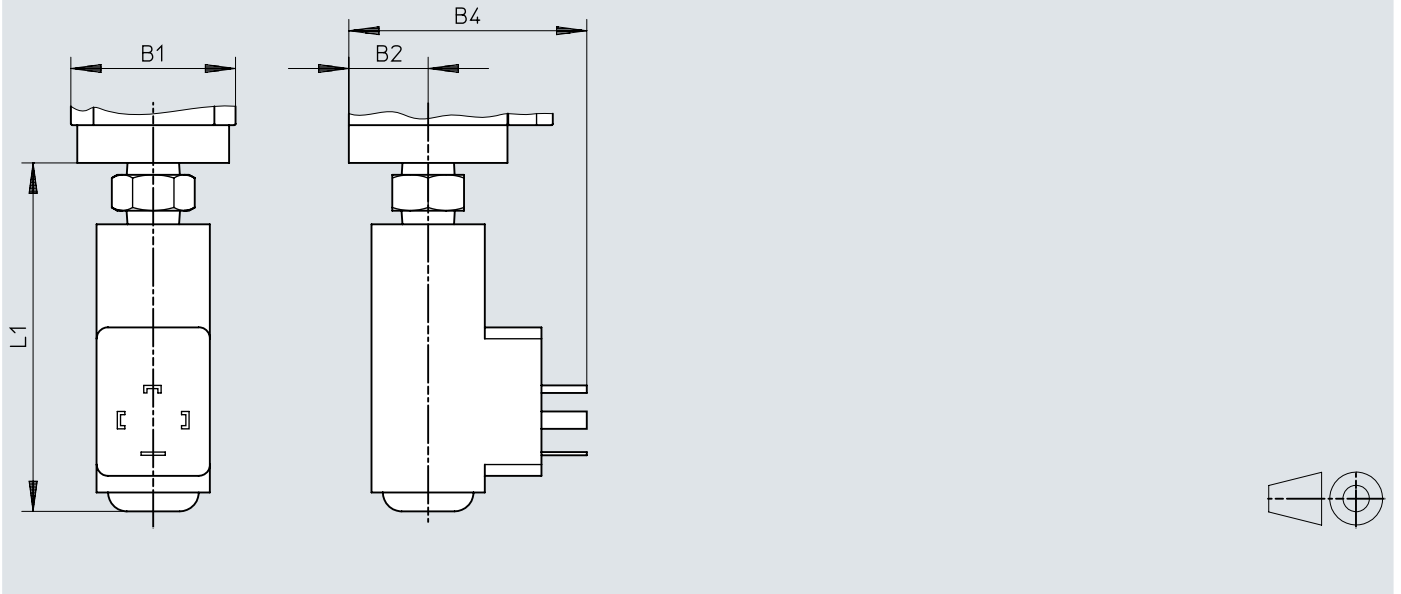

	B1	B2	B4	L1
MS4-FRM-...-X/Y	40	21	63	91,8

Dimensions

Dimensions – M12 pressure switch with adjustable pressure switching point

Download CAD data → www.festo.com

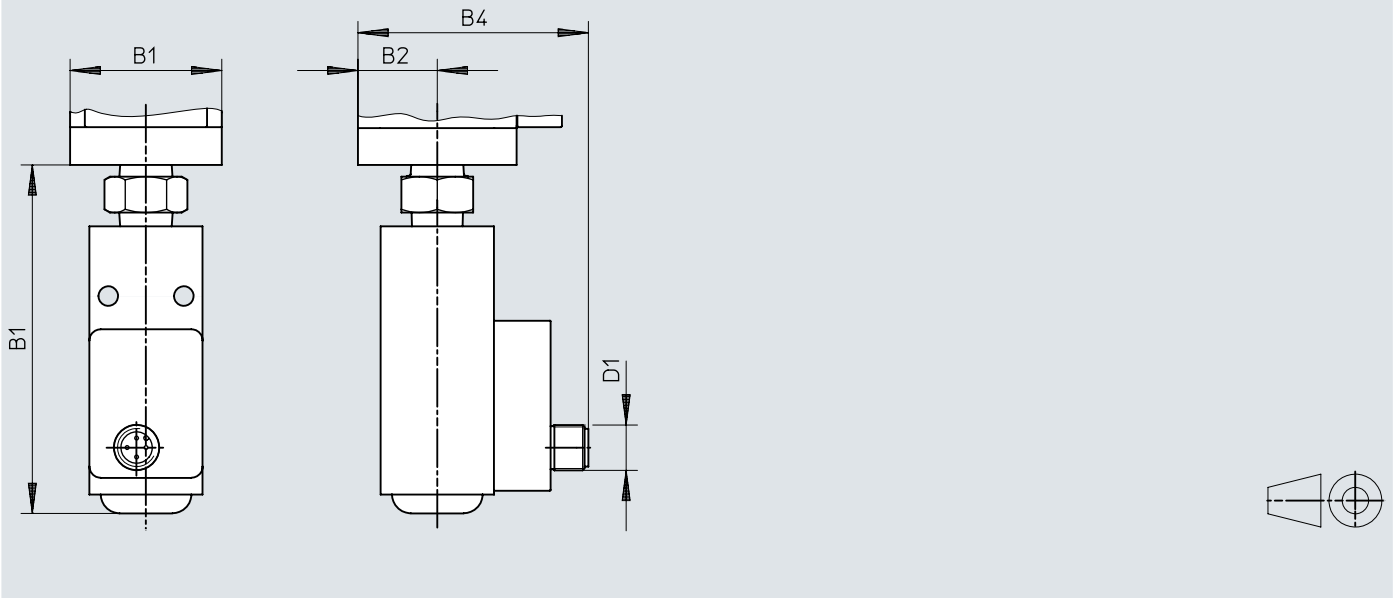

	B1	B2	B4	D1	L1
MS4-FRM-...-M12	40	21	61	M12x1	91,8

Ordering data

Ordering data						
	Pneumatic connection, port 1	Flow direction	Design	Product weight	Part no.	Type
	G1/8	From left to right	Branching module	165 g	529559	MS4-FRM-1/8
	G1/4	From right to left	Branching module, With non-return function	160 g	536971	MS4-FRM-1/4-I-Z
		From left to right			536966	MS4-FRM-1/4-I
		From right to left	Branching module	165 g	★ 529555	MS4-FRM-1/4
					529558	MS4-FRM-1/4-Z
					405 g	529557
From left to right	529556	MS4-FRM-1/4-Y				

Ordering information – Products for battery production						
	Pneumatic connection, port 1	Pressure gauge alternatives	Product weight	Part no.	Type	
	G1/4	Adapter for EN pressure gauge 1/8, without pressure gauge	165 g	8183570	MS4-FRM-1/4-A8-F1A	

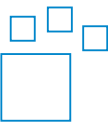
Ordering information – Modular product system						
	Design			Part no.	Type	
	Branching module			527703	MS4-FRM	

Peripherals

Peripherals overview

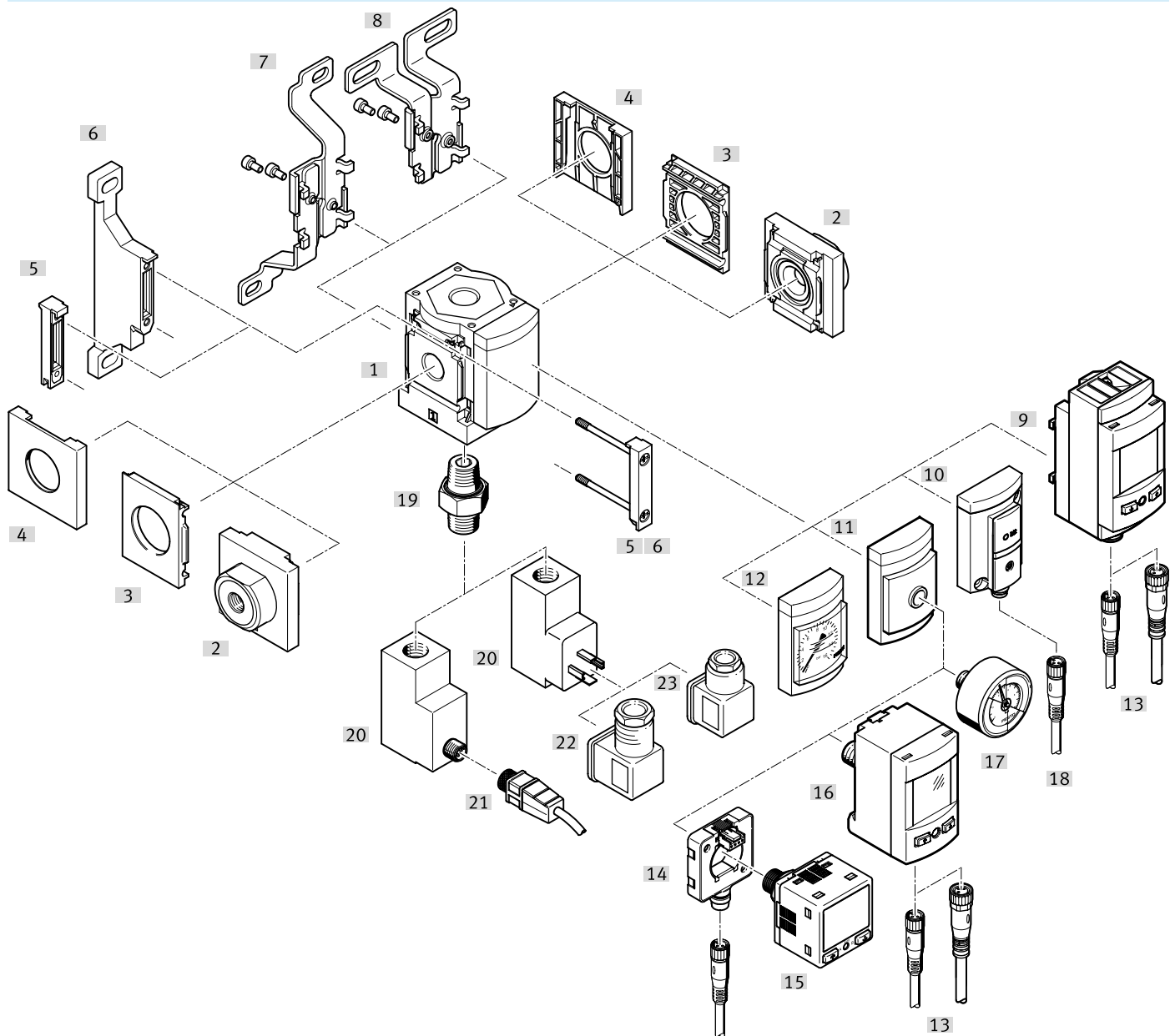



Accessories		→ Page/Internet
Type/order code	Description	
[1]	Branching module MS4-FRM	ms4-frm
[2]	Connecting plate-SET MS4-AG...	Module connector MS4/6-MV [5] or mounting bracket MS4-WP, WPB, WPE, WPM [6] is required for mounting.
[3]	Mounting plate MS4-AEND	Module connector MS4/6-MV [5] or mounting bracket MS4-WP, WPB, WPE, WPM [6] is required for mounting.
[4]	Cover cap MS4-END	19
[5]	Module connector MS4-MV	17
[6]	Mounting bracket MS4-WP	17
[6]	Mounting bracket MS4-WPB	Without illustration
[6]	Mounting bracket MS4-WPE	Without illustration
[6]	Mounting bracket MS4-WPM	Without illustration
[7]	Mounting bracket MS4-WB	17
[8]	Mounting bracket MS4-WBM	17
[10]	Pressure sensor with LCD display SPAU	Order code [AD11], [AD12]
[11]	Pressure sensor with operational status indicator SDE5	Order code [AD7], [AD8], [AD9], [AD10]

Peripherals

Accessories		→ Page/Internet
Type/order code	Description	
[12]	Adapter for EN pressure gauge 1/8, 1/4	Order code [A8], [A4] ms4-frm
[13]	Pressure gauge MS	Order code [AG], [RG] ms4-frm
[14]	Connecting cable NEBU-M8...-LE3, NEBU-M12...-LE4	18
[15]	Connecting cable NEBU-M8...-LE4, NEBU-M12...-LE4	18
[16]	Electrical adapter SASC	17
[17]	Pressure sensor SPAN	17
[18]	Pressure sensor SPAU-...-T	18
[19]	Pressure gauge MA	18
[20]	Connecting cable NEBU-M8...-LE3	18
[21]	Double nipple ESK	19
[22]	Pressure switch PEV	Order code: [X]/[Y]/[M12] Double nipple [21] is included in the scope of delivery. pev
[23]	Connecting cable NEBU-M12...-LE4	18
[24]	Angled plug socket PEV-1/4-WD-LED-...	19
[25]	Plug socket MSSD-C-4P	mssd

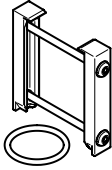
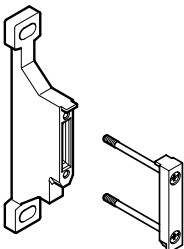
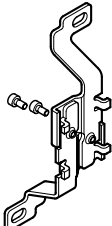
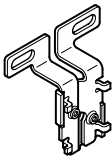
Accessories

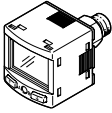
Module connector MS4-MV1				
	Size	Part no.	Type	
	4	★ 8119201	MS4-MV1	
		8176695	MS4-MV1-F1A	
Mounting bracket MS4-WP...				
	Size	Part no.	Type	
	4	★ 526063	MS4-WPB	
		8176694	MS4-WP-F1A	
		526060	MS4-WPM-D	
		541552	MS4-WPB-EX	
		541554	MS4-WP-EX	
		526061	MS4-WPM-2D	
		★ 532184	MS4-WP	
Mounting bracket MS4-WB				
	Size	Part no.	Type	
	4	★ 532185	MS4-WB	
Mounting bracket MS4-WBM				
	Size	Part no.	Type	
	4	★ 526062	MS4-WBM	
Electrical adapter SASC				
	Short type code	Part no.	Type	
	SASC	★ 8000326	SASC-P4-A-M8-A	
Pressure sensor SPAN				
	Pneumatic connection	Analogue output	Part no.	Type
	Male thread G1/8, Female thread M5		★ 8035544	SPAN-P10R-G18M-PN-PN-L1

Accessories

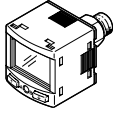
Pressure sensor SPAN				
	Pneumatic connection	Analogue output	Part no.	Type
	Male thread G1/8, Female thread M5	0 - 10 V, 4 - 20 mA, 1 - 5 V	★ 8035533	SPAN-P10R-G18M-PNLK-PNVBA-L1
	Male thread R1/8, Female thread M5		★ 8035547	SPAN-P10R-R18M-PN-PN-L1
		0 - 10 V, 4 - 20 mA, 1 - 5 V	★ 8035536	SPAN-P10R-R18M-PNLK-PNVBA-L1

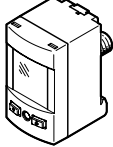
Pressure sensor SPAU...-T				
	Pneumatic connection	Electrical connection 1, connector system	Part no.	Type
	R1/8	M12x1, A-coded to EN 61076-2-101	8001206	SPAU-P10R-T-R18M-L-PNLK-PNVBA-M12D
		M8x1, A-coded, to EN 61076-2-104	8001203	SPAU-P10R-T-R18M-L-PNLK-PNVBA-M8D
	R1/4	M12x1, A-coded to EN 61076-2-101	8001208	SPAU-P10R-T-R14M-L-PNLK-PNVBA-M12D
		M8x1, A-coded, to EN 61076-2-104	8001209	SPAU-P10R-T-R14M-L-PNLK-PNVBA-M8D

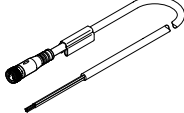
Connecting cable NEBU-M8						
	Electrical connection 1, connector system	Electrical connection 1, number of connections/cores	Electrical connection 1, cable outlet	Cable length	Part no.	Type
	M8x1, A-coded, to EN 61076-2-104	3	Straight	2.5 m	541333	NEBU-M8G3-K-2.5-LE3
				5 m	541334	NEBU-M8G3-K-5-LE3
			Angled	2.5 m	541338	NEBU-M8W3-K-2.5-LE3
				5 m	541341	NEBU-M8W3-K-5-LE3
		4	Straight	2.5 m	541342	NEBU-M8G4-K-2.5-LE4
				5 m	541343	NEBU-M8G4-K-5-LE4
			Angled	2.5 m	541344	NEBU-M8W4-K-2.5-LE4
				5 m	541345	NEBU-M8W4-K-5-LE4

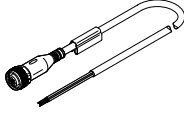
Connecting cable NEBU-M12						
	Electrical connection 1, connector system	Electrical connection 1, number of connections/cores	Electrical connection 1, cable outlet	Cable length	Part no.	Type
	M12x1, A-coded to EN 61076-2-101	5	Straight	2.5 m	541363	NEBU-M12G5-K-2.5-LE3
					550326	NEBU-M12G5-K-2.5-LE4
				5 m	541328	NEBU-M12G5-K-5-LE4
					541364	NEBU-M12G5-K-5-LE3
			Angled	2.5 m	550325	NEBU-M12W5-K-2.5-LE4
					541329	NEBU-M12W5-K-5-LE4

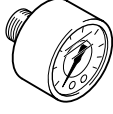
Pressure gauge MA			
	Pneumatic connection	Part no.	Type
	G1/4	183901	MA-40-16-G1/4-EN
	R1/8	525726	MA-40-16-R1/8-E-RG
	R1/4	187080	MA-40-16-R1/4-EN
		525729	MA-50-16-R1/4-E-RG

Accessories

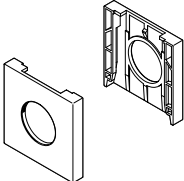
Cover cap MS4-END					
	Size			Part no.	Type
	4			538779	MS4-END

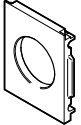
Mounting plate MS4-AEND					
	Size			Part no.	Type
	4			542966	MS4-AEND

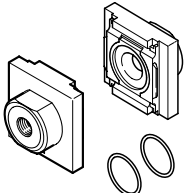
Connecting plate-SET MS4-AG...					
	Size	Pneumatic connection, port 1	Pneumatic connection, port 2	Part no.	Type
	4	G1/8	G1/8	526068	MS4-AGA
				541549	MS4-AGA-EX
		G1/4	G1/4	★ 526069	MS4-AGB
				541550	MS4-AGB-EX
		G3/8	G3/8	526070	MS4-AGC
				541551	MS4-AGC-EX

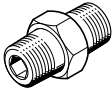
Double nipple ESK						
	Pneumatic connection, port 1	Pneumatic connection, port 2			Part no.	Type
	R1/4	R1/4			151521	ESK-1/4-1/4
		R1/2			534153	ESK-1/4-1/2

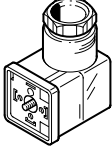
Angled plug socket PEV						
	Operational voltage range AC	Operational voltage range DC	Electrical connection	Switching status indication	Part no.	Type
		15 ... 30 V		Yellow LED, Green LED	164274	PEV-1/4-WD-LED-24
	150 ... 230 V	140 ... 180 V			164275	PEV-1/4-WD-LED-230

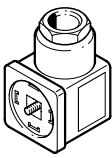
Plug socket MSSD						
	Electrical connection	Type of mounting			Part no.	Type
	3-pin, Angled socket, Type A, To DIN EN 175301-803, Square design MSC, Square design MSN1	On solenoid valve via M3 central screw			171157	MSSD-C-4P