

Valve terminal MPA-S

FESTO

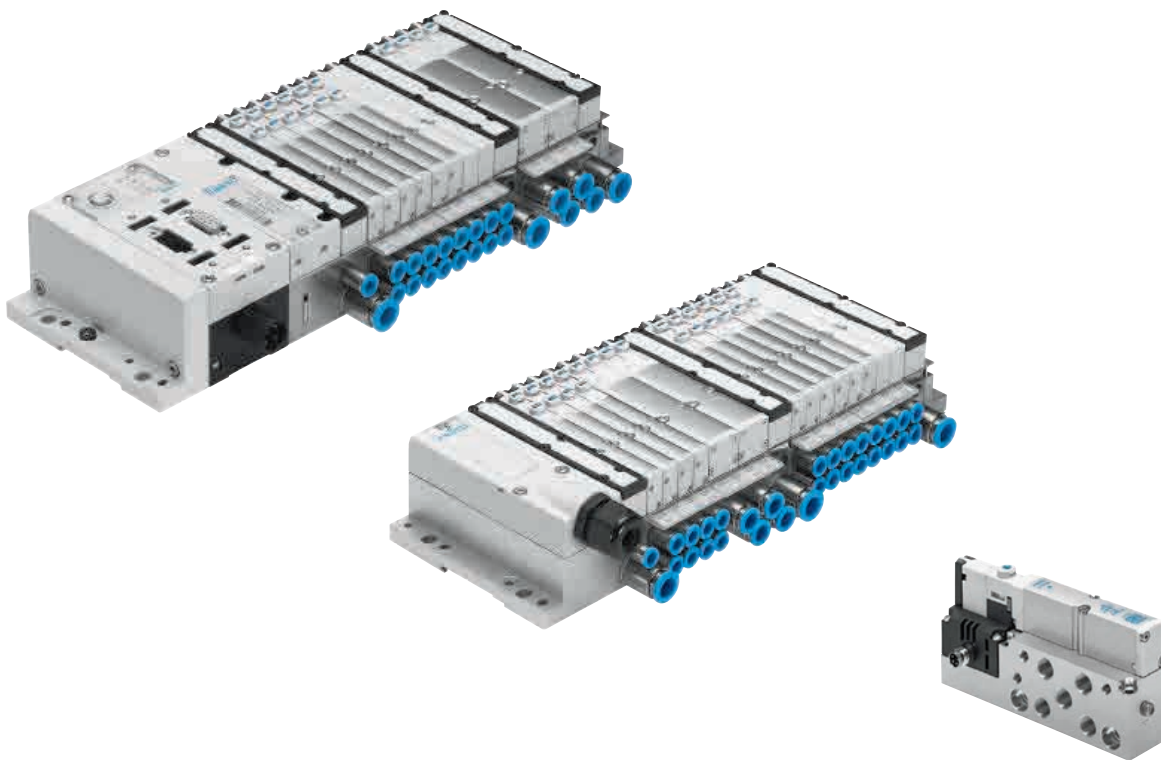

Key features



Innovative

- Flat, high-performance valves in sturdy metal housing
- MPA1: flow rates up to 360 l/min
- MPA14: flow rates up to 670 l/min
- MPA2: flow rates up to 850 l/min
- Standardised from the individual valve to the valve terminal with multi-pin plug, AS-Interface, CPI and fieldbus connection and control block
- Dream team: fieldbus valve terminal suitable for electrical peripherals CPX. This means:
 - Forward-looking internal communication system for actuating the valves and CPX modules
 - Diagnostics down to the individual valve
 - Valves can be actuated with or without (standard) separate electrical circuits

Versatile

- Modular system offering a range of configuration options
- Expandable with up to 128 solenoid coils
- Conversions and extensions possible at a later date
- Further sub-bases can be expanded using just three screws, sturdy separating seals on metal separator plates
- Possible to integrate innovative function modules
- Manual regulators, swivelling pressure gauges
- Proportional pressure regulator
- Air supply can be extended via additional pressure zones with supply plates
- Wide range of pressures
- –0.09 ... 1 MPa
- Wide range of valve functions
- Safety function with switchable pilot air

Reliable

- Sturdy and durable metal components
 - Valves
 - Sub-bases
 - Seals
- Fast troubleshooting with LEDs on the valves and diagnostics via fieldbus
- Extensive operating voltage range $\pm 25\%$
- Easy to service thanks to replaceable valves and electronic modules
- Manual override either non-detenting, detenting or secured against unauthorised activation (concealed)
- Durable thanks to tried-and-tested piston spool valves
- Large and durable labelling system, suitable for barcodes

Easy to install

- Ready-to-install and tested unit
- Reduced selection, ordering, installation and commissioning costs
- Secure wall mounting or H-rail mounting

Key features

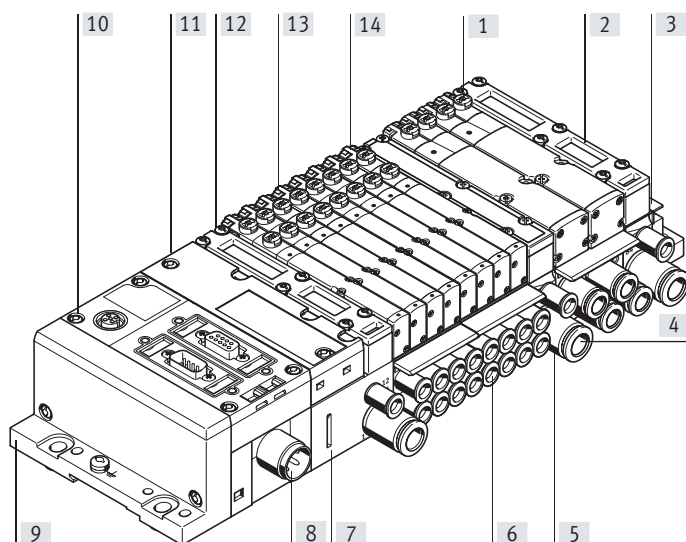

- [1] Safe operation:
Manual override, non-detenting/
detenting or concealed
- [2] Space-saving:
Flat valves and flat plate silencer
- [3] Variable:
64 valve positions/128 solenoid
coils (fieldbus control)
24 valve positions/24 solenoid
coils (multi-pin control)
- [4] Practical:
Sturdy metal thread or pre-as-
sembled push-in fittings
- [5] Modular:
Supply plates for creating pres-
sure zones as well as numerous
additional exhaust and supply
ports
- [6] Wide range of valve functions
- [7] Convenient: large inscription la-
bels
- [8] Reliable:
Operating voltage range $\pm 25\%$,
outputs and valves can each be
switched off separately
- [9] Quick to mount:
Directly using screws or on an
H-rail, automatic earthing
- [10] CPX diagnostic interface for hand-
held devices (channel-oriented di-
agnostics down to the individual
valve)
- [11] Straightforward electrical connec-
tion:
Multi-pin connection, fieldbus in-
terface, control block, AS-interface,
CPI
- [12] Pneumatic interface to CPX
- [13] Width 10 mm, 14 mm and 20 mm
- [14] Reduced downtimes: two-colour
LED diagnostics on site

Equipment options

Valve functions

- 5/2-way valve, single solenoid
 - 5/2-way valve, double solenoid
 - 2x 3/2-way valve,
normally open
 - 2x 3/2-way valve,
normally closed
 - 2x 3/2-way valve,
1x normally open,
1x normally closed
 - 5/3-way valve
mid-position pressurised
 - 5/3-way valve
mid-position closed
 - 5/3-way valve
mid-position exhausted
 - 2x2/2-way valve
1x normally closed
1x normally closed, reversible
 - 2x 2/2-way valve
normally closed
 - 1x 3/2-way valve
normally closed
external compressed air supply
 - 1x 3/2-way valve,
normally open,
external compressed air supply
 - Manual pressure regulators
 - Pilot air switching valve
 - Proportional pressure regulators (for
CPI connection, fieldbus)
 - Pressure sensor
- All valves have the same compact di-
mensions with an overall length of
107 mm and a width of 10 mm,
14 mm or 20 mm.
A height of 55 mm makes them a per-
fect match for the electrical peripher-
als CPX.

Special features

Multi-pin terminal

- Max. 24 valve positions/max. 24 so-
lensoid coils
- Parallel modular valve links via cir-
cuit boards
- Electronics module with integrated
holding current reduction
- Any compressed air supply
- Creating pressure zones

Fieldbus terminal/control block

- Max. 64 valve positions/
max. 128 solenoid coils
- Internal CPX bus system for valve ac-
tuation
- Module for electrical valve actuation
with or without separate electrical
circuits
- Any compressed air supply
- Creating pressure zones

Individual valve

- Electrical M8 connection, 4-pin with
screw connection
- Detachable electronics module with
integrated holding current reduction

AS-Interface

- 2 to 8 valves, freely configurable
(max. 8 solenoid coils) with input
feedback.

CPI interface

- Max. 32 valve positions/
max. 32 solenoid coils

Combinable

- MPA1: flow rates up to 360 l/min
- MPA14: flow rates up to 670 l/min
- MPA2: flow rates up to 850 l/min
- MPA1, MPA14 and MPA2 can be
combined on one valve terminal

Electrical supply plate

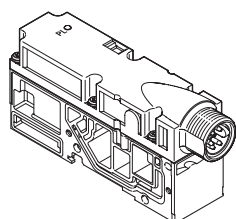

- Increases the maximum number of
valve positions possible to 64, with
max. 128 solenoid coils
- Creation of separate, individually
disconnectable circuits (voltage
zones)
- Greater economic efficiency thanks
to more valves/solenoid coils per
valve terminal
- Increased safety as valve groups can
be individually disconnected, e.g.
for emergency-off functions

Note

The electrical supply plate is option-
ally available with M18 or 7/8" con-
nection.

Key features

Ordering data – Product options

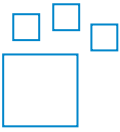

Configurable product
This product and all its product options can be ordered using the configurator.

The configurator can be found at
→ www.festo.com/catalogue/...
Enter the part number or the type.

Part no.	Type
197330	CPX
546279	MPA-ASI-VI
546280	MPA-CPI-VI
530411	MPA-FB-VI
569926	MPAL-VI
539105	MPA-MPM-VI

Key features

Individual connection

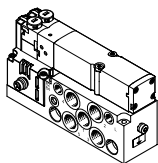

Valves on individual sub-bases can also be used for actuators further away from the valve terminal.

The electrical connection is established using a standard 4-pin M8 plug (EN 60947-5-2).

More information
→ VMPA1

Multi-pin plug connection

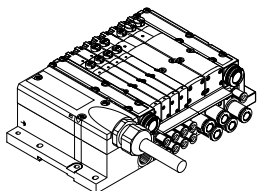

The signals are transmitted from the controller to the valve terminal via a pre-assembled or self-assembled multi-core cable to the multi-pin plug connection. This substantially reduces installation time.

The valve terminal can be equipped with max. 24 solenoid coils. This corresponds to 4 to 24 MPA1 or 4 to 24 MPA14 or 2 to 24 MPA2 valves, or a combination of all of these.

Versions

- Sub-D connection
- Pre-assembled multi-pin cable
- Multi-pin cable for self-assembly

AS-Interface connection

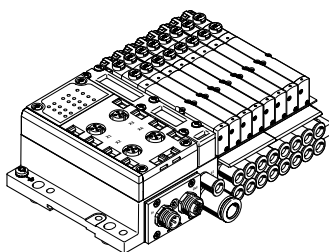

A special feature of the AS-Interface is the simultaneous transmission of data and supply power via a two-core cable. The encoded cable profile prevents connection with incorrect polarity. The valve terminal with AS-Interface is available in the following versions:

- With two to eight modular valve positions (max. 8 solenoid coils). This corresponds to 2 to 8 MPA1, 2 to 8 MPA14 or 2 to 8 MPA2 valves, or a combination of all of these.
- With all available valve functions.

The connection technology used for the inputs can be selected as with CPX: M8, M12, Sub-D, Cage Clamp (terminals to IP20).

More information
→ Internet: as-interface

Installation system CPI

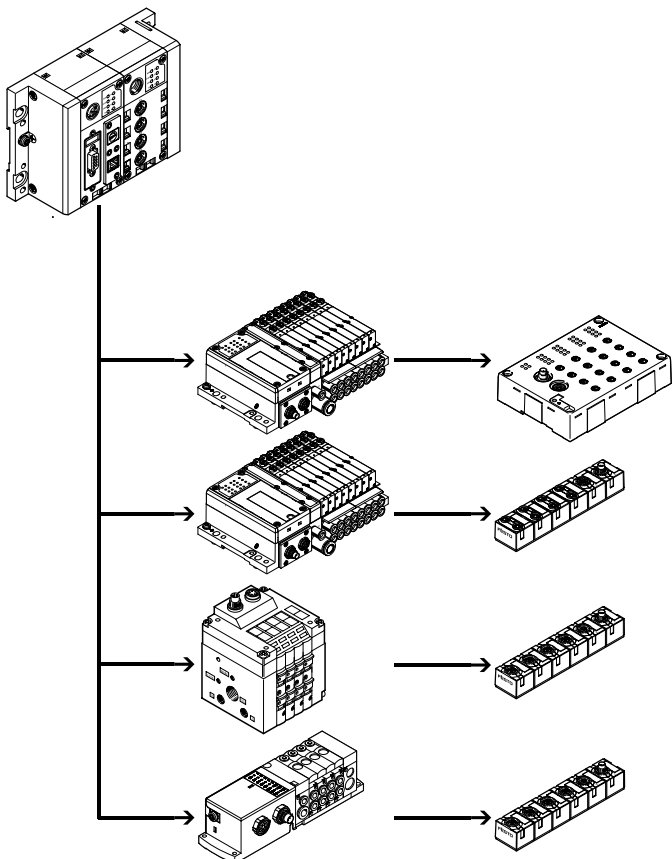

Valve terminal for installation system CPI:
The valve terminal with CP connection is provided for connection to a higher-level bus node or to control blocks. A bus node or control block additionally enables the connection of decentralised input/output units. The following bus protocols are supported:

- PROFIBUS DP
- INTERBUS®
- DeviceNet®
- CANopen
- CC-LINK®
- EtherNet/IP
- PROFINET
- POWERLINK
- EtherCAT®
- Sercos III

Four strings having up to 32 inputs and outputs can be connected to a bus node or control block. The connecting cables transmit the power supply for the input modules and the load voltage for the valves as well as control signals.

More information
→ Internet: cpi

Key features

Fieldbus connection via the CPX system

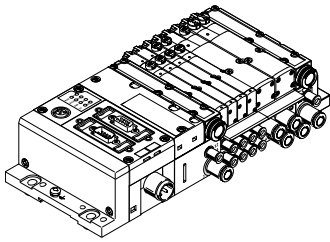

An integrated bus node manages communication with a higher-order PLC. This enables space-saving pneumatic and electronic solutions to be implemented.

Valve terminals with fieldbus interfaces can be configured with up to 16 sub-bases. In combination with the MPA1 or MPA14 and 8 solenoid coils per sub-base, up to 128 solenoid coils can thus be controlled. An MPA2 with 4 solenoid coils per sub-base can actuate 64 solenoid coils.

Variants

- PROFIBUS DP
- INTERBUS®
- DeviceNet®
- CANopen
- CC-LINK®
- EtherNet/IP
- PROFINET
- POWERLINK
- EtherCAT®
- Sercos III
- Front end controller, remote
- Front end controller
- Remote I/O
- Modbus/TCP
- CPX terminal

→ More information: www.festo.com/catalogue/cpx → Support/Downloads.

Control block connection via the CPX system

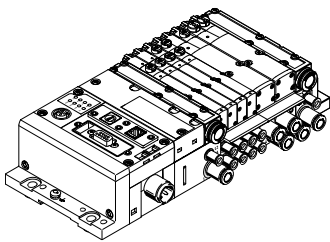

With controllers that are integrated in the Festo valve terminals, stand-alone control units to IP65 without control cabinets can be set up.

In the slave operating mode, these valve terminals can be used for intelligent preprocessing and are therefore ideal modules for designing decentralised intelligence.

In the master operating mode, terminal groups can be designed with many options and functions that can autonomously control a medium-sized machine/system.

→ More information: www.festo.com/catalogue/cpx → Support/Downloads.

Note

Note possible restrictions for the IP protection class
→ ATEX declaration of conformity

Peripherals overview

Modular pneumatic components

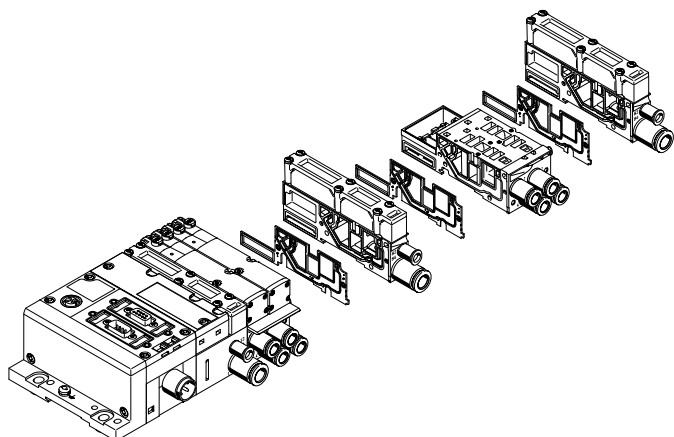

The modular design of the MPA enables outstanding flexibility right from the planning stage and offers maximum ease of service in operation. The system consists of sub-bases and valves.

The sub-bases are screwed together, thus forming the support system for the valves. They contain the ducts for supplying compressed air to and exhausting from the valve terminal as well as the working ports for the pneumatic drives for each valve. Each sub-

base is connected to the next using three screws. Individual valve terminal sections can be isolated and further blocks can be inserted by loosening these screws. This ensures that the valve terminal can be rapidly and reliably extended.

Modular electrical peripherals

The valves are actuated differently depending on whether a multi-pin terminal or fieldbus terminal is used.

The MPA with CPX interface is based on the internal bus system of the CPX and uses this serial communication system for all solenoid coils and a range of electrical input and output functions.

Serial links enable the following:

- Transmission of switching information
- High valve density
- Compact design
- Diagnostics related to valve position

- Separate power supply for valves
- Flexible conversion without address shifting
- Transmission of status, parameter and diagnostic data
- Option of CP interface
- CPX-CEC as stand-alone controller with access via Ethernet and web server

→ More information: www.festo.com/catalogue/cpx → Support/Downloads.

MPA with electrical peripherals CPX

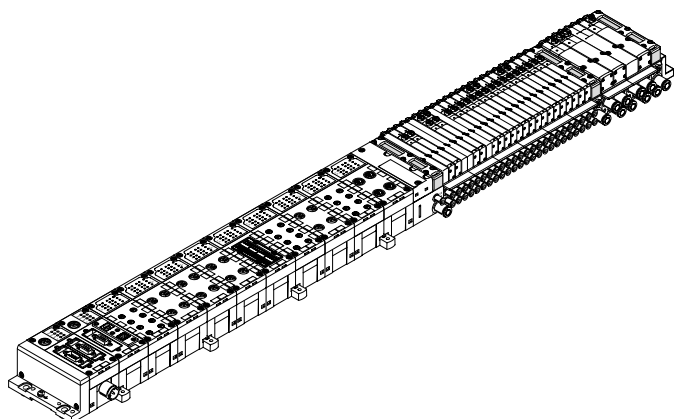

Modularity with electrical peripherals CPX

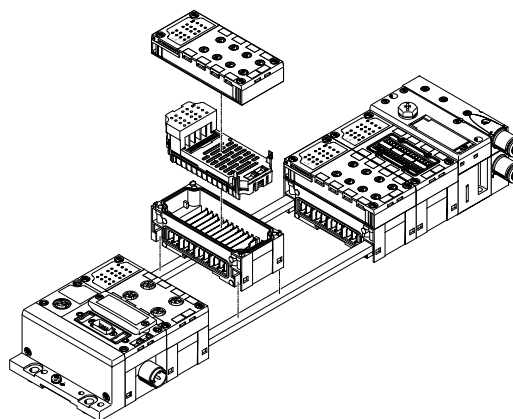

Peripherals overview

Individual sub-base

Ordering:

- Using individual part numbers

Individual sub-bases can be equipped with any valve (VMPA... of the corresponding width).

The electrical connection is established using a standard 4-pin M8 plug (EN 60947-5-2).

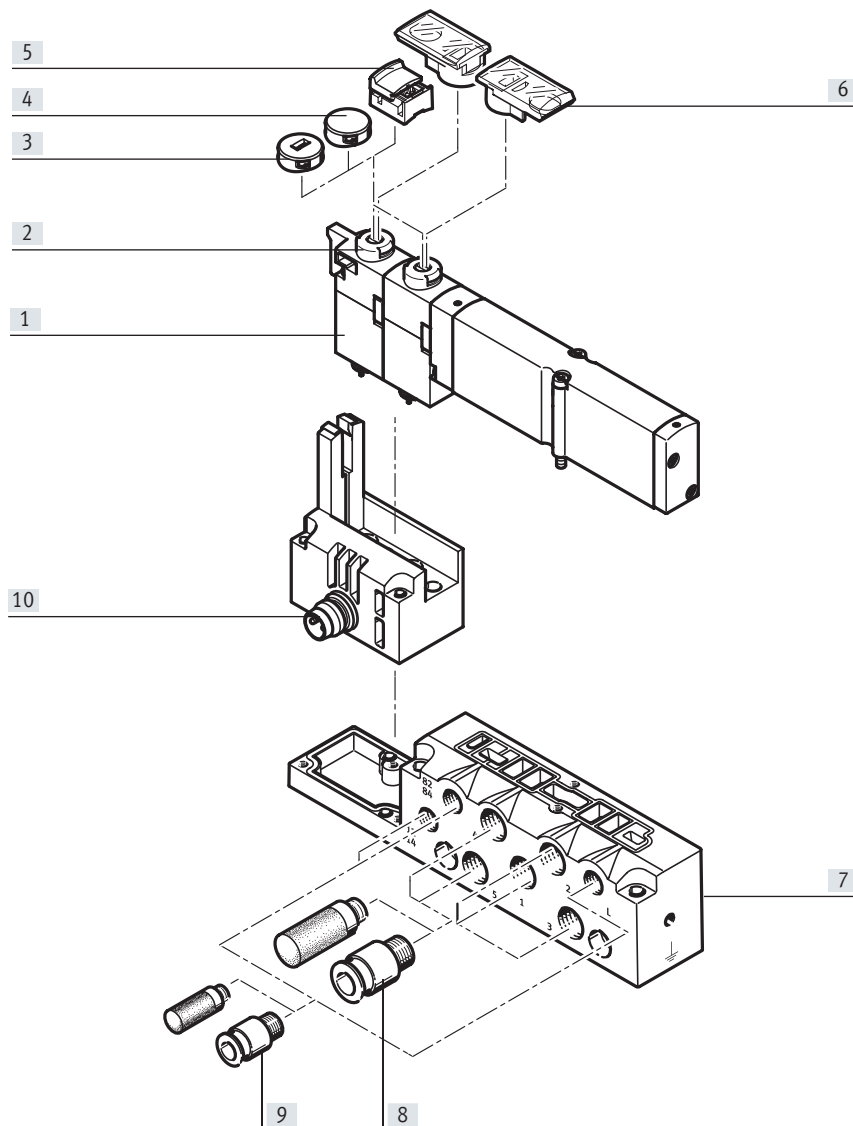

Designation	Description	→ Page/Internet
[1] Solenoid valve	Width 10 mm, 14 mm, 20 mm	VMPA1
[2] Manual override (MO)	Non-detenting/detenting by turning, per solenoid coil	VMPA1
[3] Cover cap, coded	After fitting the cover cap, manual override operation is non-detenting only	VMPA1
[4] Cover cap, concealed	After fitting the cover cap, manual override is blocked	VMPA1
[5] Cover cap, manual override detenting	After fitting the cover cap, manual override is detenting and can be operated without tools	VMPA1
[6] Inscription label holder	Can be pushed onto the manual override	VMPA1
[7] Sub-base	For individual valve VMPA...	VMPA1
[8] Fittings, silencers or blanking plugs	For working ports (2, 4) and working air/exhaust ports (1, 3, 5)	VMPA1
[9] Fittings and/or silencers	For pilot air supply/pilot exhaust air (12/14, 82/84) and pressure compensation	VMPA1
[10] Electrical connection M8	4-pin	VMPA1

Peripherals overview

Pneumatic components of the valve terminal – Multi-pin plug, AS-Interface

The sub-bases are prepared for either

- 2 or 4 single solenoid valves
- 2 or 4 double solenoid valves

depending on the size.

- Double solenoid valve positions can be equipped with any valve or a cover plate.

- Single solenoid valve positions can only be equipped with single solenoid valves.

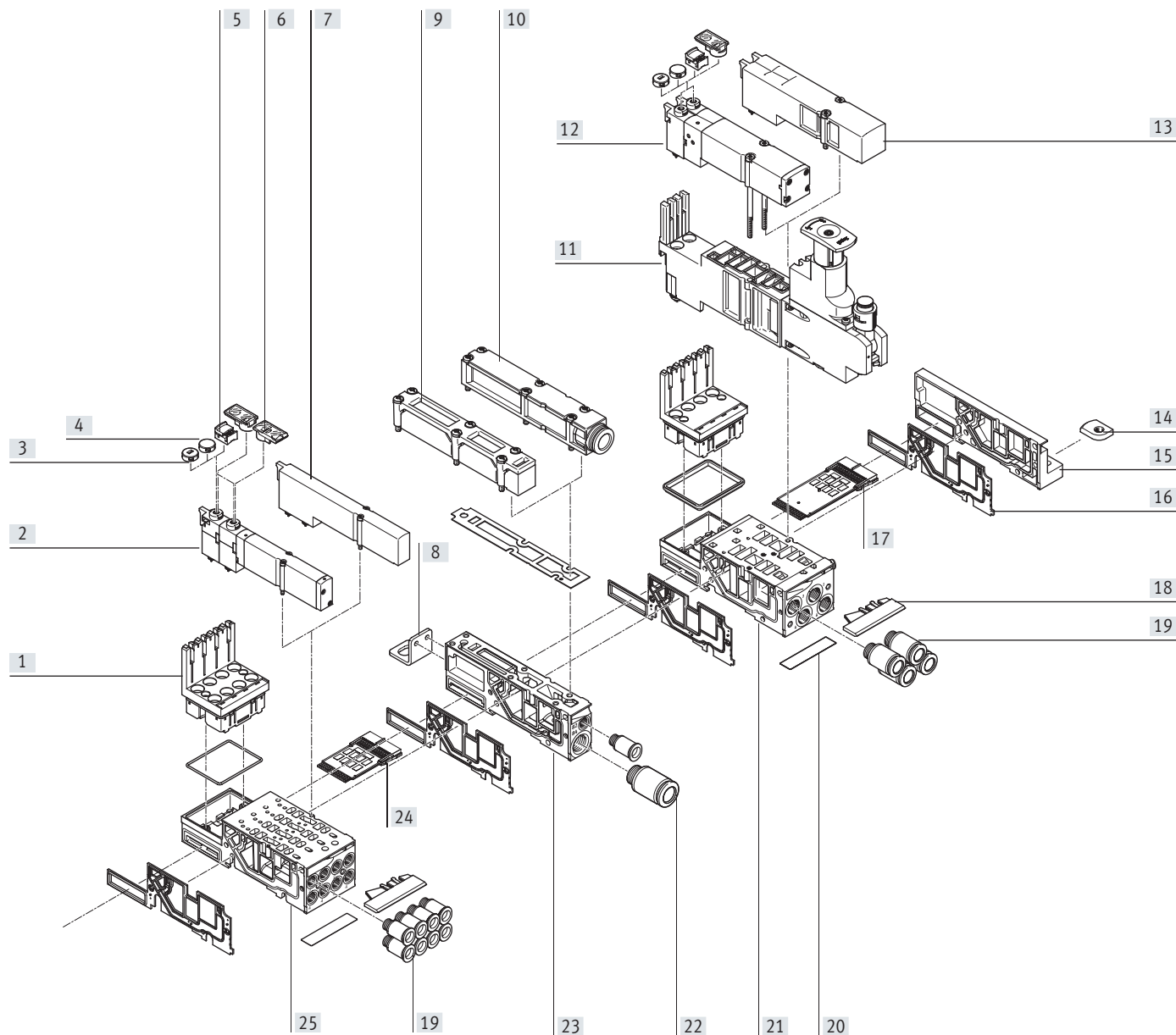

Peripherals overview

Pneumatic components of the valve terminal – Multi-pin plug, AS-Interface		
Designation	Description	→ Page/Internet
[1] Electronics module	For connecting valves	84, 89, 93
[2] Solenoid valve	Width 10 mm, 14 mm	81, 86
[3] Cover cap, coded	After fitting the cover cap, manual override operation is non-detenting only	96
[4] Cover cap, concealed	After fitting the cover cap, manual override is blocked	96
[5] Cover cap, manual override detenting	After fitting the cover cap, manual override is detenting and can be operated without tools	96
[6] Inscription label holder	Can be pushed onto the manual override	99
[7] Cover plate	For unused valve position (vacant position), width 10 mm, 14 mm	81, 86
[8] Mounting	Optional for valve terminal mounting (on supply plate)	99
[9] Flat plate silencer	–	–
[10] Exhaust air plate	For ducted exhaust air	97
[11] Regulator plate	Vertical stacking (pressure regulator, vertical pressure shut-off plate, vertical pressure supply plate)	82
[12] Solenoid valve	Width 20 mm	90
[13] Cover plate	For unused valve position (vacant position), width 20 mm	90
[14] H-rail mounting	–	99
[15] Right end plate	–	95
[16] Separating seal	For sub-base	96
[17] Electrical interlinking module	For multi-pin plug connection, for AS-Interface, for a sub-base with pneumatic supply plate (on the left next to the sub-base), width 10 mm, 14 mm, 20 mm	85, 89, 93
[18] Inscription labels	Inscription label holder for paper foil label	99
[19] Threaded connectors	For working ports	98
[20] Paper foil label	For inscription label holder	99
[21] Sub-base	For two valve positions width 20 mm	92
[22] Threaded connectors	For pneumatic supply plate	98
[23] Supply plate	–	97
[24] Electrical interlinking module	For width 10 mm, 14 mm, 20 mm	85, 89, 93
[25] Sub-base	For four valve positions width 10 mm, 14 mm	84, 88

Peripherals overview

Pneumatic components of the valve terminal – CPI connection, fieldbus

The sub-bases are prepared for either

- 2 or 4 single solenoid valves
- 2 or 4 double solenoid valves

depending on the size.

- Double solenoid valve positions can be equipped with any valve or a cover plate.

- Single solenoid valve positions can only be equipped with single solenoid valves.

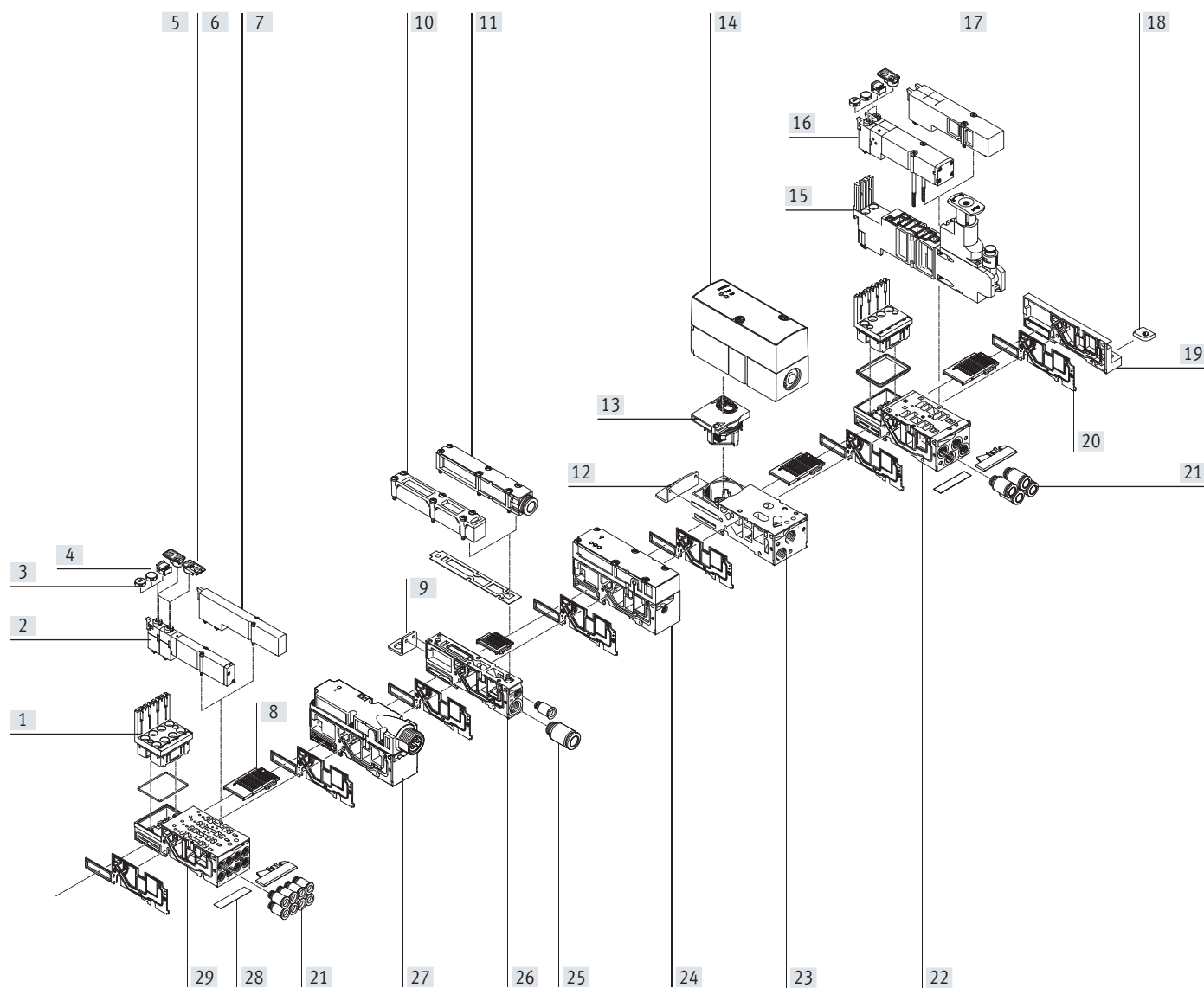

Peripherals overview

Pneumatic components of the valve terminal – CPI connection, fieldbus		
Designation	Description	→ Page/Internet
[1] Electronics module	–	84, 89, 93
[2] Solenoid valve	Width 10 mm, 14 mm	81, 86
[3] Cover cap, coded	After fitting the cover cap, manual override operation is non-detenting only	96
[4] Cover cap, concealed	After fitting the cover cap, manual override is blocked	96
[5] Cover cap, manual override detenting	After fitting the cover cap, manual override is detenting and can be operated without tools	96
[6] Inscription label holder	Can be pushed onto the manual override	99
[7] Cover plate	For unused valve position (vacant position), width 10 mm, 14 mm	81, 86
[8] Electrical interlinking module	For fieldbus connection, for proportional pressure regulator, width 10 mm, 14 mm, 20 mm	85, 89, 93
[9] Mounting	Optional for valve terminal mounting (on supply plate)	99
[10] Flat plate silencer	–	–
[11] Exhaust air plate	For ducted exhaust air	97
[12] Mounting	Optional for valve terminal mounting (on the sub-base of the proportional pressure regulator)	99
[13] Electronics module	For proportional pressure regulator	94
[14] Proportional pressure regulator	–	94
[15] Regulator plate	Vertical stacking (pressure regulator, vertical pressure shut-off plate, vertical pressure supply plate)	91
[16] Solenoid valve	Width 20 mm	90
[17] Cover plate	For unused valve position (vacant position), width 20 mm	96
[18] H-rail mounting	–	99
[19] Right end plate	–	95
[20] Separating seal	For sub-base	96
[21] Threaded connectors	For working ports	98
[22] Sub-base	For two valve positions width 20 mm	92
[23] Sub-base	For proportional pressure regulator	94
[24] Pressure sensor	–	96
[25] Threaded connectors	For pneumatic supply plate	98
[26] Supply plate	–	97
[27] Electrical supply plate	For auxiliary voltage supply for large valve terminals	96
[28] Paper foil label	For inscription label holder	99
[29] Sub-base	For four valve positions width 10 mm, 14 mm	84, 88

Peripherals overview

Valve terminal with multi-pin plug connection

Order code:

- 32P... for the pneumatic components
- 32E... for the electric components

MPA valve terminals with multi-pin plug connection can be expanded by up to 24 solenoid coils.

The multi-pin plug connection is designed as a removable 25-pin Sub-D connection to IP65.

The cable can be selected when ordering:

- 2.5 m
- 5 m
- 10 m

In each case for max. 8 or 24 valves

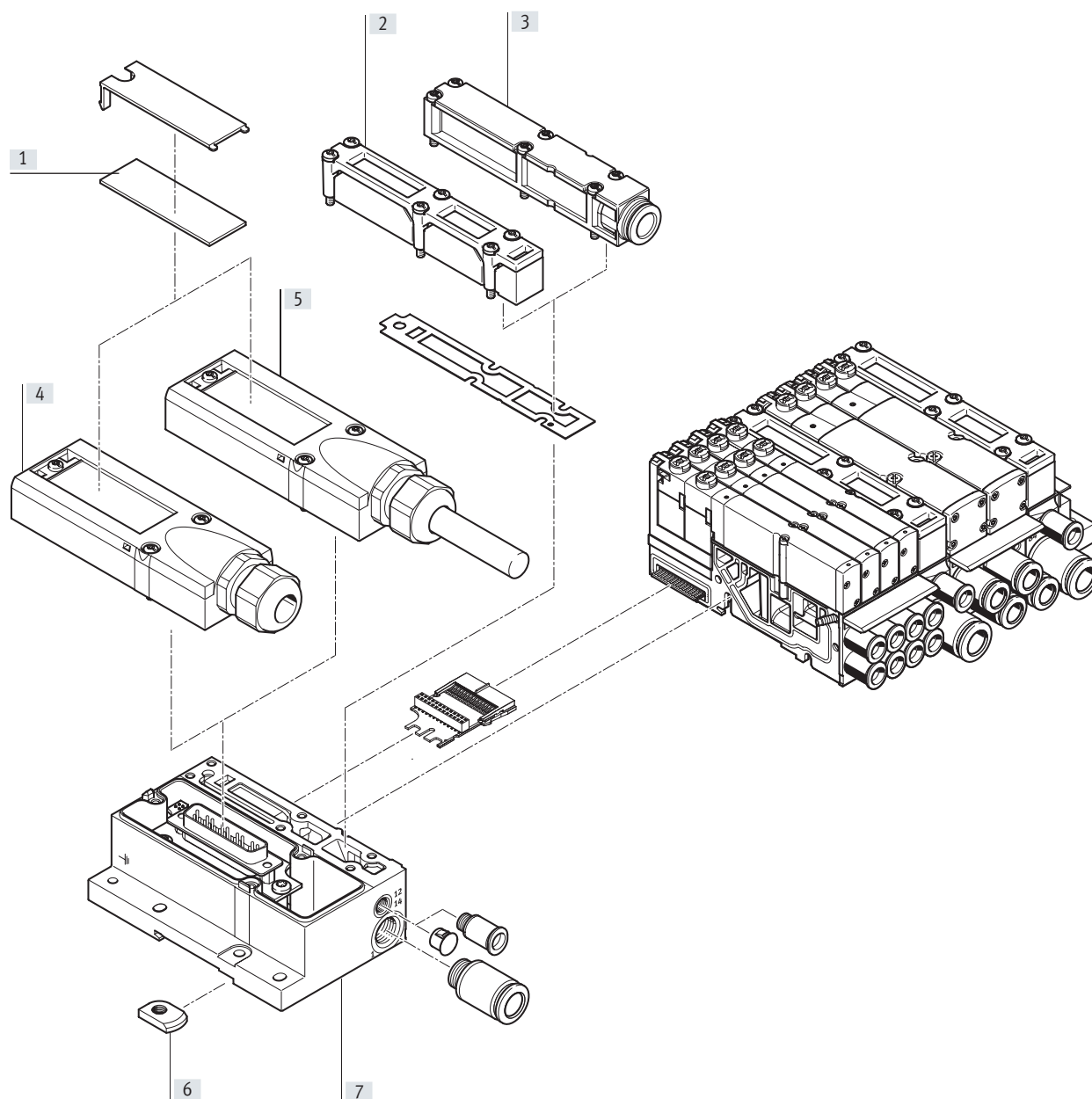

Designation	Description	→ Page/Internet
[1] Inscription labels	Large, for multi-pin plug connection	-
[2] Flat plate silencer	For pneumatic interface	-
[3] Exhaust air plate	For ducted exhaust air	97
[4] Multi-pin plug connection	For self-assembly	97
[5] Multi-pin plug connection	With multi-pin cable	97
[6] H-rail mounting	-	99
[7] Electrical interface	For multi-pin plug	95

Peripherals overview

Valve terminal with AS-Interface connection

Order code:

- 32P-... for the pneumatic components
- 52E-... for the electric components

MPA valve terminals with AS-Interface can be expanded by up to 8 solenoid coils.

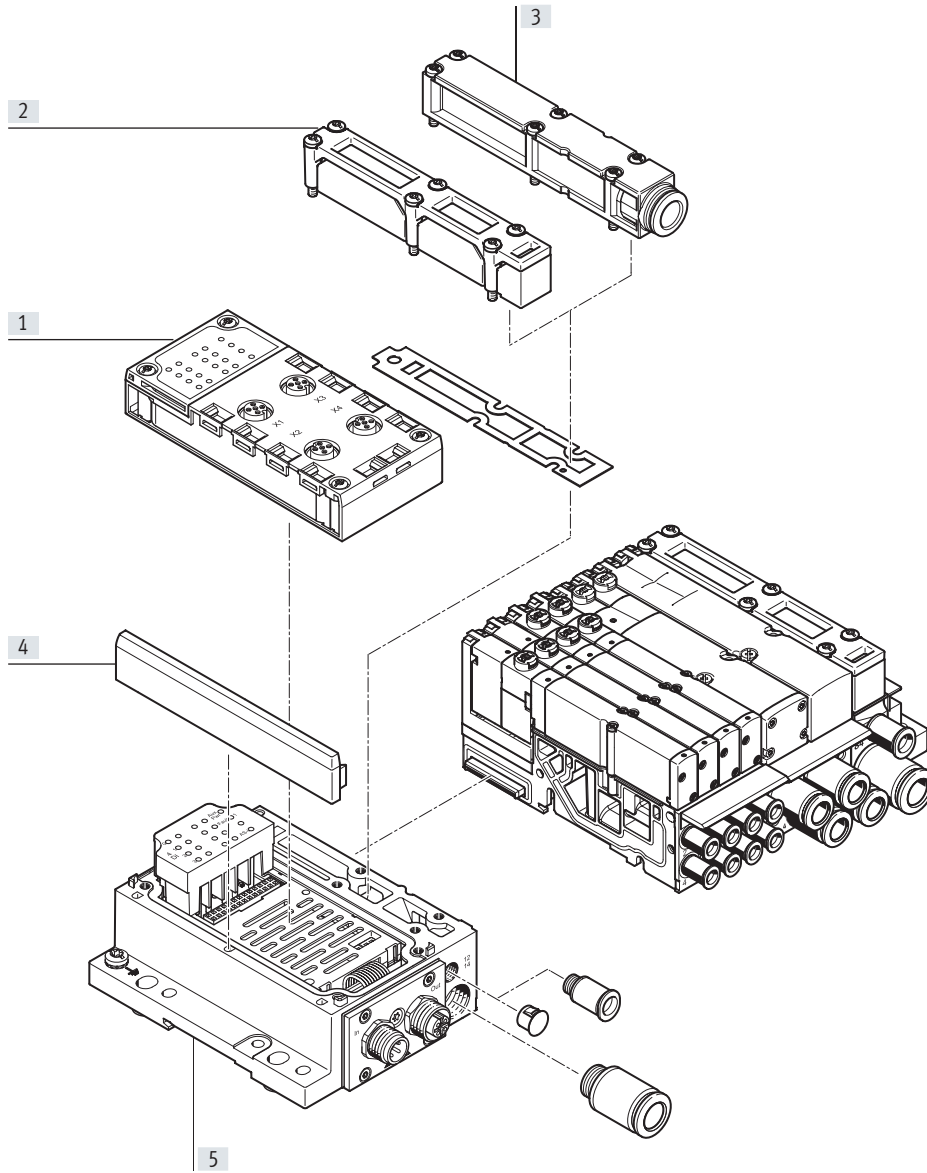

Designation	Description	→ Page/Internet
[1] Manifold block	-	95
[2] Flat plate silencer	For pneumatic interface	-
[3] Exhaust air plate	For ducted exhaust air	97
[4] Cover	-	-
[5] Electrical interface	-	95

Peripherals overview

Valve terminal with CPI connection

Order code:

- 32P... for the pneumatic components
- 56E... for the electrical peripherals

MPA valve terminals with CPI connection can be expanded by up to 32 solenoid coils.

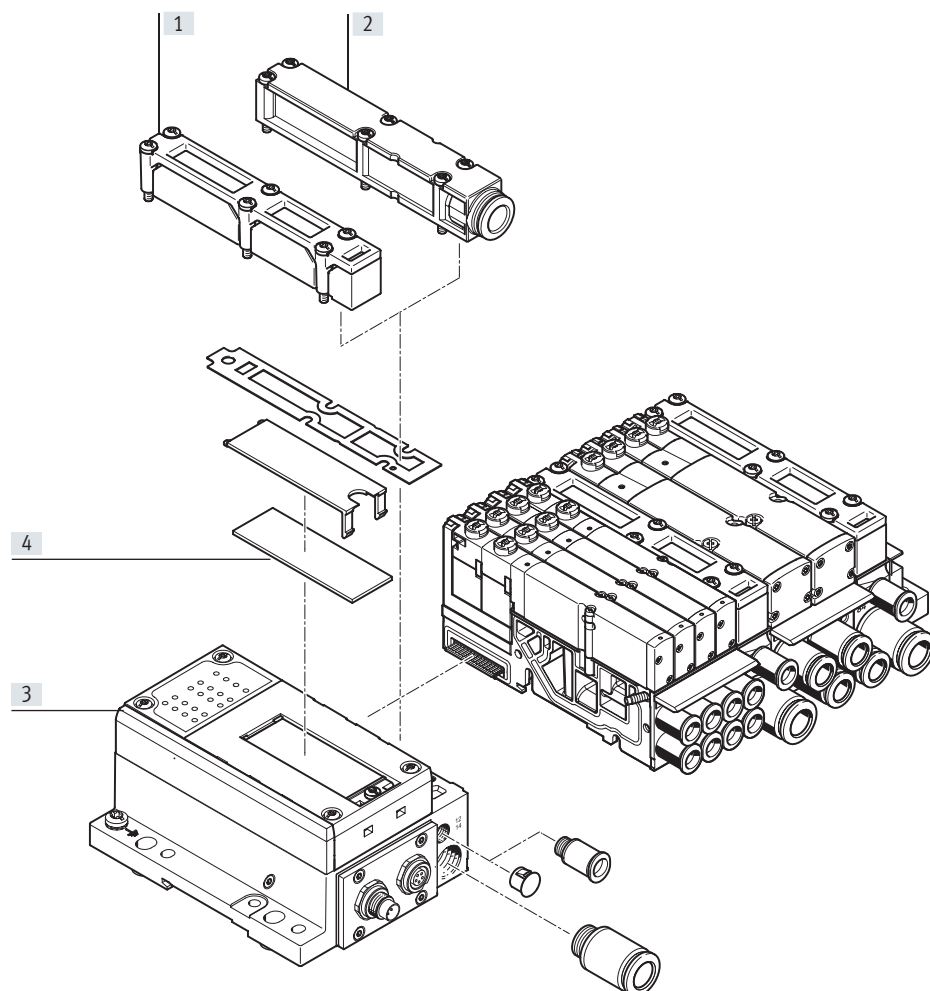

Designation	Description	→ Page/Internet
[1] Flat plate silencer	For pneumatic interface	-
[2] Exhaust air plate	For ducted exhaust air	97
[3] Electrical interface	-	95
[4] Inscription labels	Large for CPI electrical interface	-

Peripherals overview

Valve terminal with fieldbus interface, control block (electrical peripherals CPX)

Order code:

- 32P-... for the pneumatic components
- 50E-... for the electrical peripherals

Valve terminals with fieldbus interfaces can be configured with up to 16 sub-bases. In combination with MPA1 or MPA14 and 8 solenoid coils per sub-base, up to 128 solenoid coils can thus be equipped. An MPA2 with 4 solenoid coils per sub-base can actuate 64 solenoid coils.

Each valve position can be equipped with any valve or a cover plate. The rules for CPX apply to the equipment that can be used with the electrical peripherals CPX.
In general:

- Digital inputs/outputs
- Analogue inputs/outputs
- Parameterisation of inputs and outputs
- Integrated, convenient diagnostics
- Preventive maintenance concepts

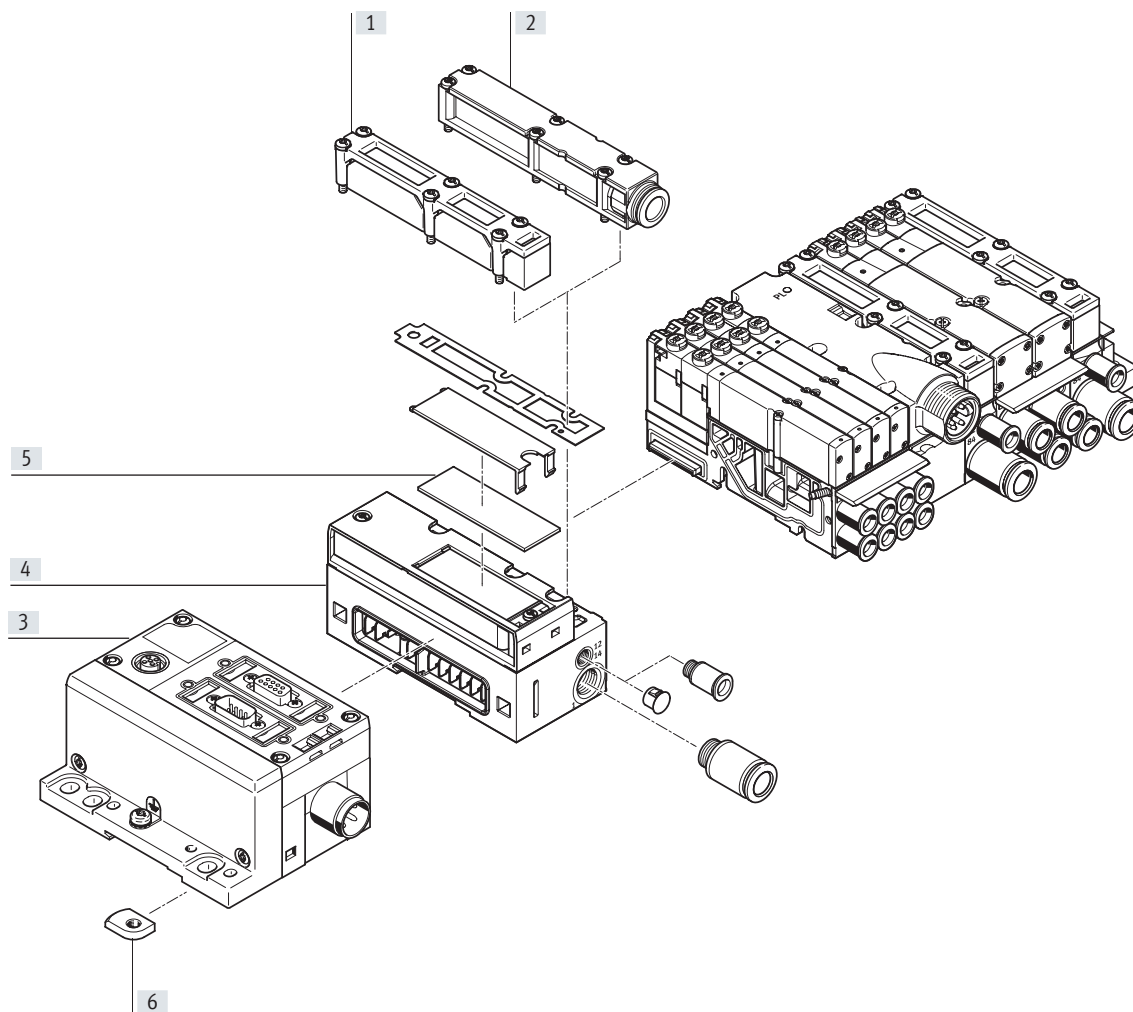

Designation	Description	→ Page/Internet
[1] Flat plate silencer	For pneumatic interface	-
[2] Exhaust air plate	For ducted exhaust air	97
[3] CPX modules	-	-
[4] Pneumatic interface	For CPX modules	95
[5] Inscription labels	Large, for pneumatic interface CPX	-
[6] H-rail mounting	-	99

Key features – Pneumatic components

Sub-base valve

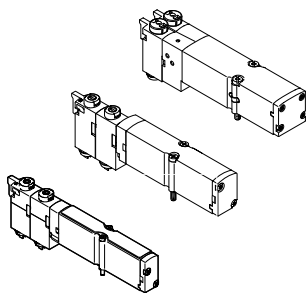

MPA offers a comprehensive range of valve functions. All valves have a patented sealing system, which ensures efficient sealing, a broad pressure range and a long service life. They have a pneumatic pilot control for optimising performance. Compressed air is supplied via a pilot air supply port.

Sub-base valves can be replaced quickly since the tubing connections remain on the sub-base. This design is also particularly flat.

Whatever valve function is required, there are sub-base valves with one solenoid coil (single solenoid) or with two solenoid coils (double solenoid or two single solenoid valves in one housing).

Design

Valve replacement

The valves are attached to the metal sub-base using two screws,

which means that they can be easily replaced. The mechanical sturdiness of the sub-base guarantees good long-term sealing.

Extension

Cover plates can be replaced by valves at a later date. The dimensions, mounting points and existing pneumatic installations remain unchanged during this process.

The valve code (M, MS, MU, J, N, NS, NU, K, KS, KU, H, HS, HU, B, G, E, X, W, D, DS, I) is located on the front of the valve beneath the manual override.

5/2-way valve		Valve size [mm]	Description
Code	Circuit symbol		
M		10, 14, 20	<ul style="list-style-type: none"> • Single solenoid • Pneumatic spring return • Reversible • Operating pressure -0.09 ... +1 MPa
MS		10, 14, 20	<ul style="list-style-type: none"> • Single solenoid • Mechanical spring return • Reversible • Operating pressure -0.09 ... +0.8 MPa
MU		10	<ul style="list-style-type: none"> • Single solenoid • Polymer poppet valve • Mechanical spring return • Reversible • Operating pressure -0.09 ... +1 MPa • 5/2-way function is achieved using two mechanically separate switching elements
J		10, 14, 20	<ul style="list-style-type: none"> • Double solenoid • Reversible • Operating pressure -0.09 ... +1 MPa

Key features – Pneumatic components

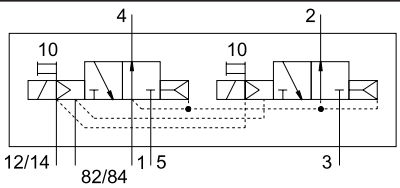
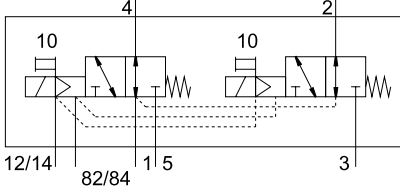
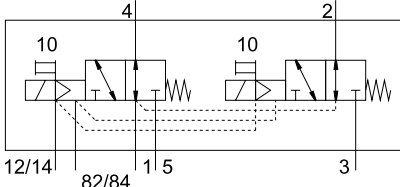
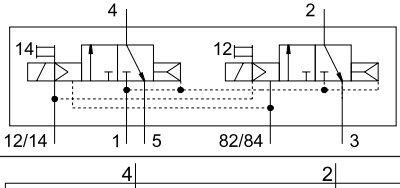
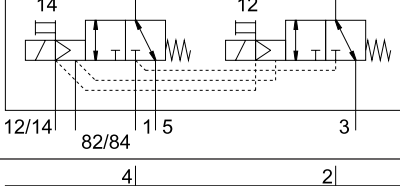
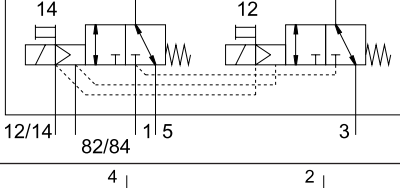
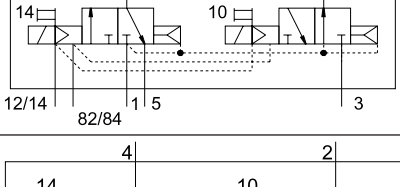
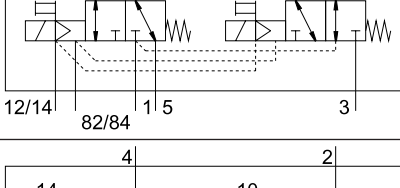
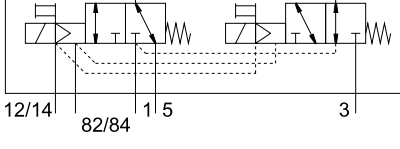
2x 3/2-way valve			
Code	Circuit symbol	Valve size [mm]	Description
N		10, 14, 20	<ul style="list-style-type: none"> • Single solenoid • Normally open • Pneumatic spring return • Operating pressure 0.3 ... 1 MPa
NS		10, 14, 20	<ul style="list-style-type: none"> • Single solenoid • Normally open • Mechanical spring return • Reversible • Operating pressure -0.09 ... +0.8 MPa
NU		10	<ul style="list-style-type: none"> • Single solenoid • Polymer poppet valve • Normally open • Mechanical spring return • Reversible • Operating pressure -0.09 ... +1 MPa
K		10, 14, 20	<ul style="list-style-type: none"> • Single solenoid • Normally closed • Pneumatic spring return • Operating pressure 0.3 ... 1 MPa
KS		10, 14, 20	<ul style="list-style-type: none"> • Single solenoid • Normally closed • Mechanical spring return • Reversible • Operating pressure -0.09 ... +0.8 MPa
KU		10	<ul style="list-style-type: none"> • Single solenoid • Polymer poppet valve • Normally closed • Mechanical spring return • Reversible • Operating pressure -0.09 ... +1 MPa
H		10, 14, 20	<ul style="list-style-type: none"> • Single solenoid • Normal position <ul style="list-style-type: none"> - 1x normally closed - 1x normally open • Pneumatic spring return • Operating pressure 0.3 ... 1 MPa
HS		10, 14, 20	<ul style="list-style-type: none"> • Single solenoid • Normal position <ul style="list-style-type: none"> - 1x normally closed - 1x normally open • Mechanical spring return • Reversible • Operating pressure -0.09 ... +0.8 MPa
HU		10	<ul style="list-style-type: none"> • Single solenoid • Polymer poppet valve • Normal position <ul style="list-style-type: none"> - 1x normally closed - 1x normally open • Mechanical spring return • Reversible • Operating pressure -0.09 ... +1 MPa

Key features – Pneumatic components

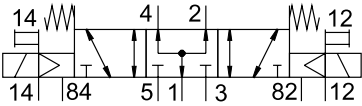
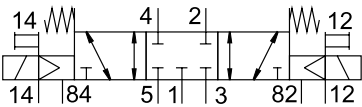
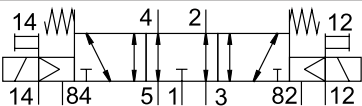
5/3-way valve			
Code	Circuit symbol	Valve size [mm]	Description
B		10, 14, 20	<ul style="list-style-type: none"> • Mid-position pressurised¹⁾ • Mechanical spring return • Reversible • Operating pressure -0.09 ... +1 MPa
G		10, 14, 20	<ul style="list-style-type: none"> • Mid-position closed¹⁾ • Mechanical spring return • Reversible • Operating pressure -0.09 ... +1 MPa
E		10, 14, 20	<ul style="list-style-type: none"> • Mid-position exhausted¹⁾ • Mechanical spring return • Reversible • Operating pressure -0.09 ... +1 MPa

1) If neither solenoid coil is energised, the valve is moved to its mid-position by spring force.
If both coils are energised at the same time, the valve remains in the previously assumed switching position.

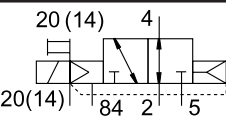
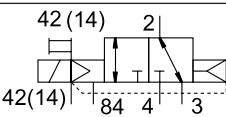
3/2-way valve			
Code	Circuit symbol	Valve size [mm]	Description
W		10, 14, 20	<ul style="list-style-type: none"> • Single solenoid • Normally open • External pressure supply • Pneumatic spring return • Reversible • Operating pressure -0.09 ... +1 MPa <p>Pressure supplied at working port 2 (-0.09 ... +1 MPa) can be switched with both internal and external pilot air supply.</p>
X		10, 14, 20	<ul style="list-style-type: none"> • Single solenoid • Normally closed • External pressure supply • Pneumatic spring return • Reversible • Operating pressure -0.09 ... +1 MPa <p>Pressure supplied at working port 4 (-0.09 ... +1 MPa) can be switched with both internal and external pilot air supply.</p>

Key features – Pneumatic components

2x 2/2-way valve			
Code	Circuit symbol	Valve size [mm]	Description
D	<p>12/14 82/84 1</p>	10, 14, 20	<ul style="list-style-type: none"> • Single solenoid • Normally closed • Pneumatic spring return • Operating pressure 0.3 ... 1 MPa
DS	<p>12/14 82/84 1</p>	10, 14, 20	<ul style="list-style-type: none"> • Single solenoid • Normally closed • Mechanical spring return • Reversible • Operating pressure -0.09 ... +0.8 MPa
I	<p>12/14 82/84 5 1</p>	10, 14, 20	<ul style="list-style-type: none"> • Single solenoid • 1x normally closed • 1x normally closed, reversible only • Pneumatic spring return • Operating pressure 0.3 ... 1 MPa • Vacuum at port 3/5 only

Note

A filter must be installed upstream of valves operated in vacuum mode. This prevents any foreign matter in the intake air getting into the valve (e.g. when operating a suction cup).

3/2-way valve			
Code	Circuit symbol	Valve size [mm]	Description
IS		10, 14	<ul style="list-style-type: none"> • Single solenoid • Normally closed • Mechanical spring return • Operating pressure 0.3 ... 0.8 MPa • With internal power supply
IU		10, 14	<ul style="list-style-type: none"> • Single solenoid • Normally closed • Mechanical spring return • Operating pressure 0.3 ... 0.8 MPa • With internal power supply • With external sensor M8 plug connector
ES		10, 14	<ul style="list-style-type: none"> • Single solenoid • Normally closed • Mechanical spring return • Operating pressure 0.3 ... 0.8 MPa • With external power supply
EU		10, 14	<ul style="list-style-type: none"> • Single solenoid • Normally closed • Mechanical spring return • Operating pressure 0.3 ... 0.8 MPa • With external power supply • With external sensor M8 plug connector

Key features – Pneumatic components

Vertical stacking

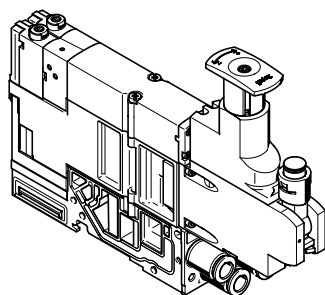

Additional functional units can be added to each valve position between the sub-base and the valve.

These functions are known as vertical stacking modules and enable special functions or control of an individual valve position.

Pressure regulator plate

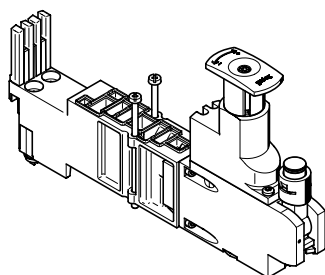

An adjustable pressure regulator can be installed between the sub-base and the valve in order to control the force of the triggered actuator.

This pressure regulator maintains a constant output pressure (secondary side) independent of pressure fluctua-

tions (primary side) and air consumption.

Standard version:

- For pressure regulation up to 6 bar or up to 10 bar
- Without pressure gauge (optional, rotatable, M5 connection with

MPA1, cartridge connection with MPA2)

- MPA2: Regulator head with 3 positions (locked, reference position, idle running)
- MPA1: Set using screwdriver

Vertical pressure shut-off plate for MPA1

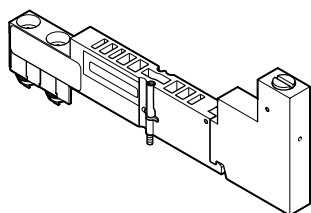

The vertical pressure shut-off plate can be used to hot swap individual valves without switching off the overall air supply.

The working pressure for the individual valve can be switched off manually via the vertical pressure shut-off plate using the actuating element.

Key features – Pneumatic components

Vertical stacking

Vertical pressure supply plate for MPA2

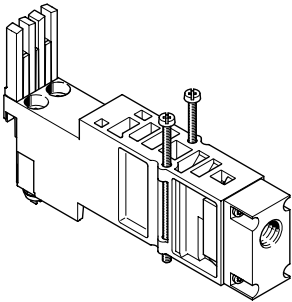

This vertical pressure supply plate enables an individual valve to be supplied with individual operating pressure independently of the operating pressure of the valve terminal.

The exhaust and pilot air supply of the valve are still provided via the central ports of the valve terminal.

Check valve

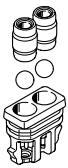

The check valves prevent the air (back pressure) from exhaust ducts 3 and 5 from entering the solenoid valve, preventing the back pressure from having a disruptive effect on other connected actuators.

The check valves are integrated into ducts 3 and 5 of the sub-bases designed specifically for this purpose.

Please see the relevant assembly instructions:

→ www.festo.com/catalogue/mpa → Support/Downloads.

This function makes it possible to effectively protect single-acting process valves from the effects of back pressure.

This ensures reliable and feedback-free switching operations, especially in the case of rapid switching operations.

Note

- Special sub-bases are available for use with check valves.
- Standard sub-bases cannot be retrofitted with check valves.
- Pre-assembled sub-bases with integrated check valves are available.
- Check valves and fixed flow restrictors cannot be used at the same time (in the same duct).

Key features – Pneumatic components

Vertical stacking

Vertical stacking components, valve size 10 mm

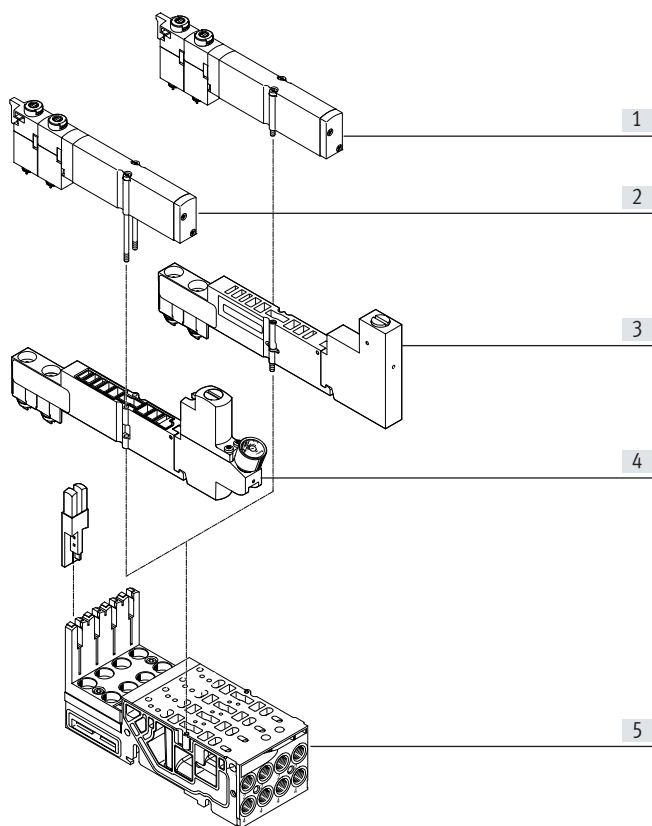

- [1] Valve VMPA1
- [2] Valve VMPA1, retaining screws replaced by long version (included in the scope of delivery of the regulator plate)
- [3] Vertical pressure shut-off plate VMPA1-HS
- [4] Regulator plate VMPA1
- [5] Sub-base

Vertical stacking components, valve size 20 mm

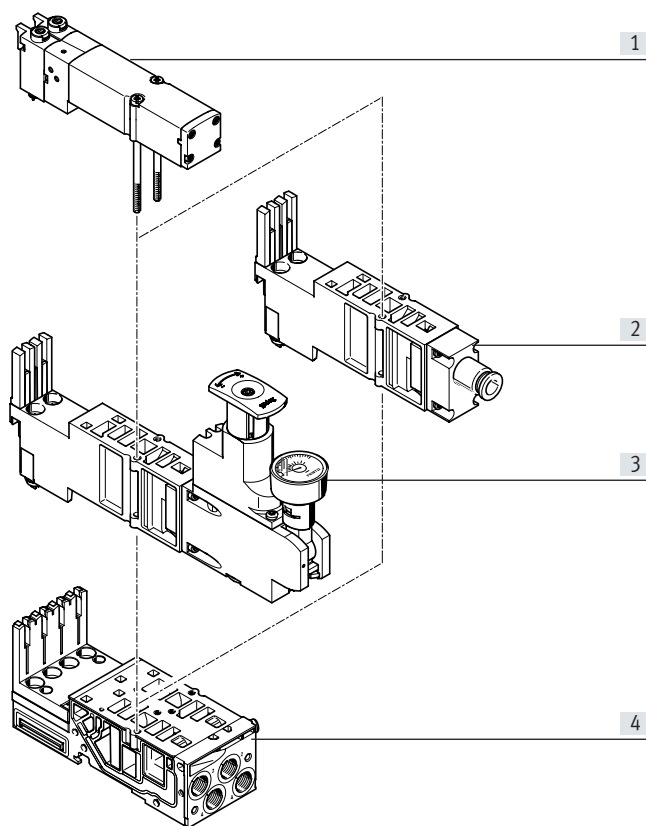

- [1] Valve VMPA2
- [2] Vertical pressure supply plate
- [3] Regulator plate VMPA2
- [4] Sub-base

Fixed flow restrictor for manifold sub-bases MPA1

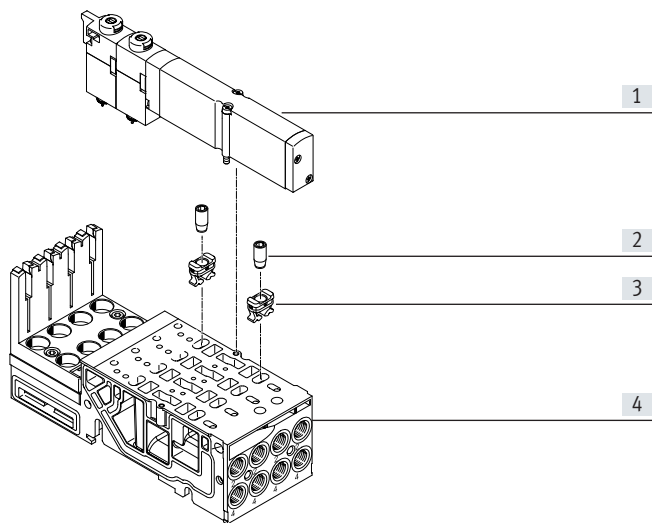

- [1] Valve VMPA1
- [2] Fixed flow restrictor
- [3] Retaining bracket
- [4] Sub-base

The fixed flow restrictor can be used to permanently set the exhaust flow rate in ducts 3 and 5. To be able to screw the restrictor into the sub-base, the retaining bracket is first pressed into the exhaust openings on the sub-base as far as the stop.

The fixed flow restrictor can then be screwed in flush with the top side of the retaining bracket. The restrictor screw cuts a thread into the retaining bracket as it is screwed in. As the restrictor is being screwed in, two hooks on the retaining bracket also deform to fix it into the sub-base.

Key features – Pneumatic components

Vertical stacking

Check valve

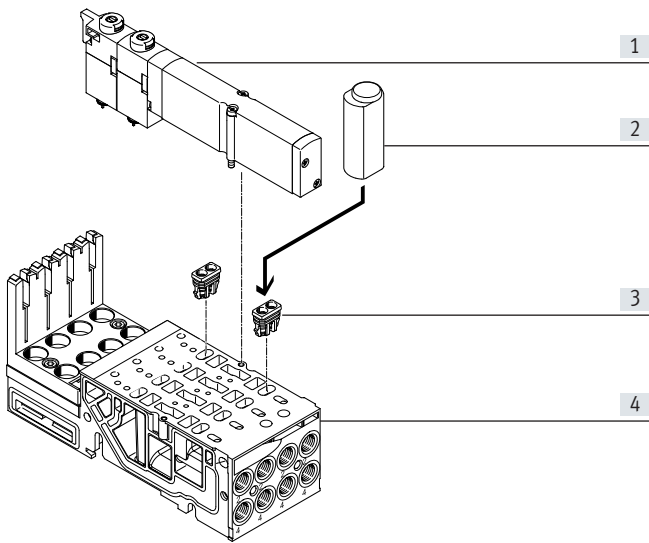

- [1] Valve VMPA14
- [2] Assembly tool
- [3] Check valve
- [4] Sub-base

Festo check valves can only be used in combination with the sub-bases designed specifically for this purpose. The check valves should be installed according to the specifications using the enclosed assembly tool. Once installed, the check valves cannot be removed.

Please see the relevant assembly instructions:

→ www.festo.com/catalogue/mpa → Support/Downloads.

There are special sub-bases available that facilitate the installation of check valves for widths 14 mm and 20 mm.

Note

- Special sub-bases are available for use with check valves.
- Standard sub-bases cannot be retrofitted with check valves.
- Pre-assembled sub-bases with integrated check valves are available.
- Check valves and fixed flow restrictors cannot be used at the same time (in the same duct).

Key features – Pneumatic components

Vertical stacking

Mode of operation of the pressure regulator plate (P regulator) for port 1; code: PA, PF

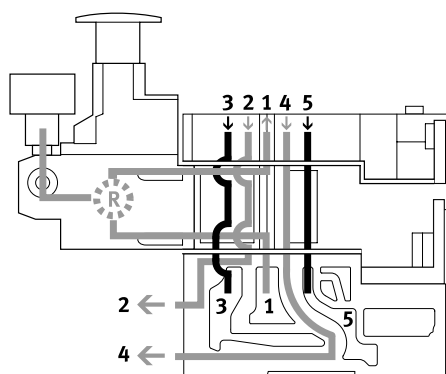

This pressure regulator regulates the pressure upstream of the valve in duct 1. Ducts 2 and 4 thus have the same regulated pressure.

During exhausting, the exhaust flow in the valve is from duct 2 to duct 3 and from duct 4 to duct 5.

Benefits

- The pressure regulator is not affected by exhausting, since the pressure is regulated upstream of the valve.
- The pressure regulator can always be adjusted, since the pressure from the valve terminal is always present.

Application examples

- An equal working pressure is required at working ports 2 and 4.
- A working pressure (e.g. 3 bar) lower than the operating pressure at the valve terminal (e.g. 8 bar) is required.

Operating mode of the pressure regulator plate (B regulator) for port 2; code: PC, PH

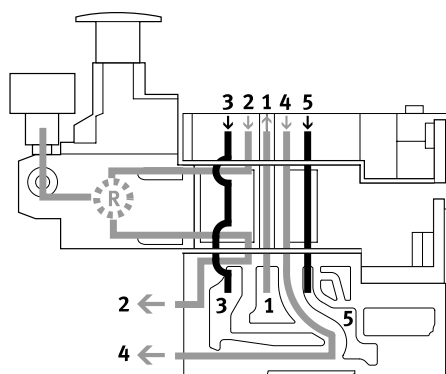

This pressure regulator regulates the pressure in duct 2 after the pressure medium flows through the valve. During exhausting, the air flow in the valve is exhausted from duct 2 to duct 3 via the pressure regulator.

Constraints

The pressure regulator can only be adjusted in the switched state (e.g. the valve has switched to 2 and exhausts from 4 to 5).

Sample application

The pressure regulator facilitates the reduction of pressure at port 2 of an individual valve rather than the operating pressure of the valve terminal

Key features – Pneumatic components

Vertical stacking

Operating mode of the pressure regulator plate (A regulator) for port 4; code: PB, PK

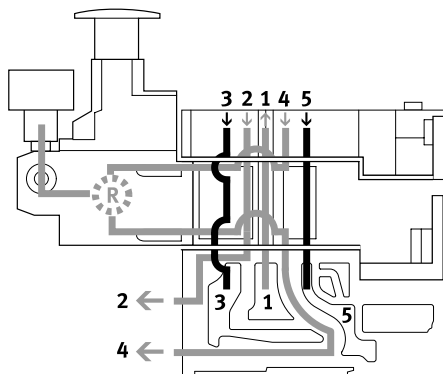

This pressure regulator regulates the pressure in duct 4 after the pressure medium flows through the valve. During exhausting, the air flow in the valve is exhausted from duct 4 to duct 5 via the pressure regulator.

Constraints

The pressure regulator can only be adjusted in the switched state (e.g. the valve has switched to 4 and exhausts from 2 to 3).

Sample application

If different working pressures are required at ports 4 and 2. The pressure from duct 1 is present at port 2.

Operating mode of the pressure regulator plate (B regulator, reversible) for port 2, reversible; code: PL, PN

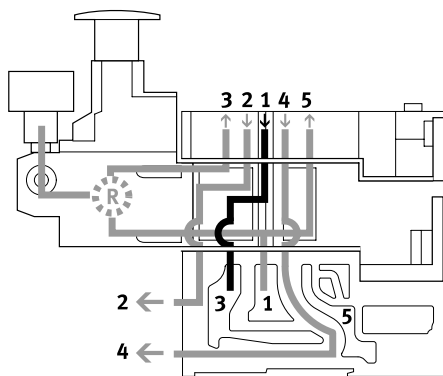

The reversible B regulator splits the supply air in duct 1 and regulates the pressure upstream of the valve in duct 3 (the unregulated pressure from duct 1 is in duct 5). The regulated air is then routed to duct 2. The valve is thus operated in reverse mode.

During exhausting, the exhaust flow in the valve is from duct 2 to duct 1 and the air is returned to duct 3 via the intermediate plate.

Application examples

- If a different pressure than the operating pressure of the valve terminal is required in duct 2.
- When fast exhausting is required.
- When the pressure regulator must always be adjustable.

Benefits

- Fast cycle times
- 50% higher exhaust flow rate, as air is not exhausted via the pressure regulator. The load on the pressure regulator is also reduced.
- No quick exhaust valves are required.
- Operating pressure is always present at the pressure regulator, as the pressure is regulated upstream of the valve, i.e. the regulator can always be adjusted.

Note

Reversible pressure regulator plates should only be combined with valves that can be operated in reverse mode.

Constraints

- 2x 3/2-way valves (code N, K, H) cannot be used, as pressure is present at ports 3 and 5.

Key features – Pneumatic components

Vertical stacking

Operating mode of the pressure regulator plate (A regulator, reversible) for port 4, reversible; code: PK, PM

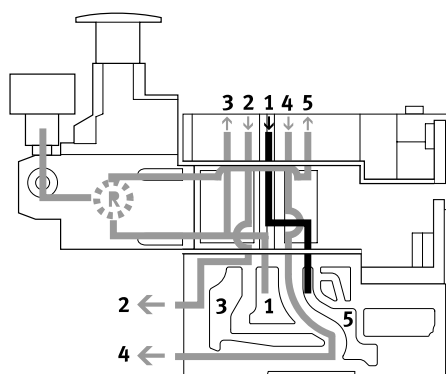

The reversible A regulator splits the working air in duct 1 and supplies the pressure upstream of the valve into duct 5 (the unregulated pressure from duct 1 is in duct 3). The regulated air is then routed to duct 4. The valve is thus operated in reversible mode.

During exhausting, the exhaust flow in the valve is from duct 4 to duct 1 and the air is returned to duct 5 via the intermediate plate.

Application examples

- If a different pressure than the operating pressure of the valve terminal is required in duct 4.
- When fast exhausting is required.
- When the pressure regulator must always be adjustable.

Note

Reversible pressure regulator plates should only be combined with valves that can be operated in reverse mode.

Benefits

- Fast cycle times
- 50% higher exhaust flow rate, as air is not exhausted via the pressure regulator. The load on the pressure regulator is also reduced.
- No quick exhaust valves are required.
- Operating pressure is always present at the pressure regulator, as the pressure is regulated upstream of the valve, i.e. the regulator can always be adjusted.

Constraints

- 2x 3/2-way valves (code N, K, H) cannot be used, as pressure is present at ports 3 and 5.

Key features – Pneumatic components

Vertical stacking – Pressure regulator plate				
Code		Width	Control range	Description
		[mm]		
Pressure regulator plate for port 1 (P regulator)				
PA		10	Up to max. 10 bar	Regulates the operating pressure in duct 1 upstream of the directional control valve
		14		
		20		
PF		10	Up to max. 6 bar	
		14		
		20		
Pressure regulator plate for port 2 (B regulator)				
PC		10	Up to max. 10 bar	Regulates the operating pressure in duct 2 downstream of the directional control valve
		14		
		20		
PH		10	Up to max. 6 bar	
		14		
		20		
Pressure regulator plate for port 4 (A regulator)				
PB		10	Up to max. 10 bar	Regulates the operating pressure in duct 4 downstream of the directional control valve
		14		
		20		
PG		10	Up to max. 6 bar	
		14		
		20		
Pressure regulator plate for port 2, reversible (B regulator)				
PL		20	Up to max. 10 bar	Reversible pressure regulator for port 2
PN		20	Up to max. 6 bar	
Pressure regulator plate for port 4, reversible (A regulator)				
PK		20	Up to max. 10 bar	Reversible pressure regulator for port 4
PM		20	Up to max. 6 bar	

Key features – Pneumatic components

Description of proportional pressure regulator

The proportional pressure regulator VPPM-... is used to regulate pressure proportional to a specified setpoint value.

A built-in pressure sensor records the pressure at the working port and compares this value with the setpoint value. In the event of deviations between the setpoint value and actual value,

the valve regulates until the output pressure has reached the setpoint value. For a constant pressure supply, which is required for high control quality, the proportional pressure regulator has an additional supply port. The proportional pressure regulator can be configured via the PLC or on-site via the interface for CPX-FMT. The pro-

portional pressure regulator can be used for CPI connection and fieldbus.



Note

Output pressure will be unregulated if there is a break in the power supply cable.

Proportional pressure regulator Illustration	Code	Type	Linearity error full-scale [%]	Input pressure 1 [MPa]	Pressure regulation range [MPa]
	QA	VPPM-6TA-L-1-F-0L2H	2	0 ... 0.4	0.002 ... 0.2
	QB	VPPM-6TA-L-1-F-0L6H	2	0 ... 0.8	0.006 ... 0.6
	QC	VPPM-6TA-L-1-F-0L10H	2	0 ... 1.1	0.01 ... 1
	QD	VPPM-6TA-L-1-F-0L2H-S1	1	0 ... 0.4	0.002 ... 0.2
	QE	VPPM-6TA-L-1-F-0L6H-S1	1	0 ... 0.8	0.006 ... 0.6
	QF	VPPM-6TA-L-1-F-0L10H-S1	1	0 ... 1.1	0.01 ... 1
	QG	VPPM-8TA-L-1-F-0L2H-C1	2	0 ... 0.4	0.002 ... 0.2
	QH	VPPM-8TA-L-1-F-0L6H-C1	2	0 ... 0.8	0.006 ... 0.6
	QK	VPPM-8TA-L-1-F-0L10H-C1	2	0 ... 1.1	0.01 ... 1
	QL	VPPM-8TA-L-1-F-0L2H-S1C1	1	0 ... 0.4	0.002 ... 0.2
	QM	VPPM-8TA-L-1-F-0L6H-S1C1	1	0 ... 0.8	0.006 ... 0.6
	QN	VPPM-8TA-L-1-F-0L10H-S1C1	1	0 ... 1.1	0.01 ... 1

Key features – Pneumatic components

Terms related to the proportional-pressure regulator

Hysteresis

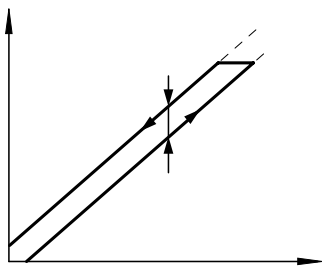

There is always a linear relationship within a certain tolerance between the setpoint value entered and the pressure output. Nevertheless, it makes a difference whether the setpoint value is entered as rising or falling. The difference between the maximum deviations is referred to as hysteresis.

Linearity error

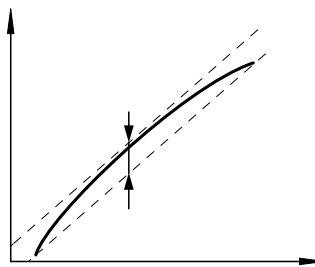

A perfectly linear progression of the control characteristic of the output pressure is theoretical. The maximum percentage deviation from this theoretical control characteristic is referred to as the linearity error. The percentage value refers to the maximum output pressure (full scale).

Response sensitivity

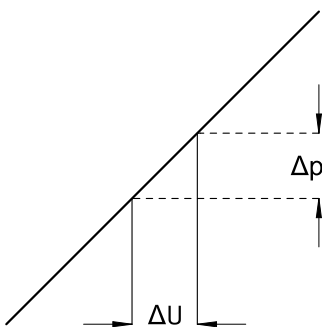

The response sensitivity of the device determines how sensitively one can change, i.e. adjust, a pressure. The smallest setpoint value difference that results in a change in the output pressure is referred to as the response sensitivity. In this case, 0.01 bar.

Repetition accuracy (reproducibility)

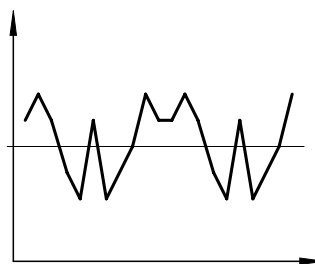

The repetition accuracy is the margin within which the fluidic output variable is scattered when the same electrical input signal coming from the same direction is repeatedly adjusted. The repetition accuracy is expressed as a percentage of the maximum fluidic output signal.

Zero point suppression

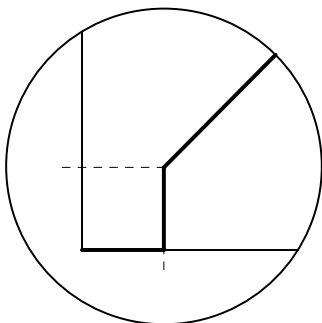

In practice, there can be a residual voltage or residual current at the setpoint input of the VPPM via the setpoint generator. Zero point suppression is used so the valve is reliably exhausted at a setpoint value of zero.

Key features – Pneumatic components

Cover plate

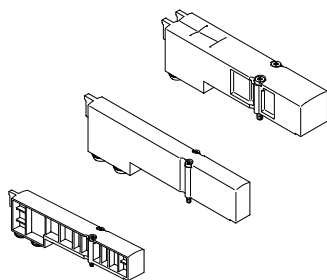

Plate without valve function for reserving valve positions on a valve terminal.

Valve and cover plates are attached to the sub-base using two screws.

Valve function		Width [mm]	Description
Code	Circuit symbol		
L	—	10, 14, 20	For valve terminal only: cover plate for valve position

Compressed air supply and exhaust

Pneumatic interface

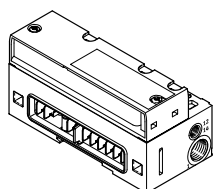

The valve terminal MPA can be supplied with air at one or more points. This ensures that the valve terminal will always have an adequate air supply and exhaust, even with large-scale expansions. The main supply to the valve terminal is located on the pneumatic interface, which links the electrical and pneu-

matic parts. Additional provision is made for several supply plates.

supply plates and on the right end plate (VMPA-ERP-G).

Exhausting is either via integrated flat plate silencers or common lines for ducted exhaust air.

These exhausts are located on the pneumatic interface as well as on the

Supply plate

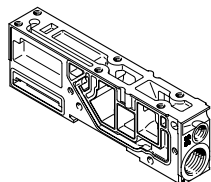

When there is a need to increase the air supply, additional supply plates can be provided.

Exhausting is either via integrated flat plate silencers or common lines for ducted exhaust air.

For ducted exhaust air, at least one additional supply plate is required, which

is used to exhaust the air from the pilot air supply (port 82/84) (when using a right end plate without port 82/84).

Vertical pressure supply plate

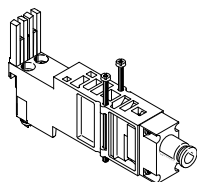

The individual compressed air supply of a single valve with a width of 20 mm can be realised using the vertical pressure supply plate VMPA2-VSP-

Right end plate (VMPA-ERP-G)

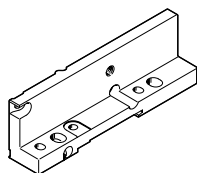

The air to be exhausted can be ducted using the right end plate with port 82/84 (VMPA-ERP-G).

Key features – Pneumatic components

Pilot air supply

The port for the main pneumatic supply is located on the pneumatic interface.

The ports differ for the following types of pilot air supply:

- Internal
- External

Internal pilot air supply

If the required working pressures are between 0.3 and 0.8 MPa, internal pilot air supply can be selected.

The pilot air supply is then branched from the working air 1 in the pneumatic interface using an internal connection. Port 12/14 is sealed with a blanking plug.

External pilot air supply

If the supply pressure is less than 0.3 MPa or greater than 0.8 MPa, you must operate your MPA valve terminal with external pilot air supply. In this case, the pilot air is additionally supplied via port 12/14 on the pneumatic interface.



Note

If a gradual pressure build-up in the system using a soft-start valve is chosen, an external pilot air supply should be connected so that the pilot pressure applied during switch-on is already very high.

Pilot air switching valve

The pilot air switching valve supplies the downstream valves in a pressure zone with pilot air (12/14). The pilot air switching valve can be used to implement the safety function “Protection against unexpected start-up”.

The compressed air to the pilot air switching valve can be supplied either internally via duct 1 of the valve terminal (or pressure zone) or externally via port 2 of the sub-base on which the pilot air switching valve is located.

In the case of internal pressure supply from duct 1, vacuum operation (in duct 1) is not possible.

When configuring the compressed air supply, please ensure that the pilot air switching valve has a working pressure of 0.3...0.8 MPa. Like all valves MPA, the pilot air switching valve has a manual override.

Pilot air switching valve

Internal pilot air supply

Normal position:

- Pressure is supplied via duct 1.
- Duct 2 on the sub-base is sealed with a blanking plug.
- Operating pressure of 0.3...0.8 MPa required in duct 1.
- In the normal position of the valve, duct 14 is exhausted to atmosphere via port 4 of the sub-base (silencer).

Switching status:

- In the switched position, duct 12/14 of the valve terminal is supplied with pressure from duct 1 via the pilot air switching valve.
- The integrated pressure sensor reports the presence of pressure in duct 12/14.

External pilot air supply

Normal position:

- Pressure is supplied via duct 2.
- The connection between duct 1 and the valve is closed.
- No restriction on the operating pressure in duct 1.
- In the normal position of the valve, duct 14 is exhausted to atmosphere via port 4 of the sub-base (silencer).

Switching status:

- In the switched position, duct 12/14 of the valve terminal is supplied with pressure from duct 2 via the pilot air switching valve.
- The integrated pressure sensor reports the presence of pressure in duct 12/14.

Key features – Pneumatic components

Fluid power supply and pilot air supply				Information
Code	Illustration			
	Type of compressed air supply and pilot air supply			
	Pneumatic interface	Supply plate	End plate, right	
S				<p>Internal pilot air supply, flat plate silencer</p> <ul style="list-style-type: none"> • Pilot air supply is branched internally from port 1 in the pneumatic interface • Exhaust port 3/5 and pilot exhaust port 82/84 via flat plate silencer • For operating pressure in the range 0.3 ... 0.8 MPa
T				<p>External pilot air supply, flat plate silencer</p> <ul style="list-style-type: none"> • Pilot air supply between 0.3 and 0.8 MPa is connected at port 12/14 • Exhaust port 3/5 and pilot exhaust port 82/84 via flat plate silencer • For operating pressure in the range -0.09 ... +1 MPa (suitable for vacuum)
V				<p>Internal pilot air supply, ducted exhaust air</p> <ul style="list-style-type: none"> • Pilot air supply is branched internally from port 1 in the pneumatic interface • Exhaust port 3/5: connection to pneumatic interface and supply plate • Pilot exhaust port 82/84: connection to supply plate only • For operating pressure in the range 0.3 ... 0.8 MPa
X				<p>External pilot air supply, ducted exhaust air</p> <ul style="list-style-type: none"> • Pilot air supply (0.3 ... 0.8 MPa) is connected at port 12/14. • Exhaust port 3/5: connection to pneumatic interface and supply plate • Pilot exhaust port 82/84: connection to supply plate only • For operating pressure in the range -0.09 ... +1 MPa (suitable for vacuum)
Y				<p>Internal pilot air supply, ducted exhaust air via right-hand end plate</p> <ul style="list-style-type: none"> • Pilot air supply is branched internally from port 1 in the pneumatic interface • Exhaust port 3/5: connection to pneumatic interface and supply plate • Pilot exhaust air 82/84 ducted via right-hand end plate (VMPA-EPR-G) • For operating pressure in the range 0.3 ... 0.8 MPa
Z				<p>External pilot air supply, ducted exhaust air via right-hand end plate</p> <ul style="list-style-type: none"> • Pilot air supply (0.3 ... 0.8 MPa) is connected at port 12/14. • Exhaust port 3/5: connection to pneumatic interface and supply plate • Pilot exhaust air 82/84 ducted via right-hand end plate (VMPA-EPR-G) • For operating pressure in the range -0.09 ... +1 MPa (suitable for vacuum)

Key features – Pneumatic components

Fluid power supply and pilot air supply			Information
Code	Illustration		
	Type of compressed air supply and pilot air supply		
	Pilot air switching valve		
IS, IU			<p>Internal pilot air supply, pilot air switching valve</p> <ul style="list-style-type: none"> • Pilot air supply is branched internally from port 1 in the pilot air switching valve • Pilot air supply for the pressure zone to the right of the pilot air switching valve • In the unswitched state, duct 12/14 is exhausted via a silencer at port 4 of the pilot air switching valve • For operating pressure in the range 0.3 ... 0.8 MPa • Separating seal to pneumatic interface required
ES, EU			<p>External pilot air supply, pilot air switching valve</p> <ul style="list-style-type: none"> • Pilot air supply is connected externally via port 2 on the pilot air switching valve • Pilot air supply for the pressure zone to the right of the pilot air switching valve • In the unswitched state, duct 12/14 is exhausted via a silencer at port 4 of the pilot air switching valve • For operating pressure in the range -0.09 ... +1.0 MPa • Separating seal to pneumatic interface required
Pneumatic interface			
Code	Pneumatic interface design variants		Information
	Illustration	Type	
M		VMPA-...-EPL-...	<ul style="list-style-type: none"> • Used together with compressed air supply S, T, V, X • In combination with V or X, the pilot exhaust air must be exhausted at at least one supply plate. With several supply plates, port 82/84 on the final one is open ex works.

Key features – Pneumatic components

Supply plate

Additional supply plates can be used for larger terminals or to create pressure zones.

If several valves are to be operated simultaneously at full flow rate, it is recommended that a supply plate be positioned after every 8 valves (MPA1 or MPA14), or every 4 valves (MPA2).

Supply plates can be configured at any point upstream or downstream of sub-bases.

This applies to the following interfaces:

- MPA with CPX
- MPA with multi-pin plug connection
- MPA with AS-Interface connection
- MPA with CPI connection

MPA with ducted exhaust air

When using a right-hand end plate without port 82/84, it is essential that a supply plate for ducted exhaust air is used. Alternatively, an end plate with port 82/84 (VMPA-EPR-G) can be used for ducted exhaust air. In this case, no supply plate is required.

Supply plates contain the ports:

- Compressed air supply (1)
- Exhaust for the pilot air supply (82/84) and pressure compensation
- Exhaust air (3/5)

Depending on your order, the exhaust ducts are either ducted or exhausted via the flat plate silencer.

The supply plate is configured using the code letter U if no directly adjoining separating seal is required.

If a separating seal (S, T or R) is selected directly to the right or left of the supply plate, then the code letter V or W identifies the position of the left or right separating seal. The code for the separating seal (S, T or R) is placed in front of the code for the supply plate (V or W).

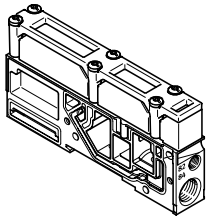
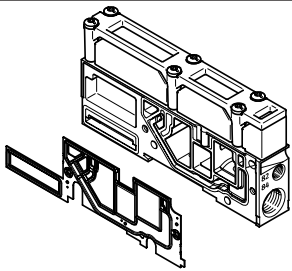
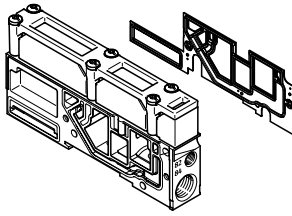
Supply plate (without exhaust plate)			
Code ¹⁾	Illustration	Type	Information
U		VMPA1-...-SP...	Supply plate without separating seal (no R, S or T selected)
V		VMPA1-...-SP...	Supply plate with separating seal on left, if R, S or T selected
W		VMPA1-...-SP...	Supply plate with separating seal on right, if R, S or T selected

1) Depending on the air supply code S, T, V, X, the supply plate is equipped with a silencer or an exhaust plate.

Key features – Electrical components

Electrical supply plate

Additional electrical supply plates can be used for larger terminals.

This enables up to 64 valve positions/128 solenoid coils to be supplied.

MPA with CPX

Electrical supply plates can be configured at any point upstream or downstream of sub-bases.

An electrical supply plate is required after 8 valve sub-bases.

MPA with CPI connection

Electrical supply plates can be configured at any point upstream or downstream of sub-bases.

An electrical supply plate is required after 8 valve sub-bases.



Note

Please note that only the electronics modules with a separate circuit are permitted to the right of the electrical supply plate.

The electrical supply plate must not be installed directly to the left of a pneumatic supply plate (type VMMA1-FB-SP...).



Note

For MPA with CPI connection, a maximum of 24 of the 32 MPA1 or MPA14 coils or 12 of the 16 MPA2 coils can be switched on simultaneously.

Electrical supply plate

Code	Illustration	Type	Information
L		VMPA-FB-SP-V	Electrical supply plate with M18 plug connection, 3-pin
		VMPA-FB-SP-7/8-V-5POL	Electrical supply plate with 7/8" plug connection, 5-pin
		VMPA-FB-SP-7/8-V-4POL	Electrical supply plate with 7/8" plug connection, 4-pin

Pin allocation for power supply

	Pin	Allocation
Pin allocation for M18		
	2	24 V DC valves
	3	0 VDC
	4	FE
Pin allocation for 7/8", 5-pin		
	1	0 V DC valves
	2	n.c.
	3	FE (leading)
	4	n.c.
	5	24 V DC valves
Pin allocation for 7/8", 4-pin		
	A	n.c.
	B	24 V DC valves
	C	FE
	D	0 V DC valves (leading)

Key features – Pneumatic components

Creating pressure zones and separating exhaust air

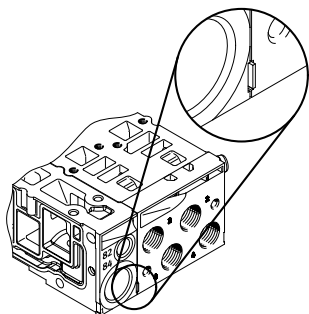

MPA offers a number of options for creating pressure zones if different working pressures are required. Depending on the electrical interface, up to 16 pressure zones are possible. A pressure zone is created by isolating the internal supply ducts between the sub-bases using an appropriate separating seal or using a separator that is permanently integrated in the sub-base (code I or code III).

Compressed air is supplied and exhausted via a supply plate. The position of the supply plates and separating seals can be freely selected with the valve terminal MPA. Separating seals are integrated ex-works as per your order. Separating seals can be recognised by their coding, even when the valve terminal is assembled.

Note
The following must be taken into account for expansion or conversions at a later date:
Different separating seals are required for operating with ducted exhaust air and operation with flat plate silencers.

Creating pressure zones – using a separating seal					
Code	For operation with flat plate silencer		For operation with ducted exhaust air		Information
	Illustrated examples	Coding	Illustrated examples	Coding	
-	 VMPA...DPU		 VMPA...DP		No duct separation
T	 VMPA...DPU-P		 VMPA...DP-P		Duct 1 separated
S	 VMPA...DPU-PRS		 VMPA...DP-PRS		Duct 1 and 3/5 separated
R	 VMPA...DPU-RS		 VMPA...DP-RS		Duct 3/5 separated

Creating pressure zones – using a separating seal			
Code	For operation with pilot air switching valve		Information
	Illustrated examples	Coding	
N ^{1), 2)}	 VMPA...DPU-N		<ul style="list-style-type: none"> Ducts 12/14 and 1, 3, 5 separated Coding with yellow marking
K ¹⁾	 VMPA...DPU-K		<ul style="list-style-type: none"> Duct 12/14 separated Coding with black marking

1) Only in combination with pilot air switching valve
2) Only in combination with additional feed/supply plate

Key features – Pneumatic components

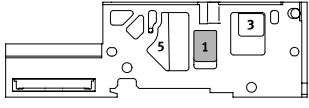
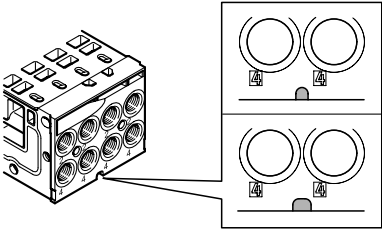
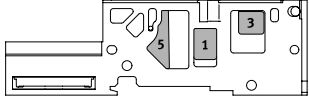
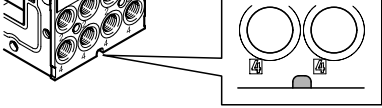
Creating pressure zones – via sub-base			Information
Code	For operation with flat plate silencer or with ducted exhaust air		
	Illustrated examples	Coding	
I			Duct 1 separated (short marking)
III			Duct 1 and 3/5 separated (long marking)



Note

Duct separation cannot be removed at a later date and takes place in the centre of the sub-base:

- Between valve 2 and 3 for width 10 mm
- Between valve 2 and 3 for width 14 mm
- Between valve 1 and 2 for width 20 mm

Key features – Pneumatic components

Examples: compressed air supply and pilot air supply

Internal pilot air supply, flat plate silencer

Pneumatic supply to the valve terminal: code S

The illustration on the right shows an example of the configuration and connection of the air supply with internal pilot air supply. Port 12/14 on the pneumatic interface or on the electrical interface (multi-pin) is tightly sealed. Ports 3/5 and 82/84 are exhausted via the flat plate silencers. Port 82/84 is tightly sealed. Separating seals can optionally be used to create pressure zones.

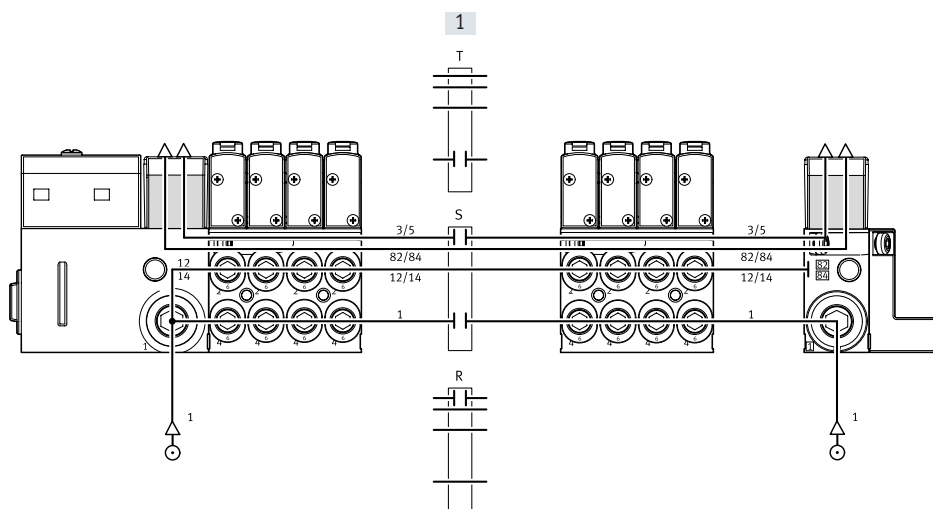

[1] Optional separating seal

External pilot air supply, flat plate silencer

Pneumatic supply to the valve terminal: code T

The illustration on the right shows an example of how the compressed air supply is configured and connected when using external pilot air supply. Port 12/14 on the pneumatic interface or the electrical interface (multi-pin) is equipped with a fitting for this purpose. Ports 3/5 and 82/84 are exhausted via the flat plate silencers. Port 82/84 is tightly sealed. Separating seals can optionally be used to create pressure zones.

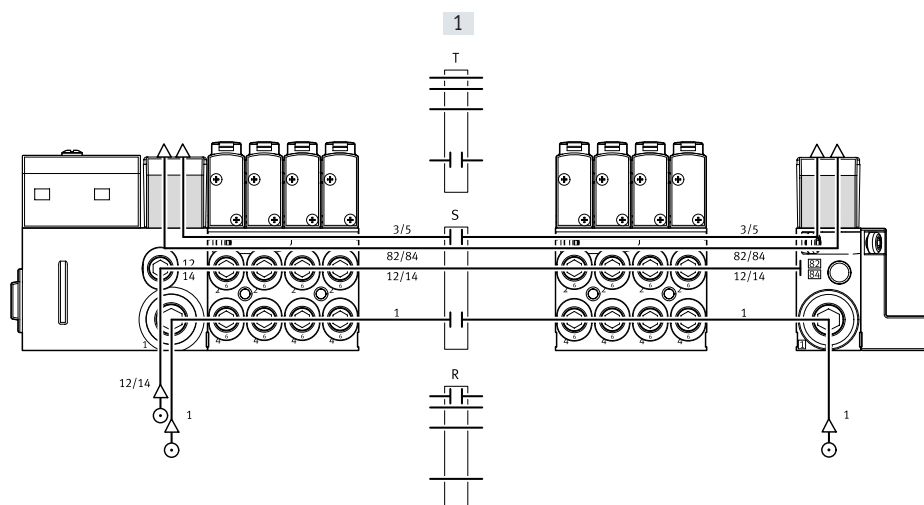

[1] Optional separating seal

Key features – Pneumatic components

Examples: compressed air supply and pilot air supply

Internal pilot air supply, ducted exhaust air

Pneumatic supply to the valve terminal: code V

The illustration on the right shows an example of the configuration and connection of the compressed air supply with internal pilot air supply. Port 12/14 on the pneumatic interface or on the electrical interface (multi-pin) is tightly sealed. Exhaust ports 3/5 and 82/84 are exhausted via the appropriate connections. Separating seals can optionally be used to create pressure zones.

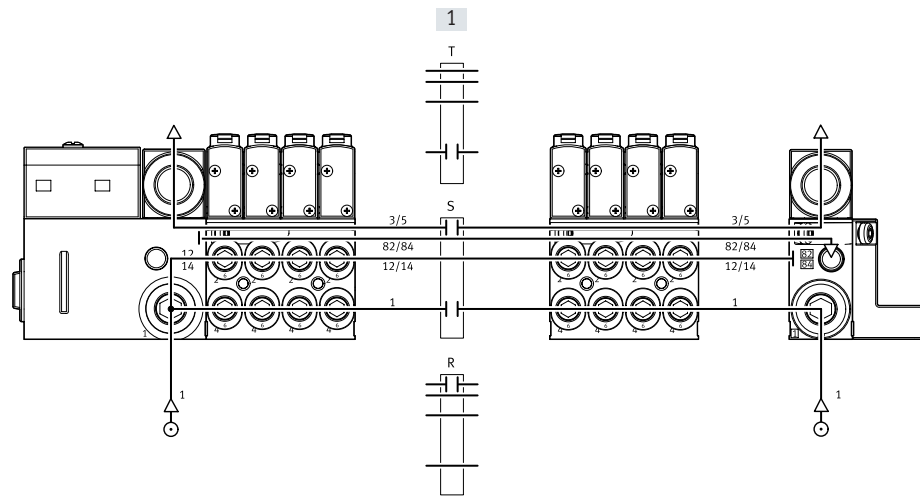

[1] Optional separating seal

External pilot air supply, ducted exhaust air

Pneumatic supply to the valve terminal: code X

The illustration on the right shows an example of the configuration and connection of the compressed air supply in the case of external pilot air supply. Port 12/14 on the pneumatic interface or the electrical interface (multi-pin) is equipped with a fitting for this purpose. Exhaust ports 3/5 and 82/84 are exhausted via the appropriate connections. Separating seals can optionally be used to create pressure zones.

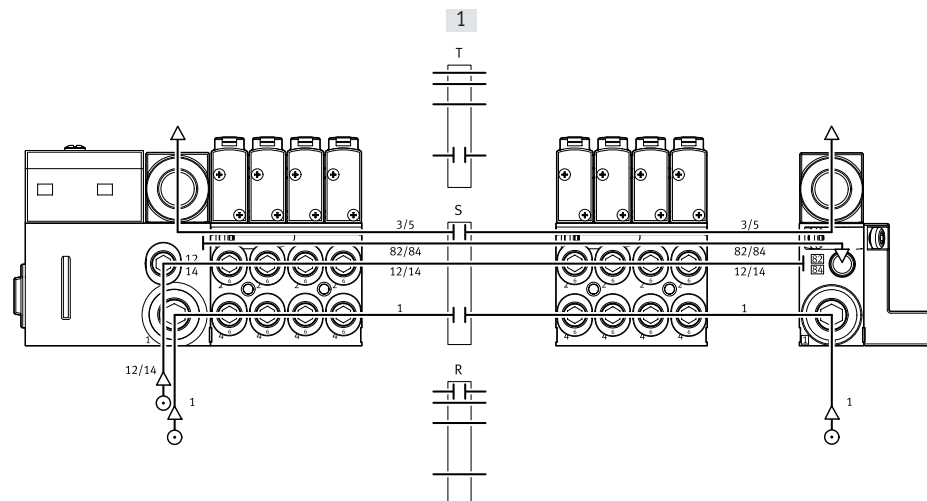

[1] Optional separating seal

Key features – Pneumatic components

Examples: compressed air supply and pilot air supply

Internal pilot air supply, ducted exhaust air 82/84 via right-hand end plate

Pneumatic supply to the valve terminal: code Y

The illustration on the right shows an example of the configuration and connection of the compressed air supply with internal pilot air supply. Port 12/14 on the pneumatic interface or on the electrical interface (multi-pin) is tightly sealed. The exhaust port 3/5 is exhausted via the corresponding ports. The exhaust air from port 82/84 is ducted via the right end plate (VM-PA-EPR-G). In this case, there is no need for a power supply module for exhausting the ducted exhaust air 82/84. Separating seals can optionally be used to create pressure zones.

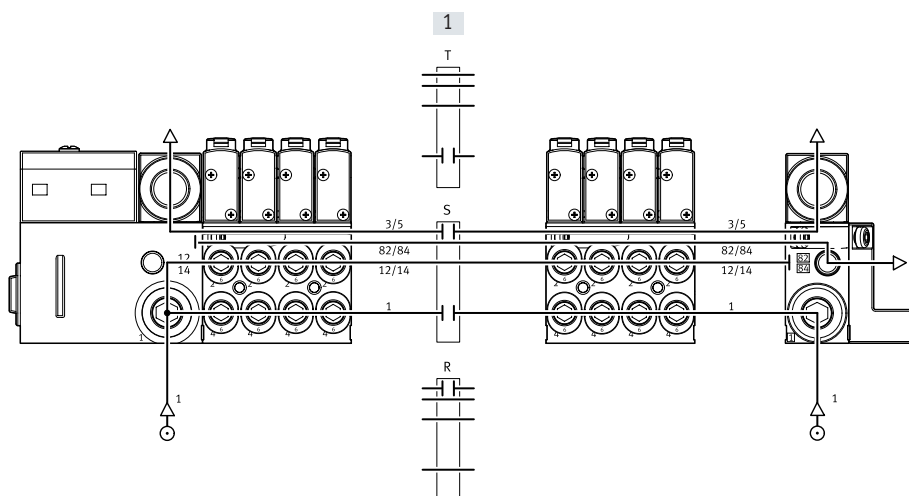

[1] Optional separating seal

External pilot air supply, ducted exhaust air 82/84 via right-hand end plate

Pneumatic supply to the valve terminal: code Z

The illustration on the right shows an example of the configuration and connection of the compressed air supply in the case of external pilot air supply. Port 12/14 on the pneumatic interface or the electrical interface (multi-pin) is equipped with a fitting for this purpose. The exhaust port 3/5 is exhausted via the corresponding ports. The exhaust air from port 82/84 is ducted via the right end plate (VMPA-EPR-G). In this case, there is no need for a power supply module for exhausting the ducted exhaust air 82/84. Separating seals can optionally be used to create pressure zones.

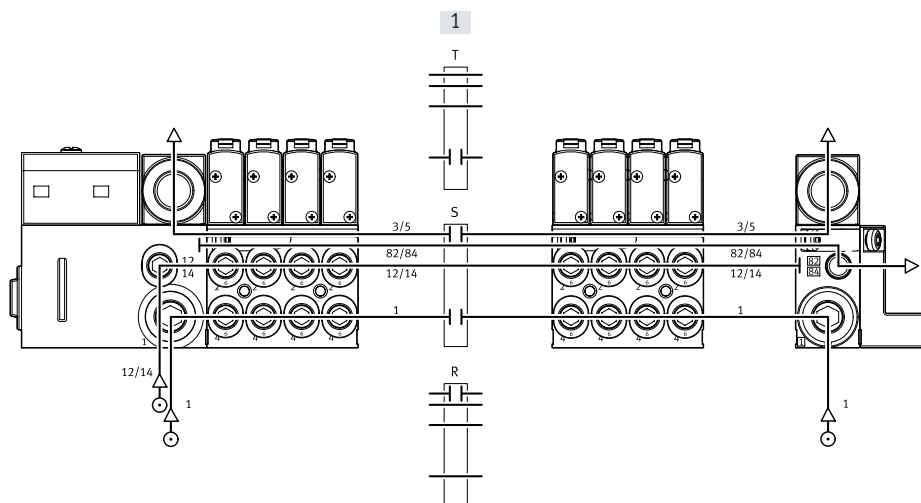

[1] Optional separating seal

Key features – Pneumatic components

Examples: compressed air supply and pilot air supply

Pilot air switching valve for internal pilot air supply

Pneumatic supply to the valve terminal with internal pilot air.

Second pressure zone with pilot air switching valve with internal pilot air supply: code IU, IS

The illustration on the right shows an example of the configuration and connection of the compressed air supply with internal pilot air supply. Port 12/14 on the pneumatic interface or on the electrical interface (multi-pin) and on the pilot air switching valve is tightly sealed. Exhaust ports 3/5 and 82/84 are exhausted via the appropriate connections. The separating seal is essential when using the pilot air switching valve. Pilot air supply for the pressure zone to the right of the pilot air switching valve can be individually switched off by the pilot air switching valve of duct 1 of this pressure zone.

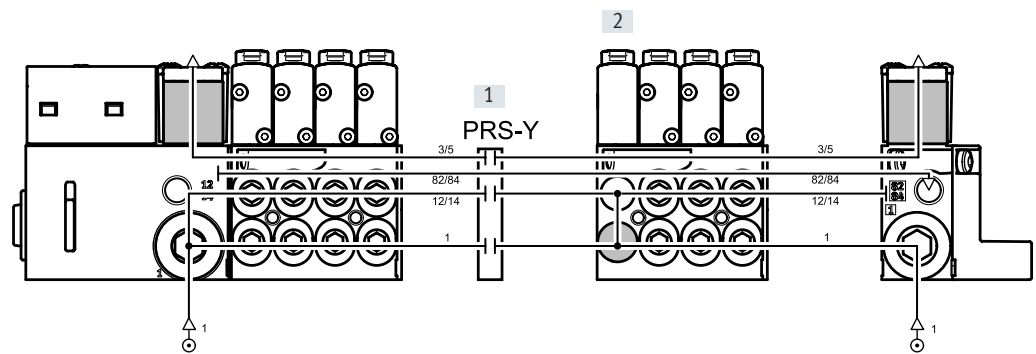

- [1] Separating seal, specifically for pilot air switching valve with separation of duct 12/14
- [2] Pilot air switching valve for internal pilot air supply

Key features – Pneumatic components

Examples: compressed air supply and pilot air supply

Pilot air switching valve for external pilot air supply

Pneumatic supply to the valve terminal with external pilot air.

Second pressure zone with pilot air switching valve with external pilot air supply: code EU, ES

The illustration on the right shows an example of the configuration and connection of the compressed air supply in the case of external pilot air supply. Port 12/14 on the pneumatic interface or the electrical interface (multi-pin) is equipped with a fitting for this purpose. Exhaust ports 3/5 and 82/84 are exhausted via the appropriate connections. A separating seal with separation of duct 12/14 is essential when using the pilot air switching valve. Pilot air supply for the pressure zone to the right of the pilot air switching valve can be individually switched off by the pilot air switching valve. The pilot air switching valve obtains the compressed air supply for the pilot air from port 2 of the sub-base.

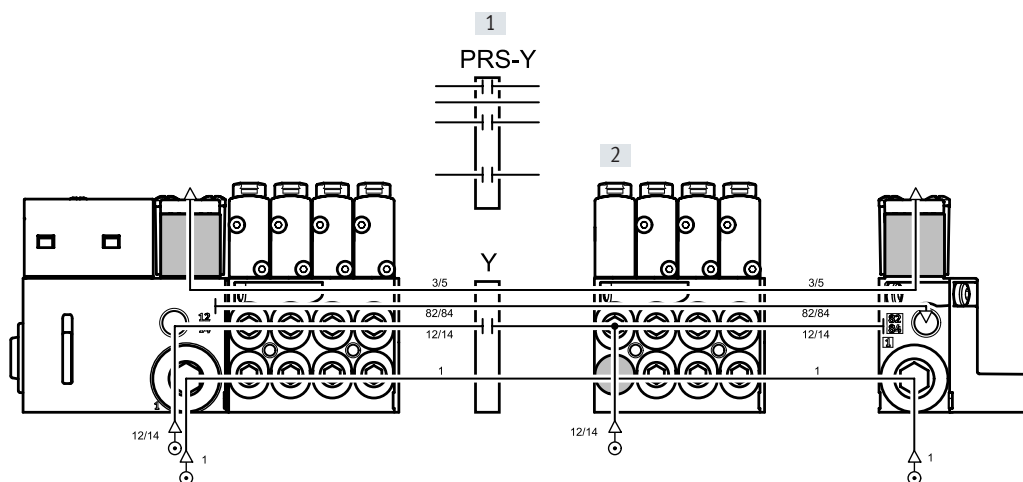

- [1] Separating seal, specifically for pilot air switching valve with separation of duct 12/14
- [2] Pilot air switching valve for external pilot air supply

Key features – Pneumatic components

Examples: Creating pressure zones

MPA with CPX terminal connection

The illustration shows an example of the configuration and connection of three pressure zones using separating seals – with external pilot air supply.

- [1] Zone 1
- [2] Zone 2
- [3] Zone 3
- [4] Pilot air supply
- [5] P1
- [6] P2
- [7] P3

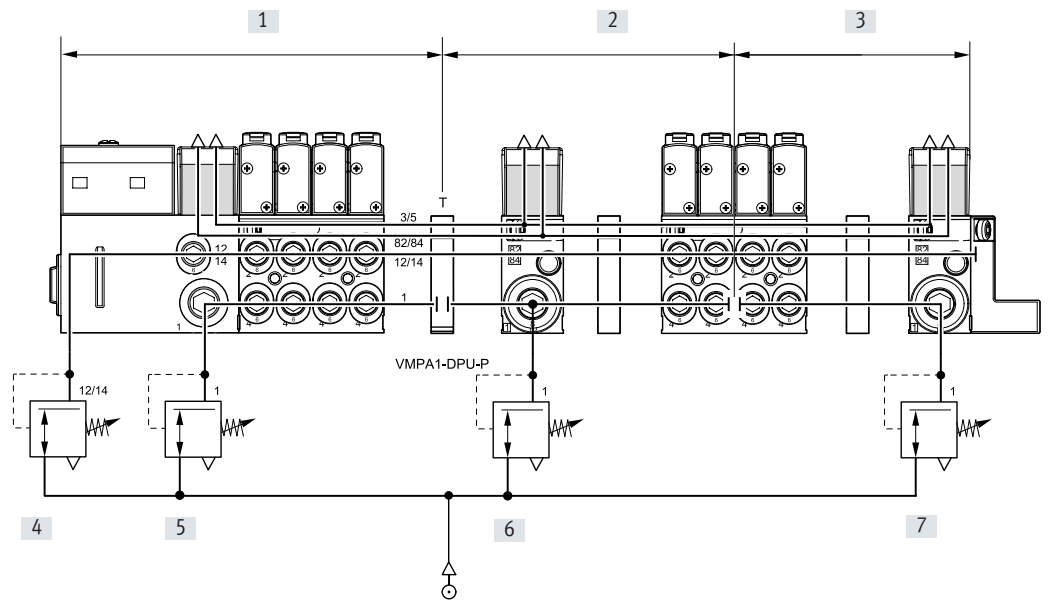

MPA with multi-pin plug connection

The illustration shows an example of the configuration and connection of the pressure zones – with external pilot air supply.

- [1] Zone 1
- [2] Zone 2
- [3] Pilot air supply
- [4] P1
- [5] P2

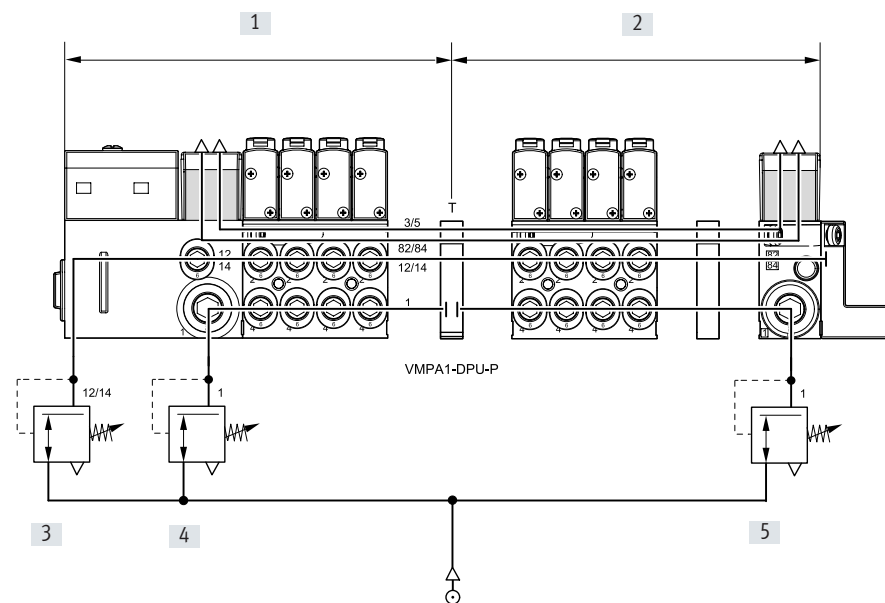

Key features – Pneumatic components

Examples: Creating pressure zones

Sub-base with pressure zone separation in duct 1

Another option for pressure zone separation can be achieved by using sub-bases with pressure zone separation.

The illustration on the right shows the variant with pressure zone separation in duct 1.

Pilot air supply

- [1] Zone 1
- [2] Zone 2
- [3] Pilot air supply
- [4] P1
- [5] P2

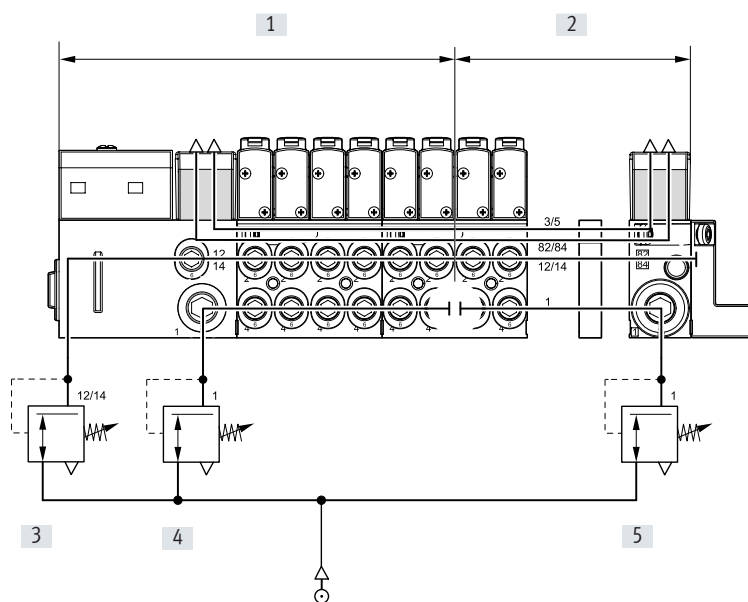

Sub-base with pressure zone separation in duct 1 and duct 3/5

The illustration on the right shows the variant with pressure zone separation in duct 1 and duct 3/5.

Pilot air supply

- [1] Zone 1
- [2] Zone 2
- [3] Pilot air supply
- [4] P1
- [5] P2

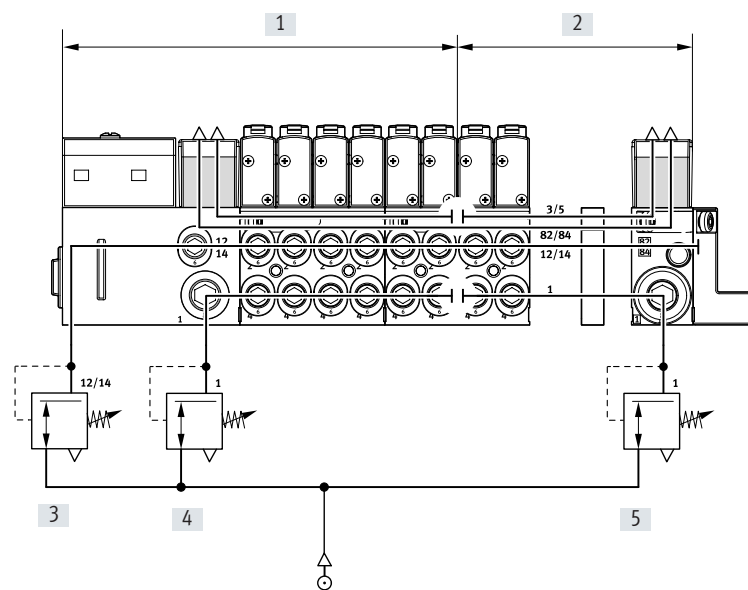

Key features – Pneumatic components

Sub-base

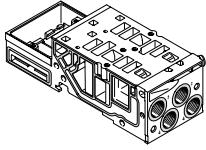

MPA is based on a modular system consisting of sub-bases and valves. The sub-bases are screwed together, thus forming the support system for the valves. They contain the ducts for supplying compressed air to and exhausting the valve terminal as well as the working

ports for the pneumatic drives for each valve. Each sub-base is connected to the next using three screws. Individual valve terminal sections can be isolated and further blocks can be inserted by loosening these screws. This ensures that

the valve terminal can be rapidly and reliably extended.

Sub-base variants

Code	Illustration	Type	Width [mm]	Number of valve positions (solenoid coils)	Information
Sub-base for multi-pin plug/fieldbus connection					
A, C ¹⁾		VMPA1-FB-AP-4-1	10	4 (8/4 ¹⁾)	Working ports (2, 4) on sub-base <ul style="list-style-type: none"> • Connection sizes: MPA1: M7, QS4, QS6 • Code I: duct 1 separated in the sub-base • Code III: duct 1 and duct 3/5 separated in the sub-base
AI, CI ¹⁾		VMPA1-FB-AP-4-1-T1			
AIII, CIII ¹⁾		VMPA1-FB-AP-4-1-S1			
E, F ¹⁾		VMPA14-FB-AP-4-1	14	4 (8/4 ¹⁾)	Working ports (2, 4) on sub-base <ul style="list-style-type: none"> • Connection sizes MPA14: G1/8, QS6, QS8 • Code I: duct 1 separated in the sub-base • Code III: duct 1 and duct 3/5 separated in the sub-base
EI, FI ¹⁾		VMPA14-FB-AP-4-1-T1			
EIII, FIII ¹⁾		VMPA14-FB-AP-4-1-S1			
B, D ¹⁾		VMPA2-FB-AP-2-1	20	2 (4/2 ¹⁾)	Working ports (2, 4) on sub-base <ul style="list-style-type: none"> • Connection sizes MPA2: G1/8, QS6, QS8 • Code I: duct 1 separated in the sub-base • Code III: duct 1 and duct 3/5 separated in the sub-base
BI, DI ¹⁾		VMPA2-FB-AP-2-1-TO			
BIII, DIII ¹⁾		VMPA2-FB-AP-2-1-SO			
Sub-base for pilot air switching valve, for fieldbus connection					
QA		VMPA1-AP-4-EMG-8-S	10	1+3 (2+6/3) Pilot air switching valve + valves	Working ports (2, 4) on sub-base <ul style="list-style-type: none"> • Connection sizes: MPA1: M7, QS4, QS6 • Including electronics module
		VMPA1-AP-4-EMG-D2-8-S			
QE		VMPA-14-AP-4-EMG-8-S	14	1+3 (2+6/3) Pilot air switching valve + valves	Working ports (2, 4) on sub-base <ul style="list-style-type: none"> • Connection sizes MPA14: G1/8, QS6, QS8 • Including electronics module
		VMPA14-AP-4-EMG-D2-8-S			

1) Only possible with multi-pin plug connection

Key features – Pneumatic components

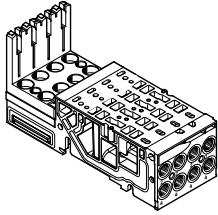
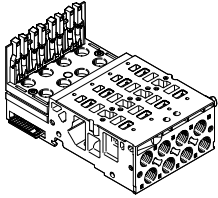
Sub-base variants					
Code	Illustration	Type	Width	Number of valve positions (solenoid coils)	Information
			[mm]		
Sub-base for pilot air switching valve, for multi-pin plug connection					
QA		VMPA-1-AP-4-EMM-8-SK	10	1+3 (2+6/3) Pilot air switching valve + valves	Working ports (2, 4) on sub-base <ul style="list-style-type: none"> • Connection sizes: MPA1: M7, QS4, QS6 • Including electronics module
		VMPA1-AP-4-EMM-8-SL			
QE		VMPA14-AP-4-EMM-8-SK	14	1+3 (2+6/3) Pilot air switching valve + valves	Working ports (2, 4) on sub-base <ul style="list-style-type: none"> • Connection sizes MPA14: G1/8, QS6, QS8 • Including electronics module
		VMPA14-AP-4-EMM-8-SL			

Key features – Pneumatic components

Pressure sensor

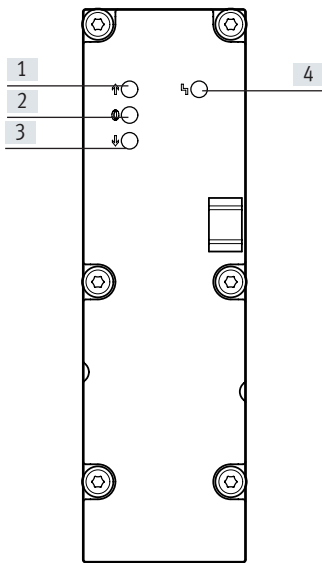

- [1] Red LED: pressure exceeded
- [2] Green LED: pressure maintained
- [3] Red LED: pressure not reached
- [4] Red LED: common error display

Using three LEDs, the pressure sensor indicates whether the applied pressure exceeds, conforms to or hasn't reached the setpoint value. An additional LED indicates common errors (limit exceeded or not reached). The limits for pressure monitoring are set through parameterisation. The pressure sensor plate can be parameterised via the PLC or the interface for CPX-FMT.

Alternatively the pressure in the exhaust duct (3/5) and the process pressure (external) can be measured. Pressure measurement in the exhaust duct is used for monitoring the operating pressure during reverse operation (supply to 3/5).

Pressure sensor versions

Code	Illustration	Type	Use
PE		VMPA-FB-PS-1	Monitoring the operating pressure in duct 1
PF		VMPA-FB-PS-3/5	Monitoring the pressure in exhaust ducts 3 and 5 (Monitoring the exhaust performance or pressure monitoring with reversibly operated valve terminal)
PG		VMPA-FB-PS-P1	Monitoring an external process pressure

Key features – Pneumatic components

Electrical interface versions					
Code	Illustration	Type	Width [mm]	Number of valve positions (solenoid coils)	Information
Electronics module for multi-pin plug (MPM)					
A, C		VMPA1-MPM-EMM-8 VMPA1-MPM-EMM-4	10	4 (8) 4 (4)	Each solenoid coil is assigned to a specific pin of the multi-pin plug for the valves to be actuated. Regardless of whether valve positions are fitted with cover plates or valves, they are used to control: <ul style="list-style-type: none"> • One address for a single coil • Two addresses for a double coil
E, F		VMPA14-MPM-EMM-8 VMPA14-MPM-EMM-4	14	4 (8) 4 (4)	
B, D		VMPA2-MPM-EMM-4 VMPA2-MPM-EMM-2	20	2 (4) 2 (2)	
Electronics module for fieldbus with standard diagnostics					
A, H		VMPA1-FB-EMS-8 VMPA1-FB-EMG-8	10	4 (8)	The electronics module includes serial communication and facilitates: <ul style="list-style-type: none"> • Transmission of switching information • Actuation of up to 8 solenoid coils • Position-based diagnostics • Separate voltage supply for valves • Transmission of status, parameter and diagnostic data There are different versions: <ul style="list-style-type: none"> • Without separate circuit (VMPA...-FB-EMS-...) • With separate circuit (VMPA...-FB-EMG-...) Diagnostic function: <ul style="list-style-type: none"> • Fault: valve load voltage
E, H		VMPA14-FB-EMS-8 VMPA14-FB-EMG-8	14	4 (8)	
B, QB, H		VMPA2-FB-EMS-4 VMPA2-FB-EMG-4	20	2 (4)	
Electronics module for fieldbus with enhanced diagnostic function					
A, H		VMPA1-FB-EMS-D2-8 VMPA1-FB-EMG-D2-8	10	4 (8)	The electronics module with enhanced diagnostic function includes the same functions as the electronics module with standard diagnostics. The diagnostic function is further enhanced: <ul style="list-style-type: none"> • Fault: valve load voltage • Fault: wire break (open load) • Fault: short-circuit valve load voltage • Message: condition monitoring
E, H		VMPA14-FB-EMS-D2-8 VMPA14-FB-EMG-D2-8	14	4 (8)	
B, QB, H		VMPA2-FB-EMS-D2-4 VMPA2-FB-EMG-D2-4	20	2 (4)	

Note

- Multi-pin with modular links
- Sub-bases VMPA1, VMPA14 and VMPA2 can be combined as required
- Positive- or negative-switching control is possible (mixed operation is not permitted)
- Double solenoid valves cannot be mounted on single solenoid electronics modules
- Single solenoid valves can be mounted on double solenoid electronics modules

Key features – Pneumatic components

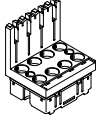
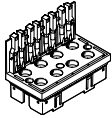
Electrical interface versions					
Code	Illustration	Type	Width [mm]	Number of valve positions (solenoid coils)	Information
Electronics module for pilot air switching valve, for fieldbus					
A, H, QA		VMPA1-FB-EMG-8-S	10	1+3 (2+6/3) Pilot air switching valve + valves	The electronics module includes serial communication and facilitates: <ul style="list-style-type: none"> • Transmission of switching information • Control of 1 pilot air switching valve plus up to 3 further valves (with max. 6 solenoid coils) • Position-based diagnostics • Separate voltage supply for valves • Transmission of status, parameter and diagnostic data • With separate circuit
A, H, QE		VMPA1-FB-EMG-D2-8-S			The electronics module with enhanced diagnostics function includes the same functions as the electronics module with standard diagnostics. The diagnostics function is further enhanced: <ul style="list-style-type: none"> • Fault: valve load voltage • Fault: wire break (open load) • Fault: short-circuit valve load voltage • Message: condition monitoring • Control of 1 pilot air switching valve plus 3 further valves (with max. 6 solenoid coils)
E, H, QA		VMPA14-FB-EMG-8-S	14	1+3 (2+6/3) Pilot air switching valve + valves	The electronics module includes serial communication and facilitates: <ul style="list-style-type: none"> • Transmission of switching information • Control of 1 pilot air switching valve plus up to 3 further valves (with max. 6 solenoid coils) • Position-based diagnostics • Separate voltage supply for valves • Transmission of status, parameter and diagnostic data • With separate circuit
E, H, QE		VMPA14-FB-EMG-D2-8-S			The electronics module with enhanced diagnostics function includes the same functions as the electronics module with standard diagnostics. The diagnostics function is further enhanced: <ul style="list-style-type: none"> • Fault: valve load voltage • Fault: wire break (open load) • Fault: short-circuit valve load voltage • Message: condition monitoring • Control of 1 pilot air switching valve plus 3 further valves (with max. 6 solenoid coils)

Key features – Pneumatic components

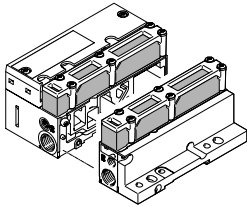
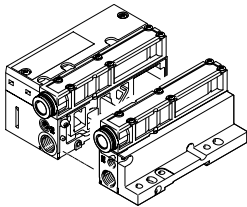
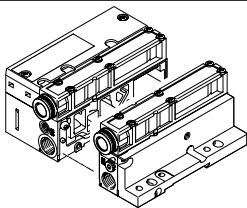
Ports for supply and exhaust							
Code		Connection	Designation	Code L Push-in connector Large	Code K Push-in connector Small	Code D Thread for supply	
S		Internal pilot air supply, silencer					
		1	Working air/vacuum supply	Push-in fitting	QS-G1/4-10-I	QS-G1/4-8-I	G1/4
		3/5	Exhaust air	Flat plate silencer	–	–	–
		12/14	Pilot air supply	–	–	–	–
		82/84	Pilot exhaust air	Flat plate silencer	–	–	–
	Pressure compensation port	Exhausts via silencer to atmosphere					
T		External pilot air supply, silencer					
		1	Working air/vacuum supply	Push-in fitting	QS-G1/4-10-I	QS-G1/4-8-I	G1/4
		3/5	Exhaust air	Flat plate silencer	–	–	–
		12/14	Pilot air supply	Push-in fitting	QSM-M7-6-I	QSM-M7-6-I	M7
		82/84	Pilot exhaust air	Flat plate silencer	–	–	–
	Pressure compensation port	Exhausts via silencer to atmosphere					
V		Internal pilot air supply, ducted exhaust air					
		1	Working air/vacuum supply	Push-in fitting	QS-G1/4-10-I	QS-G1/4-8-I	G1/4
		3/5	Exhaust air	Push-in fitting	QS-10	QS-10	QS-10
		12/14	Pilot air supply	–	–	–	–
		82/84	Pilot exhaust air	Push-in fitting	QSM-M7-6-I	QSM-M7-6-I	M7
	Pressure compensation port	Exhausts into duct 82/84					
X		External pilot air supply, ducted exhaust air					
		1	Working air/vacuum supply	Push-in fitting	QS-G1/4-10-I	QS-G1/4-8-I	G1/4
		3/5	Exhaust air	Push-in fitting	QS-10	QS-10	QS-10
		12/14	Pilot air supply	Push-in fitting	QSM-M7-6-I	QSM-M7-6-I	M7
		82/84	Pilot exhaust air	Push-in fitting	QSM-M7-6-I	QSM-M7-6-I	M7
	Pressure compensation port	Exhausts into duct 82/84					
Y		Internal pilot air supply, ducted exhaust air via right-hand end plate (VMPA-EPR-G)					
		1	Working air/vacuum supply	Push-in fitting	QS-G1/4-10-I	QS-G1/4-8-I	G1/4
		3/5	Exhaust air	Push-in fitting	QS-10	QS-10	QS-10
		12/14	Pilot air supply	–	–	–	–
		82/84	Pilot exhaust air	Push-in fitting	QSM-M5-3-I	QSM-M5-3-I	M5
	Pressure compensation port	Exhausts into duct 82/84					
Z		External pilot air supply, ducted exhaust air via right-hand end plate (VMPA-EPR-G)					
		1	Working air/vacuum supply	Push-in fitting	QS-G1/4-10-I	QS-G1/4-8-I	G1/4
		3/5	Exhaust air	Push-in fitting	QS-10	QS-10	QS-10
		12/14	Pilot air supply	Push-in fitting	QSM-M7-6-I	QSM-M7-6-I	M7
		82/84	Pilot exhaust air	Push-in fitting	QSM-M5-3-I	QSM-M5-3-I	M5
	Pressure compensation port	Exhausts into duct 82/84					

Key features – Mounting

Valve terminal mounting

Sturdy terminal mounting via:

- Four through-holes for wall mounting
- Additional mounting brackets
- H-rail mounting

 **Note**

When wall mounting valve terminals MPA with more than 4 sub-bases, use additional mounting brackets type VMPA-BG-RW to prevent damage to the valve terminal. The mounting

brackets can be mounted on the pneumatic supply plates.

Wall mounting – Multi-pin plug connection, AS-Interface and CPI connection

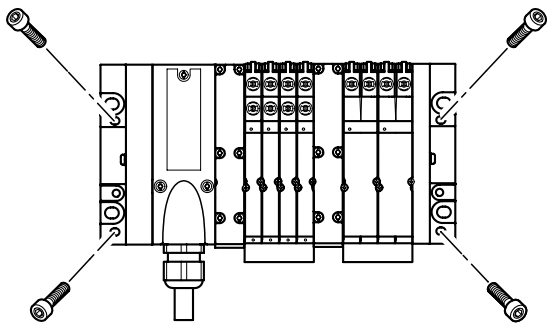

The MPA valve terminal is screwed onto the mounting surface using four M4 or M6 screws. The mounting holes

are on the pneumatic interface and on the right end plate. Optional mounting brackets are also available.

Wall mounting – Fieldbus connection

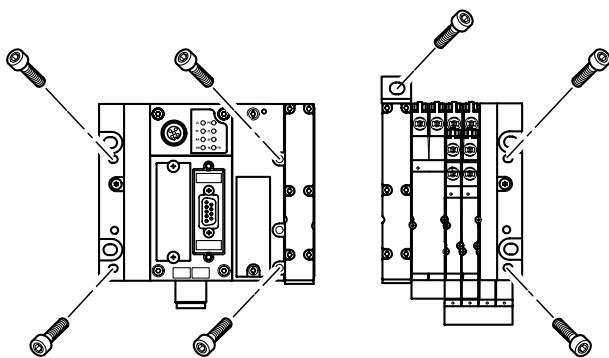

The MPA valve terminal is screwed onto the mounting surface using six M4 or M6 screws. The mounting holes are on the left end plate (CPX) and on the right end plate MPA.

The pneumatic interface also provides further mounting holes as well as optional mounting brackets.

H-rail mounting

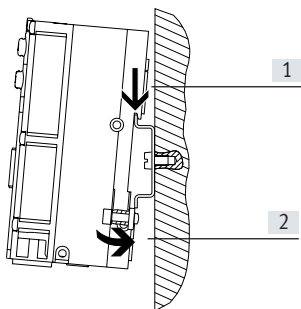

The valve terminal MPA is hooked onto the H-rail → arrow [1].

The valve terminal MPA is then swivelled onto the H-rail and secured in place with the clamping piece → arrow [2].

The following MPA mounting kit is required for H-rail mounting of the valve terminal:

- CPX-CPA-BG-NRH

This enables the valve terminal to be mounted on an H-rail to EN 60715.

 **Note**

More information about mounting solenoid valves on individual sub-bases can be found at → VMPA1

Key features – Display and operation

Display and operation

Every solenoid coil is allocated an LED that indicates its signal status.

- Indicator 12 shows the signal status of the coil for output 2
- Indicator 14 shows the signal status of the coil for output 4

Manual override

The manual override (MO) enables the valve to be switched when not electrically activated or energised.

The valve is switched by pushing the manual override. The set switching status can also be locked by turning the manual override (code R).

Alternatives:

- The cover cap (code N or as an accessory) prevents the manual override from being locked. The manual override can then only be activated by pushing it.
- The cover cap (code V or as an accessory) can prevent the manual override from being accidentally activated.

- The cover cap (code Y or as an accessory) can be used to operate the manual override in detenting mode without additional tools.

Pneumatic connection and control elements

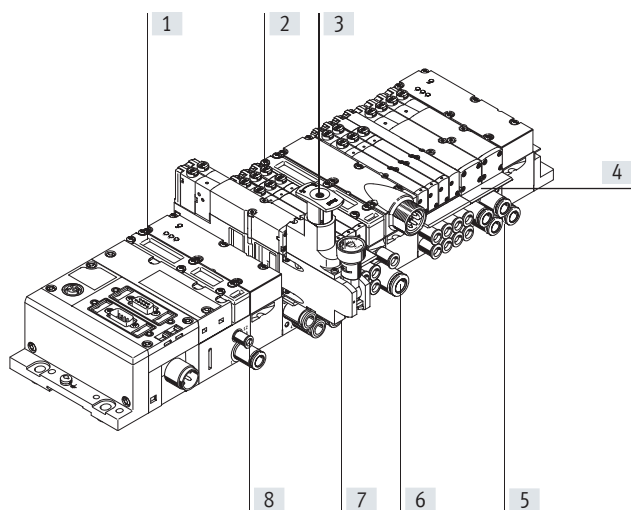

- [1] Flat plate silencer for exhaust port 3/5
- [2] Manual override (for each pilot solenoid coil, non-detenting or non-detenting/detenting)
- [3] Adjusting knob for optional pressure regulator plate
- [4] Inscription label holder for sub-base
- [5] Working ports 2 and 4, per valve position
- [6] Supply port 1
- [7] Pressure gauge (optional)
- [8] Ports 12 and 14 for supplying the external pilot air

Note
A manually operated valve (manual override) cannot be reset electrically. Conversely, an electrically actuated valve cannot be reset using the mechanical manual override.

Electrical connection and display components on the AS-Interface

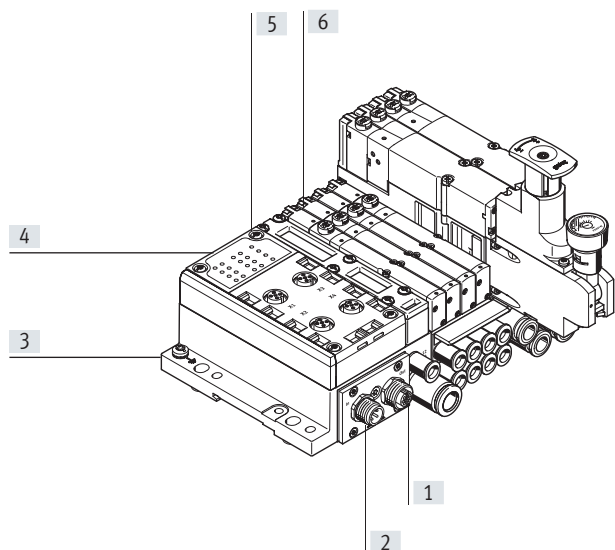

- [1] M12 socket for AS-Interface bus and additional supply (AS-i Out)
- [2] M12 plug for AS-Interface bus and auxiliary power supply (AS-i In)
- [3] Earth connection
- [4] Status LEDs for inputs
- [5] Status LEDs for AS-Interface
- [6] Diagnostic LEDs for valves

Key features – Display and operation

Manual override (MO)

MO with automatic return (non-detenting),

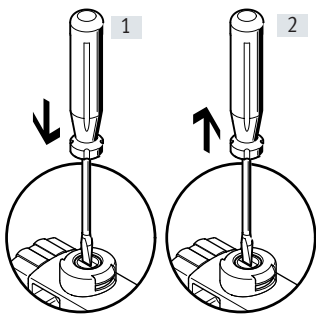

- [1] Press in the plunger of the MO with a pointed object or screwdriver. The pilot valve switches and actuates the main valve.
- [2] Remove the pointed object or screwdriver. The spring force pushes the plunger of the manual override back. The pilot valve returns to its normal position as does the single solenoid main valve (not the case with double solenoid valve code J).

MO with locking (detenting)

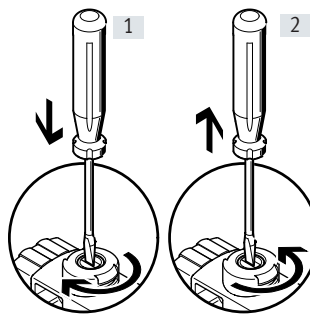

- [1] Press in the plunger of the MO with a pointed object or screwdriver until the valve switches and then turn the plunger clockwise by 90° until the stop is reached. The valve remains actuated
- [2] Turn the plunger anti-clockwise by 90° until the stop is reached and then remove the pointed object or screwdriver. The spring force pushes the plunger of the manual override back. The valve returns to its normal position (not with double solenoid valve code J).

MO with automatic return (non-detenting),

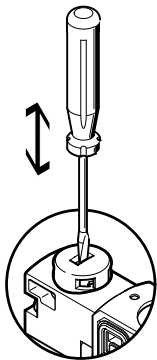

MO is actuated by pushing it with a pointed object or screwdriver and reset by spring force (detenting position prevented by coded cover cap). Valves can be ordered with a fitted cover cap in the valve terminal configurator using the selection menu “Manual override” (code N).

MO with lock – Assembly

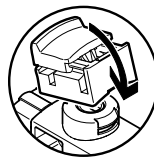

Turn MO to clip it onto the pilot valve. The MO cap can then be operated (detenting) without tools. Valves can be ordered with a fitted cover cap in the valve terminal configurator using the selection menu “Manual override” (code N).

MO with lock – Actuation

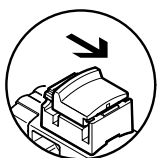

Sliding the cap for the MO with latch in the direction of the arrow results in:

- Cap locks into the end position
- The pilot valve switches and actuates the main valve.

MO with lock – Actuation

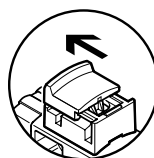

Sliding the cap for the MO with latch in the direction of the arrow results in:

- Cap locks into the end position
- The spring force pushes the plunger of the manual override back.
- The pilot valve returns to its normal position as does the main single solenoid valve (not the case with double solenoid valve code J).

Key features – Display and operation

Inscription system

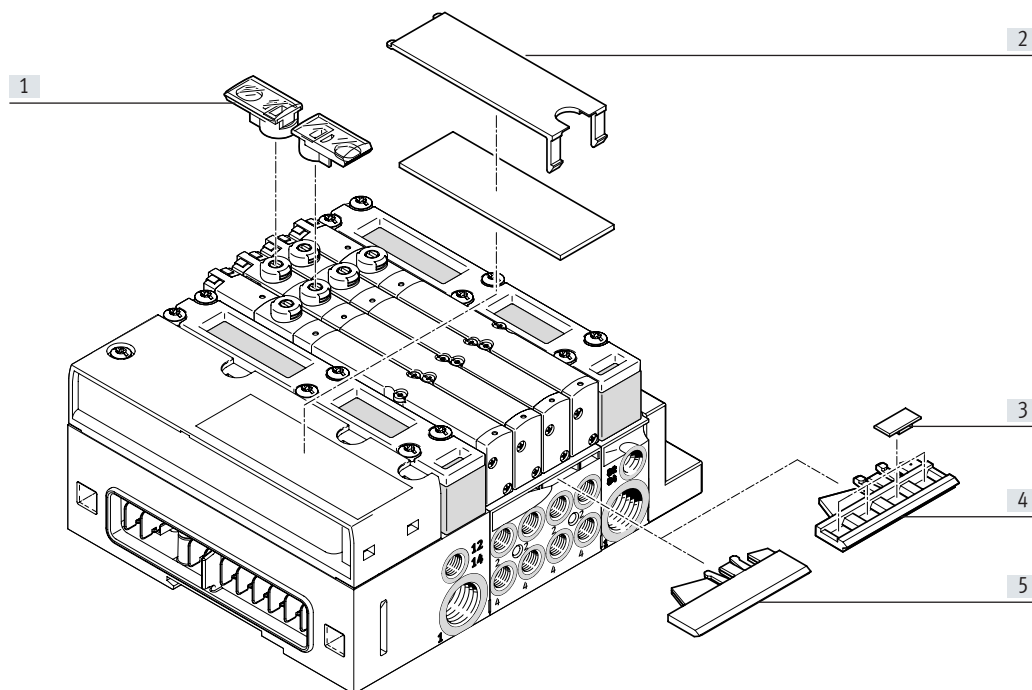

- [1] Inscription label holder ASLR-D-L1
- [2] Inscription label on the flat plate silencer of the pneumatic interface
- [3] Inscription labels IBS-6x10
- [4] Inscription label holder for sub-base VMPA...-ST-2-4, 4-fold, for IBS-6x10 inscription labels
- [5] Inscription label holder for sub-base VMPA...-ST-1-4, transparent, for paper foil labels

To label the valve, an inscription label holder VMPA1-ST-1-4 (for paper foil labels) or VMPA1-ST-2-4 (for inscription labels IBS-6x10) can be mounted on every sub-base size 10 or 20.

The sub-base for width 14 is wider. Separate inscription label holders VMPA14-ST-1-4 (for paper labels) or VMPA14-ST-2-4 (for inscription labels IBS-6x10) are therefore available for width 14.

The inscription label holder ASLR-D-L1 can be pushed onto the manual override. Inscription label holders/inscription labels that can be ordered individually → page 99.

As an alternative or in addition, large inscription labels can be applied to the flat plate silencer on the pneumatic interface. Labelling templates can be downloaded from the online portal: Additional information: www.festo.com/catalogue/mpa → Support/Downloads.

Key features – Electrical components

Electrical power as a result of current reduction

Each MPA solenoid coil is protected with a spark arresting protective circuit as well as against polarity reversal. In addition, all valve types have integrated current reduction.

MPA valves are supplied with operating voltage in the range 18 ... 30 V (24 V +/-25%). This high tolerance is made possible by the integrated control electronics and offers additional safety, e.g. in the case of a drop in operating voltage.

Individual valve

Valves on individual sub-bases can also be used for actuators that are further away from the valve terminal.

- Detachable electronics module with integrated holding current reduction
- Electrical M8 connection, 4-pin with screw connection



Note

More information about the individual valve interface can be found at → VMPA1

Electrical multi-pin plug connection

The following multi-pin plug connection is offered for the valve terminal MPA:

- Sub-D multi-pin plug connection (25-pin)

Pin 1 ... 24 are used for addresses 1 ... 24 in order.

If fewer than 24 addresses are used for the valve terminal, the remaining pins

to 24 are left free. Pin 25 is reserved for the neutral conductor. The valves are switched by positive or negative logic (PNP or NPN). Mixed operation is not permitted. Each pin on the multi-pin plug can actuate exactly one solenoid coil. If the maximum configurable number of valve positions is 24, this means that 24 valves can be addressed, each with a single solenoid coil.

With 12 or fewer valve positions, 2 solenoid coils per valve can be addressed. With 12 or more valve positions, the number of available valve positions for valves with two solenoid coils decreases.



Note

If a single solenoid valve is mounted on a double solenoid valve position, the second address is also occupied and cannot be used.

Guidelines on addressing for valves/solenoid coils

- The maximum possible number of addresses for multi-pin plug connection is 24.
- Each sub-base/electronics module occupies a specific number of addresses/pins:
 - Sub-base MPA1 for 4 single solenoid valves: 4
 - Sub-base MPA1 for 4 double solenoid valves: 8
 - Sub-base MPA2 for 2 single solenoid valves: 2
 - Sub-base MPA2 for 2 double solenoid valves: 4
- The addresses are numbered from left to right in ascending order. The following applies at the individual valve positions: address x for coil 14 and address x+1 for coil 12.
- If single solenoid valves are mounted on sub-bases for double solenoid valves, the address of coil 12 and the assigned pin will remain unused.

Key features – Electrical components

AS-Interface® fieldbus connection

The AS-Interface allows individual components or small component groups to be widely distributed in terms of space.

The AS-Interface connection of valve terminal MPA-S can be used to control up to 8 solenoid coils.

The electrical interface of the valve terminal contains the LEDs that indicate

the signal status and the protective circuit for the valves.



Note

More information can be found at
→ Internet: [as-interface](#)

CPI fieldbus connection

All CP valve terminals and CP modules are connected using a ready-to-install CP cable, and are attached to the CP interface. 4 modules, for example one CPV valve terminal and one to three CP

input modules, make up an installation string that ends at the CP interface. The installation system supports a maximum of 4 installation strings

that can be connected to a CP bus node.



Note

More information can be found at
→ Internet: [cpi](#)

Fieldbus connection CPX

All functions and features of the electrical peripherals CPX are permitted in connection with the CPX interface. This means that:

- The valves and electrical outputs are supplied via the operating voltage connection CPX
- The valves are supplied and switched off independently via a separate valve connection on the CPX (code V)



Note

More information can be found at
→ Internet: [cpx](#)

Key features – Electrical components

Pin allocation – Sub-D socket, cable

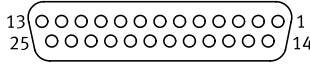
	Pin	Address/coil	Wire colour ²⁾		Pin	Address/coil	Wire colour ²⁾	
	1	0	WH		17	16	WH PK	
	2	1	GN		18	17	PK BN	
	3	2	YE		19	18	WH BU	
	4	3	GY		20	19	BN BU	
	5	4	PK		21	20	WH RD	
	6	5	BU		22	21	BN RD	
	7	6	RD		23	22	WH BK	
	8	7	VT		24	23	BN	
	9	8	GY PK		25	0 V ¹⁾	BK	
	10	9	RD BU		<p> Note The drawing shows a view of the Sub-D socket on the multi-pin plug cable VMPA-KMS1-....</p>			
	11	10	WH GN					
	12	11	BN GN					
	13	12	WH YE					
	14	13	YE BN					
	15	14	WH GY					
	16	15	GY BN					

1) 0 V with positive-switching control signals; in the case of negative-switching control signals, connect 24 V; mixed operation is not permitted!
2) To IEC 757

Dimensions

Download CAD data → www.festo.com

Connecting cables

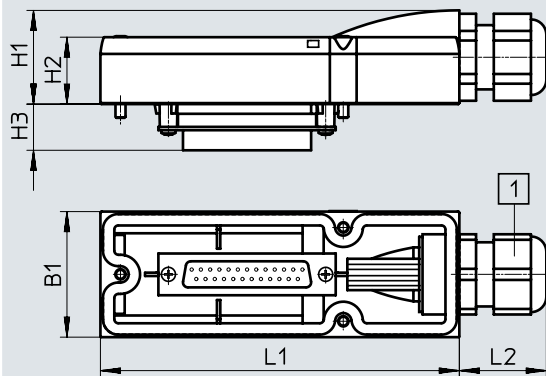

[1] Cable connector with clamping range 6 ... 12 mm

The wire colours refer to the following pre-assembled multi-pin cables from Festo:

- VMPA-KMS1-8-... Valve terminal for up to 4 valve positions (8 coils)
- VMPA-KMS1-24-... Valve terminal with 8 ... 24 valve positions

Type	L1	L2	B1	H1	H2	H3
VMPA-KMS-H	107.3	26	37.6	28	20	13.8

Type	Casing	Length [m]	Wire x mm ²	D [mm]	Weight [g]	Part no.
VMPA-KMS1-8-2.5	PVC	2.5	10 x 0.34	6.9	287	533195
VMPA-KMS2-8-2.5-PUR	PUR	2.5	10 x 0.25	8.3	237	533504
VMPA-KMS1-8-5	PVC	5	10 x 0.34	6.9	510	533196
VMPA-KMS2-8-5-PUR	PUR	5	10 x 0.25	8.3	460	533505
VMPA-KMS1-8-10	PVC	10	10 x 0.34	6.9	956	533197
VMPA-KMS2-8-10-PUR	PUR	10	10 x 0.25	8.3	906	533506
VMPA-KMS1-24-2.5	PVC	2.5	25 x 0.34	11.4	563	533192
VMPA-KMS2-24-2.5-PUR	PUR	2.5	25 x 0.25	11.2	411	533501
VMPA-KMS1-24-5	PVC	5	25 x 0.34	11.4	1062	533193
VMPA-KMS2-24-5-PUR	PUR	5	25 x 0.25	11.2	910	533502
VMPA-KMS1-24-10	PVC	10	25 x 0.34	11.4	2055	533194
VMPA-KMS2-24-10-PUR	PUR	10	25 x 0.25	11.2	1908	533503
VMPA-KMS-H	Hood for self-assembly				71	533198

Key features – Electrical components

Instructions for use		
Operating materials	Bio-oils	Mineral oils
<p>Operate your system with unlubricated compressed air, if possible. Festo valves and cylinders are designed so that, if used as intended, they will not require additional lubrication and will still achieve a long service life. The quality of compressed air downstream of the compressor must correspond to that of unlubricated compressed air. If possible, do not operate the entire system with lubricated compressed air. The lubricators should, where possible, always be installed directly upstream of the actuator requiring them.</p>	<p>Incorrect additional oil and too high an oil content in the compressed air reduce the service life of the valve terminal.</p> <p>Use Festo special oil OFSW-32 or the alternatives listed in the Festo catalogue (as specified in DIN 51524 HLP32; basic oil viscosity 32 CST at 40°C).</p>	<p>When using mineral oils (e.g. HLP oils to DIN 51524, parts 1 to 3) or similar oils based on poly-alpha-olefins (PAO), the maximum residual oil content of 5 mg/m³ must not be exceeded (see ISO 8573-1 Class 4).</p> <p>A higher residual oil content is not permitted, regardless of the compressor oil, because the permanent lubrication would otherwise be flushed out over a period of time.</p>

Datasheet – Valve terminal

-  - Flow rate
 - MPA1: up to 360 l/min
 - MPA14: up to 670 l/min
 - MPA2: up to 850 l/min

-  - Voltage
 - 24 V DC

-  - Valve width
 - MPA1: 10 mm
 - MPA14: 14 mm
 - MPA2: 20 mm

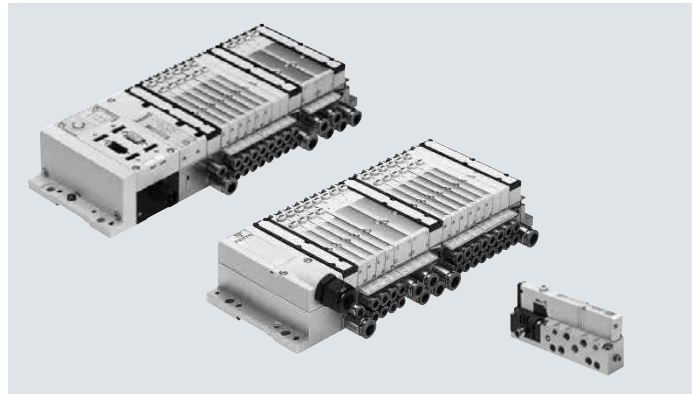

General technical data

Valve terminal design	Modular, valve sizes can be mixed			
Electrical control	Fieldbus	Multi-pin plug	AS-i interface	CPI interface
Actuation type	Electrical			
Nominal voltage	[V DC]	24		
Operating voltage range	[V DC]	18 ... 30		
Residual ripple	[Vss]	4		
Max. no. of valve positions		64 (FB), 24 (MP)		
Valve size	[mm]	10, 14, 20		
Pilot air supply	Internal or external			
Lubrication	Life-time lubrication, PWIS-free (free of paint-wetting impairment substances)			
Type of mounting	Wall mounting On H-rail to EN 60715			
Mounting position	Any (wall mounting) Horizontal only (H-rail)			
Manual override	Non-detenting, detenting			
Protection rating to EN 60529	IP67 (for all types of signal transmission in assembled state)			
Pneumatic connections				
Pneumatic connection	Via sub-base or individual connection			
Supply port	1	G1/4 (M7 with individual sub-base)		
Exhaust port	3/5	QS-10, QS-3/8" (M7 with individual sub-base)		
Working ports	2/4	Dependent on the connection type selected MPA1: M7, QS4, QS6, 3/16", 1/4" MPA14: G1/8, QS6, QS8, 1/4", 5/16" MPA2: G1/8, QS6, QS8, 1/4", 5/16"		
Pilot air connection	12/14	M7 (M5 with individual sub-base)		
Pilot exhaust air port	82/84	M7 (M5 with individual sub-base and with end plate VMPE-EPR-G)		
Pressure compensation port	With ducted exhaust air: via port 82/84 (M5 with individual sub-base and with end plate VMPE-EPR-G) With flat plate silencer: exhausting to atmosphere			

-  - **Note**
 Note possible restrictions for the IP protection class
 → ATEX declaration of conformity

Datasheet

Operating and environmental conditions	
Operating medium	Compressed air to ISO 8573-1:2010 [7:4:4]
Note on operating/ pilot medium	Lubricated operation possible (in which case lubrication will always be required)
Operating pressure	[MPa] -0.09 ... 1
	[bar] -0.9 ... 10
Pilot pressure	[MPa] 0.3 ... 0.8
	[bar] 3 ... 8
Ambient temperature	[°C] -5 ... +50
Temperature of medium	[°C] -5 ... +50
Storage temperature ¹⁾	[°C] -20 ... +40
Relative humidity	Max. 90% at 40°C

1) Long-term storage

Certifications ¹⁾				
Type	MPA-MPM-VI (multi-pin plug interface)	MPA-FB-VI (fieldbus interface)	MPA-ASI-VI (AS-i interface)	MPA-CPI-VI (CPI interface)
Part number	539105	530411	546279	546280
ATEX category for gas	II 3 G			
Type of (ignition) protection for gas	Ex ec IICT4 Gc X			
ATEX ambient temperature	[°C] $-5 \leq T_a \leq +50$			
Explosion protection certification outside the EU	-	EPL Gc (BR)	-	-
Certificate-issuing authority	-	DNV 15.0193 X	-	-
CE marking (see declaration of conformity)	To EU EMC Directive ²⁾			
	To EU Explosion Protection Directive (ATEX)			
KC marking	KC EMC			
Certification	c UL us - Recognized (OL)			
	RCM			
Corrosion resistance class CRC ³⁾	1	1	0	0

1) Interface versions that are not listed do not have any of the listed certifications

2) For information about the area of use, see the EC declaration of conformity at: www.festo.com/catalogue/... → Support/Downloads.

If the devices are subject to usage restrictions in residential, commercial or light-industrial environments, further measures for the reduction of the emitted interference may be necessary.

3) More information: www.festo.com/x/topic/crc

Datasheet

Pilot pressure p2 as a function of working pressure p1 with external pilot air supply

For valves with code: M, J, B, G, E, W, X

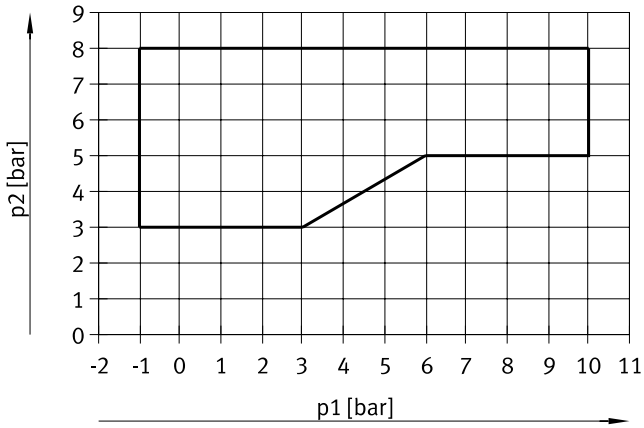

For valves with code: N, K, H, D, I

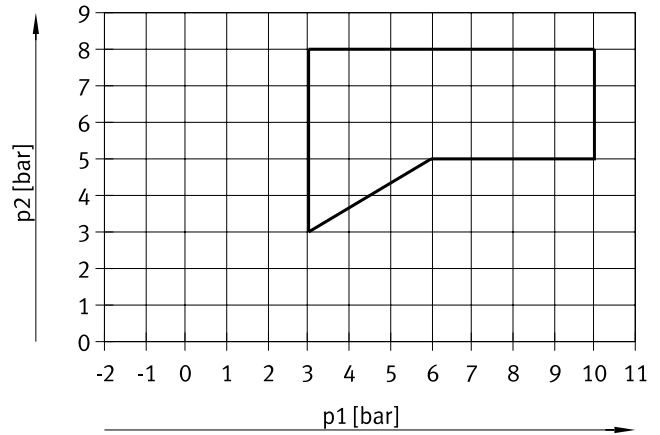

Pilot pressure p2 as a function of working pressure p1 for valves with mechanical spring return

For valves in width 10 mm with code: MS, NS, KS, HS, DS

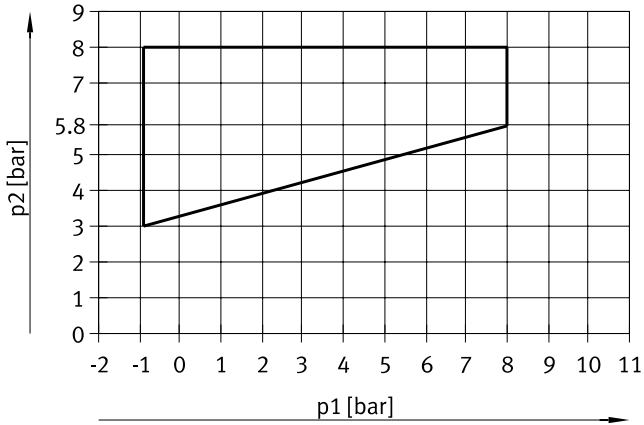

For valves in width 20 mm with code: MS, NS, KS, HS, DS

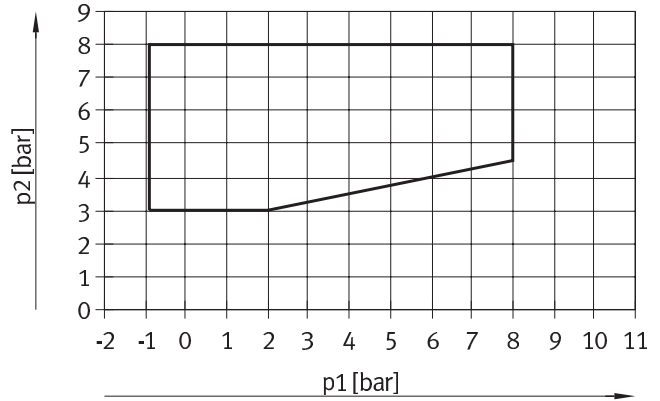

For valves in width 10 mm with code: MU, NU, KU, HU

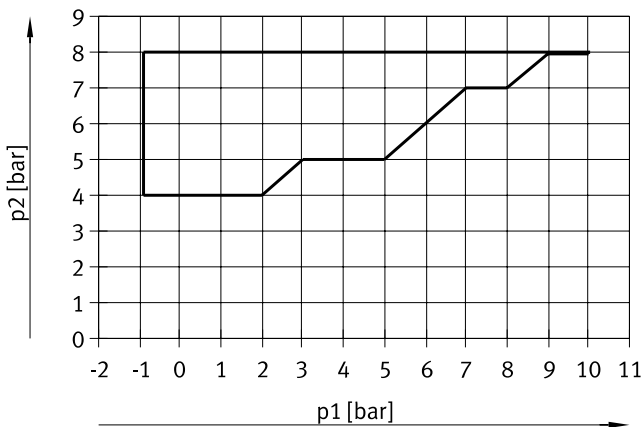

Datasheet

Flow rate q_n as a function of output pressure p_2 with pressure regulator plates (width 20 mm)

(P regulator plate) for port 1

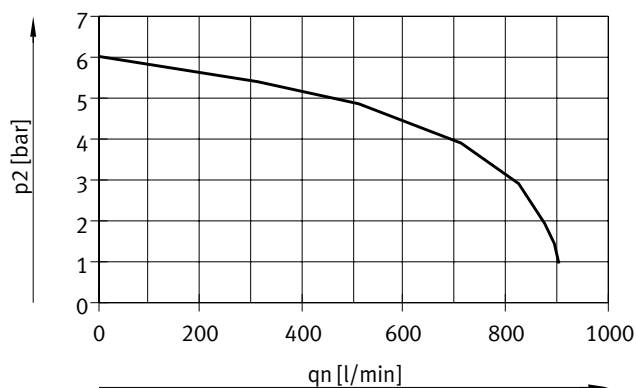

Supply pressure 10 bar,
regulated pressure set at 6 bar

(B regulator plates) for port 2

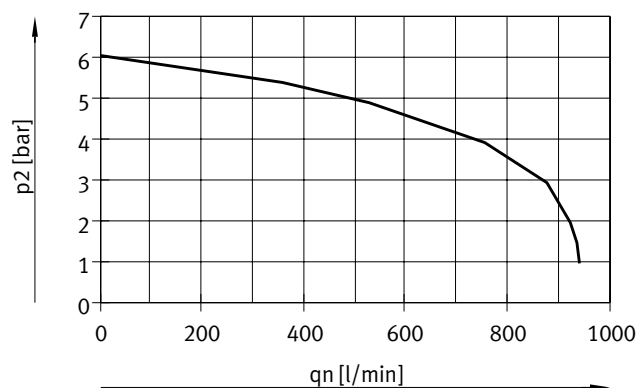

Supply pressure 10 bar,
regulated pressure set at 6 bar

Flow rate q_n as a function of output pressure p_2 with pressure regulator plates (width 20 mm)

(A regulator plates) for ports 4

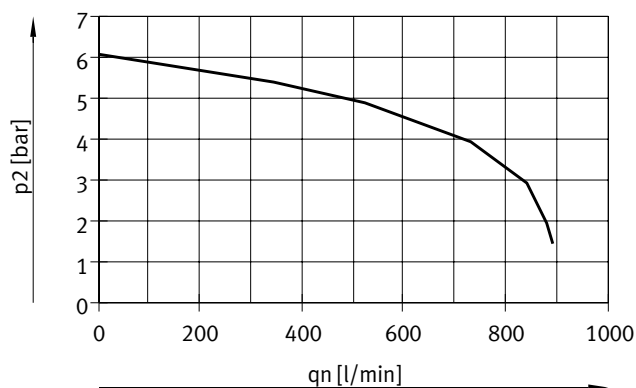

Supply pressure 10 bar,
regulated pressure set at 6 bar

(B regulator plates, rev.) for ports 3, reversible

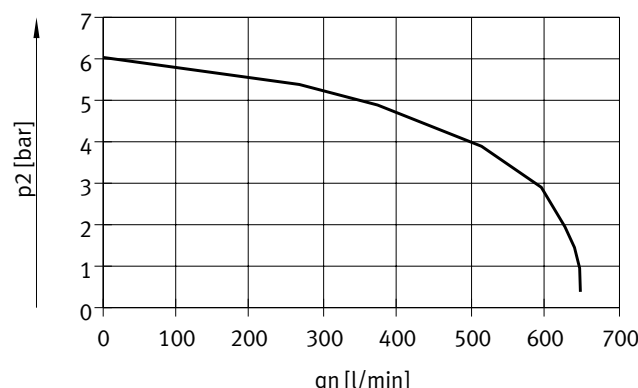

Supply pressure 10 bar,
regulated pressure set at 6 bar

Flow rate q_n as a function of output pressure p_2 with pressure regulator plates (width 20 mm)

(A regulator plates, rev.) for ports 5, reversible

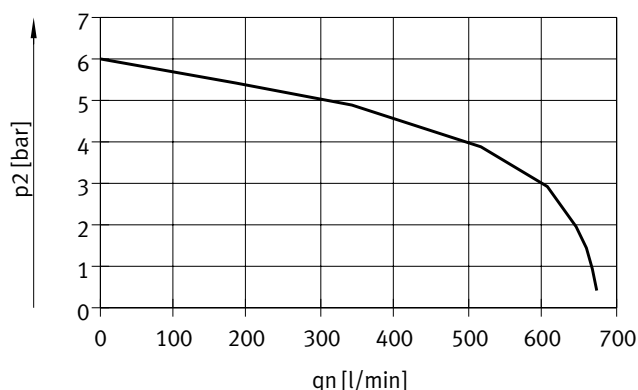

Supply pressure 10 bar,
regulated pressure set at 6 bar

Datasheet

Technical data – Valve width 10 mm																
Code		M	J	N	K	H	B	G	E	X	W	D	I			
Design		Piston spool valve														
Sealing principle		Soft														
Overlap		Positive overlap														
Reset method		Pneumatic spring			–			Pneumatic spring			Mechanical spring			Pneumatic spring		
Switching times	On	[ms]	10	10	10	10	10	10	10	10	10	10	10	8		
	Off	[ms]	20	–	20	20	20	35	35	35	20	20	20	20		
	Change-over	[ms]	–	15	–	–	–	15	15	15	–	–	–	–		
Standard nominal flow rate		[l/min]	360	360	300	230	300	300	320	240	255	255	230	260		
Operating pressure		[MPa]	–0.09 ... +1			0.3 ... 1			–0.09 ... +1			–0.09 ... +1			0.3 ... 1	
		[bar]	–0.9 ... +10			3 ... 10			–0.9 ... +10			–0.9 ... +10			3 ... 10	
Pilot pressure		[MPa]	0.3 ... 0.8													
		[bar]	3 ... 8													
Max. tightening torque for valve mounting		[Nm]	0.25													
Materials		Die-cast aluminium														
Product weight		[g]	49	56	56	56	56	56	56	56	49	49	56	56		

Technical data – Valve width 10 mm															
Code		MS	NS	KS	HS	DS	MU	NU	KU	HU					
Design		Piston spool valve					Poppet valve with spring return								
Sealing principle		Soft					Soft								
Overlap		Positive overlap					Negative overlap								
Reset method		Mechanical spring					Mechanical spring								
Switching times	On	[ms]	10	14	14	14	14	10	10	8	10				
	Off	[ms]	27	16	16	16	16	14	8	10	10				
	Change-over	[ms]	–	–	–	–	–	–	–	–	–				
Max. switching frequency		[Hz]	2	–	–	–	–	–	–	–	–				
Standard nominal flow rate		[l/min]	360	300	230	300	230	140 ... 190	190	160	140 ... 190				
Note on standard nominal flow rate		–					1 → 2: 190 l/min 1 → 4: 140 l/min		–		1 → 2: 190 l/min 1 → 4: 140 l/min				
Operating pressure		[MPa]	–0.09 ... +0.8					–0.09 ... +1							
		[bar]	–0.9 ... +8					–0.9 ... +10							
Pilot pressure		[MPa]	0.3 ... 0.8					0.4 ... 0.8							
		[bar]	3 ... 8					4 ... 8							
Max. tightening torque for valve mounting		[Nm]	0.25					0.25							
Materials		Die-cast aluminium					Reinforced PPA								
Product weight		[g]	56					35		42		42		42	

Technical data – Valve width 10 mm													
Code		ES	EU			IS	IU						
Design		Poppet valve with spring return											
Sealing principle		Soft											
Overlap		Negative overlap											
Reset method		Mechanical spring											
Operating pressure		[MPa]	0.3 ... 0.8										
		[bar]	3 ... 8										
Pilot pressure		[MPa]	0.3 ... 0.8										
		[bar]	3 ... 8										
Max. tightening torque for valve mounting		[Nm]	0.65			0.65			0.25		0.65		
Materials		Die-cast aluminium											
Product weight		[g]	32										

Datasheet

Technical data – Valve width 14 mm								
Code		M	J	N	K	H	B	
Design		Piston spool valve						
Sealing principle		Soft						
Overlap		Positive overlap						
Reset method		Pneumatic spring					Mechanical spring	
Switching times	On	[ms]	13	9	9	10	10	12
	Off	[ms]	20	–	28	28	26	40
	Change-over	[ms]	–	24	–	–	–	18
Standard nominal flow rate	[l/min]	550 ... 670	550 ... 670	550 ... 650	550 ... 600	550 ... 650	550 ... 630	
Note on standard nominal flow rate		MPA-S: 550 l/min MPA-L: 670 l/min	MPA-S: 550 l/min MPA-L: 670 l/min	MPA-S: 550 l/min MPA-L: 650 l/min	MPA-S: 550 l/min MPA-L: 600 l/min	MPA-S: 550 l/min MPA-L: 650 l/min	MPA-S: 550 l/min MPA-L: 630 l/min	
Operating pressure	[MPa]	–0.09 ... +1			0.3 ... 1		–0.09 ... +1	
	[bar]	–0.9 ... +10			3 ... 10		–0.9 ... +10	
Pilot pressure	[MPa]	0.3 ... 0.8						
	[bar]	3 ... 8						
Max. tightening torque for valve mounting	[Nm]	0.65						
Materials		Die-cast aluminium						
Product weight	[g]	77						

Technical data – Valve width 14 mm								
Code		G	E	X	W	D	I	
Design		Piston spool valve						
Sealing principle		Soft						
Overlap		Positive overlap						
Reset method		Mechanical spring			Pneumatic spring			
Switching times	On	[ms]	10	12	12	12	9	10
	Off	[ms]	40	40	20	20	26	28
	Change-over	[ms]	20	18	–	–	–	–
Standard nominal flow rate	[l/min]	500 ... 610	420 ... 480	360 ... 400	300 ... 340	550 ... 650	550 ... 670	
Note on standard nominal flow rate		MPA-S: 500 l/min MPA-L: 610 l/min	MPA-S: 420 l/min MPA-L: 480 l/min	MPA-S: 360 l/min MPA-L: 400 l/min	MPA-S: 340 l/min MPA-L: 300 l/min	MPA-S: 550 l/min MPA-L: 650 l/min	MPA-S: 550 l/min MPA-L: 670 l/min	
Operating pressure	[MPa]	–0.09 ... +1				0.3 ... 1		
	[bar]	–0.9 ... +10				3 ... 10		
Pilot pressure	[MPa]	0.3 ... 0.8						
	[bar]	3 ... 8						
Max. tightening torque for valve mounting	[Nm]	0.65						
Materials		Die-cast aluminium						
Product weight	[g]	77						

Datasheet

Technical data – Valve width 14 mm							
Code		MS	NS	KS	HS	DS	
Design		Piston spool valve					
Sealing principle		Soft					
Overlap		Positive overlap					
Reset method		Mechanical spring					
Switching times	On	[ms]	10	12	12	12	10
	Off	[ms]	30	20	20	20	20
	Change-over	[ms]	–	–	–	–	–
Max. switching frequency		[Hz]	2	–	–	–	–
Standard nominal flow rate		[l/min]	550 ... 670	470 ... 520	470 ... 560	470 ... 520	500 ... 570
Note on standard nominal flow rate			MPA-S: 550 l/min MPA-L: 670 l/min	MPA-S: 470 l/min MPA-L: 520 l/min	MPA-S: 470 l/min MPA-L: 560 l/min	MPA-S: 470 l/min MPA-L: 520 l/min	MPA-S: 500 l/min MPA-L: 570 l/min
Operating pressure		[MPa]	–0.09 ... +0.8				
		[bar]	–0.9 ... +8				
Pilot pressure		[MPa]	0.3 ... 0.8				
		[bar]	3 ... 8				
Max. tightening torque for valve mounting		[Nm]	0.65	0.25			
Materials		Die-cast aluminium					
Product weight		[g]	77				

Technical data – Valve width 14 mm							
Code		ES	EU	IS	IU		
Design		Poppet valve with spring return					
Sealing principle		Soft					
Overlap		Negative overlap					
Reset method		Mechanical spring					
Operating pressure		[MPa]	0.3 ... 0.8				
		[bar]	3 ... 8				
Pilot pressure		[MPa]	0.3 ... 0.8				
		[bar]	3 ... 8				
Max. tightening torque for valve mounting		[Nm]	0.25				
Materials		Die-cast aluminium					
Product weight		[g]	36				

Technical data – Valve width 20 mm							
Code		M	J	N	K	H	B
Design		Piston spool valve					
Sealing principle		Soft					
Overlap		Positive overlap					
Reset method		Pneumatic spring					Mechanical spring
Switching times	On	[ms]	15	9	8	8	11
	Off	[ms]	28	–	28	28	46
	Change-over	[ms]	–	22	–	–	23
Standard nominal flow rate		[l/min]	670	670	550 ... 610	500 ... 550	550
Note on standard nominal flow rate			–	–	MPA-S: 550 l/min MPA-L: 610 l/min	MPA-S: 500 l/min MPA-L: 550 l/min	–
Operating pressure		[MPa]	–0.09 ... +1		0.3 ... 1		–0.09 ... +1
		[bar]	–0.9 ... +10		3 ... 10		–0.9 ... +10
Pilot pressure		[MPa]	0.3 ... 0.8				
		[bar]	3 ... 8				
Max. tightening torque for valve mounting		[Nm]	0.65				
Materials		Die-cast aluminium					
Product weight		[g]	100				

Datasheet

Technical data – Valve width 20 mm								
Code		G	E	X	W	D	I	
Design		Piston spool valve						
Sealing principle		Soft						
Overlap		Positive overlap						
Reset method		Mechanical spring			Pneumatic spring			
Switching times	On	[ms]	10	11	13	13	7	7
	Off	[ms]	40	47	22	22	25	25
	Change-over	[ms]	21	23	–	–	–	–
Standard nominal flow rate		[l/min]	610	590	470	470	650 ... 840	650 ... 850
Note on standard nominal flow rate			–	–	–	–	MPA-S: 650 l/min MPA-L: 840 l/min	MPA-S: 650 l/min MPA-L: 850 l/min
Operating pressure		[MPa]	–0.09 ... +1				0.3 ... 1	
		[bar]	–0.9 ... +10				3 ... 10	
Pilot pressure		[MPa]	0.3 ... 0.8					
		[bar]	3 ... 8					
Max. tightening torque for valve mounting		[Nm]	0.65					
Materials		Die-cast aluminium						
Product weight		[g]	100					

Technical data – Valve width 20 mm								
Code		MS	NS	KS	HS	DS		
Design		Piston spool valve						
Sealing principle		Soft						
Overlap		Positive overlap						
Reset method		Mechanical spring						
Switching times	On	[ms]	8	12	12	12	12	
	Off	[ms]	36	25	25	25	25	
	Change-over	[ms]	–	–	–	–	–	
Max. switching frequency		[Hz]	2	–	–	–	–	
Standard nominal flow rate		[l/min]	670 ... 840	550 ... 620	500	550	650 ... 820	
Note on standard nominal flow rate			MPA-S: 670 l/min MPA-L: 840 l/min	MPA-S: 550 l/min MPA-L: 620 l/min	–	–	MPA-S: 650 l/min MPA-L: 820 l/min	
Operating pressure		[MPa]	–0.09 ... +0.8					
		[bar]	–0.9 ... +8					
Pilot pressure		[MPa]	0.3 ... 0.8					
		[bar]	3 ... 8					
Max. tightening torque for valve mounting		[Nm]	0.65					
Materials		Die-cast aluminium						
Product weight		[g]	100					

Safety characteristics				
		Valve width 10 mm	Valve width 14 mm	Valve width 20 mm
Max. positive test pulse with 0 signal	[µs]	400	400	400
Max. negative test pulse with 1 signal	[µs]	200	200	900
Shock resistance		Shock test with severity level 2 to FN 942017-5 and EN 60068-2-27		
Vibration resistant		Transport application test with severity level 2 to FN 942017-4 and EN 60068-2-6		

Datasheet

Electrical data – MPA with electronics module VMPA...-FB... (CPX terminal, CPI interface)			
	MPA1	MPA14	MPA2
Intrinsic current consumption per electronics module			
At 24 V U _{EL/SEN} ¹⁾ (internal electronics, all outputs 0-signal)	[mA]	Typically 8	
At 24 V U _{val} ²⁾ (internal electronics, without valves)			
VMPA...-EMG..., separate circuits	[mA]	Typically 23	
VMPA...-EMS..., without separate circuits	[mA]	Typically 3	
Maximum current consumption per solenoid coil at nominal voltage			
Nominal pick-up current	[mA]	58	99
Nominal current following current reduction	[mA]	9	18
Time until current reduction	[ms]	24	24
Diagnostic message			
Undervoltage U _{AUS} ³⁾	[V]	17.5 ... 16	

Electrical data – MPA with electronics module VMPA...-MPM... (AS-Interface, multi-pin)			
	MPA1	MPA14	MPA2
Current consumption at Sub-D multi-pin plug connection per solenoid coil at nominal voltage			
Nominal pick-up current	[mA]	80	100
Nominal current with current reduction	[mA]	25	20
Time until current reduction	[ms]	25	50

Calculation example for current consumption (CPX terminal, CPI interface)		
Current consumption with two solenoid coils MPA2 switched in parallel and one electronics module VMPA...-EMS... without separate circuits	[mA]	I _{EL/SEN} = 8
Nominal pick-up current (duration 24 ms)	[mA]	I _{VAL} = 3 (intrinsic current consumption of electronics module) + 2 x 99 (MPA2) = 202
Nominal current with current reduction (after 24 ms)	[mA]	I _{VAL} = 3 (intrinsic current consumption of electronics module) + 2 x 18 (MPA2) = 39

- 1) Power supply for electronics and sensors
- 2) Load voltage supply for valves
- 3) Load voltage outside of function range

Datasheet

Materials	
Sub-base	Die-cast aluminium
Seals	NBR, elastomer
Supply plate	Die-cast aluminium
End plate, right	Die-cast aluminium
Pneumatic interface, left	Die-cast aluminium, PA
Exhaust air plate	PA
Flat plate silencer	PE
Electrical supply plate	Housing: Die-cast aluminium Cover: Reinforced PA
Electronics module	PA
Electrical link	Bronze/PBT
Regulator plate	Control section, housing: PA; seals: NBR
Note on materials	RoHS-compliant

Product weight			
Approx. weight [g]	MPA1	MPA14	MPA2
Basic weight of sub-base ¹⁾	210 (4 valve positions)	252 (4 valve positions)	210 (2 valve positions)
Individual sub-base (VMPA ... I C...)	92	184	233
Per vacant position L	20	40	45
Right end plate with port 82/84 for ducted exhaust air (connecting thread M5)	55		
Right end plate, without port 82/84	58		
Pneumatic interface, left ¹⁾			
• With flat plate silencer	315		
• With ducted exhaust air	324		
Supply plate ¹⁾			
• With flat plate silencer	111		
• With ducted exhaust air	120		
Electrical supply plate	200		
Regulator plate (MPA1)	73.8		
Regulator plate (MPA2)	180		
QSM-M5-3-I	3		
QSM-M5-5/32-I-U-M	3		
QSM-M5-4-I	4		
QSM-M5-3/16-I-U-M	4		
QSM-M5-6-I	5		
QSM-M5-1/4-I-U-M	5		
QSM-M7-4-I	4		
QSM-M7-3/16-I-U-M	4		
QSM-M7-6-I	5		
QSM-M7-1/4-I-U-M	5		
QS-G1/8-6-I	11		
QS-1/8-1/4-I-U-M	11		
QS-G1/8-8-I	13		
QS-1/8-5/16-I-U-M	13		
QS-G1/4-8-I	22		
QS-1/4-5/16-I-U-M	22		
QS-G1/4-10-I	22		
QS-1/4-3/8-I-U-M	22		

1) With sheet metal seal, inscription label holder, screws

Datasheet

Dimensions

Download CAD data → www.festo.com

Valve terminal with multi-pin plug connection:

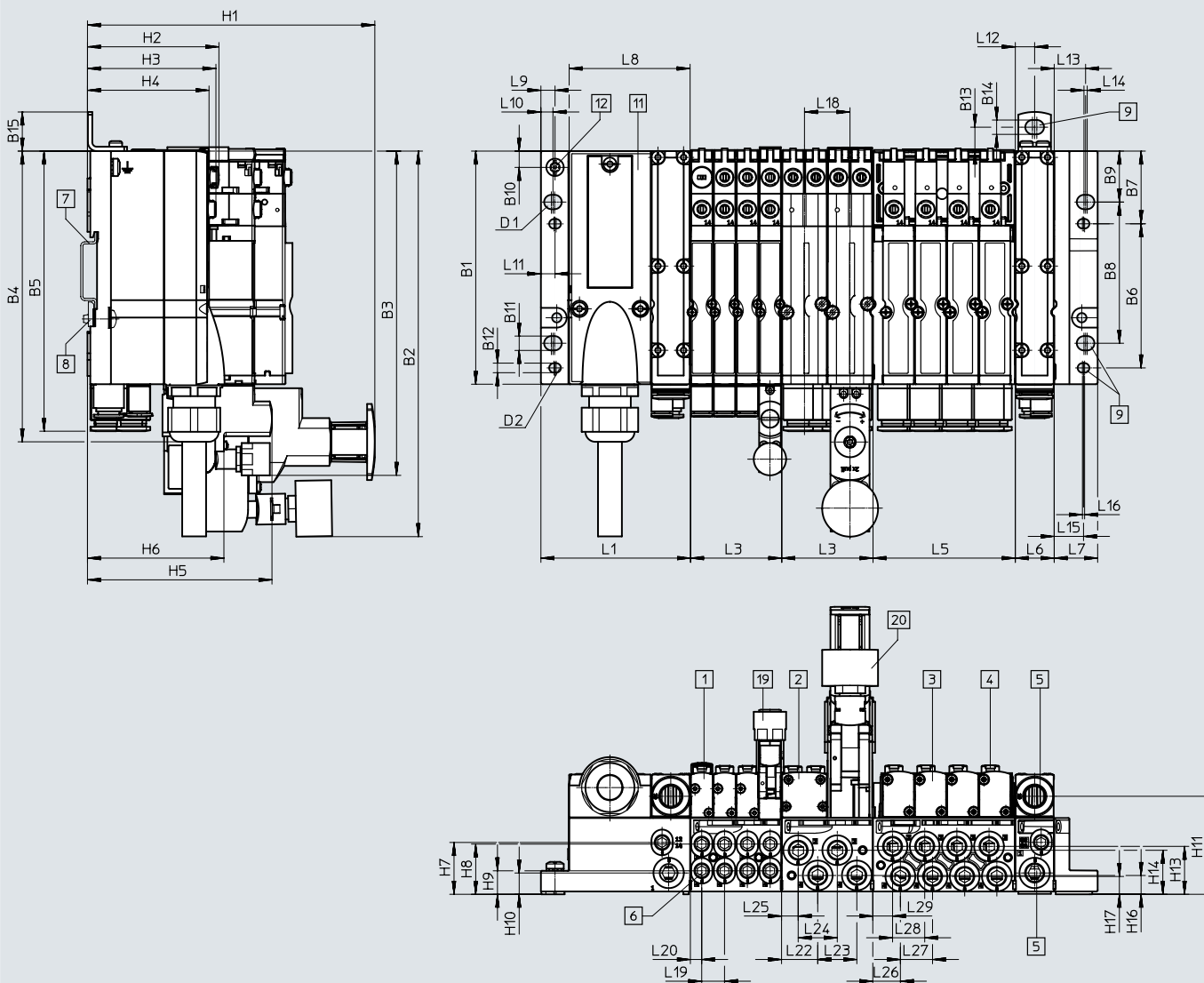

- [1] Solenoid valve MPA1
- [2] Solenoid valve MPA2
- [3] Solenoid valve MPA14
- [4] Manual override
- [5] Supply/exhaust ports
- [6] Working ports
- [7] H-rail
- [8] H-rail mounting
- [9] Mounting holes
- [11] Multi-pin plug connection
- [12] Earthing screw
- [19] Vertical stacking MPA1
- [20] Vertical stacking MPA2

Type	B1	B2	B3	B4	B5	B6	B7	B8	B9	B10	B11	B12	B13	B14	B15
MPA-S (MP)	107.3	178	149.2	133.8	128.9	66.3	33.5	65	23.5	7.5	6.6	4.4	11	6.6	18

Type	D1	D2	H1	H2	H3	H4	H5	H6	H7	H8	H9	H10	H11	H13	H14
MPA-S (MP)	M6	M4	132.3	60.5	59	56	84.9	63.1	23.9	23.1	10.8	9.8	45.1	22.1	20.3

Type	H16	H17	L1	L3 ¹⁾	L5 ¹⁾	L6	L7	L8	L9	L10	L11	L12	L13
MPA-S (MP)	8.7	8.2	68.9	n x 42	n x 65.5	17.9	20	55.8	6.5	5.6	6.5	9	14.5

Type	L14	L15	L16	L18	L19	L20	L22	L23	L24	L25	L26	L27	L28	L29
MPA-S (MP)	1.5	13.5	1	21	10.5	5.3	16.7	18	18	7.7	12.7	14.8	14.8	9.1

1) n = number of sub-bases (with MPA1, width 10 mm and MPA14, width 14 mm, max. 4 valve positions on sub-base; with MPA2, width 20 mm, max. 2 valve positions on sub-base)

Datasheet

Dimensions

Download CAD data → www.festo.com

Valve terminal with AS-Interface connection

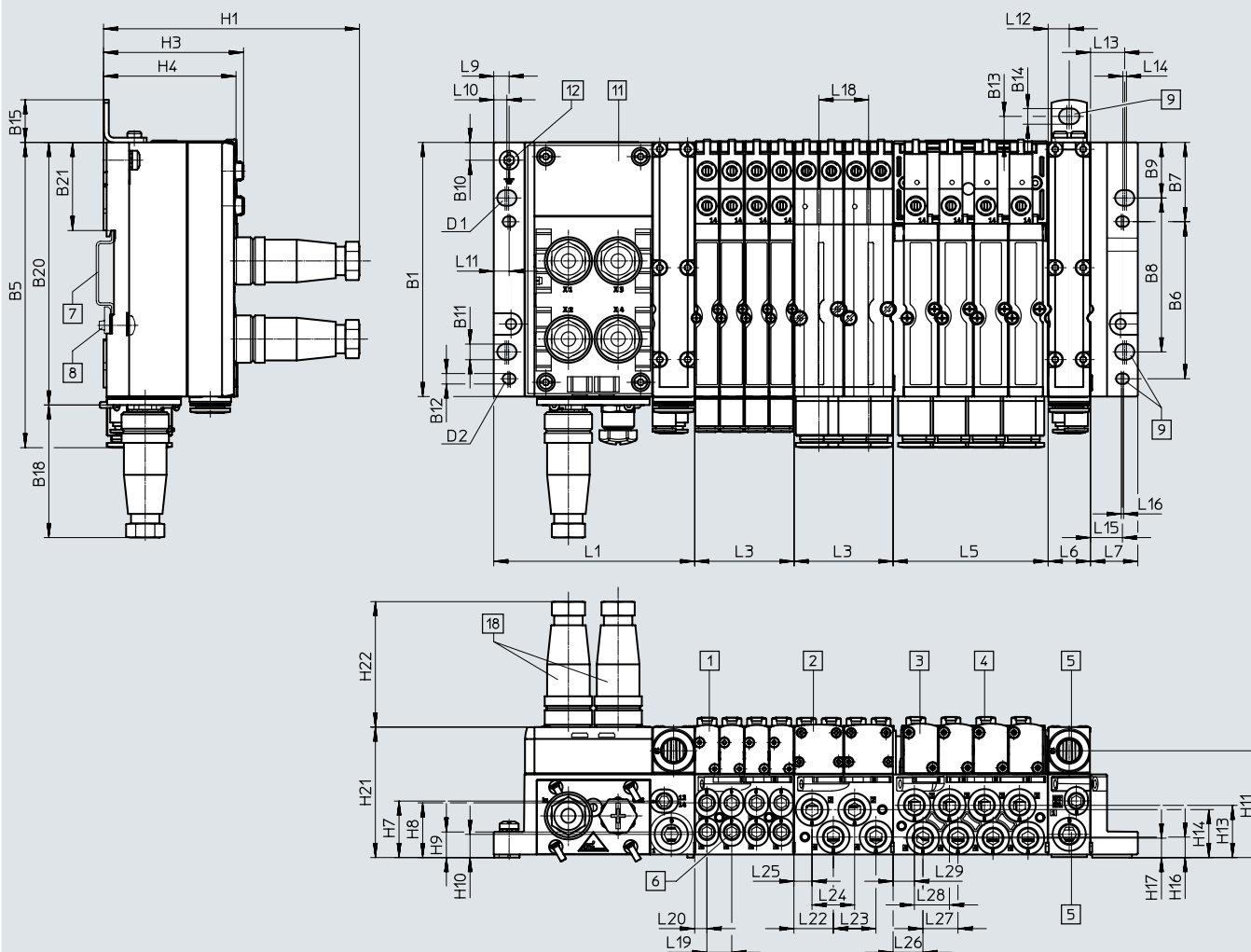

- [1] Solenoid valve MPA1
- [2] Solenoid valve MPA2
- [3] Solenoid valve MPA14
- [4] Manual override
- [5] Supply/exhaust ports
- [6] Working ports
- [7] H-rail
- [8] H-rail mounting
- [9] Mounting holes
- [11] Manifold block
- [12] Earthing screw
- [18] Plug M12

Type	B1	B5	B6	B7	B8	B9	B10	B11	B12	B13	B14	B15	B18	B20	B21
MPA-S (AS-i)	107.3	128.9	66.3	33.5	65	23.5	7.5	6.6	4.4	11	6.6	18	56	110.9	37.2

Type	D1	D2	H1	H3	H4	H7	H8	H9	H11	H13	H14	H16	H17	H21	H22
MPA-S (AS-i)	M6	M4	108.1	59	56	23.9	23.1	10.8	45.1	22.1	20.3	8.7	8.2	55.1	53

Type	L1	L3 ¹⁾	L5 ¹⁾	L6	L7	L9	L10	L11	L12	L13	L14	L15
MPA-S (AS-i)	85	n x 42	n x 65.5	17.9	20	6.5	5.6	6.5	9	14.5	1.5	13.5

Type	L16	L18	L19	L20	L22	L23	L24	L25	L26	L27	L28	L29
MPA-S (AS-i)	1	21	10.5	5.2	16.7	18	18	7.7	12.6	14.8	14.8	9

1) n = number of sub-bases (with MPA1, width 10 mm and MPA14, width 14 mm, max. 4 valve positions on sub-base; with MPA2, width 20 mm, max. 2 valve positions on sub-base)

Datasheet

Dimensions

Download CAD data → www.festo.com

Valve terminal with CPI connection

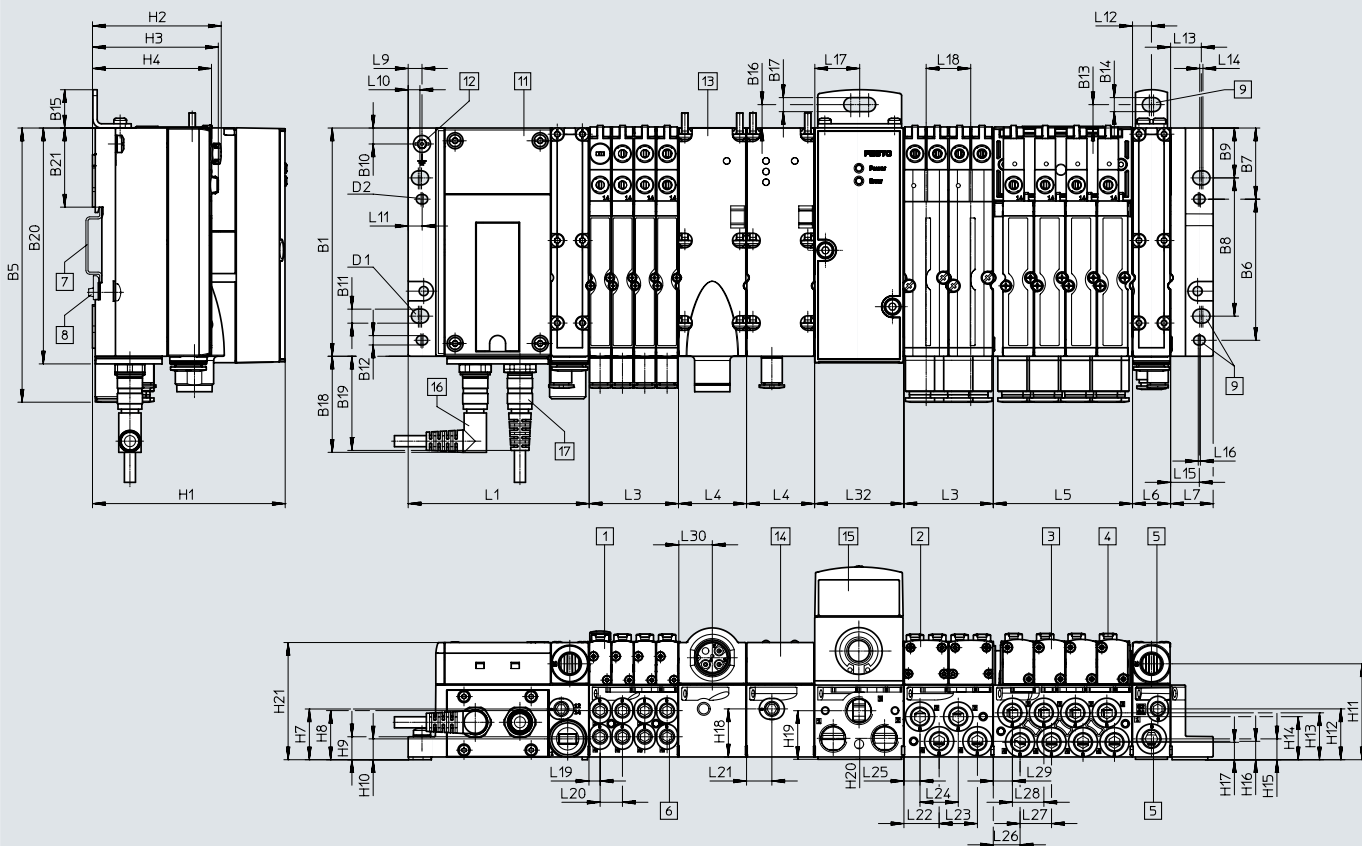

- [1] Solenoid valve MPA1
- [2] Solenoid valve MPA2
- [3] Solenoid valve MPA14
- [4] Manual override
- [5] Supply/exhaust ports
- [6] Working ports
- [7] H-rail
- [8] H-rail mounting
- [9] Mounting holes
- [11] Manifold block
- [12] Earthing screw
- [13] Electrical supply plate
- [14] Pressure sensor
- [15] Proportional pressure regulator
- [16] Connecting cable with angled plug
- [17] Connecting cable with straight plug

Type	B1	B5	B6	B7	B8	B9	B10	B11	B12	B13	B14	B15	B16	B17	B18	B19	B20	B21
MPA-S (CPI)	107.3	128.9	66.3	33.5	65	23.5	7.5	6.6	4.4	11	6.6	18	11	6.6	45.2	44.3	110.9	37.2

Type	D1	D2	H1	H2	H3	H4	H7	H8	H9	H10	H11	H12	H13	H14	H15	H16	H17
MPA-S (CPI)	M6	M4	90.6	60.5	59.1	56	23.9	23.1	10.8	9.8	45.1	23.9	22.1	20.3	9.8	8.7	8.2

Type	H18	H19	H20	H21	L1	L3 ¹⁾	L4	L5 ¹⁾	L6	L7	L9	L10	L11	L12	L13
MPA-S (CPI)	22.6	22.9	9.9	55.1	85	n x 42	32	n x 65.5	17.9	20	6.5	5.5	6.5	9	14.5

Type	L14	L15	L16	L17	L18	L19	L20	L21	L22	L23	L24	L25	L26	L27	L28	L29	L30	L32
MPA-S (CPI)	1.5	13.5	1	21	21	5.3	10.5	11.9	16.6	18	18	7.6	12.6	14.8	14.8	9	15.8	42

1) n = number of sub-bases (with MPA1, width 10 mm and MPA14, width 14 mm, max. 4 valve positions on sub-base; with MPA2, width 20 mm, max. 2 valve positions on sub-base)

Datasheet

Dimensions

Download CAD data → www.festo.com

Valve terminal with fieldbus interface

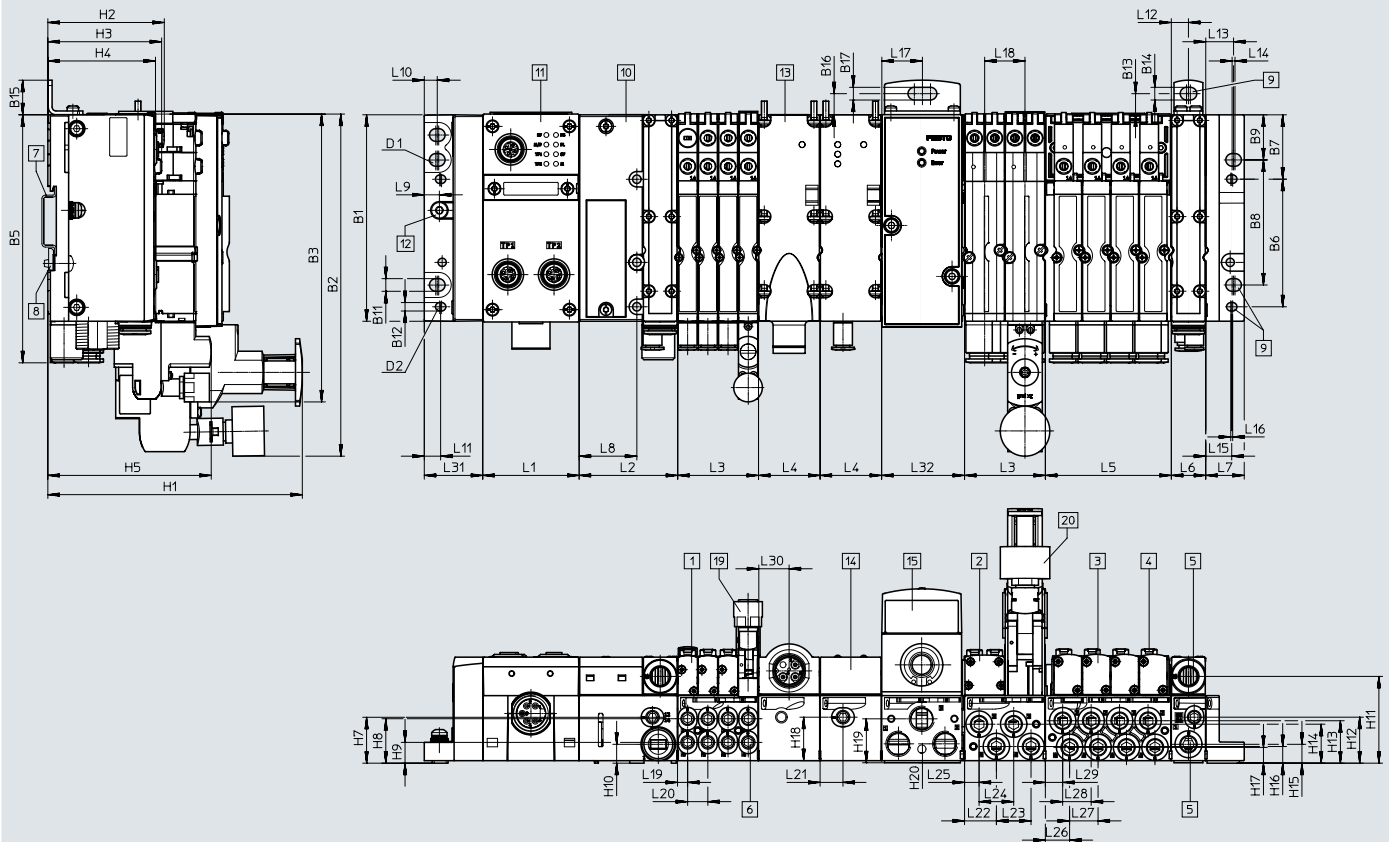

- [1] Solenoid valve MPA1
- [2] Solenoid valve MPA2
- [3] Solenoid valve MPA14
- [4] Manual override
- [5] Supply/exhaust ports
- [6] Working ports
- [7] H-rail
- [8] H-rail mounting
- [9] Mounting holes
- [10] Pneumatic interface MPA
- [11] CPX module
- [12] Earthing screw
- [13] Electrical supply plate
- [14] Pressure sensor
- [15] Proportional pressure regulator
- [19] Vertical stacking MPA1
- [20] Vertical stacking MPA2

Type	B1	B2	B3	B5	B6	B7	B8	B9	B11	B12	B13	B14	B15	B16	B17	D1	D2
MPA-S (FB)	107.3	178	149.2	129	66.4	33.5	65	23.5	6.6	4.4	11	6.6	18	11	6.6	M6	M4

Type	H1	H2	H3	H4	H5	H7	H8	H9	H10	H11	H12	H13	H14	H15	H16	H17	H18	H19	H20
MPA-S (FB)	132.3	60.5	59.1	56	84.9	23.9	23.1	10.8	9.8	45.1	23.9	22.1	20.3	9.8	8.7	8.2	22.6	22.9	9.9

Type	L1 ¹⁾	L2	L3 ²⁾	L4	L5 ²⁾	L6	L7	L8	L9	L10	L11	L12	L13	L14	L15	L16
MPA-S (FB)	m x 50.1	51.3	n x 42	32	n x 65.5	17.9	20	30	7.9	6.8	8.5	9	14.5	1.5	13.5	1

Type	L17	L18	L19	L20	L21	L22	L23	L24	L25	L26	L27	L28	L29	L30	L31	L32
MPA-S (FB)	21	21	5.3	10.5	11.9	16.6	18	18	7.6	12.6	14.8	14.8	9	15.8	30.4	42

1) m = number of CPX modules
 2) n = number of sub-bases (with MPA1, width 10 mm and MPA14, width 14 mm, max. 4 valve positions on sub-base; with MPA2, width 20 mm, max. 2 valve positions on sub-base)

Datasheet

Dimensions

Download CAD data → www.festo.com

Vertical stacking components, regulator plate VMPA1

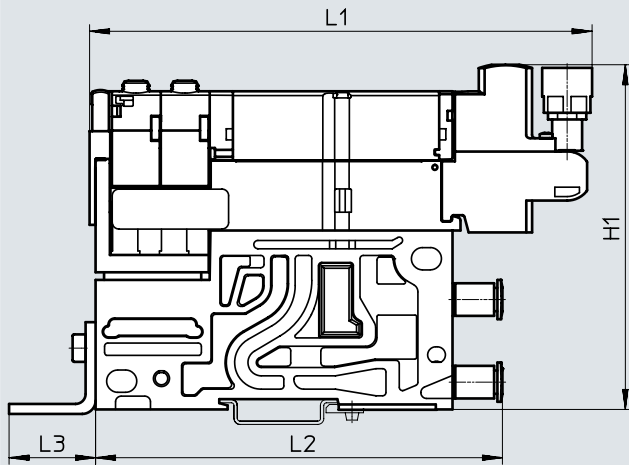

Type	H1	L1	L2	L3
VMPA1-...	105	151.1	122.3	26.9

Vertical stacking components, regulator plate VMPA2

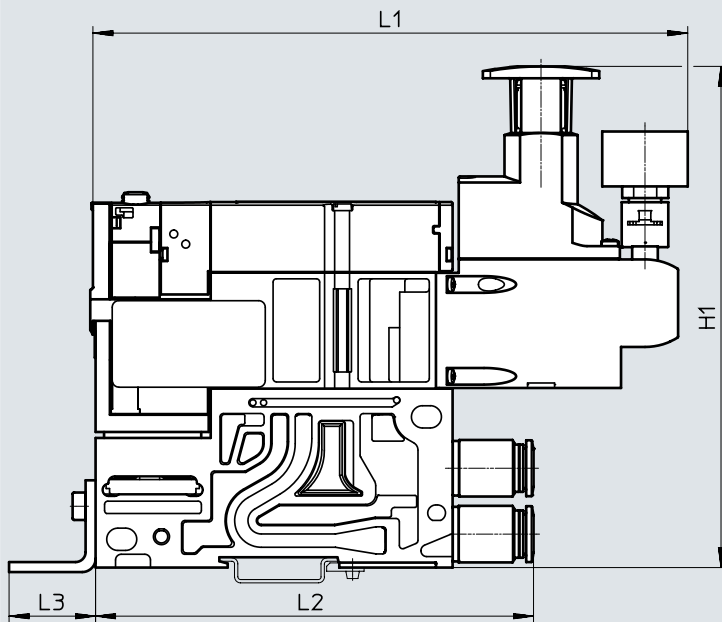



Type	H1	L1	L2	L3
VMPA2-...	152	179.6	131.6	26.9

Datasheet – Proportional pressure regulator VPPM

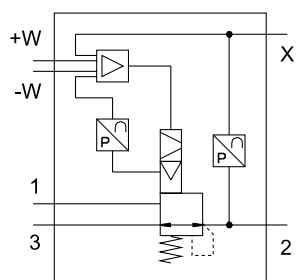
Function:



-  - Flow rate
380 ... 1650 l/min
-  - Pressure regulation ranges
0.02 ... 10 bar
-  - Voltage
21.6 ... 26.4 V DC





General technical data

		VPPM-6TA	VPPM-8TA
Valve function		3-way proportional pressure regulator	
Design		Piloted diaphragm regulator	
Range of applications		For CPI connection, for fieldbus	
Type of mounting		Via through-hole or accessories	
Sealing principle		Soft	
Actuation type		Electrical	
Type of control		Piloted	
Mounting position		Any	
Reset method		Mechanical spring	
Display type		LED	Back-lit LCD
Pneumatic connection	1, 2, 3	Sub-base	
Nominal width	Pressurisation [mm]	6	8
	Exhausting [mm]	4.5	7
Standard nominal flow rate	2 bar type [l/min]	380	450
	6 bar type [l/min]	900	1050
	10 bar type [l/min]	1400	1650
Product weight	[g]	400	500
Material	Housing	Anodised wrought aluminium alloy	

Electrical data

Electrical connection		Via E-box
Operating voltage range	[V DC]	21.6 ... 26.4
Residual ripple	[%]	10
Max. electrical power consumption	[W]	7
Duty cycle	[%]	100
Short circuit current rating		For all electrical connections
Reverse polarity protection		For all electrical connections
Protection rating to EN 60529		IP65

-  - **Note**
Output pressure will be unregulated if there is a break in the power supply cable.

-  - **Note**
Note possible restrictions for the IP protection class
→ ATEX declaration of conformity

Datasheet – Proportional pressure regulator VPPM

Flow rate q_n from 1 → 2 as a function of output pressure p_2

VPPM-6TA-...-0L2H-...

(2 bar)

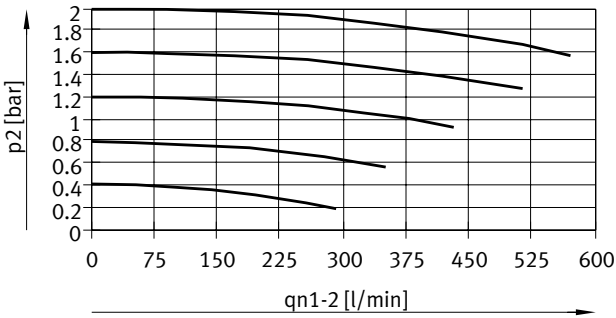

VPPM-6TA-...-0L6H-...

(6 bar)

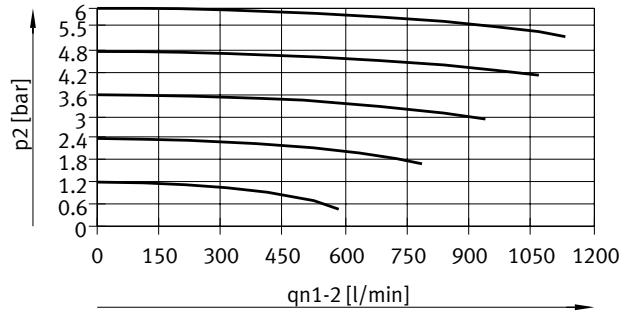

VPPM-6TA-...-0L10H-...

(10 bar)

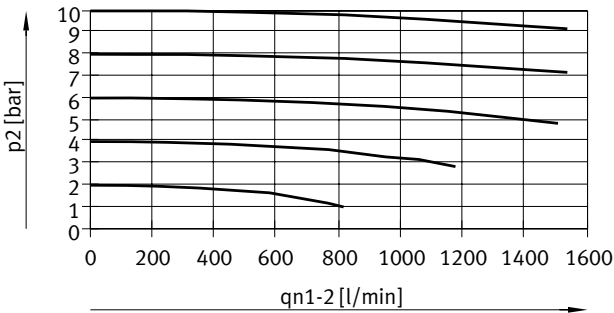

Flow rate q_n from 2} → 3 as a function of output pressure p_2

VPPM-6TA-...-0L2H-...

(2 bar)

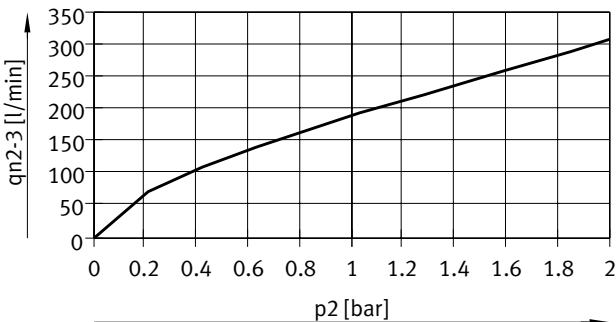

VPPM-6TA-...-0L6H-...

(6 bar)

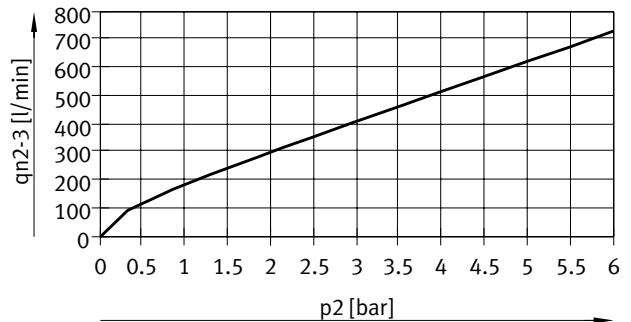

VPPM-6TA-...-0L10H-...

(10 bar)

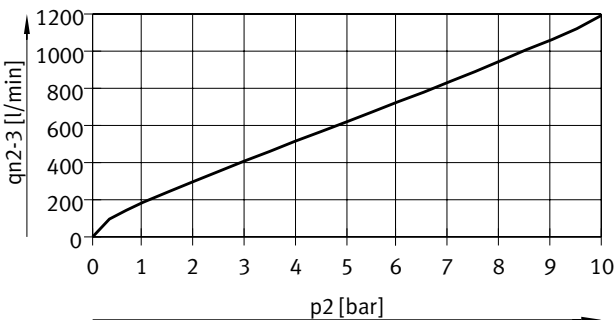

Datasheet – Proportional pressure regulator VPPM

Flow rate q_n from 1 → 2 as a function of output pressure p_2

VPPM-8TA-...-0L2H-... (2 bar)

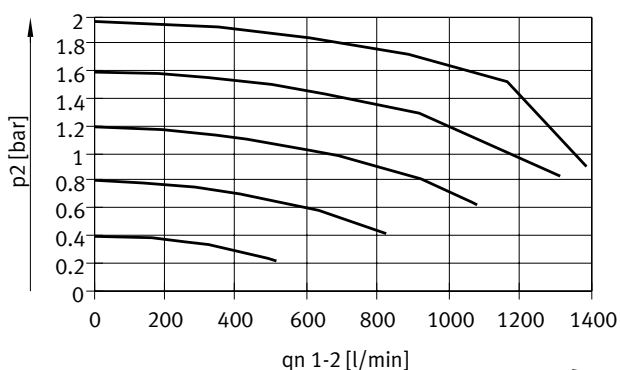

VPPM-8TA-...-0L6H-... (6 bar)

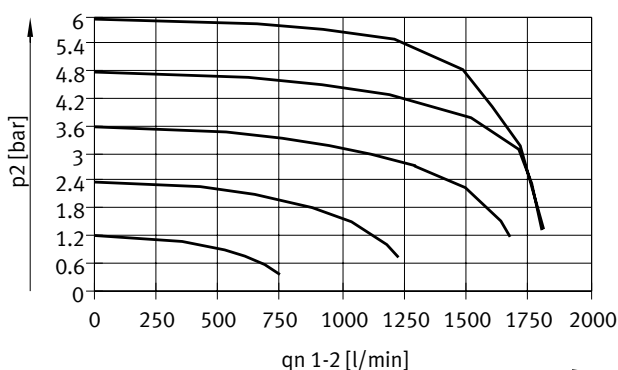

VPPM-8TA-...-0L10H-... (10 bar)

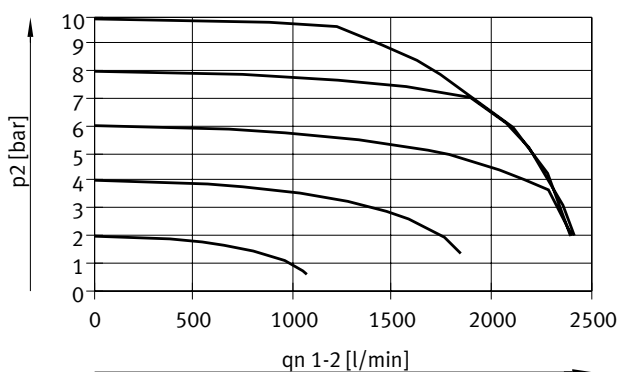

Flow rate q_n from 2 → 3 as a function of output pressure p_2

VPPM-8TA-...-0L2H-... (2 bar)

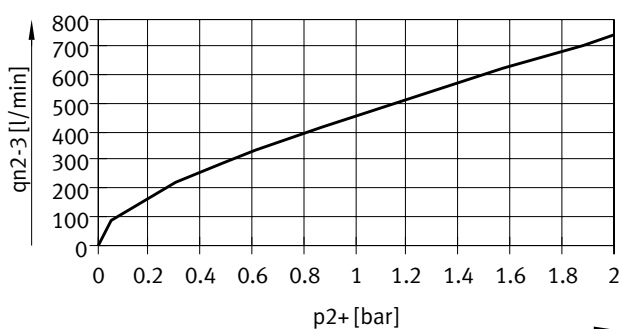

VPPM-8TA-...-0L6H-... (6 bar)

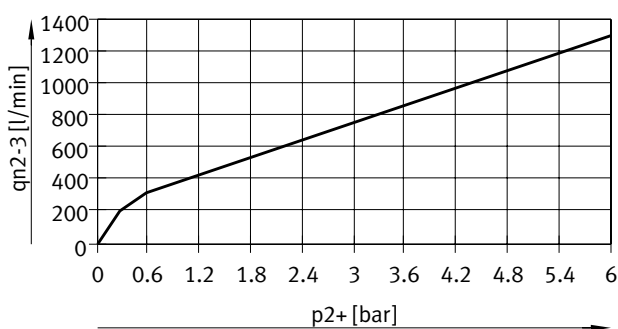

VPPM-8TA-...-0L10H-... (10 bar)



Datasheet – Proportional pressure regulator VPPM

Operating and environmental conditions			VPPM-6TA	VPPM-8TA
Operating medium			Compressed air to ISO 8573-1:2010 [7:4:4] Inert gases	
Note on the operating/pilot medium			Lubricated operation not possible	
Pressure regulation range	VPPM-...-0L2H-...	[MPa]	0.002 ... 0.2	
		[bar]	0.02 ... 2	
	VPPM-...-0L6H-...	[MPa]	0.006 ... 0.6	
		[bar]	0.06 ... 6	
VPPM-...-0L10H-...	[MPa]	0.01 ... 1		
	[bar]	0.1 ... 10		
Input pressure 1 ¹⁾	VPPM-...-0L2H-...	[MPa]	0 ... 0.4	
		[bar]	0 ... 4	
	VPPM-...-0L6H-...	[MPa]	0 ... 0.8	
		[bar]	0 ... 8	
VPPM-...-0L10H-...	[MPa]	0 ... 1.1		
	[bar]	0 ... 11		
Max. pressure hysteresis	VPPM-...-0L2H-...	[bar]	0.01	
	VPPM-...-0L6H-...	[bar]	0.03	
	VPPM-...-0L10H-...	[bar]	0.05	
Linearity error FS (full scale)	Standard	[%]	2	
	Type S1	[%]	1	
Repetition accuracy FS (full scale)		[%]	0.5	
Temperature coefficient		[%/K]	0.04	
Ambient temperature		[°C]	0 ... 60	0 ... 50
Temperature of medium		[°C]	10 ... 50	
Corrosion resistance class CRC ²⁾			2	
KC marking			KC EMC	
CE marking (see declaration of conformity) ⁴⁾			To EU EMC Directive ³⁾	
			To EU RoHS Directive	
UKCA marking (see declaration of conformity) ⁴⁾			To UK EMC regulations ³⁾	
			To UK RoHS regulations	
Certification			RCM	
			c UL us - Listed (OL)	
Certificate-issuing authority			UL E322346	
LABS (PWIS) conformity			VDMA24364-B1/B2-L	

1) Input pressure 1 should always be 1 bar greater than the maximum regulated output pressure.

2) More information: www.festo.com/x/topic/crc

3) For information about the area of use, see the EC declaration of conformity at: www.festo.com/catalogue/... → Support/Downloads.

If the devices are subject to usage restrictions in residential, commercial or light-industrial environments, further measures for the reduction of the emitted interference may be necessary.

4) More information: www.festo.com/catalogue/... → Support/Downloads.

LEDs on the proportional pressure regulator VPPM-6TA

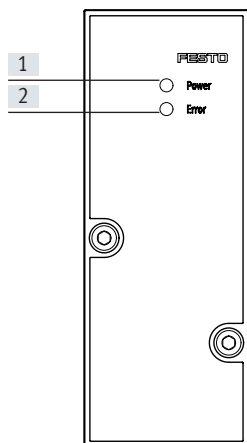

[1] Green power LED

[2] Red error LED

Datasheet – Proportional pressure regulator VPPM

Dimensions

Download CAD data → www.festo.com

VPPM-6TA

[1] Socket head screw M4x55

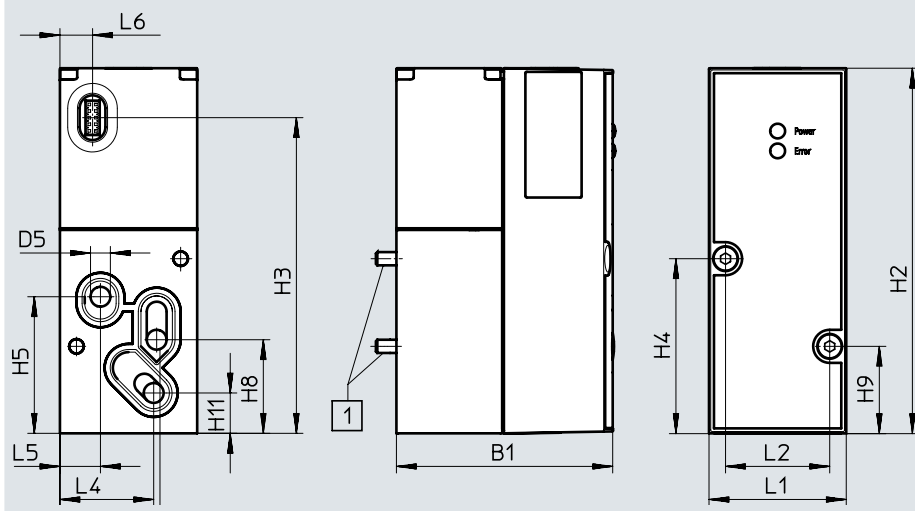

Type	B1	D5 ∅	H2	H3	H4	H5	H8	H9	H11
VPPM-6TA	55.5	6	110.4	95.5	52.8	41.3	28.3	26.3	12.2

Type	L1	L2	L3	L4	L5	L6
VPPM-6TA	41.5	31.5	30.3	28.4	12.3	9.9

VPPM-8TA with LCD

[1] Socket head screw M4x77

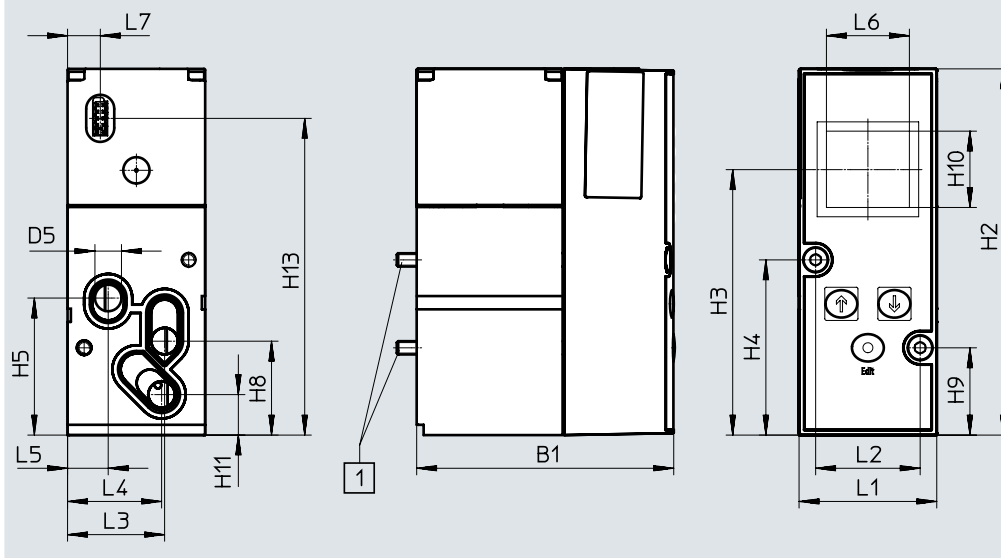

Type	B1	D5 ∅	H2	H3	H4	H5	H8	H9	H10	H11	H13
VPPM-8TA	77.4	8	110.4	80	52.8	41.3	28.3	26.3	23	12.2	95.5

Type	L1	L2	L3	L4	L5	L6	L7
VPPM-8TA	41.5	31.5	29.3	28.4	12.3	25	9.9

Datasheet – Proportional pressure regulator VPPM

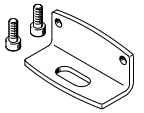
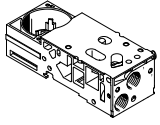
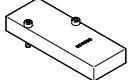
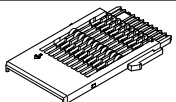
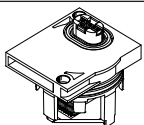

Ordering data					
Code	Overall accuracy [%]	Input pressure 1 [MPa]	Pressure regulation range [MPa]	Part no.	Type
QA	2	0 ... 0.4	0.002 ... 0.2	542220	VPPM-6TA-L-1-F-0L2H
QD	1	0 ... 0.4	0.002 ... 0.2	542217	VPPM-6TA-L-1-F-0L2H-S1
QB	2	0 ... 0.8	0.006 ... 0.6	542221	VPPM-6TA-L-1-F-0L6H
QE	1	0 ... 0.8	0.006 ... 0.6	542218	VPPM-6TA-L-1-F-0L6H-S1
QC	2	0 ... 1.1	0.01 ... 1	542222	VPPM-6TA-L-1-F-0L10H
QF	1	0 ... 1.1	0.01 ... 1	542219	VPPM-6TA-L-1-F-0L10H-S1
QL	1	0 ... 0.4	0.002 ... 0.2	572410	VPPM-8TA-L-1-F-0L2H-S1C1
QG	2	0 ... 0.4	0.002 ... 0.2	572410	VPPM-8TA-L-1-F-0L2H-C1
QM	1	0 ... 0.8	0.006 ... 0.6	572408	VPPM-8TA-L-1-F-0L6H-S1C1
QH	2	0 ... 0.8	0.006 ... 0.6	572411	VPPM-8TA-L-1-F-0L6H-C1
QN	1	0 ... 1.1	0.01 ... 1	572409	VPPM-8TA-L-1-F-0L10H-S1C1
QK	2	0 ... 1.1	0.01 ... 1	572412	VPPM-8TA-L-1-F-0L10H-C1

Ordering data – Accessories			
Designation		Part no.	Type
	Mounting	558844	VMPA-BG
	Sub-base without electrical interlinking module and without electronics module	542223	VMPA-FB-AP-P1
	Cover plate	559638	VMPA-P-RP
	Electrical interlinking module for sub-base of the proportional pressure regulator	537998	VMPA1-FB-EV-AB
	Electronics module	542224	VMPA-FB-EMG-P1

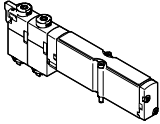
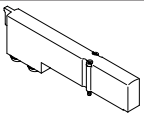
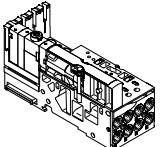
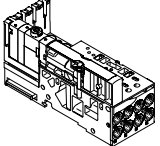

Accessories

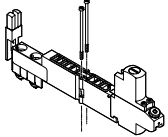
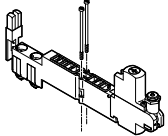
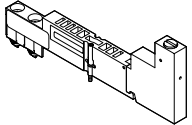
Ordering data		Code	Valve function	Part no.	Type
Individual solenoid valve – width 10 mm					
	5/2-way valve				
	Position function 1-32: M	Single solenoid		533342	VMPA1-M1H-M-PI
	Position function 1-32: MS	Single solenoid, mechanical spring return		571334	VMPA1-M1H-MS-PI
	Position function 1-32: MU	Polymer poppet valve, single solenoid, mechanical spring return		553113	VMPA1-M1H-MU-PI
	Position function 1-32: J	Double solenoid		533343	VMPA1-M1H-J-PI
	2x 3/2-way valve				
	Position function 1-32: N	Normally open		533348	VMPA1-M1H-N-PI
	Position function 1-32: NS	Normally open, mechanical spring return		556839	VMPA1-M1H-NS-PI
	Position function 1-32: NU	Polymer poppet valve, normally open, mechanical spring return		553111	VMPA1-M1H-NU-PI
	Position function 1-32: K	Normally closed		533347	VMPA1-M1H-K-PI
	Position function 1-32: KS	normally closed, mechanical spring return		556838	VMPA1-M1H-KS-PI
	Position function 1-32: KU	Polymer poppet valve, normally closed, mechanical spring return		553110	VMPA1-M1H-KU-PI
	Position function 1-32: H	1x normally open, 1x normally closed		533349	VMPA1-M1H-H-PI
	Position function 1-32: HS	1x normally open, 1x normally closed, mechanical spring return		556840	VMPA1-M1H-HS-PI
	Position function 1-32: HU	Polymer poppet valve, 1x normally open, 1x normally closed, mechanical spring return		553112	VMPA1-M1H-HU-PI
	5/3-way valve				
	Position function 1-32: B	Mid-position pressurised		533344	VMPA1-M1H-B-PI
	Position function 1-32: G	Mid-position closed		533345	VMPA1-M1H-G-PI
	Position function 1-32: E	Mid-position exhausted		533346	VMPA1-M1H-E-PI
	1x 3/2-way valve				
	Position function 1-32: W	Normally open, external compressed air supply		540050	VMPA1-M1H-W-PI
Position function 1-32: X	Normally closed, external compressed air supply		534415	VMPA1-M1H-X-PI	
2x 2/2-way valve					
Position function 1-32: D	Normally closed		533350	VMPA1-M1H-D-PI	
Position function 1-32: DS	normally closed, mechanical spring return		556841	VMPA1-M1H-DS-PI	
Position function 1-32: I	1x normally closed, 1x normally closed, reversible only		543605	VMPA1-M1H-I-PI	
Vacant position – width 10 mm					
	Position function 1-32: L	Cover plate for a valve position in width 10 mm A self-adhesive label is supplied.		533351	VMPA1-RP
Pilot air switching valve – Width 10 mm					
	Valve positions 0-64	3/2-way pilot air switching valve, internal pilot air supply via duct 1 of the pressure zone		8126790	VMPA1-M1H-IS-PI
		3/2-way pilot air switching valve, internal pilot air supply via duct 1 of the pressure zone, with pilot air detection via sensor, external, M8 plug connection		8126792	VMPA1-M1H-IU-PI
	Valve positions 0-64	3/2-way pilot air switching valve, external pilot air supply via duct 2 of manifold block		8126791	VMPA1-M1H-ES-PI
		3/2-way pilot air switching valve, external pilot air supply via duct 2 of the manifold block, with pilot air detection via sensor, external, M8 plug connection		8126793	VMPA1-M1H-EU-PI

Accessories



Ordering data	Code	Description	Part no.	Type		
Vertical stacking modules – width 10 mm						
	Pressure regulator 1-32: PF	Pressure regulator plate with fixed threaded connection M5	For port 1	0.5 ... 6 bar	564911	VMPA1-B8-R1-M5-06
	Pressure regulator 1-32: PA			0.5 ... 8.5 bar	564908	VMPA1-B8-R1-M5-10
	Pressure regulator 1-32: PH		For port 2	2 ... 6 bar	564912	VMPA1-B8-R2-M5-06
	Pressure regulator 1-32: PC			2 ... 8.5 bar	564909	VMPA1-B8-R2-M5-10
	Pressure regulator 1-32: PG		For port 4	2 ... 6 bar	564913	VMPA1-B8-R3-M5-06
	Pressure regulator 1-32: PB			2 ... 8.5 bar	564910	VMPA1-B8-R3-M5-10
	Pressure regulator 1-32: PF	Pressure regulator plate with swivelling threaded connection M5	For port 1	0.5 ... 6 bar	549052	VMPA1-B8-R1C2-C-06
	Pressure regulator 1-32: PA			0.5 ... 8.5 bar	543339	VMPA1-B8-R1C2-C-10
	Pressure regulator 1-32: PH		For port 2	2 ... 6 bar	549053	VMPA1-B8-R2C2-C-06
	Pressure regulator 1-32: PC			2 ... 8.5 bar	543340	VMPA1-B8-R2C2-C-10
	Pressure regulator 1-32: PG		For port 4	2 ... 6 bar	549054	VMPA1-B8-R3C2-C-06
	Pressure regulator 1-32: PB			2 ... 8.5 bar	543341	VMPA1-B8-R3C2-C-10
	Pressure regulator 1-32: PS	Vertical pressure shut-off plate For manually disconnecting an individual valve from the compressed air supply of the valve terminal (duct 1 and 12/14 pilot air supply), operating pressure 3 ... 8 bar		567805	VMPA1-HS	
	Pressure gauge 1-32: VE	Screw-in pressure gauge with M5 thread for pressure regulator plate with swivelling threaded connection	Unit of measure: bar	132340	MA-15-10-M5	
	Pressure gauge 1-32: VD		Unit of measure: psi	132341	MA-15-145-M5-PSI	
	Pressure gauge 1-32: VC	Locking push-in fitting with thread M5 for pressure regulator plate		153291	QSK-M5-4	

Accessories

Ordering data		Code	Description	Part no.	Type	PU ¹⁾
Fixed flow restrictor – Width 10 mm						
	Pneumatic port 3, 1-40: V03	Hollow bolt, for flow control of the exhaust air	3.5 ... 5.5 l/min	572544	VMPA1-FT-NW0.3-10	10
	Pneumatic port 5, 1-40: Q03		9 ... 12 l/min	572545	VMPA1-FT-NW0.5-10	10
	Pneumatic port 3, 1-40: V05		18 ... 22 l/min	572546	VMPA1-FT-NW0.7-10	10
	Pneumatic port 5, 1-40: Q05		36 ... 41 l/min	572547	VMPA1-FT-NW1.0-10	10
	Pneumatic port 3, 1-40: V07		52 ... 58 l/min	572548	VMPA1-FT-NW1.2-10	10
	Pneumatic port 5, 1-40: Q07		81 ... 89 l/min	572549	VMPA1-FT-NW1.5-10	10
	Pneumatic port 3, 1-40: V10		105 ... 115 l/min	572550	VMPA1-FT-NW1.7-10	10
	Pneumatic port 5, 1-40: Q10					
	Pneumatic port 3, 1-40: V12					
	Pneumatic port 5, 1-40: Q12					
	Pneumatic port 3, 1-40: V15					
	Pneumatic port 5, 1-40: Q15					
	Pneumatic port 3, 1-40: V17					
	Pneumatic port 5, 1-40: Q17					
Restrictor set – width 10 mm						
	–	Fixed flow restrictor, two of each size, two retainers and one assembly tool		572543	VMPA1-FT-NW0.3-1.7	14
Retainer for fixed flow restrictor – Width 10 mm						
	–	Retainer for exhaust outlet in the port plate		572542	VMPA1-FTI-10	10

1) Packaging unit.

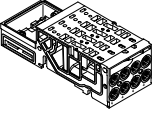
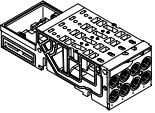
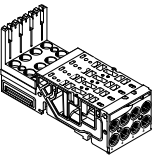
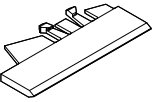
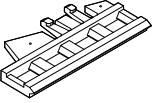
Accessories

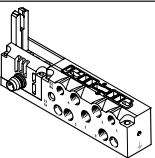
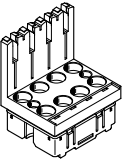
Ordering data		Code	Description	Part no.	Type
Sub-base – width 10 mm					
	-	For multi-pin plug/fieldbus, four valve positions, no electrical interlinking module	No duct separation	533352	VMPA1-FB-AP-4-1
			Duct 1 blocked	538657	VMPA1-FB-AP-4-1-T1
			Duct 1 blocked and duct 3/5 blocked	555901	VMPA1-FB-AP-4-1-S1
Sub-bases with check valve in duct 3 and 5 – width 10 mm					
	-	For multi-pin plug/fieldbus, four valve positions, no electrical interlinking module	No duct separation	8034547	VMPA1-FB-AP-4-1-RV
			Duct 1 blocked	8034549	VMPA1-FB-AP-4-1-T1-RV
			Duct 1 blocked and duct 3/5 blocked	8034551	VMPA1-FB-AP-4-1-S1-RV
Sub-base – including electrical interlinking and electronics modules – width 10 mm					
	-	For fieldbus	Four valve positions	546802	VMPA1-AP-4-1-EMS-8
		For multi-pin plug	Four solenoid coils	546806	VMPA1-AP-4-1-EMM-4
			Eight solenoid coils	546804	VMPA1-AP-4-1-EMM-8
				8157743	VMPA1-AP-4-EMM-8-SK
				8157744	VMPA1-AP-4-EMM-8-SL
		For fieldbus	Eight solenoid coils	8157739	VMPA1-AP-4-EMG-8-S
	8157740	VMPA1-AP-4-EMG-D2-8-S			
Inscription label holder for sub-base – width 10 mm					
	-	For foil Inscription label holder for sub-base, transparent, for paper foil label		533362	VMPA1-ST-1-4
	-	For IBS Inscription label holder for sub-base, 4-fold, for IBS-6x10		544384	VMPA1-ST-2-4
	-	Inscription labels, 6 x 10 in frames, pack of 64		18576	IBS-6x10
Sub-base – width 10 mm					
	-	For individual connection, without ATEX specification	Internal pilot air	533394	VMPA1-IC-AP-1
			External pilot air	533395	VMPA1-IC-AP-S-1
		For individual connection, with ATEX specification: II 3G Ex nA IIC T4 XGc	Internal pilot air	8005149	VMPA1-IC-AP-1-EX1E
			External pilot air	8005150	VMPA1-IC-AP-S-1-EX1E
Electronics module – width 10 mm					
	-	For fieldbus connection, without separate circuit	8 coils	533360	VMPA1-FB-EMS-8
		For fieldbus connection, with separate circuit	8 coils	533361	VMPA1-FB-EMG-8
				8108543	VMPA1-FB-EM-8-S
		For fieldbus connection, with enhanced diagnostic function, without separate circuit	8 coils	543331	VMPA1-FB-EMS-D2-8
		For fieldbus connection, with enhanced diagnostic function, with separate circuit	8 coils	543333	VMPA1-FB-EMG-D2-8
				8108545	VMPA1-FB-EMG-D2-8-S
For multi-pin plug connection	4 coils	537987	VMPA1-MPM-EMM-4		
	8 coils	537988	VMPA1-MPM-EMM-8		



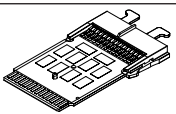
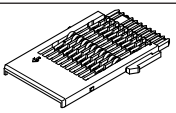

Accessories

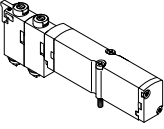
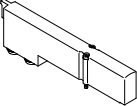
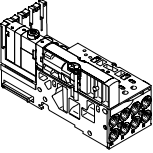
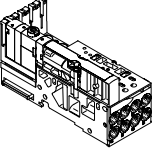
Ordering data	Code	Description	Part no.	Type	
Electrical interlinking module – width 10 mm					
	–	For a multi-pin connection and AS-Interface for a sub-base	4 coils	537993	VMPA1-MPM-EV-AB-4
			8 coils	537994	VMPA1-MPM-EV-AB-8
	–	For multi-pin plug connection and AS-Interface for a sub-base with pneumatic supply plate (on the left next to the sub-base)	4 coils	537995	VMPA1-MPM-EV-ABV-4
			8 coils	537996	VMPA1-MPM-EV-ABV-8
	–	For fieldbus connection and CPI, for sub-bases MPA size 1 and 2 and proportional pressure regulator	537998	VMPA1-FB-EV-AB	
		For fieldbus connection and CPI for a pneumatic supply plate	537999	VMPA1-FB-EV-V	

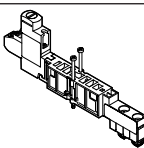
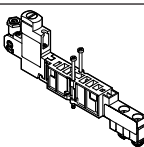
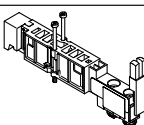
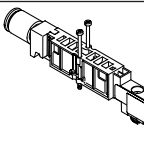
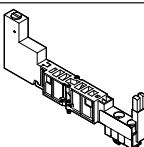

Accessories

Ordering data		Code	Valve function	Part no.	Type
Individual solenoid valve – width 14 mm					
	5/2-way valve				
	Position function 1-32: M	Single solenoid	573718	VMPA14-M1H-M-PI	
	Position function 1-32: MS	Single solenoid, mechanical spring return	573974	VMPA14-M1H-MS-PI	
	Position function 1-32: J	Double solenoid	573717	VMPA14-M1H-J-PI	
	2x 3/2-way valve				
	Position function 1-32: N	Normally open	573725	VMPA14-M1H-N-PI	
	Position function 1-32: NS	Normally open, mechanical spring return	575977	VMPA14-M1H-NS-PI	
	Position function 1-32: K	Normally closed	573724	VMPA14-M1H-K-PI	
	Position function 1-32: KS	normally closed, mechanical spring return	575976	VMPA14-M1H-KS-PI	
	Position function 1-32: H	1x normally open, 1x normally closed	573726	VMPA14-M1H-H-PI	
	Position function 1-32: HS	1x normally open, 1x normally closed, mechanical spring return	575979	VMPA14-M1H-HS-PI	
	5/3-way valve				
	Position function 1-32: B	Mid-position pressurised	573719	VMPA14-M1H-B-PI	
	Position function 1-32: G	Mid-position closed	573721	VMPA14-M1H-G-PI	
	Position function 1-32: E	Mid-position exhausted	573720	VMPA14-M1H-E-PI	
	3/2-way valve				
	Position function 1-32: W	Normally open, external compressed air supply	573723	VMPA14-M1H-W-PI	
	Position function 1-32: X	Normally closed, external compressed air supply	573722	VMPA14-M1H-X-PI	
	2x 2/2-way valve				
	Position function 1-32: D	Normally closed	573727	VMPA14-M1H-D-PI	
Position function 1-32: DS	normally closed, mechanical spring return	575978	VMPA14-M1H-DS-PI		
Position function 1-32: I	1x normally closed, 1x normally closed, reversible only	573728	VMPA14-M1H-I-PI		
Vacant position – width 14 mm					
	Position function 1-32: L	Cover plate for a valve position in width 14 mm A self-adhesive label is supplied.	573729	VMPA14-RP	
Pilot air switching valve – Width 14 mm					
	Valve positions 0-64	3/2-way pilot air switching valve, internal pilot air supply via duct 1 of the pressure zone	8126785	VMPA14-M1H-IS-PI	
		3/2-way pilot air switching valve, internal pilot air supply via duct 1 of the pressure zone, with pilot air detection via sensor, external, M8 plug connection	8126787	VMPA14-M1H-IU-PI	
	Valve positions 0-64	3/2-way pilot air switching valve, external pilot air supply via duct 2 of manifold block	8126786	VMPA14-M1H-ES-PI	
		3/2-way pilot air switching valve, external pilot air supply via duct 2 of the manifold block, with pilot air detection via sensor, external, M8 plug connection	8126788	VMPA14-M1H-EU-PI	

Accessories

Ordering data		Code	Description	Part no.	Type	
Vertical stacking modules – width 14 mm						
	Pressure regulator 1-32: PF	Optional pressure gauge possible	Pressure regulator for 1	0.5 ... 6 bar	8043342	VMPA14-B8-R1C2-C-06
	Pressure regulator 1-32: PA			0.5 ... 8.5 bar	8043339	VMPA14-B8-R1C2-C-10
	Pressure regulator 1-32: PH		Pressure regulator for 2	2 ... 6 bar	8043343	VMPA14-B8-R2C2-C-06
	Pressure regulator 1-32: PC			2 ... 6 bar	8043340	VMPA14-B8-R2C2-C-10
	Pressure regulator 1-32: PG		Pressure regulator for 4	2 ... 6 bar	8043344	VMPA14-B8-R3C2-C-06
	Pressure regulator 1-32: PB			2 ... 6 bar	8043341	VMPA14-B8-R3C2-C-10
	Pressure regulator 1-32: PF	–	Pressure regulator for 1	0.5 ... 6 bar	8043518	VMPA14-B8-R1-M5-06
	Pressure regulator 1-32: PA			0.5 ... 8.5 bar	8043515	VMPA14-B8-R1-M5-10
	Pressure regulator 1-32: PH		Pressure regulator for 2	2 ... 6 bar	8043519	VMPA14-B8-R2-M5-06
	Pressure regulator 1-32: PC			2 ... 6 bar	8043516	VMPA14-B8-R2-M5-10
	Pressure regulator 1-32: PG		Pressure regulator for 4	2 ... 6 bar	8043520	VMPA14-B8-R3-M5-06
	Pressure regulator 1-32: PB			2 ... 6 bar	8043517	VMPA14-B8-R3-M5-10
	Pressure regulator 1-32: PV	Vertical pressure supply plate	Connecting thread	G1/8	8110621	VMPA14-VSP-0
				With fitting for tubing O.D.	6 mm	8110627
8 mm	8110622	VMPA14-VSP-QS8				
10 mm	8110625	VMPA14-VSP-QS10				
1/4"	8110626	VMPA14-VSP-QS1/4				
5/16"	8110624	VMPA14-VSP-QS5/16				
				3/8"	8110623	VMPA14-VSP-QS3/8
	Pressure regulator 1-32: PS	Vertical pressure shut-off plate For manually disconnecting an individual valve from the compressed air supply of the valve terminal (duct 1 and 12/14 pilot air supply), operating pressure 3 ... 8, internal pilot air supply			8110429	VMPA14-HS
	Pressure gauge 1-32: VE	Screw-in pressure gauge with M5 thread for pressure regulator plate with swivelling threaded connection	Unit of measure: bar	132340	MA-15-10-M5	
	Pressure gauge 1-32: VD		Unit of measure: psi	132341	MA-15-145-M5-PSI	
	Pressure gauge 1-32: VC	Push-in fitting, self-sealing, with M5 thread for pressure regulator plate		153291	QSK-M5-4	
Check valve – width 14 mm						
	–	Check valve for installation in duct 3 or 5 (scope of delivery: 10 check valves, one assembly tool)		8039820	VMPA14-RV	

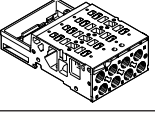
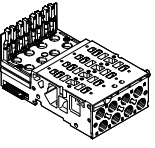
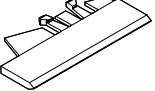
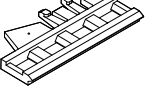
Accessories

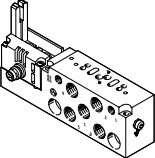
Ordering data		Code	Description	Part no.	Type
Sub-base – width 14 mm					
	-	For multi-pin plug/fieldbus, four valve positions, no electrical interlinking module	No duct separation	8074666	VMPA14-FB-AP-4-1
			Duct 1 blocked	8043928	VMPA14-FB-AP-4-1-T1
			Duct 1 blocked and duct 3/5 blocked	8043929	VMPA14-FB-AP-4-1-S1
Sub-base – including electrical interlinking and electronics modules – width 14 mm					
	-	For fieldbus	Four valve positions	8066778	VMPA14-AP-4-1-EMS-8
			For multi-pin plug	Four solenoid coils	8066779
		For multi-pin plug	Eight solenoid coils	8066780	VMPA14-AP-4-1-EMM-8
				8157745	VMPA14-AP-4-EMM-8-SK
				8157746	VMPA14-AP-4-EMM-8-SL
		For fieldbus	Eight solenoid coils	8157741	VMPA14-AP-4-EMG-8-S
	8157742		VMPA14-AP-4-EMG-D2-8-S		
Inscription label holder for sub-base – width 14 mm					
	-	For foil Inscription label holder for sub-base, transparent, for paper foil label		8085996	VMPA14-ST-1-4
	-	For IBS Inscription label holder for sub-base, 4-fold, for IBS-6x10		8085997	VMPA14-ST-2-4
	-	Inscription labels, 6 x 10 in frames, pack of 64		18576	IBS-6x10
Sub-base – width 14 mm					
	-	For individual connection, without ATEX specification	Internal pilot air	8023666	VMPA14-IC-AP-1
			External pilot air	8023667	VMPA14-IC-AP-S-1
		For individual connection, with ATEX specification: II 3G Ex nA IIC T4 XGc	Internal pilot air	8023668	VMPA14-IC-AP-1-EX1E
			External pilot air	8023669	VMPA14-IC-AP-S1-EX1E



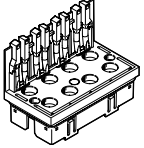
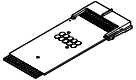
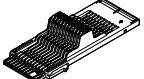

Accessories

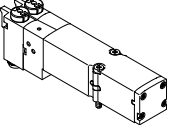
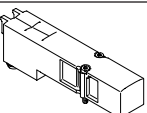
Ordering data		Code	Description	Part no.	Type
Electronics module – width 14 mm					
	–	For fieldbus connection, without separate circuit	8 coils	8066764	VMPA14-FB-EMS-8
		For fieldbus connection, with separate circuit	8 coils	8066765	VMPA14-FB-EMG-8
				8108547	VMPA14-FB-EMG-8-S
		For fieldbus connection, with enhanced diagnostic function, without separate circuit	8 coils	8066766	VMPA14-FB-EMS-D2-8
		For fieldbus connection, with enhanced diagnostic function, with separate circuit	8 coils	8066767	VMPA14-FB-EMG-D2-8
				8108549	VMPA14-FB-EMG-D2-8-S
For multi-pin plug connection	4 coils	8066768	VMPA14-MPM-EMM-4		
	8 coils	8066769	VMPA14-MPM-EMM-8		
Electrical interlinking module – width 14 mm					
	–	For a multi-pin connection and AS-Interface for a sub-base	4 coils	8066770	VMPA14-MPM-EV-AB-4
			8 coils	8066771	VMPA14-MPM-EV-AB-8
		For multi-pin plug connection and AS-Interface for a sub-base with pneumatic supply plate (on the left next to the sub-base)	4 coils	8066772	VMPA14-MPM-EV-ABV-4
			8 coils	8066773	VMPA14-MPM-EV-ABV-8
	–	For fieldbus connection and CPI, for sub-bases MPA size 14		8066774	VMPA14-FB-EV-AB

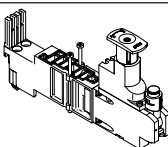
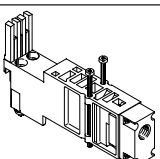
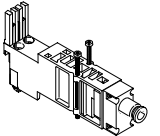

Accessories

Ordering data		Code	Valve function	Part no.	Type	
Individual solenoid valve – width 20 mm						
	5/2-way valve					
	Position function 1-32: M	Single solenoid		537952	VMPA2-M1H-M-PI	
	Position function 1-32: MS	Single solenoid, mechanical spring return		571333	VMPA2-M1H-MS-PI	
	Position function 1-32: J	Double solenoid		537953	VMPA2-M1H-J-PI	
	2x 3/2-way valve					
	Position function 1-32: N	Normally open		537958	VMPA2-M1H-N-PI	
	Position function 1-32: NS	Normally open, mechanical spring return		568655	VMPA2-M1H-NS-PI	
	Position function 1-32: K	Normally closed		537957	VMPA2-M1H-K-PI	
	Position function 1-32: KS	normally closed, mechanical spring return		568656	VMPA2-M1H-KS-PI	
	Position function 1-32: H	1x normally open, 1x normally closed		537959	VMPA2-M1H-H-PI	
	Position function 1-32: HS	1x normally open, 1x normally closed, mechanical spring return		568658	VMPA2-M1H-HS-PI	
	5/3-way valve					
	Position function 1-32: B	Mid-position pressurised		537954	VMPA2-M1H-B-PI	
	Position function 1-32: G	Mid-position closed		537955	VMPA2-M1H-G-PI	
	Position function 1-32: E	Mid-position exhausted		537956	VMPA2-M1H-E-PI	
	1x 3/2-way valve					
	Position function 1-32: W	Normally open, external compressed air supply		540051	VMPA2-M1H-W-PI	
	Position function 1-32: X	Normally closed, external compressed air supply		537961	VMPA2-M1H-X-PI	
	2x 2/2-way valve					
Position function 1-32: D	Normally closed		537960	VMPA2-M1H-D-PI		
Position function 1-32: DS	normally closed, mechanical spring return		568657	VMPA2-M1H-DS-PI		
Position function 1-32: I	1x normally closed, 1x normally closed, reversible only		543703	VMPA2-M1H-I-PI		
Vacant position – width 20 mm						
	Position function 1-32: L	Cover plate for a valve position in width 20 mm A self-adhesive label is supplied.		537962	VMPA2-RP	

Accessories

Ordering data		Code	Valve function	Part no.	Type		
Vertical stacking modules – width 20 mm							
	Pressure regulator 1-32: PA	Pressure regulator plate (with 10 mm cartridge connection for pressure gauge)	For port 1	0.5 ... 8.5 bar	543342	VMPA2-B8-R1C2-C-10	
	Pressure regulator 1-32: PF			0.5 ... 8.5 bar	549055	VMPA2-B8-R1C2-C-06	
	Pressure regulator 1-32: PC		For port 2	2 ... 8.5 bar	543343	VMPA2-B8-R2C2-C-10	
	Pressure regulator 1-32: PH			2 ... 8.5 bar	549056	VMPA2-B8-R2C2-C-06	
	Pressure regulator 1-32: PB		For port 4	2 ... 8.5 bar	543344	VMPA2-B8-R3C2-C-10	
	Pressure regulator 1-32: PG			2 ... 8.5 bar	549057	VMPA2-B8-R3C2-C-06	
	Pressure regulator 1-32: PL		For port 2, reversible	0.5 ... 8.5 bar	543347	VMPA2-B8-R6C2-C-10	
	Pressure regulator 1-32: PN			0.5 ... 6 bar	549113	VMPA2-B8-R6C2-C-06	
	Pressure regulator 1-32: PK		For port 4, reversible	0.5 ... 8.5 bar	543348	VMPA2-B8-R7C2-C-10	
	Pressure regulator 1-32: PM			0.5 ... 6 bar	549114	VMPA2-B8-R7C2-C-06	
	Pressure regulator 1-32: PV	Vertical pressure supply plate	Connecting thread	G1/8	8029486	VMPA2-VSP-0	
				With fitting for tubing O.D.	6 mm	8035441	VMPA2-VSP-QS6
			8 mm		8029488	VMPA2-VSP-QS8	
			10 mm		8029489	VMPA2-VSP-QS10	
			1/4"		8035442	VMPA2-VSP-QS1/4	
5/16"	8029491	VMPA2-VSP-QS5/16					
	Pressure gauge 1-32: T	Pressure gauge, 10 mm cartridge connection, for pressure regulator plate	Display unit bar/psi	0 ... 16 bar	543487	PAGN-26-16-P10	
	–			0 ... 10 bar	543488	PAGN-26-10-P10	
			–	Display unit MPa	0 ... 1.0 MPa	563736	PAGN-26-1M-P10
					0 ... 1.6 MPa	563735	PAGN-26-1.6M-P10
	Pressure gauge 1-32: VF	Threaded adapter for cartridge connection 10 mm to thread G1/8		565811	QSP10-G1/8		
Check valve – width 20 mm							
	–	Check valve for installation in duct 3 or 5 (scope of delivery: 10 check valves, one assembly tool)		8039821	VMPA2-RV		

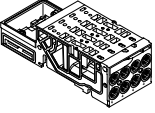
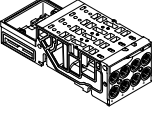
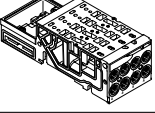
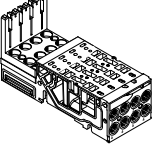
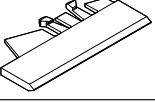
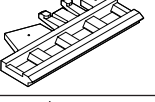
Accessories

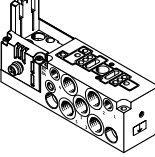
Ordering data		Code	Description	Part no.	Type
Sub-base – width 20 mm					
	-	For multi-pin plug/fieldbus, two valve positions, no electrical interlinking module	No duct separation	538000	VMPA2-FB-AP-2-1
			Duct 1 blocked	538677	VMPA2-FB-AP-2-1-T0
			Duct 1 blocked and duct 3/5 blocked	555902	VMPA2-FB-AP-2-1-S0
Sub-bases for check valves – width 20 mm					
	-	For multi-pin plug/fieldbus, two valve positions, no electrical interlinking module	No duct separation	578863	VMPA2-FB-APF-2-1
			Duct 1 blocked	578864	VMPA2-FB-APF-2-1-T0
			Duct 1 blocked and duct 3/5 blocked	578865	VMPA2-FB-APF-2-1-S0
Sub-bases with check valve in duct 3 and 5 – width 20 mm					
	-	For multi-pin plug/fieldbus, two valve positions, no electrical interlinking module	No duct separation	8034548	VMPA2-FB-AP-2-1-RV
			Duct 1 blocked	8034550	VMPA2-FB-AP-2-1-T0-RV
			Duct 1 blocked and duct 3/5 blocked	8034552	VMPA2-FB-AP-2-1-S0-RV
Sub-base – including electrical interlinking and electronics modules – width 20 mm					
	-	For fieldbus	Two valve positions	546803	VMPA2-AP-2-1-EMS-4
		For multi-pin plug	Two solenoid coils	546807	VMPA2-AP-2-1-EMM-2
			Four solenoid coils	546805	VMPA2-AP-2-1-EMM-4
Inscription label holder for sub-base – width 20 mm					
	-	For foil Inscription label holder for sub-base, transparent, for paper foil label		533362	VMPA1-ST-1-4
	-	For IBS Inscription label holder for sub-base, 4-fold, for IBS-6x10		544384	VMPA1-ST-2-4
	-	Inscription labels, 6 x 10 in frames, pack of 64		18576	IBS-6x10
Sub-base – width 20 mm					
	-	For individual connection, without ATEX specification	Internal pilot air	537981	VMPA2-IC-AP-1
			External pilot air	537982	VMPA2-IC-AP-S-1
		For individual connection, with ATEX specification: II 3G Ex nA IIC T4 XGc	Internal pilot air	8005151	VMPA2-IC-AP-1-EX1E
			External pilot air	8005152	VMPA2-IC-AP-S-1-EX1E

Accessories

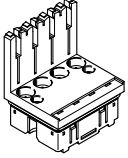
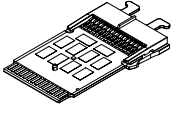
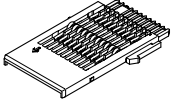
Ordering data					
	Code	Description		Part no.	Type
Electronics module – width 20 mm					
	–	For fieldbus connection, without separate circuit	4 coils	537983	VMPA2-FB-EMS-4
		For fieldbus connection, with separate circuit	4 coils	537984	VMPA2-FB-EMG-4
		For fieldbus connection, with enhanced diagnostic function, without separate circuit	4 coils	543332	VMPA2-FB-EMS-D2-4
		For fieldbus connection, with enhanced diagnostic function, with separate circuit	4 coils	543334	VMPA2-FB-EMG-D2-4
		For multi-pin plug connection	2 coils	537985	VMPA2-MPM-EMM-2
			8 coils	537986	VMPA2-MPM-EMM-4
Electrical interlinking module – width 20 mm					
	–	For a multi-pin connection and AS-Interface for a sub-base	2 coils	537989	VMPA2-MPM-EV-AB-2
			4 coils	537993	VMPA1-MPM-EV-AB-4
		For multi-pin plug connection and AS-Interface for a sub-base with pneumatic supply plate (on the left next to the sub-base)	2 coils	537991	VMPA2-MPM-EV-ABV-2
			4 coils	537995	VMPA1-MPM-EV-ABV-4
	–	For fieldbus connection and CPI, for sub-bases MPA size 1 and 2 and proportional pressure regulator		537998	VMPA1-FB-EV-AB
		For fieldbus connection and CPI for a pneumatic supply plate		537999	VMPA1-FB-EV-V

Accessories

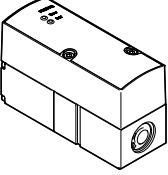

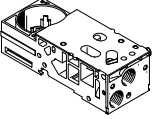
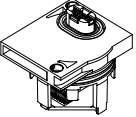

Ordering data						
	Code	Pressure regulation range	Input pressure 1	Full-scale linearity error	Part no.	Type
Proportional-pressure regulator						
	QA	0.002 ... 0.2 MPa	0 ... 0.4 MPa	2%	542220	VPPM-6TA-L-1-F-0L2H
	QD	0.002 ... 0.2 MPa	0 ... 0.4 MPa	1%	542217	VPPM-6TA-L-1-F-0L2H-S1
	QL	0.002 ... 0.2 MPa	0 ... 0.4 MPa	1%	572407	VPPM-8TA-L-1-F-0L2H-S1C1
	QG	0.002 ... 0.2 MPa	0 ... 0.4 MPa	2%	572410	VPPM-8TA-L-1-F-0L2H-C1
	QB	0.006 ... 0.6 MPa	0 ... 0.8 MPa	2%	542221	VPPM-6TA-L-1-F-0L6H
	QE	0.006 ... 0.6 MPa	0 ... 0.8 MPa	1%	542218	VPPM-6TA-L-1-F-0L6H-S1
	QM	0.006 ... 0.6 MPa	0 ... 0.8 MPa	1%	572408	VPPM-8TA-L-1-F-0L6H-S1C1
	QH	0.006 ... 0.6 MPa	0 ... 0.8 MPa	2%	572411	VPPM-8TA-L-1-F-0L6H-C1
	QC	0.01 ... 1 MPa	0 ... 1.1 MPa	2%	542222	VPPM-6TA-L-1-F-0L10H
	QF	0.01 ... 1 MPa	0 ... 1.1 MPa	1%	542219	VPPM-6TA-L-1-F-0L10H-S1
	QN	0.01 ... 1 MPa	0 ... 1.1 MPa	1%	572409	VPPM-8TA-L-1-F-0L10H-S1C1
QK	0.01 ... 1 MPa	0 ... 1.1 MPa	2%	572412	VPPM-8TA-L-1-F-0L10H-C1	

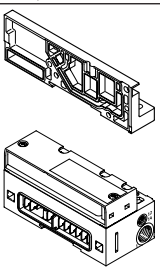
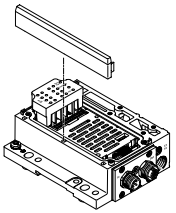
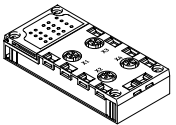
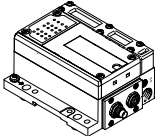
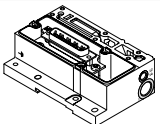
Ordering data			
Designation		Part no.	Type
Sub-base for proportional pressure regulator			
	without electrical interlinking module and without electronics module	542223	VMPA-FB-AP-P1
Electronics module for proportional pressure regulator			
	-	542224	VMPA-FB-EMG-P1

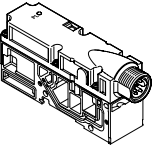
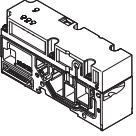
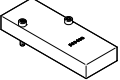

Accessories

Ordering data				Part no.	Type	
Designation						
End plate and fieldbus pneumatic interface						
	End plate, right	with port 82/84 for ducted exhaust air (M5 connecting thread)	–	8029133	VMPA-EPR-G	
		Without port 82/84	–	533373	VMPA-EPR	
	Pneumatic interface	Ducted exhaust air, internal pilot air	For CPX plastic interlinking block		533370	VMPA-FB-EPL-G
			For CPX metal interlinking block		552286	VMPA-FB-EPLM-G
		Ducted exhaust air, external pilot air	For CPX plastic interlinking block		533369	VMPA-FB-EPL-E
			For CPX metal interlinking block		552285	VMPA-FB-EPLM-E
		Flat plate silencer, internal pilot air	For CPX plastic interlinking block		533372	VMPA-FB-EPL-GU
			For CPX metal interlinking block		552288	VMPA-FB-EPLM-GU
	Flat plate silencer, external pilot air	For CPX plastic interlinking block		533371	VMPA-FB-EPL-EU	
		For CPX metal interlinking block		552287	VMPA-FB-EPLM-EU	
Electrical interface for AS-Interface						
	4 inputs/4 outputs, to spec. 2.1	Internal pilot air	Ducted exhaust air	546989	VMPA-ASI-EPL-G-4E4A-Z	
			Silencer	546991	VMPA-ASI-EPL-GU-4E4A-Z	
		External pilot air	Ducted exhaust air	546988	VMPA-ASI-EPL-E-4E4A-Z	
			Silencer	546990	VMPA-ASI-EPL-EU-4E4A-Z	
	8 inputs/8 outputs, to spec. 2.1	Internal pilot air	Ducted exhaust air	546993	VMPA-ASI-EPL-G-8E8A-Z	
			Silencer	546995	VMPA-ASI-EPL-GU-8E8A-Z	
		External pilot air	Ducted exhaust air	546992	VMPA-ASI-EPL-E-8E8A-Z	
			Silencer	546994	VMPA-ASI-EPL-EU-8E8A-Z	
	8 inputs/8 outputs, to spec. 3.0, expanded addressing range	Internal pilot air	Ducted exhaust air	573184	VMPA-ASI-EPL-G-8E8A-CE	
			Silencer	573186	VMPA-ASI-EPL-GU-8E8A-CE	
		External pilot air	Ducted exhaust air	573183	VMPA-ASI-EPL-E-8E8A-CE	
			Silencer	573185	VMPA-ASI-EPL-EU-8E8A-CE	
Manifold block for AS-Interface						
	Socket M12, 5-pin			195704	CPX-AB-4-M12X2-5POL	
	M8 socket, 3-pin			195706	CPX-AB-8-M8-3POL	
	Spring-loaded terminals, 32-pin			195708	CPX-AB-8-KL-4POL	
	Socket, Sub-D, 25-pin			525676	CPX-AB-1-SUB-BU-25POL	
Electrical interface for CPI						
	External pilot air	Ducted exhaust air		546983	VMPA-CPI-EPL-E	
		Silencer		546985	VMPA-CPI-EPL-EU	
	Internal pilot air	Ducted exhaust air		546984	VMPA-CPI-EPL-G	
		Silencer		546986	VMPA-CPI-EPL-GU	
Electrical interface for multi-pin plug connection						
	External pilot air	Ducted exhaust air		540893	VMPA1-MPM-EPL-E	
		Silencer		540895	VMPA1-MPM-EPL-EU	
	Internal pilot air	Ducted exhaust air		540894	VMPA1-MPM-EPL-G	
		Silencer		540896	VMPA1-MPM-EPL-GU	

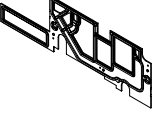

Accessories

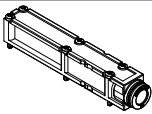
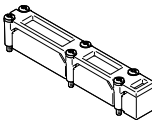
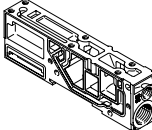
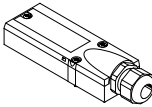
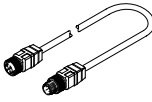
Ordering data		Part no.	Type	
Designation				
Electrical supply plate				
	Plug connection M18, 3-pin	541082	VMPA-FB-SP-V	
	Plug connection 7/8", 5-pin	541083	VMPA-FB-SP-7/8-V-5POL	
	Plug connection 7/8", 4-pin	541084	VMPA-FB-SP-7/8-V-4POL	
Pressure sensor				
	For monitoring the operating pressure in duct 1	541085	VMPA-FB-PS-1	
	For monitoring the pressure in exhaust ducts 3 and 5	541086	VMPA-FB-PS-3/5	
	For monitoring an external process pressure	541087	VMPA-FB-PS-P1	
Covering				
	Cover plate	559638	VMPA-P-RP	
	Cover cap for manual override with coded cover cap, manual override non-detenting (10 pieces)	540897	VMPA-HBT-B	
	Cover cap for manual override, concealed, manual override blocked (pack of 10)	540898	VMPA-HBV-B	
	Cover cap for manual override, manual override detenting, can be operated manually without accessories (pack of 10)	8002234	VAMC-L1-CD	
	Inscription label holder for inscription label and cover for signal status indication and manual override (blocked) (pack of 10)	570818	ASLR-D-L1	
Seal for sub-base				
	MPA with ducted exhaust air	No duct separation	533359	VMPA1-DP
		Duct 12/14 separated	8161482	VMPA1-DP-Y
		Duct 1 separated	533363	VMPA1-DP-P
		Duct 3/5 separated	533364	VMPA1-DP-RS
		Duct 1 and 3/5 separated	533365	VMPA1-DP-PRS
		Ducts 1, 3/5 and 12/14 separate	8161481	VMPA1-DP-PRS-Y
	MPA with flat plate silencer	No duct separation	533355	VMPA1-DPU
		Duct 1 separated	533356	VMPA1-DPU-P
		Duct 3/5 separated	533357	VMPA1-DPU-RS
		Duct 1 and 3/5 separated	533358	VMPA1-DPU-PRS

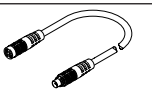
Accessories

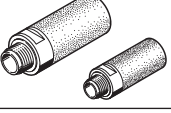
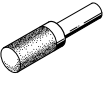

Ordering data		Part no.	Type	
Designation				
Exhaust air plate				
	Ducted exhaust air, with 10 mm push-in connector	533375	VMPA-AP	
	Ducted exhaust air, with connector QS-3/8	541629	VMPA-AP-3/8	
	Flat plate silencer	533374	VMPA-APU	
Supply plate (without exhaust plate)				
	For ducted exhaust air	533354	VMPA1-FB-SP	
	For flat plate silencer	533353	VMPA1-FB-SPU	
Multi-pin plug connection, electrical				
	Cover without connecting cable, for self-assembly	533198	VMPA-KMS-H	
	PVC connecting cable for 8 solenoid coils	2.5 m	533195	VMPA-KMS1-8-2.5
		5 m	533196	VMPA-KMS1-8-5
		10 m	533197	VMPA-KMS1-8-10
	PVC connecting cable for 24 solenoid coils	2.5 m	533192	VMPA-KMS1-24-2.5
		5 m	533193	VMPA-KMS1-24-5
		10 m	533194	VMPA-KMS1-24-10
	PUR connecting cable for 8 solenoid coils, suitable for energy chains	2.5 m	533504	VMPA-KMS2-8-2.5-PUR
		5 m	533505	VMPA-KMS2-8-5-PUR
		10 m	533506	VMPA-KMS2-8-10-PUR
	PUR connecting cable for 24 solenoid coils, suitable for energy chains	2.5 m	533501	VMPA-KMS2-24-2.5-PUR
		5 m	533502	VMPA-KMS2-24-5-PUR
10 m		533503	VMPA-KMS2-24-10-PUR	
Connecting cable, AS-Interface connection				
	<ul style="list-style-type: none"> Straight socket, M12 x 1, 5-pin, A-coded Straight plug, M12 x 1, 4-pin, A-coded 	0.5 m	8000208	NEBU-M12G5-K-0.5-M12G4
	Modular system for a choice of connecting cables		-	→ Internet: nebu
Connecting cable, CPI connection				
	<ul style="list-style-type: none"> Angled plug, 5-pin Angled socket, 5-pin 	0.25 m	540327	KVI-CP-3-WS-WD-0.25
		0.5 m	540328	KVI-CP-3-WS-WD-0.5
		2 m	540329	KVI-CP-3-WS-WD-2
		5 m	540330	KVI-CP-3-WS-WD-5
		8 m	540331	KVI-CP-3-WS-WD-8
	<ul style="list-style-type: none"> Straight plug, 5-pin Straight socket, 5-pin 	2 m	540332	KVI-CP-3-GS-GD-2
		5 m	540333	KVI-CP-3-GS-GD-5
		8 m	540334	KVI-CP-3-GS-GD-8

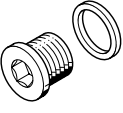
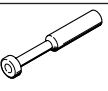
Accessories

Ordering data		Size	Part no.	Type	PU ¹⁾	
Designation						
Push-in connector for sub-base, pneumatic interface, supply plate						
	M5 connecting thread for tubing O.D.	3 mm	Mini	153313	QSM-M5-3-I	10
		4 mm	Standard	153315	QSM-M5-4-I	10
			Mini	578370	NPQH-DK-M5-Q4-P10	10
		6 mm	Standard	153317	QSM-M5-6-I	10
			Mini	578371	NPQH-DK-M5-Q6-P10	10
		5/32"	Standard	130593	QSM-M5-5/32-I-U-M	1
	183750			QSM-M5-3/16-I-U-M	1	
	130591			QSM-M5-1/4-I-U-M	50	
	M7 connecting thread for tubing O.D.	4 mm	Standard	153319	QSM-M7-4-I	10
			Mini	578372	NPQH-DK-M7-Q4-P10	10
		6 mm	Standard	153321	QSM-M7-6-I	10
			Mini	132919	QSM-M7-6-I-R-100	100
		3/16"	Standard	578373	NPQH-DK-M7-Q6-P10	10
				183739	QSM-M7-3/16-I-U-M	1
	1/4"	Standard	183740	QSM-M7-1/4-I-U-M	50	
			186107	QS-G1/8-6-I	10	
	G1/8 connecting thread for tubing O.D.	6 mm	Mini	578375	NPQH-DK-G18-Q6-P10	10
			Standard	186109	QS-G1/8-8-I	10
		8 mm	Mini	578376	NPQH-DK-G18-Q8-P10	10
			Standard	183741	QS-1/8-1/4-I-U-M	1
1/4"		Standard	183742	QS-1/8-5/16-I-U-M	1	
			186110	QS-G1/4-8-I	10	
G1/4 connecting thread for tubing O.D.	8 mm	Mini	578377	NPQH-DK-G14-Q8-P10	10	
		Standard	186112	QS-G1/4-10-I	10	
	10 mm	Mini	578378	NPQH-DK-G14-Q10-P10	10	
		Standard	183743	QS-1/4-5/16-I-U-M	1	
	5/16"	Standard	183744	QS-1/4-3/8-I-U-M	1	
			183744	QS-1/4-3/8-I-U-M	1	
Silencer						
	Connecting thread	M5		165003	UC-M5	1
		M7		161418	UC-M7	1
		G1/4		165004	UC-1/4	1
		G1/8		161419	UC-1/8	1
	Push-in sleeve connection	3 mm		165005	UC-QS-3H	1
		4 mm		165006	UC-QS-4H	1
		6 mm		165007	UC-QS-6H	1
		8 mm		175611	UC-QS-8H	1
		10 mm		526475	UC-QS-10H	1
Blanking plug						
	M5 thread			3843	B-M5	10
				578404	NPQH-BK-M5-P10	10
	M7 thread			174309	B-M7	10
				578405	NPQH-BK-M7-P10	10
	G1/8 thread			3568	B-1/8	10
				578406	NPQH-BK-G18-P10	10
	G1/4 thread			3569	B-1/4	10
				578407	NPQH-BK-G14-P10	10
Plug						
	Blanking plug for tubing O.D.	4 mm		153267	QSC-4H	10
		6 mm		153268	QSC-6H	10
		8 mm		153269	QSC-8H	10
		10 mm		153270	QSC-10H	10
		3/16"		564785	QBC-3/16H-U	10
		1/4"		564786	QBC-1/4H-U	10
		5/16"		564787	QBC-5/16H-U	10
		3/8"		564788	QBC-3/8H-U	10

1) Packaging unit.

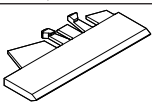
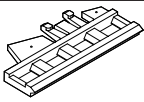
Accessories

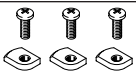
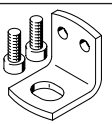
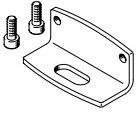
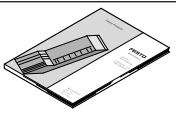
Ordering data		Part no.	Type
Designation			
Inscription labels			
	For foil Inscription label holder for sub-base, transparent, for paper foil label	Can be used for VMPA1, VMPA2	533362 VMPA1-ST-1-4
		Can be used for VMPA14	8085996 VMPA14-ST-1-4
	For IBS Inscription label holder for sub-base, 4-fold, for IBS-6x10	Can be used for VMPA1, VMPA2	544384 VMPA1-ST-2-4
		Can be used for VMPA14	8085997 VMPA14-ST-2-4
	Inscription labels, 6 x 10 in frames, pack of 64		18576 IBS-6x10
	Inscription label holder for an inscription label and a cover for the manual override, pack of 10		570818 ASLR-D-L1
Mounting			
	For H-rail		526032 CPX-CPA-BG-NRH
	Mounting (for supply plate)		534416 VMPA-BG-RW
	Mounting (for proportional pressure regulator valve sub-base)		558844 VMPA-BG
User documentation			
	MPA pneumatic components	German	534240 P.BE-MPA-DE
		English	534241 P.BE-MPA-EN
		French	534243 P.BE-MPA-FR
		Spanish	534242 P.BE-MPA-ES
		Italian	534244 P.BE-MPA-IT
	Manual – MPA electronic components (pneumatic modules, pressure sensors, proportional pressure regulators, etc.)	German	562112 P.BE-MPA-Elektronik-DE
		English	562113 P.BE-MPA-Elektronik-EN
		French	562115 P.BE-MPA-Elektronik-FR
		Spanish	562114 P.BE-MPA-Elektronik-ES
		Italian	562116 P.BE-MPA-Elektronik-IT

Festo - Your Partner in Automation



1 Festo Inc.
5300 Explorer Drive
Mississauga, ON L4W 5G4
Canada

Festo Customer Interaction Center
Tel: 1 877 463 3786
Fax: 1 877 393 3786
Email: customer.service.ca@festo.com



2 Festo Pneumatic
Av. Ceylán 3,
Col. Tequesquináhuac
54020 Tlalneantla,
Estado de México

Multinational Contact Center
01 800 337 8669
ventas.mexico@festo.com



3 Festo Corporation
1377 Motor Parkway
Suite 310
Islandia, NY 11749

Festo Customer Interaction Center
1 800 993 3786
1 800 963 3786
customer.service.us@festo.com



4 Regional Service Center
7777 Columbia Road
Mason, OH 45040

Connect with us



www.festo.com/socialmedia



www.festo.com

Subject to change