

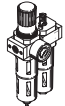

Filter regulators LFR-EX4, D series, metal

FESTO





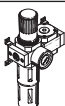
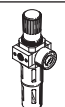
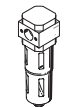
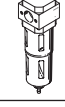
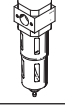
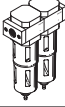
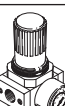

Product range overview – Service unit components, D series, metal

Type	Size	Pneumatic connection										Pressure regulation range [bar]			Grade of filtration [µm]			
		M5	M7	G1/8	G1/4	G3/8	G1/2	G3/4	G1	QS4	QS6	0.5 ...	0.5 ...	2.5 ...	0.01	1	5	40
Service units																		
 FRC/FRCS	Micro	■	■	■	-	-	-	-	-	■	■	■	-	-	-	-	■	-
	Mini	-	-	■	■	■	-	-	-	-	-	■	■	-	-	-	■	■
	Midi	-	-	-	■	■	■	■	-	-	-	■	■	-	-	-	■	■
	Maxi	-	-	-	-	-	■	■	■	-	-	■	■	-	-	-	■	■
 FRC-K	Micro	-	-	-	-	-	-	-	-	-	-	-	-	-	-	-	-	-
	Mini	-	-	■	■	-	-	-	-	-	-	■	■	-	-	-	-	■
	Midi	-	-	-	■	■	■	-	-	-	-	■	■	-	-	-	-	■
	Maxi	-	-	-	-	-	■	■	-	-	-	■	■	-	-	-	-	■
 LFR-K LFRS-K	Micro	-	-	-	-	-	-	-	-	-	-	-	-	-	-	-	-	-
	Mini	-	-	■	■	-	-	-	-	-	-	■	■	-	-	-	-	■
	Midi	-	-	-	■	■	■	-	-	-	-	■	■	-	-	-	-	■
	Maxi	-	-	-	-	-	■	■	-	-	-	■	■	-	-	-	-	■
Individual devices																		
 Filter regulators LFR/LFRS	Micro	■	■	■	-	-	-	-	-	■	■	■	-	-	-	-	■	-
	Mini	-	-	■	■	■	-	-	-	-	-	■	■	-	-	-	■	■
	Midi	-	-	-	■	■	■	■	-	-	-	■	■	-	-	-	■	■
	Maxi	-	-	-	-	-	■	■	■	-	-	■	■	-	-	-	■	■
 Filter LF	Micro	■	■	■	-	-	-	-	-	■	■	-	-	-	-	-	■	-
	Mini	-	-	■	■	■	-	-	-	-	-	-	-	-	-	-	■	■
	Midi	-	-	-	■	■	■	■	-	-	-	-	-	-	-	-	■	■
	Maxi	-	-	-	-	-	■	■	■	-	-	-	-	-	-	-	■	■
 Fine and micro filters LFMA/LFMB	Micro	-	-	-	-	-	-	-	-	-	-	-	-	-	-	-	-	-
	Mini	-	-	■	■	■	-	-	-	-	-	-	-	-	■	■	-	-
	Midi	-	-	-	■	■	■	■	-	-	-	-	-	-	■	■	-	-
	Maxi	-	-	-	-	-	■	■	■	-	-	-	-	-	■	■	-	-
 Activated carbon filters LFX	Micro	-	-	-	-	-	-	-	-	-	-	-	-	-	-	-	-	-
	Mini	-	-	■	■	■	-	-	-	-	-	-	-	-	-	-	-	-
	Midi	-	-	-	■	■	■	■	-	-	-	-	-	-	-	-	-	-
	Maxi	-	-	-	-	-	■	■	■	-	-	-	-	-	-	-	-	-
 Filter combinations LFMBA	Micro	-	-	-	-	-	-	-	-	-	-	-	-	-	-	-	-	-
	Mini	-	-	■	■	■	-	-	-	-	-	-	-	-	■	■	-	-
	Midi	-	-	-	■	■	■	■	-	-	-	-	-	-	■	■	-	-
	Maxi	-	-	-	-	-	■	■	■	-	-	-	-	-	■	■	-	-
 Pressure regulators LRS	Micro	■	■	■	-	-	-	-	-	■	■	■	-	-	-	-	-	-
	Mini	-	-	■	■	■	-	-	-	-	-	■	■	-	-	-	-	-
	Midi	-	-	-	■	■	■	■	-	-	-	■	■	-	-	-	-	-
	Maxi	-	-	-	-	-	■	■	■	-	-	■	■	-	-	-	-	-

Product range overview – Service unit components, D series, metal

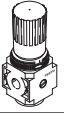
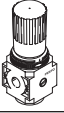
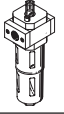
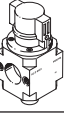
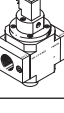
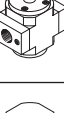
Type	Size	Bowl guard		Condensate drain			Pressure indicator		Actuator lock		Supply voltage			Options			→ Page/ Internet
		Metal bowl guard	Plastic bowl	Manual	Semi-automatic	Fully automatic	With pressure gauge	Without pressure gauge	Rotary knob with latch	Rotary knob with integrated lock	24 V DC	110 V AC	230 V AC	Directly actuated pressure regulator with integrated return flow function	Pilot actuated pressure regulator with integrated return flow function	Differential pressure display	
Service units																	
FRC/FRCS	Micro	-	■	■	■	-	■	■	■	-	-	-	-	-	-	-	frc
	Mini	■	-	■	-	■	■	■	■	■	-	-	-	-	-	-	
	Midi	■	-	■	-	■	■	■	■	■	-	-	-	-	-	-	
	Maxi	■	-	■	-	■	■	■	■	■	-	-	-	■	■	-	
FRC-K	Micro	-	-	-	-	-	-	-	-	-	-	-	-	-	-	-	frc
	Mini	■	-	■	-	■	■	-	■	-	■	-	-	-	-	-	
	Midi	■	-	■	-	■	■	-	■	-	■	-	-	-	-	-	
	Maxi	■	-	■	-	■	■	-	■	-	■	-	-	■	■	-	
LFR-K LFRS-K	Micro	-	-	-	-	-	-	-	-	-	-	-	-	-	-	-	frc
	Mini	■	-	■	-	■	■	-	■	■	■	-	-	-	-	-	
	Midi	■	-	■	-	■	■	-	■	■	■	-	-	-	-	-	
	Maxi	■	-	■	-	■	■	-	■	■	■	-	-	■	■	-	
Individual devices																	
Filter regulators LFR/LFRS	Micro	-	■	■	■	-	■	■	■	-	-	-	-	-	-	-	lfr
	Mini	■	-	■	-	■	■	■	■	■	-	-	-	-	-	-	
	Midi	■	-	■	-	■	■	■	■	■	-	-	-	-	-	-	
	Maxi	■	-	■	-	■	■	■	■	■	-	-	-	■	■	-	
Filter LF	Micro	-	■	■	■	-	-	-	-	-	-	-	-	-	-	-	lf
	Mini	■	-	■	-	■	-	-	-	-	-	-	-	-	-	-	
	Midi	■	-	■	-	■	-	-	-	-	-	-	-	-	-	-	
	Maxi	■	-	■	-	■	-	-	-	-	-	-	-	-	-	-	
Fine and micro filters LFMA/LFMB	Micro	-	-	-	-	-	-	-	-	-	-	-	-	-	-	-	lfma, lfmb
	Mini	■	-	■	-	■	-	-	-	-	-	-	-	-	-	■	
	Midi	■	-	■	-	■	-	-	-	-	-	-	-	-	-	■	
	Maxi	■	-	■	-	■	-	-	-	-	-	-	-	-	-	■	
Activated carbon filters LFX	Micro	-	-	-	-	-	-	-	-	-	-	-	-	-	-	-	lfx
	Mini	■	-	-	-	-	-	-	-	-	-	-	-	-	-	-	
	Midi	■	-	-	-	-	-	-	-	-	-	-	-	-	-	-	
	Maxi	■	-	-	-	-	-	-	-	-	-	-	-	-	-	-	
Filter combinations LFMBA	Micro	-	-	-	-	-	-	-	-	-	-	-	-	-	-	-	lfmba
	Mini	■	-	■	-	■	-	-	-	-	-	-	-	-	-	■	
	Midi	■	-	■	-	■	-	-	-	-	-	-	-	-	-	■	
	Maxi	■	-	■	-	■	-	-	-	-	-	-	-	-	-	■	
Pressure regulators LR/LRS	Micro	-	-	-	-	-	■	■	■	-	-	-	-	-	-	-	lr
	Mini	-	-	-	-	-	■	■	■	■	-	-	-	■	-	-	
	Midi	-	-	-	-	-	■	■	■	■	-	-	-	■	-	-	
	Maxi	-	-	-	-	-	■	■	■	■	-	-	-	■	■	-	

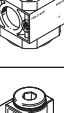
Product range overview – Service unit components, D series, metal

Type	Size	Pneumatic connection										Pressure regulation range [bar]		
		M5	M7	G1/8	G1/4	G3/8	G1/2	G3/4	G1	QS4	QS6	0.5 ... 7	0.5 ... 12	
Individual devices														
Pressure regulators LRB/LRBS		Micro	–											
		Mini	–	–	–	■	–	–	–	–	–	–	■	■
		Midi	–	–	–	–	■	–	–	–	–	–	■	■
		Maxi	–											
Pressure regulator manifolds LRB-K		Micro	–											
		Mini	–	–	–	■	■	–	–	–	–	–	■	■
		Midi	–	–	–	–	■	■	–	–	–	–	■	■
		Maxi	–											
Lubricators LOE		Micro	■	■	■	–	–	–	–	–	■	■	–	–
		Mini	–	–	■	■	■	–	–	–	–	–	–	–
		Midi	–	–	–	■	■	■	■	–	–	–	–	–
		Maxi	–	–	–	–	–	■	■	■	–	–	–	–
On/off valves HE		Micro	–											
		Mini	–	–	■	■	■	–	–	–	–	–	–	
		Midi	–	–	–	■	■	■	■	–	–	–	–	
		Maxi	–	–	–	–	–	■	■	■	–	–	–	
On/off valves HEE		Micro	–											
		Mini	–	–	■	■	■	–	–	–	–	–	–	
		Midi	–	–	–	■	■	■	■	–	–	–	–	
		Maxi	–	–	–	–	–	■	■	■	–	–	–	
On/off valves HEP		Micro	–											
		Mini	–	–	■	■	■	–	–	–	–	–	–	
		Midi	–	–	–	■	■	■	■	–	–	–	–	
		Maxi	–	–	–	–	–	■	■	■	–	–	–	
Soft-start valves HEL		Micro	–											
		Mini	–	–	■	■	■	–	–	–	–	–	–	
		Midi	–	–	–	■	■	■	■	–	–	–	–	
		Maxi	–	–	–	–	–	■	■	■	–	–	–	
Membrane air dryers LDM1		Micro	–											
		Mini	–											
		Midi	–											
		Maxi	–	–	–	–	–	■	■	■	–	–	–	
Branching modules FRM		Micro	–											
		Mini	–	–	■	■	■	–	–	–	–	–	–	
		Midi	–	–	–	■	■	■	■	–	–	–	–	
		Maxi	–	–	–	–	–	■	■	■	–	–	–	
Distributor block FRZ		Micro	–											
		Mini	–	–	–	–	–	–	–	–	–	–	–	
		Midi	–	–	–	–	–	–	–	–	–	–	–	
		Maxi	–	–	–	–	–	–	–	–	–	–	–	

Product range overview – Service unit components, D series, metal

Type	Size	Bowl guard		Pressure indicator		Actuator lock		Supply voltage			Options		→ Page/ Internet	
		Metal bowl guard	Plastic bowl	With pressure gauge	Without pressure gauge	Rotary knob with latch	Rotary knob with integrated lock	24 V DC	110 V AC	230 V AC	With non-return function	Pressure switch		
Individual devices														
Pressure regulators LRB/LRBS	Micro	-				■	■	■	-	-	-	-	-	lrb
	Mini	-	-	-		■	■	■	-	-	-	-	-	
	Midi	-	-	-		■	■	■	-	-	-	-	-	
	Maxi	-	-											
Pressure regulator manifolds LRB-K	Micro	-												lrb
	Mini	-	-	-		■	■	-	-	-	-	-	-	
	Midi	-	-	-		■	■	-	-	-	-	-	-	
	Maxi	-	-											
Lubricators LOE	Micro	-	■	-		■	-	-	-	-	-	-	-	loe
	Mini	■	-	-		■	-	-	-	-	-	-	-	
	Midi	■	-	-		■	-	-	-	-	-	-	-	
	Maxi	■	-	-		■	-	-	-	-	-	-	-	
On/off valves HE	Micro	-												he
	Mini	-	-	-		■	■	-	-	-	-	-	-	
	Midi	-	-	-		■	■	-	-	-	-	-	-	
	Maxi	-	-	-		■	■	-	-	-	-	-	-	
On/off valves HEE	Micro	-												hee
	Mini	-	-	-		■	-	-	■	■	■	-	-	
	Midi	-	-	-		■	-	-	■	■	■	-	-	
	Maxi	-	-	-		■	-	-	■	■	■	-	-	
On/off valves HEP	Micro	-												hep
	Mini	-	-	-		■	-	-	-	-	-	-	-	
	Midi	-	-	-		■	-	-	-	-	-	-	-	
	Maxi	-	-	-		■	-	-	-	-	-	-	-	
Soft-start valves HEL	Micro	-												hel
	Mini	-	-	-		■	-	-	-	-	-	-	-	
	Midi	-	-	-		■	-	-	-	-	-	-	-	
	Maxi	-	-	-		■	-	-	-	-	-	-	-	
Membrane air dryers LDM1	Micro	-												ldm1
	Mini	-												
	Midi	-												
	Maxi	■	-	-		■	-	-	-	-	-	-	-	
Branching modules FRM	Micro	-												frm
	Mini	-	-	-		■	-	-	-	-	-	■	■	
	Midi	-	-	-		■	-	-	-	-	-	■	■	
	Maxi	-	-	-		■	-	-	-	-	-	■	■	
Distributor block FRZ	Micro	-												frz
	Mini	-	-	-		■	-	-	-	-	-	-	-	
	Midi	-	-	-		■	-	-	-	-	-	-	-	
	Maxi	-	-	-		■	-	-	-	-	-	-	-	

Peripherals overview

Midi

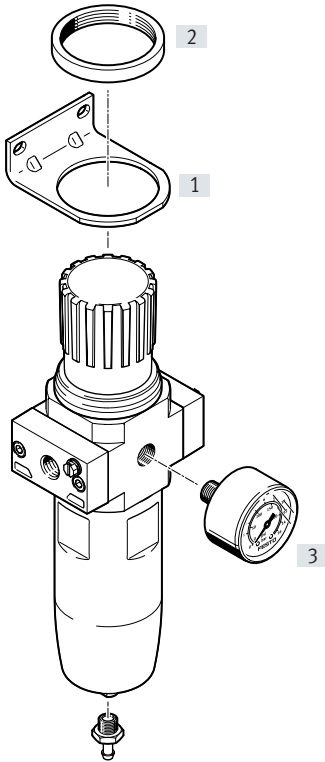

Mounting attachments and accessories

		→ Page/Internet
[1]	Mounting bracket HR-D-R3	12
[2]	Knurled nut (included in the scope of delivery) HMR	–
[3]	Pressure gauge MA	12

Type codes

001	Series
LFR	Filter regulator

002	Pneumatic connection
1/4	Female thread G1/4
1/2	Female thread G1/2
N1/2	Female thread 1/2 NPT
N1/4	Female thread 1/4 NPT

003	Version
D	D series, metal

004	Pressure regulation range
	0.5 ... 12 bar (0.05 ... 1.2 MPa)
16	0.5 ... 16 bar

005	Grade of filtration
	40 µm
5M	5 µm

006	Pressure gauge
0	Without pressure gauge

007	Size
MIDI	Grid dimension 55 mm (without connecting plates)



008	Temperature range
T3	-40 ... +80°C
T18	-20 ... +80°C

009	EU certification
EX4	II 2GD

Datasheet

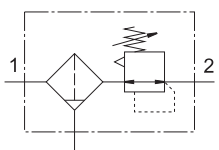
Function



-  Flow rate
1150 ... 3400 l/min
-  Temperature range
-40 ... +80°C
-  Operating pressure
1 ... 20 bar



- Space-saving design with filter and regulator in a single unit
- Good particle separation and high flow rate
- Good regulation characteristics with minimal hysteresis
- Robust housing for the specific requirements of process automation
- Suitable for use outdoors and at temperatures down to -40°C
- Resistant to UV radiation and corrosive environments
- Two pressure regulation ranges: 0.5°... 12 bar and 0.5 ... 16 bar
- Two pressure gauge connections for flexible installation
- Setting values are secured by locking the rotary knob
- Suitable for use in potentially explosive environments in zones 1 and 21
- New filter cartridges → page 12

General technical data

Size	Midi			
Pneumatic connection 1, 2 ¹⁾	G1/4	G1/2	1/4 NPT	1/2 NPT
Design	Filter regulator without pressure gauge			
Type of mounting	Via accessories In-line installation			
Mounting position	Vertical ±5°			
Grade of filtration [µm]	5 40			
Air purity class at the output	Compressed air to ISO 8573-1:2010 [6:8:4] (grade of filtration 5 µm) Compressed air to ISO 8573-1:2010 [7:8:4] (grade of filtration 40 µm) Inert gases			
Bowl guard	Integrated as metal bowl			
Condensate drain	Manual			
Actuator lock	Rotary knob with latch			
Pressure regulation range [bar]	0.5 ... 12 0.5 ... 16 (0.5 ... 12 in temperature range +60 ... +80°C)			
Max. pressure hysteresis [MPa]	0.02			
	[psi] 2.9			
Pressure indicator	Prepared for G1/4			
Max. condensate volume [cm ³]	42			

1) Connecting plates with female thread

Standard nominal flow rate $q_{nN}^{1)}$ [l/min]

Type	LFR...-T18		LFR...-T3	
Pneumatic connection 1, 2	G1/4, 1/4 NPT	G1/2, 1/2 NPT	G1/4, 1/4 NPT	G1/2, 1/2 NPT
Pressure regulation range 0.5 ... 12 bar				
Grade of filtration	40 µm	2000	3400	2000
	5 µm	1600	2600	1600
Pressure regulation range 0.5 ... 16 bar				
Grade of filtration	40 µm	1475	1970	1190
	5 µm	1370	1665	1150

1) Measured at $p_1 = 10$ bar, $p_2 = 6$ bar and $\Delta p = 1$ bar.

Datasheet

Operating and environmental conditions		
Type	LFR...-T18	LFR...-T3
Operating pressure [bar]	1 ... 20	
Operating medium	Compressed air to ISO 8573-1:2010 [-:9:-]	
	Inert gases	
LABS (PWIS) conformity	VDMA24364 zone III	
Ambient temperature [°C]	-20 ... +80	-40 ... +80
Temperature of medium [°C]	-20 ... +80	-40 ... +80
Storage temperature [°C]	-20 ... +80	-40 ... +80
Corrosion resistance class CRC ¹⁾	3	

1) Corrosion resistance class CRC 3 to Festo standard FN 940070

High corrosion stress. Outdoor exposure under moderate corrosive conditions. External visible parts with primarily functional surface requirements that are in direct contact with a normal industrial environment.

ATEX		
Type	LFR...-T18-EX4	LFR...-T3-EX4
ATEX category for gas	II 2G	
Type of ignition protection for gas	Ex h IIC T6 Gb X	
ATEX category for dust	II 2D	
Type of ignition protection for dust	Ex h IIIC T85°C Db X	
Explosion-proof ambient temperature	-20°C ≤ Ta ≤ +80°C	-40°C ≤ Ta ≤ +80°C
CE marking (see declaration of conformity) ¹⁾	To EU Explosion Protection Directive (ATEX)	
UKCA marking (see declaration of conformity) ¹⁾	To UK regulations for explosions	
Explosion protection certification outside the EU ¹⁾	EPL Db (GB)	
	EPL Gb (GB)	

1) Additional information www.festo.com/catalogue/lfr → Support/Downloads.

Weight [g]	
Size	Midi
Filter regulator LFR...-EX4	1400

Materials	
Housing	Die-cast zinc
Connecting plates	Die-cast zinc/aluminium
Regulating knob	POM
Knurled nut	Aluminium
Bowl	Wrought aluminium alloy
Seals	NBR
Note on materials	RoHS-compliant

Datasheet

Dimensions

Download CAD data → www.festo.com

Midi

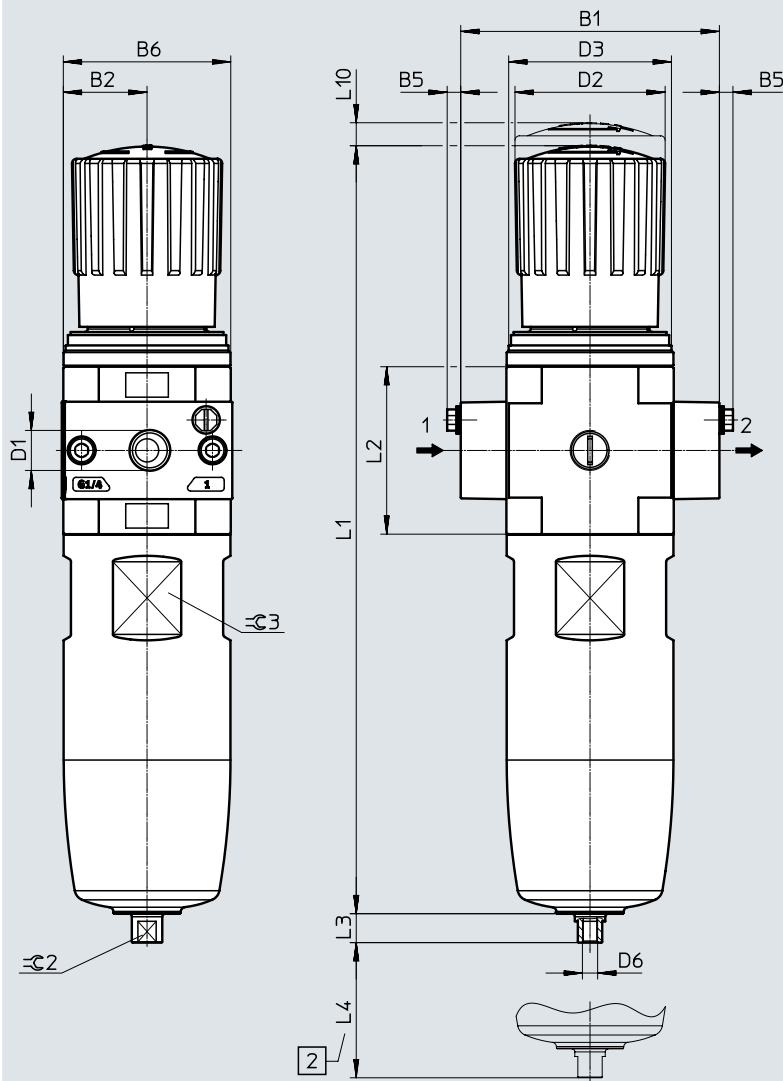

[2] Installation dimension

→ Flow direction

Type	B1	B2	B5	B6	D1	D2 ∅	D3	D6
LFR-1/4-...-MIDI	85	27.5	~4.5	55	G1/4	49	M52x1.5	M5
LFR-1/2-...-MIDI					G1/2			
LFR-N1/4-...-MIDI					1/4 NPT			
LFR-N1/2-...-MIDI					1/2 NPT			

Type	L1	L2	L3	L4 min.	L10	≅ 2	≅ 3
LFR-1/4-...-MIDI	252.5	55	9.5	80	2.5	8	50
LFR-1/2-...-MIDI							
LFR-N1/4-...-MIDI							
LFR-N1/2-...-MIDI							

† Note: This product corresponds to ISO 1179-1 and ISO 228-1.

Datasheet

Dimensions – Accessories

Download CAD data → www.festo.com

With mounting bracket HR-D-R3

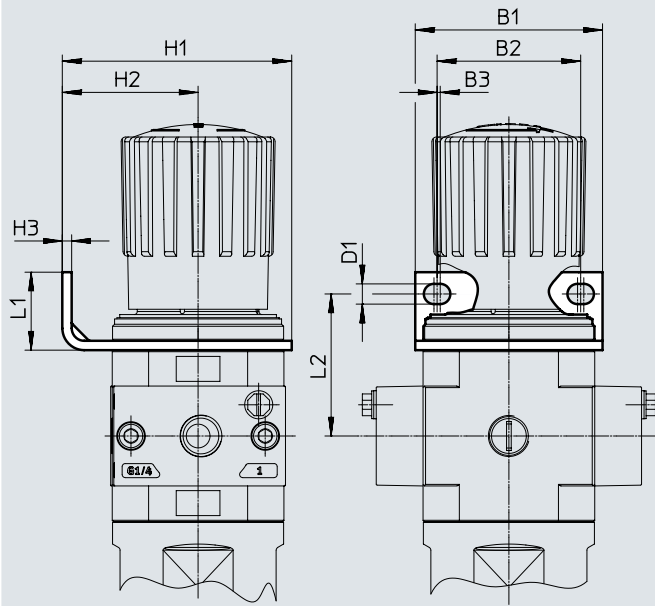
Mounting bracket HR-D-R3
→ page 12

B1	B2	B3	D1	H1	H2	H3	L1	L2
60	46	1	6.5	73.5	43.5	3	25	45.5

Ordering data

Temperature range –20 ... +80°C, rotary knob with latch, connecting plates with threaded connection

Size	Connection	Grade of filtration 5 µm		Grade of filtration 40 µm	
		Part no.	Type	Part no.	Type

Pressure regulation range 0.5 ... 12 bar

Midi	G1/4	4772764	LFR-1/4-D-5M-O-MIDI-T18-EX4	4772765	LFR-1/4-D-O-MIDI-T18-EX4
	G1/2	4772768	LFR-1/2-D-5M-O-MIDI-T18-EX4	4772769	LFR-1/2-D-O-MIDI-T18-EX4
	1/4 NPT	4772772	LFR-N1/4-D-5M-O-MIDI-T18-EX4	4772773	LFR-N1/4-D-O-MIDI-T18-EX4
	1/2 NPT	4772776	LFR-N1/2-D-5M-O-MIDI-T18-EX4	4772777	LFR-N1/2-D-O-MIDI-T18-EX4

Pressure regulation range 0.5 ... 16 bar

Midi	G1/4	4772766	LFR-1/4-D-16-5M-O-MIDI-T18-EX4	4772767	LFR-1/4-D-16-O-MIDI-T18-EX4
	G1/2	4772770	LFR-1/2-D-16-5M-O-MIDI-T18-EX4	4772771	LFR-1/2-D-16-O-MIDI-T18-EX4
	1/4 NPT	4772774	LFR-N1/4-D-16-5M-O-MIDI-T18-EX4	4772775	LFR-N1/4-D-16-O-MIDI-T18-EX4
	1/2 NPT	4772778	LFR-N1/2-D-16-5M-O-MIDI-T18-EX4	4772779	LFR-N1/2-D-16-O-MIDI-T18-EX4

Ordering data

Temperature range –40 ... +80°C, rotary knob with latch, connecting plates with threaded connection

Size	Connection	Grade of filtration 5 µm		Grade of filtration 40 µm	
		Part no.	Type	Part no.	Type

Pressure regulation range 0.5 ... 12 bar

Midi	G1/4	5271792	LFR-1/4-D-5M-O-MIDI-T3-EX4	5271793	LFR-1/4-D-O-MIDI-T3-EX4
	G1/2	5271796	LFR-1/2-D-5M-O-MIDI-T3-EX4	5271797	LFR-1/2-D-O-MIDI-T3-EX4
	1/4 NPT	5271800	LFR-N1/4-D-5M-O-MIDI-T3-EX4	5271801	LFR-N1/4-D-O-MIDI-T3-EX4
	1/2 NPT	5271804	LFR-N1/2-D-5M-O-MIDI-T3-EX4	5271805	LFR-N1/2-D-O-MIDI-T3-EX4

Pressure regulation range 0.5 ... 16 bar

Midi	G1/4	5271794	LFR-1/4-D-16-5M-O-MIDI-T3-EX4	5271795	LFR-1/4-D-16-O-MIDI-T3-EX4
	G1/2	5271798	LFR-1/2-D-16-5M-O-MIDI-T3-EX4	5271799	LFR-1/2-D-16-O-MIDI-T3-EX4
	1/4 NPT	5271802	LFR-N1/4-D-16-5M-O-MIDI-T3-EX4	5271803	LFR-N1/4-D-16-O-MIDI-T3-EX4
	1/2 NPT	5271806	LFR-N1/2-D-16-5M-O-MIDI-T3-EX4	5271807	LFR-N1/2-D-16-O-MIDI-T3-EX4

Accessories

Mounting bracket HR-D-R3

- For wall mounting an individual component

Material:
Steel

Note on materials:
RoHS-compliant

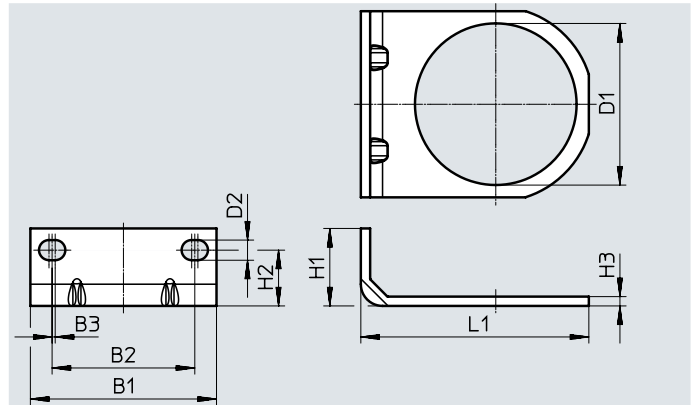

Dimensions								
B1	B2	B3	D1 ∅	D2	H1	H2	H3	L1
60	46	1	52.1	6.5	25	18	3	73.5

Ordering data				
Size	CRC ¹⁾	Weight [g]	Part no.	Type
Midi	3	73	4650310	HR-D-R3

1) Corrosion resistance class CRC 3 to Festo standard FN 940070

High corrosion stress. Outdoor exposure under moderate corrosive conditions. External visible parts with primarily functional surface requirements that are in direct contact with a normal industrial environment.

Filter cartridges, D series, metal



Ordering data			
Size	Grade of filtration [µm]	Part no.	Type
Midi	5 (colour: blue)	159594	LFP-D-MIDI-5M
	40 (colour: white)	363667	LFP-D-MIDI-40M

Ordering data – Pressure gauge MA					Datasheets → Internet: ma	
	Nominal size	Pneumatic connection	Display range		Part no.	Type
			[bar]	[psi]		
	40	G1/4	0 ... 16	0 ... 232	183901	MA-40-16-G1/4-EN
			0 ... 25	0 ... 360	183902	MA-40-25-G1/4-EN

Festo - Your Partner in Automation



1 Festo Inc.
 5300 Explorer Drive
 Mississauga, ON L4W 5G4
 Canada

Festo Customer Interaction Center
 Tel: 1 877 463 3786
 Fax: 1 877 393 3786
 Email: customer.service.ca@festo.com



2 Festo Pneumatic
 Av. Ceylán 3,
 Col. Tequesquináhuac
 54020 Tlalnepantla,
 Estado de México

Multinational Contact Center
 01 800 337 8669
ventas.mexico@festo.com



3 Festo Corporation
 1377 Motor Parkway
 Suite 310
 Islandia, NY 11749

Festo Customer Interaction Center
 1 800 993 3786
 1 800 963 3786
customer.service.us@festo.com



4 Regional Service Center
 7777 Columbia Road
 Mason, OH 45040

Connect with us



www.festo.com/socialmedia



www.festo.com

Subject to change