

Piloted check valve HGL

FESTO



Characteristics

At a glance

Shut-off valve with manual override option.

- Valve function: piloted non-return function
- Screw-in with male thread
- Pneumatically piloted
- Pilot air connection: M5, G1/8, G1/4, G3/8, QS-4
- Manually operated exhaust with separate accessories possible

Additional measures are required for use in safety-related applications; in Europe, for example, the standards listed under the EC Machinery Directive must be observed.

Product segmentation



Festo Core Range

Solves the majority of your automation tasks

With the Festo Core Range, we have selected the most important products and functions from our broad product catalogue, and added the quickest delivery. The Core Range offers you the best value with the expected high Festo quality.

- Quickest delivery, worldwide – wherever, whenever
- Expected high Festo quality
- Easy and fast to select

Diagrams

[Further information → hgl](#)



The diagrams shown in this document are also available online. These can be used to display precise values.

Type code

001	Series	
HGL	Piloted check valve	

002	Pneumatic connection 2	
M5	Male thread M5	
1/8	Male thread G1/8	
1/4	Male thread G1/4	
3/8	Male thread G3/8	
1/2	Male thread G1/2	

003	Pneumatic connection 1	
	Connection size as for port 1 or 2	
QS-4	Push-in connector 4 mm	
QS-6	Push-in connector 6 mm	
QS-8	Push-in connector 8 mm	
QS-10	Push-in connector 10 mm	
QS-12	Push-in connector 12 mm	

004	Generation	
	None	
B	Series B	

Datasheet

General technical data – Push-in connector HGL

Pneumatic connection, port 1	QS-4	QS-6	QS-8	QS-10	QS-12
Pneumatic connection, port 2	M5	G1/8	G1/4	G3/8	G1/2
Pilot air port 21	QS-4	M5	G1/8	G1/4	G3/8
Valve function	Piloted non-return function				
Type of actuation	Pneumatic				
Type of mounting	Screw-in, Via male thread				
Mounting position	optional				
Nominal torque	1.25 Nm	3.5 Nm	11 Nm	12.5 Nm	14 Nm
Tolerance for nominal tightening torque	± 10%				

General technical data – Female thread HGL

Pneumatic connection, port 1	M5	G1/8	G1/4	G3/8	G1/2
Pneumatic connection, port 2	M5	G1/8	G1/4	G3/8	G1/2
Pilot air port 21	M5	M5 G1/8	G1/8	G1/4	G3/8
Valve function	Piloted non-return function				
Type of actuation	Pneumatic				
Type of mounting	Screw-in, Via male thread				
Mounting position	optional				
Nominal torque	1.25 Nm	3.5 Nm	11 Nm	12.5 Nm	14 Nm
Tolerance for nominal tightening torque	± 10%				

Function

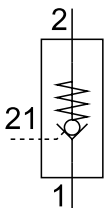

Operating and environmental conditions – Push-in connector HGL

Pneumatic connection, port 2	M5	G1/8	G1/4	G3/8	G1/2			
Pneumatic connection, port 1	QS-4	QS-6	QS-8	QS-10	QS-12			
Operating pressure	0.5 ... 10 bar							
Pilot pressure	2 ... 10 bar			1 ... 10 bar				
Operating medium	Compressed air to ISO 8573-1:2010 [7:4:4]							
Note on operating and pilot medium	Lubricated operation possible (in which case lubricated operation will always be required)							
Standard nominal flow rate 1->2 (6-5)	130 l/min	200 l/min	270 l/min	390 l/min	400 l/min	830 l/min	890 l/min	1,400 l/min
Standard flow rate 1->2 (6-0)	200 l/min	300 l/min	400 l/min	640 l/min	670 l/min	1,200 l/min	1,300 l/min	2,100 l/min
Ambient temperature	-10 ... 60°C							
Media temperature	-10 ... 60°C							
Storage temperature	-10 ... 60°C							
Corrosion resistance class CRC ¹⁾	2 - Moderate corrosion stress							
Maritime classification ²⁾	See certificate							

1) More information www.festo.com/x/topic/kbk

2) More information www.festo.com/catalogue/hgl → Support/Downloads.

Datasheet

Operating and environmental conditions – Female thread HGL

Pneumatic connection, port 2	M5	G1/8	G1/4	G3/8	G1/2
Operating pressure	0.5 ... 10 bar				
Pilot pressure	2 ... 10 bar			1 ... 10 bar	
Operating medium	Compressed air to ISO 8573-1:2010 [7:4:4]				
Note on operating and pilot medium	Lubricated operation possible (in which case lubricated operation will always be required)				
Standard nominal flow rate 1->2 (6-5)	130 l/min	300 l/min	550 l/min	1,100 l/min	1,600 l/min
Standard flow rate 1->2 (6-0)	200 l/min	430 l/min	680 l/min	1,500 l/min	2,100 l/min
Ambient temperature	-10 ... 60°C				
Media temperature	-10 ... 60°C				
Storage temperature	-10 ... 60°C				
Corrosion resistance class CRC ¹⁾	2 - Moderate corrosion stress				
Maritime classification ²⁾	See certificate				

1) More information www.festo.com/x/topic/kbk

2) More information www.festo.com/catalogue/hgl → Support/Downloads.

Materials

Material swivel fitting	Die-cast zinc
Material release ring	POM
Material hollow bolt	Wrought aluminium alloy, Anodised
Material seals	NBR
Material non-return collar	NBR
Note on materials	RoHS-compliant
LABS (PWIS) conformity	VDMA24364-B2-L
Cleanroom class	Class 4 according to ISO 14644-1

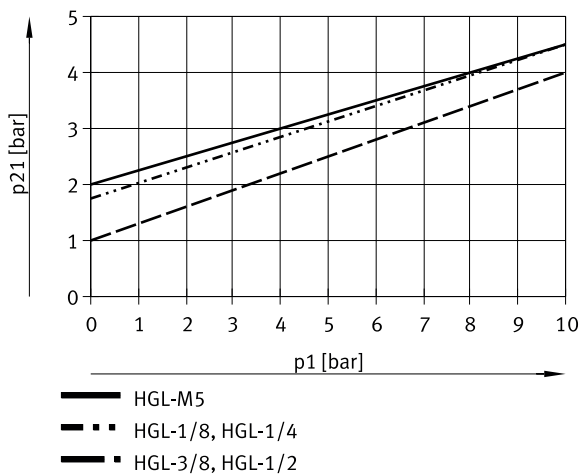
Minimum pilot pressure p₂₁ as a function of operating pressure p₁

Dimensions

Dimensions – Push-in connector HGL-M5

Download CAD data → www.festo.com

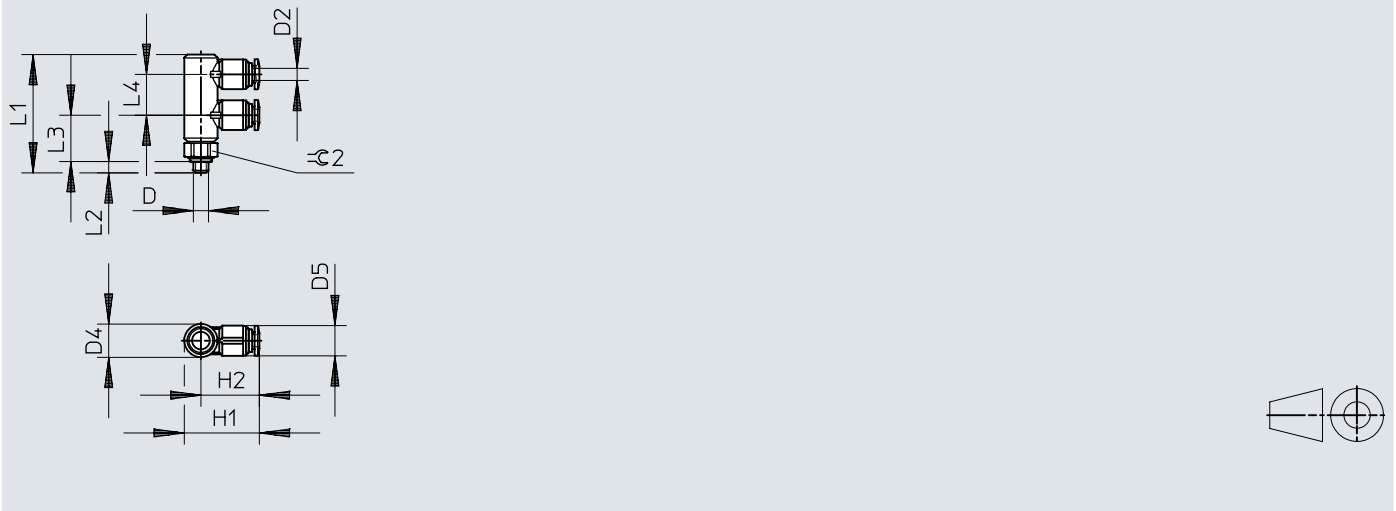

	D	D2	D4	D5	H1	H2	L1	L2	L3	L4	±0.2
HGL-M5-QS-4	M5	4	11	10	24,9	19,4	38,5	3,5	15	13,5	10

Dimensions

Dimensions – Push-in connector HGL-1/8, HGL-1/4, HGL-3/8

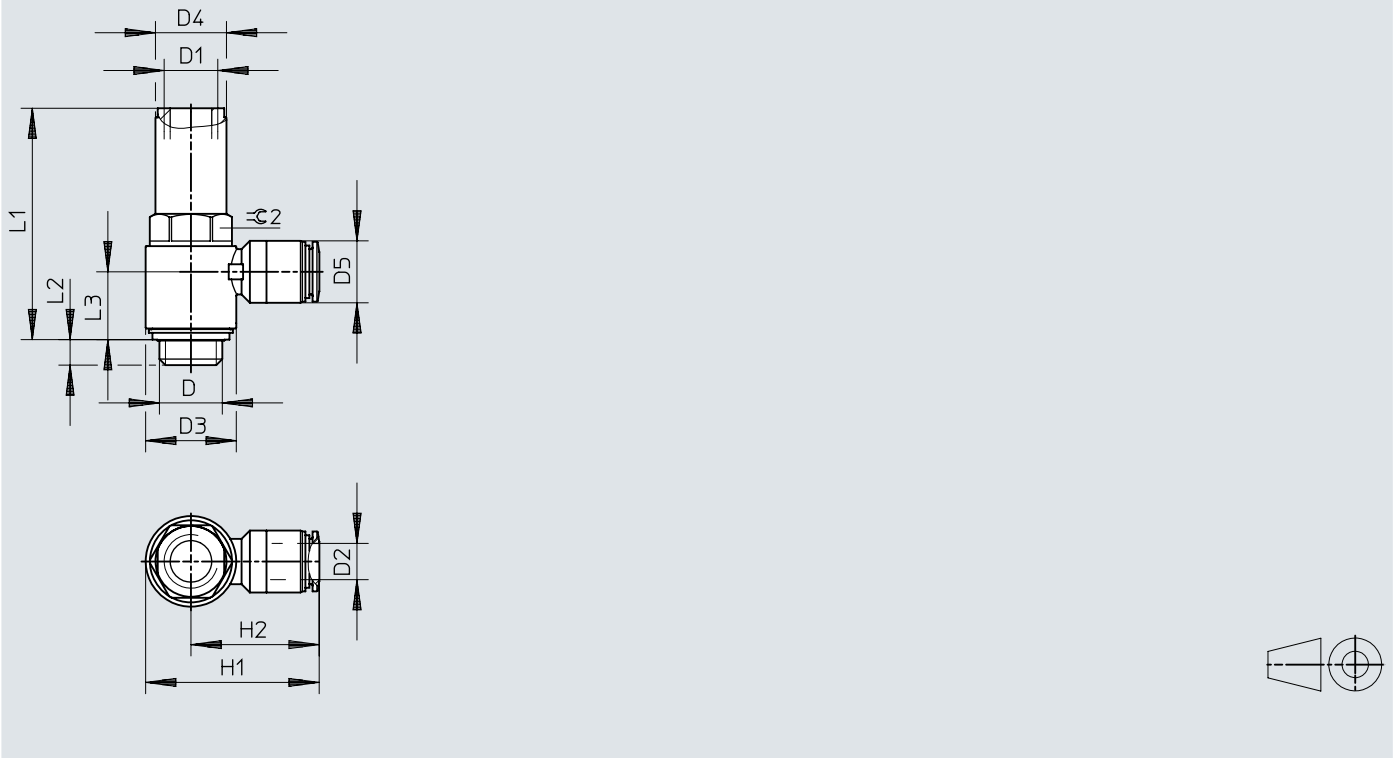
Download CAD data → www.festo.com

	D	D1	D2	D3 ∅	D4 ∅	D5 ∅	H1	H2	L1	L2	L3	L4	≈G 1	≈G 2
HGL-1/8-QS-4	G1/8	M5	4	13,8	11,8	10,2	29,4	22,5	42,6	5,4	13,9	37,8	8	12
HGL-1/8-QS-6			6			12,5	25,7	13,2						
HGL-1/4-QS-8	G1/4	G1/8	8	17,8	16	14,5	39,6	30,7	50,8	6,5	16,6	44,5	12	16
HGL-1/4-QS-10			10			17,5	33,1	15,5						
HGL-3/8-QS-8	G3/8	G1/4	8	22,4	18,8	14,5	44,1	32,9	56,3	7	18,2	49,5	15	19
HGL-3/8-QS-10			10			17,5	35,5	18,2						

Dimensions

Dimensions – Push-in connector HGL-1/2

Download CAD data → www.festo.com

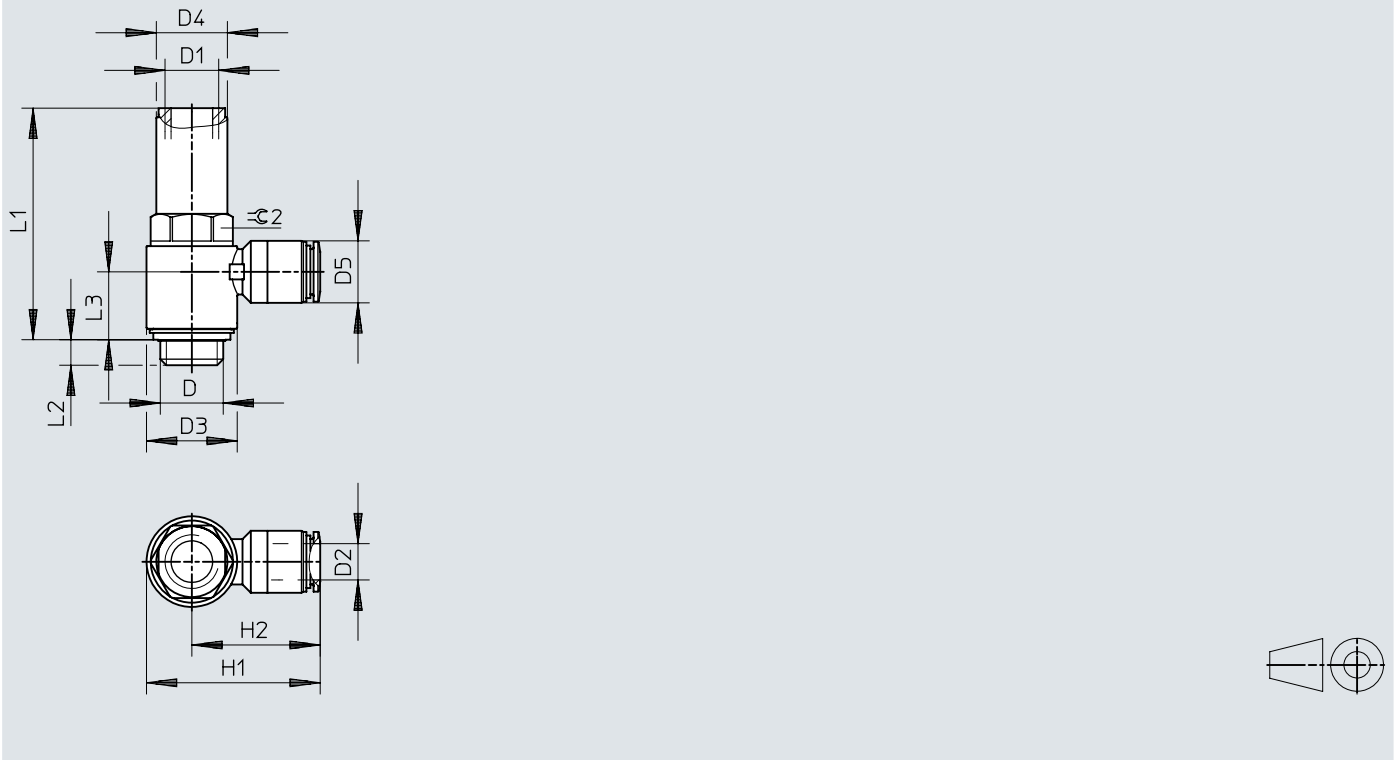

	D	D1	D2	D3 ∅	D4 ∅	D5 ∅	H1	H2	L1	L2	L3	≈ 24
HGL-1/2-QS-12	G1/2	G3/8	12	27,8	23,5	20,5	55,3	41,4	75,8	8,8	22,4	24

Dimensions

Dimensions – Female thread HGL-M5-B

Download CAD data → www.festo.com

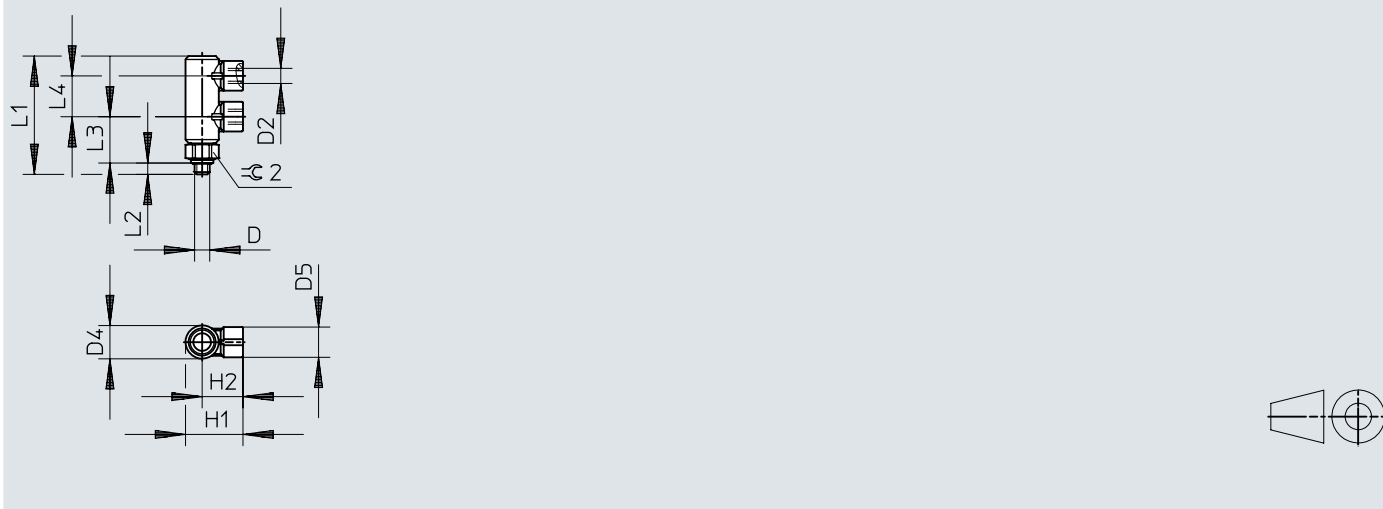

	D	D2	D4 ∅	D5 ∅	H1	H2	L1	L2	L3	L4	☉ 2
HGL-M5-B	M5	M5	11	10	19	13,5	38,5	3,5	15	13,5	10

Dimensions

Dimensions – Female thread HGL-1/8-B, HGL-1/4-B, HGL-3/8-B

Download CAD data → www.festo.com

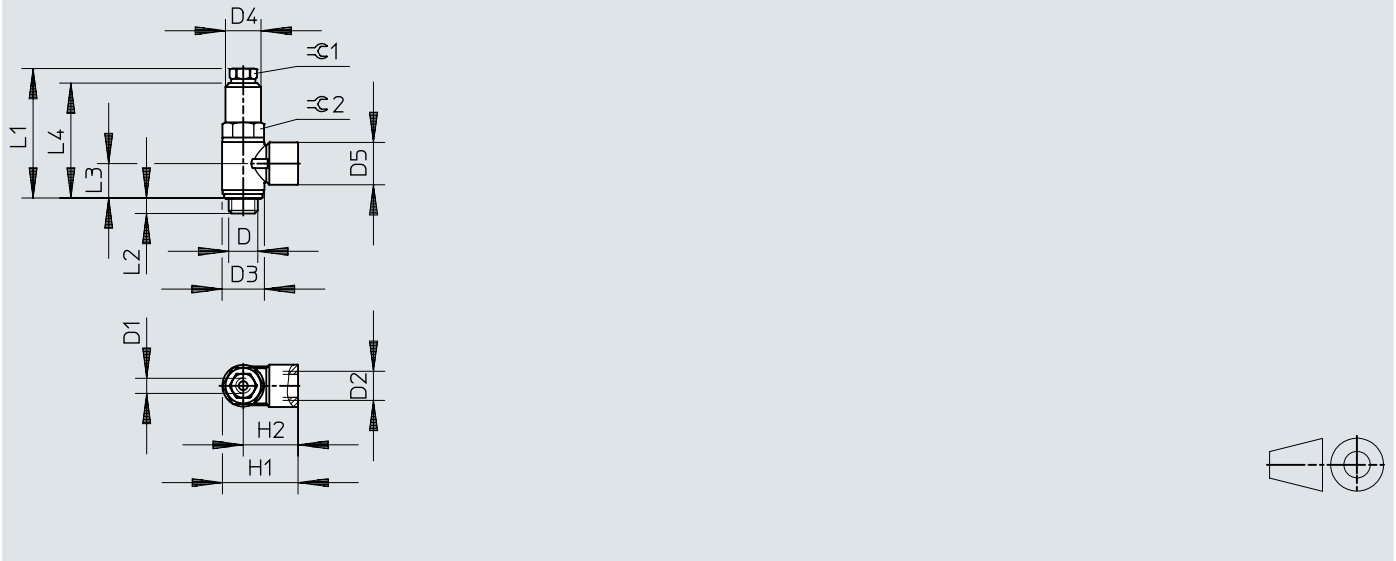

	D	D1	D2	D3 ∅	D4 ∅	D5 ∅	H1	H2	L1	L2	L3	L4	≙1	≙2
HGL-1/8-B	G1/8	M5	G1/8	14	11,8	14	25,1	18,1	42,6	5,4	11,2	37,8	8	12
HGL-1/4-B	G1/4	G1/8	G1/4	18	16	17,5	34	25	50,8	6,5	13,5	44,5	12	16
HGL-3/8-B	G3/8	G1/4	G3/8	23,8	18,8	20	39,3	27,4	56,3	7	15,1	49,5	15	19

Dimensions

Dimensions – Female thread HGL-1/8-1/8-B

Download CAD data → www.festo.com

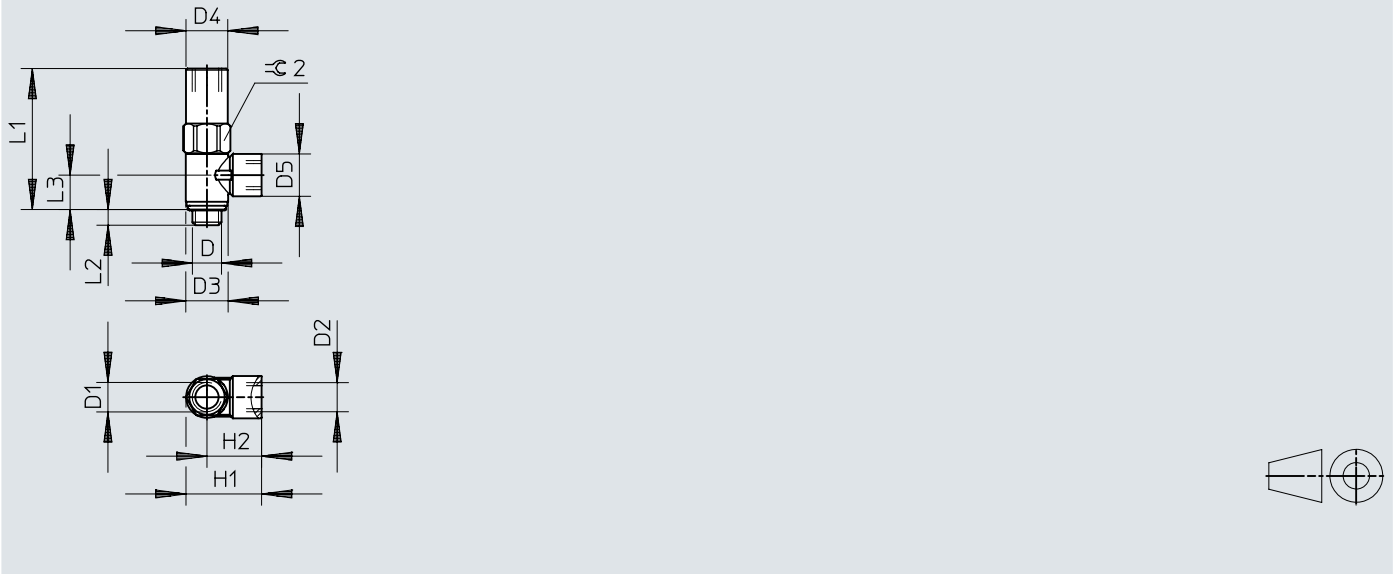

	D	D1	D2	D3	D4	D5	H1	H2	L1	L2	L3	≈ 2
HGL-1/8-1/8-B	G1/8	G1/8	G1/8	14	13,8	14	25,1	18,1	46,7	5,2	11,2	14

Dimensions

Dimensions – Female thread HGL-1/2-B

Download CAD data → www.festo.com

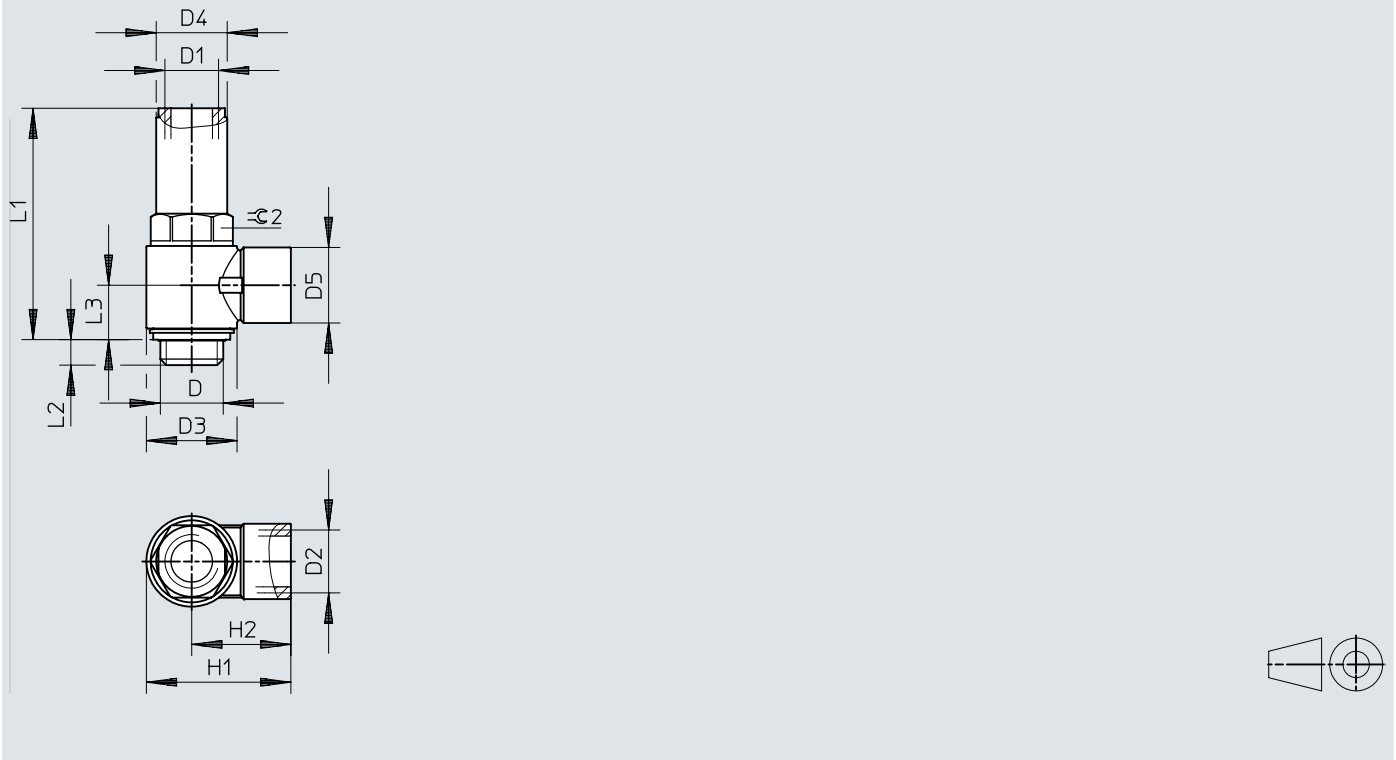

	D	D1	D2	D3 ∅	D4 ∅	D5 ∅	H1	H2	L1	L2	L3	⊕ 2
HGL-1/2-B	G1/2	G3/8	G1/2	30	23,5	25	47,8	32,8	75,8	8,8	17,7	24

Dimensions

Dimensions – Manual override HAB

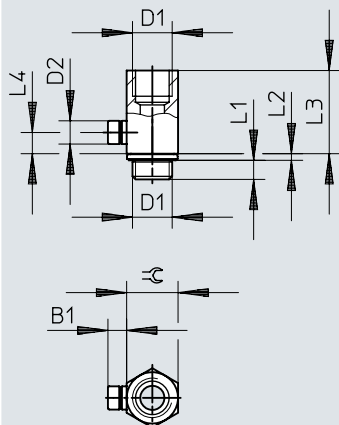
Download CAD data → www.festo.com

	B1	D1	D2 ∅	L1	L2	L3	L4	≈∅
HAB-1/8	6,2	G1/8	7,7	4,7	1,8	19,1	5	13
HAB-1/4	6,2	G1/4	7,7	5,8	2,2	28	7	17
HAB-3/8	6,2	G3/8	7,7	6,05	3,35	28,4	7	19
HAB-1/2	6,2	G1/2	7,7	7,9	2,6	38,5	7	24

Ordering data

Push-in connector HGL – M thread

	Pneumatic connection, port 2	Pilot air port 21	Pneumatic connection, port 1	Product weight	Part no.	Type
	M5	M5	M5	21 g	★ 530029	HGL-M5-B
		QS-4	QS-4		★ 530038	HGL-M5-QS-4

Push-in connector HGL – G thread

	Pneumatic connection, port 2	Pilot air port 21	Pneumatic connection, port 1	Product weight	Part no.	Type
	G1/8	M5	G1/8	20.8 g	★ 530030	HGL-1/8-B
			QS-4	18.4 g	★ 530039	HGL-1/8-QS-4
			QS-6	21.4 g	★ 530040	HGL-1/8-QS-6
	G1/4	G1/8	G1/8	26.2 g	543253	HGL-1/8-1/8-B
			G1/4	41.2 g	★ 530031	HGL-1/4-B
			QS-8	38.7 g	★ 530041	HGL-1/4-QS-8
	G3/8	G1/4	QS-10	45 g	★ 530042	HGL-1/4-QS-10
			G3/8	62.9 g	★ 530032	HGL-3/8-B
			QS-8	54.7 g	★ 530043	HGL-3/8-QS-8
	G1/2	G3/8	QS-10	60.3 g	★ 530044	HGL-3/8-QS-10
			G1/2	129.4 g	★ 530033	HGL-1/2-B
			QS-12	116.9 g	★ 530045	HGL-1/2-QS-12

Female thread HGL – M-thread

	Pneumatic connection, port 2	Pilot air port 21	Pneumatic connection, port 1	Product weight	Part no.	Type
	M5	M5	M5	21 g	★ 530029	HGL-M5-B

Female thread HGL – G-thread

	Pneumatic connection, port 2	Pilot air port 21	Pneumatic connection, port 1	Product weight	Part no.	Type
	G1/8	M5	G1/8	20.8 g	★ 530030	HGL-1/8-B
		G1/8		26.2 g	543253	HGL-1/8-1/8-B
	G1/4	G1/4	G1/4	41.2 g	★ 530031	HGL-1/4-B
	G3/8		G3/8	62.9 g	★ 530032	HGL-3/8-B
	G1/2		G1/2	129.4 g	★ 530033	HGL-1/2-B

Accessories

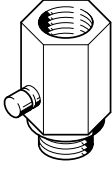
Manual override HAB				
	Pneumatic connection, port 1	Nominal size	Part no.	Type
	G1/8	4.1 mm	184585	HAB-1/8
	G1/4	7 mm	184586	HAB-1/4
	G3/8	11 mm	184587	HAB-3/8
	G1/2	14 mm	184588	HAB-1/2