

## Parallel grippers DHPC

**FESTO**



## Key features

### At a glance

#### General

- Resilient and precise ball guide
- High gripping forces with compact dimensions
- Max. repetition accuracy
- Wide range of mounting and connection options
- Optionally with protective dust cap

#### Flexible range of applications

- Sensor technology:
  - Proximity switches for sensing the piston position at the end positions
  - Position transmitter for sensing the piston position at any location
  - Size 16 ... 40 with T-slot and C-slot
- Can be used either as double-acting or single-acting gripper
- Suitable for external and internal gripping

### Gripper characteristic

[L] Long stroke

- Available for sizes 10 ... 25

### Position sensing

[A] Via proximity switch

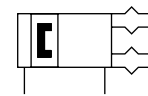

### Gripping force backup

[NC] Normally closed



### Gripping force backup

[NO] Normally open

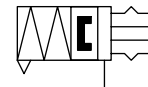

### Pneumatic connection

[B] Underneath

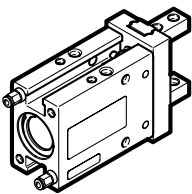

### Pneumatic connection

[S] On the side

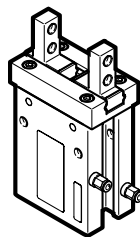

### Pneumatic connection

[Z] Via mounting spigot

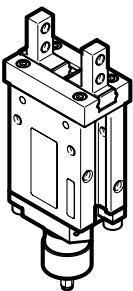

### Type of mounting for gripper fingers

[ ] Standard

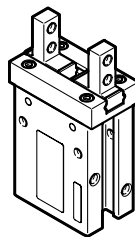

### Type of mounting for gripper fingers

[1] Mounting holes on the side

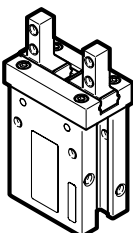

### Type of mounting for gripper fingers

[2] Flat gripper fingers

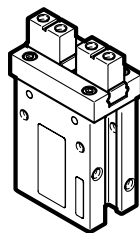

## Key features

### Dust protection

[C] Protective dust cap

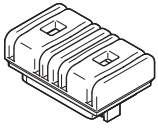

- Available for sizes 10 ... 25

### Mounting options

On the side

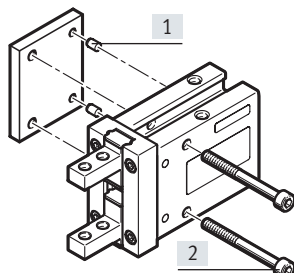
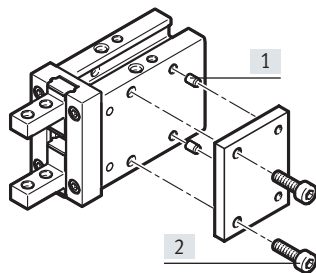

Vertical

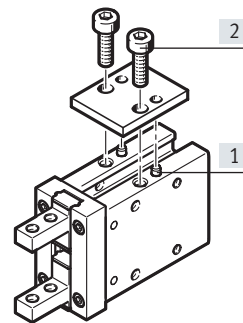

- [1] Centring sleeves
- [2] Retaining screws

From underneath

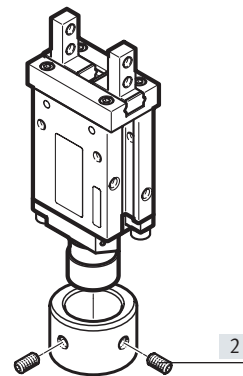
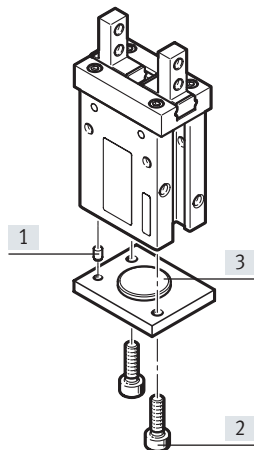
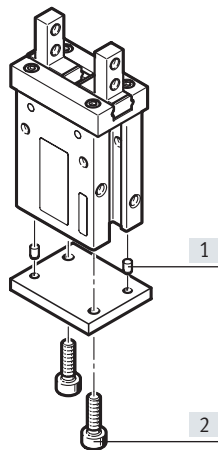

- [1] Centring sleeves
- [2] Retaining screws
- [3] Base

### Mounting external gripper fingers

Standard

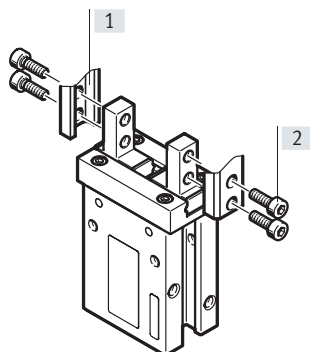

Mounting holes on the side

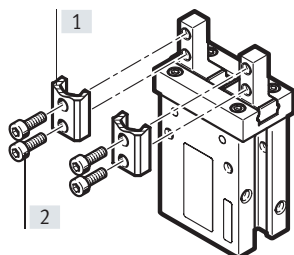

Flat gripper fingers

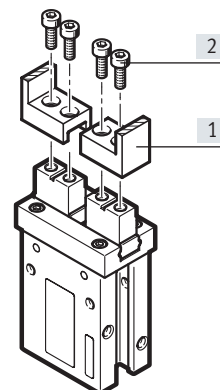

- [1] External gripper fingers
- [2] Retaining screws

Peripherals overview

Peripherals overview

Size 6

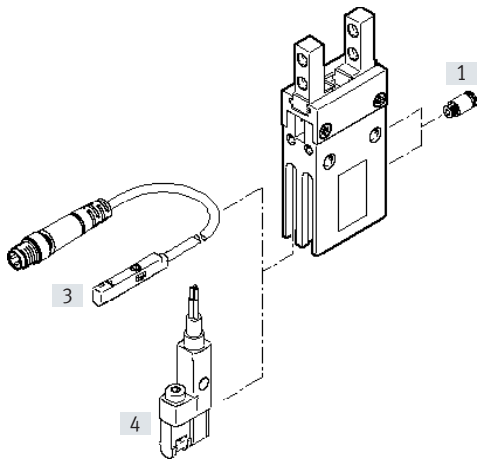

Size 10

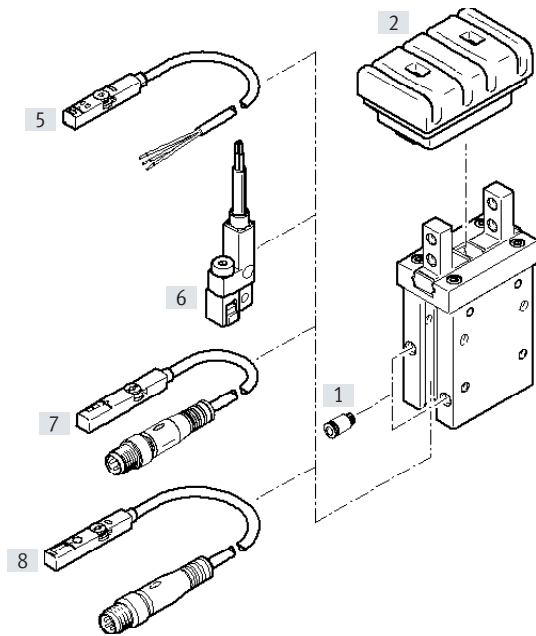

Size 16 ... 40

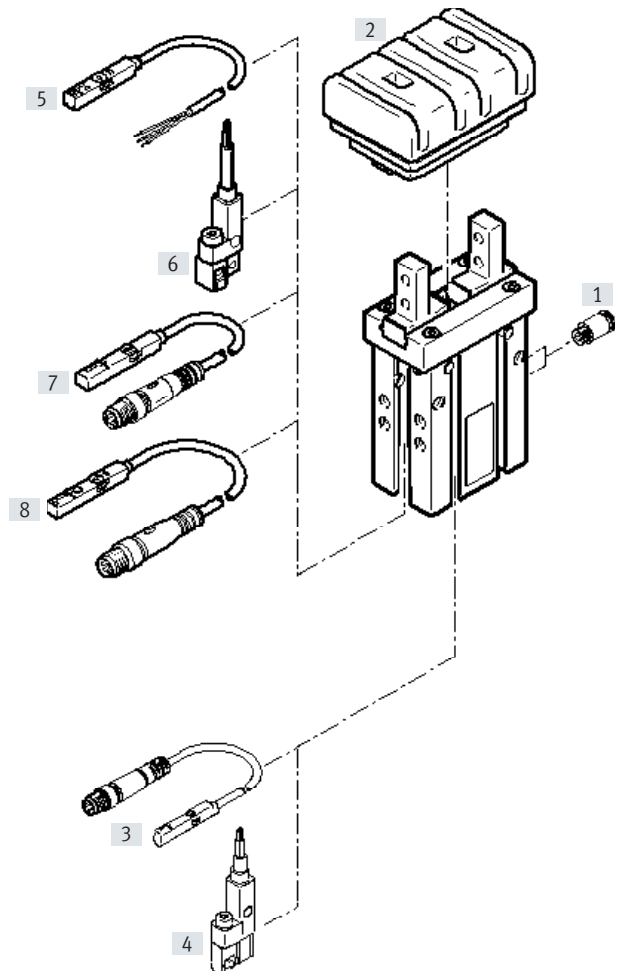

## Peripherals overview

Accessories				
	Type/order code	For size	Description	→ Page/Internet
[1]	Push-in fitting QS	6 ... 40	For connecting tubing with standard O.D.	qs
[2]	Protective dust cap DHAS-DP	10 ... 25	For protecting the gripper against the ingress of dust	40
[3]	Proximity switch SMT-10M	6, 16 ... 40	For sensing the piston position at the end positions	41
[4]	Proximity switch SMT-10G	6, 16 ... 40	For sensing the piston position at the end positions	41
[5]	Proximity switch SMT-8M	10 ... 40	For sensing the piston position at the end positions	41
[6]	Proximity switch SMT-8G	10 ... 40	For sensing the piston position at the end positions	41
[7]	Position transmitter SMAT-8M	10 ... 40	For sensing the piston position at any location	42
[8]	Position transmitter SDAS-MHS	10 ... 40	For sensing the piston position at any location	42

## Type codes

001	Series	
DHPC	Parallel gripper	
002	Gripper characteristic	
	Standard	
L	Long stroke	
003	Size	
6	6	
10	10	
16	16	
20	20	
25	25	
32	32	
40	40	
004	Position sensing	
A	For proximity sensor	

005	Gripping force backup	
	None	
NC	N/O contact	
NO	Opening	
006	Pneumatic connection	
B	Bottom	
S	On the side	
Z	Via mounting spigot	
007	Dust protection	
	None	
C	Protective dust cap	
008	Type of mounting gripper finger	
	None	
1	Mounting holes at the side	
2	Flat gripper fingers	

Datasheet

Function  
Double-acting  
DHPC-...-A

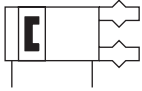

- Size  
6 ... 40 mm
- Total stroke  
4 ... 30 mm

Function  
Single-acting  
Normally closed: DHPC-...-NC



Normally open: DHPC-...-NO



General technical data		6	10	16	20	25	32	40
Size		6	10	16	20	25	32	40
Design	Lever							
	Force-guided motion sequence							
	Connection direction underneath							
	Connection direction on the side							
	Connection via mounting spigot							
	Type of mounting for gripper fingers: standard							
	Sideways mounting of gripper fingers							
	Flat mounting of gripper fingers							
Mode of operation	Double-acting							
	Single-acting							
	Closed							
	Open							
Gripper function	Parallel							
Guide	Ball guide							
Number of gripper jaws	2							
Stroke per gripper jaw								
Standard gripper characteristic	[mm]	2	2	3	5	7	11	15
Long stroke gripper characteristic	[mm]	-	4	6	9	11	-	-
Pneumatic connection		M3			M5			
Connection via mounting spigot		M5						
Gripper repetition accuracy <sup>1)</sup>	[mm]	≤ 0.02						
Max. replacement accuracy	[mm]	0.2						
Max. operating frequency of gripper	[Hz]	3						1
Rotational symmetry	[mm]	≤ 0.2						
Position sensing		Via proximity switch						
Type of mounting	Direct mounting via through-hole							
	Direct mounting via thread							
	-	With through-hole and dowel pin						
	-	With female thread and dowel pin						
	On mounting frame							
Mounting position		Any						

1) Under constant exposure to operating conditions, end-position drift occurs in the direction of movement of the gripper jaws, at 100 consecutive strokes

## Datasheet

Operating and environmental conditions								
Size		6	10	16	20	25	32	40
Min. operating pressure								
Double-acting	[MPa]	0.15	0.2	0.1	0.1	0.1	0.1	0.1
Single-acting	[MPa]	0.35	0.35	0.25	0.25	0.25	0.25	0.25
Double-acting	[bar]	1.5	2	1	1	1	1	1
Single-acting	[bar]	3.5	3.5	2.5	2.5	2.5	2.5	2.5
Max. operating pressure								
	[MPa]	0.8	0.8	0.8	0.8	0.8	0.8	0.8
	[bar]	8	8	8	8	8	8	8
Operating medium		Compressed air to ISO 8573-1:2010 [7:4:4]						
Note on the operating/pilot medium		Lubricated operation possible (in which case lubricated operation will always be required)						
Ambient temperature <sup>1)</sup>	[°C]	-10 ... +60						

1) Note operating range of proximity switches

Weight [g]								
Size		6	10	16	20	25	32	40
Double-acting								
DHPC...A-S		25	49	110	224	440	778	1396
DHPC...A-S-1		25	49	110	224	440	778	1396
DHPC...A-S-2		25	49	113	224	437	773	1487
DHPC...A-B		25	49	111	224	441	779	1408
DHPC...A-B-1		25	49	111	224	441	779	1408
DHPC...A-B-2		25	49	114	224	438	774	1481
DHPC-L...A-S		-	59	121	261	484	-	-
DHPC-L...A-S-1		-	59	121	261	484	-	-
DHPC-L...A-S-2		-	59	124	261	484	-	-
DHPC-L...A-B		-	59	124	261	484	-	-
DHPC-L...A-B-1		-	59	124	261	484	-	-
DHPC-L...A-B-2		-	59	127	261	484	-	-
Single-acting								
DHPC...A...S		27	57	111	224	441	831	1469
DHPC...A...S-1		27	57	111	224	441	831	1469
DHPC...A...S-2		27	57	114	224	438	826	1560
DHPC...A...B		27	57	112	224	442	832	1473
DHPC...A...B-1		27	57	112	224	442	832	1473
DHPC...A...B-2		27	57	115	224	439	821	1564
DHPC...A...Z		31	66	136	270	519	938	1649
DHPC...A...Z-1		31	66	136	270	519	938	1649
DHPC...A...Z-2		31	66	139	270	516	933	1740
DHPC-L...A...S		-	66	126	261	495	-	-
DHPC-L...A...S-1		-	66	126	261	495	-	-
DHPC-L...A...S-2		-	66	129	261	495	-	-
DHPC-L...A...B		-	66	126	261	495	-	-
DHPC-L...A...B-1		-	66	126	261	495	-	-
DHPC-L...A...B-2		-	66	129	261	495	-	-
DHPC-L...A...Z		-	74	151	306	571	-	-
DHPC-L...A...Z-1		-	74	151	306	571	-	-
DHPC-L...A...Z-2		-	74	154	306	571	-	-



Datasheet

Materials

Sectional view

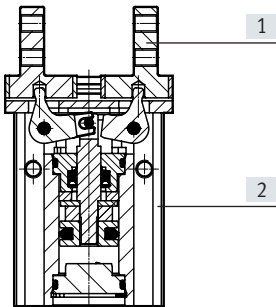

Parallel gripper

[1]	Gripper jaw	High-alloy stainless steel
[2]	Housing	Anodised aluminium
-	Protective dust cap	NBR
	Note on materials	RoHS-compliant
	PWIS conformity	VDMA24364-B2-L

Gripping force [N] at 6 bar

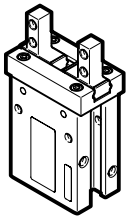

Size		6	10	16	20	25	32	40
Gripping force per gripper jaw								
DHPC...-A	Opening	7.3	25.6	64.7	96.3	152.6	246.9	388.6
	Closing	5.5	21.5	53.9	79.8	127.8	221.3	358.6
DHPC...-NO	Closing	3.9	16.4	43.4	69.7	120.6	207.6	337.5
DHPC...-NC	Opening	5.2	19.6	50.5	85.5	145.7	233	366.8

Characteristic load values at the gripper jaws

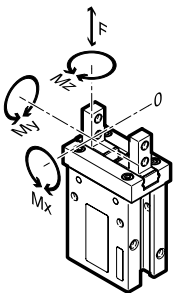

The indicated permissible forces and torques apply to a single gripper jaw. They include the lever arm, additional applied loads due to the workpiece or external gripper fingers and acceleration forces occurring during movement.

The zero coordinate line (gripper jaw guide) must be taken into consideration when calculating torques.

Size		6	10	16	20	25	32	40
Max. permissible force F	[N]	5	29	49	73.5	127.5	171.5	245
Max. permissible torque $M_x$	[Nm]	0.02	0.13	0.34	0.66	0.97	1.5	2.3
Max. permissible torque $M_y$	[Nm]	0.04	0.27	0.68	1.33	1.94	3	4.5
Max. permissible torque $M_z$	[Nm]	0.02	0.13	0.68	0.66	0.97	1.5	2.3

Datasheet

Mass moments of inertia [kgm<sup>2</sup>x10<sup>-4</sup>]

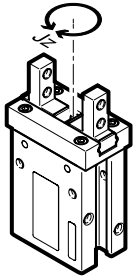

Mass moment of inertia of the parallel gripper in relation to the central axis, without external gripper fingers, with no load.

Size	6	10	16	20	25	32	40
<b>Double-acting</b>							
DHPC...A-S	0.011	0.04	0.146	0.515	1.6	5.54	14.87
DHPC...A-S-1	0.011	0.04	0.146	0.515	1.6	5.54	14.87
DHPC...A-S-2	0.011	0.04	0.147	0.515	1.59	5.51	15.84
DHPC...A-B	0.011	0.04	0.148	0.515	1.6	5.55	15.49
DHPC...A-B-1	0.011	0.04	0.148	0.515	1.6	5.55	15.49
DHPC...A-B-2	0.011	0.04	0.149	0.515	1.59	5.51	16.3
DHPC-L...A-S	-	0.057	0.214	0.515	2.14	-	-
DHPC-L...A-S-1	-	0.057	0.214	0.515	2.14	-	-
DHPC-L...A-S-2	-	0.057	0.219	0.515	2.14	-	-
DHPC-L...A-B	-	0.057	0.215	0.515	2.14	-	-
DHPC-L...A-B-1	-	0.057	0.215	0.515	2.14	-	-
DHPC-L...A-B-2	-	0.057	0.220	0.515	2.14	-	-
<b>Single-acting</b>							
DHPC...A...S	0.012	0.045	0.146	0.515	1.6	5.76	15.31
DHPC...A...S-1	0.012	0.045	0.146	0.515	1.6	5.76	15.31
DHPC...A...S-2	0.012	0.045	0.150	0.515	1.59	5.73	16.27
DHPC...A...B	0.012	0.045	0.148	0.515	1.6	5.77	15.35
DHPC...A...B-1	0.012	0.045	0.148	0.515	1.6	5.77	15.35
DHPC...A...B-2	0.012	0.045	0.152	0.515	1.59	5.69	16.31
DHPC...A...Z	0.013	0.049	0.167	0.574	1.76	6.08	16.17
DHPC...A...Z-1	0.013	0.049	0.167	0.574	1.76	6.08	16.17
DHPC...A...Z-2	0.013	0.049	0.171	0.574	1.75	6.01	17.06
DHPC-L...A...S	-	0.062	0.215	0.764	2.18	-	-
DHPC-L...A...S-1	-	0.062	0.215	0.764	2.18	-	-
DHPC-L...A...S-2	-	0.062	0.220	0.764	2.18	-	-
DHPC-L...A...B	-	0.062	0.216	0.764	2.18	-	-
DHPC-L...A...B-1	-	0.062	0.216	0.764	2.18	-	-
DHPC-L...A...B-2	-	0.062	0.221	0.764	2.18	-	-
DHPC-L...A...Z	-	0.069	0.258	0.828	2.34	-	-
DHPC-L...A...Z-1	-	0.069	0.258	0.828	2.34	-	-
DHPC-L...A...Z-2	-	0.069	0.263	0.828	2.34	-	-

## Datasheet

## Gripper jaw backlash

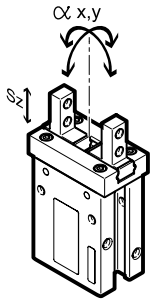

The gripper has a ball guide, which eliminates any possible backlash between the gripper jaws and the housing. The backlash values listed in the table have been calculated based on the traditional accumulative tolerance method.

Size	6	10	16	20	25	32	40
Max. gripper jaw backlash Sz [mm]	0						
Max. gripper jaw angular backlash a x, y [°]	0						

## Opening and closing times [ms] at 6 bar

Without external gripper fingers

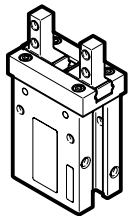

The indicated opening and closing times [ms] were measured at room temperature at an operating pressure of 6 bar with a horizontally mounted gripper without additional gripper fingers. The grippers must be throttled for larger loads [g]. Opening and closing times must then be adjusted accordingly.

Size		6	10	16	20	25	32	40
DHPC...-A	Opening	9	12	29	62	79	114	158
	Closing	11	14	31	40	68	107	153
DHPC...-A-NO	Opening	8	28	29	75	131	174	300
	Closing	6	26	11	29	38	76	67
DHPC...-A-NC	Opening	16	12	30	86	114	162	370
	Closing	16	26	65	38	49	55	78
DHPC-L...-A	Opening	–	15	40	110	162	–	–
	Closing	–	15	40	75	93	–	–
DHPC-L...-A-NO	Opening	–	22	18	156	171	–	–
	Closing	–	12	17	51	46	–	–
DHPC-L...-A-NC	Opening	–	25	50	176	176	–	–
	Closing	–	26	52	50	83	–	–

Datasheet

Gripping force  $F_{Gr}$  per gripper jaw as a function of the operating pressure and lever arm  $x$

The gripping forces as a function of the operating pressure and lever arm can be determined from the following graphs.

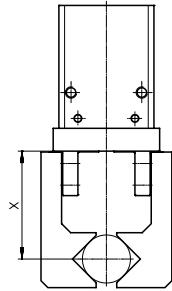

- 2 bar
- · - · 4 bar
- - - 6 bar
- · · · · 8 bar

**Note**  
 Engineering software  
 Gripper selection  
 → [www.festo.com](http://www.festo.com)

External gripping (closing)

Double-acting

DHPC-6-A

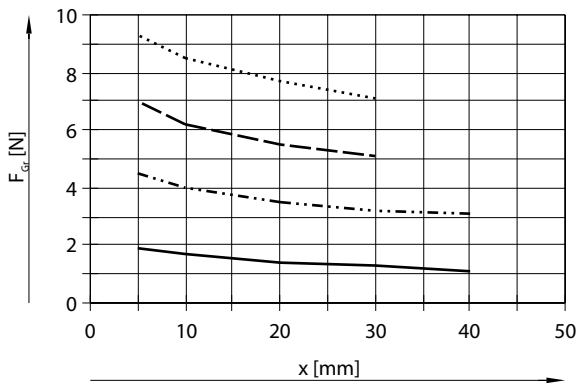

Single-acting

DHPC-6-A-NO

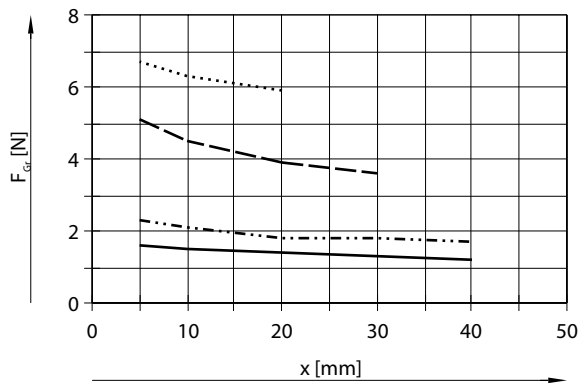

DHPC-10-A/DHPC-L-10-A

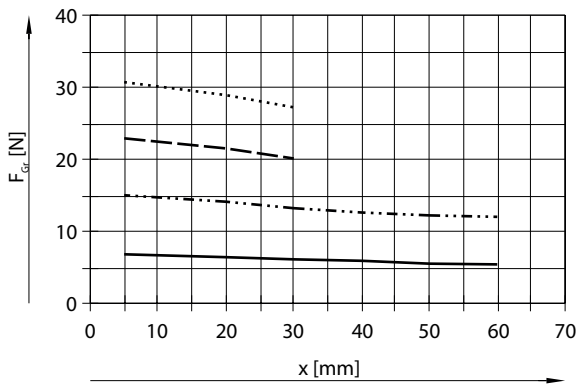

DHPC-10-A-NO/DHPC-L-10-A-NO

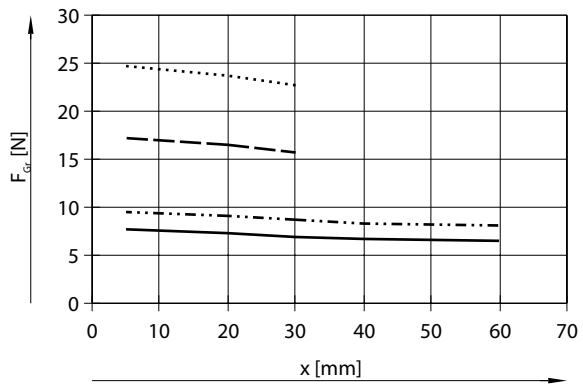

DHPC-16-A/DHPC-L-16-A

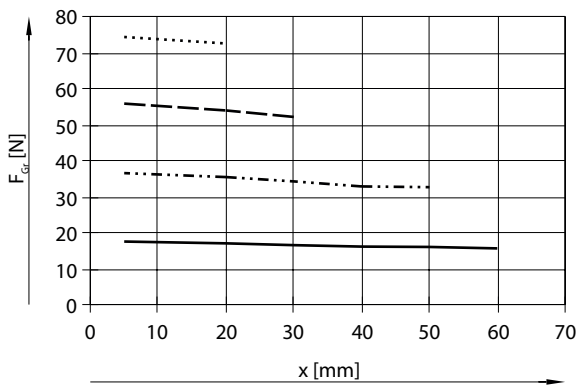

DHPC-16-A-NO/DHPC-L-16-A-NO

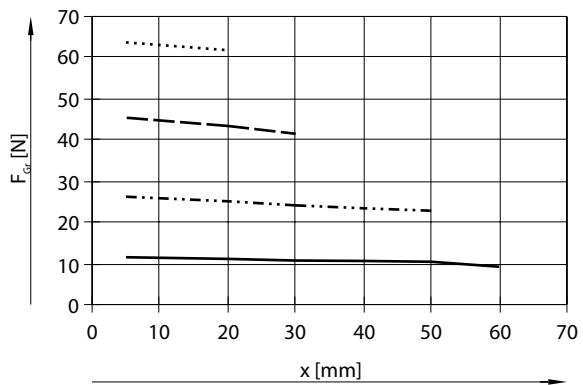

Datasheet

Gripping force  $F_{Gr}$  per gripper jaw as a function of the operating pressure and lever arm  $x$

The gripping forces as a function of the operating pressure and lever arm can be determined from the following graphs.

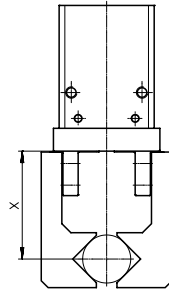

- 2 bar
- · - · - 4 bar
- - - - 6 bar
- 8 bar

 **Note**  
 Engineering software  
 Gripper selection  
 → [www.festo.com](http://www.festo.com)

Internal gripping (opening)

Double-acting

DHPC-6-A

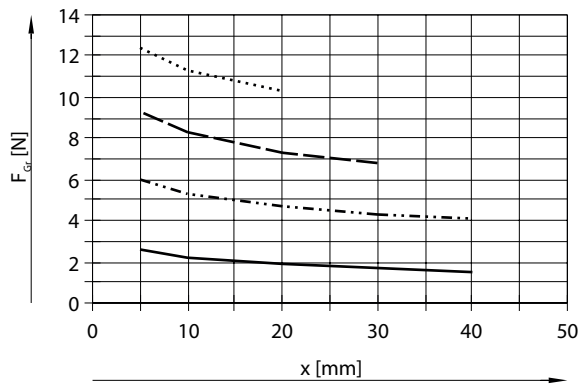

Single-acting

DHPC-6-A-NC

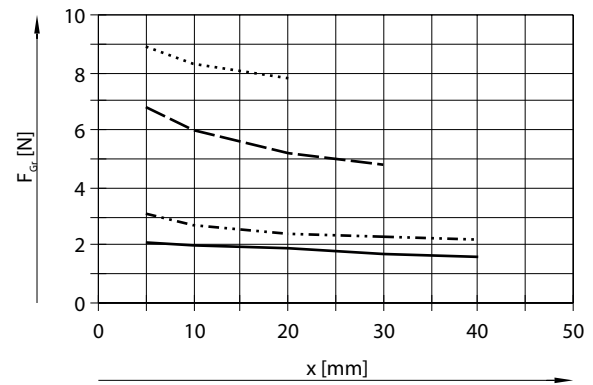

DHPC-10-A/DHPC-L-10-A

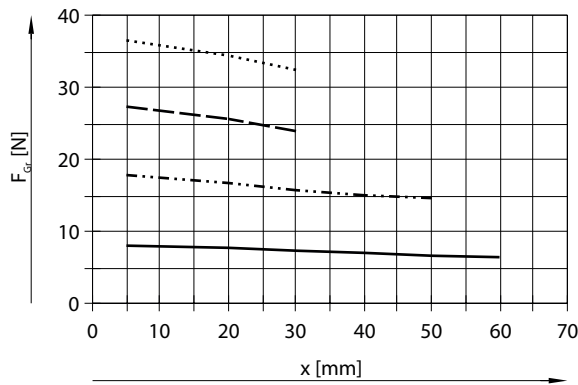

DHPC-10-A-NC/DHPC-L-10-A-NC

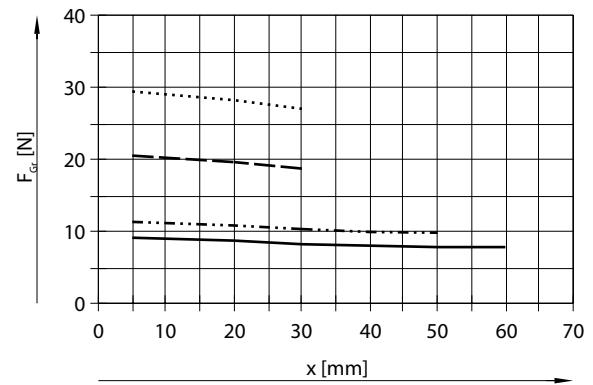

DHPC-16-A/DHPC-L-16-A

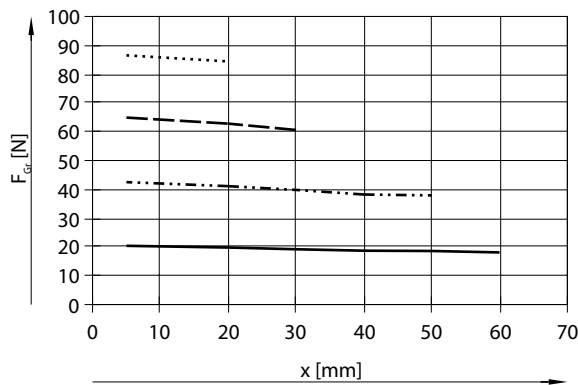

DHPC-16-A-NC/DHPC-L-16-A-NC

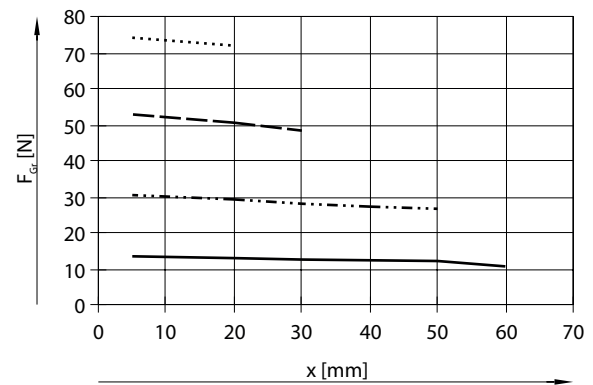

Datasheet

Gripping force  $F_{Gr}$  per gripper jaw as a function of the operating pressure and lever arm  $x$

The gripping forces as a function of the operating pressure and lever arm can be determined from the following graphs.

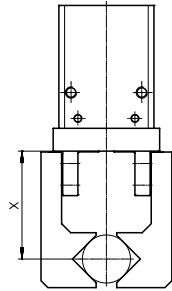

- 2 bar
- · - · - 4 bar
- - - - 6 bar
- 8 bar

 **Note**  
 Engineering software  
 Gripper selection  
 → [www.festo.com](http://www.festo.com)

External gripping (closing)

Double-acting

DHPC-20-A/DHPC-L-20-A

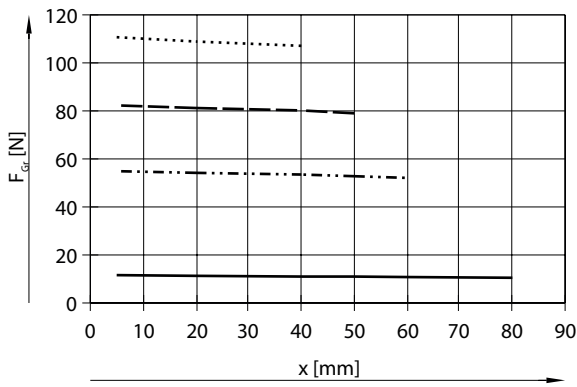

Single-acting

DHPC-20-A-NO/DHPC-L-20-A-NO

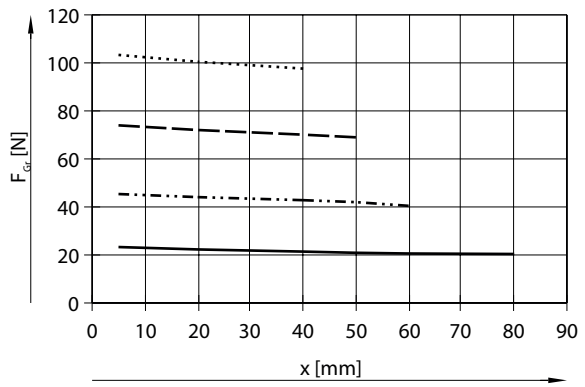

DHPC-25-A/DHPC-L-25-A

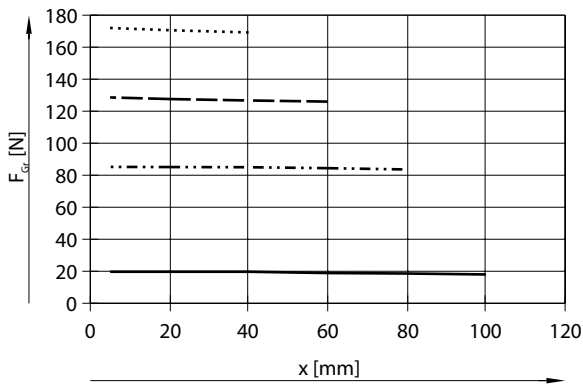

DHPC-25-A-NO/DHPC-L-25-A-NO

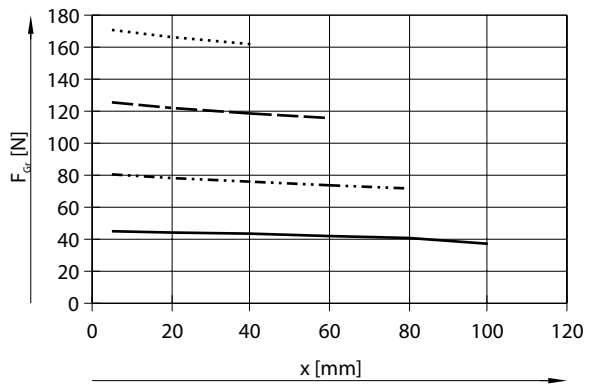

Datasheet

Gripping force  $F_{Gr}$  per gripper jaw as a function of the operating pressure and lever arm  $x$

The gripping forces as a function of the operating pressure and lever arm can be determined from the following graphs.

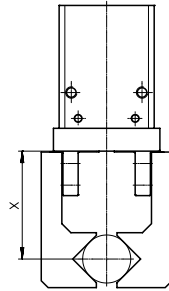

- 2 bar
- · - · - 4 bar
- - - - 6 bar
- 8 bar

**Note**  
 Engineering software  
 Gripper selection  
 → [www.festo.com](http://www.festo.com)

Internal gripping (opening)

Double-acting

DHPC-20-A/DHPC-L-20-A

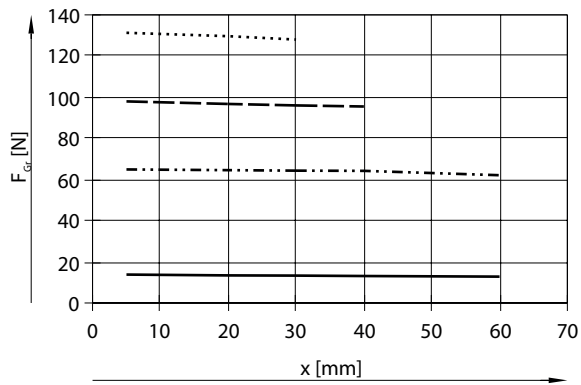

Single-acting

DHPC-20-A-NC/DHPC-L-20-A-NC

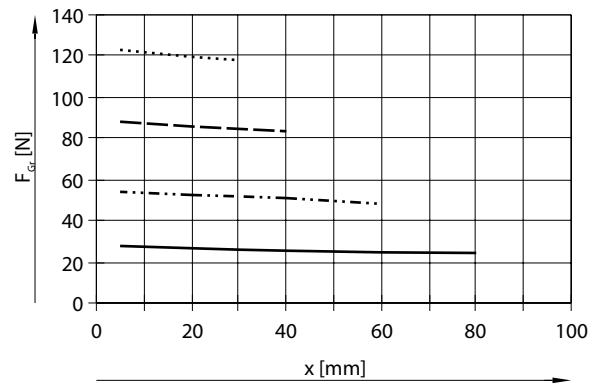

DHPC-25-A/DHPC-L-25-A

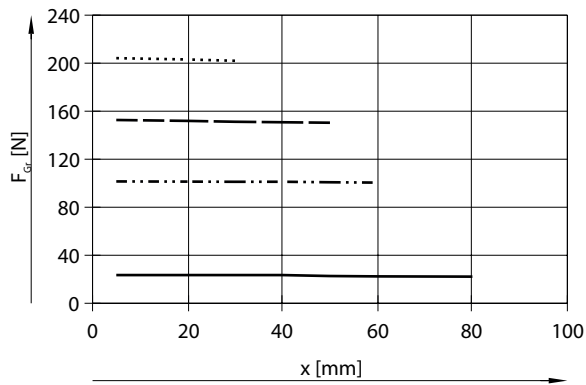

DHPC-25-A-NC/DHPC-L-25-A-NC

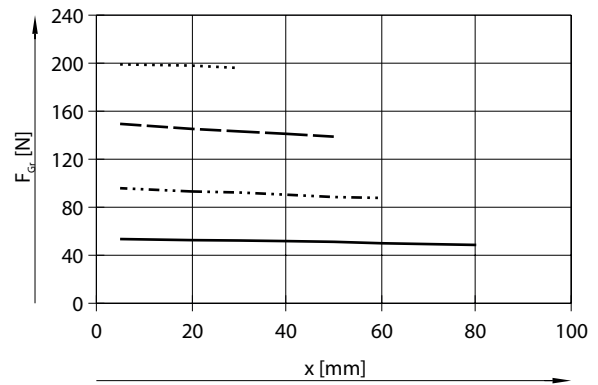

Datasheet

Gripping force  $F_{Gr}$  per gripper jaw as a function of the operating pressure and lever arm  $x$

The gripping forces as a function of the operating pressure and lever arm can be determined from the following graphs.

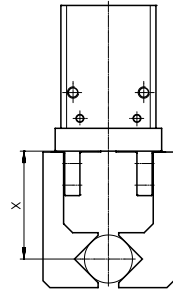

- 2 bar
- · - · - 4 bar
- - - - 6 bar
- · · · · 8 bar

**Note**  
 Engineering software  
 Gripper selection  
 → [www.festo.com](http://www.festo.com)

External gripping (closing)

Double-acting

DHPC-32-A

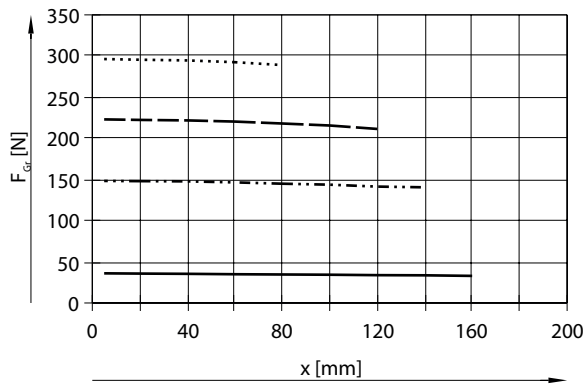

Single-acting

DHPC-32-A-NO

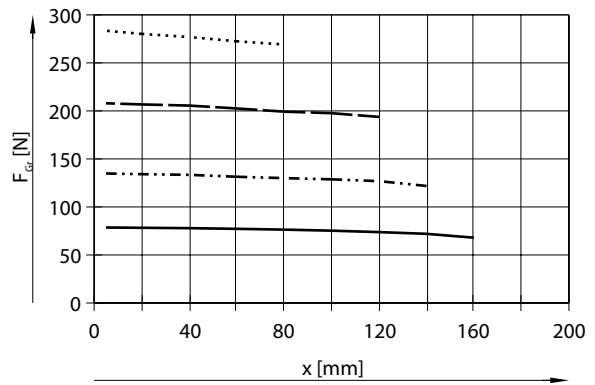

DHPC-40-A

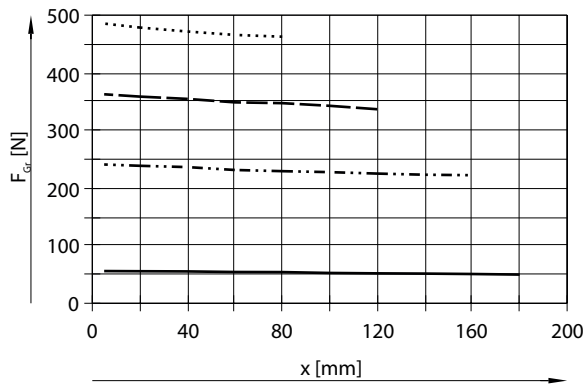

DHPC-40-A-NO

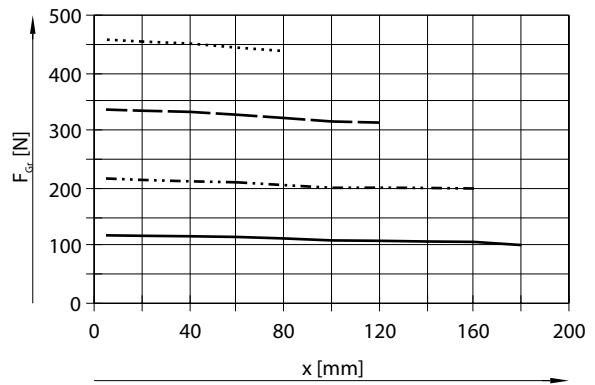



Datasheet

Gripping force  $F_{Gr}$  per gripper jaw as a function of the operating pressure and lever arm  $x$

The gripping forces as a function of the operating pressure and lever arm can be determined from the following graphs.

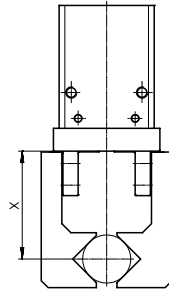

- 2 bar
- · - · 4 bar
- - - 6 bar
- 8 bar

**Note**  
 Engineering software  
 Gripper selection  
 → [www.festo.com](http://www.festo.com)

Internal gripping (opening)

Double-acting

DHPC-32-A

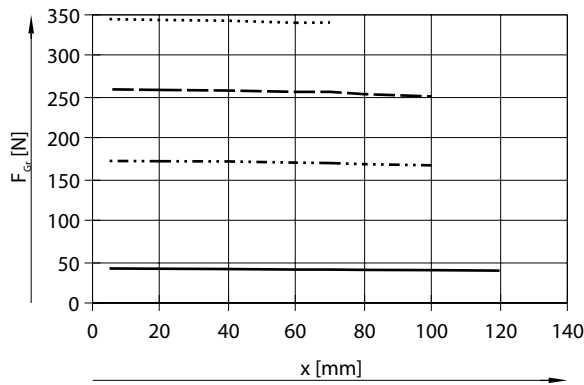

Single-acting

DHPC-32-A-NC

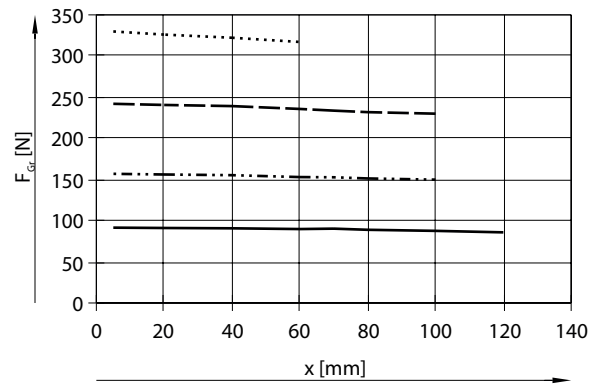

DHPC-40-A

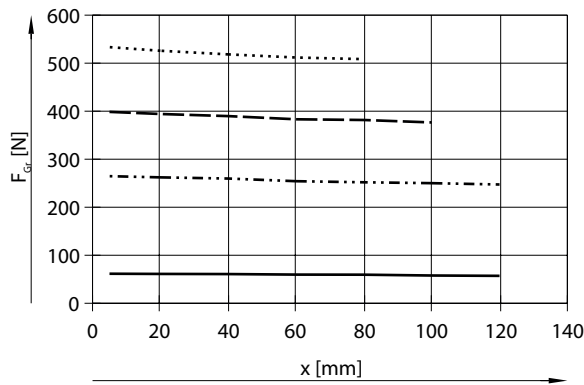

DHPC-40-A-NC

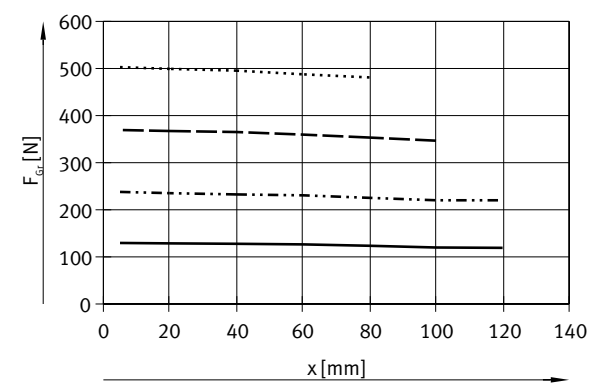

## Datasheet

### Gripping force $F_{Gr}$ per gripper jaw at 6 bar as a function of lever arm $x$ and eccentricity $y$

External and internal gripping (closing and opening)

The gripping forces at 6 bar as a function of eccentric application of force (distance from the zero co-ordinate line shown opposite to the pressure point at which the fingers grip the workpiece) and the maximum permissible off-centre point at which force is applied can be determined for the various sizes using the following graphs (→ page 19/21).

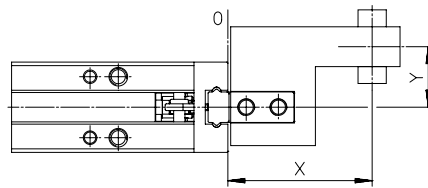

### Calculation example

Assuming:

DHPC-16-A

Lever arm  $x = 10$  mm

Eccentricity  $y = 11$  mm

To be determined:

Gripping force at 6 bar

Procedure:

- Determine the intersection  $xy$  between the lever arm  $x$  and eccentricity  $y$  in the graph

- Draw an arc (with centre at origin) through intersection  $xy$
  - Determine the intersection between the arc and X-axis
  - Read the gripping force
- Result:  
gripping force  $F_{Gr} = \text{approx. } 53.9$  N

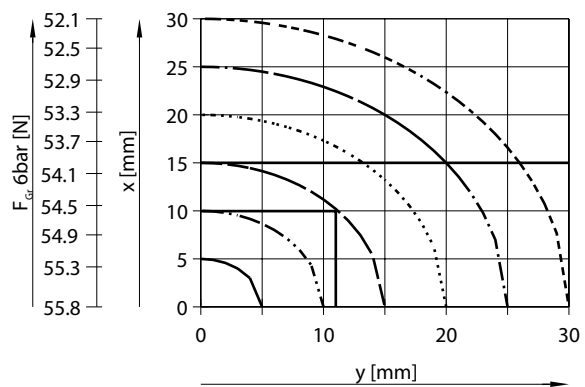

Datasheet

External gripping (closing)

Double-acting

DHPC-6-A

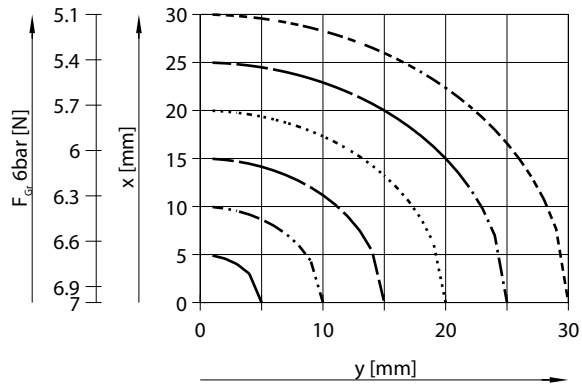

Single-acting

DHPC-6-A-NC

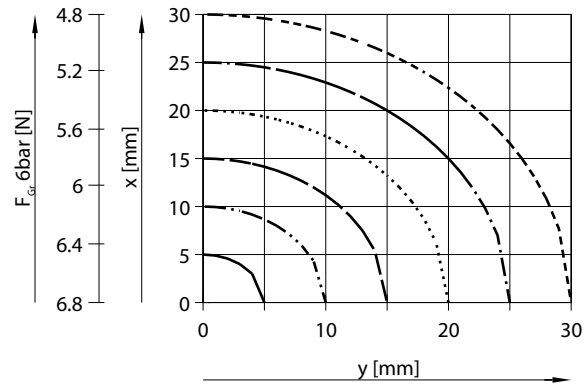

DHPC-10-A/DHPC-L-10-A

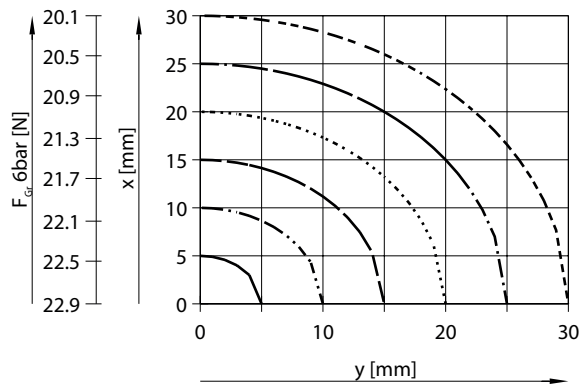

DHPC-10-A-NC/DHPC-L-10-A-NC

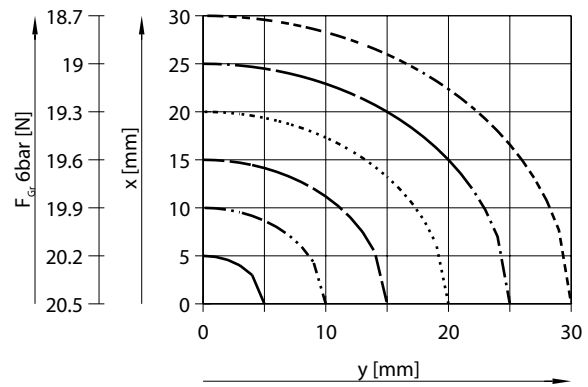

DHPC-16-A/DHPC-L-16-A

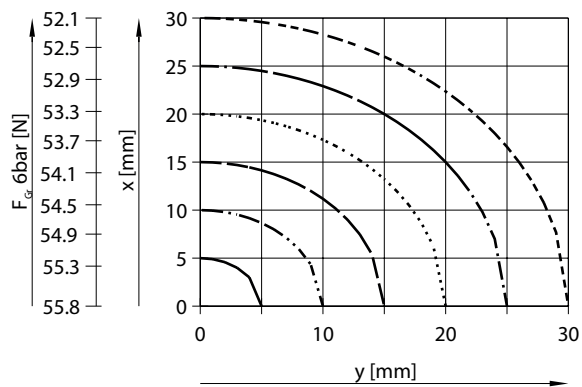

DHPC-16-A-NC/DHPC-L-16-A-NC

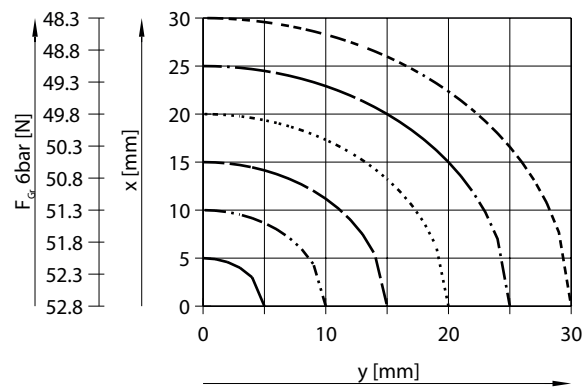

DHPC-20-A/DHPC-L-20-A

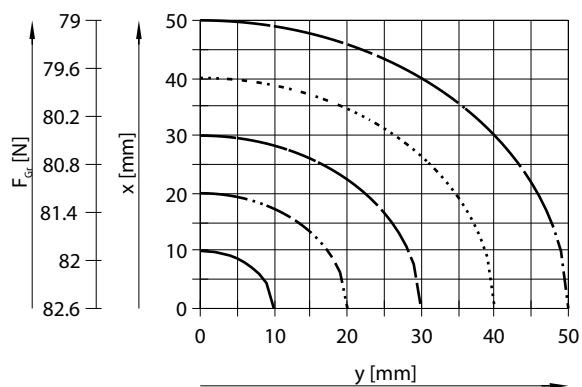

DHPC-20-A-NC/DHPC-L-20-A-NC

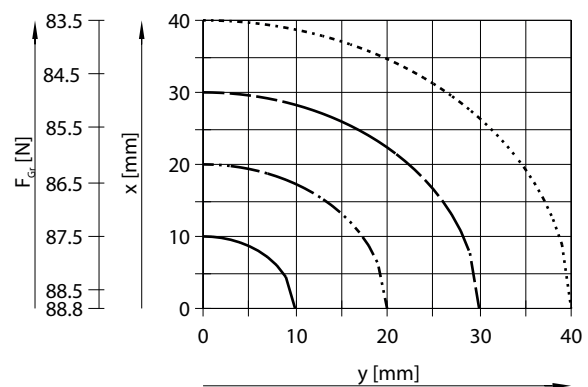

Datasheet

External gripping (closing)

Double-acting

DHPC-25-A/DHPC-L-25-A

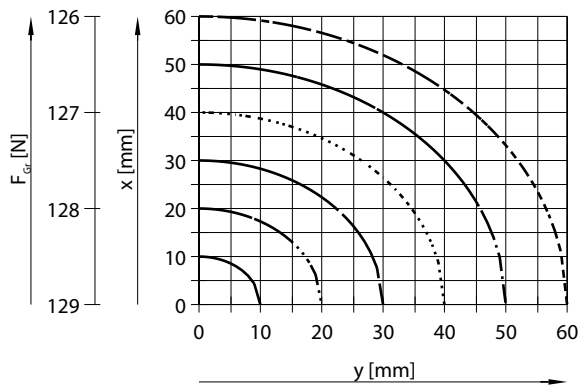

Single-acting

DHPC-25-A-NC/DHPC-L-25-A-NC

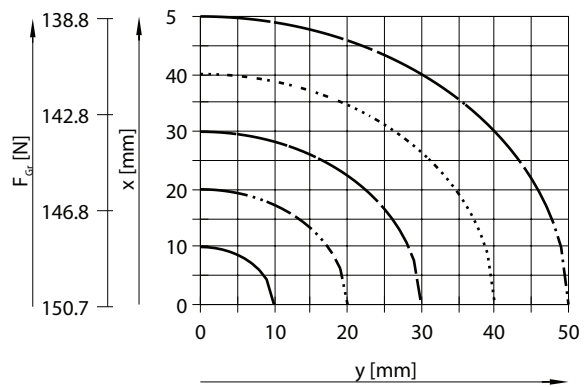

DHPC-32-A

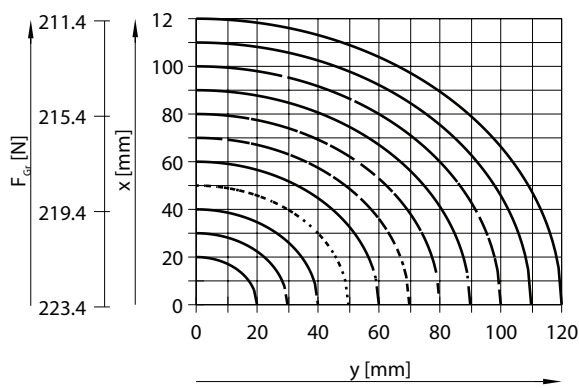

DHPC-32-A-NC

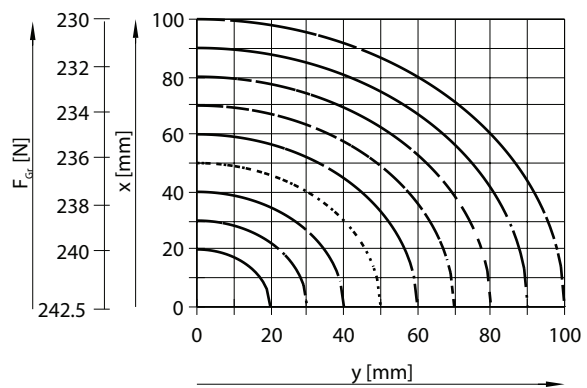

DHPC-40-A

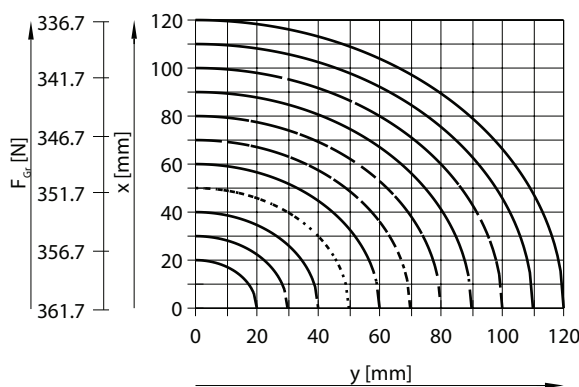

DHPC-40-A-NC

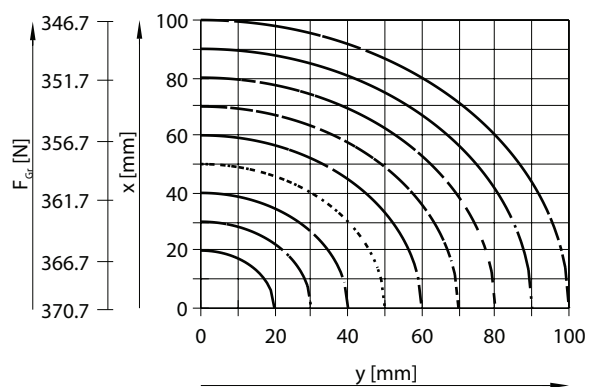

Datasheet

Internal gripping (opening)

Double-acting

DHPC-6-A

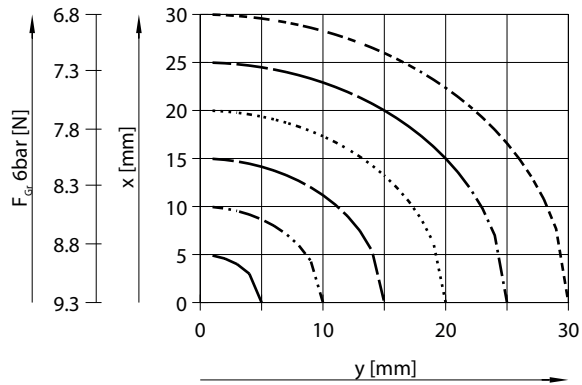

Single-acting

DHPC-6-A-NO

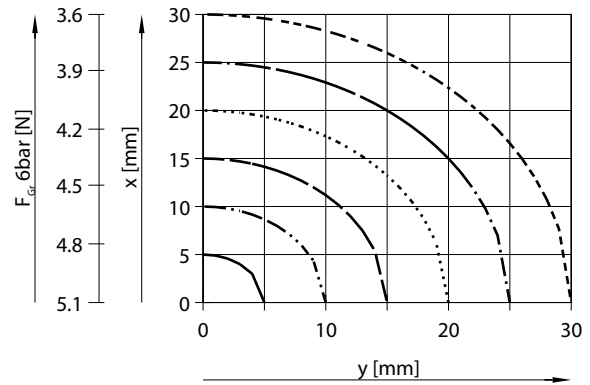

DHPC-10-A/DHPC-L-10-A

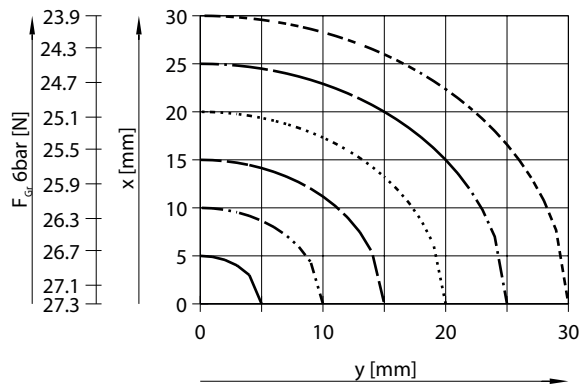

DHPC-10-A-NO/DHPC-L-10-A-NO

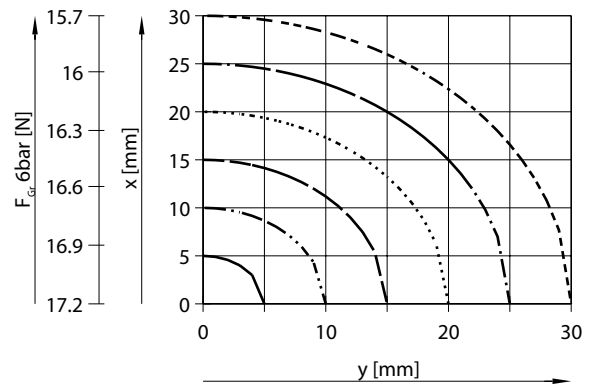

DHPC-16-A/DHPC-L-16-A

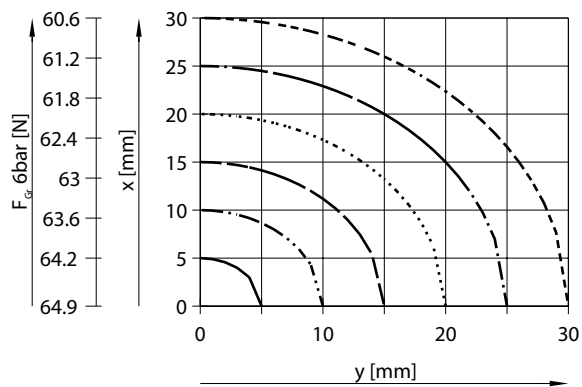

DHPC-16-A-NO/DHPC-L-16-A-NO

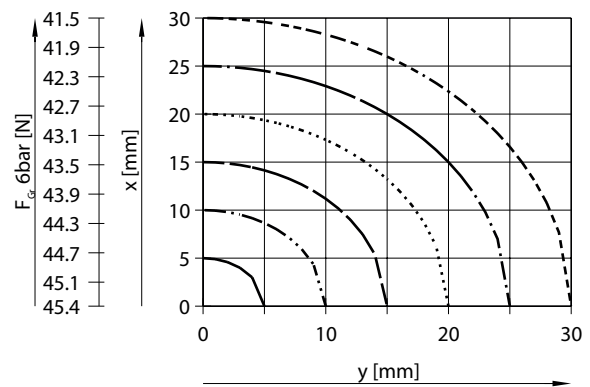

DHPC-20-A/DHPC-L-20-A

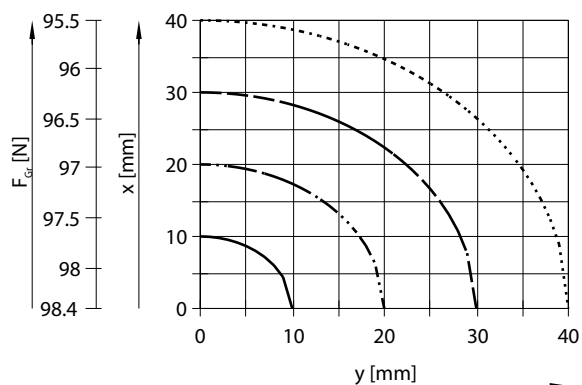

DHPC-20-A-NO/DHPC-L-20-A-NO

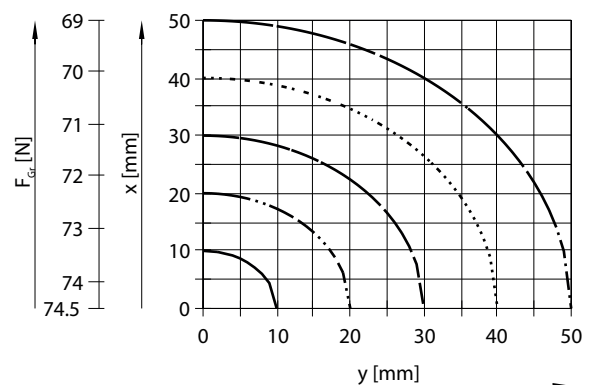

Datasheet

Internal gripping (opening)

Double-acting

DHPC-25-A/DHPC-L-25-A

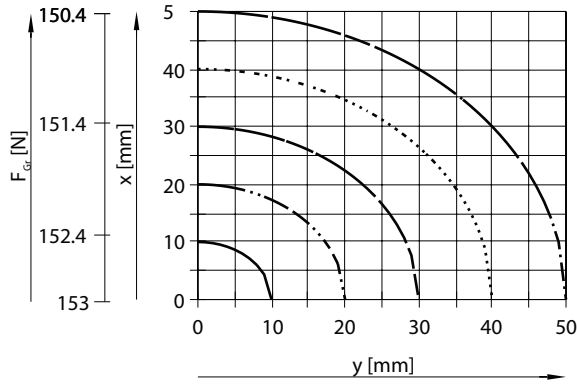

Single-acting

DHPC-25-A-NO/DHPC-L-25-A-NO

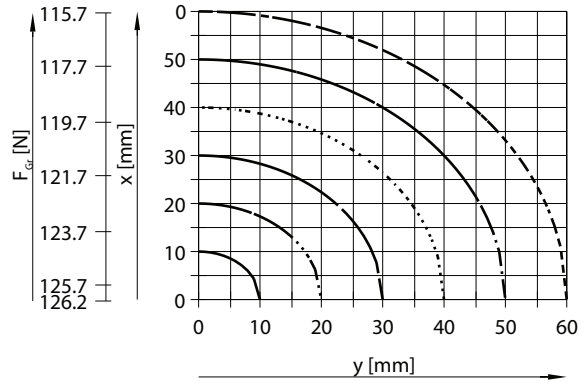

DHPC-32-A

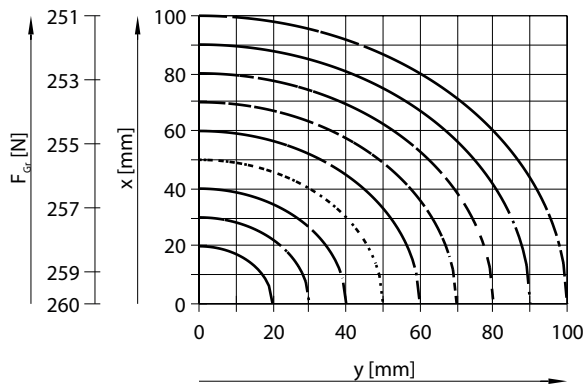

DHPC-32-A-NO

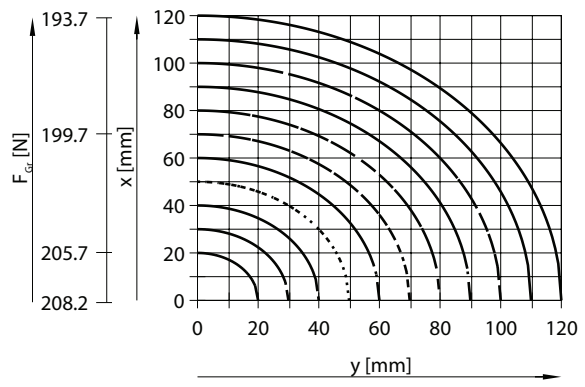

DHPC-40-A

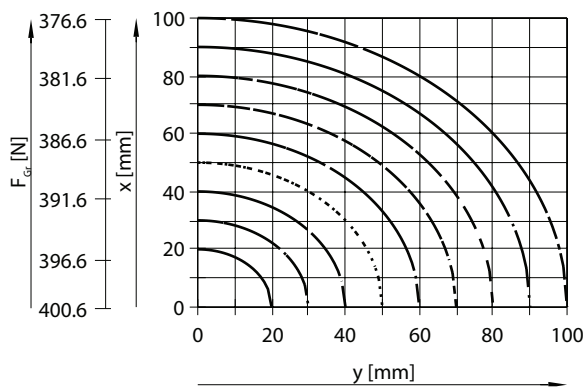

DHPC-40-A-NO

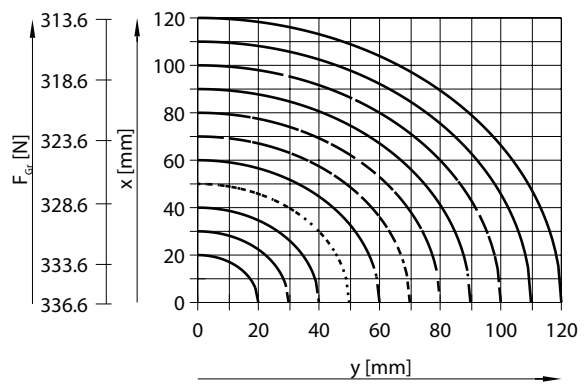

Datasheet

Dimensions

Download CAD data → [www.festo.com](http://www.festo.com)

DHPC-6-...-S: Pneumatic connection on the side

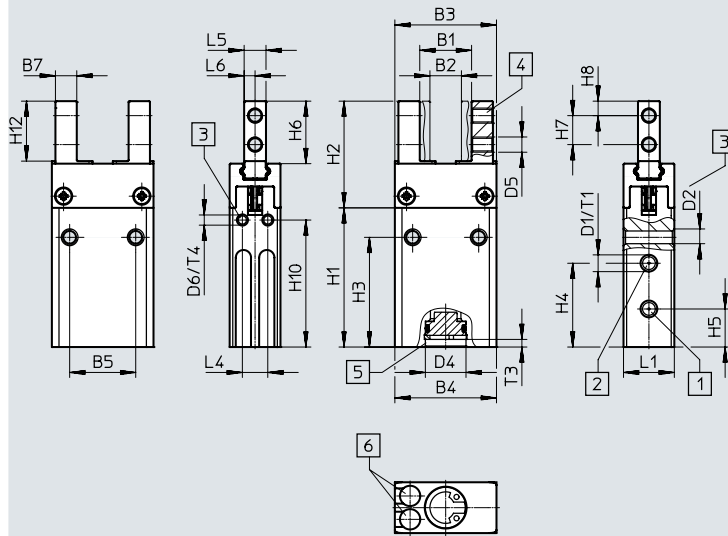

- [1] Pneumatic connection, opening
- [2] Pneumatic connection, closing
- [3] Threaded hole for mounting the gripper
- [4] Threaded hole for mounting the gripper fingers
- [5] Centring hole
- [6] C-slot for proximity switch

Size	B1	B2	B3	B4	B5	B7	D1	D2	D4 ∅ H11	D5	D6	H1	H2	H3
[mm]			-0.2	+0.3		-0.1								
DHPC-6-A-S	10.2	6.2	20	20	13	4.3	M3	M3	8	M3	M2	27.4	21	21.6
DHPC-6-A-NO/NC-S												32		24.8

Size	H4	H5	H6	H7	H8	H10	H12	L1	L4	L5	L6	T1	T3	T4
[mm]								+0.25		-0.05				
DHPC-6-A-S						25								
DHPC-6-A-NO/NC-S	16.5	7.5	12.3	5.7	2.9	28	11.8	10	5	4.3	2.2	4.5	1.5	4.5

Datasheet

**Dimensions**

Download CAD data → [www.festo.com](http://www.festo.com)

DHPC-6-...-B: Pneumatic connection underneath

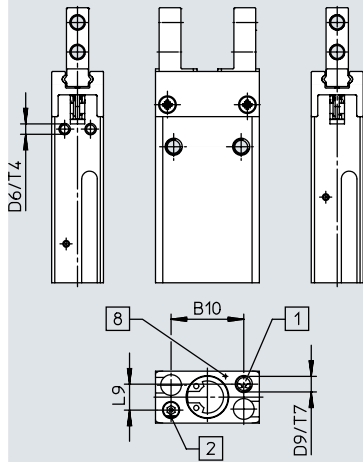

- [1] Pneumatic connection, opening
- [2] Pneumatic connection, closing
- [8] Marking: pneumatic connection, opening

Size	B10	D6	D9	L9	T4	T7
[mm]						
DHPC-6-A-B	14	M2	M3	5	4.5	4
DHPC-6-A-NO/NC-B						



Datasheet

Dimensions

Download CAD data → [www.festo.com](http://www.festo.com)

DHPC-6-...-Z: Pneumatic connection via mounting spigot

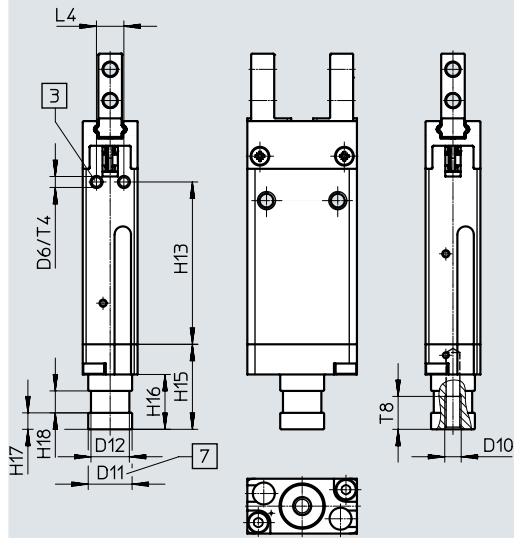

[3] Threaded hole for mounting the gripper

[7] Mounting spigot

Size	D6	D10	D11 ∅ f8	D12 ∅	H13	H15	H16	H17	H18	L4	T4	T8
[mm]												
DHPC-6-A-NO/NC-Z	M2	M5	8	7	28	15.5	10	3	4	5	4.5	6

Datasheet

**Dimensions**

Download CAD data → [www.festo.com](http://www.festo.com)

DHPC-10...40...S: Pneumatic connection on the side

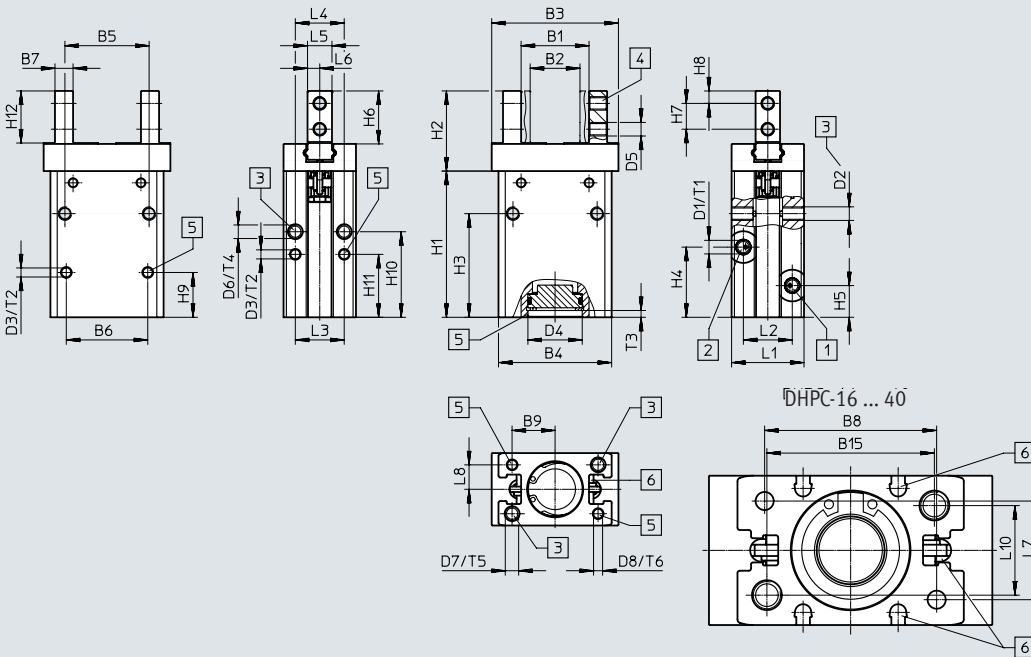

- [1] Pneumatic connection, opening
- [2] Pneumatic connection, closing
- [3] Threaded hole for mounting the gripper
- [4] Threaded hole for mounting the gripper fingers
- [5] Centring hole
- [6] DHPC-10: T-slot for proximity switch  
DHPC-16 ... 40: C-slot and T-slot for proximity switch

Size	B1	B2	B3	B4	B5	B6	B7	B8	B9	B15	D1	D2	D3 ∅ H9	D4 ∅	D5
[mm]			-0.2	+0.3		±0.02	-0.1	±0.02	±0.02						
DHPC-10-A-S	15	11	28	25	18.6	18	4	19	9.5	19	M3	M3	2	12 H9	M3
DHPC-L-10-A-S	19		34												
DHPC-10-A-NO/NCS	15		28												
DHPC-L-10-A-NO/NCS	19		34												
DHPC-16-A-S	19.8	13.8	37.4	32	27	24.4	5	25	12.5	25	M4	M4	3	17 H8	M4
DHPC-L-16-A-S	25.8		46.4												
DHPC-16-A-NO/NCS	19.8		37.4												
DHPC-L-16-A-NO/NCS	25.8		46.4												
DHPC-20-A-S	25.6	15.6	50.2	40	31.6	28.4	8	31	15.5	30	M5	M5	4	21 H8	M4
DHPC-L-20-A-S	33.6		62.2												
DHPC-20-A-NO/NCS	25.6		50.2												
DHPC-L-20-A-NO/NCS	33.6		62.2												
DHPC-25-A-S	32.6	18.6	62.6	50	37.4	33	10	38	19	37	M5	M6	5	26 H8	M5
DHPC-L-25-A-S	40.6		74.6												
DHPC-25-A-NO/NCS	32.6		62.6												
DHPC-L-25-A-NO/NCS	40.6		74.6												
DHPC-32-A-S	47.9	25.9	97	60	40	46	12	46	23	46	M8	M8	5	33 H9	M6
DHPC-32-A-NO/NCS	47.9														
DHPC-40-A-S	60.9	30.9	118	72	54	28	14	56	28	56	M8	M8	5	41 H9	M8
DHPC-40-A-NO/NCS	60.9														

## Datasheet

Size [mm]	D6	D7	D8 ∅ H9	H1	H2	H3	H4	H5	H6	H7	H8	H9 +0.1	H10	H11 +0.1	H12
DHPC-10-A-S	M3	M3	2	32.3	17.7	22.9	15.5	7	11.7	5.7	2.75	9.9	18.9	13.9	11.5
DHPC-L-10-A-S				39.9		26	18.9					12	21	16	
DHPC-10-A-NO/NCS				41.4		32	19					28	23		
DHPC-L-10-A-NO/NCS				48.06		34.16	21					20.16	29.16	24.16	
DHPC-16-A-S	M4	M4	3	43.1	24.3	31.7	26.5	9	16.3	7	4	14	25.6	19	15
DHPC-L-16-A-S				46.8		34.3	30.2					29.3			
DHPC-16-A-NO/NCS				43.1		31.7	26.5					25.6			
DHPC-L-16-A-NO/NCS				51.1		38.6	33.4					18.3	33.6	23.3	
DHPC-20-A-S	M5	M5	4	53.6	30.8	41	33	10.2	21.3	9	5	16	33	23	20
DHPC-L-20-A-S				59.2		44	36					36			
DHPC-20-A-NO/NCS				53.6		41	33					33			
DHPC-L-20-A-NO/NCS				62.9		47.7	40					19.7	39.7	26.7	
DHPC-25-A-S	M6	M6	5	65.1	37.6	45.5	37.5	10.5	26.7	12	6	20	36	25	25
DHPC-L-25-A-S				70.1		49	41.7					24	40	29	
DHPC-25-A-NO/NCS				65.1		45.5	37.5					22	39	30	
DHPC-L-25-A-NO/NCS				74.1		53	45.2					31.4	49.4	40.4	
DHPC-32-A-S	M8	M8	5	71	43.5	48	39	11	31.5	14	7	22	39	30	29.3
DHPC-L-32-A-S				80.4		57.4	41					31.4	49.4	40.4	
DHPC-32-A-NO/NCS				86.4		60.4	47.4					28	49	36	
DHPC-40-A-S	M8	M8	5	86.4	54.5	60.4	47.4	12	39.5	17	9	28	49	36	36
DHPC-L-40-A-NO/NCS				95.7		69.7	49					37.3	58.3	45.3	

Size [mm]	L1 +0.3	L2	L3 ±0.02	L4	L5 -0.05	L6	L7 <sup>1)</sup> ±0.02	L8 ±0.02	L10	T1	T2	T3	T4	T5	T6
DHPC-10-A-S	16	10.8	10.8	10.8	5.4	2.7	10.8	5.4	10.8	4	3	1.5	4	4	3
DHPC-L-10-A-S															
DHPC-10-A-NO/NCS															
DHPC-L-10-A-NO/NCS															
DHPC-16-A-S	20	11.9	12	12	7	3.5	13	6.5	13	4.5	4	2	4.5	6	4
DHPC-L-16-A-S															
DHPC-16-A-NO/NCS															
DHPC-L-16-A-NO/NCS															
DHPC-20-A-S	26	15.6	16	14	8.3	4.2	17	8.5	16.6	6	4	3	8	10	4
DHPC-L-20-A-S															
DHPC-20-A-NO/NCS															
DHPC-L-20-A-NO/NCS															
DHPC-25-A-S	33	20.4	21	21	12	6	21.8	10.9	19.8	7.5	4	3.5	10	12	4
DHPC-L-25-A-S															
DHPC-25-A-NO/NCS															
DHPC-L-25-A-NO/NCS															
DHPC-32-A-S	40	24	26	26	15.2	7.6	26	13	26	5	4	4	13	17	5
DHPC-L-32-A-S															
DHPC-32-A-NO/NCS	48	28	32	32	18	9	32	16	32	8	5	4	13	17	5
DHPC-L-40-A-S															
DHPC-40-A-NO/NCS	48	28	32	32	18	9	32	16	32	8	5	4	13	17	5
DHPC-L-40-A-NO/NCS															

1) Dimension L7 refers exclusively to the distance between the centring hole [5] and the threaded hole for mounting the gripper [3]

Datasheet

**Dimensions**

Download CAD data → [www.festo.com](http://www.festo.com)

DHPC-10...40...-B: Pneumatic connection underneath

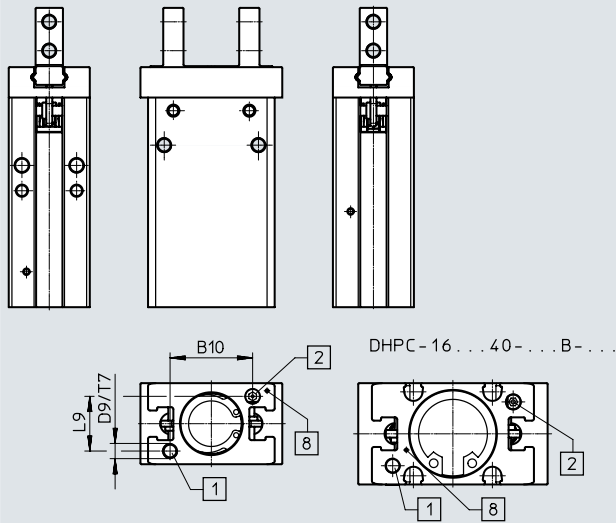

- [1] Pneumatic connection, opening
- [2] Pneumatic connection, closing
- [8] Marking: pneumatic connection, closing

Size	B10	D9	L9	T7
[mm]				
DHPC-10-A-B	16.3	M3	10.8	4
DHPC-L-10-A-B				
DHPC-10-A-NO/NC-B				
DHPC-L-10-A-NO/NC-B				
DHPC-16-A-B	23.8	M3	12.6	4.5
DHPC-L-16-A-B				
DHPC-16-A-NO/NC-B				
DHPC-L-16-A-NO/NC-B				
DHPC-20-A-B	29	M3	16.6	7
DHPC-L-20-A-B				
DHPC-20-A-NO/NC-B				
DHPC-L-20-A-NO/NC-B				
DHPC-25-A-B	38	M5	21	8
DHPC-L-25-A-B				
DHPC-25-A-NO/NC-B				
DHPC-L-25-A-NO/NC-B				
DHPC-32-A-B	46	M5	26	8
DHPC-32-A-NO/NC-B				
DHPC-40-A-B				
DHPC-40-A-NO/NC-B	56	M5	32	8

Datasheet

Dimensions

Download CAD data → [www.festo.com](http://www.festo.com)

DHPC-10...40-...-Z: Pneumatic connection via mounting spigot

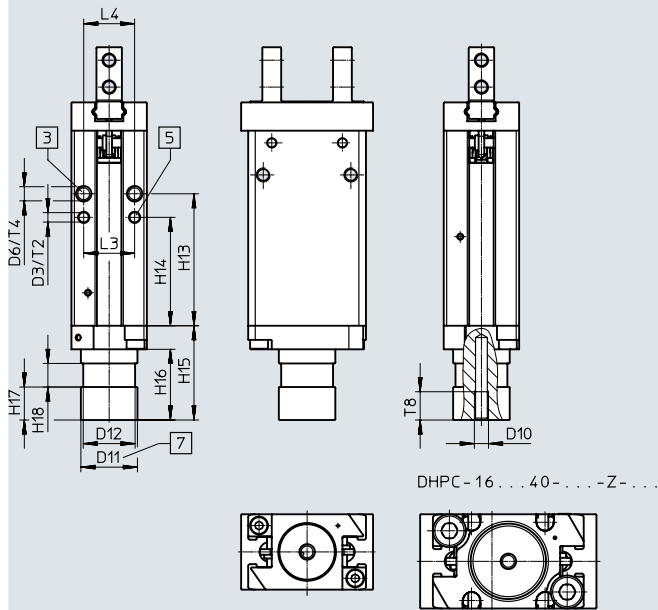

- [3] Threaded hole for mounting the gripper
- [5] Centring hole
- [7] Mounting spigot

Size	D3	D6	D10	D11	D12	H13	H14	H15	H16	H17	H18	L3	L4	T2	T4	T8
[mm]	∅ H9			∅ f8	∅							±0.02				
DHPC-10-A-NO/NC-Z	2	M3	M5	12	11	28	23	20	15	7	5	10.8	10.8	3	4	6
DHPC-L-10-A-NO/NC-Z						29.2	24.2								4.5	8
DHPC-16-A-NO/NC-Z	3	M4		16	14	25.6	19	28	18	8		12	12	4	8	
DHPC-L-16-A-NO/NC-Z						33.6	23.3									
DHPC-20-A-NO/NC-Z	4	M5		20	18	33	23	30	20	10		16	14	4	8	
DHPC-L-20-A-NO/NC-Z						39.7	26.7									34
DHPC-25-A-NO/NC-Z		M6		25	23	36	25	34	23	13		21	21	10		
DHPC-L-25-A-NO/NC-Z	40					29										
DHPC-32-A-NO/NC-Z	5	M8	32	30	49.4	40.4	35.4	26	26	5	32	32	13			
DHPC-40-A-NO/NC-Z					58.3	45.3								37.4		

Datasheet

Dimensions – Gripper finger mounting

Download CAD data → [www.festo.com](http://www.festo.com)

DHPC-...-A: Standard

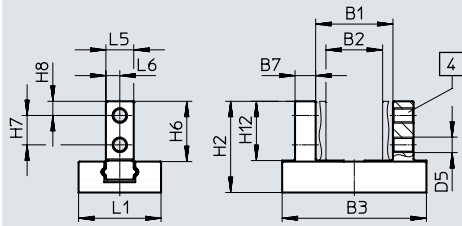

[4] Threaded hole for mounting the gripper fingers

Size	B1	B2	B3	B7	D5	H2	H6
[mm]				-0.1			
DHPC-6-A	10.2	6.2	20 -0.2	4.2	M3	21	12.3
DHPC-10-A	15	11	28 -0.2	4		17.7	11.7
DHPC-L-10-A	19		34 -0.2	5		24.3	16.3
DHPC-16-A	19.8	13.8	37.4 -0.2		8		
DHPC-L-16-A	25.8		46.4 -0.2				
DHPC-20-A	25.6	15.6	50.2 -0.2	10	M5	37.6	26.6
DHPC-L-20-A	33.6		62.2 -0.2				
DHPC-25-A	32.6	18.6	62.6	12	M6	43.5	31.5
DHPC-L-25-A	40.6		74.6				
DHPC-32-A	47.9	25.9	97	14	M8	54.5	39.5
DHPC-40-A	60.9	30.9	118				

Size	H7	H8	H12	L1	L5	L6
[mm]					-0.05	
DHPC-6-A	5.7	2.9	11.8	10	4.3	2.2
DHPC-10-A		2.8	11.5	16	5.4	2.7
DHPC-L-10-A						
DHPC-16-A	7	4	15	20	7	3.5
DHPC-L-16-A						
DHPC-20-A	9	5	20	26	8.3	4.2
DHPC-L-20-A						
DHPC-25-A	12	6	37.6	33	12	6
DHPC-L-25-A						
DHPC-32-A	14	7	43.5	40	15.2	7.6
DHPC-40-A	17	9	54.5	48	18	9

## Datasheet

## Dimensions – Gripper finger mounting

Download CAD data → [www.festo.com](http://www.festo.com)

DHPC-...-A-...-1: Mounting holes on the side

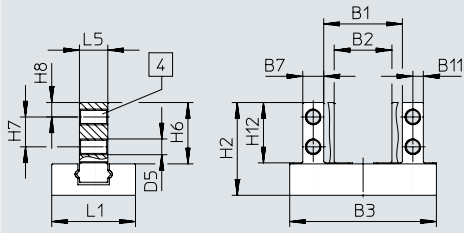

[4] Threaded hole for mounting the gripper fingers

Size	B1	B2	B3	B7	B11	D5	H2
[mm]				-0.1			
DHPC-6-A-...-1	10.2	6.2	20 -0.2	4.2	2.1	M3	21
DHPC-10-A-...-1	15	11	28 -0.2	4	2		17.7
DHPC-L-10-A-...-1	19		34 -0.2				
DHPC-16-A-...-1	19.8	13.8	37.4 -0.2	5	2.5	M4	24.3
DHPC-L-16-A-...-1	25.8		46.4 -0.2				
DHPC-20-A-...-1	25.6	15.6	50.2 -0.2	8	4	M5	30.8
DHPC-L-20-A-...-1	33.6		62.2 -0.2				
DHPC-25-A-...-1	32.6	18.6	62.6	10	5	M6	37.6
DHPC-L-25-A-...-1	40.6		74.6				
DHPC-32-A-...-1	47.9	25.9	97	12	6	M8	43.5
DHPC-40-A-...-1	60.9	30.9	118	14	7		54.5

Size	H6	H7	H8	H12	L1	L5
[mm]						-0.05
DHPC-6-A-...-1	12.3	5.7	2.9	11.8	10	4.3
DHPC-10-A-...-1	11.7		2.8	11.5	16	5.4
DHPC-L-10-A-...-1						
DHPC-16-A-...-1	16.3	7	4	15	20	7
DHPC-L-16-A-...-1						
DHPC-20-A-1	21.3	9	5	20	26	8.3
DHPC-L-20-A-1						
DHPC-25-A-1	26.6	12	6	37.6	33	12
DHPC-L-25-A-1						
DHPC-32-A-1	31.5	14	7	43.5	40	15.2
DHPC-40-A-1	39.5	17	9	54.5	48	18

Datasheet

**Dimensions – Gripper finger mounting**

Download CAD data → [www.festo.com](http://www.festo.com)

DHPC-...-A-...-2: Flat gripper fingers

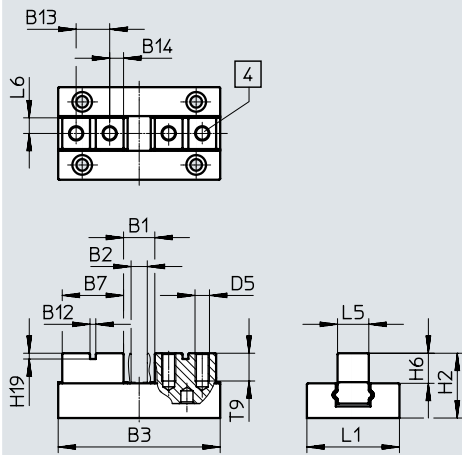

[4] Threaded hole for mounting the gripper fingers

Size	B1	B2	B3	B7	B12	B13	B14	D5
[mm]				-0.1	H9			
DHPC-6-A-...-2	5.4	1.4	20 -0.2	6.6	–	3.8	1.4	M2
DHPC-10-A-...-2			28 -0.2	10.6	2	6	2.3	M2.5
DHPC-L-10-A-...-2	9.4		34 -0.2	11.6		7		
DHPC-16-A-...-2	7.4		37.4 -0.2	14.3	2.5	8	3.2	M3
DHPC-L-16-A-...-2	13.4	46.4 -0.2	15.8	3	9	3.4		
DHPC-20-A-...-2	12	2	50.2 -0.2		18.1	3	10.1	4
DHPC-L-20-A-...-2	20		62.2 -0.2	20.1	12.1		4	
DHPC-25-A-...-2	16		62.6	22.3	4	11.9	5.2	M5
DHPC-L-25-A-...-2	24		74.6	24.3		13.1	5.6	
DHPC-32-A-...-2	24.9	2.9	97	34.6	5	20	7.3	M6
DHPC-40-A-...-2	32.9		118	41.1	6	23.1	9	M8

Size	H2	H6	H19	L1	L5	L6	T9
[mm]					-0.05		
DHPC-6-A-...-2	15.1	6.4	–	10	4.3	2.2	4
DHPC-10-A-...-2	11.2	5.2	2	16	5.4	2.7	5
DHPC-L-10-A-...-2							
DHPC-16-A-...-2	16.3	8.3	2.5	20	7	3.5	6
DHPC-L-16-A-...-2							
DHPC-20-A-...-2	20	10.5	3	26	8.3	4.2	7
DHPC-L-20-A-...-2							
DHPC-25-A-...-2	24.1	13.1	4	33	12	6	10
DHPC-L-25-A-...-2							
DHPC-32-A-...-2	24	12	5	40	15.2	7.6	12
DHPC-40-A-...-2	39.5	24.5	6	48	18	9	16



## Datasheet

## Dimensions – Dust protection

Download CAD data → [www.festo.com](http://www.festo.com)

DHPC-...-A-...-C: With protective dust cap

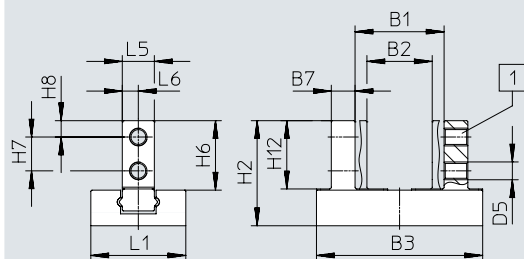

[1] Threaded hole for mounting the gripper fingers

Size	B1	B2	B3	B7	D5	H2	H6
[mm]				-0.1			
DHPC-10-A-...-C	15	11	28	4	M3	21.3	15.3
DHPC-L-10-A-...-C	19		34				
DHPC-16-A-...-C	19.8	13.8	37.4	5		28.9	20.9
DHPC-L-16-A-...-C	25.8		46.4				
DHPC-20-A-...-C	25.6	15.6	50.2	8	M4	35.7	26.2
DHPC-L-20-A-...-C	33.6		62.2				
DHPC-25-A-...-C	32.6	18.6	62.6	10	M5	43.1	32.1
DHPC-L-25-A-...-C	40.6		74.6				

Size	H7	H8	H12	L1	L5	L6
[mm]					-0.05	
DHPC-10-A-...-C	5.7	2.8	15.1	16	5.4	2.7
DHPC-L-10-A-...-C						
DHPC-16-A-...-C	7	4	19.6	20	7	3.5
DHPC-L-16-A-...-C						
DHPC-20-A-...-C	9	5	24.9	26	8.3	4.2
DHPC-L-20-A-...-C						
DHPC-25-A-...-C	12	6	30.5	33	12	6
DHPC-L-25-A-...-C						

Datasheet

Ordering data – Pneumatic connection underneath						
Size [mm]	Double-acting		Single-acting		Closing	
	Part no.	Type	Opening Part no.	Type	Part no.	Type
6	Standard gripper characteristic					
	Type of mounting for gripper fingers: standard					
	8116738	DHPC-6-A-B	-	-	-	-
	Type of mounting for gripper fingers: mounting holes on the side					
	8116739	DHPC-6-A-B-1	-	-	-	-
	Type of mounting for flat gripper fingers					
	8116740	DHPC-6-A-B-2	-	-	-	-
10	Standard gripper characteristic					
	Type of mounting for gripper fingers: standard					
	8116756	DHPC-10-A-B	-	-	-	-
	Type of mounting for gripper fingers: mounting holes on the side					
	8116757	DHPC-10-A-B-1	-	-	-	-
	Type of mounting for flat gripper fingers					
	8116758	DHPC-10-A-B-2	-	-	-	-
	Long stroke gripper characteristic					
	Type of mounting for gripper fingers: standard					
	8116774	DHPC-L-10-A-B	-	-	-	-
	Type of mounting for gripper fingers: mounting holes on the side					
	8116775	DHPC-L-10-A-B-1	-	-	-	-
	Type of mounting for flat gripper fingers					
8116776	DHPC-L-10-A-B-2	-	-	-	-	
16	Standard gripper characteristic					
	Type of mounting for gripper fingers: standard					
	8116788	DHPC-16-A-B	-	-	-	-
	Type of mounting for gripper fingers: mounting holes on the side					
	8116789	DHPC-16-A-B-1	-	-	-	-
	Type of mounting for flat gripper fingers					
	8116790	DHPC-16-A-B-2	-	-	-	-
	Long stroke gripper characteristic					
	Type of mounting for gripper fingers: standard					
	8116806	DHPC-L-16-A-B	-	-	-	-
	Type of mounting for gripper fingers: mounting holes on the side					
	8116807	DHPC-L-16-A-B-1	-	-	-	-
	Type of mounting for flat gripper fingers					
8116808	DHPC-L-16-A-B-2	-	-	-	-	
20	Standard gripper characteristic					
	Type of mounting for gripper fingers: standard					
	8116820	DHPC-20-A-B	-	-	-	-
	Type of mounting for gripper fingers: mounting holes on the side					
	8116821	DHPC-20-A-B-1	-	-	-	-
	Type of mounting for flat gripper fingers					
	8116822	DHPC-20-A-B-2	-	-	-	-
	Long stroke gripper characteristic					
	Type of mounting for gripper fingers: standard					
	8116838	DHPC-L-20-A-B	-	-	-	-
	Type of mounting for gripper fingers: mounting holes on the side					
	8116839	DHPC-L-20-A-B-1	-	-	-	-
	Type of mounting for flat gripper fingers					
8116840	DHPC-L-20-A-B-2	-	-	-	-	

## Datasheet

Ordering data – Pneumatic connection underneath						
Size [mm]	Double-acting		Single-acting Opening		Closing	
	Part no.	Type	Part no.	Type	Part no.	Type
25	Standard gripper characteristic					
	Type of mounting for gripper fingers: standard					
	<b>8116852</b>	<b>DHPC-25-A-B</b>	-		-	
	Type of mounting for gripper fingers: mounting holes on the side					
	<b>8116853</b>	<b>DHPC-25-A-B-1</b>	-		-	
	Type of mounting for flat gripper fingers					
	<b>8116854</b>	<b>DHPC-25-A-B-2</b>	-		-	
	Long stroke gripper characteristic					
	Type of mounting for gripper fingers: standard					
	<b>8116870</b>	<b>DHPC-L-25-A-B</b>	-		-	
Type of mounting for gripper fingers: mounting holes on the side						
<b>8116871</b>	<b>DHPC-L-25-A-B-1</b>	-		-		
Type of mounting for flat gripper fingers						
<b>8116872</b>	<b>DHPC-L-25-A-B-2</b>	-		-		
32	Standard gripper characteristic					
	Type of mounting for gripper fingers: standard					
	<b>8116884</b>	<b>DHPC-32-A-B</b>	-		-	
	Type of mounting for gripper fingers: mounting holes on the side					
	<b>8116885</b>	<b>DHPC-32-A-B-1</b>	-		-	
	Type of mounting for flat gripper fingers					
<b>8116886</b>	<b>DHPC-32-A-B-2</b>	-		-		
40	Standard gripper characteristic					
	Type of mounting for gripper fingers: standard					
	<b>8116897</b>	<b>DHPC-40-A-B</b>	-		-	
	Type of mounting for gripper fingers: mounting holes on the side					
	<b>8116898</b>	<b>DHPC-40-A-B-1</b>	-		-	
Type of mounting for flat gripper fingers						
<b>8116899</b>	<b>DHPC-40-A-B-2</b>	-		-		

Datasheet

Ordering data – Pneumatic connection on the side						
Size [mm]	Double-acting		Single-acting Opening		Closing	
	Part no.	Type	Part no.	Type	Part no.	Type
6	Standard gripper characteristic					
	Type of mounting for gripper fingers: standard					
	8116735	DHPC-6-A-S	8116741	DHPC-6-A-NO-S	8116747	DHPC-6-A-NC-S
	Type of mounting for gripper fingers: mounting holes on the side					
	8116736	DHPC-6-A-S-1	8116742	DHPC-6-A-NO-S-1	8116748	DHPC-6-A-NC-S-1
	Type of mounting for flat gripper fingers					
	8116737	DHPC-6-A-S-2	8116743	DHPC-6-A-NO-S-2	8116749	DHPC-6-A-NC-S-2
10	Standard gripper characteristic					
	Type of mounting for gripper fingers: standard					
	8116753	DHPC-10-A-S	8116759	DHPC-10-A-NO-S	8116765	DHPC-10-A-NC-S
	Type of mounting for gripper fingers: mounting holes on the side					
	8116754	DHPC-10-A-S-1	8116760	DHPC-10-A-NO-S-1	8116766	DHPC-10-A-NC-S-1
	Type of mounting for flat gripper fingers					
	8116755	DHPC-10-A-S-2	8116761	DHPC-10-A-NO-S-2	8116767	DHPC-10-A-NC-S-2
	Long stroke gripper characteristic					
	Type of mounting for gripper fingers: standard					
	8116771	DHPC-L-10-A-S	8116777	DHPC-L-10-A-NO-S	8116780	DHPC-L-10-A-NC-S
	Type of mounting for gripper fingers: mounting holes on the side					
	8116772	DHPC-L-10-A-S-1	8116778	DHPC-L-10-A-NO-S-1	8116781	DHPC-L-10-A-NC-S-1
	Type of mounting for flat gripper fingers					
8116773	DHPC-L-10-A-S-2	8116779	DHPC-L-10-A-NO-S-2	8116782	DHPC-L-10-A-NC-S-2	
16	Standard gripper characteristic					
	Type of mounting for gripper fingers: standard					
	8116785	DHPC-16-A-S	8116791	DHPC-16-A-NO-S	8116797	DHPC-16-A-NC-S
	Type of mounting for gripper fingers: mounting holes on the side					
	8116786	DHPC-16-A-S-1	8116792	DHPC-16-A-NO-S-1	8116798	DHPC-16-A-NC-S-1
	Type of mounting for flat gripper fingers					
	8116787	DHPC-16-A-S-2	8116793	DHPC-16-A-NO-S-2	8116799	DHPC-16-A-NC-S-2
	Long stroke gripper characteristic					
	Type of mounting for gripper fingers: standard					
	8116803	DHPC-L-16-A-S	8116809	DHPC-L-16-A-NO-S	8116812	DHPC-L-16-A-NC-S
	Type of mounting for gripper fingers: mounting holes on the side					
	8116804	DHPC-L-16-A-S-1	8116810	DHPC-L-16-A-NO-S-1	8116813	DHPC-L-16-A-NC-S-1
	Type of mounting for flat gripper fingers					
8116805	DHPC-L-16-A-S-2	8116811	DHPC-L-16-A-NO-S-2	8116814	DHPC-L-16-A-NC-S-2	
20	Standard gripper characteristic					
	Type of mounting for gripper fingers: standard					
	8116817	DHPC-20-A-S	8116823	DHPC-20-A-NO-S	8116829	DHPC-20-A-NC-S
	Type of mounting for gripper fingers: mounting holes on the side					
	8116818	DHPC-20-A-S-1	8116824	DHPC-20-A-NO-S-1	8116830	DHPC-20-A-NC-S-1
	Type of mounting for flat gripper fingers					
	8116819	DHPC-20-A-S-2	8116825	DHPC-20-A-NO-S-2	8116831	DHPC-20-A-NC-S-2
	Long stroke gripper characteristic					
	Type of mounting for gripper fingers: standard					
	8116835	DHPC-L-20-A-S	8116841	DHPC-L-20-A-NO-S	8116844	DHPC-L-20-A-NC-S
	Type of mounting for gripper fingers: mounting holes on the side					
	8116836	DHPC-L-20-A-S-1	8116842	DHPC-L-20-A-NO-S-1	8116845	DHPC-L-20-A-NC-S-1
	Type of mounting for flat gripper fingers					
8116837	DHPC-L-20-A-S-2	8116843	DHPC-L-20-A-NO-S-2	8116846	DHPC-L-20-A-NC-S-2	

## Datasheet

Ordering data – Pneumatic connection on the side						
Size [mm]	Double-acting		Single-acting Opening		Closing	
	Part no.	Type	Part no.	Type	Part no.	Type
25	Standard gripper characteristic					
	Type of mounting for gripper fingers: standard					
	8116849	DHPC-25-A-S	8116855	DHPC-25-A-NO-S	8116861	DHPC-25-A-NC-S
	Type of mounting for gripper fingers: mounting holes on the side					
	8116850	DHPC-25-A-S-1	8116856	DHPC-25-A-NO-S-1	8116862	DHPC-25-A-NC-S-1
	Type of mounting for flat gripper fingers					
	8116851	DHPC-25-A-S-2	8116857	DHPC-25-A-NO-S-2	8116863	DHPC-25-A-NC-S-2
	Long stroke gripper characteristic					
	Type of mounting for gripper fingers: standard					
	8116867	DHPC-L-25-A-S	8116873	DHPC-L-25-A-NO-S	8116876	DHPC-L-25-A-NC-S
	Type of mounting for gripper fingers: mounting holes on the side					
	8116868	DHPC-L-25-A-S-1	8116874	DHPC-L-25-A-NO-S-1	8116877	DHPC-L-25-A-NC-S-1
Type of mounting for flat gripper fingers						
8116869	DHPC-L-25-A-S-2	8116875	DHPC-L-25-A-NO-S-2	8116878	DHPC-L-25-A-NC-S-2	
32	Standard gripper characteristic					
	Type of mounting for gripper fingers: standard					
	8116881	DHPC-32-A-S	8116887	DHPC-32-A-NO-S	8116890	DHPC-32-A-NC-S
	Type of mounting for gripper fingers: mounting holes on the side					
	8116882	DHPC-32-A-S-1	8116888	DHPC-32-A-NO-S-1	8116891	DHPC-32-A-NC-S-1
	Type of mounting for flat gripper fingers					
8116883	DHPC-32-A-S-2	8116889	DHPC-32-A-NO-S-2	8116892	DHPC-32-A-NC-S-2	
40	Standard gripper characteristic					
	Type of mounting for gripper fingers: standard					
	8116894	DHPC-40-A-S	8116900	DHPC-40-A-NO-S	8116903	DHPC-40-A-NC-S
	Type of mounting for gripper fingers: mounting holes on the side					
	8116895	DHPC-40-A-S-1	8116901	DHPC-40-A-NO-S-1	8116904	DHPC-40-A-NC-S-1
Type of mounting for flat gripper fingers						
8116896	DHPC-40-A-S-2	8116902	DHPC-40-A-NO-S-2	8116905	DHPC-40-A-NC-S-2	

Datasheet

Ordering data – Pneumatic connection via mounting spigot						
Size [mm]	Double-acting		Single-acting		Closing	
	Part no.	Type	Opening Part no.	Type	Part no.	Type
6	Standard gripper characteristic					
	Type of mounting for gripper fingers: standard					
	–		<b>8116744</b>	<b>DHPC-6-A-NO-Z</b>	<b>8116750</b>	<b>DHPC-6-A-NC-Z</b>
	Type of mounting for gripper fingers: mounting holes on the side					
	–		<b>8116745</b>	<b>DHPC-6-A-NO-Z-1</b>	<b>8116751</b>	<b>DHPC-6-A-NC-Z-1</b>
	Type of mounting for flat gripper fingers					
–		<b>8116746</b>	<b>DHPC-6-A-NO-Z-2</b>	<b>8116752</b>	<b>DHPC-6-A-NC-Z-2</b>	
10	Standard gripper characteristic					
	Type of mounting for gripper fingers: standard					
	–		<b>8116762</b>	<b>DHPC-10-A-NO-Z</b>	<b>8116768</b>	<b>DHPC-10-A-NC-Z</b>
	Type of mounting for gripper fingers: mounting holes on the side					
	–		<b>8116763</b>	<b>DHPC-10-A-NO-Z-1</b>	<b>8116769</b>	<b>DHPC-10-A-NC-Z-1</b>
	Type of mounting for flat gripper fingers					
–		<b>8116764</b>	<b>DHPC-10-A-NO-Z-2</b>	<b>8116770</b>	<b>DHPC-10-A-NC-Z-2</b>	
16	Standard gripper characteristic					
	Type of mounting for gripper fingers: standard					
	–		<b>8116794</b>	<b>DHPC-16-A-NO-Z</b>	<b>8116800</b>	<b>DHPC-16-A-NC-Z</b>
	Type of mounting for gripper fingers: mounting holes on the side					
	–		<b>8116795</b>	<b>DHPC-16-A-NO-Z-1</b>	<b>8116801</b>	<b>DHPC-16-A-NC-Z-1</b>
	Type of mounting for flat gripper fingers					
–		<b>8116796</b>	<b>DHPC-16-A-NO-Z-2</b>	<b>8116802</b>	<b>DHPC-16-A-NC-Z-2</b>	
20	Standard gripper characteristic					
	Type of mounting for gripper fingers: standard					
			<b>8116826</b>	<b>DHPC-20-A-NO-Z</b>	<b>8116832</b>	<b>DHPC-20-A-NC-Z</b>
	Type of mounting for gripper fingers: mounting holes on the side					
			<b>8116827</b>	<b>DHPC-20-A-NO-Z-1</b>	<b>8116833</b>	<b>DHPC-20-A-NC-Z-1</b>
	Type of mounting for flat gripper fingers					
		<b>8116828</b>	<b>DHPC-20-A-NO-Z-2</b>	<b>8116834</b>	<b>DHPC-20-A-NC-Z-2</b>	
25	Standard gripper characteristic					
	Type of mounting for gripper fingers: standard					
	–		<b>8116858</b>	<b>DHPC-25-A-NO-Z</b>	<b>8116864</b>	<b>DHPC-25-A-NC-Z</b>
	Type of mounting for gripper fingers: mounting holes on the side					
	–		<b>8116859</b>	<b>DHPC-25-A-NO-Z-1</b>	<b>8116865</b>	<b>DHPC-25-A-NC-Z-1</b>
	Type of mounting for flat gripper fingers					
–		<b>8116860</b>	<b>DHPC-25-A-NO-Z-2</b>	<b>8116866</b>	<b>DHPC-25-A-NC-Z-2</b>	

## Ordering data – Modular product system

Ordering table											
Size	6	10	16	20	25	32	40	Conditions	Code	Enter code	
Module no.	8116728	8116729	8116730	8116731	8116732	8116733	8116734				
Design	Parallel gripper								DHPC	DHPC	
Gripper characteristic	Standard										
	–				Long stroke			–		-L	
Size [mm]	6	10	16	20	25	32	40		...		
Position sensing	Via proximity switch									-A	-A
Gripping force backup	None										
	Closing							[1]		-NC	
	Opening							[1]		-NO	
Pneumatic connection	Underneath									-B	
	On the side									-S	
	Via mounting spigot									-Z	
Dust protection	None										
	–				Protective dust cap			–		-C	
Type of mounting for gripper fingers	Standard										
	Mounting holes on the side									-1	
	Flat gripper fingers							[2]		-2	

[1] NC, NO Mandatory specification with pneumatic connection via mounting spigot Z

[2] 2 Not with dust protection via protective dust cap C

Accessories

Protective dust cap  
DHAS-DP-B23-...-N

Material: NBR

RoHS-compliant

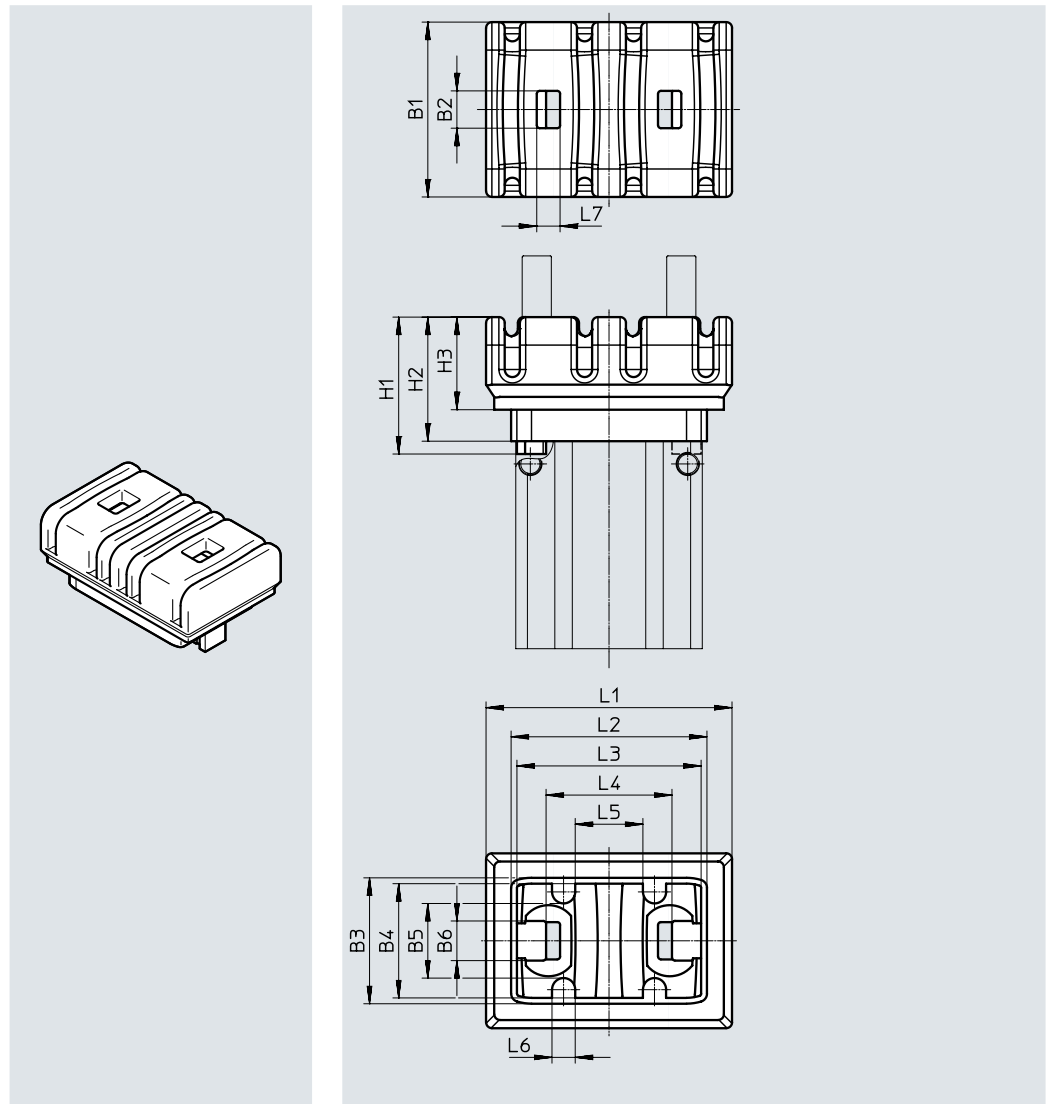

Dimensions and ordering data

Size	B1	B2	B3	B4	B5	B6	H1	H2	H3	L1	L2	L3	L4	L5	L6	L7	Weight [g]	Part no.	Type
10	22	5	17.2	15.6	-	6.8	17	15.5	10.5	33.4	26.2	24.6	14.8	-	-	3.2	2.7	8116783	DHAS-DP-B23-10-N
	19.8						17.3	11.3	37.6	3.7							8116784	DHAS-DP-B23-10-L-N	
16	30	6.4	21.6	19.6	12.8		23.5	21.3	15.9	42.2	33.6	31.6	21.6	11.6	4	4	6.7	8116815	DHAS-DP-B23-16-N
							24.6	21.9		52							8.1	8116816	DHAS-DP-B23-16-L-N
20	36	8	27.4	25.4	18.4		26.9	23.7	17.7	55.2	41.4	39.4	22	12.8	4	6.8	10	8116847	DHAS-DP-B23-20-N
							27.9			67.2							12.1	8116848	DHAS-DP-B23-20-L-N
25	43	11.5	34.6	32.6	23.4		35	27	20	67.8	51.6	49.6	32	16.8	4.2	8.6	16.6	8116879	DHAS-DP-B23-25-N
							36.5			79.5							17.6	8116880	DHAS-DP-B23-25-L-N

 Note

The protective dust cap can only be fitted on grippers with variant DHPC-...-C.





## Accessories

## Proximity switch for size 6, 16 ... 40

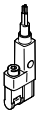

Ordering data – Proximity switch for C-slot, magneto-resistive							Datasheets → Internet: smt
	Type of mounting	Electrical connection, outlet direction of connection	Switching output	Cable length [m]	Part no.	Type	
N/O							
	Inserted in the slot from above	Cable, 3-core, lengthwise	PNP	2.5	551373	SMT-10M-PS-24V-E-2.5-L-OE	
		Plug M8x1, 3-pin, in-line		0.3	551375	SMT-10M-PS-24V-E-0.3-L-M8D	
		Cable, 3-core, crosswise	NPN	2.5	551374	SMT-10M-PS-24V-E-2.5-Q-OE	
		Plug M8x1, 3-pin, crosswise		0.3	551376	SMT-10M-PS-24V-E-0.3-Q-M8D	

Ordering data – Proximity switch for C-slot, magneto-resistive							Datasheets → Internet: smt
	Type of mounting	Electrical connection, outlet direction of connection	Switching output	Cable length [m]	Part no.	Type	
N/O							
	Inserted into the slot lengthwise	Cable, 3-core, crosswise	PNP	2.5	547862	SMT-10G-PS-24V-E-2.5Q-OE	
		Plug M8x1, 3-pin, crosswise		0.3	547863	SMT-10G-PS-24V-E-0.3Q-M8D	
		Cable, 3-core, crosswise	NPN	2.5	8065030	SMT-10G-NS-24V-E-2.5Q-OE	
		Plug M8x1, 3-pin, crosswise		0.3	8065029	SMT-10G-NS-24V-E-0.3Q-M8D	

## Proximity switch for size 10 ... 40

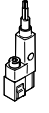
Ordering data – Proximity switch for T-slot, magneto-resistive							Datasheets → Internet: smt
	Type of mounting	Electrical connection outlet direction of connection	Switching output	Cable length [m]	Part no.	Type	
N/O							
	Inserted in the slot from above, short design	Cable, 3-core, lengthwise	PNP	2.5	574335	SMT-8M-A-PS-24V-E-2.5-OE	
		Plug M8x1, 3-pin, in-line		0.3	574334	SMT-8M-A-PS-24V-E-0.3-M8D	
		Plug M12x1, 3-pin, in-line		0.3	574337	SMT-8M-A-PS-24V-E-0.3-M12	
		Cable, 3-core, lengthwise	NPN	2.5	574338	SMT-8M-A-NS-24V-E-2.5-OE	
		Plug M8x1, 3-pin, in-line		0.3	574339	SMT-8M-A-NS-24V-E-0.3-M8D	
N/C							
	Inserted in the slot from above, short design	Cable, 3-core, lengthwise	PNP	7.5	574340	SMT-8M-A-PO-24V-E-7.5-OE	

Ordering data – Proximity switch for T-slot, magneto-resistive							Datasheets → Internet: smt
	Type of mounting	Electrical connection, outlet direction of connection	Switching output	Cable length [m]	Part no.	Type	
N/O							
	Inserted into the slot lengthwise	Cable, 3-core, crosswise	PNP	2.5	547859	SMT-8G-PS-24V-E-2.5Q-OE	
		Plug M8x1, 3-pin, crosswise		0.3	547860	SMT-8G-PS-24V-E-0.3Q-M8D	
		Cable, 3-core, crosswise	NPN	2.5	8065028	SMT-8G-NS-24V-E-2.5Q-OE	
		Plug M8x1, 3-pin, crosswise		0.3	8065027	SMT-8G-NS-24V-E-0.3Q-M8D	

Ordering data – Connecting cables						Datasheets → Internet: nebu
	Electrical connection, left	Electrical connection, right	Cable length [m]	Part no.	Type	
	Straight socket, M8x1, 3-pin	Cable, open end, 3-core	2.5	541333	NEBU-M8G3-K-2.5-LE3	
			5	541334	NEBU-M8G3-K-5-LE3	
	Straight socket, M12x1, 5-pin	Cable, open end, 3-core	2.5	541363	NEBU-M12G5-K-2.5-LE3	
			5	541364	NEBU-M12G5-K-5-LE3	
	Angled socket, M8x1, 3-pin	Cable, open end, 3-core	2.5	541338	NEBU-M8W3-K-2.5-LE3	
			5	541341	NEBU-M8W3-K-5-LE3	
	Angled socket, M12x1, 5-pin	Cable, open end, 3-core	2.5	541367	NEBU-M12W5-K-2.5-LE3	
			5	541370	NEBU-M12W5-K-5-LE3	

## Accessories

## Position transmitter for size 10 ... 40

The position transmitter continuously senses the position of the piston.  
It has an analogue output with an output signal relative to the piston position.

## Ordering data – Position transmitters for T-slot

Datasheets → Internet: position transmitter

	Position measuring range	Analogue output [V]	Analogue output [mA]	Type of mounting	Electrical connection	Cable length [m]	Part no.	Type
	0 ... 40	0 ... 10	–	Inserted in the slot from above	Plug M8x1, 4-pin, in-line	0.3	553744	SMAT-8M-U-E-0.3-M8D



## Ordering data – Position transmitters for T-slot

Datasheets → Internet: sdas

	Description	Type of mounting	Electrical connection	Cable length [m]	Part no.	Type
	Choice of two operating modes: • two adjustable switching outputs • IO-Link®	Inserted in the slot from above	Plug M8x1, 4-pin, in-line	0.3	8063974	SDAS-MHS-M40-1L-PNLK-PN-E-0.3-M8
			Cable, open end	2.5	8063975	SDAS-MHS-M40-1L-PNLK-PN-E-2.5-LE

## Ordering data – Connecting cables

Datasheets → Internet: nebu

	Electrical connection, left	Electrical connection, right	Cable length [m]	Part no.	Type
	Straight socket, M8x1, 4-pin	Cable, open end, 4-core	2.5	541342	NEBU-M8G4-K-2.5-LE4
			5	541343	NEBU-M8G4-K-5-LE4
	Angled socket, M8x1, 4-pin	Cable, open end, 4-core	2.5	541344	NEBU-M8W4-K-2.5-LE4
			5	541345	NEBU-M8W4-K-5-LE4

# Festo - Your Partner in Automation



**1 Festo Inc.**  
5300 Explorer Drive  
Mississauga, ON L4W 5G4  
Canada

**Festo Customer Interaction Center**  
Tel: 1 877 463 3786  
Fax: 1 877 393 3786  
Email: [customer.service.ca@festo.com](mailto:customer.service.ca@festo.com)



**2 Festo Pneumatic**  
Av. Ceylán 3,  
Col. Tequesquináhuac  
54020 Tlalnepantla,  
Estado de México

**Multinational Contact Center**  
01 800 337 8669  
[ventas.mexico@festo.com](mailto:ventas.mexico@festo.com)



**3 Festo Corporation**  
1377 Motor Parkway  
Suite 310  
Islandia, NY 11749

**Festo Customer Interaction Center**  
1 800 993 3786  
1 800 963 3786  
[customer.service.us@festo.com](mailto:customer.service.us@festo.com)



**4 Regional Service Center**  
7777 Columbia Road  
Mason, OH 45040

Connect with us



[www.festo.com/socialmedia](http://www.festo.com/socialmedia)



[www.festo.com](http://www.festo.com)

Subject to change