

Terminal CPX-P

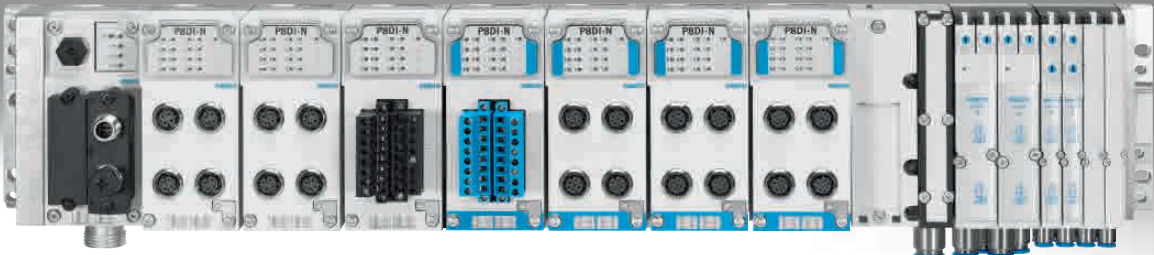

Key features



Key features

Installation concept

- Economical from the smallest configuration up to the maximum number of modules
- Up to 9 electrical input/output modules plus bus node and pneumatic interface/electronics modules for valves
- Extensive range of functions and connection options for the electrical modules
- Choice of connection technology for technically and economically optimised connections
- Can be used as a dedicated remote I/O module

Electrics

- High operating voltage tolerance ($\pm 25\%$)
- Open to all fieldbus protocols and Ethernet
- IT services and TCP/IP such as remote maintenance, remote diagnostics, web server, SMS and e-mail alert
- Digital inputs and outputs, 4-way/8-way/16-way, optionally available with individual channel diagnostics
- Analogue inputs and outputs, 2-way/4-way
- Analogue inputs and outputs with HART protocol
- Input modules for connecting NAMUR sensors
- Pressure inputs
- Temperature inputs
- IP65 or IP20

Mounting

- Wall or H-rail mounting, also on mobile units
- Conversions/extensions are possible at any time, individual linking
- Modular system offering a range of configuration options
- Fully assembled and tested unit
- Reduced costs for selection, ordering, assembly and commissioning thanks to the central CPX-P terminal
- Choice of pneumatic components for optimised control chain

Operation

- Fast troubleshooting thanks to an extensive selection of LEDs (some of which are multi-coloured) on the bus node and on all I/O modules
- Suitable for direct machine mounting (IP65/IP67) or in a control cabinet with a terminal connection (IP20)
- Supports module and channel-oriented diagnostics
- Fieldbus/Ethernet remote diagnostics
- Innovative diagnostic support with integrated web server/web monitor or Festo Maintenance Tool (CPX-FMT) with USB adapter (NEFC) for PC
- Optimised commissioning thanks to parameterisable functions
- Reliable servicing with connection blocks and modules that are quick to replace without changing the wiring

Key features

Variants of the CPX-P terminal controller (with bus node, without preprocessing)

Bus node

Different bus nodes are used for integration in the control systems of various manufacturers.

The CPX-P terminal can therefore be operated on commonly used fieldbus systems:

- PROFIBUS-DP
- PROFINET
- DeviceNet

- CANopen

Integration in universal networks based on Ethernet opens up new possibilities. Faster data transmission, real-time capability and above all additional IT services such as file transfer, web server, as website integrated in the CPX-P terminal, text

message/e-mail alerts, etc. open up a wide range of synergies.

These include standardised and universal communication technology across all areas, including operating level, management level and field level in the production environment, with protection to IP65.

The following protocols are supported:

- EtherNet/IP
- Modbus/TCP
- PROFINET
- EtherCAT

Bus node

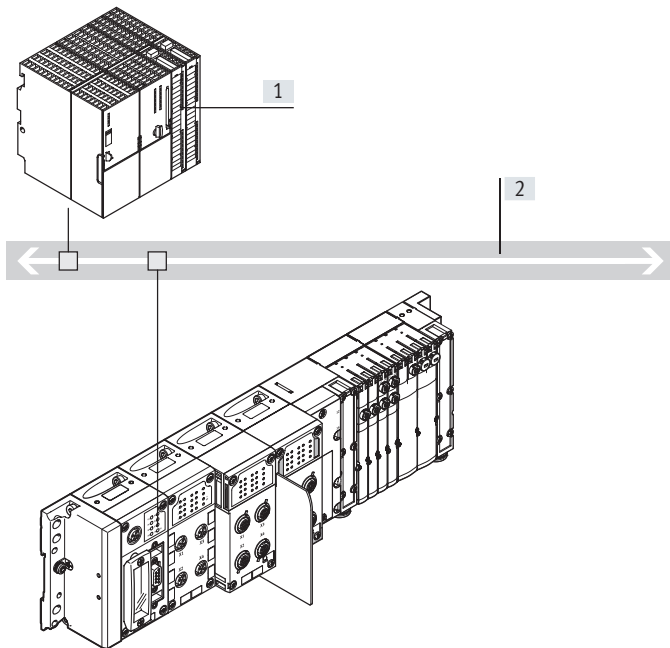

- [1] Higher-order controller (PLC)
[2] Fieldbus

- Communication with the higher-order controller via fieldbus
- No preprocessing
- Fieldbus protocol dependent on CPX bus node used
- More than 90 I/Os, depending on bus node used

Industrial Ethernet bus node

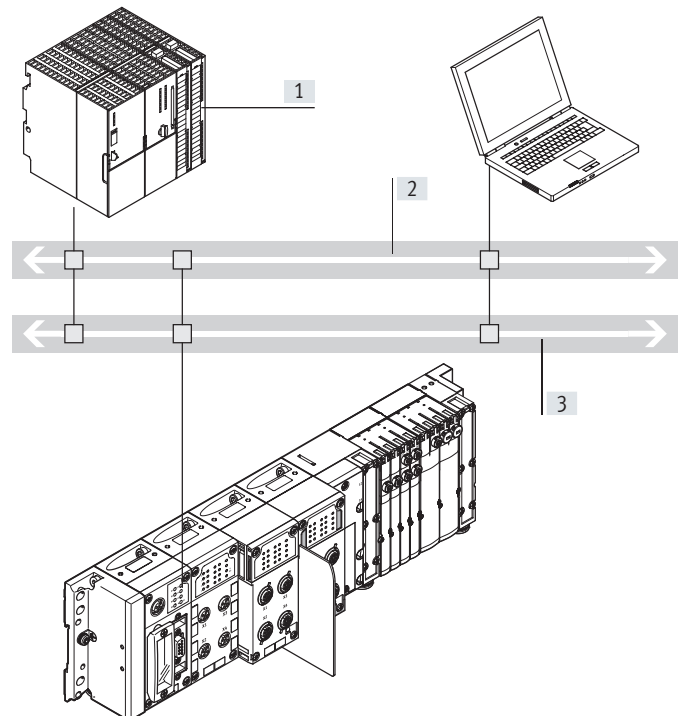

- [1] Higher-order controller (PLC)
[2] Industrial Ethernet
[3] IT services:
– Web
– Email
– Data transmission

- Connection to a higher-order controller directly via EtherNet/IP, Modbus/TCP, EtherCAT or PROFINET
- No preprocessing
- Monitoring via Ethernet and web applications
- More than 300 I/Os

Note

Every electrical interface can be combined with an appropriate number of I/O modules and/or pneumatic components, depending on its address capacity.

Likewise, every pneumatic variant of the CPX-P terminal can be operated with every electrical interface variant.

Key features

Variants of the CPX-P terminal controller (with preprocessing in the control block)

Control block

The optional front end controllers CPX-CEC enable simultaneous access via Ethernet, in parallel with a bus node, as well as autonomous preprocessing.

Access via Modbus/TCP and EasyIP is also possible.

Commissioning, programming, and diagnostics using the Festo software tool FST with hardware configurator.

With control block in stand-alone mode

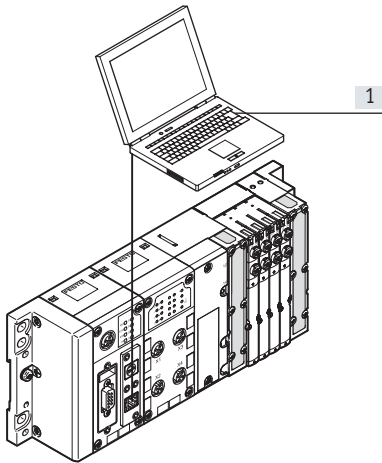

[1] CODESYS/FST

- Decentralised controller with direct machine mounting
- Downloading programs via Ethernet (or via the programming interface)
- Supports full expansion of all CPX peripherals
- More than 300 I/Os

Can be successfully used in the follow applications:

- Stand-alone individual workstations
- Interlinked, stand-alone sub-systems
- Automation using IT technology

With control block in Festo EasyIP mode

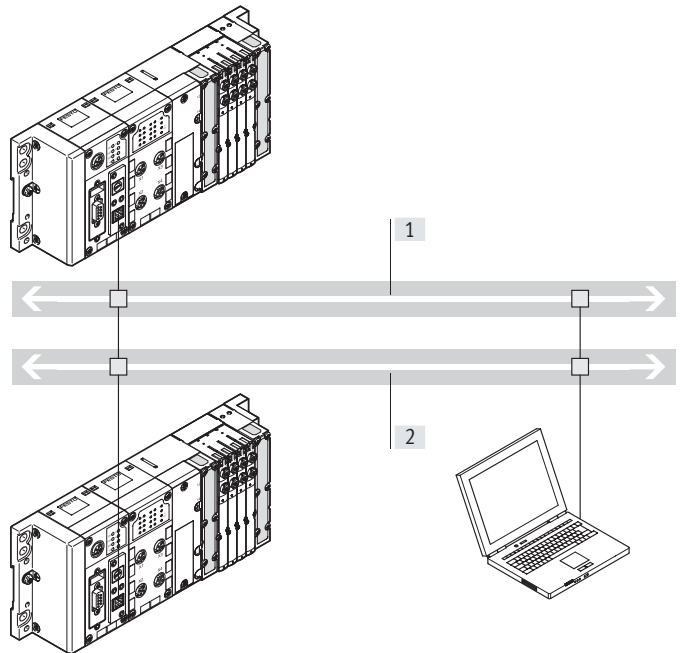

[1] Industrial Ethernet

- [2] IT services:
- Web
 - Email
 - Data transmission

- Fast preprocessing of the CPX-P peripherals in the control block
- Exchange of any data between the control blocks via EasyIP
- Remote diagnostics
- No higher-order controller is required
- More than 300 I/Os per CPX-P control block

Key features

Variants of the CPX-P terminal controller (with preprocessing in the control block)

With control block as remote controller on Ethernet

Remote controller via Ethernet as the preprocessing unit for decentralised, stand-alone sub-systems using IT technology.

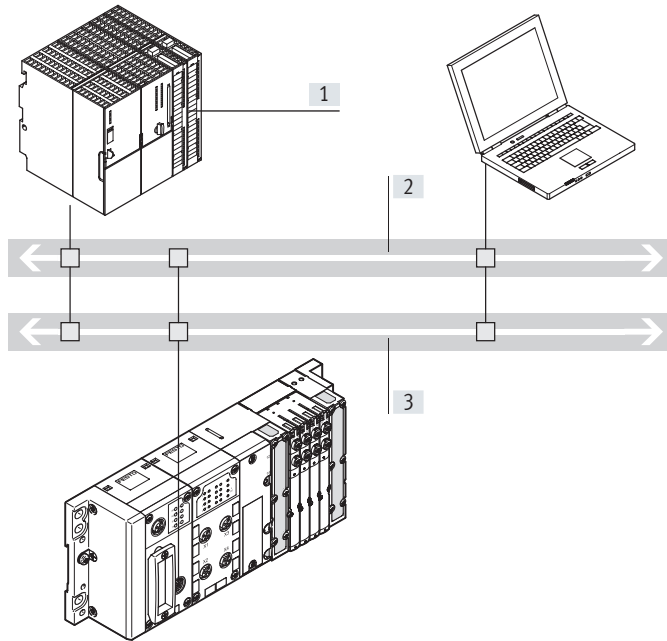

[1] Higher-order controller (PLC)

[2] Industrial Ethernet

[3] IT services:

- Web
- Email
- Data transmission

- Connection to a higher-order controller via Ethernet, no further bus node is required
- Monitoring via Ethernet and web applications
- Preprocessing of the CPX-P peripherals by CPX-P control block
- More than 300 I/Os

With control block as remote controller on the fieldbus

Fieldbus remote controller (combination with bus nodes for PROFIBUS DP, PROFINET, CANopen, DeviceNet or EtherCAT) as the preprocessing unit for

decentralised, stand-alone subsystems.

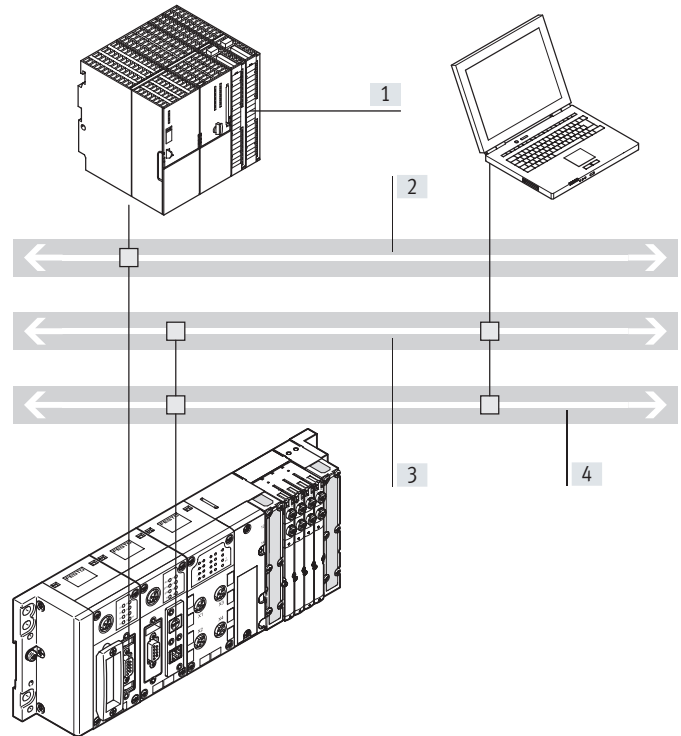

[1] Higher-order controller (PLC)

[2] Fieldbus

[3] Industrial Ethernet

[4] IT services:

- Web
- Email
- Data transmission

- Fast preprocessing of the CPX-P peripherals in the control block
- Communication with the higher-order controller via fieldbus
- Optional additional monitoring via Ethernet and web applications
- Downloading programs via programming interface
- More than 300 I/Os, bus node is only used for communication with the higher-order PLC
- Option of two bus nodes for redundant communication configuration

Key features

Variants of the CPX-P terminal controller (with preprocessing in the control block)

With control block as CANopen fieldbus master

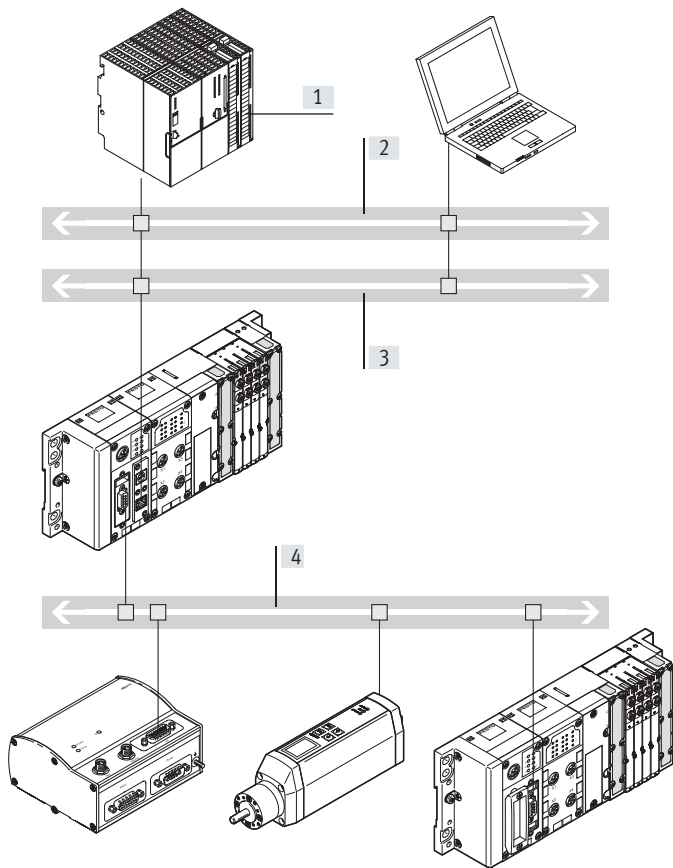

- [1] Higher-order controller (PLC)
- [2] Industrial Ethernet
- [3] IT services:
 - Web
 - Email
 - Data transmission
- [4] Fieldbus (CANopen)

Features:

- Connection to a higher-order controller via Ethernet, no further bus node is required
- Monitoring via Ethernet
- Preprocessing of the CPX-P peripherals by CPX-P control block
- More than 300 I/Os
- Up to 128 stations with repeater technology on CANopen

Operating modes:

- Remote controller on Ethernet
- Control block in Festo EasyIP mode

Key features

Interface of inputs and outputs to the CPX-P terminal

Digital and analogue CPX-P I/O modules

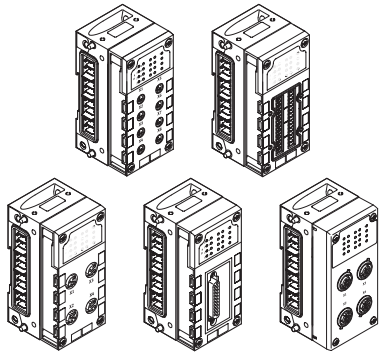

Electrical connection

The connection technology for sensors and additional actuators offers a wide range of digital and analogue input and output modules and is freely selectable – as appropriate to your standard or the application.

The input/output modules can be combined as required with the connection blocks:

- M12, 5-pin
- M12 5-pin, with quick lock and metal thread
- M12, 8-pin
- M8, 3-pin
- M8, 4-pin
- Sub-D 25-pin
- CageClamp® (with cover also to IP65/67)
- Screw terminal and spring-loaded terminal

CPX modules for NAMUR sensors

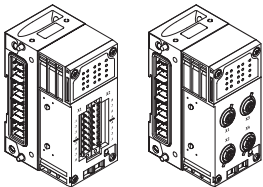

Electrical connection

The electronics modules for NAMUR sensors can only be combined with certain connection blocks.

The input modules can be combined as required with the connection blocks:

- M12, 4-pin
- Screw terminal and spring-loaded terminal

CPX modules for NAMUR sensors, intrinsically safe circuits for ATEX applications

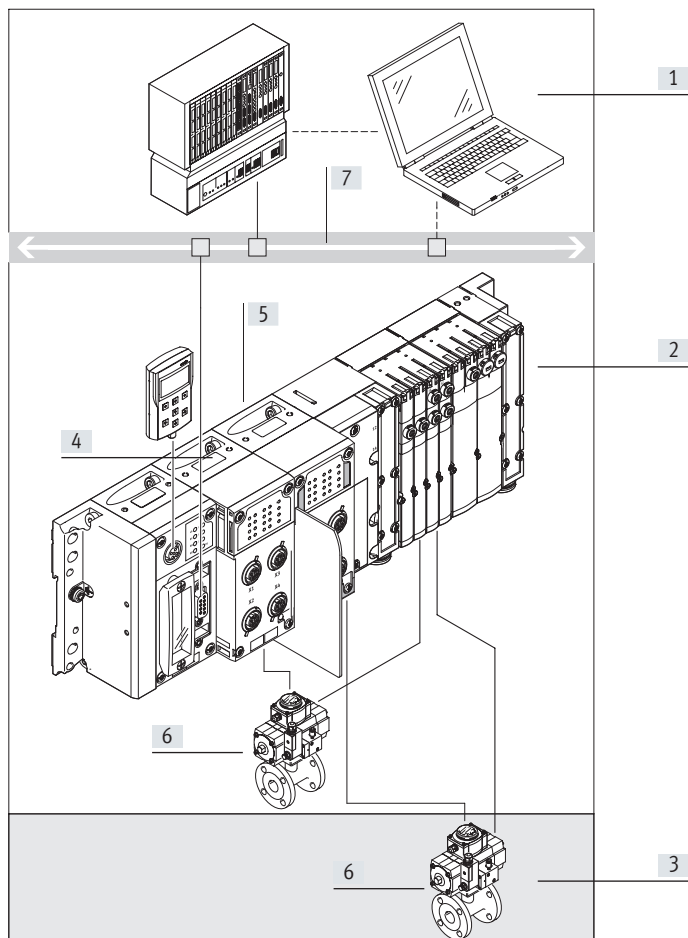

- [1] Higher-order controller (PLC)
- [2] Non-ATEX zone; non-intrinsically safe circuits are permitted
- [3] ATEX zone; only intrinsically safe circuits are permitted
- [4] CPX input module for NAMUR sensors, non-intrinsically safe design
- [5] CPX input module for NAMUR sensors, intrinsically safe design
- [6] Actuator/machine component with NAMUR sensors
- [7] Fieldbus

CPX-P modules are suitable for configuring intrinsically safe or non-intrinsically safe circuits, depending on the design selected.

This enables components from both safe and potentially explosive zones to be connected to the CPX-P terminal. The components for the intrinsically safe zone are marked in blue or entirely coloured blue to distinguish them visually.

Note

Intrinsically safe circuits are circuits which release so little energy during operation, or in the event of certain faults under specified test conditions, that no ignition can occur in a particular potentially explosive atmosphere.

Key features

Interface of inputs and outputs to the CPX-P terminal

With CPX-CTEL interface

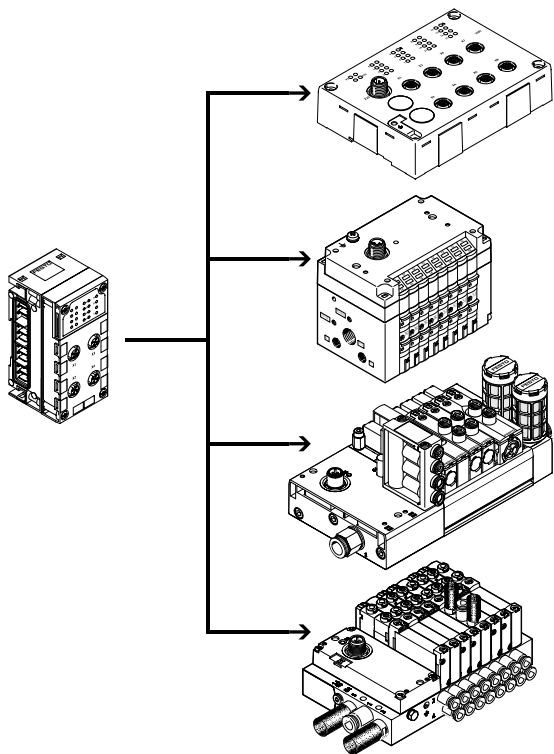

- Up to 4 devices with individual electronic protection per CPX-CTEL master
- Max. 64 inputs/64 outputs per I-Port interface
- The maximum length of a string is 20 m.
- Input modules with 16 digital inputs (connection technology M8 3-pin and M12 5-pin)
- Valve terminals with I-Port interface (up to 48 solenoid coils, different valve functions)

Several CPX-P CTEL masters can be combined on one CPX-P terminal (depending on the controller used).
Combination of central CPX-P I/O modules and decentrally mounted I/O modules with I-Port interface.

With CPX-CTEL-2 interface

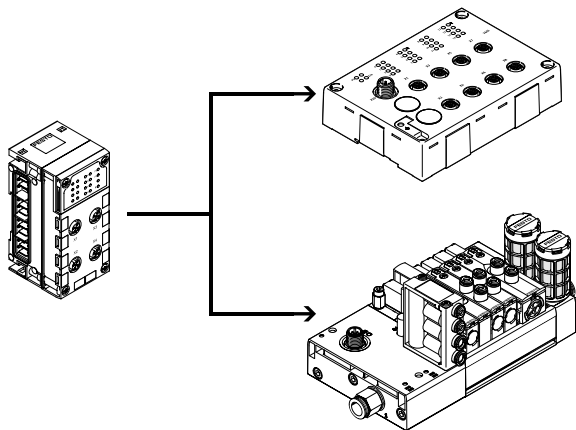

- Up to 2 IO-Link devices with individual electronic protection per CPX-CTEL-2 interface
- Max. 16-byte inputs/16-byte outputs per IO-Link device
- The maximum length of a string is 20 m.

Several CPX-CTEL-2 interfaces can be combined on one CPX-P terminal (depending on the controller used).
Combination of central CPX-P I/O modules and decentrally mounted I/O modules with IO-Link interface.

Key features

Pneumatic variants of the CPX-P terminal

With valve terminal MPA-S – centralised

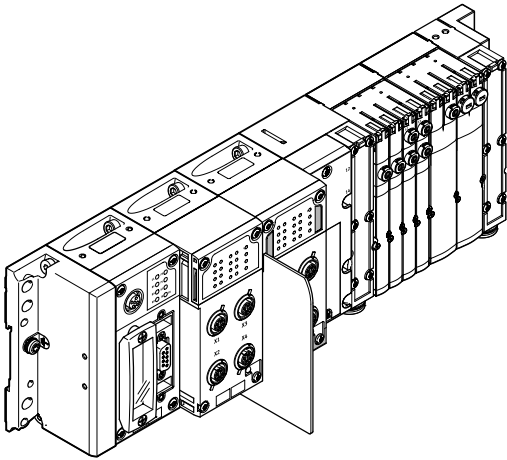

The electrical terminal CPX-P is a modular peripheral system for valve terminals. The system is specifically designed so that the valve terminal can be adapted to suit different applications.

The modular system design lets you configure the number of valves, inputs and additional outputs to suit the application.

Ordering

The CPX-P terminal with valve terminal is fully assembled according to your order specifications and individually tested. It consists of the electrical peripherals including the desired actuation and the selected components from the MPA-S modular system.

The CPX-P terminal with valve terminal is ordered using two separate order codes. One order code defines the electrical peripherals type CPX-P, while the other specifies the pneumatic components of the valve terminal.

The electrical peripherals type CPX-P can also be configured without a valve terminal and can be used on a field-bus. To order this, only the order code for the electrical peripherals is required.

The order lists for the pneumatic components can be found at
→ Internet: mpa-s
(valve terminal MPA-S)

Peripherals overview

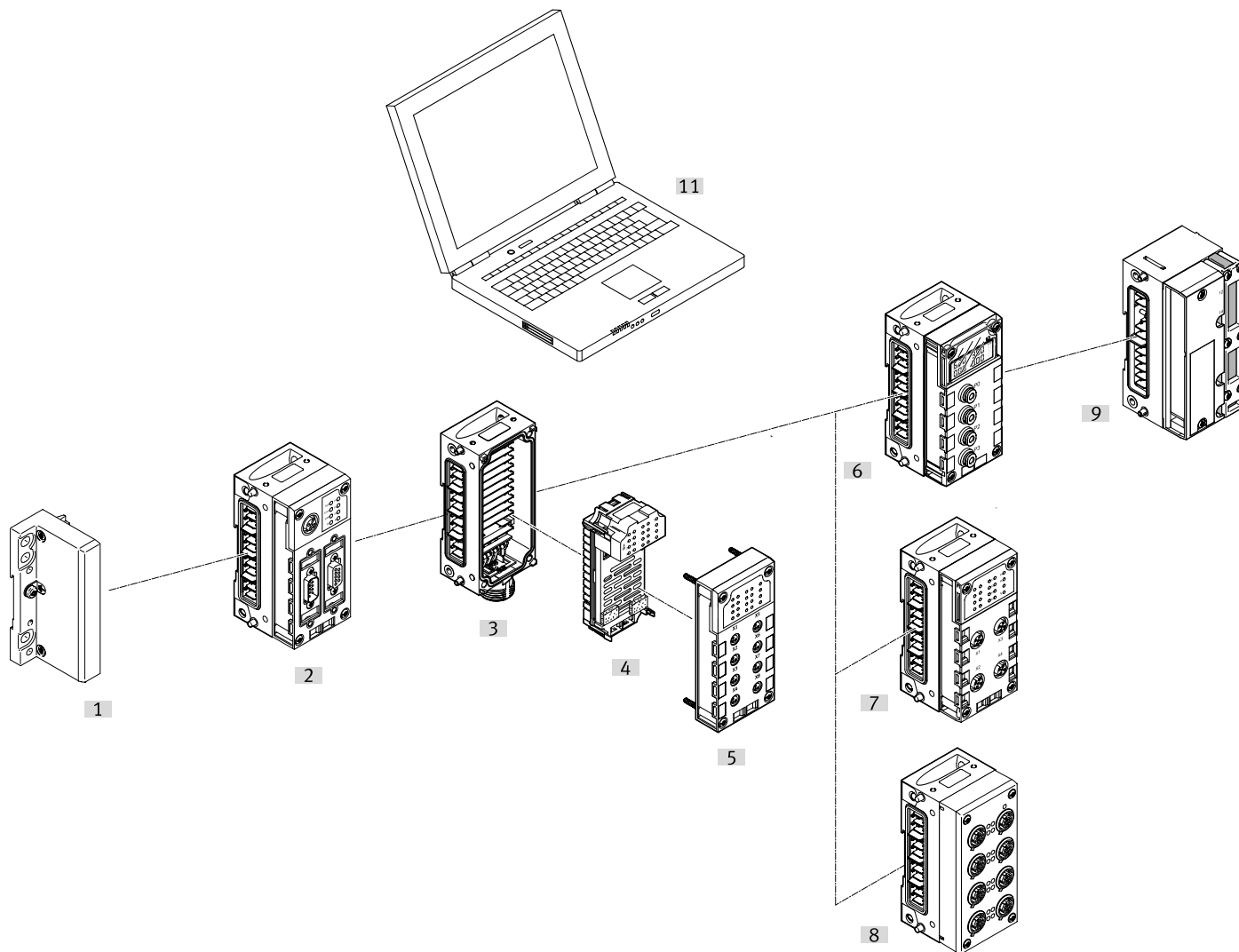

Designation	Type	Description	→ Page/Internet
[1] End plate	CPX-M-EPR-EV CPX-M-EPL-EV	<ul style="list-style-type: none"> • Mounting holes for wall mounting • Functional earth connection • Special earthing plate for safe and easy connection to the machine bed or H-rail 	
[2] Bus node	CPX-FB CPX-M-FB	<ul style="list-style-type: none"> • Fieldbus/Industrial Ethernet connection using various types of connection technology • Setting fieldbus parameters via DIL switch • Display of fieldbus and peripheral equipment status via LED 	
Control block	CPX-CEC	<ul style="list-style-type: none"> • Preprocessing, stand-alone controller or remote unit CPX-CEC • Connection via Ethernet TCP/IP or Sub-D programming interface • Setting operating modes via DIL switch and program selection via rotary switch • CPX-CMX products for controlling axes 	
[3] Interlinking block	CPX-M-GE	<ul style="list-style-type: none"> • Internal linking of the power supply and serial communication • External power supply for the entire system or for outputs • Connection accessories for 7/8" • Individual linking with M6 screws, individually expandable 	

Peripherals overview

Designation	Type	Description	→ Page/Internet
[4] Electronics module	CPX-4DE	Input module with 4 digital inputs, positive logic (PNP)	
	CPX-8DE	Input module with 8 digital inputs, positive logic (PNP)	
	CPX-8DE-D	Input module with 8 digital inputs, positive logic (PNP), enhanced diagnostic function	
	CPX-8NDE	Input module with 8 digital inputs, negative logic (NPN)	
	CPX-P-8DE-N	NAMUR input module with 8 digital inputs	
	CPX-P-8DE-N-IS	Input module to NAMUR standard with 8 digital inputs, intrinsically safe version	
	CPX-F8DE-P	PROFIsafe input module with 8 digital inputs	
	CPX-16DE	Input module with 16 digital inputs, internal electronic fuse per module	
	CPX-M-16DE-D	Input module with 16 digital inputs, internal electronic fuse per channel pair, for CPX in metal	
	CPX-4DA	Output module with 4 digital outputs, 1 A per channel	
	CPX-8DA	Output module with 8 digital outputs, 0.5 A per channel	
	CPX-8DA-H	Output module with 8 digital outputs, 2.1 A per channel pair	
	CPX-8DE-8DA	Input/output module with 8 digital inputs and 8 digital outputs	
	CPX-2ZE2DA	Counter module with 2 digital inputs and 2 digital outputs	
	CPX-4AE-4AA-H	HART input/output module with 4 analogue input/outputs	
	CPX-2AE-U-I	Input module with 2 analogue current or voltage inputs	
	CPX-4AE-U-I	Input module with 4 analogue current or voltage inputs	
	CPX-4AE-I	Input module with 4 analogue current inputs	
	CPX-4AE-T	Input module for temperature inputs	
	CPX-4AE-TC	Input module for temperature inputs with cold junction compensation	
CPX-2AA-U-I	Output module with 2 analogue current or voltage outputs		
CPX-FVDA-P2	PROFIsafe shut-off module for shutting off the supply voltage for valves, with two digital outputs		
[5] Plastic connection block	CPX-AB	<ul style="list-style-type: none"> Choice of 8 connection technology variants Degree of protection IP65, IP67 or IP20 Can be combined with the electronics modules Connection accessories for M8/M12/Sub-D M8/M12/Sub-D, etc. connecting cables Modular system for M8/M12 connecting cables 	–
[6] Analogue electronics module for pressure inputs	CPX-4AE-P	<ul style="list-style-type: none"> Pneumatic connection QS-4 Degree of protection IP65, IP67 4 analogue pressure inputs (0 ... 10 bar, –1 ... +1 bar) 	
[7] CTEL interface	CPX-CTEL	<ul style="list-style-type: none"> Interfaces for decentralised installation systems, thus optimising the pneumatic control chains (short tubes/short cycle times) Actuation for I/O modules and valve terminals Power supply and bus interface via the same cable M9, M12 connection technology Degree of protection IP65, IP67 	
[8] Metal connection block	CPX-M-AB	<ul style="list-style-type: none"> Can be combined with the electronics modules Connection technology M12x1, 5-pin Degree of protection IP65, IP67 Connection accessories for M12 Connecting cables M12 Modular system for choice of connecting cables M12 	–
[9] Pneumatic interface MPA-S	VMPA-FB	<ul style="list-style-type: none"> Control of valve terminal MPA-S Control of pressure sensors Control of proportional pressure regulators 	
[11] Web monitor	–	<ul style="list-style-type: none"> Website integrated in the CPX terminal Dynamic status indication Online diagnostics and SMS/e-mail alert 	–

Peripherals overview

Individual overview of modules

Bus node

→ Page 52

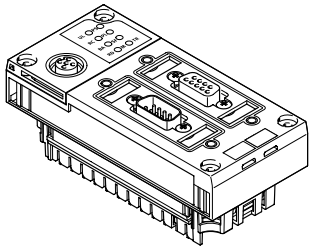

- Bus node for
- PROFIBUS-DP
 - DeviceNet
 - CANopen
 - EtherNet/IP
 - PROFINET
 - EtherCAT

Control block

→ Page 45

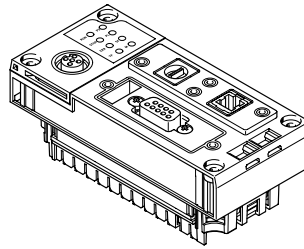

- CPX-CEC
- Programming with CODESYS
 - Ethernet interface
 - Modbus/TCP
 - EasyIP
 - CANopen master

CTEL interface

→ Page 86

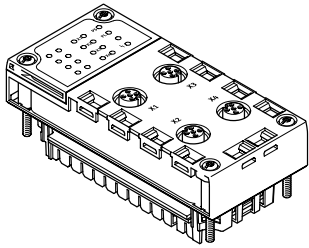

- Interface CPX-CTEL
- CTEL master
 - Max. 4 devices with individual electronic protection
 - Max. 64 inputs/64 outputs per I-Port interface
 - The maximum length of a string is 20 m

Electrical interface CPX-CTEL-2

→ Page 92

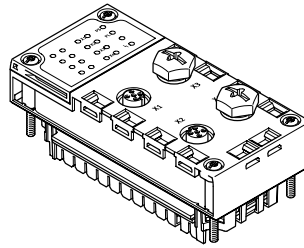

- Interface CPX-CTEL-2
- Master for IO-Link
 - Max. 2 devices with individual electronic protection
 - Process data length of the inputs and outputs is limited to 16 bytes for inputs and 16 bytes for outputs per port
 - The maximum length of a string is 20 m

Modules for controlling pneumatic drive units

→ Page 97

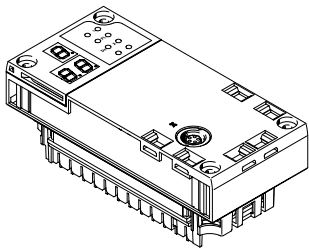

- CPX-CMIX
- Measuring module
 - CAN input (Festo specification) for measuring signal

- Recording the absolute position values or speed values of the connected drive

Plastic connection block

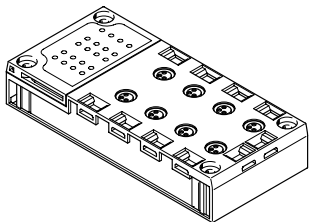

- Direct machine mounting
(connection block to IP65/IP67)
- M8, 3-pin
 - M8, 4-pin
 - M12, 5-pin
 - M12 5-pin quick lock, shielded with metal thread
 - M12, 8-pin
 - Sub-D 25-pin
 - Spring-loaded terminal with cover

- Protected fitting space
(degree of protection IP20)
- Spring-loaded terminal

- Shielding concept
- Optional screening plate for connection block with M12 connection technology

Metal connection block

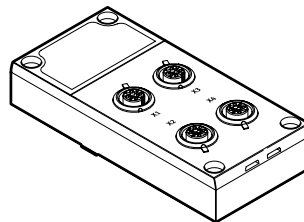

- Direct machine mounting
(connection block to IP65/IP67)
- M12, 5-pin

Peripherals overview

Individual overview of modules

Digital electronics module for inputs/outputs

→ Page 104

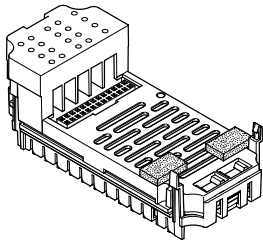

Digital inputs

- 4 digital inputs
- 8 digital inputs
- 16 digital inputs

Digital outputs

- 4 digital outputs (1 A per channel, individual channel diagnostics)
- 8 digital outputs (0.5 A per channel, individual channel diagnostics)
- 8 digital outputs (2.1 A/50 W lamp load per channel pair, individual channel diagnostics)

Multi I/O modules

- 8 digital inputs and 8 digital outputs
- 2 digital inputs (counter channels, connection to various encoders) and 2 digital outputs (directly controlled by the input values)

Analogue electronics module for inputs/outputs

→ Page 139

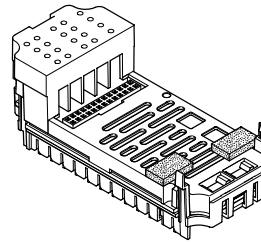

Analogue inputs

- 2 analogue inputs (0 ... 10 V DC, 0 ... 20 mA, 4 ... 20 mA)
- 4 analogue inputs (1 ... 5 V, 0 ... 10 V, -5 ... +5 V, -10 ... +10 V, 0 ... 20 mA, 4 ... 20 mA, -20 ... +20 mA)
- 4 analogue inputs with HART protocol

Analogue temperature inputs

- 4 analogue inputs for temperature measurement (Pt100, Pt200, Pt500, Pt1000, Ni100, Ni120, Ni500, Ni1000)
- 4 analogue inputs for temperature measurement (thermocouple and PT1000 sensor for cold-junction compensation)

Analogue outputs

- 2 analogue outputs (0 ... 10 V DC, 0 ... 20 mA, 4 ... 20 mA)
- 4 analogue outputs with HART protocol

PROFIsafe input module

→ Page 115

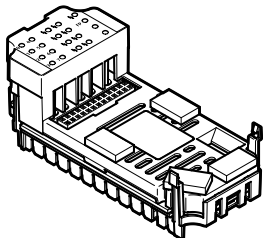

Digital inputs

- 8 digital inputs
- 11 function modes
- 5 independent clock outputs

PROFIsafe shut-off module

→ Page 158

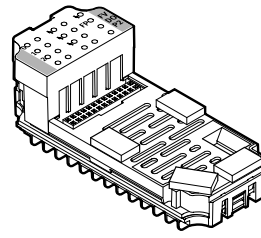

Digital outputs

- 2 digital outputs
- Supply voltage for valves can be shut off

Peripherals overview

Individual overview of modules

Connection block for NAMUR sensors and HART input/output module

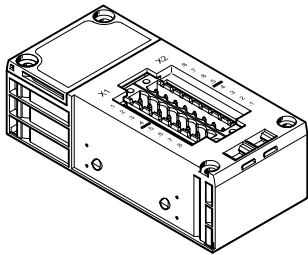

- Direct machine mounting
(connection block to IP65)
- M12, 4-pin
- Protected fitting space
(connection block to IP20)
- Screw terminal
 - Spring-loaded terminal

Digital electronics module for NAMUR sensors

→ Page 100

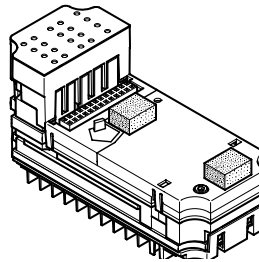

- Digital inputs
- 8 digital inputs for NAMUR sensors or wired mechanical contacts
 - Intrinsically safe design with additional protective measures in the event of failure

Metal interlinking block – Individual linking

→ Page 163

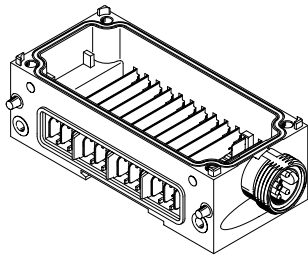

- System linking
- Different voltages for supplying the modules
 - Serial communication between the modules
- System supply
- 7/8" 5-pin

- In addition to system linking, power supply for the
- Electronics plus sensors (8 A)
 - Valves plus actuators (8 A)

- Additional supply
- In addition to system linking, power supply for the
- Actuators (8 A per supply)

- Expandability
- Can be expanded as required by up to 10 interlinking blocks

Note

The 7/8" supply is subject to the following restrictions due to the available accessories:

- 5-pin 8 A

Pneumatic interface MPA-S

→ Page 169

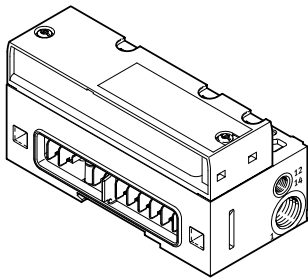

- Valve terminal
- MPA1 (360 l/min)
 - MPA14 (550 l/min)
 - MPA2 (700 l/min)
 - Up to 128 solenoid coils
 - Up to 16 modules can be configured

End plate

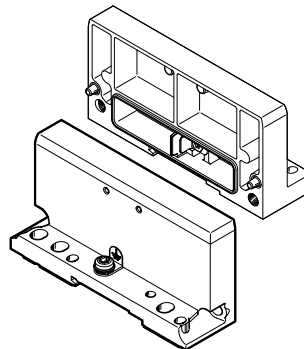

- End plate
- Left
 - Right (for use without valves)

Peripherals overview

General basic data and guidelines

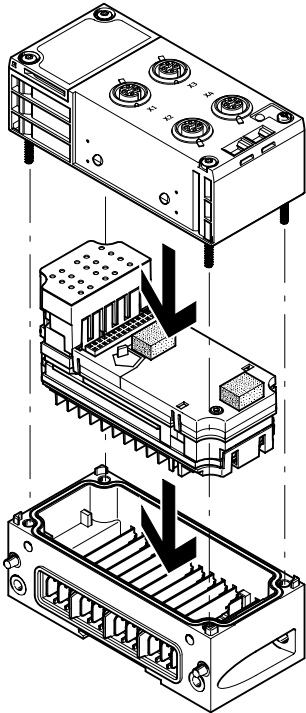

Max. 11 modules in total:

- One bus node and/or one control block
- Up to 9 additional input/output modules
- In addition a pneumatic interface
 - Always positioned as the last module on the right-hand side
 - 16 MPA modules can be configured

- Address capacity max. 512 inputs and 512 outputs, depending on bus node or control block
- One interlinking block with system supply
- Multiple interlinking blocks with additional supplies
- The connection blocks can be combined with the electronics modules for inputs/outputs, with restrictions (→ table below)
- The electronics modules for inputs/outputs can be combined with various interlinking blocks

Combinations of connection blocks and digital input modules

	Digital electronics modules						
	CPX-4DE	CPX-8DE	CPX-8DE-D	CPX-8NDE	CPX-F8DE-P	CPX-16DE	CPX-M-16DE-D
Connection blocks, plastic design							
CPX-AB-8-M8-3POL	■	■	■	■	–	–	–
CPX-AB-8-M8X2-4POL	–	–	–	–	–	■	–
CPX-AB-4-M12x2-5POL	■	■	■	■	–	–	–
CPX-AB-4-M12x2-5POL-R	■	■	■	■	–	–	–
CPX-P-AB-4XM12-4POL	–	–	–	–	–	–	–
CPX-P-AB-4XM12-4POL-8DE-N-IS	–	–	–	–	–	–	–
CPX-AB-4-M12-8POL	–	–	–	–	–	–	–
CPX-AB-8-KL-4POL	■	■	■	■	■	■	–
CPX-P-AB-2XKL-8POL	–	–	–	–	–	–	–
CPX-P-AB-2XKL-8POL-8DE-N-IS	–	–	–	–	–	–	–
CPX-AB-1-SUB-BU-25POL	■	■	■	■	–	■	–
Connection blocks, metal design							
CPX-M-AB-4-M12X2-5POL	■	■	■	■	■	–	–
CPX-M-AB-8-M12X2-5POL	–	–	–	–	–	–	■

Peripherals overview

Combination of connection blocks and digital input modules for NAMUR sensors		Digital electronics modules				
	CPX-P-8DE-N	CPX-P-8DE-N-IS				
Connection blocks, plastic design						
CPX-AB-8-M8-3POL	–	–				
CPX-AB-8-M8X2-4POL	–	–				
CPX-AB-4-M12x2-5POL	–	–				
CPX-AB-4-M12x2-5POL-R	–	–				
CPX-P-AB-4XM12-4POL	■	–				
CPX-P-AB-4XM12-4POL-8DE-N-IS	–	■				
CPX-AB-4-M12-8POL	–	–				
CPX-AB-8-KL-4POL	–	–				
CPX-P-AB-2XKL-8POL	■	–				
CPX-P-AB-2XKL-8POL-8DE-N-IS	–	■				
CPX-AB-1-SUB-BU-25POL	–	–				
Connection blocks, metal design						
CPX-M-AB-4-M12X2-5POL	–	–				
CPX-M-AB-8-M12X2-5POL	–	–				
Combinations of connection blocks and digital output modules or multi I/O modules		Digital electronics modules				
	CPX-4DA	CPX-8DA	CPX-8DA-H	CPX-8DE-8DA	CPX-2ZE2DA	CPX-FVDA-P2
Connection blocks, plastic design						
CPX-AB-8-M8-3POL	■	■	–	–	–	–
CPX-AB-8-M8X2-4POL	■	■	■	–	–	–
CPX-AB-4-M12x2-5POL	■	■	–	–	–	–
CPX-AB-4-M12x2-5POL-R	■	■	■	–	–	–
CPX-P-AB-4XM12-4POL	–	–	–	–	–	–
CPX-P-AB-4XM12-4POL-8DE-N-IS	–	–	–	–	–	–
CPX-AB-4-M12-8POL	–	–	–	■	–	–
CPX-AB-8-KL-4POL	■	■	■	■	–	■
CPX-P-AB-2XKL-8POL	–	–	–	–	–	–
CPX-P-AB-2XKL-8POL-8DE-N-IS	–	–	–	–	–	–
CPX-AB-1-SUB-BU-25POL	■	■	■	■	–	–
Connection blocks, metal design						
CPX-M-AB-4-M12X2-5POL	■	■	■	–	–	■
CPX-M-AB-8-M12X2-5POL	–	–	–	–	–	–

Peripherals overview

Combinations of connection blocks and analogue electronics modules for inputs/outputs	Analogue electronics modules							
	CPX-4AE-4AA-H	CPX-2AE-U-I	CPX-4AE-U-I	CPX-4AE-I	CPX-2AA-U-I	CPX-4AE-P	CPX-4AE-T	CPX-4AE-TC
Connection blocks, plastic design								
CPX-AB-8-M8-3POL	-	-	-	-	-	-	-	-
CPX-AB-8-M8X2-4POL	-	-	-	-	-	-	-	-
CPX-AB-4-M12x2-5POL	-	■	■	■	■	-	■	■
CPX-AB-4-M12x2-5POL-R	-	■	■	■	■	-	■	■
CPX-P-AB-4XM12-4POL	■	-	-	-	-	-	-	-
CPX-P-AB-4XM12-4POL-8DE-N-IS	-	-	-	-	-	-	-	-
CPX-AB-4-M12-8POL	-	-	-	-	-	-	-	-
CPX-AB-8-KL-4POL	-	■	■	■	■	-	■	■
CPX-P-AB-2XKL-8POL	■	-	-	-	-	-	-	-
CPX-P-AB-2XKL-8POL-8DE-N-IS	-	-	-	-	-	-	-	-
CPX-AB-1-SUB-BU-25POL	-	■	■	■	■	-	-	-
Connection blocks, metal design								
CPX-M-AB-4-M12X2-5POL	-	■	■	■	■	-	■	■
CPX-M-AB-8-M12X2-5POL	-	-	-	-	-	-	-	-

Key features – Electrical components

Electrical connection – Connection block with M8, 3-pin connection

CPX-AB-8-M8-3POL

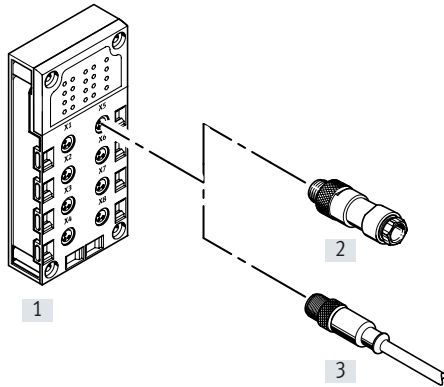

- Compact for pre-assembled individual connection
- 8 sockets
- 3-pin design for connecting one channel per socket

Note
Festo delivers pre-assembled M8/M12 connecting cables (NEBU modular system) on request:

- Tailored to the application
- Perfectly fitting
- Easy to install

Combination of connection block and electrical connection technology

Connection block	Connection technology	Plug/connecting cable	Selectable connection technology
[1] CPX-AB-8-M8-3POL	Socket M8, 3-pin	[2] SEA-GS-M8	Solder lugs
		[2] SEA-3GS-M8-S	Screw terminals
		[3] NEBU-...-M8G3 (modular system for choice of connecting cables)	Socket, M8, 3-pin
			Socket, M8, 4-pin
			Socket, M12, 5-pin
		Open cable end	

Key features – Electrical components

Electrical connection – Connection block with M8, 4-pin connection

CPX-AB-8-M8X2-4POL

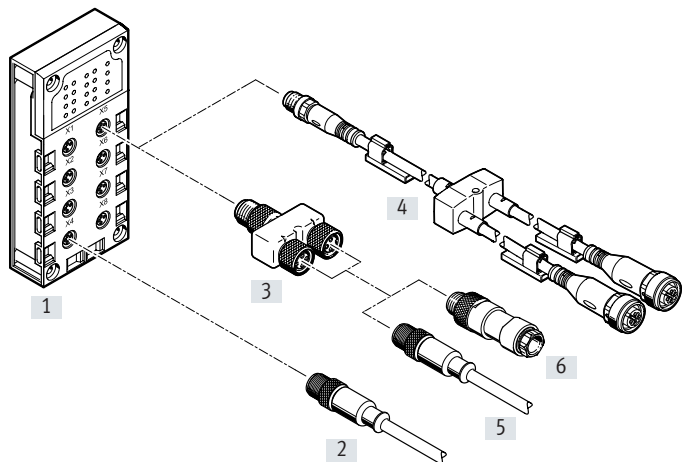

- Compact for pre-assembled individual connection
- 8 sockets
- 4-pin design for connection of 2 channels per socket

Combination of connection block and electrical connection technology

Connection block	Connection technology	Plug/connecting cable	Selectable connection technology	Plug/connecting cable	Selectable connection technology
[1] CPX-AB-8-M8X2-4POL	Socket, M8, 4-pin	[2] NEBU-...-M8G4 (modular system for choice of connecting cables)	Socket, M8, 3-pin	-	-
			Socket M8, 4-pin	-	-
			Socket, M12, 5-pin	-	-
			Open cable end	-	-
		[3] NEDY-L2R1-V1-M8G3-N-M8G4 (T-adapter)	1x plug M8, 4-pin to 2x socket, M8, 3-pin	[6] SEA-GS-M8	Solder lugs
		[4] NEDY-... (modular system for all types of sensor/actuator distributor)	2x socket, M8, 3-pin	[6] SEA-3GS-M8-S	Screw terminals
			2x socket, M8, 4-pin	[5] NEBU-...-M8G3 (modular system for choice of connecting cables)	Socket, M8, 3-pin
			2x socket, M12, 5-pin	Socket, M8, 4-pin	
			2x socket, type A	Socket, M12, 5-pin	
			2x socket, type B	Open cable end	
			2x socket, type C	-	-
			2x socket, plug pattern H	-	-
			2x socket, plug pattern ZB	-	-
			2x socket, plug pattern ZC	-	-
2x open cable end	-		-		

Key features – Electrical components

Combination of connection block and electrical connection technology							
Connection block	Connection technology	Plug/connecting cable	Selectable connection technology	Plug/connecting cable	Selectable connection technology		
[1] CPX-AB-4-M12x2-5POL CPX-AB-4-M12x2-5POL-R	Socket, M12, 5-pin	[2] SEA-GS-7	Screw terminals	–	–		
		[2] SEA-4GS-7-2.5	Screw terminals	–	–		
		[2] SEA-GS-9	Screw terminals	–	–		
		[2] SEA-M12-5GS-PG7	Screw terminals	–	–		
		[2] SEA-GS-11-DUO	Screw terminals, for two cables	–	–		
		[2] SEA-5GS-11-DUO	Screw terminals, for two cables	–	–		
		[3] NEBU-...-M12G5 (modular system for choice of connecting cables)	Socket, M8, 4-pin Socket, M12, 5-pin Open cable end	– – –	– – –		
		[4] NEDY-... (modular system for all types of sensor/actuator distributor)	2x socket, M8, 3-pin 2x socket, M8, 4-pin 2x socket, M12, 5-pin 2x socket, type A 2x socket, type B 2x socket, type C 2x socket, plug pattern H 2x socket, plug pattern ZB 2x socket, plug pattern ZC 2x open cable end	– – – – – – – – – –	– – – – – – – – – –		
		[5] NEDY-L2R1-V1-M8G3-N-M12G4 (T-adapter)	Plug, M12, 4-pin to 2x socket, M8, 3-pin	–	–		
		[5] NEDY-L2R1-V1-M12G5-N-M12G4 (T-adapter)	Plug, M12, 4-pin to 2x socket, M12, 5-pin	–	–		
				[6] SEA-GS-M8	Solder lugs		
				[6] SEA-3GS-M8-S	Screw terminals		
				[7] NEBU-...-M8G3 (modular system for choice of connecting cables)	Socket, M8, 3-pin Socket, M8, 4-pin Socket, M12, 5-pin Open cable end		
				[6] SEA-GS-7	Screw terminals		
				[6] SEA-4GS-7-2.5	Screw terminals		
				[6] SEA-GS-9	Screw terminals		
				[6] SEA-M12-5GS-PG7	Screw terminals		
				[6] SEA-GS-11-DUO	Screw terminals, for two cables		
				[6] SEA-5GS-11-DUO	Screw terminals, for two cables		
				[7] NEBU-...-M12G5 (modular system for choice of connecting cables)	Socket, M8, 4-pin Socket, M12, 5-pin Open cable end		

Key features – Electrical components

Electrical connection – Connection block (metal design)

CPX-M-AB-4-M12X2-5POL with connection socket M12, 5-pin

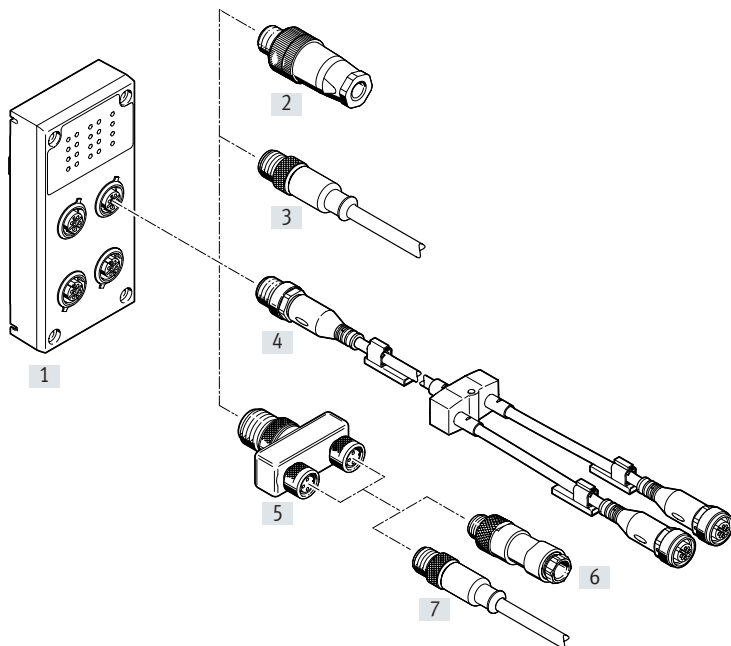

- Suitable for self-assembly and sturdy with 2 channels per connection
- 4 sockets
- 5-pin design per connection
- With two channels per connection, the corresponding input signals can be easily connected via a T-adapter and conventional cables with M8 connection.

CPX-M-AB-8-M12X2-5POL with connection socket M12, 5-pin

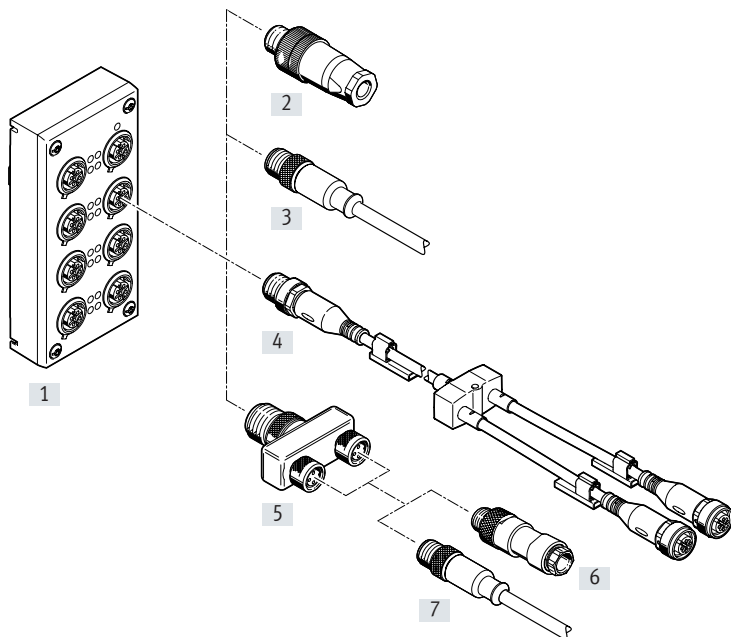

- Suitable for self-assembly and sturdy with 2 channels per connection
- 8 sockets
- 5-pin design per socket
- With two channels per connection, the corresponding input signals can be easily connected via a T-adapter and conventional connecting cables with M8 connection.

 **Note**
Max. 4 T-adapters (NEDY) can be mounted on a connection block.

Key features – Electrical components

Combination of connection block and electrical connection technology					
Connection block	Connection technology	Plug/connecting cable	Connection technology	Plug/connecting cable	Connection technology
[1] CPX-M-AB-4-M12X2-5POL CPX-M-AB-8-M12X2-5POL	Socket, M12, 5-pin	[2] SEA-GS-7	Screw terminals	–	–
		[2] SEA-4GS-7-2.5	Screw terminals	–	–
		[2] SEA-GS-9	Screw terminals	–	–
		[2] SEA-M12-5GS-PG7	Screw terminals	–	–
		[2] SEA-GS-11-DUO	Screw terminals, for two cables	–	–
		[2] SEA-5GS-11-DUO	Screw terminals, for two cables	–	–
		[3] NEBU-...-M12G5	Socket, M8, 4-pin	–	–
		(modular system for choice of connecting cables)	Socket, M12, 5-pin	–	–
			Open cable end	–	–
		[4] NEDY-... (modular system for all types of sensor/ actuator distributor)	2x socket, M8, 3-pin	–	–
			2x socket, M8, 4-pin	–	–
			2x socket, M12, 5-pin	–	–
			2x socket, type A	–	–
			2x socket, type B	–	–
			2x socket, type C	–	–
			2x socket, plug pattern H	–	–
			2x socket, plug pattern ZB	–	–
			2x socket, plug pattern ZC	–	–
			2x open cable end	–	–
		[5] NEDY-L2R1-V1-M8G3-N-M12G4 (T-adapter)	Plug M12, 4-pin to 2x socket, M8, 3-pin	[6] SEA-GS-M8	Solder lugs
				[6] SEA-3GS-M8-S	Screw terminals
		[5] NEDY-L2R1-V1-M12G5-N-M12G4 (T-adapter)	Plug M12, 4-pin to 2x socket M12, 5-pin	[7] NEBU-...-M8G3 (modular system for choice of connecting cables)	Socket, M8, 3-pin
					Socket, M8, 4-pin
					Socket, M12, 5-pin
					Open cable end
				[6] SEA-GS-7	Screw terminals
				[6] SEA-4GS-7-2.5	Screw terminals
				[6] SEA-GS-9	Screw terminals
				[6] SEA-M12-5GS-PG7	Screw terminals
[6] SEA-GS-11-DUO	Screw terminals, for two cables				
[6] SEA-5GS-11-DUO	Screw terminals, for two cables				
[7] NEBU-...-M12G5 (modular system for choice of connecting cables)	Socket, M8, 4-pin				
	Socket, M12, 5-pin				
	Open cable end				

Key features – Electrical components

Electrical connection – Connection block with M12, 4-pin connection

CPX-P-AB-4XM12-4POL

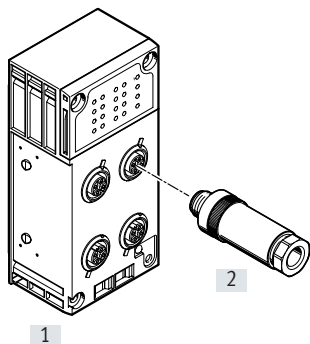

- Suitable for self-assembly and sturdy
- 4 sockets
- 4-pin design per connection

Combination of connection block and electrical connection technology

Connection block	Connection technology	Plug/connecting cable	Selectable connection technology
[1] CPX-P-AB-4XM12-4POL	Socket, M12, 4-pin	[2] SEA-GS-HAR-4POL	Insulation displacement connector
		[2] SEA-4GS-7-2.5	Screw terminal
		[2] SEA-GS-7	Screw terminal
		[2] SEA-GS-9	Screw terminal

Electrical connection – Connection block with M12, 4-pin connection

CPX-P-AB-4XM12-4POL-8DE-N-IS

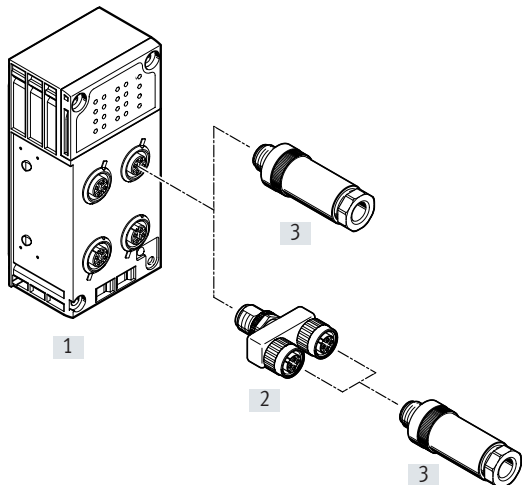

- Suitable for self-assembly and sturdy with 2 channels per connection
- 4 sockets
- 4-pin design per connection
- With two channels per connection, the corresponding input signals can be easily connected via a T-adaptor.

Combination of connection block and electrical connection technology

Connection block	Connection technology	Plug/connecting cable	Selectable connection technology	Plug/connecting cable	Selectable connection technology
[1] CPX-P-AB-4XM12-4POL-8DE-N-IS	Socket, M12, 4-pin	[3] NECU-M-S-A12G4-IS	Plug, M12, 4-pin	-	-
		[3] NECU-S-M12G4-...-IS	Plug, M12, 4-pin	-	-
		[2] NEDU-M12D4-M12T4-IS (T-adaptor)	1x plug M12, 4-pin to 2x socket M12, 4-pin	[3] NECU-S-M12G4-...-IS	Plug, M12, 4-pin

Key features – Electrical components

Electrical connection – Connection block with M12, 8-pin connection

CPX-AB-4-M12-8POL

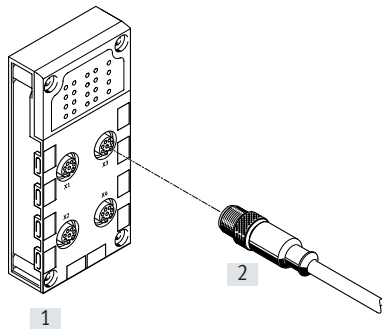

- Connection to cylinder/valve combinations with max. 3 inputs and 2 outputs
- 4 sockets
- 8-pin design per socket

Combination of connection block and electrical connection technology

Connection block	Connection technology	Plug/connecting cable	Selectable connection technology
[1] CPX-AB-4-M12-8POL	Socket, M12, 8-pin	[2] KM12-8GD8GS-2-PU (pre-assembled connecting cable)	Socket, M12, 8-pin

Electrical connection – Connection block with spring-loaded terminal connection

CPX-AB-8-KL-4POL

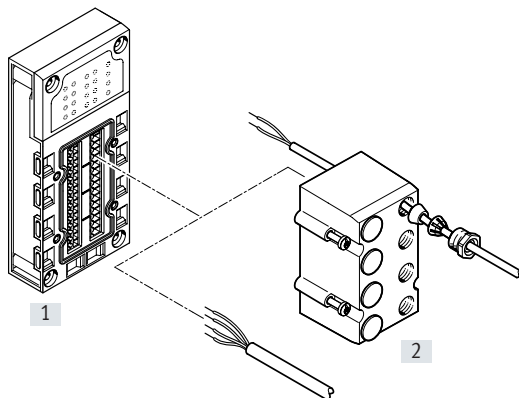

- Quick connection technology for use in control cabinets
- 32 spring-loaded terminals
- 4 spring-loaded terminals per channel
- Wire cross-sections 0.05 ... 1.5 mm²
- Optional cover with fittings for IP65/67 connection
 - 8 through-holes M9
 - 1 through-hole M16
 - Blanking plug
 - For I/O distributors, control desks or individual sensors/actuators

Combination of connection block and electrical connection technology

Connection block	Connection technology	Plug/connecting cable	Selectable connection technology
[1] CPX-AB-8-KL-4POL	Spring-loaded terminals, 32-pin	[2] AK-8KL (cover)	–

Key features – Electrical components

Electrical connection – Connection block with clamping connector

CPX-P-AB-2XKL-8POL and CPX-P-AB-2XKL-8POL-8DE-N-IS

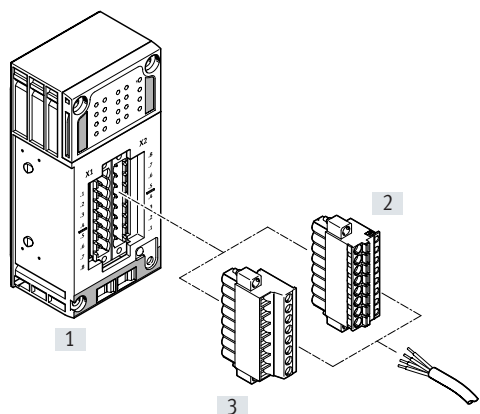

- Quick connection technology for use in control cabinets
- Spring-loaded terminals or screw terminals
- Wire cross sections 0.2 ... 2.5 mm²

Combination of connection block and electrical connection technology

Connection block	Connection technology	Plug/connecting cable	Selectable connection technology
[1] CPX-P-AB-2XKL-8POL	Plug, 8-pin	[2] NECU-L3G8-C1	Spring-loaded terminals
		[3] NECU-L3G8-C2	Screw terminals
[1] CPX-P-AB-2XKL-8POL-8DE-N-IS	Plug, 8-pin	[2] NECU-L3G8-C1-IS	Spring-loaded terminals
		[3] NECU-L3G8-C2-IS	Screw terminals

Electrical connection – Connection block with Sub-D connection

CPX-AB-1-SUB-BU-25POL

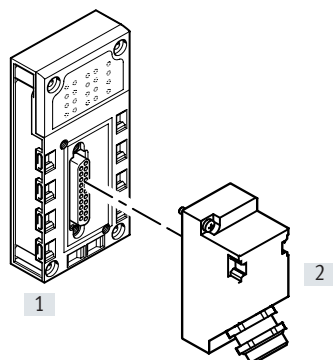

- Multi-pin connection for I/O distributor or control desk
- One Sub-D socket
- 25-pin design

Combination of connection block and electrical connection technology

Connection block	Connection technology	Plug/connecting cable	Selectable connection technology
[1] CPX-AB-1-SUB-BU-25POL	Sub-D socket, 25-pin	[2] SD-SUB-D-ST25	Crimp contacts

Key features – Mounting

Hood

Description

→ 175

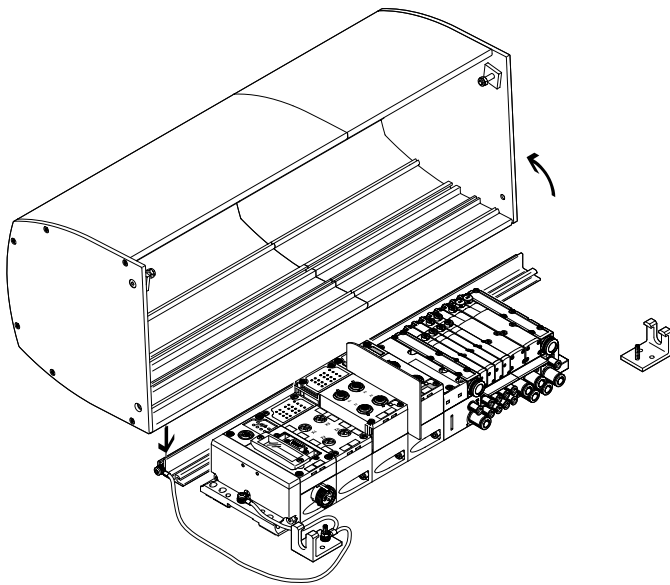

The CPX hood CAFC is a space- and cost-saving alternative to a control cabinet. It is designed as an extruded aluminium profile and is installed on a mounting plate. The valve terminal is well protected and is quick to install without the need for a complex cabinet through-feed for cables and tubing.

The rail and the two mounting brackets are mounted on a base plate. The hood is attached to the retaining rail and secured with two screws. There is also a stand-by position (detent of the hood in the open position). The hood is locked using two side screws (which meet the requirements for a special fastener in compliance with ATEX). The CPX hood can be ordered online using the valve terminal configurator.

Advantages of the CPX hood

- Impact protection (min. 7 J) for the modules underneath in combination with a suitable mounting plate provided by the user
- Protection against electrostatic discharge by using electrically conductive materials and the option of connecting an earth wire
- Protection against disconnection of live plugs (by securing the hood with at least one special fastener to EN 60079-0, 9.2 and 20)
- UV protection for the CPX-P and MPA modules underneath

Points to note when using the CPX hood

- CPX-P power supply via angled plugs, no T-plugs
- Electrical supply plate/additional supply only possible with angled plug
- No MPA vertical stacking
- Use of larger push-in fittings (for tubing O.D. larger than 12 mm) only possible with the angled design
- Ducted exhaust air only with elbow connector
- The permissible ambient temperature range of the valve terminal is reduced by 5°C.

 **Note**

The CPX hood has no influence on the ATEX classification of the valve terminal or of the CPX-P terminal.

The CPX hood has no influence on the IP protection class of the valve terminal or of the CPX-P terminal.

The CPX hood does not protect against the effects of the weather in installations that are not in enclosed spaces.

Key features – Mounting

Hood Mounting

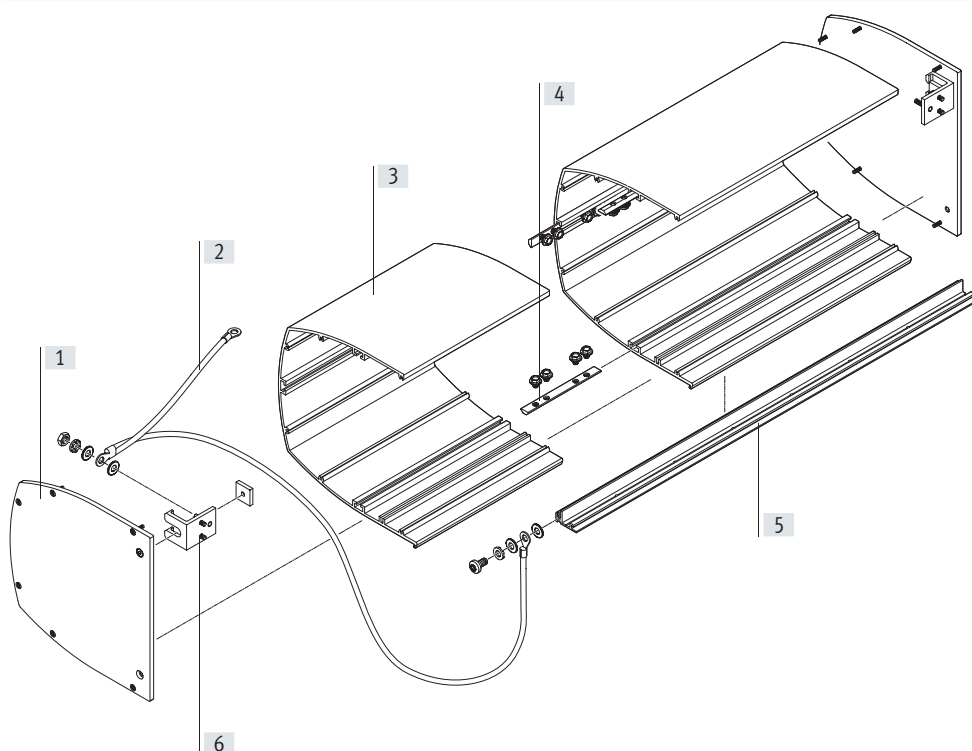

Procedure:

- Assemble the rail and mounting bracket included in the mounting kit
- Attach the earthing cable
- Assemble the hood (if applicable, screw together several hood sections and attach the side covers)
- Attach and secure the hood

- [1] Side cover
- [2] Earthing cable
- [3] Hood section
- [4] Slot nut with screws, for joining the hood sections
- [5] Rail
- [6] Mounting bracket

Technical data

Weight:

- Hood: approx. 500 g per 100 mm of length

- Mounting rail: approx. 550 g per 1000 mm of length
- Side pieces: approx. 500 g per side

- Ambient temperature –5 ... +50°C

- RoHS-compliant

Plug coding

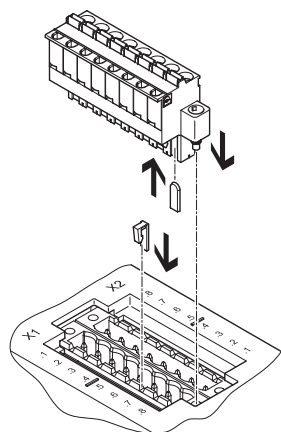

The connection blocks CPX-P-AB-2XKL-8POL and CPX-P-AB-2XKL-8POL-8DE-N-IS, and the sockets NECU-L3G8, can be matched to one another using the coding elements CPX-P-KDS-AB-2XKL.

This reduces the possibility of the socket being plugged back into an incorrect slot after being disconnected from the CPX-P terminal (connection safeguard).

Key features – Mounting

Mounting options

The valve terminals with CPX-P terminal support different mounting options for direct machine mounting with a

high degree of protection and for control cabinet installation.

H-rail mounting

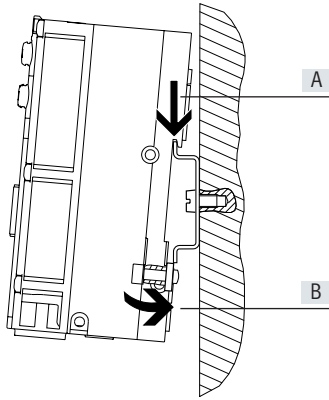

The H-rail mounting is part of the rear profile of the CPX-P interlinking blocks. The CPX-P terminal can be attached to the H-rail using the H-rail mounting kit. The CPX-P terminal is mounted on the H-rail (see arrow A) and

then swivelled onto the H-rail and secured in place with the clamping element (see arrow B). The optional earthing plate enables a connection to be established to the machine potential/earth in one easy step.

The following mounting kit is needed for H-rail mounting:

- CPX-CPA-BG-NRH

This allows the CPX-P terminal to be mounted to the H-rails to EN 60715. An additional mounting kit may be required for combination with valve terminals.

Wall mounting

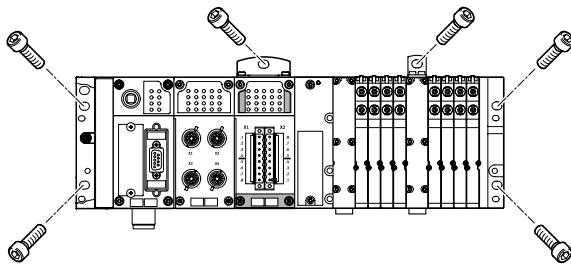

The end plates of the CPX-P terminal, the valve terminal and the pneumatic interface include mounting holes for wall mounting. Additional mountings for the CPX-P terminal are available for longer valve terminals.

Additional mountings

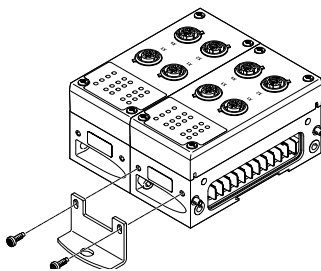

Additional mounting brackets for the CPX-P terminal that can be screwed onto the interlinking blocks are available for longer valve terminals.

Note

For CPX-P terminals with 4 or more interlinking blocks: you need additional mounting brackets of type CPX-M-BG-RW approx. every 100 or 150 mm. These are supplied pre-assembled.

Linking with screws

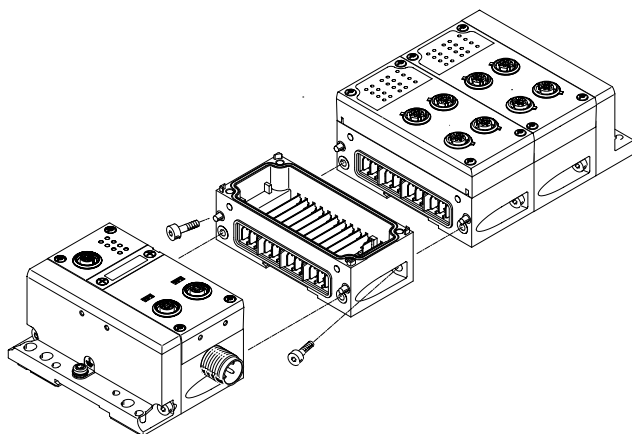

The CPX-P modules are mechanically connected using an angled fitting. The CPX-P terminal can thus be expanded at any time.

Key features – Power supply

Power supply concept

General

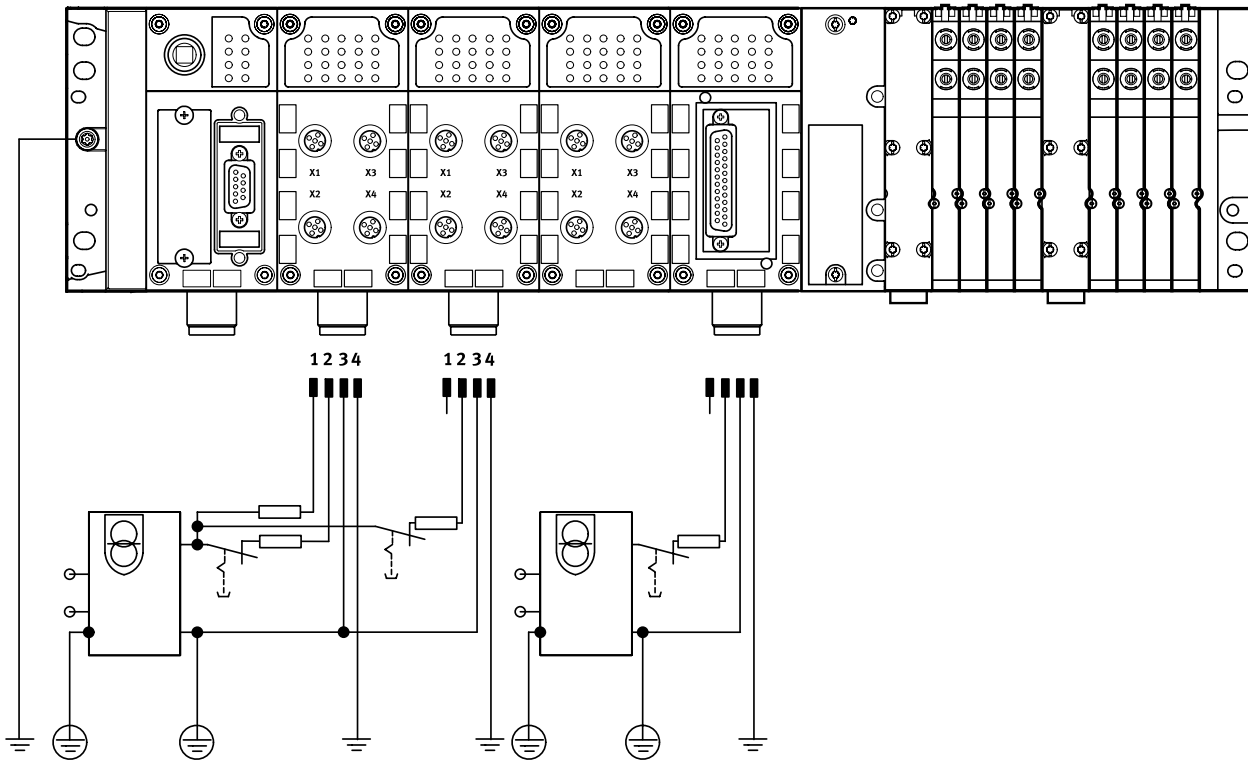

The use of decentralised devices on the fieldbus – particularly with a high degree of protection for direct machine mounting – demands a flexible power supply concept. A valve terminal with

CPX-P is, in principle, supplied with all voltages via a single connection.

A distinction is made between supply for

- Electronics plus sensors
- Valves plus actuators

Connection technology:

- 7/8"

Interlinking blocks

Interlinking blocks represent the backbone of the CPX-P terminal with all supply lines. They provide the power supply for the modules used on them as well as their bus connections.

Many applications require the CPX-P terminal to be segmented into voltage zones. This applies in particular to the separate disconnection of the outputs.

The interlinking blocks provide either an easy-to-install central power supply for the entire CPX-P terminal or galvanically isolated, all-pin disconnectable potential groups/voltage segments.

Key features – Power supply

Interlinking blocks

With system supply

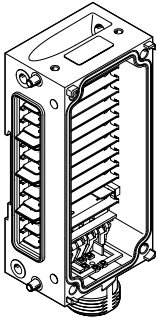

- CPX-M-GE-EV-S-7/8-5POL
- CPX-M-GE-EV-S-7/8-5POL-VL

Connection technology

- 7/8" 5-pin

- For CPX-P terminal modules and connected sensors
- For valves that are connected to the CPX-P terminal via a pneumatic interface

- For actuators that are connected to output modules of the CPX-P terminal

Without power supply

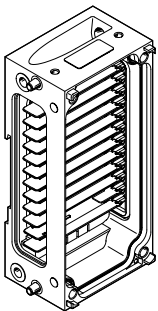

- CPX-M-GE-EV
- CPX-M-GE-EV-FVO

With additional supply for outputs

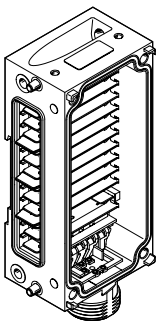

- CPX-M-GE-EV-Z-7/8-5POL
- CPX-M-GE-EV-Z-7/8-5POL-VL

Connection technology

- 7/8" 5-pin

- For actuators that are connected to output modules of the CPX-P terminal

 **Note**

For 7/8":

- Commercially available accessories are often limited to max. 8 A

 **Note**

The valve terminal MPAS has either a 7/8" 5-pin, 7/8" 4-pin or M18 3-pin power supply for one or more valve voltage zones. Galvanically isolated, all-pin disconnectable with

voltage monitoring in the following MPA module.

Key features – Diagnostics

Diagnostics

System performance

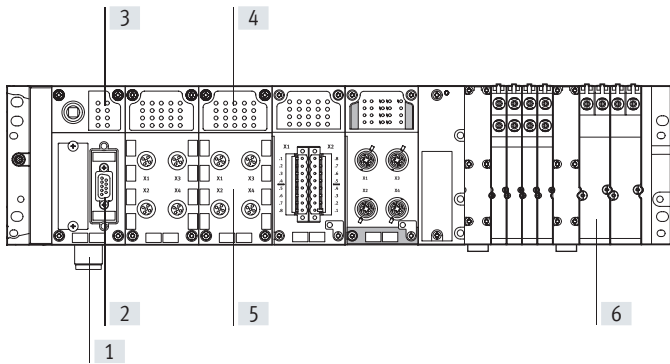

Detailed diagnostic functions are needed in order to quickly locate the causes of errors in the electrical installation and therefore reduce downtimes in production plants. A basic distinction is made between on-the-spot diagnostics using LEDs or PC and diagnostics using a bus interface.

The CPX-P terminal supports on-the-spot diagnostics via a row of LEDs. This is separate from the connection area and therefore provides good visual access to status and diagnostic information.

- [1] Undervoltage monitoring
- [2] Diagnostics via bus interface
- [3] Diagnostic overview LED
 - Fieldbus status
 - CPX-P status
- [4] Status and diagnostic LED for module and I/O channels
- [5] Module and channel-specific diagnostics
- [6] Valve-specific diagnostic module and solenoid coils

Module and channel-specific diagnostics are supported, for example:

- Undervoltage detection for outputs and valves
- Short circuit detection for sensors, outputs and valves
- Open-load detection for a missing solenoid coil
- Storage of the last 40 causes of errors with error start and error end

The diagnostic messages can be read out via the bus interface in the higher-order controller and visualised for the central recording and evaluation of error causes. This is done using the individual fieldbus-specific channels. The CPX-CEC also offers the option of access via the integrated Ethernet interface (remote maintenance via PC/web applications).

Overview of LEDs on the bus node

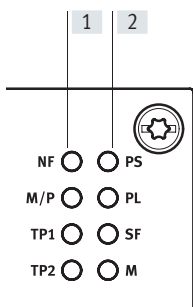

- [1] Fieldbus-specific LEDs
On each bus node, a maximum of 4 fieldbus-specific LEDs display the fieldbus communication status of the CPX-P terminal with the higher-order controller.

- [2] CPX-P-specific LEDs
A further 4 CPX-P-specific LEDs provide non-fieldbus-specific information about the status of the CPX-P terminal, for example
 - Power system
 - Power load
 - System fault
 - Modify parameters

Input/output module status and diagnostic LEDs

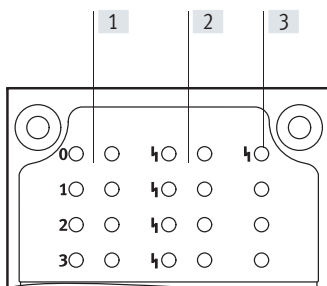

- [1] Status LEDs for the inputs and outputs
Each input and output channel is assigned a status LED.

- [2] Channel-oriented diagnostic LEDs
Depending on the module design, another diagnostic LED is available for each I/O channel

- [3] Group diagnostic LEDs
An LED displays the group diagnostics for each module

Key features – Parameterisation

Diagnostics

Display on a PC

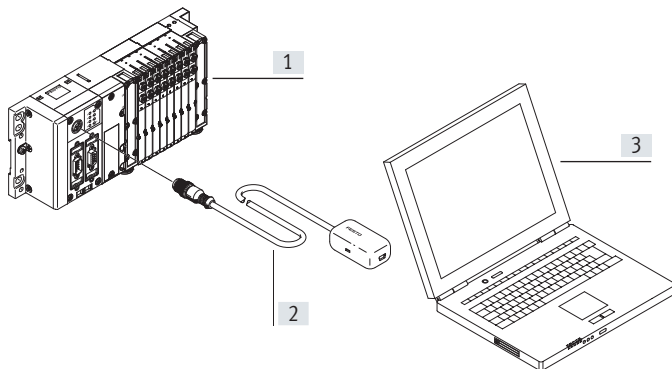

- | | |
|---|-------------------------------------|
| [1] CPX-P terminal with valve terminal | Maintenance Tool (CPX-FMT) software |
| [2] Adapter diagnostic interface to USB | – Fault location and type |
| [3] Laptop/portable device with USB interface and installed CPX-P | – Without programming |
| | – Storing the configuration |
| | – Preparing screenshots |

Parameterisation

Changes to the application are often required during commissioning. The parameterisable characteristics of the CPX-P modules mean that functions can be very easily changed by using configuration software. This reduces the number of modules needed and,

consequently, the amount of storage space required.

It is therefore possible, for example, to reduce the input debounce time for an input module – normally 3 ms – to 0.1 ms on a "fast" input module for faster processes, or to set the response

of a valve following a fieldbus interruption.

Depending on the modules used, parameterisation can be performed via the following interfaces:

- Ethernet
- Fieldbus

- Control block direct interface (programming interface)

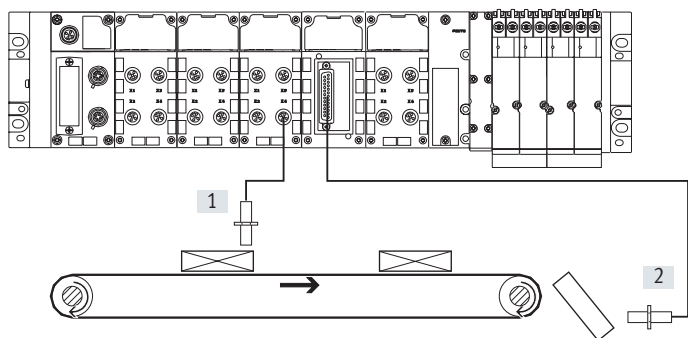

- | |
|--------------------------------|
| [1] Input debounce time 3 ms |
| [2] Input debounce time 0.1 ms |

Key features – Addressing

Addressing

The various CPX-P modules occupy a different number of I/O addresses within the CPX-P system. The maximum address space for bus nodes depends on the performance of the fieldbus systems.

Maximum system configuration:

- 1 bus node or control block
- 9 I/O modules
- 1 pneumatic interface (e.g. pneumatic interface MPA-S with up to 16 MPA connection blocks)

The maximum system configuration can be limited in individual cases by exceeding the address space.



Note

Please refer to the detailed description of the configuration/addressing rules in the technical data for CPX-P bus nodes.

Overview – Allocated addresses for CPX-P modules

	Inputs [bit]	Outputs [bit]
CPX-CTEL-4-M12-5POL	0, 64, 128, 192, 256 ¹⁾	0, 64, 128, 192, 256 ¹⁾
CPX-CTEL-2-M12-5POL-LK	64, 128, 192, 256 ¹⁾	64, 128, 192, 256 ¹⁾
CPX-CMIX-M1-1	48	48
CPX-4DE	4	–
CPX-8DE	8	–
CPX-8DE-D	8	–
CPX-8NDE	8	–
CPX-P-8DE-N	16	8
CPX-P-8DE-N (inputs configured as counter)	80	16
CPX-P-8DE-N-IS	16	8
CPX-P-8DE-N-IS (inputs configured as counter)	80	16
CPX-F8DE-P	48	56
CPX-16DE	16	–
CPX-M-16DE-D	16	–
CPX-4DA	–	4
CPX-8DA	–	8
CPX-8DA-H	–	8
CPX-8DE-8DA	8	8
CPX-2ZE2DA	96	96
CPX-4AE-4AA-H	0, 16, 32, 48, 64, 128, 144, 160, 176, 192 ¹⁾	0, 16, 32, 48, 64 ¹⁾
CPX-2AE-U-I	2 x 16	–
CPX-4AE-U-I	4 x 16	–
CPX-4AE-I	4 x 16	–
CPX-4AE-P-B2	4 x 16	–
CPX-4AE-P-D10	4 x 16	–
CPX-4AE-T	4 x 16	–
CPX-4AE-TC	4 x 16	–
CPX-2AA-U-I	–	2 x 16
CPX-FVDA-P2	48	48
VMPA1-FB-EMS-8	–	8
VMPA1-FB-EMG-8	–	8
VMPA2-FB-EMS-4	–	4
VMPA2-FB-EMG-4	–	4
VMPA1-FB-EMS-D2-8	–	8
VMPA1-FB-EMG-D2-8	–	8
VMPA2-FB-EMS-D2-4	–	4
VMPA2-FB-EMG-D2-4	–	4
VMPA-FB-PS-1	16	–
VMPA-FB-PS-3/5	16	–
VMPA-FB-PS-P1	16	–
VMPA-FB-EMG-P1	16	16

1) Dependent on the DIL switch setting on the module

Key features – Addressing

Overview – Address space for CPX-P bus node and control block							
	Protocol	Max. total		Max. digital		Max. analogue	
		Inputs	Outputs	Inputs	Outputs	Inputs	Outputs
CPX-CEC	<ul style="list-style-type: none"> • CODESYS Level 2 • TCP/IP • Easy IP • Modbus TCP 	512 bits	512 bits	512 DI	512 DO	32 AI	18 AO
CPX-FB11	DeviceNet	512 bits	512 bits	512 DI	512 DO	32 AI	18 AO
CPX-FB13	PROFIBUS	512 bits	512 bits	512 DI	512 DO	32 AI	18 AO
CPX-FB14	CANopen	256 bits	256 bits	64 DI (+ 64 DI)	64 DO (+ 64 DO)	8 AI (+ 8 AI)	8 AO (+ 8 AO)
CPX-FB33	PROFINET RT	512 bits	512 bits	512 DI	512 DO	32 AI	18 AO
CPX-M-FB34	PROFINET RT	512 bits	512 bits	512 DI	512 DO	32 AI	18 AO
CPX-M-FB35	PROFINET RT	512 bits	512 bits	512 DI	512 DO	32 AI	18 AO
CPX-FB36	EtherNet/IP	512 bits	512 bits	512 DI	512 DO	32 AI	18 AO
CPX-FB37	EtherCAT	512 bits	512 bits	512 DI	512 DO	32 AI	18 AO
CPX-FB43	PROFINET RT	512 bits	512 bits	512 DI	512 DO	32 AI	18 AO
CPX-M-FB44	PROFINET RT	512 bits	512 bits	512 DI	512 DO	32 AI	18 AO
CPX-M-FB45	PROFINET RT	512 bits	512 bits	512 DI	512 DO	32 AI	18 AO

 **Note**

The bandwidth of the bus nodes can be restricted by the choice of module and the maximum number of modules.

Data sheet

-  - Module width
50 mm



-  - **Note**

The data shown here apply to the CPX-P system. If components with lower values are used in the system, the specification for the entire system is reduced to the values of those components.

Example

Degree of protection IP65 applies only to the fully assembled system with fitted plugs or covers (which must also conform to IP65). If components with a lower degree of protection are used, the protection level of the entire

system is reduced to the degree of protection of the component with the lowest degree of protection, for example CageClamp connection block with degree of protection IP20.

General technical data

Module no.			562818
Max. number of modules ¹⁾	Control block		1
	Bus node		1
	I/O modules		9
	Pneumatic interface		1
Max. address capacity	Inputs	[byte]	64
	Outputs	[byte]	64
Internal cycle time		[ms]	< 1
Configuration support			Fieldbus-specific
LED displays	Bus node/control block		Up to 4 LEDs, bus-specific 4 LEDs, CPX-P-specific • PS = Power system • PL = Power load • SF = System fault • M = Modify parameter/forcing active
	I/O modules		Min. one group diagnostic LED Channel-oriented status and diagnostic LED, depending on module
	Pneumatic interface		One group diagnostics LED Valve status LED on valve
Diagnostics			<ul style="list-style-type: none"> • Channel and module-oriented diagnostics for inputs/outputs and valves • Detection of module undervoltage for the different potential values • Storage of the last 40 errors with timestamp (acyclic access)

1) A maximum of 11 modules in total can be combined.
(e.g. 1 control block + 9 I/O modules + 1 pneumatic interface, or 1 control block + 1 bus node + 8 I/O modules + 1 pneumatic interface)

Data sheet

General technical data			
Module no.		562818	
Parameterisation		Module-specific and entire system, for example: <ul style="list-style-type: none"> • Diagnostic behaviour • Condition monitoring • Profile of inputs • Fail-safe response of outputs and valves 	
Commissioning support		Forcing of inputs and outputs	
Nominal operating voltage	[V DC]	24	
Operating voltage range	[V DC]	18 ... 30	
Power supply	Interlinking block with system supply		
	Electronics plus sensors	[A]	8
	Actuators plus valves	[A]	8
	Additional supply		
	Actuators	[A]	8
Current consumption		Depending on system configuration	
Mains buffering (bus electronics only)	[ms]	10	
Power supply connection		7/8" 5-pin	
Fuse concept		Per module with electronic fuses	
Tests	Vibration test to DIN IEC 68	<ul style="list-style-type: none"> • With wall mounting: Severity level 2 • With H-rail mounting: Severity level 1 	
	Shock test to DIN IEC 68	<ul style="list-style-type: none"> • With wall mounting: Severity level 2 • With H-rail mounting: Severity level 1 	
Immunity to interference		EN 61000-6-2 (industry)	
Interference emission		EN 61000-6-4 (industry)	
Isolation test for galvanically isolated circuits to IEC 1131 Part 2	[V DC]	500	
Galvanic isolation of electrical voltages	[V DC]	80	
Protection against direct and indirect contact		PELV	
Materials		End plates: Die-cast aluminium	
PWIS conformity		VDMA24364-B2-L	
Grid dimension	[mm]	50	
Operating and environmental conditions			
Module no.		562818	
Ambient temperature	[°C]	-5 ... +50	
Storage temperature	[°C]	-20 ... +70	

Data sheet

Certifications and approvals – Maximum values	
Module no.	562818
ATEX category gas	II 3G
Type of ignition protection for gas	Ex nA IIC T4 Gc
Explosion-proof ambient temperature [°C]	$-5 \leq T_a \leq +50$
CE marking (see declaration of conformity) ¹⁾	To EU Explosion Protection Directive (ATEX)
	To EU EMC Directive ²⁾
	To EU Machinery Directive
	To EU RoHS Directive
UKCA marking (see declaration of conformity) ¹⁾	To UK EX instructions
	To UK instructions for EMC
	To UK instructions for machines
	To UK RoHS instructions
KC mark	KC EMC
Degree of protection to EN 60529	IP20, IP65
Certification	c UL us - Recognized (OL)
	RCM mark
Explosion protection certification outside the EU	EPL Gc (BR)
Certificate issuing authority	DNV 15.0193 X

1) More information: www.festo.com/catalogue/... → Support/Downloads.

2) For information about the area of use, see the EC declaration of conformity at: www.festo.com/catalogue/... → Support/Downloads.

If the devices are subject to usage restrictions in residential, commercial or light-industrial environments, further measures for the reduction of the emitted interference may be necessary.

 **Note**

The values indicated represent the maximum performance limits that can be achieved with the fully assembled product.

Depending on the individual components used, the value actually achieved for the overall product may be lower.





You can select e.g. the individual components required to achieve the ATEX category by choosing the corresponding features in the online product configurator:

→ Internet: cpx-p

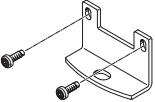
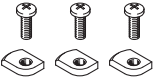
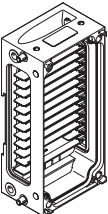

Data sheet

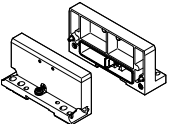
Weights [g]						
Control block	CEC...V3	135	PROFIsafe	Shut-off module	50	
Bus node	FB11	120		Input module	46	
	FB13	115	Counter module	2ZE2DA	130	
	FB14	115	CTEL interface	CTEL	110	
	FB33	280	Electrical interface	CTEL-2	110	
	FB34	280	Axis interface	CM-HPP	140	
	FB35	280	Measuring module	CMIX	140	
	FB36	125	Plastic connection block	8-way, M8 3-pin	62	
	FB37	125		8-way, M8 4-pin	65	
	FB43	185		4-way, M12 5-pin	60	
	FB44	280		4-way, M12 5-pin, quick lock, shielded with metal thread	87	
	FB45	280		4-way, M12 8-pin	65	
	I/O module	4 digital outputs		42	Spring-loaded terminal, 32-pin	75
		4 digital inputs		39	Sub-D 25-pin	72
8 digital inputs		39		8-way, DIL switch	57	
8 digital inputs, positive logic (PNP), enhanced diagnostic function		45				
8 digital inputs, negative logic (NPN)		40	Connection block for NAMUR and HART module	4-way, M12 4-pin	120	
8 digital inputs to NAMUR		100		Clamping connector 8-pin	100	
16 digital inputs, internal electronic fuse per module		41	Metal connection block	4-way, M12 5-pin	112	
16 digital inputs, internal electronic fuse per channel pair, for CPX in metal		46			4-way, M12 5-pin, pulsed sensor supply	110
8 digital inputs, 8 digital outputs		48			8-way, M12 5-pin	152
8 digital outputs, power supply 0.5 A per channel		49	Interlinking block, metal	Without power supply	169	
8 digital outputs, power supply 2.1 A per channel pair		48			System supply, 7/8" 5-pin	187
2 analogue current or voltage inputs		48	Tie rods	1-way	41	
4 analogue current inputs		47			2-way	71
2 analogue current or voltage outputs		49			3-way	97
4 analogue inputs/outputs, HART		77.4			4-way	127
2 or 4 analogue temperature inputs		47			5-way	156
4 analogue temperature inputs, with 2-wire connection for a PT1000 sensor for cold junction compensation		46			6-way	173
4 analogue pressure inputs		115			7-way	199
					8-way	247
					9-way	274
				10-way	301	
		End plate for metal design	Left-hand	113		
				Right-hand	113	
		End plate with extension	Left-hand	190		
				Right-hand	175	
		Pneumatic interface	MPA-S	238.4		

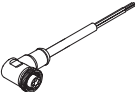
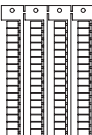
Data sheet

Ordering data – Accessories				Part no.	Type
Designation					
Mounting					
	Attachment for wall mounting (for long valve terminals, 2 mounting brackets and 4 screws)			550217	CPX-M-BG-RW-2x
	Mounting for H-rail			526032	CPX-CPA-BG-NRH
Interlinking block					
	Without power supply		–	550206	CPX-M-GE-EV
	With system supply	7/8" connection, 5-pin	–	550208	CPX-M-GE-EV-S-7/8-5POL
			For ATEX environment	8022165	CPX-M-GE-EV-S-7/8-5POL-VL
	With additional supply for outputs	7/8" connection, 5-pin	–	550210	CPX-M-GE-EV-Z-7/8-5POL
For ATEX environment			8022158	CPX-M-GE-EV-Z-7/8-5POL-VL	
Mounting accessories					
	Screws for mounting the bus node/connection block on an interlinking block	Bus node/plastic connection block		550219	CPX-M-M3x22-4x
		Bus node/metal connection block		550216	CPX-M-M3x22-S-4x
End plates					
	End plate	Right-hand		550214	CPX-M-EPR-EV
		Left-hand		550212	CPX-M-EPL-EV
Power supply					
	Plug socket for mains connection 7/8", straight, 5-pin		0.25 ... 2.0 mm ²	543107	NECU-G78G5-C2
	Plug socket for mains connection 7/8", angled, 5-pin – open cable end, 5-pin		2 m	573855	NEBU-G78W5-K-2-N-LE5
Inscription labels					
	Inscription labels 6x10 mm, 64 pieces, in frame			18576	IBS-6x10

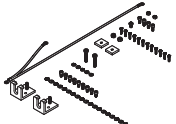
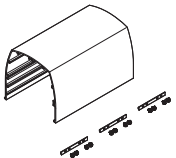
Data sheet

Ordering data – Accessories			Part no.	Type
Designation				
Hood				
	Mounting rail for attaching the hood	1000 mm	572256	CAFC-X1-S
	Mounting kit for CPX hood		572257	CAFC-X1-BE
	Hood section for CPX-P terminal including mounting attachments for connecting several hood sections in series.	200 mm	572258	CAFC-X1-GAL-200
		300 mm	572259	CAFC-X1-GAL-300
User documentation				
	CPX-P system manual	German	526445	P.BE-CPX-SYS-DE
		English	526446	P.BE-CPX-SYS-EN
		Spanish	526447	P.BE-CPX-SYS-ES
		French	526448	P.BE-CPX-SYS-FR
		Italian	526449	P.BE-CPX-SYS-IT

Data sheet

User documentation

Comprehensive user documentation is vital for the fast and reliable use of fieldbus components.

The manuals provided by Festo contain step-by-step instructions for using the CPX-P terminal:

1. Installation
2. Commissioning and parameterisation
3. Diagnostics

Application-oriented explanations are provided for integrating the CPX-P terminal in the programming and configuration software of the various controller manufacturers.

Use the order code to select the language you want.

The manual for the configuration you have ordered is supplied automatically.

Device description files and icons are provided to support the integration of the CPX-P terminal in the configuration software of the various controller manufacturers.

The documents can be downloaded quickly and easily from the Festo website.

→ www.festo.com

Overview – User documentation

Type	Title	Description
Pneumatics		
P.BE-MPA-...	Valve terminals with MPA-S pneumatics	Instructions on assembly, installation, commissioning and diagnostics of the MPA-S pneumatic components.
Electronics		
P.BE-CPX-SYS-...	System description, installation and commissioning	Overview of the design, components and mode of operation of the CPX-P terminal; installation and commissioning instructions as well as basic principles of parameterisation.
CPX-FVDA-P2-...	PROFIsafe shut-off module	Connection technology and assembly, installing and commissioning instructions for the PROFIsafe shut-off module of the type CPX-FVDA-P2.
P.BE-CPX-EA-...	CPX-P-EA modules, digital	Connection technology and assembly, installation and commissioning instructions for digital input and output modules of type CPX-... as well as the MPA pneumatic interface.
P.BE-CPX-P-EA-...	CPX-P-EA modules, NAMUR sensors	Connection technology and assembly, installation and commissioning instructions for digital input and output modules of type CPX-P-....
CPX-F8DE-P-...	Input module CPX-F8DE-N	Connection technology and assembly, installation and commissioning instructions for the PROFIsafe input module of type CPX-F8DE-P.
P.BE-CPX-2ZE2DA-...	I/O-module CPX-2ZE2DA	Connection technology and assembly, installation and commissioning instructions for counter modules of type CPX-2ZE2DA.
P.BE-CPX-AX-...	CPX-P-EA modules, analogue	Connection technology and assembly, installation and commissioning instructions for analogue input and output modules of type CPX-... as well as pressure sensors and proportional-pressure regulators.
P.BE-CPX-CTEL-...	CPX CTEL interface	Instructions on assembly, installation, commissioning and diagnostics of the CTEL master.
P.BE-CPX-CTEL-LK-...	Electrical interface CPX-CTEL-2	Instructions on assembly, installation, commissioning and diagnostics of the electrical interface for IO-Link.
P.BE-CPX-CMIX-...	CPX measuring module	Instructions on assembly, installation, commissioning and diagnostics of the measuring module (CMIX).
P.BE-CPX-FB-... CPX-FB-...	CPX bus node	Instructions on assembly, installation, commissioning and diagnostics of the relevant bus node.
CPX-(M)-FB33_35/43_45-...	CPX bus node for PROFINET	Instructions on assembly, installation, commissioning and diagnostics of the relevant bus node.
P.BE-CPX-CEC-...	CPX CODESYS controller (control block)	Instructions on assembly, installation, commissioning and diagnostics of the relevant control block.

Data sheet – CPX-P Maintenance Tool

Function

The CPX Maintenance Tool (CPX-FMT) combines service software with a connecting adapter. The service software is a tool for the design, parameterisation and online diagnostics of the CPX-P terminal.

The USB-to-M12 adapter features built-in galvanic isolation (between CPX-P and PC) and enables a PC to be connected to the diagnostic interface of the CPX-P terminal.

- Adapters
- Software on CD-ROM



Application

Only from Festo

The CPX-FMT software enables access to CPX valve terminals via Ethernet with the bus nodes EtherNet/IP (FB 36) and PROFINET (FB 33, FB 34, FB 35). The bus nodes or control blocks can be connected directly to a PC via a USB adapter from Festo. Diagnostic data such as the error trace or module diagnostics can be read out and parameters can be modified in plain text. The data can be used directly on a

PC. There is an option, for example, to send screenshots of a configuration or the current error trace directly via e-mail. In addition, CPX configurations can also be saved and archived directly as a CPX-FMT project. Undocumented changes can subsequently be identified using the online/offline comparison function. On-site tests such as the actuation of valves or the emulation of sensor

feedback (in both cases called "forcing"), for example, can be performed without an existing controller infrastructure. It must be noted that only local parameters on the CPX valve terminal can be changed and saved using the CPX-FMT. The configuration of the networks or controller software cannot be influenced.

General technical data		
Type		NEFC-M12G5-0.3-U1G5
System requirements	PC	IBM-compatible
	Drive	CD-ROM
	Interfaces	USB port (specification USB 1.1 or higher)
	Operating system	Microsoft Windows 2000 or XP
Function range		<ul style="list-style-type: none"> • Configuration and parameterisation • Reading out of system, module, channel diagnostics and error trace • Saving of the configuration as a project • Integration of plug-ins/links to self-executing programs
Scope of delivery		<ul style="list-style-type: none"> • Adapter, M12, 5-pin to mini USB socket • CD-ROM with installation program
Type of mounting		Screw-in
Electrical connection		Plug M12x1, 5-pin
Adapter cable composition		4 x 0.34 mm ²
Cable length	[m]	0.3
Degree of protection to EN 60529		IP20
CE marking (see declaration of conformity) ¹⁾		To EU RoHS Directive
UKCA marking (see declaration of conformity) ¹⁾		To UK RoHS instructions
Ambient temperature	[°C]	-5 ... +50
Material	Housing	ABS
	Cable sheath	PUR
	Pin contact	Gold-plated brass
Note on materials		RoHS-compliant
PWIS conformity		VDMA24364-B2-L

1) Additional information: www.festo.com/catalogue/... → Support/Downloads.

Data sheet – CPX-P Maintenance Tool

Dimensions

Download CAD data → www.festo.com

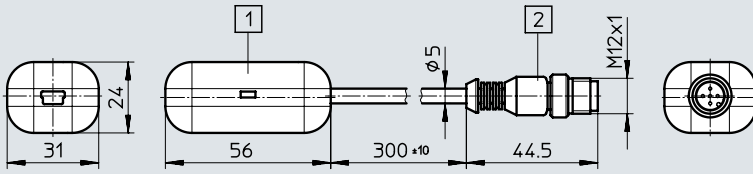

- [1] Mini B 5P USB port
- [2] Plug M12x1, 5-pin

Ordering data

Designation

Part no.

Type



CPX-P Maintenance Tool (CPX-FMT), software and USB-to-M12 adapter

547432

NEFC-M12G5-0.3-U1G5

Data sheet – CODESYS controller

- Industrial Ethernet
- TCP/IP
- EasyIP
- Web interface
- Email
- Data transfer

The CODESYS controller is a modern control system for CPX-P terminals that enables programming with CODESYS to IEC 61131-3.

The power supply to and communication with other modules takes place via the interlinking block.

In addition to network connections, LEDs are also provided for the bus status, operating status of the PLC and CPX-P peripherals information, as are switching elements and a diagnostic interface for CPX-FMT.



Application			
Bus connection		Communication protocols	Operating modes
The CPX-CEC is a remote controller that can be connected to a higher-order PLC via the bus nodes of the CPX-P terminal or via Ethernet. At the same time, it is possible to operate the CPX-CEC as a	compact stand-alone controller directly on the machine.	<ul style="list-style-type: none"> • Fieldbus via CPX-P bus nodes • Modbus/TCP • EasyIP 	<ul style="list-style-type: none"> • Stand-alone • Remote controller, fieldbus • Remote controller, Ethernet
Setting options			
The CPX-CEC has the following interfaces for monitoring, programming and commissioning:	<ul style="list-style-type: none"> • For the CPX-FMT • Ethernet interface for IT applications • Remote diagnostics 	The operating mode and fieldbus protocol are set using the DIL switch on the CPX-CEC.	The integrated web server offers a convenient means of querying data saved in the CPX-CEC.
Characteristics			
<ul style="list-style-type: none"> • Easy control of valve terminal configurations with MPA, VTSA • Diagnostics with flexible monitoring options for pressure, flow rate, cylinder operating time, air consumption 	<ul style="list-style-type: none"> • Activation of decentralised installation systems on the basis of CPI control of applications in proportional pneumatics • AS-Interface control via gateway 	<ul style="list-style-type: none"> • Connection to all fieldbuses as a remote controller and for preprocessing • Control of electric actuators as individual axes via CANopen (CPX-CEC-C1/-M1) 	<ul style="list-style-type: none"> • Early warnings and visualisation options • Servo-pneumatic applications

Data sheet – CODESYS controller

General technical data		
Protocol	CODESYS Level 2	
	EasyIP	
	Modbus TCP	
	TCP/IP	
Processing time	Approx. 200 µs/1 k instructions	
Programming software	CODESYS provided by Festo	
Programming language	To IEC 61131-3	
	Sequential function chart (SFC)	
	Instruction list (IL)	
	Function chart (FCH), additional continuous function chart (CFC)	
	Ladder diagram (LD)	
	Structured text (ST)	
Programming	Operating language	German, English
	Support for file handling	Yes
Device-specific diagnostics	Diagnostic memory	
	Channel and module-oriented diagnostics	
	Undervoltage/short-circuit modules	
LED displays	Bus-specific	TP: Link/traffic
	Product-specific	RUN: PLC status
		STOP: PLC status
		ERR: PLC runtime error
		PS: Electronics supply, sensor supply
		PL: Load supply
		SF: System fault
		M: Modify/forcing active
IP address setting	DHCP	
	Via CODESYS	
	Via MMI	
Function blocks	CPX-P diagnostic status, copy CPX-P diagnostic trace, read CPX-P module diagnostics, and more	
Dimensions (including interlinking block) W x L x H	[mm]	50 x 107 x 55

Materials

Housing	PA-reinforced
	PC
Note on materials	RoHS-compliant
PWIS conformity	VDMA24364-B2-L

Operating and environmental conditions

Ambient temperature	[°C]	-5 ... +50
Storage temperature	[°C]	-20 ... +70
Relative humidity	[%]	95, non-condensing
Corrosion resistance class CRC ¹⁾		2

1) More information: www.festo.com/x/topic/kbk

Electrical data

Nominal operating voltage	[V DC]	24
Load voltage	Nominal operating voltage	[V DC] 24
	With pneumatics type VTSA	[V DC] 21.6 ... 26.4
	With pneumatics type MPA	[V DC] 18 ... 30
	Without pneumatics	[V DC] 18 ... 30
Power failure buffering	[ms]	10
Intrinsic current consumption at nominal operating voltage	[mA]	Typically 85
Degree of protection to EN 60529		IP65, IP67

Data sheet – CODESYS controller

Technical data				
Type		CPX-CEC-C1-V3	CPX-CEC-M1-V3	CPX-CEC-S1-V3
Additional functions		Motion functions for electric drives	SoftMotion functions for electric drives	Diagnostic functions RS232 communication function
CPU data	Flash	[MB]	32	
	RAM	[MB]	256	
	Processor	[MHz]	800	
Control interface		CAN bus	CAN bus	–
Parameterisation		CODESYS V3		
Configuration support		CODESYS V3		
Program memory, user program		[MB]	16	
Flags		CODESYS variable concept		
Remanent data		[kB]	28	
Control elements		DIL switch for CAN termination		–
		Rotary switch for RUN/STOP		Rotary switch for RUN/STOP
Total number of axes		127	31	–
Ethernet	Number	1		
	Connection technology	RJ45 socket, 8-pin		
	Data transmission speed	[Mbps]	1 0/100	
	Supported protocols	TCP/IP, EasyIP, Modbus TCP		
Fieldbus interface	Number	1		1
	Connection technology	Sub-D plug, 9-pin		Sub-D socket, 9-pin
	Data transmission speed, can be set via software	[kbps]	125, 250, 500, 800, 1000	
	Supported protocols	CAN bus		RS232 interface
	Max. cable length	[m]	–	
	Galvanic isolation		Yes	

Data sheet – CODESYS controller

Connection and display elements CPX-CEC-C1/-M1

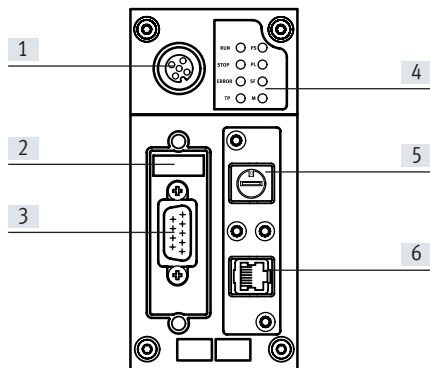

- [1] CPX-FMT connection
- [2] DIL switch
- [3] Fieldbus interface (Sub-D plug, 9-pin)
- [4] Status LEDs, bus-specific and product-specific
- [5] RUN/STOP rotary switch
- [6] Ethernet interface (RJ45 socket, 8-pin)

Pin allocation – CPX-CEC-C1/-M1

	Pin	Signal	Meaning
Fieldbus interface, Sub-D plug			
	1	n.c.	Not connected
	2	CAN_L	CAN low
	3	CAN_GND	CAN ground
	4	n.c.	Not connected
	5	CAN_SHLD	Connection to functional earth FE
	6	CAN_GND	CAN ground (optional) ¹⁾
	7	CAN_H	CAN high
	8	n.c.	Not connected
	9	n.c.	Not connected
Housing	Shielding	Plug housing must be connected to FE	
Ethernet interface, RJ45 plug			
	1	TD+	Transmitted data+
	2	TD-	Transmitted data-
	3	RD+	Received data+
	4	n.c.	Not connected
	5	n.c.	Not connected
	6	RD-	Received data-
	7	n.c.	Not connected
	8	n.c.	Not connected
Housing	Shielding	Shielding	

1) If a servo drive is connected to an external power supply, CAN ground (optional), pin 6, cannot be used on the CPX-CEC-C1/-M1.

Data sheet – CODESYS controller

Connection and display elements CPX-CEC-S1

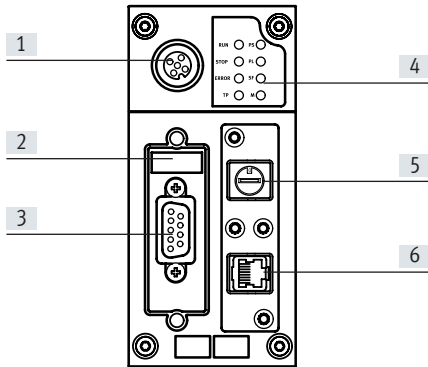







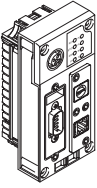

- [1] CPX-FMT connection
- [2] DIL switch
- [3] RS232 interface
(Sub-D socket, 9-pin)
- [4] Status LEDs, bus-specific and
product-specific
- [5] RUN/STOP rotary switch
- [6] Ethernet interface (RJ45 socket,
8-pin)



Pin allocation – CPX-CEC-S1

Terminal allocation	Pin	Signal	Designation
RS 232 interface, Sub-D socket			
	1	n.c.	Not connected
	2	RxD	Received data
	3	TxD	Transmitted data
	4	n.c.	Not connected
	5	GND	Data reference potential
	6	n.c.	Not connected
	7	n.c.	Not connected
	8	n.c.	Not connected
	9	n.c.	Not connected
	Shielding	Shielding	Connection to functional earth
Ethernet interface, RJ45 plug			
	1	TD+	Transmitted data+
	2	TD-	Transmitted data-
	3	RD+	Received data+
	4	n.c.	Not connected
	5	n.c.	Not connected
	6	RD-	Received data-
	7	n.c.	Not connected
	8	n.c.	Not connected
Housing	Shielding	Shielding	

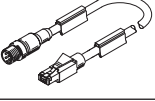
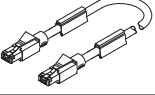
Data sheet – CODESYS controller

Ordering data						
Designation				Part no.	Type	
Control block						
	Motion functions for electric drives		135 g	3473128	CPX-CEC-C1-V3	
	SoftMotion functions for electric drives		135 g	3472765	CPX-CEC-M1-V3	
	RS232 communication function		135 g	3472425	CPX-CEC-S1-V3	
Fieldbus interface						
	Sub-D plug, 9-pin, for CANopen			532219	FBS-SUB-9-BU-2x5POL-B	
	Micro style bus connection, 2xM12 for DeviceNet/CANopen			525632	FBA-2-M12-5POL	
	Socket for micro style connection, M12			18324	FBSD-GD-9-5POL	
	Plug for micro style connection, M12			175380	FBS-M12-5GS-PG9	
	Open style bus connection for 5-pin terminal strip for DeviceNet/CANopen			525634	FBA-1-SL-5POL	
	Terminal strip for open style connection, 5-pin			525635	FBSD-KL-2x5POL	
Ethernet interface						
	RJ45 plug		Degree of protection IP 65, IP67	534494	FBS-RJ45-8-GS	
	Cover for RJ45 connection		Degree of protection IP 65, IP67	534496	AK-RJ45	
	Straight plug, RJ45, 8-pin	Straight plug, M12x1, 4-pin, D-coded	Degree of protection IP20	1 m	8040451	NEBC-D12G4-ES-1-S-R3G4-ET
				3 m	8040452	NEBC-D12G4-ES-3-S-R3G4-ET
				5 m	8040453	NEBC-D12G4-ES-5-S-R3G4-ET
				10 m	8040454	NEBC-D12G4-ES-10-S-R3G4-ET
	Straight plug, RJ45, 8-pin	Straight plug, RJ45, 8-pin	Degree of protection IP20	1 m	8040455	NEBC-R3G4-ES-1-S-R3G4-ET

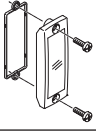
Data sheet – Control block CPX-CEC

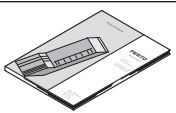
Ordering data		Part no.	Type
Designation			
Covers and attachments			
	Inspection cover, transparent, for Sub-D connection	533334	AK-SUB-9/15-B
	Inscription label holder for connection block	536593	CPX-ST-1
User documentation			
	Manual for control block CPX-CEC	German	569121 P.BE-CPX-CEC-DE
		English	569122 P.BE-CPX-CEC-EN

Data sheet – DeviceNet bus node



Bus node for handling communication between the electrical terminal CPX-P and a DeviceNet network.

The bus node is provided with system supply via the interlinking block and processes communication with the I/O modules.

The status of the CPX-P terminal is displayed as a common message via 4 CPX-P-specific LEDs.

The fieldbus communication status is displayed via the three DeviceNet-specific LEDs.

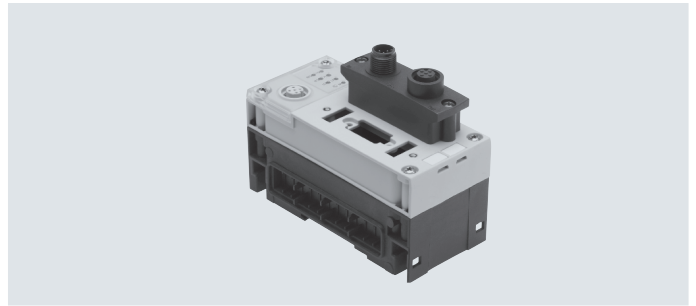

Application

Bus connection

The bus connection can be selected when ordering, either micro style as 2xM12 round plugs or open style as a terminal strip with IP20 protection.

Both connection types have the function of an integrated T-distributor with incoming and outgoing bus line.

DeviceNet implementation

The CPX-FB11 operates with the Predefined Master/Slave Connection Set as a Group 2 Only Server. The polled I/O, change of state or cyclic method is used for the transmission of cyclic I/O data. The type of transmission can be selected in the network configuration.

The device diagnostics for all bus nodes CPX-FB11 is effectively gathered via strobed I/O and displayed in the input table of the controller. In addition to cyclic data transmission, acyclic communication is supported through explicit messaging, which enables detailed device diagnostics and parameterisation.

A comprehensive EDS file supports the display of acyclic data. It is also possible to display system information and assign parameters while the controller is running via the user program or the configuration software.

An example of this is access to the integrated diagnostic memory function, i.e. storage of the last 40 errors with timestamp, module, channel and error type.

With its address capacity of 64 byte inputs and 64 byte outputs, the CPX-FB11 supports any configuration of I/O modules, including pneumatic interface.

Points to note in connection with CPX-CEC

When a bus node is combined with a control block (CPX-CEC, in the fieldbus remote controller operating mode), the connected I/Os and/or valves, sensors and actuators are controlled via the CPX-P control block.

In this case, the bus node only provides the communication interface to the PLC. Communication between the control block and CPX-P bus node takes place by interlinking the CPX-P modules and takes up the following address capacity in the CPX-P system:

- 8 byte outputs
- 8 byte inputs

The following address capacity remains in the control block or CPX system for activating the peripherals:

- 56 byte inputs
- 56 byte outputs

Data sheet – DeviceNet bus node

General technical data			
Type	CPX-FB11		
Fieldbus interface	Either <ul style="list-style-type: none"> • Micro style bus connection: 2xM12 with degree of protection IP65/IP67 • Open style bus connection: 5-pin terminal strip, IP20 		
Baud rate	[kbps]	125, 250, 500	
Addressing range	0 ... 63 Set using DIL switch		
Product	Type	Communication adapter (12 dec.)	
	Code	4554 dec.	
Types of communication	Polled I/O, change of state/cyclic, strobed I/O and explicit messaging		
Configuration support	EDS file and bitmaps		
Max. address capacity	Inputs	[byte]	64
	Outputs	[byte]	64
LED displays (bus-specific)	MS = Module status NS = Network status IO = I/O status		
Device-specific diagnostics	Module and channel-oriented diagnostics via manufacturer-specific diagnostic object		
Parameterisation	<ul style="list-style-type: none"> • Module and system parameterisation via configuration interface in plain text (EDS) • Online in run or program mode 		
Additional functions	<ul style="list-style-type: none"> • Storage of the last 40 errors with timestamp (access via EDS) • 8-bit system status in process image for inputs • 2-byte inputs and 2-byte outputs, system diagnostics in process image 		
Control elements	DIL switch		
Operating voltage	Nominal value	[V DC]	24
	Permissible range	[V DC]	18 ... 30
	Power failure buffering	[ms]	10
Current consumption	[mA]	Typically 200	
Degree of protection to EN 60529	IP65, IP67		
Temperature range	Operation	[°C]	-5 ... +50
	Storage/transport	[°C]	-20 ... +70
Materials	PA-reinforced, PC		
PWIS conformity	VDMA24364-B2-L		
Grid dimension	[mm]	50	
Dimensions (including interlinking block) W x L x H	[mm]	50 x 107 x 50	
Product weight	[g]	120	

 **Note**

Please observe the general limits and guidelines for the system when configuring the electrical modules.

Data sheet – DeviceNet bus node

Connection and display components

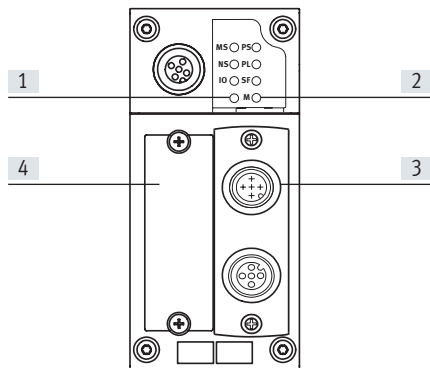







- [1] Bus-specific LEDs
- [2] CPX-P-specific status LEDs
- [3] Selectable fieldbus interface
Micro style
Open style
- [4] DIL switch cover

Pin allocation for the DeviceNet interface

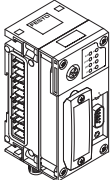
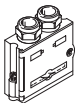

Terminal allocation	Pin	Signal-specific wire colour ¹⁾	Signal	Designation
Sub-D plug				
	1	–	n.c.	Not connected
	2	Blue	CAN_L	Received/transmitted data low
	3	Black	0 V bus	0 V CAN interface
	4	–	n.c.	Not connected
	5	Bare	Shielding	Connection to housing
	6	–	n.c.	Not connected
	7	White	CAN_H	Received/transmitted data high
	8	–	n.c.	Not connected
	9	Red	24 V DC bus	24 V DC supply CAN interface
Micro style bus connection (M12), incoming/outgoing				
	1	Bare	Shielding	Connection to housing
	2	Red	24 V DC bus	24 V DC supply CAN interface
	3	Black	0 V bus	0 V CAN interface
	4	White	CAN_H	Received/transmitted data high
	5	Blue	CAN_L	Received/transmitted data low
	1	Bare	Shielding	Connection to housing
	2	Red	24 V DC bus	24 V DC supply CAN interface
	3	Black	0 V bus	0 V CAN interface
	4	White	CAN_H	Received/transmitted data high
	5	Blue	CAN_L	Received/transmitted data low
Open style bus connection				
	1	Black	0 V bus	0 V CAN interface
	2	Blue	CAN_L	Received/transmitted data low
	3	Bare	Shielding	Connection to housing
	4	White	CAN_H	Received/transmitted data high
	5	Red	24 V DC bus	24 V DC supply CAN interface
7/8" bus connection				
	1	Black	Shielding	Connection to housing
	2	Blue	24 V DC	24 V DC supply CAN interface
	3	Bare	0 V	0 V CAN interface
	4	White	CAN_H	Received/transmitted data high
	5	Red	CAN_L	Received/transmitted data low

1) Typical for DeviceNet cables

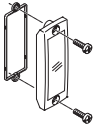
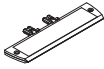
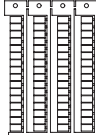
Data sheet – DeviceNet bus node

Ordering data		Part no.	Type
Designation			
Bus node			
	DeviceNet bus node	526172	CPX-FB11
Bus connection			
	Sub-D plug	532219	FBS-SUB-9-BU-2x5POL-B
	Connection block, 9-pin Sub-D socket, 5-pin 7/8" plug	571052	CPX-AB-1-7/8-DN
	Micro style bus connection, 2xM12	525632	FBA-2-M12-5POL
	Socket for micro style connection, M12	18324	FBSD-GD-9-5POL
	Plug for micro style connection, M12	175380	FBS-M12-5GS-PG9
	Open style bus connection for 5-pin terminal strip	525634	FBA-1-SL-5POL
	Terminal strip for open style connection, 5-pin	525635	FBSD-KL-2x5POL
Covers			
	Cover cap for sealing unused M12 connections (10 pieces)	165592	ISK-M12
	Inspection cover, transparent, for Sub-D connection	533334	AK-SUB-9/15-B
Inscription label			
	Inscription label holder for connection block	536593	CPX-ST-1
	Inscription labels 6x10 mm, 64 pieces, in frame	18576	IBS-6x10

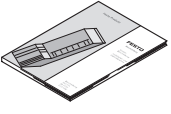
Data sheet – DeviceNet bus node

Ordering data		Part no.	Type
Designation			
User documentation			
	User documentation for bus node CPX-FB11	German	526421 P.BE-CPX-FB11-DE
		English	526422 P.BE-CPX-FB11-EN
		Spanish	526423 P.BE-CPX-FB11-ES
		French	526424 P.BE-CPX-FB11-FR
		Italian	526425 P.BE-CPX-FB11-IT
Software			
	Adapter M12, 5-pin to mini USB socket, and controller software	547432	NEFC-M12G5-0.3-U1G5

Data sheet – PROFIBUS bus node



Bus node for handling communication between the electrical terminal CPX-P and a higher-order master via PROFIBUS DP.

The bus node is provided with system supply via the interlinking block and processes communication with the I/O modules.

The status of the CPX-P terminal is displayed as a common message via 4 CPX-P-specific LEDs.

The fieldbus communication status is displayed via the PROFIBUS-specific error LED.

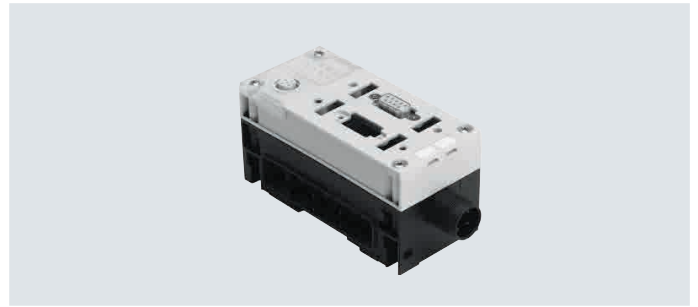

Application

Bus connection

The bus connection is established via a 9-pin Sub-D socket with a typical PROFIBUS allocation (to EN 50170).

The bus connector plug (with degree of protection IP65/IP67 from Festo or degree of protection IP20 from other manufacturers) facilitates the connection of an incoming and an outgoing bus cable.

An active bus terminal can be connected using the DIL switch integrated in the plug.

The Sub-D interface is designed for controlling network components with a fibre-optic cable connection.

PROFIBUS DP implementation

The CPX-FB13 supports the PROFIBUS DP protocol to EN 50170 Volume 2 for cyclic I/O exchange, parameterisation and diagnostic functions (DPV0).

In addition to DPV0, acyclic communication to the advanced specification DPV1 is supported. DPV1 provides acyclic access to advanced system information and allows parameterisation while the controller is running via the user program.

An example of this is access to the integrated diagnostic memory function, i.e. storage of the last 40 errors with timestamp, module, channel and error type.

With its address capacity of 64 byte inputs and 64 byte outputs, the CPX-FB13 supports any configuration of I/O modules, including pneumatic interface.

Points to note in connection with CPX-CEC

When a bus node is combined with a control block (CPX-CEC, in the fieldbus remote controller operating mode), the connected I/Os and/or valves, sensors and actuators are controlled via the CPX-P control block.

In this case, the bus node only provides the communication interface to the PLC. Communication between the control block and CPX-P bus node takes place by interlinking the CPX-P modules and takes up the following address capacity in the CPX-P system:

- 8 byte outputs
- 8 byte inputs

The following address capacity remains in the control block or CPX system for activating the peripherals:

- 56 byte inputs
- 56 byte outputs

Data sheet – PROFIBUS bus node

General technical data			
Type	CPX-FB13		
Fieldbus interface	Sub-D socket, 9-pin (EN 50170) Galvanically isolated 5 V		
Baud rate	[Mbps]	0.0096 ... 12	
Addressing range	1 ... 125 Set using DIL switch		
Product family	4: Valves		
ID number	0x059E		
Types of communication	DPV0: Cyclic communication DPV1: Acyclic communication		
Configuration support	GSD file and bitmaps		
Max. address capacity	Inputs	[byte]	64
	Outputs	[byte]	64
LED displays (bus-specific)	BF: Bus fault		
Device-specific diagnostics	Identifier and channel-oriented diagnostics to EN 50170 (PROFIBUS standard)		
Parameterisation	<ul style="list-style-type: none"> Start-up parameterisation via configuration interface in plain text (GSD) Acyclic parameterisation via DPV1 		
Additional functions	<ul style="list-style-type: none"> Storage of the last 40 errors with timestamp (access via DPV1) 8-bit system status in process image for inputs 2-byte inputs and 2-byte outputs, system diagnostics in process image 		
Control elements	DIL switch		
Operating voltage	Nominal value	[V DC]	24
	Permissible range	[V DC]	18 ... 30
	Power failure buffering	[ms]	10
Current consumption			[mA]
			Typically 200
Degree of protection to EN 60529	IP65, IP67		
Temperature range	Operation	[°C]	-5 ... +50
	Storage/transport	[°C]	-20 ... +70
Materials	PA-reinforced, PC		
PWIS conformity	VDMA24364-B2-L		
Grid dimension			[mm]
			50
Dimensions (including interlinking block) W x L x H			[mm]
			50 x 107 x 50
Product weight			[g]
			115

 **Note**

Please observe the general limits and guidelines for the system when configuring the electrical modules.

Data sheet – PROFIBUS bus node

Connection and display components

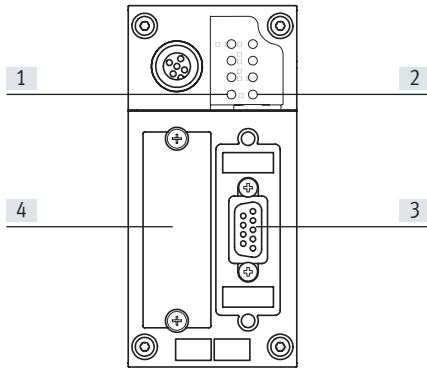







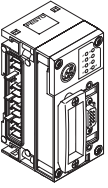

- [1] Bus status LEDs/bus fault
- [2] CPX-P-specific status LEDs
- [3] Fieldbus interface (Sub-D socket, 9-pin)
- [4] DIL switch cover

Pin allocation for PROFIBUS DP interface

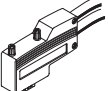

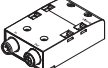
Terminal allocation	Pin	Signal	Designation
Sub-D socket			
	1	n.c.	Not connected
	2	n.c.	Not connected
	3	RxD/TxD-P	Received/transmitted data P
	4	CNTR-P ¹⁾	Repeater control signal
	5	DGND	Data reference potential (M5V)
	6	VP	Supply voltage (P5V)
	7	n.c.	Not connected
	8	RxD/TxD-N	Received/transmitted data N
	9	n.c.	Not connected
	Housing	Shielding	Connection to housing
Bus connection M12 adapter (B-coded)			
<p>Incoming</p>	1	n.c.	Not connected
	2	RxD/TxD-N	Received/transmitted data N
	3	n.c.	Not connected
	4	RxD/TxD-P	Received/transmitted data P
	5 and M12	Shielding	Connection to FE (functional earth)
<p>Outgoing</p>	1	VP	Supply voltage (P5V)
	2	RxD/TxD-N	Received/transmitted data N
	3	DGND	Data reference potential (M5V)
	4	RxD/TxD-P	Received/transmitted data P
	5 and M12	Shielding	Connection to FE (functional earth)

1) The repeater control signal CNTR-P is realised as a TTL signal.

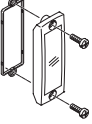
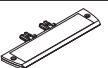
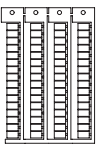
Data sheet – PROFIBUS bus node

Ordering data		Part no.	Type
Designation			
Bus node			
	PROFIBUS bus node	195740	CPX-FB13
Bus connection			
	Sub-D plug, straight	532216	FBS-SUB-9-GS-DP-B
	Sub-D plug, angled	533780	FBS-SUB-9-WS-PB-K
	Bus connection, adapter from 9-pin Sub-D plug to 5-pin M12 plug/socket, B-coded	533118	FBA-2-M12-5POL-RK
	Connection block, adapter from 9-pin Sub-D plug to 5-pin M12 plug/socket, B-coded	541519	CPX-AB-2-M12-RK-DP
	5-pin M12x1 straight socket, for self-assembly of a connecting cable compatible with FBA-2-M12-5POL-RK and CPX-AB-2-M12-RK-DP	1067905	NECU-M-B12G5-C2-PB
	Plug M12x1, 5-pin, straight, for self-assembly of a connecting cable compatible with FBA-2-M12-5POL-RK and CPX-AB-2-M12-RK-DP	1066354	NECU-M-S-B12G5-C2-PB
	Terminating resistor, M12, B-coded for PROFIBUS	1072128	CACRS-B12G5-220-PB
Covers			
	Cover cap for sealing unused M12 connections (10 pieces)	165592	ISK-M12
	Inspection cover, transparent, for Sub-D connection	533334	AK-SUB-9/15-B
Inscription label			
	Inscription label holder for connection block	536593	CPX-ST-1
	Inscription labels 6x10 mm, 64 pieces, in frame	18576	IBS-6x10

Data sheet – CPX-FB13 bus node, PROFIBUS DP

Ordering data		Part no.	Type
Designation			
User documentation			
	User documentation for bus node CPX-FB13	German	526427 P.BE-CPX-FB13-DE
		English	526428 P.BE-CPX-FB13-EN
		Spanish	526429 P.BE-CPX-FB13-ES
		French	526430 P.BE-CPX-FB13-FR
		Italian	526431 P.BE-CPX-FB13-IT
Software			
	Adapter M12, 5-pin to mini USB socket, and controller software	547432	NEFC-M12G5-0.3-U1G5

Data sheet – CANopen bus node



Bus node for handling communication between the electrical terminal CPX-P and a CANopen network master or CANopen network.

The bus node is provided with system supply via the interlinking block and processes communication with the I/O modules.

The status of the CPX-P terminal is displayed as a common message via 4 CPX-P-specific LEDs.

The different CANopen statuses and the fieldbus communication status are visualised via 3 additional LEDs.

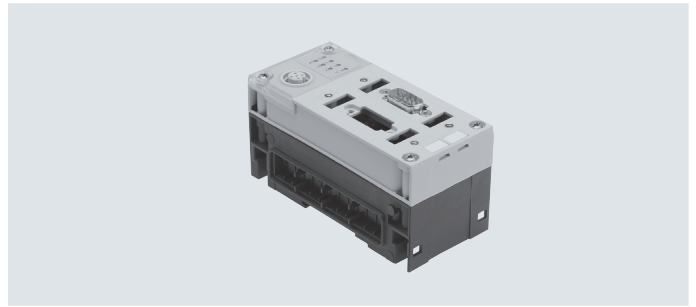

Application

Bus connection

The bus connection is established via a 9-pin Sub-D plug (pin) as per the CAN in Automation (CiA) specification DS 102 with additional 24 V CAN transceiver supply (option as per DS 102).

The bus connector plug (with degree of protection IP65/IP67 from Festo or degree of protection IP20 from other manufacturers) facilitates the connection of an incoming and an outgoing bus cable.

There are 4 contacts available for the 4 wires (CAN_L, CAN_H, 24 V, 0 V) of the incoming and outgoing bus cables respectively.

CANopen implementation

The CPX-FB14 supports the CANopen protocol in accordance with the specifications DS 301 V4.01 and DS 401 V2.0.

Implementation is based on the CiA Predefined Connection Set.

There are 4 PDOs available for fast I/O data exchange.

Enhanced system information can also be accessed via SDO communication. SDO communication also facilitates parameterisation before network start-up or while the controller is running via the user program.

An example of this is access to the integrated diagnostic memory function, i.e. storage of the last 40 errors with timestamp, module, channel and error type.

With its address capacity, the CPX-FB14 supports a large number of I/O module configurations, including pneumatic interface.

By default, 8 byte digital inputs and 8 byte digital outputs can be addressed via PDO 1.

8 analogue input channels and 8 analogue output channels can be addressed via PDO 2 and 3. Status and diagnostic information can be evaluated via PDO 4.

Additional 8 byte digital inputs and outputs as well as 8 analogue input and output channels can be addressed via mapping.

Points to note in connection with CPX-CEC

When a bus node is combined with a control block (CPX-CEC, in the fieldbus remote controller operating mode), the connected I/Os and/or valves, sensors and actuators are controlled via the CPX-P control block.

In this case, the bus node only provides the communication interface to the PLC.

Communication between the control block and CPX-P bus node takes place by interlinking the CPX-P modules and takes up the following address capacity in the CPX-P system:

- 8 byte outputs
- 8 byte inputs

The following address capacity remains in the control block or CPX system for activating the peripherals:

- 56 byte inputs
- 56 byte outputs

Data sheet – CANopen bus node

General technical data			
Type	CPX-FB14		
Fieldbus interface	Sub-D plug, 9-pin (to DS 102) Bus interface galvanically isolated via optocoupler 24 V supply for CAN interface via bus		
Baud rate	[kbps]	125, 250, 500 and 1000 can be set via DIL switch	
Addressing range	Node ID 1 ... 127 Set using DIL switch		
Product family	Digital inputs and outputs		
Communication profile	DS 301, V4.01		
Device profile	DS 401, V2.0		
Number	PDO	4 Tx/4 Rx	
	SDO	1 server SDO	
Configuration support	EDS file and bitmaps		
Max. address capacity	Inputs	[byte]	16 digital, 16 analogue channels
	Outputs	[byte]	16 digital, 16 analogue channels
LED displays (bus-specific)	MS = Module status NS = Network status IO = I/O status		
Device-specific diagnostics	Via emergency message Object 1001, 1002 and 1003		
Parameterisation	Via SDO		
Additional functions	<ul style="list-style-type: none"> Storage of the last 40 errors with timestamp (access via SDO) 8-bit system status via transmit PDO 4 (default) 2-byte inputs and 2-byte outputs, system diagnostics via PDO 4 Minimum boot-up Variable PDO mapping Emergency message Node guarding Heart beat 		
Control elements	DIL switch		
Operating voltage	Nominal value	[V DC]	24
	Permissible range	[V DC]	18 ... 30
	Power failure buffering	[ms]	10
Current consumption			[mA] Typically 200
Degree of protection to EN 60529	IP65, IP67		
Temperature range	Operation	[°C]	-5 ... +50
	Storage/transport	[°C]	-20 ... +70
Materials	PA-reinforced, PC		
PWIS conformity	VDMA24364-B2-L		
Grid dimension			[mm] 50
Dimensions (including interlinking block) W x L x H			[mm] 50 x 107 x 50
Product weight			[g] 115

 **Note**

Please observe the general limits and guidelines for the system when configuring the electrical modules.

Data sheet – CANopen bus node

Connection and display components

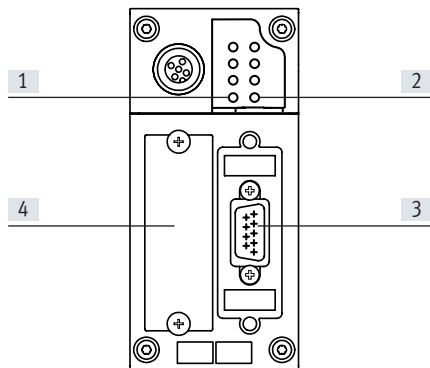









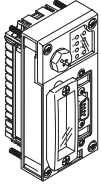
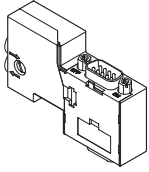
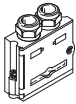
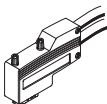

- [1] Bus-specific LEDs
- [2] CPX-P-specific status LEDs
- [3] Fieldbus interface (Sub-D plug, 9-pin)
- [4] DIL switch cover

Pin allocation of the CANopen interface

Terminal allocation	Pin	Signal	Designation
Sub-D plug			
	1	n.c.	Not connected
	2	CAN_L	Received/transmitted data low
	3	CAN_GND	0 V CAN interface
	4	n.c.	Not connected
	5	CAN_SHLD	Optional shielded connection
	6	GND	Ground ¹⁾
	7	CAN_H	Received/transmitted data high
	8	n.c.	Not connected
	9	CAN_V+	24 V DC supply CAN interface
	Housing	Shielding	Connection to FE (functional earth)
Micro style bus connection (M12)			
	1	Shielding	Connection to FE (functional earth)
	2	CAN_V+	24 V DC supply CAN interface
	3	CAN_GND	0 V CAN interface
	4	CAN_H	Received/transmitted data high
	5	CAN_L	Received/transmitted data low
	1	Shielding	Connection to FE (functional earth)
	2	CAN_V+	24 V DC supply CAN interface
	3	CAN_GND	0 V CAN interface
	4	CAN_H	Received/transmitted data high
	5	CAN_L	Received/transmitted data low
Open style bus connection			
	1	CAN_GND	0 V CAN interface
	2	CAN_L	Received/transmitted data low
	3	Shielding	Connection to FE (functional earth)
	4	CAN_H	Received/transmitted data high
	5	CAN_V+	24 V DC supply CAN interface

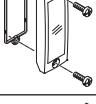
1) Connected internally via Pin 3

Data sheet – CANopen bus node

Ordering data		Part no.	Type	
Designation				
Bus node				
	CANopen bus node	526174	CPX-FB14	
Bus connection				
	Sub-D socket for CANopen with terminating resistor and programming interface	574588	NECU-S1W9-C2-ACO	
	Sub-D socket	532219	FBS-SUB-9-BU-2x5POL-B	
	Sub-D socket, angled	533783	FBS-SUB-9-WS-CO-K	
	Connection block, 9-pin Sub-D socket, 5-pin 7/8" plug	571052	CPX-AB-1-7/8-DN	
	Micro style bus connection, 2xM12, 5-pin	525632	FBA-2-M12-5POL	
	Fieldbus socket for micro style connection, M12, 5-pin	18324	FBSD-GD-9-5POL	
	Plug for micro style connection, M12, 5-pin	175380	FBS-M12-5GS-PG9	
	Open style bus connection	525634	FBA-1-SL-5POL	
	Terminal strip for open style connection, 5-pin	525635	FBSD-KL-2x5POL	
	Inspection cover, transparent	533334	AK-SUB-9/15-B	
	Inscription label holder for connection block	536593	CPX-ST-1	
User documentation				
	User documentation for bus node CPX-FB14	German	526409	P.BE-CPX-FB14-DE
		English	526410	P.BE-CPX-FB14-EN
		Spanish	526411	P.BE-CPX-FB14-ES
		French	526412	P.BE-CPX-FB14-FR
		Italian	526413	P.BE-CPX-FB14-IT
Software				
	Adapter M12, 5-pin to mini USB socket, and controller software	547432	NEFC-M12G5-0.3-U1G5	

Data sheet – PROFINET bus node, M12, D-coded



Bus node for operating the CPX-P valve terminal on PROFINET.

The bus node is provided with system supply via the interlinking block and processes communication with the I/O modules.

The status of the CPX-P terminal is displayed as a common message via 4 CPX-P-specific LEDs.

The fieldbus communication status is displayed via three bus-specific LEDs.



Application

Bus connection

The bus connection is established via two M12 sockets, D-coded to IEC 61076-2-101 with degree of protection IP65, IP67.

Both connections are equivalent 100BaseTX Ethernet ports with integrated auto MDI functionality (crossover and patch cables can be

used) that are brought together via an internal switch.

- Maximum segment length 100 m
- Transmission rate 100 Mbps

PROFINET implementation

The CPX-FB33 supports the PROFINET protocol on the basis of the Ethernet standard and TCP/IP technology to IEEE802.3. This guarantees a data exchange with a high data transmission rate, for example I/O data from sensors, actuators or robot controllers, PLCs or process equipment. In addition, non-real-time critical information such as diagnostic

information, configuration information, etc. can be transferred. The Ethernet bandwidth is sufficient to transfer both data types (real-time and non-real-time) in parallel.

The bus node features LEDs for bus status and CPX-P peripheral information as well as switch elements, memory stick and a diagnostic interface. The purpose of the memory stick is to guarantee fast replacement of the bus node in the event of an error. PROFINET provides the user with access to all peripherals, diagnostic data and parameter data of the CPX-P valve terminal.

The bus node can be used as a remote I/O or remote controller. All information relevant to the CPX-P can be read out and, depending on the function, changed via the diagnostic interface.

Points to note in connection with CPX-CEC

When a bus node is combined with a control block (CPX-CEC, in the fieldbus remote controller operating mode), the connected I/Os and/or valves, sensors and actuators are controlled via the CPX-P control block.

In this case, the bus node only provides the communication interface to the PLC. Communication between the control block and CPX-P bus node takes place by interlinking the CPX-P modules and takes up the following address capacity in the CPX-P system:

- 8 byte outputs
- 8 byte inputs

The following address capacity remains in the control block or CPX system for activating the peripherals:

- 56 byte inputs
- 56 byte outputs

Data sheet – PROFINET bus node, M12, D-coded

General technical data			CPX-FB33	CPX-FB43
Type				
Fieldbus interface			2x socket, M12, 4-pin, D-coded	
Baud rate		[Mbps]	100	
Protocol			PROFINET RT PROFINET IRT	
Max. address capacity	Inputs	[byte]	64	
	Outputs	[byte]	64	
LED displays	(bus-specific)		M/P = Maintenance/PROFenergy NF = Network fault TP1 = Network active port 1 TP2 = Network active port 2	
	(product-specific)		M = Modify, parameterisation PL = Load supply PS = Electronic supply, sensor supply SF = System fault	
Device-specific diagnostics			<ul style="list-style-type: none"> Channel and module-oriented diagnostics Undervoltage of modules Diagnostic memory 	
Configuration support			GSDML file	
Parameterisation			<ul style="list-style-type: none"> System parameters Diagnostic behaviour Signal setup Fail-safe response Forcing of channels 	
Additional functions			<ul style="list-style-type: none"> Start-up parameterisation in plain text via fieldbus Fast start-up (FSU) Channel-oriented diagnostics via fieldbus Acyclic data access via fieldbus System status can be displayed using process data Additional diagnostic interface for operator units Acyclic data access via Ethernet 	<ul style="list-style-type: none"> Start-up parameterisation in plain text via fieldbus Fast start-up (FSU) Channel-oriented diagnostics via fieldbus Acyclic data access via fieldbus System status can be displayed using process data Additional diagnostic interface for operator units Acyclic data access via Ethernet I&M, LLDP, MRP, MRPD, MQTT, PROFIsafe, PROFenergy, S2 system redundancy
Control elements			<ul style="list-style-type: none"> DIL switch Optional memory card 	<ul style="list-style-type: none"> DIL switch
Operating voltage	Nominal value	[V DC]	24	
	Permissible range	[V DC]	18 ... 30	
Current consumption		[mA]	Typically 120	Typically 70
Degree of protection to EN 60529			IP65, IP67	
Temperature range	Operation	[°C]	- 5... +50	
	Storage/transport	[°C]	-20 ... +70	
Certification				RCM
Materials	Housing		Die-cast aluminium	
Note on materials				RoHS-compliant
PWIS conformity			VDMA24364-B2-L	VDMA24364-B2-L
Dimensions (including interlinking block) W x L x H		[mm]	50 x 107 x 50	50 x 107 x 50
Product weight		[g]	280	185

 **Note**

Please observe the general limits and guidelines for the system when configuring the electrical modules.

 **Note**

Always use the correct screws for the interlinking block; this depends on whether the block is made of metal or plastic:

- Self-tapping screws for plastic interlinking blocks

- Screws with metric thread for metal interlinking blocks

Data sheet – PROFINET bus node, M12, D-coded

Connection and display components

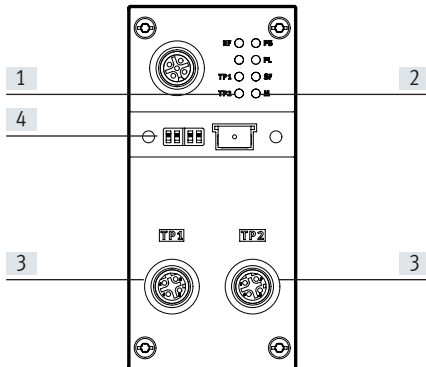



- [1] Bus-specific status LEDs
- [2] CPX-P-specific status LEDs
- [3] Fieldbus interface (M12 socket, 4-pin, D-coded)
- [4] Transparent cover for DIL switch and memory card

Pin allocation for the fieldbus interface

Terminal allocation	Pin	Signal	Designation
Socket, M12, D-coded			
	1	TD+	Transmitted data+
	2	RD+	Received data+
	3	TD-	Transmitted data-
	4	RD-	Received data-
	Housing		Shielding

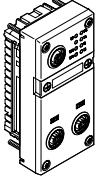
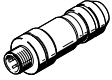
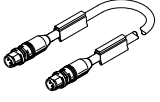
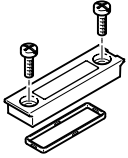
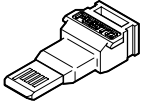
Data sheet – PROFINET bus node, M12, D-coded

Ordering data				Part no.	Type
Designation					
Bus node					
	PROFINET bus node	–		548755	CPX-FB33
		<ul style="list-style-type: none"> • I&M • LLDP • MRP • MRPD • PROFlenergy • S2 system redundancy 		8110369	CPX-FB43
Bus connection					
	Plug M12x1, 4-pin, D-coded			543109	NECU-M-S-D12G4-C2-ET
	Connecting cable, straight plug, M12x1, 4-pin, D-coded	Straight plug, M12x1, 4-pin, D-coded	0.5 m	8040446	NEBC-D12G4-ES-0.5-S-D12G4-ET
			1 m	8040447	NEBC-D12G4-ES-1-S-D12G4-ET
			3 m	8040448	NEBC-D12G4-ES-3-S-D12G4-ET
			5 m	8040449	NEBC-D12G4-ES-5-S-D12G4-ET
			10 m	8040450	NEBC-D12G4-ES-10-S-D12G4-ET
		Straight plug, RJ45, 8-pin	1 m	8040451	NEBC-D12G4-ES-1-S-R3G4-ET
			3 m	8040452	NEBC-D12G4-ES-3-S-R3G4-ET
			5 m	8040453	NEBC-D12G4-ES-5-S-R3G4-ET
Open end, 4-wire	10 m	8040454	NEBC-D12G4-ES-10-S-R3G4-ET		
	5 m	8040456	NEBC-LE4-ES-5-D12G4-ET		
	Transparent cover for DIL switch and memory card			548757	CPX-AK-P
	Memory card for PROFINET bus node, 2MB			4798288	CPX-SK-3
	Cover cap for sealing unused bus connections (10 pieces)			165592	ISK-M12
User documentation					
	Electronics manual, CPX bus node, type CPX-FB33	German		548759	CPX-(M)-FB33_35/43_45-DE
		English		548760	CPX-(M)-FB33_35/43_45-EN
		Spanish		548761	CPX-(M)-FB33_35/43_45-ES
		French		548762	CPX-(M)-FB33_35/43_45-FR
		Italian		548763	CPX-(M)-FB33_35/43_45-IT

Data sheet – PROFINET bus node, push-pull RJ45



Bus node for operating the CPX-P terminal on PROFINET. The bus node is provided with system supply via the interlinking block and processes communication with the I/O modules. The status of the CPX-P terminal is displayed as a common message via 4 CPX-P-specific LEDs. The fieldbus communication status is displayed via three bus-specific LEDs.

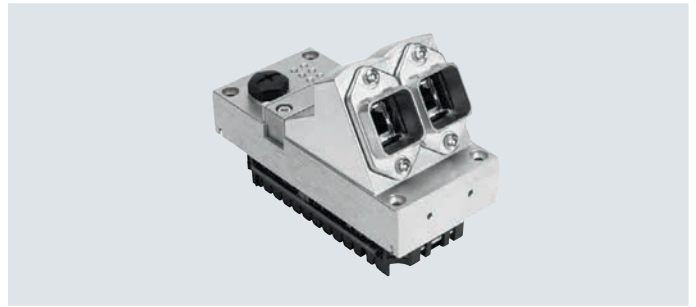

Application

Bus connection

The bus connection is established via two RJ45 push-pull sockets to IEC 61076-3-106 and IEC 60603 with degree of protection IP65, IP67.

Both connections are equivalent 100BaseTX Ethernet ports with integrated auto MDI functionality (crossover and patch cables can be

used) that are brought together via an internal switch.

- Maximum segment length 100 m
- Transmission rate 100 Mbps

PROFINET implementation

The CPX-M-FB34 supports the PROFINET protocol on the basis of the Ethernet standard and TCP/IP technology to IEEE802.3. This guarantees a data exchange with a high data transmission rate, for example I/O data from sensors, actuators or robot controllers, PLCs or process equipment. In addition, non-real-time critical information such as diagnostic

information, configuration information, etc. can be transferred. The Ethernet bandwidth is sufficient to transfer both data types (real-time and non-real-time) in parallel.

The bus node features LEDs for bus status and CPX-P peripheral information as well as switch elements, memory stick and a diagnostic interface. The purpose of the memory stick is to guarantee fast replacement of the bus node in the event of an error. PROFINET provides the user with access to all peripherals, diagnostic and parameter data of the CPX-P terminal. The bus

node can be used as a remote I/O or remote controller. All information relevant to the CPX-P can be read out and, depending on the function, changed via the diagnostic interface.

Points to note in connection with CPX-CEC

When a bus node is combined with a control block (CPX-CEC, in the fieldbus remote controller operating mode), the connected I/Os and/or valves, sensors and actuators are controlled via the CPX-P control block.

In this case, the bus node only provides the communication interface to the PLC. Communication between the control block and CPX-P bus node takes place by interlinking the CPX-P modules and takes up the following address capacity in the CPX-P system:

- 8/16 byte outputs
- 8/16 byte inputs

The following address capacity remains in the control block or CPX system for activating the peripherals:

- 56/48 byte inputs
- 56/48 byte outputs

Data sheet – PROFINET bus node, push-pull RJ45

General technical data			
Type		CPX-M-FB34	CPX-M-FB44
Fieldbus interface		2x RJ45 push-pull socket, AIDA	
Baud rate	[Mbps]	100	
Protocol		PROFINET RT PROFINET IRT	
Max. address capacity	Inputs	[byte]	64
	Outputs	[byte]	64
LED displays	(bus-specific)	M/P = Maintenance/PROFenergy NF = Network fault TP1 = Network active port 1 TP2 = Network active port 2	
	(product-specific)	M = Modify, parameterisation PL = Load supply PS = Electronic supply, sensor supply SF = System fault	
Device-specific diagnostics		<ul style="list-style-type: none"> Channel and module-oriented diagnostics Undervoltage of modules Diagnostic memory 	
Configuration support		GSDML file	
Parameterisation		<ul style="list-style-type: none"> System parameters Diagnostic behaviour Signal setup Fail-safe response Forcing of channels 	
Additional functions		<ul style="list-style-type: none"> Start-up parameterisation in plain text via fieldbus Fast start-up (FSU) Channel-oriented diagnostics via fieldbus Acyclic data access via fieldbus and via Ethernet System status can be displayed using process data Additional diagnostic interface for operator unit 	<ul style="list-style-type: none"> Start-up parameterisation in plain text via fieldbus Fast start-up (FSU) Channel-oriented diagnostics via fieldbus Acyclic data access via fieldbus and via Ethernet System status can be displayed using process data Additional diagnostic interface for operator unit I&M, LLDP, MRP, MRPD, MQTT, PROFIsafe, PROFenergy, S2 system redundancy
Control elements		<ul style="list-style-type: none"> DIL switch Optional memory card 	<ul style="list-style-type: none"> DIL switch
Operating voltage	Nominal value	[V DC]	24
	Permissible range	[V DC]	18 ... 30
Intrinsic current consumption at nominal operating voltage		[mA]	Typically 120
Degree of protection to EN 60529			IP65, IP67
Temperature range	Operation	[°C]	-5 ... +50
	Storage/transport	[°C]	-20 ... +70
Certification			RCM
Housing material		Die-cast aluminium	
Note on materials			RoHS-compliant
PWIS conformity		VDMA24364-B2-L	VDMA24364-B2-L
Dimensions (including interlinking block) W x L x H		[mm]	50 x 107 x 80
Product weight		[g]	280

 **Note**

Please observe the general limits and guidelines for the system when configuring the electrical modules.

 **Note**

Always use the correct screws for the interlinking block; this depends on whether the block is made of metal or plastic:

- Self-tapping screws for plastic interlinking blocks

- Screws with metric thread for metal interlinking blocks

Data sheet – PROFINET bus node, push-pull RJ45

Connection and display components

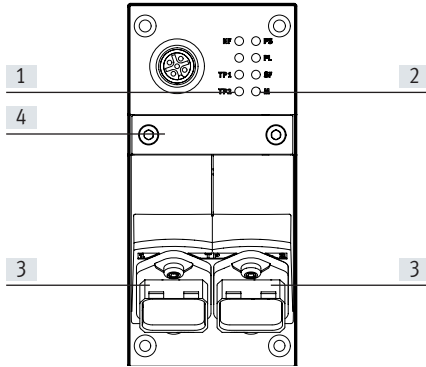



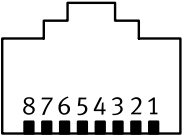

- [1] Bus-specific status LEDs
- [2] CPX-P-specific status LEDs
- [3] Fieldbus interface (RJ45 socket, 8-pin)
- [4] DIL switch and memory card (under cover)

Pin allocation for the fieldbus interface

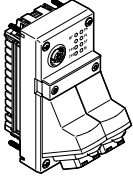
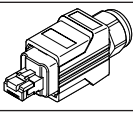
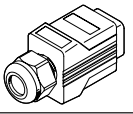
Terminal allocation	Pin	Signal	Designation
RJ45 socket			
	1	TD+	Transmitted data+
	2	TD-	Transmitted data-
	3	RD+	Received data+
	4	n.c.	Not connected
	5	n.c.	Not connected
	6	RD-	Received data-
	7	n.c.	Not connected
	8	n.c.	Not connected
	Housing	Shielding	Shielding

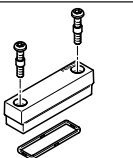
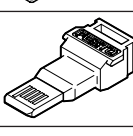
Data sheet – PROFINET bus node, push-pull RJ45

Ordering data		Part no.	Type
Designation			
Bus node			
	PROFINET bus node	–	548751 CPX-M-FB34
		<ul style="list-style-type: none"> • I&M • LLDP • MRP • MRPD • PROFlenergy • S2 system redundancy 	8110370 CPX-M-FB44
Bus connection			
	RJ45 plug, 8-pin, push-pull		552000 FBS-RJ45-PP-GS
	Cover cap for bus connection		548753 CPX-M-AK-C
	Cover cap for bus connection		2873540 CPX-M-AK-D
	Cover for DIL switch and memory card		548754 CPX-M-AK-M
	Memory card for PROFINET bus node CPX-M-FB34, 2MB		4798288 CPX-SK-3
User documentation			
	Electronics manual, CPX bus node, type CPX-M-FB34	German	548759 CPX-(M)-FB33_35/43_45-DE
		English	548760 CPX-(M)-FB33_35/43_45-EN
		Spanish	548761 CPX-(M)-FB33_35/43_45-ES
		French	548762 CPX-(M)-FB33_35/43_45-FR
		Italian	548763 CPX-(M)-FB33_35/43_45-IT

Data sheet – PROFINET bus node, push-pull SCRJ



Bus node for operating the CPX-P terminal on PROFINET.
 The bus node is provided with system supply via the interlinking block and processes communication with the I/O modules.
 The status of the CPX-P terminal is displayed as a common message via 4 CPX-P-specific LEDs.
 The fieldbus communication status is displayed via three bus-specific LEDs.

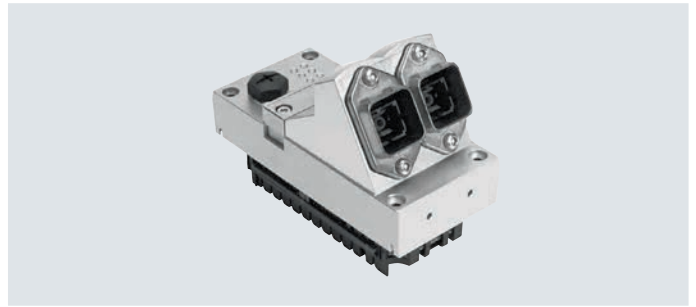

Application

Bus connection

The bus connection is established via SCRJ push-pull sockets to IEC 61754-24 (fibre-optic cable, AIDA standard) with degree of protection IP65, IP67.

The connections on the bus node are equivalent 100BaseFX Ethernet ports that are brought together via an internal switch.

Fibre-optic cables made from plastic (POF, 980/1000 µm) are also suitable for transmission.

- Maximum segment length 50 m
- Transmission rate 100 Mbps
- Supports LLDP and SNMP

PROFINET implementation

The bus nodes support the PROFINET protocol on the basis of the Ethernet standard and TCP/IP technology to IEEE802.3.
 This guarantees a data exchange with a high data transmission rate, for example I/O data from sensors, actuators or robot controllers, PLCs or process equipment. In addition, non-real-time

critical information such as diagnostic information, configuration information, etc. can be transferred.
 The Ethernet bandwidth is sufficient to transfer both data types (real-time and non-real-time) in parallel.
 The bus node features LEDs for bus status and CPX-P peripheral information as well as switch elements,

memory stick and a diagnostic interface. The purpose of the memory stick is to guarantee fast replacement of the bus node in the event of an error.
 PROFINET provides the user with access to all peripherals, diagnostic and parameter data of the CPX-P terminal. The bus node can be used as a remote I/O or remote controller. All information

relevant to the CPX-P can be read out and, depending on the function, changed via the diagnostic interface.

Points to note in connection with CPX-CEC

When a bus node is combined with a control block (CPX-CEC, in the fieldbus remote controller operating mode), the connected I/Os and/or valves, sensors and actuators are controlled via the CPX-P control block.

In this case, the bus node only provides the communication interface to the PLC.
 Communication between the control block and CPX-P bus node takes place by interlinking the CPX-P modules and takes up the following address capacity in the CPX-P system:

- 8/16 byte outputs
- 8/16 byte inputs

The following address capacity remains in the control block or CPX system for activating the peripherals:

- 56/48 byte inputs
- 56/48 byte outputs

Data sheet – PROFINET bus node, push-pull SCRJ

General technical data			CPX-M-FB35	CPX-M-FB45
Type			2x SCRJ push-pull socket, AIDA	
Fieldbus interface			2x SCRJ push-pull socket, AIDA	
Baud rate	[Mbps]		100	
Protocol			PROFINET RT PROFINET IRT	
Max. address capacity	Inputs	[byte]	64	
	Outputs	[byte]	64	
LED displays	(bus-specific)		M/P = Maintenance/PROFenergy NF = Network fault TP1 = Network active port 1 TP2 = Network active port 2	
	(product-specific)		M = Modify, parameterisation PL = Load supply PS = Electronic supply, sensor supply SF = System fault	
Device-specific diagnostics			<ul style="list-style-type: none"> Channel and module-oriented diagnostics Undervoltage of modules Diagnostic memory 	
Configuration support			GSDML file	
Parameterisation			<ul style="list-style-type: none"> System parameters Diagnostic behaviour Signal setup Fail-safe response Forcing of channels 	
Additional functions			<ul style="list-style-type: none"> Start-up parameterisation in plain text via fieldbus Fast start-up (FSU) Channel-oriented diagnostics via fieldbus Acyclic data access via fieldbus and via Ethernet System status can be displayed using process data Additional diagnostic interface for operator unit 	
				<ul style="list-style-type: none"> I&M LLDP MRP MRPD MQTT PROFIsafe PROFenergy S2 system redundancy
Control elements			DIL switch, optional memory card	DIL switch
Operating voltage	Nominal value	[V DC]	24	
	Permissible range	[V DC]	18 ... 30	
Intrinsic current consumption at nominal operating voltage		[mA]	Typically 150	Typically 145
Certification			–	RCM
Degree of protection to EN 60529			IP65, IP67	
Temperature range	Operation	[°C]	– 5... +50	
	Storage/transport	[°C]	–20 ... +70	
Housing material			Die-cast aluminium	
Note on materials			RoHS-compliant	
PWIS conformity			VDMA24364-B2-L	
Grid dimension		[mm]	50	
Dimensions (including interlinking block) W x L x H		[mm]	50 x 107 x 80	
Product weight		[g]	280	

 **Note**

Please observe the general limits and guidelines for the system when configuring the electrical modules.

 **Note**

Always use the correct screws for the interlinking block; this depends on whether the block is made of metal or plastic:

- Self-tapping screws for plastic interlinking blocks

- Screws with metric thread for metal interlinking blocks

Data sheet – PROFINET bus node, push-pull SCRJ

Connection and display components

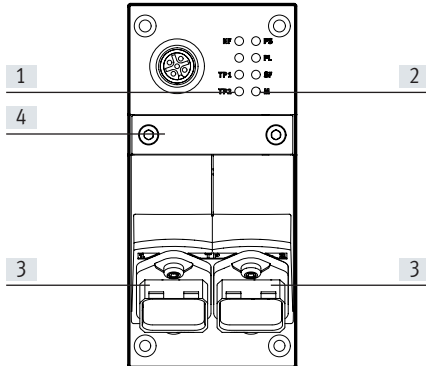





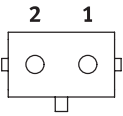

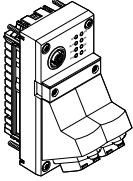
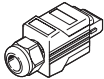

- [1] Bus-specific status LEDs
- [2] CPX-P-specific status LEDs
- [3] Fieldbus interface (SCRJ socket, 2-pin)
- [4] DIL switch and memory card (under cover)

Pin allocation for the fieldbus interface

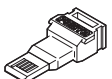
Terminal allocation	Pin	Signal	Designation
SCRJ socket			
	1	TX	Outgoing
	2	Rx	Incoming

Data sheet – PROFINET bus node, push-pull SCRJ

Ordering data		Part no.	Type
Designation			
Bus node			
	2x SCRJ push-pull socket, AIDA	–	548749 CPX-M-FB35
		<ul style="list-style-type: none"> • I&M • LLDP • MRP • MRPD • PROFlenergy • S2 system redundancy 	8110371 CPX-M-FB45
Bus connection			
	SCRJ plug, 2-pin, push-pull	571017	FBS-SCRJ-PP-GS
	Cover cap for bus connection	548753	CPX-M-AK-C
	Cover cap for bus connection	2873540	CPX-M-AK-D
	Cover for DIL switch and memory card	548754	CPX-M-AK-M
	Memory card for PROFINET bus node, 2MB	4798288	CPX-SK-3
	Screws for attaching an inscription label to the bus node (12 pieces)	550222	CPX-M-M2.5X8-12X
User documentation			
	Electronics manual, CPX-P bus node	German	548759 CPX-(M)-FB33_35/43_45-DE
		English	548760 CPX-(M)-FB33_35/43_45-EN
		Spanish	548761 CPX-(M)-FB33_35/43_45-ES
		French	548762 CPX-(M)-FB33_35/43_45-FR
		Italian	548763 CPX-(M)-FB33_35/43_45-IT
Software			
	Adapter M12, 5-pin to mini USB socket, and controller software	547432	NEFC-M12G5-0.3-U1G5

Data sheet – EtherNet/IP bus node

- Industrial Ethernet
- EtherNet/IP
- Web

Bus node for handling communication between the electrical terminal CPX-P and the EtherNet/IP network.

The bus node is provided with system supply via the interlinking block and processes communication with the I/O modules.

The status of the CPX-P terminal is displayed as a common message via 4 CPX-P-specific LEDs.

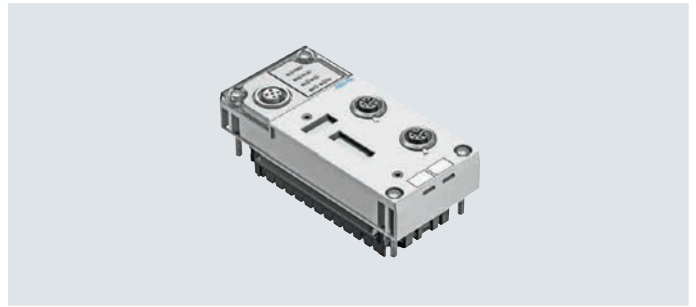

Application

Bus connection

The bus connection is established via an M12 plug, D-coded to IEC 947-5-2 with degree of protection IP65, IP67.

EtherNet/IP is an open bus system based on the Ethernet standard and TCP/IP technology (IEEE802.3).

EtherNet/IP implementation

The CPX-FB36 supports the two operating modes: remote I/O and remote controller. In remote I/O operating mode, all functions of the CPX-P terminal are

directly controlled by the EtherNet/IP master (host). In addition to activation via a bus system, it is possible to use IT technologies. An integrated web server enables diagnostic data to be visualised via

HTML. Various programs support direct access to the device data from the automation network. The EtherNet/IP node for CPX-P supports the transmission technology that

conforms to DIN EN 50173/CAT 5 as an integrated interface.

Points to note in connection with CPX-CEC

When a bus node is combined with a control block (CPX-CEC, in the fieldbus remote controller operating mode), the connected I/Os and/or valves, sensors and actuators are controlled via the CPX-P control block.

In this case, the bus node only provides the communication interface to the PLC. Communication between the control block and CPX-P bus node takes place by interlinking the CPX-P modules and takes up the following address capacity in the CPX-P system:

- 8 byte outputs
- 8 byte inputs

The following address capacity remains in the control block or CPX system for activating the peripherals:

- 56 byte inputs
- 56 byte outputs

Data sheet – EtherNet/IP bus node

General technical data			
Type			CPX-FB36
Fieldbus interface			2x M12x1 socket, 4-pin, D-coded
Baud rate	[Mbps]		10/100
Protocol			EtherNet/IP Modbus TCP
Max. address capacity, inputs	[byte]		64
Max. address volume for outputs	[byte]		64
LED displays (bus-specific)			MS = Module status NS = network status TP1 = Network active port 1 TP2 = Network active port 2
Device-specific diagnostics			<ul style="list-style-type: none"> Module and channel-oriented diagnostics Undervoltage of modules Diagnostic memory
Configuration support			<ul style="list-style-type: none"> EDS file L5K export with CPX-FMT
Parameterisation			<ul style="list-style-type: none"> Diagnostic behaviour Fail-safe response Forcing of channels Idle mode characteristics Signal setup System parameters
Additional functions			<ul style="list-style-type: none"> EtherNet/IP Quickconnect Ring topology (DLR) Acyclic data access via "Explicit Message" and Ethernet Integrated switch IP addressing via DHCP, DIL switch or operator unit Channel-oriented diagnostics via fieldbus Start-up parameterisation in plain text via fieldbus System status can be displayed using process data Additional diagnostic interface for operator units
Control elements			DIL switch
Operating voltage	Nominal value	[V DC]	24
	Permissible range	[V DC]	18 ... 30
Current consumption at nominal voltage		[mA]	Typically 100
Degree of protection to EN 60529			IP65, IP67
Temperature range	Operation	[°C]	-5... +50
	Storage/transport	[°C]	-20 ... +70
Materials			PA-reinforced
Note on materials			RoHS-compliant
PWIS conformity			VDMA24364-B2-L
Grid dimension		[mm]	50
Dimensions (including interlinking block) W x L x H		[mm]	50 x 107 x 50
Product weight		[g]	125

 **Note**

Please observe the general limits and guidelines for the system when configuring the electrical modules.

Data sheet – EtherNet/IP bus node

Connection and display components

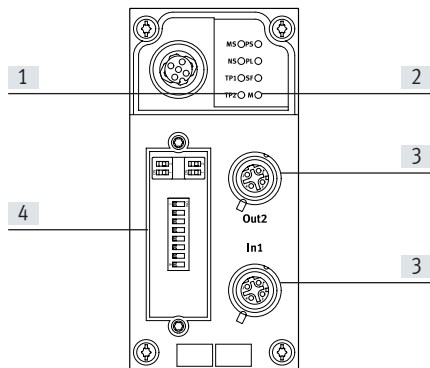





- [1] Bus-specific status LEDs
- [2] CPX-P-specific status LEDs
- [3] Fieldbus interface (M12 socket, 4-pin, D-coded)
- [4] Transparent DIL switch cover

Pin allocation for the fieldbus interface

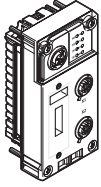
Terminal allocation	Pin	Signal	Designation
Socket M12, D-coded			
	1	TD+	Transmitted data+
	2	RD+	Received data+
	3	TD-	Transmitted data-
	4	RD-	Received data-
	Housing	FE	Shielding

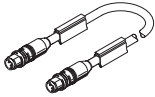
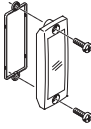
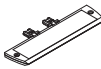
Data sheet – EtherNet/IP bus node

Ordering data				Part no.	Type
Designation					
Bus node					
	EtherNet/IP bus node			1912451	CPX-FB36
Bus connection					
	Plug M12x1, 4-pin, D-coded			543109	NECU-M-S-D12G4-C2-ET
	Connecting cable, straight plug, M12x1, 4-pin, D-coded	Straight plug, M12x1, 4-pin, D-coded	0.5 m	8040446	NEBC-D12G4-ES-0.5-S-D12G4-ET
			1 m	8040447	NEBC-D12G4-ES-1-S-D12G4-ET
			3 m	8040448	NEBC-D12G4-ES-3-S-D12G4-ET
			5 m	8040449	NEBC-D12G4-ES-5-S-D12G4-ET
			10 m	8040450	NEBC-D12G4-ES-10-S-D12G4-ET
			Straight plug, RJ45, 8-pin	1 m	8040451
	3 m	8040452		NEBC-D12G4-ES-3-S-R3G4-ET	
	5 m	8040453		NEBC-D12G4-ES-5-S-R3G4-ET	
	Open end, 4-wire	10 m	8040454	NEBC-D12G4-ES-10-S-R3G4-ET	
5 m		8040456	NEBC-LE4-ES-5-D12G4-ET		
	Inspection cover, transparent			533334	AK-SUB-9/15-B
	Inscription label holder for connection block			536593	CPX-ST-1
User documentation					
	User documentation for bus node CPX-FB36		German	8024074	CPX-FB36-DE
			English	8024075	CPX-FB36-EN
			Spanish	8024076	CPX-FB36-ES
			French	8024077	CPX-FB36-FR
			Italian	8024078	CPX-FB36-IT
			Chinese	8024079	CPX-FB36-ZH
Software					
	Adapter M12, 5-pin to mini USB socket, and controller software			547432	NEFC-M12G5-0.3-U1G5

Data sheet – EtherCAT bus node



Bus node for operating the CPX-P terminal on EtherCAT.

The bus node is provided with system supply via the interlinking block and processes communication with the I/O modules.

The status of the CPX-P terminal is displayed as a common message via 4 CPX-P-specific LEDs.

The fieldbus communication status is displayed via 4 bus-specific LEDs.

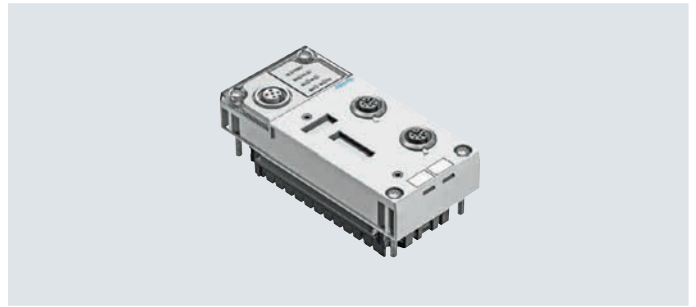

Application

Bus connection

The bus connection is established via two sockets M12x1, D-coded to IEC 61076-2-101 with degree of protection IP65, IP67.

Both connections are equivalent 100BaseTX Ethernet ports with integrated auto MDI functionality (crossover and patch cable can be

used) that are brought together via an internal switch.

- Maximum segment length 100 m
- Transmission rate 100 Mbps

EtherCAT implementation

The CPX-FB37 supports the EtherCAT protocol on the basis of the Ethernet standard and TCP/IP technology to IEEE802.3.

This guarantees a data exchange with a high data transmission rate, for example I/O data from sensors, actuators or robot controllers, PLCs or process equipment. In addition, non-real-time critical information such as diagnostic information, configuration information, etc. can be transferred.

The data bandwidth is sufficient to transfer both data types (real-time and non-real-time) in parallel.

The bus node features LEDs for bus status and CPX-P peripheral information as well as switch elements and a diagnostic interface. The bus node can be used as a remote I/O or remote controller. All information relevant to the CPX-P can be read out and, depending on the function, changed via the diagnostic interface.

The functions MDP (modular device profile) and CoE (CAN over EtherCAT) enable easy access to parameters and diagnostic data via EtherCAT.

Specific EtherCAT functions:

- CoE (parameters and diagnostics or fail-safe mode): all module parameters can be set
- FoE (file over EtherCAT) makes it possible to download firmware easily
- EoE (Ethernet over EtherCAT): diagnostic data can be retrieved easily using a browser
- MDP (modular device profile): easy configuration using a module selection box
- Hot connect, easy replacement of an EtherCAT CPX-P terminal

- DC (distributed clocks), time-synchronised data transmission

Points to note in connection with CPX-CEC

When a bus node is combined with a control block (CPX-CEC, in the fieldbus remote controller operating mode), the connected I/Os and/or valves, sensors and actuators are controlled via the CPX-P control block.

In this case, the bus node only provides the communication interface to the PLC.

Communication between the control block and CPX-P bus node takes place by interlinking the CPX-P modules and takes up the following address capacity in the CPX-P system:

- 8/16 byte outputs
- 8/16 byte inputs

The following address capacity remains in the control block or CPX system for activating the peripherals:

- 56/48 byte inputs
- 56/48 byte outputs

Data sheet – EtherCAT bus node

General technical data			
Type	CPX-FB37		
Fieldbus interface	2x M12x1 socket, 4-pin, D-coded		
Baud rate	[Mbps]	100	
Protocol	EtherCAT		
Max. address capacity	Inputs	[byte]	64
	Outputs	[byte]	64
LED displays	Bus-specific		Error = Communication error L/A1 = Network active port 1 L/A2 = Network active port 2 Run = Communication status
	Product-specific		M = Modify, parameterisation PL = Load supply PS = Electronic supply, sensor supply SF = System fault
Device-specific diagnostics	<ul style="list-style-type: none"> Channel and module-oriented diagnostics Undervoltage of modules Diagnostic memory 		
Configuration support	ESI file		
Parameterisation	<ul style="list-style-type: none"> System parameters Diagnostic behaviour Signal setup Fail-safe response Forcing of channels 		
Additional functions	<ul style="list-style-type: none"> System status can be displayed using process data Additional diagnostic interface for operator units Emergency message Acyclic data access via fieldbus Diagnostics object Compatibility mode with CPX-FB38 Modular device profile (MDP) Variable PDO mapping 		
Control elements	DIL switch		
Operating voltage	Nominal value	[V DC]	24
	Permissible range	[V DC]	18 ... 30
Current consumption		[mA]	Typically 100
Degree of protection to EN 60529	IP65, IP67		
Temperature range	Operation	[°C]	-5... +50
	Storage/transport	[°C]	-20 ... +70
Materials	Housing		PA-reinforced
Note on materials	RoHS-compliant		
PWIS conformity	VDMA24364-B2-L		
Grid dimension		[mm]	50
Dimensions (including interlinking block) W x L x H		[mm]	50 x 107 x 50
Product weight		[g]	125

 **Note**

Please observe the general limits and guidelines for the system when configuring the electrical modules.

 **Note**

Always use the correct screws for the interlinking block; this depends on whether the block is made of metal or plastic:

- Self-tapping screws for plastic interlinking blocks
- Screws with metric thread for metal interlinking blocks

Data sheet – EtherCAT bus node

Connection and display components

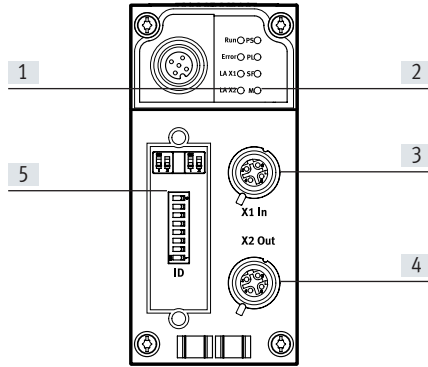





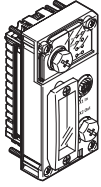

- [1] Bus-specific status LEDs
- [2] CPX-P-specific status LEDs
- [3] Fieldbus interface, input (socket M12x1, 4-pin, D-coded)
- [4] Fieldbus interface, output (socket M12x1, 4-pin, D-coded)
- [5] DIL switch

Pin allocation for the fieldbus interface

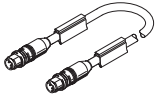
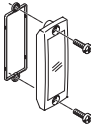
Terminal allocation	Pin	Signal	Designation
M12x1 socket, D-coded			
	1	TD+	Transmitted data+
	2	RD+	Received data+
	3	TD-	Transmitted data-
	4	RD-	Received data-
	Housing	FE	Shielding

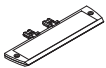
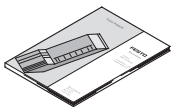
Data sheet – EtherCAT bus node

Ordering data				Part no.	Type
Designation					
Bus node					
	EtherCAT bus node			2735960	CPX-FB37
Bus connection					
	Plug M12x1, 4-pin, D-coded			543109	NECU-M-S-D12G4-C2-ET
	Connecting cable, straight plug, M12x1, 4-pin, D-coded	Straight plug, M12x1, 4-pin, D-coded	0.5 m	8040446	NEBC-D12G4-ES-0.5-S-D12G4-ET
			1 m	8040447	NEBC-D12G4-ES-1-S-D12G4-ET
			3 m	8040448	NEBC-D12G4-ES-3-S-D12G4-ET
			5 m	8040449	NEBC-D12G4-ES-5-S-D12G4-ET
			10 m	8040450	NEBC-D12G4-ES-10-S-D12G4-ET
			Straight plug, RJ45, 8-pin	1 m	8040451
	3 m	8040452		NEBC-D12G4-ES-3-S-R3G4-ET	
	5 m	8040453		NEBC-D12G4-ES-5-S-R3G4-ET	
	Open end, 4-wire	10 m	8040454	NEBC-D12G4-ES-10-S-R3G4-ET	
5 m		8040456	NEBC-LE4-ES-5-D12G4-ET		
	Inspection cover, transparent			533334	AK-SUB-9/15-B
	Cover cap for sealing unused bus connections (10 pieces)			165592	ISK-M12
	Inscription label holder for connection block			536593	CPX-ST-1
User documentation					
	Electronics manual, CPX-P bus node, type CPX-FB37		German	8029674	P.BE-CPX-FB37-DE
			English	8029675	P.BE-CPX-FB37-EN
			Spanish	8029676	P.BE-CPX-FB37-ES
			French	8029677	P.BE-CPX-FB37-FR
			Italian	8029678	P.BE-CPX-FB37-IT
			Chinese	8029679	P.BE-CPX-FB37-ZH
Software					
	Adapter M12, 5-pin to mini USB socket, and controller software			547432	NEFC-M12G5-0.3-U1G5

Data sheet – I-Port interface

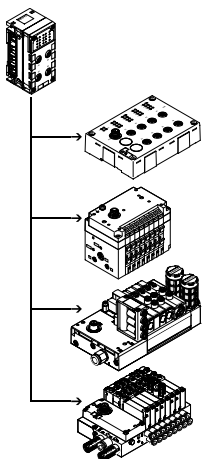

The electrical interface CPX-P CTEU master establishes the connection to modules of the CTEL/CTEU series that have an I-Port interface (device). The I/O data from the connected devices are transmitted to the connected CPX-P bus node and thus to the higher-order controller via fieldbus. A maximum of 4 devices can be connected to a CPX-P CTEU master via suitable M12 interfaces.



Application

I-Port interface

As well as transmitting the communication data, the I-Port interfaces of a CPX-P CTEU master also transmit the power supply to the connected sensors and the load supply to the valves (or

outputs). Both circuits are supplied separately with 24 V, using a separate reference potential.

The connecting cables with a dual function as signal cable and supply

cable must meet the corresponding increased requirements.

Configuration example – CPX-P CTEU master with CTEL modules

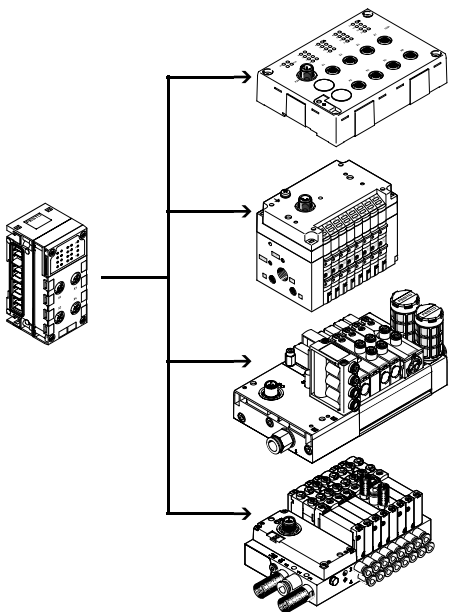

The CPX-P CTEU master provides 4 external I-Port interfaces, each of which can be connected to a device. I-Port is an interface for exchanging serial data for connecting decentralised modules or valve terminals from Festo. The I-Port interface is based on IO-Link and is compatible with it in certain areas. The connection type corresponds to a star topology. In other words, only one module or valve terminal can be connected to each I-Port.

The limitations with respect to IO-Link include:

- Permanently set baud rate of 230.4 kbps
- SIO mode is not supported
- Max. 32 bytes of input data and 32 bytes of output data
- Only one dump of the master commands is used
- Configuration via IO-DD is not supported.

Data sheet – I-Port interface

Implementation

The CPX-P CTEL master from Festo enables modules with an I-Port interface to be connected to a CPX-P system:

- Max. 4 devices with individual electronic protection
- Max. 64 inputs/64 outputs per I-Port interface
- The maximum length of a string is 20 m.

The following device variants are available:

- Input modules with 16 digital inputs (connection technology M8 3-pin and M12 5-pin)
- Valve terminals with I-Port interface (up to 48 solenoid coils, different valve functions)

The decentralised arrangement of the modules and valve terminals with I-Port enables them to be mounted close to the cylinders and actuators or sensors to be controlled. This means that the compressed air supply lines and sensor connecting cables used can be shortened, and it may be possible to use smaller valves, thereby saving costs.

Several CPX-P CTEL masters can be combined in one CPX-P terminal, depending on the address capacity of the bus node.

Example:

- CPX-FB13 (512 I/O)
- A maximum of 2 CPX-P CTEL masters is possible (each with 256 I/O)

Configuration

Settings

The precise number of the I/O bytes made available depends on the requirements of the connected devices or of the suitable selected operating mode.

The operating mode or preset configuration of the CPX-P CTEL master can be specified by the user.

Selecting the operating mode and setting the manual configuration takes place via the DIL switches. These DIL switches are not required during continuous operation and are only accessible in the disassembled state.

Manual configuration

In the case of manual configuration (tool change mode), the volume of inputs and outputs in the process image of the CPX-P system or of the higher-order fieldbus can be defined manually using the DIL switches.

The process image then always has the same scope, regardless of the connected devices. The I/O length specified always applies to all four I-Ports (max. 8 bytes per I-Port).

Automatic configuration

In the case of automatic configuration, the I/O length for each I-Port is determined individually and this derived value is used to select the appropriate or next highest configuration preset.

Power supply for I-Port devices

The CPX-P CTEL master provides two separate power supplies for the connected devices:

- For operating the device and the inputs connected to it
- For the outputs and valves that are connected to the device

The power supply for the devices and the inputs is provided by the power supply for the electronics and sensors of the CPX-P terminal. The power supply for the outputs and valves is provided by the power supply for the valves of the CPX-P terminal.

The interlinking block with additional supply ensures a separate supply voltage for the valves and outputs. This means it is possible to disconnect this supply voltage separately. The valves and outputs of the connected I-Port devices can therefore be

disconnected separately without disconnecting the devices.

Data sheet – I-Port interface

General technical data			
Type	CPX-CTEL-4-M12-5POL		
Protocol	I-Port		
Max. address capacity	Outputs	[bit]	256
	Inputs	[bit]	256
I-Port connection	4x socket M12, 5-pin, A-coded		
Number of I-Port interfaces	4		
Maximum cable length	[m]	20	
Internal cycle time	[ms]	1 per 8 bits of user data	
Galvanic isolation	Channel – channel	No	
	Channel – internal bus	Yes, with intermediate supply	
LED displays	X1 ... 4 = Status of the I-Port interface 1 ... 4 PS = Electronic supply PL = Load supply -  - = Module error		
Diagnostics	<ul style="list-style-type: none"> • Communication error • Module short circuit • Module-oriented diagnostics • Undervoltage 		
Parameterisation	<ul style="list-style-type: none"> • Diagnostic behaviour • Failsafe per channel • Forcing per channel • Idle mode per channel • Module parameters • Tool change mode 		
Additional functions	Tool change mode		
Control elements	DIL switch		
Operating voltage	Nominal value	[V DC]	24 (reverse polarity protected)
	Permissible range	[V DC]	18 ... 30
	Power failure buffering	[ms]	10
Intrinsic current consumption at nominal operating voltage	[mA]	Typically 65	
Max. power supply per channel	[A]	4x 1.6	
Max. residual current of outputs per channel	[A]	4x 1.6	
Degree of protection to EN 60529	IP65, IP67		
Temperature range	Operation	[°C]	-5 ... +50
	Storage/transport	[°C]	-20 ... +70
Materials	PA-reinforced, PC		
Note on materials	RoHS-compliant		
PWIS conformity	VDMA24364-B2-L		
Grid dimension	[mm]	50	
Dimensions (including interlinking block) W x L x H	[mm]	50 x 107 x 55	
Product weight	[g]	110	

 - **Note**

Please observe the general limits and guidelines for the system when configuring the electrical modules.

Data sheet – I-Port interface

Connection and display components

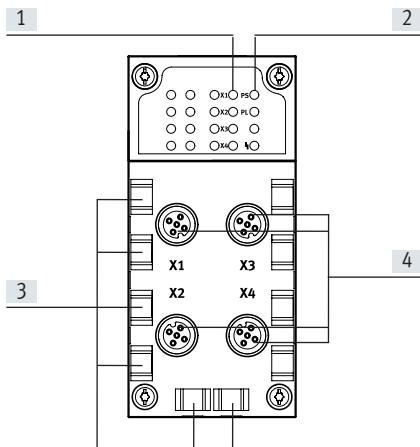

- [1] Status LEDs for I-Port interfaces
- [2] CPX-P-specific status LEDs
- [3] Holders for inscription labels (IBS 6x10)
- [4] I-Port interfaces for up to 4 devices

Combinations of bus nodes/control blocks with interface CPX-CTEL

Bus node/control block	Part no.	Interface
		CPX-CTEL-4-M12-5POL
CPX-CEC-C1-V3	3473128	■
CPX-CEC-M1-V3	3472765	■
CPX-CEC-S1-V3	3472425	■
CPX-FB11	526172	■
CPX-FB13	195740	■
CPX-FB14	526174	■
CPX-FB33	548755	■
CPX-M-FB34	548751	■
CPX-M-FB35	548749	■
CPX-FB36	1912451	■
CPX-FB37	2735960	■
CPX-FB43	8110369	■
CPX-M-FB44	8110370	■
CPX-M-FB45	8110371	■

Pin allocation – I-Port interface

Terminal allocation	Pin	Signal	Designation
	1	24 V _{SEN}	24 V DC supply voltage for electronics and inputs
	2	24 V _{VAL}	24 V DC load voltage supply for valves and outputs
	3	0 V _{SEN}	0 V DC supply voltage for electronics and sensors
	4	C/Q _{I-PORT}	Communication signal C/Q, data transmission line
	5	0 V _{VALVES}	0 V DC load voltage supply for valves and outputs

Data sheet – I-Port interface



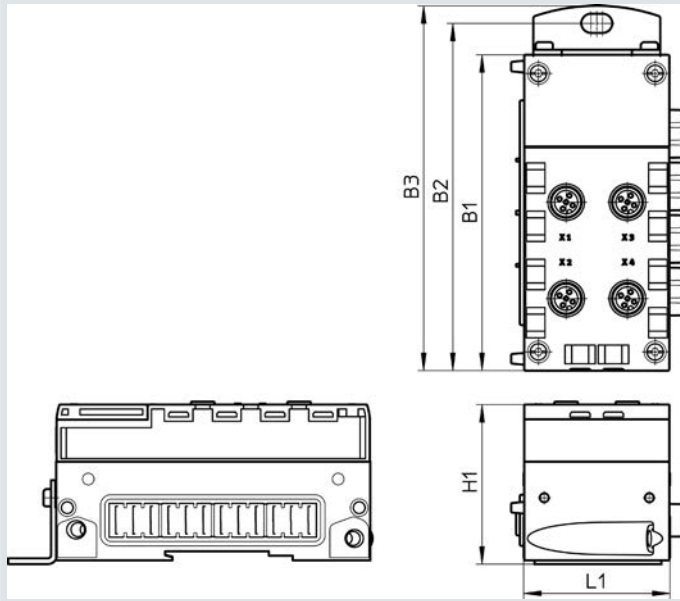

Dimensions

Download CAD data → www.festo.com

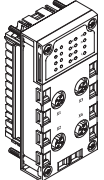

Type	B1	B2	B3	H1	L1
CPX-CTEL-4-M12-5POL	108.1	118.9	124.9	55.1	50

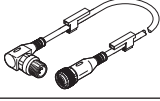
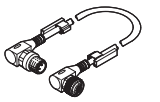
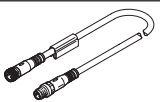
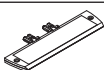
Data sheet – I-Port interface

Ordering data		Part no.	Type
Designation			
CPX-P CTEL master			
	Interface for a maximum of 4 I/O modules and valve terminals with I-Port interface (devices)		1577012 CPX-CTEL-4-M12-5POL
Bus connection			
	Cover cap	M12	165592 ISK-M12
	Connecting cable M12-M12, 5-pin • Straight socket • Angled plug	Cable characteristic: standard	0.5 m 8003617 NEBU-M12G5-K-0.5-M12W5
			2 m 8003618 NEBU-M12G5-K-2-M12W5
	Connecting cable M12-M12, 5-pin • Angled socket • Angled plug	Cable characteristic: standard	0.5 m 570733 NEBU-M12W5-K-0.5-M12W5
			2 m 570734 NEBU-M12W5-K-2-M12W5
	Connecting cable M12-M12, 5-pin • Straight socket • Straight plug	Cable characteristic: suitable for use with energy chains	5 m 574321 NEBU-M12G5-E-5-Q8N-M12G5
			7.5 m 574322 NEBU-M12G5-E-7.5-Q8N-M12G5
			10 m 574323 NEBU-M12G5-E-10-Q8N-M12G5
	Inscription label holder for connection block		536593 CPX-ST-1
User documentation			
	User documentation CPX-P CTEL master	German	574600 P.BE-CPX-CTEL-DE
		English	574601 P.BE-CPX-CTEL-EN
		Spanish	574602 P.BE-CPX-CTEL-ES
		French	574603 P.BE-CPX-CTEL-FR
		Italian	574604 P.BE-CPX-CTEL-IT

Data sheet – IO-Link interface

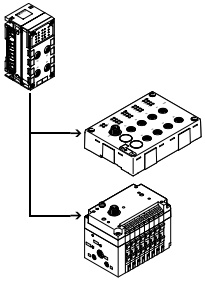

The electrical interface CPX-CTEL-2-... enables the connection of modules with IO-Link interface (IO-Link device) to the CPX-P terminal. The I/O data from the connected devices are transmitted to the connected CPX-P bus node and thus to the higher-order controller via fieldbus. A maximum of two IO-Link devices can be connected to an electrical interface CPX-CTEL-2-... via the suitable M12 interfaces.



Application

IO-Link interface

The communication system IO-Link is used to exchange serial data from decentralised function modules (devices) at the field level. The electrical interface CPX-CTEL-2-... provides two external IO-Link

interfaces, each of which can be connected to a device. The connection type corresponds to a star topology, which means that only one device can be connected to each port.

The address space that the module makes available and assigns accordingly in the CPX-P system can be configured according to various presettings. Selecting the operating mode and setting the manual configuration takes

place via the DIL switches. These DIL switches are not required during continuous operation and are only accessible in the disassembled state.

Restrictions

The interfaces (ports) of electrical interface CPX-CTEL-2-... support the connection of IO-Link devices with few limitations.

- The process data length of the inputs and outputs is limited to 16 bytes each per port
- The driver strength on the C/Q line is limited to 250 mA

- SIO mode is not supported

Power supply for devices

The electrical interface CPX-CTEL-2-... provides two separate power supplies for the connected devices:

- For operating the device and the inputs connected to it
- For the outputs and valves that are connected to the device

The power supply for the devices and the inputs is provided by the power

supply for the electronics and sensors of the CPX-P terminal. The power supply for the outputs and valves is provided by the power supply for the valves of the CPX-P terminal. The interlinking block with additional supply ensures a separate supply voltage for the valves and outputs. This

means it is possible to disconnect this supply voltage separately. The valves and outputs of the connected I-Port devices can therefore be disconnected separately without disconnecting the devices.

Data sheet – IO-Link interface

General technical data			
Type	CPX-CTEL-2-M12-5POL-LK		
Protocol	IO-Link, master version V 1.0		
Max. address capacity	Outputs	[bit]	256
	Inputs	[bit]	256
I-Port connection	2x socket M12, 5-pin, A-coded		
Number of IO-Link interfaces	2		
Maximum cable length	[m]	20	
Internal cycle time	[ms]	1 per 8 bits of user data	
Galvanic isolation	Channel – channel	No	
	Channel – internal bus	Yes, with intermediate supply	
LED displays	X1 ... 2 = Status of the IO-Link interface 1 ... 2 PS = Electronic supply PL = Load supply -  - = Module error		
Diagnostics	<ul style="list-style-type: none"> • Communication error • Module short circuit • Module-oriented diagnostics • Undervoltage 		
Parameterisation	<ul style="list-style-type: none"> • Diagnostic behaviour • Failsafe per channel • Forcing per channel • Idle mode per channel • Module parameters 		
Additional functions	–		
Control elements	DIL switch		
Operating voltage	Nominal value	[V DC]	24 (reverse polarity protected)
	Permissible range	[V DC]	18 ... 30
	Power failure buffering	[ms]	10
Intrinsic current consumption at nominal operating voltage	[mA]	Typically 65	
Max. power supply per channel	[A]	2x 1.6	
Max. residual current of outputs per channel	[A]	2x 1.6	
Degree of protection to EN 60529	IP65, IP67		
Temperature range	Operation	[°C]	–5 ... +50
	Storage/transport	[°C]	–20 ... +70
Materials	PA-reinforced, PC		
Note on materials	RoHS-compliant		
PWIS conformity	VDMA24364-B2-L		
Grid dimension	[mm]	50	
Dimensions (including interlinking block) W x L x H	[mm]	50 x 107 x 55	
Product weight	[g]	110	

 **Note**

Please observe the general limits and guidelines for the system when configuring the electrical modules.

Data sheet – IO-Link interface

Connection and display components

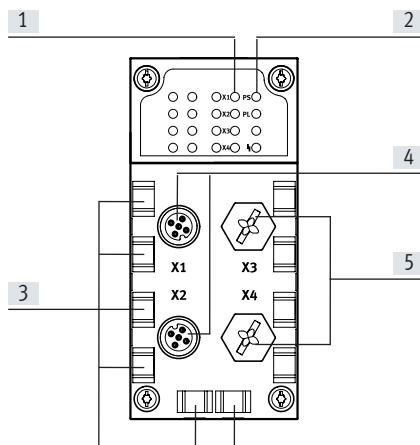

- [1] Status LEDs for I-Port interfaces
- [2] CPX-P-specific status LEDs
- [3] Holders for inscription labels (IBS 6x10)
- [4] IO-Link interfaces for up to 2 devices
- [5] Unused connections

Combinations of bus nodes/control blocks with interface CPX-CTEL-2

Bus node/control block	Part no.	Interface
		CPX-CTEL-2-M12-5POL-LK
CPX-CEC-C1-V3	3473128	■
CPX-CEC-M1-V3	3472765	■
CPX-CEC-S1-V3	3472425	■
CPX-FB33	548755	■
CPX-M-FB34	548751	■
CPX-M-FB35	548749	■
CPX-FB36	1912451	■
CPX-FB43	8110369	■
CPX-M-FB44	8110370	■
CPX-M-FB45	8110371	■

Pin allocation of IO-Link interface

Terminal allocation	Pin	Signal	Designation
	1	24 V _{SEN}	24 V DC supply voltage for electronics and inputs
	2	24 V _{VAL}	24 V DC load voltage supply for valves and outputs
	3	0 V _{SEN}	0 V DC supply voltage for electronics and sensors
	4	C/Q _{I-Port}	Communication signal C/Q, data transmission line
	5	0 V _{VALVES}	0 V DC load voltage supply for valves and outputs



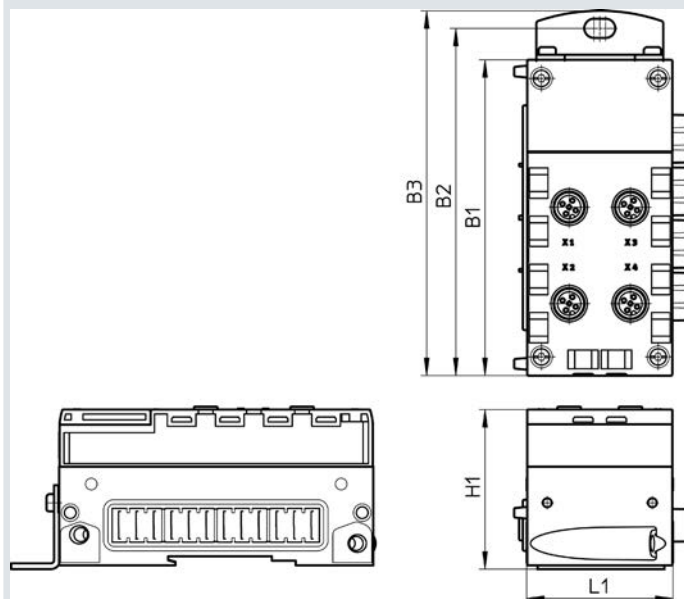

Data sheet – IO-Link interface

Dimensions

Download CAD data → www.festo.com

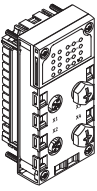
Type	B1	B2	B3	H1	L1
CPX-CTEL-2-M12-5POL-LK	108.1	118.9	124.9	55.1	50

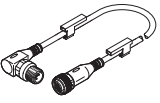
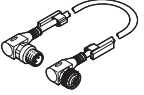
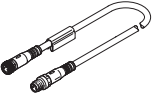
Data sheet – IO-Link interface

Ordering data				Part no.	Type
CPX-P CTEL master, IO-Link					
	Interface for max. 2 I/O modules and valve terminals with IO-Link interface (devices)			2900543	CPX-CTEL-2-M12-5POL-LK
Bus connection					
	Cover cap	M12		165592	ISK-M12
	Connecting cable M12-M12, 5-pin • Straight socket • Angled plug	Cable characteristic: standard	0.5 m	8003617	NEBU-M12G5-K-0.5-M12W5
			2 m	8003618	NEBU-M12G5-K-2-M12W5
	Connecting cable M12-M12, 5-pin • Angled socket • Angled plug	Cable characteristic: standard	0.5 m	570733	NEBU-M12W5-K-0.5-M12W5
			2 m	570734	NEBU-M12W5-K-2-M12W5
	Connecting cable M12-M12, 5-pin • Straight socket • Straight plug	Cable characteristic: suitable for use with energy chains	5 m	574321	NEBU-M12G5-E-5-Q8N-M12G5
			7.5 m	574322	NEBU-M12G5-E-7.5-Q8N-M12G5
			10 m	574323	NEBU-M12G5-E-10-Q8N-M12G5
	Inscription label holder for connection block			536593	CPX-ST-1
User documentation					
	User documentation for CPX-P CTEL master	German	8034115	P.BE-CPX-CTEL-LK-DE	
		English	8034116	P.BE-CPX-CTEL-LK-EN	
		Spanish	8034117	P.BE-CPX-CTEL-LK-ES	
		French	8034118	P.BE-CPX-CTEL-LK-FR	
		Italian	8034119	P.BE-CPX-CTEL-LK-IT	
		Swedish	8034120	P.BE-CPX-CTEL-LK-ZH	

Data sheet – Measuring module for displacement encoder

The measuring module CPX-CMIX is intended exclusively for use in the CPX-P terminal.

It offers movement and measurement in one, as an integral component of the terminal CPX-P – the modular peripheral system for decentralised automation tasks.

The modular design means that valves, digital inputs and outputs, positioning modules, end-position controllers and measuring modules, as appropriate to the application, can be combined in almost any way on the CPX-P terminal.

Advantages:

- Pneumatics and electrics – movement and measurement on one platform
- Innovative measurement technology – piston rod drives, rodless drives, rotary drives
- Actuation via fieldbus
- Remote maintenance, remote diagnostics, web server, text message and e-mail alert are all possible via TCP/IP
- Modules can be quickly exchanged and expanded without altering the wiring



General technical data

Operating voltage

Operating voltage range	[V DC]	18 ... 30
Nominal operating voltage	[V DC]	24
Current consumption at nominal operating voltage	[mA]	80
Short circuit current rating		Yes
Power failure buffering	[ms]	10

Number of axis strings		1
Axes per string		1
Length of connecting cable to axis	[m]	≤ 30
Max. number of modules		9

Display		7-segment display	
Assigned addresses	Outputs	[bit]	6x8
	Inputs	[bit]	6x8

Diagnostics	Channel and module-oriented
	Via local 7-segment display
	Undervoltage of modules
	Undervoltage of measuring system

Status indication	Power load
	Error

Control interface

Data	CAN bus with Festo protocol
	Digital
Electrical connection	5-pin
	M9
	Socket

Materials: Housing	PA-reinforced		
Note on materials	RoHS-compliant		
PWIS conformity	VDMA24364-B2-L		
Product weight	[g]	140	
Dimensions	Length	[mm]	107
	Width	[mm]	50
	Height	[mm]	55

Data sheet – Measuring module for displacement encoder

Operating and environmental conditions		
Ambient temperature	[°C]	-5 ... +50
Storage temperature	[°C]	-20 ... +70
Relative humidity	[%]	5 ... 95, non-condensing
Degree of protection to IEC 60529		IP65

Connection and display components

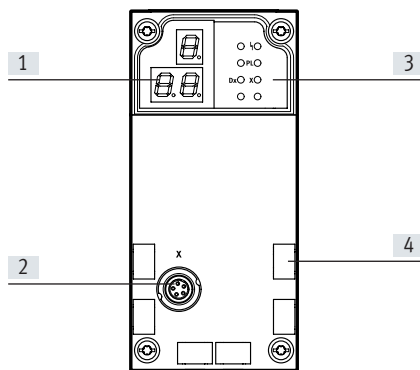







- [1] 3-digit display
- [2] Control interface
- [3] Status LEDs
- [4] Inscription labels

Pin allocation – Control interface			
Terminal allocation	Pin	Signal	Designation
	1	+24 V	Nominal operating voltage
	2	+24 V	Load voltage
	3	0 V	Ground
	4	CAN_H	CAN high
	5	CAN_L	CAN low
	Housing	Shielding	Cable shielding

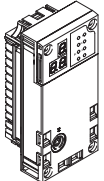
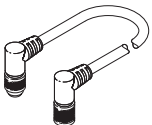
Permitted bus nodes/CEC		
Bus node/CEC	Protocol	Max. number of CMIX modules
CPX-CEC...	-	9
CPX-FB11	DeviceNet ¹⁾	9
CPX-FB13	PROFIBUS ²⁾	9
CPX-FB14	CANopen	5
CPX-FB33	PROFINET RT, M12	9
CPX-M-FB34	PROFINET RT, RJ45	9
CPX-M-FB35	PROFINET RT, SCRJ	9
CPX-FB36	EtherNet/IP	9
CPX-FB37	EtherCAT	9
CPX-FB43	PROFINET RT, M12	9
CPX-M-FB44	PROFINET RT, RJ45	9
CPX-M-FB45	PROFINET RT, SCRJ	9

1) As of revision 20 (R20)
 2) As of revision 23 (R23)

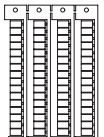
Data sheet – Measuring module for displacement encoder

Ordering data		Part no.	Type
Designation			
Measuring module			
	Order code in the CPX-P configurator: T2	567417	CPX-CMIX-M1-1
Connecting cable			
	Connecting cable M9-M9, 5-pin • Angled socket • Angled plug	0.25 m	540327 KVI-CP-3-WS-WD-0.25
		0.5 m	540328 KVI-CP-3-WS-WD-0.5
		2 m	540329 KVI-CP-3-WS-WD-2
	Connecting cable M9-M9, 5-pin • Straight socket • Straight plug	5 m	540330 KVI-CP-3-WS-WD-5
		8 m	540331 KVI-CP-3-WS-WD-8
		2 m	540332 KVI-CP-3-GS-GD-2
	5 m	540333 KVI-CP-3-GS-GD-5	
	8 m	540334 KVI-CP-3-GS-GD-8	
	Connecting component M9-M9, 5-pin, for cabinet through-feed	543252	KVI-CP-3-SSD
	For displacement encoder MME: Connection between displacement encoder MME and measuring module CPX-CMIX	2 m	575898 NEBP-M16W6-K-2-M9W5
Screws			
	For mounting on the metal interlinking block	550219	CPX-M-M3X22-4X
Inscription labels			
	Inscription labels 6x10, in frames	Pack of 64	18576 IBS-6x10
User documentation			
	User documentation, measuring module CPX-CMIX ¹⁾	German	567053 P.BE-CPX-CMIX-DE
		English	567054 P.BE-CPX-CMIX-EN
		Spanish	567055 P.BE-CPX-CMIX-ES
		French	567056 P.BE-CPX-CMIX-FR
		Italian	567057 P.BE-CPX-CMIX-IT

1) User documentation in paper form is not included in the scope of delivery

Data sheet – Input module, digital, NAMUR

Function

Digital input modules enable the connection of up to eight NAMUR sensors (or wired mechanical contacts). In addition, the first four channels can alternatively be used as counters or for frequency measurement. M12 and terminal strip connection technology can be used, in either intrinsically safe or non-intrinsically safe design.

Area of application

- Input modules for 24 V DC sensor supply voltage
- Module features can be parameterised
- The input module receives the supply voltage for the electronics and the sensors from the interlinking block
- Module protection and diagnostics through integrated electronic protection in each channel

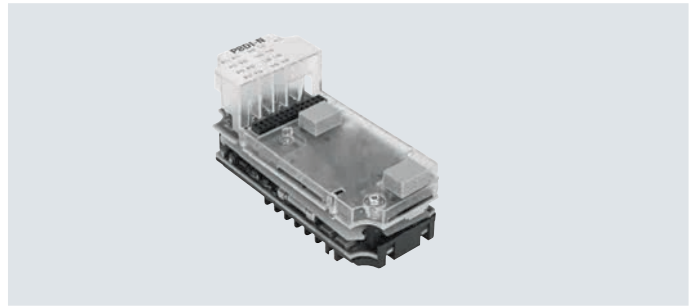

General technical data		
Number of inputs		8
Maximum cable length	[m]	200
Input debounce time	[ms]	3 (0, 10, 20 parameterisable)
Fuse protection (short circuit)		Internal electronic fuse per channel
Module current consumption (power supply for electronics)	[mA]	Typically 75
Nominal operating voltage	[V DC]	24 (reverse polarity protected)
Permissible voltage fluctuations	[%]	±25
Power failure buffering	[ms]	20
Residual ripple	[Vss]	0.4
Galvanic isolation	Channel – channel	No
	Channel – internal bus	Yes
Input characteristics		To EN 60947-5-6
Switching level		To EN 60947-5-6
LED displays	Group diagnostics	1
	Channel diagnostics	8
	Channel status	8
Diagnostics		Wire break per channel
		Limit value violation per channel
		Parameterisation error
		Overload per channel
Parameterisation		Data format
		Input debounce time per channel
		Input function per channel
		Replacement value in diagnostic case per channel
		Upper limit value per channel
		Signal extension time per channel
		Gate time per channel
		Monitoring of limit values per channel
		Monitoring of short circuit per channel
		Monitoring of wire break per channel
		Monitoring of parameters
		Lower limit value per channel
		Upper limit value per channel
		Counter configuration per channel
Control elements		DIL switch
Additional functions		Frequency measurement
		Counter function
Degree of protection to EN 60529		Depending on the connection block

Data sheet – Input module, digital, NAMUR

General technical data		
Grid dimension	[mm]	50
Dimensions (including interlinking block and connection block) W x L x H	[mm]	50 x 107 x 70
Product weight	[g]	100

Explosion protection parameters of the module inputs			
Type		CPX-P-8DE-N	CPX-P-8DE-N-IS
Maximum output power	[mW]	–	42
Maximum output voltage	[V]	–	10
Maximum output current	[mA]	–	16.8
Maximum external inductance	[mH]	–	125
Maximum external capacitance	[µF]	–	3

Certifications and approvals – Maximum values			
Type		CPX-P-8DE-N	CPX-P-8DE-N-IS
ATEX category gas		–	II (1) G
Type of ignition protection for gas		–	[Ex ia Ga] IIC
ATEX category for dust		–	II (1) D
Type of ignition protection for dust		–	[Ex ia Da] IIIC
Explosion protection certification outside the EU		–	EPL Ga (IEC Ex)
		–	EPL Da (IEC-Ex)
		–	EPL Ga (BR)
		–	EPL Da (BR)
Explosion-proof ambient temperature	[°C]	–	$-5 \leq T_a \leq +70$
Certificate issuing authority		–	ZELM 12 ATEX 0500 X
		–	IECEX ZLM 12.0007 X
		–	DNV 15.0192 X

 **Note**

The module CPX-P-8DE-N-IS has additional safety measures for possible faults, such as non-resettable fuses, to ensure safe operation in accordance with the ignition protection type.

If the module is operated within the permissible parameters, these protective measures will be irrelevant.

 **Note**

Only the end plate, the pneumatic interface or another module in intrinsically safe design are permitted directly to the right of modules in intrinsically safe design (CPX-P-8DE-N-IS) within the CPX-P terminal.

 **Note**

The insulating plate CPX-P-AB-IP must be mounted between a module in intrinsically safe design (CPX-P-8DE-N-IS) and another, non-intrinsically safe CPX input or output module.

 **Note**

The above-mentioned certifications for the module CPX-P-8DE-N-IS do not apply if the module is used outside the appropriately configured CPX-P terminal.

Materials

Housing	PA-reinforced PC
Note on materials	RoHS-compliant
PWIS conformity	VDMA24364-B2-L

Operating and environmental conditions

Type		CPX-P-8DE-N	CPX-P-8DE-N-IS
Ambient temperature	[°C]	–5 ... +50	–5 ... +50
Storage temperature	[°C]	–20 ... +70	–20 ... +70
Relative humidity	[%]	95, non-condensing	95, non-condensing
CE marking (see declaration of conformity) ¹⁾		–	To EU Explosion Protection Directive (ATEX)

1) Additional information: www.festo.com/catalogue/... → Support/Downloads.

Data sheet – Input module, digital, NAMUR

Connection and display components

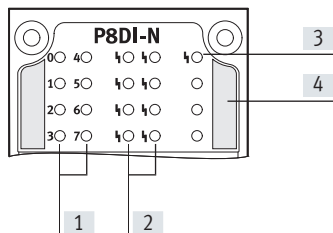

- [1] Status LEDs (green)
For allocation to inputs
→ Pin allocation for module
- [2] Channel-related error LEDs (red)
- [3] Error LED (red, module error)
- [4] Marking for intrinsically safe variant, CPX-P-8DE-N-IS (blue)

Combinations of connection blocks and digital input modules

Connection blocks	Part no.	Digital input modules	
		CPX-P-8DE-N	CPX-P-8DE-N-IS
CPX-P-AB-4XM12-4POL	565706	■	-
CPX-P-AB-2XKL-8POL	565704	■	-
CPX-P-AB-4XM12-4POL-8DE-N-IS	565705	-	■
CPX-P-AB-2XKL-8POL-8DE-N-IS	565703	-	■

Pin allocation

Connection block outputs CPX-P-8DE-N and CPX-P-8DE-N-IS







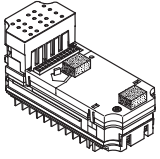
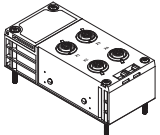

CPX-P-AB-4XM12-4POL and CPX-P-AB-4XM12-4POL-8DE-N-IS

	<p>X1.1: BN+ [0] X1.2: BU- [0] X1.3: BN+ [1] X1.4: BU- [1]</p> <p>X2.1: BN+ [2] X2.2: BU- [2] X2.3: BN+ [3] X2.4: BU- [3]</p>	<p>X3.1: BN+ [4] X3.2: BU- [4] X3.3: BN+ [5] X3.4: BU- [5]</p> <p>X4.1: BN+ [6] X4.2: BU- [6] X4.3: BN+ [7] X4.4: BU- [7]</p>
--	---	---

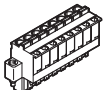
CPX-P-AB-2XKL-8POL and CPX-P-AB-2XKL-8POL-8DE-N-IS

	<p>X1.1: BN+ [0] X1.2: BU- [0] X1.3: BN+ [1] X1.4: BU- [1]</p> <p>X1.5: BN+ [2] X1.6: BU- [2] X1.7: BN+ [3] X1.8: BU- [3]</p>	<p>X2.1: BN+ [4] X2.2: BU- [4] X2.3: BN+ [5] X2.4: BU- [5]</p> <p>X2.5: BN+ [6] X2.6: BU- [6] X2.7: BN+ [7] X2.8: BU- [7]</p>
--	---	---

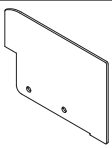
Data sheet – Input module, digital, NAMUR

Ordering data		Part no.	Type		
Designation					
Input module, digital, to NAMUR					
	8 digital inputs	565933	CPX-P-8DE-N		
	8 digital inputs, intrinsically safe design	565934	CPX-P-8DE-N-IS		
<p>Note</p> <p>An intrinsically safe circuit may only be created using components and accessories approved for intrinsically safe operation.</p>					
Connection block					
	Plastic	4x socket, M12, 4-pin	For non-intrinsically safe design	565706	CPX-P-AB-4XM12-4POL
			For intrinsically safe design	565705	CPX-P-AB-4XM12-4POL-8DE-N-IS
	2x plug, 8-pin	For non-intrinsically safe design	565704	CPX-P-AB-2XKL-8POL	
		For intrinsically safe design	565703	CPX-P-AB-2XKL-8POL-8DE-N-IS	
Plug					
	Push-in T-connector	1x plug M12, 4-pin	2x socket M12, 4-pin	562248	NEDU-M12D4-M12T4-IS ¹⁾
	Socket, 8-pin	Spring-loaded terminal	Black	565712	NECU-L3G8-C1
			Blue	565711	NECU-L3G8-C1-IS ¹⁾
		Screw terminal	Black	565710	NECU-L3G8-C2
			Blue	565709	NECU-L3G8-C2-IS ¹⁾
	Plug M12, 4-pin	Spring-loaded terminal	For cable \varnothing 4 ... 8 mm	575719	NECU-M-S-A12G4-IS ¹⁾
			Screw terminal	For cable \varnothing 2.5 ... 2.9 mm	570955
		For cable \varnothing 4 ... 6 mm	570953	NECU-S-M12G4-P1-IS ¹⁾	
		For cable \varnothing 6 ... 8 mm	570954	NECU-S-M12G4-P2-IS ¹⁾	
		For cable \varnothing 2x3 mm or 2x5 mm	570956	NECU-S-M12G4-D-IS ¹⁾	
Cover					
	Cover cap for closing off unused connections (10 pieces)	For M12 connections	165592	ISK-M12	
Coding element					
	To ensure that a coded socket NECU-L3G8 can only be inserted in the matching coded connection block CPX-P-AB-2XKL (96 of each)	For NECU-L3G8	565713	CPX-P-KDS-AB-2XKL	
Screening plate					
	Insulating plate for safe separation of intrinsically safe and non-intrinsically safe areas of the CPX terminal	565708	CPX-P-AB-IP		
User documentation					
	User documentation	German	575378	P.BE-CPX-P-EA-DE	
		English	575379	P.BE-CPX-P-EA-EN	
		Spanish	575380	P.BE-CPX-P-EA-ES	
		French	575381	P.BE-CPX-P-EA-FR	
		Italian	575382	P.BE-CPX-P-EA-IT	
		Swedish	575383	P.BE-CPX-P-EA-SV	

1) Component preferred for operation in intrinsically safe circuits.

Data sheet – Input module, digital

Function

Digital input modules enable the connection of two-wire and three-wire sensors (proximity switches, inductive or capacitive sensors, etc.).

Depending on the connection block selected, the module supports various connection concepts with different numbers of sockets (single or double allocation).

Area of application

- Input modules for 24 V DC sensor supply voltage
- PNP or NPN logic
- Supports connection blocks with M12, M8, Sub-D and terminal connection
- Module features can be parameterised
- The input module receives the supply voltage for the electronics and the sensors from the interlinking block
- Module protection and diagnostics through integrated electronic protection

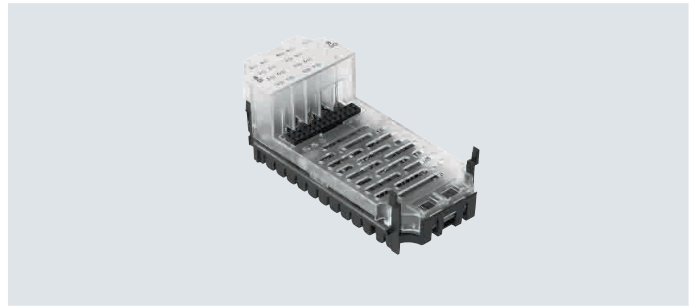

General technical data		CPX-4DE	CPX-8DE	CPX-8DE-D	CPX-8NDE
Type					
Number of inputs		4	8	8	8
Max. residual current of inputs per module	[A]	0.7	1	0.7	0.7
Fuse protection		Internal electronic fuse per module	Internal electronic fuse per module	Internal electronic fuse per channel	Internal electronic fuse per module
Intrinsic current consumption at operating voltage	[mA]	Typically 15			
Operating voltage	Nominal value	24 [V DC]			
	Permissible range	18 ... 30 [V DC]			
Galvanic isolation	Channel – channel	No			
	Channel – internal bus	No			
Switching level	Signal 0	≤ 5 [V DC]			≥ 11
	Signal 1	≥ 11 [V DC]			≤ 5
Input debounce time	[ms]	3 (0.1, 10, 20 parameterisable)			
Input characteristic		IEC 1131-T2			
Switching logic		Positive logic (PNP)			Negative logic (NPN)
LED displays	Group diagnostics	1	1	1	1
	Channel diagnostics	–	–	8	–
	Channel status	4	8	8	8
Diagnostics		Short circuit/overload per channel			
Parameterisation		<ul style="list-style-type: none"> • Module monitoring • Behaviour after short circuit • Input debounce time • Signal extension time 			
Degree of protection to EN 60529		Depending on connection block			
Temperature range	Operation	–5 ... +50 [°C]			
	Storage/transport	–20 ... +70 [°C]			
Materials		PA-reinforced, PC			
PWIS conformity		VDMA24364-B2-L			
Grid dimension	[mm]	50			
Dimensions (including interlinking block and connection block) W x L x H	[mm]	50 x 107 x 50			
Product weight	[g]	39	39	45	40

Data sheet – Input module, digital

Connection and display components

CPX-4DE

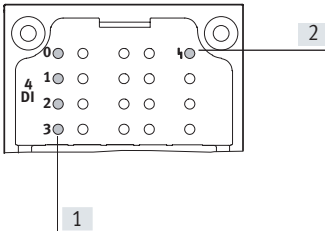

CPX-8DE

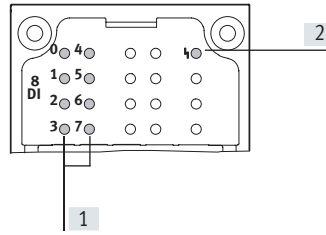

CPX-8DE-D

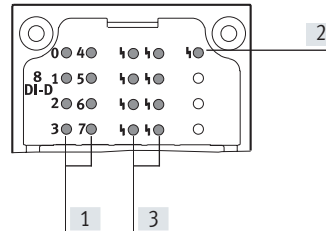

CPX-8NDE

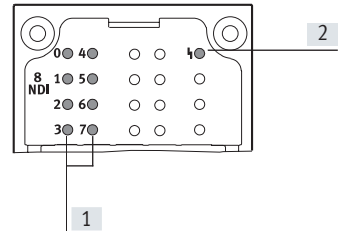

[1] Status LEDs (green)

[2] Error LED (red, module error)

[3] Channel-related error LEDs (red)

For allocation to inputs
→ Pin allocation for module

Combinations of connection blocks and digital input modules

Connection blocks	Part no.	Digital input modules			
		CPX-4DE	CPX-8DE	CPX-8DE-D	CPX-8NDE
CPX-AB-8-M8-3POL	195706	■	■	■	■
CPX-AB-4-M12X2-5POL	195704	■	■	■	■
CPX-AB-4-M12X2-5POL-R	541254	■	■	■	■
CPX-AB-8-KL-4POL	195708	■	■	■	■
CPX-AB-1-SUB-BU-25POL	525676	■	■	■	■
CPX-M-AB-4-M12X2-5POL	549367	■	■	■	■

Pin allocation





Connection block inputs	CPX-4DE	CPX-8DE, CPX-8DE-D and CPX-8NDE		
CPX-AB-8-M8-3POL				
	X1.1: 24 V _{SEN} X1.3: 0 V _{SEN} X1.4: Input x X2.1: 24 V _{SEN} X2.3: 0 V _{SEN} X2.4: Input x+1 X3.1: 24 V _{SEN} X3.3: 0 V _{SEN} X3.4: Input x+1 X4.1: 24 V _{SEN} X4.3: 0 V _{SEN} X4.4: n.c.	X5.1: 24 V _{SEN} X5.3: 0 V _{SEN} X5.4: Input x+2 X6.1: 24 V _{SEN} X6.3: 0 V _{SEN} X6.4: Input x+3 X7.1: 24 V _{SEN} X7.3: 0 V _{SEN} X7.4: Input x+3 X8.1: 24 V _{SEN} X8.3: 0 V _{SEN} X8.4: n.c.	X1.1: 24 V _{SEN x} X1.3: 0 V _{SEN x} X1.4: Input x X2.1: 24 V _{SEN x+1} X2.3: 0 V _{SEN x+1} X2.4: Input x+1 X3.1: 24 V _{SEN x+2} X3.3: 0 V _{SEN x+2} X3.4: Input x+2 X4.1: 24 V _{SEN x+3} X4.3: 0 V _{SEN x+3} X4.4: Input x+3	X5.1: 24 V _{SEN x+4} X5.3: 0 V _{SEN x+4} X5.4: Input x+4 X6.1: 24 V _{SEN x+5} X6.3: 0 V _{SEN x+5} X6.4: Input x+5 X7.1: 24 V _{SEN x+6} X7.3: 0 V _{SEN x+6} X7.4: Input x+6 X8.1: 24 V _{SEN x+7} X8.3: 0 V _{SEN x+7} X8.4: Input x+7
CPX-AB-4-M12X2-5POL, CPX-AB-4-M12X2-5POL-R¹⁾ and CPX-M-AB-4-M12X2-5POL				
	X1.1: 24 V _{SEN} X1.2: Input x+1 X1.3: 0 V _{SEN} X1.4: Input x X1.5: FE X2.1: 24 V _{SEN} X2.2: n.c. X2.3: 0 V _{SEN} X2.4: Input x+1 X2.5: FE	X3.1: 24 V _{SEN} X3.2: Input x+3 X3.3: 0 V _{SEN} X3.4: Input x+2 X3.5: FE X4.1: 24 V _{SEN} X4.2: n.c. X4.3: 0 V _{SEN} X4.4: Input x+3 X4.5: FE	X1.1: 24 V _{SEN x} X1.2: Input x+1 X1.3: 0 V _{SEN x} X1.4: Input x X1.5: FE X2.1: 24 V _{SEN x+2} X2.2: Input x+3 X2.3: 0 V _{SEN x+2} X2.4: Input x+2 X2.5: FE	X3.1: 24 V _{SEN x+4} X3.2: Input x+5 X3.3: 0 V _{SEN x+4} X3.4: Input x+4 X3.5: FE X4.1: 24 V _{SEN x+6} X4.2: Input x+7 X4.3: 0 V _{SEN x+6} X4.4: Input x+6 X4.5: FE

1) Speedcon quick lock, additional shielding on metal thread

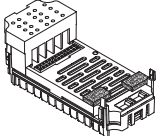
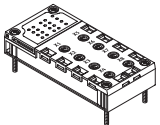

Data sheet – Input module, digital

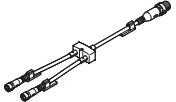
Pin allocation								
Connection block inputs		CPX-4DE		CPX-8DE, CPX-8DE-D and CPX-8NDE				
CPX-AB-8-KL-4POL								
	X1.0:	24 V _{SEN}	X5.0:	24 V _{SEN}	X1.0:	24 V _{SEN x}	X5.0:	24 V _{SEN x+4}
	X1.1:	0 V _{SEN}	X5.1:	0 V _{SEN}	X1.1:	0 V _{SEN x}	X5.1:	0 V _{SEN x+4}
	X1.2:	Input x	X5.2:	Input x+2	X1.2:	Input x	X5.2:	Input x+4
	X1.3:	FE	X5.3:	FE	X1.3:	FE	X5.3:	FE
	X2.0:	24 V _{SEN}	X6.0:	24 V _{SEN}	X2.0:	24 V _{SEN x+1}	X6.0:	24 V _{SEN x+5}
	X2.1:	0 V _{SEN}	X6.1:	0 V _{SEN}	X2.1:	0 V _{SEN x+1}	X6.1:	0 V _{SEN x+5}
	X2.2:	Input x+1	X6.2:	Input x+3	X2.2:	Input x+1	X6.2:	Input x+5
	X2.3:	FE	X6.3:	FE	X2.3:	FE	X6.3:	FE
	X3.0:	24 V _{SEN}	X7.0:	24 V _{SEN}	X3.0:	24 V _{SEN x+2}	X7.0:	24 V _{SEN x+6}
	X3.1:	0 V _{SEN}	X7.1:	0 V _{SEN}	X3.1:	0 V _{SEN x+2}	X7.1:	0 V _{SEN x+6}
	X3.2:	Input x+1	X7.2:	Input x+3	X3.2:	Input x+2	X7.2:	Input x+6
	X3.3:	FE	X7.3:	FE	X3.3:	FE	X7.3:	FE
	X4.0:	24 V _{SEN}	X8.0:	24 V _{SEN}	X4.0:	24 V _{SEN x+3}	X8.0:	24 V _{SEN x+7}
	X4.1:	0 V _{SEN}	X8.1:	0 V _{SEN}	X4.1:	0 V _{SEN x+3}	X8.1:	0 V _{SEN x+7}
	X4.2:	n.c.	X8.2:	n.c.	X4.2:	Input x+3	X8.2:	Input x+7
	X4.3:	FE	X8.3:	FE	X4.3:	FE	X8.3:	FE
CPX-AB-1-SUB-BU-25POL								
	1:	Input x	14:	Input x+2	1:	Input x	14:	Input x+4
	2:	Input x+1	15:	Input x+3	2:	Input x+1	15:	Input x+5
	3:	Input x+1	16:	Input x+3	3:	Input x+2	16:	Input x+6
	4:	n.c.	17:	n.c.	4:	Input x+3	17:	Input x+7
	5:	24 V _{SEN}	18:	24 V _{SEN}	5:	24 V _{SEN x+1}	18:	24 V _{SEN x+4}
	6:	0 V _{SEN}	19:	24 V _{SEN}	6:	0 V _{SEN x+1}	19:	24 V _{SEN x+5}
	7:	24 V _{SEN}	20:	24 V _{SEN}	7:	24 V _{SEN x+3}	20:	24 V _{SEN x+6}
	8:	0 V _{SEN}	21:	24 V _{SEN}	8:	0 V _{SEN x+3}	21:	24 V _{SEN x+7}
	9:	24 V _{SEN}	22:	0 V _{SEN}	9:	24 V _{SEN x}	22:	0 V _{SEN x+2 u. 3}
	10:	24 V _{SEN}	23:	0 V _{SEN}	10:	24 V _{SEN x+2}	23:	0 V _{SEN x+2 u. 3}
	11:	0 V _{SEN}	24:	0 V _{SEN}	11:	0 V _{SEN x}	24:	0 V _{SEN x+2 u. 3}
	12:	0 V _{SEN}	25:	FE	12:	0 V _{SEN x+2}	25:	FE
	13:	FE	Housing:	FE	13:	FE	Housing:	FE

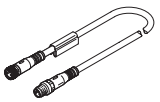
Data sheet – Input module, digital

Ordering data				Part no.	Type
Designation					
Input module, digital					
	4 digital inputs, positive logic (PNP)			195752	CPX-4DE
	8 digital inputs, positive logic (PNP)			195750	CPX-8DE
	8 digital inputs, positive logic (PNP), enhanced diagnostic function			541480	CPX-8DE-D
	8 digital inputs, negative logic (NPN)			543813	CPX-8NDE
Connection block					
	Plastic	8x socket M8, 3-pin		195706	CPX-AB-8-M8-3POL
		4x socket M12, 5-pin		195704	CPX-AB-4-M12X2-5POL
		4x socket, M12 with quick-lock technology, 5-pin		541254	CPX-AB-4-M12X2-5POL-R
		Spring-loaded terminal, 32-pin		195708	CPX-AB-8-KL-4POL
		1x Sub-D socket, 25-pin		525676	CPX-AB-1-SUB-BU-25POL
	Metal	4x socket M12, 5-pin		549367	CPX-M-AB-4-M12X2-5POL
Distributor					
	1x plug M12, 4-pin	2x socket M8, 3-pin		8005311	NEDY-L2R1-V1-M8G3-N-M12G4
		2x socket M12, 5-pin		8005310	NEDY-L2R1-V1-M12G5-N-M12G4
	Modular system for all types of sensor/actuator distributor			–	NEDY-... → Internet: nedy
Plug					
	M8, 3-pin	Solderable		18696	SEA-GS-M8
		Screw-in		192009	SEA-3GS-M8-S
	M12, 4-pin	PG7, for cable Ø 4 ... 6 mm		18666	SEA-GS-7
		PG7, for cable Ø 2.5 ... 2.9 mm		192008	SEA-4GS-7-2.5
		PG9, for cable Ø 6 ... 8 mm		18778	SEA-GS-9
		PG11, for 2x cable Ø 3 ... 5 mm		18779	SEA-GS-11-DUO
M12, 5-pin	PG7, for cable Ø 4 ... 6 mm		175487	SEA-M12-5GS-PG7	
	PG11, for 2x cable Ø 2.5 ... 5 mm		192010	SEA-5GS-11-DUO	
	Sub-D, 25-pin		527522	SD-SUB-D-ST25	
Connecting cable					
	1x socket M8, 3-pin	1x plug M8, 3-pin	0.5 m	541346	NEBU-M8G3-K-0.5-M8G3
			1.0 m	541347	NEBU-M8G3-K-1-M8G3
			2.5 m	541348	NEBU-M8G3-K-2.5-M8G3
			5.0 m	541349	NEBU-M8G3-K-5-M8G3
	Modular system for a choice of connecting cables			–	NEBU-... → Internet: nebu

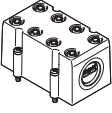
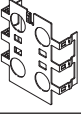
Data sheet – Input module, digital

Ordering data		Part no.	Type	
Designation				
Cover				
	Cover for CPX-AB-8-KL-4POL (IP65, IP67)	<ul style="list-style-type: none"> • 8 cable through feeds M9 • 1 cable through feed for multi-pin plug 	538219	AK-8KL
	Fittings kit		538220	VG-K-M9
Screening plate				
	Screening plate for M12 connections		526184	CPX-AB-S-4-M12
User documentation				
	User documentation	German	526439	P.BE-CPX-EA-DE
		English	526440	P.BE-CPX-EA-EN
		Spanish	526441	P.BE-CPX-EA-ES
		French	526442	P.BE-CPX-EA-FR
		Italian	526443	P.BE-CPX-EA-IT

Data sheet – Input module, digital, 16 inputs

Function

Digital input modules enable the connection of two-wire and three-wire sensors (proximity switches, inductive or capacitive sensors, etc.). Depending on the connection block selected, the module supports various connection concepts with different numbers of sockets (single or double allocation).

Area of application

- Input modules for 24 V DC sensor supply voltage
- PNP logic
- Module features can be parameterised
- The input module receives the supply voltage for the electronics and the sensors from the interlinking block
- Module protection and diagnostics through integrated electronic protection

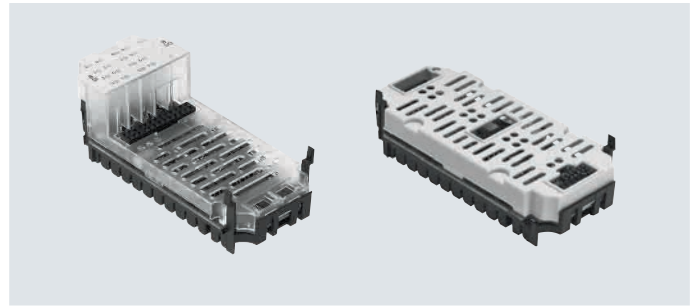

General technical data			CPX-16DE	CPX-M-16DE-D
Type				
Number of inputs			16	16
Max. residual current of inputs per module	[A]		1.8	1.8
Intrinsic current consumption at operating voltage	[mA]		Typically 15	Typically 34
Fuse protection			Internal electronic fuse per module	Internal electronic fuse per channel pair, additional safety fuse
Nominal operating voltage	[V DC]		24	
Operating voltage range	[V DC]		18 ... 30	
Galvanic isolation	Channel – channel		No	
	Channel – internal bus		No	
Switching level	Signal 0	[V DC]	≤ 5	
	Signal 1	[V DC]	≥ 11	
Input debounce time	[ms]		3 (0.1, 10, 20 parameterisable)	
Input characteristic			IEC 1131-T2	
Switching logic			Positive logic (PNP)	
LED displays	Group diagnostics		1	1
	Channel diagnostics		–	16
	Channel status		16	16
Diagnostics			Short circuit/overload per channel	
Parameterisation			<ul style="list-style-type: none"> • Module monitoring • Behaviour after short circuit • Input debounce time • Signal extension time 	
Degree of protection to EN 60529			Depending on connection block	
Temperature range	Operation	[°C]	–5 ... +50	
	Storage/transport	[°C]	–20 ... +70	
Materials			PA-reinforced, PC	
PWIS conformity			VDMA24364-B2-L	
Grid dimension		[mm]	50	
Dimensions (including interlinking block and connection block) W x L x H		[mm]	50 x 107 x 50	
Product weight		[g]	41	46

Data sheet – Input module, digital, 16 inputs

Connection and display components

CPX-16DE

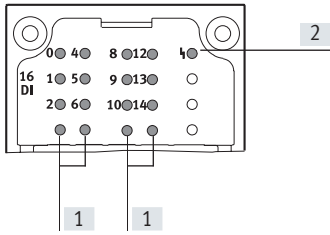

- [1] Status LEDs (green)
For allocation to inputs
→ Pin allocation for module
- [2] Error LED (red, module error)

CPX-M-16DE-D

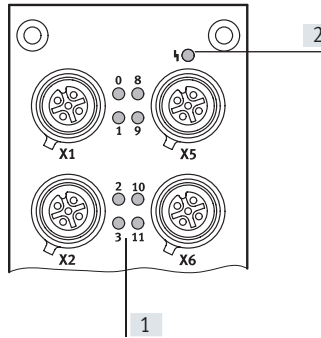

- [1] Common status LEDs (green)/error LEDs (red) for each input signal
- [2] Error LED (red, module error)

Combinations of connection blocks and digital input modules

Connection blocks	Part no.	Digital input modules	
		CPX-16DE	CPX-M-16DE-D
CPX-AB-8-M8X2-4POL	541256	■	-
CPX-AB-8-KL-4POL	195708	■	-
CPX-AB-1-SUB-BU-25POL	525676	■	-
CPX-M-AB-8-M12X2-5POL	549335	-	■

Pin allocation

Connection block inputs

CPX-16DE

CPX-AB-8-M8x2-4POL

Diagram	CPX-16DE	CPX-M-16DE-D
	X1.1: 24 V _{SEN}	X5.1: 24 V _{SEN}
	X1.2: Input x+1	X5.2: Input x+9
	X1.3: 0 V _{SEN}	X5.3: 0 V _{SEN}
	X1.4: Input x	X5.4: Input x+8
	X2.1: 24 V _{SEN}	X6.1: 24 V _{SEN}
	X2.2: Input x+3	X6.2: Input x+11
	X2.3: 0 V _{SEN}	X6.3: 0 V _{SEN}
	X2.4: Input x+2	X6.4: Input x+10
	X3.1: 24 V _{SEN}	X7.1: 24 V _{SEN}
	X3.2: Input x+5	X7.2: Input x+13
	X3.3: 0 V _{SEN}	X7.3: 0 V _{SEN}
	X3.4: Input x+4	X7.4: Input x+12
	X4.1: 24 V _{SEN}	X8.1: 24 V _{SEN}
	X4.2: Input x+7	X8.1: Input x+15
	X4.3: 0 V _{SEN}	X8.3: 0 V _{SEN}
	X4.4: Input x+6	X8.4: Input x+14



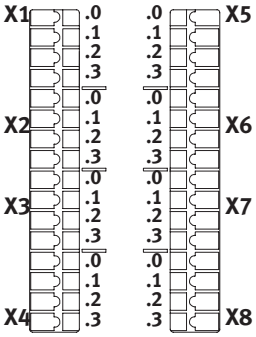
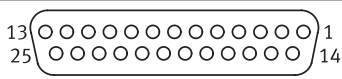

Data sheet – Input module, digital, 16 inputs

Pin allocation		CPX-16DE
Connection block inputs		
CPX-AB-8-KL-4POL		
	<p>X1.0: Input x+8 X1.1: 24 V_{SEN} X1.2: Input x X1.3: FE</p> <p>X2.0: Input x+9 X2.1: 24 V_{SEN} X2.2: Input x+1 X2.3: FE</p> <p>X3.0: Input x+10 X3.1: 24 V_{SEN} X3.2: Input x+2 X3.3: FE</p> <p>X4.0: Input x+11 X4.1: 24 V_{SEN} X4.2: Input x+3 X4.3: FE</p>	<p>X5.0: Input x+12 X5.1: 0 V_{SEN} X5.2: Input x+4 X5.3: FE</p> <p>X6.0: Input x+13 X6.1: 0 V_{SEN} X6.2: Input x+5 X6.3: FE</p> <p>X7.0: Input x+14 X7.1: 0 V_{SEN} X7.2: Input x+6 X7.3: FE</p> <p>X8.0: Input x+15 X8.1: 0 V_{SEN} X8.2: Input x+7 X8.3: FE</p>
CPX-AB-1-SUB-BU-25POL		
	<p>1: Input x 2: Input x+1 3: Input x+2 4: Input x+3 5: Input x+9 6: 24 V_{SEN} 7: Input x+11 8: 24 V_{SEN} 9: Input x+8 10: Input x+10 11: 24 V_{SEN} 12: 24 V_{SEN} 13: FE</p>	<p>14: Input x+4 15: Input x+5 16: Input x+6 17: Input x+7 18: Input x+12 19: Input x+13 20: Input x+14 21: Input x+15 22: 0 V_{SEN} 23: 0 V_{SEN} 24: 0 V_{SEN} 25: FE Housing: FE</p>

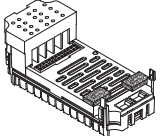
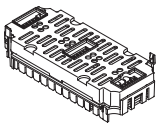
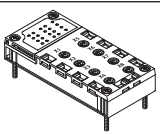

Data sheet – Input module, digital, 16 inputs

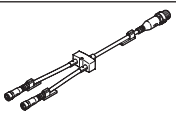
Pin allocation		CPX-M-16DE-D	
Connection block inputs		CPX-M-AB-8-M12X2-5POL	
		X1.1: $24 V_{Sx}$	X5.1: $24 V_{Sx+8}$
		X1.2: Input x+1	X5.2: Input x+9
		X1.3: $0 V_{Sx}$	X5.3: $0 V_{Sx+8}$
		X1.4: Input x	X5.4: Input x+8
		X1.5: FE	X5.5: FE
		X2.1: $24 V_{Sx+2}$	X6.1: $24 V_{Sx+10}$
		X2.2: Input x+3	X6.2: Input x+11
		X2.3: $0 V_{Sx+2}$	X6.3: $0 V_{Sx+10}$
		X2.4: Input x+2	X6.4: Input x+10
		X2.5: FE	X6.5: FE
		X3.1: $24 V_{Sx+4}$	X7.1: $24 V_{Sx+12}$
		X3.2: Input x+5	X7.2: Input x+13
		X3.3: $0 V_{Sx+4}$	X7.3: $0 V_{Sx+12}$
		X3.4: Input x+4	X7.4: Input x+12
		X3.5: FE	X7.5: FE
		X4.1: $24 V_{Sx+6}$	X8.1: $24 V_{Sx+14}$
		X4.2: Input x+7	X8.2: Input x+15
		X4.3: $0 V_{Sx+6}$	X8.3: $0 V_{Sx+14}$
		X4.4: Input x+6	X8.4: Input x+14
		X4.5: FE	X8.5: FE

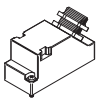
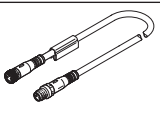
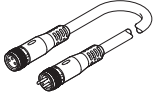
Data sheet – Input module, digital, 16 inputs

Ordering data			Part no.	Type	
Designation					
Input module, digital					
	16 digital inputs, internal electronic fuse per module		543815	CPX-16DE	
	16 digital inputs, internal electronic fuse per channel pair		550202	CPX-M-16DE-D	
Connection block					
	Plastic	8x socket, M8, 4-pin	541256	CPX-AB-8-M8X2-4POL	
		Spring-loaded terminal, 32-pin	195708	CPX-AB-8-KL-4POL	
		1x Sub-D socket, 25-pin	525676	CPX-AB-1-SUB-BU-25POL	
	Metal	8x socket M12, 5-pin	549335	CPX-M-AB-8-M12X2-5POL	
Distributor					
	1x plug M8, 4-pin	2x socket M8, 3-pin	8005312	NEDY-L2R1-V1-M8G3-N-M8G4	
	Modular system for all types of sensor/actuator distributor		–	NEDY-... → Internet: nedy	
Plug					
	M8, 3-pin	Solderable	18696	SEA-GS-M8	
		Screw-in	192009	SEA-3GS-M8-S	
	Sub-D, 25-pin		527522	SD-SUB-D-ST25	
Connecting cable					
	1x socket M8, 3-pin	1x plug M8, 3-pin	0.5 m	541346	NEBU-M8G3-K-0.5-M8G3
			1.0 m	541347	NEBU-M8G3-K-1-M8G3
			2.5 m	541348	NEBU-M8G3-K-2.5-M8G3
			5.0 m	541349	NEBU-M8G3-K-5-M8G3
	Modular system for a choice of connecting cables		–	NEBU-... → Internet: nebu	

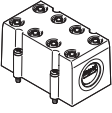
Data sheet – Input module, digital, 16 inputs

Ordering data		Part no.	Type
Designation			
Cover			
	Cover for CPX-AB-8-KL-4POL (IP65/67)	<ul style="list-style-type: none"> • 8 cable through feeds M9 • 1 cable through feed for multi-pin plug 	538219 AK-8KL
	Fittings kit for cover AK-8KL		538220 VG-K-M9
	Cover cap for closing off unused M8 connections (10 pieces)		177672 ISK-M8
User documentation			
	User documentation	German	526439 P.BE-CPX-EA-DE
		English	526440 P.BE-CPX-EA-EN
		Spanish	526441 P.BE-CPX-EA-ES
		French	526442 P.BE-CPX-EA-FR
		Italian	526443 P.BE-CPX-EA-IT

Data sheet – Input module, digital, PROFIsafe

Function

The PROFIsafe input module has 8 input channels whose signal status is detected for safety reasons, with the information transmitted to a suitable safety controller using the PROFIsafe safety protocol in combination with the appropriate fieldbus (PROFINET or PROFIBUS). This function is exclusively available for safety controllers using the PROFIsafe protocol, profile version 2.4.

Area of application

- Input module for 24 V DC sensor supply voltage
- Supports connection blocks with M12 and terminal connection
- Module features can be parameterised
- The input module receives the supply voltage for the electronics and the sensors from the interlinking block
- Module protection and diagnostics through integrated electronic protection

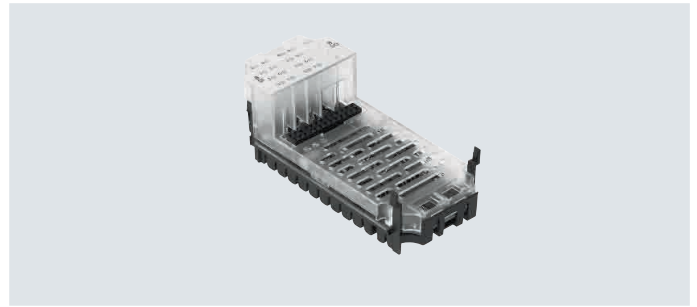

Description

Module-based passivation

While channel-based passivation is disabled, the input module, in accordance with PROFIsafe specification, switches all information in the input

image to the safe status, even when there is only one channel error.

Channel-based passivation

In the case of channel-based passivation, when a channel error occurs, the input module switches the input information of the affected channel pair to 0, depending on the function mode.

- The input information for unaffected channel pairs does not change
- The input module remains integrated.
- The input module indicates the current channel error status to the control unit via the input image.

Applications

The inputs on the PROFIsafe input module can be combined for multi-channel sensor applications. Every two inputs form a channel pair, which is set separately with one of 11 function modes.

The function mode has an influence on the evaluation of the input signals, and optionally on the generation of clock signals.

There are five independent clock outputs available for safe operation of passive sensors; the pulse patterns are used in some operating modes to detect crossovers in the signal paths.

The entire input module is designed to ensure that the input channels provide either secure data or no data at all, even when there is a fault present in the system

Range of applications

- Use as an input module for a higher-order safety controller. Several input modules can be used together and these monitor mutually independent sensors
- Use of multi-channel sensor applications with up to 8 secure inputs, which can be grouped and are suitable for configuration with the help of 11 different function modes
- Connection of various switches and sensors within the safety chain



Note

The safety integrity level, Performance Level and category for the system as a whole correspond to that of the component in the safety chain with the lowest characteristic value.

Application examples

- Two-hand control device for starting a function
- Operating mode selector switch with 4 positions
- Light curtain
- End-position switch
- Emergency stop switch for incidents
- Rotary indexing table
- Acknowledge button with request
- Safety door with two N/O switches

Data sheet – Input module, digital, PROFIsafe

General technical data			
Type	CPX-F8DE-P		
Number of inputs	8		
Safety function	Reliable detection and evaluation of input statuses		
Max. address capacity	Inputs	[byte]	6
	Outputs	[byte]	7
Maximum cable length			[m] 200
Max. power supply	Per module	[A]	3
Current consumption of module			[mA] Typically 35 (power supply for electronics)
Operating voltage	Nominal value	[V DC]	24
	Permissible range	[V DC]	20.4 ... 28.8
Voltage drop per channel			[V] 0.6
Residual ripple			[Vss] 2 within voltage range
Galvanic isolation	Channel – channel	No	
Input characteristics	To IEC 61131-2, type 2		
Switching logic	Inputs	PNP (positive switching)	
Safety integrity level	As per EN 62061	Reliable detection and evaluation of input statuses up to SIL CL3	
	As per EN 61508	Reliable detection and evaluation of input statuses up to SIL3	
Performance Level	As per ISO 13849	Reliable detection and evaluation of input statuses up to Cat 4 and PL e	
Failure rate per hour (PFH)	1.0x 10 ⁻⁹		
Certificate issuing authority	01/205/5444.01/21		
	TÜV Rh. UK 01/205U/5444.00/22		
LED displays	Group diagnostics	1	
	Channel diagnostics	8	
	Channel status	8	
	Failsafe protocol active	1	
Diagnostics	<ul style="list-style-type: none"> • Short circuit per channel • Undervoltage • Overvoltage • Excessive temperature • Crossover per channel • Wire break per channel • Communication • Process data error • Self-test 		
Control elements	DIL switch		
Degree of protection to EN 60529	Depending on connection block		
Grid dimension	[mm]	50	
Dimensions (including interlinking block and connection block) W x L x H	[mm]	50 x 107 x 55	
Product weight	[g]	46	

Data sheet – Input module, digital, PROFIsafe

Materials		
Note on materials		RoHS-compliant
PWIS conformity		VDMA24364-B2-L
Operating and environmental conditions		
Ambient temperature	[°C]	-5 ... +50
Storage temperature	[°C]	-20 ... +70
CE marking (see declaration of conformity) ¹⁾		To EU Machinery Directive
		To EU EMC Directive
		To EU RoHS Directive
UKCA marking (see declaration of conformity) ¹⁾		To UK instructions for machines
		To UK instructions for EMC
		To UK RoHS instructions
Certification		c UL us - Recognized (OL)

1) More information: www.festo.com/catalogue/... → Support/Downloads.

Connection and display components

CPX-F8DE-P

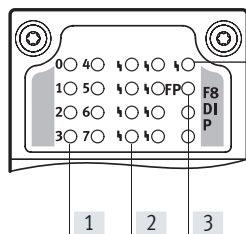

- [1] Channel-related status LEDs (green):
- [2] Channel-related error LEDs (red)
- [3] Fail-safe protocol active (green)
- [4] Error LED (red, module error)

Combinations of bus nodes/control blocks with PROFIsafe input module

Bus node/control block	Part no.	PROFIsafe input module
		CPX-F8DE-P
CPX-FB13	195740	■
CPX-FB33	548755	■
CPX-M-FB34	548751	■
CPX-M-FB35	548749	■
CPX-FB43	8110369	■
CPX-M-FB44	8110370	■
CPX-M-FB45	8110371	■

 - **Note**

The PROFIsafe input module CPX-F8DE-P can only be connected as of software release 21 or release 30 (in the case of CPX-FB13).

Data sheet – Input module, digital, PROFIsafe

Combinations of connection blocks and PROFIsafe input module		
Connection blocks	Part no.	PROFIsafe input module
		CPX-F8DE-P
CPX-M-AB-4-M12X2-5POL	549367	■
CPX-AB-8-KL-4POL	195708	■



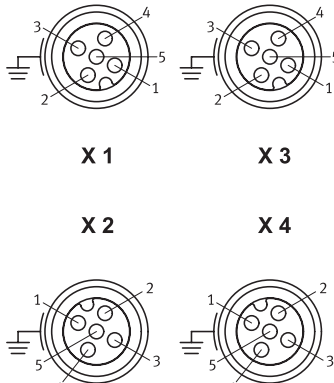

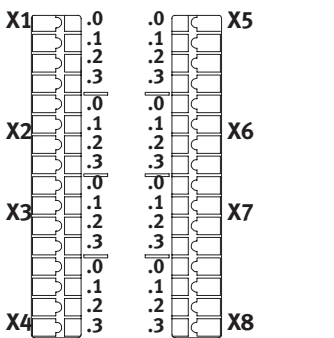

Pin allocation	
Connection block inputs	CPX-F8DE-P

CPX-M-AB-4-M12X2-5POL		
 <p>X 1 X 3</p> <p>X 2 X 4</p>	<p>X1.1: 24 V_{SEN}</p> <p>X1.2: Input x+1</p> <p>X1.3: 0 V_{SEN}</p> <p>X1.4: Input x</p> <p>X1.5: FE</p> <p>X2.1: 24 V_{SEN}</p> <p>X2.2: Input x+3</p> <p>X2.3: 0 V_{SEN}</p> <p>X2.4: Input x+2</p> <p>X2.5: FE</p>	<p>X3.1: 24 V_{SEN}</p> <p>X3.2: Input x+5</p> <p>X3.3: 0 V_{SEN}</p> <p>X3.4: Input x+4</p> <p>X3.5: FE</p> <p>X4.1: 24 V_{SEN}</p> <p>X4.2: Input x+7</p> <p>X4.3: 0 V_{SEN}</p> <p>X4.4: Input x+6</p> <p>X4.5: FE</p>

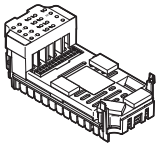
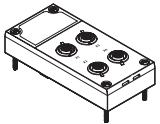
CPX-AB-8-KL-4POL		
 <p>X1 .0 .0 X5</p> <p> .1 .1</p> <p> .2 .2</p> <p> .3 .3</p> <p>X2 .0 .0 X6</p> <p> .1 .1</p> <p> .2 .2</p> <p> .3 .3</p> <p>X3 .0 .0 X7</p> <p> .1 .1</p> <p> .2 .2</p> <p> .3 .3</p> <p>X4 .0 .0 X8</p> <p> .1 .1</p> <p> .2 .2</p> <p> .3 .3</p>	<p>X1.0: 24 V_{SEN}</p> <p>X1.1: 0 V_{SEN}</p> <p>X1.2: Input x</p> <p>X1.3: FE</p> <p>X2.0: 24 V_{SEN x}</p> <p>X2.1: 24 V_{SEN x+1}</p> <p>X2.2: Input x+1</p> <p>X2.3: FE</p> <p>X3.0: 24 V_{SEN}</p> <p>X3.1: 0 V_{SEN}</p> <p>X3.2: Input x+2</p> <p>X3.3: FE</p> <p>X4.0: 24 V_{SEN x+2}</p> <p>X4.1: 24 V_{SEN x+3}</p> <p>X4.2: Input x+3</p> <p>X4.3: FE</p>	<p>X5.0: 24 V_{SEN}</p> <p>X5.1: 0 V_{SEN}</p> <p>X5.2: Input x+4</p> <p>X5.3: FE</p> <p>X6.0: 24 V_{SEN x+4}</p> <p>X6.1: 24 V_{SEN x+5}</p> <p>X6.2: Input x+5</p> <p>X6.3: FE</p> <p>X7.0: 24 V_{SEN}</p> <p>X7.1: 0 V_{SEN}</p> <p>X7.2: Input x+6</p> <p>X7.3: FE</p> <p>X8.0: 24 V_{SEN x+6}</p> <p>X8.1: 24 V_{SEN x+7}</p> <p>X8.2: Input x+7</p> <p>X8.3: FE</p>

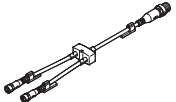
Data sheet – Input module, digital, PROFIsafe

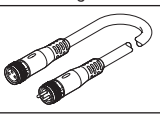
Combinations of interlinking blocks and PROFIsafe input module				
Interlinking blocks	Part no.	PROFIsafe input module CPX-F8DE-P		
CPX-M-GE-EV-S-7/8-5POL	550208			■
CPX-M-GE-EV-S-7/8-5POL-VL	8022165			■
CPX-M-GE-EV	550206			■
CPX-M-GE-EV-FVO	567806			–
CPX-M-GE-EV-Z-7/8-5POL	550210			■
CPX-M-GE-EV-Z-7/8-5POL-VL	8022158			■

Ordering data					
Description		Part no.	Type		
PROFIsafe input module					
	8 digital inputs, positive logic (PNP), for reliable detection and evaluation of input statuses		2597424	CPX-F8DE-P	
Connection block					
	Plastic	Spring-loaded terminal, 32-pin		195708	CPX-AB-8-KL-4POL
	Metal	4x socket M12, 5-pin	Unpulsed sensor supply	549367	CPX-M-AB-4-M12X2-5POL
Distributor					
	1x plug M12, 4-pin	2x socket M12, 5-pin		8005310	NEDY-L2R1-V1-M12G5-N-M12G4
	Modular system for all types of sensor/actuator distributor		–	NEDY-... → Internet: nedy	
Plug					
	M12, 4-pin	PG7, for cable \varnothing 4 ... 6 mm	18666	SEA-GS-7	
		PG7, for cable \varnothing 2.5 ... 2.9 mm	192008	SEA-4GS-7-2.5	
		PG9, for cable \varnothing 6 ... 8 mm	18778	SEA-GS-9	
		PG11, for 2x cable \varnothing 3 ... 5 mm	18779	SEA-GS-11-DUO	
	M12, 5-pin	PG7, for cable \varnothing 4 ... 6 mm	175487	SEA-M12-5GS-PG7	
		PG11, for 2x cable \varnothing 2.5 ... 5 mm	192010	SEA-5GS-11-DUO	
Connecting cable					
	Modular system for a choice of connecting cables		–	NEBU-... → Internet: nebu	
User documentation					
	User documentation for PROFIsafe input module		German	8035496	CPX-F8DE-P-DE
			English	8035497	CPX-F8DE-P-EN
			Spanish	8035498	CPX-F8DE-P-ES
			French	8035499	CPX-F8DE-P-FR
			Italian	8035500	CPX-F8DE-P-IT
			Chinese	8035501	CPX-F8DE-P-ZH

Data sheet – Output module, digital

Function

Digital outputs control actuators such as individual valves, hydraulic valves, heating controllers and many more. Separate circuits are created using an additional supply. Parallel connection of the outputs of a module enables consuming devices to be controlled with up to 4 A.

Area of application

- Output module for 24 V DC supply voltage
- PNP logic
- Module features can be parameterised
- The output module receives the voltage supply for the electronics and the outputs from the interlinking block
- Module protection and diagnostics through integrated electronic protection in each channel

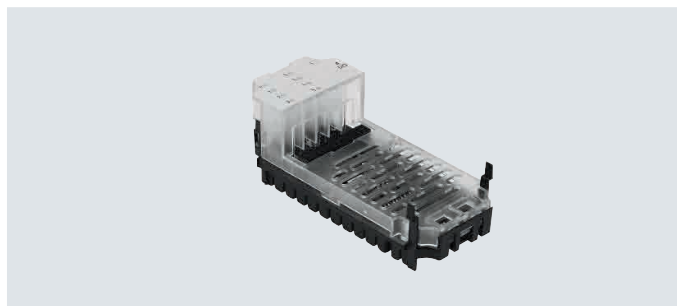

General technical data			CPX-4DA	CPX-8DA	CPX-8DA-H
Type					
Number of outputs			4	8	8
Max. power supply	Per module	[A]	4		8.4
	Per channel	[A]	1 (24 W lamp load, 4 channels can be connected in parallel)	0.5 (12 W lamp load, 8 channels can be connected in parallel)	2.1 (50 W lamp load), per channel pair
Fuse protection (short circuit)			Internal electronic fuse per channel		
Module current consumption (power supply for electronics)		[mA]	Typically 16		Typically 34
Operating voltage	Nominal value	[V DC]	24		
	Permissible range	[V DC]	18 ... 30		
Galvanic isolation	Channel – channel		No		
	Channel – internal bus		Yes, with intermediate supply		
Output characteristic			Based on IEC 1131-2		
Switching logic			Positive logic (PNP)		
LED displays	Group diagnostics		1	1	1
	Channel diagnostics		4	8	8
	Channel status		4	8	8
Diagnostics			<ul style="list-style-type: none"> • Short circuit/overload, channel x • Undervoltage of outputs 		
Parameterisation			<ul style="list-style-type: none"> • Module monitoring • Behaviour after short circuit • Fail-safe channel x • Forcing channel x • Idle mode channel x 		
Degree of protection to EN 60529			Depending on connection block		
Temperature range	Operation	[°C]	–5 ... +50		
	Storage/transport	[°C]	–20 ... +70		
Materials			PA-reinforced, PC		
PWIS conformity			VDMA24364-B2-L		
Grid dimension		[mm]	50		
Dimensions (including interlinking block and connection block) W x L x H		[mm]	50 x 107 x 50		
Product weight		[g]	42	49	48

Data sheet – Output module, digital

Connection and display components

CPX-4DA

CPX-8DA

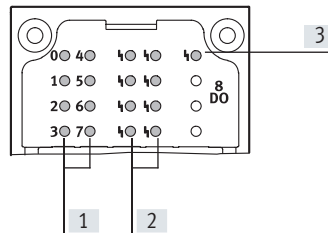
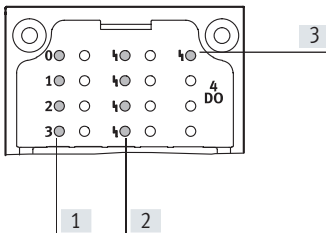

- [1] Status LEDs (yellow)
For allocation to outputs
→ Pin allocation for module
- [2] Channel-related error LEDs (red)
- [3] Error LED (red, module error)

Combinations of connection block and digital output module

Connection blocks	Part no.	Digital output module		
		CPX-4DA	CPX-8DA	CPX-8DA-H
CPX-AB-8-M8-3POL	195706	■	■	–
CPX-AB-8-M8X2-4POL	541256	■	■	■
CPX-AB-4-M12X2-5POL	195704	■	■	–
CPX-AB-4-M12X2-5POL-R	541254	■	■	■
CPX-AB-8-KL-4POL	195708	■	■	■
CPX-AB-1-SUB-BU-25POL	525676	■	■	■
CPX-M-AB-4-M12X2-5POL	549367	■	■	■

Pin allocation

Connection block outputs	CPX-4DA		CPX-8DA	
CPX-AB-8-M8-3POL				
X1 4 1 3	X1.1: n.c. X1.3: 0 V _{OUT} X1.4: Output x	X5 4 1 3	X5.1: n.c. X5.3: 0 V _{OUT} X5.4: Output x+2	X1.1: n.c. X1.3: 0 V _{OUT} X1.4: Output x
X2 4 1 3	X2.1: n.c. X2.3: 0 V _{OUT} X2.4: Output x+1	X6 4 1 3	X6.1: n.c. X6.3: 0 V _{OUT} X6.4: Output x+3	X5.1: n.c. X5.3: 0 V _{OUT} X5.4: Output x+4
X3 4 1 3	X3.1: n.c. X3.3: 0 V _{OUT} X3.4: Output x+1	X7 4 1 3	X7.1: n.c. X7.3: 0 V _{OUT} X7.4: Output x+3	X2.1: n.c. X2.3: 0 V _{OUT} X2.4: Output x+1
X4 4 1 3	X4.1: n.c. X4.3: 0 V _{OUT} X4.4: n.c.	X8 4 1 3	X8.1: n.c. X8.3: 0 V _{OUT} X8.4: n.c.	X3.1: n.c. X3.3: 0 V _{OUT} X3.4: Output x+2
				X4.1: n.c. X4.3: 0 V _{OUT} X4.4: Output x+3
				X5.1: n.c. X5.3: 0 V _{OUT} X5.4: Output x+5
				X6.1: n.c. X6.3: 0 V _{OUT} X6.4: Output x+5
				X7.1: n.c. X7.3: 0 V _{OUT} X7.4: Output x+6
				X8.1: n.c. X8.3: 0 V _{OUT} X8.4: Output x+7

Data sheet – Output module, digital





Pin allocation		CPX-4DA		CPX-8DA and CPX-8DA-H	
Connection block outputs		CPX-4DA		CPX-8DA and CPX-8DA-H	
CPX-AB-8-M8X2-4POL					
		X1.1: 0 V _{OUT} X1.2: Output x+1 X1.3: 0 V _{OUT} X1.4: Output x X2.1: 0 V _{OUT} X2.2: n.c. X2.3: 0 V _{OUT} X2.4: Output x+1 X3.1: 0 V _{OUT} X3.2: Output x+3 X3.3: 0 V _{OUT} X3.4: Output x+2 X4.1: 0 V _{OUT} X4.2: n.c. X4.3: 0 V _{OUT} X4.4: Output x+3	X5.1: 0 V _{OUT} X5.2: n.c. X5.3: 0 V _{OUT} X5.4: n.c. X6.1: 0 V _{OUT} X6.2: n.c. X6.3: 0 V _{OUT} X6.4: n.c. X7.1: 0 V _{OUT} X7.2: n.c. X7.3: 0 V _{OUT} X7.4: n.c. X8.1: 0 V _{OUT} x+1 X8.2: n.c. X8.3: 0 V _{OUT} x+3 X8.4: n.c.	X1.1: 0 V _{OUT} X1.2: Output x+1 X1.3: 0 V _{OUT} X1.4: Output x X2.1: 0 V _{OUT} X2.2: Output x+3 X2.3: 0 V _{OUT} X2.4: Output x+2 X3.1: 0 V _{OUT} X3.2: Output x+5 X3.3: 0 V _{OUT} X3.4: Output x+4 X4.1: 0 V _{OUT} X4.2: Output x+7 X4.3: 0 V _{OUT} X4.4: Output x+6	X5.1: 0 V _{OUT} X5.2: n.c. X5.3: 0 V _{OUT} X5.4: n.c. X6.1: 0 V _{OUT} X6.2: n.c. X6.3: 0 V _{OUT} X6.4: n.c. X7.1: 0 V _{OUT} X7.2: n.c. X7.3: 0 V _{OUT} X7.4: n.c. X8.1: 0 V _{OUT} X8.2: n.c. X8.3: 0 V _{OUT} X8.4: n.c.
CPX-AB-4-M12X2-5POL¹⁾ and CPX-AB-4-M12X2-5POL-R²⁾ and CPX-M-AB-4-M12X2-5POL					
		X1.1: n.c. X1.2: Output x+1 X1.3: 0 V _{OUT} X1.4: Output x X1.5: FE X2.1: n.c. X2.2: n.c. X2.3: 0 V _{OUT} X2.4: Output x+1 X2.5: FE	X3.1: n.c. X3.2: Output x+3 X3.3: 0 V _{OUT} X3.4: Output x+2 X3.5: FE X4.1: n.c. X4.2: n.c. X4.3: 0 V _{OUT} X4.4: Output x+3 X4.5: FE	X1.1: n.c. X1.2: Output x+1 X1.3: 0 V _{OUT} X1.4: Output x X1.5: FE X2.1: n.c. X2.2: Output x+3 X2.3: 0 V _{OUT} X2.4: Output x+2 X2.5: FE	X3.1: n.c. X3.2: Output x+5 X3.3: 0 V _{OUT} X3.4: Output x+4 X3.5: FE X4.1: n.c. X4.2: Output x+7 X4.3: 0 V _{OUT} X4.4: Output x+6 X4.5: FE
CPX-AB-8-KL-4POL					
		X1.0: n.c. X1.1: 0 V _{OUT} X1.2: Output x X1.3: FE X2.0: n.c. X2.1: 0 V _{OUT} X2.2: Output x+1 X2.3: FE X3.0: n.c. X3.1: 0 V _{OUT} X3.2: Output x+1 X3.3: FE X4.0: n.c. X4.1: 0 V _{OUT} X4.2: n.c. X4.3: FE	X5.0: n.c. X5.1: 0 V _{OUT} X5.2: Output x+2 X5.3: FE X6.0: n.c. X6.1: 0 V _{OUT} X6.2: Output x+3 X6.3: FE X7.0: n.c. X7.1: 0 V _{OUT} X7.2: Output x+3 X7.3: FE X8.0: n.c. X8.1: 0 V _{OUT} X8.2: n.c. X8.3: FE	X1.0: n.c. X1.1: 0 V _{OUT} X1.2: Output x X1.3: FE X2.0: n.c. X2.1: 0 V _{OUT} X2.2: Output x+1 X2.3: FE X3.0: n.c. X3.1: 0 V _{OUT} X3.2: Output x+2 X3.3: FE X4.0: n.c. X4.1: 0 V _{OUT} X4.2: Output x+3 X4.3: FE	X5.0: n.c. X5.1: 0 V _{OUT} X5.2: Output x+4 X5.3: FE X6.0: n.c. X6.1: 0 V _{OUT} X6.2: Output x+5 X6.3: FE X7.0: n.c. X7.1: 0 V _{OUT} X7.2: Output x+6 X7.3: FE X8.0: n.c. X8.1: 0 V _{OUT} X8.2: Output x+7 X8.3: FE

1) Not suitable for CPX-8DA-H.
 2) Speedcon quick lock, additional shielding on metal thread



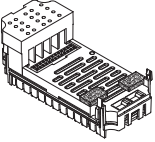
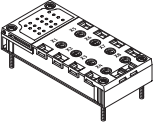

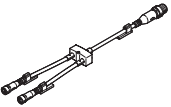
Data sheet – Output module, digital

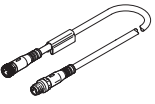
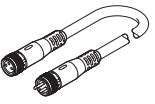
Pin allocation		CPX-4DA		CPX-8DA and CPX-8DA-H	
Connection block outputs		CPX-4DA		CPX-8DA and CPX-8DA-H	
CPX-AB-1-SUB-BU-25POL					
		1: Output x	14: Output x+2	1: Output x	14: Output x+4
		2: Output x+1	15: Output x+3	2: Output x+1	15: Output x+5
		3: Output x+1	16: Output x+3	3: Output x+2	16: Output x+6
		4: n.c.	17: n.c.	4: Output x+3	17: Output x+7
		5: n.c.	18: n.c.	5: n.c.	18: n.c.
		6: 0 V _{OUT}	19: n.c.	6: 0 V _{OUT}	19: n.c.
		7: n.c.	20: n.c.	7: n.c.	20: n.c.
		8: 0 V _{OUT}	21: n.c.	8: 0 V _{OUT}	21: n.c.
		9: n.c.	22: 0 V _{OUT}	9: n.c.	22: 0 V _{OUT}
		10: n.c.	23: 0 V _{OUT}	10: n.c.	23: 0 V _{OUT}
		11: 0 V _{OUT}	24: 0 V _{OUT}	11: 0 V _{OUT}	24: 0 V _{OUT}
		12: 0 V _{OUT}	25: FE	12: 0 V _{OUT}	25: FE
		13: FE	Housing: FE	13: FE	Housing: FE

Data sheet – Output module, digital

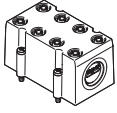
Ordering data				Part no.	Type
Designation					
Output module, digital					
	4 digital outputs, power supply 1 A per channel			195754	CPX-4DA
	8 digital outputs, power supply 0.5 A per channel			541482	CPX-8DA
	8 digital outputs, power supply 2.1 A per channel pair			550204	CPX-8DA-H
Connection block					
	Plastic	8x socket, M8, 3-pin		195706	CPX-AB-8-M8-3POL
		8x socket, M8, 4-pin		541256	CPX-AB-8-M8X2-4POL
		4x socket, M12, 5-pin		195704	CPX-AB-4-M12X2-5POL
		4x socket, M12, 5-pin with quick-lock technology		541254	CPX-AB-4-M12X2-5POL-R
		Spring-loaded terminal, 32-pin		195708	CPX-AB-8-KL-4POL
	Metal	1x Sub-D socket, 25-pin		525676	CPX-AB-1-SUB-BU-25POL
4x socket, M12, 5-pin		549367	CPX-M-AB-4-M12X2-5POL		
Distributor					
	1x plug M8, 4-pin		2x socket M8, 3-pin	8005312	NEDY-L2R1-V1-M8G3-N-M8G4
	1x plug M12, 4-pin		2x socket M8, 3-pin	8005311	NEDY-L2R1-V1-M8G3-N-M12G4
			2x socket M12, 5-pin	8005310	NEDY-L2R1-V1-M12G5-N-M12G4
	Modular system for all types of sensor/actuator distributor			–	NEDY-... → Internet: nedy
Plug					
	M8, 3-pin	Solderable		18696	SEA-GS-M8
		Screw-in		192009	SEA-3GS-M8-S
		Insulation displacement connector	0.1 ... 0.14 mm ²	564945	NECU-S-M8G3-HX-Q3
			0.14 ... 0.34 mm ²	562024	NECU-S-M8G3-HX
	M12, 4-pin	PG7, for cable ø 4 ... 6 mm		18666	SEA-GS-7
		PG7, for cable ø 2.5 ... 2.9 mm		192008	SEA-4GS-7-2.5
		PG9, for cable ø 6 ... 8 mm		18778	SEA-GS-9
		PG11, for 2x cable ø 3 ... 5 mm		18779	SEA-GS-11-DUO
M12, 5-pin	PG7, for cable ø 4 ... 6 mm		175487	SEA-M12-5GS-PG7	
	PG11, for 2x cable ø 2.5 ... 5 mm		192010	SEA-5GS-11-DUO	
	Sub-D, 25-pin		527522	SD-SUB-D-ST25	
Connecting cable					
	1x socket M8, 3-pin	1x plug M8, 3-pin	0.5 m	541346	NEBU-M8G3-K-0.5-M8G3
			1.0 m	541347	NEBU-M8G3-K-1-M8G3
			2.5 m	541348	NEBU-M8G3-K-2.5-M8G3
			5.0 m	541349	NEBU-M8G3-K-5-M8G3
	Modular system for a choice of connecting cables			–	NEBU-... → Internet: nebu

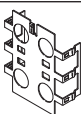
Data sheet – Output module, digital

Ordering data		Part no.	Type
Designation			
Cover			
	Cover for CPX-AB-8-KL-4POL (IP65/67)	<ul style="list-style-type: none"> 8 cable through feeds M9 1 cable through feed for multi-pin plug 	538219 AK-8KL
	Fittings kit, cover for AK-8KL		538220 VG-K-M9
	Cover cap for closing off unused connections (10 pieces)	For M8 connections	177672 ISK-M8
		For M12 connections	165592 ISK-M12
Screening plate			
	Screening plate for connection block <ul style="list-style-type: none"> CPX-AB-4-M12X2-5POL CPX-AB-4-M12X2-5POL-R 	526184	CPX-AB-S-4-M12
User documentation			
	User documentation	German	526439 P.BE-CPX-EA-DE
		English	526440 P.BE-CPX-EA-EN
		Spanish	526441 P.BE-CPX-EA-ES
		French	526442 P.BE-CPX-EA-FR
		Italian	526443 P.BE-CPX-EA-IT

Data sheet – Input/output module, digital

Area of application

- Digital multi I/O module for 24 V DC supply voltage
- Supports connection blocks with Sub-D, terminal connection and M12 connection (8-pin)
- Module features can be parameterised
- The inputs receive the voltage supply for the electronics and the sensors from the interlinking block
- The outputs receive the voltage supply for the electronics and the outputs from the interlinking block
- Module protection and diagnostics through integrated electronic fuse protection for the sensor power supply and integrated electronic fuse protection in each output channel

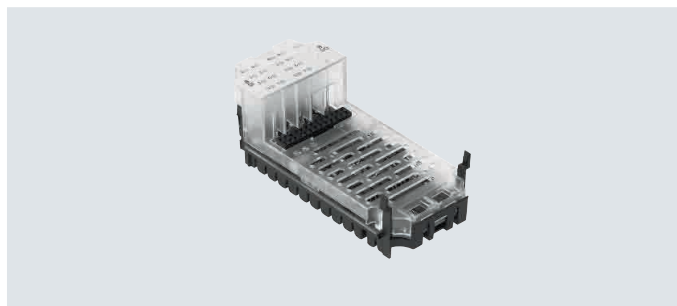

General technical data			CPX-8DE-8DA
Type			CPX-8DE-8DA
Number	Inputs		8
	Outputs		8
Max. power supply Per module	Sensor supply	[A]	0.7
	Outputs	[A]	4
Max. power supply per channel		[A]	0.5 (12 W lamp load, channels A0 ... A03 can be connected in parallel to A4 ... A7)
Fuse protection (short circuit)			Internal electronic fuse per channel
Intrinsic current consumption at nominal operating voltage		[mA]	Typically 22
Operating voltage	Nominal value	[V DC]	24
	Permissible range	[V DC]	18 ... 30
Galvanic isolation, inputs	Channel – channel		No
	Channel – internal bus		No
Galvanic isolation, outputs	Channel – channel		No
	Channel – internal bus		Yes, with intermediate supply
Characteristic curve	Inputs		IEC 1131-T2
	Outputs		IEC 1131-T2
Switching level, inputs	Signal 0	[V DC]	≤ 5
	Signal 1	[V DC]	≥ 11
Input debounce time		[ms]	3 (0.1 ms, 10 ms, 20 ms parameterisable)
Switching logic			Positive logic (PNP)
LED displays	Group diagnostics		1
	Channel status		16
Diagnostics			<ul style="list-style-type: none"> • Short circuit/overload per channel • Undervoltage of outputs
Parameterisation			<ul style="list-style-type: none"> • Input debounce time • Failsafe per channel • Forcing per channel • Idle mode per channel • Signal extension time • Module monitoring • Behaviour after short circuit
Degree of protection to EN 60529			Depending on connection block
Temperature range	Operation	[°C]	-5 ... +50
	Storage/transport	[°C]	-20 ... +70
Materials			PA-reinforced, PC
PWIS conformity			VDMA24364-B2-L
Grid dimension		[mm]	50
Dimensions (including interlinking block and connection block) W x L x H		[mm]	50 x 107 x 50
Product weight		[g]	48

Data sheet – Input/output module, digital

Connection and display components

CPX-8DE-8DA

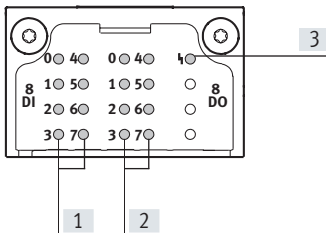

- [1] Status LEDs (green)
For allocation to inputs
→ Pin allocation for module
- [2] Status LEDs (yellow)
For allocation to outputs
→ Pin allocation for module

- [3] Error LED (red, module error)

Connection block/digital I/O module combinations

Connection blocks	Part no.	Digital I/O module
		CPX-8DE-8DA
CPX-AB-4-M12-8POL	526178	■
CPX-AB-8-KL-4POL	195708	■
CPX-AB-1-SUB-BU-25POL	525676	■

Pin allocation

Connection block inputs/outputs

CPX-8DE-8DA

CPX-AB-4-M12-8POL

	<p>X1.1: 24 V_{SEN}</p> <p>X1.2: Input x</p> <p>X1.3: Input x+1</p> <p>X1.4: 0 V_{SEN}</p> <p>X1.5: Output x</p> <p>X1.6: Output x+1</p> <p>X1.7: Input x+4</p> <p>X1.8: 0 V_{OUT}</p> <p>X2.1: 24 V_{SEN}</p> <p>X2.2: Input x+2</p> <p>X2.3: Input x+3</p> <p>X2.4: 0 V_{SEN}</p> <p>X2.5: Output x+2</p> <p>X2.6: Output x+3</p> <p>X2.7: Input x+6</p> <p>X2.8: 0 V_{OUT}</p>	<p>X3.1: 24 V_{SEN}</p> <p>X3.2: Input x+4</p> <p>X3.3: Input x+5</p> <p>X3.4: 0 V_{SEN}</p> <p>X3.5: Output x+4</p> <p>X3.6: Output x+5</p> <p>X3.7: n.c.</p> <p>X3.8: 0 V_{OUT}</p> <p>X4.1: 24 V_{SEN}</p> <p>X4.2: Input x+6</p> <p>X4.3: Input x+7</p> <p>X4.4: 0 V_{SEN}</p> <p>X4.5: Output x+6</p> <p>X4.6: Output x+7</p> <p>X4.7: n.c.</p> <p>X4.8: 0 V_{OUT}</p>
--	---	---

Data sheet – Input/output module, digital

Pin allocation		CPX-8DE-8DA	
CPX-AB-8-KL-4POL			
	<p>X1.0: 24 V_{SEN} X1.1: 0 V_{SEN} X1.2: Input x X1.3: FE</p> <p>X2.0: Input x+4 X2.1: Input x+5 X2.2: Input x+1 X2.3: FE</p> <p>X3.0: 24 V_{SEN} X3.1: 0 V_{SEN} X3.2: Input x+2 X3.3: FE</p> <p>X4.0: Input x+6 X4.1: Input x+7 X4.2: Input x+3 X4.3: FE</p>	<p>X5.0: Output x+4 X5.1: 0 V_{OUT} X5.2: Output x X5.3: FE</p> <p>X6.0: Output x+5 X6.1: 0 V_{OUT} X6.2: Output x+1 X6.3: FE</p> <p>X7.0: Output x+6 X7.1: 0 V_{OUT} X7.2: Output x+2 X7.3: FE</p> <p>X8.0: Output x+7 X8.1: 0 V_{OUT} X8.2: Output x+3 X8.3: FE</p>	
CPX-AB-1-SUB-BU-25POL			
	<p>0V Valves 24V Valves 0V Output 24V Output 0V El./Sen. 24V El./Sen. FE</p>	<p>1: Input x 2: Input x+1 3: Input x+2 4: Input x+3 5: Input x+4 6: Input x+5 7: Input x+6 8: Input x+7 9: 24 V_{SEN} 10: 24 V_{SEN} 11: 0 V_{SEN} 12: 0 V_{SEN} 13: FE</p>	<p>14: Output x 15: Output x+1 16: Output x+2 17: Output x+3 18: Output x+4 19: Output x+5 20: Output x+6 21: Output x+7 22: 0 V_{OUT} 23: 0 V_{OUT} 24: 0 V_{OUT} 25: FE Housing: FE</p>

Data sheet – Input/output module, digital

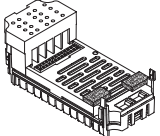
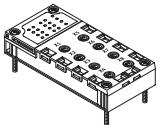
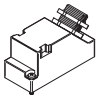
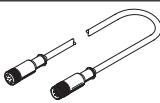
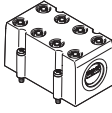
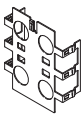
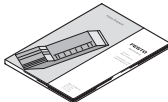
Ordering data		Part no.	Type
Designation			
Input/output module, digital			
	8 digital inputs, 8 digital outputs	526257	CPX-8DE-8DA
Connection block			
	Plastic	4x socket M12, 8-pin	526178 CPX-AB-4-M12-8POL
		Spring-loaded terminal, 32-pin	195708 CPX-AB-8-KL-4POL
		1x socket, Sub-D, 25-pin	525676 CPX-AB-1-SUB-BU-25POL
Plug			
	Sub-D, 25-pin	527522	SD-SUB-D-ST25
Connecting cable			
	Connecting cable M12	525617	KM12-8GD8GS-2-PU
Cover			
	Cover for CPX-AB-8-KL-4POL (IP65, IP67)	<ul style="list-style-type: none"> • 8 cable through feeds M9 • 1 cable through feed for multi-pin plug 	538219 AK-8KL
	Fittings kit		538220 VG-K-M9
Screening plate			
	Screening plate for M12 connections	526184	CPX-AB-S-4-M12
User documentation			
	User documentation	German	526439 P.BE-CPX-EA-DE
		English	526440 P.BE-CPX-EA-EN
		Spanish	526441 P.BE-CPX-EA-ES
		French	526442 P.BE-CPX-EA-FR
		Italian	526443 P.BE-CPX-EA-IT

Data sheet – Counter module, digital

Function

The counter module has two channels. Depending on the parameterisation, these can independently be used as counter inputs or as incremental value encoder inputs or SSI. The counter module additionally has one output per channel. The outputs can either be controlled by a counter channel or an incremental value encoder channel, i.e. through an event such as "Comparative value reached". Alternatively, outputs can also be controlled via process data.

Area of application

- Continuous counting
- One-off counting to count limit
- One-off counting to count limit, return to load value
- Periodic counting
- Measurement of frequencies
- Measurement of rotational speeds
- Measurement of duty cycle
- Measurement of position
- Measurement of speed
- Measuring with pulse generators
- Measurement with pulse generators and direction encoders
- Measurement with incremental encoders
- Measurement with SSI absolute encoders

**Description****Applications**

- | | | |
|---|---|---|
| <ul style="list-style-type: none"> • Recording travel and speed of a conveyor • Position and speed synchronisation of conveyors and pick & place applications • Counting goods e.g. in packaging installations | <ul style="list-style-type: none"> • Systems for filling by weight and volume • Monitoring motor speeds • Measuring equipment for determining the position of axis systems (linear, rotational) • Controlling fast-switching valves | <ul style="list-style-type: none"> • Controlling the opening time of a valve • Activating semiconductor relays • Temperature monitoring and rotational speed control for drives • Change of direction in fast drives • Control of motors with pulse-width modulation (PWM) |
|---|---|---|

Supported devices

- | | | | |
|---|--|--|--|
| <ul style="list-style-type: none"> • 5 V incremental encoder, single-ended or differential, with two 90° phase offset tracks | <ul style="list-style-type: none"> • 24 V incremental encoder, single-ended, with two 90° phase offset tracks | <ul style="list-style-type: none"> • 24 V pulse generator with or without direction level • 24 V direct current motors | <ul style="list-style-type: none"> • Absolute encoder with SSI interface (13 bits to 25 bits) |
|---|--|--|--|

Data sheet – Counter module, digital

General technical data			
Type	CPX-2ZE2DA		
Number	Inputs		2
	Outputs		2
Max. power supply Per module	Inputs	[A]	2
	Outputs	[A]	10
Max. power supply per channel		[A]	5 (adjustable, 20 W lamp load)
Max. cable length		[m]	30
Fuse protection (short circuit)	Internal electronic fuse per channel		
Intrinsic current consumption at nominal operating voltage		[mA]	Typically 35
Operating voltage	Nominal value	[V DC]	24
	Permissible range	[V DC]	18 ... 30
Galvanic isolation, inputs	Channel – channel		No
	Channel – internal bus		No
Galvanic isolation, outputs	Channel – channel		No
	Channel – internal bus		Yes, if an intermediate supply is used
Characteristic curve	Inputs		To IEC 1131-2, type 2
	Outputs		IEC 1131-T2
Switching level	Signal 0	[V DC]	≤ 5
	Signal 1	[V DC]	≥ 11
Input debounce time		[μs]	0.1 (0.2 μs, 0.4 μs, 0.8 μs, 1 μs, 2 μs, 4 μs, 8 μs, 10 μs, 50 μs, 100 μs, 500 μs, 1 ms, 3 ms, 10 ms, 20 ms parameterisable)
Switching logic	Inputs		Positive logic (PNP)
	Outputs		<ul style="list-style-type: none"> • Negative logic (NPN) • Positive logic (PNP) • Push-pull driver
LED displays	Group diagnostics		1
	Channel diagnostics		2
	Channel status		10
	Module diagnostics		2
Diagnostics	Operating mode-dependent diagnostics		
Parameterisation	<ul style="list-style-type: none"> • Switch-on/off delay • Frequency output • Speed measurement • Impulse output • Pulse train • Rotational speed measurement • Frequency measurement • Period duration measurement • Motor operating mode • Determine position • Pulse width modulation • One-off counting • Continuous counting • Periodic counting 		
Degree of protection to EN 60529	IP65, IP67		
Temperature range	Operation	[°C]	-5 ... +50
	Storage/transport	[°C]	-20 ... +70
Certification	UL – Recognized (OL)		
Information on materials: Housing	Plastic		
Note on materials	RoHS-compliant		
PWIS conformity	VDMA24364-B2-L		
Grid dimension		[mm]	50
Dimensions (including interlinking block and connection block) W x L x H		[mm]	50 x 107 x 50
Product weight		[g]	130

Data sheet – Counter module, digital

Connection and display components

CPX-2ZE2DA

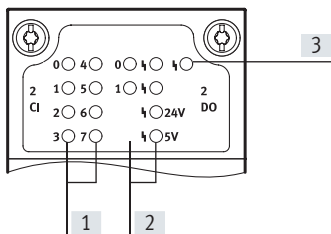

- [1] Status LEDs (green)
For allocation to inputs
→ Pin allocation for module
- [2] Status LEDs (yellow, red)
For allocation to outputs
→ Pin allocation for module
- [3] Error LED (red, module error)

Pin allocation

Inputs/outputs

CPX-2ZE2DA

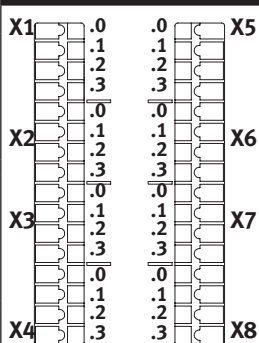

Channel 0

- X1.0: Input
- X1.1: Input
- X1.2: Input
- X1.3: Input
- X2.0: Input
- X2.1: Input
- X2.2: 5 V DC
- X2.3: 0 V
- X3.0: 24 V DC
- X3.1: 0 V
- X3.2: 24 V DC for digital input DI
- X3.3: Digital input DI
- X4.0: 0 V for digital input DI
- X4.1: Digital output DO
- X4.2: Reference potential for DO
- X4.3: FE



Duct 1

- X5.0: Input
- X5.1: Input
- X5.2: Input
- X5.3: Input
- X6.0: Input
- X6.1: Input
- X6.2: 5 V DC
- X6.3: 0 V
- X7.0: 24 V DC
- X7.1: 0 V
- X7.2: 24 V DC for digital input DI
- X7.3: Digital input DI
- X8.0: 0 V for digital input DI
- X8.1: Digital output DO
- X8.2: Reference potential for DO
- X8.3: FE

Note

The allocation and designation of inputs differs fundamentally depending on which type of encoder is connected. Appropriate allocation diagrams can be found in the user documentation for the counter module.

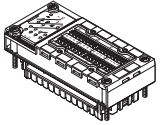
Data sheet – Counter module, digital

Ordering data		Part no.	Type
Designation			
Counter module, digital			
	2 digital inputs, 2 digital outputs	576046	CPX-2ZE2DA
User documentation			
	User documentation for counter module CPX-2ZE2DA	German	8035733 P.BE-CPX-2ZE2DA-DE
		English	8035734 P.BE-CPX-2ZE2DA-EN
		Spanish	8035735 P.BE-CPX-2ZE2DA-ES
		French	8035736 P.BE-CPX-2ZE2DA-FR
		Italian	8035737 P.BE-CPX-2ZE2DA-IT
		Chinese	8035738 P.BE-CPX-2ZE2DA-ZH

Data sheet – HART input/output module

Function

The HART input/output module allows the connection of up to 4 sensors or actuators. The corresponding communication channel is made available for sensors or actuators that communicate using the HART protocol.

With the HART protocol, a conventional analogue 4 ... 20 mA current signal is modulated by a second frequency-modulated signal.

Each of the 4 connections of the module can be configured as inputs or outputs.

Area of application

- Multi I/O module for 24 V DC supply voltage
- Supports connection blocks with M12 and terminal connection
- Module features can be parameterised
- The module receives the voltage supply for the electronics, outputs and the sensors from the interlinking block
- Module protection and diagnostics through integrated electronic protection

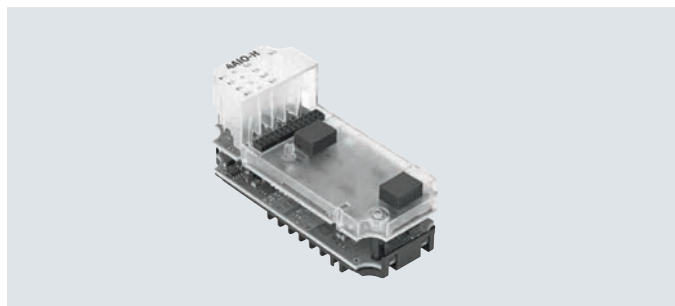

General technical data		CPX-4AE-4AA-H		
Type				
Protocol	HART			
Number of selectable analogue inputs/outputs	4			
Type of sensor	0 ... 20 mA		4 ... 20 mA	
Operating voltage	Nominal value	[V DC]	24	
	Permissible range	[V DC]	18 ... 30	
Power failure buffering	[ms]	10		
Intrinsic current consumption at nominal operating voltage	[mA]	Typically 170		
Maximum short circuit current	[mA]	22		
Maximum open circuit voltage	[V]	28.8		
Minimum available sensor voltage	20.7 V DC at 20 mA			
Fuse protection (short circuit)	Internal electronic fuse per channel			
Reverse polarity protection	For all electrical connections			
Galvanic isolation	Channel – channel	No		
	Channel – internal bus	Yes		
Signal range	0 ... 20 mA		4 ... 20 mA	
Data format	15 bits + prefix			
	Scalable to 15 bits			
Maximum load	[Ω]	750		
Maximum input resistance	[Ω]	300		
Maximum cable length	[m]	500		
Basic error limit at 25°C	[%]	±0.1		
Operating error limit related to the ambient temperature range	[%]	±0.3		
Repetition accuracy	0.05% at 20°C			
LED displays	Group diagnostics	1		
	Channel diagnostics	4		
	Channel status	4		
Control elements	DIL switch			
Diagnostics	<ul style="list-style-type: none"> • Wire break per channel • Limit value violation per channel • Short circuit/overload per channel • Parameterisation error • Overflow/underflow • Limit value violation to NE43 per channel 			

Data sheet – HART input/output module

General technical data	
Parameterisation	<ul style="list-style-type: none"> • Data format • Failsafe per channel • Forcing per channel • Limit value monitoring per channel • Idle mode per channel • Measured value smoothing • Signal range per channel • Monitoring overflow/underflow • Monitoring to NE43, inputs • Monitoring of wire break per channel • Wire break per channel • Limit value violation per channel • Short circuit/overload per channel • Parameterisation error • Overflow/underflow • Limit value violation to NE43 per channel • Number of HART repetitions • Hysteresis for limit values • HART variables (4 pieces) • Behaviour after short circuit/overload
Degree of protection to EN 60529	Depending on connection block

Technical data – Mechanical components	
Type of mounting	On interlinking block
Product weight [g]	77.4
Grid dimension [mm]	50
Dimensions (including interlinking block and connection block) W x L x H [mm]	50 x 107 x 70

Materials	
Housing	PA-reinforced, PC
Note on materials	RoHS-compliant
PWIS conformity	VDMA24364-B2-L

Operating and environmental conditions	
Ambient temperature [°C]	-5 ... +50
Storage temperature [°C]	-20 ... +70
Relative humidity [%]	95, non-condensing
Corrosion resistance class CRC ¹⁾	1 (when installed)
CE marking (see declaration of conformity) ³⁾	To EU EMC Directive ²⁾

1) More information: www.festo.com/x/topic/kbk

2) For information about the area of use, see the EC declaration of conformity at: www.festo.com/catalogue/... → Support/Downloads.

If the devices are subject to usage restrictions in residential, commercial or light-industrial environments, further measures for the reduction of the emitted interference may be necessary.

3) Additional information: www.festo.com/catalogue/... → Support/Downloads.

Safety characteristics	
Shock resistance	Shock test with severity level 2 to FN 942017-5 and EN 60068-2-27
Vibration resistance	Transport application test with severity level 2 to FN 942017-4 and EN 60068-2-6

Data sheet – HART input/output module

Connection and display components

CPX-4EA-4AA-H

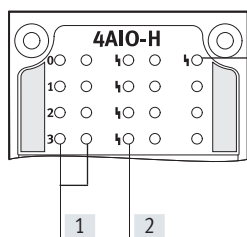

- [1] Status LEDs:
 - Inputs (green)
 - Outputs (yellow)
 - Pin allocation for module
- [2] Error LEDs (red)
 - Allocation to inputs/outputs
 - Pin allocation for module
- [3] Error LED (red, module error)

Combinations of bus nodes/control blocks with HART input/output module

Bus node/control block	Part no.	Protocol	Can be combined as of release	HART variables in process image only	Full HART functionality
CPX-CEC-C1-V3	3473128	CODESYS Level 2	3.5.12.174	–	■
CPX-CEC-M1-V3	3472765	CODESYS Level 2	3.5.12.174	–	■
CPX-CEC-S1-V3	3472425	CODESYS Level 2	3.5.12.174	–	■
CPX-FB11	526172	DeviceNet	25	■	–
CPX-FB13	195740	PROFIBUS	34	–	■
CPX-FB14	526174	CANopen	30	■	–
CPX-FB33	548755	PROFINET RT, M12	33	–	■
CPX-M-FB34	548751	PROFINET RT, RJ45	33	–	■
CPX-M-FB35	548749	PROFINET RT, SCRJ	33	–	■
CPX-FB36	1912451	EtherNet/IP	15	–	■
CPX-FB37	2735960	EtherCAT	7	■	–
CPX-FB43	8110369	PROFINET RT, M12	45	–	■
CPX-M-FB44	8110370	PROFINET RT, RJ45	45	–	■
CPX-M-FB45	8110371	PROFINET RT, SCRJ	45	–	■

Combinations of connection blocks with HART input/output module

Connection blocks	Part no.	HART input/output module
		CPX-4EA-4AA-H
CPX-P-AB-4XM12-4POL	565706	■
CPX-P-AB-2XKL-8POL	565704	■





Data sheet – HART input/output module

Pin allocation		CPX-4AE-4AA-H			
Connection block inputs/outputs		Inputs		Outputs	
CPX-P-AB-4XM12-4POL					
		X1.1: $24 V_{SEN\ x}$ X1.2: 0 V X1.3: Input x X1.4: 0 V	X3.1: $24 V_{SEN\ x+2}$ X3.2: 0 V X3.3: Input x+2 X3.4: 0 V	X1.1: Output I0+ X1.2: 0 V X1.3: – X1.4: 0 V	X3.1: Output I2+ X3.2: 0 V X3.3: – X3.4: 0 V
		X2.1: $24 V_{SEN\ x+1}$ X2.2: 0 V X2.3: Input x+1 X2.4: 0 V	X4.1: $24 V_{SEN\ x+3}$ X4.2: 0 V X4.3: Input x+3 X4.4: 0 V	X2.1: Output I1+ X2.2: 0 V X2.3: – X2.4: 0 V	X4.1: Output I3+ X4.2: 0 V X4.3: – X4.4: 0 V
CPX-P-AB-2XKL-8POL					
		X1.1: $24 V_{SEN\ x}$ X1.2: 0 V X1.3: Input x X1.4: 0 V	X2.1: $24 V_{SEN\ x+2}$ X2.2: 0 V X2.3: Input x+2 X2.4: 0 V	X1.1: Output I0+ X1.2: 0 V X1.3: – X1.4: 0 V	X2.1: Output I2+ X2.2: 0 V X2.3: – X2.4: 0 V
		X1.5: $24 V_{SEN\ x+1}$ X1.6: 0 V X1.7: Input x+1 X1.8: 0 V	X2.5: $24 V_{SEN\ x+3}$ X2.6: 0 V X2.7: Input x+3 X2.8: 0 V	X1.5: Output I1+ X1.6: 0 V X1.7: – X1.8: 0 V	X2.5: Output I3+ X2.6: 0 V X2.7: – X2.8: 0 V

 **Note**

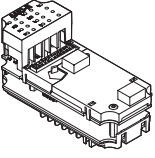
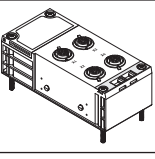
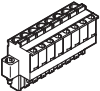
In the case of mixed operation of inputs and outputs in one module, the connections are first assigned input signals and then output signals, in ascending order.

Data sheet – HART input/output module

Ordering data				Part no.	Type
Designation					
HART input/output module					
	4 analogue inputs/outputs			8059847	CPX-4AE-4AA-H
Connection block					
	Plastic	4x socket, M12, 4-pin		565706	CPX-P-AB-4XM12-4POL
		2x plug, 8-pin		565704	CPX-P-AB-2XKL-8POL
Plugs					
	8-pin socket	Spring-loaded terminal	Connection cross section 0.2 ... 2.5 mm ²	565712	NECU-L3G8-C1
		Screw terminal	Connection cross section 0.2 ... 2.5 mm ²	565710	NECU-L3G8-C2
	Plug M12x1, 4-pin, straight, A-coded	Screw terminal	Connection cross section 0.14 ... 0.5 mm ²	192008	SEA-4GS-7-2.5
			Nominal conductor cross section 0.14 ... 0.75 mm ²	18666	SEA-GS-7
			Permissible cable \varnothing 4 ... 6 mm	18778	SEA-GS-9
Cover					
	Cover cap for sealing unused connections M12x1 (10 pieces)			165592	ISK-M12
Coding element					
	To ensure that a coded socket NECU-L3G8 can only be inserted in the matching coded connection block CPX-P-AB-2XKL (96 of each)		For NECU-L3G8	565713	CPX-P-KDS-AB-2XKL

Data sheet – Input module, analogue

Function

Analogue modules control devices with a standardised analogue interface such as pressure switches, temperature, flow rate, filling level, etc. Depending on the connection block selected, the analogue module supports various connection concepts with different numbers of sockets or terminals.

Area of application

- Analogue module for 0 ... 10 V, 0 ... 20 mA or 4 ... 20 mA
- Supports connection blocks with Sub-D, terminal connection and M12 connection
- Analogue module features can be parameterised
- Different data formats available
- Operation with and without galvanic isolation possible
- The analogue module receives the voltage supply for the electronics and the sensors from the interlinking block
- Analogue module protection and diagnostics through integrated electronic fuse protection

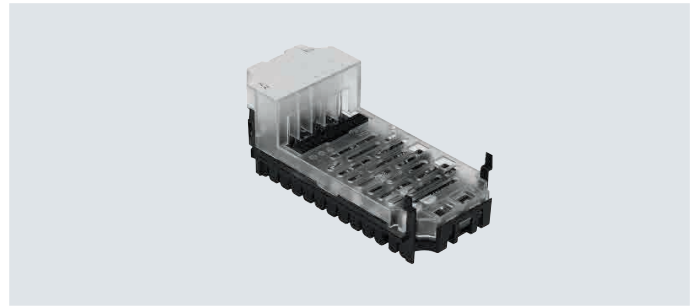

General technical data		CPX-2AE-U-I		CPX-4AE-U-I		CPX-4AE-I
		Voltage input	Current input	Voltage input	Current input	Current input
Type						
Number of analogue inputs		2		4		4
Max. power supply per module	[A]	0.7				
Fuse protection		Internal electronic fuse				
Current consumption from 24 V sensor supply (quiescent current)	[mA]	Typically 50				
Current consumption from 24 V sensor supply (at full load)	[A]	Max. 0.7				
Nominal operating voltage for load voltage	[V DC]	24 ±2%				
Nominal operating voltage	[V DC]	24				
Operating voltage range	[V DC]	18 ... 30				
Signal range (parameterisable for each channel with DIL switch or software)		0 ... 10 V	0 ... 20 mA 4 ... 20 mA	1 ... 5 V 0 ... 10 V -5 ... +5 V -10 ... +10 V	0 ... 20 mA 4 ... 20 mA -20 ... +20 mA	0 ... 20 mA 4 ... 20 mA
Operational error limit	[%]	±0.5	–	±0.3	±0.3	±0.6
Basic error limit (at 25°C)	[%]	±0.3	–	±0.2	±0.2	±0.5
Repetition accuracy (at 25°C)	[%]	0.15	0.15	0.1	0.1	0.15
Input resistance		100 kΩ	≤ 100 Ω	100 kΩ	≤ 100 Ω	≤ 100 Ω
Max. permissible input voltage	[V DC]	30	–	-30 ... +30	–	–
Max. permissible input current	[mA]	–	40	–	Internally limited to 60	40
Conversion time per channel	[μs]	Typically 150				
Cycle time (module)	[ms]	≤ 4		≤ 0.5		≤ 10
Data format		12 bits + prefix Scalable to 15 bits		15 bits + prefix Scalable to 15 bits		12 bits + prefix Scalable to 15 bits
Cable length	[m]	Max. 30 (shielded)				

Data sheet – Input module, analogue

General technical data		CPX-2AE-U-I	CPX-4AE-U-I	CPX-4AE-I	
Galvanic isolation	Channel – channel	No			
	Channel – internal bus	Yes, with external sensor supply			
LED displays	Group diagnostics	1			
	Channel diagnostics	Via flashing frequency of group diagnostics	4	Via flashing frequency of group diagnostics	
Diagnostics	Wire break per channel				
	Limit value violation per channel				
	Parameterisation error				
	Short circuit, input signal	Overload at input	Short circuit, input signal		
	–	Overflow/underflow	–		
	–	Short circuit in sensor supply	–		
Parameterisation	Data format				
	Forcing per channel				
	Limit value monitoring per channel				
	Measured value smoothing				
	Signal range per channel				
	Monitoring of wire break per channel				
	Behaviour after short circuit				
	–	Behaviour after overload at input	–		
	–	Sensor supply active	–		
	Degree of protection to EN 60529				
Depending on connection block					
Temperature range	Operation	[°C]	–5 ... +50		
	Storage/transport	[°C]	–20 ... +70		
Materials		PA-reinforced, PC			
Note on materials		–	RoHS-compliant	–	
PWIS conformity		VDMA24364-B2-L	VDMA24364-B2-L	VDMA24364-B2-L	
Grid dimension		[mm]	50		
Dimensions (including interlinking block and connection block) W x L x H		[mm]	50 x 107 x 50		
Product weight		[g]	48	46	47

Data sheet – Input module, analogue

Connection and display components

CPX-2AE-U-I and CPX-4AE-I

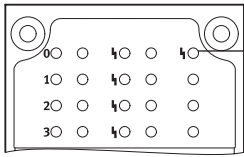

1 [1] Error LED (red; module error)

CPX-4AE-U-I

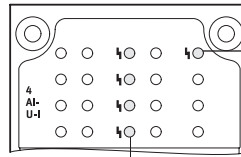

1 [1] Error LED (red; module error)
2 [2] Channel-related error LEDs (red)

Combinations of connection blocks and analogue module

Connection blocks	Part no.	Analogue module		
		CPX-2AE-U-I	CPX-4AE-U-I	CPX-4AE-I
CPX-AB-4-M12X2-5POL	195704	■	■	■
CPX-AB-4-M12X2-5POL-R	541254	■	■	■
CPX-AB-8-KL-4POL	195708	■	■	■
CPX-AB-1-SUB-BU-25POL	525676	■	■	■
CPX-M-AB-4-M12X2-5POL	549367	■	■	■

Pin allocation

Connection block inputs	CPX-2AE-U-I	CPX-4AE-U-I	CPX-4AE-I
-------------------------	-------------	-------------	-----------

CPX-AB-4-M12X2-5POL, CPX-AB-4-M12X2-5POL-R¹⁾ and CPX-M-AB-4-M12X2-5POL

Diagram	CPX-2AE-U-I	CPX-4AE-U-I	CPX-4AE-I
<p>X 1 X 3</p>	X1.1: 24 V _{SEN}	X3.1: 24 V _{SEN}	X1.1: 24 V _{SEN}
	X1.2: Input U0+	X3.2: Input U1+	X1.2: Input I0+
<p>X 2 X 4</p>	X1.3: 0 V _{SEN}	X3.3: 0 V _{SEN}	X1.3: 0 V _{SEN}
	X1.4: Input U0-	X3.4: Input U1-	X1.4: Input I0-
	X1.5: FE ²⁾	X3.5: FE ²⁾	X1.5: FE ²⁾
	X2.1: 24 V _{SEN}	X4.1: 24 V _{SEN}	X2.1: 24 V _{SEN}
	X2.2: Input I0+	X4.2: Input I1+	X2.2: Input I1+
	X2.3: 0 V _{SEN}	X4.3: 0 V _{SEN}	X2.3: 0 V _{SEN}
	X2.4: Input I0-	X4.4: Input I1-	X2.4: Input I1-
	X2.5: FE ²⁾	X4.5: FE ²⁾	X2.5: FE ²⁾

CPX-AB-8-KL-4POL

Diagram	CPX-2AE-U-I	CPX-4AE-U-I	CPX-4AE-I
<p>X1 .0 .0 X5 .1 .1 .2 .2 .3 .3 X2 .0 .0 X6 .1 .1 .2 .2 .3 .3 .0 .0 X3 .1 .1 X7 .2 .2 .3 .3 .0 .0 X4 .1 .1 X8 .2 .2 .3 .3</p>	X1.0: 24 V _{SEN}	X5.0: 24 V _{SEN}	X1.0: 24 V _{SEN}
	X1.1: 0 V _{SEN}	X5.1: 0 V _{SEN}	X1.1: 0 V _{SEN}
	X1.2: Input U0-	X5.2: Input U1-	X1.2: Input I0-
	X1.3: FE	X5.3: FE	X1.3: FE
	X2.0: n.c.	X6.0: n.c.	X2.0: n.c.
	X2.1: n.c.	X6.1: n.c.	X2.1: n.c.
	X2.2: Input U0+	X6.2: Input U1+	X2.2: Input I0+
	X2.3: FE	X6.3: FE	X2.3: FE
	X3.0: 24 V _{SEN}	X7.0: 24 V _{SEN}	X3.0: 24 V _{SEN}
	X3.1: 0 V _{SEN}	X7.1: 0 V _{SEN}	X3.1: 0 V _{SEN}
	X3.2: Input I0-	X7.2: Input I1-	X3.2: Input I1-
	X3.3: FE	X7.3: FE	X3.3: FE
	X4.0: n.c.	X8.0: n.c.	X4.0: n.c.
	X4.1: n.c.	X8.1: n.c.	X4.1: n.c.
	X4.2: Input I0+	X8.2: Input I1+	X4.2: Input I1+
	X4.3: FE	X8.3: FE	X4.3: FE





1) Speedcon quick lock, additional shielding on metal thread
2) FE/shield additionally on metal thread

Data sheet – Input module, analogue

Pin allocation		CPX-2AE-U-I		CPX-4AE-U-I		CPX-4AE-I		
Connection block inputs		CPX-2AE-U-I		CPX-4AE-U-I		CPX-4AE-I		
CPX-AB-1-SUB-BU-25POL								
	1:	Input U0-	14:	Input U1-	1:	Input 0-	14:	Input 2-
	2:	Input U0+	15:	Input U1+	2:	Input 0+	15:	Input 2+
	3:	Input I0-	16:	Input I1-	3:	Input 1-	16:	Input 3-
	4:	Input I1+	17:	Input I1+	4:	Input 1+	17:	Input 3+
	5:	n.c.	18:	24 V _{SEN}	5:	n.c.	18:	24 V _{SEN}
	6:	n.c.	19:	n.c.	6:	n.c.	19:	n.c.
	7:	n.c.	20:	24 V _{SEN}	7:	n.c.	20:	24 V _{SEN}
	8:	n.c.	21:	n.c.	8:	n.c.	21:	n.c.
	9:	24 V _{SEN}	22:	0 V _{SEN}	9:	24 V _{SEN}	22:	0 V _{SEN}
	10:	24 V _{SEN}	23:	0 V _{SEN}	10:	24 V _{SEN}	23:	0 V _{SEN}
	11:	0 V _{SEN}	24:	0 V _{SEN}	11:	0 V _{SEN}	24:	0 V _{SEN}
	12:	0 V _{SEN}	25:	FE	12:	0 V _{SEN}	25:	FE
	13:	Shielding ¹⁾	Housing:	FE	13:	Shielding ¹⁾	Housing:	FE

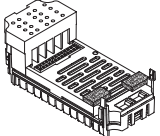
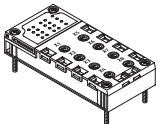
1) Connect shield to functional earth FE

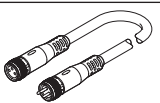
Data sheet – Input module, analogue

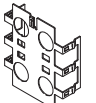
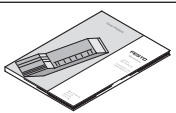
Ordering data		Part no.	Type
Designation			
Input module, analogue			
	2 analogue current or voltage inputs	526168	CPX-2AE-U-I
	4 analogue current or voltage inputs	573710	CPX-4AE-U-I
	4 analogue current inputs	541484	CPX-4AE-I
Connection block			
	Plastic	4x socket, M12, 5-pin	195704 CPX-AB-4-M12X2-5POL
		4x socket, M12 with quick-lock technology, 5-pin	541254 CPX-AB-4-M12X2-5POL-R
		Spring-loaded terminal, 32-pin	195708 CPX-AB-8-KL-4POL
		1x Sub-D socket, 25-pin	525676 CPX-AB-1-SUB-BU-25POL
	Metal	4x socket, M12, 5-pin	549367 CPX-M-AB-4-M12X2-5POL
Plug			
	M12, 5-pin	PG7, for cable \varnothing 4 ... 6 mm	175487 SEA-M12-5GS-PG7
	Sub-D, 25-pin		527522 SD-SUB-D-ST25
Connecting cable			
	Modular system for a choice of connecting cables		– NEBU-... → Internet: nebu
Cover			
	Cover for CPX-AB-8-KL-4POL (IP65/67)	<ul style="list-style-type: none"> 8 cable through feeds M9 1 cable through feed for multi-pin plug 	538219 AK-8KL
	Fittings kit for cover AK-8KL		538220 VG-K-M9
	Cover cap for closing off unused M12 connections (10 pieces)		165592 ISK-M12
Screening plate			
	Screening plate for connection block <ul style="list-style-type: none"> CPX-AB-4-M12X2-5POL CPX-AB-4-M12X2-5POL-R 		526184 CPX-AB-S-4-M12
User documentation			
	User documentation	German	526415 P.BE-CPX-AX-DE
		English	526416 P.BE-CPX-AX-EN
		Spanish	526417 P.BE-CPX-AX-ES
		French	526418 P.BE-CPX-AX-FR
		Italian	526419 P.BE-CPX-AX-IT

Data sheet – Input module, analogue, with pressure sensors

Function

The pressure input modules make it possible to process a maximum of 4 pressures. The internal measured value of the sensor (analogue value with 10-bit resolution) is converted into an internal numerical format as appropriate to the parameterisation and made available to the bus node as a process image. It is additionally also possible to combine 2 channels in each case to form a differential pressure channel.

Area of application

- Measuring range: 0 ... 10 bar or -1 ... +1 bar
- Choice of units of measurement
- Processing a maximum of 4 pressures per module
- Pressure indication via LCD display
- Direct connection via QS4 push-in connectors
- Error message via CPX-P
- Channel-oriented diagnostics



General technical data			CPX-4AE-P-B2	CPX-4AE-P-D10
Type				
Number of analogue inputs			4	
Pneumatic connection			QS-4	
Nominal operating voltage	[V DC]		24	
Operating voltage range	[V DC]		18 ... 30	
Intrinsic current consumption	[mA]		Typically 50	
Measured variable			4 x relative or 2 x differential pressure measurement	
Displayable units			<ul style="list-style-type: none"> • kPa • mbar • psi 	
Pressure measuring range	Start value	[bar]	-1	0
	Final value	[bar]	1	10
Internal cycle time		[ms]	5	
Data format			<ul style="list-style-type: none"> • 15 bits + prefix • Binary notation in mbar, kPa, psi 	
LED displays			Group diagnostics	
Diagnostics			<ul style="list-style-type: none"> • Limit value violation per channel • Parameterisation error • Sensor limit per channel 	
Parameterisation			<ul style="list-style-type: none"> • Diagnostic delay per channel • Hysteresis per module • Unit of measurement • Measured value smoothing per channel • Limit value monitoring per channel • Sensor limit per channel • Measurement of relative/differential pressure 	
Degree of protection to EN 60529			IP65, IP67	
Operating medium			Compressed air to ISO 8573-1:2010 [7:4:4]	
Note on the operating/pilot medium			Lubricated operation possible (in which case lubricated operation will always be required)	
Ambient temperature		[°C]	-5 ... 50	
Storage temperature		[°C]	-20 ... 70	
Temperature of medium		[°C]	0 ... 50	
Materials			PA-reinforced, PC	
Note on materials			RoHS-compliant	
PWIS conformity			VDMA24364-B2-L	
Grid dimension		[mm]	50	
Dimensions (including interlinking block) W x L x H		[mm]	50 x 107 x 55	
Product weight		[g]	115	

 **Note**

Extreme pneumatic conditions, e.g. high cycle rate with high pressure amplitudes, can damage the sensors.

Data sheet – Input module, analogue, with pressure sensors

Connection and display components

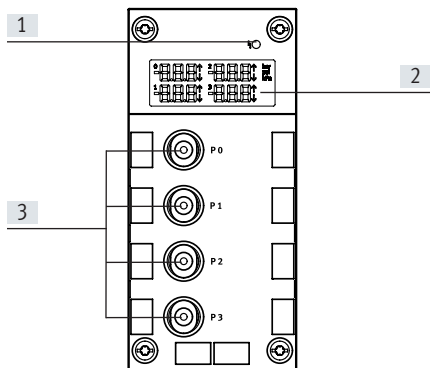

- [1] Error LED (red; module error)
- [2] LCD display with permanent display of the four measured pressures, unit of measurement and if applicable limit value violation
- [3] QS connections

Ordering data

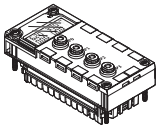
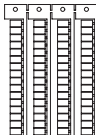
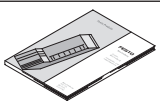
Designation		Part no.	Type
Input module, analogue			
	4 analogue pressure inputs, pressure range -1 ... +1 bar	560361	CPX-4AE-P-B2
	4 analogue pressure inputs, pressure range 0 ... 10 bar	560362	CPX-4AE-P-D10
Inscription labels			
	Inscription labels 6x10 mm, 64 pieces, in frame	18576	IBS-6x10
User documentation			
	User documentation	German	526415 P.BE-CPX-AX-DE
		English	526416 P.BE-CPX-AX-EN
		Spanish	526417 P.BE-CPX-AX-ES
		French	526418 P.BE-CPX-AX-FR
		Italian	526419 P.BE-CPX-AX-IT

Data sheet – Input module, analogue, for temperature inputs

Function

The CPX-PT100 analogue input module with 4 channels for temperature measurement enables the connection of up to 4 temperature sensors of the type PT100-PT1000, Ni100-Ni1000, etc. The temperature module supports various connection concepts with different numbers of sockets or terminals as appropriate to the connection block selected.

Area of application

- Temperature module for temperature sensors PT100, PT200, PT500, PT1000, Ni100, Ni120, Ni500, Ni1000
- Supports connection blocks with M12 and terminal connection
- Temperature module features can be parameterised
- 2-wire, 3-wire and 4-wire connection
- The temperature module is provided with voltage supply for the electronics and the sensors via the interlinking block
- Temperature module protection and diagnostics through integrated electronic fuse protection

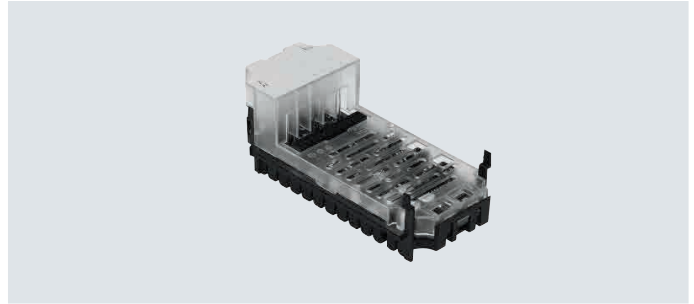

General technical data			
Type		CPX-4AE-T	
		Temperature input	
Number of analogue inputs		Choice of 2 or 4	
Max. power supply per module		[A]	0.7
Fuse protection		Internal electronic fuse for sensor supply	
Current consumption from 24 V sensor supply (quiescent current)		[mA]	Typically 50
Sensor supply voltage		[V DC]	24 ±25%
Sensor type (parameterisable for each channel with DIL switch)		PT100, PT200, PT500, PT1000 Ni100, Ni120, Ni500, Ni1000	
Temperature range	Pt standard	[°C]	-200 ... +850
	Pt climatic	[°C]	-120 ... +130
	Ni	[°C]	-60 ... +180
Sensor connection technology		2-wire, 3-wire and 4-wire technology	
Resolution		15 bits + prefix	
Operating error limit relative to input range		[%]	±0.06
Basic error limit (25°C)	Standard	[K]	±0.6
	Pt climatic	[K]	±0.2
Temperature errors relative to input range		[%]	±0.001
Linearity errors (no software scaling)		[%]	±0.02
Repetition accuracy (at 25°C)		[%]	±0.05
Max. line resistance per conductor		[Ω]	10
Max. permissible input voltage		[V]	±30
Cycle time (module)		[ms]	≤ 250

Data sheet – Input module, analogue, for temperature inputs

General technical data		
Data format		15 bits + prefix, complement of two, binary notation in tenths of a degree
Cable length	[m]	Max. 200 (shielded)
Galvanic isolation	Channel – channel	No
	Channel – internal bus	Yes
LED displays	Group diagnostics	1
	Channel diagnostics	4
Diagnostics		<ul style="list-style-type: none"> • Short circuit/overload, channel • Parameterisation error • Value falling below nominal range/full-scale value • Value exceeding nominal range/full-scale value • Wire break
Parameterisation		<ul style="list-style-type: none"> • Unit of measurement and interference frequency suppression • Diagnostic message in the event of a wire break or short circuit • Limit monitoring per channel • Sensor connection technology • Sensor type/temperature coefficient, temperature range • Limit value per channel • Measured value smoothing
Degree of protection to EN 60529		Depending on connection block
Temperature range	Operation	[°C] –5 ... +50
	Storage/transport	[°C] –20 ... +70
Materials		PA-reinforced, PC
PWIS conformity		VDMA24364-B2-L
Grid dimension	[mm]	50
Dimensions (including interlinking block and connection block) W x L x H	[mm]	50 x 107 x 50
Product weight	[g]	47

Connection and display components

CPX-4AE-T

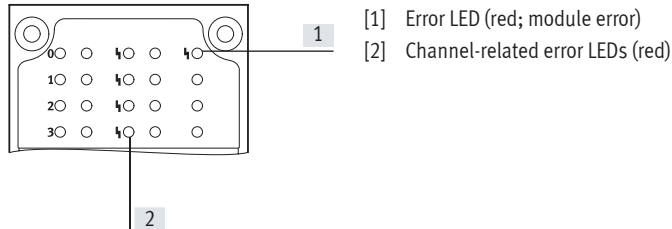

Combinations of connection blocks and analogue module



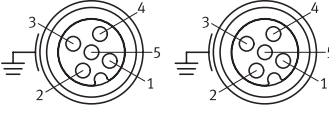
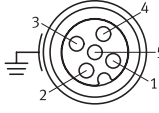
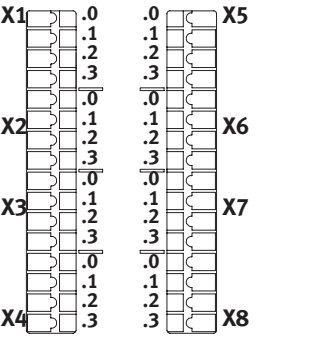

Connection blocks	Part no.	Temperature module
		CPX-4AE-T
CPX-AB-4-M12X2-5POL	195704	■
CPX-AB-4-M12X2-5POL-R	541254	■
CPX-AB-8-KL-4POL	195708	■
CPX-M-AB-4-M12X2-5POL	549367	■

Data sheet – Input module, analogue, for temperature inputs

Pin allocation		CPX-4AET
Connection block inputs		
CPX-AB-4-M12X2-5POL, CPX-AB-4-M12X2-5POL-R¹⁾ and CPX-M-AB-4-M12X2-5POL		
 <p>X 1</p> <p>X 2</p>	 <p>X 3</p> <p>X 4</p>	<p>X1.1: Input I0+</p> <p>X1.2: Input U0+</p> <p>X1.3: Input I0-</p> <p>X1.4: Input U0-</p> <p>X1.5: FE²⁾</p> <p>X2.1: Input I1+</p> <p>X2.2: Input U1+</p> <p>X2.3: Input I1-</p> <p>X2.4: Input U1-</p> <p>X2.5: FE²⁾</p>
		<p>X3.1: Input I2+</p> <p>X3.2: Input U2+</p> <p>X3.3: Input I2-</p> <p>X3.4: Input U2-</p> <p>X3.5: FE²⁾</p> <p>X4.1: Input I3+</p> <p>X4.2: Input U3+</p> <p>X4.3: Input I3-</p> <p>X4.4: Input U3-</p> <p>X4.5: FE²⁾</p>
CPX-AB-8-KL-4POL		
 <p>X1</p> <p>X2</p> <p>X3</p> <p>X4</p>	<p>X5</p> <p>X6</p> <p>X7</p> <p>X8</p>	<p>X1.0: Input I0+</p> <p>X1.1: Input I0-</p> <p>X1.2: Input U0-</p> <p>X1.3: FE</p> <p>X2.0: n.c.</p> <p>X2.1: n.c.</p> <p>X2.2: Input U0+</p> <p>X2.3: FE</p> <p>X3.0: Input I1+</p> <p>X3.1: Input I1-</p> <p>X3.2: Input U1-</p> <p>X3.3: FE</p> <p>X4.0: n.c.</p> <p>X4.1: n.c.</p> <p>X4.2: Input U1+</p> <p>X4.3: FE</p>
		<p>X5.0: Input I2+</p> <p>X5.1: Input I2-</p> <p>X5.2: Input U2-</p> <p>X5.3: FE</p> <p>X6.0: n.c.</p> <p>X6.1: n.c.</p> <p>X6.2: Input U2+</p> <p>X6.3: FE</p> <p>X7.0: Input I3+</p> <p>X7.1: Input I3-</p> <p>X7.2: Input U3-</p> <p>X7.3: FE</p> <p>X8.0: n.c.</p> <p>X8.1: n.c.</p> <p>X8.2: Input U3+</p> <p>X8.3: FE</p>

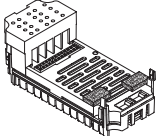
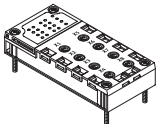
1) Speedcon quick lock, additional shielding on metal thread
 2) FE/shield additionally on metal thread

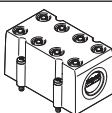
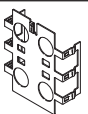
Data sheet – Input module, analogue, for temperature inputs

Ordering data		Part no.	Type
Designation			
Input module, analogue			
	2 or 4 analogue temperature inputs	541486	CPX-4AE-T
Connection block			
	Plastic	4x socket M12, 5-pin	195704 CPX-AB-4-M12X2-5POL
		4x socket, M12 with quick-lock technology, 5-pin	541254 CPX-AB-4-M12X2-5POL-R
		Spring-loaded terminal, 32-pin	195708 CPX-AB-8-KL-4POL
	Metal	4x socket M12, 5-pin	549367 CPX-M-AB-4-M12X2-5POL
Plug			
	M12, 5-pin	PG7, for cable \varnothing 4 ... 6 mm	175487 SEA-M12-5GS-PG7
Cover			
	Cover for CPX-AB-8-KL-4POL (IP65, IP67)	<ul style="list-style-type: none"> 8 cable through feeds M9 1 cable through feed for multi-pin plug 	538219 AK-8KL
	Fittings kit		538220 VG-K-M9
Screening plate			
	Screening plate for M12 connections	526184	CPX-AB-S-4-M12
User documentation			
	User documentation	German	526415 P.BE-CPX-AX-DE
		English	526416 P.BE-CPX-AX-EN
		Spanish	526417 P.BE-CPX-AX-ES
		French	526418 P.BE-CPX-AX-FR
		Italian	526419 P.BE-CPX-AX-IT

Data sheet – Input module, analogue, for thermocouple

Function

The CPX-4AE-TC analogue input module with 4 channels for temperature measurement enables up to 4 thermocouple sensors to be connected.

The channels feature wire break and short circuit detection.

If no cold junction compensation sensor is being used, an internal theoretical value of 25°C can be used (accuracy is impaired).

Area of application

- Supports connection blocks with M12 and terminal connection
- Temperature module features can be parameterised
- 2-wire connection
- 2-wire connection for a PT1000 sensor for cold junction compensation
- The temperature module is provided with voltage supply for the electronics and the sensors via the interlinking block
- Temperature module protection and diagnostics through integrated electronic fuse protection

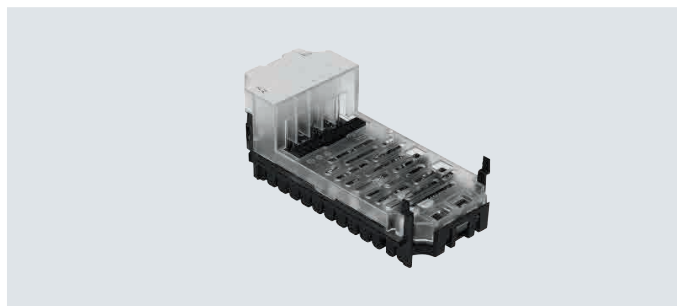

General technical data		
Type		CPX-4AE-TC Temperature input
Number of analogue inputs		4
Fuse protection (short circuit)		Internal electronic fuse per channel
Nominal operating voltage	[V DC]	24
Operating voltage range	[V DC]	18 ... 30
Sensor type (parameterisable for each channel with software)		<ul style="list-style-type: none"> • Type B +400 ... +1820°C, 8 µV/°C • Type E –270 ... +900°C, 60 µV/°C • Type J –200 ... +1200°C, 51 µV/°C • Type K –200 ... +1370°C, 40 µV/°C • Type N –200 ... +1300°C, 38 µV/°C • Type R 0 ... +1760°C, 12 µV/°C • Type S 0 ... +1760°C, 11 µV/°C • Type T –200 ... +400°C, 40 µV/°C
Sensor connection technology		2-wire technology
Operating error limit relative to ambient temperature	[%]	Max. ±0.6
Basic error limit (at 25°C)	[%]	Max. ±0.4
Repetition accuracy (at 25°C)	[%]	±0.05
Max. line resistance per conductor	[Ω]	10
Max. residual current per module	[mA]	30
Max. permissible input voltage	[V]	±30
Internal cycle time (module)	[ms]	250

Data sheet – Input module, analogue, for thermocouple

General technical data		
Data format		<ul style="list-style-type: none"> • 15 bits + prefix, complement of two • Binary notation in tenths of a degree
Cable length	[m]	Max. 50 (shielded)
Galvanic isolation	Channel – channel	No
	Channel – internal bus	Yes
LED displays	Group diagnostics	1
	Channel diagnostics	4
Diagnostics		<ul style="list-style-type: none"> • Parameterisation error • Wire break per channel • Limit value violation per channel
Parameterisation		<ul style="list-style-type: none"> • Monitoring of wire break per channel • Unit of measurement • Cold-junction compensation • Sensor type per channel • Limit value monitoring per channel • Measured value smoothing
Degree of protection to EN 60529		Depending on connection block
Temperature range	Operation	[°C] –5 ... +50
	Storage/transport	[°C] –20 ... +70
Materials		PA-reinforced, PC
PWIS conformity		VDMA24364-B2-L
Grid dimension	[mm]	50
Dimensions (including interlinking block and connection block) W x L x H	[mm]	50 x 107 x 50
Product weight	[g]	46

Connection and display components

CPX-4AE-TC

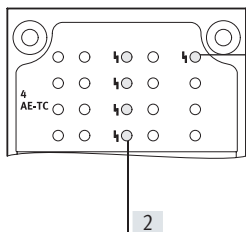

- [1] Error LED (red; module error)
 [2] Channel-related error LEDs (red)

Combinations of connection blocks and analogue module

Connection blocks	Part no.	Temperature module
		CPX-4AE-TC
CPX-AB-4-M12X2-5POL	195704	■
CPX-AB-4-M12X2-5POL-R	541254	■
CPX-AB-8-KL-4POL	195708	■
CPX-M-AB-4-M12X2-5POL	549367	■



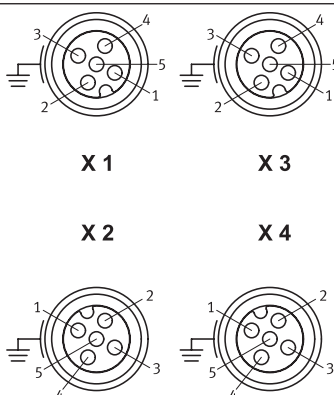
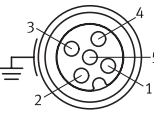
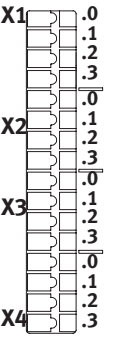
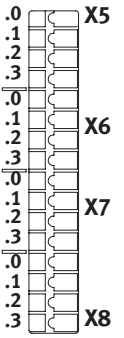

Data sheet – Input module, analogue, for thermocouple

Pin allocation		CPX-4AETC	
Connection block inputs		CPX-AB-4-M12X2-5POL, CPX-AB-4-M12X2-5POL-R ¹⁾ and CPX-M-AB-4-M12X2-5POL	
 <p>X 1</p> <p>X 2</p>	 <p>X 3</p> <p>X 4</p>	<p>X1.1: Cold junction compensation 0+</p> <p>X1.2: Input signal U0+</p> <p>X1.3: Cold junction compensation 0-</p> <p>X1.4: Input signal U0-</p> <p>X1.5: FE²⁾</p> <p>X2.1: Cold junction compensation 1+</p> <p>X2.2: Input signal U1+</p> <p>X2.3: Cold junction compensation 1-</p> <p>X2.4: Input signal U1-</p> <p>X2.5: FE²⁾</p>	<p>X3.1: Cold junction compensation 2+</p> <p>X3.2: Input signal U2+</p> <p>X3.3: Cold junction compensation 2-</p> <p>X3.4: Input signal U2-</p> <p>X3.5: FE²⁾</p> <p>X4.1: Cold junction compensation 3+</p> <p>X4.2: Input signal U3+</p> <p>X4.3: Cold junction compensation 3-</p> <p>X4.4: Input signal U3-</p> <p>X4.5: FE²⁾</p>
CPX-AB-8-KL-4POL			
 <p>X1</p> <p>X2</p>	 <p>X5</p> <p>X6</p> <p>X7</p> <p>X8</p>	<p>X1.0: Cold junction compensation 0+</p> <p>X1.1: Cold junction compensation 0-</p> <p>X1.2: Input signal U0-</p> <p>X1.3: FE</p> <p>X2.0: n.c.</p> <p>X2.1: n.c.</p> <p>X2.2: Input signal U0+</p> <p>X2.3: FE</p> <p>X3.0: Cold junction compensation 1+</p> <p>X3.1: Cold junction compensation 1-</p> <p>X3.2: Input signal U1-</p> <p>X3.3: FE</p> <p>X4.0: n.c.</p> <p>X4.1: n.c.</p> <p>X4.2: Input signal U1+</p> <p>X4.3: FE</p>	<p>X5.0: Cold junction compensation 2+</p> <p>X5.1: Cold junction compensation 2-</p> <p>X5.2: Input signal U2-</p> <p>X5.3: FE</p> <p>X6.0: n.c.</p> <p>X6.1: n.c.</p> <p>X6.2: Input signal U2+</p> <p>X6.3: FE</p> <p>X7.0: Cold junction compensation 3+</p> <p>X7.1: Cold junction compensation 3-</p> <p>X7.2: Input signal U3-</p> <p>X7.3: FE</p> <p>X8.0: n.c.</p> <p>X8.1: n.c.</p> <p>X8.2: Input signal U3+</p> <p>X8.3: FE</p>

1) Speedcon quick lock, additional shielding on metal thread

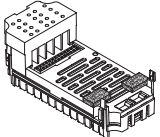
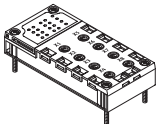
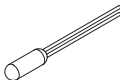
2) FE/shield additionally on metal thread

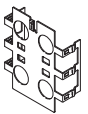
Data sheet – Input module, analogue, for thermocouple

Ordering data		Part no.	Type
Designation			
Input module, analogue			
	4 analogue temperature inputs, with 2-wire connection for a PT1000 sensor for cold junction compensation		553594 CPX-4AE-TC
Connection block			
	Plastic	4x socket M12, 5-pin	195704 CPX-AB-4-M12X2-5POL
		4x socket, M12 with quick-lock technology, 5-pin	541254 CPX-AB-4-M12X2-5POL-R
		Spring-loaded terminal, 32-pin	195708 CPX-AB-8-KL-4POL
	Metal	4x socket M12, 5-pin	549367 CPX-M-AB-4-M12X2-5POL
Cold junction compensation			
	PT1000 temperature sensor for cold junction compensation		553596 CPX-W-PT1000
Plug			
	M12, 5-pin	PG7, for cable \varnothing 4 ... 6 mm	175487 SEA-M12-5GS-PG7
Cover			
	Cover for CPX-AB-8-KL-4POL (IP65, IP67)		538219 AK-8KL
	Fittings kit		538220 VG-K-M9
Screening plate			
	Screening plate for M12 connections		526184 CPX-AB-S-4-M12
User documentation			
	User documentation	German	526415 P.BE-CPX-AX-DE
		English	526416 P.BE-CPX-AX-EN
		Spanish	526417 P.BE-CPX-AX-ES
		French	526418 P.BE-CPX-AX-FR
		Italian	526419 P.BE-CPX-AX-IT

Data sheet – Output module, analogue

Function

Analogue modules control devices with a standard analogue interface such as proportional valves, etc.

Depending on the connection block selected, the analogue module supports various connection concepts with different numbers of sockets or terminals.

Area of application

- Analogue module for 0 ... 10 V, 0 ... 20 mA or 4 ... 20 mA
- Supports connection blocks with Sub-D, terminal connection and M12 connection
- Analogue module features can be parameterised
- Different data formats available
- Operation with and without galvanic isolation possible
- The analogue module receives the voltage supply for the electronics and the actuators from the interlinking block
- Analogue module protection and diagnostics through integrated electronic fuse protection

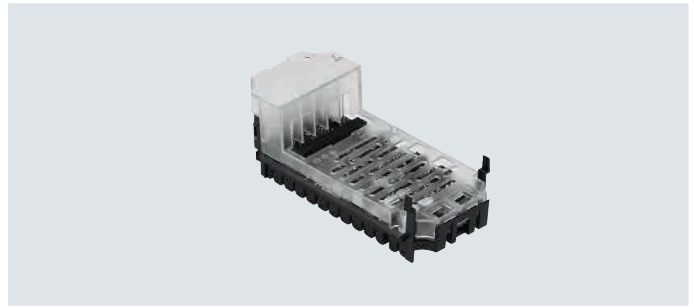
**General technical data**

Type		CPX-2AA-U-I	
		Voltage output	Current output
Number of analogue outputs		2	
Max. actuator supply per module [A]		2.8	
Fuse protection		Internal electronic fuse for actuator supply	
Current consumption from 24 V sensor supply (at full load) [mA]		Max. 150	
Current consumption from 24 V actuator supply (at full load) [A]		4 ... 10	
Supply voltage for actuators [V DC]		24 ±25%	
Signal range (parameterisable for each channel with DIL switch or software)		0 ... 10 V DC	0 ... 20 mA 4 ... 2 mA
Resolution [bit]		12	
Number of units		4096	
Absolute accuracy [%]		±0.6	
Linearity errors (no software scaling) [%]		±0.1	
Repetition accuracy (at 25°C) [%]		0.05	
Encoder selection	Load resistance for ohmic load [kΩ]	Min. 1	Max. 0.5
	Load resistance for capacitive load [μF]	Max. 1	–
	Load resistance for inductive load [mH]	–	Max. 1
	Short circuit protection for analogue output	Yes	–
	Short circuit current of analogue output [mA]	Approx. 20	–
	Open circuit voltage [V DC]	–	18
	Destruction limit against externally applied voltage [V DC]	15	
	Actuator connection	2 wires	
Cycle time (module) [ms]	≤ 4		

Data sheet – Output module, analogue

General technical data			CPX-2AA-U-I	
Type			Voltage output	Current output
Response time	For ohmic load	[ms]	0.1	0.1
	For capacitive load	[ms]	0.7	–
	For inductive load	[ms]	–	0.5
Data format			15 bits + prefix, linear scaling 12 bits right-justified 12 bits left-justified, S7 compatible 12 bits left-justified, S5 compatible	
Cable length		[m]	Max. 30 (shielded)	
LED displays	Group diagnostics		1	
	Channel diagnostics		Yes, via flashing frequency of group diagnostics	
Diagnostics			<ul style="list-style-type: none"> • Short circuit/overload, actuator supply • Parameterisation error • Value falling below nominal range/full-scale value • Value exceeding nominal range/full-scale value • Wire break 	
Parameterisation			<ul style="list-style-type: none"> • Short circuit monitoring, actuator supply • Short circuit monitoring, analogue output • Behaviour after short circuit, actuator supply • Data format • Lower limit value/full-scale value • Upper limit value/full-scale value • Monitoring value falling below nominal range/full-scale value • Monitoring value exceeding nominal range/full-scale value • Monitoring wire break • Signal range 	
Degree of protection to EN 60529			Depending on connection block	
Temperature range	Operation	[°C]	–5 ... +50	
	Storage/transport	[°C]	–20 ... +70	
Materials			PA-reinforced, PC	
PWIS conformity			VDMA24364-B2-L	
Grid dimension		[mm]	50	
Dimensions (including interlinking block and connection block) W x L x H		[mm]	50 x 107 x 50	
Product weight		[g]	49	

Connection and display components

CPX-2AA-U-I

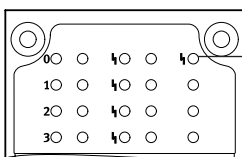

[1] Error LED (red; module error)

Combinations of connection blocks and analogue module



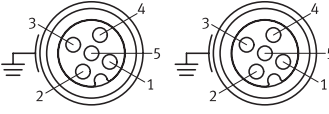
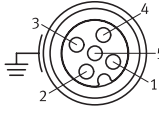
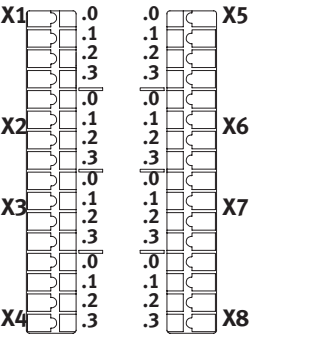
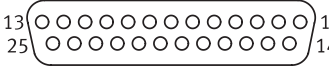

Connection blocks	Part no.	Analogue module
		CPX-2AA-U-I
CPX-AB-4-M12X2-5POL	195704	■
CPX-AB-4-M12X2-5POL-R	541254	■
CPX-AB-8-KL-4POL	195708	■
CPX-AB-1-SUB-BU-25POL	525676	■
CPX-M-AB-4-M12X2-5POL	549367	■

Data sheet – Output module, analogue

Pin allocation		CPX-2AA-U-I
Connection block outputs		
CPX-AB-4-M12X2-5POL, CPX-AB-4-M12X2-5POL-R¹⁾, CPX-M-AB-4-M12X2-5POL		
 <p>X 1</p> <p>X 2</p>	 <p>X 3</p> <p>X 4</p>	<p>X1.1: 24 V_{OUT}</p> <p>X1.2: Output U0+</p> <p>X1.3: 0 V_{OUT}</p> <p>X1.4: Output GND</p> <p>X1.5: FE²⁾</p> <p>X2.1: 24 V_{OUT}</p> <p>X2.2: Output I0+</p> <p>X2.3: 0 V_{OUT}</p> <p>X2.4: Output GND</p> <p>X2.5: FE²⁾</p>
		<p>X3.1: 24 V_{OUT}</p> <p>X3.2: Output U1+</p> <p>X3.3: 0 V_{OUT}</p> <p>X3.4: Output GND</p> <p>X3.5: FE²⁾</p> <p>X4.1: 24 V_{OUT}</p> <p>X4.2: Output I1+</p> <p>X4.3: 0 V_{OUT}</p> <p>X4.4: Output GND</p> <p>X4.5: FE²⁾</p>
CPX-AB-8-KL-4POL		
 <p>X1</p> <p>X2</p> <p>X3</p> <p>X4</p>	<p>X5</p> <p>X6</p> <p>X7</p> <p>X8</p>	<p>X1.0: 24 V_{OUT}</p> <p>X1.1: 0 V_{OUT}</p> <p>X1.2: Output GND</p> <p>X1.3: FE</p> <p>X2.0: n.c.</p> <p>X2.1: n.c.</p> <p>X2.2: Output U0+</p> <p>X2.3: FE</p> <p>X3.0: 24 V_{OUT}</p> <p>X3.1: 0 V_{OUT}</p> <p>X3.2: Output GND</p> <p>X3.3: FE</p> <p>X4.0: n.c.</p> <p>X4.1: n.c.</p> <p>X4.2: Output I0+</p> <p>X4.3: FE</p>
		<p>X5.0: 24 V_{OUT}</p> <p>X5.1: 0 V_{OUT}</p> <p>X5.2: Output GND</p> <p>X5.3: FE</p> <p>X6.0: n.c.</p> <p>X6.1: n.c.</p> <p>X6.2: Output U1+</p> <p>X6.3: FE</p> <p>X7.0: 24 V_{OUT}</p> <p>X7.1: 0 V_{OUT}</p> <p>X7.2: Output GND</p> <p>X7.3: FE</p> <p>X8.0: n.c.</p> <p>X8.1: n.c.</p> <p>X8.2: Output I1+</p> <p>X8.3: FE</p>
CPX-AB-1-SUB-BU-25POL		
	<p>1: Output GND</p> <p>2: Output U0+</p> <p>3: Output GND</p> <p>4: Output I0+</p> <p>5: n.c.</p> <p>6: n.c.</p> <p>7: n.c.</p> <p>8: n.c.</p> <p>9: 24 V_{OUT}</p> <p>10: 24 V_{OUT}</p> <p>11: 0 V_{OUT}</p> <p>12: 0 V_{OUT}</p> <p>13: Shielding³⁾</p>	<p>14: Output GND</p> <p>15: Output U1+</p> <p>16: Output GND</p> <p>17: Output I1+</p> <p>18: 24 V_{OUT}</p> <p>19: n.c.</p> <p>20: 24 V_{OUT}</p> <p>21: n.c.</p> <p>22: 0 V_{OUT}</p> <p>23: 0 V_{OUT}</p> <p>24: 0 V_{OUT}</p> <p>25: FE</p> <p>Housing: FE</p>

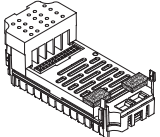
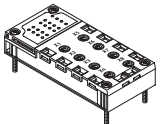
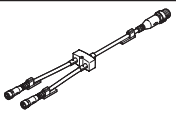
1) Speedcon quick lock, additional shielding on metal thread
 2) FE/shield additionally on metal thread
 3) Connect shield to functional earth FE

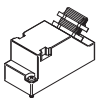
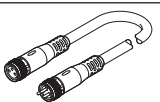
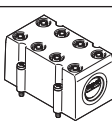
Data sheet – Output module, analogue

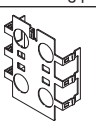
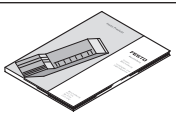
Ordering data		Part no.	Type	
Designation				
Output module, analogue				
	2 analogue current or voltage outputs		526170 CPX-2AA-U-I	
Connection block				
	Plastic	4x socket, M12, 5-pin	195704 CPX-AB-4-M12X2-5POL	
		4x socket, M12 with quick-lock technology, 5-pin	541254 CPX-AB-4-M12X2-5POL-R	
		Spring-loaded terminal, 32-pin	195708 CPX-AB-8-KL-4POL	
		1x Sub-D socket, 25-pin	525676 CPX-AB-1-SUB-BU-25POL	
	Metal	4x socket, M12, 5-pin	549367 CPX-M-AB-4-M12X2-5POL	
Distributor				
	Modular system for all types of sensor/actuator distributor		– NEDY... → Internet: nedy	
Plug				
	M12, 5-pin	PG7, for cable \varnothing 4 ... 6 mm	175487 SEA-M12-5GS-PG7	
	Sub-D, 25-pin		527522 SD-SUB-D-ST25	
Connecting cable				
	Modular system for a choice of connecting cables		– NEBU... → Internet: nebu	
Cover				
	Cover for CPX-AB-8-KL-4POL (IP65/67)		538219 AK-8KL	
	Fittings kit, cover for AK-8KL		538220 VG-K-M9	
	Cover cap for closing off unused M12 connections (10 pieces)		165592 ISK-M12	
Screening plate				
	Screening plate for connection block		526184 CPX-AB-S-4-M12	
		• CPX-AB-4-M12X2-5POL		
		• CPX-AB-4-M12X2-5POL-R		
User documentation				
	User documentation		German	526415 P.BE-CPX-AX-DE
			English	526416 P.BE-CPX-AX-EN
			Spanish	526417 P.BE-CPX-AX-ES
			French	526418 P.BE-CPX-AX-FR
			Italian	526419 P.BE-CPX-AX-IT

Data sheet – PROFIsafe shut-off module

Function

The PROFIsafe shut-off module interrupts the contact rails of the interlinking block for valves and outputs. The supply voltage for valves can be switched by the module within the CPX-P terminal and via a connection block to two consuming devices. Actuation takes place via the bus node (PROFINET) of the CPX-P terminal.

Area of application

- Output module for 24 V DC supply voltage
- Shut-off module for supply voltage for valves
- Can only be used with PROFINET or PROFIBUS bus nodes
- The shut-off module is supplied with voltage for the electronics and the outputs by the interlinking block
- The outputs are supplied from the power supply for valves (V_{Valves})

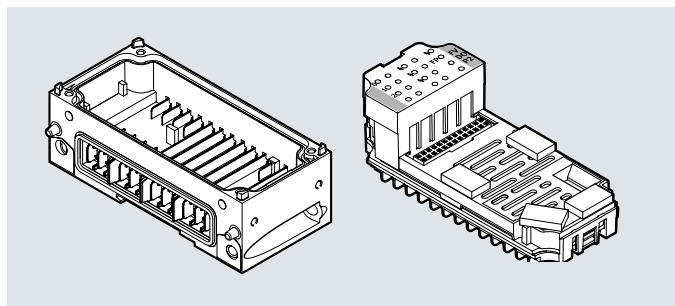

General technical data			
Type	CPX-FVDA-P2		
Number of outputs	2		
Note on outputs	1 internal channel for switching off the supply voltage for valves 2 external outputs		
Max. address capacity	Inputs	[byte]	6
	Outputs	[byte]	6
Maximum cable length		[m]	200
Max. power supply	Per module	[A]	5
	Per channel	[A]	1.5
Fuse protection (short circuit)	Internal electronic fuse per channel		
Current consumption of module		[mA]	Typically 65 (power supply for valves)
		[mA]	Typically 25 (power supply for electronics)
Operating voltage	Nominal value	[V DC]	24
	Permissible range	[V DC]	20.4 ... 28.8
Voltage drop per channel		[V]	0.6
Residual ripple		[Vss]	2 within voltage range
Load capacity to FE		[nF]	400
Max. response time to shut-off command		[ms]	23
Galvanic isolation	Channel – channel		No
	Channel – internal bus		Yes, with intermediate supply
Switching logic	Outputs		P-M switching
Safety integrity level	Safe switch-off, SIL3		
Performance Level	Safe switch-off/category 3, Performance Level e		
Failure rate per hour (PFH)	1.0x 10 ⁻⁹		
Certificate issuing authority	01/205/50294/13		
LED displays	Group diagnostics		1
	Channel diagnostics		3
	Channel status		3
	Failsafe protocol active		1
Diagnostics	<ul style="list-style-type: none"> • Short circuit/overload per channel • Undervoltage of valves • Cross circuit • Wire break per channel 		
Parameterisation	<ul style="list-style-type: none"> • Monitoring of wire break per channel • Diagnostic behaviour 		
Degree of protection to EN 60529	Depending on connection block		
Grid dimension		[mm]	50
Dimensions (including interlinking block and connection block) W x L x H		[mm]	50 x 107 x 55
Product weight		[g]	50

Data sheet – PROFIsafe shut-off module

Materials		
Housing		PA-reinforced, PC
Note on materials		RoHS-compliant
PWIS conformity		VDMA24364-B2-L
Operating and environmental conditions		
Ambient temperature	[°C]	-5 ... +50
Storage temperature	[°C]	-20 ... +70
CE marking (see declaration of conformity) ¹⁾		To EU Machinery Directive
		To EU EMC Directive
		To EU RoHS Directive
UKCA marking (see declaration of conformity) ¹⁾		To UK instructions for machines
		To UK instructions for EMC
		To UK RoHS instructions
Certification		cUL us - Recognized (OL)

1) More information: www.festo.com/catalogue/... → Support/Downloads.

Connection and display components

CPX-FVDA-P2

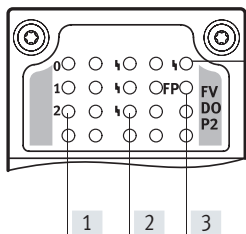

- [1] Status LEDs (yellow):
 0: Supply voltage for valves
 1: X1
 2: X2
- [2] Channel-related error LEDs (red)
 [3] Fail-safe protocol active (green)
 [4] Error LED (red, module error)

Combinations of bus nodes/control blocks and PROFIsafe shut-off module

Bus node/control block	Part no.	PROFIsafe shut-off module
		CPX-FVDA-P2
CPX-FB13	195740	■
CPX-FB33	548755	■
CPX-M-FB34	548751	■
CPX-M-FB35	548749	■
CPX-FB43	8110369	■
CPX-M-FB44	8110370	■
CPX-M-FB45	8110371	■

 **Note**

The PROFIsafe shut-off module CPX-FVDA-P2 can only be connected as of software release 21 or release 30 (in the case of CPX-FB13).

Data sheet – PROFIsafe shut-off module

Combinations of connection blocks and PROFIsafe shut-off module		
Connection blocks	Part no.	PROFIsafe shut-off module
		CPX-FVDA-P2
CPX-M-AB-4-M12X2-5POL	549367	■
CPX-AB-8-KL-4POL	195708	■

Pin allocation	
Connection block outputs	CPX-FVDA-P2

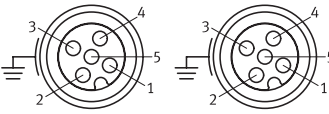
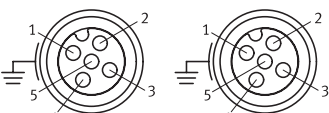

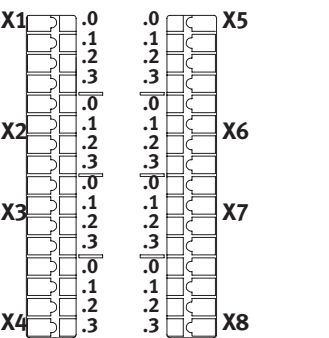
CPX-M-AB-4-M12X2-5POL		
 <p>X 1 X 3</p>	X1.1: 0 V _{OUT} 1 (cannot be switched off) X1.2: 24 V _{OUT} 1 (cannot be switched off) X1.3: 0 V _{OUT} 1 (can be switched off via fieldbus) X1.4: 24 V _{OUT} 1 (can be switched off via fieldbus) X1.5: FE	X3.1: n.c. X3.2: n.c. X3.3: n.c. X3.4: n.c. X3.5: FE
	 <p>X 2 X 4</p>	X2.1: 0 V _{OUT} 2 (cannot be switched off) X2.2: 24 V _{OUT} 2 (cannot be switched off) X2.3: 0 V _{OUT} 2 (can be switched off via fieldbus) X2.4: 24 V _{OUT} 2 (can be switched off via fieldbus) X2.5: FE

CPX-AB-8-KL-4POL		
 <p>X1 X5 X2 X6 X3 X7 X4 X8</p>	X1.0: 0 V _{OUT} 1 (cannot be switched off) X1.1: 0 V _{OUT} 1 (can be switched off via fieldbus) X1.2: 24 V _{OUT} 1 (can be switched off via fieldbus) X1.3: FE X2.0: n.c. X2.1: n.c. X2.2: 24 V _{OUT} 1 (cannot be switched off) X2.3: FE X3.0: 0 V _{OUT} 2 (cannot be switched off) X3.1: 0 V _{OUT} 2 (can be switched off via fieldbus) X3.2: 24 V _{OUT} 2 (can be switched off via fieldbus) X3.3: FE X4.0: n.c. X4.1: n.c. X4.2: 24 V _{OUT} 2 (cannot be switched off) X4.3: FE	X5.0: n.c. X5.1: n.c. X5.2: n.c. X5.3: n.c. X6.0: n.c. X6.1: n.c. X6.2: n.c. X6.3: n.c. X7.0: n.c. X7.1: n.c. X7.2: n.c. X7.3: n.c. X8.0: n.c. X8.1: n.c. X8.2: n.c. X8.3: n.c.



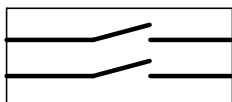
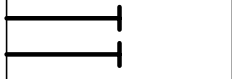
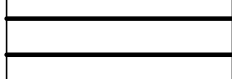

Data sheet – PROFIsafe shut-off module

Combinations of interlinking blocks and PROFIsafe shut-off module		
Interlinking blocks	Part no.	PROFIsafe shut-off module
		CPX-FVDA-P2
CPX-M-GE-EV-S-7/8-5POL	550208	–
CPX-M-GE-EV-S-7/8-5POL-VL	8022165	–
CPX-M-GE-EV	550206	–
CPX-M-GE-EV-FVO	567806	■
CPX-M-GE-EV-Z-7/8-5POL	550210	–
CPX-M-GE-EV-Z-7/8-5POL-VL	8022158	–

General technical data		
Type	CPX-M-GE-EV-FVO	
Nominal operating voltage	[V DC]	24
Acceptable current load (per contact/contact rail)	[A]	16
Degree of protection to EN 60529		Depending on connection block
Ambient temperature	[°C]	–5 ... +50
Materials		Die-cast aluminium
Note on materials		RoHS-compliant
PWIS conformity		VDMA24364-B2-L
Type of mounting		Angled fitting
Grid dimension	[mm]	50
Dimensions W x L x H	[mm]	50 x 107 x 35
Product weight	[g]	170

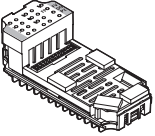
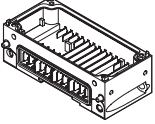
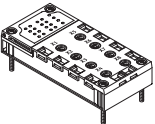
Pin allocation		
Circuitry	Pin	Allocation
 0V Valves 24V Valves	–	–
	–	–
	–	–
	–	–
 0V Output 24V Output		
 0V El./Sen. 24V El./Sen.		
 FE		

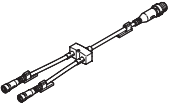
Data sheet – PROFI-safe shut-off module

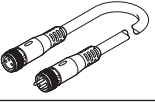
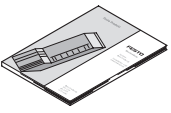
Ordering data		Description	Part no.	Type
PROFI-safe shut-off module				
	Electronics module (can only be used with CPX-M-GE-EV-FVO)	PROFINET, PROFIBUS	1971599	CPX-FVDA-P2
	Metal interlinking block (exclusively for CPX-FVDA-P2)		567806	CPX-M-GE-EV-FVO
Connection block				
	Plastic	Spring-loaded terminal, 32-pin	195708	CPX-AB-8-KL-4POL
	Metal	4x socket M12, 5-pin	549367	CPX-M-AB-4-M12X2-5POL
Distributor				
	1x plug M12, 4-pin	2x socket M12, 5-pin	8005310	NEDY-L2R1-V1-M12G5-N-M12G4
	Modular system for all types of sensor/actuator distributor		–	NEDY-... → Internet: nedy
Plug				
	M12, 4-pin	PG7, for cable \varnothing 4 ... 6 mm	18666	SEA-GS-7
		PG7, for cable \varnothing 2.5 ... 2.9 mm	192008	SEA-4GS-7-2.5
		PG9, for cable \varnothing 6 ... 8 mm	18778	SEA-GS-9
		PG11, for 2x cable \varnothing 3 ... 5 mm	18779	SEA-GS-11-DUO
	M12, 5-pin	PG7, for cable \varnothing 4 ... 6 mm	175487	SEA-M12-5GS-PG7
		PG11, for 2x cable \varnothing 2.5 ... 5 mm	192010	SEA-5GS-11-DUO
Connecting cable				
	Modular system for a choice of connecting cables		–	NEBU-... → Internet: nebu
User documentation				
	User documentation for PROFI-safe shut-off module	German	8022606	CPX-FVDA-P2-DE
		English	8022607	CPX-FVDA-P2-EN
		Spanish	8022608	CPX-FVDA-P2-ES
		French	8022609	CPX-FVDA-P2-FR
		Italian	8022610	CPX-FVDA-P2-IT
		Chinese	8022611	CPX-FVDA-P2-ZH

Data sheet – Interlinking block with system supply

Function

Interlinking blocks ensure the electrical supply of all other CPX-P modules. They have contact rails from which the other CPX-P components on the interlinking modules are supplied with current.

Internal division of the power supply makes it possible to switch off specific areas of the sensors and actuators individually.

Area of application





- 24 V DC supply voltage for electronics of the CPX-P terminal
- 24 V DC supply voltage for inputs
- 24 V DC supply voltage for valves
- 24 V DC supply voltage for outputs

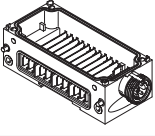

General technical data			
Nominal operating voltage	[V DC]	24	
Degree of protection to EN 60529		Depending on connection block	
Ambient temperature	[°C]	-5 ... +50	
Grid dimension	[mm]	50	
Dimensions W x L x H	[mm]	50 x 107 x 35	
Electrical connection		7/8", 5-pin	
Power supply	Sensors and electronics	[A]	Max. 8
	Valves and outputs	[A]	Max. 8
Materials		Die-cast aluminium	
Note on materials		RoHS-compliant	
PWIS conformity		VDMA24364-B2-L	
Product weight	[g]	187	

Pin allocation			
Circuitry	Pin	Allocation	
Round plug, 5-pin			
		1	0 V valves and outputs
		2	0 V electronics and sensors
		3	FE
		4	24 V DC supply voltage for electronics and sensors
		5	24 V DC load voltage supply for valves and outputs

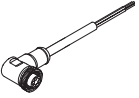
Data sheet – Interlinking block with system supply

Ordering data				Part no.	Type
Designation					
Interlinking block with system supply					
	7/8" connection, metal interlinking block	5-pin	–	550208	CPX-M-GE-EV-S-7/8-5POL
			For ATEX environment	8022165	CPX-M-GE-EV-S-7/8-5POL-VL
Connection sockets 7/8"					
	Power supply socket	5-pin		543107	NECU-G78G5-C2
	Angled socket, 5-pin	Open cable end, 5-pin	2 m	573855	NEBU-G78W5-K-2-N-LE5
Mounting accessories					
	Screws for mounting the bus node/connection block on an interlinking block	Bus node/plastic connection block		550219	CPX-M-M3x22-4x
		Bus node/metal connection block		550216	CPX-M-M3x22-S-4x

Data sheet – Interlinking block without power supply

Function

Interlinking blocks ensure the electrical supply of all other CPX-P modules. They have contact rails from which the other CPX-P components on the interlinking modules are supplied with current.

Internal division of the power supply makes it possible to switch off specific areas of the sensors and actuators individually.

Area of application

- All voltages are fed through to the next module via the interlinking blocks without supply.
- The connected electronics module for inputs/outputs or bus node taps off the required voltage.





General technical data

Electrical connection		–
Nominal operating voltage	[V DC]	24
Acceptable current load (per contact/contact rail)	[A]	16
Degree of protection to EN 60529		Depending on connection block
Ambient temperature	[°C]	–5 ... +50
Materials		Aluminium
Note on materials		RoHS-compliant
PWIS conformity		VDMA24364-B2-L
Grid dimension	[mm]	50
Dimensions W x L x H	[mm]	50 x 107 x 35
Product weight	[g]	169

Pin allocation

Circuitry	Pin	Allocation										
<table border="1" style="display: inline-table; vertical-align: top;"> <tr><td> </td></tr> <tr><td> </td></tr> <tr><td> </td></tr> <tr><td> </td></tr> <tr><td> </td></tr> <tr><td> </td></tr> <tr><td> </td></tr> <tr><td> </td></tr> <tr><td> </td></tr> <tr><td> </td></tr> </table>											–	–
0V Valves	–	–										
24V Valves	–	–										
0V Output	–	–										
24V Output	–	–										
0V El./Sen.												
24V El./Sen.												
FE												

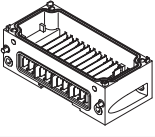
Data sheet – Interlinking block without power supply

Ordering data		Part no.	Type
Designation			
Interlinking block without power supply			
	Metal interlinking block	550206	CPX-M-GE-EV
Mounting accessories			
	Screws for mounting the bus node/connection block on an interlinking block	Bus node/plastic connection block	550219 CPX-M-M3x22-4x
		Bus node/metal connection block	550216 CPX-M-M3x22-S-4x

Data sheet – Interlinking block with additional supply for outputs

Function

Interlinking blocks ensure the electrical supply of all other CPX-P modules. They have contact rails from which the other CPX-P components on the interlinking modules are supplied with current.

Internal division of the power supply makes it possible to switch off specific areas of the sensors and actuators individually.

Area of application

- 24 V DC supply voltage for outputs



**General technical data**

Nominal operating voltage	[V DC]	24
Degree of protection to EN 60529		Depending on connection block
Ambient temperature	[°C]	-5 ... +50
Grid dimension	[mm]	50
Dimensions W x L x H	[mm]	50 x 107 x 35
Electrical connection		7/8", 5-pin
Power supply	Outputs	[A] Max. 8
Materials		Die-cast aluminium
Note on materials		RoHS-compliant
PWIS conformity		VDMA24364-B2-L
Product weight	[g]	187

Pin allocation – Metal interlinking blocks

Circuitry	Pin	Allocation
Round plug, 5-pin		
	1	0 V outputs
	2	n.c.
	3	FE
	4	n.c.
	5	24 V DC load voltage supply for outputs

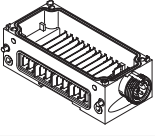
Data sheet – Interlinking block with additional supply for outputs

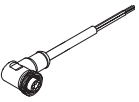
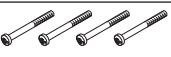
Ordering data				Part no.	Type
Designation					
Interlinking block with additional supply for outputs					
	7/8" connection, metal interlinking block	5-pin	–	550210	CPX-M-GE-EV-Z-7/8-5POL
			For ATEX environment	8022158	CPX-M-GE-EV-Z-7/8-5POL-VL
Connection sockets 7/8"					
	Power supply socket	5-pin		543107	NECU-G78G5-C2
	Angled socket, 5-pin	Open cable end, 5-pin	2 m	573855	NEBU-G78W5-K-2-N-LE5
Mounting accessories					
	Screws for mounting the bus node/connection block on an interlinking block	Bus node/plastic connection block		550219	CPX-M-M3x22-4x
		Bus node/metal connection block		550216	CPX-M-M3x22-S-4x

Data sheet – Pneumatic interface for valve terminal MPA-S

Function

The pneumatic interface VMPA-FB establishes the electromechanical connection between the CPX-P terminal and the valve terminal MPA-S.

The signals from the bus node are forwarded to the control electronics in the electrical modules of the valve terminal MPA-S via the integrated CPX-P bus. The bus signal for activating the solenoid coils is converted in the electronics module for max. 8 coils.

From a technical point of view, the individual MPA pneumatic modules each represent a separate electrical module with digital outputs. Galvanically isolated valves can be supplied with power via the interlinking block CPX-GE-EV-V.

Area of application

- Interface to the valve terminal MPA-S
- Max. 128 solenoid coils
- Characteristics of the electronics module of the valve terminal MPA-S can be parameterised; for example, status of the solenoid coils in the event of fieldbus communication being interrupted (fail-safe), individual channel diagnostics can be activated, condition monitoring can be activated individually for each valve
- The pneumatic interface receives the voltage for the electronics and the supply voltage for the valves from the left interlinking block and feeds them through to the electronics modules of the valve terminal MPA-S
- Electronics modules of the valve terminal MPA-S:
 - Undervoltage of valves
 - Short circuit of valves
 - Open load of valves
 - Counter preset reached in condition monitoring



General technical data		VMPA-FB-EPL-G	VMPA-FB-EPL-E
Type			
Valve terminal design		Modular, valve sizes can be mixed	
Maximum number of valve positions		64	
Maximum number of pressure zones		17	
Signal status indication		LED	
Pilot air supply		Internal	External
Operating pressure	[MPa]	0.3 ... 0.8	-0.09 ... 1
	[bar]	3 ... 8	-0.9 ... 10
Pilot pressure	[MPa]	0.3 ... 0.8	0.3 ... 0.8
	[bar]	3 ... 8	3 ... 8
Product weight	[g]	320	
Degree of protection		IP67	

Technical data – Electrics		
Nominal operating voltage	[V DC]	24
Permissible voltage fluctuations	[%]	±25

Materials	
Note on materials	RoHS-compliant
LABS (PWIS) conformity	VDMA24364-B1/B2-L

Data sheet – Pneumatic interface for valve terminal MPA-S

Overview – Pneumatic interface VMPA-FB

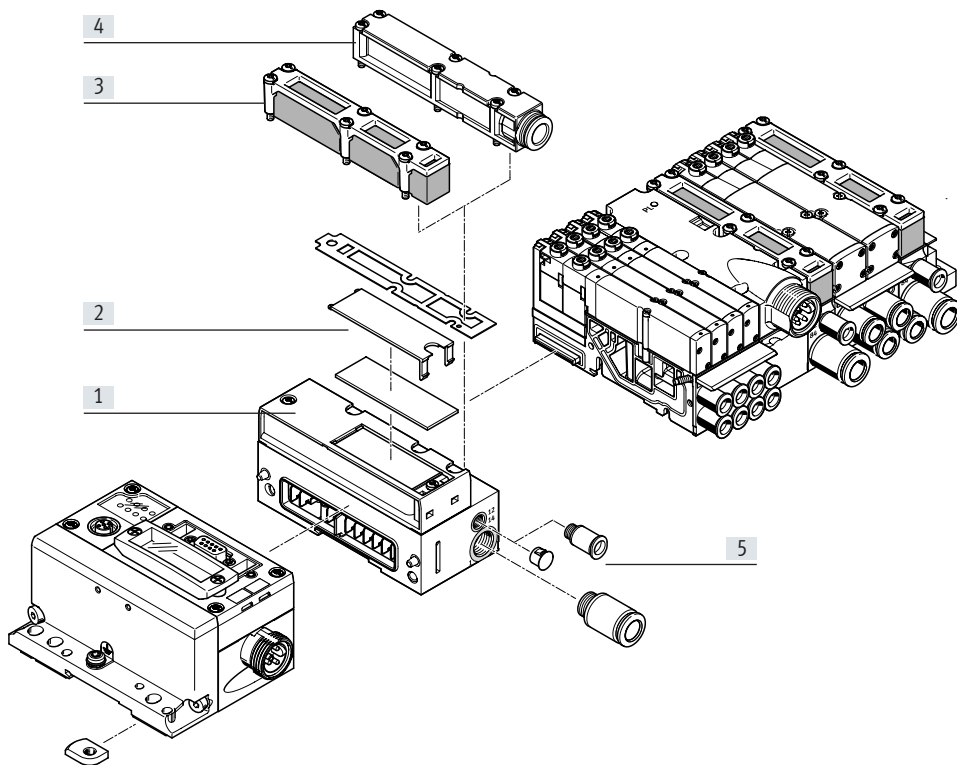

- [1] Pneumatic interface VMPA-FB
- [2] Inscription label
- [3] Flat plate silencer
- [4] Exhaust plate for ducted exhaust air
- [5] Fittings

Ordering data

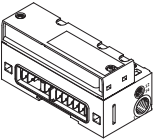
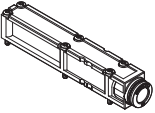
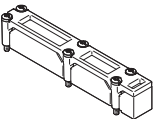
Designation		Part no.	Type
Pneumatic interface			
	Ducted exhaust air	Internal pilot air	552286 VMPA-FB-EPLM-G
		External pilot air	552285 VMPA-FB-EPLM-E
	Flat plate silencer	Internal pilot air	552288 VMPA-FB-EPLM-GU
		External pilot air	552287 VMPA-FB-EPLM-EU
Exhaust plate			
	For ducted exhaust air, with push-in connector	For tubing O.D. 10 mm	533375 VMPA-AP
		For tubing O.D. 3/8"	541629 VMPA-AP-3/8
	Flat plate silencer	533374	VMPA-APU

Data sheet

Dimensions – Metal interlinking block

Download CAD data → www.festo.com

With bus nodes and connection blocks

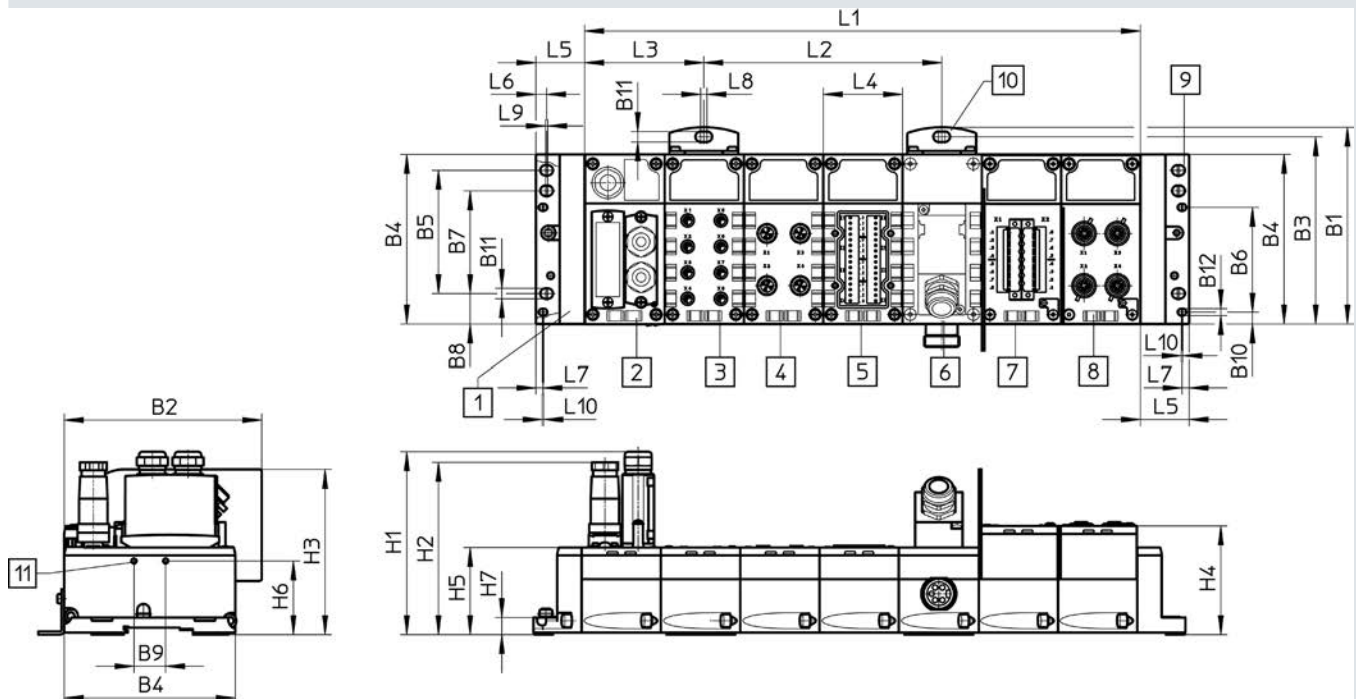

- | | | | |
|---|---|---|--|
| [1] Left-hand end plate | [5] Connection block
CPX-AB-8-KL-4POL | [8] Connection block
CPX-P-AB-4XM12-4POL | [10] Mounting bracket for wall
mounting |
| [2] Bus node | [6] Connection block
CPX-AB-1-SUB-BU-25POL | [9] Right-hand end plate | [11] Hole for self-tapping screw
M2.5 |
| [3] Connection block
CPX-AB-8-M8-3POL | [7] Connection block
CPX-P-AB-4-2XKL-8POL | | |
| [4] Connection block
CPX-AB-4-M12X2-5POL | | | |

Type	B1	B2	B3	B4	B5	B6	B7	B8	B9	B10	B11	B12
CPX-P	124.9	124.6	118.9	108.1	78	66.3	65	19.3	20	7.9	6.6	4.4

Type	H1	H2	H3	H4	H5	H6	H7
CPX-P	116	109	106.2	69.2	55.1	46.6	10.8

Type	L1	L2	L3	L4	L5	L6	L7	L8	L9	L10
CPX-P	nx50.1	150.3	125.3	50.1	30.4	6.8	4.5	4	1.5	1

Data sheet

Dimensions

Download CAD data → www.festo.com

With bus node and valve terminal MPA-S

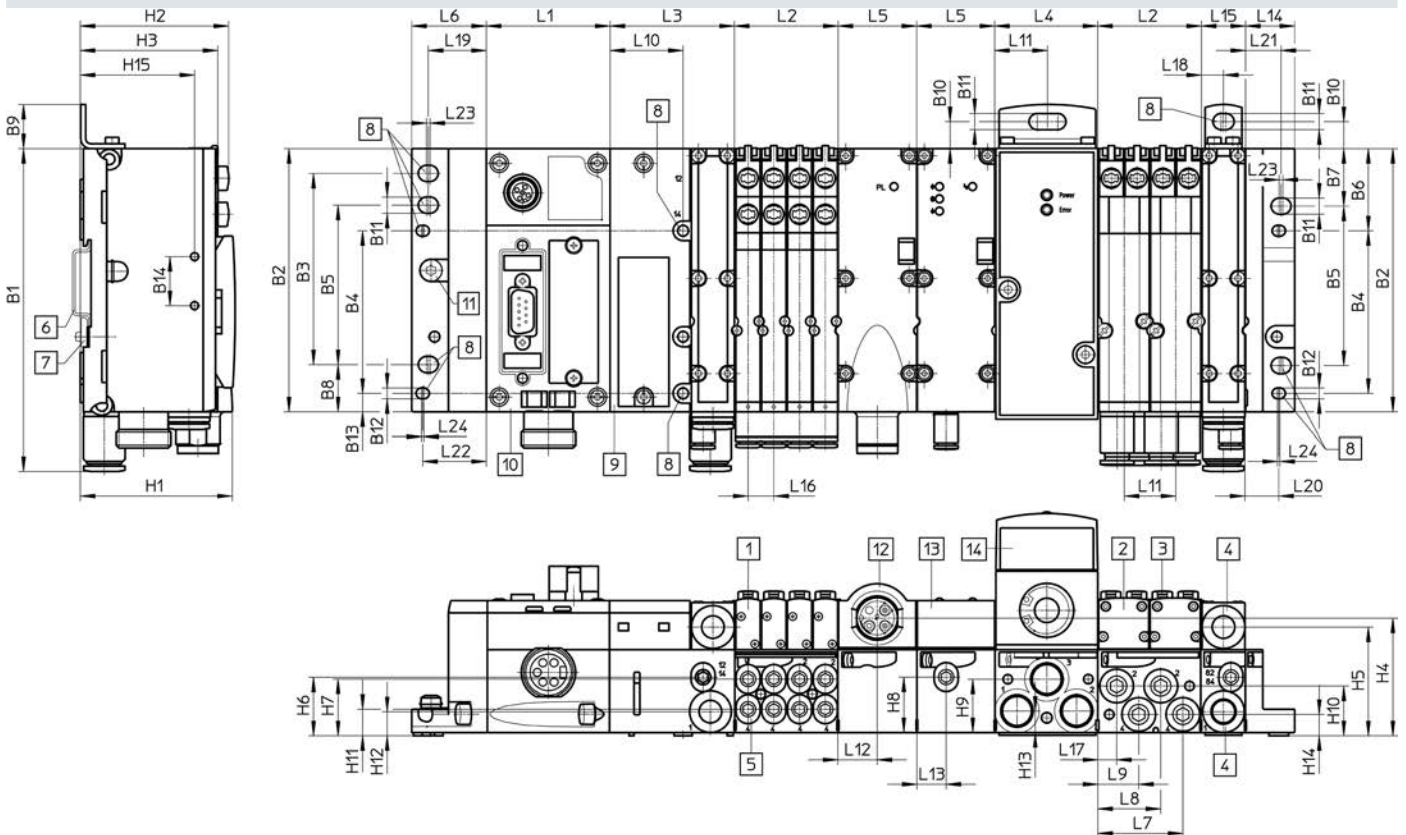

- | | | | | |
|--------------------------|---------------------------------|--------------------------------------|---|--|
| [1] Solenoid valve MPA1 | [6] H-rail | [11] Earthing screw | n | Number of sub-bases in a grid of 4 MPA1 or 2 MPA2 valves |
| [2] Solenoid valve MPA2 | [7] H-rail mounting | [12] Electrical supply plate | m | Number of CPX-P modules |
| [3] Manual override | [8] Mounting holes | [13] Pressure sensor | | |
| [4] Supply/exhaust ports | [9] Pneumatic interface VMPA-FB | [14] Proportional-pressure regulator | | |
| [5] Working ports | [10] CPX-P module | | | |







Type	B1	B2	B3	B4	B5	B6	B7	B8	B9	B10	B11	B12	B13	B14
CPX-P	131.4	107.3	78	66.3	65	33.5	23.5	19.3	18	11	6.6	4.4	7.5	20

Type	H1	H2	H3	H4	H5	H6	H7	H8	H9	H10	H11	H12	H13	H14	H15
CPX-P	62	60.5	56	48	44.3	23.9	23.1	22.6	21.8	20.3	10.8	9.8	8.8	8.7	46.6

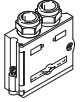
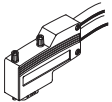
Type	L1	L2	L3	L4	L5	L6	L7	L8	L9	L10	L11	L12
CPX-P	m x 50.1	n x 42	51.2	42	32	30.4	34.7	25.7	16.7	30	21	16



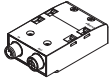

Type	L13	L14	L15	L16	L17	L18	L19	L20	L21	L22	L23	L24
CPX-P	12	20	18	10.5	7.7	9	23.7	13.5	14.5	25.9	1.5	1

Accessories

Ordering data					Part no.	Type
Designation						
Plugs						
	Sub-D socket, 9-pin		For DeviceNet		532219	FBS-SUB-9-BU-2x5POL-B
	Sub-D plug, 9-pin		For PROFIBUS DP		532216	FBS-SUB-9-GS-DP-B
	Sub-D plug, angled		For PROFIBUS DP		533780	FBS-SUB-9-WS-PB-K
	Bus connection, adapter to M12 plug/socket, 5-pin	Sub-D plug, 9-pin	B-coded	For PROFIBUS DP	533118	FBA-2-M12-5POL-RK
		Sub-D socket, 9-pin	Micro style	For DeviceNet	525632	FBA-2-M12-5POL
	M12 socket, 5-pin	Screw terminal	For FBA-2-M12-5POL		18324	FBSD-GD-9-5POL
		Screw terminal	For FBA-2-M12-5POL-RK and CPX-AB-2-M12-RK-DP		1067905	NECU-M-B12G5-C2-PB
	Plug M8, 3-pin	Solderable	For NEDY-L2R1-V1-M8G3-N-M8G4		18696	SEA-GS-M8
		Screw-in	For NEDY-L2R1-V1-M8G3-N-M8G4		192009	SEA-3GS-M8-S
	Plug M12, 4-pin	Spring-loaded terminal	For cable Ø 4 ... 8 mm		575719	NECU-M-S-A12G4-IS¹⁾
			Screw terminal	D-coded	For Ethernet	543109
		For cable Ø 2.5 ... 2.9 mm		570955	NECU-S-M12G4-P1-Q6-IS¹⁾	
		For cable Ø 2x3 mm or 2x5 mm		570956	NECU-S-M12G4-D-IS¹⁾	
		For 2x cable Ø 3 ... 5 mm		18779	SEA-GS-11-DUO	
		For cable Ø 4 ... 6 mm		570953	NECU-S-M12G4-P1-IS¹⁾	
				18666	SEA-GS-7	
		For cable Ø 6 ... 8 mm		570954	NECU-S-M12G4-P2-IS¹⁾	
				18778	SEA-GS-9	
		Plug M12, 5-pin	Screw terminal	For 2x cable Ø 2.5 ... 5 mm		192010
	For cable Ø 4 ... 6 mm			175487	SEA-M12-5GS-PG7	
	For FBA-2-M12-5POL			175380	FBS-M12-5GS-PG9	
For FBA-2-M12-5POL-RK and CPX-AB-2-M12-RK-DP				1066354	NECU-M-S-B12G5-C2-PB	
	Connection block, adapter to 5-pin 7/8" plug	Sub-D socket, 9-pin	–	For DeviceNet	571052	CPX-AB-1-7/8-DN
	Connection block, adapter to M12 plug/socket	Sub-D plug, 9-pin	B-coded	For PROFIBUS DP	541519	CPX-AB-2-M12-RK-DP
	Open style bus connection for 5-pin terminal strip			For DeviceNet	525634	FBA-1-SL-5POL
	5-pin terminal strip			For open style connection	525635	FBSD-KL-2x5POL

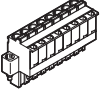

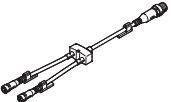
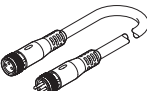

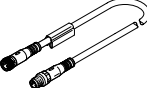

1) Component preferred for operation in intrinsically safe circuits.

Accessories

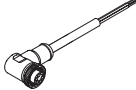
Ordering data				Part no.	Type	
Designation						
Connectors						
	RJ45 plug			534494	FBS-RJ45-8-GS	
	Socket, 8-pin	Spring-loaded terminal	Black	565712	NECU-L3G8-C1	
			Blue	565711	NECU-L3G8-C1-IS ¹⁾	
	Screw terminal	Black	565710	NECU-L3G8-C2		
		Blue	565709	NECU-L3G8-C2-IS ¹⁾		
	Sub-D plug, 25-pin			527522	SD-SUB-D-ST25	
Connecting cable						
	Modular system for all types of sensor/actuator distributor			–	NEDY-... → Internet: nedy	
	Modular system for a choice of connecting cables			–	NEBU-... → Internet: nebu	
	Push-in T-connector	1x plug M8, 4-pin	2x socket M8, 3-pin	8005312	NEDY-L2R1-V1-M8G3-N-M8G4	
		1x plug M12, 4-pin	2x socket M8, 3-pin	8005311	NEDY-L2R1-V1-M8G3-N-M12G4	
			2x socket M12, 4-pin	562248	NEDU-M12D4-M12T4-IS ¹⁾	
			2x socket, M12, 5-pin	8005310	NEDY-L2R1-V1-M12G5-N-M12G4	
	1x socket M8, 3-pin	1x plug M8, 3-pin	0.5 m	541346	NEBU-M8G3-K-0.5-M8G3	
			1.0 m	541347	NEBU-M8G3-K-1-M8G3	
			2.5 m	541348	NEBU-M8G3-K-2.5-M8G3	
			5.0 m	541349	NEBU-M8G3-K-5-M8G3	
			Connecting cable M12-M12	5-pin	Straight plug/ straight socket	1.5 m
			3.5 m	530901		KV-M12-M12-3.5

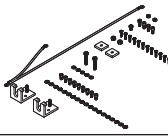
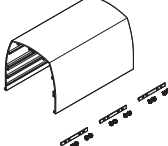
1) Component preferred for operation in intrinsically safe circuits.

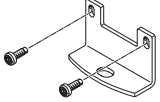
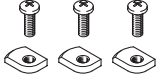
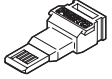
Accessories

Ordering data		Part no.	Type
Designation			
Connectors and accessories – Power supply			
	Power supply socket, straight	7/8" connection, 5-pin	543107 NECU-G78G5-C2
	7/8" power supply socket, 5-pin, angled socket	Open cable end, 5-pin	2 m 573855 NEBU-G78W5-K-2-N-LE5
Hood			
	Mounting rail for attaching the hood	1000 mm	572256 CAFC-X1-S
	Mounting kit for CPX hood		572257 CAFC-X1-BE
	Hood section for CPX-P terminal including mounting attachments for connecting several hood sections in series	200 mm	572258 CAFC-X1-GAL-200
		300 mm	572259 CAFC-X1-GAL-300
Screws			
	Screws for mounting the bus node/connection block on an interlinking block	Bus node/plastic connection block	550219 CPX-M-M3x22-4x
		Bus node/metal connection block	550216 CPX-M-M3x22-S-4x
	Screws for mounting an inscription label on the bus node (CPX-FB33)	Pack of 12	550222 CPX-M-M2.5X8-12X
Mounting			
	Attachment for wall mounting (for long valve terminals, 2 mounting brackets and 4 screws)	Version for metal interlinking plates	550217 CPX-M-BG-RW-2x
	Mounting for H-rail		526032 CPX-CPA-BG-NRH
Function blocks			
	Memory card for PROFINET bus node, 2MB		4798288 CPX-SK-3
	Terminating resistor, M12, B-coded for PROFIBUS		1072128 CACR-S-B12G5-220-PB
	Adapter M12, 5-pin to mini USB socket, and controller software		547432 NEFC-M12G5-0.3-U1G5

Accessories

Ordering data		Part no.	Type
Designation			
Covers and attachments			
	Cover for CPX-AB-8-KL-4POL (IP65/67)	8 cable through feeds M9 1 cable through feed for multi-pin plug	538219 AK-8KL
	Fittings kit for cover AK-8KL		538220 VG-K-M9
	Screening plate for connection block • CPX-AB-4-M12X2-5POL • CPX-AB-4-M12X2-5POL-R		526184 CPX-AB-S-4-M12
	Inspection cover, transparent		533334 AK-SUB-9/15-B
	Transparent cover for DIL switch and memory card		548757 CPX-AK-P
	Cover for RJ45 connection		534496 AK-RJ45
	Cover cap for closing off unused connections (10 pieces)	For M8 connections	177672 ISK-M8
		For M12 connections	165592 ISK-M12
	Coding element (96 pieces of each)	For NECU-L3G8	565713 CPX-P-KDS-AB-2XKL
	Insulating plate for safe separation of intrinsically safe and non-intrinsically safe areas of the CPX terminal		565708 CPX-P-AB-IP ¹⁾
Inscription labels			
	Inscription label holder for connection block		536593 CPX-ST-1
	Inscription labels 6x10 mm, 64 pieces, in frame		18576 IBS-6x10

1) Component preferred for operation in intrinsically safe circuits.

Festo - Your Partner in Automation



1 Festo Inc.
5300 Explorer Drive
Mississauga, ON L4W 5G4
Canada

Festo Customer Interaction Center
Tel: 1 877 463 3786
Fax: 1 877 393 3786
Email: customer.service.ca@festo.com

2 Festo Pneumatic
Av. Ceylán 3,
Col. Tequesquináhuac
54020 Tlalnepantla,
Estado de México

Multinational Contact Center
01 800 337 8669
ventas.mexico@festo.com

3 Festo Corporation
1377 Motor Parkway
Suite 310
Islandia, NY 11749

Festo Customer Interaction Center
1 800 993 3786
1 800 963 3786
customer.service.us@festo.com

4 Regional Service Center
7777 Columbia Road
Mason, OH 45040

Connect with us



www.festo.com/socialmedia



www.festo.com

Subject to change