

XW6T

Downsize Control Panels and Save Work with Common Terminal Blocks with Visible Indicators

- Indicators make wiring completion simply visible. Proper wiring without skillful operators.
- Simply check the indicators for wiring maintenance, helping reduce maintenance works.
- Short Bars enable pre-connected common wiring. No troublesome crossover wiring required.
- The best-in-class slim models available to help downsize control panels.
- Wiring system interface with Push-In Plus technology enables no loosening of wiring, providing a maintenance-free operation.

 Refer to *Safety Precautions* on page 11.

Model Number Legend

Model Reference

Use this legend when determining the product specifications from the model number. Select models from **Ordering Information** for orders.

XW6T - COM **X**

(1) (2) (3)

(1) Maximum Applicable Stranded Wire
 1.5: 1.5 mm²
 2.5: 2.5 mm²

(2) Number of Pins
 8: 8 pins
 12: 12 pins
 16: 16 pins
 20: 20 pins
 40: 40 pins

(3) Color of Short Bars
 RD: Red
 BL: Blue
 YL: Yellow

Part Names and Configuration

Terminal Block

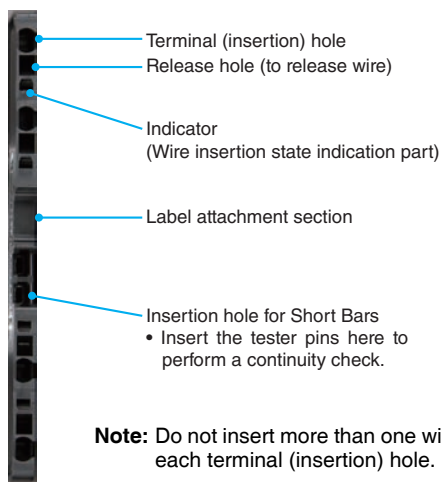

Basic Configuration

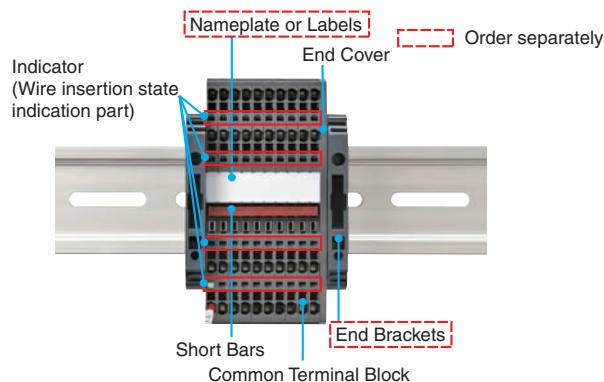

Name	Description
Common Terminal Block	Five types of 8/12/16/20/40 pins are available.
End Cover	This part is required to prevent electrical shock. Attached on the end surface (metal exposure part) of the last terminal block.
End Brackets	This part is available as an accessory. End blocks must be attached on the both ends to hold terminal block in place.
Nameplate or Labels	This part is available as an accessory. Select the most suitable one for your needs. You can also use commercially available nameplates that are 9.5 mm wide and 0.5 mm thick.
Short Bars	All pins are shorted.
Indicator	Turns in green when the connection is completed.













For the most recent information on models that have been certified for safety standards, refer to your OMRON website.

XW6T

Ordering Information

Model

Appearance	Maximum Conductor Cross Section Fine Stranded (mm ²)	Number of pins	Color of Short Bars	Weight (g)	Model
	1.5	8	Red	Approx. 16	XW6T-COM1.5X8RD
			Blue		XW6T-COM1.5X8BL
			Yellow		XW6T-COM1.5X8YL
		12	Red	Approx. 23	XW6T-COM1.5X12RD
			Blue		XW6T-COM1.5X12BL
			Yellow		XW6T-COM1.5X12YL
		16	Red	Approx. 29	XW6T-COM1.5X16RD
			Blue		XW6T-COM1.5X16BL
			Yellow		XW6T-COM1.5X16YL
		20	Red	Approx. 36	XW6T-COM1.5X20RD
			Blue		XW6T-COM1.5X20BL
			Yellow		XW6T-COM1.5X20YL
	40	Red	Approx. 68	XW6T-COM1.5X40RD	
		Blue		XW6T-COM1.5X40BL	
		Yellow		XW6T-COM1.5X40YL	
	2.5	8	Red	Approx. 28	XW6T-COM2.5X8RD
			Blue		XW6T-COM2.5X8BL
			Yellow		XW6T-COM2.5X8YL
		12	Red	Approx. 41	XW6T-COM2.5X12RD
			Blue		XW6T-COM2.5X12BL
			Yellow		XW6T-COM2.5X12YL
		16	Red	Approx. 53	XW6T-COM2.5X16RD
			Blue		XW6T-COM2.5X16BL
			Yellow		XW6T-COM2.5X16YL
		20	Red	Approx. 65	XW6T-COM2.5X20RD
			Blue		XW6T-COM2.5X20BL
			Yellow		XW6T-COM2.5X20YL
	40	Red	Approx. 126	XW6T-COM2.5X40RD	
		Blue		XW6T-COM2.5X40BL	
		Yellow		XW6T-COM2.5X40YL	

Note: Products will be delivered in the form of common terminal blocks (with terminal blocks, a short bar, and an end cover) as shown in the appearance.

(Example) XW6T-COM1.5X8RD set contents
 Terminal block unit (4 terminals) × 2
 Short bar (two-poles, red) × 1
 End cover × 1

Accessories (Order separately)

Terminal Block Unit (For addition)

Appearance	Applicable Terminal Blocks	Model	Application
	XW6T-COM1.5X□□□□	XW6T-COM1.5	This is a Terminal Block for addition. By using it with Short Bars as a set, Addition of the common points is available. Always attach the end cover after addition to prevent electrical shock. (Refer to page 14 for details.)
	XW6T-COM2.5X□□□□	XW6T-COM2.5	

Short Bars

Appearance	Applicable Terminal Blocks	Number of poles	Covering color	Model*	Application
	XW6T-COM1.5X□□□□	2	Red (RD) Blue (BL) Yellow (YL)	XW5S-P1.5-2□	Used for crossover wiring between Terminal Blocks.
		3		XW5S-P1.5-3□	
		4		XW5S-P1.5-4□	
		5		XW5S-P1.5-5□	
		10		XW5S-P1.5-10□	
	XW6T-COM2.5X□□□□	2	Red (RD) Blue (BL) Yellow (YL)	XW5S-P2.5-2□	
		3		XW5S-P2.5-3□	
		4		XW5S-P2.5-4□	
		5		XW5S-P2.5-5□	
		10		XW5S-P2.5-10□	

* Replace the box (□) in the model number with the code for the covering color. Selection of the box (□): RD=Red, BL=Blue, YL=Yellow

End Cover

Appearance	Applicable Terminal Blocks	Model	Application
	XW6T-COM1.5X□□□□	XW6E-COM1.5	This part is required to prevent electrical shock. Attach end covers for the Terminal Blocks before use on the following parts. (Refer to page 14 for details.) • Exposed metal surface of the last Terminal Block • Any Terminal Block that is next to a different shape of Terminal Blocks.
	XW6T-COM2.5X□□□□	XW6E-COM2.5	

Labels

Appearance	Applicable Terminal Blocks	Model	Minimum order in sheets (quantity per sheet)	Application
	XW6T-COM1.5X□□□□	XW5Z-P1.5LB1	5 sheets with 102 top labels per sheet	Used to identify wiring. (Material: PA resin, blank)
		XW5Z-P1.5LB2	5 sheets with 108 side labels per sheet	
	XW6T-COM2.5X□□□□	XW5Z-P2.5LB1	5 sheets with 72 top labels per sheet	
		XW5Z-P2.5LB2	5 sheets with 72 side labels per sheet	

Note: 1. Different models are used for the top and side surfaces.

2. If you use commercially available nameplates (9.5 mm width and 0.5 mm thickness), you can use a commercially available printer. Check with the manufacturer of the nameplates for information on applicable printers.

3. Refer to page 14 for details on printing labels.

End Brackets



Appearance	Width (mm)	Model	Application
	6	XW5Z-EP6	End Brackets are installed on the both ends of the Terminal Blocks to prevent them from moving on DIN Track.

Note: Short bars and end covers come attached to the common terminal blocks. Please select when necessary for expansion applications.

XW6T

Ratings and Performance

Ratings

Model		XW6T-COM1.5X□□□□				XW6T-COM2.5X□□□□			
Appearance and internal wiring									
Applicable wire sizes *1	Nominal cross section	0.75 mm ² (1.5 mm ²)*2				2.5 mm ²			
	Minimum conductor cross section solid	0.14 mm ²				0.14 mm ²			
	Maximum conductor cross section solid	1.5 mm ²				4.0 mm ²			
	Minimum conductor cross section fine stranded	0.08 mm ²				0.14 mm ²			
	Maximum conductor cross section fine stranded	1.5 mm ²				2.5 mm ²			
	Minimum conductor cross section (flex., stranded) with ferrule with plastic sleeve	0.14 mm ²				0.14 mm ²			
	Maximum conductor cross section (flex., stranded) with ferrule with plastic sleeve	0.75 mm ² (1.5 mm ²)*2				2.5 mm ²			
Dimensions	A × 78 × 31.3 (Dimension A...8 pins: 9.2, 12 pins: 12.7, 16 pins: 16.2, 20 pins: 19.7, 40 pins: 37.2)				A × 82.6 × 36.1 (Dimension A...8 pins: 12.6, 12 pins: 17.8, 16 pins: 23.0, 20 pins: 28.2, 40 pins: 54.2)				
IEC rated voltage	500 V				800 V				
IEC rated current	17.5 A/1.5 mm ²				24 A/2.5 mm ²				
Usage Group (UG)	B, C		D		B, C				
UL rated voltage	300 V	51 to 150 V	151 to 300 V	301 to 600 V	600 V				
UL rated current	15 A/AWG14 (solid wires) 10 A/AWG16	15 A/AWG14 (solid wires) 10 A/AWG16	10 A/AWG16	5 A/AWG16-20	20 A/AWG12 (solid wire), 15 A/AWG14				
Withstand voltage	1,890 VAC for 1 min (leakage current: 1 mA max.)				2,000 VAC for 1 min (leakage current: 1 mA max.)				
End Cover	XW6E-COM1.5				XW6E-COM2.5				
Special tool	XW4Z-00B				XW4Z-00B				
Applicable nameplates	XW5Z-P1.5LB□ or commercially available nameplate with 9.5 mm width and 0.5 mm thickness				XW5Z-P2.5LB□ or commercially available nameplate with 9.5 mm width and 0.5 mm thickness				

*1. For the applicable wire ranges, refer to page 11 for solid and stranded wires and to page 13 for ferrules.

*2. You can also use ferrules for 1.0 to 1.5 mm² wires if you use ferrules without insulation sleeve.

Performance

Ambient temperature range	-40 to 55°C (with no condensation or icing)
Ambient humidity range	5 to 95%RH
Insulating material	PA resin
Fire resistance	UL94 V-0
Insertion durability	50 times
Vibration resistance	10 to 150 Hz, Acceleration of 50 m/s ² for 80 min each in X, Y, and Z directions.
Shock resistance	500 m/s ² for 11 ms each in 6 directions 5 times
Ambient storage temperature	-40 to 85°C (with no condensation or icing)
Ambient storage humidity	5 to 95%RH

Standards

Compliant standard

- UL1059
- CSA (C22.2 No.158)
- IEC 60947-7-1

Certification

- cURus (File No. E245101)

Dimensions

(Unit: mm)

Model

XW6T-COM1.5X□□□□

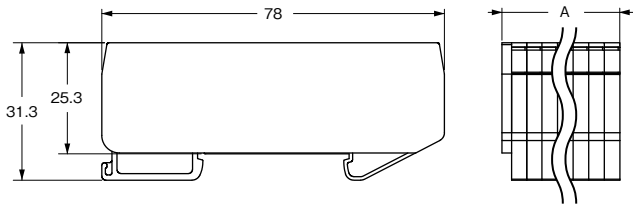

Dimension A

Model	Number of pins	Dimensions
XW6T-COM1.5X8□□	8 pins	9.2
XW6T-COM1.5X12□□	12 pins	12.7
XW6T-COM1.5X16□□	16 pins	16.2
XW6T-COM1.5X20□□	20 pins	19.7
XW6T-COM1.5X40□□	40 pins	37.2

XW6T-COM2.5X□□□□

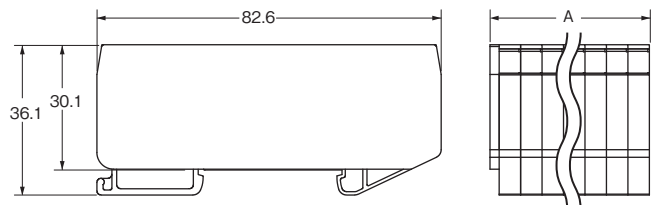

Dimension A

Model	Number of pins	Dimensions
XW6T-COM2.5X8□□	8 pins	12.6
XW6T-COM2.5X12□□	12 pins	17.8
XW6T-COM2.5X16□□	16 pins	23.0
XW6T-COM2.5X20□□	20 pins	28.2
XW6T-COM2.5X40□□	40 pins	54.2

Accessories (Order separately)

(For addition) Terminal Block

XW6T-COM1.5

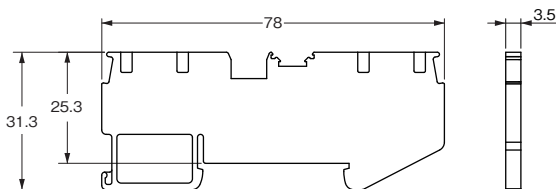

XW6T-COM2.5

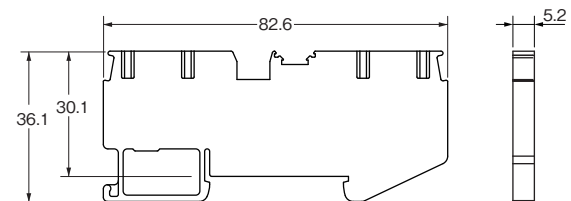

XW6T

Short Bars

XW5S-P1.5-□

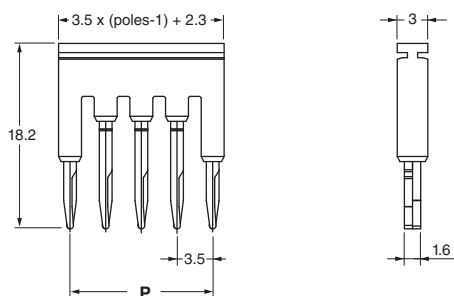

Model	P (mm)
XW5S-P1.5-2□	3.5
XW5S-P1.5-3□	7.0
XW5S-P1.5-4□	10.5
XW5S-P1.5-5□	14.0
XW5S-P1.5-10□	31.5

XW5S-P2.5-□

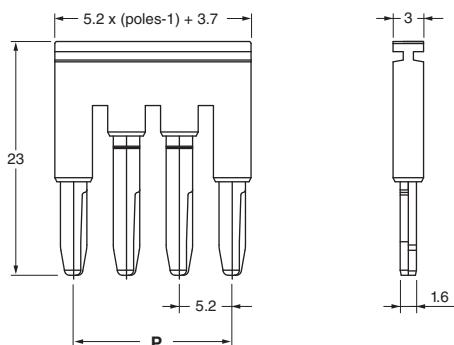

Model	P (mm)
XW5S-P2.5-2□	5.2
XW5S-P2.5-3□	10.4
XW5S-P2.5-4□	15.6
XW5S-P2.5-5□	20.8
XW5S-P2.5-10□	46.8

End Cover

XW6E-COM1.5

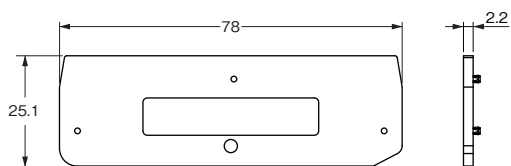

XW6E-COM2.5

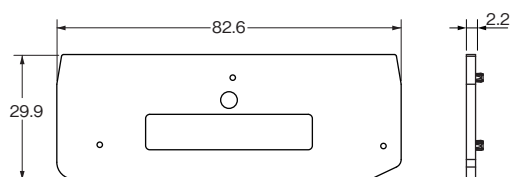

End Brackets

XW5Z-EP6

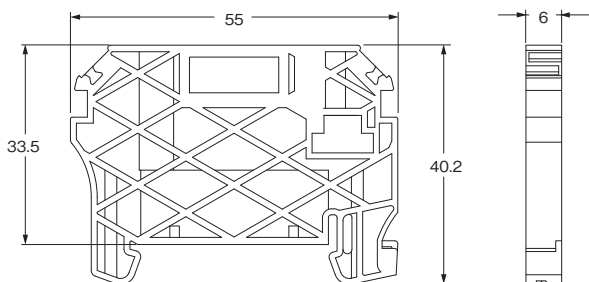

Safety Precautions

Warning Indications

Precautions for Safe Use	Supplementary comments on what to do or avoid doing, to use the product safely.
Precautions for Correct Use	Supplementary comments on what to do or avoid doing, to prevent failure to operate, malfunction, or undesirable effects on product performance.

Precautions for Safe Use

- Do not drop the Terminal Block.
Terminal Block functionality may be inhibited.
- Terminal Block is designed to satisfy the functions when mounting on the DIN Track. Always mount on the DIN Track.
- Do not exceeds the ratings. Doing so may result failure or burning.
- Mount the Terminal Block on a DIN Track and secure both ends with the Terminal Brackets.
- Do not use Terminal Blocks in locations where toxic gases, such as sulfide gas (H₂S and SO₂), ammonia gas (NH₃), nitrogen gas (HNO₃), chlorine gas (Cl₂), or in locations subject to high temperature or humidity. Doing so may cause functional failure, such as damages due to contact failure or corrosion.
- Do not use the Terminal Blocks submersed in oil or water, or in locations continuously subject to splashes of oil or water. Doing so may result in oil or water entering and damaging the Terminal Blocks.
- Do not use or keep the Terminal Blocks under the following conditions:
 - Subject to severe temperature changes.
 - Subject to high humidity and condensation.
 - Subject to severe vibration or shock.
 - Where direct rays of the sun strike.
 - Where sea breeze may be present.
- When disposing, dispose the Terminal Blocks as industrial wastes.
- Do not wire anything to the release holes.
- Do not tilt or twist a flat-blade screwdriver while it is inserted into a release hole on the terminal block. The terminal block may be damaged.
- Insert a flat-blade screwdriver into the release holes at an angle. The terminal block may be damaged if you insert the screwdriver straight in.
- Do not allow the flat-blade screwdriver to fall out while it is inserted into a release hole.
- Do not bend a wire past its natural bending radius or pull on it with excessive force. Doing so may sever the cable. Do not apply excessive force to the Terminal Blocks. Doing so may cause connection failure due to damage or deformation.
- Do not insert more than one wire into each terminal insertion hole.
- When mounting multiple Terminal Blocks, mount them so that the conductive parts of the adjacent Terminal Blocks are facing in the same direction. If they face in different directions, short circuit may occur between adjacent Terminal Blocks.
- Do not use wires with discoloration, doing so may cause conduction failure.
- When stripping the wire coatings, be sure not to damage the core wire. Doing so may cause connection failure.
- Do not perform wiring with wet hands. Doing so may result operation failure or malfunction when power is supplied.

- To prevent wiring materials from smoking or ignition, use the wiring materials given in the following table with referring the ratings of wires.

	Recommended wire		Stripping length (Ferrules not used)
	Solid wire	Stranded wire	
XW6T-COM1.5X□□□□	0.14 to 1.5 mm ² / AWG 26 to 14	0.08 to 1.5 mm ² / AWG 28 to 16	8 mm
XW6T-COM2.5X□□□□	0.14 to 4.0 mm ² / AWG 26 to 12	0.14 to 2.5 mm ² / AWG 26 to 14	10 mm

Precautions for Correct Use

1. Precautions for Correct Use

- Always mount End Covers to the following locations when you use Terminal Blocks.
 - Exposed metal surface of the last Terminal Block
 - Any Terminal Block that is next to a different shape of Terminal Blocks.
 Not doing so may result electrical shock.
- When you wire the Terminal Block, do not subject it or the wires to stress. Secure the wires so that they do not resonate with vibrations from the facilities in installation conditions.
- Always turn OFF the power supply before wiring. Electrical shock may occur.
- Do not insert a flat-blade screwdriver into the indicator part. Doing so may cause failure of function that indicates wire insertion state.
- When you use wires thinner than AWG22 (0.34 mm² or equivalent), the wire insertion state indication may not properly function due to low rigidity of the conductive part. In addition, for the indicator, moving distance of the indicator may vary due to the feature of resin depending on the usage environment.

2. Connecting Wires to the Push-In Plus Terminal Block

Part Names of the Terminal Block

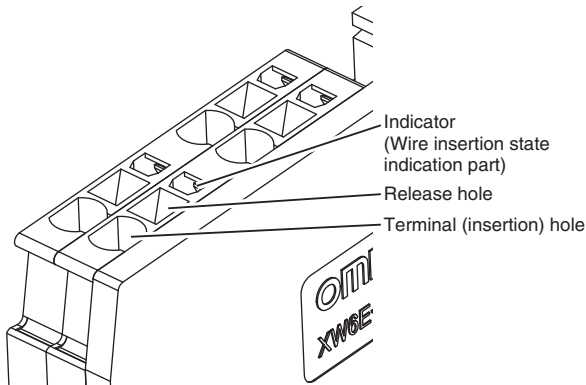

Connecting Wires with Ferrules (hereinafter referred to as Ferrules) and Solid Wires

Insert the solid wire or ferrule straight into the Terminal Block until the end strikes the Terminal Block. If a wire is difficult to connect because it is too thin, use a flat-blade screwdriver in the same way as when connecting stranded wire. When the wire is inserted, the wire insertion state indication part turns in green.

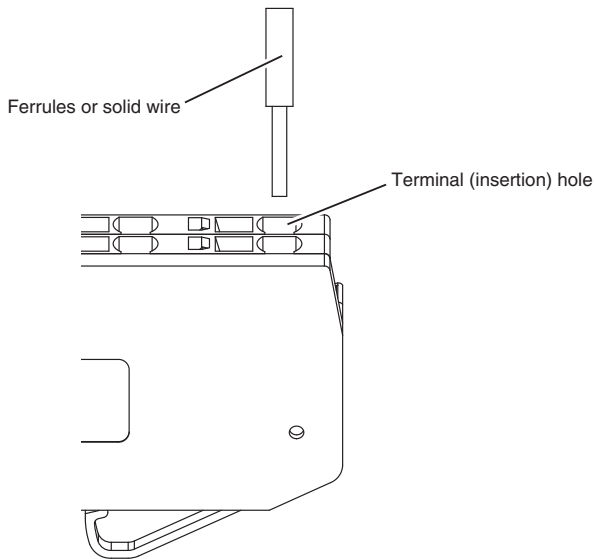

Connecting Stranded Wires

Use the following procedure to connect the wires to the terminal block.

1. Hold a flat-blade screwdriver at an angle and insert it into the release hole. The angle should be between 10° and 15°. If the flat-blade screwdriver is inserted correctly, you will feel the spring in the release hole respond.
2. With the flat-blade screwdriver still inserted into the release hole, insert the wire into the terminal hole until it strikes the terminal block. Always twist stranded wires together before inserting them. When the wire is inserted, the wire insertion state indication part turns in green.

3. Remove the flat-blade screwdriver from the release hole.

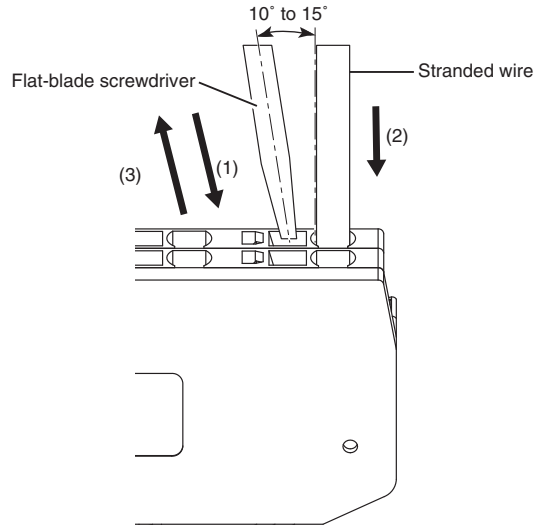

Checking Connections

- When you complete wiring, an indicator for the wire insertion state turns to green.
- To prevent short circuits, insert the stripped part of a stranded or solid wire or the conductor part of a ferrule until it is hidden inside the terminal insertion hole.
- After the connection, the wire insertion state indication of the indicator may shift by a load applied to the wire at wiring or other causes. Even in such a case, there is no problem in the electrical connection as long as the indicator shows a part of green to indicate the proper insertion of wire.



Wire non-insertion state:
Green is not indicated.



Wire insertion state:
Green is indicated.

3. Removing Wires from the Push-In Plus Terminal Block

Use the following procedure to remove wires from the terminal block. The same method is used to remove stranded wires, solid wires, and ferrules.

1. Hold a flat-blade screwdriver at an angle and insert it into the release hole.
2. With the flat-blade screwdriver still inserted into the release hole, remove the wire from the terminal insertion hole.
3. Remove the flat-blade screwdriver from the release hole.

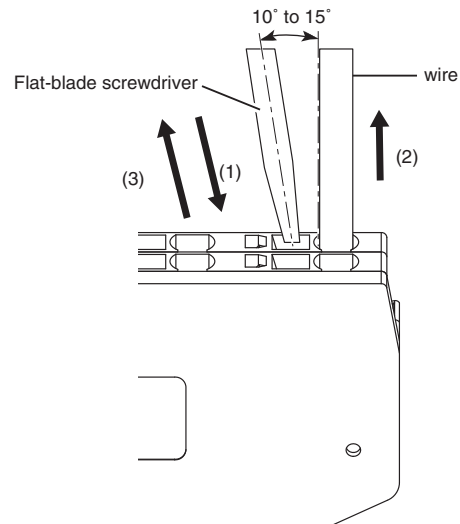

4. Recommended Ferrules and Crimp Tools

Recommended ferrules

XW6T-COM1.5X□□□□

Applicable wire		Ferrule Conductor length (mm)	Stripping length (mm) (Ferrules used)	Recommended ferrules		
(mm ²)	(AWG)			Manufactured by Phoenix Contact	Manufactured by Weidmuller	Manufactured by Wago
0.14	26	8	10	AI 0,14-8	H0.14/12	---
0.25	24	8	10	AI 0,25-8	H0.25/12	FE-0.25-8N-YE
		10	12	AI 0,25-10	---	---
0.34	22	8	10	AI 0,34-8	H0.34/12	FE-0.34-8N-TQ
		10	12	AI 0,34-10	---	---
0.50	20	8	10	AI 0,5-8	H0.5/14	FE-0.5-8N-WH
		10	12	AI 0,5-10	H0.5/16	FE-0.5-10N-WH
0.75	18	8	10	AI 0,75-8	H0.75/14	FE-0.75-8N-GY
		10	12	AI 0,75-10	H0.75/16	FE-0.75-10N-GY
Recommended crimp tools				CRIMPFOX6 CRIMPFOX6T-F CRIMPFOX10S	PZ6 roto	Variocrimp4

- Note:** 1. Make sure that the outer diameter of the wire is smaller than the inner diameter of the insulation sleeve of the recommended ferrule.
2. Make sure that the ferrule processing dimensions conform to the following figure.

Processing dimensions of ferrules

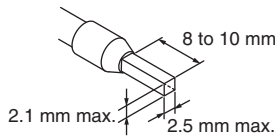

3. For the ferrule which is for applicable wire (1 to 1.5 mm²/ AWG 18 to 16), please use a ferrule without an insulation sleeve. (Refer to the following table.)

Applicable wire		Ferrule Conductor length (mm)	Stripping length (mm) (Ferrules used)	Recommended ferrules		
(mm ²)	(AWG)			Manufactured by Phoenix Contact	Manufactured by Weidmuller	Manufactured by Wago
1/1.25	18/17	8	8	A 1-8	---	F-1.0-8
		10	10	A 1-10	H1,0/10	F-1.0-10
1.25/1.5	17/16	10	10	A 1,5-10	H1,5/10	F-1.5-10
Recommended crimp tools				CRIMPFOX6 CRIMPFOX6T-F CRIMPFOX10S	PZ6 roto	Variocrimp4

XW6T-COM2.5X□□□□

Applicable wire		Ferrule Conductor length (mm)	Stripping length (mm) (Ferrules used)	Recommended ferrules		
(mm ²)	(AWG)			Manufactured by Phoenix Contact	Manufactured by Weidmuller	Manufactured by Wago
0.14	26	8	10	AI 0,14-8	H0.14/12	---
0.25	24	8	10	AI 0,25-8	H0.25/12	FE-0.25-8N-YE
		10	12	AI 0,25-10	---	---
0.34	22	8	10	AI 0,34-8	H0.34/12	FE-0.34-8N-TQ
		10	12	AI 0,34-10	---	---
0.50	20	8	10	AI 0,5-8	H0.5/14	FE-0.5-8N-WH
		10	12	AI 0,5-10	H0.5/16	FE-0.5-10N-WH
0.75	18	8	10	AI 0,75-8	H0.75/14	FE-0.75-8N-GY
		10	12	AI 0,75-10	H0.75/16	FE-0.75-10N-GY
1/1.25	18/17	8	10	AI 1-8	H1.0/14	FE-1.0-8N-RD
		10	12	AI 1-10	H1.0/16	FE-1.0-10N-RD
1.25/1.5	17/16	8	10	AI 1,5-8	H1.5/14	FE-1.5-8N-BK
		10	12	AI 1,5-10	H1.5/16	FE-1.5-10N-BK
2.5	14	10	12	AI 2,5-10	H2.5/16DS	FE-2.5-10N-BU
Recommended crimp tools				CRIMPFOX6 CRIMPFOX6T-F CRIMPFOX10S	PZ6 roto	Variocrimp4

- Note:** 1. Make sure that the outer diameter of the wire is smaller than the inner diameter of the insulation sleeve of the recommended ferrule.
2. Make sure that the ferrule processing dimensions conform to the following figure.

Processing dimensions of ferrules

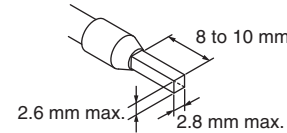

Recommended Flat-blade Screwdriver

Use a flat-blade screwdriver to connect and remove wires. Use the following flat-blade screwdriver. The following table shows manufacturers and models as of 2018/Dec.

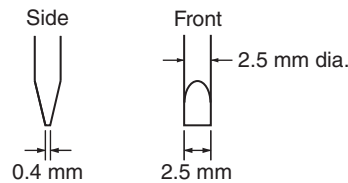

Model	Manufacturer
ESD 0,40x2,5	Wera
SZS 0,4x2,5 SZF 0-0,4x2,5 *	Phoenix Contact
0.4x2.5x75 302	Wiha
AEF.2,5x75	Facom
210-719	Wago
SDIS 0.4x2.5x75	Weidmuller
9900(-2.5x75)	Vessel

* OMRON's exclusive purchase model XW4Z-00B is available to order as SZF 0-0,4 x 2,5 (manufactured by Phoenix Contact).

Equivalent Labels from Other Companies and Recommended Label Printers

Use the following label printer.

The following table gives the manufacturer's model number as of August 2019.

Manufacturer	Omron	Phoenix Contact	Weidmuller	Cembre
Label	XW5Z-P1.5LB1	UCT-TM3,5	NA	MG-CPM-04 41392
	XW5Z-P2.5LB1	UCT-TM5	MF 8/5	MG-CPM-04 41390N
			MF 10/5	
			MF 12/5	
XW5Z-P1.5LB2	UCT-TMF3,5	---	---	
XW5Z-P2.5LB2	UCT-TMF5	---	---	
Label printer	--- *	BLUEMARK CLED, THERMOMARK CARD SET PLUS, THERMOMARK CARD	PrintJet ADVANCED, Plotter MCP Plus, Plotter MCP Basic	Markingenius MG3

* When using a printing tool, use a Phoenix Contact label printer.
Note: Ask the label manufacturer or printer manufacturer for details.

5. Mounting to DIN Track/Removing from DIN Track

Mounting Method

- To mount a Terminal Block to a DIN Track, press it against the DIN Track as shown in the following figure.
- * Even when Terminal Block seems like tilting before mounting it on the DIN Track, it is no problem for the functions.
- After mounting, push Short Bar securely and check it for no gap or no tilting.



Removal Method

To remove a Terminal Block from the DIN Track, insert the tip of a flat-blade screwdriver in the groove on the Short Bar, remove the Short Bar so that lifting it up from the Terminal Block (1), operate the screwdriver so that it catches the hook (2), and then remove the Terminal Block with the divided state (3). However, do not apply excessive force to the Terminal Block. Doing so may damage it.

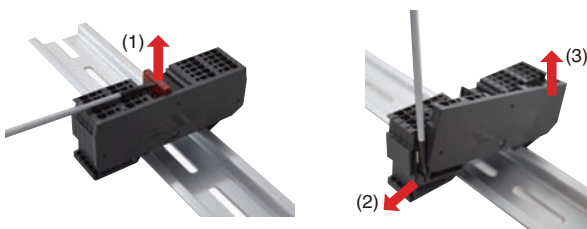

Replacing Method



- (1) Mount the Terminal Block with divided state on the DIN Track.
- (2) Insert Short Bars into the insertion holes for Short Bars.
- (3) Insert Short Bars for securely.

Adding Method of Common Terminal Blocks

- (1) Remove the End Cover.

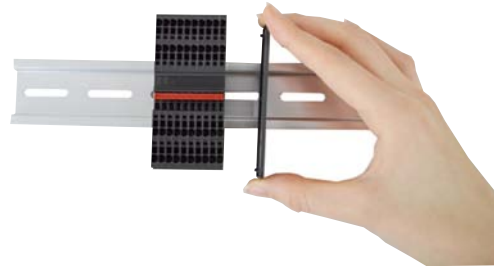

- (2) Mount a Common Terminal Block (for addition) on the DIN Track.
- (3) Replace the End Cover.

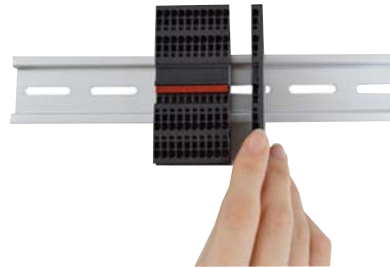

- (4) Mount a Short Bar so that it overlaps with the existing Short Bar.

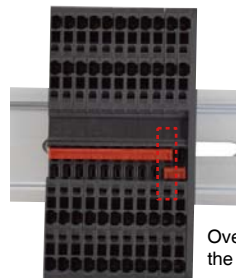

Overlapping Short Bars enables to add the number of Common Terminal Blocks.

Labels

Mounting Method

Top-surface Labels

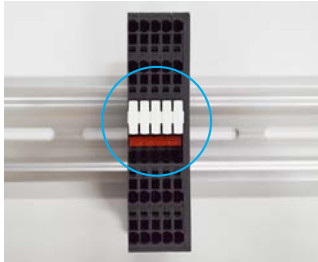
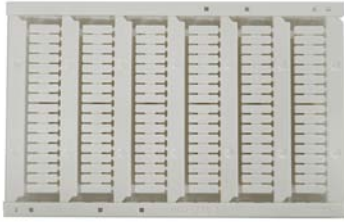

1. Remove the Labels one at a time.
2. Insert them on the tops of the Terminal Blocks.

Note: If multiple Terminal Blocks of the same type are used side by side, you can use multiple Labels still connected to each other.

Side-surface Labels

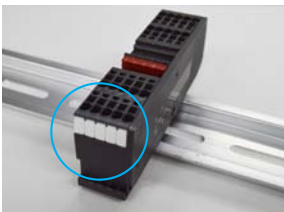
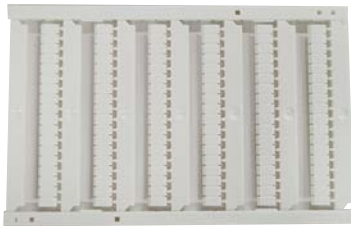

1. Remove the Labels one at a time.
 2. Insert them on the sides of the Terminal Blocks.
- Note:** 1. Different models of Labels are used for the top and side surfaces.
2. If multiple Terminal Blocks of the same type are used side by side, you can use multiple Labels still connected to each other.

6. Storage

Ambient storage temperature

-40 to 85°C (with no condensation or icing)

Ambient storage humidity

5 to 95%RH

OMRON AUTOMATION AMERICAS HEADQUARTERS • Chicago, IL USA • 847.843.7900 • 800.556.6766 • automation.omron.com

OMRON CANADA, INC. • HEAD OFFICE

Toronto, ON, Canada • 416.286.6465 • 866.986.6766 • automation.omron.com

OMRON ELECTRONICS DE MEXICO • HEAD OFFICE

Ciudad de México • 52.55.5901.4300 • 01.800.386.6766 • mela@omron.com

OMRON ELECTRONICS DE MEXICO • SALES OFFICE

San Pedro Garza García, N.L. • 81.12.53.7392 • 01.800.386.6766 • mela@omron.com

OMRON ELECTRONICS DE MEXICO • SALES OFFICE

Eugenio Garza Sada, León, Gto • 01.800.386.6766 • mela@omron.com

OMRON ELETRÔNICA DO BRASIL LTDA • HEAD OFFICE

São Paulo, SP, Brasil • 55.11.2101.6300 • www.omron.com.br

OMRON ARGENTINA • SALES OFFICE

Buenos Aires, Argentina • +54.11.4521.8630 • +54.11.4523.8483
mela@omron.com

OTHER OMRON LATIN AMERICA SALES

+54.11.4521.8630 • +54.11.4523.8483 • mela@omron.com

Authorized Distributor:

Controllers & I/O

- Machine Automation Controllers (MAC) • Motion Controllers
- Programmable Logic Controllers (PLC) • Temperature Controllers • Remote I/O

Robotics

- Industrial Robots • Mobile Robots

Operator Interfaces

- Human Machine Interface (HMI)

Motion & Drives

- Machine Automation Controllers (MAC) • Motion Controllers • Servo Systems
- Frequency Inverters

Vision, Measurement & Identification

- Vision Sensors & Systems • Measurement Sensors • Auto Identification Systems

Sensing

- Photoelectric Sensors • Fiber-Optic Sensors • Proximity Sensors
- Rotary Encoders • Ultrasonic Sensors

Safety

- Safety Light Curtains • Safety Laser Scanners • Programmable Safety Systems
- Safety Mats and Edges • Safety Door Switches • Emergency Stop Devices
- Safety Switches & Operator Controls • Safety Monitoring/Force-guided Relays

Control Components

- Power Supplies • Timers • Counters • Programmable Relays
- Digital Panel Meters • Monitoring Products

Switches & Relays

- Limit Switches • Pushbutton Switches • Electromechanical Relays
- Solid State Relays

Software

- Programming & Configuration • Runtime