

SmartSlice
GRT1-CRT

CompoNet Communications Unit

OPERATION MANUAL

OMRON

SmartSlice
GRT1-CRT
CompoNet Communications Unit
Operation Manual

Produced May 2008

Introduction

Thank you for buying a SmartSlice CompoNet Communications Unit. The CompoNet Communications Unit is an interface unit which complies with the CompoNet standard. It connects SmartSlice I/O Units to a CompoNet Master Unit. Be sure you understand the functions and performance of the Units fully before you use them.

Intended Audience

This manual is for the personnel below. This personnel must understand electrical systems (must be an electrical engineer or the equivalent).

- ♦ Personnel responsible for the selection of FA systems
- ♦ Personnel responsible for the designs of FA systems
- ♦ Personnel responsible for the installation of and connections in FA systems
- ♦ Personnel responsible for the management of FA systems

Precaution

This manual contains data which is necessary for you to use a CompoNet Communications Unit. Read and understand this manual fully before you use the CompoNet Communications Unit. After you read this manual, keep it in a safe location where it will be available for use when necessary. Be sure that the end user of the CompoNet Communications Unit has this manual.

Read and Understand this Manual

Please read and understand this manual before using the product. Please consult your OMRON representative if you have any questions or comments.

Warranty and Limitations of Liability

<i>WARRANTY</i>

<p>OMRON's exclusive warranty is that the products are free from defects in materials and workmanship for a period of one year (or other period if specified) from date of sale by OMRON.</p>

<p>OMRON MAKES NO WARRANTY OR REPRESENTATION, EXPRESS OR IMPLIED, REGARDING NON-INFRINGEMENT, MERCHANTABILITY, OR FITNESS FOR PARTICULAR PURPOSE OF THE PRODUCTS. ANY BUYER OR USER ACKNOWLEDGES THAT THE BUYER OR USER ALONE HAS DETERMINED THAT THE PRODUCTS WILL SUITABLY MEET THE REQUIREMENTS OF THEIR INTENDED USE. OMRON DISCLAIMS ALL OTHER WARRANTIES, EXPRESS OR IMPLIED.</p>

<i>LIMITATIONS OF LIABILITY</i>
--

<p>OMRON SHALL NOT BE RESPONSIBLE FOR SPECIAL, INDIRECT, OR CONSEQUENTIAL DAMAGES, LOSS OF PROFITS OR COMMERCIAL LOSS IN ANY WAY CONNECTED WITH THE PRODUCTS, WHETHER SUCH CLAIM IS BASED ON CONTRACT, WARRANTY, NEGLIGENCE, OR STRICT LIABILITY.</p>

<p>In no event shall the responsibility of OMRON for any act exceed the individual price of the product on which liability is asserted.</p>

<p>IN NO EVENT SHALL OMRON BE RESPONSIBLE FOR WARRANTY, REPAIR, OR OTHER CLAIMS REGARDING THE PRODUCTS UNLESS OMRON'S ANALYSIS CONFIRMS THAT THE PRODUCTS WERE PROPERLY HANDLED, STORED, INSTALLED, AND MAINTAINED AND NOT SUBJECT TO CONTAMINATION, ABUSE, MISUSE, OR INAPPROPRIATE MODIFICATION OR REPAIR.</p>
--

Application Considerations

SUITABILITY FOR USE

OMRON shall not be responsible for conformity with any standards, codes, or regulations that apply to the combination of products in the customer's application or use of the products.

At the customer's request, OMRON will provide applicable third party certification documents identifying ratings and limitations of use that apply to the products. This information by itself is not sufficient for a complete determination of the suitability of the products in combination with the end product, machine, system, or other application or use.

The following are some examples of applications for which particular attention must be given. This is not intended to be an exhaustive list of all possible uses of the products, nor is it intended to imply that the uses listed may be suitable for the products:

- Outdoor use, uses involving potential chemical contamination or electrical interference, or conditions or uses not described in this manual.
- Nuclear energy control systems, combustion systems, railroad systems, aviation systems, medical equipment, amusement machines, vehicles, safety equipment, and installations subject to separate industry or government regulations.
- Systems, machines, and equipment that could present a risk to life or property.

Please know and observe all prohibitions of use applicable to the products.

NEVER USE THE PRODUCTS FOR AN APPLICATION INVOLVING SERIOUS RISK TO LIFE OR PROPERTY WITHOUT ENSURING THAT THE SYSTEM AS A WHOLE HAS BEEN DESIGNED TO ADDRESS THE RISKS, AND THAT THE OMRON PRODUCTS ARE PROPERLY RATED AND INSTALLED FOR THE INTENDED USE WITHIN THE OVERALL EQUIPMENT OR SYSTEM.

Disclaimers

CHANGE IN SPECIFICATIONS

Product specifications and accessories may be changed at any time based on improvements and other reasons.

It is our practice to change model numbers when published ratings or features are changed, or when significant construction changes are made. However, some specifications of the products may be changed without any notice. When in doubt, special model numbers may be assigned to fix or establish key specifications for your application on your request. Please consult with your OMRON representative at any time to confirm actual specifications of purchased products.

DIMENSIONS AND WEIGHTS

Dimensions and weights are nominal and are not to be used for manufacturing purposes, even when tolerances are shown.

PERFORMANCE DATA

Performance data given in this manual is provided as a guide for the user in determining suitability and does not constitute a warranty. It may represent the result of OMRON's test conditions, and the users must correlate it to actual application requirements. Actual performance is subject to the OMRON Warranty and Limitations of Liability.

ERRORS AND OMISSIONS



The information in this manual has been carefully checked and is believed to be accurate; however, no responsibility is assumed for clerical, typographical, or proofreading errors, or omissions.

Safety Precautions

Safety Indications

The indications below are used in this manual for safety precautions which are necessary to use the CompoNet Communications Unit safely. The contents of these safety precautions are important. Always obey them.

These are the indications for safety precautions.

 WARNING	<p>Indicates a potentially hazardous situation which, if not avoided, could result in death or serious injury. Additionally, there may be severe property damage.</p>
 Caution	<p>Indicates a potentially hazardous situation which, if not avoided, may result in minor or moderate injury, or property damage.</p>

Precaution for Safe Usage

- “Precautions for Safe Application” shows the operations that you must do or not do to use the product safely.

Precaution for Correct Usage

- “Precautions for Correct Application” shows operations that you must do or not do to make sure that the product operates, prevent malfunctions, and prevent bad effects on performance and functions.
-

Descriptions of Symbols



This symbol shows operations that you must not do.
The specified operation shows in the circle.
This example shows “do not disassemble.”



This symbol shows precautions (including warnings).
The specified operation shows in the triangle.
This example shows a general precaution.



This symbol shows operations that you must do.
The specified operation shows in the circle.
This example shows a general precaution for something that you must do.

WARNING

Do not try to disassemble a Unit or touch the terminal block while the power is ON. Doing this can cause electrical shock.



Make sure that the voltage and current input to the Units are in the specified ranges. If the voltage and current are not in the specified ranges, there can be Unit malfunctions or fire.



Turn OFF the I/O power supply to a SmartSlice I/O Unit before you replace it with the online replacement procedure. If there is external power to a terminal for a Relay Output Slave, for example, turn OFF the external power before you replace the SmartSlice I/O Unit. If you replace a Slave I/O Unit with the power ON, incorrect outputs, incorrect inputs, or electric shock can occur.



Apply safety measures in external circuits (that is, not in the SmartSlice I/O Terminal) to keep safety in the system. These measures must keep safety if a malfunction in the control system or other external factor which has an effect on the control system causes a problem. Include the items below. Not doing this can cause serious accidents.



- There must be emergency stop circuits, interlock circuits, limit circuits, and other safety measures in external control circuits.
- The SmartSlice outputs can stay ON or OFF because of welding or burning of the output relays, or destruction of the output transistors. As a countermeasure for such errors, there must be external safety measures to keep safety in the system.
- The SmartSlice I/O Terminal will continue operating when one or more I/O Units are missing from the SmartSlice I/O Terminal. The other I/O Units will continue the control operations, including the control of the outputs. As a countermeasure for such errors, there must be external safety measures to keep safety in the system.

The CPU Unit refreshes I/O when the program is stopped in PROGRAM mode. Fully make sure that it is safe before changing the status of bits or words in memory allocated to Output Slaves, Special I/O Units, or CPU Bus Units. If you change the bits or words allocated to a Slave or Unit, you could cause incorrect operation of the loads connected to the Slave or Unit. The operations below will change memory status.



- Transferring I/O memory data to the CPU Unit from a Programming Device
- Changing present values in memory from a Programming Device
- Force-setting or force-resetting bits from a Programming Device
- Transferring I/O memory files from a Memory Card or EM file memory to the CPU Unit
- Transferring I/O memory from a host computer or from a PLC on a network

Precautions for Safe Usage

- Put a Unit in the special box during transportation. Make sure that the Unit is moved carefully, and not given too much vibration or shock during transportation.
- Do not let a Unit fall or give it too much vibration or shock. This can cause malfunction or cause damage to the Unit.
- Install the SmartSlice I/O Terminal correctly on DIN Track.
- Be sure that you correctly lock the terminal block, the communications cable connectors, and other items with locking devices.
- Correctly connect the Units as this manual shows.
- Interference between the Flat Cables for more than one CompoNet System can cause operation that is not stable. Keep the Flat Cables for different CompoNet Systems apart by a minimum of 5 mm. Interference can occur for Sheathed Cable or Unsheathed Cable.
- Do not let metal objects enter the Unit when connecting or installing it.
- Connect ferrules to the wires when you connect the wires. Do not connect stranded wires directly to terminals.
- Use the specified communications cables and connectors.
- Use the correct polarity when connecting the terminals.
- Put the ferrules fully into the holes.
- Do a full check of the terminal block before you attach it.
- Do not bend the cables to more than their normal bending radius or pull on the cables.
- Obey the following precautions when connecting communications cables.
 - Keep the communications cables away from the power lines or high-tension lines.
 - Do not bend the communications cables with too much force.
 - Do not pull on the communications cables with too much force.
 - Do not put objects on the communications cables.
 - Put the communications cables in ducts.
- If the power supply conditions are bad, install countermeasures to make sure that the power supply always has the rated voltage.
- You must make interlock circuits, limit circuits, and other safety measures in circuits that are external to the control system.
- Use the power supply voltage which this manual specifies.
- Make sure that there will be no problems when the Unit changes to fixed allocations for the I/O Areas before you clear the Registration Table. (You set user remote I/O allocations in the Registration Table.)
- Do not let the communications distance be higher than the specified value.
- Install circuit breakers and other safety measures to prevent Unit damage which short-circuits in external wires can cause.
- Install failsafe measures to make sure that the system is safe if disconnected signal lines or short power interruptions cause incorrect signals.
- Always obey the voltage specifications for power supply connections and I/O jumpers. Incorrect connections can cause malfunctions.
- Do not apply a voltage or connect a load which is larger than the maximum switch capacity to an Output Slave.
- Do not apply a voltage which is larger than the rated voltage to an Input Slave.
- Be sure there are no mistakes in connections or switch settings before you turn ON the power supply.

- Be sure to turn OFF the power to the PLC and Slaves before doing these operations.
 - Assembling a SmartSlice I/O Terminal
 - Setting the rotary switches
 - Connecting cables
- Be sure that there will be no bad effects on the system before doing these operations.
 - Changing the operating mode of the CPU Unit
 - Setting or resetting bits in memory
 - Changing set values or present values on the user program
- Before touching a Unit, touch a grounded metal object to release static electricity from your body.
- When you replace a part, be sure that the specifications of the replacement part are correct.
- Do not try to disassemble, repair, or change a Unit.

Precautions for Correct Usage

Correctly install the Units as this manual shows.

Do not install the Units in these locations.

- Locations with direct sunlight
- Locations with temperatures or humidity not in the range specified in the specifications
- Locations with condensation as the result of large changes in temperature
- Locations with corrosive gases or flammable gases
- Locations with dust (specially iron dust) or salts
- Locations with water, acid, oil, or chemicals
- Locations with shock or vibration

Install applicable and sufficient countermeasures if you install the system in these locations.

- Locations with static electricity or other types of noise
- Locations with strong electromagnetic fields
- Locations with possible exposure to radioactivity
- Locations near power lines

EC Directives

Applicable Directives

- EMC Directive
- Low Voltage Directive

Concepts

EMC Directive

The SmartSlice I/O Terminals are electrical devices which are installed in a machine in application. The Terminals comply with the EMC Directive. This makes it easier for the machine in which a Terminal is installed to more easily comply with the EMC directive. (See note.)

The EMC-related performance of the OMRON devices which comply with EC Directives changes with the machine in which they are installed. This includes the configuration, connections, and other conditions of the machine. The customer must do the checks to make sure that the devices and the machine conform to EMC standards.

Note:

The applicable EMC (electro-magnetic compatibility) standards are EN 61131-2 and EN 61000-6-2 for EMS (electro-magnetic susceptibility) and EN 61131-2 and EN 61000-6-4 for electro-magnetic interference. The 10-m regulations apply for radiated emissions.

Low Voltage Directive

Devices which operate at voltages from 50 to 1,000 VAC or 75 to 1,500 VDC must comply with the related safety requirements. The applicable standard is EN 61131-2.

Complying with EC Directives

The SmartSlice I/O Units comply with EC Directives. These measures are necessary for the machine containing a SmartSlice I/O Units to comply with the EC Directives.

1. You must install the SmartSlice I/O Units in a control panel.
2. You must use reinforced insulation or double insulation for the DC power supplies used for the Unit power supplies, and the I/O power supplies. Make sure that the outputs are stable if a 10-ms interruption occurs at the input.
We recommend the S82J Power Supply which is made by OMRON. (See note.)
3. The SmartSlice I/O Units which conform to EC Directives conform to the EMI standards (EN 61131-2 (Immunity Zone A), EN 61000-6-2, and EN 61000-6-4). The radiated emission properties (10-m regulations) can change with the configuration of the control panel, other devices which are connected to the control panel, connections, and other conditions.
You must make sure that the completed machine complies with EC Directives.
4. Compliance tests were done with I/O wires of a maximum length of 30 m.

Note:

Compliance tests for EMC standards were done with the recommended power supply.

Related Manuals

This table shows the manuals which are related to the CompoNet Communications Unit. Read these manuals together with this Manual.

Cat. No.	Manual	Contents
W476 (this manual)	SmartSlice CompoNet Communications Unit Operation Manual	This manual tells you about the functions, specifications, and operating procedures of the CompoNet Communications Unit.
W455	GRT1 Series SmartSlice I/O Units Operation Manual	This manual tells you about the models, functions, specifications, and operating procedures of the SmartSlice I/O Units.
W456	CS/CJ Series CompoNet Master Unit Operation Manual	This manual tells you about the CompoNet network, communications specifications, connection procedures, and the CS/CJ-series CompoNet Master Unit.
W342	SYSMAC CS/CJ/CP Series and SYSMAC One NSJ Series Communications Commands Reference Manual	This manual tells you about the communications commands which you can use with the CS/CJ-series CompoNet Master Unit.

About this Manual

Section	Overview
Section 1 Features and System Configuration	Section 1 tells you about the SmartSlice system. It also tells you about the features, system configuration, and specifications of the CompoNet Communications Unit.
Section 2 Nomenclature and Functions	Section 2 tells you about the names and functions of the parts of the CompoNet Communications Unit.
Section 3 Installing the Units	Section 3 tells you how to install the CompoNet Communications Unit and SmartSlice I/O Units.
Section 4 Connecting the Units	Section 4 tells you how to connect the CompoNet Communications Unit and SmartSlice I/O Units.
Section 5 Unit Settings and I/O Allocations	Section 5 tells you how to set the unit address and unit number. It also tells how to allocate I/O in the CompoNet Master Unit.
Section 6 Smart Functions	Section 6 tells you about the many smart functions of the SmartSlice system.
Section 7 Basic Operation	Section 7 gives the procedures for and example of operating a SmartSlice system.
Section 8 Remote I/O Communications	Section 8 tells you about the communications timing for remote I/O communications and message communications. It also gives more information on communications.
Section 9 Error Procedures	Section 9 tells you how to troubleshoot problems that you can have with the CompoNet Communications Unit and SmartSlice I/O Units. It also tells how to see the error history with the CX-Integrator.
Appendices	The appendices give an overview of explicit messages (for example, to send commands) and a list of command functions. The appendices also give lists of related products.

About this Manual

TABLE OF CONTENTS

SECTION 1

Features and System Configuration	1
1-1 The SmartSlice I/O System	2
1-2 Features of the CompoNet SmartSlice I/O Terminals	3
1-3 System Configuration	5
1-4 Specifications	7

SECTION 2

Nomenclature and Functions	11
2-1 Nomenclature	12
2-2 Indicators	14
2-3 Switches	18

SECTION 3

Installing the Units	21
3-1 Installing a SmartSlice I/O Terminal	22
3-2 Installing the Turnback Units	27

SECTION 4

Connecting the Units	29
4-1 Connecting the Communications Cables	30
4-2 Connecting the Power Supply Cables	31
4-3 Connecting the Turnback Cables	35
4-4 Precautions When Connecting the Power Supplies	36
4-5 Connecting the Signal Lines for External Devices	38

SECTION 5

Unit Settings and I/O Allocations	39
5-1 Setting the Node Addresses	40
5-2 Unit Numbers for SmartSlice I/O Units	41
5-3 I/O Allocations to CompoNet Master Unit	42

SECTION 6

Smart Functions	53
6-1 Overview of Smart Functions	54
6-2 Registration Table	54
6-3 Backup Function	57
6-4 Automatic Restore Function	58
6-5 Replacing Units Online	59
6-6 Automatic Baud Rate Recognition	59
6-7 Software Setting of I/O Allocations	60

TABLE OF CONTENTS

6-8	Unit Conduction Time Monitor	71
6-9	Unit Comments	73
6-10	Network Communications Error History Monitor	75
6-11	I/O Communications Error History Monitor	76
6-12	Last Maintenance Date	77
SECTION 7		
Basic Operation.....		81
7-1	Setting Example and Basic Procedures	82
7-2	Preparing for Work	84
7-3	Hardware Connections and Settings	85
7-4	Starting Communications	87
7-5	Making Sure That Operation Is Correct	88
SECTION 8		
Remote I/O Communications		89
8-1	Performance of Remote I/O Communications	90
8-2	Performance of Message Communications	93
SECTION 9		
Error Procedures		95
9-1	Error Procedures with Indicators	96
9-2	Error Procedures with CX-Integrator	100
9-3	Other Error Causes and Error Procedures	105
Appendices		
A	CompoNet Explicit Messages	109
B	Object Implementation	117
C	Standard Models	119
D	Power Consumption and Weight Tables	121
E	Total I/O Current Consumption Table	123
Index.....		125
Revision History		129

SECTION 1

Features and System Configuration

This section tells you about the SmartSlice system. It also tells you about the features, system configuration, and specifications of the CompoNet Communications Unit.

1-1	The SmartSlice I/O System	2
1-2	Features of the CompoNet SmartSlice I/O Terminals	3
1-3	System Configuration	5
1-4	Specifications	7
1-4-1	Specifications of the SmartSlice System	7
1-4-2	Specifications of the CompoNet Communications Unit	7
1-4-3	Dimensions	9

1-1 The SmartSlice I/O System

SmartSlice is a building-block style remote I/O system which you make from a Communications Unit and a number of SmartSlice I/O Units. Each SmartSlice I/O Unit has a small number of I/O points. You can use a SmartSlice I/O system to decrease wire connection, installation, and space requirements.

The CompoNet SmartSlice System is a new type of network. It has the basic features of previous CompoNet Slave Units and the features of a SmartSlice I/O system. The CompoNet Communications Unit and installed SmartSlice I/O Units together make a "SmartSlice I/O Terminal." You can mix SmartSlice I/O Units to make a system for different applications. You can also use many other functions. The other functions include functions to monitor the operation of the system.

This is an example of a CompoNet SmartSlice System.

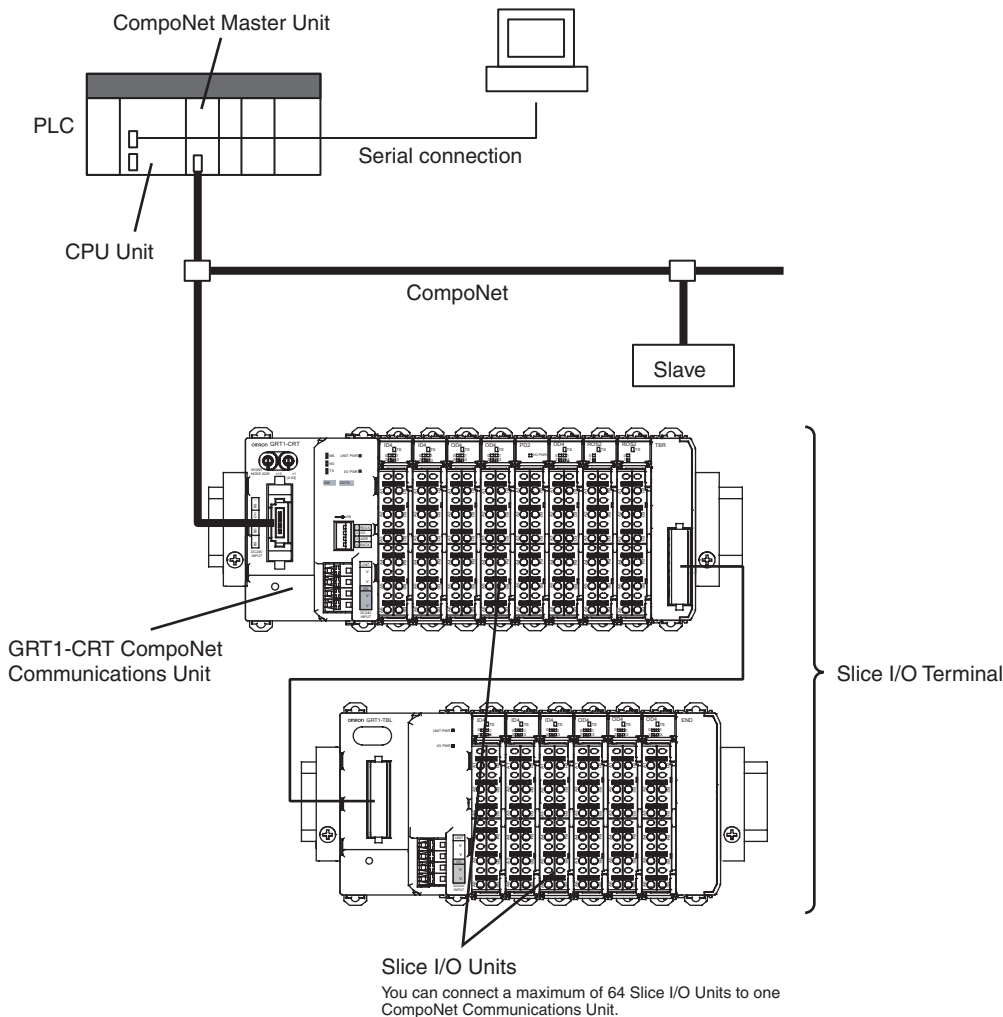

1-2 Features of the CompoNet SmartSlice I/O Terminals

This section tells you the features of a CompoNet SmartSlice System.

Each SmartSlice I/O Terminal Is One CompoNet Node

You can control a CompoNet Communications Unit with a maximum of 64 connected SmartSlice I/O Units as one Slave from the CompoNet Master Unit.

Remote I/O Communications

You can use remote I/O communications to share I/O data between the CompoNet Master Unit and the SmartSlice I/O Units through the CompoNet Communications Unit. You can also allocate status data of the CompoNet Communications Unit in the CompoNet Master Unit. You can also use the CX-Integrator or explicit messages to allocate status information on the network participation status of SmartSlice I/O Units in the CompoNet Master Unit.

Easy Startup

All you must do to start operation is to set the node address with the rotary switches and to set the DIP switch. These switches are on the CompoNet Communications Unit. When you turn ON the power supply, the CompoNet Master Unit automatically reads the Unit configuration and allocates I/O to the SmartSlice I/O Terminals. You do not have to set parameters with special software.

Easy I/O Connections

All SmartSlice I/O Units connected to the CompoNet Communications Unit have screwless clamp terminals. All you must do is to put 10-mm ferrules on the wires and then push the ferrules into the screwless clamp terminals. It is not necessary to tighten screws.

Table Registration

You can use the DIP switch on the CompoNet Communications Unit to record the connected SmartSlice I/O Units in a table. The table tells the sequence and I/O capacity of each SmartSlice I/O Unit. After you complete registration, the CompoNet Communications Unit will compare the configuration with the table each time that the power is turned ON. You can set a status flag in the CompoNet Master Unit to show when the configurations do not agree.

Back Up and Restore Parameters

You can use the DIP switch on the CompoNet Communications Unit to back up the parameters in the I/O Units to memory in the CompoNet Communications Unit. You can do this for maintenance, for example, when you replace an I/O Unit. You can also use the DIP switch to restore the parameters in the CompoNet Communications Unit to the I/O Units after you replace an I/O Unit.

Online Replacement of I/O Units

SmartSlice I/O Units have a base block, main block, and terminal block. You can disconnect these blocks. With this block structure, you do not have to turn OFF the Unit power supply to replace SmartSlice I/O Units.

Note You must turn OFF the I/O power supply to the SmartSlice I/O Unit before you replace it. If there is external power to a terminal on the SmartSlice I/O Unit, also turn OFF the external power before you replace the SmartSlice I/O Unit.

Automatic Baud Rate Recognition

The CompoNet Communications Unit automatically finds the communications baud rate of the CompoNet Master Unit. It is not necessary to set the baud rate.

Software Setting of I/O Allocations

You can record the node addresses and I/O configurations of Dummy Units in the registration table to prepare for expansion of SmartSlice I/O Units. When you add the I/O Units, it will not be necessary for you to set the node addresses or I/O configurations. It will also not be necessary to change the ladder programming very much. You can also write the ladder programming for the full configuration and set the Units that you will add as Dummy Units. When you change the unit configuration, it will not be necessary to change the I/O map.

Unit Conduction Time Monitor

The Unit Conduction Time Monitor records the total time that the internal circuit power in DeviceNet Communications Unit is ON. You can set a threshold in the CompoNet Communications Unit to tell the CompoNet Master Unit when the conduction time is longer than the threshold. You can set the threshold or read the conduction time with the CX-Integrator or with an explicit message.

Unit Comments

You can set a comment (for example, a name or the application) for each CompoNet Communications Unit to record the name in the CompoNet Communications Unit. You can use the comments to easily identify CompoNet Communications Units when you set or monitor parameters with the CX-Integrator. You can set or read the comments with the CX-Integrator or with an explicit message.

Communications Error History Monitor

There is a communications error history in the CompoNet Communications Unit. It records the four newest errors in communications with the CompoNet network and the 64 newest errors in communications in the SmartSlice I/O Terminal. You can read the communications error status with the CX-Integrator or with an explicit message.

Last Maintenance Date

You can record the last date on which you did maintenance in the CompoNet Communications Unit. You can write the last maintenance date with the CX-Integrator or with an explicit message.

1-3 System Configuration

This is an example of a CompoNet SmartSlice System.

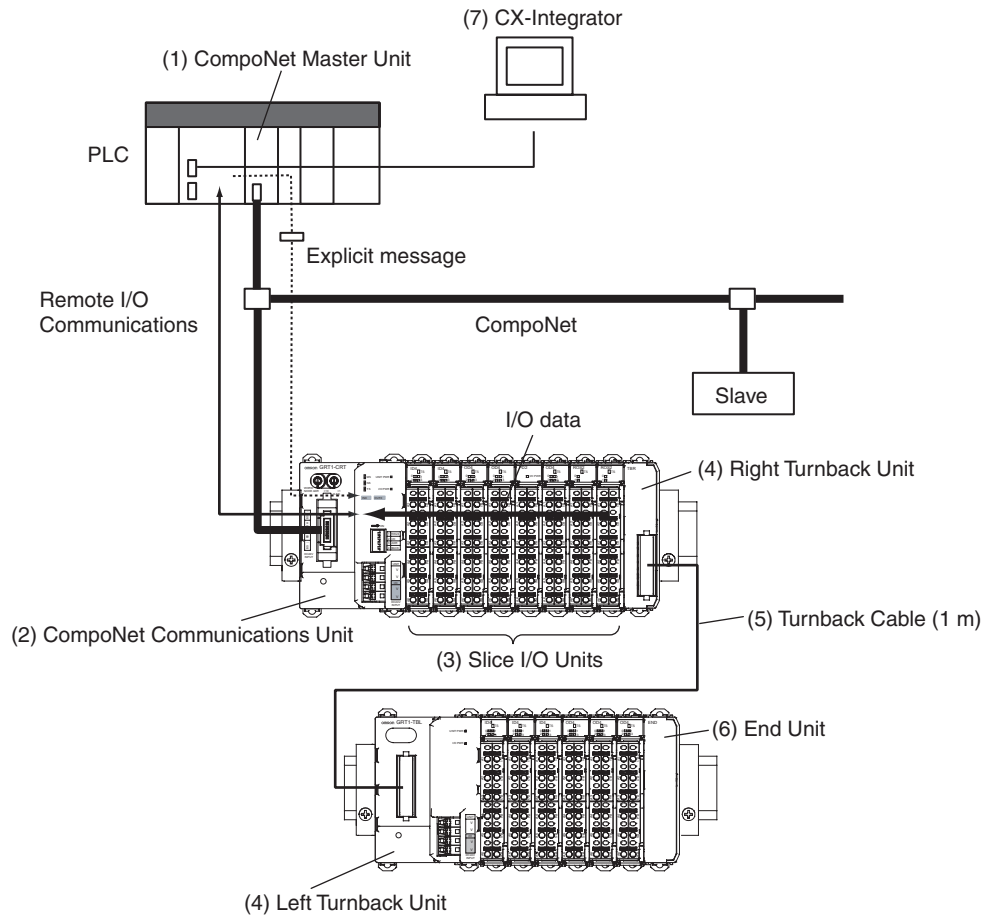

No.	Name	Function
1	CompoNet Master Unit	<p>The CompoNet Master Unit controls the CompoNet network and transfers data to and from all Slave Units.</p> <p>The CompoNet Master Unit can send explicit messages to the CompoNet Communication Unit.</p>
2	CompoNet Communications Unit (GRT1-CRT)	<p>The CompoNet Communications Unit is the interface with the CompoNet network. You connect it to the CompoNet Master Unit. You connect each CompoNet Communications Unit to SmartSlice I/O Units with the number of I/O points which is necessary in each location. The CompoNet Communications Unit does communications with the SmartSlice I/O Units.</p> <p>The CompoNet Communications Unit temporarily keeps the I/O data from the SmartSlice I/O Units which are connected to it. I/O data is transferred to and from the CompoNet Master Unit all at one time during remote I/O communications.</p>
3	SmartSlice I/O Units	<p>The SmartSlice I/O Units do communications with the CompoNet Master Unit through the CompoNet Communications Unit.</p> <p>You can normally connect a maximum of 64 SmartSlice I/O Units to one CompoNet Communications Unit. There are restrictions in the number of SmartSlice I/O Units if the total data size is too large or power supply capacity is too small.</p>
4	Turnback Units (Right Turnback Unit: GRT1-TBR, Left Turnback Unit: GRT1-TBL)	You use a Turnback Unit to expand or divide a SmartSlice I/O Terminal.
5	Turnback Cable (GCN2-100)	You use a Turnback Cable to connect a Left Turnback Unit to a Right Turnback Unit.
6	End Unit (GRT1-END)	You connect an End Unit to the end of the SmartSlice I/O Terminal.
7	CX-Integrator	<p>You use the CX-Integrator to write the parameters in the CompoNet Communications Unit and SmartSlice I/O Units and to monitor these parameters.</p> <p>The CX-Integrator runs on a Windows computer.</p>

1-4 Specifications

This section tells you the specifications of the SmartSlice System and the CompoNet Communications Unit.

1-4-1 Specifications of the SmartSlice System

General Specifications

Item	Specification
Ambient operating temperature	-10 to 55°C (with no icing or condensation)
Ambient operating humidity	25% to 85%
Ambient storage temperature	-25 to 65°C (with no icing or condensation)
Noise immunity	Complies with IEC 61000-4-4, 2.0 kV.
Vibration resistance	10 to 60 Hz: 0.7-mm double amplitude 60 to 150 Hz: 50 m/s ²
Withstand voltage	500 VAC (between isolated circuits)
Enclosure rating	IP20

SmartSlice Bus Communications Specifications

Item	Specification
Types of communications	I/O communications and message communications
Turnback Cables	Length: 1 m, Maximum number of cables: 2
Connections between Units in SmartSlice I/O Terminal	Building-block structure with slide connectors
Base block power supply	Voltage: 24 VDC, Current: 4 A
Event messages	You can use event messages.

1-4-2 Specifications of the CompoNet Communications Unit

Item	Specification
Model	GRT1-CRT
I/O points	Inputs: 32 bytes maximum (including status and areas which the Unit does not use) Output: 32 bytes maximum (including areas which the Unit does not use)
Maximum number of SmartSlice I/O Units	64 (Do not count the End Unit.)
Status area	1 word (This word shows the status of the CompoNet Communications Unit.)
Parameter backup and restore	You can back up or restore a maximum of 2 KB of data for one CompoNet Communications Unit.
Network power supply	14 to 26.4 VDC
I/O power supply	20.4 to 26.4 VDC
Baud rate	The CompoNet Communications Unit uses the baud rate of the CompoNet Master Unit (93.75 kbps, 1.5 Mbps, 3 Mbps, or 4 Mbps).

Item	Specification
Communications media	<p>You can use these cables:</p> <p>Round Cable I (JIS C 3306, VCTF 2-core 0.75-mm² twisted-pair cable)</p> <p>Round Cable II (JIS C 3306, VCTF 4-core 0.75-mm² twisted-pair cable)</p> <p>Flat Cable I (without sheath, DCA4-4F10)</p> <p>Flat Cable II (with sheath, DCA5-4F10)</p> <p>Note The Round Cable I, Round Cable II, Flat Cable I, and Flat Cable II are different types of cable. You must use a Repeater to divide a branch line from the main line to use more than one type of cable.</p>
Indicators	<p>MS (green/red): This indicator shows the status of the CompoNet Communications Unit.</p> <p>NS (green/red): This indicator shows the communications status of the CompoNet network.</p> <p>TS (green/red): This indicator shows the status of the SmartSlice I/O Terminal.</p> <p>UNIT PWR (green): This indicator shows the status of the Unit power supply.</p> <p>I/O PWR (green): This indicator shows the status of the I/O power supply.</p>
Switches	<p>Rotary switches: There are two rotary switches. You use them to set the node address.</p> <p>DIP switch: There is one DIP switch with four pins. You use them to set the operating mode.</p>
Connectors	There is one CompoNet communications connector.
Terminals	<p>Clamp terminals for Unit power supply (24 VDC)</p> <p>Clamp terminals for I/O power supply (24 VDC)</p>
Power consumption	2.5 W
Power consumption for each SmartSlice I/O Terminal block	<p>80 W max.</p> <p>(You must divide the I/O Terminal into blocks to use more than 80 W.)</p>
SmartSlice I/O Terminal blocks	Main block and a maximum of two expansion blocks
Current consumption for I/O power supply	4 A max.
Weight	125 g
Accessories	None

1-4-3 Dimensions

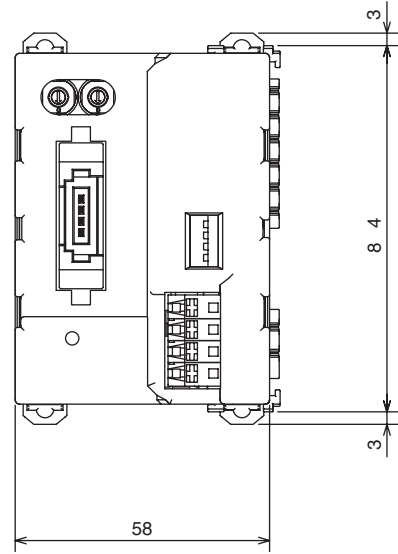
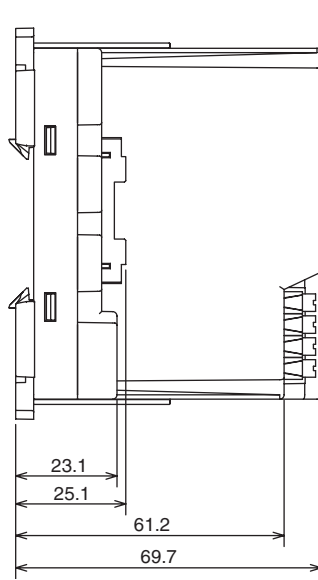
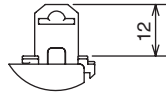

(mm)

SECTION 2

Nomenclature and Functions

This section tells you about the names and functions of the parts of the CompoNet Communications Unit.

2-1	Nomenclature	12
2-1-1	CompoNet Communications Unit	12
2-1-2	SmartSlice I/O Units	13
2-2	Indicators	14
2-2-1	MS Indicator	14
2-2-2	NS Indicator	15
2-2-3	TS Indicator	16
2-2-4	UNIT PWR Indicator	17
2-2-5	I/O PWR Indicator	17
2-3	Switches	18
2-3-1	Rotary Switches	18
2-3-2	DIP Switch	18

2-1 Nomenclature

This section tells you about the names and functions of the parts of the CompoNet Communications Unit.

2-1-1 CompoNet Communications Unit

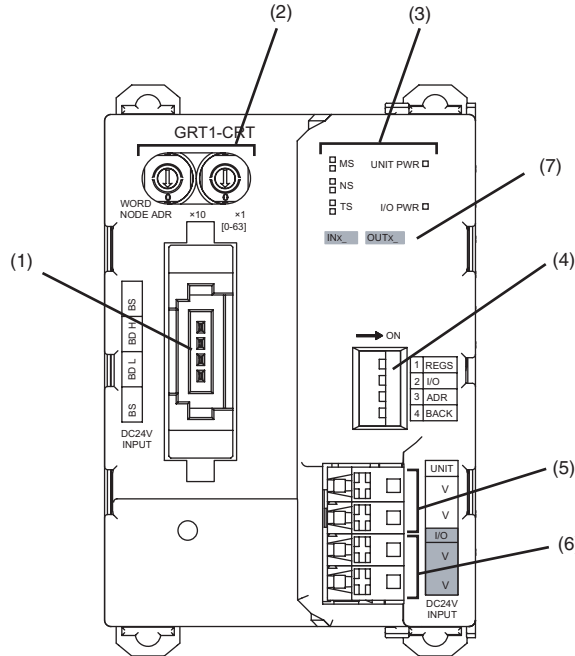

No.	Name	Function
1	CompoNet communications connector	Connect the communications cable for the CompoNet network to this connector.
2	Rotary switches	Set the node address of the CompoNet Communications Unit as a CompoNet slave.
3	Indicators	These indicators show the status of communications and the Units.
4	DIP switch	Use this DIP switch to create the registration table, set the I/O allocation mode, back up SmartSlice I/O Unit parameters, and restore SmartSlice I/O Unit parameters.
5	Terminals for Unit power supply	Use these terminals to send 24-VDC power to the internal circuits of the CompoNet Communications Units and the SmartSlice I/O Units.
6	Terminals for I/O power supply	Use these terminals to send 24-VDC power to the external I/O which connect to the SmartSlice I/O Units.
7	Device label	This label shows the I/O memory area that the Unit uses. The Unit has an input area and an output area. The sizes of the areas change if the SmartSlice I/O Unit configuration changes.

2-1-2 SmartSlice I/O Units

A SmartSlice I/O Unit has three blocks. You can remove each block.

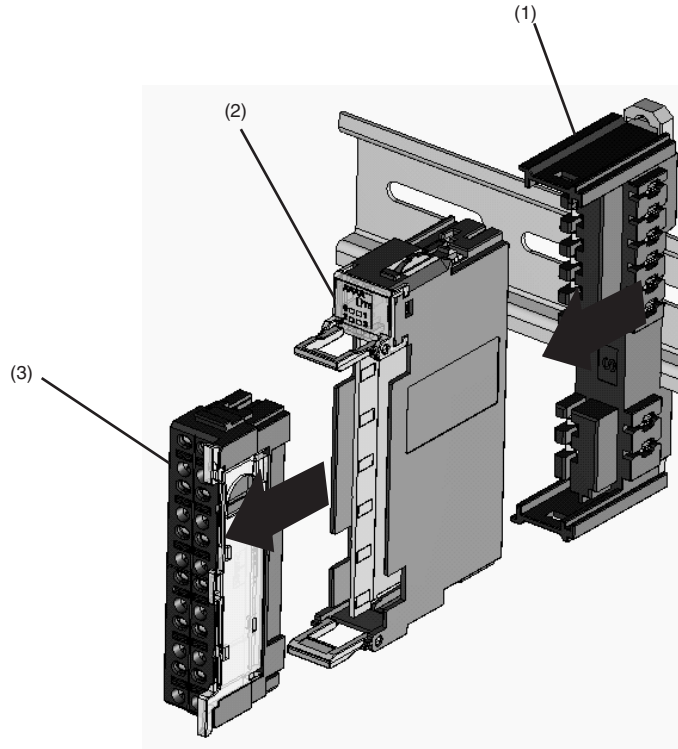

No.	Name	Function
1	Base Block	This is the bus between the SmartSlice I/O Units. You do not have to disconnect the Base Block when you replace the Main Block, for example, when there is damage to the Main Block.
2	Main Block	This is the primary part of the SmartSlice I/O Unit.
3	Terminal Block	This block has the terminals for the SmartSlice I/O Unit. You do not have to disconnect the wires from the Terminal Block when you replace the Main Block.

Refer to the *GRT1 Series SmartSlice I/O Units Operation Manual* (Cat. No. W455) for information on each model of SmartSlice I/O Unit and specifications.

2-2 Indicators

This section tells you the specifications of the LED indicators on the front panel of the CompoNet Communications Unit.

2-2-1 MS Indicator

The MS indicator shows the status of the CompoNet Communications Unit.

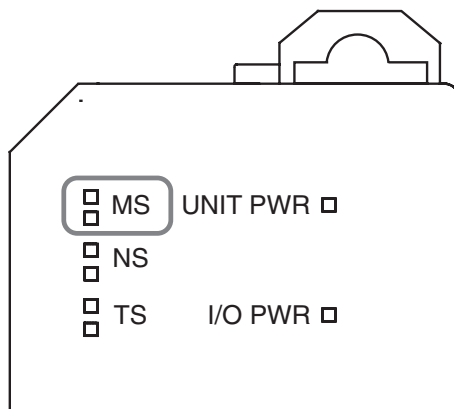

Color	Status		
Green	<input type="checkbox"/>	Lit	Normal status
Red	<input type="checkbox"/>	Lit	Fatal error <ul style="list-style-type: none"> • Unit hardware error • Watchdog timer error • EEPROM memory error
	<input type="checkbox"/>	Flashing	Non-fatal error <ul style="list-style-type: none"> • Switch setting error (Pin 1 (REGS) and pin 2 (I/O) are ON on the DIP switch when the Unit power supply came ON.) • Logic error in parameter settings
---	<input type="checkbox"/>	Not lit	No power <ul style="list-style-type: none"> • The Unit power supply is OFF. • The Unit is being reset. • Unit initialization is not complete.

2-2-2 NS Indicator

The NS indicator shows the communications status of the CompoNet network.

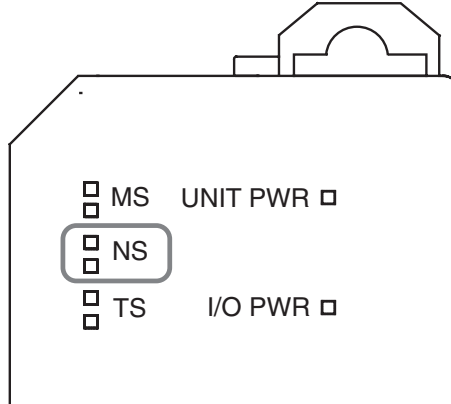

Color	Status		
Green	<input type="checkbox"/>	Lit	The Unit is online and the communications connection is completed. (The network status is normal.)
	<input type="checkbox"/>	Flashing	The Unit is online but the communications connection is not completed. (The baud rate is synchronized, but the CompoNet Master Unit is completing the connection.)
Red	<input type="checkbox"/>	Lit	A fatal communications error occurred. (The CompoNet Communications Unit found an error for which communications on the CompoNet network are not possible.) <ul style="list-style-type: none"> • Communications error • Duplication of node addresses • Bus Off error
	<input type="checkbox"/>	Flashing	Non-fatal communications error <ul style="list-style-type: none"> • Communications timeout
---	<input type="checkbox"/>	Not lit	The Unit is offline or the power supply is OFF. <ul style="list-style-type: none"> • There is no power supply to the CompoNet Communications Unit. • The check for node address duplication is not completed at the CompoNet Master Unit.

2-2-3 TS Indicator

The TS indicator shows the status of the communications with the SmartSlice I/O Units.

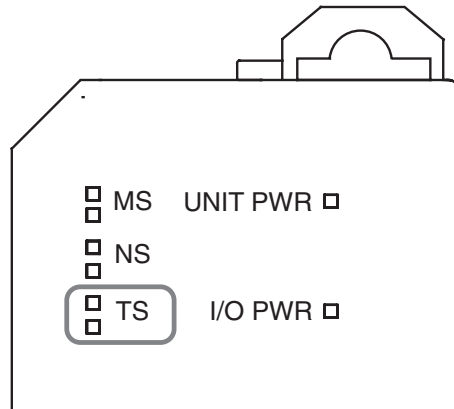

Color	Status		
Green	<input type="checkbox"/>	Lit	The CompoNet Communications Unit is in communications with the SmartSlice I/O Units.
	<input type="checkbox"/>	Flashing each second	The SmartSlice I/O Units are joining communications at this time.
		Flashing each 0.5 second	<ul style="list-style-type: none"> The CompoNet Communications Unit is backing up parameters from the SmartSlice I/O Units. The CompoNet Communications Unit is restoring parameters to the SmartSlice I/O Units.
Red	<input type="checkbox"/>	Lit	<ul style="list-style-type: none"> Fatal communications error
		Flashing each 2 seconds	<ul style="list-style-type: none"> The CompoNet Communications Unit could not back up the parameters from the SmartSlice I/O Units. The CompoNet Communications Unit could not restore the parameters to the SmartSlice I/O Units. The CompoNet Communications Unit could not make the Registration Table. Pin 1 (REGS) of the DIP switch turned ON when pin 2 (I/O) was ON. You turn ON pin 1 to allocate I/O using software. You turn ON pin 2 to allocate I/O with the Registration Table.
	<input type="checkbox"/>	Flashing	<ul style="list-style-type: none"> Non-fatal communications error Communications timeout Registration Table verification error A replaced SmartSlice I/O Unit is the incorrect model.
---	<input type="checkbox"/>	Not lit	<ul style="list-style-type: none"> No power The CompoNet Communications Unit did not start communications with the SmartSlice I/O Units. The CompoNet Communications Unit found an overcurrent.

2-2-4 UNIT PWR Indicator

The UNIT PWR indicator shows the status of the Unit power supply.

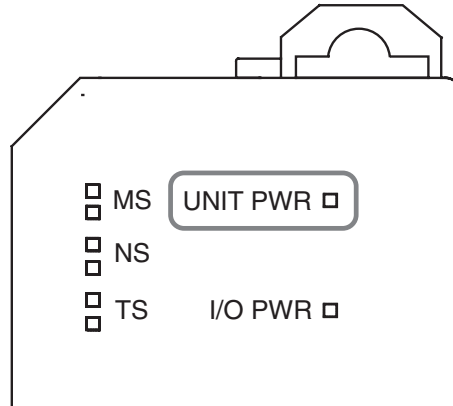

Color	Status		
Green	<input checked="" type="checkbox"/>	Lit	The 24-VDC Unit power supply to the CompoNet Communications Unit is ON.
---	<input type="checkbox"/>	Not lit	The Unit power supply is OFF.

2-2-5 I/O PWR Indicator

The I/O PWR indicator shows the status of the I/O power supply.

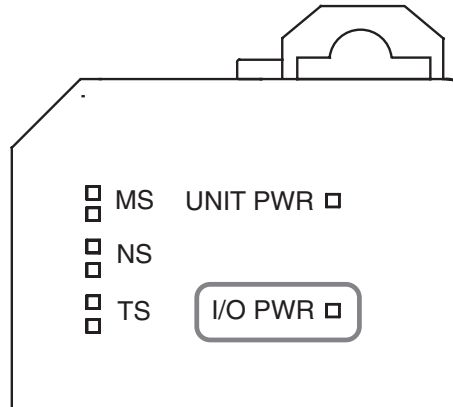

Color	Status		
Green	<input checked="" type="checkbox"/>	Lit	The 24-VDC I/O power supply to the CompoNet Communications Unit is ON.
---	<input type="checkbox"/>	Not lit	The I/O power supply is OFF.

2-3 Switches

This section tells you the functions of the rotary switches and the DIP switch on the front panel of the CompoNet Communications Unit.

2-3-1 Rotary Switches

Use the rotary switches to set the node address of the CompoNet Communications Unit as a slave on the CompoNet network. Set the node address as a decimal number between 0 and 63.

Set the 10s digit on the left rotary switch and set the 1s digit on the right rotary switch.

The setting of the switches is read when the Unit power supply turns ON.

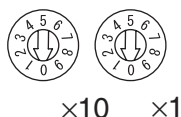

2-3-2 DIP Switch

Use the DIP switch to create the registration table, set the I/O allocation mode, back up SmartSlice I/O Unit parameters, and restore the SmartSlice I/O Unit parameters.

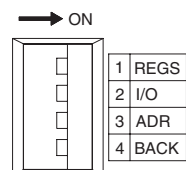

Note All pins on the DIP switch are OFF in the factory settings.

Pin 1: REGS

Use pin 1 to make or change the Registration Table. The setting of pin 1 when the Unit power supply turns ON enables or disables the Registration Table. While the Unit power supply is ON, turn ON pin 1 to make the registration table.

- The Pin Setting When the Unit Power Supply Turns ON

Pin setting	Description
ON	If there is no Registration Table, the CompoNet Communications Unit will record the connected SmartSlice I/O Units in a table. The table tells the sequence and I/O capacity of each SmartSlice I/O Unit. If there is a Registration Table, the CompoNet Communications Unit will automatically compare the connected SmartSlice I/O Units with the Registration Table. If the connected SmartSlice I/O Units do not agree with the Registration Table, communications will not start for all SmartSlice I/O Units.
OFF	The CompoNet Communications Unit will disable the Registration Table and will do communications with all SmartSlice I/O Units.

- Changing the Pin Setting While the Unit Power Supply Is ON

Pin setting	Description
OFF to ON	The CompoNet Communications Unit makes the Registration Table.

Note The setting of pin 1 is enabled when pin 2 (I/O) is OFF (Automatic I/O Allocation Mode).

Pin 2: I/O

Use pin 2 to set the Software I/O Allocation Mode.

Pin setting	Description
ON	The Software I/O Allocation Mode is set. You can make a Registration Table with the CX-Integrator to allocate I/O. For each SmartSlice I/O Unit in the table, you can specify if the Unit is installed or not. When you turn ON the power, the Communications Unit will do a check only for installed Units. The Units which are not installed will have empty spaces in the I/O data for the CompoNet Master Unit.
OFF	The Automatic I/O Allocation Mode is set. Use this mode to automatically detect SmartSlice I/O Units when the power supply turns ON.

Note The CompoNet Communications Unit reads the setting of pin 2 when the Unit power supply turns ON.

Pin 3: ADR

Use pin 3 to control the automatic restore function.

Pin setting	Description
ON	If pin 1 (REGS) or pin 2 (I/O) is ON, the CompoNet Communications Unit will automatically restore the parameters to the SmartSlice I/O Units.
OFF	The CompoNet Communications Unit will not restore the parameters.

Pin 4: BACK

Use pin 4 to back up the parameters of all installed SmartSlice I/O Units.

If you turn pin 4 ON, OFF, ON in 3 s or less when pin 1 (REGS) or pin 2 (I/O) is ON, the parameters of all the SmartSlice I/O Units will be backed up to the CompoNet Communications Unit. While the parameters are being backed up, the TS indicator will flash green each 0.5 s.

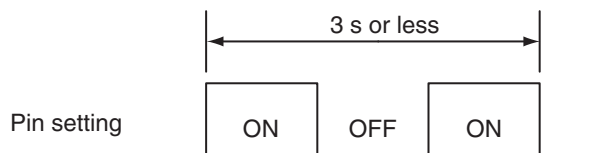

SECTION 3

Installing the Units

This section tells you how to install the CompoNet Communications Unit and SmartSlice I/O Units.

3-1	Installing a SmartSlice I/O Terminal	22
3-1-1	Installing the CompoNet Communications Unit	22
3-1-2	Installing the First SmartSlice I/O Unit	23
3-1-3	Installing the Other SmartSlice I/O Units.	24
3-1-4	Installing the End Unit	25
3-1-5	Installing the End Plates	26
3-2	Installing the Turnback Units	27

3-1 Installing a SmartSlice I/O Terminal

This section tells you how to install the CompoNet Communications Unit and SmartSlice I/O Units.

3-1-1 Installing the CompoNet Communications Unit

You install the CompoNet Communications Unit and SmartSlice I/O Units on DIN Track.

Necessary Tools

Name	Model	Remarks
35-mm DIN Tracks	PFP-50N	Length: 50 cm
	PFP-100N	Length: 100 cm
	PFP-100N2	Length: 100 cm
End Plate	PFP-M	Two End Plates are necessary for each SmartSlice I/O Terminal block.

Installation Direction

You can install the SmartSlice I/O Terminal in these directions.

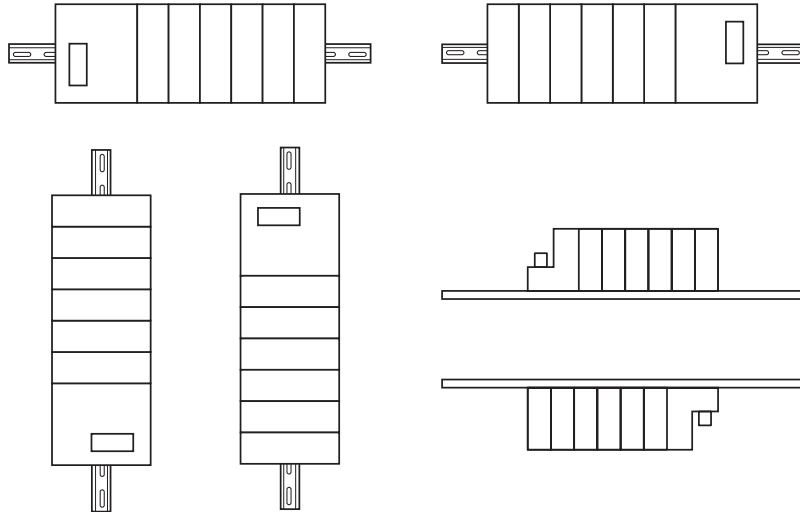

Installation Procedure

- 1,2,3... 1. Install the DIN Track.
Use one screw for each three holes in the DIN Track. There must be a screw for each 105 mm or less.

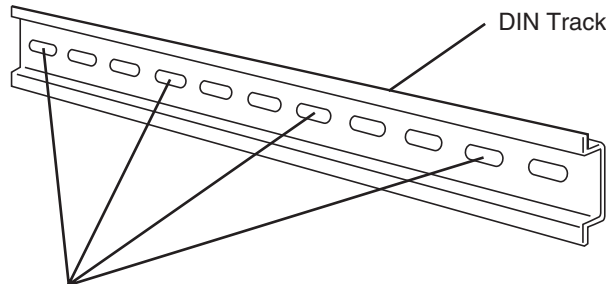

One screw for each three holes

- 2. Press the CompoNet Communications Unit with force until you hear it lock on the DIN Track.
After you install the CompoNet Communications Unit, make sure that it is locked correctly on the DIN Track.

(2) Make sure that the installation hooks on the Unit are locked on the DIN Track.

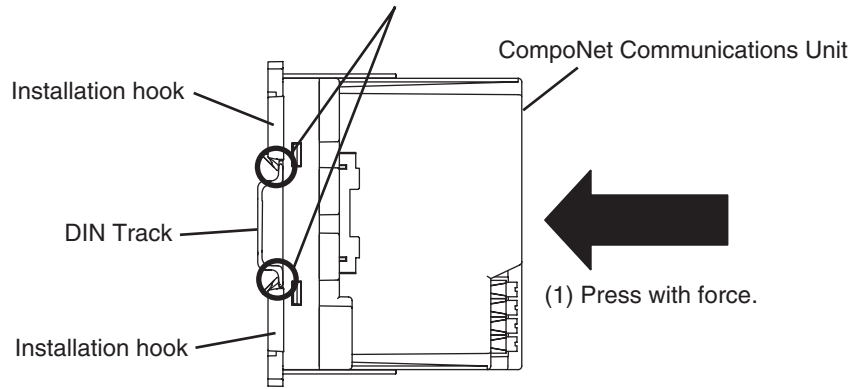

Note If the installation hooks do not lock correctly, release the hooks first, push the CompoNet Communications Unit against the DIN Track, and then lock the hooks. The subsequent page shows how to release the hooks.

Removal Procedure

Use a flat-blade screwdriver or equivalent tool to pull out the hooks. This will unlock them. Then pull out the CompoNet Communications Unit in a perpendicular direction to the DIN Track.

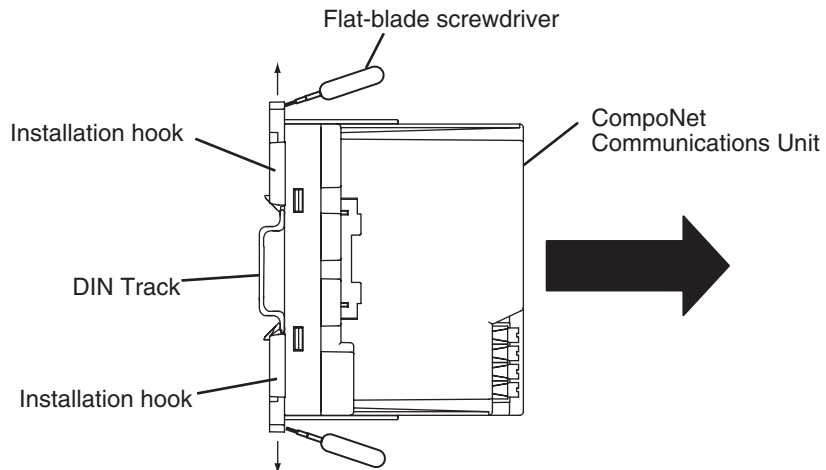

3-1-2 Installing the First SmartSlice I/O Unit

Press the SmartSlice I/O Unit along the side of the CompoNet Communications Unit to install it. It must engage with the CompoNet Communications Unit.

Press the SmartSlice I/O Unit until you hear it lock on the DIN Track.

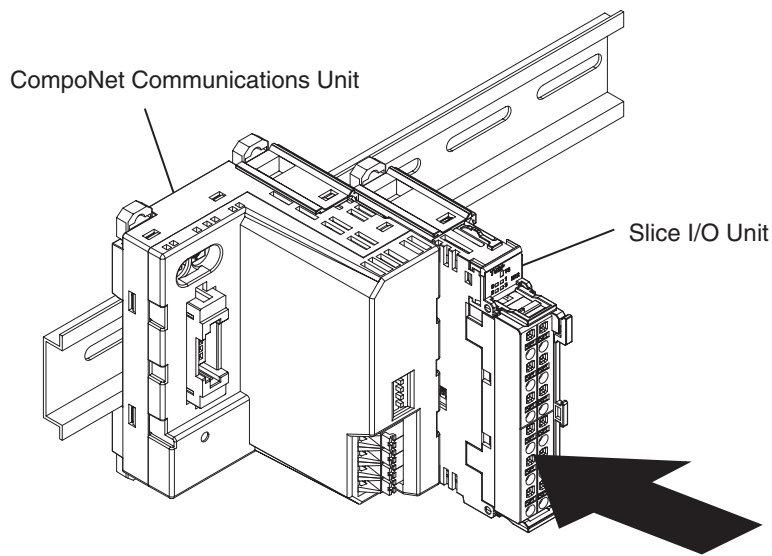

3-1-3 Installing the Other SmartSlice I/O Units

Install the other SmartSlice I/O Units with the same procedure as the first SmartSlice I/O Unit.

You can normally connect a maximum of 64 SmartSlice I/O Units to one CompoNet Communications Unit. (There are restrictions in the number of SmartSlice I/O Units if the total data size is too large or power supply capacity is too small.)

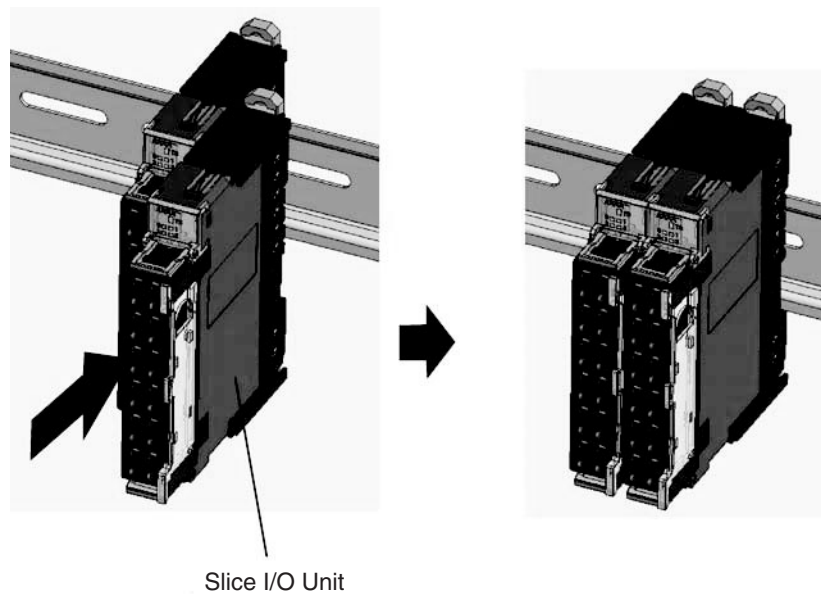

3-1-4 Installing the End Unit

You must install an End Unit (GRT1-END) to the end of the last block in the SmartSlice I/O Terminal. You connect it with the same procedure as for SmartSlice I/O Units.

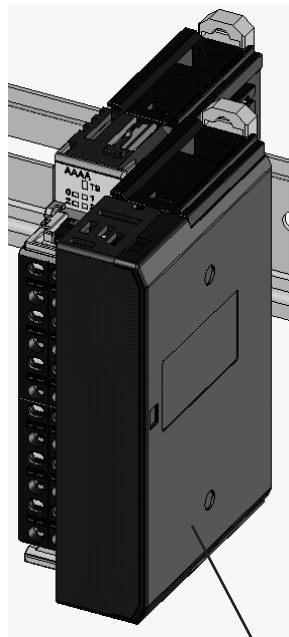

End Unit

Precaution for Correct Usage

- Make sure that the guides on the Units are locked together when you install the Units.

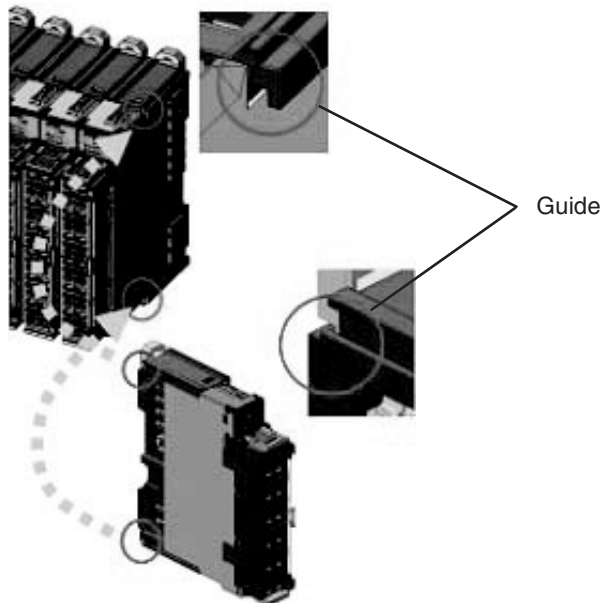

3-1-5 Installing the End Plates

You must install an End Plate on each end of each block in a SmartSlice I/O Terminal. The End Plates prevent the blocks from moving.

- 1,2,3...**
1. Put the bottom of the End Plate on the DIN Track. Then put the top of the End Plate on the DIN Track and pull down on the End Plate.
 2. Install one End Plate on the left side and one on the right side of the Smart-Slice I/O Terminal. Then tighten the screws.

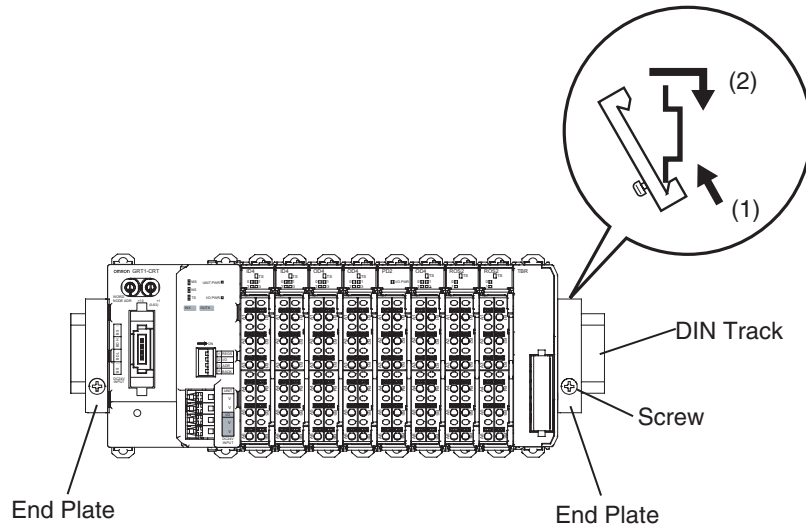

3-2 Installing the Turnback Units

Note You can use Turnback Units to expand or divide a SmartSlice I/O Terminal.

Install a Right Turnback Unit (GRT1-TBR) on the right side of the block. Install a Left Turnback Unit (GRT1-TBL) on the left side of the expansion or divided block. Then install the necessary SmartSlice I/O Units.

Connect the Right Turnback Unit to the Left Turnback Unit with a Turnback Cable (GCN2-100). (Refer to *Connecting the Turnback Cables* on page 35.)

There can be three blocks in a SmartSlice I/O Terminal, one main block and two expansion blocks.

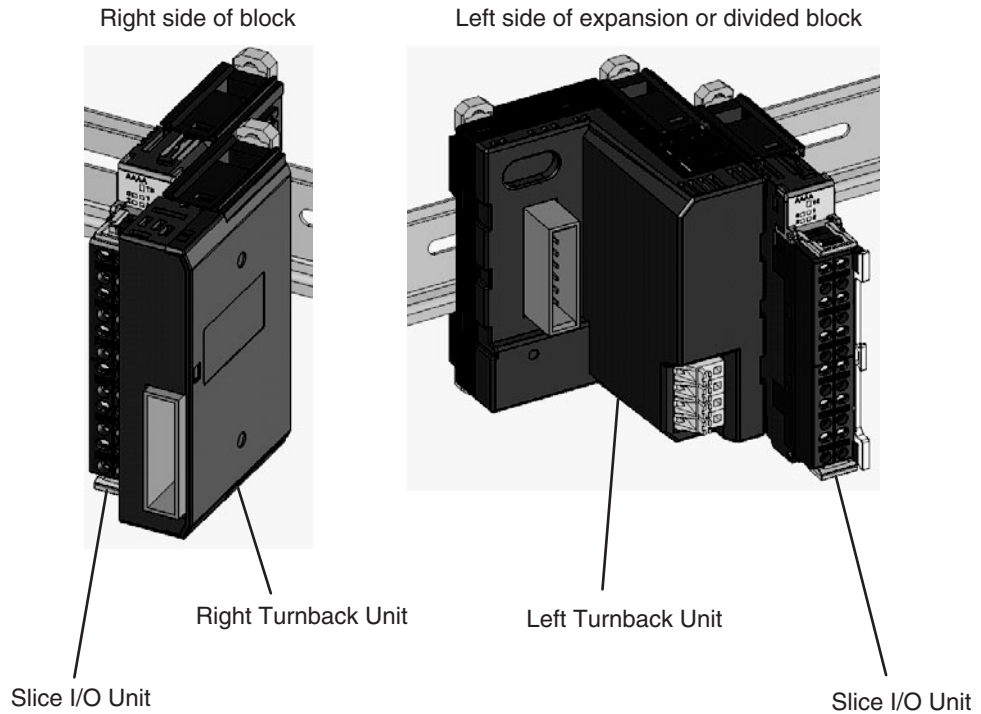

Precaution for Correct Usage

- You must install an End Unit (GRT1-END) on the end of the last block in the SmartSlice I/O Terminal.
- There are limits for each block to the capacity of the Unit power supply and the I/O power supply. If the Unit power consumption of the SmartSlice I/O Units in one block is higher than 80 W, you must divide the SmartSlice I/O Terminal. Refer to *Precautions When Connecting the Power Supplies* on page 36 for more information.

SECTION 4

Connecting the Units

This section tells you how to connect the CompoNet Communications Unit and SmartSlice I/O Units.

4-1	Connecting the Communications Cables	30
4-1-1	Using Flat Cables I/II	30
4-1-2	Using Round Cables I/II	30
4-2	Connecting the Power Supply Cables	31
4-2-1	Types of Power Supply	31
4-2-2	Recommended Power Supplies	31
4-2-3	Power Supply Terminals	31
4-2-4	Connecting the Unit Power Supply Cables	33
4-2-5	Connecting the I/O Power Supply Cables	34
4-3	Connecting the Turnback Cables	35
4-4	Precautions When Connecting the Power Supplies	36
4-5	Connecting the Signal Lines for External Devices	38

4-1 Connecting the Communications Cables

You can use different types of communications cable in a CompoNet network. You can use the connector on the CompoNet Communications Unit for Flat Cable or round cable.

4-1-1 Using Flat Cables I/II

- 1,2,3...
1. Connect a Flat Cable Branch Line Connector (DCN4-BR4 or DCN5-BR4) to the communications cable. Refer to the *CS/CJ-series CompoNet Master Unit Operation Manual* (Cat. No. W456) for the connection procedure.
 2. Connect the CompoNet cable to the connector on the CompoNet Communications Unit. Push in until you hear the connector lock.

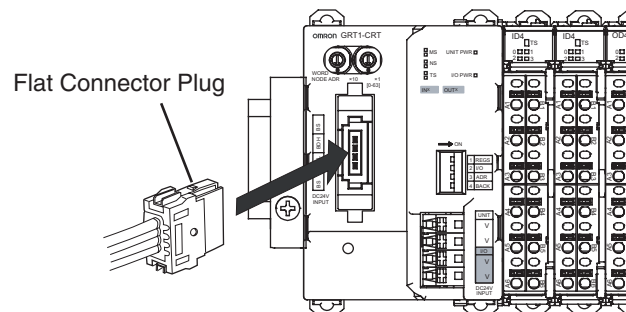

4-1-2 Using Round Cables I/II

- 1,2,3...
1. Connect a Screw Terminal Block Adapter (DCN4-TB4) to the communications connector on the CompoNet Communications Unit.

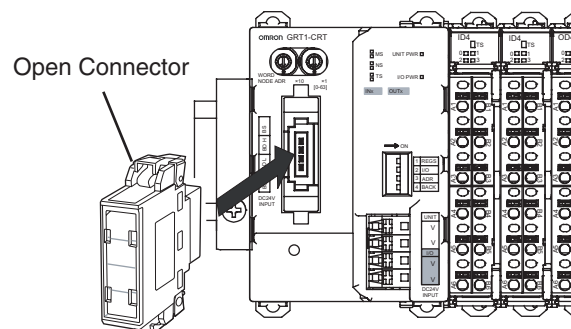

2. Open the terminal cover on the Screw Terminal Block Adapter and connect the cable conductors to BDH (communications data high signal) and to BDL (communications data low signal) on the terminal block. For Round Cable II, also connect BS+ (communications power supply +) and BS- (communications power supply -).

Note Do not connect the BS+ and BS- terminals.

4-2 Connecting the Power Supply Cables

You connect the power supply cables to the power supply terminals on the CompoNet Communications Unit. Network power is not necessary if you connect the Communications Unit to a host network.

4-2-1 Types of Power Supply

You must connect two types of power supply to the CompoNet Communications Unit.

■ Unit Power Supply

The Unit power supply is for the internal circuits in the CompoNet Communications Unit and connected SmartSlice I/O Units. The connectors on the Base Blocks send the power to the SmartSlice I/O Units.

■ I/O Power Supply

The I/O power supply is for the external I/O devices which connect to the SmartSlice I/O Units. The connectors on the Base Blocks send the power to the SmartSlice I/O Units.

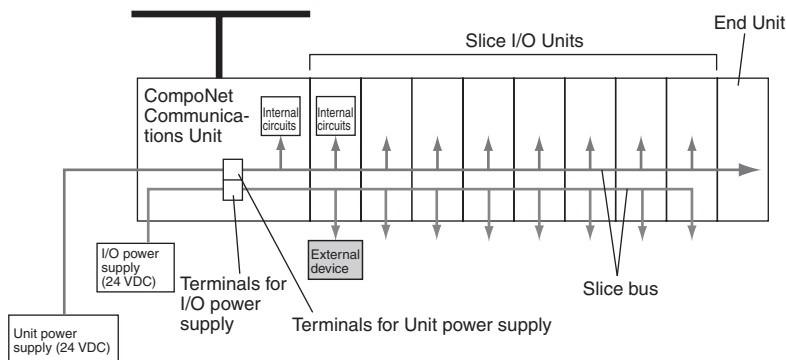

4-2-2 Recommended Power Supplies

Use an SELV power supply with overcurrent protection.

An SELV power supply has redundant or reinforced insulation between the I/O, an output voltage of 30 Vr.m.s and a 42.4-V peak or maximum of 60 VDC.

We recommend these Power Supplies.

- S82K-10024 (from OMRON)
- S82J-10024D (from OMRON)

4-2-3 Power Supply Terminals

The power supply terminals on the CompoNet Communications Unit and Turnback Units are screwless clamp terminals. If you connect ferrules on the wires, all you must do to connect the wires is to push the ferrules into the terminals.

Applicable Wires for Screwless Clamp Terminals

■ **Types and Sizes**

Type	Applicable wire gauge
Stranded wires	AWG20 to AWG16 (0.5 to 1.25 mm ²)
Solid wires	
Ferrules	

■ **Stripping Length for Stranded Wires and Solid Wires**

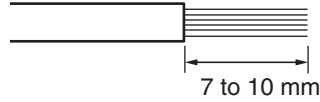

■ **Conductor Length for Ferrules**

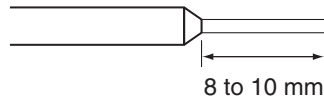

We recommend the ferrules in the table below.

Manufacturer	Model	Applicable wire	Crimping Tool
Phoenix Contact	AI0.5-10WH	0.5 mm ² (AWG 20)	CRIMPFOX UD6 (order number 1204436) or CRIMPFOX ZA3 Series
	AI0.75-10GY	0.75 mm ² (AWG 18)	
	AI1.5-10BK	1.25 mm ² (AWG 16)	
Weidmüller	H0.5/16 OR	0.5 mm ² (AWG 20)	PZ1.5 Crimping Tool (order number 990599)
	H0.75/16 W	0.75 mm ² (AWG 18)	
	H1.5/16 R	1.25 mm ² (AWG 16)	

Connecting Wires or Ferrules

■ **Connecting Wires with Ferrules**

Push the ferrule fully into the wire hole of the screwless clamp terminal.

Push the ferrule fully into the hole.

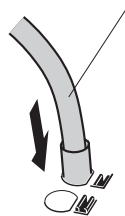

■ **Connecting Wires without Ferrules**

Press in the release button adjacent to the connection hole of the screwless clamp terminal with a small flat-blade screwdriver. Then push the wire fully into the wire hole of the screwless clamp terminal and release the button.

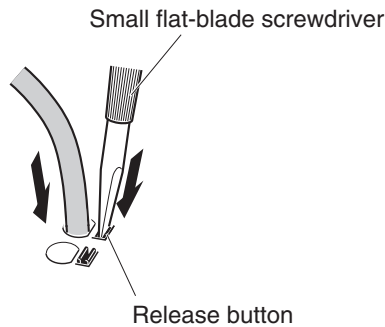

Disconnecting Wires or Ferrules

Press in the release button adjacent to the connection hole of the screwless clamp terminal with a small flat-blade screwdriver. Then pull out the wire or ferrule and release the button.

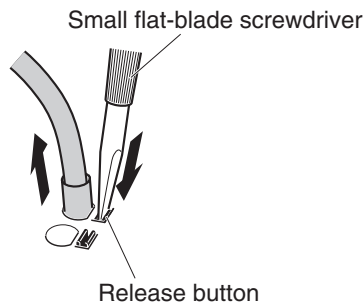

We recommend this screwdriver to connect or disconnect wires or ferrules.

Model: SZF1 Flat-blade Screwdriver

Manufacturer: Phoenix Contact

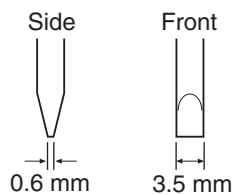

4-2-4 Connecting the Unit Power Supply Cables

Connect the Unit power supply cable (24 VDC) to the power supply terminals on the CompoNet Communications Unit. These terminals send power to the internal circuits of the CompoNet Communications Units and the SmartSlice I/O Units.

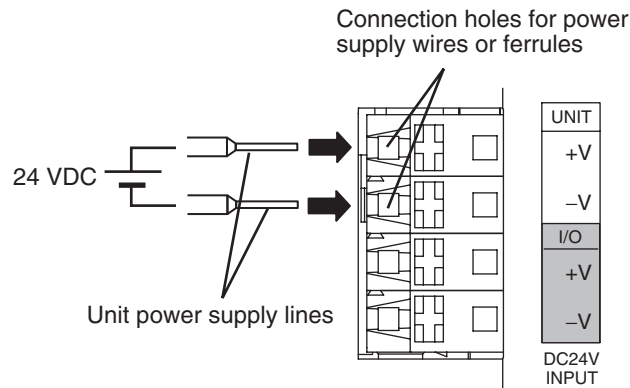

Precaution for Correct Usage

- Use an insulated power supply.

4-2-5 Connecting the I/O Power Supply Cables

Connect the I/O power supply cable (24 VDC) to the power supply terminals on the CompoNet Communications Unit. These terminals send 24-VDC power to the external I/O which connect to the SmartSlice I/O Units.

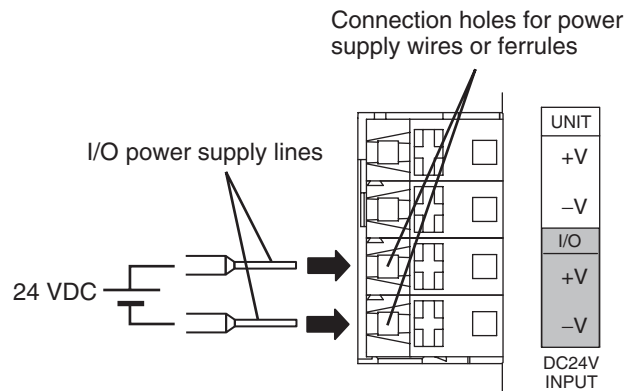

Precaution for Correct Usage

- Use an insulated power supply.

- Note**
- (1) The Left Turnback Unit (GRT1-TBL) has the same type of power supply terminals with screwless clamp terminals.
 - (2) The terminals on the CompoNet Communications Unit and Left Turnback Unit (GRT1-TBL) are not the same as the terminals on the I/O Power Feed Units (for example, the GRT1-PD2 and GRT1-PD8). Refer to the *GRT1 Series SmartSlice I/O Units Operation Manual* (Cat. No. W455) for the connection procedure.

4-3 Connecting the Turnback Cables

Note You use Turnback Units to expand or divide a SmartSlice I/O Terminal.

Connect the Right Turnback Unit (GRT1-TBR) on the block to the Left Turnback Unit (GRT1-TBL) on the subsequent block with a Turnback Cable (GCN2-100). Press the connector on the cable into the connector on the Turnback Unit until you hear it lock.

You can connect a maximum of 2 expansion blocks for one CompoNet Communications Unit.

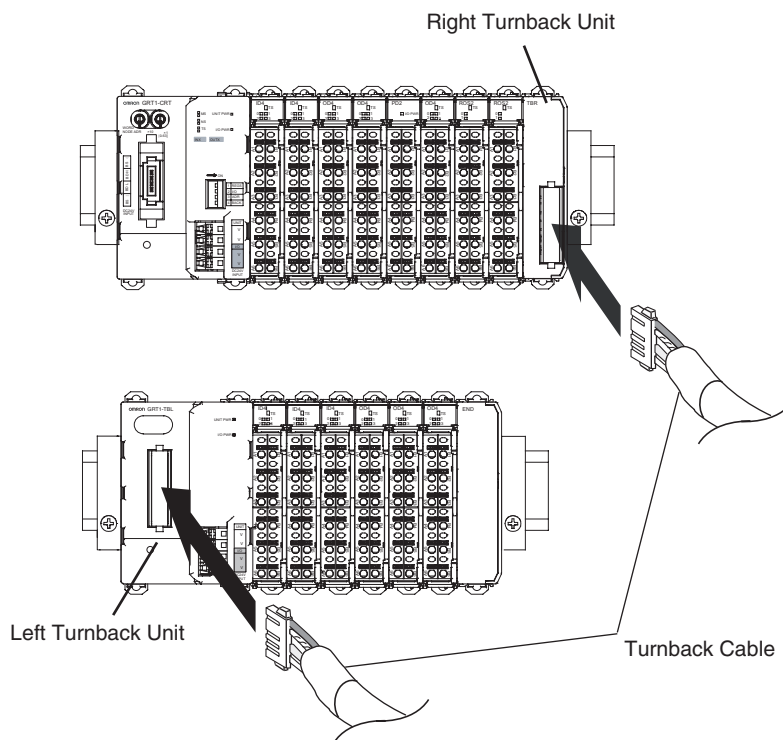

Precaution for Correct Usage

- The Turnback Cable does not send power. Connect the Left Turnback Unit to the same power supply as the CompoNet Communications Unit.

4-4 Precautions When Connecting the Power Supplies

There are limits for each block to the capacities of the power supplies. The total power consumption of the CompoNet Communications Unit and SmartSlice I/O Units must not be larger than 80 W. The total current consumption of the I/O devices which connect to the SmartSlice I/O Units must not be larger than 4 A.

If the current consumption or power consumption is too large, do the procedure below.

Total Unit Power Consumption

- 1,2,3...
1. Refer to *Appendix D Power Consumption and Weight Tables* and calculate the total power consumption. Include the CompoNet Communications Unit and the connected SmartSlice I/O Units.
 2. If the total power consumption is larger than 80 W, connect a Right Turnback Unit (GRT1-TBR) where the total power consumption is 80 W or less. Then connect a Left Turnback Unit (GRT1-TBL) to start a new block.
 3. Connect the Right Turnback Unit to the Left Turnback Unit with a Turnback Cable (GCN2-100).
 4. Connect the Unit power supply (24 VDC) to the Unit power supply terminals on the Left Terminal Block. Connect the I/O power supply (24 VDC) to the I/O power supply terminals on the Left Terminal Block

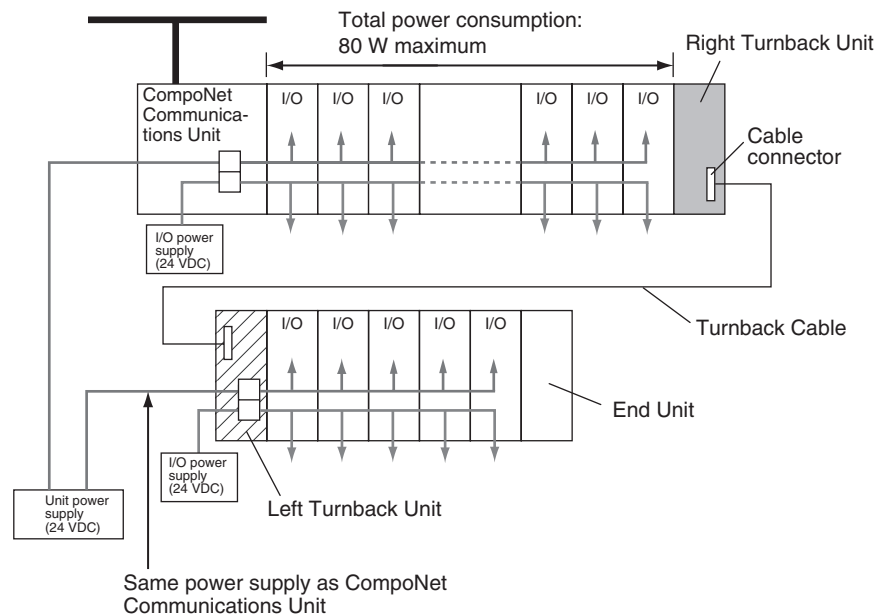

Precaution for Correct Usage

- Connect all blocks to the same Unit power supply.

Total I/O Current Consumption

- 1,2,3...
1. Refer to *Appendix E Total I/O Current Consumption Table* and calculate the total current consumption of all connected SmartSlice I/O Units. Include the Turnback Unit.
 2. If the total current consumption is larger than 4 A, do one of these procedures:

- Use Turnback Units to divide the SmartSlice I/O Terminal into two blocks. Connect a Right Turnback Unit (GRT1-TBR) where the total current consumption is 4 A or less. Then connect a Left Turnback Unit (GRT1-TBL) to start a new block. Connect the Right Turnback Unit to the Left Turnback Unit with a Turnback Cable (GCN2-100). Connect the Unit power supply (24 VDC) to the Unit power supply terminals on the Left Turnback Unit. Connect the I/O power supply (24 VDC) to the I/O power supply terminals on the Left Turnback Unit.
- Add an I/O Power Feed Unit to start a new I/O power supply group. Make sure that each group uses less than 4 A.

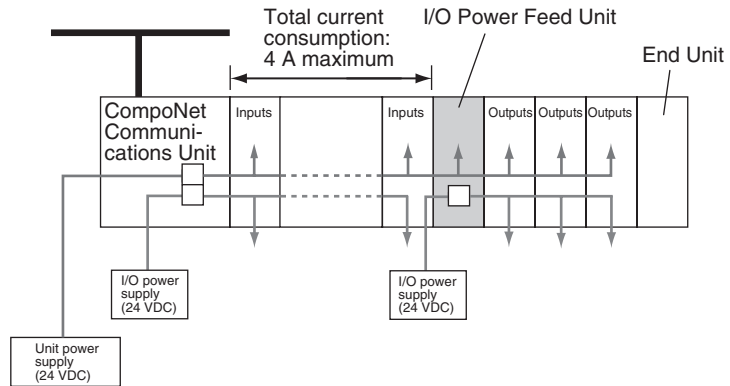

Note You can connect an I/O Power Feed Unit at the necessary location in the SmartSlice I/O Terminal to divide the input and output power supplies.

4-5 Connecting the Signal Lines for External Devices

Connect the I/O signal lines from the external devices to the I/O terminals on the SmartSlice I/O Units. The I/O terminals on the SmartSlice I/O Units are the same type of screwless clamp terminal as on the CompoNet Communications Unit.

Refer to the *GRT1 Series SmartSlice I/O Units Operation Manual* (Cat. No. W455) for more information.

SECTION 5

Unit Settings and I/O Allocations

This section tells you how to set the unit address and unit number. It also tells how to allocate I/O in the CompoNet Master Unit.

5-1	Setting the Node Addresses	40
5-2	Unit Numbers for SmartSlice I/O Units	41
5-3	I/O Allocations to CompoNet Master Unit	42
5-3-1	Overview of I/O Allocations	42
5-3-2	Restrictions for Data Sizes and Number of Units	44
5-3-3	Status Words	46
5-3-4	Allocating I/O with the CX-Integrator	51

5-1 Setting the Node Addresses

There are two types of node on a CompoNet Network: The slaves and a CompoNet Master Unit. The slaves connect to external I/O. The Master Unit controls the CompoNet Network and sends I/O data between the PLC and the slaves.

A SmartSlice I/O Terminal is a slave on a CompoNet Network. You must set a node address for it.

You can use the node address to find the first word that is allocated to the SmartSlice I/O Terminal.

The SmartSlice I/O Terminal is a Word Slave.

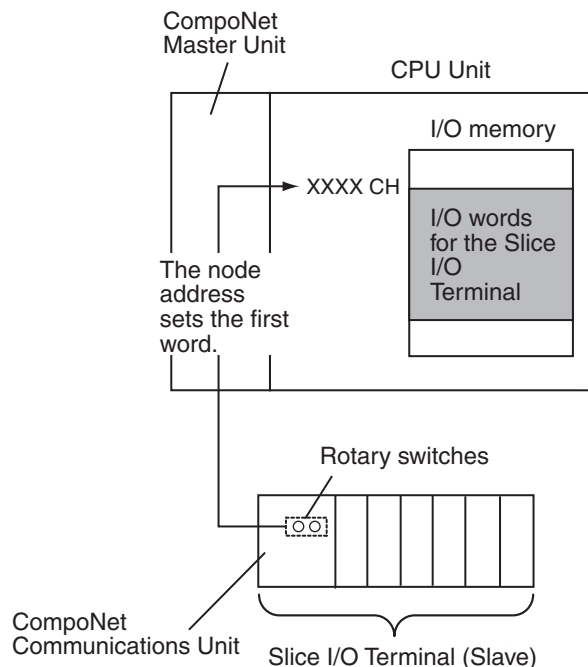

Setting Procedure

- 1,2,3...**
1. Turn OFF the Unit power supply to the CompoNet Master Unit and the CompoNet Communications Unit.
 2. Set the 10s digit of the node address on the left rotary switch and set the 1s digit on the right rotary switch.
Set the node address to between 0 and 63. Do not set the same address for more than one node (nodes for CompoNet Master Unit and slaves).

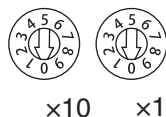

3. Turn ON the power supplies.

Note If you set a node address that is the same as a different node, the NS indicator on the CompoNet Communications Unit will come ON in red. A network configuration error will occur and normal communications will not be possible.

5-2 Unit Numbers for SmartSlice I/O Units

Unit numbers identify the SmartSlice I/O Units connected in a SmartSlice I/O Terminal.

The system automatically allocates the unit numbers for SmartSlice I/O Units. The SmartSlice I/O Unit on the right side of the CompoNet Communications Unit is Unit 1. The other SmartSlice I/O Units get unit numbers 2 to 64 in sequence from the left side to the right side of the SmartSlice I/O Terminal.

The CompoNet Master Unit uses the unit numbers to allocate I/O.

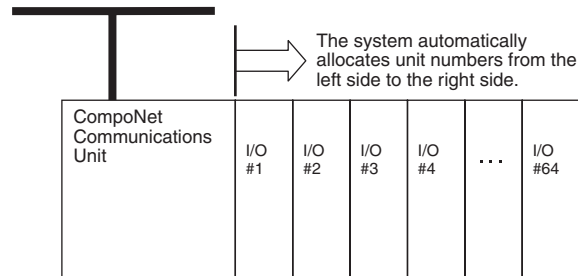
**Note**

- (1) The node address of the SmartSlice I/O Terminal has no relation to the unit numbers of the SmartSlice I/O Units.
- (2) The I/O Power Feed Units (for example, the GRT1-PD2 and GRT1-PD8) do not get unit numbers.

5-3 I/O Allocations to CompoNet Master Unit

The system allocates words in an Input Area and Output Area to the Smart-Slice I/O Units using the node number of the SmartSlice I/O Terminal. These words are in the I/O memory of the CPU Unit of the CompoNet Master Unit.

You can also use the CX-Integrator to set I/O allocations.

Note You can also use Software I/O Allocation Mode to allocate words to a Dummy Unit. A Dummy Unit is a SmartSlice I/O Unit that is not connected in the SmartSlice I/O Terminal. Refer to 6-7 *Software Setting of I/O Allocations* on page 60 for more information.

5-3-1 Overview of I/O Allocations

This section gives an overview of I/O allocations to the CompoNet Master Unit.

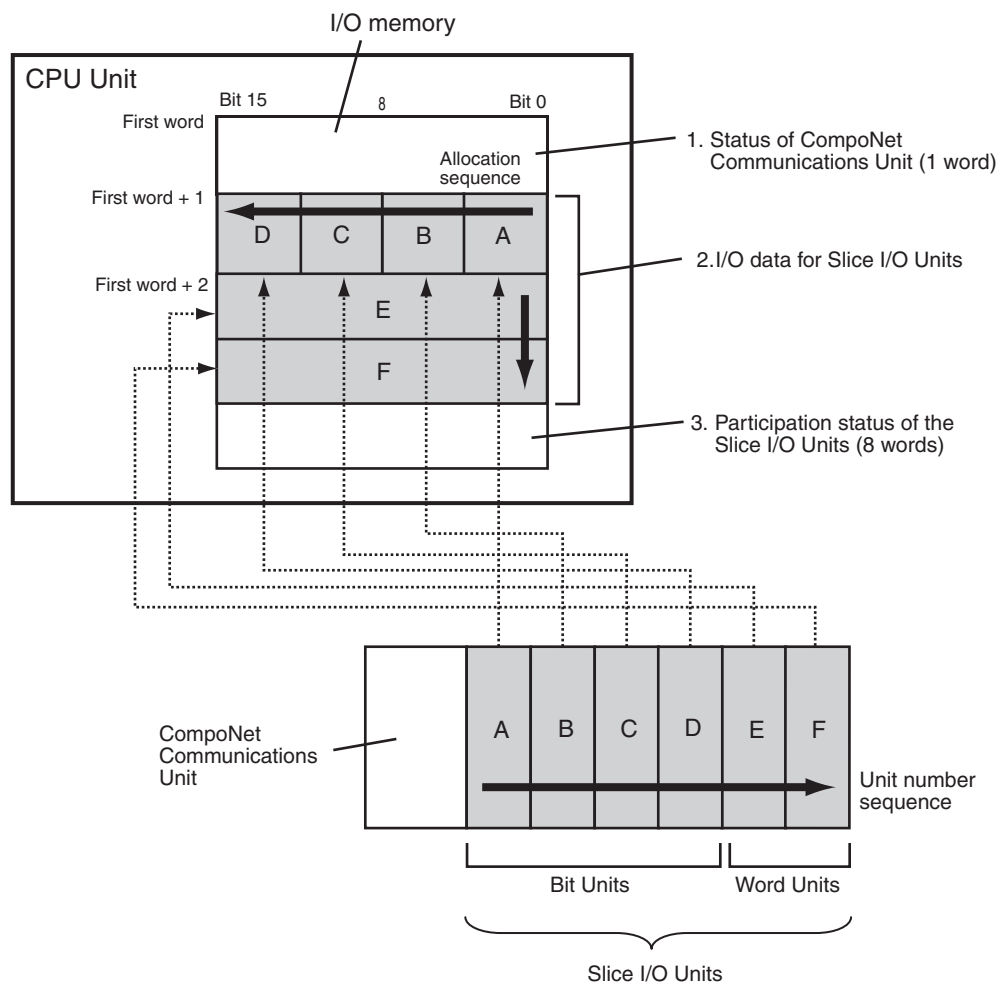

1. Status of the CompoNet Communications Unit
The Status Word shows the status of the SmartSlice I/O Units in the SmartSlice I/O Terminal.
2. I/O Data for SmartSlice I/O Units
The system allocates the bits or words to the SmartSlice I/O Units in the SmartSlice I/O Terminal in the same sequence as the unit numbers. It allocates lower bits first and words with lower addresses first.

- The system allocates 2 bits to each Bit Unit starting from the lower bits. Bit Units are SmartSlice I/O Units that have two or more bits of I/O (for example, the GRT1-ID4/OD4).
- The system allocates words to each Word Unit starting from words with lower addresses. Word Units are SmartSlice I/O Units that have one or more words of I/O (for example, the GRT1-AD2/DA2C).

Refer to the *GRT1 Series SmartSlice I/O Units Operation Manual* (Cat. No. W455) for information on each Bit Unit and Word Unit model of SmartSlice I/O Units and specifications.

3. Participation Status of the SmartSlice I/O Units

The system allocates 8 words for the participation status of the SmartSlice I/O Units.

Allocation Example

The system allocates words to the SmartSlice I/O Units in the sequence in which they are connected (in the sequence of unit numbers). The models of the SmartSlice I/O Units have no effect on the sequence of allocations.

Unless you use the CX-Integrator to set I/O allocations, the system always allocates words in the same sequence starting from the first word for the node address. The sequence is the status, left SmartSlice I/O Unit, subsequent SmartSlice I/O Unit on the right side, other SmartSlice I/O Units. The system allocates words to Input Units in the Input Area and to Output Units in the Output Area.

The system allocates words for status of the CompoNet Communications Unit and the participation status of the SmartSlice I/O Units in the Input Area.

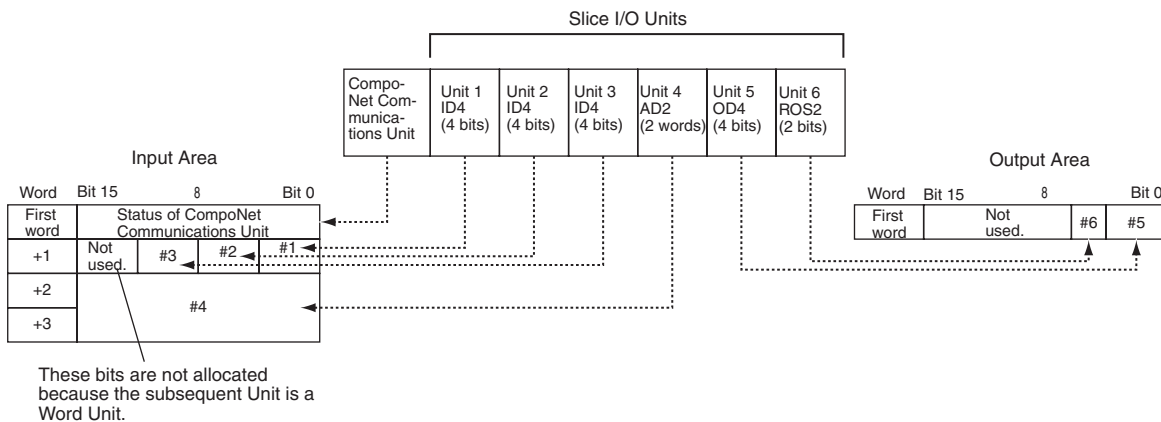

Data Patterns in I/O Memory

You can make these patterns in I/O memory for I/O allocations.

■ Input Area

- Input data + Status of CompoNet Communications Unit (default setting)
- Input data + Status of CompoNet Communications Unit + Participation status of SmartSlice I/O Units

■ Output Area

- Output data only

You can use the CX-Integrator to select from these patterns.

Bits That Are Not Used

The figure below shows a 4-bit Unit (Unit 5) that gets two bits in one word and two bits in the subsequent word. The subsequent Unit (Unit 6) is a Word Unit that gets two words. The system allocates the subsequent two full words to this Unit and does not allocate the other bits in the +1 word.

Unit 8 in the figure is an 8-bit Unit. The system allocates only full words to 8-bit Units. In this example, the system allocates the subsequent full word (the +5 word) and does not allocate the other bits in the +4 word. (The first four bits in the +4 word are for Unit 7.)

Configuration Example for Slice I/O Terminal

CompoNet Communications Unit	#1 OD4	#2 OD4	#3 OD4	#4 ROS2	#5 OD4	#6 DA2	#7 OD4	#8 OD8
------------------------------	--------	--------	--------	---------	--------	--------	--------	--------

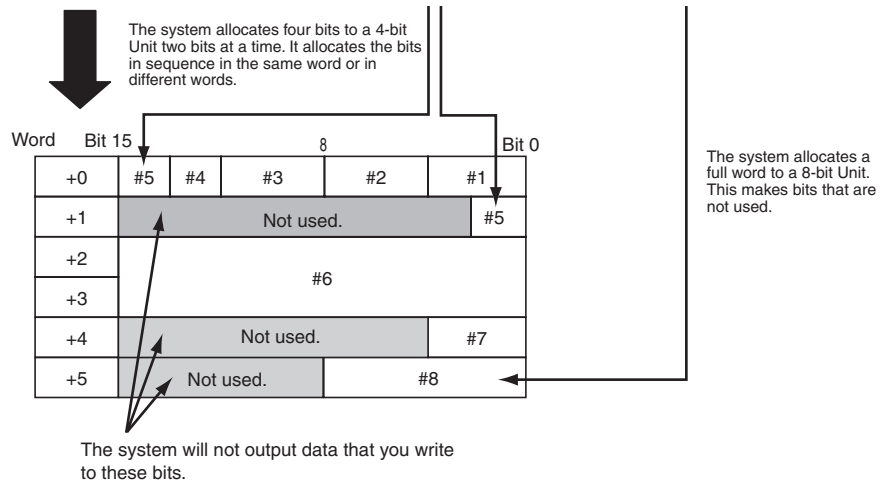

5-3-2 Restrictions for Data Sizes and Number of Units

There are restrictions on the SmartSlice I/O Units that you can connect to one CompoNet Communications Unit. The restrictions are for the number and models of SmartSlice I/O Units that you connect.

- You can connect a maximum of 64 SmartSlice I/O Units. (This does not include the End Unit.)
- The Input Area must be no larger than 32 bytes. This includes bits for Word Units, bits for Bit Units, status words, and bits that are not used.
- The Output Area must be no larger than 32 bytes. This includes bits for Word Units, bits for Bit Units, and bits that are not used.

These are examples of the restrictions.

Permitted Configurations

- Bit Input Units Only

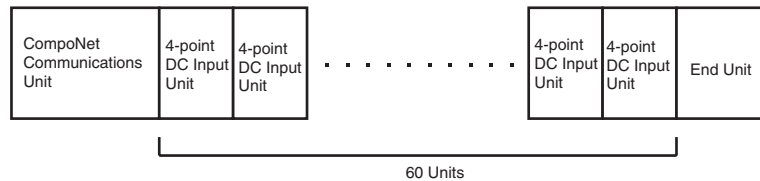

Four-point DC Input Unit (GRT1-ID4): 4 bits × 60 = 30 bytes in Input Area

Two bytes are used for CompoNet Communications Unit status. The total is 32 bytes.

• Bit Output Units Only

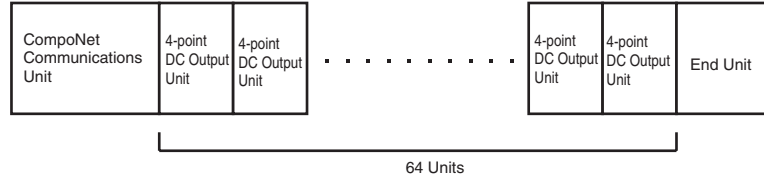

Four-point DC Output Unit (GRT1-OD4): $4 \text{ bits} \times 64 = 32 \text{ bytes}$ in Output Area

Two bytes are used for CompoNet Communications Unit status.
The total is 32 bytes in the Output Area and two bytes in the Input Area

• Word Input Units Only

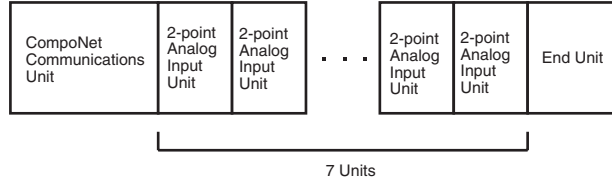

Two-point Analog Input Unit (GRT1-AD2): $2 \text{ words (4 bytes)} \times 7 = 28 \text{ bytes}$ in Input Area

Two bytes are used for CompoNet Communications Unit status. The total is 30 bytes.

• Word Output Units Only

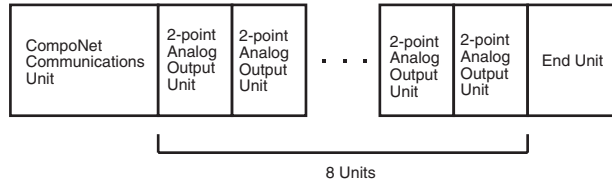

Two-point Analog Output Unit (GRT1-DA2C): $2 \text{ words (4 bytes)} \times 8 = 32 \text{ bytes}$ in Output Area

Two bytes are used for CompoNet Communications Unit status.
The total is 32 bytes in the Output Area and two bytes in the Input Area.

• Word Units and Bit Units Together

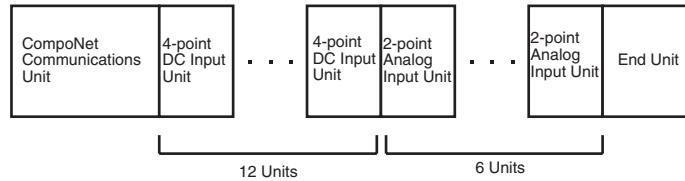

Four-point DC Input Unit (GRT1-ID4): $4 \text{ bits} \times 12 = 6 \text{ bytes}$ in Input Area
Analog Input Unit (GRT1-AD2): $2 \text{ words (4 bytes)} \times 6 = 24 \text{ bytes}$ in Input Area

Two bytes are used for CompoNet Communications Unit status.

→ Total: 32 bytes in Input Area

• Input Units and Output Units

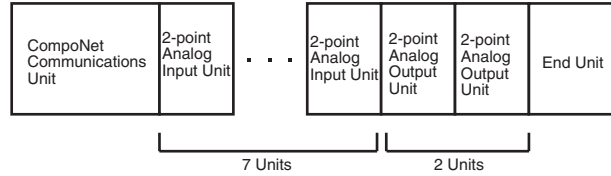

Two-point Analog Input Unit (GRT1-AD2): 2 words (4 bytes) × 7 + Communications Unit status = 30 bytes in Input Area
 Analog Output Unit (GRT1-DA2C): 2 words (4 bytes) × 2 = 8 bytes in Output Area

→ Totals: 30 bytes in Input Area
 8 bytes in Output Area

Bad Configurations

• Too Many Allocated Bits

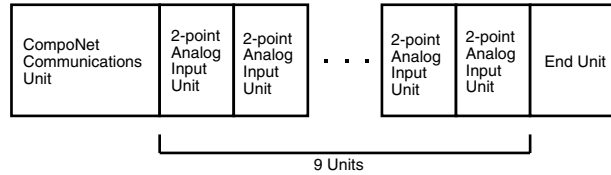

Two-point Analog Input Unit (GRT1-AD2): 2 words (4 bytes) × 9 = 38 bytes in Input Area

Two bytes are used for CompoNet Communications Unit status.

• Too Many Units

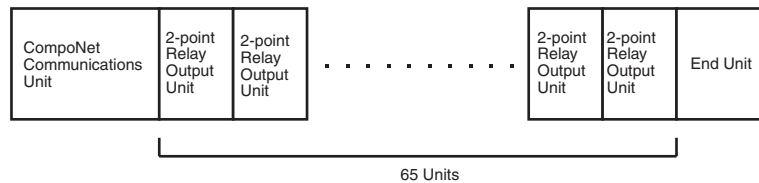

Two-point Relay Output Unit (GRT1-ROS2): 2 bits × 65 = 17 bytes in Output Area
 2 bytes in the Input Area

Two bytes are used for CompoNet Communications Unit status.

• Too Many Allocated Bits with Bits That Are Not Used

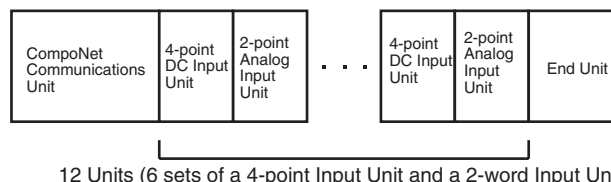

Four-point DC Input Unit (GRT1-ID4): 4 bits × 6 = 3 bytes in Input Area
 Two-point Analog Input Unit (GRT1-AD2): 2 words (4 bytes) × 6 = 24 bytes in Input Area

Two bytes are used for CompoNet Communications Unit status.

→ Total: 29 bytes + 9 unused bytes = 38 bytes in Input Area

5-3-3 Status Words

The status words show the status of the SmartSlice I/O Units in the Smart-Slice I/O Terminal, the connection status with the CompoNet Master Unit, and the participation status.

There are two type of status: Status of the CompoNet Communications Unit and the participation status of the SmartSlice I/O Units. There are different words for each of these.

Status of the CompoNet Communications Unit

This status word shows the status of the SmartSlice I/O Units in the Smart-Slice I/O Terminal, the connection status with the CompoNet Master Unit, and other status.

By default, the system allocates 1 word of the Input Area.

The flags in this word show the status. You can use the CX-Integrator or explicit messages to read these flags.

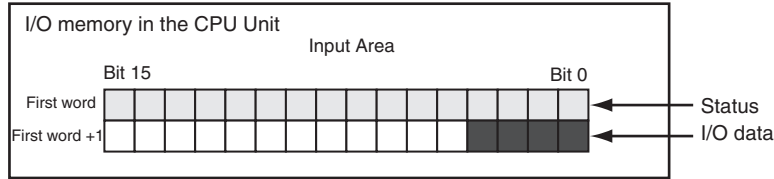

↑ The Input Area contains this status and the I/O data.

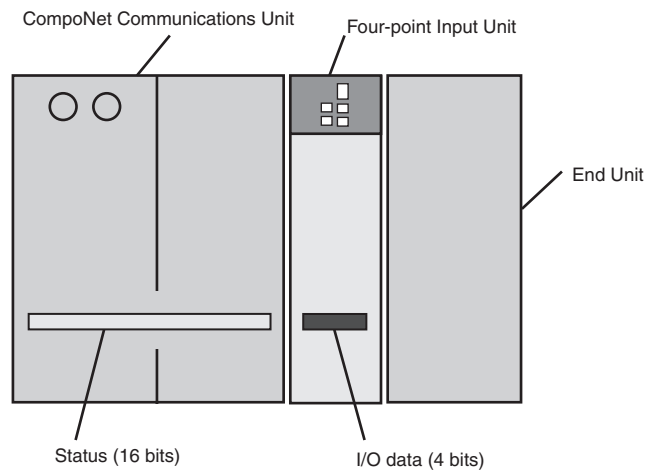

The table below gives the meanings of the flags.

Bit	Description	Meaning
0	SmartSlice Bus Communications Error Flag OFF: Normal, ON: Communications error	This flag turns ON when there is a communications error in the SmartSlice bus in the SmartSlice I/O Terminal.
1	Reserved.	---
2	SmartSlice I/O Unit Warning Flag OFF: Normal, ON: Error	This flag turns ON when there is a minor error in a SmartSlice I/O Unit. It will turn ON when there is an error in one or more of the SmartSlice I/O Units in the SmartSlice I/O Terminal.
3	Reserved.	---
4	SmartSlice I/O Unit Alarm Flag OFF: Normal, ON: Error	This flag turns ON when there is a serious error in a SmartSlice I/O Unit. It will turn ON when there is an error in one or more of the SmartSlice I/O Units in the SmartSlice I/O Terminal.
5	Reserved.	---
6	Reserved.	---
7	Reserved.	---
8	Reserved.	---
9	Reserved.	---
10	Reserved.	---

Bit	Description	Meaning
11	Reserved.	---
12	Unit Maintenance Flag OFF: Normal, ON: Error (more than threshold)	This flag turns ON when the operating time is longer than the threshold set for the Unit Conduction Time Monitor.
13	Automatic Restore Monitor Flag OFF: The parameters were restored. ON: Restore operation error	This flag turns ON when an error occurs in the operation to automatically restore parameters to the SmartSlice I/O Units.
14	CompoNet Communications Unit Error Flag OFF: Normal, ON: Error	This is an overview flag. It turns ON when one of the flags in bits 0 to 4, 12, or 13 turns ON.
15	I/O Refreshing Flag OFF: I/O communications stopped. ON: I/O communications are normal.	This flag is ON while I/O data communications on the SmartSlice bus are normal.

Participation Status of the SmartSlice I/O Units

These status words show the participation status of the SmartSlice I/O Units that connect to the CompoNet Communications Unit.

The system allocates eight words for the participation status. It makes no difference how many SmartSlice I/O Units are in the SmartSlice I/O Terminal. Four words contain the Participating Flags and the other four words contain the Withdrawn Flags.

Word	Bit 15								Bit 8								Bit 0																																																
	#16	#15	#14	#13	#12	#11	#10	#9	#8	#7	#6	#5	#4	#3	#2	#1	#32	#31	#30	#29	#28	#27	#26	#25	#24	#23	#22	#21	#20	#19	#18	#17	#48	#47	#46	#45	#44	#43	#42	#41	#40	#39	#38	#37	#36	#35	#34	#33	#64	#63	#62	#61	#60	#59	#58	#57	#56	#55	#54	#53	#52	#51	#50	#49	
Participating Flags	+0	#16	#15	#14	#13	#12	#11	#10	#9	#8	#7	#6	#5	#4	#3	#2	#1	#32	#31	#30	#29	#28	#27	#26	#25	#24	#23	#22	#21	#20	#19	#18	#17	#48	#47	#46	#45	#44	#43	#42	#41	#40	#39	#38	#37	#36	#35	#34	#33	#64	#63	#62	#61	#60	#59	#58	#57	#56	#55	#54	#53	#52	#51	#50	#49
	+1	#32	#31	#30	#29	#28	#27	#26	#25	#24	#23	#22	#21	#20	#19	#18	#17	#48	#47	#46	#45	#44	#43	#42	#41	#40	#39	#38	#37	#36	#35	#34	#33	#64	#63	#62	#61	#60	#59	#58	#57	#56	#55	#54	#53	#52	#51	#50	#49																
	+2	#48	#47	#46	#45	#44	#43	#42	#41	#40	#39	#38	#37	#36	#35	#34	#33	#64	#63	#62	#61	#60	#59	#58	#57	#56	#55	#54	#53	#52	#51	#50	#49																																
	+3	#64	#63	#62	#61	#60	#59	#58	#57	#56	#55	#54	#53	#52	#51	#50	#49																																																
Withdrawn Flags	+4	#16	#15	#14	#13	#12	#11	#10	#9	#8	#7	#6	#5	#4	#3	#2	#1	#32	#31	#30	#29	#28	#27	#26	#25	#24	#23	#22	#21	#20	#19	#18	#17	#48	#47	#46	#45	#44	#43	#42	#41	#40	#39	#38	#37	#36	#35	#34	#33	#64	#63	#62	#61	#60	#59	#58	#57	#56	#55	#54	#53	#52	#51	#50	#49
	+5	#32	#31	#30	#29	#28	#27	#26	#25	#24	#23	#22	#21	#20	#19	#18	#17	#48	#47	#46	#45	#44	#43	#42	#41	#40	#39	#38	#37	#36	#35	#34	#33	#64	#63	#62	#61	#60	#59	#58	#57	#56	#55	#54	#53	#52	#51	#50	#49																
	+6	#48	#47	#46	#45	#44	#43	#42	#41	#40	#39	#38	#37	#36	#35	#34	#33	#64	#63	#62	#61	#60	#59	#58	#57	#56	#55	#54	#53	#52	#51	#50	#49																																
	+7	#64	#63	#62	#61	#60	#59	#58	#57	#56	#55	#54	#53	#52	#51	#50	#49																																																

* There is one Participating Flag and one Withdrawn Flag for each unit number (for each Slice I/O Unit). (There are flags for 64 Slice I/O Units.)

The table below gives the meanings of the flags.

Flag	Meaning
Participating Flag	ON: The Unit is participating in communications (correctly allocated in the CompoNet Master Unit). OFF: The Unit has not joined communications. (If the Registration Table is enabled and there was a verification error for the Unit, the Participating Flag will be OFF.)
Withdrawn Flag	ON: There is a communications error or the Unit joined and then disconnected from communications. OFF: The Unit did not join communications at all or is participating in communications at this time.

- Note**
- (1) You must use the CX-Integrator to allocate words for the participation status.
 - (2) The TS indicators on the SmartSlice I/O Units also show the status of the communications and the status of the SmartSlice I/O Units.

Warning Status in the CompoNet Communications Unit

The warning status in the CompoNet Communications Unit tells you the minor errors that occur in the CompoNet Communications Unit. The warning status is not in an I/O area. You can access it only with an explicit message.

This table shows the warning status.

Bit	Name	Description
0	Manchester error rate comparison value high	The code error rate is higher than the high comparison value.
1	Reserved.	Not used.
2	Reserved.	Not used.
3	Unit total time warning	This bit turns ON when the total operating time is higher than the threshold value.
4	Reserved.	Not used.
5	Reserved.	Not used.
6	Reserved.	Not used.
7	Reserved.	Not used.
8	Reserved.	Not used.
9	Reserved.	Not used.
10	Reserved.	Not used.
11	Reserved.	Not used.
12	Reserved.	Not used.
13	Reserved.	Not used.
14	Reserved.	Not used.
15	Reserved.	Not used.

Alarm Status in the CompoNet Communications Unit

The alarm status in the CompoNet Communications Unit tells you the serious errors that occur in the CompoNet Communications Unit. The alarm status is not in an I/O area. You can access it only with an explicit message.

This table shows the alarm status.

Bit	Name	Description
0	Manchester error rate comparison value high high	The code error rate is higher than the high high comparison value.
1	Non-volatile data error	EEPROM memory error
2	Reserved.	Not used.
3	Reserved.	Not used.
4	Reserved.	Not used.
5	Reserved.	Not used.
6	Reserved.	Not used.
7	Reserved.	Not used.
8	DPRAM interface error	The DPRAM interface sent a status error.
9	Reserved.	Not used.
10	Reserved.	Not used.
11	Reserved.	Not used.
12	Reserved.	Not used.
13	Reserved.	Not used.
14	Reserved.	Not used.
15	Reserved.	Not used.

Doing a Check of the Communications Status with the CX-Integrator

You can use the CX-Integrator to do a check of the communications status.

- 1,2,3...
1. Start the CX-Integrator.
 2. Right-click the icon of CompoNet Communications Unit and select **Maintenance Information**. (From the Maintenance Mode Window, double-click the icon.) The Monitor Window will show.
 3. Click the **Status** Tab. The window will show the communications status of the SmartSlice I/O Units.

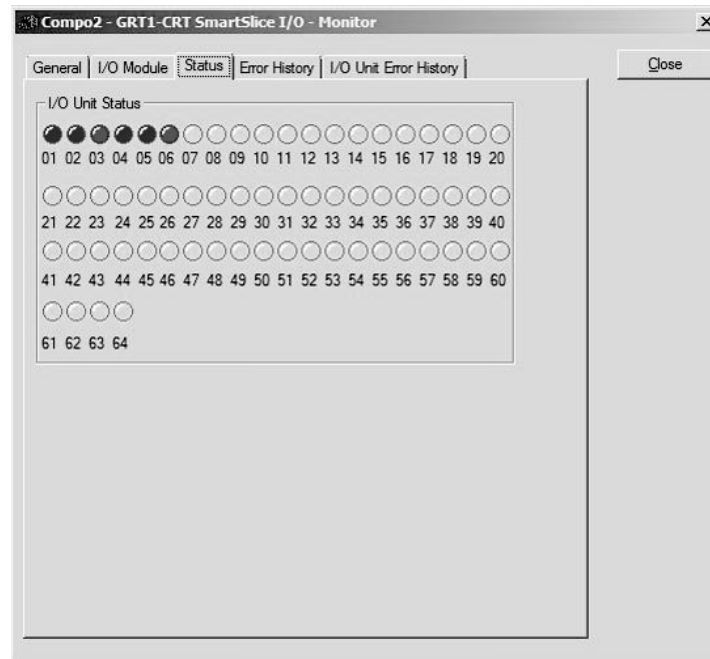

These are the meanings of the colors of the status indicators.

- Red: The Alarm Status Bit for the SmartSlice I/O Unit is ON.
- Yellow: The Warning Status Bit for the SmartSlice I/O Unit is ON.
- Blue: The SmartSlice I/O Unit is communicating as normal.

4. Click the **Close** Button.

Refer to the *GRT1 Series SmartSlice I/O Units Operation Manual* (Cat. No. W455) for information on errors in SmartSlice I/O Units.

5-3-4 Allocating I/O with the CX-Integrator

You can use the CX-Integrator to set I/O allocations. Use this procedure.

- 1,2,3...
1. Start the CX-Integrator.
 2. Double-click the icon of the CompoNet Master Unit. (In the Maintenance Mode Window, right-click the icon and select **Parameter – Edit**.) The Configuration Window will show.

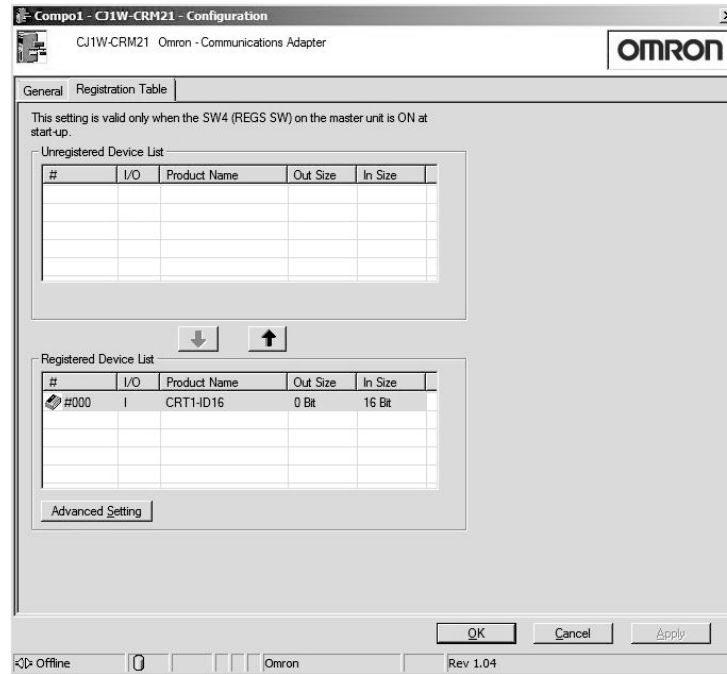

3. Click the **Software Setting Table** Tab and set the areas, addresses, and number of nodes for word outputs and word inputs. The area is the memory area in the CPU Unit and the address is the address of the first word to allocate. “Node” is the number of words in the Input or Output Area. If status words are necessary, set them too.

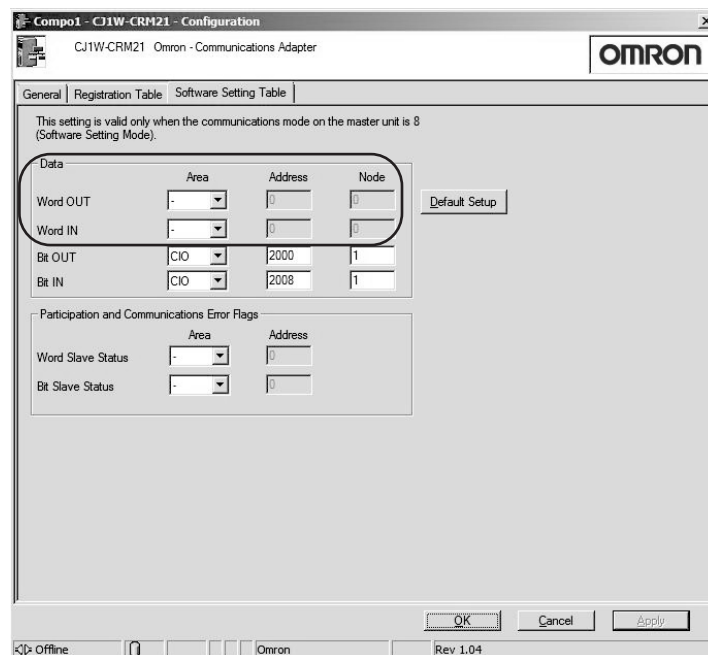

Note The “number of nodes” is the number of words in the Input and Output Areas that the SmartSlice I/O Terminal uses. To find the number of words in the Input and Output Areas, open the Configuration Window of the Communications Unit and click the **I/O Map** Tab. The tab page will show the number of words in the Input Area and the Output Area.

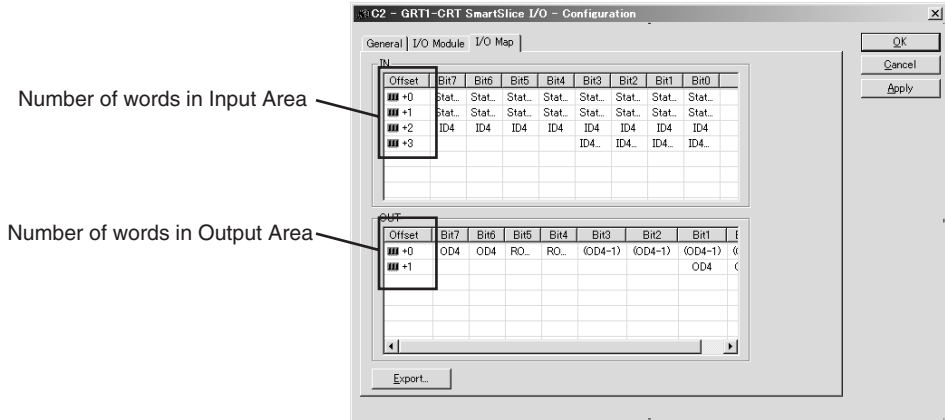

4. Click the **General** Tab, and then click the **Transfer [PC to Unit]** Button. The CX-Integrator will start to download the parameters.
5. Click the **OK** Button to complete the procedure.

SECTION 6

Smart Functions

This section tells you about the many smart functions of the SmartSlice system.

6-1	Overview of Smart Functions	54
6-2	Registration Table	54
6-2-1	Making a Registration Table	54
6-2-2	Verifying the Registration Table	55
6-2-3	Clearing the Registration Table	56
6-3	Backup Function	57
6-3-1	Backup Procedure	57
6-3-2	Doing a Check of the Backup Results	57
6-4	Automatic Restore Function	58
6-4-1	Restore Procedure	58
6-4-2	Doing a Check of the Restore Results	59
6-5	Replacing Units Online	59
6-6	Automatic Baud Rate Recognition	59
6-7	Software Setting of I/O Allocations	60
6-7-1	Starting in Software I/O Allocation Mode	62
6-7-2	Making, Downloading, and Clearing the Software Setting Table	63
6-7-3	Showing the Settings	67
6-7-4	Editing Parameters of SmartSlice I/O Units	70
6-8	Unit Conduction Time Monitor	71
6-8-1	Monitoring the Unit Conduction Time	72
6-8-2	Setting the Threshold	72
6-9	Unit Comments	73
6-9-1	Reading Comments	74
6-9-2	Writing Comments	74
6-10	Network Communications Error History Monitor	75
6-10-1	Reading the Error History	75
6-11	I/O Communications Error History Monitor	76
6-11-1	Reading the Error History	77
6-12	Last Maintenance Date	77
6-12-1	Reading the Last Maintenance Date	77
6-12-2	Writing the Last Maintenance Date	78

6-1 Overview of Smart Functions

This section gives an overview of the smart functions of the CompoNet Smart-Slice system.

Function	Overview	Method
Registration Table	The Registration Table contains information on the SmartSlice I/O Units in the Smart-Slice I/O Terminal.	DIP switch
Backup Function	You can read the parameter settings from all SmartSlice I/O Units in the SmartSlice I/O Terminal and save them.	DIP switch
Automatic Restore Function	You can automatically restore the parameter settings that you backed up in the CompoNet Communications Unit.	DIP switch
Replacing Units Online	You can replace a SmartSlice I/O Unit without turning OFF the power supply.	---
Automatic Baud Rate Recognition	The CompoNet Communications Unit automatically uses the same baud rate as the CompoNet Master Unit.	---
Software Setting of I/O Allocations	You can set Dummy Units (SmartSlice I/O Units that are not installed at this time) in a Software Setting Table. The settings include the node address and I/O configuration information.	DIP switch (You use the CX-Integrator to make, download, and clear the Software Setting Table.)
Unit Conduction Time Monitor	The system calculates and records the time that the internal power supply in the Unit is ON in increments of 0.1-hour.	CX-Integrator or explicit messages
Unit Comments	You can set a comment (for example, a name) for each SmartSlice I/O Unit.	CX-Integrator or explicit messages
Network Communications Error History Monitor	The system records the last four errors in communications with the CompoNet network.	CX-Integrator or explicit messages
I/O Communications Error History Monitor	The system records the last 64 errors in communications between the CompoNet Communications Unit and the SmartSlice I/O Units.	CX-Integrator or explicit messages
Last Maintenance Date	You can record the last date you did maintenance.	CX-Integrator or explicit messages

6-2 Registration Table

You can use the DIP switch on the CompoNet Communications Unit to record the connected SmartSlice I/O Units in a table. The table tells the sequence and I/O capacity of each SmartSlice I/O Unit.

When the power is subsequently turned ON, the CompoNet Communications Unit automatically compares the information in the Registration Table with the connected SmartSlice I/O Units.

6-2-1 Making a Registration Table

Precaution for Correct Usage

- Before making the Registration Table, make sure that all SmartSlice I/O Units are participating in communications. The TS indicators must be lit in green.
- Before making the Registration Table, make sure that pin 2 (I/O) on the DIP switch is OFF (Automatic I/O Allocation Mode). You cannot make the Registration Table if pin 2 is ON (Software I/O Allocation Mode).

Turn ON pin 1 (REGS) on the DIP switch while the power to the SmartSlice I/O Terminal is ON.

The CompoNet Communications Unit will read the I/O configuration information and make a Registration Table.

The CompoNet Communications Unit will overwrite a previous Registration Table with the new one.

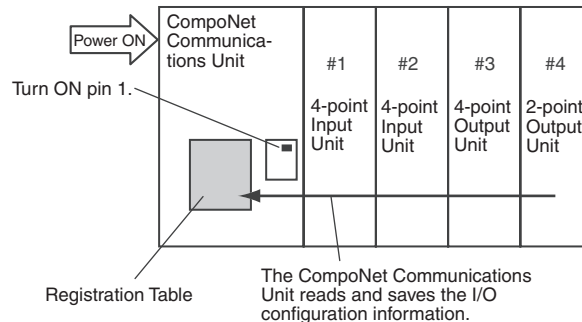

• Contents of Registration Table

The Registration Table contains the number of SmartSlice I/O Units and the I/O size for each Unit.

Unit number (from the left side)	I/O	Number of I/O
#1	Input	4 points
#2	Input	4 points
#3	Output	4 points
#4	Output	2 points

6-2-2 Verifying the Registration Table

The CompoNet Communications Unit will verify the Registration Table if the power turns ON when pin 1 (REGS) on the CompoNet Communications Unit is ON. The CompoNet Communications Unit automatically compares the information in the Registration Table with the connected SmartSlice I/O Units.

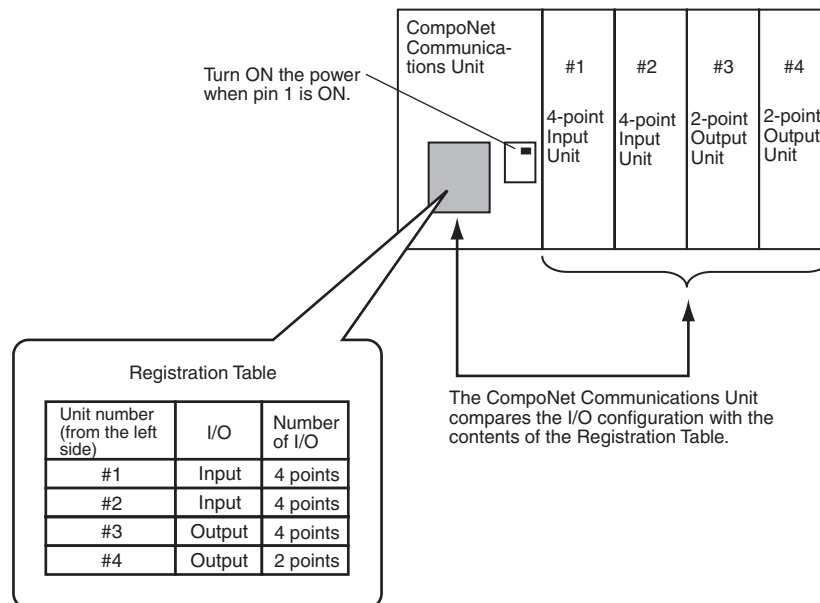

The TS indicator on the CompoNet Communications Unit will flash in red if there is one or more differences.

If the TS indicator flashes in red, the CompoNet Communications Unit will not communicate with the SmartSlice I/O Units.

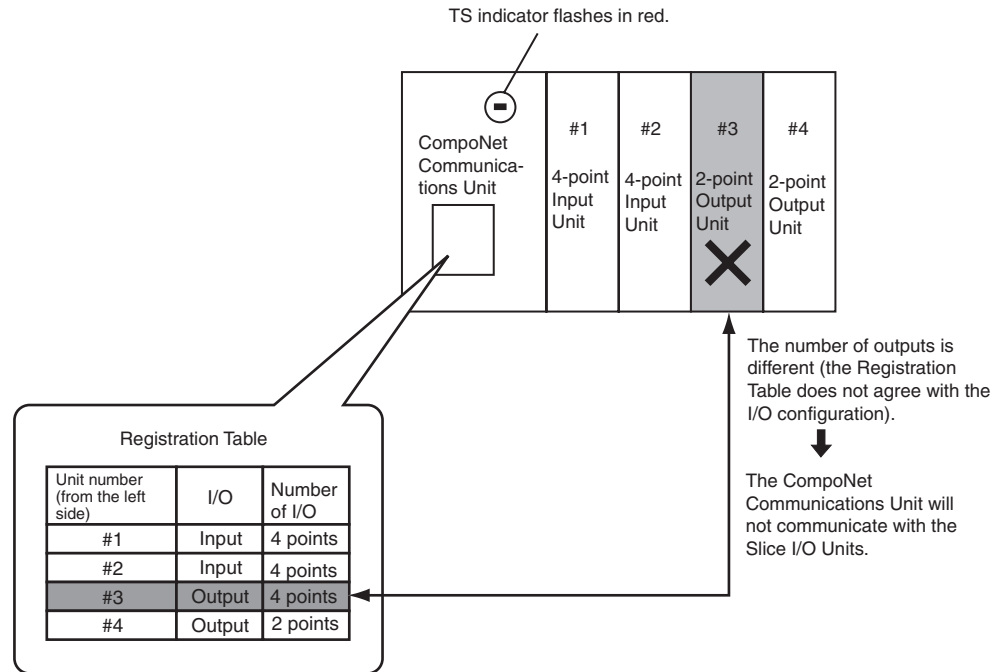

Use the procedures in the table below if there are differences between the Registration Table and the I/O configuration.

Cause	Procedure
Unit failure caused a SmartSlice I/O Unit to not be in the Registration Table.	Correct the cause (for example, replace the Unit), turn OFF pin 1 (REGS) on the CompoNet Communications Unit, and reset the Unit power supply. Then turn ON pin 1 to make the Registration Table again.
There is a SmartSlice I/O Unit that is not in the Registration Table.	Turn OFF pin 1 and reset the Unit power supply. Then turn ON pin 1 to make the Registration Table again.

Note If you start with CompoNet Communications Unit with pin 1 ON and no Registration Table, the TS indicator will flash in red. This shows a Registration Table Verification Error.

6-2-3 Clearing the Registration Table

To clear the Registration Table, turn ON the power supply to the CompoNet Communications Unit when pin 1 (REGS) is OFF.

6-3 Backup Function

The backup function saves the parameters from the SmartSlice I/O Units to memory in the CompoNet Communications Unit.

If you back up the parameters, you can use the automatic restore function to download the parameters in the CompoNet Communications Unit to the SmartSlice I/O Units. This is useful when you replace SmartSlice I/O Units.

We recommend that you back up the parameters at a set interval to prevent losing the parameter for SmartSlice I/O Unit failures.

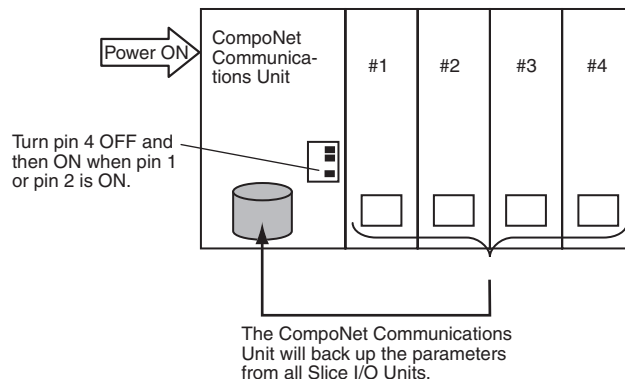

These conditions are necessary to back up the parameters. Do a check of these conditions before you back up the parameters.

- Pin 1 (REGS) or pin 2 (I/O) on the DIP switch on the CompoNet Communications Unit must be ON.
- All SmartSlice I/O Units must be participating in communications (to back up the parameters for all SmartSlice I/O Units at one time).

6-3-1 Backup Procedure

Turn pin 4 (BACK) OFF and then ON in 3 seconds.



The CompoNet Communications Unit will start to back up the parameters.

Precaution for Correct Usage

- Do not turn OFF the power supply or reset the CompoNet Communications Unit from the CX-Integrator during the backup operation. The backup data will not be correct.

6-3-2 Doing a Check of the Backup Results

The TS indicator on the CompoNet Communications Unit flashes green during the backup operation. The backup operation is completed when the TS indicator goes OFF.

If the CompoNet Communications Unit could not back up the parameters, the TC indicator will come ON in red for 2 seconds.

- Note** (1) To clear the backup data, reset the Unit power supply with pin 1 turned OFF. This operation will clear the Registration Table and the backup data.

- (2) The CompoNet Communications Unit will clear the backup data if you change the operating mode.

The CompoNet Communications Unit will clear the backup data if you back up the parameters with pin 2 (I/O) ON (Software I/O Allocation Mode) and then make the Registration Table from the CX-Integrator.

6-4 Automatic Restore Function

After you replace a SmartSlice I/O Unit, you can use the Automatic Restore Function to automatically download the parameters in the CompoNet Communications Unit to the SmartSlice I/O Units.

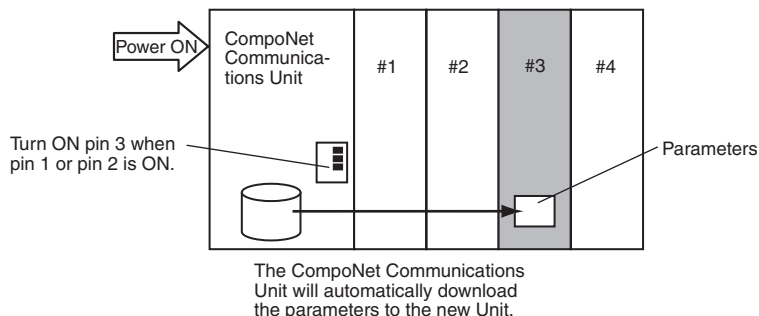

These conditions are necessary to automatically restore the parameters. Do a check of these conditions before you restore the parameters.

- There must be backup data in the CompoNet Communications Unit.
- Pin 1 (REGS) or pin 2 (I/O) on the DIP switch on the CompoNet Communications Unit must be ON.
- The new SmartSlice I/O Unit must have the same unit number and model number as the previous SmartSlice I/O Unit, but a different serial number.

6-4-1 Restore Procedure

- 1,2,3...
1. Turn ON pin 3 (ADR) on the CompoNet Communications Unit to enable the Automatic Restore Function.
 2. Turn OFF the I/O power supply and replace the SmartSlice I/O Unit. Refer to the *GRT1 Series SmartSlice I/O Units Operation Manual* (Cat. No. W455) for information on how to replace SmartSlice I/O Units.

The CompoNet Communications Unit will detect the SmartSlice I/O Unit that you replaced and it will download the parameters to it.

⚠ WARNING Turn OFF the I/O power supply to a SmartSlice I/O Unit before you replace it. Incorrect inputs, incorrect outputs, or electrical shock can occur if you do not turn OFF the I/O power supply. If there is external power to a terminal for a Relay Output Slave, for example, turn OFF the external power before you replace the SmartSlice I/O Unit.

Precaution for Correct Usage

- Do not turn OFF the power supply or reset the CompoNet Communications Unit from the CX-Integrator during the restore operation. The restored data will not be correct.

3. Turn ON the I/O power supply.

6-4-2 Doing a Check of the Restore Results

The TS indicator on the CompoNet Communications Unit flashes green during the restore operation. The restore operation is completed when the TS indicator stops flashing.

If the CompoNet Communications Unit restored the parameters, it will reset the SmartSlice I/O Units automatically and the TS indicator on the CompoNet Communications Unit will come ON in green.

If the CompoNet Communications Unit could not restore the parameters, the TS indicator on the CompoNet Communications Unit will come ON in red for 2 seconds. The Automatic Restore Monitor Flag (bit 13 in the status word for the CompoNet Communications Unit) will also turn ON.

If the new SmartSlice I/O Unit is not the same model as the previous Unit, the TS indicator on the CompoNet Communications Unit will flash in red.

6-5 Replacing Units Online

You can replace a SmartSlice I/O Unit in the SmartSlice I/O Terminal without turning OFF the Unit power supply.

A SmartSlice I/O Unit has a base block, main block, and terminal block. When you replace a SmartSlice I/O Unit, do not replace the base block and replace the other blocks.

Communications with the other SmartSlice I/O Units will continue while you replace the SmartSlice I/O Unit.

If you back up the parameters, you can turn ON pin 3 (ADR) with pin 1 (REGS) or pin 2 (I/O) ON to automatically restore the parameters.

Refer to the *GRT1 Series SmartSlice I/O Units Operation Manual* (Cat. No. W455) for information on how to replace SmartSlice I/O Units.

 **WARNING** Turn OFF the I/O power supply to a SmartSlice I/O Unit before you replace it. Incorrect inputs, incorrect outputs, or electrical shock can occur if you do not turn OFF the I/O power supply. If there is external power to a terminal for a Relay Output Slave, for example, turn OFF the external power before you replace the SmartSlice I/O Unit.

Precaution for Correct Usage

- Replace only one SmartSlice I/O Unit at a time.
- Always replace a SmartSlice I/O Unit with a Unit of the same model number. If you use a different model, incorrect outputs can occur or restoring the parameters will not be possible.
- If it is necessary to replace the base block, turn OFF the unit power supply and the I/O power supplies and replace the full SmartSlice I/O Unit. You can also use the Automatic Restore Function after you replace the full SmartSlice I/O Unit.

6-6 Automatic Baud Rate Recognition

The CompoNet Communications Unit will automatically detect the baud rate set in the CompoNet Master Unit and use it for communications with the CompoNet Master Unit.

The CompoNet Communications Unit will set the baud rate when it establishes communications with the CompoNet Master Unit. It will save the baud rate until the power supply is turned OFF.

Note If you change the baud rate of the CompoNet Master Unit, reset the power supply of the CompoNet Communications Unit.

6-7 Software Setting of I/O Allocations

You can set Dummy Units in a Software Setting Table for SmartSlice I/O Units that are not in the SmartSlice I/O Terminal. The settings include the node numbers and I/O configurations.

When you then add the SmartSlice I/O Units, it will not be necessary for you to set the unit numbers or I/O configurations. It will also not be necessary to change the ladder programming very much.

The Software Setting Table contains the I/O configuration information (including the Dummy Units). You can use the CX-Integrator to set or read it.

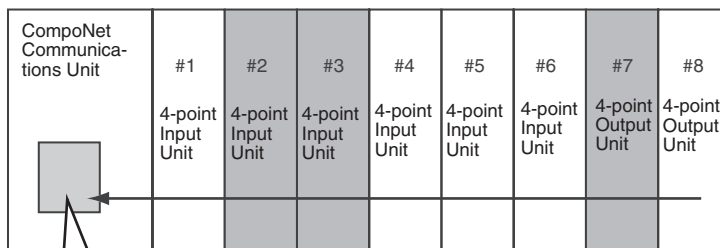
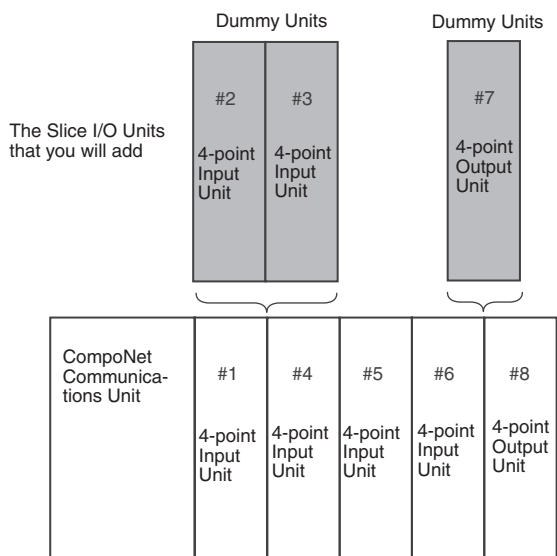

Software Setting Table
The Software Setting Table contains the I/O configuration, including Dummy Units.

	Bit 15	8	Bit 0		Bit 15	8	Bit 0
First word +0	#4	#3	#2	#1		#8	#7
First word +1			#6	#5			

You can set Dummy Units to make the I/O configuration information and ladder programming for the maximum configuration. This will decrease the effects of changes in the SmartSlice I/O Unit configuration on the I/O configuration information and ladder programming.

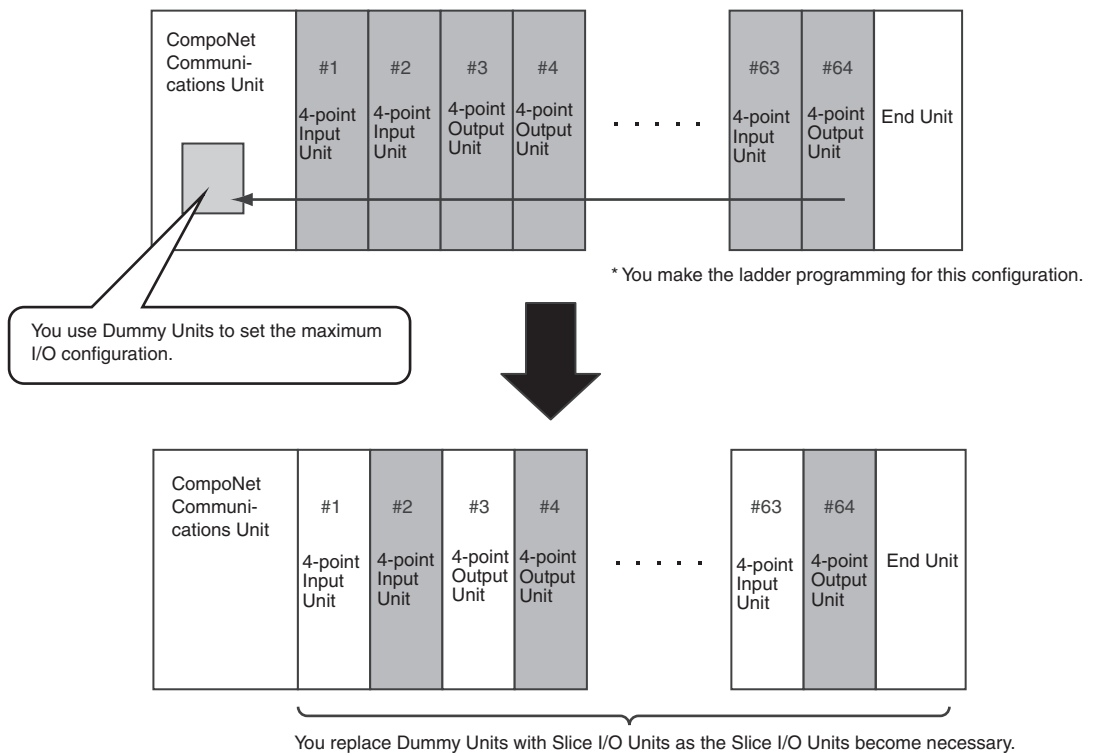

Note There are no changes in the I/O configuration information when you replace a Dummy Unit with a SmartSlice I/O Unit. You also do not have to change the ladder programming.

6-7-1 Starting in Software I/O Allocation Mode

On the DIP switch, turn OFF pin 1 (REGS), turn ON pin 2 (I/O), and then turn ON or reset the Unit power supply. The CompoNet Communications Unit will start in Software I/O Allocation Mode and you can download the Software Setting Table.

- Note**
- (1) If pin 1 and pin 2 are ON when you turn ON the Unit power supply, the MS indicator will flash in red to show an error. The operation will stop.
 - (2) If you turn ON pin 1 in Software I/O Allocation Mode, the TS indicator will come ON in red for 2 seconds to show an error. The operation will continue.
 - (3) If you start in Software I/O Allocation Mode and there is no correct Registration Table in the CompoNet Communications Unit, there will be a Registration Table Logic Error. The MS indicator will flash in red and I/O operation will stop. If that occurs, make the Software Setting Table, download it, and turn ON or reset the Unit power supply.
 - (4) The unit numbers include unit numbers for Dummy Units.

6-7-2 Making, Downloading, and Clearing the Software Setting Table

You use the CX-Integrator to make, download, and clear the Software Setting Table for a CompoNet Communications Unit.

Making the Software Setting Table

- 1,2,3...
1. Start the CX-Integrator.
 2. Double-click the icon of the CompoNet Communications Unit. (In the Maintenance Mode Window, right-click the icon and select **Parameter – Edit**.) The Configuration Window will show.

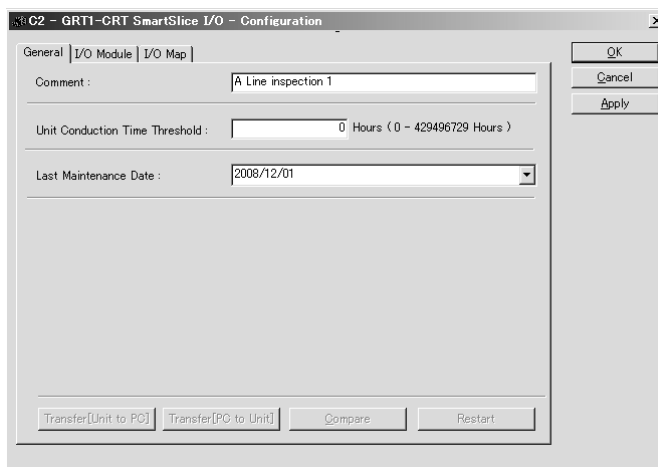

3. Click the **I/O Module** Tab and select the **Use Software Configuration Mode** Check Box. This will enable the Mount Check Boxes.

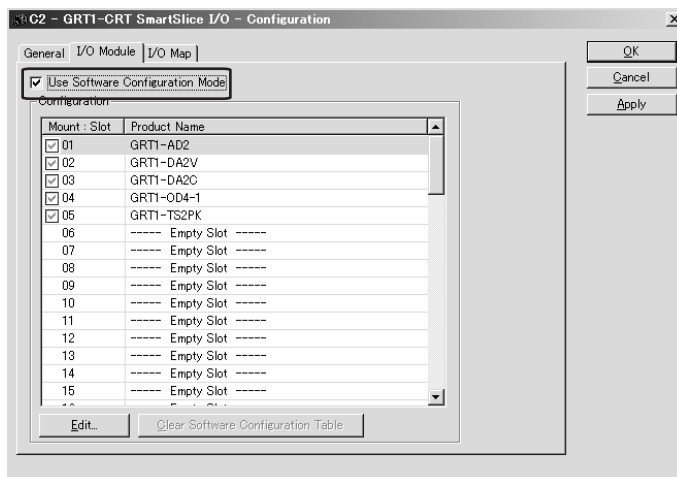

4. Select the *Mount* Check Boxes for all SmartSlice I/O Units in the Smart-Slice I/O Terminal and clear the *Mount* Check Boxes for all Dummy Units.

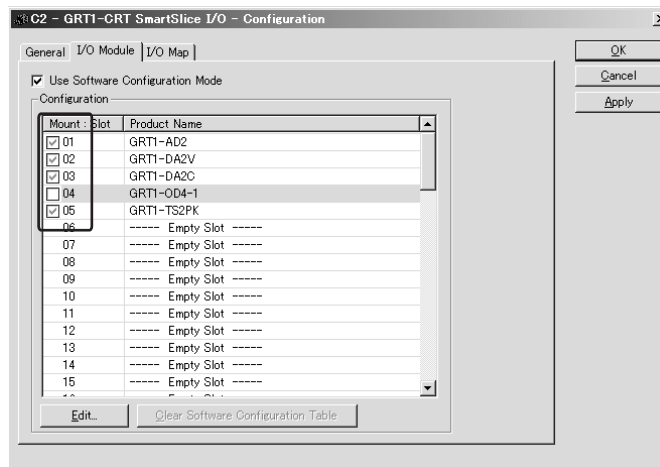

Note By default, the Mount Check Boxes are selected for all SmartSlice I/O Units.

Downloading the Software Setting Table

- 1,2,3... 1. Start the CX-Integrator.
2. Double-click the icon of the CompoNet Communications Unit. (In the Maintenance Mode Window, right-click the icon and select **Parameter – Edit**.) The Configuration Window will show.

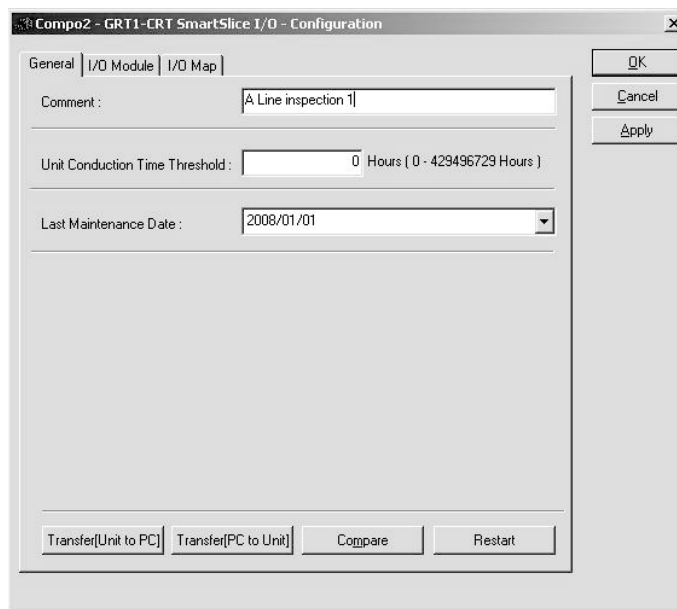

3. Click the **General** Tab.

- Click the **Transfer [PC to Unit]** Button. The CX-Integrator will download the Software Setting Table to the CompoNet Communications Unit.

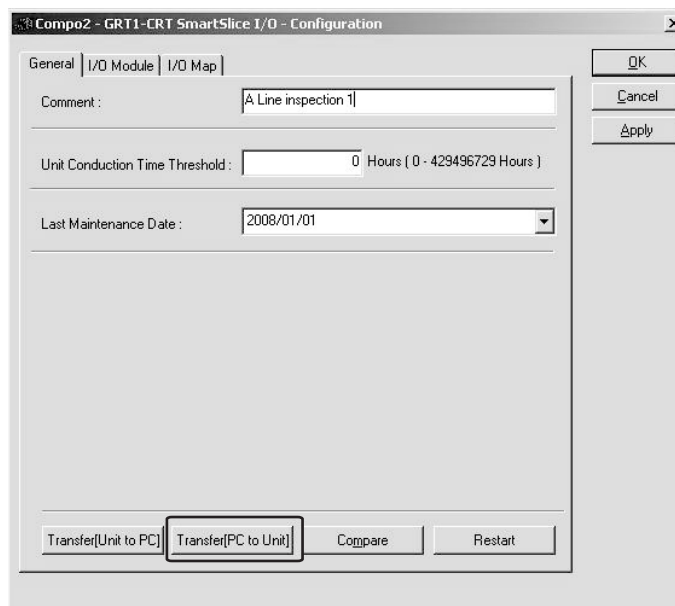

The CompoNet Communications Unit will automatically reset after the Software Setting Table is downloaded. It will then download the parameters to the SmartSlice I/O Units. This enables the Software Setting Table.

- Click the **OK** Button to complete the procedure.

Note

- If the CompoNet Communications Unit is not in Software I/O Allocation Mode when the parameters are downloaded, the CX-Integrator will download only the normal parameters.
- If you downloaded a Software Setting Table before, clear the Table, reset the power supply, and then download the Table from the CX-Integrator again.

Clearing the Software Setting Table

- 1,2,3... 1. Start the CX-Integrator.
2. Double-click the icon of the CompoNet Communications Unit. (In the Maintenance Mode Window, right-click the icon and select **Parameter – Edit**.) The Configuration Window will show.

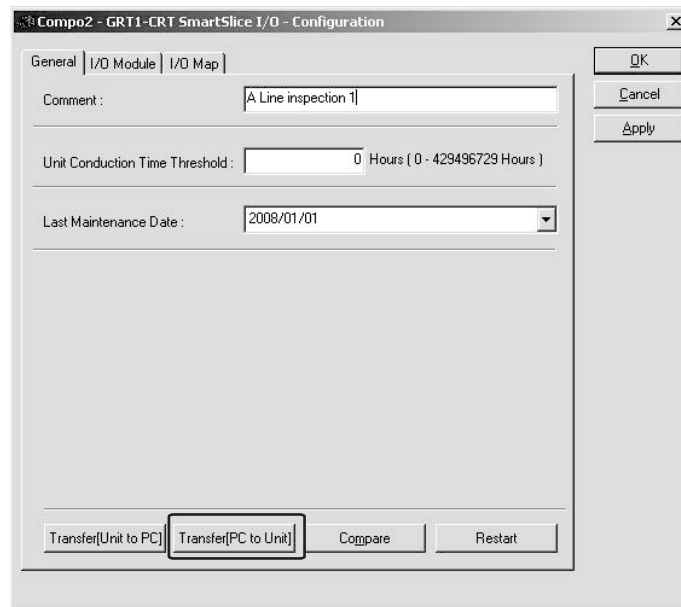

3. Click the **I/O Module** Tab.
4. Click the **Clear Software Configuration Table** Button.

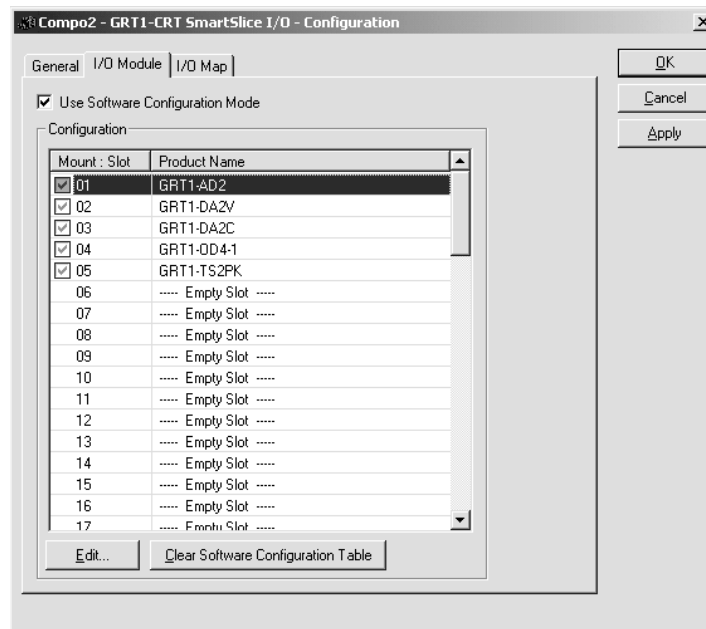

The CompoNet Communications Unit will clear the Software Setting Table.

- Note** Clear the Software Setting Table and then set it again if you change the I/O size of any Slave (for example, changing the I/O size for the GRT1-AD2 or GRT1-TS2P). You must also do this when you change only an I/O size and do not change the configuration.

6-7-3 Showing the Settings

You can use the CX-Integrator to show the Unit configuration (including Dummy Units) as an I/O map.

1,2,3...

1. Start the CX-Integrator.
2. Right-click the icon of CompoNet Communications Unit and select **Maintenance Information**. (From the Maintenance Mode Window, double-click the icon.) The Monitor Window will show.

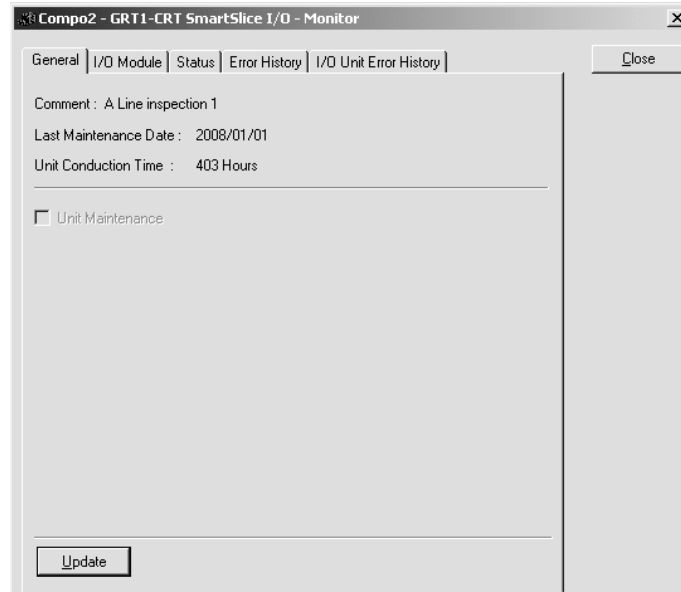

3. Click the **I/O Module** Tab. The Unit configuration information, including Dummy Units, will show.

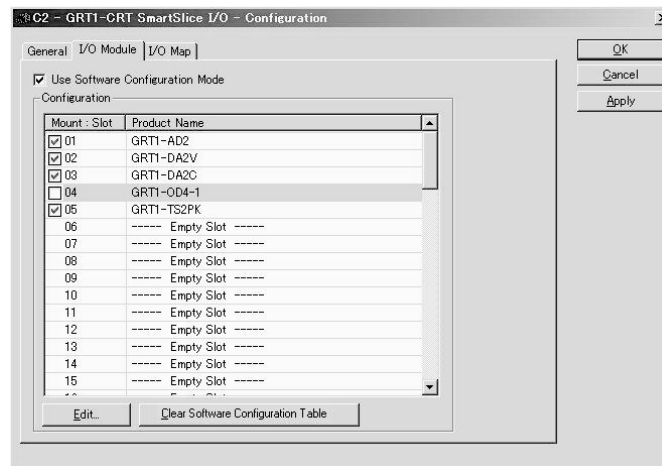

4. Click the **Close** Button to complete the procedure.

Note Click the **I/O Map** Tab from the Master Unit Configuration Window to show an I/O map of the Unit configuration that is set. You can also save the Unit configuration in a CSV file.

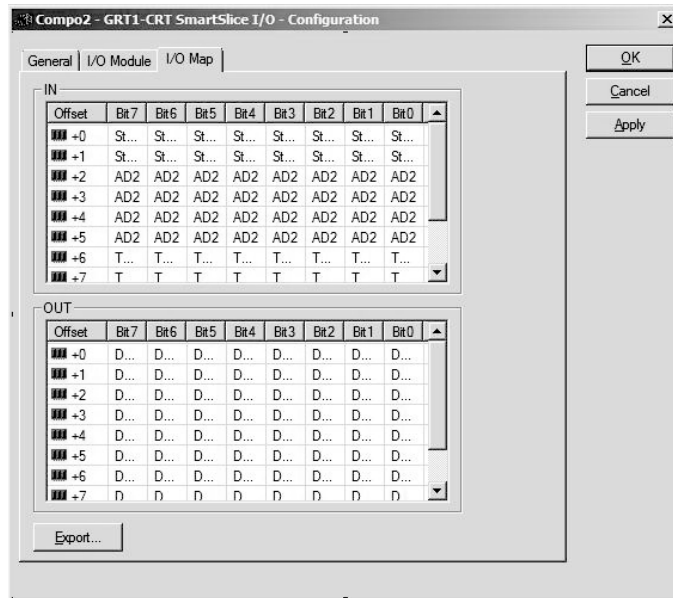

Saving the Unit Configuration in CSV Format

1,2,3...

1. Click the **I/O Map** Tab from the Master Unit Configuration Window and then click the **Export** Button.

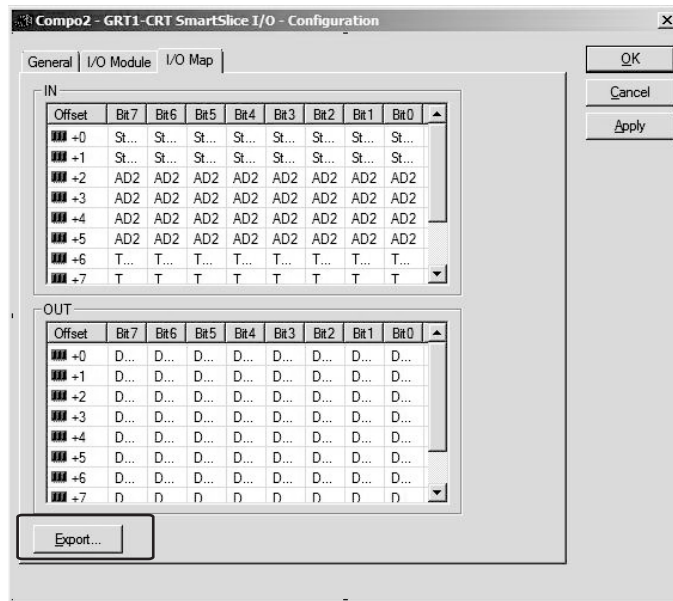

2. Save the Unit configuration to a file.

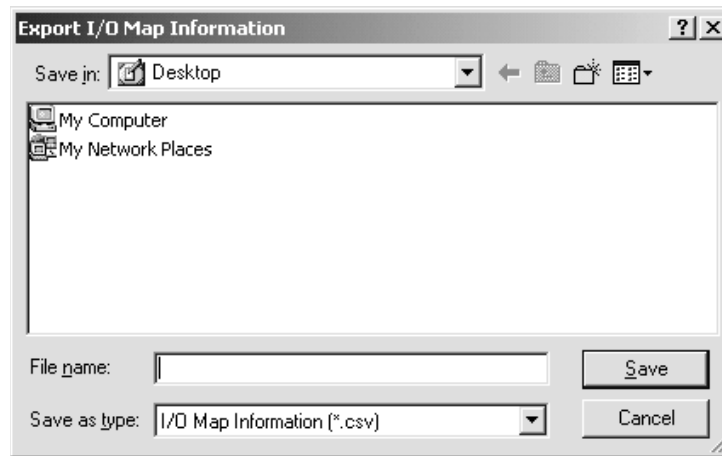

The CSV file will contain the Units that are set in the input and output areas and their I/O sizes.

	A	B	C	D	E	F	G	H	I	J	K	L	M
1	IN Offset	Bit7	Bit6	Bit5	Bit4	Bit3	Bit2	Bit1	Bit0				
2	0	Status	Status	Status	Status	Status	Status	Status	Status				
3	1	Status	Status	Status	Status	Status	Status	Status	Status				
4	2	AD2	AD2	AD2	AD2	AD2	AD2	AD2	AD2				
5	3	AD2	AD2	AD2	AD2	AD2	AD2	AD2	AD2				
6	4	AD2	AD2	AD2	AD2	AD2	AD2	AD2	AD2				
7	5	AD2	AD2	AD2	AD2	AD2	AD2	AD2	AD2				
8	6	TS2PK	TS2PK	TS2PK	TS2PK	TS2PK	TS2PK	TS2PK	TS2PK				
9	7	TS2PK	TS2PK	TS2PK	TS2PK	TS2PK	TS2PK	TS2PK	TS2PK				
10	8	TS2PK	TS2PK	TS2PK	TS2PK	TS2PK	TS2PK	TS2PK	TS2PK				
11	9	TS2PK	TS2PK	TS2PK	TS2PK	TS2PK	TS2PK	TS2PK	TS2PK				
12	OUT Offset	Bit7	Bit6	Bit5	Bit4	Bit3	Bit2	Bit1	Bit0				
13	0	DA2V	DA2V	DA2V	DA2V	DA2V	DA2V	DA2V	DA2V				
14	1	DA2V	DA2V	DA2V	DA2V	DA2V	DA2V	DA2V	DA2V				
15	2	DA2V	DA2V	DA2V	DA2V	DA2V	DA2V	DA2V	DA2V				
16	3	DA2V	DA2V	DA2V	DA2V	DA2V	DA2V	DA2V	DA2V				
17	4	DA2C	DA2C	DA2C	DA2C	DA2C	DA2C	DA2C	DA2C				
18	5	DA2C	DA2C	DA2C	DA2C	DA2C	DA2C	DA2C	DA2C				
19	6	DA2C	DA2C	DA2C	DA2C	DA2C	DA2C	DA2C	DA2C				
20	7	DA2C	DA2C	DA2C	DA2C	DA2C	DA2C	DA2C	DA2C				
21	8					OD4-1	OD4-1	OD4-1	OD4-1				
22													
23													
24													
25													
26													
27													
28													
29													
30													

6-7-4 Editing Parameters of SmartSlice I/O Units

Installed Units

Use this procedure to edit the parameters of installed Units. Installed Units are those for which the Mount Check Box is selected in the I/O Module Tab Page of the Configuration Window.

1. Start the CX-Integrator.
2. Double-click the icon of the CompoNet Communications Unit. (In the Maintenance Mode Window, right-click the icon and select **Parameter – Edit**.) The Configuration Window will show.

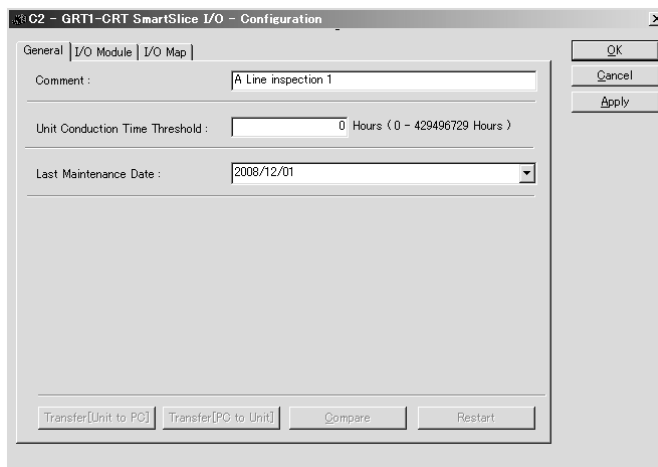

3. Click the **I/O Module** Tab.
4. Select the Unit to edit the parameters and click the **Edit** Button.

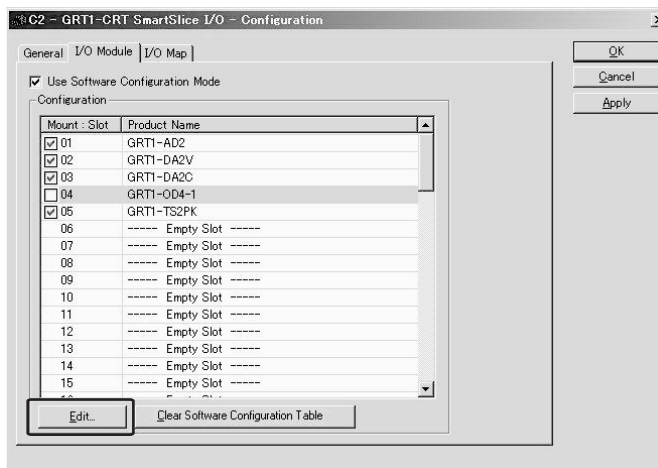

The Configuration Window will be displayed for the selected Unit. Refer to the *GRT1 Series SmartSlice I/O Units Operation Manual* (Cat. No. W455) for information the parameters.

Note An installed SmartSlice I/O Unit will return a normal response if you send an explicit message directly to the Unit. The CX-Integrator is not required to do this. Refer to the *GRT1 Series SmartSlice I/O Units Operation Manual* (Cat. No. W455) for information on explicit messages.

Dummy Units

You can edit the parameters for Dummy Units with the same procedure as installed Units. You will not be able to upload or download the parameters. You can save the parameters in network configuration files in the CX-Configurator.

Note A Dummy Unit will return an error response if you send an explicit message directly to the Unit. The CX-Integrator is not required to do this.

6-8 Unit Conduction Time Monitor

The Unit Conduction Time Monitor records the total time that the internal circuit power in CompoNet Communications Unit is ON. The time is in increments of 0.1 hours.

You can use the CX-Integrator to set a threshold for the conduction time. You can set the threshold to between 0 and 429,496,729 hours. The threshold is saved in the CompoNet Communications Unit. If the Unit conduction time becomes larger than the threshold, the Unit Maintenance Flag will turn ON (bit 12 of the status word for the CompoNet Communications Unit) to notify the CompoNet Master Unit.

You can read the Unit conduction time and the status flags with the CX-Integrator or explicit messages.

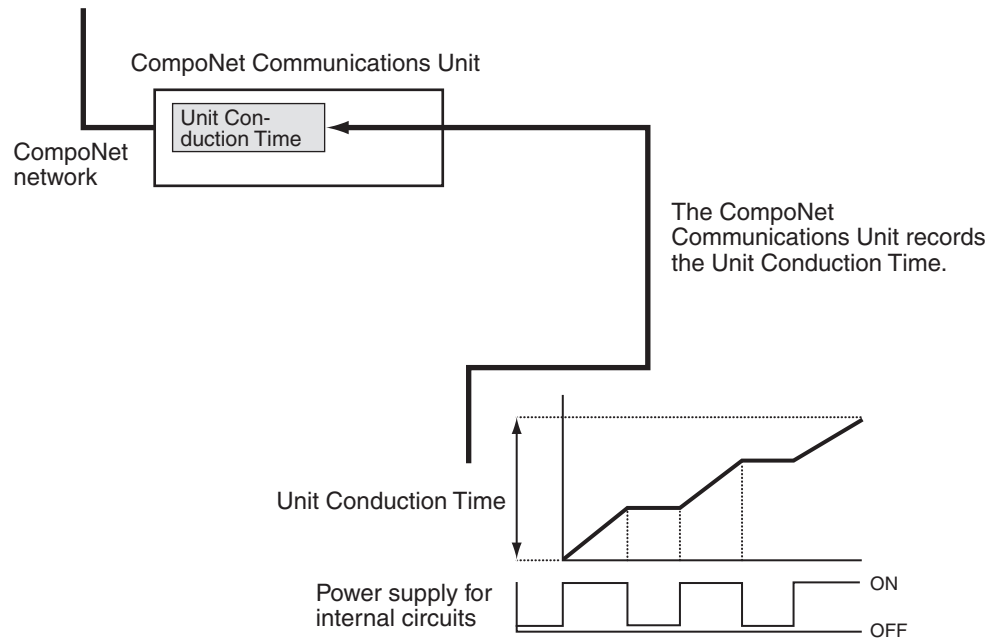

6-8-1 Monitoring the Unit Conduction Time

- 1,2,3...
1. Start the CX-Integrator.
 2. Right-click the icon of CompoNet Communications Unit and select **Maintenance Information**. (From the Maintenance Mode Window, double-click the icon.) The Monitor Window will show.
You can monitor the Unit Conduction Time on the General Tab Page.

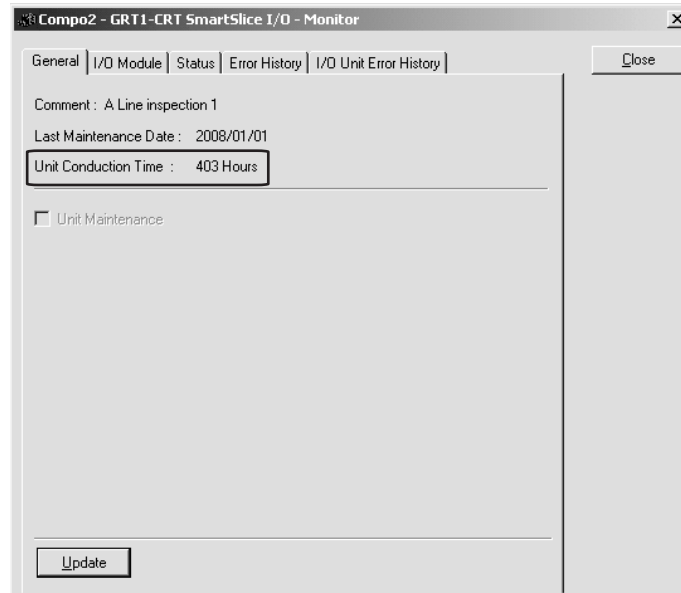

3. Click the **Close** Button to complete the procedure.

6-8-2 Setting the Threshold

- 1,2,3...
1. Start the CX-Integrator.
 2. Double-click the icon of the CompoNet Communications Unit. (In the Maintenance Mode Window, right-click the icon and select **Parameter – Edit**.) The Configuration Window will show.

- On the General Tab Page, enter a value for the Unit Conduction Time Threshold. The time can be between 0 and 429,496,729 hours. (The default value is 0 hours.)

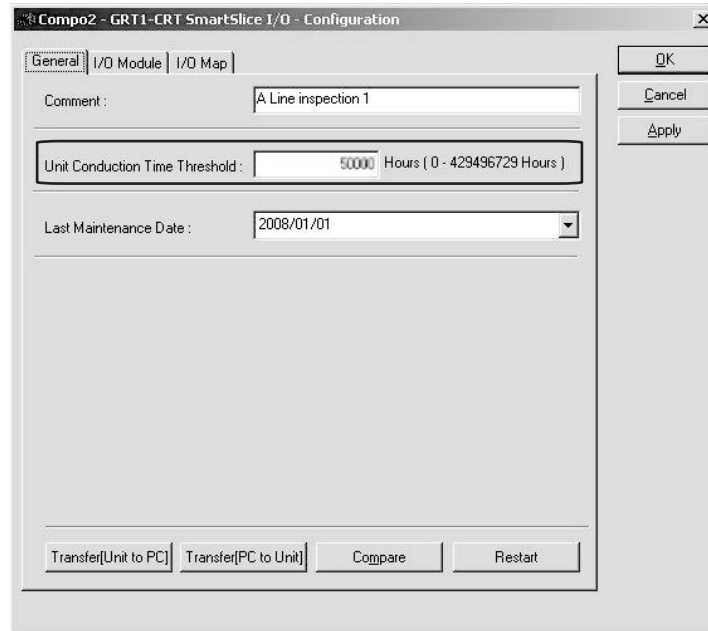

- Click the **Transfer [PC to Unit]** Button to download the setting, and then click the **Reset** Button to reset the CompoNet Communications Unit.
- Click the **OK** Button to complete the procedure.

6-9 Unit Comments

You can set a comment for each CompoNet Communications Unit to record the name in the CompoNet Communications Unit. Each comment can be 32 characters long.

You can use the CX-Integrator or explicit messages to read and write unit comments.

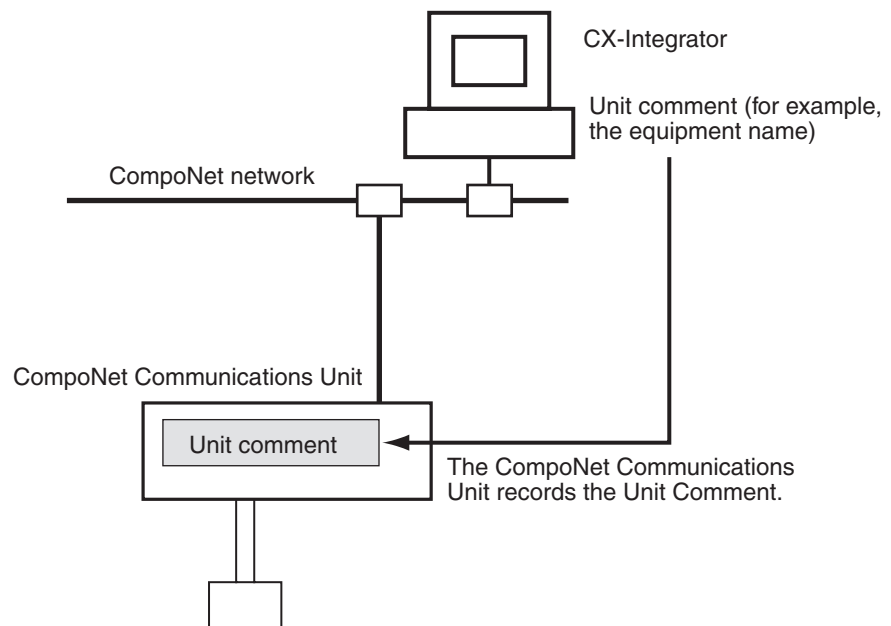

6-9-1 Reading Comments

- 1,2,3...
1. Start the CX-Integrator.
 2. Right-click the icon of CompoNet Communications Unit and select **Maintenance Information**. (From the Maintenance Mode Window, double-click the icon.) The Monitor Window will show.
The General Tab Page shows the comment.

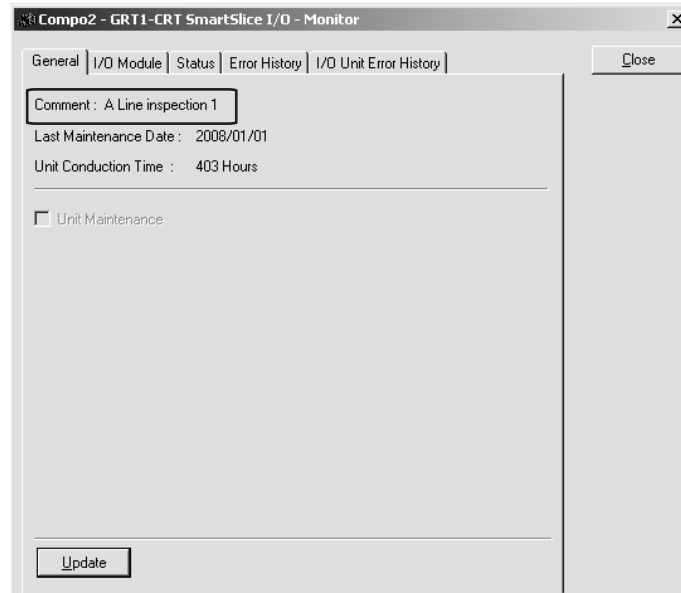

Note The comment shows by the icon of the CompoNet Communications Unit in the Maintenance Mode Window.

3. Click the **Close** Button to complete the procedure.

6-9-2 Writing Comments

- 1,2,3...
1. Start the CX-Integrator.
 2. Double-click the icon of the CompoNet Communications Unit. (In the Maintenance Mode Window, right-click the icon and select **Parameter – Edit**.) The Configuration Window will show.

- On the General Tab Page, enter the comment in the *Comment* Field.

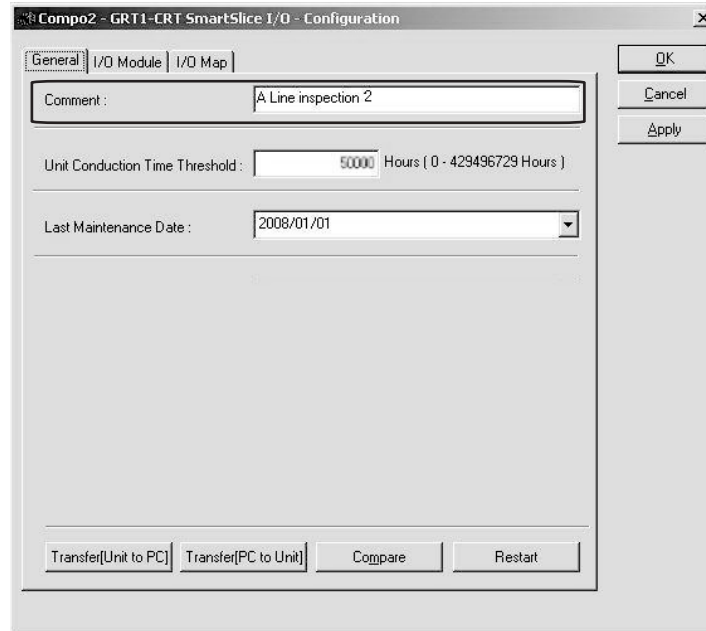

- Click the **Transfer [PC to Unit]** Button to download the setting, and then click the **Reset** Button to reset the CompoNet Communications Unit.
- Click the **OK** Button to complete the procedure.

6-10 Network Communications Error History Monitor

The CompoNet Communications Unit records the last four errors in communications between the CompoNet Master Unit and the CompoNet Communications Unit.

If there are more than four errors, the CompoNet Communications Unit deletes previous errors.

You can read the error history with the CX-Integrator or explicit messages.

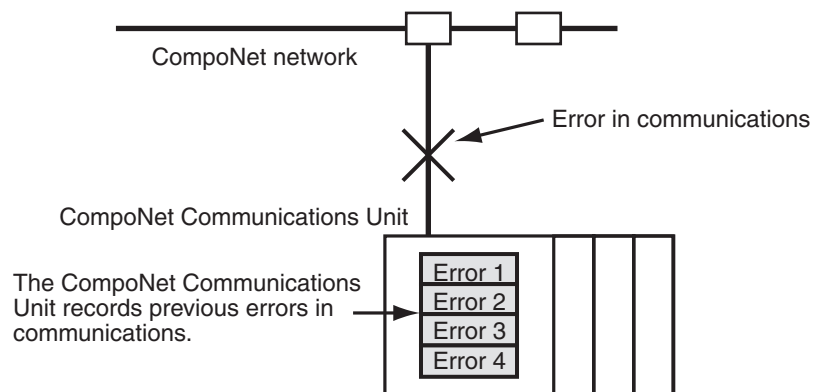

Refer to *9-2-1 Communications Errors on CompoNet Networks* on page 100 for information on the contents of the error history.

6-10-1 Reading the Error History

- 1,2,3... 1. Start the CX-Integrator.

2. Right-click the icon of CompoNet Communications Unit and select **Maintenance Information**. (From the Maintenance Mode Window, double-click the icon.)
The Monitor Window will show.
3. Click the **Error History** Tab.
The window will show the last four errors in communications.

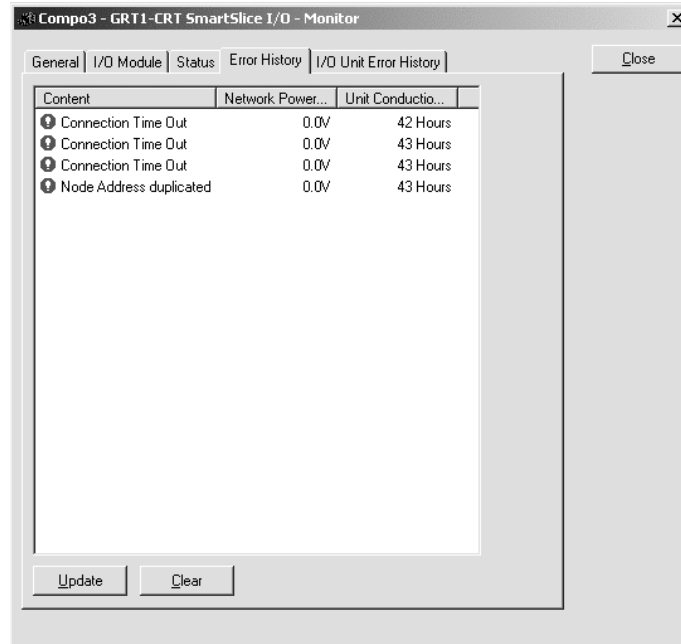

You can click the **Clear** Button to clear the error history.

4. Click the **Close** Button to complete the procedure.

6-11 I/O Communications Error History Monitor

The CompoNet Communications Unit records the last 64 errors in communications between the CompoNet Communications Unit and the SmartSlice I/O Units and errors in the SmartSlice I/O Terminal.

If there are more than 64 errors, the CompoNet Communications Unit deletes previous errors.

You can read the error history with the CX-Integrator or explicit messages.

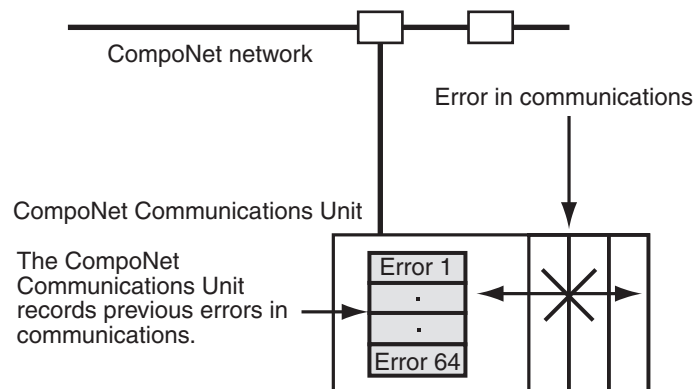

Refer to 9-2-3 *Errors in SmartSlice I/O Terminals* on page 102 for information on the contents of the error history.

6-11-1 Reading the Error History

- 1,2,3...
1. Start the CX-Integrator.
 2. Right-click the icon of the CompoNet Communications Unit and select **Maintenance Information**. (From the Maintenance Mode Window, double-click the icon.) The Monitor Window will show.
 3. Click the **I/O Unit Error History** Tab. The window will show the last 64 errors in communications.

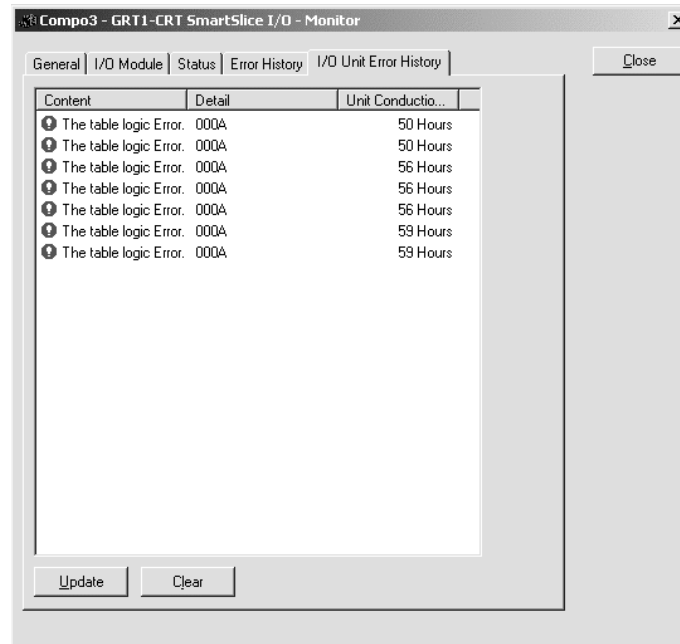

You can click the **Clear** Button to clear the error history.

4. Click the **Close** Button to complete the procedure.

6-12 Last Maintenance Date

You can record the last date on which you did maintenance in the CompoNet Communications Unit.

This lets you easily know the subsequent date for maintenance.

You can read the Last Maintenance Date with the CX-Integrator or explicit messages.

6-12-1 Reading the Last Maintenance Date

- 1,2,3...
1. Start the CX-Integrator.

2. Right-click the CompoNet Communications Unit and select **Maintenance Information**. (In the Maintenance Mode Window, double-click the icon of the CompoNet Communications Unit.) The Maintenance Information Window will show.

The General Tab Page will show the last maintenance date.

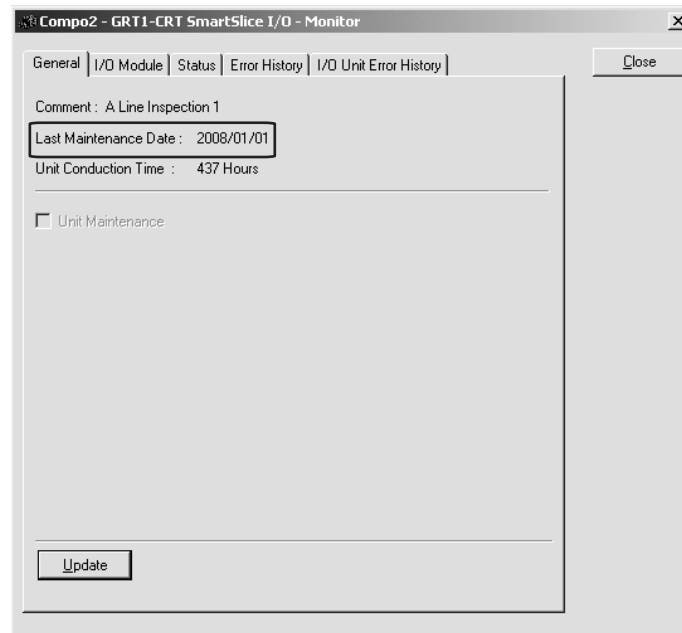

3. Click the **OK** Button to complete the procedure.

6-12-2 Writing the Last Maintenance Date

- 1,2,3...**
1. Start the CX-Integrator.
 2. Double-click the icon of the CompoNet Communications Unit. (In the Maintenance Mode Window, right-click the icon and select **Parameter – Edit**.) The Configuration Window will show.

3. Click the last maintenance date on the calendar that shows for the Last Maintenance Date Field.

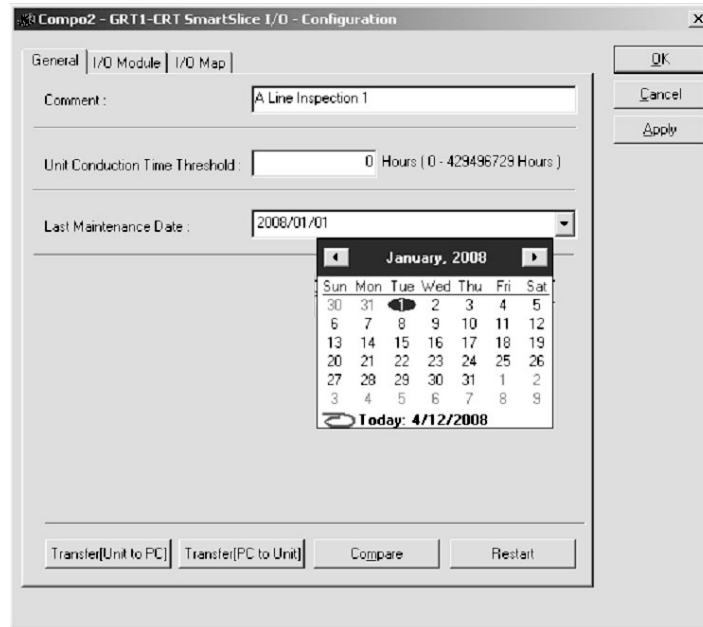

Click the arrow buttons at the top of the calendar to show other months.
 Click the date at the bottom of the calendar to enter the date of today.

4. Click the **Transfer [PC to Unit]** Button to download the setting, and then click the **Reset** Button to reset the CompoNet Communications Unit.
5. Click the **OK** Button to complete the procedure.

SECTION 7

Basic Operation

This section gives the procedures for and an example of operating a SmartSlice system.

7-1	Setting Example and Basic Procedures	82
7-1-1	System Setting Example	82
7-1-2	Basic Procedures	83
7-2	Preparing for Work	84
7-2-1	Selecting the SmartSlice I/O Units	84
7-2-2	Making Sure That SmartSlice Specifications Are Applicable	84
7-3	Hardware Connections and Settings	85
7-3-1	Installing a SmartSlice I/O Terminal	85
7-3-2	Connecting the Communications Cables and Power Cables	85
7-3-3	Setting the SmartSlice I/O Terminals	85
7-4	Starting Communications	87
7-4-1	Making the I/O Tables	87
7-4-2	Starting the SmartSlice System	87
7-5	Making Sure That Operation Is Correct	88
7-5-1	Unit Indications	88
7-5-2	Doing a Check of I/O	88

7-1 Setting Example and Basic Procedures

This section shows an easy example of the procedure for you to use a CompoNet SmartSlice System.

7-1-1 System Setting Example

This example shows a system which turns ON a lamp when you turn ON a switch. The switch connects to a SmartSlice Input Unit and the lamp connects to a SmartSlice Output Unit.

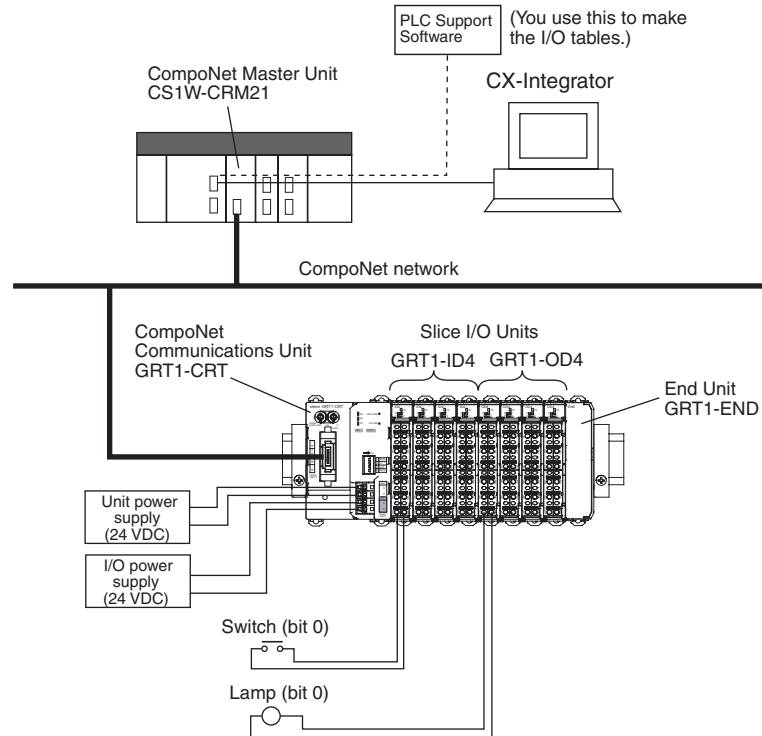

7-1-2 Basic Procedures

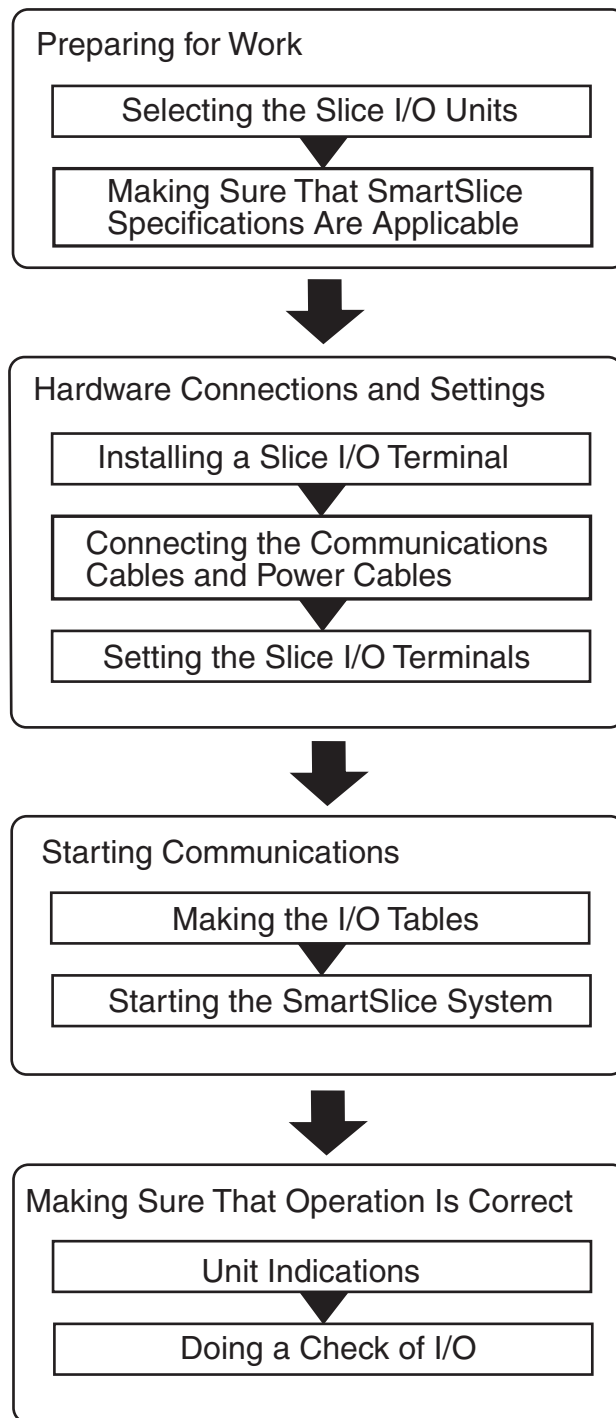

Note This example tells you the most basic setting and application procedures. For information on other settings which are necessary for system operation, refer to the *CS/CJ-series CompoNet Master Unit Operation Manual* (Cat. No. W456) and the *GRT1 Series SmartSlice I/O Units Operation Manual* (Cat. No. W455).

7-2 Preparing for Work

Before you connect the Units and set the parameters, you must select the SmartSlice I/O Units and be sure that the specifications are applicable.

7-2-1 Selecting the SmartSlice I/O Units

You select the SmartSlice I/O Units for the numbers and types of I/O that are necessary.

Refer to the datasheets and manuals for the SmartSlice I/O Units.

This example uses these Units.

Name	Model	Number
CompoNet Master Unit	CS1W-CRM21	1
CompoNet Communications Unit	GRT1-CRT	1
SmartSlice Input Units	GRT1-ID4	4
SmartSlice Output Units	GRT1-OD4	4
End Unit	GRT1-END	1

7-2-2 Making Sure That SmartSlice Specifications Are Applicable

There are restrictions in the SmartSlice I/O Units which can connect to one CompoNet Communications Unit. Refer to the table below.

Be sure the SmartSlice I/O Units obey these restrictions.

Item	Restriction
Number of Smart-Slice I/O Units	64 maximum (Do not include the End Unit.)
Number of I/O bytes	Inputs: 32 bytes maximum (including the status words and bits which the Units do not use) Output: 32 bytes maximum (including the bits which the Units do not use)
Total power consumption	80 W maximum per block

Refer to *5-3 I/O Allocations to CompoNet Master Unit* on page 42 for more information.

This table shows the same items for this example.

Item	Totals
Number of Smart-Slice I/O Units	8
Number of I/O bytes	4 bit inputs \times 4 = 2 bytes 4 bit outputs \times 4 = 2 bytes
Power consumption	GRT1-CRT CompoNet Communications Unit: 3 W \times 1 = 3 W GRT1-ID4 SmartSlice Input Unit: 1 W \times 4 = 4 W GRT1-OD4 SmartSlice Output Unit: 1 W \times 4 = 4 W GRT1-END End Unit: 0 W Total: 11 W

7-3 Hardware Connections and Settings

This section tells you how to install, connect, and set a SmartSlice I/O Terminal.

7-3-1 Installing a SmartSlice I/O Terminal

You install a SmartSlice I/O Terminal on DIN Track.

Note Refer to *3-1 Installing a SmartSlice I/O Terminal* on page 22 for information on how to install a SmartSlice I/O Terminal.

7-3-2 Connecting the Communications Cables and Power Cables

Use this procedure to connect the SmartSlice I/O Terminal.

1. Connecting the Communications Cables

You connect the communications cable for the CompoNet network to the communications connector on the CompoNet Communications Unit.

Note Refer to *4-1 Connecting the Communications Cables* on page 30 for the connection procedure.

2. Connecting the Unit Power Supply

Connect a 24-VDC power supply for the internal circuits of the CompoNet Communications Unit and SmartSlice I/O Units to the Unit power supply terminals on the CompoNet Communications Unit.

3. Connecting the I/O Power Supply

Connect a 24-VDC power supply for the outputs connected to SmartSlice Output Units to the I/O power supply terminals on the CompoNet Communications Unit.

Note Refer to *4-2 Connecting the Power Supply Cables* on page 31 for the connection procedure.

4. Connecting the External Devices

Connect the I/O signal lines from the external devices (in this example, the switch and lamp) to the I/O terminals on the SmartSlice I/O Units.

Note Refer to *4-5 Connecting the Signal Lines for External Devices* on page 38 for the connection procedure.

7-3-3 Setting the SmartSlice I/O Terminals

Use this procedure to set the SmartSlice I/O Terminal.

1. Setting the Node Addresses

Set the rotary switches on the CompoNet Communications Unit to the node address of the SmartSlice I/O Terminal on the CompoNet network.

Precaution for Correct Usage

- Do not set the same node address for more than one node.
- Turn OFF the Unit power supply before you change the node address setting.

Note Refer to *5-1 Setting the Node Addresses* on page 40 for the setting procedure.

2. Turning ON the Unit Power Supply

Turn ON pin 1 (REGS) on the DIP switch on the CompoNet Communications Unit, and then turn ON the Unit power supply.

The CompoNet Communications Unit will make a Registration Table showing the SmartSlice I/O Units which connect to it.

If there was a Registration Table before, the CompoNet Communications Unit will automatically compare the connected SmartSlice I/O Units with the Registration Table. The TS indicator on the CompoNet Communications Unit will flash in red if there is one or more differences. Communications with all SmartSlice I/O Units will not start.

If the TS indicator flashes in red, turn OFF pin 1, clear the Registration Table, reset the Unit power supply, and turn pin 1 ON again. The CompoNet Communications Unit will make a Registration Table for the configuration at the time.

Note Refer to *6-2 Registration Table* on page 54 for more information on the Registration Table.

3. Setting the Functions of the CompoNet Communications Unit

Start the CX-Integrator and set the function of the CompoNet Communications Unit.

If there are no settings to make, go to step 4.

Note Refer to *6-1 Overview of Smart Functions* on page 54 for information on the functions.

4. Manually Allocating Memory to SmartSlice I/O Units and Setting the Functions

Use the CX-Integrator to manually allocate memory to SmartSlice I/O Units or to set functions.

If there are no settings to make, go to *7-4 Starting Communications* on page 87.

Note Refer to the *GRT1 Series SmartSlice I/O Units Operation Manual* (Cat. No. W455) for more information on SmartSlice I/O Units.

7-4 Starting Communications

This section tells you how to make the I/O tables, start the system, and start communications.

7-4-1 Making the I/O Tables

You must make I/O tables in the CPU Unit of the CompoNet Master Unit. The I/O tables show the Units in the PLC and their locations.

You use a PLC Programming Device (the CX-Programmer or a Programming Console) to make the I/O tables.

Refer to the manual for the Master Unit for more information.

7-4-2 Starting the SmartSlice System

Turn ON the Unit power supply and I/O power supply to the CompoNet Communications Unit.

7-5 Making Sure That Operation Is Correct

This section tells you how to do a check of the operation of the system.

7-5-1 Unit Indications

The system operation is correct if the indicators on the CompoNet Master Unit and CompoNet Communications Unit are in this status.

■ **CompoNet Master Unit**

- MS and NS indicators: Lit green
- 7-segment display: Shows 0, 1, 2, or 3 (to show the baud rate)

■ **CompoNet Communications Unit**

- MS, NS, and TS indicators: Lit green
- Unit power indicator: Lit green
- I/O power indicator: Lit green

Note If there is an error in communications, the 7-segment display on the CompoNet Master Unit will show the error code, the slave type, and the related node address.

Refer to the *CS/CJ-series CompoNet Master Unit Operation Manual* (Cat. No. W456) for more information.

7-5-2 Doing a Check of I/O

Use this procedure to see if the CPU Unit of the PLC correctly writes data to the Input Area and correctly sends data from the Output Area.

- 1,2,3...** 1. Connect a PLC Programming Device (the CX-Programmer or a Programming Console) to the CPU Unit and enter the ladder program below.

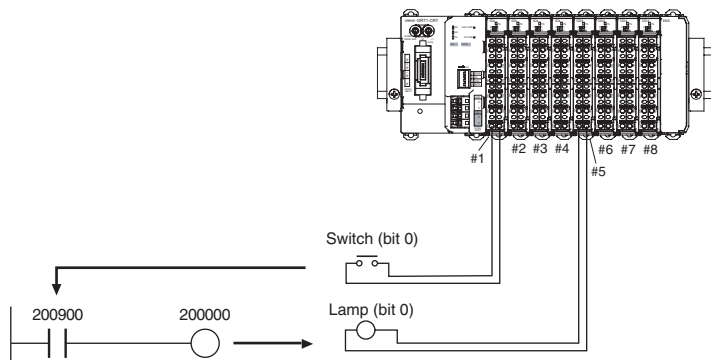

Note The figure below shows the allocations of I/O bits in the CPU Unit to the SmartSlice I/O Terminal.

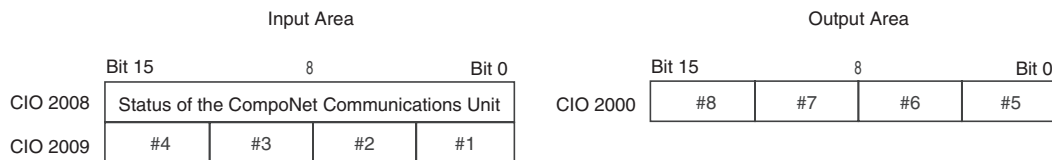

2. Turn ON the switch which connects to the GRT1-ID4 SmartSlice Input Unit and be sure that the lamp which connects to the GRT1-OD4 SmartSlice Output Unit comes ON.

SECTION 8

Remote I/O Communications

This section tells you about the communications timing for remote I/O communications and message communications. It also gives more information on communications features.

8-1	Performance of Remote I/O Communications	90
8-1-1	I/O Response Time	90
8-2	Performance of Message Communications.	93
8-2-1	Message Communications Time.....	93

8-1 Performance of Remote I/O Communications

This section tells you about the performance of remote I/O communications with SmartSlice I/O Terminals. Use this information when the timing of I/O is important.

The equations in this section have these conditions.

- All Slaves must be in communications with the Master.
- The CompoNet Master Unit must not show an error.

8-1-1 I/O Response Time

The I/O response time is from when an input at an Input Slave shows at the CompoNet Master Unit until it makes an output at an Output Slave. Both the Input Slave and Output Slave are in the SmartSlice I/O Terminal. The ladder program in the CPU Unit of the PLC processes the input to make the output.

Maximum I/O Response Time

Use the equation below to calculate the maximum I/O response time (T_{MAX}).

$$T_{MAX} = T_{IN} + T_{SL-IN} + T_{SL-CI} + T_{NetCyc} \times 2 + 0.1 \text{ ms} + T_{NetCyclnt} + T_{CrmInMax} + T_{Cyc} \times 2 + T_{CrmOutMax} + T_{NetOut} + T_{SL-CO} + T_{SL-OUT} + T_{OUT}$$

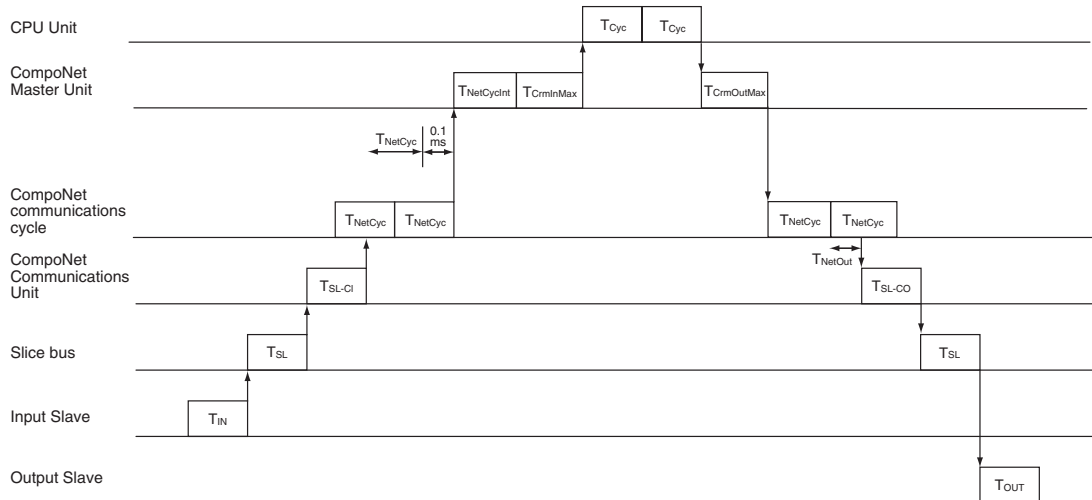

- T_{IN} : ON (OFF) delay time for Input Unit
- T_{SL} : Communications cycle time of SmartSlice bus
- T_{SL-CI} : Input data processing time for CompoNet Communications Unit
- T_{NetCyc} : Communications cycle time of CompoNet network
- 0.1 ms: Read time interval for input data
- $T_{NetCyclnt}$: Interrupt processing time
- $T_{CrmInMax}$: Maximum input processing time at CompoNet Master Unit
- T_{Cyc} : Cycle time of CPU Unit
- $T_{CrmOutMax}$: Maximum output processing time at CompoNet Master Unit
- T_{NetOut} : Part of communications cycle time given to output frames
- T_{SL-CO} : Output data processing time for CompoNet Communications Unit
- T_{OUT} : ON (OFF) delay time for Output Unit

Minimum I/O Response Time

Use the equation below to calculate the minimum I/O response time (T_{MIN}).

$$T_{MIN} = T_{IN} + T_{SL-IN} + T_{SL-CI} + T_{CrmInMin} + T_{Cyc} \times 2 + T_{CrmOutMin} + T_{NetOut} + T_{SL-CO} + T_{SL-OUT} + T_{OUT}$$

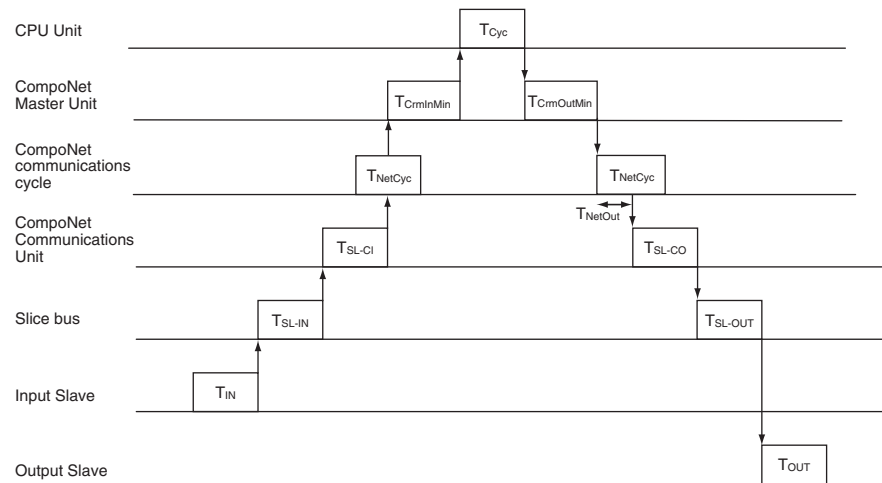

- T_{IN} : ON (OFF) delay time for Input Unit
- T_{SL-IN} : Communications time for input data on SmartSlice bus
- T_{SL-CI} : Input data processing time for CompoNet Communications Unit
- $T_{CrmInMax}$: Minimum input processing time at CompoNet Master Unit
- T_{Cyc} : Cycle time of CPU Unit
- $T_{CrmOutMax}$: Minimum output processing time at CompoNet Master Unit
- T_{NetOut} : Part of communications cycle time given to output frames
- T_{SL-CO} : Output data processing time for CompoNet Communications Unit
- T_{SL-OUT} : Communications time for output data on SmartSlice bus
- T_{OUT} : ON (OFF) delay time for Output Unit

ON (OFF) Delay Time for I/O Units: T_{IN}/T_{OUT}

SmartSlice I/O Units have different ON/OFF delay times. Refer to the SmartSlice GRT1 Series SmartSlice I/O Units Operation Manual (Cat. No. W455) for more information.

Communications Cycle Time of SmartSlice Bus: T_{SL}

This is the time from communications with one SmartSlice I/O Unit until the subsequent communications with the same SmartSlice I/O Unit.

$$T_{SL} = 0.66 + (\text{The total size of Word Input Units (in bytes)} \times 0.011) + (\text{The total size of Bit Input Units (in bits)} \times 0.009) + (\text{The total size of Word Output Units (in bytes)} \times 0.004) + (\text{The total size of Bit Output Units (in bits)} \times 0.001) \text{ [ms]}$$

Data Processing Times for CompoNet Communications Unit: T_{SL-CI}/T_{SL-CO}

These are the data processing times for the CompoNet Communications Unit. The input data processing time and output data processing time are different.

$$T_{SL-CI} = 0.71 + \text{Total input size (in bytes)} \times 0.003 \text{ [ms]}$$

$$T_{SL-CO} = 0.2 + \text{Total output size (in bytes)} \times 0.001 \text{ [ms]}$$

Communications Times on the SmartSlice Bus: T_{SL-IN}/T_{SL-OUT}

These are the times for communications with a SmartSlice I/O Units. The input data processing time and output data processing time are different.

$$T_{SL-IN} = 0.01 \times \text{Input size (in bytes)} \text{ [ms]}$$

$$T_{SL-OUT} = 0.18 + \text{Total Output size (in bytes)} \times 0.002 \text{ [ms]}$$

Note Refer to the *CS/CJ-series CompoNet Master Unit Operation Manual* (Cat. No. W456) for information on these variables: Communications cycle time of CompoNet network (T_{NetCyc}), interrupt processing time ($T_{\text{NetCyclInt}}$), maximum/minimum input processing time at CompoNet Master Unit ($T_{\text{CrmInMax}}/T_{\text{CrmInMin}}$), cycle time of the CPU Unit (T_{Cyc}), maximum/minimum output processing time at Master ($T_{\text{CrmOutMax}}/T_{\text{CrmOutMin}}$), part of communications cycle time given to output frames (T_{NetOut}).

8-2 Performance of Message Communications

This section tells you about the performance of message communications between the CompoNet network and a SmartSlice I/O Terminal.

8-2-1 Message Communications Time

The message communications time is the time from starting to send a message on the CompoNet network until the SmartSlice I/O Terminal receives the message. You send data messages with the SEND instruction and receive data messages with the RECV instruction. You send FINS command messages with the CMND instruction.

Message Communications Time to the CompoNet Communications Unit

Use the following equation to get an estimate of the message communications time to the CompoNet Communications Unit.

Message communications time = Communications cycle time of CompoNet network (T_{NetCyc}) \times {(Number of message bytes + 15) \div 6 + 1}

The number of message bytes includes all bytes for the destination node address, service code, class ID, instance ID, attribute ID, and service data. Refer to the *CS/CJ-series CompoNet Master Unit Operation Manual* (Cat. No. W456) for information on this variable: Communications cycle time of CompoNet network (T_{NetCyc}).

Message Communications Time to the SmartSlice I/O Unit

When you send a message to a SmartSlice I/O Unit, you must add the message communications time on the SmartSlice bus to the message communications time to the CompoNet Communications Unit.

Use the following equation to get an estimate of the message communications time on the SmartSlice bus.

Message communications time = $T_{\text{SL}} \times$ Number of frames

Number of frames = Number of message bytes \div 30 (Round up decimal digits.)

- Note**
- (1) When using message communications, execute the communications instructions (SEND, RECV, and CMND) at intervals longer than the message communications time. If a message that was sent or received is lost, the CompoNet Master Unit will record an error in the error history. You can read the error history with the CX-Integrator or FINS commands.
 - (2) This message communications time is an estimate. It is not the maximum value. The frequency of messages, the load on the remote node, the communications cycle time, and other factors have an effect on the message communications time. The message communications time can be longer than the value you calculate here if there is a high load on the CompoNet Master Unit.

SECTION 9

Error Procedures

This section tells you how to troubleshoot problems that you can have with the CompoNet Communications Unit and SmartSlice I/O Units. It also tells how to see the error history with the CX-Integrator.

9-1	Error Procedures with Indicators	96
9-1-1	CompoNet Communications Unit	96
9-1-2	SmartSlice I/O Units	99
9-1-3	I/O Power Feed Units	99
9-1-4	Left Turnback Units	99
9-2	Error Procedures with CX-Integrator	100
9-2-1	Communications Errors on CompoNet Networks	100
9-2-2	Communications Status of SmartSlice Bus	101
9-2-3	Errors in SmartSlice I/O Terminals	102
9-3	Other Error Causes and Error Procedures	105

9-1 Error Procedures with Indicators

You can do a check for minor errors that occur with a SmartSlice I/O Terminal using the indicators on the CompoNet Communications Unit and SmartSlice I/O Units.

This section tells you about the errors that the indicators show and the procedures for them.

9-1-1 CompoNet Communications Unit

Indicators

Name	Function
MS	The MS indicator shows the status of the CompoNet Communications Unit.
NS	The NS indicator shows the communications status of the CompoNet network.
TS	The TS indicator shows the status of the SmartSlice I/O Terminal.
UNIT PWR	The UNIT PWR indicator shows the status of the Unit power supply.
I/O PWR	The I/O PWR indicator shows the status of the I/O power supply.

Primary Errors That the Indicators Show and Error Procedures

Name	Color	Status	Primary error	Error procedure	
MS	Green	Lit	Normal status	---	
	Red	Lit	Hardware fault in CompoNet Communications Unit	Reset the Unit power supply. If the problem stays, replace the CompoNet Communications Unit.	
			Flashing	Pin 1 (REGS) and pin 2 (I/O) on the DIP switch are ON.	Turn OFF one of these pins and reset the Unit power supply.
				The Registration Table data is corrupt.	Make the registration table again.
				The setting data for the smart function is corrupt.	Write the correct parameters again with the CX-Integrator.
			The backup data is corrupt.	Back up the data again.	
	Not lit	There is no Unit power supply.	Make sure that there is a Unit power supply.		
NS	Green	Lit	Normal status	---	
		Flashing	The Unit is online but the communications connection is not completed. (The CompoNet Master Unit is completing the connection.)	<ul style="list-style-type: none"> • Make sure that you started the CompoNet Master Unit. • Make sure that the SmartSlice I/O Terminal is in the Registration Table in the CompoNet Master Unit. 	
	Red	Lit	The same node address is set for two or more nodes on the CompoNet network.	Correct the node address settings and reset the CompoNet Communications Unit.	
			Communications stopped because there are too many communications errors.	Do a check of these items and then reset the CompoNet Communications Unit. <ul style="list-style-type: none"> • Make sure that the trunk line cables and branch line cables are not too long. • Make sure that the cables are not broken or loose. • Make sure that terminating resistance connections are correct. • Make sure that the CompoNet Units and cables are not near sources of noise. 	
		Flashing	Communications timeout	Do a check of these items and then reset the CompoNet Communications Unit. <ul style="list-style-type: none"> • Make sure that the trunk line cables and branch line cables are not too long. • Make sure that the cables are not broken or loose. • Make sure that terminating resistance connections are correct. • Make sure that the CompoNet Units and cables are not near sources of noise. 	
		Not lit	Node address duplication check not complete	If only one CompoNet Communications Unit shows this status, make sure that the connection of the communications cable is correct.	

Name	Color	Status	Primary error	Error procedure
TS	Green	Lit	Normal status	---
		Flashing	The total I/O size of the SmartSlice I/O Units is larger than the specification.	Make the configuration smaller. The I/O size must be no larger than 32 input bytes and 32 output bytes. Then reset the CompoNet Communications Unit.
			Backing up parameters	Let the backup operation continue until it is completed.
			Restoring parameters	Let the restore operation continue until it is completed.
			Doing process to join the network	Let the join process continue until it is completed.
			The process to join the network was not completed correctly.	Make sure that you connected the End Unit correctly and then reset the CompoNet Communications Unit.
	Red	Lit	Configuration error for SmartSlice I/O Units	Do a check of these items. <ul style="list-style-type: none"> • Make sure that there are no more than 64 SmartSlice I/O Units. • Make sure that the I/O size is no larger than 32 input bytes and 32 output bytes.
		Lit for 2 s	Backup operation failure	Back up the data again.
			Restore operation failure	Make sure that the SmartSlice I/O Units are installed correctly and reset the CompoNet Communications Unit.
			Pin 1 (REGS) of the DIP switch turned ON in Software I/O Allocation Mode.	Turn OFF pin 1 and then reset the CompoNet Communications Unit.
		Flashing	Communications error on SmartSlice bus	Make sure that the Base Blocks are correctly connected in the SmartSlice I/O Terminal.
			The Registration Table is enabled, but it does not agree with the I/O configuration.	Do a check of the I/O configuration and reset the CompoNet Communications Unit.
			In Software I/O Allocation Mode, an I/O Unit that is set to "Mount" in the Software Setting Table is missing.	Make sure that the correct SmartSlice I/O Unit is installed or remove the "Mount" setting and then reset the CompoNet Communications Unit.
Not lit		There is no Unit power supply.	Make sure that the CompoNet Communications Unit has a Unit power supply.	
UNIT PWR	Green	Lit	Normal status	---
	Not lit		There is no Unit power supply.	Make sure that the CompoNet Communications Unit has a Unit power supply with sufficient capacity for the SmartSlice I/O Terminal.
I/O PWR	Green	Lit	Normal status	---
	Not lit		There is no I/O power supply.	Make sure that the CompoNet Communications Unit has an I/O power supply with sufficient capacity for the SmartSlice I/O Units and connected sensors and actuators.

9-1-2 SmartSlice I/O Units

Indicators

Name	Function
TS	The TS indicator shows the status of the SmartSlice I/O Unit.

Primary Errors That the Indicators Show and Error Procedures

Name	Color	Status	Primary error	Error procedure
TS	Green	Lit	Normal status	---
		Flashing	Backing up parameters	Let the backup operation continue until it is completed.
	Restoring parameters		Let the restore operation continue until it is completed.	
	Red	Lit	Hardware fault in SmartSlice I/O Unit	Reset the Unit power supply. If the problem stays, replace the SmartSlice I/O Unit.
		Flashing	Communications error	Make sure that the communications connector is connected correctly.
			Switch setting error	Make sure that there are no incorrect switch settings (GRT1-AD2, GRT1-DA2□, and GRT1-TS2□□).
Not lit	There is no Unit power supply.		Make sure that the CompoNet Communications Unit has a Unit power supply.	

9-1-3 I/O Power Feed Units

Indicators

Name	Function
I/O PWR	The I/O PWR indicator shows the status of the I/O power supply.

Primary Errors That the Indicators Show and Error Procedures

Name	Color	Status	Primary error	Error procedure
I/O PWR	Green	Lit	Normal status	---
	Not lit		There is no I/O power supply.	Make sure that the CompoNet Communications Unit has an I/O power supply.

9-1-4 Left Turnback Units

Indicators

Name	Function
UNIT PWR	The UNIT PWR indicator shows the status of the Unit power supply.
I/O PWR	The I/O PWR indicator shows the status of the I/O power supply.

Primary Errors That the Indicators Show and Error Procedures

Name	Color	Status	Primary error	Error procedure
UNIT PWR	Green	Lit	Normal status	---
	Not lit		There is no Unit power supply.	Make sure that there is a Unit power supply to the Left Turnback Unit.
I/O PWR	Green	Lit	Normal status	---
	Not lit		There is no I/O power supply.	Make sure that there is an I/O power supply to the Left Turnback Unit.

9-2 Error Procedures with CX-Integrator

You can use the CX-Integrator to do checks of the communications status of the SmartSlice bus and error information better than with the Unit indicators. The CompoNet Communications Unit keeps a history of previous errors in internal memory. You can also use the CX-Integrator to see the error history.

9-2-1 Communications Errors on CompoNet Networks

You can use the Error History Tab Page in the CX-Integrator to see the last four communications errors between the CompoNet Master Unit and CompoNet Communications Unit. The Error History Tab Page shows the error and the total Unit ON time when the error occurred.

Refer to *6-10 Network Communications Error History Monitor* on page 75 for information on seeing the Error History Tab Page.

Error History Tab Page

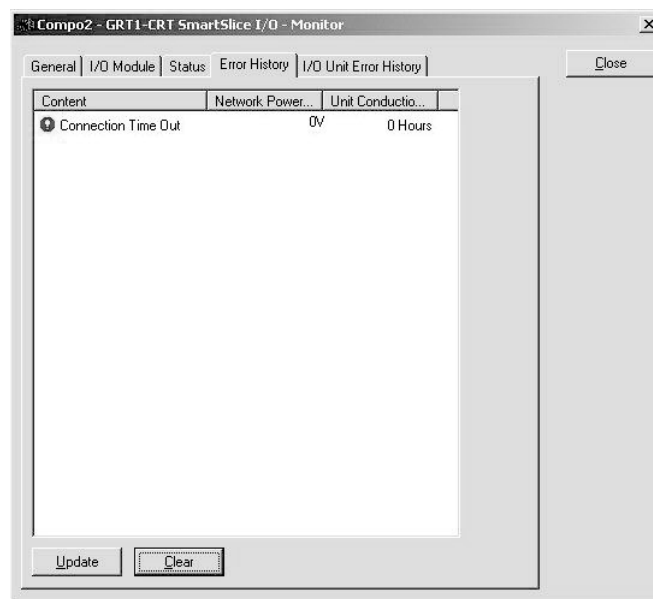

Error Information

Error name	Description	Error procedure	Keeping error history during power interruptions
Connection timeout	CompoNet communications timeout	If normal noise causes the error, communications will recover automatically. If this error occurs frequently, do a check of these items. <ul style="list-style-type: none"> • Make sure that the trunk line cables and branch line cables are not too long. • Make sure that the cables are not broken or loose. • Make sure that terminating resistance connections are correct. • Make sure that there is not too much noise. 	Kept
Duplication in node addresses	The same node address is set for two or more nodes on the CompoNet network.	Correct the node address settings. You can set each address only one time. Then reset the CompoNet Communications Unit.	Kept

9-2-2 Communications Status of SmartSlice Bus

The Status Tab Page of the CX-Integrator shows the communications status between the CompoNet Communications Unit and the SmartSlice I/O Units. Refer to 5-3-3 *Status Words* on page 46 for information on seeing the Status Tab Page.

Status Tab Page

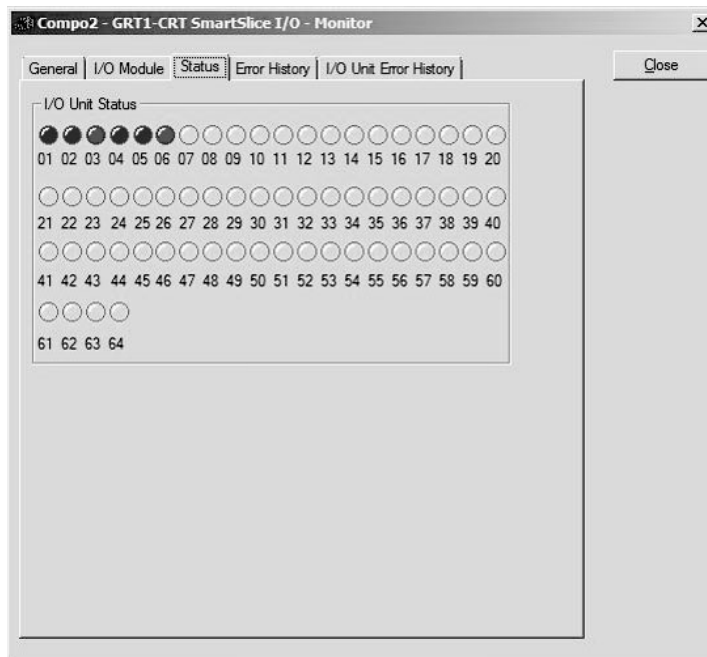

Indicator color	Status
Red	The Alarm Status Bit for the SmartSlice I/O Unit is ON.
Yellow	The Warning Status Bit for the SmartSlice I/O Unit is ON
Blue	The SmartSlice I/O Unit has no errors.

9-2-3 Errors in SmartSlice I/O Terminals

You can see the last 64 communications errors between the CompoNet Communications Unit and SmartSlice I/O Units or internal errors in SmartSlice I/O Units. The error history gives an error description, the error code, and the total Unit ON time for errors in SmartSlice I/O Units.

Refer to *6-11 I/O Communications Error History Monitor* on page 76 for information on seeing the Error History Tab Page.

Error History Tab Page

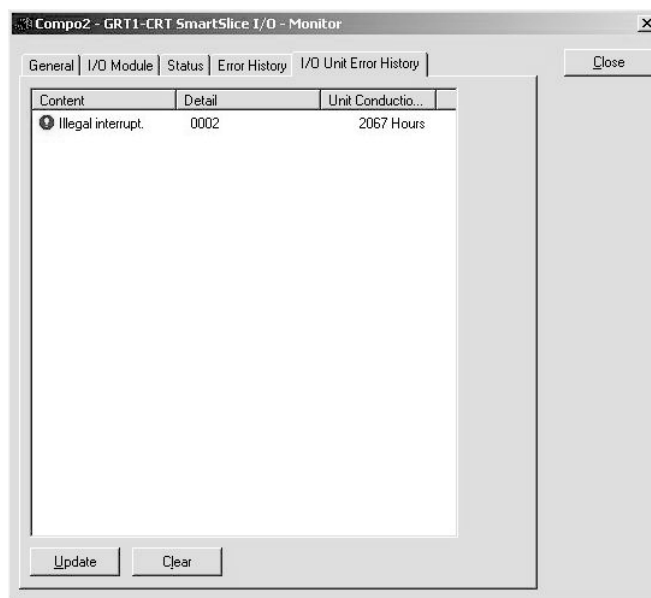

More Information on Errors in the CompoNet Communications Unit

Error code (hexadecimal value)	Error description	“Detail”		Keeping error history during power interruptions	Procedure
		1st byte	2nd byte		
0002	WDT error	0x00	0x00	Kept	If this error occurs frequently, replace the CompoNet Communications Unit.
0370	Verification error: Slave is not there.	0x00	0x00	Not kept	Connect the correct SmartSlice I/O Units and reset the CompoNet Communications Unit.
0372	Verification error: Slave is participating but is not registered.	0x80: SmartSlice I/O	Node addresses (hexadecimal value)	Not kept	Remove the SmartSlice I/O Units that are not necessary and reset the CompoNet Communications Unit.

Error code (hexadecimal value)	Error description	“Detail”		Keeping error history during power interruptions	Procedure
		1st byte	2nd byte		
021A	Logic error in table settings Cause There is a checksum error or invalid setting in one of these tables. <ul style="list-style-type: none"> • Registration Table • Slave parameters • Network parameters • Backup/restore data 	0x00	0x0A: Registra- tion Table 0x0B: Slave parameters 0x0C: Network parameters 0x0F: Backup/ restore data	Kept	Download the settings again.
0602	Memory access error Cause <ul style="list-style-type: none"> • There is a hardware fault in the nonvolatile memory element in the Unit. • ADR failed (communications failed) 	0x01: Read error 0x02: Write error	0x07: Error his- tory 0x09: Identity information 0x0A: Registra- tion Table 0x0C: Network parameters 0x0F: Backup/ restore data	Kept (Not kept in error history)	If this error occurs frequently, replace the CompoNet Communications Unit.

More Information on Errors in SmartSlice I/O Units

Error code (hexadecimal value)	Error description	"Detail"		Keeping error history during power interruptions	Procedure
		1st byte	2nd byte		
0300	Reception error for backup data	0x80: SmartSlice I/O	Node addresses (hexadecimal value)	Not kept	<ul style="list-style-type: none"> • Make sure that the SmartSlice I/O Units are correctly connected. • Make sure that there are no sources of noise near the Unit.
0374	Transmission error Cause A transmission error occurred.	0x80: SmartSlice I/O	Node addresses (hexadecimal value)	Not kept	<ul style="list-style-type: none"> • Make sure that the SmartSlice I/O Units are correctly connected. • Make sure that there are no sources of noise near the Unit.
0375	Communications stopped because of a transmission error Cause A transmission error occurred when the Unit was set to stop communications for transmission errors.	0x80: SmartSlice I/O	Node addresses (hexadecimal value)	Kept	<ul style="list-style-type: none"> • Make sure that the SmartSlice I/O Units are correctly connected. • Make sure that there are no sources of noise near the Unit.
0376	Slave duplication error Cause A Slave duplication error occurred.	0x80: SmartSlice I/O	Node addresses (hexadecimal value)	Not kept	Make sure that the SmartSlice I/O Units are connected correctly and then reset the Compo-Net Communications Unit.
0378	I/O size error	0x00	0x00	Not kept	Make sure that the SmartSlice I/O Units are connected correctly and then reset the Compo-Net Communications Unit.
0379	SmartSlice configuration error	0x00	0x00	Not kept	Make sure that the SmartSlice I/O Units are connected correctly and then reset the Compo-Net Communications Unit.

9-3 Other Error Causes and Error Procedures

This section tells you about the errors that the indicators show and the procedures for them.

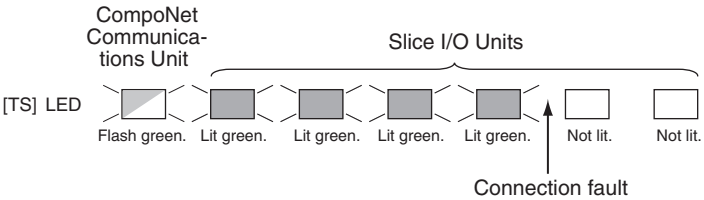
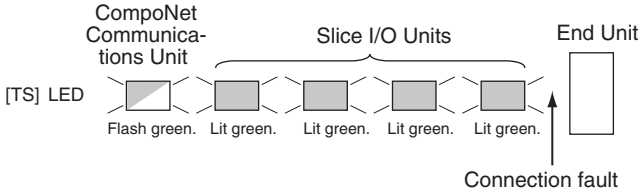
Status	Possible cause and procedure
<p>The UNIT PWR indicator on the CompoNet Communications Unit is flashing.</p>	<p>The Unit power supply is not sufficient. Calculate the power supply requirement of the SmartSlice I/O Terminal and replace the power supply with one that has a sufficient capacity.</p>
<p>The MS and NS indicators on the Communications Unit flash while changing between red and green. The TS indicator on a SmartSlice I/O Unit flashes while changing between red and green.</p>	<p>The Unit power supply is not sufficient. Calculate the power supply requirement of the SmartSlice I/O Terminal and replace the power supply with one that has a sufficient capacity.</p>
<p>The TS indicator on the CompoNet Communications Unit flashes green and the TS indicators do not come ON on the SmartSlice I/O Units on part of the SmartSlice I/O Terminal.</p>	<p>The slide connector on the left side of the Unit where the TS indicator does not come ON is not connected properly. Connect this slide connector correctly. After you correct the connection of the I/O Unit, turn ON the power again.</p> 
<p>The TS indicator on the CompoNet Communications Unit flashes green and the TS indicators on the SmartSlice I/O Units come ON in green.</p>	<p>The End Unit is not connected correctly. After you correct the connection of the End Unit, turn ON the power again.</p> 
<p>After the MS indicator on the Communications Unit comes ON in green, the NS indicator comes ON in red immediately, without flashing.</p>	<p>Do a check of these items and then reset the CompoNet Communications Unit.</p> <ul style="list-style-type: none"> • Make sure that all node addresses are within the specified range and that each node address is set only once. Make sure that the configuration of Repeater Units is correct. • Make sure that only one Slave uses the same I/O area words. If more than one Slave uses the same words, correct the node addresses. Set each node address on only one Slave. • Refer to the error procedure below at "The NS indicator on the CompoNet Communications Unit comes ON in green but makes a change to red after a short time." • If the NS indicator comes ON in red on only one Slave, replace the Slave.

Status	Possible cause and procedure
<p>The NS indicator on the CompoNet Communications Unit comes ON in green but makes a change to red after a short time.</p> <p>OR</p> <p>The NS indicator on the CompoNet Communications Unit comes ON in green but flashes red after a short time.</p>	<p>Do a check of these items and then reset the CompoNet Communications Unit.</p> <ul style="list-style-type: none"> • Make sure that there is terminating resistance of 121 Ω at each end of the trunk line of the network. If terminating resistance is not connected, connect 121 Ω. • Make sure that the settings for all Slaves are correct. • Make sure that the connections of the communications cables are correct. • Make sure that the connections and settings of the power supply cables are correct. • Make sure that there are no disconnections in the connections to the connectors for the communications cables and power supply cables at all nodes. • If there are sources of noise in the area, do noise countermeasures for the Master Unit, Slaves, and communications cables. • If you are using an OMRON Master Unit and there is an error in the Master Unit, refer to the <i>CS/CJ-series CompoNet Master Unit Operation Manual</i> (Cat. No. W456). If you are using a Master Unit from a different company, refer to the operation manual for the Master Unit. • If the NS indicator comes ON in red on only one CompoNet Communications Unit, replace the Unit.
<p>The NS indicator on the CompoNet Communications Unit goes OFF and stays OFF.</p>	<p>Do a check of these items and then reset the CompoNet Communications Unit.</p> <ul style="list-style-type: none"> • Make sure that the operation of the CompoNet Master Unit is correct. If you are using an OMRON Master Unit, make sure the operating mode and slave node addresses are correct. If you are using a Master Unit from a different company, refer to the operation manual for the Master Unit. • Make sure that the connections of the connectors for all Slaves are correct. • Make sure that the operation of the CompoNet Master Unit is correct. If you are using an OMRON Master Unit, refer to the <i>CS/CJ-series CompoNet Master Unit Operation Manual</i> (Cat. No. W456). If you are using a Master Unit from a different company, refer to the operation manual for the Master Unit. • Make sure that the connections of the communications cables are correct. • Make sure that the connections and settings of the power supply cables are correct. • Make sure that there are no disconnections in the connections to the connectors for the communications cables and power supply cables.
<p>The NS indicator on the CompoNet Communications Unit continues to flash.</p>	<ul style="list-style-type: none"> • Make sure that the operation of the CompoNet Master Unit is correct. If you are using an OMRON Master Unit, make sure the operating mode and slave node addresses are correct. If you are using a Master Unit from a different company, refer to the operation manual for the Master Unit. • Make sure that the Slave is in the Registration Table in the Master Unit. If you are using an OMRON Master Unit, a new Slave will not join the network if you add it when the Master Unit is operating with the Registration Table. Clear the Registration Table, make sure that the new Slave is in the network, and then create the Registration Table. If you are using a Master Unit from a different company, refer to the operation manual for the Master Unit for information on using the Registration Table. • Make sure that the I/O areas of the Slaves are not more than the permitted area for the Master Unit. If it is necessary, correct the node addresses.

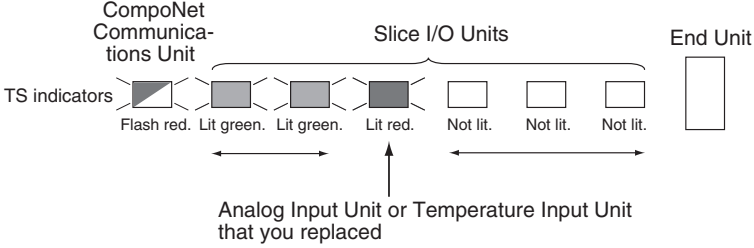
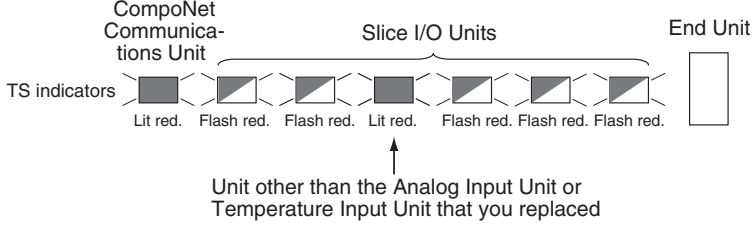
Status	Possible cause and procedure
<p>The NS indicator on the CompoNet Communications Unit flashes green and comes ON in green again and again.</p> <p>OR</p> <p>The NS indicator on the CompoNet Communications Unit flashes red and green again and again.</p>	<ul style="list-style-type: none"> If you are using an OMRON Master Unit, do a check of these items and do the error procedure for the indicator status on the Master Unit. Create the Registration Table again. Clear the Registration Table, make sure that the Slaves are in the network, and then create the Registration Table. Make sure that you did not set the same I/O area for more than one Slave. If two Slaves have the same I/O area, correct the node addresses. Each node address can set only one time. Make sure that the I/O area for the Slave is in the area permitted by the Master Unit. When using a Master Unit from a different company, make sure that the I/O size in the Registration Table in the Master Unit agrees with the I/O size of the Slave.
<p>You replaced an Analog Input Unit or Temperature Input Unit and the indicators are as below: The TS indicator on the CompoNet Communications Unit is flashing red, the TS indicator on the replaced Unit comes ON in red, the TS indicator on the left adjacent Unit comes ON in green, and the TS indicator on the right adjacent Unit does not come ON.</p>	<p>You created the Registration Table or backed up the parameters and then replaced a standard SmartSlice I/O Unit with an Analog or Temperature Input Unit. Or, you replaced an Analog or Temperature Input Unit with a different model of Analog or Temperature Input Unit.</p> <p>Replace the I/O Unit with a Unit with the same model number. After you replace the Unit, reset the power supply.</p> 
<p>You replaced an Analog Input Unit or Temperature Input Unit and the indicators are as below: The TS indicator on the CompoNet Communications Unit comes ON in red, the TS indicator on the replaced Unit comes ON in red, and the TS indicators on the other Units flash red.</p>	<p>You created the Registration Table or backed up the parameters and then replaced a SmartSlice I/O Unit (that is not an Analog or Temperature Input Unit) with a Unit with a different model number.</p> <p>Replace the I/O Unit with a Unit with the same model number. After you replace the Unit, reset the power supply.</p> 

Appendix A

CompoNet Explicit Messages

You can send CompoNet explicit messages from the CompoNet Master Unit to the SmartSlice I/O Terminal to read and write the parameters of the SmartSlice I/O Terminal.

The SmartSlice I/O Terminal executes the command from the CompoNet Master Unit and sends back a response.

Sending Explicit Messages with FINS Commands

The CS/CJ-series CompoNet Master Units use FINS commands to send CompoNet explicit messages.

Refer to the *SYSMAC CS/CJ/CP Series and SYSMAC One NSJ Series Communications Command Reference Manual* (Cat. No. W342) for information on FINS commands.

Flow of Messages

The CMND instruction sends the FINS commands. You use the CX-Programmer to enter the CMND instruction.

When the CMND instruction sends a FINS command from the CPU Unit to the CompoNet Master Unit, the CompoNet Master Unit changes it into a CompoNet explicit message and sends it to the SmartSlice I/O Terminal.

The CompoNet Master Unit also changes the response from the SmartSlice I/O Terminal from a CompoNet explicit message to a FINS response and sends it to the CPU Unit.

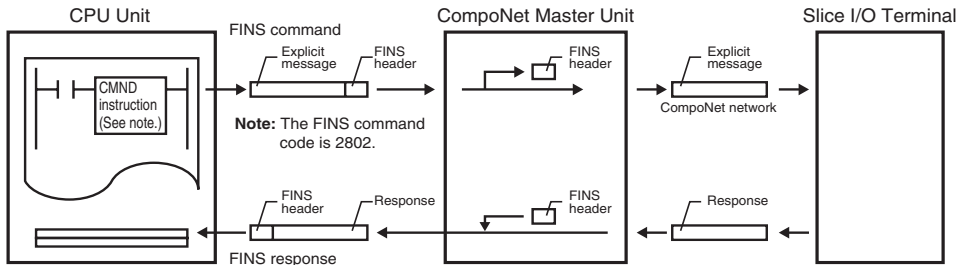

FINS Formats

You use FINS command code 2802 hex to send CompoNet explicit messages.

Command Format

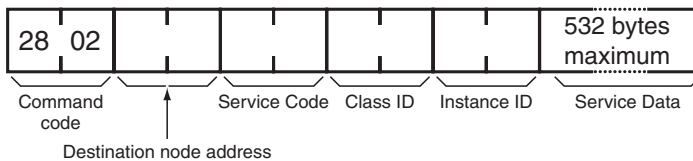

Response Format

The format below is for normal responses to CompoNet explicit messages.

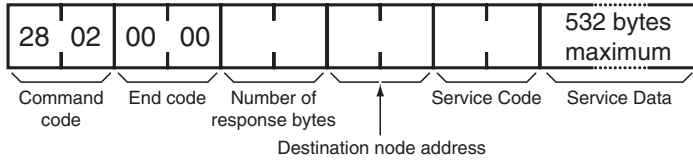

The format below is for error responses to CompoNet explicit messages. (Communications error in CompoNet explicit messages cause these errors.)

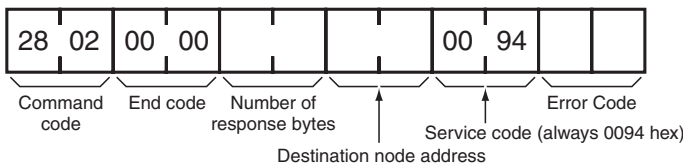

The format below is for when the Unit cannot send the CompoNet explicit message or when there is a timeout. (FINS communications errors cause these problems.)

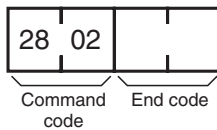

Descriptions of Parameters

- **Destination Node Address (Command)**
Specify the node address of the SmartSlice I/O Terminal to which to send the explicit message. Specify 10xx hex as the destination node address for the CompoNet Communications Unit. Here, xx is the node address of the CompoNet Communications Unit in hexadecimal.
- **Service Code (Command and Response)**
In the command, specify the service code defined by the CompoNet network. Refer to Service Code Table, below, for more information.
The response contains the service code from the command with the leftmost bit turned ON. The service code will be 0094 hex in an error response.

Service Code Table

Service	Read	Write	Reset	Save
Command	0E hex	10 hex	05 hex	16 hex
Normal response	8E hex	90 hex	85 hex	96 hex

- **Class ID (Command)**
Specify the class ID of the explicit message.
- **Instance ID (Command)**
Specify the instance ID of the explicit message.

- Service Data (Command and Response)
In the command, specify the data defined for the service code.
The response will contain the response data defined for the service code.
- Number of Response Bytes (Response)
The response will contain the number of bytes of response data starting from the destination node address.
- Destination Node Address (Response)
The response will contain the node address of the SmartSlice I/O Terminal which sent the explicit response.
- Error Code (Response)
In an error response, the response will contain the error code defined by the CompoNet network.
Refer to Error Code Table, below, for more information.

Error Code Table

Response code	Error name	Cause
08FF	Service not supported	The service code is not correct.
09FF	Invalid attribute value	The attribute value is not correct. The write data is out of range
16FF	Object does not exist	The instance ID is not correct.
15FF	Too much data	The data is longer than the specified number of bytes.
13FF	Not enough data	The data is shorter than the specified number of bytes.
0CFF	Object state conflict	Command execution was not possible because of an internal hardware error.
20FF	Invalid Parameter	A parameter is not correct.
0EFF	Attribute not settable	The command specified a read-only attribute ID with a service code to write data.
10FF	Device state conflict	Command execution was not possible because of an internal hardware error.
14FF	Attribute not supported	The attribute is not correct.
19FF	Store operation failure	Saving data in memory was not possible.

- End Code (Response)
The response contains the end code for the FINS command.

Refer to the *SYSMAC CS/CJ/CP Series and SYSMAC One NSJ Series Communications Command Reference Manual* (Cat. No. W342) for more information.

Explicit Message Tables for CompoNet Communications Units

Reading Warning Status and Alarm Status

Explicit message	Service	Function	Command					Response
			Service Code	Class ID	Instance ID	Attribute ID	Data size	
Warning Status Read	Read	This message reads the warning status bits for the CompoNet Communications Unit.	0E hex	95 hex	01 hex	C5 hex	---	2 bytes
Alarm Status Read	Read	This message reads the alarm status bits for the CompoNet Communications Unit.	0E hex	95 hex	01 hex	C6 hex	---	2 bytes

Note Refer to *5-3-3 Status Words* on page 46 for information on status for the CompoNet Communications Unit.

Setting/Monitoring Unit Conduction Time

Explicit message	Service	Function	Command					Response
			Service Code	Class ID	Instance ID	Attribute ID	Data size	
Unit Maintenance Set Value	Read	This message reads the set value (unit: 0.1 h) for the conduction time of the CompoNet Communications Unit.	0EHex	95Hex	01Hex	73Hex	---	4 bytes 0000 0000 to FFFF FFFF hex (0 to 4,294,967,295)
	Write	This message writes the set value (unit: 0.1 h) for the conduction time of the CompoNet Communications Unit.	10Hex	95Hex	01Hex	73Hex	4 bytes 0000 0000 to FFFF FFFF hex (0 to 4,294,967,295)	---
Unit Maintenance Present Value	Read	This message reads the present value (unit: 0.1 h) of the conduction time of the CompoNet Communications Unit.	0EHex	95Hex	01Hex	71Hex	---	4 bytes 0000 0000 to FFFF FFFF hex (0 to 4,294,967,295)
Unit Maintenance Flag	Read	This message reads the monitor status of the conduction time for the CompoNet Communications Unit.	0EHex	95Hex	01Hex	72Hex	---	1 byte 00 hex: In range 01 hex: Out of range (larger than the threshold)

Alarm Information Read

Explicit message	Service	Function	Command					Response
			Service Code	Class ID	Instance ID	Attribute ID	Data size	
Alarm Information Read	Read	This message reads the alarm information from the SmartSlice I/O Terminal.	0EHex	9CHex	01Hex	73Hex	---	32 bytes (See note.)

Note The table below shows the structure of the alarm information.

Bit	15 to 12	11 to 8	7 to 4	3 to 0
First word	SmartSlice I/O Unit node #4	SmartSlice I/O Unit node #3	SmartSlice I/O Unit node #2	SmartSlice I/O Unit node #1
First word + 1	SmartSlice I/O Unit node #8	SmartSlice I/O Unit node #7	SmartSlice I/O Unit node #6	SmartSlice I/O Unit node #5
First word + 2	SmartSlice I/O Unit node #12	SmartSlice I/O Unit node #11	SmartSlice I/O Unit node #10	SmartSlice I/O Unit node #9
.
.

Bit	15 to 12	11 to 8	7 to 4	3 to 0
First word + 13	SmartSlice I/O Unit node #56	SmartSlice I/O Unit node #55	SmartSlice I/O Unit node #54	SmartSlice I/O Unit node #53
First word + 14	SmartSlice I/O Unit node #60	SmartSlice I/O Unit node #59	SmartSlice I/O Unit node #58	SmartSlice I/O Unit node #57
First word + 15	SmartSlice I/O Unit node #64	SmartSlice I/O Unit node #63	SmartSlice I/O Unit node #62	SmartSlice I/O Unit node #61

Meanings of Bits for SmartSlice I/O Units

Bits	Meaning
0, 4, 8, and 12	Warning (minor error)
1, 5, 9, and 13	Alarm (serious error)
2, 6, 10, and 14	Reserved.
3, 7, 11, and 15	Reserved.

Note The specified errors for warnings and alarms are different for different SmartSlice I/O Units. Refer to the *GRT1 Series SmartSlice I/O Units Operation Manual* (Cat. No. W455) for more information.

Application Example for Explicit Messages

Sending an Explicit Message with the CMND Instruction

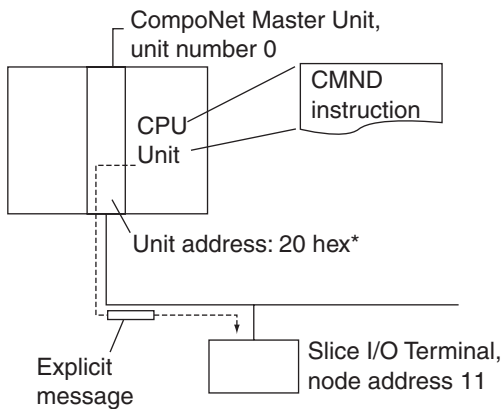

*The unit address of the CompoNet Master Unit (a Special I/O Unit) is the unit number plus 20 hex.

Operation

This example reads the Unit maintenance present value from the SmartSlice I/O Terminal. The command uses these values: Class ID: 95 hex, Instance ID: 01 hex, and Attribute ID: 71 hex.

The command code is 2802 hex (to send an explicit message).

The command data is in words starting from D01000 in the CPU Unit. The words starting from D02000 will contain the response data.

Command Operands

[CMND S D C]

S	D01000	+0	: 2802 hex	Command code
		+1	: 100B hex	Destination node address (SmartSlice I/O Terminal: Node address 11)
		+2	: 000E hex	Service Code 0E hex
		+3	: 0095 hex	Class ID 0095 hex
		+4	: 0001 hex	Instance ID 0001 hex
		+5	: 7100 hex	Attribute ID 71 hex (The command does not use the rightmost two bytes (00) because the number of data bytes is 11.)
D	D02000		:	First word for response data
C	D00000	+0	: 000B hex	Number of command data bytes: 11
		+1	: 000E hex	Number of response data bytes: 14
		+2	: 0000 hex	Destination network address (CompoNet Master Unit): 0
		+3	: 0020 hex	Destination node address (CompoNet Master Unit): 0
			:	Destination unit address (CompoNet Master Unit): 20 hex
		+4	: 0000 hex	Response necessary, communications port 0, number of retries: 0 hex
		+5	: 0064 hex	Response monitor time

Response

D02000	+0	: 2802 hex	
	+1	: 0000 hex	
	+2	: 0008 hex	
	+3	: 100B hex	Destination node address: 11 (0B hex)
	+4	: 008E hex	Normal end (8E hex)
	+5	: 2F07 hex	The right byte goes in the higher bit addresses in memory for the unit maintenance present value (0000072F hex). (Refer to the note for more information.)
	+6	: 0000 hex	

Note (1) If the service data is two bytes or four bytes (for example, word data or error clear codes), specify the right byte first in the command format.
 Example: Specify the word data 1234 hex in this sequence: 34 hex → 12 hex.
 Specify the double word data 12345678 hex in this sequence: 78 hex → 56 hex → 34 hex → 12 hex.
 These are the command formats.

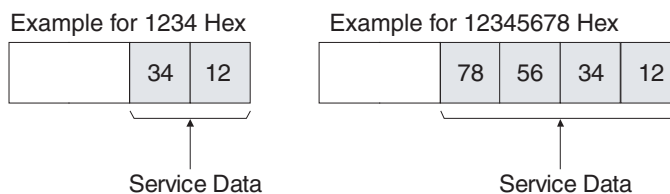

Set data for operand S and on for the CMND instruction as these figures show.

Example for 1234 Hex

Starting with the Left Byte

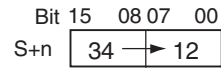

Starting with the Right Byte

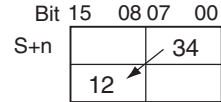

Example for 12345678 Hex

Starting with the Left Byte

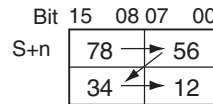

Starting with the Right Byte

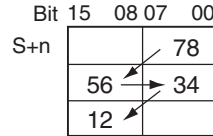

- (2) The sequence of data bytes is the same for service data in the response format. The right byte will be first for 2-byte or 4-byte data.

Appendix B

Object Implementation

Identity Object (0x01)

Object class	Attribute	Not supported.
	Service	Not supported.

Object instance	Attribute	ID	Contents	Get	Set	Value
		1	Vendor code	Yes	---	OMRON Corporation: ID = 47 (0x2F)
2	Device type	Yes	---	Communications Adapter: ID = 12 (0x0C)		
3	Product code	Yes	---	1603 (0x0643)		
4	Revision	Yes	---	Major = 01, Minor = 01		
5	Status (bits supported)	Yes	---			
6	Serial number	Yes	---	00820A30 to 008390DF hex		
7	Product name	Yes	---	GRT1-CRT		
8	State	---	---			
	Service	Code	Contents	Parameter option		
		05	Reset	No		
		0E	Get_Attribute_Single	No		

Assembly Object (0x04)

Object class	Attribute	Supported.
	Service	Supported.

Object instance	ID	Attribute	ID	Contents	Get	Set	Value
	90		3	Input data	Yes	---	---
93	3	Communications Unit status + Input data	Yes	---	---		
94	3	Participation table + Communications Unit status + Input data	Yes	---	---		
A0	3	Output data	Yes	---	---		
---	Service	Code	Contents	Parameter option			
---		0E	Get_Attribute_Single	No			

Connection Object (0x05)

Object class	Attribute	Supported.
	Service	Supported.
	Maximum number of active connections	1

Object instance	Section	Information			Maximum number of instances			
	Instance type	Polled I/O			1			
	Production trigger	Cyclic			---			
	Transport type	Server						
	Transport class	2						
	Attribute	ID	Contents		Get	Set	Value	
		1	State		Yes	---	---	
		2	Instance type		Yes	---	01H	
		3	Transport class trigger		Yes	---	82H: (In and Mix slaves) 80H: (Out slaves and Repeaters)	
		4	Produced connection ID		---	---	---	
		5	Consumed connection ID		---	---	---	
		6	Initial comm.characteristics		---	---	---	
		7	Produced connection size		Yes	---		
		8	Consumed connection size		Yes	---		
		9	Expected packet rate		Yes	Yes	---	
		12	Watchdog time-out action		Yes	Yes	00	
		13	Produced connection path length		Yes	---		
		14	Produced connection path		Yes	---		
		15	Consumed connection path length		Yes	---		
		16	Consumed connection path		Yes	---		
17		Production inhibit time		---	---	---		
Service		Code	Contents		Parameter option			
	05	Reset		No				
	0E	Get_Attribute_Single		No				
	10	Set_Attribute_Single		No				

Appendix C

Standard Models

CompoNet Communications Unit

Model	Specifications
GRT1-CRT	SmartSlice CompoNet Communications Unit A total of 64 SmartSlice I/O Units can connect to one CompoNet Communications Unit.

SmartSlice I/O Units

Model	Specifications
GRT1-ID4	Four-point SmartSlice DC Input Unit, NPN
GRT1-ID4-1	Four-point SmartSlice DC Input Unit, PNP
GRT1-OD4	Four-point SmartSlice Transistor Output Unit, NPN
GRT1-OD4-1	Four-point SmartSlice Transistor Output Unit, PNP
GRT1-ID8	Eight-point SmartSlice DC Input Unit, NPN
GRT1-ID8-1	Eight-point SmartSlice DC Input Unit, PNP
GRT1-OD8	Eight-point SmartSlice Transistor Output Unit, NPN
GRT1-OD8-1	Eight-point SmartSlice Transistor Output Unit, PNP
GRT1-ROS2	Two-point SmartSlice Relay Output Unit
GRT1-AD2	Two-channel SmartSlice Analog Input Unit
GRT1-DA2C	Two-channel SmartSlice Analog Output Unit with Current Outputs
GRT1-DA2V	Two-channel SmartSlice Analog Output Unit with Voltage Outputs
GRT1-IA4-1	Four-point SmartSlice AC Input Unit (Input voltage: 100 to 120 VAC 50/60 Hz)
GRT1-IA4-2	Four-point SmartSlice AC Input Unit (Input voltage: 200 to 240 VAC 50/60 Hz)
GRT1-TS2T	Two-channel SmartSlice Temperature Input Unit for Thermocouples (input types: R, S, K, J, T, B, L, E, U, N, W, and PL2)
GRT1-TS2P	Two-channel SmartSlice Temperature Input Unit for Pt100 Temperature Resistance Thermometers
GRT1-TS2PK	Two-channel SmartSlice Temperature Input Unit for Pt1000 Temperature Resistance Thermometers
GRT1-CT1	SmartSlice Counter Unit, NPN
GRT1-CT1-1	SmartSlice Counter Unit, PNP
GRT1-END	End Unit
GRT1-PD2	I/O Power Feed Unit
GRT1-PD8	I/O Power Feed Unit with overcurrent protection
GRT1-PD8-1	I/O Power Feed Unit, PNP, with 4 voltage and 8 ground terminals
GRT1-PC8	I/O Power Connection Unit, NPN, with 8 voltage and 4 ground terminals
GRT1-PC8-1	I/O Power Connection Unit, PNP, with 4 voltage and 8 ground terminals
GRT1-TBR	Right Turnback Unit
GRT1-TBL	Left Turnback Unit
GRT1-PD2G	I/O Power Feed Unit with overcurrent protection
GRT1-OD4G-1	Four-point Transistor Output Unit (PNP) with overcurrent and short-circuit protection
GRT1-OD4G-3	Four-point 2-A Transistor Output Unit (PNP) with overcurrent and short-circuit protection
GRT1-OD8G-1	Eight-point Transistor Output Unit (PNP) with overcurrent and short-circuit protection
GRT1-IA4-1	Four-point AC Input Unit (Input voltage: 100 to 120 VAC 50/60 Hz)
GRT1-IA4-2	Four-point AC Input Unit (Input voltage: 200 to 240 VAC 50/60 Hz)

Model	Specifications
GRT1-TS2T	Two-point Temperature Input Unit Thermocouple input, Input type: R, S, K, J, T, E, B, N, L, U, W, or PL2
GRT1-CP1-L	Positioning Unit with one counter (with encoder A, B, and Z Inputs), 1 digital input, and 2 digital outputs (PNP)

Turnback Unit Connection Cable

Model	Specifications
GCN2-100	Turnback Cable (1 m) You can use two Turnback Cables for each CompoNet Communications Unit.

CompoNet Communications Cables

Model	Specifications
---	Round cable I (2-core VCTF cable) JIS C 3306, Nominal cross-section (conductor diameter): 0.75 mm ² , Finished diameter: 2.3 mm
---	Round cable II (4-core VCTF cable) JIS C 3306, Nominal cross-section (conductor diameter): 0.75 mm ² , Finished diameter: 2.3 mm
DCA4-4F10	Flat Cable I (unsheathed cable, 4-core flat cable, UL certification) Length: 100 m, Conductor diameter: 0.75 mm ² × 2, 0.5 mm ² × 2
DCA5-4F10	Flat Cable II (sheathed cable, 4-core flat cable, UL certification) Length: 100 m, Conductor diameter: 0.75 mm ² × 2, 0.5 mm ² × 2

Connectors for Communications Cables

Model	Specifications
DCN4-TR4	Flat Cable Trunk Line Connector for Flat Cable I (unsheathed cable)
DCN5-TR4	Flat Cable Trunk Line Connector for Flat Cable II (sheathed cable)
DCN4-BR4	Flat Cable Branch Line Connector for Flat Cable I (unsheathed cable)
DCN5-BR4	Flat Cable Branch Line Connector for Flat Cable II (sheathed cable)
DCN4-MD4	Multidrop Connector for multidrop connections
DCN4-TB4	Screw Terminal Block Adapter (for Unit connection) Use the Screw Terminal Block Adapter to connect the communications connector on a CompoNet Communications Unit, Slave, or Repeater Unit to a terminal block. The terminal screws are M3.

Terminating Resistance

Model	Specifications
DRS1-T	Terminating Resistance for Round Cable I, terminal block type, 121 Ω
DCN4-TM4	Terminating Resistance for Round Cable II, Flat Cable I, connector type, 121 Ω
DCN5-TM4	Terminating Resistance for Flat Cable II, connector type, 121 Ω

Appendix D

Power Consumption and Weight Tables

CompoNet Communications Unit

Model	Power consumption (W)	Weight (g)
GRT1-CRT	3	137

SmartSlice I/O Units

Model	Power consumption (W)	Weight (g)
GRT1-ID4	1	76
GRT1-ID4-1	1	76
GRT1-OD4	1	76
GRT1-OD4-1	1	76
GRT1-ID8	1.5	80
GRT1-ID8-1	1.5	80
GRT1-OD8	1.2	80
GRT1-OD8-1	1.2	80
GRT1-ROS2	1	80
GRT1-AD2	1.5	82
GRT1-DA2C	2	82
GRT1-DA2V	1.5	82
GRT1-IA4-1	1.0	76
GRT1-IA4-2	1.0	76
GRT1-TS2T	1.5	86
GRT1-TS2P	1.5	86
GRT1-TS2PK	1.5	86
GRT1-CT1	1.1	80
GRT1-CT1-1	1.1	80
GRT1-END	0	49
GRT1-PD2	0.2	72
GRT1-PD2G	1.2	76
GRT1-PD8	0.2	75
GRT1-PD8-1	0.2	75
GRT1-PC8	0.2	75
GRT1-PC8-1	0.2	75
GRT1-TBR	0	56
GRT1-TBL	0	108
GRT1-OD4G-1	1	76
GRT1-OD4G-3	1.8	76
GRT1-OD8G-1	1.4	60
GRT1-IA4-1	1.0	76
GRT1-IA4-2	1.0	76
GRT1-CP1-L	1.2	80
GRT1-PD2G	1.2	76
GRT1-TS2T	1.5	86

Appendix E

Total I/O Current Consumption Table

Model	Total I/O current consumption (mA)
GRT1-ID4	33
GRT1-ID4-1	33
GRT1-OD4	12
GRT1-OD4-1	12
GRT1-ID8	38
GRT1-ID8-1	38
GRT1-OD8	8
GRT1-OD8-1	8
GRT1-ROS2	30
GRT1-AD2	0
GRT1-DA2C	0
GRT1-DA2V	0
GRT1-IA4-1	0
GRT1-IA4-2	0
GRT1-TS2T	0
GRT1-TS2P	0
GRT1-TS2PK	0
GRT1-CT1	21
GRT1-CT1-1	21
GRT1-END	0
GRT1-PD2	4
GRT1-PD2G	19
GRT1-PD8	4
GRT1-PD8-1	4
GRT1-PC8	4
GRT1-PC8-1	4
GRT1-TBR	0
GRT1-TBL	4
GRT1-OD4G-1	12
GRT1-OD4G-3	10
GRT1-OD8G-1	17
GRT1-IA4-1	0
GRT1-IA4-2	0
GRT1-TS2T	0
GRT1-CP1-L	28
GRT1-PD2G	19

Index

A

alarm status
 CompoNet Communications Unit, 49
allocation
 starting point, 41
Automatic Restore Monitor Flag, 48, 59

B

backup, 19
 checking results, 57
 function, 57
 procedure, 57
Base Block, 13
baud rate
 automatic recognition, 59
Bit Units, 43

C

calendar, 79
communications cable, 30
communications connector, 12, 30
CompoNet Communications Unit Error Flag, 48
CompoNet Master Unit, 6
connection timeout, 101
connector
 CompoNet communications, 12
current consumption
 total I/O current consumption, 36
CX-Integrator, 6

D

dimensions, 9
DIN Tracks, 22
DIP switch, 12, 18
 pin 1 (REGS), 18
 pin 2 (I/O), 19
 pin 3 (ADR), 19
 pin 4 (BACK), 19
Dummy Units, 60, 70

E

End Plate, 22

 installing, 26
End Unit, 6
 installing, 25
error flags, 47
error history
 I/O communications, 76
 network communications, 75

F

ferrules, 32
 connecting, 32
 disconnecting, 33
flags, 46
Flat Cable, 30
Flat Cable Branch Line Connector, 30
Flat Connector Plug, 30

I

I/O allocation, 42
 CX-Integrator, 51
 software setting, 60
I/O configuration
 information, 54
I/O memory, 42
 allocated data, 42
I/O Power Feed Units, 37
I/O power supply, 31, 36, 37
 connecting, 34
 terminals, 34
I/O PWR indicator, 17
I/O Refreshing Flag, 48
I/O response time, 90
 maximum value, 90
 minimum value, 90
I/O signal lines, 38
I/O size error, 104
indicators, 12
Input Area, 43
installation, 21

L

Last Maintenance Date, 77
logic error
 table settings, 103

M

Main Block, 13
memory access error, 103
message communications
 number of bytes, 93
 time required, 93
mounting tracks, 22
MS indicator, 14

N

node address, 18, 40
 duplicated, 101
NS indicator, 15

O

Output Area, 43

P

parameters
 editing, 70
power consumption
 total Unit power consumption, 36
power supplies
 recommended, 31
 types, 31
power supply terminals, 31

R

reception error
 backup data, 104
Registration Table, 18, 54
 clearing, 56
 making, 54
 Verification Error, 56
 verifying, 55
release button, 33
remote I/O communications, 90
replacing
 online, 59
restore, 19
 automatic, 58
 procedure, 58
restrictions

 installation, 44
rotary switches, 12, 18, 40
round cable, 30

S

Screw Terminal Block Adapter, 30
screwdriver, 33
screwless clamp terminals, 31, 38
 applicable wires, 32
settings
 showing, 67
slave duplication error, 104
slice bus, 31
SmartSlice Bus Communications Error Flag, 47
SmartSlice configuration error, 104
SmartSlice I/O Terminals, 2
 installation, 22
SmartSlice I/O Unit Alarm Flag, 47
SmartSlice I/O Unit Warning Flag, 47
SmartSlice I/O Units, 6
 connecting, 24
 editing parameters, 70
Software I/O Allocation Mode, 19, 62
 starting in, 62
Software Setting Table, 60
 clearing, 66
 downloading, 64
 making, 63
specifications
 communications, 7
 CompoNet Communications Unit, 7
 SmartSlice, 7
status, 43
 CompoNet Communications Unit, 46
status area, 47

T

Terminal Block, 13
terminals
 I/O power supply, 12
 Unit power supply, 12
total power ON time, 71
transmission error, 104
troubleshooting, 95
TS indicator, 16

Turnback Cable, 6, 36

connecting, 35

Turnback Units, 6, 36, 37

installing, 27

U

unit comments, 73

reading, 74

writing, 74

Unit Conduction Time

monitoring, 72

setting the threshold, 72

Unit Conduction Time Monitor, 71

threshold, 71

Unit Maintenance Flag, 48, 71

unit numbers, 41, 42

Unit power supply, 31, 36, 37

connecting, 33

terminals, 33

UNIT PWR indicator, 17

unused bits, 44

V

verification errors, 102

W

warning status

CompoNet Communications Unit, 49

WDT error, 102

wires

connecting, 32, 33

disconnecting, 33

Word Units, 43

Revision History

A manual revision code shows as a suffix to the catalog number on the front cover of the manual. Page numbers are those in the previous version.

Cat. No. W476-E1-01



Revision code

The following table outlines the changes made to the manual during each revision. Page numbers refer to the previous version.

Revision code	Date	Revised content
01	May 2008	Original production

Revision History
