

**MOSFET 50A 450~500V**

**PD7M441H PD7M440H**  
**P2H7M441H P2H7M440H**

**PD7M441H/440H**

**P2H7M441H/440H**

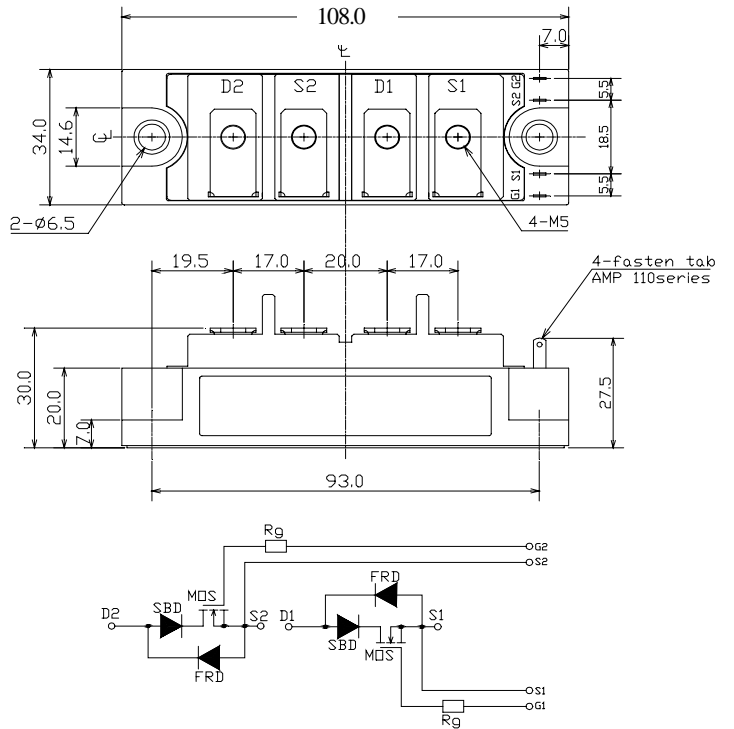
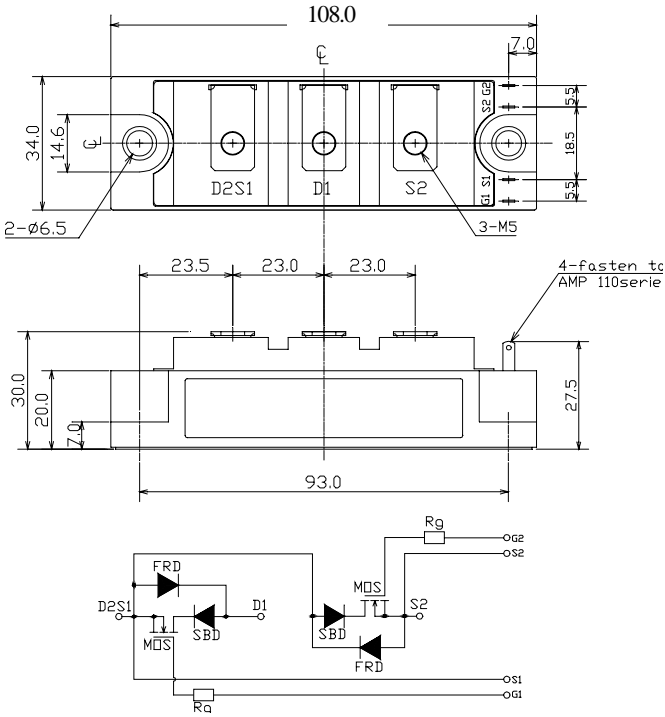

質量 Approximate Weight :220g

質量 Approximate Weight :220g

**最大定格 Maximum Ratings**

項目 Rating	記号 Symbol	耐圧・クラス Grade		単位 Unit
		PD7M441H/P2H7M441H	PD7M440H/P2H7M440H	
ドレイン・ソース間電圧 Drain-Source Voltage	$V_{DSS}$	450	500	V
		$V_{GS}=0V$		
ゲート・ソース間電圧 Gate-Source Voltage	$V_{GSS}$	$\pm 20$		V
ドレイン電流 (連続) Continuous Drain Current	$I_D$	50 ( $T_c=25$ )		A
		35 ( $T_c=25$ )		
パルスドレイン電流 Pulsed Drain Current	$I_{DM}$	100 ( $T_c=25$ )		A
全損失 Total Power Dissipation	$P_D$	350 ( $T_c=25$ )		W
動作接合温度範囲 Operating Junction Temperature Range	$T_{jw}$	- 40 ~ +150		
保存温度範囲 Storage Temperature Range	$T_{stg}$	- 40 ~ +125		
絶縁耐圧 RMS Isolation Voltage	$V_{iso}$	2000		V
		端子 - ベース間, AC1 分間 Terminals to Base, AC 1 min .		
締付トルク Mounting Torque	$F_{tor}$	3.0 ( 本体取付 Module Base to Heat sink )		N · m
		2.0 ( ネジ端子部 Bus bar to Main Terminals )		

## 電気的特性 Electrical Characteristics ( @Tc = 25 unless otherwise noted )

項目 Characteristic	記号 Symbol	条件 Condition	特性値 (最大) Maximum Value			単位 Unit
			最小 Min.	標準 Typ.	最大 Max.	
ドレイン遮断電流 Zero Gate Voltage Drain Current	IDSS	V <sub>DS</sub> = V <sub>DSS</sub> , V <sub>GS</sub> = 0V			1	mA
		T <sub>J</sub> = 125 , V <sub>DS</sub> = V <sub>DSS</sub> , V <sub>GS</sub> = 0V			4	
ゲート・ソース間しきい値電圧 Gate-Source Threshold Voltage	V <sub>GS(th)</sub>	V <sub>DS</sub> = V <sub>GS</sub> , I <sub>D</sub> = 1mA	2	3.1	4	V
ゲート・ソース間漏れ電流 Gate-Source Leakage Current	I <sub>GSS</sub>	V <sub>GS</sub> = ±20V, V <sub>DS</sub> = 0V			1	μA
ドレイン・ソース間オン抵抗 (MOSFET部) Static Drain-Source On-Resistance	r <sub>DS(on)</sub>	V <sub>GS</sub> = 10V, I <sub>D</sub> = 25A		110	120	m
ドレイン・ソース間オン電圧 Drain-Source On-Voltage	V <sub>DS(on)</sub>	V <sub>GS</sub> = 10V, I <sub>D</sub> = 25A		3.2	3.4	V
順伝達コンダクタンス Forward Transconductance	g <sub>fg</sub>	V <sub>DS</sub> = 15V, I <sub>D</sub> = 25A		45		S
入力容量 Input Capacitance	C <sub>iss</sub>	V <sub>GS</sub> = 0V V <sub>DS</sub> = 25V f = 1MHz		9.0		nF
出力容量 Output Capacitance	C <sub>oss</sub>			1.7		nF
帰還容量 Reverse Transfer Capacitance	C <sub>rss</sub>			0.32		nF
ターン・オン遅延時間 Turn-On Delay Time	t <sub>d(on)</sub>			120		ns
上昇時間 Rise Time	t <sub>r</sub>	V <sub>DD</sub> = 1/2V <sub>DSS</sub> I <sub>D</sub> = 25A		80		ns
ターン・オフ遅延時間 Turn-Off Delay Time	t <sub>d(off)</sub>	V <sub>GS</sub> = -5V, +10V R <sub>G</sub> = 7		240		ns
下降時間 Fall Time	t <sub>f</sub>			50		ns

## 内部ダイオード定格・特性 Source-Drain Diode Ratings and Characteristics ( @Tc = 25 unless otherwise noted )

項目 Characteristic	記号 Symbol	条件 Condition	特性値 (最大) Maximum Value			単位 Unit
			最小 Min.	標準 Typ.	最大 Max.	
ソース電流 (連続) Continuous Source Current	I <sub>S</sub>	D. C.			35	A
パルスソース電流 Pulsed Source Current	I <sub>SM</sub>				100	A
ダイオード順電圧 Diode Forward Voltage	V <sub>SD</sub>	I <sub>S</sub> = 50A			1.9	V
逆回復時間 Reverse Recovery Time	t <sub>rr</sub>	I <sub>S</sub> = 50A - dis/dt = 100A/μs		100		ns
逆回復電荷 Reverse Recovery Charge	Q <sub>r</sub>			0.15		μC

## 熱抵抗特性 Thermal Characteristics

項目 Characteristic	記号 Symbol	条件 Condition	特性値 (最大) Maximum Value			単位 Unit
			最小 Min.	標準 Typ.	最大 Max.	
熱抵抗 (接合部 - ケース間) Thermal Resistance, Junction to Case	R <sub>th(j-c)</sub>	MOSFET			0.36	/W
		Diode			2.0	
接触熱抵抗 (ケース - 冷却フィン間) Thermal Resistance, Case to Heatsink	R <sub>th(c-f)</sub>	サーマルコンパウンド塗布 Mounting surface flat, smooth, and greased			0.1	

定格・特性曲線

Fig. 1 Typical Output Characteristics

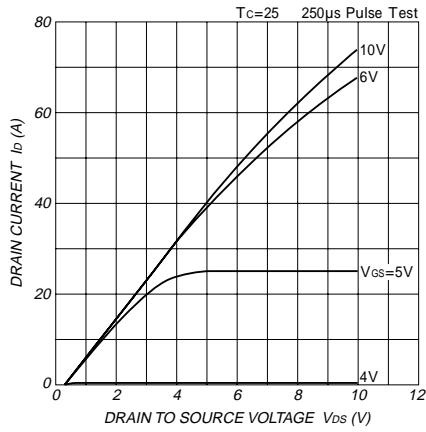

Fig. 2 Typical Drain-Source On-Voltage Vs. Gate-Source Voltage

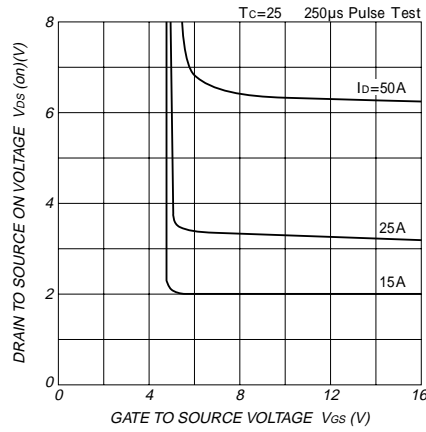

Fig. 3 Typical Drain-Source On Voltage Vs. Junction Temperature

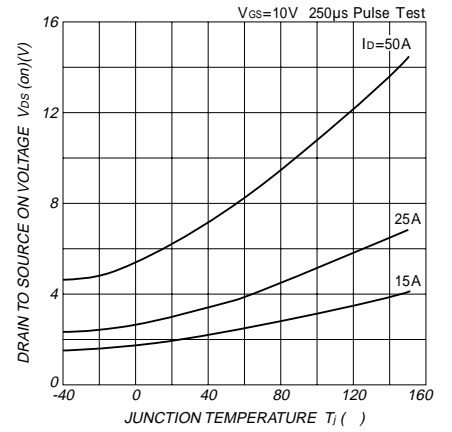

Fig. 4 Typical Capacitance Vs. Drain-Source Voltage

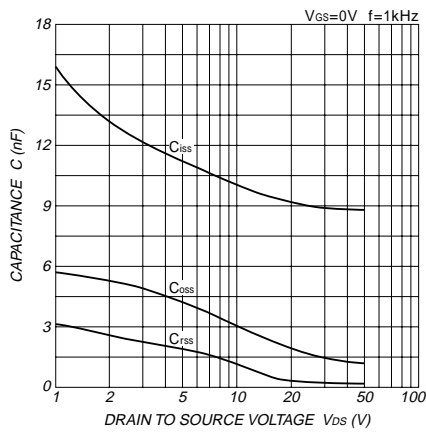

Fig. 5 Typical Gate Charge Vs. Gate-Source Voltage

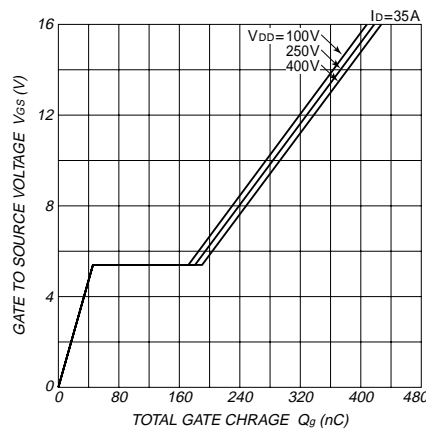

Fig. 6 Typical Switching Time Vs. Series Gate impedance

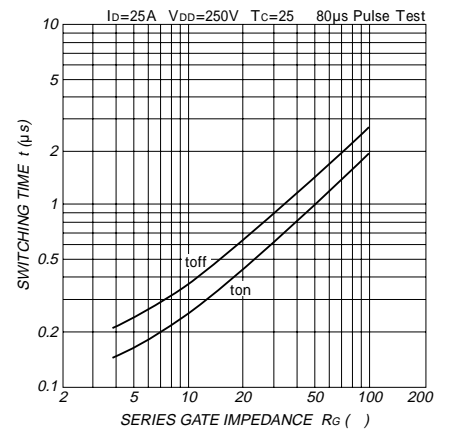

Fig. 7 Typical Switching Time Vs. Drain Current

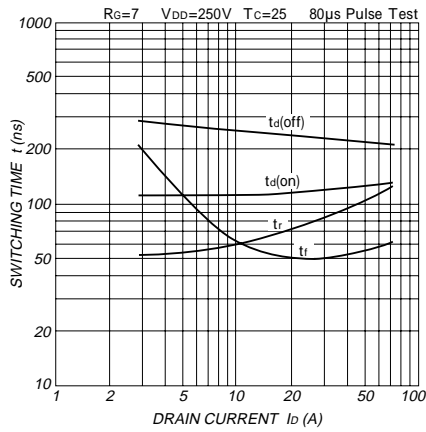

Fig. 8 Typical Source-Drain Diode Forward Characteristics

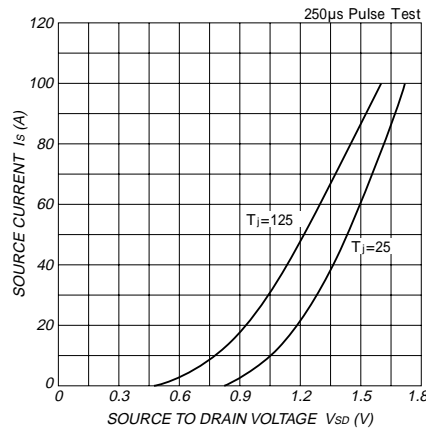

Fig. 9 Typical Reverse Recovery Characteristics

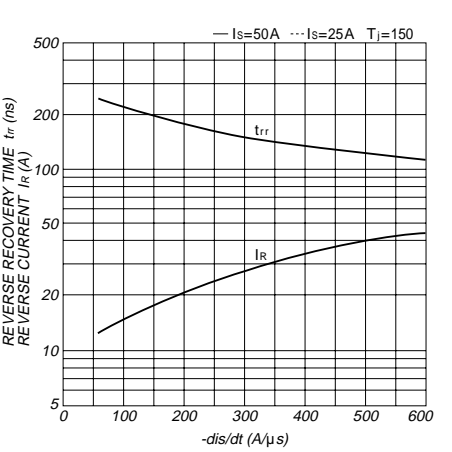

Fig. 10 Maximum Safe Operating Area

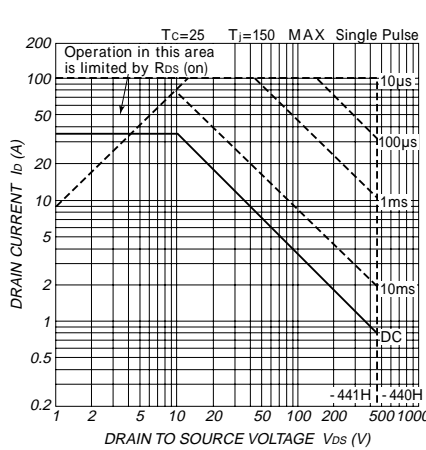

Fig. 11-1 Normalized Transient Thermal impedance(MOSFET)

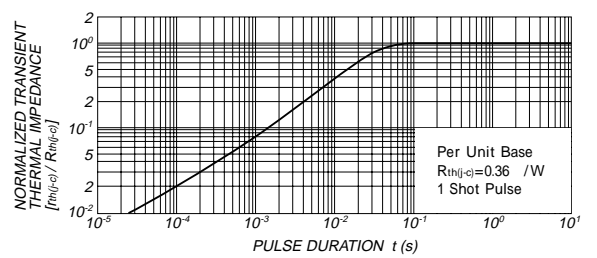
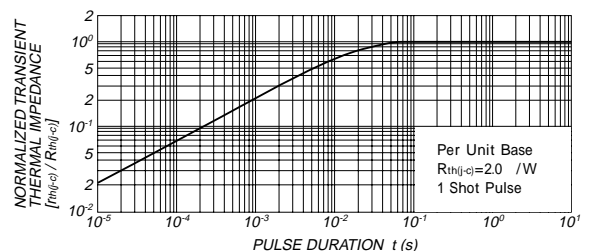

Fig. 11-2 Normalized Transient Thermal impedance(DIODE)



MOSFETデータシート