



Programmable Controller

CC-Link IE Field Network Basic Remote I/O Module User's Manual

-NZ2MFB2-16A
-NZ2MF2S2-16A
-NZ2MFB1-32D
-NZ2MF2S1-32D
-NZ2MFB2-16R
-NZ2MF2S2-16R
-NZ2MFB1-32T
-NZ2MF2S1-32T
-NZ2MFB1-32TE1
-NZ2MF2S1-32TE1
-NZ2MFB1-32DT
-NZ2MF2S1-32DT
-NZ2MFB1-32DTE1
-NZ2MF2S1-32DTE1



SAFETY PRECAUTIONS

(Read these precautions before using this product.)

Before using this product, please read this manual and the relevant manuals carefully and pay full attention to safety to handle the product correctly.

The precautions given in this manual are concerned with this product only. For the safety precautions of the programmable controller system, refer to the user's manual for the CPU module used.

In this manual, the safety precautions are classified into two levels: "⚠ WARNING" and "⚠ CAUTION".

 WARNING	Indicates that incorrect handling may cause hazardous conditions, resulting in death or severe injury.
 CAUTION	Indicates that incorrect handling may cause hazardous conditions, resulting in minor or moderate injury or property damage.

Under some circumstances, failure to observe the precautions given under "⚠ CAUTION" may lead to serious consequences.

Observe the precautions of both levels because they are important for personal and system safety.

Make sure that the end users read this manual and then keep the manual in a safe place for future reference.

[Design Precautions]

WARNING

- When a communication failure occurs in the network, data in the CPU module on the master station are held. Check the data link status of each station stored in the special register (SD) and configure an interlock circuit in the program to ensure that the entire system will operate safely.
 - When the module is disconnected due to a communication failure in the network or the CPU module is in the STOP state, all outputs are held or turned off according to the function setting switch setting. Configure an interlock circuit in the program to ensure that the entire system will always operate safely even in such a case. If not, an accident may occur due to an incorrect output or malfunction.
 - Outputs may remain on or off due to a failure of the module. Configure an external circuit for monitoring output signals that could cause a serious accident.
 - Do not use any "use prohibited" signals as a remote I/O signal since they are used by the system. Do not write any data to the "use prohibited" areas in the remote register. Doing so may result in an accident due to an incorrect output or malfunction.
 - To maintain the safety of the programmable controller system against unauthorized access from external devices via the network, take appropriate measures. To maintain the safety against unauthorized access via the Internet, take measures such as installing a firewall.
-

[Design Precautions]

CAUTION

- Do not install the control lines or communication cables together with the main circuit lines or power cables. Keep a distance of 100mm or more between them. Failure to do so may result in malfunction due to noise.
 - During control of an inductive load such as a lamp, heater, or solenoid valve, a large current (approximately ten times greater than normal) may flow when the output is turned from off to on. Therefore, use a module that has a sufficient current rating.
-

[Security Precautions]

WARNING

- To maintain the security (confidentiality, integrity, and availability) of the programmable controller and the system against unauthorized access, denial-of-service (DoS) attacks, computer viruses, and other cyberattacks from external devices via the network, take appropriate measures such as firewalls, virtual private networks (VPNs), and antivirus solutions.
-

[Installation Precautions]

WARNING

- Shut off the external power supply (all phases) used in the system before mounting or removing a module. Failure to do so may result in electric shock or cause the module to fail or malfunction.
-

[Installation Precautions]

CAUTION

- Use the module in an environment that meets the general specifications in this manual. Failure to do so may result in electric shock, fire, malfunction, or damage to or deterioration of the product.
 - Do not directly touch any conductive parts and electronic components of the module. Doing so can cause malfunction or failure of the module.
 - Securely connect the cable connectors. Poor contact may cause malfunction.
-

[Wiring Precautions]

WARNING

- Shut off the external power supply (all phases) used in the system before wiring. Failure to do so may result in electric shock or cause the module to fail or malfunction.
-

[Wiring Precautions]

CAUTION

- Individually ground the FG terminal of the programmable controller with a ground resistance of 100 ohms or less. Failure to do so may result in electric shock or malfunction.
 - Tighten any unused terminal screws within the specified torque range. Undertightening can cause a short circuit due to contact with a solderless terminal.
 - Use applicable solderless terminals and tighten them within the specified torque range. If any spade solderless terminal is used, it may be disconnected when a terminal block screw comes loose, resulting in failure.
 - Check the rated voltage and terminal layout before wiring to the module, and connect the cables correctly. Connecting a power supply with a different voltage rating or incorrect wiring may cause a fire or failure.
 - Tighten the terminal block screws within the specified torque range. Undertightening can cause short circuit, fire, or malfunction. Overtightening can damage the screw and/or module, resulting in drop, short circuit, fire, or malfunction.
 - Prevent foreign matter such as dust or wire chips from entering the module. Such foreign matter can cause a fire, failure, or malfunction.
 - Place the cables in a duct or clamp them. If not, dangling cable may swing or inadvertently be pulled, resulting in damage to the module or cables or malfunction due to poor contact.
 - Do not install the control lines or communication cables together with the main circuit lines or power cables. Keep a distance of 100mm or more between them. Failure to do so may result in malfunction due to noise.
 - When disconnecting the cable from the module, do not pull the cable by the cable part. For the cable with connector, hold the connector part of the cable. For the cable connected to the terminal block, loosen the terminal screw. Pulling the cable connected to the module may result in malfunction or damage to the module or cable.
 - When an overcurrent caused by an error of an external device or a failure of the programmable controller flows for a long time, it may cause smoke and fire. To prevent this, configure an external safety circuit, such as a fuse.
 - Mitsubishi Electric programmable controllers must be installed in control panels. Wiring and replacement of a module must be performed by qualified maintenance personnel with knowledge of protection against electric shock. For wiring methods, refer to "INSTALLATION AND WIRING" in this manual.
-

[Startup and Maintenance Precautions]

WARNING

- Do not touch any terminal while power is on. Doing so will cause electric shock or malfunction.
 - Shut off the external power supply (all phases) used in the system before cleaning the module or retightening the terminal block screws or connector screws. Failure to do so may cause the module to fail or malfunction.
-

[Startup and Maintenance Precautions]

CAUTION

- Do not disassemble or modify the module. Doing so may cause failure, malfunction, injury, or a fire.
 - Do not drop or apply strong shock to the module. Doing so may damage the module.
 - Shut off the external power supply (all phases) used in the system before mounting or removing a module. Failure to do so may cause the module to fail or malfunction.
 - After the first use of the product, do not connect/remove the terminal block more than 50 times (Compliant with IEC 61131-2 and JIS B 3502). Exceeding the limit may cause malfunction.
 - Before handling the module or connection cables, touch a conducting object such as a grounded metal to discharge the static electricity from the human body. Failure to do so may cause the module to fail or malfunction.
 - Startup and maintenance of a control panel must be performed by qualified maintenance personnel with knowledge of protection against electric shock. Lock the control panel so that only qualified maintenance personnel can operate it.
-

[Disposal Precautions]

CAUTION

- When disposing of this product, treat it as industrial waste.
-

CONDITIONS OF USE FOR THE PRODUCT

- (1) Mitsubishi programmable controller ("the PRODUCT") shall be used in conditions;
- i) where any problem, fault or failure occurring in the PRODUCT, if any, shall not lead to any major or serious accident; and
 - ii) where the backup and fail-safe function are systematically or automatically provided outside of the PRODUCT for the case of any problem, fault or failure occurring in the PRODUCT.
- (2) The PRODUCT has been designed and manufactured for the purpose of being used in general industries. MITSUBISHI SHALL HAVE NO RESPONSIBILITY OR LIABILITY (INCLUDING, BUT NOT LIMITED TO ANY AND ALL RESPONSIBILITY OR LIABILITY BASED ON CONTRACT, WARRANTY, TORT, PRODUCT LIABILITY) FOR ANY INJURY OR DEATH TO PERSONS OR LOSS OR DAMAGE TO PROPERTY CAUSED BY the PRODUCT THAT ARE OPERATED OR USED IN APPLICATION NOT INTENDED OR EXCLUDED BY INSTRUCTIONS, PRECAUTIONS, OR WARNING CONTAINED IN MITSUBISHI'S USER, INSTRUCTION AND/OR SAFETY MANUALS, TECHNICAL BULLETINS AND GUIDELINES FOR the PRODUCT.
- ("Prohibited Application")
- Prohibited Applications include, but not limited to, the use of the PRODUCT in;
- Nuclear Power Plants and any other power plants operated by Power companies, and/or any other cases in which the public could be affected if any problem or fault occurs in the PRODUCT.
 - Railway companies or Public service purposes, and/or any other cases in which establishment of a special quality assurance system is required by the Purchaser or End User.
 - Aircraft or Aerospace, Medical applications, Train equipment, transport equipment such as Elevator and Escalator, Incineration and Fuel devices, Vehicles, Manned transportation, Equipment for Recreation and Amusement, and Safety devices, handling of Nuclear or Hazardous Materials or Chemicals, Mining and Drilling, and/or other applications where there is a significant risk of injury to the public or property.
- Notwithstanding the above restrictions, Mitsubishi may in its sole discretion, authorize use of the PRODUCT in one or more of the Prohibited Applications, provided that the usage of the PRODUCT is limited only for the specific applications agreed to by Mitsubishi and provided further that no special quality assurance or fail-safe, redundant or other safety features which exceed the general specifications of the PRODUCTS are required. For details, please contact the Mitsubishi representative in your region.
- (3) Mitsubishi shall have no responsibility or liability for any problems involving programmable controller trouble and system trouble caused by DoS attacks, unauthorized access, computer viruses, and other cyberattacks.

INTRODUCTION

Thank you for purchasing the CC-Link IE Field Network Basic remote I/O module (hereafter abbreviated as I/O module). This manual describes the procedures, system configuration, parameter settings, functions, and troubleshooting of the relevant products listed below.

Before using this product, please read this manual and the relevant manuals carefully and develop familiarity with the functions and performance of the I/O module to handle the product correctly.

When applying the program and circuit examples provided in this manual to an actual system, ensure the applicability and confirm that it will not cause system control problems.

Please make sure that the end users read this manual.

Relevant products

NZ2MFB2-16A, NZ2MF2S2-16A, NZ2MFB1-32D, NZ2MF2S1-32D, NZ2MFB2-16R, NZ2MF2S2-16R, NZ2MFB1-32T, NZ2MF2S1-32T, NZ2MFB1-32TE1, NZ2MF2S1-32TE1, NZ2MFB1-32DT, NZ2MF2S1-32DT, NZ2MFB1-32DTE1, NZ2MF2S1-32DTE1

MELIPC

When using the MELIPC, regard "CPU module" as "MELIPC" and read this manual and the relevant manuals.

CONTENTS

SAFETY PRECAUTIONS	1
CONDITIONS OF USE FOR THE PRODUCT	5
INTRODUCTION	6
RELEVANT MANUALS	9
TERMS	10
GENERIC TERMS AND ABBREVIATIONS	10
CHAPTER 1 PRODUCT LINEUP	11
1.1 Input Module	11
1.2 Output Module	11
1.3 I/O Combined Module	12
CHAPTER 2 PART NAMES	13
CHAPTER 3 SPECIFICATIONS	15
3.1 General Specifications	15
3.2 Performance Specifications	16
Input module	16
Output module	28
I/O combined module	46
3.3 Function List	62
3.4 List of Functions of Each Module	62
CHAPTER 4 PROCEDURES BEFORE OPERATION	63
CHAPTER 5 SYSTEM CONFIGURATION	65
CHAPTER 6 INSTALLATION AND WIRING	67
6.1 Before Using the I/O Modules	67
Input modules	67
Output module	68
6.2 Setting Switch	73
IP address setting switch setting	73
Function setting switch setting	76
6.3 Installation Environment and Installation Position	77
Installation environment	77
Installation position	77
Installation direction	78
6.4 Installation	79
Mounting the module on a DIN rail	79
6.5 Wiring	81
Wiring of terminal block for module power supply and FG	81
Wiring of Ethernet cable	83
Wiring of external device and I/O terminal block	84
CHAPTER 7 PARAMETER SETTING	88
7.1 Network Configuration Setting	88

CHAPTER 8	FUNCTIONS	90
8.1	Input Response Time Setting Function	90
8.2	Output HOLD/CLEAR Setting Function	91
8.3	Protection Function	92
8.4	SLMP communication function	93
CHAPTER 9	PROGRAMMING	94
9.1	Precautions for Programming	94
9.2	Program Example	95
CHAPTER 10	MAINTENANCE AND INSPECTION	99
CHAPTER 11	TROUBLESHOOTING	101
11.1	Checking the LEDs	101
11.2	CC-Link IE Field Network Basic Diagnostics	103
11.3	Troubleshooting by Symptom	104
11.4	Examples of Troubles with the I/O Module	105
	Troubleshooting for input circuit	105
	Troubleshooting for output circuit	110
11.5	Method for Checking Errors	116
11.6	Error Code List	117
	I/O module specific error	117
	CC-Link IE Field Network Basic related error	117
APPENDICES		118
Appendix 1	Remote I/O Signal	118
	List of remote I/O signals	118
	Details of remote input signals	123
	Details of remote output signals	123
Appendix 2	Remote Register	124
	List of remote register	124
Appendix 3	Setting IP Addresses and Subnet Masks	125
Appendix 4	Diagnostic Information of Slave Station	127
	Diagnostic information list	127
	Diagnostic information details	128
Appendix 5	Processing Time	131
Appendix 6	EMC and Low Voltage Directives	132
	Measures to comply with the EMC Directive	132
	Requirements to compliance with the Low Voltage Directive	138
Appendix 7	How to Check Serial Number and Function Version	139
Appendix 8	External Dimensions	140
INDEX		142
REVISIONS		144
WARRANTY		145
TRADEMARKS		146

RELEVANT MANUALS

Manual name [manual number]	Description	Available form
CC-Link IE Field Network Basic Remote I/O Module User's Manual [SH-081763ENG] (this manual)	Part names, specifications, procedures before operation, system configuration, installation, wiring, parameter settings, functions, programming, and troubleshooting of the I/O module	Print book e-Manual PDF
CC-Link IE Field Network Basic Reference Manual [SH-081684ENG]	Specifications, procedures before operation, system configuration, programming, functions, parameter settings, and troubleshooting of CC-Link IE Field Network Basic	Print book e-Manual PDF
SLMP Reference Manual [SH-080956ENG]	The protocol (SLMP) used for data reading or writing from an external device to the Ethernet-equipped module	Print book e-Manual PDF
GX Works3 Operating Manual [SH-081215ENG]	System configuration, parameter settings, and online operations of GX Works3	e-Manual PDF
GX Works2 Version 1 Operating Manual (Common) [SH-080779ENG]	Functions common to Simple project and Structured project, such as the system configuration, parameter settings, and online operations of GX Works2	Print book e-Manual PDF

Point

e-Manual refers to the Mitsubishi Electric FA electronic book manuals that can be browsed using a dedicated tool.

e-Manual has the following features:

- Required information can be cross-searched in multiple manuals.
- Other manuals can be accessed from the links in the manual.
- The hardware specifications of each part can be found from the product figures.
- Pages that users often browse can be bookmarked.
- Sample programs can be copied to an engineering tool.

TERMS

Unless otherwise specified, this manual uses the following terms.

Term	Description
Cyclic transmission	A function by which data are periodically exchanged among stations on the same network using link devices
Link device	A device (RX, RY, RWr, RWW) in a CPU module and a MELIPC that is used for communications with a slave station
Master station	A station that controls the entire CC-Link IE Field Network Basic. Only one master station can be used in a network.
Reference response time	A time period taken from when a slave station on CC-Link IE Field Network Basic receives a request from the master station until it returns the response to the master station.
Reserved station	A station reserved for future use. This station is not actually connected, but counted as a connected station.
Slave station	A station that performs cyclic transmission with the master station on CC-Link IE Field Network Basic. The station exchanges I/O signals (bit data) or I/O data (word data) with another station.
SLMP	A SeamLess Message Protocol. This protocol is used to access an SLMP-compatible device or a programmable controller connected to an SLMP-compatible device from an external device.

GENERIC TERMS AND ABBREVIATIONS

Unless otherwise specified, this manual uses the following generic terms and abbreviations.

Generic term/abbreviation	Description
I/O combined module	A generic term for CC-Link IE Field Network Basic remote I/O modules where a digital signal can be input and output
I/O module	A generic term for CC-Link IE Field Network Basic remote I/O modules
Input module	A generic term for CC-Link IE Field Network Basic remote I/O modules where a digital signal can be input
Output module	A generic term for CC-Link IE Field Network Basic remote I/O modules where a digital signal can be output

1 PRODUCT LINEUP

1.1 Input Module

Module name		Input specifications	Module power supply current	Weight	Model	Reference
AC input module		Screw terminal block 100 to 120VAC, 16 points	64mA	0.31kg	NZ2MFB2-16A	☞ Page 16 NZ2MFB2-16A AC input module
		Spring clamp terminal block 100 to 120VAC, 16 points	64mA	0.26kg	NZ2MF2S2-16A	☞ Page 19 NZ2MF2S2-16A AC input module
DC input module	Positive common/ negative common shared type	Screw terminal block 24VDC, 32 points	71mA	0.30kg	NZ2MFB1-32D	☞ Page 22 NZ2MFB1-32D DC input module
		Spring clamp terminal block 24VDC, 32 points	71mA	0.25kg	NZ2MF2S1-32D	☞ Page 25 NZ2MF2S1-32D DC input module

1.2 Output Module

Module name		Output specifications	Module power supply current	Weight	Model	Reference
Contact output module		Screw terminal block 240VAC/24VDC, 2A/point, 16 points	153mA	0.35kg	NZ2MFB2-16R	☞ Page 28 NZ2MFB2-16R contact output module
		Spring clamp terminal block 240VAC/24VDC, 2A/point, 16 points	153mA	0.30kg	NZ2MF2S2-16R	☞ Page 31 NZ2MF2S2-16R contact output module
Transistor output module	Sink type	Screw terminal block 12 to 24VDC, 0.5A/point, 32 points	85mA	0.30kg	NZ2MFB1-32T	☞ Page 34 NZ2MFB1-32T transistor output module
		Spring clamp terminal block 12 to 24VDC, 0.5A/point, 32 points	85mA	0.25kg	NZ2MF2S1-32T	☞ Page 37 NZ2MF2S1-32T transistor output module
	Source type	Screw terminal block 12 to 24VDC, 0.1A/point, 32 points	84mA	0.30kg	NZ2MFB1-32TE1	☞ Page 40 NZ2MFB1-32TE1 transistor output module
		Spring clamp terminal block 12 to 24VDC, 0.1A/point, 32 points	84mA	0.25kg	NZ2MF2S1-32TE1	☞ Page 43 NZ2MF2S1-32TE1 transistor output module

1.3 I/O Combined Module

Module name		Input specifications, output specifications	Module power supply current	Weight	Model	Reference
DC input/transistor output module	Input part: Positive common type	Screw terminal block 24VDC, 16 points	79mA	0.30kg	NZ2MFB1-32DT	☞ Page 46 NZ2MFB1-32DT DC input/transistor output module
	Output part: Sink type	Screw terminal block 24VDC, 0.5A/point, 16 points				
	Input part: Positive common type	Spring clamp terminal block 24VDC, 16 points	79mA	0.25kg	NZ2MF2S1-32DT	☞ Page 50 NZ2MF2S1-32DT DC input/transistor output module
	Output part: Sink type	Spring clamp terminal block 24VDC, 0.5A/point, 16 points				
	Input part: Negative common type	Screw terminal block 24VDC, 16 points	79mA	0.30kg	NZ2MFB1-32DTE1	☞ Page 54 NZ2MFB1-32DTE1 DC input/transistor output module
	Output part: Source type	Screw terminal block 24VDC, 0.1A/point, 16 points				
	Input part: Negative common type	Spring clamp terminal block 24VDC, 16 points	79mA	0.25kg	NZ2MF2S1-32DTE1	☞ Page 58 NZ2MF2S1-32DTE1 DC input/transistor output module
	Output part: Source type	Spring clamp terminal block 24VDC, 0.1A/point, 16 points				

2 PART NAMES

This chapter describes part names of the I/O module.

- Screw terminal block type

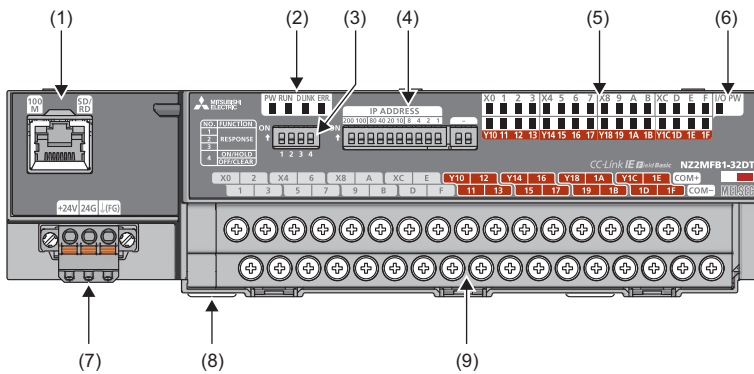

- Spring clamp terminal block type

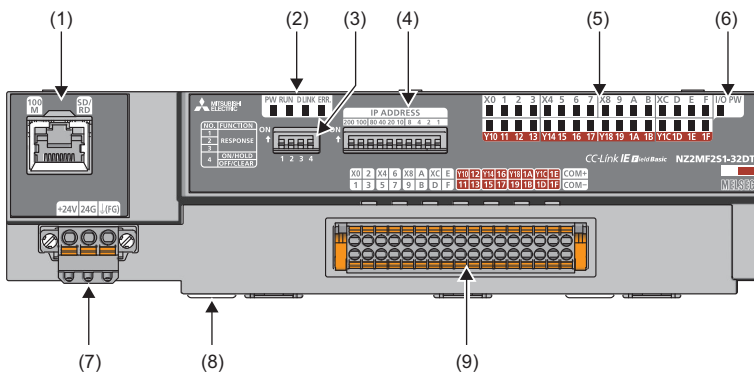

No.	Name	Application
(1)	Ethernet port	Port connector for network connection. Connect an Ethernet cable. For wiring method and precautions, refer to the following. ☞ Page 83 Wiring of Ethernet cable
	100M LED	Indicates the link status. On: Linkup in progress Off: Linkdown in progress
	SD/RD LED	Indicates the status of data communication. On: Data being sent or received Off: Data not sent/received
(2)	PW LED	Indicates the power supply status of the I/O module. On: Power supply ON Off: Power supply OFF
	RUN LED	Indicates the operating status of the I/O module. On: Operating normally. Off: A major error has occurred.
	D LINK LED	Indicates the data link status of the I/O module. On: Data link in operation. (cyclic transmission in progress) Flashing: Data link stop (cyclic transmission stopped) Off: Data link not performed. (disconnected)
	ERR. LED	Indicates the error status of the I/O module. On: A moderate error or major error has occurred. Flashing: A minor error has occurred. Off: Operating normally.
(3)	Function setting switch	Used for the input response time setting function and output HOLD/CLEAR setting function. For function details and setting method, refer to the following. ☞ Page 90 Input Response Time Setting Function ☞ Page 91 Output HOLD/CLEAR Setting Function
(4)	IP address setting switch	Switch for setting the fourth octet of IP address ☞ Page 73 IP address setting switch setting

No.	Name	Application
(5)	X0 LED to XF LED	Indicates the ON/OFF status of the inputs.*1 On: Input ON Off: Input OFF
	Y10 LED to Y1F LED	Indicates the ON/OFF status of the outputs.*2 On: Output ON Off: Output OFF
(6)	I/O PW LED	Indicates the status of the power supply from the external power supply. On: External power supply ON Off: External power supply OFF
(7)	Terminal block for module power supply and FG	A terminal block to connect the module power supply (24VDC) and FG.
(8)	DIN rail hook	A hook to mount an I/O module on a DIN rail
(9)	I/O terminal block	A terminal block for I/O power supply and I/O signals

*1 The status of actual input signals that are externally input is indicated on the LEDs regardless of the status of the remote input signal.

*2 Output commands from the I/O module are indicated on the LEDs regardless of the status of the external power supply.

3 SPECIFICATIONS

This chapter describes the specifications of the I/O module.

3.1 General Specifications

Item	Specifications					
Operating ambient temperature	0 to 55°C					
Storage ambient temperature	-25 to 75°C					
Operating ambient humidity	5 to 95%RH, non-condensing					
Storage ambient humidity						
Vibration resistance	Compliant with JIS B 3502 and IEC 61131-2	—	Frequency	Constant acceleration	Half amplitude	Sweep count
		Under intermittent vibration	5 to 8.4Hz	—	3.5mm	10 times each in X, Y, and Z directions
			8.4 to 150Hz	9.8m/s ²	—	
		Under continuous vibration	5 to 8.4Hz	—	1.75mm	—
8.4 to 150Hz	4.9m/s ²		—			
Shock resistance	Compliant with JIS B 3502 and IEC 61131-2 (147m/s ² , 3 times each in X, Y, and Z directions)					
Operating atmosphere	No corrosive gases, flammable gases, less conductive dust					
Operating altitude* ¹	0 to 2000m					
Installation location	Inside a control panel* ²					
Overvoltage category* ³	II or less					
Pollution degree* ⁴	2 or less					
Equipment class	Class I					

*1 Do not use or store the I/O module under pressure higher than the atmospheric pressure of altitude 0m. Doing so may cause malfunction. When using the I/O module under pressure, please consult your local Mitsubishi representative.

*2 If the environment satisfies the operating ambient temperature, operating ambient humidity and other conditions, the module can be used even outside the control panel.

*3 This indicates the section of the power supply to which the equipment is assumed to be connected between the public electrical power distribution network and the machinery within premises.

Category II applies to equipment for which electrical power is supplied from fixed facilities. The surge voltage withstand level for up to the rated voltage of 300V is 2500V.

*4 This index indicates the degree to which conductive material is generated in terms of the environment in which the equipment is used. Pollution degree 2 is when only non-conductive pollution occurs. A temporary conductivity caused by condensing must be expected occasionally.

Point

To ensure that this product complies with the EMC Directive, refer to the following.

☞ Page 132 EMC and Low Voltage Directives

3.2 Performance Specifications

Input module

NZ2MFB2-16A AC input module

Item	NZ2MFB2-16A	
Station type	Slave station	
Number of input points	16 points	
Rated input voltage/rated frequency	100 to 120VAC (+10%/-15%), 50/60Hz (±3Hz)	
Rated input current	8.2mA (100VAC, 60Hz), 6.8mA (100VAC, 50Hz)	
Inrush current	200mA maximum within 1ms	
Input voltage distortion ratio	Within 5%	
Max. number of simultaneous input points	100%	
ON voltage/ON current	80VAC or more/5mA or more (50Hz, 60Hz)	
OFF voltage/OFF current	30VAC or less/1.7mA or less (50Hz, 60Hz)	
Input impedance	Approx. 15kΩ (60Hz), approx. 18kΩ (50Hz)	
Input response time	OFF→ON	20ms or less (100VAC 60Hz)
	ON→OFF	
Withstand voltage	1400VACrms for 1 minute between all AC external terminals and the ground 510VACrms for 1 minute between all DC external terminals and the ground	
Insulation resistance	10MΩ or higher between all AC external terminals and the ground, all DC external terminals and the ground (500VDC insulation resistance tester)	
Noise immunity	Noise voltage: 1500Vp-p (AC type), 500Vp-p (DC type), noise width 1μs, noise frequency 25 to 60Hz (noise simulator condition)	
Protection degree	IP1X	
Wiring method for common	16 points/common (2-wire, screw terminal block type)	
External interface	Communication part	RJ45 connector
	Module power supply part	Terminal block for module power supply and FG (Two-piece spring clamp terminal block)
	I/O part	34-point one-piece terminal block Tightening torque range for terminal screw (M3 × 5.2 screw): 0.59 to 0.88N·m
Applicable DIN rail	TH35-7.5Fe, TH35-7.5Al (compliant with IEC 60715/JIS C 2812)	
Applicable wire size	For power supply	Stranded wire: 0.3 to 1.5mm ² (22 to 16 AWG), terminal slot size: 2.8mm × 2.0mm ^{*2}
	For I/O	Core: 0.3 to 2.0mm ² (22 to 14 AWG)
Applicable solderless terminal	Terminal block for module power supply and FG ^{*1}	☞ Page 81 Applicable solderless terminal
	Terminal block for input	☞ Page 84 Applicable solderless terminal
Number of occupied stations	One station	
Reference response time	1ms	
Communication cable	An Ethernet cable that meets the 100BASE-TX standard For details, refer to the following. ☞ CC-Link IE Field Network Basic Reference Manual	
Module power supply	Voltage	24VDC (ripple rate: 5% or less) (Allowable voltage range: 20.4 to 28.8VDC)
	Current	64mA or less (24VDC, all points ON)
Weight	0.31kg	

*1 Only one wire can be connected to a terminal of the terminal block for module power supply and FG. Multiple wires cannot be connected to a terminal. Connecting two or more wires may cause a poor contact.

*2 It is recommended to use the bar solderless terminal for wiring.

External connection

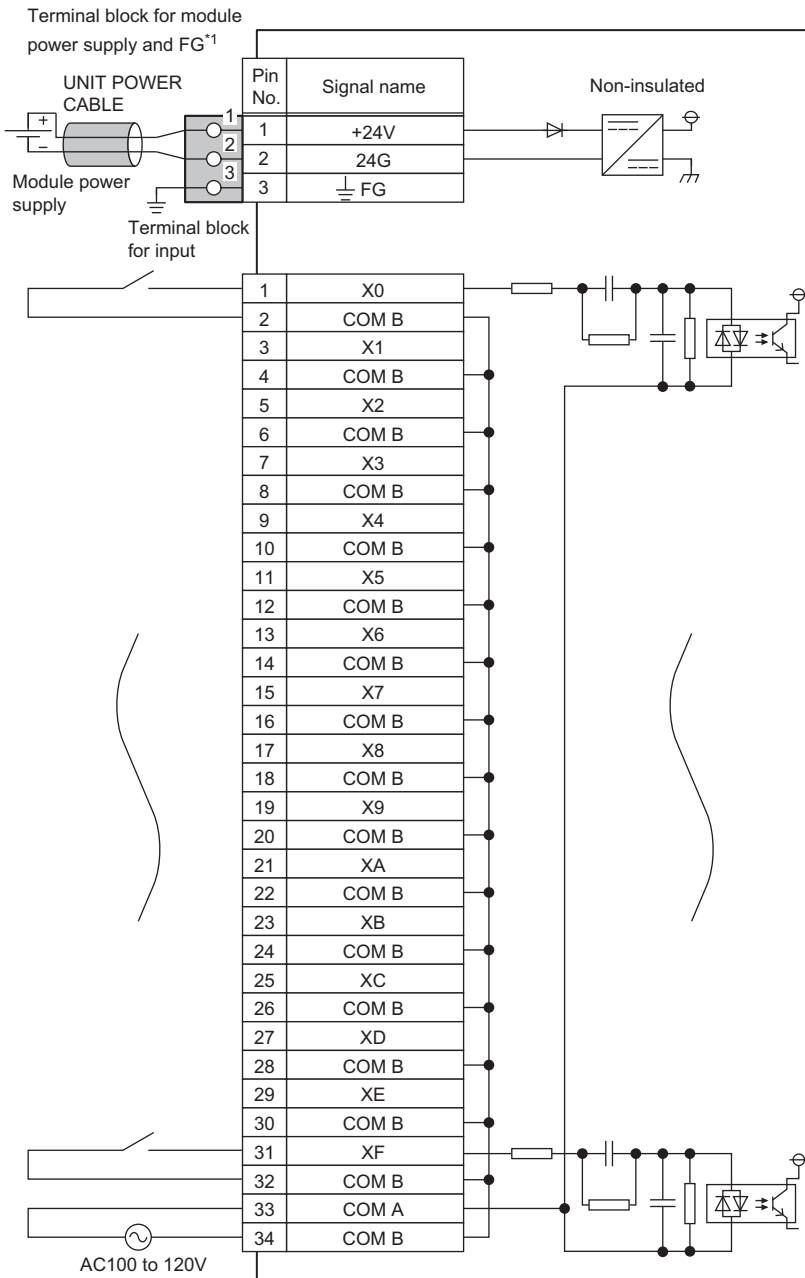

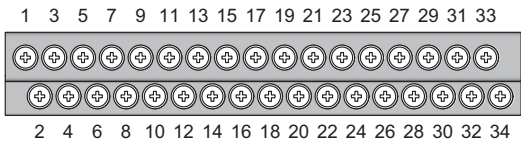

*1 Only one wire can be connected to a terminal of the terminal block for module power supply and FG. Multiple wires cannot be connected to a terminal. Connecting two or more wires may cause a poor contact.

■ Terminal block for input



Pin number	Signal name	Pin number	Signal name
1	X0	17	X8
2	COM B	18	COM B
3	X1	19	X9
4	COM B	20	COM B
5	X2	21	XA
6	COM B	22	COM B
7	X3	23	XB
8	COM B	24	COM B
9	X4	25	XC
10	COM B	26	COM B
11	X5	27	XD
12	COM B	28	COM B
13	X6	29	XE
14	COM B	30	COM B
15	X7	31	XF
16	COM B	32	COM B
—		33	COM A
		34	COM B

NZ2MF2S2-16A AC input module

Item		NZ2MF2S2-16A
Station type		Slave station
Number of input points		16 points
Rated input voltage/rated frequency		100 to 120VAC (+10%/-15%), 50/60Hz (± 3 Hz)
Rated input current		8.2mA (100VAC, 60Hz), 6.8mA (100VAC, 50Hz)
Inrush current		200mA maximum within 1ms
Input voltage distortion ratio		Within 5%
Max. number of simultaneous input points		100%
ON voltage/ON current		80VAC or more/5mA or more (50Hz, 60Hz)
OFF voltage/OFF current		30VAC or less/1.7mA or less (50Hz, 60Hz)
Input impedance		Approx. 15k Ω (60Hz), approx. 18k Ω (50Hz)
Input response time	OFF→ON	20ms or less (100VAC 60Hz)
	ON→OFF	
Withstand voltage		1400VACrms for 1 minute between all AC external terminals and the ground 510VACrms for 1 minute between all DC external terminals and the ground
Insulation resistance		10M Ω or higher between all AC external terminals and the ground, all DC external terminals and the ground (500VDC insulation resistance tester)
Noise immunity		Noise voltage: 1500Vp-p (AC type), 500Vp-p (DC type), noise width 1 μ s, noise frequency 25 to 60Hz (noise simulator condition)
Protection degree		IP1X
Wiring method for common		16 points/common (2-wire, terminal block type)
External interface	Communication part	RJ45 connector
	Module power supply part	Terminal block for module power supply and FG (Two-piece spring clamp terminal block)
	I/O part	34-point two-piece spring clamp terminal block
Applicable DIN rail		TH35-7.5Fe, TH35-7.5Al (compliant with IEC 60715/JIS C 2812)
Applicable wire size	For power supply	Stranded wire: 0.3 to 1.5mm ² (22 to 16 AWG), terminal slot size: 2.8mm \times 2.0mm ^{*2}
	For I/O	Stranded wire: 0.3 to 1.5mm ² (22 to 16 AWG), terminal slot size: 2.4mm \times 1.5mm ^{*2}
Applicable solderless terminal	Terminal block for module power supply and FG ^{*1}	 Page 81 Applicable solderless terminal
	Terminal block for input ^{*1}	 Page 85 Applicable solderless terminal
Number of occupied stations		One station
Reference response time		1ms
Communication cable		An Ethernet cable that meets the 100BASE-TX standard For details, refer to the following.  CC-Link IE Field Network Basic Reference Manual
Module power supply	Voltage	24VDC (ripple rate: 5% or less) (Allowable voltage range: 20.4 to 28.8VDC)
	Current	64mA or less (24VDC, all points ON)
Weight		0.26kg

*1 Only one wire can be connected to a terminal of the terminal block for module power supply and FG or the terminal block for input. Multiple wires cannot be connected to a terminal. Connecting two or more wires may cause a poor contact.

*2 It is recommended to use the bar solderless terminal for wiring.

External connection

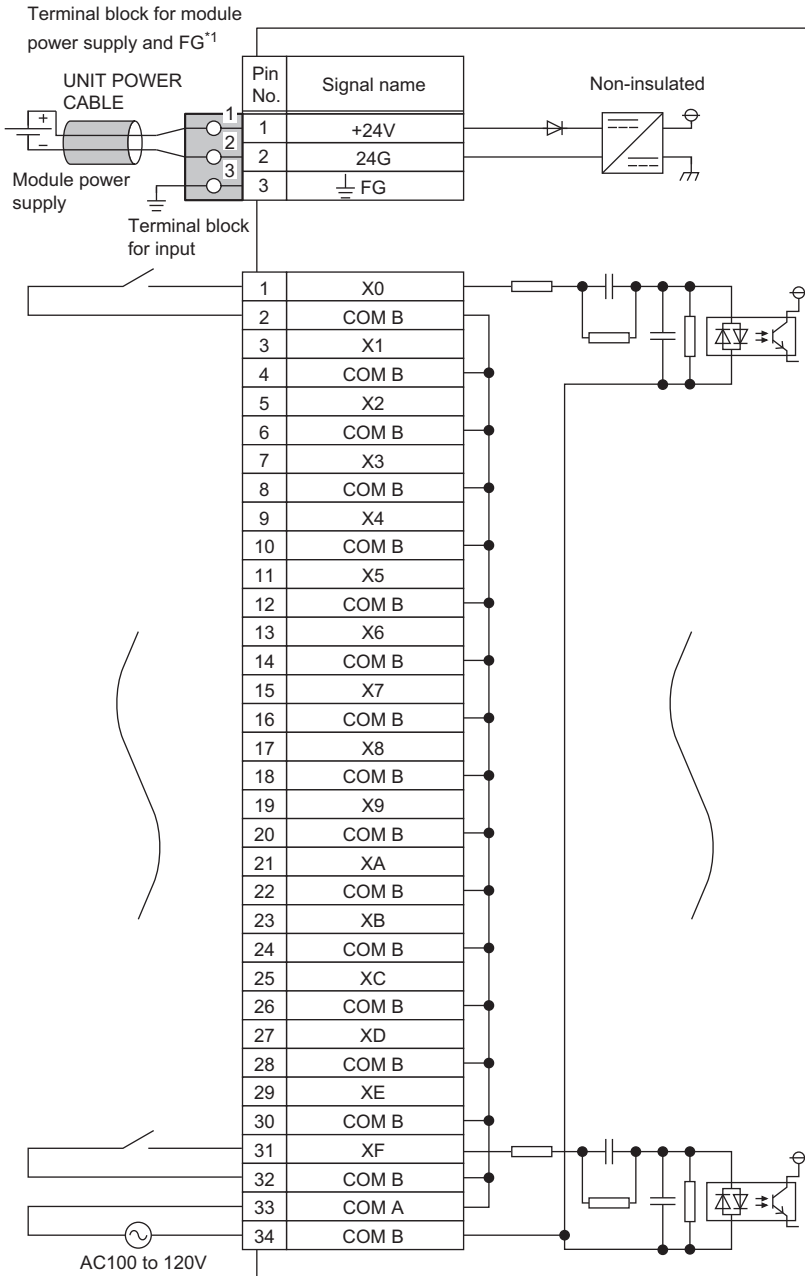

*1 Only one wire can be connected to a terminal of the terminal block for module power supply and FG or the terminal block for input. Multiple wires cannot be connected to a terminal. Connecting two or more wires may cause a poor contact.

Terminal block for input

1 3 5 7 9 11 13 15 17 19 21 23 25 27 29 31 33

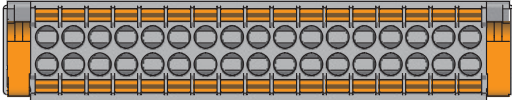

2 4 6 8 10 12 14 16 18 20 22 24 26 28 30 32 34

Pin number	Signal name	Pin number	Signal name
1	X0	17	X8
2	COM B	18	COM B
3	X1	19	X9
4	COM B	20	COM B
5	X2	21	XA
6	COM B	22	COM B
7	X3	23	XB
8	COM B	24	COM B
9	X4	25	XC
10	COM B	26	COM B
11	X5	27	XD
12	COM B	28	COM B
13	X6	29	XE
14	COM B	30	COM B
15	X7	31	XF
16	COM B	32	COM B
—		33	COM A
		34	COM B

NZ2MFB1-32D DC input module

Item		NZ2MFB1-32D
Station type		Slave station
Number of input points		32 points
Rated input voltage		24VDC (ripple rate: 5% or less) (Allowable voltage range: 20.4 to 28.8VDC)
Rated input current		6.0mA TYP. (for 24VDC)
Isolation method		Photocoupler isolation
Max. number of simultaneous input points		100%
ON voltage/ON current		15VDC or more/4mA or more
OFF voltage/OFF current		5VDC or less/1.7mA or less
Input resistance		3.8kΩ
Input response time	OFF→ON	0ms* ¹ /0.2ms/1ms/1.5ms/5ms/10ms/20ms/70ms
	ON→OFF	(Initial setting: 10ms)
Input type		Positive common/negative common shared type
Withstand voltage		500VAC for 1 minute between all DC external terminals and the ground
Insulation resistance		10MΩ or higher between all DC external terminals and ground (500VDC insulation resistance tester)
Noise immunity* ²		Noise voltage 500Vp-p, noise width 1μs, noise frequency 25 to 60Hz (DC type noise simulator condition)
Protection degree		IP2X
Wiring method for common		32 points/common (two points) (1-wire, screw terminal block type)
External interface	Communication part	RJ45 connector
	Module power supply part	Terminal block for module power supply and FG (Two-piece spring clamp terminal block)
	I/O part	34-point one-piece terminal block Tightening torque range for terminal screw (M3 × 5.2 screw): 0.59 to 0.88N·m
Applicable DIN rail		TH35-7.5Fe, TH35-7.5Al (compliant with IEC 60715/JIS C 2812)
Applicable wire size	For power supply	Stranded wire: 0.3 to 1.5mm ² (22 to 16 AWG), terminal slot size: 2.8mm × 2.0mm* ⁴
	For I/O	Core: 0.3 to 2.0mm ² (22 to 14 AWG)
Applicable solderless terminal	Terminal block for module power supply and FG* ³	☞ Page 81 Applicable solderless terminal
	Terminal block for input	☞ Page 84 Applicable solderless terminal
Number of occupied stations		One station
Reference response time		1ms
Communication cable		An Ethernet cable that meets the 100BASE-TX standard For details, refer to the following. ☞ CC-Link IE Field Network Basic Reference Manual
Module power supply	Voltage	24VDC (ripple rate: 5% or less) (Allowable voltage range: 20.4 to 28.8VDC)
	Current	71mA or less (24VDC, all points ON)
Weight		0.30kg

*1 If the input response time is set to "0ms", the actual input response time is 80μs at OFF → ON, and 160μs at ON → OFF.

*2 It is the noise immunity of when the input response time setting value is other than "0ms". Note that the module is easily affected by noise if "0ms" is set.

*3 Only one wire can be connected to a terminal of the terminal block for module power supply and FG. Multiple wires cannot be connected to a terminal. Connecting two or more wires may cause a poor contact.

*4 It is recommended to use the bar solderless terminal for wiring.

External connection

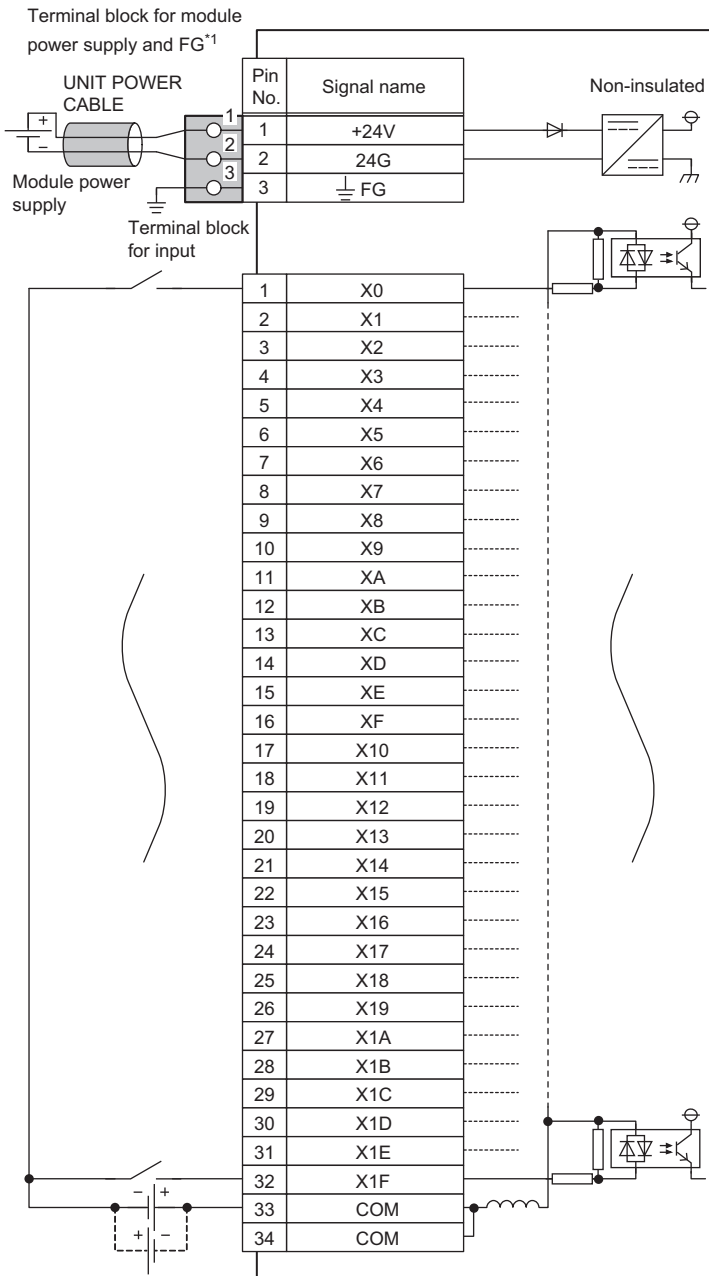

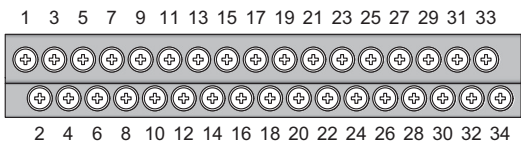

*1 Only one wire can be connected to a terminal of the terminal block for module power supply and FG. Multiple wires cannot be connected to a terminal. Connecting two or more wires may cause a poor contact.

■ Terminal block for input



Pin number	Signal name	Pin number	Signal name
1	X0	17	X10
2	X1	18	X11
3	X2	19	X12
4	X3	20	X13
5	X4	21	X14
6	X5	22	X15
7	X6	23	X16
8	X7	24	X17
9	X8	25	X18
10	X9	26	X19
11	XA	27	X1A
12	XB	28	X1B
13	XC	29	X1C
14	XD	30	X1D
15	XE	31	X1E
16	XF	32	X1F
—		33	COM
		34	COM

NZ2MF2S1-32D DC input module

Item		NZ2MF2S1-32D
Station type		Slave station
Number of input points		32 points
Rated input voltage		24VDC (ripple rate: 5% or less) (Allowable voltage range: 20.4 to 28.8VDC)
Rated input current		6.0mA TYP. (for 24VDC)
Isolation method		Photocoupler isolation
Max. number of simultaneous input points		100%
ON voltage/ON current		15VDC or more/4mA or more
OFF voltage/OFF current		5VDC or less/1.7mA or less
Input resistance		3.8k Ω
Input response time	OFF→ON	0ms ^{*1} /0.2ms/1ms/1.5ms/5ms/10ms/20ms/70ms (Initial setting: 10ms)
	ON→OFF	
Input type		Positive common/negative common shared type
Withstand voltage		500VAC for 1 minute between all DC external terminals and the ground
Insulation resistance		10M Ω or higher between all DC external terminals and ground (500VDC insulation resistance tester)
Noise immunity ^{*2}		Noise voltage 500Vp-p, noise width 1 μ s, noise frequency 25 to 60Hz (DC type noise simulator condition)
Protection degree		IP2X
Wiring method for common		32 points/common (two points) (1-wire, spring clamp terminal block type)
External interface	Communication part	RJ45 connector
	Module power supply part	Terminal block for module power supply and FG (Two-piece spring clamp terminal block)
	I/O part	34-point two-piece spring clamp terminal block
Applicable DIN rail		TH35-7.5Fe, TH35-7.5Al (compliant with IEC 60715/JIS C 2812)
Applicable wire size	For power supply	Stranded wire: 0.3 to 1.5mm ² (22 to 16 AWG), terminal slot size: 2.8mm × 2.0mm ^{*4}
	For I/O	Stranded wire: 0.3 to 1.5mm ² (22 to 16 AWG), terminal slot size: 2.4mm × 1.5mm ^{*4}
Applicable solderless terminal	Terminal block for module power supply and FG ^{*3}	 Page 81 Applicable solderless terminal
	Terminal block for input ^{*3}	 Page 85 Applicable solderless terminal
Number of occupied stations		One station
Reference response time		1ms
Communication cable		An Ethernet cable that meets the 100BASE-TX standard For details, refer to the following.  CC-Link IE Field Network Basic Reference Manual
Module power supply	Voltage	24VDC (ripple rate: 5% or less) (Allowable voltage range: 20.4 to 28.8VDC)
	Current	71mA or less (24VDC, all points ON)
Weight		0.25kg

*1 If the input response time is set to "0ms", the actual input response time is 80 μ s at OFF → ON, and 160 μ s at ON → OFF.

*2 It is the noise immunity of when the input response time setting value is other than "0ms". Note that the module is easily affected by noise if "0ms" is set.

*3 Only one wire can be connected to a terminal of the terminal block for module power supply and FG or the terminal block for input. Multiple wires cannot be connected to a terminal. Connecting two or more wires may cause a poor contact.

*4 It is recommended to use the bar solderless terminal for wiring.

External connection

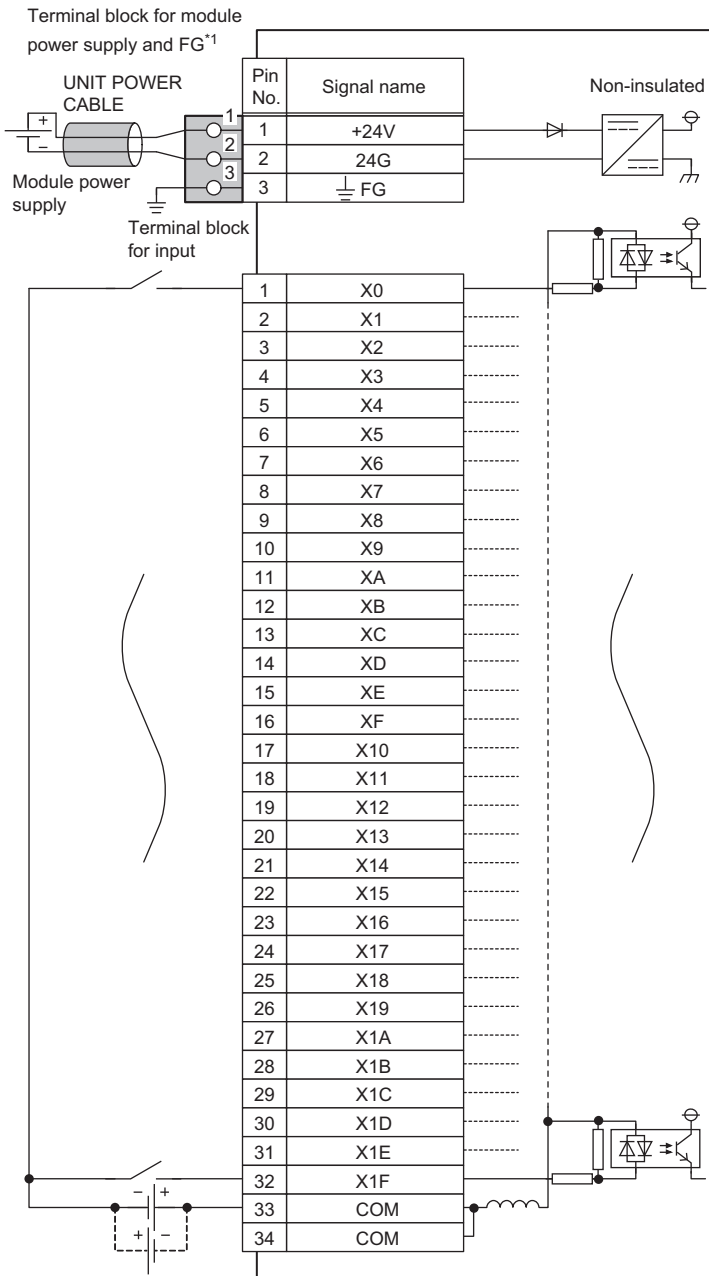

*1 Only one wire can be connected to a terminal of the terminal block for module power supply and FG or the terminal block for input. Multiple wires cannot be connected to a terminal. Connecting two or more wires may cause a poor contact.

Terminal block for input

1 3 5 7 9 11 13 15 17 19 21 23 25 27 29 31 33

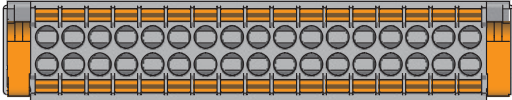

2 4 6 8 10 12 14 16 18 20 22 24 26 28 30 32 34

Pin number	Signal name	Pin number	Signal name
1	X0	17	X10
2	X1	18	X11
3	X2	19	X12
4	X3	20	X13
5	X4	21	X14
6	X5	22	X15
7	X6	23	X16
8	X7	24	X17
9	X8	25	X18
10	X9	26	X19
11	XA	27	X1A
12	XB	28	X1B
13	XC	29	X1C
14	XD	30	X1D
15	XE	31	X1E
16	XF	32	X1F
—		33	COM
		34	COM

Output module

NZ2MFB2-16R contact output module

Item		NZ2MFB2-16R
Station type		Slave station
Number of output points		16 points
Rated switching voltage/current		24VDC 2A (resistance load)/point, 8A/common 240VAC 2A (COS ϕ = 1)/point, 8A/common
Minimum switching load		5VDC 1mA
Maximum switching load		264VAC 125VDC
Output response time	OFF→ON	10ms or less
	ON→OFF	12ms or less
Life	Mechanical	20 million times or more
	Electrical	Rated switching voltage/current load 100 thousand times or more ☞ Page 69 Relay life (contact switching life)
Maximum switching frequency		3600 times/hour
Surge suppressor		None
Fuse		None
Withstand voltage		2300VACrms for 1 minute between all AC external terminals and the ground 510VACrms for 1 minute between all DC external terminals and the ground
Insulation resistance		10M Ω or higher between all AC external terminals and the ground, all DC external terminals and the ground (500VDC insulation resistance tester)
Noise immunity		Noise voltage: 1500Vp-p (AC type), 500Vp-p (DC type), noise width 1 μ s, noise frequency 25 to 60Hz (noise simulator condition)
Protection degree		IP1X
Wiring method for common		16 points/common (2-wire, screw terminal block type)
External interface	Communication part	RJ45 connector
	Module power supply part	Terminal block for module power supply and FG (Two-piece spring clamp terminal block)
	I/O part	34-point one-piece terminal block Tightening torque range for terminal screw (M3 \times 5.2 screw): 0.59 to 0.88N·m
Applicable DIN rail		TH35-7.5Fe, TH35-7.5Al (compliant with IEC 60715/JIS C 2812)
Applicable wire size	For power supply	Stranded wire: 0.3 to 1.5mm ² (22 to 16 AWG), terminal slot size: 2.8mm \times 2.0mm ^{*2}
	For I/O	Core: 0.3 to 2.0mm ² (22 to 14 AWG)
Applicable solderless terminal	Terminal block for module power supply and FG ^{*1}	☞ Page 81 Applicable solderless terminal
	Terminal block for output	☞ Page 84 Applicable solderless terminal
Number of occupied stations		One station
Reference response time		1ms
Communication cable		An Ethernet cable that meets the 100BASE-TX standard For details, refer to the following. ☞ CC-Link IE Field Network Basic Reference Manual
Module power supply	Voltage	24VDC (ripple rate: 5% or less) (Allowable voltage range: 20.4 to 28.8VDC)
	Current	153mA or less (24VDC, all points ON)
Weight		0.35kg

*1 Only one wire can be connected to a terminal of the terminal block for module power supply and FG. Multiple wires cannot be connected to a terminal. Connecting two or more wires may cause a poor contact.

*2 It is recommended to use the bar solderless terminal for wiring.

External connection

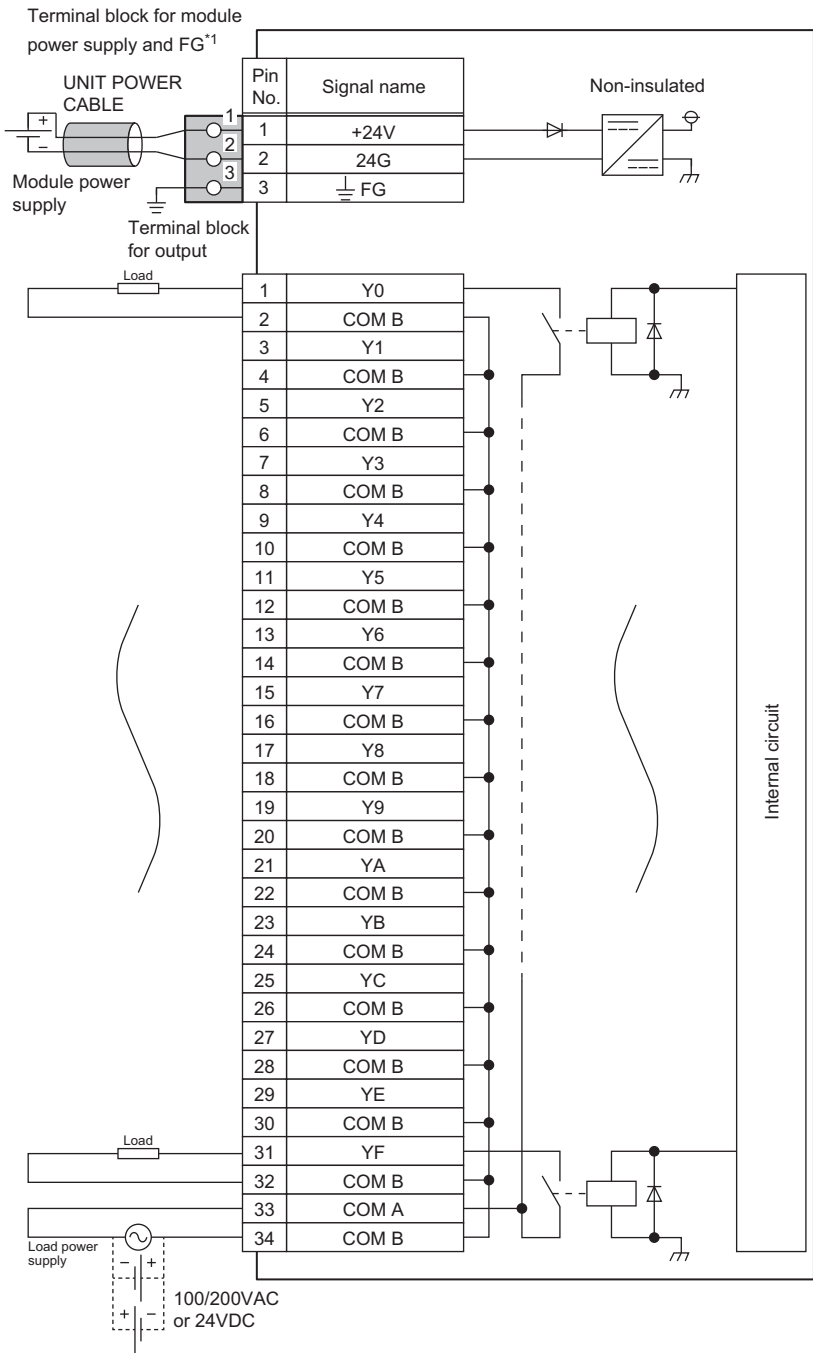

*1 Only one wire can be connected to a terminal of the terminal block for module power supply and FG. Multiple wires cannot be connected to a terminal. Connecting two or more wires may cause a poor contact.

■ Terminal block for output

1 3 5 7 9 11 13 15 17 19 21 23 25 27 29 31 33

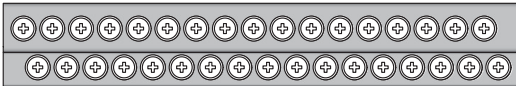

2 4 6 8 10 12 14 16 18 20 22 24 26 28 30 32 34

Pin number	Signal name	Pin number	Signal name
1	Y0	17	Y8
2	COM B	18	COM B
3	Y1	19	Y9
4	COM B	20	COM B
5	Y2	21	YA
6	COM B	22	COM B
7	Y3	23	YB
8	COM B	24	COM B
9	Y4	25	YC
10	COM B	26	COM B
11	Y5	27	YD
12	COM B	28	COM B
13	Y6	29	YE
14	COM B	30	COM B
15	Y7	31	YF
16	COM B	32	COM B
—		33	COM A
		34	COM B

NZ2MF2S2-16R contact output module

Item		NZ2MF2S2-16R
Station type		Slave station
Number of output points		16 points
Rated switching voltage/current		24VDC 2A (resistance load)/point, 8A/common 240VAC 2A (COS ϕ = 1)/point, 8A/common
Minimum switching load		5VDC 1mA
Maximum switching load		264VAC 125VDC
Output response time	OFF→ON	10ms or less
	ON→OFF	12ms or less
Life	Mechanical	20 million times or more
	Electrical	Rated switching voltage/current load 100 thousand times or more ☞ Page 69 Relay life (contact switching life)
Maximum switching frequency		3600 times/hour
Surge suppressor		None
Fuse		None
Withstand voltage		2300VACrms for 1 minute between all AC external terminals and the ground 510VACrms for 1 minute between all DC external terminals and the ground
Insulation resistance		10M Ω or higher between all AC external terminals and the ground, all DC external terminals and the ground (500VDC insulation resistance tester)
Noise immunity		Noise voltage: 1500Vp-p (AC type), 500Vp-p (DC type), noise width 1 μ s, noise frequency 25 to 60Hz (noise simulator condition)
Protection degree		IP1X
Wiring method for common		16 points/common (2-wire, terminal block type)
External interface	Communication part	RJ45 connector
	Module power supply part	Terminal block for module power supply and FG (Two-piece spring clamp terminal block)
	I/O part	34-point two-piece spring clamp terminal block
Applicable DIN rail		TH35-7.5Fe, TH35-7.5Al (compliant with IEC 60715/JIS C 2812)
Applicable wire size	For power supply	Stranded wire: 0.3 to 1.5mm ² (22 to 16 AWG), terminal slot size: 2.8mm × 2.0mm ^{*2}
	For I/O	Stranded wire: 0.3 to 1.5mm ² (22 to 16 AWG), terminal slot size: 2.4mm × 1.5mm ^{*2}
Applicable solderless terminal	Terminal block for module power supply and FG ^{*1}	☞ Page 81 Applicable solderless terminal
	Terminal block for output ^{*1}	☞ Page 85 Applicable solderless terminal
Number of occupied stations		One station
Reference response time		1ms
Communication cable		An Ethernet cable that meets the 100BASE-TX standard For details, refer to the following. ☞ CC-Link IE Field Network Basic Reference Manual
Module power supply	Voltage	24VDC (ripple rate: 5% or less) (Allowable voltage range: 20.4 to 28.8VDC)
	Current	153mA or less (24VDC, all points ON)
Weight		0.30kg

*1 Only one wire can be connected to a terminal of the terminal block for module power supply and FG or the terminal block for output. Multiple wires cannot be connected to a terminal. Connecting two or more wires may cause a poor contact.

*2 It is recommended to use the bar solderless terminal for wiring.

External connection

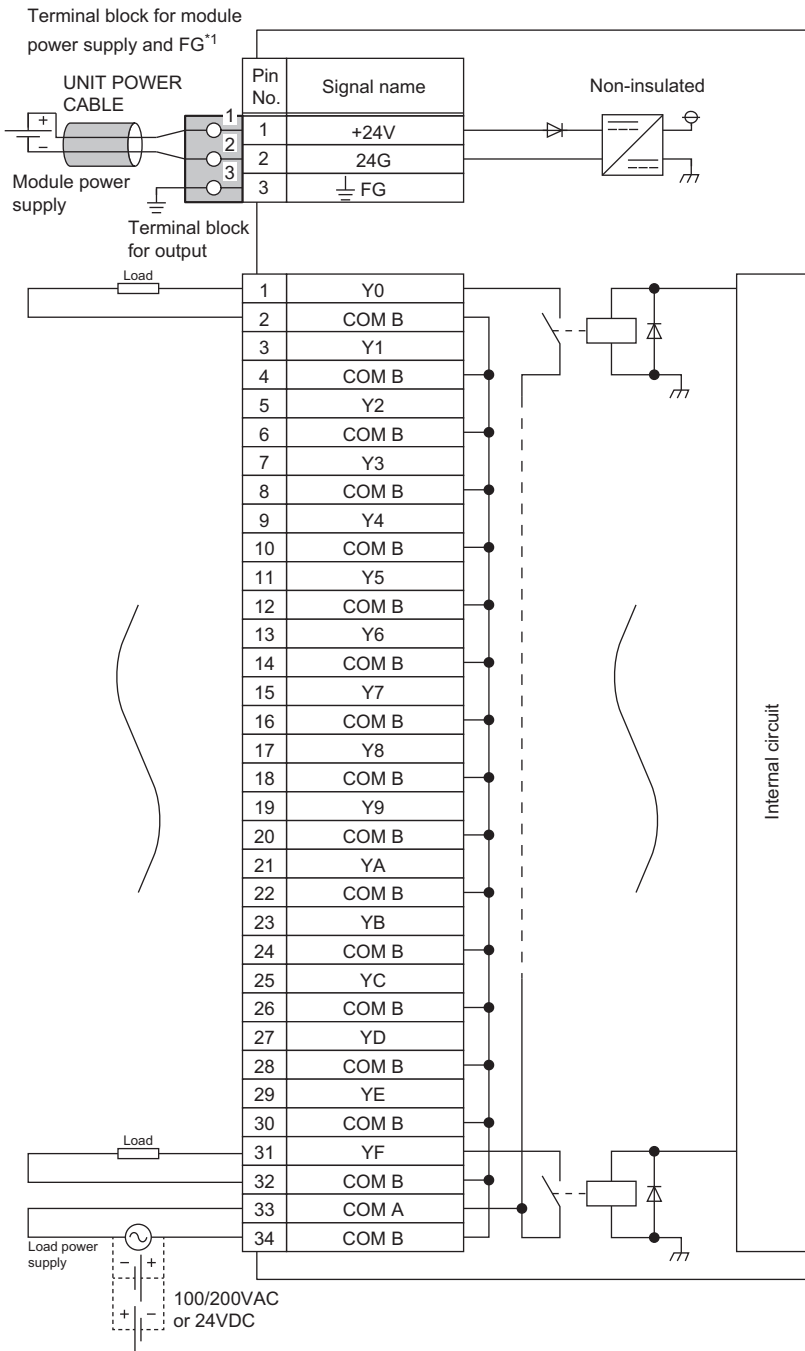

*1 Only one wire can be connected to a terminal of the terminal block for module power supply and FG or the terminal block for output. Multiple wires cannot be connected to a terminal. Connecting two or more wires may cause a poor contact.

Terminal block for output

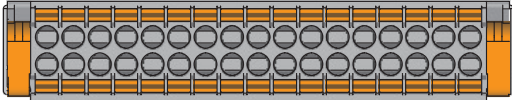

1 3 5 7 9 11 13 15 17 19 21 23 25 27 29 31 33



2 4 6 8 10 12 14 16 18 20 22 24 26 28 30 32 34

Pin number	Signal name	Pin number	Signal name
1	Y0	17	Y8
2	COM B	18	COM B
3	Y1	19	Y9
4	COM B	20	COM B
5	Y2	21	YA
6	COM B	22	COM B
7	Y3	23	YB
8	COM B	24	COM B
9	Y4	25	YC
10	COM B	26	COM B
11	Y5	27	YD
12	COM B	28	COM B
13	Y6	29	YE
14	COM B	30	COM B
15	Y7	31	YF
16	COM B	32	COM B
—		33	COM A
		34	COM B

NZ2MFB1-32T transistor output module

Item		NZ2MFB1-32T
Station type		Slave station
Number of output points		32 points
Rated load voltage		12/24VDC (ripple rate: 5% or less) (Allowable voltage range: 10.2 to 28.8VDC)
Max. load current		0.5A/point, 5A/common
Isolation method		Photocoupler isolation
Max. inrush current		Current is limited by the overload protection function.
Leakage current at OFF		0.1mA or less
Max. voltage drop at ON		0.3VDC(TYP.)0.5A, 0.6VDC(MAX.)0.5A
Output response time	OFF→ON	0.5ms or less
	ON→OFF	1.5ms or less (resistance load)
Surge suppressor		Zener diode
External power supply for output part	Voltage	12/24VDC (ripple rate: 5% or less) (Allowable voltage range: 10.2 to 28.8VDC)
	Current	25mA or less (TYP. 24VDC per common) External load current is not included.
Output type		Sink type
Withstand voltage		500VAC for 1 minute between all DC external terminals and the ground
Insulation resistance		10MΩ or higher between all DC external terminals and ground (500VDC insulation resistance tester)
Noise immunity		Noise voltage 500Vp-p, noise width 1μs, noise frequency 25 to 60Hz (DC type noise simulator condition)
Protection degree		IP2X
Wiring method for common		32 points/common (two points) (1-wire, screw terminal block type)
Protection function	Overload protection function	Limited current when detecting overcurrent: 1A or more/point Activated to each point.
	Overheat protection function	Activated to each point.
External interface	Communication part	RJ45 connector
	Module power supply part	Terminal block for module power supply and FG (Two-piece spring clamp terminal block)
	I/O part	34-point one-piece terminal block Tightening torque range for terminal screw (M3 × 5.2 screw): 0.59 to 0.88N·m
Applicable DIN rail		TH35-7.5Fe, TH35-7.5Al (compliant with IEC 60715/JIS C 2812)
Applicable wire size	For power supply	Stranded wire: 0.3 to 1.5mm ² (22 to 16 AWG), terminal slot size: 2.8mm × 2.0mm ^{*2}
	For I/O	Core: 0.3 to 2.0mm ² (22 to 14 AWG)
Applicable solderless terminal	Terminal block for module power supply and FG ^{*1}	 Page 81 Applicable solderless terminal
	Terminal block for output	 Page 84 Applicable solderless terminal
Number of occupied stations		One station
Reference response time		1ms
Communication cable		An Ethernet cable that meets the 100BASE-TX standard For details, refer to the following.  CC-Link IE Field Network Basic Reference Manual
Module power supply	Voltage	24VDC (ripple rate: 5% or less) (Allowable voltage range: 20.4 to 28.8VDC)
	Current	85mA or less (24VDC, all points ON)
Weight		0.30kg

*1 Only one wire can be connected to a terminal of the terminal block for module power supply and FG. Multiple wires cannot be connected to a terminal. Connecting two or more wires may cause a poor contact.

*2 It is recommended to use the bar solderless terminal for wiring.

External connection

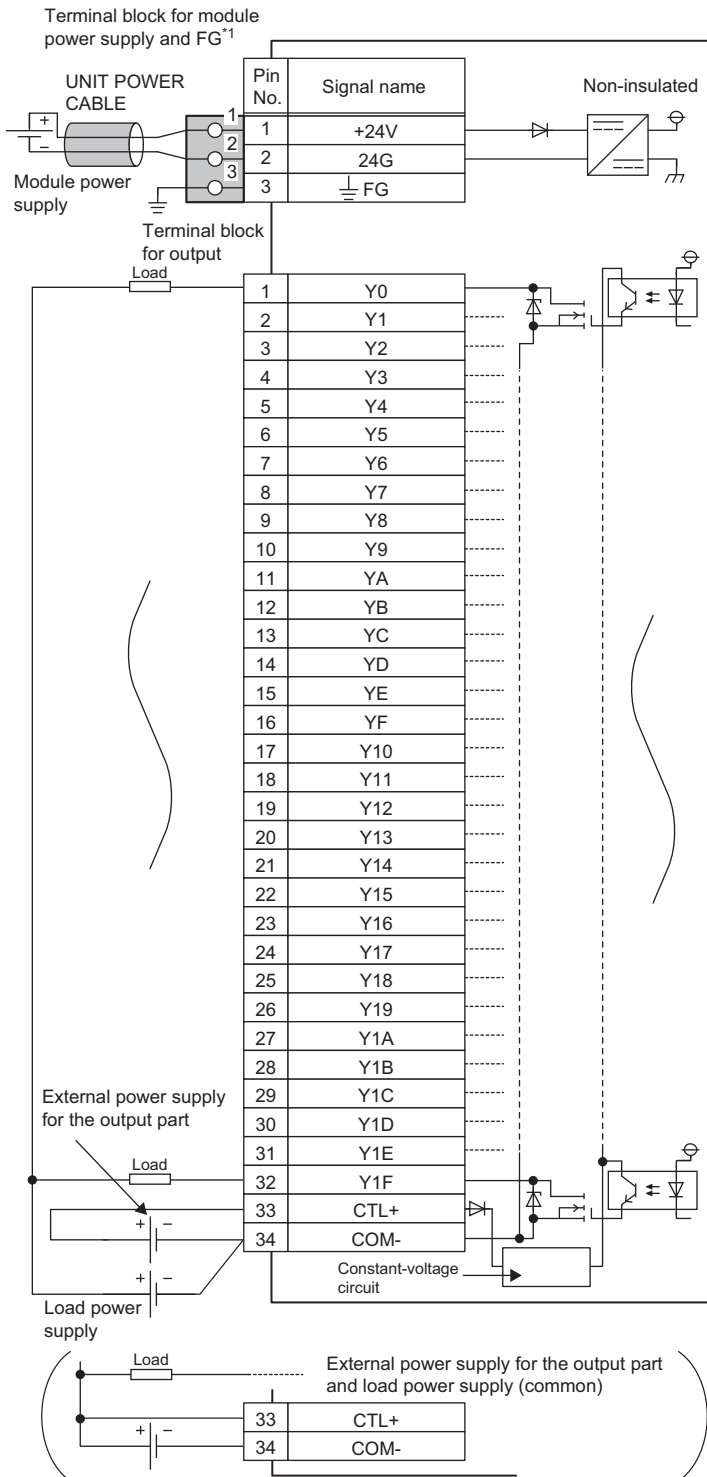

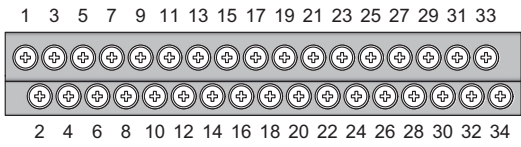

*1 Only one wire can be connected to a terminal of the terminal block for module power supply and FG. Multiple wires cannot be connected to a terminal. Connecting two or more wires may cause a poor contact.

■ Terminal block for output



Pin number	Signal name	Pin number	Signal name
1	Y0	17	Y10
2	Y1	18	Y11
3	Y2	19	Y12
4	Y3	20	Y13
5	Y4	21	Y14
6	Y5	22	Y15
7	Y6	23	Y16
8	Y7	24	Y17
9	Y8	25	Y18
10	Y9	26	Y19
11	YA	27	Y1A
12	YB	28	Y1B
13	YC	29	Y1C
14	YD	30	Y1D
15	YE	31	Y1E
16	YF	32	Y1F
—		33	CTL+
		34	COM-

NZ2MF2S1-32T transistor output module

Item		NZ2MF2S1-32T
Station type		Slave station
Number of output points		32 points
Rated load voltage		12/24VDC (ripple rate: 5% or less) (Allowable voltage range: 10.2 to 28.8VDC)
Max. load current		0.5A/point, 5A/common
Isolation method		Photocoupler isolation
Max. inrush current		Current is limited by the overload protection function.
Leakage current at OFF		0.1mA or less
Max. voltage drop at ON		0.3VDC(TYP.)0.5A, 0.6VDC(MAX.)0.5A
Output response time	OFF→ON	0.5ms or less
	ON→OFF	1.5ms or less (resistance load)
Surge suppressor		Zener diode
External power supply for output part	Voltage	12/24VDC (ripple rate: 5% or less) (Allowable voltage range: 10.2 to 28.8VDC)
	Current	25mA or less (TYP. 24VDC per common) External load current is not included.
Output type		Sink type
Withstand voltage		500VAC for 1 minute between all DC external terminals and the ground
Insulation resistance		10MΩ or higher between all DC external terminals and ground (500VDC insulation resistance tester)
Noise immunity		Noise voltage 500Vp-p, noise width 1μs, noise frequency 25 to 60Hz (DC type noise simulator condition)
Protection degree		IP2X
Wiring method for common		32 points/common (two points) (1-wire, spring clamp terminal block type)
Protection function	Overload protection function	Limited current when detecting overcurrent: 1A or more/point Activated to each point.
	Overheat protection function	Activated to each point.
External interface	Communication part	RJ45 connector
	Module power supply part	Terminal block for module power supply and FG (Two-piece spring clamp terminal block)
	I/O part	34-point two-piece spring clamp terminal block
Applicable DIN rail		TH35-7.5Fe, TH35-7.5Al (compliant with IEC 60715/JIS C 2812)
Applicable wire size	For power supply	Stranded wire: 0.3 to 1.5mm ² (22 to 16 AWG), terminal slot size: 2.8mm × 2.0mm ^{*2}
	For I/O	Stranded wire: 0.3 to 1.5mm ² (22 to 16 AWG), terminal slot size: 2.4mm × 1.5mm ^{*2}
Applicable solderless terminal	Terminal block for module power supply and FG ^{*1}	 Page 81 Applicable solderless terminal
	Terminal block for output ^{*1}	 Page 85 Applicable solderless terminal
Number of occupied stations		One station
Reference response time		1ms
Communication cable		An Ethernet cable that meets the 100BASE-TX standard For details, refer to the following.  CC-Link IE Field Network Basic Reference Manual
Module power supply	Voltage	24VDC (ripple rate: 5% or less) (Allowable voltage range: 20.4 to 28.8VDC)
	Current	85mA or less (24VDC, all points ON)
Weight		0.25kg

*1 Only one wire can be connected to a terminal of the terminal block for module power supply and FG or the terminal block for output. Multiple wires cannot be connected to a terminal. Connecting two or more wires may cause a poor contact.

*2 It is recommended to use the bar solderless terminal for wiring.

External connection

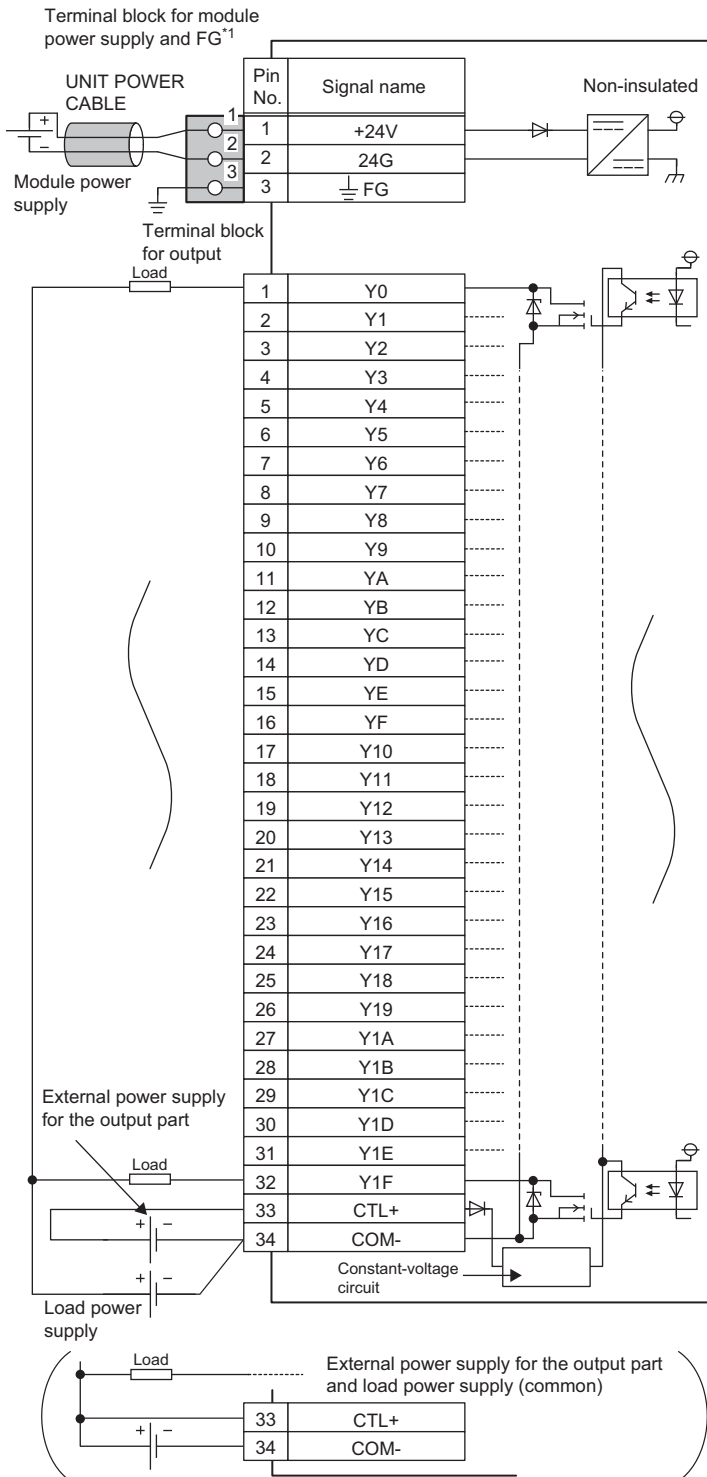

*1 Only one wire can be connected to a terminal of the terminal block for module power supply and FG or the terminal block for output. Multiple wires cannot be connected to a terminal. Connecting two or more wires may cause a poor contact.

Terminal block for output

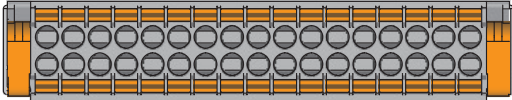

1 3 5 7 9 11 13 15 17 19 21 23 25 27 29 31 33



2 4 6 8 10 12 14 16 18 20 22 24 26 28 30 32 34

Pin number	Signal name	Pin number	Signal name
1	Y0	17	Y10
2	Y1	18	Y11
3	Y2	19	Y12
4	Y3	20	Y13
5	Y4	21	Y14
6	Y5	22	Y15
7	Y6	23	Y16
8	Y7	24	Y17
9	Y8	25	Y18
10	Y9	26	Y19
11	YA	27	Y1A
12	YB	28	Y1B
13	YC	29	Y1C
14	YD	30	Y1D
15	YE	31	Y1E
16	YF	32	Y1F
—		33	CTL+
		34	COM-

NZ2MFB1-32TE1 transistor output module

Item		NZ2MFB1-32TE1
Station type		Slave station
Number of output points		32 points
Rated load voltage		12/24VDC (ripple rate: 5% or less) (Allowable voltage range: 10.2 to 28.8VDC)
Max. load current		0.1A/point, 2A/common
Isolation method		Photocoupler isolation
Max. inrush current		Current is limited by the overload protection function.
Leakage current at OFF		0.1mA or less
Max. voltage drop at ON		0.1VDC(TYP.)0.1A, 0.2VDC(MAX.)0.1A
Output response time	OFF→ON	0.5ms or less
	ON→OFF	1.5ms or less (resistance load)
Surge suppressor		Zener diode
External power supply for output part	Voltage	12/24VDC (ripple rate: 5% or less) (Allowable voltage range: 10.2 to 28.8VDC)
	Current	25mA or less (TYP. 24VDC per common) External load current is not included.
Output type		Source type
Withstand voltage		500VAC for 1 minute between all DC external terminals and the ground
Insulation resistance		10MΩ or higher between all DC external terminals and ground (500VDC insulation resistance tester)
Noise immunity		Noise voltage 500Vp-p, noise width 1μs, noise frequency 25 to 60Hz (DC type noise simulator condition)
Protection degree		IP2X
Wiring method for common		32 points/common (two points) (1-wire, screw terminal block type)
Protection function	Overload protection function	Limited current when detecting overcurrent: 1 to 3A/point Activated to each point.
	Overheat protection function	Activated to two points.
External interface	Communication part	RJ45 connector
	Module power supply part	Terminal block for module power supply and FG (Two-piece spring clamp terminal block)
	I/O part	34-point one-piece terminal block Tightening torque range for terminal screw (M3 × 5.2 screw): 0.59 to 0.88N·m
Applicable DIN rail		TH35-7.5Fe, TH35-7.5Al (compliant with IEC 60715/JIS C 2812)
Applicable wire size	For power supply	Stranded wire: 0.3 to 1.5mm ² (22 to 16 AWG), terminal slot size: 2.8mm × 2.0mm ^{*2}
	For I/O	Core: 0.3 to 2.0mm ² (22 to 14 AWG)
Applicable solderless terminal	Terminal block for module power supply and FG ^{*1}	 Page 81 Applicable solderless terminal
	Terminal block for output	 Page 84 Applicable solderless terminal
Number of occupied stations		One station
Reference response time		1ms
Communication cable		An Ethernet cable that meets the 100BASE-TX standard For details, refer to the following.  CC-Link IE Field Network Basic Reference Manual
Module power supply	Voltage	24VDC (ripple rate: 5% or less) (Allowable voltage range: 20.4 to 28.8VDC)
	Current	84mA or less (24VDC, all points ON)
Weight		0.30kg

*1 Only one wire can be connected to a terminal of the terminal block for module power supply and FG. Multiple wires cannot be connected to a terminal. Connecting two or more wires may cause a poor contact.

*2 It is recommended to use the bar solderless terminal for wiring.

External connection

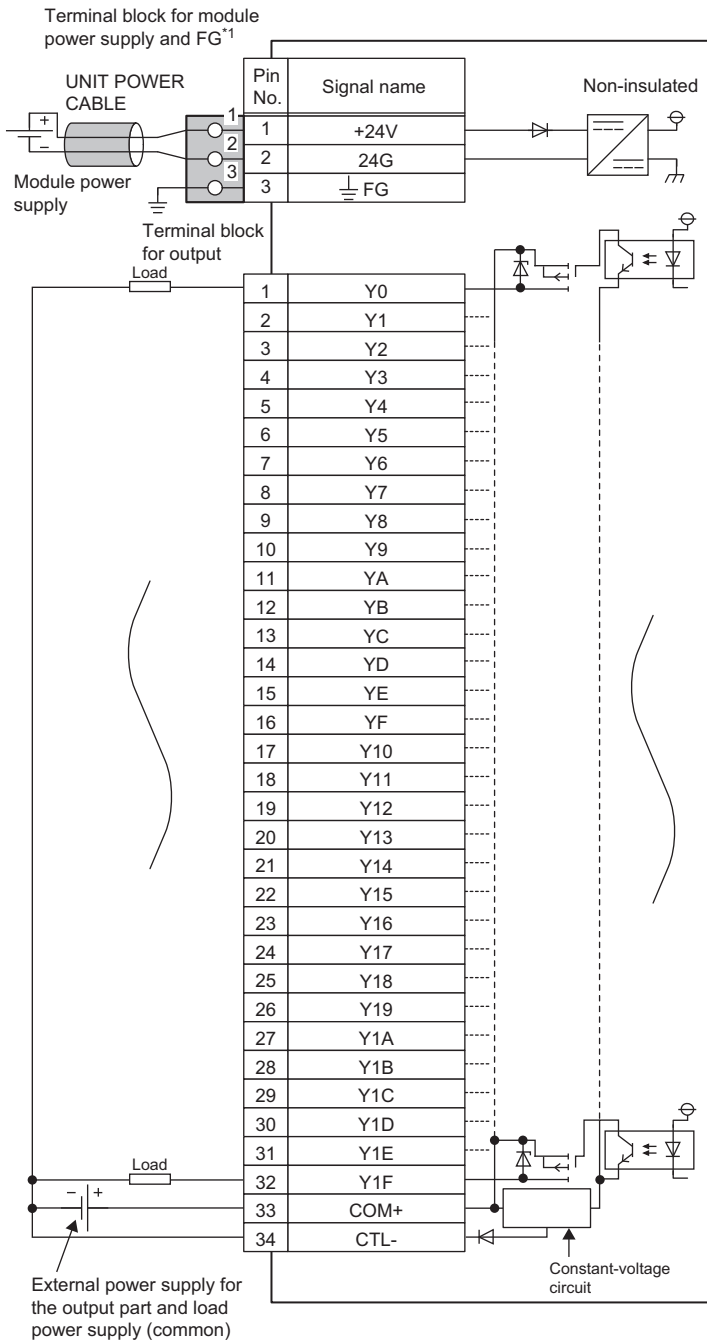

*1 Only one wire can be connected to a terminal of the terminal block for module power supply and FG. Multiple wires cannot be connected to a terminal. Connecting two or more wires may cause a poor contact.

■ Terminal block for output

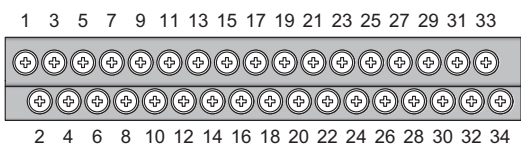

Pin number	Signal name	Pin number	Signal name
1	Y0	17	Y10
2	Y1	18	Y11
3	Y2	19	Y12
4	Y3	20	Y13
5	Y4	21	Y14
6	Y5	22	Y15
7	Y6	23	Y16
8	Y7	24	Y17
9	Y8	25	Y18
10	Y9	26	Y19
11	YA	27	Y1A
12	YB	28	Y1B
13	YC	29	Y1C
14	YD	30	Y1D
15	YE	31	Y1E
16	YF	32	Y1F
—		33	COM+
		34	CTL-

NZ2MF2S1-32TE1 transistor output module

Item		NZ2MF2S1-32TE1
Station type		Slave station
Number of output points		32 points
Rated load voltage		12/24VDC (ripple rate: 5% or less) (Allowable voltage range: 10.2 to 28.8VDC)
Max. load current		0.1A/point, 2A/common
Isolation method		Photocoupler isolation
Max. inrush current		Current is limited by the overload protection function.
Leakage current at OFF		0.1mA or less
Max. voltage drop at ON		0.1VDC(TYP.)0.1A, 0.2VDC(MAX.)0.1A
Output response time	OFF→ON	0.5ms or less
	ON→OFF	1.5ms or less (resistance load)
Surge suppressor		Zener diode
External power supply for output part	Voltage	12/24VDC (ripple rate: 5% or less) (Allowable voltage range: 10.2 to 28.8VDC)
	Current	25mA or less (TYP. 24VDC per common) External load current is not included.
Output type		Source type
Withstand voltage		500VAC for 1 minute between all DC external terminals and the ground
Insulation resistance		10MΩ or higher between all DC external terminals and ground (500VDC insulation resistance tester)
Noise immunity		Noise voltage 500Vp-p, noise width 1μs, noise frequency 25 to 60Hz (DC type noise simulator condition)
Protection degree		IP2X
Wiring method for common		32 points/common (two points) (1-wire, spring clamp terminal block type)
Protection function	Overload protection function	Limited current when detecting overcurrent: 1 to 3A/point Activated to each point.
	Overheat protection function	Activated to two points.
External interface	Communication part	RJ45 connector
	Module power supply part	Terminal block for module power supply and FG (Two-piece spring clamp terminal block)
	I/O part	34-point two-piece spring clamp terminal block
Applicable DIN rail		TH35-7.5Fe, TH35-7.5Al (compliant with IEC 60715/JIS C 2812)
Applicable wire size	For power supply	Stranded wire: 0.3 to 1.5mm ² (22 to 16 AWG), terminal slot size: 2.8mm × 2.0mm ^{*2}
	For I/O	Stranded wire: 0.3 to 1.5mm ² (22 to 16 AWG), terminal slot size: 2.4mm × 1.5mm ^{*2}
Applicable solderless terminal	Terminal block for module power supply and FG ^{*1}	☞ Page 81 Applicable solderless terminal
	Terminal block for output ^{*1}	☞ Page 85 Applicable solderless terminal
Number of occupied stations		One station
Reference response time		1ms
Communication cable		An Ethernet cable that meets the 100BASE-TX standard For details, refer to the following. ☞ CC-Link IE Field Network Basic Reference Manual
Module power supply	Voltage	24VDC (ripple rate: 5% or less) (Allowable voltage range: 20.4 to 28.8VDC)
	Current	84mA or less (24VDC, all points ON)
Weight		0.25kg

*1 Only one wire can be connected to a terminal of the terminal block for module power supply and FG or the terminal block for output. Multiple wires cannot be connected to a terminal. Connecting two or more wires may cause a poor contact.

*2 It is recommended to use the bar solderless terminal for wiring.

External connection

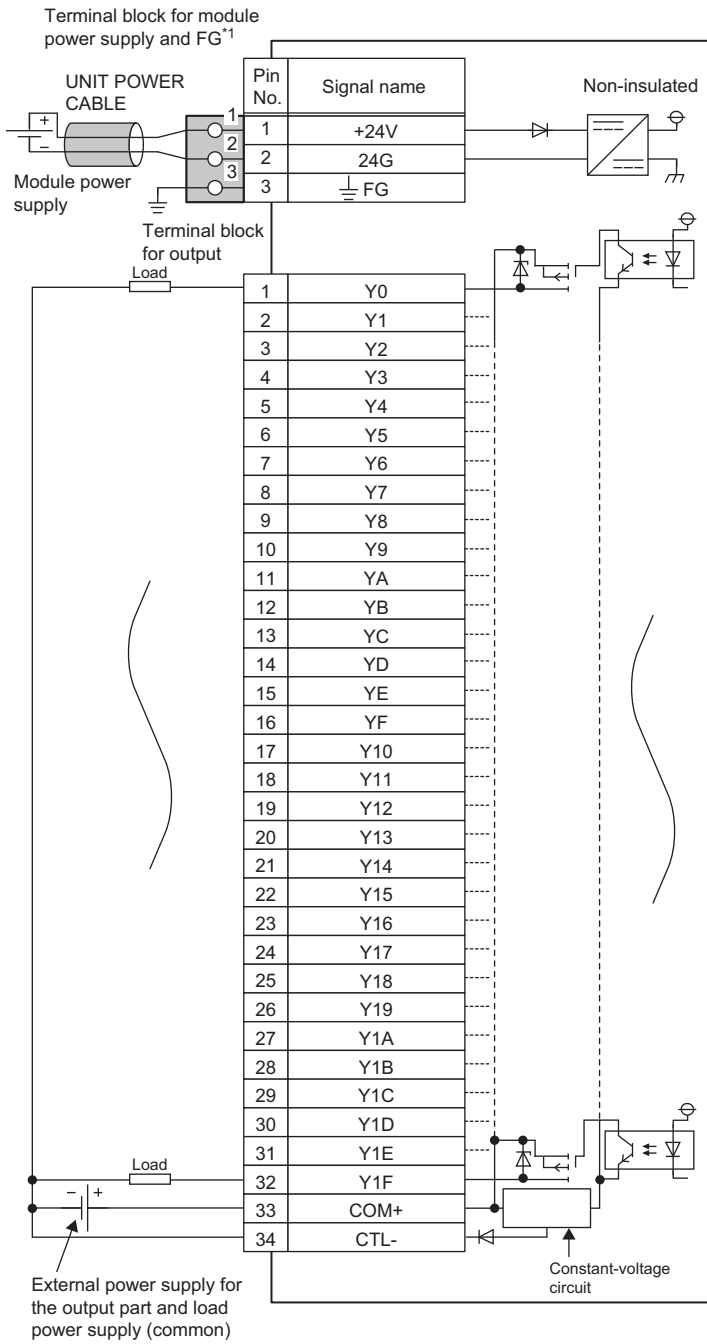

*1 Only one wire can be connected to a terminal of the terminal block for module power supply and FG or the terminal block for output. Multiple wires cannot be connected to a terminal. Connecting two or more wires may cause a poor contact.

Terminal block for output

1 3 5 7 9 11 13 15 17 19 21 23 25 27 29 31 33

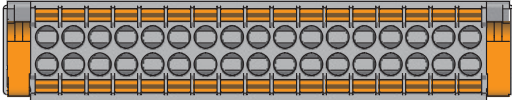

2 4 6 8 10 12 14 16 18 20 22 24 26 28 30 32 34

Pin number	Signal name	Pin number	Signal name
1	Y0	17	Y10
2	Y1	18	Y11
3	Y2	19	Y12
4	Y3	20	Y13
5	Y4	21	Y14
6	Y5	22	Y15
7	Y6	23	Y16
8	Y7	24	Y17
9	Y8	25	Y18
10	Y9	26	Y19
11	YA	27	Y1A
12	YB	28	Y1B
13	YC	29	Y1C
14	YD	30	Y1D
15	YE	31	Y1E
16	YF	32	Y1F
—		33	COM+
		34	CTL-

I/O combined module

NZ2MFB1-32DT DC input/transistor output module

Item	NZ2MFB1-32DT		
	Input specifications	Output specifications	
Station type	Slave station		
Number of input points	16 points	—	
Rated input voltage	24VDC (ripple rate: 5% or less) (Allowable voltage range: 20.4 to 28.8VDC)		
Rated input current	6.0mA TYP. (for 24VDC)		
Isolation method	Photocoupler isolation		
Max. number of simultaneous input points	100%		
ON voltage/ON current	15VDC or more/4mA or more		
OFF voltage/OFF current	5VDC or less/1.7mA or less		
Input resistance	3.8k Ω		
Input response time	OFF→ON		0ms ^{*1} /0.2ms/1ms/1.5ms/5ms/10ms/20ms/70ms (Initial setting: 10ms)
	ON→OFF		
Input type	Positive common type		
Number of output points	—	16 points	
Rated load voltage		24VDC (ripple rate: 5% or less) (Allowable voltage range: 20.4 to 28.8VDC)	
Max. load current		0.5A/point, 4A/common	
Isolation method		Photocoupler isolation	
Max. inrush current		Current is limited by the overload protection function.	
Leakage current at OFF		0.1mA or less	
Max. voltage drop at ON		0.3VDC(TYP.)0.5A, 0.6VDC(MAX.)0.5A	
Output response time	OFF→ON	0.5ms or less	
	ON→OFF	1.5ms or less (resistance load)	
Surge suppressor		Zener diode	
External power supply for output part	Voltage	24VDC (ripple rate: 5% or less) (Allowable voltage range: 20.4 to 28.8VDC)	
	Current	15mA or less (TYP. 24VDC per common) External load current is not included.	
Output type		Sink type	
Protection function	Overload protection function	Limited current when detecting overcurrent: 1A or more/point Activated to each point.	
	Overheat protection function	Activated to each point.	
Wiring method for common	16 points/common (1-wire, screw terminal block type)	16 points/common (1-wire, screw terminal block type)	
Withstand voltage	500VAC for 1 minute between all DC external terminals and the ground		
Insulation resistance	10M Ω or higher between all DC external terminals and ground (500VDC insulation resistance tester)		
Noise immunity ^{*2}	Noise voltage 500Vp-p, noise width 1 μ s, noise frequency 25 to 60Hz (DC type noise simulator condition)		
Protection degree	IP2X		
External interface	Communication part	RJ45 connector	
	Module power supply part	Terminal block for module power supply and FG (Two-piece spring clamp terminal block)	
	I/O part	34-point one-piece terminal block Tightening torque range for terminal screw (M3 \times 5.2 screw): 0.59 to 0.88N·m	
Applicable DIN rail	TH35-7.5Fe, TH35-7.5Al (compliant with IEC 60715/JIS C 2812)		
Applicable wire size	For power supply	Stranded wire: 0.3 to 1.5mm ² (22 to 16 AWG), terminal slot size: 2.8mm \times 2.0mm ^{*4}	
	For I/O	Core: 0.3 to 2.0mm ² (22 to 14 AWG)	

Item		NZ2MFB1-32DT	
		Input specifications	Output specifications
Applicable solderless terminal	Terminal block for module power supply and FG*3	☞ Page 81 Applicable solderless terminal	
	I/O terminal block	☞ Page 84 Applicable solderless terminal	
Number of occupied stations		One station	
Reference response time		1ms	
Communication cable		An Ethernet cable that meets the 100BASE-TX standard For details, refer to the following. ☞ CC-Link IE Field Network Basic Reference Manual	
Module power supply	Voltage	24VDC (ripple rate: 5% or less) (Allowable voltage range: 20.4 to 28.8VDC)	
	Current	79mA or less (24VDC, all points ON)	
Weight		0.30kg	

*1 If the input response time is set to "0ms", the actual input response time is 80μs at OFF → ON, and 160μs at ON → OFF.

*2 It is the noise immunity of when the input response time setting value is other than "0ms". Note that the module is easily affected by noise if "0ms" is set.

*3 Only one wire can be connected to a terminal of the terminal block for module power supply and FG. Multiple wires cannot be connected to a terminal. Connecting two or more wires may cause a poor contact.

*4 It is recommended to use the bar solderless terminal for wiring.

External connection

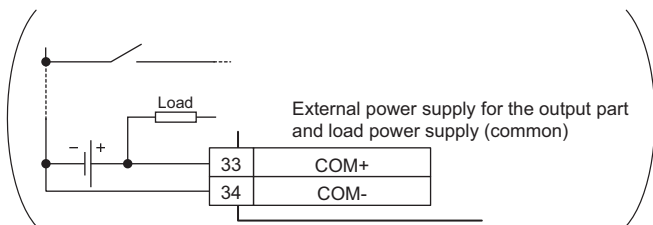
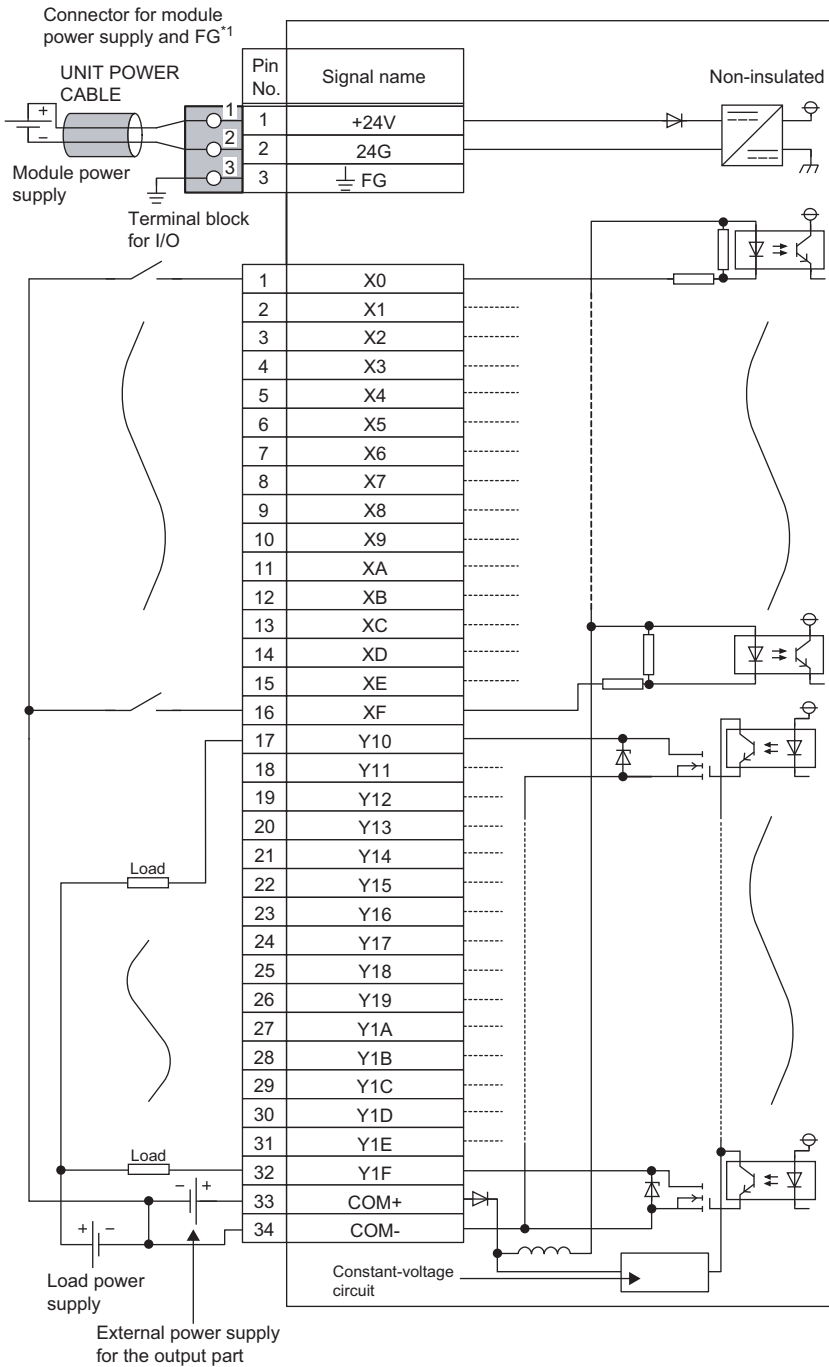

*1 Only one wire can be connected to a terminal of the terminal block for module power supply and FG. Multiple wires cannot be connected to a terminal. Connecting two or more wires may cause a poor contact.

I/O terminal block

1 3 5 7 9 11 13 15 17 19 21 23 25 27 29 31 33

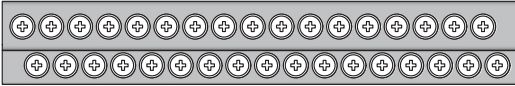

2 4 6 8 10 12 14 16 18 20 22 24 26 28 30 32 34

Pin number	Signal name	Pin number	Signal name
1	X0	17	Y10
2	X1	18	Y11
3	X2	19	Y12
4	X3	20	Y13
5	X4	21	Y14
6	X5	22	Y15
7	X6	23	Y16
8	X7	24	Y17
9	X8	25	Y18
10	X9	26	Y19
11	XA	27	Y1A
12	XB	28	Y1B
13	XC	29	Y1C
14	XD	30	Y1D
15	XE	31	Y1E
16	XF	32	Y1F
—		33	COM+
		34	COM-

NZ2MF2S1-32DT DC input/transistor output module

Item	NZ2MF2S1-32DT		
	Input specifications	Output specifications	
Station type	Slave station		
Number of input points	16 points	—	
Rated input voltage	24VDC (ripple rate: 5% or less) (Allowable voltage range: 20.4 to 28.8VDC)		
Rated input current	6.0mA TYP. (for 24VDC)		
Isolation method	Photocoupler isolation		
Max. number of simultaneous input points	100%		
ON voltage/ON current	15VDC or more/4mA or more		
OFF voltage/OFF current	5VDC or less/1.7mA or less		
Input resistance	3.8kΩ		
Input response time	OFF→ON		0ms ^{*1} /0.2ms/1ms/1.5ms/5ms/10ms/20ms/70ms (Initial setting: 10ms)
	ON→OFF		
Input type	Positive common type		
Number of output points	—	16 points	
Rated load voltage		24VDC (ripple rate: 5% or less) (Allowable voltage range: 20.4 to 28.8VDC)	
Max. load current		0.5A/point, 4A/common	
Isolation method		Photocoupler isolation	
Max. inrush current		Current is limited by the overload protection function.	
Leakage current at OFF		0.1mA or less	
Max. voltage drop at ON		0.3VDC(TYP.)0.5A, 0.6VDC(MAX.)0.5A	
Output response time	OFF→ON	0.5ms or less	
	ON→OFF	1.5ms or less (resistance load)	
Surge suppressor		Zener diode	
External power supply for output part	Voltage	24VDC (ripple rate: 5% or less) (Allowable voltage range: 20.4 to 28.8VDC)	
	Current	15mA or less (TYP. 24VDC per common) External load current is not included.	
Output type		Sink type	
Protection function	Overload protection function	Limited current when detecting overcurrent: 1A or more/point Activated to each point.	
	Overheat protection function	Activated to each point.	
Wiring method for common	16 points/common (1-wire, spring clamp terminal block type)	16 points/common (1-wire, spring clamp terminal block type)	
Withstand voltage	500VAC for 1 minute between all DC external terminals and the ground		
Insulation resistance	10MΩ or higher between all DC external terminals and ground (500VDC insulation resistance tester)		
Noise immunity ^{*2}	Noise voltage 500Vp-p, noise width 1μs, noise frequency 25 to 60Hz (DC type noise simulator condition)		
Protection degree	IP2X		
External interface	Communication part	RJ45 connector	
	Module power supply part	Terminal block for module power supply and FG (Two-piece spring clamp terminal block)	
	I/O part	34-point two-piece spring clamp terminal block	
Applicable DIN rail	TH35-7.5Fe, TH35-7.5Al (compliant with IEC 60715/JIS C 2812)		
Applicable wire size	For power supply	Stranded wire: 0.3 to 1.5mm ² (22 to 16 AWG), terminal slot size: 2.8mm × 2.0mm ^{*4}	
	For I/O	Stranded wire: 0.3 to 1.5mm ² (22 to 16 AWG), terminal slot size: 2.4mm × 1.5mm ^{*4}	
Applicable solderless terminal	Terminal block for module power supply and FG ^{*3}	☞ Page 81 Applicable solderless terminal	
	I/O terminal block ^{*3}	☞ Page 85 Applicable solderless terminal	
Number of occupied stations	One station		
Reference response time	1ms		

Item		NZ2MF2S1-32DT	
		Input specifications	Output specifications
Communication cable		An Ethernet cable that meets the 100BASE-TX standard For details, refer to the following.  CC-Link IE Field Network Basic Reference Manual	
Module power supply	Voltage	24VDC (ripple rate: 5% or less) (Allowable voltage range: 20.4 to 28.8VDC)	
	Current	79mA or less (24VDC, all points ON)	
Weight		0.25kg	

- *1 If the input response time is set to "0ms", the actual input response time is 80 μ s at OFF \rightarrow ON, and 160 μ s at ON \rightarrow OFF.
- *2 It is the noise immunity of when the input response time setting value is other than "0ms". Note that the module is easily affected by noise if "0ms" is set.
- *3 Only one wire can be connected to a terminal of the terminal block for module power supply and FG or the I/O terminal block. Multiple wires cannot be connected to a terminal. Connecting two or more wires may cause a poor contact.
- *4 It is recommended to use the bar solderless terminal for wiring.

External connection

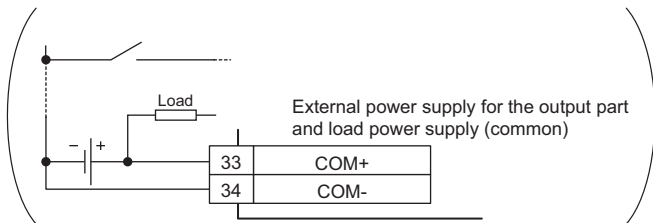
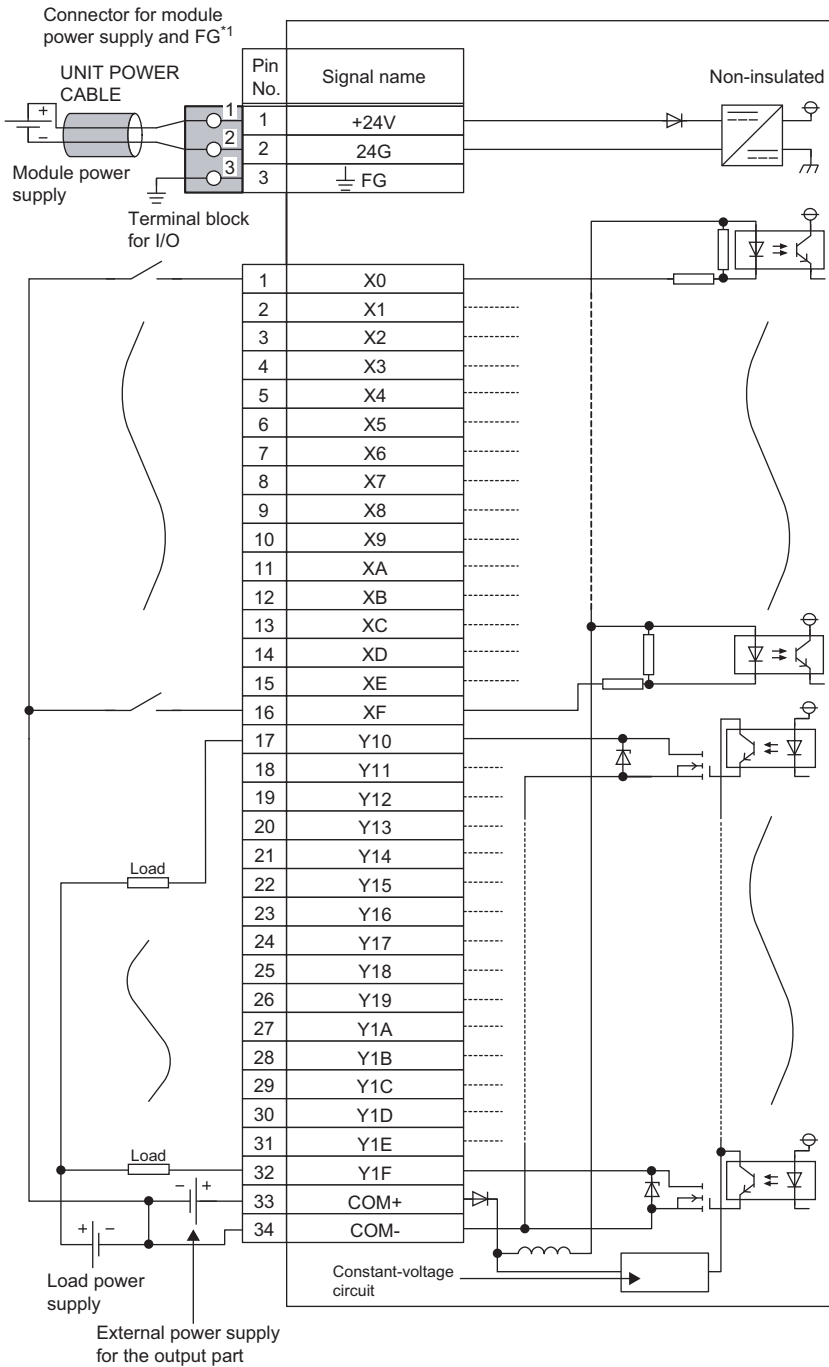

*1 Only one wire can be connected to a terminal of the terminal block for module power supply and FG or the I/O terminal block. Multiple wires cannot be connected to a terminal. Connecting two or more wires may cause a poor contact.

I/O terminal block

1 3 5 7 9 11 13 15 17 19 21 23 25 27 29 31 33

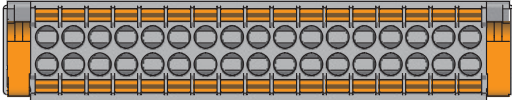

2 4 6 8 10 12 14 16 18 20 22 24 26 28 30 32 34

Pin number	Signal name	Pin number	Signal name
1	X0	17	Y10
2	X1	18	Y11
3	X2	19	Y12
4	X3	20	Y13
5	X4	21	Y14
6	X5	22	Y15
7	X6	23	Y16
8	X7	24	Y17
9	X8	25	Y18
10	X9	26	Y19
11	XA	27	Y1A
12	XB	28	Y1B
13	XC	29	Y1C
14	XD	30	Y1D
15	XE	31	Y1E
16	XF	32	Y1F
—		33	COM+
		34	COM-

NZ2MFB1-32DTE1 DC input/transistor output module

Item	NZ2MFB1-32DTE1		
	Input specifications	Output specifications	
Station type	Slave station		
Number of input points	16 points	—	
Rated input voltage	24VDC (ripple rate: 5% or less) (Allowable voltage range: 20.4 to 28.8VDC)		
Rated input current	6.0mA TYP. (for 24VDC)		
Isolation method	Photocoupler isolation		
Max. number of simultaneous input points	100%		
ON voltage/ON current	15VDC or more/4mA or more		
OFF voltage/OFF current	5VDC or less/1.7mA or less		
Input resistance	3.8kΩ		
Input response time	OFF→ON		0ms ^{*1} /0.2ms/1ms/1.5ms/5ms/10ms/20ms/70ms (Initial setting: 10ms)
	ON→OFF		
Input type	Negative common type		
Number of output points	—	16 points	
Rated load voltage		24VDC (ripple rate: 5% or less) (Allowable voltage range: 20.4 to 28.8VDC)	
Max. load current		0.1A/point, 1.6A/common	
Isolation method		Photocoupler isolation	
Max. inrush current		Current is limited by the overload protection function.	
Leakage current at OFF		0.1mA or less	
Max. voltage drop at ON		0.1VDC(TYP.)0.1A, 0.2VDC(MAX.)0.1A	
Output response time	OFF→ON	0.5ms or less	
	ON→OFF	1.5ms or less (resistance load)	
Surge suppressor		Zener diode	
External power supply for output part	Voltage	24VDC (ripple rate: 5% or less) (Allowable voltage range: 20.4 to 28.8VDC)	
	Current	20mA or less (TYP. 24VDC per common) External load current is not included.	
Output type		Source type	
Protection function	Overload protection function	Limited current when detecting overcurrent: 1 to 3A/point Activated to each point.	
	Overheat protection function	Activated to two points.	
Wiring method for common	16 points/common (1-wire, screw terminal block type)	16 points/common (1-wire, screw terminal block type)	
Withstand voltage	500VAC for 1 minute between all DC external terminals and the ground		
Insulation resistance	10MΩ or higher between all DC external terminals and ground (500VDC insulation resistance tester)		
Noise immunity ^{*2}	Noise voltage 500Vp-p, noise width 1μs, noise frequency 25 to 60Hz (DC type noise simulator condition)		
Protection degree	IP2X		
External interface	Communication part	RJ45 connector	
	Module power supply part	Terminal block for module power supply and FG (Two-piece spring clamp terminal block)	
	I/O part	34-point one-piece terminal block Tightening torque range for terminal screw (M3 × 5.2 screw): 0.59 to 0.88N·m	
Applicable DIN rail	TH35-7.5Fe, TH35-7.5Al (compliant with IEC 60715/JIS C 2812)		
Applicable wire size	For power supply	Stranded wire: 0.3 to 1.5mm ² (22 to 16 AWG), terminal slot size: 2.8mm × 2.0mm ^{*4}	
	For I/O	Core: 0.3 to 2.0mm ² (22 to 14 AWG)	
Applicable solderless terminal	Terminal block for module power supply and FG ^{*3}	☞ Page 81 Applicable solderless terminal	
	I/O terminal block	☞ Page 84 Applicable solderless terminal	
Number of occupied stations	One station		

Item		NZ2MFB1-32DTE1	
		Input specifications	Output specifications
Reference response time		1ms	
Communication cable		An Ethernet cable that meets the 100BASE-TX standard For details, refer to the following.  CC-Link IE Field Network Basic Reference Manual	
Module power supply	Voltage	24VDC (ripple rate: 5% or less) (Allowable voltage range: 20.4 to 28.8VDC)	
	Current	79mA or less (24VDC, all points ON)	
Weight		0.30kg	

- *1 If the input response time is set to "0ms", the actual input response time is 80 μ s at OFF \rightarrow ON, and 160 μ s at ON \rightarrow OFF.
- *2 It is the noise immunity of when the input response time setting value is other than "0ms". Note that the module is easily affected by noise if "0ms" is set.
- *3 Only one wire can be connected to a terminal of the terminal block for module power supply and FG. Multiple wires cannot be connected to a terminal. Connecting two or more wires may cause a poor contact.
- *4 It is recommended to use the bar solderless terminal for wiring.

External connection

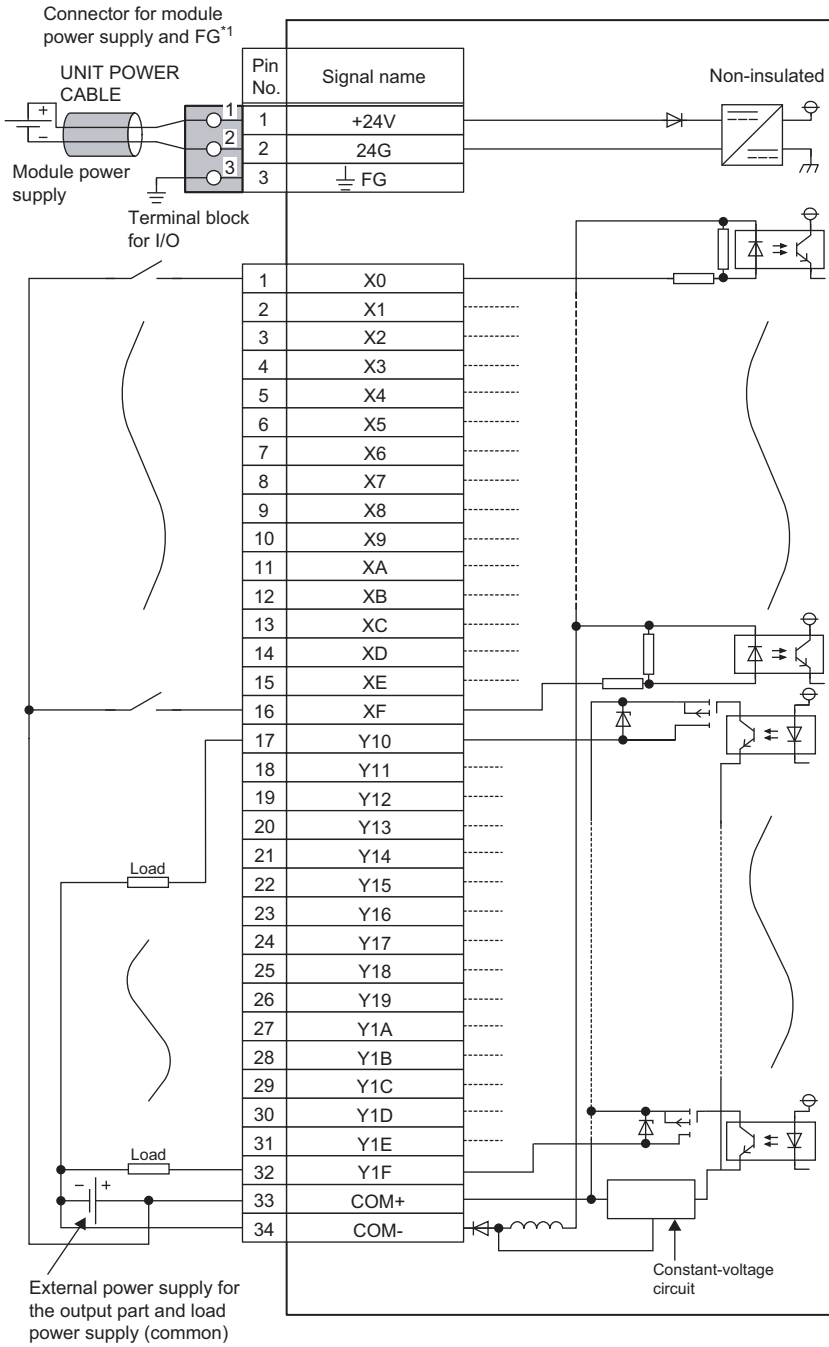

*1 Only one wire can be connected to a terminal of the terminal block for module power supply and FG. Multiple wires cannot be connected to a terminal. Connecting two or more wires may cause a poor contact.

I/O terminal block

1 3 5 7 9 11 13 15 17 19 21 23 25 27 29 31 33

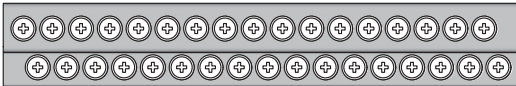

2 4 6 8 10 12 14 16 18 20 22 24 26 28 30 32 34

Pin number	Signal name	Pin number	Signal name
1	X0	17	Y10
2	X1	18	Y11
3	X2	19	Y12
4	X3	20	Y13
5	X4	21	Y14
6	X5	22	Y15
7	X6	23	Y16
8	X7	24	Y17
9	X8	25	Y18
10	X9	26	Y19
11	XA	27	Y1A
12	XB	28	Y1B
13	XC	29	Y1C
14	XD	30	Y1D
15	XE	31	Y1E
16	XF	32	Y1F
—		33	COM+
		34	COM-

NZ2MF2S1-32DTE1 DC input/transistor output module

Item	NZ2MF2S1-32DTE1		
	Input specifications	Output specifications	
Station type	Slave station		
Number of input points	16 points	—	
Rated input voltage	24VDC (ripple rate: 5% or less) (Allowable voltage range: 20.4 to 28.8VDC)		
Rated input current	6.0mA TYP. (for 24VDC)		
Isolation method	Photocoupler isolation		
Max. number of simultaneous input points	100%		
ON voltage/ON current	15VDC or more/4mA or more		
OFF voltage/OFF current	5VDC or less/1.7mA or less		
Input resistance	3.8kΩ		
Input response time	OFF→ON		0ms ^{*1} /0.2ms/1ms/1.5ms/5ms/10ms/20ms/70ms (Initial setting: 10ms)
	ON→OFF		
Input type	Negative common type		
Number of output points	—	16 points	
Rated load voltage		24VDC (ripple rate: 5% or less) (Allowable voltage range: 20.4 to 28.8VDC)	
Max. load current		0.1A/point, 1.6A/common	
Isolation method		Photocoupler isolation	
Max. inrush current		Current is limited by the overload protection function.	
Leakage current at OFF		0.1mA or less	
Max. voltage drop at ON		0.1VDC(TYP.)0.1A, 0.2VDC(MAX.)0.1A	
Output response time	OFF→ON	0.5ms or less	
	ON→OFF	1.5ms or less (resistance load)	
Surge suppressor		Zener diode	
External power supply for output part	Voltage	24VDC (ripple rate: 5% or less) (Allowable voltage range: 20.4 to 28.8VDC)	
	Current	20mA or less (TYP. 24VDC per common) External load current is not included.	
Output type		Source type	
Protection function	Overload protection function	Limited current when detecting overcurrent: 1 to 3A/point Activated to each point.	
	Overheat protection function	Activated to two points.	
Wiring method for common	16 points/common (1-wire, spring clamp terminal block type)	16 points/common (1-wire, spring clamp terminal block type)	
Withstand voltage	500VAC for 1 minute between all DC external terminals and the ground		
Insulation resistance	10MΩ or higher between all DC external terminals and ground (500VDC insulation resistance tester)		
Noise immunity ^{*2}	Noise voltage 500Vp-p, noise width 1μs, noise frequency 25 to 60Hz (DC type noise simulator condition)		
Protection degree	IP2X		
External interface	Communication part	RJ45 connector	
	Module power supply part	Terminal block for module power supply and FG (Two-piece spring clamp terminal block)	
	I/O part	34-point two-piece spring clamp terminal block	
Applicable DIN rail	TH35-7.5Fe, TH35-7.5Al (compliant with IEC 60715/JIS C 2812)		
Applicable wire size	For power supply	Stranded wire: 0.3 to 1.5mm ² (22 to 16 AWG), terminal slot size: 2.8mm × 2.0mm ^{*4}	
	For I/O	Stranded wire: 0.3 to 1.5mm ² (22 to 16 AWG), terminal slot size: 2.4mm × 1.5mm ^{*4}	
Applicable solderless terminal	Terminal block for module power supply and FG ^{*3}	☞ Page 81 Applicable solderless terminal	
	I/O terminal block ^{*3}	☞ Page 85 Applicable solderless terminal	
Number of occupied stations	One station		
Reference response time	1ms		

Item		NZ2MF2S1-32DTE1	
		Input specifications	Output specifications
Communication cable		An Ethernet cable that meets the 100BASE-TX standard For details, refer to the following.  CC-Link IE Field Network Basic Reference Manual	
Module power supply	Voltage	24VDC (ripple rate: 5% or less) (Allowable voltage range: 20.4 to 28.8VDC)	
	Current	79mA or less (24VDC, all points ON)	
Weight		0.25kg	

- *1 If the input response time is set to "0ms", the actual input response time is 80 μ s at OFF \rightarrow ON, and 160 μ s at ON \rightarrow OFF.
- *2 It is the noise immunity of when the input response time setting value is other than "0ms". Note that the module is easily affected by noise if "0ms" is set.
- *3 Only one wire can be connected to a terminal of the terminal block for module power supply and FG or the I/O terminal block. Multiple wires cannot be connected to a terminal. Connecting two or more wires may cause a poor contact.
- *4 It is recommended to use the bar solderless terminal for wiring.

External connection

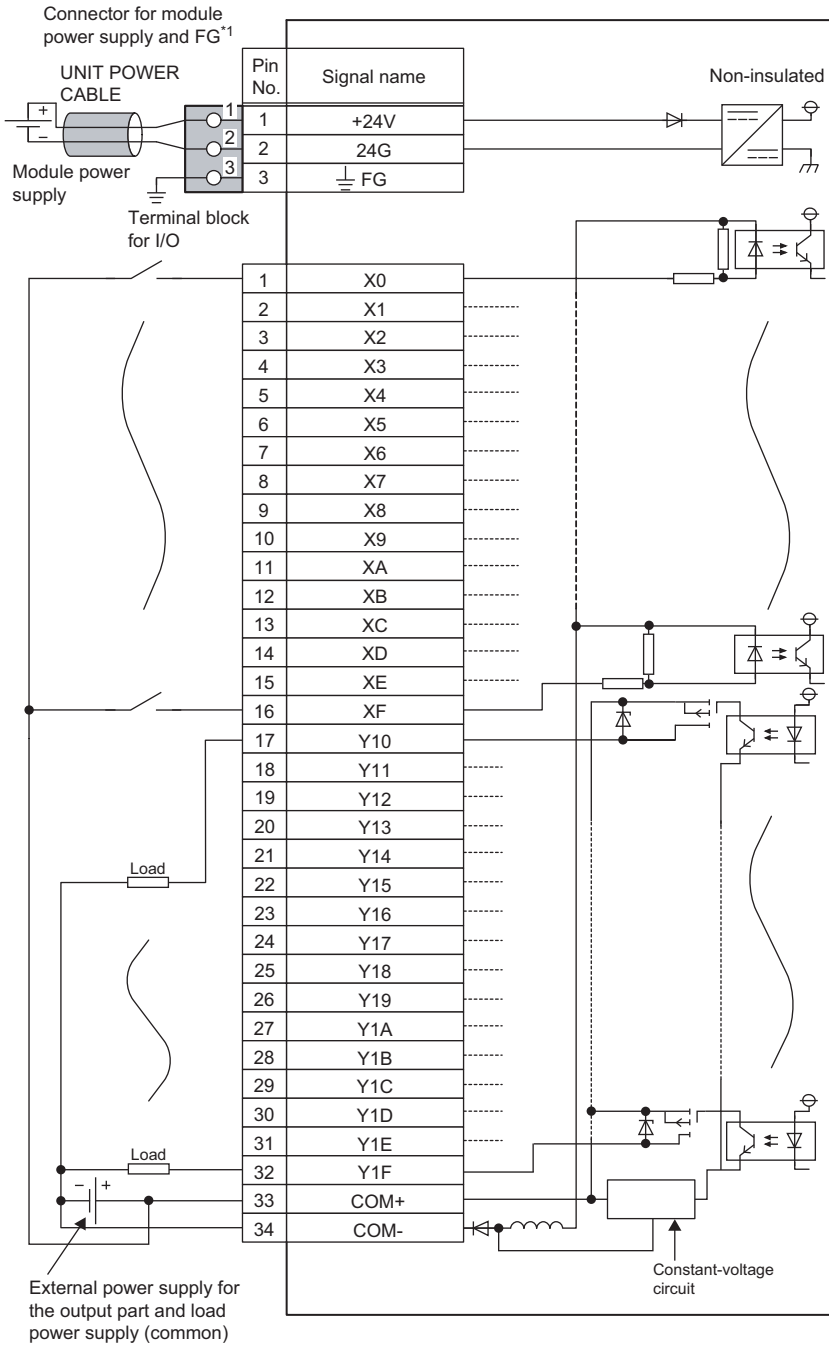

*1 Only one wire can be connected to a terminal of the terminal block for module power supply and FG or the I/O terminal block. Multiple wires cannot be connected to a terminal. Connecting two or more wires may cause a poor contact.

I/O terminal block

1 3 5 7 9 11 13 15 17 19 21 23 25 27 29 31 33

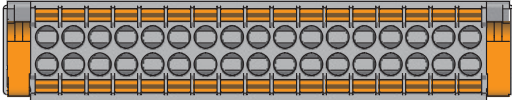

2 4 6 8 10 12 14 16 18 20 22 24 26 28 30 32 34

Pin number	Signal name	Pin number	Signal name
1	X0	17	Y10
2	X1	18	Y11
3	X2	19	Y12
4	X3	20	Y13
5	X4	21	Y14
6	X5	22	Y15
7	X6	23	Y16
8	X7	24	Y17
9	X8	25	Y18
10	X9	26	Y19
11	XA	27	Y1A
12	XB	28	Y1B
13	XC	29	Y1C
14	XD	30	Y1D
15	XE	31	Y1E
16	XF	32	Y1F
—		33	COM+
		34	COM-

3.3 Function List

This section lists the functions of I/O modules.

Item	Description	Reference
Input function	The ON/OFF status (X signal) of inputs is notified to Remote input (RX) of the master station.	—
Output function	The ON/OFF status (Y signal) of outputs is controlled with Remote output (RY) of the master station.	—
Input response time setting function	This function prevents an incorrect input due to noise by setting the response time until the module recognizes an actual input as the X signal.	Page 90 Input Response Time Setting Function
Output HOLD/CLEAR setting function	When the I/O module is disconnected from data link, or the CPU module operating status is STOP, whether to hold or clear the last output value can be set by this function.	Page 91 Output HOLD/CLEAR Setting Function
Protection function	The overload protection function and overheat protection function protect the internal circuit from overcurrent and its heat.	Page 92 Protection Function
SLMP communication function	SLMP can be used to communicate with the I/O module.	Page 93 SLMP communication function

3.4 List of Functions of Each Module

This section lists the functions of each module.

○: Available, —: Not available

Model name	Input function	Output function	Input response time setting function	Output HOLD/CLEAR setting function	Protection function	SLMP communication function
NZ2MFB2-16A	○	—	—	—	—	○
NZ2MF2S2-16A	○	—	—	—	—	○
NZ2MFB1-32D	○	—	○	—	—	○
NZ2MF2S1-32D	○	—	○	—	—	○
NZ2MFB2-16R	—	○	—	○	—	○
NZ2MF2S2-16R	—	○	—	○	—	○
NZ2MFB1-32T	—	○	—	○	○	○
NZ2MF2S1-32T	—	○	—	○	○	○
NZ2MFB1-32TE1	—	○	—	○	○	○
NZ2MF2S1-32TE1	—	○	—	○	○	○
NZ2MFB1-32DT	○	○	○	○	○	○
NZ2MF2S1-32DT	○	○	○	○	○	○
NZ2MFB1-32DTE1	○	○	○	○	○	○
NZ2MF2S1-32DTE1	○	○	○	○	○	○

4 PROCEDURES BEFORE OPERATION

This chapter describes the procedures before operation.

1. IP address setting switch setting

Set the fourth octet of IP address of I/O module.

 Page 73 IP address setting switch setting

2. Function setting switch setting

Set the input response time setting and output HOLD/CLEAR setting of the I/O module.

 Page 76 Function setting switch setting

3. Connection

Mount the I/O module on the DIN rail.

 Page 79 Mounting the module on a DIN rail

4. Wiring

Wire the power supply, Ethernet cables, and external devices to the I/O module.

 Page 81 Wiring

5. Parameter setting and programming

Set the network parameter of the master station and create a program.

 Page 88 Network Configuration Setting

 Page 94 PROGRAMMING

Point

To replace the module, follow the procedure described below:

- Turn off the module power supply and remove the I/O module.
 - Prepare a new I/O module and perform the procedure before operation, from "IP address setting switch setting" to "Parameter setting and programming". At this time, the settings of IP address setting switch and function setting switch must be the same as the settings for I/O module before replacement.
 - Check that the D LINK LED and RUN LED of I/O module are on and ERR. LED is off before restarting control operation.
-

MEMO

5 SYSTEM CONFIGURATION

Applicable master station

For the CPU module that can be used as the master station of CC-Link IE Field Network Basic, refer to the following.

 CC-Link IE Field Network Basic Reference Manual

Compatible software version

For the compatible software version, always keep the configuration tool of the master station up to date.

When the latest software version is necessary, please consult your local Mitsubishi representative.

Applicable profile

A profile is required to use the I/O module in the network configuration setting of CC-Link IE Field Network Basic.

When the latest profile of the I/O module is necessary, please consult your local Mitsubishi representative.

The profile is a setting file that stores information required for the start-up, operation, and maintenance of devices supporting the CC-Link family.

A module is added to the "Module List" of the network configuration setting window by profile registration to the configuration tool of the master station.

For the profile registration, refer to the following.

 Operating manual for the tool to be used

Ethernet cable

For the specifications of the Ethernet cable, refer to the following.

 CC-Link IE Field Network Basic Reference Manual

Hub

For compatible hubs, refer to the following.

 CC-Link IE Field Network Basic Reference Manual

MEMO

6 INSTALLATION AND WIRING

This chapter describes the installation and wiring of the I/O module.

6.1 Before Using the I/O Modules

Input modules

Precautions common to all input modules

■Number of simultaneous ON points

The number of input points that can be turned on at the same time varies depending on the input voltage and ambient temperature. Refer to the maximum number of simultaneous input points of the specifications of each input module. (Page 16 Performance Specifications)

Precautions when using the DC input module

■Measures against back EMF

When connecting an inductive load, connect a diode in parallel with the load. Use the diode that satisfies the following conditions:

- A reverse breakdown voltage is ten or more times as high as the circuit voltage.
- A forward current is two or more times as high as the load current.

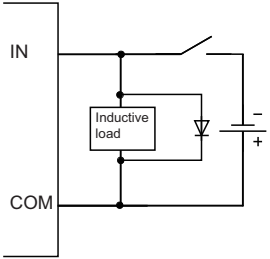
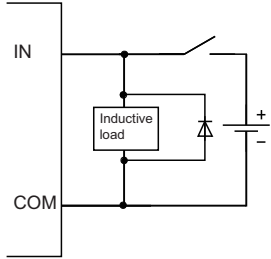
Positive common	Negative common
	

Output module

Precautions common to all output modules

■Maximum switching frequency when load is driven

The maximum switching frequency imposes a limit on the use; an ON state or an OFF state must not be changed without an interval of at least one second.

■Load to be connected

When connecting a counter or timer utilizing a DC/DC converter as a load of the output module, select an output module whose maximum load current is higher than the inrush current of a load to be connected. If the selection is based on the average current of a load to be connected, an inrush current flows cyclically from the load while the output module is in an ON state or in operation, which can cause failure of the module. If it is necessary to select a module on the basis of the average current of a load to be connected, to alleviate the effect of the inrush current, take any of the following corrective actions:

- Connecting a resistor in series with the load

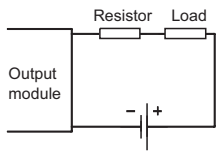

- Connecting an inductor in series with the load

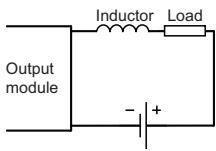

Precautions when using the contact output module

When using the contact output module, carefully consider the following points:

- Relay life (contact switching life)
- Influence on the relay life by a connected load
- Measures against back EMF

■ Relay life (contact switching life)

Applicable module: NZ2MFB2-16R, NZ2MF2S2-16R

The relay life varies depending on the environment where a module is used. When using a module, take the use environment into consideration.

The relay life curve below shows the actual service values, not the guaranteed values. Since an actual contact switching life may be shorter than the relay life curve, replace the module with a sufficient margin for the life.

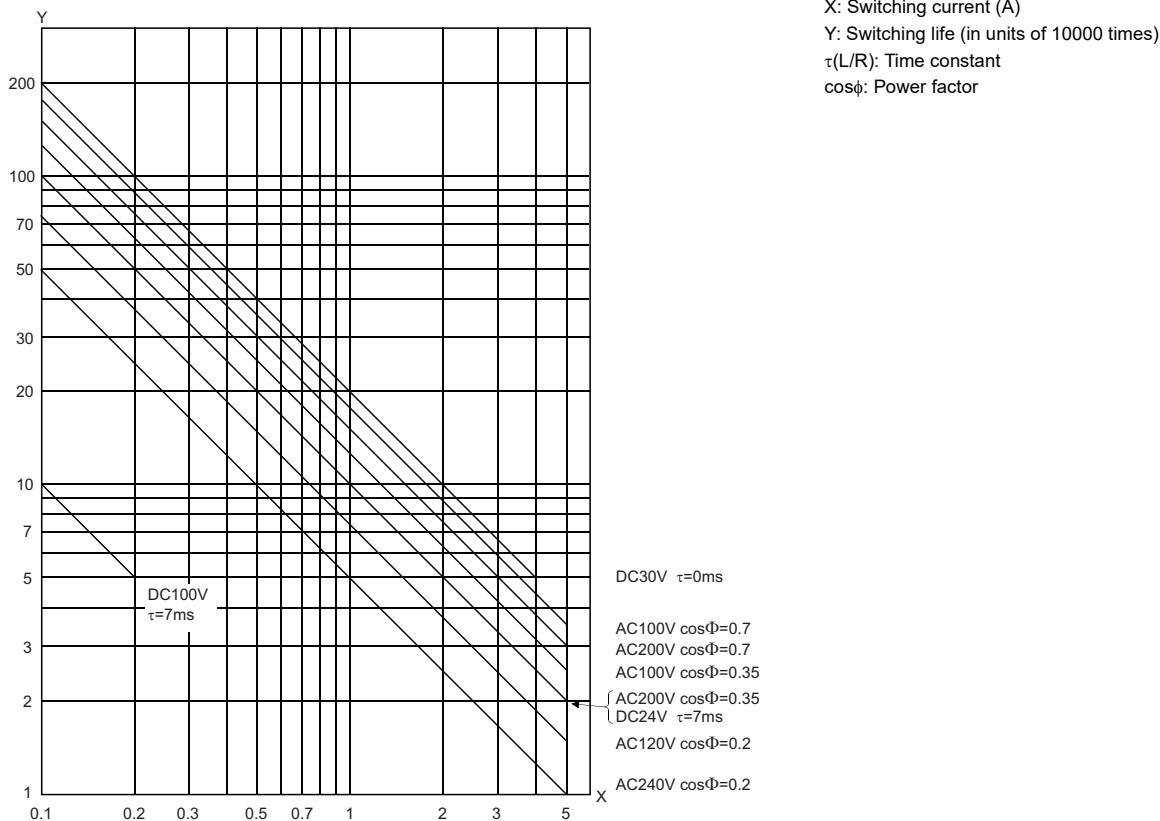

Use environment	Contact switching life
Rated switching voltage/current load	100 thousand times
1.5A at 200VAC, 1A at 240VAC ($\text{COS}\phi = 0.7$)	100 thousand times
0.4A at 200VAC, 0.3A at 240VAC ($\text{COS}\phi = 0.7$)	300 thousand times
1A at 200VAC, 0.5A at 240VAC ($\text{COS}\phi = 0.35$)	100 thousand times
0.3A at 200VAC, 0.15A at 240VAC ($\text{COS}\phi = 0.35$)	300 thousand times
1A at 24VDC, 0.1A at 100VDC ($L/R = 7\text{ms}$)	100 thousand times
0.3A at 24VDC, 0.03A at 100VDC ($L/R = 7\text{ms}$)	300 thousand times

Influence on the relay life by a connected load

An actual relay life can be substantially shorter than the relay life curve depending on the type of a connected load and the characteristics of its inrush current. (☞ Page 69 Relay life (contact switching life))

The inrush current generated by a connected load can lead to contact welding of the module. To prevent shortening of the relay life and contact welding, take the following measures:

- Considering the possibility of a high inrush current, select a load so that the inrush current generated by the connected load falls within the range of the rated current of the module.
- Connect a relay capable of withstanding the inrush current, outside the module.

The following table lists the relations between typical loads and each inrush current.

Select a load so that the inrush current, i , and rated current, i_o , fall within the range of the rated switching current described in the module specifications. In some loads, the inrush current flows for a long time.

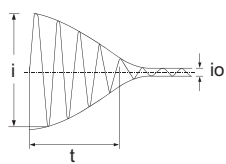
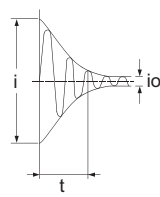
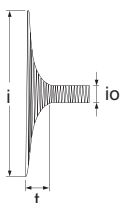
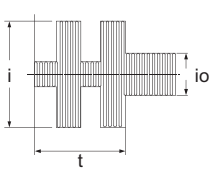
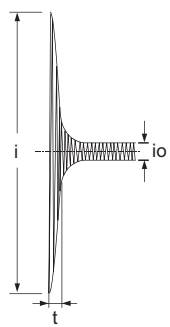
Load type	Waveform	Inrush current i / rated current i_o	Waveform	Inrush current i / rated current i_o
Inductive load	Load of a solenoid  i : Inrush current i_o : Rated current t : 0.07 to 0.1 seconds	Approx. 10 to 20 times	Load of an electromagnetic contactor  i : Inrush current i_o : Rated current t : 0.017 to 0.033 seconds (1 to 2 cycle)	Approx. 3 to 10 times
	Lamp load		Load of an incandescent lamp  i : Inrush current i_o : Rated current t : Approx. 0.33 seconds	
	Load of a fluorescent lamp  i : Inrush current i_o : Rated current t : within 10 seconds	Approx. 5 to 10 times	—	—
Capacitive load	Capacitive load ^{*2}  i : Inrush current i_o : Rated current t : 0.008 to 0.33 seconds (0.5 to 2 cycle)	Approx. 20 to 40 times	—	—

- *1 A typical discharge lamp circuit is configured with a combination of discharge tubes, transformers, choke coils, capacitors and others. Because of this, be especially careful of the case of a high power factor and a low power supply impedance, where the inrush current flowing into the output module can be 20 to 40 times as high as the rated current.
- *2 When the wiring is long, be careful with the cable capacity as well.

Measures against back EMF

Provide a contact protection circuit for an extended contact life, noise prevention at contact close, and reduction of the carbides and nitric acids formed by an arc discharge.

An incorrect circuit involves a high risk of contact welding.

With the contact protection circuit, the recovery time may be delayed.

The following table shows typical examples of the contact protection circuit.

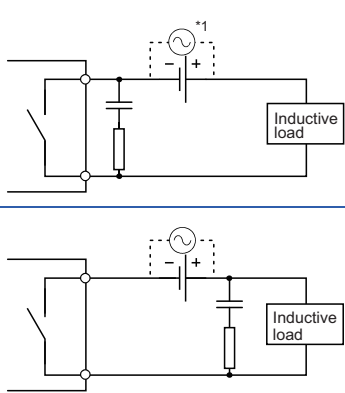
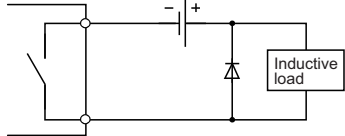
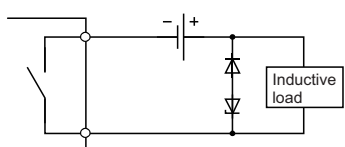
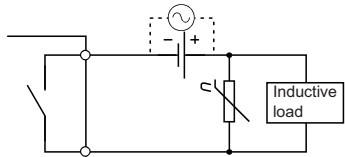
Circuit example	Element selection criteria	Remarks
Capacitor + resistance method (CR method) 	Estimate the constants of a capacitor and resistance with the following as a guide. Some differences, however, may arise from a variation in the nature and characteristics of the load. <ul style="list-style-type: none"> • Capacitor: 0.5 to 1 (μF) for a load current of 1A • Resistance: 0.5 to 1 (Ω) for a power supply voltage of 1V Use a capacitor whose withstand voltage is equal to or higher than the rated voltage. In an AC circuit, use a capacitor with no polarity.	When a relay or solenoid is used as the load, the recovery time is delayed. A capacitor has the effect of reducing a discharge at contact OFF, while a resistance has the effect of limiting a current at contact ON.
Diode method 	Use a diode that satisfies the following conditions: <ul style="list-style-type: none"> • A reverse breakdown voltage is ten or more times as high as the circuit voltage. • A forward current is two or more times as high as the load current. 	The recovery time is delayed than the CR method.
Diode + zener diode method 	Use a zener diode whose zener voltage is equivalent to or higher than the power supply voltage.	This method is suitable for the case where the diode method results in a substantial delay in the recovery time.
Varistor method 	Select a varistor whose cut-off voltage (Vc) satisfies the following condition: <ul style="list-style-type: none"> • $V_c > \text{Power supply voltage} \times 1.5 (V)$ • $V_c > \text{Power supply voltage} \times 1.5 (V) \times \sqrt{2}$ (on AC power supply) Note that selecting an element of an excessively high Vc leads to a weaker effect.	The recovery time is a little delayed.

*1 On AC power supply, the impedance of the CR needs to be sufficiently higher than that of the load. (for preventing errors due to the leakage current of the CR).

Point

- Avoid using contact protection circuits like the following. Although they are highly effective in reducing the arc at current cutoff, a charge current flows into the capacitor when the contact turns on or off, which leads to the risk of contact welding. A DC inductive load, generally considered to be more difficult to open and close than a resistive load, can achieve the same performance of a resistive load in an appropriate configuration of the protection circuit.

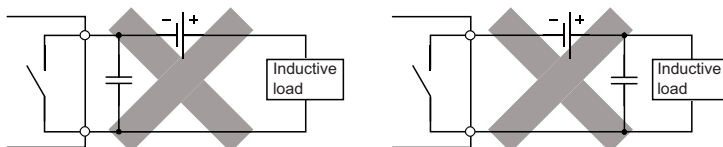

- Install the protection circuit near the load or contact (module). A long distance between them may inhibit the effect of the protection circuit. As a guide, install it at a distance of no more than 50cm.

Precautions when using the transistor output module

Measures against reverse current

In the following connections, a reverse current flows to the output element, which can cause failure.

When wiring, set up diodes as the following figures show:

- When connecting transistor output modules in parallel

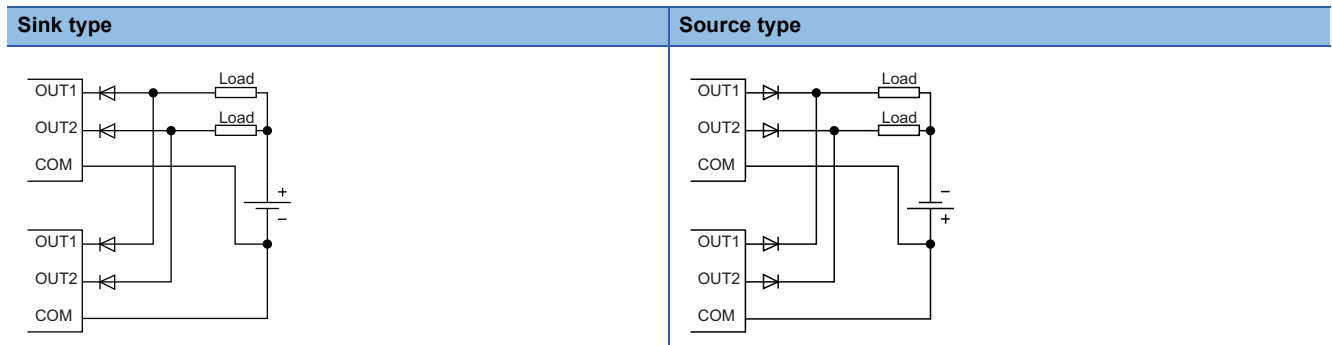

- When providing another circuit in parallel with a transistor output module

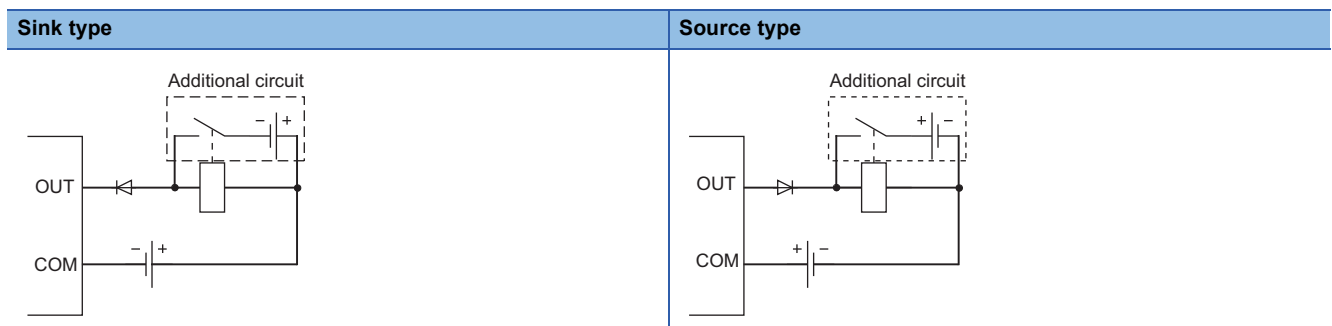

Measures against back EMF

When connecting an inductive load, connect a diode in parallel with the load.

Use the diode that satisfies the following conditions:

- A reverse breakdown voltage is ten or more times as high as the circuit voltage.
- A forward current is two or more times as high as the load current.

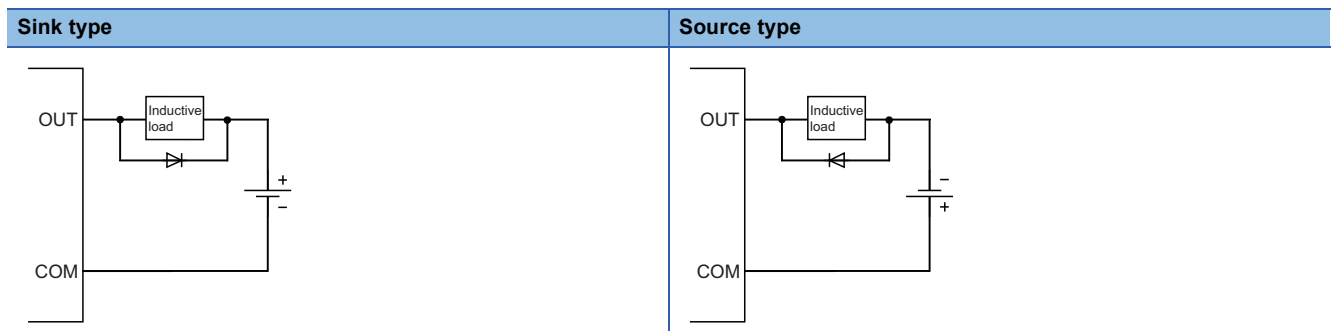

About element protection of the output module

If excessive noise affects the terminals of the output module, the output may be turned on to help the protection of the output element. Adjust the voltage between terminals of the output module to fall within the operating load voltage range by taking measures such as the following:

- To use an inductive load such as a relay, a surge suppressor is required on the load side as well. Take appropriate measures with the measures against back EMF as a guide.
- To prevent excessive noise, avoid installing power cables together with I/O cables.

6.2 Setting Switch

IP address setting switch setting

Set the fourth octet of IP address using the IP address setting switch on the front of I/O module.

The setting of IP address setting switch is enabled when the I/O module is powered on. Thus, set this function when the module is powered off.

Setting procedure

- Set the hundreds place digit to 200 or 100 of IP address setting switch.
- Set the tens place digit to 80, 40, 20, or 10 of IP address setting switch.
- Set the ones place digit to 8, 4, 2, or 1 of IP address setting switch.

Ex.

To set to 235:

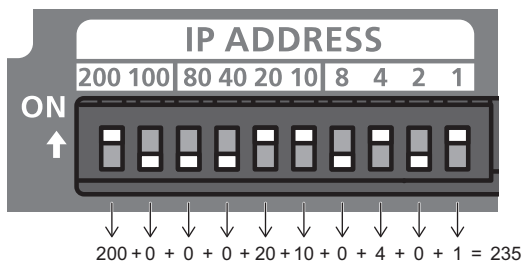

Setting range

The setting value must be in the range between 1 and 254.

If the value equal to or more than 255 is set, the following events occur.

- A moderate error occurs and ERR. LED turns on.
- The IP address of I/O module will be 192.168.3.100.

Point

- Do not change the IP address setting switch while the module is powered on. Changing the IP address setting switch while the module is powered on causes a minor error and flashes the ERR. LED. Returning the IP address setting switch to the previous setting eliminates the error and turns off the ERR. LED.
- Do not set an IP address with duplicated fourth octet in the access range of CC-Link IE Field Network Basic. Duplicated fourth octet causes the duplicated IP address due to the automatic setting of the first to third octet, resulting in failure of data link establishment. (☞ Page 125 Setting IP Addresses and Subnet Masks)

Automatic setting of the first to third octet of IP address

The first to third octet of IP address is automatically set by the I/O module according to the settings of the master station. (The factory default setting is 192.168.3.)

■When there is one master station:

Receives the information of network configuration setting from the master station.

Searches for the IP address with fourth octet matching the IP address setting switch from the network configuration setting information.

If any address with matched fourth octet is found, the first to third octet is set to the own station based on the matched network configuration setting information.

No.	Model Name	STA#	Station Type	RX/RV Setting			RWw/RWv Setting			Group No.	RSVD STA	IP Address	Subnet Mask
				Points	Start	End	Points	Start	End				
0	Host Station	0	Master Station								192.168.1.100	255.255.255.0	
1	NZ2MFB1-3ZDT	1	Slave Station	64 (1 Occupied Station)	0000	003F	32	0000	001F	1	No Setting	192.168.1.10	255.255.255.0

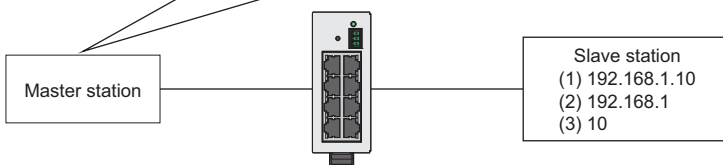

- (1) IP address of I/O module
- (2) The first to third octet of network configuration setting
- (3) The setting value of IP address setting switch

■When there are multiple master stations:

Receives the information of network configuration setting from the master station 1 and 2.

Searches for the IP address with fourth octet matching the IP address setting switch from the network configuration setting information of the master station 1 and 2.

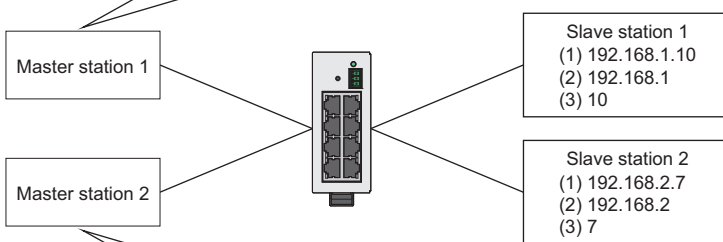

If any address with matched fourth octet is found, the first to third octet is set to the own station based on the matched network configuration setting information.

No.	Model Name	STA#	Station Type	RX/RV Setting			RWw/RWv Setting			Group No.	RSVD STA	IP Address	Subnet Mask
				Points	Start	End	Points	Start	End				
0	Host Station	0	Master Station								192.168.1.100	255.255.255.0	
1	NZ2MFB1-3ZDT	1	Slave Station	64 (1 Occupied Station)	0000	003F	32	0000	001F	1	No Setting	192.168.1.10	255.255.255.0



No.	Model Name	STA#	Station Type	RX/RV Setting			RWw/RWv Setting			Group No.	RSVD STA	IP Address	Subnet Mask
				Points	Start	End	Points	Start	End				
0	Host Station	0	Master Station								192.168.2.101	255.255.255.0	
1	NZ2MFB1-3ZDT	1	Slave Station	64 (1 Occupied Station)	0000	003F	32	0000	001F	1	No Setting	192.168.2.7	255.255.255.0

- (1) IP address of I/O module
- (2) The first to third octet of network configuration setting
- (3) The setting value of IP address setting switch

-
- Automatic setting of the first to third octet of IP address is executed only once during the initial communication with the master station after the I/O module is powered on. When the IP address of the I/O module in the network parameter at the master station is changed while the data link between the I/O module and master station is established, power off and on the I/O module as well after the parameter of master station is reflected.
 - The subnet mask for automatic setting of the first to third octet of IP address is 255.255.255.0 (fixed). If the subnet mask needs to be set to the value other than 255.255.255.0, set the IP address and subnet mask manually. ( Page 125 Setting IP Addresses and Subnet Masks)
 - If the module is powered on while the IP address setting switch is 0, IP address is not set automatically. Operation starts with the IP address and subnet mask set from the configuration tool of the master station. ( Page 125 Setting IP Addresses and Subnet Masks)
-

Function setting switch setting

Set the input response time setting and output HOLD/CLEAR setting using the function setting switch on the front of I/O module.

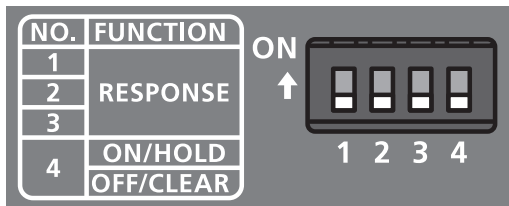

No.	Switch name	Function to be used	Setting details
1	Function setting switch 1 to 3	Input response time setting function	Set the input response time.
2			For setting method, refer to the following.
3			Page 90 Setting method
4	Function setting switch 4	Output HOLD/CLEAR setting function	Set output HOLD/CLEAR. For setting method, refer to the following. Page 91 Setting method

Point

Do not change the function setting switch while the module is powered on. Changing the function setting switch while the module is powered on causes a minor error and flashes the ERR. LED. Returning the function setting switch to the previous setting eliminates the error and turns off the ERR. LED.

6.3 Installation Environment and Installation Position

Installation environment

Installation location

Do not install the I/O module to the place where:

- Ambient temperature is outside the range of 0 to 55°C;
- Ambient humidity is outside the range of 5 to 95%RH;
- Condensation occurs due to rapid temperature change;
- Corrosive gas or combustible gas is present;
- Conductive powder such as dust and iron powder, oil mist, salinity, or organic solvent is filled;
- The I/O module is exposed to direct sunlight;
- A strong electric field or strong magnetic field is generated; and
- The I/O module is subject to vibration and shock.

Installation surface

Install the I/O module on the flat surface. When the installation surface is uneven, excessive force is applied to the printed-circuit board and may cause a defect.

Installation position

When installing the I/O module in a control panel, provide clearance of 60mm or longer (1) between the module and the sides of control panel or neighboring modules to ensure good ventilation and an easy module change.

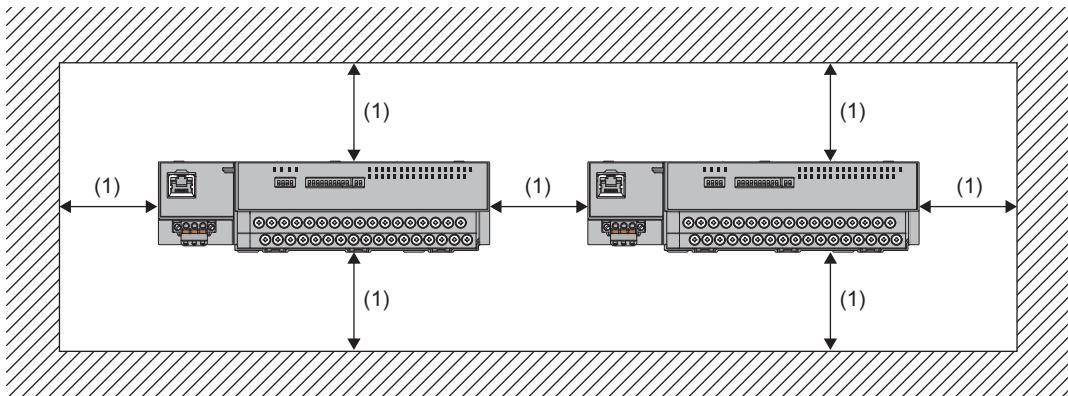

Installation direction

The I/O module can be installed in six directions.
Use the DIN rail (1) to install the module.



(3)

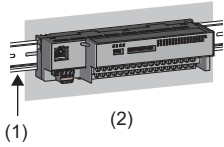

(1)

(2)

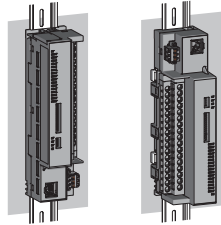

(4)

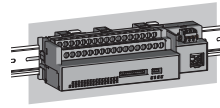

(6)

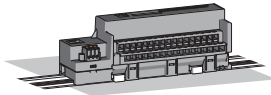

(5)

- (1) DIN rail
- (2) Horizontal installation
- (3) Downward installation
- (4) Vertical installation
- (5) Upward installation
- (6) Horizontal installation (upside down)

6.4 Installation

Mounting the module on a DIN rail

Point

An example of the use of the DIN rail stopper is described in the following procedure. Fix the module according to the manual of the DIN rail stopper used.

Mounting procedure

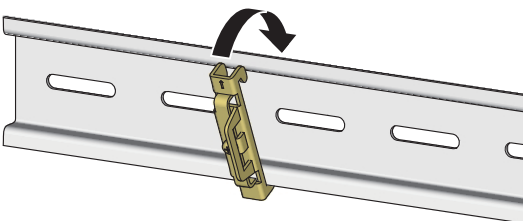
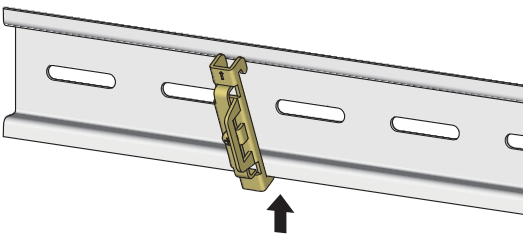
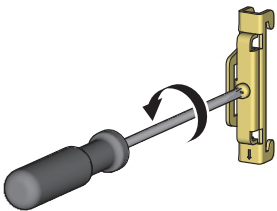
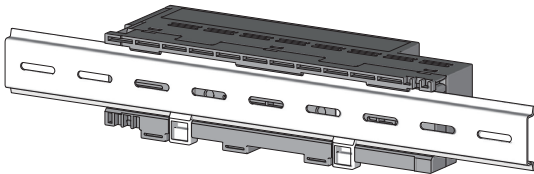
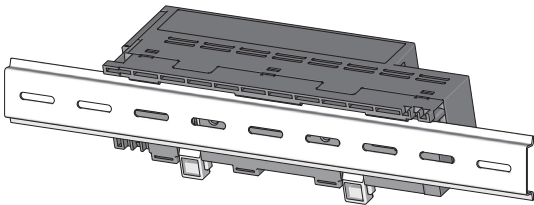
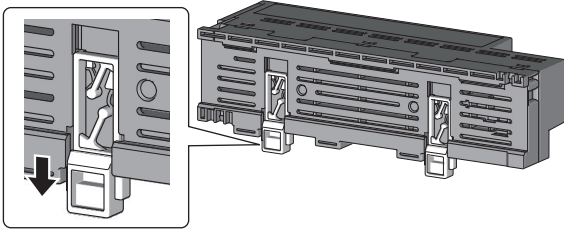

1. Pull down all DIN rail hooks on the back of the module. The hooks should be pulled down until they click.

2. Hang the upper tabs of the module on a DIN rail, and push the module in position.

3. Lock the DIN rail hooks to the DIN rail to secure the module in position. Push each hook up until it clicks. If the hooks are beyond the reach, use a tool such as a driver.

4. Loosen the screw on DIN rail stopper.

5. Hitch the bottom hook of the DIN rail stopper to the bottom of the DIN rail. Hitch the hook according to the orientation of the arrow on the front of the stopper.

6. Hitch the upper hook of the DIN rail stopper to the top of the DIN rail.

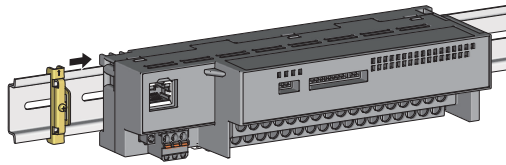

7. Slide the DIN rail stopper up to the left side of the module.

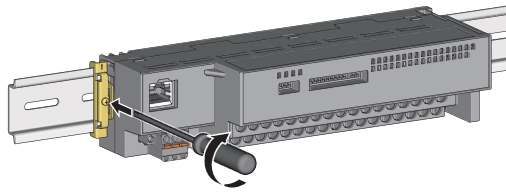

8. Hold the DIN rail stopper in the direction opposite to the arrow on the stopper and tighten the screw with a driver.

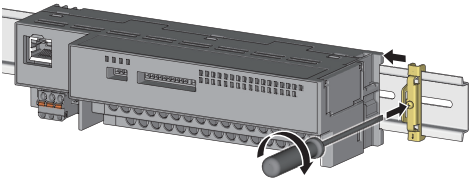

9. Install the DIN rail stopper on the right side of the module in the same procedure.

Install the stopper upside down for the right side.

Point

Do not slide the module from the edge of the DIN rail when mounting it. The module may be damaged.

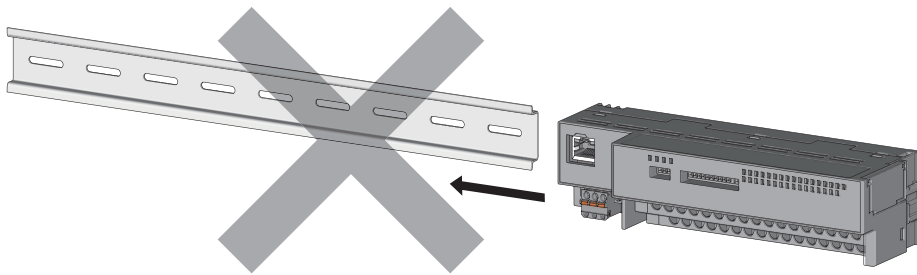

Removal procedure

Remove the module from the DIN rail by reversing the above procedure.

Applicable DIN rail model (compliant with IEC 60715/JIS C 2812)

- TH35-7.5Fe
- TH35-7.5Al

Interval between DIN rail mounting screws

Tighten the screws at intervals of 200mm or less.

DIN rail stopper

Use a stopper that is attachable to the DIN rail.

6.5 Wiring

Wiring of terminal block for module power supply and FG

Wiring of spring clamp terminal block

■Tightening torque

Tighten the terminal block mounting screw within the following specified torque range.

Tightening the screw too much may damage the module case.

Screw type	Tightening torque range
Terminal block mounting screw (M2.5 screw)	0.2 to 0.3N·m

■Wire to be used

The following table describes the wire to be connected to the terminal block for module power supply and FG.

Diameter	Type	Material	Temperature rating
22 to 16 AWG	Stranded	Copper	75°C or more

■Applicable solderless terminal

The following table lists the applicable solderless terminal.

Product name	Model name	Applicable wire size	Bar solderless terminal tool*1	Contact
Bar solderless terminal	AI 0.34-8TQ	0.3mm ² , 0.34mm ²	CRIMPFOX6	PHOENIX CONTACT GmbH & Co. KG
	AI 0.5-8WH, AI 0.5-10WH	0.5mm ²		
	AI 0.75-8GY, AI 0.75-10GY	0.75mm ²		
	AI 1-8RD, AI 1-10RD	1.0mm ²		
	AI 1.5-8BK, AI 1.5-10BK	1.5mm ²		
	TE 0.5-8, TE 0.5-10	0.3 to 0.5mm ²	NH-79	
TE 0.75-8, TE 0.75-10	0.75mm ²			
TE 1.0-8, TE 1.0-10	1.0mm ²			
TE 1.5-8, TE 1.5-10	1.5mm ²			

*1 Use a bar solderless terminal tool whose manufacturer is the same as that of the bar solderless terminal used.

■Installing or removing the terminal block

To remove the terminal block, loosen the terminal block mounting screw with a flathead screwdriver.

To install the terminal block, tighten the terminal block mounting screw with a flathead screwdriver.

Failure to secure the terminal block may cause drop, short circuit, or malfunction.

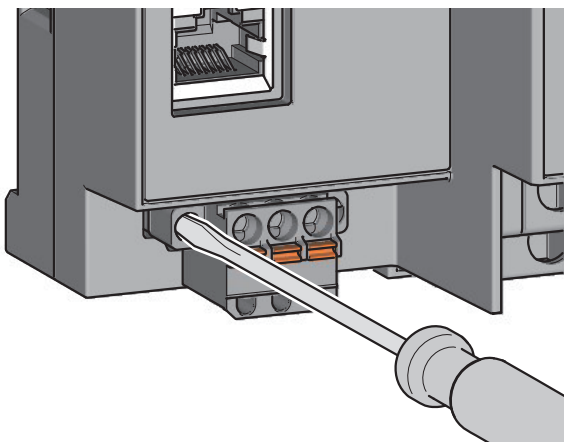

■Connecting and disconnecting the cable

To connect the cable, fully insert a wire having a bar solderless terminal into a wire insertion opening. After inserting the wire, pull it lightly to check that it is securely clamped.

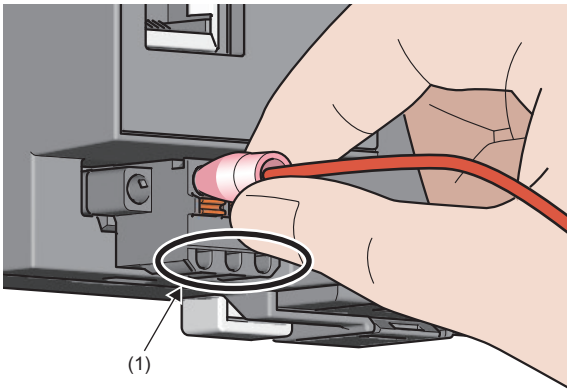

Point

Continuity can be checked with test terminal (1).

To disconnect the cable, push in the open/close button with a Phillips screwdriver or flathead screwdriver. With the button pushed in, pull out the wire having a bar solderless terminal.

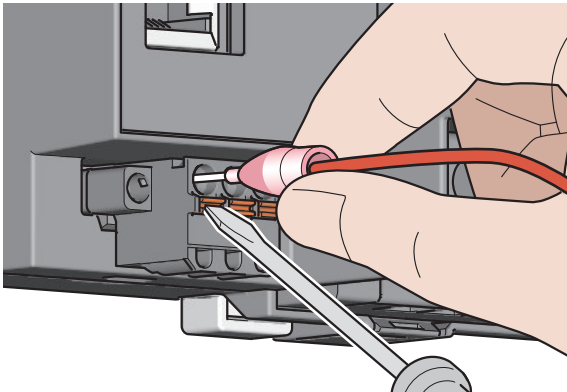

■Precautions

- Use a bar solderless terminal for the wiring to the spring clamp terminal block. If a stripped wire is inserted into a wire insertion opening, the wire cannot be securely clamped.
- For how long the wire should be stripped, follow the specifications of the bar solderless terminal used. To attach a bar solderless terminal to a wire, use a crimping tool.
- Before inserting a bar solderless terminal into a wire insertion opening, check the shape of the opening and the shape of the terminal. Insert the terminal paying attention to the orientation. If a bar solderless terminal larger than the wire insertion opening is inserted, the terminal block may be damaged.

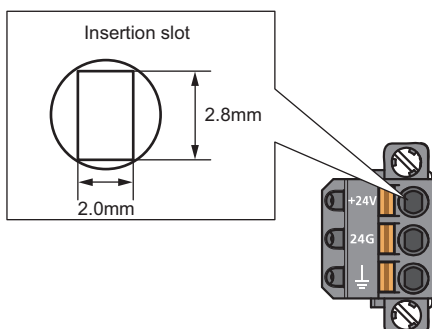

Wiring of Ethernet cable

Wiring method

■Installation method

1. Power off the power supplies of the I/O module and the external device.
2. Push the Ethernet cable connector into the I/O module until it clicks. Pay attention to the connector's direction.
3. Power on the module power supply of the I/O module.
4. Power on the external device.
5. Check if the 100M LED on the port into which the Ethernet cable is connected is on.*1

*1 The time taken for the 100M LED to turn on after connection of the Ethernet cable may vary. The 100M LED normally turns on in a few second. However, if link-up processing is repeated due to a condition of a device on the line, the longer time may be required. If the 100M LED does not turn on, refer to the following and take a corrective action.

 Page 102 When the 100M LED turns off

■How to disconnect

1. Power off the module power supply of the I/O module.
2. Press down the latch of the Ethernet cable and unplug the cable.

Precautions

For precautions when wiring the Ethernet cable, refer to the following.

 CC-Link IE Field Network Basic Reference Manual

Wiring of external device and I/O terminal block

Wiring of screw terminal block

■Tightening torque

Tighten the terminal screw within the following specified torque range.

Tightening the screw too much may damage the module case.

Screw type	Tightening torque range
Terminal screw (M3 × 5.2 screw)	0.59 to 0.88N·m

■Wire to be used

The following table describes the wire to be connected to the screw terminal block.

Diameter	Type	Material	Temperature rating
22 to 14 AWG	Stranded	Copper	75°C or more

■Applicable solderless terminal

The following table lists the applicable solderless terminal.

Model name	Applicable wire size	Contact
RAV1.25-3	0.3 to 1.25mm ²	—
V2-MS3	1.25 to 2.0mm ²	JST Mfg. Co., Ltd.
TGV2-3N	1.25 to 2.0mm ²	NICHIFU Co., Ltd.

■Signal name and wiring

For the signal names of the terminal block and wiring of the external device, refer to the specifications of each module.

Incorrect wiring can cause malfunction of or damage on the module.

☞ Page 16 Performance Specifications

■Wiring method

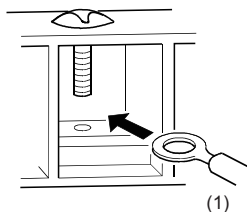

1. Loosen the terminal screw. Connect the round solderless terminal (1) as it is.

Point

- Do not put oil on the terminal and screw. Failure to do so may damage the screw.
- The number of the applicable solderless terminals must be two or less. When inserting two applicable solderless terminals, insert them back-to-back. Otherwise the screw cannot be tightened and it may damage the screw.
- Tighten the terminal screw with an applicable driver. Tightening with an inapplicable driver may damage the screw.

Wiring of spring clamp terminal block

■Wire to be used

The following table describes the wire to be connected to the spring clamp terminal block.

Diameter	Type	Material	Temperature rating
22 to 16 AWG	Stranded	Copper	75°C or more

■Applicable solderless terminal

The following table lists the applicable solderless terminal.

Product name	Model name	Applicable wire size* ¹	Bar solderless terminal tool* ²	Contact
Bar solderless terminal	AI 0.34-10TQ	0.3mm ² , 0.34mm ²	CRIMPFOX6	PHOENIX CONTACT GmbH & Co. KG
	AI 0.5-10WH	0.5mm ²		
	AI 0.75-10GY	0.75mm ²		
	A 0.5-10	0.5mm ²		
	A 0.75-10	0.75mm ²		
	A 1.0-10	1.0mm ²		
	A 1.5-10	1.5mm ²		

*1 When using a solderless terminal with an insulation sleeve, select the terminal whose applicable wire size is 0.75mm² or smaller.

*2 Use a bar solderless terminal tool whose manufacturer is the same as that of the bar solderless terminal used.

■Installing or removing the terminal block

The following procedures show how to install and remove the terminal block.

- Lock and release lever positions

To make it easy to install and remove the terminal block, a three-stage positioning stopper is attached so that the lever does not freely turn around.

When installing or removing the terminal block, turn the lever to the lock or release lever position.

Figure viewed from the module right surface: When pulling the terminal block

1. Release lever position

This lever position shows the state in which the terminal block (1) has been completely pulled out from the module.

Turn from the locking lever position to the release lever position (2) and lift the terminal block from the module.

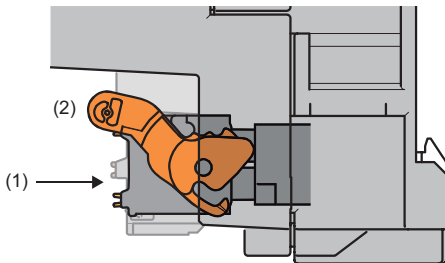
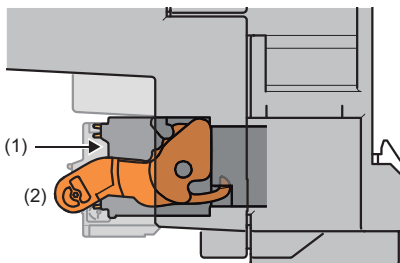

Figure viewed from the module right surface: When insertion of the terminal block has completed

2. Lock lever position

This position shows the state in which the terminal block (1) completely fits the module. Check the lock lever position (2) and pull the terminal block lightly to confirm that the module completely fits the terminal block.



- Removal procedure

Turn the lever to the release lever position and remove the terminal block from the module.

- Installation procedure

Move the lever to the locking lever position and push the terminal block. If the terminal block is fully pushed in, the hook of the lever hangs on the module and fits the terminal block.

Point 

The terminal block can be inserted with the lever locations other than the lock lever position.
After insertion, confirm that the lever is in the lock lever position.

■Signal name and wiring

For the signal names of the terminal block and wiring of the external device, refer to the specifications of each module. Incorrect wiring can cause malfunction of or damage on the module.

☞ Page 16 Performance Specifications

■Wiring method

- Stripping a wire

The strip length of wire must be 10mm.

- Connecting the cable

Insert wire in which the tip thereof has been processed into a wire insertion opening (2) and push it to the back.

If the wire cannot be inserted by this method, insert the wire to the back while pressing the release button (1) using a flathead screwdriver with a tip width of 2.0 to 2.5mm. Once the wire is inserted to the back, remove the screwdriver.

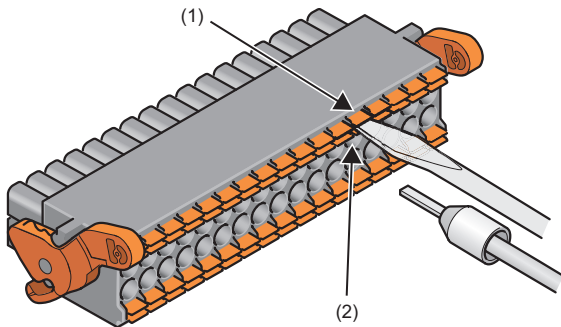

Point

Pull the wire or bar solderless terminal lightly to confirm that it is securely clamped.

- Disconnecting the cable

Pull the wire while pressing the release button using a flathead screwdriver with a tip width of 2.0 to 2.5mm.

Precautions

- Use a crimping tool to connect a bar solderless terminal to a wire. (☞ Page 85 Applicable solderless terminal)
- When inserting a bar solderless terminal, make sure that the size of the terminal and its insertion direction are correct to prevent the terminal from getting stuck in or the terminal block damage. When using a bar solderless terminal other than the applicable solderless terminals, make sure that the cross-sectional shape of the terminal after processing (the size includes an error in processing) is smaller than the size mentioned below. For the correct terminal insertion direction, refer to the figure below.

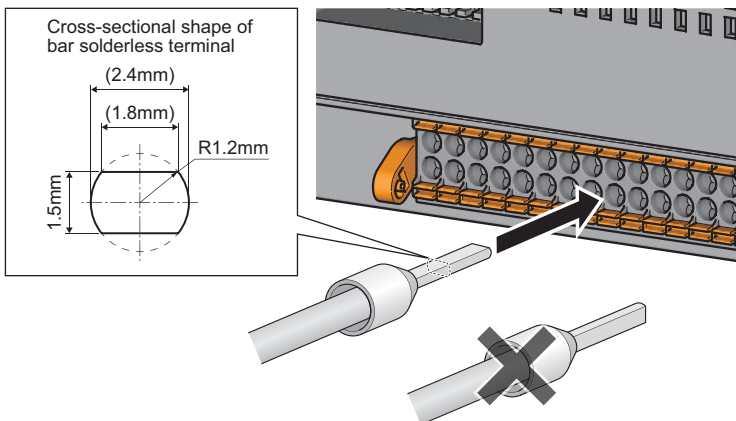

Point

For details on the finish shape of a bar solderless terminal including an error in processing, contact the manufacturers of the bar solderless terminal and the bar solderless terminal tool.

7 PARAMETER SETTING

7.1 Network Configuration Setting

Write the network configuration setting into the master station before starting the operation of I/O module.
For how to set the network configuration of the master station, refer to the following.

📖 CC-Link IE Field Network Basic Reference Manual

Setting procedure

1. Display the network configuration setting window.

For how to display the network configuration setting window, refer to the following.

📖 CC-Link IE Field Network Basic Reference Manual

2. Select the I/O module to be connected from the "Module List", and then drag and drop it.

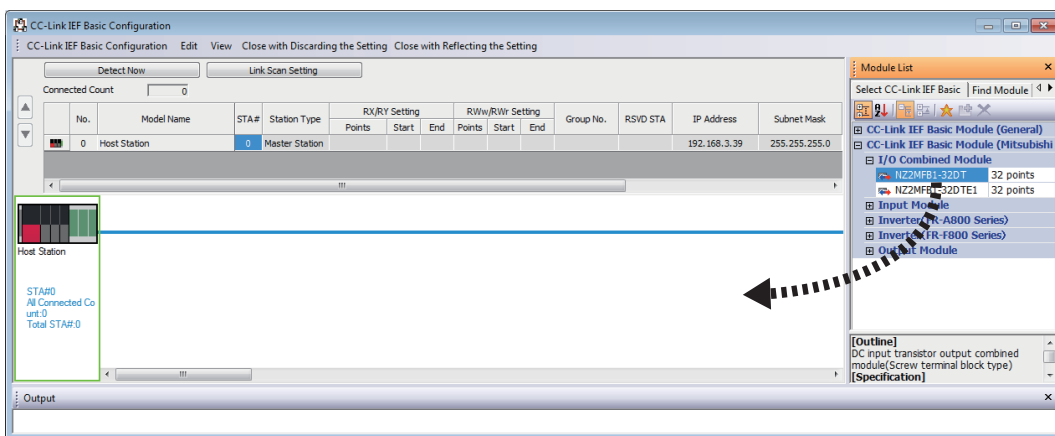

3. After the I/O module appears, enter the IP address and subnet mask.

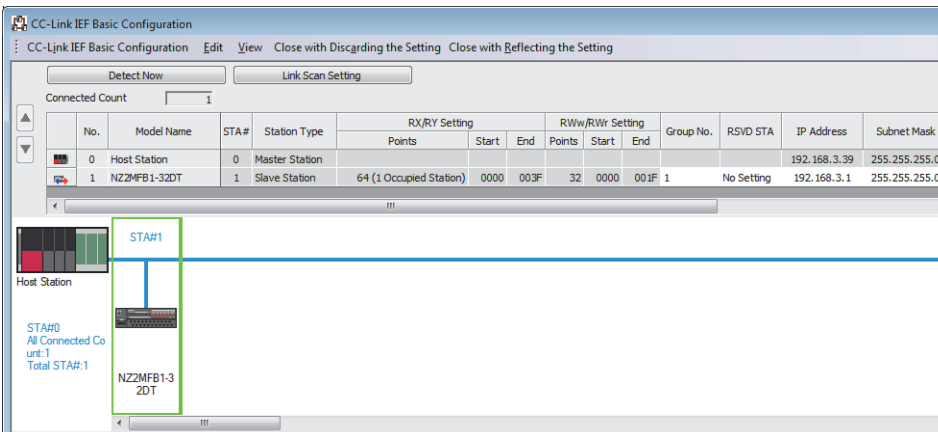

The setting items of I/O module		Setting details
IP Address	First to third octet	Same value as the first to third octet of the IP address of master station
	Fourth octet	Same as the value of IP address setting switch of I/O module
Subnet Mask		255.255.255.0 ^{*1}

*1 The subnet mask for automatic setting of the first to third octet of IP address is 255.255.255.0 (fixed). If the subnet mask needs to be set to the value other than 255.255.255.0, set the IP address and subnet mask manually. (📖 Page 125 Setting IP Addresses and Subnet Masks)

4. Close the network configuration setting window.

 [Network Configuration Settings] ⇒ [Close with Reflecting the Setting]

5. Write the set parameter to the CPU module of the master station and reset the CPU module, or turn off and on the power supply.

 [Online] ⇒ [Write to PLC]

Setting item

For details on items for network configuration setting, refer to the following.

 CC-Link IE Field Network Basic Reference Manual

8 FUNCTIONS

This chapter describes the details of the functions available in the I/O module, and the setting method for those functions.

8.1 Input Response Time Setting Function

This function prevents an incorrect input due to noise by setting the response time until the module recognizes an actual input as the X signal.

Setting method

1. Set the input response time using the function setting switch 1 to 3 of I/O module.

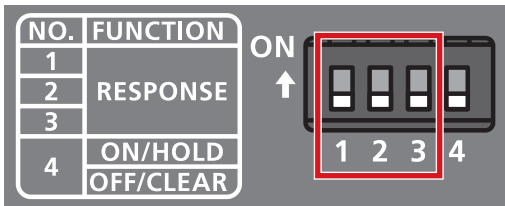

Function setting switch 1 to 3			Input response time setting
1	2	3	
OFF	OFF	OFF	10ms (default)
OFF	OFF	ON	0ms
OFF	ON	OFF	0.2ms
OFF	ON	ON	1ms
ON	OFF	OFF	1.5ms
ON	OFF	ON	5ms
ON	ON	OFF	20ms
ON	ON	ON	70ms

The setting status of input response time can be checked by bit0 to bit2 of detailed module information (upper).

For details, refer to the following.

Page 129 Detailed module information (upper)

Precautions

Noise may be taken in as an input depending on the input response time setting.

The pulse width which is taken in as an input varies depending on the input response time.

To set the input response time, consider fully the operating environment.

The following table shows the minimum values of the pulse widths which may be taken in as an input. The pulse widths lower than the values shown below can be filtered as noise.

Value of input response time setting	0ms	0.2ms	1.0ms	1.5ms	5ms	10ms	20ms	70ms
The minimum value of the pulse width which may be taken in as an input (the maximum pulse widths which can be filtered as noise)	—	0.004ms	0.15ms	0.4ms	2ms	4ms	9ms	36ms

8.2 Output HOLD/CLEAR Setting Function

When the I/O module is disconnected from data link, or the CPU module operating status is STOP, whether to hold or clear the last output value can be set by this function.

Output HOLD/CLEAR setting and its operation

When HOLD or CLEAR is set for an output, the output is turned on or off as follows.

Operating status		Output HOLD/CLEAR setting HOLD		Output HOLD/CLEAR setting CLEAR	
		Last output status OFF	Last output status ON	Last output status OFF	Last output status ON
Data link in operation	CPU module in RUN	OFF	ON	OFF	ON
	CPU module in STOP	OFF	ON	OFF	OFF
	CPU module in PAUSE	OFF	ON	OFF	ON
	CPU module in RESET	OFF	ON	OFF	OFF
	CPU module suspended by error	OFF	ON	OFF	OFF
During disconnection/cyclic stop		OFF	ON	OFF	OFF

If a moderate or major error has occurred in the I/O module, output turns off regardless of the output HOLD/CLEAR setting.

Setting method

1. Set HOLD or CLEAR using the function setting switch 4 of I/O module.

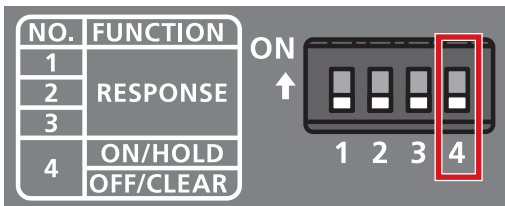

Function setting switch 4	Output HOLD/CLEAR setting
OFF	CLEAR (default)
ON	HOLD

The setting status of output HOLD/CLEAR setting can be checked by bit3 of detailed module information (upper).

For details, refer to the following.

Page 129 Detailed module information (upper)

8.3 Protection Function

The overload protection function and overheat protection function protect the internal circuit from overcurrent and its heat.

Overload protection function

If the transistor output module and I/O combined module (transistor output part) detect overcurrent, the module performs the current limiting operation (that imposes a limit on the output current to a constant value and keeps the output).

For the overcurrent detection value and the limited current, refer to the overload protection function in the specifications for each module.

☞ Page 28 Output module

☞ Page 46 I/O combined module

If the load current becomes equal to the overcurrent detection value or lower, the module returns to normal operation.

Overheat protection function

If the transistor output module and I/O combined module (transistor output part) keep outputting the overcurrent caused by an overload, heat is generated inside the module. If the module detects a high heat in its inside, it turns off the output.

The multiple points at which the overheat protection function operates depend on the module. Refer to the overheat protection function in the specifications for each module.

☞ Page 28 Output module

☞ Page 46 I/O combined module

If the heat descends, the module automatically returns to normal operation.

Point

The overload protection function and the overheat protection function do not protect external devices but protect the internal circuit of the module.

A problem on a load may raise the internal temperature of the module, causing deterioration in output elements and discoloration on the case and the printed-circuit board. Turn off the corresponding output as soon as a problem on a load is found, and remove the cause.

8.4 SLMP communication function

SLMP can be used to communicate with the I/O module.

For details on SLMP, refer to the following.

 SLMP Reference Manual

Available command

Item		Command	Subcommand	Description
Type	Operation			
Remote Control	Remote Reset	1006	0000	Executes the remote RESET for I/O module.

Communication setting

If I/O module and SLMP are used for communication, use the following settings.

- Communication method: UDP/IP
- Port number: 61550
- Code: Binary code

How to use

If SLMP command needs to be sent from the CPU module to I/O module, use the SP.SLMPSND instruction.

For the SP.SLMPSND instruction, refer to the manual for respective series.

 MELSEC iQ-R Programming Manual (CPU Module Instructions, Standard Functions/Function Blocks)

 MELSEC iQ-F FX5 Programming Manual (Instructions, Standard Functions/Function Blocks)

 QnUCPU User's Manual (Communication via Built-in Ethernet Port)

 MELSEC-L CPU Module User's Manual (Built-In Ethernet Function)

Point

When the I/O module detects an SLMP command error, abnormal response is returned whereas error status does not occur in the I/O module. Since an error code is stored in the end code of the abnormal response data, refer to the following table to check the error contents and take actions.

 Page 93 End code of SLMP communications

End code of SLMP communications

The codes that are stored in the end codes when the I/O module returns the abnormal response are as follows:

End code	Error name	Description and cause	Action
C059H	Command error	A command or subcommand is incorrectly specified.	Correct the command or subcommand and send it again.
C05CH	Request message error	Request message is incorrect.	Correct the content and send it again.
C061H	Request data length error	Request data length does not match the number of data.	Correct the content or length of request data and send it again.
CEE1H	Request message size error	The size of request message has exceeded the upper limit.	Correct the content and send it again.

9 PROGRAMMING

This chapter describes the programming of the I/O module.

9.1 Precautions for Programming

Cyclic transmission program

To create a cyclic transmission program, configure an interlock so that the process is executed while the cyclic transmission is normally performed between the master station and slave station. For the interlock program of cyclic transmission, refer to the following.

 CC-Link IE Field Network Basic Reference Manual

9.2 Program Example

System configuration

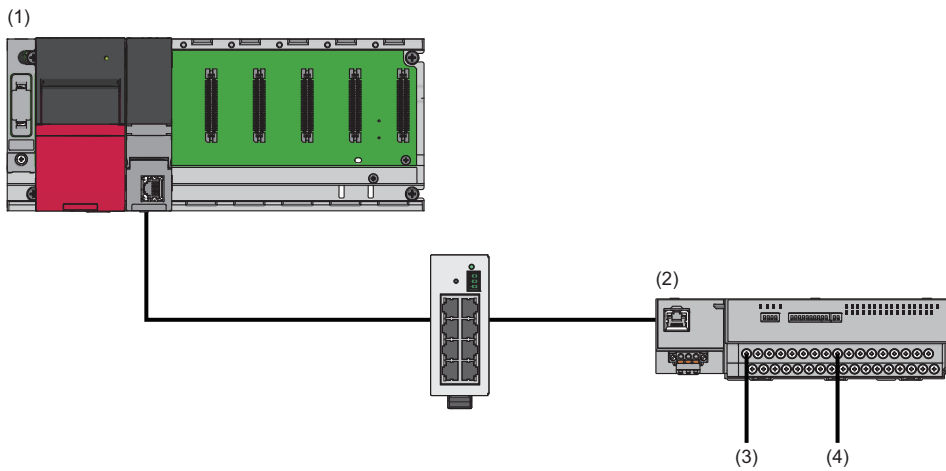

- (1) Master station
 - Power supply module: R62P
 - CPU module: R04CPU
- (2) Slave station (station number: 1, IP address setting switch: 1)
 - I/O combined module: NZ2MFB1-32DT
- (3) X0 input signal (pressing button)
- (4) Y10 output signal (lamp)



The setting procedure assumes the use of GX Works3.

■Assignment of link devices

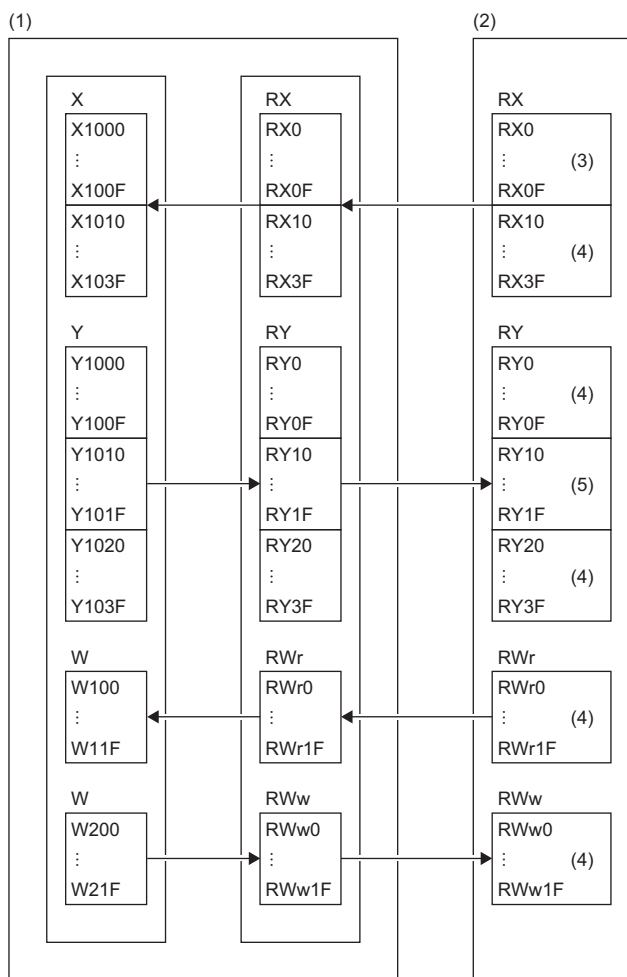

(1) Master station: CPU module

(2) Slave station (station number 1): I/O combined module

(3) Input signal

(4) Use prohibited

(5) Output signal

Label to be used

■Module label

Use the following module labels.

Module label	Description	Device
RCPU.stSM.bSts_CyclicTransmission	Cyclic transmission status	SM1536
RCPU.stSD.bnSts_CyclicTransmission_Station[1]	Cyclic transmission status of each station (station number 1)	SD1536.0

■Label to be defined

Define the global labels as follows.

Label Name	Data Type	Class	Assign (Device/Label)
bStartDirection_1	Bit	VAR_GLOBAL	M200
PressingButton	Bit	VAR_GLOBAL	X1000
Lamp	Bit	VAR_GLOBAL	Y1010

Setting procedure

1. Create a project with the contents below.

 [Project] ⇒ [New...]

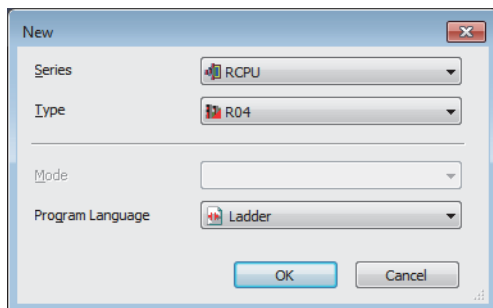

2. Set whether or not to use CC-Link IE Field Network Basic.

 [Navigation window] ⇒ [Parameter] ⇒ [CPU module model name] ⇒ [Module Parameter] ⇒ [Basic Settings]

3. Display the network configuration setting window and configure the setting as follows.

 [Navigation window] ⇒ [Parameter] ⇒ [CPU module model name] ⇒ [Module Parameter] ⇒ [Basic Settings] ⇒ [Network Configuration Settings]

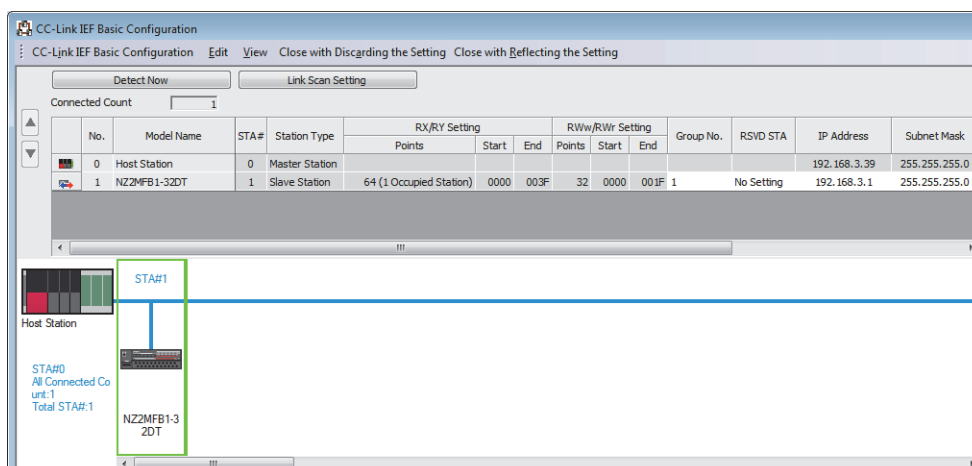

4. Close the network configuration setting window.

 [Network Configuration Settings] ⇒ [Close with Reflecting the Setting]

5. Display the refresh setting window and configure the setting as follows.

 [Navigation window] ⇒ [Parameter] ⇒ [CPU module model name] ⇒ [Module Parameter] ⇒ [Basic Settings] ⇒ [Refresh Settings]

Link Side					CPU Side				
Device Name	Points	Start	End		Target	Device Name	Points	Start	End
RX	64	00000	0003F	↔	Specify Device	X	64	01000	0103F
RY	64	00000	0003F	↔	Specify Device	Y	64	01000	0103F
RWr	32	00000	0001F	↔	Specify Device	W	32	00100	0011F
RWw	32	00000	0001F	↔	Specify Device	W	32	00200	0021F

6. After the parameter setting, click the [Apply] button.

7. Write the set parameter to the CPU module of the master station and reset the CPU module, or turn off and on the power supply.

 [Online] ⇒ [Write to PLC]

Program example

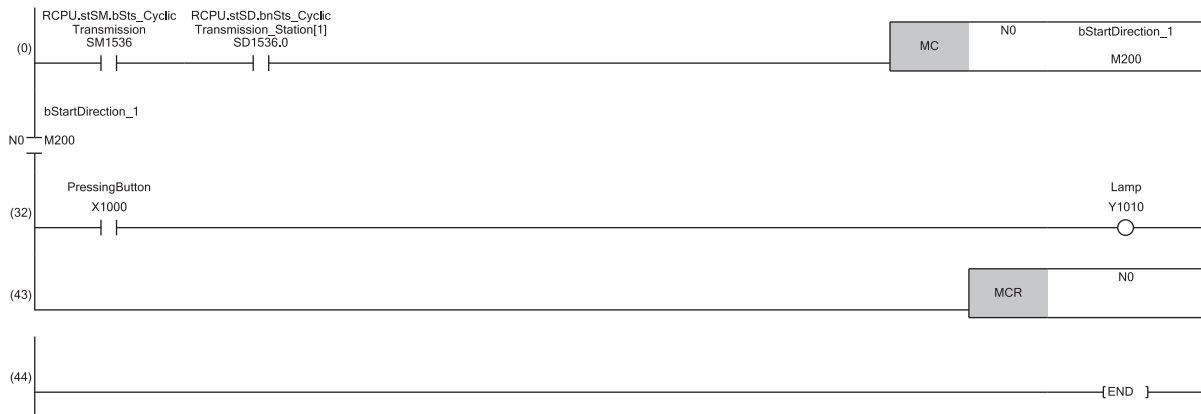

10 MAINTENANCE AND INSPECTION

The I/O module has no special item to be inspected. However, to maintain the best condition of the system, perform the inspection in accordance with the items described in the user's manual of the CPU module used.

MEMO

11 TROUBLESHOOTING

This chapter describes error contents that may occur while the I/O module is used and those troubleshooting.

11.1 Checking the LEDs

This section describes how to troubleshoot the system by the LEDs.

Determine the status of module error

Error status can be determined by the On/Off status of RUN LED and ERR. LED as follows.

RUN LED	ERR. LED	Error type* ¹	Description
Off	On* ²	Major error	Indicates that the module has stopped operation due to hardware failure.
On	On	Moderate error	Indicates that the module has stopped control operation due to setting error.
On	Flashing	Minor error	Indicates that the module has been operating despite the detection of communication failure or change of switch.

*1 When multiple errors occur, the error status is displayed in the order of major error > moderate error > minor error.

*2 When the module is failed, the LED may not turn on.

When the PW LED does not turn on

Check item	Action
Is any LED other than the PW LED turned on?	When any LED other than the PW LED turns on, the possible cause is a hardware failure. Please consult your local Mitsubishi representative.
Is the module power supply (24VDC) wired?	Wire the module power supply (24VDC).
Is the module power supply (24VDC) turned on?	Turn on the module power supply (24VDC).
Is the voltage of the module power supply (24VDC) within the specified range?	Set the voltage value within the range of performance specifications.

When the I/O PW LED does not turn on

Check item	Action
Is the external power supply (24VDC) wired?	Wire the external power supply (24VDC).
Is the external power supply (24VDC) turned on?	Turn on the external power supply (24VDC).
Is the voltage of the external power supply (24VDC) within the specified range?	Set the voltage value within the range of performance specifications.

When the RUN LED does not turn on

Check item	Action
Does the voltage of the module power supplied externally reach to the voltage of the specifications?	Check that module power supply voltage is within the range of performance specifications. (☞ Page 16 Performance Specifications)
Has any hardware failure occurred?	After the check, power off and on the module power supply. If the RUN LED does not turn on even after the module power supply is powered off and on, the possible cause is a module failure. Please consult your local Mitsubishi representative.

When the D LINK LED turns off

Check item	Action
Has any error occurred?	Determine the error factor by the CC-Link IE Field Network Basic diagnostic window or LED status of I/O module, and take action.
Is the station-to-station distance 100m or less?	Change the station-to-station distance to 100m or less.
Does the cabling condition (bending radius) meet the specifications?	Refer to the manual for the Ethernet cable used, and correct the bending radius.
Does the switching hub normally operate?	<ul style="list-style-type: none"> • Check that a 100BASE-TX-compliant switching hub is used. • Check that the power supply of the switching hub is turned on.
Is the IP address of the I/O module duplicated with any of other devices?	IP address of the I/O module must not be duplicated with another device.

When the D LINK LED flashes

Check item	Action
Does the IP address setting of I/O module match the IP address of I/O module specified in the configuration setting of master station?	The IP address of I/O module must match the IP address specified in the configuration setting of master station.
Is the I/O module set to a reserved station?	Set the reserved station specification of I/O module to have no setting in the network configuration setting, and reflect the changed parameter in the CPU module.
Is the number of occupied stations set to other than 1?	Set the number of occupied stations of I/O module to 1 in the network configuration setting, and reflect the changed parameter in the CPU module.
Is the IP address of the I/O module duplicated with any of other devices?	IP address of the I/O module must not be duplicated with another device.

When the 100M LED turns off

Check item	Action
Are Ethernet cables normal?	<ul style="list-style-type: none">• Check that 100BASE-TX-compliant Ethernet cables are used.• Check that the station-to-station distance is 100m or less.• Check that the Ethernet cables are not disconnected.
Do the switching hub and other stations in the system normally operate?	<ul style="list-style-type: none">• Check that a 100BASE-TX-compliant switching hub is used.• Check that the power supplies of the switching hub and other stations are turned on.



When the SD/RD LED remains turned off

Check item	Action
Are Ethernet cables normal?	<ul style="list-style-type: none">• Check that 100BASE-TX-compliant Ethernet cables are used.• Check that the station-to-station distance is 100m or less.• Check that the Ethernet cables are not disconnected.
Do the switching hub and other stations in the system normally operate?	<ul style="list-style-type: none">• Check that a 100BASE-TX-compliant switching hub is used.• Check that the power supplies of the switching hub and other stations are turned on.

When the ERR. LED turns on

Check item	Action
Has any moderate or major error occurred?	Determine the error factor by the CC-Link IE Field Network Basic diagnostic window or LED status of I/O module, and take action.

When the ERR. LED flashes

Check item	Action
Has any minor error occurred?	<ul style="list-style-type: none">• Determine the error factor by the CC-Link IE Field Network Basic diagnostic window, and take action.•  Page 103 CC-Link IE Field Network Basic Diagnostics• Determine the error factor by the error code of diagnostic information 2 of slave station, and take action.•  Page 127 Diagnostic information list

11.2 CC-Link IE Field Network Basic Diagnostics

Check the network status or error definition of I/O module to perform troubleshooting by executing the CC-Link IE Field Network Basic diagnostics.

How to use

For how to use the CC-Link IE Field Network Basic diagnostics, refer to the following.

 CC-Link IE Field Network Basic Reference Manual

11.3 Troubleshooting by Symptom

Perform troubleshooting by symptom when the I/O module does not operate properly with no error.
Check the following items in the order from the top.

When the ON/OFF status of an external input cannot be read

Check item	Action
Is the corresponding LED (X0 LED to X1F LED) of the input module and I/O combined module on when an external input device is on?	If the LED does not turn on, there is a problem on the input wiring. Check the wiring confirming that the input wiring is not disconnected or short-circuited, or the voltage of the input signal is correct. For the rated input voltage, check the rated input voltage column of each I/O module specifications. ☞ Page 16 Input module ☞ Page 46 I/O combined module Refer to the following as well. ☞ Page 105 Troubleshooting for input circuit
Is the setting of the refresh device correct?	Check the refresh parameter and correct the setting of the refresh device so that it matches with the setting in the program. For the setting of the refresh parameters, refer to the following. 📖 CC-Link IE Field Network Basic Reference Manual
Is data link established? (Check the data link status on the CC-Link IE Field Network Basic diagnostic window.)	Determine the error factor by the CC-Link IE Field Network Basic diagnostic window or LED status of I/O module, and take action.

When the ON/OFF status of an external output cannot be changed

Check item	Action
Is the I/O PW LED turned on?	Take corrective action according to the following. ☞ Page 101 When the I/O PW LED does not turn on
Is the corresponding LED (Y0 LED to Y1F LED) of the output module and I/O combined module on when an external output signal RY0 to RY1F is turned on?	If the LED turns on, there is a problem on the output wiring. Check the wiring confirming that the output wiring is not disconnected or short-circuited. Refer to the following as well. ☞ Page 110 Troubleshooting for output circuit
Is the setting of the refresh device correct?	Check the refresh parameter and correct the setting of the refresh device so that it matches with the setting in the program. For the setting of the refresh parameters, refer to the following. 📖 CC-Link IE Field Network Basic Reference Manual
Is data link established? (Check the data link status on the CC-Link IE Field Network Basic diagnostic window.)	Determine the error factor by the CC-Link IE Field Network Basic diagnostic window or LED status of I/O module, and take action.

When "Communication Setting Reflection of Slave Station" does not work

Check item	Action
Is the IP address setting switch of I/O module set to 0?	Set the IP address setting switch of I/O module to 0 and execute "Communication Setting Reflection of Slave Station" again.
Is the MAC address for the selected I/O module correct?	Check that the MAC address for the selected I/O module matches with the MAC address for the target I/O module, and execute "Communication Setting Reflection of Slave Station" again.

11.4 Examples of Troubles with the I/O Module

Troubleshooting for input circuit

An input signal does not turn off No.1

■Cause

There is a leakage current from the input switch (driven by a contactless switch and others).

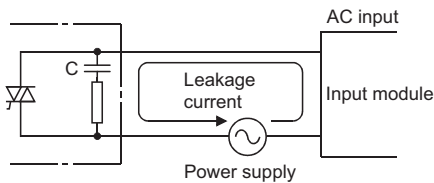

■Action

Connect an appropriate resistor so that the voltage between terminals of the input module would fall below the OFF voltage.

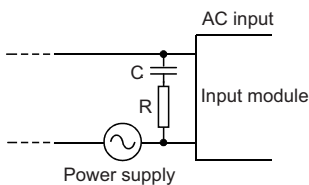

The recommended CR constant is as follows: 0.1 to $0.47\mu\text{F}$ + 47 to 120Ω ($1/2\text{W}$).

An input signal does not turn off No.2

■Cause

There is a leakage current from the input switch (driven by a limit switch with neon lamp).

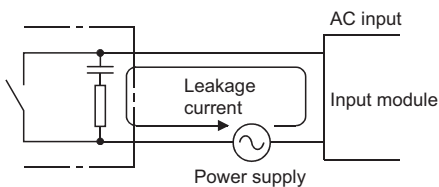

■Action

Take either of the following actions:

- Connect an appropriate resistor so that the voltage between terminals of the input module would fall below the OFF voltage. (Same as the action taken when an input signal does not turn off No.1)
- Make the circuit independent and provide another display circuit.

An input signal does not turn off No.3

■Cause

There is a leakage current due to the line capacity of the wiring cables. (The line capacity, C , of a twisted pair cable is as follows: $C = \text{approx. } 100\text{pF/m.}$)

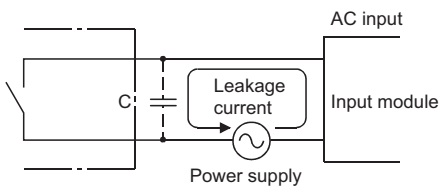

■Action

Connect an appropriate resistor so that the voltage between terminals of the input module would fall below the OFF voltage. (Same as the action taken when an input signal does not turn off No.1)

A leakage current is not generated, however, where the power supply lies in the input device side like the figure below:

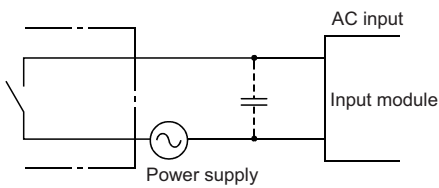

An input signal does not turn off No.4

■Cause

Even though the switch with LED indicator is turned off, leakage current exceeding the OFF current flowing through the input module has occurred.

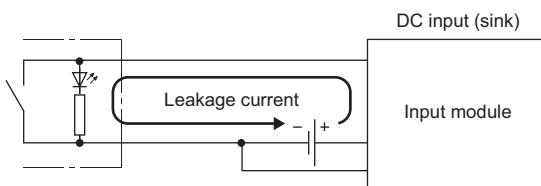

■Action

Connect an appropriate resistor so that the current flowing through the input module falls below the OFF current.

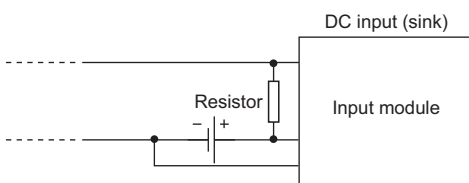

For the calculation example of a resistor to be connected, refer to the following.

☞ Page 107 Calculation example

■Calculation example

If the switch with LED indicator with maximum leakage current of 3mA when 24VDC is supplied to the NZ2MFB1-32D is connected

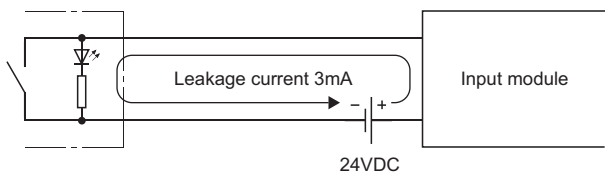

1. The OFF current of NZ2MFB1-32D is not 1.7mA or lower. Therefore, connect a resistor as shown below.

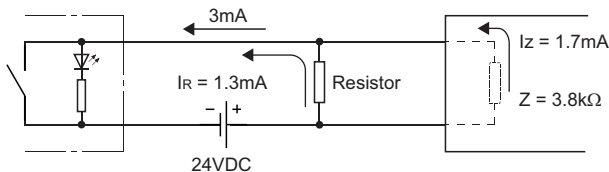

Z: Input impedance

2. To satisfy the condition that the OFF current of NZ2MFB1-32D is 1.7mA or lower, the current through the connected resistor should be 1.3mA or higher. From the formula below, the connected resistor (R) is 4.97kΩ or lower.

$$R \leq \frac{I_z}{I_R} \times Z = \frac{1.7}{1.3} \times 3.8 = 4.97[\text{k}\Omega]$$

3. When the resistor (R) is 2.7kΩ, for example, the power capacity (W) of the resistor (R) becomes 0.308W.

$$W = V^2 \div R = 28.8^2 \div 2700 = 0.308[\text{W}]$$

V: Input voltage

4. Because the resistor requires the power capacity of 3 to 5 times as large as the actual current consumption, the resistor connected to the terminal should be 2.7kΩ; and 1 to 2W.

5. OFF voltage when the resistor (R) is connected becomes 4.74V. This satisfies that the OFF voltage of NZ2MFB1-32D is 5V or lower.

$$\frac{1}{\frac{1}{2.7[\text{k}\Omega]} + \frac{1}{3.8[\text{k}\Omega]}} \times 3[\text{mA}] = 4.74[\text{V}]$$

An input signal does not turn off No.5

■Cause

By using two power supplies, a sneak path is configured.

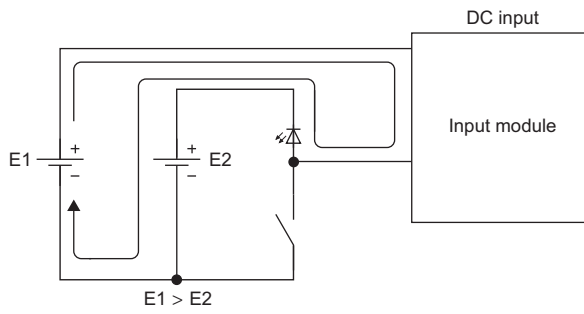

■Action

- Use one power supply.
- To prevent the sneak path, connect a diode as shown below.

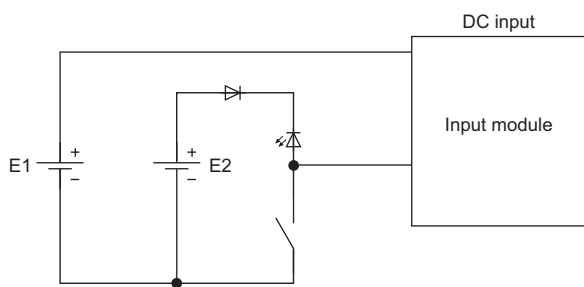

An input signal does not turn on (AC input module).

■Cause

Around the zero cross voltage (1) of the input signal (AC), there are step-like deformations as shown below:

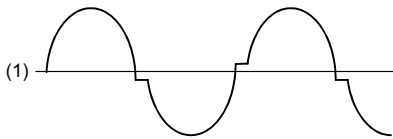

■Action

Improve the input signal waveform by using an on-line type UPS and others.

A signal incorrectly inputs data

■Cause

Noise is taken as input data.

■Action

Set a longer input response time.

☞ Page 90 Input Response Time Setting Function

Ex.

1ms→5ms

If the issue still continues, take the following two actions.

- To prevent excessive noise, avoid installing power cables together with I/O cables.
- Connect surge absorbers to noise-generating devices such as relays and conductors using the same power supply or take other noise reduction measures.

Troubleshooting for output circuit

A load momentarily turns on when the external power supply is powered on

■Cause

An incorrect output occurs due to the stray capacitance (C) between collector and emitter of a photocoupler. There is no problem with the normal load. When a high sensitivity load (such as solid state relay) is used, however, this incorrect output may occur.

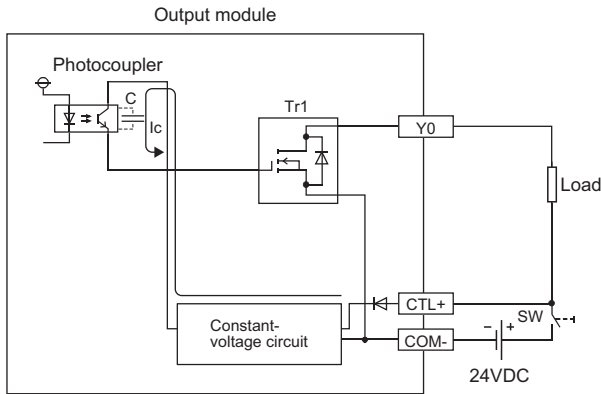

When the external power supply is powered on rapidly, the current (I_c) flows due to the stray capacitance (C) between collector and emitter of a photocoupler.

The current (I_c) flows to the gate of the transistor ($Tr1$) of the next stage and the output $Y0$ turns on for approximately $100\mu s$.

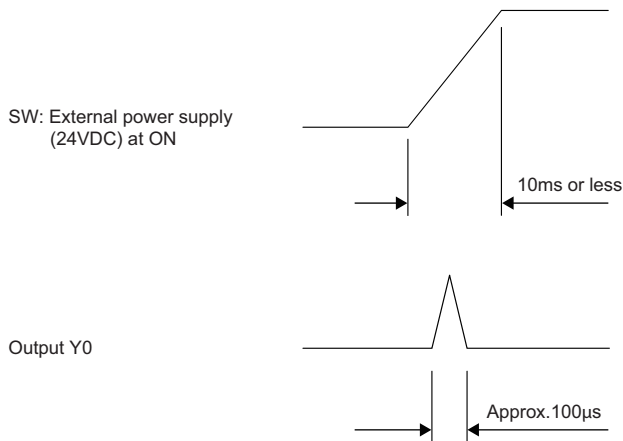

■Action

Before turning on or off the external power supply, check that the rise time of the external power supply is 10ms or more. Then, install a switch (SW1) to the primary side of the external power supply.

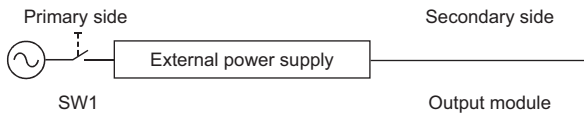

When installing the switch to the secondary side, connect a capacitor and resistor, and increase the rise time (10ms or more).

• Sink output

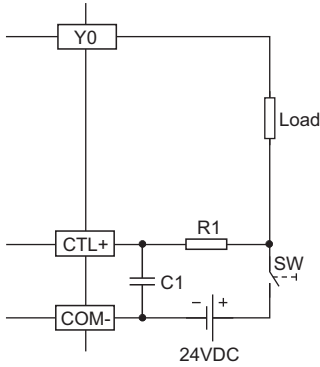

• Source output

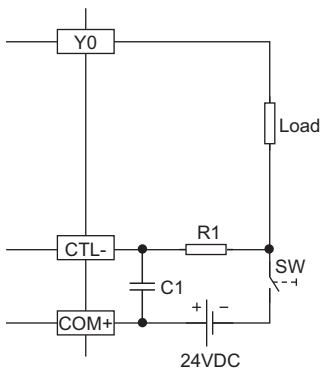

R1: Several tens of ohms

Power capacity $\geq (\text{External power supply current}^{*1})^2 \times \text{Resistance value} \times (3 \text{ to } 5)^{*2}$

C1: Several hundreds of microfarads 50V

(Example)

R1 = 40Ω, C1 = 300μF

Time constant is calculated as shown below.

$$C1 \times R1 = 300 \times 10^{-6} \times 40$$

$$= 12 \times 10^{-3}\text{s}$$

$$= 12\text{ms}$$

*1 For the current consumption of the external power supply for the module, refer to the manuals.

*2 Select the power capacity of resistor to be 3 to 5 times as large as the actual power consumption.

A load momentarily turns on from off when the system is powered off

■Cause

When an inductive load is connected, [2] Load may turn on from off due to a sneak current of back EMF at [1] Shutoff.

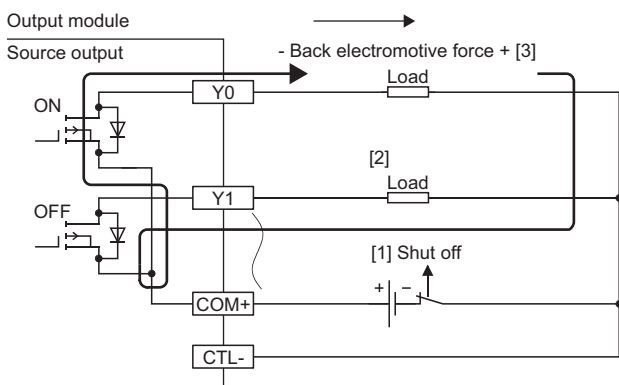
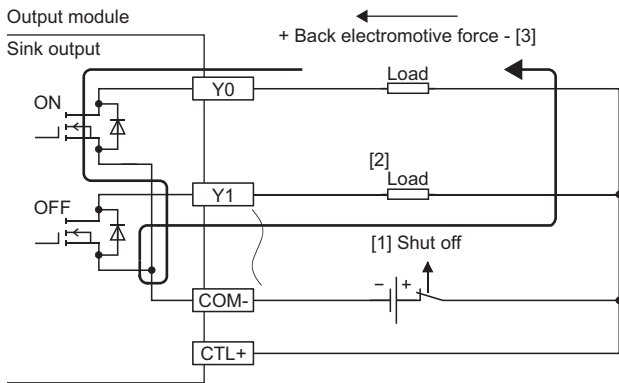

Action

Take either of the following two actions:

- Action 1: To suppress the back EMF, connect a diode parallel to the load where back EMF is generated in [3].

[3]	
Sink output	Source output
<p>+ Back electromotive force -</p>	<p>- Back electromotive force +</p>

- Action 2: Configure a sneak current path by connecting a diode across positive and negative of the external power supply. When simultaneously taking an action for the case where load is briefly turned on when powering on the external power supply, connect the diode in parallel with C1 and R1 as shown in the frame of dotted line.

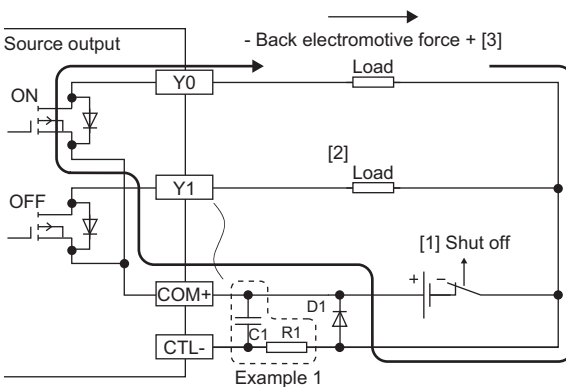
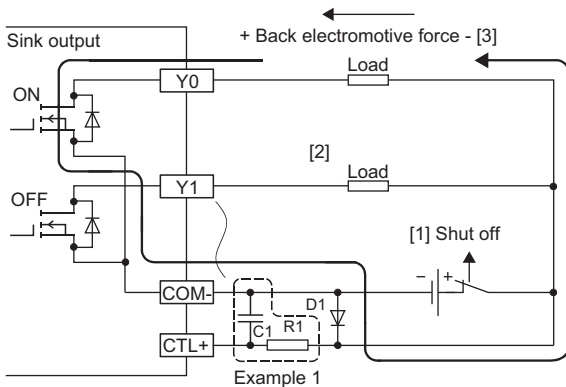

D1:

Reverse voltage VR (VRM)^{*1}

Forward current IF (IFM)^{*2}

*1 Approximately 10 times as large as the rated voltage in the specifications

Example: 24VDC → Approximately 200V

*2 Twice as much as the maximum load current (common) in the specifications or more

Example: 2A/1 common → 4A or more

When the output module is off, the LED connected as a load dimly turns on

■Cause

The load operates by the leakage current when the output module is off.

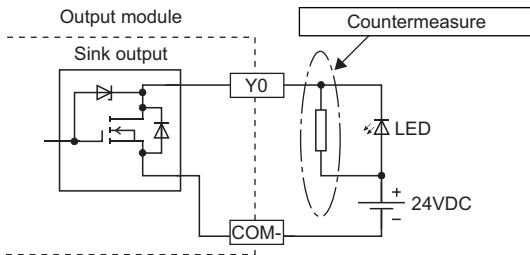

■Action

Connect a resistor of 5 to 50k Ω in parallel with the LED load.

When a digital display unit is connected as a load, the display may not be normal

■Cause

The load operates by the leakage current when the output module is off.

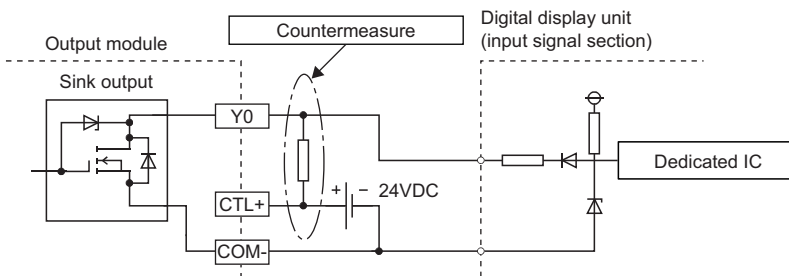

■Action

Install a pull-up resistor of 5 to 50k Ω and 0.5 (W) between the outputs of 24VDC power supply and the output module.

When output is turned on, load connected to other outputs is turned on simultaneously

■Cause

When a non-wiring state occurs due to, for example, a shutoff or disconnection between 0V of the external power supply and the common of a load, a current flows across the load that is off through an unexpected circuit of the output element that is off.

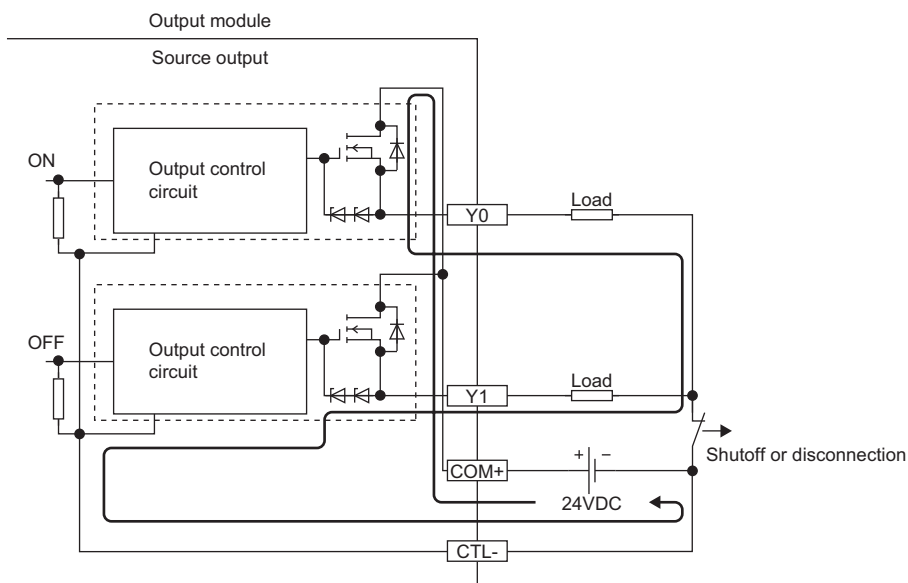

Continuous use in this state may cause failure.

■Action

Connect the external power supply with the load correctly.

To prevent the state described above, install diodes in each output terminal as shown below.

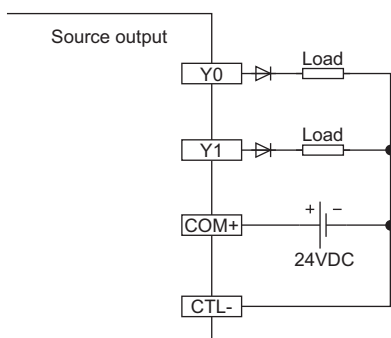

A load inputs data incorrectly due to a chattering.

■Cause

A device with a high input response speed is connected to the contact output module.

■Action

Use a transistor output module.

11.5 Method for Checking Errors

The errors for the I/O module can be classified into the following three categories. The checking methods for each error are as follows.

Classification	Checking method
I/O module specific error	<ul style="list-style-type: none"> • CC-Link IE Field Network Basic diagnostics ☞ Page 103 CC-Link IE Field Network Basic Diagnostics • Buffer memory of master station or special register ☞ Page 127 Diagnostic information list
CC-Link IE Field Network Basic related error	CC-Link IE Field Network Basic diagnostics ☞ Page 103 CC-Link IE Field Network Basic Diagnostics
SLMP communication related error	End code of SLMP communications ☞ Page 93 End code of SLMP communications

Point

- When multiple I/O module specific errors have occurred, the error codes are stored in the following priority.
- When the error type differs, they are stored in the order of major error > moderate error > minor error.
 - When the error status is the same, they are stored in reverse chronological order.

Method for clearing an error

Method for clearing I/O module specific error

The method for clearing an error depends on the error type.

Error type	Clearing an error
Major error	The error cannot be cleared.
Moderate error	Eliminate the error cause, and then power off and on the I/O module.
Minor error	Error is automatically cleared after the error cause is eliminated.

Method for clearing CC-Link IE Field Network Basic related error

After eliminating the error cause of I/O module, clear the error on the CC-Link IE Field Network Basic diagnostic window. For how to use the CC-Link IE Field Network Basic diagnostics, refer to the following.

☞ CC-Link IE Field Network Basic Reference Manual

Method for clearing SLMP communication related error

When the I/O module detects an SLMP command error, error status does not occur in the I/O module. Thus, error clear is not needed.

11.6 Error Code List

I/O module specific error

I/O module specific error codes are as follows.

Error code	Error type	Error name	Description and cause	Action
0010H	Major error	Hardware error	Module hardware error	Power off and on the module power supply. If this error persists, the module may be in failure. Please consult your local Mitsubishi representative.
0101H	Moderate error	IP address setting switch setting out of range error	An IP address setting switch is set outside the range between 0 and 254.	Power off the module power supply, set the IP address setting switch in the range of 0 to 254, and then power on the module power supply again.
0201H	Minor error	IP address setting switch changed error	An IP address setting switch has been changed with the module power supply on.	Return the IP address setting switch to the previous setting.
0202H	Minor error	Function setting switch 1 to 3 changed error	The function setting switch 1 to 3 has been changed with the module power supply on.	Return the function setting switch 1 to 3 to the previous setting.
0203H	Minor error	Function setting switch 4 changed error	The function setting switch 4 has been changed with the module power supply on.	Return the function setting switch 4 to the previous setting.

CC-Link IE Field Network Basic related error

For CC-Link IE Field Network Basic related error codes, refer to the manual for respective series.

 MELSEC iQ-R CPU Module User's Manual (Application)

 MELSEC iQ-F FX5 User's Manual (Application)

 QCPU User's Manual (Hardware Design, Maintenance and Inspection)

 MELSEC-L CPU Module User's Manual (Hardware Design, Maintenance and Inspection)

 MELIPC MI5000 Series User's Manual (Application)

APPENDICES

Appendix 1 Remote I/O Signal

List of remote I/O signals

This section lists I/O signals for a master station.

Remote input (RX) indicates the input signal from the I/O module to the master station.

Remote output (RY) indicates the output signal from the master station to the I/O module.



Do not use any "Use prohibited" remote I/O signals. Doing so may result in an accident due to an incorrect output or malfunction.

Input module

■16-point module

Remote input		Remote output	
Signal direction: Input module → Master station		Signal direction: Master station → Input module	
Device number	Description	Device number	Description
RX0	External input signal X0	RY0	Use prohibited
RX1	External input signal X1	RY1	
RX2	External input signal X2	RY2	
RX3	External input signal X3	RY3	
RX4	External input signal X4	RY4	
RX5	External input signal X5	RY5	
RX6	External input signal X6	RY6	
RX7	External input signal X7	RY7	
RX8	External input signal X8	RY8	
RX9	External input signal X9	RY9	
RXA	External input signal XA	RYA	
RXB	External input signal XB	RYB	
RXC	External input signal XC	RYC	
RXD	External input signal XD	RYD	
RXE	External input signal XE	RYE	
RXF	External input signal XF	RYF	
RX10	Use prohibited	RY10	
⋮		⋮	
RX3F		RY3F	

■32-point module

Remote input		Remote output	
Signal direction: Input module → Master station		Signal direction: Master station → Input module	
Device number	Description	Device number	Description
RX0	External input signal X0	RY0	Use prohibited
RX1	External input signal X1	RY1	
RX2	External input signal X2	RY2	
RX3	External input signal X3	RY3	
RX4	External input signal X4	RY4	
RX5	External input signal X5	RY5	
RX6	External input signal X6	RY6	
RX7	External input signal X7	RY7	
RX8	External input signal X8	RY8	
RX9	External input signal X9	RY9	
RXA	External input signal XA	RYA	
RXB	External input signal XB	RYB	
RXC	External input signal XC	RYC	
RXD	External input signal XD	RYD	
RXE	External input signal XE	RYE	
RXF	External input signal XF	RYF	
RX10	External input signal X10	RY10	
RX11	External input signal X11	RY11	
RX12	External input signal X12	RY12	
RX13	External input signal X13	RY13	
RX14	External input signal X14	RY14	
RX15	External input signal X15	RY15	
RX16	External input signal X16	RY16	
RX17	External input signal X17	RY17	
RX18	External input signal X18	RY18	
RX19	External input signal X19	RY19	
RX1A	External input signal X1A	RY1A	
RX1B	External input signal X1B	RY1B	
RX1C	External input signal X1C	RY1C	
RX1D	External input signal X1D	RY1D	
RX1E	External input signal X1E	RY1E	
RX1F	External input signal X1F	RY1F	
RX20	Use prohibited	RY20	
⋮		⋮	
RX3F		RY3F	

Output module

■16-point module

Remote input		Remote output	
Signal direction: Output module → Master station		Signal direction: Master station → Output module	
Device number	Description	Device number	Description
RX0	Use prohibited	RY0	External output signal Y0
RX1		RY1	External output signal Y1
RX2		RY2	External output signal Y2
RX3		RY3	External output signal Y3
RX4		RY4	External output signal Y4
RX5		RY5	External output signal Y5
RX6		RY6	External output signal Y6
RX7		RY7	External output signal Y7
RX8		RY8	External output signal Y8
RX9		RY9	External output signal Y9
RXA		RYA	External output signal YA
RXB		RYB	External output signal YB
RXC		RYC	External output signal YC
RXD		RYD	External output signal YD
RXE		RYE	External output signal YE
RXF		RYF	External output signal YF
RX10	Use prohibited	RX10	Use prohibited
⋮		⋮	
RX3F		RY3F	

■32-point module

Remote input		Remote output	
Signal direction: Output module → Master station		Signal direction: Master station → Output module	
Device number	Description	Device number	Description
RX0	Use prohibited	RY0	External output signal Y0
RX1		RY1	External output signal Y1
RX2		RY2	External output signal Y2
RX3		RY3	External output signal Y3
RX4		RY4	External output signal Y4
RX5		RY5	External output signal Y5
RX6		RY6	External output signal Y6
RX7		RY7	External output signal Y7
RX8		RY8	External output signal Y8
RX9		RY9	External output signal Y9
RXA		RYA	External output signal YA
RXB		RYB	External output signal YB
RXC		RYC	External output signal YC
RXD		RYD	External output signal YD
RXE		RYE	External output signal YE
RXF		RYF	External output signal YF
RX10		RY10	External output signal Y10
RX11		RY11	External output signal Y11
RX12		RY12	External output signal Y12
RX13		RY13	External output signal Y13
RX14		RY14	External output signal Y14
RX15		RY15	External output signal Y15
RX16		RY16	External output signal Y16
RX17		RY17	External output signal Y17
RX18		RY18	External output signal Y18
RX19		RY19	External output signal Y19
RX1A		RY1A	External output signal Y1A
RX1B		RY1B	External output signal Y1B
RX1C		RY1C	External output signal Y1C
RX1D		RY1D	External output signal Y1D
RX1E		RY1E	External output signal Y1E
RX1F		RY1F	External output signal Y1F
RX20	RY20	Use prohibited	
⋮	⋮		
RX3F		RY3F	

A

I/O combined module

■32-point module

Remote input		Remote output	
Signal direction: I/O combined module → Master station		Signal direction: Master station → I/O combined module	
Device number	Description	Device number	Description
RX0	External input signal X0	RY0	Use prohibited
RX1	External input signal X1	RY1	
RX2	External input signal X2	RY2	
RX3	External input signal X3	RY3	
RX4	External input signal X4	RY4	
RX5	External input signal X5	RY5	
RX6	External input signal X6	RY6	
RX7	External input signal X7	RY7	
RX8	External input signal X8	RY8	
RX9	External input signal X9	RY9	
RXA	External input signal XA	RYA	
RXB	External input signal XB	RYB	
RXC	External input signal XC	RYC	
RXD	External input signal XD	RYD	
RXE	External input signal XE	RYE	
RXF	External input signal XF	RYF	
RX10	Use prohibited	RY10	External output signal Y10
RX11		RY11	External output signal Y11
RX12		RY12	External output signal Y12
RX13		RY13	External output signal Y13
RX14		RY14	External output signal Y14
RX15		RY15	External output signal Y15
RX16		RY16	External output signal Y16
RX17		RY17	External output signal Y17
RX18		RY18	External output signal Y18
RX19		RY19	External output signal Y19
RX1A		RY1A	External output signal Y1A
RX1B		RY1B	External output signal Y1B
RX1C		RY1C	External output signal Y1C
RX1D		RY1D	External output signal Y1D
RX1E		RY1E	External output signal Y1E
RX1F		RY1F	External output signal Y1F
RX20		RY20	Use prohibited
⋮		⋮	
RX3F		RY3F	

Details of remote input signals

The following describes the details of the remote input signals for the master station.

External input signal (RX0 to RX1F)

This signal shows the on/off status of the external input of input module and I/O combined module.

Details of remote output signals

The following describes the details of the remote output signals for the master station.

External output signal (RY0 to RY1F)

This signal turns on/off external output of output module and I/O combined module.

Appendix 2 Remote Register

List of remote register

Use of the remote register is prohibited.



Do not read or write the data from/to any "Use prohibited" remote register areas. Doing so may result in an accident due to an incorrect output or malfunction.

Remote register (RWr)		Remote register (RWw)	
Signal direction: I/O module → Master station		Signal direction: Master station → I/O module	
Device number	Description	Device number	Description
RWr0	Use prohibited	RWw0	Use prohibited
⋮			
RWr1F			
		RWw1F	

Appendix 3 Setting IP Addresses and Subnet Masks

This section describes the setting procedure of IP addresses and subnet masks.

This setting is required when changing IP addresses and subnet masks to specific values. This setting is not required if these values need not be changed.

Setting procedure

1. Record the MAC address for I/O module.
2. Set the IP address setting switch to 0.
3. Connect the master station and I/O module, and power them on.
4. Display the network configuration setting window from the configuration tool of the master station.

For how to display the network configuration setting window, refer to the following.

CC-Link IE Field Network Basic Reference Manual

5. Execute the automatic detection of connected device.

[Network Configuration Settings] ⇒ [Detect Now]

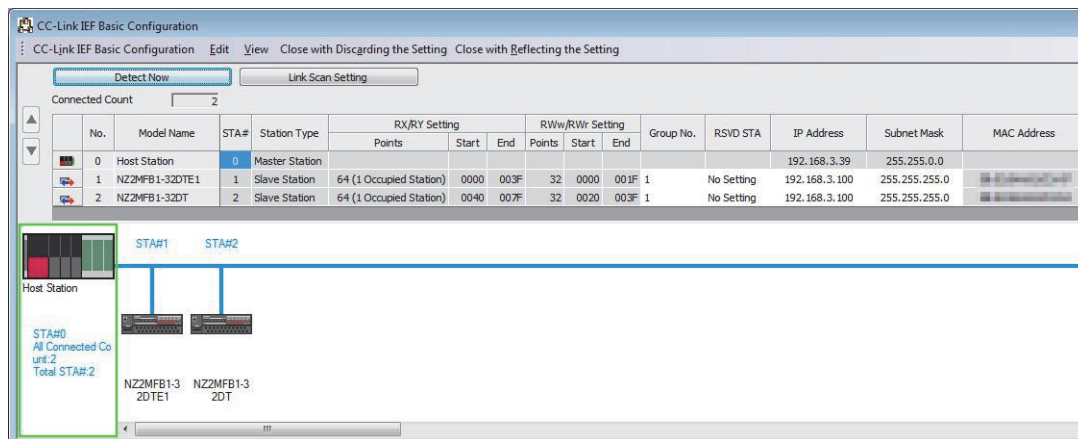

6. Select the target I/O module using the MAC address recorded in the step 1, and set an IP address and subnet mask.

No.	Model Name	STA#	Station Type	RX/RX Setting			RWw/RWw Setting			Group No.	RSVD STA	IP Address	Subnet Mask	MAC Address
				Points	Start	End	Points	Start	End					
0	Host Station	0	Master Station								192.168.3.39	255.255.0.0		
1	NZZMFB1-3DTE1	1	Slave Station	64 (1 Occupied Station)	0000	003F	32	0000	001F	1	No Setting	192.168.3.100	255.255.255.0	
2	NZZMFB1-3DT	2	Slave Station	64 (1 Occupied Station)	0040	007F	32	0020	003F	1	No Setting	192.168.3.2	255.255.0.0	

7. Right-click the I/O module in which the setting is reflected, and select "Communication Setting Reflection of Slave Station".

[Online] ⇒ [Communication Setting Reflection of Slave Station]

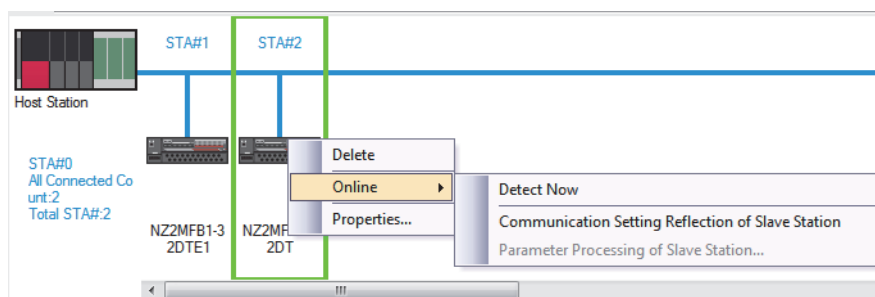

8. I/O module restarts, and starts operation with the preset IP address and subnet mask.
9. Write the set parameter to the CPU module of the master station and reset the CPU module, or turn off and on the power supply.

[Online] ⇒ [Write to PLC]



-
- Set the IP address in the range between 0.0.0.1 and 223.255.255.254.
 - Set the subnet mask in the range between 192.0.0.0 and 255.255.255.252.
 - If the IP address setting switch is not 0, the setting is not reflected.
 - Settings other than the IP address and subnet mask are not reflected.
 - If "Communication Setting Reflection of Slave Station" is executed to an I/O module where the IP address setting switch is set to a value other than 0, an error message is displayed.
 - If the subnet mask is not set, only the setting of IP address is reflected.
-

Appendix 4 Diagnostic Information of Slave Station







Diagnostic information list

This section shows the list of diagnostic information of slave station that can be checked in the special register (SD) or buffer memory of master station.

Note that the information shown here are diagnostic information 2 only.

For other diagnostic information, refer to the following.

 CC-Link IE Field Network Basic Reference Manual

Name		Buffer memory/SD			Reference
		MELSEC iQ-R	MELSEC iQ-F	MELSEC-Q/L	
Diagnostic information 2	Manufacturer code	UnG1068	SD11144	SD1758	 Page 128 Manufacturer code
	Model code (lower)	UnG1070	SD11146	SD1760	 Page 128 Model code
	Model code (upper)	UnG1071	SD11147	SD1761	
	Device version	UnG1072	SD11148	SD1762	 Page 128 Device version
	Module information	UnG1074	SD11150	SD1764	 Page 128 Module information
	Error code	UnG1075	SD11151	SD1765	 Page 128 Error code
	Detailed module information (lower)	UnG1076	SD11152	SD1766	 Page 128 Detailed module information (lower)
	Detailed module information (upper)	UnG1077	SD11153	SD1767	 Page 129 Detailed module information (upper)

Diagnostic information details

This section shows the details of diagnostic information of slave station that can be checked in the special register (SD) or buffer memory of master station.

Note that the information shown here are diagnostic information 2 only.

For other diagnostic information, refer to the following.

 CC-Link IE Field Network Basic Reference Manual

Manufacturer code

0000H (fixed) (manufacturer code for I/O module) is stored.

Model code

Model code for I/O module is stored.

Model name	Model code (upper)	Model code (lower)
NZ2MFB2-16A	0000H	3006H
NZ2MF2S2-16A	0000H	300DH
NZ2MFB1-32D	0000H	3001H
NZ2MF2S1-32D	0000H	3008H
NZ2MFB2-16R	0000H	3007H
NZ2MF2S2-16R	0000H	300EH
NZ2MFB1-32T	0000H	3002H
NZ2MF2S1-32T	0000H	3009H
NZ2MFB1-32TE1	0000H	3003H
NZ2MF2S1-32TE1	0000H	300AH
NZ2MFB1-32DT	0000H	3004H
NZ2MF2S1-32DT	0000H	300BH
NZ2MFB1-32DTE1	0000H	3005H
NZ2MF2S1-32DTE1	0000H	300CH

Device version

0001H (fixed) (device version for I/O module) is stored.

Module information

Operating status of I/O module is stored.

■bit0 (I/O control status)

I/O control status of I/O module is stored.

Stored value	I/O control status
0	A moderate or major error has occurred, and I/O processing is stopped.
1	No error or minor error has occurred, and I/O processing is under operation.

■bit1 to bit15 (use prohibited)

Use of this area is prohibited.

Error code

An error code is stored when an I/O module specific error occurs.

For error codes to be stored, refer to the following.

 Page 117 I/O module specific error

Detailed module information (lower)

Use of this area is prohibited.

Detailed module information (upper)

The function setting status of I/O module is stored.

■bit0 to bit2 (input response time setting status)

The setting status of input response time setting is stored. The input response time setting is determined depending on the status of the function setting switch 1 to 3 when the module power supply is on.

Stored value			Input response time
b2	b1	b0	
0	0	0	10ms
0	0	1	0ms
0	1	0	0.2ms
0	1	1	1.0ms
1	0	0	1.5ms
1	0	1	5ms
1	1	0	20ms
1	1	1	70ms

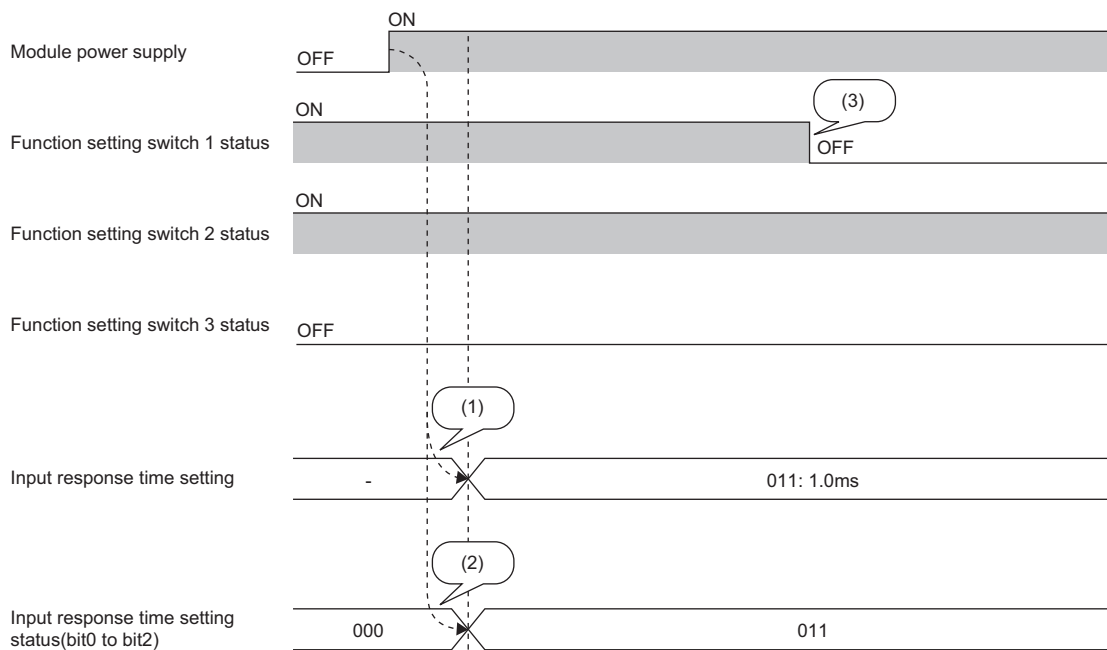

-----> : Performed by I/O module

- (1) The input response time setting is determined depending on the status of the function setting switch 1 to 3 when the module power supply is on.
- (2) For input response time setting status, the setting status of input response time is stored instead of the status of function setting switch 1 to 3.
- (3) The input response time setting is not changed even if the function setting switch 1 to 3 is changed during operation.

■bit3 (output HOLD/CLEAR setting status)

The setting status of output HOLD/CLEAR setting is stored. The output HOLD/CLEAR setting is determined depending on the status of the function setting switch 4 when the module power supply is on.

Stored value	Output HOLD/CLEAR setting
bit3	
0	CLEAR
1	HOLD

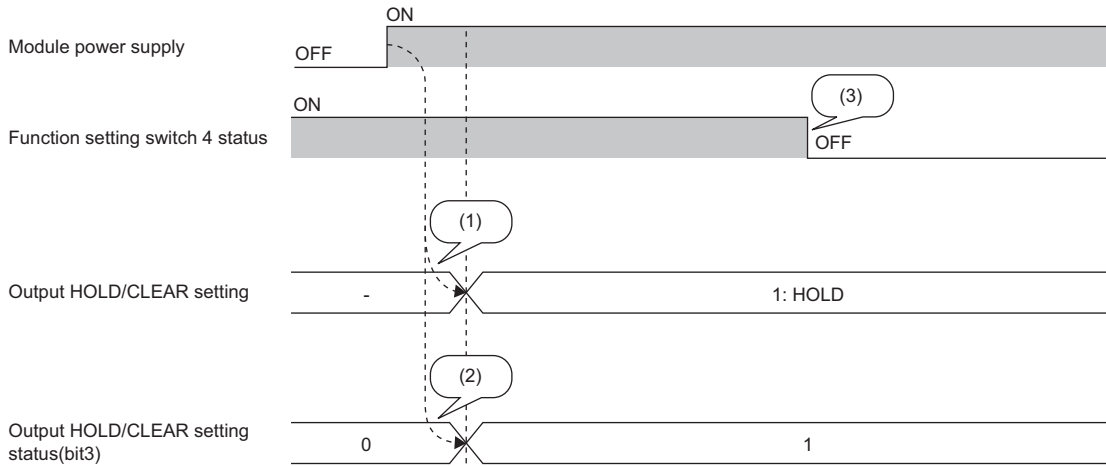

-----> : Performed by I/O module

- (1) The output HOLD/CLEAR setting is determined depending on the status of the function setting switch 4 when the module power supply is on.
- (2) For output HOLD/CLEAR setting status, the setting status of output HOLD/CLEAR setting is stored instead of the status of function setting switch 4.
- (3) The output HOLD/CLEAR setting is not changed even if the function setting switch 4 is changed during operation.

■bit4 to bit14 (use prohibited)

Use of this area is prohibited.

■bit15 (state in which the number of writes for flash memory has reached the upper limit)

The state in which the number of writes for flash memory has reached the upper limit is stored. The upper limit of the number of writes is 200 thousand.

Stored value	The state in which the number of writes for flash memory has reached the upper limit
bit15	
0	Not reached
1	Reached

Appendix 5 Processing Time

For the processing time of CC-Link IE Field Network Basic, refer to the following.

 CC-Link IE Field Network Basic Reference Manual

Response processing time of slave station

This section shows the response processing time of slave station.

■Input reflection processing time of slave station (input)

The input reflection processing time of the slave station (input) = Input response time^{*1} + Internal processing time (0.2ms)

*1 If the input response time is "0ms", use 0.14ms for calculation.

■Output reflection processing time of slave station (output)

The output reflection processing time of the slave station (output) = Output response time (1.5ms at ON → OFF) + Internal processing time (0.2ms) = 1.7ms

Appendix 6 EMC and Low Voltage Directives

Compliance with the EMC Directive, which is one of the EU directives, has been mandatory for products sold within EU member states since 1996 as well as compliance with the Low Voltage Directive since 1997. For products compliant to the EMC and Low Voltage Directives, their manufacturers are required to declare compliance and affix the CE marking.

Sales representative in EU member states

The sales representative in EU member states is:

Company: MITSUBISHI ELECTRIC EUROPE B.V.

Address: Mitsubishi-Electric-Platz 1, 40882 Ratingen, Germany

Measures to comply with the EMC Directive

The EMC Directive sets requirements for emission (conducted and radiated electromagnetic interference emitted by a product) and immunity (the ability of a product not to be influenced by externally generated electromagnetic interference).

This section describes the precautions for machinery constructed with the modules to comply with the EMC Directive.

These precautions are based on the requirements of the EMC Directive and the harmonized standards. However, they do not guarantee that the entire machinery constructed according to the descriptions complies with the EMC Directive.

The manufacturer of the machinery must determine the testing method for compliance and declare conformity to the EMC Directive.

EMC Directive related standards

■ Emission requirements

Standard	Test item	Test details	Standard value
EN61131-2: 2007	CISPR16-2-3 Radiated emission ^{*2}	Radio waves from the product are measured.	<ul style="list-style-type: none"> • 30M-230MHz QP: 40dBμV/m (10m in measurement range)^{*1} • 230M-1000MHz QP: 47dBμV/m (10m in measurement range)
	CISPR16-2-1, CISPR16-1-2 Conducted emission ^{*2}	Noise from the product to the power line is measured.	<ul style="list-style-type: none"> • 150k-500kHz QP: 79dB, Mean: 66dB^{*1} • 500k-30MHz QP: 73dB, Mean: 60dB

*1 QP: Quasi-peak value, Mean: Average value

*2 The module is an open type device (a device designed to be housed in other equipment) and must be installed inside a conductive control panel. The tests were conducted with the module installed in a control panel.

■ Immunity requirements

Standard	Test item	Test details	Standard value
EN61131-2: 2007	EN61000-4-2 Electrostatic discharge immunity ^{*1}	Immunity test in which electrostatic is applied to the cabinet of the equipment.	<ul style="list-style-type: none"> • 8kV Air discharge • 4kV Contact discharge
	EN61000-4-3 Radiated, radio-frequency, electromagnetic field immunity ^{*1}	Immunity test in which electric fields are radiated to the product.	<ul style="list-style-type: none"> • 80% AM modulation@1kHz • 80M to 1000MHz: 10V/m • 1.4G to 2.0GHz: 3V/m • 2.0G to 2.7GHz: 1V/m
	EN61000-4-4 First transient burst immunity ^{*1}	Immunity test in which burst noise is applied to the power line and signal line.	<ul style="list-style-type: none"> • AC/DC main power, I/O power, AC I/O (unshielded): 2kV • DC I/O, analog, communication lines: 1kV
	EN61000-4-5 Surge immunity ^{*1}	Immunity test in which lightning surge is applied to the power line and signal line.	<ul style="list-style-type: none"> • AC power line, AC I/O power, AC I/O (unshielded): 2kV CM, 1kV DM • DC power line, DC I/O power: 0.5kV CM, DM • DC I/O, AC I/O (shielded), analog^{*2}, communication lines: 1kV CM
	EN61000-4-6 Conducted RF immunity ^{*1}	Immunity test in which high frequency noise is applied to the power line and signal line	<ul style="list-style-type: none"> • 0.15M-80MHz, • 80% AM modulation @1kHz, 10Vrms
	EN61000-4-8 Power-frequency magnetic field immunity ^{*1}	Immunity test in which the product is installed in inductive magnetic field	<ul style="list-style-type: none"> • 50Hz/60Hz, 30A/m
	EN61000-4-11 Voltage dips and interruption immunity ^{*1}	Immunity test in which power supply voltage is momentarily interrupted	<ul style="list-style-type: none"> • 0%, 0.5 periods, starting at zero-crossing • 0%, 250/300 cycles (50/60Hz) • 40%, 10/12 cycles (50/60Hz) • 70%, 25/30 cycles (50/60Hz)

*1 The module is an open type device (a device designed to be housed in other equipment) and must be installed inside a conductive control panel. The tests were conducted with the module installed in a control panel.

*2 The accuracy of an analog-digital converter module may temporarily vary within $\pm 10\%$.

A

Installation in a control panel

The module is open type devices and must be installed inside a control panel.

This ensures safety as well as effective shielding of programmable controller-generated electromagnetic noise.

■Control panel

- Use a conductive control panel.
- When securing the top or bottom plate using bolts, cover the grounding part on the control panel so that the part will not be painted.
- To ensure electrical contact between the inner plate and control panel, take measures such as covering the bolts so that conductivity can be ensured in the largest possible area.
- Ground the control panel with a thick ground cable so that low impedance can be ensured even at high frequencies.
- Holes in the control panel must be 10cm diameter or less. If the holes are larger than 10cm, radio wave may leak. In addition, because radio waves leak through a clearance between the control panel and its door, reduce the clearance as much as possible. The leakage of radio waves can be suppressed by the direct application of an EMI gasket on the paint surface.

Our tests have been carried out on a control panel having the damping characteristics of 37dB (max.) and 30dB (mean) (measured by 3m method, 30 to 300MHz).

■Wiring of power cables and ground cables

Near the power supply part, provide a ground point to the control panel. Ground the FG terminal with the thickest and shortest possible ground cable (30cm or shorter).

Cables extended out of the control panel

Use a shielded cable for a cable extended out of the control panel such as an I/O signal line (including a common line) and cable for communications.

If a shielded cable is not used or not grounded correctly, the noise immunity will not meet the specified value.

■ Grounding a shielded cable

- Ground the shield of a shielded cable as close to the module as possible so that the grounded cable will not be affected by electromagnetic induction from ungrounded cables.
- Ground the exposed shield to a large area on the control panel. A clamp fitting can be used as shown below. In this case, mask off the inner wall surface of the control panel, which comes in contact with the clamp fitting.

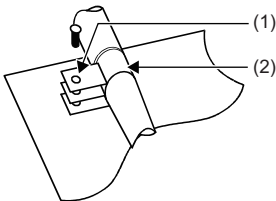

- (1) Paint masking
- (2) Clamp fitting

Point

Do not use the tip of a PVC wire soldered onto a shield of the shielded cable for grounding. Doing so will raise the high frequency impedance, resulting in loss of the shielding effect.

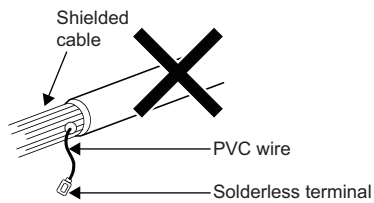

A

■Grounding the cable clamp

Use shielded cables for external wiring and ground the shields of the external wiring cables to the control panel with the AD75CK cable clamp (manufactured by Mitsubishi Electric Corporation). (Ground the shield section 20 to 30cm away from the module.)

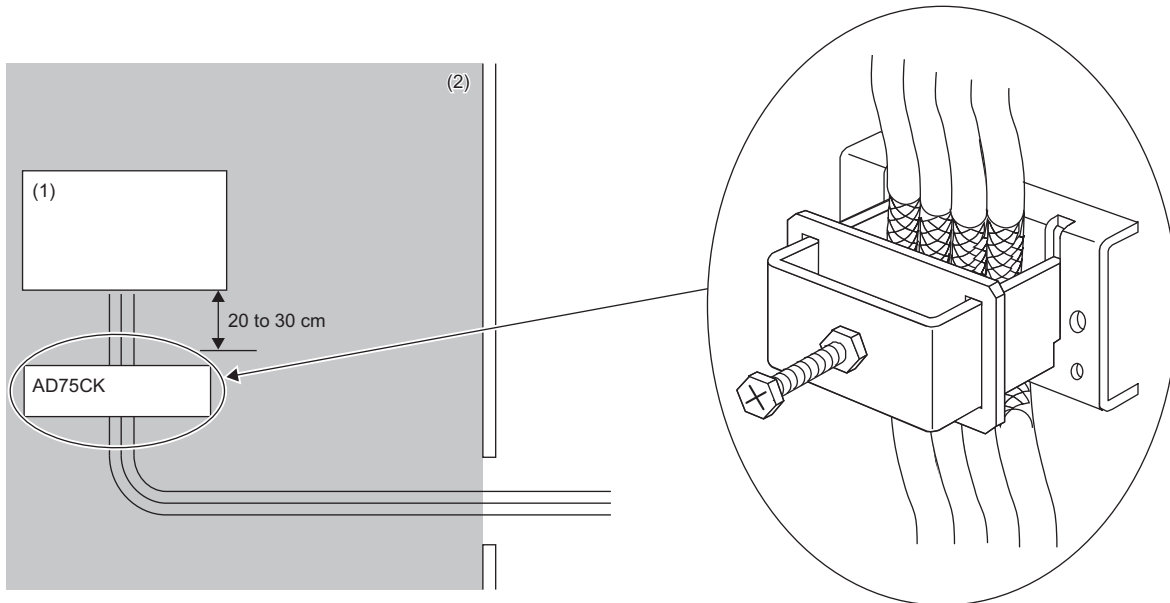

(1) Module

(2) Inside a control panel

For detail on AD75CK, refer to the following.

 AD75CK-type Cable Clamping Instruction Manual

■External power supply

- Use a CE-marked product for an external power supply and always ground the FG terminal. (External power supply used for the tests conducted by Mitsubishi Electric Corporation: TDK-Lambda DRJ100-24-1, DLP-120-24-1, IDEC PS5R-SF24, PS5R-F24)
- Use a power cable of 10m or shorter when connecting it to the module power supply terminal.
- Use a power cable of 30m or shorter when connecting it to the external power supply for output part.

Others

■ Ferrite core

A ferrite core has the effect of reducing radiated noise in the 30MHz to 100MHz band. It is recommended to attach ferrite cores if shielded cables coming out of the control panel do not provide sufficient shielding effects.

Note that the ferrite cores must be attached at the position closest to the cable hole inside the control panel. If attached at an improper position, the ferrite core will not produce any effect.

For the FG terminal on a module that is connected to the external power supply, and the Ethernet cable, attach a ferrite core 4cm away from the module.

(Ferrite core used for the tests conducted by Mitsubishi Electric Corporation: NEC TOKIN ESD-SR-250, TDK ZCAT3035-1330)

Ex.

Attachment

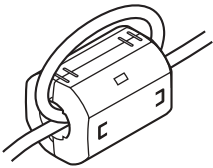

■ Noise filter (power supply line filter)

A noise filter is a component which has an effect on conducted noise. Attaching the filter can suppress more noise. (The noise filter has the effect of reducing conducted noise of 10MHz or less.)

Connect a noise filter to the external power supply of the module. Use a noise filter with the damping characteristics equivalent to those of RSEN-2006 (manufactured by TDK-Lambda Corporation). Note that a noise filter is not required if the module is used in Zone A defined in EN61131-2.

The precautions for attaching a noise filter are described below.

- Do not bundle the cables on the input side and output side of the noise filter. If bundled, the output side noise will be induced into the input side cables from which the noise was filtered.

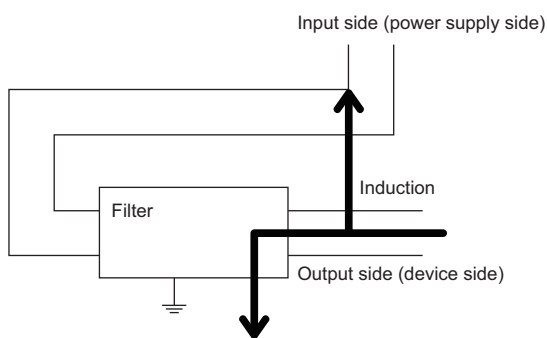

- Problematic example
Noise is induced when the input and output cables are bundled.

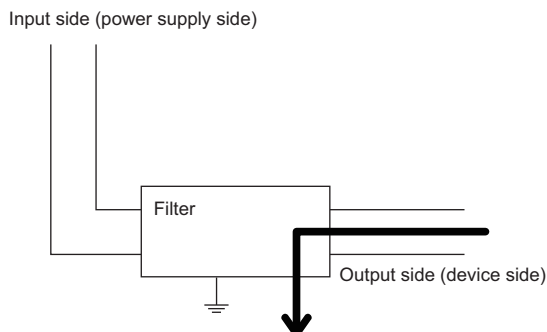

- Modification example
Install the input and output cables separately.

- Ground the noise filter ground terminal to the control panel with the shortest cable possible (approx. 10cm).
- The cable length between the noise filter and the module must be 3m or shorter.

A

Requirements to compliance with the Low Voltage Directive

I/O modules with their rated input/output voltages being 100VAC and 200VAC systems have a dangerous voltage inside (a peak voltage of 42.4V or higher). Therefore, for CE-marked I/O modules, reinforced insulation is applied between the primary and secondary circuits.

I/O modules which operate at 24VDC or lower rated input/output voltage are not targeted for the Low Voltage Directive compliance.

Appendix 7 How to Check Serial Number and Function Version

The serial number and function version of the I/O module can be checked on the rating plate.

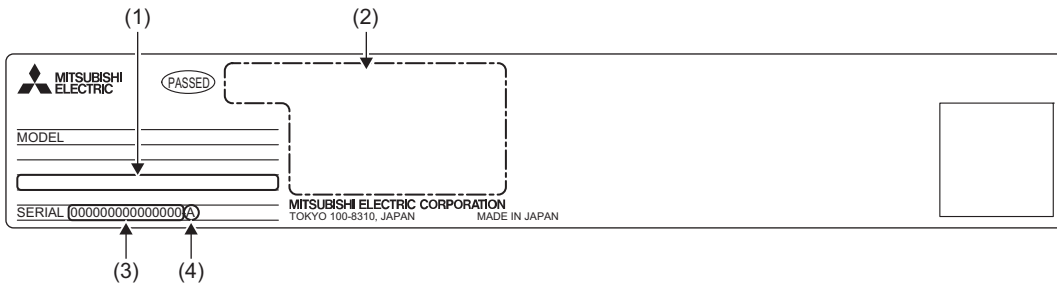

- (1) MAC address
- (2) Relevant standard symbol
- (3) Serial number
- (4) Function version



Appendix 8 External Dimensions

Screw terminal block type

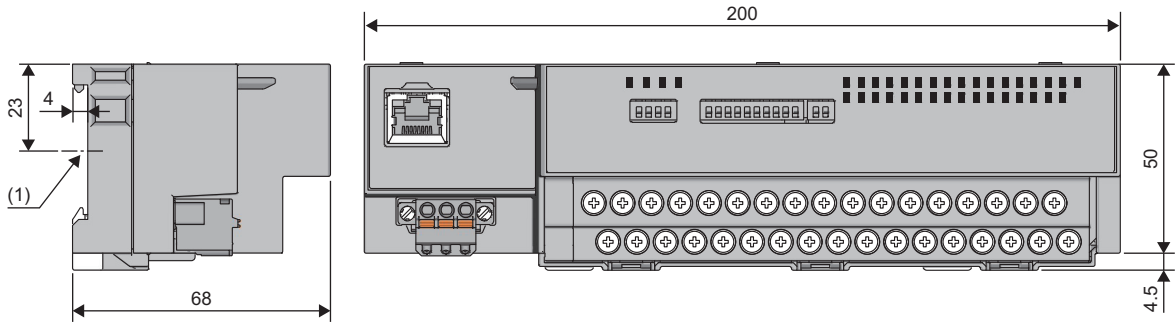

(Unit: mm)

(1) Center of DIN rail

Spring clamp terminal block type

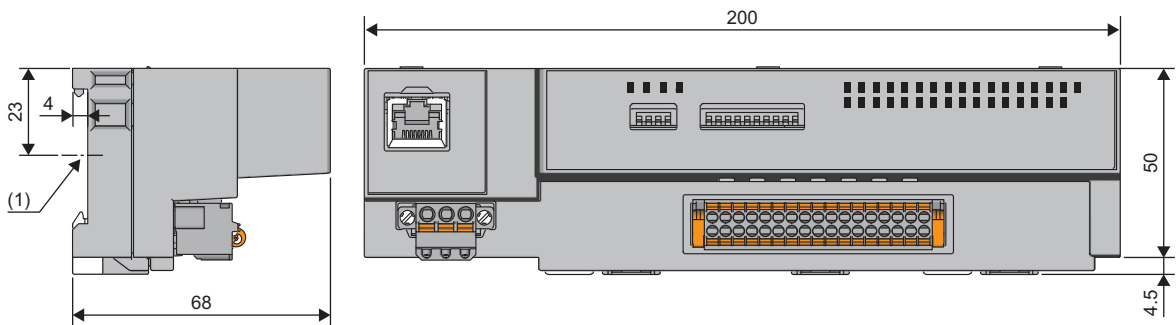

(Unit: mm)

(1) Center of DIN rail

MEMO

A

INDEX

A

- Applicable master station 65
- Applicable profile 65

C

- CC-Link IE Field Network Basic diagnostics 103
- Compatible software version 65

E

- End code of SLMP communications 93
- Error code list 117
- Ethernet cable 65

F

- Function setting switch 13

H

- Hub 65

I

- Input response time setting function 90
- IP address setting switch 13

M

- Method for checking errors. 116
- Method for clearing an error 116

N

- Network configuration setting 88

O

- Output HOLD/CLEAR setting function 91

P

- Program example 98
- Protection function 92

R

- Response processing time of slave station 131

S

- SLMP communication function 93

MEMO

REVISIONS

*The manual number is given on the bottom left of the back cover.

Revision date	*Manual number	Description
April 2017	SH(NA)-081763ENG-A	First edition
July 2017	SH(NA)-081763ENG-B	■Added or modified parts Section 11.1, 11.3, Appendix 3
April 2018	SH(NA)-081763ENG-C	■Added models NZ2MF2S1-32D, NZ2MF2S1-32T, NZ2MF2S1-32TE1, NZ2MF2S1-32DT, NZ2MF2S1-32DTE1 ■Added or modified parts INTRODUCTION, Section 1.1, 1.2, 1.3, Chapter 2, Section 3.2, 3.4, Chapter 5, Section 6.2, 6.5, 8.4, 11.1, 11.4, 11.5, 11.6, Appendix 3, 4, 6, 8
March 2020	SH(NA)-081763ENG-D	■Added or modified parts SAFETY PRECAUTIONS, TERMS, GENERIC TERMS AND ABBREVIATIONS
October 2020	SH(NA)-081763ENG-E	■Added or modified parts SAFETY PRECAUTIONS, CONDITIONS OF USE FOR THE PRODUCT, INTRODUCTION, Section 1.1, 1.2, 3.2, 3.4, 6.3, 6.5, Appendix 4

Japanese manual number: SH-081762-E

This manual confers no industrial property rights of any other kind, nor does it confer any patent licenses. Mitsubishi Electric Corporation cannot be held responsible for any problems involving industrial property rights which may occur as a result of using the contents noted in this manual.

© 2017 MITSUBISHI ELECTRIC CORPORATION

WARRANTY

Please confirm the following product warranty details before using this product.

1. Gratis Warranty Term and Gratis Warranty Range

If any faults or defects (hereinafter "Failure") found to be the responsibility of Mitsubishi occurs during use of the product within the gratis warranty term, the product shall be repaired at no cost via the sales representative or Mitsubishi Service Company.

However, if repairs are required onsite at domestic or overseas location, expenses to send an engineer will be solely at the customer's discretion. Mitsubishi shall not be held responsible for any re-commissioning, maintenance, or testing on-site that involves replacement of the failed module.

[Gratis Warranty Term]

The gratis warranty term of the product shall be for one year after the date of purchase or delivery to a designated place. Note that after manufacture and shipment from Mitsubishi, the maximum distribution period shall be six (6) months, and the longest gratis warranty term after manufacturing shall be eighteen (18) months. The gratis warranty term of repair parts shall not exceed the gratis warranty term before repairs.

[Gratis Warranty Range]

- (1) The range shall be limited to normal use within the usage state, usage methods and usage environment, etc., which follow the conditions and precautions, etc., given in the instruction manual, user's manual and caution labels on the product.
- (2) Even within the gratis warranty term, repairs shall be charged for in the following cases.
 1. Failure occurring from inappropriate storage or handling, carelessness or negligence by the user. Failure caused by the user's hardware or software design.
 2. Failure caused by unapproved modifications, etc., to the product by the user.
 3. When the Mitsubishi product is assembled into a user's device, Failure that could have been avoided if functions or structures, judged as necessary in the legal safety measures the user's device is subject to or as necessary by industry standards, had been provided.
 4. Failure that could have been avoided if consumable parts (battery, backlight, fuse, etc.) designated in the instruction manual had been correctly serviced or replaced.
 5. Failure caused by external irresistible forces such as fires or abnormal voltages, and Failure caused by force majeure such as earthquakes, lightning, wind and water damage.
 6. Failure caused by reasons unpredictable by scientific technology standards at time of shipment from Mitsubishi.
 7. Any other failure found not to be the responsibility of Mitsubishi or that admitted not to be so by the user.

2. Onerous repair term after discontinuation of production

- (1) Mitsubishi shall accept onerous product repairs for seven (7) years after production of the product is discontinued. Discontinuation of production shall be notified with Mitsubishi Technical Bulletins, etc.
- (2) Product supply (including repair parts) is not available after production is discontinued.

3. Overseas service

Overseas, repairs shall be accepted by Mitsubishi's local overseas FA Center. Note that the repair conditions at each FA Center may differ.

4. Exclusion of loss in opportunity and secondary loss from warranty liability

Regardless of the gratis warranty term, Mitsubishi shall not be liable for compensation to:

- (1) Damages caused by any cause found not to be the responsibility of Mitsubishi.
- (2) Loss in opportunity, lost profits incurred to the user by Failures of Mitsubishi products.
- (3) Special damages and secondary damages whether foreseeable or not, compensation for accidents, and compensation for damages to products other than Mitsubishi products.
- (4) Replacement by the user, maintenance of on-site equipment, start-up test run and other tasks.

5. Changes in product specifications

The specifications given in the catalogs, manuals or technical documents are subject to change without prior notice.

TRADEMARKS

The company names, system names and product names mentioned in this manual are either registered trademarks or trademarks of their respective companies.

In some cases, trademark symbols such as [™] or [®] are not specified in this manual.

SH(NA)-081763ENG-E(2010)MEE

MODEL: CCIEFB-IO-U-E

MODEL CODE: 13JX73

mitsubishi electric corporation

HEAD OFFICE : TOKYO BUILDING, 2-7-3 MARUNOUCHI, CHIYODA-KU, TOKYO 100-8310, JAPAN
NAGOYA WORKS : 1-14, YADA-MINAMI 5-CHOME, HIGASHI-KU, NAGOYA, JAPAN

When exported from Japan, this manual does not require application to the
Ministry of Economy, Trade and Industry for service transaction permission.

Specifications subject to change without notice.