

Personal Computer Embedded Type Servo System Controller

Motion Control Software SWM-G User's Manual (Startup)

-MR-SWVG16-U
-MR-SWVG32-U
-MR-SWVG64-U
-MR-SWVG128-U



SAFETY PRECAUTIONS

(Read these precautions before using this product.)

Before using this product, please read this manual and the relevant manuals carefully and pay full attention to safety to handle the product correctly.

The precautions given in this manual are concerned with this product only.

In this manual, the safety precautions are classified into two levels: "⚠️ WARNING" and "⚠️ CAUTION".

 WARNING	Indicates that incorrect handling may cause hazardous conditions, resulting in death or severe injury.
 CAUTION	Indicates that incorrect handling may cause hazardous conditions, resulting in minor or moderate injury or property damage.

Under some circumstances, failure to observe the precautions given under "⚠️ CAUTION" may lead to serious consequences.

Observe the precautions of both levels because they are important for personal and system safety.

Make sure that the end users read this manual and then keep the manual in a safe place for future reference.

[Design Precautions]

WARNING

- Configure external safety circuits to ensure that the entire system operates safely even when a fault occurs in the personal computer. Failure to do so may result in an accident due to an incorrect output or malfunction.
 - (1) Configure safety circuits externally, such as an emergency stop circuit, protection circuit, and protective interlock circuit for forward/reverse operation or upper/lower limit positioning.
 - (2) If an incorrect home position return direction is set, motion control may continue without deceleration. To prevent machine damage caused by this, configure an external interlock circuit.
 - (3) When this product detects an error, the motion slows down and stops or the motion rapidly stops, depending on the stop setting in parameter. Set the parameter to meet the specifications of the positioning control system. In addition, set the home position return parameter and positioning data within the specified setting range.
 - For the operating status of each station after a communication failure, refer to manuals for the network used. Incorrect output or malfunction due to a communication failure may result in an accident.
 - When modifying control while this product is running, configure an interlock in the program to ensure that the entire system always operates safely. For other forms of control (such as program modification, parameter change, forced output, or operating status change (status control)), read the relevant manuals carefully and ensure that the operation is safe before proceeding. Improper operation may damage machines or cause accidents. Determine corrective actions to be taken by the system in case of a communication failure.
 - Especially, when a remote system is controlled, immediate action cannot be taken if a problem occurs due to a communication failure. To prevent this, configure an interlock in the program, and determine corrective actions to be taken by the system in case of a communication failure.
 - If a communication cable is disconnected, the network may be unstable, resulting in a communication failure of multiple stations. Configure an interlock in the program to ensure that the entire system will always operate safely even if communications fail. Failure to do so may result in an accident due to an incorrect output or malfunction.
-

[Design Precautions]

WARNING

- If safety standards (ex. robot safety rules, etc.) apply to the system using the servo amplifier and servomotor, make sure that the safety standards are satisfied.
 - Construct a safety circuit external to each remote station if the abnormal operation of the remote stations to be connected to this product differs from the safety directive operation in the system.
-

[Design Precautions]

CAUTION

- Do not install the control lines or communication cables together with the main circuit lines or power cables. Keep a distance of 100 mm or more between them. Failure to do so may result in malfunction due to noise.
 - After the personal computer is powered on or rebooted, the time taken for the system to enter the RUN status varies depending on the system configuration and/or performance of the personal computer. Design circuits so that the entire system will always operate safely, regardless of the time.
-

[Security Precautions]

WARNING

- To maintain the security (confidentiality, integrity, and availability) of the system against unauthorized access, denial-of-service (DoS) attacks, computer viruses, and other cyberattacks from external devices via the network, take appropriate measures such as firewalls, virtual private networks (VPNs), and antivirus solutions.
-

[Wiring Precautions]

CAUTION

- Ground the controllers in which this product is installed, servo amplifiers, and servo motors with a ground resistance of 100 ohm or less. Do not use a common grounding with other equipment.
 - Do not install the control lines or communication cables together with the main circuit lines or power cables. Keep a distance of 100 mm or more between them. Failure to do so may result in malfunction due to noise.
 - Place the cables in a duct or clamp them. If not, dangling cable may swing or inadvertently be pulled, resulting in damage to the cables or malfunction due to poor contact.
 - Check the interface type and correctly connect the cable. Incorrect wiring (connecting the cable to an incorrect interface) may cause failure of the external device.
 - When disconnecting the cable, do not pull the cable by the cable part. Pulling the cable may result in malfunction or damage to the cable.
 - Prevent foreign matter such as dust or wire chips from entering the personal computer. Such foreign matter can cause a fire, failure, or malfunction.
 - For Ethernet cables to be used in the system, select the ones that meet the specifications in the user's manual. If not, normal data transmission is not guaranteed.
-

[Startup and Maintenance Precautions]

WARNING

- Shut off the external power supply (all phases) used in the system before cleaning. Failure to do so may result in electric shock or malfunction.
 - Do not connect or disconnect any communication cable while power is on. Failure to do so may cause malfunction.
-

[Startup and Maintenance Precautions]

CAUTION

- When modifying control while this product is running, configure an interlock in the program to ensure that the entire system will always operate safely. For other forms of control (such as program modification, parameter change, forced output, or operating status change (status control)), read the relevant manuals carefully and ensure that the operation is safe before proceeding. Improper operation may damage machines or cause accidents. Determine corrective actions to be taken by the system in case of a communication failure.
 - Especially, when a remote system is controlled, immediate action cannot be taken if a problem occurs due to a communication failure. To prevent this, configure an interlock in the program, and determine corrective actions to be taken by the system in case of a communication failure.
 - Use any radio communication device such as a cellular phone or PHS (Personal Handy-phone System) more than 25 cm away in all directions from the personal computer. Failure to do so may cause malfunction.
 - Maintenance must be performed by qualified maintenance personnel with knowledge.
 - Before testing the operation, set a low speed value for the speed limit parameter so that the operation can be stopped immediately upon occurrence of a hazardous condition.
 - Confirm and adjust the program and each parameter before operation. Unpredictable movements may occur depending on the machine.
 - When using the absolute position system function, on starting up, and when the absolute position motor has been replaced, always perform a home position return.
 - Before starting the operation, confirm the brake function.
 - Do not perform a megger test (insulation resistance measurement) during inspection.
 - After maintenance and inspections are completed, confirm that the position detection of the absolute position detection function is correct.
 - Extreme adjustments and changes may lead to unstable operation, so never make them.
-

[Operating Precautions]

CAUTION

- When modifying control (such as data modification, program change, or operating status change (status control)), read relevant manuals carefully and ensure the safety before operation. Incorrect change or modification may cause system malfunction, damage to the machines, or accidents.
 - Do not go near the machine during test operations. Doing so may lead to injuries.
-

CONDITIONS OF USE FOR THE PRODUCT

- (1) Mitsubishi Motion Control Software ("the PRODUCT") shall be used in conditions;
- i) where any problem, fault or failure occurring in the PRODUCT, if any, shall not lead to any major or serious accident; and
 - ii) where the backup and fail-safe function are systematically or automatically provided outside of the PRODUCT for the case of any problem, fault or failure occurring in the PRODUCT.
- (2) The PRODUCT has been designed and manufactured for the purpose of being used in general industries. MITSUBISHI SHALL HAVE NO RESPONSIBILITY OR LIABILITY (INCLUDING, BUT NOT LIMITED TO ANY AND ALL RESPONSIBILITY OR LIABILITY BASED ON CONTRACT, WARRANTY, TORT, PRODUCT LIABILITY) FOR ANY INJURY OR DEATH TO PERSONS OR LOSS OR DAMAGE TO PROPERTY CAUSED BY the PRODUCT THAT ARE OPERATED OR USED IN APPLICATION NOT INTENDED OR EXCLUDED BY INSTRUCTIONS, PRECAUTIONS, OR WARNING CONTAINED IN MITSUBISHI'S USER, INSTRUCTION AND/OR SAFETY MANUALS, TECHNICAL BULLETINS AND GUIDELINES FOR the PRODUCT.
- ("Prohibited Application")
- Prohibited Applications include, but not limited to, the use of the PRODUCT in;
- Nuclear Power Plants and any other power plants operated by Power companies, and/or any other cases in which the public could be affected if any problem or fault occurs in the PRODUCT.
 - Railway companies or Public service purposes, and/or any other cases in which establishment of a special quality assurance system is required by the Purchaser or End User.
 - Aircraft or Aerospace, Medical applications, Train equipment, transport equipment such as Elevator and Escalator, Incineration and Fuel devices, Vehicles, Manned transportation, Equipment for Recreation and Amusement, and Safety devices, handling of Nuclear or Hazardous Materials or Chemicals, Mining and Drilling, and/or other applications where there is a significant risk of injury to the public or property.
- Notwithstanding the above restrictions, Mitsubishi may in its sole discretion, authorize use of the PRODUCT in one or more of the Prohibited Applications, provided that the usage of the PRODUCT is limited only for the specific applications agreed to by Mitsubishi and provided further that no special quality assurance or fail-safe, redundant or other safety features which exceed the general specifications of the PRODUCTS are required. For details, please contact the Mitsubishi representative in your region.
- (3) We will not responsible for any problems on Motion Control Software and systems caused by DoS attacks, unauthorized accesses, computer viruses, and other cyber attacks.

INTRODUCTION

Thank you for purchasing Motion Control Software SWM-G.

This manual describes the required performance specifications, procedures before operation, and settings for using Motion Control Software SWM-G.

Before using this product, please read this manual and the relevant manuals carefully and develop familiarity with the functions and performance of the product to handle it correctly.

When applying program examples provided in this manual to an actual system, ensure the applicability and confirm that it will not cause system control problems.

Please make sure that the end users read this manual.

Applicable module

MR-SWVG16-U, MR-SWVG32-U, MR-SWVG64-U, MR-SWVG128-U

CONTENTS

SAFETY PRECAUTIONS	1
CONDITIONS OF USE FOR THE PRODUCT	4
INTRODUCTION	4
RELEVANT MANUALS	6
TERMS	6
CHAPTER 1 OVERVIEW	7
1.1 System Configuration	7
1.2 Architecture	8
CHAPTER 2 SPECIFICATIONS	9
2.1 Performance Specifications	9
CHAPTER 3 FUNCTION LIST	11
CHAPTER 4 PROCEDURES BEFORE OPERATION AND SETTING	13
4.1 Wiring and Connection of System Configuration Devices	14
4.2 Startup and Initial Setting of the Engineering Tool (SWMOS)	15
4.3 Network Configuration Setting	18
4.4 Parameter Setting of the Servo Amplifier	24
CHAPTER 5 OPERATION EXAMPLE	29
5.1 Operation Check with Tool	29
5.2 Operation Check with Sample Project	32
System configuration	32
Specifications	32
Parameter setting	33
Sample program operations	33
CHAPTER 6 TROUBLESHOOTING	38
APPENDIX	40
Appendix 1 SWM-G Setting Example by Application	40
Using the virtual axis	40
Single turn (Unlimited length feeding)	42
Appendix 2 How to Use the IP Communication	44
IP communication setting procedure	44
MR Configurator2 communication setting using the IP communication	51
Appendix 3 Configuration of CC-Link IE TSN	53
Appendix 4 Absolute Position Detection System	54
Setting the servo amplifier	54
Restoring the current value	54
Appendix 5 How to Create a New Program	56
Appendix 6 Network Configuration Setting with IETSN Configurator	63
Appendix 7 How to Set the MR Configurator2 Alarm Occurrence Time	74
REVISIONS	78
WARRANTY	79
TRADEMARKS	80

RELEVANT MANUALS

Manual name [manual number]	Description	Available form
Motion Control Software SWM-G User's Manual (Startup) [IB-0300562ENG] (this manual)	Specifications, procedures before operation, and settings of Motion Control Software SWM-G.	PDF
Motion Control Software SWM-G User's Manual (Installation) [IB-0300561ENG]	Required procedures and settings for installing Motion Control Software SWM-G in a personal computer.	PDF
Motion Control Software SWM-G Operating Manual [IB-0300563ENG]	System configuration, parameter settings, and online function operations of Motion Control Software SWM-G.	PDF

TERMS

Unless otherwise specified, this manual uses the following terms.

Term	Description
I/O size	The number of I/O points. It is expressed in bytes.
MR Configurator2	The product name of the servo setup software.
MR-J5-G	An MR-J5-□G□(-RJ) servo amplifier.
MR-J5W-G	An MR-J5W□-□G servo amplifier.
NIC	A network interface card for Ethernet connection.
RTX	An extension function that operates Windows in real time, which is developed by IntervalZero.
RTX64	RTX64 is compatible with 64-bit natively.
SWM-G	A generic product name for Motion Control Software SWM-G.
SWM-G engine	A task on RTX64 that performs management of SWM-G modules, axis management, and API processing.
SWMOS	A generic product name for the engineering tool SWM-G Operating Station.
Device	An object for the communication between a user application and the SWM-G engine or each module.
Personal computer	A generic term for personal computers where Windows® operates.
Platform	A generic term for network connection functions to be loaded to RTX64. CC-Link IE TSN and a simulator are available as modules.
Module	A generic term for modules to be loaded to RTX64. A file with the extension ".rtdll".
User unit	A unit of the position defined by the user (such as 1 mm and 1 μs). It is abbreviated as "U". The speed is expressed as "U/s", the acceleration is expressed as "U/s ² ", and the jerk is expressed as "U/s ³ " in user unit.

1 OVERVIEW

Motion Control Software SWM-G is software that is installed in a personal computer to perform motion control and network control. Connect the personal computer to servo amplifiers or remote stations such as a remote I/O using CC-Link IE TSN. Connect the personal computer in star topology or line topology using Ethernet cables. Star topology and line topology can be combined in a network.

In Motion Control Software SWM-G, up to 128 axes of servo motors can be controlled.

1.1 System Configuration

The following shows the SWM-G system configuration.

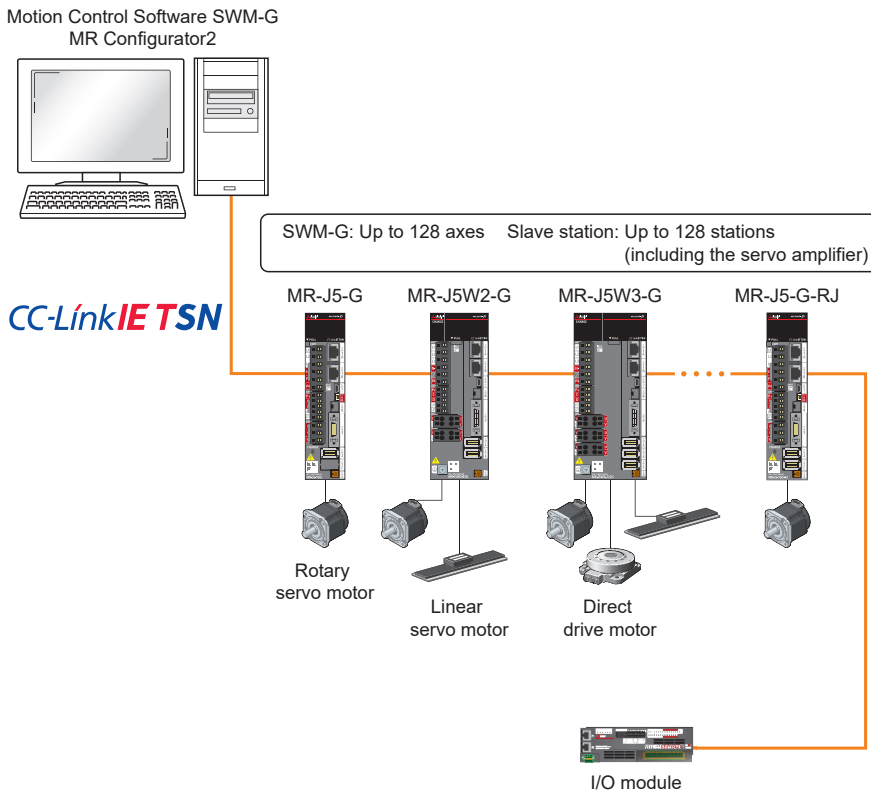

Point

- Connecting to the NIC port set at the time of installation is required.
- When using multi-axis servo amplifiers, the invalid axis setting cannot be used.

1.2 Architecture

All the functions of SWM-G have been implemented in "rtdll" and can be used by loading them. The following shows the overall flow chart of data in the SWM-G architecture.

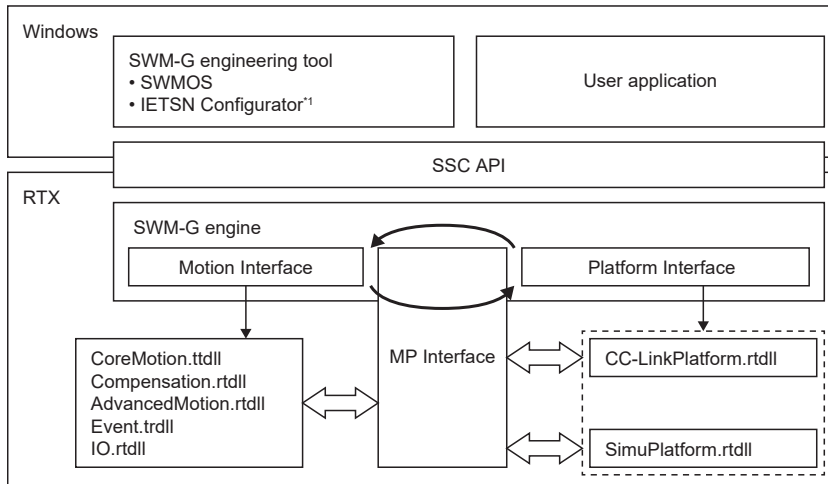

*1 For the versions that can be used, refer to the following.
 ☞ Page 63 Network Configuration Setting with IETSN Configurator

Item	Description
SWM-G engineering tool	SWMOS: An integrated utility.
User application	A program created by the user.
SSC API	An interface library with SWM-G.
SWM-G engine	Performs the motion control and network management.
Motion Interface	A motion interface.
Platform Interface	A platform interface.
MP Interface	A motion-platform interface.
CoreMotion.rtdll	Performs the basic motion control.
Compensation.rtdll	Performs the compensation processing.
AdvancedMotion.rtdll	Performs the advanced motion control.
Event.rtdll	Performs the event processing.
IO.rtdll	Performs the I/O control.
CCLinkPlatform.rtdll	Communicates with the CC-Link IE TSN remote stations.
SimuPlatform.rtdll	Simulates the virtual axis.

2 SPECIFICATIONS

2.1 Performance Specifications

The following shows the performance specifications of SWM-G.

Item	MR-SWMG16-U	MR-SWMG32-U	MR-SWMG64-U	MR-SWMG128-U
Number of control axes	16 axes	32 axes	64 axes	128 axes
Number of connected stations	Up to 128 stations			
CC-Link IE TSN	Communication speed	1Gbps/100Mbps ^{**2}		
	Communication cycle	Standard 1 ms, Can be set to 0.125 ms to 8 ms by the user		
	Other communication specifications	Mixture of class B, Hot Connect, SDO communication, IP communication		
	Transmission line type	Line topology, star topology, line + star topology		
I/O size	Input 8000 bytes, output 8000 bytes			
Positioning	Up to 128 axes simultaneously (absolute value command, relative value command) Override is possible			
Acceleration/deceleration processing	Trapezoidal, S-curve, jerk ratio, parabolic, sine, advanced-S, trapezoidal moving average time, jerk-limited, jerk limited S-curve, jerk-limited advanced-S, two velocity trapezoidal, two velocity S-curve, two velocity jerk ratio, time acceleration trapezoidal, time acceleration S-curve, time acceleration jerk ratio, time acceleration parabolic, time acceleration sine, time acceleration advanced-S, constant deceleration, jerk ratio/fix velocity-T, jerk ratio/fix velocity-S, jerk-limited/fix velocity-T, jerk-limited/fix velocity-S			
Interpolation function	2- to 4-axis linear interpolation (up to 128 axes), 2-axis circular interpolation, 3-axis circular interpolation, 3-axis helical interpolation, PVT			
Continuous path	Combination of linear and circular interpolation, spline interpolation, pre-read speed automatic control, linear/circular continuous path with rotation stage			
Real-time control	Event, triggered motion, position synchronous output			
Synchronous control	Simple synchronization, synchronous gear ratio, synchronous phase offset, synchronous compensation, dynamic establishment/cancellation of synchronization, multiple pairs (up to 64 pairs) of synchronization between 1 axis and multiple axes (synchronous group)			
Electronic cam	Cam curves of eight systems can be defined, cam curve per communication cycle, phase operation, clutch			
Home position return function ^{*3}	Home position return using the Z-phase (index pulse), home position sensor, limit sensor, limit proximity sensor, external input signal, mechanical end, and gantry axis can be performed.			
Compensation function	Backlash/pitch error compensation, plane strain (straightness) compensation			

*1 When there are two ports, 1Gbps devices and 100Mbps devices can be assigned to each port.

*2 When multiple CC-Link IE TSN classes are mixed, the functionality and performance of a part of the network or the entire network are equivalent to the lower CC-Link IE TSN class.

*3 It does not support the home position return mode of the servo amplifier.

3 FUNCTION LIST

The following shows the SWM-G functions.

Function		Description
Home position return		Aligns the axis coordinates with the physical machine coordinates.
Basic function	Position control	Moves the specified axis to the specified position.
	Speed control	Accelerates or decelerates the command axis to the target speed using the specified parameter and keeps it moving after it reaches the target speed. The control not including the position loop is performed on the command to the servo amplifier.
	Torque control	Maintains a constant torque in the specified direction. The control not including the position loop is performed on the command to the servo amplifier.
	JOG operation	Performs the JOG operation on the command axis using the specified parameter.
	Linear interpolation	Interpolates the axis so that it moves in a straight line in synchronization.
	Circular interpolation	Interpolates two axes onto a circular arc.
	3D circular interpolation	Interpolates three axes onto a circular arc in a 3D space.
	Helical interpolation	Moves three axes in spirals.
	Override	Overwrites the target value of the axis executing the command. Including the target position, every parameter of the motion command can be changed.
	Trigger motion	Delays the execution of the motion command until the specified trigger condition is satisfied.
	Synchronous control	If the command position of the master axis changes, the command position of the slave axis also changes by the same amount.
Advanced function	Spline interpolation	Moves two to six axes along the path defined by a point sequence or other parameters.
	PVT control	Commands the axis using a point cloud consisting of position, speed, and time. The axis passes the position of each point at the specified speed and at the specified time.
	Path interpolation	Two interpolation axes follow the defined path with either a single motion profile or different motion profiles for each segment.
	Rotation path interpolation	Rotates the entire path by adding the rotating axis to the path interpolation.
	Pre-read path interpolation	Specifies the speed limit and acceleration limit for each interpolation axis in addition to the path interpolation function. The interpolation speed and acceleration of each path segment are adjusted so that the path is completed in the shortest time within the axis limit.
	E-CAM	Controls the command position of the slave axis according to the position of the master axis. The command position of the slave axis is calculated from the position of the master axis using the point data defined in the E-CAM table.
Compensation function	Pitch error compensation	Compensates the physical irregularities of the axes by defining the offsets measured at the command positions at regular intervals of the axes.
	2D pitch error compensation	Calculates the pitch offset from the positions of two reference axes instead of one axis.
	Backlash compensation	Applies the offsets when the axis changes the movement direction.
Others	Touch probe	Latches the axis position. Two types of touch probes are available; A hardware touch probe and software touch probe.
	Position synchronous output	Used to set the output signal when a specific condition is satisfied.
	Planned speed override	Overwrites the speed of the axis executing the position command when a specific condition is satisfied.
	IO	Performs the I/O module control.
	User memory	Performs the user memory control.
	Logging	Saves the data specified by the setting.
PM motion		Instead of sending the position, speed, or torque command to the servo drive for each cycle, the motion command is sent to the servo drive only when the PM motion module function is called.

MEMO

4 PROCEDURES BEFORE OPERATION AND SETTING

This chapter describes the procedures before the operation of SWM-G.

1. Setup

Install Motion Control Software SWM-G in a personal computer.

For details, refer to the following.

 Motion Control Software SWM-G User's Manual (Installation)

2. Wiring and connection of system configuration devices

Connect the personal computer and remote stations such as servo amplifiers with Ethernet cables.

 Page 14 Wiring and Connection of System Configuration Devices

3. Startup and initial setting of the engineering tool (SWMOS)

Start the engineering tool (SWMOS) and set the CC-Link IE TSN platform.

 Page 15 Startup and Initial Setting of the Engineering Tool (SWMOS)

4. Network configuration setting

Set the network configuration.

 Page 18 Network Configuration Setting

5. Parameter setting of the servo amplifier

Set the parameters of the drive unit to be used.

 Page 24 Parameter Setting of the Servo Amplifier

4.1 Wiring and Connection of System Configuration Devices

Connect the personal computer and remote stations such as servo amplifiers with Ethernet cables.

Set the rotary switches of the servo amplifiers.

In the initial state of the servo amplifiers, the rotary switches (SW1/SW2) correspond to the fourth octet of the IP address.

System configuration example

In the following system configuration example, the initial values of the IP addresses are used.

Applicable device	IP address
Personal computer (master)	192.168.3.253
MR-J5-G	192.168.3.1
MR-J5W3-G	192.168.3.2

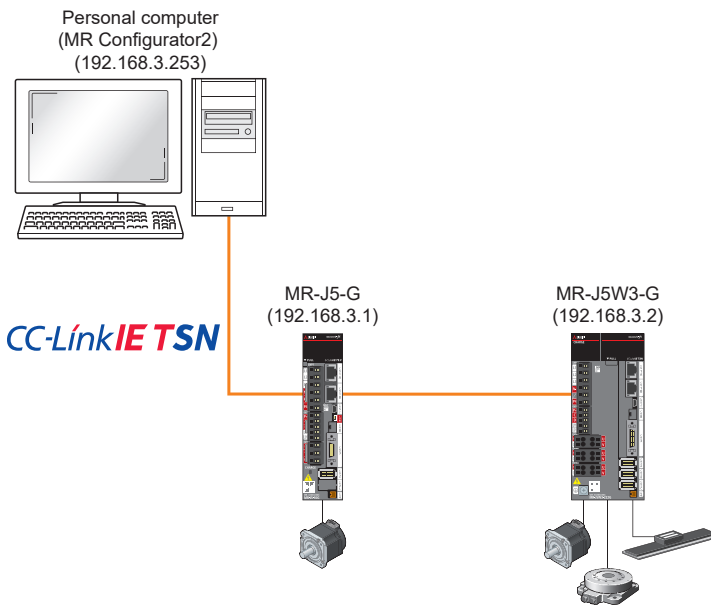

Point

- Connecting to the set NIC port is required.
- When using multi-axis servo amplifiers, the invalid axis setting cannot be used.

4.2 Startup and Initial Setting of the Engineering Tool (SWMOS)

Start the engineering tool SWM-G Operating Station (SWMOS) and set the CC-Link IE TSN platform. This setting allows the communication with CC-Link IE TSN remote stations.

Starting SWMOS

1. Select [SWM-G] ⇒ [SWMOS] (1) from the Windows start menu.

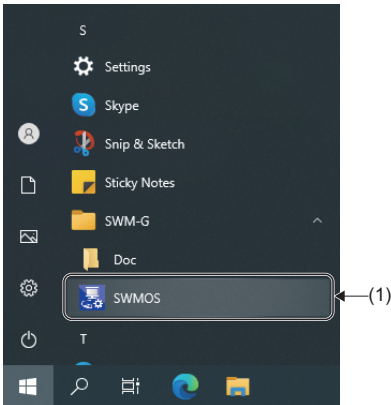

Point

For details of the SWM-G functions, select [SWM-G] ⇒ [Doc] from the Windows start menu and refer to the following manual stored in the Doc folder.

SWM-G User Manual

2. When SWMOS is started, the "Getting started" screen and "SWMOS" screen appear. In the "Getting started" screen, the system version, license information, and others can be checked. Click the [Close] button to close the "Getting started" screen.

■ "SWMOS" screen

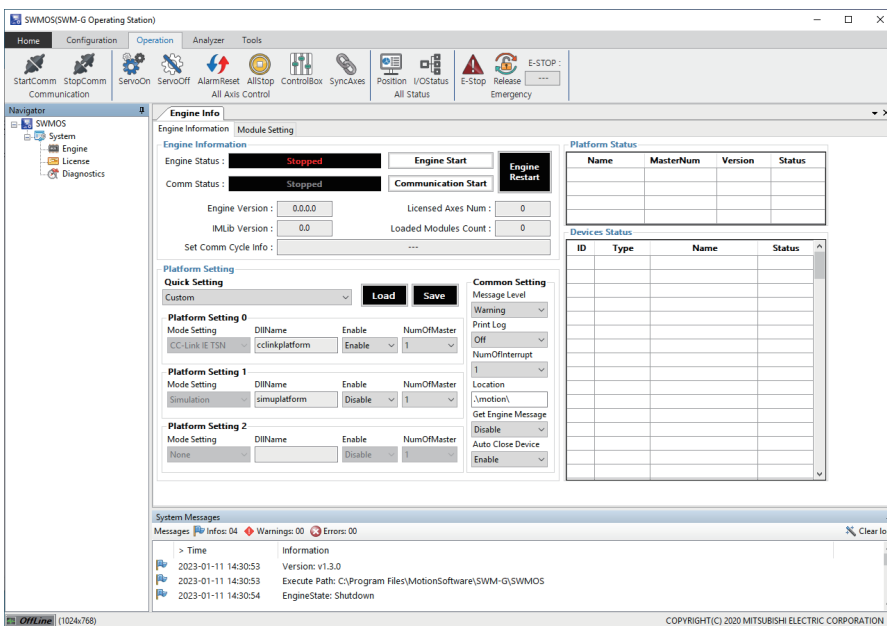

■ "Getting started" screen

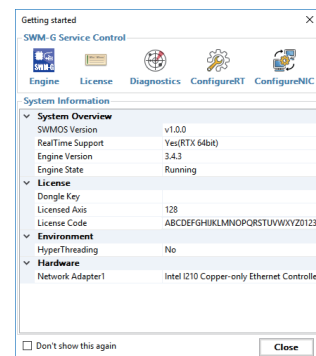

Point

If you select "Don't show this again" in the "Getting started" screen and click the [Close] button to close the screen, the "Getting started" screen will not be displayed at the next startup.

Checking and setting the platform

1. Select [System] ⇒ [Engine] (1) in the navigation window on the "SWMOS" screen to display the Engine Info window. Select the [Engine Information] tab (2) and check the settings in [Platform Setting] (3).

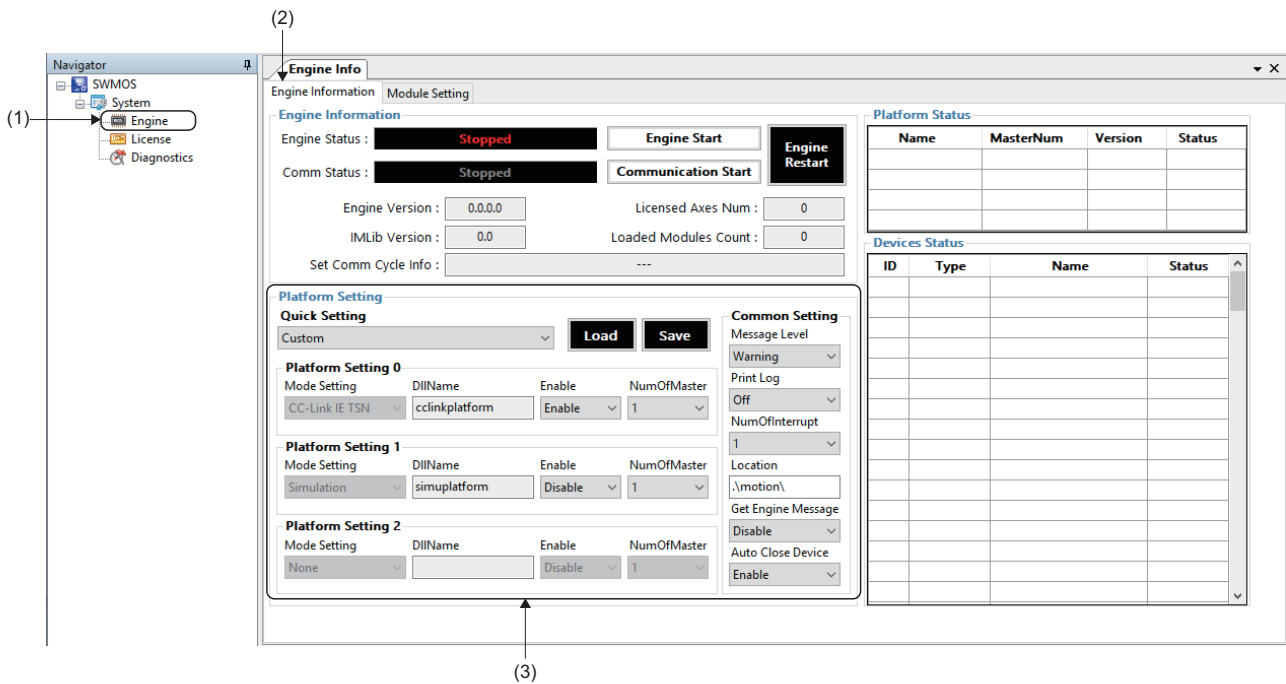

2. Select [Platform Setting] ⇒ [Quick Setting] (4), select "CC-Link IE TSN", and click the [Save] button (5).

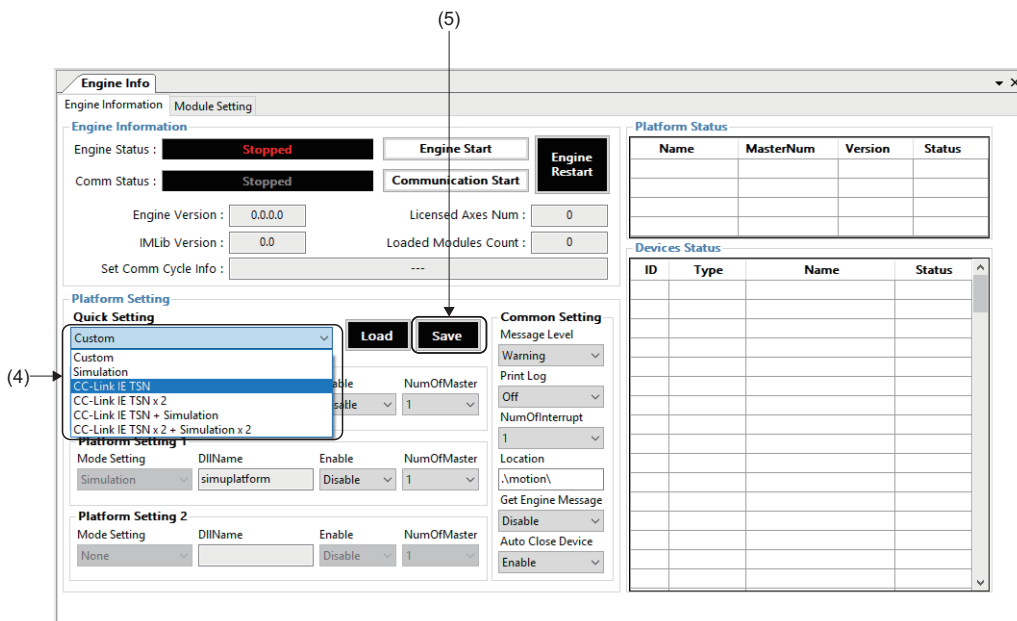

3. When the message "Do you want to save in Module.ini?" appears, click the [Yes] button.

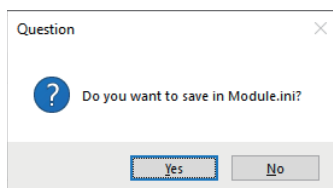

- When the message "Do you want to restart the SWM-GEEngine?" appears, click the [Yes] button to restart the engine.

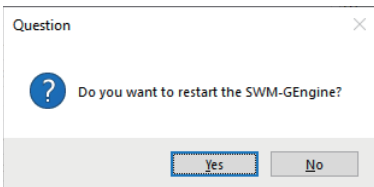

- When the engine is restarted, the status can be checked in [Engine Status] (6) in [Engine Information]. Update the status in order of "Stopped" → "Preparing" → "Running". The network information is displayed in [Platform Status] (7).

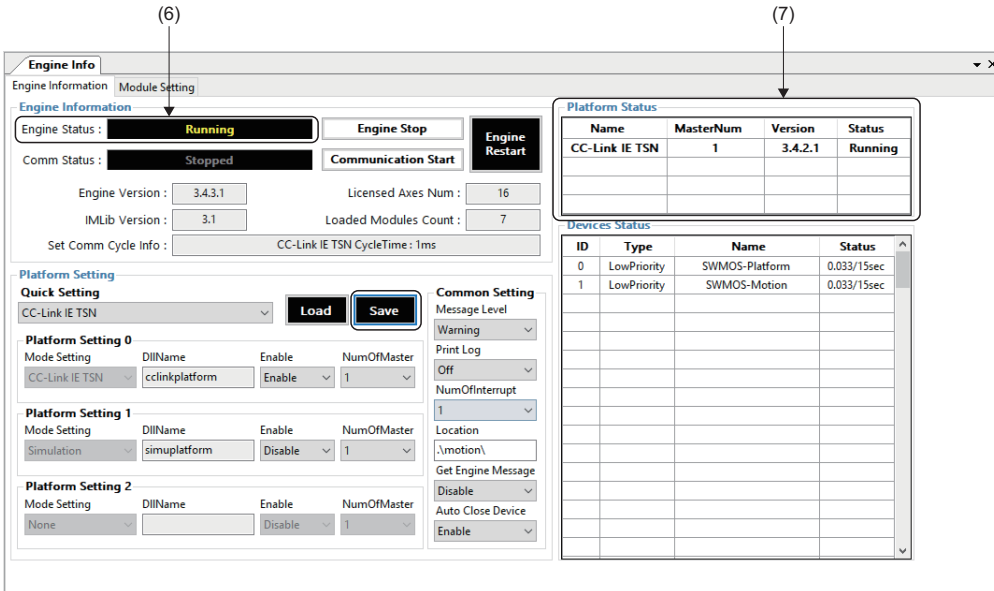

- With the above settings, the preparation for communicating with the CC-Link IE TSN remote stations has been completed. Since the engine will be stopped by closing the "SWMOS" screen, leave it in the execution state.

4.3 Network Configuration Setting

After setting the CC-Link IE TSN platform, set the network configuration.

This section describes the settings using the system configuration example in Section 4.1. (Page 14 System configuration example)

Displaying the CC-Link IE TSN setting screen

1. Select [SWMOS] ⇒ [Network] ⇒ [Comm1] (1) in the navigation window on the "SWMOS" screen to display the Comm1 window.
2. Select [CC-Link IE TSN] (2) in the [Comm1] tree. [Master Setting] (3) and [Slave Setting] (4) are displayed.

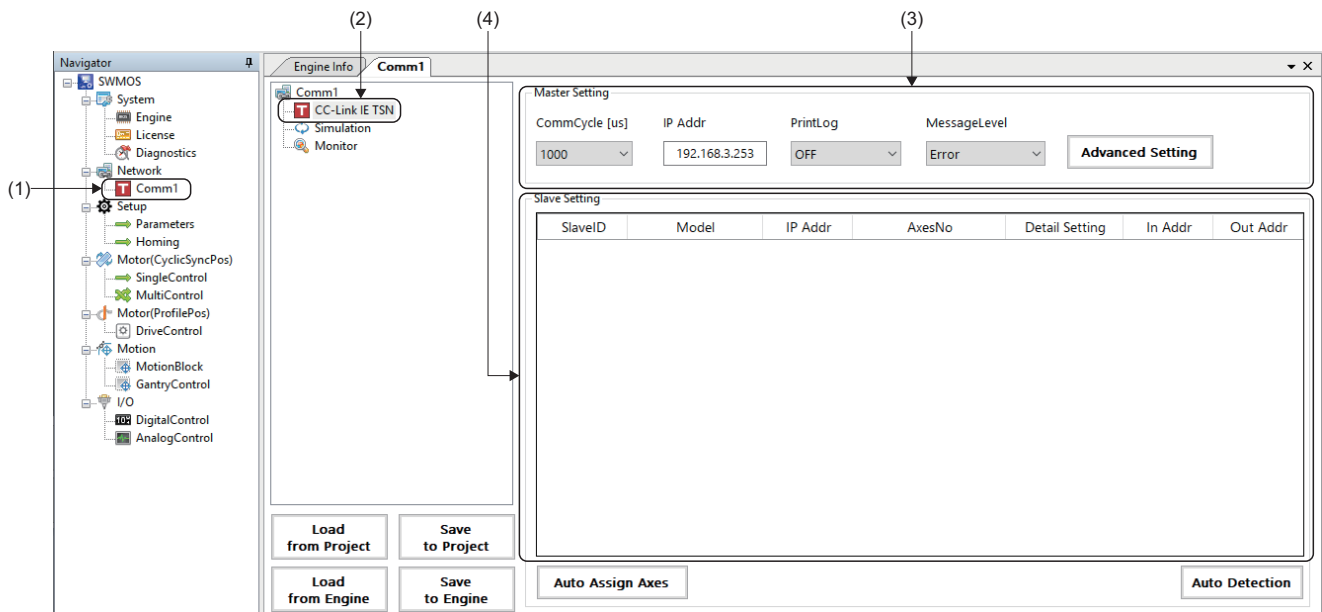

Master setting

1. Set [Communication cycle (CommCycle)] (1) and [IP address (IP Addr)] (2) in [Master Setting]. (In the explanation of this section, the initial values are set.)
- Communication cycle: 1000[μs]
 - IP address: 192.168.3.253

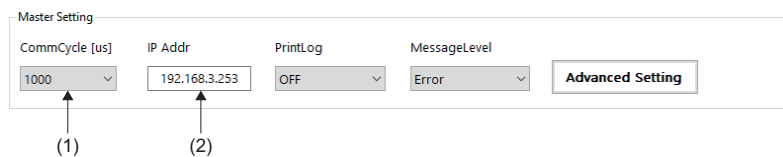

Slave setting

1. Right-click the object list in the slave setting, and click [Add] (3) to add a line in the object list.
Add lines for the number of remote stations to be connected.
2. Double-click a cell in the [Model] (4) column.

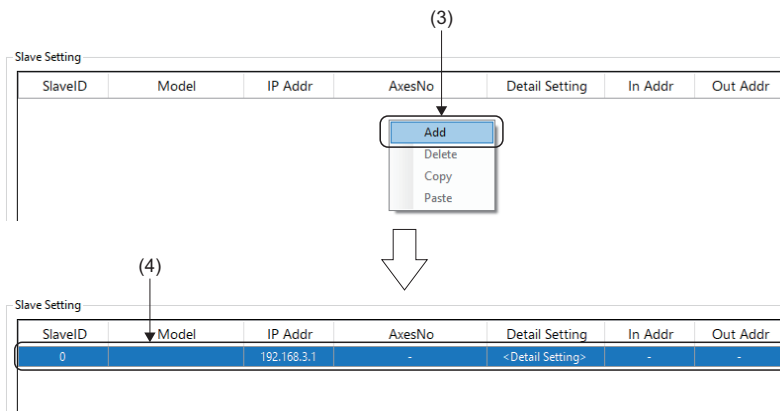

3. The "Model Selection" screen is displayed. Select a remote station to be added (example: MR-J5-G) from the list, and click the [OK] button.

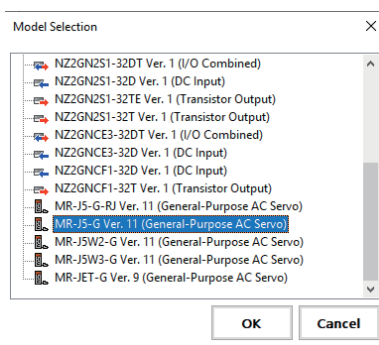

4. The selected remote station is displayed in the cell in the [Model] (4) column.
5. Set the IP address (5) of the remote station. (In the explanation of this section, the initial values are set.)
6. Double-click a cell in the [AxesNo] (6) column.

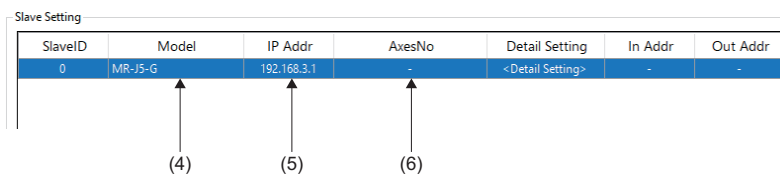

7. The "Axis Number Setting" screen is displayed. Set the axis number for the drop number, and click the [OK] button. For a multi-axis, set axis numbers for the number of axes.

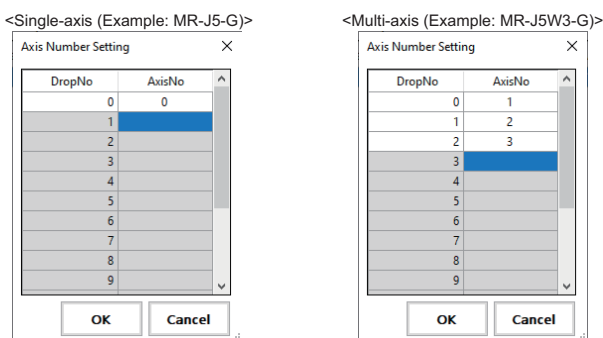

8. The axis numbers set in [AxesNo] (6) are displayed.

SlaveID	Model	IP Addr	AxesNo	Detail Setting	In Addr	Out Addr
0	MR-J5-G	192.168.3.1	0	<Detail Setting>	-	-
1	MR-J5W3-G	192.168.3.2	1,2,3	<Detail Setting>	-	-

↑
(6)

Point

When setting axis numbers, click the [Auto Assign Axes] button to automatically assign axis numbers. For details of the Auto Assign Axes, refer to "Automatic assignment of axis numbers" in the following manual.
 Motion Control Software SWM-G Operating Manual

Saving the settings

1. Click the [Save to Project] (1) button.

The screenshot shows a software window with a tree view on the left containing 'Comm1', 'CC-Link IE TSN', 'Simulation', and 'Monitor'. The main area is divided into 'Master Setting' and 'Slave Setting'. The 'Slave Setting' table is identical to the one in step 8. Below the table are buttons for 'Auto Assign Axes' and 'Auto Detection'. At the bottom left, there are four buttons: 'Load from Project', 'Save to Project' (labeled 1), 'Load from Engine', and 'Save to Engine'.

2. The confirmation message "Do you want to save the setting to the project data?" appears. Click the [Yes] button.

*1 If the setting has an error, an error message appears. ( Page 23 Network setting error information)

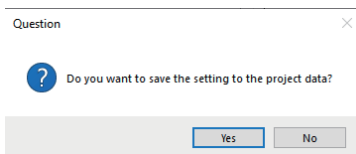

3. The "Folder browsing" screen appears.

<When saving the setting in a newly created folder>

- Enter the "Folder name" in the folder name entry column (2), and click the [New Folder] button (3). A folder (4) is created under "NETWORK". Select the created folder, and click the [OK] button.

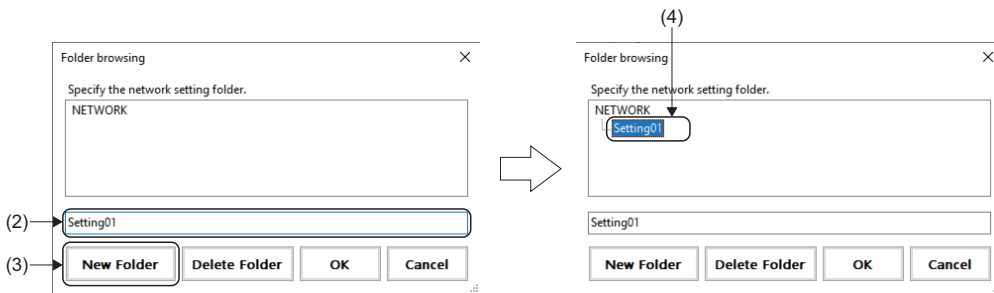

<When saving the setting in an existing folder>

- Select the save destination folder, and click the [OK] button.

4. When the saving is completed, the completion message "Succeeded in saving the setting to the project data." appears. Click the [OK] button.

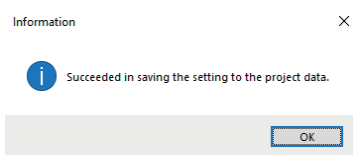

Point

Save the master setting and slave setting as a setting file in the specified folder. Manage the setting files in the following folder.

<Storage destination folder>

C:\Program Files\MotionSoftware\SWM-G\SWMOS\SWMOSPack\Project\SWMOS\NETWORK

Precautions

- The settings are not applied to the SWM-G engine only by saving the setting file with the [Save to Project] button. Write the settings to the SWM-G engine with the [Save to Engine] button to apply the settings to the SWM-G engine.

Writing to the SWM-G engine

1. Click the [Save to Engine] button (1).

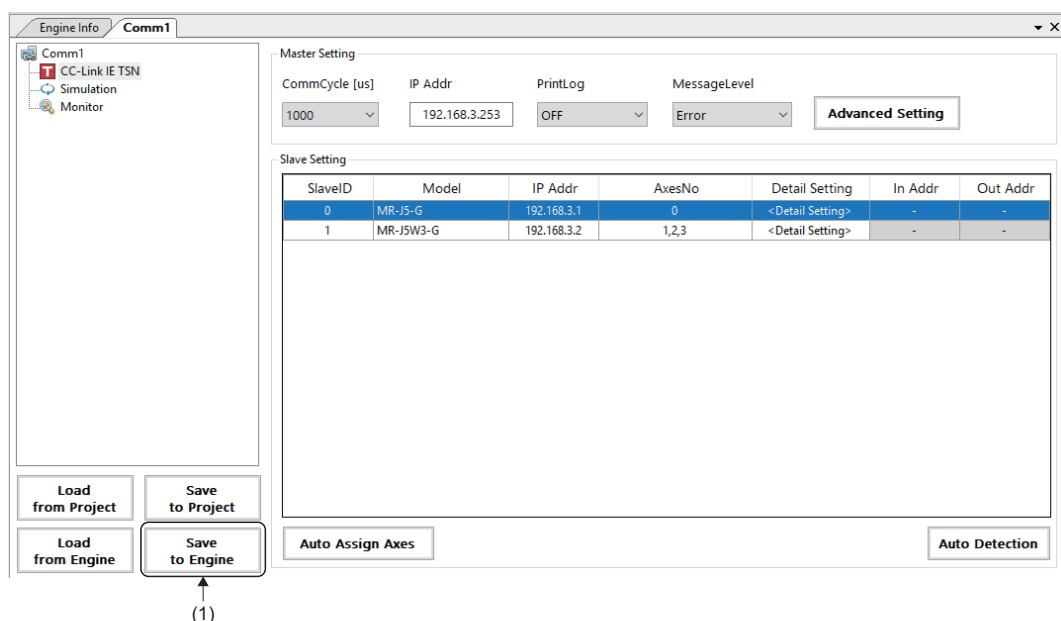

2. The confirmation message "Do you want to save setting to the engine?" appears. Click the [Yes] button.

*1 If the setting has an error, an error message appears. (Page 23 Network setting error information)

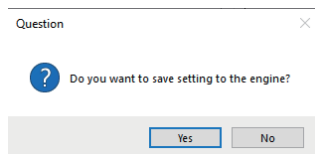

3. When the loading is completed, the completion message "Succeeded in saving the setting to the engine." appears. Click the [OK] button to close the message.

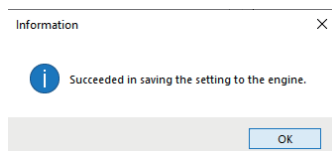

Network setting error information

When the network setting file is saved with the [Save to Project] button or written to the SWM-G engine with the [Save to Engine] button, if the setting has an error, the following message appears.

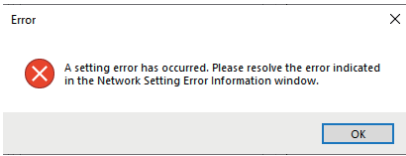

Click the [OK] button to close the error message. The "Network Setting Error Information" screen appears. Check the displayed error details and eliminate the error. For details of the "Network Setting Error Information" screen, refer to the following.

 Motion Control Software SWM-G Operating Manual

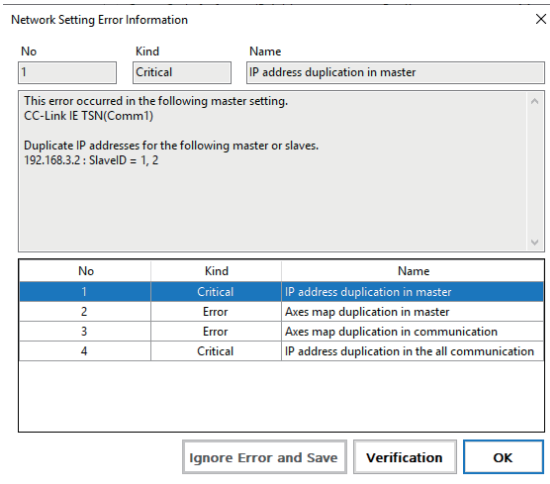

4.4 Parameter Setting of the Servo Amplifier

Set the parameters of the drive unit to be used.

Set the servo amplifier (MR-J5-G) with MR Configurator2.

The following shows the procedure for setting the parameters of the servo amplifier as an example.

- Parameter

No.	Name	Setting value
PA04.2	Servo forced stop selection	1: Disabled (The forced stop input EM1 and EM2 are not used)
PD01.2	Input signal automatic on selection	■Forward rotation stroke end (LSP) 1: Automatic on ■Reverse rotation stroke end (LSN) 1: Automatic on
PT01.1	Speed/acceleration/deceleration unit selection	1: (Speed: Command unit/s, acceleration/deceleration: Command unit/s ²)* ¹

*1 The command unit is fixed to pulse. Therefore, "pulse/s" is used as the speed unit instead of "r/min".

Precautions

- In the parameter change example, the input signal of the servo amplifier is not used. Configure the settings according to the safety measures required for the customer's intended use.
- The parameters of the servo amplifier are not managed in SWM-G.
- When the servo parameter [PT01.1 (Speed/acceleration/deceleration unit selection)] is set to "1: (Speed: Command unit/s, acceleration/deceleration: command unit/s²)", the digits may overflow since the command unit is 32-bit. In that case, adjust it using the gear on the servo amplifier side.

Point

- MR Configurator2 is software for servo parameter setting, graph measurement/display, test operation, and others. This section describes the procedure for connecting the servo amplifier to a personal computer where MR Configurator2 has been installed and starting up the servo amplifier. For details of how to use MR Configurator2, refer to the following.
 - MR Configurator2 Help
- Set the parameters for all the connected axes.

Parameter setting procedure

1. Start MR Configurator2. Select [Project] ⇒ [New] (1) from the menu and create a new project.

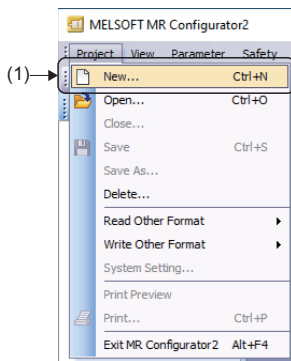

2. When a new project is created, the "New Project" screen appears. Click the [Switch to Multi-axis Project] button (2).

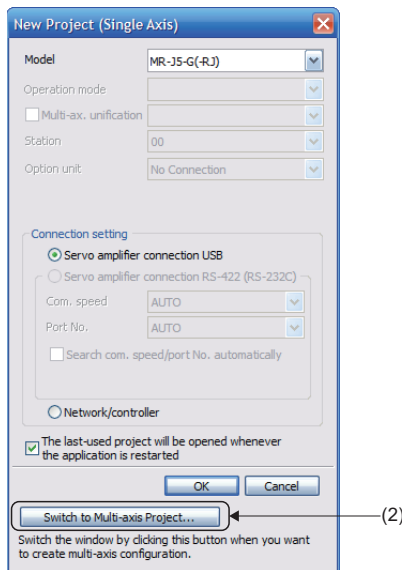

3. The screen is switched to the "New Project" screen of the multi-axis project. Set each item. For how to set the items, refer to the following.

☞ Page 51 MR Configurator2 communication setting using the IP communication

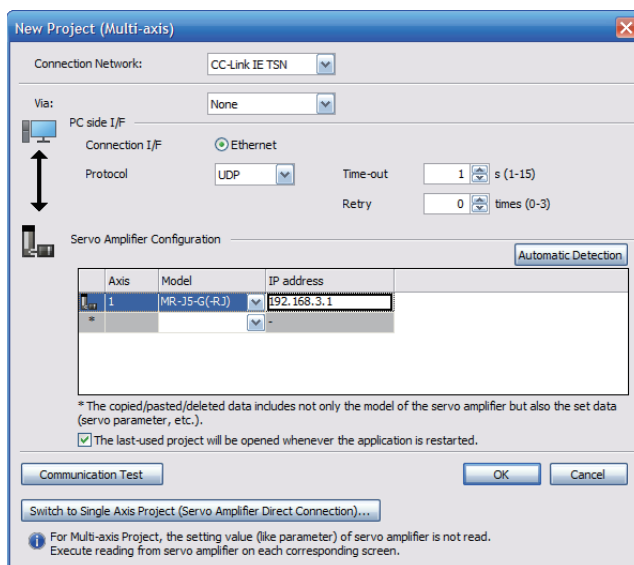

4. When the setting is completed, click the [OK] button. The created project appears.

- Double click [Axis1:MR-J5-G-(RJ) Standard] ⇒ [Parameter] (3) in the project window to display the parameter setting window. Select the group of the parameters to be set in the display selection tree (4) and set the parameters.

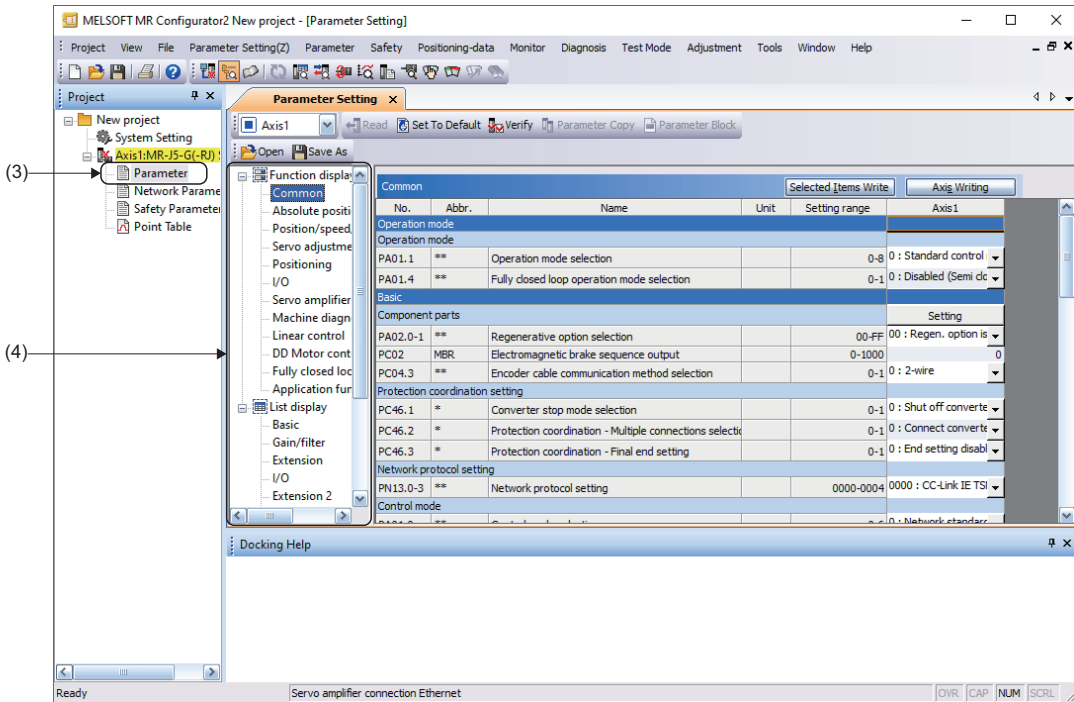

- Setting the servo parameter [PA04.2(Servo forced stop selection)]

Select [Function display (List)] ⇒ [Common] ⇒ [Basic] ⇒ [Forced stop] in the display selection tree and set [PA04.2(Servo forced stop selection)] (5) to "1: Disabled (The forced stop input EM1 and EM2 are not used)".

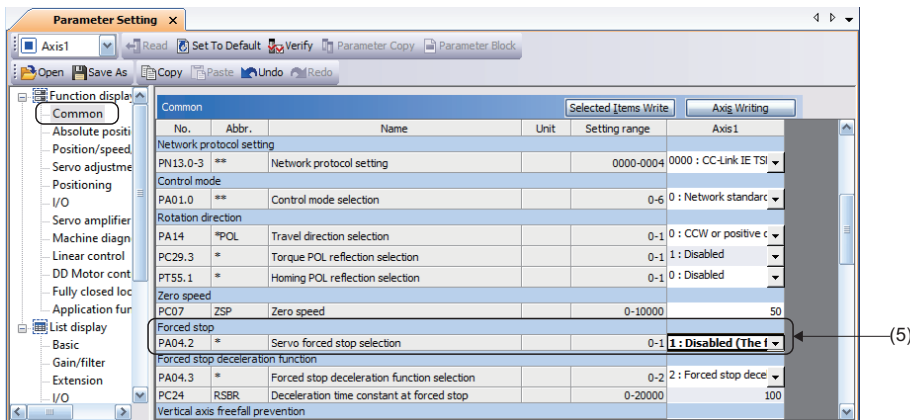

- Setting the servo parameter [PD01.2(Input signal automatic on selection)]
 Select [Function display (List)] ⇒ [I/O] ⇒ [Digital I/O] ⇒ [Device assignment] ⇒ [PD01.0-7(Input signal automatic ON selection 1)] (6) in the display selection tree and click the [Setting] button. When the "Auto ON Setting" screen appears, set [LSP] and [LSN] to "ON" in [Auto ON assignment] (7) and click the [OK] button. Set "00000C00" in the setting column.

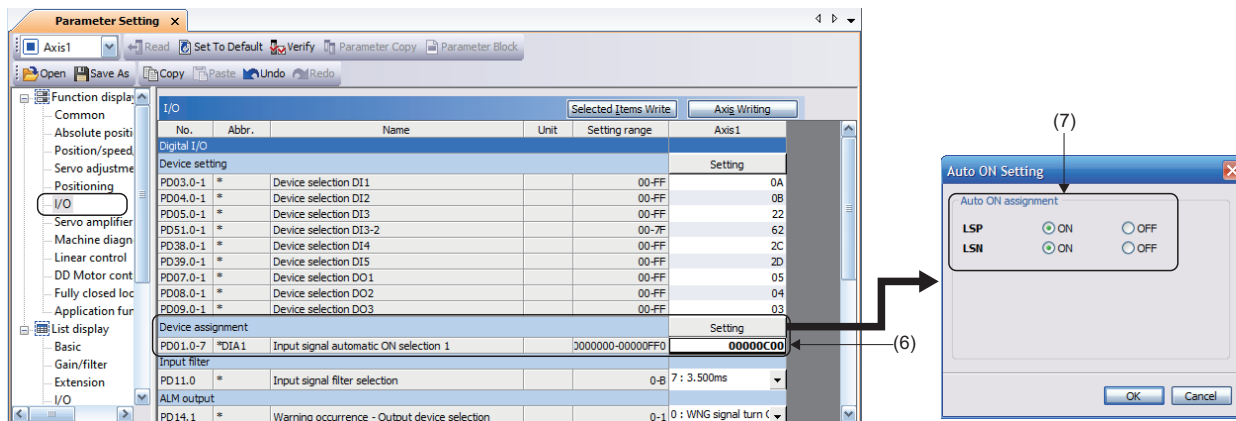

- Setting the servo parameter [PT01.1(Speed/acceleration/deceleration unit selection)]
 Select [List display] ⇒ [Positioning control] ⇒ [PT01 (Command mode selection)] (8) in the display selection tree and set "00000310" in the setting column.

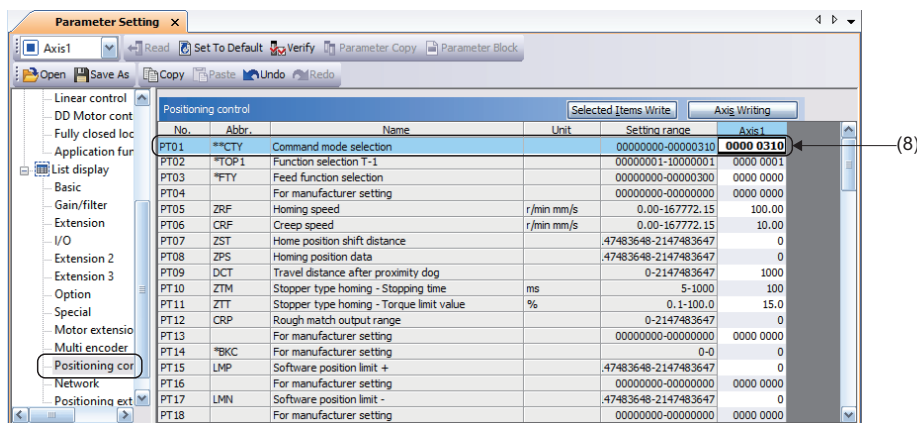

Point

The command unit is fixed to pulse. Therefore, "pulse/s" is used as the speed unit instead of "r/min".

- When the parameter setting is completed, click the [Axis Writing] button (9).

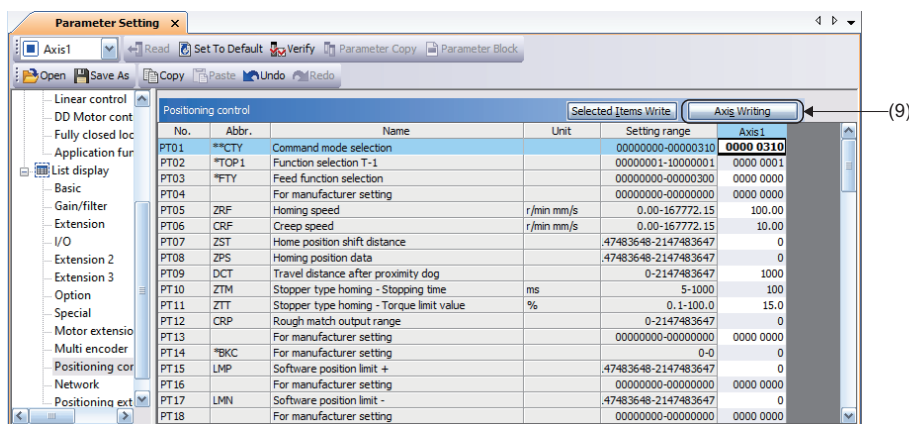

7. When the message "Execute writing. Continue?" appears, click the [Yes] button.

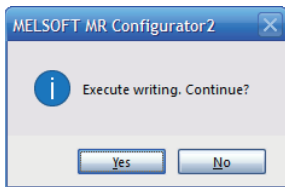

8. Writing of the servo parameters is started and all the parameters are written to the servo amplifier.

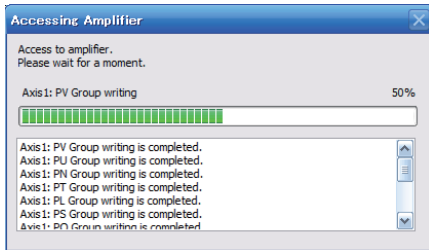

9. When the writing is completed successfully, the message "Writing is completed. Please switch the power supply of the servo amplifier off and on again." appears. Click the [OK] button.

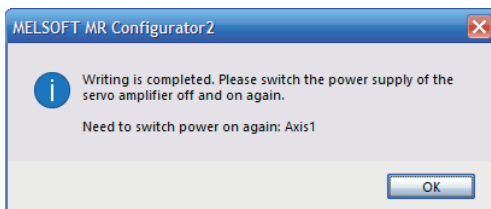

10. Turn on the control power supply of the servo amplifier again or click the [Software reset] icon (10) to reset the servo amplifier. (Servo parameters marked with * or ** in their abbreviations are enabled by turning on the control power supply again or clicking the [Software Reset] icon.)

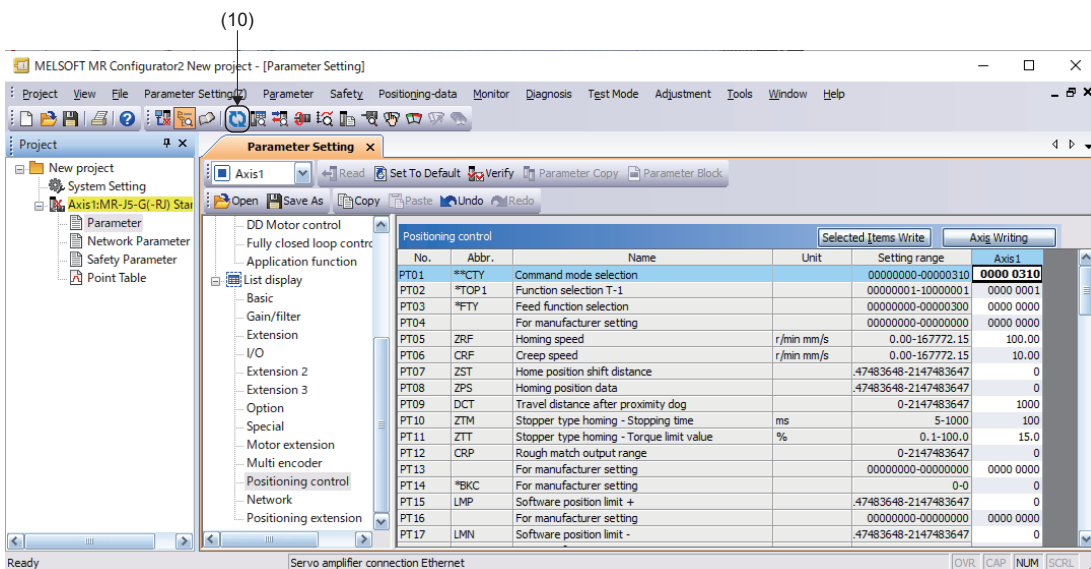

5 OPERATION EXAMPLE

5.1 Operation Check with Tool

This section describes the procedure for performing the JOG operation using an engineering tool.

1. Start SWMOS.

For how to start SWMOS, refer to the following.

☞ Page 15 Starting SWMOS

2. Select [Setup] ⇒ [Parameters] (1) in the navigation window to display the Parameters window. Select the [Essential] tab (2) and display the parameters of each axis. (The default values are displayed for the parameters.)

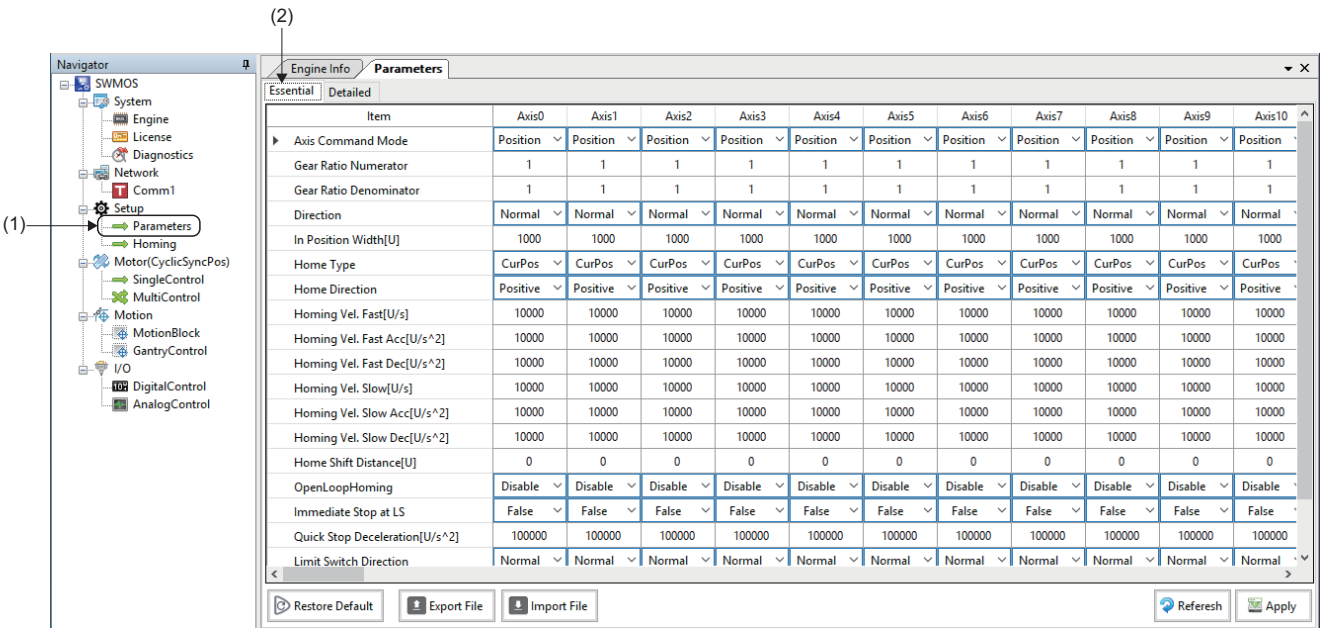

3. Change the axis parameters. The following shows an example of changing the parameters of axis 1 (Axis0).

- Gear ratio numerator (Gear Ratio Numerator): 67108864
- Gear ratio denominator (Gear Ratio Denominator): 1000

4. When the parameters are changed, click the [Apply] button (3).

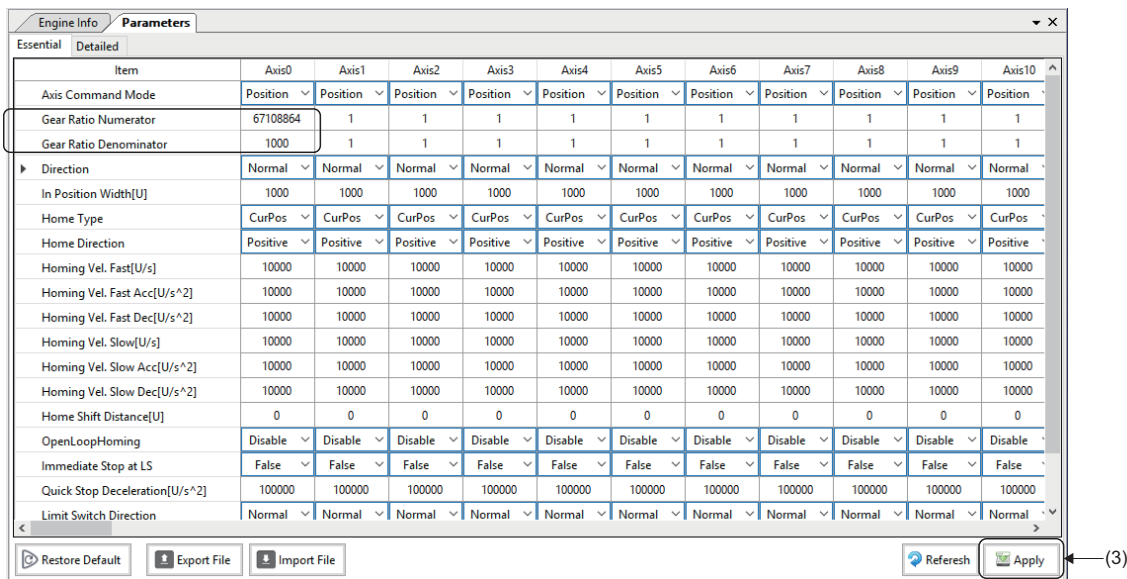

- When the writing is completed, the message "All parameters have been saved." appears and the changes are applied to the engine immediately.

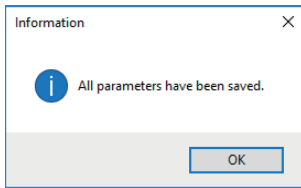

Point

To set the changed parameters with the same settings at the next startup, save the parameters to a file with the [Export File] button, and read the file in which the parameters are saved with the [Import File] button at the next startup. For details of the operations, refer to the following.

Motion Control Software SWM-G Operating Manual

- Control the axes. Click [Operation] ⇒ [Control Box] (4) in the ribbon.

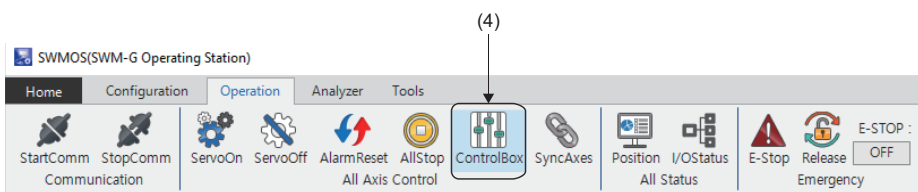

- The "Axes Control Box" screen appears. Operating each button on the "Axes Control Box" screen starts or stops the communication and performs servo ON/OFF for the axis.

- [Online]/[Offline] button: Starts/stops the communication.
- [All Servo On] button: Performs servo ON for all axes.
- [All Servo Off] button: Performs servo OFF for all axes.

Offline screen

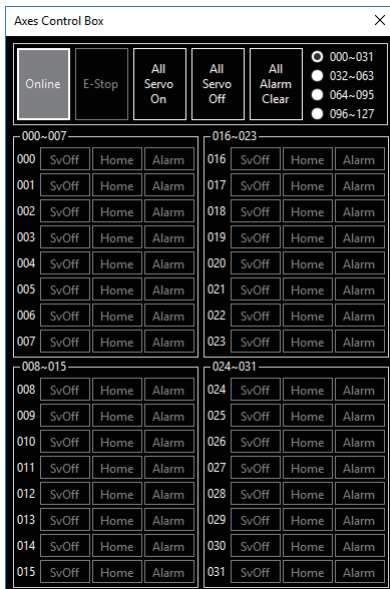

Online screen (All Servo OFF)

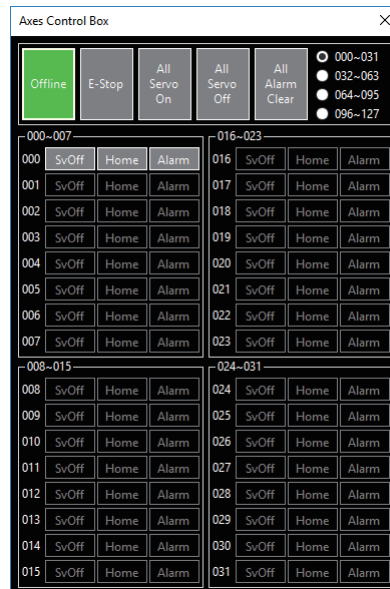

Online screen (All Servo ON)

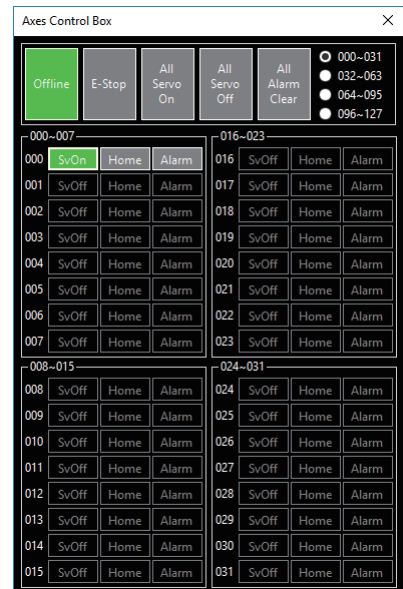

- Check the axis status. Click [Operation] ⇒ [Position] (5) in the ribbon.

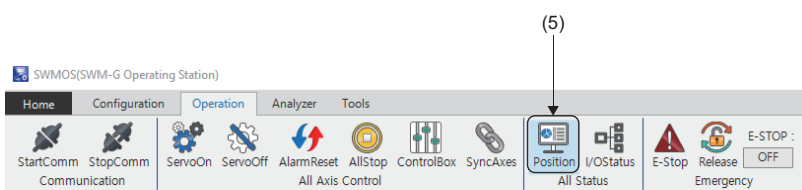

9. The [Axis Position] tab (6) appears. The axis status can be checked.

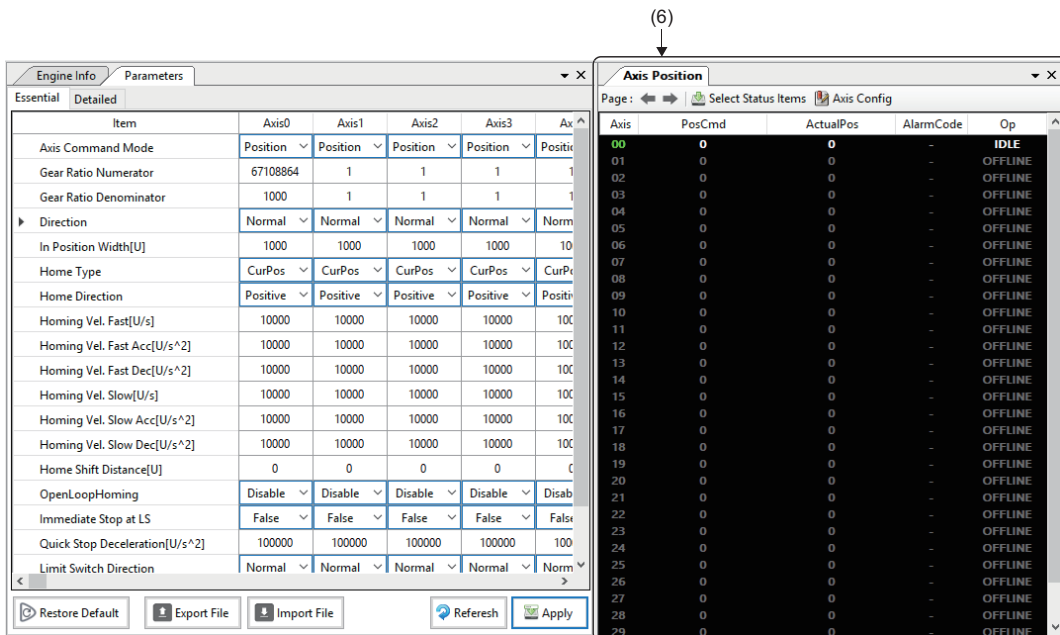

10. Select [Motor(CyclicSyncPos)] ⇒ [SingleControl] (7) in the navigation window to display the Single Control window. Select the [TestMove] tab ⇒ [Position] tab (8). Set the parameters (Jog Speed, Accel/Decel, Jerk Ratio) in "Jog" (9), and perform the JOG operation with the [JOG CCW] button or [JOG CW] button.

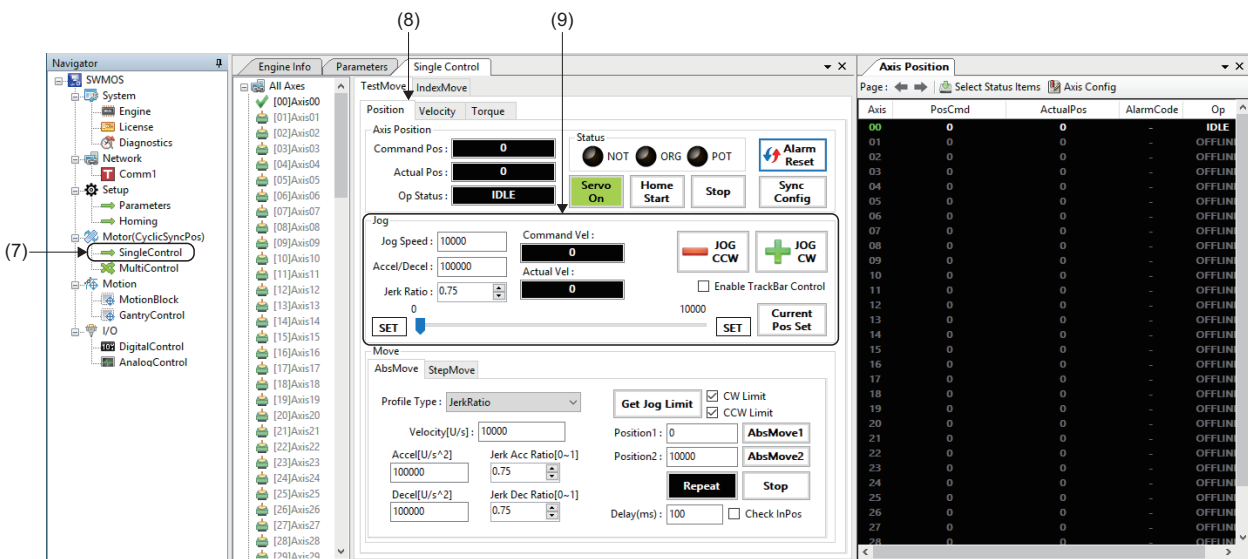

Point

Press the [JOG CCW] button to perform operation in the address decreasing direction, and the [JOG CW] button to perform operation in the address increasing direction. For details of the JOG operation, refer to the following.

Motion Control Software SWM-G Operating Manual

5.2 Operation Check with Sample Project

This section describes the programming procedure and basic programs.

When applying program examples provided in this manual to an actual system, ensure the applicability and confirm that it will not cause system control problems.

This section describes an example of a 1-axis system using a ball screw.

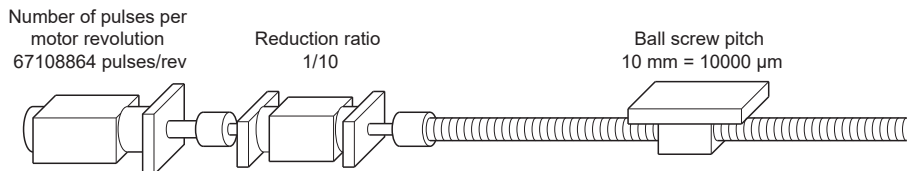

$$\text{Electronic gear} = \frac{\text{Electronic gear numerator}}{\text{Electronic gear denominator}} = \frac{\text{Number of pulses per motor revolution}}{\text{Movement amount of machine end per motor revolution (Position command unit)}} = \frac{67108864}{1/10 \times 10000} = \frac{67108864}{1000}$$

System configuration

This example uses the system configuration below.



- Connecting to the set NIC port is required.

Specifications

Item	Description
Ball screw lead (PB)	10000[μm] (= 10[mm])
Reduction ratio (NL/NM)	1/10 (load side [NL]/motor side [NM]) When the motor rotates 10 times, the ball screw on the load side rotates once.
Encoder resolution	67108864 [pulse]
Servo amplifier	MR-J5-G series
Position command unit (user unit)	μm
Speed command unit	μm/s
Control cycle	1.0[ms]

Parameter setting

Servo parameter (axis 1)

For how to set the servo parameters, refer to the following.

☞ Page 24 Parameter Setting of the Servo Amplifier

No.	Name	Setting value
PA04.2	Servo forced stop selection	1: Disabled (The forced stop input EM1 and EM2 are not used)
PD01.2	Input signal automatic on selection	■Forward rotation stroke end (LSP) 1: Automatic on ■Reverse rotation stroke end (LSN) 1: Automatic on
PT01.1	Speed/acceleration/deceleration unit selection	1: (Speed: Command unit/s, acceleration/deceleration: Command unit/s ²)

Program-side parameter (Axis0)

Parameter name	Setting value
Gear ratio Numerator	67108864
Gear ratio Denominator	1000

Sample program operations

The sample program is executed in the following processing order.

Processing order	Description	Details
1	Device creation	A device is an object of the SSCApi class that opened the communication channel with the SWM-G engine. Applications using the SWM-G library call the CreateDevice function at the start.
2	Communication start	The communication with the platform where the engine is operating is started with the StartCommunication function.
3	Servo ON	Many motion functions are arranged in the CoreMotion module. The SetServoOn function in the CoreMotion module is called to perform the servo ON.
4	Home position return	The home position return parameter is read with GetHomeParam. The home position return type is changed to the current position (CurrentPos), and the home position return parameter is set with the SetHomeParam function. The home position return is performed with the StartHome function.
5	Positioning operation*1	The motion profile is specified to perform the positioning operation with the StartMov function. The motion profile determines the movement speed from the current position to the target position, acceleration, and jerk shape.
6	Servo OFF	The servo OFF is performed with the SetServoOn function.
7	Communication stop	When the communication is started with StartCommunication, the device must be closed after the communication is stopped with StopCommunication.
8	Device closing	The application calls the CloseDevice function before the end.

*1 The settings of the positioning operation are as follows.

Item	Description
Motion profile	Trapezoid
Axis number	Axis0
Target position	100000[μm]
Target speed	25000[μm/s]
Acceleration	100000[μm/s ²]
Deceleration	100000[μm/s ²]

Opening the sample program

The sample project is stored in the following folder.

Copy the sample program to a location where it can be edited.

- Default storage destination folder at installation

Storage destination folder

C:\Program Files\MotionSoftware\SWM-G\Samples

The following example uses a sample program that is used to perform the basic operation of the servo axis.

1. Open the following solution file (03_MotorControl.sln) in the sample folder (Samples).

Solution file storage location

\Samples\Cpp\VS□□□□\1_BasicMotion\03_MotorControl\03_MotorControl.sln

*1 □□□□= Indicates the version of Visual Studio to be used. Select according to the version of Visual Studio to be used.

*2 This explanation uses Visual Studio 2017.

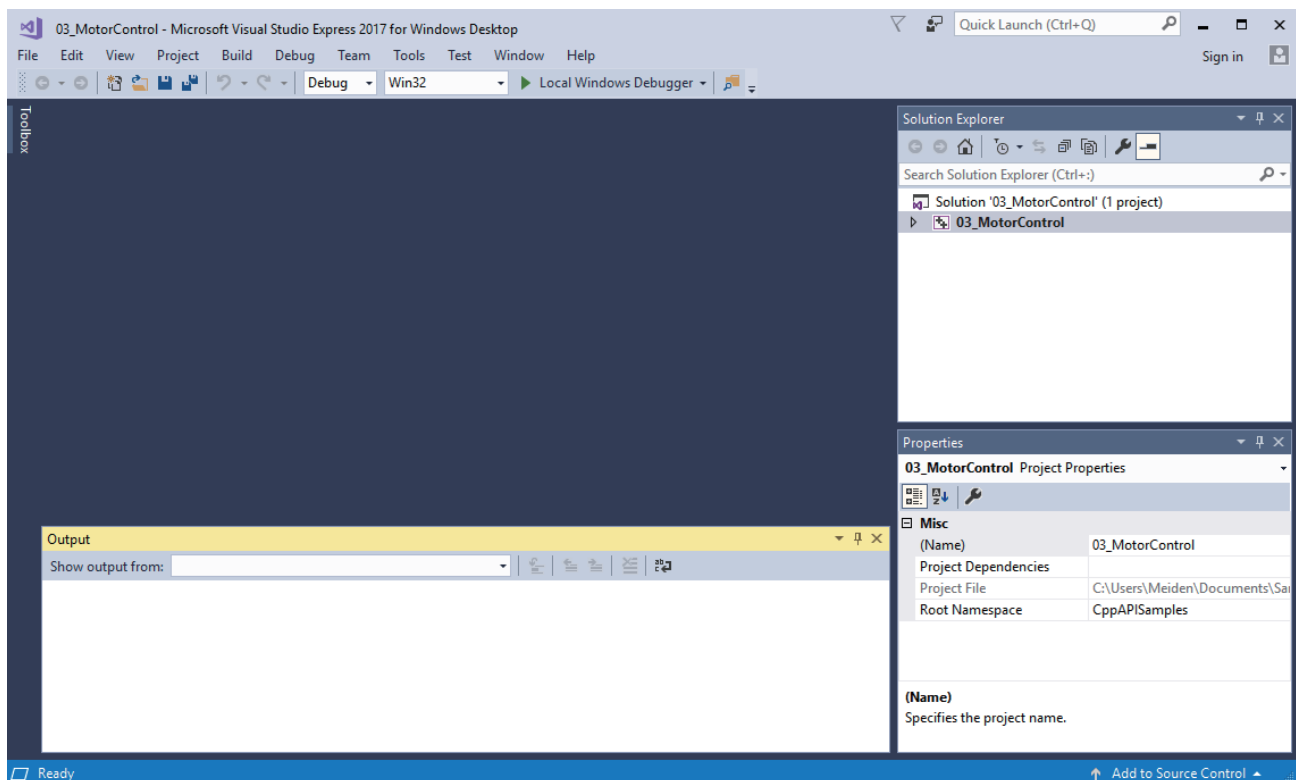

2. Select [Build] ⇒ [Configuration Manager] (1) from the menu.

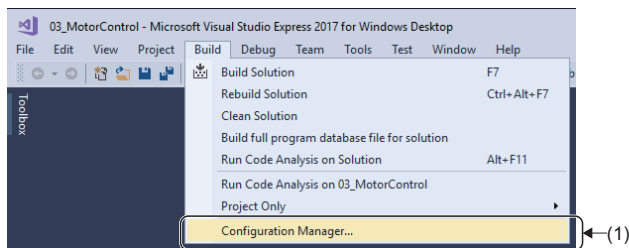

3. The "Configuration Manager" screen appears. Set "x64" (2) for [Active solution platform] and click the [Close] button to close the "Configuration Manager" screen.

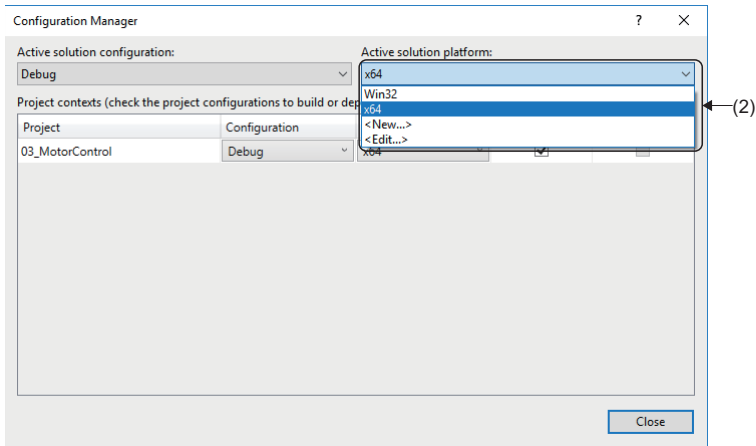

4. Click [03_MotorControl] ⇒ [Source Files] and double-click [03_MotorControl.cpp] (3) in the Solution Explorer window. A source code opens, and the processing descriptions described in the sample program operation descriptions can be referred to.

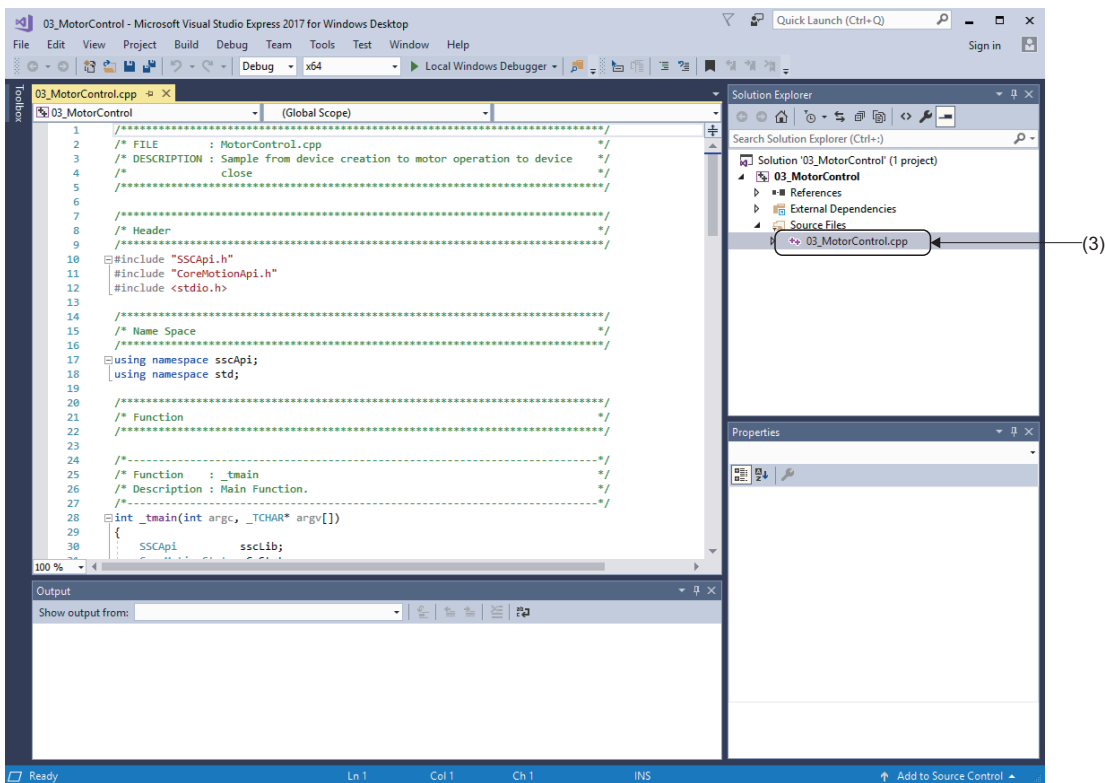

Parameter, positioning data setting

The sample project is designed to operate with the default parameters. Therefore, modify the gear setting and positioning data according to the program example setting.

■ Gear setting

Enter the following code.

If the gear setting fails, the message appears and the processing continues without setting.

```
double encoderPulsesPerRevolution = 67108864;
double encoderUserUnitsPerRevolution = 1000;
int err;

// Set the gear ratio.
err = sscLib_cm.config->SetGearRatio(0, encoderPulsesPerRevolution, encoderUserUnitsPerRevolution);
if (err != ErrorCode::None) {
    printf("Failed to set gear ratio. Error=%d\n", err);
}
```

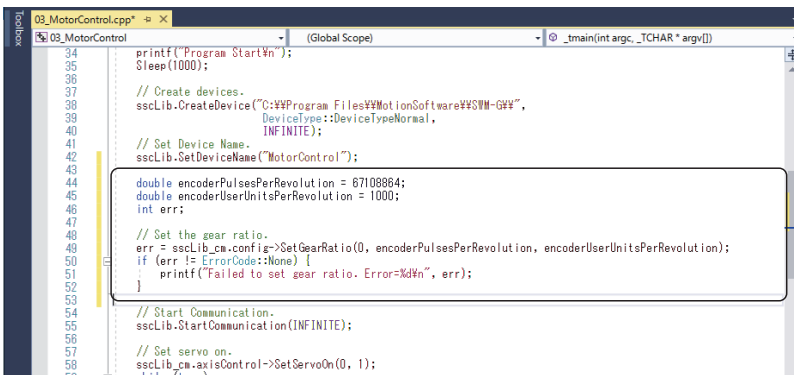

```
03_MotorControl.cpp (Global Scope) @ _tmain(int argc, _TCHAR * argv[])
34 printf("Program Start\n");
35 Sleep(1000);
36
37 // Create devices.
38 sscLib.CreateDevice("C:\\Program Files\\MotionSoftware\\SSM-G\\",
39                   DeviceType::DeviceTypeNormal,
40                   INFINITE);
41
42 // Set Device Name.
43 sscLib.SetDeviceName("MotorControl");
44
45 double encoderPulsesPerRevolution = 67108864;
46 double encoderUserUnitsPerRevolution = 1000;
47 int err;
48
49 // Set the gear ratio.
50 err = sscLib_cm.config->SetGearRatio(0, encoderPulsesPerRevolution, encoderUserUnitsPerRevolution);
51 if (err != ErrorCode::None) {
52     printf("Failed to set gear ratio. Error=%d\n", err);
53 }
54
55 // Start Communication.
56 sscLib.StartCommunication(INFINITE);
57
58 // Set servo on.
59 sscLib_cm.axisControl->SetServoOn(0, 1);
60
```

■ Positioning data modification

Modify the codes as follows.

```
//-----
// Create a command value.
//-----
Motion::PosCommand posCommand = Motion::PosCommand();
posCommand.profile.type = ProfileType::Trapezoidal;
posCommand.axis = 0;
posCommand.target = 100000;
posCommand.profile.velocity = 25000;
posCommand.profile.acc = 100000;
posCommand.profile.dec = 100000;
```

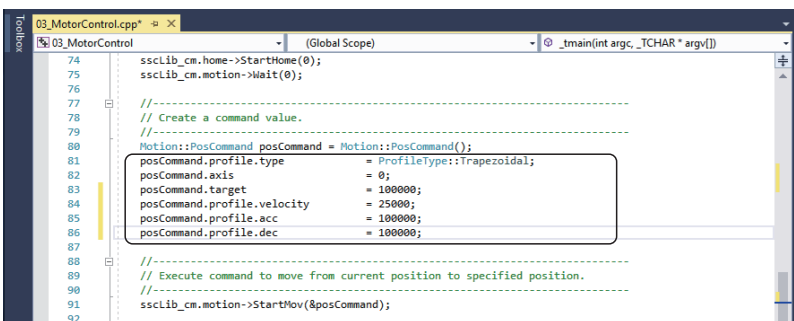

```
03_MotorControl.cpp (Global Scope) @ _tmain(int argc, _TCHAR * argv[])
74 sscLib_cm.home->StartHome(0);
75 sscLib_cm.motion->Wait(0);
76
77 //-----
78 // Create a command value.
79 //-----
80 Motion::PosCommand posCommand = Motion::PosCommand();
81 posCommand.profile.type = ProfileType::Trapezoidal;
82 posCommand.axis = 0;
83 posCommand.target = 100000;
84 posCommand.profile.velocity = 25000;
85 posCommand.profile.acc = 100000;
86 posCommand.profile.dec = 100000;
87
88 //-----
89 // Execute command to move from current position to specified position.
90 //-----
91 sscLib_cm.motion->StartMov(&posCommand);
92
```

Build execution

1. Select [Build] ⇒ [Build Solution] (1) from the menu to execute the build.

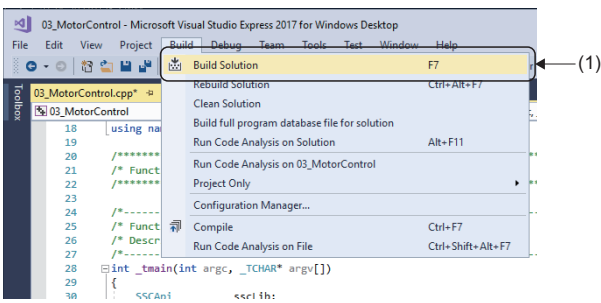

2. When the build is completed, the output results are displayed in the output window.

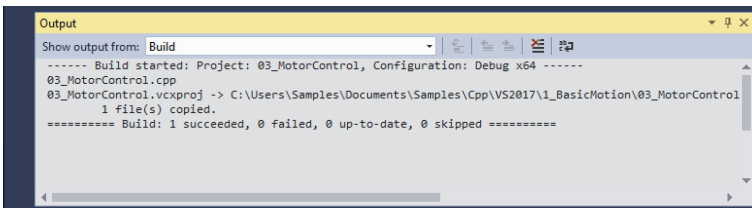



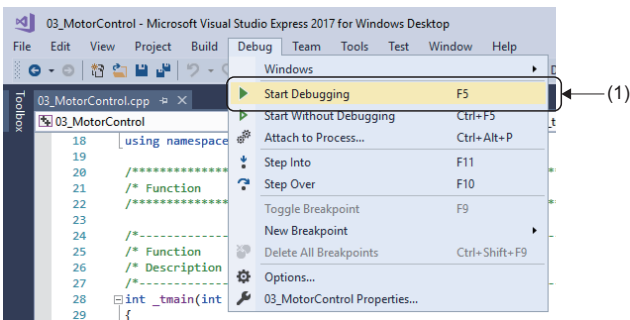

Program execution

1. Select [Debug] ⇒ [Start Debugging] (1) to execute the program.

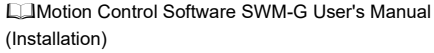

6 TROUBLESHOOTING

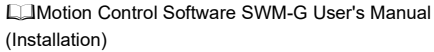
This section describes errors that may occur in SWM-G and actions to be taken.

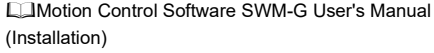
Description	Cause	Action
The tool does not start.	<ul style="list-style-type: none"> The setup has not been completed. The license has not been registered. 	Run the installer and set up the incomplete items. For details, refer to the following. 
The communication is not established.	The network configuration setting is incorrect.	Check the master setting and the advanced setting of the network setting again, and rewrite the information to the engine.
	<ul style="list-style-type: none"> The CUI file is incorrect. The PDO information is insufficient. 	<ul style="list-style-type: none"> Check the slave setting and the detail setting of the network setting again, and rewrite the information to the engine. Recreate the CUI file with CC-Link IE TSN Configurator.
	The definition of the NIC to be used for the communication is incorrect.	Check the NIC setting again. (If an NIC other than I210 is used, convert I210 for RTX again.)
	The NIC has not been converted for RTX64.	Check Device Manager and check that the NIC to be used for the communication has been converted for RTX64.
	The HAL timer interval setting and PC performance are not good enough for the communication cycle setting and the number of control axes.	<ul style="list-style-type: none"> Check if unnecessary simulation axes are operating. When the communication cycle is short, change the HAL timer interval from "100us" to "50us" or "20us". Adjust the time slot.
The screen turns blue, and cannot be executed.	Memory access violations of RTX have occurred.	Disable the following Windows settings. <ul style="list-style-type: none"> Windows Memory Diagnostic Hyper-V Device Guard and Credential Guard (for Windows 10 Enterprise) For details, refer to the following. 
The axis operation is unstable.	"Hyper-Threading" of the CPU is enabled.	Disable "Hyper-Threading" of the CPU. For details, refer to the following. 
The sample program or created program cannot be built.	The project setting of Visual Studio is incorrect.	Open the property page of the Visual Studio project and check the following settings. <ul style="list-style-type: none"> Additional include directory setting for general C/C++ Additional library directory setting for general linker Post-build event setting after build events For details, refer to "Configuring a new C++ project" in the following manual. 
The following message appears, and SWMOS does not start.	The versions of Windows and RTX are mismatched. (The version "2004 or later" of Windows10 and the version "3.7.2 or earlier" of RTX are used.)	Update RTX referring to "Applying the RTX update file" in the following manual. 
	A function that is not supported by RTX is enabled.	Disable the X2APIC function in the BIOS setting.

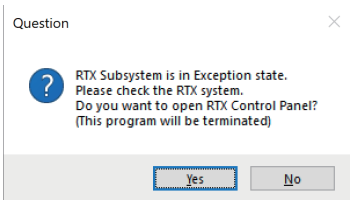

APPENDIX

Appendix 1 SWM-G Setting Example by Application

Using the virtual axis

The virtual axis can be simulated by using the simulator platform (SimuPlatform).

The virtual axis can be used as an amplifier-less simulator, or as a synchronization master by using it with the real axis. Note that if the virtual axis is used with the real axis, the axis number is common to them.

Setting the virtual axis

1. Select [System] ⇒ [Engine] (1) in the navigation window on the "SWMOS" screen to display the Engine Info window.
2. Select the [Engine Information] tab (2). In [Quick Setting] (3) under [Platform Setting], select the following, and click the [Save] button (4).
 - Simulation
 - CC-Link IE TSN+Simulation
 - CC-Link IE TSN×2+Simulation×2

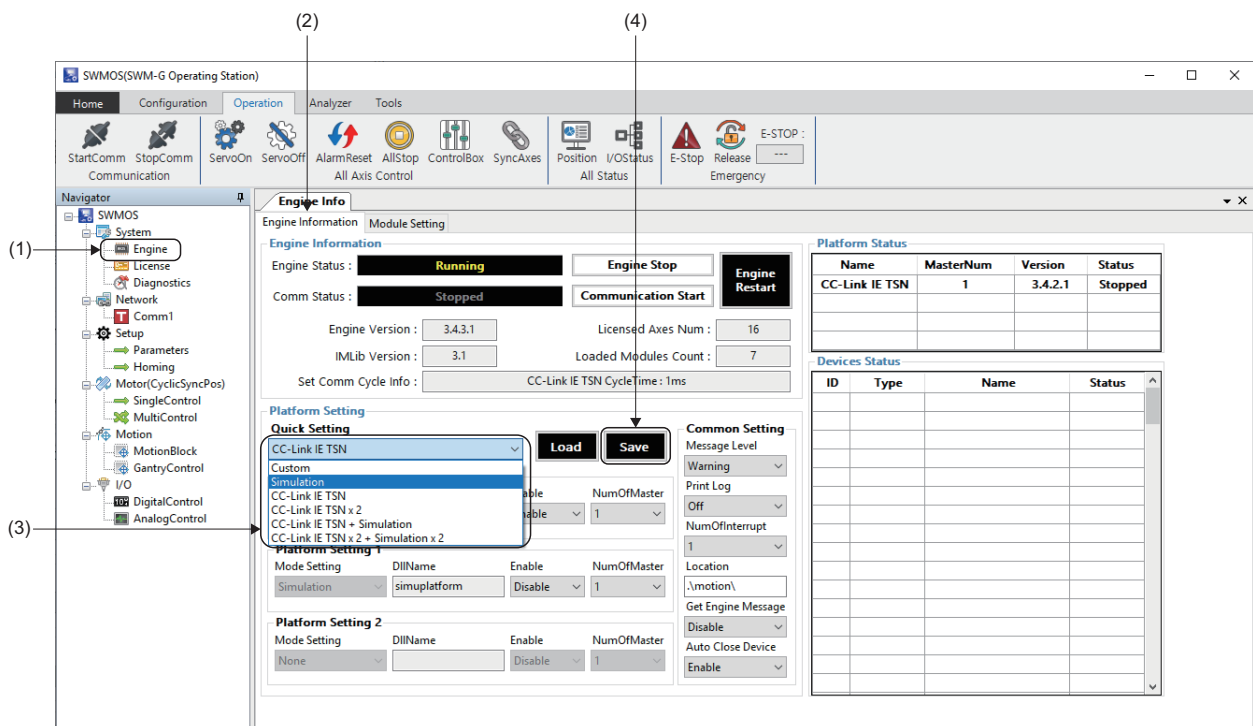

3. When the message "Do you want to save in Module.ini?" appears, click the [Yes] button.

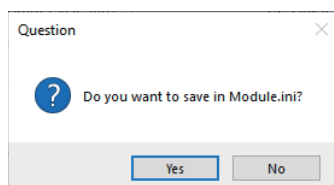

4. When the message "Do you want to restart the SWM-GEEngine?" appears, click the [Yes] button to restart the engine.

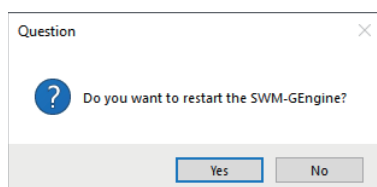

5. After the engine is restarted, "Simulation" is displayed in [Platform Status] (5). It can be operated in the same way as a normal axis.

- When "Simulation" is set

(5)

The screenshot shows the 'Engine Info' window with the 'Platform Setting' dropdown set to 'Simulation'. The 'Platform Status' table is as follows:

Name	MasterNum	Version	Status
Simulation	-	3.4.3.2	Running

The 'Devices Status' table is also visible:

ID	Type	Name	Status
0	LowPriority	SWMOS-Platform	0.095/15sec
1	LowPriority	SWMOS-Motion	0.095/15sec

- When "CC-Link IE TSN + Simulation" is set

(5)

The screenshot shows the 'Engine Info' window with the 'Platform Setting' dropdown set to 'CC-Link IE TSN + Simulation'. The 'Platform Status' table is as follows:

Name	MasterNum	Version	Status
CC-Link IE TSN	1	3.4.2.1	Running
Simulation	-	3.4.3.2	Running

The 'Devices Status' table is also visible:

ID	Type	Name	Status
0	LowPriority	SWMOS-Platform	0.080/15sec
1	LowPriority	SWMOS-Motion	0.096/15sec

- When "CC-Link IE TSN × 2 + Simulation × 2" is set

(5)

The screenshot shows the 'Engine Info' window with the 'Platform Setting' dropdown set to 'CC-Link IE TSN x 2 + Simulation x 2'. The 'Platform Status' table is as follows:

Name	MasterNum	Version	Status
CC-Link IE TSN	2	3.4.2.1	Running
Simulation	-	3.4.3.2	Running

The 'Devices Status' table is also visible:

ID	Type	Name	Status
0	LowPriority	SWMOS-Platform	0.048/15sec
1	LowPriority	SWMOS-Motion	0.033/15sec



Single turn (Unlimited length feeding)

Some axes, such as a rotating axis, do not have a linear movement range and can rotate in any direction indefinitely. Therefore, the position command of this axis can be excessive after rotating in one direction for a long time. To avoid this case, configure the position command as a "Single Turn Mode axis" so that it stays within a specific position range.

Setting procedure

1. Select [Setup] ⇒ [Parameters] (1) in the navigation window to display the Parameters window.
2. Select the [Detailed] tab (2). Select the target axis (example: [00]Axis00) (3) in the axis tree and select the [Servo] tab (4).
3. Select "Enable" for [Single Turn Axis] and set a count value to [Single Turn Encoder Count].

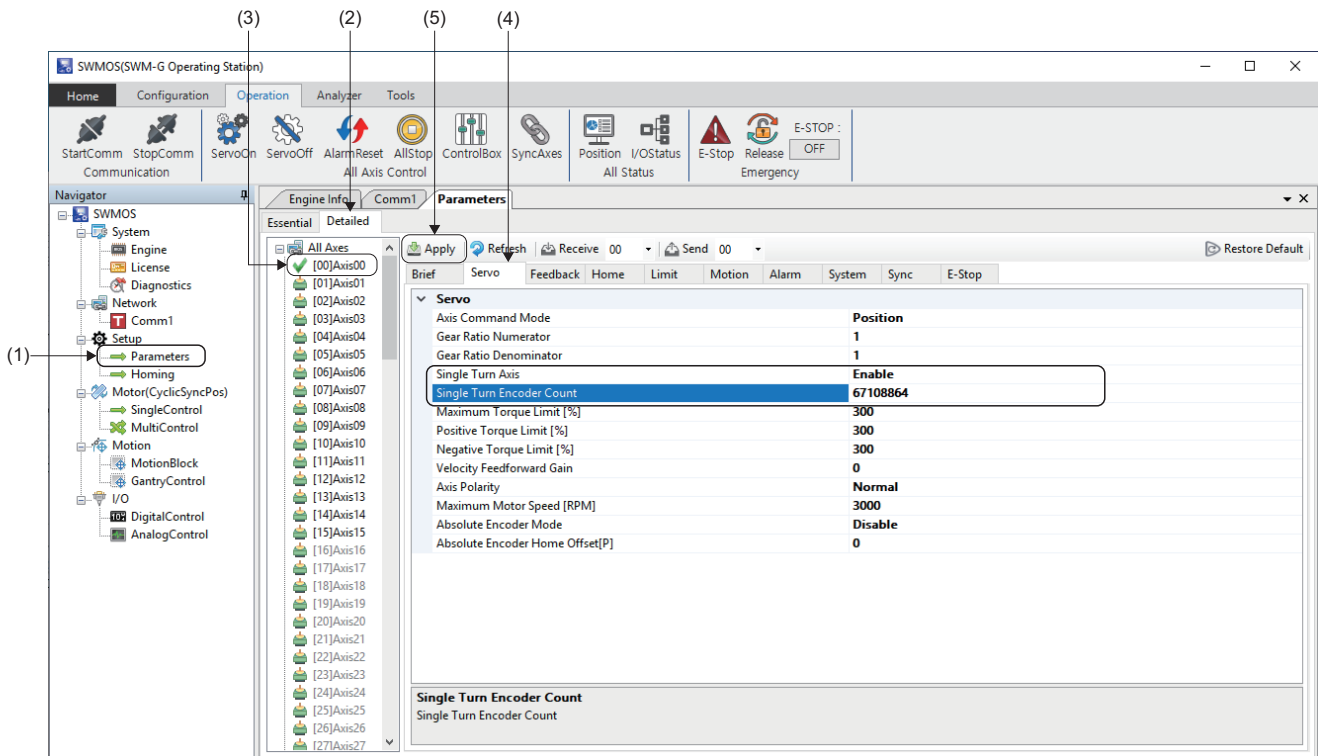

4. When the setting is completed, click the [Apply] button (5).
5. When the writing is completed, the message "0Axis parameters have been saved." appears.

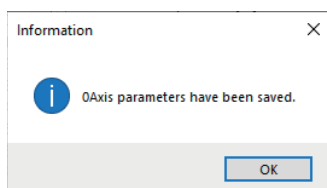

Setting example

The following shows a setting example when the Single Turn Mode axis is configured with one rotation of 360[degree].

Item	Setting value
Gear Ratio Numerator (gear numerator)	67108864
Gear Ratio Denominator (gear denominator)	360
Single Turn Axis	Enable
Single Turn Encoder Count	67108864

Example of a table mechanism with reducer

For the table mechanism with a reducer such as a timing belt or gear, rounding off the gear numerator setting value is required in addition to the electronic gear setting of SWM-G and an error may occur during the unlimited length feeding. In that case, the electronic gear setting can be configured without error by using the electronic gear of the servo amplifier.

Servo motor: 67108864[pulse/rev]

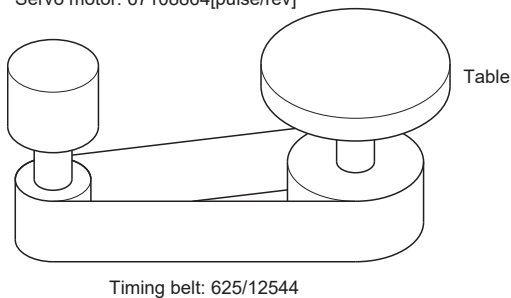

Item	Setting value
Table	360[degree/rev]
Reduction ratio	625/12544
Servo motor encoder resolution	67108864[pulse/rev]

■ Setting procedure

Follow the setting procedure below.

1. Determine the "Command unit per pulse" of the servo pulse command. (Example: Set "0.000001[degree]" per pulse.)
2. Calculate the electronic gear numerator (CMX) and electronic gear denominator (CDV) of the servo amplifier (MR-J5(W)-G).

- Electronic gear numerator (CMX) = $67108864 \times 12544 = 841813590016$
- Electronic gear denominator (CDV) = $360 \times 625 \div 0.000001 = 225000000000$

3. Reduce CMX and CDV to "2147483647" or less. (Example: Reduce by "512".)

- Electronic gear numerator (CMX) = $841813590016 \div 512 = 1644167168$
- Electronic gear denominator (CDV) = $225000000000 \div 512 = 439453125$

Set the electronic gear numerator (CMX) to 1644167168 and the electronic gear denominator (CDV) to 439453125 for the servo amplifier (MR-J5(W)-G).

4. Set the electronic gear of SWM-G in a single turn.

- Gear numerator = $360000000[\text{pulse}] (360 \div 0.000001[\text{degree}]^{*1})$
- Gear denominator = $360[\text{degree}]$

*1 Command unit per pulse

Point

When the electronic gear numerator (CMX) or electronic gear denominator (CDV) cannot be reduced to "2147483647" or less, reduce them by adjusting the command unit per pulse. If they cannot be reduced even after adjusting the command unit per pulse, set the approximate values. In that case, an error occurs in the unlimited length feeding.

A

Appendix 2 How to Use the IP Communication

IP communication setting procedure

The IP communication mixed function enables communications between applications that operate in the Windows space or RTX space and devices in the CC-Link IE TSN network via the SWM-G engine.

The IP communication mixed function can be used when SWM-G is in the communication state.

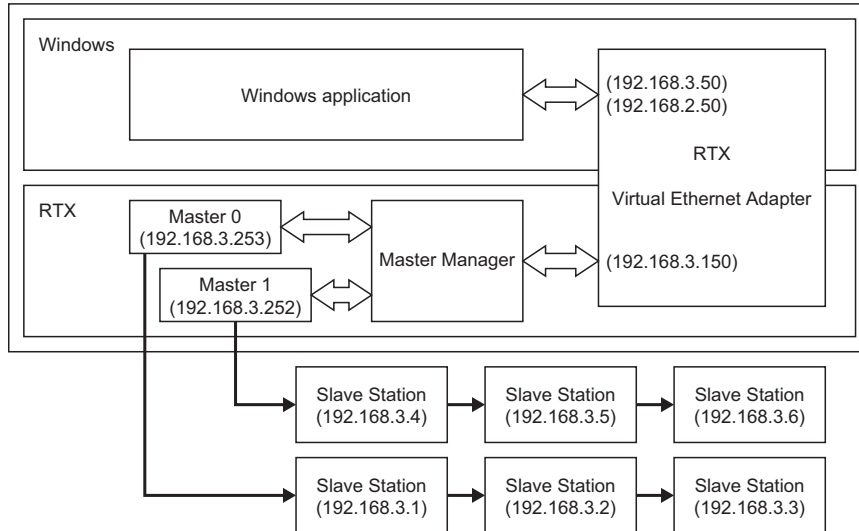

Setting procedure

To use the IP communication mixed function, configure the following settings.

- (1) Enable Virtual NIC of RTX. (☞ Page 44 Enabling Virtual NIC of RTX)
- (2) Set the IP address of Virtual NIC seen from the Windows side. (☞ Page 47 Setting the IP address of Virtual NIC seen from the Windows side)
- (3) Set the IP communication mixed function in SWM-G. (☞ Page 49 Setting the IP communication mixed function in SWM-G)
- (4) Start RT-TCP/IP Stack. (☞ Page 50 Starting RT-TCP/IP Stack)

The network address of the LAN used to connect the master or remote station is set to "192.168.3.0".

Read the IP addresses as necessary to prevent the duplication of them considering the operating environment.

■ Enabling Virtual NIC of RTX

1. Select [RTX64 ### Runtime] *1⇒ [Control Panel] (1) from the Windows start menu.

*1 ### = RTX version

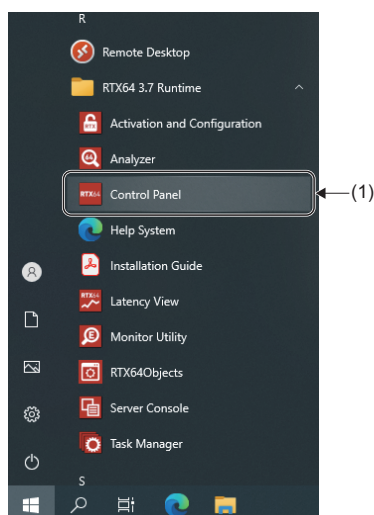

2. The "RTX64 ### Control Panel" screen*¹ appears. Click [Configure the RT-TCP/IP Stack] (2).

*1 ### = RTX version

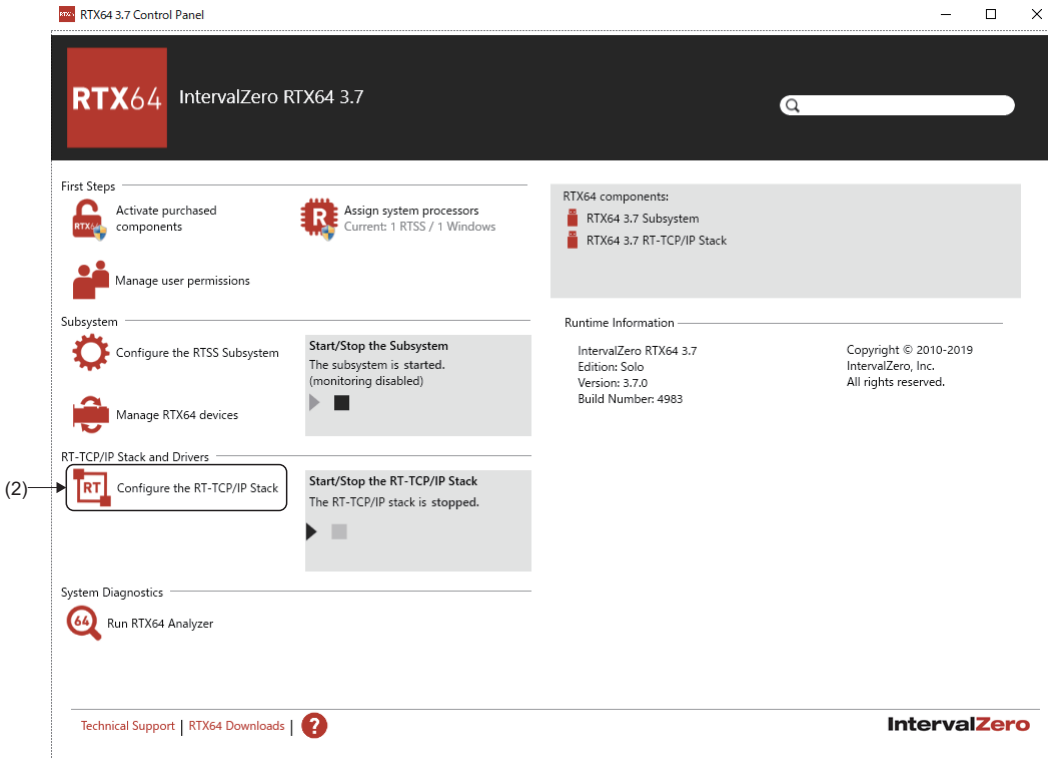

3. The "Configure the RT-TCP/IP Stack" screen appears. Click [Manage Interfaces and Filters] (3).

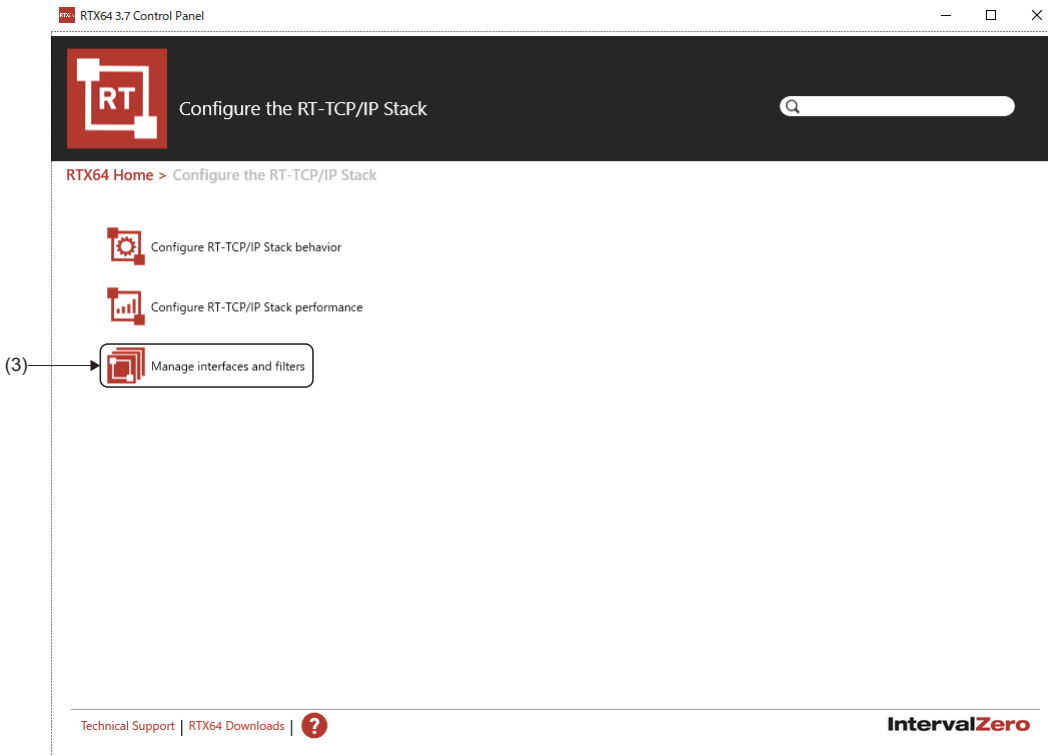

- The "Manage Interfaces and Filters" screen appears. Select the existing "RTX64 Virtual Network Interface (Interface name: RtVirtualNic)" (4) and click the [X] button (5) to delete. Click the [+] button (6).

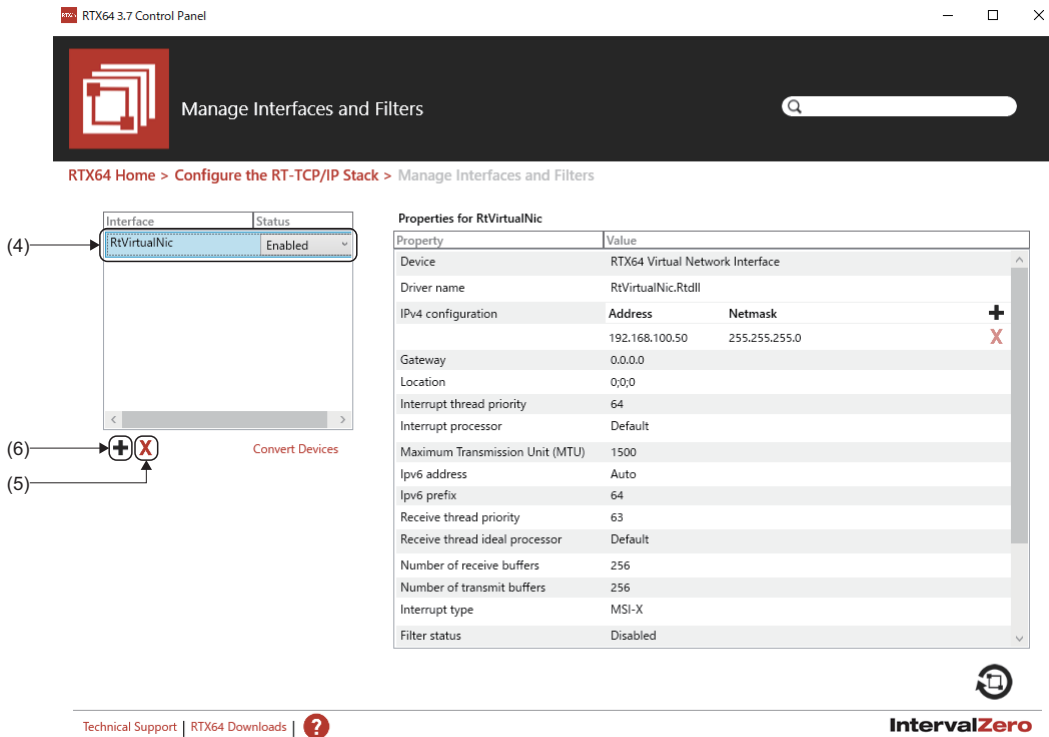

- The "Add Interface" screen appears. Set each item and click the [OK] button.

Item	Description
Device Name:	Select "RTX64 Virtual Network Interface".
Driver Name:	Select "C:\Program Files\MotionSoftware\SWM-G\Platform\CCLink\RtVirtualNic_SSS.rtdll". *: Click the [...] button (7) to display the "Open" screen. Select a file from the folder and click [Open] button to select.
Friendly Name:	Enter an arbitrary name. <Example> RtvN_SSS
Ipv4 address:	Set an arbitrary IP address. <Example> 192.168.3.150

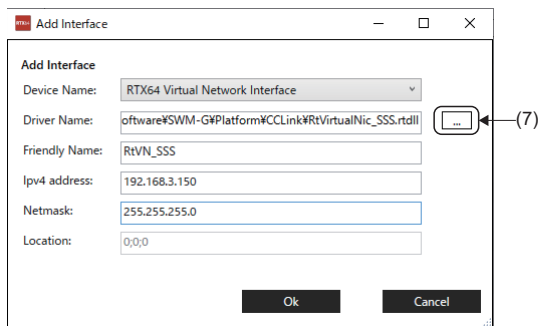

- The screen returns to the "Manage Interfaces and Filters" screen. The name "RTX64 Virtual Network Interface (Interface name: RtvN_SSS)" entered in "Friendly Name" is added. Set [Status] (8) of the added "RTX64 Virtual Network Interface (Interface name: RtvN_SSS)" to "Enable".

When the setting is completed, click the [X] button in the upper right of the screen to close the "Manage Interfaces and Filters" screen.

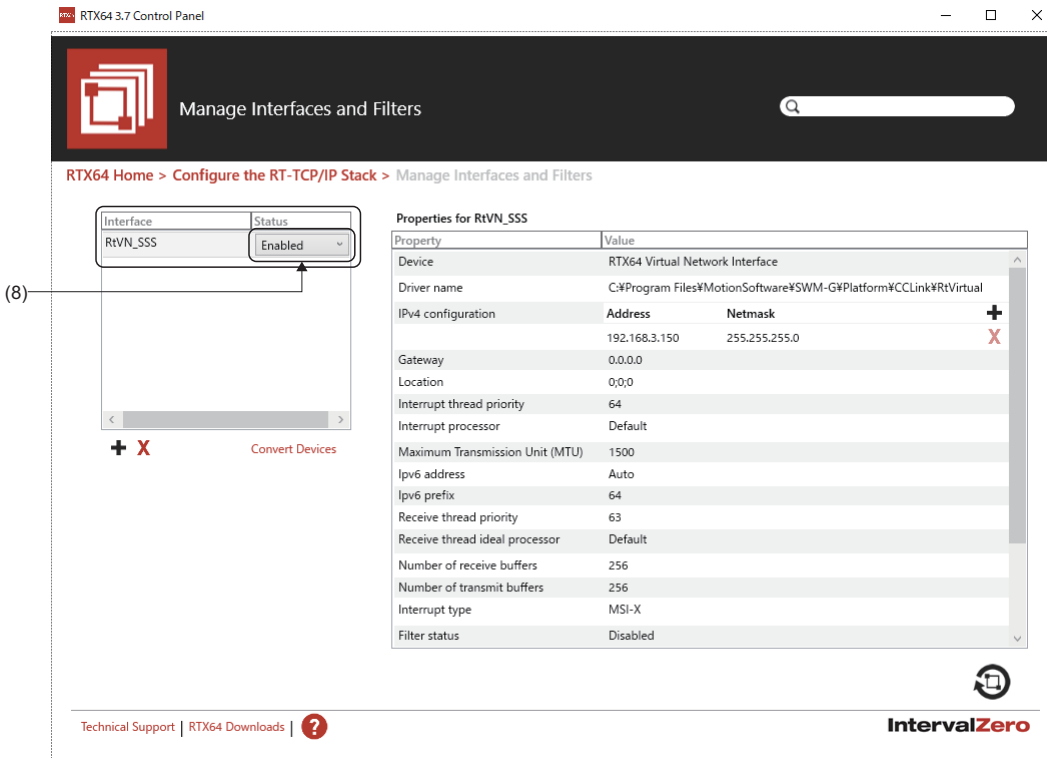

■ Setting the IP address of Virtual NIC seen from the Windows side

Set the IP address of Virtual NIC on the Windows side.

Set an IP address different from the one set in "Enabling Virtual NIC of RTX" (Page 44 Enabling Virtual NIC of RTX).

- Select [Windows System] ⇒ [Control Panel] ⇒ [Network and Internet] ⇒ [View network status and tasks] ⇒ [Change adapter settings] from the Windows start menu to display the "Network Connections" screen.
- Right-click the network device whose device name is "Windows Virtual RTX64 Ethernet Adaptor" (1) and select [Properties] (2).

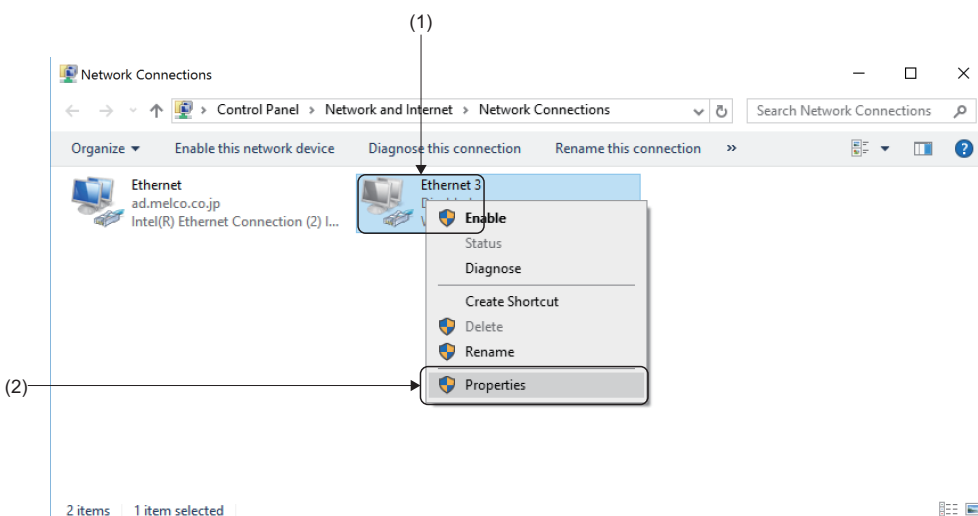

3. The "Properties" screen appears. Select "Internet Protocol Version 4 (TCP/IPv4)" (3) and click the [Properties] (4) button.

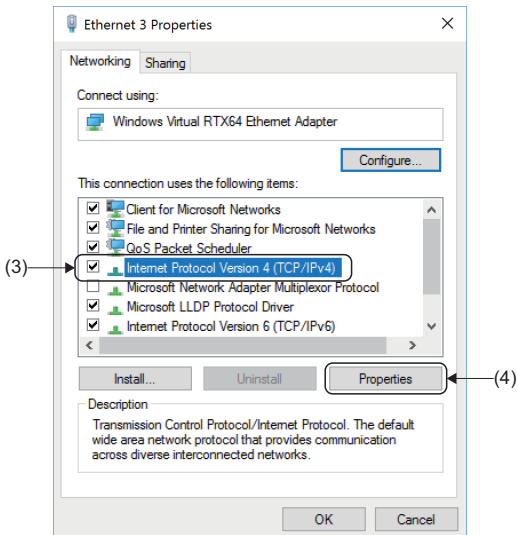

4. The "Internet Protocol Version 4 (TCP/IPv4) Properties" screen appears. Select "Use the following IP address" and set "IP address" and "Subnet mask".

<Example> IP address: 192.168.3.50, Subnet mask: 255.255.255.0

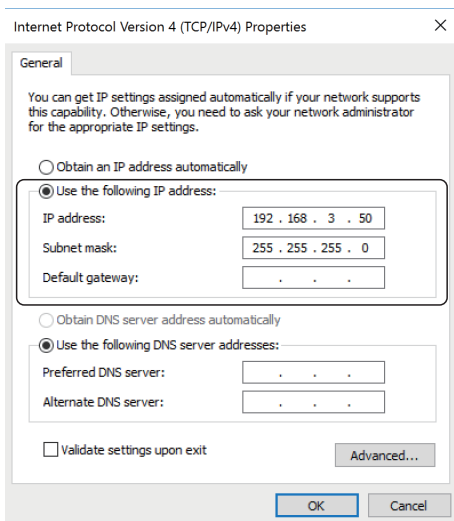

5. When the setting is completed, click the [OK] button, close the "Internet Protocol Version 4 (TCP/IPv4) Properties" screen, and close all the screens to end the setting.

■ Setting the IP communication mixed function in SWM-G

Enable the IP communication mixed function. Set it with VNTx defined in the network.

1. Select [SWMOS] ⇒ [Network] ⇒ [Comm1] (1) in the navigation window on the "SWMOS" screen to display the Comm1 window.
2. Select [CC-Link IE TSN] (2) in the [Comm1] tree. Select [Master Setting] ⇒ [IP address (IP Addr)] (3) to set the IP address (example: 192.168.3.253), and click the [Advanced Setting] button (4).

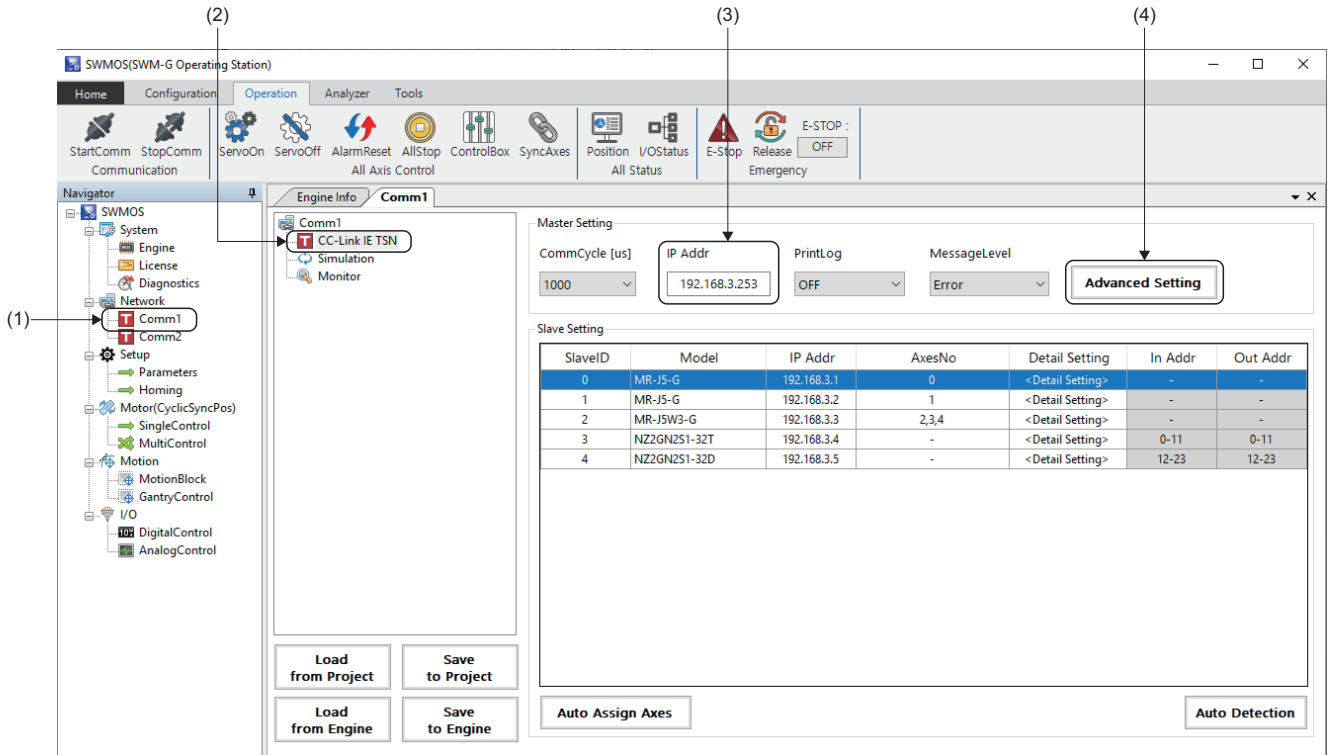

3. The "Master Advanced Setting" screen appears. Select "VNTx" (5). In addition, change the time slot setting as necessary. Since the IP communication is performed only in the time slot "TSLT0", the IP packet does not compress the communications of other time slots. When expanding the IP communication bandwidth, increase the ratio of "TSLT0" as long as the bandwidths of other time slots can be secured sufficiently. Set them in TSLT (6) defined in the network. (Example: 0: 0.25, 1: 0.5, 2: 0.25)
4. When the setting is completed, click the [OK] button to close the "Master Advanced Setting" screen.

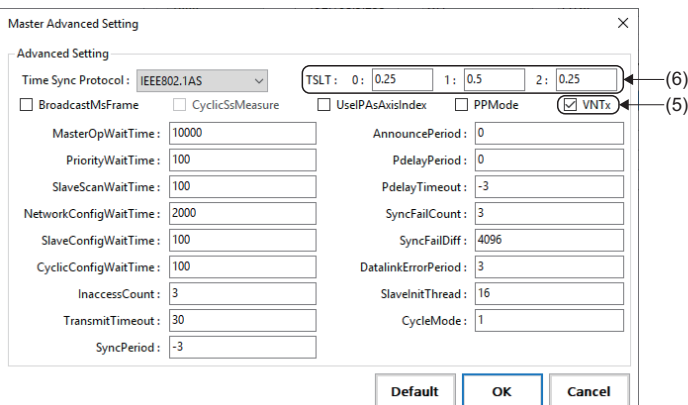

5. Return to the Comm1 window. Click the [Save to Project] button to save the setting file. For the saving operation of the setting file, refer to the following.

Page 20 Saving the settings



6. Click the [Save to Engine] button to write the set information to the SWM-G engine.

For the writing operation to the SWM-G engine, refer to the following.

☞ Page 22 Writing to the SWM-G engine

7. The definition file is loaded and used when the next communication starts.

■ Starting RT-TCP/IP Stack

To use the IP communication mixed function, starting RT-TCP/IP Stack from RTX Control Panel is required.

1. Select [RTX64 ### Runtime] *1 ⇒ [Control Panel] (1) from the Windows start menu.

*1 ### = RTX version

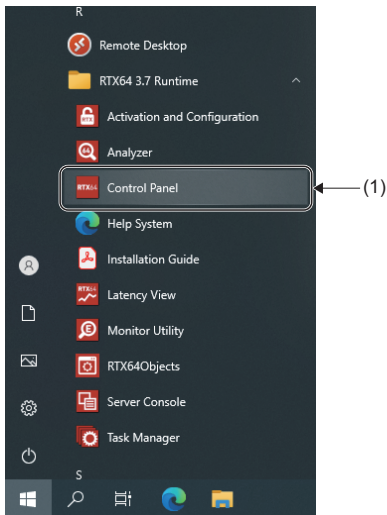

2. The "RTX64 ### Control Panel" screen *1 appears. Click the [▶] button (2) in "Start/Stop the RT-TCP/IP Stack" to start RT-TCP/IP Stack. When RT-TCP/IP Stack starts, the [▶] button changes to a [■] button. Click the [■] button to stop RT-TCP/IP Stack.

*1 ### = RTX version

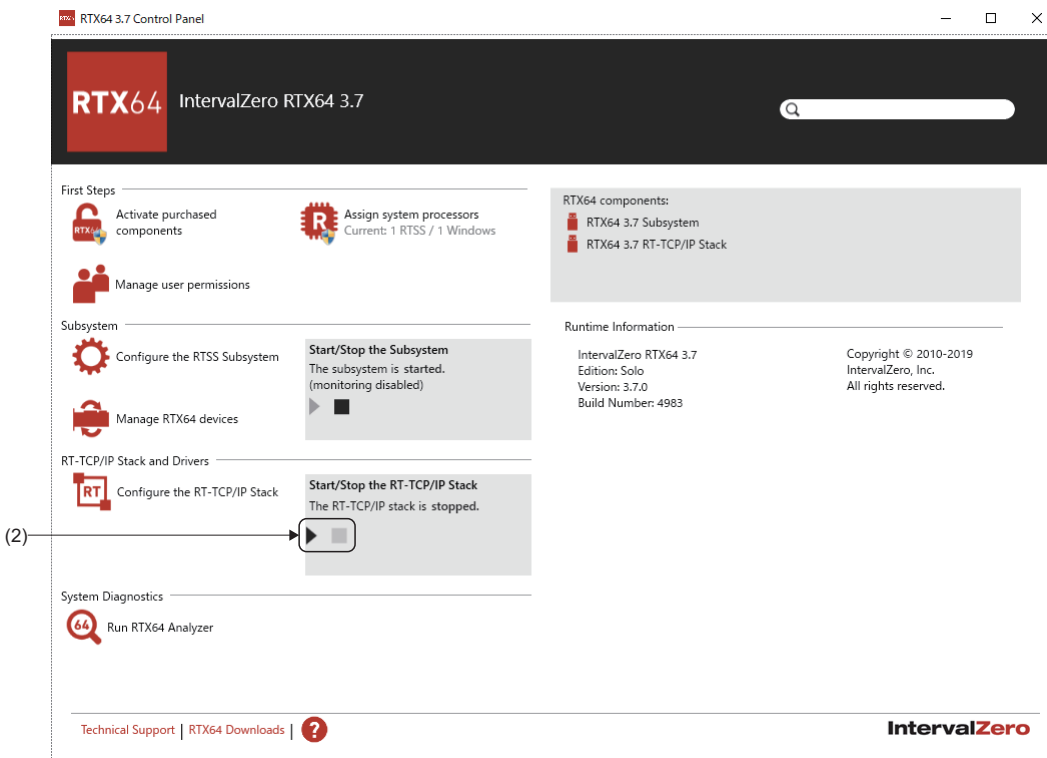

3. When the setting is completed, click the [×] button in the upper right of the screen to close the "Manage Interfaces and Filters" screen.

MR Configurator2 communication setting using the IP communication

This section describes how to connect MR Configurator2 to the servo amplifier using the IP communication function. The IP communication function enables communications with devices in the CC-Link IE TSN network via the SWM-G engine. The servo parameters can be set via the CC-Link IE TSN network.

Connection procedure

1. In SWMOS, click [Operation] ⇒ [StartComm] (1) in the ribbon to start the communication.

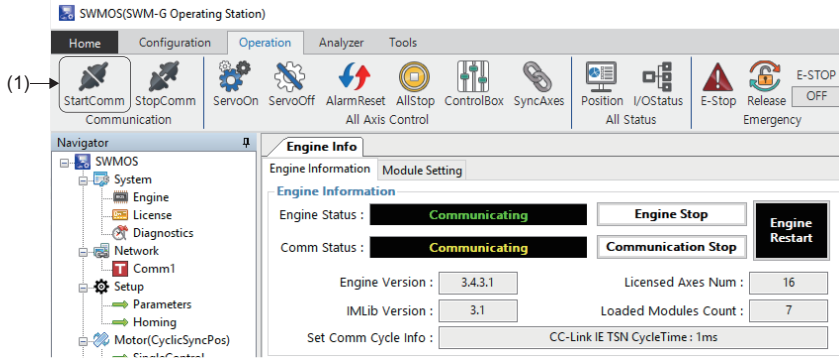

2. Start MR Configurator2. Select [Project] ⇒ [New] (2) from the menu to create a new project.

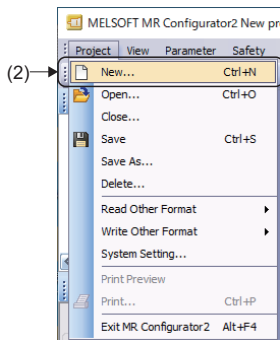

3. When a new project is created, the "New Project" screen appears. Click the [Switch to Multi-axis Project] button (3).

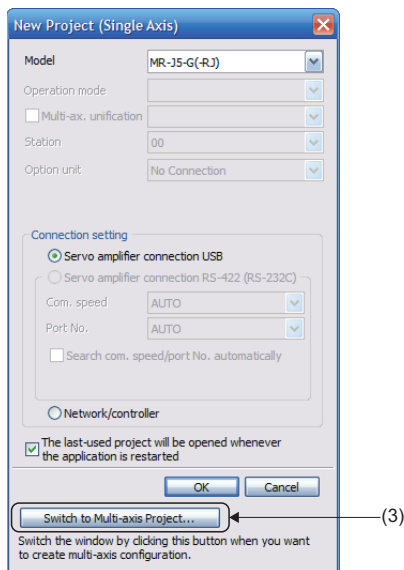

4. The screen is switched to the "New Project" screen of the multi-axis project. Set each item.
(Example) Set the following items.

	Item	Setting value	
(4)	Connection Network	CC-link IE TSN	
(5)	Via	None	
(6)	PC side I/F	Connection I/F	Ethernet
		Protocol	UDP
		Time-out	1
		Retry	0
(7)	Servo Amplifier Configuration	Model	MR-J5-G(-RJ)
		IP address	192.168.3.1

5. When the setting is completed, turn on the control circuit power supply of the servo amplifier and click the [Communication Test] button (8).

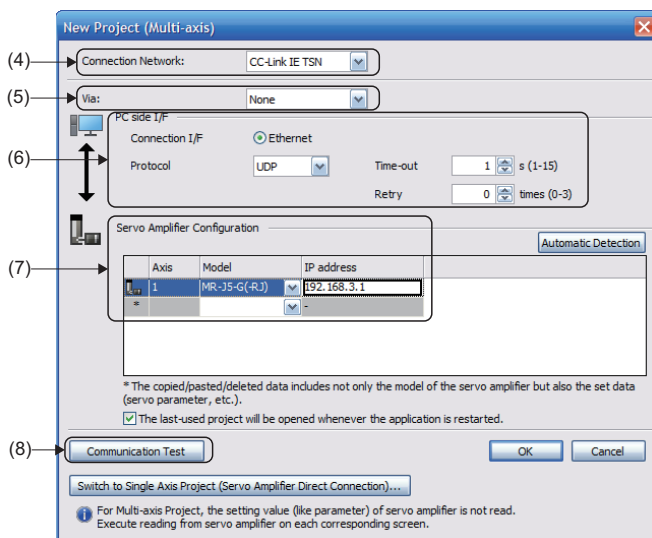

6. When the communication is succeeded, the message "The connection succeeded" appears. Click the [OK] button.

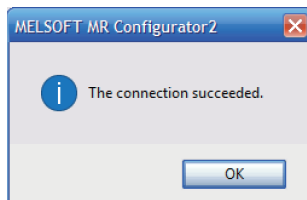

7. The screen returns to the "New Project" screen. Click the [OK] button to close the screen.
With the above settings, MR Configurator2 can be connected to the servo amplifier using the IP communication function.

Appendix 3 Configuration of CC-Link IE TSN

Transmission line type

■ Star topology/line topology

Connect the personal computer in star topology or line topology using Ethernet cables.

Star topology and line topology can be combined in a network.

CC-Link IE TSN Class

Select either of the following items according to the devices to be connected.

Connected device information	System configuration	Switching hub	Supported standard
CC-Link IE TSN Class B only	Select this if the system is to be configured without connecting CC-Link IE TSN Class A devices.	TSN hub (CC-Link IE TSN Class B switching hub)	IEEE802.1AS
Mixture of CC-Link IE TSN Class B/A or CC-Link IE TSN Class A only	Select this if a CC-Link IE TSN Class A device or Ethernet device is connected to the configuration of CC-Link IE TSN Class B devices only.	General-purpose hub (CC-Link IE TSN Class A switching hub)	IEEE1588

Appendix 4 Absolute Position Detection System

Setting the servo amplifier

When using the absolute position detection system in the servo amplifier (MR-J5(W)-B), set the following servo parameters.

- Servo parameter

No.	Name	Setting value
PA03.0	Absolute position detection system selection	1: Enabled (Absolute position detection system)
PC29.5	[AL.0E3 Absolute position counter warning] selection	0: Disabled
PC41.0	[AL.090.1 Homing incomplete] detection selection	1: Disabled

Since SWM-G does not manage the parameters of the servo amplifier, setting "Absolute position detection system selection" to "1: Enabled" causes the following servo alarms/warnings.

When [AL.025 Absolute position erased] occurs, turn on the control circuit power supply of the servo amplifier and clear the warning.

- [AL.025 Absolute position erased]
- [AL.090 Homing incomplete warning]
- [AL.0E3 Absolute position counter warning]

Restoring the current value

The absolute encoder parameter assumes that the axis moves within the range between $-(2^{31})$ and $2^{31}-1$ [pulse] (before applying the gear ratio).

When the axis moves at or below $-(2^{31})$ [pulse] or beyond $2^{31}-1$ [pulse], the absolute encoder parameter cannot apply the home position correctly. When the axis moves at or below $-(2^{31})$ [pulse] or beyond $2^{31}-1$ [pulse], the current position is required to be manually restored.

The following describes how to restore the current position manually using a sample program.

The sample program is stored in the following folder.

Sample program (default)

C:\Program Files\MotionSoftware\SWM-G\Samples\Extra\AbsoluteEncoder

Processing descriptions

Before stopping the SWM-G engine, save the following current value restoration data in a file, and restore the current value based on the saved current value restoration data, ABS counter acquired from the servo amplifier, and Encoder Command at the startup at the next startup of the SWM-G engine.

The sample program can execute the processing before stopping the engine and the processing after starting the engine.

■ Current value restoration data

Data	Description
Encoder Command	Encoder Command in the axis state (32-bit integral command position to be sent to the servo)
Encoder Command(64bit)	ABS counter (Obj.2B0Dh) of the servo amplifier and encoder value (64 bits) generated in Encoder Command
Pos Cmd	Pos Cmd in the axis state (axis command position)
Absolute Encoder Home Offset	The value of the absolute encoder home position offset of the axis parameter

Descriptions of the sample program

The sample program is a project of Visual Studio.

The sample program outputs files such as current value restoration data. "C:\Temp" is specified as the output destination folder of the file in the program. Change it as necessary.

Execute the sample program with the SWM-G engine running.

When the program AbsoluteEncoder is executed, the following console menu is displayed.

Enter the processing number (0 to 2) and press .

```

=====
0:Execution of processing before stopping.
1:Execution of processing after starting.
2:End Program
-

```

The processing when the processing number (0 to 2) is selected is as follows.

- [0]: The processing before stopping the SWM-G engine is executed. The current value restoration data is saved.
- [1]: The processing after starting the SWM-G engine is executed. The current value is restored.
- [2]: The program is ended.

Function list

The following shows the list of functions. For other details, check the descriptions of the program.

No.	Function name	Name	Description
1	_tmain()	Main processing	Executes each processing by entering numerical values. (Target axes: 0 axis) <ul style="list-style-type: none"> • 0: Executes the processing before stopping the SWM-G engine. • 1: Executes the processing after starting the SWM-G engine. • 2: Ends the program. The following is the menu for debug. <ul style="list-style-type: none"> • 100: Parameter export • 101: Parameter import • 102: Acquired data display The code for debug is enabled by defining "DEBUG_CODE".
2	ProcessingBeforeEngineStop()	Processing before stopping the SWM-G engine	Saves the current value restoration data.
3	ProcessingAafterEngineStart()	Processing after starting the SWM-G engine	Restores the current value from the current value restoration data.
4	ReadAbsCounter()	ABS counter reading	Reads the ABS counter (Obj.2B0Dh) from the servo amplifier.
5	ExportData()	Current value restoration data saving	Saves the current value restoration data.
6	ImportData()	Current value restoration data reading	Reads the current value restoration data.
7	Make64bitEncoderCommand()	Encoder Command (64-bit) generation	Generates the Encoder Command (64-bit) value from Encode Command and the ABS counter.
8	MakeMovementAndTurnAmount()	Movement amount/turn amount calculation	Calculates the movement amount (encoder value) and turn amount with the values before and after stopping the engine.
9	RestoreAbsoluteEncoderHomeOffset()	Current value restoration (when the single turn is enabled)	Restores the current value when the single turn is enabled.
10	GetAndExportAll()	Parameter export	Exports the parameters to a file. (For debug)
11	ImportAndSetAll()	Parameter import	Imports the parameters to a file. (For debug)



Appendix 5 How to Create a New Program

This section describes how to create a C++ project using the SWM-G library.



For details of the languages and versions supporting the SWM-G library, refer to the following.
 SWM-G User Manual

Creation procedure

The following describes how to create a Visual C++ project using Visual Studio 2017 as an example.

1. Select [File] ⇒ [New Project] (1) from the menu.

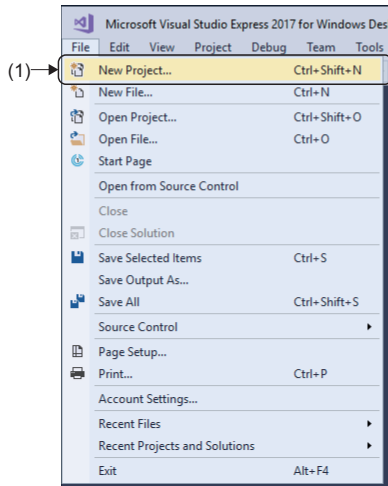

2. The "New Project" screen appears. Select [Installed] ⇒ [Visual C++] (2) to display the templates that can be used in Visual C++. Select [Console App] (3), enter the project name, storage location, and solution name, and click the [OK] button.

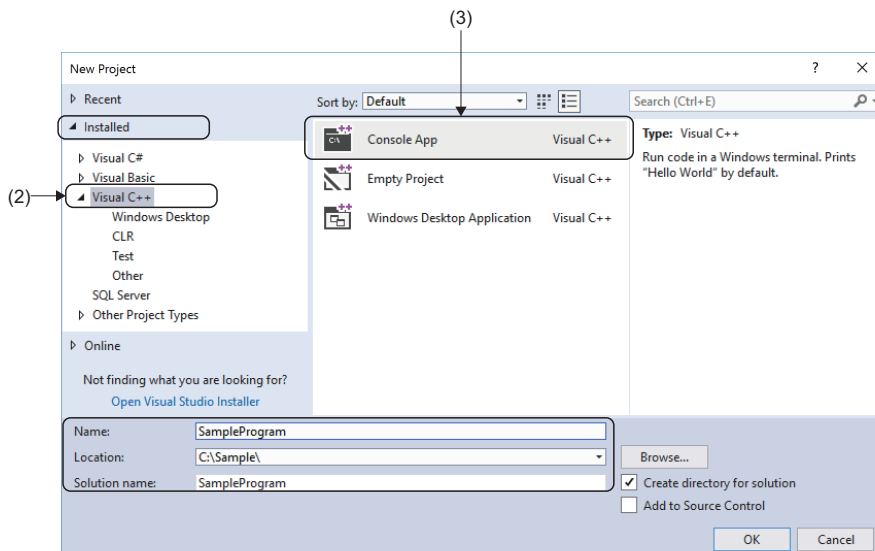

3. Create a Visual C++ project.

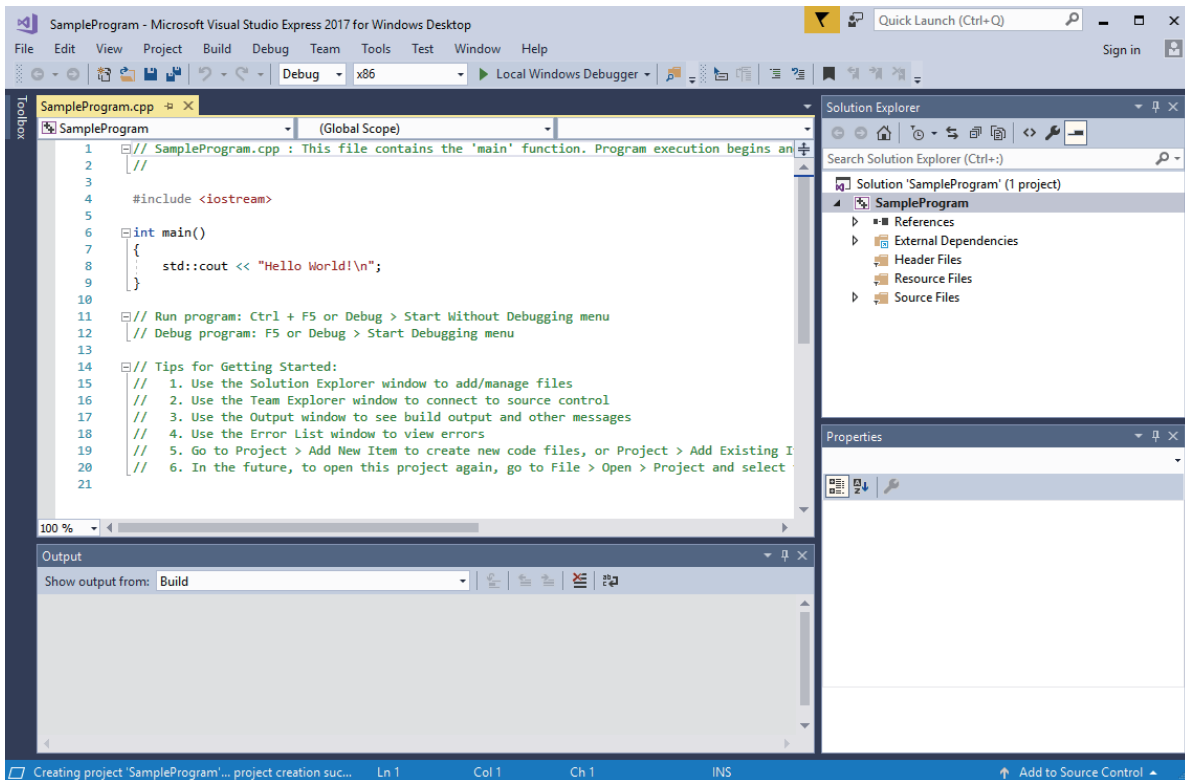

4. Select [Build] ⇒ [Configuration Manager] (4) from the menu.

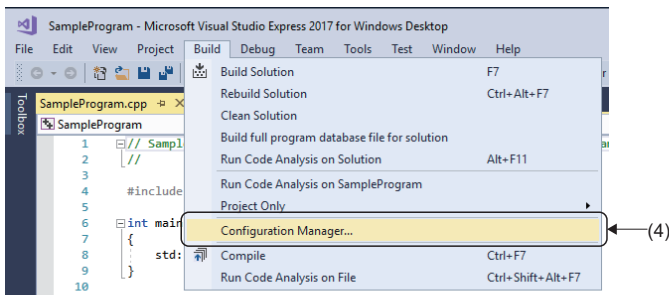

5. The "Configuration Manager" screen appears. Set "x64" (5) for [Active solution platform] and click the [Close] button to close the "Configuration Manager" screen.

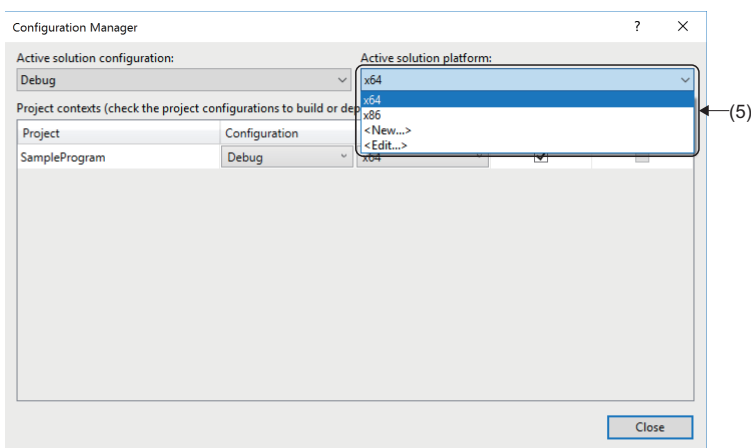

6. Next, open the property page of the project. Select [Project] ⇒ [□□□ Properties] (6) from the menu.

*1 □□□= Indicates the created project name.

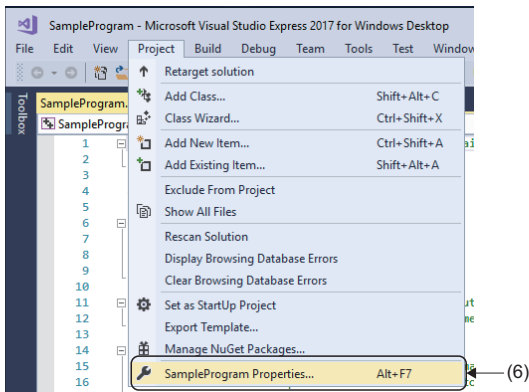

7. The "Property Pages" screen appears. Select [Configuration Properties] ⇒ [C/C++] ⇒ [General] (7) to display the items under [General]. Select [Additional Include Directories], click the [▼] button (8), and select [<Edit...>] (9).

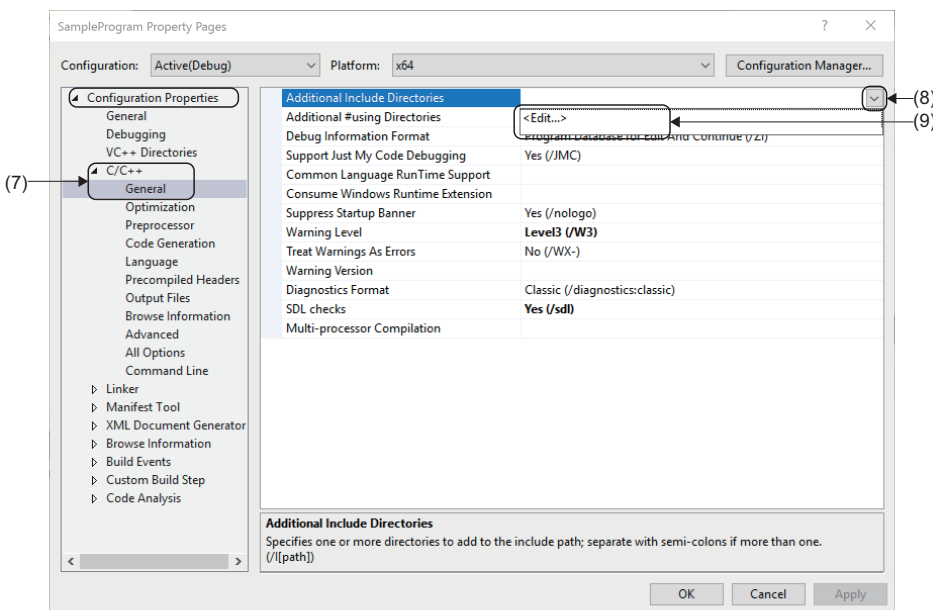

8. The "Additional Include Directories" screen appears. Add the include folder in the SWM-G installation folder. Enter the path of the following include folder and click the [OK] button.

Include folder (default)

C:\Program Files\MotionSoftware\SWM-G\Include

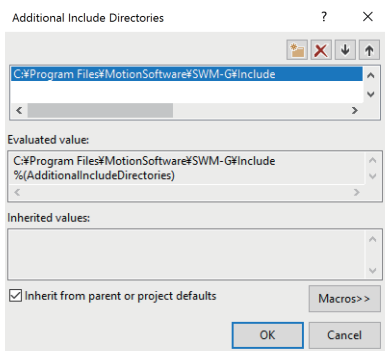

9. The screen returns to the "Property Pages" screen. The entered include folder is displayed.

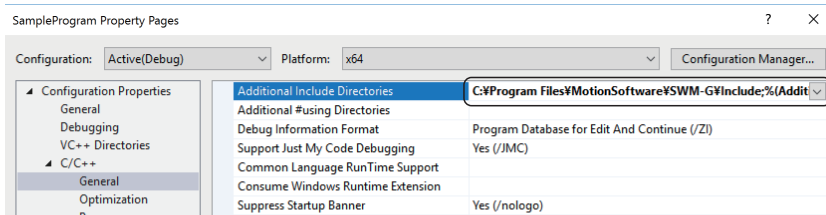

10. Select [Configuration Properties] ⇒ [Linker] ⇒ [General] (10) to display the items under [General]. Select [Additional Library Directories], click the [▼] button (11), and select [<Edit...>] (12).

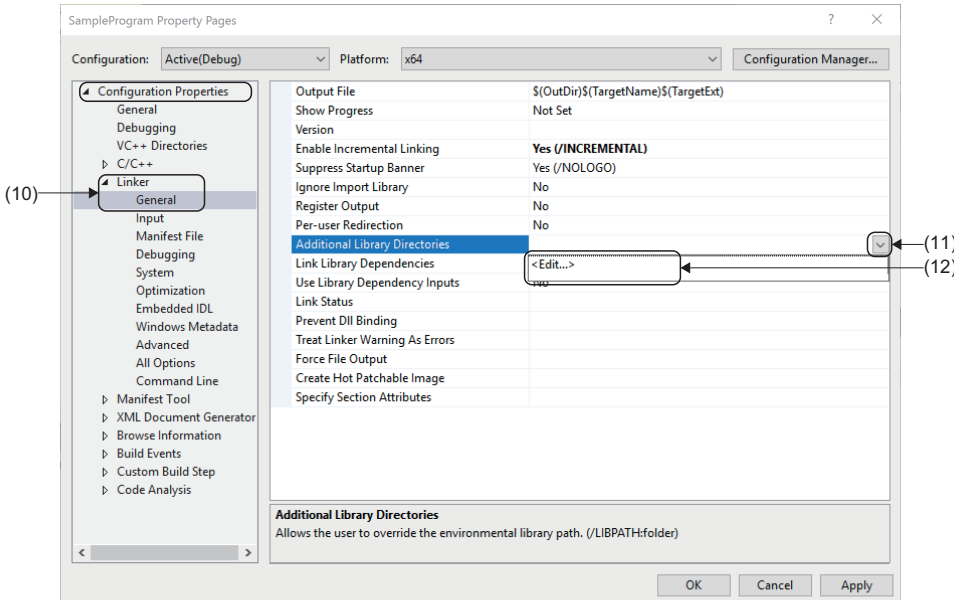

11. The "Additional Library Directories" screen appears. Add the library folder in the SWM-G installation folder. Enter the path of the following library folder and click the [OK] button.

Library folder (default)
 C:\Program Files\MotionSoftware\SWM-G\Lib

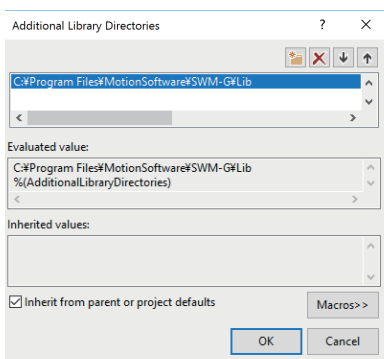

12. The screen returns to the "Property Pages" screen. The entered library folder is displayed.

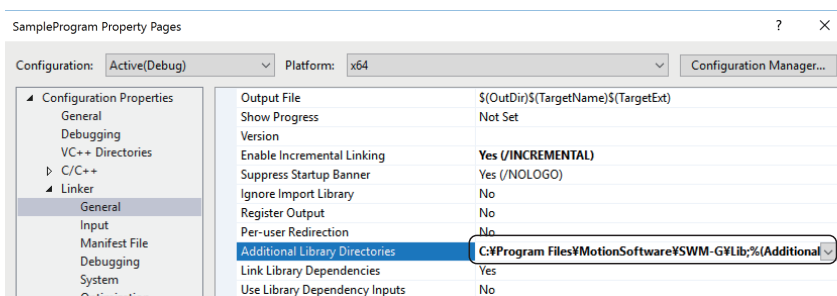

13. Select [Configuration Properties] ⇒ [Linker] ⇒ [Input] (13) to display the items under [Input]. Select [Additional Dependencies], click the [v] button (14), and select [<Edit...>] (15).

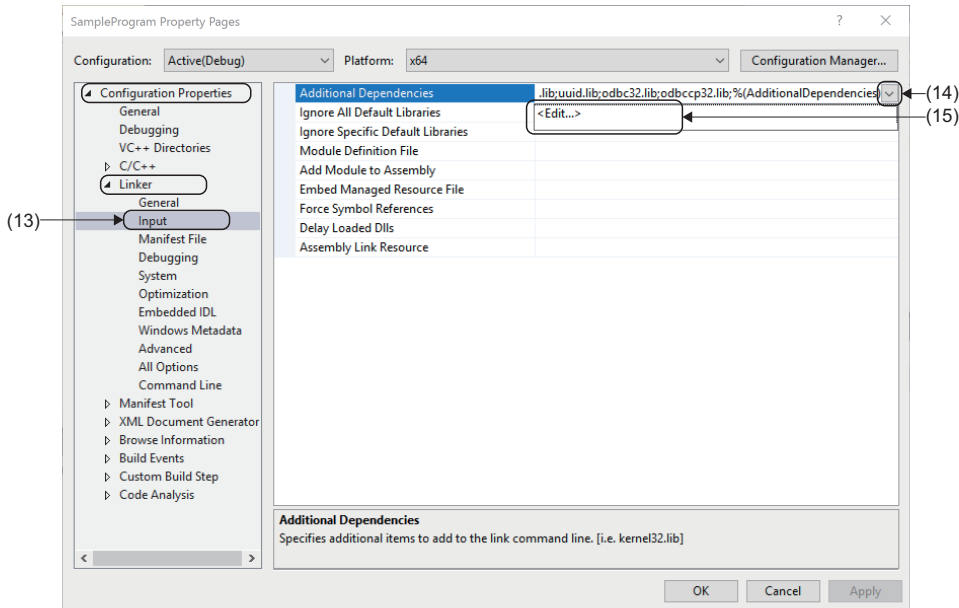

14. The "Additional Dependencies" screen appears. Add the libraries. Enter the following libraries and click the [OK] button.

Library

- AdvancedMotionApi.lib
- CompensationApi.lib
- CoreMotionApi.lib
- EventApi.lib
- IMDI.lib
- IOApi.lib
- LogApi.lib
- UserMemoryApi.lib
- SSCApi.lib
- legacy_stdio_definitions.lib *1
- legacy_stdio_wide_specifiers.lib *1

*1 Add this library only when Visual Studio 2015 or later is used.

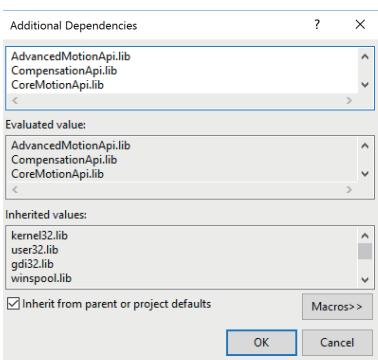

15. The screen returns to the "Property Pages" screen. The entered library is displayed.

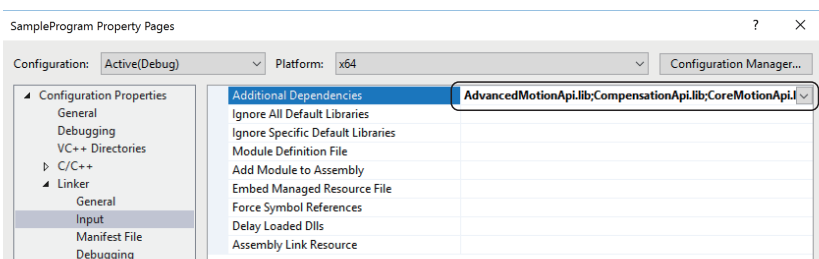

16. Windows applications created by using the SWM-G library do not operate unless "IMDII.dll" exists in the application directory. Define this DLL in the build event so that the DLL is automatically copied to the application directory every time the application compiles it.

Select [Configuration Properties] ⇒ [Build Events] ⇒ [Post-Build Event] (16) to display the items under [Post-Build Event]. Select [Command Line], click the [▼] button (17), and select [<Edit...>] (18).

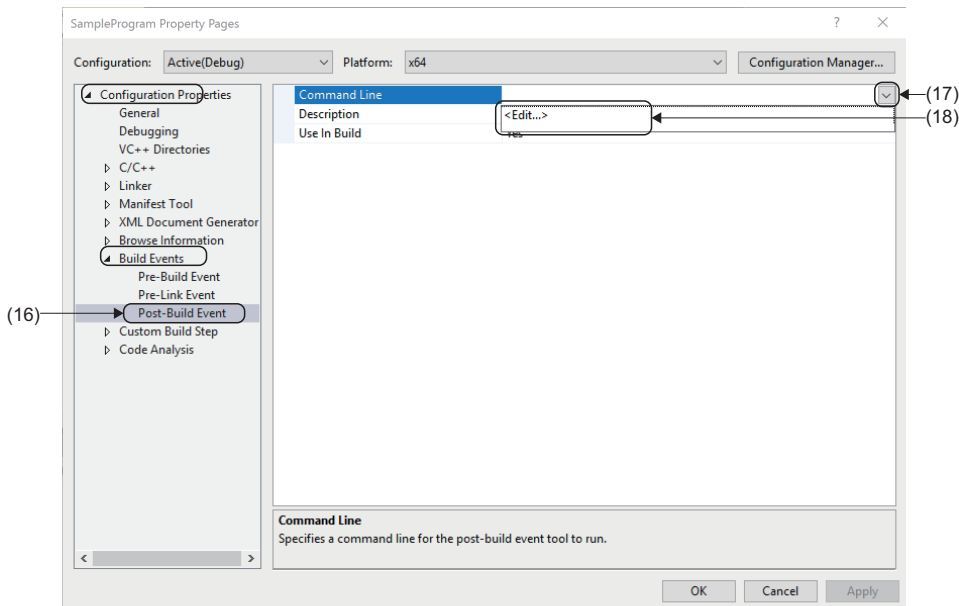

17. The "Command Line" screen appears. Add a command line. Enter the following command line and click the [OK] button.

Command line

```
copy /y "C:\Program Files\MotionSoftware\SWM-G\lib\IMDII.dll" "%(OutDir)"
```

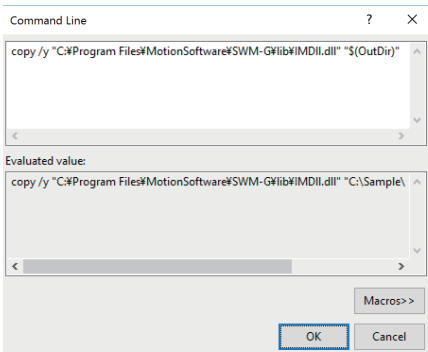

18. The screen returns to the "Property Pages" screen. The entered command line is displayed. Click the [OK] button to apply the settings and close the "Property Pages" screen.

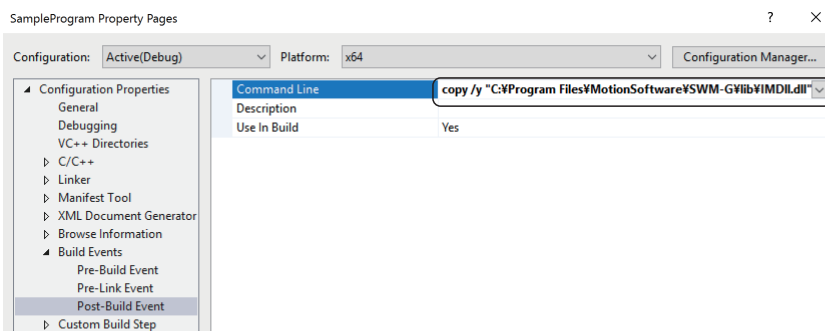

19. The C++ application using the SWM-G library needs to include the header files supporting the library to be used. For the files including the main routine, add the following header files.

Header file

```
#include "AdvancedMotionApi.h"
#include "CompensationApi.h"
#include "CoreMotionApi.h"
#include "EventApi.h"
#include "IOApi.h"
#include "LogApi.h"
#include "UserMemoryApi.h"
#include "SSCApi.h"
```

20. The configuration of the C++ project has been completed.

Point

For details of how to use the SWM-G library, refer to the following.

 SWM-G User Manual

Appendix 6 Network Configuration Setting with IETSN Configurator

Use IETSN Configurator, which is the CC-Link IE TSN network management tool.

This section describes how to set the network configuration by using IETSN Configurator.

This section describes the settings using the system configuration example in Section 4.1. ( Page 14 System configuration example)

Precautions

- IETSN Configurator configures the same network setting as the SWMOS network setting, but they are not compatible. When the network setting is configured using SWMOS, do not configure the setting with IETSN Configurator. If the network setting is configured using IETSN Configurator, it is recommended to switch to the SWMOS network setting.
- When using a SWM-G version that is "1.001B" or later, the network setting can be configured with IETSN Configurator. When using a SWM-G version that is "1.004E" or later, it is recommended to configure the network setting with SWMOS. For the checking method of the SWMOS version, refer to "SWMOS About" in the following manual.
 Motion Control Software SWM-G Operating Manual

Installing IETSN Configurator

1. Unzip the download module in a place and double-click "IETSNConfigurator_Setup.exe" in the "sw1dnn-swmg-m_*****1" folder ⇒ "IETSNConfigurator" folder.
*1 ****=SWM-G version
2. The IETSN configurator installation window appears. Select or enter the required information according to the instructions on the screen.

■ Uninstalling IETSN Configurator

Uninstall IETSN Configurator from Control Panel on Windows. For details, refer to "Uninstallation Procedure" in the following manual.

 Motion Control Software SWM-G User's Manual (Installation)

Starting SWMOS and IETSN Configurator

1. Select [SWM-G] ⇒ [SWMOS] (1) from the Windows start menu to start SWMOS.
2. Select [SWM-G] ⇒ [IETSN Configurator] (2) from the Windows start menu.

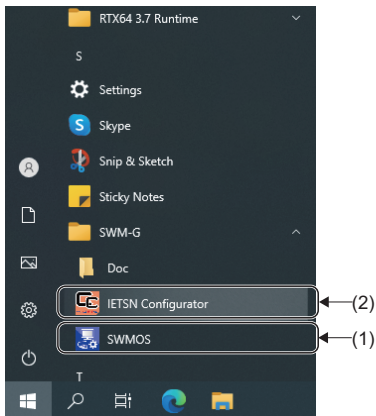

3. After starting IETSN Configurator, the "CC-Link IE Network Configurator" screen appears.

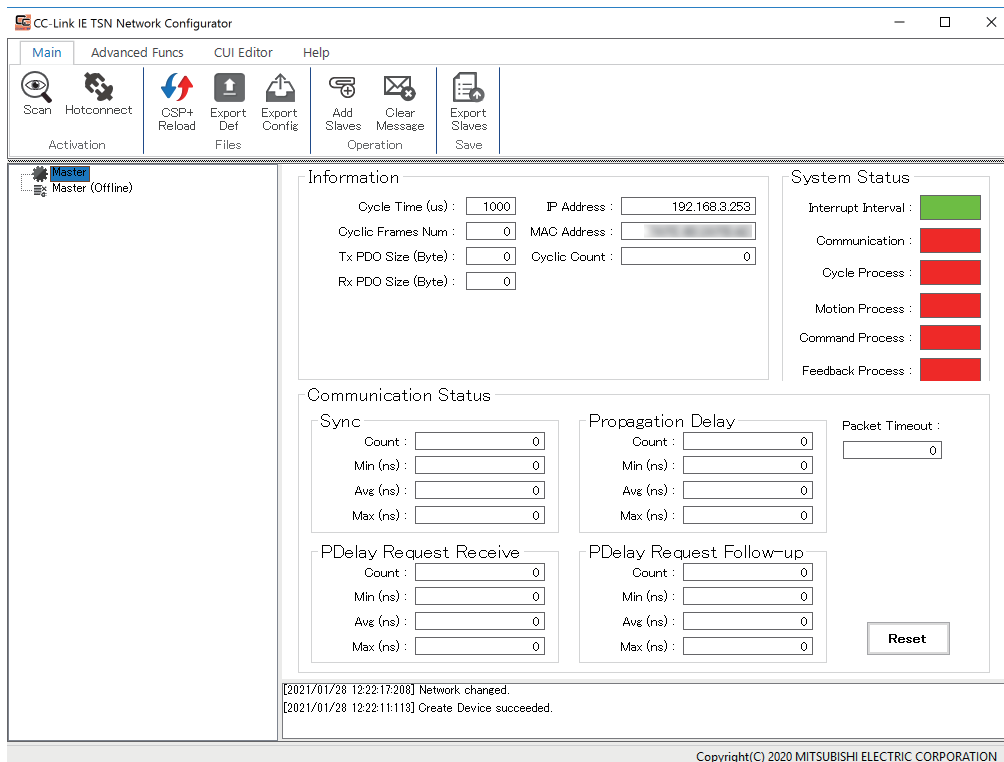

Point

Since IETSN Configurator uses the SWM-G engine, SWMOS must be started in advance. IETSN Configurator will not operate normally if SWMOS is started after IETSN Configurator is started.

Loading CSP+ (CC-Link Family System Profile Plus)

1. Click [Main] ⇒ [CSP+ Reload] (1) in the ribbon.

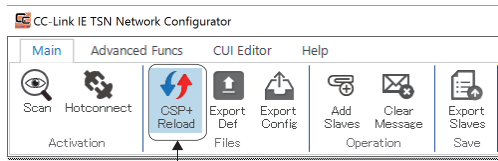

2. The "CSP+ Reload" screen appears. The CSP+ information loaded at the startup can be checked. The selection columns of the loaded files are displayed in gray.

By clicking the [Reload] button, the files displayed in the CSP+ list will be reloaded and the list will be updated.

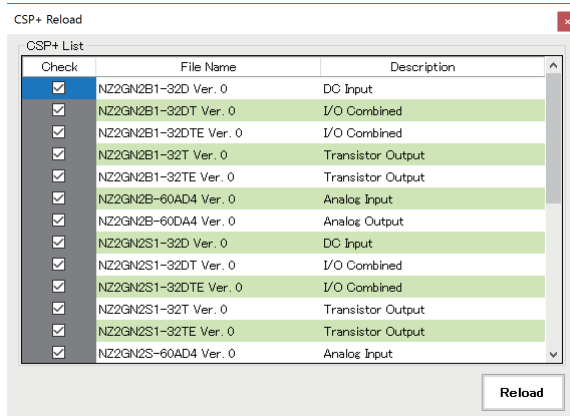

3. After checking the displayed contents, click the [×] button in the upper right of the screen to close the "CSP+ Reload" screen.

Point

If no CSP+ files are displayed in the list, add CSP+ files. For details of how to add and update the CSP+ files, refer to the following.

 Motion Control Software SWM-G Operating Manual

Master setting

1. Click [Main] ⇒ [Export Def] (1) in the ribbon.

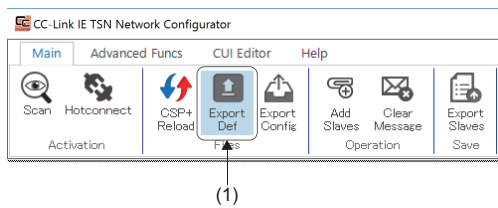

2. The "Master Settings" screen appears. Initial values are displayed for each parameter. Set [CommCycle] (2) and [IPAddr] (3) in "Basic Setting" and click the [Save] button. (In the explanation of this section, the initial values are set.)
 - Communication cycle: 1000[μs]
 - IP address: 192.168.3.253

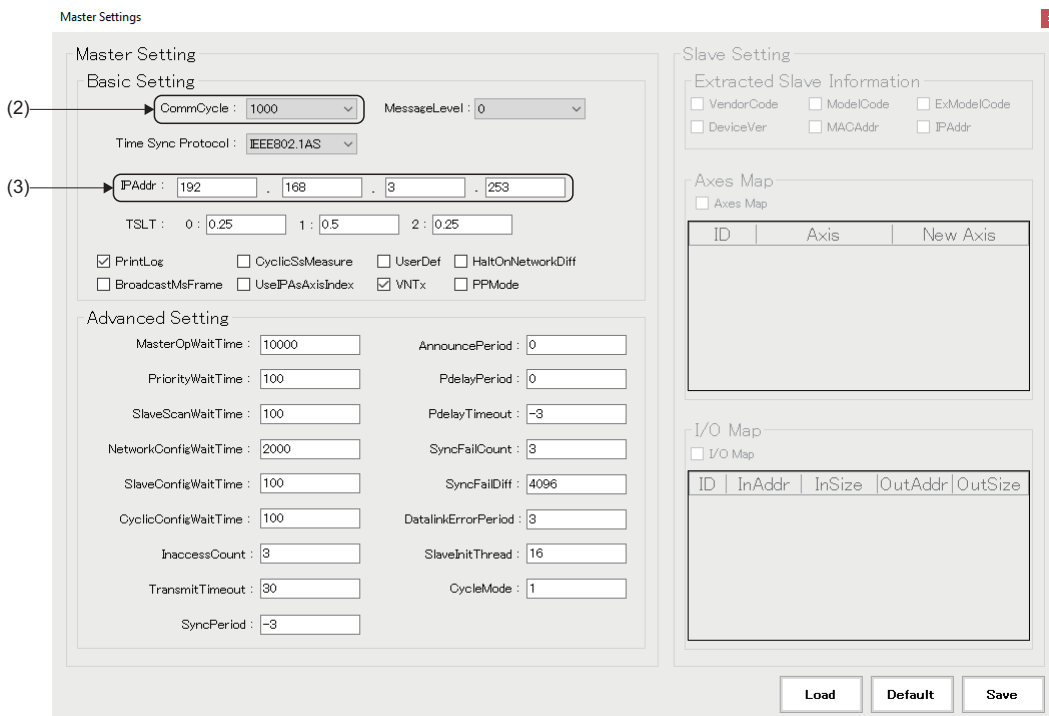

3. If the definition file has already existed, the message "Master Definition File is already exists. Do you want to replace it?" appears. Click the [Yes] button.

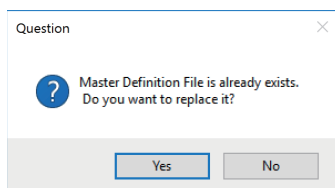

4. When the setting is updated, the message "Master Definition File is generated successfully." appears. Click the [OK] button.

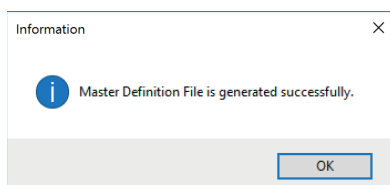

5. When the setting is completed, click the [×] button in the upper right of the screen to close the "Master Settings" screen. The definition file is loaded and used when the next communication starts.

Adding remote stations

1. Click [Main] ⇒ [Add Slaves] (1) in the ribbon.

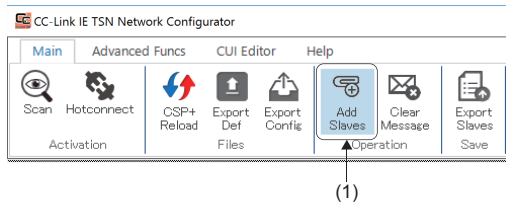

2. The "Add slaves" screen appears. Select the remote stations to be connected in [Resource CSP+] (2) and click the [Add] button (3) to add them to [Slave List] (4). After the slave devices have been added to the slave list, click the [OK] button. (In the explanation of this section, the CSP+ files of "MR-J5-G" and "MR-J5W3-G" are added.)

*: If there are multiple same remote stations, select only one CSP+ file to add, and there is no need to add multiple CSP+ files.

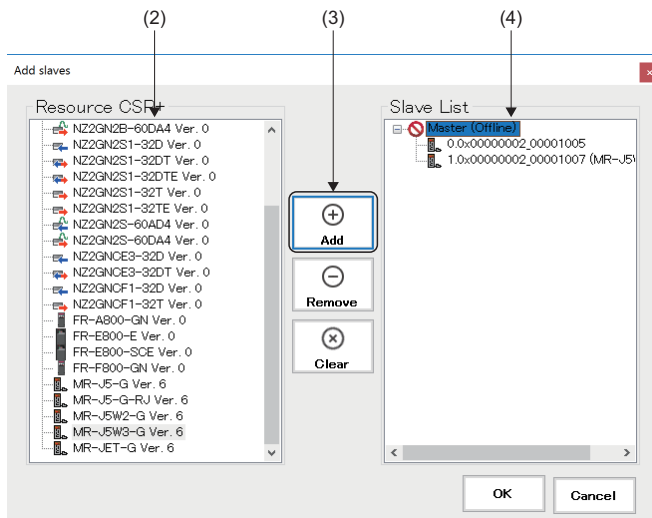

3. The remote stations (5) are added in the tree on the "CC-Link IE Network Configurator" screen.

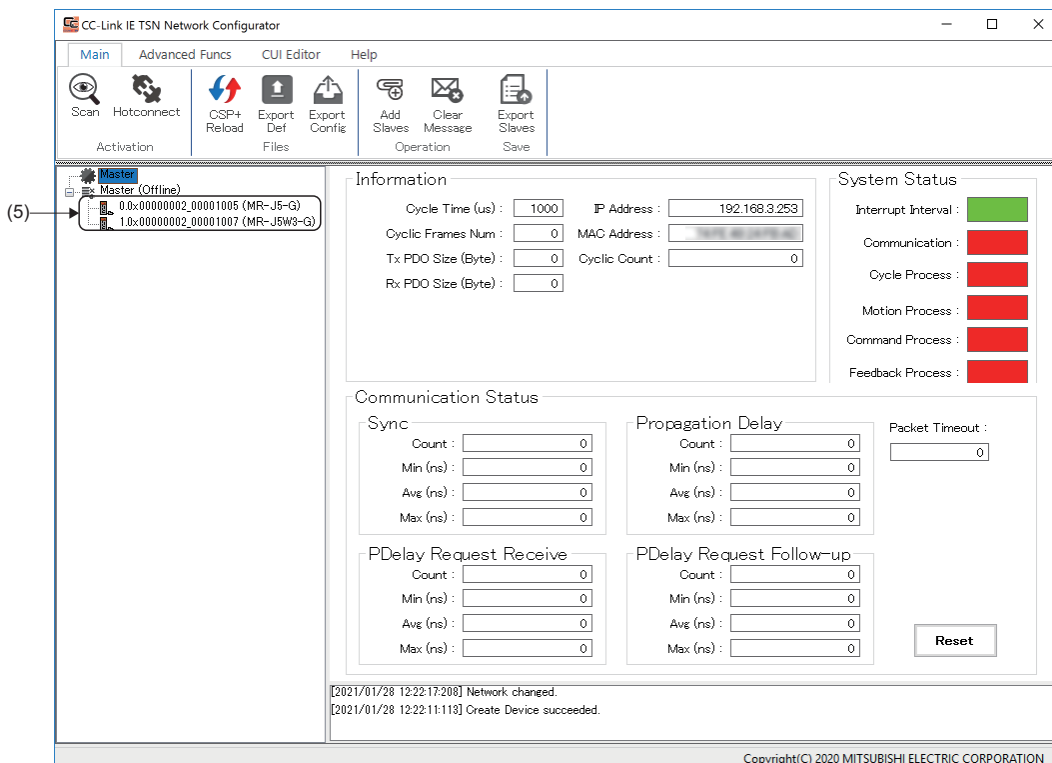

CC-Link Unit Information (CUI) setting

Create a CUI file to be used to initialize and set the remote stations at the start of communication.

The CUI file can be manually created. However, it is basically recommended that the CUI file is created by loading the CSP+ files into "IETSN Configurator" and editing the PDO.

Set the CUI file for each remote station. The setting is loaded and used when the next communication with the remote stations starts.

■ For MR-J5-G

1. Select the added remote station in the tree on the "CC-Link IE Network Configurator" screen and click [CUI Editor] ⇒ [Load] (1) in the ribbon.

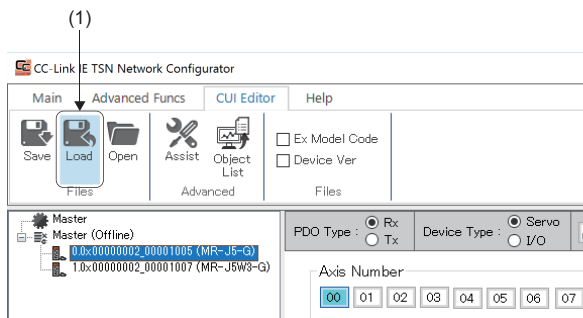

2. The "Please select a CUI file." screen appears. When the name of an existing setting file is displayed, click the [Open] button.

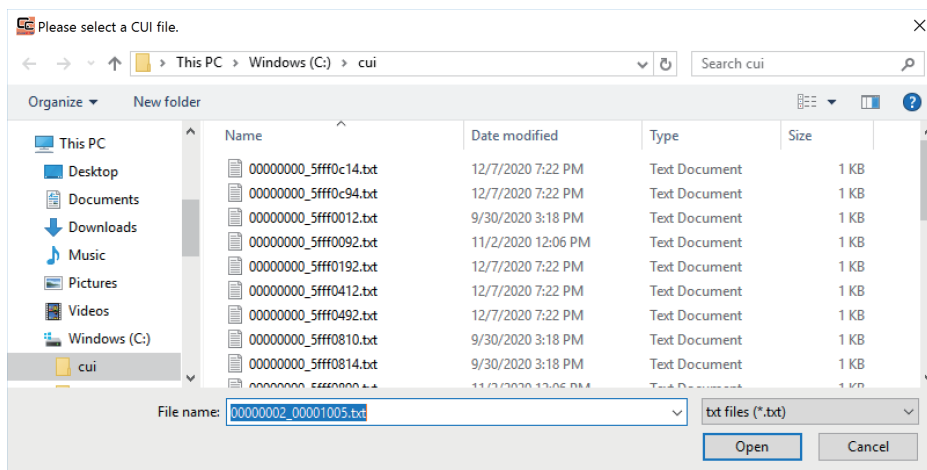

3. When the loading is completed, the message "CUI File is loaded successfully." appears. Click the [OK] button.

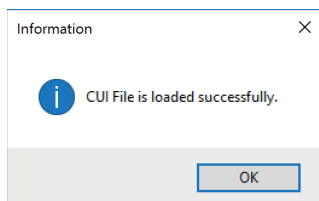

4. When the loading is completed successfully, the set PDO object list and PDO entry list appear.
For a single-axis servo amplifier, set only the axis number [00].
 5. In "PDO Type" (2), switch "Rx" or "Tx" and set the PDO object list for "Rx" and "Tx".
In the initial value setting, "1st Receive PDO Mapping" is set for Rx and "1st Transmit PDO Mapping" is set for Tx. When the setting is changed, click the [Save] button (3) to update the CUI file.
- *1 For the PDO object list, set only one object each for Rx and Tx.

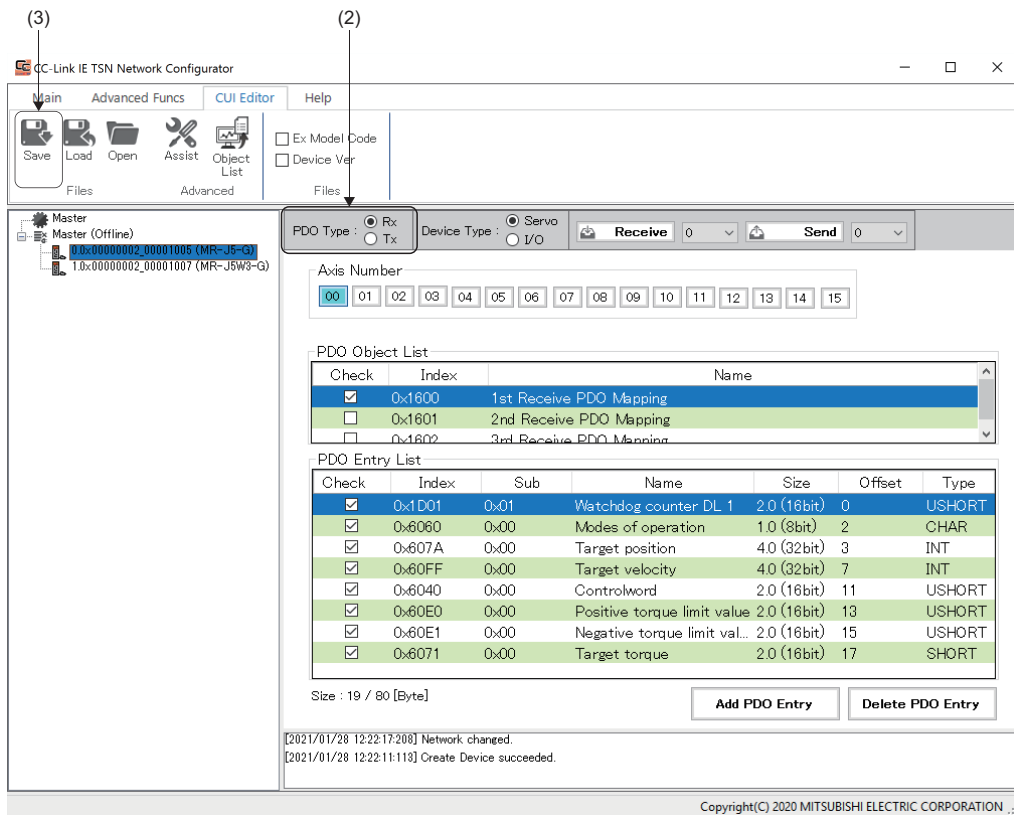

■ For MR-J5W3-G

1. Select the added remote station in the tree on the "CC-Link IE Network Configurator" screen and click [CUI Editor] ⇒ [Load] (1) in the ribbon.

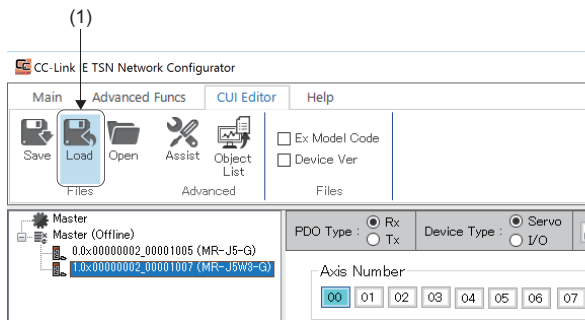

2. The "Please select a CUI file." screen appears. When the name of an existing setting file is displayed, click the [Open] button.

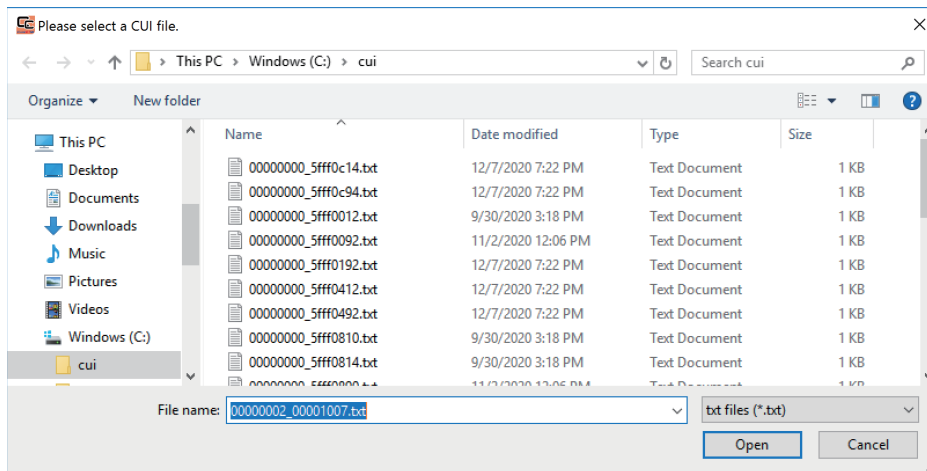

3. When the loading is completed, the message "CUI File is loaded successfully." appears. Click the [OK] button.

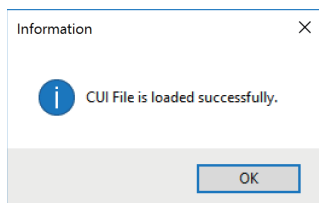

4. When the loading is completed successfully, the set PDO object list and PDO entry list appear.
 5. In "PDO Type" (2), switch "Rx" or "Tx" and set the PDO object list for "Rx" and "Tx".
 In the initial value setting, "1st Receive PDO Mapping" is set for Rx and "1st Transmit PDO Mapping" is set for Tx. When the setting is changed, click the [Save] button (3) to update the CUI file.
 For a 3-axis servo amplifier, click the [00] to [02] buttons (4) of the axis number, and switch to the axis to be set and set the axis numbers for multiple axes. The axis numbers are as follows. [00]: A-axis, [01]: B-axis, [02]: C-axis
- *1 For the PDO object list, set only one object each for Rx and Tx.

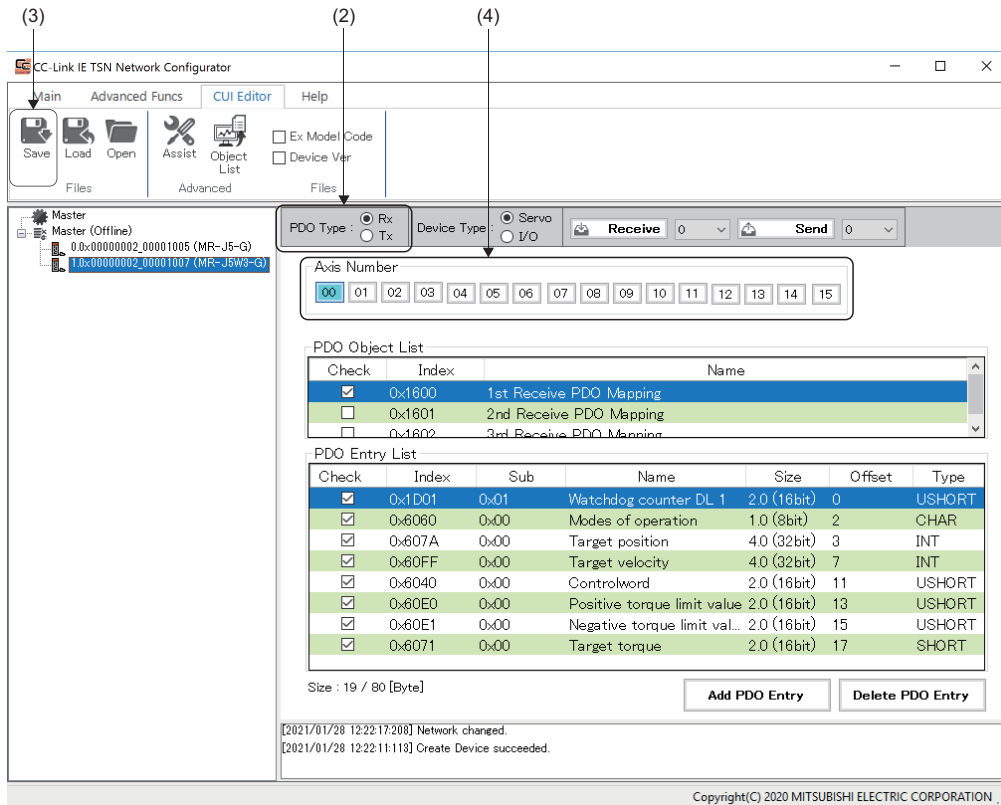

For details of the mapping change, refer to the following.

 Motion Control Software SWM-G Operating Manual

Connection check with the servo amplifier

1. Turn on the control circuit power supply of the servo amplifier.
2. Click [Main] ⇒ [Scan] (1) in the ribbon. The connected servo amplifiers are displayed in the tree on the "CC-Link IE Network Configurator" screen.

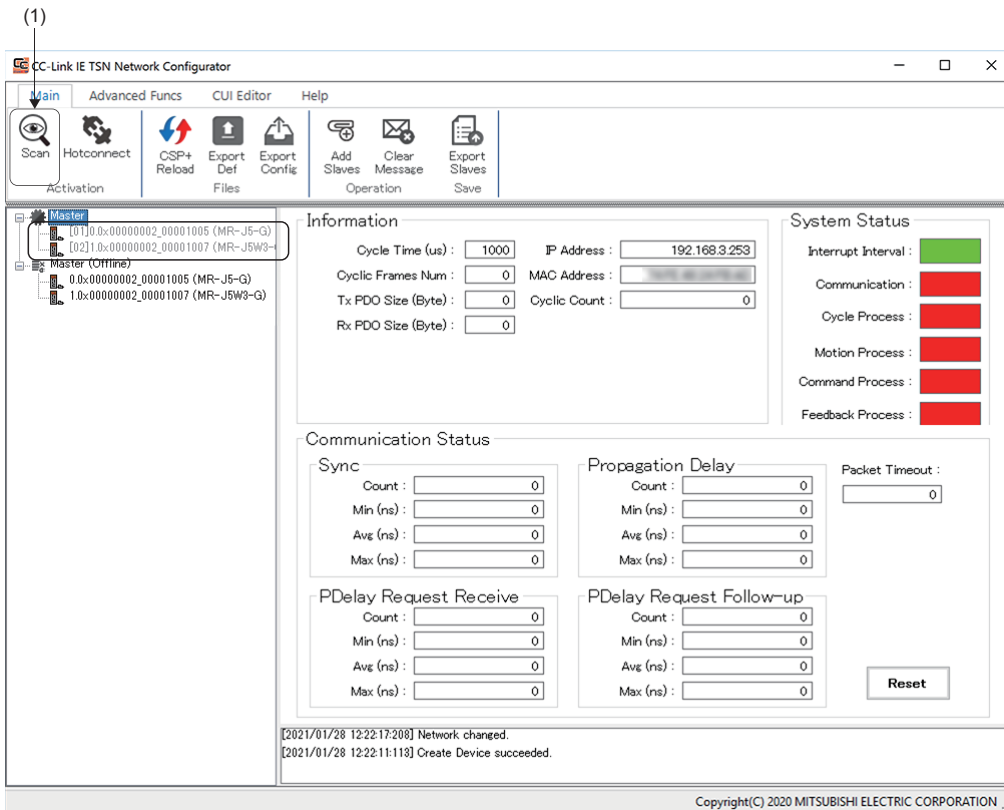

3. Switch to the "SWMOS" screen and click [Operation] ⇒ [StartComm] (2) in the ribbon to start the communication.

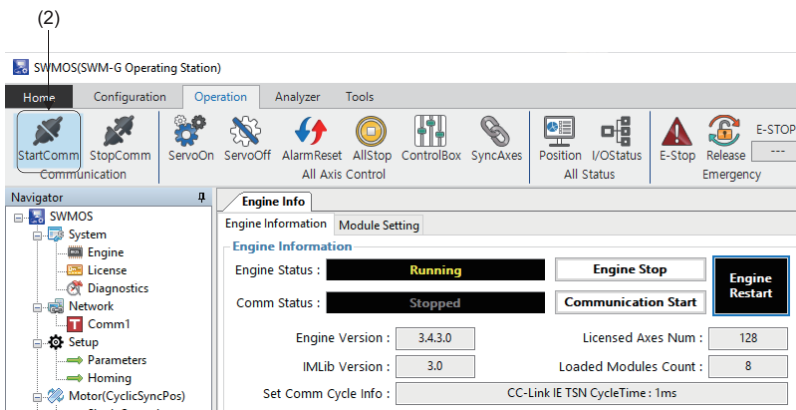

4. When the communication is started, the display of [Engine Status] and [Comm Status] in the [Engine Information] tab on the Engine Info window is switched to "Communicating".

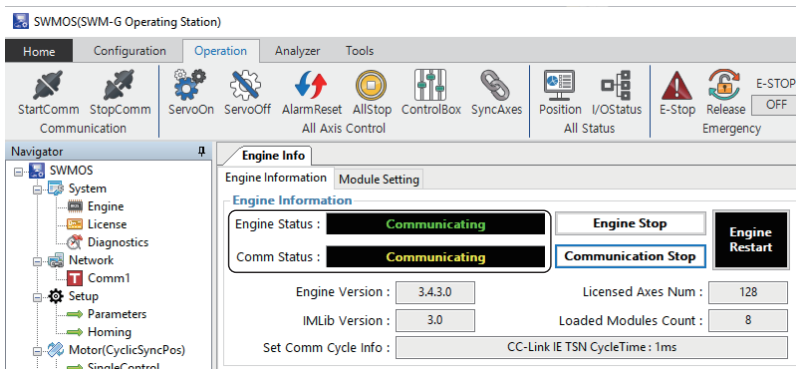

- Switch to the "CC-Link IE Network Configurator" screen, and select [Main] in the ribbon to check the connection status. When the communication with the servo amplifier is established, the display color of the tree changes from gray to black. The system status, communication status, and others can be checked.

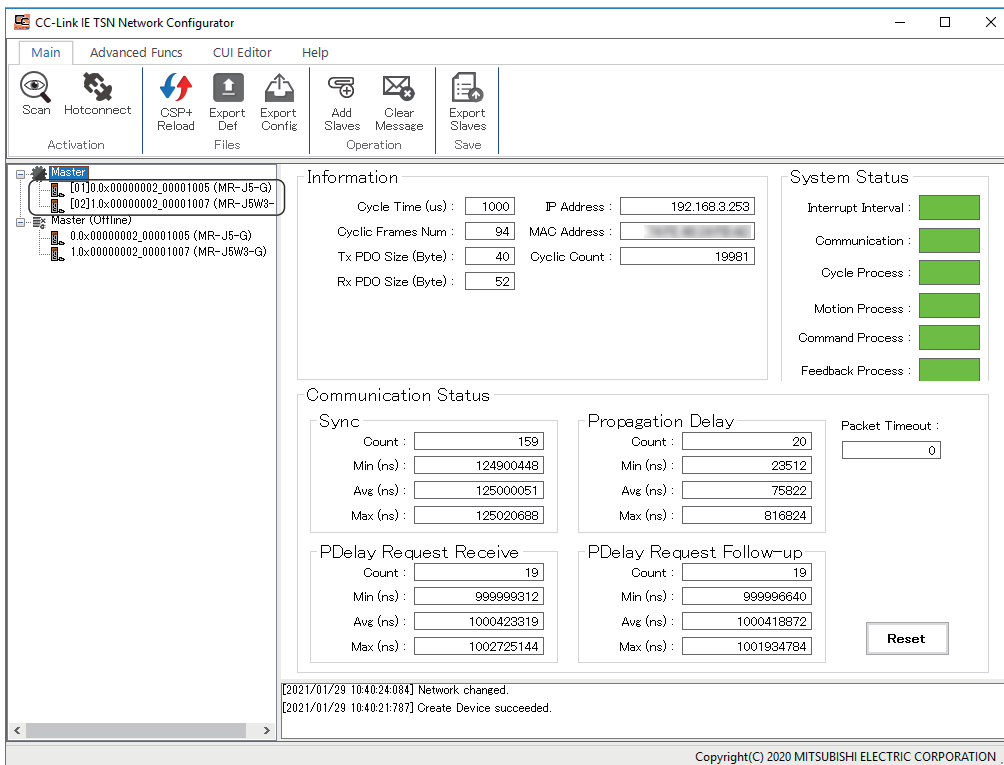

- After checking the communication status, switch to the "SWMOS" screen and click [Operation] ⇒ [StopComm] (3) in the ribbon to end the communication.

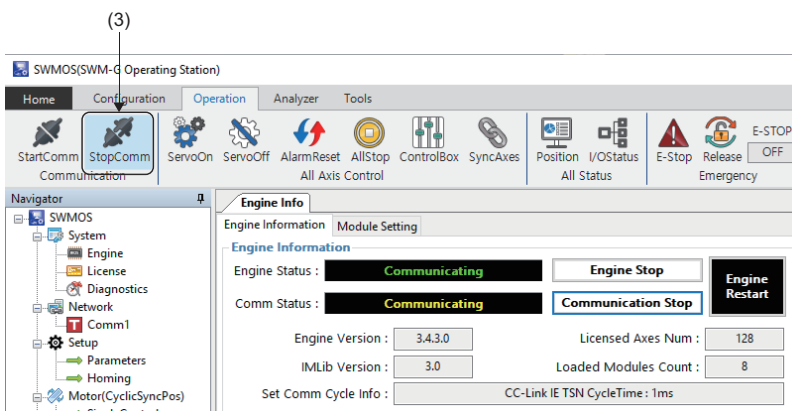

- When the communication is ended, the display of [Engine Status] is switched to "Running" and the display of [Comm Status] is switched to "Stopped" in the [Engine Information] tab on the Engine Info window.

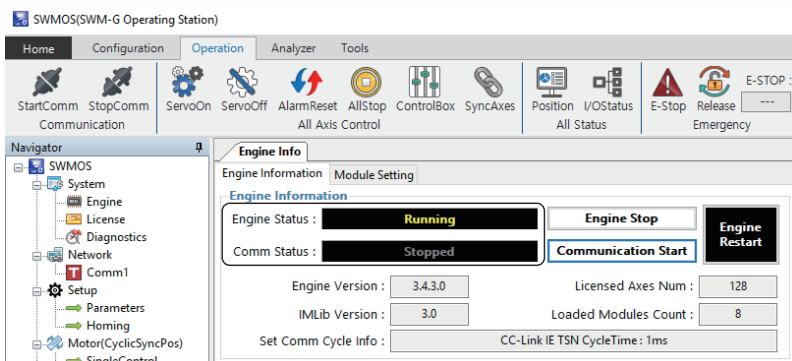

- When the communication is ended and the servo amplifier is disconnected, turn off the control circuit power supply of the servo amplifier.



Appendix 7 How to Set the MR Configurator2 Alarm Occurrence Time

This section describes how to correct the alarm occurrence times in the alarm history displayed on the "alarm display" of MR Configurator2 when the times do not match with the Windows "Current date and time" (Japan Standard Time).

Setting procedure (for Japan time zone)

This setting is necessary for sending commands to the remote station.

Commands directly edit the CUI (CC-Link Unit Information) file for each device.

Precautions

- This setting requires directly editing the CUI file.
- CUI files cannot be opened during communication. Edit the CUI file after stopping communication.
- When the network configuration setting is updated (a CUI file is updated) in SWMOS or IETSN Configurator, the command must be set again.

■ Network configuration setting with SWMOS

1. Start Windows Explorer, and open the following folder.

CUI file storage destination

C:\CUI

2. Select the file of the remote station for which the time will be set, and open it with a text editor.

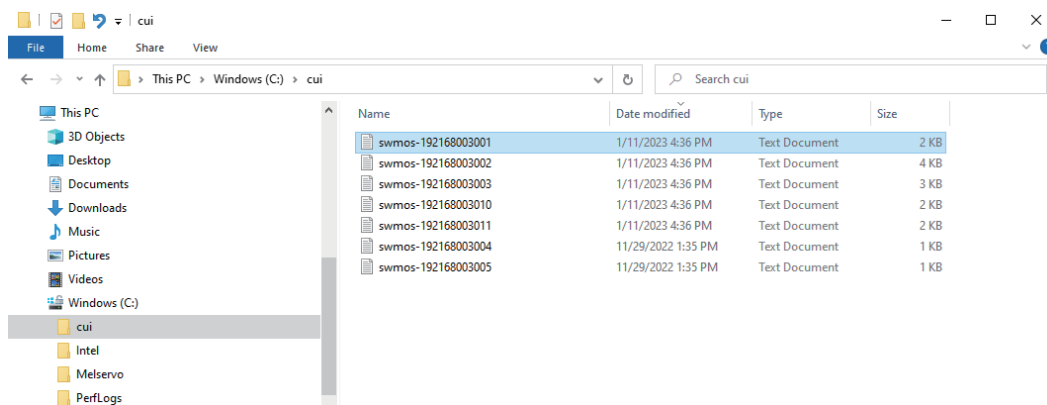

3. The CUI file of the selected remote station is displayed.

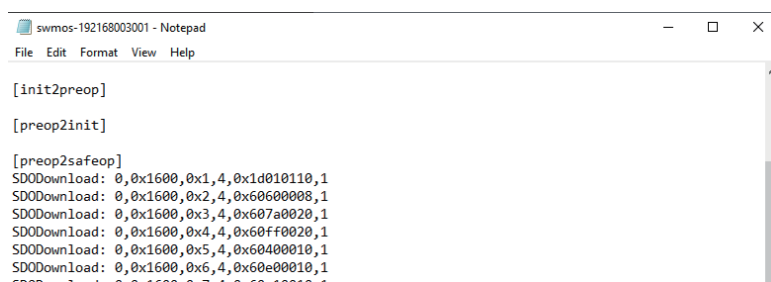

4. Add a command to the [preop2safeop] section of the CUI file.

The contents of the command specify the time difference between UTC and Japan in minutes. (Example: 9 hours × 60 minutes = 540 minutes)

Command added to the CUI file

```
SlmpSend: 0,0x3062, 0x00, 0, 0, 540, 0
```

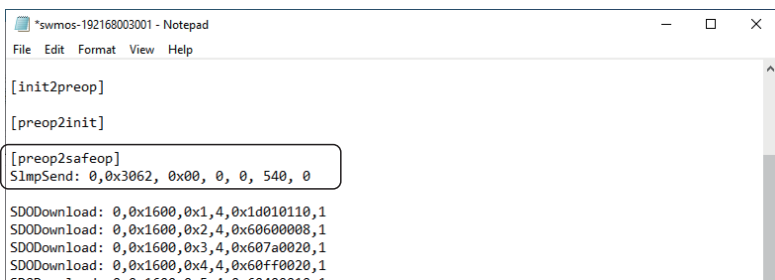

5. When the command has been added to the CUI file, save the CUI file and close it.

Point

For details of CUI file operation commands, refer to the following.

 SWM-G User Manual

■ Network configuration setting with IETSN Configurator

1. Select [SWM-G] ⇒ [IETSN Configurator] from the Windows start menu to start IETSN Configurator.
2. The "CC-Link IE Network Configurator" screen appears. Select the remote station for which the time will be set from the tree on the "CC-Link IE Network Configurator" screen and click [CUI Editor] ⇒ [Open] (1) in the ribbon.

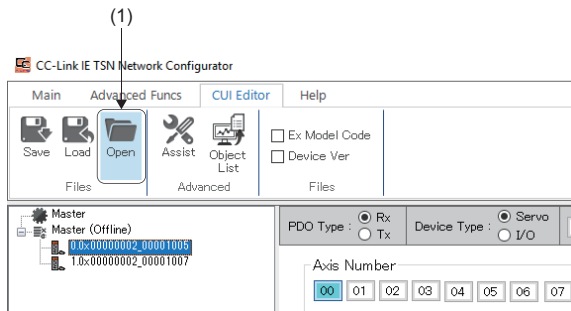

3. The CUI file of the selected remote station is displayed.

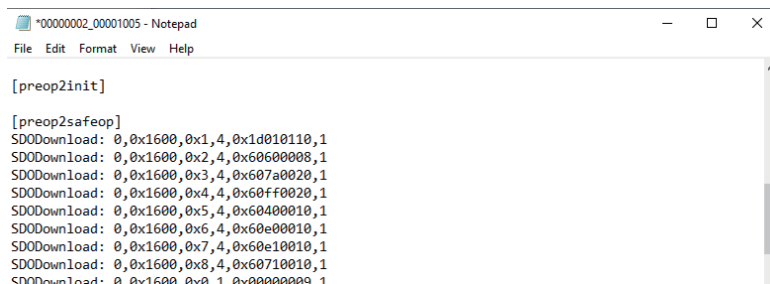

4. Add a command to the [preop2safeop] section of the CUI file. The contents of the command specify the time difference between UTC and Japan in minutes. (Example: 9 hours x 60 minutes = 540 minutes)

Command added to the CUI file

SlmpSend: 0,0x3062, 0x00, 0, 0, 540, 0



5. When the command has been added to the CUI file, save the CUI file and close it.

Point

For details of CUI file operation commands, refer to the following.

SWM-G User Manual

MEMO

REVISIONS

*The manual number is given on the bottom left of the back cover.

Revision date	*Manual number	Description
February 2021	IB(NA)-0300562ENG-A	First edition
November 2021	IB(NA)-0300562ENG-B	■Added or modified parts Chapter 6
June 2022	IB(NA)-0300562ENG-C	■Added or modified parts Appendix 6
February 2023	IB(NA)-0300562ENG-D	■Added or modified parts Chapter 1, 4, 6, Section 1.2, 2.1, 4.1, 4.2, 4.3, Appendix 1, 2, 3, 5, 6, 7
May 2023	IB(NA)-0300562ENG-E	■Added or modified parts Section 1.1, 4.1, 4.4, Appendix 1, 2, 4,

Japanese manual number: IB-0300559-E

This manual confers no industrial property rights of any other kind, nor does it confer any patent licenses. Mitsubishi Electric Corporation cannot be held responsible for any problems involving industrial property rights which may occur as a result of using the contents noted in this manual.

© 2021 MITSUBISHI ELECTRIC CORPORATION

WARRANTY

Please confirm the following product warranty details before using this product.

1. Gratis Warranty Term and Gratis Warranty Range

If any faults or defects (hereinafter "Failure") found to be the responsibility of Mitsubishi occurs during use of the product within the gratis warranty term, the product shall be repaired at no cost via the sales representative or Mitsubishi Service Company.

However, if repairs are required onsite at domestic or overseas location, expenses to send an engineer will be solely at the customer's discretion. Mitsubishi shall not be held responsible for any re-commissioning, maintenance, or testing on-site that involves replacement of the failed module.

[Gratis Warranty Term]

For terms of warranty, please contact your original place of purchase.

[Gratis Warranty Range]

- (1) The range shall be limited to normal use within the usage state, usage methods and usage environment, etc., which follow the conditions and precautions, etc., given in the instruction manual, user's manual and caution labels on the product.
- (2) Even within the gratis warranty term, repairs shall be charged for in the following cases.
 1. Failure occurring from inappropriate storage or handling, carelessness or negligence by the user. Failure caused by the user's hardware or software design.
 2. Failure caused by unapproved modifications, etc., to the product by the user.
 3. When the Mitsubishi product is assembled into a user's device, Failure that could have been avoided if functions or structures, judged as necessary in the legal safety measures the user's device is subject to or as necessary by industry standards, had been provided.
 4. Failure that could have been avoided if consumable parts (battery, backlight, fuse, etc.) designated in the instruction manual had been correctly serviced or replaced.
 5. Failure caused by external irresistible forces such as fires or abnormal voltages, and Failure caused by force majeure such as earthquakes, lightning, wind and water damage.
 6. Failure caused by reasons unpredictable by scientific technology standards at time of shipment from Mitsubishi.
 7. Any other failure found not to be the responsibility of Mitsubishi or that admitted not to be so by the user.

2. Onerous repair term after discontinuation of production

- (1) Mitsubishi shall accept onerous product repairs for seven (7) years after production of the product is discontinued. Discontinuation of production shall be notified with Mitsubishi Technical Bulletins, etc.
- (2) Product supply (including repair parts) is not available after production is discontinued.

3. Overseas service

Overseas, repairs shall be accepted by Mitsubishi's local overseas FA Center. Note that the repair conditions at each FA Center may differ.

4. Exclusion of loss in opportunity and secondary loss from warranty liability

Regardless of the gratis warranty term, Mitsubishi shall not be liable for compensation to:

- (1) Damages caused by any cause found not to be the responsibility of Mitsubishi.
- (2) Loss in opportunity, lost profits incurred to the user by Failures of Mitsubishi products.
- (3) Special damages and secondary damages whether foreseeable or not, compensation for accidents, and compensation for damages to products other than Mitsubishi products.
- (4) Replacement by the user, maintenance of on-site equipment, start-up test run and other tasks.

5. Changes in product specifications

The specifications given in the catalogs, manuals or technical documents are subject to change without prior notice.

TRADEMARKS

Microsoft, Visual C++, Visual Studio, and Windows are either registered trademarks or trademarks of Microsoft Corporation in the United States and/or other countries.

Intel is a registered trademark or a trademark of Intel Corporation in the United States and/or other countries.

The company names, system names, and product names mentioned in this manual are either registered trademarks or trademarks of their respective companies.

In some cases, trademark symbols such as [™] or [®] are not specified in this manual.

IB(NA)-0300562ENG-E(2305)

MODEL: SWMG-U-S-E

MITSUBISHI ELECTRIC CORPORATION

HEAD OFFICE: TOKYO BLDG., 2-7-3, MARUNOUCHI, CHIYODA-KU, TOKYO 100-8310, JAPAN
NAGOYA WORKS: 1-14, YADA-MINAMI 5-CHOME, HIGASHI-KU, NAGOYA 461-8670, JAPAN

When exported from Japan, this manual does not require application to the
Ministry of Economy, Trade and Industry for service transaction permission.

Specifications subject to change without notice.