

Programmable Controller

Transition from MELSEC-AnS/QnAS (Small Type) Series to L Series Handbook

(Fundamentals)

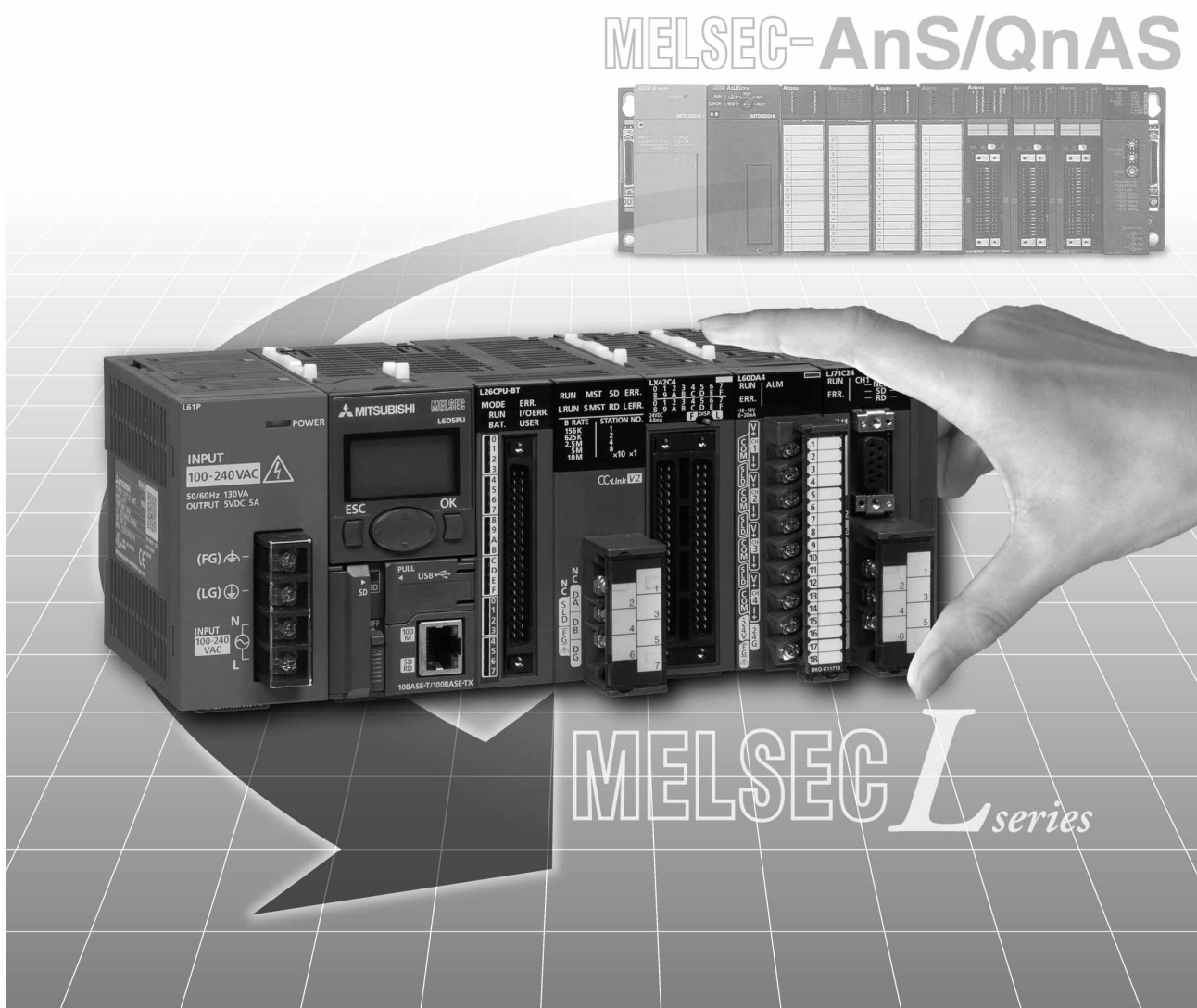

Apr. 2018 Edition

● SAFETY PRECAUTIONS ●

(Read these precautions before using this product.)

Before using this product, please read this handbook and the relevant manuals carefully and pay full attention to safety to handle the product correctly.

In this manual, the safety precautions are classified into two levels: "⚠ WARNING" and "⚠ CAUTION"



Indicates that incorrect handling may cause hazardous conditions, resulting in death or severe injury.



Indicates that incorrect handling may cause hazardous conditions, resulting in minor or moderate injury or property damage.

Under some circumstances, failure to observe the precautions given under "⚠ CAUTION" may lead to serious consequences.

Make sure that the end users read this handbook and then keep the manual in a safe place for future reference.

[Design Precautions]

⚠ WARNING

- Configure safety circuits external to the programmable controller to ensure that the entire system operates safely even when a fault occurs in the external power supply or the programmable controller. Failure to do so may result in an accident due to an incorrect output or malfunction.
 - (1) Emergency stop circuits, protection circuits, and protective interlock circuits for conflicting operations (such as forward/reverse rotations or upper/lower limit positioning) must be configured external to the programmable controller.
 - (2) Machine OPR (Original Point Return) of the positioning function is controlled by two kinds of data: an OPR direction and an OPR speed. Deceleration starts when the near-point watchdog signal turns on. If an incorrect OPR direction is set, motion control may continue without deceleration. To prevent machine damage caused by this, configure an interlock circuit external to the programmable controller.
 - (3) When the CPU module detects an error during control by the positioning function, the motion slows down and stops.
 - (4) Outputs may remain on or off due to a failure of a component such as a transistor in an output circuit. Configure an external circuit for monitoring output signals that could cause a serious accident.

[Design Precautions]

WARNING

(5) When the programmable controller detects an abnormal condition, it stops the operation and all outputs are:

	L series module	AnS series module
Overcurrent or overvoltage protection of the power supply module is activated.	All outputs are turned off.	All outputs are turned off.
The CPU module detects an error such as a watchdog timer error by the self-diagnostic function.	All outputs are held or turned off according to the parameter setting.	All outputs are turned off.

Also, all outputs may be turned on if an error occurs in a part, such as an I/O control part, where the CPU module cannot detect any error. To ensure safety operation in such a case, provide a safety mechanism or a fail-safe circuit external to the programmable controller. For a fail-safe circuit example, refer to "General Safety Requirements" in the MELSEC-L CPU Module User's Manual (Hardware Design, Maintenance and Inspection)

- In an output circuit, when a load current exceeding the rated current or an overcurrent caused by a load short-circuit flows for a long time, it may cause smoke and fire. To prevent this, configure an external safety circuit, such as a fuse.
- Configure a circuit so that the programmable controller is turned on first and then the external power supply. If the external power supply is turned on first, an accident may occur due to an incorrect output or malfunction.
- Configure a circuit so that the external power supply is turned off first and then the programmable controller. If the programmable controller is turned off first, an accident may occur due to an incorrect output or malfunction.
- For the operating status of each station after a communication failure, refer to relevant manuals for each network. Incorrect output or malfunction due to a communication failure may result in an accident.
- When changing data from a peripheral device connected to the CPU module to the running programmable controller, configure an interlock circuit in the program to ensure that the entire system will always operate safely. For other forms of control (such as program modification or operating status change) of a running programmable controller, read the relevant manuals carefully and ensure that the operation is safe before proceeding. Especially, when a remote programmable controller is controlled by an external device, immediate action cannot be taken if a problem occurs in the programmable controller due to a communication failure. To prevent this, configure an interlock circuit in the program, and determine corrective actions to be taken between the external device and CPU module in case of a communication failure.
- An absolute position restoration by the positioning function may turn off the servo-on signal (servo off) for approximately 20ms, and the motor may run unexpectedly. If this causes a problem, provide an electromagnetic brake to lock the motor during absolute position restoration.
- When configuring the system using the LA1S extension base unit, ensure that no empty slot exists on the base unit. For the empty slot, attach a blank cover (A1SG60) or a dummy module (A1SG62). In addition, when using the LA1S extension base unit (LA1S51B), attach the dustproof cover included with the LA1S51B. Without this cover, inner parts of a module may fly apart at the short-circuit test or when overcurrent or overvoltage is accidentally applied to the external I/O part.

[Design Precautions]**⚠ CAUTION**

- Do not install the control lines or communication cables together with the main circuit lines or power cables. Keep a distance of 100mm or more between them. Failure to do so may result in malfunction due to noise.
- During control of an inductive load such as a lamp, heater, or solenoid valve, a large current (approximately ten times greater than normal) may flow when the output is turned from off to on. Therefore, use a module that has a sufficient current rating.
- After the CPU module is powered on or is reset, the time taken to enter the RUN status varies depending on the system configuration, parameter settings, and/or program size. Design circuits so that the entire system will always operate safely, regardless of the time.

[Installation Precautions]**⚠ WARNING**

- Shut off the external power supply (all phases) used in the system before connecting or disconnecting a module. Failure to do so may result in electric shock or cause the module to fail or malfunction.

[Installation Precautions]**⚠ CAUTION**

- Use the programmable controller in an environment that meets the general specifications in the MELSEC-L CPU Module User's Manual (Hardware Design, Maintenance and Inspection). Failure to do so may result in electric shock, fire, malfunction, or damage to or deterioration of the product.
- To interconnect modules, engage the respective connectors and securely lock the module joint levers. Incorrect interconnection may cause malfunction, failure, or drop of the module.
- Do not directly touch any conductive parts and electronic components of the module. Doing so can cause malfunction or failure of the module.
- Securely connect an extension cable to the connectors of a branch module and an extension module. After connections, check that the cable is inserted completely. Poor contact may cause malfunction.
- To mount an AnS/QnAS series module, fully insert the module fixing projection(s) located in the lower part of the module into the hole(s) in the base unit and tighten module mounting screws within the specified torque range. Incorrect interconnection or lack of the screw tightening may cause malfunction, failure, or drop of the module. Overtightening can damage the screw and/or module, resulting in drop, short circuit, or malfunction.

[Wiring Precautions]**⚠ WARNING**

- Shut off the external power supply (all phases) used in the system before wiring. Failure to do so may result in electric shock or cause the module to fail or malfunction.
- After installation and wiring, attach the included terminal cover to the module before turning it on for operation. Failure to do so may result in electric shock.

[Wiring Precautions]

CAUTION

- Individually ground the FG and LG terminals of the programmable controller with a ground resistance of 100Ω or less. Failure to do so may result in electric shock or malfunction.
- Use applicable solderless terminals and tighten them within the specified torque range. If any spade solderless terminal is used, it may be disconnected when a terminal block screw comes loose, resulting in failure.
- Check the rated voltage and terminal layout before wiring to the module, and connect the cables correctly. Connecting a power supply with a different voltage rating or incorrect wiring may cause a fire or failure.
- Do not connect outputs of multiple power supply modules in parallel. Doing so can cause the power supply modules to be overheated, resulting in a fire or failure.
- Connectors for external devices must be crimped or pressed with the tool specified by the manufacturer, or must be correctly soldered. Incomplete connections may cause short circuit, fire, or malfunction.
- Securely connect the connector to the module.
- Do not install the control lines or communication cables together with the main circuit lines or power cables. Keep a distance of 100mm or more between them. Failure to do so may result in malfunction due to noise.
- Place the cables in a duct or clamp them. If not, dangling cable may swing or inadvertently be pulled, resulting in damage to the module or cables or malfunction due to poor contact.
- Check the interface type and correctly connect the cable. Incorrect wiring (connecting the cable to an incorrect interface) may cause failure of the module and external device.
- Tighten the terminal block screws within the specified torque range. Undertightening can cause short circuit, fire, or malfunction. Overtightening can damage the screw and/or module, resulting in drop, short circuit, fire, or malfunction.
- When disconnecting the cable from the module, do not pull the cable by the cable part. For the cable with connector, hold the connector part of the cable. For the cable connected to the terminal block, loosen the terminal screw. Pulling the cable connected to the module may result in malfunction or damage to the module or cable.
- Prevent foreign matter such as dust or wire chips from entering the module. Such foreign matter can cause a fire, failure, or malfunction.
- A protective film is attached to the top of the module to prevent foreign matter, such as wire chips, from entering the module during wiring. Do not remove the film during wiring. Remove it for heat dissipation before system operation.
- To use the high-speed counter function, ground the shield cable on the encoder side (relay box) with a ground resistance of 100Ω or less. Failure to do so may cause malfunction.
- Mitsubishi Electric programmable controllers must be installed in control panels. Connect the main power supply to the power supply module in the control panel through a relay terminal block. Wiring and replacement of a power supply module must be performed by qualified maintenance personnel with knowledge of protection against electric shock.
For wiring methods, refer to the MELSEC-L CPU Module User's Manual (Hardware Design, Maintenance and Inspection).

[Startup and Maintenance Precautions]

WARNING

- Do not touch any terminal while power is on. Doing so will cause electric shock or malfunction.
- Correctly connect the battery connector. Do not charge, disassemble, heat, short-circuit, solder, or throw the battery into the fire. Also, do not expose it to liquid or strong shock.
Doing so will cause the battery to produce heat, explode, ignite, or leak, resulting in injury and fire.
- Shut off the external power supply (all phases) used in the system before cleaning the module or retightening the terminal block screws or the connector screws. Failure to do so may result in electric shock.

[Startup and Maintenance Precautions]

CAUTION

- Before performing online operations (especially, program modification, forced output, and operating status change) for the running CPU module from the peripheral device connected, read relevant manuals carefully and ensure the safety. Improper operation may damage machines or cause accidents.
- Do not disassemble or modify the modules. Doing so may cause failure, malfunction, injury, or a fire.
- Use any radio communication device such as a cellular phone or PHS (Personal Handy-phone System) more than 25cm away in all directions from the programmable controller. Failure to do so may cause malfunction.
- Shut off the external power supply (all phases) used in the system before connecting or disconnecting a module. Failure to do so may cause the module to fail or malfunction.
- Tighten the terminal block screws and the connector screws within the specified torque range. Undertightening can cause drop of the component or wire, short circuit, or malfunction. Overtightening can damage the screw and/or module, resulting in drop, short circuit, or malfunction.
- After the first use of the product (module, display unit, and terminal block), the number of connections/disconnections is limited to 50 times (in accordance with IEC 61131-2). Exceeding the limit may cause malfunction.
- After the first use of the SD memory card, the number of insertions/removals is limited to 500 times. Exceeding the limit may cause malfunction.
- Do not drop or apply shock to the battery to be installed in the module. Doing so may damage the battery, causing the battery fluid to leak inside the battery. If the battery is dropped or any shock is applied to it, dispose of it without using.
- Before handling the module, touch a conducting object such as a grounded metal to discharge the static electricity from the human body. Failure to do so may cause the module to fail or malfunction.
- Before testing the operation by the positioning function, set a low speed value for the speed limit parameter so that the operation can be stopped immediately upon occurrence of a hazardous condition.

[Disposal Precautions]

CAUTION

- When disposing of this product, treat it as industrial waste. When disposing of batteries, separate them from other wastes according to the local regulations. For details on battery regulations in EU member states, refer to the MELSEC-L CPU Module User's Manual (Hardware Design, Maintenance and Inspection).

[Transportation Precautions]

CAUTION

- When transporting lithium batteries, follow the transportation regulations. For details on the regulated models, refer to the MELSEC-L CPU Module User's Manual (Hardware Design, Maintenance and Inspection).

● CONDITIONS OF USE FOR THE PRODUCT ●

- (1) Mitsubishi programmable controller ("the PRODUCT") shall be used in conditions;
- i) where any problem, fault or failure occurring in the PRODUCT, if any, shall not lead to any major or serious accident; and
 - ii) where the backup and fail-safe function are systematically or automatically provided outside of the PRODUCT for the case of any problem, fault or failure occurring in the PRODUCT.

- (2) The PRODUCT has been designed and manufactured for the purpose of being used in general industries.

MITSUBISHI SHALL HAVE NO RESPONSIBILITY OR LIABILITY (INCLUDING, BUT NOT LIMITED TO ANY AND ALL RESPONSIBILITY OR LIABILITY BASED ON CONTRACT, WARRANTY, TORT, PRODUCT LIABILITY) FOR ANY INJURY OR DEATH TO PERSONS OR LOSS OR DAMAGE TO PROPERTY CAUSED BY the PRODUCT THAT ARE OPERATED OR USED IN APPLICATION NOT INTENDED OR EXCLUDED BY INSTRUCTIONS, PRECAUTIONS, OR WARNING CONTAINED IN MITSUBISHI'S USER, INSTRUCTION AND/OR SAFETY MANUALS, TECHNICAL BULLETINS AND GUIDELINES FOR the PRODUCT.

("Prohibited Application")

Prohibited Applications include, but not limited to, the use of the PRODUCT in;

- Nuclear Power Plants and any other power plants operated by Power companies, and/or any other cases in which the public could be affected if any problem or fault occurs in the PRODUCT.
- Railway companies or Public service purposes, and/or any other cases in which establishment of a special quality assurance system is required by the Purchaser or End User.
- Aircraft or Aerospace, Medical applications, Train equipment, transport equipment such as Elevator and Escalator, Incineration and Fuel devices, Vehicles, Manned transportation, Equipment for Recreation and Amusement, and Safety devices, handling of Nuclear or Hazardous Materials or Chemicals, Mining and Drilling, and/or other applications where there is a significant risk of injury to the public or property.

Notwithstanding the above, restrictions Mitsubishi may in its sole discretion, authorize use of the PRODUCT in one or more of the Prohibited Applications, provided that the usage of the PRODUCT is limited only for the specific applications agreed to by Mitsubishi and provided further that no special quality assurance or fail-safe, redundant or other safety features which exceed the general specifications of the PRODUCTS are required. For details, please contact the Mitsubishi representative in your region.

REVISIONS

* The handbook number is given on the bottom left of the back cover.

Print Date	* Handbook Number	Revision
Oct. 2012	L(NA)08258ENG-A	First edition
Nov. 2013	L(NA)08258ENG-B	Addition of LCPU modules and review of alternative models <div style="border: 1px solid black; padding: 2px;">Model addition</div> L02SCPU, L02SCPU-P, L06CPU, L06CPU-P, L26CPU, L26CPU-P, L63SP, LH42C4NT1P
Sep. 2014	L(NA)08258ENG-C	<div style="border: 1px solid black; padding: 2px;">Model addition</div> LY18R2A, LY28S1A, LG69 <div style="border: 1px solid black; padding: 2px;">Addition</div> Section 1.2.3, 5.3 <div style="border: 1px solid black; padding: 2px;">Partial correction</div> Chapter 3, Section 5.1, 6.1, Appendix 2.3
Jun. 2015	L(NA)08258ENG-D	<div style="border: 1px solid black; padding: 2px;">Model addition</div> LA1S extension base unit <div style="border: 1px solid black; padding: 2px;">Addition</div> Section 1.2.4, 5.4, 7.1.4 <div style="border: 1px solid black; padding: 2px;">Partial correction</div> SAFETY PRECAUTIONS, Section 1.1, 1.2.3, 5.2.2, 7.6.3, 7.6.4, Appendix 2.3
Feb. 2016	L(NA)08258ENG-E	<div style="border: 1px solid black; padding: 2px;">Partial correction</div> Cover, WARRANTY
Aug. 2016	L(NA)08258ENG-F	<div style="border: 1px solid black; padding: 2px;">Change</div> Chapter 8→Appendix 1, Appendix 1→Appendix 2, Appendix 2→Appendix 3 <div style="border: 1px solid black; padding: 2px;">Partial correction</div> Section 1.2.3, 1.2.4, 2.1, 2.2, 2.3.1, 2.4.1, 5.1, 5.2.1, 5.4.1, 5.4.6, 5.4.8, Appendix 3.2
Apr. 2018	L(NA)08258ENG-G	<div style="border: 1px solid black; padding: 2px;">Partial correction</div> GENERIC TERMS AND ABBREVIATIONS, Section 1.1, 1.2.5, 3.3
Apr. 2018	L(NA)08258ENG-H	<div style="border: 1px solid black; padding: 2px;">Partial correction</div> Front cover, back cover

Japanese Handbook Version L08254-F

This handbook confers no industrial property rights or any rights of any other kind, nor does it confer any patent licenses. Mitsubishi Electric Corporation cannot be held responsible for any problems involving industrial property rights which may occur as a result of using the contents noted in this handbook.

CONTENTS

SAFETY PRECAUTIONS	A - 1
CONDITIONS OF USE FOR THE PRODUCT	A - 7
REVISIONS	A - 8
CONTENTS	A - 9
GENERIC TERMS AND ABBREVIATIONS	A - 13

CHAPTER 1 INTRODUCTION **1 - 1 to 1 - 19**

1.1 Considerations before Selection of Alternative Models for Replacement	1 - 1
1.2 Suggestions for Transition from the AnS/QnAS (Small Type) Series to the L Series	1 - 3
1.2.1 Advantages of transition to L series	1 - 3
1.2.2 Suggestions for transition to the L series	1 - 7
1.2.3 Replacement using an upgrade tool	1 - 10
1.2.4 Suggestion for transition utilizing the LA1S extension base unit	1 - 17
1.2.5 Precautions for replacement	1 - 19

CHAPTER 2 REPLACEMENT OF CPU MODULE **2 - 1 to 2 - 23**

2.1 List of Alternative Models of CPU Module	2 - 1
2.2 CPU Module Performance Specifications	2 - 8
2.3 Functional Comparison of CPU Module	2 - 13
2.3.1 Comparison of the functions between the AnS series and L series	2 - 13
2.3.2 Comparison of the functions between the QnAS series and L series	2 - 15
2.4 Precautions for CPU Module Replacement	2 - 18
2.4.1 Memory for CPU module	2 - 18
2.4.2 Keyword registration and password registration	2 - 20
2.4.3 Write during RUN	2 - 20
2.4.4 I/O number assignment	2 - 21
2.4.5 Programming tool for the LCPU and connection cable	2 - 23

CHAPTER 3 REPLACEMENT OF I/O MODULE **3 - 1 to 3 - 78**

3.1 List of Alternative Models of I/O Module	3 - 1
3.2 Comparison of I/O Module Specifications	3 - 13
3.2.1 Comparison of input module specifications	3 - 13
3.2.2 Comparison of output module specifications	3 - 37
3.2.3 I/O combined modules	3 - 61
3.3 Precautions for I/O Module Replacement	3 - 77

CHAPTER 4 REPLACEMENT OF POWER SUPPLY MODULE **4 - 1 to 4 - 7**

4.1 List of Alternative Models of Power Supply Module	4 - 1
4.2 Comparison of Power Supply Module Specifications	4 - 2
4.3 Precautions for Power Supply Module Replacement	4 - 7

CHAPTER 5 REPLACEMENT OF BASE UNIT AND EXTENSION CABLE 5 - 1 to 5 - 17

5.1	List of Alternative Models of Base Unit and Extension Cable	5 - 1
5.2	Specifications Comparison of the Base Units	5 - 2
5.2.1	AnS/QnAS series base unit specifications	5 - 2
5.2.2	MELSEC-L series branch module and extension module	5 - 4
5.3	Width of the System After Replacement	5 - 6
5.4	LA1S Extension Base Unit	5 - 9
5.4.1	List of LA1S extension base unit models	5 - 9
5.4.2	LA1S extension base unit specifications	5 - 9
5.4.3	Applicable LCPU	5 - 9
5.4.4	Extension cable	5 - 10
5.4.5	System configuration	5 - 11
5.4.6	System equipment list	5 - 13
5.4.7	I/O addresses when the LA1S extension base unit is used	5 - 15

CHAPTER 6 MEMORY AND BATTERY REPLACEMENT 6 - 1 to 6 - 2

6.1	List of Alternative Models for Memory	6 - 1
6.2	Precautions for Memory and Battery Replacement	6 - 1

CHAPTER 7 REPLACEMENT OF PROGRAM 7 - 1 to 7 - 51

7.1	Program Replacement Procedure	7 - 4
7.1.1	Program conversion procedure from AnS/QnASCPU to LCPU	7 - 4
7.1.2	Changing programmable controller type	7 - 5
7.1.3	AnSCPU program conversion ratio	7 - 7
7.1.4	Reading (Reusing) other format files	7 - 9
7.2	Instruction Conversion	7 - 15
7.2.1	List of instructions conversion from AnSCPU to LCPU (Sequence/Basic/Application instructions)	7 - 15
7.2.2	List of instruction conversion from AnSCPU to LCPU (Dedicated instructions)	7 - 21
7.2.3	Instructions that may need a replacement at instruction conversion from AnSCPU to LCPU	7 - 24
7.2.4	Instruction conversion from QnASCPU to LCPU	7 - 27
7.2.5	Instructions that may need a replacement at instruction conversion from QnASCPU to LCPU	7 - 28
7.3	Precautions for Replacement of Parameter	7 - 29
7.3.1	Conversion from AnSCPU to LCPU	7 - 29
7.3.2	Conversion from QnASCPU to LCPU	7 - 30
7.4	Replacement of Special Relay	7 - 33
7.4.1	Replacing the AnSCPU with the LCPU	7 - 33
7.4.2	Replacing the QnASCPU with the LCPU	7 - 33
7.5	Replacement of Special Register	7 - 34
7.5.1	Replacing the AnSCPU with the LCPU	7 - 34
7.5.2	Replacing the QnASCPU with the LCPU	7 - 34
7.6	Precautions for Replacement of the MELSAP-II with the MELSAP3	7 - 35

7.6.1	Starting SFC program	7 - 35
7.6.2	Block information (SFC information device)	7 - 35
7.6.3	Specifications comparison between MELSAP-II and MELSAP3	7 - 36
7.6.4	MELSAP3 specifications comparison between QnASCPU and LCPU	7 - 37
7.6.5	SFC diagram that cannot be read normally in another format	7 - 38
7.7	Precautions for Program Replacement	7 - 39
7.7.1	List of applicable devices	7 - 39
7.7.2	I/O control method	7 - 41
7.7.3	Usable data format for instructions	7 - 41
7.7.4	Timer	7 - 42
7.7.5	Counter	7 - 43
7.7.6	Display instructions	7 - 43
7.7.7	Index register	7 - 44
7.7.8	Instructions where format is changed (Excluding AnUSCPU dedicated instructions)	7 - 46
7.7.9	AnUSCPU dedicated instruction	7 - 47
7.7.10	Setting method when multiple sequence programs are created	7 - 48
7.7.11	Precautions for file register replacement	7 - 50
7.7.12	Boot run method (Writing programs to ROM)	7 - 51

APPENDICES
APPX- 1 to APPX - 6

Appendix 1	External Dimensions	APPX - 1
Appendix 2	Spare Parts Storage	APPX - 1
Appendix 3	Relevant Manuals	APPX - 2
Appendix 3.1	Replacement handbooks	APPX - 2
Appendix 3.2	AnS series manuals	APPX - 3
Appendix 3.3	L series manuals	APPX - 5
Appendix 3.4	Programming tool manuals	APPX - 6

- For the products shown in handbooks for transition, catalogues, and transition examples, refer to the manuals for the relevant products and check the detailed specifications, precautions for use, and restrictions before replacement.

For the products manufactured by Mitsubishi Electric Engineering Co., Ltd., Mitsubishi Electric System & Service Co., Ltd., and other companies, refer to the catalogue for each product and check the detailed specifications, precautions for use, and restrictions before use.

The manuals and catalogues for our products, products manufactured by Mitsubishi Electric Engineering Co., Ltd., and Mitsubishi Electric System & Service Co., Ltd. are shown in Appendix of each handbook for transition.

- Products shown in this handbook are subject to change without notice.

GENERIC TERMS AND ABBREVIATIONS

Unless otherwise specified, this handbook uses the following generic terms and abbreviations.

Generic term/abbreviation	Description
■ Series	
A series	The abbreviation for large types of Mitsubishi Electric MELSEC-A series programmable controllers
AnS series	The abbreviation for compact types of Mitsubishi Electric MELSEC-A series programmable controllers
A/AnS series	A generic term for A series and AnS series
QnA series	The abbreviation for large types of Mitsubishi Electric MELSEC-QnA series programmable controllers
QnAS series	The abbreviation for compact types of Mitsubishi Electric MELSEC-QnA series programmable controllers
QnA/QnAS series	A generic term for QnA series and QnAS series
A/AnS/QnA/QnAS series	A generic term for A series, AnS series, QnA series, and QnAS series
Q series	The abbreviation for Mitsubishi Electric MELSEC-Q series programmable controllers
L series	The abbreviation for Mitsubishi Electric MELSEC-L series programmable controllers
■ CPU module type	
CPU module	A generic term for A series, AnS series, QnA series, QnAS series, Q series, and L series CPU modules
Universal model QCPU	A generic term for the Q00U(J)CPU, Q01UCPU, Q02UCPU, Q03UD(E)CPU, Q03UDVCPU, Q04UD(E)HCPU, Q04UDVCPU, Q06UD(E)HCPU, Q06UDVCPU, Q10UD(E)HCPU, Q13UD(E)HCPU, Q13UDVCPU, Q20UD(E)HCPU, Q26UD(E)HCPU, and Q26UDVCPU
LCPU	A generic term for the L02SCPU, L02SCPU-P, L02CPU, L02CPU-P, L06CPU, L06CPU-P, L26CPU, L26CPU-P, L26CPU-BT, and L26CPU-PBT
■ CPU module model	
ACPU	A generic term for MELSEC-A series CPU modules
AnSCPU	A generic term for MELSEC-AnS series CPU modules
AnNCP	A generic term for the A1NCP, A1NCPUP21/R21, A1NCPUP21-S3, A2NCP, A2NCP-S1, A2NCPUP21/R21, A2NCPUP21/R21-S1, A2NCPUP21-S3(S4), A3NCP, A3NCPUP21/R21, and A3NCPUP21-S3
AnACPU	A generic term for the A2ACPU, A2ACPU-S1, A3ACPU, A2ACPUP21/R21, A2ACPUP21/R21-S1, and A3ACPUP21/R21
AnUCPU	A generic term for the A2UCPU, A2UCPU-S1, A3UCPU, and A4UCPU
AnUS(H)CPU	A generic term for the A2USCPU, A2USCPU-S1, A2USHCPU-S1
A/AnSCPU	A generic term for MELSEC-A series and -AnS series CPU modules
AnN/AnACPU	A generic term for the AnNCP and AnACPU
AnN/AnA/AnSCPU	A generic term for the AnNCP, AnACPU, and AnSCPU
QnACPU	A generic term for MELSEC-QnA series CPU modules
QnASCPU	A generic term for MELSEC-QnAS series CPU modules
QnA/QnASCPU	A generic term for MELSEC-QnA series and -QnAS series CPU modules
A/AnS/QnA/QnASCPU	A generic term for MELSEC-A series, -AnS series, -QnA series, and -QnAS series CPU modules
QCPU	A generic term for MELSEC-Q series CPU modules
LCPU	A generic term for MELSEC-L series CPU modules

1 INTRODUCTION

1.1 Considerations before Selection of Alternative Models for Replacement

This transition handbook describes the model selection of CPU modules and I/O modules after replacing models, for the transition from the MELSEC-AnS/QnAS series to the MELSEC-L series. At the transition from MELSEC-AnS/QnAS series to MELSEC-L series, some items such as the replacement procedure, installation location, specifications comparisons between existing modules and replaced modules, and replacement method are required to be considered beforehand. The following shows major options. Consider them sufficiently in advance. (It is necessary to understand the existing system configuration before making considerations)

(Major items required to be considered in advance)

1) Installation location

- a) Whether sufficient space can be secured, because the mounting method is changed from one where modules are mounted on a base unit (MELSEC-AnS/QnAS series) to a configuration where no base unit is required (MELSEC-L series) and modules are connected with a DIN rail.
- b) Whether the transition from the existing system takes place step by step (replacing only the existing CPU module with an L series CPU module, for instance) or the whole transition takes place at one time. If the step-by-step method is taken, which module is to be used continuously?
- c) Whether sufficient space can be secured if the installation of an additional base unit is required for the replacement.

2) Replacement schedule

3) Model selection after replacing models (I/O module)

- a) Whether a module whose specifications (including rated input current) and functions are equivalent to that of the existing module exists or not in the L series.
- b) Whether to use the existing module continuously or to replace the module with an L series module.
- c) Whether to use the existing external wiring or to newly wire the system.

4) Model selection after replacing models (intelligent function module (such as analog and high-speed counter modules))

- a) Whether the specifications of replaced modules and connection external device match or not.
- b) Eight channel modules are needed in terms of analog modules or two modules are needed for replacement when voltage and current ones coexist. Whether the maximum number of connectable modules is not exceeded.

- 5) **Model selection after replacing models (communication module (computer link module))**
 - a) Whether the communication target device is compatible with the L series module commands in the communication using the MC protocol or not.
 - b) Whether the communication target device software (program) can be changed to L series CPU-compatible or not.
- 6) **Model selection after replacing models (communication module (Ethernet module))**
 - a) When the replacement of MELSECNET (II) takes place step-by-step, is it already examined whether the existing network using local station modules can be maintained by utilizing the LA1S extension base unit?
 - b) Whether the communication target device is compatible with the L series module commands in the communication using the MC protocol or not.
 - c) Whether the communication target device software (program) can be changed to L series CPU-compatible or not.
- 7) **Model selection after replacing models (network module (MELSECNET (II)))**
 - a) When the replacement of MELSECNET (II) takes place step-by-step, is it already examined whether the existing network using local station modules can be maintained by utilizing the LA1S extension base unit?
 - b) If the existing network cannot be maintained, the replacement with CC-Link IE is required, and thus batch replacement with Q/LCPUs must be performed for all stations. Is the feasibility already examined?
 - c) The replacement with CC-Link IE requires new installation of communication cables. Is the feasibility already examined?
In addition, is the station-to-station distance and overall cable distance already examined?
- 8) **Model selection after replacing models (network module (MELSECNET/MINI(-S3)))**
 - a) Whether a new communication cable installation has been considered or not at the replacement from MELSECNET/MINI(-S3) to CC-Link.
- 9) **Program utilization**
 - a) Whether using the program in the existing system or creating a new program.
 - b) Whether the workload and cost of correction have been considered or not when using the program of intelligent function module and communication module (nonprocedural mode).

☒ Point

This replacement handbook gives description as transition from the AnS/QnAS series to the L series. If the transition is found to be difficult while considered, use the existing AnS/QnAS series modules by utilizing the LA1S extension base unit or consider the replacement with Universal model QCPUs. For the replacement with Universal model QCPUs, refer to the following.
Transition from MELSEC-AnS/QnAS (Small Type) Series to Q Series Handbook (Fundamentals)
L08219ENG

1.2 Suggestions for Transition from the AnS/QnAS (Small Type) Series to the L Series

1.2.1 Advantages of transition to L series

(1) Advanced performance of device (Tact time reduction)

The L series includes faster operation processing speed, faster bus speed and dual processors of Super MSP (MELSEC SEQUENCE PROCESSOR) and general-purpose processor to provide approximately five times more efficient processing than the AnS/QnAS series, and realizes more advanced performance of device.

(2) Flexible configuration without a base unit

The L series does not need a base unit. Installation in the minimum space is possible, without the restriction by a base unit size.

Also, adding a module is not restricted by the number of base slots, and the system cost for addition of an extension base unit can be suppressed.

(3) Improved maintainability

(a) The Ethernet ports and USB ports enable the program reading/writing time to be greatly reduced, resulting in improvement of on-site maintainability.

In the case of direct connection through Ethernet, the IP address setting on the personal computer need not be changed and connection with the network in use is available.

(b) Flash ROM is used for the program memory, and ROM operation (battery-less operation) can be performed without a memory card.

(c) As large files can be managed, old programs can be stored as revision history in memory.

(4) System cost reduction by built-in functions

An LCPU is equipped with the following built-in functions.

Flexible combinations of the built-in functions make the dedicated function modules unnecessary and enable a variety types of control while reducing the system cost.

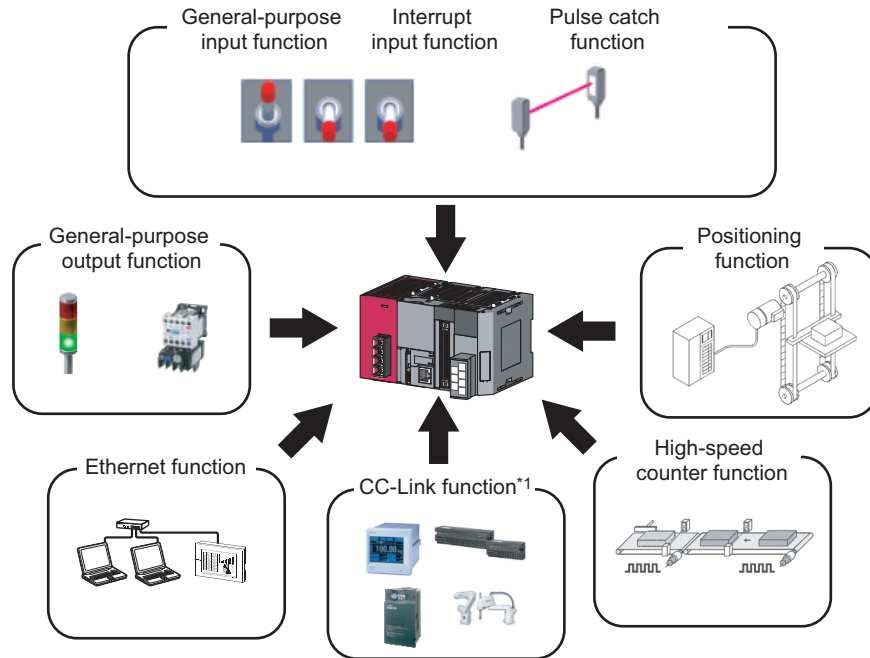

*1 The CC-Link function can be used with L26CPU-BT and L26CPU-PBT.

(a) Built-in I/O function

Functions		Features
Positioning function ^{*2}		Maximum speed: 200K pulse High-speed start: 30μs (shortest) S-curve acceleration and deceleration are supported. *Can replace an A1SD75P2 positioning module (pulse train output).
High-speed counter function ^{*2}		Maximum count: 200K pulse Open collector, differential line driver input High-precision ON/OFF measurement in increments of 5μs High-precision PWM control max. 200kHz (high-speed pulse output) *Can replace A1SD62/A1SD62D high-speed counter modules.
Pulse catch function		Minimum input response time: 10μs Can detect pulse signals having shorter ON time than scan time. *Can replace an A1SP60 pulse catch module.
Interrupt input function		A built-in function, resulting in high speed. Regarding all input points, interrupt input is supported. *Can replace an A1SI61 interrupt module.
General-purpose input function	High speed	Number of input points: 6 Minimum input response time: 10μs 24VDC input (rated input current: 6.0mA) or differential input
	Standard	Number of input points: 10 Minimum input response time: 100μs 24VDC (rated input current: 4.1mA)
General-purpose output function ^{*1}		Number of output points: 8 Output response time: 1μs or less 5 to 24VDC (rated load current: 0.1A per point)

*1 The L02SCPU, L02CPU, L06CPU, L26CPU, and L26CPU-BT are of the sink type, L02SCPU-P, L02CPU-P, L06CPU-P, L26CPU-P, and L26CPU-PBT are of the source type.

*2 Assignment of the each signal (such as phase A, phase B and near-point dog) to be used for the high-speed counter function and the positioning function has been pre-determined, and the signals cannot be assigned arbitrarily.

(b) Built-in Ethernet function

1) Connection with a programming tool or a GOT

The CPU module can be connected with a programming tool or a GOT.

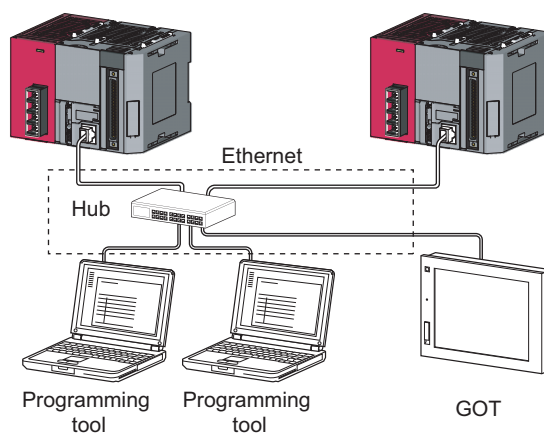

2) Direct connection with a programming tool (simple connection)

The CPU module can be directly connected with a programming tool through a single Ethernet cable (simple connection), without using a hub.

When direct connection is made, communications can be performed without setting an IP address or host name in terms of connection destination specification.

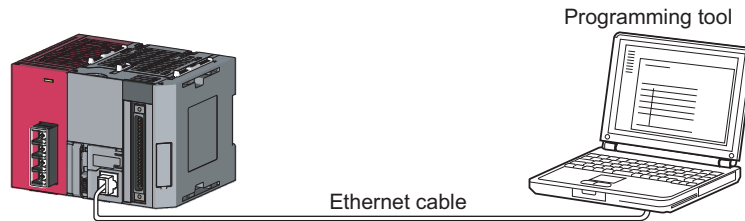

3) Communications using the MC protocol

Communications using the MC protocol can be performed through the built-in Ethernet port. The device data of the CPU module can be written and read using the MC protocol from a personal computer or a display.

CPU module operation monitoring, data analysis, and production management can be performed with devices such as a personal computer and a display, by writing and reading device data. In addition, illegal access from the outside can be protected with the remote password function.

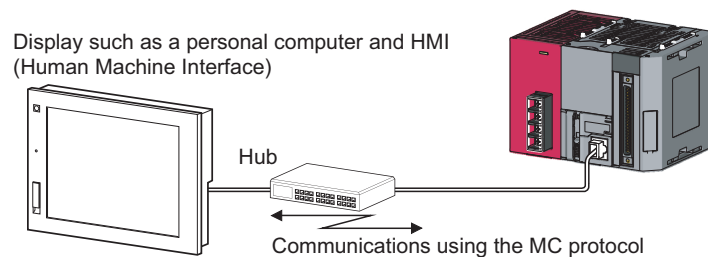

(c) Built-in CC-Link function (L26CPU-BT/-PBT only)

The built-in CC-Link function enables communications at master/local stations which support CC-Link Ver. 2.0.

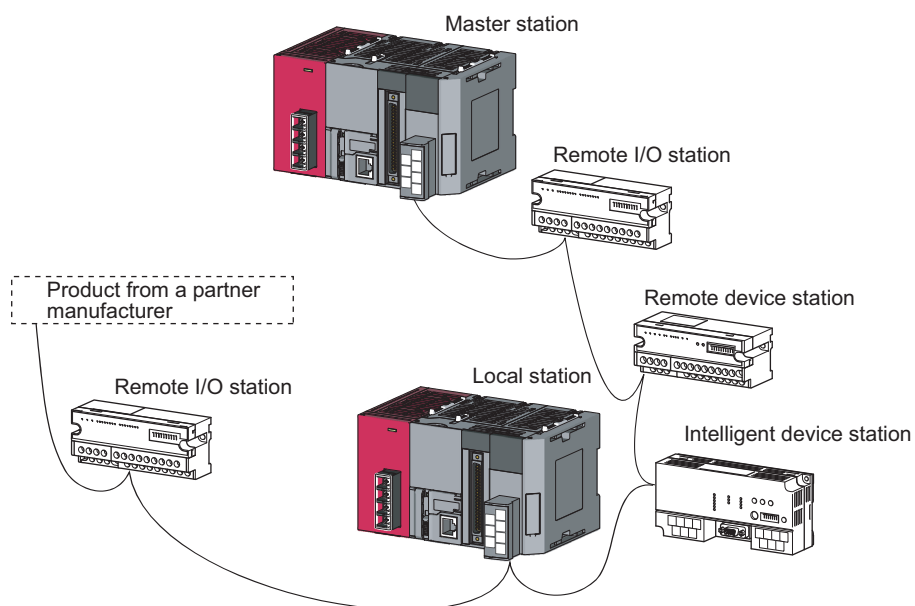

1.2.2 Suggestions for transition to the L series

(1) Replacing the CPU module with the LCPU, and replacing the existing AnS/QnAS series modules with the built-in functions or L series modules

Method: Replace the existing AnS/QnAS series modules with the built-in functions of the LCPU or L series modules.

If there is no L series module equivalent to the existing module, use FA goods.

Advantage: A configuration that requires no base unit is employed, and much less space is needed inside the control panel.

Because various types of built-in I/O-relevant control functions can be flexibly combined to expand functions, dedicated function modules are not needed and the system cost can be reduced.

Use of an upgrade tool and FA goods enables easy transition to the L series.

- Existing AnS/QnAS series

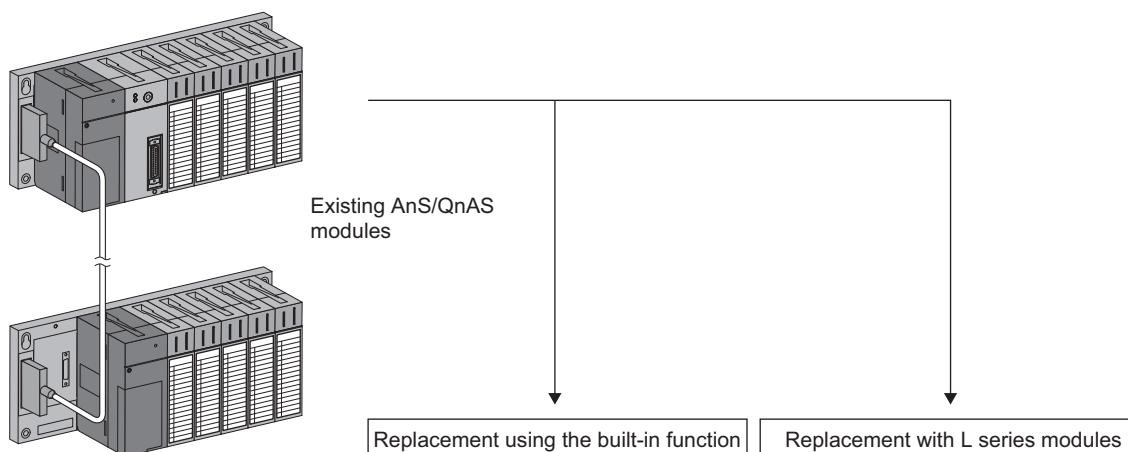

- L series after replacement (no base unit required, arbitrary combination on a DIN rail)

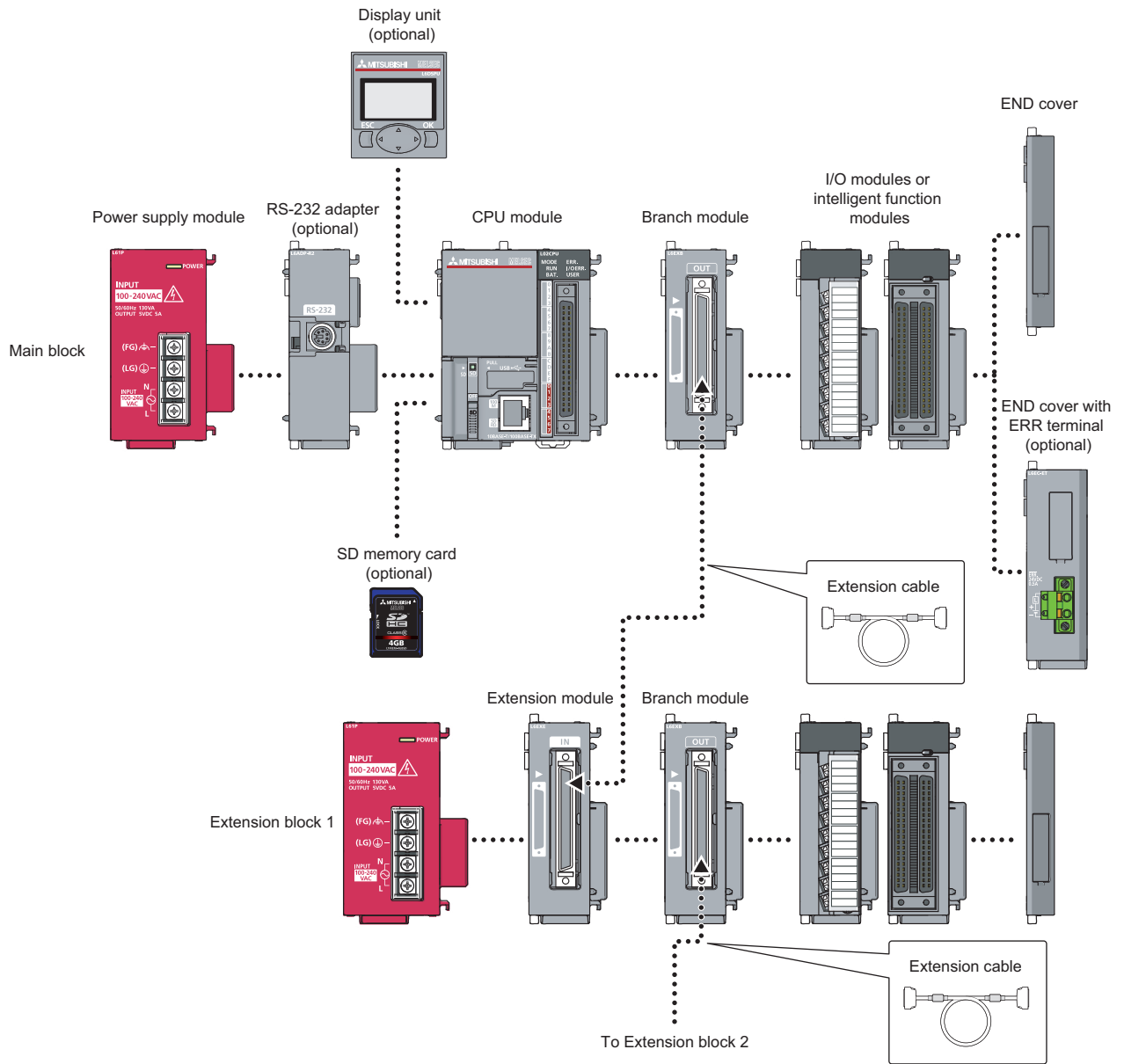

(Configuration after module combination)

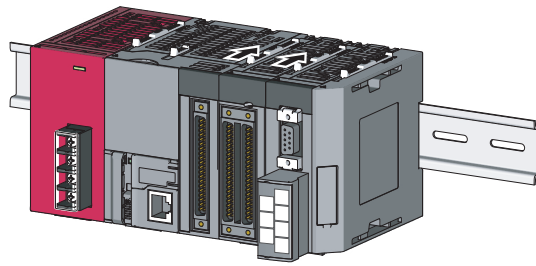

Replacement procedures:

Step 1

- Remove the existing AnS/QnAS (Small Type) series module with the base unit, then attach the DIN rail for mounting the L series.

Mounting area is as shown below. When the number of modules is the same, mounting is possible within the current mounting area.

- AnS main base unit (A1S38B), H × W: 130mm × 430mm
- L series (configured with a power supply module (L02CPU), eight L series modules, and an END cover), H × W: 90mm × 350mm

When the existing base unit is of a DIN rail mounting type, it can be used as an L series which requires DIN rail replacement.

- Mount the each module selected as replacement modules, to the DIN rail.

Step 2

- For the terminal block type module, remove the wiring of the existing AnS/QnAS (Small Type) series module, and rearrange the wiring for the L series modules mounted to the DIN rail.
The wiring of the existing AnS/QnAS (Small Type) series modules can be used as it is for the L series modules if a conversion adapter is used. For details, refer to Section 1.2.3.
- For the 40-pin connector type I/O module, only the connector can be moved without rearranging the wiring.
- When I/O modules that cannot be replaced with the L series modules are used, they can be replaced by using FA goods (such as converter modules and terminal modules, manufactured by Mitsubishi Electric Engineering Co., Ltd.).

Step 3

- Programs are automatically converted* by changing the programmable controller type from AnS/QnAS CPU to LCPU using GX Developer.
Because I/O assignment to the same numbers as before is possible even when module arrangement is changed, the program for I/O module and line numbers need not be changed.

* Some instructions are not automatically converted. In case of intelligent function module or network module, programs and parameters need be changed.

For the MELSEC-A/QnA(small type) series to L series transition related products manufactured by Mitsubishi Electric Engineering Co., Ltd. or Mitsubishi Electric System & Service Co., Ltd., please contact your local Mitsubishi representative.

1.2.3 Replacement using an upgrade tool

Method: Replace the modules using an upgrade tool. (The existing installation holes and wiring are utilized.)

Advantage: The existing wiring can be used as is, and no additional screw hole machining is required. Therefore, time required for replacement can be reduced.

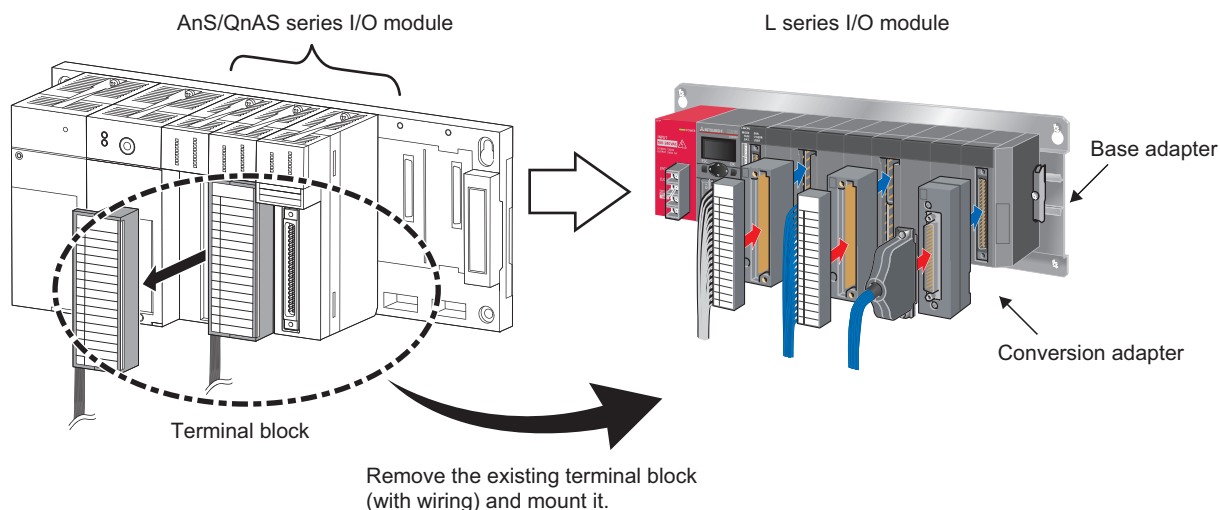

(1) Use of a conversion adapter (manufactured by Mitsubishi Electric Engineering Co., Ltd.)

Use of a conversion adapter enables the use of existing wiring connected to the terminal block or connector as is in the new system, reducing the time required for replacement.

If the wires connected to the existing terminal block are large in diameter, interference may occur between the modules and the terminal block may not be connected to a conversion adapter. In this case, connect a space module (LG69) on the left side of the module in the new system to ensure enough wiring space.

- List of conversion adapters

Module type	Existing model	Model to be replaced	Conversion adapter	LG69	Remarks	
Input module	A1SX10	LX10	ERNT-ASLTXY10	Connectable	The existing wiring can be used as is.	
	A1SX10EU					
	A1SX40	LX40C6	ERNT-ASLTX40			
	A1SX40-S2					
	A1SX80		ERNT-ASLTX80			
	A1SX80-S2					
	A1SX81	LX41C4	ERNT-ASLCXY81			Not required
A1SX81-S2						
Output module	A1SY10	LY10R2	ERNT-ASLTXY10	Connectable	The existing wiring can be used as is.	
	A1SY10EU					
	A1SY22	LY20S6	ERNT-ASLTY22			
	A1SY40	LY40NT5P	ERNT-ASLTY40			
	A1SY40P		ERNT-ASLTY50			
	A1SY50		ERNT-ASLTY80			
	A1SY80	LY40PT5P				
	A1SY81	LY41PT1P	ERNT-ASLCXY81			Not required
A1SY81EP						
Analog input module	A1S64AD	L60AD4	ERNT-ASLT64AD	Connectable	The existing wiring can be used as is.	
Analog output module	A1S62DA	L60DA4	ERNT-ASLT62DA			

Module type	Existing model	Model to be replaced	Conversion adapter	LG69	Remarks
High-speed counter module	A1SD61	LD62	ERNT-ASLTD61	Connectable	The existing wiring can be used as is.*1
	A1SD62		ERNT-ASLTD62		

*1 The LD62 is wired with a connector. The conversion adapter enables the change from a terminal block to a connector.

(2) Use of a space module (LG69)

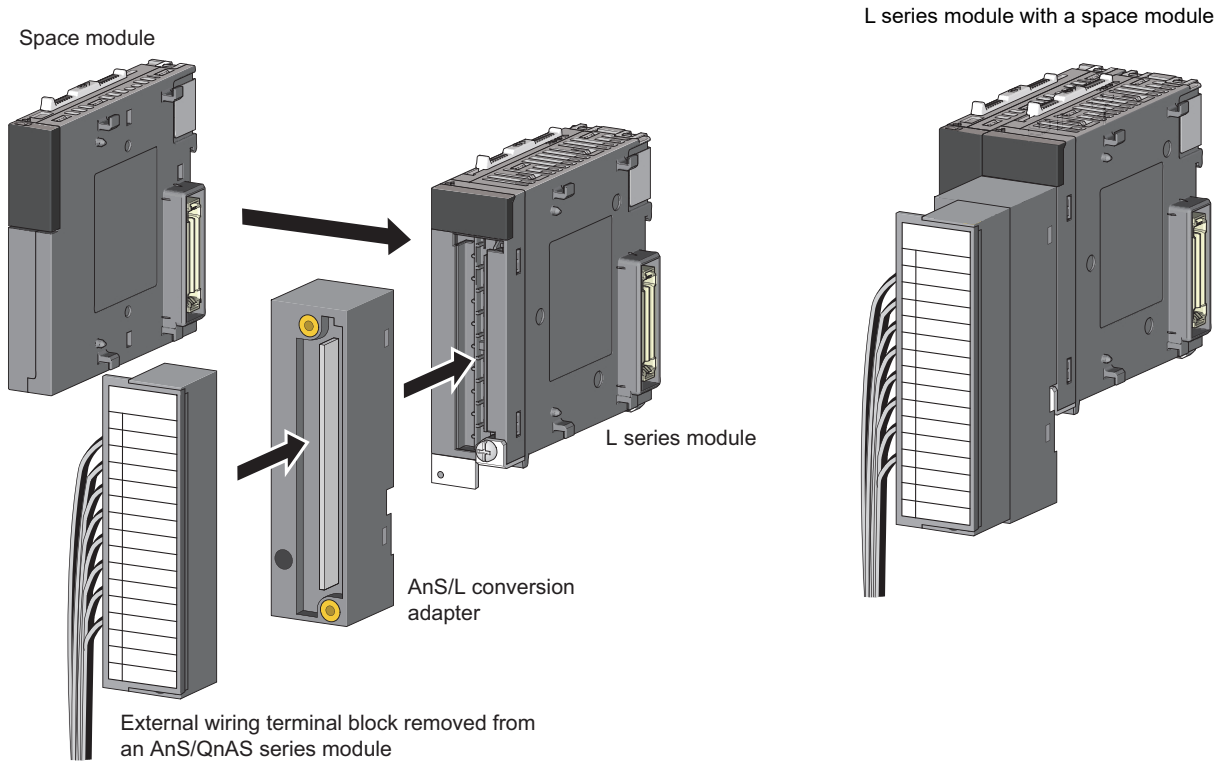

(a) Number of modules when only specified modules are used

The number of modules that can be connected to a main block will be as described below when only following L series modules are used.

Module type	Model
I/O module	LX10, LX28, LX40C6, LX41C4, LX42C4 LY10R2, LY18R2A, LY20S6, LY28S1A, LY40NT5P, LY41NT1P, LY42NT1P, LY40PT5P, LY41PT1P, LY42PT1P LH42C4NT1P, LH42C4PT1P
Analog module	L60AD4, L60DA4, L60AD2DA2, L60TCTT4, L60TCRT4, L60TCTT4BW ^{*1} , L60TCRT4BW ^{*1}
Counter module	LD62, LD62D
Positioning module	LD75P1 ^{*1} , LD75P2 ^{*1} , LD75P4 ^{*1} , LD75D1 ^{*1} , LD75D2 ^{*1} , LD75D4 ^{*1}
Network module	LJ61BT11, LJ71C24, LJ71C24-R2

^{*1} These modules occupy two module spaces. The modules without an asterisk occupy one module space.

Up to eight sets can be connected according to the counting method shown below. (To use the space module, connect only one unit on the left side of each module.)

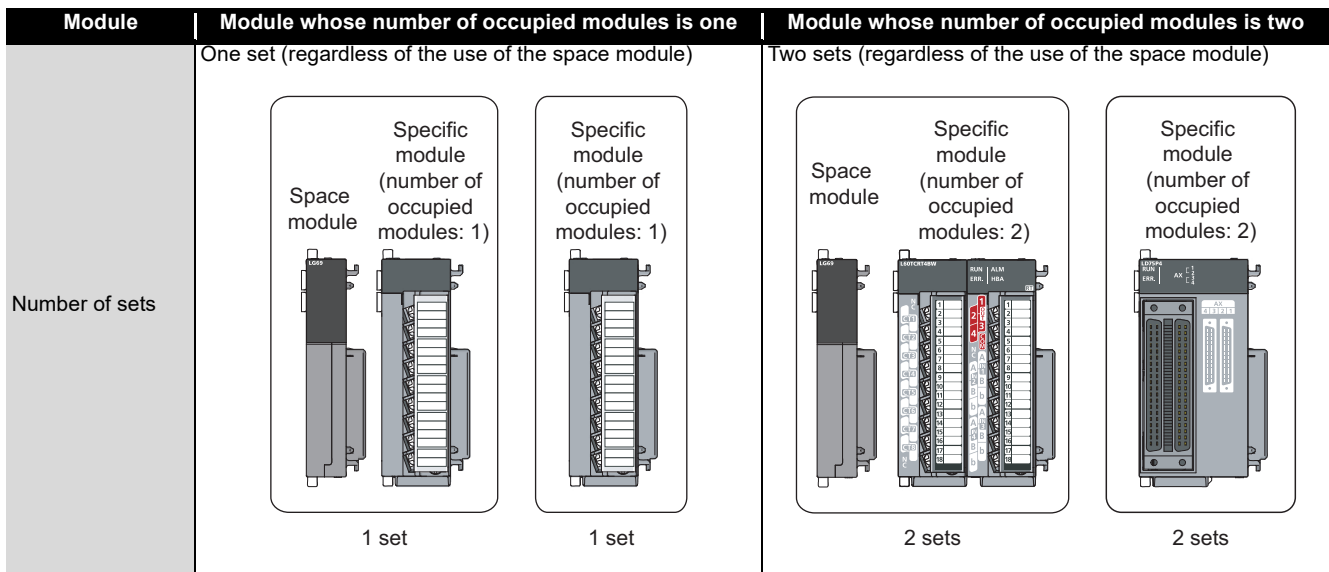

☒ Point

- When a branch module (L6EXB) is used, eight sets of modules and the branch module can be connected in a main block.
- Do not set any space module in PLC parameters (I/O assignment setting).

• Possible configuration examples

1) All modules use the space module (LG69).



●: Conversion adapter

2) Six modules use the space module (LG69) and two modules do not.

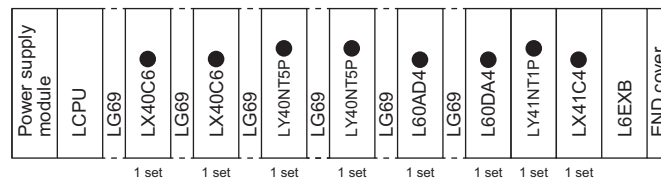

●: Conversion adapter

• Impossible configuration example

Nine sets of modules are connected.

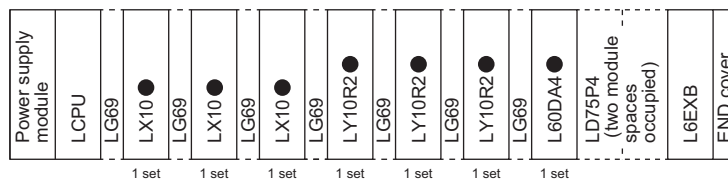

●: Conversion adapter

(b) Number of modules when modules other than specified ones are also used

Up to ten modules can be connected in a main block. As shown below, count the space module/branch module as one module.

Modules cannot be counted as a set.

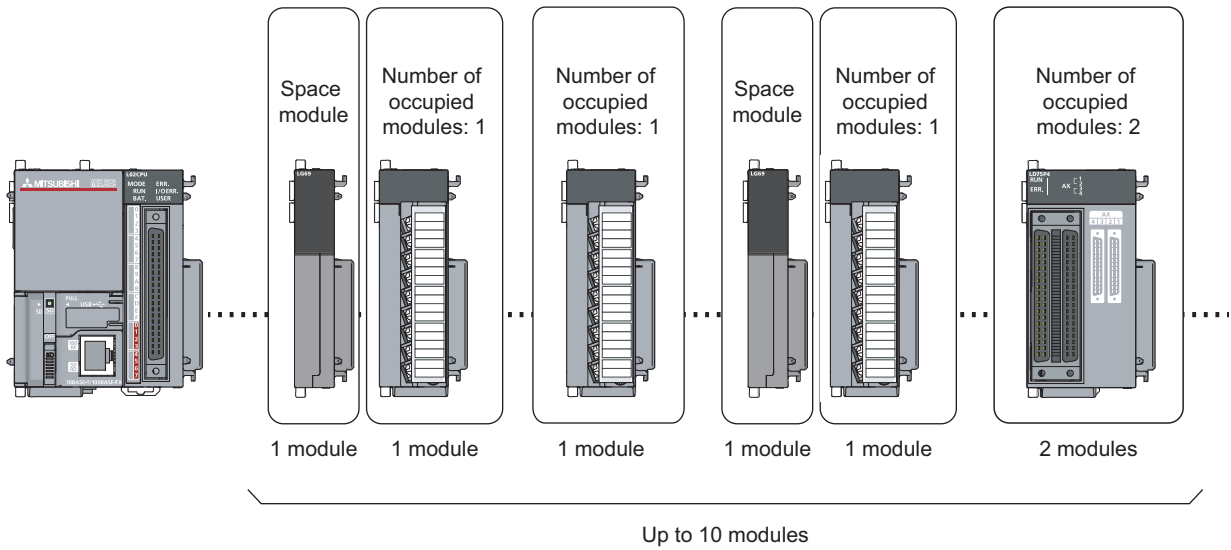

- Possible configuration example
Ten modules including the branch module (L6EXB) are connected.

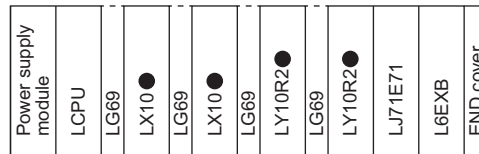

● : Conversion adapter

- Impossible configuration example
Twelve modules including the branch module (L6EXB) are connected.

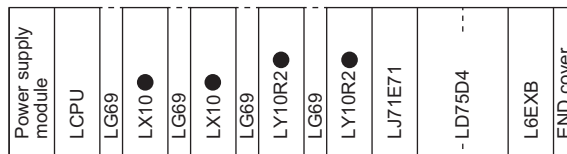

● : Conversion adapter

(3) Use of a base adapter (manufactured by Mitsubishi Electric Engineering Co., Ltd.)

Use of a DIN rail integrated base adapter enables L series module installation using the existing MELSEC-AnS/QnAS series base unit installation holes.

(a) List of base adapters

Product	AnS series model	Base adapter model
Main base unit	A1S32B	ERNT-ASLB32
	A1S33B	ERNT-ASLB33
	A1S35B	ERNT-ASLB35
	A1S38B	ERNT-ASLB38
	A1S38HB	
Extension base unit (type requiring power supply module)	A1S65B(-S1)	ERNT-ASLB65
	A1S68B(-S1)	ERNT-ASLB68
Extension base unit (type requiring no power supply module)	A1S52B(-S1)	ERNT-ASLB52
	A1S55B(-S1)	ERNT-ASLB55
	A1S58B(-S1)	ERNT-ASLB58
Integrated type	A1SJCPU	ERNT-ASLBJ
	A1SJCPU-S3	
	A1SJHCPU	

(b) How to select a base adapter

A DIN rail that is the same width as the existing AnS/QnAS series base unit is integrated with a base adapter. The number of modules mounted to a base adapter is decided by calculating the width of the system after replacement, considering the actual width and dimensional tolerance of modules.

If the width of the system after replacement is too large, consider mounting modules directly to a DIN rail.

- How to calculate the width of the system after replacement

Calculate the width of the system using the following formula.

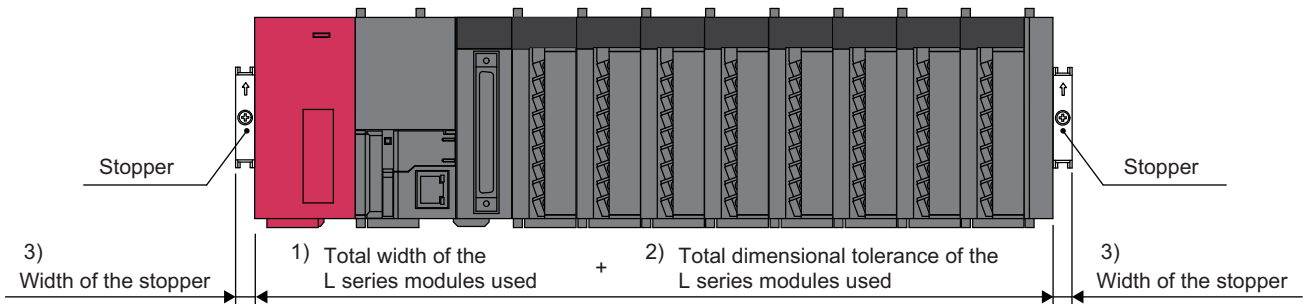

1)	2)	3)
Total width of the L series modules used	+ Total dimensional tolerance of the L series modules used	+ Total width of the stoppers
*1	*2	*3

*1 Actual width described in the manual

*2 For details, refer to Section 5.3.

*3 Width of the metal fittings used (When the metal fittings provided with a base adapter are used, the width is 9mm each (18mm for two).)

(c) Number of L series modules that can be mounted to a base adapter

AnS series base unit	Extension base unit	Base adapter	Number of modules using the LG69	Number of modules not using the LG69	AnS series base unit	Base adapter	Number of modules using the LG69	Number of modules not using the LG69	
A1S38B, A1S38HB	Not used	ERNT-ASLB38	0	8	A1S58B (-S1)	ERNT-ASLB58	0	8	
			1	7			1	7	
			2	6			2	5	
			3	4			3	4	
			4	3			4	2	
			5	1			5	0	
	Used			6	0	A1S55B (-S1)	ERNT-ASLB55	0	5
				0	8			1	3
				1	7			2	2
				2	5	3	0		
				3	3	A1S52B (-S1)	ERNT-ASLB52	0	1
				4	2			1	0
				5	0			0	8
				A1S35B	Not used	ERNT-ASLB35	0	5	A1S68B (-S1)
1	4	2	6						
2	2	3	5						
3	1	4	4						
0	5	5	2						
Used		1	3		6		1		
		2	1		0		5		
		3	0		1		4		
		A1S65B (-S1)	ERNT-ASLB65		0		3	2	3
					1		2	3	2
2	0			4	0				
0	2								
A1S33B	Not used	ERNT-ASLB33	1	1					
			2	0					
	Used		0	2					
A1S32B	Not used	ERNT-ASLB32	1	1					
			0	2					
	Used		0	1					
A1SJHCPU (-S3)	Not used	ERNT-ASLBJ	0	5					
			1	4					
			2	3					
			3	1					
	Used			0	5				
				1	3				
				2	2				
				3	0				

For the width of the system after replacement, refer to Section 5.3.

1.2.4 Suggestion for transition utilizing the LA1S extension base unit

(1) Replacing the CPU module with the LCPU, and using the existing AnS/QnAS (small type) series modules temporarily and replacing them step by step with L series module

Method: By using the LA1S extension base unit (LA1S6□B, LA1S51B), replace modules step by step while reusing AnS/QnAS series modules temporarily.

Advantage: The cost/workload for transition can be divided while functions are gradually being expanded.

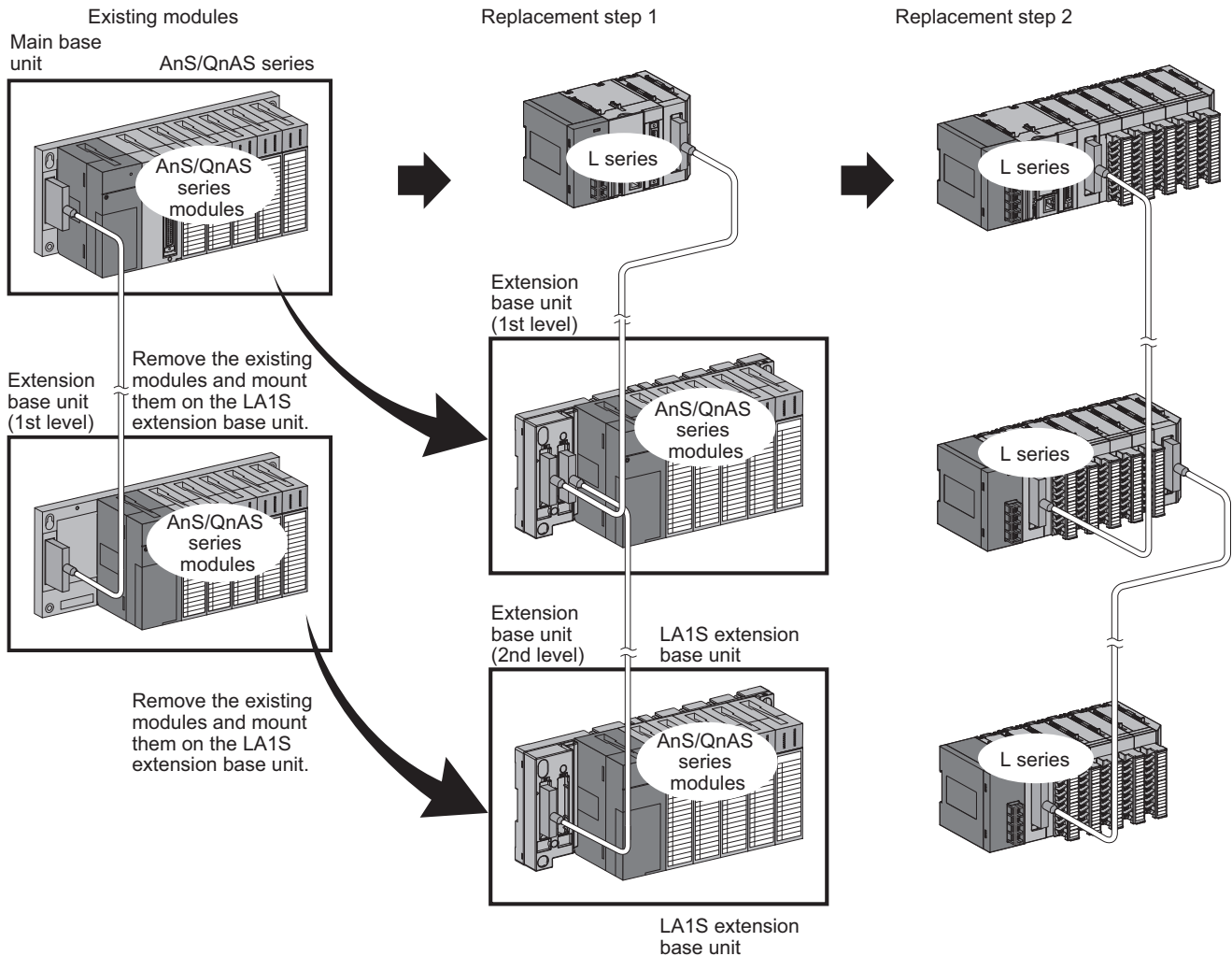

- The LA1S extension base unit has two models, LA1S6□B and LA1S51B. AnS/QnAS series modules can be reused for the transition from AnS/QnAS series.
- When existing AnS/QnAS series modules are reused, by assigning I/O using parameter settings, the programs can be reused without change of the existing I/O addresses. For details on the I/O address setting method using I/O assignment, refer to Section 5.4.7.

☒ Point

- 1) The LA1S extension base unit can be used for a LCPU with a serial number (first five digits) of "16112" or later.
 - 2) The number of connectable LA1S extension base units (including an extension block) is as follows.
 - L02SCPU(-P)/L02CPU(-P): Max. two base units
 - L06CPU(-P)/L26CPU(-P/-BT/-PBT): Max. three base units (If three or more extension base units are used in the existing system configuration, skip "Replacement step 1" and replace modules with "Replacement step 2" directly.)
 - 3) For details and precautions on the LA1S extension base unit (such as mountable AnS/QnAS series modules), refer to Section 5.4 or MELSEC-L LA1S Extension Base Unit User's Manual.
-

1.2.5 Precautions for replacement

- (1) Before replacing the A/AnS/QnA/QnAS series by the L series, be sure to refer to manuals for each L series module to check the functions, specifications, grounding method, and usage.
- (2) For products manufactured by Mitsubishi Electric Engineering Co., Ltd. and Mitsubishi Electric System & Service Co., Ltd., refer to the catalog for each product shown in Appendix to develop an understanding of the detailed specifications, precautions and restrictions for use for correct usage.
- (3) After replacing the A/AnS/QnA/QnAS series by the L series, be sure to check operations of the whole system before the actual operation.

Point

Before replacing modules, ensure that FG terminals of the programmable controller system are securely grounded to the earth.

The programmable controller maintains the noise immunity that complies with the EMC Directive by releasing the noise into the earth through FG terminals. For this reason, if the grounding is insufficient, the system may be affected by the noise when its configuration is changed. When the grounding condition is difficult to be checked, consider to take the following steps as a temporary action.

- (1) Apply the independent ground instead of the current grounding method.
 - (2) Attach a ferrite core between the ground cable and FG terminal of the module.
-

2 REPLACEMENT OF CPU MODULE

2.1 List of Alternative Models of CPU Module

The following is an example of alternative L series CPU modules that can be chosen based on compatibility with previous AnS/QnAS series CPU module.

Select the optimal modules based on the type of controls performed by the existing AnS/QnAS series CPU module as well as specifications, scalability, and cost of the system after the replacement.

AnS/QnAS series model		L series alternative model	
Product	Model	Model	Remarks (restrictions)
CPU module	A1SJHCPU	L02SCPU L02SCPU-P L02CPU L02CPU-P	1) I/O control: Selectable (refresh or direct mode) → Refresh mode only 2) Processing speed (LD instruction): During refresh 0.33μs → 0.04μs (L02CPU, L02CPU-P), 0.33μs → 0.06μs (L02SCPU, L02SCPU-P) 3) Number of I/O points: 256 → 1024 4) Number of I/O device points: 2048 → 8192 5) Program capacity: 8K steps → 20K steps 6) Number of file register points: 8K → 64K 7) Built-in function: None → Built-in I/O function and Ethernet function (L02CPU, L02CPU-P only) 8) Number of extension base unit: One base unit (max. 13 slots) → Two blocks (max. 30 modules) 9) Applicable memory: Built-in RAM or E ² PROM cassette (sold separately) → Program memory, standard RAM, standard ROM, or memory card (sold separately) (L02CPU, L02CPU-P only) 10) Microcomputer program: Available → Not available 11) Configuration: Base unit (five slots), CPU module, and power supply module are integrated. → Modules are connected. (No base unit is required.)
	A1SJHCPU-S8	L02SCPU L02SCPU-P L02CPU L02CPU-P	1) I/O control: Selectable (refresh or direct mode) → Refresh mode only 2) Processing speed (LD instruction): During refresh 0.33μs → 0.04μs (L02CPU, L02CPU-P), 0.33μs → 0.06μs (L02SCPU, L02SCPU-P) 3) Number of I/O points: 256 → 1024 4) Number of I/O device points: 2048 → 8192 5) Program capacity: 8K steps → 20K steps 6) Number of file register points: 8K → 64K 7) Built-in function: None → Built-in I/O function and Ethernet function (L02CPU, L02CPU-P only) 8) Number of extension base unit: One base unit (max. 16 slots) → Two blocks (max. 30 modules) 9) Applicable memory: Built-in RAM or E ² PROM cassette (sold separately) → Program memory, standard RAM, standard ROM, or memory card (sold separately) (L02CPU, L02CPU-P only) 10) Microcomputer program: Available → Not available 11) Configuration: Base unit (eight slots), CPU module, and power supply module are integrated. → Modules are connected. (No base unit is required.)

AnS/QnAS series model		L series alternative model	
Product	Model	Model	Remarks (restrictions)
CPU module	A1SJCPU A1SJCPU-S3	L02SCPU L02SCPU-P L02CPU L02CPU-P	<ol style="list-style-type: none"> 1) I/O control: Selectable (refresh or direct mode) → Refresh mode only 2) Processing speed (LD instruction): During refresh 1.0μs → 0.04μs (L02CPU, L02CPU-P), 1.0μs → 0.06μs (L02SCPU, L02SCPU-P) 3) Number of I/O points: 256 → 1024 4) Number of I/O device points: 256 → 8192 5) Program capacity: 8K steps → 20K steps 6) Number of file register points: 4K → 64K 7) Built-in function: None → Built-in I/O function and Ethernet function (L02CPU, L02CPU-P only) 8) Number of extension base unit: One base unit (max. 13 slots) → Two blocks (max. 30 modules) 9) Applicable memory: Built-in RAM or E²PROM cassette (sold separately) → Program memory, standard RAM, standard ROM, or memory card (sold separately) (L02CPU, L02CPU-P only) 10) Microcomputer program: Available → Not available 11) Configuration: Base unit (five slots), CPU module, and power supply module are integrated. → Modules are connected. (No base unit is required.)
	A1SHCPU	L02SCPU L02SCPU-P L02CPU L02CPU-P	<ol style="list-style-type: none"> 1) I/O control: Selectable (refresh or direct mode) → Refresh mode only 2) Processing speed (LD instruction): During refresh 0.33μs → 0.04μs (L02CPU, L02CPU-P), 0.33μs → 0.06μs (L02SCPU, L02SCPU-P) 3) Number of I/O points: 256 → 1024 4) Number of I/O device points: 2048 → 8192 5) Program capacity: 8K steps → 20K steps 6) Number of file register points: 8K → 64K 7) Built-in function: None → Built-in I/O function and Ethernet function (L02CPU, L02CPU-P only) 8) Number of extension base unit: One base unit (max. 16 slots) → Two blocks (max. 30 modules) 9) Applicable memory: Built-in RAM or E²PROM cassette (sold separately) → Program memory, standard RAM, standard ROM, or memory card (sold separately) (L02CPU, L02CPU-P only) 10) Microcomputer program: Available → Not available 11) Configuration: Modules are mounted on a base unit. → Modules are connected. (No base unit is required.)
	A1SCPU	L02SCPU L02SCPU-P L02CPU L02CPU-P	<ol style="list-style-type: none"> 1) I/O control: Selectable (refresh or direct mode) → Refresh mode only 2) Processing speed (LD instruction): During refresh 1.0μs → 0.04μs (L02CPU, L02CPU-P), 1.0μs → 0.06μs (L02SCPU, L02SCPU-P) 3) Number of I/O points: 256 → 1024 4) Number of I/O device points: 256 → 8192 5) Program capacity: 8K steps → 20K steps 6) Number of file register points: 4K → 64K 7) Built-in function: None → Built-in I/O function and Ethernet function (L02CPU, L02CPU-P only) 8) Number of extension base unit: One base unit (max. 16 slots) → Two blocks (max. 30 modules) 9) Applicable memory: Built-in RAM or E²PROM cassette (sold separately) → Program memory, standard RAM, standard ROM, or memory card (sold separately) (L02CPU, L02CPU-P only) 10) Microcomputer program: Available → Not available 11) Configuration: Modules are mounted on a base unit. → Modules are connected. (No base unit is required.)

AnS/QnAS series model		L series alternative model	
Product	Model	Model	Remarks (restrictions)
CPU module	A1SCPUC24-R2	L02SCPU L02SCPU-P	1) I/O control: Selectable (refresh or direct mode) → Refresh mode only 2) Processing speed (LD instruction): During refresh 0.33μs → 0.06μs 3) Number of I/O points: 256 → 1024 4) Number of I/O device points: 256 → 8192 5) Program capacity: 8K steps → 20K steps 6) Number of file register points: 4K → 64K 7) Built-in function: None → Built-in I/O function 8) Number of extension base unit: One base unit (max. 16 slots) → Two blocks (max. 30 modules) 9) Applicable memory: Built-in RAM or E ² PROM cassette (sold separately) → Program memory, standard RAM or standard ROM 10) Microcomputer program: Available → Not available 11) Configuration: Modules are mounted on a base unit. → Modules are connected. (No base unit is required.) 12) Built-in computer link function: Type 1 to 4, nonprocedural mode → type 4, 5 Replaceable to LJ71C24 other than type 4, 5
			1) I/O control: Selectable (refresh or direct mode) → Refresh mode only 2) Processing speed (LD instruction): During refresh 0.25μs → 0.04μs (L02CPU, L02CPU-P), 0.25μs → 0.06μs (L02SCPU, L02SCPU-P) 3) Number of I/O points: 512 → 1024 4) Number of I/O device points: 2048 → 8192 5) Program capacity: 14K steps → 20K steps 6) Number of file register points: 8K → 64K 7) Built-in function: None → Built-in I/O function and Ethernet function (L02CPU, L02CPU-P only) 8) Number of extension base unit: One base unit (max. 16 slots) → Two blocks (max. 30 modules) 9) Applicable memory: Built-in RAM or E ² PROM cassette (sold separately) → Program memory, standard RAM, standard ROM, or memory card (sold separately) (L02CPU, L02CPU-P only) 10) Microcomputer program: Available → Not available 11) Configuration: Modules are mounted on a base unit. → Modules are connected. (No base unit is required.)
	A2SHCPU	L02SCPU L02SCPU-P L02CPU L02CPU-P	1) I/O control: Selectable (refresh or direct mode) → Refresh mode only 2) Processing speed (LD instruction): During refresh 0.25μs → 0.04μs (L02CPU, L02CPU-P), 0.25μs → 0.06μs (L02SCPU, L02SCPU-P) 3) Number of I/O points: 512 → 1024 4) Number of I/O device points: 2048 → 8192 5) Program capacity: 30K steps → 20K steps 6) Number of file register points: 8K → 64K 7) Built-in function: None → Built-in I/O function and Ethernet function (L02CPU, L02CPU-P only) 8) Number of extension base unit: Three base units (max. 32 slots) → Two blocks (max. 30 modules) 9) Applicable memory: Built-in RAM or E ² PROM cassette (sold separately) → Program memory, standard RAM, standard ROM, or memory card (sold separately) (L02CPU, L02CPU-P only) 10) Microcomputer program: Available → Not available 11) Configuration: Modules are mounted on a base unit. → Modules are connected. (No base unit is required.)
			1) I/O control: Selectable (refresh or direct mode) → Refresh mode only 2) Processing speed (LD instruction): 0.25μs → 0.0095μs 3) Number of I/O points: 512 → 4096 4) Number of I/O device points: 2048 → 8192 5) Program capacity: 30K steps → 60K steps 6) Number of file register points: 8K → 384K 7) Built-in function: None → Built-in I/O function and Ethernet function 8) Number of extension base unit: Three base units (max. 32 slots) → Three blocks (max. 40 modules) 9) Applicable memory: Built-in RAM or E ² PROM cassette (sold separately) → Program memory, standard RAM, standard ROM, or memory card (sold separately) 10) Microcomputer program: Available → Not available 11) Configuration: Modules are mounted on a base unit. → Modules are connected. (No base unit is required.)

AnS/QnAS series model		L series alternative model	
Product	Model	Model	Remarks (restrictions)
CPU module	A2SCPU	L02SCPU L02SCPU-P L02CPU L02CPU-P	1) I/O control: Selectable (refresh or direct mode) → Refresh mode only 2) Processing speed (LD instruction): During refresh 1.0μs → 0.04μs (L02CPU, L02CPU-P), 1.0μs → 0.06μs (L02SCPU, L02SCPU-P) 3) Number of I/O points: 512 → 1024 4) Number of I/O device points: 512 → 8192 5) Program capacity: 14K steps → 20K steps 6) Number of file register points: 4K → 64K 7) Built-in function: None → Built-in I/O function and Ethernet function (L02CPU, L02CPU-P only) 8) Number of extension base unit: One base unit (max. 16 slots) → Two blocks (max. 30 modules) 9) Applicable memory: Built-in RAM or E ² PROM cassette (sold separately) → Program memory, standard RAM, standard ROM, or memory card (sold separately) (L02CPU, L02CPU-P only) 10) Microcomputer program: Available → Not available 11) Configuration: Modules are mounted on a base unit. → Modules are connected. (No base unit is required.)
	A2USCPU A2ASCPU	L02SCPU L02SCPU-P L02CPU L02CPU-P	1) I/O control: Refresh mode only 2) Processing speed (LD instruction): 0.2μs → 0.04μs (L02CPU, L02CPU-P), 0.2μs → 0.06μs (L02SCPU, L02SCPU-P) 3) Number of I/O points: 512 → 1024 4) Number of I/O device points: 8192 → 8192 5) Program capacity: 14K steps → 20K steps 6) Number of file register points: 8K → 64K 7) Built-in function: None → Built-in I/O function and Ethernet function (L02CPU, L02CPU-P only) 8) Number of extension base unit: One base unit (max. 16 slots) → Two blocks (max. 30 modules) 9) Applicable memory: Built-in RAM or E ² PROM cassette (sold separately) → Program memory, standard RAM, standard ROM, or memory card (sold separately) (L02CPU, L02CPU-P only) 10) Microcomputer program: Not available 11) Configuration: Modules are mounted on a base unit. → Modules are connected. (No base unit is required.) 12) Sequence instruction: AnA/AnU dedicated instructions are replaceable.* ¹
	A2USCPU-S1 A2ASCPU-S1	L06CPU L06CPU-P	1) I/O control: Refresh mode only 2) Processing speed (LD instruction): 0.2μs → 0.0095μs 3) Number of I/O points: 1024 → 4096 4) Number of I/O device points: 8192 → 8192 5) Program capacity: 14K steps → 60K steps 6) Number of file register points: 8K → 384K 7) Built-in function: None → Built-in I/O function and Ethernet function 8) Number of extension base unit: Three base units (max. 32 slots) → Three blocks (max. 40 modules) 9) Applicable memory: Built-in RAM or E ² PROM cassette (sold separately) → Program memory, standard RAM, standard ROM, or memory card (sold separately) 10) Microcomputer program: Not available 11) Configuration: Modules are mounted on a base unit. → Modules are connected. (No base unit is required.) 12) Sequence instruction: AnA/AnU dedicated instructions are replaceable.* ¹

AnS/QnAS series model		L series alternative model	
Product	Model	Model	Remarks (restrictions)
CPU module	A2USHCPU-S1	L02SCPU L02SCPU-P L02CPU L02CPU-P	1) I/O control: Refresh mode only 2) Processing speed (LD instruction): 0.09μs → 0.04μs (L02CPU, L02CPU-P), 0.09μs → 0.06μs (L02SCPU, L02SCPU-P) 3) Number of I/O points: 1024 → 1024 4) Number of I/O device points: 8192 → 8192 5) Program capacity: 30K steps → 20K steps 6) Number of file register points: 8K → 64K 7) Built-in function: None → Built-in I/O function and Ethernet function (L02CPU, L02CPU-P only) 8) Number of extension base unit: One base unit (max. 16 slots) → Two blocks (max. 30 modules) 9) Applicable memory: Built-in RAM or E ² PROM cassette (sold separately) → Program memory, standard RAM, standard ROM, or memory card (sold separately) (L02CPU, L02CPU-P only) 10) Microcomputer program: Not available 11) Configuration: Modules are mounted on a base unit. → Modules are connected. (No base unit is required.) 12) Sequence instruction: AnA/AnU dedicated instructions are replaceable.*1
		L06CPU L06CPU-P	1) I/O control: Refresh mode only 2) Processing speed (LD instruction): 0.09μs → 0.0095μs 3) Number of I/O points: 1024 → 4096 4) Number of I/O device points: 8192 → 8192 5) Program capacity: 30K steps → 60K steps 6) Number of file register points: 8K → 384K 7) Built-in function: None → Built-in I/O function and Ethernet function 8) Number of extension base unit: One base unit (max. 16 slots) → Three blocks (max. 40 modules) 9) Applicable memory: Built-in RAM or E ² PROM cassette (sold separately) → Program memory, standard RAM, standard ROM, or memory card (sold separately) 10) Microcomputer program: Not available 11) Configuration: Modules are mounted on a base unit. → Modules are connected. (No base unit is required.) 12) Sequence instruction: AnA/AnU dedicated instructions are replaceable.*1
	A2ASCPU-S30	L06CPU L06CPU-P	1) I/O control: Refresh mode only 2) Processing speed (LD instruction): 0.9μs → 0.0095μs 3) Number of I/O points: 1024 → 4096 4) Number of I/O device points: 8192 → 8192 5) Program capacity: 30K steps → 60K steps 6) Number of file register points: 8K → 384K 7) Built-in function: None → Built-in I/O function and Ethernet function 8) Number of extension base unit: Three base units (max. 32 slots) → Three blocks (max. 40 modules) 9) Applicable memory: Built-in RAM or E ² PROM cassette (sold separately) → Program memory, standard RAM, standard ROM, or memory card (sold separately) 10) Microcomputer program: Not available 11) Configuration: Modules are mounted on a base unit. → Modules are connected. (No base unit is required.) 12) Sequence instruction: AnA/AnU dedicated instructions are replaceable.*1

*1 The instruction for file registers and special function modules need to be replaced with those for the L series.

AnS/QnAS series model		L series alternative model	
Product	Model	Model	Remarks (restrictions)
CPU module	Q2ASCPU	L02SCPU L02SCPU-P L02CPU L02CPU-P	1) I/O control: Refresh mode only 2) Processing speed (LD instruction): 0.2 μ s \rightarrow 0.04 μ s (L02CPU, L02CPU-P), 0.2 μ s \rightarrow 0.06 μ s (L02SCPU, L02SCPU-P) 3) Number of I/O points: 512 \rightarrow 1024 4) Number of I/O device points: 8192 \rightarrow 8192 5) Program capacity: 28K steps \rightarrow 20K steps 6) Number of file register points: 0K (Memory card (sold separately) is necessary.) \rightarrow 64K 7) Built-in function: None \rightarrow Built-in I/O function and Ethernet function (L02CPU, L02CPU-P only) 8) Number of extension base unit: One base unit (max. 16 slots) \rightarrow Two blocks (max. 30 modules) 9) Applicable memory: Built-in RAM or memory card (sold separately) \rightarrow Program memory, standard RAM, standard ROM, or memory card (sold separately) (L02CPU, L02CPU-P only) 10) Microcomputer program: Not available 11) Configuration: Modules are mounted on a base unit. \rightarrow Modules are connected. (No base unit is required.)
		L06CPU L06CPU-P	1) I/O control: Refresh mode only 2) Processing speed (LD instruction): 0.2 μ s \rightarrow 0.0095 μ s 3) Number of I/O points: 512 \rightarrow 4096 4) Number of I/O device points: 8192 \rightarrow 8192 5) Program capacity: 28K steps \rightarrow 60K steps 6) Number of file register points: 0K (Memory card (sold separately) is necessary.) \rightarrow 384K 7) Built-in function: None \rightarrow Built-in I/O function, Ethernet function 8) Number of extension base unit: One base unit (max. 16 slots) \rightarrow Three blocks (max. 40 modules) 9) Applicable memory: Built-in RAM or memory card (sold separately) \rightarrow Program memory, standard RAM, standard ROM, or memory card (sold separately) 10) Microcomputer program: Not available 11) Configuration: Modules are mounted on a base unit. \rightarrow Modules are connected. (No base unit is required.)
	Q2ASCPU-S1	L06CPU L06CPU-P	1) I/O control: Refresh mode only 2) Processing speed (LD instruction): 0.2 μ s \rightarrow 0.0095 μ s 3) Number of I/O points: 1024 \rightarrow 4096 4) Number of I/O device points: 8192 \rightarrow 8192 5) Program capacity: 60K steps \rightarrow 60K steps 6) Number of file register points: 0K (Memory card (sold separately) is necessary.) \rightarrow 384K 7) Built-in function: None \rightarrow Built-in I/O function and Ethernet function 8) Number of extension base unit: One base unit (max. 16 slots) \rightarrow Three blocks (max. 40 modules) 9) Applicable memory: Built-in RAM or memory card (sold separately) \rightarrow Program memory, standard RAM, standard ROM, or memory card (sold separately) 10) Microcomputer program: Not available 11) Configuration: Modules are mounted on a base unit. \rightarrow Modules are connected. (No base unit is required.)
		L26CPU L26CPU-P L26CPU-BT L26CPU-PBT	1) I/O control: Refresh mode only 2) Processing speed (LD instruction): 0.2 μ s \rightarrow 0.0095 μ s 3) Number of I/O points: 1024 \rightarrow 4096 4) Number of I/O device points: 8192 \rightarrow 8192 5) Program capacity: 60K steps \rightarrow 260K steps 6) Number of file register points: 0K (Memory card (sold separately) is necessary.) \rightarrow 384K 7) Built-in function: None \rightarrow Built-in I/O function, Ethernet function, and CC-Link function (L26CPU-BT/L26CPU-PBT only) 8) Number of extension base unit: One base unit (max. 16 slots) \rightarrow Three blocks (max. 40 modules) 9) Applicable memory: Built-in RAM or memory card (sold separately) \rightarrow Program memory, standard RAM, standard ROM, or memory card (sold separately) 10) Microcomputer program: Not available 11) Configuration: Modules are mounted on a base unit. \rightarrow Modules are connected. (No base unit is required.)

AnS/QnAS series model		L series alternative model	
Product	Model	Model	Remarks (restrictions)
CPU module	Q2ASHCPU	L02SCPU L02SCPU-P L02CPU L02CPU-P	1) I/O control: Refresh mode only 2) Processing speed (LD instruction): 0.075μs → 0.04μs (L02CPU, L02CPU-P), 0.075μs → 0.06μs (L02SCPU, L02SCPU-P) 3) Number of I/O points: 512 → 1024 4) Number of I/O device points: 8192 → 8192 5) Program capacity: 28K steps → 20K steps 6) Number of file register points: 0K (Memory card (sold separately) is necessary.) → 64K 7) Built-in function: None → Built-in I/O function and Ethernet function (L02CPU, L02CPU-P only) 8) Number of extension base unit: One base unit (max. 16 slots) → Two blocks (max. 30 modules) 9) Applicable memory: Built-in RAM or memory card (sold separately) → Program memory, standard RAM, standard ROM, or memory card (sold separately) (L02CPU, L02CPU-P only) 10) Microcomputer program: Not available 11) Configuration: Modules are mounted on a base unit. → Modules are connected. (No base unit is required.)
		L06CPU L06CPU-P	1) I/O control: Refresh mode only 2) Processing speed (LD instruction): 0.075μs → 0.0095μs 3) Number of I/O points: 512 → 4096 4) Number of I/O device points: 8192 → 8192 5) Program capacity: 28K steps → 60K steps 6) Number of file register points: 0K (Memory card (sold separately) is necessary.) → 384K 7) Built-in function: None → Built-in I/O function and Ethernet function 8) Number of extension base unit: One base unit (max. 16 slots) → Three blocks (max. 40 modules) 9) Applicable memory: Built-in RAM or memory card (sold separately) → Program memory, standard RAM, standard ROM, or memory card (sold separately) 10) Microcomputer program: Not available 11) Configuration: Modules are mounted on a base unit. → Modules are connected. (No base unit is required.)
	Q2ASHCPU-S1	L06CPU L06CPU-P	1) I/O control: Refresh mode only 2) Processing speed (LD instruction): 0.075μs → 0.0095μs 3) Number of I/O points: 1024 → 4096 4) Number of I/O device points: 8192 → 8192 5) Program capacity: 60K steps → 60K steps 6) Number of file register points: 0K (Memory card (sold separately) is necessary.) → 384K 7) Built-in function: None → Built-in I/O function and Ethernet function 8) Number of extension base unit: One base unit (max. 16 slots) → Three blocks (max. 40 modules) 9) Applicable memory: Built-in RAM or memory card (sold separately) → Program memory, standard RAM, standard ROM, or memory card (sold separately) 10) Microcomputer program: Not available 11) Configuration: Modules are mounted on a base unit. → Modules are connected. (No base unit is required.)
		L26CPU L26CPU-P L26CPU-BT L26CPU-PBT	1) I/O control: Refresh mode only 2) Processing speed (LD instruction): 0.075μs → 0.0095μs 3) Number of I/O points: 1024 → 4096 4) Number of I/O device points: 8192 → 8192 5) Program capacity: 60K steps → 260K steps 6) Number of file register points: 0K (Memory card (sold separately) is necessary.) → 384K 7) Built-in function: None → Built-in I/O function, Ethernet function, and CC-Link function (L26CPU-BT/L26CPU-PBT only) 8) Number of extension base unit: One base unit (max. 16 slots) → Three blocks (max. 40 modules) 9) Applicable memory: Built-in RAM or memory card (sold separately) → Program memory, standard RAM, standard ROM, or memory card (sold separately) 10) Microcomputer program: Not available 11) Configuration: Modules are mounted on a base unit. → Modules are connected. (No base unit is required.)

2.2 CPU Module Performance Specifications

○ : Available △ : Although available, specifications such as setting method partially differ. × : Not available

Function	Description	AnS series							
		A1SJHCPU A1SJHCPU-S8 A1SHCPU	A1SJCPU A1SCPU	A2SHCPU A2SHCPU-S1	A2SCPU	A2USCPU A2USCPU-S1 A2ASCPU A2ASCPU-S1	A2USHCPU-S1 A2ASCPU-S30		
Control method	Repetitive operation of stored program	○	○	○	○	○	○		
I/O control method	Refresh mode/direct mode	○ *1	○ *1	○ *1	○ *1	○ *2	○ *2		
Programming language	Language dedicated to sequence control (relay symbol, logic symbol, MELSAP language)	○	○	○	○	○	○		
Processing speed	Sequence instructions (μs/step)	0.33	1.0	0.25	1.0	0.2	0.09 (-S30: 0.2)		
Watchdog timer (WDT)	Watchdog timer (WDT) (ms)	10 to 2000	10 to 2000	10 to 2000	10 to 2000	200	200		
Memory capacity	User memory built-in capacity (byte)	64K (RAM)*3	64K (RAM)*3	64K (RAM) (-S1: 192K)*3	64K (RAM)*3	64K (RAM) (-S1: 256K)*3	256K (RAM)*3		
	Sold separately	Memory cassette*4 (E ² PROM)	Memory cassette*4 (E ² PROM)	Memory cassette*4 (E ² PROM)	Memory cassette*4 (E ² PROM)	Memory cassette*4 (E ² PROM)	Memory cassette*4 (E ² PROM)		
Program capacity	Sequence program (step)	Max. 8K	Max. 8K	Max. 14K (-S1: 30K)	Max. 14K	Max. 14K	Max. 30K		
	Microcomputer program (byte)	Max. 14K *8	Max. 14K *8	Max. 26K (-S1: 58K)*8	Max. 26K *8	×	×		
Number of I/O points	Number of I/O points (point)*6	256	256	512	512	512 (-S1: 1024)	1024		
Number of device points (point)	Input device (X)*9	2048	256	2048	512	8192	8192		
	Output device (Y)*9	2048	256	2048	512	8192	8192		
	Internal relay (M)	Total 2048	Total 2048	Total 2048	Total 2048	Total 8192	Total 8192		
	Latch relay (L)								
	Step relay (S)								
	Annunciator (F)	256	256	256	256	2048	2048		
	Edge relay (V)	×	×	×	×	×	×		
	Link relay (B)	1024	1024	1024	1024	8192 (A2AS: 4096)	8192		
	Timer (T)	256	256	256	256	2048 (default: 256)			
	Counter (C)	256	256	256	256	1024 (default: 256)			
	Data register (D)	1024	1024	1024	1024	8192 (A2AS: 6144)	8192		
	Link register (W)	1024	1024	1024	1024	8192 (A2AS: 4096)	8192		
	File register	(R)	8192	4096	8192	4096	8192	8192	
		(ZR)	×	×	×	×	×	×	

○ : Available △ : Although available, specifications such as setting method partially differ. × : Not available

	QnAS series		L series				Precautions for replacement	Reference
	Q2ASCPU Q2ASCPU-S1	Q2ASHCPU Q2ASHCPU-S1	L02SCPU L02SCPU-P	L02CPU L02CPU-P	L06CPU L06CPU-P	L26CPU(-BT) L26CPU-P(BT)		
	○	○	○	○	○	○	—	
	○ *2	○ *2	○ *2	○ *2	○ *2	○ *2	For the L series, only refresh mode is available. To input or output data in direct mode, use the direct input/output dedicated instructions.	
	○	○	○	○	○	○	The MELSEC language for the A/An series is MELSEC-II. For the QnA/Q2AS/Q/L series, it is MELSEC3.	
	0.2	0.075	0.04	0.04	0.0095	0.0095	—	
	10 to 2000	10 to 2000	10 to 2000ms (Set in increments of 10ms)	10 to 2000ms (Set in increments of 10ms)	10 to 2000ms (Set in increments of 10ms)	10 to 2000ms (Set in increments of 10ms)	—	
	Program memory (RAM) ^{*7}	Program memory (RAM) ^{*7}	<ul style="list-style-type: none"> • Program memory^{*7} • Standard RAM: 128K • Standard ROM: 512K 	<ul style="list-style-type: none"> • Program memory^{*7} • Standard RAM: 128K • Standard ROM: 512K 	<ul style="list-style-type: none"> • Program memory^{*7} • Standard RAM: 768K • Standard ROM: 1024K 	<ul style="list-style-type: none"> • Program memory^{*7} • Standard RAM: 768K • Standard ROM: 2048K 	—	
	Memory card (Max. 2M)	Memory card (Max. 2M)	—	SD/SDH memory card ^{*5} • SD: 2GB • SDH: 4GB	SD/SDH memory card ^{*5} • SD: 2GB • SDH: 4GB	SD/SDH memory card ^{*5} • SD: 2GB • SDH: 4GB	—	
	Max. 28K (-S1: 60K)	Max. 28K (-S1: 60K)	Max. 20K	Max. 20K	Max. 60K	Max. 260K	—	
	×	×	×	×	×	×	For the L series, microcomputer programs cannot be used. Consider replacing those microcomputer programs with sequence programs.	
	512 (S1: 1024)	512 (S1: 1024)	1024	1024	4096	4096	—	
	8192	8192	8192	8192	8192	8192	—	
	8192	8192	8192	8192	8192	8192	—	
	8192	8192	8192	8192	8192	8192	—	
	8192	8192	8192	8192	8192	8192	—	
	8192 ^{*10}	8192 ^{*10}	8192 ^{*10}	8192 ^{*10}	8192 ^{*10}	8192 ^{*10}	—	
	2048	2048	2048	2048	2048	2048	—	
	2048	2048	2048	2048	2048	2048	—	
	8192	8192	8192	8192	8192	8192	—	
	2048	2048	2048	2048	2048	2048	—	
	1024	1024	1024	1024	1024	1024	—	
	12288	12288	12288	12288	12288	12288	—	
	8192	8192	8192	8192	8192	8192	—	
	32768 ^{*11}	32768 ^{*11}	32768	32768	32768	32768	—	
	Max. 1018K	Max. 1018K	65536	65536	393216	393216	—	

○ : Available △ : Although available, specifications such as setting method partially differ. × : Not available

Function	Description	AnS series							
		A1SJHCPU A1SJHCPU-S8 A1SHCPU	A1SJCPU A1SCPU	A2SHCPU A2SHCPU-S1	A2SCPU	A2USCPU A2USCPU-S1 A2ASCPU A2ASCPU-S1	A2USHCPU-S1 A2ASCPU-S30		
Number of device points (point)	Accumulator (A)	2	2	2	2	2	2		
	Index register	(Z)	1	1	1	1	7	7	
		(V)	1	1	1	1	7	7	
	Nesting (N)	8	8	8	8	8	8		
	Pointer (P)	256	256	256	256	256	256		
	Interrupt pointer (I)	32	32	32	32	32	32		
	Special relay (M/SM)	256	256	256	256	256	256		
	Special register (D/SD)	256	256	256	256	256	256		
	Special link relay (SB)	×	×	×	×	×	×		
	Special link register (SW)	×	×	×	×	×	×		
	Function input (FX)	×	×	×	×	×	×		
	Function output (FY)	×	×	×	×	×	×		
Function register (FD)	×	×	×	×	×	×			
Number of comment points*13	Comment	3648	3648	3648	3648	4032	4032		
	Extended comment	×	×	×	×	3968	3968		
Self-diagnostics	Watchdog timer (WDT), Memory error detection, CPU error detection, and Battery error detection.	○	○	○	○	○	○		
Operation mode when an error occurs	Stop/Continue setting	○	○	○	○	○	○		
Output mode switching at changing from STOP to RUN	Re-output operation status before STOP/Selection of output after operation execution	○	○	○	○	○	○		
Built-in function	Built-in I/O function	×	×	×	×	×	×		
	Built-in Ethernet function	×	×	×	×	×	×		
	Built-in CC-Link function	×	×	×	×	×	×		

○ : Available △ : Although available, specifications such as setting method partially differ. × : Not available

	QnAS series		L series				Precautions for replacement	Reference
	Q2ASCPU Q2ASCPU-S1	Q2ASHCPU Q2ASHCPU-S1	L02SCPU L02SCPU-P	L02CPU L02CPU-P	L06CPU L06CPU-P	L26CPU-(BT) L26CPU-P(BT)		
	×	×	×	×	×	×	The QnAS/L series CPU modules do not use the accumulator since the instruction format is different from the AnS series. Upon replacement, the accumulator is converted into the special register (SD718, SD719). Program modification is not required.	
	16	16	20	20	20	20	—	
	×	×	×	×	×	×	For the Q2AS/L series, this device is used as the edge relay.	
	15	15	15	15	15	15	—	
	4096	4096	4096	4096	4096	4096	—	
	48	48	256	256	256	256	—	
	2048	2048	2048	2048	2048	2048	—	
	2048	2048	2048	2048	2048	2048	—	
	2048	2048	2048	2048	2048	2048	—	
	2048	2048	2048	2048	2048	2048	—	
	16	16	16	16	16	16	—	
	16	16	16	16	16	16	—	
	5	5	5	5	5	5	—	
	Max. approx. 50K *11*12	Max. approx. 50K *11*12	Within the total memory capacity resulted from sum of the program memory, standard RAM and standard ROM	Within the total memory capacity resulted from sum of the program memory, standard RAM, standard ROM, and memory card	Within the total memory capacity resulted from sum of the program memory, standard RAM, standard ROM, and memory card	Within the total memory capacity resulted from sum of the program memory, standard RAM, standard ROM, and memory card	—	
	×	×	×	×	×	×	—	
	○	○	○	○	○	○	—	
	○	○	○	○	○	○	—	
	○	○	○	○	○	○	—	
	×	×	○	○	○	○	—	
	×	×	×	○	○	○	—	
	×	×	×	×	×	○ *14	—	

- *1 I/O control mode (refresh mode or direct mode) is selectable with the I/O control method setting switch.
- *2 Only refresh mode is available, but instructions and devices that can use direct mode exist.
- *3 Free space areas (except that in the program memory) can be used as user memory.
- *4 Memory cassette is for copying programs to the ROM. Use of the cassette does not increase the memory capacity.
- *5 Only one memory card can be used.
- *6 The number of I/O points represents the number of accessible points to actual I/O modules.
- *7 The memory capacity corresponds to the maximum number of steps in a sequence program.
- *8 The program capacity is included to a sequence program.
- *9 The points indicate the number of usable points in the program.
- *10 For the QnAS and L series, the Step relay (S) is dedicated for SFC programs.
- *11 A memory card (sold separately) is required.
- *12 The points apply when the size of a memory card used is 2M bytes.
- *13 The number of comment points indicate the maximum number of points that can be written to the CPU module.
- *14 Only the L26CPU-BT and L26CPU-PBT are acceptable.

2.3 Functional Comparison of CPU Module

2.3.1 Comparison of the functions between the AnS series and L series

○ : Available △ : Although available, specifications such as setting method partially differ. × : Not available

Function	Description	AnS series		LCPU	Precautions for replacement	Reference
		AnSHCPU AnSCPU (C24-R2)	A2US(H) CPU(-S1) A2ASCPU (-S1/-S30)			
Constant scan	Executes the sequence program at the constant time intervals regardless of the processing time of the program.	○	○	△	Set this function with the special register (D9020) for the AnS series, and with parameters for the L series.	
Latch (data retention during power failure)	Holds the data of devices when power-off, reset and a momentary power failure longer than the allowable momentary power failure time occurs.	○	○	○	—	
Remote RUN/ STOP	Remotely runs or stops the program operations in the CPU module from external switches or peripherals.	○	○	○	—	
PAUSE	Stops operations while holding the output status.	○	○	△	Set the PAUSE enable flag with the special relay (M9040) for the AnS series, and with the special relay (SM206) for the L series.*1	
Interrupt processing	Executes the program that corresponds to the cause when an interrupt cause occurs.	○	○	○	—	
Microcomputer mode	Executes various controls and operations over utility programs and user created microcomputer programs stored in the microcomputer program area by calling them from the sequence program.	○	×	×	Consider replacing those microcomputer programs with sequence programs. Instructions from any utility package need to be replaced with the corresponding instructions of the LCPU.	
Control Display priority of ERROR LED	Sets the ERROR LED on/off status at an error.	○	○	○	Target errors vary by model, but no functional difference exists.	
ROM operation	Enables operation with parameters and programs stored in ROM not to lose user programs due to battery exhaustion.	○	○	△	For the AnS series CPU modules, an E ² PROM cassette (sold separately) is required for copying data to the ROM for ROM operation. For the LCPU, whose program memory is a Flash ROM, the ROM operation is not required.	Section 7.7.12
Data protection function (system protection, keyword registration/ password registration)	Prevents unauthorized access from peripherals to programs and comments in the built-in memory of a CPU module, memory cassettes, or memory cards.	○	○	△	The L series prohibits each file from being read/written by password registration, whereas the AnS series prohibit the parameters and programs from being read/written to the user memory by keyword registration.	Section 2.4.2
Output status setting at changing from STOP to RUN	The settings for the output status at changing from STOP to RUN (Y) between "re-output operation status before STOP" and "output after operation execution".	○	○	○	To replace the AnS series with the L series, resetting the parameters is necessary.	
Clock function	Reads or writes the internal clock data of the CPU module. The clock data consists of year, month, day, hour, minute, second and a day of the week.	○	△	△	The L series handles the year in four digits (western calendar), whereas the AnS series handles the year in the last two digits.	

*1 Device numbers are converted upon the programmable controller type change by GX Developer.

○ : Available △ : Although available, specifications such as setting method partially differ. × : Not available

Function	Description	AnS series		LCPU	Precautions for replacement	Reference
		AnSHCPU AnSCPU (C24-R2)	A2US(H) CPU(-S1) A2ASCPU (-S1/-S30)			
Debug	Write during RUN	○	○	○*1	For the L series, setting the reserved capacity for the write during RUN in advance is required.	Section 2.4.3
	Status latch	○	○	×	The L series does not support the status latch function.	
	Sampling trace	○	○	○	—	
	Step operation	○	○	×	The L series does not support the step operation function. Consider debugging with the simulation function of GX Works2.	
	Off-line switch	○	○	×	The L series does not support the off-line switch function. Consider using the forced on/off function of external I/O, instead.	
Maintenance	Online I/O module change	×	×	×	To replace the I/O modules online, use the Process CPU.	
	Self-diagnostic function	○	○	○	Error codes differ between the AnS series and L series.	
Built-in function	Built-in I/O function	×	×	○	The built-in I/O function for an LCPU includes the following: <ul style="list-style-type: none"> • General-purpose input function • General-purpose output function • Interrupt input function • Pulse catch function • Positioning function • High-speed counter function 	Section 1.2.1
	Built-in Ethernet function	×	×	○	—	Section 1.2.1
	Built-in CC-Link function	×	×	○*2	—	Section 1.2.1

*1 Setting the reserved capacity for the write during RUN in advance is required. (Default-set to 500 steps.)

*2 Only the L26CPU-BT and L26CPU-PBT are acceptable.

2.3.2 Comparison of the functions between the QnAS series and L series

○ : Available △ : Although available, specifications such as setting method partially differ. × : Not available

Function	Description	QnAS series		LCPUCPU	Precautions for replacement	Reference
		Q2ASCPU(S1)/ Q2ASHCPU(S1)				
Control	Constant scan	Executes the sequence program at the constant time intervals regardless of the processing time of the program.	○	○	—	
	Latch (data retention during power failure)	Holds the data of devices when power-off, reset, and a momentary power failure longer than the allowable momentary power failure time occurs.	○	○	—	
	Remote RUN/STOP	Remotely runs or stops the program operations in the CPU module from external switches or peripherals.	○	○	—	
	PAUSE	Stops operations while holding the output status.	○	○	—	
	Interrupt processing	Executes the program that corresponds to the cause when an interrupt cause occurs.	○	○	—	
	Display priority of ERROR LED	Sets the ERROR LED on/off status at an error.	○	○	Target errors vary by model, but no functional difference exists.	
	File management	Manages such as parameters, sequence programs, device comments, and file registers as files.	○	○	Memory configuration and data to be stored differ between the QnAS series and L series.	Section 2.4.1
	Structured program	Allows to select an execution type which suits for the usage of the program. In addition, each program can be divided according to each designer and process.	○	○	—	
	I/O assignment	Assigns I/O points for each module regardless of its mounted position.	○	△	The assignment of the XY addresses differ depending on the built-in I/O function. Configure the start XY setting with parameters (I/O assignment setting).	Section 2.4.4
	Boot operation (ROM-use operation)	Reads sequence programs stored in the memory card to the built-in memory of the CPU module when the operating status of the module is changed to RUN and executes the read programs.	○	△	For the LCPUCPU, whose program memory is a Flash ROM, the ROM operation is not required.	Section 7.7.12
	Data protection function (system protection, keyword registration/password registration)	Prevents unauthorized access from peripherals to programs and comments in the built-in memory of a CPU module or memory cards.	○	△	The L series prohibits each file from being read/written by password registration, whereas the QnAS series prohibit the parameters and programs from being read/written to the user memory by keyword registration.	Section 2.4.2
	Device initial value	Sets an initial value of device memory, file registers, and special function modules when the CPU module is set from STOP to RUN.	○	○	Memory configuration and data to be stored differ between the QnAS series and L series.	Section 2.4.1
Output status setting at changing from STOP to RUN	The settings for the output status at changing from STOP to RUN (Y) between "re-output operation status before STOP" and "output after operation execution".	○	○	To replace the QnAS series with L series, resetting the parameters is necessary.		

○ : Available △ : Although available, specifications such as setting method partially differ. × : Not available

Function	Description	QnAS series		LCPU	Precautions for replacement	Reference
		Q2ASCPU(S1)	Q2ASHCPU(S1)			
Control	Number of general data processing	○	○	△	For the L series, use the COM instructions or set the communication reserved time with the special register (SD315) as necessary.	
	Clock function	○	○	△	The L series handles the year in four digits (western calendar), whereas the QnAS series handles the year in the last two digits. Pay attention to the handling of the day of the week data.	
Debug	Write during RUN	○ ^{*1}	○	○	Setting the reserved capacity for the write during RUN in advance is required.	Section 2.4.3
	Status latch	○ ^{*2*3}	○	×	The L series does not support the status latch function.	
	Program trace	○ ^{*2*3}	○	×	The L series does not support the program trace function.	
	Simulation function	○ ^{*2*3}	○	×	The L series does not support the simulation function. Consider debugging with the simulation function of GX Works2.	
	Step operation	○	○	×	The L series does not support the step operation function. Consider debugging with the simulation function of GX Works2.	
	Execution time measurement (program monitor list, scan time measurement)	○	○	○	The execution time measurement can be checked on the Program monitor list window of GX Works2.	
	Module access interval read	○	○	○	It is referred to as "Module service interval time" in L series.	
Maintenance	Online I/O module change	○	○	×	To replace the I/O modules online, use the Process CPU.	
	Self-diagnostic function	○	○	○	Error codes differ between the QnAS series and L series.	
	Error history	○	○	○	—	

*1 Setting the reserved capacity for the write during RUN in advance is required. (Default-set to 500 steps.)

*2 An SRAM card is required.

*3 SW□IVD/NX-GPPQ is required.

○ : Available △ : Although available, specifications such as setting method partially differ. × : Not available

Function		Description	QnAS series		LCPU	Precautions for replacement	Reference
			Q2ASCPU(S1)	Q2ASHCPU(S1)			
Built-in function	Built-in I/O function	Individual function dedicated modules are not required by using the built-in I/O function. That enables a small-scale system composed of only a CPU module to be built up.	×		○	The built-in I/O function for an LCPU includes the following: <ul style="list-style-type: none"> • General-purpose input function • General-purpose output function • Interrupt input function • Pulse catch function • Positioning function • High-speed counter function 	Section 1.2.1
	Built-in Ethernet function	Serves for connecting programming tools and GOT, using the built-in Ethernet function.	×		○	—	Section 1.2.1

2.4 Precautions for CPU Module Replacement

2.4.1 Memory for CPU module

The memory configuration is shown in (1). Examine the following points depending on the memory capacity before replacement and applications.

- Memory to store
- Whether to use a memory card

(1) Memory configuration and data that can be stored

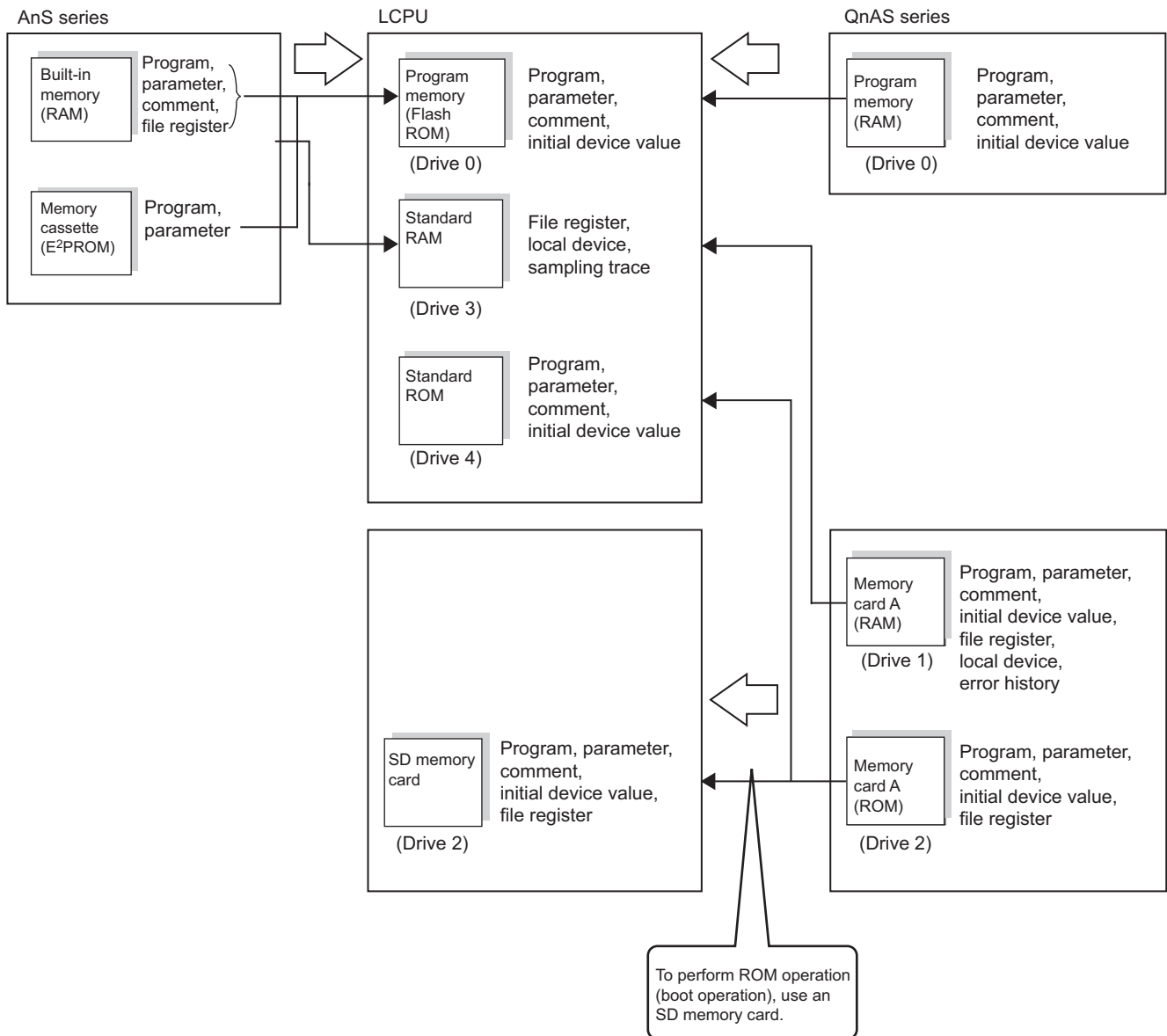

(2) Capacity of each memory

The following table lists the memory of CPU modules, in which programs and data including the user program are stored, and the memory capacity.

(The memory capacity of each item is different depending on the CPU module type. For details, refer to the manual for the QCPU.)

Item		Model		
		AnS series	QnAS series	L series
Built-in RAM		Max. 64K bytes (A2USHCPU-S1 and A2ASCPU-S1/S30: 256K bytes)	Max. 240K bytes (program memory)	Max. 1040K bytes
Memory cassette	E ² PROM	64K bytes (for writing programs to ROM)	—	—
Memory card	SRAM card	—	Max. 2M bytes	—
	E ² PROM card	—	Max. 512k bytes	—
	SD memory card	—	—	2GB
	SDHC memory card	—	—	4GB
Standard RAM		—	—	Max. 768K bytes
Standard ROM		—	—	Max. 2048K bytes

2.4.2 Keyword registration and password registration

The L series prohibits the programs from being read/written by password registration, whereas the AnS/QnAS series prohibits the programs from being read/written by keyword registration. Available functions are described below.

Item	Model		
	AnS series	QnAS series	L series
Prohibition method for writing to program	<p>The following attribute can be set to the specified memory.</p> <ul style="list-style-type: none"> • Prohibition of read/write 	<p>Either of the following attributes can be set to the specified memory (drive).</p> <ul style="list-style-type: none"> • Prohibition of read/write/display • Prohibition of write 	<p>Batch password setting for all files provides the equivalent function. (Supplement)</p> <p>By using a password, the following attributes can be set to each specified file of the specified memory (drive).</p> <ul style="list-style-type: none"> • Prohibition of read/write/display • Prohibition of write

2.4.3 Write during RUN

To execute the write during RUN, reserving the program capacity for increase upon the write during RUN in advance is required.

(1) For the AnS series

The program capacity is decided by the parameter (memory capacity setting), and can be increased within the capacity range upon write during RUN.

(2) For the QnAS/L series

Setting the program capacity for increase upon the write during RUN is required in the write to programmable controller. (This set capacity is called as the write during RUN reserved steps. By default 500 steps are reserved.)

2.4.4 I/O number assignment

The following table lists to determine the number of slots on the base unit for each series.

Item	Model		
	AnS series	QnAS series	L series
Number of slots on the base unit	Fixed to eight slots regardless of the actual number.		A configuration that requires no base unit. Depends on the number of modules to be actually connected. For the L series, the built-in functions occupy 16/48 points in terms of the I/O points. When replacement is performed, the start XY addresses of the each slot are to be set through "I/O assignment" of the parameters.

The following gives an example of replacing the A1S35B+A1S68B system (default parameter is used) with the L series system.

(1) I/O number assignment of the AnS series

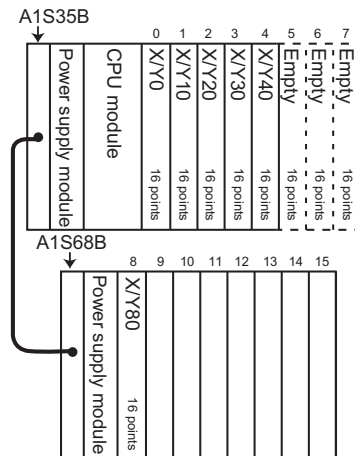

(2) I/O number assignment of the L series

The assignment examples of I/O number (when the L26CPU-BT is used) are shown below.

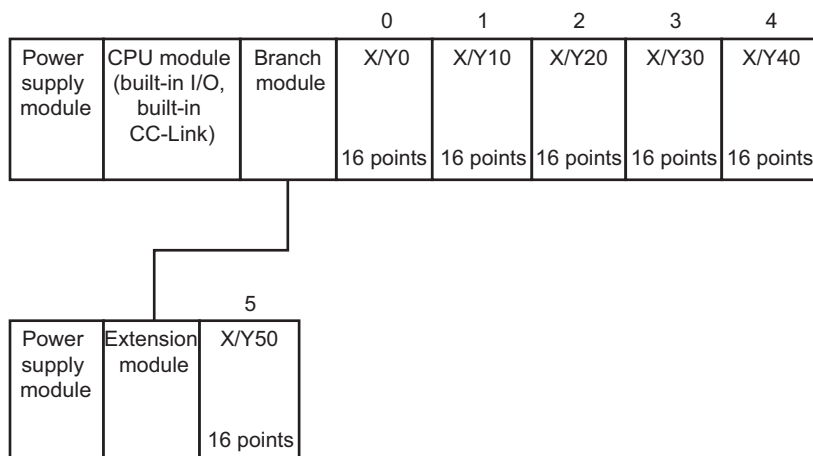

The each start I/O number is as shown in the table below.

Target	L02CPU(-P), L02SCPU(-P) L06CPU(-P), L26CPU(-P)		L26CPU-BT(-PBT)	
	Default	I/O assignment	Default	I/O assignment
Built-in I/O	0000 _H	Change of setting available	0000 _H	Change of setting available
Built-in CC-Link	—	—	0010 _H	Change of setting available
Module at the right of the CPU module	0010 _H	Change of setting available	0030 _H	Change of setting available

For the built-in Ethernet, RS-232 adapter, RS-422/485 adapter, and END cover, assigning start I/O numbers is not necessary.

The assignment of I/O numbers is to be performed with the I/O assignment setting.

[Project] window → [Parameter] → [PLC Parameter] → [I/O Assignment]

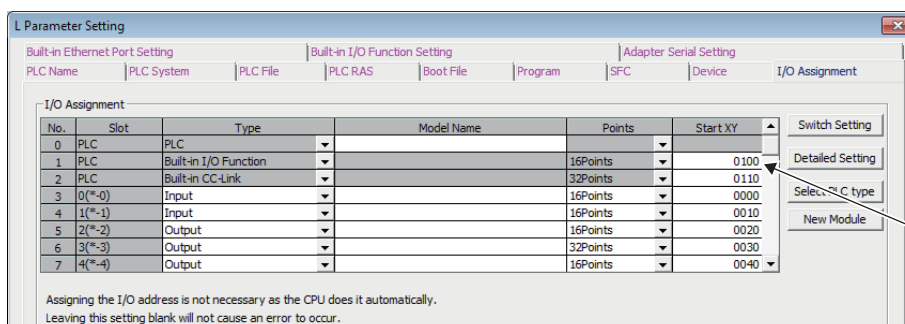

2.4.5 Programming tool for the LCPU and connection cable

(1) Programming tool for the LCPU

After the transition from MELSEC AnS/QnAS series to L series, programming (including a programmable controller type change) of the LCPU is possible only with GX Developer. Program files can be processed with GX Works2 after the programmable controller type is changed to LCPU. For the method to open the project created with GX Developer with GX Works2, refer to Section 7.1.4.

(2) Connection cable

A personal computer where GX Works2 or GX Developer has been installed can be connected to the LCPU with an Ethernet cable, USB cable, or RS-232 cable (when the L02SCPU(-P) is used or an RS-232 adapter is connected).

Note that the RS-232/RS-422 conversion cable for the AnS/QnAS series CPU module is not available. When an RS-232 cable or USB cable is used, failure of modules may occur, depending on models of personal computers and its use conditions. For details, refer to the following.

TECHNICAL BULLETIN "Cautions when using MELSEC-Q/L/QS/AnS series, MELSEC iQ-R series, and GOT-A900/GOT1000/GOT2000 series connected to a personal computer with the RS-232/USB interface (T99-0032)"

Ethernet connection	USB connection	RS-232 connection
Available (Built-in Ethernet function) ^{*1}	Available (USB A type - USB mini B type) ^{*2}	Available (when the L02SCPU(-P) is used or an RS-232 adapter is connected) ^{*3}

- *1 Use the Ethernet cable which satisfies the following specifications:
 For 10 BASE-T connection: Ethernet standards compatible cable category 3 or higher (STP/UTP cable)
 For 100 BASE-TX connection: Ethernet standards compatible cable category 5 or higher (STP cable)
- *2 Operation has been confirmed with the following USB cables:
 KU-AMB530 (manufactured by SANWA SUPPLY INC.)
 USB-M53 (manufactured by ELECOM CO., LTD.)
 MR-J3USBCBL3M (manufactured by Mitsubishi Electric Corporation)
 GT09-C30USB-5P (manufactured by Mitsubishi Electric System & Service Co., Ltd.)
- *3 Operation has been confirmed with the following RS-232 cable:
 QC30R2

3 REPLACEMENT OF I/O MODULE

3.1 List of Alternative Models of I/O Module

When the AnS/QnAS series I/O module cannot be directly replaced with the L series I/O module, consider using the Q series module or FA goods (manufactured by Mitsubishi Electric Engineering Co., Ltd.). For details, refer to the following.

- Transition from MELSEC-AnS/QnAS (Small Type) Series to Q Series Handbook (Fundamentals)

AnS/QnAS series model		L series alternative model	
Product	Model	Model	Remarks (restrictions)
Input module	A1SX10	LX10	1) External wiring: Changed 2) Number of slots: Not changed 3) Program: Number of occupied I/O points: Not changed 4) Specifications: Rated input voltage: Not changed Operating voltage range: Not changed Rated input current: Changed (approx. 6mA (60Hz) → 8.2mA (60Hz)) ON voltage/ON current: Not changed OFF voltage/OFF current: Changed Input resistance: Changed 5) Functions: Not changed
	A1SX10EU	LX10	1) External wiring: Changed 2) Number of slots: Not changed 3) Program: Number of occupied I/O points: Not changed 4) Specifications: Rated input voltage: Not changed Operating voltage range: Not changed Rated input current: Changed (approx. 7mA (60Hz) → 8.2mA (60Hz)) ON voltage/ON current: Not changed OFF voltage/OFF current: Changed Input resistance: Changed 5) Functions: Not changed

AnS/QnAS series model		L series alternative model	
Product	Model	Model	Remarks (restrictions)
Input module	A1SX20	LX28	1) External wiring: Changed 2) Number of slots: Changed (Two modules are required.) 3) Program: Number of occupied I/O points: Changed 4) Specifications: Rated input voltage: Changed (200 to 240VAC → 100 to 240VAC) Operating voltage range: Not changed Rated input current: Changed (approx. 9mA (60Hz) → 16.4mA (60Hz)) ON voltage/ON current: Changed OFF voltage/OFF current: Changed Input resistance: Changed 5) Functions: Not changed
	A1SX20EU	LX28	1) External wiring: Changed 2) Number of slots: Changed (Two modules are required.) 3) Program: Number of occupied I/O points: Changed 4) Specifications: Rated input voltage: Changed (200 to 240VAC → 100 to 240VAC) Operating voltage range: Not changed Rated input current: Changed (approx. 11mA (60Hz) → 16.4mA (60Hz)) ON voltage/ON current: Changed OFF voltage/OFF current: Changed Input resistance: Changed 5) Functions: Not changed

AnS/QnAS series model		L series alternative model	
Product	Model	Model	Remarks (restrictions)
Input module	A1SX30	LX40C6	1) External wiring: Changed 2) Number of slots: Not changed 3) Program: Number of occupied I/O points: Not changed 4) Specifications: Rated input voltage: Changed (12VDC not applicable, 12/24VAC not applicable) Rated input current: Changed (8.5mA → 6mA) ON voltage/ON current: Changed OFF voltage/OFF current: Changed Input resistance: Changed 5) Functions: Not changed [When applying AC input] Convert 12/24VAC to DC externally before input to the LX40C6.
	A1SX40	LX40C6	1) External wiring: Changed 2) Number of slots: Not changed 3) Program: Number of occupied I/O points: Not changed 4) Specifications: Rated input voltage: Changed (12VDC not applicable) Rated input current: Changed (approx. 7mA → 6mA) ON voltage/ON current: Changed OFF voltage/OFF current: Changed Input resistance: Changed 5) Functions: Not changed
	A1SX40-S1	LX40C6	1) External wiring: Changed 2) Number of slots: Not changed 3) Program: Number of occupied I/O points: Not changed 4) Specifications: Rated input voltage: Not changed Rated input current: Changed (approx. 7mA → 6mA) ON voltage/ON current: Changed OFF voltage/OFF current: Changed Input resistance: Changed Response time: Changed 5) Functions: Not changed
	A1SX40-S2	LX40C6	1) External wiring: Changed 2) Number of slots: Not changed 3) Program: Number of occupied I/O points: Not changed 4) Specifications: Rated input voltage: Not changed Rated input current: Changed (approx. 7mA → 6mA) ON voltage/ON current: Changed OFF voltage/OFF current: Changed Input resistance: Changed 5) Functions: Not changed

AnS/QnAS series model		L series alternative model	
Product	Model	Model	Remarks (restrictions)
Input module	A1SX41	LX41C4	1) External wiring: Not changed 2) Number of slots: Not changed 3) Program: Number of occupied I/O points: Not changed 4) Specifications: Rated input voltage: Changed (12VDC not applicable) Rated input current: Changed (approx. 7mA → 4mA) ON voltage/ON current: Changed OFF voltage/OFF current: Changed Input resistance: Changed 5) Functions: Not changed
	A1SX41-S1	LX41C4	1) External wiring: Not changed 2) Number of slots: Not changed 3) Program: Number of occupied I/O points: Not changed 4) Specifications: Rated input voltage: Not changed Rated input current: Changed (approx. 7mA → 4mA) ON voltage/ON current: Changed OFF voltage/OFF current: Changed Input resistance: Changed Response time: Changed 5) Functions: Not changed
	A1SX41-S2	LX41C4	1) External wiring: Not changed 2) Number of slots: Not changed 3) Program: Number of occupied I/O points: Not changed 4) Specifications: Rated input voltage: Not changed Rated input current: Changed (approx. 7mA → 4mA) ON voltage/ON current: Changed OFF voltage/OFF current: Changed Input resistance: Changed 5) Functions: Not changed
	A1SX42	LX42C4	1) External wiring: Not changed 2) Number of slots: Not changed 3) Program: Number of occupied I/O points: Not changed 4) Specifications: Rated input voltage: Changed (12VDC not applicable) Rated input current: Changed (approx. 5mA → 4mA) ON voltage/ON current: Changed OFF voltage/OFF current: Changed Input resistance: Changed 5) Functions: Not changed
	A1SX42-S1	LX42C4	1) External wiring: Not changed 2) Number of slots: Not changed 3) Program: Number of occupied I/O points: Not changed 4) Specifications: Rated input voltage: Not changed Rated input current: Changed (approx. 5mA → 4mA) ON voltage/ON current: Changed OFF voltage/OFF current: Changed Input resistance: Changed Response time: Changed 5) Functions: Not changed

AnS/QnAS series model		L series alternative model	
Product	Model	Model	Remarks (restrictions)
Input module	A1SX42-S2	LX42C4	1) External wiring: Not changed 2) Number of slots: Not changed 3) Program: Number of occupied I/O points: Not changed 4) Specifications: Rated input voltage: Not changed Rated input current: Changed (approx. 5mA → 4mA) ON voltage/ON current: Changed OFF voltage/OFF current: Changed Input resistance: Changed 5) Functions: Not changed
	A1SX71	LX41C4	1) External wiring: Not changed 2) Number of slots: Not changed 3) Program: Number of occupied I/O points: Not changed 4) Specifications: Rated input voltage: Changed (5VDC, 12VDC not applicable) Rated input current: Changed (approx. 7mA → 4mA) ON voltage/ON current: Changed OFF voltage/OFF current: Changed Input resistance: Changed 5) Functions: Not changed
	A1SX80	LX40C6	1) External wiring: Changed 2) Number of slots: Not changed 3) Program: Number of occupied I/O points: Not changed 4) Specifications: Rated input voltage: Changed (12VDC not applicable) Rated input current: Changed (approx. 7mA → 6mA) ON voltage/ON current: Changed OFF voltage/OFF current: Changed Input resistance: Changed 5) Functions: Not changed
	A1SX80-S1	LX40C6	1) External wiring: Changed 2) Number of slots: Not changed 3) Program: Number of occupied I/O points: Not changed 4) Specifications: Rated input voltage: Not changed Rated input current: Changed (approx. 7mA → 6mA) ON voltage/ON current: Changed OFF voltage/OFF current: Changed Input resistance: Changed Response time: Changed 5) Functions: Not changed
	A1SX80-S2	LX40C6	1) External wiring: Changed 2) Number of slots: Not changed 3) Program: Number of occupied I/O points: Not changed 4) Specifications: Rated input voltage: Not changed Rated input current: Changed (approx. 7mA → 6mA) ON voltage/ON current: Changed OFF voltage/OFF current: Changed Input resistance: Changed 5) Functions: Not changed

AnS/QnAS series model		L series alternative model	
Product	Model	Model	Remarks (restrictions)
Input module	A1SX81	LX41C4	1) External wiring: Not changed (37-pin D-sub connector → 40-pin connector) 2) Number of slots: Not changed 3) Program: Number of occupied I/O points: Not changed 4) Specifications: Rated input voltage: Changed (12VDC not applicable) Rated input current: Changed (approx. 7mA → 4mA) ON voltage/ON current: Changed OFF voltage/OFF current: Changed Input resistance: Changed 5) Functions: Not changed
	A1SX81-S2	LX41C4	1) External wiring: Changed (37-pin D-sub connector → 40-pin connector) 2) Number of slots: Not changed 3) Program: Number of occupied I/O points: Not changed 4) Specifications: Rated input voltage: Not changed (12VDC not applicable) Rated input current: Changed (approx. 7mA → 4mA) ON voltage/ON current: Changed OFF voltage/OFF current: Changed Input resistance: Changed 5) Functions: Not changed
	A1SX82-S1	LX42C4	1) External wiring: Not changed 2) Number of slots: Not changed 3) Program: Number of occupied I/O points: Not changed 4) Specifications: Rated input voltage: Not changed Rated input current: Changed (approx. 5mA → 4mA) ON voltage/ON current: Changed OFF voltage/OFF current: Changed Input resistance: Changed Response time: Changed 5) Functions: Not changed
Output module	A1SY10 A1SY10EU	LY10R2	1) External wiring: Changed 2) Number of slots: Not changed 3) Program: Number of occupied I/O points: Not changed 4) Specifications: Rated output voltage: Not changed Rated output current: Not changed (If the A1SY10EU is replaced with the LY10R2, the contact life span will be reduced to half.) Wiring method for common: Changed (8 points/common → 16 points/common) 5) Functions: Not changed

AnS/QnAS series model		L series alternative model	
Product	Model	Model	Remarks (restrictions)
Output module	A1SY14EU	LY10R2	1) External wiring: Changed 2) Number of slots: Not changed 3) Program: Number of occupied I/O points: Not changed 4) Specifications: Rated output voltage: Not changed Rated output current: Not changed (The contact life span will be reduced to half.) Wiring method for common: Changed (4 points/common → 16 points/common) 5) Functions: Not changed
	A1SY18A	LY18R2A	1) External wiring: Changed 2) Number of slots: Not changed 3) Program: Number of occupied I/O points: Not changed 4) Specifications: Rated output voltage: Not changed Rated output current: Not changed (The contact life span will be reduced to half.) Wiring method for common: Not changed 5) Functions: Not changed
	A1SY18AEU		
	A1SY22	LY20S6	1) External wiring: Changed 2) Number of slots: Not changed 3) Program: Number of occupied I/O points: Not changed 4) Specifications: Rated output voltage: Not changed Rated output current: Not changed Wiring method for common: Changed (8 points/common → 16 points/common) 5) Function: Changed (no fuse)
	A1SY28A	LY28S1A	1) External wiring: Changed 2) Number of slots: Not changed 3) Program: Number of occupied I/O points: Not changed 4) Specifications: Rated output voltage: Not changed Rated output current: Not changed Wiring method for common: Not changed 5) Functions: Changed (no varistor)
	A1SY28EU	LY28S1A	1) External wiring: Changed 2) Number of slots: Not changed 3) Program: Number of occupied I/O points: Not changed 4) Specifications: Rated output voltage: Not changed Rated output current: Changed (0.6A → 1A) Wiring method for common: Changed (4 points/common → Independent common) 5) Function: Not changed

AnS/QnAS series model		L series alternative model	
Product	Model	Model	Remarks (restrictions)
Output module	A1SY40	LY40NT5P	1) External wiring: Changed 2) Number of slots: Not changed 3) Program: Number of occupied I/O points: Not changed 4) Specifications: Rated output voltage: Not changed Rated output current: Not changed Wiring method for common: Changed (8 points/common → 16 points/common) 5) Functions: Changed (fuse → overheat and overload protection)
	A1SY40P	LY40NT5P	1) External wiring: Changed 2) Number of slots: Not changed 3) Program: Number of occupied I/O points: Not changed 4) Specifications: Rated output voltage: Not changed Rated output current: Not changed Wiring method for common: Changed (8 points/common → 16 points /common) 5) Functions: Not changed
	A1SY41	LY41NT1P	1) External wiring: Not changed 2) Number of slots: Not changed 3) Program: Number of occupied I/O points: Not changed 4) Specifications: Rated output voltage: Not changed Rated output current: Not changed 5) Functions: Changed (fuse → overheat and overload protection)
	A1SY41P	LY41NT1P	1) External wiring: Not changed 2) Number of slots: Not changed 3) Program: Number of occupied I/O points: Not changed 4) Specifications: Rated output voltage: Not changed Rated output current: Not changed 5) Functions: Not changed
	A1SY42	LY42NT1P	1) External wiring: Not changed 2) Number of slots: Not changed 3) Program: Number of occupied I/O points: Not changed 4) Specifications: Rated output voltage: Not changed Rated output current: Not changed 5) Functions: Changed (fuse → overheat and overload protection)
	A1SY42P	LY42NT1P	1) External wiring: Not changed 2) Number of slots: Not changed 3) Program: Number of occupied I/O points: Not changed 4) Specifications: Rated output voltage: Not changed Rated output current: Not changed 5) Functions: Not changed

AnS/QnAS series model		L series alternative model	
Product	Model	Model	Remarks (restrictions)
Output module	A1SY50	LY40NT5P	1) External wiring: Changed 2) Number of slots: Not changed 3) Program: Number of occupied I/O points: Not changed 4) Specifications: Rated output voltage: Not changed Rated output current: Not changed Wiring method for common: Changed (8 points/common → 16 points /common) 5) Functions: Changed (fuse → overheat and overload protection)
	A1SY60	(None)	Consider replacing with the LY40NT5P + FA-TH16Y2TR20.* * The FA-TH16Y2TR20 is one of FA goods (manufactured by Mitsubishi Electric Engineering Co., Ltd.).
	A1SY60E		
	A1SY68A		
	A1SY71	(None)	Consider reexamining the external device to be connected.
	A1SY80	LY40PT5P	1) External wiring: Changed 2) Number of slots: Not changed 3) Program: Number of occupied I/O points: Not changed 4) Specifications: Rated output voltage: Not changed Rated input current: Changed (0.8A → 0.5A) Wiring method for common: Changed (8 points/common → 16 points /common) 5) Functions: Changed (fuse → overheat and overload protection)
	A1SY81	LY41PT1P	1) External wiring: changed (37-pin D-sub connector → 40-pin connector) 2) Number of slots: Not changed 3) Program: Number of occupied I/O points: Not changed 4) Specifications: Rated output voltage: Not changed Rated output current: Not changed 5) Functions: Changed (fuse → overheat and overload protection)
	A1SY81EP	LY41PT1P	1) External wiring: changed (37-pin D-sub connector → 40-pin connector) 2) Number of slots: Not changed 3) Program: Number of occupied I/O points: Not changed 4) Specifications: Rated output voltage: Not changed Rated output current: Not changed 5) Functions: Not changed
	A1SY82	LY42PT1P	1) External wiring: Not changed 2) Number of slots: Not changed 3) Program: Number of occupied I/O points: Not changed 4) Specifications: Rated output voltage: Not changed Rated output current: Not changed 5) Functions: Changed (fuse → overheat and overload protection)

AnS/QnAS series model		L series alternative model	
Product	Model	Model	Remarks (restrictions)
I/O module	A1SH42	LH42C4NT1P	1) External wiring: Not changed 2) Number of slots: Not changed 3) Program: Not changed 4) Specifications: (Input part) Rated input voltage: Changed (12VDC not applicable.) Rated input current: Changed (approx. 5mA → 4mA) ON voltage/ON current: Changed OFF voltage/OFF current: Changed Input resistance: Changed (Output part) Rated output voltage: Not changed Rated output current: Not changed 5) Functions: Changed (fuse → overheat and overload protection)
	A1SH42P	LH42C4NT1P	1) External wiring: Not changed 2) Number of slots: Not changed 3) Program: Not changed 4) Specifications: (Input part) Rated input voltage: Changed (12VDC not applicable) Rated input current: Changed (approx. 5mA → 4mA) ON voltage/ON current: Changed OFF voltage/OFF current: Changed Input resistance: Changed (Output part) Rated output voltage: Not changed Rated output current: Not changed 5) Functions: Not changed
	A1SH42-S1	LH42C4NT1P	1) External wiring: Not changed 2) Number of slots: Not changed 3) Program: Not changed 4) Specifications: (Input part) Rated input voltage: Not changed Rated input current: Changed (approx. 5mA → 4mA) ON voltage/ON current: Changed OFF voltage/OFF current: Changed Input resistance: Changed Response time: Changed (Output part) Rated output voltage: Not changed Rated output current: Not changed 5) Functions: Changed (fuse → overheat and overload protection)
	A1SH42P-S1	LH42C4NT1P	1) External wiring: Not changed 2) Number of slots: Not changed 3) Program: Not changed 4) Specifications: (Input part) Rated input voltage: Not changed Rated input current: Changed (approx. 5mA → 4mA) ON voltage/ON current: Changed OFF voltage/OFF current: Changed Input resistance: Changed Response time: Changed (Output part) Rated output voltage: Not changed Rated output current: Not changed 5) Functions: Not changed

AnS/QnAS series model		L series alternative model	
Product	Model	Model	Remarks (restrictions)
I/O module	A1SX48Y18	LX40C6 + LY10R2	1) External wiring: Changed 2) Number of slots: Changed (Two modules are required.) 3) Program: Number of occupied I/O points: Changed (16 → 32 (16 × 2)) 4) Specifications: (Input part) Rated input voltage: Not changed Rated input current: Changed (approx. 7mA → 6mA) ON voltage/ON current: Changed OFF voltage/OFF current: Changed Input resistance: Changed (Output part) Rated output voltage: Not changed Rated output current: Not changed 5) Functions: Not changed
	A1SX48Y58	LX40C6 + LY40NT5P	1) External wiring: Changed 2) Number of slots: Changed (Two modules are required.) 3) Program: Number of occupied I/O points: Changed (16 → 32 (16 × 2)) 4) Specifications: (Input part) Rated input voltage: Not changed Rated input current: Changed (approx. 7mA → 6mA) ON voltage/ON current: Changed OFF voltage/OFF current: Changed Input resistance: Changed (Output part) Rated output voltage: Not changed Rated output current: Not changed 5) Functions: Not changed
	A1SJ-56DT	LX40C6 + LY40NT5P	1) External wiring: Changed 2) Number of slots: Changed 3) Program: Number of occupied I/O points: Changed (128 (empty 4 slots included) → 64) 4) Specifications: (Input part) Rated input voltage: Not changed Rated input current: Changed (approx. 7mA → 6mA) ON voltage/ON current: Changed OFF voltage/OFF current: Changed Input resistance: Changed (Output part) Rated output voltage: Not changed Rated output current: Not changed 5) Functions: Not changed

3.2 Comparison of I/O Module Specifications

3.2.1 Comparison of input module specifications

(1) Comparison of specifications between A1SX10 and LX10

○ : Compatible, △ : Partially changed, × : Incompatible

Specifications	A1SX10	LX10	Compatibility	Precautions for replacement	
Number of input points	16 points	16 points	○		
Insulation method	Photocoupler	Photocoupler	○		
Rated input voltage	100 to 120VAC 50/60Hz	100 to 120VAC (+10%/-15%), 50/60Hz (±3Hz)	○		
Input voltage distortion	Within 5%	Within 5%	○		
Rated input current	Approx. 6mA (100VAC, 60Hz)	8.2mA (100VAC, 60Hz) 6.8mA (100VAC, 50Hz)	○	The input current is higher in the LX10. ^{*2}	
Inrush current	Max. 200mA within 1ms (132VAC)	Max. 200mA within 1ms	○		
Operating voltage range	85 to 132VAC (50/60Hz ±5%)	85 to 132VAC (50/60Hz ±3Hz)	○		
Max. number of simultaneous input points	Refer to the derating figure. ^{*1}	Refer to the derating figure. ^{*1}	○	Use it within the range shown in the derating figure.	
ON voltage/ON current	80VAC or higher/5mA or higher	80VAC or higher/5mA or higher (50Hz, 60Hz)	○		
OFF voltage/OFF current	30VAC or lower/1.4mA or lower	30VAC or lower/1.7mA or lower (50Hz, 60Hz)	△	The OFF current is higher in the LX10. ^{*2}	
Input resistance	Approx. 18kΩ (60Hz) Approx. 21kΩ (50Hz)	Approx. 12.2kΩ (60Hz) Approx. 14.6kΩ (50Hz)	○		
Response time	OFF → ON	20ms or less (100VAC, 60Hz)	15ms or less (100VAC 50Hz, 60Hz)	○	
	ON → OFF	35ms or less (100VAC, 60Hz)	20ms or less (100VAC 50Hz, 60Hz)	○	
Wiring method for common	16 points/common (common terminal: TB9, TB18)	16 points/common (common terminal: TB17)	○		
Operation status indicator	ON status of LED	ON status of LED	○		
External connection system	20-point terminal block (M3.5 × 7 screws)	18-point terminal block (M3 × 6 screws)	×	Wiring change is required. ^{*3}	
Applicable wire size	0.75 to 1.25mm ²	0.3 to 0.75mm ²	×		
Applicable solderless terminal	R1.25-3.5, R2-3.5, RAV1.25-3.5, RAV2-3.5	R1.25-3 (Solderless terminal with an insulation sleeve cannot be used.)	×		
Current consumption	0.05A (Typ., all points ON)	0.09A (Typ., all points ON)	△	Review the current capacity since the current consumption is increased.	
External dimensions	130(H) × 34.5(W) × 93.6(D)mm	90(H) × 28.5(W) × 117(D)mm	△	Wiring space is narrower.	
Weight	0.21kg	0.17kg	△		

*1 The derating figure is shown below.

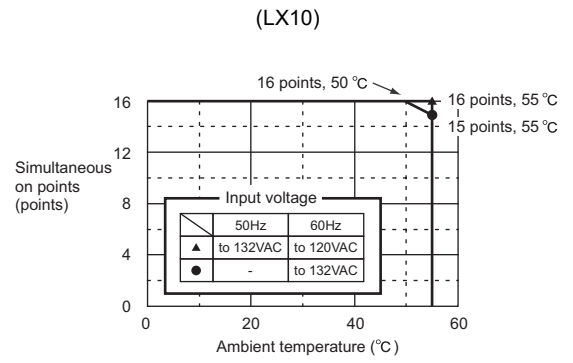
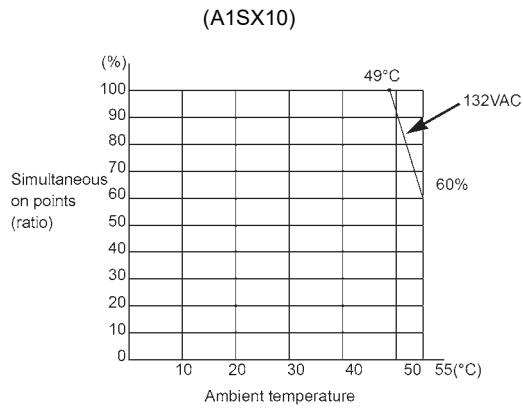

*2 Check the specifications of a sensor or switch to be connected to the LX10.

*3 Wiring change is not required if the conversion adapter (ERNT-ASLTX10, manufactured by Mitsubishi Electric Engineering Co., Ltd.) is used.

(2) Comparison of specifications between A1SX10EU and LX10

○ : Compatible, △ : Partially changed, × : Incompatible

Specifications		A1SX10EU	LX10	Compatibility	Precautions for replacement
Number of input points		16 points	16 points	○	
Insulation method		Photocoupler	Photocoupler	○	
Rated input voltage		100 to 120VAC 50/60Hz	100 to 120VAC (+10%/-15%), 50/60Hz (±3Hz)	○	
Input voltage distortion		Within 5%	Within 5%	○	
Rated input current		Approx. 7mA (120VAC 60Hz)	8.2mA (100VAC, 60Hz) 6.8mA (100VAC, 50Hz)	○	The input current is higher in the LX10.*2
Inrush current		Max. 200mA within 1ms (132VAC)	Max. 200mA within 1ms	○	
Operating voltage range		85 to 132VAC (50/60Hz ±5%)	85 to 132VAC (50/60Hz ±3Hz)	○	
Max. number of simultaneous input points		100%	Refer to the derating figure.*1	○	Use it within the range shown in the derating figure.
ON voltage/ON current		80VAC or higher/5mA or higher	80VAC or higher/5mA or higher (50Hz, 60Hz)	○	
OFF voltage/OFF current		30VAC or lower/1.4mA or lower	30VAC or lower/1.7mA or lower (50Hz, 60Hz)	△	The OFF current is higher in the LX10.*2
Input resistance		Approx. 18kΩ (60Hz) Approx. 21kΩ (50Hz)	Approx. 12.2kΩ (60Hz) Approx. 14.6kΩ (50Hz)	○	The input resistance is reduced.*2
Response time	OFF → ON	20ms or less (100VAC, 60Hz)	15ms or less (100VAC 50Hz, 60Hz)	○	
	ON → OFF	35ms or less (100VAC, 60Hz)	20ms or less (100VAC 50Hz, 60Hz)	○	
Wiring method for common		16 points/common (common terminal: TB9, TB18)	16 points/common (common terminal: TB17)	○	
Operation status indicator		ON status of LED	ON status of LED	○	
External connection system		20-point terminal block (M3.5 × 7 screws)	18-point terminal block (M3 × 6 screws)	×	Wiring change is required.*3
Applicable wire size		0.75 to 1.25mm ² (AWG16 to AWG19)	0.3 to 0.75mm ²	×	
Applicable solderless terminal		RAV1.25-3.5	R1.25-3 (Solderless terminal with an insulation sleeve cannot be used.)	×	
Withstand voltage (between all external circuits and internal circuit)		1780VACrms for 3 cycles (2000m above sea level)	1400VAC, 1 minute (altitude 2000m)	○	
Insulation resistance		10MΩ or higher (insulation resistance tester)	10MΩ or higher (insulation resistance tester)	○	
Noise immunity		IEC 801-4:1kV	Noise voltage 1500Vp-p, noise width 1μs, noise frequency 25 to 60Hz (noise simulator condition)	○	
Current consumption		0.05A (Typ., all points on)	0.09A (Typ., all points on)	△	Review the current capacity since the current consumption is increased.
External dimensions		130(H) × 34.5(W) × 93.6(D)mm	90(H) × 28.5(W) × 117(D)mm	△	Wiring space is narrower.
Weight		0.21kg	0.17kg	△	

*1 The following shows the derating figure.

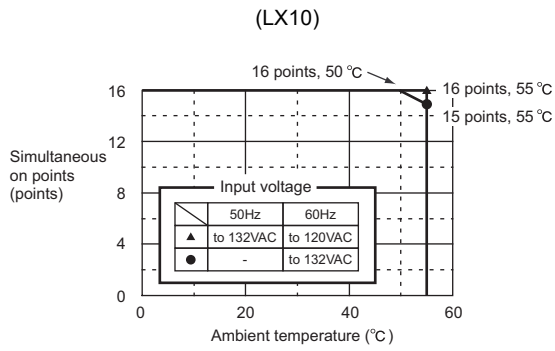

*2 Check the specifications of the sensor or switches to be connected to the LX10.

*3 Wiring change is not required if the conversion adapter (ERNT-ASLTXY10, manufactured by Mitsubishi Electric Engineering Co., Ltd.) is used.

(3) Comparison of the specification between the A1SX20 and LX28

○ : Compatible, △ : Partially changed, × : Incompatible

Specifications		A1SX20	LX28	Compatibility	Precautions for replacement
Number of input points		16 points	8 points	△	If using nine or more points, use LX28s for the number of points.
Insulation method		Photocoupler	Photocoupler	○	
Rated input voltage		200 to 240VAC 50/60Hz	100 to 240VAC (+10%/-15%) 50/60Hz (±3Hz)	○	
Input voltage distortion		Within 5%	Within 5%	○	
Rated input current		Approx. 9mA (200VAC 60Hz)	16.4mA (200VAC, 60Hz) 13.7mA (200VAC, 50Hz) 8.2mA (100VAC 60Hz) 6.8mA (100VAC 50Hz)	△	The input current is higher than LX28.
Inrush current		Max. 500mA within 1ms (264VAC)	Max. 950mA, within 1 ms	△	The inrush current is increased.*2
Operating voltage range		170 to 264 VAC (50/60Hz ±5%)	85 to 264VAC (50/60Hz ±3Hz)	○	
Max. number of simultaneous input points		Refer to the derating figure.*1	Refer to the derating figure.*1	○	
ON voltage/ON current		80VAC or higher/4mA or higher	80VAC or higher/5mA or higher (50Hz, 60Hz)	△	The ON current is higher than LX28.*2
OFF voltage/OFF current		30VAC or lower/1mA or lower	30VAC or lower/1.7mA or lower (50Hz, 60Hz)	△	The OFF current is higher than LX28.*2
Input resistance		Approx. 22kΩ (60Hz), Approx. 27kΩ (50Hz)	Approx. 12.2kΩ (60Hz) Approx. 14.6kΩ (50Hz)	○	The input resistance is reduced.*2
Response time	OFF → ON	30ms or less (200VAC, 60Hz)	15ms or less (100VAC 50Hz, 60Hz) 10ms or less (200VAC 50Hz, 60Hz)	○	
	ON → OFF	55ms or less (200VAC, 60Hz)	20ms or less (100/200VAC 50Hz, 60Hz)	○	
Wiring method for common		16 points/common (common terminal: TB9, TB18)	8 points/common (common terminal: TB17)	△	
Operation status indicator		ON status of LED	ON status of LED	○	
External connection system		20-point terminal block (M3.5 × 7 screws)	18-point terminal block (M3 × 6 screws)	×	Wiring change is required.
Applicable wire size		0.75 to 1.25mm ²	0.3 to 0.75mm ²		
Applicable solderless terminal		R1.25-3.5, R2-3.5, RAV1.25-3.5, RAV2-3.5	R1.25-3 (Solderless terminal with an insulation cannot be used.)	△	Compatible with a solderless terminal applicable to the existing module
Current consumption		0.05A (Typ., all points ON)	0.09A (Typ., all points ON)	△	Review the current capacity since the current consumption is increased.
External dimensions		130(H) × 34.5(W) × 93.6(D)mm	90(H) × 28.5(W) × 117(D)mm	△	Wiring space is narrower.
Weight		0.23kg	0.15kg	△	

*1 The derating figure is shown below.

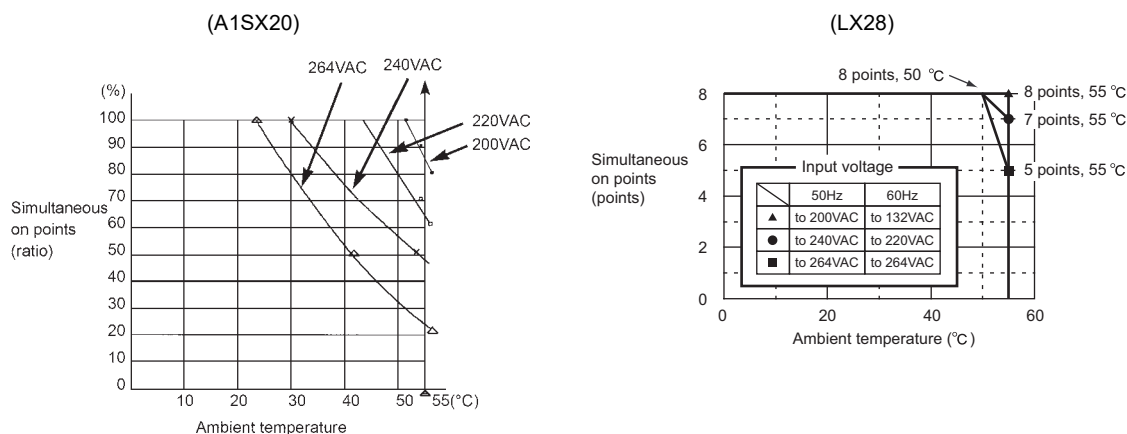

*2 Check the specifications of a sensor or switch to be connected to the LX28.

(4) Comparison of specifications between A1SX20EU and LX28

○ : Compatible, △ : Partially changed, × : Incompatible

Specifications		A1SX20EU	LX28	Compatibility	Precautions for replacement
Number of input points		16 points	8 points	△	If using nine or more points, use the same number of LX28s as the number of points.
Insulation method		Photocoupler	Photocoupler	○	
Rated input voltage		200 to 240VAC 50/60Hz	100 to 240VAC (+10%/-15%), 50/60Hz (±3Hz)	○	
Input voltage distortion		Within 5%	Within 5%	○	
Rated input current		Approx. 11mA (240VAC 60Hz)	16.4mA (200VAC, 60Hz) 13.7mA (200VAC, 50Hz) 8.2mA (100VAC, 60Hz) 6.8mA (100VAC, 50Hz)	△	The input current is higher in the LX28.*2
Inrush current		Max. 500mA within 1ms (264VAC)	Max. 950mA within 1ms	△	The input current is higher in the LX28.*2
Operating voltage range		170 to 264 VAC (50/60Hz ±5%)	85 to 264VAC (50/60Hz ±3Hz)	○	
Max. number of simultaneous input points		Refer to the derating figure.*1	Refer to the derating figure.*1	○	
ON voltage/ON current		80VAC or higher/4mA or higher	80VAC or higher/5mA or higher (50Hz, 60Hz)	△	The ON current is higher in the LX28.*2
OFF voltage/OFF current		30VAC or lower/1mA or lower	30VAC or lower/1.7mA or lower (50Hz, 60Hz)	△	The OFF current is higher in the LX28.*2
Input resistance		Approx. 22kΩ (60Hz), Approx. 27kΩ (50Hz)	Approx. 12.2kΩ (60Hz) Approx. 14.6kΩ (50Hz)	○	The input resistance is reduced.*2
Response time	OFF → ON	30ms or less (200VAC, 60Hz)	15ms or less (100VAC 50Hz, 60Hz) 10ms or less (200VAC 50Hz, 60Hz)	○	
	ON → OFF	55ms or less (200VAC, 60Hz)	20ms or less (100/200VAC 50Hz, 60Hz)	○	
Wiring method for common		16 points/common (common terminal: TB9, TB18)	8 points/common (common terminal: TB17)	△	Wiring of the terminal block needs to be changed due to the change from 1 common to 2 commons.
Operation status indicator		ON status of LED	ON status of LED	○	
External connection system		20-point terminal block (M3.5 × 7 screws)	18-point terminal block (M3 × 6 screws)	×	Wiring change is required.
Applicable wire size		0.75 to 1.25mm ² (AWG16 to AWG19)	0.3 to 0.75mm ²		
Applicable solderless terminal		RAV1.25-3.5	R1.25-3 (Solderless terminal with an insulation sleeve cannot be used.)		
Withstand voltage		2830VACrms for 3 cycles (2000m above sea level)	2300VAC, 1 minute (altitude 2000m)	○	
Insulation resistance		10MΩ or higher (insulation resistance tester)	10MΩ or higher (insulation resistance tester)	○	
Noise immunity		IEC 801-4:1kV	Noise voltage 1500Vp-p, noise width 1μs, noise frequency 25 to 60Hz (noise simulator condition)	○	
Current consumption		0.05A (Typ., all points ON)	0.09A (Typ., all points ON)	△	Review the current capacity since the current consumption is increased.
External dimensions		130(H) × 34.5(W) × 93.6(D)mm	90(H) × 28.5(W) × 117(D)mm	△	Wiring space is narrower.
Weight		0.23kg	0.15kg	△	

*1 The derating figure is shown below.

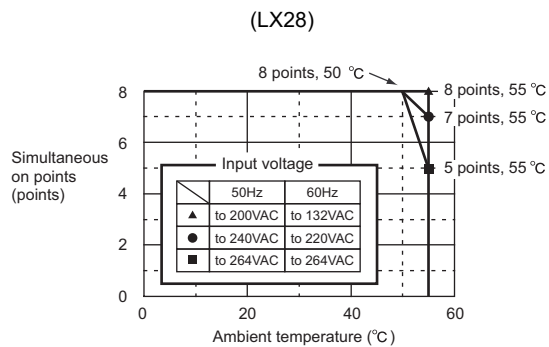
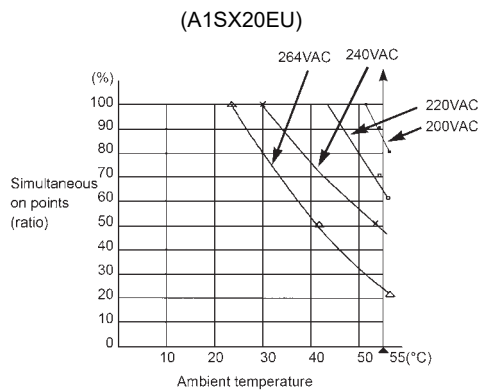

*2 Check the specifications of a sensor or switch to be connected to the LX28.

(5) Comparison of specifications between A1SX30 and LX40C6

○ : Compatible, △ : Partially changed, × : Incompatible

Specifications		A1SX30	LX40C6	Compatibility	Precautions for replacement
Number of input points		16 points	16 points	○	
Insulation method		Photocoupler	Photocoupler	○	
Rated input voltage		12/24VDC, 12/24VAC (50/60Hz)	24VDC	△	The input voltage 12VDC and 12/24VAC cannot be used. ^{*2}
Rated input current		8.5mA (24VDC/AC) 4mA (12VDC/AC)	6.0mA Typ. (at 24VDC)	△	The input current is lower in the LX40C6. ^{*3}
Operating voltage range		10.2 to 26.4VDC (ripple ratio within 5%), 10.2 to 26.4VAC (50/60Hz ±5%)	20.4 to 28.8VDC (ripple ratio within 5%)	△	The input voltage 12VDC and 12/24VAC cannot be used. ^{*2}
Max. number of simultaneous input points		Refer to the derating figure. ^{*1}	Refer to the derating figure. ^{*1}	○	Use it within the range shown in the derating figure.
ON voltage/ON current		7VDC/AC or higher/2mA or higher	15VDC or higher/4mA or higher	△	The ON voltage and ON current are higher in the LX40C6. ^{*3}
OFF voltage/OFF current		2.7VDC/AC or lower/0.7mA or lower	8VDC or lower/2mA or lower	△	The OFF voltage and OFF current are higher in the LX40C6. ^{*3}
Input resistance		Approx. 2.7kΩ	Approx. 3.8kΩ	△	The input resistance is higher in the LX40C6. ^{*3}
Response time	OFF → ON	20ms or less (12/24VDC), 25ms or lower (12/24VAC 60Hz)	1ms, 5ms, 10ms, 20ms, or less than 70ms (To be set with the CPU module's PLC parameter) Default: 10ms	○	Set the input response time of the parameter to 20ms.
	ON → OFF	20ms or less (12/24VDC), 20ms or lower (12/24VAC 60Hz)	1ms, 5ms, 10ms, 20ms, or less than 70ms (To be set with the CPU module's PLC parameter) Default: 10ms	○	Set the input response time of the parameter to 20ms.
Wiring method for common		16 points/common (common terminal: TB9, TB18)	16 points/common (common terminal: TB17)	○	
Operation status indicator		ON status of LED	ON status of LED	○	
External connection system		20-point terminal block (M3.5 × 7 screws)	18-point terminal block (M3 × 6 screws)	×	Wiring change is required. The compatible screw size and wire size are decreased.
Applicable wire size		0.75 to 1.25mm ²	0.3 to 0.75mm ²	×	
Applicable solderless terminal		R1.25-3.5, R2-3.5, RAV1.25-3.5, RAV2-3.5	R1.25-3 (Solderless terminal with an insulation sleeve cannot be used.)	×	
Current consumption		0.05A (Typ., all points ON)	0.09A (Typ., all points ON)	△	Review the current capacity since the current consumption is increased.
External dimensions		130(H) × 34.5(W) × 93.6(D)mm	90(H) × 28.5(W) × 117(D)mm	△	Wiring space is narrower.
Weight		0.20kg	0.15kg	△	

*1 The derating figure is shown below.

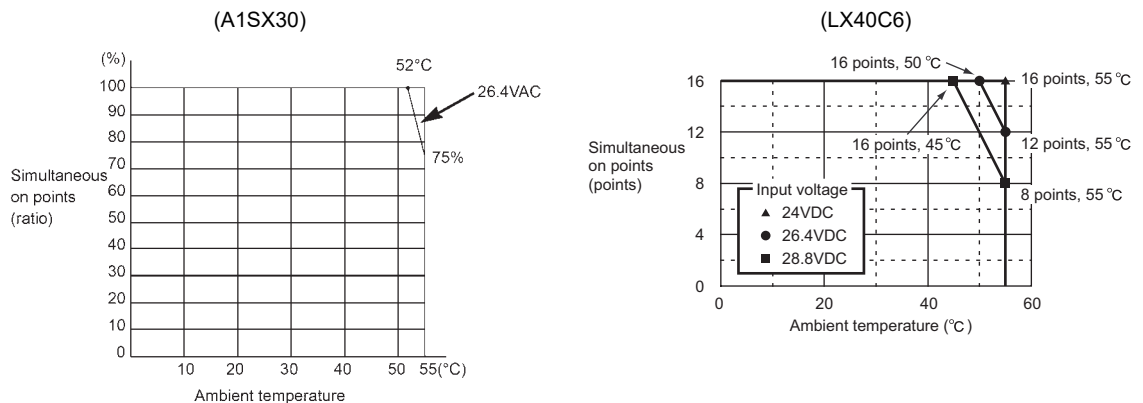

*2 If using with 12/24VAC or 12VDC, consider reexamining device to be connected.

*3 Check the specifications of a sensor or switch to be connected to the LX40C6.

(6) Comparison of specifications between A1SX40 and LX40C6

○ : Compatible, △ : Partially changed, × : Incompatible

Specifications		A1SX40	LX40C6	Compatibility	Precautions for replacement
Number of input points		16 points	16 points	○	
Insulation method		Photocoupler	Photocoupler	○	
Rated input voltage		12/24VDC	24VDC	△	The input voltage 12VDC cannot be used.*2
Rated input current		Approx. 3mA/Approx. 7mA	6.0mA Typ. (at 24VDC)	△	The input current is lower in the LX40C6.*2
Operating voltage range		10.2 to 26.4VDC (ripple ratio within 5%)	20.4 to 28.8VDC (ripple ratio within 5%)	△	The input voltage 12VDC cannot be used.
Max. number of simultaneous input points		100% (at 26.4VDC)	Refer to the derating figure.*1	○	Use it within the range shown in the derating figure.
ON voltage/ON current		8VDC or higher/2mA or higher	15VDC or higher/4mA or higher	△	The ON voltage and ON current are higher in the LX40C6.*2
OFF voltage/OFF current		4VDC or lower/1mA or lower	8VDC or lower/2mA or lower	△	The OFF voltage and OFF current are higher in the LX40C6.*2
Input resistance		Approx. 3.3kΩ	Approx. 3.8kΩ	△	The input resistance is higher in the LX40C6.*2
Response time	OFF → ON	10ms or less (24VDC)	1ms, 5ms, 10ms, 20ms, or less than 70ms (To be set with the CPU module's PLC parameter) Default: 10ms	○	Set the input response time of parameter to the default value (10ms).
	ON → OFF	10ms or less (24VDC)	1ms, 5ms, 10ms, 20ms, or less than 70ms (To be set with the CPU module's PLC parameter) Default: 10ms	○	
Wiring method for common		16 points/common (common terminal: TB9, TB18)	16 points/common (common terminal: TB17)	○	
Operation status indicator		ON status of LED	ON status of LED	○	
External connection system		20-point terminal block (M3.5 × 7 screws)	18-point terminal block (M3 × 6 screws)	×	Wiring change is required.*3 The compatible screw size and wire size are decreased.
Applicable wire size		0.75 to 1.25mm ²	0.3 to 0.75mm ²	×	
Applicable solderless terminal		R1.25-3.5, R2-3.5, RAV1.25-3.5, RAV2-3.5	R1.25-3 (Solderless terminal with an insulation sleeve cannot be used.)	×	
Current consumption		0.05A (Typ., all points on)	0.09A (Typ., all points ON)	△	Review the current capacity since the current consumption is increased.
External dimensions		130(H) × 34.5(W) × 93.6(D)mm	90(H) × 28.5(W) × 117(D)mm	△	Wiring space is narrower.
Weight		0.20kg	0.15kg	△	

*1 The derating figure is shown below.

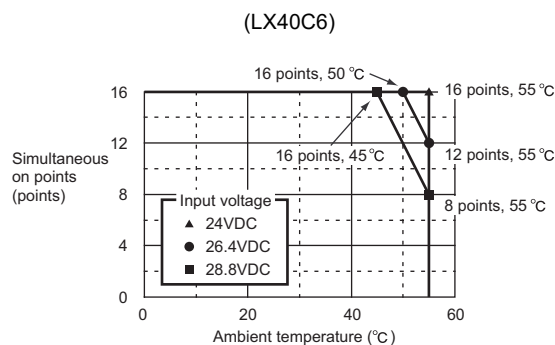

*2 Check the specifications of a sensor or switch to be connected to the LX40C6.

*3 Wiring change is not required if the conversion adapter (ERNT-ASLTX40, manufactured by Mitsubishi Electric Engineering Co., Ltd.) is used.

(7) Comparison of specifications between A1SX40-S1 and LX40C6

○ : Compatible, △ : Partially changed, × : Incompatible

Specifications		A1SX40-S1	LX40C6	Compatibility	Precautions for replacement
Number of input points		16 points	16 points	○	
Insulation method		Photocoupler	Photocoupler	○	
Rated input voltage		24VDC	24VDC	○	
Rated input current		Approx. 7mA	6.0mA Typ. (at 24VDC)	△	The input current is lower in the LX40C6.*2
Operating voltage range		19.2 to 26.4VDC (ripple ratio within 5%)	20.4 to 28.8VDC (ripple ratio within 5%)	△	The operating voltage range differs.*2
Max. number of simultaneous input points		100% (at 26.4VDC)	Refer to the derating figure.*1	○	Use it within the range shown in the derating figure.
ON voltage/ON current		14VDC or more/4.0mA or higher	15VDC or higher/4mA or higher	△	The ON voltage is higher in the LX40C6.*2
OFF voltage/OFF current		6.5VDC or lower/1.7mA or lower	8VDC or lower/2mA or lower	△	The OFF voltage and OFF current are higher in the LX40C6.*2
Input resistance		Approx. 3.3kΩ	Approx. 3.8kΩ	△	The input resistance is higher in the LX40C6.*2
Response time	OFF → ON	0.1ms or less (24VDC)	1ms, 5ms, 10ms, 20ms, or less than 70ms (To be set with the CPU module's PLC parameter) Default: 10ms	×	The response time differs. Consider the modification depending on what to be controlled, including the sensor and switch to be connected.
	ON → OFF	0.2ms or less (24VDC)	1ms, 5ms, 10ms, 20ms, or less than 70ms (To be set with the CPU module's PLC parameter) Default: 10ms	×	
Wiring method for common		16 points/common (common terminal: TB9, TB18)	16 points/common (common terminal: TB17)	○	
Operation status indicator		ON status of LED	ON status of LED	○	
External connection system		20-point terminal block (M3.5 × 7 screws)	18-point terminal block (M3 × 6 screws)	×	Wiring change is required. The compatible screw size and wire size are decreased.
Applicable wire size		0.75 to 1.25mm ²	0.3 to 0.75mm ²	×	
Applicable solderless terminal		R1.25-3.5, R2-3.5, RAV1.25-3.5, RAV2-3.5	R1.25-3 (Solderless terminal with an insulation sleeve cannot be used.)	×	
Current consumption		0.05A (Typ., all points ON)	0.09A (Typ., all points ON)	△	Review the current capacity since the current consumption is increased.
External dimensions		130(H) × 34.5(W) × 93.6(D)mm	90(H) × 28.5(W) × 117(D)mm	△	Wiring space is narrower.
Weight		0.20kg	0.15kg	△	

*1 The derating figure is shown below.

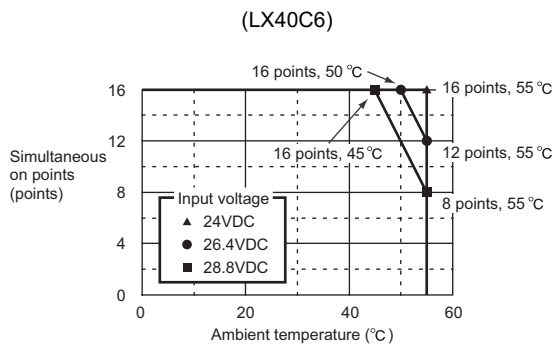

*2 Check the specifications of a sensor or switch to be connected to the LX40C6.

(8) Comparison of specifications between A1SX40-S2 and LX40C6

○ : Compatible, △ : Partially changed, × : Incompatible

Specifications		A1SX40-S2	LX40C6	Compatibility	Precautions for replacement
Number of input points		16 points	16 points	○	
Insulation method		Photocoupler	Photocoupler	○	
Rated input voltage		24VDC	24VDC	○	
Rated input current		Approx. 7mA	6.0mA Typ. (at 24VDC)	△	The input current is lower in the LX40C6. ^{*2}
Operating voltage range		19.2 to 26.4VDC (ripple ratio within 5%)	20.4 to 28.8VDC (ripple ratio within 5%)	△	The operating voltage range differs. ^{*2}
Max. number of simultaneous input points		100% (at 26.4VDC)	Refer to the derating figure. ^{*1}	○	Use it within the range shown in the derating figure.
ON voltage/ON current		14VDC or higher/3.5mA or higher	15VDC or higher/4mA or higher	△	The ON voltage and ON current are higher in the LX40C6. ^{*2}
OFF voltage/OFF current		6.5VDC or lower/1.7mA or lower	8VDC or lower/2mA or lower	△	The OFF voltage and OFF current are higher in the LX40C6. ^{*2}
Input resistance		Approx. 3.3kΩ	Approx. 3.8kΩ	△	The input resistance is higher in the LX40C6. ^{*2}
Response time	OFF → ON	10ms or less (24VDC)	1ms, 5ms, 10ms, 20ms, or less than 70ms (To be set with the CPU module's PLC parameter) Default: 10ms	○	Set the input response time of parameter to the default value (10ms).
	ON → OFF	10ms or less (24VDC)	1ms, 5ms, 10ms, 20ms, or less than 70ms (To be set with the CPU module's PLC parameter) Default: 10ms	○	
Wiring method for common		16 points/common (common terminal: TB9, TB18)	16 points/common (common terminal: TB17)	○	
Operation status indicator		ON status of LED	ON status of LED	○	
External connection system		20-point terminal block (M3.5 × 7 screws)	18-point terminal block (M3 × 6 screws)	×	Wiring change is required. ^{*3} The compatible screw size and wire size are decreased.
Applicable wire size		0.75 to 1.25mm ²	0.3 to 0.75mm ²	×	
Applicable solderless terminal		R1.25-3.5, R2-3.5, RAV1.25-3.5, RAV2-3.5	R1.25-3 (Solderless terminal with an insulation sleeve cannot be used.)	×	
Current consumption		0.05A (Typ., all points ON)	0.09A (Typ., all points ON)	△	Review the current capacity since the current consumption is increased.
External dimensions		130(H) × 34.5(W) × 93.6(D)mm	90(H) × 28.5(W) × 117(D)mm	△	Wiring space is narrower.
Weight		0.20kg	0.15kg	△	

*1 The derating figure is shown below.

(LX40C6)

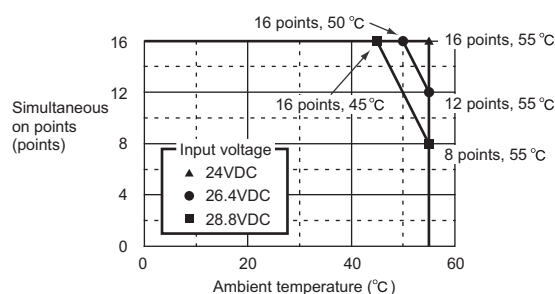

*2 Check the specifications of a sensor or switch to be connected to the LX40C6.

*3 Wiring change is not required if the conversion adapter (ERNT-ASLTX40, manufactured by Mitsubishi Electric Engineering Co., Ltd.) is used.

(9) Comparison of specifications between A1SX41 and LX41C4

○ : Compatible, △ : Partially changed, × : Incompatible

Specifications		A1SX41	LX41C4	Compatibility	Precautions for replacement
Number of input points		32 points	32 points	○	
Insulation method		Photocoupler	Photocoupler	○	
Rated input voltage		12/24VDC	24VDC	△	The input voltage 12VDC cannot be used.*2
Rated input current		Approx. 3mA/Approx. 7mA	4.0mA Typ. (at 24VDC)	△	The input current is lower in the LX41C4.*2
Operating voltage range		10.2 to 26.4VDC (ripple ratio within 5%)	20.4 to 28.8VDC (ripple ratio within 5%)	△	The input voltage 12VDC cannot be used.*2
Max. number of simultaneous input points		Refer to the derating figure.*1	Refer to the derating figure.*1	○	Use it within the range shown in the derating figure.
ON voltage/ON current		8VDC or higher/2mA or higher	19VDC or higher/3mA or higher	△	The ON voltage and ON current are higher in the LX41C4.*2
OFF voltage/OFF current		4VDC or lower/1mA or lower	9VDC or lower/1.7mA or lower	△	The OFF voltage and OFF current are higher in the LX41C4.*2
Input resistance		Approx. 3.3kΩ	Approx. 5.7kΩ	△	The input resistance is higher in the LX41C4.*2
Response time	OFF → ON	10ms or less (24VDC)	1ms, 5ms, 10ms, 20ms, or less than 70ms (To be set with the CPU module's PLC parameter) Default: 10ms	○	Set the input response time of parameter to the default value (10ms).
	ON → OFF	10ms or less (24VDC)	1ms, 5ms, 10ms, 20ms, or less than 70ms (To be set with the CPU module's PLC parameter) Default: 10ms	○	
Wiring method for common		32 points/common (common terminal: B1, B2)	32 points/common (common terminal: B01, B02)	○	
Operation status indicator		ON status of LED	ON status of LED	○	
External connection system		40-pin connector (included with a module)	40-pin connector (sold separately)	○	Existing external wiring can be used as it is.
Applicable wire size		0.3mm ²	0.3mm ² (for A6CON1)	○	
Current consumption		0.08A (Typ., all points ON)	0.1A (Typ., all points ON)	△	Review the current capacity since the current consumption is increased.
External dimensions		130(H) × 34.5(W) × 93.6(D)mm	90(H) × 28.5(W) × 95(D)mm	○	
Weight		0.21kg	0.11kg	△	

*1 The derating figure is shown below.

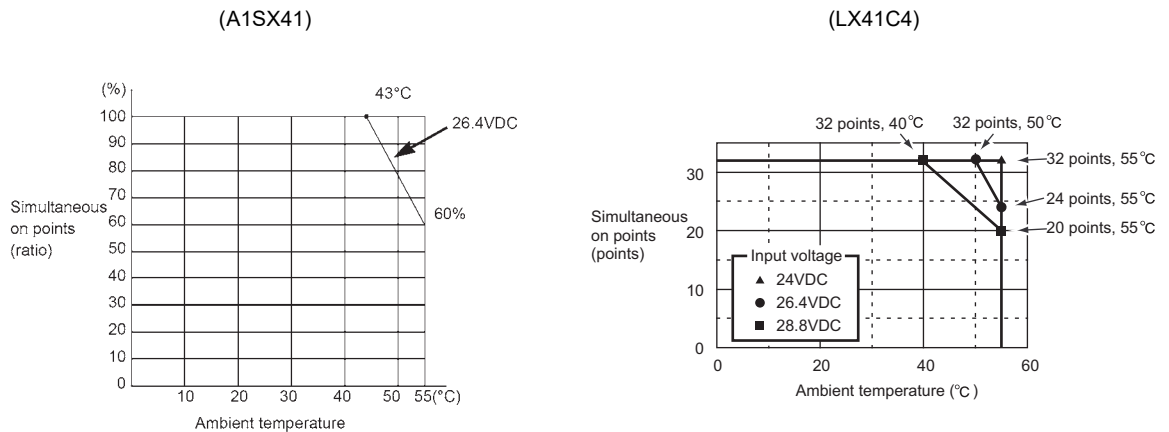

*2 Check the specifications of a sensor or switch to be connected to the LX41C4.

(10) Comparison of specifications between A1SX41-S1 and LX41C4

○ : Compatible, △ : Partially changed, × : Incompatible

Specifications		A1SX41-S1	LX41C4	Compatibility	Precautions for replacement
Number of input points		32 points	32 points	○	
Insulation method		Photocoupler	Photocoupler	○	
Rated input voltage		24VDC	24VDC	○	
Rated input current		Approx. 7mA	4.0mA Typ. (at 24VDC)	△	The input current is lower in the LX41C4. ^{*2}
Operating voltage range		19.2 to 26.4VDC (ripple ratio within 5%)	20.4 to 28.8VDC (ripple ratio within 5%)	△	The operating voltage range differs. ^{*2}
Max. number of simultaneous input points		Refer to the derating figure. ^{*1}	Refer to the derating figure. ^{*1}	○	Use it within the range shown in the derating figure.
ON voltage/ON current		17VDC or higher/4.5mA or higher	19VDC or higher/3mA or higher	△	The ON voltage is higher in the LX40C6. ^{*2}
OFF voltage/OFF current		3.5VDC or lower/0.8mA or lower	9VDC or lower/1.7mA or lower	△	The OFF voltage and OFF current are higher in the LX41C4. ^{*2}
Input resistance		Approx. 3.3kΩ	Approx. 5.7kΩ	△	The input resistance is higher in the LX41C4. ^{*2}
Response time	OFF → ON	0.3ms or less (24VDC)	1ms, 5ms, 10ms, 20ms, or less than 70ms (To be set with the CPU module's PLC parameter) Default: 10ms	×	The response time differs. Consider the modification depending on what to be controlled, including the sensor and switch to be connected.
	ON → OFF	0.3ms or less (24VDC)	1ms, 5ms, 10ms, 20ms, or less than 70ms (To be set with the CPU module's PLC parameter) Default: 10ms	×	
Wiring method for common		32 points/common (common terminal: B1, B2)	32 points/common (common terminal: B01, B02)	○	
Operation status indicator		ON status of LED	ON status of LED	○	
External connection system		40-pin connector (included with a module)	40-pin connector (sold separately)	○	Existing external wiring can be used as it is.
Applicable wire size		0.3mm ²	0.3mm ² (for A6CON1)	○	
Current consumption		0.12A (Typ., all points ON)	0.1A (Typ., all points ON)	○	
External dimensions		130(H) × 34.5(W) × 93.6(D)mm	90(H) × 28.5(W) × 95(D)mm	○	
Weight		0.21kg	0.11kg	△	

*1 The derating figure is shown below.

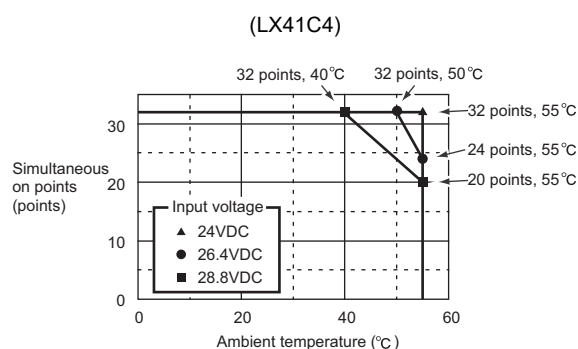
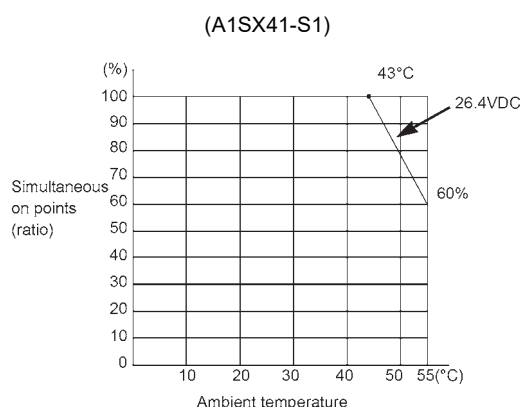

*2 Check the specifications of a sensor or switch to be connected to the LX41C4.

(11) Comparison of specifications between A1SX41-S2 and LX41C4

○ : Compatible, △ : Partially changed, × : Incompatible

Specifications		A1SX41-S2	LX41C4	Compatibility	Precautions for replacement
Number of input points		32 points	32 points	○	
Insulation method		Photocoupler	Photocoupler	○	
Rated input voltage		24VDC	24VDC	○	
Rated input current		Approx. 7mA	4.0mA Typ. (at 24VDC)	△	The input current is lower in the LX41C4.*2
Operating voltage range		19.2 to 26.4VDC (ripple ratio within 5%)	20.4 to 28.8VDC (ripple ratio within 5%)	△	The operating voltage range differs.*2
Max. number of simultaneous input points		Refer to the derating figure.*1	Refer to the derating figure.*1	○	Use it within the range shown in the derating figure.
ON voltage/ON current		14VDC or higher/3.5mA or higher	19VDC or higher/3mA or higher	△	The ON voltage is higher in the LX41C4.*2
OFF voltage/OFF current		6.5VDC or lower/1.7mA or lower	9VDC or lower/1.7mA or lower	△	The OFF voltage is higher in the LX41C4.*2
Input resistance		Approx. 3.3kΩ	Approx. 5.7kΩ	△	The input resistance is higher in the LX41C4.*2
Response time	OFF → ON	10ms or less (24VDC)	1ms, 5ms, 10ms, 20ms, or less than 70ms (To be set with the CPU module's PLC parameter) Default: 10ms	○	Set the input response time of parameter to the default value (10ms).
	ON → OFF	10ms or less (24VDC)	1ms, 5ms, 10ms, 20ms, or less than 70ms (To be set with the CPU module's PLC parameter) Default: 10ms	○	
Wiring method for common		32 points/common (common terminal: B1, B2)	32 points/common (common terminal: B01, B02)	○	
Operation status indicator		ON status of LED	ON status of LED	○	
External connection system		40-pin connector (included with a module)	40-pin connector (sold separately)	○	Existing external wiring can be used as it is.
Applicable wire size		0.3mm ²	0.3mm ² (for A6CON1)	○	
Current consumption		0.08A (Typ., all points ON)	0.1A (Typ., all points ON)	△	Review the current capacity since the current consumption is increased.
External dimensions		130(H) × 34.5(W) × 93.6(D)mm	90(H) × 28.5(W) × 95(D)mm	○	
Weight		0.21kg	0.11kg	△	

*1 The derating figure is shown below.

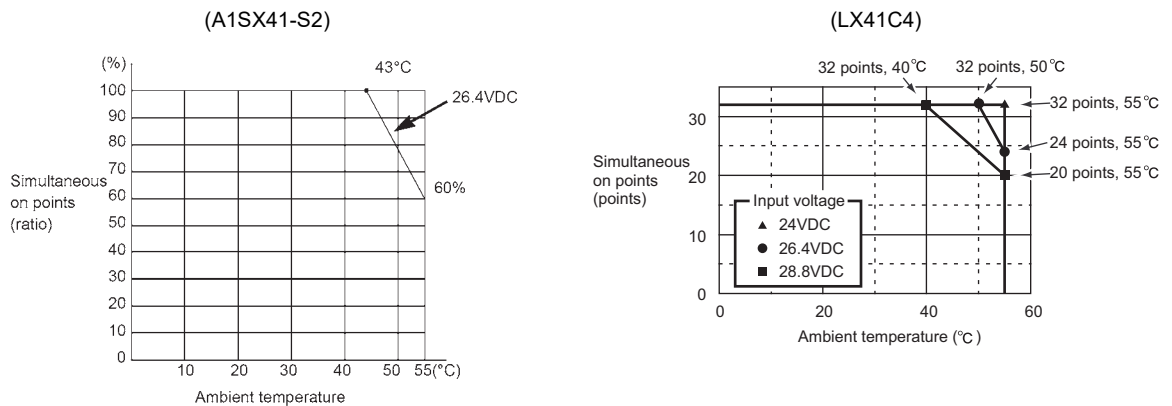

*2 Check the specifications of a sensor or switch to be connected to the LX41C4.

(12) Comparison of specifications between A1SX42 and LX42C4

○ : Compatible, △ : Partially changed, × : Incompatible

Specifications		A1SX42	LX42C4	Compatibility	Precautions for replacement
Number of input points		64 points	64 points	○	
Insulation method		Photocoupler	Photocoupler	○	
Rated input voltage		12/24VDC	24VDC	△	The input voltage 12VDC cannot be used.*2
Rated input current		Approx. 2mA/Approx. 5mA	4.0mA Typ. (at 24VDC)	△	The input current is lower in the LX42C4.*2
Operating voltage range		10.2 to 26.4VDC (ripple ratio within 5%)	20.4 to 28.8VDC (ripple ratio within 5%)	△	The input voltage 12VDC cannot be used.
Max. number of simultaneous input points		Refer to the derating figure.*1	Refer to the derating figure.*1	○	Use it within the range shown in the derating figure.
ON voltage/ON current		8VDC or higher/2mA or higher	19VDC or higher/3mA or higher	△	The ON voltage and ON current are higher in the LX42C4.*2
OFF voltage/OFF current		4VDC or lower/0.6mA or lower	9VDC or lower/1.7mA or lower	△	The OFF voltage and OFF current are higher in the LX42C4.*2
Input resistance		Approx. 5kΩ	Approx. 5.7kΩ	△	The input resistance is higher in the LX42C4.*Q
Response time	OFF → ON	10ms or less (24VDC)	1ms, 5ms, 10ms, 20ms, or less than 70ms (To be set with the CPU module's PLC parameter) Default: 10ms	○	Set the input response time of parameter to the default value (10ms).
	ON → OFF	10ms or less (24VDC)	1ms, 5ms, 10ms, 20ms, or less than 70ms (To be set with the CPU module's PLC parameter) Default: 10ms	○	
Wiring method for common		32 points/common (Common terminal: 1B1, 1B2, 2B1, 2B2)	32 points/common (Common terminal: 1B01, 1B02, 2B01, 2B02)	○	
Operation status indicator		ON status of LED 32-point switching indication with the switch	ON status of LED 32-point switching indication with the switch	○	
External connection system		40-pin connector 2 pieces (included with a module)	40-pin connector 2 pieces (sold separately)	○	Existing external wiring can be used as it is.
Applicable wire size		0.3mm ²	0.3mm ² (for A6CON1)	○	
Current consumption		0.09A (Typ., all points ON)	0.12A (Typ., all points ON)	△	Review the current capacity since the current consumption is increased.
External dimensions		130(H) × 34.5(W) × 93.6(D)mm	90(H) × 28.5(W) × 95(D)mm	○	
Weight		0.28kg	0.12kg	△	

*1 The derating figure is shown below.

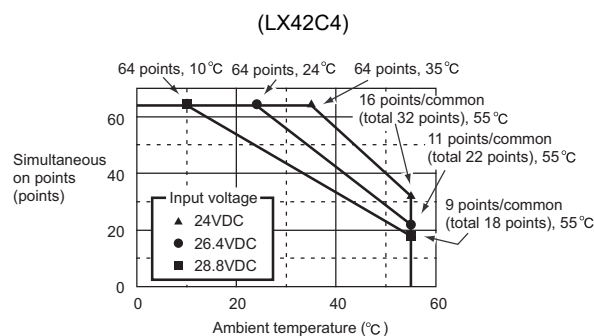
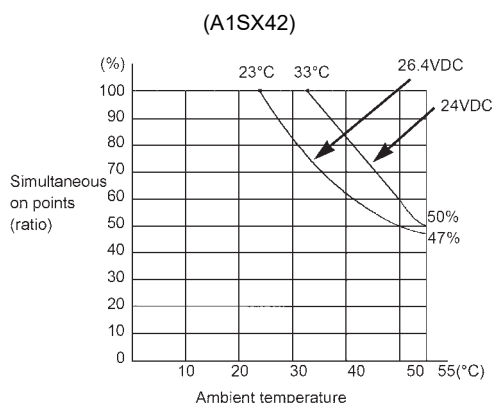

*2 Check the specifications of a sensor or switch to be connected to the LX42C4.

(13) Comparison of specifications between A1SX42-S1 and LX42C4

○ : Compatible, △ : Partially changed, × : Incompatible

Specifications		A1SX42-S1	LX42C4	Compatibility	Precautions for replacement
Number of input points		64 points	64 points	○	
Insulation method		Photocoupler	Photocoupler	○	
Rated input voltage		24VDC	24VDC	○	
Rated input current		Approx. 5mA	4.0mA Typ. (at 24VDC)	△	The input current is lower in the LX42C4.*2
Operating voltage range		19.2 to 26.4VDC (ripple ratio within 5%)	20.4 to 28.8VDC (ripple ratio within 5%)	△	The operating voltage range differs.*2
Max. number of simultaneous input points		Refer to the derating figure.*1	Refer to the derating figure.*1	○	Use it within the range shown in the derating figure.
ON voltage/ON current		18.5VDC or higher/3.5mA or higher	19VDC or higher/3mA or higher	△	The ON voltage is higher in the LX42C4.*2
OFF voltage/OFF current		3VDC or lower/0.45mA or lower	9VDC or lower/1.7mA or lower	△	The OFF voltage and OFF current are higher in the LX42C4.*2
Input resistance		Approx. 4.7kΩ	Approx. 5.7kΩ	△	The input resistance is higher in the LX42C4.*2
Response time	OFF → ON	0.3ms or less (24VDC)	1ms, 5ms, 10ms, 20ms, or less than 70ms (To be set with the CPU module's PLC parameter) Default: 10ms	△	The response time differs. Consider the modification depending on what to be controlled, including the sensor and switch to be connected.
	ON → OFF	0.3ms or less (24VDC)	1ms, 5ms, 10ms, 20ms, or less than 70ms (To be set with the CPU module's PLC parameter) Default: 10ms	△	
Wiring method for common		32 points/common (Common terminal: 1B1, 1B2, 2B1, 2B2)	32 points/common (Common terminal: 1B01, 1B02, 2B01, 2B02)	○	
Operation status indicator		ON status of LED 32-point switching indication with the switch	ON status of LED 32-point switching indication with the switch	○	
External connection system		40-pin connector 2 pieces (included with a module)	40-pin connector 2 pieces (sold separately)	○	Existing external wiring can be used as it is.
Applicable wire size		0.3mm ²	0.3mm ² (for A6CON1)	○	
Current consumption		0.16A (Typ., all points ON)	0.12A (Typ., all points ON)	○	
External dimensions		130(H) × 34.5(W) × 93.6(D)mm	90(H) × 28.5(W) × 95(D)mm	○	
Weight		0.28kg	0.12kg	△	

*1 The derating figure is shown below.

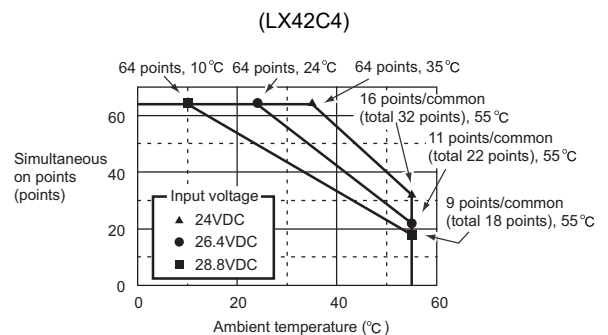
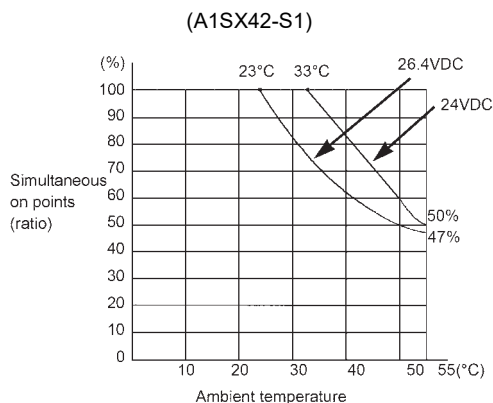

*2 Check the specifications of a sensor or switch to be connected to the LX42C4.

(14) Comparison of specifications between A1SX42-S2 and LX42C4

○ : Compatible, △ : Partially changed, × : Incompatible

Specifications		A1SX42-S2	LX42C4	Compatibility	Precautions for replacement
Number of input points		64 points	64 points	○	
Insulation method		Photocoupler	Photocoupler	○	
Rated input voltage		24VDC	24VDC	○	
Rated input current		Approx. 5mA	4.0mA Typ. (at 24VDC)	△	The input current is lower in the LX42C4.*2
Operating voltage range		19.2 to 26.4VDC (ripple ratio within 5%)	20.4 to 28.8VDC (ripple ratio within 5%)	△	The operating voltage range differs.*2
Max. number of simultaneous input points		Refer to the derating figure.*1	Refer to the derating figure.*1	○	Use it within the range shown in the derating figure.
ON voltage/ON current		17.5VDC or higher/3.5mA or higher	19VDC or higher/3mA or higher	△	The ON voltage is higher in the LX42C4.
OFF voltage/OFF current		7VDC or lower/1.7mA or lower	9VDC or lower/1.7mA or lower	△	The OFF voltage is higher in the LX42C4.*2
Input resistance		Approx. 4.7kΩ	Approx. 5.7kΩ	△	The input resistance is higher in the LX42C4.*2
Response time	OFF → ON	10ms or less (24VDC)	1ms, 5ms, 10ms, 20ms, or less than 70ms (To be set with the CPU module's PLC parameter) Default: 10ms	○	Set the input response time of parameter to the default value (10ms).
	ON → OFF	10ms or less (24VDC)	1ms, 5ms, 10ms, 20ms, or less than 70ms (To be set with the CPU module's PLC parameter) Default: 10ms	○	
Wiring method for common		32 points/common (Common terminal: 1B1, 1B2, 2B1, 2B2)	32 points/common (Common terminal: 1B01, 1B02, 2B01, 2B02)	○	
Operation status indicator		ON status of LED 32-point switching indication with the switch	ON status of LED 32-point switching indication with the switch	○	
External connection system		40-pin connector 2 pieces (included with a module)	40-pin connector 2 pieces (sold separately)	○	Existing external wiring can be used as it is.
Applicable wire size		0.3mm ²	0.3mm ² (for A6CON1)	○	
Current consumption		0.09A (Typ., all points ON)	0.12A (Typ., all points ON)	△	Review the current capacity since the current consumption is increased.
External dimensions		130(H) × 34.5(W) × 93.6(D)mm	90(H) × 28.5(W) × 95(D)mm	○	
Weight		0.28kg	0.12kg	△	

*1 The derating figure is shown below.

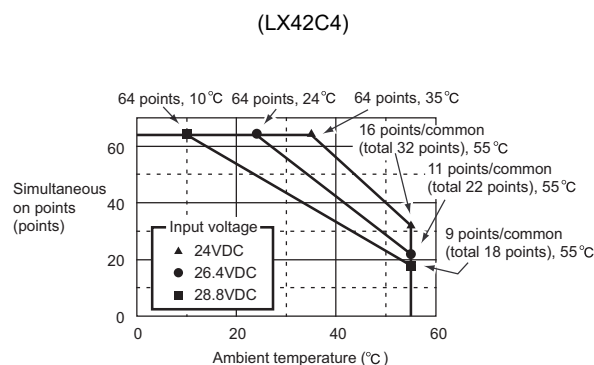
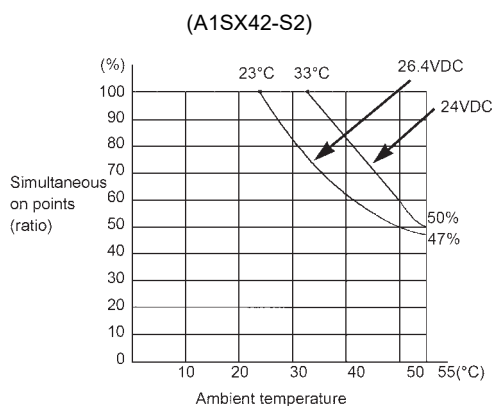

*2 Check the specifications of a sensor or switch to be connected to the LX42C4.

(15) Comparison of specifications between A1SX71 and LX41C4

○ : Compatible, △ : Partially changed, × : Incompatible

Specifications		A1SX71	LX41C4	Compatibility	Precautions for replacement
Number of input points		32 points	32 points	○	
Insulation method		Photocoupler	Photocoupler	○	
Rated input voltage		5VDC/12VDC/24VDC	24VDC	△	The input voltages 5VDC and 12VDC cannot be used.*2
Rated input current		5VDC Approx. 1.2mA 12VDC Approx. 3.3mA 24VDC Approx. 7mA	4mA Typ. (at 24VDC)	△	The input current is lower in the LX41C4.*2
Operating voltage range		4.5 to 26.4VDC (ripple ratio within 5%)	20.4 to 28.8VDC (ripple ratio within 5%)	△	The input voltages 5VDC and 12VDC cannot be used.*2
Max. number of simultaneous input points		Refer to the derating figure.*1	Refer to the derating figure.*1	○	Use it within the range shown in the derating figure.
ON voltage/ON current		3.5VDC or higher/1mA or higher	19VDC or higher/3mA or higher	△	The ON voltage and ON current are higher in the LX41C4.*2
OFF voltage/OFF current		1VDC or lower/0.1mA or lower	9VDC or lower/1.7mA or lower	△	The OFF voltage and OFF current are higher in the LX41C4.*2
Input resistance		Approx. 3.5kΩ	Approx. 5.7kΩ	△	The input resistance is higher in the LX41C4.*2
Response time	OFF → ON	1.5ms or less	1ms, 5ms, 10ms, 20ms, or less than 70ms (To be set with the CPU module's PLC parameter) Default: 10ms	△	The response time differs. Consider the modification depending on what to be controlled, including the sensor and switch to be connected.
	ON → OFF	3ms or less	1ms, 5ms, 10ms, 20ms, or less than 70ms (To be set with the CPU module's PLC parameter) Default: 10ms	△	
Wiring method for common		32 points/common (common terminal: B1, B2)	32 points/common (common terminal: B01, B02)	○	
Operation status indicator		ON status of LED	ON status of LED	○	
External connection system		40-pin connector (included with a module)	40-pin connector (sold separately)	○	Existing external wiring can be used as it is.
Applicable wire size		0.3mm ²	0.3mm ²	○	
Current consumption		0.075A (Typ., all points ON)	0.1A (Typ., all points ON)	△	Review the current capacity since the current consumption is increased.
External dimensions		130(H) × 34.5(W) × 93.6(D)mm	90(H) × 28.5(W) × 95(D)mm	○	
Weight		0.19kg	0.11kg	△	

*1 The derating figure is shown below.

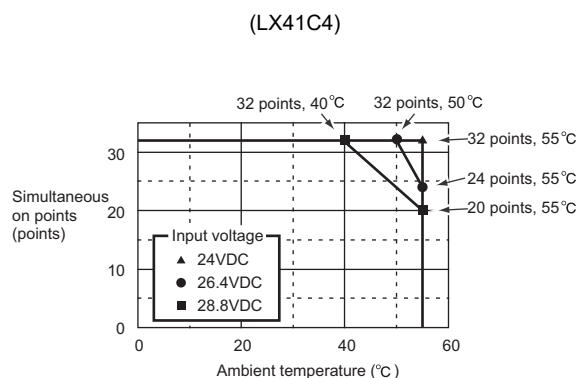
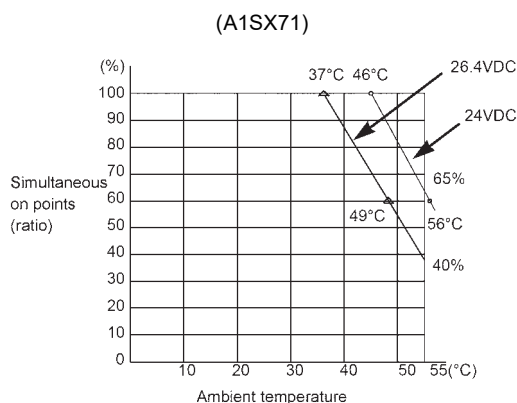

*2 Check the specifications of a sensor or switch to be connected to the LX41C4.

(16) Comparison of specifications between A1SX80 and LX40C6

○ : Compatible, △ : Partially changed, × : Incompatible

Specifications		A1SX80	LX40C6	Compatibility	Precautions for replacement
Number of input points		16 points	16 points	○	
Insulation method		Photocoupler	Photocoupler	○	
Rated input voltage		12/24VDC	24VDC	△	The input voltage 12VDC cannot be used.*2
Rated input current		Approx. 3mA/Approx. 7mA	6.0mA Typ. (at 24VDC)	△	The input current is higher in the LX40C6.*2
Operating voltage range		10.2 to 26.4VDC (ripple ratio within 5%)	20.4 to 28.8VDC (ripple ratio within 5%)	△	The input voltage 12VDC cannot be used.*2
Max. number of simultaneous input points		100% (at 26.4VDC)	Refer to the derating figure.*1	○	Use it within the range shown in the derating figure.
ON voltage/ON current		8VDC or higher/2mA or higher	15VDC or higher/4mA or higher	△	The ON voltage and ON current is higher in the LX40C6.*2
OFF voltage/OFF current		4VDC or lower/1mA or lower	8VDC or lower/2mA or lower	△	The OFF current is higher in the LX40C6.*2
Input resistance		Approx. 3.3kΩ	Approx. 3.8kΩ	△	The input resistance is higher in the LX40C6.*2
Response time	OFF → ON	10ms or less (24VDC)	1ms, 5ms, 10ms, 20ms, or less than 70ms (To be set with the CPU module's PLC parameter) Default: 10ms	○	Set the input response time of parameter to the default value (10ms).
	ON → OFF	10ms or less (24VDC)	1ms, 5ms, 10ms, 20ms, or less than 70ms (To be set with the CPU module's PLC parameter) Default: 10ms	○	
Wiring method for common		16 points/common (common terminal: TB9, TB18)	16 points/common (common terminal: TB17)	○	
Operation status indicator		ON status of LED	ON status of LED	○	
External connection system		20-point terminal block (M3.5 × 7 screws)	18-point terminal block (M3 × 6 screws)	×	Wiring change is required.*3 The compatible screw size and wire size are decreased.
Applicable wire size		0.75 to 1.25mm ²	0.3 to 0.75mm ²	×	
Applicable solderless terminal		R1.25-3.5, R2-3.5, RAV1.25-3.5, RAV2-3.5	R1.25-3 (Solderless terminal with an insulation sleeve cannot be used.)	×	
Current consumption		0.05A (Typ., all points ON)	0.09A (Typ., all points ON)	△	Review the current capacity since the current consumption is increased.
External dimensions		130(H) × 34.5(W) × 93.6(D)mm	90(H) × 28.5(W) × 117(D)mm	○	
Weight		0.20kg	0.2015kg	△	

*1 The derating figure is shown below.

(LX40C6)

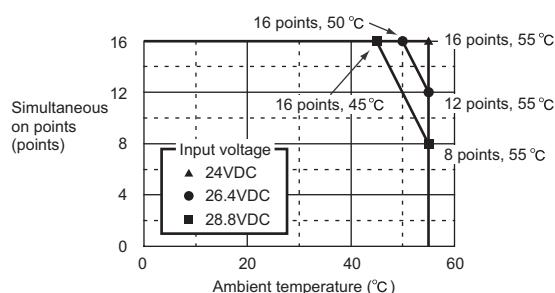

*2 Check the specifications of a sensor or switch to be connected to the LX40C6.

*3 Wiring change is not required if the conversion adapter (ERNT-ASLTX80, manufactured by Mitsubishi Electric Engineering Co., Ltd.) is used.

(17) Comparison of specifications between A1SX80-S1 and LX40C6

○ : Compatible, △ : Partially changed, × : Incompatible

Specifications		A1SX80-S1	LX40C6	Compatibility	Precautions for replacement
Number of input points		16 points	16 points	○	
Insulation method		Photocoupler	Photocoupler	○	
Rated input voltage		24VDC	24VDC	○	
Rated input current		Approx. 7mA	6.0mA Typ. (at 24VDC)	△	The input current is lower in the LX40C6.*2
Operating voltage range		19.2 to 26.4VDC (ripple ratio within 5%)	20.4 to 28.8VDC (ripple ratio within 5%)	△	The operating voltage range differs.*2
Max. number of simultaneous input points		Refer to the derating figure.*1	Refer to the derating figure.*1	○	Use it within the range shown in the derating figure.
ON voltage/ON current		17VDC or higher/5mA or higher	15VDC or higher/4mA or higher	△	The ON voltage/ON current differ.*2
OFF voltage/OFF current		5VDC or lower/1.7mA or lower	8VDC or lower/2mA or lower	△	The OFF current is higher in the LX40C6.*2
Input resistance		Approx. 3.3kΩ	Approx. 3.8kΩ	△	The input resistance is higher in the LX40C6.*2
Response time	OFF → ON	0.4ms (24VDC)	1ms, 5ms, 10ms, 20ms, or less than 70ms (To be set with the CPU module's PLC parameter) Default: 10ms	△	The response time differs. Consider the modification depending on what to be controlled, including the sensor and switch to be connected.
	ON → OFF	0.5ms (24VDC)	1ms, 5ms, 10ms, 20ms, or less than 70ms (To be set with the CPU module's PLC parameter) Default: 10ms	△	
Wiring method for common		16 points/common (common terminal: TB9, TB18)	16 points/common (common terminal: TB17)	○	
Operation status indicator		ON status of LED	ON status of LED	○	
External connection system		20-point terminal block (M3.5 × 7 screws)	18-point terminal block (M3 × 6 screws)	×	Wiring change is required. The compatible screw size and wire size are decreased.
Applicable wire size		0.75 to 1.25mm ²	0.3 to 0.75mm ²	×	
Applicable solderless terminal		R1.25-3.5, R2-3.5, RAV1.25-3.5, RAV2-3.5	R1.25-3 (Solderless terminal with an insulation sleeve cannot be used.)	×	
Current consumption		0.05A (Typ., all points ON)	0.09A (Typ., all points ON)	△	Review the current capacity since the current consumption is increased.
External dimensions		130(H) × 34.5(W) × 93.6(D)mm	90(H) × 28.5(W) × 117(D)mm	○	
Weight		0.20kg	0.15kg	△	

*1 The derating figure is shown below.

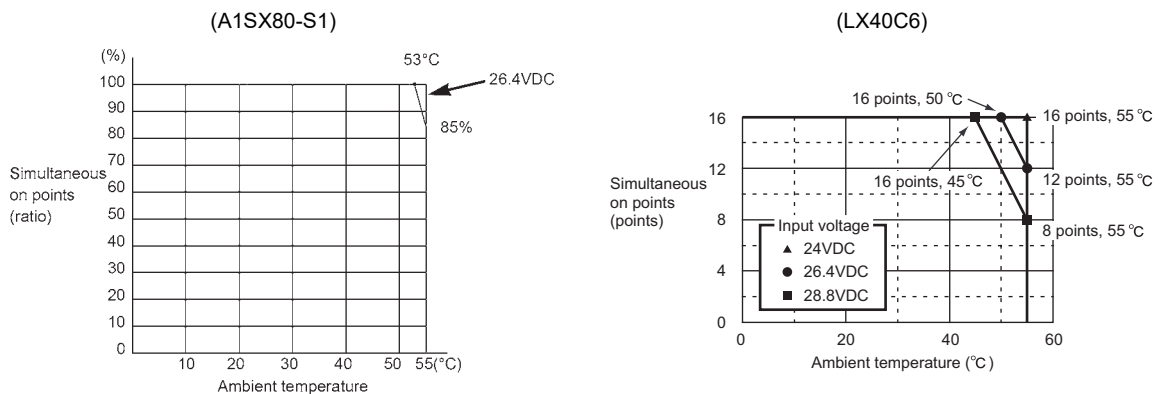

*2 Check the specifications of a sensor or switch to be connected to the LX40C6.

(18) Comparison of specifications between A1SX80-S2 and LX40C6

○ : Compatible, △ : Partially changed, × : Incompatible

Specifications		A1SX80-S2	LX40C6	Compatibility	Precautions for replacement
Number of input points		16 points	16 points	○	
Insulation method		Photocoupler	Photocoupler	○	
Rated input voltage		24VDC	24VDC	○	
Rated input current		Approx. 7mA	6.0mA Typ. (at 24VDC)	△	The input current is lower in the LX40C6. *2
Operating voltage range		19.2 to 26.4VDC (ripple ratio within 5%)	20.4 to 28.8VDC (ripple ratio within 5%)	△	The operating voltage range differs. *2
Max. number of simultaneous input points		100% (at 26.4VDC)	Refer to the derating figure. *1	○	Use it within the range shown in the derating figure.
ON voltage/ON current		13VDC or more/3.5mA or higher	15VDC or more/4mA or higher	△	The ON voltage and ON current are higher in the LX40C6. *2
OFF voltage/OFF current		6VDC or lower/1.7mA or lower	8VDC or lower/2mA or lower	△	The OFF current is higher in the LX40C6. *2
Input resistance		Approx. 3.3kΩ	Approx. 3.8kΩ	△	The input resistance is higher in the LX40C6. *2
Response time	OFF → ON	10ms or less (24VDC)	1ms, 5ms, 10ms, 20ms, or less than 70ms (To be set with the CPU module's PLC parameter) Default: 10ms	○	Set the input response time of parameter to the default value (10ms).
	ON → OFF	10ms or less (24VDC)	1ms, 5ms, 10ms, 20ms, or less than 70ms (To be set with the CPU module's PLC parameter) Default: 10ms	○	
Wiring method for common		16 points/common (common terminal: TB9, TB18)	16 points/common (common terminal: TB17)	○	
Operation status indicator		ON status of LED	ON status of LED	○	
External connection system		20-point terminal block (M3.5 × 7 screws)	18-point terminal block (M3 × 6 screws)	×	Wiring change is required. *3 The compatible screw size and wire size are decreased.
Applicable wire size		0.75 to 1.25mm ²	0.3 to 0.75mm ²	×	
Applicable solderless terminal		R1.25-3.5, R2-3.5, RAV1.25-3.5, RAV2 to 3.5	R1.25-3 (Solderless terminal with an insulation sleeve cannot be used.)	×	
Current consumption		0.05A (Typ., all points ON)	0.09A (Typ., all points ON)	△	Review the current capacity since the current consumption is increased.
External dimensions		130(H) × 34.5(W) × 93.6(D)mm	90(H) × 28.5(W) × 117(D)mm	○	
Weight		0.20kg	0.15kg	△	

*1 The derating figure is shown below.

(LX40C6)

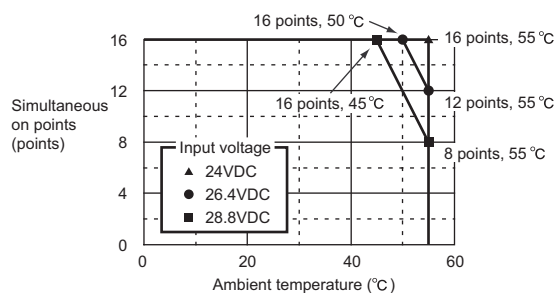

*2 Check the specifications of a sensor or switch to be connected to the LX40C6.

*3 Wiring change is not required if the conversion adapter (ERNT-ASLTX80, manufactured by Mitsubishi Electric Engineering Co., Ltd.) is used.

(19) Comparison of specifications between A1SX81 and LX41C4

○ : Compatible, △ : Partially changed, × : Incompatible

Specifications		A1SX81	LX41C4	Compatibility	Precautions for replacement
Number of input points		32 points	32 points	○	
Insulation method		Photocoupler	Photocoupler	○	
Rated input voltage		12/24VDC	24VDC	△	The input voltage 12VDC cannot be used.*2
Rated input current		Approx. 3mA/Approx. 7mA	4mA Typ. (at 24VDC)	△	The input current is lower in the LX41C4.*2
Operating voltage range		10.2 to 26.4VDC (ripple ratio within 5%)	20.4 to 28.8VDC (ripple ratio within 5%)	△	The input voltage 12VDC cannot be used.*2
Max. number of simultaneous input points		Refer to the derating figure.*1	Refer to the derating figure.*1	○	Use it within the range shown in the derating figure.
ON voltage/ON current		8VDC or higher/2mA or higher	19VDC or higher/3mA or higher	△	The ON voltage and ON current are higher in the LX41C4.*2
OFF voltage/OFF current		4VDC or lower/1mA or lower	9VDC or lower/1.7mA or lower	△	The OFF voltage and OFF current are higher in the LX41C4.*2
Input resistance		Approx. 3.3kΩ	Approx. 5.7kΩ	△	The input resistance is higher in the LX41C4.*2
Response time	OFF → ON	10ms or less (24VDC)	1ms, 5ms, 10ms, 20ms, or less than 70ms (To be set with the CPU module's PLC parameter) Default: 10ms	○	Set the input response time of parameter to the default value (10ms).
	ON → OFF	10ms or less (24VDC)	1ms, 5ms, 10ms, 20ms, or less than 70ms (To be set with the CPU module's PLC parameter) Default: 10ms	○	
Wiring method for common		32 points/common (common terminal: 17, 18, 36)	32 points/common (common terminal: B01, B02)	○	
Operation status indicator		ON status of LED	ON status of LED	○	
External connection system		37-pin D-sub connector (included with a module)	40-pin connector (sold separately)	×	Wiring change is required.*3
Applicable wire size		0.3mm ²	0.3mm ² (for A6CON1 and A6CON4)	×	
Current consumption		0.08A (Typ., all points ON)	0.1A (Typ., all points ON)	△	Review the current capacity since the current consumption is increased.
External dimensions		130(H) × 34.5(W) × 93.6(D)mm	90(H) × 28.5(W) × 95(D)mm	○	
Weight		0.24kg	0.11kg	△	

*1 The derating figure is shown below.

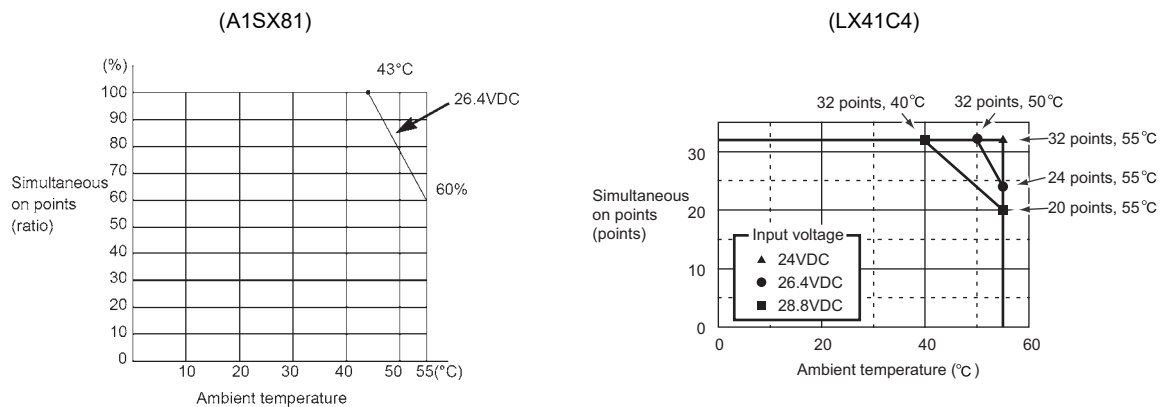

*2 Check the specifications of a sensor or switch to be connected to the LX41C4.

*3 Wiring change is not required if the conversion adapter (ERNT-ASLCXY81, manufactured by Mitsubishi Electric Engineering Co., Ltd.) is used.

(20) Comparison of specifications between A1SX81-S2 and LX41C4

○ : Compatible, △ : Partially changed, × : Incompatible

Specifications		A1SX81-S2	LX41C4	Compatibility	Precautions for replacement
Number of input points		32 points	32 points	○	
Insulation method		Photocoupler	Photocoupler	○	
Rated input voltage		24VDC	24VDC	○	
Rated input current		Approx. 7mA	4mA Typ. (at 24VDC)	△	The input current is lower in the LX41C4. ^{*2}
Operating voltage range		19.2 to 26.4VDC (ripple ratio within 5%)	20.4 to 28.8VDC (ripple ratio within 5%)	△	The operating voltage range differs. ^{*2}
Max. number of simultaneous input points		Refer to the derating figure. ^{*1}	Refer to the derating figure. ^{*1}	○	Use it within the range shown in the derating figure.
ON voltage/ON current		13VDC or higher/3.5mA or higher	19VDC or higher/3mA or higher	△	The ON voltage is higher in the LX41C4. ^{*2}
OFF voltage/OFF current		6VDC or lower/1.7mA or lower	9VDC or lower/1.7mA or lower	△	The OFF voltage is higher in the LX41C4. ^{*2}
Input resistance		Approx. 3.3kΩ	Approx. 5.7kΩ	△	The input resistance is higher in the LX41C4. ^{*2}
Response time	OFF → ON	10ms or less (24VDC)	1ms, 5ms, 10ms, 20ms, or less than 70ms (To be set with the CPU module's PLC parameter) Default: 10ms	○	Set the input response time of parameter to the default value (10ms).
	ON → OFF	10ms or less (24VDC)	1ms, 5ms, 10ms, 20ms, or less than 70ms (To be set with the CPU module's PLC parameter) Default: 10ms	○	
Wiring method for common		32 points/common (common terminal: 17, 18, 36)	32 points/common (Common terminal: 1B01, 1B02, 2B01, 2B02)	○	
Operation status indicator		ON status of LED	ON status of LED	○	
External connection system		37-pin D-sub connector (included with a module)	40-pin connector (sold separately)	×	Wiring change is required. ^{*3}
Applicable wire size		0.3mm ²	0.3mm ² (for A6CON1 and A6CON4)		
Current consumption		0.08A (Typ., all points ON)	0.1A (Typ., all points ON)	△	Review the current capacity since the current consumption is increased.
External dimensions		130(H) × 34.5(W) × 93.6(D)mm	90(H) × 28.5(W) × 95(D)mm	○	
Weight		0.24kg	0.11kg	△	

*1 The derating figure is shown below.

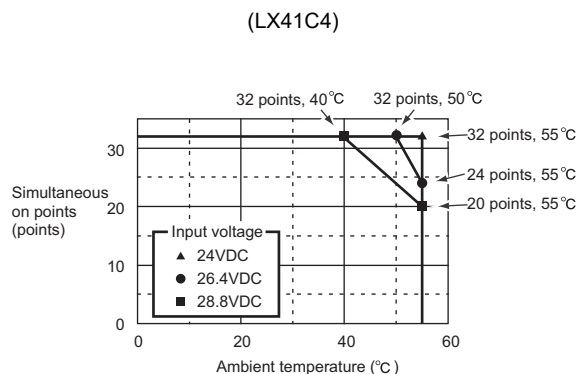
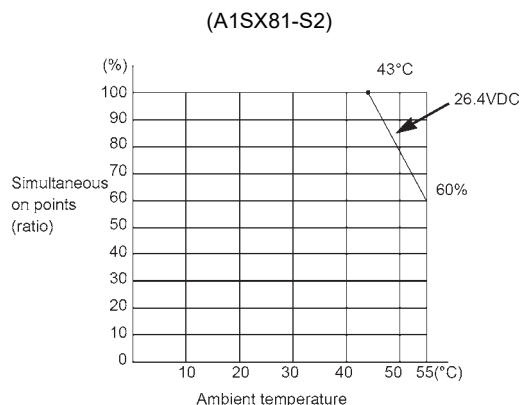

*2 Check the specifications of a sensor or switch to be connected to the LX41C4.

*3 Wiring change is not required if the conversion adapter (ERNT-ASLCXY81, manufactured by Mitsubishi Electric Engineering Co., Ltd.) is used.

(21) Comparison of specifications between A1SX82-S1 and LX42C4

○ : Compatible, △ : Partially changed, × : Incompatible

Specifications		A1SX82-S1	LX42C4	Compatibility	Precautions for replacement
Number of input points		64 points	64 points	○	
Insulation method		Photocoupler	Photocoupler	○	
Rated input voltage		24VDC	24VDC	○	
Rated input current		Approx. 5mA	4mA Typ. (at 24VDC)	△	The input current is lower in the LX42C4.*2
Operating voltage range		19.2 to 26.4VDC (ripple ratio within 5%)	20.4 to 28.8VDC (ripple ratio within 5%)	△	The operating voltage range differs.*2
Max. number of simultaneous input points		50% (16 points/common) (at 24VDC)	Refer to the derating figure.*1	○	Use it within the range shown in the derating figure.
ON voltage/ON current		18.5VDC or higher/3.5mA or higher	19VDC or higher/3mA or higher	△	The ON voltage is higher in the LX42C4.*2
OFF voltage/OFF current		3VDC or lower/0.45mA or lower	9VDC or lower/1.7mA or lower	△	The OFF voltage is higher in the LX42C4.*2
Input resistance		Approx. 4.7kΩ	Approx. 5.7kΩ	△	The input resistance is higher in the LX42C4.*2
Response time	OFF → ON	0.3ms or less (24VDC)	1ms, 5ms, 10ms, 20ms, or less than 70ms (To be set with the CPU module's PLC parameter) Default: 10ms	△	The response time differs. Consider the modification depending on what to be controlled, including the sensor and switch to be connected.
	ON → OFF	0.3ms or less (24VDC)	1ms, 5ms, 10ms, 20ms, or less than 70ms (To be set with the CPU module's PLC parameter) Default: 10ms	△	
Wiring method for common		32 points/common (Common terminal: 1B1, 1B2, 2B1, 2B2)	32 points/common (Common terminal: 1B01, 1B02, 2B01, 2B02)	○	
Operation status indicator		ON status of LED 32-point switching indication with the switch	ON status of LED 32-point switching indication with the switch	○	
External connection system		40-pin connector 2 pieces (included with a module)	40-pin connector (sold separately)	○	Existing external wiring can be used as it is.
Applicable wire size		0.3mm ²	0.3mm ²	○	
Current consumption		0.16A (Typ., all points ON)	0.12A (Typ., all points ON)	○	
External dimensions		130(H) × 34.5(W) × 93.6(D)mm	90(H) × 28.5(W) × 95(D)mm	○	
Weight		0.28kg	0.12kg	△	

*1 The derating figure is shown below.

(LX42C4)

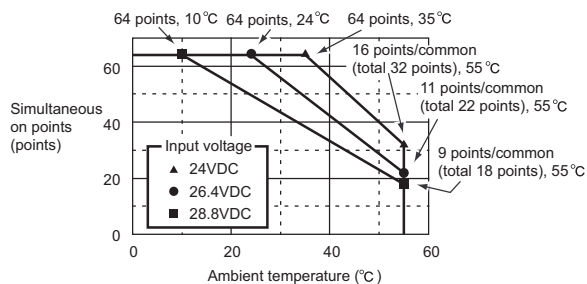

*2 Check the specifications of a sensor or switch to be connected to the LX42C4.

3.2.2 Comparison of output module specifications

(1) Comparison of specifications between A1SY10 and LY10R2

○ : Compatible, △ : Partially changed, × : Incompatible

Specifications		A1SY10	LY10R2	Compatibility	Precautions for replacement
Number of output points		16 points	16 points	○	
Insulation method		Photocoupler	Relay	△	The insulation method differs, but the performance is the equivalent.
Rated switching voltage/current		24VDC 2A (resistance load)/point 240VAC 2A (COSφ=1)/point 8A/common	24VDC 2A (resistance load)/point 240VAC 2A (COSφ=1)/point 8A/common	○	
Min. switching load		5VDC 1mA	5VDC 1mA	○	
Max. switching voltage		264VAC 125VDC	264VAC 125VDC	○	
Response time	OFF → ON	10ms or less	10ms or less	○	
	ON → OFF	12ms or less	12ms or less	○	
Life	Mechanical	20 million times or more	20 million times or more	○	
	Electrical	Rated switching voltage/current load 100000 times or more	Rated switching voltage/current load 100000 times or more	○	
		200VAC 1.5A, 240VAC 1A (COSφ=0.7) 100000 times or more 200VAC 1A, 240VAC 0.5A (COSφ=0.35) 100000 times or more 24VDC 1A, 100VDC 0.1A (L/R=7ms) 100000 times or more	200VAC 1.5A, 240VAC 1A (COSφ=0.7) 100000 times or more 200VAC 0.4A, 240VAC 0.3A (COSφ=0.7) 300000 times or more 200VAC 1A, 240VAC 0.5A (COSφ=0.35) 100000 times or more 200VAC 0.3A, 240VAC 0.15A (COSφ=0.35) 300000 times or more 24VDC 1A, 100VDC 0.1A (L/R=7ms) 100000 times or more 24VDC 0.3A, 100VDC 0.03A (L/R=7ms) 300000 times or more	○	
Max. switching frequency	3600 times/hr	3600 times/hr	○		
Surge suppressor		Not supported	Not supported	○	
Wiring method for common		8 points/common (common terminal: TB9, TB18)	16 points/common (common terminal: TB17)	△	As the common is changed from 2 commons to 1 common, wiring with a different voltage for each common is not possible.
Operation status indicator		ON status of LED	ON status of LED	○	
Fuse		None	None	○	
External power supply	Voltage	24VDC ±10% Ripple voltage 4Vp-p or lower	—	○	An external power supply is not required.
	Current	90mA (Typ., 24VDC, all points ON)	—	○	
External connection system		20-point terminal block (M3.5 × 7 screws)	18-point terminal block (M3 × 6 screws)	×	Wiring change is required.*1 The compatible screw size and wire size are decreased.
Applicable wire size		0.75 to 1.25mm ²	Core: 0.3 to 0.75mm ² (outside diameter: 2.8mm or less)	×	
Applicable solderless terminal		R1.25-3.5, R2-3.5, RAV1.25-3.5, RAV2-3.5	R1.25-3 (Solderless terminal with an insulation sleeve cannot be used.)	×	
Current consumption		0.12A (Typ., all points ON)	0.46A (Typ., all points ON)	△	Review the current capacity since the current consumption is increased.
External dimensions		130(H) × 34.5(W) × 93.6(D)mm	90(H) × 28.5(W) × 117(D)mm	△	Wiring space is narrower.
Weight		0.25kg	0.21kg	△	

*1 Wiring change is not required if the conversion adapter (ERNT-ASLTYX10, manufactured by Mitsubishi Electric Engineering Co., Ltd.) is used.

(2) Comparison of specifications between A1SY10EU and LY10R2

○ : Compatible, △ : Partially changed, × : Incompatible

Specifications		A1SY10EU	LY10R2	Compatibility	Precautions for replacement
Number of output points		16 points	16 points	○	
Insulation method		Photocoupler	Relay	△	The insulation method differs, but the performance is the equivalent.
Rated switching voltage/current		24VDC 2A (resistance load)/point 120VAC 2A (COSφ=1)/point 8A/common	24VDC 2A (resistance load)/point 240VAC 2A (COSφ=1)/point 8A/common	○	
Min. switching load		5VDC 1mA	5VDC 1mA	○	
Max. switching voltage		132VAC 125VDC	264VAC 125VDC	○	
Response time	OFF → ON	10ms or less	10ms or less	○	
	ON → OFF	12ms or less	12ms or less	○	
Life	Mechanical	20 million times or more	20 million times or more	○	
	Electrical	Rated switching voltage/current load 200000 times or more	Rated switching voltage/current load 100000 times or more	△	Replace the module more frequently because the life cycle is reduced by approximately half.
		100VAC 2A, 120VAC 2A (COSφ=0.7) 200000 times or more 100VAC 2A, 120VAC 2A (COSφ=0.35) 100000 times or more 24VDC 1.5A, 100VDC 0.1A (L/R=7ms) 100000 times or more	200VAC 1.5A, 240VAC 1A (COSφ=0.7) 100000 times or more 200VAC 0.4A, 240VAC 0.3A (COSφ=0.7) 300000 times or more 200VAC 1A, 240VAC 0.5A (COSφ=0.35) 100000 times or more 200VAC 0.3A, 240VAC 0.15A (COSφ=0.35) 300000 times or more 24VDC 1A, 100VDC 0.1A (L/R=7ms) 100000 times or more 24VDC 0.3A, 100VDC 0.03A (L/R=7ms) 300000 times or more	△	
Max. switching frequency	3600 times/hr	3600 times/hr	○		
Surge suppressor		Not supported	Not supported	○	
Wiring method for common		8 points/common (common terminal: TB9, TB18)	16 points/common (common terminal: TB17)	△	As the common is changed from 2 commons to 1 common, wiring with a different voltage for each common is not possible.
Operation status indicator		ON status of LED	ON status of LED	○	
Fuse		None	None	○	
External power supply	Voltage	24VDC ±10% Ripple voltage 4Vp-p or lower	—	○	An external power supply is not required.
	Current	90mA (Typ., 24VDC, all points on)	—	○	
External connection system		20-point terminal block (M3.5 × 7 screws)	18-point terminal block (M3 × 6 screws)	×	
Applicable wire size		0.75 to 1.25mm ² (AWG16 to AWG19)	Core: 0.3 to 0.75mm ² (outside diameter: 2.8mm or less)	×	Wiring change is required.*1 The compatible screw size and wire size are decreased.
Applicable solderless terminal		RAV1.25-3.5	R1.25-3 (Solderless terminal with an insulation sleeve cannot be used.)	×	
Withstand voltage		(Between all AC external circuits and relay driving power, internal 5V circuit) 1780VACrms for 3 cycles (2000m above sea level) (Between relay driving power and internal 5V circuit) 500VACrms for 3 cycles (2000m above sea level)	2300VAC, 1 minute (altitude 2000m)	○	
Insulation resistance		10MΩ or higher (insulation resistance tester)	10MΩ or higher (insulation resistance tester)	○	

Specifications	A1SY10EU	LY10R2	Compatibility	Precautions for replacement
Noise immunity	IEC 801-4:1kV	Noise voltage 1500Vp-p, noise width 1μs, noise frequency 25 to 60Hz (noise simulator condition)	○	
Current consumption	0.12A (Typ., all points ON)	0.46A (Typ., all points ON)	△	Review the current capacity since the current consumption is increased.
External dimensions	130(D) × 34.5(W) × 93.6(D)mm	90(H) × 28.5(W) × 117(D)mm	△	Wiring space is narrower.
Weight	0.25kg	0.21kg	△	

*1 Wiring change is not required if the conversion adapter (ERNT-ASLTX10, manufactured by Mitsubishi Electric Engineering Co., Ltd.) is used.

(3) Comparison of specifications between A1SY14EU and LY10R2

○ : Compatible, △ : Partially changed, × : Incompatible

Specifications		A1SY14EU	LY10R2	Compatibility	Precautions for replacement
Number of output points		12 points (16 points occupied)	16 points	○	
Insulation method		Photocoupler	Relay	△	The insulation method differs, but the performance is the equivalent.
Rated switching voltage/current		24VDC 2A (resistance load)/point/ 240VAC 2A (COSφ=1)/point 8A/common	24VDC 2A (resistance load)/point/ 240VAC 2A (COSφ=1)/point 8A/common	○	
Min. switching load		5VDC 1mA	5VDC 1mA	○	
Max. switching voltage		264VAC 125VDC	264VAC 125VDC	○	
Response time	OFF → ON	10ms or less	10ms or less	○	
	ON → OFF	12ms or less	12ms or less	○	
Life	Mechanical	20 million times or more	20 million times or more	○	
	Electrical	Rated switching voltage/current load 200000 times or more	Rated switching voltage/current load 100000 times or more	△	Replace the module more frequently because the life cycle is reduced by approximately half.
200VAC 2A, 240VAC 1.8A (COSφ=0.7) 200000 times or more 200VAC 1.1A, 240VAC 0.9A (COSφ=0.35) 200000 times or more 24VDC 1.1A, 100VDC 0.1A (L/R=7ms) 200000 times or more		200VAC 1.5A, 240VAC 1A (COSφ=0.7) 100000 times or more 200VAC 0.4A, 240VAC 0.3A (COSφ=0.7) 300000 times or more 200VAC 1A, 240VAC 0.5A (COSφ=0.35) 100000 times or more 200VAC 0.3A, 240VAC 0.15A (COSφ=0.35) 300000 times or more 24VDC 1A, 100VDC 0.1A (L/R=7ms) 100000 times or more 24VDC 0.3A, 100VDC 0.03A (L/R=7ms) 300000 times or more	△		
Max. switching frequency		3600 times/hr	3600 times/hr	○	
Surge suppressor		Not supported	Not supported	○	
Wiring method for common		4 points/common (common terminal: TB5, TB10, TB15)	16 points/common (common terminal: TB17)	△	As the common is changed from 3 commons to 1 common, wiring with a different voltage for each common is not possible.
Operation status indicator		ON status of LED	ON status of LED	○	
Fuse		None	None	○	
External power supply	Voltage	24VDC ±10% Ripple voltage 4Vp-p or lower	—	○	An external power supply is not required.
	Current	100mA (Typ., 24VDC, all points ON) (must be SELV power supply)	—	○	
External connection system		20-point terminal block (M3.5 × 7 screws)	18-point terminal block (M3 × 6 screws)	×	
Applicable wire size		0.75 to 1.25mm ² (AWG16 to AWG19)	Core: 0.3 to 0.75mm ² (outside diameter: 2.8mm or less)	×	Wiring change is required. The compatible screw size and wire size are decreased.
Applicable solderless terminal		RAV1.25-3.5	R1.25-3 (Solderless terminal with an insulation sleeve cannot be used.)	×	
Withstand voltage		(Between all AC external circuits and relay driving power, internal 5V circuit) 2830VACrms for 3 cycles (2000m above sea level) (Between relay driving power and internal 5V circuit) 500VACrms for 3 cycles (2000m above sea level)	2300VAC, 1 minute (altitude 2000m)	○	
Insulation resistance		10MΩ or higher (insulation resistance tester)	10MΩ or higher (insulation resistance tester)	○	

Specifications	A1SY14EU	LY10R2	Compatibility	Precautions for replacement
Noise immunity	IEC 801-4:1kV	Noise voltage 1500Vp-p, noise width 1μs, noise frequency 25 to 60Hz (noise simulator condition)	○	
Current consumption	0.12A (Typ., all points ON)	0.46A (Typ., all points ON)	△	Review the current capacity since the current consumption is increased.
External dimensions	130(H) × 34.5(W) × 93.6(D)mm	90(H) × 28.5(W) × 117(D)mm	△	Wiring space is narrower.
Weight	0.25kg	0.21kg	△	

(4) Comparison of specifications between A1SY18A and LY18R2A

○ : Compatible, △ : Partially changed, × : Incompatible

Specifications		A1SY14EU	LY10R2	Compatibility	Precautions for replacement
Number of output points		8 points (16 points occupied)	8 points (16 points occupied)	○	
Insulation method		Photocoupler	Relay	△	The insulation method differs, but the performance is the equivalent.
Rated switching voltage/current		24VDC 2A (resistance load)/point 240VAC 2A (COSφ=1)/point 8A/module	24VDC 2A (resistance load)/point 240VAC 2A (COSφ=1)/point 8A/module	○	
Min. switching load		5VDC 1mA	5VDC 1mA	○	
Max. switching voltage		264VAC 125VDC	264VAC 125VDC	○	
Response time	OFF → ON	10ms or less	10ms or less	○	
	ON → OFF	12ms or less	12ms or less	○	
Life	Mechanical	20 million times or more	20 million times or more	○	
	Electrical	Rated switching voltage/current load 200000 times or more	Rated switching voltage/current load 100000 times or more	△	Replace the module more frequently because the life cycle is reduced by approximately half.
200VAC 1.5A, 240VAC 1A (COSφ=0.7) 200000 times or more 200VAC 0.75A, 240VAC 0.5A (COSφ=0.35) 200000 times or more 24VDC 1A, 100VDC 0.1A (L/R=7ms) 200000 times or more		200VAC 1.5A, 240VAC 1A (COSφ=0.7) 100000 times or more 200VAC 0.4A, 240VAC 0.3A (COSφ=0.7) 300000 times or more 200VAC 1A, 240VAC 0.5A (COSφ=0.35) 100000 times or more 200VAC 0.3A, 240VAC 0.15A (COSφ=0.35) 300000 times or more 24VDC 1A, 100VDC 0.1A (L/R=7ms) 100000 times or more 24VDC 0.3A, 100VDC 0.03A (L/R=7ms) 300000 times or more	△		
Max. switching frequency		3600 times/hr	3600 times/hr	○	
Surge suppressor		Not supported	Not supported	○	
Wiring method for common		All points independent	All points independent	○	
Operation status indicator		ON status of LED	ON status of LED	○	
Fuse		None	None	○	
External power supply	Voltage	24VDC ±10% Ripple voltage 4Vp-p or lower	—	○	An external power supply is not required.
	Current	75mA (Typ., 24VDC, all points ON)	—	○	
External connection system		20-point terminal block (M3.5 × 7 screws)	18-point terminal block (M3 × 6 screws)	×	Wiring change is required.
Applicable wire size		0.75 to 1.25mm ²	Core: 0.3 to 0.75mm ² (outside diameter: 2.8mm or less)	×	
Applicable solderless terminal		R1.25-3.5, R2-3.5, RAV1.25-3.5, RAV2-3.5	R1.25-3 (Solderless terminal with an insulation sleeve cannot be used.)	×	
Current consumption		0.24A (Typ., all points ON)	0.26A (Typ., all points ON)	△	Review the current capacity since the current consumption is increased.
External dimensions		130(H) × 34.5(W) × 93.6(D)mm	90(H) × 28.5(W) × 117(D)mm	△	Wiring space is narrower.
Weight		0.25kg	0.18kg	△	

(5) Comparison of specifications between A1SY18AEU and LY18R2A

○ : Compatible, △ : Partially changed, × : Incompatible

Specifications		A1SY18AEU	LY18R2A	Compatibility	Precautions for replacement
Number of output points		8 points (16 points occupied)	8 points (16 points occupied)	○	
Insulation method		Photocoupler	Relay	△	The insulation method differs, but the performance is the equivalent.
Rated switching voltage/current		24VDC 2A (resistance load)/point 240VAC 2A (COSφ=1)/point	24VDC 2A (resistance load)/point 240VAC 2A (COSφ=1)/point 8A/module	△	Calculate the total current value when inputs are simultaneously on.
Min. switching load		5VDC 1mA	5VDC 1mA	○	
Max. switching voltage		264VAC 125VDC	264VAC 125VDC	○	
Response time	OFF → ON	10ms or less	10ms or less	○	
	ON → OFF	12ms or less	12ms or less	○	
Life	Mechanical	20 million times or more	20 million times or more	○	Replace the module more frequently because the life cycle is reduced by approximately half.
	Electrical	Rated switching voltage/current load 200000 times or more	Rated switching voltage/current load 100000 times or more	△	
		200VAC 1.5A, 240VAC 1A (COSφ=0.7) 200000 times or more 200VAC 0.75A, 240VAC 0.5A (COSφ=0.35) 200000 times or more 24VDC 1A, 100VDC 0.1A (L/R=7ms) 200000 times or more	200VAC 1.5A, 240VAC 1A (COSφ=0.7) 100000 times or more 200VAC 0.4A, 240VAC 0.3A (COSφ=0.7) 300000 times or more 200VAC 1A, 240VAC 0.5A (COSφ=0.35) 100000 times or more 200VAC 0.3A, 240VAC 0.15A (COSφ=0.35) 300000 times or more 24VDC 1A, 100VDC 0.1A (L/R=7ms) 100000 times or more 24VDC 0.3A, 100VDC 0.03A (L/R=7ms) 300000 times or more	△	
Max. switching frequency		3600 times/hr	3600 times/hr	○	
Surge suppressor		Not supported	Not supported	○	
Wiring method for common		All points independent	All points independent	○	
Operation status indicator		ON status of LED	ON status of LED	○	
Fuse		None	None	○	
External power supply	Voltage	24VDC ±10% Ripple voltage 4Vp-p or lower	—	○	An external power supply is not required.
	Current	75mA (Typ., 24VDC, all points ON)	—	○	
External connection system		20-point terminal block (M3.5 × 7 screws)	18-point terminal block (M3 × 6 screws)	×	Wiring change is required.
Applicable wire size		0.75 to 1.25mm ² (AWG16 to AWG19)	Core: 0.3 to 0.75mm ² (outside diameter: 2.8mm or less)	×	
Applicable solderless terminal		RAV1.25-3.5	R1.25-3 (Solderless terminal with an insulation sleeve cannot be used.)	×	
Withstand voltage		(Between all AC external circuits and relay driving power, internal 5V circuit) 2830VACrms for 3 cycles (2000m above sea level) (Between relay driving power and internal 5V circuit) 500VACrms for 3 cycles (2000m above sea level)	2300VAC, 1 minute (altitude 2000m)	○	
Insulation resistance		10MΩ or higher (insulation resistance tester)	10MΩ or higher (insulation resistance tester)	○	
Noise immunity		IEC 801-4:1kV	Noise voltage 1500Vp-p, noise width 1μs, noise frequency 25 to 60Hz (noise simulator condition), Fast transient/burst immunity test IEC 61000-4-4:1kV	○	

Specifications	A1SY18AEU	LY18R2A	Compatibility	Precautions for replacement
Current consumption	0.24A (Typ., all points ON)	0.26A (Typ., all points ON)	△	Review the current capacity since the current consumption is increased.
External dimensions	130(H) × 34.5(W) × 93.6(D)mm	90(H) × 28.5(W) × 117(D)mm	△	Wiring space is narrower.
Weight	0.25kg	0.18kg	△	

(6) Comparison of specifications between A1SY22 and LY20S6*1

○ : Compatible, △ : Partially changed, × : Incompatible

Specifications		A1SY22	LY20S6	Compatibility	Precautions for replacement
Number of output points		16 points	16 points	○	
Insulation method		Photocoupler	Photocoupler	○	
Rated load voltage		AC100/240V 50/60Hz ±3Hz	100 to 240VAC (+10%/-15%), 50/60Hz (±3Hz)	○	
Max. load voltage		264VAC	264VAC	○	
Max. load current		0.6A/point, 2.4A/common	0.6A/point, 4.8A/common	○	
Min. load voltage/ current		24VAC 100mA 100VAC 10mA 240VAC 20mA	24VAC 100mA 100VAC 25mA 240VAC 25mA	△	Since the minimum load current is increased, select a load carefully.
Max. inrush current		20A 10ms or lower 8A 100ms or lower	20A, 1 cycle or lower	○	
Leakage current at OFF		1.5mA (at 120VAC 60Hz) 3mA (at 240VAC 60Hz)	1.5mA or less (at 120VAC 60Hz) 3mA or less (at 240VAC 60Hz)	○	
Max. voltage drop at ON		1.5VAC or lower (0.1 to 0.6A) 1.8VAC or lower (50 to 100mA) 2VAC or lower (10 to 50mA)	1.5V or lower (when the load current is 0.6A)	△	The voltage drop values differ.
Response time	OFF → ON	1ms or less	1ms + 0.5 cycles or less	○	
	ON → OFF	1ms + 0.5 cycles or less	1ms + 0.5 cycles or less	○	
Surge suppressor		CR absorber (0.01μF + 47Ω)	CR absorber	○	
Wiring method for common		8 points/common (common terminal: TB9, TB19)	16 points/common (common terminal: TB17)	△	As the common is changed from 2 commons to 1 common, wiring with a different voltage for each common is not possible.
Operation status indicator		ON status of LED	ON status of LED	○	
Fuse rating (breaking capacity)		5A (1 fuse/common) Not exchangeable (breaking capacity: 70A)	Not supported (Connecting a fuse to each external wiring is recommended.)	×	Fuses are not built in.*2
Fuse blown indication		Supported (The corresponding LED turns on when a fuse is blown. Then, a signal is output to the CPU module.)	—	×	
External power supply	Voltage	100 to 240VAC (85 to 264VAC)	—	○	An external power supply is not required.
	Current	2mA (Typ, 200VAC/common)	—		
External connection system		20-point terminal block (M3.5 × 7 screws)	18-point terminal block (M3 × 6 screws)	×	Wiring change is required.*3
Applicable wire size		0.75 to 1.25mm ²	Core: 0.3 to 0.75mm ² (outside diameter: 2.8mm or less)	×	
Applicable solderless terminal		R1.25-3.5, R2-3.5, RAV1.25-3.5, RAV2-3.5	R1.25-3 (Solderless terminal with an insulation sleeve cannot be used.)	×	
Current consumption		0.27A (Typ., all points on)	0.3A (Typ., all points ON)	△	Review the current capacity since the current consumption is increased.
External dimensions		130(H) × 34.5(W) × 93.6(D)mm	90(H) × 28.5(W) × 117(D)mm	△	Wiring space is narrower.
Weight		0.24kg	0.22kg	△	

*1 Because of characteristics of a triac, there are precautions to check before replacing modules.

Refer to Section 3.3 (4) to check if there are applicable precautions.

*2 Connect a fuse to each external terminal to prevent the external device and module at load short from burnout.

Also, configure an external circuit if fuse blown indication is required.

*3 Wiring change is not required if the conversion adapter (ERNT-ASLTY22, manufactured by Mitsubishi Electric Engineering Co., Ltd.) is used.

(7) Comparison of specifications between A1SY28A and LY28S1A*1

○ : Compatible, △ : Partially changed, × : Incompatible

Specifications		A1SY28A	LY28S1A	Compatibility	Precautions for replacement
Number of output points		8 points (16 points occupied)	8 points (16 points occupied)	○	
Insulation method		Photocoupler	Photocoupler	○	
Rated load voltage		100 to 240VAC, 50/60Hz	100 to 240VAC (+10%/-15%), 50/60Hz (±3Hz)	○	
Load voltage distortion ratio		±3Hz	Within 5%	○	
Max. load voltage		264VAC	264VAC	○	
Max. load current		1A/point, 8A/module (132VAC, 46°C), 8A/module (264VAC, 40°C), 4A/module (132VAC, 55°C), 2A/module (264VAC, 55°C),	1A/point, 8A/module	○	Use it within the range shown in the derating figure.*2
Min. load voltage/current		24VAC 100mA 100VAC 55mA 240VAC 55mA	24VAC 100mA 100VAC 25mA 240VAC 25mA	○	
Max. inrush current		25A 10ms or lower 10A 100ms or lower	20A, 1 cycle or lower	△	Since the inrush current values differ, select a load carefully.
Leakage current at OFF		1.5mA (at 120VAC 60Hz) 3mA (at 240VAC 60Hz)	1.5mA or less (at 120VAC 60Hz) 3mA or less (at 240VAC 60Hz)	○	
Max. voltage drop at ON		1.5VAC or lower (0.2 to 1A) 1.8VAC or lower (0.1 to 0.2A) 3VAC or lower (55 to 100mA)	1.5V or lower (when the load current is 0.6A)	△	The voltage drop values differ.
Response time	OFF → ON	1ms or less	1ms + 0.5 cycles or less	○	
	ON → OFF	1ms + 0.5 cycles or less	1ms + 0.5 cycles or less	○	
Surge suppressor		CR absorber (0.01μF + 47Ω), Varistor (387 to 473V)	CR absorber	△	If a varistor is required, attach it externally.
Wiring method for common		No common (All points independent)	No common (All points independent)	○	
Operation status indicator		ON status of LED	ON status of LED	○	
Fuse		None	None	○	
External connection system		20-point terminal block (M3.5 × 7 screws)	18-point terminal block (M3 × 6 screws)	×	Wiring change is required.
Applicable wire size		0.75 to 1.25mm ²	Core: 0.3 to 0.75mm ² (outside diameter: 2.8mm or less)	×	
Applicable solderless terminal		R1.25-3.5, R2-3.5, RAV1.25-3.5, RAV2-3.5	R1.25-3 (Solderless terminal with an insulation sleeve cannot be used.)	×	
Current consumption		0.13A (Typ., all points on)	0.2A (Typ., all points ON)	△	Review the current capacity since the current consumption is increased.
External dimensions		130(H) × 34.5(W) × 93.6(D)mm	90(H) × 28.5(W) × 117(D)mm	△	Wiring space is narrower.
Weight		0.25kg	0.15kg	△	

- *1 Because of characteristics of a triac, there are precautions to check before replacing modules. Refer to Section 3.3 (4) to check if there are applicable precautions.
- *2 The derating figure is shown below.

(LY28S1A)

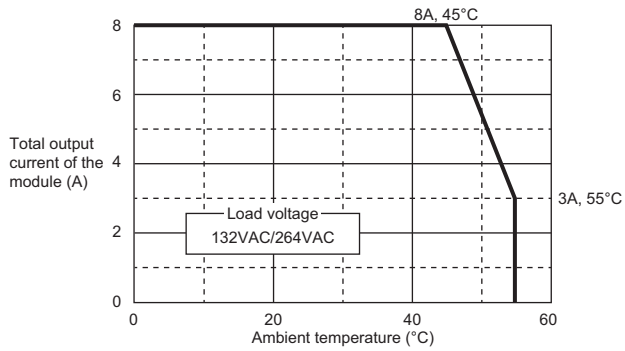

(8) Comparison of specifications between A1SY28EU and LY28S1A*1

○ : Compatible, △ : Partially changed, × : Incompatible

Specifications		A1SY28EU	LY28S1A	Compatibility	Precautions for replacement
Number of output points		8 points (16 points occupied)	8 points (16 points occupied)	○	
Insulation method		Photocoupler	Photocoupler	○	
Rated load voltage		100 to 240VAC, 50/60Hz	100 to 240VAC (+10%/-15%), 50/60Hz (±3Hz)	○	
Load voltage distortion ratio		±3Hz	Within 5%	○	
Max. load voltage		264VAC	264VAC	○	
Max. load current		0.6A/point, 2.4A/common (49°C), 1.9A/common (55°C)	1A/point, 8A/module	○	Use it within the range shown in the derating figure.*2
Min. load voltage/ current		24VAC 15mA 120VAC 15mA 240VAC 15mA	24VAC 100mA 100VAC 25mA 240VAC 25mA	△	Since the minimum load current is increased, select a load carefully.
Max. inrush current		30A 10ms or lower 15A 100ms or lower	20A, 1 cycle or lower	△	Since the inrush current values differ, select a load carefully.
Leakage current at OFF		1.5mA (at 240VAC 60Hz)	1.5mA or less (at 120VAC 60Hz) 3mA or less (at 240VAC 60Hz)	△	The leakage current values differ.
Max. voltage drop at ON		1.5VAC or lower (15mA to 1A)	1.5V or lower (when the load current is 0.6A)	△	The voltage drop values differ.
Response time	OFF → ON	1ms or less	1ms + 0.5 cycles or less	○	
	ON → OFF	1ms + 0.5 cycles or less	1ms + 0.5 cycles or less	○	
Surge suppressor		CR absorber (0.1μF + 47Ω)	CR absorber	○	
Wiring method for common		4 points/common	No common (All points independent)	△	Create a common by short-circuiting one side of the terminal for each contact on the terminal block.
Operation status indicator		ON status of LED	ON status of LED	○	
Fuse		None	None	○	
External connection system		20-point terminal block (M3.5 × 7 screws)	18-point terminal block (M3 × 6 screws)	×	Wiring change is required.
Applicable wire size		0.75 to 1.25mm ²	Core: 0.3 to 0.75mm ² (outside diameter: 2.8mm or less)	×	
Applicable solderless terminal		RAV1.25-3.5	R1.25-3 (Solderless terminal with an insulation sleeve cannot be used.)	×	
Withstand voltage		2830VACrms for 3 cycles (2000m above sea level)	2300VAC, 1 minute (altitude 2000m)	○	
Insulation resistance		10MΩ or higher (insulation resistance tester)	10MΩ or higher (insulation resistance tester)	○	
Noise immunity		IEC 801-4:1kV	Noise voltage 1500Vp-p, noise width 1μs, noise frequency 25 to 60Hz (noise simulator condition)	○	
Current consumption		0.27A (Typ., all points on)	0.2A (Typ., all points ON)	○	
External dimensions		130(H) × 34.5(W) × 93.6(D)mm	90(H) × 28.5(W) × 117(D)mm	△	Wiring space is narrower.
Weight		0.25kg	0.19kg	△	

- *1 Because of characteristics of a triac, there are precautions to check before replacing modules. Refer to Section 3.3 (4) to check if there are applicable precautions.
- *2 The derating figure is shown below.

(LY28S1A)

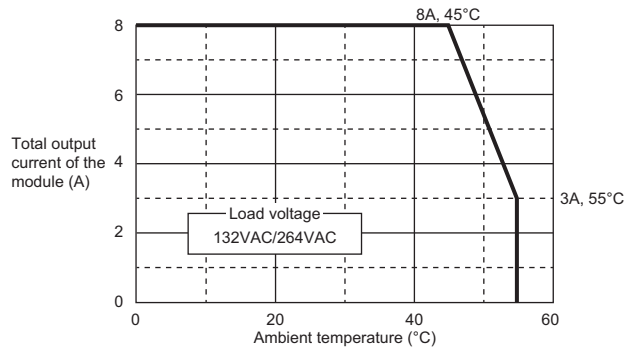

(9) Comparison of specifications between A1SY40 and LY40NT5P

○ : Compatible, △ : Partially changed, × : Incompatible

Specifications		A1SY40	LY40NT5P	Compatibility	Precautions for replacement
Number of output points		16 points	16 points	○	
Insulation method		Photocoupler	Photocoupler	○	
Rated load voltage		12/24VDC	12/24VDC	○	
Operating load voltage range		10.2 to 30VDC (peak voltage: 30VDC)	10.2 to 28.8VDC	△	Voltage exceeding 28.8VDC is not applicable.
Max. load current		0.1A/point, 0.8A/common	0.5A/point, 5A/common	○	
Max. inrush current		0.4A 10ms or lower	Current limiting by the overload current function	△	Since the inrush current values differ, select a load carefully.
Leakage current at OFF		0.1mA or lower	0.1mA or lower	○	
Max. voltage drop at ON		1.0VDC (Typ.) 0.1A 2.5VDC (Max.) 0.1A	0.2VDC (Typ.) 0.5A 0.3VDC (Max.) 0.5A	○	
Response time	OFF → ON	2ms or less	0.5ms or less	○	
	ON → OFF	2ms or less (resistive load)	1ms or less (rated load, resistive load)	○	
Surge suppressor		Zener diode	Zener diode	○	
Wiring method for common		8 points/common (common terminal: TB10, TB20)	16 points/common (common terminal: TB18)	△	As the common is changed from 2 commons to 1 common, wiring with a different voltage for each common is not possible.
Operation status indicator		ON status of LED	ON status of LED	○	
Fuse rating (breaking capacity)		1.6A (1 fuse/common) Not exchangeable (breaking capacity: 50A)	—		Protection functions are supported.
Fuse blown indication		Supported The corresponding LED turns on when a fuse is blown. Then, a signal is output to the CPU module.)	—	△	
Protection function		—	Supported Overload protection function (current limiting when overcurrent is detected: 1.5 to 3.5A/point, activates in increments of 1 point) Overheat protection function (activates in increments of 1 point)		
External power supply	Voltage	12/24VDC (10.2 to 30VDC)	10.2 to 28.8VDC (ripple ratio within 5%)	○	
	Current	8mA (Typ., 24VDC/common)	9mA (at 24VDC)	△	The needed current capacity is increased.
External connection system		20-point terminal block (M3.5 × 7 screws)	18-point terminal block (M3 × 6 screws)	×	
Applicable wire size		0.75 to 1.5mm ²	Core: 0.3 to 0.75mm ² (outside diameter: 2.8mm or less)	×	Wiring change is required.*1 The compatible screw size and wire side are decreased.
Applicable solderless terminal		R1.25-3.5, R2-3.5, RAV1.25-3.5, RAV2-3.5	R1.25-3 (Solderless terminal with an insulation sleeve cannot be used.)	×	
Current consumption		0.27A (Typ., all points ON)	0.1A (Typ., all points ON)	○	
External dimensions		130(H) × 34.5(W) × 93.6(D)mm	90(H) × 28.5(W) × 117(D)mm	△	Wiring space is narrower.
Weight		0.19kg	0.15kg	△	

*1 Wiring change is not required if the conversion adapter (ERNT-ASLTY40, manufactured by Mitsubishi Electric Engineering Co., Ltd.) is used.

(10) Comparison of specifications between A1SY40P and LY40NT5P

○ : Compatible, △ : Partially changed, × : Incompatible

Specifications		A1SY40P	LY40NT5P	Compatibility	Precautions for replacement
Number of output points		16 points	16 points	○	
Insulation method		Photocoupler	Photocoupler	○	
Rated load voltage		12/24VDC	12/24VDC	○	
Operating load voltage range		10.2 to 30VDC (peak voltage 30VDC)	10.2 to 28.8VDC	△	Voltage exceeding 28.8VDC is not applicable.
Max. load current		0.1A/point, 0.8A/common	0.5A/point, 5A/common	○	
Max. inrush current		0.7A 10ms or lower	Current limiting by the overload current function	△	Since the inrush current values differ, select a load carefully.
Leakage current at OFF		0.1mA or lower	0.1mA or lower	○	
Max. voltage drop at ON		0.1VDC (Typ.) 0.1A 0.2VDC (Max.) 0.1A	0.2VDC (Typ.) 0.5A 0.3VDC (Max.) 0.5A	○	
Response time	OFF → ON	0.5ms or less	0.5ms or less	○	
	ON → OFF	1ms or less (rated load, resistive load)	1ms or less (rated load, resistive load)	○	
Surge suppressor		Zener diode	Zener diode	○	
Fuse		Not supported	Not supported	○	
Wiring method for common		8 points/common (common terminal: TB10, TB20)	16 points/common (common terminal: TB17)	△	As the common is changed from 2 commons to 1 common, wiring with a different voltage for each common is not possible.
Operation status indicator		ON status of LED	ON status of LED	○	
Protection function		Supported (overheat protection function, overload protection function) • The overheat protection function is activated in increments of 1 points. • The overload protection function is activated in increments of 1 point.	Supported Overload protection function (current limiting when overcurrent is detected: 1.5 to 3.5A/point, activates in increments of 1 point) Overheat protection function (activates in increments of 1 point)	○	
External power supply	Voltage	12/24VDC (10.2 to 30VDC)	10.2 to 28.8VDC (ripple ratio within 5%)	△	Voltage exceeding 28.8VDC is not applicable.
	Current	11mA (Typ., 24VDC/common)	9mA (at 24VDC)	△	The needed current capacity is increased.
External connection system		20-point terminal block (M3.5 × 7 screws)	18-point terminal block (M3 × 6 screws)	×	
Applicable wire size		0.75 to 1.5mm ²	Core: 0.3 to 0.75mm ² (outside diameter: 2.8mm or less)	×	Wiring change is required.*1 The compatible screw size and wire size are decreased.
Applicable solderless terminal		R1.25-3.5, R2-3.5, RAV1.25-3.5, RAV2-3.5	R1.25-3 (Solderless terminal with an insulation sleeve cannot be used.)	×	
Current consumption		0.079A (Typ., all points ON)	0.1A (Typ., all points ON)	×	
External dimensions		130(H) × 34.5(W) × 93.6(D)mm	90(H) × 28.5(W) × 117(D)mm	○	Wiring space is narrower.
Weight		0.13kg	0.15kg	△	The weight is increased.

*1 Wiring change is not required if the conversion adapter (ERNT-ASLTY40, manufactured by Mitsubishi Electric Engineering Co., Ltd.) is used.

(11) Comparison of specifications between A1SY41 and LY41NT1P

○ : Compatible, △ : Partially changed, × : Incompatible

Specifications		A1SY41	LY41NT1P	Compatibility	Precautions for replacement
Number of output points		32 points	32 points	○	
Insulation method		Photocoupler	Photocoupler	○	
Rated load voltage		12/24VDC	12 to 24VDC	○	
Operating load voltage range		10.2 to 30VDC (peak voltage 30VDC)	10.2 to 28.8VDC	△	Voltage exceeding 28.8VDC is not applicable.
Max. load current		0.1A/point 2A/common	0.1A/point 2A/common	○	
Max. inrush current		0.4A 10ms or lower	Current limiting by the overload current function	△	Since the inrush current values differ, select a load carefully.
Leakage current at OFF		0.1mA or lower	0.1mA or lower	○	
Max. voltage drop at ON		1.0VDC (Typ.) 0.1A 2.5VDC (Max.) 0.1A	0.1VDC (Typ.) 0.1A 0.2VDC (Max.) 0.1A	○	
Response time	OFF → ON	2ms or less	0.5ms or less	○	
	ON → OFF	2ms or less (resistive load)	1ms or less (rated load, resistive load)	○	
Surge suppressor		Zener diode	Zener diode	○	
Wiring method for common		32 points/common (common terminal: A1, A2)	32 points/common (common terminal: A01, A02)	○	
Operation status indicator		ON status of LED	ON status of LED	○	
Fuse rating (breaking capacity)		3.2A (1 fuse/common) Not exchangeable (breaking capacity: 50A)	—	△	Protection functions are supported.
Fuse blown indication		Supported (The corresponding LED turns on when a fuse is blown. Then, a signal is output to the CPU module.)			
Protection function		—			
External power supply	Voltage	12/24VDC (10.2 to 30VDC)	10.2 to 28.8VDC (ripple ratio within 5%)	△	Voltage exceeding 28.8VDC is not applicable.
	Current	8mA (Typ., 24VDC/common)	13mA (at 24VDC)	△	The current value is increased.
External connection system		40-pin connector (included with a module)	40-pin connector (sold separately)	○	Existing external wiring can be used as it is.
Applicable wire size		0.3mm ²	0.3mm ² (for A6CON1 and A6CON4)	○	
Current consumption		0.500A (Typ., all points ON)	0.140A (Typ., all points ON)	○	
External dimensions		130(H) × 34.5(W) × 93.6(D)mm	90(H) × 28.5(W) × 95(D)mm	○	
Weight		0.21kg	0.11kg	△	

(12) Comparison of specifications between A1SY41P and LY41NT1P

○ : Compatible, △ : Partially changed, × : Incompatible

Specifications		A1SY41P	LY41NT1P	Compatibility	Precautions for replacement
Number of output points		32 points	32 points	○	
Insulation method		Photocoupler	Photocoupler	○	
Rated load voltage		12/24VDC	12 to 24VDC	○	
Operating load voltage range		10.2 to 30VDC (peak voltage 30VDC)	10.2 to 28.8VDC	△	Voltage exceeding 28.8VDC is not applicable.
Max. load current		0.1A/point 2A/common	0.1A/point 2A/common	○	
Max. inrush current		0.7A 10ms or lower	Current limiting by the overload current function	△	Since the inrush current values differ, select a load carefully.
Leakage current at OFF		0.1mA or lower	0.1mA or lower	○	
Max. voltage drop at ON		0.1VDC (Typ.) 0.1A 0.2VDC (Max.) 0.1A	0.1VDC (Typ.) 0.1A 0.2VDC (Max.) 0.1A	○	
Response time	OFF → ON	1ms or less	0.5ms or less	○	
	ON → OFF	1ms or less (rated load, resistive load)	1ms or less (rated load, resistive load)	○	
Surge suppressor		Zener diode	Zener diode	○	
Fuse		Not supported	Not supported	○	
Wiring method for common		32 points/common (common terminal: A1, A2)	32 points/common (common terminal: A01, A02)	○	
Operation status indicator		ON status of LED	ON status of LED	○	
Protection function		Supported (overheat protection function, overload protection function) • The overheat protection function is activated in increments of 1 point. • The overload protection function is activated in increments of 1 point.	Supported Overload protection function (current limiting when overcurrent is detected: 1 to 3A/point, activates in increments of 1 point) Overheat protection function (activates in increments of 1 point)	○	
External power supply	Voltage	12/24VDC (10.2 to 30VDC)	10.2 to 28.8VDC (ripple ratio within 5%)	△	Voltage exceeding 28.8VDC is not applicable.
	Current	12mA (Typ., 24VDC/common)	13mA (at 24VDC)	△	The current value is increased.
External connection system		40-pin connector (included with a module)	40-pin connector (sold separately)	○	Existing external wiring can be used as it is.
Applicable wire size		0.3mm ²	0.3mm ² (for A6CON1 and A6CON4)	○	
Current consumption		0.141A (Typ., all points ON)	0.140A (Typ., all points ON)	○	
External dimensions		130(H) × 34.5(W) × 93.6(D)mm	90(H) × 28.5(W) × 95(D)mm	○	
Weight		0.15kg	0.11kg	△	

(13) Comparison of specifications between A1SY42 and LY42NT1P

○ : Compatible, △ : Partially changed, × : Incompatible

Specifications		A1SY42	LY42NT1P	Compatibility	Precautions for replacement
Number of output points		64 points	64 points	○	
Insulation method		Photocoupler	Photocoupler	○	
Rated load voltage		12/24VDC	12 to 24VDC	○	
Operating load voltage range		10.2 to 30VDC (peak voltage 30VDC)	10.2 to 28.8VDC	△	Voltage exceeding 28.8VDC is not applicable.
Max. load current		0.1A/point, 1.6A/common	0.1A/point, 2A/common	○	
Max. inrush current		0.4A 10ms or lower	Current limiting by the overload current function	△	Since the inrush current values differ, select a load carefully.
Leakage current at OFF		0.1mA or lower	0.1mA or lower	○	
Max. voltage drop at ON		1.0VDC (Typ.) 0.1A 2.5VDC (Max.) 0.1A	0.1VDC (Typ.) 0.1A 0.2VDC (Max.) 0.1A	○	
Response time	OFF → ON	2ms or less	0.5ms or less	○	
	ON → OFF	2ms or less (resistive load)	1ms or less (rated load, resistive load)	○	
Surge suppressor		Zener diode	Zener diode	○	
Wiring method for common		32 points/common (Common terminal: 1A1, 1A2, 2A1, 2A2)	32 points/common (Common terminal: 1A01, 1A02, 2A01, 2A02)	○	
Operation status indicator		ON status of LED 32-point switching indication with the switch	ON status of LED 32-point switching indication with the switch	○	
Fuse rating (breaking capacity)		3.2A (1 fuse/common) Not exchangeable (breaking capacity: 50A)	—	△	Protection functions are supported.
Fuse blown indication		Supported (The corresponding LED turns on when a fuse is blown. Then, a signal is output to the CPU module.)			
Protection function		—			
External power supply	Voltage	12/24VDC (10.2 to 30VDC)	10.2 to 28.8VDC (ripple ratio within 5%)	△	Voltage exceeding 28.8VDC is not applicable.
	Current	8mA (Typ., 24VDC/common)	9mA (24VDC)/common	△	The current value is higher in the LY42NT1P.
External connection system		40-pin connector 2 pieces (included with a module)	40-pin connector 2 pieces (sold separately)	○	Existing external wiring can be used as it is.
Applicable wire size		0.3mm ²	0.3mm ² (for A6CON1 and A6CON4)	○	
Current consumption		0.93A (Typ., all points ON)	0.19A (Typ., all points ON)	○	
External dimensions		130(H) × 34.5(W) × 93.6(D)mm	90(H) × 28.5(W) × 95(D)mm	○	
Weight		0.27kg	0.12kg	△	

(14) Comparison of specifications between A1SY42P and LY42NT1P

○ : Compatible, △ : Partially changed, × : Incompatible

Specifications		A1SY42P	LY42NT1P	Compatibility	Precautions for replacement
Number of output points		64 points	64 points	○	
Insulation method		Photocoupler	Photocoupler	○	
Rated load voltage		12/24VDC	12 to 24VDC	○	
Operating load voltage range		10.2 to 30VDC (peak voltage 30VDC)	10.2 to 28.8VDC	△	Voltage exceeding 28.8VDC is not applicable.
Max. load current		0.1A/point, 2A/common	0.1A/point, 2A/common	○	
Max. inrush current		0.7A 10ms or lower	Current limiting by the overload current function	△	Since the inrush current values differ, select a load carefully.
Leakage current at OFF		0.1mA or lower	0.1mA or lower	○	
Max. voltage drop at ON		0.1VDC (Typ.) 0.1A 0.2VDC (Max.) 0.1A	0.1VDC (Typ.) 0.1A 0.2VDC (Max.) 0.1A	○	
Response time	OFF → ON	1ms or less	0.5ms or less	○	
	ON → OFF	1ms or less (rated load, resistive load)	1ms or less (rated load, resistive load)	○	
Surge suppressor		Zener diode	Zener diode	○	
Wiring method for common		32 points/common (Common terminal: 1A1, 1A2, 2A1, 2A2)	32 points/common (Common terminal: 1A01, 1A02, 2A01, 2A02)	○	
Operation status indicator		ON status of LED 32-point switching indication with the switch	ON status of LED 32-point switching indication with the switch	○	
Protection function		Supported (overheat protection function, overload protection function) • The overheat protection function is activated in increments of 1 point. • The overload protection function is activated in increments of 1 point.	Supported Overload protection function (current limiting when overcurrent is detected: 1 to 3A/point, activates in increments of 1 point) Overheat protection function (activates in increments of 1 point)	○	
External power supply	Voltage	12/24VDC (10.2 to 30VDC)	10.2 to 28.8VDC (ripple ratio within 5%)	△	Voltage exceeding 28.8VDC is not applicable.
	Current	14mA (Typ., 24VDC/common)	9mA (24VDC)/common	○	
External connection system		40-pin connector 2 pieces (included with a module)	40-pin connector 2 pieces (sold separately)	○	Existing external wiring can be used as it is.
Applicable wire size		0.3mm ²	0.3mm ² (for A6CON1 and A6CON4)	○	
Current consumption		0.17A (Typ., all points ON)	0.19A (Typ., all points ON)	△	Review the current capacity since the current consumption is increased.
External dimensions		130(H) × 34.5(W) × 93.6(D)mm	90(H) × 28.5(W) × 95(D)mm	△	Wiring space is narrower.
Weight		0.17kg	0.12kg	△	

(15) Comparison of specifications between A1SY50 and LY40NT5P

○ : Compatible, △ : Partially changed, × : Incompatible

Specifications		A1SY50	LY40NT5P	Compatibility	Precautions for replacement
Number of output points		16 points	16 points	○	
Insulation method		Photocoupler	Photocoupler	○	
Rated load voltage		12/24VDC	12/24VDC	○	
Operating load voltage range		10.2 to 30VDC (peak voltage 30VDC)	10.2 to 28.8VDC	△	Voltage exceeding 28.8VDC is not applicable.
Max. load current		0.5A/point, 2A/common	0.5A/point, 5A/common	○	
Max. inrush current		4A 10ms or less	Current limiting by the overload current function	△	Since the inrush current values differ, select a load carefully.
Leakage current at OFF		0.1mA or lower	0.1mA or lower	○	
Max. voltage drop at ON		0.9VDC (Typ.) 0.5A 1.5VDC (Max.) 0.5A	0.2VDC (Typ.) 0.5A 0.3VDC (Max.) 0.5A	○	
Response time	OFF → ON	2ms or less	0.5ms or less	○	
	ON → OFF	2ms or less (resistive load)	1ms or less (rated load, resistive load)	○	
Surge suppressor		Zener diode	Zener diode	○	
Wiring method for common		8 points/common (common terminal: TB10, TB20)	16 points/common (common terminal: TB18)	△	As the common is changed from 2 commons to 1 common, wiring with a different voltage for each common is not possible.
Operation status indicator		ON status of LED	ON status of LED	○	
Fuse rating (breaking capacity)		3.2A (1 fuse/common) Not exchangeable (breaking capacity: 50A)	Not supported	△	Protection functions are supported.
Fuse blown indication		Supported (The corresponding LED turns on when a fuse is blown. Then, a signal is output to the CPU module.)			
Protection function		—			
External power supply	Voltage	12/24VDC (10.2 to 30VDC)	10.2 to 28.8VDC (ripple ratio within 5%)	△	Voltage exceeding 28.8VDC is not applicable.
	Current	60mA (Typ., 24VDC for each common)	9mA (at 24VDC)	○	
External connection system		20-point terminal block (M3.5 × 7 screws)	18-point terminal block (M3 × 6 screws)	×	
Applicable wire size		0.75 to 1.25mm ²	Core: 0.3 to 0.75mm ² (outside diameter: 2.8mm or less)	×	Wiring change is required.*1 The compatible screw size and wire size are decreased.
Applicable solderless terminal		R1.25-3.5, R2-3.5, RAV1.25-3.5, RAV2-3.5	R1.25-3 (Solderless terminal with an insulation sleeve cannot be used.)	×	
Current consumption		0.12A (Typ., all points ON)	0.1A (Typ., all points ON)	○	
External dimensions		130(H) × 34.5(W) × 93.6(D)mm	90(H) × 28.5(W) × 117(D)mm	△	Wiring space is narrower.
Weight		0.20kg	0.15kg	△	

*1 Wiring change is not required if the conversion adapter (ERNT-ASLTY50, manufactured by Mitsubishi Electric Engineering Co., Ltd.) is used.

(16) Comparison of specifications between A1SY80 and LY40PT5P

○ : Compatible, △ : Partially changed, × : Incompatible

Specifications		A1SY80	LY40PT5P	Compatibility	Precautions for replacement
Number of output points		16 points	16 points	○	
Insulation method		Photocoupler	Photocoupler	○	
Rated load voltage		12/24VDC	12/24VDC	○	
Operating load voltage range		10.2 to 30VDC (peak voltage 30VDC)	10.2 to 28.8VDC	△	Voltage exceeding 28.8VDC is not applicable.
Max. load current		0.8A/point, 3.2A/common	0.5A/point, 5A/common	△	The maximum load current is lower in the LY40PT5P.
Max. inrush current		8A 10ms or lower	Current limiting by the overload current function	△	Since the inrush current values differ, select a load carefully.
Leakage current at OFF		0.1mA or lower	0.1mA or lower	○	
Max. voltage drop at ON		1.5VDC (Max.) 0.8A	0.2VDC (Typ.) 0.5A 0.3VDC (Max.) 0.5A	○	
Response time	OFF → ON	2ms or less	0.5ms or less	○	
	ON → OFF	2ms or less (resistive load)	1ms or less (rated load, resistive load)	○	
Surge suppressor		Zener diode	Zener diode	○	
Wiring method for common		8 points/common (common terminal: TB9, TB19)	16 points/common (common terminal: TB17)	△	As the common is changed from 2 commons to 1 common, wiring with a different voltage for each common is not possible.
Operation status indicator		ON status of LED	ON status of LED	○	
Fuse rating (breaking capacity)		5A (1 fuse/common) Cannot be changed. (breaking capacity: 50A)	—		Protection functions are supported.
Fuse blown indication		Supported (The corresponding LED turns on when a fuse is blown. Then, a signal is output to the CPU module.)	—	△	
Protection function		—	Supported (overcurrent detection: 1.5A or higher/point, activates in increments of 1 point) Overheat protection function (activates in increments of 1 point)		
External power supply	Voltage	12/24VDC (10.2 to 30VDC)	10.2 to 28.8VDC (ripple ratio within 5%)	△	Voltage exceeding 28.8VDC is not applicable.
	Current	20mA (Typ., 24VDC/common)	17mA (at 24VDC)	○	
External connection system		20-point terminal block (M3.5 × 7 screws)	18-point terminal block (M3 × 6 screws)	×	
Applicable wire size		0.75 to 1.25mm ²	Core: 0.3 to 0.75mm ² (outside diameter: 2.8mm or less)	×	Wiring change is required.*1 The compatible screw size and wire size are decreased.
Applicable solderless terminal		R1.25-3.5, R2-3.5, RAV1.25-3.5, RAV2-3.5	R1.25-3 (Solderless terminal with an insulation sleeve cannot be used.)	×	
Current consumption		0.12A (Typ., all points ON)	0.1A (Typ., all points ON)	○	
External dimensions		130(H) × 34.5(W) × 93.6(D)mm	90(H) × 28.5(W) × 117(D)mm	△	Wiring space is narrower.
Weight		0.20kg	0.15kg	△	

*1 Wiring change is not required if the conversion adapter (ERNT-ASLTY80, manufactured by Mitsubishi Electric Engineering Co., Ltd.) is used.

(17) Comparison of specifications between A1SY81 and LY41PT1P

○ : Compatible, △ : Partially changed, × : Incompatible

Specifications		A1SY81	LY41PT1P	Compatibility	Precautions for replacement
Number of output points		32 points	32 points	○	
Insulation method		Photocoupler	Photocoupler	○	
Rated load voltage		12/24VDC	12/24VDC	○	
Operating load voltage range		10.2 to 30VDC (peak voltage 30VDC)	10.2 to 28.8VDC	△	Voltage exceeding 28.8VDC is not applicable.
Max. load current		0.1A/point, 2A/common	0.1A/point, 2A/common	○	
Max. inrush current		0.4A 10ms or lower	Current limiting by the overload current function	△	Since the inrush current values differ, select a load carefully.
Leakage current at OFF		0.1mA or lower	0.1mA or lower	○	
Max. voltage drop at ON		1.0VDC (Typ.) 0.1A 2.5VDC (Max.) 0.1A	0.1VDC (Typ.) 0.1A 0.2VDC (Max.) 0.1A	○	
Response time	OFF → ON	2ms or less	0.5ms or less	○	
	ON → OFF	2ms or less (resistive load)	1ms or less (rated load, resistive load)	○	
Surge suppressor		Zener diode	Zener diode	○	
Wiring method for common		32 points/common (common terminal: 17, 18, 36)	32 points/common (common terminal: B01, B02)	○	
Operation status indicator		ON status of LED	ON status of LED	○	
Fuse rating (breaking capacity)		3.2A (1 fuse/common) Not exchangeable (breaking capacity: 50A)	—	△	Protection functions are supported.
Fuse blown indication		Supported (The corresponding LED turns on when a fuse is blown. Then, a signal is output to the CPU module.)	—		
Protection function		—	Supported Overload protection function (current limiting when overcurrent is detected: 1 to 3A/point) • The overheat protection function activates in increments of 1 point. • The overload protection function is activated in increments of 2 points.		
External power supply	Voltage	12/24VDC (10.2 to 30VDC)	10.2 to 28.8VDC (ripple ratio within 5%)	△	Voltage exceeding 28.8VDC is not applicable.
	Current	8mA (Typ., 24VDC/common)	20mA (at 24VDC)	△	The current value is higher in the LY41PT1P.
External connection system		37-pin D-sub connector (included with a module)	40-pin connector (sold separately)	×	Wiring change is required.*1
Applicable wire size		0.3mm ²	0.3mm ²	○	
Current consumption		0.50A (Typ., all points ON)	0.14A (Typ., all points ON)	○	
External dimensions		130(H) × 34.5(W) × 93.6(D)mm	90(H) × 28.5(W) × 95(D)mm	○	
Weight		0.23kg	0.11kg	△	

*1 Wiring change is not required if the conversion adapter (ERNT-ASLCXY81, manufactured by Mitsubishi Electric Engineering Co., Ltd.) is used.

(18) Comparison of specifications between A1SY81EP and LY41PT1P

○ : Compatible, △ : Partially changed, × : Incompatible

Specifications		A1SY81EP	LY41PT1P	Compatibility	Precautions for replacement
Number of output points		32 points	32 points	○	
Insulation method		Photocoupler	Photocoupler	○	
Rated load voltage		12/24VDC	12/24VDC	○	
Operating load voltage range		10.2 to 26.4VDC	10.2 to 28.8VDC	○	
Max. load current		0.1A/point, 2A/common (25°C), 0.05A/point, 1.6A/common (55°C)	0.1A/point, 2A/common	○	
Max. inrush current		No limit (overload protection function)	Current limiting by the overload current function	△	Since the inrush current values differ, select a load carefully.
Leakage current at OFF		0.1mA or lower	0.1mA or lower	○	
Max. voltage drop at ON		3.5VDC (0.1A Max.), 2.5VDC (0.1A Min.)	0.1VDC (Typ.) 0.1A 0.2VDC (Max.) 0.1A	○	
Response time	OFF → ON	0.5ms or less	0.5ms or less	○	
	ON → OFF	1.5ms or less (resistance load)	1ms or less (rated load, resistive load)	○	
Surge suppressor		Clamp diode	Zener diode	○	
Wiring method for common		32 points/common (common terminal: 17, 18, 36)	32 points/common (common terminal: B01, B02)	○	
Operation status indicator		ON status of LED	ON status of LED	○	
Protection function		Supported (overheat protection function, overload protection function) • The overheat protection function is activated in increments of 8 points. • If the function is activated even for 1 point within the range of 8 points, outputs of all 8 points are turned off.	Supported Overload protection function (current limiting when overcurrent is detected: 1 to 3A/point) • The overcurrent detection activates in increments of 1 point. • The overload protection function is activated in increments of 2 points.	○	
External power supply	Voltage	12/24VDC (10.2 to 26.4VDC)	10.2 to 28.8VDC (ripple ratio within 5%)	○	
	Current	80mA (Typ., 24VDC/common)	20mA (at 24VDC)	○	
External connection system		37-pin D-sub connector (included with a module)	40-pin connector (sold separately)	×	Wiring change is required.*1
Applicable wire size		0.3mm ²	0.3mm ²	○	
Current consumption		0.50A (Typ., all points ON)	0.14A (Typ., all points ON)	○	
External dimensions		130(H) × 34.5(W) × 93.6(D)mm	90(H) × 28.5(W) × 95(D)mm	○	
Weight		0.25kg	0.11kg	△	

*1 Wiring change is not required if the conversion adapter (ERNT-ASLCXY81, manufactured by Mitsubishi Electric Engineering Co., Ltd.) is used.

(19) Comparison of specifications between A1SY82 and LY42PT1P

○ : Compatible, △ : Partially changed, × : Incompatible

Specifications		A1SY82	LY42PT1P	Compatibility	Precautions for replacement
Number of output points		64 points	64 points	○	
Insulation method		Photocoupler	Photocoupler	○	
Rated load voltage		12/24VDC	12/24VDC	○	
Operating load voltage range		10.2 to 30VDC	10.2 to 28.8VDC	△	Voltage exceeding 28.8VDC is not applicable.
Max. load current		0.1A/point, 1.6A/common	0.1A/point, 2A/common	○	
Max. inrush current		0.4A 10ms or lower	Current limiting by the overload current function	△	Since the inrush current values differ, select a load carefully.
Leakage current at OFF		0.1mA or lower	0.1mA or lower	○	
Max. voltage drop at ON		1.0VDC (Typ.) 0.1A 2.5VDC (Max.) 0.1A	0.1VDC (Typ.) 0.1A 0.2VDC (Max.) 0.1A	○	
Response time	OFF → ON	2ms or less	0.5ms or less	○	
	ON → OFF	2ms or less (resistive load)	1ms or less (rated load, resistive load)	○	
Surge suppressor		Zener diode	Zener diode	○	
Wiring method for common		32 points/common (Common terminal: 1B1, 1B2, 2B1, 2B2)	32 points/common (Common terminal: 1B01, 1B02, 2B01, 2B02)	○	
Operation status indicator		ON status of LED 32-point switching indication with the switch	ON status of LED 32-point switching indication with the switch	○	
Fuse rating (breaking capacity)		3.2A (1 fuse/common) Not exchangeable (breaking capacity: 50A)	—	△	Protection functions are supported.
Fuse blown indication		Supported (The corresponding LED turns on when a fuse is blown. Then, a signal is output to the CPU module.)	—		
Protection function		—	Supported Overload protection function (current limiting when overcurrent is detected: 1 to 3A/point) • The overcurrent detection activates in increments of 1 point. • The overload protection function is activated in increments of 2 points.		
External power supply	Voltage	12/24VDC (10.2 to 30VDC)	10.2 to 28.8VDC (ripple ratio within 5%)	△	Voltage exceeding 28.8VDC is not applicable.
	Current	8mA (Typ., 24VDC/common)	20mA (24VDC)/common	△	The current value is higher in the LY42PT1P.
External connection system		40-pin connector (included with a module)	40-pin connector (sold separately)	○	Existing external wiring can be used as it is.
Applicable wire size		0.3mm ²	0.3mm ² (for A6CON1 and A6CON4)	○	
Current consumption		0.93A (Typ., all points ON)	0.19A (Typ., all points ON)	○	
External dimensions		130(H) × 34.5(W) × 93.6(D)mm	90(H) × 28.5(W) × 95(D)mm	○	
Weight		0.27kg	0.12kg	△	

3.2.3 I/O combined modules

(1) Comparison of specifications between A1SH42 and LH42C4NT1P

○ : Compatible, △ : Partially changed, × : Incompatible

Specifications		A1SH42	LH42C4NT1P	Compatibility	Precautions for replacement	
Input specifications	Number of input points	32 points	32 points	○		
	Insulation method	Photocoupler	Photocoupler	○		
	Input type	Sink type	Sink type (positive common)	○		
	Rated input voltage	12/24VDC	24VDC	△	The input voltage 12VDC cannot be used.	
	Operating voltage range	10.2 to 26.4VDC (ripple ratio within 5%)	20.4 to 28.8VDC (ripple ratio within 5%)	△	The input voltage 12VDC cannot be used.	
	Rated input current	Approx. 2mA (12VDC) Approx. 5mA (24VDC)	Approx. 4.0mA TYP (at 24VDC)	△	The input current is lower in the LH42C4NT1P. ^{*1}	
	Max. number of simultaneous input points	60% (20 points/common) (at 24VDC)	Refer to the derating figure. ^{*2}	○		
	ON voltage/ON current	8VDC or higher/2mA or higher	19VDC or higher/3mA or higher	△	The input voltage 12VDC cannot be used. ^{*1}	
	OFF voltage/OFF current	4VDC or lower/0.6mA or lower	9VDC or lower/1.7mA or lower	△	The input voltage 12VDC cannot be used. ^{*1}	
	Input resistance	Approx. 5kΩ	Approx. 5.7kΩ	△	The input resistance is higher in the LH42C4NT1P. ^{*1}	
	Response time	OFF → ON	10ms or less (24VDC)	1ms/5ms/10ms/20ms/70ms or less (The value is set in PLC parameter of the CPU module.) Default: 10ms	○	Set the input response time of parameter to the default value (10ms).
		ON → OFF	10ms or less (24VDC)	1ms/5ms/10ms/20ms/70ms or less (The value is set in PLC parameter of the CPU module.) Default: 10ms	○	
	Wiring method for common		32 points/common (common terminal: 1B1, 1B2)	32 points/common (common terminal: 1B01, 1B02)	○	
Output specifications	Number of output points	32 points	32 points	○		
	Insulation method	Photocoupler	Photocoupler	○		
	Output type	Sink type	Sink type	○		
	Rated load voltage	12/24VDC	12/24VDC	○		
	Operating load voltage range	10.2 to 30VDC (peak voltage 30VDC)	10.2 to 28.8VDC	△	Voltage exceeding 28.8VDC is not applicable.	
	Max. load current	0.1A/point, 2A/common	0.1A/point, 2A/common	○		
	Max. inrush current	0.4A 10ms or lower	Current limiting by the overload current function	△	Since the inrush current values differ, select a load carefully.	
	Leakage current at OFF	0.1mA or lower	0.1mA or lower	○		
	Max. voltage drop at ON	0.1VDC (Typ.) 0.1A 0.2VDC (Max.) 0.1A	0.1VDC (Typ.) 0.1A 0.2VDC (Max.) 0.1A	○		
	Response time	OFF → ON	2ms or less	0.5ms or less	○	
		ON → OFF (resistive load)	2ms or less	1ms or less (rated load, resistive load)	○	
	Surge suppressor	Zener diode	Zener diode	○		

Specifications		A1SH42	LH42C4NT1P	Compatibility	Precautions for replacement
Output specifications	Fuse rating (breaking capacity)	3.2A (1 fuse/common) Not exchangeable (breaking capacity: 50A)	—	△	Protection functions are supported.
	Fuse blown indication	Supported (The corresponding LED turns on when a fuse is blown. Then, a signal is output to the CPU module.)			
	Protection function	Not supported	Supported Overload protection function (current limiting when overcurrent is detected: 1 to 3A/point, activates in increments of 1 point) Overheat protection function (activates in increments of 1 point)		
	Wiring method for common		32 points/common (common terminal: 2A1, 2A2)	32 points/common (Common terminal: 2A01, 2A02)	○
	External power supply	Voltage	12/24VDC (10.2 to 30VDC)	10.2 to 28.8VDC ripple ratio within 5%	△
Current		8mA (Typ., 24VDC/common)	9mA (at 24VDC) /common	△	The current consumption is higher in the LH42C4NT1P.
Operation status indicator		ON status of LED 32-point switching indication with the switch	ON status of LED 32-point switching indication with the switch	○	
External connection system		Two 40-pin connectors (included with a module)	Two 40-pin connectors (sold separately)	○	Existing external wiring can be used as it is.
Applicable wire size		0.3mm ²	0.3mm ² (for A6CON1 and A6CON4)	○	
Number of occupied I/O points		32 points (I/O assignment: output)	32 points (I/O assignment: I/O mix)	○	
Current consumption		0.50A (Typ., all points ON, total of the input and output parts)	0.16A (Typ., all points ON)	○	
External dimensions		130(H) × 34.5(W) × 93.6(D)mm	90(H) × 28.5(W) × 95(D)mm	○	
Weight		0.27kg	0.12kg	△	

*1 Check the specifications of a sensor or switch to be connected to the LH42C4NT1P.

*2 The derating figure is shown below.

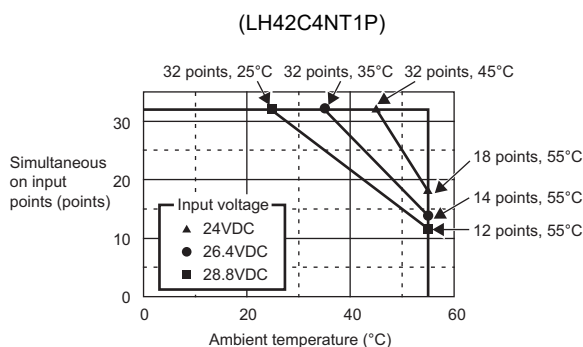

(2) Comparison of specifications between A1SH42P and LH42C4NT1P

○ : Compatible, △ : Partially changed, × : Incompatible

Specifications		A1SH42P	LH42C4NT1P	Compatibility	Precautions for replacement	
Input specifications	Number of input points	32 points	32 points	○		
	Insulation method	Photocoupler	Photocoupler	○		
	Input type	Sink type	Sink type (positive common)	○		
	Rated input voltage	12V/24VDC	24VDC	△	The input voltage 12VDC cannot be used.	
	Operating voltage range	10.2 to 26.4VDC (ripple ratio within 5%)	20.4 to 28.8VDC (ripple ratio within 5%)	△	The input voltage 12VDC cannot be used.	
	Rated input current	Approx. 2mA (12VDC) Approx. 5mA (24VDC)	Approx. 4.0mA TYP (at 24VDC)	△	The input current is lower in the LH42C4NT1P.*1	
	Max. number of simultaneous input points	60% (20 points/common) (at 24VDC)	Refer to the derating figure.*2	○		
	ON voltage/ON current	8VDC or higher/2mA or higher	19VDC or higher/3mA or higher	△	The input voltage 12VDC cannot be used.*1	
	OFF voltage/OFF current	4VDC or lower/0.6mA or lower	9VDC or lower/1.7mA or lower	△	The input voltage 12VDC cannot be used.*1	
	Input resistance	Approx. 5kΩ	Approx. 5.7kΩ	△	The input resistance is higher in the LH42C4NT1P.*1	
	Response time	OFF → ON	10ms or less (24VDC)	1ms/5ms/10ms/20ms/70ms or less (The value is set in PLC parameter of the CPU module.) Default: 10ms	○	Set the input response time of parameter to the default value (10ms).
		ON → OFF	10ms or less (24VDC)	1ms/5ms/10ms/20ms/70ms or less (The value is set in PLC parameter of the CPU module.) Default: 10ms	○	
	Wiring method for common		32 points/common (common terminal: 1B1, 1B2)	32 points/common (common terminal: 1B01, 1B02)	○	
Output specifications	Number of output points	32 points	32 points	○		
	Insulation method	Photocoupler	Photocoupler	○		
	Output type	Sink type	Sink type	○		
	Rated load voltage	12/24VDC	12/24VDC	○		
	Operating load voltage range	10.2 to 30VDC (peak voltage 30VDC)	10.2 to 28.8VDC	△	Voltage exceeding 28.8VDC is not applicable.	
	Max. load current	0.1A/point, 2A/common	0.1A/point, 2A/common	○		
	Max. inrush current	0.7A 10ms or lower	Current limiting by the overload current function	△	Since the inrush current values differ, select a load carefully.	
	Leakage current at OFF	0.1mA or lower	0.1mA or lower	○		
	Max. voltage drop at ON	0.1VDC (Typ.) 0.1A 0.2VDC (Max.) 0.1A	0.1VDC (Typ.) 0.1A 0.2VDC (Max.) 0.1A	○		
	Response time	OFF → ON	1ms or less	0.5ms or less	○	
		ON → OFF	1ms or less (resistive load)	1ms or less (rated load, resistive load)	○	
Surge suppressor		Zener diode	Zener diode	○		
Fuse		Not supported	Not supported	△		

Specifications		A1SH42P	LH42C4NT1P	Compatibility	Precautions for replacement	
Output specifications	Protection function	Supported (overheat protection function, overload protection function) • The overheat protection function is activated in increments of 1 point. • The overload protection function is activated in increments of 1 point.	Supported Overload protection function (current limiting when overcurrent is detected: 1 to 3A/point, activates in increments of 1 point) Overheat protection function (activates in increments of 1 point)	○		
	Wiring method for common		32 points/common (common terminal: 2A1, 2A2)	32 points/common (Common terminal: 2A01, 2A02)	○	
	External power supply	Voltage	12/24VDC (10.2 to 30VDC)	10.2 to 28.8VDC ripple ratio within 5%	△	Voltage exceeding 28.8VDC is not applicable.
Current		12mA (Typ., 24VDC/common)	9mA (at 24VDC) /common	○		
Operation status indicator		ON status of LED 32-point switching indication with the switch	ON status of LED 32-point switching indication with the switch	○		
External connection system		Two 40-pin connectors (included with a module)	Two 40-pin connectors (sold separately)	○	Existing external wiring can be used as it is.	
Applicable wire size		0.3mm ²	0.3mm ² (for A6CON1 and A6CON4)	○		
Number of occupied I/O points		32 points (I/O assignment: output)	32 points (I/O assignment: I/O mix)	○		
Current consumption		0.13A (Typ., all points ON)	0.16A (Typ., all points ON)	△	The current consumption is higher in the LH42C4NT1P.	
External dimensions		130(H) × 34.5(W) × 93.6(D)mm	90(H) × 28.5(W) × 95(D)mm	○		
Weight		0.17kg	0.12kg	△		

*1 Check the specifications of a sensor or switch to be connected to the LH42C4NT1P.

*2 The derating figure is shown below.

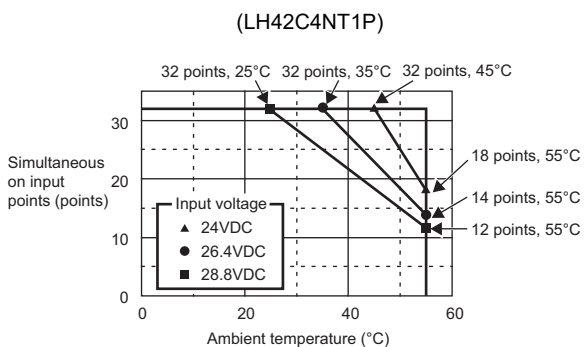

(3) Comparison of specifications between A1SH42-S1 and LH42C4NT1P

○ : Compatible, △ : Partially changed, × : Incompatible

Specifications		A1SH42-S1	LH42C4NT1P	Compatibility	Precautions for replacement	
Input specifications	Number of input points	32 points	32 points	○		
	Insulation method	Photocoupler	Photocoupler	○		
	Input type	Sink type	Sink type (positive common)	○		
	Rated input voltage	24VDC	24VDC	○		
	Operating voltage range	19.2 to 26.4VDC (ripple ratio within 5%)	20.4 to 28.8VDC (ripple ratio within 5%)	○		
	Rated input current	Approx. 5mA	Approx. 4.0mA TYP (at 24VDC)	△	The input current is lower in the LH42C4NT1P.*1	
	Max. number of simultaneous input points	60% (20 points/common) (at 24VDC)	Refer to the derating figure.*2	○		
	ON voltage/ON current	15VDC or higher/ 3mA or higher	19VDC or higher/3mA or higher	△	The ON voltage/ON current differ.*1	
	OFF voltage/OFF current	3VDC or lower/0.5mA or lower	9VDC or lower/1.7mA or lower	△	The OFF voltage/OFF current differ.*1	
	Input resistance	Approx. 5kΩ	Approx. 5.7kΩ	△	The input resistance is higher in the LH42C4NT1P.*1	
	Response time	OFF → ON	0.3ms or less	1ms/5ms/10ms/20ms/70ms or less (The value is set in PLC parameter of the CPU module.) Default: 10ms	△	The response time differs. Set the time according to the control.
		ON → OFF	0.3ms or less	1ms/5ms/10ms/20ms/70ms or less (The value is set in PLC parameter of the CPU module.) Default: 10ms	△	
	Wiring method for common		32 points/common (common terminal: 1B1, 1B2)	32 points/common (common terminal: 1B01, 1B02)	○	
Output specifications	Number of output points	32 points	32 points	○		
	Insulation method	Photocoupler	Photocoupler	○		
	Output type	Sink type	Sink type	○		
	Rated load voltage	12/24VDC	12/24VDC	○		
	Operating load voltage range	10.2 to 30VDC (peak voltage 30VDC)	10.2 to 28.8VDC	△	Voltage exceeding 28.8VDC is not applicable.	
	Max. load current	0.1A/point, 1.6A/common	0.1A/point, 2A/common	○		
	Max. inrush current	0.7A 10ms or lower	Current limiting by the overload current function	△	Since the inrush current values differ, select a load carefully.	
	Leakage current at OFF	0.1mA or lower	0.1mA or lower	○		
	Max. voltage drop at ON	0.1VDC (Typ.) 0.1A 0.2VDC (Max.) 0.1A	0.1VDC (Typ.) 0.1A 0.2VDC (Max.) 0.1A	○		
	Response time	OFF → ON	1ms or less	0.5ms or less	○	
		ON → OFF	1ms or less (resistive load)	1ms or less (rated load, resistive load)	○	
Surge suppressor		Zener diode	Zener diode	○		

Specifications		A1SH42-S1	LH42C4NT1P	Compatibility	Precautions for replacement	
Output specifications	Fuse rating (breaking capacity)	3.2A (1 fuse/common) Not exchangeable (breaking capacity: 50A)	—	△	Protection functions are supported.	
	Fuse blown indication	Supported (The corresponding LED turns on when a fuse is blown. Then, a signal is output to the CPU module.)				
	Protection function	Not supported				
	Wiring method for common		32 points/common (common terminal: 2A1, 2A2)	32 points/common (Common terminal: 2A01, 2A02)	○	
	External power supply	Voltage	12/24VDC (10.2 to 30VDC)	10.2 to 28.8VDC ripple ratio within 5%	△	Voltage exceeding 28.8VDC is not applicable.
		Current	8mA (Typ., 24VDC/common)	9mA (at 24VDC) /common	△	The current consumption is higher in the LH42C4NT1P.
Operation status indicator		ON status of LED 32-point switching indication with the switch	ON status of LED 32-point switching indication with the switch	○		
External connection system		Two 40-pin connectors (included with a module)	Two 40-pin connectors (sold separately)	○	Existing external wiring can be used as is.	
Applicable wire size		0.3mm ²	0.3mm ² (for A6CON1 and A6CON4)	○		
Number of occupied I/O points		32 points (I/O assignment: output)	32 points (I/O assignment: I/O mix)	○		
Current consumption		0.50A (Typ., all points ON, total of input and output parts)	0.16A (Typ., all points ON)	○		
External dimensions		130(H) × 34.5(W) × 93.6(D)mm	90(H) × 28.5(W) × 95(D)mm	○		
Weight		0.27kg	0.12kg	△		

*1 Check the specifications of a sensor or switch to be connected to the LH42C4NT1P.

*2 The derating figure is shown below.

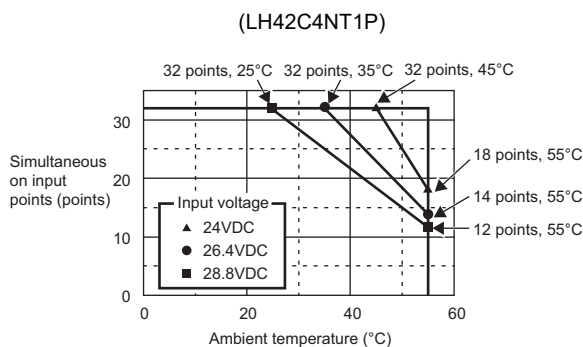

(4) Comparison of specifications between A1SH42P-S1 and LH42C4NT1P

○ : Compatible, △ : Partially changed, × : Incompatible

Specifications		A1SH42P-S1	LH42C4NT1P	Compatibility	Precautions for replacement	
Input specifications	Number of input points	32 points	32 points	○		
	Insulation method	Photocoupler	Photocoupler	○		
	Input type	Sink type	Sink type (positive common)	○		
	Rated input voltage	24VDC	24VDC	○		
	Operating voltage range	19.2 to 26.4VDC (ripple ratio within 5%)	20.4 to 28.8VDC (ripple ratio within 5%)	△	The operating voltage range differs.	
	Rated input current	Approx. 5mA	Approx. 4.0mA TYP (at 24VDC)	△	The input current is lower in the LH42C4NT1P.*1	
	Max. number of simultaneous input points	60% (20 points/common) (at 24VDC)	Refer to the derating figure.*2	○		
	ON voltage/ON current	15VDC or higher/3mA or higher	19VDC or higher/3mA or higher	△	The ON voltage/ON current differ.*1	
	OFF voltage/OFF current	3VDC or lower/0.5mA or lower	9VDC or lower/1.7mA or lower	△	The OFF voltage/OFF current differ.*1	
	Input resistance	Approx. 5kΩ	Approx. 5.7kΩ	△	The input resistance is higher in the LH42C4NT1P.*1	
	Response time	OFF → ON	0.3ms or less	1ms/5ms/10ms/20ms/70ms or less (The value is set in PLC parameter of the CPU module.) Default: 10ms	△	The response time differs. Set the time according to the control.
		ON → OFF	0.3ms or less	1ms/5ms/10ms/20ms/70ms or less (The value is set in PLC parameter of the CPU module.) Default: 10ms	△	
	Wiring method for common		32 points/common (common terminal: 1B1, 1B2)	32 points/common (common terminal: 1B01, 1B02)	○	
Output specifications	Number of output points	32 points	32 points	○		
	Insulation method	Photocoupler	Photocoupler	○		
	Output type	Sink type	Sink type	○		
	Rated load voltage	12/24VDC	12/24VDC	○		
	Operating load voltage range	10.2 to 30VDC (peak voltage 30VDC)	10.2 to 28.8VDC	△	Voltage exceeding 28.8VDC is not applicable.	
	Max. load current	0.1A/point, 2A/common	0.1A/point, 2A/common	○		
	Max. inrush current	0.7A 10ms or lower	Current limiting by the overload current function	△	Since the inrush current values differ, select a load carefully.	
	Leakage current at OFF	0.1mA or lower	0.1mA or lower	○		
	Max. voltage drop at ON	0.1VDC (Typ.) 0.1A 0.2VDC (Max.) 0.1A	0.1VDC (Typ.) 0.1A 0.2VDC (Max.) 0.1A	○		
	Response time	OFF → ON	1ms or less	0.5ms or less	○	
		ON → OFF	1ms or less (resistive load)	1ms or less (rated load, resistive load)	○	
	Surge suppressor	Zener diode	Zener diode	○		
	Fuse	Not supported	Not supported	○		

Specifications		A1SH42P-S1	LH42C4NT1P	Compatibility	Precautions for replacement	
Output specifications	Protection function	Supported (overheat protection function, overload protection function) • The overheat protection function is activated in increments of 1 point. • The overload protection function is activated in increments of 1 point.	Supported Overload protection function (current limiting when overcurrent is detected: 1 to 3A/point, activates in increments of 1 point) Overheat protection function (activates in increments of 1 point)	○		
	Wiring method for common		32 points/common (common terminal: 2A1, 2A2)	32 points/common (Common terminal: 2A01, 2A02)	○	
	External power supply	Voltage	12/24VDC (10.2 to 30VDC)	10.2 to 28.8VDC ripple ratio within 5%	△	Voltage exceeding 28.8VDC is not applicable.
Current		12mA (Typ., 24VDC/common)	9mA (at 24VDC) /common	○		
Operation status indicator		ON status of LED 32-point switching indication with the switch	ON status of LED 32-point switching indication with the switch	○		
External connection system		Two 40-pin connectors (included with a module)	Two 40-pin connectors (sold separately)	○	Existing external wiring can be used as is.	
Applicable wire size		0.3mm ²	0.3mm ² (for A6CON1 and A6CON4)	○		
Number of occupied I/O points		32 points (I/O assignment: output)	32 points (I/O assignment: I/O mix)	○		
Current consumption		0.13A (Typ., all points ON)	0.16A (Typ., all points ON)	△	The current consumption is higher in the LH42C4NT1P.	
External dimensions		130(H) × 34.5(W) × 93.6(D)mm	90(H) × 28.5(W) × 95(D)mm	○		
Weight		0.17kg	0.12kg	△		

*1 Check the specifications of a sensor or switch to be connected to the LH42C4NT1P.

*2 The derating figure is shown below.

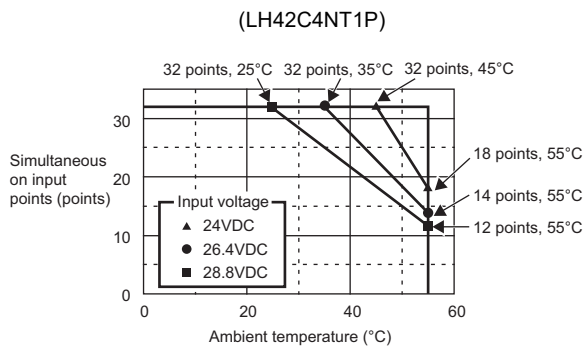

(5) Comparison of specifications between A1SX48Y18 and LX40C6/LY10R2

(a) Comparison of specifications between A1SX48Y18 (input part) and LX40C6

○ : Compatible, △ : Partially changed, × : Incompatible

Specifications		A1SX48Y18 (input specifications)	LX40C6	Compatibility	Precautions for replacement
Number of input points		8 points	16 points	○	
Insulation method		Photocoupler	Photocoupler	○	
Input type		Sink type	Sink type	○	
Rated input voltage		24VDC	24VDC	○	
Rated input current		Approx. 7mA	6.0mA Typ. (at 24VDC)	△	The input current is lower in the LX40C6.*2
Operating voltage range		19.2 to 26.4VDC (ripple ratio within 5%)	20.4 to 28.8VDC (ripple ratio within 5%)	△	The operating voltage range differs.
Max. number of simultaneous input points		100% (at 26.4VDC)	Refer to the derating figure.*1	○	If the number of points to be replaced is eight or less, simultaneous ON (100%) is resulted.
ON voltage/ON current		14VDC or higher/3.5mA or higher	15V or higher/4mA or higher	△	The ON voltage/ON current differ.*2
OFF voltage/OFF current		6.5VDC or lower/1.7mA or lower	8V or lower/2mA or lower	△	The OFF voltage differs.*2
Input resistance		Approx. 3.3kΩ	Approx. 3.8kΩ	△	The input resistance is higher in the LX40C6.*2
Response time	OFF → ON	10ms or less (24VDC)	1ms, 5ms, 10ms, 20ms, 70ms or less (The value is set in PLC parameter of the CPU module.) Default: 10ms	○	Set the input response time of parameter to the default value (10ms).
	ON → OFF	10ms or less (24VDC)	1ms, 5ms, 10ms, 20ms, 70ms or less (The value is set in PLC parameter of the CPU module.) Default: 10ms	○	
Wiring method for common		8 points/common (common terminal: TB9)	16 points/common (common terminal: TB17)	○	
Operation status indicator		ON status of LED	ON status of LED	○	
External connection system		20-point terminal block (M3.5 × 7 screws)	18-point terminal block (M3 × 6 screws)	×	Wiring change is required. The compatible screw size and wire size are decreased.
Applicable wire size		0.75 to 1.25mm ²	Core: 0.3 to 0.75mm ² (outside diameter: 2.8mm or less)	×	
Applicable solderless terminal		R1.25-3.5, R2-3.5, RAV1.25-3.5, RAV2-3.5	R1.25-3 (Solderless terminal with an insulation sleeve cannot be used.)	×	
Number of occupied I/O points		16 points (I/O assignment: Output 16 points)	16 points (I/O assignment: Input 16 points)	△	With the LX40C6 and LY10R2, the number of occupied I/O points will be 32.
Current consumption		0.085A (Typ., all points ON, total of the input and output parts)	0.09A (Typ., all points ON)	△	With the LY10R2, the current consumption will be 0.55A. Review the current capacity since the current consumption is increased.
External dimensions		130(H) × 34.5(W) × 93.6(D)mm	90(H) × 28.5(W) × 117(D)mm	×	Two modules (LX40C6 and LY10R2) are required.
Weight		0.23kg	0.15kg	△	With the LY10R2, the weight will be 0.36kg.

*1 The derating figure is shown below.

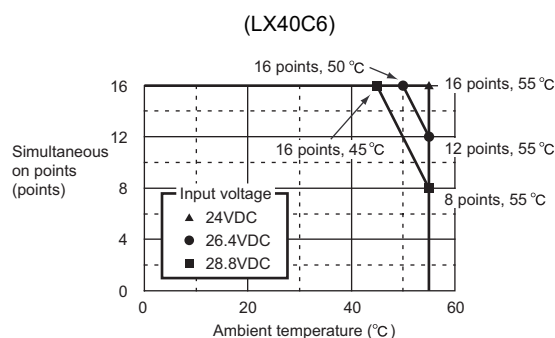

*2 Check the specifications of a sensor or switch to be connected to the LX40C6.

(b) Comparison of specifications between A1SX48Y18 (output part) and LY10R2

○ : Compatible, △ : Partially changed, × : Incompatible

Specifications		A1SX48Y18 (output specifications)	LY10R2	Compatibility	Precautions for replacement
Number of output points		8 points	16 points	○	
Insulation method		Photocoupler	Relay	△	The insulation method differs, but the performance is the equivalent.
Output type		Contact output	Contact output	○	
Rated switching voltage/current		24VDC 2A (resistance load) 240VAC 2A (COSφ=1)/point 8A/common	24VDC 2A (resistive load)/point 240VAC 2A (COSφ=1)/point 8A/common	○	
Min. switching load		5VDC 1mA	5VDC 1mA	○	
Max. switching voltage		264VAC 125VDC	264VAC 125VDC	○	
Response time	OFF → ON	10ms or less	10ms or less	○	
	ON → OFF	12ms or less	12ms or less	○	
Life	Mechanical	20 million times or more	20 million times or more	○	
	Electrical	Rated switching voltage/current load 100000 times or more 200VAC 1.5A, 240VAC 1A (COSφ=0.7) 100000 times or more 200VAC 1A, 240VAC 0.5A (COSφ=0.35) 100000 times or more 24VDC 1A, 100VDC 0.1A (L/R=7ms) 100000 times or more	Rated switching voltage/current load 100000 times or more 200VAC 1.5A, 240VAC 1A (COSφ=0.7) 100000 times or more 200VAC 0.4A, 240VAC 0.3A (COSφ=0.7) 300000 times or more 200VAC 1A, 240VAC 0.5A (COSφ=0.35) 100000 times or more 200VAC 0.3A, 240VAC 0.15A (COSφ=0.35) 300000 times or more 24VDC 1A, 100VDC 0.1A (L/R=7ms) 100000 times or more 24VDC 0.3A, 100VDC 0.03A (L/R=7ms) 300000 times or more	○	
Max. switching frequency		3600 times/hr	3600 times/hr	○	
Surge suppressor		Not supported	Not supported	○	
Wiring method for common		8 points/common (common terminal: TB18)	16 points/common (common terminal: TB17)	○	
Operation status indicator		ON status of LED	ON status of LED	○	
Fuse		Not supported	Not supported	○	
External power supply	Voltage	24VDC ±10% Ripple voltage 4Vp-p or less	—	○	An external power supply is not required.
	Current	45mA (Typ, 24VDC, all points on)	—	○	
External connection system		20-point terminal block (M3.5 × 7 screws)	18-point terminal block (M3 × 6 screws)	×	
Applicable wire size		0.75 to 1.25mm ²	Core: 0.3 to 0.75mm ² (outside diameter: 2.8mm or less)	×	Wiring change is required. The compatible screw size and wire size are decreased.
Applicable solderless terminal		R1.25-3.5, R2-3.5, RAV1.25-3.5, RAV2-3.5	R1.25-3 (Solderless terminal with an insulation sleeve cannot be used.)	×	
Number of occupied I/O points		16 points (I/O assignment: Output 16 points)	16 points (I/O assignment: Output 16 points)	△	With the LX40C6 and LY10R2, the number of occupied I/O points will be 32.
Current consumption		0.085A (Typ., all points ON, total of the input and output parts)	0.46A (Typ., all points ON)	△	With the LX40C6, the current consumption will be 0.55A. Review the current capacity since the current consumption is increased.
External dimensions		130(H) × 34.5(W) × 93.6(D)mm	90(H) × 28.5(W) × 117(D)mm	×	Two modules (LX40C6 and LY10R2) are required.
Weight		0.23kg	0.21kg	△	With the LX40C6, the weight will be 0.36kg.

(6) Comparison of specifications between A1SX48Y58 and LX40C6/LY40NT5P

(a) Comparison of specifications between A1SX48Y58 (input part) and LX40C6

○ : Compatible, △ : Partially changed, × : Incompatible

Specifications		A1SX48Y58 (input specifications)	LX40C6	Compatibility	Precautions for replacement
Number of input points		8 points	16 points	○	
Insulation method		Photocoupler	Photocoupler	○	
Input type		Sink type	Sink type	○	
Rated input voltage		24VDC	24VDC	○	
Rated input current		Approx. 7mA	6.0mA Typ. (for 24VDC)	△	The input current is lower in the LX40C6.*2
Operating voltage range		19.2 to 26.4VDC (ripple ratio within 5%)	20.4 to 28.8VDC (ripple ratio within 5%)	△	The operating voltage range differs.
Max. number of simultaneous input points		100% (at 26.4VDC)	Refer to the derating figure.*1	○	If the number of points to be replaced is eight or lower, simultaneous ON (100%) is resulted.
ON voltage/ON current		14VDC or higher/3.5mA or higher	15V or higher/4mA or higher	△	The ON voltage/ON current differ.*2
OFF voltage/OFF current		6.5VDC or lower/1.7mA or lower	8V or lower/2mA or lower	△	The OFF voltage differs.*2
Input resistance		Approx. 3.3kΩ	Approx. 3.8kΩ	△	The input resistance is higher in the LX40C6.*2
Response time	OFF → ON	10ms or less (24VDC)	1ms, 5ms, 10ms, 20ms, 70ms or less (The value is set in PLC parameter of the CPU module.) Default: 10ms	○	Set the input response time of parameter to the default value (10ms).
	ON → OFF	10ms or less (24VDC)	1ms, 5ms, 10ms, 20ms, 70ms or less (The value is set in PLC parameter of the CPU module.) Default: 10ms	○	
Wiring method for common		8 points/common (common terminal: TB9)	16 points/common (common terminal: TB17)	○	
Operation status indicator		ON status of LED	ON status of LED	○	
External connection system		20-point terminal block (M3.5 × 7 screws)	18-point terminal block (M3 × 6 screws)	×	Wiring change is required. The compatible screw size and wire size are decreased.
Applicable wire size		0.75 to 1.25mm ²	Core: 0.3 to 0.75mm ² (outside diameter: 2.8mm or less)	×	
Applicable solderless terminal		R1.25-3.5, R2-3.5 RAV1.25-3.5, RAV2-3.5	R1.25-3 (Solderless terminal with an insulation value cannot be used.)	×	
Number of occupied I/O points		16 points (I/O assignment: Output 16 points)	16 points (I/O assignment: Input 16 points)	△	With the LX40C6 and LY40NT5P, the number of occupied I/O points will be 32.
Current consumption		0.06A (Typ., all points ON, total of the input and output parts)	0.09A (Typ., all points ON)	△	With the LX40C6 and LY40NT5P, the current consumption will be 0.19A. Review the current capacity since the current consumption is increased.
External dimensions		130(H) × 34.5(W) × 93.6(D)mm	90(H) × 28.5(W) × 117(D)mm	×	Two modules (LX40C6 and LY40NT5P) are required.
Weight		0.20kg	0.15kg	△	With the LY40NT5P, the weight will be 0.30kg.

*1 The derating figure is shown below.

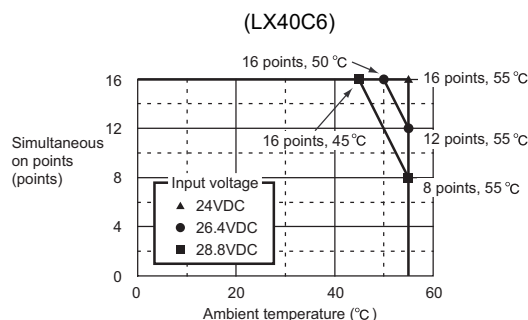

*2 Check the specifications of a sensor or switch to be connected to the LX40C6.

(b) Comparison of specifications between A1SX48Y58 (output part) and LY40NT5P

○ : Compatible, △ : Partially changed, × : Incompatible

Specifications		A1SX48Y58 (output specifications)	LY40NT5P	Compatibility	Precautions for replacement
Number of output points		8 points	16 points	△	With the LX40C6, the number of occupied I/O points will be 32.
Insulation method		Photocoupler	Photocoupler	○	
Output type		Sink type	Sink type	○	
Rated load voltage		12/24VDC	12/24VDC	○	
Operating load voltage range		10.2 to 30VDC (peak voltage 30VDC)	10.2 to 28.8VDC	△	Voltage exceeding 28.8VDC is not applicable.
Max. load current		0.5A/point, 2A/common	0.5A/point, 5A/common	○	
Max. inrush current		4A 10ms or lower	Current limiting by the overload current function	△	Since the inrush current values differ, select a load carefully.
Leakage current at OFF		0.1mA or lower	0.1mA or lower	○	
Max. voltage drop at ON		0.9VDC (Typ.) 0.5A 1.5VDC (Max.) 0.5A	0.2VDC (Typ.) 0.5A, 0.3VDC (Max.) 0.5A	○	
Response time	OFF → ON	2ms or less	0.5ms or less	○	
	ON → OFF	2ms or less (resistive load)	1ms or less (rated load, resistive load)	○	
Surge suppressor		Zener diode	Zener diode	○	
Fuse rating (breaking capacity)		3.2A Not exchangeable (breaking capacity: 50A)	—	△	Protection functions are supported.
Fuse blown indication		Supported (The corresponding LED turns on when a fuse is blown. Then, a signal is output to the CPU module.)			
Protection function		Not supported	Supported Overload protection function (current limiting when overcurrent is detected: 1.5 to 3A/point, activates in increments of 1 point) Overheat protection function (activates in increments of 1 point)		
Wiring method for common		8 points/common (common terminal: TB19)	16 points/common (common terminal: TB18)	○	
External power supply	Voltage	12/24VDC (10.2 to 30VDC)	10.2 to 28.8VDC (ripple ratio within 5%)	△	Voltage exceeding 28.8VDC is not applicable.
	Current	60mA (Typ., 24VDC for each common)	9mA (at 24VDC)	○	
Operation status indicator		ON status of LED	ON status of LED	○	
External connection system		20-point terminal block (M3.5 × 7 screws)	18-point terminal block (M3 × 6 screws)	×	
Applicable wire size		0.75 to 1.25mm ²	Core: 0.3 to 0.75mm ² (outside diameter: 2.8mm or less)	×	Wiring change is required. The compatible screw size and wire size are decreased.
Applicable solderless terminal		R1.25-3.5, R2-3.5 RAV1.25-3.5, RAV2-3.5	R1.25-3 (Solderless terminal with an insulation sleeve cannot be used.)	×	
Number of occupied I/O points		16 points (I/O assignment: Output 16 points)	16 points (I/O assignment: Output 16 points)	△	With the LX40C6 and LY40NT5P, the number of occupied I/O points will be 32.
Current consumption		0.06A (Typ., all points ON, total of the input and output parts)	0.09A (Typ., all points ON)	△	With the LX40C6 and LY40NT5P, the current consumption will be 0.19A. Review the current capacity since the current consumption is increased.
External dimensions		130(H) × 34.5(W) × 93.6(D)mm	90(H) × 28.5(W) × 117(D)mm	×	Two modules (LX40C6 and LY40NT5P) are required.
Weight		0.20kg	0.15kg	△	With the LX40C6, the weight will be 0.30kg.

(7) Comparison of specifications between A1SJ-56DT and LX40C6/LY40NT5P

(a) Comparison of specifications between A1SJ-56DT (input part) and LX40C6

○ : Compatible, △ : Partially changed, × : Incompatible

Specifications		A1SJ-56DT (input specifications)	LX40C6	Compatibility	Precautions for replacement
Number of input points		32 points	16 points	△	When 17 or more points are used, use two LX40C6 modules.
Insulation method		Photocoupler	Photocoupler	○	
Input type		Sink type	Sink type	○	
Rated input voltage		24VDC	24VDC	○	
Rated input current		Approx. 7mA	6.0mA Typ. (for 24VDC)	△	The input current is lower in the LX40C6.*2
Operating voltage range		19.2 to 26.4VDC (ripple ratio within 5%)	20.4 to 28.8VDC (ripple ratio within 5%)	△	The operating voltage range differs.
Max. number of simultaneous input points		60% (10 points/common)	Refer to the derating figure.*1	○	
ON voltage/ON current		14VDC or higher/3.5mA or higher	15VDC or higher/4mA or higher	△	The ON voltage/ON current differ.*2
OFF voltage/OFF current		6.5VDC or lower/1.7mA or lower	8VDC or lower/2mA or lower	△	The OFF voltage/OFF current differ.*2
Input resistance		Approx. 3.3kΩ	Approx. 3.8kΩ	△	The input resistance is higher in the LX40C6.*2
Response time	OFF → ON	10ms or less (24VDC)	1ms, 5ms, 10ms, 20ms, or less than 70ms (To be set with the CPU module's PLC parameter) Default: 10ms	○	Set the input response time of parameter to the default value (10ms).
	ON → OFF	10ms or less (24VDC)	1ms, 5ms, 10ms, 20ms, or less than 70ms (To be set with the CPU module's PLC parameter) Default: 10ms	○	
Wiring method for common		16 points/common (common terminal: TB17, TB34)	16 points/common (common terminal: TB17)	○	
Operation status indicator		ON status of LED	ON status of LED	○	
External connection system		34-point terminal block connector 2 pieces (M3.5 × 6 screws)	18-point terminal block (M3 × 6 screws)	×	Wiring change is required.
Applicable wire size		0.75 to 2mm ²	0.3 to 0.75mm ²	×	
Applicable solderless terminal		R1.25-3.5, R2-3.5 RAV1.25-3.5, RAV2-3.5	R1.25-3 (Solderless terminal with an insulation value cannot be used.)	×	
Number of occupied I/O points		128 points (For slot 0, output 64 points; for slot 1 to 4, empty 16 points)	16 points	—	
Current consumption		0.22A (Typ., all points on)	0.09A (Typ., all points ON)	—	The module configuration differs. Recalculate the current consumption.
External dimensions		130(H) × 174.5(W) × 65.6(D)mm	90(H) × 28.5(W) × 117(D)mm	△	Wiring space is narrower.
Weight		0.70kg	0.15kg	△	

*1 The derating figure is shown below.

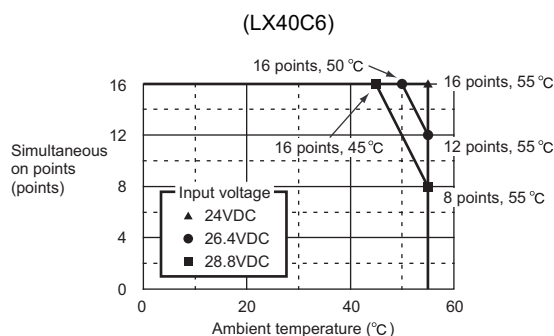

*2 Check the specifications of a sensor or switch to be connected to the LX40C6.

(b) Comparison of specifications between A1SJ-56DT (output part) and the LY40NT5P

○ : Compatible, △ : Partially changed, × : Incompatible

Specifications		A1SJ-56DT (output specifications)	LY40NT5P	Compatibility	Precautions for replacement
Number of output points		24 points	16 points	△	When 17 or more points are used, use two LX40C6 modules.
Insulation method		Photocoupler	Photocoupler	○	
Output type		Sink type	Sink type	○	
Rated load voltage		24VDC	12/24VDC	○	
Operating load voltage range		19.2 to 30VDC (peak voltage 30VDC)	10.2 to 28.8VDC	△	Voltage exceeding 28.8VDC is not applicable.
Max. load current		0.5A/point, 4A/common	0.5A/point, 5A/common	△	The consumption of current by entire unit must not exceed 5A.
Max. inrush current		4A 10ms or lower	Current limiting by the overload current function	△	Since the inrush current values differ, select a load carefully.
Leakage current at OFF		0.1mA or lower	0.1mA or lower	○	
Max. voltage drop at OFF		0.9VDC (Typ.) 0.5A 1.5VDC (Max.) 0.5A	0.2VDC (Typ.) 0.5A 0.3VDC (Max.) 0.5A	○	
Response time	OFF → ON	2ms or less	0.5ms or less	○	
	ON → OFF	2ms or less (resistive load)	1ms or less (rated load, resistive load)	○	
Surge suppressor		Zener diode	Zener diode	○	
Wiring method for common		8 points/common (common terminal: TB10, TB20, TB30)	16 points/common (common terminal: TB17)	△	As the number of points per common is changed to 16, wiring with a different voltage for each common is not possible.
Operation status indicator		ON status of LED	ON status of LED	○	
Fuse rating (breaking capacity)		Not supported	Not supported	—	
Fuse blown indication					
External power supply	Voltage	24VDC (19.2 to 30VDC)	10.2 to 28.8VDC (ripple ratio within 5%)	○	
	Current	60mA (Typ., 24VDC for each common)	9mA (at 24VDC)	○	
External connection system		34-point terminal block connector 2 pieces (M3.5 × 6 screws)	18-point terminal block (M3 × 6 screws)	×	Wiring change is required.
Applicable wire size		0.75 to 2mm ²	Core: 0.3 to 0.75mm ² (outside diameter: 2.8mm or less)	×	
Applicable solderless terminal		R1.25-3.5, R2-3.5 RAV1.25-3.5, RAV2-3.5	R1.25-3 (Solderless terminal with an insulation value cannot be used.)	×	
Number of occupied I/O points		128 points (For slot 0, output 64 points; for slot 1 to 4, empty 16 points)	16 points	—	
Current consumption		0.22A (Typ., all points on)	0.1A (Typ., all points ON)	—	The module configuration differs. Recalculate the current consumption.
External dimensions		130(H) × 174.5(W) × 65.6(D)mm	90(H) × 28.5(W) × 117(D)mm	△	Wiring space is narrower.
Weight		0.70kg	0.15kg	△	

(8) Comparison of specifications between A1SJ-56DR and LX40C6/LY10

(a) Comparison of specifications between A1SJ-56DR (input part) and LX40C6

○ : Compatible, △ : Partially changed, × : Incompatible

Specifications		A1SJ-56DR (input specifications)	LX40C6	Compatibility	Precautions for replacement
Number of input points		32 points	16 points	△	When 17 or more points are used, use two LX40C6 modules.
Insulation method		Photocoupler	Photocoupler	○	
Input type		Sink type	Sink type	○	
Rated input voltage		24VDC	24VDC	○	
Rated input current		Approx. 7mA	6.0mA Typ. (for 24VDC)	△	The input current is lower in the LX40C6.*2
Operating voltage range		19.2 to 26.4VDC ripple ratio within 5%)	20.4 to 28.8VDC (ripple ratio within 5%)	△	The operating voltage range differs.
Max. number of simultaneous input points		60% (10 points/common) Simultaneously on	Refer to the derating figure.*1	○	
ON voltage/ON current		14VDC or higher/3.5mA or higher	15VDC or higher/4mA or higher	△	The ON voltage/ON current differ.*2
OFF voltage/OFF current		6.5VDC or lower/1.7mA or lower	8VDC or lower/2mA or lower	△	The OFF voltage/OFF current differ.*2
Input resistance		Approx. 3.3kΩ	Approx. 3.8kΩ	△	The input resistance is higher in the LX40C6.*2
Response time	OFF → ON	10ms or less (24VDC)	1ms, 5ms, 10ms, 20ms, or less than 70ms (To be set with the CPU module's PLC parameter) Default: 10ms	○	Set the input response time of parameter to the default value (10ms).
	ON → OFF	10ms or less (24VDC)	1ms, 5ms, 10ms, 20ms, or less than 70ms (To be set with the CPU module's PLC parameter) Default: 10ms	○	
Wiring method for common		16 points/common (common terminal: TB17, TB34)	16 points/common (common terminal: TB17)	○	
Operation status indicator		ON status of LED	ON status of LED	○	
External connection system		34-point terminal block connector 2 pieces (M3.5 × 6 screws)	18-point terminal block (M3 × 6 screws)	×	Wiring change is required.
Applicable wire size		0.75 to 2mm ²	0.3 to 0.75mm ²	×	
Applicable solderless terminal		R1.25-3.5, R2-3.5 RAV1.25-3.5, RAV2-3.5	R1.25-3 (Solderless terminal with an insulation value cannot be used.)	×	
Number of occupied I/O points		128 points (For slot 0, output 64 points; for slot 1 to 4, empty 16 points)	16 points	—	
Current consumption		0.22A (Typ., all points on)	0.09A (Typ., all points ON)	—	The module configuration differs. Recalculate the current consumption.
External dimensions		130(H) × 174.5(W) × 65.6(D)mm	90(H) × 28.5(W) × 117(D)mm	△	Wiring space is narrower.
Weight		0.80kg	0.15kg	△	

*1 The derating figure is shown below.

(LX40C6)

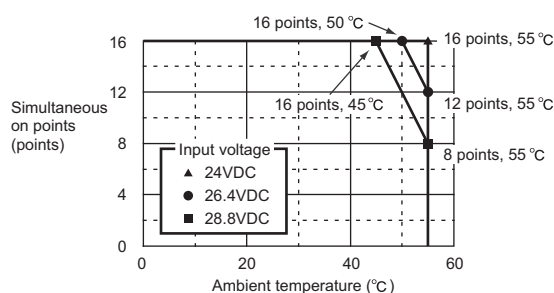

*2 Check the specifications of a sensor or switch to be connected to the LX40C6.

(b) Comparison of specifications between A1SJ-56DR (output part) and LY10R2

○ : Compatible, △ : Partially changed, × : Incompatible

Specifications		A1SJ-56DR (output specifications)	LY10R2	Compatibility	Precautions for replacement
Number of output points		24 points	16 points	△	When 17 or more points are used, use two LY10R2 modules.
Insulation method		Photocoupler	Relay	△	The insulation method differs, but the performance is the equivalent.
Output type		Contact output	Contact output	○	
Rated switching voltage/current		24VDC 2A (resistance load) 240VAC 2A (COSφ=1)/point, 5A/common	24VDC 2A (resistance load) 240VAC 2A (COSφ=1)/point, 8A/common	△	The consumption of current by entire unit must not exceed 8A.
Min. switching load		5VDC 1mA	5VDC 1mA	○	
Max. switching load		264VAC 125VDC	264VAC 125VDC	○	
Max. switching frequency		3600 times/hr	3600 times/hr	○	
Surge suppressor		Not supported	Not supported	—	
Response time	OFF → ON	10ms or less	10ms or less	○	
	ON → OFF	12ms or less	12ms or less	○	
Life	Mechanical	20 million times or more	20 million times or more	○	
	Electrical	Rated switching voltage/current load 100000 times or more	Rated switching voltage/current load 100000 times or more	○	
		200VAC 1.5A, 240VAC 1A (COSφ=0.7) 100000 times or more	200VAC 1.5A, 240VAC 1A (COSφ=0.7) 100000 times or more 200VAC 0.4A, 240VAC 0.3A (COSφ=0.7) 300000 times or more	○	
		200VAC 1A, 240VAC 0.5A (COSφ=0.35) 100000 times or more	200VAC 1A, 240VAC 0.5A (COSφ=0.35) 100000 times or more 200VAC 0.3A, 240VAC 0.15A (COSφ=0.35) 300000 times or more		
		24VDC 1A, 100VDC 0.1A (L/R=7ms) 100000 times or more	24VDC 1A, 100VDC 0.1A (L/R=7ms) 100000 times or more 24VDC 0.3A, 100VDC 0.03A (L/R=7ms) 300000 times or more		
Wiring method for common		8 points/common (common terminal: TB9, TB18, TB27)	16 points/common (common terminal: TB17)	△	As the number of points per common is changed to 16, wiring with a different voltage for each common is not possible.
Operation status indicator		ON status of LED	ON status of LED	○	
Fuse		Not supported	Not supported	-	
External power supply	Voltage	24VDC ±10% Ripple voltage 4Vp-p or less	—	○	An external power supply is not required.
	Current	140mA (Typ., 24VDC, all points on)	—	○	
External connection system		34-point terminal block connector 2 pieces (M3.5 × 6 screws)	18-point terminal block (M3 × 6 screws)	×	Wiring change is required.
Applicable wire size		0.75 to 2mm ²	Core: 0.3 to 0.75mm ² (outside diameter: 2.8mm)	×	
Applicable solderless terminal		R1.25-3.5, R2-3.5, RAV1.25-3.5, RAV2-3.5	R1.25-3 (Solderless terminal with an insulation value cannot be used.)	×	
Number of occupied I/O points		128 points (For slot 0, output 64 points; for slot 1 to 4, empty 16 points)	16 points/module (I/O assignment: Output 16 points)	—	
Current consumption		0.22A (Typ., all points on)	0.46A (Typ., all points ON)	—	The module configuration differs. Recalculate the current consumption.
External dimensions		130(H) × 174.5(W) × 65.6(D)mm	90(H) × 28.5(W) × 117(D)mm	△	Wiring space is narrower.
Weight		0.80kg	0.21kg	△	

3.3 Precautions for I/O Module Replacement

(1) Size of wire and solderless terminal

Since the module and terminal block of the L series are smaller than those of the AnS/QnAS series, the applicable size of wire and solderless terminal for a terminal block differ between the two series.

Therefore, when replacing the AnS/QnAS series with the L series, use the wire and solderless terminal that satisfy the specifications of the L series I/O modules.

(2) Connectors for external wiring

(a) Connectors for external wiring do not come with L series 32- and 64-point I/O modules.

(b) Purchase the connector (A6CON□) as required.

The pin layout is the same between AnS/QnAS series and L series I/O modules (connector type).

External wiring can be used even after AnS/QnAS series I/O modules are replaced with L series I/O modules.

(Without changing external wiring, existing connectors can be connected to L series I/O modules.)

Note, however, that the L series does not include a module having a 37-pin D-sub connector, change of the wiring to the 40-pin connector is needed.

(3) Precautions for input module

(a) Specifications change of rated input current

Check the specifications of connecting devices (such as sensors and switches) since rated input current is reduced for some L series input modules compared to that for the AnS/QnAS series.

(b) Specifications change of OFF current

Check the specifications of connecting devices (such as sensors and switches) since OFF current is increased for some L series input modules compared to that for the AnS/QnAS series.

(c) Specifications change of the maximum number of simultaneous input points

The maximum number of simultaneous input points is reduced for some L series input modules compared to that for the AnS/QnAS series.

When replacing the AnS/QnAS series with the L series, refer to the derating figure and use the points within the range shown in the figure.

(d) Specifications change of rated voltage value

For the L series LX4□DC input module, only 24VDC can be applied.

Because there is no replacement input unit for use at 12VDC, consider changing external device to be connected.

(e) Specifications change of response time

For L series DC input modules, the I/O response time can be set with parameters.

Set the I/O response time with parameters while adjusting it to the response time of the AnS/QnAS series module.

(f) Specifications change of common terminal arrangement

The common terminal arrangement may differ between the AnS/QnAS series and L series. To apply different voltages for each common, take measures, such as using different modules according to the applied voltage.

(4) Precautions for output module

(a) Specifications change of common terminal arrangement

The common terminal arrangement may differ between the AnS/QnAS series and L series. To apply different voltages for each common, take measures, such as using different modules according to the applied voltage.

(b) Specifications change of maximum load current per common

The maximum load current per common may differ between the AnS/QnAS series and L series. Check the specifications of the maximum load current per common for both series.

(c) Precautions for using the triac output module

Because of characteristics of a triac, a sudden change of voltage or current may cause unstable operations of a triac used for the triac output module.

Whether the voltage or current change causes a problem differs depending on an individual part (each triac), thus refer to the following to check if there are applicable precautions.

- MELSEC-L I/O Module User's Manual

(5) Replacement of I/O combined module

When replacing the AnS/QnAS series A1SX□Y□ type I/O combined module with the L series, replacement with two modules (input module and output module) is needed. Because the number of occupied points differs and the XY address changes, the program needs to be modified. Also consider replacing with the Q series.

4 REPLACEMENT OF POWER SUPPLY MODULE

4.1 List of Alternative Models of Power Supply Module

AnS/QnAS series model		L series alternative models	
Product	Model	Model	Remarks (restrictions)
Power supply module	A1S61PN	L61P	1) External wiring: Changed 2) Number of slots: Not changed 3) Specifications: Changed (allowable momentary power failure time: 20ms → 10ms)
	A1S62PN	L61P	1) External wiring: Changed 2) Number of slots: Not changed 3) Specifications: Changed (with 24VDC output → no 24VDC output) (allowable momentary power failure time: 20ms → 10ms)
	A1S63P	L63P	1) External wiring: Changed 2) Number of slots: Not changed 3) Specifications: Not changed
		L63SP	1) External wiring: Changed 2) Number of slots: Not changed 3) Specifications: Not changed
	A1SJHCPU (power supply part)	L61P	1) External wiring: Changed 2) Number of slots: Changed (integrated → power supply module alone) 3) Specifications: Changed (The input power supply is switched from 100 to 120V or 200 to 240V. (In-between voltage cannot be applied.) → wide range of 100 to 240V applicable) (allowable momentary power failure time: 20ms → 10ms)

4.2 Comparison of Power Supply Module Specifications

(1) Specifications comparison between A1S61PN and L61P

○ : Compatible, △ : Partially changed, × : Incompatible

Specifications	A1S61PN	L61P	Compatibility	Precautions for replacement
Input power supply	100 to 240VAC + 10% to 15% (85 to 264VAC)	100 to 240VAC + 10% to 15% (85 to 264VAC)	○	
Input frequency	50/60Hz ±5%	50/60Hz ±5%	○	
Input voltage distortion	Within 5%	Within 5%	○	
Max. input apparent power	105VA	130VA	△	Check the capacity when using a UPS.
Inrush current	20A within 8ms	20A within 8ms	○	
Rated output current	5VDC	5A	○	
	24VDC	—	—	
Overcurrent protection	5VDC	5.5A or higher	○	
	24VDC	—	—	
Overvoltage protection	5VDC	5.5 to 6.5V	○	
	24VDC	—	—	
Efficiency	65% or higher	70% or higher	○	
Fuse	Built-in (Replacement by service personnel only)	Built-in (Replacement by service personnel only)	○	
Allowable momentary power failure time	Within 20ms	Within 10ms	△	The allowable momentary power failure time is reduced.
Withstand voltage	Between batch inputs and LG and batch outputs and FG 2830VAC rms/3 cycles (altitude 2,000m)	Between batch inputs and LG and batch outputs and FG 2300VAC/minute (altitude: 0 to 2,000m)	○	
Insulation resistance	Between batch inputs and LG and batch outputs and FG 10MΩ or more with the 500VDC insulation resistance tester	10MΩ or more with a 500VDC insulation resistance tester (between input/LG batch and output/FG batch; between input batch and LG; between output batch and FG)	○	
Noise immunity	<ul style="list-style-type: none"> According to a noise simulator with 1500Vp-p noise voltage, 1μs noise width, and 25 to 60Hz noise frequency noise voltage IEC801-4, 2kV 	<ul style="list-style-type: none"> According to a noise simulator with 1500Vp-p noise voltage, 1μs noise width, and 25 to 60Hz noise frequency noise voltage IEC61000-4-4, 2kV 	○	
Operation status indicator	LED indication (Turns on when 5VDC is output.)	LED indication (normal: on (green), error: off)	○	
Terminal screw size	M3.5 × 7	M3.5 screws	○	
Applicable wire size	0.75 to 2mm ²	0.75 to 2mm ²	○	
Applicable solderless terminal	RAV1.25-3.5, RAV2-3.5	RAV1.25-3.5, RAV2-3.5 0.8mm or less thickness Max. two sheets can be connected to one terminal.	○	
Applicable tightening torque	59 to 88N•cm	66 to 89N•cm	△	Tighten within the applicable tightening torque.
External dimensions	130(H) × 55(W) × 93.6(D)mm	90(H) × 45(W) × 95(D)mm	△	Wiring space is narrower.
Weight	0.60kg	0.32kg	△	
Accessory	Not equipped	Not equipped	○	

(2) Specifications comparison between A1S62PN and L61P

○ : Compatible, △ : Partially changed, × : Incompatible

Specifications	A1S62PN	L61P	Compatibility	Precautions for replacement
Input power supply	100 to 240VAC + 10% to 15% (85 to 264VAC)	100 to 240VAC + 10% to 15%), (85 to 264VAC)	○	
Input frequency	50/60Hz ± 5%	50/60Hz ± 5%	○	
Input voltage distortion	Within 5%	Within 5%	○	
Max. input apparent power	105VA	130VA	△	Check the capacity when using a UPS.
Inrush current	20A within 8ms	20A within 8ms	○	
Rated output current	5VDC	3A	○	There is no 24VDC output current. If necessary, prepare an external power supply.
	24VDC	0.6A	×	
Overcurrent protection	5VDC	3.3A or higher	○	
	24VDC	0.66A or higher	—	
Overvoltage protection	5VDC	5.5 to 6.5V	○	
	24VDC	—	—	
Efficiency	65% or higher	70% or higher	○	
Fuse	Built-in (Replacement by service personnel only)	Built-in (Replacement by service personnel only)	○	
Allowable momentary power failure time	Within 20ms	Within 10ms	△	The allowable momentary power failure time is reduced.
Withstand voltage	Between batch inputs and LG and batch outputs and FG 2830VAC rms/3 cycles (altitude 2000m)	Between batch inputs and LG and batch outputs and FG 2300VAC/minute (altitude: 0 to 2000m)	○	
Insulation resistance	Between batch inputs and LG and batch outputs and FG 10MΩ or more with the 500VDC insulation resistance tester	10MΩ or more with a 500VDC insulation resistance tester (between input/LG batch and output/FG batch; between input batch and LG; between output batch and FG)	○	
Noise immunity	<ul style="list-style-type: none"> • According to a noise simulator with 1500Vp-p noise voltage, 1μs noise width, and 25 to 60Hz noise frequency • noise voltage IEC801-4, 2kV 	<ul style="list-style-type: none"> • According to a noise simulator with 1500Vp-p noise voltage, 1μs noise width, and 25 to 60Hz noise frequency • noise voltage IEC61000-4-4, 2kV 	○	
Operation status indicator	LED indication (Turns on when 5VDC is output.)	LED indication (normal: on (green), error: off)	○	
Terminal screw size	M3.5 × 7	M3.5 screws	○	
Applicable wire size	0.75 to 2mm ²	0.75 to 2mm ²	○	
Applicable solderless terminal	RAV1.25-3.5, RAV2-3.5	RAV1.25-3.5, RAV2-3.5 0.8mm or less thickness Max. two sheets can be connected to one terminal.	○	
Applicable tightening torque	59 to 88N•cm	66 to 89N•cm	△	Tighten within the applicable tightening torque.
External dimensions	130(H) × 55(W) × 93.6(D)mm	90(H) × 45(W) × 95(D)mm	△	Wiring space is narrower.
Weight	0.60kg	0.32kg	△	
Accessory	Not equipped	Not equipped	○	

(3) Specifications comparison between A1S63P and L63P

○ : Compatible, △ : Partially changed, × : Incompatible

Specifications	A1S63P	L63P	Compatibility	Precautions for replacement
Input power supply	24VDC + 30% to 35% (15.6 to 31.2VDC)	24VDC + 30% to 35% (15.6 to 31.2VDC)	○	
Input frequency	—	—	—	
Input voltage distortion	—	—	—	
Max. input apparent	41W	45W	○	
Inrush current	81A within 1ms	100A within 1ms When 24VDC is input	○	
Rated output current	5VDC	5A	○	
	24VDC	—	—	
Overcurrent protection	5VDC	5.5A or higher	○	
	24VDC	—	—	
Overvoltage protection	5VDC	5.5 to 6.5V	○	
	24VDC	—	—	
Efficiency	65% or higher	70% or higher	○	
Fuse	Built-in (Replacement by service personnel only)	Built-in (Replacement by service personnel only)	○	
Allowable momentary power failure time	Within 10ms (24VDC or more)	Within 10ms at 24VDC input	○	
Withstand voltage	Between primary and 5VDC 500VAC	510VAC/minute (altitude 0 to 2000m) Between input/LG batch and output/FG batch	○	
Insulation resistance	Between batch inputs and LG and batch outputs and FG 10MΩ or more with the 500VDC insulation resistance tester	10MΩ or more with the 500VDC insulation resistance tester (between input/LG batch and output/FG batch; between input batch and LG; between output batch and FG)	○	
Noise immunity	According to a noise simulator with 500Vp-p noise voltage, 1μs noise width, and 25 to 60Hz noise frequency	<ul style="list-style-type: none"> By noise simulator of 500Vp-p noise voltage, 1μs noise width, and 25 to 60Hz noise frequency noise voltage IEC61000-4-4, 2kV 	○	
Operation status indicator	LED indication (Turns on when 5VDC is output.)	LED indication (normal: on (green), error: off)	○	
Terminal screw size	M3.5 × 7	M3.5 screws	○	
Applicable wire size	0.75 to 2mm ²	0.75 to 2mm ²	○	
Applicable solderless terminal	RAV1.25-3.5, RAV2-3.5	RAV1.25-3.5, RAV2-3.5 0.8mm or less thickness Max. two sheets can be connected to one terminal.	○	
Applicable tightening torque	59 to 88N·cm	66 to 89N·cm	△	Tighten within the applicable tightening torque.
External dimensions	130(H) × 55(W) × 93.6(D)mm	90(H) × 45(W) × 95(D)mm	△	Wiring space is narrower.
Weight	0.50kg	0.29kg	△	
Accessory	Not equipped	Not equipped	○	

(4) Specifications comparison between A1S63P and L63SP

○ : Compatible, △ : Partially changed, × : Incompatible

Specifications	A1S63P	L63SP	Compatibility	Precautions for replacement
Input power supply	24VDC + 30% to 35% (15.6 to 31.2VDC)	24VDC + 30% to 35% (15.6 to 31.2VDC)	○	
Input frequency	—	—	—	
Input voltage distortion	—	—	—	
Max. input apparent	41W	45W	○	
Inrush current	81A within 1ms	100A within 1ms When 24VDC is input	○	
Rated output current	5VDC	5A	○	
	24VDC	—	—	
Overcurrent protection	5VDC	5.5A or higher	○	
	24VDC	—	—	
Overvoltage protection	5VDC	5.5 to 6.5V	○	
	24VDC	—	—	
Efficiency	65% or higher	70% or higher	○	
Fuse	Built-in (Replacement by service personnel only)	Built-in (Replacement by service personnel only)	○	
Allowable momentary power failure time	Within 10ms (24VDC or more)	Within 10ms at 24VDC input	○	
Withstand voltage	Between primary and 5VDC 500VAC	—	×	Not isolated between 24VDC for primary side and 5VDC for secondary side
Insulation resistance	Between batch inputs and LG and batch outputs and FG 10MΩ or more with the 500VDC insulation resistance tester	—	×	Not isolated between 24VDC for primary side and 5VDC for secondary side
Noise immunity	According to a noise simulator with 500Vp-p noise voltage, 1μs noise width, and 25 to 60Hz noise frequency	<ul style="list-style-type: none"> • By noise simulator of 500Vp-p noise voltage, 1μs noise width, and 25 to 60Hz noise frequency • noise voltage IEC61000-4-4, 2kV 	○	
Operation status indicator	LED indication (Turns on when 5VDC is output.)	LED indication (normal: on (green), error: off)	○	
Terminal screw size	M3.5 × 7	M3.5 screws	○	
Applicable wire size	0.75 to 2mm ²	0.75 to 2mm ²	○	
Applicable solderless terminal	RAV1.25-3.5, RAV2-3.5	RAV1.25-3.5, RAV2-3.5 0.8mm or less thickness Max. two sheets can be connected to one terminal.	○	
Applicable tightening torque	59 to 88N•cm	66 to 89N•cm	△	Tighten within the applicable tightening torque.
External dimensions	130(H) × 55(W) × 93.6(D)mm	90(H) × 45(W) × 95(D)mm	△	Wiring space is narrower.
Weight	0.50kg	0.19kg	△	
Accessory	Not equipped	Not equipped	○	

(5) Specifications comparison between A1SJHCPU (power supply part) and L61P

○ : Compatible, △ : Partially changed, × : Incompatible

Specifications	A1SJHCPU (power supply part)	L61P	Compatibility	Precautions for replacement
Input power supply	100 to 120VAC + 10% to 15% (85 to 132VAC)	100 to 240VAC + 10% to 15% (85 to 264VAC)	○	
	200 to 240VAC + 10% to 15% (170 to 264VAC)			
Input frequency	50/60Hz ±3%	50/60Hz ±5%	○	
Input voltage distortion	Within 5%	Within 5%	○	
Max. input apparent power	100VA	130VA	△	Check the capacity when using a UPS.
Inrush current	20A within 8ms	20A within 8ms	○	
Rated output current	5VDC	3A	○	
	24VDC	—	—	
Overcurrent protection	5VDC	3.3A or higher	○	
	24VDC	—	—	
Overvoltage protection	5VDC	5.5 to 6.5V	○	
	24VDC	—	—	
Efficiency	65% or higher	70% or higher	○	
Fuse	Built-in (Replacement by service personnel only)	Built-in (Replacement by service personnel only)	○	
Allowable momentary power failure time	Within 20ms (100VAC or more)	Within 10ms	△	The allowable momentary power failure time is reduced.
Withstand voltage	Between batch inputs and LG and batch outputs and FG 2830VAC rms/3 cycles (altitude 2000m)	Between batch inputs and LG and batch outputs and FG 2300VAC/minute (altitude: 0 to 2000m)	○	
Insulation resistance	Between batch inputs and LG and batch outputs and FG 10MΩ or more with the 500VDC insulation resistance tester	10MΩ or more with a 500VDC insulation resistance tester (between input/LG batch and output/FG batch; between input batch and LG; between output batch and FG)	○	
Noise immunity	<ul style="list-style-type: none"> According to a noise simulator with 1500Vp-p noise voltage, 1μs noise width, and 25 to 60Hz noise frequency noise voltage IEC801-4, 2kV 	<ul style="list-style-type: none"> According to a noise simulator with 1500Vp-p noise voltage, 1μs noise width, and 25 to 60Hz noise frequency noise voltage IEC61000-4-4, 2kV 	○	
Operation status indicator	POWER indicator LED indication	LED indication (normal: on (green), error: off)	○	
Terminal screw size	M3.5 × 8	M3.5 screws	○	
Applicable wire size	0.3 to 2mm ²	0.75 to 2mm ²	○	
Applicable solderless terminal	RAV1.25-3.5, RAV2-3.5	RAV1.25-3.5, RAV2-3.5 0.8mm or less thickness Max. two sheets can be connected to one terminal.	○	
Applicable tightening torque	59 to 88N•cm	66 to 89N•cm	△	Tighten within the applicable tightening torque.
External dimensions	130(H) × 330(W) × 82(D)mm	90(H) × 45(W) × 95(D)mm	△	Wiring space is narrower.
Weight	7.00kg (Total weight of the base unit, CPU module, and power supply module)	0.32kg	△	
Accessory	Not equipped	Not equipped	○	

4.3 Precautions for Power Supply Module Replacement

- (1) Current consumption differs between the L series and AnS/QnAS series modules. Select the power supply module with the result of calculating the current consumption of entire system.
- (2) Input power supply of the L61P is wide range type applicable to 100 to 240VAC.
The power supply can be used for operating voltage of both 100VAC and 200VAC.
- (3) The L61P does not output 24VDC current.
Prepare an external 24VDC power supply, when replacing A1S62PN with the L61P and when using the 24VDC current output of A1S62PN.
- (4) The allowable momentary power failure time of the L61P is shorter than the A1S61PN, A1S62PN, and A1SJHCPU (power supply part).
A measure against the momentary power failure is required, consider an appropriate solution such as attachment of a UPS to the power supply circuit.

5 REPLACEMENT OF BASE UNIT AND EXTENSION CABLE

5.1 List of Alternative Models of Base Unit and Extension Cable

AnS/QnAS series model		L series alternative model	
Product	Model	Model	Remarks (restrictions)
Main base unit	A1S32B	—	<ul style="list-style-type: none"> L series configuration requires no base unit and modules are mounted onto a DIN rail. The DIN rail length differs depending on the module configuration. *1
	A1S33B		
	A1S35B		
	A1S38B		
	A1S38HB		
	A1S38HBEU		
Extension base unit	Type requiring no power supply module	—	<ul style="list-style-type: none"> L series system can be extended using a branch module and an extension module. *2
	A1S52B(-S1)		
	A1S55B(-S1)		
	A1S58B(-S1)		
	Type requiring power supply module		
A1S65B(-S1)			
A1S68B(-S1)			
Extension cable	A1SC01B	LC06E	Cable length: 0.055m → 0.6m
	A1SC03B	LC06E	Cable length: 0.33m → 0.6m
	A1SC07B	LC10E	Cable length: 0.7m → 1.0m
	A1SC12B	LC30E	Cable length: 1.2m → 3.0m
	A1SC30B	LC30E	Cable length: 3.0m
	A1SC60B	—	—

*1 For the width of the modules used in the system, refer to Section 5.3.

*2 For details on the L series system expansion, refer to Section 2.1 on the MELSEC-L CPU Module User's Manual (Hardware Design, Maintenance and Inspection).

5.2 Specifications Comparison of the Base Units

The MELSEC-L series does not need a base unit. When transiting from the MELSEC-AnS/QnAS series, examine the system size and installation method while considering the replacement modules of the MELSEC-L series besides pre-replacement status.

5.2.1 AnS/QnAS series base unit specifications

(1) Main base unit

Item	Model			
	AnS/QnAS series			
	A1S32B	A1S33B	A1S35B	A1S38B/A1S38HB/ A1S38HBEU
Number of mountable I/O modules	2 modules can be mounted.	3 modules can be mounted.	5 modules can be mounted.	8 modules can be mounted.
Extendability	An extension base unit can be connected.	An extension base unit can be connected.	An extension base unit can be connected.	An extension base unit can be connected.
Mounting hole size	φ6 bell-shaped hole (For M5 screw)	φ6 bell-shaped hole (For M5 screw)	φ6 bell-shaped hole (For M5 screw)	φ6 bell-shaped hole (For M5 screw)
External dimensions	130(H) × 220(W) × 28(D)mm	130(H) × 255(W) × 28(D)mm	130(H) × 325(W) × 28(D)mm	130(H) × 430(W) × 28(D)mm
Panel installation dimensions	200 × 110mm	235 × 110mm	305 × 110mm	410 × 110mm

(2) Extension base unit

(a) Type requiring no power supply module

Item	Model					
	AnS/QnAS series					
	A1S52B	A1S52B-S1	A1S55B	A1S55B-S1	A1S58B	A1S58B-S1
Number of mountable I/O modules	2 modules can be mounted.		5 modules can be mounted.		8 modules can be mounted.	
Extendability	An extension base unit cannot be connected.	An extension base unit can be connected.	An extension base unit cannot be connected.	An extension base unit can be connected.	An extension base unit cannot be connected.	An extension base unit can be connected.
Mounting hole size	φ6 bell-shaped hole (For M5 screw)		φ6 bell-shaped hole (For M5 screw)		φ6 bell-shaped hole (For M5 screw)	
External dimensions	130(H) × 155(W) × 28(D)mm		130(H) × 260(W) × 28(D)mm		130(H) × 365(W) × 28(D)mm	
Panel installation dimensions	135 × 110mm		240 × 110mm		345 × 110mm	

(b) Type requiring power supply module

Item	Model			
	AnS/QnAS series			
	A1S65B	A1S65B-S1	A1S68B	A1S68B-S1
Number of mountable I/O modules	5 modules can be mounted.		8 modules can be mounted.	
Extendability	An extension base unit cannot be connected.	An extension base unit can be connected.	An extension base unit cannot be connected.	An extension base unit can be connected.
Mounting hole size	φ6 bell-shaped hole (For M5 screw)		φ6 bell-shaped hole (For M5 screw)	
External dimensions	130(H) × 315(W) × 28(D)mm		130(H) × 420(W) × 28(D)mm	
Panel installation dimensions	295 × 110mm		400 × 110mm	

5.2.2 MELSEC-L series branch module and extension module

With branch and extension modules, the MELSEC-L series allows max. 40 modules to be connected through addition of three blocks.

However, number of extension blocks differs depending on the CPU module used.

The following table lists number of extension blocks for each CPU module used and number of connectable modules.

CPU module model name ^{*1}	Number of extension blocks ^{*2}	Number of connectable modules ^{*2*3}
L02SCPU(-P), L02CPU(-P)	Max. two blocks	30 modules • Basic block: 9 modules • Extension block 1: 10 modules • Extension block 2: 11 modules
L06CPU(-P), L26CPU(-P/-BT/-PBT)	Max. three blocks	40 modules • Basic block: 9 modules • Extension block 1: 10 modules • Extension block 2: 10 modules • Extension block 3: 11 modules

*1 The CPU module with a serial number (first five digits) of "13072" or later.

*2 The number includes the LA1S extension base unit when the base unit is connected.

*3 The total of the I/O module, intelligent function module, network module, and branch module. It does not include a power supply module, CPU module, display unit, extension module, RS-232 adapter, RS-422/485 adapter, and END cover. When the LA1S extension base unit is connected, this indicates the number of modules mountable on the connected LA1S extension base unit.

(1) Branch module

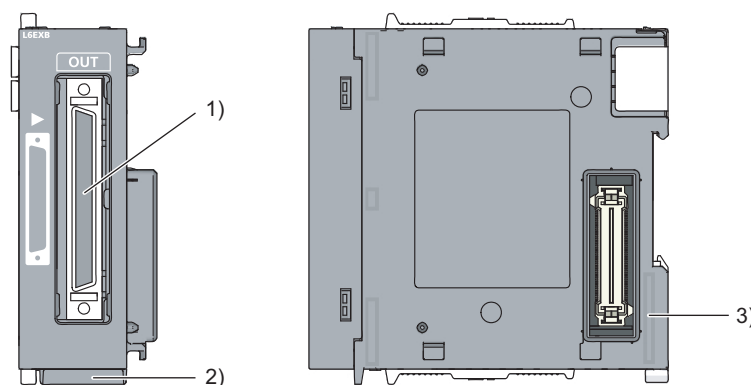

No.	Name	Application
1)	Extension connector (OUT)	Is used to attach an extension cable (for signal transfer with an extension module).
2)	Serial number display section	Displays serial number of the rating plates.
3)	DIN rail hook	Is used to mount to the DIN rail.

(2) Extension module

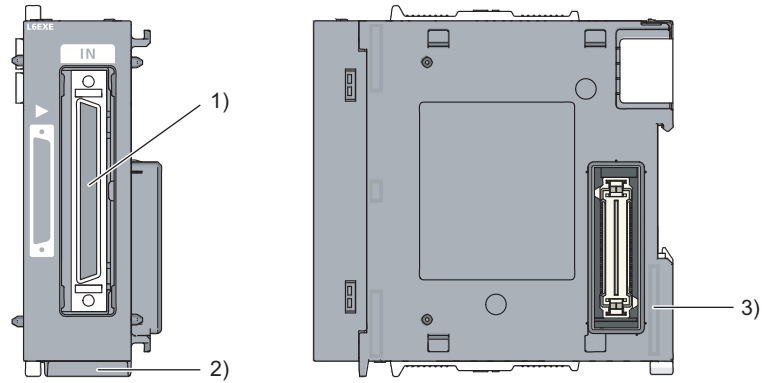

No.	Name	Application
1)	Extension connector (IN)	Is used to attach an extension cable (for signal transfer with a branch module).
2)	Serial number display section	Displays serial number of the rating plates.
3)	DIN rail hook	Is used to mount to the DIN rail.

Item		L6EXB	L6EXE
External dimensions	H	90mm	90mm
	W	28.5mm	28.5mm
	D	95mm	95mm
Internal current consumption		0.08A	0.08A
Weight		0.12kg	0.13kg

5.3 Width of the System After Replacement

(a) Width of the L series modules used

Since modules have dimensional tolerance, use the following values (actual width + tolerance) as the width of each module.

Module type	Actual width (mm)	Tolerance (mm)	Width for calculation (mm)
Power supply module	45	1.0	46
CPU module	70	1.0	71
I/O module	28.5	0.5	29
Branch module/Extension module	28.5	0.5	29
Two-slot type module	45	1.0	45.5
Space module (LG69)	16.5	0.5	17
Stopper (two pieces)	17 ^{*1}	1.0 ^{*1}	18 ^{*1}
END cover	13	0.5	13.5

*1 The value is the width of the stoppers provided with a base adapter (manufactured by Mitsubishi Electric Engineering Co., Ltd.). The value differs depending on the stoppers used.

(b) Existing base unit width and width of the system after replacement

The width of the system differs depending on the modules used (such as option modules and modules occupying two module spaces). Calculate the width according to the actual configuration. Use the values in the following table as a reference.

Base unit used before replacement	Width (mm)	Extension ^{*4}	Configuration after replacement		
			Number of modules using the LG69	Number of modules not using the LG69	Width of the system (mm) ^{*1}
A1S38B, A1S38HB	430	No	0	8	380.5
			1	7	397.5
			2	6	414.5
			3	5	431.5
			4	4	448.5
			5	3	465.5
			6	2	482.5
			7	1	499.5
		Yes	8	0	516.5
			0	8	409.5
			1	7	426.5
			2	6	443.5
			3	5	460.5
			4	4	477.5
			5	3	494.5
			6	2	511.5
A1S35B	325	No	7	1	528.5
			8	0	545.5
			0	5	293.5
			1	4	310.5
			2	3	327.5
			3	2	344.5
			4	1	361.5
			5	0	378.5
		Yes	0	5	322.5
			1	4	339.5
			2	3	356.5
			3	2	373.5
			4	1	390.5
			5	0	407.5

Base unit used before replacement	Width (mm)	Extension ^{*4}	Configuration after replacement		
			Number of modules using the LG69	Number of modules not using the LG69	Width of the system (mm) ^{*1}
A1S33B	255	No	0	3	235.5
			1	2	252.5
			2	1	269.5
		Yes	3	0	286.5
			0	3	264.5
			1	2	281.5
A1S32B	220	No	2	1	298.5
			3	0	315.5
			0	2	206.5
		Yes	1	1	223.5
			2	0	240.5
			0	2	235.5
A1SJHCPU, A1SJCPU(-S3) ^{*2}	330	No	1	1	252.5
			2	0	269.5
			0	5	293.5
			1	4	310.5
			2	3	327.5
		Yes	3	2	344.5
			4	1	361.5
			5	0	378.5
			0	5	322.5
			1	4	339.5
A1S58B ^{*3}	365	—	2	3	356.5
			3	2	373.5
			4	1	390.5
			5	0	407.5
			0	8	338.5
			1	7	355.5
			2	6	372.5
			3	5	389.5
A1S55B ^{*3}	260	—	4	4	406.5
			5	3	423.5
			6	2	440.5
			7	1	457.5
			8	0	474.5
A1S52B ^{*3}	155	—	0	5	251.5
			1	4	268.5
			2	3	285.5
			3	2	302.5
			4	1	319.5
A1S68B	420	—	5	0	336.5
			0	2	164.5
			1	1	181.5
			2	0	198.5
			0	8	338.5
			1	7	355.5
			2	6	372.5
			3	5	389.5
4	4	406.5			
5	3	423.5			
6	2	440.5			
7	1	457.5			
8	0	474.5			

Base unit used before replacement	Width (mm)	Extension*4	Configuration after replacement		
			Number of modules using the LG69	Number of modules not using the LG69	Width of the system (mm)*1
A1S65B	315	—	0	5	251.5
			1	4	268.5
			2	3	285.5
			3	2	302.5
			4	1	319.5
			5	0	336.5

*1 Width of the L system = Total width of the L series modules used + Total dimensional tolerance of the L series modules used + Total width of the stoppers

*2 The CPU module, power supply module, and base unit are integrated.

Since the CPU module and power supply module also need to be replaced, the external dimensions become larger.

*3 A power supply module is required for an extension block. Add the width of the power supply module.

*4 When the system is extended, a branch module (L6EXB) is included.

5.4 LA1S Extension Base Unit

When the AnS/QnAS series CPU module is replaced with the L series module using the LA1S extension base unit, AnS/QnAS series-compatible module can be utilized without change.

5.4.1 List of LA1S extension base unit models

Type	Existing base unit model name	LA1S extension base unit model name	Remarks
Main base unit	A1S35B	LA1S65B	<ul style="list-style-type: none"> Because the main base unit is replaced with the extension base unit, the external dimensions and installation dimensions of the unit will change, and thus reprocessing for mounting holes is required.
	A1S38B	LA1S68B	
Extension base unit (type requiring a power supply module)	A1S65B(-S1)	LA1S65B	<ul style="list-style-type: none"> The external dimensions and installation dimensions of both units are the same, and thus the installation of the unit using the existing mounting holes is possible.
	A1S68B(-S1)	LA1S68B	
Extension base unit (type requiring no power supply module)	A1S55B(-S1)	LA1S65B	<ul style="list-style-type: none"> A power supply module needs to be selected. The external dimensions and installation dimensions differ between the units, and thus reprocessing for mounting holes is required. The width of the system (W) increases by 55mm, and thus securing the space for the installation is required.
	A1S58B(-S1)	LA1S68B	
	—	LA1S51B	<ul style="list-style-type: none"> A power supply module does not need to be mounted. The LA1S51B cannot be used with the LA1S6□B. Because the base unit is newly installed, processing for mounting holes is required. Securing the space for the installation is required within the 1m of the extension cable length.

5.4.2 LA1S extension base unit specifications

Item	Model			
	LA1S51B	LA1S65B	LA1S68B	
Number of mountable I/O modules	1	5	8	
Extendability	An extension base unit cannot be connected.	Connecting an additional base unit is possible.		
Internal current consumption (5VDC)	150mA			
Mounting hole size	M5 screw hole			
External dimensions	H	130mm		
	W	120mm	315mm	420mm
	D	38.5mm		
Weight	0.32kg	0.74kg	0.97kg	
Accessory	Mounting screw M5 × 25 4 screws			
	Dustproof cover × 1	—		

5.4.3 Applicable LCPU

A LCPU that can be mounted on the LA1S extension base unit is a CPU module with a serial number (first five digits) of 16112 or later.

When connecting the LA1S extension base unit as an extension base unit, check the serial number of the LCPU used.

5.4.4 Extension cable

Item	Model		
	LC06E	LC10E	LC30E
Cable length	0.6m	1.0m	3.0m
Conductor resistance value	0.034Ω	0.051Ω	0.14Ω
Weight	0.19kg	0.23kg	0.45kg

5.4.5 System configuration

This section describes the system configuration and precautions for use of LA1S6□B and LA1S51B type extension base units.

(1) Connection order of extension base units

Connect the LA1S extension base unit in the following order.

- For the LA1S6□B connection
In the order of an extension block and the LA1S6□B from the nearest position of the main block
- For the LA1S51B connection
In the order of an extension block and the LA1S51B from the nearest position of the main block
The LA1S51B can be used only for the last extension level.

Remarks

The LA1S extension base units, LA1S6□B and LA1S51B, cannot be used together.

.....

(2) Extension level setting of extension base units

To use LA1S extension base units, setting extension level (1 to 3) using the extension level setting connector is required.

Set the extension level 1 to the extension block connected to the main block, and set level 2 and 3 in the connection order of extension base units.

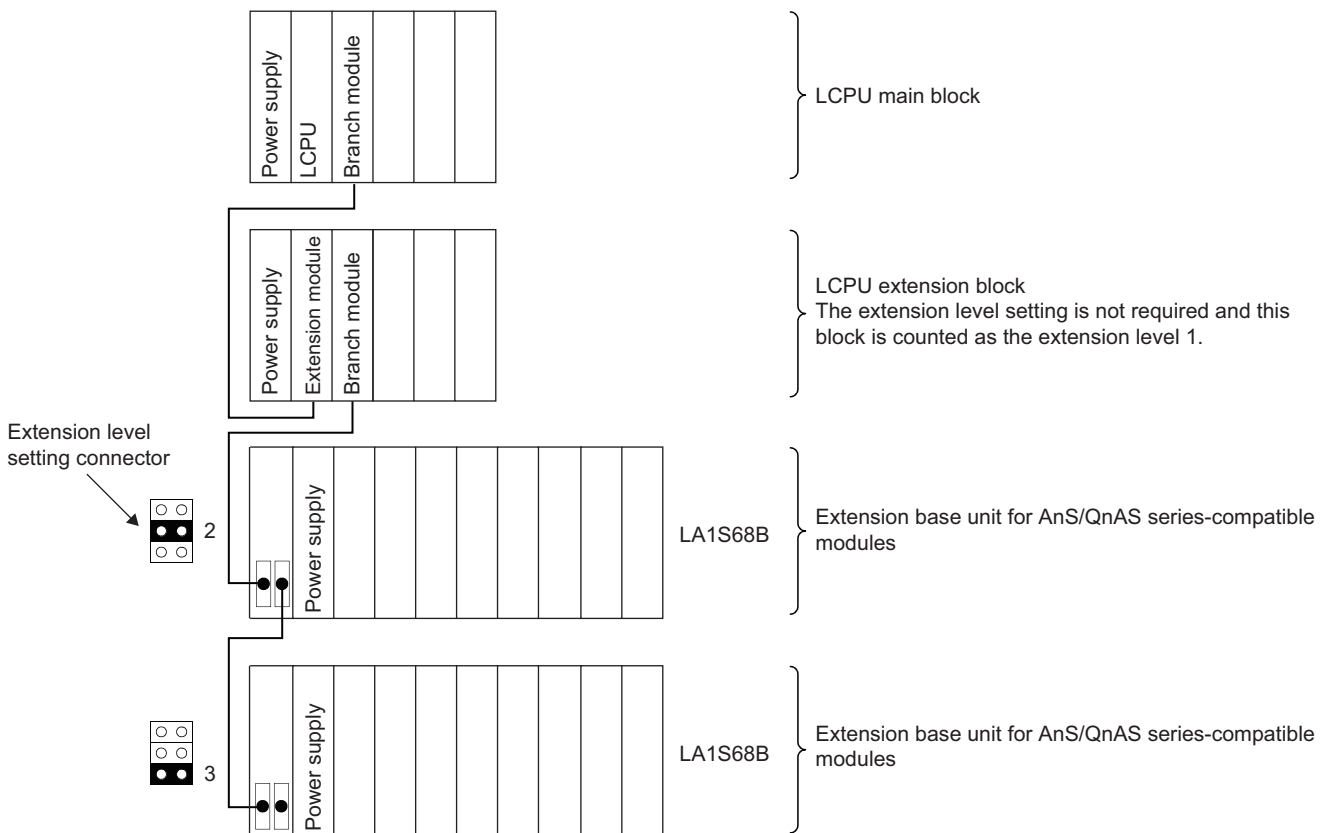

■Points to remember when using the LA1S extension base unit

- (a) The LA1S extension base unit can be used for a LCPU with a serial number (first five digits) of 16112 or later.
- (b) The number of connectable LA1S extension base units (including an extension block) is as follows.
 - L02SCPU(-P)/L02CPU(-P): Max. two base units
 - L06CPU(-P)/L26CPU(-P/-BT/-PBT): Max. three base units
- (c) When setting the extension level, set level 1 to an extension block.
Example) For the configuration of Main block + Extension block level 1 + LA1S68B
Set the extension level 2 to the LA1S68B.
- (d) The LA1S6□B and the LA1S51B cannot be used together.
- (e) The LA1S51B can be used only for the last extension level because the base unit does not have the extension cable connector (OUT).
- (f) When connecting the LA1S extension base unit, ensure that the overall cable distance of the extension cable is 3m or shorter.
In addition, when connecting the LA1S51B, ensure that the extension cable (between a branch module and the LA1S51B) is 1m or shorter.
When the LA1S51B is connected in the system including an extension block, the overall cable distance must be 3m or shorter.
- (g) When connecting the LA1S51B, mount a branch module next to the CPU module in the main block or next to the extension module in the extension block.
Mounting the branch module on the END cover side causes an error.
- (h) When replacing A1S5□B type extension base unit (the type not requiring a power supply module) with the LA1S extension base unit, mount a power supply module (models to be produced continuously: A1S61P/A1S63P) since it is needed.
In addition, processing for mounting holes is required because the installation dimensions differ between the units.
- (i) LA1S extension base unit does not support the bus connection of a GOT.
Consider connecting a GOT to the Ethernet port of the CPU module, RS-232 adapter (optional), or RS-422/485 adapter (optional).

5.4.6 System equipment list

The following table lists configurable devices that can be used with the LA1S extension base unit.

Product	Model				Remarks
Power supply module	A1S61PN,	A1S62PN,	A1S63P		
Input module	A1SX10, A1SX30, A1SX41, A1SX42-S1, A1SX80-S1, A1SX82-S1,	A1SX10EU, A1SX40, A1SX41-S1, A1SX42-S2, A1SX80-S2, A1S42X	A1SX20, A1SX40-S1, A1SX41-S2, A1SX71, A1SX81,	A1SX20EU, A1SX40-S2, A1SX42, A1SX80, A1SX81-S2,	
Output module	A1SY10, A1SY18AEU, A1SY40P, A1SY42P, A1SY68A, A1SY82,	A1SY10EU, A1SY22, A1SY41, A1SY50, A1SY71, A1S42Y	A1SY14EU, A1SY28A, A1SY41P, A1SY60, A1SY80,	A1SY18A, A1SY40, A1SY42, A1SY60E, A1SY81,	
I/O module	A1SH42,	A1SH42-S1,	A1SX48Y58,	A1SX48Y18	
High-speed counter module	A1SD61, A1SD62D-S1	A1SD62,	A1SD62E,	A1SD62D,	*1
A/D converter module	A1S64AD,	A1S68AD			
D/A converter module	A1S62DA,	A1S68DAI,	A1S68DAV		
Analog I/O module	A1S63ADA,	A1S66ADA			
Temperature input module	A1S62RD3N,	A1S62RD4N,	A1S68TD		
Temperature control module	A1S62TCTT-S2, A1S62TCRT-S2, A1S64TCTT-S1, A1S64TCRT-S1,	A1S62TCRTBW-S2, A1S62TCTTBW-S2, A1S64TCTTBW-S1, A1S64TCRTBW-S1		A1S64TCTRT, A1S64TCTRTBW,	
Pulse catch module	A1SP60				
Analog timer module	A1ST60				
Interrupt module	A1SI61				*3
Positioning module	A1SD70				
	A1SD75P1-S3,	A1SD75P2-S3,	A1SD75P3-S3		*1
	A1SD75M1,	A1SD75M2,	A1SD75M3		*1
MELSECNET/MINI-S3 master module	A1SJ71PT32-S3				*1
Computer link module	A1SJ71UC24-R4				*2*4
Intelligent communication module	A1SD51S				*2
MELSECNET, MELSECNET/B local station data link module	A1SJ71AP23Q,	A1SJ71AR23Q,	A1SJ71AT23BQ		*2*5
Paging interface module	A1SD21-S1				*2
Position detection module	A1S62LS				
PC fault detection module	A1SS91				
Memory card interface module	A1SD59J-S2				
ID interface module	A1SD35ID1,	A1SD35ID2			
MELSEC-I/O LINK master module	A1SJ51T64				
B/NET interface module	A1SJ71B62-S3				
JEMANET (OPCN-1) interface module	A1SJ71J92-S3				*2
S-LINK master module	A1SJ71SL92N				
AS-i master module	A1SJ71AS92				
Blank cover	A1SG60				
Dummy module	A1SG62				

- *1 The dedicated instructions in AnS/QnAS series programs are not applicable to the LCPU programs. Replace them with the FROM/TO instructions.
- *2 Up to six modules having the same product name can be mounted.
- *3 This module cannot be used when one of the built-in I/O functions for an LCPU, the "interrupt input function", is used.
- *4 Only the multidrop link function can be used. (The computer link function (dedicated protocols/no procedure) cannot be used.)
- *5 By using the A/QnA-Q conversion support tool, a sample program for link refresh is automatically created. Because the sample program is created in the format of GX Developer, change the programmable controller type to the LCPU using GX Works2. For details, refer to Section 7.1.4.

5.4.7 I/O addresses when the LA1S extension base unit is used

This section describes I/O addresses (I/O assignment) when the LA1S extension base unit is used.

(1) Concept of I/O addresses when the LA1S extension base unit is used

I/O addresses are assigned in either of following ways when the LA1S extension base unit is used.

- (a) **Assign the I/O address of the L series module to the lowest address and assign that of the AnS/QnAS series module to the L series module I/O address + 1 or later.**
- (b) **Assign the I/O address of the AnS/QnAS series module to the lowest address and assign that of the L series module to the AnS/QnAS series module I/O address + 1 or later.**

☒ Point

- (1) Assign I/O addresses in the address order of either of the followings.
 - (a) L series module → AnS/QnAS series module
 - (b) AnS/QnAS series module → L series module

Note that the CPU module does not start due to an error if the addresses are assigned in the order of different series mixed, such as L series module → AnS/QnAS series module → L series module and vice versa.
 - (2) The LA1S extension base unit (LA1S6□B, LA1S51B) occupies I/O addresses for eight modules. (I/O addresses can be assigned in increments of a slot as well.)
-

(2) I/O address assignment example

The following figure and tables show an assignment example to utilize the existing AnS/QnAS series modules without I/O address change and to use the program with minimum modification by using the LA1S6□B type extension base unit.

Configure the I/O assignment setting of the LA1S extension base unit with GX Works2.

(a) System configuration example

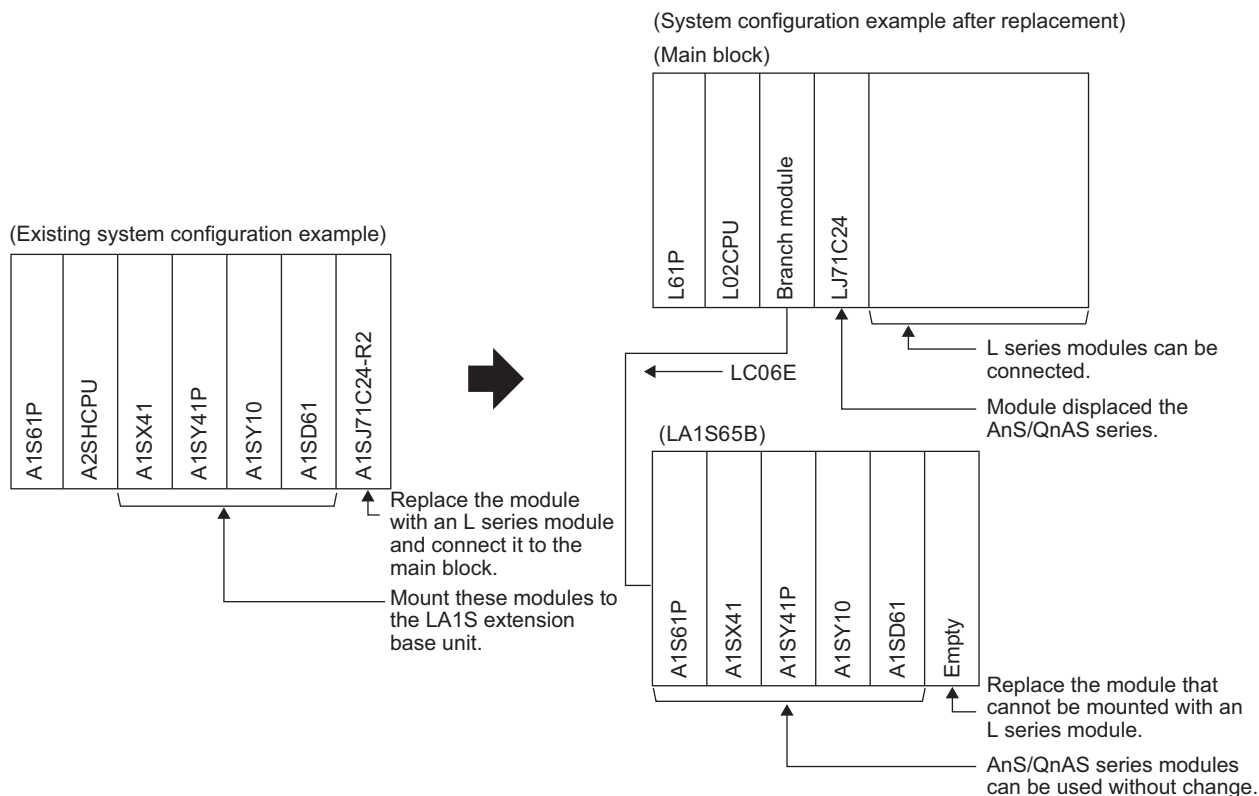

(b) I/O assignment example of the parameter

(LCPU main block side)

Slot	Type	Model	Point	Start XY ^{*1}	
Main block	CPU	Built-in I/O function	—	100	
	0 ^{*2}	Branch (for LA1S extension)	L6EXB		
	1	Intelligent	LJ71C24	110	
	2	(Set the item when adding a new module.)			(Set a number of "130" or later, according to the number of occupied points of the module.)
	3				
4					

*1 Set the number of "Last address of AnS/QnAS series modules on the extension base unit + 1 or later".

The setting example is for the case when the start XY of the main block module is set to "XY100".

*2 Setting when the LA1S extension base unit is connected.

When connecting the extension block, set the slot for "Branch".

(LA1S extension base unit side)

Slot ^{*3}	Type	Model	Point	Start XY ^{*4}
Extension base unit	n+1	Input	A1SX41	00
	n+2	Output	A1SY41P	20
	n+3	Output	A1SY10	40
	n+4	Intelligent	A1SD61	50
	n+5	Empty	—	Any value

- *3 "n" is the last slot number of the main block side.
- *4 By setting the addresses of the existing AnS/QnAS series modules, the program can be reused without I/O address change.

6 MEMORY AND BATTERY REPLACEMENT

6.1 List of Alternative Models for Memory

AnS/QnAS series model		L series alternative model	
Product	Model	Model	Remarks (restrictions)
Memory cassette (E ² ROM)	A1SNMCA-2KE	Unnecessary	Because the program memory of the LCPU is a flash ROM, ROM writing is not needed.
	A1SNMCA-8KE		
	A2SNMCA-30KE		
Memory cassette (EP-ROM)	A1SNMCA-8KP		
Memory card (SRAM)	Q1MEM-64S	Unnecessary	Standard RAM can replace the file register.
	Q1MEM-128S		
	Q1MEM-256S		
	Q1MEM-512S		
	Q1MEM-1MS		
	Q1MEM-2MS		
Memory card (SRAM+E ² ROM)	Q1MEM-64SE	Unnecessary	<ul style="list-style-type: none"> • Because the program memory of the LCPU is a flash ROM, ROM writing is not needed. • Standard RAM can replace the file register.
	Q1MEM-128SE		
	Q1MEM-256SE		
	Q1MEM-512SE		
	Q1MEM-1MSE		

6.2 Precautions for Memory and Battery Replacement

(1) Precaution for memory replacement

When using multiple blocks of extension file registers or sampling trace function for the L series, the SD memory card for the series is required.

(2) Precaution for battery replacement

The battery for the A series (A6BAT*) should be replaced with the one for L series (Q6BAT, Q7BAT). Refer to the users manual of each CPU module for battery life, since it varies depending on the type of CPU module and memory cassette.

* The A6BAT is not a model to be discontinued.

7 REPLACEMENT OF PROGRAM

This chapter describes replacement procedures and precautions for using programs and comments of the AnS/QnASCPU in the LCPU.

(1) Comparison between AnSCPU and LCPU

Item		AnSCPU specifications	LCPU specifications and precautions for replacement	Compatibility	Reference
Sequence program	Main	<ul style="list-style-type: none"> Main program is required. The SFC is dealt as the microcomputer program of main program. 	[Specification] <ul style="list-style-type: none"> Each program is dealt as one file. [Measure] <ul style="list-style-type: none"> Execute the file setting of PLC parameter. 	△	Section 7.7.10
	SFC				
Microcomputer program		<ul style="list-style-type: none"> A user-created microcomputer program and the microcomputer program of the utility package are available. 	[Specification] <ul style="list-style-type: none"> Creating microcomputer program is not applicable. [Measure] <ul style="list-style-type: none"> Replace the AnSCPU user-created microcomputer program with sequence program since the microcomputer program execution is not applicable. Instructions from any utility package need to be replaced with the corresponding instructions of the LCPU. 	×	—
Instruction		<ul style="list-style-type: none"> Dedicated instructions for the AnA/AnU CPU (including LED instruction) are available. 	[Specification] <ul style="list-style-type: none"> With "Change PLC type", instructions are converted automatically except some instructions. [Measure] <ul style="list-style-type: none"> Instructions that cannot be converted are converted through the SM1255 and SD1255 devices, and the program needs to be modified. 	△	Section 7.2
File register		<ul style="list-style-type: none"> The file register is used to expand the data register area and stored in the user memory area. One block is set in 8k points unit. 	[Specification] <ul style="list-style-type: none"> Data is stored in the standard RAM. One block is set in 32k points unit. [Measure] <ul style="list-style-type: none"> Execute the file setting of PLC parameter. 	△	Section 7.7.11
Timer, Counter		<ul style="list-style-type: none"> Timer and counter are processed with the END. 	[Specification] <ul style="list-style-type: none"> Timer and counter are processed when executing an instruction [Measure] <ul style="list-style-type: none"> Review the programs since the processing timing differs between timer and counter 	△	Section 7.7.4, Section 7.7.5

Item	AnSCPU specifications	LCPU specifications and precautions for replacement	Compatibility	Reference
Parameter	<ul style="list-style-type: none"> Dedicated parameters for each CPU module is provided. 	[Specification] <ul style="list-style-type: none"> Dedicated parameters for each CPU module is provided. [Measure] <ul style="list-style-type: none"> Check and re-set the parameters since specifications and functions differ between the two CPU modules. 	△	Section 7.3
Special relay	<ul style="list-style-type: none"> 256 points of M9000 to M9255 are provided. 	[Specification] <ul style="list-style-type: none"> 1800 points of SM0 to SM1799 are provided. [Measure] <ul style="list-style-type: none"> Although automatic conversion is executed for the LCPU replacement, review the points since some specifications differ between the two CPU modules. 	△	Section 7.4
Special register	<ul style="list-style-type: none"> 256 points of D9000 to D9255 are provided. 	[Specification] <ul style="list-style-type: none"> 1800 points of SD0 to SD1799 are provided. [Measure] <ul style="list-style-type: none"> Although automatic conversion is executed for the LCPU replacement, review the points since some specifications differ between the two CPU modules. 	△	Section 7.5
Comment	<ul style="list-style-type: none"> Comments are managed as a common comment or program original comment. The comment capacity of AnSCPU is max. 127k (64k + 63k) bytes. 	[Specification] <ul style="list-style-type: none"> For the LCPU, comments are managed as common comments or comments by program. Comments are automatically replaced upon the LCPU conversion. The comment capacity of the LCPU depends on memory capacity. 	○	Section 7.1.2
Writing programs to ROM	<ul style="list-style-type: none"> The ROM operation is executed with the EP-ROM. 	[Specification] <ul style="list-style-type: none"> Because the program memory of the LCPU is a flash ROM, no alternative method is required. The LCPU allows boot operations with an SD memory card. 	△	Section 7.7.12

(2) Comparison between QnASCPU and LCPU

Item	QnASCPU specifications	LCPU specifications and precautions for replacement	Compatibility	Reference
Sequence program SFC program	<ul style="list-style-type: none"> Each program is dealt as one file. 	[Specification] <ul style="list-style-type: none"> Each program is dealt as one file. 	○	—
Instruction	<ul style="list-style-type: none"> Dedicated instructions such as the display (LED) instruction and status latch (SLT) instruction are available. 	[Specification] <ul style="list-style-type: none"> With "Change PLC type", instructions are converted automatically except some instructions. [Measure] <ul style="list-style-type: none"> Instructions not converted are converted through the SM1255 and SD1255 devices, and thus the program needs to be modified. 	△	Section 7.2
File register	<ul style="list-style-type: none"> Data is stored in a memory card. One block is set in 32k points unit. 	[Specification] <ul style="list-style-type: none"> Data is stored in the standard RAM One block is set in 32k points unit. [Measure] <ul style="list-style-type: none"> Review the setting. 	△	Section 7.7.11
Parameter	<ul style="list-style-type: none"> Dedicated parameters for each CPU module is provided. 	[Specification] <ul style="list-style-type: none"> Dedicated parameters for each CPU module is provided [Measure] <ul style="list-style-type: none"> Check and re-set the parameters since specifications and functions differ between the two CPU modules. 	△	Section 7.3
Special relay	<ul style="list-style-type: none"> 1800 points of SM0 to SM1799 are provided. 	[Specification] <ul style="list-style-type: none"> 1800 points of SM0 to SM1799 are provided [Measure] <ul style="list-style-type: none"> Review the points since some specifications differ between the two CPU modules. 	△	Section 7.4
Special register	<ul style="list-style-type: none"> 1800 points of SD0 to SD1799 are provided. 	[Specification] <ul style="list-style-type: none"> 1800 points of SD0 to SD1799 are provided. [Measure] <ul style="list-style-type: none"> Review the points since some specifications differ between the two CPU modules. 	△	Section 7.5
Comment	<ul style="list-style-type: none"> Comments are managed as a common comment or program original comment. 	[Specification] <ul style="list-style-type: none"> Comments are managed as common comments or comments by program. 	○	Section 7.1.2
Writing programs to ROM	<ul style="list-style-type: none"> The boot run is executed with program and parameter stored in a memory card. One memory card can be installed. 	[Specification] <ul style="list-style-type: none"> Because the program memory of the LCPU is a flash ROM, no alternative method is required. The LCPU allows boot operations with an SD memory card. 	△	Section 7.7.12

7.1 Program Replacement Procedure

To replace programs and comments created by the AnS/QnAS series with the ones for the L series, configure the setting in the Change PLC type window of GX Developer.

7.1.1 Program conversion procedure from AnS/QnASCPU to LCPU

Program conversion procedure follows the order of (1) → (2) → (3) below.

- (1) Reading process of conversion source data
- (2) Program conversion from AnS/QnASCPU to LCPU with "Change PLC type"
- (3) Writing process of converted data

For details on the change operation, refer to Section 7.1.2.

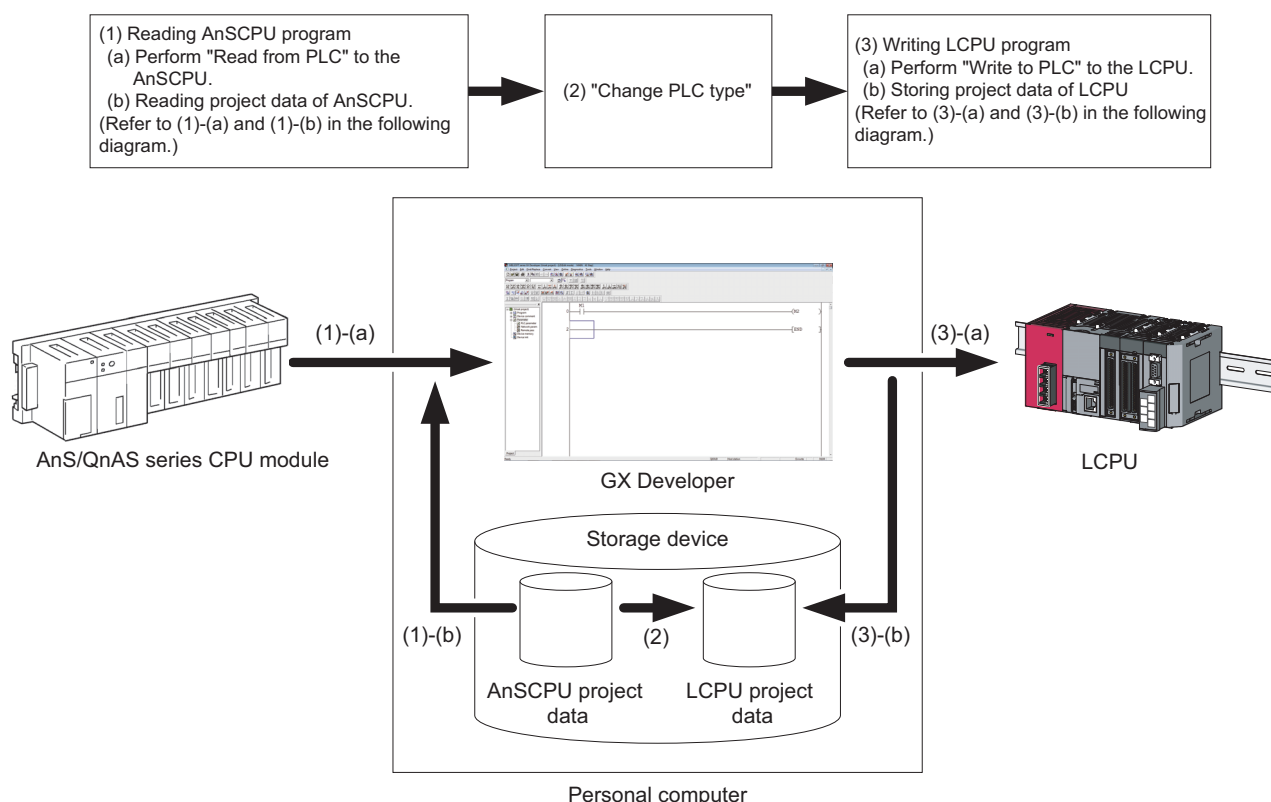

☒ Point

GX Developer supports only the L02CPU and L26CPU-BT. When replacing the type with the L02SCPU(-P), L02CPU-P, L06CPU(-P), L26CPU(-P), or L26CPU-PBT, use GX Works2. For details, refer to Section 7.1.4.

7.1.2 Changing programmable controller type

"Change PLC type" is a function that changes the target programmable controller type of the data read to GX Developer.

Some instructions that cannot be automatically converted are changed to "OUT SM1255" for LCPU. Search for these instructions or SM1255 in the converted program and modify the program manually. For intelligent function modules and network modules, review programs and parameters.

(1) Applicable range of conversion from AnS/QnASCPU by GX Developer

The following table lists other CPU modules to show the applicable range of conversion from the AnS/QnASCPU.

Product	Change source	Change destination			
		ACPU, AnSCPU	QnACPU, QnASCPU	QCPU	LCPU
GX Developer	AnSCPU, QnASCPU	○	○	○	△*1

*1 The conversion to the L02CPU and L26CPU-BT are acceptable.
The conversion to the L02SCPU(-P), L02CPU(-P), L06CPU(-P), L26CPU(-P), and L26CPU-PBT are not acceptable with GX Developer.

(2) Operation of GX Developer

(a) Select "Change PLC type" of the "Project" menu.

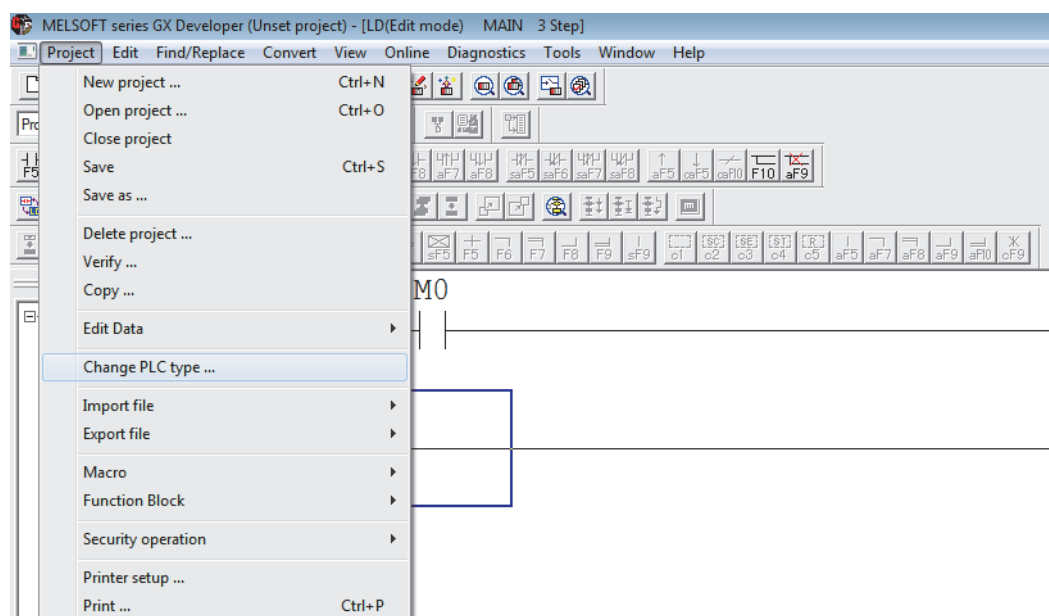

(b) Specify the target programmable controller type in the "Change PLC type" window.

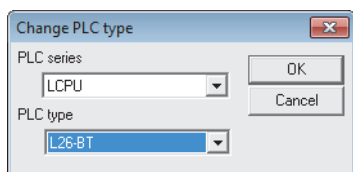

Click the [OK] button after setting the PLC type.

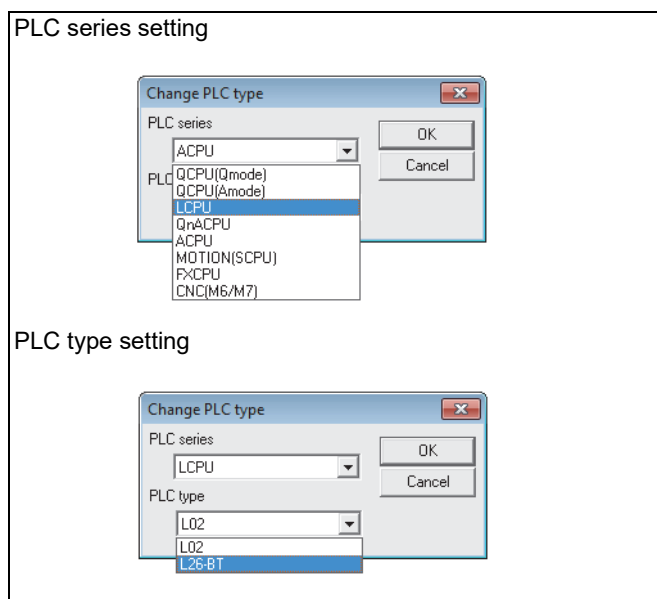

(c) Select the conversion method of the special relay/registers.*1

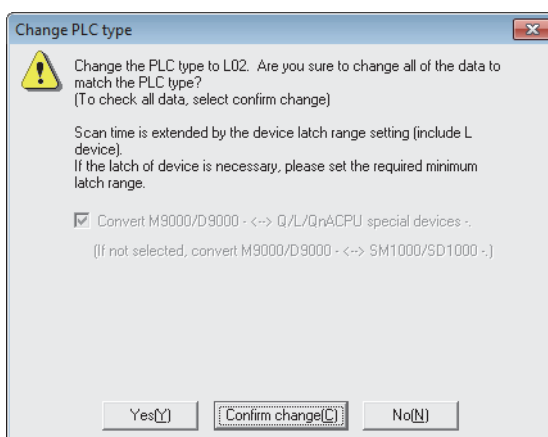

Specify the conversion destination of the special relay/register (AnS series CPU modules: M9000s/D9000s).

Check [Convert M9000/D9000 ←→ Q/L/QnACPU special devices].

- Checked: Converted to the L dedicated device.
- Not "checked": Converted to the A compatible (SM1000s/SD1000s).

This setting remains "checked" with LCPU selected.

For a CPU type where a device conversion destination is to be specified, selecting "checked" is recommended.

Click the [Yes] or [Confirm change] button after specifying the device conversion destination to start "Change PLC type".

- [Yes]: The change is executed without intermediate steps of user confirmation.
- [Confirm change]: Asks the user for confirming the changes.

*1 When changing from the QnAS series to the L series, the conversion method of the special relay and special register cannot be selected.
(The Change PLC type window above does not show a message for specifying a device conversion destination, but A-compatible devices (SM1000s/SD1000s) are automatically converted into L dedicate devices.)

7.1.3 AnSCPU program conversion ratio

- **Conversion ratio of common instructions (Sequence/basic/application instructions)**

The following table lists the conversion ratio when changing the programmable controller type of the AnSCPU common instructions to the LCPU.

More than 90% of the common instructions are automatically converted.

Instruction type	Number of instructions	LCPU			
		Number of instructions that can be changed automatically	Number of instructions needing manual change	Conversion ratio (rough standard)	
Sequence instruction	Contact instruction	6	6	0	100%
	Association instruction	5	5	0	100%
	Output instruction	6	5	1	83%
	Shift instruction	2	2	0	100%
	Master control instruction	2	2	0	100%
	Termination instruction	2	2	0	100%
	Other instructions	3	3	0	100%
Total number of sequence instructions		26	25	1	96%
Basic instruction	Comparison operation instruction	36	36	0	100%
	Arithmetic operation instruction	40	40	0	100%
	BCD ⇔ BIN conversion instruction	8	8	0	100%
	Data transfer instruction	16	16	0	100%
	Program branch instruction	9	9	0	100%
	Link refresh instruction	2	2	0	100%
Total number of basic instructions		112	111	1	99%
Application instruction	Logical operation instruction	18	18	0	100%
	Rotation instruction	16	16	0	100%
	Shift instruction	12	12	0	100%
	Data processing instruction	20	19	1	95%
	FIFO instruction	4	4	0	100%
	Buffer memory access instruction	8	8	0	100%
	FOR to NEXT instruction	2	2	0	100%
	Local station, remote I/O station access instruction	4	0	4	0%
	Display instruction	5	1	4	20%
Other instructions	10	2	8	20%	
Total number of application instructions		99	82	17	83%
Total number of sequence/basic/application instructions		237	218	19	92%

• **Conversion ratio of dedicated instructions**

The following table lists the conversion ratio when changing the programmable controller type of the AnSCPU dedicated instructions to the LCPU.

Instruction type	Number of instructions	LCPU			
		Number of instructions that can be changed automatically	Number of instructions needing manual change	Conversion ratio (rough standard)	
Dedicated instruction (Functional extension)	Direct input/output instruction	3	3	0	100%
	Structured program instruction	6	2	4	33%
	Data operation instruction	6	6	0	100%
	I/O operation instruction	2	1	1	50%
	Real number processing instruction	27	27	0	100%
	Character string processing instruction	25	24	1	96%
	Data control instruction	6	6	0	100%
	Clock instruction	2	2	0	100%
	Extension file register instruction	7	0	7	0%
	PID control instruction	3	2	1	67%
Subtotal	91	74	17	81%	
Dedicated instruction (For modules)	Instruction for data link	9	5	4	56%
	Instruction for special function modules	59	0	59	0%
	Subtotal	68	5	63	7%
Total number of dedicated instructions		159	78	81	49%

Remarks

If the change target programmable controller has the equivalent functions and instructions, automatic conversion is performed.

Some instructions are not converted for the following causes.

Refer to Section 7.2 "Instruction Conversion" to change the program manually.

- (1) The change target programmable controller does not support the equivalent functions and instructions.
 - (2) Instructions to specified modules cause to change the module and buffer memory configuration.
 - (3) Multiple instructions with the same name and argument exist.
 - (4) The conversion causes a mismatch in the instructions.
-

7.1.4 Reading (Reusing) other format files

(1) Procedure for reading files in the GPPQ/GPPA format to GX Developer

The following explains how to read (appropriate) files in the GPPQ/GPPA format other than that of GX Developer. Follow this procedure to convert them to the file format of GX Developer.

(a) GX Developer operation procedure

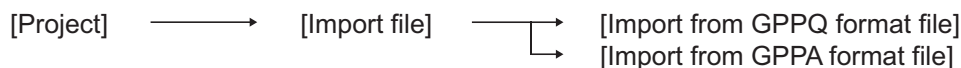

(b) Setting window

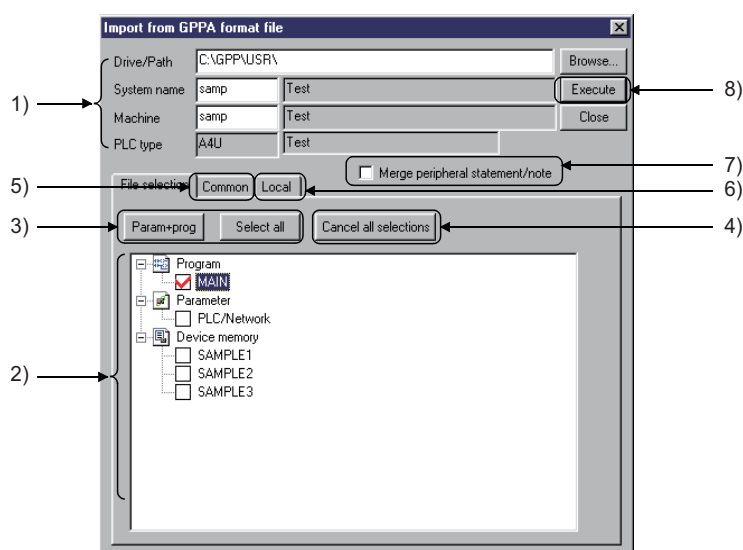

1) Drive/Path, System name, Machine, PLC type

These settings specify the location of data created in GPPQ or GPPA format. Enter the system name and machine name of the data specified in the Drive/Path. Clicking the [Browse] button shows the window for choosing the system name and machine name. Double-click the file to be read to specify.

2) Source data list

The source data list displays data created in GPPQ or GPPA format. Check the checkbox of data names to be selected. For the selected comments, the range of device comment, which can be read with the "Common" tab or "Local" tab, are settable.

3) [Param+prog] button/[Select all] button

- [Param+prog] button
This button selects only the parameter data and program data of the source data.
- [Select all] button
This button selects all data in a source data list.
Comment 2 is selected for the AnS/QnAS series, and the device memories of the number of data are displayed.
The first data name is selected for comments and file registers in the Q/QnAS series.

4) [Cancel all selections] button

The [Cancel all selections] button cancels all the selected data.

5) <<Common>> tab window (AnS/QnAS series)

Set this when specifying the range for common comments and read data.

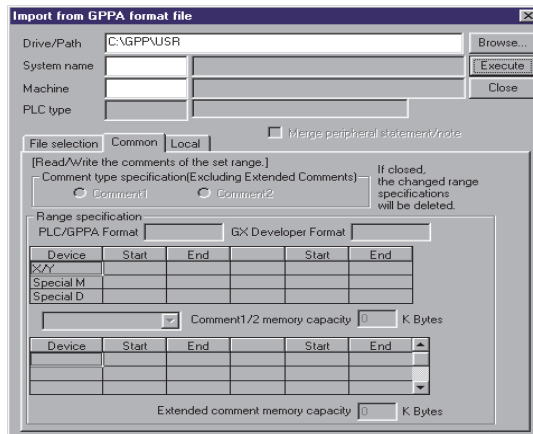

6) <<Local>> tab window (AnS/QnAS series)

Set this when specifying the range for comments by program and read data.

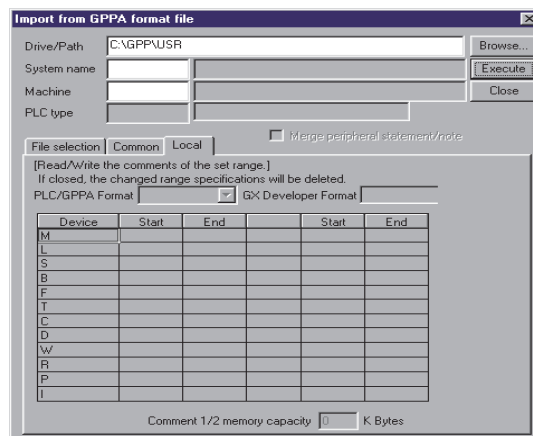

7) Merge peripheral statement/note

For details on peripheral statements and merging notes, refer to GX Developer Operating Manual.

8) [Execute] button

Click this button after the setting.

(c) Setting procedure

1) Data selection

- Set a drive/path for reading in GPPQ or GPPA format.
- Click the [Browse] button to set the system name and machine name of the project to be read.
- Check the checkbox of data to be selected by with the [Param+prog] button, [Select all] button, or the mouse.
- Click the [Execute] button after the necessary settings.

2) Canceling data selection

- When canceling the selected data arbitrarily:
Clear the checkmark (P) in the checkbox with the mouse or space key.
- When canceling all the selected data:
Click the [Cancel all selection] button.

(d) Precautions for reading the other format files

For AnS series	
A6GPP, SW0S-GPPA format data	Read data with GX Developer after performing the corresponding format conversion with GPPA. For the operating methods, refer to the Type SW□SRXV/NX/IVD-GPPA (GPP) Software package Operating Manual.
For data selection	For device comment selection, either comment 2 or comment 1 can be selected.
GPPA format file reading	Deletes the project data on GX Developer and read the other format file. The area in excess of the program capacity is deleted when read. When the file includes microcomputer programs edited with other than the SFC program (such as SW0SRX-FNUP), they are lost.

For QnAS series	
Ladder return positions	Returning places are different between GPPQ and GX Developer. Because of this, if the total of return sources and return destinations exceeds 24 lines in a single ladder block, the program is not displayed properly. Corrective action: Add SM400 (Always ON) to adjust the return positions.
For data selection	For the device memory and file register, only one data name for each item can be selected.

(2) Procedure for reading files in GX Developer format to GX Works2

The following explains how to appropriately read files in GX Developer format to GX Works2. Follow this procedure to convert the read files to the file format of GX Works2.

(a) GX Works2 operation procedure

[Project] → [Open Other Data] → [Open Other Project]

(b) Setting window

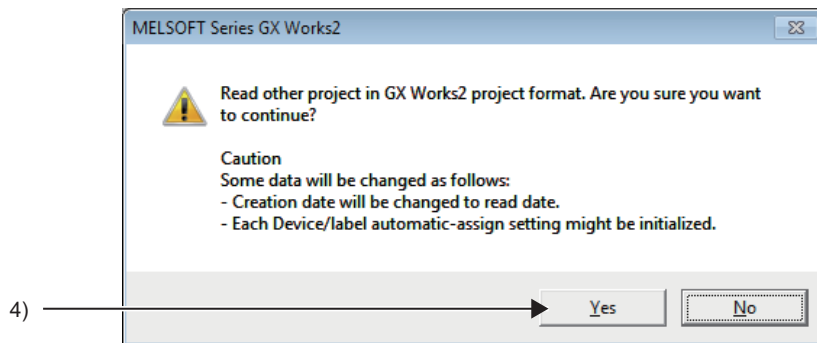
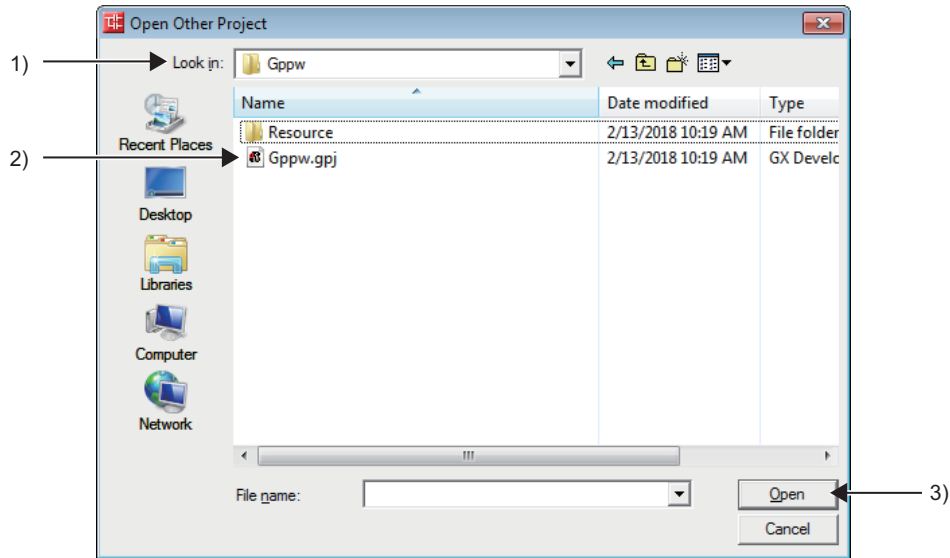

1) Look in

Display the place where the files in GX Developer format are stored and specify the file to be read.

2) Name

Select "*.gpj" for the file extension to use the file as a project file.

3) [Open] button

After selecting the file, click the [Open] button to open the execution window.

4) [Yes] button

Clicking [Yes] button executes the file read.

When the file read is completed, a completion message is displayed.

The file becomes available for GX Works2 operation.

Remarks

(1) Performing the LCUP programming using GX Developer as a programming tool has following restrictions.

- Model of available CPU module: L02CPU, L26CPU-BT only
- Limitation of I/O assignment
(The XY address settings of existing AnS/QnAS series modules is not available when the LA1S extension base unit is connected.)

To perform a restricted operation, use GX Works2 (Ver.1.525X or later) as a programming tool.

The settings required when the LA1S extension base unit is used can be configured using GX Works2 (Ver.1.525X or later).

(2) To use the existing A/QnACPU program with GX Works2, follow the procedure below.

(a) A/QnACPU program conversion procedure

- 1) Read project data from the existing A/QnACPU using GX Developer and save the file.
↓
- 2) By using "Change PLC type", convert the read A/QnACPU program to a Universal model QCPU, which can be specified with GX Developer.
↓
- 3) Read the converted QCPU program by other format read (Project - Open Other Data - Open Other Project) of GX Works2.
↓
- 4) By using "Change PLC type", convert the read Universal model QCPU program to a LCPU program.
↓
- 5) After that, configure various settings and modify the program using GX Works2.

(b) Conversion procedure of the difference information embedded Q program (A/QnA-Q conversion support tool)

- 1) Read project data from the existing A/QnACPU using GX Developer and save the file.
↓
- 2) By using "Change PLC type", convert the read A/QnACPU program to a Universal model QCPU, which can be specified with GX Developer, and save it.
↓
- 3) Output the difference information embedded Q program and the review information list using the A/QnA-Q conversion support tool.
↓
- 4) Modify the difference information embedded Q program with GX Developer while referring to the review information list.
↓
- 5) Read the difference information embedded Q program by other format read (Project - Open Other Data - Open Other Project) of GX Works2.
↓
- 6) By using "Change PLC type", convert the read difference information embedded Q program to a LCPU program.
↓
- 7) After that, configure various settings and modify the program using GX Works2.

- (c) Conversion procedure of the MELSECNET (II) local station dedicated module link refresh program (A/QnA-Q conversion support tool)
 - 1) Using the A/QnA-Q conversion support tool, set the output type of CPU to a Universal model QCPU and output the MELSECNET (II) local station dedicated module link refresh program.
↓
 - 2) Read the MELSECNET (II) local station dedicated module link refresh program by other format read (Project - Open Other Data - Open Other Project) of GX Works2.
↓
 - 3) By using "Change PLC type", convert the read MELSECNET (II) local station dedicated module link refresh program to a LCPU program.



7.2 Instruction Conversion

GX Developer enables instruction conversion using "Change PLC type".

The following explains how to process both applicable instructions and not applicable instructions for the conversion.

7.2.1 List of instructions conversion from AnSCPU to LCPU (Sequence/Basic/ Application instructions)

○ : Automatic conversion × : Manual conversion needed

Description	AnSCPU	LCPU		Reference
	Instruction name	Instruction name	Conversion	
BIN 16-bit addition and subtraction operations	+	+	○	
	+P	+P	○	
	-	-	○	
	-P	-P	○	
BIN 16-bit multiplication and subtraction operations	*	*	○	
	*P	*P	○	
	/	/	○	
	/P	/P	○	
Ladder block series connection	ANB	ANB	○	
Series connection	AND	AND	○	
BIN 16-bit data comparisons	AND<	AND<	○	
	AND<=	AND<=	○	
	AND<>	AND<>	○	
	AND=	AND=	○	
	AND>	AND>	○	
	AND>=	AND>=	○	
BIN 32-bit data comparisons	ANDD<	ANDD<	○	
	ANDD<=	ANDD<=	○	
	ANDD<>	ANDD<>	○	
	ANDD=	ANDD=	○	
	ANDD>	ANDD>	○	
	ANDD>=	ANDD>=	○	
Series connection	ANI	ANI	○	
Conversion from hexadecimal BIN to ASCII	ASC	OUT SM1255	×	Section 7.2.3 (3)
BCD 4-digit addition and subtraction operations	B+	B+	○	
	B+P	B+P	○	
	B-	B-	○	
	B-P	B-P	○	
BCD 4-digit multiplication and division operations	B*	B*	○	
	B*P	B*P	○	
	B/	B/	○	
	B/P	B/P	○	
Conversion from BIN data to 4-digit BCD	BCD	BCD	○	
	BCDP	BCDP	○	
Conversion from BCD 4-digit data to BIN data	BIN	BIN	○	
	BINP	BINP	○	
Block 16-bit data transfer	BMOV	BMOV	○	
	BMOVP	BMOVP	○	

○ : Automatic conversion × : Manual conversion needed

Description	AnSCPU	LCPU		Reference
	Instruction name	Instruction name	Conversion	
Bit reset for word devices	BRST	BRST	○	
	BRSTP	BRSTP	○	
Bit set for word devices	BSET	BSET	○	
	BSETP	BSETP	○	
1-bit shift to left of n-bit data	BSFL	BSFL	○	
	BSFLP	BSFLP	○	
1-bit shift to right of n-bit data	BSFR	BSFR	○	
	BSFRP	BSFRP	○	
Subroutine program calls	CALL	CALL	○	
	CALLP	CALLP	○	
Special format failure check	CHK	OUT SM1255	×	Section 7.2.3 (3)
Bit device output inversion	CHK	OUT SM1255	×	Section 7.2.3 (1)
Pointer branch instruction	CJ	CJ	×	Section 7.7.8
Carry flag reset	CLC	OUT SM1255	×	Section 7.2.3 (3)
16-bit data negation transfer	CML	CML	○	
	CMLP	CMLP	○	
Refresh	COM	COM	○	
BIN 32-bit addition and subtraction operation	D+	D+	○	
	D+P	D+P	○	
	D-	D-	○	
	D-P	D-P	○	
BIN 32-bit multiplication and division operation	D*	D*	○	
	D*P	D*P	○	
	D/	D/	○	
	D/P	D/P	○	
Logical products with 32-bit data	DAND	DAND	○	
	DANDP	DANDP	○	
BCD 8-digit addition and subtraction operation	DB+	DB+	○	
	DB+P	DB+P	○	
	DB-	DB-	○	
	DB-P	DB-P	○	
BCD 8-digit multiplication and division operation	DB*	DB*	○	
	DB*P	DB*P	○	
	DB/	DB/	○	
	DB/P	DB/P	○	
Conversion from BIN data to data 8-digit	DBCD	DBCD	○	
	DBCDP	DBCDP	○	
Conversion from data 8-digit to BIN data	DBIN	DBIN	○	
	DBINP	DBINP	○	
32-bit data negation transfer	DCML	DCML	○	
	DCMLP	DCMLP	○	
32-bit BIN data decrement	DDEC	DDEC	○	
	DDECP	DDECP	○	
16-bit BIN data decrement	DEC	DEC	○	
	DECP	DECP	○	
8 → 256-bit decode	DECO	DECO	○	
	DECOP	DECOP	○	
2-word data read from the intelligent / special function module	DFRO	DFRO	○*1	
	DFROP	DFROP	○*1	
Interrupt disable instruction	DI	DI	○	

*1 Note that the buffer memory address between L series and AnS series may differ.

○ : Automatic conversion × : Manual conversion needed

Description	AnSCPU	LCPU		Reference
	Instruction name	Instruction name	Conversion	
Refresh disable	DI	DI	○	
32-bit BIN data increment	DINC	DINC	○	
	DINCP	DINCP	○	
4-bit linking of 16-bit data	DIS	DIS	○	
	DISP	DISP	○	
32-bit data transfer	DMOV	DMOV	○	
	DMOV P	DMOV P	○	
Logical sums of 32-bit data	DOR	DOR	○	
	DOR P	DOR P	○	
Left rotation of 32-bit data	DRCL	DRCL	○	Section 7.7.8
	DRCL P	DRCL P	○	Section 7.7.8
Right rotation of 32-bit data	DRCR	DRCR	○	Section 7.7.8
	DRCR P	DRCR P	○	Section 7.7.8
Left rotation of 32-bit data	DROL	DROL	○	Section 7.7.8
	DROL P	DROL P	○	Section 7.7.8
Right rotation of 32-bit data	DROR	DROR	○	Section 7.7.8
	DROR P	DROR P	○	Section 7.7.8
1-word shift to left of n-word data	DSFL	DSFL	○	
	DSFL P	DSFL P	○	
1-word shift to right of n-word data	DSFR	DSFR	○	
	DSFR P	DSFR P	○	
32-bit data check	DSUM	DSUM	○	Section 7.7.8
	DSUM P	DSUM P	○	Section 7.7.8
2-word data write to the intelligent / special function module	DTO	DTO	○*1	
	DTOP	DTOP	○*1	
Timing pulse generation	DUTY	DUTY	○	
32-bit data conversion	DXCH	DXCH	○	
	DXCH P	DXCH P	○	
32-bit data exclusive NOR operations	DXNR	DXNR	○	
	DXNR P	DXNR P	○	
32-bit exclusive OR operations	DXOR	DXOR	○	
	DXOR P	DXOR P	○	
Interrupt enable instruction	EI	EI	○	
Link refresh enable	EI	EI	○	
256 → 8-bit encode	ENCO	ENCO	○	
	ENCOP	ENCOP	○	
Sequence program termination	END	END	○	
Main routine program end	FEND	FEND	○	
Reading oldest data from tables	FIFR	FIFR	○	
	FIFR P	FIFR P	○	
Writing data to the data table	FIFW	FIFW	○	
	FIFW P	FIFW P	○	
Identical 16-bit data block transfer	FMOV	FMOV	○	
	FMOV P	FMOV P	○	
FOR to NEXT instruction	FOR	FOR	○	
1-word data read from the intelligent / special function module	FROM	FROM	○*1	
	FROM P	FROM P	○*1	
16-bit BIN data increment	INC	INC	○	
	INCP	INCP	○	
Return from interrupt programs	IRET	IRET	○	

*1 Note that the buffer memory address between L series and AnS series may differ.

○ : Automatic conversion × : Manual conversion needed

Description	AnSCPU	LCPU		Reference
	Instruction name	Instruction name	Conversion	
Pointer branch instruction	JMP	JMP	○	
Operation start	LD	LD	○	
BIN 16-bit data comparison	LD<	LD<	○	
	LD<=	LD<=	○	
	LD<>	LD<>	○	
	LD=	LD=	○	
	LD>	LD>	○	
	LD>=	LD>=	○	
BIN 32-bit data comparison	LDD<	LDD<	○	
	LDD<=	LDD<=	○	
	LDD<>	LDD<>	○	
	LDD=	LDD=	○	
	LDD>	LDD>	○	
	LDD>=	LDD>=	○	
Operation start	LDI	LDI	○	
ASCII code display instruction	LED	OUT SM1255	×	Section 7.2.3 (3)

*1 Note that the buffer memory address between L series and AnS series may differ.

○ : Automatic conversion × : Manual conversion needed

Description	AnSCPU	LCPU		Reference
	Instruction name	Instruction name	Conversion	
Character display instruction LED	LEDA	OUT SM1255	×	Section 7.2.3 (3)
	LEDB	OUT SM1255	×	Section 7.2.3 (3)
Comment display instruction LED	LEDC	OUT SM1255	×	Section 7.2.3 (3)
Annunciator reset instruction	LEDR	LEDR	○	
Local station data read	LRDP	OUT SM1255	×	Section 7.2.3 (3)
Local station data write	LWTP	OUT SM1255	×	Section 7.2.3 (3)
Master control set, reset	MC	MC	○	
	MCR	MCR	○	
16-bit data transfer	MOV	MOV	○	
	MOV _P	MOV _P	○	
Operation result pop	MPP	MPP	○	
Operation result push	MPS	MPS	○	
Operation result read	MRD	MRD	○	
BIN 16-bit data 2's complement	NEG	NEG	○	
	NEG _P	NEG _P	○	
FOR to NEXT instruction	NEXT	NEXT	○	
No operation (NOP, NOPLF)	NOP	NOP	○	
	NOPLF	NOPLF	○	
Parallel connection	OR	OR	○	
BIN 16-bit data comparisons	OR<	OR<	○	
	OR<=	OR<=	○	
	OR<>	OR<>	○	
	OR=	OR=	○	
	OR>	OR>	○	
	OR>=	OR>=	○	
Ladder block parallel connection	ORB	ORB	○	
BIN 32-bit data comparisons	ORD<	ORD<	○	
	ORD<=	ORD<=	○	
	ORD<>	ORD<>	○	
	ORD=	ORD=	○	
	ORD>	ORD>	○	
	ORD>=	ORD>=	○	
Parallel connection	ORI	ORI	○	
Output instruction	OUT	OUT	○ ^{*1}	
Trailing edge output	PLF	PLF	○	
Leading edge output	PLS	PLS	○	
Print ASCII code instruction	PR	OUT SM1255	×	Section 7.2.3 (3)
Print comment instruction	PRC	OUT SM1255	×	Section 7.2.3 (3)
Left rotation of 16-bit data	RCL	RCL	○	Section 7.7.8
	RCL _P	RCL _P	○	Section 7.7.8
Right rotation of 16-bit data	RCR	RCR	○	Section 7.7.8
	RCR _P	RCR _P	○	Section 7.7.8
Return from subroutine program	RET	RET	○	
Remote I/O station data read	RFRP	OUT SM1255	×	Section 7.2.3 (3)
Read from automatic updating buffer memory	RIFR	OUT SM1255	×	Section 7.2.3 (11)
Read from intelligent device station buffer memory (with handshake)	RIRCV	OUT SM1255	×	Section 7.2.3 (11)
Read from intelligent device station buffer memory	RIRD	OUT SM1255	×	Section 7.2.3 (11)
Write to intelligent device station buffer memory (with handshake)	RISEND	OUT SM1255	×	Section 7.2.3 (11)
Write to automatic updating buffer memory	RITO	OUT SM1255	×	Section 7.2.3 (11)
Write to intelligent device station buffer memory	RIWT	OUT SM1255	×	Section 7.2.3 (11)
Network parameter setting	RLPA	OUT SM1255	×	Section 7.2.3 (11)

*1 The high-speed timer or retentive timer can also be converted according to the parameter setting.

○ : Automatic conversion × : Manual conversion needed

Description	AnSCPU	LCPU		Reference
	Instruction name	Instruction name	Conversion	
Automatic refresh parameter setting	RRPA	OUT SM1255	×	Section 7.2.3 (11)
Left rotation of 16-bit data	ROL	ROL	○	Section 7.7.8
	ROLP	ROLP	○	Section 7.7.8
Right rotation of 16-bit data	ROR	ROR	○	Section 7.7.8
	RORP	RORP	○	Section 7.7.8
Bit device reset	RST	RST	○	
Remote I/O station data write	RTOP	OUT SM1255	×	Section 7.2.3 (3)
Pointer branch instruction	SCJ	SCJ	○	
7 segment decode	SEG	SEG	○	
Partial refresh	SEG	SEG	×	Section 7.7.8
16-bit data search	SER	SER	○	Section 7.7.8
	SERP	SERP	○	Section 7.7.8
Bit device set	SET	SET	○	
16-bit data n-bit left shift	SFL	SFL	○	
	SFLP	SFLP	○	
16-bit data n-bit right shift	SFR	SFR	○	
	SFRP	SFRP	○	
Bit device shift	SFT	SFT	○	
	SFTP	SFTP	○	
Setting and resetting status latch	SLT	OUT SM1255	×	Section 7.2.3 (3)
	SLTR	OUT SM1255	×	Section 7.2.3 (3)
Carry flag set	STC	OUT SM1255	×	Section 7.2.3 (3)
Sequence program stop	STOP	STOP	○	
Setting and resetting sampling trace	STRA	OUT SM1255	×	Section 7.2.3 (3)
	STRAR	OUT SM1255	×	Section 7.2.3 (3)
16-bit data check	SUM	SUM	○	
	SUMP	SUMP	○	
Microcomputer program	SUB	OUT SM1255	×	Section 7.2.3 (2)
	SUBP	OUT SM1255	×	Section 7.2.3 (2)
1-word data write to the intelligent/ special function unit	TO	TO	○*1	
	TOP	TOP	○*1	
4-bit linking of 16-bit data	UNI	UNI	○	
	UNIP	UNIP	○	
Logical products with 16-bit data	WAND	WAND	○	
	WANDP	WANDP	○	
WDT reset	WDT	WDT	○	
	WDTP	WDTP	○	
Logical sums of 16-bit data	WOR	WOR	○	
	WORP	WORP	○	
16-bit data exclusive NOR operations	WXNR	WXNR	○	
	WXNRP	WXNRP	○	
16-bit exclusive OR operations	WXOR	WXOR	○	
	WXORP	WXORP	○	
16-bit data conversion	XCH	XCH	○	
	XCHP	XCHP	○	

*1 Note that the buffer memory address between L series and AnS series may differ.

7.2.2 List of instruction conversion from AnSCPU to LCPU (Dedicated instructions)

○ : Automatic conversion × : Manual conversion needed

Description	AnSCPU	LCPU		Reference
	Instruction name	Instruction name	Conversion	
COS ⁻¹ operation on floating-point data	ACOS	ACOS	○	
Floating-point data addition	ADD	E+	○	
Conversion from hexadecimal BIN to ASCII	ASC	ASC	○	
SIN ⁻¹ operation on floating-point data	ASIN	ASIN	○	
TAN ⁻¹ operation on floating-point data	ATAN	ATAN	○	
BCD type COS ⁻¹ operation	BACOS	BACOS	○	
BIN 16-bit dead band controls	BAND	BAND	○	
BCD type SIN ⁻¹ operations	BASIN	BASIN	○	
BCD type TAN ⁻¹ operations	BATAN	BATAN	○	
Conversion from BCD 4-digit data to decimal ASCII	BCDDA	BCDDA	○	
BCD type COS operations	BCOS	BCOS	○	
BCD 8-digit square roots	BDSQR	BDSQR	○	
Conversion from BIN 16-bit data to decimal ASCII	BINDA	BINDA	○	
Conversion from BIN 16-bit data to hexadecimal ASCII	BINHA	BINHA	○	
Block move between extension file registers	BMOVR	OUT SM1255	×	Section 7.2.3 (4)
Forced end of FOR to NEXT instruction loop	BREAK	BREAK	○	
BCD type SIN operation	BSIN	BSIN	○	
BCD 4-digit square roots	BSQR	BSQR	○	
BCD type TAN operation	BTAN	BTAN	○	
Data linking in byte units	BTOW	BTOW	○	
Block exchange between extension file registers	BXCHR	OUT SM1255	×	Section 7.2.3 (4)
Consecutive display of the same character	CC1	OUT SM1255	×	Section 7.2.3 (11)
	CC2	OUT SM1255	×	Section 7.2.3 (11)
Changing the character color	CCDSP	OUT SM1255	×	Section 7.2.3 (11)
	CCDSPV	OUT SM1255	×	Section 7.2.3 (11)
Special format failure check	CHK	OUT SM1255	×	Section 7.2.3 (3), (4)
Changing check format of CHK	CHKEND	OUT SM1255	○	Section 7.2.3 (4)
Displaying numerals	CIN0 to CIN9	OUT SM1255	×	Section 7.2.3 (11)
Displaying letters of the alphabet	CINA to CINZ	OUT SM1255	×	Section 7.2.3 (11)
Clearing display of specified area	CINCLR	OUT SM1255	×	Section 7.2.3 (11)
Displaying "-" (hyphen)	CINHP	OUT SM1255	×	
Displaying "-" (minus)	CINMP	OUT SM1255	×	
Displaying "." (period, decimal point)	CINPT	OUT SM1255	×	
Displaying spaces	CINSP	OUT SM1255	×	Section 7.2.3 (11)
Clearing the display area	CLS	OUT SM1255	×	Section 7.2.3 (11)
Clearing the VRAM area	CLV	OUT SM1255	×	Section 7.2.3 (11)
Setting the display mode	CMODE	OUT SM1255	×	Section 7.2.3 (11)
Transferring canvas data to the VRAM area	CMOV	OUT SM1255	×	Section 7.2.3 (11)
Setting normal display for characters	CNOR	OUT SM1255	×	Section 7.2.3 (11)
Displaying the cursor	COFF	OUT SM1255	×	Section 7.2.3 (11)
Specifying the character display color	COLOR	OUT SM1255	×	Section 7.2.3 (11)
Reading device comment data	COMRD	COMRD	○	
Displaying the cursor	CON1	OUT SM1255	×	Section 7.2.3 (11)
	CON2	OUT SM1255	×	Section 7.2.3 (11)
COS operations on floating decimal point data	COS	COS	○	
Displaying a canvas window	CPS1	OUT SM1255	×	Section 7.2.3 (11)
Changing the VRAM display address	CPS2	OUT SM1255	×	Section 7.2.3 (11)
Consecutive display of the same character	CR1	OUT SM1255	×	Section 7.2.3 (11)
	CR2	OUT SM1255	×	Section 7.2.3 (11)
Switching between normal and highlighted display for characters	CRDSP	OUT SM1255	×	Section 7.2.3 (11)
	CRDSPV	OUT SM1255	×	Section 7.2.3 (11)

○ : Automatic conversion × : Manual conversion needed

Description	AnSCPU	LCPU		Reference
	Instruction name	Instruction name	Conversion	
Setting highlighted display for characters	CREV	OUT SM1255	×	Section 7.2.3 (11)
Scrolling the window	CSCRD	OUT SM1255	×	Section 7.2.3 (11)
	CSCRU	OUT SM1255	×	Section 7.2.3 (11)
Conversion from decimal ASCII to BCD 4-digit data	DABCD	DABCD	○	
Conversion from decimal ASCII to BIN 16-bit data	DABIN	DABIN	○	
Reading clock data	DATERD	DATERD	○	
Writing clock data	DATEWR	DATEWR	○	
BIN 32-bit dead band controls	DBAND	DBAND	○	
Conversion from BCD 8-digit data to decimal ASCII data	DBCDDA	DBCDDA	○	
Conversion from BIN 32-bit data to decimal ASCII data	DBINDA	DBINDA	○	
Conversion from BIN 32-bit data to hexadecimal ASCII data	DBINHA	DBINHA	○	
Conversion from decimal ASCII to BCD 8-digit data	DDABCD	DDABCD	○	
Conversion from decimal ASCII to BIN 32-bit data	DDABIN	DDABIN	○	
Conversion from floating-point radian to angle	DEG	DEG	○	
Conversion from BIN 32-bit data to floating-point data	DFLOAT	DFLT	○	
Conversion from hexadecimal ASCII to BIN 32-bit data	DHABIN	DHABIN	○	
Conversion from floating-point data to BIN 32-bit data	DINT	DINT	○	
Dissociation of random data	DIS	NDIS	○	
Division of floating decimal point data	DIV	E/	○	
Upper and lower limit controls for BIN 32-bit data	DLIMIT	DLIMIT	○	
Direct output	DOUT	OUT	○	
Direct Reset	DRST	RST	○	
32-bit data search	DSER	DSER	○	
Direct Set	DSET	SET	○	
Conversion from BIN 32-bit data to character string	DSTR	DSTR	○	
Bit tests	DTEST	DTEST	○	
Conversion from character string to BIN 32-bit data	DVAL	DVAL	○	
Zone control for BIN 32-bit data	DZONE	DZONE	○	
Displaying characters	EPR	OUT SM1255	×	Section 7.2.3 (11)
	EPRN	OUT SM1255	×	Section 7.2.3 (11)
Writing characters to the VRAM	EPRV	OUT SM1255	×	Section 7.2.3 (11)
	EPRNV	OUT SM1255	×	Section 7.2.3 (11)
Exponent operation on floating-point data	EXP	EXP	○	
Subroutine program output OFF calls inversion	FCALL	FCALL	○	
Bit device output inversion	FF	FF	○	
Conversion from BIN 16-bit data to floating-point data	FLOAT	FLT	○	
Reading VRAM data	GET	OUT SM1255	×	Section 7.2.3 (8), (9), (11)
Conversion from hexadecimal ASCII to BIN 16-bit data	HABIN	HABIN	○	
Conversion from ASCII to hexadecimal BIN	HEX	HEX	○	
ASCII code conversion of specified character strings	INPUT	OUT SM1255	×	Section 7.2.3 (11)
Receiving data	INPUT2	OUT SM1255	×	Section 7.2.3 (9)
	INPUT4	OUT SM1255	×	Section 7.2.3 (9)
Conversion from floating-point data to BIN 16-bit data	INT	INT	○	
Index qualification of a circuit block	IX	OUT SM1255	×	Section 7.2.3 (4)
	IXEND	OUT SM1255	×	Section 7.2.3 (4)
Entering data from number keys	KEY	KEY	△	
Detecting character-string length	LEN	LEN	○	
Upper and lower limit controls for BIN 16-bit data	LIMIT	LIMIT	○	
Setting the cursor position	LOCATE	OUT SM1255	×	Section 7.2.3 (11)
Natural logarithm operation on floating-point data	LOG	LOG	○	
Reading word devices in local station	LRDP	OUT SM1255	×	Section 7.2.3 (4)
Writing data to word devices in local station	LWTP	OUT SM1255	×	Section 7.2.3 (4)
Communication with remote terminal modules	MINI	OUT SM1255	×	Section 7.2.3 (10)

○ : Automatic conversion × : Manual conversion needed

Description	AnSCPU	LCPU		Reference
	Instruction name	Instruction name	Conversion	
Error resetting with remote terminal modules	MINIERR	OUT SM1255	×	Section 7.2.3 (10)
Multiplication of floating decimal point data	MUL	E*	○	
Monitoring PID Control Status	PID57	OUT SM1255	×	Section 7.2.3 (4)
PID control	PIDCONT	PIDCONT	×	Section 7.2.3 (4)
PID control data setting	PIDINIT	PIDINIT	×	Section 7.2.3 (4)
Displaying ASCII characters	PR	OUT SM1255	×	Section 7.2.3 (7), (8), (10), (11)
Sending data up to 00 _H code	PR2	OUT SM1255	×	Section 7.2.3 (9)
	PR4	OUT SM1255	×	Section 7.2.3 (9)
Displaying ASCII characters	PRN	OUT SM1255	×	Section 7.2.3 (7), (8), (10), (11)
	PRN2	OUT SM1255	×	Section 7.2.3 (9)
Sending specified number of bytes of data	PRN4	OUT SM1255	×	Section 7.2.3 (9)
	PRV	OUT SM1255	×	Section 7.2.3 (11)
Writing ASCII characters to the VRAM	PRNV	OUT SM1255	×	Section 7.2.3 (11)
	PUT	OUT SM1255	×	Section 7.2.3 (8), (9), (11)
Reading present value	PVRD1	OUT SM1255	×	Section 7.2.3 (6)
	PVRD2	OUT SM1255	×	Section 7.2.3 (6)
Setting preset data	PVWR1	OUT SM1255	×	Section 7.2.3 (6)
	PVWR2	OUT SM1255	×	Section 7.2.3 (6)
Conversion from floating-point angle to radian	RAD	RAD	○	
Remote I/O station data read	RFRP	OUT SM1255	×	Section 7.2.3 (4)
Changing the extension file register block number	RSET	OUT SM1255	×	Section 7.2.3 (4)
Remote I/O station data write	RTOP	OUT SM1255	×	Section 7.2.3 (4)
Block addition and subtraction	SADD	\$+	○	
Comparison between character strings	SCMP	OUT SM1255	×	Section 7.2.3 (4)
SIN operation on floating-point data	SIN	SIN	○	
Character string transfer	SMOV	\$MOV	○	
Reading communication status	SPBUSY	OUT SM1255	×	Section 7.2.3 (7), (9), (10)
Forced stop of communication processing	SPCLR	OUT SM1255	×	Section 7.2.3 (7), (9), (10)
Square root operations for floating-point data	SQR	SQR	○	
Reading the display status	STAT	OUT SM1255	×	Section 7.2.3 (11)
Conversion from BIN 16-bit data to character string	STR	STR	○	
Subtraction of floating-point data	SUB	E-	○	
Setting comparison reference data	SVWR1	OUT SM1255	×	Section 7.2.3 (6)
	SVWR2	OUT SM1255	×	Section 7.2.3 (6)
Upper and lower byte exchanges	SWAP	SWAP	○	
TAN operation on floating-point data	TAN	TAN	○	
Bit test	TEST	TEST	○	
Linking of random data	UNI	NUNI	○	
Conversion from character string to BIN 16-bit data	VAL	VAL	○	
Data dissociation in byte units	WTOB	WTOB	○	
Link refresh of specified network	ZCOM	S.ZCOM	○	Section 7.2.3 (5)
Reading/writing data from/to special function module in MELSECNET/10 remote I/O station	ZNFR	OUT SM1255	×	Section 7.2.3 (5)
	ZNTO	OUT SM1255	×	Section 7.2.3 (5)
Reading from/writing to word devices in the MELSECNET/10 station	ZNRD	J.ZNRD	○	Section 7.2.3 (5)
	ZNWR	J.ZNWR	○	Section 7.2.3 (5)
Zone control for BIN 16-bit data	ZONE	ZONE	○	
Direct read/write of extension file registers in 1-word units	ZRRD	OUT SM1255	×	Section 7.2.3 (4)
	ZRWR	OUT SM1255	×	Section 7.2.3 (4)
Direct read/write of extension file registers in units of bytes	ZRRDB	OUT SM1255	×	Section 7.2.3 (4)
	ZRWRB	OUT SM1255	×	Section 7.2.3 (4)

7.2.3 Instructions that may need a replacement at instruction conversion from AnSCPU to LCPU

Some instructions are not automatically converted upon the replacement of the AnS series CPU with L series CPU.

The following table lists the instructions that are not automatically converted. Reviewing the program is recommended.

Item No.	Instruction type	AnSCPU Instruction name	Corrective action
(1)	Sequence instruction	Bit device output inversion	CHK (Counter measure) Review the program and change manually. (Supplement) Change candidate instruction: [FF] instruction
(2)	Basic instruction	Program switching instruction	CHG (Counter measure) Review the program with referring to Section 7.7.10.
		Microcomputer program call instruction	SUB SUBP (Counter measure) Change manually to the same instructions of the L series.
(3)	Application instruction	ASCII characters convert instruction	ASC (Counter measure) Review the program and change manually. (Supplement) Change candidate instruction: [\$MOV] instruction
		MELSEC (II), B local station, remote I/O station access instruction	LRDP LWTP RFRP RTOP (Counter measure) Reprogram for the network modules to use with an LCPU.
		Display instructions (except dedicated instruction)	LED LEDA LEDB LEDC (Counter measure) Setting an external display is recommended since the LCPU does not support the LED display function.
		Special format failure check	CHK (Counter measure) There is no alternative action.
		Status latch instruction	SLT SLTR (Counter measure) There is no alternative action.
			STRAR
		Carry flag instruction	STC CLC (Counter measure) Review the program and change manually. (Supplement) Change candidate instructions: [STC] → [SET SM700] instruction [CLC] → [RST SM700] instruction
			Print ASCII code instruction
		Print comment instruction	PRC For the measures for an LCPU, refer to technical news (No. FA-A-0068).

Item No.	Instruction type	AnSCPU Instruction name	Corrective action	
(4)	Dedicated instruction	Structured program instruction	CHK	(Counter measure)
			CHKEND	There is no alternative action.
			IX	(Counter measure)
			IXEND	There is no alternative action.
		MELSECNET (II), B local station, remote I/O station access instruction	LRDP	(Counter measure) Reprogram for the network modules to use with the LCPU.
			LWTP	
			RFRP	
			RTOP	
		Character string data comparison	SCMP	(Counter measure) Review the program and change manually. (Supplement) Change candidate instructions: [LD\$=], [AND\$=], [OR\$=] instruction
		Numerical key input from keyboard	KEY	(Counter measure) Setting an external display that can input the figure is recommended.
		Extension file register instruction	BMOVR	(Counter measure) Review the program and change manually. (Supplement) Change candidate instructions: [BMOV], [MOV], [RSET] instruction
			BXCHR	
			RSET	
			ZRRD	
			ZRRDB	
ZRWR				
PID control instruction	PID57	(Counter measure) There is no alternative action.		
	PIDINT	(Counter measure)		
	PIDCONT	Refer to the existing program and change to the PID instruction of the LCPU.		
(5)	Network dedicated instruction	ZCOM	(Counter measure) Review the program and change manually. (Supplement) Change candidate instructions: [S(P).ZCOM Jn] or [S(P).ZCOM Un] instruction	
			ZNRD	(Counter measure) Reprogram the network modules to use with the LCPU.
		ZNWR		
		ZNFR		
		ZNTO		

Item No.	Instruction type	AnSCPU Instruction name	Corrective action
(6)	Control instruction for high-speed counter module type AD61(S1)	PVWR1	(Counter measure) Reprogram the network modules to use with the LCPU.
		PVWR2	
		SVWR1	
		SVWR2	
		PVRD1	
		PVRD2	
(7)	Control instruction for computer link module type AJ71C24 (S3, S6, S8)/ AJ71UC24	PRN	
		PR	
		INPUT	
		SPBUSY	
		SPCLR	
(8)	Control instruction for memory card/centronics interface module type AD59 (S1)	PRN	(Counter measure) Reprogram the network modules to use with the LCPU. Restructuring the system is required depending on the module to be used.
		PR	
		GET	
		PUT	
(9)	Control instruction for terminal interface module type AJ71C21 (S1)	PRN2	
		PRN4	
		PR2	
		PR4	
		INPUT2	
		INPUT4	
		GET	
		PUT	
		SPBUSY	
		SPCLR	
(10)	Control instruction for MELSECNET/MINI-S3 master module type AJ71PT32-S3	INPUT	
		PRN	
		PR	
		MINI	
		MINIERR	
		SPBUSY	
		SPCLR	

Item No.	Instruction type	AnSCPU Instruction name	Corrective action
(11)	Special function module dedicated instruction	Control instruction for AD57 (S1) CRT controller module/ AD58 LCD controller module	
		CMODE	
		CPS1	
		CPS2	
		CMOV	
		CLS	
		CLV	
		CSCRU	
		CSCRD	
		CON1	
		CON2	
		COFF	
		LOCATE	
		CNOR	
		CREV	
		CRDSP	
		CRDSPV	
		COLOR	
		CCDSP	
		CCDSPV	(Counter measure)
		PRN	Reprogram the network modules to use with the LCPU.
		PR	Restructuring the system is required depending on the module to be used.
		PRNV	
		PRV	
		EPRN	
		EPR	
		EPRNV	
		EPRV	
		CR1	
		CR2	
		CC1	
		CC2	
		CINMT	
		CIN□ (□: 0 to 9, A to Z)	
		CINSP	
		CINCLR	
		INPUT	
GET			
PUT			
STAT			
CC-Link instruction	RIFR		
	RIRCV		
	RIRD	(Counter measure)	
	RISEND	Change manually to the same instructions of the L series.	
	RITO		
	RIWT		
	RLPA	(Counter measure)	
RRPA	Set parameters with GX Works2.		

7.2.4 Instruction conversion from QnASCPU to LCPU

The automatic conversion is applied to the instructions of which equivalent functions and instructions exist in the change target LCPU.

For instructions that are not automatically converted, consider reviewing the program referring to the inconvertible instructions described in Section 7.2.5.

Reprogram for the modules to use with the LCPU, since the specifications of the intelligent function module instructions differ between LCPU compatible modules and QnASCPU compatible modules.

7.2.5 Instructions that may need a replacement at instruction conversion from QnASCPU to LCPU

Some instructions are not automatically converted upon the replacement of the QnAS series CPU modules with L series CPU modules.

The following table lists the instructions that are not automatically converted and their measures. Reviewing the program is recommended.

Instruction type		QnASCPU Instruction name	Corrective action
Sequence instruction	Index modification of entire ladder	IX	(Counter measure) Review the program and change manually. (Supplement) Change candidate instruction: [IX] → [ZPUSH]
		IXEND	Replace the IX instruction with the ZPUSH instruction and set the contents of index modification table to index register. [IXEND] → [ZP.P]
	Modification value specification in index modification of entire ladder	IXDEV	(Counter measure)
		IXSET	Change the program so that the device offset values specified the IXSET instruction are directly set to the index modification table using the MOV instruction.
	Print ASCII code instruction	PR	(Counter measure)
	Print comment instruction	PRC	For the measure for the LCPU, refer to the technical news (No.FA-A-0068).
	Special format failure checks instruction	CHKST	(Counter measure) Review the program and change manually.
		CHK	
	Format change instruction for CHK instruction	CHKCIR CHKEND	For details, please refer to the technical news (No.FA-A-0068).
	Program low-speed execution registration instruction	PLOW	(Counter measure) • Use the PSCAN instruction instead of this instruction when low-speed execution type programs are replaced with scan execution type programs. • No instruction can be used if low-speed execution type programs are replaced with fixed scan execution type programs.
Program execution status check instruction	PCHK	(Counter measure) Check a program execution status on the Program monitoring list window of GX Works2. For the program list monitoring, refer to the MELSEC-L CPU Module User's Manual (Function Explanation, Program Fundamentals).	
Application instruction	Display instruction	LED	(Counter measure) Setting an external display is recommended since the LCPU does not support the LED display function.
		LEDC	
	Status latch instruction	SLT	(Counter measure) There is no alternative action.
		SLTR	
	Sampling trace instruction	STRA	(Counter measure) Review the program and change manually. (Supplement) Change candidate instructions: [STRA] → [TRACE] instruction [STRAR] → [TRACER] instruction
		STRAR	
Program trace instruction	PTRA	(Counter measure) There is no alternative action.	
	PTRAR		
	PTRAEXE		
Other instructions	EROMWR	(Counter measure) There is no alternative action.	
PID control instruction	PID57	(Counter measure) There is no alternative action.	
Special function modules instruction Example: G. INPUT, G. PRN	G (P). [Instruction name]	(Counter measure) Reprogram for the special function modules to use with the LCPU.	

7.3 Precautions for Replacement of Parameter

7.3.1 Conversion from AnSCPU to LCPU

This section explains the parameter conversion upon replacement of the AnSCPU programs with the LCPU.

<Compatibility>

○: Common item between AnSCPU and LCPU, that can be converted directly

△: Item that requires re-setting after the conversion, since the functions/specifications are partially different

×: Item to be deleted, since no common item exists between the AnSCPU and LCPU

Confirm the parameters after the conversion, and correct/re-set as required.

Name		Compatibility	Remarks		
Memory capacity	Sequence program capacity	△	No need to care about the program capacity.		
	Microcomputer program capacity	×	No microcomputer program is available.		
	Comment capacity	△	Not required, since comments can be created for all devices.		
	File register capacity	△	Resetting is required since the specifications are different.		
PLC RAS setting	WDT setting	△	This becomes default (200ms).		
	Operation mode when an error occurs	△	This becomes default (All stop).		
	Annunciator display mode	×	No compatible function is available.		
PLC system setting	RUN-PAUSE contact	△	Re-setting is required.		
	Output mode at STOP to RUN	△	This becomes default (Output before STOP).		
	Data communications request batch processing	△	Please use COM instructions. The setting can be also configured through the service processing settings in the PLC parameter.		
	Interrupt counter setting	△	Re-setting is required.		
I/O assignment		△	Reexamination is needed due to the change from the base unit mounting method to the connection method that requires no base unit.		
Device setting	Number of device points	○	This resets to default.		
	Latch range	Latch relay L	○	M and L are different devices. "L" on the program is converted to "L".	
		Data register D	○		
		Link relay B	○		
		Link register W	○		
		Low-speed timer High-speed timer Extension low-speed timer Extension high-speed timer	△	These counters are converted as one device. Reviewing is required, since all range from lowest device number to highest device number is included in the latch range.	
		Retentive timer Extension retentive timer	△	These counters are converted as one device. Reviewing is required, since all range from lowest device number to highest device number is included in the latch range.	
		Counter Extension counter	△	These counters are converted as one device. Reviewing is required, since all range from lowest device number to highest device number is included in the latch range.	
		Network parameter	MELSECNET (II), /B	×	Parameters are deleted, since the L series CPU module is not compatible with the MELSECNET (II), /B.
			MELSECNET/10 (H)	×	The LCPU supports only CC-Link IE Field Network, and thus the parameters are deleted.
MELSECNET/MINI	×		Parameters are deleted, since the LCPU is not compatible with the MELSECNET/MINI.		

7.3.2 Conversion from QnASCPU to LCPU

This section explains the parameter conversion upon replacement of the QnASCPU program with the LCPU.

The symbols in the table indicate the following meanings:

<Compatibility>

○: Common item between QnASCPU and LCPU, that can be converted directly

△: Item that requires re-setting after the conversion, since the functions/specifications are partially different

×: Item to be deleted, since no common item exists between the QnASCPU and LCPU

Confirm the parameters after the conversion, and correct/re-set as required.

Name		Compatibility	Remarks
PLC name setting	Label	○	
	Comment	○	
PLC system setting	Timer limit setting	Low speed	○
		High speed	○
	RUN-PAUSE contact	RUN	○
		PAUSE	○
	Remote reset	○	
	Output mode at STOP to RUN	○	
	Common pointer number	○	
	General data processing	△	Please use COM instructions. The setting can be also configured through the service processing settings in the PLC parameter.
	Number of empty slots	○	
	System interrupt setting	Interrupt counter setting number	△
I28 Fixed scan interval		○	
I29 Fixed scan interval		○	
I30 Fixed scan interval		○	
PLC file setting	File register	△	Resetting is required, since the usable target memory is changed.
	Comment file used in a command	△	Confirmation is required, since the usable target memory is changed. A memory card becomes unnecessary by setting the target memory to "Standard ROM".
	Device initial value	△	Confirmation is required, since the usable target memory is changed. A memory card becomes unnecessary by setting the target memory to "Standard ROM".
	File for local device	△	Auto conversion is performed only for "Standard RAM".

Name		Compatibility	Remarks	
Device setting	Input relay	○		
	Output relay	○		
	Internal relay	○		
	Latch relay	○		
	Link relay	○		
	Annunciator	○		
	Link special relay	○		
	Edge relay	○		
	Step relay	○		
	Timer	○		
	Retentive timer	○		
	Counter	○		
	Data register	○		
	Link register	○		
	Link special register	○		
	Total of device	○		
PLC RAS setting	WDT setting	WDT setting	○	
		Initial execution monitoring time	○	
		Low speed execution monitoring time	×	The LCPU does not support a low-speed execution program function.
	Error check	Carry out battery check	○	
		Carry out fuse blown check	×	The LCPU does not support a fuse blowout check function.
		Carry out I/O module comparison	△	For the LCPU, this setting is fixed to "stop".
	Operation mode when an error occurs	Computation error	○	
		Expanded command error	×	The LCPU does not support extension instructions.
		Fuse blown	×	The LCPU does not support a fuse blowout check function.
		I/O module comparison error	△	For the LCPU, this setting is fixed to "stop".
		Special module access error	○	The name changes to "Intelligent module program execution error".
		Memory card access error	○	
	Memory card operation error	○		
	Constant scan	○		
	Annunciator display mode	F number display	×	The LCPU does not support a display function.
		Comment display	×	The LCPU does not support a display function.
		Occurrence time	×	The LCPU does not support a display function.
	Error history	Drive	○	
		File name	○	
		History number	○	
Low speed program execution time	×	The LCPU does not support a low-speed program.		
I/O assignment	△	Reexamination is needed due to the change from the base unit mounting method to the connection method that requires no base unit.		
Boot file setting	○			
Program setting	○			
SFC setting	SFC program start mode	○		
	Start conditions	○		
	Operation mode when the block is stopped	○		

	Name	Compatibility	Remarks
Network parameter	MELSECNET (II), /B	×	Parameters are deleted, since the L series CPU module is not compatible with the MELSECNET (II), /B.
	MELSECNET/10 (H)	×	The LCPU supports only CC-Link IE Field Network, and thus the parameters are deleted.
	MELSECNET/MINI	×	Parameters are deleted, since the LCPU is not compatible with the MELSECNET/MINI.
	CC-Link	△	For parameter settings with a software package, max. two sheets can be set for the L02CPU and max. four sheets can be set for the L26CPU-BT. ^{*1} If the number of sheets set with parameters is to be exceeded, use the dedicated instruction to set parameters.
	Ethernet	△	When replacement is performed using the CPU built-in Ethernet port, the setting destination is changed from the network parameters to "Built-in Ethernet port setting" in the PLC parameter.

*1 For the number of mountable CC-Link modules and the number of settable parameters with the software package, refer to the MELSEC-L CC-Link System Master/Local Module User's Manual.

7.4 Replacement of Special Relay

The special relay is an internal relay that has a set application in a programmable controller. This section explains how to replace the special relay when replacing the AnSCPU programs for the LCPU.

For details on the AnS/QnASCPU special relays not compatible with the LCPU, please refer to the MELSEC-L CPU Module User's Manual (Function Explanation, Program Fundamentals) and the MELSEC-Q/L Programming Manual (Common Instruction).

7.4.1 Replacing the AnSCPU with the LCPU

The LCPU uses the different special relay from the one for the AnSCPU.

With "Change PLC type", the automatic conversion is applied to the replacement of the AnSCPU special relays (M9000 and after) with the LCPU special relay (SM). (Refer to Section 7.1.2.)

Point

The AnSCPU special relays are not compatible with the LCPU.

Those special relays not compatible with the LCPU are converted to dummy special relays (SM1255) when changing programmable controller type. Search the dummy special relays (SM1255) and correct the programs as required.

7.4.2 Replacing the QnASCPU with the LCPU

Basically, the special relay for the QnASCPU can be used without modification in the LCPU.*1

Note that, however, some of them are not compatible with the LCPU.

*1 When programs for the QnASCPU are replaced with those for the LCPU by "Change PLC type", devices for the QnASCPU, SM1000 to SM1255 and SD1000 to SD1255, are replaced with those for the LCPU.
(Example: SM1036→SM400, SD1008→SD0)

7.5 Replacement of Special Register

The special register is an internal register that has a set application in a programmable controller. This section explains how to replace the special register when replacing the AnSCPU programs for the LCPU.

For details on the AnS/QnASCPU special relays not compatible with the LCPU, please refer to the MELSEC-L CPU Module User's Manual (Function Explanation, Program Fundamentals) and the MELSEC-Q/L Programming Manual (Common Instruction).

7.5.1 Replacing the AnSCPU with the LCPU

The LCPU uses the different special register from the one for the AnSCPU.

With "Change PLC type", the automatic conversion is applied to the replacement of the AnSCPU special registers (D9000 and after) with the LCPU special register (SD). (Refer to Section 7.1.2.)

Point

Some AnSCPU special register are not compatible with the LCPU.

Those special register not compatible with the LCPU are converted to dummy special registers (SD1255) when changing programmable controller type. Search the dummy special registers (SD1255) and correct the programs as required.

7.5.2 Replacing the QnASCPU with the LCPU

Basically, special registers for the QnASCPU can be used without modification in the LCPU.*¹

Note that, however, some of them are not compatible with the LCPU.

*1 When programs for the QnASCPU are replaced with those for the LCPU by "Change PLC type", devices for the QnASCPU, SM1000 to SM1255 and SD1000 to SD1255, are replaced with those for the LCPU (Example: SM1036 to SM400; SD1008 to SD0).

7.6 Precautions for Replacement of the MELSAP-II with the MELSAP3

The basic operation of the MELSAP3 is the same as the MELSAP-II, but the specifications are partially different.

This section provides the precautions for the replacement.

7.6.1 Starting SFC program

The SFC program can be started by using the special relay for Start/stop SFC program.

The special relay for the AnSCPU for Start/stop SFC program (M9101) is replaced with the special relay for the LCPU for Start/stop SFC program (SM321) upon converting from the AnSCPU to LCPU.

The specifications of the special relay for starting or stopping SFC program partially differ between the AnSCPU and LCPU.

Specifications		Precautions for replacement
MELSAP-II (M9101)	MELSAP3 (SM321)	
Switches ON and OFF with user operation.	SFC program starts up at default, since system automatically turns it on.	When starting/stopping the SFC program according to user conditions, turn the SM321 to ON/OFF with program.

7.6.2 Block information (SFC information device)

The MELSAP-II and MELSAP3 have different method of executing the "Block START/STOP" and "Reading of the number of active steps and active step numbers" with block information (SFC information device).

Item	Specifications		Precautions for replacement
	MELSAP-II	MELSAP3	
Block START/STOP methods	<p>[START] Switching the block active bit on, executes forced start.</p> <p>[STOP] Switching the block clear bit on, stops the block also switching from ON to OFF executes forced stop.</p>	<p>[START] Switching the block START/STOP bit on starts the concerned block forcibly.</p> <p>[STOP] Switching the block START/STOP bit off stops the concerned block forcibly.</p>	<p>[START] Adjusting program is not required when replacing the SFC program of the AnSCPU with the LCPU, since in that case, the "Block active bit" is replaced with the "Block START/STOP bit".</p> <p>[STOP] Add the program that resets the "Block START/STOP bit" to the "Block clear bit". Delete the program that switches the "Block clear bit" ON/OFF.</p>
The number of active steps and active step numbers reading	Reads the number of active steps in the corresponding block and active step numbers.	Reads only the number of active steps in the corresponding block.	To read the active step numbers, use the "Active step batch readout instructions (MOV, DMOV, BMOV)".

7.6.3 Specifications comparison between MELSAP-II and MELSAP3

A part of the specifications of SFC program (MELSAP3) are different from those of SFC program (MELSAP-II).

Item	MELSAP-II	MELSAP3	
	A/AnSCPU	LCPU	
		L02CPU	L06CPU, L26CPU
SFC block	Max. 256 blocks	Max. 128 blocks	Max. 320 blocks
Number of SFC steps	Max. 255 steps/block	Max. 128 steps/block	Max. 512 steps/block
Step transition monitoring timer	Equipped (8 timers)	Not equipped	Not equipped

7.6.4 MELSAP3 specifications comparison between QnASCPU and LCPU

A part of the specifications of SFC program for LCPU (MELSAP3) are different from those of SFC program for QnASCPU (MELSAP3).

Item		MELSAP3		
		QnA/QnASCPU	LCPU	
			L02CPU	L06CPU, L26CPU
SFC block		Max. 320 blocks	Max. 128 blocks	Max. 320 blocks
Number of SFC steps		Max. 512 steps/block	Max. 128 steps/block	Max. 512 steps/block
Step transition monitoring timer		Equipped (10 timers)	Not equipped	Not equipped
SFC program start mode setting	Act at block multi-activated	Equipped	Equipped	Equipped
	Act at step multi-activated * Operation mode at the time of step duplicate initiation	Supported	Not supported (Transfer only)	Not supported (Transfer only)
	Periodic execution block setting	Supported	Not supported	Not supported
SFC control instruction*2	Forced transition check instruction			
	LD TRn*1	Supported	Not supported	Not supported
	LD BLm\TRn*1			
	Active step change instruction			
	SCHG (D)	Supported	Not supported	Not supported
	Transition control instruction			
	SET TRn	Supported	Not supported	Not supported
	SET BLm\TRn			
	RST TRn			
	RST BLm\TRn			
Block switching instruction				
BRSET (S)	Supported	Not supported	Not supported	
SFC program for program execution management		Supported	Not supported	Not supported
Program execution type setting		Supported	Not supported	Not supported

*1 LDI/AND/OR/LDI/ANI/ORI instructions correspond besides the LD instruction.

*2 All SFC control instructions not described can be executed by MELSAP3 compatible CPU modules.

7.6.5 SFC diagram that cannot be read normally in another format

SFC diagram created by SW□IVD/NX-GPPA may cause an error such as incorrect reading.

Add dummy steps before replacement with SW□IVD/NX-GPPA.

(Refer to "PRECAUTIONS FOR CREATING SFC PROGRAMS" in the GX Developer Version 8 Operating Manual (SFC).)

(Example)

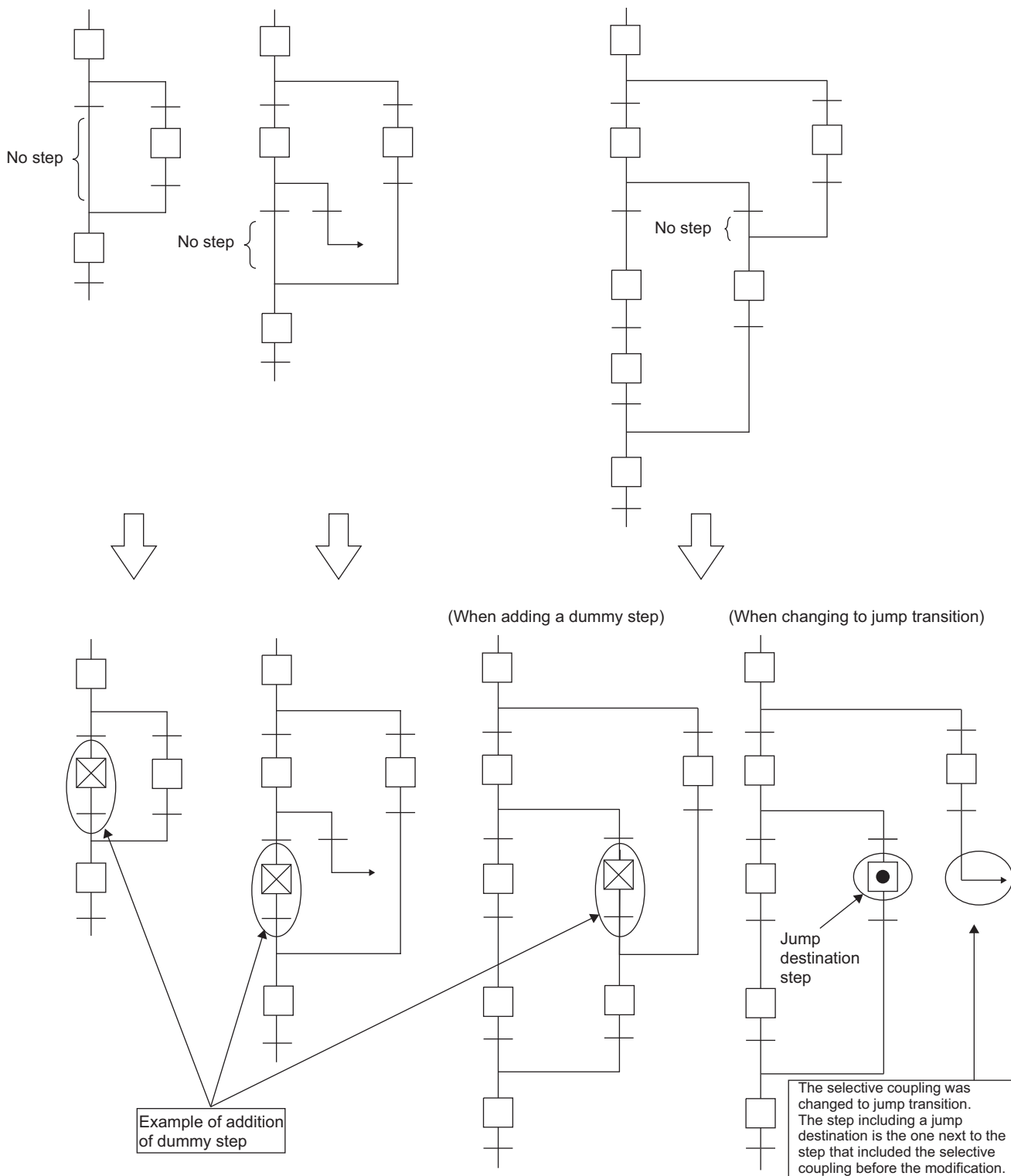

7.7 Precautions for Program Replacement

7.7.1 List of applicable devices

Device name		LCPU	QnASCPU	AnSCPU	
Number of I/O points*6		L02SCPU(-P): 1024 points L02CPU(-P): 1024 points L06CPU(-P): 4096 points L26CPU(-P/-BT/-PBT): 4096 points	Q2AS: 512 points Q2AS-S1: 1024 points Q2ASH: 512 points Q2ASH-S1: 1024 points	A2US: 512 points A2US-S1: 1024 points A2USH-S1: 1024 points	A1SJH: 256 points A1SH: 256 points A2SH: 512 points
Number of I/O device points*5		8192 points			2048 points
Internal relay		8192 points*1		Total 8192 points	Total 2048 points
Latch relay		8192 points*1			
Step relay	For sequence programs	—			
	SFC	8192 points			
Annunciator		2048 points*1	2048 points	256 points	
Edge relay		2048 points*1		—	
Link relay		8192 points*1	8192 points	1024 points	
Link special relay		2048 points		56 points	
Timer		2048 points*1		Total 2048 points	Total 256 points
Retentive timer		0 points*1			
Counter		1024 points*1	1024 points	256 points	
Data register		12288 points*1		8192 points	1024 points
Link register		8192 points*1		8192 points	1024 points
Link special register		2048 points		56 points	
Function input		16 points (FX0 to FXF)*4		—	
Function output		16 points (FY0 to FYF)*4		—	
Special relay		2048 points		256 points	
Function registers		5 points (FD0 to FD4)		—	
Special register		2048 points		256 points	
Link direct device		Specified from J□□□		—	
Special direct devices		Specified from U□V□		—	
Index register	Z	20 points (Z0 to Z19)		7 points (Z, Z1 to Z6)	1 point (Z)
	V*2	—		7 points (V, V1 to V6)	1 point (V)
File register		32768 points/block*7 (R0 to R32767)	32768 points/block (R0 to R32767)	8192 points/block (R0 to R8191)	
Extended data register*1		0 points		—	
Extended link register*1		0 points		—	
Accumulator*3		—		2 points	
Nesting		15 points	16 points	8 points	
Pointer		4096 points		256 points	
Interrupt pointer		256 points	48 points	32 points	
SFC block device		128 points	320 points	—	
SFC transition device		—	512 points/block	—	
Decimal constant		K-2147483648 to K2147483647			
Hexadecimal constant		H0 to HFFFFFFF			
Real constant*6		E±1.17550-38 to E±3.40282+38		—	
Character string		"LCPU", "ABCD"		—	

- *1 The number of points for use can be changed with parameters.
- *2 "V" is used for edge relay for the QnASCPU.
- *3 The format of instructions that use the accumulator for the AnSCPU/AnUSCPU is changed for the LCPU/QnASCPU.
- *4 Each five points of FX0 to FX4 and FY0 to FY4 can be used on the programs.
- *5 The number of points that can be used on the programs.
- *6 The number of accessible points to actual I/O modules.
- *7 For the LCPU, set the total number of points of file register, extended data register, and extended link register with parameters.

Point

Some devices and constants are not listed in the "List of applicable devices". For details, refer to the MELSEC-L CPU Module User's Manual (Function Explanation, Program Fundamentals).

7.7.2 I/O control method

○: Usable, —: Unusable

I/O control method		LCPU	QnASCPU	AnSCPU	
				AnUS(H)CPU	AnS(J)HCPU
Refresh mode		○	○	○	○ ^{*2}
Direct input/output method	Partial refresh instructions	○	○	○	○
	Dedicated instructions ^{*1}	—	—	○	—
	Direct access input	○	○	—	—
	Direct access output	○	○	—	—
Direct mode		—	—	—	○ ^{*2}

*1 The direct output dedicated instructions are DOUT, DSET, and SRST.
Direct output dedicated instructions are not available.

*2 The DIP switch on the CPU module enables to switch between refresh mode and direct mode.

7.7.3 Usable data format for instructions

○: Usable, △: Conditionally usable, —: Unusable

Setting data		LCPU	QnASCPU	AnSCPU	
				AnUS(H)CPU	AnS(J)HCPU
Bit data	Bit device	○	○	○	○
	Word device	○ (Bit specification required)	—	—	—
Word data	Bit device	○ (Digit specification required)	○ (Digit specification required)	○ (Digit specification required)	○ (Digit specification required)
	Word device	○	○	○	○
Double-word data	Bit device	○ (Digit specification required)	○ (Digit specification required)	○ (Digit specification required)	○ (Digit specification required)
	Word device	○	○	○	○
Real number data		○	△ ^{*2}	△ ^{*1}	△ ^{*1}
Character string data		○	△ ^{*2}	△ ^{*1}	△ ^{*1}

*1 The CPU module can use these data with the registration of the microcomputer package for the floating decimal point real number type of the SW0SRXV-FN2UP package.

*2 The AnA/AnU dedicated instruction can be used.

7.7.4 Timer

Function		LCPU/QnACPU	AnSCPU	
			AnUS(H)CPU	AnS(J)HCPU
Low-speed timer	Measurement unit	<ul style="list-style-type: none"> • 100ms (Default) Change of setting possible in the range of 1 to 1000ms (Parameter) (QnACPU: 10 to 1000ms) 	<ul style="list-style-type: none"> • 100ms fixed 	
	Specifying method			
High-speed timer	Measurement unit	<ul style="list-style-type: none"> • 10ms (Default) Change of setting possible in the range of 0.1 to 100ms (parameter) (QnACPU: 1 to 100ms) 	<ul style="list-style-type: none"> • 10ms fixed 	
	Specifying method			
Retentive timer	Measurement unit	<ul style="list-style-type: none"> • The same measurement unit as low-speed timer 	<ul style="list-style-type: none"> • 100ms fixed 	
	Specifying method			
High-speed retentive timer	Measurement unit	<ul style="list-style-type: none"> • The same measurement unit as high-speed timer 	<ul style="list-style-type: none"> • Not equipped 	
	Specifying method			
Setting range for set value		• 1 to 32767	• 1 to 32767	
Processing the set value 0		• Instant-on	• Infinite (No time up)	
Updating present value		• When executing the OUT Tn instruction	• At the END processing	
ON/OFF processing for contact				

(1) Precautions for using timer

The following shows precautions when using timers. For details, refer to the MELSEC-L CPU Module User's Manual (Function Explanation, Program Fundamentals).

(a) QnAS/LCPU timer ladder programming method

Set the number of points for the timer and retentive timer in the Device setting of the parameter setting.

To use the low-speed timer, high-speed timer, retentive timer and high-speed retentive timer separately, add "H" or "S" to the OUT instruction in programming.

Ex.)	Low-speed timer:	OUT	T0	Kn
	High-speed timer:	OUTH	T0	Kn
	Low-speed retentive timer:	OUT	ST0	Kn
	High-speed retentive timer:	OUTH	ST0	Kn

When the timer circuit of the AnSCPU is used following the change of the personal computer type, the program need not to be changed because automatic replacement is performed in accordance with the parameter settings of the AnSCPU.

(b) When the timer setting value is "K1"

When the timer setting value is "K1", instant time-up may occur depending on the timing of the timer coil initiation condition.

If a low-speed timer is in use, replace it with a high-speed timer and change the setting value to "K10".

When another coil is to be initiated at the timer contact, change the order of the description.

For details, refer to the MELSEC-L CPU Module User's Manual (Function Explanation, Program Fundamentals).

7.7.5 Counter

Function	LCPU/QnASCPU	AnSCPU	
		AnUS(H)CPU	AnS(J)HCPU
Specifying method			
Updating present value ON/OFF processing for contact	• When executing the OUT Cn instruction	• At the END processing	

7.7.6 Display instructions

Instruction	LCPU	QnASCPU	AnSCPU	
			AnUS(H)CPU	AnS(J)HCPU
PR ^{*1}	Instruction not supported	• With SM701 OFF: Outputs characters before 00 _H . • With SM701 ON: Outputs 16 characters.	• With M9049 OFF: Outputs characters before 00 _H . • With M9049 ON: Outputs 16 characters.	
PRC ^{*1}		• With SM701 OFF: Outputs comments in 32 characters. • With SM701 ON: Outputs first 16 characters of comment.	• Outputs comment in 16 characters.	

*1 For the LCPU, display instructions cannot be used. Consider replacement with a display unit or touch panel.

7.7.7 Index register

(1) Replacing index register

"Z, Z1 to Z6, V, V1 to V6" and "Z0 to Z15" are used as index register for the AnS series and L series, respectively. Therefore, their specifications differ.

"V" is used as edge relay for the L series. The device is used to memorize the PLS/PLF information to contacts from the start of the ladder block.

The following table lists replacement of index register when AnS series program was used to the L series with "Change PLC type".

AnS series	L series
Z	Z0
Z1 to Z6	Z1 to Z6
V	Z7
V1 to V6	Z8 to Z13

☒ Point

When modifying contact instructions of timer/counter with indexes, A2USCPU/A2USHCPU-S1 have no restrictions on index registers.

For the LCPU, only "Z0, Z1" is available as an index register which can be specified when the index modification of the timer counter's contact instruction is performed.

When using index registers other than "Z, Z1" in the existing A2USCPU/A2USHCPU-S1, it is replaced with "SM1255" as unconvertible instruction. Therefore, correcting/changing program is required.

(2) Index register 32-bit specification

When using index register as 32-bit instruction in the AnS series, Z and V that has the same number with Z are processed as low-order 16-bit value and high-order 16-bit value, respectively.

However, the L series processes Z_n and $Z_n + 1$ as low-order 16 bits and high-order 16 bits, respectively.

If a program to which "Change PLC type" is performed includes index register with 32-bit specification, reviewing the index register after "Change PLC type" is necessary.

The following lists an example using an instruction whose operation result will be in 32 bits.

Instruction	AnS series	L series
DMOV D0 Z1	V1, Z1 (High order) (Low order)	Z2, Z1 (High order) (Low order)
/ D0 D1 Z1	Z1 (Quotient) V1 (Remainder)	Z1 (Quotient) Z2 (Remainder)

When using the AnS series program to the L series with "Change PLC type", the operation result may be stored to the index register having different number as intended one.

(Example)

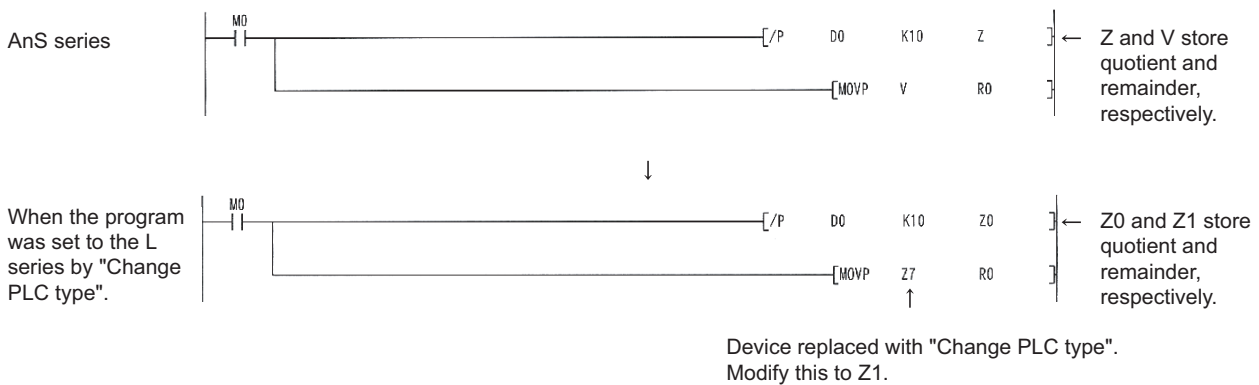

7.7.8 Instructions where format is changed (Excluding AnUSCPU dedicated instructions)

Instructions using the accumulator for the AnSCPU are changed in their format, since the LCPU/QnASCPU do not have the accumulator (A0, A1).

The accumulator A0 is converted to SD718, the accumulator A1 is converted to SD719.

Function	LCPU/QnASCPU		AnSCPU	
	Format of instruction	Remarks	Format of instruction	Remarks
16 bits Clockwise rotation	$\text{ROR } \boxed{D} \boxed{n}$	• D: Rotation data	$\text{ROR } \boxed{n}$	• Rotation data is set in A0.
	$\text{RCR } \boxed{D} \boxed{n}$	• D: Rotation data • Use SM700 for carry flag.	$\text{RCR } \boxed{n}$	• Rotation data is set in A0. • Use M9012 for carry flag.
16 bits Counterclockwise rotation	$\text{ROL } \boxed{D} \boxed{n}$	• D: Rotation data	$\text{ROL } \boxed{n}$	• Rotation data is set in A0.
	$\text{RCL } \boxed{D} \boxed{n}$	• D: Rotation data • Use SM700 for carry flag.	$\text{RCL } \boxed{n}$	• Rotation data is set in A0. • Use M9012 for carry flag.
32 bits Clockwise rotation	$\text{DROR } \boxed{D} \boxed{n}$	• D: Rotation data	$\text{DROR } \boxed{n}$	• Rotation data is set in A0, A1.
	$\text{DRCR } \boxed{D} \boxed{n}$	• D: Rotation data • Use SM700 for carry flag.	$\text{DRCR } \boxed{n}$	• Rotation data is set in A0, A1. • Use M9012 for carry flag.
32 bits Counterclockwise rotation	$\text{DROL } \boxed{D} \boxed{n}$	• D: Rotation data	$\text{DROL } \boxed{n}$	• Rotation data is set in A0, A1.
	$\text{DRCL } \boxed{D} \boxed{n}$	• D: Rotation data • Use SM700 for carry flag.	$\text{DRCL } \boxed{n}$	• Rotation data is set in A0, A1. • Use M9012 for carry flag.
16 bits Data search	$\text{SER } \boxed{S1} \boxed{S2} \boxed{D} \boxed{n}$	• Search result is stored in D, D + 1 device.	$\text{SER } \boxed{S1} \boxed{S2} \boxed{n}$	• Search result is stored in A0, A1.
32 bits Data search	$\text{DSER } \boxed{S1} \boxed{S2} \boxed{D} \boxed{n}$	• Search result is stored in D, D + 1 device.	$\text{DSER } \boxed{S1} \boxed{S2} \boxed{n}$	• Search result is stored in A0, A1.
16-bit data checks	$\text{SUM } \boxed{S} \boxed{D}$	• Check result is stored in D device.	$\text{SUM } \boxed{S}$	• Check result is stored in A0.
32-bit data checks	$\text{DSUM } \boxed{S} \boxed{D}$	• Check result is stored in D device.	$\text{DSUM } \boxed{S}$	• Check result is stored in A0.
Partial refresh	$\text{RFS } \boxed{D} \boxed{n}$	• Add dedicated instruction.	$\text{SEG } \boxed{D} \boxed{n}$	• Only when M9052 is on. ^{*1}
8-characters ASCII conversion	$\text{\$MOV } \text{(Character strings)} \boxed{D}$		$\text{ASC } \text{(Character strings)} \boxed{D}$	^{*2}
Carry flag set	$\text{SET } \boxed{\text{SM700}}$	• No dedicated instruction	STC	^{*2}
Carry flag reset	$\text{RST } \boxed{\text{SM700}}$	• No dedicated instruction	CLC	^{*2}
Jump to the END instruction	GOEND	• Add dedicated instruction.	$\text{CJ } \boxed{\text{P255}}$	• P255: END instruction specification ^{*2}

*1 Deleting or adjusting is required, since it becomes the instruction of different function.

*2 Converted to "SM1255" as inconvertible instruction.

7.7.9 AnUSCPU dedicated instruction

(1) Display method of dedicated instruction

The dedicated instructions for the AnUSCPU using LEDA, LEDB, LEDC, SUB, and LEDR instructions are changed into instructions in the same format as basic instructions and application instructions for the LCPU.

The instruction that conversion is not performed because the corresponding instructions to LCPU/ QnASCPU are not supported is converted into OUT SM1255.

Replace or delete instructions that has been converted to the OUT SM1255.

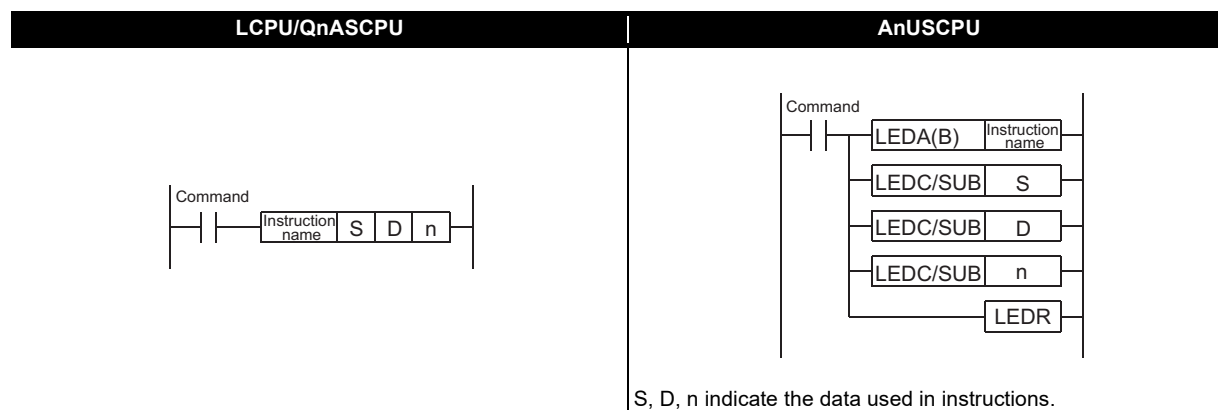

(2) Dedicated instruction with changed instruction name

For the AnUSCPU, some instruction names are the same as the basic instructions/application instructions. Those names have been changed for the LCPU/QnASCPU.

Function	QnAS/LCPU	AnUSCPU
Floating decimal point addition	E+	ADD
Floating decimal point subtraction	E-	SUB
Floating decimal point multiplication	E*	MUL
Floating decimal point division	E/	DIV
Data dissociation	NDIS	DIS
Data linking	NUNI	UNI

7.7.10 Setting method when multiple sequence programs are created

For the AnSCPU, when a main program including SFC program is replaced for the LCPU, the programs are separated into different programs.

For the separated programs in the LCPU, the Program setting of the parameter setting is required.

This section provides precautions on settings after replacement including program settings.

(1) Program files at replacement

(a) When main program contains SFC program

For the AnSCPU, the SFC program operates as the microcomputer program of main program. Since the LCPU deals the SFC program as one program, the SFC program is converted to "MAIN-SFC". Accordingly, two separate programs are created when the A series CPU module is converted; "MAIN", converted from main program, and "MAIN-SFC".

Register in the order of MAIN, MAIN-SFC in the Program setting of the parameter setting of GX Developer, and set all execution types to "Scan".

For precautions of replacing from the AnSCPU SFC (MELSAP-II) to the LCPU (MELSAP3), refer to Section 7.6.

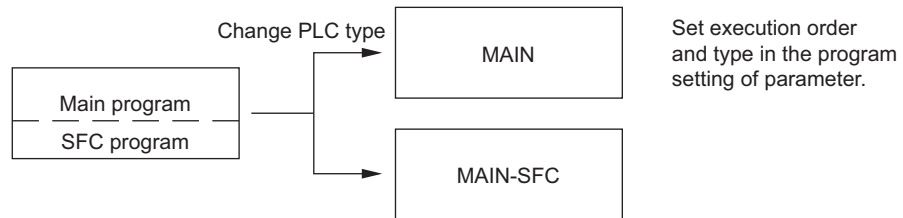

(2) Program setting of GX Developer

The following explains required program settings for executing multiple programs.

The execution type of program is set in Program setting of the PLC parameter setting of GX Developer. CPU module executes the programs of the specified execution type in the setting order.

The screenshot shows the 'L parameter setting' dialog box. It features a table with columns for 'Program name', 'Execute type', 'Fixed scan interval', and 'In unit'. The table contains three rows of data:

Program name	Execute type	Fixed scan interval	In unit
PROGRAM3	Fixed scan	400 ms	
PROGRAM2	Wait		
PROGRAM1	Scan		

Arrows labeled (a), (b), (b) 5, and (b) 5 point to the 'Program name' column, the 'Execute type' column, the 'Fixed scan interval' column, and the 'In unit' column respectively. A note on the right states: 'Programs are executed in selected sequence'.

(a) Program name

Set a name for a program to be executed with a CPU module.

(b) Execution type

Select the execution type of files set in the program name.

1) Initial execution type (Initial)

This type of programs is executed only one time, when switching the power supply from OFF to ON or STOP status to RUN status.

2) Scan execution type (Scan)

This type of programs is executed every scan, after having executed the initial execution type program.

3) Stand-by type (Wait)

This type of program is executed only when demanded.

4) Fixed scan execution type (Fixed scan)

This type of program is executed per interval set in the "Fixed scan interval" and "In unit".

- Fixed cycle interval

Sets the program execution interval of fixed execution type program.

Setting range depends on the unit set in the fixed scan interval.

- For "ms": 0.5 to 999.5ms (0.5ms unit)

- For "s": 1 to 60s (1s unit)

- Unit

Selects the unit ("ms" or "s") for the fixed scan interval.

7.7.11 Precautions for file register replacement

This section provides precautions for replacing the AnSCPU or QnASCPU using file registers with the LCPU.

	AnSCPU	QnASCPU	LCPU
Storage destination	Built-in RAM	Memory card (Max. 1 card, 2 drives)	Standard RAM
Maximum number of points	Depending on the memory capacity built in the CPU in use	1018K points (When using 2M memory cards)	Standard RAM: Max. 384K points (Depending on CPU model)
Number of points for one block	8K points	32K points	32K points

(1) Changing storage destination after replacement

(a) Changing storage destination after replacement of the AnSCPU

The value whose capacity has been set with the parameter of AnSCPU is not converted, since the storage destination is different.

Set the storage destination and capacity (points) in the file setting of the PLC parameter setting.

Select "Use the following file" when setting the storage destination.

Selecting "Use the following file" makes the file equivalent to the AnSCPU.

(b) Changing storage destination after replacement of the QnASCPU

Drive number for storing file registers differs between the QnASCPU and LCPU.

As the drive which stores file registers, the standard RAM is fixed.

(2) Number of points for one block

(a) Number of points for one block after replacement of the AnSCPU

For the AnSCPU with the extension file registers, the number of points for one block is 8k points.

For the LCPU, the number of points for one block is in increments of 32K points.

(b) Number of points for one block after replacement of the QnASCPU

Definition of file register capacity is the same for the QnASCPU and LCPU.

When the maximum number of points are the same, program adjustment for file registers is not required.

7.7.12 Boot run method (Writing programs to ROM)

The ROM operation of the AnSCPU corresponds to the boot run of the LCPU. The overview of the boot run is explained below. For details, refer to the MELSEC-L CPU Module User's Manual (Function Explanation, Program Fundamentals).

(1) LCPU boot operation procedure

Because the program memory of the LCPU is flash ROM, boot operation is not needed.

(The data written to files are not erased even if a battery error occurs.)

However, boot operation from an SD memory card is possible.

For the procedure of the boot operation using an SD memory card, refer to the following:

Procedure 1: Configure the boot file settings.

Set the names of the files to be booted to the program memory in the Boot file tab of the PLC parameter window.

Procedure 2: Mount the memory card.

Mount the memory card to the CPU module.

Procedure 3: Write data to the memory card.

Write the parameters and programs set in the Boot file tab to the memory card.

Procedure 4: Execute the program.

Set the RUN/STOP/RESET switch to reset.

The BOOT LED turns on after a boot from the specified memory is completed.

APPENDICES

Appendix 1 External Dimensions

For the external dimensions of each module described in this handbook, refer to the user's manual of each module.

Appendix 2 Spare Parts Storage

- (1) The general specifications of programmable controllers are as follows. Please do not store spare parts under a high temperature or high humidity condition, even within the range guaranteed by the specifications.

Storage ambient temperature	-20 to 75°C
Storage ambient humidity	10 to 90%, no condensation

- (2) Store in a place avoiding direct sunlight.
- (3) Store under condition with less dust or no corrosive gas.
- (4) The battery capacity of an A6BAT battery or a lithium-coin battery (commercially available) for memory card will be decreased by its self-discharging even when not used. Replace it with new one in 5 years as a guideline.
- (5) For a power supply module, CPU module with built-in power supply, or analog module that use any aluminum electrolytic capacitor, which is indicated in the table below, take the following measures since the characteristics will be deteriorated when the aluminum electrolytic capacitor is left un-energized for a long time.

Product	Model (AnS series)
CPU module (Power supply built-in type)	A1SJHCPU
Power supply module	A1S61PN, A1S62PN, A1S63P
Analog module	A1S64AD, A1S68AD, A1S62DA, A1S68DAI, A1S68DAV, A1S63ADA, A1S66ADA

[Countermeasures for preventing aluminum electrolytic capacitor characteristics deterioration]

Apply the rated voltage to the aluminum electrolytic capacitor for several hours once a year to activate it, or rotate products at the periodic inspection (in every 1 year or two).

[Reference]

The life of an aluminum electrolytic capacitor, even if not used, under a normal temperature decreases approximately at 1/4 speed of the case when it is energized.

Appendix 3 Relevant Manuals

Appendix 3.1 Replacement handbooks

(1) Transition guides

No.	Manual name	Manual number	Model code
1	MELSEC-A/QnA Series Transition Guide	L08077E	-
2	MELSEC-AnS/QnAS (Small Type) Series Transition Guide	L08236E	-

(2) Transition handbooks

No.	Manual name	Manual number	Model code
1	Transition from MELSEC-AnS/QnAS (Small Type) Series to L Series Handbook (Fundamentals)	L08258ENG	-
2	Transition from MELSEC-AnS/QnAS (Small Type) Series to L Series Handbook (Intelligent Function Modules)	L08259ENG	-
3	Transition from MELSEC-AnS/QnAS (Small Type) Series to L Series Handbook (Network Modules)	L08260ENG	-
4	Transition from MELSEC-AnS/QnAS (Small Type) Series to L Series Handbook (Communications)	L08261ENG	-
5	Transition from MELSEC-A0J2H Series to Q Series Handbook	L08060ENG	-
6	Transition from MELSECNET/MINI-S3, A2C(I/O) to CC-Link Handbook	L08061ENG	-
7	Transition from MELSEC-I/OLINK to CC-Link/LT Handbook	L08062ENG	-
8	Transition from MELSEC-I/OLINK to AnyWire DB A20 Handbook	L08263ENG	-
9	Transition of CPUs in MELSEC Redundant System Handbook (Transition from Q4ARCPU to QnPRHCPU)	L08117ENG	-

(3) Transition examples manual

No.	Manual name	Manual number	Model code
1	MELSEC-A/QnA (Large), AnS/QnAS (Small) Transition Examples	L08121E	-

(4) Others

No.	Manual name	Manual number	Model code
1	Procedures for Replacing Positioning Module AD71 with QD75	FA-A-0060	-

Appendix 3.2 AnS series manuals

No.	Manual name	Manual number	Model code
1	Type A1S/A1SC24-R2/A2SCPU(S1) User's Manual	IB-66320	13J672
2	Type A1SJH(S8)/A1SH/A2SHCPU (S1) User's Manual	IB-66779	13JL22
3	Type A2USCPU(S1) User's Manual	IB-66536	13JE78
4	Type A2USHCPU-S1/A2USCPU(S1)/A2ASCPU(S1/S30) User's Manual	IB-66789	13JL30
5	Model Q2AS(H)CPU (S1) User's Manual	SH-3599	13J858
6	Type ACPU/QCPU-A (A Mode) (Fundamentals) Programming Manual	IB-66249	13J740
7	Type ACPU/QCPU-A (A Mode) (Common Instructions) Programming Manual	IB-66250	13J741
8	Type AnSHCPU/AnACPU/AnUCPU/QCPU-A (A Mode) Programming Manual (Dedicated Instructions)	IB-66251	13J742
9	Type AnACPU/AnUCPU/QCPU-A (A mode) Programming Manual (PID Control Instructions)	IB-66258	13J744
10	Type MELSAP-II(SFC) Programming Manual	IB-66361	13JF40
11	QnACPU Programming Manual (Fundamentals)	IB-66614	13JF46
12	QnACPU Programming Manual (Special Function Module)	SH-4013	13JF56
13	QCPU(Q Mode)/QnACPU Programming Manual (Common Instructions)	SH-080039	13JF58
14	QCPU(Q Mode)/QnACPU Programming Manual (PID Control Instructions)	SH-080040	13JF59
15	QCPU(Q Mode)/QnACPU Programming Manual (SFC)	SH-080041	13JF60
16	I/O module type Building block User's Manual	IB-66140	13J643
17	Computer Link Module (Com.link func./Print. func.) User's Manual	SH-3511	13JF77
18	Serial Communications Module User's Manual (Modem Function Additional Version)	SH-66612	13J825
19	For A Ethernet Interface Module User's Manual	SH-080192	13JR45
20	For QnA Ethernet Interface Module User's Manual	SH-080146	13JR33
21	Type A1SD51S Intelligent communication module User's Manual	IB-66551	13JE90
22	AD51H-BASIC Programming Manual (Debug and Compile)	SH-080091	13JF64
23	AD51H-BASIC Programming Manual (Command)	SH-080090	13JF63
24	Serial communication compatible with MODBUS type AJ71UC24-S2/A1SJ71UC24-R2-S2/A1SJ71UC24-R4-S2 User's Manual	IB-66583	13J806
25	Model AJ71DN91/A1SJ71DN91 DeviceNet Master Module User's Manual	SH-4004	13JL69
26	PROFIBUS-DP Interface Module Type AJ71PB92D/A1SJ71PB92D User's Manual	IB-66773	13JL20
27	PROFIBUS-DP Slave Module Type A1SJ71PB93D User's Manual	SH-080195	13JR47
28	Control & Communication Link System Master/Local Module Type AJ61BT11/A1SJ61BT11 User's Manual	IB-66721	13J872
29	Control & Communication Link System Master/Local Module type AJ61QBT11/A1SJ61QBT11 User's Manual	IB-66722	13J873
30	A/D converter module type A1S64AD User's Manual	IB-66336	13J676
31	Analog-Digital Converter Module type A1S68AD User's Manual	IB-66576	13J757
32	D/A converter module type A1S62DA User's Manual	IB-66335	13J673
33	Digital-Analog Converter Module Type A1S68DAV/DAI User's Manual	IB-66587	13J810
34	Thermocouple input module type A1S68TD User's Manual	IB-66571	13J781
35	Type A68RD3N/4N,A1S62RD3N/4N Pt100 Input Module User's Manual	SH-080193	13JR46
36	A1S62TCTT-S2 Heating-Cooling Temperature Control Module A1S62TCTTBW-S2 Heating-Cooling Temperature Control Module with Wire Breakage Detection Function User's Manual	SH-3643	13JL35
37	A1S62TCRT-S2 Heating-Cooling Temperature Control Module A1S62TCRTBW-S2 Heating-Cooling Temperature Control Module with Wire Breakage Detection Function User's Manual	SH-3644	13JL36

No.	Manual name	Manual number	Model code
38	Temperature Control Module Type A1S64TCTRT/Temperature Control Module with Disconnection Detection Function Type A1S64TCTRTBW User's Manual	SH-080549ENG	13JR79
39	A1S64TCRT-S1 Temperature Control Module A1S64TCRTBW-S1 Temperature Control Module with Disconnection Detection Function User's Manual	IB-66756	13JL03
40	A1S64TCTT-S1 Temperature Control Module/A1S64TCTTBW-S1 Temperature Control Module with Disconnection Detection Function User's Manual	IB-66747	13J891
41	Positioning module type A1SD70 User's Manual	IB-66367	13JE04
42	A1SD75M1/M2/M3, AD75M1/M2/M3 Positioning module User's Manual	IB-66715	13J870
43	A1SD75P1-S3/P2-S3/P3-S3, AD75P1-S3/P2-S3/P3-S3 Positioning Module User's Manual	IB-66716	13J871
44	Type A1S62LS User's Manual	IB-66647	13J837
45	High speed counter module type A1SD61 User's Manual	IB-66337	13J674
46	High speed counter module Type A1SD62, A1SD62E, A1SD62D(S1) User's Manual	IB-66593	13J816
47	Pulse catch module type A1SP60 (Hardware) User's Manual	IB-66477	13JE61
48	Analog timer module type A1ST60 (Hardware) User's Manual	IB-66479	13JE57
49	Analog input/output module type A1S63ADA User's Manual	IB-66435	13JE30
50	Analog Input/Output Module Type A1S66ADA User's Manual	IB-66819	13JL41
51	MELSECNET/MINI-S3 Master Module Type AJ71PT32-S3, AJ71T32-S3, A1SJ71PT32-S3, A1SJ71T32-S3 User's Manual	IB-66565	13JE64
52	AS-i Master module type A1SJ71AS92 User's Manual	SH-080085	13JR15
53	A1SD59J-S2/MIF Memory Card Interface Module User's Manual	SH-080056	13JR05

Appendix 3.3 L series manuals

No.	Manual name	Manual number	Model code
1	MELSEC Consolidated Catalog	L08322ENG	—
2	MELSEC-L CPU Module User's Manual (Function Explanation, Program Fundamentals)	SH-080889ENG	13JZ35
3	MELSEC-L CPU Module User's Manual (Hardware Design, Maintenance and Inspection)	SH-080890ENG	13JZ36
4	MELSEC-L CPU Module User's Manual (Built-In Ethernet Function)	SH-080891ENG	13JZ37
5	MELSEC-L CPU Module User's Manual (Built-In I/O Function)	SH-080892ENG	13JZ38
6	QnUDVCPULCPU User's Manual (Data Logging Function)	SH-080893ENG	13JZ39
7	MELSEC-Q/L Programming Manual (Common Instruction)	SH-080809ENG	13JW10
8	MELSEC-Q/L/QnA Programming Manual (SFC)	SH-080041	13JF60
9	MELSEC-Q/L Programming Manual (MELSAP-L)	SH-080076	13JF61
10	MELSEC-Q/L Programming Manual (Structured Text)	SH-080366E	13JF68
11	MELSEC-Q/L/QnA Programming Manual (PID Control Instructions)	SH-080040	13JF59
12	MELSEC-L I/O Module User's Manual	SH-080888ENG	13JZ34
13	MELSEC-L Analog-Digital Converter Module User's Manual (L60AD4, L60ADVL8, L60ADIL8)	SH-080899ENG	13JZ42
14	MELSEC-L Dual Channel Isolated High Resolution Analog-Digital Converter Module User's Manual (L60AD4-2GH)	SH-081103ENG	13JZ72
15	MELSEC-L Digital-Analog Converter Module User's Manual (L60DA4, L60DAVL8, L60DAIL8)	SH-080900ENG	13JZ43
16	MELSEC-L Analog Input/Output Module User's Manual (L60AD2DA2)	SH-081167ENG	13JZ87
17	MELSEC-L Temperature Control Module User's Manual (L60TCTT4, L60TCTTBW, L60TCRT4, L60TCRTBW)	SH-081000ENG	13JZ64
18	MELSEC-L High-Speed Counter Module User's Manual (LD62, LD62D)	SH-080920ENG	13JZ49
19	MELSEC-L LD75P/LD75D Positioning Module User's Manual (LD75P1, LD75P2, LD75P4, LD75D1, LD75D2, LD75D4)	SH-080911ENG	13JZ46
20	MELSEC-L Serial Communication Module User's Manual (Basic) (LJ71C24, LJ71C24-R2)	SH-080894ENG	13JZ40
21	MELSEC-Q/L Serial Communication Module User's Manual (Application) (QJ71C24N, QJ71C24N-R2, QJ71C24N-R4, QJ71C24, QJ71C24-R2, QJ71CMON, QJ71CMO, LJ71C24, LJ71C24-R2)	SH-080007	13JL87
22	MELSEC-Q/L MELSEC Communication Protocol Reference Manual (QJ71C24N, QJ71C24N-R2, QJ71C24N-R4, QJ71C24, QJ71C24-R2, QJ71E71-100, QJ71E71-B5, QJ71E71-B2, QJ71CMON, QJ71CMO, LJ71C24, LJ71C24-R2, LJ71E71-100)	SH-080008	13JF89
23	MELSEC-L Ethernet Interface Module User's Manual (Basic) (LJ71E71-100)	SH-081105ENG	13JZ73
24	MELSEC-Q/L Ethernet Interface Module User's Manual (Web function) (QJ71E71-100, QJ71E71-B5, QJ71E71-B2, LJ71E71-100)	SH-080180	13JR40
25	MELSEC-Q/L Ethernet Interface Module User's Manual (Application) (QJ71E71-100, QJ71E71-B5, QJ71E71-B2, LJ71E71-100)	SH-080010	13JL89
26	MELSEC-L CC-Link System Master/Local Module User's Manual (L26CPU-BT, L26CPU-PBT, LJ61BT11)	SH-080895ENG	13JZ41
27	MELSEC-L CC-Link/LT Master Module User's Manual (LJ61CL12)	SH-081012ENG	13JZ65
28	MELSEC-L LA1S Extension Base Unit User's Manual (LA1S65B, LA1S68B, LA1S51B)	IB-0800541	13J297
29	MELSECNET, MELSECNET/B Local Station Data Link Module User's Manual (A1SJ71AP23Q, A1SJ71AR23Q, A1SJ71AT23BQ)	SH-080670ENG	13JR98

Appendix 3.4 Programming tool manuals

No.	Manual name	Manual number	Model code
1	GX Works2 Version 1 Operating Manual (Common)	SH-080779ENG	13JU63
2	GX Works2 Version 1 Operating Manual (Intelligent Function Module)	SH-080921ENG	13JU69
3	GX Developer Version 8 Operating Manual	SH-080373E	13JU41

WARRANTY

Please confirm the following product warranty details before using this product.

1. Gratis Warranty Term and Gratis Warranty Range

If any faults or defects (hereinafter "Failure") found to be the responsibility of Mitsubishi occurs during use of the product within the gratis warranty term, the product shall be repaired at no cost via the sales representative or Mitsubishi Service Company.

However, if repairs are required onsite at domestic or overseas location, expenses to send an engineer will be solely at the customer's discretion. Mitsubishi shall not be held responsible for any re-commissioning, maintenance, or testing on-site that involves replacement of the failed module.

[Gratis Warranty Term]

The gratis warranty term of the product shall be for one year after the date of purchase or delivery to a designated place. Note that after manufacture and shipment from Mitsubishi, the maximum distribution period shall be six (6) months, and the longest gratis warranty term after manufacturing shall be eighteen (18) months. The gratis warranty term of repair parts shall not exceed the gratis warranty term before repairs.

[Gratis Warranty Range]

- (1) The range shall be limited to normal use within the usage state, usage methods and usage environment, etc., which follow the conditions and precautions, etc., given in the instruction manual, user's manual and caution labels on the product.
- (2) Even within the gratis warranty term, repairs shall be charged for in the following cases.
 1. Failure occurring from inappropriate storage or handling, carelessness or negligence by the user. Failure caused by the user's hardware or software design.
 2. Failure caused by unapproved modifications, etc., to the product by the user.
 3. When the Mitsubishi product is assembled into a user's device, Failure that could have been avoided if functions or structures, judged as necessary in the legal safety measures the user's device is subject to or as necessary by industry standards, had been provided.
 4. Failure that could have been avoided if consumable parts (battery, backlight, fuse, etc.) designated in the instruction manual had been correctly serviced or replaced.
 5. Failure caused by external irresistible forces such as fires or abnormal voltages, and Failure caused by force majeure such as earthquakes, lightning, wind and water damage.
 6. Failure caused by reasons unpredictable by scientific technology standards at time of shipment from Mitsubishi.
 7. Any other failure found not to be the responsibility of Mitsubishi or that admitted not to be so by the user.

2. Onerous repair term after discontinuation of production

- (1) Mitsubishi shall accept onerous product repairs for seven (7) years after production of the product is discontinued. Discontinuation of production shall be notified with Mitsubishi Technical Bulletins, etc.
- (2) Product supply (including repair parts) is not available after production is discontinued.

3. Overseas service

Overseas, repairs shall be accepted by Mitsubishi's local overseas FA Center. Note that the repair conditions at each FA Center may differ.

4. Exclusion of loss in opportunity and secondary loss from warranty liability

Regardless of the gratis warranty term, Mitsubishi shall not be liable for compensation to:

- (1) Damages caused by any cause found not to be the responsibility of Mitsubishi.
- (2) Loss in opportunity, lost profits incurred to the user by Failures of Mitsubishi products.
- (3) Special damages and secondary damages whether foreseeable or not, compensation for accidents, and compensation for damages to products other than Mitsubishi products.
- (4) Replacement by the user, maintenance of on-site equipment, start-up test run and other tasks.

5. Changes in product specifications

The specifications given in the catalogs, manuals or technical documents are subject to change without prior notice.

Ethernet is a registered trademark of Fuji Xerox Co., Ltd. in Japan.

Microsoft and Windows are either registered trademarks or trademarks of Microsoft Corporation in the United States and/or other countries.

Unicode is either a registered trademark or a trademark of Unicode, Inc. in the United States and other countries.

The company names, system names and product names mentioned in this manual are either registered trademarks or trademarks of their respective companies.

In some cases, trademark symbols such as '™' or '®' are not specified in this manual.

Programmable Controller

Country/Region	Sales office	Tel/Fax
USA	MITSUBISHI ELECTRIC AUTOMATION, INC. 500 Corporate Woods Parkway, Vernon Hills, IL 60061, U.S.A.	Tel : +1-847-478-2100 Fax : +1-847-478-2253
Mexico	MITSUBISHI ELECTRIC AUTOMATION, INC. Mexico Branch Mariano Escobedo #69, Col. Zona Industrial, Tlalnepantla Edo. Mexico, C.P.54030	Tel : +52-55-3067-7500
Brazil	MITSUBISHI ELECTRIC DO BRASIL COMÉRCIO E SERVIÇOS LTDA. Avenida Adelino Cardana, 293, 21 andar, Bethaville, Barueri SP, Brazil	Tel : +55-11-4689-3000 Fax : +55-11-4689-3016
Germany	MITSUBISHI ELECTRIC EUROPE B.V. German Branch Mitsubishi-Electric-Platz 1, 40882 Ratingen, Germany	Tel : +49-2102-486-0 Fax : +49-2102-486-1120
UK	MITSUBISHI ELECTRIC EUROPE B.V. UK Branch Travellers Lane, Hatfield, Hertfordshire, AL10 8XB, U.K.	Tel : +44-1707-28-8780 Fax : +44-1707-27-8695
Ireland	MITSUBISHI ELECTRIC EUROPE B.V. Irish Branch Westgate Business Park, Ballymount, Dublin 24, Ireland	Tel : +353-1-4198800 Fax : +353-1-4198890
Italy	MITSUBISHI ELECTRIC EUROPE B.V. Italian Branch Centro Direzionale Colleoni-Palazzo Sirio Viale Colleoni 7, 20864 Agrate Brianza(Milano) Italy	Tel : +39-039-60531 Fax : +39-039-6053-312
Spain	MITSUBISHI ELECTRIC EUROPE, B.V. Spanish Branch Carretera de Rubí, 76-80-Apdo. 420, 08190 Sant Cugat del Vallés (Barcelona), Spain	Tel : +34-935-65-3131 Fax : +34-935-89-1579
France	MITSUBISHI ELECTRIC EUROPE B.V. French Branch 25, Boulevard des Bouvets, 92741 Nanterre Cedex, France	Tel : +33-1-55-68-55-68 Fax : +33-1-55-68-57-57
Czech Republic	MITSUBISHI ELECTRIC EUROPE B.V. Czech Branch Avenir Business Park, Radlicka 751/113e, 158 00 Praha5, Czech Republic	Tel : +420-251-551-470 Fax : +420-251-551-471
Poland	MITSUBISHI ELECTRIC EUROPE B.V. Polish Branch ul. Krakowska 50, 32-083 Balice, Poland	Tel : +48-12-347-65-00 Fax : +48-12-630-47-01
Sweden	MITSUBISHI ELECTRIC EUROPE B.V. (Scandinavia) Fjellievägen 8, SE-22736 Lund, Sweden	Tel : +46-8-625-10-00 Fax : +46-46-39-70-18
Russia	MITSUBISHI ELECTRIC (RUSSIA) LLC St. Petersburg Branch Piskarevsky pr. 2, bld 2, lit "Sch", BC "Benuea", office 720; 195027 St. Petersburg, Russia	Tel : +7-812-633-3497 Fax : +7-812-633-3499
Turkey	MITSUBISHI ELECTRIC TURKEY A.Ş Ümraniye Branch Serifali Mah. Kale Sok. No:41 34775 Umraniye - Istanbul, Turkey	Tel : +90-216-969-2500 Fax : +90-216-526-3995
UAE	MITSUBISHI ELECTRIC EUROPE B.V. Dubai Branch Dubai Silicon Oasis, P.O.BOX 341241, Dubai, U.A.E.	Tel : +971-4-3724716 Fax : +971-4-3724721
South Africa	ADROIT TECHNOLOGIES 20 Waterford Office Park, 189 Witkoppen Road, Fourways, South Africa	Tel : +27-11-658-8100 Fax : +27-11-658-8101
China	MITSUBISHI ELECTRIC AUTOMATION (CHINA) LTD. No.1386 Hongqiao Road, Mitsubishi Electric Automation Center, Shanghai, China	Tel : +86-21-2322-3030 Fax : +86-21-2322-3000
Taiwan	SETSUYO ENTERPRISE CO., LTD. 6F, No.105, Wugong 3rd Road, Wugu District, New Taipei City 24889, Taiwan	Tel : +886-2-2299-2499 Fax : +886-2-2299-2509
Korea	MITSUBISHI ELECTRIC AUTOMATION KOREA CO., LTD. 7F-9F, Gangseo Hangang Xi-tower A, 401, Yangcheon-ro, Gangseo-Gu, Seoul 07528, Korea	Tel : +82-2-3660-9530 Fax : +82-2-3664-8372
Singapore	MITSUBISHI ELECTRIC ASIA PTE. LTD. 307, Alexandra Road, Mitsubishi Electric Building, Singapore 159943	Tel : +65-6473-2308 Fax : +65-6476-7439
Thailand	MITSUBISHI ELECTRIC FACTORY AUTOMATION (THAILAND) CO., LTD. 12th Floor, SV.City Building, Office Tower 1, No. 896/19 and 20 Rama 3 Road, Kwaeng Bangpongpan, Khet Yannawa, Bangkok 10120, Thailand	Tel : +66-2682-6522 Fax : +66-2682-6020
Vietnam	MITSUBISHI ELECTRIC VIETNAM COMPANY LIMITED Hanoi Branch 6th Floor, Detech Tower, 8 Ton That Thuyet Street, My Dinh 2 Ward, Nam Tu Liem District, Hanoi, Vietnam	Tel : +84-4-3937-8075 Fax : +84-4-3937-8076
Malaysia	MITSUBISHI ELECTRIC SALES MALAYSIA SDN. BHD. Lot 11, Jalan 219, 46100 Petaling Jaya, Selangor Darul Ehsan, Malaysia	Tel : +60-3-7626-5000 Fax : +60-3-7658-3544
Indonesia	PT. MITSUBISHI ELECTRIC INDONESIA Gedung Jaya 11th Floor, JL. MH. Thamrin No.12, Jakarta Pusat 10340, Indonesia	Tel : +62-21-3192-6461 Fax : +62-21-3192-3942
India	MITSUBISHI ELECTRIC INDIA PVT. LTD. Pune Branch Emerald House, EL-3, J Block, M.I.D.C., Bhosari, Pune-411026, Maharashtra, India	Tel : +91-20-2710-2000 Fax : +91-20-2710-2100
Australia	MITSUBISHI ELECTRIC AUSTRALIA PTY. LTD. 348 Victoria Road, P.O. Box 11, Rydalmere, N.S.W 2116, Australia	Tel : +61-2-9684-7777 Fax : +61-2-9684-7245

MITSUBISHI ELECTRIC CORPORATION

HEAD OFFICE: TOKYO BUILDING, 2-7-3, MARUNOUCHI, CHIYODA-KU, TOKYO 100-8310, JAPAN
NAGOYA WORKS: 1-14, YADA-MINAMI 5, HIGASHI-KU, NAGOYA, JAPAN