



INVERTER

Plug-in option

FR-A8AX

INSTRUCTION MANUAL

16-bit digital input function

PRE-OPERATION INSTRUCTIONS	1
INSTALLATION	2
16-BIT DIGITAL INPUT	3

Safety instructions

Thank you for choosing this Mitsubishi Electric inverter plug-in option.

This Instruction Manual provides handling information and precautions for use of this product. Incorrect handling might cause an unexpected fault. Before using this product, read this Instruction Manual carefully to ensure proper use.

Please forward this Instruction Manual to the end user.

Do not attempt to install, operate, maintain or inspect this product until you have read this Instruction Manual and supplementary documents carefully. Do not use this product until you have a full knowledge of this product mechanism, safety information and instructions. In this Instruction Manual, the safety instruction levels are classified into "WARNING" and "CAUTION".

 **WARNING** Incorrect handling may cause hazardous conditions, resulting in death or severe injury.

 **CAUTION** Incorrect handling may cause hazardous conditions, resulting in medium or slight injury, or may cause only material damage.

Note that even the  **CAUTION** level may lead to a serious consequence depending on conditions. Be sure to follow the instructions of both levels as they are critical to personnel safety.

◆ Electric shock prevention

WARNING

- Do not remove the front cover or the wiring cover of the inverter while the inverter power is ON, and do not operate the inverter with the front cover or the wiring cover removed as the exposed high voltage terminals or the charging part of the circuitry can be touched. Doing so may cause an electric shock.
 - Even if power is OFF, do not remove the front cover of the inverter except for wiring or periodic inspection as the inside of the inverter is charged. Doing so may cause an electric shock.
 - Before wiring or inspection, check that the display of the inverter operation panel is OFF. Any person who is involved in wiring or inspection shall wait for 10 minutes or longer after the power supply has been cut off, and check that there are no residual voltage using a digital multimeter or the like. The capacitor is charged with high voltage for some time after power OFF, and it is dangerous.
 - Any person who is involved in wiring or inspection of this product shall be fully competent to do the work.
 - This product must be installed before wiring. Otherwise you may get an electric shock or be injured.
 - Do not touch this product or handle the cables with wet hands. Doing so may cause an electric shock.
 - Do not subject the cables to scratches, excessive stress, heavy loads or pinching. Doing so may cause an electric shock.
-

◆ Injury prevention

CAUTION

- The voltage applied to each terminal must be as specified in the Instruction Manual. Otherwise an explosion or damage may occur.
 - The cables must be connected to the correct terminals. Otherwise an explosion or damage may occur.
 - The polarity (+ and -) must be correct. Otherwise an explosion or damage may occur.
 - While power is ON or for some time after power OFF, do not touch the inverter as it will be extremely hot. Doing so may cause burns.
-

◆ Additional instructions

The following instructions must be also followed. If this product is handled incorrectly, it may cause unexpected fault, an injury, or an electric shock.

CAUTION

Transportation and installation

- Do not install or operate this product if it is damaged or has parts missing.
- Do not stand or place heavy objects on this product.
- Ensure the mounting orientation of this product is correct.
- Foreign conductive objects must be prevented from entering the inverter. That includes screws and metal fragments or flammable substance such as oil.
- If halogens (including fluorine, chlorine, bromine, and iodine) contained in fumigants for wood packages enter this product, the product may be damaged. Prevent the entry of fumigant residuals or use an alternative method such as heat disinfection. Note that sterilization or disinfection of wood packages should be performed before packing the product.

Test operation

- Before starting operation, confirm or adjust the parameter settings. Failure to do so may cause some machines to make unexpected motions.
-
-

WARNING

Usage

- Do not modify this product.
 - Do not remove any part which is not instructed to be removed in the Instruction Manuals. Doing so may lead to a failure or damage of this product.
-

CAUTION

Usage

- As all parameters return to their initial values after Parameter clear or All parameter clear is performed, the parameters must be set again as required before the operation is started.
- To avoid damage to this product due to static electricity, static electricity in your body must be discharged before you touch this product.

Maintenance, inspection and parts replacement

- Do not carry out a megger (insulation resistance) test.

Disposal

- This product must be treated as industrial waste.
-
-

General instruction

- For clarity, illustrations in this Instruction Manual may be drawn with covers or safety guards removed. Ensure all covers and safety guards are properly installed prior to starting operation.
-



— CONTENTS —

Safety instructions	2
<hr/>	
1 PRE-OPERATION INSTRUCTIONS	7
<hr/>	
1.1 Unpacking and checking the product.....	7
1.1.1 Product confirmation	7
1.2 Component names	8
1.3 Specifications	9
2 INSTALLATION	10
<hr/>	
2.1 Pre-installation instructions	10
2.2 Installation procedure	11
2.3 Wiring.....	15
3 16-BIT DIGITAL INPUT	19
<hr/>	
3.1 Connection diagram	19
3.2 Terminals.....	21
3.3 Code input example.....	22
3.4 Parameter list.....	23
3.5 Setting the parameter.....	24
3.5.1 Selection of input method (Pr.304)	24
3.5.2 Read timing operation selection (Pr.305)	25
3.5.3 Bias and gain adjustment (Pr.300 to Pr.303).....	27
3.5.4 Digital input unit selection (Pr.329).....	29
3.5.5 16-bit digital torque command (FR-A800 series only).....	31
3.6 Precautions	34

APPENDIX	35
Appendix 1 Instructions for compliance with the EU Directives	35
Appendix 2 Instructions for EAC	36
Appendix 3 Restricted Use of Hazardous Substances in Electronic and Electrical Products	37
Appendix 4 Referenced Standard (Requirement of Chinese standardized law)	38
Appendix 5 Regarding Directive on Waste Electrical and Electronic Equipment	39
Appendix 6 Compliance with the UK certification scheme	40
REVISIONS	43





1 PRE-OPERATION INSTRUCTIONS

1.1 Unpacking and checking the product

Take the plug-in option out of the package, check the product name, and confirm that the product is as you ordered and intact. This product is a plug-in option made for the FR-A800/F800 series.

1.1.1 Product confirmation

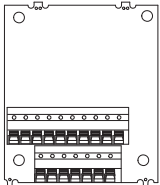
Check the enclosed items.

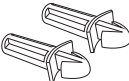
<p>Plug-in option: 1</p>  A technical drawing of a rectangular plug-in option. It features a top edge with two mounting holes, a bottom edge with two mounting holes, and a central section with two rows of pins. The top row has 10 pins, and the bottom row has 10 pins. There are also two circular holes on the left and right sides of the bottom edge.	<p>Mounting screws (M3 × 8 mm): 2 (Refer to page 11.)</p>  Two screws with a Phillips head and a hexagonal base, shown from different angles.	<p>Spacer: 2 (Refer to page 11.)</p>  Two L-shaped spacers, one shown from the side and one from the top-down perspective.
--	--	--

1.2 Component names

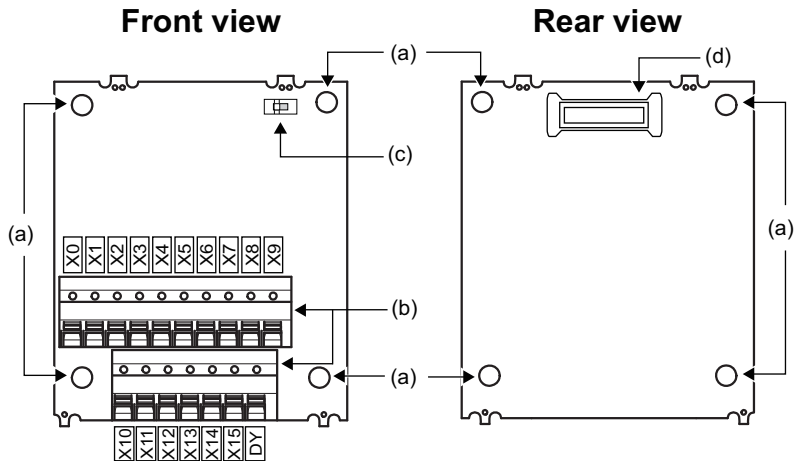

Symbol	Name	Description	Refer to page
a	Mounting hole	Used to fix this product to the inverter by inserting a mounting screw or a spacer.	11
b	Terminal block	Used for connecting devices to input signals to the inverter.	15
c	Switch for manufacturer setting	Switch for manufacturer setting. Do not change the initially-set status ().	—
d	Board mounted option connector	Used to connect this product to the option connector on the inverter.	11

1.3 Specifications

◆ **Types of digital input signals**

3-digit or 4-digit BCD code

12-bit or 16-bit binary

◆ **Selection of digital input signals**

On operation panel or parameter unit

◆ **Input current**

5 mA (24 VDC) ... Per circuit

◆ **Input specifications**

Relay contact signal or open collector input

◆ **Adjustment function**

- Bias and gain
- Analog compensation input (set on operation panel)

2 INSTALLATION

2.1 Pre-installation instructions

Check that the inverter's input power and the control circuit power are both OFF.

CAUTION

- Do not install or remove the plug-in option while the input power is ON. Doing so may damage the inverter or plug-in option.
 - To avoid damage due to static electricity, static electricity in your body must be discharged before you touch the product.
-

2.2 Installation procedure

1. Remove the inverter front cover. (Refer to Chapter 2 of the Instruction Manual (Detailed) of the inverter instructions for removing the front cover.)
2. Insert two spacers into the mounting holes that will not be used for mounting screws (see the diagrams on [page 12](#) to identify the holes).
3. Fit the board mounted option connector on this product to the guide of the option connector on the inverter, and insert the option as far as it goes.
4. Fasten this product to the inverter using the two mounting screws through the holes on either side (tightening torque 0.33 N·m to 0.40 N·m). If the screw holes do not line up, the connector may not be inserted deep enough. Check the connector.

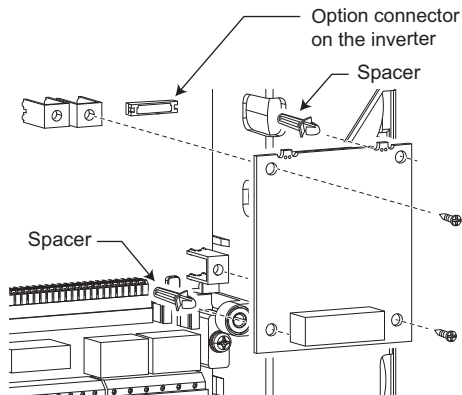

Example of installation to connector 1

◆ **Insertion positions of screws and spacers (RS-485 model)**

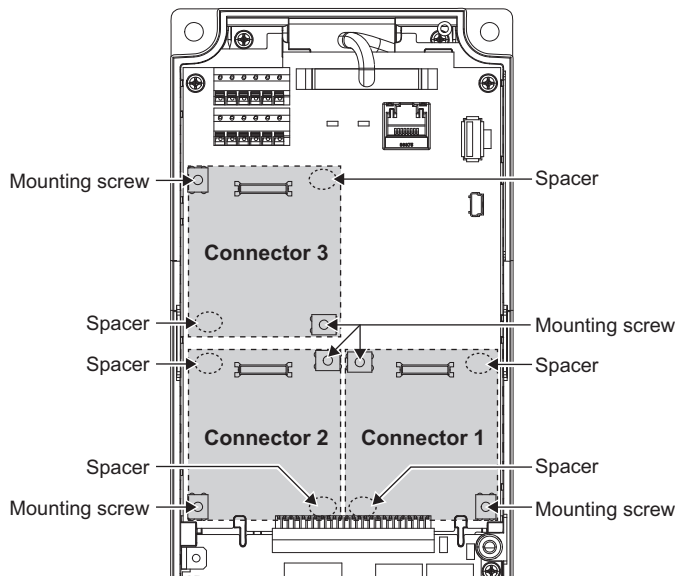

◆ Insertion positions of screws and spacers (Ethernet model)

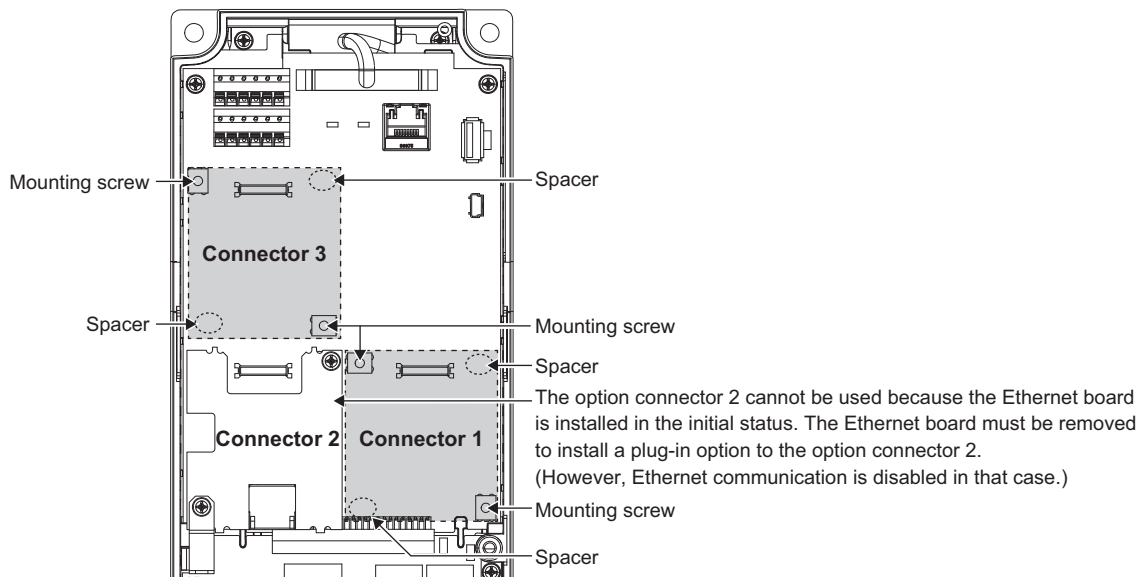

NOTE

- When installing/removing the plug-in option, hold the sides of the option. Do not press on the parts on the option circuit board. Stress applied to the parts by pressing, etc. may cause a failure.
- Be careful not to drop mounting screws during the installation or removal of the plug-in option.
- Only one option attached to the option connector with high priority can function at once if more than one option of the same name are installed together on an inverter. Priority is given to option connectors in descending order (1 to 3), and options having a lower priority do not function.
- When the inverter cannot recognize the option due to improper installation or any other reason, the protective function (E.1 to E.3) is activated and the inverter cannot be operated. The indication shown (when a fault occurs) depends on the connector used (option connector 1 to 3).

Mounted position	Fault indication
Option connector 1	E. 1
Option connector 2	E. 2
Option connector 3	E. 3

- When removing the plug-in option, remove the two screws on either side, and then pull it straight out. Pressure applied to the option connector and to the option board may break the option.

2.3 Wiring

1. For the wiring, strip off the sheath of a cable, and use it with a crimp terminal. For single wire, the stripped wire can be used without crimp terminal. Connect the end of wires (crimp terminal or stranded wire) to the terminal block.

Strip the signal wires as follows. If too much of the wire is stripped, a short circuit may occur with neighboring wires. If not enough of the wire is stripped, wires may become loose and fall out.

Twist the stripped end of wires to prevent them from fraying. Do not solder them.

Wire strip length

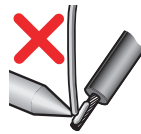
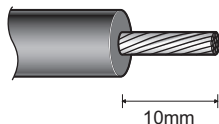

Crimp the terminals on the wire.

Insert the wire into a crimp terminal, making sure that 0 to 0.5 mm of the wire protrudes from the end of the sleeve. Check the condition of the crimp terminals after crimping. Do not use the crimp terminals of which the crimping is inappropriate, or the face is damaged.

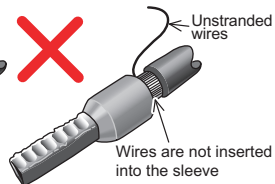
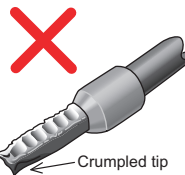
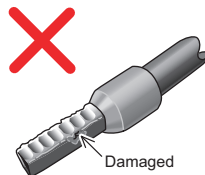
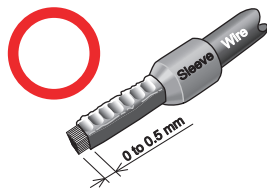

CAUTION

- After wiring, wire offcuts must not be left in the inverter. They may cause a fault, failure or malfunction.

Crimp terminals commercially available (as of October 2020. The product may be changed without notice.)

Wire gauge (mm ²)	Ferrule part No.			Manufacturer	Crimping tool model No.
	With insulation sleeve	Without insulation sleeve	For UL wire ^{*1}		
0.3	AI 0,34-10TQ	—	—	Phoenix Contact Co., Ltd.	CRIMPFOX 6
0.5	AI 0,5-10WH	—	AI 0,5-10WH-GB		
0.75	AI 0,75-10GY	A 0,75-10	AI 0,75-10GY-GB		
1	AI 1-10RD	A 1-10	AI 1-10RD/1000GB		
1.25, 1.5	AI 1,5-10BK	A 1,5-10	—		
0.75 (for two cables)	AI-TWIN 2 × 0,75-10GY	—	—		

*1 A ferrule terminal with an insulation sleeve compatible with the MTW wire which has a thick wire insulation.

Wire gauge (mm ²)	Blade terminal part No.	Insulation cap part No.	Manufacturer	Crimping tool model No.
0.3 to 0.75	BT 0.75-11	VC 0.75	NICHIFU Co., Ltd.	NH 69

- 2.** Insert the wire into the socket.
When using single wire or stranded wires without crimp terminal, push an open/close button all the way down with a flathead screwdriver, and insert the wire.

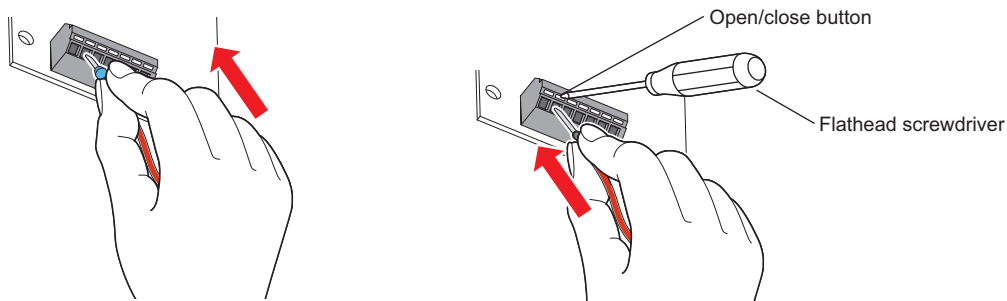

- Wire removal
Pull the wire while pushing the open/close button all the way down firmly with a flathead screwdriver.

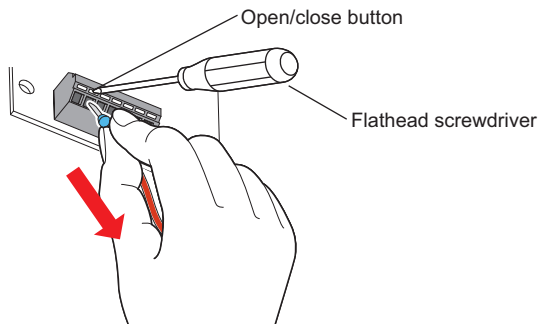

NOTE

- When using stranded wires without a crimp terminal, twist enough to avoid short circuit with a nearby terminals or wires.
- Pulling out the wire forcefully without pushing the open/close button all the way down may damage the terminal block.
- Use a small flathead screwdriver (tip thickness: 0.4 mm/tip width: 2.5 mm). If a flathead screwdriver with a narrow tip is used, terminal block may be damaged.

Commercially available products (as of October 2020. The product may be changed without notice.)

Product name	Model	Manufacturer
Screwdriver	SZF 0- 0,4 × 2,5	Phoenix Contact Co., Ltd.

- Place the flathead screwdriver vertical to the open/close button. In case the blade tip slips, it may cause an inverter damage or injury.
- When wiring cables to the inverter's RS-485 terminals while a plug-in option is mounted, take caution not to let the cables touch the circuit board of the option or of the inverter. Otherwise, electromagnetic noises may cause malfunctions.

3 16-BIT DIGITAL INPUT

3.1 Connection diagram

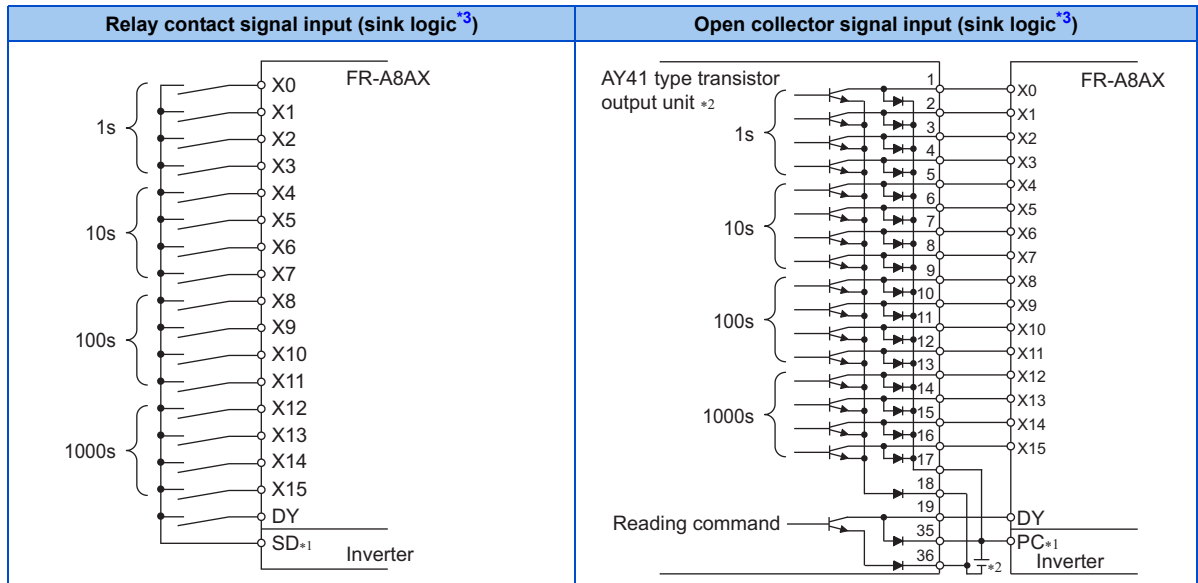

3

- *1 Use terminal SD or PC on the inverter.
- *2 AY41 type unit requires 24 VDC power.
Example of connection with the output module (AY41 type) of Mitsubishi Electric programmable controller. For details on the output module, refer to the Instruction Manual of the output module.
- *3 The control logic is the same as that of the inverter. When the logic of the inverter is changed, the option logic also changes. Refer to the Instruction Manual of the inverter for how to switch the control logic of the inverter.

NOTE

- As the input signals are at low level, use two parallel micro signal contacts or a twin contact for relay contact inputs to prevent a contact fault.

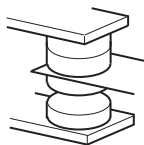

Micro signal contacts

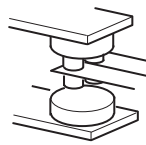

Twin contacts

- A transistor of the following specifications should be selected for the open collector signal:

Electrical characteristics of the transistor used

$I_c \geq 10 \text{ mA}$

Leakage current: 100 μA maximum

$V_{CE} \geq 30 \text{ V}$

$I_c \geq 10 \text{ mA}$, $V_{CE}(\text{sat})$ voltage is 3 V maximum

- Notes on descriptions in this Instruction Manual

Connection diagrams in this Instruction Manual appear with the control logic of the input terminals as sink logic, unless otherwise specified.

3.2 Terminals

- FR-A8AX

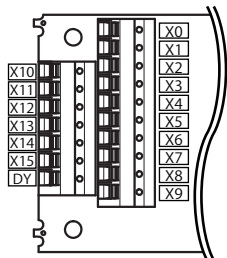

Terminal location	Terminal symbol	Description
Built-in option	X0 to X15	Digital signal input terminal (frequency setting / torque command signal terminal ^{*1}). Input the digital signal at the relay contact or open collector terminal. (Refer to page 19 .) For the digital signal input, choose either BCD code or binary. BCD code input is 3-digit (999 maximum) or 4-digit (9999 maximum). Binary input is 12-bit (X0 to X11, HFFF maximum) or 16-bit (X0 to X15, HFFFF maximum).
	DY	Data read timing input signal. Use when a digital signal read timing signal is necessary. When Pr.305 Read timing operation selection = "1", data is read only while the DY signal is ON. In addition, the X0 to X15 data before the signal is turned OFF is retained by turning OFF the DY signal. (Refer to page 25 .)
Inverter	SD	Common terminal (sink). Common terminal for digital and data read timing signals. Use terminal SD of the inverter.
	PC	External transistor common (sink), common terminal (source). Connect this terminal to the external power supply common terminal (+) of a transistor output (open collector output) device, such as a programmable controller, to avoid malfunction by undesirable current. When the source logic is selected, this terminal is used as a common terminal. Use terminal PC of the inverter.

*1 Torque command values can be input to the FR-A800 series only.

3.3 Code input example

The following table explains examples of terminal status and input value during BCD code input and binary input.

BCD code input (when the input value is 6325)				Binary input (when the input value is HAB65)			
Digit	Terminal name	Terminal input status	Input value	Terminal name	Terminal input status	Input value (hexadecimal)	Input value (decimal)
1	X0	ON	5	X0	ON	5	43877
	X1	OFF		X1	OFF		
	X2	ON		X2	ON		
	X3	OFF		X3	OFF		
10	X4	OFF	2	X4	OFF	6	
	X5	ON		X5	ON		
	X6	OFF		X6	ON		
	X7	OFF		X7	OFF		
100	X8	ON	3	X8	ON	B	
	X9	ON		X9	ON		
	X10	OFF		X10	OFF		
	X11	OFF		X11	ON		
1000	X12	OFF	6	X12	OFF	A	
	X13	ON		X13	ON		
	X14	ON		X14	OFF		
	X15	OFF		X15	ON		

NOTE

- For BCD code input, the input value of each digit is from 0 to 9. When a value greater than 9 is input, it becomes invalid and the last value is retained.
- When **Pr.304 Digital input and analog input compensation enable/disable selection** = "0 to 4", X12 to X15 become disabled.

3.4 Parameter list

The following parameters are used for the plug-in option (FR-A8AX).

The FR-A8AX does not function with the initial setting. When a value other than "9999" is set in **Pr.304**, digital input is enabled. Set the following parameters according to applications.

Pr.	Pr. group	Name	Setting range	Minimum setting increments	Initial value	Refer to page
300 ^{*1}	D600 ^{*1}	BCD input bias	0 to 590 Hz	0.01 Hz	0 Hz	28
301 ^{*1}	D601 ^{*1}	BCD input gain	0 to 590 Hz, 9999	0.01 Hz	60/50 Hz ^{*3}	28
302 ^{*1}	D602 ^{*1}	BIN input bias	0 to 590 Hz	0.01 Hz	0 Hz	28
303 ^{*1}	D603 ^{*1}	BIN input gain	0 to 590 Hz, 9999	0.01 Hz	60/50 Hz ^{*3}	28
304 ^{*1}	D604 ^{*1}	Digital input and analog input compensation enable/disable selection	0 to 4, 10 to 14, 9999 ^{*4}	1	9999	24, 25, 31
305 ^{*1}	D605 ^{*1}	Read timing operation selection	0, 1, 10	1	0	25
329 ^{*1*2}	D606 ^{*1*2}	Digital input unit selection	0, 1, 2, 3	1	1	29
447 ^{*1*5}	D620 ^{*1*5}	Digital torque command bias	0 to 400%	1%	0	31
448 ^{*1*5}	D621 ^{*1*5}	Digital torque command gain	0 to 400%, 9999	1%	150%	31
804 ^{*5}	D400 ^{*5}	Torque command source selection	0, 1, 3 to 6	1	0	31

*1 Parameters which can be displayed when the plug-in option (FR-A8AX) is mounted.

*2 For **Pr.329**, write is disabled during operation even when "2" is set in **Pr.77**. To change the parameter setting value, stop the operation. Also, parameter clear is invalid.

*3 The initial values differ for the FM type and CA type of the inverter.

*4 The setting range of **Pr. 304** differs according to the inverter used. (Refer to [page 24](#))

*5 These parameters can be set for the FR-A800 series only.

NOTE

- For binary input, the input data is taken in hexadecimal, and for BCD code input, the input data is taken in decimal.

3.5 Setting the parameter

3.5.1 Selection of input method (Pr.304)

Pr.304 setting	BCD code input	Binary input	Availability of analog input compensation ^{*1} (○: Enabled, ×: Disabled)
0	3 digits	—	×
1	—	12 bits	×
2	3 digits	—	○
3	—	12 bits	○
4 ^{*2}	—	12 bits. Torque command value input.	—
10	4 digits	—	×
11	—	16 bits	×
12	4 digits	—	○
13	—	16 bits	○
14 ^{*2}	—	16 bits. Torque command value input.	—
9999 (Initial value)	No function		

*1 Use terminal 1 for analog input compensation. Refer to the Instruction Manual (Detailed) of the inverter for details on terminal 1.

*2 These parameters can be set for the FR-A800 series only. For details on the torque command value input, refer to [page 31](#).

NOTE

- Signals X12 to X15 become invalid when "0 to 4" is set in **Pr.304**.
- Refer to [page 22](#) for a BCD code/binary input example.
- If 0 to 5 V (0 to 10 V) is input at the inverter terminal 1 from the external potentiometer with the FR-A8AX installed, the inverter operates at the frequency obtained by adding the FR-A8AX BCD code input and the compensation input from terminal 1 only when "2, 3, 12, or 13" is set in **Pr.304**. For example, when switching the inputs to perform manual operation with potentiometer input or automatic operation with BCD code input, set the BCD code input to "0" under manual operation.

3.5.2 Read timing operation selection (Pr.305)

Pr.305 setting	Filter	Description
0 (Initial value)	Not used	The set frequency data entered from the digital signal input terminals (X0 to X15) is always imported independently of whether the DY signal is ON or OFF.
1	Not used	The set frequency data entered from the digital signal input terminals (X0 to X15) is imported only when the DY signal is ON. The set frequency data is not imported when the DY signal is OFF. Therefore, even if the input status of the X0 to X15 signal changes, the set frequency data before the DY signal is turned OFF is valid.
10	Used	<p>The set frequency data entered from the digital signal input terminals (X0 to X15) is always imported independently of whether the DY signal is ON or OFF. The filter absorbs subtle timing differences of digital signal acquisition.</p>

◆ When "0 or 10" is set in Pr.305

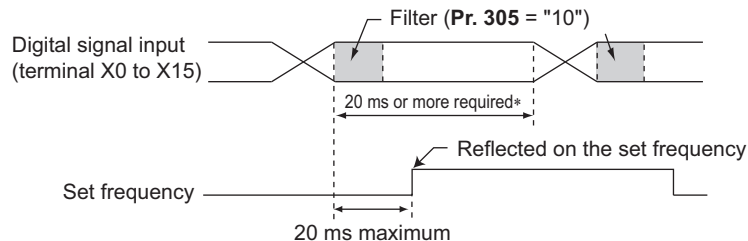

- * Hold the digital signal input (X0 to X15) status for 20 ms or more. Changing the signal within 20 ms may not reflect it on the set frequency.

◆ How to use the DY signal (when "1" is set in Pr.305)

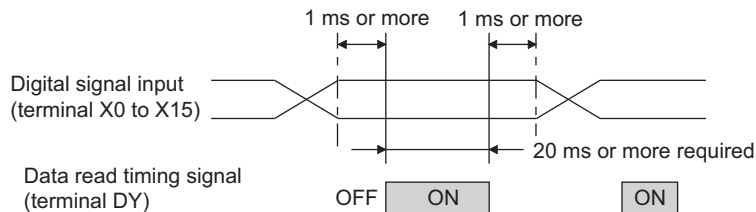

NOTE

- When **Pr.305 = "1"**, all terminals from X0 to X15 are recognized as OFF when the inverter is turned ON while terminal DY is in OFF state.

3.5.3 Bias and gain adjustment (Pr.300 to Pr.303)

Pr.	Name	Setting range	Initial value
300	BCD input bias	0 to 590 Hz	0 Hz
301	BCD input gain	0 to 590 Hz, 9999	60/50 Hz ^{*1}
302	BIN input bias	0 to 590 Hz	0 Hz
303	BIN input gain	0 to 590 Hz, 9999	60/50 Hz ^{*1}

*1 The initial values differ for the FM type and CA type of the inverter.

◆ How to set the digital input value as the output frequency setting

When "9999" is set in **Pr.301** (BCD code input) or **Pr.303** (binary input), the digital input value is set as the output frequency. (For example, to set the output frequency to 120 Hz when the BCD code input is "120")

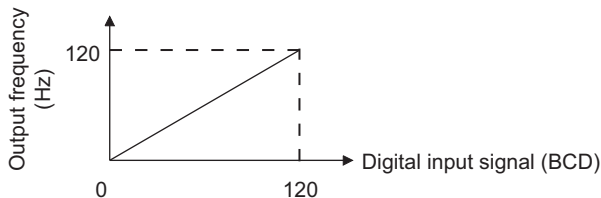

NOTE

- When this setting method is used, the "bias" setting (**Pr.300** or **Pr.302**) cannot be made.

◆ Bias/gain adjustment for digital inputs

■ Bias adjustment

Bias adjustments can be made for the digital input signal.

Set the set frequency at the digital input signal of 0.

For BCD code input, set using **Pr.300**, and for binary input, set using **Pr.302**.

■ Gain adjustment

Maximum output frequency (gain) adjustment can be made for the digital input signal.

Set the output frequency when the digital input signal is "999" or "9999" (BCD code input), or "HFFF" or "HFFFF" (binary input).

For BCD code input, set using **Pr.301**, and for binary input, set using **Pr.303**.

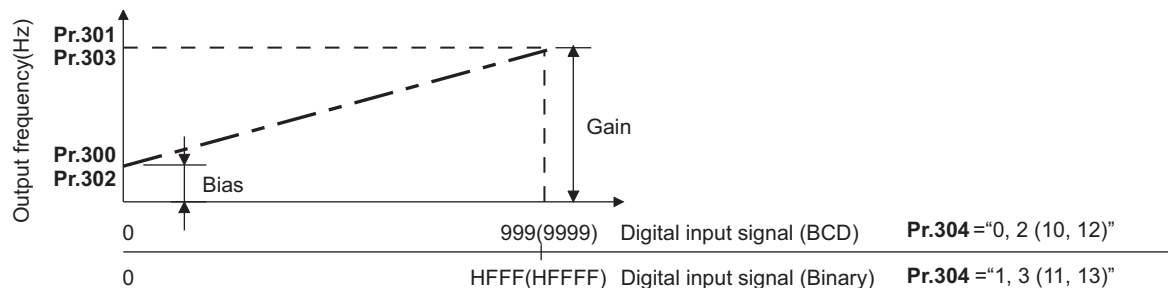

3.5.4 Digital input unit selection (Pr.329)

Pr.	Name	Setting range	Initial value
329	Digital input unit selection	0, 1, 2, 3	1

When "9999" is set in **Pr.301** or **Pr.303**, it is possible to set the increments when the digital input signal is set as the output frequency. (Refer to [page 27](#).)

Frequency = digital input signal value × **Pr.329** input increments

Pr.329 setting	Input value increments	Available frequencies ^{*1}			
		12 bits		16 bits	
		BCD code	Binary	BCD code	Binary
0	10	0 to 9990 Hz	0 to 40950 Hz	0 to 99990 Hz	0 to 655350 Hz
1 (Initial value)	1	0 to 999 Hz	0 to 4095 Hz	0 to 9999 Hz	0 to 65535 Hz
2	0.1	0 to 99.9 Hz	0 to 409.5 Hz	0 to 999.9 Hz	0 to 6553.5 Hz
3	0.01	0 to 9.99 Hz	0 to 40.95 Hz	0 to 99.99 Hz	0 to 655.35 Hz

*1 These are not the inverter maximum output frequencies.

<Example>

- **Pr.329** = "0"

BCD code = 111→1110 Hz, binary = H100 (256 in decimal)→2560 Hz

- **Pr.329** = "1"

BCD code = 111→111 Hz, binary = H100 (256 in decimal)→256 Hz

- **Pr.329** = "2"

BCD code = 111→11.1 Hz, binary = H100 (256 in decimal)→25.6 Hz

- **Pr.329** = "3"

BCD code = 111→1.11 Hz, binary = H100 (256 in decimal)→2.56 Hz

 **NOTE**

- When a value other than "9999" is set in **Pr.301** or **Pr.303**, **Pr.329** becomes invalid.
-

3.5.5 16-bit digital torque command (FR-A800 series only)

Pr.	Name	Setting range	Initial value
304	Digital input and analog input compensation enable/disable selection	0 to 4, 10 to 14, 9999	9999
447	Digital torque command bias	0 to 400%	0
448	Digital torque command gain	0 to 400%, 9999	150%
804	Torque command source selection	0, 1, 3 to 6	0

Digital torque command can be given under torque control using the FR-A8AX.

A digital command can be given using the FR-A8AX when "4 (12-bit)" or "14 (16-bit)" is set in **Pr.304** and "4" is set in **Pr.804**.

Pr.804 setting	Description	Remarks
0	Torque command by terminal 1 analog input	Refer to the Instruction Manual of the inverter for the details.
1	Torque command by parameter setting Setting value of Pr.805 or Pr.806 (-400% to 400%)	
3	Torque command through the CC-Link / CC-Link IE Field Network / CC-Link IE TSN communication (FR-A8NC/FR-A8NCE/FR-A8NCG) Torque command via PROFIBUS-DP communication (FR-A8NP)	Refer to the Instruction Manual of FR-A8NC/FR-A8NCE/FR-A8NCG/FR-A8NP for details.
4	12-bit digital input (FR-A8AX)	When "4" is set in Pr.304
	16-bit digital input (FR-A8AX)	When "14" is set in Pr.304
5	Torque command through the CC-Link / CC-Link IE Field Network / CC-Link IE TSN communication (FR-A8NC/FR-A8NCE/FR-A8NCG)	Refer to the Instruction Manual of FR-A8NC/FR-A8NCE/FR-A8NCG/FR-A8NP for details.
6	Torque command via PROFIBUS-DP communication (FR-A8NP)	

The input signal uses the last 15 (11) bits as torque command and the most significant bit as sign.

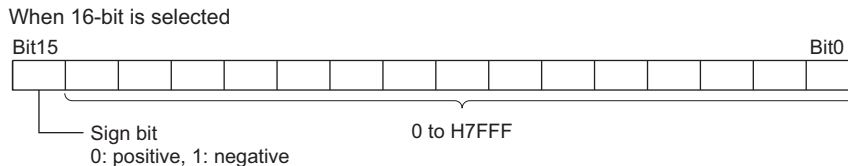

NOTE

- The digital torque command is input only as a binary input.
- When a digital torque command is selected, **Pr.329 Digital input unit selection** becomes disabled.

◆ Input method of torque command

Torque command may be input in either of the following two ways:

■ Set the torque commands at 0 and H7FFF (H7FF) signal inputs

Set the torque command value when the input signal is "0" in **Pr.447** and the torque command value when the input signal is "H7FFF (H7FF)" in **Pr.448**.

The figure on the right shows the case when the torque command value is set using input signal H7FFF (H7FF) when the torque command value is 150% (initial value of **Pr.448**). When the most significant bit of input signal is positive, a negative torque command value (-150%) is also set at the same time.

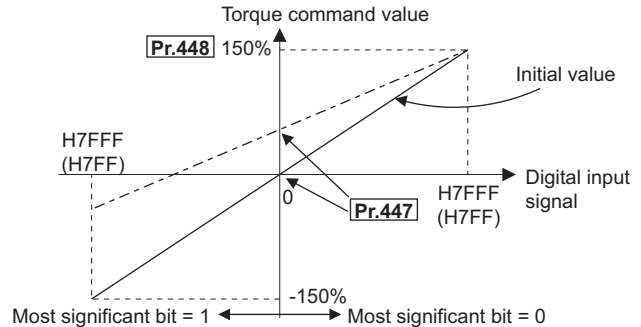

■ Use the digital input value as the torque command

When "9999" is set in **Pr.448**, the input signal is considered as a torque command value.

For example, the torque command value when the input signal is H190 is 400%, as shown below.

Even if a value higher than H190 is input, the torque command value is clamped at 400%.

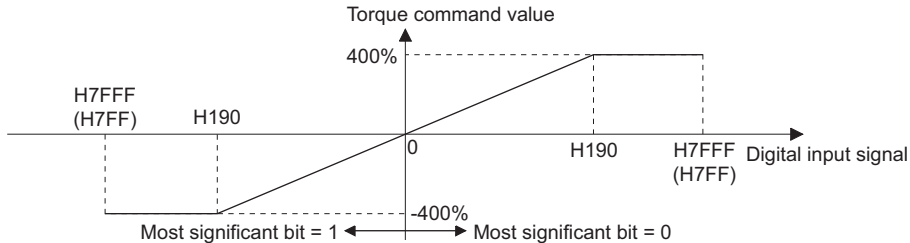

3.6 Precautions

- Acceleration/deceleration time

When the digital input signal is set as the frequency, the acceleration/deceleration time is the period of time required to reach **Pr.20 Acceleration/deceleration reference frequency**, in the same way when the analog input signal is set.

- The following restrictions are applied on the digital input signal:

When one of H0A to H0F is input to each digit while BCD code input is set, the operation is performed with the inputs previous to H0A to H0F. H0A to H0F inputs are ignored.

If binary input is changed to BCD code input while H0A to H0F are being input, the set frequency becomes 0 Hz.

- The priorities of the frequency setting are as follows:

JOG > Stop-on contact (RT, RL) > Multi-speed command (RH, RM, RL) > PID (X14) > AU (terminal 4) > Pulse train input > Digital command by the FR-A8AX > terminal 2

Note that terminal 2 is invalid when the digital input is enabled.

APPENDIX

Appendix 1 Instructions for compliance with the EU Directives

The EU Directives are issued to standardize different national regulations of the EU Member States and to facilitate free movement of the equipment, whose safety is ensured, in the EU territory.

Since 1996, compliance with the EMC Directive that is one of the EU Directives has been legally required. When a manufacturer confirms its equipment to be compliant with the EMC Directive, the manufacturer must declare the conformity and affix the CE marking.

- The authorized representative in the EU

The authorized representative in the EU is shown below.

Name: Mitsubishi Electric Europe B.V.

Address: Mitsubishi-Electric-Platz 1, 40882 Ratingen, Germany

◆ EMC Directive

We declare that this product conforms with the EMC Directive when installed in a compatible inverter, and affix the CE marking on the packaging plate.

- EMC Directive: 2014/30/EC
- Standard(s): EN 61800-3 (Second environment / PDS Category "C3")

■ Note

- To install and wire the inverter, refer to the "Instructions for compliance with the EU Directives" in the Instruction Manual enclosed with the inverter.
- Confirm that the final integrated system with the inverter conforms with the EMC Directive.

◆ EU RoHS Directive

We declare that this product conforms with the EU RoHS Directive (2011/65/EU) when installed in a compatible inverter, and affix the CE marking on the packaging plate.



Appendix 2 Instructions for EAC

The product certified in compliance with the Eurasian Conformity has the EAC marking on the packaging plate.

Note: EAC marking

In 2010, three countries (Russia, Belarus, and Kazakhstan) established a Customs Union for the purposes of revitalizing the economy by forming a large economic bloc by abolishing or reducing tariffs and unifying regulatory procedures for the handling of articles.

Products to be distributed over these three countries of the Customs Union must comply with the Customs Union Technical Regulations (CU-TR), and the EAC marking must be affixed to the products.

For information on the country of origin, manufacture year and month, and authorized sales representative (importer) in the CU area of this product, refer to the following:

- Country of origin indication

Check the package of this product.

Example: MADE IN JAPAN

- Manufactured year and month

Check the SERIAL number indicated on this product.

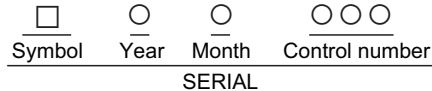

The SERIAL consists of one symbol, two characters indicating the production year and month, and three characters indicating the control number. The last digit of the production year is indicated as the Year, and the Month is indicated by 1 to 9, X (October), Y (November), or Z (December).

- Authorized sales representative (importer) in the CU area

The authorized sales representative (importer) in the CU area is shown below.

Name: Mitsubishi Electric Turkey A.S. Head Office

Address: Serifali Mahallesi Kale Sokak. No:41 34775 Umraniye, Istanbul, Turkey

Phone: +90-216-969-25-00

Fax: +90-216-661-44-47

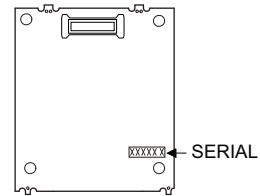

Appendix 3 Restricted Use of Hazardous Substances in Electronic and Electrical Products

The mark of restricted use of hazardous substances in electronic and electrical products is applied to the product as follows based on the "Management Methods for the Restriction of the Use of Hazardous Substances in Electrical and Electronic Products" of the People's Republic of China.

电器电子产品有害物质限制使用标识要求



本产品中所含有的有害物质的名称、含量、含有部件如下表所示。

- 产品中所含有害物质的名称及含量

部件名称 *2	有害物质 *1					
	铅 (Pb)	汞 (Hg)	镉 (Cd)	六价铬 (Cr (VI))	多溴联苯 (PBB)	多溴二苯醚 (PBDE)
电路板组件 (包括印刷电路板及其构成的零部件, 如电阻、电容、集成电路、连接器等)、电子部件	×	○	×	○	○	○
金属壳体、金属部件	×	○	○	○	○	○
树脂壳体、树脂部件	○	○	○	○	○	○
螺丝、电线	○	○	○	○	○	○

上表依据 SJ/T11364 的规定编制。

○：表示该有害物质在该部件所有均质材料中的含量均在 GB/T26572 规定的限量要求以下。

×：表示该有害物质在该部件的至少一种均质材料中的含量超出 GB/T26572 规定的限量要求。

*1 即使表中记载为 ×，根据产品型号，也可能会有有害物质的含量为限制值以下的情况。

*2 根据产品型号，一部分部件可能不包含在产品中。

Appendix 4 Referenced Standard (Requirement of Chinese standardized law)

This Product is designed and manufactured accordance with following Chinese standards.

EMC: GB/T 12668.3

Appendix 5 Regarding Directive on Waste Electrical and Electronic Equipment

This symbol mark is for EU countries only, and is according to the directive 2012/19/ EU Article 14 Information for users and Annex IX.

This symbol mark means that electrical and electronic equipment, at their end-of-life, should be disposed of separately from your household waste.

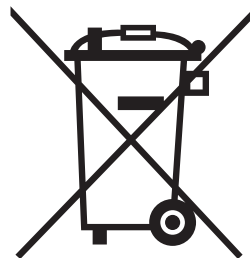

Appendix 6 Compliance with the UK certification scheme

We declare that this product conforms with the related technical requirements under UK legislation when installed in a compatible inverter, and affix the UKCA (UK Conformity Assessed) marking on the packaging plate.

Approval conditions are the same as those for the EU Directives. (Refer to [page 35.](#))



UKCA marking:

The UKCA marking is used for products sold in the markets of Great Britain (England, Wales, and Scotland) from January 1, 2021 after the departure of the UK from the EU on January 31, 2020.

MEMO

MEMO

REVISIONS

*The manual number is given on the bottom left of the back cover.

Revision date	*Manual number	Revision
Aug. 2013	IB(NA)-0600495ENG-A	First edition
Oct. 2014	IB(NA)-0600495ENG-B	Added • Compatibility with the FR-F800 series
Dec. 2023	IB(NA)-0600495ENG-C	Added • Instructions for compliance with the EU Directives • Instructions for EAC • Restricted Use of Hazardous Substances in Electronic and Electrical Products • Referenced Standard (Requirement of Chinese standardized law) • Regarding Directive on Waste Electrical and Electronic Equipment • Compliance with the UK certification scheme

INVERTER

mitsubishi electric corporation

HEAD OFFICE: TOKYO BUILDING 2-7-3, MARUNOUCHI, CHIYODA-KU, TOKYO 100-8310, JAPAN

IB(NA)-0600495ENG-C(2312) MEE

Printed in Japan

Specifications subject to change without notice.