



Programmable Controller

**MELSEC iQ-R**  
series

# MELSEC iQ-R C Intelligent Function Module User's Manual (Startup)

---

-RD55UP06-V  
-RD55UP12-V



# SAFETY PRECAUTIONS

---



(Read these precautions before using this product.)

Before using this product, please read this manual and the relevant manuals carefully, and pay full attention to safety to handle the product correctly.

The precautions given in this manual are concerned with this product only. For the safety precautions of the programmable controller system, refer to the user's manual for the CPU module used.

In this manual, the safety precautions are classified into two levels: "⚠️ WARNING" and "⚠️ CAUTION".

---

 <b>WARNING</b>	Indicates that incorrect handling may cause hazardous conditions, resulting in death or severe injury.
 <b>CAUTION</b>	Indicates that incorrect handling may cause hazardous conditions, resulting in minor or moderate injury or property damage.

---

Under some circumstances, failure to observe the precautions given under "⚠️ CAUTION" may lead to serious consequences.

Observe the precautions of both levels because they are important for personal and system safety.

Make sure that the end users read this manual and then keep the manual in a safe place for future reference.

## [Design Precautions]

---

### **WARNING**

- Configure safety circuits external to the programmable controller to ensure that the entire system operates safely even when a fault occurs in the external power supply or the programmable controller. Failure to do so may result in an accident due to an incorrect output or malfunction.
    - (1) Emergency stop circuits, protection circuits, and protective interlock circuits for conflicting operations (such as forward/reverse rotations or upper/lower limit positioning) must be configured external to the programmable controller.
    - (2) When the programmable controller detects an abnormal condition, it stops the operation and all outputs are:
      - Turned off if the overcurrent or overvoltage protection of the power supply module is activated.
      - Held or turned off according to the parameter setting if the self-diagnostic function of the CPU module detects an error such as a watchdog timer error.
    - (3) All outputs may be turned on if an error occurs in a part, such as an I/O control part, where the CPU module cannot detect any error. To ensure safety operation in such a case, provide a safety mechanism or a fail-safe circuit external to the programmable controller. For a fail-safe circuit example, refer to the MELSEC iQ-R Module Configuration Manual.
    - (4) Outputs may remain on or off due to a failure of a component such as a relay and transistor in an output circuit. Configure an external circuit for monitoring output signals that could cause a serious accident.
  - In an output circuit, when a load current exceeding the rated current or an overcurrent caused by a load short-circuit flows for a long time, it may cause smoke and fire. To prevent this, configure an external safety circuit, such as a fuse.
  - Configure a circuit so that the programmable controller is turned on first and then the external power supply. If the external power supply is turned on first, an accident may occur due to an incorrect output or malfunction.
  - Configure a circuit so that the external power supply is turned off first and then the programmable controller. If the programmable controller is turned off first, an accident may occur due to an incorrect output or malfunction.
  - For the operating status of each station after a communication failure, refer to manuals for the network used. For the manuals, please consult your local Mitsubishi representative. Incorrect output or malfunction due to a communication failure may result in an accident.
  - When connecting an external device with a CPU module or intelligent function module to modify data of a running programmable controller, configure an interlock circuit in the program to ensure that the entire system will always operate safely. For other forms of control (such as program modification, parameter change, forced output, or operating status change) of a running programmable controller, read the relevant manuals carefully and ensure that the operation is safe before proceeding. Improper operation may damage machines or cause accidents. When a Safety CPU is used, data cannot be modified while the Safety CPU is in SAFETY MODE.
  - Especially, when a remote programmable controller is controlled by an external device, immediate action cannot be taken if a problem occurs in the programmable controller due to a communication failure. To prevent this, configure an interlock circuit in the program, and determine corrective actions to be taken between the external device and CPU module in case of a communication failure.
-

## [Design Precautions]

---

### **WARNING**

- Do not write any data to the "system area" and "write-protect area" of the buffer memory in the module. Also, do not use any "use prohibited" signals as an output signal from the CPU module to each module. Doing so may cause malfunction of the programmable controller system. For the "system area", "write-protect area", and the "use prohibited" signals, refer to the user's manual for the module used. For areas used for safety communications, they are protected from being written by users, and thus safety communications failure caused by data writing does not occur.
  - If a communication cable is disconnected, the network may be unstable, resulting in a communication failure of multiple stations. Configure an interlock circuit in the program to ensure that the entire system will always operate safely even if communications fail. Incorrect output or malfunction due to a communication failure may result in an accident. When safety communications are used, an interlock by the safety station interlock function protects the system from an incorrect output or malfunction.
- 

## [Design Precautions]

---

### **CAUTION**

- Do not install the control lines or communication cables together with the main circuit lines or power cables. Doing so may result in malfunction due to electromagnetic interference. Keep a distance of 100mm or more between those cables.
  - During control of an inductive load such as a lamp, heater, or solenoid valve, a large current (approximately ten times greater than normal) may flow when the output is turned from off to on. Therefore, use a module that has a sufficient current rating.
  - After the CPU module is powered on or is reset, the time taken to enter the RUN status varies depending on the system configuration, parameter settings, and/or program size. Design circuits so that the entire system will always operate safely, regardless of the time.
  - Do not power off the programmable controller or reset the CPU module while the settings are being written. Doing so will make the data in the flash ROM and SD memory card undefined. The values need to be set in the buffer memory and written to the flash ROM and SD memory card again. Doing so also may cause malfunction or failure of the module.
  - When changing the operating status of the CPU module from external devices (such as the remote RUN/STOP functions), select "Do Not Open by Program" for "Opening Method" of "Module Parameter". If "Open by Program" is selected, an execution of the remote STOP function causes the communication line to close. Consequently, the CPU module cannot reopen the line, and external devices cannot execute the remote RUN function.
-

## [Security Precautions]

---

### **WARNING**

- To maintain the security (confidentiality, integrity, and availability) of the programmable controller and the system against unauthorized access, denial-of-service (DoS) attacks, computer viruses, and other cyberattacks from external devices via the network, take appropriate measures such as firewalls, virtual private networks (VPNs), and antivirus solutions.
- 

## [Installation Precautions]

---

### **WARNING**

- Shut off the external power supply (all phases) used in the system before mounting or removing the module. Failure to do so may result in electric shock or cause the module to fail or malfunction.
- 

## [Installation Precautions]

---

### **CAUTION**

- Use the programmable controller in an environment that meets the general specifications in the MELSEC iQ-R Module Configuration Manual. Failure to do so may result in electric shock, fire, malfunction, or damage to or deterioration of the product.
  - To mount a module, place the concave part(s) located at the bottom onto the guide(s) of the base unit, and push in the module until the hook(s) located at the top snaps into place. Incorrect interconnection may cause malfunction, failure, or drop of the module.
  - To mount a module with no module fixing hook, place the concave part(s) located at the bottom onto the guide(s) of the base unit, push in the module, and fix it with screw(s). Incorrect interconnection may cause malfunction, failure, or drop of the module.
  - When using the programmable controller in an environment of frequent vibrations, fix the module with a screw.
  - Tighten the screws within the specified torque range. Undertightening can cause drop of the component or wire, short circuit, or malfunction. Overtightening can damage the screw and/or module, resulting in drop, short circuit, or malfunction. For the specified torque range, refer to the MELSEC iQ-R Module Configuration Manual.
  - When using an extension cable, connect it to the extension cable connector of the base unit securely. Check the connection for looseness. Poor contact may cause malfunction.
  - When using an SD memory card, fully insert it into the SD memory card slot. Check that it is inserted completely. Poor contact may cause malfunction.
  - Securely insert an extended SRAM cassette into the cassette connector of the CPU module. After insertion, close the cassette cover and check that the cassette is inserted completely. Poor contact may cause malfunction.
  - Beware that the module could be very hot while power is on and immediately after power-off.
  - Do not directly touch any conductive parts and electronic components of the module, SD memory card, extended SRAM cassette, or connector. Doing so can cause malfunction or failure of the module.
-

## [Wiring Precautions]

---

### **WARNING**

- Shut off the external power supply (all phases) used in the system before installation and wiring. Failure to do so may result in electric shock or cause the module to fail or malfunction.
- After installation and wiring, attach a blank cover module (RG60) to each empty slot before powering on the system for operation. Also, attach an extension connector protective cover<sup>\*1</sup> to each unused extension cable connector as necessary. Directly touching any conductive parts of the connectors while power is on may result in electric shock.

\*1 For details, please consult your local Mitsubishi Electric representative.

---

## [Wiring Precautions]

---

### **CAUTION**

- Individually ground the FG and LG terminals of the programmable controller with a ground resistance of 100 ohms or less. Failure to do so may result in electric shock or malfunction.
  - Use applicable solderless terminals and tighten them within the specified torque range. If any spade solderless terminal is used, it may be disconnected when the terminal screw comes loose, resulting in failure.
  - Check the rated voltage and signal layout before wiring to the module, and connect the cables correctly. Connecting a power supply with a different voltage rating or incorrect wiring may cause fire or failure.
  - Connectors for external devices must be crimped or pressed with the tool specified by the manufacturer, or must be correctly soldered. Incomplete connections may cause short circuit, fire, or malfunction.
  - Securely connect the connector to the module. Poor contact may cause malfunction.
  - Do not install the control lines or communication cables together with the main circuit lines or power cables. Doing so may result in malfunction due to noise. Keep a distance of 100mm or more between those cables.
  - Place the cables in a duct or clamp them. If not, dangling cables may swing or inadvertently be pulled, resulting in malfunction or damage to modules or cables. In addition, the weight of the cables may put stress on modules in an environment of strong vibrations and shocks. Do not clamp the extension cables with the jacket stripped. Doing so may change the characteristics of the cables, resulting in malfunction.
  - Check the interface type and correctly connect the cable. Incorrect wiring (connecting the cable to an incorrect interface) may cause failure of the module and external device.
  - Tighten the terminal screws or connector screws within the specified torque range. Undertightening can cause drop of the screw, short circuit, fire, or malfunction. Overtightening can damage the screw and/or module, resulting in drop, short circuit, fire, or malfunction.
  - When disconnecting the cable from the module, do not pull the cable by the cable part. For the cable with connector, hold the connector part of the cable. For the cable connected to the terminal block, loosen the terminal screw. Pulling the cable connected to the module may result in malfunction or damage to the module or cable.
  - Prevent foreign matter such as dust or wire chips from entering the module. Such foreign matter can cause a fire, failure, or malfunction.
-

## [Wiring Precautions]

---

### **CAUTION**

- When a protective film is attached to the top of the module, remove it before system operation. If not, inadequate heat dissipation of the module may cause a fire, failure, or malfunction.
  - Programmable controllers must be installed in control panels. Connect the main power supply to the power supply module in the control panel through a relay terminal block. Wiring and replacement of a power supply module must be performed by qualified maintenance personnel with knowledge of protection against electric shock. For wiring, refer to the MELSEC iQ-R Module Configuration Manual.
  - For Ethernet cables to be used in the system, select the ones that meet the specifications in the user's manual for the module used. If not, normal data transmission is not guaranteed.
- 

## [Startup and Maintenance Precautions]

---

### **WARNING**

- Do not touch any terminal while power is on. Doing so will cause electric shock or malfunction.
  - Correctly connect the battery connector. Do not charge, disassemble, heat, short-circuit, solder, or throw the battery into the fire. Also, do not expose it to liquid or strong shock. Doing so will cause the battery to produce heat, explode, ignite, or leak, resulting in injury and fire.
  - Shut off the external power supply (all phases) used in the system before cleaning the module or retightening the terminal screws, connector screws, or module fixing screws. Failure to do so may result in electric shock.
-



## [Startup and Maintenance Precautions]

---

### CAUTION

- When connecting an external device with a CPU module or intelligent function module to modify data of a running programmable controller, configure an interlock circuit in the program to ensure that the entire system will always operate safely. For other forms of control (such as program modification, parameter change, forced output, or operating status change) of a running programmable controller, read the relevant manuals carefully and ensure that the operation is safe before proceeding. Improper operation may damage machines or cause accidents.
  - Especially, when a remote programmable controller is controlled by an external device, immediate action cannot be taken if a problem occurs in the programmable controller due to a communication failure. To prevent this, configure an interlock circuit in the program, and determine corrective actions to be taken between the external device and CPU module in case of a communication failure.
  - Do not disassemble or modify the modules. Doing so may cause failure, malfunction, injury, or a fire.
  - Use any radio communication device such as a cellular phone or PHS (Personal Handy-phone System) more than 25cm away in all directions from the programmable controller. Failure to do so may cause malfunction.
  - Shut off the external power supply (all phases) used in the system before mounting or removing the module. Failure to do so may cause the module to fail or malfunction.
  - Tighten the screws within the specified torque range. Undertightening can cause drop of the component or wire, short circuit, or malfunction. Overtightening can damage the screw and/or module, resulting in drop, short circuit, or malfunction.
  - After the first use of the product, do not perform each of the following operations more than 50 times (IEC 61131-2/JIS B 3502 compliant). Exceeding the limit may cause malfunction.
    - Mounting/removing the module to/from the base unit
    - Inserting/removing the extended SRAM cassette or battery-less option cassette to/from the CPU module
    - Mounting/removing the terminal block to/from the module
    - Connecting/disconnecting the extension cable to/from the base unit
  - After the first use of the product, do not insert/remove the SD memory card to/from the CPU module more than 500 times. Exceeding the limit may cause malfunction.
  - Do not touch the metal terminals on the back side of the SD memory card. Doing so may cause malfunction or failure of the module.
  - Do not touch the integrated circuits on the circuit board of an extended SRAM cassette or a battery-less option cassette. Doing so may cause malfunction or failure of the module.
  - Do not drop or apply shock to the battery to be installed in the module. Doing so may damage the battery, causing the battery fluid to leak inside the battery. If the battery is dropped or any shock is applied to it, dispose of it without using.
  - Startup and maintenance of a control panel must be performed by qualified maintenance personnel with knowledge of protection against electric shock. Lock the control panel so that only qualified maintenance personnel can operate it.
-

## [Startup and Maintenance Precautions]

---

### CAUTION

- Before handling the module, touch a conducting object such as a grounded metal to discharge the static electricity from the human body. Wearing a grounded antistatic wrist strap is recommended. Failure to discharge the static electricity may cause the module to fail or malfunction.
  - After unpacking, eliminate static electricity from the module to prevent electrostatic discharge from affecting the module. If an electrostatically charged module comes in contact with a grounded metal object, a sudden electrostatic discharge of the module may cause failure.  
For details on how to eliminate static electricity from the module, refer to the following.  
Antistatic Precautions Before Using MELSEC iQ-R Series Products (FA-A-0368)
  - Use a clean and dry cloth to wipe off dirt on the module.
- 

## [Operating Precautions]

---

### CAUTION

- When changing data and operating status, and modifying program of the running programmable controller from an external device such as a personal computer connected to an intelligent function module, read relevant manuals carefully and ensure the safety before operation. Incorrect change or modification may cause system malfunction, damage to the machines, or accidents.
  - Do not power off the programmable controller or reset the CPU module while the setting values in the buffer memory are being written to the flash ROM in the module. Doing so will make the data in the flash ROM undefined. The values need to be set in the buffer memory and written to the flash ROM again. Doing so can cause malfunction or failure of the module.
  - Before using the Shell command, check the specifications of the command. For the specifications, refer to the manual of VxWorks. If the command is not properly executed, the system failure/stop (watchdog timer) may occur and the entire programmable controller system may stop.
- 

## [Disposal Precautions]

---

### CAUTION

- When disposing of this product, treat it as industrial waste.
  - When disposing of batteries, separate them from other wastes according to the local regulations. For details on battery regulations in EU member states, refer to the MELSEC iQ-R Module Configuration Manual.
- 

## [Transportation Precautions]

---

### CAUTION

- When transporting lithium batteries, follow the transportation regulations. For details on the regulated models, refer to the MELSEC iQ-R Module Configuration Manual.
  - The halogens (such as fluorine, chlorine, bromine, and iodine), which are contained in a fumigant used for disinfection and pest control of wood packaging materials, may cause failure of the product. Prevent the entry of fumigant residues into the product or consider other methods (such as heat treatment) instead of fumigation. The disinfection and pest control measures must be applied to unprocessed raw wood.
-

# CONDITIONS OF USE FOR THE PRODUCT

---

- (1) MELSEC programmable controller ("the PRODUCT") shall be used in conditions;
- i) where any problem, fault or failure occurring in the PRODUCT, if any, shall not lead to any major or serious accident; and
  - ii) where the backup and fail-safe function are systematically or automatically provided outside of the PRODUCT for the case of any problem, fault or failure occurring in the PRODUCT.
- (2) The PRODUCT has been designed and manufactured for the purpose of being used in general industries. MITSUBISHI ELECTRIC SHALL HAVE NO RESPONSIBILITY OR LIABILITY (INCLUDING, BUT NOT LIMITED TO ANY AND ALL RESPONSIBILITY OR LIABILITY BASED ON CONTRACT, WARRANTY, TORT, PRODUCT LIABILITY) FOR ANY INJURY OR DEATH TO PERSONS OR LOSS OR DAMAGE TO PROPERTY CAUSED BY the PRODUCT THAT ARE OPERATED OR USED IN APPLICATION NOT INTENDED OR EXCLUDED BY INSTRUCTIONS, PRECAUTIONS, OR WARNING CONTAINED IN MITSUBISHI ELECTRIC USER'S, INSTRUCTION AND/OR SAFETY MANUALS, TECHNICAL BULLETINS AND GUIDELINES FOR the PRODUCT.
- ("Prohibited Application")
- Prohibited Applications include, but not limited to, the use of the PRODUCT in;
- Nuclear Power Plants and any other power plants operated by Power companies, and/or any other cases in which the public could be affected if any problem or fault occurs in the PRODUCT.
  - Railway companies or Public service purposes, and/or any other cases in which establishment of a special quality assurance system is required by the Purchaser or End User.
  - Aircraft or Aerospace, Medical applications, Train equipment, transport equipment such as Elevator and Escalator, Incineration and Fuel devices, Vehicles, Manned transportation, Equipment for Recreation and Amusement, and Safety devices, handling of Nuclear or Hazardous Materials or Chemicals, Mining and Drilling, and/or other applications where there is a significant risk of injury to the public or property.
- Notwithstanding the above restrictions, Mitsubishi Electric may in its sole discretion, authorize use of the PRODUCT in one or more of the Prohibited Applications, provided that the usage of the PRODUCT is limited only for the specific applications agreed to by Mitsubishi Electric and provided further that no special quality assurance or fail-safe, redundant or other safety features which exceed the general specifications of the PRODUCTS are required. For details, please contact the Mitsubishi Electric representative in your region.
- (3) Mitsubishi Electric shall have no responsibility or liability for any problems involving programmable controller trouble and system trouble caused by DoS attacks, unauthorized access, computer viruses, and other cyberattacks.

## CONSIDERATIONS FOR USE

---

### Considerations for the Wind River Systems product

---

C intelligent function modules have an embedded real-time operating system, VxWorks, manufactured by Wind River Systems, Inc. in the United States. We, Mitsubishi, make no warranty for the Wind River Systems product and will not be liable for any problems and damages caused by the Wind River Systems product during use of a C intelligent function module. For the problems or specifications of the Wind River Systems product, refer to the corresponding manual or consult Wind River Systems, Inc.

Contact information is available on the following website.

- Wind River Systems, Inc.: [www.windriver.com](http://www.windriver.com)

# INTRODUCTION

---

Thank you for purchasing the Mitsubishi MELSEC iQ-R series programmable controllers.

This manual describes the performance specifications, procedure before operation, wiring, and operation examples to use the module listed below.

Before using this product, please read this manual and the relevant manuals carefully and develop familiarity with the performance of the MELSEC iQ-R series programmable controller to handle the product correctly.

When applying the program examples provided in this manual to an actual system, ensure the applicability and confirm that it will not cause system control problems.

Note that the menu names and operating procedures may differ depending on an operating system in use and its version.

When reading this manual, replace the names and procedures with the applicable ones as necessary.

Please make sure that the end users read this manual.

## Relevant product

---

RD55UP06-V, RD55UP12-V



# COMPLIANCE WITH EMC AND LOW VOLTAGE DIRECTIVES

---

## Method of ensuring compliance

---

To ensure that Mitsubishi Electric programmable controllers maintain the EMC and Low Voltage Directives or other regulations when incorporated into other machinery or equipment, certain measures may be necessary. Please refer to one of the following manuals.



-  MELSEC iQ-R Module Configuration Manual(SH-081262ENG)
-  Safety Guidelines (IB-0800525)

The CE mark on the side of the programmable controller indicates compliance with EMC and Low Voltage Directives.

## Additional measures

---

To ensure that this product maintains the EMC and Low Voltage Directives or other regulations, please refer to the following.

-  MELSEC iQ-R Module Configuration Manual(SH-081262ENG)
-  Safety Guidelines (IB-0800525)

# CONTENTS

SAFETY PRECAUTIONS .....	1
CONDITIONS OF USE FOR THE PRODUCT .....	9
CONSIDERATIONS FOR USE .....	9
INTRODUCTION .....	10
COMPLIANCE WITH EMC AND LOW VOLTAGE DIRECTIVES .....	10
RELEVANT MANUALS .....	12
TERMS .....	13
GENERIC TERMS AND ABBREVIATIONS .....	13
<b>CHAPTER 1 PART NAMES</b> .....	<b>14</b>
<b>CHAPTER 2 SPECIFICATIONS</b> .....	<b>16</b>
2.1 Performance Specifications .....	16
2.2 Drive and File Configuration .....	17
<b>CHAPTER 3 FUNCTION LIST</b> .....	<b>21</b>
<b>CHAPTER 4 PROCEDURE BEFORE OPERATION</b> .....	<b>23</b>
4.1 Setting Parameters .....	24
4.2 Creating User Program .....	26
Programming procedure .....	26
Checking VxWorks image file .....	29
Creating a script file .....	30
Registering a user program .....	32
4.3 SD Memory Card .....	34
Inserting and removing an SD memory card .....	34
<b>CHAPTER 5 SYSTEM CONFIGURATION</b> .....	<b>35</b>
5.1 Overall System Configuration .....	35
5.2 Connected Device Configuration .....	37
5.3 Considerations for System Configuration .....	37
For an RD55UP12-V .....	37
5.4 Supported Software Packages .....	38
<b>CHAPTER 6 WIRING</b> .....	<b>39</b>
6.1 Wiring of an Ethernet cable .....	39
<b>CHAPTER 7 OPERATION EXAMPLES</b> .....	<b>41</b>
<b>APPENDIX</b> .....	<b>45</b>
Appendix 1 External Dimensions .....	45
<b>INDEX</b> .....	<b>48</b>
REVISIONS .....	50
WARRANTY .....	51
INFORMATION AND SERVICES .....	52
TRADEMARKS .....	52

# RELEVANT MANUALS

Manual name [manual number]	Description	Available form
MELSEC iQ-R C Intelligent Function Module User's Manual (Startup) [SH-081566ENG] (this manual)	Specifications, procedure before operation, wiring, and operation examples of a C intelligent function module	Print book e-Manual PDF
MELSEC iQ-R C Intelligent Function Module User's Manual (Application) [SH-081567ENG]	Functions, input/output signals, buffer memory, parameter setting, and troubleshooting of a C intelligent function module	Print book e-Manual PDF
MELSEC iQ-R Module Configuration Manual [SH-081222ENG]	The combination of the MELSEC iQ-R series modules, common information on the installation/wiring in the system, and specifications of the power supply module, base unit, SD memory card, and battery	Print book e-Manual PDF
MELSEC iQ-R C Intelligent Function Module Programming Manual [SH-081568ENG]	Programming specifications and dedicated function libraries of a C intelligent function module	e-Manual PDF
MELSEC iQ-R C Controller Module/C Intelligent Function Module Programming Manual (Data Analysis) [SH-081756ENG]	Programming specifications and dedicated function libraries for analyzing the data of a C Controller module and a C intelligent function module	e-Manual PDF
MELSEC iQ-R C Intelligent Function Module Function Block Reference [BCN-P5999-1037]	Specifications, functions, and input/output labels of function blocks for a C intelligent function module	e-Manual PDF
MELSEC iQ-R Programming Manual (Module Dedicated Instructions) [SH-081976ENG]	Dedicated instructions for the intelligent function modules	e-Manual PDF
GX Works3 Operating Manual [SH-081215ENG]	System configurations, parameter settings, and operation methods for the online function in GX Works3	e-Manual PDF
CW Configurator Operating Manual [SH-081382ENG]	System configuration, parameter settings, and operation method for the online function in CW Configurator	e-Manual PDF
CW Workbench/CW-Sim Operating Manual [SH-081373ENG]	System configuration, specifications, functions, and troubleshooting of CW Workbench/CW-Sim	e-Manual PDF

This manual does not describe the following detailed information.

- General specifications
- Applicable combinations of CPU modules and the other modules, and the number of mountable modules
- Applicable combinations of remote head modules and the other modules, and the number of mountable modules
- Installation

For details, refer to the following manual.

 MELSEC iQ-R Module Configuration Manual

## Point

e-Manual refers to the Mitsubishi Electric FA electronic book manuals that can be browsed using a dedicated tool.

e-Manual has the following features:

- Required information can be cross-searched in multiple manuals.
- Other manuals can be accessed from the links in the manual.
- Hardware specifications of each part can be found from the product figures.
- Pages that users often browse can be bookmarked.

# TERMS

Unless otherwise specified, this manual uses the following terms.

Term	Description
Data analysis function	A dedicated function library offered by a C Controller module and a C intelligent function module. It is used for data analysis processing.
Intelligent function module	A module that has functions other than an input or output, such as an A/D converter module and D/A converter module
MELSEC iQ-R series data link function	A dedicated function library offered by a C intelligent function module. It is used to access an own station or modules on the network.

# GENERIC TERMS AND ABBREVIATIONS

Unless otherwise specified, this manual uses the following generic terms and abbreviations.

Generic term/abbreviation	Description
CW Configurator	A generic product name for SWnDND-RCCPU ('n' indicates its version.)
CW Workbench	An abbreviation for a C Controller module and C intelligent function module engineering tool, CW Workbench
CW-Sim	An abbreviation for VxWorks simulator that can operate and debug C Controller module programs and C intelligent function module programs on a personal computer with CW Workbench installed, without connecting to an actual device (target)
CW-Sim Standalone	An abbreviation for VxWorks simulator that can operate C Controller module programs and C intelligent function module programs even on a personal computer without CW Workbench installed
C intelligent function module	A generic term for MELSEC iQ-R series C intelligent function modules
C intelligent function module dedicated function	A dedicated function library offered by a C intelligent function module. It is used to control a C intelligent function module.
C Controller module	A generic term for MELSEC iQ-R series C Controller modules
GX Works3	A generic product name for SWnDND-GXW3 ('n' indicates its version.)
RD55UP06-V	A generic term for an RD55UP06-V and RD55UP06-V(R). When the classification is needed between an RD55UP06-V and RD55UP06-V(R), 'RD55UP06-V' or 'RD55UP06-V(R)' is mentioned.
RD55UP12-V	A generic term for an RD55UP12-V and RD55UP12-V(R). When the classification is needed between an RD55UP12-V and RD55UP12-V(R), 'RD55UP12-V' or 'RD55UP12-V(R)' is mentioned.
RD55UP06-V(R)	An abbreviation for an RD55UP06-V C intelligent function module supporting a redundant system
RD55UP12-V(R)	An abbreviation for an RD55UP12-V C intelligent function module supporting a redundant system
VxWorks	A product name for a real-time operating system manufactured by Wind River Systems, Inc.
Wind River Workbench	A generic term for Wind River Workbench manufactured by Wind River Systems, Inc.
Engineering tool	Another term for the software package for the MELSEC programmable controllers. It indicates GX Works3 and CW Configurator in this manual.
Dedicated function library	A generic term for C intelligent function module dedicated functions, MELSEC iQ-R series data link functions, data analysis functions, and statistical analysis functions
Target device	A personal computer or another CPU module to connect for data communication
Statistical analysis function	A dedicated function library offered by a C Controller module and a C intelligent function module. It is used for statistical analysis processing.
Power supply module	A generic term for MELSEC iQ-R series power supply modules

# 1 PART NAMES

This chapter shows the part names of a C intelligent function module.

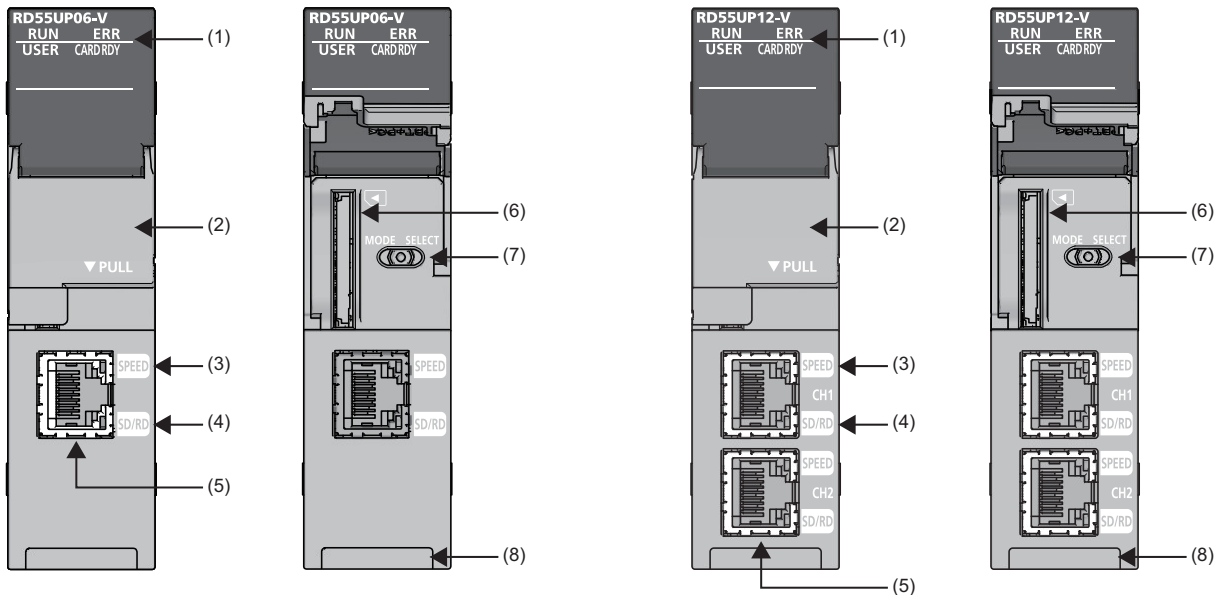

No.	Name	Description
(1)	RUN LED	Indicates the operating status. <ul style="list-style-type: none"> <li>• ON: In operation</li> <li>• Flashing (high-speed) *1: Waiting for the online module change confirmation</li> <li>• Flashing (low-speed) *1: Initializing (including the execution of the script file, "STARTUP.CMD")</li> <li>• OFF: Watchdog timer error (hardware failure)/Online module change available state</li> </ul>
	ERR LED	Indicates the error status. <ul style="list-style-type: none"> <li>• ON: Module minor error or watchdog timer error (hardware failure)</li> <li>• Flashing: Module major error or moderate error</li> <li>• OFF: In normal status</li> </ul>
	CARD RDY LED	Indicates the access status of an SD memory card. <ul style="list-style-type: none"> <li>• ON: Accessible (mounted)</li> <li>• Flashing: Being prepared (mounted/unmounted)</li> <li>• OFF: Inaccessible (not inserted/unmounted)</li> </ul>
	USER LED	Indicates the USER LED status. <ul style="list-style-type: none"> <li>• ON/OFF/Flashing: Controlled by a user program</li> </ul>
(2)	Slot cover	A cover of the SD memory card slot and the switch. Open this cover to insert/remove a card or to operate the switch. Close the cover unless inserting/removing an SD memory card or operating the switch to prevent foreign material intrusion such as dust.
(3)	SPEED LED	Indicates the communication speed and the link status for Ethernet. <ul style="list-style-type: none"> <li>• ON (orange): Linking-up (1000 Mbps)</li> <li>• ON (green): Linking-up (100 Mbps)</li> <li>• OFF: Linking-down or linking-up (10 Mbps)</li> </ul>
(4)	SD/RD LED	Indicates the data sending/receiving status in Ethernet. <ul style="list-style-type: none"> <li>• ON: Being sent/received</li> <li>• OFF: Not being sent/received</li> </ul>
(5)	Ethernet port	A port for connecting a C intelligent function module to an Ethernet device (A C intelligent function module distinguishes among 1000BASE-T, 100BASE-TX, and 10BASE-T depending on an external device.)
(6)	SD memory card slot	A slot for inserting an SD memory card
(7)	MODE/SELECT switch *2	A switch for performing the following operations: <ul style="list-style-type: none"> <li>• If the switch is held on the MODE side: An event is notified to the user program.</li> <li>• If the switch is held on the SELECT side: The SD memory card is unmounted.</li> </ul>
(8)	Product information marking	Displays the product information (16 digits) of a module.

\*1 High speed: Flashing at an interval of every 400 [ms]. Low speed: Flashing at an interval of every 2 [s].

\*2 Operate the switch by a fingertip. Using tools such as a screwdriver may cause damage to the switch.





# 2 SPECIFICATIONS

This chapter shows the specifications of C intelligent function modules.

## 2.1 Performance Specifications

This section shows the performance specifications.

Item		Specification		
		RD55UP06-V	RD55UP12-V	
Hardware	Endian format		Little endian	
	MPU		ARM® Cortex-A9 Dual Core	
	Memory capacity	Work RAM	128 MB	1 GB
		ROM	12 MB	
Software	OS		VxWorks Version 6.9	
	Programming language		C language (C/C++)	
SD memory card slot	Interface		SD/SDHC memory card (up to 16 GB)	
	Power supply		+3.3 VDC, up to 200 mA	
Ethernet port	Number of channels		1	2
	Interface		<ul style="list-style-type: none"> <li>• 1000BASE-T</li> <li>• 100BASE-TX</li> <li>• 10BASE-T</li> </ul>	
	Data transmission rate	1000BASE-T	1 Gbps	
		100BASE-TX	100 Mbps	
		10BASE-T	10 Mbps	
	Number of cascade connections*1	1000BASE-T	Consult the manufacturer of the repeater hub used.	
		100BASE-TX	2 levels maximum	
		10BASE-T	4 levels maximum	
	Maximum segment length		100 m (length between a hub and a node)	
	Communication method		Full-duplex/half-duplex	
Supported function		Auto-negotiation (automatic recognition of the communication speed/communication method) Auto-MDI/MDI-X (automatic recognition of a straight/crossover cable)		
Applicable connector for external wiring		RJ45		
IP version		IPv4 supported		
Number of occupied I/O points		32 points		
Clock function		Acquired from a CPU module (CPU No.1 in a multiple CPU system).		
Allowable momentary power failure time		According to the power supply module		
5 VDC internal current consumption		1.09 A	1.10A	
External dimensions	Height		106 mm	
	Width		27.8 mm	
	Depth		110 mm	
Weight		0.24 kg		

\*1 For a repeater hub.  
For a switching hub, consult the manufacturer of the hub used.

### Precautions

An RD55UP12-V takes longer to get in operation (turn ON the RUN LED) than an RD55UP06-V because the RD55UP12-V has a larger memory capacity (work RAM).

## 2.2 Drive and File Configuration

This section shows drives and file configuration.

### Drive configuration

The following table shows the drive names and file systems corresponding to memory.

Type	Memory name	Drive name	File system	Application
CPU built-in memory	Standard ROM	/ROM	FAT16	Memory to store user programs, script files, or any file/folder. The number of writable times (life) of the standard ROM is limited. It can be accessed from an FTP, a Telnet, and a user program.
	System memory	/SYSTEMROM	FAT16	Memory to store system files. Files cannot be written to the system memory.
Memory card	SD memory card	/SD	FAT16/FAT32	Memory to store user programs, script files, or any file/folder. It can be accessed from an FTP, a Telnet, and a user program.

### Memory life

The following shows the number of writable times (life) of the standard ROM.

#### ■Standard ROM life

The life is represented as a write count index value and data can be written until it reaches to 100,000 times. However, since the system increases the life for writing of the standard ROM, the write count index value differs from the actual write count. When the write count index value exceeds 100,000 times, the following cases occur. In this case, replace the C intelligent function module.

- Decreasing the writing speed to the standard ROM
- Unable to write to the standard ROM

#### ■Checking the write count index value

The write count index value can be acquired by using the C intelligent function module function (CITL\_GetUnitStatus).

When the write count index value exceeds 100,000 times, it will be registered in the event history.

#### Point

- Since the operation of the standard ROM is checked at factory acceptance test, the initial value of the write count index is not 0.
- Since a C intelligent function module always checks data in the standard ROM, the write count index value may be increased.

## File configuration

The following tables show the availability of the files stored in each drive.

### Precautions

Do not perform an operation to specify the same drive name as each drive (such as creating or deleting '/ROM'); otherwise, the system error may occur.

#### ■/ROM

○: Access allowed/Valid, ×: Access not allowed/Invalid

File name	Description	Storage location	FTP access	Factory setting	After initialization
User program	Created by a user	/ROM	○	×	×
Script file			○	×	×
Any file			○	×	×
RD55UP06-V_PARAM.DAT <sup>*1,*2</sup>	Service/account setting	/ROM	○	×	×
RD55UP12-V_PARAM.DAT <sup>*1,*3</sup>					

- \*1 It is created as a hidden file for the service/account setting.  
Do not delete this file; otherwise, the setting returns to its initial value.
- \*2 For an RD55UP06-V
- \*3 For an RD55UP12-V

#### ■/SYSTEMROM

○: Access allowed/Valid, ×: Access not allowed/Invalid

File name	Description	Storage location	FTP access	Factory setting	After initialization
prjParams.h	VxWorks component list file	/SYSTEMROM	○	○	○
RD55UP06-V_XX <sup>*1,*2</sup>	VxWorks image file	/SYSTEMROM/ OS_IMAGEFILE	○	○	○
RD55UP12-V_XX <sup>*1,*3</sup>					
CITLFunc.h	C intelligent function module dedicated function header file	/SYSTEMROM/INCLUDE	○	○	○
MDRFunc.h	MELSEC iQ-R series data link function header file		○	○	○
DANLFunc.h	Data analysis function/statistical analysis function header file		○	○	○

- \*1 "XX" at the end of the file name indicates firmware version.
- \*2 For an RD55UP06-V
- \*3 For an RD55UP12-V

#### ■/SD

○: Access allowed/Valid, ×: Access not allowed/Invalid

File name	Description	Storage location	FTP access	Factory setting	After initialization
User program	Created by a user	/SD <sup>*1</sup>	○	×	×
Script file			○	×	×
Any file			○	×	×

- \*1 A drive is created when an SD memory card is inserted.

## Precautions

The following shows the considerations for operating a file.

### ■Writing files

Before writing files with an FTP or a Telnet during user program operation, make sure that the files to be written will not affect the running user program.

### ■Accessing the same file

In a C intelligent function module, the files being written cannot be accessed, and also the files being accessed cannot be written.

### ■Number of files

Up to 512 files can be stored in the root folder for the standard ROM of a C intelligent function module.<sup>\*1</sup> (A folder will also be included in the number of files.) However, the maximum number may be reduced depending on a file name length and character types.

For an SD memory card, the number of files that can be stored differ depending on the memory capacity and a file system format. Take caution when using the memory.

<sup>\*1</sup> This number applies when storing a file which is composed of a file name within 8 characters and an extension within 3 characters, and which includes alphanumeric characters (not including lower-case characters) only.

### ■Creating a folder

Do not create a folder in the root ("/") of a C intelligent function module. If a folder is created, an error may occur or an unintended folder may be created. (These errors also occur when transferring a folder to the root ("/") from FTP.)

### ■File names and folder names

Use alphanumeric characters and special characters (excluding \, /, \*, ?, <, >, |, :, ", \$) for a file name and folder name to be stored. Otherwise, the following symptoms may occur.

- Garbled file name and folder name
- Loss of file and folder

Special characters (~, ,, space) cannot be used as a first character in the file name or directory name.

When only a special character (.) is used for a folder name, a folder cannot be created.

- A special character (.) following the usable character codes is not included in the folder name.

A folder, "a" is created when a folder name starts with "a...".

When a file name is composed of lower-case characters, it may be displayed all in upper-case characters when referred to from FTP or Telnet.

### ■File writing destination

Do not write files to the standard ROM using a user program.

Since the number of writable times (life) of the standard ROM is limited, the available period of a C intelligent function module is shortened.

When writing a file from a user program, write it to an SD memory card or a network device<sup>\*1</sup> (via FTP/NFS/netDrv).

<sup>\*1</sup> For details, refer to the manual for VxWorks.

## ■Removing an SD memory card

If an SD memory card is unmounted while writing data to a user file in the memory card, data corruption or file system error may occur. When writing data to a user file, close the user file before unmounting.

## ■Formatting an SD memory card

An SD memory card can be formatted by describing the following contents in a user program and execute it.

```
int fd = 0;
fd = open("/SD", 2, 750);    /*(1)*/
ioctl(fd, 5, 0);           /*(2)*/
close(fd);                  /*(3)*/
```

- (1) Opens an SD memory card
- (2) Formats the SD memory card
- (3) Closes the SD memory card

## ■File corruption

If powering OFF the system, or powering OFF and ON or resetting a CPU module while accessing a file in the standard ROM, data in the standard ROM may be corrupted or a file system failure may occur. Shut down the standard ROM with the C intelligent function module dedicated function (CITL\_ShutdownRom), then power OFF or reset them.

A C intelligent function module checks the system at startup, but it does not check user-created files stored in the standard ROM. Create a program for checking them as necessary.

### Ex.

The following shows an example for checking a program for any corruption by comparing the sum value calculated when writing the program with the one calculated when starting the module.

#### Sum value calculation

When writing or changing a user program file 'fileA.out,' follow the procedure below to calculate the sum value of 'fileA.out' with the C intelligent function module dedicated function (CITL\_CalculateSum).

1. Write the user program file 'fileA.out' to the standard ROM. (/ROM/DirA/fileA.out)
2. Calculate the sum value of 'fileA.out' with the C intelligent function module dedicated function (CITL\_CalculateSum).
3. Create a file (/ROM/hash/fileA.out.txt) and write the calculated sum value to the file.

#### Check for corruption

Follow the procedure below to compare the sum value calculated in 'Sum value calculation' when starting the C intelligent function module with that of 'fileA.out' stored in the standard ROM, and check that the user program is not corrupted.

1. Create a user program for performing the following processing:
  - ① Calculating the sum value of 'fileA.out' with the C intelligent function module dedicated function (CITL\_CalculateSum)
  - ② Reading the sum value calculated when writing 'fileA.out' from the file (/ROM/hash/fileA.out.txt)
  - ③ Comparing the two sum values to check that the data is not corrupted
2. Create a script file (STARTUP.CMD) in which loading user programs and generating tasks for executing functions are described.
3. Write the script file 'STARTUP.CMD' to the standard ROM.
4. Power OFF and ON or reset the CPU module.

#### If the data is corrupted



Restore the data by either of the following methods:

- Deleting the file in which data is corrupted and writing the file to the C intelligent function module again
- Using the chkdisk command to repair the file in which data is corrupted

When using the chkdisk command, be sure to use the sp command to start a task from Shell of CW Workbench or Telnet. For details on the chkdisk command, refer to the manual for VxWorks.

# 3 FUNCTION LIST

This chapter shows the functions of C intelligent function modules.

Function		Description
Program related function	Device access function	To access devices of a CPU module.
	Label communication function	To read/write data from/to labels stored in a CPU module.
	User program execution function from CPU module	To execute the registered user program by a dedicated instruction from a CPU module.
	Interrupt function to a CPU module	To notify an interrupt to a CPU module.
	Interrupt function to a C intelligent function module	To notify an interrupt to a C intelligent function module.
	Data analysis function	To perform data analysis processing such as fast Fourier transform, digital filter operation, and calculation of a standard deviation.
	Data analysis or statistical analysis using a CPU module	Using a dedicated instruction or a module FB, analysis processing can be performed on a C intelligent function module.
Ethernet communication function	FTP function	To read/write each file by using an FTP command from a target device.
	Telnet function	To execute shell commands using the Telnet tool.
RAS function	Program monitoring (WDT) function	To monitor and detect errors on the hardware and a user program.
	Error history function	To register an error to the buffer memory.
	Event history function	To register an event log in the event history of a CPU module.
	Self-diagnostic function	To check an Ethernet interface and a hardware.
	Initialization function	To initialize a C intelligent function module.
Security function	Individual identification information read function	To restrict execution of a user program.
	File access restriction function	To restrict file access.
	Service/account setting function	To restrict services to be operated and accounts that can be logged in to a C intelligent function module.
	IP filter function	To restrict access to C intelligent function module by identifying the IP address of the access source.
Time synchronization function		To synchronize time with a CPU module.
Sampling function		To sample target data from a CPU module.
SD memory card boot function		To start Linux stored in an SD memory card.
Online module change function		To replace a module with another without stopping a running system. For the procedure, refer to the following:  MELSEC iQ-R Online Module Change Manual
Firmware update function		To update the firmware of a C intelligent function module. For details on the firmware update function, refer to the following:  MELSEC iQ-R Module Configuration Manual

# MEMO

---



# 4 PROCEDURE BEFORE OPERATION

---

This chapter shows the procedure before operation of a C intelligent function module.

## 1. Mounting modules on a base unit

Do not use an electric screwdriver to attach and remove module fixing screws.

## 2. Inserting an SD memory card (📖 Page 34 Inserting and removing an SD memory card)

Insert an SD memory card if necessary.

## 3. Turning the power of the system ON

## 4. Parameter settings (📖 Page 24 Setting Parameters)

Set parameters with an engineering tool.

## 5. Resetting the system

Check the RUN LED and ERR LED. If an error occurred, take corrective actions following the troubleshooting. (📖MELSEC iQ-R C Intelligent Function Module User's Manual (Application))

## 6. Creating a user program (📖 Page 26 Creating User Program)

## 7. Resetting the system

## 8. Executing the program

## 9. Starting operation

# 4.1 Setting Parameters

Set parameters with an engineering tool.

## Point

Parameters can be set in CW Configurator with the following procedure.  
However, the settings regarding program language and module labels are not available.

## Startup method

### Operating procedure

Start an engineering tool.

☞ Start GX Works3 or CW Configurator from "MELSOFT" in Windows® Start.

## Parameter settings

### Operating procedure

1. Create a new project.

☞ [Project] ⇒ [New] from the menu

2. Select "Series", "Type", and "Program Language" and click the [OK] button.

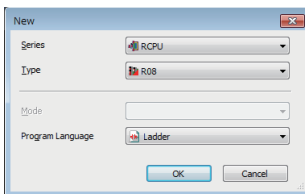

3. Set whether to use module labels, click the [OK] button.

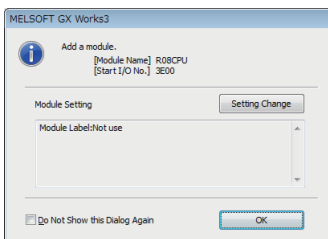

4. The "Add New Module" screen appears.

☞ [Navigation window] ⇒ [Parameter] ⇒ right-click [Module Information] ⇒ [Add New Module]

5. Add a C intelligent function module.

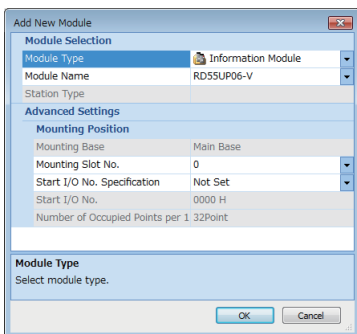

Item	Description
Module Type	Select "Information Module".
Module Name	Select "RD55UP06-V," "RD55UP06-V(R)," "RD55UP12-V," or "RD55UP12-V(R)." <sup>*1</sup>
Mounting Slot No.	Select the slot number where the C intelligent function module is mounted.
Start I/O No. Specification	If "Start I/O No." of the C intelligent function module is not specified, select "Not Set", and if specified, select "Set".
Start I/O No.	If "Set" is selected for "Start I/O No. Specification", enter the start I/O number of the C intelligent function module.

\*1 Select "RD55UP06-V(R)" or "RD55UP12-V(R)" when using a C intelligent function module in a redundant system.

6. Set whether to use module labels, click the [OK] button.

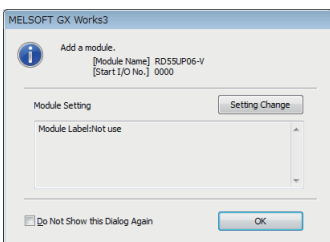

7. Set the module parameter of the C intelligent function module.

[Navigation window] ⇒ [Parameter] ⇒ [Module Information] ⇒ double-click a module name.

8. Write the settings to the CPU module with an engineering tool after completing the parameter settings.

9. Apply the settings by resetting the CPU module, or turning the power OFF and ON.

## 4.2 Creating User Program

Create a user program by using VxWorks standard API functions and functions offered by a C intelligent function module in accordance with the specification of VxWorks.

For programming method of VxWorks standard API functions, refer to the manual for VxWorks of the following version.

- VxWorks Version 6.9

For details on the dedicated function library of a C intelligent function module, refer to the following:

📖 MELSEC iQ-R C Intelligent Function Module Programming Manual

📖 MELSEC iQ-R C Controller Module/C Intelligent Function Module Programming Manual (Data Analysis)

### Point



For details on sample programs, please contact your local Mitsubishi Electric sales office or representative.

## Programming procedure

The following shows the procedure for creating a user program.

For details on project creation and programming method, refer to the following:

📖 CW Workbench/CW-Sim Operating Manual

1. Install CW Workbench on a personal computer.
2. Start CW Workbench, and check that VxWorks image file of the personal computer is the same as that of the C intelligent function module. ( Page 29 Checking VxWorks image file)
3. Create a project of the user program.
4. Configure various settings to use the dedicated function library.
5. Create a user program.
6. Debug the user program.
7. Create a script file to start the user program. ( Page 30 Creating a script file)
8. Register the created user program and the script file to the C intelligent function module. ( Page 32 Registering a user program)

## Considerations for creating a user program

The following shows the considerations when creating a user program.

### ■Endian format (memory layout)

The endian format (memory layout) of a C intelligent function module is little endian. Compile a user program in the little endian format.

### ■VxWorks real-time process (RTP)

C intelligent function module does not support applications running in VxWorks real-time process. Create a user program as an application based on the VxWorks kernel.

### ■Build property

When compiling a user program, enter "-mlong-calls" in the box next to the [Tool Flags] button, and enter "-fsigned-char" in the boxes next to the [Debug mode] and [Non Debug mode] buttons.

 [Project Explorer] of CW Workbench ⇒ right-click the respective project ⇒ [Properties] ⇒ [Build Properties] ⇒ [Tools]

## ■User program execution

Execute a user program by starting a task from the script file. The system may malfunction if the user program is executed without the task being started.

## ■Startup of a task performing floating-point operations

Always specify the VX\_FP\_TASK option for the third argument of taskSpawn when activating the following tasks.

- A task performing floating-point operations
- A task calling a function that returns floating-point value
- A task calling a function that takes floating-point value as an argument
- A task calling a data analysis function
- A task calling a statistical analysis function

Activating the above task without the VX\_FP\_TASK option specified may cause the operating system runaway. For information on specifying the VX\_FP\_TASK option in a script file, refer to the following:

☞ Page 30 Creating a script file

For more details on the VX\_FP\_TASK option, refer to the manual for VxWorks.

## ■Priority of tasks to be executed

Set the priority of a task to execute a user program as described below.

- When the access is not made with FTP while executing the user program, set the priority of the user program to 100 or more (100 to 255). Operating with the priority set to 0 to 99 may cause improper operation of the system.
- When the access is made with FTP while executing a user program, the actual FTP processing (task) of the C intelligent function module is performed at the priority of 200. Set the priority of the user program to 201 to 255. When setting the priority to 100 to 200, set a wait processing (such as taskDelay) in the user program to let the actual FTP processing operate.

## ■Communication with a target device via Ethernet

To communicate with a target device via Ethernet, check the port number being used in the C intelligent function module in advance using the VxWorks standard "netstat" command\*1. Do not use any port number that has already been used. Normal communication may not be performed if used.

\*1 Execute the "netstat" command using the Telnet tool.

## ■When no response is returned from a function

The response from a function may not be returned when an error occurs on C intelligent function module. Design a user program take into account the possibility of no response from the function.

The error occurrence status can be checked using the C intelligent function module dedicated function (CITL\_GetErrInfo).

## ■Memory fragmentation

Allocating and deallocating memory frequently may cause improper operation of the system due to memory fragmentation.

## ■Restrictions on MELSEC iQ-R series data link functions

A path for a MELSEC iQ-R series data link function does not support to be shared among multiple tasks. Make sure to manage a path opening/closing for each task.

## ■When changing system clock rate

Use the C intelligent function module dedicated function (CITL\_SysClkRateSet) to change the system clock rate, and do not use the VxWorks standard API function (sysClkRateSet). Otherwise, the operation of VxWorks will be unstable.

## ■Settings of IP address

Set the IP address of the C intelligent function module using an engineering tool. If it is set by a user program, the network may be no longer functional properly.

## ■Considerations for interrupt service routine

Fully understand the specifications on VxWorks, operating system of a C intelligent function module, before creating a routine which will be executed in an interrupt service routine. Setting an inappropriate value to an argument of functions or executing a function other than C intelligent function module dedicated functions for ISR may cause the VxWorks runaway.

In the dedicated function library (excluding data analysis functions and statistical analysis functions) offered by a C intelligent function module, C intelligent function module dedicated functions for ISR can be used. To execute other dedicated functions synchronously with an interrupt, implement the notification processing in a user program and perform the processing in a task.

## Considerations for CW Workbench connection

This section explains the considerations for CW Workbench connection.

### ■Errors occurred during program download

When a user program is specified and downloaded to a target (C intelligent function module) with CW Workbench, the system failure/stop (such as user watchdog timer error) may occur in the C intelligent function module during the download if the user program size is too large.

Take the following corrective action in the case of system failure/stop.

- Load the program and debug it in a C intelligent function module.

### ■Interrupt processing delay

During remote debugging with CW Workbench, a C intelligent function module may be in the interrupt-disabled state. Any processing called from an interrupt routine (such as C intelligent function module dedicated functions for ISR) is not executed during that time. Interrupts that are expected to occur at the fixed interval such as periodic timer interrupt may be delayed.

### ■Restarting C intelligent function module

To restart a C intelligent function module, ensure that CW Workbench is disconnected. When the C intelligent function module is restarted with CW Workbench connected, CW Workbench automatically establishes the connection once the C intelligent function module has been started up. At that time, an error may occur since the system task which has been operating in the C intelligent function module is temporarily blocked.

### ■Message displayed on Host Shell

Message(s) issued by VxWorks during Host Shell connection may be displayed. For details on messages of VxWorks, refer to the manual for VxWorks or the help of CW Workbench.

## Checking VxWorks image file

Check that VxWorks image files of the personal computer and C intelligent function module are in the same version before debugging the user program.

The image files of different version cannot debug normally.

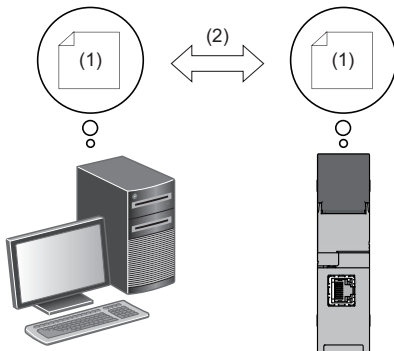

- (1) VxWorks image file
- (2) Same version

### Checking method

The checking methods for the VxWorks image file are shown below.

#### ■C intelligent function module

Check the firmware version with the diagnostic function of an engineering tool or the rating plate on the C intelligent function module side.

#### ■Personal computer

Check the file name of VxWorks image file specified with CW Workbench.

- RD55UP06-V\_XX\*<sup>1</sup>
- RD55UP12-V\_XX\*<sup>1</sup>

\*<sup>1</sup> XX: Firmware version

### If the version is different

If the version of VxWorks image file is different, acquire the new image file stored in the C intelligent function module.

1. Connect a C intelligent function module with a personal computer. (☞ Page 39 WIRING)
2. Acquire the VxWorks image file\*<sup>1</sup> using FTP function from the C intelligent function module.  
\*<sup>1</sup> Stored in the system memory (/SYSTEMROM/OS\_IMAGEFILE).
3. Reconfigure the target server setting with CW Workbench.

#### Point

The default settings of the FTP function are as follows:

- Login name: target
- Password: password

# Creating a script file

A script file "STARTUP.CMD" is a file to describe the loading destination of a user program which starts when starting a C intelligent function module and the starting order of tasks.

## Considerations for creating a script file

### ■Starting a user program

Describe a command so that a user program is executed by activating the task<sup>\*1</sup>.

\*1 Priority: 100 to 255

### ■Specifying VX\_FP\_TASK option

When VX\_FP\_TASK option is specified in the third argument of taskSpawn, specify "0x1000000".

The VX\_FP\_TASK option is specified for "funcA" function as follows:

```
taskSpawn("taskA",100,0x1000000,20000,funcA,0,0,0,0,0,0)
```

## Script file storage location

A script file can be stored in the root folder of the standard ROM and an SD memory card.

Store a script file in the root directory.

### ■When script files stored into both the standard ROM and SD memory card

When a script file is stored in both memory, the script file in the SD memory card has priority, and the script file in the standard ROM is not executed.

#### Point

In the system which has been operated by a script file stored in the standard ROM, its processing can be switched for maintenance easily by installing an SD memory card in which a script file for maintenance work is stored.

## Description of scripts

### ■Description of commands

- Only one command can be described in one line.
- Up to 12 arguments can be specified for one command.

### ■Description of comment statements

- Describe "/" at the beginning of a line.
- There is no limit on the number of characters in a statement.

### ■Executing C++ functions

Describe the function declaration portion on C++ source code as follows.

- extern "C" {Function declaration portion}

#### Point

Description of commands in a script file allows the following operations.

- Copying a user program
- Formatting the standard ROM

Commands described in a script file are the same as contents described in a startup script file for VxWorks. For more details, refer to the manual for VxWorks.



## Example of script file description

The following shows an example to load a user program in the standard ROM and SD memory card using a script file in the standard ROM.

### Storage file

Memory	File storage destination path	File name	Description
Standard ROM	/ROM	STARTUP.CMD	Script file to load a user program
	/ROM/DirA	fileA.out	User program ("funcA" function has been already included.)
SD memory card	/SD/DirB	fileB.out	User program ("funcB" function has been already included.)

### Task details

Activation order	Task name	Priority	Stack size	Function name	Argument specification
1	Default: tN (N = 1, 2, ...)	Default: 100	Default: 20000 bytes	funcA	None
2	taskB	120	5000 bytes	funcB	Specified (First argument: 10)

### Example of script file (STARTUP.CMD) description

```
ld(1,0,"/ROM/DirA/fileA.out")          /*(1)*/
ld(1,0,"/SD/DirB/fileB.out")          /*(2)*/
sp(funcA,0,0,0,0,0,0,0,0,0)           /*(3)*/
taskSpawn("taskB",120,0,5000,funcB,10,0,0,0,0,0) /*(4)*/
```

(1) Load the "fileA.out" file from the "DirA" folder of the standard ROM.

(2) Load the "fileB.out" file from the "DirB" folder of the SD memory card.

(3) Create a "funcA" function with the default task name (t1). ("funcA" function has been already included in fileA.out)

(4) Create a "funcB" with the task name "taskB". ("funcB" function has been already included in fileB.out)

#### Point

Up to 12 arguments can be specified for one command. Therefore, in the example of script file description above, up to seven arguments can be passed to the function entry specified for taskSpawn (example: funcB). If eight or more arguments are specified, the task will not be activated.

# Registering a user program

This section shows the procedure to register a user program.

1. Describe the loading destination of the user program which starts at the time of the C intelligent function module startup in the script file "STARTUP.CMD".
2. Write the script files and user program file to the C intelligent function module.
3. Reset the CPU module, or turn the power OFF and ON.

### Point

- User program files can be stored in any memory that can store files.
- To register by overwriting, close the file before overwriting it. Overwriting with the file opened may fail.

## How to write

The following methods are available to write a script file and a user program.

- Writing from a personal computer by using the FTP function
- Writing from an SD memory card by copying with a command in a script file

### ■When writing files using the FTP function from a personal computer

The following shows the procedure to write files using the FTP function from a personal computer.

1. Create the following files.

File name	Description
STARTUP.CMD	Script file to load a user program
file.out*1	User program file

\*1 Any file name

- STARTUP.CMD

```
ld(1,0,"/ROM/file.out") /*(1)*/
```

```
sp(func,0,0,0,0,0,0,0,0) /*(2)*/
```

(1) Load the "file.out" file from the root folder of the standard ROM.

(2) Create "func" function with the default task name (t1). ("func" function has been already included in file.out)

2. Turn the power of the CPU module ON.
3. Connect a C intelligent function module with a personal computer. (📄 Page 39 WIRING)
4. Access the C intelligent function module using the FTP function.
5. Write the script file and user program to the standard ROM.
6. Reset the CPU module, or turn the power OFF and ON.
7. Check that the RUN LED starts flashing (low-speed). ("STARTUP.CMD" is executed.)
8. Check that the RUN LED turns ON. ("file.out" is executed.)

### Point

The default settings of the FTP function are as follows:

- Login name: target
- Password: password

## ■When writing files from an SD memory card by copying with a command in a script file

The following shows the procedure to copy files in an SD memory card by using a command in a script file.

Copy a file in the SD memory card in the following cases.

- When a personal computer and a C intelligent function module cannot be connected normally
- When writing a same user program in multiple C intelligent function modules

### 1. Create the following files.

File Name	Description
STARTUP.CMD	Script file to copy each file to the standard ROM
STARTUP.ROM* <sup>1</sup>	Script file to load a user program
file.out* <sup>2</sup>	User program file

\*1 Any file name other than "STARTUP.CMD"

\*2 Any file name

#### • STARTUP.CMD

```
copy("/SD/file.out","/ROM/file.out") /*(1)*/
```

```
copy("/SD/STARTUP.ROM","/ROM/STARTUP.CMD") /*(2)*/
```

(1) Copy the user program "file.out" in the SD memory card to the standard ROM.

(2) Change the name of the script file "STARTUP.ROM" for operation in the SD memory card to "STARTUP.CMD" and then copy to the standard ROM.

#### • STARTUP.ROM

```
ld(1,0,"/ROM/file.out") /*(1)*/
```

```
sp(func,0,0,0,0,0,0,0) /*(2)*/
```

(1) Load the "file.out" file from the root folder of the standard ROM.

(2) Create "func" function with the default task name (t1). ("func" function has been already included in file.out)

2. Write the created files to the SD memory card.
3. Insert the SD memory card to the C intelligent function module.
4. Reset the CPU module, or turn the power OFF and ON.
5. Check that the RUN LED starts flashing. ("STARTUP.CMD" is executed.)
6. Check that the RUN LED turns ON. ("STARTUP.CMD" processing is completed.)
7. Turn the power of the CPU module OFF, and remove the SD memory card from the C intelligent function module.
8. Turn the power of the CPU module ON.
9. Check that the RUN LED starts flashing (low-speed). (The file name is changed and the "STARTUP.CMD" copied to the standard ROM is executed.)
10. Check that the RUN LED turns ON. ("file.out" is executed.)

## 4.3 SD Memory Card

This section shows an SD memory card used for a C intelligent function module.

For available SD memory cards, refer to the following:

☞ Page 37 Connected Device Configuration

### Inserting and removing an SD memory card

Insert or remove an SD memory card by following the procedure below. Failure to do so may cause data corruption in the SD memory card.

#### How to insert an SD memory card

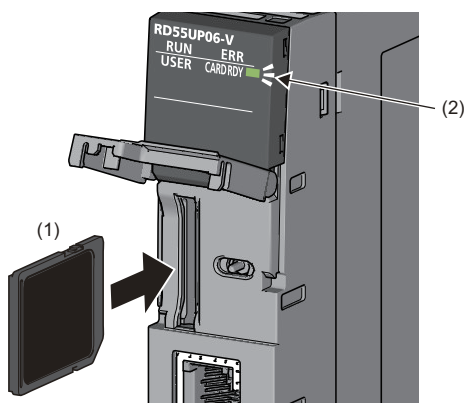

1. Insert an SD memory card (1) straight into the SD memory card slot with its cutout pointed down. Make sure it is not uplifted after inserting it.
2. The CARD RDY LED (2) keeps flashing until the SD memory card is ready to be used.
3. Once the CARD RDY LED (2) turns ON, the card can be used.

#### How to remove an SD memory card

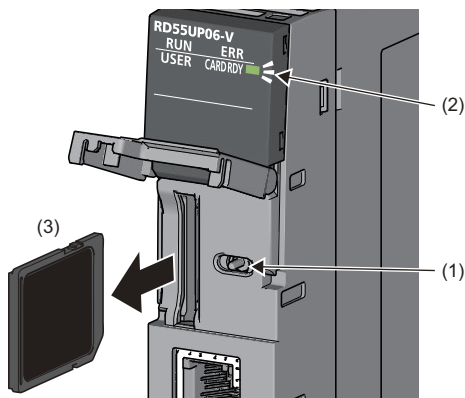

1. Check that no SD memory card is accessed.
2. Hold the MODE/SELECT switch (1) in the SELECT position to unmount the SD memory card. The CARD RDY LED (2) is flashing, which indicates that process of unmounting SD memory card is in progress, and later upon successful completion, the LED turns OFF.
3. Push the SD memory card (3) in once, and pull it out straight.

#### Point

An SD memory card can also be unmounted with a user program using the C intelligent function module dedicated function (CITL\_UnmountMemoryCard).

#### Precautions

Do not perform the following operations while accessing the files in an SD memory card. Doing so may result in data corruption in the SD memory card or file system error.

- Turning the power of the system OFF
- Resetting the CPU module, or turning the power OFF and ON
- Unmounting or removing the SD memory card

# 5 SYSTEM CONFIGURATION

This chapter shows the system configuration of a C intelligent function module.

For system configurations applicable for MELSEC iQ-R series and the number of mountable CPU modules when using a C intelligent function module, refer to the following:

📖 MELSEC iQ-R Module Configuration Manual

## 5.1 Overall System Configuration

This section shows the overall system configuration using a C intelligent function module.

### RD55UP06-V

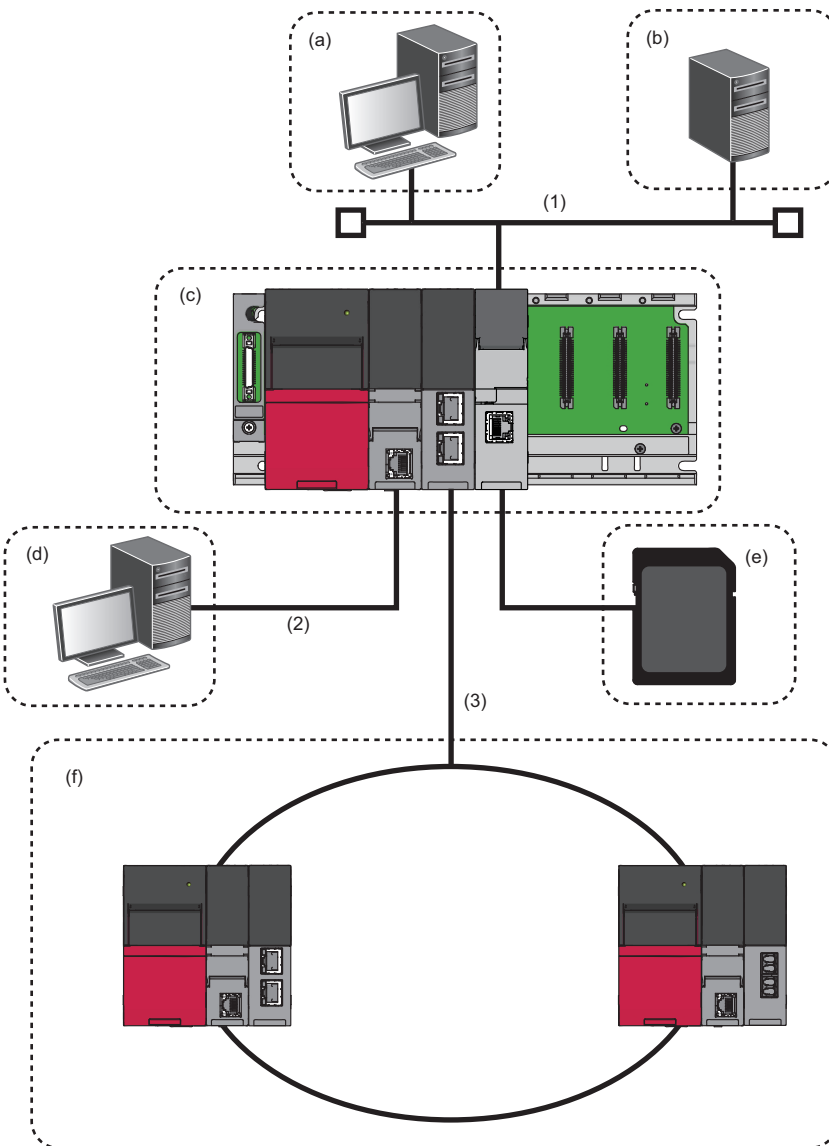

- (1) Ethernet
- (2) USB/Ethernet
- (3) CC-Link IE Controller Network, CC-Link IE Field Network, CC-Link, Ethernet
- (a) CW Workbench
- (b) Superior server
- (c) Programmable controller system
- (d) Engineering tool
- (e) SD memory card
- (f) Access target CPU

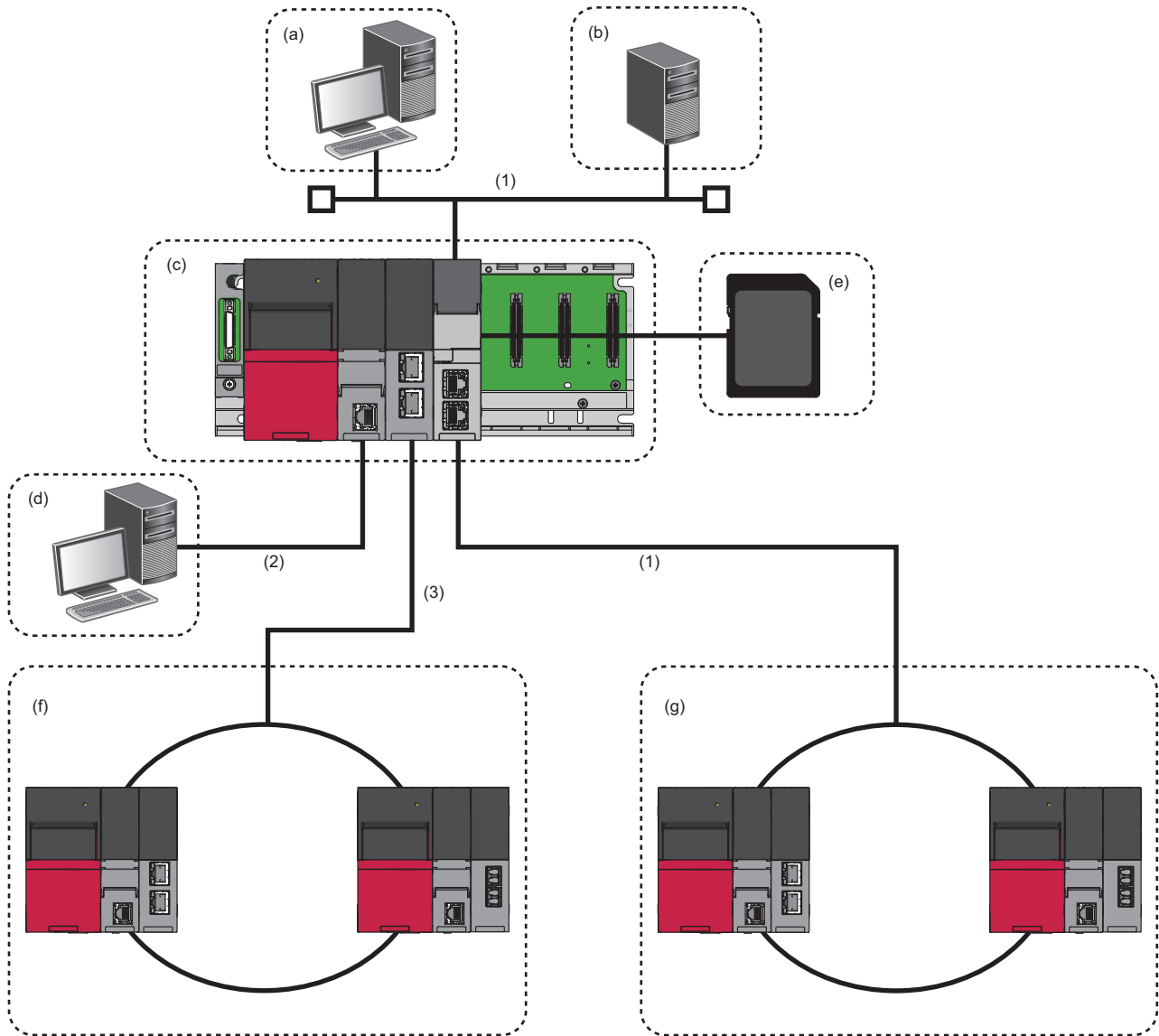

- (1) Ethernet
- (2) USB/Ethernet
- (3) CC-Link IE Controller Network, CC-Link IE Field Network, CC-Link, Ethernet
- (a) CW Workbench
- (b) Superior server
- (c) Programmable controller system
- (d) Engineering tool
- (e) SD memory card
- (f) Access target CPU
- (g) Ethernet device

## 5.2 Connected Device Configuration

This section shows the connectable devices to a C intelligent function module.

### SD memory cards (sold separately)

One SD memory card is required for using a C intelligent function module.

Use one of the following SD memory cards manufactured by Mitsubishi Electric.

Model name	Capacity
NZ1MEM-2GBSD	2 GB
NZ1MEM-4GBSD	4 GB
NZ1MEM-8GBSD	8 GB
NZ1MEM-16GBSD	16 GB

## 5.3 Considerations for System Configuration

5

### For an RD55UP12-V

#### Considerations for network settings

When using Ethernet ports CH1 and CH2 at the same time, assign a different network address to each port. Messages for each network address are sent from the Ethernet port to which the address is assigned.

Therefore, if an Ethernet port is not connected to its assigned network, communication may not be established properly.

**Ex.**

When a ping is executed from a personal computer (192.168.3.10) to CH2 of a C intelligent function module (192.168.4.3)

- IP address assignments for the C intelligent function module

Ethernet port	Setting
CH1	IP Address: 192.168.3.3 Subnet mask: 255.255.255.0
CH2	IP Address: 192.168.4.3 Subnet mask: 255.255.255.0

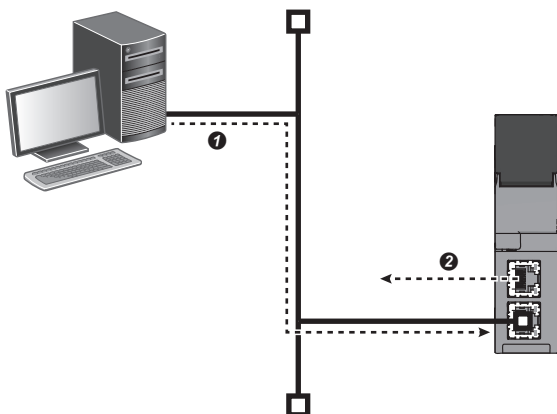

❶: A ping request is sent from a personal computer (192.168.3.10) to the Ethernet port CH2 of an RD55UP12-V (192.168.4.3).

❷: A ping response is sent from the Ethernet port CH1 of the RD55UP12-V (192.168.3.3).

The request sent from the personal computer reaches CH2 without any problem. However, since the response message is to the personal computer (192.168.3.10), it is sent from CH1 (192.168.3.3) to which a network address of 192.168.3.XX is assigned.

If CH1 is not connected to a network, the response is not returned to the personal computer.

## 5.4 Supported Software Packages

This section shows the software packages supported by each C intelligent function module.

Software package	Software version	
	RD55UP06-V	RD55UP12-V
GX Works3	1.020W or later	1.065T or later
CW Configurator	1.009K or later	1.012N or later
CW Workbench	C or later	H or later
CW-Sim		
CW-Sim Standalone		
Wind River Workbench	3.3	



# 6 WIRING

## 6.1 Wiring of an Ethernet cable

This section shows the procedure for connecting and disconnecting Ethernet cables.

### Ethernet Cable

An Ethernet cable compliant with IEEE802.3 1000BASE-T/100BASE-TX/10BASE-T standards can be used.

Transmission rate	Unshielded twisted pair cable (UTP cable) Shielded twisted pair cable (STP cable)	
	Straight cable	Crossover cable
1 Gbps	Category 5e or higher	Category 5e
100 Mbps	Category 5 or higher	Category 5 or 5e
10 Mbps	Category 3 or higher	Category 3 to 5e

### How to connect an Ethernet cable

1. Check the insertion direction, and insert an Ethernet cable into the Ethernet port on the C intelligent function module until it clicks.
2. Lightly pull the cable to check that it is securely connected.
3. Check that the SPEED LED of the Ethernet port is ON.

#### Point

- The time required from when an Ethernet cable is connected to when the SPEED LED turns ON may vary. Normally, it turns ON in a few seconds. However, it may take longer because the linking-up processing is repeated due to the device condition on the line.
- When the SPEED LED does not turn ON, check if the connected Ethernet cable has any failure.
- The SPEED LED turns OFF when connecting with an Ethernet device on the network the data transmission speed of which is 10 Mbps. Check the communication status by performing the PING test, etc.

### How to disconnect an Ethernet cable

Pull out the Ethernet cable while pinching a clip on the connector.

### IP address setting

To use the Ethernet port, set the IP address with an engineering tool.

 [Navigation window] ⇒ [Parameter] ⇒ [Module Information] ⇒ Target module ⇒ [Basic Setting] ⇒ [Own Node Setting] ⇒ [IP Address Setting]

The default IP address is as follows:

#### ■RD55UP06-V

- 192.168.3.3

#### ■RD55UP12-V

- Ethernet port CH1: 192.168.3.3
- Ethernet port CH2: None (no setting)

## Precautions

### ■ Considerations for IP address setting

The following shows the considerations for setting IP address.

- Set the same value for the network portion of the IP addresses for the target device to be connected and the Ethernet port.
- Do not set the IP address for a C intelligent function module with a user program.

### ■ Considerations for Ethernet device connection

The following shows the considerations for connecting Ethernet devices.

- When the C intelligent function module has been replaced and also IP address has been changed, then reset the Ethernet device too. If the Ethernet device holds the Ethernet address (MAC address) of the communication target, continuous communication may not be performed since the module replacement will change the Ethernet address (MAC address).
- Perform the troubleshooting in accordance with the manual for the Ethernet device when an error occurred on the Ethernet device.
- When Telnet or Shell of CW Workbench is connected to a C intelligent function module, an event/error message may be displayed once VxWorks detects a network error. For details on the displayed event/message, refer to the manual for VxWorks. Please ask Wind River Systems, Inc. for any event/message which cannot be handled.

### ■ Considerations for 1000BASE-T/100BASE-TX connection

In a high-speed data communication (1 Gbps/100 Mbps) via 1000BASE-T/100BASE-TX connection, a communication error may occur due to the effect of high frequency noise generated from the equipment other than C intelligent function module, depending on the installation environment.

Take the following countermeasures on a C intelligent function module when constructing a network system.

- Do not install the twisted pair cables together with the main circuit or power lines, or bring them close to each other.
- Make sure to place the twisted pair cable in a duct.
- In the environment where the cable is susceptible to noise, use a shielded twisted pair cable (STP cable).
- In an environment where the system is susceptible to noise, include a retry processing in a user program.
- Change the target device connected with the C intelligent function module to one which communicates at 10 Mbps, and decrease the data transmission rate.

# 7 OPERATION EXAMPLES

This chapter shows the examples for operating USER LED using a C intelligent function module dedicated function by the system on which a C intelligent function module is used. (☞ Page 23 PROCEDURE BEFORE OPERATION)

The USER LED of the C intelligent function module flashes as shown in the following operation example:

- USER LED: OFF → ON (Red) → Flashing at low speed (Red) → Flashing at high speed (Red) → ON (Green) → Flashing at low speed (Green) → Flashing at high speed (Green)

## Configurations

This section shows the system configuration to be used in the operation example.

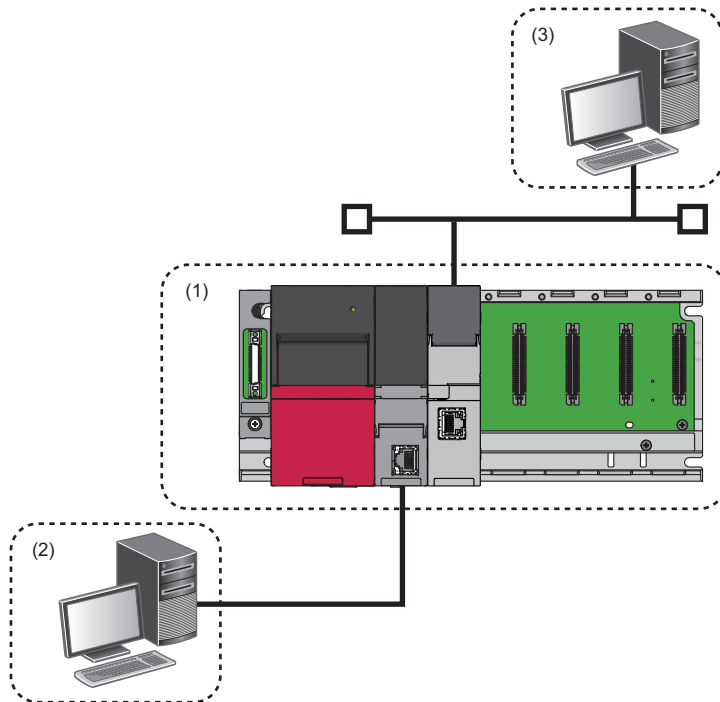

Configurations		Connection Target	Connection Method	
(1)	Programmable controller system	R35B	—	
		R61P	—	
		R04CPU	—	
		RD55UP06-V (this product)	—	
(2)	GX Works3	SWnDND-GXW3 (n: version)	R04CPU	USB/Ethernet
(3)	CW Workbench	SWnDND-CWWR-E/EV/EVZ (n: version)	RD55UP06-V	Ethernet

## Setting parameters

This section shows the parameter setting required for the operation example.

### ■ Adding new module

Add an C intelligent function module to the project created by using an engineering tool and set parameters. (📖 Page 24 Parameter settings)

#### Operating procedure

**1.** Open the "Add new module" screen.

👉 [Navigation window] ⇨ [Parameter] ⇨ right-click [Module Information] ⇨ [Add New Module]

**2.** Add a C intelligent function module in the "Add New Module" screen.

👉 [Module Type] ⇨ [Information Module], [Module Name] ⇨ [RD55UP06-V]

**3.** Set the module parameter of the C intelligent function module.

Use the initial parameters when adding modules in the operation example.

For details on the parameters, refer to the following:

📖 MELSEC iQ-R C Intelligent Function Module User's Manual (Application)

**4.** Write the parameters to the CPU module, and reset the CPU module, or turn the power OFF and ON.

👉 [Online] ⇨ [Write to PLC]

## Creating a user program

The following shows the procedure for creating a user program.

Source codes to be used in the operation example are as follows:

### Header file/function to be used

Header file/function	Description
CITLFunc.h	A header file of a C intelligent function module dedicated function.
CITL_SetLEDStatus	A function that sets the LED status of a C intelligent function module.

```
#include "CITLFunc.h"
#include "taskLib.h"
short sSetLEDStatus(void){
    short sRet=0;           /*(1)*/
    long lLed=0;           /*(2)*/
    unsigned short usLedInfo=0; /*(3)*/

    for(usLedInfo=0; usLedInfo<7; usLedInfo++){ /*(4)*/
        sRet=CITL_SetLEDStatus(lLed, usLedInfo); /*(5)*/
        if(sRet==0){ /*(6)*/
            taskDelay(100);
        }else{ /*(7)*/
            break;
        }
    }
    return sRet;
}
```

- (1) Return value of CITL\_SetLEDStatus function
- (2) Target LED
- (3) LED status information
- (4) LED status information specification
- (5) LED status setting
- (6) If succeeded in LED status setting
- (7) If failed in LED status setting

### Programming procedure

The following shows the procedure for creating a user program. (📖 Page 26 Creating User Program)

For details on procedures 1 to 3, refer to the following:

📖 CW Workbench/CW-Sim Operating Manual

1. Start CW Workbench, and check that VxWorks image file of the C intelligent function module is the same as that of the personal computer.
2. Create a project for a user program.
3. Create a user program and then debug.

## Executing a user program

This section shows the procedure for executing the user program created with CW Workbench.

### Operating procedure

1. Create a script file to start the user program. (📖 Page 30 Creating a script file)
2. Save the user program and the script file to the C intelligent function module. (📖 Page 32 Registering a user program)
3. Reset the CPU module, or turn the power OFF and ON.
4. The registered user program is executed.

# MEMO

---

# APPENDIX

## Appendix 1 External Dimensions

The following figures show the external dimensions of a C intelligent function module.

### RD55UP06-V

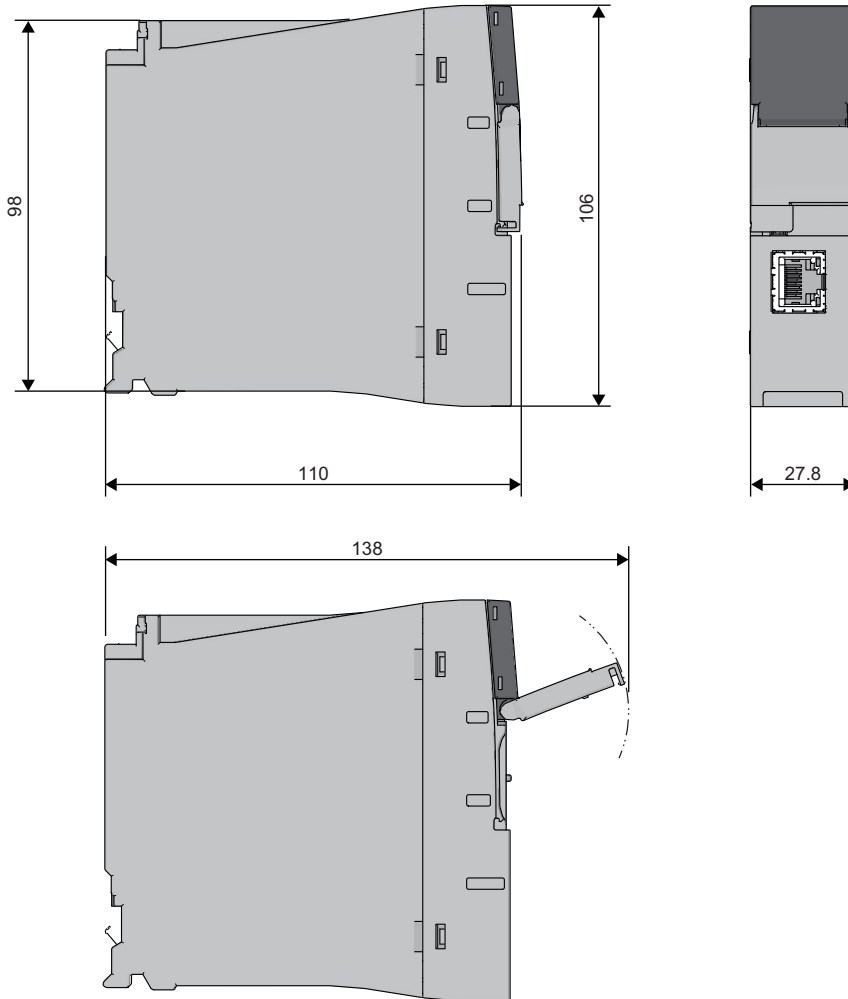

(Unit: mm)

A

# RD55UP12-V

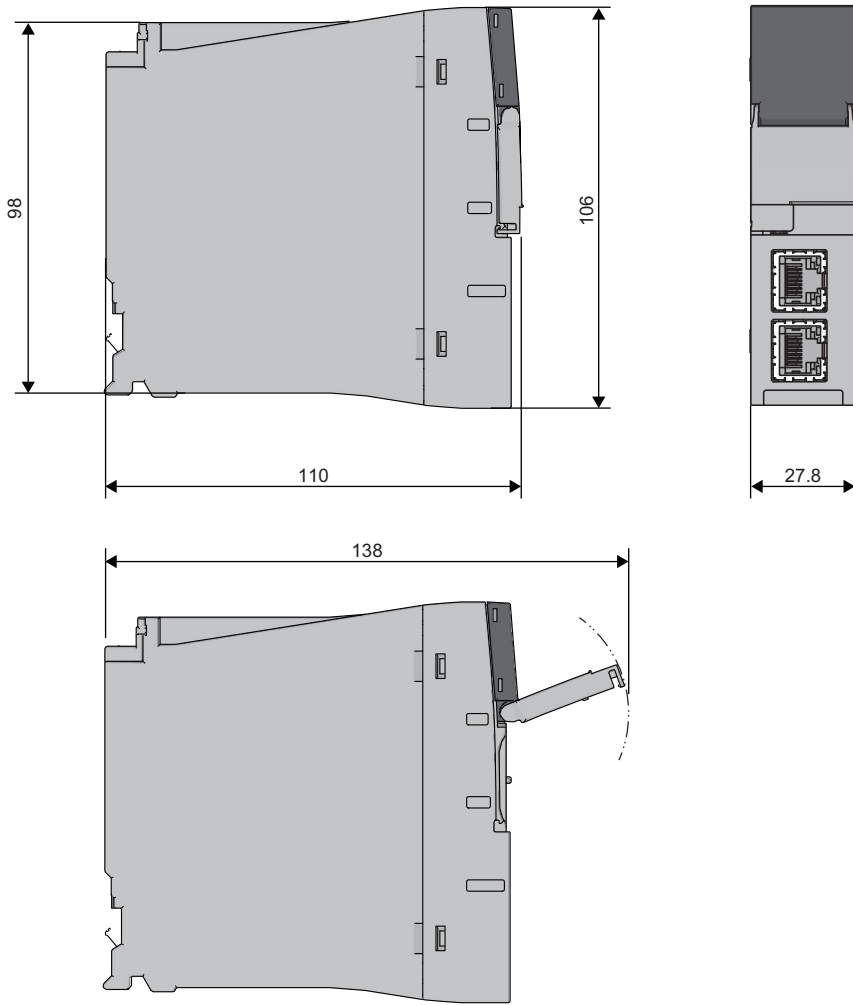

(Unit: mm)



# MEMO

---

A

# INDEX

---

## C

---

CARD RDY LED . . . . .	14
CITLFunc.h . . . . .	18

## D

---

DANLFunc.h . . . . .	18
Drive configuration . . . . .	17

## E

---

Endian format . . . . .	26
ERR LED . . . . .	14
Ethernet cable . . . . .	39
Ethernet port . . . . .	14,16

## I

---

Interrupt service routine . . . . .	28
IP address . . . . .	39

## M

---

MDRFunc.h . . . . .	18
Memory life . . . . .	17
MODE/SELECT switch . . . . .	14
MPU . . . . .	16

## O

---

OS . . . . .	16
--------------	----

## P

---

Priority . . . . .	27
Product information marking . . . . .	14

## R

---

RUN LED . . . . .	14
-------------------	----

## S

---

Script file . . . . .	30
SD memory card . . . . .	17,34,37
SD memory card slot . . . . .	16
SD/RD LED . . . . .	14
SPEED LED . . . . .	14
Standard ROM . . . . .	17
System memory . . . . .	17

## U

---

USER LED . . . . .	14
User program . . . . .	26,32

## V

---

VxWorks component list file . . . . .	18
VxWorks image file . . . . .	18,26,29

# MEMO

---

# REVISIONS

\*The manual number is given on the bottom left of the back cover.

Revision date	*Manual number	Description
December 2015	SH(NA)-081566ENG-A	First edition
January 2017	SH(NA)-081566ENG-B	■Added or modified parts SAFETY PRECAUTIONS, Chapter 3
April 2017	SH(NA)-081566ENG-C	■Added or modified parts RELEVANT MANUALS, TERMS, Section 2.2, Chapter 3, Section 4.2
December 2017	SH(NA)-081566ENG-D	■Added or modified parts TERMS, Section 2.2, Chapter 3, Section 4.2
September 2018	SH(NA)-081566ENG-E	■Added or modified parts TERMS, Chapter 3, Section 4.1
July 2020	SH(NA)-081566ENG-F	■Added or modified parts SAFETY PRECAUTIONS, CONDITIONS OF USE FOR THE PRODUCT, INTRODUCTION, RELEVANT MANUALS, Chapter 1, Section 2.1, Section 2.2, Chapter 3, Section 4.1, Section 4.2, Section 5.1, Section 5.3, Section 5.4, Section 6.1, Appendix 1
March 2023	SH(NA)-081566ENG-G	■Added or modified parts INTRODUCTION, Section 2.2
March 2024	SH(NA)-081566ENG-H	■Added or modified parts TERMS, GENERIC TERMS AND ABBREVIATIONS, Section 4.1, Section 5.4

Japanese manual number: SH-081563-H

This manual confers no industrial property rights or any rights of any other kind, nor does it confer any patent licenses. Mitsubishi Electric Corporation cannot be held responsible for any problems involving industrial property rights which may occur as a result of using the contents noted in this manual.

© 2015 MITSUBISHI ELECTRIC CORPORATION

# WARRANTY

---

Please confirm the following product warranty details before using this product.

## **1. Gratis Warranty Term and Gratis Warranty Range**

If any faults or defects (hereinafter "Failure") found to be the responsibility of Mitsubishi occurs during use of the product within the gratis warranty term, the product shall be repaired at no cost via the sales representative or Mitsubishi Service Company.

However, if repairs are required onsite at domestic or overseas location, expenses to send an engineer will be solely at the customer's discretion. Mitsubishi shall not be held responsible for any re-commissioning, maintenance, or testing on-site that involves replacement of the failed module.

[Gratis Warranty Term]

The gratis warranty term of the product shall be for one year after the date of purchase or delivery to a designated place. Note that after manufacture and shipment from Mitsubishi, the maximum distribution period shall be six (6) months, and the longest gratis warranty term after manufacturing shall be eighteen (18) months. The gratis warranty term of repair parts shall not exceed the gratis warranty term before repairs.

[Gratis Warranty Range]

- (1) The range shall be limited to normal use within the usage state, usage methods and usage environment, etc., which follow the conditions and precautions, etc., given in the instruction manual, user's manual and caution labels on the product.
- (2) Even within the gratis warranty term, repairs shall be charged for in the following cases.
  1. Failure occurring from inappropriate storage or handling, carelessness or negligence by the user. Failure caused by the user's hardware or software design.
  2. Failure caused by unapproved modifications, etc., to the product by the user.
  3. When the Mitsubishi product is assembled into a user's device, Failure that could have been avoided if functions or structures, judged as necessary in the legal safety measures the user's device is subject to or as necessary by industry standards, had been provided.
  4. Failure that could have been avoided if consumable parts (battery, backlight, fuse, etc.) designated in the instruction manual had been correctly serviced or replaced.
  5. Failure caused by external irresistible forces such as fires or abnormal voltages, and Failure caused by force majeure such as earthquakes, lightning, wind and water damage.
  6. Failure caused by reasons unpredictable by scientific technology standards at time of shipment from Mitsubishi.
  7. Any other failure found not to be the responsibility of Mitsubishi or that admitted not to be so by the user.

## **2. Onerous repair term after discontinuation of production**

- (1) Mitsubishi shall accept onerous product repairs for seven (7) years after production of the product is discontinued. Discontinuation of production shall be notified with Mitsubishi Technical Bulletins, etc.
- (2) Product supply (including repair parts) is not available after production is discontinued.

## **3. Overseas service**

Overseas, repairs shall be accepted by Mitsubishi's local overseas FA Center. Note that the repair conditions at each FA Center may differ.

## **4. Exclusion of loss in opportunity and secondary loss from warranty liability**

Regardless of the gratis warranty term, Mitsubishi shall not be liable for compensation to:

- (1) Damages caused by any cause found not to be the responsibility of Mitsubishi.
- (2) Loss in opportunity, lost profits incurred to the user by Failures of Mitsubishi products.
- (3) Special damages and secondary damages whether foreseeable or not, compensation for accidents, and compensation for damages to products other than Mitsubishi products.
- (4) Replacement by the user, maintenance of on-site equipment, start-up test run and other tasks.

## **5. Changes in product specifications**

The specifications given in the catalogs, manuals or technical documents are subject to change without prior notice.

# INFORMATION AND SERVICES

---

For further information and services, please contact your local Mitsubishi Electric sales office or representative.  
Visit our website to find our locations worldwide.

MITSUBISHI ELECTRIC Factory Automation Global Website  
Locations Worldwide  
[www.MitsubishiElectric.com/fa/about-us/overseas/](http://www.MitsubishiElectric.com/fa/about-us/overseas/)

## TRADEMARKS

---

Windows is a trademark of the Microsoft group of companies.

Arm is a registered trademark of Arm Limited (or its subsidiaries) in the US and/or elsewhere.

VxWorks and Wind River are either registered trademarks or trademarks of Wind River Systems, Inc.

The company names, system names and product names mentioned in this manual are either registered trademarks or trademarks of their respective companies.

In some cases, trademark symbols such as <sup>™</sup> or <sup>®</sup> are not specified in this manual.



SH(NA)-081566ENG-H(2403)KWIX

MODEL: RD55UP06-V-U-IN-E

MODEL CODE: 13JX42

## **MITSUBISHI ELECTRIC CORPORATION**

HEAD OFFICE: TOKYO BLDG., 2-7-3, MARUNOUCHI, CHIYODA-KU, TOKYO 100-8310, JAPAN  
NAGOYA WORKS: 1-14, YADA-MINAMI 5-CHOME, HIGASHI-KU, NAGOYA 461-8670, JAPAN

When exported from Japan, this manual does not require application to the  
Ministry of Economy, Trade and Industry for service transaction permission.

Specifications subject to change without notice.