

Numerical Control (CNC)

Instruction Manual

NC Analyzer2

Introduction

This instruction manual describes how to use NC Analyzer2. Incorrect handling may lead to unforeseen accidents, so make sure to read this instruction manual thoroughly before operation to ensure correct usage.

NC Analyzer2 supports the following NC series.

Notation used in this manual	Applicable NC
M8V, M8V series	M800VW/M800VS/M80VW/M80V series
M8, M8 series	M800W/M800S/M80W/M80 series
E80, E80 series	E80 series
M7V, M7V series	M700VW/M700VS/M70V series
E70, E70 series	E70 series
C80, C80 series	C80 series
C70, C70 series	C70 series

Notes on Reading This Manual

- (1) For the specifications of individual machine tools, refer to the manuals issued by the respective machine tool builders. The restrictions and available functions described by the machine tool builders have precedence over this manual.
- (2) This manual describes as many special operations as possible, but it should be kept in mind that operations not mentioned in this manual cannot be performed.

Notes on Using This Software

(1) Decimal point

Regardless of the language used on the OS which NC Analyzer2 is installed on, "." is used for decimal points.

Safety Instructions

Always read the specifications issued by the machine tool builder, this manual, related manuals and attached documents before installation, operation, programming, maintenance or inspection to ensure correct use.

Understand this controller, safety items and cautions before using the unit.

This manual ranks the safety precautions into "DANGER", "WARNING" and "CAUTION".



When the user may be subject to imminent fatalities or major injuries if handling is mistaken.



When the user may be subject to fatalities or major injuries if handling is mistaken.



When the user may be subject to injuries or when physical damage may occur if handling is mistaken.

Note that even items classified into " CAUTION", may lead to major results depending on the situation. In any case, important information that must always be observed is described.

DANGER





Not applicable in this manual.

WARNING

Not applicable in this manual.

CAUTION

1. Matters concerning Products and Manual

-  Restrictions and available functions described in the operation manual published by the machine tool builders have precedence over this manual.
-  It should be kept in mind that operations not described in this manual cannot be performed.
-  The descriptions in this manual are based on the premise that all optional features have been added. When using the system, check the specification of the machine tool builders.
-  Some screens and functions may be different or unavailable depending on the version of the NC system.
-  To protect the availability, integrity and confidentiality of the NC system against cyber-attacks including unauthorized access, denial-of-service (Dos) (*1) attack, and computer virus from external sources via a network, take security measures such as firewall, VPN, and anti-virus software.

(*1) Denial-of-service (Dos) refers to a type of cyber-attack that disrupts services by overloading the system or by exploiting a vulnerability of the system.
-  Mitsubishi Electric assumes no responsibility for any problems caused to the NC system by any type of cyber-attacks including DoS attack, unauthorized access and computer virus.

Trademarks

MELDAS, MELSEC, EZSocket, EZMotion, iQ Platform, MELSOFT, GOT, CC-Link, CC-Link/LT and CC-Link IE are either trademarks or registered trademarks of Mitsubishi Electric Corporation in Japan and/or other countries.

Ethernet is a registered trademark of Xerox Corporation in the United States and/or other countries.

Microsoft® and Windows® are either trademarks or registered trademarks of Microsoft Corporation in the United States and/or other countries.

Other company and product names that appear in this manual are trademarks or registered trademarks of the respective companies.

CONTENTS

1. INTRODUCTION	1
1.1 Overview	1
1.2 Applicable Models and Versions	3
1.3 Corresponding CNC	6
1.4 Display Unit	13
2. INSTALLATION AND SETUP	14
2.1 Operation Environment	14
2.2 Connection Diagram	14
2.3 First Installation Procedure	15
2.4 Installation Procedure When Upgrading	17
2.5 Procedure of Uninstalling	18
2.5.1 Procedure for Uninstalling Using the Control Panel	18
3. HOW TO USE	19
3.1 Setup	19
3.1.1 Setting Up the Personal Computer	19
3.1.2 Setting Open Parameters	19
3.1.3 Other Setups/Precautions	21
3.1.4 Starting the NC Analyzer2	22
3.1.5 Exit NC Analyzer2	24
3.1.6 Menu Selection Items	25
3.1.6.1 Right Click of Project Review	28
3.1.6.2 Right Click the Waveform Window	29
3.1.7 Toolbar Selection Items	30
3.1.7.1 Tool Bar of Project Preview	31
3.1.8 Button Selection Items	32
3.1.9 Shortcut Key List	35
3.2 Project	36
3.2.1 Create a New Project	36
3.2.1.1 NC Basic Information Window	37
3.2.2 Save as Project Name	39
3.2.3 Import data	40
3.2.4 Read Sampling Data (CSV) in a Batch	42
3.3 Adjustment Wizard	46
3.3.1 Velocity Loop Gain Adjustment	46
3.3.2 Lost Motion Adjustment	55
3.3.3 Variable Full-closed Torsion Adjustment	61
3.4 Measurement and Adjustment	71
3.4.1 Frequency Response Measurement	71
3.4.2 Reciprocation Acceleration/Deceleration Measurement	75
3.4.2.1 Automatic Remeasurement	86
3.4.3 Roundness Measurement	90
3.4.4 Spindle Acceleration/Deceleration Measurement	94
3.4.5 Spindle Orientation Measurement	97
3.4.6 Synch Tap Error Measurement	100
3.4.7 Spindle C-axis Measurement	104
3.4.8 Spindle Synchronization Measurement	107
3.4.9 PLC Axis Acceleration/Deceleration Measurement	110
3.4.10 Arbitrary Path Measurement	113

3.4.11 Read NCSAMP File.....	116
3.5 Tools.....	120
3.5.1 Option	120
3.5.2 Read NC Parameter	123
3.5.3 Waveform Comparison	123
3.5.4 Output Log File	124
3.5.5 Copy Image to Clipboard	124
3.6 View	125
3.6.1 Changing of Theme Color	125
3.7 Language	126
3.8 Waveform Window	127
3.8.1 Frequency Response Waveform.....	128
3.8.2 Time-series Waveform	130
3.8.2.1 FFT Waveform	133
3.8.3 Roundness Waveform.....	135
3.8.4 Arbitrary Program Waveform.....	137
3.8.5 Arbitrary Program Waveform (3D).....	139
3.8.5.1 Selected Point Information Display	142
3.8.6 Torque Characteristics	143
3.9 Data Information.....	145
3.9.1 Analysis Settings Panel.....	145
3.9.2 Parameter Setup Panel.....	146
3.10 Other Functions	147
3.10.1 Set Waveform Color and Plot.....	147
3.10.2 Data Transformation	148
3.10.2.1 Arbitrary Data Calculation	151
3.10.3 Coordinate Setting	154
3.10.3.1 Time-series Waveform	154
3.10.3.2 FFT Waveform	155
3.10.3.3 Roundness Waveform	156
3.10.3.4 Arbitrary Program Waveform	158
3.10.3.5 Torque Characteristics	158
3.10.4 Arbitrary graph setting	159
3.10.4.1 Roundness Waveform, Arbitrary Path Waveform, Arbitrary Path Waveform (3D) [XY/YZ/ZX]	159
3.10.4.2 Arbitrary Path Waveform (3D) [XYZ].....	160
3.10.5 Time Axis Offset	161
4. PRECAUTIONS.....	162
4.1 Precautions for Using Adjustment Wizard	162
4.2 Precautions for Using Measurement and Adjustment.....	164
5. APPENDIX.....	166
5.1 Adjustment Wizard Messages	166
5.2 Measurement and Adjustment Messages	168
5.3 Graph Function Messages	177
5.4 Project Messages.....	180
5.5 Waveform Comparison Message	182
5.6 Import Data Message	183
5.7 Output Log File Message	185
5.8 The Setting Range and Optimum Value of the Velocity Loop Gain for Each Motor Type and Encoder Type	186
5.9 Setting Firewall Exceptions	187
5.10 Trouble Shooting	191

1. INTRODUCTION

1.1 Overview

With the NC Analyzer2, the motor can be adjusted automatically by activating the motor using vibration signals. And characteristics of the servo control system can be measured by measuring/analyzing the feedback.

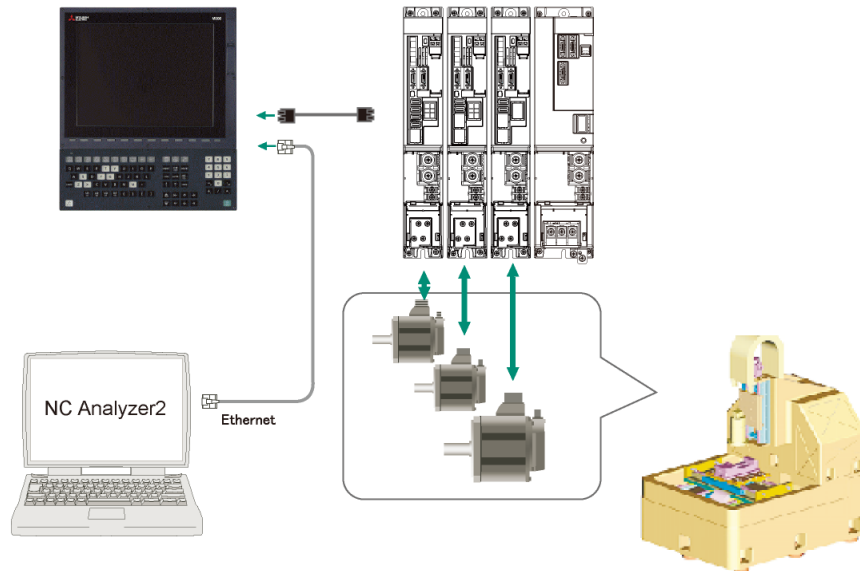

1. INTRODUCTION

<Function>

Automatic adjustment	Description
Velocity loop gain adjustment	Automatically adjusts velocity loop gain and resonance filters.
Lost motion adjustment	Automatically adjusts the lost motion for the delay in response which occurs when the machine rotation is reversed.
Variable full-closed torsion adjustment	Automatically adjusts the variable full-closed torsion for the delay in response which occurs when the machine rotation direction is reversed.

Measurement	Description
Frequency response measurement	Measures the frequency response of speed loop for the designated axis. The result will be output as frequency response waveform.
Reciprocation acceleration/deceleration measurement	Measures the reciprocation acceleration/deceleration for the designated axis. The result will be output as time-series waveform. (Note 1)
Roundness measurement	Measures the roundness for the designated axis. The result will be output as roundness waveform. (Note 1)
Spindle acceleration/deceleration measurement	Measures the spindle acceleration/deceleration for the designated axis. The result will be output as time-series waveform. (Note 1)
Spindle orientation measurement	Measures the spindle orientation for the designated axis. The result will be output as time-series waveform. (Note 1)
Synch tap error measurement	Measures the synchronous tap error for the designated axis. The result will be output as time-series waveform. (Note 1)
Spindle C-axis measurement	Executes the reciprocation acceleration/deceleration measurement of spindle C axis with specified axis. The result will be output as time-series waveform. (Note 1)
Spindle synchronization measurement	Executes an arbitrary machining program with specified axis, and measures spindle synchronization by using that data. The result will be output as time-series waveform.
PLC axis acceleration/deceleration measurement	Executes an arbitrary machining program with specified axis, and measures PLC axis acceleration/deceleration by using that data. The result will be output as time-series waveform.
Arbitrary path measurement (Note 2)	Executes an arbitrary machining program with specified two axes. The result is output as an arbitrary program waveform. (Note 1)

(Note 1) For the measurement, use a machining program created by the program creation function of NC Analyzer2 or an arbitrary machining program.

(Note 2) Two or more NC axes in the same system are needed.

1. INTRODUCTION

1.2 Applicable Models and Versions

The configuration of the CNC, and the model and the version of the CNC and drive unit which can use this software are as follows:

Item		Range
Number of part systems		Maximum 8 part systems (Note 5) (Note 6)
Number of axes	Servo axis (NC axis and PLC axis)	Maximum 16 axes in one part system (Note 5)
	Spindle	Maximum 8 axes

NC Analyzer2	CNC						
	M8V	M8	E80	M7V	E70	C80	C70
BND-1801W000-A0	-	A1 version or later (Note 1) (Note 2) (Note 4) (Note 6)	-	G4 version or later (Note 2) (Note 3)	J0 version or later (Note 2) (Note 3)	-	-
BND-1801W000-A1			D3 version or later			A1 version or later (Note 4)	C4 version or later (Note 2) (Note 3)
BND-1801W000-A2							
BND-1801W000-A3							
BND-1801W000-A4							
BND-1801W000-A5							
BND-1801W000-A6							
BND-1801W000-A7			A0 version or later				
BND-1801W000-A8							

NC Analyzer2	Servo/spindle drive unit		
	MDS-E/EH	MDS-EM	MDS-EJ/EJH
BND-1801W000-A0	Vx: BND1501W201-A1 or later (Note 6) SP: BND1501W202-A1 or later	Vx: BND1501W201-A2 or later (Note 6) SP: BND1501W202-A2 or later	Vx: BND1501W201-A0 or later (Note 6) SP: BND1501W202-A0 or later

NC Analyzer2	Servo/spindle drive unit		
	MDS-D2/DH2	MDS-DM2	MDS-DJ
BND-1801W000-A0	Vx: BND1501W101-A0 or later SP: BND1501W102-A0 or later	Vx: BND1501W101-A0 or later SP: BND1501W102-A0 or later	Vx: BND-1501W101-A0 or later SP: BND-1501W102-A0 or later

NC Analyzer2	Servo/spindle drive unit			
	MDS-D/DH	MDS-D-SVJ3/SPV3	MDS-DM	
			V3	SPVx
BND-1801W000-A0	Vx: BND1501W001-B0 or later SP: BND1501W002-B0 or later	SVJ3: BND1501W105-A1 or later SPJ3: BND1501W106-A1 or later	V3: BND-1501W012-B0 or later	SV: BND-1501W016-C0 or later SP: BND-1501W018-A2 or later

- (Note 1) M80W series is only supported by NC Analyzer2 A3 version or later. The version of M80W needs to be C0 version or later.
- (Note 2) The high-cycle sampling is supported by M700V series J0 version, or the combination of M800 series C3 version or later and the drive unit BND1501W201-A4 version or later or BND1501W202-A4 version or later.
- (Note 3) The PLC device signal measurement function is only supported by M7V/E70 series K0 version or later, and C70 series DA version or later.
- (Note 4) The measurement function of spindle-mode servo axes can be used in the following combinations.
 - [M8 Series]
Combination of NC Analyzer2 version A4 or later and M8 Series version C1 or later
 - [C80 Series]
Combination of NC Analyzer2 version A6 or later and C80 Series version B7 or later

1. INTRODUCTION

(Note 5) The following are the restrictions on the use of the frequency response measurement and the velocity loop gain adjustment.

[M8 series]

For a configuration of 17 or more NC axes, or 5 or more part systems, the frequency response measurement and the velocity loop gain adjustment can only be used with a combination of NC Analyzer2 version A5 or later and M8 series version C4 or later.

[C80 series]

For a configuration of 2 part systems and 17 axes or more, or 3 part systems or more, the frequency response measurement and the velocity loop gain adjustment can only be used with a combination of NC Analyzer2 version A5 or later and C80 series version B6 or later.

(Note 6) Variable full-closed torsion adjustment is compatible with the combination of NC Analyzer2 version A6 or later, M8 Series version C6 or later, and the drive unit BND1501W201-A6 version or later (servo axis only) for the first part system of the machining center.

1. INTRODUCTION

List of Supported Functions at Each CNC (Servo axis)

Axis name			Function name	M8V/M8/ E80	M7V/E70	C80	C70								
Servo axis	NC axis	Single axis	Automatic adjustment	Velocity loop gain adjustment	○	○	○	○							
				Lost motion adjustment	○	○	○	○							
				Variable full-closed torsion adjustment	○ (Note 2)	-	-	-							
		Waveform measurement	Frequency response measurement	Reciprocation acceleration/deceleration measurement	○	○	○	○							
				Roundness measurement	○	○	○	○							
				Arbitrary path measurement	○	○	○	○							
				Velocity loop gain adjustment	○	○	○	○							
		Parallel synchronization control axis (Note 1)	Automatic adjustment	Lost motion adjustment	Variable full-closed torsion adjustment	○ (Note 2)	-	-	-						
	Waveform measurement									Frequency response measurement	Reciprocation acceleration/deceleration measurement	○	○	○	○
											Roundness measurement	○	○	○	○
			Arbitrary path measurement	○	○	○	○								
			Velocity loop gain adjustment	○	○	○	○								
	PLC axis		Single axis	Waveform measurement	Frequency response measurement	-	-	○ (Note 3)	-						
					PLC axis acceleration/deceleration measurement	○	○	○	○						

(Note 1) The supported functions of the E80 series and E70 series are restricted by the NC specification.

(Note 2) Supported only by M8V/M8 series.

(Note 3) Frequency response measurement for PLC axes is supported by NC Analyzer2 version A6 or later and C80 series version B9 or later.

However, frequency response measurement is not supported when PLC axis indexing is enabled.

List of Supported Functions at Each CNC (Spindle)

Axis name	Function name	M8V/ M8/E80	M7V/E70	C80	C70	
Spindle	Waveform measurement	Spindle acceleration/deceleration measurement	○	○	○	○
		Spindle orientation measurement	○	○	○	○
		Synch tap error measurement	○	○	○	○
		Spindle C-axis measurement	○	○	○	○
		Spindle synchronization measurement	○	○	○	○

(Note 1) The spindle does not correspond to the gear ratio.

(Note 2) The supported functions of the E80 series and E70 series are restricted by the NC specification.

1. INTRODUCTION

1.3 Corresponding CNC

Functions that can be executed vary depending on NC version and a combination of related parameters "#1164 ATS (auto tuning function)", and "#1224 aux08/bit0 (sampling data output)", and "#14301 valVDC (Variable full-closed torsion compensation ON)".

Legends of combination patterns of related parameters

Abbreviation for notation	Pattern
○	Does not depend on parameter settings
ATS	Can be executed when "#1164" is "1"
AUX	Can be executed when "#1224 aux08/bit0" is "1"
ATS/AUX	Can be executed when "#1164 ATS" is "1" and "#1224 aux08/bit0" is "1"
ATS/AUX/VDC	Can be executed when "#1164 ATS" is "1", "#1224 aux08/bit0" is "1", and "#14301 valVDC" is "1"

1. INTRODUCTION

Function Detail List

Function		M8V	M8	E80	M7V		E70	C80	C70
		A0 version or later	A1 version or later	D3 version or later	G3 version or earlier	G4 version or later	J0 version or later	A1 version or later	C4 version or later
Automatic adjustment	Velocity loop gain adjustment	ATS/AUX	ATS/AUX	ATS/AUX	ATS	ATS	ATS	ATS/AUX	ATS
	Lost motion adjustment	ATS/AUX	ATS/AUX	ATS/AUX	ATS	ATS	ATS	ATS/AUX	ATS
	Variable full-closed torsion adjustment	ATS/AUX/ VDC	ATS/AUX/ VDC (Note 2)	/	/	/	/	/	/
Measurement	Frequency response measurement	ATS/AUX	ATS/AUX	ATS/AUX	ATS	ATS	ATS	ATS/AUX	ATS
	Reciprocation acceleration/deceleration measurement	AUX	AUX	AUX	(Note 1)	○	○	AUX	○
	Roundness measurement	AUX	AUX	AUX	(Note 1)	○	○	AUX	○
	Spindle acceleration/deceleration measurement	AUX	AUX	AUX	(Note 1)	○	○	AUX	○
	Spindle orientation measurement	AUX	AUX	AUX	(Note 1)	○	○	AUX	○
	Synch tap error measurement	AUX	AUX	AUX	(Note 1)	○	○	AUX	○
	Spindle C-axis measurement	AUX	AUX	AUX	(Note 1)	○	○	AUX	○
	Spindle synchronization measurement	AUX	AUX	AUX	(Note 1)	○	○	AUX	○
	PLC axis acceleration/deceleration measurement	AUX	AUX	AUX	(Note 1)	○	○	AUX	○
	Arbitrary path measurement	AUX	AUX	AUX	(Note 1)	○	○	AUX	○
	Read NCSAMP file	AUX	AUX	AUX	/	/	/	AUX	/

(Note 1) Set "#1164 ATS" to "0" when executing the measurement with software version G3 or earlier of the M7V series.

(The function can be executed though NC may go into the state of PR as a result of changing ATS.)

(Note 2) Variable full-closed torsion adjustment is supported by M8 series version C6 or later.

1. INTRODUCTION

■Sampling Data Type List

Data that can be measured (sampled) is as follows:

(1) Axis name specification

The following sampling data can be selected when a servo axis or spindle axis is set for [Axis/Type] in the sampling condition setting screen of each measurement.

Data type	Normal	High-cycle sampling
Position command	○	○
Position FB	○	○
Position droop	○	○
Model position	○	-
Droop error (Note 1)(Note 2)	○	○
Motor-end position	○	-
Speed command (mm/min)	○	○
Speed command (r/min)	○	○
Speed FB (mm/min)	○	○
Speed FB(r/min)	○	○
Current command	○	-
Current FB	○	-
Load meter	○	-
Output (Note 3)	○	-
Torque (Note 3)	○	-
Cycle counter (Note 3)	○	-
Control input 1	○	-
Control input 2	○	-
Control input 3	○	-
Control input 4	○	-
Control input 5	○	-
Control input 6	○	-
Control output 1	○	-
Control output 2	○	-
Control output 3	○	-
Control output 4	○	-
Control output 5	○	-
Control output 6	○	-
Monitor output 1 (Note 4)	○	-
Monitor output 2 (Note 4)	○	-
q axis current command	-	○
d axis current command	-	○
q axis current FB	-	○
d axis current FB	-	○
Speed error (mm/min)	-	○
Speed error (r/min)	-	○
PLC (bit)	○	-
PLC (1 word)	○	-
PLC (2 words)	○	-
NC Smp (CHn)	○	○

○: Available -: Not available

1. INTRODUCTION

(Note 1) Droop error is the deviation from ideal position considering servo tracking delay.

(Note 2) "Model error" was changed to "droop error" from version A5 and after. The model error data which was measured up until A4 version is displayed as droop error. The measured data does not change.

(Note 3) Output, torque and cycle counter are displayed on C70, C80 series only. The supported version is as follows.

[C80 series]

Combination of NC Analyzer2 version A7 or later and C80 series version BC or later

[C70 series]

Combination of NC Analyzer2 version A8 or later and C70 series version DR or later

(Note 4) Refer to "3.4.2 Reciprocation Acceleration/Deceleration Measurement" - "(3) Monitor output data screen" for details of monitor output.

1. INTRODUCTION

■Device list

The devices which can be used with each CNC are as follows.

[M8V/M8/E80/M7V/E70/C80]

Device (Note 1)	Device range	Unit	Sampling data type
X	X0 to X1FFF	1 bit	PLC (bit)
Y	Y0 to Y1FFF	1 bit	
M	M0 to M10239	1 bit	
F	F0 to F1023	1 bit	
L	L0 to L511	1 bit	
SM	SM0 to SM1023	1 bit	
SB	SB0 to SB1F	1 bit	
SW	SW0 to SW1FF	16 bits	PLC (1 word) PLC (2 words)
T (Note 2)	T0 to T703	1 bit	PLC (bit)
ST (Note 2)	ST0 to ST63	1 bit	
C (Note 2)	C0 to C255	1 bit	
D	D0 to D2047	16 bits	PLC (1 word) PLC (2 words)
R	R0 to R32767	16 bits	
B	B0 to B1FFF	1 bit	PLC (bit)
V	V0 to V255	1 bit	
SD	SD0 to SD1023	16 bits	PLC (1 word) PLC (2 words)
W	W0 to W1FFF	16 bits	

(Note 1) Assume that the devices to be handled on the NC side can be specified.

(Note 2) T, ST, C devices can also acquire output contacts, setting values, and current values.

The following devices do not require size specification.

The table below shows how to specify the devices and how to set them.

Device range	Unit	Details
1000 + Device No.	1 bit	Output contacts
2000 + Device No.	16 bits	Setting values
3000 + Device No.	16 bits	Current values

(Example) To acquire the output contact of T703, specify T1703.

To acquire the setting value of C55, specify C2055.

To acquire the current value of ST1, specify ST3001.

1. INTRODUCTION

[C70]

Device (Note 1)	Device range	Unit	Sampling data type
X	X0 to XAFF	1 bit	PLC (bit)
Y	Y0 to YE7F	1 bit	
M	M0 to M8191	1 bit	
L	L0 to L255	1 bit	
F	F0 to F127	1 bit	
SM (Note 2)	SM0 to SM127	1 bit	
SB (Note 2)	SB0 to SB1FF	1 bit	
B	B0 to B1FFF	1 bit	PLC (1 word) PLC (2 words)
T	T0 to T255	1 bit	
	T1000 to T1255	1 bit	
	T2000 to T2255	16 bits	
	T3000 to T3255	16 bits	
C	T4000 to T4255	16 bits	
	C0 to C127	1 bit	
	C1000 to C1127	1 bit	
	C2000 to C2127	16 bits	
SD (Note 2)	C3000 to C3127	16 bits	PLC (1 word) PLC (2 words)
	C4000 to C4127	16 bits	
SW (Note 2)	SD0 to SD2047	16 bits	PLC (1 word) PLC (2 words)
D	SW0 to SW1FF	16 bits	
R	D0 to D8191	16 bits	
S (ZR (Note 3))	R0 to R39215	16 bits	
W	S (ZR) 50000 to S (ZR) 52399	16 bits	
Z	W0 to W1FFF	16 bits	
	Z0 to Z15	16 bits	

(Note 1) Assume that the devices to be handled on the NC side can be specified.

(Note 2) Each device can also be set with the following notation.

SM device: E device or N device

SB device: O device

SD device: P device

SW device: Q device

(Note 3) Set ZR device as S device.

(Example) Correct: S50200, Incorrect: ZR50200

1. INTRODUCTION

There are restrictions for combinations on the same axis for the following sampling data types. Sampling cannot be performed for combinations that are not available.

Sampling can be performed on the same axis simultaneously for combinations indicated by "○" in the sampling data type combination list.

Sampling cannot be performed on the same axis simultaneously for combinations indicated by "-" in the sampling data type combination list. Sampling can be performed simultaneously on different axes.

Sampling data type combination list (servo axis/PLC axis)

		Sampling data type							
		Position command	Model position	Droop error	Motor-end position	Speed command	Current command	Monitor output 1	Monitor output 2
Sampling data type	Position command	○	-	-	-	-	-	-	-
	Model position	-	○	○	-	-	-	-	-
	Droop error	-	○	○	-	-	-	-	-
	Motor-end position	-	-	-	○	-	-	-	-
	Speed command	-	-	-	-	○	○	-	-
	Current command	-	-	-	-	○	○	-	-
	Monitor output 1	-	-	-	-	-	-	○	○
Monitor output 2	-	-	-	-	-	-	○	○	

○: Available -: Not available

Sampling data type combination list (spindle)

		Sampling data type								
		Position command	Model position	Droop error	Motor-end position	Speed command	Current command	Current FB	Monitor output 1	Monitor output 2
Sampling data type	Position command	○	-	-	-	-	-	-	-	-
	Model position	-	○	○	-	-	-	-	-	-
	Droop error	-	○	○	-	-	-	-	-	-
	Motor-end position	-	-	-	○	-	-	-	-	-
	Speed command	-	-	-	-	○	○	○	-	-
	Current command	-	-	-	-	○	○	○	-	-
	Current FB	-	-	-	-	○	○	○	-	-
	Monitor output 1	-	-	-	-	-	-	-	○	○
Monitor output 2	-	-	-	-	-	-	-	○	○	

○: Available -: Not available

1. INTRODUCTION

1.4 Display Unit

In this manual, metric system is used. Refer to the following table for each unit for metric system and inch system.

Sampling data type	Unit			
	Metric system		Inch system	
	Linear axis	Rotation axis (including spindle)	Linear axis	Rotation axis (including spindle)
Position command Position feedback Model position Motor end position FB	mm	deg	inch	deg
Position droop (Note 1) Droop error	um	mdeg	minch	mdeg
Speed command Speed feedback (Note 2)	mm/min	deg/min	inch/min	deg/min
Current command Current feedback Load meter	%	%	%	%
Output	W	W	W	W
Torque	Nm	Nm	Nm	Nm
Cycle counter (Note 5)	p	p	p	p

(Note 1) "μ" (micro) is displayed as "u" on the screen. "mdeg" is 1/1000 deg and "minch" is 1/1000 inch.

(Note 2) "r/min" (number of rotations per minute) is also used for speed unit. The same unit is used regardless of the conditions.

(Note 3) The unit of current command and current feedback is % to the stall current of the motor.

(Note 4) The unit of the parameter set in the NC does not change even though the setting of "#1041 I_inch" (Initial state (inch)) is switched. Refer to "3.5.1 Option" about changing metric system and inch system.

(Note 5) Pulse is displayed as "p" on the screen.

2. INSTALLATION AND SETUP

2.1 Operation Environment

NC Analyzer2 operates in the following personal computer environment.

- Basic software: Windows 11, Windows 10
- RAM: 4 GB or more for Windows 11, 2 GB or more for Windows 10
- Display: Resolution XGA (1024×768) or more
- With Ethernet port
- Peripheral device: CD-ROM drive
- Display languages: English/Japanese/Chinese (Simplified Chinese)/Chinese (Traditional Chinese)/Korean (Note 1)

(Note 1) When the software is installed, only English and Japanese can be selected. To switch the display language to Chinese (Simplified), Chinese (Traditional), or Korean, select the language from the menu [Language (L)] of NC Analyzer2 and restart the software.

(Note 2) At the time of the first start after the installation, exceptions setting must be made for the Windows Firewall.

When the dialog of [Windows Security Alert] is displayed, check [Private network] and [Public network], and select [Allow access].

When [Cancel] is selected, communication with NC is disabled. In that case, follow "5.9 Setting Firewall Exceptions" to allow access.

2.2 Connection Diagram

The connection diagrams with the M8V/M8/E80/M7V/E70 series and C80/C70 series are shown below.

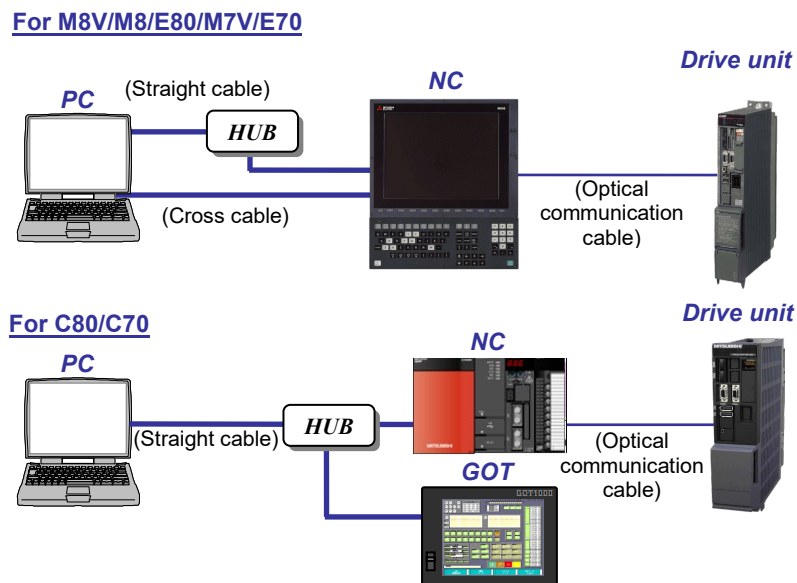

2.3 First Installation Procedure

Installation of NC Analyzer2 must be done with administrator privileges.

When User Account Control in Windows is enabled, the confirmation dialog box will pop up. Then, select "Allow (A)" to start the installation.

- (1) Execute NCA2.exe.

After the selection screen for setting language is displayed, select the language to use for installation, and press the "Next" button.

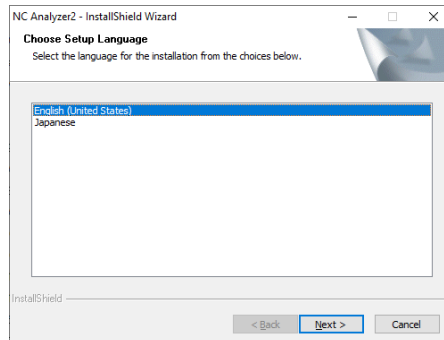

- (2) Splash screen is displayed. Then the installer is started.



- (3) The setup screen is displayed.
Press the "Next" button.

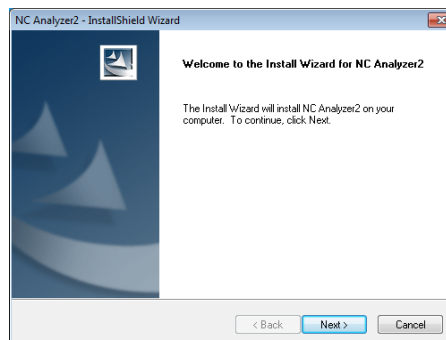

2. INSTALLATION AND SETUP

- (4) The software license agreement is displayed.
 Read the software license agreement carefully, and press the "Yes" button.
 If "No" is selected (when you do not agree to this agreement), the installation of NC Analyzer2 is discontinued.

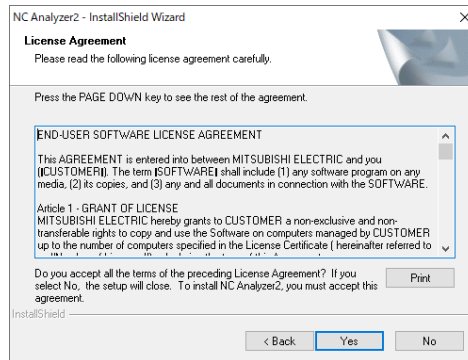

- (5) The user information screen is displayed.
 Enter the User Name and the company Name and then press the "Next" button.

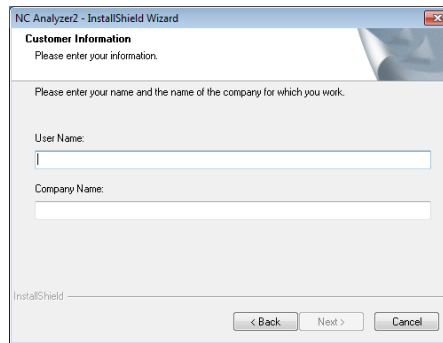

- (6) Enter the product ID on the Input Product ID screen and then press the "Next" button.

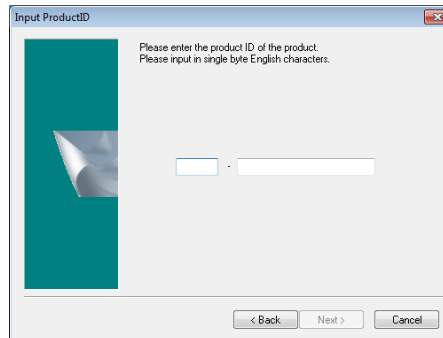

- (7) The Choose Designation Location screen is displayed.
 Press "Change" and select the installation destination.
 Press the "Next" button after the installation destination settings.

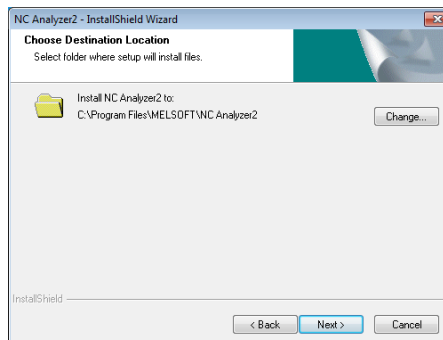

2. INSTALLATION AND SETUP

- (8) The Ready to Install will be displayed.
Press "Install" and start the installation.

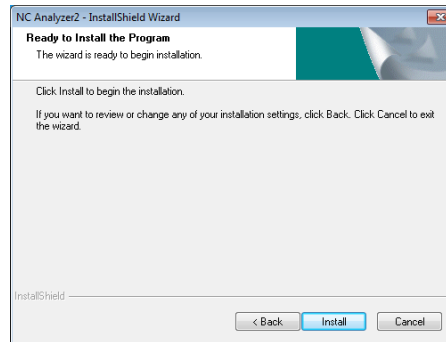

- (9) When the installation is successfully completed, the "Complete screen" is displayed.
Press the "Finish" button to complete the installation.

2.4 Installation Procedure When Upgrading

When the old version has already been installed, install the new version after uninstalling the old version.

2. INSTALLATION AND SETUP

2.5 Procedure of Uninstalling

To uninstall NC Analyzer2, execute from Control Panel.

2.5.1 Procedure for Uninstalling Using the Control Panel

- (1) Select the [Start] - [Control Panel] - [Uninstall a program].
The "Uninstall or change a program" screen is displayed.
- (2) Select the NC Analyzer2 from the list, and press "Uninstall".

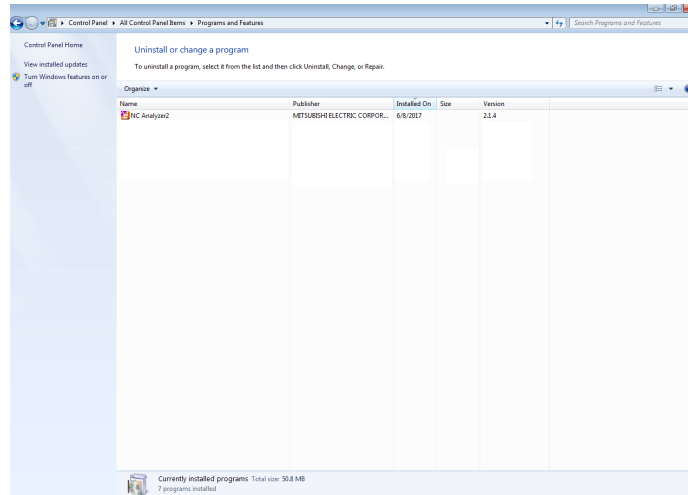

- (3) The Confirmation screen is displayed.
When the "Yes" is pressed, the uninstallation starts.
(When the "No" is pressed, return to the "Control Panel" screen.)

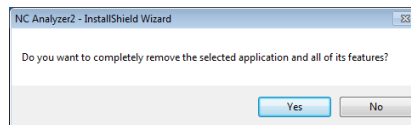

(Note) After starting the uninstallation, it cannot be canceled.

- (4) When the uninstallation is finished, the Complete screen is displayed.
Press the "Finish" button to complete the uninstallation.

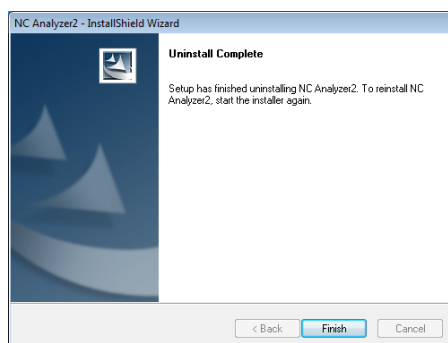

3. HOW TO USE

3. HOW TO USE

3.1 Setup

3.1.1 Setting Up the Personal Computer

Item	Description
Cross cable	Connect the personal computer to NC using a LAN cable.
NC Analyzer2	Install the NC Analyzer2.
Setting IP address	Set the IP address of the computer to have the same network address as the IP address of NC. The IP address of NC is set to "#1926 Global IP address". (Example) IP address of NC: 192.168.200.5 IP address of computer: 192.168.200.7

3.1.2 Setting Open Parameters

Correctly set the following NC parameters before starting the adjustment.

Turn OFF the CNC power after setting parameters with (PR) mark. These parameters will be enabled when the CNC power is turned ON again.

Base common parameter

[#1164(PR)] ATS (Automatic tuning function)

Set this parameter to "1" (Enable).

0: Disable

1: Enabled

(Note 1) For the relationship between parameter settings and individual functions, refer to "1.3 Corresponding CNC".

(Note 2) This parameter setting will be enabled after turning ON the power to NC again.

[#1224] aux08

bit0: Sampling data output

Set this parameter to "1" (Enable).

0: Disable

1: Enabled

(Note) For the relationship between parameter settings and individual functions, refer to "1.3 Corresponding CNC".

[#1267(PR)] ext03

bit0: High-speed high-accuracy control G code type

Set this parameter to "0" (Conventional format).

0: Conventional format (G61.1)

1: MITSUBISHI special format (G08P1)

[#1926(PR)] Global IP address (IP address)

Set the IP address of the PC to be connected to the same group as this parameters' setting value.

3. HOW TO USE

Axis specifications parameter

[#14301] vaIVDC (Variable full-closed torsion compensation ON)

Select from "Enabled" or "Disable" of variable full-closed torsion compensation.

0: Disable

1: Enabled

(Note) For the relationship between parameter settings and individual functions, refer to "1.3 Corresponding CNC".

3.1.3 Other Setups/Precautions

(1) Coordinate system offset

NC Analyzer2 creates programs created on the workpiece coordinate system. When adjustment is performed, set the coordinate system offset by keeping it in mind.

Always restore the coordinate system offset after completion of the NC Analyzer2.

(2) NC operation mode

When using the NC Analyzer2, set the NC operation mode to "Memory mode".

When "#1164 ATS" is set to "1", normal memory operation cannot be carried out. Set "#1164 ATS" to "0" to perform normal memory operation.

(3) Motor vibration and soft limit

When Vibration signal setup, Frequency response measurement, Frequency response measurement of machine or Velocity loop gain adjustment is executed, a minute vibration is added to the motor. Do not execute these functions near the soft limit. (Leave a space of at least 10 mm.)

(4) When resonance occurs in Frequency response measurement and Velocity loop gain adjustment

If a large resonance exists, adjustment cannot be made properly. In that case, reduce the velocity loop gain until the resonance become small, and execute Frequency response measurement and Velocity loop gain adjustment.

(5) Velocity loop gain adjustment

Set the following parameters before starting this adjustment and enable the speed feedback filter.

"#2217 SV017/bit3" (Speed feedback filter) is set to "1".

(6) Measurement function

To send the machining program when "#1037 cmdtyp" (Command type) is "3", "5", or "7", check the following parameter.

"#1076 AbsInc" (ABS/INC address (for the L system only)) is set to "1".

3. HOW TO USE

3.1.4 Starting the NC Analyzer2

Configuration of main screen and names of each parts are shown below.



Display item	Description	
(1) Menu	Various functions such as project setting, adjustment, and measurement can be executed. Refer to "3.1.6 Menu selection items".	
(2) Toolbar	Applicable menu functions can be executed by pressing the icon on the toolbar. Refer to "3.1.7 Toolbar selection items".	
(3) Project preview	Displays a list of NC basic information, parameters and measurement results. (*1)	
(4) Waveform window	Consists of "Graph area", "Text area", and "Note area". The window name is displayed in the following format. "File name" + "[" + "Project name" + "]"	
	(a) Graph area	Displays the graphs of the measured data and the buttons that can be selected. The graphs and waveform display can be set by clicking the buttons. Refer to "3.1.8 Button selection items".
	(b) Text area	Type of measured data is displayed.
	(c) Note area	Users can enter any notes.
(5) Data information	Displays the Analysis settings panel or the Parameter setup panel. The Analysis settings panel is displayed when switching the waveform types of arbitrary program measurement results to "Arbitrary path waveform (3D)". Switching analysis types and refining the display range can be executed in the panel. In the Parameter setup panel, NC parameters related to the selected measurement result are displayed. For details, refer to "3.9 Data Information".	
(6) Status bar	Displays the status information.	

3. HOW TO USE

(*1) Each measurement result is classified and displayed by category (waveform type).

Function		Project preview category				
		Frequency response	Time-series	Roundness	Synchronous tapping	Arbitrary program
Automatic adjustment	Velocity loop gain adjustment	○	-	-	-	-
	Lost motion adjustment	-	-	○	-	-
	Variable full-closed torsion adjustment	-	-	○	-	-
Measurement	Frequency response measurement	○	-	-	-	-
	Reciprocation acceleration/deceleration measurement	-	○	-	-	-
	Roundness measurement	-	-	○	-	-
	Spindle acceleration/deceleration measurement	-	○	-	-	-
	Spindle orientation measurement	-	○	-	-	-
	Synch tap error measurement	-	-	-	○	-
	Spindle C-axis measurement	-	○	-	-	-
	Spindle synchronization measurement	-	○	-	-	-
	PLC axis acceleration/deceleration measurement	-	○	-	-	-
	Arbitrary path measurement	-	-	-	-	○

3. HOW TO USE

Operation method

- (1) Set the NC operation mode to the "memory mode".
- (2) Release the NC emergency stop.
- (3) Select NC Analyzer2 from the "Start" menu.

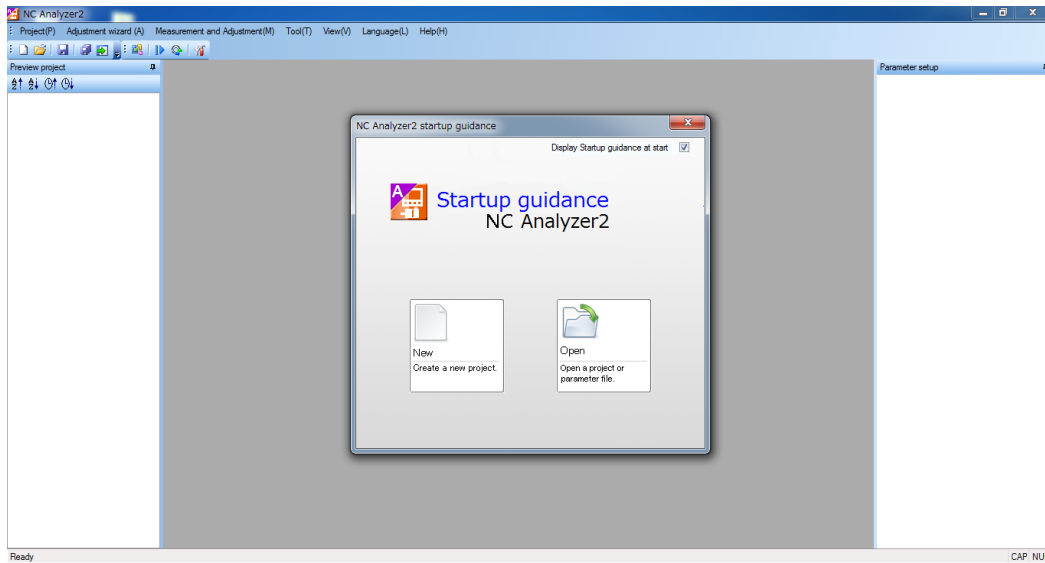

When "Display Startup guidance at start" on the option dialog is enabled, the startup guidance dialog is displayed.

Select from "New" or "Open" on the startup guidance dialog. When "Display Startup guidance at start" on the option dialog is disabled, the startup guidance dialog is not displayed and the main screen is displayed.

*How to hide the startup guidance

< Method 1 >

Uncheck the check box on the upper right of the startup guidance.

< Method 2 >

(1) Select [Tool (T)] - [Option (N)] from the menu.

(2) Uncheck "Display Startup guidance at start" check box displayed on the option dialog.

The startup guidance will not be displayed when NC Analyzer2 is started at the next time.

To display the startup guidance, check with < Method 2 > (2).

3.1.5 Exit NC Analyzer2

Operation method

- (1) Select the [Project (P)] - [Exit application] from the menu.
- (2) NC Analyzer2 is closed.

3. HOW TO USE

3.1.6 Menu Selection Items

Items that can be selected in the menu are as follows:

Project (P)

Display item	Description
New (N)	Connect to the NC and create a new project.
Open (O)	Opens a project.
Close (C)	Closes the current project.
Close all (T)	Closes all the projects.
Save (S)	Saves the selected project.
Save all (L)	Save all projects.
Save As (A)	Changes the name of the current project and saves. Saves only the selected measurement data in the project.
Import data	Adds the time series data read from the text format file for the measurement data selected in the project preview. This operation is disabled when frequency response measurement and adjustment result data is selected.
Sampling data (CSV) batch loading	Reads a sampling data file to create a project.
Import ATS file	Opens ATS file created with NC Analyzer. When ATS file is imported, a new project of NC Analyzer2 is created automatically in the same folder as ATS file. ATS file cannot be imported in the existing project.
Save image	Saves waveform window in png or bmp format. Button area or blank note area is not saved. When no waveform window is selected, this menu cannot be selected.
Delete the measurement data	Deletes the measurement data. When the measurement data is not selected in the project preview, this menu cannot be selected. When the waveform comparison is selected, operation is disabled.
Delete the selected measurement data	Deletes the selecting measurement data. Available only in "multiple selection mode".
Recently used files	Displays four recently used projects.
Exit application (X)	Closes the NC Analyzer2.

Adjustment wizard (A)

Display item	Description
Velocity loop gain adjustment (V)	Starts velocity loop gain adjustment wizard.
Lost motion adjustment	Starts lost motion adjustment wizard.
Variable full-closed torsion adjustment	Starts variable full-closed torsion adjustment wizard. This menu is not displayed when the project which was created without communicating with the NC is opened.

3. HOW TO USE

Measurement and adjustment (M)

Display item	Description
Frequency response measurement	Starts the frequency response measurement.
Reciprocation acceleration/deceleration measurement	Starts the reciprocation acceleration/deceleration measurement.
Roundness measurement	Starts the roundness measurement.
Spindle acceleration/deceleration measurement	Starts the spindle acceleration/deceleration measurement.
Spindle orientation measurement	Starts the spindle orientation measurement.
Synch tap error measurement	Starts the synch tap error measurement.
Spindle C-axis measurement	Starts the spindle/C axis acceleration/deceleration measurement. When the spindle/C axis does not exist, this menu cannot be selected.
Spindle synchronization measurement	Starts the spindle synchronization measurement.
PLC axis acceleration/deceleration measurement	Starts the PLC axis acceleration/deceleration measurement.
Arbitrary path measurement	Starts the arbitrary path measurement.
Read NCSAMP file	
Online	Imports the data file measured on the NC data sampling screen, and displays the waveform.
Offline	Imports the data file saved temporarily in the PC, and displays the waveform.
Remeasurement (M)	Starts remeasurement.
Change conditions and measure again	Starts remeasurement by changing the conditions.

Tool (T)

Display item	Description
Option (N)	Set options (startup guidance screen, detailed graph information, maintenance information, and detailed export information).
Retrieve parameter from the NC (R)	Retrieves parameters from NC and save them in All.PRM format.
Waveform comparison (P)	Compares and displays the selected waveform. The compared and displayed waveform window cannot be saved.
Output log file	Log file is output. Checking "Maintenance information" - "Enable log output" in the option dialog displays this menu.
Copy image to clipboard (C)	Copys displayed waveform to the clipboard. Button area and note area are not copied.

Window (W)

Display item	Description
Cascading (C)	Waveform files are cascaded.
Tiled (T)	Waveform files are tiled.
Vertically tiled (V)	Waveform files are vertically tiled.
Horizontally tiled (O)	Waveform files are horizontally tiled.
Close all (L)	Closes all waveform files.

3. HOW TO USE

View (V)

Display item	Description
Toolbar and docking window (T)	
Standard	Set to show/hide the standard bar.
Adjustment	Set to show/hide the adjustment bar.
Customize	Configure custom settings of the tool bar and menu.
Status bar (S)	Set to show/hide the status bar.
Change theme-color (C)	
White tone	Switches the background of graph area and text area to white base.
Grey tone	Switches the background of graph area and text area to black/gray base.

Language (L)

Display item	Description
Japanese (J)	Switches the display language to Japanese.
English (E)	Switches the display language to English.
Korean (K)	Switches the display language to Korean.
Simplified Chinese (C)	Switches the display language to Simplified Chinese.
Traditional Chinese (T)	Switches the display language to Traditional Chinese.

Help (H)

Display item	Description
NC Analyzer2 (A)	The version information of the NC Analyzer2 is displayed.

3. HOW TO USE

3.1.6.1 Right Click of Project Review

Right clicking on the project preview displays the popup menu.

The items that can be selected in the popup menu differ depending on the NC parameters and the measurement data.

(1) For NC parameters

Display item	Description
Open with NC configurator2	Opens NC parameters with NC Configurator2 to display.
Open with Text editor	Opens NC parameters with a text editor to display. (Note 1) Double-clicking NC parameters also opens a text editor.
Delete	Deletes data.
Output parameters	Outputs NC parameters to a file.
Sorting	
Sorting in ascending alphabetical order	Sorts data in ascending alphabetical order.
Sorting in descending alphabetical order	Sorts data in descending alphabetical order.
Sorting in ascending time order	Sorts data in ascending time order.
Sorting in descending time order	Sorts data in descending time order.

(Note 1) The application associated with the extension ".txt" is used for the text editor that opens the NC parameter.

Notepad is used to open the NC parameter when the application associated with the extension ".txt" is not found.

(2) For measurement data

Display item	Description
Delete	Delete data.
Export the machining program	Output the measured machining program to a file. For data measured by a machining program stored in the NC, "Run program stored in the NC and perform measurement." is displayed and the machining program is not output.
Export the sampling data in CSV format	Output the measured sampling data to a file in CSV format.
Sorting	
Sorting in ascending alphabetical order	Sort data in ascending alphabetical order.
Sorting in descending alphabetical order	Sort data in descending alphabetical order.
Sorting in ascending time order	Sort data in ascending time order.
Sorting time descending order	Sort data in descending time order.
Change name	Change the data name. Up to 40 single-byte/double-byte characters can be entered.
Import data	Adds the time series data read from the text format file for the measurement data selected in the project preview. This operation is disabled when frequency response measurement and adjustment result data is selected.
Property	Display the data property. The following are displayed in the property. [Sampling setting] - Sampling time - Sampling cycle - Sampling start condition [Machining program] - The machining program used in the measurement When a machining program stored in the NC is used, the contents of the machining program are not displayed.

3. HOW TO USE

3.1.6.2 Right Click the Waveform Window

Right clicking on the window displays the popup menu.

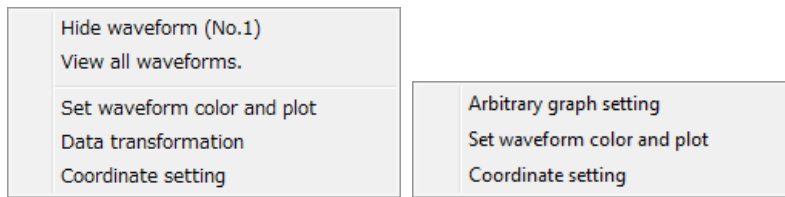

State of right click menu of waveform window

Display item	Time-series waveform	Roundness waveform	Frequency response waveform	Arbitrary program waveform	Arbitrary program waveform (3D)		FFT waveform	Torque characteristic
				Arbitrary path waveform Arbitrary shape error waveform	Arbitrary path waveform (3D) [XY/YZ/ZX]	Arbitrary path waveform (3D) [XYZ]		
Hide waveform (No.n)	○	—	—	—	—	—	○	—
View all waveforms	○	—	—	—	—	—	○	—
Set waveform color and plot	○	—	—	○	○	○	—	—
Data transformation	○	—	—	—	—	—	○	—
Coordinate setting	○	○	—	○	○	—	○	○
Arbitrary graph setting	—	○	—	○	○	○	—	—













○: Available —: Not available

Display item	Description
Hide waveform (No.n) n: Waveform number	"n" in "Hide waveform (No.n)" is the waveform number. When you select "Hide waveform (No.n)", the waveform with the smallest number of the waveforms displayed is made non-display. You can also hide the number by unchecking the check box next to the waveform number in the text area. To display the waveform, check the check box of the waveform name, or check "Display" on the "Data transformation" dialog. At initial display, all waveforms are displayed and the check boxes of waveform names are checked.
View all waveforms	Displays all waveforms that were made non-display. If there is no waveform that was made non-display, this item is not displayed.
Set waveform color and plot	Set the waveform color and the sampling plot display. Refer to "3.10.1 Set Waveform Color and Plot" for details.
Data transformation	Computes the measurement data. Refer to "3.10.2 Data Transformation" for details.
Coordinate setting	Set the coordinate setting. Refer to "3.10.3 Coordinate Setting" for details.
Arbitrary graph setting	Set data to be used for the waveform. Refer to "3.10.4 Arbitrary graph setting" for details.

3. HOW TO USE

3.1.7 Toolbar Selection Items

Items that can be selected in the toolbar are as follows:

Display item	Icon	Function
New		Connect to the NC and create a new project.
Open		Open a project.
Save		Save the selected project.
Save all		Save all projects.
Save As		Change the name of the current project and save. Save the selected measurement data in the project.
Close all		Close all the projects.
Save image		Save the displayed descriptions in the waveform window in png or bmp format. Button area or blank memo area is not saved in the image. When no waveform window is opened, this button cannot be selected.
Remeasurement		Remeasure the data using the same sampling conditions and settings of the measurement program as the measured data in the selected waveform window. When no waveform window is opened, this button cannot be selected.
Change conditions and measure again		Remeasure the data in different sampling conditions and settings of the measurement program from the measured data in the selected waveform window. When no waveform window is opened, this button cannot be selected.
Retrieve parameter from the NC		Retrieve parameters from NC.
Waveform comparison		Compare and display the selected waveform.
Change theme-color		Change theme color (background color, waveform color etc.) on waveform display area.

3. HOW TO USE

3.1.7.1 Tool Bar of Project Preview

Items that can be selected in the project preview are as follows:

Display item	Icon	Description
Sorting in ascending alphabetical order		Sort parameters and waveform files in ascending alphabetical order.
Sorting in descending alphabetical order		Sort parameters and waveform files in descending alphabetical order.
Sorting in ascending time order		Sort parameters and waveform files in ascending time order.
Sorting time descending order		Sort parameters and waveform files in descending time order.
Change to multiple selection mode		Turn icons of parameters and waveform files into checkboxes. Several checkboxes are selectable from all the opened projects. When waveform comparison is selected, operation is disabled.

(*1) Multiple selection mode

When "Change to multiple selection mode" is selected, the icons of the parameters and the waveform files in the project preview turn to checkboxes. Multiple parameters and files can be selected from all the opened projects.

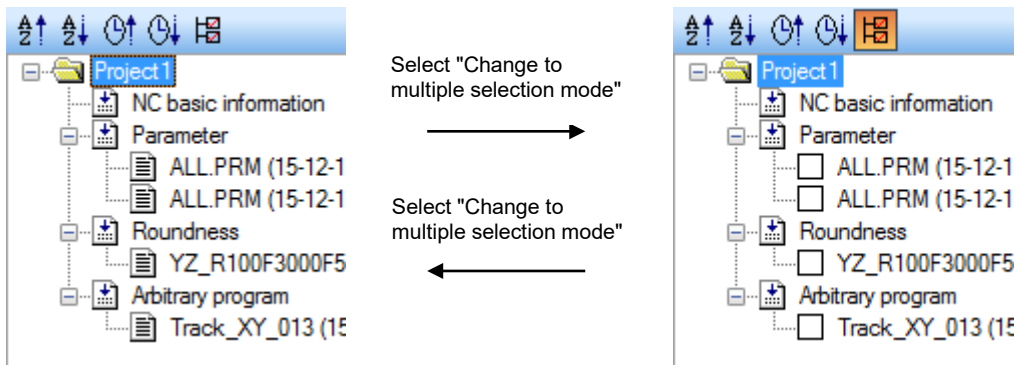

In the multiple selection mode, select "Delete the selected measurement data" from the pop-up menu that is displayed by right-clicking on the project preview to delete all the selected measurement files.





3. HOW TO USE

3.1.8 Button Selection Items

Items that can be selected in the button area are as follows:

Display item	Icon	Description
Graph Mode selection		Switch the graph modes: time series waveform, arbitrary path waveform, arbitrary path error waveform, arbitrary path waveform (3D), roundness waveform, and torque characteristics.
Cursor display		Display cursors on the graph. Drag and specify the range to measure. Display the maximum and minimum values of the range, and the measured value on the cursor in the text area.
Inter-cursor display		Adjust the inter-cursor range to the graph width automatically and enlarge the range. When the cursor display is not selected, this cannot be selected.
Autoscale (ESC)		Adjust the scale automatically to display the entire waveform.
Expand vertical scale (Ctrl+ (+))		Enlarge the selected waveform two times in the vertical axis direction. Rotating the mouse wheel back while pressing the "Ctrl" key enlarges the waveform to 1.25 times.
Reduce vertical scale (Ctrl+ (-))		Reduce the selected waveform one half in the vertical axis direction. Rotating the mouse wheel forward while pressing the "Ctrl" key reduces the waveform to 0.8 times.
Expand time scale (+)		Extend the whole waveform two times in the time axis direction, using the graph center as the reference. Rotating the mouse wheel back while pressing the "Shift" key enlarges the waveform to 1.25 times.
Reduce time scale (-)		Compress the whole waveform one-half in the time axis direction, using the graph center as the reference. Rotating the mouse wheel forward while pressing the "Shift" key reduces the waveform to 0.8 times.
Enlarge the selected range		Drag and specify the range to zoom in.
Enlarge		Enlarge the graph to 1.25 times using the graph center as the reference. Rotating the mouse wheel back while pressing the "Ctrl" key also enlarges the waveform to 1.25 times using the graph center as the reference.
Shrink		Reduce the graph to 0.8 times using the graph center as the reference. Rotating the mouse wheel front while pressing the "Ctrl" key also reduces the waveform to 0.8 times using the graph center as the reference.
Measure distance		Click two points and measure the distance between the two. The targets are sampling plot point, auxiliary line intersection, grid line intersection and the program coordinate point.
Translate		Drag to move the whole waveform in the direction it was dragged. Dragging while pressing the "Shift" key also moves the whole waveform.
Measure circular radius		Convert the path of the dragged range into an arc and display its radius.
Draw an additional line		Click the start and end points to draw an auxiliary line. The auxiliary line intersection is used for distance measurement. The auxiliary line can be moved by dragging, or be deleted by the Delete key.
Rotate		Dragging on the graph area or pressing the arrow keys (↑, ↓, ←, →) on the keyboard rotates the whole waveform.
Plot coordinates display		Display the coordinates of the waveform plot. Use the arrow keys (↑, ↓, ←, →) on the keyboard and click to select the location to display.
Master axis display		Switch the synchronization axis display to the master axis.
Slave axis display		Switch the synchronization axis display to the slave axis.
Time axis offset		Specify movement amount of the time axis shift of comparison data. Specify movement amount within half of the measurement time. Display only during the waveform comparison.
Display the overshoot information		Overshoot of position droop waveform and its time of occurrence can be displayed. (Note 1) Display only when position droop and speed command are measured.
Display the load inertia information		Load inertia of up to 4 NC axes or PLC axes (linear axes) can be displayed at a time. (Note 2) Display only when speed FB (mm/min, r/min) and current command or current FB are measured.
Set FFT range		Specify the FFT display range. Drag and move the A-B range. Move the lines A and B to extend or reduce the range. Set the range so that the number of sampling points will be a power of 2.
FFT display		Display FFT waveform for the portion you selected for FFT range setting. When FFT range setting is not selected, operation is disabled.

3. HOW TO USE

Display item	Icon	Description
Set waveform color and plot		Set the waveform color, the sampling plot display, and the grid color.
Data transformation		Computes the measurement data. Difference, rate conversion and acceleration rate conversion can be performed.
Arbitrary graph setting		Set the data used with the roundness waveform and arbitrary program waveform.
Axis setting		Set the axis data used in time-series waveform, roundness waveform, and arbitrary path measurement.
Help		Displays the measurement and adjustment method.

(Note 1) Overshoot information display

When the position droop and the speed command are measured, the overshooting information is displayed by pressing the display the overshoot information button.

The overshooting information is a combination of the maximum value of overshooting occurred when a speed was switched from acceleration to constant speed or from deceleration to stop and the time at that time.

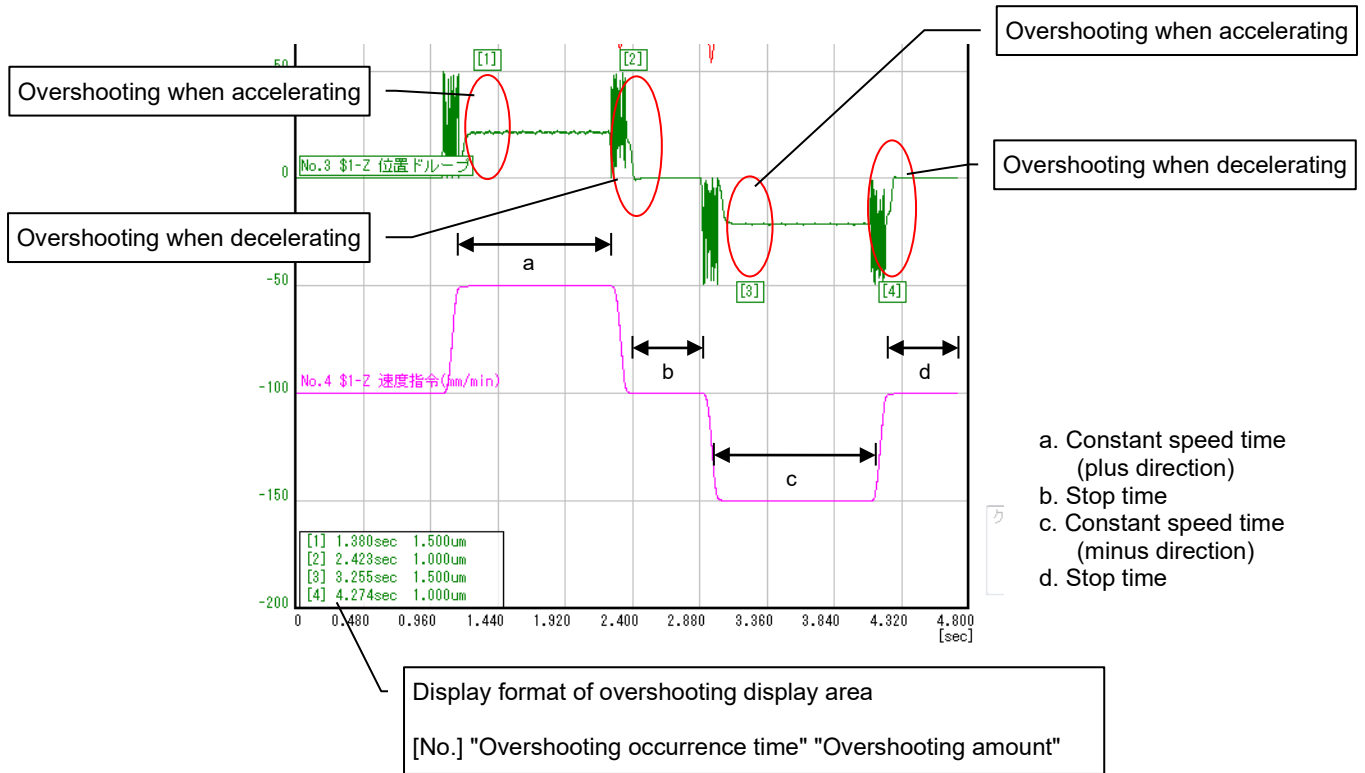

3. HOW TO USE

(Note 2) Load inertia information display

Display the load inertia ratio by pressing the display the load inertia information button when the following waveform type is measured:

Mode	Combination of waveform type
Normal sampling	- Speed FB (mm/min, r/min) - Current command or current FB
High-cycle sampling	- Current FB (mm/min, r/min) - q axis current command or q axis current FB

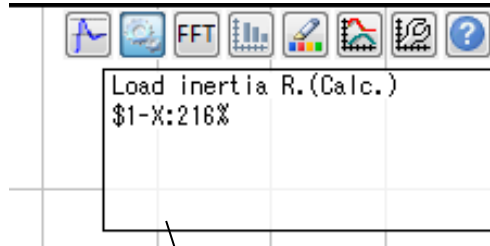

Display format of display the load inertia information area

Load inertia R.(Calc.)
"Axis name": "Load inertia ratio" %

3. HOW TO USE

3.1.9 Shortcut Key List

The items that can be selected for the shortcut keys differ depending on the cursor position.

(1) For window

Key	Description
CTRL+C	Capture waveforms in the waveform window. The buttons in the button area and note area are not included in the captured waveforms.
CTRL+W	Close the NC basic information window and the waveform window.

(2) For graph area

Key	Description
↑ Key	Move up
↓ Key	Move down
ESC or Home key on the keyboard	Autoscale
CTRL + +	Enlarge in the vertical direction
CTRL + -	Reduce in the vertical direction
+	Enlarge in the horizontal direction
-	Reduce in the horizontal direction
↑ ↓ → ← Key	Move the plot point from side to side or up and down

3. HOW TO USE

3.2 Project

3.2.1 Create a New Project

Create a new project. When creating a new file, create a project with the selected NC parameters imported.

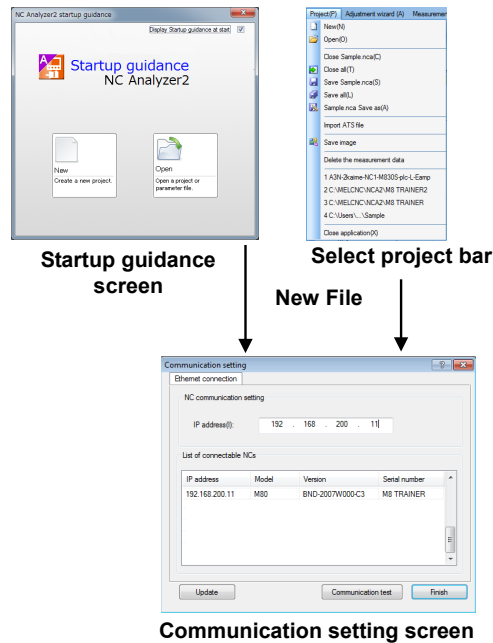

- (1) Creating a new project on the startup guidance screen or selecting "Project (P)" - "New (N)" displays the communication setting screen.
- (2) Selecting the connected NC and clicking the "Finish" button displays the new project dialog. Specify the save destination and the project name to create a project.

Display item	Description
IP address	Set the IP address of the NC to be connected. Selecting the NC displayed in "List of connectable NCs" displays the IP address of the selected NC.
List of connectable NCs	The list of NCs in the same subnet as the IP address of the PC is displayed. Clicking the title area of the list sorts all the items on the list in ascending or descending order.
Communication test	Starts communication test with the NC with the IP address displayed at the "IP address" column. During the communication test, the communication setting screen becomes inoperable, and the display of the [Communication test] button is switched to the display of "Communicating".
Update	Searches the NCs on the same subnet as the IP of the personal computer again and updates the list.
Finish	Creates a new project by communicating with the NC of the IP address displayed in the "IP Address" column. When communication is made, the parameters in the NC are read and saved as project information.
?	Pressing "?" at the top of the screen will open help file.

3. HOW TO USE

3.2.1.1 NC Basic Information Window

NC basic information window displays NC information and drive information of the created project.

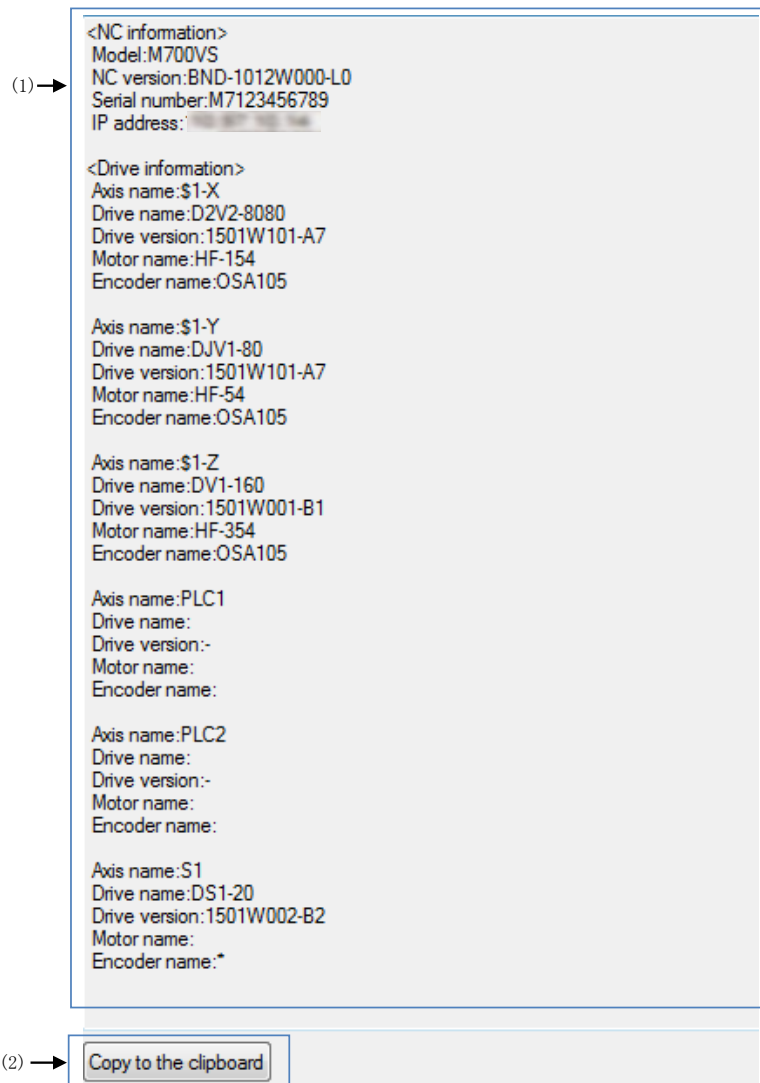

3. HOW TO USE

Display item	Description																										
(1) NC basic information																											
NC information <table border="1" data-bbox="248 331 552 488"> <tr> <td data-bbox="248 331 552 365">(a) Model</td> <td data-bbox="552 331 1425 365">Displays the NC model name.</td> </tr> <tr> <td data-bbox="248 365 552 398">(b) NC version</td> <td data-bbox="552 365 1425 398">Displays the NC version No.</td> </tr> <tr> <td data-bbox="248 398 552 432">(c) IP address</td> <td data-bbox="552 398 1425 432">Displays the NC IP address.</td> </tr> <tr> <td data-bbox="248 432 552 488">(d) Serial number</td> <td data-bbox="552 432 1425 488">Displays the NC Serial number.</td> </tr> </table>	(a) Model	Displays the NC model name.	(b) NC version	Displays the NC version No.	(c) IP address	Displays the NC IP address.	(d) Serial number	Displays the NC Serial number.																			
(a) Model	Displays the NC model name.																										
(b) NC version	Displays the NC version No.																										
(c) IP address	Displays the NC IP address.																										
(d) Serial number	Displays the NC Serial number.																										
Drive information <table border="1" data-bbox="248 533 552 1137"> <tr> <td data-bbox="248 533 552 981">(a) Axis name</td> <td data-bbox="552 533 1425 981"> Displays the axis name. <table border="1" data-bbox="608 562 1369 958"> <thead> <tr> <th data-bbox="608 562 932 595">Type</th> <th data-bbox="932 562 1369 595">Name</th> </tr> </thead> <tbody> <tr> <td data-bbox="608 595 932 629">NC axis</td> <td data-bbox="932 595 1369 629">\$s - Axis command name</td> </tr> <tr> <td data-bbox="608 629 932 707">NC axis as a synchronization control axis (master axis)</td> <td data-bbox="932 629 1369 707">\$s - Master axis command name (slave axis command name)</td> </tr> <tr> <td data-bbox="608 707 932 786">NC axis as a synchronization control axis (slave axis)</td> <td data-bbox="932 707 1369 786">\$s - Slave axis command name</td> </tr> <tr> <td data-bbox="608 786 932 842">NC axis as a spindle/C axis</td> <td data-bbox="932 786 1369 842">\$s - Axis command name (S Spindle No.)</td> </tr> <tr> <td data-bbox="608 842 932 898">NC axis as a sub part system</td> <td data-bbox="932 842 1369 898">\$s (SUB) - Axis command name</td> </tr> <tr> <td data-bbox="608 898 932 931">Spindle</td> <td data-bbox="932 898 1369 931">S Spindle No.</td> </tr> <tr> <td data-bbox="608 931 932 965">PLC axis</td> <td data-bbox="932 931 1369 965">PLC axis No.</td> </tr> </tbody> </table> \$s: Part system No. </td> </tr> <tr> <td data-bbox="248 981 552 1014">(b) Drive name</td> <td data-bbox="552 981 1425 1014">Displays the drive type.</td> </tr> <tr> <td data-bbox="248 1014 552 1048">(c) Drive version</td> <td data-bbox="552 1014 1425 1048">Displays the drive version. (When the drive is unconnected: "-")</td> </tr> <tr> <td data-bbox="248 1048 552 1081">(d) Motor name</td> <td data-bbox="552 1048 1425 1081">Displays the motor type.</td> </tr> <tr> <td data-bbox="248 1081 552 1137">(e) Encoder name</td> <td data-bbox="552 1081 1425 1137">Displays the encoder type.</td> </tr> </table>	(a) Axis name	Displays the axis name. <table border="1" data-bbox="608 562 1369 958"> <thead> <tr> <th data-bbox="608 562 932 595">Type</th> <th data-bbox="932 562 1369 595">Name</th> </tr> </thead> <tbody> <tr> <td data-bbox="608 595 932 629">NC axis</td> <td data-bbox="932 595 1369 629">\$s - Axis command name</td> </tr> <tr> <td data-bbox="608 629 932 707">NC axis as a synchronization control axis (master axis)</td> <td data-bbox="932 629 1369 707">\$s - Master axis command name (slave axis command name)</td> </tr> <tr> <td data-bbox="608 707 932 786">NC axis as a synchronization control axis (slave axis)</td> <td data-bbox="932 707 1369 786">\$s - Slave axis command name</td> </tr> <tr> <td data-bbox="608 786 932 842">NC axis as a spindle/C axis</td> <td data-bbox="932 786 1369 842">\$s - Axis command name (S Spindle No.)</td> </tr> <tr> <td data-bbox="608 842 932 898">NC axis as a sub part system</td> <td data-bbox="932 842 1369 898">\$s (SUB) - Axis command name</td> </tr> <tr> <td data-bbox="608 898 932 931">Spindle</td> <td data-bbox="932 898 1369 931">S Spindle No.</td> </tr> <tr> <td data-bbox="608 931 932 965">PLC axis</td> <td data-bbox="932 931 1369 965">PLC axis No.</td> </tr> </tbody> </table> \$s: Part system No.	Type	Name	NC axis	\$s - Axis command name	NC axis as a synchronization control axis (master axis)	\$s - Master axis command name (slave axis command name)	NC axis as a synchronization control axis (slave axis)	\$s - Slave axis command name	NC axis as a spindle/C axis	\$s - Axis command name (S Spindle No.)	NC axis as a sub part system	\$s (SUB) - Axis command name	Spindle	S Spindle No.	PLC axis	PLC axis No.	(b) Drive name	Displays the drive type.	(c) Drive version	Displays the drive version. (When the drive is unconnected: "-")	(d) Motor name	Displays the motor type.	(e) Encoder name	Displays the encoder type.	
(a) Axis name	Displays the axis name. <table border="1" data-bbox="608 562 1369 958"> <thead> <tr> <th data-bbox="608 562 932 595">Type</th> <th data-bbox="932 562 1369 595">Name</th> </tr> </thead> <tbody> <tr> <td data-bbox="608 595 932 629">NC axis</td> <td data-bbox="932 595 1369 629">\$s - Axis command name</td> </tr> <tr> <td data-bbox="608 629 932 707">NC axis as a synchronization control axis (master axis)</td> <td data-bbox="932 629 1369 707">\$s - Master axis command name (slave axis command name)</td> </tr> <tr> <td data-bbox="608 707 932 786">NC axis as a synchronization control axis (slave axis)</td> <td data-bbox="932 707 1369 786">\$s - Slave axis command name</td> </tr> <tr> <td data-bbox="608 786 932 842">NC axis as a spindle/C axis</td> <td data-bbox="932 786 1369 842">\$s - Axis command name (S Spindle No.)</td> </tr> <tr> <td data-bbox="608 842 932 898">NC axis as a sub part system</td> <td data-bbox="932 842 1369 898">\$s (SUB) - Axis command name</td> </tr> <tr> <td data-bbox="608 898 932 931">Spindle</td> <td data-bbox="932 898 1369 931">S Spindle No.</td> </tr> <tr> <td data-bbox="608 931 932 965">PLC axis</td> <td data-bbox="932 931 1369 965">PLC axis No.</td> </tr> </tbody> </table> \$s: Part system No.	Type	Name	NC axis	\$s - Axis command name	NC axis as a synchronization control axis (master axis)	\$s - Master axis command name (slave axis command name)	NC axis as a synchronization control axis (slave axis)	\$s - Slave axis command name	NC axis as a spindle/C axis	\$s - Axis command name (S Spindle No.)	NC axis as a sub part system	\$s (SUB) - Axis command name	Spindle	S Spindle No.	PLC axis	PLC axis No.										
Type	Name																										
NC axis	\$s - Axis command name																										
NC axis as a synchronization control axis (master axis)	\$s - Master axis command name (slave axis command name)																										
NC axis as a synchronization control axis (slave axis)	\$s - Slave axis command name																										
NC axis as a spindle/C axis	\$s - Axis command name (S Spindle No.)																										
NC axis as a sub part system	\$s (SUB) - Axis command name																										
Spindle	S Spindle No.																										
PLC axis	PLC axis No.																										
(b) Drive name	Displays the drive type.																										
(c) Drive version	Displays the drive version. (When the drive is unconnected: "-")																										
(d) Motor name	Displays the motor type.																										
(e) Encoder name	Displays the encoder type.																										
(2) Copy to the clipboard	Copies the NC basic information to the clipboard when "Copy to the clipboard" is selected.																										

3. HOW TO USE

3.2.2 Save as Project Name

Saves the parameters and the measurement data saved to the project selected in the project preview as a different project. The parameters and the measurement data to be saved can be selected from the list displayed in the [Save as] dialog.

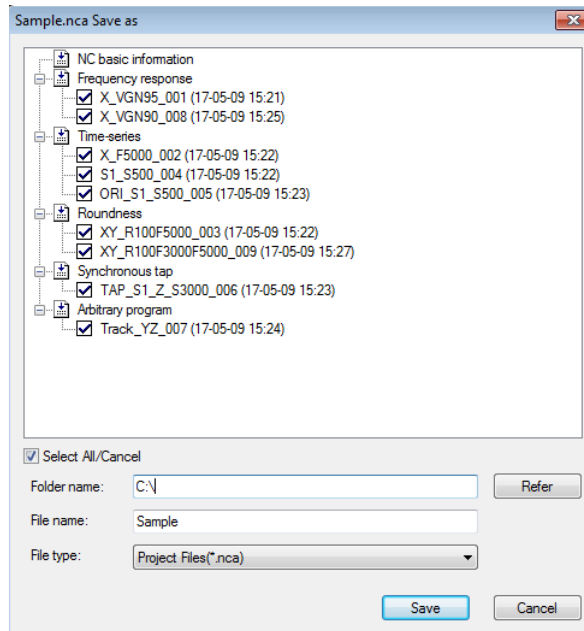

Display item	Description
Project preview	Displays the list of the parameters and the measurement data saved in the selected project. The display format is the same as the project preview on the main screen. Displays the parameters and the measurement data icons with check boxes and all the boxes are checked at initial display.
Select All/Cancel	When checked, all measurement data are checked. When unchecked, all measurement data are unchecked.
Folder name	Specify the folder where the project file is saved.
File name	Specify the project file name.
File type	Select the project file type.
Refer	Opens "Refer" window of the folder.
Save	Saves the project and closes the screen.
Cancel	Closes the project without saving.

3. HOW TO USE

3.2.3 Import data

Import data adds time series data by reading the data in text format for the measurement data selected in project preview.

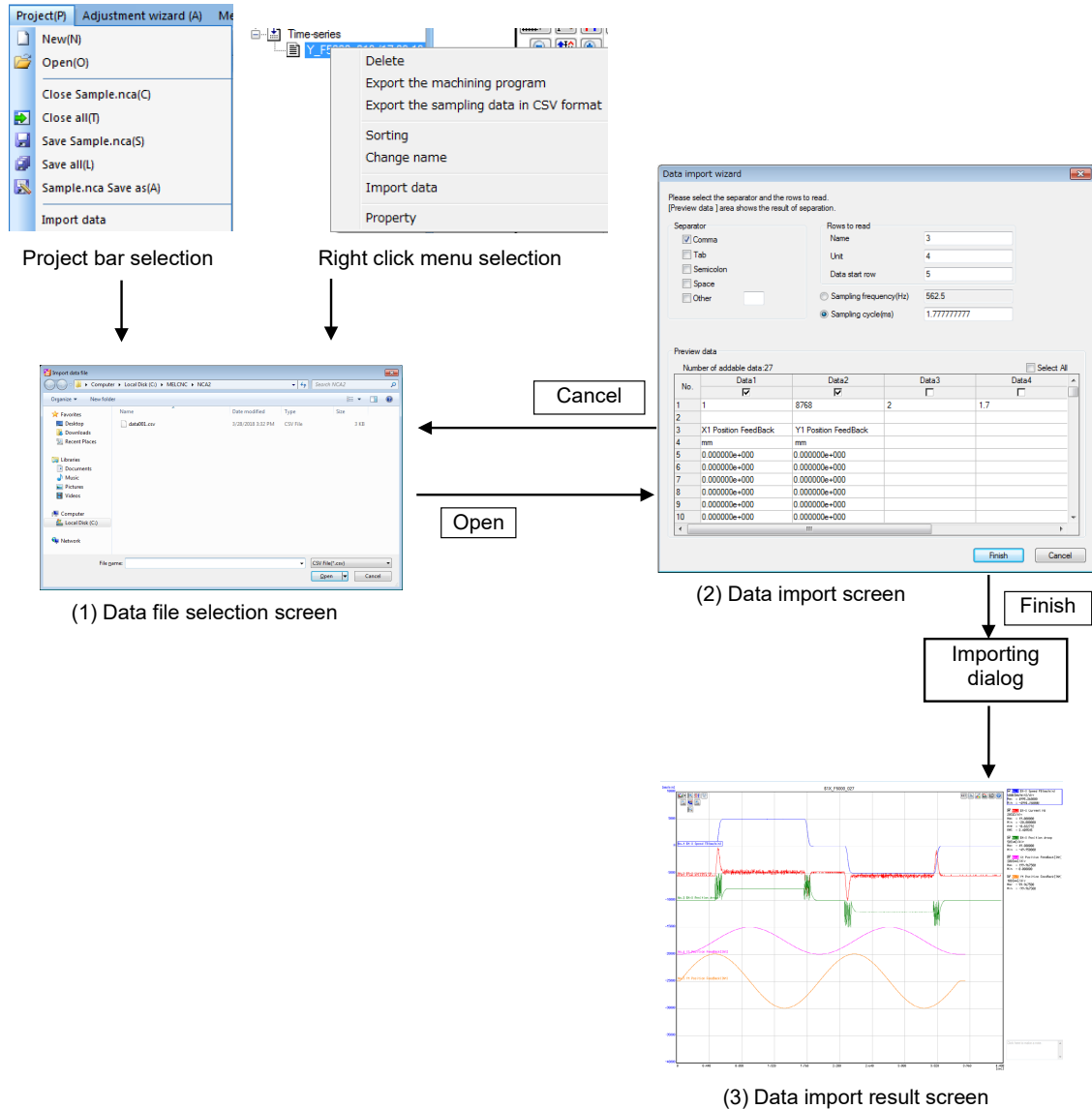

- (1) Data file selection screen
With the measured data to be added on project preview screen selected, select "Import data" from the menu or from the right-click menu to open the data file selection screen. In the "Data file selection screen", specify the data file to import.

(Note 1) Files which use an arbitrary delimiter in text format, such as CSV files, can be imported.
 (Note 2) Each column of the CSV file is read as data of one waveform.
 (Note 3) Use US-ASCII or the character codes of the personal computer on which NC Analyzer2 is used for the file to import.

3. HOW TO USE

(2) Data import wizard screen

Data to import can be selected and measuring condition can be set while confirming the designated file data in data import wizard screen. Up to 65535 rows of sampling data can be read.

Display item	Description	Initial value	Setting range
Separator	Set the delimiter for the file. Select from "Comma", "Tab", "Semi-colon", and "Space", or select "Others" to designate an arbitrary one-byte character.	Comma	Comma, tab, semi-colon, space, etc.
Rows to read	Set the Name, Unit and Data start row of the waveform which is displayed after data import. Set the Name and Unit rows before the Data start row.		
Name	The contents of the specified row number are used as the name of the waveform. When blank, the default waveform name is displayed.	Blank	Blank 1 to one row prior to data start row.
Unit	The contents of the specified row number are used as the unit of the waveform. When blank, this is treated as a dimensionless quantity.	Blank	Blank 1 to one row prior to data start row.
Data start row	The designated row to the final row of the file are treated as data rows. When blank, this is treated as the first row.	1	1 to the maximum number of rows of preview.
Measuring condition	Set the measuring conditions.		
Sampling frequency (Hz)	Set the sampling frequency of measuring data.	1000	0.001 to 1000000
Sampling cycle (ms)	Set the sampling cycle of measuring data.	1	0.001 to 1000000
Base radius (mm)	Set the base radius value of roundness measurement. This is displayed only when importing to roundness measurement data.	100	0.000001 to 999999.99999 9
Preview data	Display the imported data in a list.		
Number of addable data	Displays the number of data that can be added to the selected measured results. Up to 32 waveforms including the existing waveforms can be imported.	-	-
Data column (Check box)	Select the data columns to import. The data of the checked columns are imported.	All checked	Checked/ Unchecked
Select All	When checked, all data columns are checked. When unchecked, all data columns are unchecked.	Checked	Checked/ Unchecked
Data grid	Displays a maximum of 10,000 rows of file previews. Data cannot be edited.	-	-
Finish	Import data.	-	-
Cancel	The dialog is closed without saving the settings.	-	-

-: Not editable

(3) Data import result screen

Execute import to copy measured data which is selected in (1). File data is imported to the copied measured data.

3. HOW TO USE

3.2.4 Read Sampling Data (CSV) in a Batch

By using sampling data (CSV) batch loading, sampling data output from NC Analyzer2 can be read in a batch, displayed as waveforms, and saved in a project.

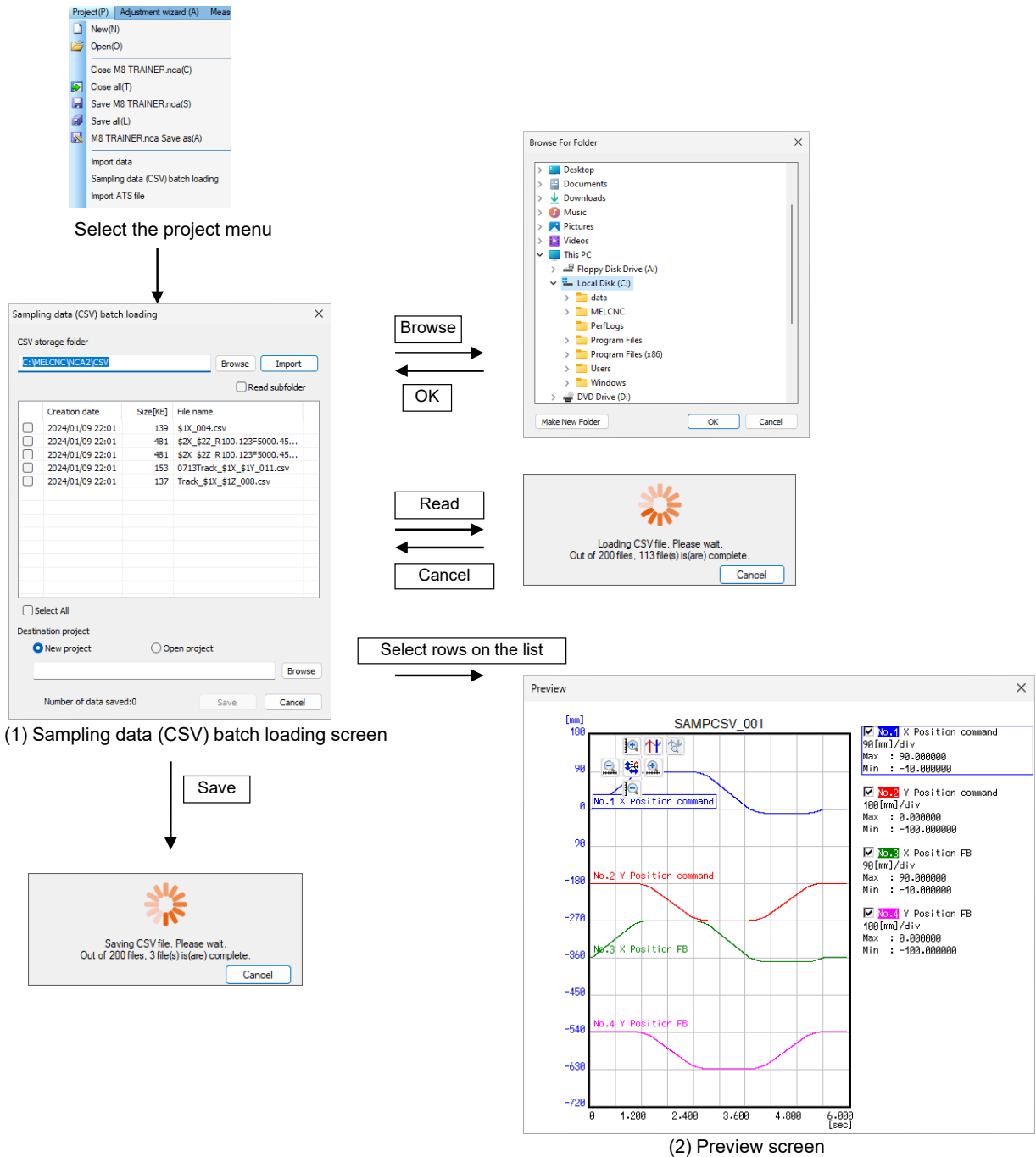

(1) Sampling data (CSV) batch loading screen

(2) Preview screen

3. HOW TO USE

(1) Sampling data (CSV) batch loading screen

Selecting "Project (P)" - "Sampling data (CSV) batch loading" displays the Sampling data (CSV) batch loading screen. In the Sampling data (CSV) batch loading screen, sampling data files are read from the specified folder and the selected sampling data is saved to a project in a batch.

The sampling data files that can be read are as follows.

Location from which the file is output		File reading availability
NC Analyzer2	Export the sampling data in CSV format	○
	Automatic remeasurement	○
NC	NCSAMP.csv	×

○: Available ×: Not available

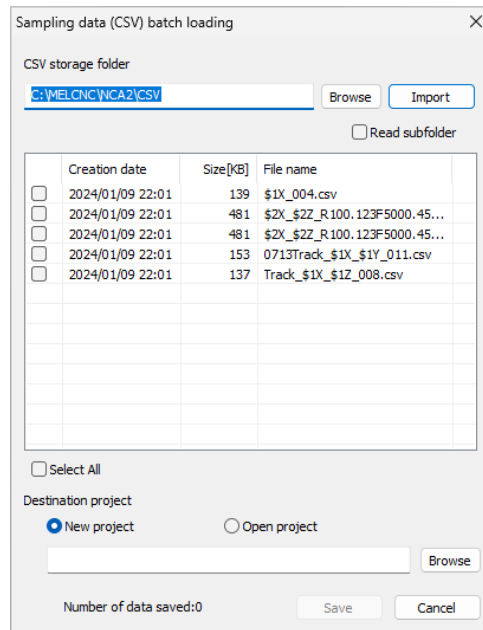

Display item	Description
CSV storage folder	Designate the folder from which the sampling data files to be read in a batch are stored.
Folder path	Designate the full path to the folder in which the sampling data files are stored.
Browse	Displays the folder selection dialog in which an arbitrary folder can be designated.
Import	<p>Reads the project stored in the folder designated in [Folder path].</p> <p>A progress dialog is displayed while reading the project. Clicking the "Cancel" button in the progress dialog discards the sampling data files that have already been read.</p> <p>(Note 1) When the number of the read sampling data files exceeds 200, an error message appears. The sampling data that has already been read is displayed.</p> <p>(Note 2) Sampling data files of frequency response measurement, velocity loop gain adjustment, or lost motion adjustment are not read.</p>
Read subfolder	<p>When checked, the sampling data files stored in the subfolders of the folder designated in [Folder path] are also read.</p> <p>When unchecked, the sampling data files stored in the subfolders are not read.</p>
Sampling data file list	<p>Displays the list of the read sampling data files.</p> <p>Clicking the top row (item part) sorts the list (in ascending or descending order).</p>
Checkbox	When checked, the data is saved to a project when the [Save] button is clicked.

3. HOW TO USE

Display item	Description
Creation date	Displays the date and time when the sampling data file was created. "YYYY/MM/DD HH:MM (year/month/day hour:minute)"
Size [KB]	Displays the size of the sampling data file.
File name	Displays the file name of the sampling data file.
Select All	Checking this selects all the checkboxes of the [Sampling data file list]. Unchecking this unselects all the checkboxes of the [Sampling data file list].
Destination project	Designate a project to save the sampling data selected in the [Sampling data file list].
New project	Saves the sampling data to a new project. Selecting this displays [File path] and the [Browse] button. Designate the full path of the project to which the sampling data will be saved in [Folder path]. Up to 200 sets of sampling data can be saved.
Open project	Saves the sampling data to an open project. Selecting this displays an open project in [File path]. Select the project to which the sampling data will be saved from the pull-down list.
File path	Designate the full path to the project file to save the sampling data. Selecting [Open project] displays an open project.
Browse	Displays the dialog in which an arbitrary folder can be designated.
Number of data saved	Displays the number of the sampling data files whose checkboxes in the [Sampling data file list] are checked.
Save	Saves the sampling data whose checkbox in the [Sampling data file list] is checked to a project. The names used to save sampling data to a project will be "SAMPCSV_n" (n=001,002,003...). The name of the original sampling data file is displayed in the memo area of the waveform window. A progress dialog is displayed while saving. Clicking the [Cancel] button cancels saving. The sampling data that has already been saved will remain saved to the project.
Cancel	Closes the Sampling data (CSV) batch loading screen without saving the project.

3. HOW TO USE

(2) Preview screen

Selecting a row in the [Sampling data file list] displays the preview screen on the right of the Sampling data (CSV) batch loading screen.

In the Preview screen, the waveforms of the rows selected in the sampling data file list are displayed.

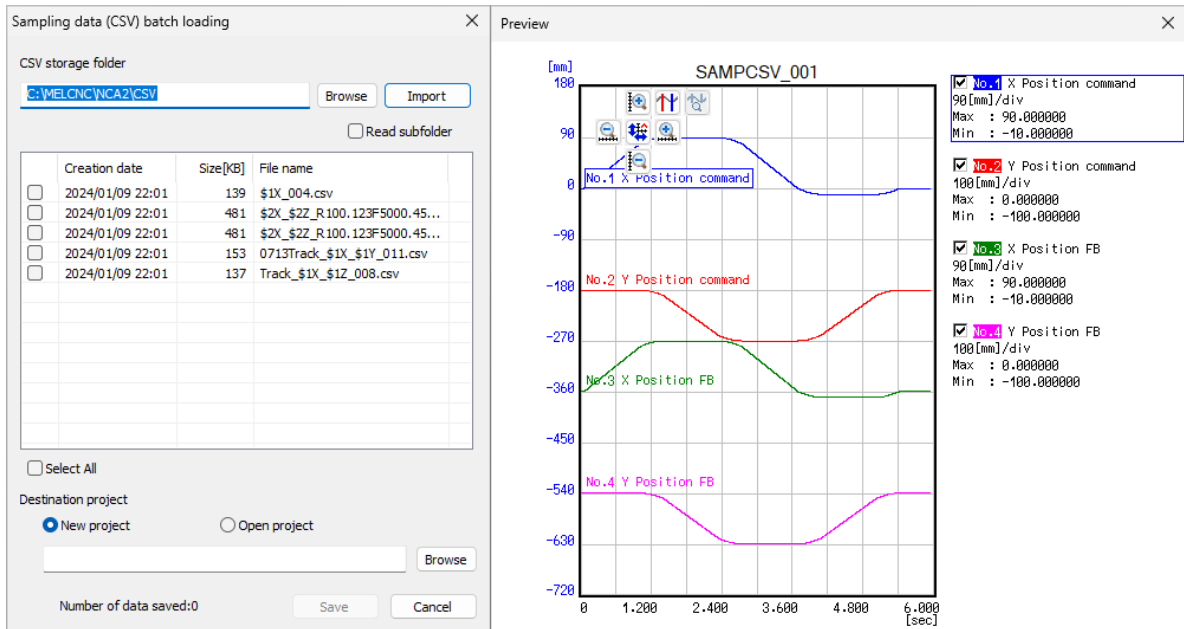

Display item	Description
Graph area	Displays graphs and a button area.
Graph	Displays time series waveforms of the rows selected in the [Sampling data file list] in the Sampling data (CSV) batch loading screen.
Button area	Displays the buttons that can be used for the displayed waveforms. For details on each button, refer to "3.1.8 Button Selection Items".
Text area	Displays waveform information of the rows selected in the [Sampling data file list] in the Sampling data (CSV) batch loading screen. For details on each button, refer to "3.8 Waveform Window".

3. HOW TO USE

3.3 Adjustment Wizard

3.3.1 Velocity Loop Gain Adjustment

The following is the flowchart for velocity loop gain adjustment.

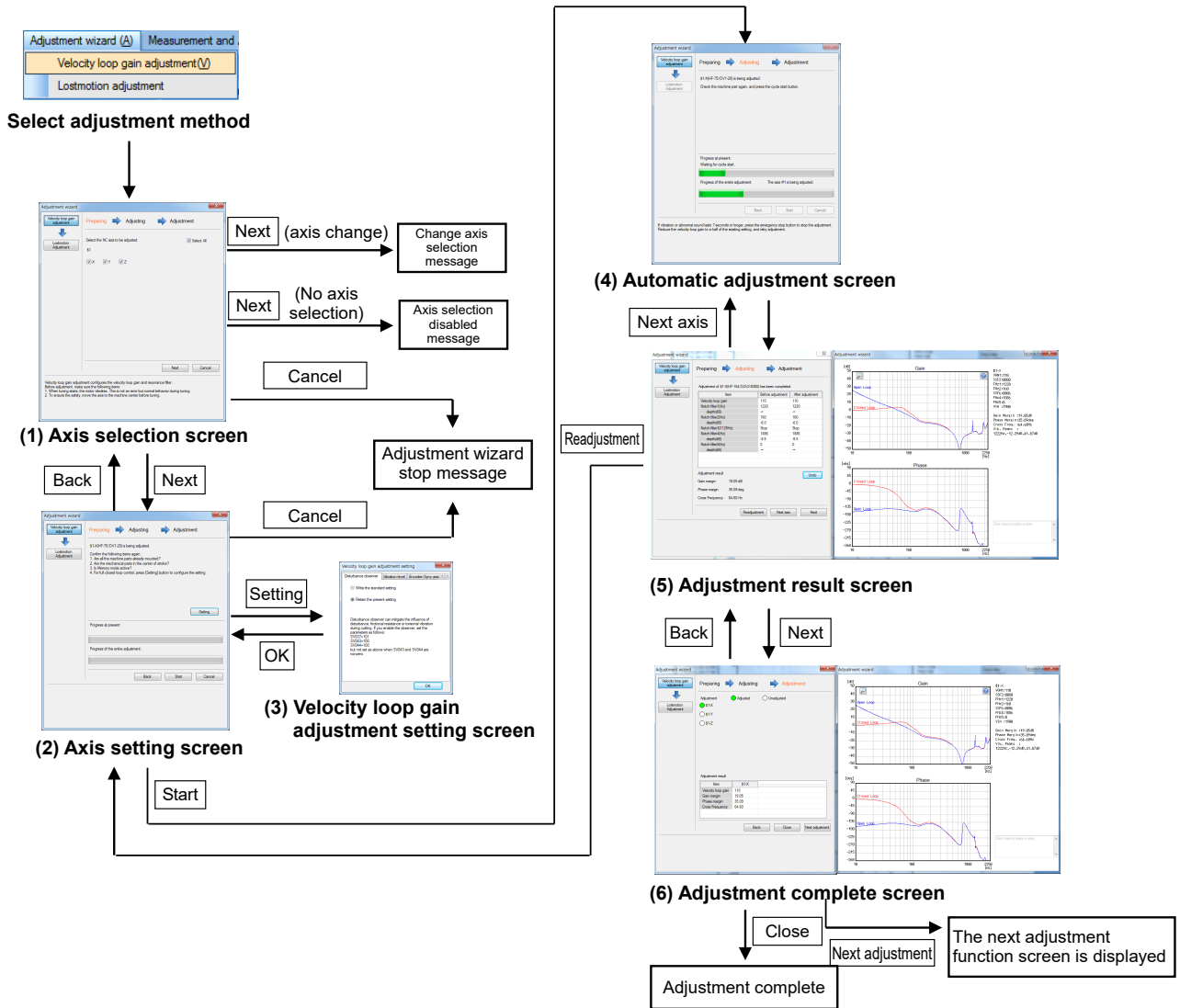

3. HOW TO USE

(1) Axis selection screen

Select "Adjustment wizard (A)" - "Velocity loop gain adjustment (V)" and display the axis selection screen. Select the NC axis to adjust on the axis selection screen and press "Next".

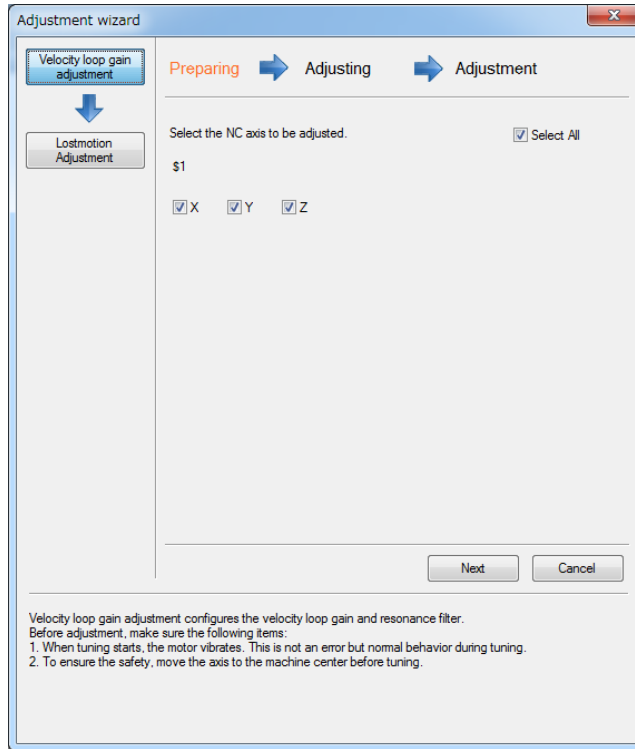

Display item	Description	Initial value	Setting range
Axis selection area	Select the NC axis to adjust. When an NC axis is displayed as "X(U)", (U) is the synchronous axis. (*) All NC axes that can be adjusted currently are displayed.	(*)	—
Select all	Checking "Select all" checks all axes. If any of axes in the axis selection area is unchecked while all axes are checked, "Select all" will be unchecked. Checking all axes checks "Select all".	ON	ON/OFF
Next	The axis setting screen is displayed. When no axis is selected, the axis unselectable message is displayed. When a different axis is set after an axis has been set, the change axis selection message is displayed.	—	—
Cancel	Stop the adjustment wizard.	—	—

3. HOW TO USE

(2) Axis setting screen

When "Setting" is pressed on the axis setting screen, the velocity loop gain adjustment setting screen is displayed.

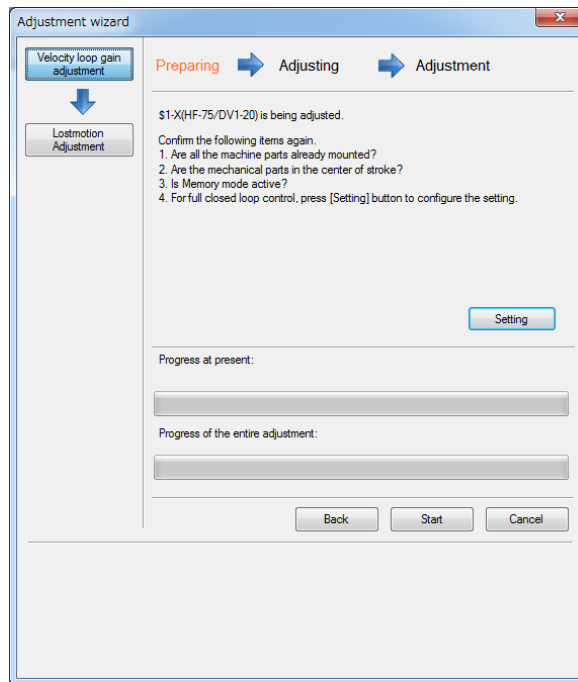

Display item	Description
Setting	The velocity loop gain adjustment setting screen is displayed.
Back	The axis selection screen is displayed.
Start	Starts velocity loop gain adjustment.
Cancel	Stops the adjustment wizard.

3. HOW TO USE

(3) Velocity loop gain adjustment setting screen

Once the settings have been checked on the velocity loop gain adjustment setting screen, return to the axis setting screen by pressing "OK" and press "Start" on the axis setting screen.

(a) [Disturbance observer] tab

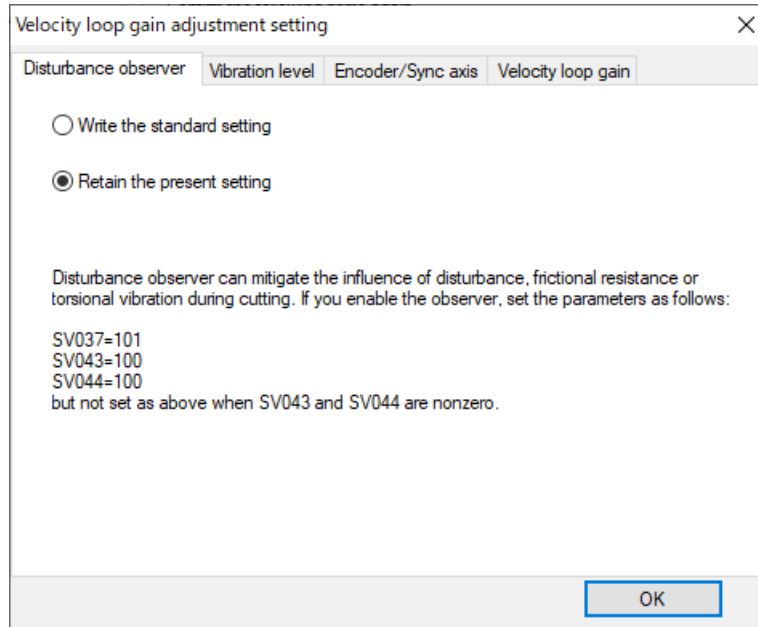

Display item	Description	Initial value	Setting range
Disturbance observer	<p>Select a disturbance observer from "Write the standard setting" / "Retain the preset setting". By setting a disturbance observer, the impact of disturbance, frictional resistance or torsional vibration during cutting can be reduced.</p> <p>When "Write the standard setting" is selected, set the following parameters as follows: #2237 SV037 JL (Load inertia scale) = 101 #2243 SV043 OBS1 (Disturbance observer filter frequency) = 100 #2244 SV044 OBS2 (Disturbance observer gain) = 100</p> <p>(Note) When "#2243 SV043 OBS1" and "#2244 SV044 OBS2" are not 0, do not set. Once set, all the current axes during adjustment will be enabled.</p>	Maintain the current setting	<p>Write the standard setting</p> <p>Retain the preset setting</p>
OK	Saves the settings and closes the window.	-	-

3. HOW TO USE

(b) [Vibration level] tab

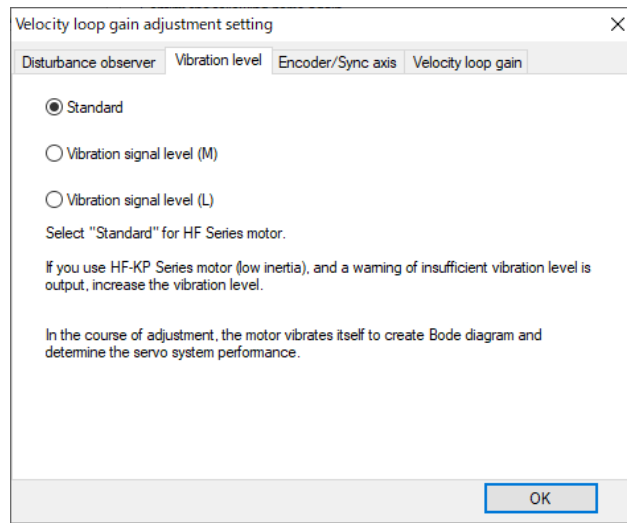

Display item	Description	Initial value	Setting range
Vibration level	Set the vibration signal level. To use the HF series motor, perform the standard adjustment. When a warning is issued for insufficient vibration strength while using the HF-KP series motor (low inertia), increase the vibration strength.	Standard	Standard Vibration level 1 (medium) Vibration level 2 (large)
OK	Saves the settings and closes the window.	-	-

(c) [Encoder/synchronous axis] tab

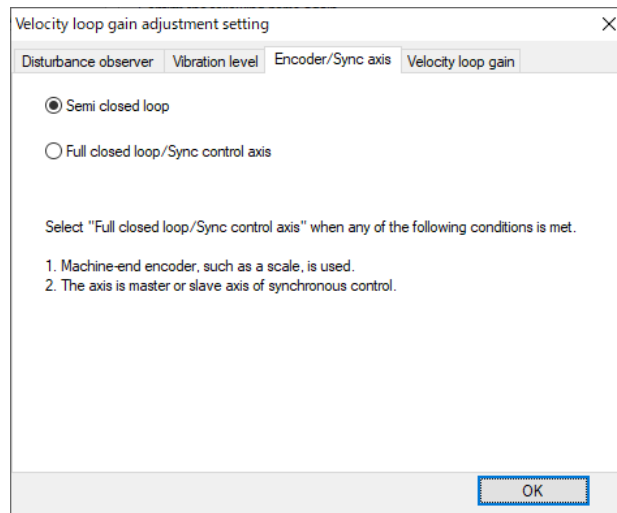

Display item	Description	Initial value	Setting range
Encoder/Async axis	Set the axis configuration. When any of the following items apply, select "Full-closed/synchronous control axis". (1) The encoder on the machine side such as scale is used. (2) The master axis or slave axis is in synchronous control.	Automatically set by the parameter	Semi-closed Full-closed/synchronous control axis
OK	Saves the settings and closes the window.	-	-

3. HOW TO USE

(d) [Velocity loop gain] tab

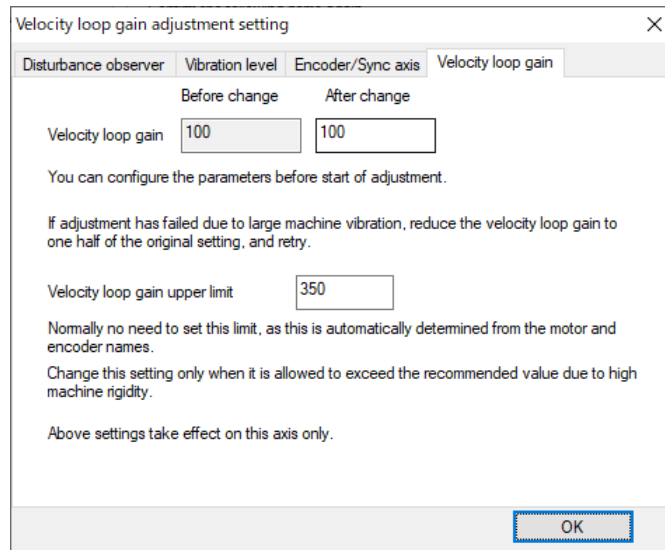

Display item	Description	Initial value	Setting range
Velocity loop gain	Set the items related to velocity loop gain. The setting value is only available to the adjustment axis. (Note) "Changed value" and "Velocity loop gain upper limit" are automatically determined by the motor type name and the encoder type name. Refer to "5.8 The Setting Range and Optimum Value of the Velocity Loop Gain for Each Motor Type and Encoder Type" for details.	-	-
Velocity loop gain	Setting values of "#2205 SV005" (Velocity loop gain 1) can be confirmed and changed at the start of adjustment. When the vibration of the machine is large and the adjustment fails, reduce the velocity loop gain to half the value of the original setting and readjust.	-	-
Current value	Displays the setting values of the parameters.	Automatically set by the parameter	-
Changed value	Set to change the current setting values.	-	1 to 30000
Velocity loop gain upper limit	Set the upper limit value of the velocity loop gain. (*) The initial value is automatically set from the motor type name and encoder type name. There is no need to change the setting value; however, it should be changed only when the mechanical rigidity is high and the setting value exceeds the recommended value.	(*)	-
OK	Saves the settings and closes the window.	-	-

3. HOW TO USE

(4) Automatic adjustment screen

When the automatic adjustment screen appears, velocity loop gain adjustment starts. Wait until the message "Waiting for cycle start" is displayed on the screen and then press the NC cycle start button.

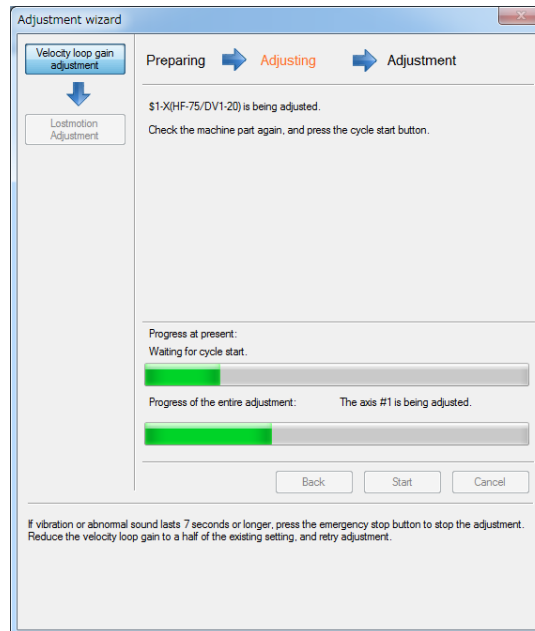

The progress changes as shown in the table below.

Display of the state of progress	Description
Reading and writing parameters.	Reading and writing parameters registered in the NC.
Waiting for cycle start.	Ready for adjustment and waiting for sampling start.
Sampling.	In measuring
Loading measurement results.	Loading measurement results.
Analyzing measurement data.	Analyzing measurement data. Displays the results in the waveform window each time the analysis is completed.
Changed parameters. Proceeding with the next adjustment.	Changed the parameters depending on the analysis results. Preparing for the next adjustment. (Note) Multiple adjustments are executed for one axis. Therefore, the waveforms displayed in the waveform window are updated every time an adjustment is completed.

(Note) [Back], [Start], and [Cancel] buttons cannot be selected until adjustment for all axes is completed.

3. HOW TO USE

(5) Adjustment result screen

Parameters and waveforms after adjustment on the adjustment result screen will appear on the screen. Pressing "Next axis" displays the automatic adjustment screen where adjustment to the next axis can be made. Pressing "Next" displays the adjustment complete screen.

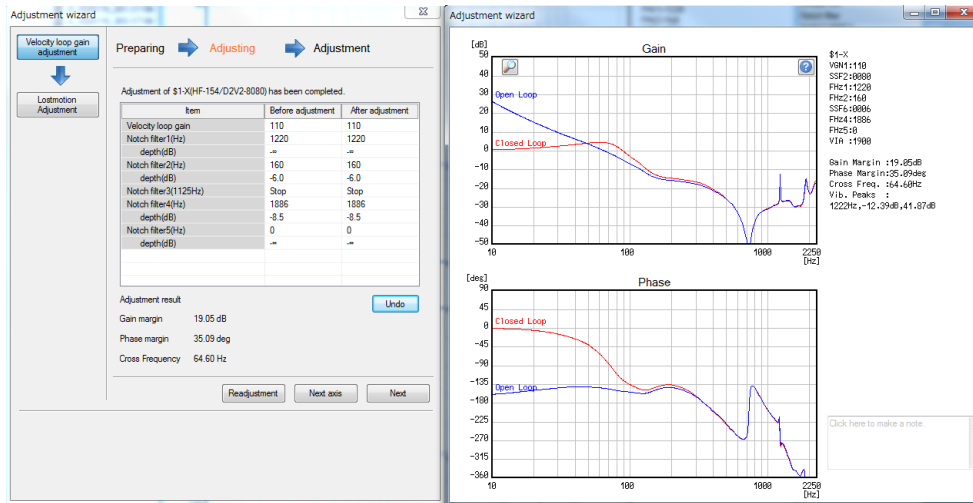

Display item	Description
Parameter change list	The parameter values before and after adjustment are displayed. When the values before and after adjustment are different, the value after adjustment is displayed in blue. The parameter values cannot be changed.
Velocity loop gain	Displays the value of "#2205 SV005 VGN1 (Velocity loop gain 1)".
Notch filter 1 (Hz)	Displays the value of "#2238 SV038 FHz1 (Notch filter frequency 1)".
Depth (dB)	Displays the value of "#2233 SV033 SSF2/bit3-1 (Depth of Notch filter 1)". (*1)
Notch filter 2 (Hz)	Displays the value of "#2246 SV046 FHz2 (Notch filter frequency 2)".
Depth (dB)	Displays the value of "#2233 SV033 SSF2/bit7-5 (Depth of Notch filter 2)". (*1)
Notch filter 3 (1125Hz)	Displays the value of "#2233 SV033 SSF2/bit4 (Notch filter 3)".
Notch filter 4 (Hz)	Displays the value of "#2287 SV087 FHz4 (Notch filter frequency 4)".
Depth (dB)	Displays the value of "#2283 SV083 SSF6/bit3-1 (Depth of Notch filter 4)". (*1)
Notch filter 5 (Hz)	Displays the value of "#2288 SV088 FHz5 (Notch filter frequency 5)".
Depth (dB)	Displays the value of "#2283 SV083 SSF6/bit7-5 (Depth of Notch filter 5)". (*1)
Undo	Parameters before adjustment are written to NC. The values on the screen are not changed. When the values are reset to the ones before adjustment, operation is disabled.
Adjustment result	Adjustment results of gain margin, phase margin and cross frequency are displayed.
Readjustment	The axis setting screen is displayed without saving adjustment results.
Next axis	Axis information is updated and the automatic adjustment screen for the next axis is displayed. When adjustment to the last axis is completed, operation is disabled.
Next	Adjustment complete screen is displayed.

(*1) The depth of the notch filter is displayed depending on the setting value of bit as shown in the following.

Setting value of bit (*)	Display
000	-∞
001	-18.1
010	-12.0
011	-8.5
100	-6.0
101	-4.1
110	-2.5
111	-1.2

(*) The setting value of bit is for "bit7,6,5" and "bit3,2,1".

3. HOW TO USE

(6) Adjustment complete screen

Adjustment complete screen is displayed when the adjustment is completed. Adjustment status of each axis specified in the axis selection screen is displayed in the adjustment complete screen.

Pressing "Close" displays the adjustment wizard confirmation dialog. Press "Yes" to finish the velocity loop gain adjustment.

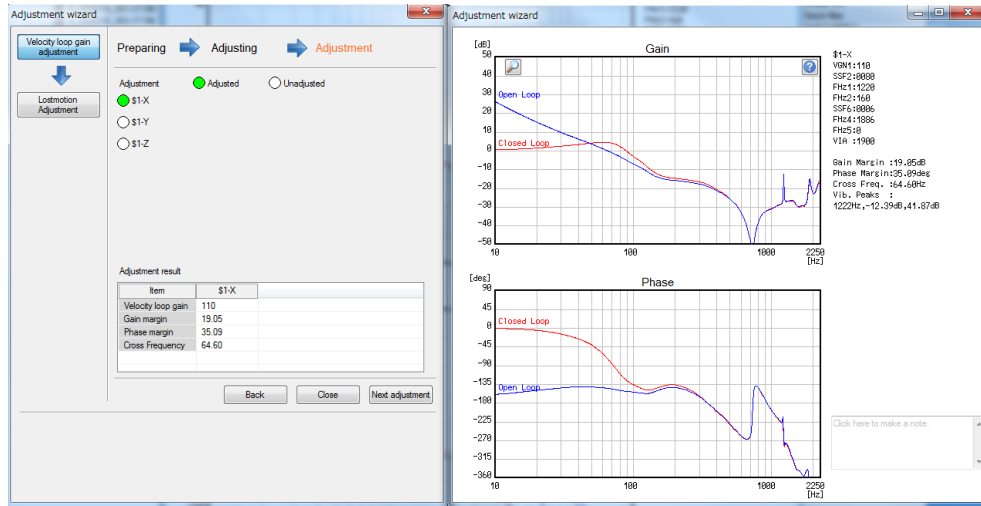

Display item	Description
Adjustment complete state display	The current adjustment state of all axes specified in the axis selection screen is displayed. Adjusted axes are displayed in green, misadjusted axes are displayed in red, and unadjusted axes are displayed in white.
Adjustment result list	Adjustment results of speed gain margin, phase margin and cross frequency are displayed.
Back	The adjustment complete screen is displayed.
Close	The adjustment wizard confirmation dialog is displayed.
Next adjustment	The next adjustment function screen is displayed.

3. HOW TO USE

3.3.2 Lost Motion Adjustment

The following is the flowchart for lost motion adjustment.

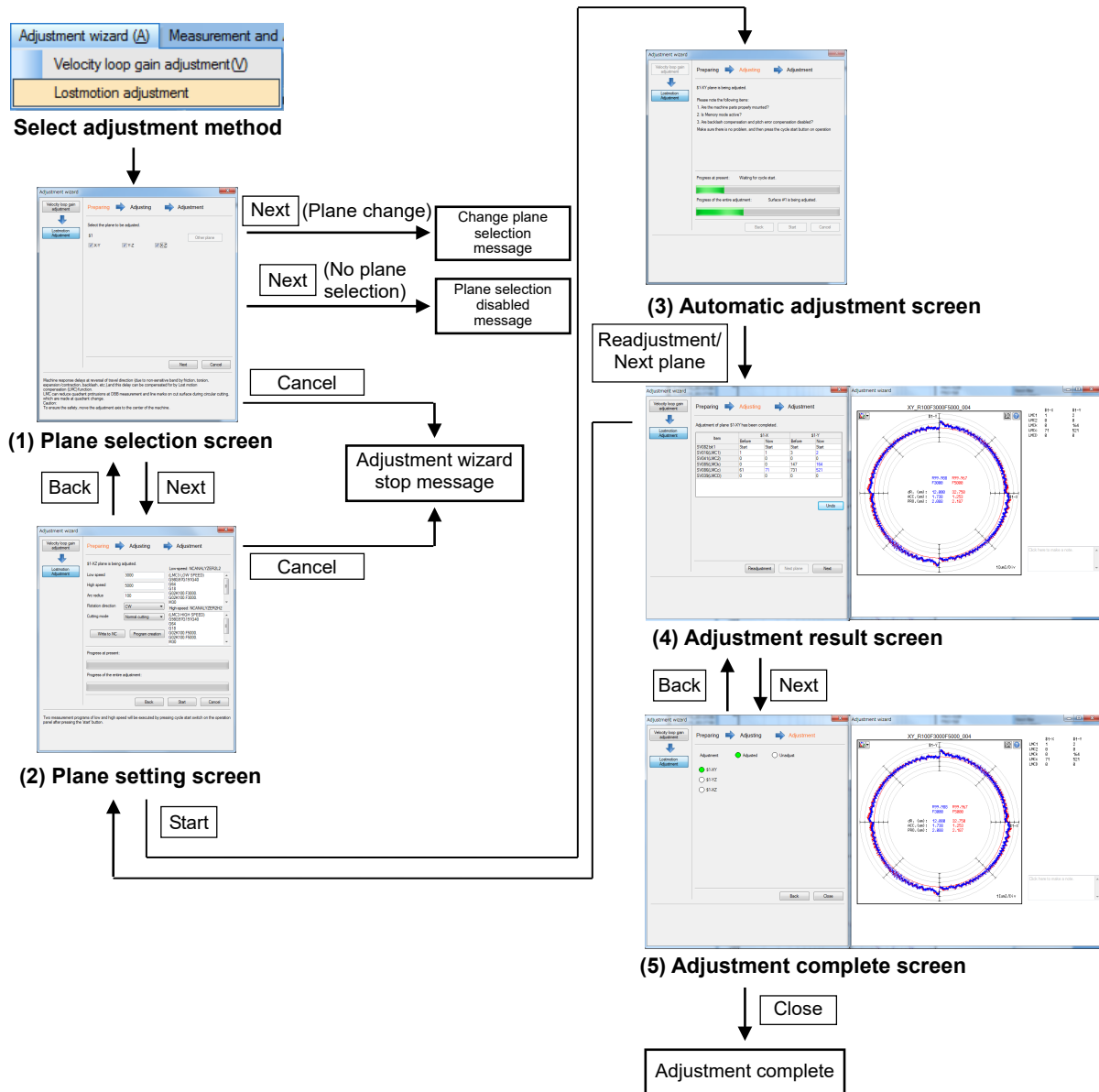

3. HOW TO USE

(1) Plane selection screen

Select "Adjustment wizard (A)" - "Lost motion adjustment" and display the plane selection screen. Select a plane to adjust on the plane selection screen and press "Next".

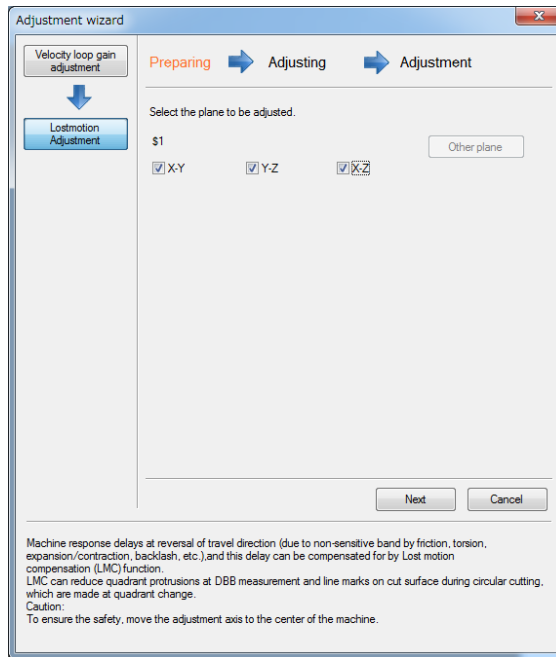

Display item	Description	Initial value	Setting range
Plane selection area	Select a plane to adjust. The lost motion adjustment needs to satisfy the following conditions. - There must be two NC axes (linear axis) in the same system. - The above-mentioned NC axes should not be the synchronous axes. A combination of two planes from the plane of axis designation names X/Y/Z is displayed. If there is only one axis in the part system, the part system is not displayed.	First plane	—
Other plane	When the number of axes in one part system is less than 3 axes, [Other plane] button turns gray and operation is disabled. When you press [Other plane] button when there are more than 4 axes, three blank axis selection boxes are displayed. All axes in the part system are displayed in the pull-down list of the axis selection box.	—	—
Next	Complete the plane selection and display a plane setting window. When no plane is selected, the plane unselectable dialog is displayed. When a different plane is selected after a plane has been set, the change plane selection dialog is displayed.	—	—
Cancel	Stop the adjustment wizard.	—	—

3. HOW TO USE

(2) Plane setting screen

After setting a plane on the plane setting screen, press "Start".

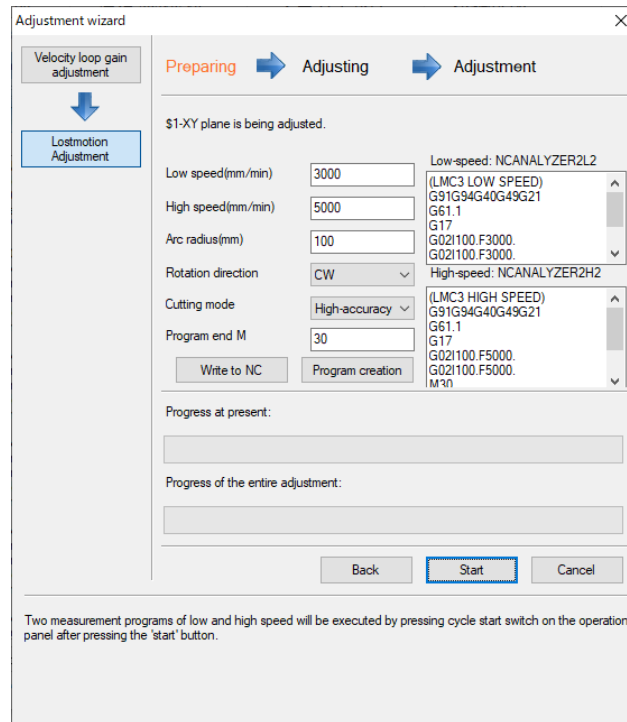

Display item	Description	Initial value	Setting range
Program creation	Set a program creation function.		
Each data for program creation function			
Low speed (mm/min)	Set the cutting feed speed during low speed.	3000	0.000001 to 999999.999999
High speed (mm/min)	Set the cutting feed speed during high speed.	5000	0.000001 to 999999.999999
Arc radius (mm)	Set the value for the radius of arc.	100	0.000001 to 999999.999999
Rotation direction	Select from "Clockwise (CW)" or "Counterclockwise (CCW)".	Clockwise (CW)	Clockwise (CW) Counterclockwise (CCW)
Cutting mode	Select from "Normal cutting mode" or "High-accuracy mode".	Normal cutting mode	Normal cutting mode High-accuracy mode
Program end M	Set the M code of program end.	30	0 to 99999999
Write to NC	Writes the programs displayed in [Program area] to the NC. If the program area is blank, the message "Enter the program" is displayed.	-	-
Program creation	Creates the measurement machining programs from various data for the program creation function. The created program is displayed in the [Program area].	-	-
Program area	Low speed program/high speed program is displayed. If the [Program area] is blank, the message "Enter the program" is displayed when "Start" is clicked.	-	-
Back	The plane selection screen is displayed.	-	-
Start	Starts lost motion adjustment.	-	-
Cancel	Stops the adjustment wizard.	-	-

3. HOW TO USE

(3) Automatic adjustment screen

When the automatic adjustment screen appears, the lost motion adjustment starts. Wait until the message "Waiting for cycle start" is displayed on the screen and then press the NC cycle start button.

The progress changes as shown in the table below.

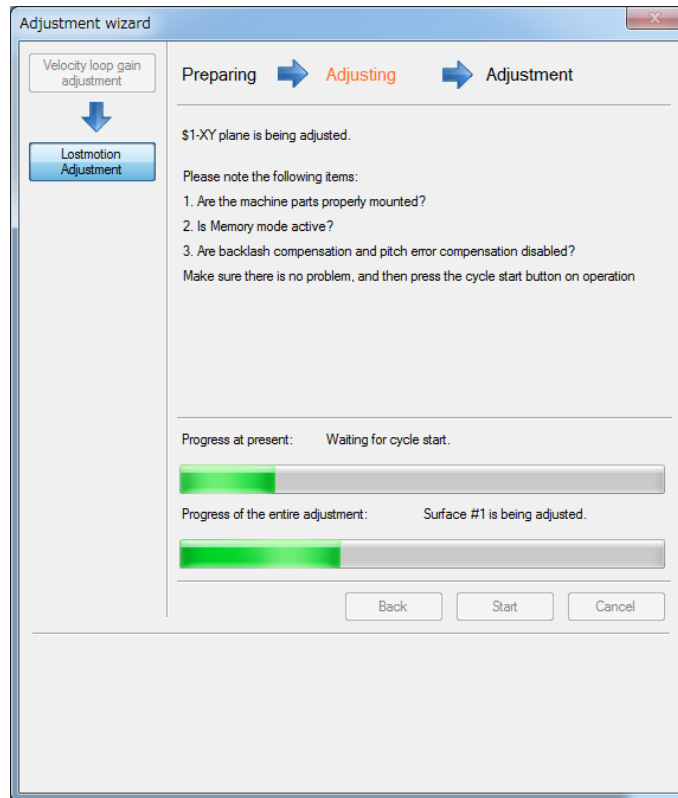

The progress changes as shown in the table below.

Display of the state of progress	Description
Writing the machining program.	Writing the machining program created in the plane setting screen to the NC.
Waiting for cycle start.	Ready for adjustment and waiting for sampling start.
Sampling.	In measuring
Loading measurement results.	Loading measurement results.
Analyzing measurement data.	Analyzing measurement data.
Changed parameters. Proceeding with the next adjustment.	Changed the parameters depending on the analysis results. Preparing for the next adjustment. (Note) Multiple adjustments are made to one plane; however, the last adjusted waveform is displayed in the waveform window.

(Note) [Back], [Start], and [Cancel] buttons cannot be selected until adjustment for all planes is completed.

3. HOW TO USE

(4) Adjustment result screen

Parameters and waveforms after adjustment on the adjustment result screen will appear on the screen. Pressing "Next plane" displays the automatic setting screen where adjustment to the next plane can be made. When "Next" is pressed, the adjustment complete screen is displayed.

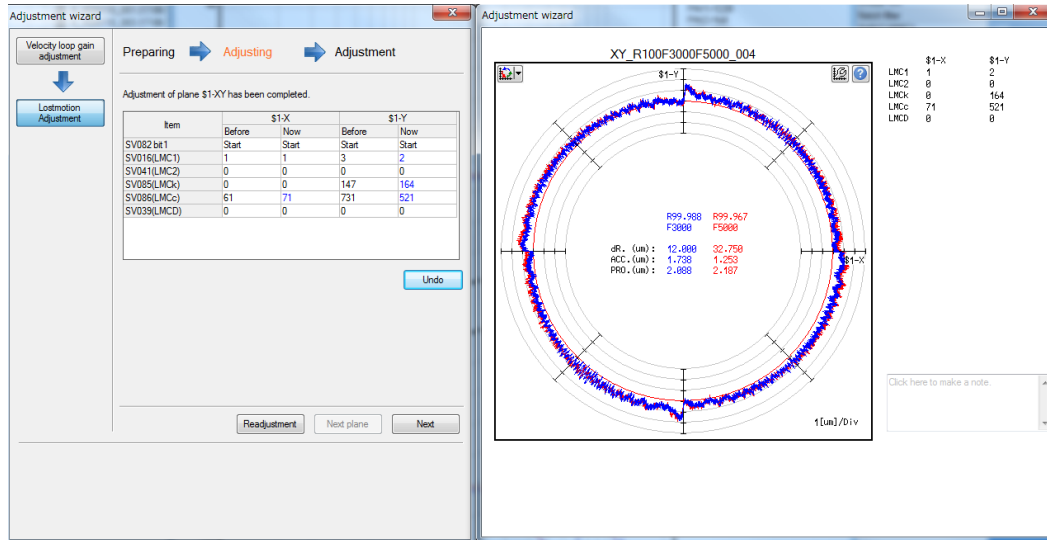

Display item	Description
Parameter change list	The parameter values before and after the adjustment are displayed for each axis. When the values before and after adjustment are different, the value after adjustment is displayed in blue. The parameter values cannot be changed.
SV082 bit1	Displays the value of "#2282 SV082 SSF5/bit1 (Lost motion compensation type 3)".
SV016 (LMC1)	Displays the value of "#2216 SV016 LMC1 (Lost motion compensation 1)".
SV041 (LMC2)	Displays the value of "#2241 SV041 LMC2 (Lost motion compensation 2)".
SV085 (LMCK)	Displays the value of "#2285 SV085 LMCK (Lost motion compensation 3 spring constant)".
SV086 (LMCC)	Displays the value of "#2286 SV086 LMCC (Lost motion compensation 3 viscous coefficient)".
SV039 (LMCD)	Displays the value of "#2239 SV039 LMCD (Lost motion timing)".
Undo	Parameters before adjustment are written to NC. The values on the screen are not changed. When the values are reset to the ones before adjustment, operation is disabled.
Readjustment	The plane setting screen is displayed.
Next plane	The plane setting screen for the next plane is displayed. When adjustment to the last plane is completed, operation is disabled.
Next	Adjustment complete screen is displayed.

3. HOW TO USE

(5) Adjustment complete screen

The status of the plane to which adjustments are made is displayed on the adjustment complete screen. Pressing "Close" displays the adjustment wizard confirmation screen. Press "Yes" to finish the lost motion adjustment.

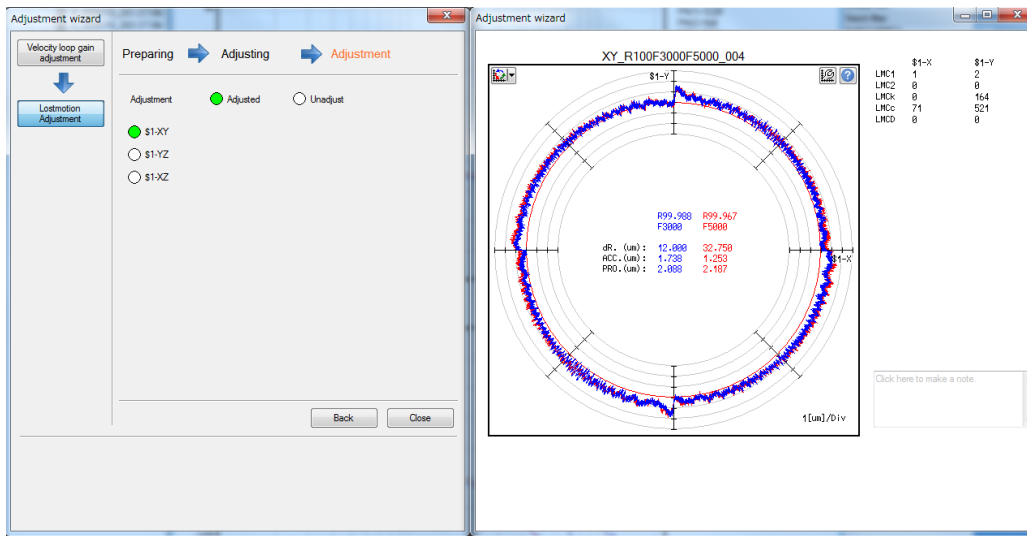

Display item	Description
Adjustment complete state display	The current adjustment state of all planes specified in the plane selection screen is displayed. The adjusted planes are displayed in green and unadjusted planes are displayed in red.
Back	The adjustment complete screen is displayed.
Close	The adjustment wizard confirmation dialog is displayed.

3. HOW TO USE

3.3.3 Variable Full-closed Torsion Adjustment

The following is a flowchart of variable full-closed torsion adjustment.

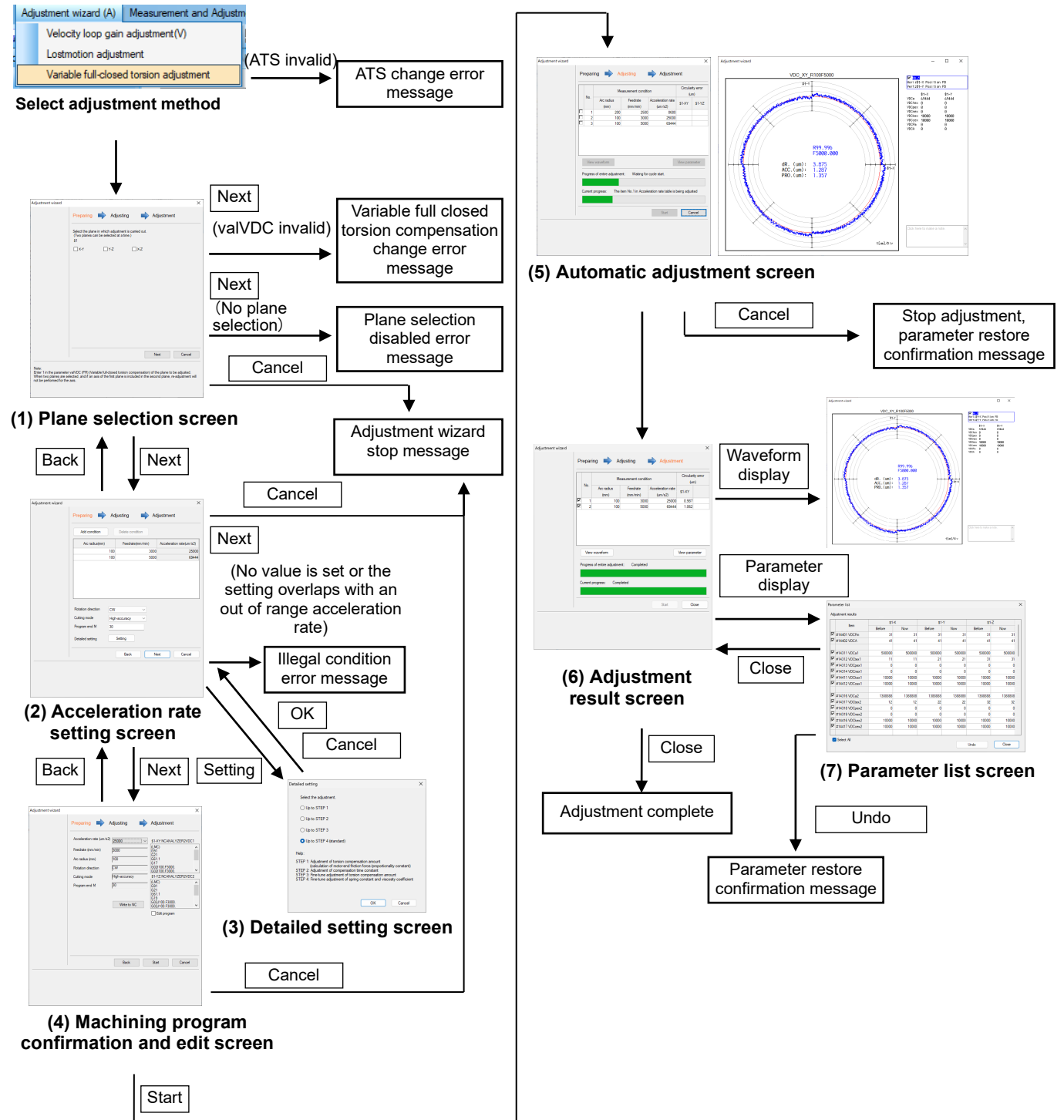

3. HOW TO USE

(1) Plane selection screen

Select "Adjustment wizard (A)" - "Variable full-closed torsion adjustment" to display the plane selection screen. Select the plane to adjust in the plane selection screen and press "Next".

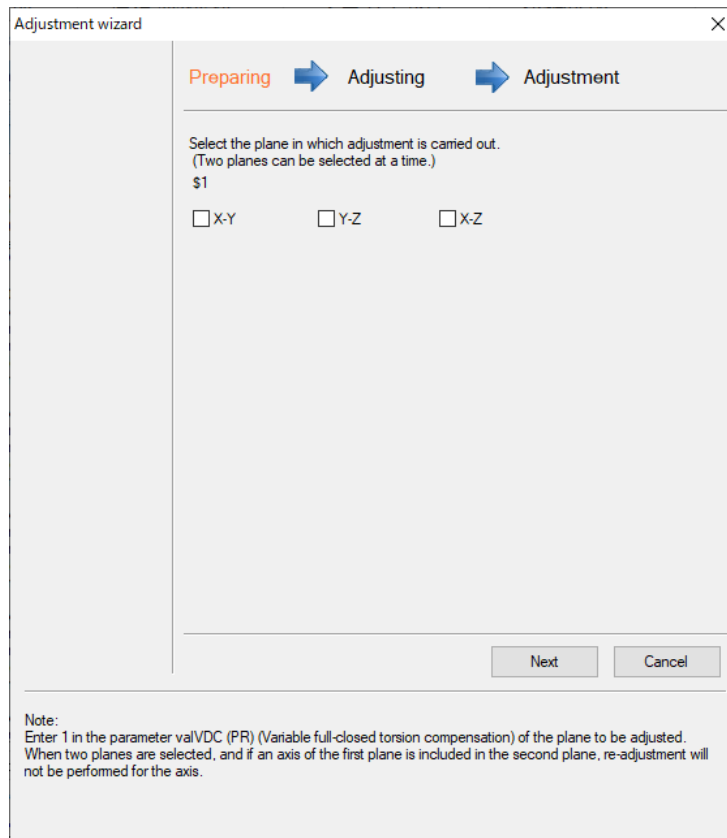

Display item	Description	Initial value	Setting range
Plane selection area	Select the plane to adjust. The axis to which the variable full-closed torsion adjustment has been made needs to satisfy the following conditions. - There must be two or more NC axes (linear axis) of the 1st part system. - The axes are not the rotary axes, PLC axes, or spindle. - The axes are not the slave axes. A combination of two planes from the plane of the basic axis I/J/K is displayed.	First plane	-
Next	The acceleration rate setting screen is displayed. When no plane is selected, the plane unselectable message is displayed.	-	-
Cancel	Stops the adjustment wizard.	-	-

3. HOW TO USE

(2) Acceleration rate setting screen

Set the acceleration rate in the acceleration rate setting screen, and press "Next".

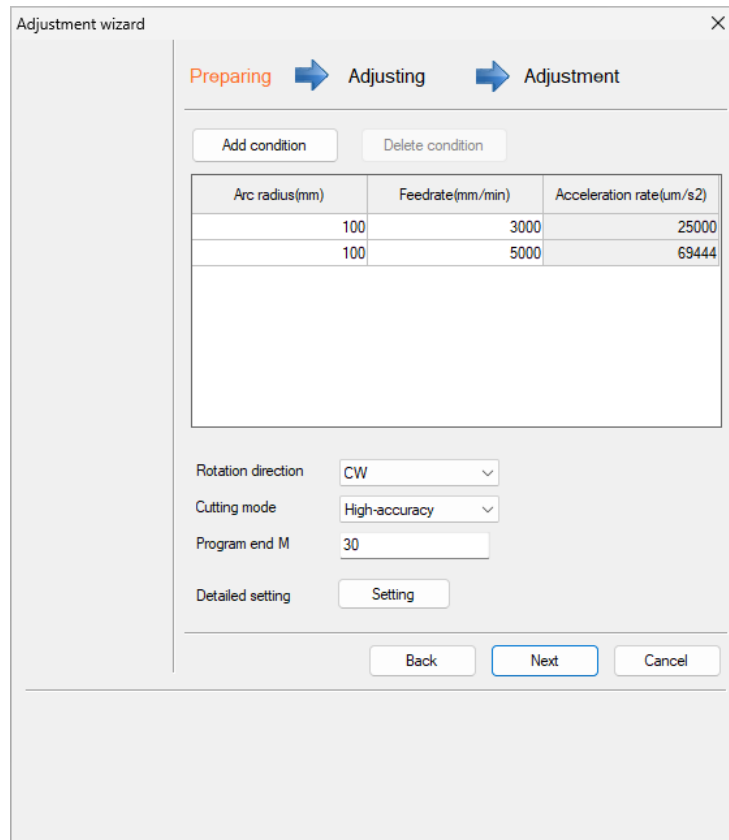

Display item	Description	Initial value	Setting range
Add condition	Adds a blank row under the final row of "Acceleration rate condition".	-	-
Delete condition	Deletes the selected acceleration rate condition.	-	-
Acceleration rate condition (*1)	Sets the measuring condition.	2	2 to 8
Arc radius (mm)	Sets the arc radius.	1st row: 100 2nd row: 100	0.000001 to 999999.999999
Feedrate (mm/min)	Sets the feedrate.	1st row: 3000 2nd row: 5000	0.000001 to 999999.999999
Acceleration rate (um/s2)	Displays the acceleration rate calculated from the arc radius and the feed rate. Selecting the column title sorts the acceleration rate in ascending order.	1st row: 25000 2nd row: 69444	1 to 2147483647
Rotation direction	Select from "CW" and "CCW".	CW	CW CCW
Cutting mode	Select from "Normal cutting" and "High-accuracy".	High-accuracy	Normal cutting High-accuracy
Program end M	Set the M code of program end.	30	0 to 99999999
Setting	The Detailed setting screen is displayed.	-	-
Back	The plane selection screen is displayed.	-	-
Next	Machining program confirmation and edit screen is displayed.	-	-
Cancel	Stops the adjustment wizard.	-	-

(*1) The unit system changes depending on "Input unit" of "Detailed information of the graph" on the Option screen.

3. HOW TO USE

(3) Detailed setting screen

When the adjustment range setting is changed, click "OK" to return to the acceleration rate setting screen, and click "Next".

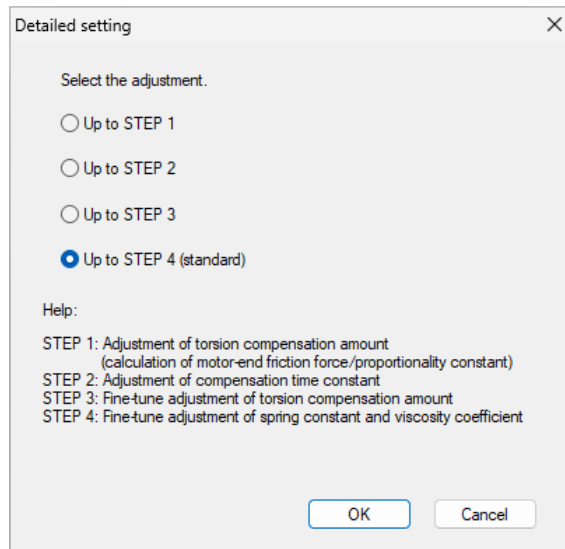

Display item	Description	Initial value	Setting range
Adjustment contents	Select the range of adjustment items. STEP1: The torsion compensation amount is adjusted. After that, the motor-end frictional force and proportionality constant are calculated. STEP2: Adjustments are made while changing the compensation time constant. STEP3: Based on the torsion compensation amount adjusted in STEP1, the projection of the roundness is finely adjusted to be minimal. STEP4: Spring constant and viscosity coefficient are adjusted so that the projection of the roundness is minimal.	Up to STEP 4 (standard)	Up to STEP 1 to Up to STEP 4 (standard)

The parameters to be adjusted differ depending on the adjustment contents (STEP1 to 4). Refer to the following table.

Item	Adjustment target parameter			
	Motor-end frictional force, proportionality constant	Torsion compensation amount	Compensation time constant	Spring constant and viscosity coefficient
Up to STEP 1	○	○	-	-
Up to STEP 2	○	○	○	-
Up to STEP 3	○	○ (fine adjustment)	○	-
Up to STEP 4 (standard)	○	○ (fine adjustment)	○	○

○: Adjusted -: Not adjusted (A fixed value is set.)

3. HOW TO USE

(4) Machining program confirmation and edit screen

Confirm the settings in the machining program confirmation and edit screen, and press "Start".

When the machining program needs to be edited, check the checkbox of "Edit program" to edit the machining program.

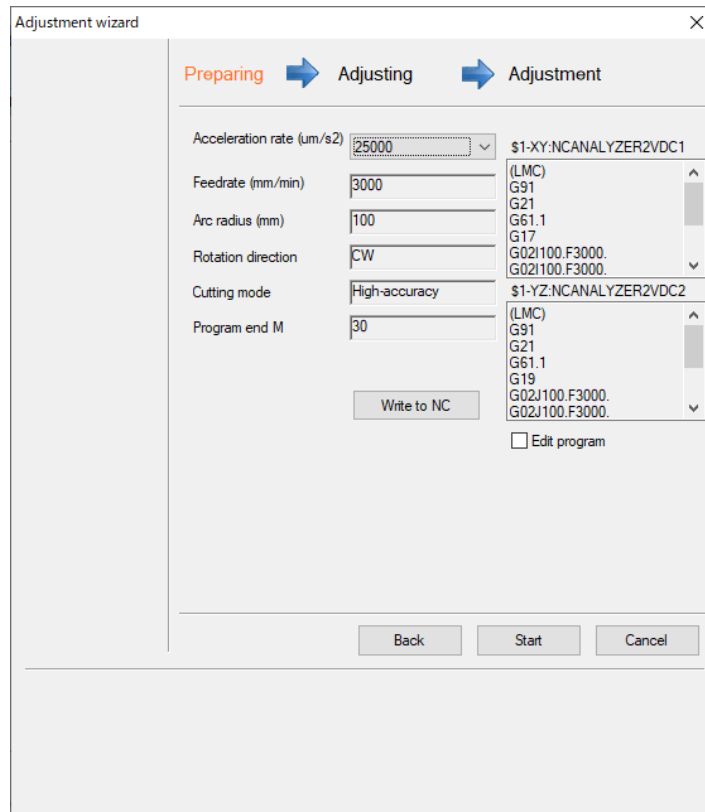

Display item	Description	Initial value	Setting range
Program creation	Set the program creation function.		
Each data for program creation function (Note 1)			
Acceleration rate (um/s2)	Select the acceleration rate to confirm and edit the machining program.	The minimum acceleration rate set in the acceleration rate setting screen	Acceleration rate set in the acceleration rate setting screen
Feedrate (mm/min)	Displays the feedrate.	-	-
Arc radius (mm)	Displays the radius of arc.	-	-
Rotation direction	Displays the rotation direction.	-	-
Cutting mode	Displays the cutting mode.	-	-
Program end M	Displays the M code of program end.	-	-
Write to NC	Clicking this button writes the programs displayed in the [program area] to the NC.	-	-
Edit program	Checking "Edit program" enables you to edit the program. The following items cannot be selected. - "Acceleration rate" - "Write to NC" button - "Back" button - "Start" button When unchecked, the program is confirmed for the displayed acceleration rate.	OFF	ON/OFF

3. HOW TO USE

Display item	Description	Initial value	Setting range
Program area	Displays the machining program created automatically under the conditions set in the acceleration rate setting screen. Do not edit the descriptions to the following items. Changing the descriptions will result in incorrect adjustment. - Plane, arc radius, feedrate, number of repetitions	-	-
Back	Displays the acceleration rate setting screen.	-	-
Start	Starts the variable full-closed torsion adjustment.	-	-
Cancel	Stops the adjustment wizard.	-	-

(Note 1) All data set on the acceleration rate setting screen is displayed.

3. HOW TO USE

(5) Automatic adjustment screen

Displays the automatic adjustment screen and starts the variable full-closed torsion adjustment. Press the cycle start button of the NC after "Waiting for cycle start." message is displayed on the screen.

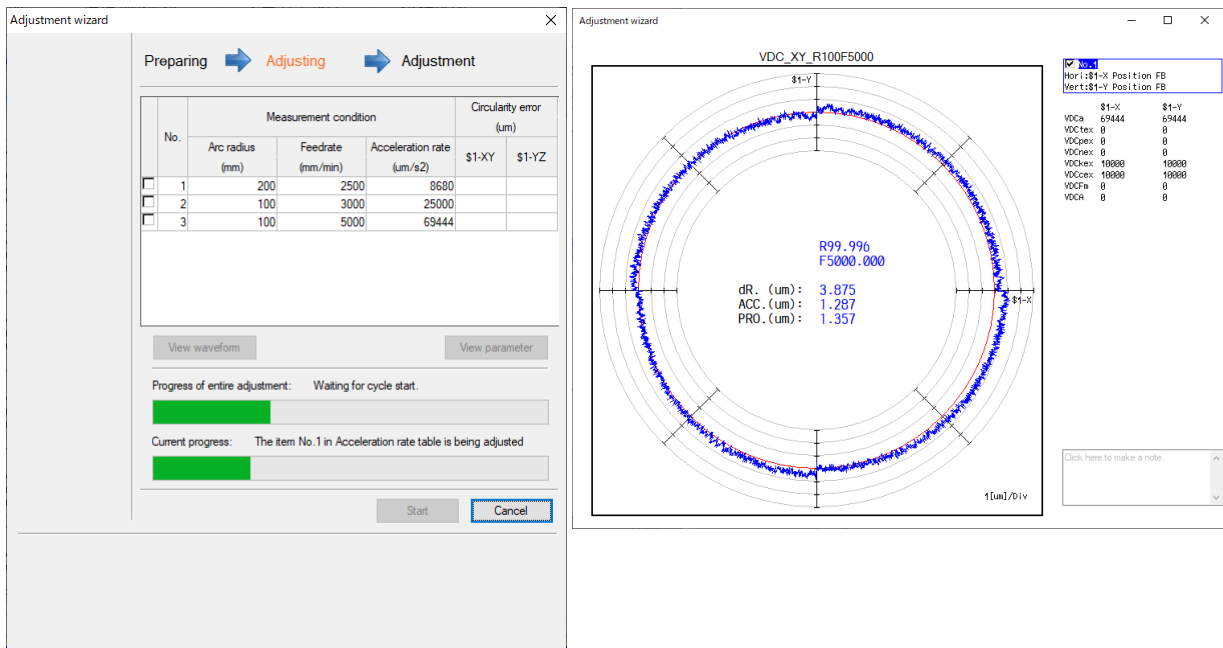

Display item	Description
Acceleration rate table list	Displays the measuring condition for each acceleration rate and circularity error after the adjustment.
No.	Displays the acceleration rate table number.
Measuring condition (*1)	Displays the measuring condition.
Arc radius (mm)	Displays the radius of arc.
Feedrate (mm/min)	Displays the feedrate.
Acceleration rate (um/s2)	Displays the acceleration rate.
Circularity error (um) (*2)	Displays circularity error after the adjustment.
First plane	Displays circularity error of the adjusted 1st plane.
Second plane	Displays circularity error of the adjusted 2nd plane. Nothing is displayed when there is only one adjustment plane.
Cancel	Displays the parameter restore confirmation message and closes the adjustment wizard. Selecting "Yes" restores the parameters and cancels the adjustment. Selecting "No" cancels the adjustment without restoring the parameter. Selecting "Cancel" continues the adjustment.

(*1) The unit system changes depending on "Input unit" of "Detailed information of the graph" on the Option screen.

(*2) The unit system changes depending on "Display unit" of "Detailed information of the graph" on the Option screen.

3. HOW TO USE

The progress changes as shown in the table below.

Display of the state of progress (upper row)	Description
Initial parameters are being configured	Writing the parameter.
Waiting for cycle start.	Ready for adjustment and waiting for sampling start.
Torsion compensation amount is being adjusted	Adjusting torsion compensation amount.
Compensation time constant is being adjusted	Adjusting compensation time constant.
Torsion compensation amount is being fine-tuned	Finely adjusting the torsion compensation amount.
Spring constant and viscosity are being adjusted	Adjusting spring constant and viscosity coefficient.
Measuring the adjusted waveform	Measuring the adjusted waveforms.
Completed	All adjustments are completed.

Display of the state of progress (lower row)	Description
The item No.n in Acceleration rate table is being adjusted	Adjusting the acceleration table No.n. (n: 1 to 8)
Measuring the item No.n in Acceleration rate table	Measuring the acceleration table No.n. (n: 1 to 8)
Completed	All adjustments are completed.

3. HOW TO USE

(6) Adjustment result screen

Displays the circularity error after the adjustment in the adjustment result screen.

Press the "View waveform" and "View parameter" buttons to display the details of the adjustment result.

Pressing the "Close" button displays the confirmation screen. Press "OK" to finish the variable full-closed torsion adjustment.

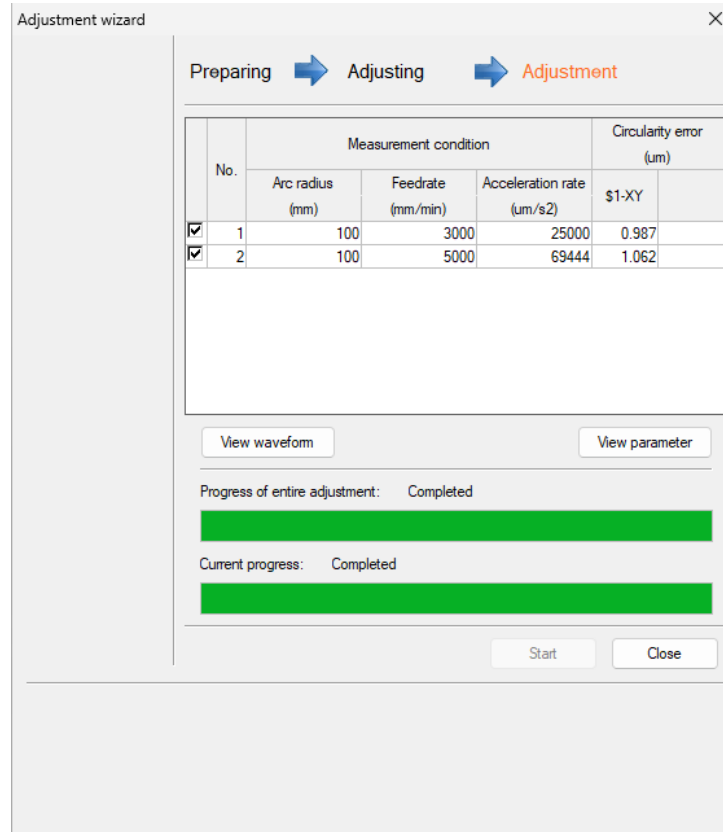

Display item	Description
Acceleration rate table list	Displays the measuring conditions for each acceleration rate and circularity error after the adjustment.
No.	Displays the acceleration rate table number. Check the checkbox of the acceleration rate next to the "No." to display the waveform.
Measuring condition	Displays the measuring condition.
Arc radius (mm)	Displays the radius of arc.
Feedrate (mm/min)	Displays the feedrate.
Acceleration rate (um/s ²)	Displays the acceleration rate.
Circularity error (um)	Displays circularity error after the adjustment.
First plane	Displays circularity error of the adjusted 1st plane.
Second plane	Displays circularity error of the adjusted 2nd plane. Nothing is displayed when there is only one adjustment plane.
View waveform	Displays the waveforms of all planes adjusted for each checked number in the acceleration rate table list. This is enabled when a checkbox is checked in the acceleration rate table list.
View parameter	Displays the parameter list screen.
Close	Displays the adjustment wizard confirmation dialog and closes the adjustment wizard.

3. HOW TO USE

(7) Parameter list screen

Displays the parameters before and after the adjustment in the parameter list screen.

Pressing "Undo" restores the parameters before the adjustment without saving the parameter after the adjustment.

Pressing "Close" closes the parameter list screen and returns to the adjustment result screen.

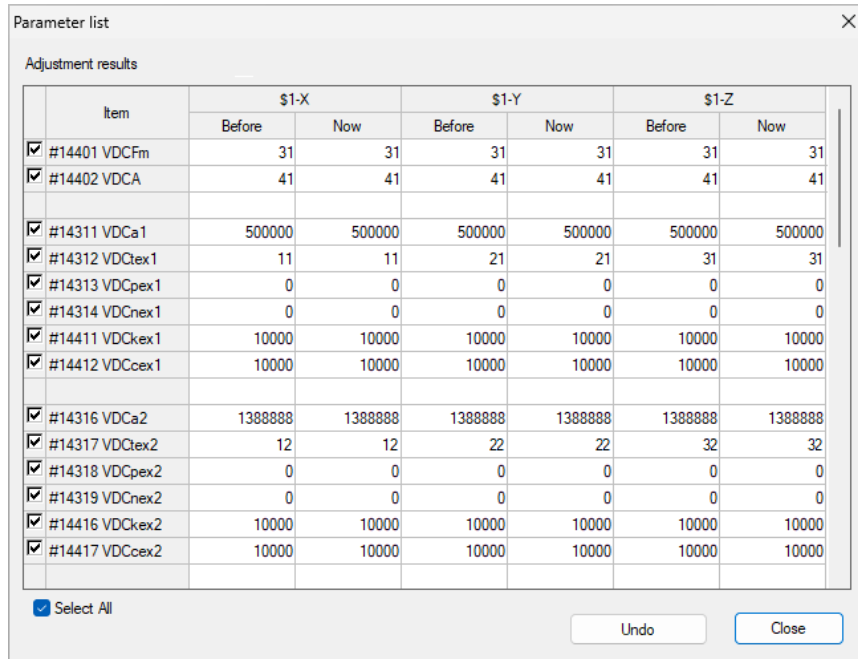

Display item	Description
Adjustment result list	Displays the parameter values before and after the adjustment for each axis. When the adjustment axis is the master axis, the parameters of the slave axis are displayed next to that of the adjustment axis. Parameter values cannot be changed.
#14401 VDCFm	Variable full-closed torsion compensation: motor-end frictional force
#14402 VDCA	Variable full-closed torsion compensation: proportionality constant
#14311 VDCa1	Variable full-closed torsion compensation acceleration 1
#14312 VDCtex1	Variable full-closed torsion compensation: compensation time constant 1
#14313 VDCpex1	Variable full-closed torsion compensation: compensation value 1 (+)
#14314 VDCnex1	Variable full-closed torsion compensation: compensation value 1 (-)
#14411 VDCkex1	Variable full-closed torsion compensation: spring constant 1
#14412 VDCcex1	Variable full-closed torsion compensation: viscosity coefficient 1
:	
:	
#14346 VDCa8	Variable full-closed torsion compensation acceleration 8
#14347 VDCtex8	Variable full-closed torsion compensation: compensation time constant 8
#14348 VDCpex8	Variable full-closed torsion compensation: compensation value 8 (+)
#14349 VDCnex8	Variable full-closed torsion compensation: compensation value 8 (-)
#14446 VDCkex8	Variable full-closed torsion compensation: spring constant 8
#14447 VDCcex8	Variable full-closed torsion compensation: viscosity coefficient 8
Select All	Checks the checkboxes of all parameters.
Undo	Returns only the values of the parameters whose checkboxes are checked to the values before adjustments and writes the values to an NC. This is enabled when any of the checkboxes is checked.
Close	Closes the parameter list screen.

3. HOW TO USE

3.4 Measurement and Adjustment

3.4.1 Frequency Response Measurement

The following is the flowchart for frequency response measurement.

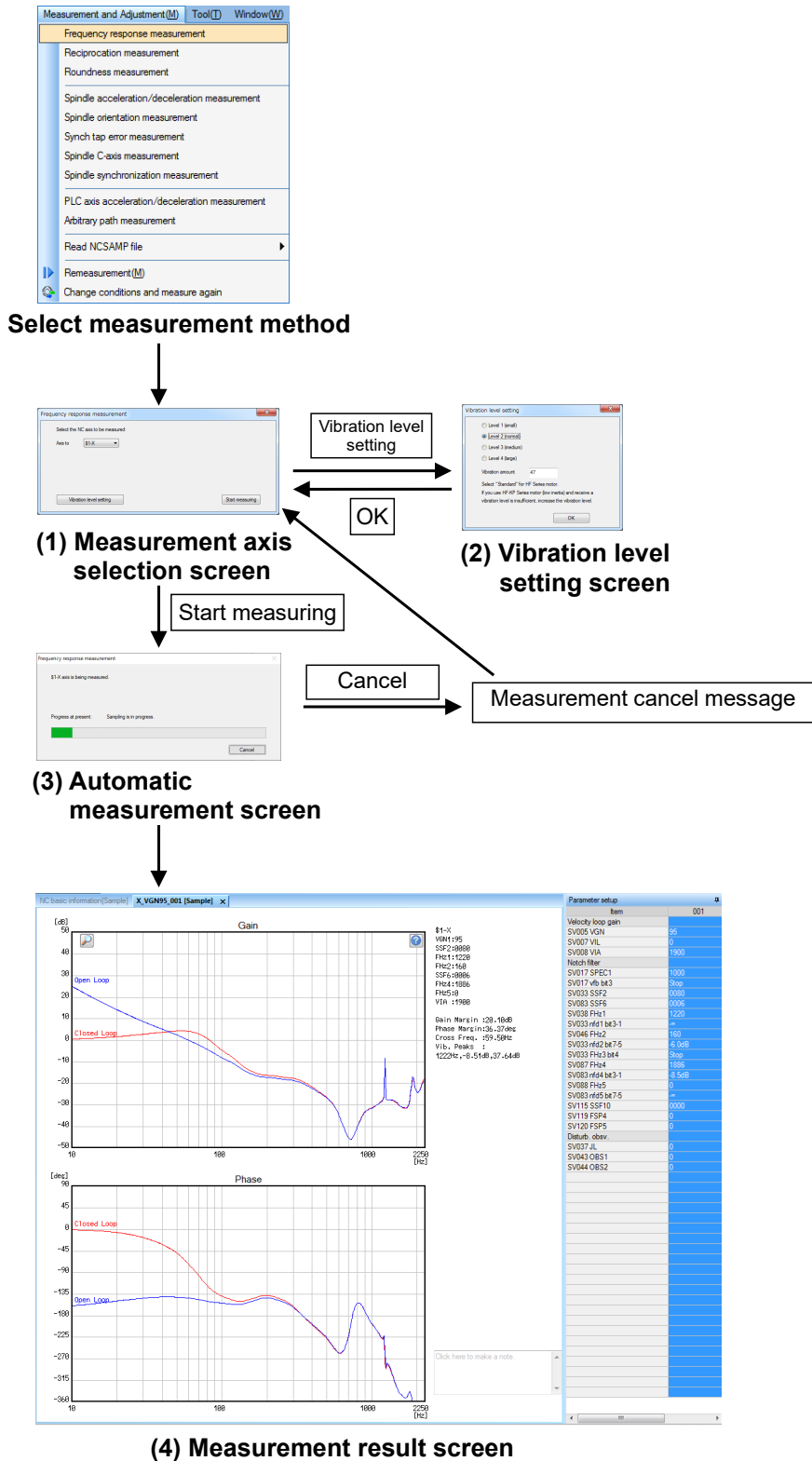

3. HOW TO USE

- (1) Measurement axis selection screen
 Select "Measurement and adjustment (M)" - "Frequency response measurement" and display the measurement axis selection screen. Select the NC axis or PLC axis to measure on the measurement axis selection screen. The last measured vibration level setting is maintained.

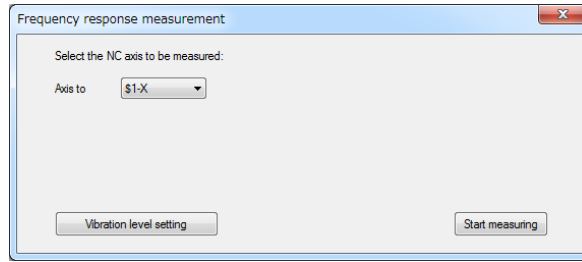

Display item	Description	Initial value	Setting range
Measurement axis	Select the NC axis or PLC axis to measure. (Note) Item differs depending on the number of the NC axis or PLC axis.	—	(Note)
Vibration level setting	The vibration level setting screen is displayed.	—	—
Start measuring	Starts frequency response measurement.	—	—

(Note) For the models that display PLC axes, refer to "List of Supported Functions at Each CNC (Servo axis)" in "1.2 Applicable Models and Versions".

3. HOW TO USE

(2) Vibration level setting screen

Clicking the [Vibration level setting] button on the measurement axis screen displays the vibration level setting screen. Confirm the vibration signal level settings on the vibration level setting screen.

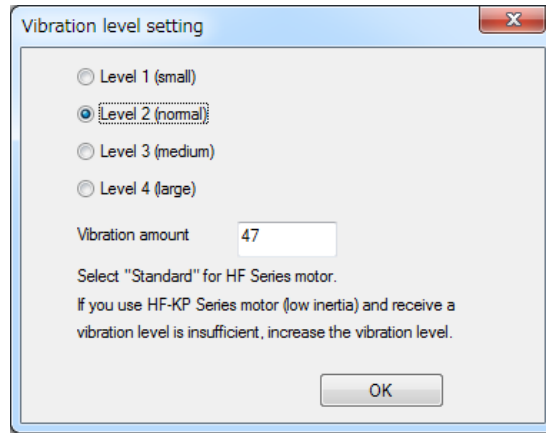

Display item	Description	Initial value	Setting range
Vibration strength	Set the vibration signal level. To use the HF series motor, set the level to "Level 2 (normal)". When a warning occurs due to insufficient vibration level while using the HF-KP series motor (low inertia), increase the vibration level. The contents corrected on the screen will not be succeeded by the next and subsequent adjustments. When the screen is displayed again, the default setting is restored.	Level 2 (normal)	Level 1 (small) Level 2 (normal) Level 3 (medium) Level 4 (large)
Vibration amount	Set the vibration amount. The vibration amount when measurement (vibration) is performed is displayed in the vibration amount display area.	0	0 to 150
OK	Saves the setting and returns to the measurement axis setting screen.	—	—

(Note 1) When the vibration level setting screen is opened, the vibration strength and vibration amount of the current measurement axis is displayed.

If the frequency response has been measured once, the previous measurement values are set when it is measured again.

(Note 2) When any of the following circumstances arises, set the vibration level to "Level 2 (normal)".

(a) When the vibration level provided from within the NC exceeds the setting range

(b) When the vibration amount provided from within the NC is other than 1 to 150

(Note 3) When the setting value of the vibration amount is outside of the range, the message "The vibration signal level is outside of the setting range" is displayed.

3. HOW TO USE

(3) Automatic measurement screen

Clicking the [Start measuring] button on the measurement axis selection screen displays the automatic measurement screen and starts the frequency response measurement.

Clicking "Cancel" displays the measurement cancel message and returns to the Measurement axis selection screen.

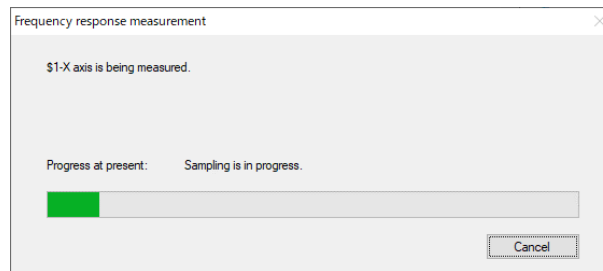

The progress changes as shown in the table below.

Display of the state of progress	Description
Initializing communication. Wait for a while.	Initializing communication.
Please press the cycle start button on operation panel.	Ready for measurement and waiting for sampling starts. Pressing the cycle start button starts measurement.
Sampling is in progress.	Measuring.
Loading measurement results.	Loading the measurement results. [Cancel] button cannot be selected.

(4) Measurement result screen

Waveforms of the measurement results are displayed in the waveform window. Refer to "3.8 Waveform Window" for details.

3. HOW TO USE

3.4.2 Reciprocation Acceleration/Deceleration Measurement

The following is the flowchart for reciprocation acceleration/deceleration measurement.

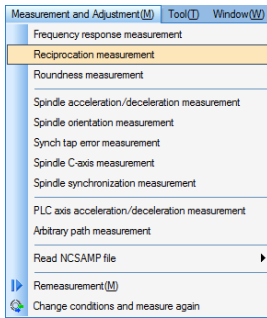

Select measurement method

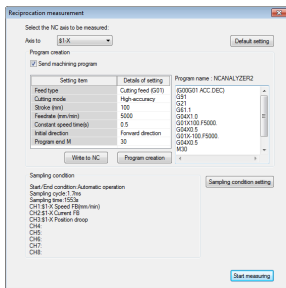

(1) Measurement axis selection screen

Sampling condition setting

OK

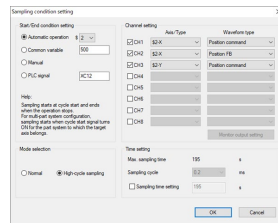

(2) Sampling condition setting screen

Monitor output setting

OK

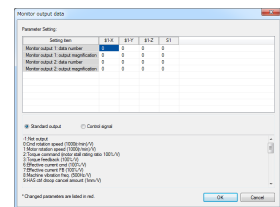

(3) Monitor output data screen

Start measuring

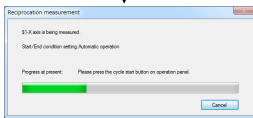

(4) Automatic measurement screen

Cancel

Measurement cancel message

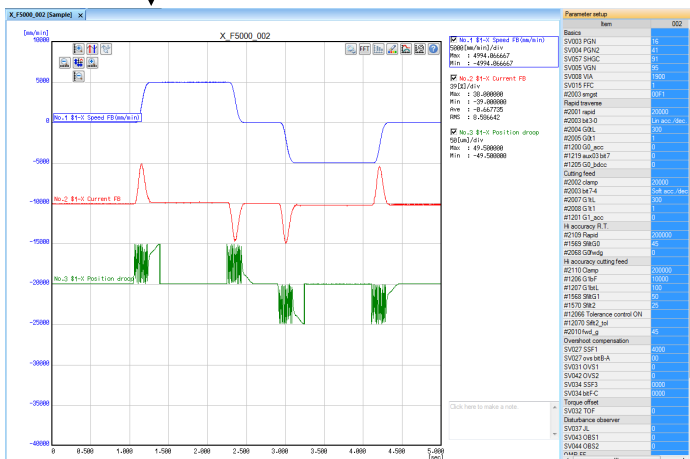

(5) Measurement result screen

3. HOW TO USE

(1) Measurement axis selection screen

Select "Measurement and adjustment (M)" - "Reciprocation acceleration/deceleration measurement" and display the measurement axis selection screen. Select the NC axis to measure on the measurement axis selection screen and create a machining program. The last measured sampling conditions (all conditions except the monitor output data screen) are maintained.

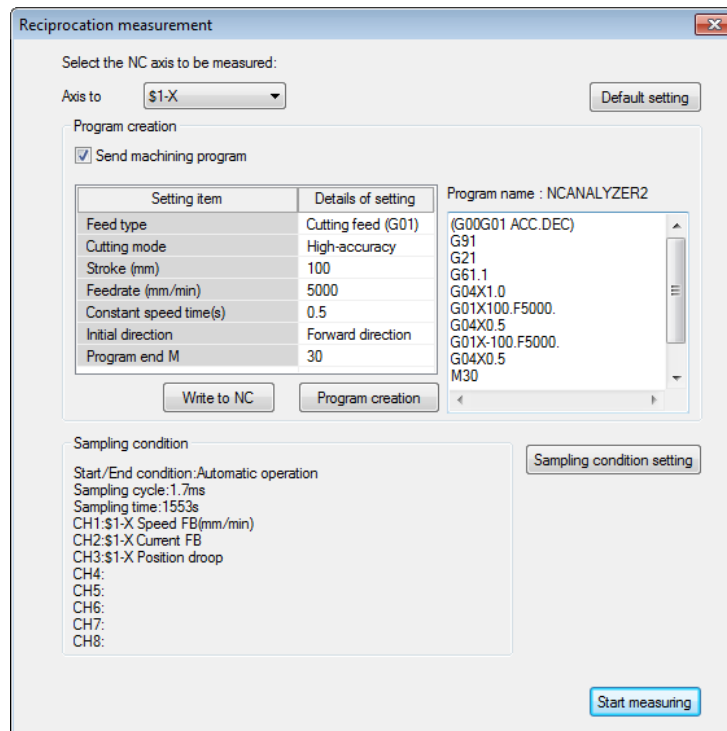

Display item	Description	Initial value	Setting range
Measurement axis	Select the NC axis to measure. (*1) The items that can be selected differ depending on the number of NC axes.	-	(*1)
Default setting	Returns the setting values of program creation and sampling condition to the initial values.	-	-
Program creation	Set the function to create a program.		
Send machining program	Checking the checkbox enables the function to create a program and write the created program to the NC. (Note) Unchecking the checkbox starts measurement without writing a program to the NC. An "Search" of the measurement program must be executed by the NC before starting measurement.	ON	ON/OFF
Data for the function to create a program			
Feed type	Select from "Cutting feed (G01)" or "Rapid feed (G00)".	Cutting feed (G01)	Cutting feed (G01) Rapid feed (G00)
Cutting mode	Select from "High-accuracy mode" or "Normal cutting mode".	Normal cutting mode	High-accuracy mode Normal cutting mode
Stroke (mm)	Set stroke.	100	-999999.999999 to 999999.999999
Feedrate (mm/min)	Set the feedrate. When "Rapid feed (G00)" is selected, this cannot be set.	5000	0.000001 to 999999.999999
Dwell time (s)	Set dwell time.	0.5	0.0 to 99999.999
Initial direction	Select from "Forward direction" or "Reverse direction".	Forward	Forward

3. HOW TO USE

Display item	Description	Initial value	Setting range
		direction	direction Reverse direction
Program end M	Set the M code of program end.	30	0 to 99999999
Write to NC	Writes the program displayed in the [Program area] to the NC and sets it as an operable program. When this button is clicked while the program area is blank, the message "Enter the program" is displayed.	-	-
Program creation	Creates measurement machining programs from various data for the program creation function. The created program is displayed in the [Program area].	-	-
Part system number	Select the part system to write the program. Displayed when the number of the part systems is two or more. (*2) When the NC axis in the sub part system is selected, the items other than "Write to NC", "Part system number", and "Program area" are unavailable and the smallest part system number in the main part system is displayed in "Part system number" as an initial value.	Part system number of the measurement axis (*2)	1 to 8
Program area	Create a program for measurement. Clicking [Start measuring] when the [Program area] is blank displays [Enter the program]. When measurement axis is switched between servo axes, between spindles or between servo axis and spindle, the [Program area] is cleared.	-	-
Sampling condition area	Displays the sampling condition being specified.	-	-
Sampling condition setting	The sampling condition setting screen is displayed.	-	-
Start measuring	Starts reciprocation acceleration/deceleration measurement.	-	-

3. HOW TO USE

(2) Sampling condition setting screen

Clicking the [Sampling condition setting] on the measurement axis selection screen displays the sampling condition setting screen.

Check the setting such as start/end condition and channels on the sampling condition setting screen.

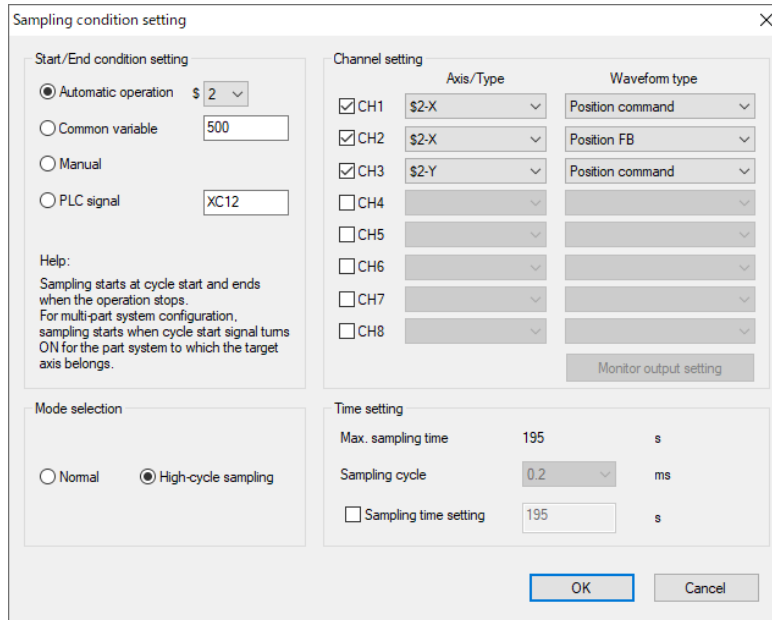

Display item	Description	Initial value	Setting range
Start/End condition setting	Select "Start/End condition setting" of sampling. For common variable and PLC signal, "Ring buffer" is automatically set. For manual and automatic operation, "One shot" is automatically set.	Automatic operation	Automatic operation/ Common variable/ Manual/ PLC signal
(1) Automatic operation	Sampling starts/ends by the PLC signals of start condition (value)/end condition (value) on "NC data sampling" screen. Sampling starts when PLC signal of start condition (value) switches from OFF to ON. Sampling ends when PLC signal of start condition (value) switches from ON to OFF.	-	-
(2) Common variable	Set the common variable value to start/end sampling. When the value of common variable changes from 0 to 1, sampling starts. When the value of common variable changes from 1 to 0, sampling ends. If this variable is a variable by system and at least one system satisfies conditions for starting sampling, sampling starts. If the variable value of any system satisfies conditions for finishing, sampling ends.	-	100 to 999
(3) Manual	Clicking the [Start measuring] button on the automatic measurement screen changes the status to waiting for sampling. Clicking the cycle start button on the operation panel during this status starts sampling. Clicking the [Stop] button after sampling ends reads the measurement result.	-	-
(4) PLC signal	Set the value of PLC signal to start/end sampling. When the value of the set PLC signal switches from OFF to ON, sampling starts. When the value of the PLC signal switches from ON to OFF, sampling ends. The user sets the PLC address.	-	(*1)

3. HOW TO USE

Display item	Description	Initial value	Setting range
Channel setting	Set data to be sampled.		
Channel number	Set the channels to be sampled. Channels checked in the checkbox are sampled. Channels unchecked in the checkbox are not sampled. When "OK" is pressed while no channel is selected, the message "Select a channel" is displayed.	-	1 to 8 (*2)
Axis/Type	Select from servo axis, spindle, PLC signals (PLC (bit), PLC (1 word), PLC (2 words), and NC Smp(CHn)). A channel number (CH1 to CH8) is displayed in (CHn) of "NC Smp(CHn)". When "NC Smp(CHn)" is selected, "Waveform type" cannot be selected, and the sampling information set on the channel information screen of NC is used for measurement. (*3)	(*4)	-
Waveform type	Select the sampling data type when servo axis or spindle is selected for [Axis/Type]. Refer to "1.3 Corresponding CNC" - "Sampling Data Type List" for data types that can be sampled. Set the PLC device value when PLC (bit)/PLC (1 word)/PLC (2 words) is selected. Data (data number, output display) set on the monitor output data screen is displayed in "Monitor output". Example: When "1" is set to data number of monitor output 1 and "100" is set to output magnification, "Monitor output 1 (No.1:100)" is displayed.	-	-
Monitor output setting	Monitor output data screen is displayed. When monitor output 1 or monitor output 2 is selected for [Waveform type], operation of the "Monitor output setting" is enabled.	-	-
Mode selection	Select from "Normal" and "High-cycle sampling". Items that can be selected for [Waveform type] switches depending on the selected mode. (Note) "High-cycle sampling" cannot be selected when high-cycle sampling is disabled.	Normal	Normal High-cycle sampling
Time setting	Set "Sampling cycle" and "Sampling time".		
Max. sampling time	Displays the maximum sampling time which can be measured with the set sampling condition and the set cycle set for [Sampling cycle setting]. The displayed time may differ from the actual maximum sampling time depending on the NC system version.	(*5)	-
Sampling cycle setting	Select the sampling cycle.	-	-
Sampling time setting	Set the sampling time. When checked, measurement is performed with the set time. When unchecked or the input box is empty, measurement is performed with [Maximum sampling time]. (Note) Up to [Maximum sampling time] can be measured. Change the sampling conditions such as channel number or [Sampling cycle] to change [Maximum sampling time].	-	-
OK	Saves the setting and returns to the measurement axis setting screen.	-	-
Cancel	Returns to the measurement axis setting screen without saving the setting.	-	-

(*1) PLC signal can be set within the range of PLC device.

(*2) When "High-cycle sampling" is selected in "Mode selection", up to two channels can be measured at the same time per axis.

3. HOW TO USE

(*3) When "NC Smp(CHn)" is selected in [Axis/Type], the sampling information set on the channel information screen of NC is used for measurement.
The following is the procedure.

(a) Set sampling information on the channel information screen of NC.

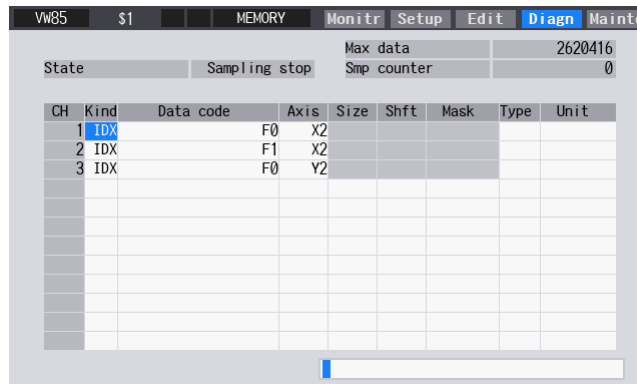

(b) When the sampling information of the channel 1 and 3 of NC is used for measurement, set CH1 and CH3 of "Channel setting" to "NC Smp(CH1)" and "NC Smp(CH3)" respectively on the sampling condition setting screen.

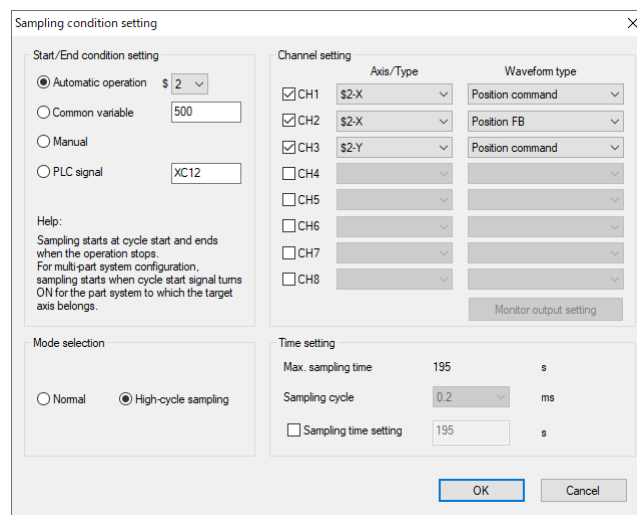

(c) When the measurement starts, the sampling information set on the channel information screen of NC is used for CH1 and CH3, and the sampling information set on NC Analyzer2 is used for CH2.

(Note 1) When "NC Smp(CHn)" is selected, consecutive numbers must be set in the channel setting.

(Note 2) "NC Smp(CHn)" cannot be selected in C70 series.

(*4) The measurement axis selected on the measurement axis selection screen is displayed.

(*5) The initial value varies depending on the NC to be connected.

3. HOW TO USE

(3) Monitor output data screen

Press "Monitor output setting" when monitor output 1 or monitor output 2 is selected for [Waveform type] of channel setting.

Check data on the monitor output data screen.

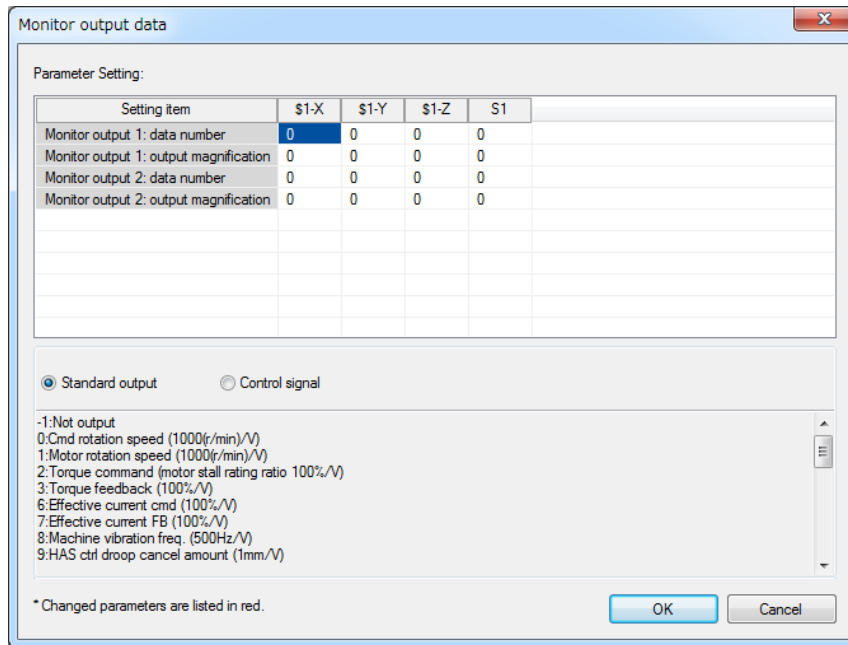

Display item	Description	Initial value	Setting range
Parameter List	Set data number and output magnification for each axis. (Note 1)	-	-
Help information display method	Help information is displayed.	-	-
Standard output/Control signal	Select the monitor output method.	-	Standard output Control signal
Help information	When the [Data number] of each servo axis and spindle on the parameter list are input, help information related to servo axis and spindle is displayed. (Note 2)	-	-
OK	The settings are saved and the window is closed.	-	-
Cancel	The window is closed without saving the settings.	-	-

(Note 1) Parameters corresponding to the data number and output magnification are as follows.

Display item	Servo axis	Spindle
Monitor output 1: Data number	#2261 SV061 DA1NO	#13125 SP125 DA1NO
Monitor output 1: Output magnification	#2263 SV063 DA1MPY	#13127 SP127 DA1MPY
Monitor output 2: Data number	#2262 SV062 DA2NO	#13126 SP126 DA2NO
Monitor output 2: Output magnification	#2264 SV064 DA2MPY	#13128 SP128 DA2MPY

3. HOW TO USE

(Note 2) Help information display switches as follows depending on the axis type being input and the selected monitor output method.

(a) Servo axis when standard output is selected

Servo axis		
	Linear axis	Rotation axis
-1	Not output	Not output
0	Command rotation speed (1000 (r/min)/V)	Command rotation speed (1000 (r/min)/V)
1	Motor rotation speed (1000 (r/min)/V)	Motor rotation speed (1000 (r/min)/V)
2	Torque command (Motor stall rating ratio 100%/V)	Torque command (Motor stall rating ratio 100%/V)
3	Torque feedback (Motor stall rating ratio 100%/V)	Torque feedback (Motor stall rating ratio 100%/V)
6	Effective current command (100%/V)	Effective current command (100%/V)
7	Effective current feedback (100%/V)	Effective current feedback (100%/V)
8	Mechanical vibration frequency (500Hz/V)	Mechanical vibration frequency (500Hz/V)
9	HAS control droop canceled amount (1mm/V)	HAS control droop canceled amount (1°/V)
30	Collision detection estimated torque (100%/V)	Collision detection estimated torque (100%/V)
31	Collision detection disturbance estimated torque (100%/V)	Collision detection disturbance estimated torque (100%/V)
32	Estimated load inertia ratio (100%/V)	Estimated load inertia ratio (100%/V)
35	Disturbance observer estimated disturbance torque (100%/V)	Disturbance observer estimated disturbance torque (100%/V)
50	Position droop (1μm/V)	Position droop (1/1000°/V)
51	Position command (1 mg/V)	Position command (1/1000°/V)
52	Position feedback (1 mm/V)	Position feedback (1/1000°/V)
53	Position F ∇ T (1 mg/s/V)	Position F ∇ T (1/1000°/s/V)
54	Deviation from ideal position (1μm/V)	Deviation from ideal position (1/1000°/V)
60	Position droop (1mm/V)	Position droop (1°/V)
61	Position command (1mm/V)	Position command (1°/V)
62	Position feedback (1mm/V)	Position feedback (1°/V)
63	Position F ∇ T (1mm/s/V)	Position F ∇ T (1°/s/V)
64	Deviation from ideal position (1mm/V)	Deviation from ideal position (1°/V)
70	Position droop (1m/V)	Position droop (1000°/V)
71	Position command (1m/V)	Position command (1000°/V)
72	Position feedback (1m/V)	Position feedback (1000°/V)
73	Position F ∇ T (1m/s/V)	Position F ∇ T (1000°/s/V)
74	Deviation from ideal position (1m/V)	Deviation from ideal position (1000°/V)
126	Saw tooth wave (0 to 5V)	Saw tooth wave (0 to 5V)
127	2.5V test data (2.5V)	2.5V test data (2.5V)

3. HOW TO USE

(b) Servo axis when control signal is selected

Servo control signal (NC -> Servo)		Servo state signal (Servo -> NC)	
-1	Not output	-1	Not output
16384	Ready-on command	16480	In the state of ready-on
16385	Servo on command	16481	In the state of servo on
16388	Position loop gain switching command	16484	Position loop gain switching in progress
16390	Excessive error detection range switching command	16486	Excessive error detection range switching
16391	Alarm reset command	16487	In the state of alarm
16392	Current limiting selection command	16488	In the state of current limiting selection
16409	Speed monitoring command enabled	16492	In-position in progress
16410	Door close in progress (controller)	16493	Current limiting in progress
16411	Door close in progress (all drive units)	16494	Absolute position undetermined
16416	Control axis removal command	16495	Warning in progress
		16496	Z phase passed
		16499	Zero speed in progress
		16503	In external emergency stop state
		16505	In the state of speed monitoring
		15506	In the state of closed door (controller)
		16507	In the state of closed door (self drive unit)
		16512	In the state of removing control axis

(c) Spindle when standard output is selected

Spindle	
-1	Not output
0	Command motor rotation speed (1000 (r/min)/V)
1	Motor rotation speed (1000 (r/min)/V)
2	Torque current command (100%/V)
3	Torque current feedback (100%/V)
35	Disturbance observer estimated disturbance torque (100%/V)
50	Position droop (1/1000°/V)
51	Position command (1/1000°/V)
52	Position feedback (1/1000°/V)
53	Position F \nearrow T (1/1000°/s/V)
54	Deviation from ideal position (1/1000°/V)
60	Position droop (1°/V)
61	Position command (1°/V)
62	Position feedback (1°/V)
63	Position F \nearrow T (1°/s/V)
64	Deviation from ideal position (1°/V)
70	Position droop (1000°/V)
71	Position command (1000°/V)
72	Position feedback (1000°/V)
73	Position F \nearrow T (1000°/s/V)
74	Deviation from ideal position (1000°/V)
110	3.0V output load meter (40%V, 120%/3V)
126	Saw tooth wave (0 to 5V)
127	2.5V test data output (2.5V)

3. HOW TO USE

(d) Spindle when control signal is selected

Spindle control signal (NC -> Spindle)		Spindle state signal (Spindle -> NC)	
-1	Not output	-1	Not output
16384	Ready-on command	16480	In the state of ready-on
16385	Servo on command	16481	In the state of servo on
16391	Alarm reset command	16487	In the state of alarm
16392	Torque limit 1 selection command	16488	In the state of torque limit 1 selection
16393	Torque limit 2 selection command	16489	In the state of torque limit 2 selection
16394	Torque limit 3 selection command	16490	In the state of torque limit 3 selection
16409	Speed monitoring command enabled	16492	In-position in progress
16410	In the state of closed door (controller)	16495	Warning in progress
16411	Door close in progress (all drive units)	16496	Z phase passed
16432	Spindle control mode selection command 1	16499	In the state of zero speed
16433	Spindle control mode selection command 2	16503	In external emergency stop state
16434	Spindle control mode selection command 3	16505	In the state of speed monitoring
16436	Gear change command	16506	In the state of closed door (controller)
16437	Gear selection command 1	16507	In the state of closed door (self drive unit)
16438	Gear selection command 2	16528	In the state of spindle control mode selection
16445	L winding selection command	16529	In the state of spindle control mode selection 2
16458	Phase synchronization suppression command	16530	In the state of spindle control mode selection 3
16459	Minimum excitation ratio 2 changeover request	16532	In the state of gear change command
16460	Speed gain set 2 changeover request	16533	In the state of gear selection 1
16461	Origin re-detection request	16534	In the state of gear selection 2
16462	Improved spindle holding power	16541	In the state of selecting L winding
		16545	Speed detection
		16550	In the state of changing winding
		16554	In the state of suppressing phase synchronization
		16555	In the state of selecting minimum excitation ratio 2
		16556	In the state of selecting speed gain set 2
		16557	Completion of origin re-detection
		16558	Completion of improved spindle holding power
		16559	In the state of 2nd in-position

3. HOW TO USE

(4) Automatic measurement screen

Clicking the [Start measuring] button in the measurement axis selection screen displays the automatic measurement screen and starts the reciprocation acceleration/deceleration measurement.

When "Cancel" is clicked, the measurement cancel message is displayed and the measurement axis selection screen reappears.

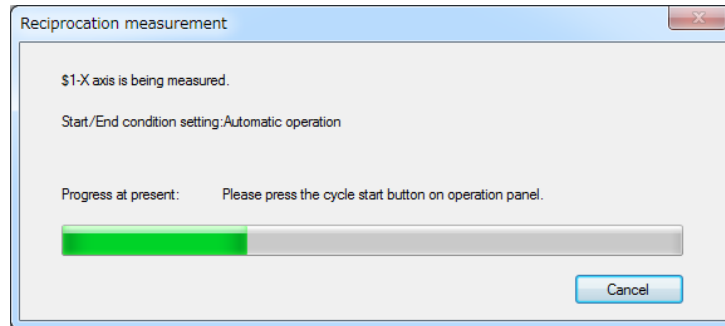

The progress changes as shown in the table below.

Display of the state of progress	Description
Writing the machining program.	Forwarding the machining program to the NC. Displayed when "Send machining program" is checked on the measurement axis selection screen.
Preparation is in progress.	Preparing for operating the program registered in the NC. Displayed when "Send machining program" is unchecked on the measurement axis selection screen.
Please press the cycle start button on operation panel.	Ready for measurement and waiting for sampling start. Pressing the cycle start button starts measurement. Displayed when "Automatic operation" is selected for [Start/End condition setting].
Waiting for sampling start.	Ready for measurement and waiting for sampling start. Displayed when a condition other than "Automatic operation" is selected for [Start/End condition setting]. (Note) When "Manual" is selected for "Start/End condition setting" on the sampling condition setting screen, clicking the [Start] button on this screen starts measurement. Clicking the [Stop] button ends the measurement.
Sampling.	In measuring
Loading measurement results.	Loading measurement results. [Cancel] button cannot be selected.

(5) Measurement result screen

Waveforms of the measurement results are displayed in the waveform window. Refer to "3.8 Waveform Window" for details.

3. HOW TO USE

3.4.2.1 Automatic Remeasurement

Automatic remeasurement repeatedly measures data with the same conditions and can output the measurement results to a CSV file. However, the measurement results are not saved to a project.

Only reciprocation acceleration/deceleration for C80/C70 series supports automatic remeasurement.

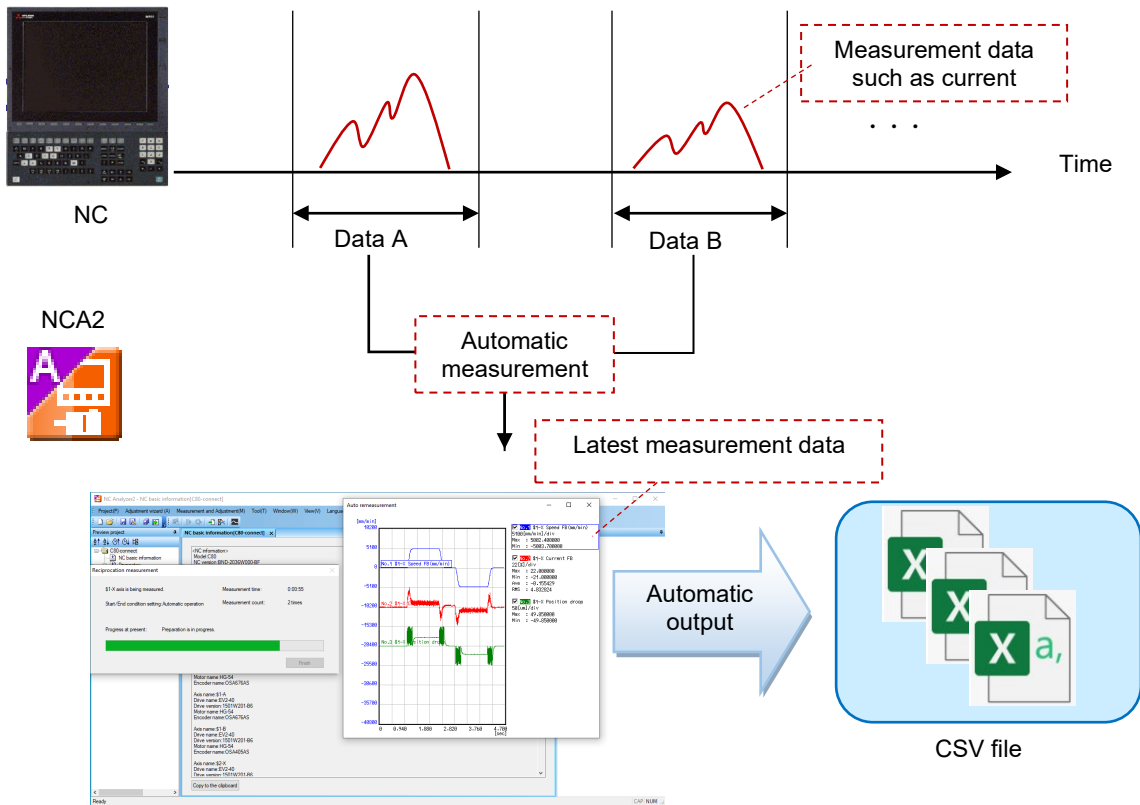

3. HOW TO USE

The following is the flowchart for automatic remeasurement.

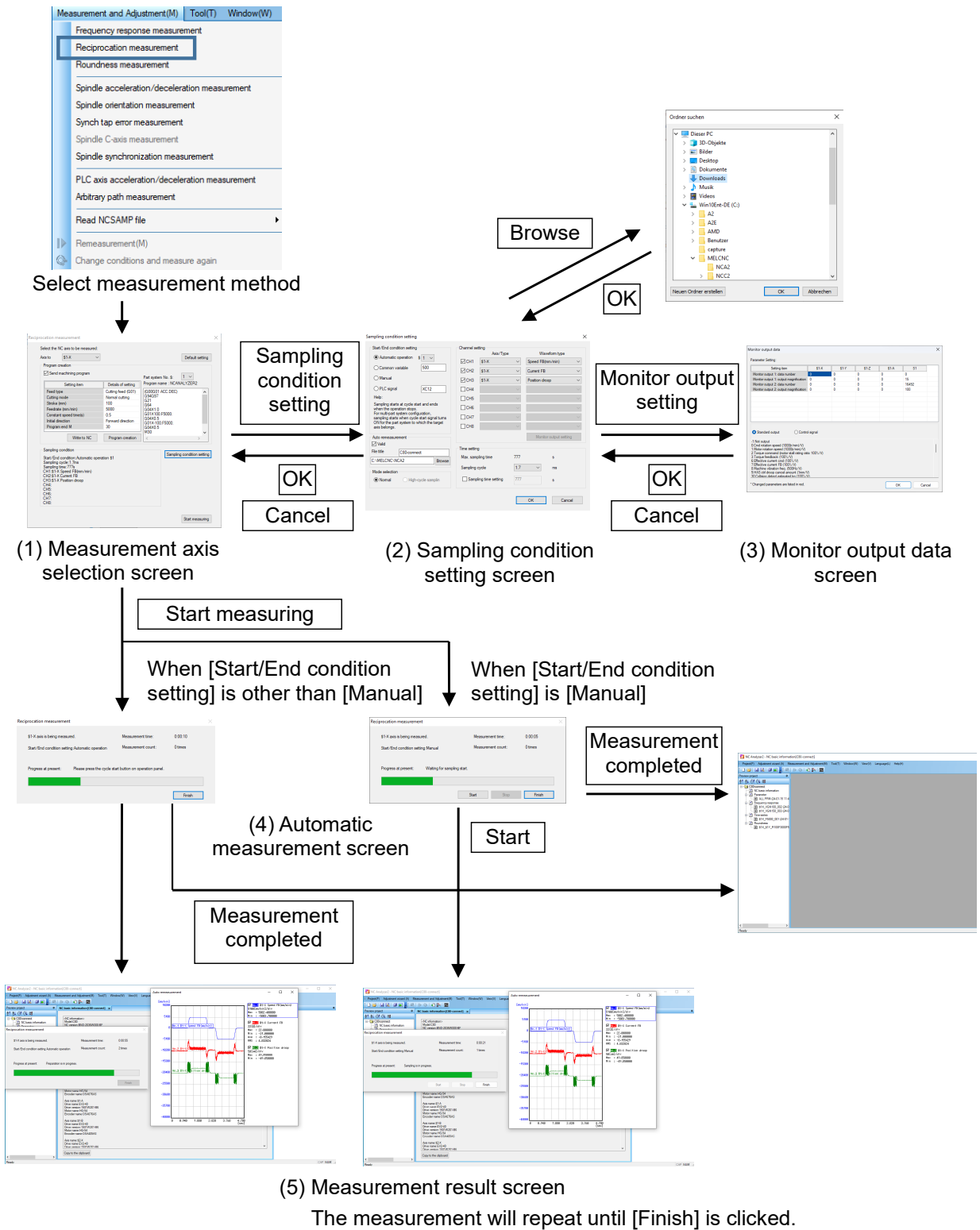

3. HOW TO USE

- (1) Measurement axis selection screen
Refer to the item "(1) Measurement axis selection screen" in "3.4.2 Reciprocation Acceleration/Deceleration Measurement".
- (2) Sampling condition setting screen

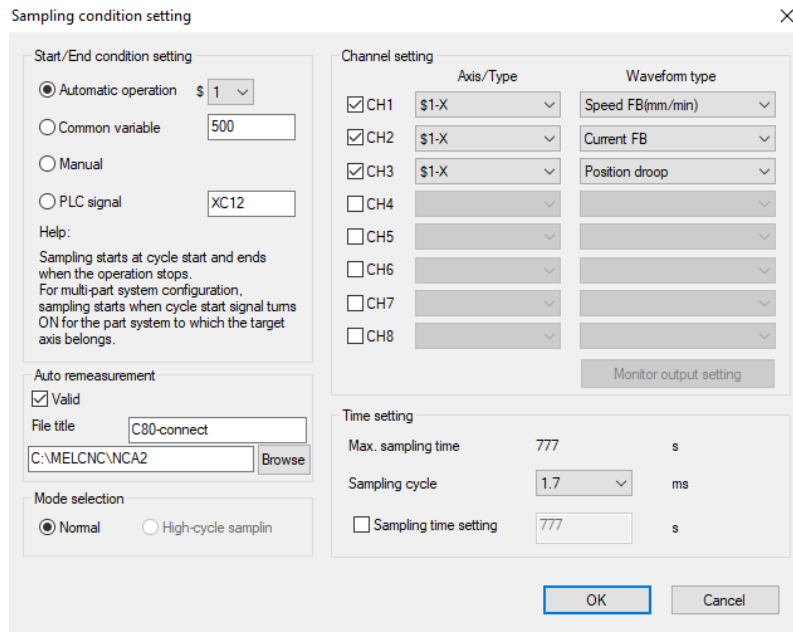

For the items other than automatic remeasurement, refer to the item "(2) Sampling condition setting screen" in "3.4.2 Reciprocation Acceleration/Deceleration Measurement".

Display item	Description	Initial value	Setting range
Auto remeasurement	Performs sampling continuously and saves the measurement results in a CSV file. The measured data is not displayed in the project preview.		
Valid (*1)	Checking this enables automatic remeasurement.	OFF	ON/ OFF
File title (*1)	Enter a name to be put at the beginning of the file name of sampling data file to be output. The file name will be "<file title>_YYYYMMDDhhmmss.csv".	Project file name	Up to 20 characters (*2)
(Folder path) (*1)	Displays the folder path where the CSV file of the sampling data is output. The path can also be entered directly.	C:\MELCNC\NCA2	- (*2)
Browse	Click to display a browsing folder dialog in which an arbitrary folder can be designated.	-	-

(*1) When executing automatic remeasurement, the values that have been set are not retained. When executing automatic remeasurement, configure the settings again.

(*2) When the size of a full path including a file name is over the size that can be created in Windows, "The path is too long. Make the name shorter." is displayed.

(Note) When [Start/End condition setting] is set to [Manual], set "Sampling time setting". When it is not set, data is sampled for the length of "Max. sampling time" and the sampling repeats.

- (3) Monitor output data screen
Refer to the item "(3) Monitor output data screen" in "3.4.2 Reciprocation Acceleration/Deceleration Measurement".

3. HOW TO USE

(4) Automatic measurement screen

Clicking the [Start measuring] button in the measurement axis selection screen displays the automatic measurement screen and starts reciprocation acceleration/deceleration measurement.

Sampling is performed for the time designated in "Sampling time setting", and the sampling is automatically executed again after the waveforms and sampling data CSV file are output.

Sampling will repeat until clicking "Finish".

The data being sampled when "Finish" is clicked is not output in the CSV file.

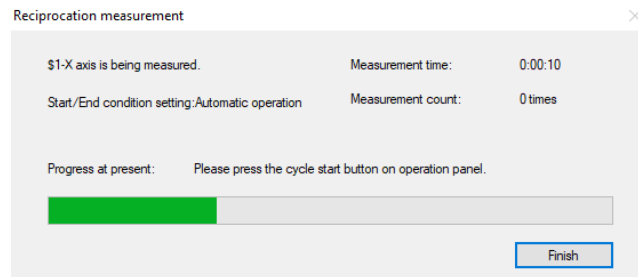

Display item	Description
Measurement time	Displays the time elapsed since the automatic remeasurement screen was displayed.
Measurement count	Displays the number of times automatic remeasurement was executed.
Progress at present:	Displays a message according to the progress.(*1)

(*1) The progress status changes as follows:

Progress status display	Description
Writing the machining program.	Forwarding the machining program to the NC. Displayed when "Send machining program" is checked on the measurement axis selection screen.
Preparation is in progress.	Preparing for operating the program registered in the NC. Displayed when "Send machining program" is unchecked on the measurement axis selection screen.
Please press the cycle start button on operation panel.	Ready for measurement and waiting for sampling start. Pressing the cycle start button starts measurement. Displayed when "Automatic operation" is selected for [Start/End condition setting].
Waiting for sampling start.	Ready for measurement and waiting for sampling start. Displayed when a condition other than "Automatic operation" is selected for [Start/End condition setting]. (Note) When "Manual" is selected for "Start/End condition setting" on the sampling condition setting screen, clicking the [Start] button on this screen starts measurement (first time only). The [Stop] button is always displayed in gray and cannot be operated.
Sampling.	In measuring
Loading measurement results.	Loading measurement results. [Cancel] button cannot be selected.

(5) Measurement result screen

Waveforms of the latest measurement results are displayed in the waveform window. However, buttons such as [Graph Mode selection] are not displayed in the waveform window. In addition, right-clicking on the waveform window does not display a menu. Refer to "3.8 Waveform Window" for details.

3. HOW TO USE

3.4.3 Roundness Measurement

The following is the flowchart for roundness measurement.

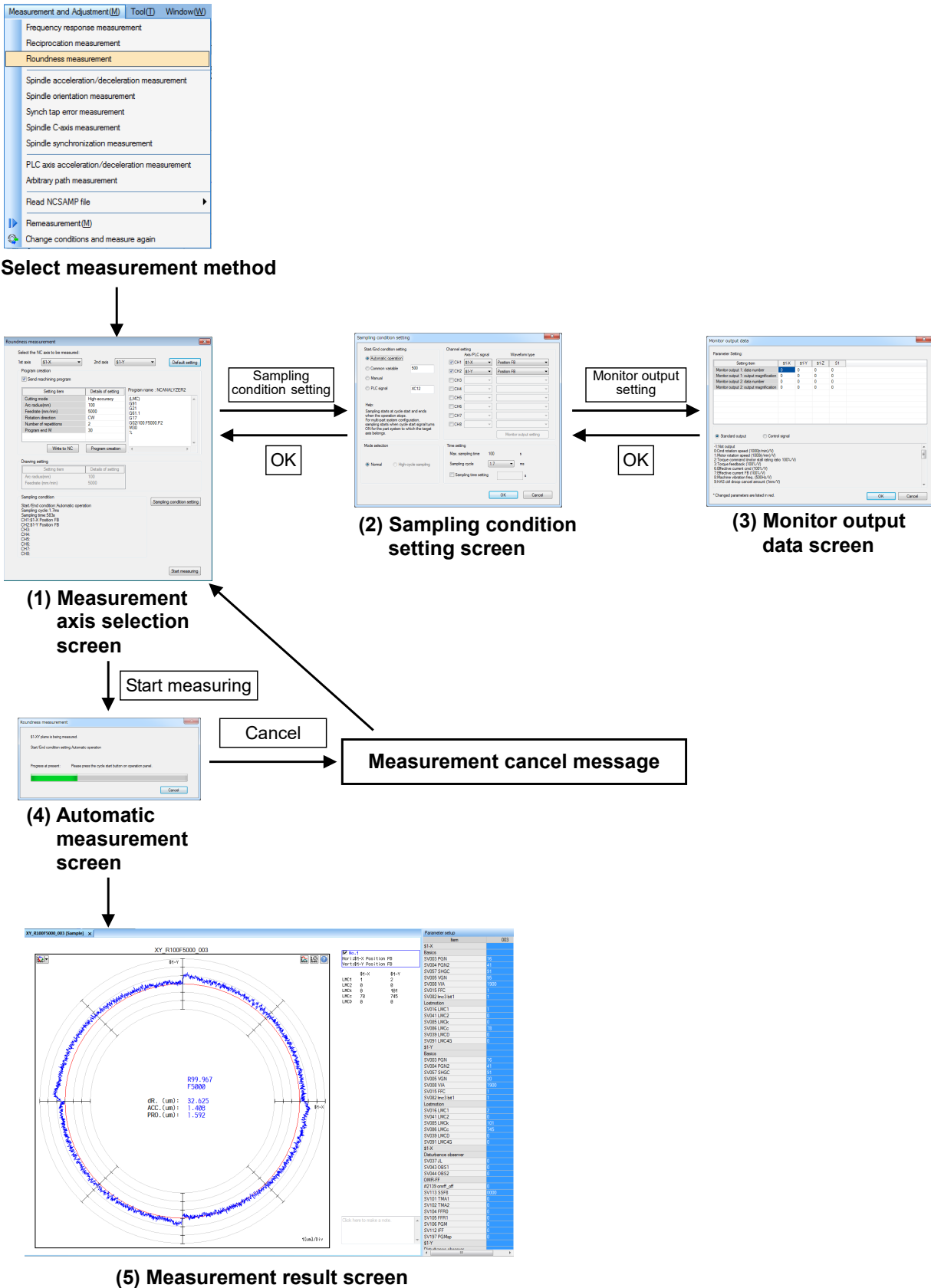

3. HOW TO USE

(1) Measurement axis selection screen

Select "Measurement and adjustment (M)" - "Roundness measurement" and display the measurement axis selection screen. Select the NC axis to measure on the measurement axis selection screen and create a machining program. The last measured sampling conditions (conditions excluding the monitor output data screen) are maintained.

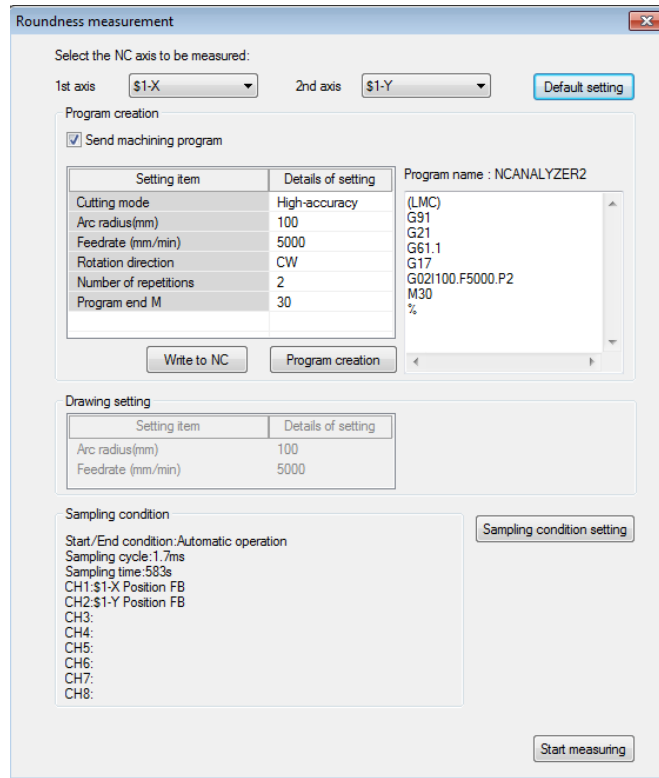

Display item	Description	Initial value	Setting range
Measurement axis	Select the NC axis to measure. (*1) When this is the first time to make this measurement, the first NC axis is set for "1st axis" and the second NC axis is set for "2nd axis". (*2) The items that can be selected differ depending on the number of the NC axes. (Note) When the same NC axis is selected for "1st axis" and "2nd axis", the message "Two axes have the same name. Select it again" is displayed. When the same NC axis is selected and "Program creation" or "Start measuring" is clicked, the message "Two axes have the same name. Select it again" is displayed.	(*1)	(*2)
Default setting	Returns the setting values of program creation and sampling condition to the initial values.	-	-
Program creation	Set a program creation function.		
Send machining program	When checked, the function to create a program is enabled. Clicking the "Start measuring" button with the check box checked, the created program is written to the NC. When unchecked, measurement starts without writing a program to the NC. An "Search" of the measurement program must be executed by the NC before starting measurement.	ON	ON/OFF
Each data for program creation function			
Cutting mode	Select from "High-accuracy mode" or "Normal cutting mode".	Normal cutting mode	High-accuracy mode Normal cutting mode

3. HOW TO USE

Display item	Description	Initial value	Setting range
Arc radius (mm)	Set radius of an arc.	100	0.000001 to 999999.999999
Feedrate (mm/min)	Set the feedrate.	5000	0.000001 to 999999.999999
Rotation direction	Select from "Clockwise (CW)" or "Counterclockwise (CCW)".	Clockwise (CW)	Clockwise (CW) Counterclockwise (CCW)
Number of repetitions	Set the number of repetitions.	2	2 to 100
Program end M	Set the M code of program end.	30	0 to 99999999
Write to NC	Writes the program displayed in the [Program area] to the NC and sets it as an operable program. When this button is clicked while the program area is blank, the message "Enter the program" is displayed.	-	-
Program creation	Creates a measurement machining program from various data for the program creation function. The created program is displayed in the [Program area].	-	-
Part system number	Select the part system to write the program. Displayed when the number of the part systems is two or more. (*3) When the NC axis in the sub part system is selected, the items other than "Write to NC", "Part system number", and "Program area" are unavailable and the smallest part system number in the main part system is displayed in "Part system number" as an initial value.	Part system number of the measurement axis (*3)	1 to 8
Program area	A program for measurement is created. When "Start measuring" is clicked while the [Program area] is blank, the message "Enter the program" is displayed. When measurement axis is switched between servo axes, between spindles or between servo axis and spindle, [Program area] is cleared.	-	-
Drawing setting	Set the reference value for the waveform drawing when measuring the program in the NC. Set the same value as the machining program to be measured. When "Send machining program" is checked, this item cannot be set because it is based on the same setting value as the data for the program creation function.		
Arc radius (mm)	Set the arc radius for waveform drawing.	100	-
Feedrate (mm/min)	Set the feedrate for waveform drawing.	5000	-
Sampling condition	Display the sampling condition being specified	-	-
Sampling condition setting	The sampling condition setting screen is displayed.	-	-
Start measuring	Roundness measurement starts.	-	-

3. HOW TO USE

(2) Sampling condition setting screen

Refer to the item "(2) Sampling condition setting screen" in "3.4.2 Reciprocation acceleration/deceleration measurement".

(3) Monitor output data screen

Refer to the item "(3) Monitor output data screen" in "3.4.2 Reciprocation acceleration/deceleration measurement".

(4) Automatic measurement screen

Refer to the item "(4) Automatic measurement screen" in "3.4.2 Reciprocation acceleration/deceleration measurement".

(5) Measurement result screen

Waveforms of the measurement results are displayed in the waveform window. Refer to "3.8 Waveform Window" for details.

3. HOW TO USE

3.4.4 Spindle Acceleration/Deceleration Measurement

The following is the flowchart for spindle acceleration/deceleration measurement.

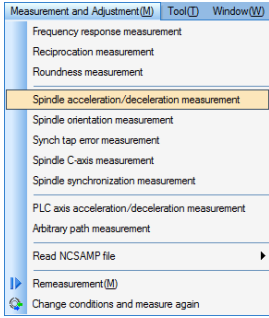

Select measurement method

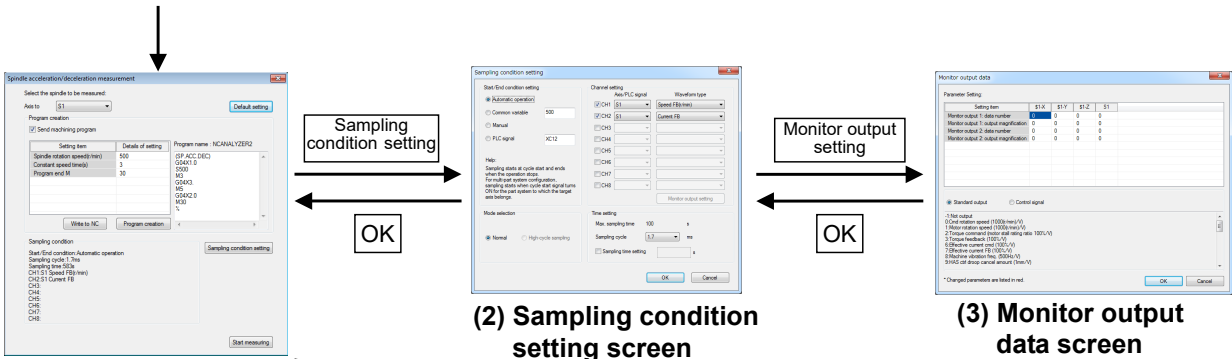

(1) Measurement axis selection screen

(2) Sampling condition setting screen

(3) Monitor output data screen

Start measuring

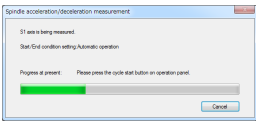

(4) Automatic measurement screen

Measurement cancel message

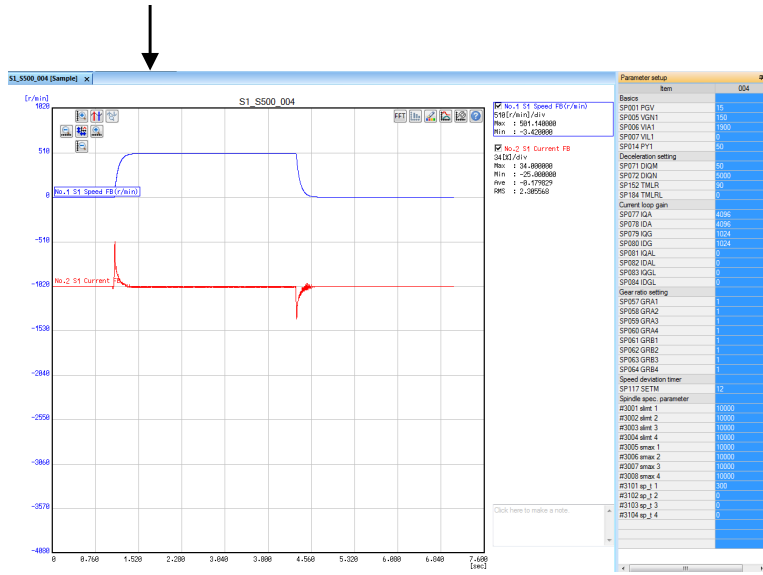

(5) Measurement result screen

3. HOW TO USE

(1) Measurement axis selection screen

Select "Measurement and adjustment (M)" - "Spindle reciprocation acceleration/deceleration measurement" and display the measurement axis selection screen. Select the spindle to measure on the measurement axis selection screen and create a machining program. The last measured sampling conditions (conditions excluding the monitor output data screen) are maintained.

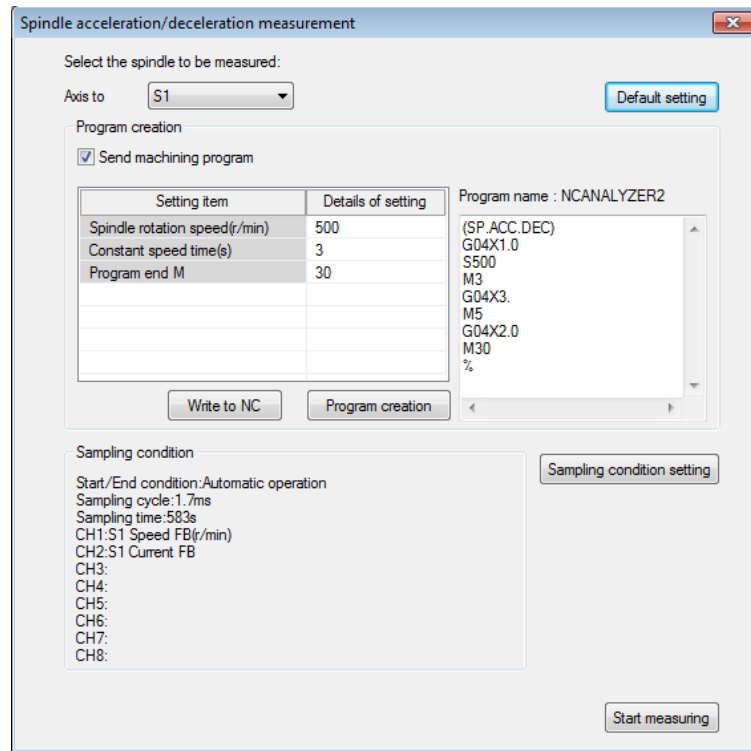

Display item	Description	Initial value	Setting range
Measurement axis	Select the spindle to measure. (*1) The items that can be selected differ depending on the number of the spindle.	-	(*1)
Default setting	Return the setting values of program creation and sampling condition to the initial values.	-	-
Program creation	Set a program creation function.		
Send machining program	When checked, the function to create a program is enabled. Clicking the "Start measuring" button with this checked writes the created program to the NC. When unchecked, measurement starts without writing a program to the NC. An "Search" of the measurement program must be executed by the NC before starting measurement.	ON	ON/OFF
Each data for program creation function			
Spindle speed (r/min)	Set the spindle speed.	500	0 to 999999
Dwell time (s)	Set dwell time.	3	0.0 to 99999.999
Spindle rotation command M	Set the spindle rotation command. This item is not displayed when the number of the spindle is 1.	S1:3 S2 or later: -	0 to 9999
Spindle stop command M	Set the spindle stop command. This item is not displayed when the number of the spindle is 1.	S1:5 S2 or later: -	0 to 9999
Program end M	Set the M code of program end.	30	0 to 99999999

3. HOW TO USE

Display item	Description	Initial value	Setting range
Write to NC	Writes the program displayed in the [Program area] to the NC and sets it as an operable program. When this button is clicked while the program area is blank, the message "Enter the program" is displayed.	-	-
Program creation	Creates a measurement machining program from various data for the program creation function. The created program is displayed in the [Program area].	-	-
Part system number	Select the part system to write the program. Displayed when the number of the part systems is two or more.	1	1 to 8
Program area	A program for measurement is created. When "Start measuring" is clicked while the [Program area] is blank, the message "Enter the program" is displayed. When measurement axis is switched, measurement programs in the program area are cleared.	-	-
Sampling condition	Display the sampling condition being specified.	-	-
Sampling condition setting	The sampling condition setting screen is displayed.	-	-
Start measuring	Spindle acceleration/deceleration measurement starts.	-	-

(2) Sampling condition setting screen

Refer to the item "(2) Sampling condition setting screen" in "3.4.2 Reciprocation acceleration/deceleration measurement".

(3) Monitor output data screen

Refer to the item "(3) Monitor output data screen" in "3.4.2 Reciprocation acceleration/deceleration measurement".

(4) Automatic measurement screen

Refer to the item "(4) Automatic measurement screen" in "3.4.2 Reciprocation acceleration/deceleration measurement".

(5) Measurement result screen

Waveforms of the measurement results are displayed in the waveform window. Refer to "3.8 Waveform Window" for details.

3. HOW TO USE

3.4.5 Spindle Orientation Measurement

The following is the flowchart for spindle orientation measurement.

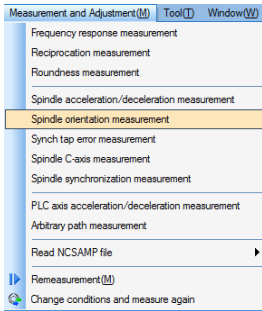

Select measurement method

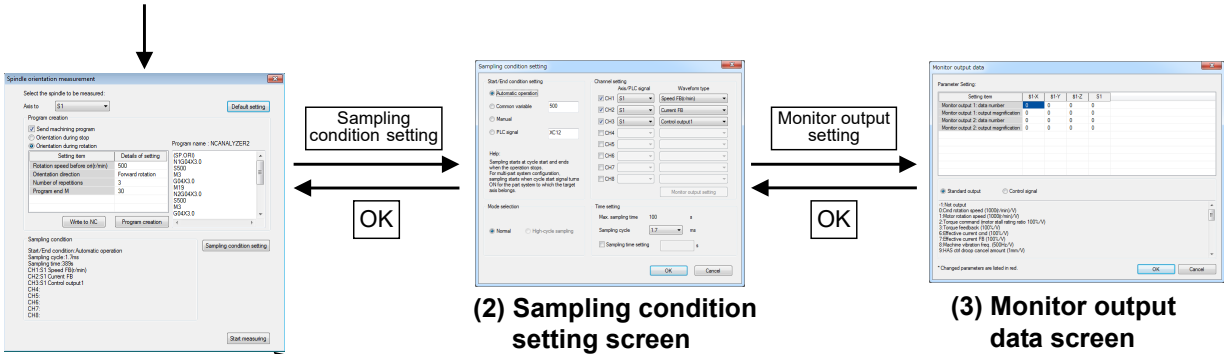

(1) Measurement axis selection screen

(2) Sampling condition setting screen

(3) Monitor output data screen

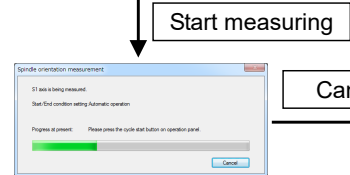

(4) Automatic measurement screen

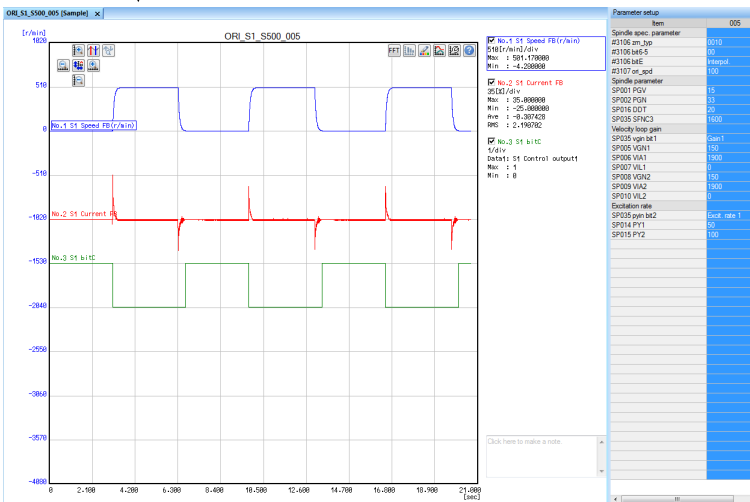
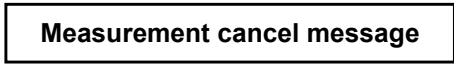

(5) Measurement result screen

3. HOW TO USE

(1) Measurement axis selection screen

Select "Measurement and adjustment (M)" - "Spindle orientation measurement" and display the measurement axis selection screen. Select the spindle to measure on the measurement axis selection screen and create a machining program. The last measured sampling conditions (conditions excluding the monitor output data screen) are maintained.

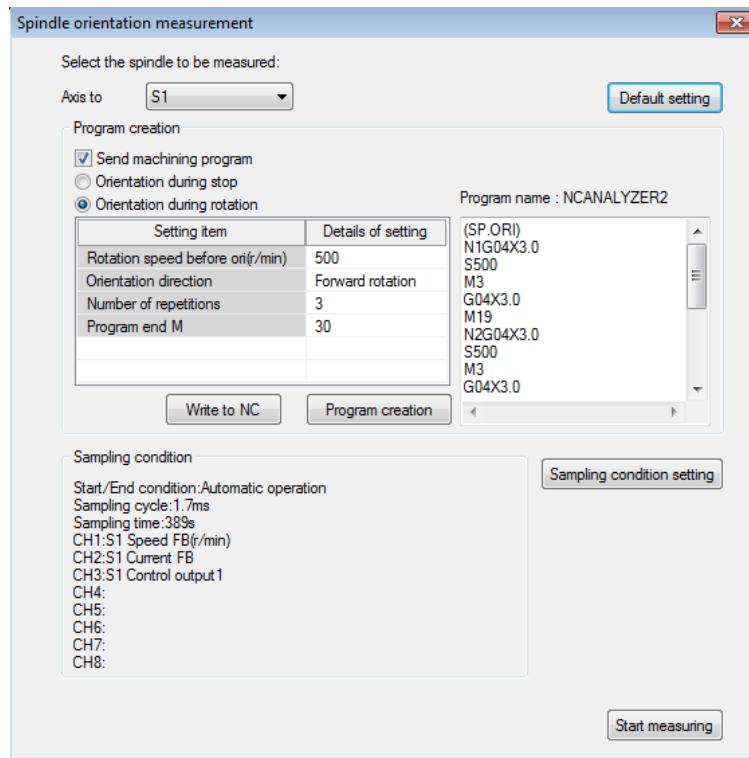

Display item	Description	Initial value	Setting range
Measurement axis	Select the spindle to measure. (*1) The items that can be selected differ depending on the number of the spindles.		(*1)
Default setting	Return the setting values of program creation and sampling condition to the initial values.	-	-
Program creation	Set a program creation function.		
Send machining program	When checked, the function to create a program is enabled. Clicking the "Start measuring" button with this checked writes the created program to the NC. When unchecked, measurement starts without writing a program to the NC. An "Search" of the measurement program must be executed by the NC before starting measurement.	ON	ON/OFF
Select orientation	Select from "Orientation during rotation" and "Orientation during stop". Setting data for a program creation function switches depending on the settings.	Orientation during rotation	Orientation during rotation Orientation during stop
Each data for program creation function (When orientation during rotation is selected)			
Rotation speed before orientation (r/min)	Set the number of rotations before orientation	500	0 to 999999
Orientation direction	Select from "Forward rotation" or "Reverse rotation".	Forward rotation	Forward rotation Reverse rotation
Number of repetitions	Set the number of repetitions.	3	1 to 100

3. HOW TO USE

Display item	Description	Initial value	Setting range
Spindle rotation command M	Set the spindle rotation command. This item is not displayed when the number of the spindle is 1.	S1: 3 S2 or later: -	0 to 9999
Spindle orientation command M	Set the spindle orientation command.	S1: 19 S2 or later: -	0 to 9999
Program end M	Set the M code of program end.	30	0 to 99999999
Each data for program creation function (When orientation during stop is selected)			
Rotation speed before orientation (r/min)	Set the number of rotations before orientation.	30	0 to 999999
Spindle rotation command M	Set the spindle rotation command. This item is not displayed when the number of the spindle is 1.	S1: 3 S2 or later: -	0 to 9999
Spindle orientation command M	Set the spindle orientation command.	S1: 19 S2 or later: -	0 to 9999
Spindle stop command M	Set the spindle stop command. This item is not displayed when the number of the spindle is 1.	S1: 5 S2 or later: -	0 to 9999
Program end M	Set the M code of program end.	30	0 to 99999999
Write to NC	Writes the program displayed in the [Program area] to the NC and sets it as an operable program. When this button is clicked while the program area is blank, the message "Enter the program" is displayed.	-	-
Program creation	Creates a measurement machining program from various data for the program creation function. The created program is displayed in the [Program area].	-	-
Part system number	Select the part system to write the program. Displayed when the number of the part systems is two or more.	1	1 to 8
Program area	A program for measurement is created. When "Start measuring" is clicked while the [Program area] is blank, the message "Enter the program" is displayed.	-	-
Sampling condition	Display the sampling condition being specified.	-	-
Sampling condition setting	The sampling condition setting screen is displayed.	-	-
Start measuring	Spindle orientation measurement starts.	-	-

(2) Sampling condition setting screen

Refer to the item "(2) Sampling condition setting screen" in "3.4.2 Reciprocation acceleration/deceleration measurement".

(3) Monitor output data screen

Refer to the item "(3) Monitor output data screen" in "3.4.2 Reciprocation acceleration/deceleration measurement".

(4) Automatic measurement screen

Refer to the item "(4) Automatic measurement screen" in "3.4.2 Reciprocation acceleration/deceleration measurement".

(5) Measurement result screen

Waveforms of the measurement results are displayed in the waveform window. Refer to "3.8 Waveform Window" for details.

3.4.6 Synch Tap Error Measurement

The following is the flowchart for synch tap error measurement.

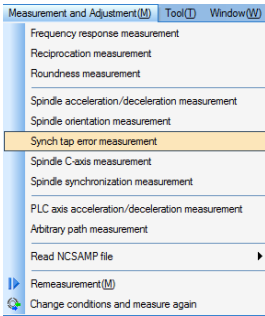

Select measurement method

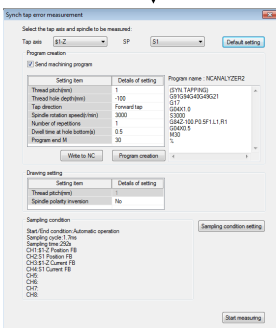

(1) Measurement axis selection screen

Sampling condition setting

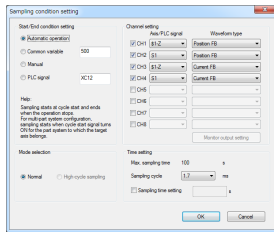

(2) Sampling condition setting screen

Monitor output setting

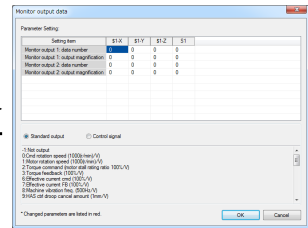

(3) Monitor output data screen

Start measuring

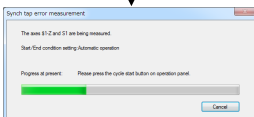

(4) Automatic measurement screen

Cancel

Measurement cancel message

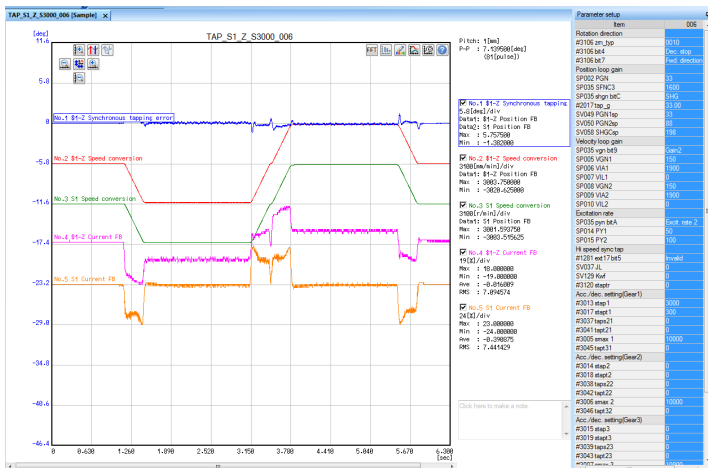

(5) Measurement result screen

3. HOW TO USE

(1) Measurement axis selection screen

Select "Measurement and adjustment (M)" - "Synch tap error measurement" and display the measurement axis selection screen. Select the tap axis and the spindle to measure on the measurement axis selection screen and create a machining program. The last measured sampling conditions (conditions excluding the monitor output data screen) are maintained.

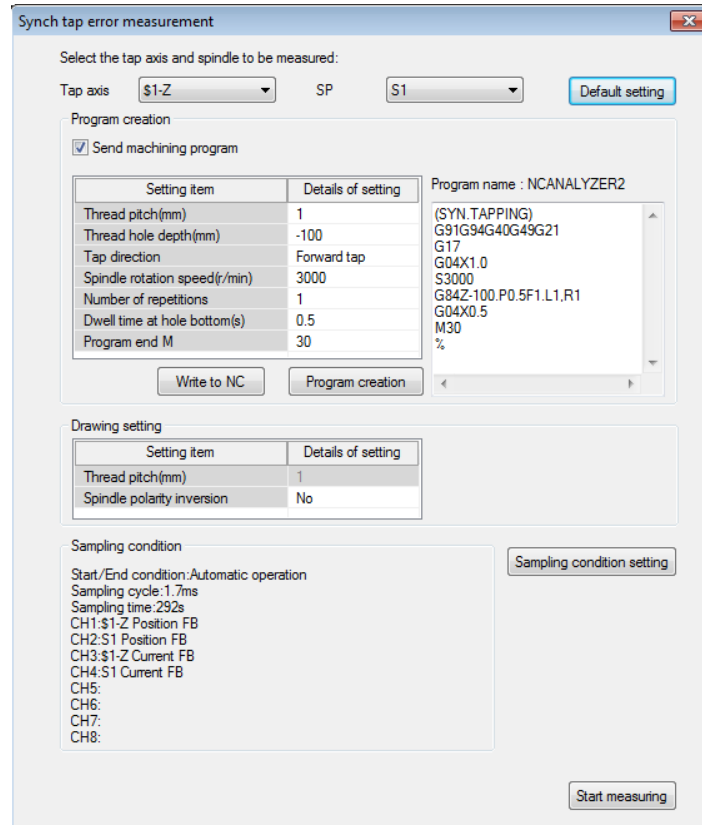

Display item	Description	Initial value	Setting range
Measurement axis	Select the tap axis and spindle to measure.		
Tap axis	Select the NC axis. (*1) The items that can be selected differ depending on the number of the NC axes.	Z axis	(*1)
Spindle	Select the spindle. (*2) The items that can be selected differ depending on the number of the spindles.	-	(*2)
Default setting	Return the setting values of program creation and sampling condition to the initial values.	-	-
Program creation	Set a program creation function.		
Send machining program	When checked, the function to create a program is enabled. Clicking the "Start measuring" button with this checked writes the created program to the NC. When unchecked, measurement starts without writing a program to the NC. An "Search" of the measurement program must be executed by the NC before starting measurement.	ON	ON/OFF
Each data for program creation function			
Thread pitch (mm)	Set the thread pitch.	1	0.000001 to 100.0
Thread hole depth (mm)	Set the depth of thread hole.	-100	-999999.999999 to 999999.999999
Tap direction	Select from "Forward tap" or "Reverse tap".	Forward tap	Forward tap Reverse tap

3. HOW TO USE

Display item	Description	Initial value	Setting range
Spindle rotation speed (r/min)	Set the spindle rotation speed.	3000	0 to 999999
Number of repetitions	Set the number of repetitions.	1	1 to 100
Dwell time at hole bottom (s)	Set the time stopped at the bottom of hole.	0	0.0 to 99999.999
Program end M	Set the M code of program end.	30	0 to 99999999
Write to NC	Writes the program displayed in the [Program area] to the NC and sets it as an operable program. When this button is clicked while the program area is blank, the message "Enter the program" is displayed.	-	-
Program creation	Creates a measurement machining program from various data for the program creation function. The created program is displayed in the [Program area].	-	-
Part system number	Select the part system to write the program. Displayed when the number of the part systems is two or more. (*3) When the NC axis in the sub part system is selected, the items other than "Write to NC", "Part system number", and "Program area" are unavailable and the smallest part system number in the main part system is displayed in "Part system number" as an initial value.	Part system number of the measurement axis (*3)	1 to 8
Program area	A program for measurement is created. When [Start measuring] is clicked while the [Program area] is blank, the message "Enter the program" is displayed. When measurement axis is switched between servo axes or between spindles, [Program area] is cleared.	-	-
Drawing setting	Set the base value of the waveform drawing when measuring the program in the NC. Set the same value as the machining program to be measured.		
Thread pitch (mm)	Set the thread pitch for waveform drawing. (Note) When "Send machining program" is checked while an axis of the main part system is selected for the tap axis, this item cannot be set because the same setting value as the data for the program creation function is used as base.	1.0	-
Spindle polarity inversion	Select "Yes" or "No" for polarity inversion of the position FB of the spindle for waveform drawing. Selecting "Yes" displays the waveform with the inverted polarity values of the spindle position FB. Selecting "No" displays the waveform with the non-inverted polarity values of the spindle position FB. When "Yes" is selected, "(*)" precedes the names of the waveforms of data 1 and data 2 on the [Data transformation] dialog.	No	Yes/No
Sampling condition	Display the sampling condition being specified.	-	-
Sampling condition setting	The sampling condition setting screen is displayed.	-	-
Start measuring	Synch tap error measurement starts.	-	-

3. HOW TO USE

(2) Sampling condition setting screen

Refer to the item "(2) Sampling condition setting screen" in "3.4.2 Reciprocation acceleration/deceleration measurement".

(3) Monitor output data screen

Refer to the item "(3) Monitor output data screen" in "3.4.2 Reciprocation acceleration/deceleration measurement".

(4) Automatic measurement screen

Refer to the item "(4) Automatic measurement screen" in "3.4.2 Reciprocation acceleration/deceleration measurement".

(5) Measurement result screen

Waveforms of the measurement results are displayed in the waveform window. Refer to "3.8 Waveform Window" for details.

3. HOW TO USE

3.4.7 Spindle C-axis Measurement

The following is the flowchart for spindle C-axis measurement.

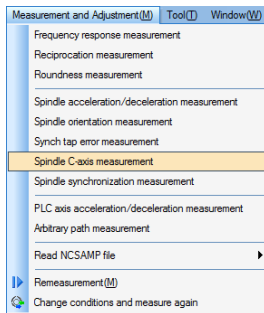

Select measurement method

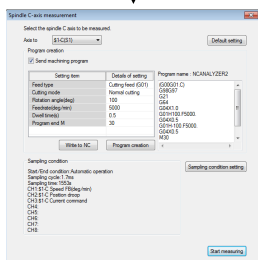

(1) Measurement axis selection screen

Sampling condition setting

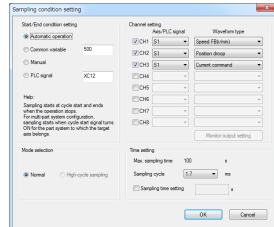

(2) Sampling condition setting screen

Monitor output setting

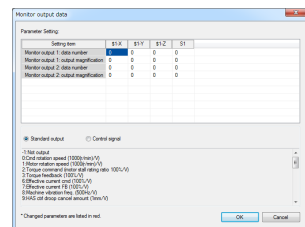

(3) Monitor output data screen

Start measuring

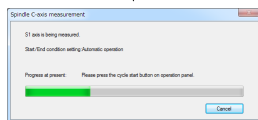

(4) Automatic measurement screen

Cancel

Measurement cancel message

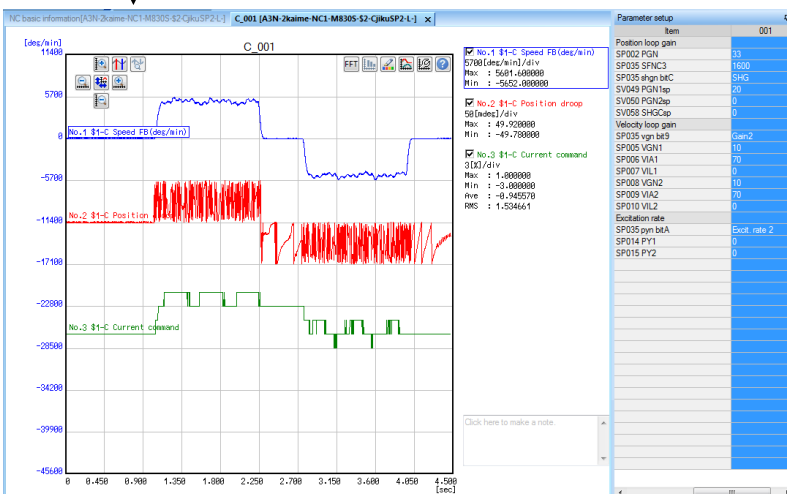

(5) Measurement result screen

3. HOW TO USE

(1) Measurement axis selection screen

Select "Measurement and adjustment (M)" - "Spindle C-axis measurement" and display the measurement axis selection screen. Select the spindle to measure on the measurement axis selection screen and create a machining program. The last measured sampling conditions (conditions excluding the monitor output data screen) are maintained.

Start measuring after switching the spindle to C axis mode.

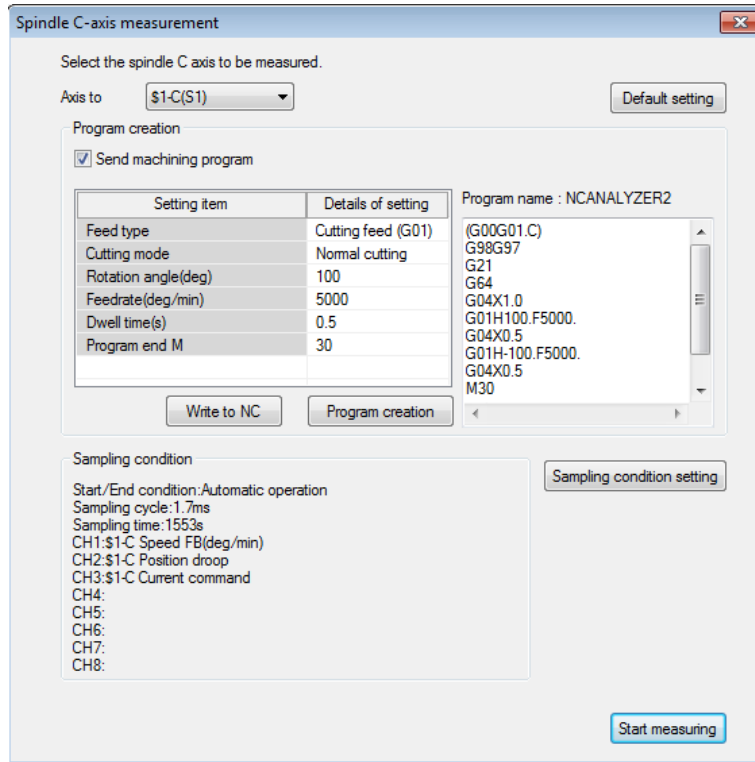

Display item	Description	Initial value	Setting range
Measurement axis	Select the spindle to measure. (*1) The items that can be selected differ depending on the number of the spindles.	-	(*1)
Default setting	Return the setting values of program creation and sampling condition to the initial values.	-	-
Program creation	Set a program creation function.		
Send machining program	When checked, the function to create a program is enabled. Clicking the "Start measuring" button with this checked writes the created program to the NC. When unchecked, measurement starts without writing a program to the NC. An "Search" of the measurement program must be executed by the NC before starting measurement.	ON	ON/OFF
Each data for program creation function			
Feed type	Select from "Cutting feed (G01)" or "Rapid feed (G00)".	Cutting feed (G01)	Cutting feed (G01) Rapid feed (G00)
Cutting mode	Select from "High-accuracy mode" or "Normal cutting mode". (*2) The initial value varies depending on the NC to be connected.	(*2)	High-accuracy mode Normal cutting mode
Rotation angle (deg)	Set the rotation angle.	100	-99999.999 to 99999.999

3. HOW TO USE

Display item	Description	Initial value	Setting range
Feed rate (deg/min)	Set the feed rate. When "Rapid feed (G00)" is selected, this cannot be set.	5000	0.000001 to 999999.999999
Dwell time (s)	Set the dwell time.	0.5	0 to 99999.999
Program end M	Set the M code of program end.	30	0 to 99999999
Write to NC	Writes the program displayed in the [Program area] to the NC and sets it as an operable program. When this button is clicked while the program area is blank, the message "Enter the program" is displayed.	-	-
Program creation	Creates a measurement machining program from various data for the program creation function. The created program is displayed in the [Program area].	-	-
Part system number	Select the part system to write the program. Displayed when the number of the part systems is two or more. (*3) When the NC axis in the sub part system is selected, the smallest part system number in the main part system is displayed in "Part system number" as an initial value.	Part system number of the measurement axis (*3)	1 to 8
Program area	A program for measurement is created. When [Start measuring] is clicked while the [Program area] is blank, the message "Enter the program" is displayed.	-	-
Sampling condition	Display the sampling condition being specified.	-	-
Sampling condition setting	The sampling condition setting screen is displayed.	-	-
Start measuring	Spindle C-axis measurement starts.	-	-

(2) Sampling condition setting screen

Refer to the item "(2) Sampling condition setting screen" in "3.4.2 Reciprocation acceleration/deceleration measurement".

(3) Monitor output data screen

Refer to the item "(3) Monitor output data screen" in "3.4.2 Reciprocation acceleration/deceleration measurement".

(4) Automatic measurement screen

Refer to the item "(4) Automatic measurement screen" in "3.4.2 Reciprocation acceleration/deceleration measurement".

(5) Measurement result screen

Waveforms of the measurement results are displayed in the waveform window. Refer to "3.8 Waveform Window" for details.

3. HOW TO USE

3.4.8 Spindle Synchronization Measurement

The following is the flowchart for spindle synchronization measurement.

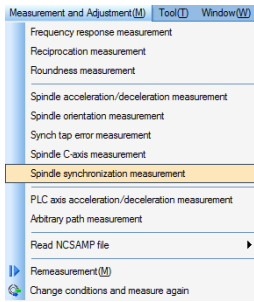

Select measurement method

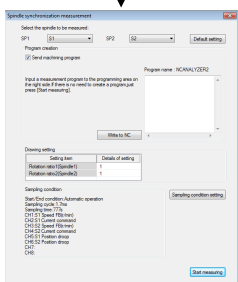

(1) Measurement axis selection screen

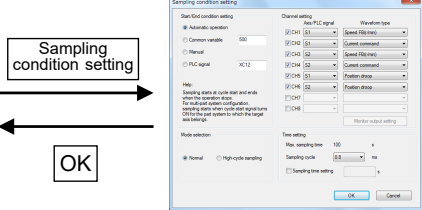

(2) Sampling condition setting screen

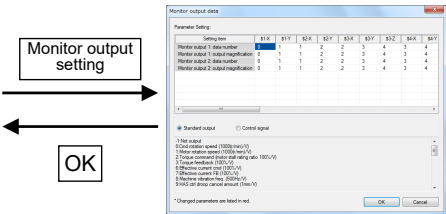

(3) Monitor output data screen

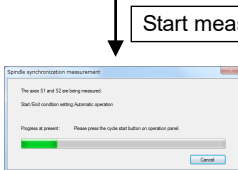

(4) Automatic measurement screen

Measurement cancel message

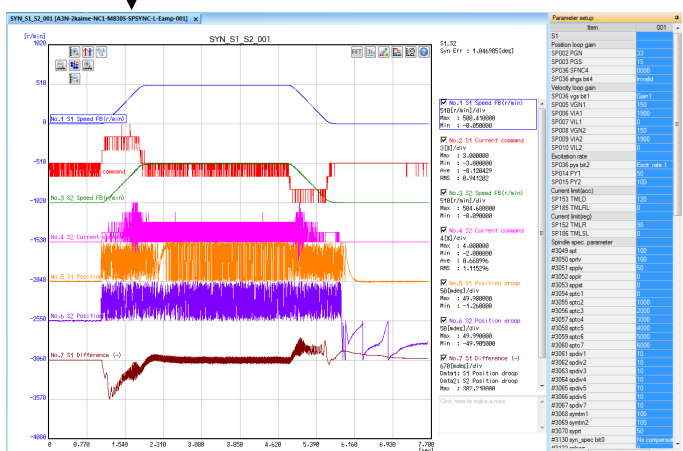

(5) Measurement result screen

3. HOW TO USE

(1) Measurement axis selection screen

Select "Measurement and adjustment (M)" - "Spindle synchronization measurement" and display the measurement axis selection screen. Select the axis of rotation of the spindle or NC axis to measure on the measurement axis selection screen and create a machining program. The last measured sampling conditions (conditions excluding the monitor output data screen) are maintained.

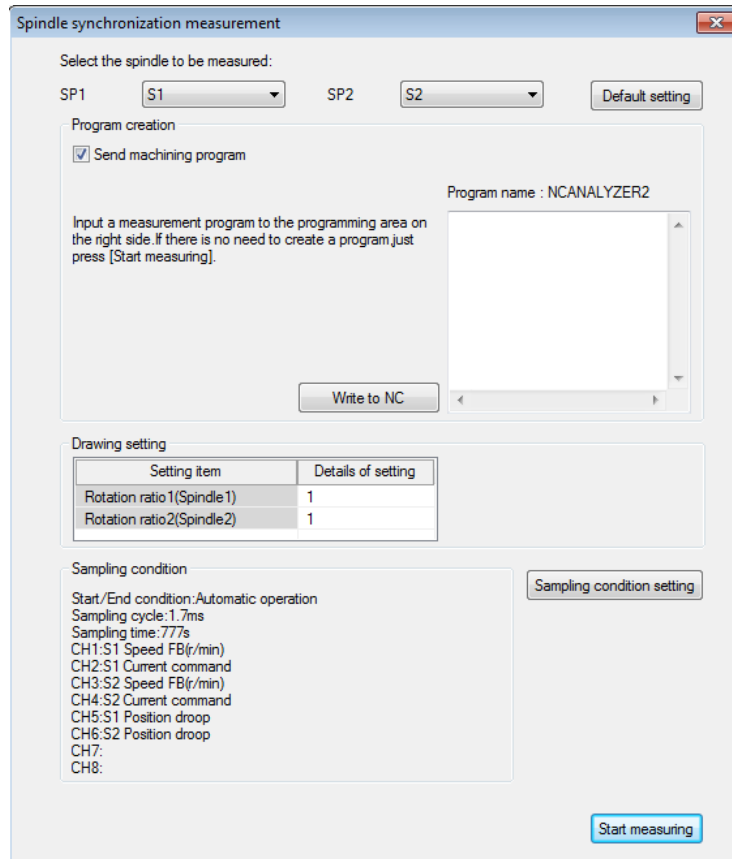

Display item	Description	Initial value	Setting range
Measurement axis	Select the axis of rotation of the spindle or NC axis. (*1) The items that can be selected differ depending on the number of the spindles. Where there is only one spindle, Spindle 2 is displayed as empty.	-	(*1)
Default setting	Return the setting values of program creation and sampling condition to the initial values.	-	-
Program creation	Set a program creation function.		
Send machining program	When checked, the function to create a program is enabled. Clicking the "Start measuring" button with this checked writes the created program to the NC. When unchecked, measurement starts without writing a program to the NC. An "Search" of the measurement program must be executed by the NC before starting measurement.	ON	ON/OFF
Write to NC	Writes the program displayed in the [Program area] to the NC and sets it as an operable program. When this button is clicked while the program area is blank, the message "Enter the program" is displayed.	-	-
Part system number	Select the part system to write the program. Displayed when the number of the part systems is two or more.	1	1 to 8

3. HOW TO USE

Display item	Description	Initial value	Setting range
Program area	A program for measurement is input. When [Start measuring] is clicked while the [Program area] is blank, the message "Enter the program" is displayed. (Note) A program is not created automatically for this measurement function. Input a measurement machining program if needed.	-	-
Drawing setting	Set each setting for the waveform drawing when executing the program in the NC.		
Rotation ratio 1 (Spindle 1)	Set Spindle 1 rotation ratio.	1	-
Rotation ratio 2 (Spindle 2)	Set Spindle 2 rotation ratio.	1	-
Sampling condition	Display the sampling condition being specified.	-	-
Sampling condition setting	The sampling condition setting screen is displayed.	-	-
Start measuring	Spindle synchronization measurement starts.	-	-

(2) Sampling condition setting screen

Refer to the item "(2) Sampling condition setting screen" in "3.4.2 Reciprocation acceleration/deceleration measurement".

(3) Monitor output data screen

Refer to the item "(3) Monitor output data screen" in "3.4.2 Reciprocation acceleration/deceleration measurement".

(4) Automatic measurement screen

Refer to the item "(4) Automatic measurement screen" in "3.4.2 Reciprocation acceleration/deceleration measurement".

(5) Measurement result screen

Waveforms of the measurement results are displayed in the waveform window. Refer to "3.8 Waveform Window" for details.

3. HOW TO USE

3.4.9 PLC Axis Acceleration/Deceleration Measurement

The following is the flowchart for PLC axis acceleration/deceleration measurement.

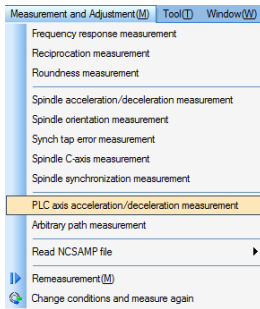

Select measurement method

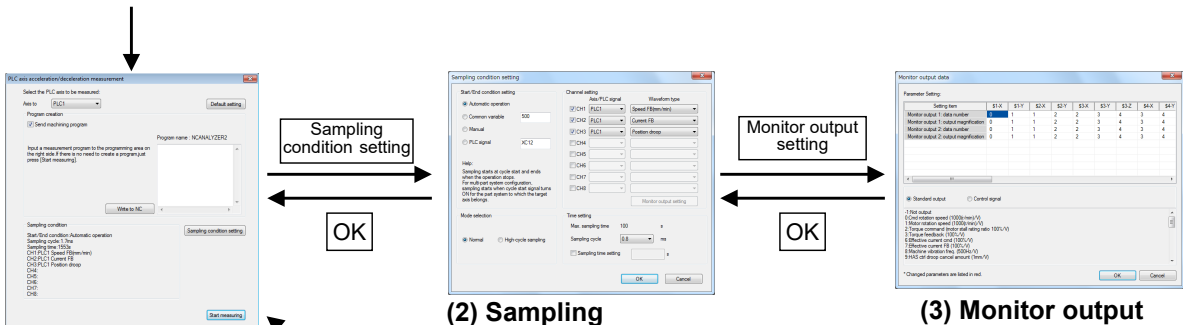

(1) Measurement axis selection screen

(2) Sampling condition setting screen

(3) Monitor output data screen

Start measuring

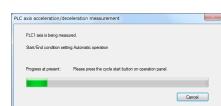

(4) Automatic measurement screen

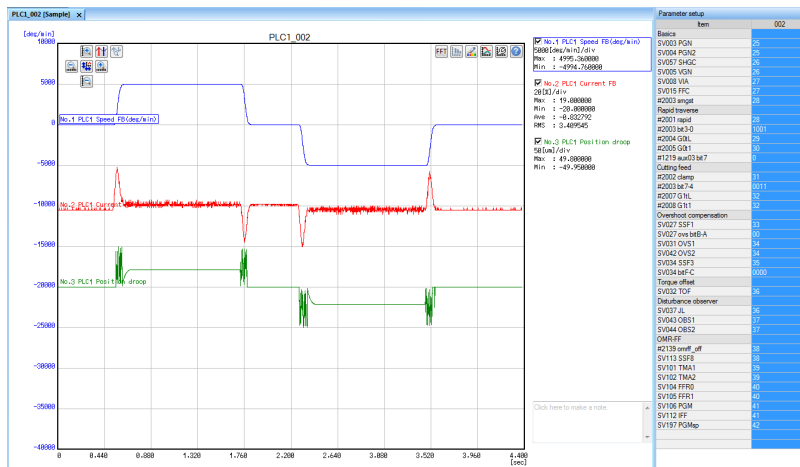
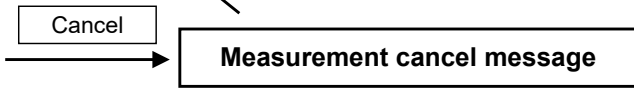

(5) Measurement result screen

3. HOW TO USE

(1) Measurement axis selection screen

Select "Measurement and adjustment (M)" - "PLC axis reciprocation acceleration/deceleration measurement" and display the measurement axis selection screen. Select the PLC axis to measure on the measurement axis selection screen and create a machining program. The last measured sampling conditions (conditions excluding the monitor output data screen) are maintained.

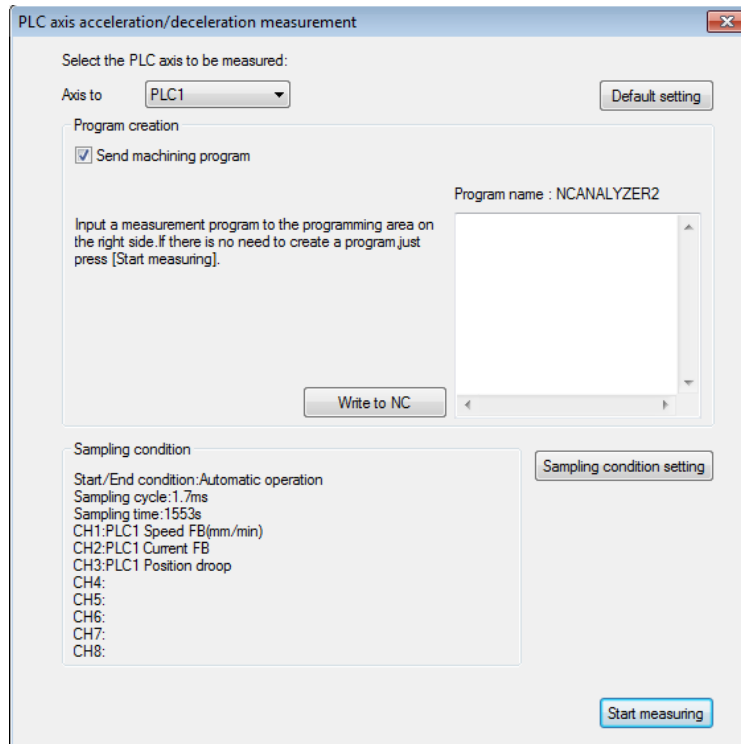

Display item	Description	Initial value	Setting range
Measurement axis	Select the PLC axis to measure. (*1) The items that can be selected differ depending on the number of the PLC axes.	-	(*1)
Default setting	Return the setting values of program creation and sampling condition to the initial values.	-	-
Program creation	Set a program creation function.		
Send machining program	When checked, the function to create a program is enabled. Clicking the "Start measuring" button with this checked writes the created program to the NC. When unchecked, measurement starts without writing a program to the NC. An "Search" of the measurement program must be executed by the NC before starting measurement.	ON	ON/OFF
Write to NC	Writes the program displayed in the [Program area] to the NC and sets it as an operable program. When this button is clicked while the program area is blank, the message "Enter the program" is displayed.	-	-
Part system number	Select the part system to write the program. Displayed when the number of the part systems is two or more. (*1) When the PLC axis in the sub part system is selected, the smallest part system number in the main part system is displayed in "Part system number" as an initial value.	Part system number of the measurement axis (*1)	1 to 8

3. HOW TO USE

Display item	Description	Initial value	Setting range
Program area	<p>A program for measurement is input.</p> <p>When [Start measuring] is clicked while the [Program area] is blank, the message "Enter the program" is displayed.</p> <p>(Note) A program is not created automatically for this measurement function. Input a measurement machining program if needed.</p>	-	-
Sampling condition	Display the sampling condition being specified.	-	-
Sampling condition setting	The sampling condition setting screen is displayed.	-	-
Start measuring	PLC axis reciprocation acceleration/deceleration measurement starts.	-	-

- (2) Sampling condition setting screen
Refer to the item "(2) Sampling condition setting screen" in "3.4.2 Reciprocation acceleration/deceleration measurement".
- (3) Monitor output data screen
Refer to the item "(3) Monitor output data screen" in "3.4.2 Reciprocation acceleration/deceleration measurement".
- (4) Automatic measurement screen
Refer to the item "(4) Automatic measurement screen" in "3.4.2 Reciprocation acceleration/deceleration measurement".
- (5) Measurement result screen
Waveforms of the measurement results are displayed in the waveform window. Refer to "3.8 Waveform Window" for details.

3. HOW TO USE

3.4.10 Arbitrary Path Measurement

The following is the flowchart for arbitrary path measurement.

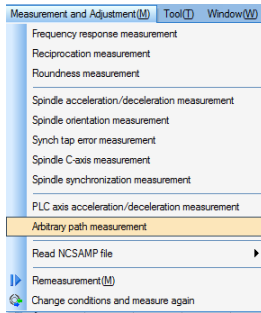

Select measurement method

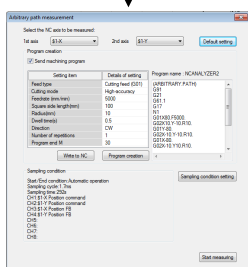

(1) Measurement axis selection screen

Sampling condition setting

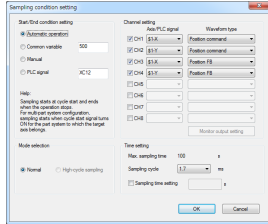

(2) Sampling condition setting screen

Monitor output setting

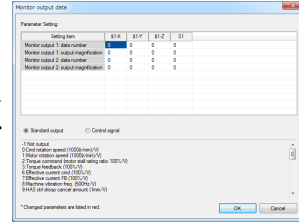

(3) Monitor output data screen

Start measuring

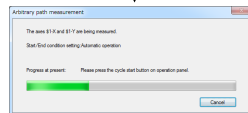

(4) Automatic measurement screen

Cancel



Measurement cancel message

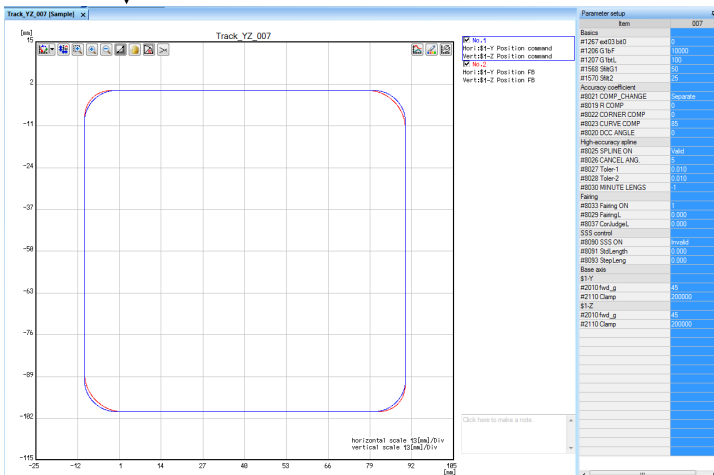

(5) Measurement result screen

3. HOW TO USE

(1) Measurement axis selection screen

Select "Measurement and Adjustment (M)" - "Arbitrary path measurement" and display the measurement axis selection screen. Select the NC axis to measure on the measurement axis selection screen and create a machining program. The last measured sampling conditions (conditions excluding the monitor output data screen) are maintained.

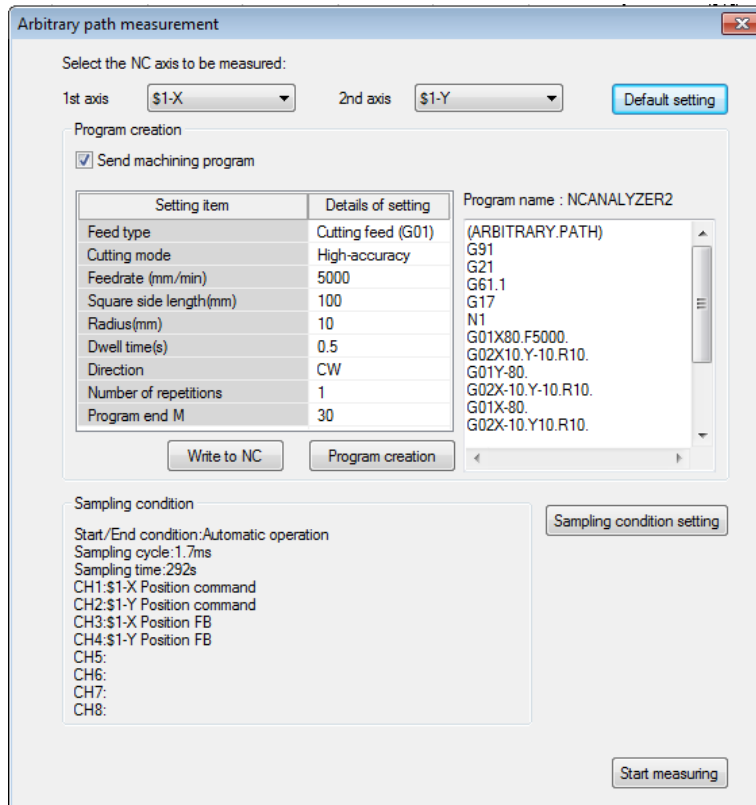

Display item	Description	Initial value	Setting range
Measurement axis	Select two NC axes to measure. (*1) The items that can be selected differ depending on the number of the NC axes. When there is a synchronous axis, a slave axis cannot be selected.	-	(*1)
Default setting	Return the setting values of program creation and sampling condition to the initial values.	-	-
Program creation	Set a program creation function.		
Send machining program	When checked, the function to create a program is enabled. Clicking the "Start measuring" button with this checked writes the created program to the NC. When unchecked, measurement starts without writing a program to the NC. An "Search" of the measurement program must be executed by the NC before starting measurement.	ON	ON/OFF
Each data for program creation function			
Feed type	Select from "Cutting feed (G01)" or "Rapid feed (G00)".	Cutting feed (G01)	Cutting feed (G01) Rapid feed (G00)
Cutting mode	Select from "High-accuracy mode" or "Normal cutting mode". (*2) The initial value varies depending on the NC to be connected.	(*2)	High-accuracy mode Normal cutting mode
Feedrate (mm/min)	Set the feedrate. When "Rapid feed (G00)" is selected, this cannot be set.	5000	0.000001 to 999999.999999

3. HOW TO USE

Display item	Description	Initial value	Setting range
One side distance (mm)	Set one side length where each axis moves.	100	0.000001 to 999999.999999
Radius (mm)	Set corner angle radius. When "0" is set to the radius, a machining program of square without corner angles is created.	10	0 to "half of one side distance"
Dwell time (s)	Set the dwell time.	0.5	0 to 99999.999
Operation direction	Select from "Clockwise (CW)" or "Counterclockwise (CCW)".	Clockwise (CW)	Clockwise (CW) Counterclockwise (CCW)
Number of repetitions	Set the number of repetitions.	1	1 to 100
Program end M	Set the M code of program end.	30	0 to 99999999
Write to NC	Writes the program displayed in the [Program area] to the NC and sets it as an operable program. When this button is clicked while the program area is blank, the message "Enter the program" is displayed.	-	-
Program creation	Creates a measurement machining program from various data for the program creation function. The created program is displayed in the [Program area].	-	-
Part system number	Select the part system to write the program. Displayed when the number of the part systems is two or more. (*3) When the NC axes in the sub part system is selected for both axes, the smallest part system number in the main part system is displayed in "Part system number" as an initial value. When the NC axes in the main part system and sub part system are selected for both axes, the part system number in the main part system is displayed in "Part system number" as an initial value.	Part system number of the measurement axis (*3)	1 to 8
Program area	A program for measurement is created. When [Start measuring] is clicked while the [Program area] is blank, the message "Enter the program" is displayed.	-	-
Sampling condition	Display the sampling condition being specified.	-	-
Sampling condition setting	The sampling condition setting screen is displayed.	-	-
Start measuring	Arbitrary path measurement starts.	-	-

- (2) Sampling condition setting screen
Refer to the item "(2) Sampling condition setting screen" in "3.4.2 Reciprocation acceleration/deceleration measurement".
- (3) Monitor output data screen
Refer to the item "(3) Monitor output data screen" in "3.4.2 Reciprocation acceleration/deceleration measurement".
- (4) Automatic measurement screen
Refer to the item "(4) Automatic measurement screen" in "3.4.2 Reciprocation acceleration/deceleration measurement".
- (5) Measurement result screen
Waveforms of the measurement results are displayed in the waveform window. Refer to "3.8 Waveform Window" for details.

3. HOW TO USE

3.4.11 Read NCSAMP File

The following is the flowchart for NCSAMP file reading.

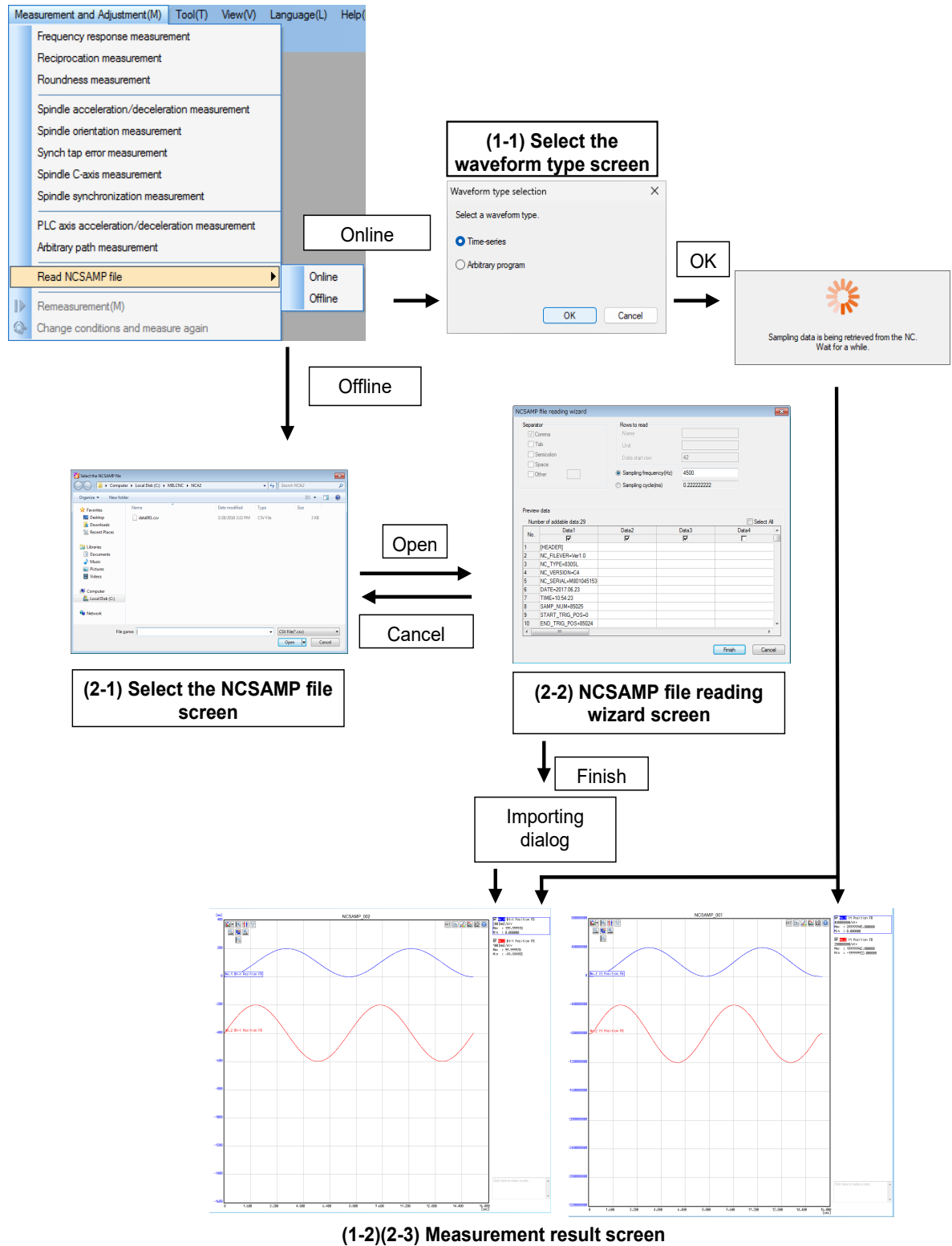

3. HOW TO USE

There are two reading formats for reading NCSAMP files, one is "Online" and the other is "Offline".

For "Online", the waveform is displayed by reading the sampling file acquired by connecting to the NC.

For "Offline", the waveform is displayed by reading the sampling data file (NCSAMP file) saved temporarily in the PC without connecting to the NC.

Refer to the following table for the function differences.

	Online	Offline
Unit conversion	Only data acquired by index number (IDX) (Note 1)	Not available
Number of CH that can be read.	Up to 16 CH	Up to 16CH

(Note 1) Only units in the sampling data registered in NC Analyzer2 are converted. When displaying the sampling data acquired by a kind other than "IDX (Index)", the measurement values are displayed as waveforms without converting the units.

Units are not displayed when the units are not converted.

(Note 2) For both online and offline, only data that was measured by setting "one-shot" for "Process Form" in the data sampling of the NC can be read.

(1) Online

Select "Measurement and Adjustment (M)" – "Read NCSAMP file" – "Online" to read the sampling data in the connected NC.

(Note) Do not change the channel information of measured NC or setting values of sampling condition until the sampling data is read. Changing condition after measuring or restarting NC will result in incorrect display of waveform.

(1-1) Waveform type selection screen

Select the waveform type to save the read sampling data.

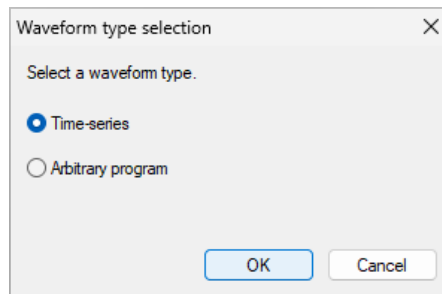

Display item	Description	Initial value	Setting range
Waveform type	Select the waveform type to save the read sampling data.	Time-series	Time-series Arbitrary program

(1-2) Measurement result screen

The measurement result is displayed in the waveform window. The measurement results are displayed as the type of waveforms selected in the Waveform type selection screen. Refer to "3.8 Waveform Window" for details.

3. HOW TO USE

(2) Offline

Select "Measurement and Adjustment (M)" – "Read NCSAMP file" – "Offline" to read the sampling data file which is stored in the PC.

(2-1) Select the NCSAMP file screen

Select the sampling data file that is stored in the PC. Only files saved with decimal display for output format and with a header can be read.

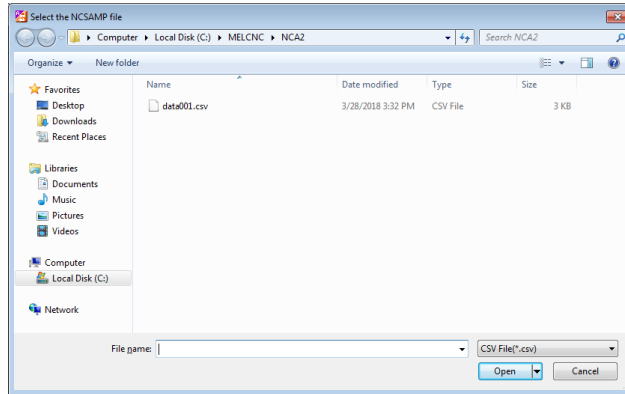

(2-2) NCSAMP file reading wizard screen

Set the preview and measuring condition of the designated file.

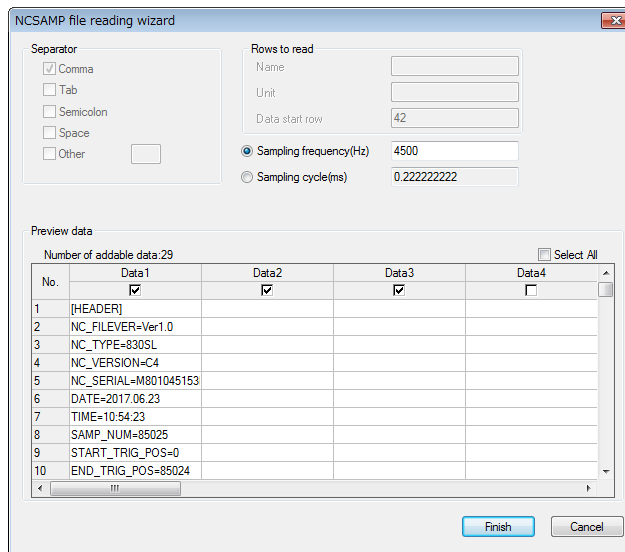

3. HOW TO USE

Display item	Description	Initial value	Setting range
Separator	Separator of file is set automatically. Only "Comma" is available for separator.	-	-
Rows to read	The "Name", "Unit", and "Data start row" of the waveform displayed after reading are automatically set.		
Name	The contents of the specified row number are used as the name of the waveform. The default waveform name is displayed.	-	-
Unit	The contents of the specified row number are used as the unit of the waveform. This is treated as a dimensionless quantity.	-	-
Data start row	The designated row to the final row of the file are treated as data rows.	-	-
Measuring condition	Set measuring conditions.		
Sampling frequency (Hz)	Set the sampling frequency of measuring data. (*1) Set automatically by data file.	(*1)	0.001 to 1000000
Sampling cycle (ms)	Set the sampling cycle of measuring data. (*2) Set automatically by data file.	(*2)	0.001 to 1000000
Preview data	Displays the imported data list.		
Number of addable data	Displays the number of data that can be added to the selected measured results. Up to 32 waveforms including the existing waveforms can be imported.	-	-
Data row (checkbox)	Select the data column to import. The target data to import is the row which the checkbox is checked.	All checked	
Select All	When checked, all the data columns are checked. When unchecked, all the data columns are unchecked.	Checked	Checked/Unchecked
Data grid	Displays a maximum of 10,000 rows of file previews.	-	-
Finish	Automatically set in the data file.	-	-
Cancel	Automatically set in the data file.	-	-

-: Not editable

(2-3) Measurement result screen

The measured result is displayed in the waveform window. Refer to "3.8 Waveform Window" for details.

3. HOW TO USE

3.5 Tools

3.5.1 Option

In Option, set startup guidance display, detailed information of the graph information, and maintenance information display.

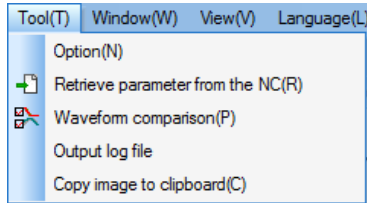

Option menu selection

↓

Startup guidance screen

Detailed information of the graph

Maintenance information screen

Export details screen

3. HOW TO USE

When "Tool (T)"- "Option (N)" is pressed, the startup guidance screen is displayed.

Display item	Description	Initial value	Setting range
Startup guidance screen			
Display Startup guidance at start	Set the Display state of guidance at startup. When checked, guidance at startup appears. When unchecked, main screen of the NC Analyzer2 appears.	ON	ON/OFF
Detailed information of the graph			
Detailed information of the graph			
Display detailed information in the graph	When checked, detailed information appears in the text area. When unchecked, brief information appears.	ON	ON/OFF
Display waveform name in the graph	When checked, items of waveform number and waveform name are displayed in the text area. When unchecked, only the waveform number is displayed.	ON	ON/OFF
Input unit	Set the unit system of the value to use when creating a program of the adjustment or measurement screens.	mm	mm/inch
Display unit	Set the unit systems of the values to use on setting screen of the waveform, and the values displayed in the waveform display area.	mm	mm/inch
FFT Initialization			
Display unit setting (Vertical axis)	Set the initial value of the vertical axis (display unit) of the FFT waveform.	dB	dB/Amp.
Scale setting (Horizontal axis)	Set the initial value of the horizontal axis (scale) of the FFT waveform. When the log scale is selected, the value is displayed on a logarithmic scale. When the linear scale is selected, the value is displayed on an equally spaced scale.	LogScale	LogScale/LinearScale
Maintenance information			
Enable log output	Switch enable/disable of log output. When checked, "Output log file" menu is displayed in "Tools (T)", and "Log output ON" is displayed in the status bar. When the menu "Tools (T)" - "Output log file" is selected, the log file (NCA2Log.log) is saved in the folder set in folder path column.	OFF	ON/OFF
Auto remeasurement log output enabled	When checked, the automatic remeasurement log file (AutoRemeasurementLog.log) of reciprocation acceleration/deceleration measurement is output to the folder set in "Folder path". Selecting the menu "Tool(T)" - "Output log file" is not necessary. The contents of the log file are always output in English. (Note) This item is displayed when a project for C80/C70 is opened.	ON	ON/OFF
Log storage folder	Designate a folder to save the log file.	-	-
Folder path	Set the full path of the folder where the log file is saved. When the field is blank, the log file is saved in the path of the initial value. (*) The initial value is "C:\MELCNC\NCA2\log".	(*)	-
Browse	When this item is clicked, the folder selection dialog is displayed and an arbitrary folder can be selected.	-	-
Export details			
Export the Time column to sampling data file	When this item is checked and "Export the sampling data in CSV format" is executed, the Time column is output. When it is unchecked, the Time column is not output. However, for the following adjustment/measurement data, the Time column is not output regardless of this item setting. - Velocity loop gain adjustment - Frequency response measurement - Read NCSAMP file (offline) - Import data	ON	ON/OFF
OK	Save the settings and close the window.	-	-

3. HOW TO USE

Display item	Description	Initial value	Setting range
Cancel	Close the window without saving the settings.	-	-

3. HOW TO USE

3.5.2 Read NC Parameter

When "Tool (T)"- "Retrieve parameter from the NC (R)" is pressed, NC parameter is retrieved.
 After retrieving NC parameter is completed, NC parameter retrieved to the project preview is displayed.

3.5.3 Waveform Comparison

When "Tools (T)" - "Waveform comparison (P)" is selected, the project preview icon becomes a check box. When the check box of the waveform to be compared is checked, the waveform is displayed in the waveform comparison window.

The limit of the waveform to be compared is 32 waveform data (8 measurement data) and it is possible to select across the project.

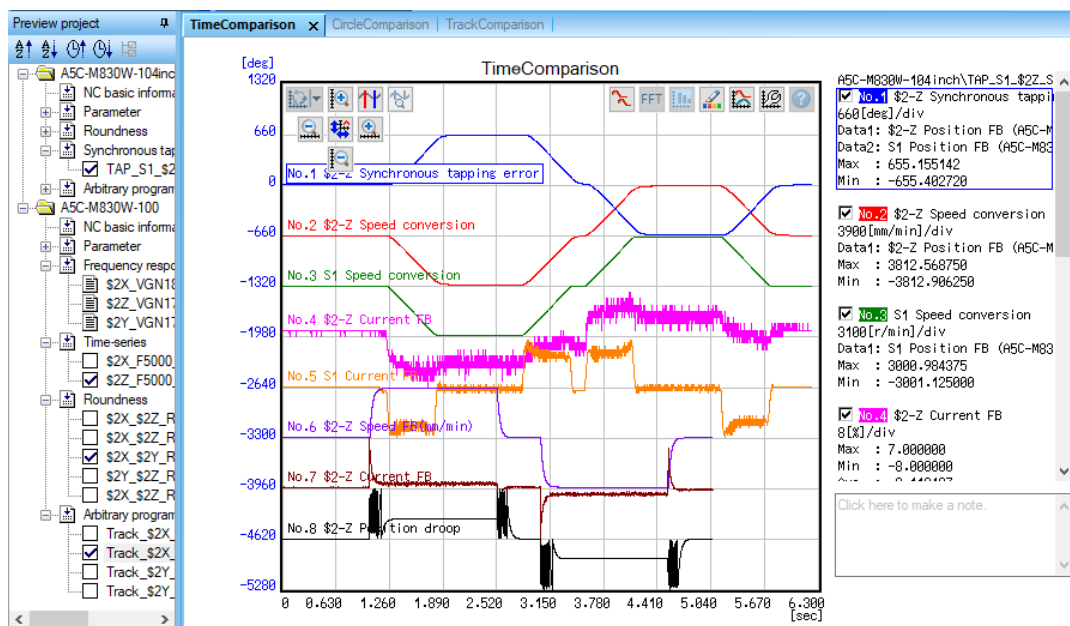

There are three types of waveform comparison windows: time series (TimeComparison), roundness (CircleComparison), and arbitrary program (TrackComparison). The displayed waveform comparison window differs depending on the project preview category. Even though the categories are different, the waveforms can be compared if they are displayed in the same waveform comparison window.

For the items displayed in the waveform comparison window, refer to "3.8.2 Time-series Waveform", "3.8.3 Roundness Waveform", "3.8.4 Arbitrary Program Waveform", and "3.8.5 Arbitrary Program Waveform (3D)".

Project preview category	Waveform comparison window		
	TimeComparison	CircleComparison	TrackComparison
Frequency response	×	×	×
Time-series	○	×	×
Roundness	×	○	×
Arbitrary program	×	×	○
Synchronous tapping	○	×	×

○: Comparable, ×: Not comparable

3. HOW TO USE

When waveforms with different sampling cycles are compared, the cursor moves to the position where each waveform has sampling data point. When there is no data at the cursor position, a value estimated using the previous and following value is displayed. Estimated values are displayed with "*" before them as shown by ValB below.

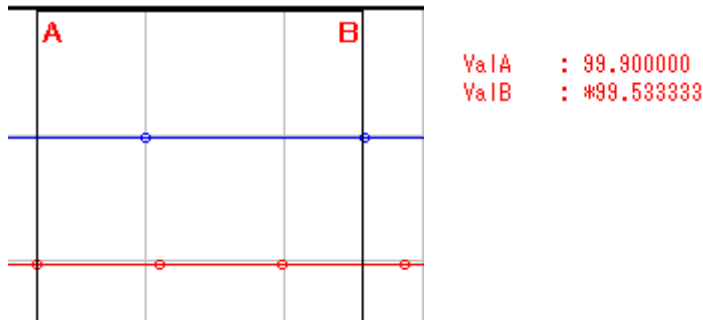

When the selection of "Waveform comparison (P)" is canceled, the waveform window to compare is deleted. The compared and displayed waveform window cannot be saved.

3.5.4 Output Log File

Press "Tools (T)" - "Output log file" to output the log file to the folder specified in "Maintenance information" - "Log storage folder" in the Option dialog.

3.5.5 Copy Image to Clipboard

When "Tool (T)"-"Copy image to clipboard (C)" is pressed, displayed waveform is copied to clipboard. Button area and note area are not copied.

3. HOW TO USE

3.6 View

3.6.1 Changing of Theme Color

Select "View (V)" - "Change theme-color (C)". Select "White tone" or "Grey tone". Background color of graph area, and the initial values of Waveform color and Plot color change with the selected theme color.

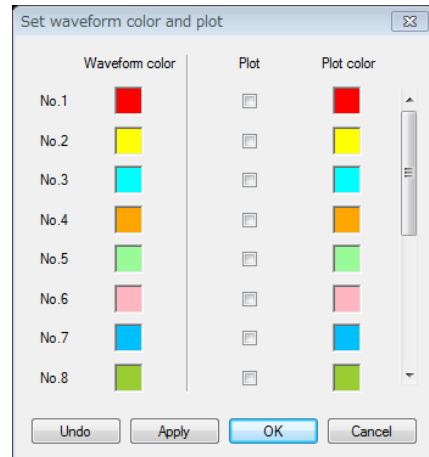
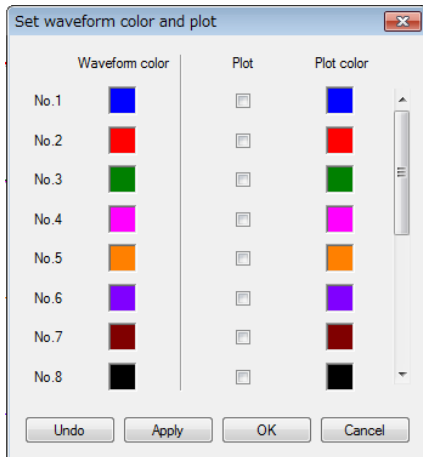
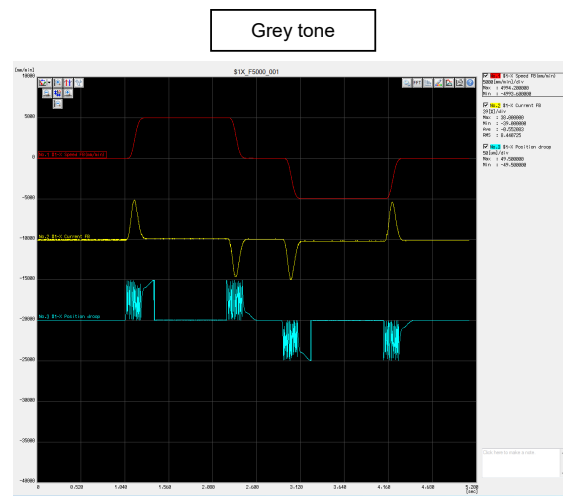
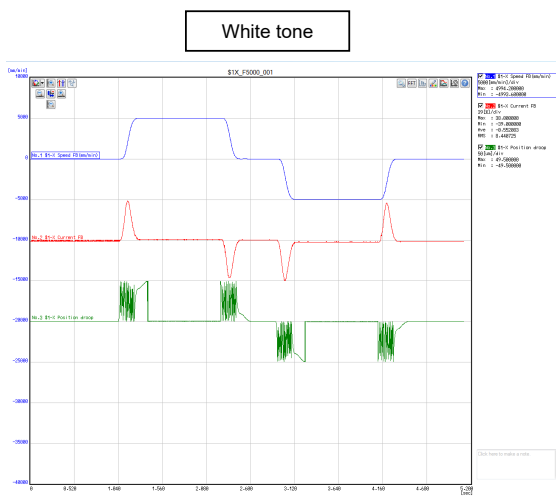
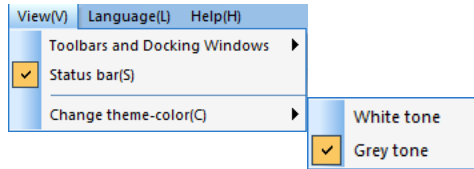

3. HOW TO USE

3.7 Language

The language can be changed. Initial setting is the language set during installation.

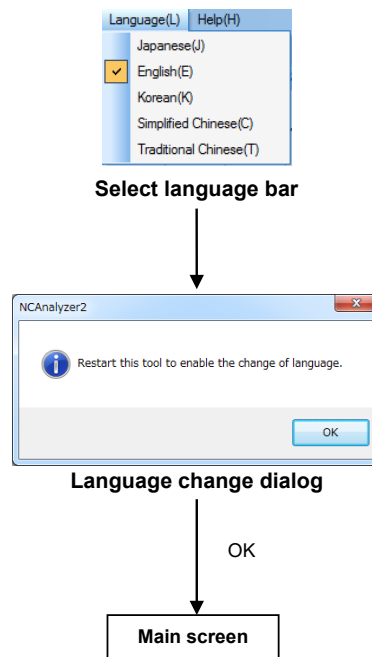

- (1) Select the language "Japanese (J)", "English (E)", "Korean (K)", "Simplified Chinese (C)" or "Traditional Chinese (T)" under "Language (L)" and display the language change dialog.
- (2) After pressing "OK" in the language change dialog, NC Analyzer2 is displayed in the selected language when NC Analyzer2 is restarted.

3. HOW TO USE

3.8 Waveform Window

Displays the results of measurement and adjustment in the waveform window.

The types of the displayed waveform include time-series waveform, roundness waveform, frequency response waveform, arbitrary program waveform (Arbitrary path waveform/Arbitrary shape error waveform), and arbitrary program waveform (3D) (arbitrary path waveform (3D)).

The type of waveform displayed for each measurement is fixed. Clicking "Graph Mode selection" displayed in the button area of the waveform window switches the type of waveform displayed in the waveform window.

Function		Waveform type					
		Frequency response waveform	Time series waveform	Roundness waveform	Arbitrary program waveform	Arbitrary program waveform (3D)	Torque characteristics
Automatic adjustment	Velocity loop gain adjustment	◎	-	-	-	-	-
	Lost motion adjustment	-	○	◎	-	-	-
	Variable full-closed torsion adjustment	-	○	◎	-	-	○
Measurement	Frequency response measurement	◎	-	-	-	-	-
	Reciprocation acceleration/deceleration measurement	-	◎	-	-	-	○
	Roundness measurement	-	○	◎	-	-	○
	Spindle acceleration/deceleration measurement	-	◎	-	-	-	○
	Spindle orientation measurement	-	◎	-	-	-	○
	Synch tap error measurement	-	◎	-	-	-	○
	Spindle C-axis measurement	-	◎	-	-	-	○
	Spindle synchronization measurement	-	◎	-	-	-	○
	PLC axis acceleration/deceleration measurement	-	◎	-	-	-	○
	Arbitrary path measurement	-	○	-	◎	○	○

◎: Initial display after adjustment or measurement, ○: Displayable, -: Not displayable

(Note) The displayed waveform may differ depending on various measurement conditions and parameter settings.

3. HOW TO USE

3.8.1 Frequency Response Waveform

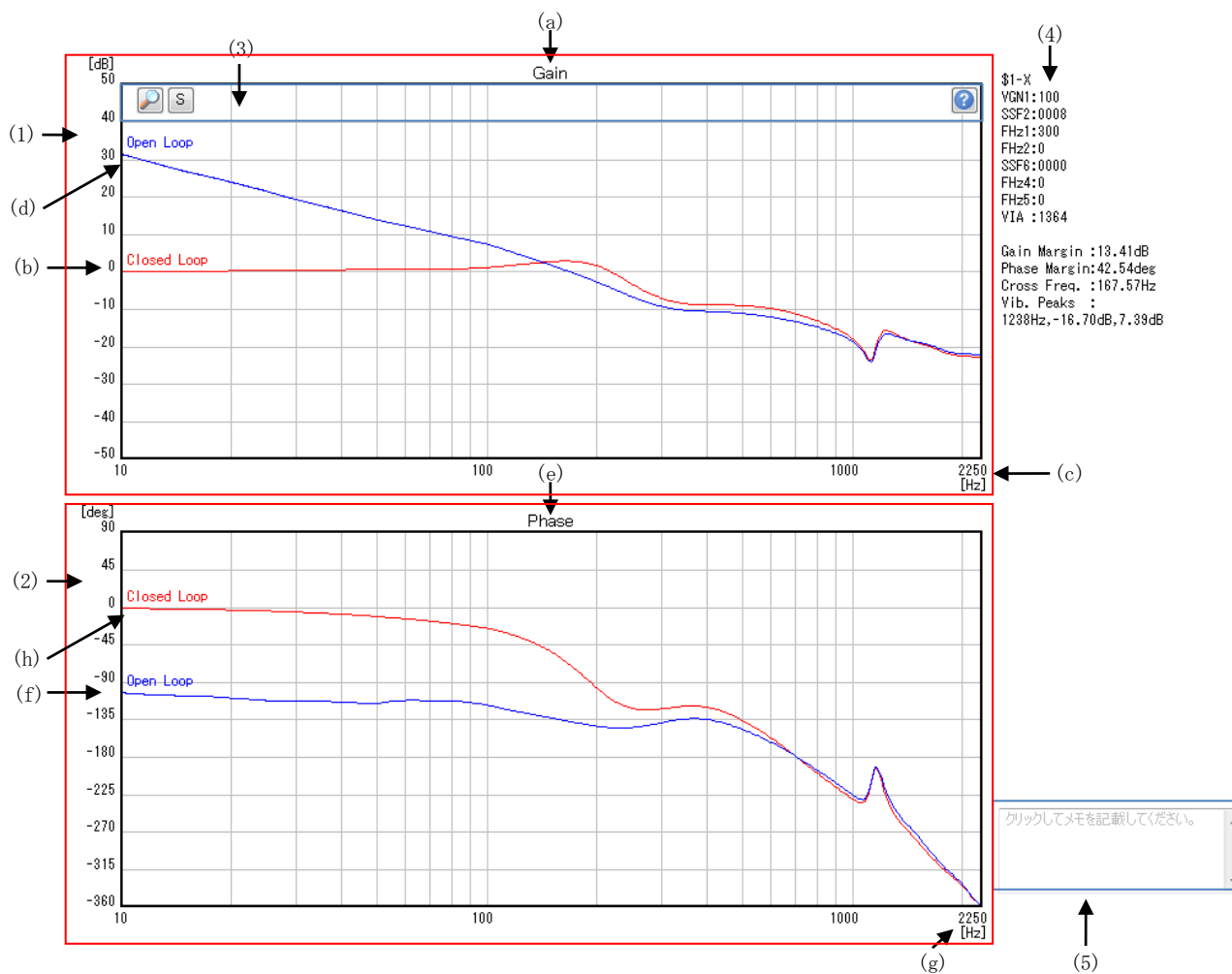

Display item	Description
(1) Characteristic diagram of amplitude - frequency	Displays the frequency response (gain curve).
(a) Title	The name is fixed as "Gain".
(b) Vertical axis coordinate	Coordinate values of the vertical axis are displayed. The unit is dB. The coordinate range is from -50 dB to 50 dB.
(c) Horizontal axis coordinate	Coordinate values of the horizontal axis are displayed. The unit is Hz.
(d) Waveform name	The speed closed loop frequency response gain curve is displayed as "Closed Loop". The speed open loop frequency response gain curve is displayed as "Open Loop".
(2) Characteristic diagram of phase - frequency	Displays the frequency response (phase curve).
(e) Title	The name is fixed as "Phase".
(f) Vertical axis coordinate	Coordinate values of the vertical axis in the coordinate system are displayed. The unit is deg. The coordinate range is from -360 deg. to 90 deg.
(g) Horizontal axis coordinate	Coordinate values of the horizontal axis in the coordinate system are displayed. The unit is Hz.
(h) Waveform name	The closed loop frequency response phase curve of the speed is displayed as "Closed Loop". The open loop frequency response phase curve of the speed is displayed as "Open Loop".

3. HOW TO USE

Display item	Description
(3) Button area	Displays the buttons that can be used for the waveform displayed on the graph area.
(i) Plot coordinates display	<p>Clicking the waveform displays the coordinate of the clicked position. When the waveform window is opened for the first time, the coordinate of the intersection of the vertical axis and "Open Loop" is displayed.</p> <p>Plot points (intersection) that displays the coordinate can be moved using the arrow keys on the keyboard.</p> <p>←: The intersection is moved in the direction of smaller frequency. Plot points are moved one by one.</p> <p>→: The intersection is moved in the direction of larger frequency. Plot points are moved one by one.</p> <p>↑: The intersection is moved in the direction of larger frequency. Plot points are moved by 10 points at a time.</p> <p>↓: The intersection is moved in the direction of smaller frequency. Plot points are moved by 10 points at a time.</p>
(j) Master axis display	<p>Displays the master axis. Initial setting is the master axis.</p>
(k) Slave axis display	<p>Displays the slave axis. Displayed when performing adjustment and measurement on two synchronous control servo axes using the velocity loop gain adjustment function and the frequency response measurement function.</p>
(l) Help	<p>Displays help file (in PDF format). If a PDF file reader is not installed, it is displayed in accordance with the OS setting. Help file varies depending on measurement function.</p>
(4) Text area	Displays the measuring results of the axis display name.
\$ns-m	Displays the axis display name.
\$s: System number	
M: Axis name	
VGN1	Displays the velocity loop gain.
SSF2	Displays the servo function 2.
FHz1	Displays the notch filter frequency 1.
FHz2	Displays the notch filter frequency 2.
SSF6	Displays the servo function 6.
FHz4	Displays the notch filter frequency 4.
FHz5	Displays the notch filter frequency 5.
VIA	Displays the speed loop lead compensation.
Gain Margin	Displays the gain margin dB.
Phase Margin	Displays the phase margin deg.
Cross Freq.	Displays the cross frequency Hz.
Vib. Peaks	<p>Displays the resonance point level (Note) Hz, dB, dB (Note) The number of lines of the resonance point depends on the number of the resonance points provided by the system.</p>
(5) Note area	<p>Remark information up to 256 characters can be entered in the waveform window. When the display is blank, "Click here to make a note" is displayed in gray text color.</p>

3. HOW TO USE

3.8.2 Time-series Waveform

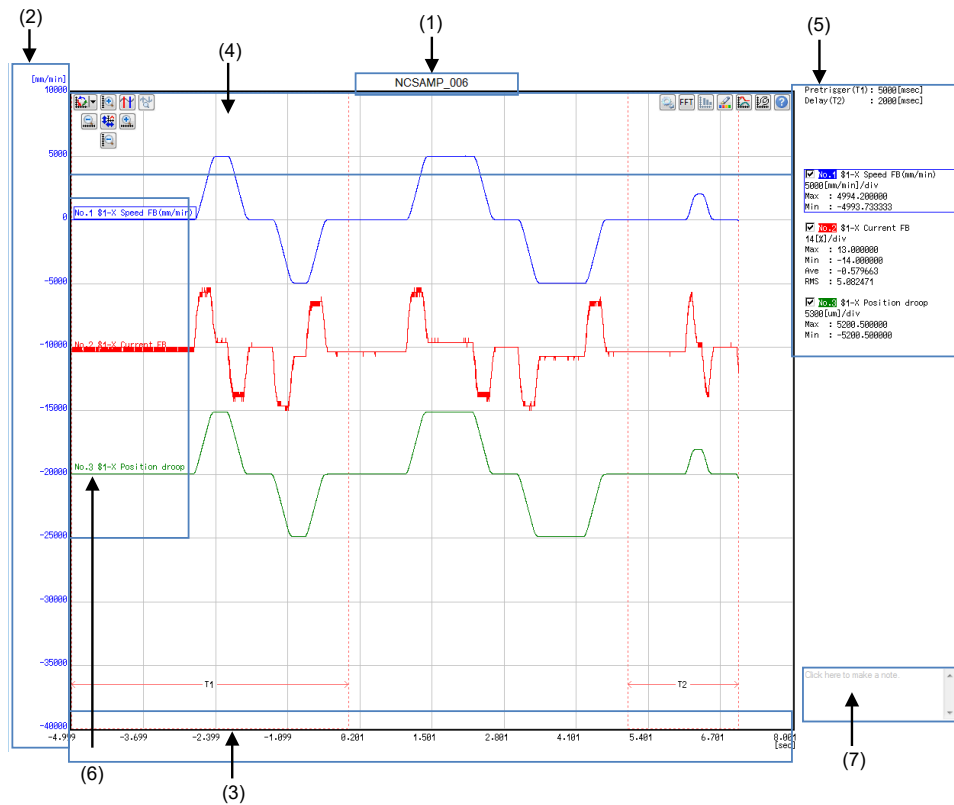

Display item	Description				
(1) Title of graph	The name of measurement is displayed				
(2) Coordinates on the vertical axis	Coordinate values on the vertical axis are displayed. If multiple waveforms are displayed, the coordinate values of the selected waveform are displayed. The unit is switched depending on waveform. Coordinate values are displayed in the same color as that of the selected waveform. When the integer part of the value of each div is 2 digits, the decimal part is not displayed. When the integer part of the value 1 digit, 1 decimal place is displayed.				
(3) Coordinates on the horizontal axis	Coordinate values on the horizontal axis are displayed. Even if multiple waveforms are selected, the same coordinate values are displayed. When the display of waveform exceeds the display area in the window as a result of expanding the horizontal axis, the scroll bar is displayed.				
(4) Button area	Displays the buttons which can be used for the displayed waveforms in the graph area.				
(a) Graph mode conversion	Switches the waveform type to be displayed in the following order. Time-series waveform -> Torque characteristics -> Time-series waveform (circulation) The pull-down menu is as shown below: <table border="1" style="margin-left: 20px;"> <tr> <td style="text-align: center;">*</td> <td style="text-align: center;">Time-series waveform</td> </tr> <tr> <td></td> <td style="text-align: center;">Torque characteristics</td> </tr> </table> The initial setting is time series waveform.	*	Time-series waveform		Torque characteristics
*	Time-series waveform				
	Torque characteristics				

3. HOW TO USE

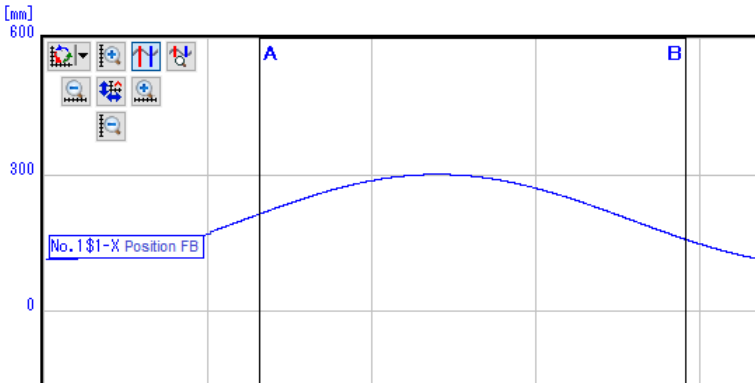
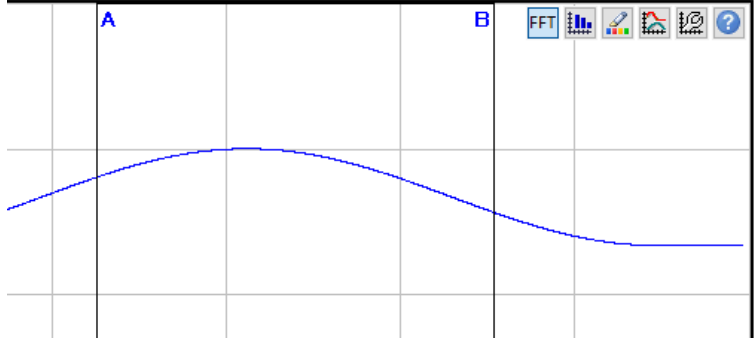
Display item	Description
(b) Cursor display	<p>Clicking the "cursor display" button changes the form of the cursor into a cross. Drag on the graph to select the entire waveform window in the vertical direction and the selected area by dragging in the horizontal direction. "A" is displayed to the left of the selected area and "B" to the right. The color of text displayed agrees with that of the currently selected waveform.</p>  <p>Dragging in the selected area moves the selected area (between the line A and line B) to the horizontal direction. Selecting and dragging the line A or B changes the width of the selected area. The selected area is not changed when the graph is enlarged/reduced. Click the [Cursor display] button again to cancel the selected area.</p>
(c) Inter-cursor display	<p>This button is enabled by clicking a "cursor display" button and selecting the area. Clicking it enlarges the selected area in the direction of the horizontal axis to the size of the entire waveform window. The selected area cannot be changed in the direction of the vertical axis. The coordinate values of the horizontal axis are displayed as the coordinate values after the area has been enlarged.</p>
(d) Autoscale	<p>Clicking this restores graphs to the initial state.</p>
(e) Expand/Reduce vertical scale	<p>Clicking this enlarges the selected waveform to twice or reduces to half in the direction of the vertical axis. The coordinate values of the vertical axis become twice/half of the original ones. Rotating the mouse wheel back/forward while pressing the "Ctrl" key enlarges the selected waveform to 1.25 times or reduces the selected waveform to 0.8 times.</p>
(f) Expand/Reduce time scale	<p>Clicking this enlarges the waveform to twice or reduces to half in the direction of the horizontal axis. The coordinate values of the horizontal axis become twice/half of the previous ones. When the area in the direction of the horizontal axis becomes full of waveform display, the horizontal axis zoom out button cannot be operated. Rotating the mouse wheel back/forward while pressing the "Shift" key enlarges the whole waveform to 1.25 times or reduces the selected waveform to 0.8 times.</p>
(g) Display the overshoot information	<p>Overshoot of position droop waveform and its time of occurrence can be displayed. Display only when the position droop and the speed command are measured.</p>
(h) Display the load inertia information	<p>Load inertia of up to 4 NC axes or PLC axes (linear axes) can be displayed at a time. Display only when the speed FB (mm/min, r/min) and the current command or the current FB are measured.</p>
(i) Time axis offset	<p>This button is displayed only in the waveform comparison window. Specify the movement amount of the comparison data of the time axis. The movement amount can be specified up to half the measurement time. For details, refer to "3.10.5 Time Axis Offset".</p>
(j) Set FFT range	<p>Clicking the "Set FFT range" button displays the area to convert to FFT waveform. "A" is displayed to the left of the selected area and "B" to the right.</p>  <p>Moving the line A and line B changes the range to convert. Click [Set FFT range] again to cancel the selected area.</p>
(k) FFT display	<p>This button is enabled by clicking a "Set FFT range" button and selecting the area. Clicking this converts data in the selected area and displays the FFT Waveform. For the FFT waveform, refer to "3.8.2.1 FFT Waveform".</p>

3. HOW TO USE

Display item	Description
(l) Set waveform color and plot	Sets the waveform color, display of the plot of the sampling points, and the grid color. Refer to "3.10.1 Set Waveform Color and Plot" for details.
(m) Data transformation	Calculates the measuring data. Refer to "3.10.2 Data transformation" for details.
(n) Coordinate setting	Sets the coordinate data. Refer to "3.10.3 Coordinate Setting" – "3.10.3.1 Time-series Waveform" for details.
(o) Help	Refer to "3.8.1 Frequency Response Waveform" – "(3) Button area" – "(l) Help" for details.
(5) Text area	Displays the all measured waveform information. Clicking the waveform information in the text area selects the waveform.
Pretrigger (T1)	When reading sampling data which has pre-trigger time set with "Read NCSAMP file (Online), the pre-trigger time is displayed. The horizontal axis of pre-trigger time displays negative values. The pre-trigger time of the selected waveform is displayed.
Delay (T2)	When reading sampling data which has delay time set with "Read NCSAMP file (Online), the delay time is displayed. The delay time of the selected waveform is displayed.
Pitch (*1)	Displays the thread pitch.
P-P (*1)	Displays the value obtained by subtracting the value of "Min" value from the value of "Max" for the entire waveform processed with "Synchronous tap error" method.
S1_S2 (*2)	Displays the axis name. The axis name specified for measurement axis in the measurement axis selection screen for S1 and S2.
Syn Er r(*2)	Displays the value obtained by subtracting the value of "Min" value from the value of "Max" for the entire waveform processed with "Difference (-)" method.
ValA (*3)	Displays the coordinate values of line A on the vertical axis.
ValB (*3)	Displays the coordinate values of line B on the vertical axis.
B-A (*3)	Displays the time between line A and line B.
1/(B-A) (*3)	Displays the frequency between line A and line B.
No.n processing system n: Waveform number	Displays the waveform number and processing system. Number and the processing system displayed in [Data transformation] dialog are displayed. (Note) When "Non-processing" or "Amount of folding" is selected for processing system, the name of Data1 is displayed.
Data1 Data2 Data3	Acquires data from Data1, Data2, and Data3 in the [Data transformation] dialog. (Note) Data of Data2 and Data3 cannot be edit depending on the processing system selected in [Data transformation] dialog. In that case, Data2 and Data3 are not displayed.
Max	Displays the maximum values within the displayed range of all waveform. Clicking [Inter-cursor display] or [Set FFT range] displays the maximum value of the waveform in the selected area.
Min	Displays the minimum values within the displayed range of all waveform. Clicking [Inter-cursor display] or [Set FFT range] displays the minimum value of the waveform in the selected area.
P-P (*3)	Displays the maximum value – minimum value in the selected area.
Ave (*3)	The average value of all the points of the waveform within the selected area is displayed. When the processing system is "Current command", "Current FB" or "Load meter", the value is always displayed.
RMS (*3)	The root-mean-square value of all the points of the waveform within the selected area is displayed. When the processing system is "Current command", "Current FB" or "Load meter", the value is always displayed.
In increments of Div [Unit]/div	Increments of div and the unit of waveform. When the measurement is performed to the axis without amplifier connected, "Error" is displayed in the unit.
(6) Name of waveform	Displays the waveform name displayed in the graph. Selecting the waveform draws a box around the name of the waveform in the same color as that of the waveform. The waveform name differs depending on the items set in [Processing system] in the [Data transformation] dialog. (a) When "Non-processing" is selected (i) Axis related data No.x \$s-m Name (x: Waveform number, \$s: System number, m: Axis name) (ii) PLC device information PLC(bit)/PLC(1word)/PLC(2word) "Device name" "Address" (b) When other than "Non-processing" is selected No.x \$n-m Name (x: Waveform number, \$s: System number, m: Axis name) The minimum value of each grid + [Unit]/div Checking "Display waveform name in the graph" in "Tools" - "Options" - "Detailed information of the graph" displays the waveform number and the waveform name in the graph.
(7) Note area	Refer to "3.8.1 Frequency Response Waveform" – "(5) Note area" for details.

(*1) Displayed when "Synch tap error measurement" is performed.
 (*2) Displayed when "Spindle synchronization measurement" is performed.
 (*3) Displayed when "Inter-cursor display" or "Set FFT range" is selected.

3. HOW TO USE

3.8.2.1 FFT Waveform

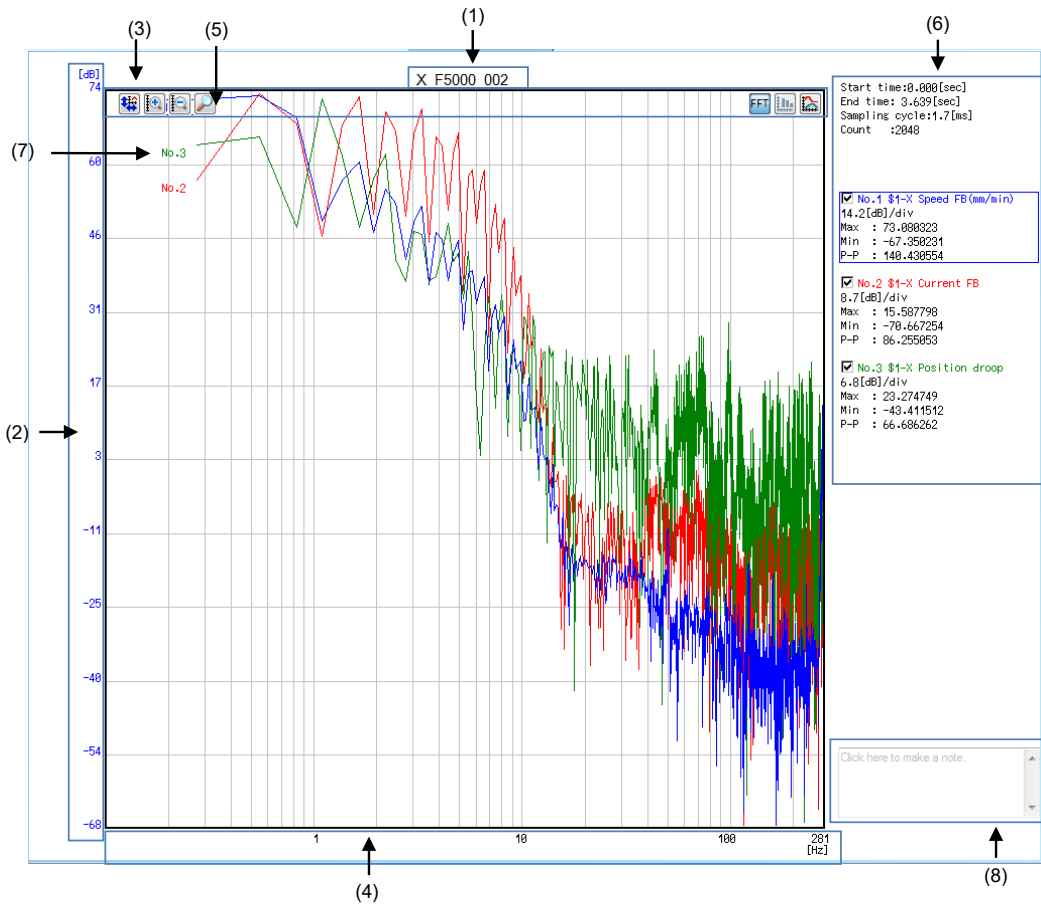

3. HOW TO USE

Display item	Function
(1) Title of graph	Displayed as the time-series waveform name before conversion.
(2) Vertical axis coordinate	Displays the coordinate values of the vertical axis. The unit is "dB" or "Amp.". Select it on the optional detailed information screen of the graph or on the axis setting screen. When multiple waveforms are displayed, the coordinate values of the selected waveform are displayed. The coordinate values and the units are displayed in the same color as that of the selected waveform. For the coordinate value, when the integer part of the value of each div is 2 digits, the decimal part is not displayed. When the integer part of the value is 1 digit, 1 decimal place is displayed.
(3) Display unit	Displays display unit of the selected vertical axis. "(FFT dB)" is displayed when "dB" is selected, and "FFT Amp." is displayed when "Amplitude" is selected.
(4) Horizontal axis coordinate	Displays the coordinate values of the horizontal axis. The unit is Hz. Select scale settings on the optional detailed information screen of the graph or on the axis setting screen. When multiple waveforms are displayed, the same coordinate values regardless of the selected waveforms are displayed.
(5) Button area	The buttons are displayed which can be used for the waveform displayed in the graph area.
(a) Autoscale	Clicking this restores graphs to the initial state.
(b) Expand/Reduce vertical scale	Clicking this enlarges the selected waveform to twice or reduces to half in the direction of the vertical axis. The coordinate values of the vertical axis become twice/half of the original ones. Rotating the mouse wheel back/forward while pressing the "Ctrl" key enlarges the selected waveform to 1.25 times or reduces the selected waveform to 0.8 times.
(c) Plot coordinates display	Clicking the graph area displays the vertical line on the clicked X coordinate position. The coordinate values of the intersection of the vertical line and waveform are displayed in the text area. The plot points (intersections) with coordinates displayed can be moved with the arrows of the keyboard. ←: The intersection is moved in the direction of smaller frequency by one scale unit each. →: The intersection is moved in the direction of larger frequency by one scale unit each. ↑: The intersection is moved in the direction of larger frequency by ten scale unit each. ↓: The intersection is moved in the direction of smaller frequency by ten scale unit each.
(d) Set FFT range	Clicking this button returns to a time-series waveform display.
(e) FFT display	This is available only for the time-series waveform chart. It becomes disabled to operate during an FFT waveform display.
(f) Data transformation	Refer to "3.10.2 Data Transformation".
(g) Coordinate Setting	Refer to "3.10.3.2 FFT Waveform".
(6) Text area	Displays information of FFT waveform. When waveform information in the text area is clicked, the waveform is selected.
Start time	Displays the time of Edge A in the area selected in the start time-series waveform.
End time	Displays the time of Edge B in the area selected in the end time-series waveform.
Sampling cycle	Displays the sampling cycle of time-series waveform.
Number of points	Displays the number of points for drawing in the time-series waveform.
No.1 Processing system	Refer to "3.8.2 Time-series Waveform" – "(5) Text area".
Data 1: Axis No. Waveform type	
Data 2: Axis No. Waveform type	
Data 3: Axis No. Waveform type	
Scale [Unit]/div	
X (*1)	Displays the horizontal coordinate values of the intersection of the line and the waveform when "Plot coordinates display" is used. (Note 1)
Y (*1)	Displays the vertical coordinate values of the intersection of the line and the waveform when "Plot coordinates display" is used. (Note 1)
Max	Displays the maximum value of the entire waveform area.
Min	Displays the minimum value of the entire waveform area.
P-P	Displays the value obtained by subtracting the "Min" value from the "Max" value in the entire waveform area.
(7) Waveform name	Only "No.n" is displayed. (n: number (1 to 32)) The waveform name is displayed in the same color as that of the waveform.
(8) Note area	Refer to "3.8.1 Frequency Response Waveform" – "(5) Note area".

(*1) Displayed when "Plot coordinates display" is used.

(Note 1) When data with a different sampling cycle is displayed and when there is no data at the cursor position, the previous and following values are used to display an estimated value.

Estimated values are displayed with "*" before the values.

3. HOW TO USE

3.8.3 Roundness Waveform

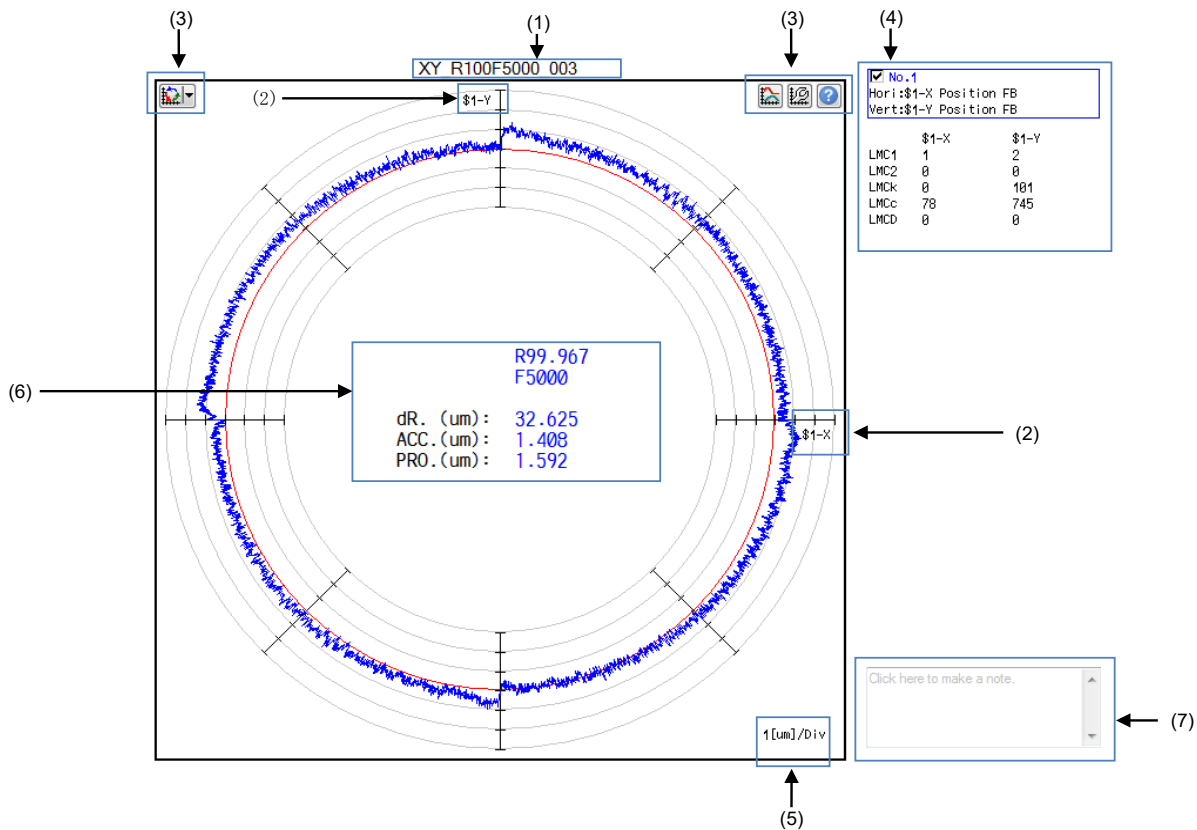

Display item	Description						
(1) Title of graph	Displays the name of measurement.						
(2) Axis name	Displays in the format of the axis display name. Vertical axis and horizontal axis are displayed.						
(3) Button area	Displays the buttons that can be used for the waveform displayed in the graph area.						
(a) Graph mode conversion	Switches the waveform type to be displayed in the following order. Time-series waveform -> Roundness waveform -> Torque characteristics -> Time-series waveform (circulation) The pull-down menu is as shown below: <table border="1" style="margin-left: 20px;"> <tr><td></td><td>Time-series waveform</td></tr> <tr><td>*</td><td>Roundness waveform</td></tr> <tr><td></td><td>Torque characteristics</td></tr> </table> The initial setting is roundness waveform.		Time-series waveform	*	Roundness waveform		Torque characteristics
	Time-series waveform						
*	Roundness waveform						
	Torque characteristics						
(b) Arbitrary graph setting	Displays the data to be used for the waveform. Refer to "3.10.4 Arbitrary graph setting" for details.						
(c) Coordinate setting	Displays the coordinate data. Refer to "3.10.3 Coordinate Setting" – "3.10.3.3 Roundness Waveform" for details.						
(d) Help	Refer to "3.8.1 Frequency Response Waveform" – "(3) Button area" – "(l) Help" for details. (Note) The help file for roundness measurement and lost motion adjustment is displayed.						
(4) Text area	Displays the waveform names of horizontal axis and vertical axis, and the axis results of the adjustment for each axis number. Displays each values of the horizontal axis on the left side and those of the vertical axis on the right side for sampling conditions and adjustment results.						
No.n	Displays the waveform No.						
Hori:	Displays the waveform name (horizontal axis).						
Vert:	Displays the waveform name (vertical axis).						
	Axis name (Sampling conditions and adjustment results are displayed below.)						
LMC1 (*1)	Displays lost motion 1.						
LMC2 (*1)	Displays lost motion 2.						
LMCk (*1)	Displays lost motion 3 spring constant.						
LMCc (*1)	Displays lost motion 3 Coefficient of viscosity.						
LMCD (*1)	Displays lost motion time.						
VDCa (*2)	Displays variable full-closed torsion compensation acceleration.						
VDCtex (*2)	Displays variable full-closed torsion compensation: compensation time constant.						
VDCpex (*2)	Displays variable full-closed torsion compensation: compensation value (+).						
VDCnex (*2)	Displays variable full-closed torsion compensation: compensation value (-).						
VDCkex (*2)	Displays variable full-closed torsion compensation: spring constant.						
VDCcex (*2)	Displays variable full-closed torsion compensation: viscosity coefficient.						

3. HOW TO USE

Display item	Description
VDCFm (*2)	Displays variable full-closed torsion compensation: motor-end frictional force.
VDCA (*2)	Displays variable full-closed torsion compensation: proportionality constant.
(5) Scale	Display value of each scale. Display data (space) [Unit]/Div.
(6) Error display area	Displays arc radius, feedrate, and the error amount. Data is displayed in the same color as that of the waveform. < When measuring the roundness > For R and F, the values of "Arc radius (mm)" and "Feedrate (mm/min)" set in the measurement axis selection screen. < When adjusting the lost motion > For R and F, the values of "Arc radius (mm)" and the "Low speed (mm/min)" set on the adjustment wizard are displayed in the left column as well as the values of "Arc radius (mm)" and the "High speed (mm/min)" are displayed in the right column.
R	Displays the radius of the arc. The displayed value differs depending on enable/disable of "correct measured value of radius" in the axis setting dialog. Refer to "3.10.3 Coordinate Setting" – "3.10.3.3 Roundness Waveform" for "correct measured value of radius".
F	Displays the feedrate.
dR. (um):	Displays the difference between the command radius and the measured radius value.
ACC.(um):	Displays the error amount P-P value other than around the quadrants.
PR0.(um):	Displays the lost motion error amount P-P value around the quadrants.
(7) Note area	Refer to "3.8.1 Frequency Response Waveform" – "(5) Note area.

(*1) Displayed when lost motion adjustment or roundness measurement is performed.

(*2) Displayed when variable full-closed torsion compensation is performed.

3. HOW TO USE

3.8.4 Arbitrary Program Waveform

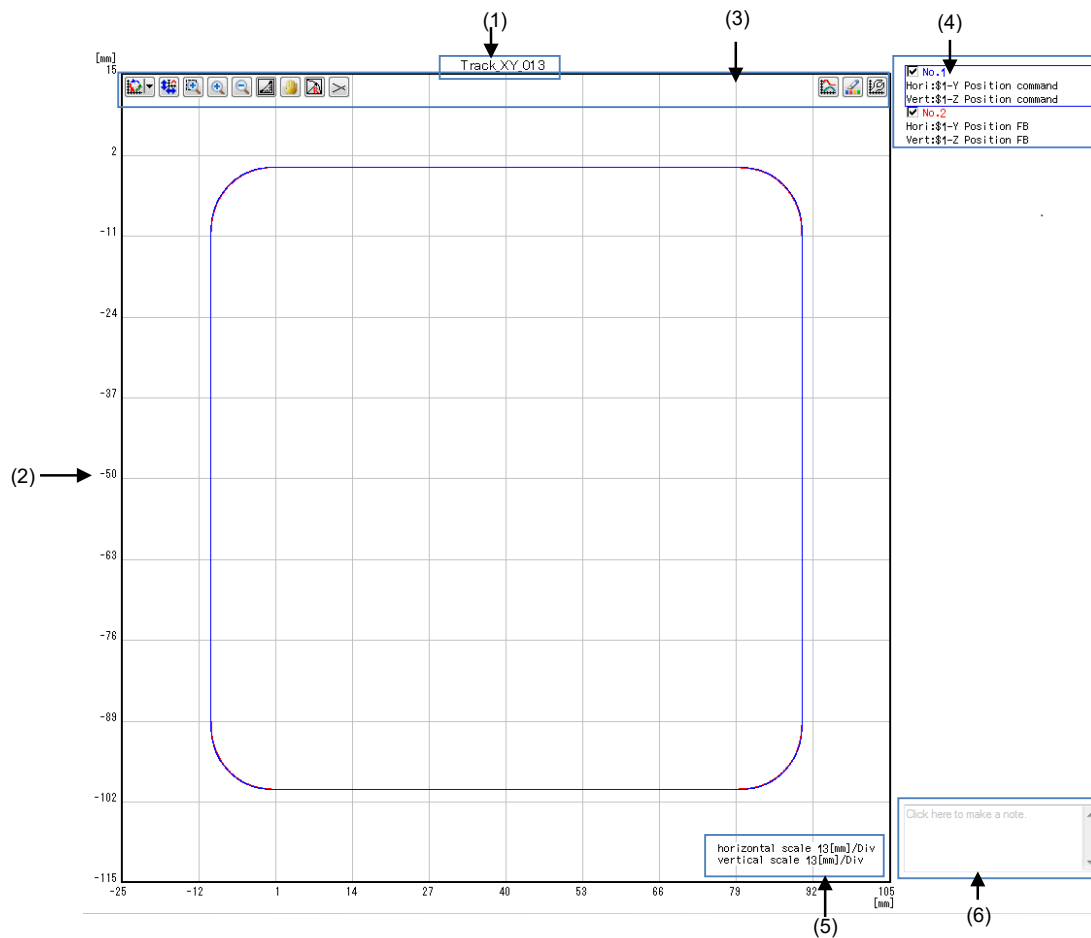

Display item	Description					
(1) Title of graph	Displays the name of measurement.					
(2) Coordinate	Displays the coordinate value of the horizontal axis and the vertical axis. Units differ depending on the waveform to display. The decimal part is displayed in 3 digits.					
(3) Button area	Displays the buttons that can be used for the waveform displayed in the graph area.					
(a) Graph mode conversion	<p>Switches the waveform type to be displayed in the following order. Time-series waveform -> Arbitrary locus waveform (Arbitrary program waveform) -> Arbitrary shape error waveform -> Arbitrary locus waveform (3D) (Arbitrary program waveform (3D)) -> Torque characteristics -> Time-series waveform (circulation)</p> <p>The pull-down menu is as shown below:</p> <table border="1" style="margin-left: 20px;"> <tr><td>Time-series waveform</td></tr> <tr><td>* Arbitrary locus waveform</td></tr> <tr><td>Arbitrary shape error waveform</td></tr> <tr><td>Arbitrary locus waveform (3D)</td></tr> <tr><td>Torque characteristics</td></tr> </table> <p>The initial setting is arbitrary locus waveform. [Arbitrary shape error waveform] Regarding the measurement results of the arbitrary path measurement, shape error in comparison with waveform may not be clear. The arbitrary shape error magnification function allows you to confirm shape error in comparison with the reference waveform by specifying waveform for which you want to magnify an error. [Arbitrary locus waveform (3D)] The measurement results of the arbitrary program measurement are displayed in 2D or 3D. For details, refer to "3.8.5 Arbitrary Program Waveform (3D)".</p>	Time-series waveform	* Arbitrary locus waveform	Arbitrary shape error waveform	Arbitrary locus waveform (3D)	Torque characteristics
Time-series waveform						
* Arbitrary locus waveform						
Arbitrary shape error waveform						
Arbitrary locus waveform (3D)						
Torque characteristics						
(b) Autoscale	Clicking this restores graphs to the initial state.					
(c) Enlarge the selected range	A cursor display will be a form of a cross if the [Enlarge the selected range] button is clicked. Drag the mouse in this state and select the area. The selected area is expanded up to all drawing area sizes.					
(d) Expansion	Enlarges all the waveforms to 1.25 times in the vertical and horizontal axis directions. Rotating the mouse wheel back while pressing the "Ctrl" key also enlarges all the waveforms to 1.25 times in the vertical and horizontal axis directions.					

3. HOW TO USE

Display item	Description
(e) Shrink	Reduces all the waveforms to 0.8 times in the vertical and horizontal axis directions. Rotating the mouse wheel forward while pressing the "Ctrl" key also reduces all the waveforms to 0.8 times in the vertical and horizontal axis directions.
(f) Measure distance	A cursor display will be a form of a cross if the [Measure distance] button is clicked. If two points on the waveform are clicked while the cursor is a cross, a straight line connecting the two points is displayed. The measurement result is displayed in the text area. <ul style="list-style-type: none"> · Pressing "Ctrl" + "↑/↓" switches the focus selection set between the first and second points. · The selected point can be moved using the arrow key on the keyboard. ↑ : Moves the focused point by 10 scale unit at a time. → : Moves the focused point by 1 scale unit at a time. ↓ : Moves the focused point by 10 scale unit at a time. ← : Moves the focused point by 1 scale unit at a time.
(g) Move	Dragging moves the waveform in the direction it was dragged to any position without changing the horizontal to vertical ratio. Dragging the waveform while pressing the "Shift" key also moves the waveform. The waveform is moved to the position where the left mouse button or the "Shift" key is released. The destination of the waveform is displayed by dashed lines during dragging.
(h) Measure circular radius	Convert the path of the dragged range into an arc and display its radius in the text area.
(i) Draw an additional line	Click the start and end points to draw an auxiliary line. The auxiliary line intersection is used for distance measurement. The auxiliary line can be moved by dragging, or be deleted by the Delete key.
(j) Arbitrary graph setting	Set data to be used for the waveform. Refer to "3.10.4 Arbitrary graph setting" for details.
(k) Set waveform color and plot	Set the waveform color, the sampling plot display, and the grid color. Refer to "3.10.1 Set Waveform Color and Plot" for details.
(l) Coordinate setting	Set the coordinate setting. Refer to "3.10.3 Coordinate Setting" – "3.10.3.4 Arbitrary Program Waveform" for details.
(4) Text area	Displays the all measured waveform information. The size of the display area is automatically adjusted depending on the displayed content.
No.n N: number (1 to 16)	Displays the title of the waveform n. The title which is fixed as "No.n" is displayed in the same color as that of the waveform. When "Arbitrary shape error waveform" is selected in graph mode conversion, "Base waveform" is added for No.1 and "Shape error waveform" is added for No.n (n=2 to 16).
Horizontal axis: \$s-m Waveform Type Vertical axis: \$s-p Waveform Type \$s: Part system number M: Horizontal axis name P: Vertical axis name	Displays the name of the waveform of the horizontal axis/vertical axis.
Point1 (*1)	Displays the coordinate point 1.
Point2 (*1)	Displays the coordinate point 2.
H (P2-P1) (*1)	Displays the distance between both points in the direction of the horizontal axis. $H(P2-P1) = H2-H1 $
V (P2-P1) (*1)	Displays the distance between both points in the direction of the vertical axis. $V(P2-P1) = V2-V1 $
Dist (P2-P1) (*1)	Displays the distance between both points. $Dist (P2-P1) = \text{SQRT} ((H2-H1)^2 + (V2-V1)^2)$ (Note 1) (Note 1) SQRT is a square root.
Radius (*2)	Displays the arc radius when you specify the area on the graph.
(5) Scale	Display the scale of horizontal and vertical axes ([Unit]/Div).
(6) Note area	Refer to "3.8.1 Frequency Response Waveform" – "(5) Note area" for details.

(*1) Displayed when "Measure distance" is selected.

(*2) Displayed when "Measure circular radius" is selected.

3. HOW TO USE

3.8.5 Arbitrary Program Waveform (3D)

Arbitrary program waveform (3D) (arbitrary path waveform (3D)) displays measurement results of arbitrary program measurement in 2D (XY/YZ/ZX) or in 3D (XYZ). Only the waveforms whose types are position command or position FB are displayed. If there is no corresponding data, the waveform and the text area are displayed as blank. In the "Analysis settings panel", the analysis type can be switched and the display range can be designated. For details, refer to "3.9.1 Analysis Settings Panel".

■ Arbitrary path waveform (3D) - [XY/YZ/ZX]

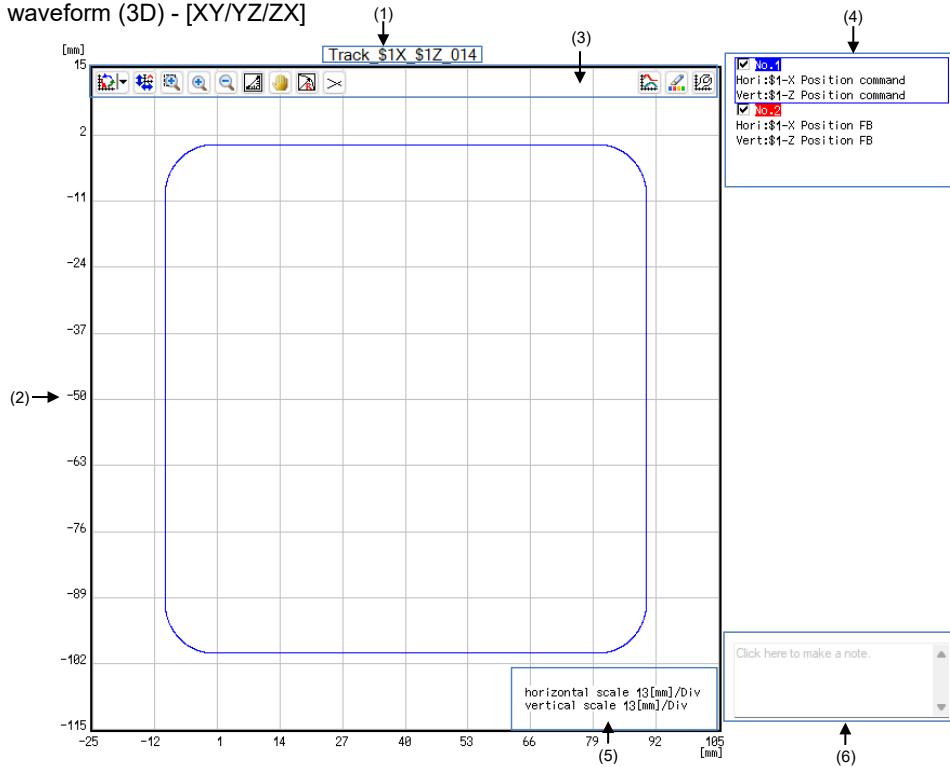

■ Arbitrary path waveform (3D) - [XYZ]

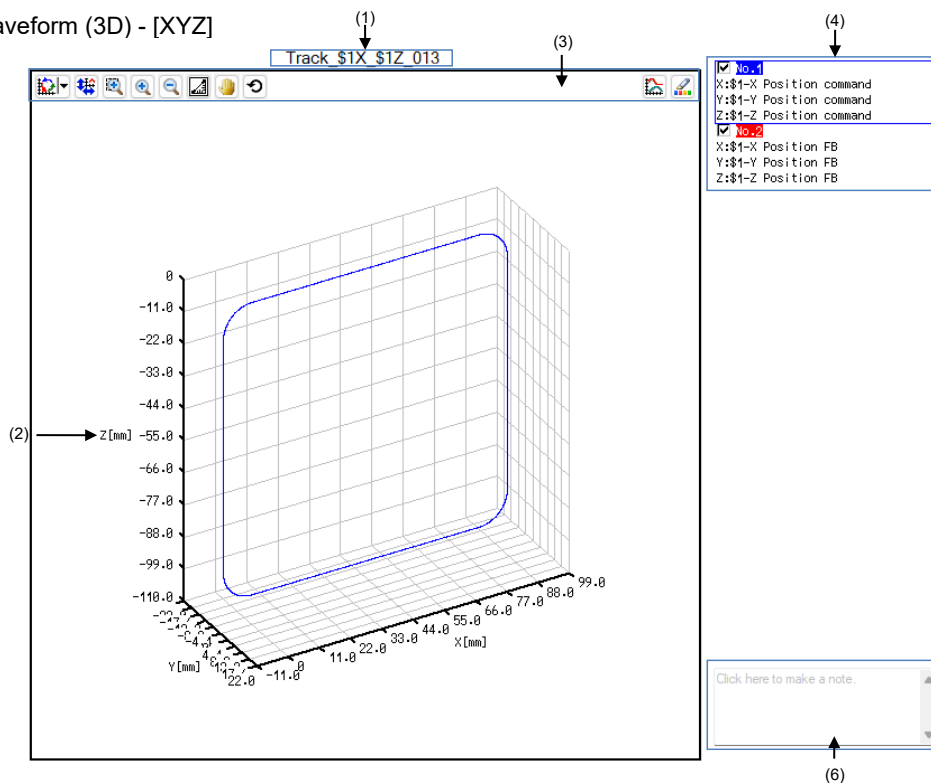

3. HOW TO USE

■ Arbitrary path waveform (3D) - [FeedMap/AccMap/JerkMap]

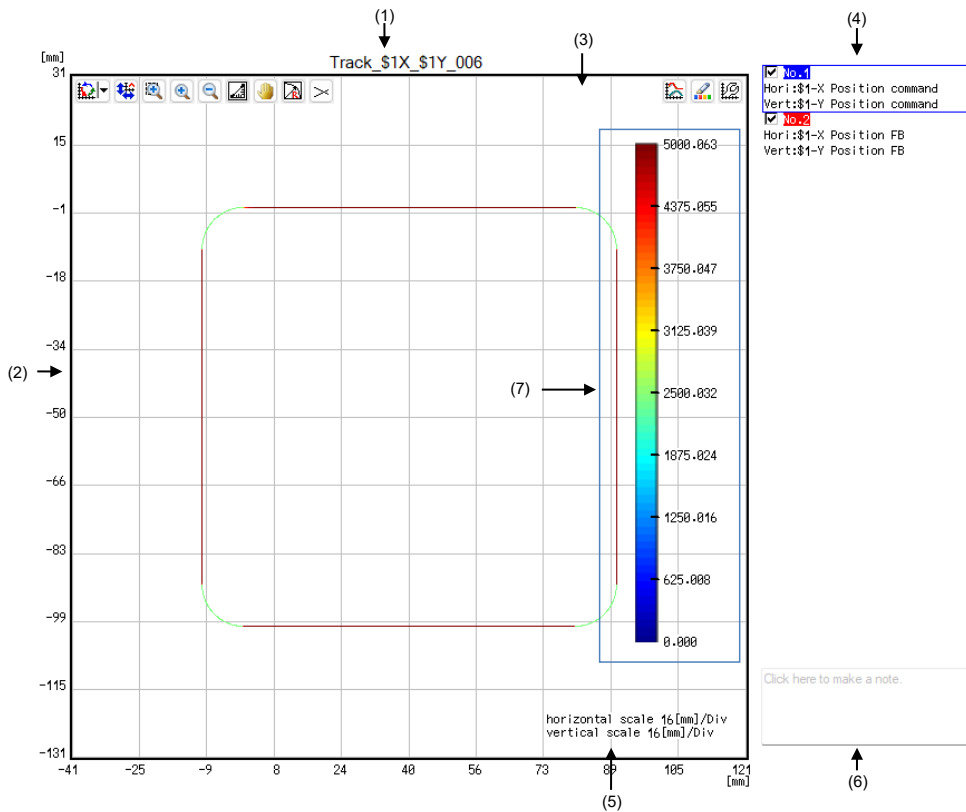

Display item	Description
(1) Title of graph	Displays the name of measurement.
(2) Coordinate	Displays the coordinate value of the horizontal axis and the vertical axis, or the X, Y, and Z axes. Units differ depending on the waveform to display. The decimal part is displayed in 3 digits. (Note) X, Y, and Z displayed on waveforms are fixed. They are not displayed as axis names of an NC.
(3) Button area	Displays the buttons that can be used for the waveform displayed in the graph area.
(a) Graph mode conversion	Switches the waveform type to be displayed. Arbitrary program waveform (3D) (arbitrary path waveform (3D)) can be switched from arbitrary program waveform.
(b) Autoscale	Clicking this restores graphs to the initial state.
(c) Enlarge the selected range	Refer to "3.8.4 Arbitrary Program Waveform" - "(c) Enlarge the selected range" for details.
(d) Expansion	Enlarges all the waveforms by 1.25 times in the vertical/horizontal axis or the X, Y, and Z axes directions. Rotating the mouse wheel back while pressing the "Ctrl" key also enlarges all the waveforms to 1.25 times.
(e) Shrink	Reduces all the waveforms to 0.8 times in the vertical/horizontal axis or the X, Y, and Z axes directions. Rotating the mouse wheel forward while pressing the "Ctrl" key also reduces all the waveforms to 0.8 times.
(f) Measure distance	Refer to "3.8.4 Arbitrary Program Waveform" - "(f) Measure distance" for details.
(g) Move	Refer to "3.8.4 Arbitrary Program Waveform" - "(g) Move" for details.
(h) Measure circular radius (*1)	Refer to "3.8.4 Arbitrary Program Waveform" - "(h) Measure circular radius" for details.
(i) Draw an additional line (*1)	Refer to "3.8.4 Arbitrary Program Waveform" - "(i) Draw an additional line" for details.
(j) Rotate	Dragging on the graph area or pressing the arrow keys (↑, ↓, ←, →) on the keyboard rotates the whole waveform.
(k) Arbitrary graph setting	Set data to be used for the waveform. Refer to "3.10.4 Arbitrary graph setting" for details.
(l) Set waveform color and plot	Set the waveform color, the sampling plot display, and the grid color. Refer to "3.10.1 Set Waveform Color and Plot" for details.
(m) Coordinate setting (*1)	Set the coordinate setting. Refer to "3.10.3 Coordinate Setting" - "3.10.3.4 Arbitrary Program Waveform" for details.
(4) Text area	Displays the all measured waveform information. The size of the display area is automatically adjusted depending on the displayed content.
No.n N: number (1 to 16)	Displays the title of the waveform n. The title which is fixed as "No.n" is displayed in the same color as that of the waveform.

3. HOW TO USE

Display item	Description
Horizontal axis: \$s-m Waveform Type Vertical axis: \$s-p Waveform Type \$: Part system number m: Horizontal axis name p: Vertical axis name	Displays the name of the waveform of the horizontal axis/vertical axis. Note that the names of the waveforms on the X, Y, and Z axes are displayed in 3D display (XYZ). X: \$s-m Waveform type Y: \$s-p Waveform type Z: \$s-q Waveform type m: Name of the X axis p: Name of the Y axis q: Z Name of the Z axis
Point1 (*3)	Displays the coordinate point 1. (*2)
Point2 (*3)	Displays the coordinate point 2. (*2)
X (P2-P1) (*3)	Displays the distance between both points in the direction of the X axis or the horizontal axis. $X(P2-P1)= X2-X1 $ For the 2D display (XY/YZ/ZX), "H(P2-P1)" is displayed.
Y (P2-P1) (*3)	Displays the distance between both points in the direction of the Y axis or the vertical axis. $Y(P2-P1)= Y2-Y1 $ For the 2D display (XY/YZ/ZX), "V(P2-P1)" is displayed.
Z (P2-P1) (*3)	Displays the distance between both points in the direction of the Z axis. $Z(P2-P1)= Z2-Z1 $ This is displayed only for 3D display [XYZ].
Dist (P2-P1) (*3)	Displays the distance between both points. - For the 2D display (XY/YZ/ZX) $Dist(P2-P1)=SQRT((H2-H1)^2+(V2-V1)^2)$ (Note 1) - For the 3D display (XYZ) $Dist(P2-P1)=SQRT((X2-X1)^2+(Y2-Y1)^2+(Z2-Z1)^2)$ (Note 1) (Note 1) SQRT is a square root.
Radius (*4)	Displays the arc radius when you specify the area on the graph.
(5) Scale	Display the scale of horizontal and vertical axes ([Unit]/Div).
(6) Note area	Refer to "3.8.1 Frequency Response Waveform" - "(5) Note area" for details.
(7) Color bar	Displays values corresponding to the waveform colors in a color map as a bar. This is displayed when analysis type is changed to [FeedMap/AccMap/JerkMap] in "Analysis settings panel".

(*1) This is not displayed for 3D display (XYZ).

(*2) The following coordinates are displayed.

- Arbitrary path waveform (3D)[XY] : XY coordinates
- Arbitrary path waveform (3D)[YZ] : YZ coordinates
- Arbitrary path waveform (3D)[ZX] : ZX coordinates
- Arbitrary path waveform (3D)[XYZ] : XYZ coordinates

(*3) This is displayed when "Measure distance" is selected.

(*4) This is displayed when "Measure circular radius" is selected.

3. HOW TO USE

3.8.5.1 Selected Point Information Display

Left-clicking a plot point on a waveform with a mouse shows the selected point and arrows to the 2 points before and after the selected point. In addition, the "coordinate values of the selected point" and the "3D distance between the selected point and the previous/next point" are displayed in the text area. Selected point information display is enabled when the graph mode of arbitrary program waveform is switched to "Arbitrary path waveform (3D)".

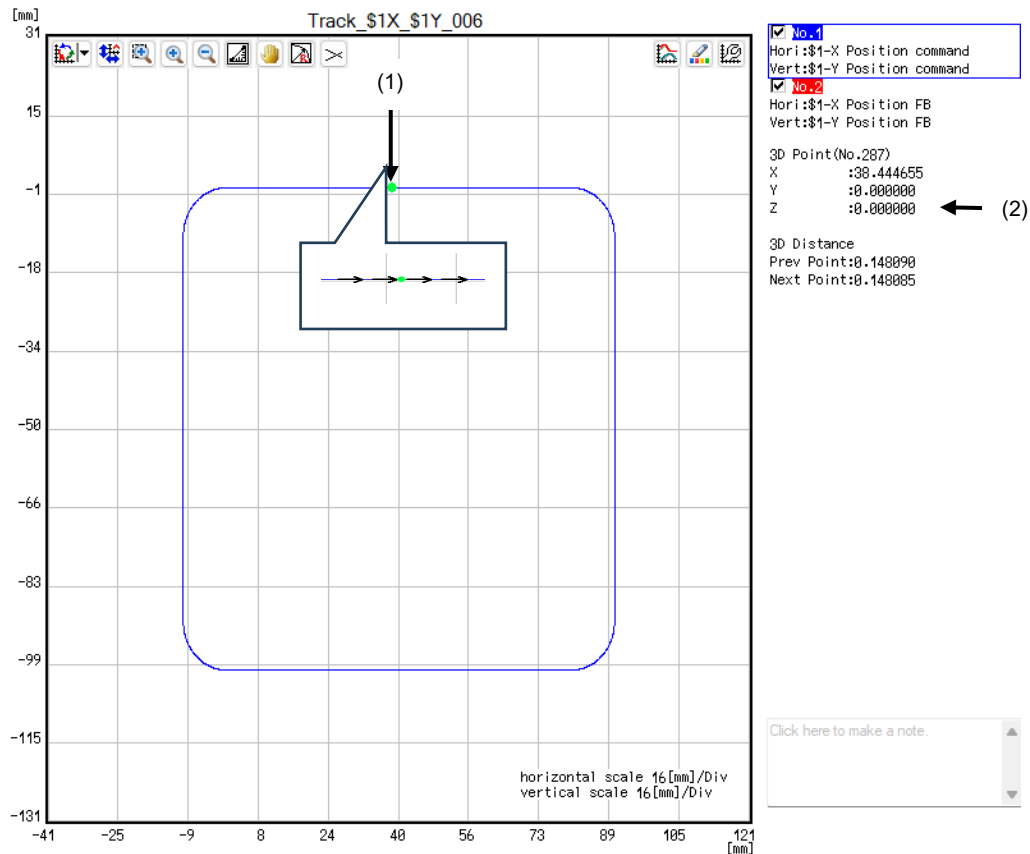

Display item	Description
(1) Selected point	Left-clicking a plot point on the displayed waveform turns the selected point "green". Black arrows indicating the moving direction between the 2 points before and after the selected point are displayed. The following operations unselect the selected point. - Clicking anywhere other than the plot point on the graph area - Unchecking the checkbox next to the waveform number in the text area to hide waveforms
(2) Selected point location information	Displays the coordinate data of the selected point and the 3D distance between the selected point and the previous/next point.
3D coordinate values (No. n) n: Plot number	The coordinate data of the selected point.
X: Y: Z:	Displays the XYZ coordinate values of the selected point.
3D distance	The 3D distance between the selected point and the previous/next point. $\text{SQRT}((X2-X1)^2+(Y2-Y1)^2+(Z2-Z1)^2)$ (*1) (*1) SQRT is a square root.
Previous coordinate:	Displays the 3D distance between the selected point and the previous point.
Next coordinate:	Displays the 3D distance between the selected point and the next point.

(Note) When performing the following operations, plot points cannot be selected, or the selected point cannot be deselected.
- Selecting any of the following buttons in the graph area
 [Enlarge the selected range], [Measure distance], [Translate], [Measure circular radius], [Draw an additional line], or [Rotate]

3. HOW TO USE

3.8.6 Torque Characteristics

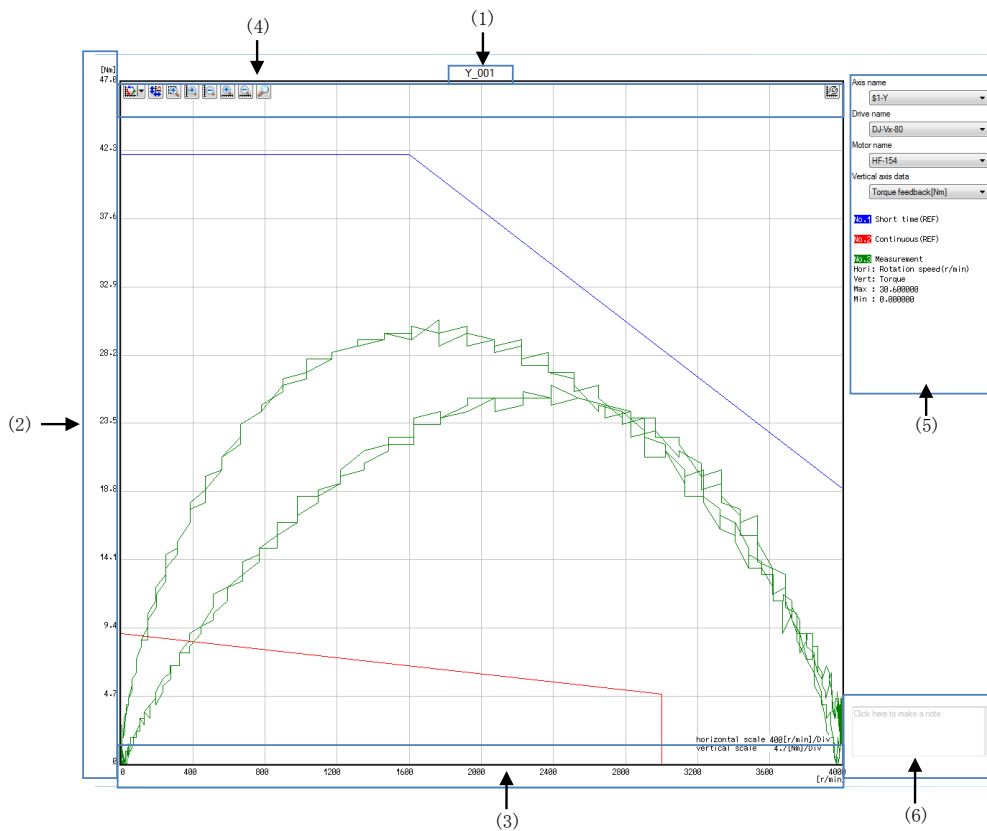

Display item	Function				
(1) Title of graph	Displays the waveform name before conversion.				
(2) Vertical axis coordinate	Displays the coordinate values of the vertical axis. Data obtained by converting the sampled current into torque is displayed. The units of the vertical axis coordinate are displayed as the unit system selected in "Vertical axis data".				
(3) Horizontal axis coordinate	Displays the coordinate values of the horizontal axis. Sampled speed is displayed with unit [r/min].				
(4) Button area	The buttons are displayed which can be used for the waveform displayed in the graph area.				
(a) Graph mode conversion	Switches the type of waveform to be displayed. Time-series waveform, Roundness waveform, and arbitrary path measurement waveform can be switched to torque characteristics. A servo axis or PLC axis that is sampled for speed and current is necessary to convert to torque characteristics. Torque characteristics cannot be selected with spindle data only or without the necessary data. The necessary sampling data to convert torque characteristics is as follows. <table border="1" style="margin-left: auto; margin-right: auto;"> <thead> <tr> <th>Speed data</th> <th>Current data</th> </tr> </thead> <tbody> <tr> <td>Speed command or speed FB</td> <td>Current command or current FB</td> </tr> </tbody> </table> (Note 1) For data measured with version A4 or earlier, only [r/min] of speed data can be converted to torque characteristics.	Speed data	Current data	Speed command or speed FB	Current command or current FB
Speed data	Current data				
Speed command or speed FB	Current command or current FB				
(b) Autoscale	Clicking this restores graphs to the initial state.				
(c) Enlarge the selected range	A cursor will be a form of a cross if selecting the [Enlarge the selected range] button. Drag the mouse in this state and select the area. The selected area is expanded up to all drawing area sizes.				
(d) Expand/Reduce vertical scale	Selecting this enlarges the whole waveform to twice or reduces to half in the direction of the vertical axis. Rotating the mouse wheel back/forward while pressing the "Ctrl" key enlarges the selected waveform to 1.25 times or reduces the selected waveform to 0.8 times. The waveform cannot be reduced more than when autoscale is selected.				
(e) Expand/Reduce time scale	Selecting this enlarges the whole waveform to twice or reduces to half in the direction of the horizontal axis. Rotating the mouse wheel back/forward while pressing the "Shift" key enlarges the selected waveform to 1.25 times or reduces the selected waveform to 0.8 times. The waveform cannot be reduced more than when autoscale is selected.				

3. HOW TO USE

Display item	Function
(f) Plot coordinates display	Clicking the "Plot coordinates display" displays the vertical line. The coordinate values of the intersection of the vertical line and waveform are displayed in the text area. The plot points (intersections) which coordinates are displayed can be moved with the arrows of the keyboard. ←: The intersection is moved in the direction of smaller frequency by one plot unit each. →: The intersection is moved in the direction of larger frequency by one plot unit each. ↑: The intersection is moved in the direction of larger frequency by ten plot unit each. ↓: The intersection is moved in the direction of smaller frequency by ten plot unit each.
(g) Coordinate setting	Refer to "3.10.3 Coordinate Setting" – "3.10.3.5 Torque Characteristics".
(5) Text area	Displays information of the torque characteristics.
Axis name	Select the servo axes and PLC axes.
Drive name	Select the drive unit for the axis which was selected in "Axis name".
Motor name	Select the motor type. The motors that can be selected vary with the drive unit set in "Drive name". Linear servo motors and direct drive motors cannot be selected.
Vertical axis data	Click here to set the torque unit. By selecting torque FB [%], the stall torque is converted as 100%. By selecting torque FB [Nm], the measured current data is converted to [Nm] units.
Short time (REF)	The boundary value of short time operation area is displayed.
Continuous (REF)	The boundary value of continuous operation area is displayed.
Measurement	Displays graph information of the torque characteristics.
Horizontal axis	Displays "Rotation speed (r/min)".
Vertical axis	Displays "Torque".
X (*1)	Displays the coordinate of the horizontal axis.
Y (*1)	Displays the coordinate of the vertical axis.
Max	Displays the maximum value of torque.
Min	Displays the minimum value of torque.
(6) Note area	Refer to "3.8.1 Frequency Response Waveform" – "(5) Note area".

(*1) Displayed when "Plot coordinates display" is used.

3. HOW TO USE

3.9 Data Information

3.9.1 Analysis Settings Panel

Switching the graph mode of arbitrary program measurement results to "Arbitrary locus waveform (3D)" displays the Analysis settings panel. Switching between 2D and 3D display, and designating the analysis type and display range can be executed in this panel.

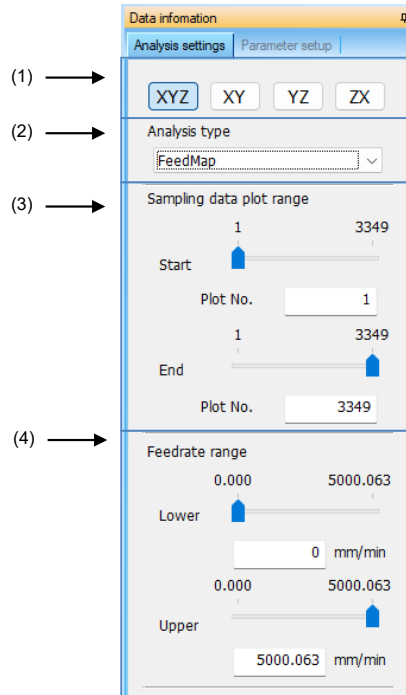

Display item	Description
(1) XYZ/XY/YZ/ZX	Switches waveforms to 3D display (XYZ) or 2D display (XY/YZ/ZX).
(2) Analysis type	Switches waveforms to Position/FeedMap/AccMap/JerkMap. FeedMap/AccMap/JerkMap displays values calculated from sampling data (position command, position FB) as a color map.
(3) Sampling data plot range	The graph display range can be refined in units of plot points of sampling data. This is displayed when using sampling data.
Start	Set the starting number of the plot point to be displayed in a graph by using the slider or by entering text.
End	Set the ending number of the plot point to be displayed in a graph by using the slider or by entering text.
(4) Feederate range/ Acc range/Jerk range	Set a display range of the color map. (*1)
Lower	Set the lower limit value of the color map by using the slider or by entering text. A value with up to three decimal places can be entered for the text.
Upper	Set the upper limit value of the color map by using the slider or by entering text. A value with up to three decimal places can be entered for the text.

(*1) The title and unit displays are switched depending on the setting in "Analysis type". Refer to the following for details.

Analysis type	Title	Display unit	
		mm	inch
FeedMap	Feederate range	mm/min	inch/min
AccMap	Acc range	m/s ²	inch/s ²
JerkMap	Jerk range	m/s ³	inch/s ³

3. HOW TO USE

3.9.2 Parameter Setup Panel

NC parameters related to the selected measurement results are displayed.

Data information	
Analysis settings	
Parameter setup	
Item	010
Acceleration	
#1206 G1bF	100000
#1207 G1btL	100
Acceleration	1.700
#1568 SfiltG1	0
#12070 Sfilt2_tol	
Tolerance control	
#12066 Tolerance control ON	
#12067 Tolerance spd coef	



High-accuracy spline	
#8025 SPLINE ON	Invalid
#8026 CANCEL ANG.	0
#8027 Toler-1	0.000
#8028 Toler-2	0.000
#8030 MINUTE LENG	0

3. HOW TO USE

3.10 Other Functions

3.10.1 Set Waveform Color and Plot

Set the waveform color, grid, plot color in "Set waveform color and plot".

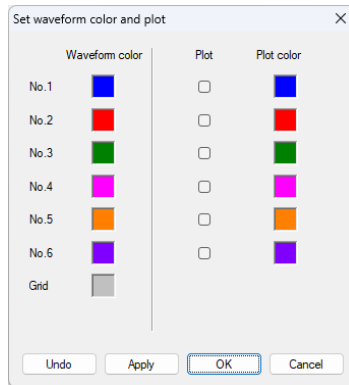

Display item	Description
Waveform color	Display the waveform color. Click No.1 to No.32 or grid color, and then designate the waveform color from the [color setting] dialog.
Plot	Set to show/hide the plot. When this is checked, the plot is displayed on the waveform. When this is unchecked, the plot is not displayed on the waveform.
Plot color	Display the plot color. Click the plot color from No.1 to No.32 and designate the plot color from the [color setting] dialog.
Undo	Change the settings of waveform color, grid, plot, and the plot color to the default.
Apply	Apply the waveform color, grid, plot, and the plot color settings.
OK	Apply the waveform color, grid, plot, and the plot color settings, and close the [waveform color and plot] dialog.
Cancel	Close the [waveform color and plot] dialog without applying the waveform color, grid, plot, and plot color settings.

3. HOW TO USE

3.10.2 Data Transformation

In data transformation, set each computation on sampling data. The computed waveforms are displayed on the graph area.

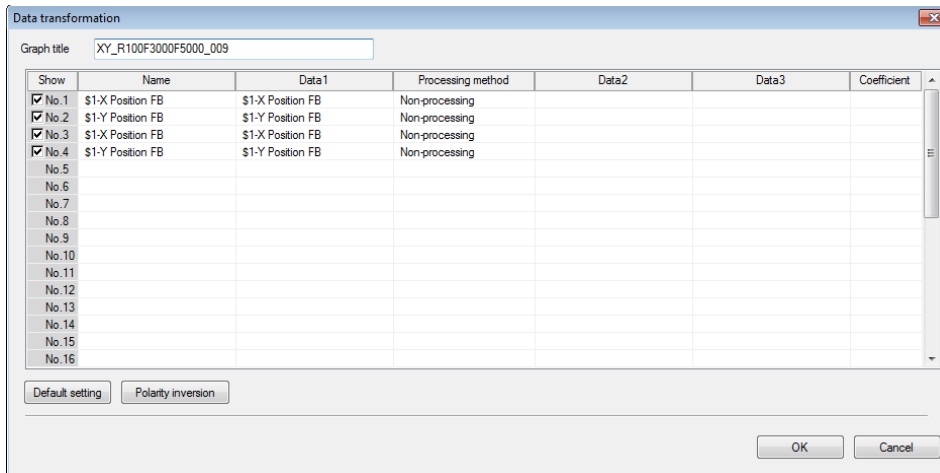

Display item	Description																																												
Graph title	Set the title of graphics. Up to 64 single-byte characters can be entered.																																												
Show	Select the waveform to display on the graph area. Closing the data transformation dialog after checking the checkbox and clicking the OK button displays the waveform on the graph area. Unchecking the checkbox hides the waveform. The waveform number which is fixed as "No. 1/2/3/.../32" is displayed.																																												
Name	Displays the waveform name.																																												
Data 1	Displays the name of sampled data. For waveform comparison, the waveforms of all channels included in the measurement data selected for comparison are displayed as "Waveform type + "(project name\measurement data name)".																																												
Processing method	Select the drawing processing method for Data 1. Refer to "List of selection items for [Processing method] for all data" for selectable "processing method". When "Data 1" is selected, the processing method is changed to "Non-processing".																																												
Data 2 Data 3	Select the content of Data 2 and Data 3 from the pull-down list. The items that can be selected from the pull-down list vary with the [Processing method] setting. <table border="1" style="width: 100%; border-collapse: collapse;"> <thead> <tr> <th>Processing method</th> <th>Data 2</th> <th>Data 3</th> <th>Selection items</th> </tr> </thead> <tbody> <tr> <td>Non-processing</td> <td style="text-align: center;">-</td> <td style="text-align: center;">-</td> <td style="text-align: center;">-</td> </tr> <tr> <td>Difference (-)</td> <td style="text-align: center;">○</td> <td style="text-align: center;">-</td> <td>Same item as the unit of Data 1</td> </tr> <tr> <td>Rate conversion</td> <td style="text-align: center;">-</td> <td style="text-align: center;">-</td> <td style="text-align: center;">-</td> </tr> <tr> <td>Acceleration rate conversion</td> <td style="text-align: center;">-</td> <td style="text-align: center;">-</td> <td style="text-align: center;">-</td> </tr> <tr> <td>Synthetic rate</td> <td style="text-align: center;">○</td> <td style="text-align: center;">○</td> <td>Position and speed of the NC axis</td> </tr> <tr> <td>Synthetic acceleration rate</td> <td style="text-align: center;">○</td> <td style="text-align: center;">○</td> <td>Position and speed of the NC axis</td> </tr> <tr> <td>Synchronous tap error</td> <td style="text-align: center;">○</td> <td style="text-align: center;">-</td> <td>Position command of the spindle/servo and position FB</td> </tr> <tr> <td>Amount of folding</td> <td style="text-align: center;">-</td> <td style="text-align: center;">-</td> <td style="text-align: center;">-</td> </tr> <tr> <td>bit0-bitF</td> <td style="text-align: center;">-</td> <td style="text-align: center;">-</td> <td style="text-align: center;">-</td> </tr> <tr> <td>Arbitrary data calculation</td> <td style="text-align: center;">○</td> <td style="text-align: center;">○</td> <td>Arbitrary sampling data Refer to "3.10.2.1 Arbitrary Data Calculation".</td> </tr> </tbody> </table> <p style="margin-left: 20px;">○: Editable, - : Not editable When the processing method is switched, Data 2 and Data 3 go blank.</p>	Processing method	Data 2	Data 3	Selection items	Non-processing	-	-	-	Difference (-)	○	-	Same item as the unit of Data 1	Rate conversion	-	-	-	Acceleration rate conversion	-	-	-	Synthetic rate	○	○	Position and speed of the NC axis	Synthetic acceleration rate	○	○	Position and speed of the NC axis	Synchronous tap error	○	-	Position command of the spindle/servo and position FB	Amount of folding	-	-	-	bit0-bitF	-	-	-	Arbitrary data calculation	○	○	Arbitrary sampling data Refer to "3.10.2.1 Arbitrary Data Calculation".
Processing method	Data 2	Data 3	Selection items																																										
Non-processing	-	-	-																																										
Difference (-)	○	-	Same item as the unit of Data 1																																										
Rate conversion	-	-	-																																										
Acceleration rate conversion	-	-	-																																										
Synthetic rate	○	○	Position and speed of the NC axis																																										
Synthetic acceleration rate	○	○	Position and speed of the NC axis																																										
Synchronous tap error	○	-	Position command of the spindle/servo and position FB																																										
Amount of folding	-	-	-																																										
bit0-bitF	-	-	-																																										
Arbitrary data calculation	○	○	Arbitrary sampling data Refer to "3.10.2.1 Arbitrary Data Calculation".																																										

3. HOW TO USE

Display item	Description																																	
	<p>For waveform comparison, the item name in the pull-down list is displayed as "Waveform type + "(project name)\measurement data name)".</p> <p>Only when the processing method is "Difference (-)", different measurement waveform types other than the imported data can be selected.</p>																																	
Coefficient	<p>Set the coefficient.</p> <p>The coefficient input format depends on the method selected in [Processing method].</p> <table border="1" data-bbox="512 436 1220 864"> <thead> <tr> <th>Processing method</th> <th>Initial value</th> <th>Input format</th> </tr> </thead> <tbody> <tr> <td>Non-processing</td> <td>-</td> <td>-</td> </tr> <tr> <td>Difference (-)</td> <td>1:1</td> <td>Ratio input</td> </tr> <tr> <td>Rate conversion</td> <td>-</td> <td>-</td> </tr> <tr> <td>Acceleration rate conversion</td> <td>-</td> <td>-</td> </tr> <tr> <td>Synthetic rate</td> <td>1:1</td> <td>Ratio input</td> </tr> <tr> <td>Synthetic acceleration rate</td> <td>1:1</td> <td>Ratio input</td> </tr> <tr> <td>Synchronous tap error</td> <td>(Note 1)</td> <td>Numeric input</td> </tr> <tr> <td>Amount of folding</td> <td>50.000</td> <td>Numeric input</td> </tr> <tr> <td>bit0-bitF</td> <td>-</td> <td>-</td> </tr> <tr> <td>Arbitrary data calculation</td> <td>-</td> <td>-</td> </tr> </tbody> </table> <p>-: Not editable</p> <p>For the ratio input, use a single byte colon and greater than or equal to "1" on each side of the colon (:).</p> <p>For numeric display, enter a number greater than or equal to "1".</p> <p>(Note 1) The value of the "thread pitch" in the axis selection screen set in synchronous tap error measure is set. For other measurements, the default value of 1 is set.</p> <p>(Note 2) When the processing method is the same, the default value of the coefficient will also become the same.</p> <p>Example: When "Synchronous tap error" is selected for Waveform No.1 "Processing method", the default value, "1", is displayed. If the coefficient of Waveform No.1 is changed to "3", the coefficient remains "1" when "Synchronous tap error" is selected for Waveform No.2 "Processing method".</p> <p>(Note 3) When checking spindle synchronous error, spindle 1 position droop is set to [Data 1], spindle 2 position droop is set to [Data 2], and the [Processing method] is set to "Difference (-)". "Rotation ratio 1 (Spindle 1)" and "Rotation ratio 2 (Spindle 2)" of the measurement axis selection screen set in spindle synchronization measurement is set to coefficient.</p>	Processing method	Initial value	Input format	Non-processing	-	-	Difference (-)	1:1	Ratio input	Rate conversion	-	-	Acceleration rate conversion	-	-	Synthetic rate	1:1	Ratio input	Synthetic acceleration rate	1:1	Ratio input	Synchronous tap error	(Note 1)	Numeric input	Amount of folding	50.000	Numeric input	bit0-bitF	-	-	Arbitrary data calculation	-	-
Processing method	Initial value	Input format																																
Non-processing	-	-																																
Difference (-)	1:1	Ratio input																																
Rate conversion	-	-																																
Acceleration rate conversion	-	-																																
Synthetic rate	1:1	Ratio input																																
Synthetic acceleration rate	1:1	Ratio input																																
Synchronous tap error	(Note 1)	Numeric input																																
Amount of folding	50.000	Numeric input																																
bit0-bitF	-	-																																
Arbitrary data calculation	-	-																																
Default setting	<p>Resets all of the contents displayed in [Data Transformation] to default values at the time of first drawing.</p> <p>It is hidden for waveform comparison.</p>																																	
Polarity inversion	<p>Displays the "Polarity inversion" dialog.</p> <p>The set data is saved to the project and used for remeasurements.</p> <p>It is hidden for waveform comparison.</p> <table border="1" data-bbox="209 1556 1431 1839"> <tr> <td data-bbox="209 1556 481 1780">Channel number</td> <td data-bbox="481 1556 1431 1780"> <p>Select the waveform to convert.</p> <p>When this is checked, an asterisk (*) preceding the name of the waveforms of Data 1 and Data 2 of the [Data Transformation] dialog is displayed.</p> <p>The data for the number of channels set in "3.4.2 Reciprocation acceleration/deceleration measurement" - "(2) Sampling condition setting screen" - "Channel setting" is displayed.</p> <p>"Channel number + Axis name + Waveform type" is displayed in the check box item name.</p> </td> </tr> <tr> <td data-bbox="209 1780 481 1809">OK</td> <td data-bbox="481 1780 1431 1809"> <p>The settings are saved and the [Polarity inversion] dialog is closed.</p> </td> </tr> <tr> <td data-bbox="209 1809 481 1839">Cancel</td> <td data-bbox="481 1809 1431 1839"> <p>The settings are eliminated and the [Polarity inversion] dialog is closed.</p> </td> </tr> </table> <p>OK</p> <p>The settings are saved and the [Data Transformation] dialog is closed.</p> <p>Cancel</p> <p>The settings are eliminated and the [Data Transformation] dialog is closed.</p>	Channel number	<p>Select the waveform to convert.</p> <p>When this is checked, an asterisk (*) preceding the name of the waveforms of Data 1 and Data 2 of the [Data Transformation] dialog is displayed.</p> <p>The data for the number of channels set in "3.4.2 Reciprocation acceleration/deceleration measurement" - "(2) Sampling condition setting screen" - "Channel setting" is displayed.</p> <p>"Channel number + Axis name + Waveform type" is displayed in the check box item name.</p>	OK	<p>The settings are saved and the [Polarity inversion] dialog is closed.</p>	Cancel	<p>The settings are eliminated and the [Polarity inversion] dialog is closed.</p>																											
Channel number	<p>Select the waveform to convert.</p> <p>When this is checked, an asterisk (*) preceding the name of the waveforms of Data 1 and Data 2 of the [Data Transformation] dialog is displayed.</p> <p>The data for the number of channels set in "3.4.2 Reciprocation acceleration/deceleration measurement" - "(2) Sampling condition setting screen" - "Channel setting" is displayed.</p> <p>"Channel number + Axis name + Waveform type" is displayed in the check box item name.</p>																																	
OK	<p>The settings are saved and the [Polarity inversion] dialog is closed.</p>																																	
Cancel	<p>The settings are eliminated and the [Polarity inversion] dialog is closed.</p>																																	

3. HOW TO USE

List of selection items for [Processing method] for all data

Data 1	Processing method									
	Non-processing	Difference (-)	Rate conversion	Acceleration rate conversion	Synthetic rate (Note 1)	Synthetic acceleration rate (Note 1)	Synchronous tap error	Amount of folding	bit0 - bitF	Arbitrary data calculation (Note 2)
Position command	○	○	○	○	○	○	○	○	-	○
Position FB	○	○	○	○	○	○	○	○	-	○
Position droop	○	○	-	-	-	-	-	○	-	○
Model position	○	○	○	○	○	○	-	○	-	○
Droop error	○	-	-	-	-	-	-	○	-	○
Motor-end position	○	○	○	○	○	○	-	○	-	○
Speed command (mm/min)	○	○	-	○	○	○	-	○	-	○
Speed command (r/min)	○	○	-	○ (Note 3)	○	○	-	○	-	○
Speed FB (mm/min)	○	○	-	○	○	○	-	○	-	○
Speed FB (r/min)	○	○	-	○ (Note 3)	○	○	-	○	-	○
Current command	○	○	-	-	-	-	-	○	-	○
Current FB	○	○	-	-	-	-	-	○	-	○
Load meter	○	○	-	-	-	-	-	○	-	○
Output Torque	○	○	-	-	-	-	-	○	-	○
Cycle counter	○	○	-	-	-	-	-	○	-	○
Control input 1 to 6	○	-	-	-	-	-	-	-	○	○
Control output 1 to 6	○	-	-	-	-	-	-	-	○	○
q axis current command	○	○	-	-	-	-	-	○	-	○
d axis current command	○	○	-	-	-	-	-	○	-	○
q axis current FB	○	○	-	-	-	-	-	○	-	○
d axis current FB	○	○	-	-	-	-	-	○	-	○
Speed error (mm/min)	○	-	-	-	-	-	-	○	-	○
Speed error (r/min)	○	-	-	-	-	-	-	○	-	○
PLC (bit)	○	-	-	-	-	-	-	-	-	○
PLC (1 word)	○	-	-	-	-	-	-	○	○	○
PLC (2 words)	○	-	-	-	-	-	-	○	-	○
Monitor output	○	-	-	-	-	-	-	○	-	○

(Note 1) Only servo axis is convertible.

(Note 2) Data after calculation does not have a unit.

(Note 3) This cannot be converted on the servo axis.

3. HOW TO USE

3.10.2.1 Arbitrary Data Calculation

Clicking "Arbitrary data calculation" for [Processing method] in the data transformation dialog displays the arbitrary data calculation dialog.

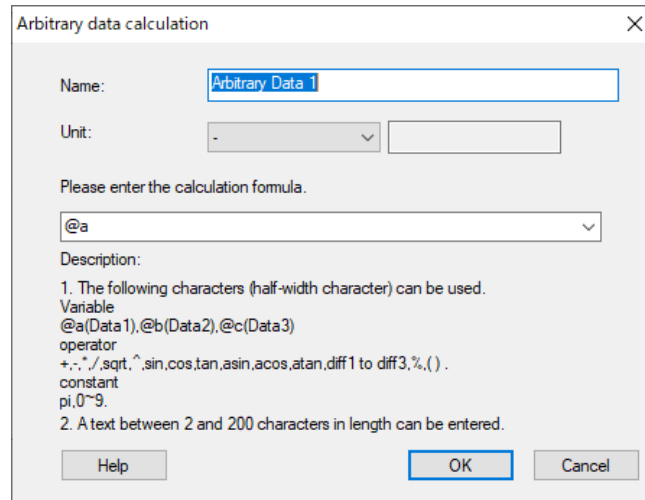

Display item	Description	Initial value	Setting range
Name	Set the waveform name displayed in the text area and graph area.	Arbitrary Data <i>n</i> (<i>n</i> = 1,2,3...) (*1)	Maximum 40 characters
Unit	Select the unit displayed in the text area and graph area. (Note 1) The display unit does not correspond to the "display unit" in the "detailed graph information screen" of the option dialog. (Note 2) Specifying the display unit does not enable the selection of data transformation that corresponds with the specified unit.	"-"	(*2)
Formula	Enter the formula. (*3)	@a	2 to 200 (single-byte character)
Help	Displays Help.	-	-
OK	The settings are applied and the [Arbitrary data calculation] dialog is closed.	-	-
Cancel	The settings are not applied and the [Arbitrary data calculation] dialog is closed.	-	-

(*1) When a formula is selected in "Processing method" of the data transformation dialog, the name of the waveform selected in the data transformation dialog is displayed.

3. HOW TO USE

(*2) Refer to the table below for the units that can be selected.

Display unit	Data type	Remarks
-	No unit	-
mm	Position	-
um		-
deg		-
mdeg		-
inch		-
minch		-
m/sec2		Acceleration
deg/sec2	-	
mm/min	Speed	-
deg/min		-
inch/min		-
r/min		-
%	Current	-
V	Voltage	-
Hz	Frequency	-
dB	Gain	-
Optional	Arbitrary specification	Displays the entered character string as the unit. Units from the unit list can be entered. A maximum of 16 characters can be entered.

(*3) The available variables, constants, and operation symbols for formula are as follows.

Item	Description	Example
Variables		
@A,@a	Data 1 of data transformation dialog	
@B,@b	Data 2 of data transformation dialog	
@C,@c	Data 3 of data transformation dialog	
Constants		
0-9	Decimal numbers and negative numbers can be specified	
Pi	π (circular constant)	
Operation symbols		
+	Addition	@a+@b,@a+1
-	Subtraction	@a-@b,@a-10
*	Multiplication	@a*@b,@a*2
/	Division	@a/@b,@a/3
sqrt	Square-root	sqrt@a
^	Power operator	@a^2
sin	Sine	sin@a
cos	Cosine	cos@a
tan	Tangent	tan@a
asin	Arcsine	asin@a
acos	Arc cosine	acos@a
atan	Arctangent	atan@a
diff1	First order differential	diff1@a
diff2	Second order differential	diff2@a
diff3	Third order differential	diff3@a
%	Remainder	@a%@b
()	Parentheses	(@a+@b)*3

3. HOW TO USE

The priority for operation symbols is as follows.

Priority	Operation symbol
Higher	()
	sqrt , ^
↓	*, / , %
Lower	sin , cos , tan , asin , acos , atan, diff1 to diff3
	+ , -

3. HOW TO USE

3.10.3 Coordinate Setting

In coordinate setting, axis data can be set.
 The contents that can be set varies with the type of waveform displayed in the waveform window.

3.10.3.1 Time-series Waveform

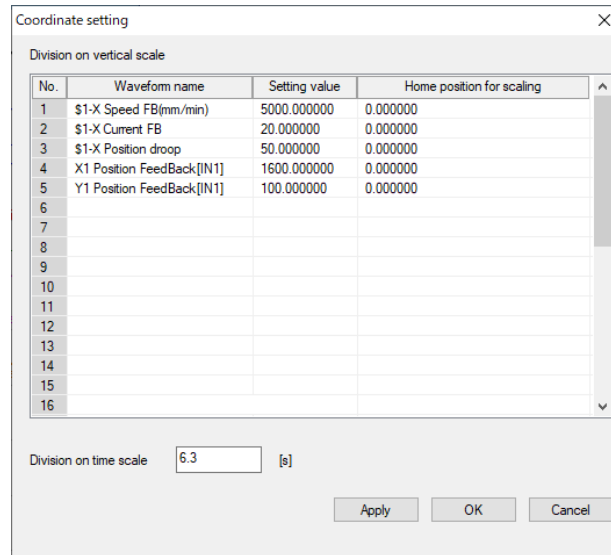

Display item	Description	Initial value	Setting range
Setting vertical axis div value	No.: A maximum of 16 items per page or 32 items in total can be displayed.		
Name of waveform	Cannot be set. The names of waveforms (excluding the waveform No.) on the time-series screen are displayed.	-	-
Setting value	Set the vertical axis div value.	-	-
Home position for scaling	Set the base value for scaling the vertical axis.	-	-
Setting time axis div value	Set the div value of the horizontal axis.	-	-
Apply	Apply the settings.	-	-
OK	The settings are applied and the [Coordinate setting] dialog is closed.	-	-
Cancel	The settings are not applied and the [Coordinate setting] dialog is closed.	-	-

3. HOW TO USE

3.10.3.2 FFT Waveform

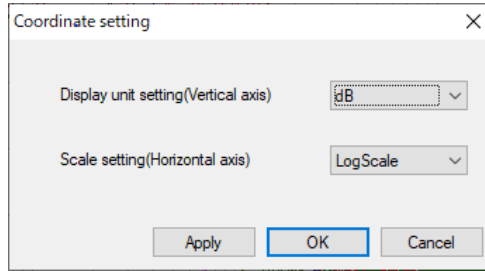

Display item	Description	Initial value	Setting range
Display unit setting (Vertical axis)	Select the display unit of the vertical axis.	(*1)	dB/Amp.
Scale setting (Horizontal axis)	Select the scale of the horizontal axis. When a log scale is selected, a logarithmic scale is displayed. When a linear scale is selected, an equally spaced scale is displayed.	(*1)	LinearScale /LogScale
Apply	Applies the settings.	-	-
OK	Applies the settings and closes the "Coordinate setting" dialog.	-	-
Cancel	Closes the "Coordinate setting" dialog without applying the settings.	-	-

(*1) The initial value is set as an option.

3. HOW TO USE

3.10.3.3 Roundness Waveform

(1) For lost motion adjustment

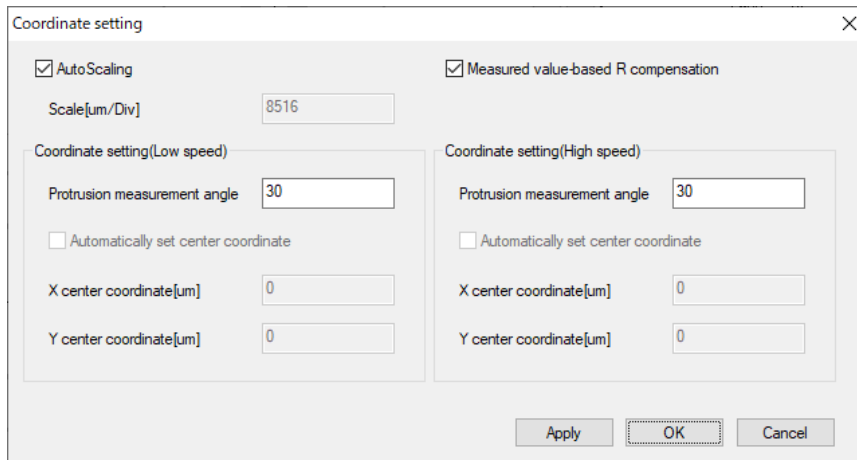

Display item	Description	Initial value	Setting range
Autoscale	When unchecked, "Automatically set central coordinate" and "Scale [um/div]" can be edited.	ON	ON/OFF
Scale [um/div]	Set scale [um/div].	1	-
Correct the measured value of radius	When this is checked, the measured value of radius is displayed for a radius value. When this is unchecked, the command radius value is displayed. The measured radius value is calculated as follows: Measured radius value = Command radius value - dR.	ON	ON/OFF
Axis setting (low speed)/ Axis setting (high speed)	For the axis setting (low speed) and the axis setting (high speed), the following items are set.		
Measuring angle of projection	Set the measuring angle of projection.	30	-
Automatically set the central coordinate	When checked, the "Central x(y) coordinate [um]" cannot be edited.	OFF	ON/OFF
Central x(y) coordinate [um]	Set the central x(y) coordinate [um].	0	-
Apply	Apply the settings.	-	-
OK	The settings are applied and the [Coordinate setting] dialog is closed.	-	-
Cancel	The settings are not applied and the [Coordinate setting] dialog is closed.	-	-

3. HOW TO USE

(2) For roundness measurement

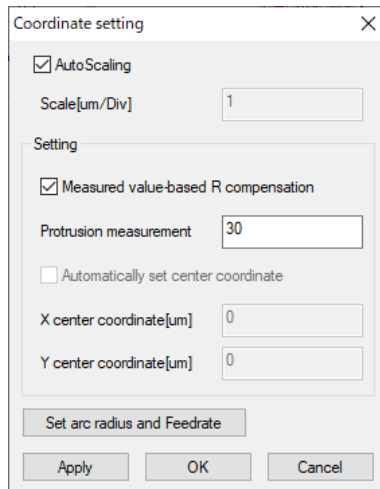

Display item	Description	Initial value	Setting range
Autoscale	When this is unchecked, "Automatically set central coordinate" and "Scale [um/div]" can be edited.	ON	ON/OFF
Scale [um/div]	Set scale [um/div].	1	-
Setting	Set the following items.	-	-
Correct the measured value of radius	When this is checked, the measured value of radius is displayed for a radius value. When this is unchecked, the command radius value is displayed. The measured radius value is calculated as follows: Measured radius value = Command radius value - dR.	ON	ON/OFF
Measuring angle of projection	Set the measuring angle of projection.	30	-
Automatically set the central coordinate	When this is checked, the "Central x(y) coordinate [um]" cannot be edited.	OFF	ON/OFF
Central x(y) coordinate [um]	Set the central x (y) coordinate [um].	0	-
Set arc radius and Feedrate	When this is checked, displays the "Arc radius/Feedrate setting" dialog. Arc radius and feedrate can be set for each roundness waveform.	-	-
Apply	Apply the settings.	-	-
OK	The settings are applied and the [Coordinate setting] dialog is closed.	-	-
Cancel	The settings are not applied and the [Coordinate setting] dialog is closed.	-	-

3. HOW TO USE

3.10.3.4 Arbitrary Program Waveform

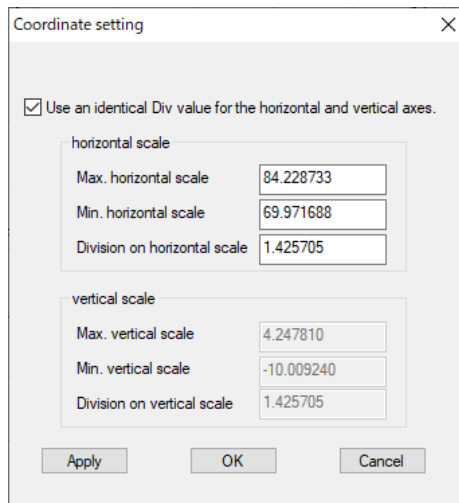

Display item	Description	Initial value	Setting range
Use an identical Div value for the horizontal and vertical axes.	When this is checked, the same div value is used for the horizontal axis and the vertical axis.	-	-
horizontal scale / vertical scale	Set the horizontal axis and vertical axis.	-	-
Max. horizontal scale (vertical scale)	Set the maximum value of coordinates in the direction of the horizontal axis (vertical axis) of the graph.	-	-
Min. horizontal scale (vertical scale)	Set the minimum value of coordinates in the direction of the horizontal axis (vertical axis) of the graph.	-	-
Division on horizontal scale (vertical scale)	Set the div value of the horizontal axis (vertical axis) of the graph.	-	-
Apply	Apply the settings.	-	-
OK	The settings are applied and the [Coordinate setting] dialog is closed.	-	-
Cancel	The settings are not applied and the [Coordinate setting] dialog is closed.	-	-

3.10.3.5 Torque Characteristics

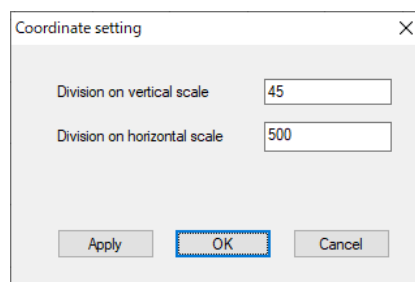

Display item	Description	Initial value	Setting range
Setting vertical axis div value	Set the vertical axis div value.	-	-
Setting horizontal axis div value	Set the horizontal axis div value.	-	-
Apply	Apply the settings.	-	-
OK	The settings are applied and the [Coordinate setting] dialog is closed.	-	-
Cancel	The settings are not applied and the [Coordinate setting] dialog is closed.	-	-

3. HOW TO USE

3.10.4 Arbitrary graph setting

3.10.4.1 Roundness Waveform, Arbitrary Path Waveform, Arbitrary Path Waveform (3D) [XY/YZ/ZX]

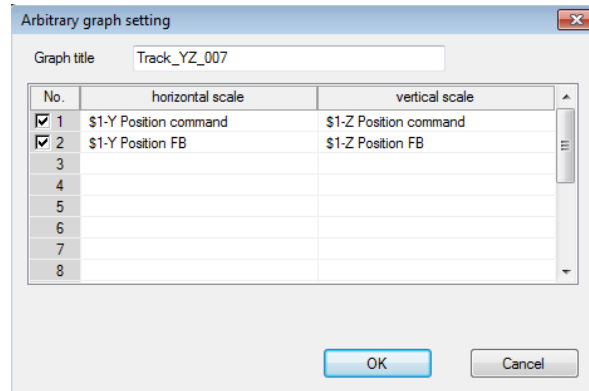

Display item	Description
Title	Display the name of measurement. Up to 64 single-byte characters can be entered.
No.	The checked waveform number is displayed. The waveform number which is fixed as "No. 1/2/3/.../32" is displayed. Setting items over eight are displayed by scroll bar.
Horizontal scale	Set the data to be used for horizontal axis.
Vertical scale	Set the data to be used for vertical axis.

(1) Data that can be set for the horizontal axis differs depending on waveforms.

Waveform	Data that can be set for the horizontal axis
Roundness waveform Arbitrary path waveform	- Position command - Position FB - Model position - Motor-end position - Imported data (mm unit only) - The results of arbitrary data calculations on the data above.
Arbitrary path waveform (3D) [XY/YZ/ZX]	- Position command - Position FB

(2) Only the same type of data as the horizontal axis can be selected for the vertical axis.

3. HOW TO USE

3.10.4.2 Arbitrary Path Waveform (3D) [XYZ]

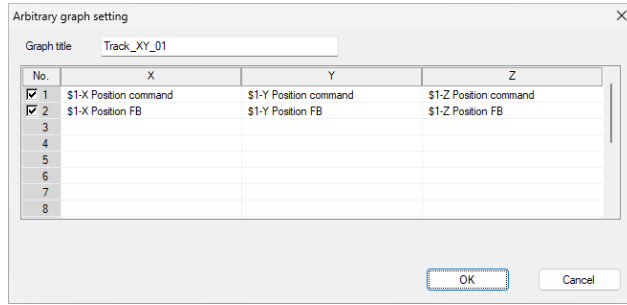

Display item	Description
Graph title	Displays the name of measurement. Up to 64 single-byte characters can be entered.
No.	The checked waveform number is displayed. The waveform number which is fixed as "No. 1/2/3/.../16" is displayed. Setting items over eight are displayed by scroll bar.
X	Set the data to be used for the X axis.
Y	Set the data to be used for the Y axis.
Z	Set the data to be used for the Z axis.

- (1) Data that can be set for the X, Y, and Z axes is as follows:
 - Position command
 - Position FB
- (2) Only the same type of data can be selected for the X, Y, and Z axes.

3. HOW TO USE

3.10.5 Time Axis Offset

The movement amount of the comparison data on the time axis can be specified by selecting "Time axis offset" in the button area of the waveform comparison window.

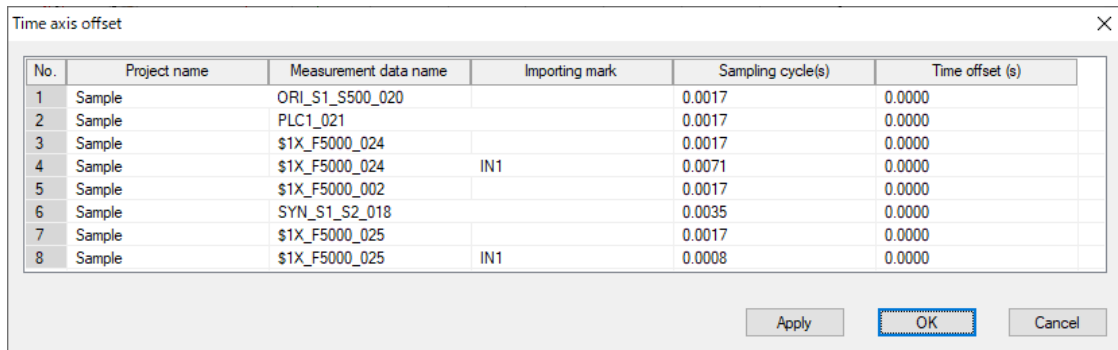

Display item	Description
Project name	Displays the project name which contains the measurement data.
Measurement data name	Displays the measurement data name.
importing mark	For importing data, "INn" is displayed. (n: Order of data imported into measurement data) When no importing data is included, "-" is displayed.
Sampling cycle	Displays the sampling period. For importing data, the input value on the data import screen is displayed.
Time offset	Set the time shift amount.

4. PRECAUTIONS

When using the NC Analyzer2, pay attention to the following.

4.1 Precautions for Using Adjustment Wizard

- (1) When using a program created with the program creation function, confirm an appropriate soft limit.
- (2) When small vibrations are applied to the motor while using "Velocity loop gain adjustment", "Frequency response measurement", the servo motor may vibrate violently. In that case, the servomotor might vibrate violently. Input the reset or emergency stop if a danger status is caused because the servomotor vibrates violently. The machine vibration can be controlled by reducing "#2205 SV005 VGN1 (speed loop gain 1)". After reducing the VGN1 to just as one-half, execute the velocity loop gain adjustment.
- (3) Confirm the effect stroke of the machine, and perform "Lost motion adjustment", paying attention to avoid interference.
- (4) Always confirm that the emergency stop and reset are valid when using.
- (5) While the automatic tuning function is executed, the display of the servo monitor screen is not updated.
- (6) If emergency stop, NC power OFF, alarm occurrence, or input power OFF (instantaneous stop) occurs while performing adjustment with NC Analyzer2, make sure to enter the servo in a ready ON after the parameter settings are returned.
- (7) Measurement or adjustment is possible even if the vibration value is less than the current limit value. In that case, the measurement or adjustment might not be completed normally. Do not set the current limit value less than 100%.
- (8) Do not adjust the axis with a motor unconnected (servo drive unit connected) or detached axis. If such an axis is adjusted, the adjustment might not be completed while keeping the automatic adjustment screen displayed. In that case, input the emergency stop or reset to stop the measurement.
- (9) Confirm that each parameter described in the section "3.1.2 Parameter Setting" is correctly set to NC. If it is not set correctly, the operation might be incorrect. In that case, input the emergency stop or reset to stop the measurement.
- (10) In each adjustment function, operation mode of all systems is checked when selected from the NC Analyzer2 main screen. If there is even one part system to which the operation mode is not set correctly, an operation mode error message and illegal part system name are displayed. So set the operation mode for subjected part system correctly. In the program creation function, only the operation mode of the part system subjected to the program creation function.
- (11) If the axis is not moved, the resonance might not be generated. Confirm the resonance is not generated even if the axis is moved by the pulse sending.
- (12) When the type name of the drive unit cannot be acquired from NC, all drive units are assumed to have not been connected.
- (13) When this function is used with other external device connected to PC, the measurement/adjustment might not be correctly completed because of the noise influence.
- (14) Input the emergency stop after inputting reset when the emergency stop is input with NC. When only the emergency stop is input, the program forwarded from this function to NC is not deleted.
- (15) When the parameters of NC, the servo and the spindle parameters are changed and the NC restarts, restart the NC Analyzer2 also. When the NC Analyzer2 is not restarted, the measurement/adjustment is executed by the parameter setting before restarting, and therefore, correct results cannot be obtained.

4. PRECAUTIONS

- (16) When the emergency stop of NC occurs while executing adjustment function, click the "Cancel" button on the automatic adjustment screen and stop the adjustment function.
- (17) The tool bar and menu bar is reset to initial settings with the language change.
- (18) Do not pull out the network cable between PC and NC while executing the adjustment function.
- (19) The adjustment function cannot be used for the axis in the sub part system.
- (20) The velocity loop gain adjustment may not be performed on the NC with multi-axis multi-part system configuration.
- (21) The machining program creation function of lost motion adjustment is compatible only when "#1037 cmdtyp" (Command type) is set to "1" to "8".
- (22) Execute "Lost motion adjustment" with "#1272 ext08 bit2" (Spiral/conical interpolation command format 2) set to "0".
- (23) When the display of the state of progress on the screen displays "Waiting for cycle start", press the cycle start button only once. After pressing the cycle start button, do not press the button again until the adjustment is completed.

Relation with other functions

- (1) NC data sampling
When the parameter "#1164 ATS" is set to "1", "Data protection" is displayed and the NC data sampling function cannot be set.
When the adjustment is executed, the NC data sampling parameters are changed.
- (2) The servo monitor screen
"ATS Sampling" is displayed and data is not updated while NC Analyzer2 is executed.
- (3) Program display
In "Lost motion adjustment", when the program is created and adjusted on NC Analyzer2, the machining program number is allocated automatically. When the machining program in NC memory is used, the machining program number in which operation search has been executed is displayed.
- (4) Search & start function
Search & Start function will be disabled for safety when the parameter "#1164 ATS" is "1".

4. PRECAUTIONS

4.2 Precautions for Using Measurement and Adjustment

- (1) Execute the vibration signal setup before the frequency response measurement is executed.
- (2) When small vibrations are applied to the motor during frequency response measurement, the servo motor may vibrate violently. Input reset (only during vibration) or emergency stop if the servomotor vibrates violently and creates a hazardous a condition. Measure the frequency response by separating about 10mm from the edge of stroke. Set a smaller amount to vibration amount at measurement on the vibration level setting screen, and measure again. In that case, set a smaller vibration amount on Vibration level setting screen, and measure again.
- (3) Always confirm that the emergency stop and reset are valid when using.
- (4) When the measurement could not be stopped even if reset is input, input the emergency stop.
- (5) Do not measure the axis with a motor unconnected (servo drive unit connected) axis, detached axis or synthetic axis composed of two or more axes (inclination Y axis in lathe system, etc.). If such an axis is measured, the measurement might not be completed while keeping the automatic measurement screen displayed. In that case, input the emergency stop or reset to stop the measurement.
- (6) Even if the parameter "#2018 no_srv (Operation with no servo control)" is set to "1", the measurement is executed when the servo drive unit and motor are connected.
- (7) Measurement or adjustment is possible even if the vibration value is less than the current limit value. In that case, the measurement or adjustment might not be completed normally. Do not set the current limit value less than 100%.
- (8) Confirm that each parameter of the axis or axis specification is correctly set to NC. If it is not set correctly, the operation might be incorrect. In that case, input the emergency stop or reset to stop measurement.
- (9) The measurement function of the machine confirms the operation mode of all part systems when the "Test" button is selected from the measurement function screen and the "OK" button is selected from each measurement function. If there is even one part system to which the operation mode is not set correctly, an operation mode error message and illegal part system name are displayed. Therefore, correctly set the operation mode for subject part system.
- (10) Automatic operation startup is valid only for the 1st part system. The gear ratio is not taken into account in the spindle measurement data.
- (11) When the type name of the drive unit cannot be acquired from NC, all drive units are assumed to have not been connected.
- (12) When this function is used with other external device connected to PC, it might not be able to measure and adjust correctly because of the noise influence.
- (13) When the tandem axis is used, use the system in which the gear ratio, motor and detector of the master axis and slave axis are the same.
- (14) Input the emergency stop after inputting reset when the emergency stop is input with NC. When only the emergency stop is input, the program forwarded from this function to NC is not deleted.
- (15) When the parameters of NC, the servo and the spindle parameters are changed and the NC restarts, also restart the NC Analyzer2. When the NC Analyzer2 is not restarted, measurement/adjustment is executed by the parameter setting before restarting, and therefore, correct results cannot be obtained.
- (16) If the internal sampling termination processing fails for time-series data measurement, the message "The sampling termination failed. Please stop operation and push the OK button" will be displayed in the warning window. Please stop operation and press the [OK] button.
- (17) The toolbar and menu bar is reset to initial settings with the language change.
- (18) Do not pull out the network cable between PC and NC while executing the measurement function.
- (19) The frequency response measurement cannot be used for the axis in the sub part system.

4. PRECAUTIONS

- (20) The frequency response measurement may not be performed on the NC with multi-axis multi-part system configuration.
- (21) The pre-trigger time displayed in NC Analyzer2 is not the value set on the NC data sampling screen. It is the pre-trigger time calculated from sampling data. If the time it takes to change from "trigger waiting" to "Sampling" is shorter than the pre-trigger time set in NC, the displayed time is shorter than the set value.
- (22) The machining program creation function is compatible only when "#1037 cndtype" (Command type) is set to "1" to "8".
- (23) For the frequency response measurement, when the display of the state of progress on the screen displays "Please press the cycle start button on operation panel.", press the cycle start button only once. After pressing the cycle start button, do not press the button again until the adjustment is completed.

5. APPENDIX

5.1 Adjustment Wizard Messages

Axis selection has been changed. Readjust from the first axis.

When the adjustment axis is changed and "Next" is pressed again in the axis selection screen after selecting the adjustment axis in the axis selection screen.

There is no adjustment axis.

When "Next" is pressed without selecting the adjustment axis on the axis selection screen.

The axis name of plane is the same. Select it again.

When the same axis is selected on the plane selection screen.

Are you sure you want to close the adjustment wizard?

To close the adjustment wizard by clicking "Close"

To close the adjustment wizard by clicking "Cancel"

The selected plane has been changed. Readjust from the first plane.

When the adjustment plane has been changed after selecting the adjustment axis and pressing "Next".

Select the adjustment plane.

When "Next" is pressed without selecting the adjustment plane on the axis selection screen.

An error occurred during adjustment. Return the parameter to the state before adjustment.

If an error occurs during adjustment.

Planes are overlapped. Select it again.

When the same plane is selected on the plane selection screen.

Communication failed

When NC Analyzer cannot connect with NC of specified IP.

Failed to communicate with the measurement target NC of the project.

Check the IP address.

Project target NC IP address:

When adjustment or measurement has been performed on the existing project (offline).

Velocity loop gain upper limit is outside the setting range.

When "OK" is pressed on the velocity loop gain adjustment screen while a value outside the setting range is input to the velocity loop gain upper limit value.

Failed to create a machining program.

This is possibly due to either of the following reasons:

1. The settings of basic axes IJK are incorrect
2. The setting of command type is not supported.
3. The axis in different system are selected.

Failed to create machining program.

- When the axis name (axname) and the name of basic axis I,J,K (base_I, base_J, base_K) are different
- When command type is set to series 8
- When axes from the different part systems are selected when performing roundness measurement or arbitrary path measurement

Enable the automatic tuning function (ATS).

When ATS (#1164 ATS) is set to "0" and "Velocity loop gain adjustment", "Lost motion adjustment", or "Variable full-closed torsion compensation" is selected

The plane cannot be defined.

Configure the basic axes I/J/K through the CNC.

When two or more parameters are blank among basic axis I (#1026 base_I), basic axis J (#1027 base_J), and basic axis K (#1028 base_K) on the NC.

Enter 1 in the parameter valVDC (Variable full-closed torsion compensation) of the axis to be adjusted.

When a synchronizing axis is adjusted, also enable the slave axis (set to 1).

When "Variable full-closed torsion compensation ON (#14301 valVDC)" is disabled and "Next" is selected on the plane selection screen.

Any of the condition settings is incorrect.

Correct them so that none of the following contents are true.

1. Feedrate or arc radius setting is blank
2. Non-numeric value has been input
3. The set value of feedrate or arc radius is out of range
(0.000001 to 999999.999999)
4. Identical acceleration rate has been set
5. The acceleration rate is out of range (1 to 2147483647) (*1)

When the measurement condition settings of acceleration rate table on the acceleration rate setting screen include any of the following

- When "Feed speed" or "Arc radius" is blank
- When values other than numerical values (such as text) are set
- When values outside the range are set for "Feed speed" or "Arc radius"
- When the same "Acceleration rate" are set in the setting condition
- When calculated acceleration rate is outside the range

(*1) When inch is set in "Input unit" of "Detailed information of the graph" on the option screen, the setting range is "0.000039" to "84546.600276".

5.2 Measurement and Adjustment Messages

This function cannot be used. Check the following items.

1. Is the spindle present?
2. Is the spindle drive unit connected correctly?

When the following function is started, spindle information cannot be obtained (the number of spindles is 0).
Synchronous tap error measurement/Spindle acceleration/deceleration measurement/Spindle orientation measurement/Spindle C-axis measurement/Spindle synchronization measurement

This function cannot be used. Check the following items.

1. Is the PLC axis present?
2. Is the PLC axis drive unit connected correctly?

When the PLC axis acceleration/deceleration measurement function is started, PLC axis information cannot be obtained.

Check that there are two or more NC axes (linear axes) in the same system.

When two axes to be measured are not the same system during roundness measurement or two NC axes are short in the same system.

Check that there are two or more NC axes in the same system.

When two axes to be measured are not the same system during arbitrary path measurement or two NC axes are short in the same system.

Cannot proceed with spindle synchronization measurement. Check that there are two or more spindles or rotation axes in the machine.

When any one of two axes is not present during spindle synchronization measurement and "Start measuring" is pressed.

Check that there is Spindle 2.

"Setting" is pressed, when any one of two axes is not present during spindle synchronization measurement.

The name of two axes is the same. Select it again.

When the name of two axes to be measured is the same during roundness measurement.

The common variable is not set.

When "OK" is pressed on the sampling condition setting screen without entering common variable.

The PLC signal is not set.

When "OK" is pressed on the sampling condition setting screen without inputting PLC signal.

This function cannot be used. Check the following items. Is a linear axis present? (The tap axis is a linear axis.)

When there is no linear axis or servo axis in the synchronous tap measurement function.

When using OMR-DD, the spindle current command and current FB(CH~) are non-selectable. Select [Load meter] and retry measurement.

When high-speed synchronous tap is enabled and the spindle current FB is selected.

Two axes are not in the same system. Select it again.

When the selected Axis 1 and Axis 2 are in a different system during roundness measurement and arbitrary path measurement and "Next" is pressed.

An error occurred in NC. Stop sampling.

When a return value from the system is -1 during adjustment or measurement.

Disable the operation with no servo control function (no_srv).

When the parameter "#2018 no_srv" for the axis to be measured or adjusted is 1.

Check if the sampling time, the number of channels and the cycle are correct.

Failed to set sampling buffer capacity on the sampling condition setting screen.

Common variable is out of the allowable setting range.

When common variable out of the allowable range is set and "OK" is pressed on the sampling condition setting screen.

The PLC device is out of the allowable setting range.

When PLC signal out of the allowable range is set and "OK" is pressed on the sampling condition setting screen.

Select channels.

When all channels are selected and "OK" is pressed on the sampling condition setting screen.

Some data cannot be sampled.

When load meter is selected for the servo axis

When model position and droop error are selected for the spindle in normal sampling mode

When spindle-mode rotary axis is measured

When spindle-mode servo axis is measured on the NC other than M8 series version C1 or later

Sampling cannot be performed by the combination of the selected data.

Sampling type combination error

The combination of sampling mode and type is wrong.

Sampling type mode error

Failed to write the machining program to NC.

The following causes are probable.

1.The relevant program is being executed.

2.The program is write protected (KEY3).

3.The relevant program is being edited.

4.Program memory capacity is insufficient.

Failed to write the machining program to NC.

5. APPENDIX

Failed to delete a machining program from the NC.
 This is possibly due to either of the following reasons.

- 1.The program is being executed.
- 2.Connection to the NC is poor.
- 3.The program to delete is not present.
- 4.Program write protection (KEY3) is ON.

Failed to delete NC machining program.

Enter the program.

The machining program area is blank.

Failed to create machining program.
 The following are the possible causes.

- 1.The basic axis IJK setting is incorrect.
- 2.Unsupported command type is set.
- 3.Axes from different part systems are selected.

Failed to create machining program.

Confirm error message 1 to 3 for details.

- The names of axes (axname) differ from those of basic axes I, J, and K (base_I, base_J, base_K).

- List 8 is set to command type.

- Axes from different part systems are selected when executing the roundness measurement or arbitrary path measurement.

Failed to write the machining program.

The file path name is too long.

File cannot be opened.

File write error.

Failed to read file.

File read error

Failed to load the sampling data. The possible causes are as follows:

- 1.Sampling data does not exist.
- 2.The sampling data output function is disabled (OFF).

Sampling data reading error

When the NCSAMP file is read with no sampling data in the connected NC

When measurement or NCSAMP file reading is performed while the parameter "#1224 aux08/bit0" (Sampling data output) is invalid (OFF)

Excessive sampling data reading.

Time-out error in reading sampling data

An error occurred during adjustment or measurement.

Other errors

5. APPENDIX

The vibration signal level is outside of the setting range.

When "OK" is pressed on the vibration level setting screen while a vibration amount outside the setting range is input

Write of machining program has failed. Make sure that the status of part systems has been changed to "Operation completed state".

When adjustment or measurement is executed while NC is not in RDY state

Failed to read NCSAMP file.

Only the NCSAMP file including 10 decimal data with header can be read.

When there is no header in the NCSAMP file which was read offline

When blank file is selected on the NCSAMP file selection screen and "Open" button is clicked

When the "Finish" button is clicked when the number of lines from the start line to the end line of data specified on the NCSAMP file read wizard screen is insufficient by four lines

When data which includes characters other than number 0 to 9, "+", "-", ".", "E" and "e" is imported from the data start row

Failed to read NCSAMP file.

Please check the file(CYCLE,HIGH_FREQ).

When the sampling cycle value of the NCSAMP file which is read offline is incorrect

Confirm the "CYCLE" key and the "HIGH_FREQ" key on the [PARAM_CON] section described on the NCSAMP file.

Failed to read NCSAMP file.

Please check the file(CHANNEL).

When number of channels in the NCSAMP file which is read offline is incorrect

Confirm the value of the "CHANNEL" key on the [PARAM_CON] section described on the NCSAMP file.

Failed to read NCSAMP file.

Please check the file(KIND-CH%d).

The number of channels in the NCSAMP file which is read offline is incorrect.

Confirm the KIND items of the NCSAMP file.

* CH□: Channel number (1 to 16)

Failed to read NCSAMP file.

Please check the file(START_COND,END_COND).

The value of sampling start/end conditions of the NCSAMP file which is read offline is incorrect.

Confirm the value of the "START_COND" key and the "END_COND" key on the [PARAM_CON] section described on the NCSAMP file.

5. APPENDIX

Failed to read NCSAMP file. This is possibly due to either of the following reasons:

1. You have no permission to create NCA project in the same directory as the NCSAMP file.
2. You have no permission to access the file.
3. Memory is insufficient.
4. The file is being opened by another user.

When offline

When there is no authority to generate an NCA project in the same path as the NCSAMP file

When there is no authority to open the data file

When memory is insufficient when the NCSAMP file is opened

When selecting a file on a shared folder which is opened by another user

Error occurred during tuning or measuring. Error #: (Refer to the following table)

Error No.	Description
51	When an error occurs in reading sampling file.
87	When using the frequency response measurement and the velocity loop gain adjustment under the following conditions. [M8 series] When a combination other than NC Analyzer2 version A5 or later and M8 series version C4 or later is used for a configuration of 17 or more NC axes, or 5 or more part systems, [C80 series] When a combination other than NC Analyzer2 version A5 or later and C80 series version B6 or later is used for a configuration of 2 part systems and 17 axes or more, or 3 part systems or more.

The project target NC is different from the connected NC.
Create a new project or open the project of the connected NC.
Project target NC serial No.:~
When NC serial number of the project and the connected NC do not match for the existing project (offline)

Set the parameter "SV002(PC2)" to a nonzero value.
When "0" is set for the value of the servo parameter machine side gear ratio (PC2)

Set the parameter "SV020(RNG2)" or "SV118(RNG2ex)" to a nonzero value.
When "0" is set for the servo parameter main side encoder resolution (RNG2) or the expansion main side encoder resolution (RNG2ex)

Sub System Control I and II are both enabled.
Correct the parameters.
When Sub part system I and Sub part system II are enabled simultaneously and the machining program is written in the NC
When Sub part system I and Sub part system II are enabled simultaneously and a new project is created

5. APPENDIX

Error occurred during tuning or measuring. Error #: (Refer to the following table)
 Measurement may be enabled by changing the vibration level in Vibration level setting.
 Change the vibration level and retry measurement.
 Or check if the selected axis is compatible with the NC system.

Error No.	Description
24	When the difference between the maximum value and minimum value of the current FB is larger than the threshold
25	When the number of times the vibration amount was calculated exceeds the specified number of times for adjustment
26	When the difference between the maximum value and minimum value of the current FB is less than the vibration amount
27	When the difference between the maximum value and minimum value of the current FB is less than 0 or the frequency response measurement has failed
34	When the vibration amount calculated by the NC is other than 1 to 150
79	When the difference between the maximum value and minimum value of the speed FB is less than the threshold
80	When the phase margin is not obtained
81	When the gain margin is not obtained
82	When the crossover frequency is not obtained

Door open signal is ON.
 Turn OFF the door open signal, and then execute again.

When the door open signal is ON

However, this message is not displayed when "Manual" is selected for "Start/End condition setting" on the sampling condition setting screen.

NC alarm 4 (AL4) is occurring.
 Cancel the alarm, and then execute again.

When the NC alarm 4 (AL4) is occurring

However, this message is not displayed when "Manual" is selected for "Start/End condition setting" on the sampling condition setting screen.

NC alarm 5 (AL5) is occurring.
 Cancel the alarm, and then execute again.

When the NC alarm 5 (AL5) is occurring

However, this message is not displayed when "Manual" is selected for "Start/End condition setting" on the sampling condition setting screen.

5. APPENDIX

Sampling could not start. Error number: 70
Possible causes are:
1. NC sampling status is not trigger waiting.
2. Incorrect sampling conditions.

When the NC sampling status is sampling stop or not trigger waiting

When the sampling condition is incorrect

When high-period sampling measurement is performed on the axis to which the drive unit is not connected

Not enough memory in the NC for storing machining programs. Remove unnecessary programs to free up storage space.

When there is insufficient free space for the program in NC at the timing of writing the program

This function cannot be used because the motor name or the motor-end encoder is different between the master and slave axes.

When motor type name or motor end encoder is different between the master axis and the slave axis at the timing of performing measurement or adjustment on the synchronous axis

The PLC axis is in the running status.
Set the status to be ready for operation, and then try again.

When the operation status of the PLC axis is command processing or axis moving

Alarm or error has occurred on the PLC axis.
Clear the alarm or error, and then try again.

When an option error, feedrate zero alarm, axis in control alarm, or control information data designation alarm occurs in the PLC axis

PLC axis reset is in progress.
Try again after the reset is completed.

When the reset signal of the PLC axis is ON

Error occurred during tuning or measuring. Error #: (Refer to the following table)
Check if the selected axis is compatible with the NC system.

Error No.	Description
87	When using the frequency response measurement and the velocity loop gain adjustment under the following conditions [C80 series] When a combination other than NC Analyzer2 version A6 or later and C80 series version B9 or later is used
92	When an axis that cannot be measured by the NC system is selected for the velocity loop gain adjustment or frequency response measurement

Cannot measure an axis for which the PLC axis indexing function is enabled.

When #12800 chgauxno specifies an axis other than 0 to the measurement axis

There is an error in the condition setting when NC Smp(CHn) is selected.

The following causes are possible.

1. The channel settings other than NC Smp(CHn) are duplicated.
2. The set channel numbers are not sequential.

When the channel settings where [Axis/Type] is not "NC Smp(CHn)" are overlapped on the sampling condition setting screen

When the checked channels are not consecutive numbers on the sampling condition setting screen

{File title}

Invalid file title.

When the file title is empty or a character that cannot be used for the file name is designated on the sampling condition setting screen

{Folder path}

The path does not exist.

Make sure that the path is correct and try again.

When there is no CSV output folder path on the sampling condition setting screen

An error occurred in the following process of calculating variable torsion compensation.

Extraction of steady portion of circular arc

When an error occurs in extracting the stationary part of position FB data or motor end position data while adjusting torsion compensation amount

An error occurred in the following process of calculating variable torsion compensation.

Calculation of lost motion compensation amount

When an error occurs in the calculation of the lost motion compensation amount while adjusting torsion compensation amount

An error occurred in the following process of calculating variable torsion compensation.

Correction of center and radius of position FB

When an error occurs in the compensation of the center/radius of position FB data while adjusting torsion compensation amount

An error occurred in the following process of calculating variable torsion compensation.

Compensation of center and radius of motor-end position

When an error occurs in the compensation of the center/radius of motor end position FB data while adjusting torsion compensation amount

An error occurred in the following process of calculating variable torsion compensation.

Calculation of speed reversal index

When an error occurs in the calculation of the speed reversal index while adjusting torsion compensation amount

5. APPENDIX

An error occurred in the following process of calculating variable torsion compensation.

Calculation of torsion compensation and LMC-linked parameters

When an error occurs in the calculation of the torsion compensation amount and LMC-linked parameters while adjusting torsion compensation amount

The number of times the torsion compensation time constant was adjusted has reached the specified maximum.

When the compensation time constant is not obtained even when the number of times the time constant was adjusted has reached the specified maximum.

Adjustment is canceled. Restore the parameters?

Yes: Restore the parameters and cancel adjustment.

No: Cancel adjustment without restoring the parameters.

Cancel: Not cancel adjustment.

Note: When adjustment is canceled, automatic operation will be stopped.

When selecting "Cancel" during automatic adjustment

Restore the parameters to the previous state before the adjustment?

When "Undo" is selected on the parameter list screen

5.3 Graph Function Messages

The sampling data format is incorrect.

When the sampling data was obtained, an error occurred.

Node ~ data is corrupted. Can't draw image.

When node data (waveform chart) is opened by double clicking.

FFT processing failed.

When FFT processing is carried out on all the waveforms that have the same value.

FFT conversion of the ~ data has failed.

An error occurred in FFT processing on waveforms.

The number of sampling data is insufficient. FFT cannot be carried out.

The number of time-series waveform is less than 4.

Conversion to torque characteristic graph has failed.

Please restart NC Analyser2.

If the method cannot solve the issue, reinstall NC Analyser2.

The data cannot be accessed when it is converted to the torque characteristics since the data of torque characteristics was deleted, or the user is not authorized, etc.

The Arc radius of the waveform %d is incorrect. The previous data before change is restored.

Set a value in the following range:

0.000001 to 999999.999999.

Values outside of the setting range were entered for arc radiuses on the screen to set the arc radius or the feedrate, and "OK" was pressed.

The Feedrate of the waveform %d is incorrect. The previous data before change is restored.

Set a value in the following range:

Null, 0.000001 to 999999.999999.

Values outside of the setting range were entered for feedrate on the screen to set the arc radius or the feedrate, and "OK" was pressed.

Name is blank. Enter the name.

When "Name" of arbitrary data calculating dialog is not set and "OK" is clicked

Sampling type is different between the set data.
 Select the same sampling type.

When multiple sets of sampling type data are set for one waveform in the graph item setting dialog for arbitrary path waveforms (3D)

The value entered in Plot No. is out of range.
 Restore the data before the change.

When a value outside the setting range is set in "Sampling data plot range" in the Analysis settings panel

The value entered for feedrate is out of range.
 The data is restored.

When a value outside the setting range is set in Feedrate range in the Analysis settings panel

The value entered for acceleration rate is out of range.
 The data is restored.

When a value outside the setting range is set in Acc range in the Analysis settings panel

The value entered for jerk is out of range.
 The data is restored.

When a value outside the setting range is set in Jerk range in the Analysis settings panel

Calculation formula is incorrect. Check if any of the following issues exists:

1. The number of characters entered is out of range (2 to 200 characters).
2. There is no setting for Data 1 variable.
3. An invalid arithmetic symbol or double-byte character is included.
4. Invalid calculation with zero is included. (Example) "@a/0", "@a%0", "0^1"

When any of the following inappropriate inputs is made in "Calculation formula" of the arbitrary data calculation dialog and "OK" is clicked

- The number of input characters exceeds the range of 2 to 200.
- "@a" is not included in the input characters.
- Incorrect mathematical operators were input.
- Characters other than half-width characters were input.
- When division is performed, "0" is specified for the divisor. (Example: @a/0)
- When exponentiation is performed, "0" is specified for the operator. (Example: 0^1)
- When a MOD operation is performed, "0" is specified after "%". (Example: @a%0)

Designation of arithmetic symbol is incorrect. Check if any of the following issues exists:

1. A negative value is specified for square root.

(Example) "sqrt (-1)"

2. No parentheses are used for the constant of trigonometric function.

(Example) "sin1"

3. No variable is specified for differential operation, or differential operators are nested.

(Example) "diff1(1)", "diff1(@a+diff1(@b))"

4. Insufficient data points for the variable specified in differential operation.

When any of the following inappropriate inputs is made in "Calculation formula" of the arbitrary data calculation dialog and "OK" is clicked.

- When the square root is calculated, a value smaller than "0" was specified. (Example: sqrt (-1))

- When trigonometric function operation is performed, constants is specified for operation symbols but the constants are not enclosed in brackets ().

- When derivative operation is performed, operation symbols do not contain variables.

- When derivative operation is performed, the derivative symbol was nested within the expression.

- When derivative operation is performed, sampling points were insufficient.

Data 2 and Data 3 corresponding to the variables @b and @c specified in the calculation formula of waveform (*1) have not been specified. Correct them.

When "Data 2" and "Data 3" corresponding to the variables "@b" and "@c" specified in the arbitrary data calculation dialog are not set, and "OK" is clicked in the data conversion dialog

(*1): Waveform No.

5.4 Project Messages

Communication has failed.

Make sure that:

1. the LAN cable is connected to LAN1 of NC
2. Firewall allows communication
3. the ping command works with the specified IP address.

When NC Analyzer2 cannot connect with NC of specified IP.

Failed to create a project. Possible causes are as follows:

1. NC version is not set.
2. Serial number is not set.

When the "Finish" button is pressed when NC version of the specified IP or serial number is not set

Failed to save data because the capacity of disk is insufficient.

Please select another disk then try again.

When there is not enough disk space to create a new project or save the project (including "Save as")

Project %s is open and can't open the designated project again.

When reopening a project that is already open

Can't open two or more files at a time.

When selecting multiple projects and dragging to NC Analyzer2

The project is being opened by another user.

When opening a file on a shared folder which is opened by another user

You have no permission to access the file. Or the file is being opened by another user.

When there is no authority to open the project

When opening a file on a shared folder which is opened by another user

The data count of the project %s has exceeded the upper limit of 200.

Delete some nodes then retry.

When the total number of parameters and measurement data saved in the project exceeds 200

The following data in the project (*project name*) is corrupt. Can't open the data.

Error number. Data of the function name under Adjustment wizard/Measurement and Adjustment created on the day when the data was created;

When corrupt waveform data is included in the project file

When waveform data for an unsupported measurement or adjustment is included in the project file

There is no readable CSV file in the specified folder.

Check the contents of the specified folder.

When a folder that has no sampling data file is set and the Import button is pressed in the Sampling data (CSV) batch loading screen

The path to the specified CSV storage folder does not exist.
Please set the path again.

When a folder path that does not exist in the CSV storage folder is set and the Import button is pressed in the Sampling data (CSV) batch loading screen

The number of readable CSV files in the specified folder exceeds the upper limit of 200.
Displays only CSV files that have been read.

When more than 200 sampling data files are read in the Sampling data (CSV) batch loading screen

The number of data to be saved exceeds the maximum number (200).
Make sure that the number of selected data does not exceed *maximum the number of data*.

When data is saved in the open project in the Sampling data (CSV) batch loading screen, and the number of the data exceeds 200 after saving

The CSV file that you have selected is in one of the following states.
Read the CSV file again.

1. The file has been deleted.
2. The file has been renamed.
3. The format is invalid.

When the preview of the selected sampling data file is displayed in the Sampling data (CSV) batch loading screen after the file was deleted, the file name was changed, or the format was changed

Failed to read the following CSV file(s).
{File name}

When the Save button is pressed in the Sampling data (CSV) batch loading screen after the sampling file to be saved was deleted, the file name was changed, or the format was changed

Out of memory.
Please reduce the number of selected data and save again.

When there is not enough memory available when the Save button is pressed in the Sampling data (CSV) batch loading screen

5.5 Waveform Comparison Message

Exit from Waveform comparison. OK to close all the waveform comparison windows?

When the "Waveform comparison" button is deselected

OK to close the waveform comparison window?

When the data node selected for comparison changes from "1" to "0"
When the project which contains the first selected data node is closed
When the application is closed

Up to 8 pieces of measurement data and up to 32 waveforms can be compared.

When the number of data nodes selected for comparison is 9 or more, or when the number of waveform is 33 or more

The following data conversion settings will be reset.

Are you sure you want to remove it from the waveform comparison target?

No.

When a data node which affects the data conversion waveform set during waveform comparison is deleted

: Waveform No., Waveform name

When there are multiple reset targets, the waveform information is displayed with line breaks.

(Example) When the waveforms of No.1 and No.4 are to be reset

No.1 \$1-X difference (-)

No.4 \$1-Y difference (-)

5.6 Import Data Message

Importing has failed.

Please check the following reasons:

1. The data is incorrect.
2. You have no permission to access the file.
3. The file is being opened by another user.
4. Memory is insufficient.
5. File does not exist.

When selecting a blank file or a file that is opened, and clicking the "Open" button on the import screen of data file

When selecting data which includes characters other than number 0 to 9, "+", "-", ".", "E" and "e", and clicking the "Finish" button on the import data screen

When the "Finish" button is clicked when the number of lines from the start line to the end line of data specified on the data import screen is insufficient by four lines

When clicking the "Open" button with no authority to open the data file

When selecting a file on a shared folder which is opened by another user and clicking the "Open" button

When memory is insufficient when the data file is opened

When the specified file does not exist

Exceeded the maximum number of data items. Please reduce them to 32 or less.

When clicking "Import data" menu while 32 items of data already exist

Please wait a moment while importing.

When clicking the "Finish" button on the data import screen

Please specify one of the Separators at least.

When clicking the "Finish" button without specifying the "Separator" on the data import screen

The selected file exceeded the maximum number of data that can be imported. You can import the maximum number of data starting from the first data row.

OK?

When clicking the "Finish" button when the size of the data file imported externally or the NCSAMP file on the hard disk exceeds 100MB

When clicking the "Finish" button when the number of data rows of the data file imported externally or the NCSAMP file on the hard disk exceeds 2,620,416

Please set the rows of name and unit before the data start row.

When setting the name and unit rows after the data start row on the import data screen and clicking the "Finish" button

Please set the name and the unit in different rows.

When setting the name and unit on the same row and clicking the "Finish" button

5. APPENDIX

Failed to import the ATS file.

When it was failed to import the ATS file at the timing of importing the file

Select the same type of nodes for importing.

The following nodes can be imported:

1. Gain waveform and phase waveform in frequency response measurement
2. Low-speed waveform and high-speed waveform in lost-motion adjustment.

When an ATS file with a different combination of data than expected is specified in the timing when the ATS file is read

5.7 Output Log File Message

Export of log file has failed, because the file is being opened or you have no permission to access the folder.

When the log file is open by another tool and the "Output log file" menu is selected

When there is no authority to copy the log file to the storage folder

Failed to create the destination folder.

The possible causes are as follows:

1. You have no permission to create the folder.
2. The specified path is invalid.

When it is failed to create the log storage folder because there is no authority to create the folder, etc.

When an invalid path is specified as the log storage folder

5.8 The Setting Range and Optimum Value of the Velocity Loop Gain for Each Motor Type and Encoder Type

The setting range and optimum value of [Velocity loop gain] which can be set on the velocity loop gain adjustment screen is shown as follows.

Motor type	Setting range	Optimum value
HF/HP Series A48	1 to 500	300
HF/HP Series A51	1 to 600	350
HF/HP Series A74	1 to 800	500
HF-KP Series	1 to 150	100
HG/HQ Series D48	1 to 500	300
HG/HQ Series D51	1 to 600	350
HG/HQ Series D74	1 to 800	500
HG46/HG56/HG96	1 to 150	100
Linear / Direct drive motor (normal)	1 to 1500	1000
Linear / Direct drive motor (special)	1 to 9999	5000
Others	1 to 150	100

5.9 Setting Firewall Exceptions

Follows the procedure below to register the exceptions for the Firewall function. (This setting can be performed by a user having the administrative right.)

1. Display "Control Panel".
2. Click "System and Security".

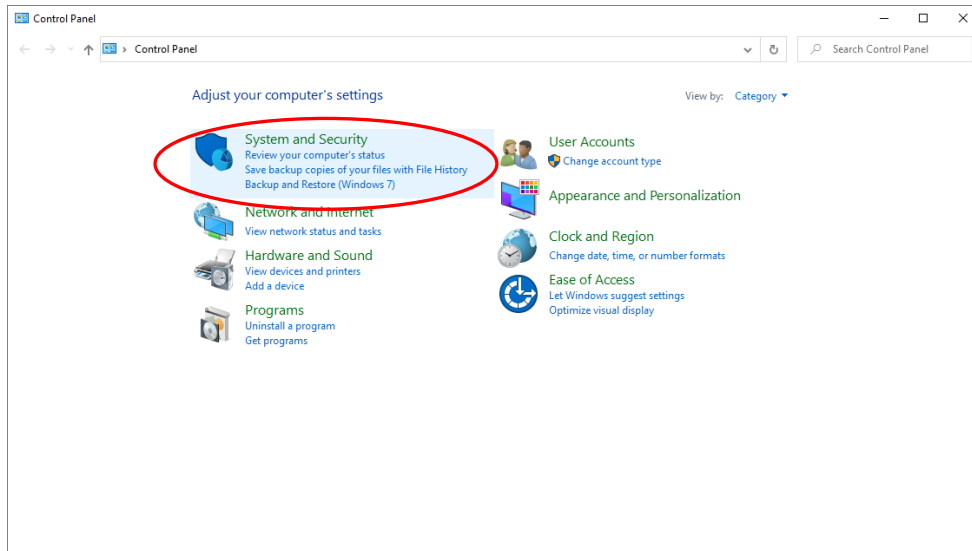

3. Click "Allow a program through Windows Firewall".

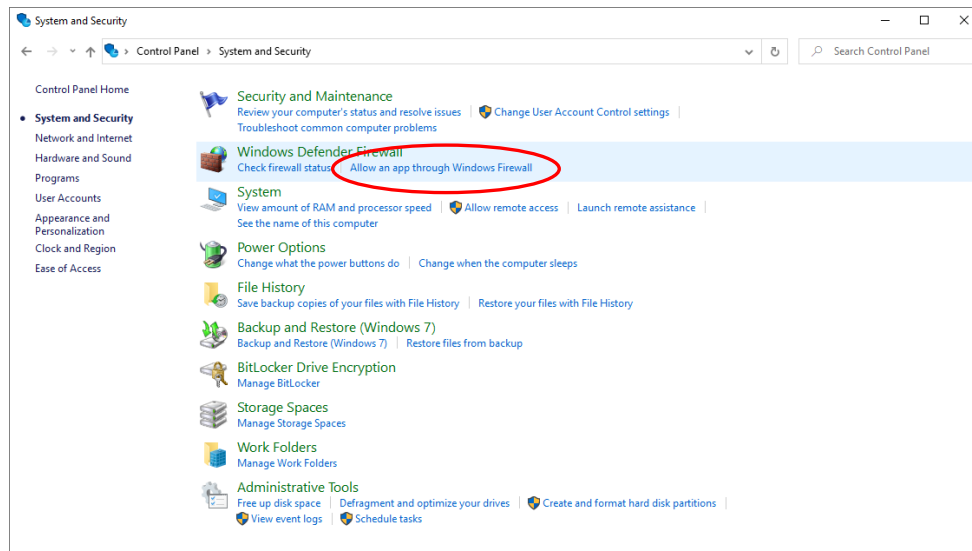

5. APPENDIX

4. Click the [Change settings] button to enable the [Allow another app] button. Then, click the [Allow another program] button

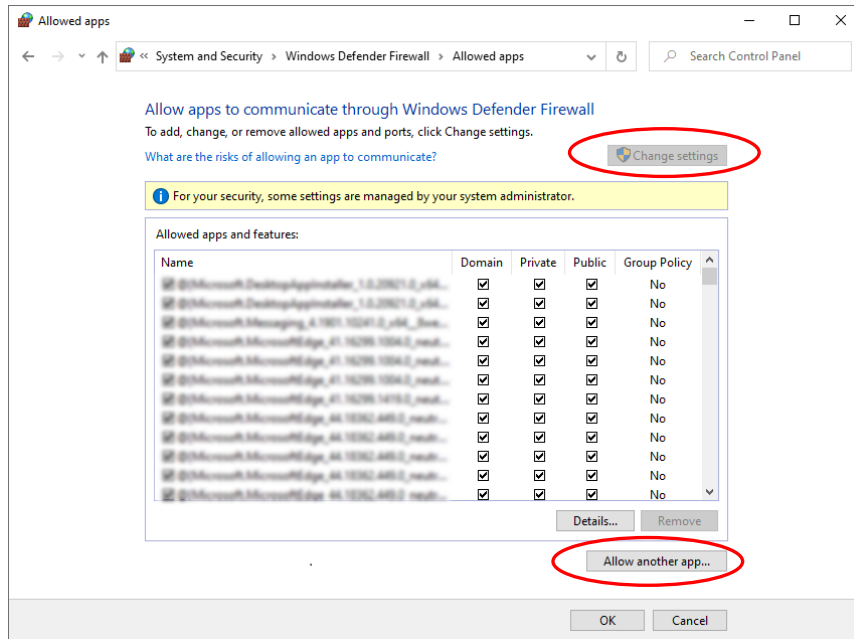

5. Click the [Browse] button.

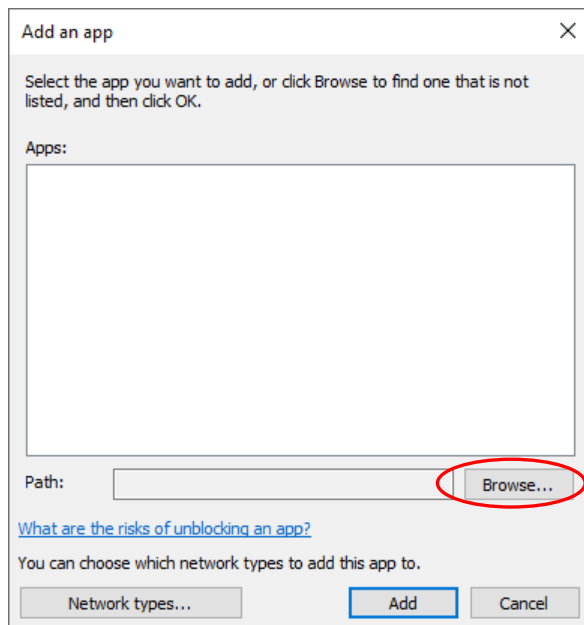

5. APPENDIX

6. Select the executable file to be registered as an exception to the firewall function, and click the [Open] button.

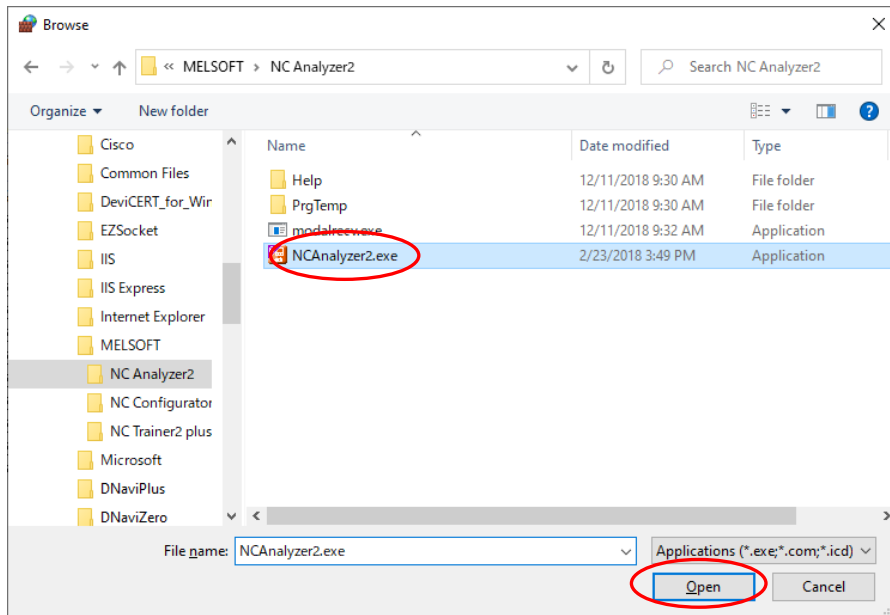

Select "C:\Program Files (x86)\MELSOFT\NC Analyzer2\NCAnalyzer2.exe".
(When the installation folder is the default)

7. Click the [Add] button.

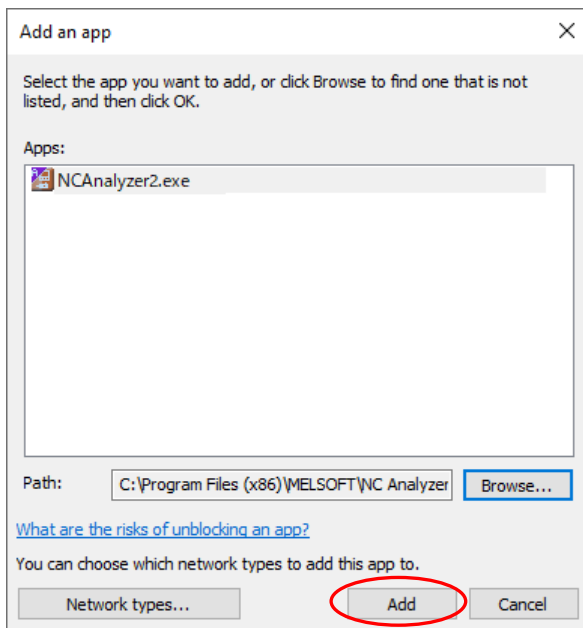

5.10 Trouble Shooting

The following shows the solutions for common problems with NC Analyzer2.

Symptom	Cause	Remedy
The screen collapses. (Icons overlap, or icons do not fit on the button.)	The size of text on the screen and the other items may be set to a value other than the default value (96DPI, 100%, 9pt) in Windows settings.	- Restore the size of text on the screen and the other items to the default value (96DPI, 100%, 9pt) - For Windows 11, Windows 10 (version 1703 or later), the functions of Windows enable it to display NC Analyzer2 at high DPI scale. (Note 1) (Note 2) (1) Select NCAnalyzer2.exe and select [Property] from the right click menu. (Note 3) (2) Check "Override high DPI scaling behavior. Scaling performed by:" on the [Compatibility] tab and select "System" from the pull down list. (3) Click the [OK] button.

(Note 1) Confirm the Windows version according to the following procedures.

- (1) Press the Windows key and [R], or select "Start" - "Windows System" - "Run".
- (2) Input "Winver" on the "Run" dialog.
- (3) Confirm the version on the displayed dialog.

(Note 2) The display of NC Analyzer2 is warped due to it being stretched.

The setting value of "Change the size of text, apps, and other items" and the recommended display resolution of Windows 11 or Windows 10 are shown below.

Setting value	Display resolution
100 %	1024 × 768 dot or more
125 %	1900 × 1200 dot or more
150 %	1900 × 1200 dot or more
175 %	2880 × 1620 dot or more
200 %	2880 × 1620 dot or more
225 %	3840 × 2160 dot or more
250 %	3840 × 2160 dot or more

(Note 3) NCAnalyzer2.exe is stored in the folder where NC Analyzer2 is installed.

When the install folder is the default, it is stored in the following folders.

64 bit: C:\Program Files (x86)\MELSOFT\NC Analyzer2\NCAnalyzer2.exe

32 bit: C:\Program Files\MELSOFT\NC Analyzer2\NCAnalyzer2.exe

Revision History

Date of revision	Manual No.	Revision details
Jun. 2015	IB(NA)-1501326-A	First edition created.
Oct. 2015	IB(NA)-1501326-B	<ul style="list-style-type: none"> - Contents were revised to correspond to NC Analyzer2 software version A1. - Contents were revised to correspond to C70 Series. - Contents were revised to be compatible with Windows 10. - Mistakes were corrected.
Jul. 2016	IB(NA)-1501326-C	<ul style="list-style-type: none"> - Contents were revised to correspond to NC Analyzer2 software version A2 and A3. - Contents were revised to correspond to M80W Series. - The following chapters were revised. <ul style="list-style-type: none"> 1.1 Overview of the NC Analyzer2 1.2 Applicable Models and Versions 1.3 Functions of NC Analyzer2 and Its Corresponding CNC 2.2 Connection Diagram 3.1.4 Starting the NC Analyzer2 3.1.6 Menu Selection Items <ul style="list-style-type: none"> 3.1.6.2 Waveform Window (Time-series Waveform) 3.1.6.3 Waveform Window (Roundness Waveform) 3.1.6.4 Waveform Window (Frequency Response Measurement) 3.1.6.5 Waveform Window (Arbitrary Path Measurement) 3.1.6.6 Waveform Window (FFT Waveform) 3.1.6.7 Right Click the Waveform Window 3.2 Project <ul style="list-style-type: none"> 3.3.1 Velocity Loop Gain Adjustment 3.3.2 Lost Motion Adjustment 3.4 Measurement and Adjustment 3.5 Tools <ul style="list-style-type: none"> 4.1 Precautions for Using Adjustment Wizard 5.2 Measurement and Adjustment Messages - The following chapters were added. <ul style="list-style-type: none"> 3.1.6.1 NC Basic Information Window 3.1.7 Toolbar Selection Items 3.1.8 Button Selection Items - Mistakes were corrected.
Jun. 2017	IB(NA)-1501326-D	<ul style="list-style-type: none"> - Contents were revised to correspond to NC Analyzer2 software version A4. - Contents were revised to correspond to C80 Series. - Windows8 was deleted from operating system. - The following chapters were revised. <ul style="list-style-type: none"> 1.2 Applicable Models and Versions 1.3 Functions of NC Analyzer2 and Its Corresponding CNC 2.2 Connection Diagram 3.1.6 Menu Selection Items <p style="text-align: right;">(Continue to the next page)</p>

Date of revision	Manual No.	Revision details
		<p style="text-align: right;">(Continued from the previous page)</p> <ul style="list-style-type: none"> 3.1.6.1 NC Basic Information Window 3.1.6.2 Waveform Window (Time-series Waveform) 3.1.6.3 Waveform Window (Roundness Waveform) 3.1.6.4 Waveform Window (Frequency Response Measurement) 3.1.6.5 Waveform Window (Arbitrary Path Measurement) 3.1.6.7 Right Click the Waveform Window 3.1.7 Toolbar Selection Items 3.1.8 Button Selection Items 3.2 Project 3.4.2 Reciprocation Acceleration/Deceleration Measurement 3.4.3 Roundness Measurement 3.4.4 Spindle Acceleration/Deceleration Measurement 3.4.5 Spindle Orientation Measurement 3.4.6 Synch Tap Error Measurement 3.4.7 Spindle C-axis Measurement 3.4.8 Spindle Synchronization Measurement 3.4.9 PLC Axis Acceleration/Deceleration Measurement 3.4.10 Arbitrary Path Measurement 3.5 Tools 4.1 Precautions for Using Adjustment Wizard 4.2 Precautions for Using Measurement and Adjustment 5.2 Measurement and Adjustment Messages 5.3 Graph Function Messages - The following chapters were added. <ul style="list-style-type: none"> 3.1.6.8 Save As - Mistakes were corrected.
Jun. 2019	IB(NA)-1501326-E	<ul style="list-style-type: none"> - Contents were revised to correspond to NC Analyzer2 software version A5. - Contents were revised to correspond to E80 Series. - The following chapters were revised. <ul style="list-style-type: none"> 1.2 Applicable Models and Versions 1.3 Functions of NC Analyzer2 and Its Corresponding CNC 1.4 Display Unit 2.1 Operation Environment 2.2 Connection Diagram 2.3 First Installation Procedure 3.1.3 Other Setup/Precautions 3.1.4 Starting the NC Analyzer2 3.1.6 Menu Selection Items <ul style="list-style-type: none"> 3.1.6.2 Waveform Window (Time-series Waveform) 3.1.6.3 Waveform Window (Roundness Waveform) 3.1.6.4 Waveform Window (Frequency Response Measurement) 3.1.6.5 Waveform Window (Arbitrary Path Measurement) 3.1.6.6 Waveform Window (FFT Waveform) 3.1.6.8 Right Click the Waveform Window <p style="text-align: right;">(Continue to the next page)</p>

Date of revision	Manual No.	Revision details
		<p style="text-align: right;">(Continued from the previous page)</p> <ul style="list-style-type: none"> 3.1.6.9 Save as 3.1.7 Toolbar Selection Items 3.1.8 Button Selection Items 3.2 Project <ul style="list-style-type: none"> 3.3.1 Velocity Loop Gain Adjustment 3.3.2 Lost Motion Adjustment 3.4.1 Frequency Response Measurement 3.4.2 Reciprocation Acceleration/Deceleration Measurement 3.4.3 Roundness Measurement 3.4.4 Spindle Acceleration/Deceleration Measurement 3.4.5 Spindle Orientation Measurement 3.4.6 Synch Tap Error Measurement 3.4.7 Spindle C-axis Measurement 3.4.8 Spindle Synchronization Measurement 3.4.9 PLC Axis Acceleration/Deceleration Measurement 3.4.10 Arbitrary Path Measurement 3.6 Tools 3.7 Language <ul style="list-style-type: none"> 4.1 Precautions for Using Adjustment Wizard 4.2 Precautions for Using Measurement and Adjustment 5.1 Adjustment Wizard Messages 5.2 Measurement and Adjustment Messages - The following chapters were added. <ul style="list-style-type: none"> 3.1.6.7 Waveform Window (Torque Characteristics) 3.1.6.10 Import data 3.4.11 Reading NCSAMP File 3.5 View - Mistakes were corrected.
Aug. 2022	IB(NA)-1501326-F	<ul style="list-style-type: none"> - Contents were revised to correspond to NC Analyzer2 software version A6. - Contents were revised to correspond to M800VW/M800VS/M80VW/M80V Series. - Windows 7 was deleted from operating system. - Chinese was deleted from the languages used for installation. - The chapter structure was changed. - The following chapters were revised. <ul style="list-style-type: none"> Introduction Safety Instructions 1.1 Overview 1.2 Applicable Models and Versions 1.3 Corresponding CNC 1.4 Display Unit 2.1 Operation Environment 2.2 Connection Diagram 2.3 First Installation Procedure <p style="text-align: right;">(Continue to the next page)</p>

Date of revision	Manual No.	Revision details
		<p style="text-align: right;">(Continued from the previous page)</p> <ul style="list-style-type: none"> 3.1.2 Setting Open Parameters 3.1.4 Starting the NC Analyzer2 3.1.6 Menu Selection Items <ul style="list-style-type: none"> 3.1.6.1 Right Click of Project Review 3.1.6.2 Right Click the Waveform Window 3.1.7 Toolbar Selection Items <ul style="list-style-type: none"> 3.1.7.1 Tool Bar of Project Preview 3.1.8 Button Selection Items 3.1.9 Shortcut Key List 3.2 1 Create a New Project <ul style="list-style-type: none"> 3.2.1.1 NC Basic Information Window 3.2.2 Save as Project Name 3.3.1 Velocity Loop Gain Adjustment 3.3.2 Lost Motion Adjustment 3.4.1 Frequency Response Measurement 3.4.2 Reciprocation Acceleration/Deceleration Measurement 3.4.3 Roundness Measurement 3.4.4 Spindle Acceleration/Deceleration Measurement 3.4.5 Spindle Orientation Measurement 3.4.6 Synch Tap Error Measurement 3.4.7 Spindle C-axis Measurement 3.4.8 Spindle Synchronization Measurement 3.4.9 PLC Axis Acceleration/Deceleration Measurement 3.4.10 Arbitrary Path Measurement 3.4.11 Read NCSAMP File 3.5.1 Option 3.5.3 Waveform Comparison 3.6.1 Changing of Theme Color 3.8 Waveform Window <ul style="list-style-type: none"> 3.8.1 Frequency Response Waveform 3.8.2 Time-series Waveform <ul style="list-style-type: none"> 3.8.2.1 FFT Waveform 3.8.3 Roundness Waveform 3.8.4 Arbitrary Program Waveform 3.8.5 Torque Characteristics 4.2 Precautions for Using Measurement and Adjustment 5.1 Adjustment Wizard Messages 5.2 Measurement and Adjustment Messages 5.3 Graph Function Messages 5.7 The Setting Range and Optimum Value of the Velocity Loop Gain for Each Motor Type and Encoder Type 5.8 Setting Firewall Exceptions - The following chapters were added. <ul style="list-style-type: none"> 3.3.3 Variable Full-closed Torsion Adjustment 3.5.4 Output Log File <p style="text-align: right;">(Continue to the next page)</p>

Date of revision	Manual No.	Revision details
		<p style="text-align: right;">(Continued from the previous page)</p> <ul style="list-style-type: none"> 3.9 Other Functions 3.9.1 Set Waveform Color and Plot 3.9.2 Data Transformation 3.9.2.1 Arbitrary Data Calculation 3.9.3 Coordinate Setting 3.9.3.1 Time-series Waveform 3.9.3.2 Roundness Waveform 3.9.3.3 Arbitrary Program Waveform 3.9.3.4 Torque Characteristics 3.9.4 Arbitrary graph setting 3.9.5 Time Axis Offset 3.9.6 Import data 5.4 Project Messages 5.5 Waveform Comparison Message 5.6 Import Data Message 5.9 Trouble Shooting <p>- Mistakes were corrected.</p>
Dec. 2022	IB(NA)-1501326-G	<ul style="list-style-type: none"> - Contents were revised to correspond to NC Analyzer2 software version A7. - Contents were revised to be compatible with Windows11. - The following chapters were revised. <ul style="list-style-type: none"> 1.3 Corresponding CNC 1.4 Display Unit 2.1 Operation Environment 2.3 First Installation Procedure 2.5.1 Procedure for Uninstalling Using the Control Panel 3.1.4 Starting the NC Analyzer2 3.1.6 Menu Selection Items 3.2.1 Create a New Project 3.3.3 Variable Full-closed Torsion Adjustment 3.4.2 Reciprocation Acceleration/Deceleration Measurement 3.5.1 Option 3.9.2 Data Transformation 3.9.6 Import data 5.2 Measurement and Adjustment Messages 5.6 Import Data Message 5.10 Trouble Shooting - The following chapters were added. <ul style="list-style-type: none"> 5.7 Output Log File Message - Mistakes were corrected.
Jan. 2024	IB(NA)-1501326-H	<ul style="list-style-type: none"> - Contents were revised to correspond to NC Analyzer2 software version A8. - Windows 8.1 was deleted from operating system. - The chapter structure was changed. - The following chapters were revised. <ul style="list-style-type: none"> 1.2 Applicable Models and Versions <p style="text-align: right;">(Continue to the next page)</p>

Date of revision	Manual No.	Revision details
		<p style="text-align: right;">(Continued from the previous page)</p> <ul style="list-style-type: none"> 1.3 Corresponding CNC 2.1 Operation Environment 2.3 First Installation Procedure 2.5.1 Procedure for Uninstalling Using the Control Panel 3.1.4 Starting the NC Analyzer2 3.1.6 Menu Selection Items <ul style="list-style-type: none"> 3.1.6.2 Right Click the Waveform Window 3.1.8 Button Selection Items <ul style="list-style-type: none"> 3.2.1 Create a New Project 3.3.3 Variable Full-closed Torsion Adjustment 3.4.1 Frequency Response Measurement 3.4.2 Reciprocation Acceleration/Deceleration Measurement 3.4.11 Read NCSAMP File 3.5.1 Option <ul style="list-style-type: none"> 3.5.3 Waveform Comparison 3.7 Language 3.8 Waveform Window <ul style="list-style-type: none"> 3.8.2 Time-series Waveform <ul style="list-style-type: none"> 3.8.4 Arbitrary Program Waveform 3.10.1 Set Waveform Color and Plot 3.10.2 Data Transformation 3.10.4 Arbitrary graph setting 3.10.5 Time Axis Offset 5.2 Measurement and Adjustment Messages 5.3 Graph Function Messages 5.4 Project Messages - The following chapters were added. <ul style="list-style-type: none"> 3.2.4 Read Sampling Data (CSV) in a Batch <ul style="list-style-type: none"> 3.4.2.1 Automatic Remeasurement 3.8.5 Arbitrary Program Waveform (3D) <ul style="list-style-type: none"> 3.8.5.1 Selected Point Information Display 3.9 Data Information <ul style="list-style-type: none"> 3.10.4.1 Roundness Waveform, Arbitrary Path Waveform, Arbitrary Path Waveform (3D) [XY/YZ/ZX] 3.10.4.2 Arbitrary Path Waveform (3D) [XYZ] - Mistakes were corrected.

Global Service Network

AMERICA

MITSUBISHI ELECTRIC AUTOMATION INC. (AMERICA FA CENTER)

HQ and Central Region Service Center (Chicago)
500 CORPORATE WOODS PARKWAY, VERNON HILLS, ILLINOIS 60061, U.S.A.
TEL: +1-847-478-2500 / FAX: +1-847-478-2650
Minneapolis, MN Service Satellite
Detroit, MI Service Satellite
Grand Rapids, MI Service Satellite
Cleveland, OH Service Satellite
St. Louis, MO Service Satellite
Indianapolis, IN Service Satellite

South/East Region Service Center (Georgia)

1845 SATELLITE BOULEVARD STE. 450, DULUTH, GEORGIA 30097, U.S.A.
TEL: +1-678-258-4529 / FAX: +1-678-258-4519
Charleston, SC Service Satellite
Charlotte, NC Service Satellite
Raleigh, NC Service Satellite
Dallas, TX Service Satellite
Houston, TX Service Satellite
Hartford, CT Service Satellite
Knoxville, TN Service Satellite
Nashville, TN Service Satellite
Huntsville, AL Satellite
Pittsburg, PA Service Satellite
Tampa, FL Service Satellite
Miami, FL Satellite
Lafayette, LA Service Satellite
Allentown, PA Satellite

Western Region Service Center (California)

5900-B KATELLA AVE. - 5900-A KATELLA AVE. CYPRESS, CALIFORNIA 90630, U.S.A.
TEL: +1-714-699-2625 / FAX: +1-847-478-2650
San Francisco, CA Satellite
Seattle, WA Service Satellite
Denver, CO Service Satellite

Canada Region Service Center (Toronto)

4299 14TH AVENUE MARKHAM, ONTARIO L3R 0J2, CANADA
TEL: +1-905-475-7728 / FAX: +1-905-475-7935
Edmonton, AB Service Satellite
Montreal, QC Service Satellite

Mexico Region Service Center (Querétaro)

Parque Tecnológico Innovación Querétaro, Lateral Carretera Estatal 431, Km 2+200, Lote 91 Modulos 1 y 2
Hacienda la Machorra, CP 76246, El Marqués, Querétaro, México
TEL: +52-442-153-6050
Monterrey, NL Service Satellite
Mexico City, DF Service Satellite

BRAZIL

MITSUBISHI ELECTRIC DO BRASIL COMÉRCIO E SERVIÇOS LTDA.

Votorantim Office
AV. GISELE CONSTANTINO, 1578, PARQUE BELA VISTA, VOTORANTIM-SP, BRAZIL CEP:18.110-650
TEL: +55-15-3023-9000
Blumenau, Santa Catarina Office

EUROPE

MITSUBISHI ELECTRIC EUROPE B.V.

European Service Headquarters (Dusseldorf, GERMANY)
Mitsubishi-Electric-Platz 1 40882 RATINGEN, GERMANY
TEL: +49-2102-486-5000 / FAX: +49-2102-486-5910

South Germany Service Center (Stuttgart)

SCHELMENWASENSTRASSE 16-20, 70567 STUTTGART, GERMANY
TEL: +49-711-770598-123 / FAX: +49-711-770598-141

France Service Center (Paris)

2 RUE DE L'UNION, 92565 RUEIL-MALMAISON CEDEX, FRANCE
TEL: +33-1-41-02-83-13 / FAX: +33-1-49-01-07-25

France Service Satellite (Lyon)

240, ALLEE JACQUES MONOD 69800 SAINT PRIEST FRANCE
TEL: +33-1-41-02-83-13 / FAX: +33-1-49-01-07-25

Italy Service Center (Milan)

VIA ENERGY PARK 14, VIMERCATE 20871 (MB) ITALY
TEL: +39-039-6053-342 / FAX: +39-039-6053-206

Italy Service Satellite (Padova)

VIA G. SAVELLI, 24 - 35129 PADOVA, ITALY
TEL: +39-039-6053-342 / FAX: +39-039-6053-206

U.K. Service Center

TRAVELLERS LANE, HATFIELD, HERTFORDSHIRE, AL10 8XB, U.K.
TEL: +44-1707-288-780 / FAX: +44-1707-278-695

Spain Service Center

CTRA. RUBI, 76-80 8174 SAINT CUGAT DEL VALLES, BARCELONA, SPAIN
TEL: +34-935-65-2236 / FAX: +34-935-89-1579

Poland Service Center

UL.KRAKOWSKA 50, 32-083 BALICE, POLAND
TEL: +48-12-347-6500 / FAX: +48-12-630-4701

Hungary Service Center

MITSUBISHI ELECTRIC EUROPE B.V. HUNGARIAN BRANCH
BUDAÖRS OFFICE PARK, SZABADSÁG ÚT 117., 2040 BUDAÖRS, HUNGARY
TEL: +36-70-433-2263

Turkey Service Center

MITSUBISHI ELECTRIC TURKEY ELEKTRİK ÜRÜNLERİ A.Ş
SERIFALI MAHALLESİ KALE SOKAK. NO.41 34775
UMRANIYE, ISTANBUL, TURKEY
TEL: +90-216-969-2500 / FAX: +90-216-661-44-47

Czech Republic Service Center

MITSUBISHI ELECTRIC EUROPE B.V. PRAGUE OFFICE
Pekařská 621/7, 155 00 PRAHA 5, CZECH REPUBLIC
TEL: +420-734-402-587

Sweden Service Center

HAMMARBACKEN 14, P.O.BOX 750 SE-19127, SOLLENTUNA, SWEDEN
TEL: +46-8-6251200 / FAX: +46-8-6251014

Bulgaria Service Center

AKHNATON Ltd. (Service Partner)
4 ANDREJ LJAPCHEV BLVD. POB 21, BG-1756 SOFIA, BULGARIA
TEL: +359-2-8176009 / FAX: +359-2-9744061

Ukraine Service Center (Kiev)

CSC Automation Ltd. (Service Partner)
4 B. YEVHENA SVERSTYUKA STR., 02002 KIEV, UKRAINE
TEL: +380-44-494-3344 / FAX: +380-44-494-3366

South Africa Service Center

Adroit Technologies (Service Partner)
20 WATERFORD OFFICE PARK, WATERFORD DRIVE, CNR OF WITKOPPEN ROAD,
FOURWAYS JOHANNESBURG SOUTH AFRICA
TEL: +27-11-658-8100 / FAX: +27-11-658-8101

ASEAN**MITSUBISHI ELECTRIC ASIA PTE. LTD. (ASEAN FA CENTER)**

Singapore Service Center
307 ALEXANDRA ROAD MITSUBISHI ELECTRIC BUILDING SINGAPORE 159943
TEL: +65-6473-2308 / FAX: +65-6476-7439

PHILIPPINES**MELCO FACTORY AUTOMATION PHILIPPINES INC.**

Head Office
128 LOPEZ RIZAL STREET, BRGY., HIGHWAY HILLS, MANDALUYONG CITY, MM PHILIPPINES 1550
TEL: +63-2-8256-8042 / FAX: +63-2-8637-2294

Philippines Service Center
KM.23 WEST SERVICE ROAD SSH, CUPANG, MUNTINLUPA CITY, PHILIPPINES
TEL: +63-2-8807-0420 / FAX: +63-2-8842-5202

VIETNAM**MITSUBISHI ELECTRIC VIETNAM CO., LTD.**

Vietnam Ho Chi Minh Service Center
11TH & 12TH FLOOR, VIETTEL TOWER B, 285 CACH MANG THANG 8 STREET, WARD 12, DISTRICT 10, HO CHI MINH CITY, VIETNAM
TEL: +84-28-3910-5945 / FAX: +84-28-3910-5947

Vietnam Hanoi Service Center
14TH FLOOR, CAPITAL TOWER, 109 TRAN HUNG DAO STREET, CUA NAM WARD, HOAN KIEM DISTRICT, HA NOI CITY, VIETNAM
TEL: +84-24-3937-8075 / FAX: +84-24-3937-8076

INDONESIA**PT. MITSUBISHI ELECTRIC INDONESIA**

Indonesia Service Center (Cikarang)
JL. KENARI RAYA BLOK G2-07A, DELTA SILICON 5, LIPPO CIKARANG - BEKASI 17550, INDONESIA
TEL: +62-21-2961-7797 / FAX: +62-21-2961-7794

MALAYSIA**MITSUBISHI ELECTRIC SALES MALAYSIA SDN. BHD.**

Malaysia Service Center (Kuala Lumpur Service Center)
LOT 11, JALAN 219, P.O BOX 1036, 46880 PETALING JAYA, SELANGOR DARUL EHSAN, MALAYSIA
TEL: +60-3-7626-5032

Johor Bahru Service Center
9, Jalan Perjiranan 4/6, Bandar Dato Onn, 81100 Johor.
TEL: 07-3642250 / 2256

Pulau Pinang Service Center
25-G, Pusat Perniagaan Perdana Jaya, Jalan Permatang Rawa, 14000 Bukit Mertajam, Pulau Pinang
TEL: +60-4-510-1838 / Fax: +60-4-510-1835

THAILAND**MITSUBISHI ELECTRIC FACTORY AUTOMATION (THAILAND) CO., LTD.**

Thailand Service Center (Bangkok)
101, TRUE DIGITAL PARK OFFICE, 5TH FLOOR, SUKHUMVIT ROAD, BANGCHAK, PHRA KHANONG, BANGKOK, 10260 THAILAND
TEL: +66-2-092-8600 / FAX: +66-2-043-1231-33

INDIA**MITSUBISHI ELECTRIC INDIA PVT., LTD.**

Service Head office and South India Service Center (Bangalore)
CNC eXPerience Park, PLOT NO. 57/A, PEENYA PHASE 3, PEENYA INDUSTRIAL AREA, BANGALORE 560058, KARNATAKA, INDIA
TEL: +91-80-4655-2121
Chennai Service Satellite
Coimbatore Service Satellite
Hyderabad Service Satellite

North India Service Center (Gurgaon)
PLOT 517, GROUND FLOOR, UDYOG VIHAR PHASE-III, GURUGRAM 122008, HARYANA, INDIA
TEL: +91-124-463-0300
Ludhiana Service Satellite
Panthenagar Service Satellite
Delhi Service Satellite
Jamshedpur Service Satellite
Manesar Service Satellite

West India Service Center (Pune)
ICC-Devi GAURAV TECHNOLOGY PARK, UNIT NO.402, FOURTH FLOOR, NORTH WING, SURVEY NUMBER 191-192 (P), NEXT to INDIAN CARD CLOTHING COMPANY Ltd, OPP. VALLABH NAGAR, PIMPRI, PUNE- 411 018, MAHARASHTRA, INDIA
TEL: +91-20-6819-2274
Kolhapur Service Satellite
Aurangabad Service Satellite
Mumbai Service Satellite

West India Service Center (Ahmedabad)
204-209, 2ND FLOOR, 31FIVE, CORPORATE ROAD PRAHLADNAGAR, AHMEDABAD -380015, GUJARAT, INDIA
TEL: + 91-79-6777-7888
Rajkot Service Satellite

CHINA**MITSUBISHI ELECTRIC AUTOMATION (CHINA) LTD. (CHINA FA CENTER)**

CNC Call Center
TEL: +86-400-921-5130

Shanghai Service Center
NO.1386 HONG QIAO ROAD, CHANG NING QU, SHANGHAI 200336, CHINA
TEL: +86-21-2322-3030 / FAX: +86-21-2322-3000*8422

Qingdao Service Center
Suzhou Service Center
Wuhan Service Center
Ningbo Service Center
Hefei Service Center
Beijing Service Center
Tianjin Service Center
Xian Service Center
Dalian Service Center
Chengdu Service Center

Shenzhen Service Center
LEVEL 8, GALAXY WORLD TOWER B, 1 YABAO ROAD, LONGGANG DISTRICT, SHENZHEN 518129, CHINA
TEL: +86-755-2399-8272 / FAX: +86-755-8229-3686

Dongguan Service Center
Xiamen Service Center

KOREA**MITSUBISHI ELECTRIC AUTOMATION KOREA CO., LTD. (KOREA FA CENTER)**

Korea Seoul Service Center
8F GANGSEO HANGANG XI-TOWER A, 401 YANGCHEON-RO, GANGSEO-GU, SEOUL 07528 KOREA
TEL: +82-2-3660-9631 / FAX: +82-2-3664-8668

Korea Daegu Service Center
2F KT BLDG. 8, HOGUK-RO, BUK-GU, DAEGU 41518, KOREA
TEL: +82-53-382-7401 / FAX: +82-53-382-7412

Korea Changwon Technical Center
#205, 888, CHANGWON-DAERO, SEONGSAN-GU, CHANGWON-SI, GYEONGSANGNAM-DO, 51532, KOREA
TEL: +82-55-261-5559 / FAX: +82-55-261-5558

TAIWAN**MITSUBISHI ELECTRIC TAIWAN CO., LTD. (TAIWAN FA CENTER)**

Taiwan Taichung Service Center
NO. 8-1, GONGYEQU 16TH RD., XITUN DIST., TAICHUNG CITY 40768, TAIWAN
TEL: +886-4-2359-0688 / FAX: +886-4-2359-0689

Taiwan Taipei Service Center
11F, NO.88, SEC.6, ZHONGSHAN N. RD., SHILIN DIST., TAIPEI CITY 11155, TAIWAN
TEL: +886-2-2833-5430 / FAX: +886-2-2833-5433

Taiwan Tainan Service Center
11F-1, NO.30, ZHONGZHENG S. RD., YONGKANG DIST., TAINAN CITY 71067, TAIWAN
TEL: +886-6-252-5030 / FAX: +886-6-252-5031

OCEANIA**MITSUBISHI ELECTRIC AUSTRALIA PTY. LTD.**

Oceania Service Center
348 VICTORIA ROAD, RYDALMERE, N.S.W. 2116 AUSTRALIA
TEL: +61-2-9684-7269 / FAX: +61-2-9684-7245

Notice

Every effort has been made to keep up with software and hardware revisions in the contents described in this manual. However, please understand that in some unavoidable cases simultaneous revision is not possible.

Please contact your Mitsubishi Electric dealer with any questions or comments regarding the use of this product.

Duplication Prohibited

This manual may not be reproduced in any form, in part or in whole, without written permission from Mitsubishi Electric Corporation.

© 2015-2024 MITSUBISHI ELECTRIC CORPORATION
ALL RIGHTS RESERVED.

MITSUBISHI ELECTRIC CORPORATION

HEAD OFFICE : TOKYO BLDG.,2-7-3 MARUNOUCHI,CHIYODA-KU,TOKYO 100-8310,JAPAN

MODEL	NC Analyzer2
MODEL CODE	100-417
Manual No.	IB-1501326