

mitsubishi

Type SW3D5F-CSKP-E Basic Communication Support Tool

Operating Manual



Mitsubishi Programmable Logic Controller

● SAFETY PRECAUTIONS ●

(Always read these instructions before using this equipment.)

Before using this product, please read this manual and the relevant manuals introduced in this manual carefully and pay full attention to safety to handle the product correctly.

The instructions given in this manual are concerned with this product. For the safety instructions of the programmable controller system, please read the CPU module user's manual.

In this manual, the safety instructions are ranked as "DANGER" and "CAUTION".



DANGER

Indicates that incorrect handling may cause hazardous conditions, resulting in death or severe injury.



CAUTION

Indicates that incorrect handling may cause hazardous conditions, resulting in medium or slight personal injury or physical damage.

Note that the  CAUTION level may lead to a serious consequence according to the circumstances. Always follow the instructions of both levels because they are important to personal safety.

Please save this manual to make it accessible when required and always forward it to the end user.

[Design Instructions]



DANGER

- When data change or status control is to be performed from a peripheral device to the running PLC, configure up an interlock circuit in the outside of the PLC system to ensure that the whole system will always operate safely.
Also, determine corrective actions to be taken for the system when a communication error occurs due to a cable connection fault or the like in online operation performed from the peripheral device to the PLC CPU.

[Design Instructions]



CAUTION

- Online operation performed with a peripheral device connected to the running CPU module (especially forced output or operating status change) should be started after carefully reading the manual and fully ensuring safety.
Not doing so can cause machine damage or accident due to an operation mistake.

REVISIONS

* The manual number is given on the bottom left of the back cover.

Print Date	* Manual Number	Revision
Sep., 1999	IB (NA)-0800014-A	First edition
Sep., 1999	IB (NA)-0800014-B	<u>Correction</u> Operating Instruction (11), section 5.3, section 5.4, section 7.3, subsection 8.1.3, subsection 8.2.3, subsection 8.3.2, subsection 8.3.4, subsection 8.4.2, subsection 8.4.4, subsection 8.5.3, subsection 11.2.2, subsection 11.3.2, subsection 11.4.2, subsection 11.5.2, subsection 11.6.2
May, 2000	IB (NA)-0800014-C	<u>Correction</u> Operating Instructions, About Manuals, About the Generic Terms and Abbreviations, section 1.1, subsection 2.2.1, section 2.3, chapter 4, section 5.2, subsection 8.2.3 <u>Addition</u> Contents, section 1.2, subsection 2.1.1, subsection 2.1.2, subsection 2.1.3, subsection 2.2.2, section 5.8, section 7.2, section 7.4, section 7.5, section 7.6, chapter 8, chapter 11
Jul., 2000	IB (NA)-0800014-D	<u>Correction</u> Subsection 9.5.2 <u>Addition</u> Subsection 11.2.2
Jun., 2001	IB (NA)-0800014-E	<u>Correction</u> Operating Instructions, section 3.1, subsection 8.2.2 <u>Addition</u> section 5.2, subsection 8.2.2
Feb., 2002	IB (NA)-0800014-F	<u>Correction</u> Section 3.1, section 3.2, section 5.5, section 5.6, section 5.8, section 7.2, section 7.4, subsection 11.2.1, subsection 11.6.1 <u>Section number changed</u> Section 7.6 → 7.5
Nov., 2003	IB (NA)-0800014-G	<u>Correction</u> Operating Instructions, About Manuals, section 1.1, subsection 2.1.1, subsection 2.1.2, subsection 2.1.3, subsection 2.2.1, subsection 2.2.2, subsection 8.1.2, subsection 8.2.2, subsection 11.2.2, subsection 11.3.2, subsection 11.4.2, subsection 11.5.2 <u>Addition</u> About the Generic Terms and Abbreviations, subsection 9.4.4 <u>New Addition</u> Software User Registration
Apr., 2004	IB (NA)-0800014-H	<u>Correction</u> Operating Instructions, section 3.1, section 3.3

Japanese Manual Version IB-0800010-I

This manual confers no industrial property rights or any rights of any other kind, nor does it confer any patent licenses. Mitsubishi Electric Corporation cannot be held responsible for any problems involving industrial property rights which may occur as a result of using the contents noted in this manual.

© 1999 MITSUBISHI ELECTRIC CORPORATION

— SOFTWARE USER REGISTRATION —

After agreeing to the terms of the Software License Agreement included in the package, please access the MELFANSweb Home Page (<http://www.MitsubishiElectric.co.jp/melfansweb>) and make a software user registration. (User registration is free of charge.)

You can also make a registration by faxing or mailing the "Software Registration Card" packed with the product.

1. Software Registration

You can make a software registration by accessing the MELFANSweb Home Page or faxing or mailing the "Software Registration Card" packed with the product.

After you have made a software registration, we will register the user and send the "Software registration confirmation" together with the user ID.

The latest information of new product, version up, and other will be available by direct mail.

2. Notes on Contact

Please ask questions concretely and clearly using terms listed in the manual.

When requesting us to solve a problem, provide us with detailed information for reproducing the problem.

In addition, contact the respective manufacturers when asking questions about the operating system (OS) or the other vender's software products.

User registration is valid only in Japan.

Operating Instructions

- (1) When using Windows NT 4.0
When using Windows NT 4.0, CSKP may be installed and used only on the administrator's authority.
- (2) Shared devices on Windows 95 and Windows 98
Having been implemented by using the service function of Windows NT 4.0, the shared devices do not support any OS other than Windows NT 4.0.
However, the shared devices of the personal computer which uses Windows NT 4.0 can be accessed from the personal computer which uses Windows 95 or Windows 98.
- (3) Computer link communication and CPU COM communication on Windows 95
On Windows 95, communication using the COM port, e.g. computer link communication or CPU COM communication, will cause a memory leak. Therefore, do not perform continuous operation.
- (4) Multithreading communication
Multithreading communication cannot be made.
- (5) Simultaneous use of CSKP and GPPW
When using GPPW and CSKP together on the same E71 module to make Ethernet communication, make the following settings.
 - Set the protocol of the "Target" screen of the Ethernet utility to "UDP/IP".
 - Set SW2 of the communication status setting switches of the E71 module to "OFF (binary)".

For this reason, if SW1D5F-CSKP-E had been used to make Ethernet communication, the utility must be set and the E71 module's switch settings changed.
- (6) Installation
 - (a) When using SW3D5F-CSKP-E
After uninstalling SW1D5F-CSKP-E or SW2D5F-CSKP-E, install SW3D5F-CSKP-E.
At this time, all settings made in each utility are erased and the settings must therefore be made again.
 - (b) When using SW3D5F-CSKP-EV
With SW2D5F-CSKP-E installed, install SW3D5F-CSKP-EV.
Unless SW2D5F-CSKP-E has been installed, SW3D5F-CSKP-EV can not be installed.
At this time, all settings made in each utility are erased and the settings must therefore be made again.
- (7) Overwrite installation
When performing overwrite installation, install the software in the folder where it had already been installed.
- (8) Start menu
When you have uninstalled CSKP, the item may remain in the start menu.
In such a case, restart the personal computer.
- (9) Software version of CC-Link master and local modules
The CC-Link master and local modules used in CC-Link communication or CC-Link G4 communication should be those of software version "N" or later.
Modules of software version "M" or earlier will not operate properly.

- (10) Software version of CC-Link G4 modules
The CC-Link G4 modules used in CC-Link G4 communication should be those of software version "D" or later.
Modules of software version "C" or earlier will not operate properly.
- (11) Restrictions on use of the FXCPU
- (a) Access to (read from/write to) CN device (current value) number 200 and later of the FXCPU cannot be made.
 - (b) When the FXCPU is used, access to devices V, Z cannot be made.
 - (c) When the FXCPU is used, access to device TN (timer current value) number 199 and earlier can be made but access to number 200 and later cannot be made.
- (12) About forced termination of processes during communication
If communication is being made with the same channel number open for multiple processes, forcing one process to be terminated by Task Manager or the like may stop the other processes at the communication function execution area.
In this case, restart after terminating all processes that use the same channel number.
- (13) About transmission speed
As the transmission speed of the QnACPU of version 9707B or later, you can set 9600bps, 19200bps or 38400bps.
For version 9707A or earlier, you can set 9600bps or 19200bps.
Also, the transmission speed of the ACPU and motion controller CPU is fixed to 9600bps.
- (14) Simultaneous use of CSKP and GPPW in CPU COM communication
When using the COM port together with GPPW for CPU COM communication, the transmission speed must be set to the same value.
- (15) Precautions for using the E71
- (a) When using the E71-S3, make broadcast setting or set the same port number as that of the module in the sequence program.
 - (b) When the E71, since broadcast cannot be performed, set the same port number as that of the module in the sequence program.
 - (c) If multiple personal computers are used to perform mdRandR (read from random devices) on a single E71 at the same time using TCP/IP, device data set in a different personal computer may be read. Please take one of the countermeasures listed below.
 - 1) Limit the use of TCP/IP to one port only and use UDP/IP for other ports.
 - 2) Perform mdReceive (batch reading from devices) by the block defined in mdRandR (read from random devices).
 - 3) Synchronize the timing between the multiple personal computers that perform mdRandR (read from random devices).
- (16) About use of the Q4ARCPU
When using the UDP/IP protocol of Ethernet communication, use the Q4ARCPU whose year and month of manufacture is "0012" or later and the QE71 whose function version is B or later.

(17) About the sample sequence programs

The sample sequence programs attached to CSKP assume that only a personal computer and Ethernet modules exist in the network. Depending on your system configuration and parameter settings, the programs must be modified. Make corrections to make the programs optimum for your system.

Also, use the sample sequence programs on your own responsibility.

When reading the sample sequence programs by using GPPW, create a folder and select [Project] – [Import file] – [Import from GPPA format file] from the GPPW menu.

(18) About relaying from MELSECNET/10-loaded station

When the MELSECNET/10 is loaded to the AnNCPU or AnACPU, it is recognized as the MELSECNET(II).

When the connection station is the AnNCPU or AnACPU, set the relay network to the MELSECNET(II).

Also, when making access to the control station, set the station number to "0".

(19) About computer link communication

When the connection station is the AnNCPU or AnACPU and the computer link module is the UC24 for computer link connection, making access to the AnNCPU, AnACPU or QnACPU via the MELSECNET/10 will cause remote operation to result in an error.

(20) About resume and other functions of the personal computer

A communications error may occur if communications are made with the PLC CPU after setting the resume function, suspend setting, power-saving function or standby mode of the personal computer.

Hence, any of the above functions should not be set for making communications with the PLC CPU.

(21) Precautions for USB communication

Connecting/disconnecting the USB cable, resetting the PLC CPU, or switching power OFF/ON frequently during communications with the PLC CPU can cause a communications error, from which recovery may not be made.

If recovery cannot be made from the communications error, completely disconnect the USB cable once and reconnect it in more than five seconds.

(Even after this operation, an error may occur at the initial communication, but communications will be made properly at the second time and later.)

INTRODUCTION

Thank you for choosing Type SW3D5F-CSKP-E Basic Communication Support Tool
Before using this product, please read this manual carefully to use Type SW3D5F-CSKP-E Basic
Communication Support Tool to its optimum.
Please forward this manual to the end user.

CONTENTS

Safety Precautions	A- 1
Revisions	A- 2
Software User Registration	A- 3
Operating Instructions	A- 4
About Manuals	A-11
How to Use This Manual	A-12
About the Generic Terms and Abbreviations	A-13
Term Definitions	A-14
Product Components	A-15
1 OVERVIEW	1- 1 to 1- 6
1.1 Features	1- 1
1.2 Utility List	1- 5
1.3 About Compatibility with the Existing Software	1- 6
2 SYSTEM CONFIGURATION	2- 1 to 2-10
2.1 System Configuration List	2- 1
2.1.1 When using Windows NT Workstation 4.0	2- 1
2.1.2 When using Windows 95	2- 2
2.1.3 When using Windows 98	2- 3
2.2 System Configurations for Use of Various Communication Formats	2- 4
2.2.1 System configurations	2- 4
2.2.2 Details of each communication form	2- 5
2.3 Operating Environment	2- 9
2.4 Usable PLC CPU	2- 9
3 INSTALL AND UNINSTALL	3- 1 to 3- 8
3.1 Install	3- 1
3.2 Icons Registered	3- 5
3.3 Uninstall	3- 7
4 OPERATION PROCEDURE	4- 1 to 4- 2

5 MAKING ACCESS TO PLC CPU	5- 1 to 5-18
5.1 Using Computer Link Communication for Making Access	5- 1
5.2 Using Ethernet Communication for Making Access	5- 3
5.3 Using CPU COM Communication for Making Access.....	5- 5
5.4 Using CPU USB Communication for Making Access.....	5- 8
5.5 Using MELSECNET/10 Communication for Making Access	5-11
5.6 Using CC-Link Communication for Making Access	5-13
5.7 Using CC-Link G4 Communication for Making Access	5-15
5.8 Using CPU Board Communication for Making Access	5-17
6 USING VARIOUS FUNCTIONS	6- 1 to 6- 6
6.1 Using the Shared Devices	6- 1
6.2 Refreshing the Devices.....	6- 3
6.3 Making Offline Debugging by Ladder Logic Test Communication	6- 5
7 OPERATIONS COMMON TO UTILITIES	7- 1 to 7-10
7.1 Starting the Utilities	7- 1
7.2 Exiting from the Utilities	7- 1
7.3 About the System Menu	7- 3
7.4 Displaying the Help Screen	7- 8
7.5 Confirming the Version	7- 9
8 OPERATIONS OF MELSEC DATA LINK UTILITIES	8- 1 to 8-30
8.1 Computer Link Utility.....	8- 1
8.1.1 Operation procedure	8- 1
8.1.2 Computer link module switch settings	8- 2
8.1.3 Operations on Target screen	8- 3
8.1.4 Operations on Communication screen	8- 6
8.1.5 Operations on Diagnostic screen	8- 7
8.2 Ethernet Utility	8- 8
8.2.1 Operation procedure	8- 8
8.2.2 Ethernet module switch settings.....	8- 9
8.2.3 Operations on Target screen	8-10
8.2.4 Operations on Diagnosis screen	8-13
8.3 CPU COM Utility	8-14
8.3.1 Operation procedure	8-14
8.3.2 Operations on Target screen	8-15
8.3.3 Operations on Communication screen	8-17
8.3.4 Operations on Diagnosis screen	8-18
8.4 CPU USB Utility.....	8-19
8.4.1 Operation procedure	8-19
8.4.2 Operations on Target screen	8-20
8.4.3 Operations on Communication screen	8-22
8.4.4 Operations on Diagnosis screen	8-23

8.5 CC-Link G4 Utility.....	8-24
8.5.1 Operation procedure	8-24
8.5.2 CC-Link G4 module switch settings.....	8-25
8.5.3 Operations on Target screen	8-26
8.5.4 Operations on Communication screen	8-28
8.5.5 Operations on Diagnosis screen	8-29

9 OPERATIONS OF OTHER UTILITIES	9- 1 to 9-26
--	---------------------

9.1 Shared Device Utility.....	9- 1
9.1.1 Operation procedure	9- 1
9.1.2 Operations on Parameter Setting screen.....	9- 2
9.2 Shared Device Server Utility.....	9- 3
9.2.1 Operation procedure	9- 3
9.2.2 About the Shared Device Server Process.....	9- 3
9.2.3 Operations on Refresh range setting screen	9- 4
9.2.4 Operations on List indication screen	9- 7
9.2.5 Operations on Status monitor screen	9- 8
9.3 Ladder Logic Test Utility	9- 9
9.3.1 Operation procedure	9- 9
9.3.2 Operations on Target screen	9-10
9.3.3 Operations on Diagnostics screen.....	9-11
9.4 Device Monitor Utility	9-12
9.4.1 Operation procedure	9-12
9.4.2 Setting to batch monitor	9-13
9.4.3 Setting to 16-point register monitor	9-14
9.4.4 Setting the monitor target.....	9-15
9.4.5 Setting the monitored device	9-16
9.4.6 Changing the word device value	9-17
9.4.7 Changing the word device value continuously.....	9-18
9.4.8 Turning the bit device ON/OFF	9-19
9.4.9 Changing the display format.....	9-19
9.4.10 About the numerical pad	9-20
9.4.11 Other operations.....	9-21
9.5 Error Viewer	9-23
9.5.1 Screen explanation	9-23
9.5.2 Log menu.....	9-24
9.5.3 View menu.....	9-25

10 SHARED DEVICES	10- 1 to 10- 4
--------------------------	-----------------------

10.1 Specifications	10- 1
10.2 System Area Information	10- 2

11.1 Cautions on Device Access	11- 1
11.2 Computer Link Communication	11- 2
11.2.1 Accessible devices	11- 2
11.2.2 Accessible range	11- 5
11.3 Ethernet Communication	11- 7
11.3.1 Accessible devices	11- 7
11.3.2 Accessible range	11-10
11.4 CPU COM Communication.....	11-11
11.4.1 Accessible devices	11-11
11.4.2 Accessible range	11-14
11.5 CPU USB Communication.....	11-17
11.5.1 Accessible devices	11-17
11.5.2 Accessible range	11-20
11.6 CC-Link G4 Communication.....	11-21
11.6.1 Accessible devices	11-21
11.6.2 Accessible range	11-24

About Manuals

The following manuals are related to this product.
Refer to this list and request the required manuals.

Relevant Manuals

Manual Name	Manual Number (Model Code)
Type SW3D5F-CSKP-E Basic Communication Support Tool Programming Manual Provides the programming procedure, detailed explanations, and error codes of the MELSEC data link library. (Packed with the product)	IB-0800015 (1LMS51)
Type A70BDE-J71QLP23/A70BDE-J71QLP23GE/A70BDE-J71QBR13/A70BDE-J71QLR23 MELSECNET/10 Interface Board User's Manual(For SW3DNF-MNET10) Describes the features, specifications, part names and setting of the MELSECNET/10 board, and the installation, uninstallation and others of the driver. (Packed with the product)	IB-0800035 (13JL93)
Type A80BDE-J61BT11 CC-Link System Master/Local Interface Board User's Manual (For SW3DNF-CCLINK) Describes the features, specifications, part names and setting of the CC-Link master board, and the installation, uninstallation and others of the driver. (Packed with the product)	IB-0800110 (13JR14)
Type A80BDE-J61BT13 CC-Link Interface Board User's Manual (For SW3DNF-CCLINK) Describes the features, specifications, part names and setting of the CC-Link local board, and the installation, uninstallation and others of the driver. (Packed with the product)	IB-0800036 (13JL94)
Type A80BDE-A2USH-S1 PLC CPU Board User's Manual (For SW0DNF-ANU-B) Describes the features, specifications, part names and setting of the CPU board, and the installation, uninstallation and others of the driver. (Packed with the product)	IB-0800087 (13JR08)

How to Use This Manual

"How to Use This Manual" is described by purposes of using CSKP.
Refer to the following and use this manual.

- (1) To know the features and utility list (Sections 1.1 and 1.2)
Features are given in Section 1.1 and a utility list in Section 1.2.
- (2) To know compatibility with the existing software (Section 1.3)
Section 1.3 presents compatibility with the existing software.
- (3) To know the system configuration (Sections 2.1 and 2.2)
These sections provide system configurations available by use of CSKP.
- (4) To know CSKP's operating environment and usable PLC CPUs (Sections 2.3 and 2.4)
CSKP's operating environment is given in Section 2.3 and usable PLC CPUs in Section 2.4.
- (5) To install or uninstall CSKP (Chapter 3)
Read Chapter 3 which describes how to install and uninstall CSKP.
- (6) To know the operation procedures of CSKP (Chapters 4 to 6)
Chapter 4 provides the operation procedures of CSKP, and Chapters 5 and 6 give simple operation procedures for communication by actually using the corresponding utilities.
- (7) To know the operation methods of the utilities (Chapters 7 to 9)
Chapter 7 provides operations common to the utilities, and Chapters 8 and 9 describe how to perform operation on a utility basis.
Read these chapters when using the utilities.
- (8) To know the specifications of the shared devices and the contents of the system area information region (Chapter 10)
Chapter 10 gives the specifications of the shared devices and the data stored in the system area information region.
- (9) To know the accessible devices and ranges (Chapter 11)
Chapter 11 provides the accessible devices and ranges.

About the Generic Terms and Abbreviations

Unless otherwise specified, this manual uses the following generic terms and abbreviations to describe Type SW3D5F-CSKP-E Basic Communication Support Tool.

Generic Term/Abbreviation	Description
CSKP	Abbreviation of Type SW3D5F-CSKP-E Basic Communication Support Tool
Windows NT 4.0	Abbreviation of Microsoft Windows NT Workstation 4.0
Windows 95	Abbreviation of Microsoft Windows 95
Windows 98	Abbreviation of Microsoft Windows 98
Windows	Generic term of Microsoft Windows 95, Microsoft Windows 98 and Microsoft Windows NT Workstation 4.0
Personal computer	DOS/V-compatible personal computer of IBM PC/AT and its compatibles
CC-Link G4 module	Abbreviation of Type AJ65BT-G4 GPP function peripheral device connection module
GPPW	Abbreviation of GPP Function Software for Windows SW□D5C-GPPW-E/SW□D5F-GPPW-E
Ladder Logic Test Tool (LLT)	Abbreviation of Ladder Logic Test Function Tool Software for Windows SW□D5C-LLT-E/SW□D5F-LLT-E
MELSECNET/10 board	Abbreviation of Type A70BDE-J71QLP23/A70BDE-J71QLP23GE/A70BDE-J71QBR13/A70BDE-J71QLR23 MELSECNET/10 interface board
CC-Link board	Abbreviation of Type A80BDE-J61BT11 CC-Link system master/local interface board and Type A80BDE-J61BT13 CC-Link interface board
CPU board	Abbreviation of Type A80BDE-A2USH-S1 PLC CPU board
AnNCPU	Generic term of the A0J2HCPU, A1SCPU, A1SCPU-S1, A1SCPUC24-R2, A1SHCPU, A1SJCPU, A1SJCPU-S3, A1SJHCPU, A1SJHCPU-S8, A1NCPUCPU, A2CCPUC24, A2CCPUC24-PRF, A2CJCPU, A2NCPUCPU, A2NCPUCPU-S1, A2SCPUCPU, A2SCPUCPU-S1, A2SHCPU, A2SHCPU-S1 and A1FXCPU
AnACPU	Generic term of the A2ACPU, A2ACPU-S1, A2ACPUP21/R21, A2ACPUP21/R21-S1, A3ACPUP21/R21, A3NCPUCPU and A3ACPU
AnUCPU	Generic term of the A2UCPU, A2UCPU-S1, A2ASCPUCPU, A2ASCPUCPU-S1, A2ASCPUCPU-S30, A3UCPU and A4UCPU
QCPU(A mode)	Generic term of the Q02CPU-A, Q02HCPUCPU-A and Q06HCPUCPU-A
QCPU (Q mode)	Generic term of the Q02CPU, Q02HCPUCPU, Q06HCPUCPU, Q12HCPUCPU and Q25HCPUCPU
QnACPU	Generic term of the Q2ACPU, Q2ACPU-S1, Q2ASCPUCPU, Q2ASCPUCPU-S1, Q2ASHCPUCPU, Q2ASHCPUCPU-S1, Q3ACPU, Q4ACPU and Q4ARCPUCPU
ACPU	Generic term of the AnNCPU, AnACPU and AnUCPU
FXCPU	Generic term of the FX0, FX0s, FX0N, FX1, FX2, FX2c, FX2N and FX2NC series
Motion Controller CPU	Generic term of the A171SHCPUCPU, A172SHCPUCPU, A273UHCPUCPU and A273UHCPUCPU-S3
C24	Generic term of the A1SCPUC24-R2, A1SJ71C24-PRF, A1SJ71C24-R2, A2CCPUC24, A2CCPUC24-PRF, AJ71C24-S6 and AJ71C24-S8
UC24	Generic term of the AJ71UC24, AJ71UC24-PRF, A1SJ71UC24-R2 and A1SJ71UC24-PRF
QC24	Generic term of the AJ71QC24, AJ71QC24-R2, AJ71QC24-R4, A1SJ71QC24, A1SJ71QC24-R2, AJ71QC24N, AJ71QC24N-R2, AJ71QC24N-R4, A1SJ71QC24N and A1SJ71QC24N-R2
Q series-compatible C24	Generic term of the QJ71C24, QJ71C24-R2, QJ71C24N and QJ71C24N-R2
Computer link module	Generic term of the C24, UC24, QC24 and Q series-compatible C24
E71	Generic term of the AJ71E71, AJ71E71-S3, A1SJ71E71-B2, A1SJ71E71-B5, A1SJ71E71-B2-S3, A1SJ71E71-B5-S3, AJ71E71N-T, AJ71E71N-B5, AJ71E71N-B2, AJ71E71N-B5T, A1SJ71E71N-T, A1SJ71E71N-B2, A1SJ71E71N-B2 and A1SJ71E71N-B5T
QE71	Generic term of the AJ71QE71, AJ71QE71-B5, A1SJ71QE71-B2, A1SJ71QE71-B5, AJ71QE71N-T, AJ71QE71N-B2, AJ71QE71N-B5, AJ71QE71N-B5T, A1SJ71QE71N-T, A1SJ71QE71N-B5, A1SJ71QE71N-B2 and A1SJ71QE71N-B5T
Q series-compatible E71	Generic term of the QJ71E71, QJ71E71-B2, QJ71E71-B5 and QJ71E71-100
Ethernet module	Generic term of the E71, QE71 and Q series-compatible E71

Term Definitions

This section describes the meaning of the main terms in this manual.

(1) Channel

Refers to a medium for personal computer communication.

This term also indicates a form of connection in personal computer communication.

(Example)

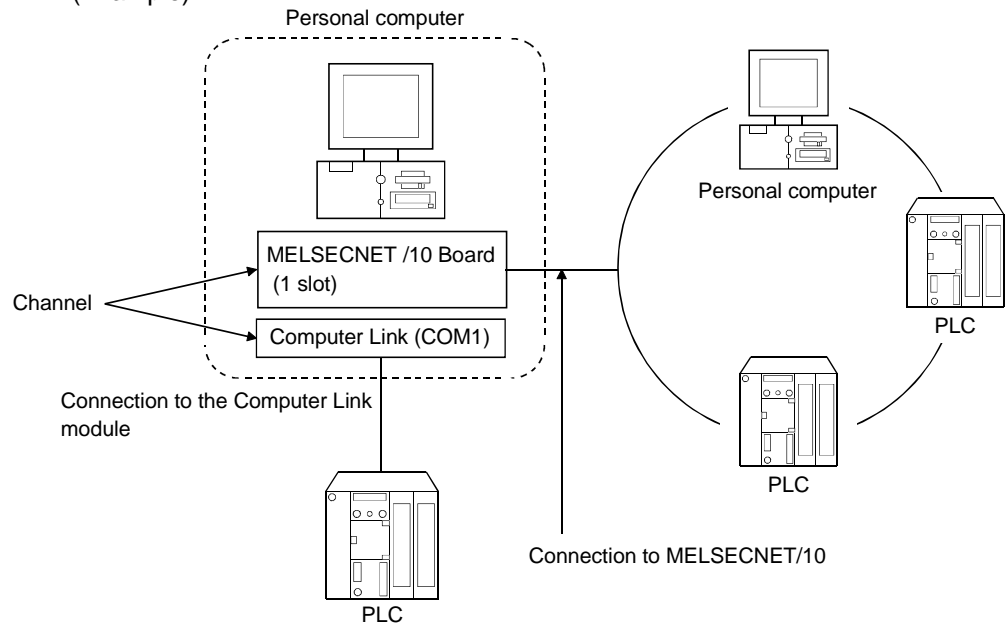

(2) Logical station number

Information about destinations in computer link communication or Ethernet communication.

(Example) During computer link communication

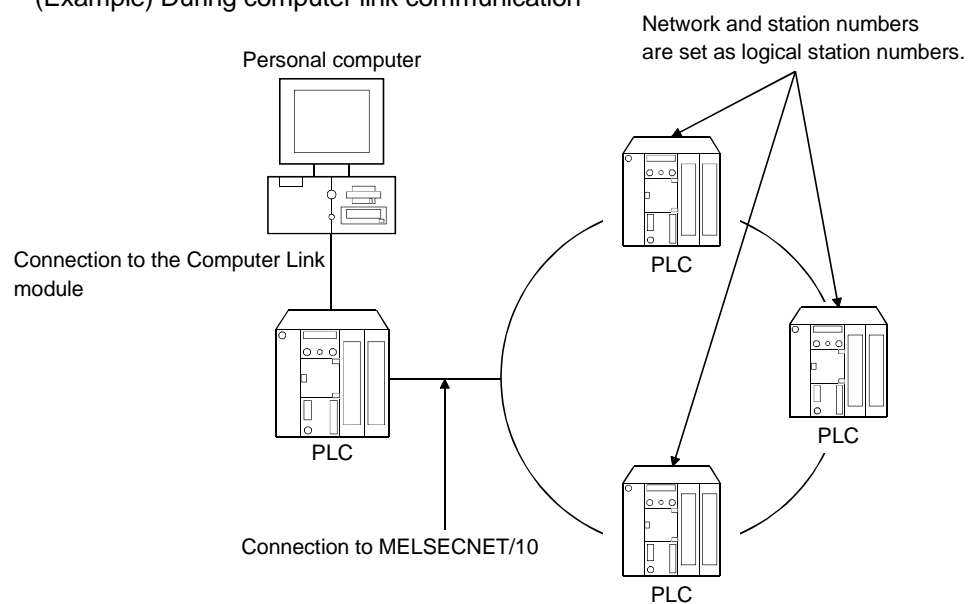

(3) Shared device

Refers to virtual devices on personal computers.

Shared devices are classified as EM (bit device) or ED (word device).

However, they can be used only with the Windows NT 4.0 operating system.

EM (Bit device)		ED (Word device)	
No. of blocks (0 to 255)	Device range (0 to 8191)	No. of blocks (0 to 255)	Device range (0 to 8191)
EM0 *1	EM0(0) to EM0(8191)	ED0 *1	ED0(0) to ED0(8191)
EM1	EM1(0) to EM1(8191)	ED1	ED1(0) to ED1(8191)
EM2	EM2(0) to EM2(8191)	ED2	ED2(0) to ED2(8191)
⋮	⋮	⋮	⋮
EM255	EM255(0) to EM255(8191)	ED255	ED255(0) to ED255(8191)

*1 System information area

Product Components

The following components are included in the package.

(1) SW3D5F-CSKP-E Basic Communication Support Tool

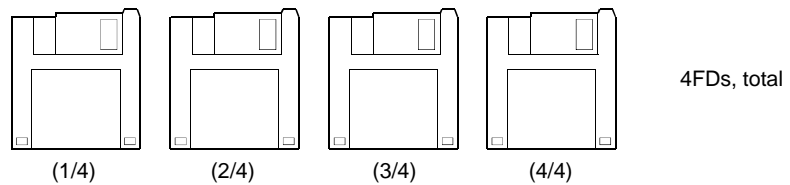

(2) Manual

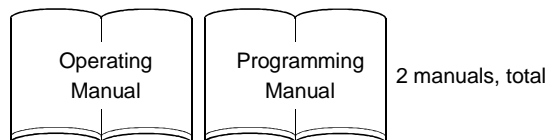

(3) Others

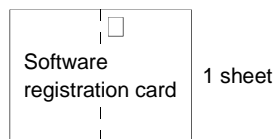

MEMO

1 OVERVIEW

CSKP is a tool which achieves several protocol communications between a personal computer and PLC using common functions.

The use of the common functions has facilitated the program development of serial and Ethernet communications, which were troublesome and complex so far.

Also, the same bit and word devices as in a PLC have been implemented in a personal computer.

Device data can be handled unchanged within a personal computer.

1.1 Features

CSKP has the following features.

- (1) Communications can be made indifferently to the communication path (communication protocol)

By utilizing any communication utility, you will have no trouble in using the communication program since CSKP controls all of the communication part.

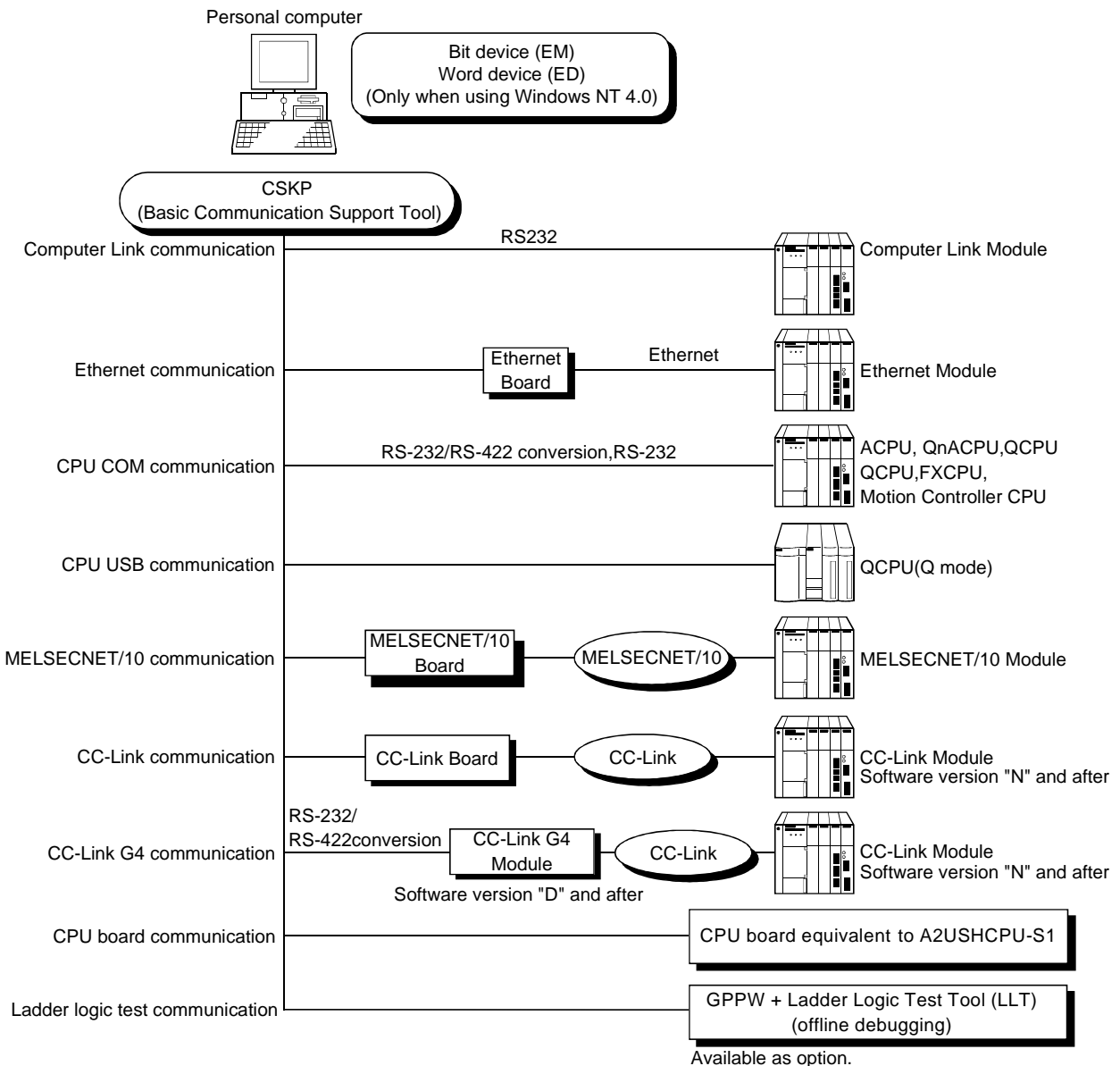

(2) Many useful utilities

The utilities available on a communication protocol basis facilitate settings made for communications.

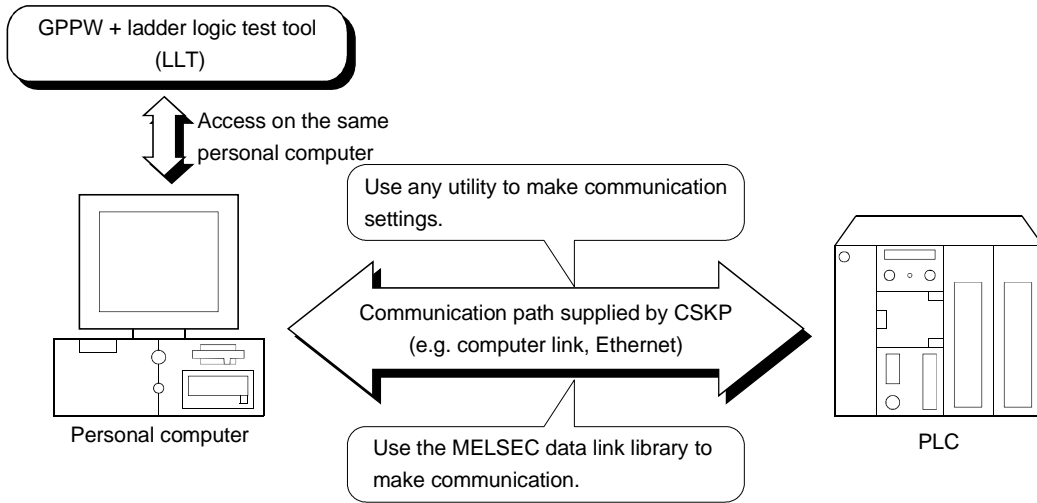

(3) Device monitor function

Use of the device monitor utility allows the status monitoring and data changing of the specified devices.

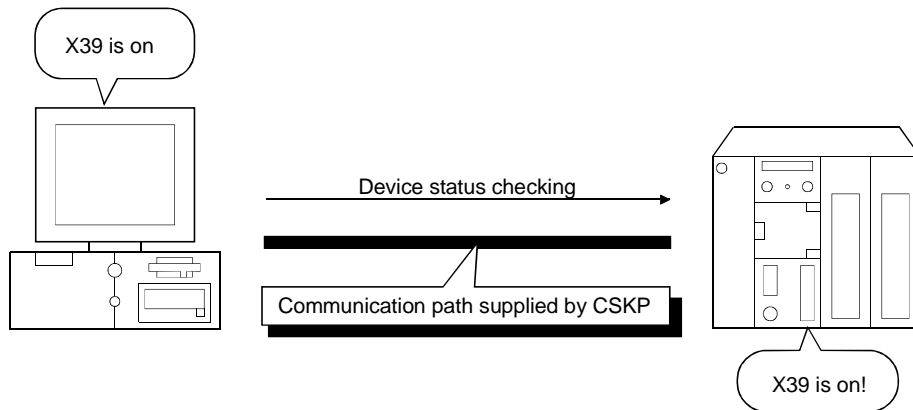

(4) Error viewer function

The error viewer gives you a quick view of the errors that occurred. Also, it leaves a history to tell you when errors had occurred.

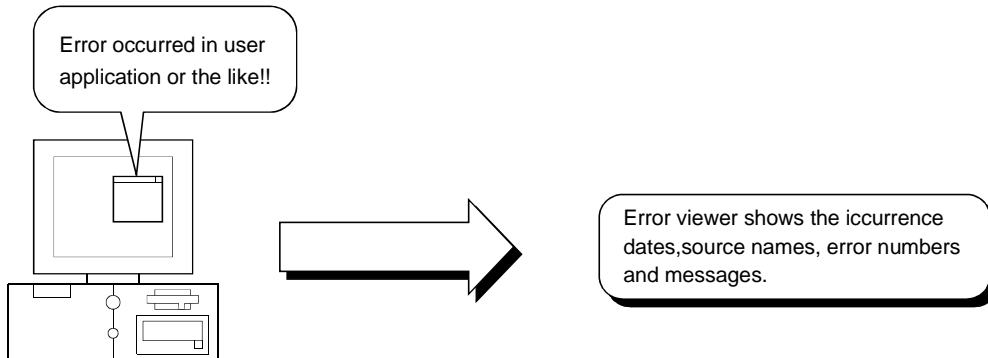

(5) Shared devices usable (EM, ED) (only when using Windows NT 4.0)

The shared devices (EM: bit device, ED: word device) are accessible between personal computers having the same OS and from a personal computer on the MELSECNET/10.

Also, since they are accessible from several programs, you can configure a high value-added system, e.g. data gathered from a PLC can be operated/processed with the other program to monitor and display its result.

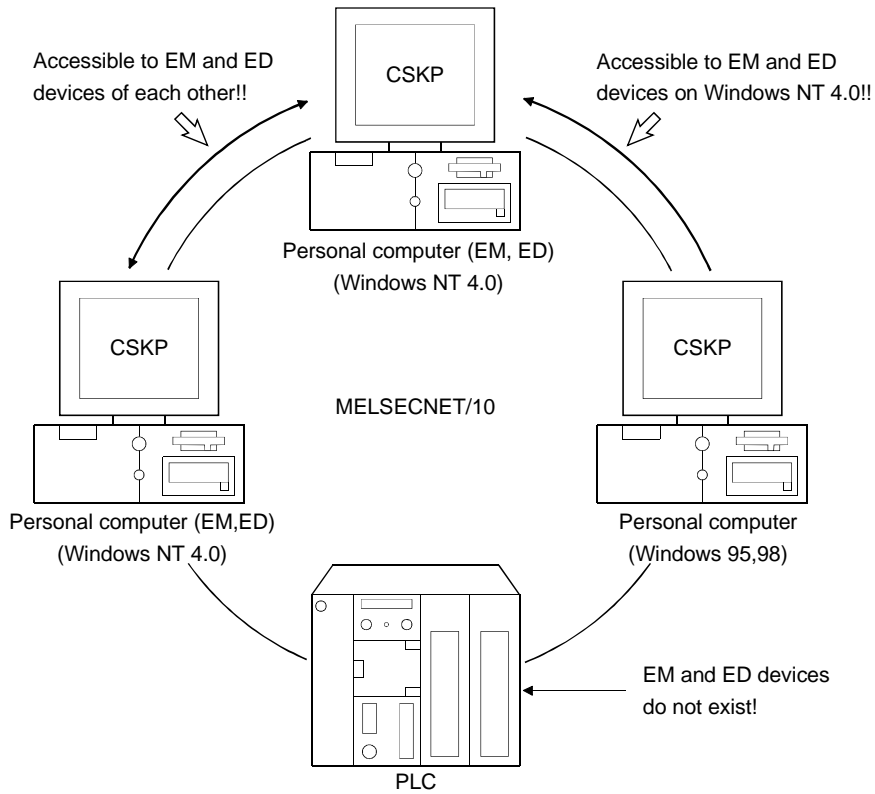

	EM (Bit Device)	ED (Word Device)
Block range	0 to 255 (No. 0 indicates system region)	
Device range	0 to 8191 per block (8192 points)	

POINT
The shared devices can be set when the Operating System is Windows NT 4.0. They cannot be set when you use Windows 95 or Windows 98. However, the shared devices on Windows NT 4.0 are accessible from Windows 95 and Windows 98.

(6) Device refreshes (only when using Windows NT 4.0)

By use of the shared device server utility, device values can be transferred between personal computers or between a personal computer and PLC without any program.

(a) Between personal computers

Device values can be transferred between personal computers on the MELSECNET/10.

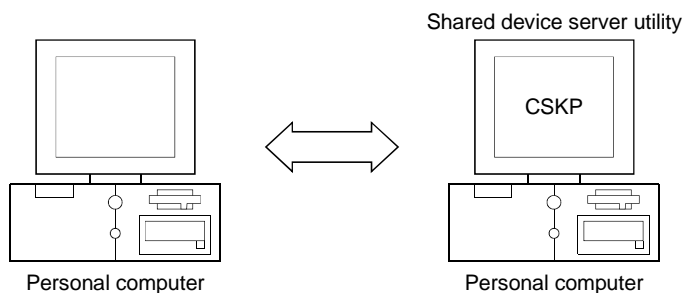

(b) Between PLC and personal computer

Device values of the specified PLC can be transferred.

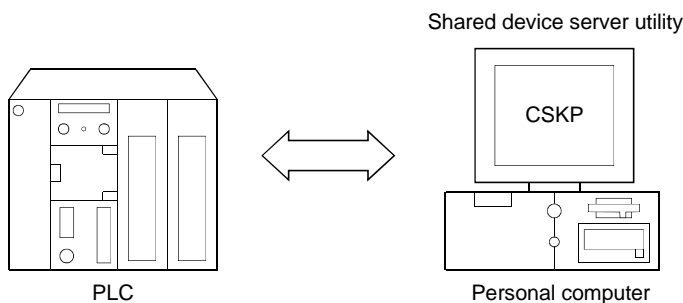

(c) Between PLCs (application)

Device values can be transferred between PLCs via a personal computer where CSKP has been installed.

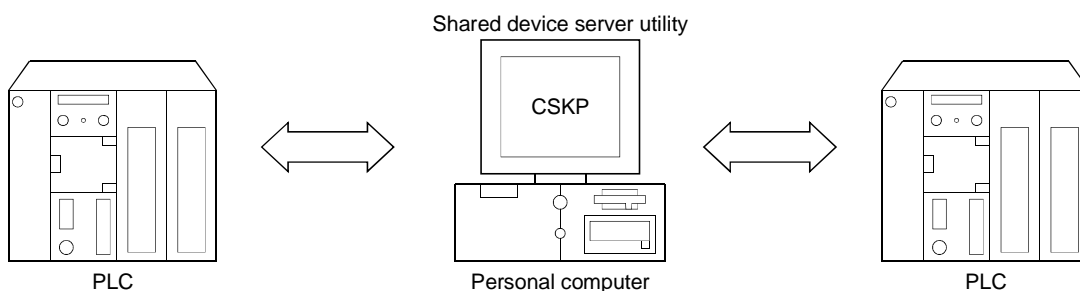

POINT
 The shared device server utility can be utilized when the OS is Windows NT 4.0.
 It cannot be utilized when you use Windows 95 or Windows 98.

- (7) Ladder logic test tool (LLT) can be used for offline debugging
By use of GPPW and ladder logic test tool (LLT), debugging can be made on a single personal computer without the PLC being connected.

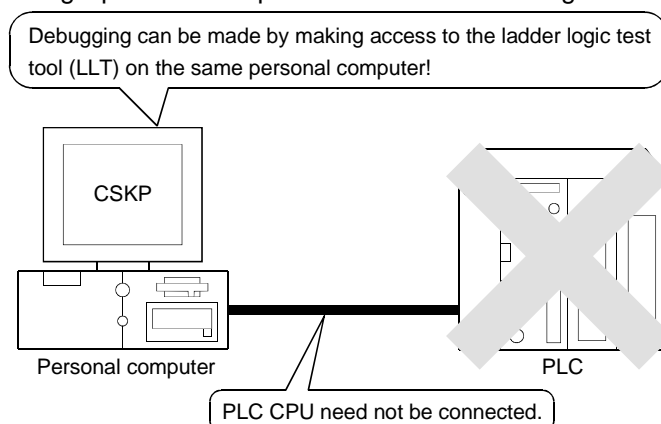

POINT
When using the ladder logic test tool (LLT), GPPW and ladder logic test tool (LLT) are required separately.

1.2 Utility List

The following table lists the utilities of CSKP.

○: Installed when CSKP is installed

×: Not installed when CSKP is installed

Utility Name	Description	Used OS			Refer To
		Win NT	Win 95	Win 98	
Computer link utility	Used to make settings for communication by use of the computer link module.	○	○	○	Section 8.1
Ethernet utility	Used to make settings for communication by use of the Ethernet module.	○	○	○	Section 8.2
CPU COM utility	Used to make settings for communication by direct connection of the personal computer with the PLC.	○	○	○	Section 8.3
CPU USB utility	Used to make settings for communication by direct connection of the personal with the PLC using the USB port.	×	×	○	Section 8.4
MELSECNET/10 utility	Used to make settings for communication by use of the MELSECNET/10 board.	○	○	○	*1
CC-Link utility	Used to make settings for communication by use of the CC-Link board.	○	○	○	*1
CC-Link G4 utility	Used to make settings for communication by use of the CC-Link G4 module.	○	○	○	Section 8.5
AnU utility	Used to make settings for communication with the A2USHCPU-S1 on the same personal computer by use of the CPU board.	○	×	×	*1
Shared device utility	Used to make settings for use of EM and ED.	○	×	×	Section 9.1
Shared device server utility	Used to make settings for refreshing devices between personal computers or between personal computer and PLC.	○	×	×	Section 9.2
Ladder logic test utility	Used to make settings for utilizing the ladder logic test tool (LLT).	○	○	○	Section 9.3
Device monitor utility	Used to monitor the statuses of devices via a network.	○	○	○	Section 9.4
Error viewer	Used to display a history of errors, which occurred so far.	○	○	○	Section 9.5

*1 Refer to the manual of the corresponding communication card.

1.3 About Compatibility with the Existing Software

Compatibility with the existing software is listed below.

		SW1D5F-CSKP-E	SW2D5F-CSKP-E	SW3D5F-CSKP-E
SW1D5F-XMOP-E		○	×	×
SW1D5F-OLEX-E		○	×	×
SW2D5F-XMOP-E	A *1	×	○	×
	B or later *1	×	○	○
SW2D5F-OLEX-E	A *1	×	○	×
	B or later *1	×	○	○
SW3D5F-XMOP-E		×	○	○
SW3D5F-OLEX-E		×	○	○

○: Simultaneously operable ×: Simultaneously inoperable

*1 Indicates the software version.

2 SYSTEM CONFIGURATION

This chapter deals with the system configuration, operating environment and usable CPU.

2.1 System Configuration List

This section lists systems which can be configured up on an operating system basis.

2.1.1 When using Windows NT Workstation 4.0

The following table lists systems which can be made up when using Windows NT Workstation 4.0.

		Personal Computer Used
Computer link communication		○
Ethernet communication		○
CPU COM communication		○
CPU USB communication *1		×
		○
MELSECNET/10 communication	Usable board	MELSECNET/10 board
	Usable driver	SW2DNF-MNET10 or later
		○
CC-Link communication	Usable board	CC-Link board
	Usable driver	SW2DNF-CCLINK or later
CC-Link G4 communication		○
		○
CPU board communication	Usable board	CPU board
	Usable driver	SW0DNF-ANU SW0DNF-ANU-B
Shared device communication		○
Ladder logic test communication		○

○: Configurable ×: Not configurable

*1 Does not support the OS used.

2.1.2 When using Windows 95

The following table lists systems which can be configured when using Windows 95.

		Personal Computer Used
Computer link communication		○
Ethernet communication		○
CPU COM communication		○
CPU USB communication *1		×
MELSECNET/10 communication		○
	Usable board	MELSECNET/10 board
	Usable driver	SW2DNF-MNET10 or later
CC-Link communication		○
	Usable board	CC-Link board
	Usable driver	SW2DNF-CCLINK or later
CC-Link G4 communication		○
CPU board communication		×*2
Shared device communication		×*1
LLT communication		○

○: Configurable ×: Not configurable

*1 Does not support the used OS.

*2 Driver is incompatible.

POINT
<p>A memory leak will take place if any of the following communications is made using the COM port on Windows 95. Therefore, do not perform continuous operation.</p> <ul style="list-style-type: none"> • Computer link communication • CPU COM communication • CC-Link G4 communication

2.1.3 When using Windows 98

The following table lists systems, which can be configured when using Windows 98.

		Personal Computer Used
Computer link communication		○
Ethernet communication		○
CPU COM communication		○
CPU USB communication		○
		×
MELSECNET/10 communication	Usable board	MELSECNET/10 board
	Usable driver	SW2DNF-MNET10 or later
		○
CC-Link communication	Usable board	CC-Link board
	Usable driver	SW2DNF-CCLINK or later
CC-Link G4 communication		○
CPU board communication		×*2
Shared device communication		○*1
LLT communication		×

○: Configurable ×: Not configurable

*1 Does not support the used OS.

*2 Driver is incompatible.

POINT
When making ladder logic test communication on Windows 98, use GPPW and LLT of the following versions or later. <ul style="list-style-type: none"> • GPPW: SW3D5C-GPPW-E, SW3D5F-GPPW-E • LLT: SW3D5C-LLT-E, SW3D5F-LLT-E

2.2 System Configurations for Use of Various Communication Formats

This section gives system configurations for use of CSKP on a communication format basis.

2.2.1 System configurations

POINT
<ul style="list-style-type: none"> • XMOP and OLEX must be purchased separately for use. • Software other than CSKP and system equipment should be purchased separately as required.

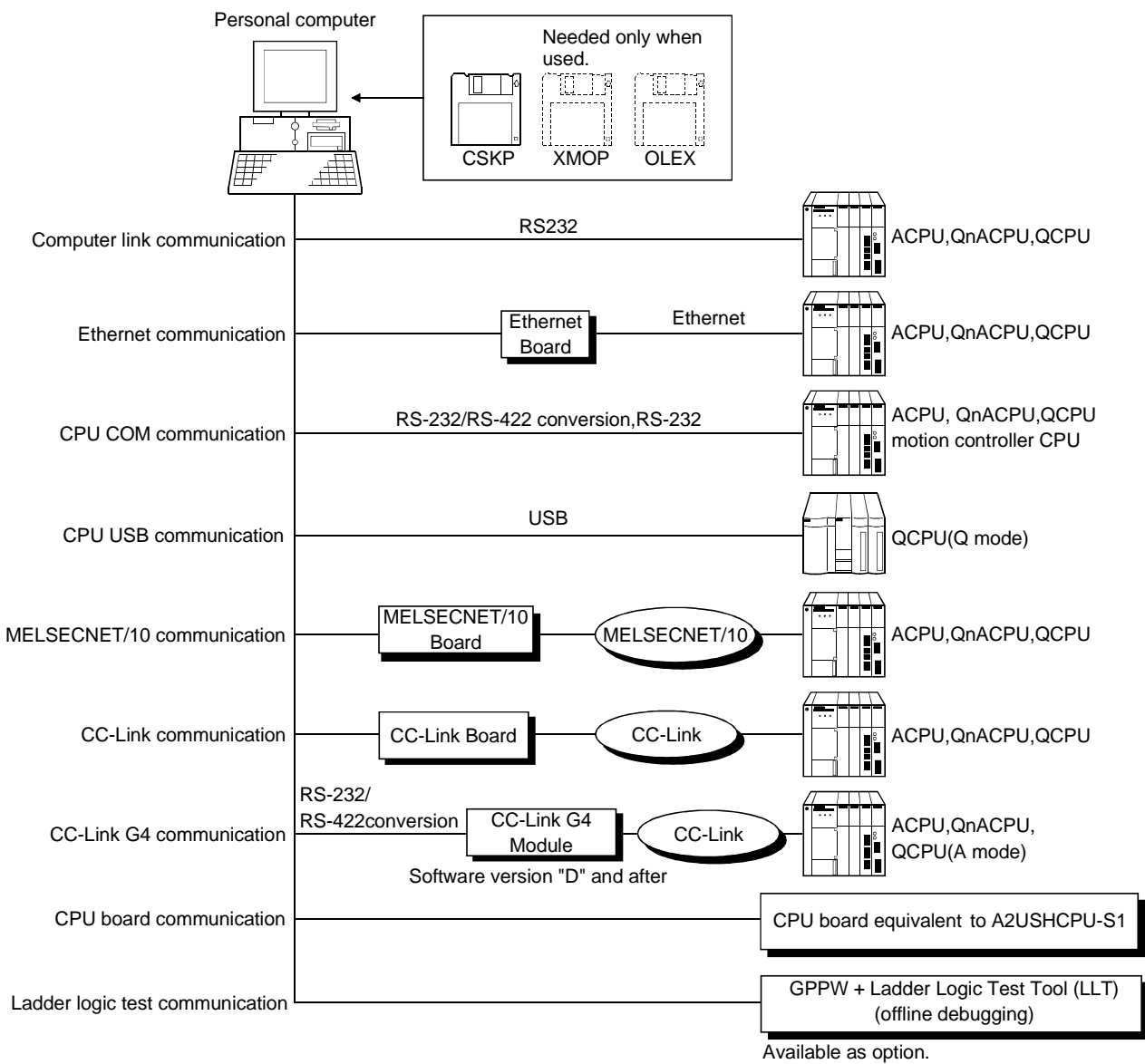

2.2.2 Details of each communication form

The table at top right of each communication format explanation indicates whether the communication format can be made up when the OSs are used.

Win NT	Win 95	Win 98
○	×	×

○ :Configurable
 × :Not configurable

(1) Computer link communication

Win NT	Win 95	Win 98
○	○	○

For the way to make connection to the computer link module, read the manual of your computer link module.

(a) Precaution

Computer link communication made on Windows 95 will cause a memory leak. Therefore do not perform continuous operation.

(b) Usable modules

Any of the following computer link modules may be used to access the PLC ACPU.

	Usable Modules
C24	A1SCPUC24-R2 *1, A1SJ71C24-PRF *2, A1SJ71C24-R2 *2, A2CCPUC24 *3, A2CCPUC24-PRF *3, AJ71C24-S6, AJ71C24-S8
UC24	AJ71UC24, AJ71UC24-PRF, A1SJ71UC24-R2, A1SJ71UC24-PRF
QC24	AJ71QC24, AJ71QC24-R2, A1SJ71QC24, A1SJ71QC24-R2, AJ71QC24N, AJ71QC24N-R2, A1SJ71QC24N, A1SJ71QC24N-R2
Q series-compatible C24	QJ71C24, QJ71C24-R2, QJ71C24N, QJ71C24N-R2

*1 Handled as equivalent to the UC24.

*2 Modules of software version "M" or later are handled as equivalent to the UC24.

*3 Modules of software version "K" or later are handled as equivalent to the UC24.

POINT
Only the RS-232 connector of the computer link (serial communication) module may be used. Therefore, the RS-422 connector and RS-422/485 terminal block cannot be used.

(2) Ethernet communication

Win NT	Win 95	Win 98
○	○	○

For the way to make connection to the Ethernet module, read the manual of your Ethernet module.

(a) Precaution

The accessible range for Ethernet communication is the same segment only. Access cannot be made beyond the router and gateway.

(b) Usable modules

Any of the following Ethernet modules may be used to access the PLC CPU.

	Usable Modules
E71 *1	AJ71E71,AJ71E71-S3,A1SJ71E71-B2,A1SJ71E71-B5, A1SJ71E71-B2-S3,A1SJ71E71-B5-S3, AJ71E71N-T, AJ71E71N-B2, AJ71E71N-B5, AJ71E71N-B5T, A1SJ71E71N-T, A1SJ71E71N-B2, A1SJ71E71N-B5, A1SJ71E71N-B5T
QE71 *1	AJ71QE71,AJ71QE71-B5,A1SJ71QE71-B2,A1SJ71QE71-B5, AJ71QE71N-T, AJ71QE71N-B2, AJ71QE71N-B5, AJ71QE71N-B5T, A1SJ71QE71N-T, A1SJ71QE71N-B2, A1SJ71QE71N-B5, A1SJ71QE71N-B5T
Q series-compatible E71	QJ71E71,QJ71E71-B2, QJ71E71-B5, QJ71E71-100

*1 Accessible as equivalent to the AnACPU when fitted to the AnUCPU.

*2 An error will occur if monitoring via QnA Ethernet and monitoring via other communication path are executed for the same CPU simultaneously.

(3) CPU COM communication

Win NT	Win 95	Win 98
○	○	○

(a) Precaution

CPU COM communication made on Windows 95 will cause a memory leak. Therefore do not perform continuous operation.

(b) Cables used for connection

The following cable(s) is (are) required for communication between the personal computer and PLC CPU.

1) RS-232 cable

RS-232 Cable	Maker
<ul style="list-style-type: none"> • F2-232CAB-1(9pin – 25pin) • QC30R2D for QCPU 	Mitsubishi Electric

2) RS-422 cable

RS-422 Cable	Maker
<ul style="list-style-type: none"> • FX-422CAB (0.3m) for ACPU, QnACPU, FX1, FX2, FX2c series • FX-422CAB-150 (1.5m) for FX1, FX2, FX2c series • FX-422CAB0 (1.5m) for FX0, FX0s, FX0N, FX2N, FX2Nc series 	Mitsubishi Electric

POINT
<ul style="list-style-type: none"> • Before handling the RS-422 interface conversion cable/converter, please read its specifications, precautions, etc. carefully in the manual of the corresponding product and handle it correctly. • When disconnecting or reconnecting the conversion cable/converter that receives 5VDC power from the RS-422 interface, power off the PLC CPU before starting work. • When disconnecting or reconnecting the peripheral device or conversion cable that does not receive 5VDC power from the RS-422 interface (whose power is supplied from an external power supply), be sure to use an earth band or touch a grounded metal object, etc. before starting work to discharge static electricity from the cable, human body, etc. After that, handle it in the following procedure. <ol style="list-style-type: none"> 1) Power off the personal computer. 2) Power off the conversion cable/converter. When it has an FG terminal, ground it. 3) Connect/disconnect the conversion cable/converter between the personal computer and PLC CPU. 4) Power on the conversion cable/converter. 5) Power on the personal computer. 6) Start up the software package.

(4) CPU USB communication

Win NT	Win 95	Win 98
×	×	○

CPU USB communication can be made only when the QCPU (Q mode) is used.

(a) About the USB cable (QCPU (Q mode) compatible)

- 1) Usable when Windows 98 and USB driver have been installed.
- 2) Unusable with Windows 95 or Windows NT Workstation 4.0.
- 3) When the USB cable is used, only one PLC CPU may be connected.
- 4) Use the USB cable which conforms to the USB Standard Rev. 1.1.
- 5) Refer to "Operating Instructions" for the precautions for and restrictions on use of the USB cable to make communications.

(5) MELSECNET/10 communication

Win NT	Win 95	Win 98
○	○	○

(a) Precautions

- 1) The communication driver used must be SW2DNF-MNET10 or later.
Any other communication driver cannot be used.
- 2) To access the QCPU (Q mode), use SW3DNF-MNET10.
Using SW2DNF-MNET10 allows access only to the ACPU, QnACPU or QCPU (A mode).

(6) CC-Link communication

Win NT	Win 95	Win 98
○	○	○

(a) Precautions

- 1) The communication driver used must be SW2DNF-CCLINK or later.
Any other communication driver cannot be used.

- 2) To access the QCPU (Q mode), use the communication drive of SW3DNF-CCLINK and the CC-Link board of software version "W" or later.
Using SW2DNF-CCLINK and the CC-Link board of software version "V" or earlier allows access only to the ACPU, QnACPU or QCPU (A mode).

- 3) The CC-Link master station module used should be of software version "N" or later.

(7) CC-Link G4 communication

Win NT	Win 95	Win 98
○	○	○

(a) Precautions

- 1) Computer link communication made on Windows 95 will cause a memory leak. Therefore do not perform continuous operation.

- 2) The CC-Link G4 module used should be of software version "D" or later.

- 3) The CC-Link master station module used should be of software version "N" or later.

(8) CPU board communication

Win NT	Win 95	Win 98
○	×	×

(a) Precautions

- 1) Use the communication driver of SW0DNF-ANU or SW0DNF-ANU-B.

(9) Ladder logic test communication

Win NT	Win 95	Win 98
○	○	○

When making ladder logic test communication on Windows 98, use GPPW and logic test function (LLT) of the following versions or later.

- GPPW : SW3D5C-GPPW-E, SW3D5F-GPPW-E
- LLT : SW3D5C-LLT-E, SW3D5F-LLT-E

POINT	GPPW and logic test function (LLT) must be purchased separately.
-------	--

2.3 Operating Environment

The operating environment of CSKP-E is indicated below.

Item	Description
Operating System	Windows 95, Windows 98, Windows NT Workstation 4.0 * ¹
CPU	Pentium 100MHz or more (multiprocessor incompatible)
Display	Resolution 800×600 dots or more (recommended 1024×768 dots)
Required memory capacity	32MB or more
Hard disk free space	15MB or more
Disk drive	3.5 inch (1.44MB) floppy disk drive
Programming language	Visual Basic 4.0 * ² , Visual Basic 5.0, Visual Basic 6.0 Visual C++ 4.2 * ² , Visual C++ 5.0, Visual C++ 6.0

*1 Service Pack 3 or higher is required for use of Windows NT Workstation 4.0.

*2 Cannot be used for CC-Link communication and CPU board communication.

2.4 Usable PLC CPU

The following PLC CPUs are usable.

	PLC CPU
ACPU	A0J2HCPU, A1SCPU, A1SCPU-S1, A1SCPUC24-R2, A1SHCPU, A1SJCPU, A1SJCPU-S3, A1SJHCPU, A1SJHCPU-S8, A1NCPU, A2CCPU, A2CCPUC24, A2CCPUC24-PRF, A2CJCPU, A2NCPU, A2NCPU-S1, A2SCPU, A2SCPU-S1, A2SHCPU, A2SHCPU-S1, A2ACPU, A2ACPU-S1, A2ACPUP21/R21, A2ACPUP21/R21-S1, A3ACPUP21/R21, A2UCPU, A2UCPU-S1, A2ASCPU, A2ASCPU-S1, A2ASCPU-S30, A3NCPU, A3ACPU, A3UCPU, A4UCPU, A1FXCPU
QnACPU	Q2ACPU, Q2ACPU-S1, Q2ASCPU, Q2ASCPU-S1, Q2ASHCPU, Q2ASHCPU-S1, Q3ACPU, Q4ACPU, Q4ARCPU
QCPU(A mode)	Q02CPU-A, Q02HCPU-A, Q06HCPU-A
QCPU(Q mode)	Q02CPU, Q02HCPU, Q06HCPU, Q12HCPU, Q25HCPU
FXCPU	FX0, FX0S, FX0N, FX1, FX2, FX2C, FX2N, FX2NC series
Motion Controller CPU	A171SHCPU, A172SHCPU, A273UHCPU, A273UHCPU-S3

3 INSTALL AND UNINSTALL

This chapter describes how to install and uninstall CSKP.

3.1 Install

This section describes how to install CSKP.

POINTS
(1) When using SW3D5F-CSKP-E After uninstalling SW1D5F-CSKP-E or SW2D5F-CSKP-E, install SW3D5F-CSKP-E.
(2) When using SW3D5F-CSKP-EV (a) With SW2D5F-CSKP-E installed, install SW3D5F-CSKP-EV. Unless SW2D5F-CSKP-E has been installed, SW3D5F-CSKP-EV cannot be installed. (b) When installing EM or ED in SW2D5F-CSKP-E, first stop the shared device from [Devices and Services] in the control panel, then install SW3D5F-CSKP-EV.
(3) When SW3D5F-CSKP-E(V) is installed, all settings made in the utilities of SW1D5F-CSKP-E or SW2D5F-CSKP-E are erased and the settings must therefore be made again.
(4) When the OS is Windows NT 4.0, log on as a user who has an administrator attribute.
(5) Start installation after removing all applications included in Startup and restarting Windows.
(6) When adding the communication path after installation, perform overwrite installation.

3

1. Switch on your personal computer, and Windows will start.

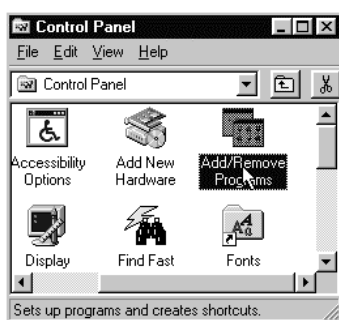

(To the next page)

2. Choose [Start]-[Setting]-[Control Panel].
When the Control Panel has opened, choose "Add/Remove Programs".

(Continued from the previous page)

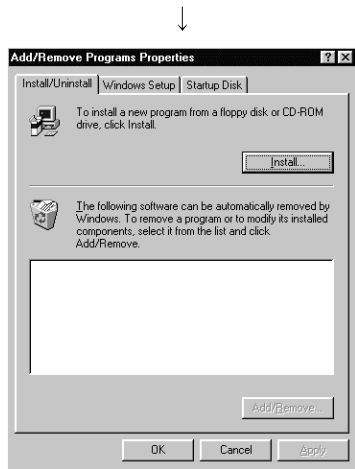

3. Click the "Install..." button.



4. When the screen on the left appears, insert the first floppy disk into the FDD and click the "Next>" button.

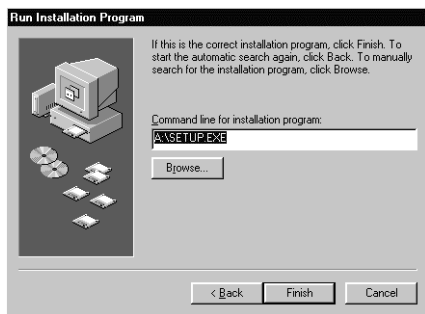

5. When the screen on the left appears, click the "Finish" button.
If you could not find "SETUP.EXE", click the "Browse..." button and find "SETUP.EXE" of the FDD.

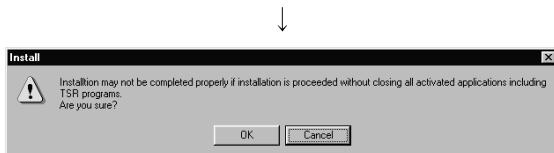

6. Confirm that all the applications have terminated then click the "OK" button.
When one or more applications are running, terminate all the applications.

(To the next page)

(Continued from the previous page)

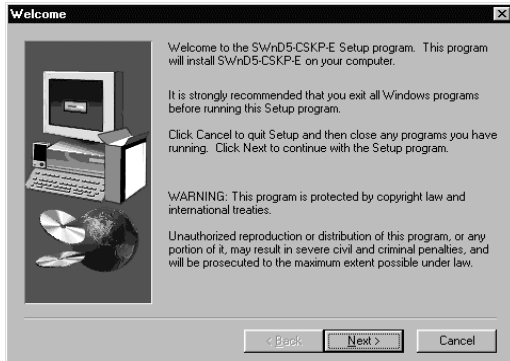

7. Check the display text, then click the "Next>" button.



8. Enter your name and company name, then click the "Next>" button.

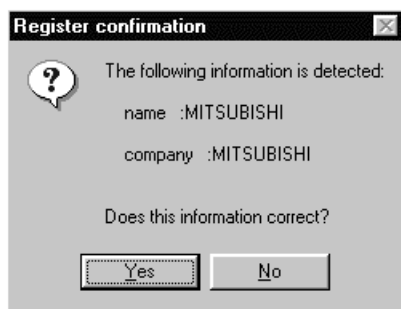

9. Check if the registered name and company name are correct. If they are correct, click the "Yes" button. To make changes, click the "No" button to display the preceding screen.



10. Input the product ID and click "Next>" button. The product ID is listed on the Software User Registration Card.

(To the next page)

(Continued from the previous page)



11. Designate a directory for installation.
 The CSKP default directory is "C:\MELSEC."
 When using the default directory, click the "Next>" button.
 When not using the default directory for installation, click the "Browse..." button, then select another directory.

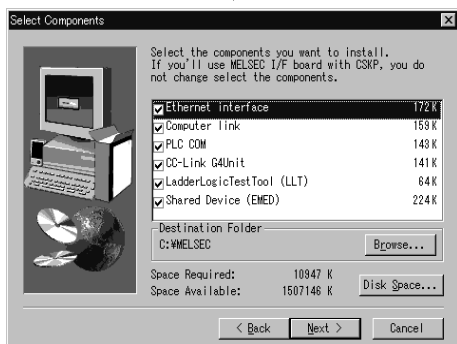

12. After setting an installation component and a directory for installation, click the "Next>" button.
 * To perform the MELSECNET/10, CC-Link or CPU board communication, click the "Next>" button without changing the check box settings. And install the necessary software package for each communication board in advance before the CSKP installation.

- "Browse..." button
Change the target folder
- "Disk Space..." button
Confirms the free space of the hard disk.

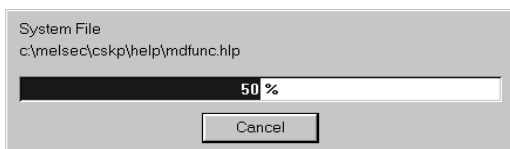

13. Installation starts. Insert the floppy disks in order according to the instructions displayed.



14. Installation is completed when the dialog box shown on the left appears.
 To restart, confirm that "Yes, I want to restart my computer now." is checked and click the "Finish" button.
 To restart later, check "No, I will restart my computer later" and click the "Finish" button.









3.2 Icons Registered

When you have installed CSKP, the following icons are registered.

POINT
The icons corresponding to the utilities of the communication paths unselected at the time of installation will not be registered.



(1) COMMUNICATION SUPPORT (CSKP-E)

The following icons are registered in [Start]-[Programs]-[Melsec application]-[Communication support (CSKP-E)].

Icon	Name	Description
	CC-Link G4 Utility	Starts the CC-Link G4 utility.
	CPU COM Utility	Starts the CPU COM utility.
	CPU USB Utility	Starts the CPU USB utility.
	Ladder logic test Utility	Starts the ladder logic test communication utility.
	Ethernet Utility	Starts the Ethernet utility.
	Error Viewer	Starts the Error Viewer.
	Device Monitor Utility	Starts the device monitor utility.
	Computer link Utility	Starts the computer link utility.

(2) Shared devices (created only when Windows NT 4.0 is used)

The following icons are registered in [Start]-[Programs]-[Melsec application]-
[Communication support (CSKP-E)]-[Shared Device].

Icon	Name	Description
	EM ED Server Process CC-Link G4 Utility	Starts the shared device server process. (This process must be operating when refreshing devices with the shared device server utility. For more information, refer to Section 9.2.)
	EM ED Server Utility	Starts the shared device server utility.
	EM ED Utility	Starts the Starts the shared device utility.

3.3 Uninstall

This section describes how to uninstall CSKP.

POINTS
The uninstaller should always be accessed from the Control Panel. Do not directly activate the installed program "Uninstaller.exe".

1. Click [Start]-[Settings]-[Control Panel] menu in order.
2. If the Control Panel appears, double-click "Add/Remove Programs."



(To the next page)

3. "Select SW3D5-CSKP-E", then click the "Add/Remove ..." button.

(Continued from the previous page)

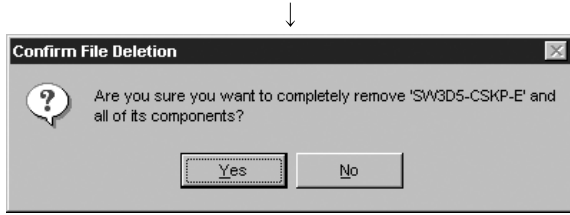

4. Click the "Yes" button to start uninstallation.

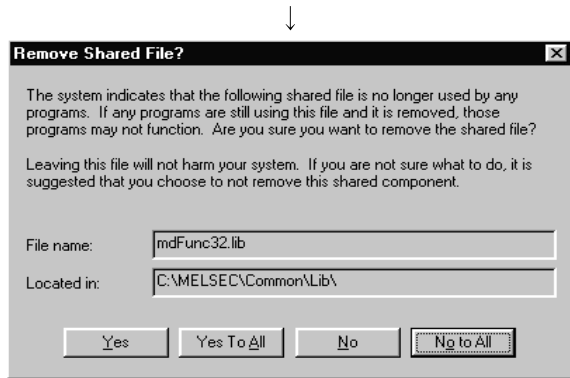

5. When the left-hand screen is displayed, click the "No to All" button.

When the "Yes" or "Yes To All" button is clicked, the shared files of the MELSEC software package are deleted and the other software package may not start normally.



6. When uninstallation is complete, click the "OK" button.

4 OPERATION PROCEDURE

This chapter explains the operation procedure of CSKP.

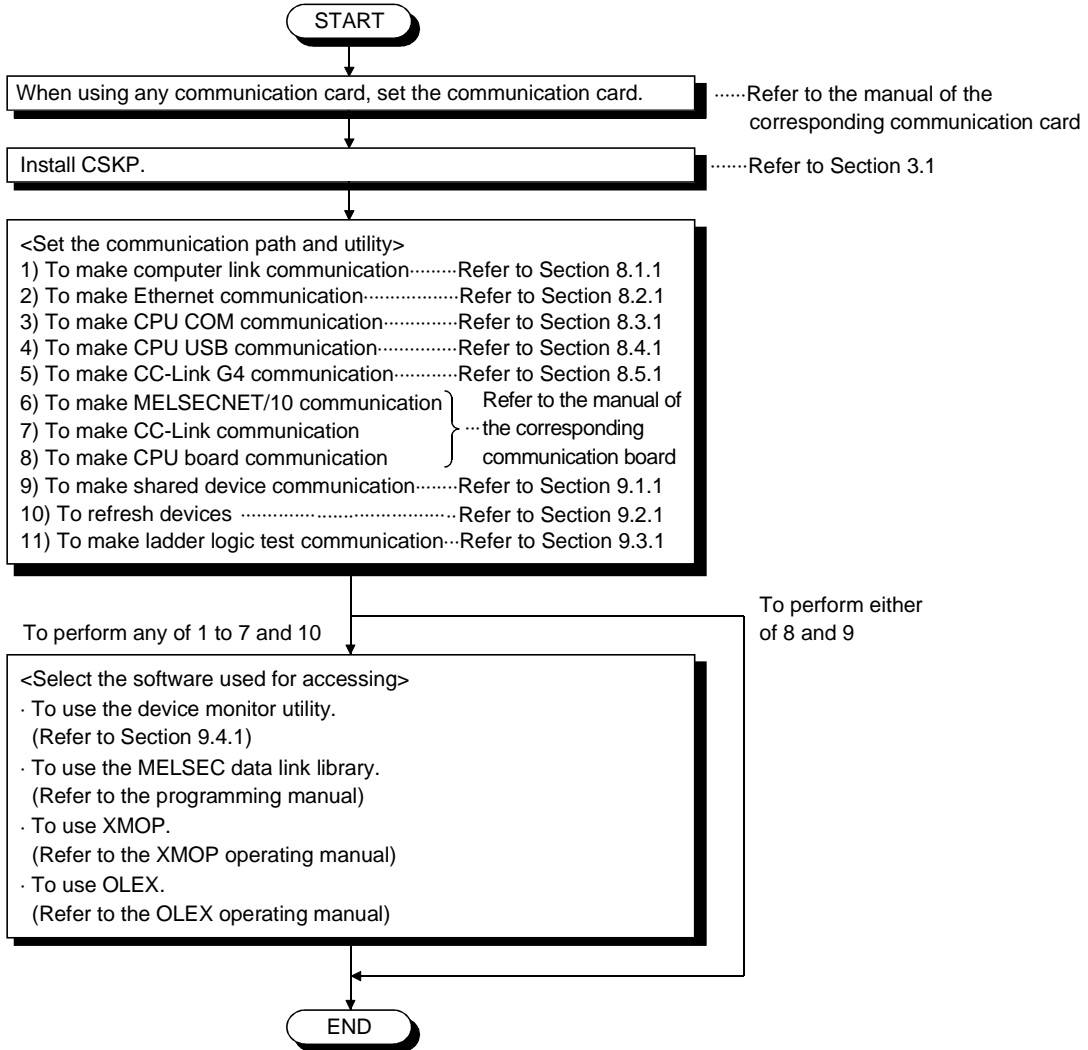

4

5 MAKING ACCESS TO PLC CPU

This chapter briefly explains the procedures for making access to the PLC CPU by use of CSKP.

5.1 Using Computer Link Communication for Making Access

This section describes the operation for making access to the PLC CPU by computer link communication.

(1) Example used in this section

The following example assumes that the computer link module of UC24 is used to access the ACPU via the MELSECNET/10.

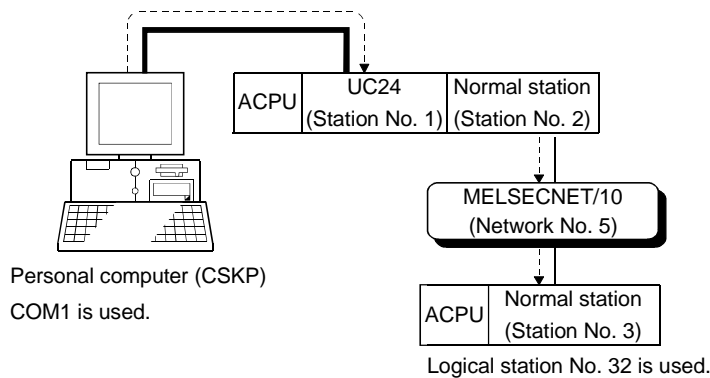

(2) Accessing procedure

1. Set the computer link module.
(Refer to the computer link module manual.)
2. To enable communication with CSKP, set the switches of the computer link module.(Refer to Section 8.1.2.)
3. Connect the computer link module and personal computer.
(Refer to Chapter 2.)
4. Click [Start]-[Programs]-[Melsec application]-[Communication support (CSKP-E)]-[Computer link Utility] to start the computer link utility.
5. Click the "Target" tab and make settings for the channel "31: Computer link (COM1)".

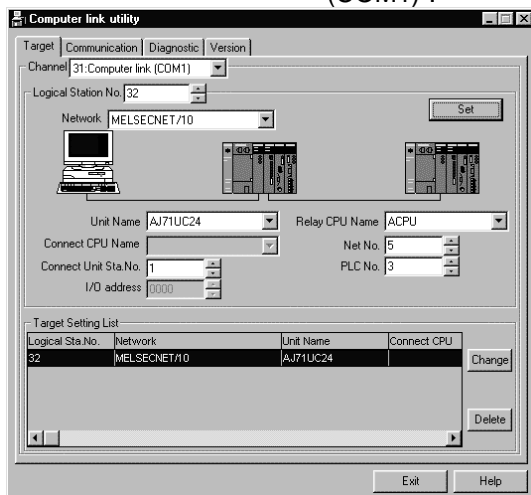

Logical Station No. : 32
 Network : MELSECNET/10
 Unit Name : AJ71UC24
 Connect Unit Sta. No. : 1 (station number of AJ71UC24)
 Relay CPU Name : ACPU
 Net No. : 5
 PLC No. : 3

6. Click the "Set" button.
7. Click the "Communication" tab and set Baud rate, Data bit, etc.
Here, set the channel to "31: Computer link (COM1)".
Also, each item must be set to the same as that on the module side.

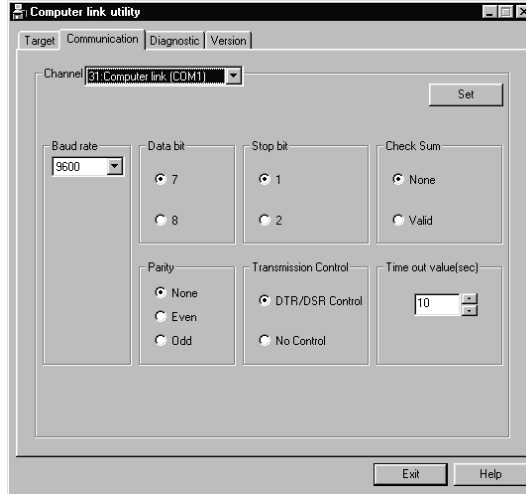

8. Click the "Set" button.
9. Click the "Diagnostic" tab and set the logical station No. for the channel "31: Computer link (COM1)". (Logical station No.: 32)

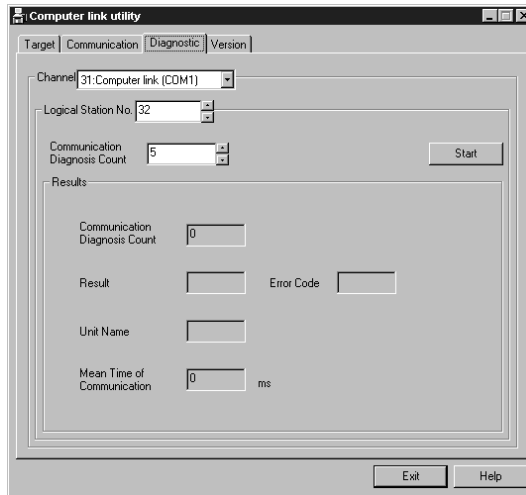

10. Click the "Start" button and confirm that communication being made is normal.
If an error has occurred, check the error code and remove the error.
(Refer to the programming manual.)
11. Click the "Exit" button to exit from the utility.
12. Using the MELSEC data link library, XMOP, OLEX or device monitor utility,
gather the device data.

5.2 Using Ethernet Communication for Making Access

This section describes the operation for making access to the PLC CPU by Ethernet communication.

(1) Example used in this section

The following example assumes that the Ethernet module of E71 is used to access the ACPU via the MELSECNET/10.

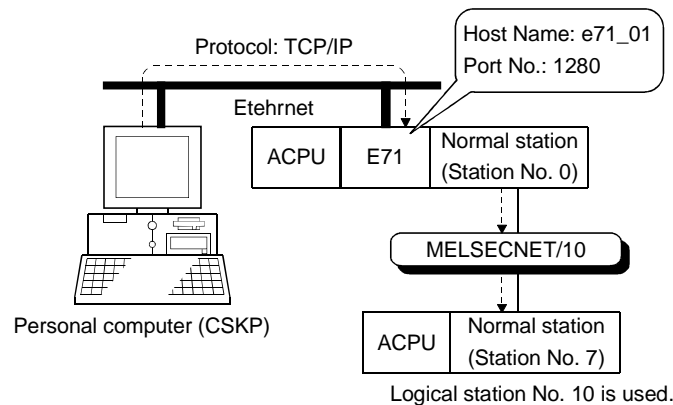

(2) Accessing procedure

1. Set the Ethernet module.
(Refer to the Ethernet module manual.)
2. To enable communication with CSKP, set the switches of the Ethernet module.
(Refer to Section 8.2.2.)
3. Edit the HOSTS file.
4. Connect the Ethernet module and personal computer to Ethernet.
(Refer to Chapter 2.)
5. Click [Start]-[Programs]-[Melsec application]-[Communication support (CSKP-E)]-[Ethernet Utility] to start the Ethernet utility.

POINT
If the IP address of the personal computer is changed after performing a communication between the Ethernet module and the personal computer, the Ethernet module must be reset.

6. Click the "Target" tab and make settings for the logical station No. "10". After that, click the "Set" button.

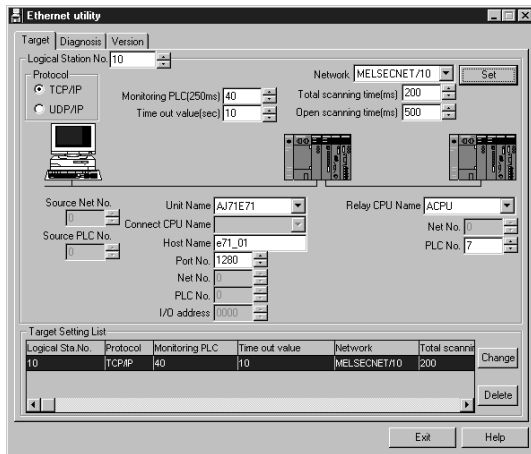

Logical Station No. : 10
 Protocol : TCP/IP
 Network : MELSECNET/10
 Unit Name : AJ71E71
 Host Name : e71_01
 Port No. : 1280
 Relay CPU Name : ACPU
 PLC No. : 7

7. Click the "Diagnosis" tab and make sure that the logical station No. is "10".

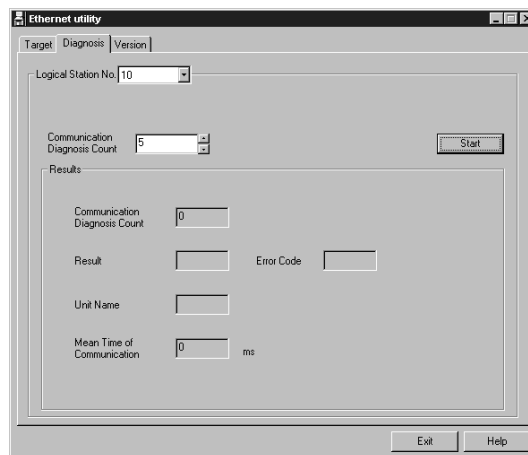

8. Click the "Start" button and confirm that communication being made is normal. If an error has occurred, check the error code and remove the error. (Refer to the programming manual.)

9. Click the "Exit" button to exit from the utility.

10. Using the MELSEC data link library, XMOP, OLEX or device monitor utility, gather the device data.

5.3 Using CPU COM Communication for Making Access

This section describes the operation for making access to the PLC CPU by CPU COM communication.

(1) Example used in this section

The following example assumes that a personal computer and QnACPU are connected to access the QnACPU via the MELSECNET/10.

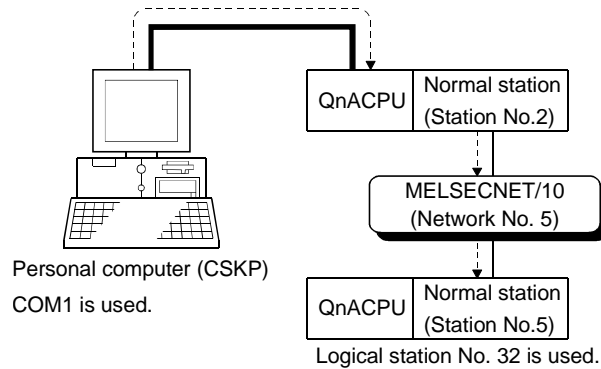

(2) Accessing procedure

1. Connect the personal computer and PLC CPU. (Refer to Chapter 2.)
2. Click [Start]-[Programs]-[Melsec application]-[Communication support (CSKP-E)]-[CPU COM Utility] to start the CPU COM utility.

- Click the "Target" tab and make settings for the channel "41:PLC COM port (COM1)".

Logical Station

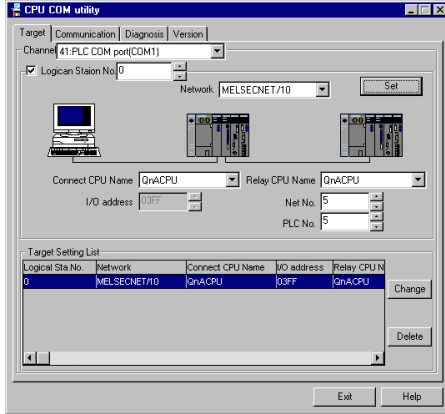

Logical Station No. : 0
 Network : MELSECNET/10
 Relay CPU Name : QnACPU
 Net No. : 5
 PLC No. : 5

Direct Station

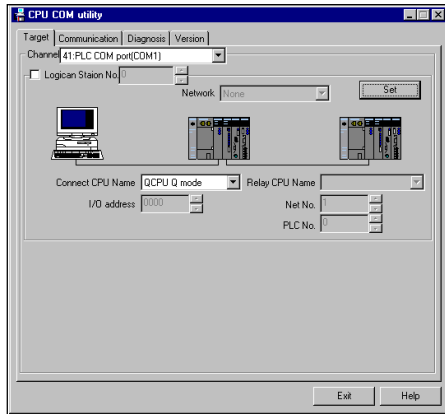

Relay CPU Name : QnACPU

- Click the "Set" button.
- Click the "Communication" tab and set Baud rate and Time out value. Here, set the channel to "41: PLC COM port (COM1)".

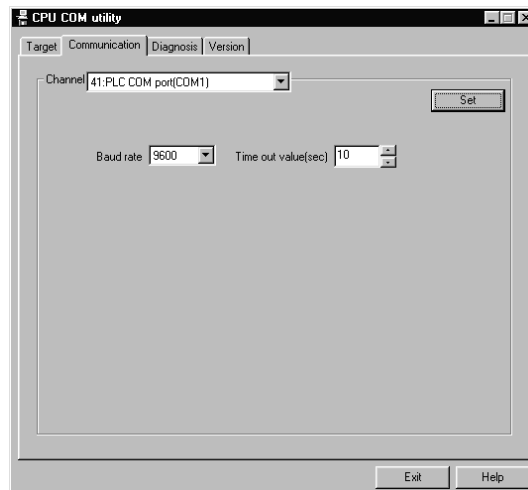

6. Click the "Set" button.

7. Click the "Diagnosis" tab and set the logical station No. for the channel "41: PLC COM port (COM1)".

Logical Station

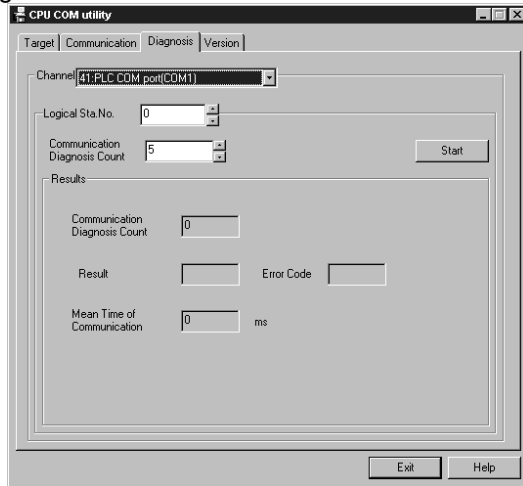

Logical Station No. : 0

Direct Station

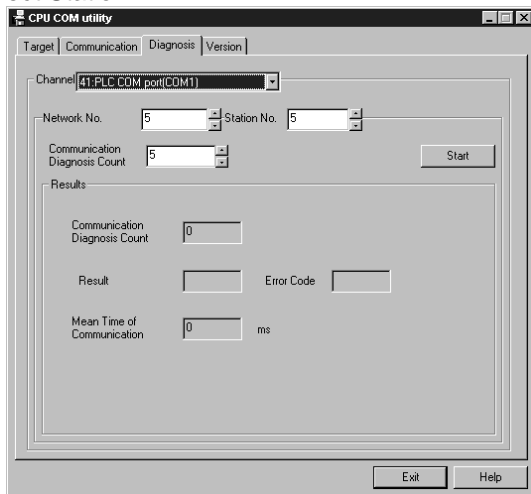

Net No. : 5

Station No. : 5

8. Click the "Start" button and confirm that communication being made is normal.
If an error has occurred, check the error code and remove the error.
(Refer to the programming manual.)

9. Click the "Exit" button to exit from the utility.

10. Using the MELSEC data link library, XMOP, OLEX or device monitor utility,
gather the device data.

5.4 Using CPU USB Communication for Making Access

This section describes the operation for making access to the PLC CPU by CPU USB communication.

(1) Example used in this section

The following example assumes that a personal computer and QCPU (Q mode) are connected to access the QnACPU via the MELSECNET/10.

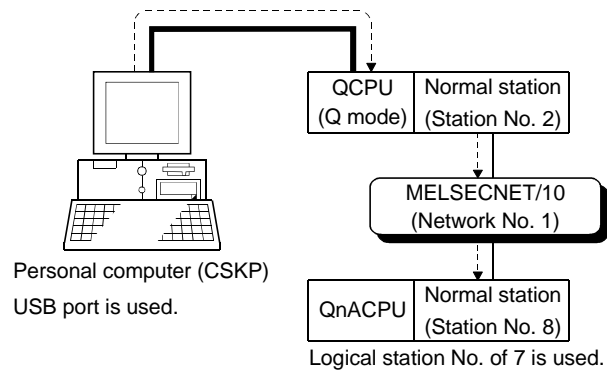

(2) Accessing procedure

1. Connect the personal computer and PLC CPU. (Refer to Chapter 2.)
2. Click [Start]-[Programs]-[Melsec application]-[Communication support (CSKP-E)]-[CPU USB Utility] to start the CPU USB utility.

3. Click the "Target" tab and make settings for the channel "141:CPU USB".

Logical Station

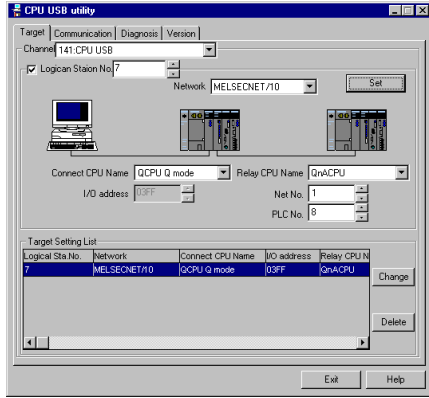

Logical Station No. : 7
 Network : MELSECNET/10
 Connect CPU Name : QCPU Q mode
 Relay CPU Name : QnACPU
 Net No. : 1
 PLC No. : 8

Direct Station

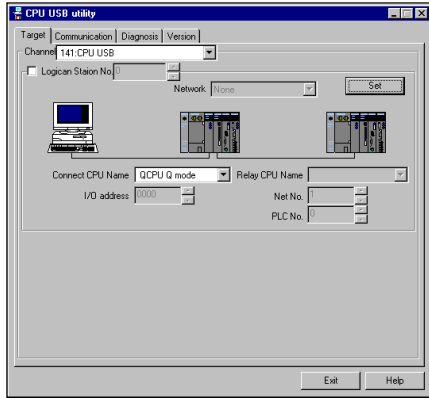

Connect CPU Name : QCPU Q mode

4. Click the "Set" button.

5. Click the "Communication" tab and set Time out value. Here, set the channel to "141: CPU USB".

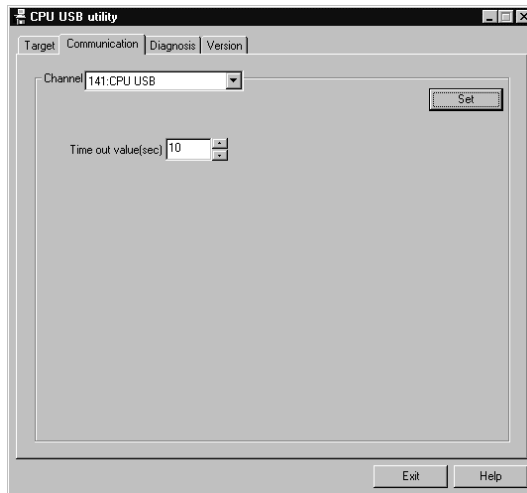

6. Click the "Set" button.

7. Click the "Diagnosis" tab and set the logical station No. for the channel "141: CPU USB".

Logical Station

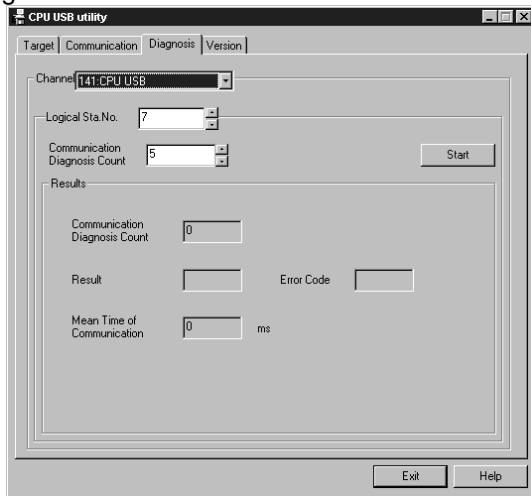

Logical Station No. : 7

Direct Station

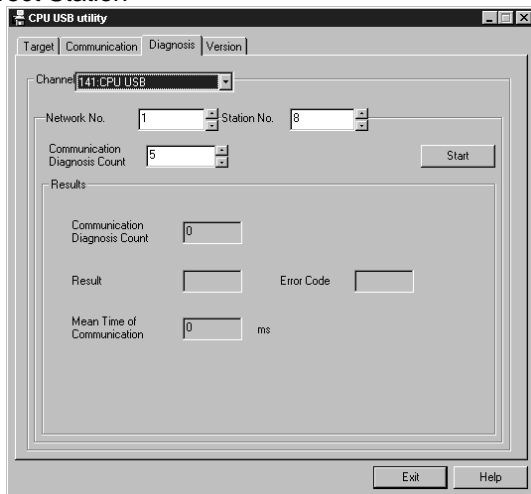

Net No. : 1
Station No. : 8

8. Click the "Start" button and confirm that communication being made is normal. If an error has occurred, check the error code and remove the error. (Refer to the programming manual.)
9. Click the "Exit" button to exit from the utility.
10. Using the MELSEC data link library, XMOP, OLEX or device monitor utility, gather the device data.

5.5 Using MELSECNET/10 Communication for Making Access

This section describes the operation for making access to the PLC CPU by MELSECNET/10 communication.

(1) Example used in this section

The following example assumes that the MELSECNET/10 board in 1 slot is used to access the ACPU of a normal station (station No.: 3) on the network No. 3.

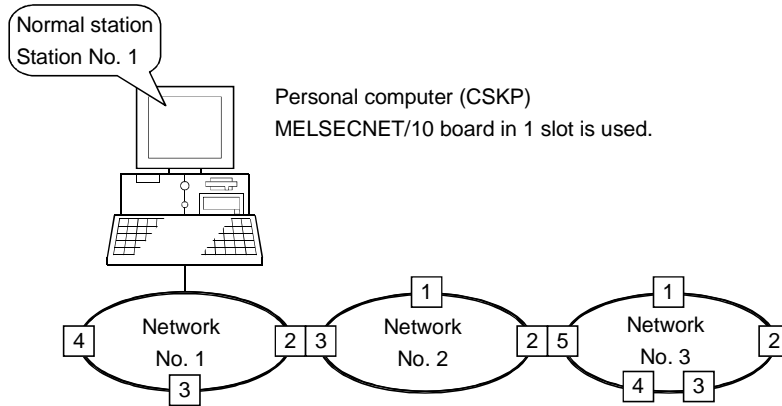

Numerals enclosed in squares indicate station numbers.

(2) Accessing procedure

1. Set the MELSECNET/10 board.
(Refer to the manual of the MELSECNET/10 board.)
2. Connect the personal computer to the MELSECNET/10. (Refer to Chapter 2.)
3. Start the MELSECNET/10 utility.
(Refer to the manual of the MELSECNET/10 board.)
4. Click the "Card information" tab and set the channel to "51:MELSECNET10 (1 slot)".
After that, set the mode to "On-line automatic return" and click the "Routing Param. Setting" button.

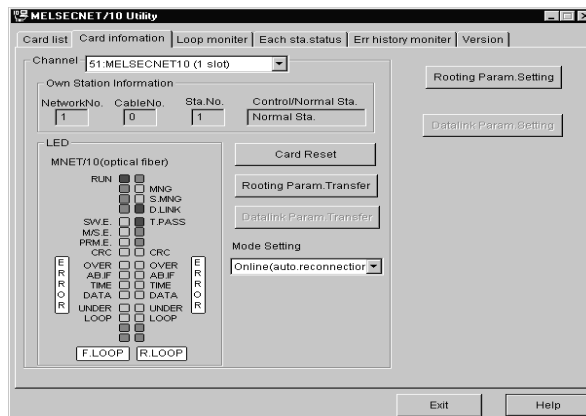

- Set the routing parameters and click the "Set" button.
After that, click the "OK" button to close the dialog box.

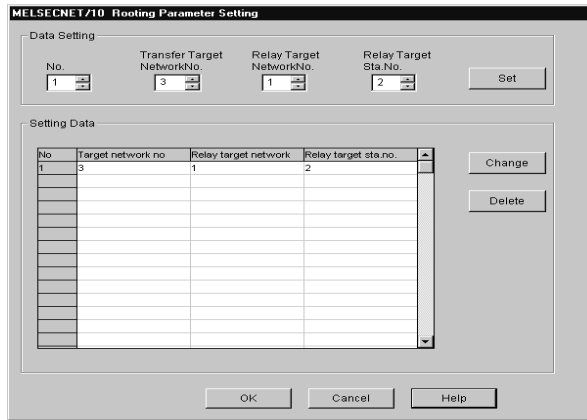

Target network No. : 3
Relay target network No. : 1
Relay target Sta. No. : 2

- Click the "Routing Param. Transfer" button to transfer the routing parameters to the MELSECNET/10 board.

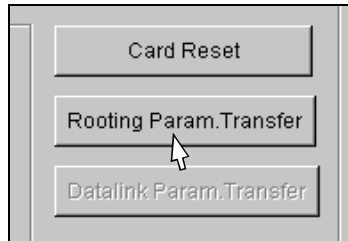

- Click the "Loop monitor" tab and make sure that the loop is normal.

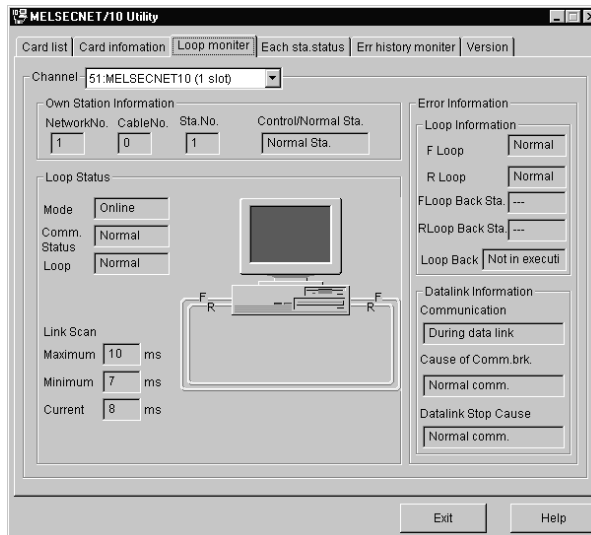

- Click the "Exit" button to exit from the utility.
- Using the MELSEC data link library, XMOP, OLEX or device monitor utility, gather the device data of the PLC CPU connected to the normal station (station No. 3).

5.6 Using CC-Link Communication for Making Access

This section describes the operation for making access to the PLC CPU by CC-Link communication.

(1) Example used in this section

The following example assumes that the CC-Link board in 1 slot is used to access the ACPU of a local station (station No.: 5) via CC-Link.

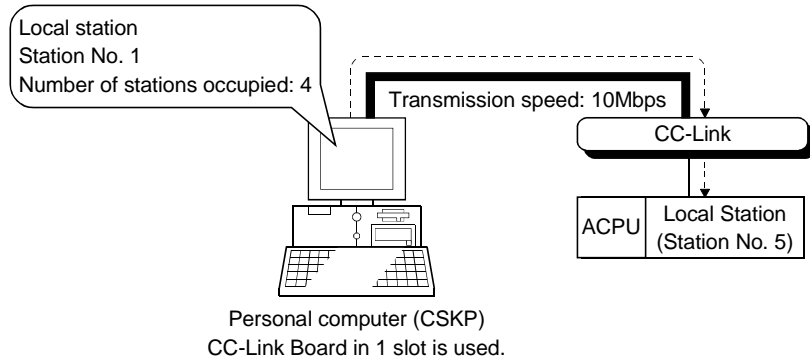

(2) Accessing procedure

1. Set the CC-Link board. (Refer to the manual of the CC-Link board.)
2. Connect the personal computer to CC-Link. (Refer to Chapter 2.)
3. Start the CC-Link utility. (Refer to the manual of the CC-Link board.)
4. Click the "Board Information" tab and set the channel to "81:CC-Link (1)", and set the own station.

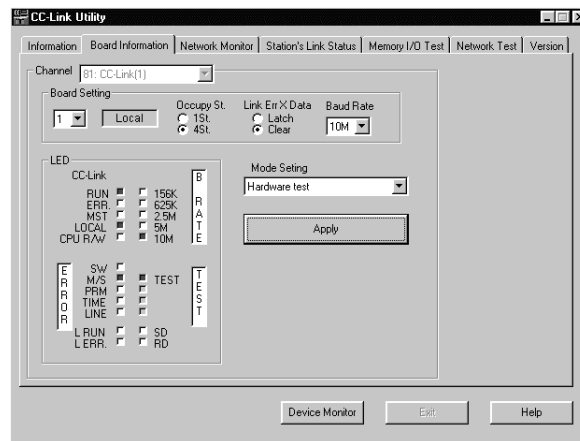

Station No. : 1
Occupy St. : 4 St.
Link Err X Data : Clear
Baud Rate : 10M

5. Set the mode to "Hardware test", click the "Apply" button, and check whether the CC-Link board is normal or not.

6. Set the mode to "Online" and click the "Apply" button.

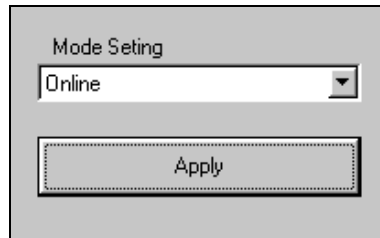

7. Click the "Network Monitor" tab and make sure that the loop of the own station is normal.

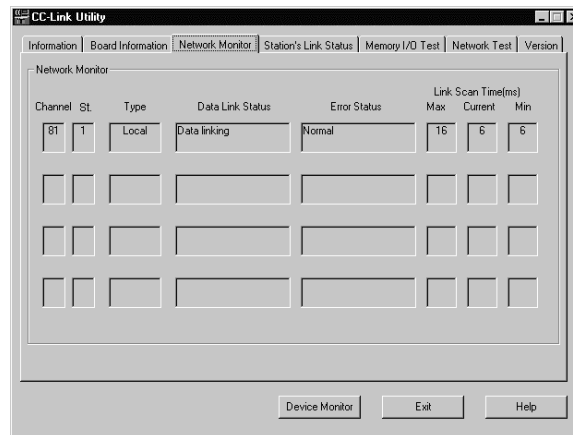

8. Click the "Exit" button to exit from the utility.
9. Using the MELSEC data link library, XMOP, OLEX or device monitor utility, gather the device data of the PLC CPU connected to the local station (station No. 5).

5.7 Using CC-Link G4 Communication for Making Access

This section describes the operation for making access to the PLC CPU by CC-Link G4 communication.

(1) Example used in this section

The following example assumes that the personal computer is connected to the CC-Link G4 module to access the QnACPU via the MELSECNET/10.

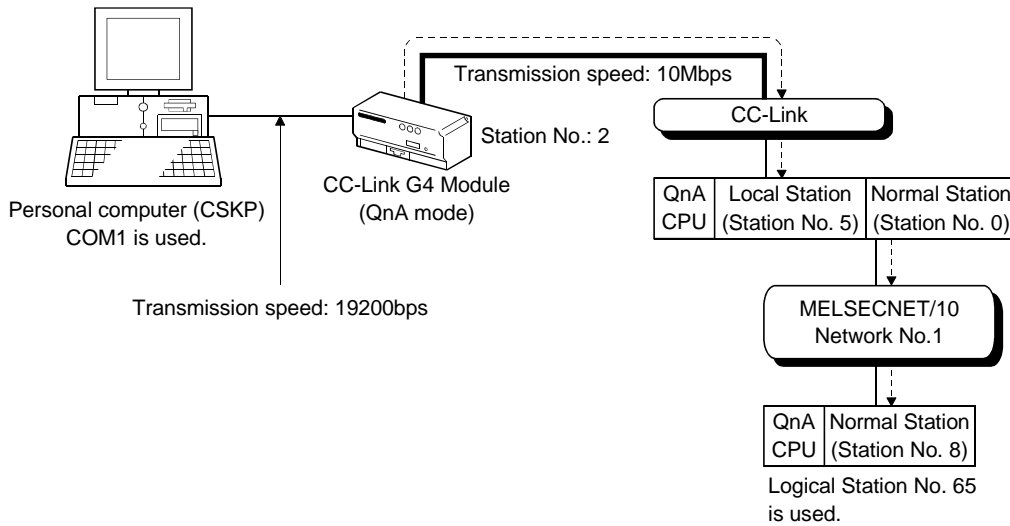

(2) Accessing procedure

1. Set the CC-Link G4 module.
(Refer to the manual of the CC-Link G4 module.)
2. To enable communication with CSKP, set the switches of the CC-Link G4 module.
(Refer to Chapter 2.)
3. Connect the CC-Link G4 module and personal computer.
(Refer to Section 2.2.7.)
4. Click [Start]-[Programs]-[Melsec application]-[Communication support (CSKP-E)]-[CC-Link G4 Utility] to start the CC-Link G4 utility.
5. Click the "Target" tab, make settings for the channel "91:CC-Link G4 (COM1)", and click the "Set" button.

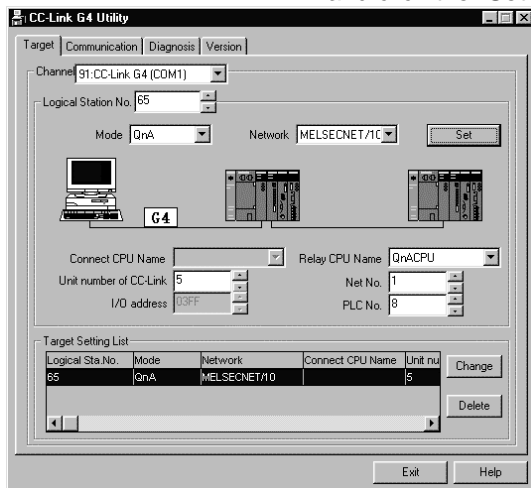

Logical Station No. : 65
 Mode : QnA
 Network : MELSECNET/10
 Replay CPU Name : QnACPU
 Unit number of CC-Link : 5
 Net No. : 1
 PLC No. : 8

- Click the "Communication" tab, set Baud rate, Transmission Control, etc., and click the "Set" button.

Here, set the channel to "91: CC-Link G4 (COM1)".

Also, each item must be set to the same as that on the module side.

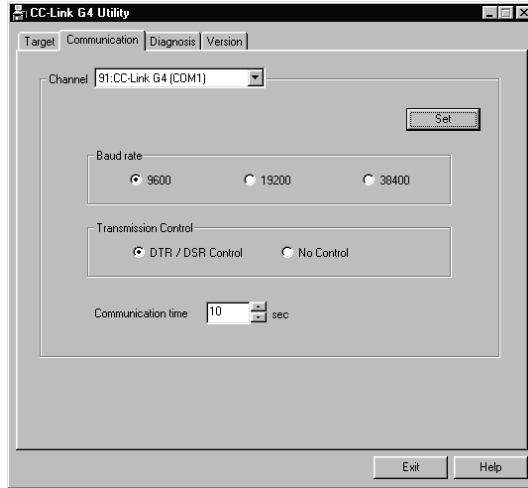

Baud rate : 19200
 Transmission Control : DTR/DSR Control
 Communication time : 5

- Click the "Diagnosis" tab and set the logical station No. for the channel "91:CC-Link G4 (COM1)". (Logical station No.: 65)

- Click the "Start" button and confirm that communication being made is normal. If an error has occurred, check the error code and remove the error. (Refer to the programming manual.)

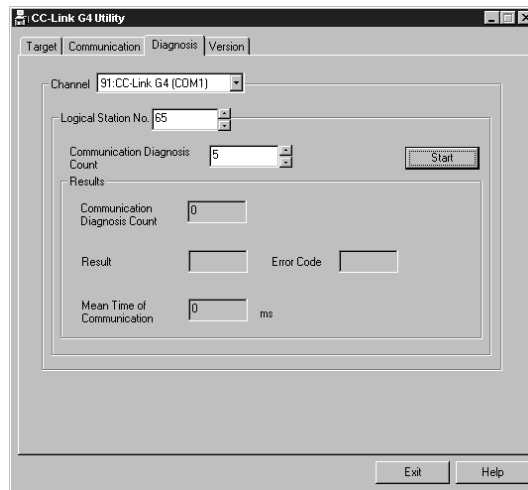

- Click the "Exit" button to exit from the utility.

- Using the MELSEC data link library, XMOP, OLEX or device monitor utility, gather the device data.

5.8 Using CPU Board Communication for Making Access

This section describes the operation for making access to the PLC CPU (CPU board) by CPU board communication.

(1) Example used in this section

The following example assumes that access is made to the CPU board (during RUN) loaded in the personal computer.

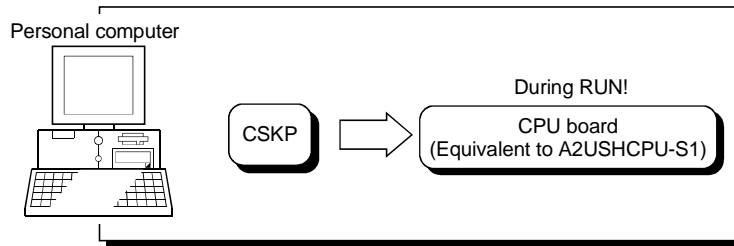

(2) Accessing procedure

1. Set the CPU board. (Refer to the manual of the CPU board.)
2. Start the AnU utility. (Refer to the manual of the CPU board.)
3. Click the "Mem. I/O Test" tab and click the "Start" button to perform the test any number of times.
Then, click the "Stop" button to stop the test and make sure that the CPU board is normal.

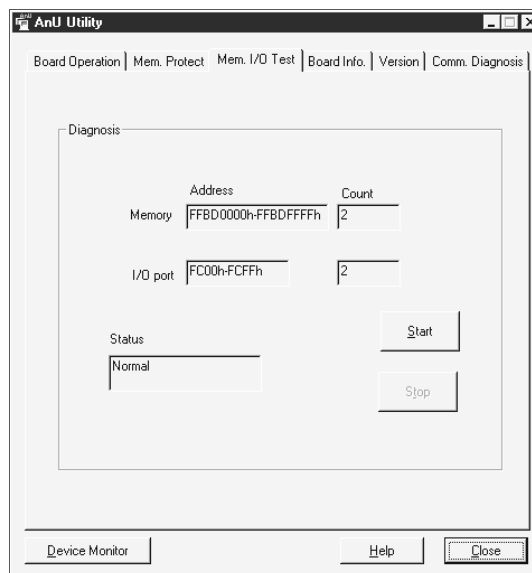

- Click the "Comm. Diagnosis" tab and click the Start button to make sure that communication is made properly.
If an error has occurred, check the error code and remove the error. (Refer to the programming manual.)

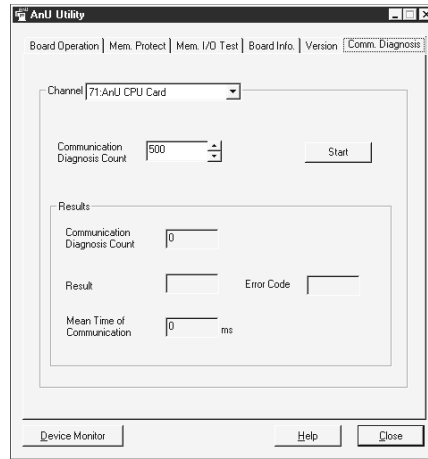

- In this section, you must perform setting to make the CPU board running on the "Board Operation" screen since access is made while the CPU board is running. Click the "Board Operation" tab.

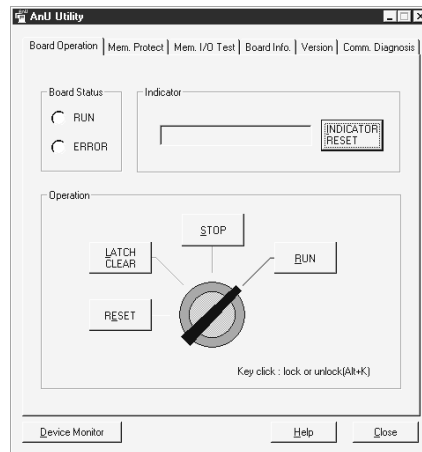

- Click the CPU operation key to choose the unlock status.
After choosing the unlock status, click the "RUN" button to make the CPU board running.

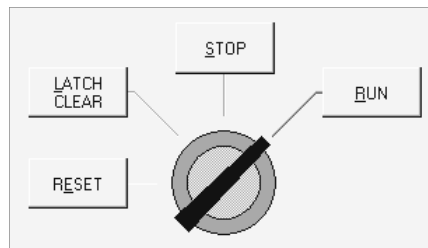

- Click the "Close" button to store the AnU utility into the taskbar.
- Using the MELSEC data link library, XMOP, OLEX or device monitor utility, gather the device data.

6 USING VARIOUS FUNCTIONS

This chapter briefly describes the procedures for using the shared devices of CSKP, refreshing the devices, and using the function of communication with the ladder logic test tool (LLT).

6.1 Using the Shared Devices

This section explains the operation for using the shared devices.

(1) Example used in this section

The following example assumes that the shared devices of personal computer B are accessed from personal computer A via the MELSECNET/10.

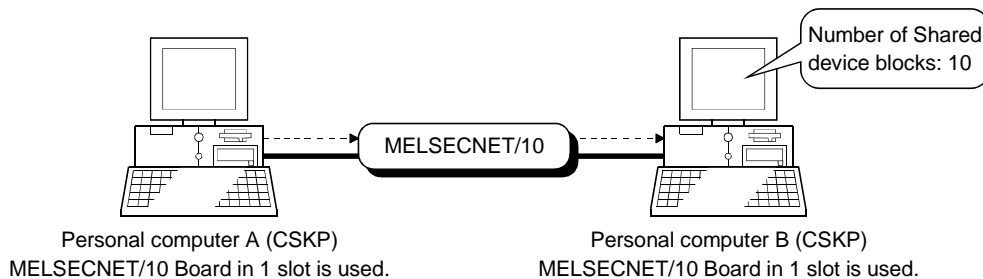

(2) Accessing procedure

1. Set the MELSECNET/10 boards of the personal computers A, B.
(Refer to the MELSECNET/10 board manual.)
2. Connect the personal computers A, B to the MELSECNET/10.
3. Click [Start]-[Programs]-[Melsec application]-[Communication support (CSKP-E)]-[EM ED]-[EM ED Utility] on the personal computer B to start the shared device utility.
4. Set the Block Count of the "Parameter Setting" tab to "10" and click the "Setting" button.

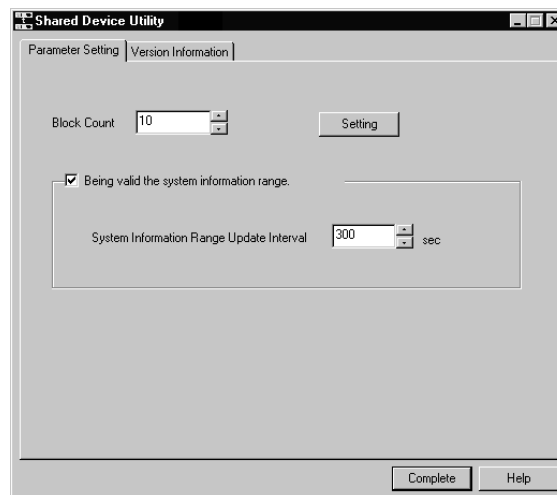

5. After clicking the "Complete" button, restart Windows NT 4.0 to make the settings valid.
6. Using the MELSEC data link library, XMOP, OLEX or device monitor utility on the personal computer A, gather the shared device data of the personal computer B.

POINT
When accessing the shared devices of the other station, the channel used should be the one of the MELSECNET/10 board, which is connected to the other station.

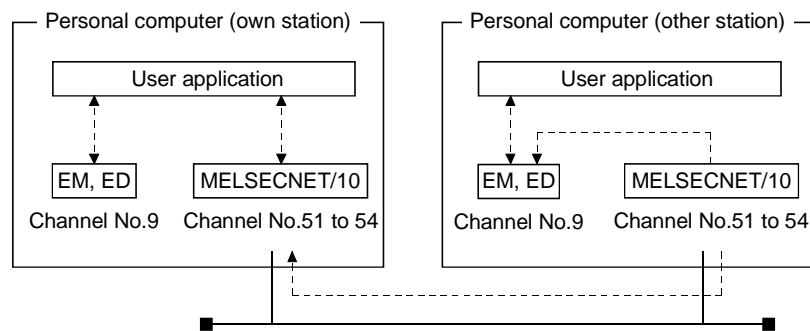

6.2 Refreshing the Devices

This section explains the operation for refreshing the devices using the shared device server process and shared device server utility.

(1) Example used in this section

The following example assumes that "X0 to X7 (decimal)" of PLC A are continually refreshed to "M8 to M15 (decimal)" of PLC B.

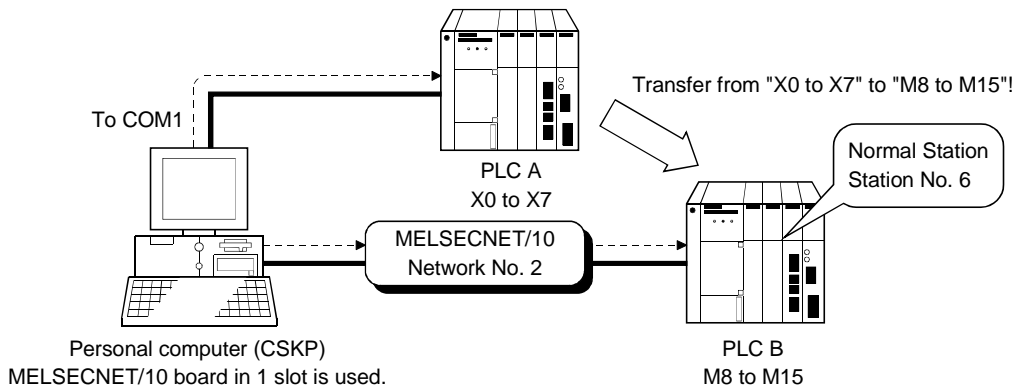

(2) Accessing procedure

1. Click [Start]-[Programs]-[Melsec application]-[Communication support (CSKP-E)]-[EM ED]-[EM ED Server Process] to start the shared device server process.
2. Click [Start]-[Programs]-[Melsec application]-[Communication support (CSKP-E)]-[EM ED]-[EM ED Server Utility] to start the shared device server utility.
3. Set the Name of Refresh range to any name.
Here set it to "Sample".

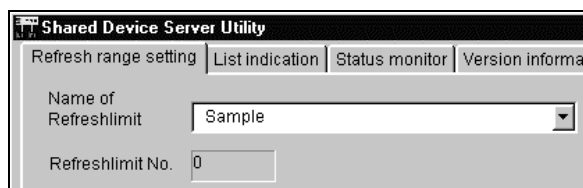

4. Set "Source" as indicated on the left.

Channel : PLC COM port (COM1)
 Network Setting : Own Sta.
 Device Type : DEC, X (input)
 Front Device No. : 0

5. Set "Target" as indicated on the left.

Channel : MELSECNET/10 (1 slot)
 Network Setting : Other Sta.
 Network No. : 2
 Sta. No. : 6
 Device Type : DEC, M (Inside relay)
 Front Device No. : 8

6. Set Transfer Size to "8" and click the "Add" button.

7. Click the "Status monitor" tab and set the Name of Refresh Limit to "Sample".
 Clicking the "Run" button starts device refresh.

Statu	Setting	Current	Source	Target comm.err	Trigger co

8. Click the "Exit" button to exit from the utility.

6.3 Making Offline Debugging by Ladder Logic Test Communication

This section describes the operation for accessing the ladder logic test tool (LLT) by Ladder logic test communication.

(1) Example used in this section

The following example assumes that the PC type of the GPPW project is "A2U (S1)".

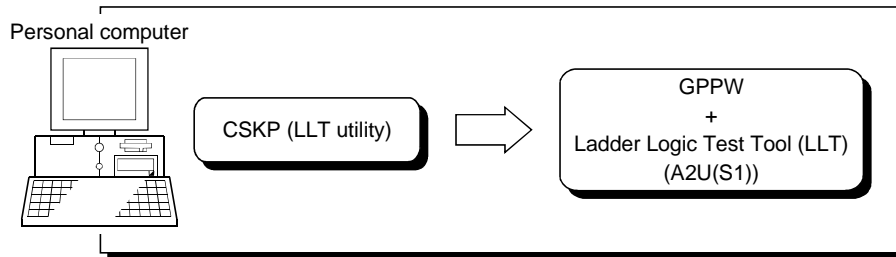

(2) Accessing procedure

1. Start GPPW and open the project.
Here open the project whose PLC type is "A2U(S1)".
2. Start the Ladder Logic Test Tool (LLT).
3. Click [Start]-[Programs]-[Melsec application]-[Communication support (CSKP-E)]-[Ladder logic test Utility] to start the ladder logic test utility.
4. Click the "Target" tab and set the PLC Type.
Here, set "ACPU" as the PLC type of the GPPW project is "A2U(S1)".
After that, click the "Set" button.

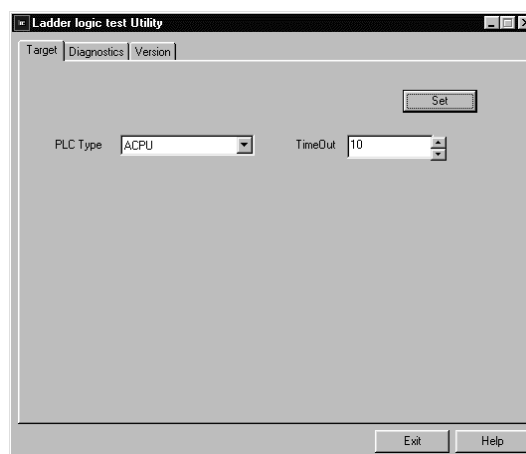

5. Click the "Diagnostics" tab .

After that, click the "Start" button and confirm that communication being made is normal.

If an error has occurred, check the error code and remove the error.

(Refer to the programming manual.)

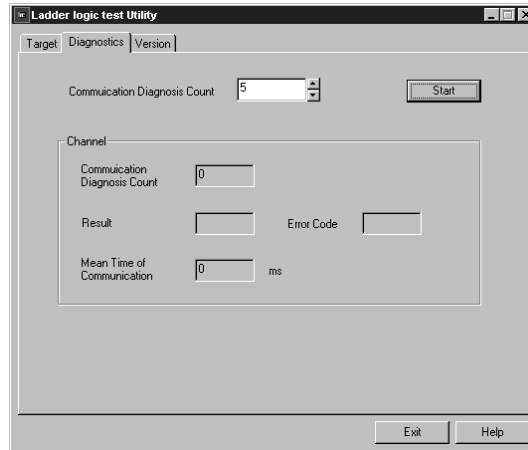

6. Click the "Exit" button to exit from the utility.

7. Using the MELSEC data link library, XMOP, OLEX or device monitor utility, gather the device data.

7 OPERATIONS COMMON TO UTILITIES

This chapter explains operations common to the utilities.

7.1 Starting the Utilities

Any utility can be started by clicking the corresponding icon in the [Start]-[Programs]-[Melsec application]-[Communication support (CSKP-E)] menu.
Refer to Section 3.2 for the icons registered.

7.2 Exiting from the Utilities

This section provides how to exit from the utilities.

- (1) When exiting from any of the following utilities, click the "Exit" button at the bottom of the corresponding utility screen.
As the dialog box appears, click the "Yes" button to exit from the utility.

- Computer link utility
- Ethernet utility
- CPU COM utility
- CPU USB utility
- CC-Link G4 utility
- Shared device utility
- Shared device server utility
- Ladder logic test utility

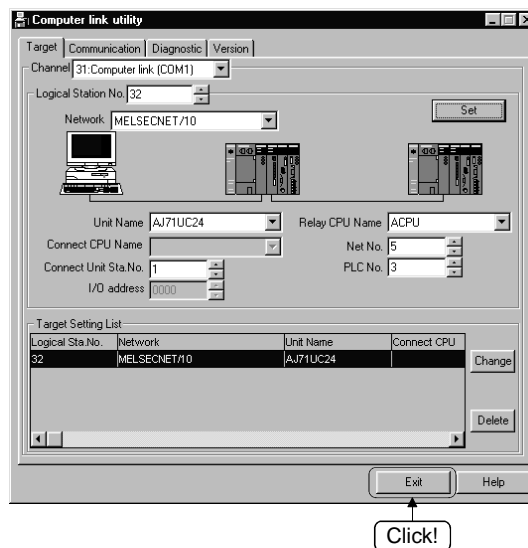

- (2) To exit from the device monitor utility, click the [Menu]-[Exit] menu on the menu bar.
As the dialog box appears, click the "Yes" button to exit from the device monitor utility.

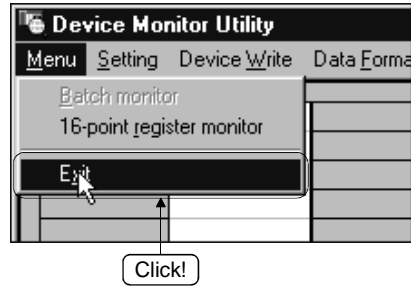

- (3) To exit from the error viewer, click the [Log]-[Exit] menu on the menu bar.

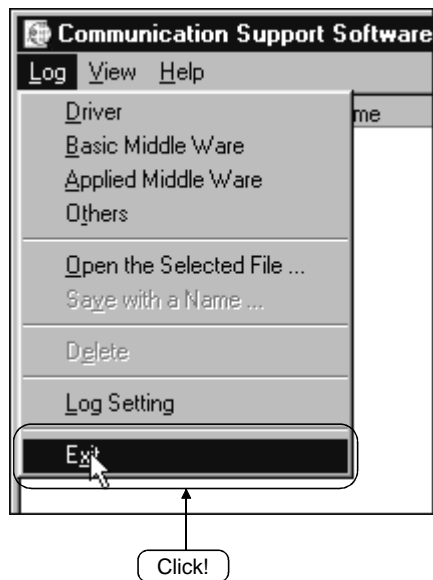

7.3 About the System Menu

Opening the system menu of any of the following utility displays the "Save as..." menu, which is unavailable for the ordinary system menu.

Clicking this menu allows the settings on the "Target" screen to be saved in a text file.

- Computer link utility
- Ethernet utility
- CPU COM utility
- CPU USB utility
- CC-Link G4 utility

(1) Operation method

The operation method for saving the settings of the Target screen in a text file is described below.

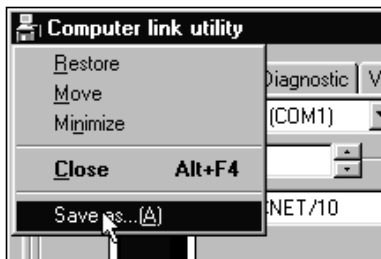

1. Click the icon at top left of the utility screen and click the "Save as..." menu.

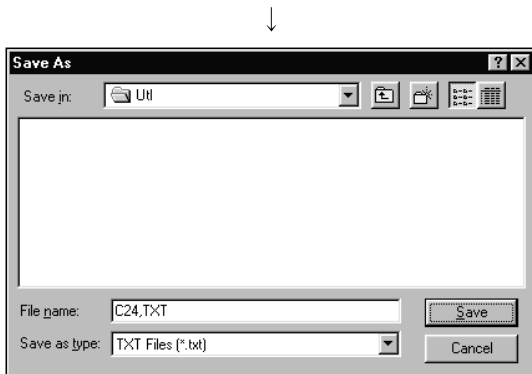

2. As the dialog box shown on the left appears, set the place to save and the file name, and click the "Save" button.

(2) File data

The data of the text file created are explained below.

(a) Communication link utility

The data of the text file created in the system menu of the communication link utility are indicated below.

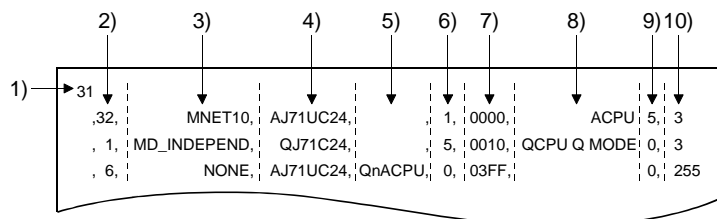

No.	Description
1)	Indicates Channel.
2)	Indicates Logical Station No.
3)	Indicates Network.
4)	Indicates Unit Name.
5)	Indicates Connect CPU Name.
6)	Indicates Connect Unit Sta. No.
7)	Indicates I/O address.
8)	Indicates Relay CPU Name.
9)	Indicates Net No.
10)	Indicates PLC No.

(b) Ethernet utility

The data of the text file created in the system menu of the Ethernet utility are indicated below.

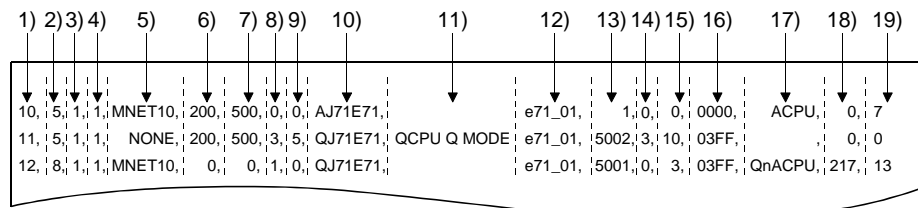

No.	Description
1)	Indicates Logical Station No.
2)	Indicates Protocol. 5: TCP/IP 8: UDP/IP
3)	Indicates Monitoring PLC.
4)	Indicates Time out value.
5)	Indicates Network.
6)	Indicates Total scanning time.
7)	Indicates Open scanning time.
8)	Indicates Source Net No.
9)	Indicates Source PLC No.
10)	Indicates Unit Name.
11)	Indicates Connect CPU Name.
12)	Indicates Host Name.
13)	Indicates Port No.
14)	Indicates Net No.
15)	Indicates PLC No.
16)	Indicates I/O address.
17)	Indicates Relay CPU Name.
18)	Indicates Net No.
19)	Indicates PLC No.

(c) CPU COM utility

The data of the text file created in the system menu of the CPU COM utility are indicated below.

[Logical Station]

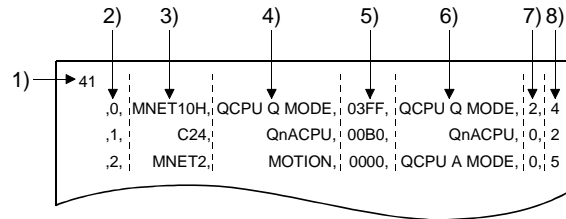

No.	Description
1)	Indicates Channel.
2)	Indicates Logical Station No.
3)	Indicates Network.
4)	Indicates Connect CPU Name.
5)	Indicates I/O address.
6)	Indicates Relay CPU Name.
7)	Indicates Net No.
8)	Indicates PLC No.

[Direct Station]



No.	Description
1)	Indicates Channel.
2)	Indicates Connect CPU Name.

(d) CPU USB utility

The data of the text file created in the system menu of the CPU USB utility are indicated below.

[Logical Station]

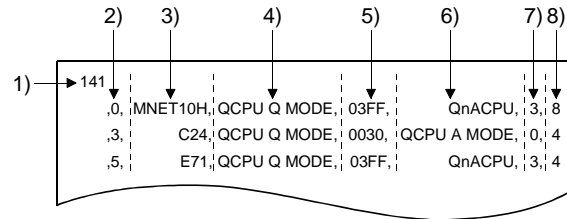

No.	Description
1)	Indicates Channel.
2)	Indicates Logical Station No.
3)	Indicates Network.
4)	Indicates Connect CPU Name.
5)	Indicates I/O address.
6)	Indicates Relay CPU Name.
7)	Indicates Net No.
8)	Indicates PLC No.

[Direct Station]

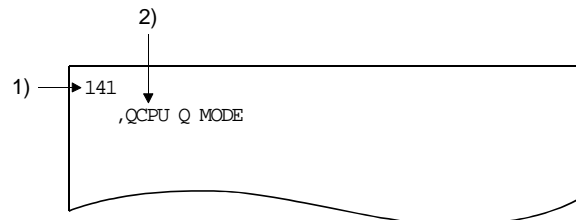

No.	Description
1)	Indicates Channel.
2)	Indicates Connect CPU Name.

(e) CC-Link G4 utility

The data of the text file created in the system menu of the CC-Link G4 utility are indicated below.

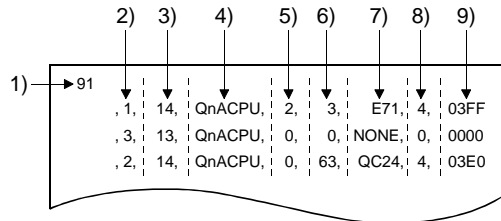

No.	Description
1)	Indicates Channel.
2)	Indicates Logical Station No.
3)	Indicates Mode. 13: A mode 14: QnA mode
4)	Indicates Connect CPU Name or Relay CPU Name.
5)	Indicates Net No.
6)	Indicates PLC No.
7)	Indicates Network.
8)	Indicates Unit number of CC-Link.
9)	Indicates I/O address.

7.4 Displaying the Help Screen

This section describes how to display the help screen of the utility.

(1) To exit from any of the following utilities, click the "Help" button at bottom right of the corresponding utility screen.

- Computer link utility
- Ethernet utility
- CPU COM utility
- CPU USB utility
- CC-Link G4 utility
- Shared device utility
- Shared device server utility
- Ladder logic test utility

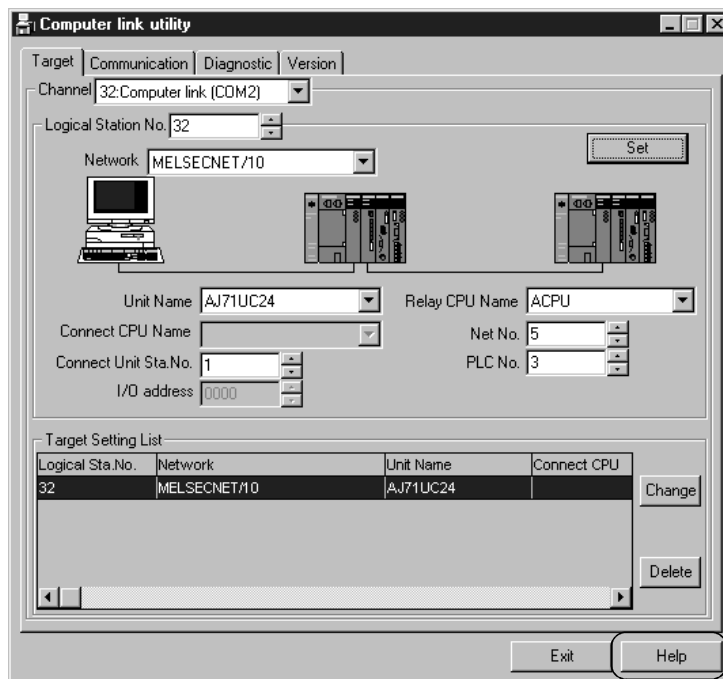

(2) To display the help screen of the device monitor utility or error viewer, click the [Help]-[Help] menu on the menu bar.

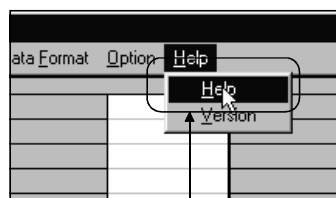

7.5 Confirming the Version

This section gives how to confirm the version of the utility.

(1) To confirm the version of any of the following utilities, click the "Version" tab.

- Computer link utility
- Ethernet utility
- CPU COM utility
- CPU USB utility
- CC-Link G4 utility
- Shared device utility
- Shared device server utility
- Ladder logic test utility

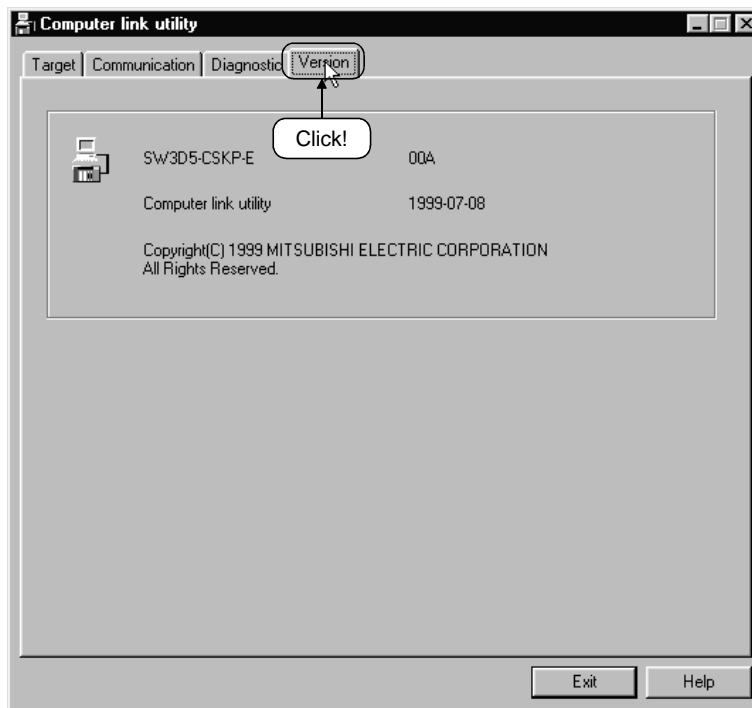

(2) To display the help screen of the device monitor utility or error viewer, click the [Help]-[Version] menu on the menu bar.

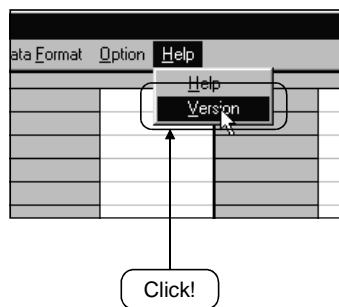

8 OPERATIONS OF MELSEC DATA LINK UTILITIES

This chapter describes the operations of the MELSEC data link utilities.
 For the operational explanation of either of the following utilities, refer to the manual of the corresponding card.

- MELSECNET/10 utility
- CC-Link utility
- AnU utility

8.1 Computer Link Utility

This section explains the operation of the computer link utility.

8.1.1 Operation procedure

The following is the operation procedure of the computer link utility.

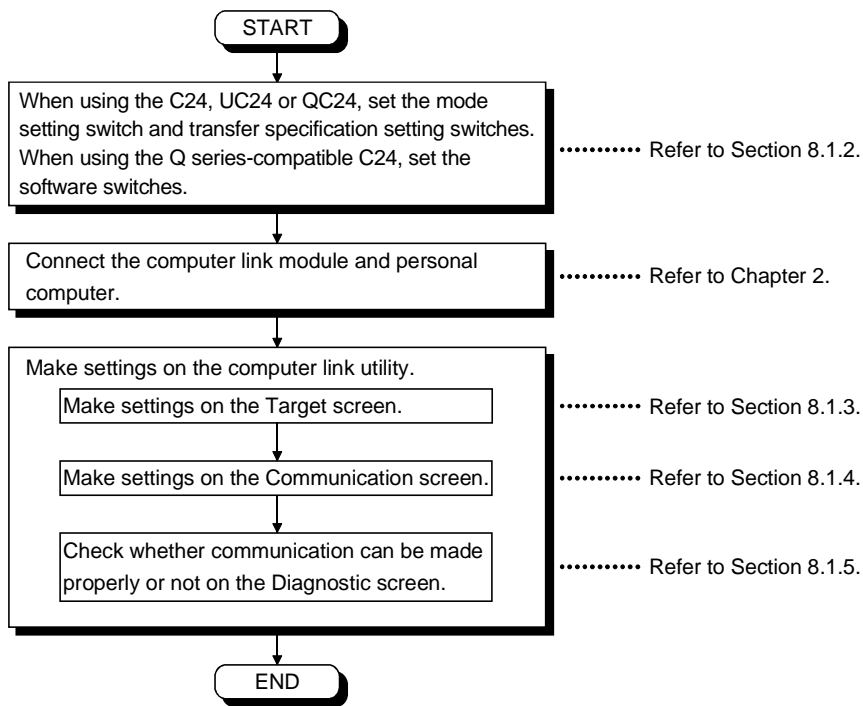

8.1.2 Computer link module switch settings

To use CSKP, make the following switch settings of the computer link (serial communication) module.

(1) QC24 settings

Mode setting switch		Set the switch number to 5 (type 5).
Transfer specification setting switches	SW1 to SW8	SW1:OFF, SW2: ON, SW3: ON, SW4:OFF, SW5:OFF, SW6: ON, SW7: ON, SW8:OFF
	SW9 to SW12	ON OFF ON OFF(9600bps), OFF ON ON OFF(19200bps), ON ON ON OFF(38400bps) * 1, OFF ON OFF ON(57600bps) * 1 ON ON OFF ON(115200bps) * 1
	SW13 to SW15	All OFF

* 1 May be set for the QC24N only.

(2) C24 or UC24 settings

(a) Mode setting switch

Set the switch number to type 1.

This causes the switch number selected to be any of 1, 5 and A according to the port used.

There are no other restrictions.

(b) Transfer specification setting switches

There are no specific fixed values to be set for the switches.

Since the switch settings depend on the module types, refer to the computer link module user's manual and make settings.

(3) Q series-compatible C24 settings

GPPW is used to make the switch settings of the Q series-compatible C24.

Choosing [Parameter]-[PLC parameter] in Project data list of GPPW and clicking the I/O assignment tab makes the "Switch setting" button appear.

Clicking this button shows the "Switch setting for I/O and intelligent functional module" screen. On this screen, make the switch settings of the Q series-compatible C24.

For full information on the software switches and setting method, refer to the Q series-compatible C24 user's manual and GPPW operating manual.

Note that usable Transmission speed are 9600bps, 19200bps, 38400bps, 57600bps and 115200bps only.

The following example assumes that the CH1 and CH2 settings are "Independent mode", "Transmission speed: 19200bps", "Parity: Odd", "Data bit: 8 bits", "Sum check: Yes", and "Station number: 1".

	Switch 1	Switch 2	Switch 3	Switch 4	Switch 5
Setting	0726H	0H	0726H	5H	1H

8.1.3 Operations on Target screen

Set the logical station number used for computer link communication.

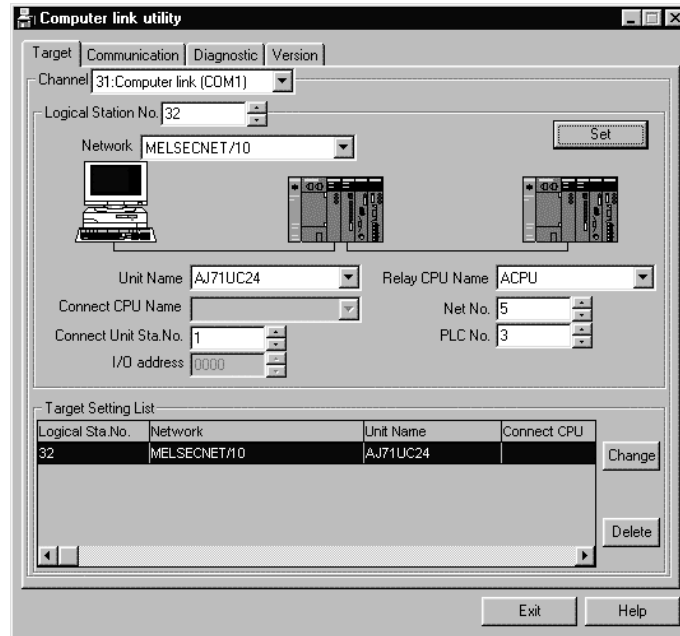

Item	Description
Channel	Set the channel to be used.
Logical Station No.	Set any logical station number. The logical station number means a number which symbolizes the information on access to the PLC CPU (station number, network number, etc.).
Network	<p>Choose the network format for access to the PLC CPU via a network.</p> <ul style="list-style-type: none"> • None • Multidrop (independent mode), Multidrop (combine mode) • MELSECNET/10H, MELSECNET/10

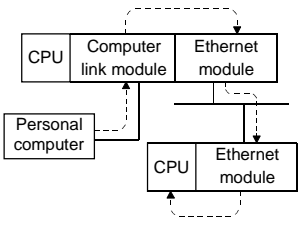
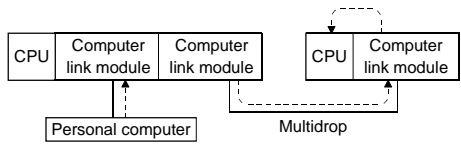
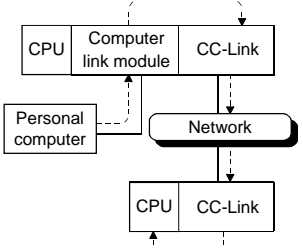
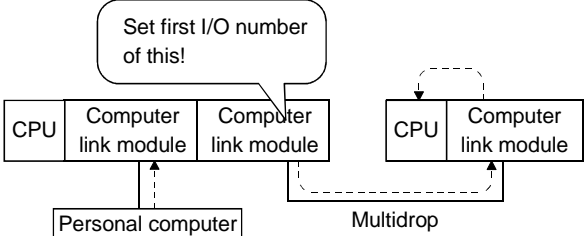
Item	Description
Network	<p>• Ethernet</p>  <p>• Computer link</p>  <p>• CC-Link</p> 
Connect CPU Name	Set the type of the PLC CPU which is loaded with the computer link (serial communication) module specified in "Unit Name".
Unit Name	Set the type of the computer link (serial communication) module connected to the personal computer.
Connect Unit Sta. No.	Set the module station number of the computer link (serial communication) module specified in "Unit Name".
I/O address	<p>Set the first I/O number of the module on the base which is loaded with the module specified in "Connect Unit Sta. No.". Set the first I/O number in hexadecimal as a multiple of 16.</p> <p>• Via computer link</p> 

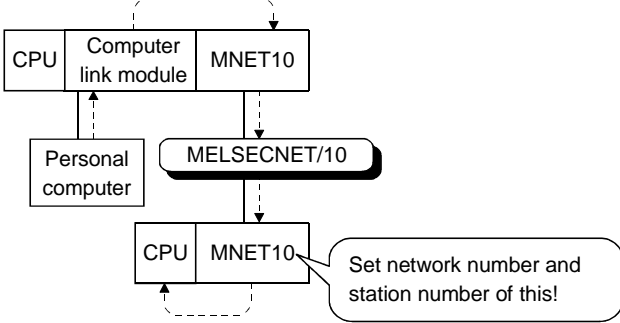
Item	Description
Relay CPU Name	Set the type of the PLC CPU used for communication via the network.
Net No.	Set the network number of the other station linked via the network from the PLC CPU which is loaded with the computer link (serial communication) module.
PLC No.	<p>Set the station number of the other station linked via the network from the PLC CPU which is loaded with the computer link (serial communication) module.</p> <ul style="list-style-type: none"> • Via MELSECNET/10 
"Set" button	The settings currently made are registered.
"Change" button	The data on the line currently selected can be displayed in the setting column and changed.
"Delete" button	Deletes the line currently selected.
Target Setting List	Shows a list of data registered so far.

8.1.4 Operations on Communication screen

Set the communication conditions of the COM port connected to the computer link (serial communication) module.

POINT

The settings on this screen must be the same as those on the computer link (serial communication) module side.

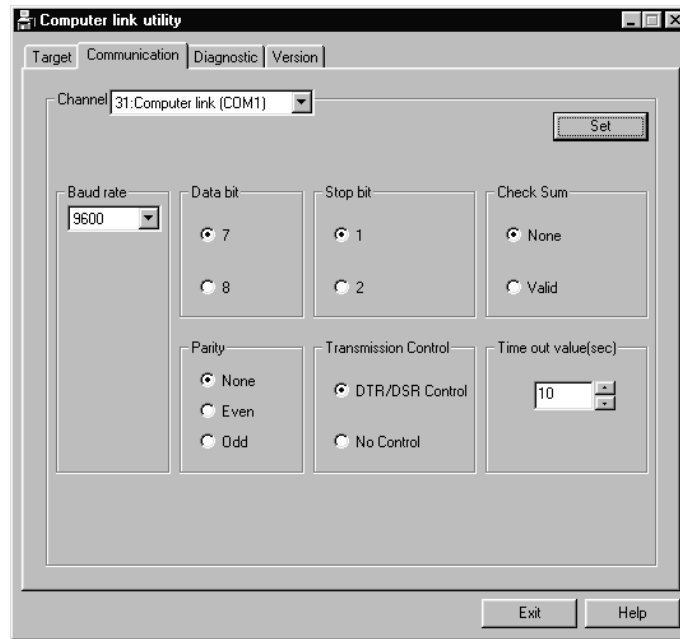

Item	Description
Channel	Set the channel to be used.
Baud rate	Set the transmission speed for communication with the computer link module.
Data bit	Set the data bit length for communication with the computer link module. When using the QC24, set it to "8".
Stop bit	Set the stop bit for communication with the computer link module. When using the QC24, set it to "1".
Parity	Set the parity bit for communication with the computer link module. When using the QC24, set it to "Odd".
Transmission Control	Set the flow control for communication with the computer link module. When using the QC24, set it to "DTR/DSR".
"Set" button	The settings currently made are registered.
Check Sum	Set whether a sum check is to be made or not for communication with the computer link module. When using the QC24, set it to "Valid".
Time out value	Set the time-out period when communication is not normal at the time of sending or receiving.

8.1.5 Operations on Diagnostic screen

Communication is made with the PLC via the computer link (serial communication) module to diagnose whether communication is normal or abnormal.

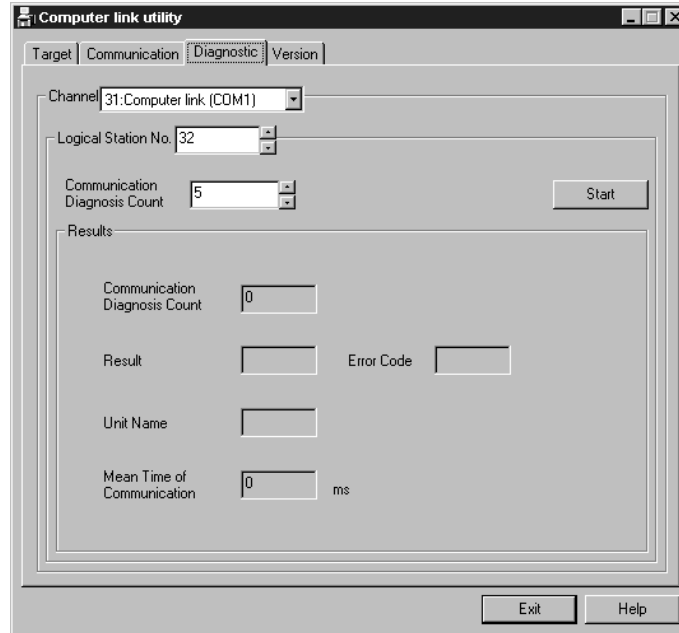

Item	Description
Channel	Set the channel to be used.
Logical Station No.	Set the logical station number.
Communication Diagnosis Count	Set the number of times the communication diagnosis will be made.
Results	Shows the results of the communication diagnosis. Communication Diagnosis Count : Shows the number of times the communication diagnosis was made. Result : Shows the result of the communication diagnosis. Unit Name : Shows the type of the module currently connected. Mean Time of Communication : Shows the mean time taken for communication. Error Code : Shows the error code of the diagnosis result. (For the definitions of the error codes, refer to the programming manual.)
"Start" button	Starts the communication diagnosis.

8.2 Ethernet Utility

This section gives the operation and setting methods of the Ethernet utility.

8.2.1 Operation procedure

The following is the operation procedure of the Ethernet utility.

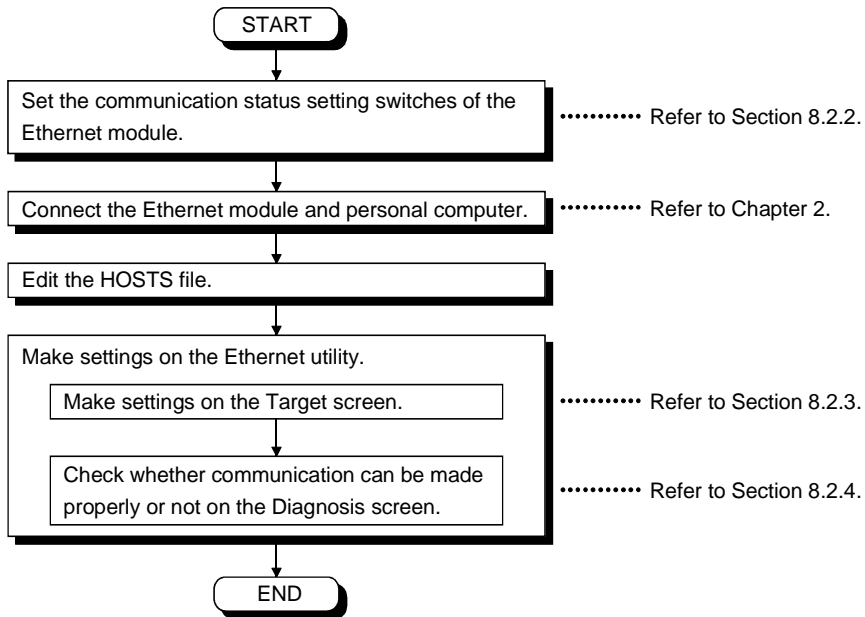

8.2.2 Ethernet module switch settings

To use CSKP, make the following switch settings of the Ethernet module.

(1) When using TCP/IP

		QE71	E71	
			1)	2)
Communication condition setting switch	SW1	OFF	OFF	OFF
	SW2	ON	ON	ON
	SW3	OFF	OFF	ON
	SW4	OFF	OFF	OFF
	SW5	OFF	OFF	
	SW6	OFF	OFF	
	SW7	ON	ON	
	SW8	OFF	OFF	

1): E71 except A1SJ71E71-B2, A1SJ71E71-B5, A1SJ71E71-B2-S3, A1SJ71E71-B5-S3
 2): A1SJ71E71-B2, A1SJ71E71-B5, A1SJ71E71-B2-S3, A1SJ71E71-B5-S3

(2) When using UDP/IP

		QE71	E71	
			1)	2)
Communication condition setting switch	SW1	OFF	OFF	OFF
	SW2	OFF	OFF	OFF
	SW3	OFF, ON *1	OFF	ON
	SW4	OFF	OFF	OFF
	SW5	OFF	OFF	
	SW6	OFF	OFF	
	SW7	ON	ON	
	SW8	OFF	OFF	

1): E71 except A1SJ71E71-B2, A1SJ71E71-B5, A1SJ71E71-B2-S3, A1SJ71E71-B5-S3
 2): A1SJ71E71-B2, A1SJ71E71-B5, A1SJ71E71-B2-S3, A1SJ71E71-B5-S3

* 1 "ON" when parameter setting was made with GPPW or the like.
 "OFF" when setting is made in sequence program.

(3) About sequence program

The following table lists whether a sequence program is needed or not for Ethernet communication.

When using the E71 (UDP/IP), set the port number (module-side) defined in the Ethernet utility of CSKP to the same number as the other node's port number defined in the sequence program.

For details, refer to the Operating Manual for the Ethernet module.

Protocol	Ethernet Module		
	E71	QE71	Q Series- Compatible E71
TCP/IP	○	○	×
UDP/IP	○	×	×

○: Sequence program is needed.
 ×: Sequence program is not needed.

POINT

If the timeout value on the personal computer side (set in the Ethernet utility) is smaller than the timer values of the Ethernet modules, communication errors will be generated more frequently.
 Set the timeout value on the personal computer side larger than the timer values of the Ethernet modules.

8.2.3 Operations on Target screen

Set the logical station number used for Ethernet communication.

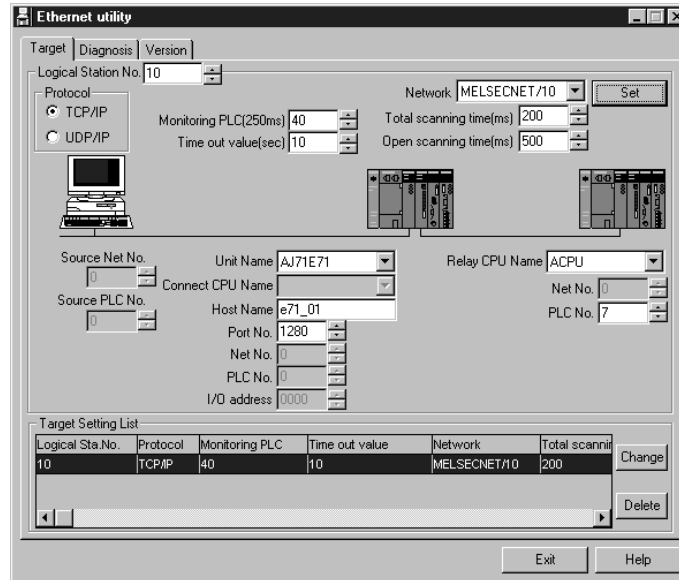

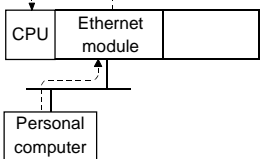
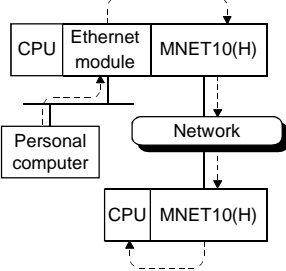
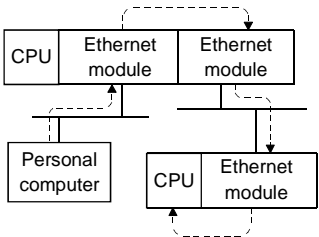
Item	Description
Logical Station No.	Set the logical station number.
Protocol	Choose the protocol to be used.
Network	<p>Choose the network format for access to the PLC CPU via a network.</p> <ul style="list-style-type: none"> • None  • MELSECNET/10H, MELSECNET/10  • Ethernet 

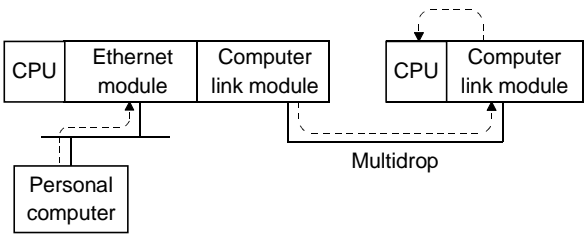
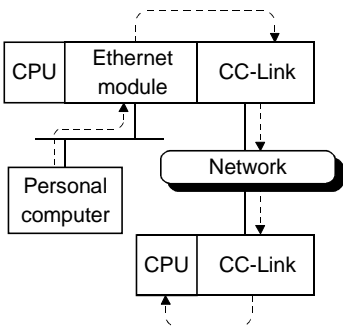
Item	Description
Network	<ul style="list-style-type: none"> • Computer link  <ul style="list-style-type: none"> • CC-Link 
Monitoring PLC	<p>Set the response waiting time when access is made to the PLC CPU loaded with the Ethernet module and to the other PLC CPU connected to the network from that CPU.</p> <p>This value is the processing time setting on the PLC CPU side only.</p> <p>It does not include the processing time on Ethernet.</p>
Time out value	<p>Set the time-out value of response time to a single communication request.</p> <p>For this value, set the value which includes the access time on the PLC CPU side and the communication time on the Ethernet loop. For this reason, set the time out value to a value longer than Monitoring PLC.</p>
Total scanning time	<p>Set the total scan time of the sequence program running on the PLC CPU to communicate with.</p>
Open scanning time	<p>Set the time required between close processing and open processing for the Ethernet communication loop.</p> <p>Normally, 500ms is the minimum time required between communication loop close processing and open processing.</p>
Source Net No.	<p>Set the network number assigned to the personal computer.</p> <p>Set this in the Ethernet parameter of the Ethernet module connected.</p>
Source PLC No.	<p>Set the station number assigned to the personal computer.</p> <p>Set this in the Ethernet parameter of the Ethernet module connected.</p>
Unit Name	<p>Set the type of the Ethernet module to be used.</p>
Connect CPU Name	<p>Choose the PLC CPU loaded with the Ethernet module connected to the personal computer.</p>
Host Name	<p>Set the host name corresponding to the IP address of the communication target station.</p> <p>Set the host name corresponding to the IP address to the HOSTS file.</p>
Port No.	<p>Set the port number of the Ethernet module used on the other communication station end.</p>
Net No.	<p>Set the network number set to the Ethernet module.</p>
PLC No.	<p>Set the station number set to the Ethernet module.</p>

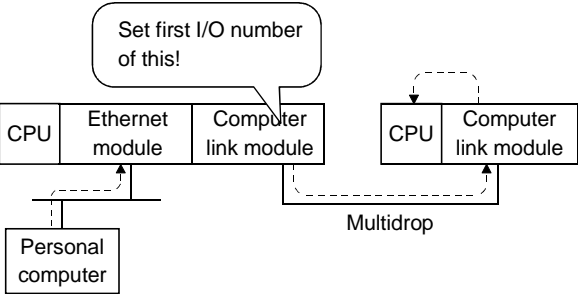
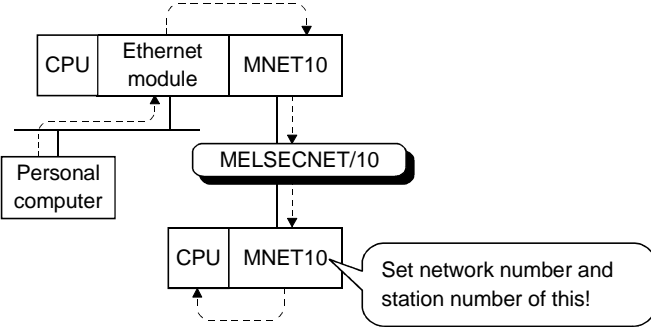
Item	Description
I/O address	<p>Set the first I/O number of the relayed network module on the base which is loaded with the Ethernet module connected to the personal computer.</p> <p>Set the first I/O number in hexadecimal as a multiple of 16.</p> <ul style="list-style-type: none"> • Via computer link 
Relay CPU Name	Set the type of the PLC CPU used for communication via the network.
Net No.	Set the network number of the other station linked via the network from the PLC CPU which is loaded with the Ethernet module.
PLC No.	<p>Set the station number of the other station linked via the network from the PLC CPU which is loaded with the Ethernet module.</p> <ul style="list-style-type: none"> • Via MELSECNET/10 
"Set" button	The settings currently made are registered.
"Change" button	The data on the line currently selected can be displayed in the setting column and changed.
"Delete" button	Deletes the line currently selected.
Target Setting List	Shows a list of data registered so far.

8.2.4 Operations on Diagnosis screen

Communication is made with the PLC via the Ethernet module to diagnose whether communication is normal or abnormal.

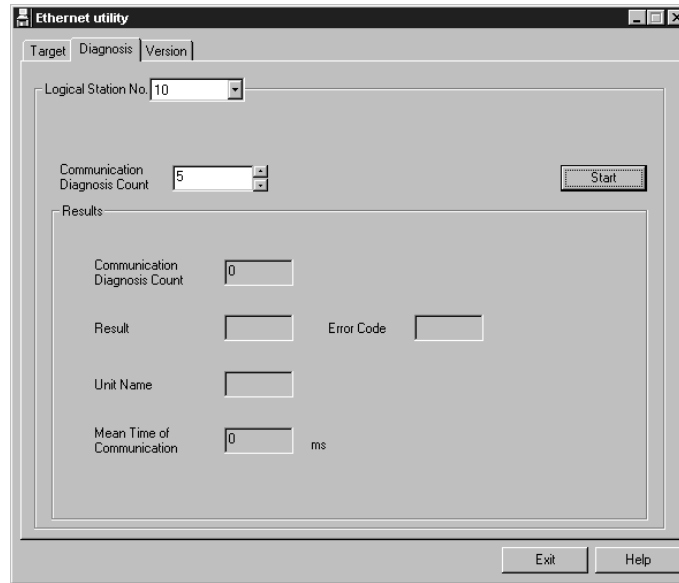

Item	Description
Logical Station No.	Set the logical station number.
Communication Diagnosis Count	Set the number of times the communication diagnosis is to be made.
Results	Shows the results of the communication diagnosis. Communication Diagnosis Count : Shows the number of times the communication diagnosis was made. Result : Shows the result of the communication diagnosis. Unit Name : Shows the type of the module currently connected. Mean Time of Communication : Shows the mean time taken for communication. Error Code : Shows the error code of the diagnosis result. (For the definitions of the error codes, refer to the programming manual.)
"Start" button	Starts the communication diagnosis.

8.3 CPU COM Utility

This section gives the operation and setting methods of the CPU COM utility.

8.3.1 Operation procedure

The following is the operation procedure of the CPU COM utility.

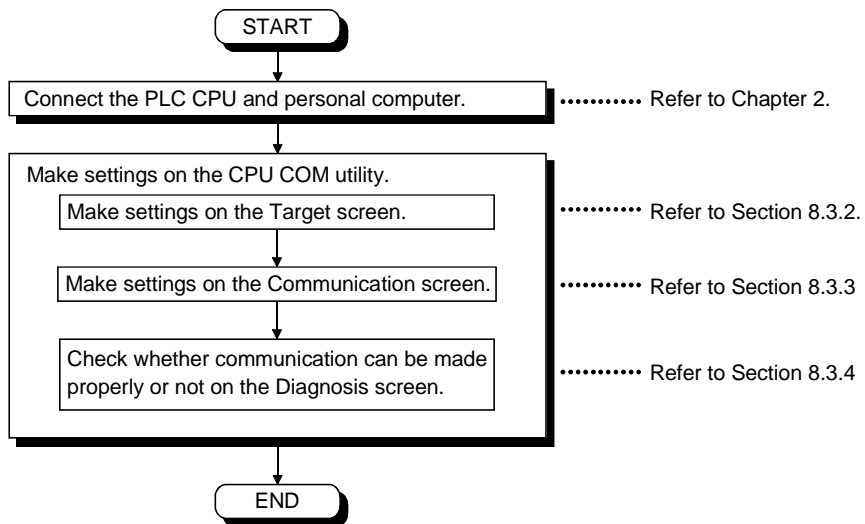

8.3.2 Operations on Target screen

Set the type of the PLC CPU connected.

[Logical Station]

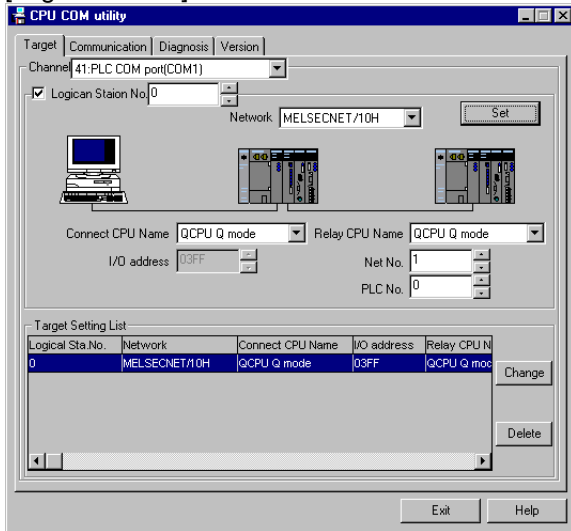

[Direct Station]

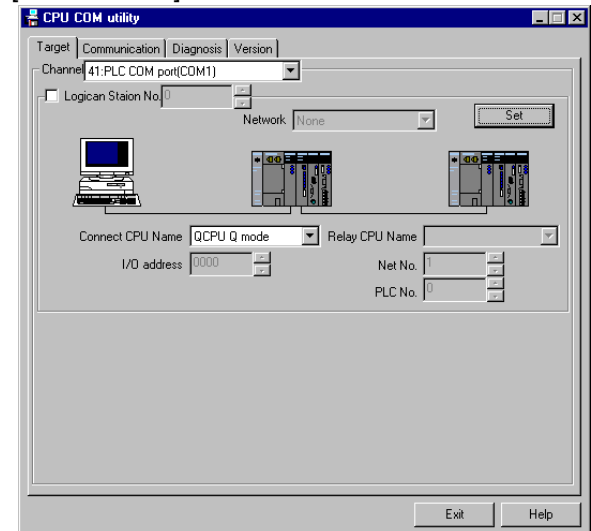

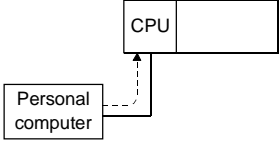
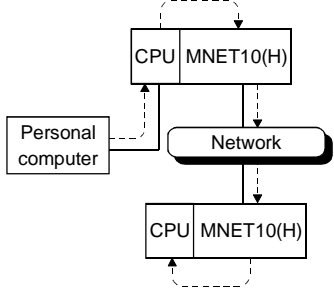
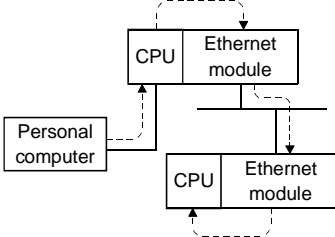
Item	Description
Channel	Set the channel to be used.
Logical Station No. (When the check box is checked, Logical Station becomes Direct Station.)	<p>[Logical Station] Set any logical station number. The logical station number means a number which symbolizes the information on access to the PLC CPU (station number, network number, etc.).</p> <p>[Direct Station] Connected PLC CPU is set.</p>
Network	<p>Choose the network format.</p> <ul style="list-style-type: none"> • None  • MELSECNET/10H, MELSECNET/10  • Ethernet 

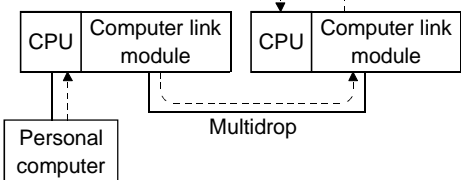
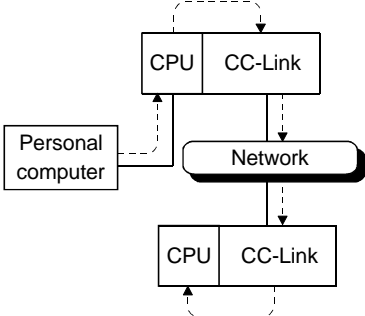
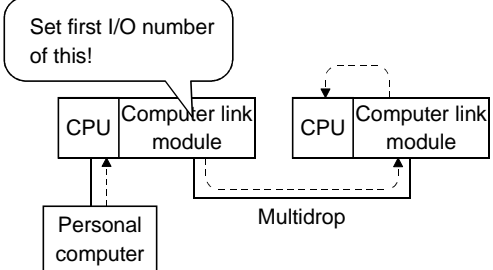
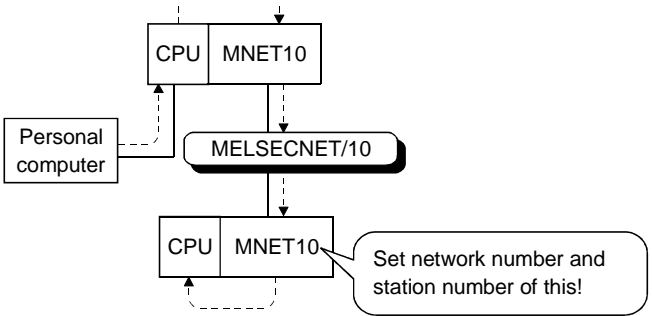
Item	Description
Network	<ul style="list-style-type: none"> • Computer link  • CC-Link 
Connect CPU Name	Set the type of the PLC CPU which is connected with the COM port of the personal computer.
I/O address	<p>Set the first I/O number of the module on the base which is loaded with the "Connect CPU Name" module when communication is made via computer link or CC-Link. Set the first I/O number in hexadecimal as a multiple of 16.</p> <ul style="list-style-type: none"> • Via computer link 
Relay CPU Name	Set the type of the PLC CPU used for communication via the network.
Net No.	Set the network number of the other station linked via the network from the PLC CPU.
PLC No.	<p>Set the station number of the other station linked via the network from the PLC CPU.</p> <ul style="list-style-type: none"> • Via MELSECNET/10 
"Set" button	The settings currently made are registered.
"Change" button	The data on the line currently selected can be displayed in the setting column and changed.
"Delete" button	Deletes the line currently selected.
Target Setting List	Shows a list of data registered so far.

8.3.3 Operations on Communication screen

Set the communication conditions of the COM port connected to the PLC CPU.

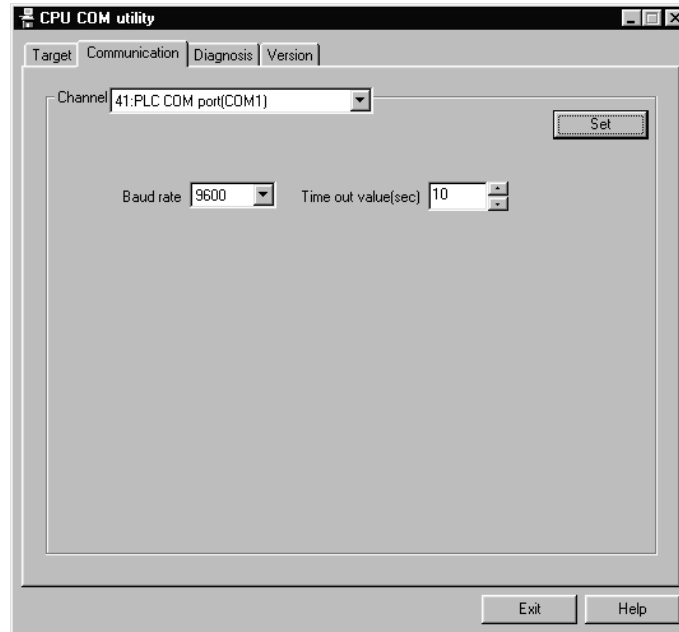

Item	Description
Channel	Set the channel to be used.
Baud rate	Set the transmission speed for communication with the PLC CPU. Set the transmission speed with which the connected PLC CPU is compatible.
"Set" button	The settings currently made are registered.
Time out value	Set the time-out period when communication is not normal at the time of sending or receiving.

8.3.4 Operations on Diagnosis screen

Communication is made with the PLC to diagnose whether communication is normal or abnormal.

[Logical Station]

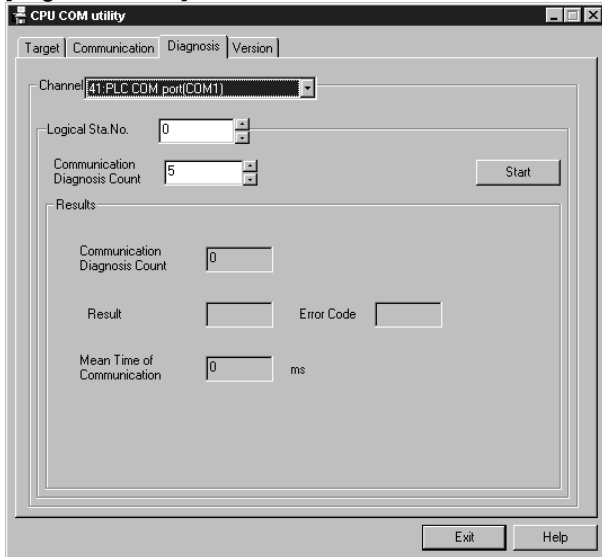

[Direct Station]

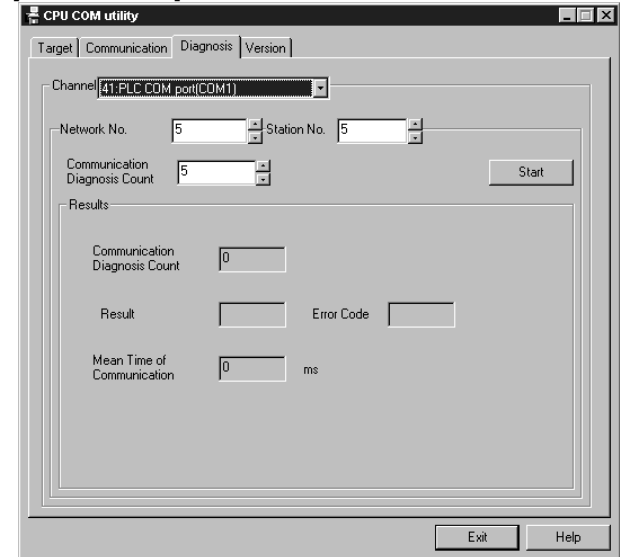

Item	Description
Channel	Set the channel used for communication diagnosis.
Logical Station No.	Set the logical station number.
Network	Set the network number.
Station No.	Set the station number.
Communication Diagnosis Count	Set the number of times the communication diagnosis will be made.
Results	Shows the results of the communication diagnosis. Communication Diagnosis Count : Shows the number of times the communication diagnosis was made. Result : Shows the result of the communication diagnosis. Mean Time of Communication : Shows the mean time taken for communication. Error Code : Shows the error code of the diagnosis result. (For the definitions of the error codes, refer to the programming manual.)
"Start" button	Starts the communication diagnosis.

8.4 CPU USB Utility

This section gives the operation and setting methods of the CPU USB utility.

8.4.1 Operation procedure

The following is the operation procedure of the CPU USB utility.

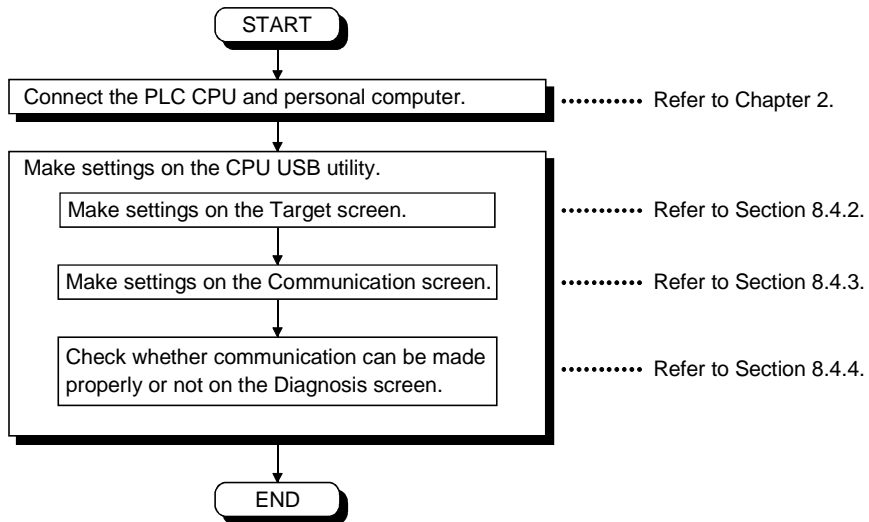

8.4.2 Operations on Target screen

Set the type of the PLC CPU connected.

[Logical Station]

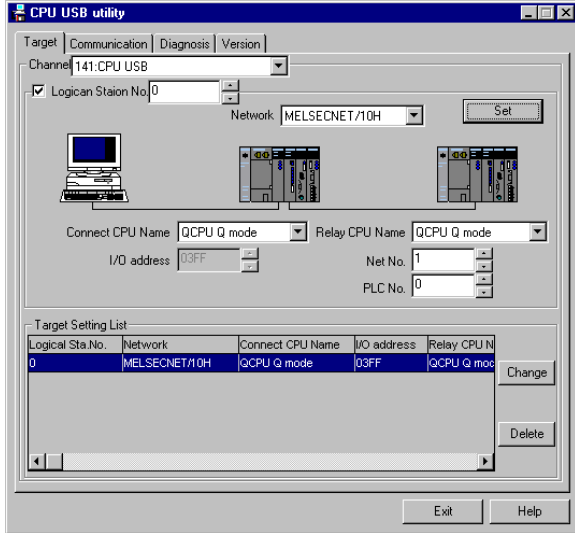

[Direct Station]

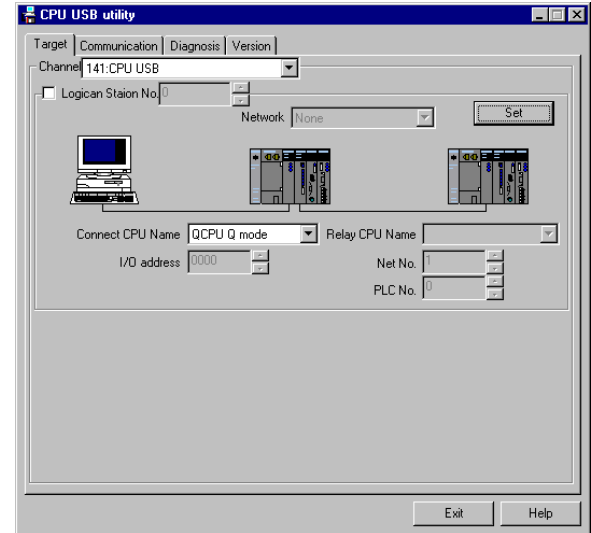

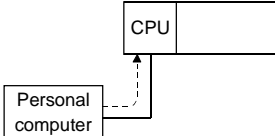
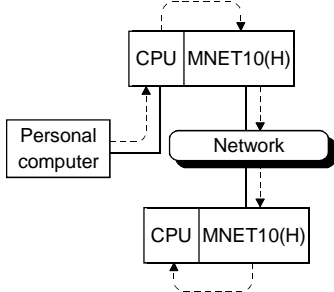
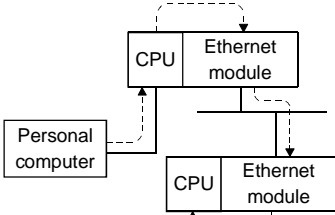
Item	Description
Channel	Set the channel to be used.
Logical Station No. (When the check box is checked, Logical Station becomes Direct Station.)	<p>[Logical Station] Set any logical station number. The logical station number means a number which symbolizes the information on access to the PLC CPU (station number, network number, etc.).</p> <p>[Direct Station] Connected PLC CPU is set.</p>
Network	<p>Choose the network format.</p> <ul style="list-style-type: none"> • None  • MELSECNET/10H, MELSECNET/10  • Ethernet 

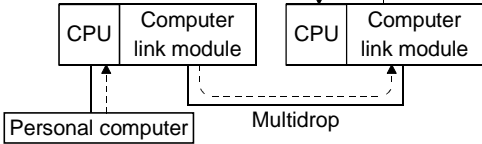
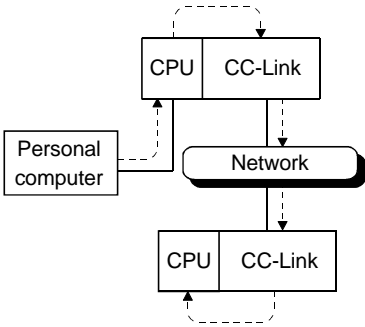
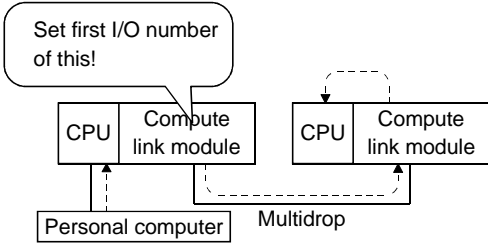
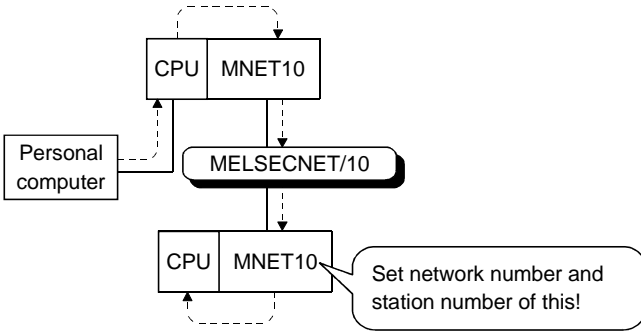
Item	Description
Network	<ul style="list-style-type: none"> • Computer link  <ul style="list-style-type: none"> • CC-Link 
Connect CPU Name	Set the type of the PLC CPU which is connected with the USB port of the personal computer.
I/O address	Set the first I/O number of the module on the base which is loaded with the "Connect CPU Name" module when communication is made via computer link or CC-Link. Set the first I/O number in hexadecimal as a multiple of 16. <ul style="list-style-type: none"> • Via computer link 
Relay CPU Name	Set the type of the PLC CPU used for communication via the network.
Net No.	Set the network number of the other station linked via the network from the PLC CPU.
PLC No.	Set the station number of the other station linked via the network from the PLC CPU. <ul style="list-style-type: none"> • Via MELSECNET/10 
"Set" button	The settings currently made are registered.
"Change" button	The data on the line currently selected can be displayed in the setting column and changed.
"Delete" button	Deletes the line currently selected.
Target Setting List	Shows a list of data registered so far.

8.4.3 Operations on Communication screen

Set the time-out value of the USB port connected to the PLC CPU.

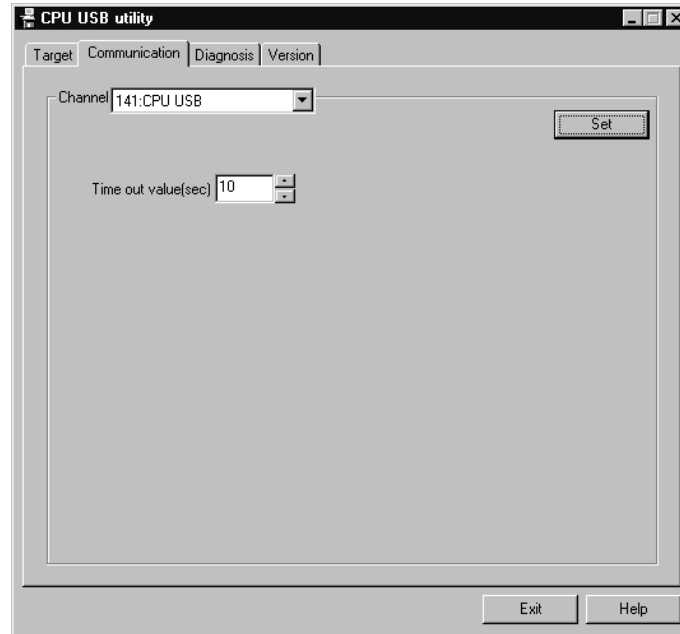

Item	Description
Time out value	Set the time-out value of the response time to a single communication request.

8.4.4 Operations on Diagnosis screen

Communication is made with the PLC to diagnose whether communication is normal or abnormal.

[Logical Station]

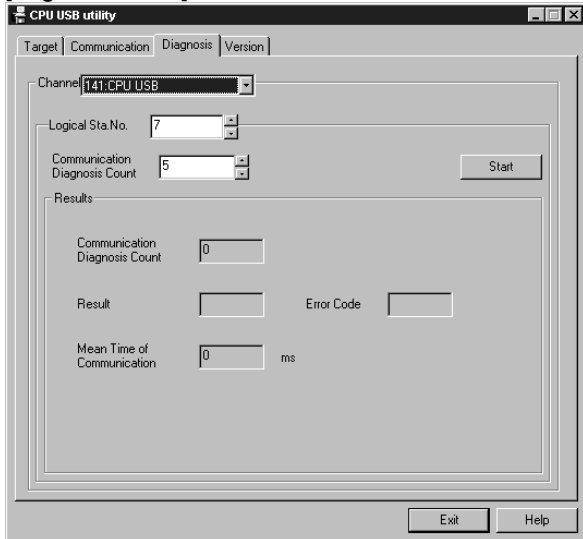

[Direct Station]

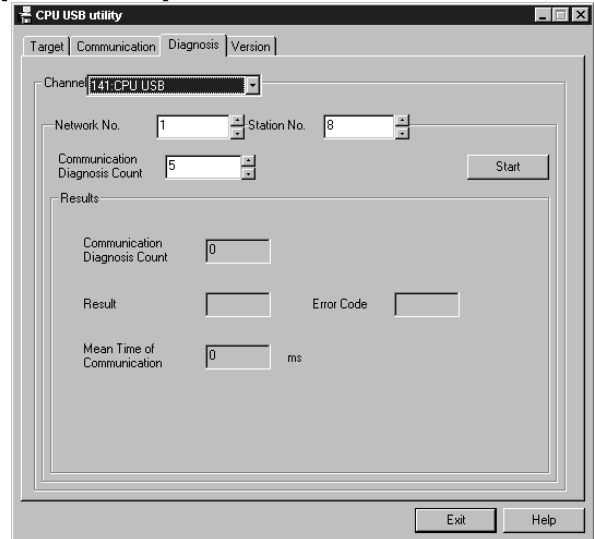

Item	Description
Channel	Set the channel used for communication diagnosis.
Logical Station No.	Set the logical station number.
Network No.	Set the network number.
Station No.	Set the station number.
Communication Diagnosis Count	Set the number of times the communication diagnosis will be made.
Results	Shows the results of the communication diagnosis. Communication Diagnosis Count : Shows the number of times the communication diagnosis was made. Result : Shows the result of the communication diagnosis. Mean Time of Communication : Shows the mean time taken for communication. Error Code : Shows the error code of the diagnosis result. (For the definitions of the error codes, refer to the programming manual.)
"Start" button	Starts the communication diagnosis.

8.5 CC-Link G4 Utility

This section explains the operation of the CC-Link G4 utility.

POINT	Use the CC-Link G4 module of software version "D" or later. Proper operation is not performed on the module of software version "C" or earlier.
-------	--

8.5.1 Operation procedure

The following is the operation procedure of the CC-Link G4 utility.

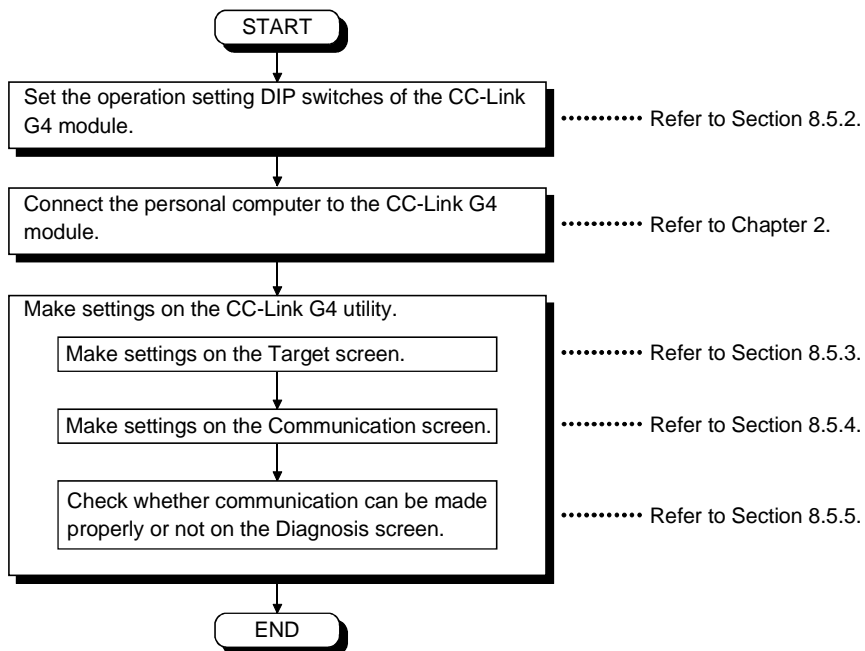

8.5.2 CC-Link G4 module switch settings

To use CSKP, make the following switch settings of the CC-Link G4 module.

(1) When using the A mode

Operation setting DIP switches	SW1	OFF
	SW2	OFF
	SW3	OFF
	SW4	OFF
	SW5	OFF
	SW6	OFF
	SW7	OFF
	SW8	OFF

(2) When using the QnA mode

Operation setting DIP switches	SW1	ON
	SW2, SW3	OFF OFF(9600bps), ON OFF(19200bps), OFF, ON(38400bps)
	SW3	OFF
	SW4	OFF
	SW5	OFF
	SW6	OFF
	SW7	OFF
	SW8	OFF

8.5.3 Operations on Target screen

Set the logical station number used for CC-Link G4 communication.

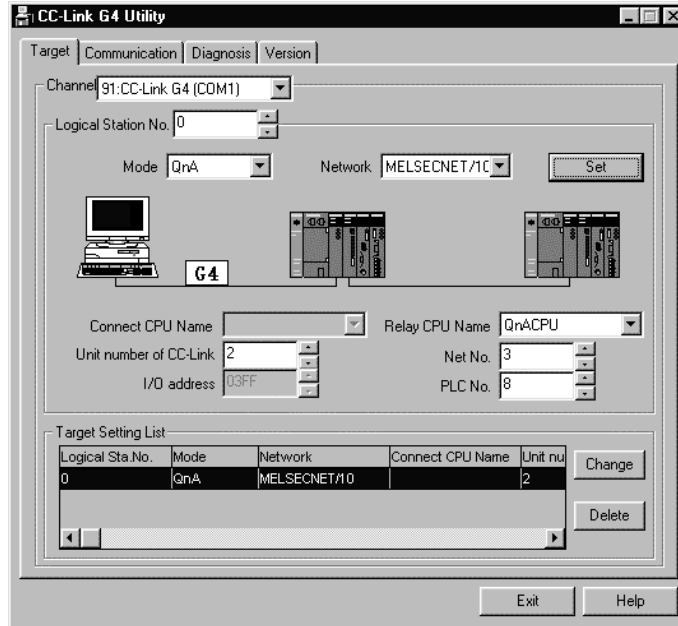

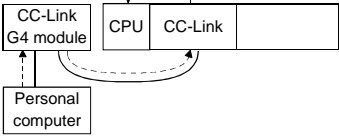
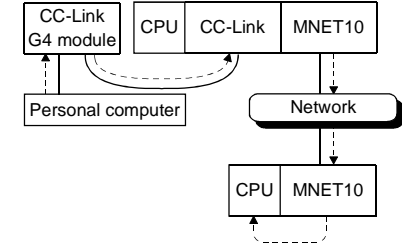
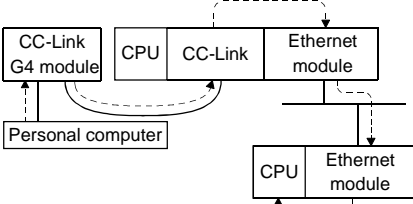
Item	Description
Channel	Set the channel to be used.
Logical Station No.	Set any logical station number. The logical station number means a number which symbolizes the information on access to the PLC CPU (station number, network number, etc.).
Mode	Set the operation mode of the CC-Link G4 module. This setting should be the same as that on the CC-Link G4 module side.
Network	<p>Choose the network format.</p> <ul style="list-style-type: none"> • None  • MELSECNET/10H, MELSECNET/10  • Ethernet 

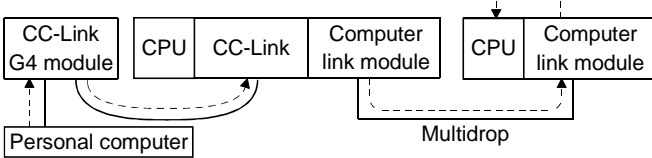
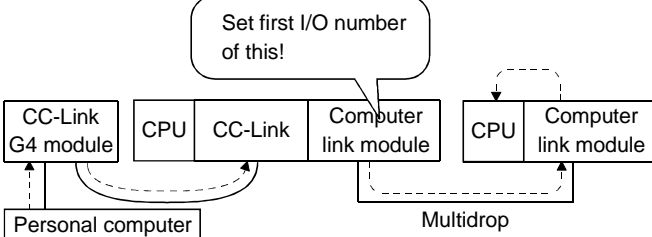
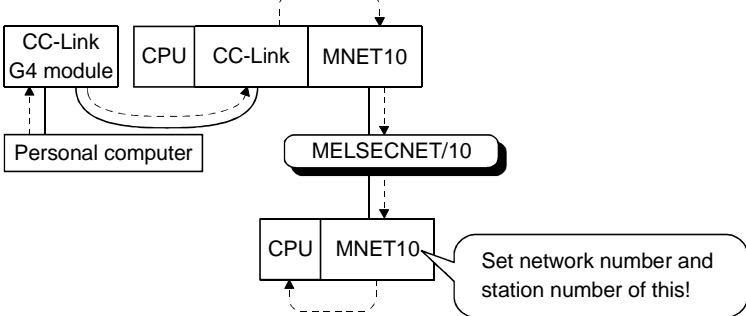
Item	Description
Network	<ul style="list-style-type: none"> • Computer link 
Connect CPU Name	When the network is not relayed, set the type of the PLC CPU used for communication.
Unit number of CC-Link	<ul style="list-style-type: none"> • Via network Set the CC-Link master/local module station number which relays access to the other network. • Not via network Set the CC-Link master/local module station number which exists on the base which contains the PLC CPU used for communication.
I/O address	<p>Set the first I/O number of the computer link module on the base which is loaded with the master/local module specified in "Unit number of CC-Link" when communication is made via computer link.</p> <p>Set the first I/O number in hexadecimal as a multiple of 16.</p> 
Relay CPU Name	Set the type of the PLC CPU used for communication via the network.
Net No.	Set the network number of the other station linked via the network from the master/local module specified in "Unit number of CC-Link".
PLC No.	<p>Set the station number of the other station linked via the network from the master/local module specified in "Unit number of CC-Link".</p> <ul style="list-style-type: none"> • Via MELSECNET/10 
"Set" button	The settings currently made are registered.
"Change" button	The data on the line currently selected can be displayed in the setting column and changed.
"Delete" button	Deletes the line currently selected.
Target Setting List	Shows a list of data registered so far.

8.5.4 Operations on Communication screen

Set the communication conditions of the COM port connected to the CC-Link G4 module.

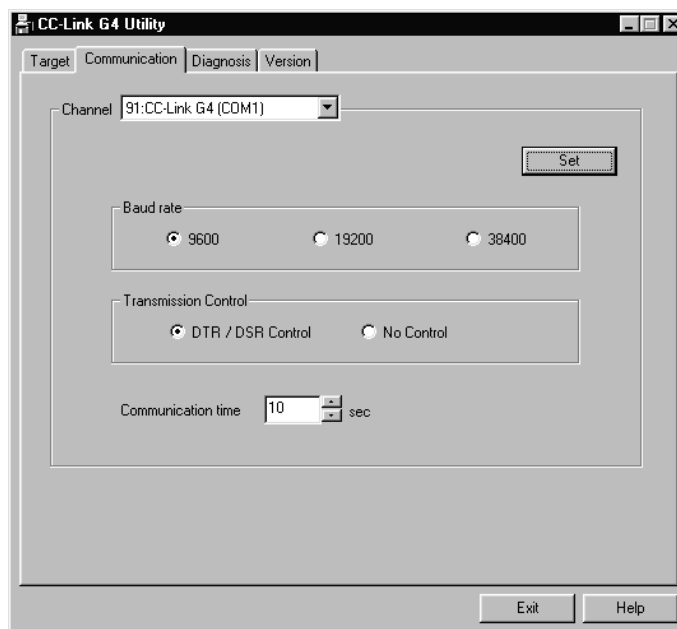

Item	Description
Channel	Set the channel to be used.
Baud rate	Set the transmission speed for communication with the CC-Link G4 module. This value must be the same as on the CC-Link G4 module side. When using the A mode, set this value to 9600bps.
Transmission Control	Set the flow control for communication with the CC-Link G4 module.
Communication time	Set the time-out period when communication is not normal at the time of sending or receiving.
"Set" button	The settings currently made are registered.

8.5.5 Operations on Diagnosis screen

Communication is made with the PLC via the CC-Link G4 module to diagnose whether communication is normal or abnormal.

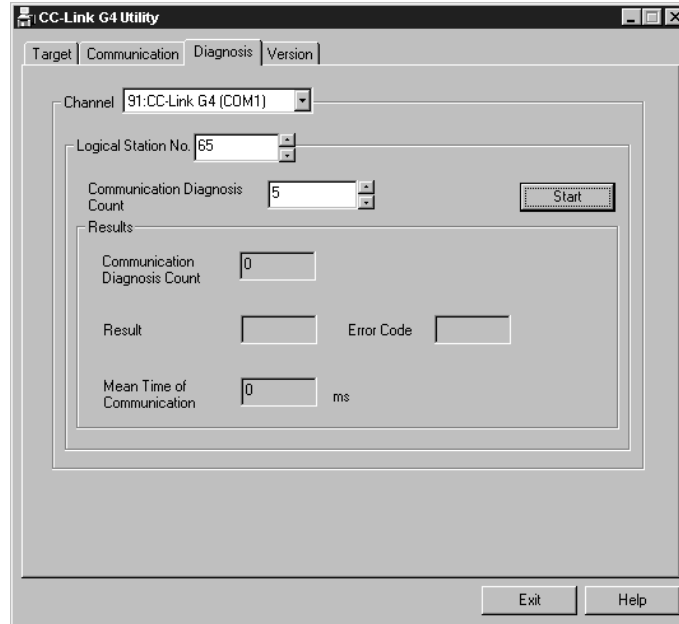

Item	Description
Channel	Set the channel to be used.
Logical Station No.	Set the logical station number.
Communication Diagnosis Count	Set the number of times the communication diagnosis will be made.
Results	Shows the results of the communication diagnosis. Communication Diagnosis Count : Shows the number of times the communication diagnosis was made. Result : Shows the result of the communication diagnosis. Mean Time of Communication : Shows the mean time taken for communication. Error Code : Shows the error code of the diagnosis result. (For the definitions of the error codes, refer to the programming manual.)
"Start" button	Starts the communication diagnosis.

9 OPERATIONS OF OTHER UTILITIES

This chapter describes the operations of the utilities other than the MELSEC data link utilities.

9.1 Shared Device Utility

This section explains the operation of the shared device utility.

POINT	When the OS is Windows NT 4.0, using the shared device utility allows the shared devices to be used. The shared devices cannot be used on Windows 95 or Windows 98.
-------	--

9.1.1 Operation procedure

The following is the operation procedure for access to the shared devices.

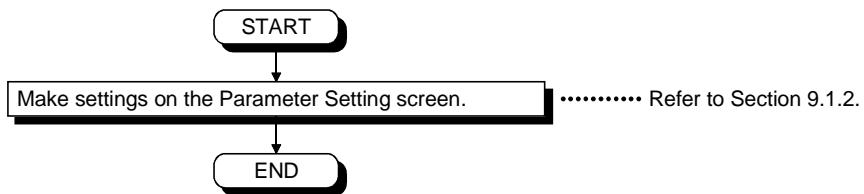

9.1.2 Operations on Parameter Setting screen

This screen allows you to specify the total number of shared device blocks and the validity of system information areas.

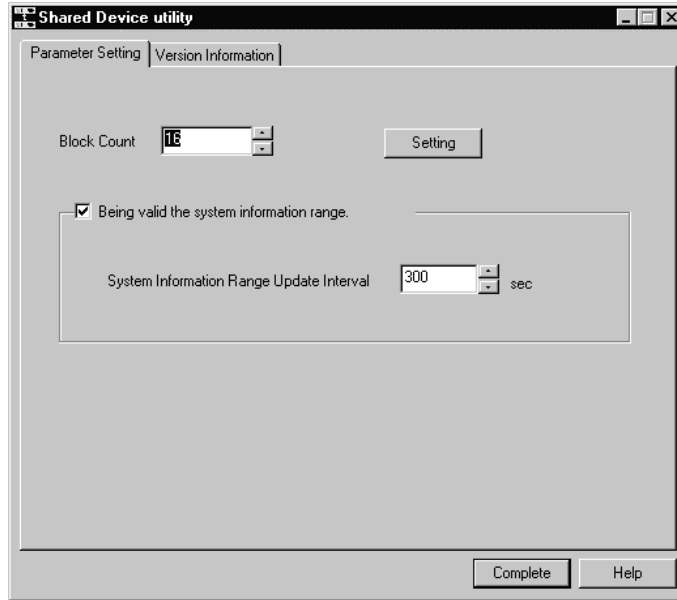

Item	Description
Block Count	Displays and sets the current total number of shared device blocks.
System Information Area	Determines whether to use the area of ED block number 0 of a shared device as a system information area. Checked : The area of ED block number 0 of a shared device is used as a system information area. Set a system information update interval because the system information range update interval will be effective. Not checked : The area of ED block number 0 of a shared device is used as a user area rather than the system information area.
"Setting" button	Specifies whether to make the current settings effective.

POINT	Parameter settings will be effective after system restart.
-------	--

9.2 Shared Device Server Utility

This section explains the operation and setting methods of the shared device server utility.

POINT	The shared device server utility may be used when the OS is Windows NT 4.0. It cannot be used on Windows 95 or Windows 98.
--------------	--

9.2.1 Operation procedure

The following is the operation procedure of the shared device server utility.

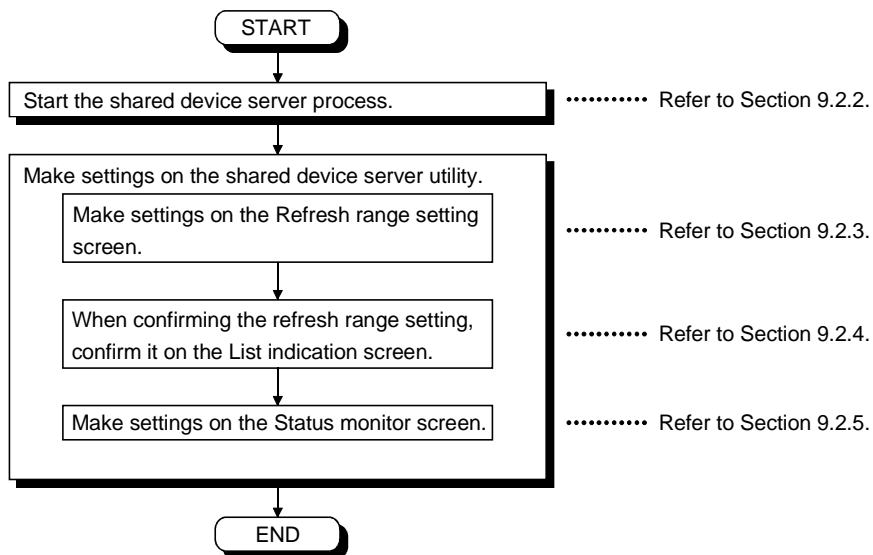

9.2.2 About the Shared Device Server Process

The shared device server process is designed to refresh the specified devices on the basis of the information set on the shared device server utility.

It must always be running when starting/stopping refresh on the "Status monitor" screen of the shared device server utility.

(1) Starting method

Click [Start]-[Programs]-[MELSEC application]-[Communication support (CSKP-E)]-[Shared Device]-[EM ED Server Process].

(2) Ending method

To terminate the shared device server process, force it to end.

Alternatively, choose "Shared Device Server" on the task bar and press the "Alt" + "F4" keys.

9.2.3 Operations on Refresh range setting screen

This screen allows you to set the source and target devices for refreshing the size and timing of transfer.

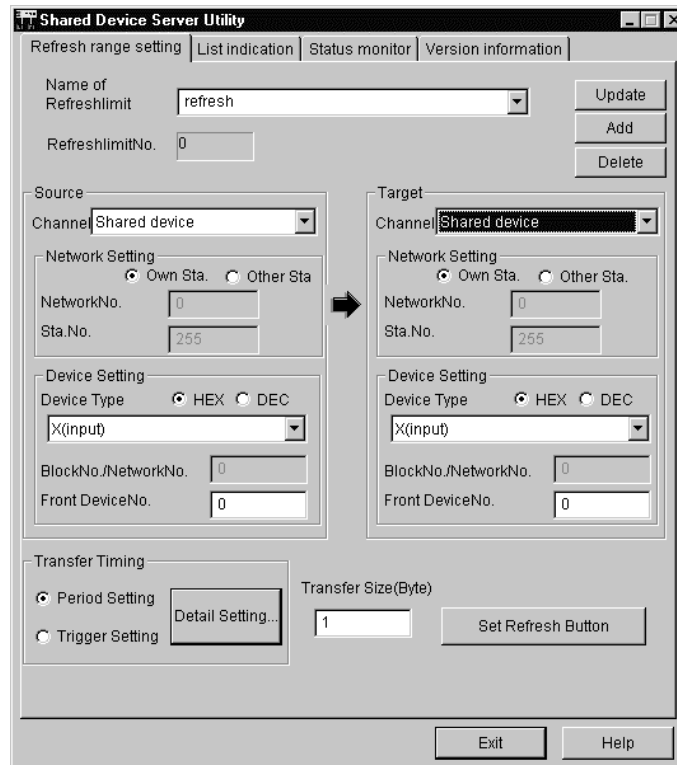

Item	Description	
Name of Refreshlimit	Name the refresh range currently set.	
Refreshlimit No.	Number integrated for management in the utility. The user need not care about this number.	
"Update" button	Updates the settings made on this screen.	
"Add" button	Adds a new refresh range.	
"Delete" button	Deletes the refresh range name currently shown.	
"Delete" button	Deletes the refresh range name currently shown.	
Source	Specify the transfer source device for refresh.	
	Item	Description
	Channel	Choose the channel to be used.
	Own Sta. • Other Sta.	Choose the own or other station.
	Network No.	Set the network number. (May be set only when the other station is chosen.)
	Sta. No.	Set the station number. (May be set only when the other station is chosen.)
	HEX • DEC	Specify decimal (DEC) or hexadecimal (HEX) of the device No.
	Device type	Choose the device type.
	Block No./Network No.	Enter the block No. or network No.
Front Device No.	Enter the first device No. of the device. (When the bit device is chosen, specify this as a multiple of 8.)	

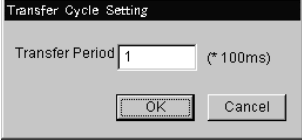
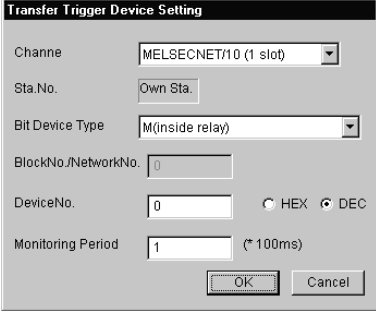
Item	Description												
Target	Specify the transfer target device for refresh. For settings, refer to "Source".												
Transfer Timing	<p>Set the timing of data transfer. Click the "Detail Setting" button and make the following settings.</p> <ul style="list-style-type: none"> • When you chose Period Setting and clicked the Detail Setting button  <p>Transfer period: Set the cycle of data transfer.</p> <ul style="list-style-type: none"> • When you chose Trigger Setting and clicked the Detail Setting button  <table border="1" data-bbox="456 1041 1414 1249"> <thead> <tr> <th>Item</th> <th>Description</th> </tr> </thead> <tbody> <tr> <td>Channel</td> <td>Choose the channel to be used.</td> </tr> <tr> <td>Bit Device Type</td> <td>Set the bit device specified for trigger.</td> </tr> <tr> <td>Block No./Network No.</td> <td>Set the block No. or network No. when EM or L * device is specified.</td> </tr> <tr> <td>Device No.</td> <td>Set the device No. of the bit device.</td> </tr> <tr> <td>Monitoring period</td> <td>Set the cycle of checking the specified bit device status.</td> </tr> </tbody> </table>	Item	Description	Channel	Choose the channel to be used.	Bit Device Type	Set the bit device specified for trigger.	Block No./Network No.	Set the block No. or network No. when EM or L * device is specified.	Device No.	Set the device No. of the bit device.	Monitoring period	Set the cycle of checking the specified bit device status.
Item	Description												
Channel	Choose the channel to be used.												
Bit Device Type	Set the bit device specified for trigger.												
Block No./Network No.	Set the block No. or network No. when EM or L * device is specified.												
Device No.	Set the device No. of the bit device.												
Monitoring period	Set the cycle of checking the specified bit device status.												
Transfer Size	Set how many bytes of transferred device data will be transferred, starting with the first device No.												

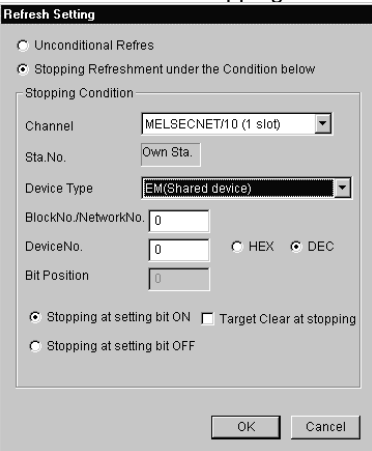
Item	Description																					
"Set Refresh" button	Set the conditions of stopping refresh operation in the dialog box displayed. 																					
	<table border="1"> <thead> <tr> <th data-bbox="459 801 692 846">Item</th> <th data-bbox="692 801 1447 846">Description</th> </tr> </thead> <tbody> <tr> <td data-bbox="459 846 692 880">Unconditional Refresh</td> <td data-bbox="692 846 1447 880">Choose when making unconditional refresh.</td> </tr> <tr> <td data-bbox="459 880 692 976">Stopping Refreshment under the Condition below</td> <td data-bbox="692 880 1447 976">Choose when setting the refresh stopping condition.</td> </tr> <tr> <td data-bbox="459 976 692 1010">Channel</td> <td data-bbox="692 976 1447 1010">Choose the channel to be used.</td> </tr> <tr> <td data-bbox="459 1010 692 1043">Device Type</td> <td data-bbox="692 1010 1447 1043">Set the device type set as the stopping condition.</td> </tr> <tr> <td data-bbox="459 1043 692 1077">Block No./Network No.</td> <td data-bbox="692 1043 1447 1077">Set the block No. or network No. when EM, ER or L* device is specified.</td> </tr> <tr> <td data-bbox="459 1077 692 1111">Device No.</td> <td data-bbox="692 1077 1447 1111">Enter the device number.</td> </tr> <tr> <td data-bbox="459 1111 692 1144">Bit Position</td> <td data-bbox="692 1111 1447 1144">Set the bit position of the word device when the word device is specified.</td> </tr> <tr> <td data-bbox="459 1144 692 1178">HEX/DEC</td> <td data-bbox="692 1144 1447 1178">Specify decimal (DEC) or hexadecimal (HEX) of the device No.</td> </tr> <tr> <td data-bbox="459 1178 692 1245">Stopping at setting bit ON Stopping at setting bit OFF</td> <td data-bbox="692 1178 1447 1245">Set the bit status for making a stop.</td> </tr> <tr> <td data-bbox="459 1245 692 1337">Target Clear at Stopping</td> <td data-bbox="692 1245 1447 1337">Checking here clears the transfer target device at a stop.</td> </tr> </tbody> </table>	Item	Description	Unconditional Refresh	Choose when making unconditional refresh.	Stopping Refreshment under the Condition below	Choose when setting the refresh stopping condition.	Channel	Choose the channel to be used.	Device Type	Set the device type set as the stopping condition.	Block No./Network No.	Set the block No. or network No. when EM, ER or L* device is specified.	Device No.	Enter the device number.	Bit Position	Set the bit position of the word device when the word device is specified.	HEX/DEC	Specify decimal (DEC) or hexadecimal (HEX) of the device No.	Stopping at setting bit ON Stopping at setting bit OFF	Set the bit status for making a stop.	Target Clear at Stopping
Item	Description																					
Unconditional Refresh	Choose when making unconditional refresh.																					
Stopping Refreshment under the Condition below	Choose when setting the refresh stopping condition.																					
Channel	Choose the channel to be used.																					
Device Type	Set the device type set as the stopping condition.																					
Block No./Network No.	Set the block No. or network No. when EM, ER or L* device is specified.																					
Device No.	Enter the device number.																					
Bit Position	Set the bit position of the word device when the word device is specified.																					
HEX/DEC	Specify decimal (DEC) or hexadecimal (HEX) of the device No.																					
Stopping at setting bit ON Stopping at setting bit OFF	Set the bit status for making a stop.																					
Target Clear at Stopping	Checking here clears the transfer target device at a stop.																					

9.2.4 Operations on List indication screen

This screen lists the settings made as a refresh range.

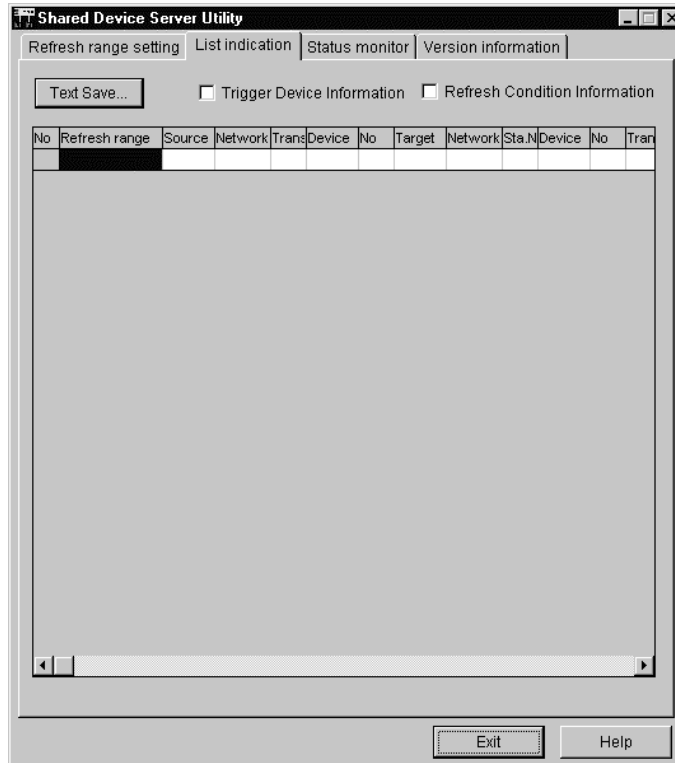

Item	Description
List of Settings	Lists the names of refresh ranges specified so far.
"Text Save" button	Saves the listed settings in the specified file.
Trigger Device information	Adds the trigger device items to the table by checking here.
Refresh Condition Information	Sets the refreshing items in the table by clicking here.

9.2.5 Operations on Status monitor screen

This screen displays or specifies the start/stop status in each refresh range and also lists the communications errors.

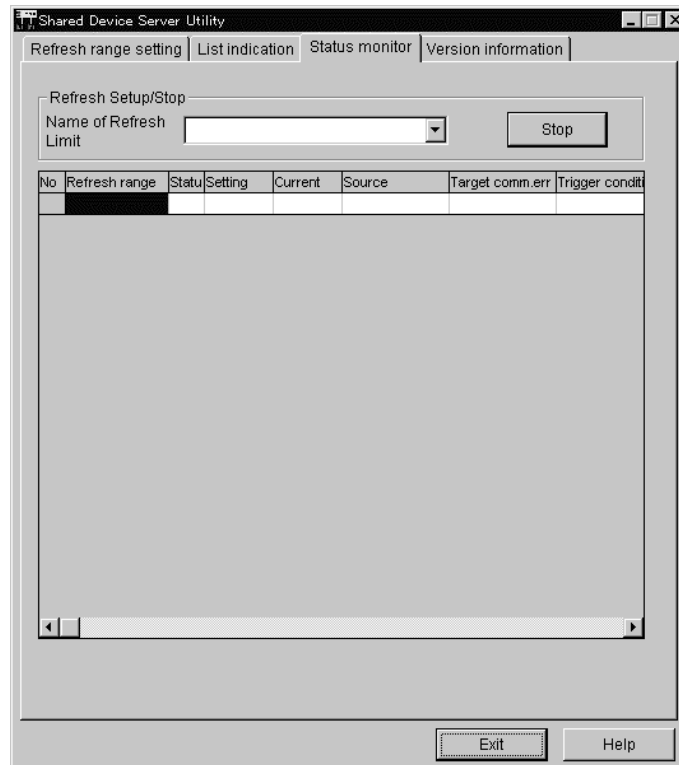

Item	Description
Name of Refresh Limit	Choose the name of a refresh range in which start or stop is specified.
"Run/Stop" button	Used to make start/stop settings. When refreshing is being performed, it displays "Stop". When refreshing is stopped, it displays "Run".
List of Refresh Range Status	Lists the refresh range names set so far.

9.3 Ladder Logic Test Utility

This section describes the operation of the Ladder logic test utility.

9.3.1 Operation procedure

The following is the operation procedure of the Ladder logic test utility.

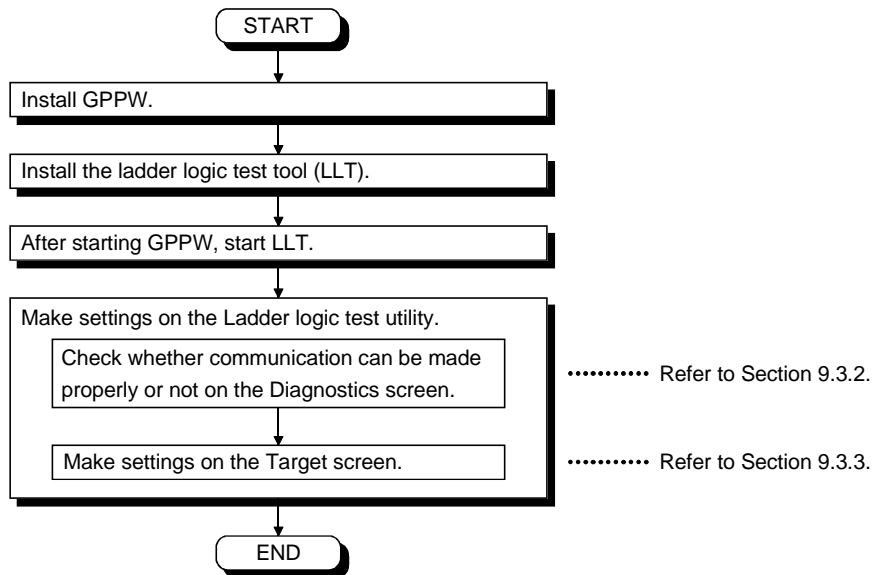

9.3.2 Operations on Target screen

Set the PLC type for ladder logic test communication.

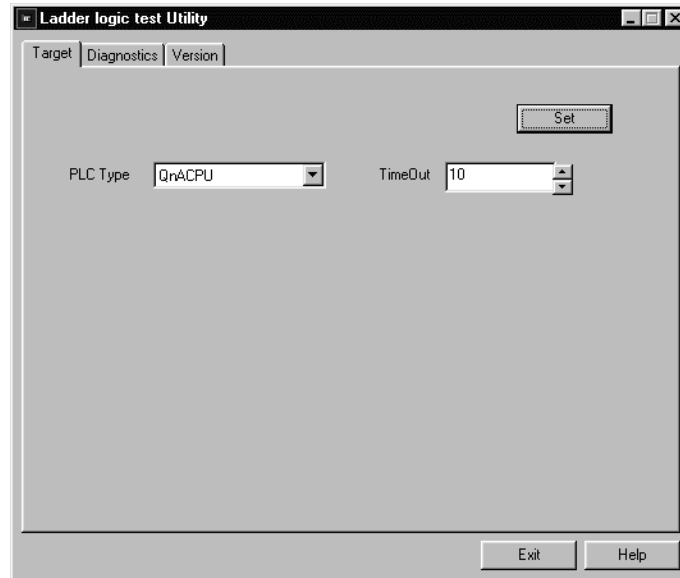

Item	Description
PLC Type	Set the type of the PLC CPU corresponding to the PC type set to the project of GPPW.
Time out	Set the time-out period when communication with LLT is not made properly.
"Set" button	The settings currently made are registered.

9.3.3 Operations on Diagnostics screen

Communication is made with LLT to diagnose whether communication is normal or abnormal.

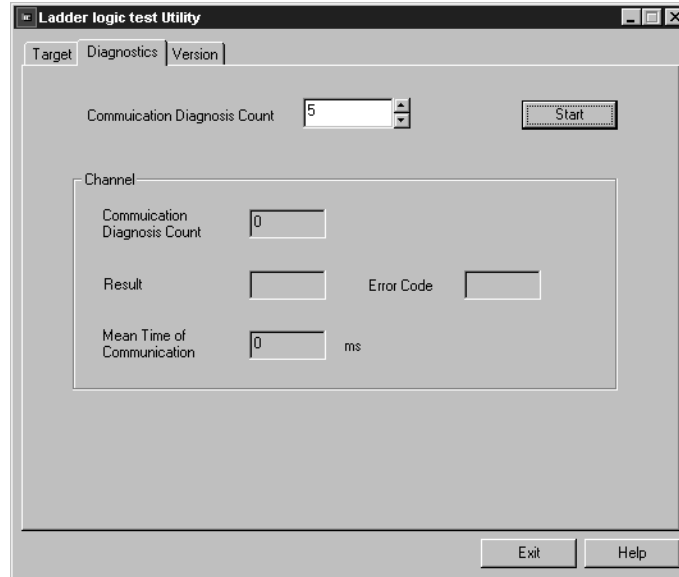

Item	Description
Communication Diagnosis Count	Set the number of times the communication diagnosis is to be made.
Results	Shows the results of the communication diagnosis. Communication Diagnosis Count : Shows the number of times the communication diagnosis was made. Result : Shows the result of the communication diagnosis. Mean Time of Communication : Shows the mean time taken for communication. Error Code : Shows the error code of the diagnosis result. (For the definitions of the error codes, refer to the programming manual.)
"Start" button	Starts the communication diagnosis.

9.4 Device Monitor Utility

This section describes the operation and setting methods of the device monitor utility.

9.4.1 Operation procedure

The following is the operation procedure of the device monitor utility.

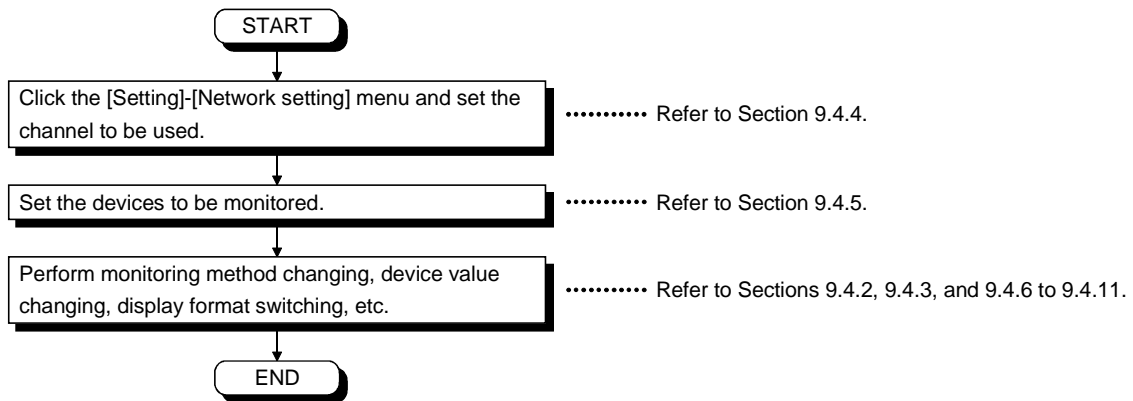

9.4.2 Setting to batch monitor

Only the specified single device is monitored.

(1) Menu to be selected

Choose [Menu]-[Batch monitor] on the menu bar.
 (May be chosen only for 16-point register monitor.)

(2) Display screen

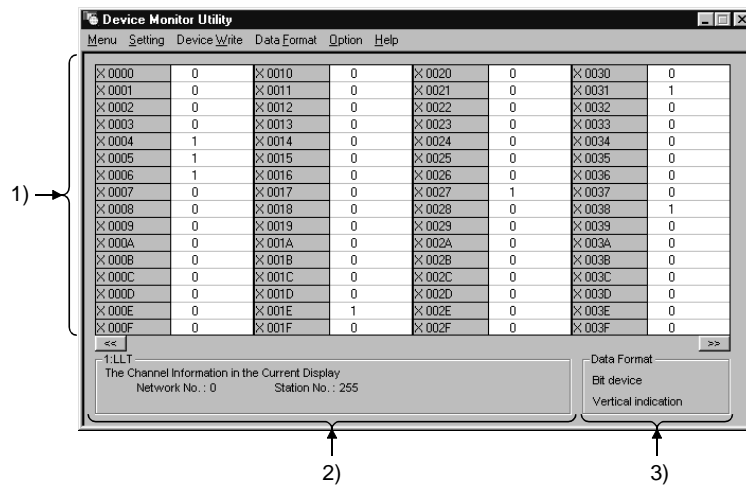

Item	Description
1) Device information	Shows the current device states. When changing the display format, refer to Section 9.4.9.
2) Network status	Shows the currently set network status. When setting the network, refer to Section 9.4.4.
3) Display method	Shows the device type being displayed (word device, bit device) and display format. When changing the device type, refer to Section 9.4.5. When changing the display format, refer to Section 9.4.9.

9.4.3 Setting to 16-point register monitor

Up to five bit devices and one word device are monitored at the same time.

(1) Menu selected

Choose [Menu]-[16-point register monitor] on the menu bar.
(May be chosen only for batch monitor.)

(2) Display screen

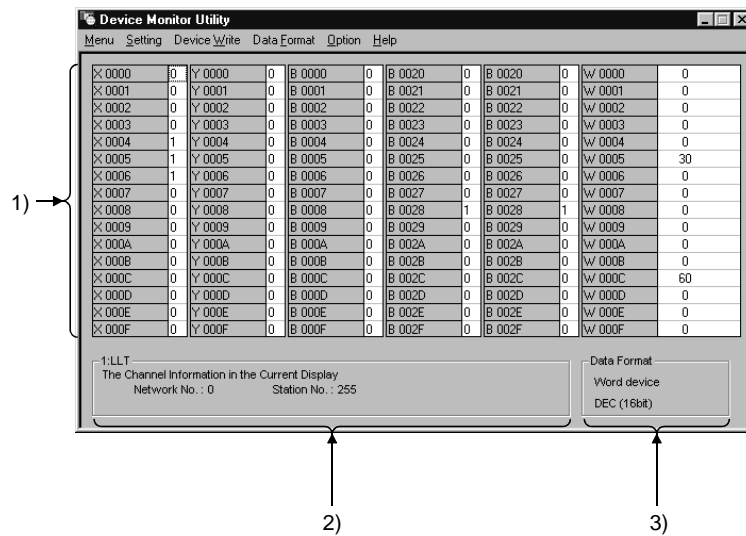

Item	Description
1) Device information	Shows the current device states. When changing the display format, refer to Section 9.4.9.
2) Network status	Shows the currently set network status. When setting the network, refer to Section 9.4.4.
3) Display method	Shows the device type being displayed (word device, bit device) and display format. When changing the device type, refer to Section 9.4.5. When changing the display format, refer to Section 9.4.9.

9.4.4 Setting the monitor target

Set the network used for device monitor.
 Make this setting when starting the device monitor utility.

(1) Menu to be selected

Choose [Setting]-[Network setting] on the menu bar.

(2) Dialog box

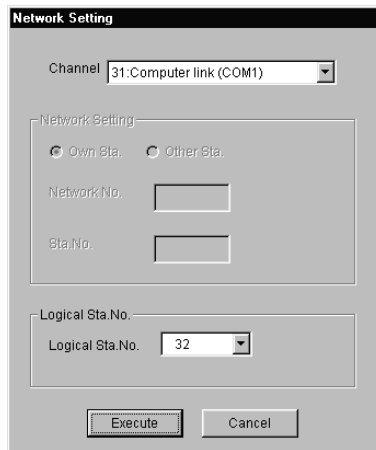

Item	Description
Channel	Set the channel to be used.
Network Setting	Specify the own or other station and set the network number and station number.
Logical Sta. No.	Set the logical station number.

POINT
<ul style="list-style-type: none"> As a monitor target, do not specify the remote I/O or intelligent device station of CC-Link. Specifying it will cause an error. When "Own Sta." is selected on "Network Setting" dialog box, "Network No." and "Sta. No." will be set to "0" and "255" respectively in "Network Status" section on "Device Monitor Utility" dialog box.

9.4.5 Setting the monitored device

Set the device to be monitored.

POINT
<p>For CC-Link communication, the following devices cannot be monitored in 16-point monitor.</p> <ul style="list-style-type: none"> • Other station RX, other station RY, other station RW, other station RAB, other station RBM, other station SB, other station SW

(1) Menu to be selected

Choose [Setting]-[Device setting] on the menu bar.

(2) Dialog box

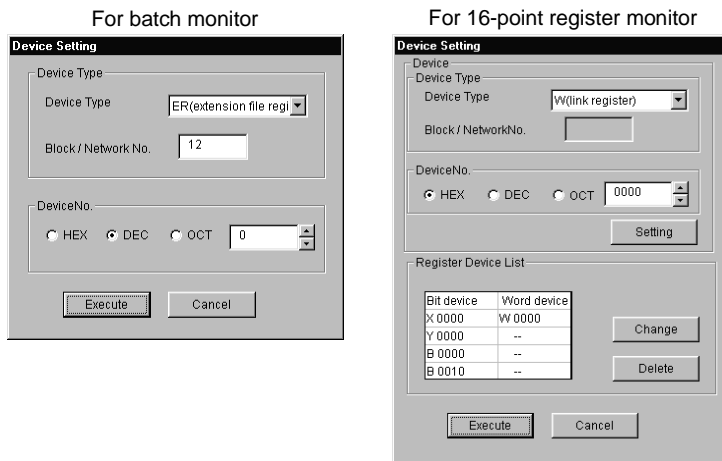

Item	Description																		
Device Type	<p>Set the type of the device to be monitored and the block number or network number. When monitoring the own station device of the CC-Link card, set as follows.</p> <table border="1"> <thead> <tr> <th>Monitored Own Station Device</th> <th>Specified Device Type</th> </tr> </thead> <tbody> <tr> <td>RX</td> <td>X</td> </tr> <tr> <td>RY</td> <td>Y</td> </tr> <tr> <td>SB</td> <td>SM</td> </tr> <tr> <td>SW</td> <td>SD</td> </tr> <tr> <td>RWw</td> <td>Ww</td> </tr> <tr> <td>RWr</td> <td>Wr</td> </tr> <tr> <td>Random access buffer</td> <td>RAB</td> </tr> <tr> <td>Buffer memory</td> <td>SPB</td> </tr> </tbody> </table>	Monitored Own Station Device	Specified Device Type	RX	X	RY	Y	SB	SM	SW	SD	RWw	Ww	RWr	Wr	Random access buffer	RAB	Buffer memory	SPB
Monitored Own Station Device	Specified Device Type																		
RX	X																		
RY	Y																		
SB	SM																		
SW	SD																		
RWw	Ww																		
RWr	Wr																		
Random access buffer	RAB																		
Buffer memory	SPB																		
Device No.	Set the first number of the device to be monitored. (HEX: Hexadecimal, DEC: Decimal, OCT: Octal)																		
Register Device List	Lists the devices registered.																		
"Setting" button	The settings made in Device Type and Device No. are registered and added to the Register Device List.																		
"Change" button	Choosing the device to be changed and clicking this button changes the registered data.																		
"Delete" button	Choosing the device to be deleted and clicking this button deletes it from the Register Device List.																		

9.4.6 Changing the word device value

Change the data of the specified word device.

(1) Menu to be selected

Choose [Device Write]-[Data changing] on the menu bar.

(2) Dialog box

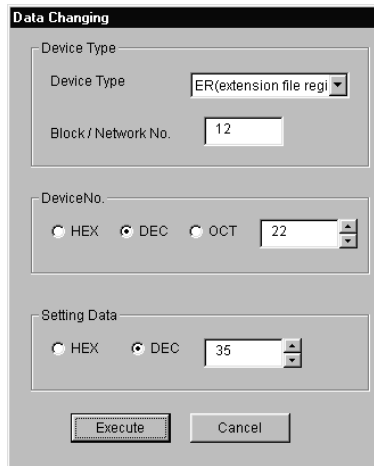

Item	Description
Device Type	Set the type of the device whose data will be changed and the block number or network number.
Device No.	Set the device No. whose data will be changed. (HEX: Hexadecimal, DEC: Decimal, OCT: Octal)
Setting Data	Set new data. (HEX: Hexadecimal, DEC: Decimal)

! DANGER

- When data change control is to be performed to the running PLC, configure up an interlock circuit in the sequence program to ensure that the whole system will always operate safely.
Also, determine corrective actions to be taken between your personal computer and PLC CPU when a data communication error occurs.

9.4.7 Changing the word device value continuously

Change the data of the preset points of the specified word device into the specified data.

(1) Menu to be selected

Choose [Device Write]-[Continuous change in data] on the menu bar.

(2) Dialog box

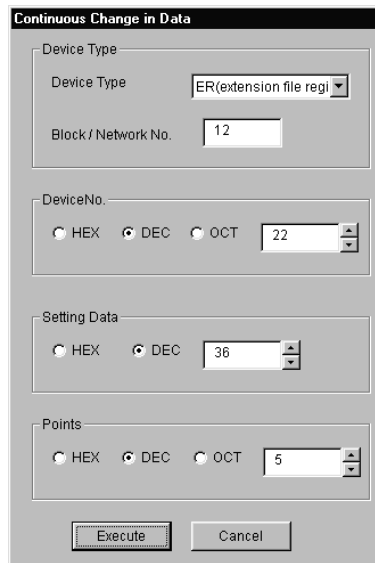

Item	Description
Device Type	Set the type of the device whose data will be changed and the block number or network number.
Device No.	Set the first address of the device No. whose data will be changed. (HEX: Hexadecimal, DEC: Decimal, OCT: Octal)
Setting Data	Set new data for continuous change. (HEX: Hexadecimal, DEC: Decimal)
Points	Set the number of points for continuous data change. (HEX: Hexadecimal, DEC: Decimal, OCT: Octal)

<p>! DANGER</p>	<p>● When data change control is to be performed to the running PLC, configure up an interlock circuit in the sequence program to ensure that the whole system will always operate safely.</p> <p>Also, determine corrective actions to be taken between your personal computer and PLC CPU when a data communication error occurs.</p>
------------------------	---

9.4.8 Turning the bit device ON/OFF

Turn the specified bit device ON/OFF.

(1) Menu to be selected

Choose [Device Write]-[Bit device setting (resetting)] on the menu bar.

(2) Dialog box

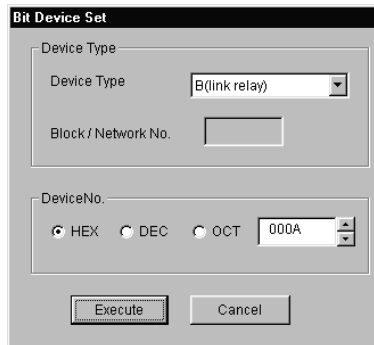

Item	Description
Device Type	Set the type of the bit device to be turned ON/OFF and the block number or network number.
Device No.	Set the device No. to be turned ON/OFF. (HEX: Hexadecimal, DEC: Decimal, OCT: Octal)

<p>! DANGER</p>	<p>● When data change control is to be performed to the running PLC, configure up an interlock circuit in the sequence program to ensure that the whole system will always operate safely.</p> <p>Also, determine corrective actions to be taken between your personal computer and PLC CPU when a data communication error occurs.</p>
------------------------	---

9.4.9 Changing the display format

Change the display format for device monitor into the selected display format.
The selectable menu differs between batch monitor and 16-point register monitor.

(1) Menu to be selected

Choose [Data Format]-[Word (Bit) device] on the menu bar.

9.4.10 About the numerical pad

By choosing [Option]-[Numerical Pad] on the menu bar, you can use the numerical pad when setting the device value, etc.

1. Click the numerical input column.

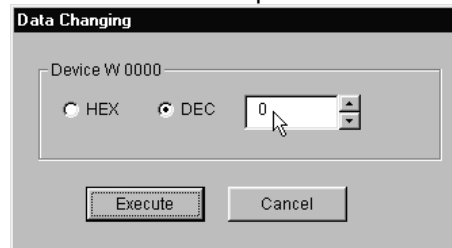

2. As the Numerical Pad appears, enter the value with the buttons. After that, click the "OK" button.

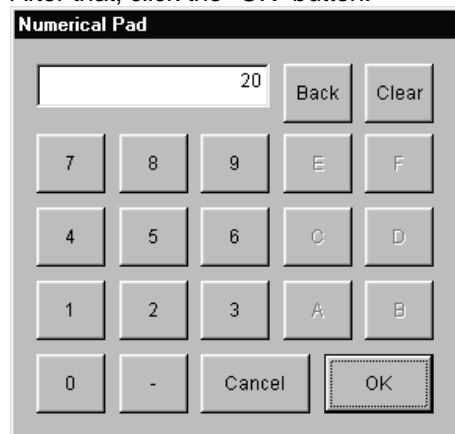

3. The value is entered.

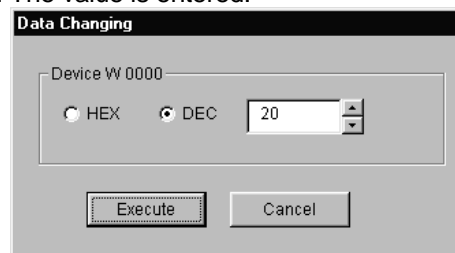

9.4.11 Other operations

Double-clicking the on-screen device number during monitoring allows you to change the data of a word device or turn a bit device ON/OFF.

(1) Word device

Perform the following operation to change the data of a word device.
(Only when the display format is 16 bits)

1. Double-click the number of the word device whose data will be changed.

W 0014	0	W 0024
W 0015	0	W 0025
W 0016	0	W 0026
W 0017	0	W 0027
W 0018	0	W 0028
W 0019	0	W 0029
W 001A	0	W 002A
W 001B	0	W 002B

2. As the dialog box shown on the left appears, set any value. After that, click the "Execute" button.

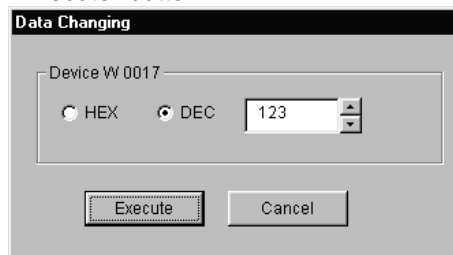

3. If it is OK to change, choose "Yes" in the dialog box below.
To cancel, choose "No".

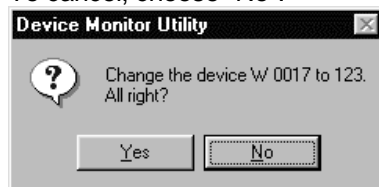

! DANGER

- When data change control is to be performed to the running PLC, configure up an interlock circuit in the sequence program to ensure that the whole system will always operate safely.
Also, determine corrective actions to be taken between your personal computer and PLC CPU when a data communication error occurs.

(2) Bit device

Perform the following operation to turn a bit device ON/OFF.

Not that this operation may be performed only when the display format is "Vertical Indication".

1. Double-click the number of the bit device whose ON/OFF will be changed.

X 0014	0	X 0024
X 0015	0	X 0025
X 0016	0	X 0026
X 0017	0	X 0027
X 0018	0	X 0028
X 0019	0	X 0029
X 001A	0	X 002A
X 001B	0	X 002B

2. If it is OK to change, choose "Yes" in the dialog box below.

To cancel, choose "No".

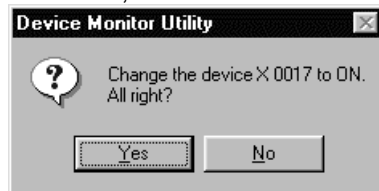

! DANGER

- When data change control is to be performed to the running PLC, configure up an interlock circuit in the sequence program to ensure that the whole system will always operate safely.
Also, determine corrective actions to be taken between your personal computer and PLC CPU when a data communication error occurs.



9.5 Error Viewer

This section describes the operation and setting methods of the device monitor utility.

9.5.1 Screen explanation

This section describes the Error Viewer screen.



Item	Description
Type	Indicates the types of errors by the following symbols.  : Normal message (Informational message concerning a normal operation.)  : Warning message (Message signaling a caution rather than an error)  : Error message (Explains the error that occurred in each module. Double-click it and see the detailed explanations of this error so as to immediately solve the error for the line to which this message has been given.)
Date and Time	Indicates the date at which an error occurred.
Time	Indicates the time at which an error occurred.
Source	Indicates the source of an error.
Error No.	Indicates the number of the error that occurred. For details of error number, see Error List Manual.
Message Contents	Explains the error.

9.5.2 Log menu

This section explains the log menu data.

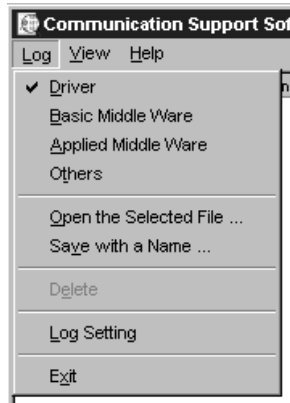

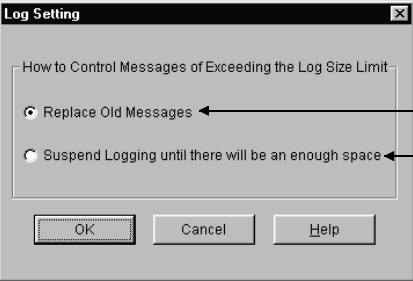
Item	Description
Error registration source type selection	Choose the type of the error registration source to be displayed on the Error Viewer. The currently selected items are checked. <ul style="list-style-type: none"> • Driver : Shows the message that occurred in the driver such as the shared memory device. • Basic Middle Ware : Shows the message which occurred in the shared memory data server, tag management process or the like. • Applied Middle Ware : Shows the message that occurred on XMOP or OLEX. • Other : Shows the message which occurred in the application package.
Open the Selected File	Opens the error log file (*.log).
Save with a Name	Saves the error log information of the currently selected error registration source (driver, etc.) in the specified file.
Delete	Deletes the error log information of the currently displayed error registration source (driver, etc.). As the dialog box appears, perform operation following the instructions.
Log Setting	Choose the processing method for the case where the error log count has exceeded the maximum registration count. <div style="display: flex; align-items: center; margin-top: 10px;">  <div style="margin-left: 20px;"> <p>← Older information is overwritten in due order.</p> <p>← Not registered until there is free space made by deletion, etc.</p> </div> </div>
Exit	Closes the Error Viewer.

9.5.3 View menu

This section describes the view menu data.

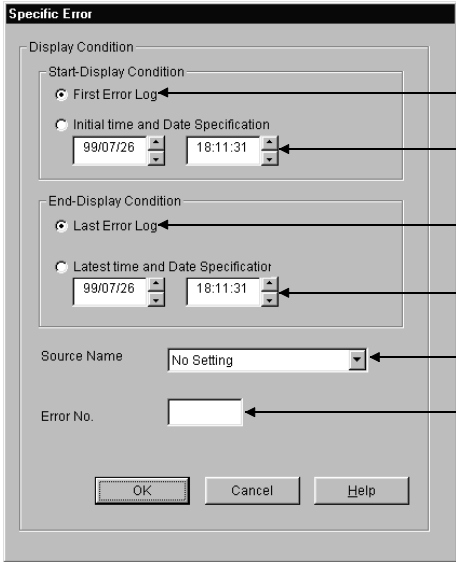
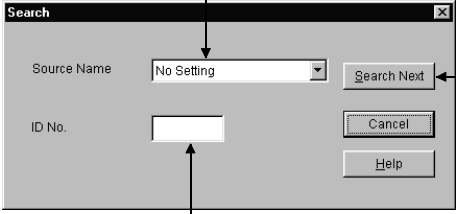

Item	Description
All Errors	Shows all errors that occurred on an error registration source type basis.
Specific Error	<p>Set the errors to be displayed on the screen under the following dialog box conditions.</p>  <ul style="list-style-type: none"> Errors in the first error log and onward are displayed. Errors from the specified date are displayed. Errors in up to the last error log are displayed. Errors until the specified date are displayed. Only errors of the preset source name are displayed. Only errors of the specified error number are displayed.
Search	<p>In the following dialog box, searches the currently displayed error log data for the source name and the error information of the error code. (This function is also made available by pressing the "F3" key.)</p> <p>Set the source name to be searched for.</p>  <ul style="list-style-type: none"> Searches the next error information. <p>Enter the error code to be searched for.</p>

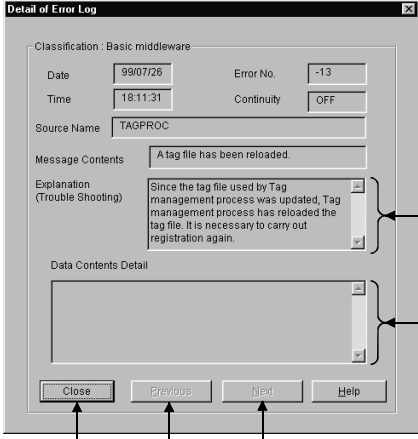
Item	Description
<p>Detail</p>	<p>Shows the detailed information on the error log currently selected. (This function is also made available by pressing the "Enter" key after selecting the display item.)</p>  <p>Shows detail of the error. It may not be displayed for some sources.</p> <p>Displayed when the driver or buffer memory contents are referred to. May not be displayed for some sources.</p> <p>Shows the detail of the next error log information.</p> <p>Shows the detail of the preceding error log information.</p> <p>Closes this dialog box.</p>
<p>Renew</p>	<p>Updates the currently displayed information.</p>

10 SHARED DEVICES

This chapter describes the shared devices (EM, ED) available when the CSKP is installed.

10.1 Specifications

The following table lists the specifications of the shared devices (EM, ED).

EM (Bit Device)		ED (Word Device)	
Number of Blocks (0 to 255)	Device Range (0 to 8191)	Number of Blocks (0 to 255)	Device Range (0 to 8191)
EM0 *1	EM0(0) to EM0(8191)	ED0 *1	ED0(0) to ED0(8191)
EM1	EM1(0) to EM1(8191)	ED1	ED1(0) to ED1(8191)
EM2	EM2(0) to EM2(8191)	ED2	ED2(0) to ED2(8191)
•	•	•	•
•	•	•	•
•	•	•	•
•	•	•	•
EM255	EM255(0) to EM255(8191)	ED255	ED255(0) to ED255(8191)

*1 System Information Area

POINTS
(1) The shared devices can be used only when the operating system (OS) is Windows NT 4.0. They cannot be used under Windows 95 and Windows 98.
(2) The number of blocks to be used differs depending on how the Shared Device Utility is set.
(3) The shared devices exist only in the personal computers rather than PC.

10.2 System Area Information

The system area information is stored in the block No. 0 of the shared devices (EM, ED).

	ED0	EM0
0 to 99	Personal computer system information	Reserved
100 to 199	Information on machine basic configuration	
200 to 399	Reserved	
400 to 599	Drive information	
600 to 999	Printer information	
1000 to 8191	Reserved	

POINT
System area information is all read-only information. No data can be written to this system area.

(1) System Area Information Details

Device number	Name	Explanation
0 to 1	Shared device identifier	EMED is stored as a 4-character shared device identifier.
2	Number of shared device blocks	The number of blocks of a shared device (EM or ED) is stored.
3 to 4	Shared device driver version	The driver version ("00A", "10B", "20C", etc.) of a shared device is stored in 3 letters.
5 to 99	Reserved	Unused areas
100 to 101	CPU type	Information about the processor mounted on a personal computer is stored in numerals as follows: 386: i386CPU 486: i486CPU 586: Pentium CPU
102 to 103	Main memory size	The overall physical size of main memory is stored in four bytes as shown below. Device No.102: Lower 2 bytes of overall physical size (Data: 0 to 0xFFFF) Device No.103: Upper 2 bytes of overall physical size (Data: 0 to 0xFFFF)
104 to 199	Reserved	Unused areas
400	Number of Drives	The total number of drives existing in a personal computer is stored.
401 to 530	Drive Information	Each type of drive, total disc capacity, and free disk capacity existing in a personal computer are stored in the following format: A Drive Information Device No. 401: Type of drive 2 ... Changeable drive 3 ... Fixed drive 4 ... Network drive 5 ... CD-ROM drive Data listed below are stored in No. 402 to 405 only when a fixed drive is used Device No. 402: Lower two bytes of total disk capacity Device No. 403: Upper two bytes of total disk capacity Device No. 404: Lower two bytes of vacant disk capacity Device No. 405: Upper two bytes of vacant disk capacity to Z Drive Information Device No. 401: Type of drive 2 ... Changeable drive 3 ... Fixed drive 4 ... Network drive 5 ... CD-ROM drive Data listed below is stored in No. 527 to 530 only when a fixed drive is used Device No. 527: Lower two bytes of total disk capacity Device No. 528: Upper two bytes of total disk capacity Device No. 529: Lower two bytes of vacant disk capacity Device No. 530: Upper two bytes of vacant disk capacity

Device number	Name	Explanation
531 to 599	Reserved	Unused areas
600	Number of Printers Connected	The total number of printers specified in the printer port of a personal computer is stored. (Network printers not included)
601 to 984	Information on Printers Connected	Information on a printer connected to the printer port of a personal computer is stored in the following format. LPT1: Information Device No. 601 to 664: Printer name (128 characters) Device No. 665 to 728: Driver name (128 names) LPT2: Information Device No. 729 to 792: Printer name (128 characters)) Device No. 793 to 856: Driver name (128 names) LPT3: Information Device No. 857 to 920: Printer name (128 characters) Device No. 921 to 984: Driver name (128 names)
985 to 999	Reserved	Unused areas

11 ACCESSIBLE DEVICES AND ACCESSIBLE RANGE

This chapter describes the accessible devices and accessible range in each communication mode.

For the accessible devices and accessible ranges of the following communication forms, refer to the manuals of the corresponding boards.

- MELSECNET/10 communication
- CC-Link communication
- CPU board communication

POINT
“Batch” or “Random” in the table implies the following
“Batch” : Batch read/Batch write
“Random” : Random read/Random write/Bit set/Bit reset

11.1 Cautions on Device Access

This section explains the cautions on extended file register access.

It is possible (depending on the type of memory cassette mounted on the PLC CPU) that no errors will occur even when a device is read and written by specifying a block number which does not exist. In such a case, the data read is not correct. Further, writing to that device may destroy the user memory of the PLC CPU.

Make sure to use the function described here, after fully confirming the kind of memory cassette, details of parameter setting, etc.

For details, refer to the AnACPU and AnUCPU User 's Manual.

11.2 Computer Link Communication

This section describes the accessible devices and accessible range in the Computer Link Communication.

11.2.1 Accessible devices

The following lists the accessible devices in the Computer Link Communication.

Device		Destination							
		A1N	A0J2H A1S(-S1) A1SH A1SJH(-S8) A1SJ(-3) A2C(J) A2N(-S1) A2S(-S1) A2SH(-S1) A1FX	A2A(-S1) A2U(-S1) A2AS(-S1) A2AS-S30 Q02(H)-A Q06H-A	A3N A3A A3U	A4U	Q2A(-S1) Q3A Q4A Q4AR Q2AS(-S1) Q2ASH(-S1) Q02(H) Q06H Q12H Q25H	FX0 FX0S FX0N FX1 FX2 FX2C FX2N FX2NC	A273UH(-S3) A171SH A172SH
X	Batch	○	○	○	○	○	○	×	○
	Random	○	○	○	○	○	○	×	○
Y	Batch	○	○	○	○	○	○	×	○
	Random	○	○	○	○	○	○	×	○
L	Batch	○	○	○	○	○	○	×	○
	Random	○	○	○	○	○	○	×	○
M	Batch	○	○	○	○	○	○	×	○
	Random	○	○	○	○	○	○	×	○
Special M(SM), SB	Batch	○	○	○	○	○	○	×	○
	Random	○	○	○	○	○	○	×	○
F	Batch	○	○	○	○	○	○	×	○
	Random	○	○	○	○	○	○	×	○
T(Contact Point)	Batch	○	○	○	○	○	○	×	○
	Random	○	○	○	○	○	○	×	○
T(Coil)	Batch	○	○	○	○	○	○	×	○
	Random	○	○	○	○	○	○	×	○
C (Contact Point)	Batch	○	○	○	○	○	○	×	○
	Random	○	○	○	○	○	○	×	○
C (Coil)	Batch	○	○	○	○	○	○	×	○
	Random	○	○	○	○	○	○	×	○
T (Current Value)	Batch	○	○	○	○	○	○	×	○
	Random	○	○	○	○	○	○	×	○
C (Current Value)	Batch	○	○	○	○	○	○	×	○
	Random	○	○	○	○	○	○	×	○
D	Batch	○	○	○	○	○	○	×	○
	Random	○	○	○	○	○	○	×	○
Special D(SD), SW	Batch	○	○	○	○	○	○	×	○
	Random	○	○	○	○	○	○	×	○
T (Main Set Value)	Batch	○	○	○	○	○	○	×	○
	Random	×	×	×	×	×	×	×	×
T (Sub Set Value 1)	Batch	○	○	○ * 1	○	○	○	×	○
	Random	○	○	×	×	×	×	×	×
T (Sub Set Value 2)	Batch	×	×	×	×	○	○	×	×
	Random	×	×	×	×	×	×	×	×
T (Sub Set Value 3)	Batch	×	×	×	×	○	○	×	×
	Random	×	×	×	×	×	×	×	×
C (Main Set Value)	Batch	○	○	○	○	○	○	×	○
	Random	×	×	×	×	×	×	×	×
C (Sub Set Value 1)	Batch	○	○	○ * 1	○	○	○	×	○
	Random	○	○	×	×	×	×	×	×

* 1 A2A(-S1)CPU is not allowed access.

11. ACCESSIBLE DEVICES AND ACCESSIBLE RANGE

MELSEC

Device		Destination							
		A1N	A0J2H A1S(-S1) A1SH A1SJH(-S8) A1SJ(-3) A2C(J) A2N(-S1) A2S(-S1) A2SH(-S1) A1FX	A2A(-S1) A2U(-S1) A2AS(-S1) A2AS-S30 Q02(H)-A Q06H-A	A3N A3A A3U	A4U	Q2A(-S1) Q3A Q4A Q4AR Q2AS(-S1) Q2ASH(-S1) Q02(H) Q06H Q12H Q25H	FX0 FX0S FX0N FX1 FX2 FX2C FX2N FX2NC	A273UH(-S3) A171SH A172SH
C (Sub Set Value 2)	Batch	×	×	×	×	○	×	×	×
	Random					×			
C (Sub Set Value 3)	Batch	×	×	×	×	○	×	×	×
	Random					×			
A	Batch	×	×	×	×	×	×	×	×
	Random								
Z	Batch	×	×	×	×	×	×	×	×
	Random								
V (Index Register)	Batch	×	×	×	×	×	×	×	×
	Random								
R (File Register)	Batch	×	○	○	○	○	○	×	○
	Random								
ER (Extended File Register)	Batch	○	○	○	○	○	○	×	○
	Random								
B	Batch	○	○	○	○	○	○	×	○
	Random								
W	Batch	○	○	○	○	○	○	×	○
	Random								
QnA Link Special Relay (on QnA CPU)	Batch	×	×	×	×	×	○	×	×
	Random								
Integrating Timer (Contact Point)	Batch	×	×	×	×	×	○	×	×
	Random						×		
Integrating Timer (Coil)	Batch	×	×	×	×	×	○	×	×
	Random						×		
QnA Link Special Register (on QnA CPU)	Batch	×	×	×	×	×	○	×	×
	Random								
QnA Edge Relay (on QnA CPU)	Batch	×	×	×	×	×	○	×	×
	Random								
Own station random access buffer	Batch	×	×	×	×	×	×	×	×
	Random								
Integrating Timer (Current Value)	Batch	×	×	×	×	×	○	×	×
	Random								
Own station link register (For sending)	Batch	×	×	×	×	×	×	×	×
	Random								
Own station link register (For receiving)	Batch	×	×	×	×	×	×	×	×
	Random								
S device of FXCPU	Batch	×	×	×	×	×	×	×	×
	Random								
Own station buffer memory	Batch	×	×	×	×	×	×	×	×
	Random								
QnA SEND function (with confirmation of arrival)	Batch	×	×	×	×	×	×	×	×
	Random								
QnA SEND function (without confirmation of arrival)	Batch	×	×	×	×	×	×	×	×
	Random								

11. ACCESSIBLE DEVICES AND ACCESSIBLE RANGE

MELSEC

Device		Destination							
		A1N	A0J2H A1S(-S1) A1SH A1SJH(-S8) A1SJ(-3) A2C(J) A2N(-S1) A2S(-S1) A2SH(-S1) A1FX	A2A(-S1) A2U(-S1) A2AS(-S1) A2AS-S30 Q02(H)-A Q06H-A	A3N A3A A3U	A4U	Q2A(-S1) Q3A Q4A Q4AR Q2AS(-S1) Q2ASH(-S1) Q02(H) Q06H Q12H Q25H	FX0 FX0S FX0N FX1 FX2 FX2C FX2N FX2NC	A273UH(-S3) A171SH A172SH
Direct Link Input	Batch	×	×	×	×	×	○ *2	×	×
	Random								
Direct Link Output	Batch	×	×	×	×	×	○ *2	×	×
	Random								
Direct Link Relay	Batch	×	×	×	×	×	○ *2	×	×
	Random								
Direct Link Register	Batch	×	×	×	×	×	○ *2	×	×
	Random								
Direct Link Special Relay (on Network Unit)	Batch	×	×	×	×	×	○ *2	×	×
	Random								
Direct Link Special Register (on Network Unit)	Batch	×	×	×	×	×	○ *2	×	×
	Random								
Special Direct Buffer Register	Batch	×	×	×	×	×	○	×	×
	Random								
Other station buffer memory	Batch	×	×	×	×	×	×	×	×
	Random								
Other station random access buffer	Batch	×	×	×	×	×	×	×	×
	Random								
Other station RX	Batch	×	×	×	×	×	×	×	×
	Random								
Other station RY	Batch	×	×	×	×	×	×	×	×
	Random								
Other station link register	Batch	×	×	×	×	×	×	×	×
	Random								
Other station SB	Batch	×	×	×	×	×	×	×	×
	Random								
Other station SW	Batch	×	×	×	×	×	×	×	×
	Random								

*2 Access is not allowed unless there's a network module available.

11.2.2 Accessible range

The accessible range for computer link communication is indicated below.

(1) Configuration

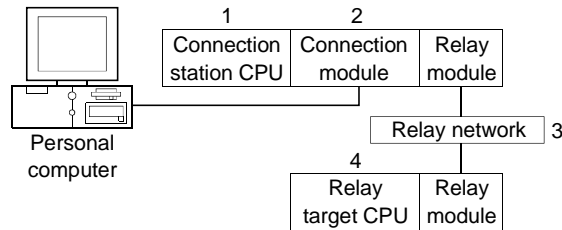

(2) Accessibility list

○: Accessible, ×: Inaccessible

Connection Station		3. Relay Network	4. Relay Target CPU					
1. CPU	2. Connection module		QCPU		QnACPU	ACPU	FXCPU	Motion controller CPU
			Q mode	A mode				
QCPU (Q mode) ○	Q series-compatible C24	MELSECNET/10H	○	×	×	×	×	×
		MELSECNET/10	○	○	○	○	×	○
		Ethernet	○ *2	×	○ *2	×	×	×
		Computer link	○	×	○	×	×	×
		CC-Link	○	○	○	○	×	○
		Multidrop (Independent mode)	○	×	○	×	×	×
		Multidrop (Combine mode) *1	○	×	×	×	×	×
QnACPU ○	QC24	MELSECNET/10H	×	×	×	×	×	×
		MELSECNET/10	×	×	○	×	×	×
		Ethernet	×	×	○ *2	×	×	×
		Computer link	×	×	○	×	×	×
		CC-Link	×	×	○	×	×	×
		Multidrop (Independent mode)	×	×	○	×	×	×
		Multidrop (Combine mode)	×	×	○	×	×	×

*1 "SW6" (sum check) of the transmission specification software switch setting in the Q series-compatible C24 parameter must be set to ON.

*2 As the network number and station number, set the parameter-set values of the QE71 on the relay module side. Also, set "Station No.↔ IP information (MNET/10 routing information)" in the QE71 parameter setting.

At this time, specify any of the IP address calculation system, table conversion system and combined system as the "Station No.↔ IP information system (MNET/10 routing system)".

Connection Station		3. Relay Network	4. Relay Target CPU					
1. CPU	2. Connection module		QCPU		QnACPU	ACPU	FXCPU	Motion controller CPU
			Q mode	A mode				
QCPU (A mode), QnACPU *3, ACPU ○	UC24	MELSECNET/10H	×	×	×	×	×	×
		MELSECNET/10	×	○	○*3	○	×	○
		Ethernet	×	×	×	×	×	×
		Computer link	×	×	×	×	×	×
		CC-Link	×	×	×	×	×	×
		Multidrop (Independent mode)	×	○	×	○	×	○
		Multidrop (Combine mode)	×	×	×	○	×	○
QCPU (A mode), QnACPU *3, ACPU ○	C24	MELSECNET/10H	×	×	×	×	×	×
		MELSECNET/10	×	○	○*3	○	×	○
		Ethernet	×	×	×	×	×	×
		Computer link	×	×	×	×	×	×
		CC-Link	×	×	×	×	×	×
		Multidrop (Independent mode)	×	○	×	○	×	○
		Multidrop (Combine mode)	×	○	×	○	×	○

*3 Operates as equivalent to AnACPU.

11.3 Ethernet Communication

This section describes the accessible devices and accessible range in the Ethernet Communication.

11.3.1 Accessible devices

The following lists the accessible devices in the Ethernet Communication.

Device		Destination							
		A1N	A0J2H A1S(-S1) A1SH A1SJH(-S8) A1SJ(-3) A2C(J) A2N(-S1) A2S(-S1) A2SH(-S1) A1FX	A2A(-S1) A2U(-S1) A2AS(-S1) A2AS-S30 Q02(H)-A Q06H-A	A3N A3A A3U	A4U	Q2A(-S1) Q3A Q4A Q4AR Q2AS(-S1) Q2ASH(-S1) Q02(H) Q06H Q12H Q25H	FX0 FX0S FX0N FX1 FX2 FX2C FX2N FX2NC	A273UH(-S3) A171SH A172SH
X	Batch	○	○	○	○	○	○	×	○
	Random	○	○	○	○	○	○	×	○
Y	Batch	○	○	○	○	○	○	×	○
	Random	○	○	○	○	○	○	×	○
L	Batch	○	○	○	○	○	○	×	○
	Random	○	○	○	○	○	○	×	○
M	Batch	○	○	○	○	○	○	×	○
	Random	○	○	○	○	○	○	×	○
Special M(SM), SB	Batch	○	○	○	○	○	○	×	○
	Random	○	○	○	○	○	○	×	○
F	Batch	○	○	○	○	○	○	×	○
	Random	○	○	○	○	○	○	×	○
T(Contact Point)	Batch	○	○	○	○	○	○	×	○
	Random	○	○	○	○	○	○	×	○
T(Coil)	Batch	○	○	○	○	○	○	×	○
	Random	○	○	○	○	○	○	×	○
C (Contact Point)	Batch	○	○	○	○	○	○	×	○
	Random	○	○	○	○	○	○	×	○
C (Coil)	Batch	○	○	○	○	○	○	×	○
	Random	○	○	○	○	○	○	×	○
T (Current Value)	Batch	○	○	○	○	○	○	×	○
	Random	○	○	○	○	○	○	×	○
C (Current Value)	Batch	○	○	○	○	○	○	×	○
	Random	○	○	○	○	○	○	×	○
D	Batch	○	○	○	○	○	○	×	○
	Random	○	○	○	○	○	○	×	○
Special D(SD), SW	Batch	○	○	○	○	○	○	×	○
	Random	○	○	○	○	○	○	×	○
T (Main Set Value)	Batch	○	○	○	○	○	×	×	○
	Random	×	×	×	×	×	×	×	×
T (Sub Set Value 1)	Batch	○	○	○ * 1	○	○	×	×	○
	Random	○	○	×	×	×	×	×	×
T (Sub Set Value 2)	Batch	×	×	×	×	×	×	×	×
	Random	×	×	×	×	×	×	×	×
T (Sub Set Value 3)	Batch	×	×	×	×	×	×	×	×
	Random	×	×	×	×	×	×	×	×
C (Main Set Value)	Batch	○	○	○	○	○	×	×	○
	Random	×	×	×	×	×	×	×	×
C (Sub Set Value 1)	Batch	○	○	○ * 1	○	○	×	×	○
	Random	○	○	×	×	×	×	×	×

* 1 A2A(-S1)CPU is not allowed access.

11. ACCESSIBLE DEVICES AND ACCESSIBLE RANGE

MELSEC

Device		Destination							
		A1N	A0J2H A1S(-S1) A1SH A1SJH(-S8) A1SJ(-3) A2C(J) A2N(-S1) A2S(-S1) A2SH(-S1) A1FX	A2A(-S1) A2U(-S1) A2AS(-S1) A2AS-S30 Q02(H)-A Q06H-A	A3N A3A A3U	A4U	Q2A(-S1) Q3A Q4A Q4AR Q2AS(-S1) Q2ASH(-S1) Q02(H) Q06H Q12H Q25H	FX0 FX0S FX0N FX1 FX2 FX2C FX2N FX2NC	A273UH(-S3) A171SH A172SH
C (Sub Set Value 2)	Batch	×	×	×	×	×	×	×	×
	Random	×	×	×	×	×	×	×	×
C (Sub Set Value 3)	Batch	×	×	×	×	×	×	×	×
	Random	×	×	×	×	×	×	×	×
A	Batch	×	×	×	×	×	×	×	×
	Random	×	×	×	×	×	×	×	×
Z	Batch	×	×	×	×	×	×	×	×
	Random	×	×	×	×	×	×	×	×
V (Index Register)	Batch	×	×	×	×	×	×	×	×
	Random	×	×	×	×	×	×	×	×
R (File Register)	Batch	×	○	○	○	○	○	×	○
	Random	×	○	○	○	○	○	×	○
ER (Extended File Register)	Batch	○	○	○	○	○	○	×	○
	Random	○	○	○	○	○	○	×	○
B	Batch	○	○	○	○	○	○	×	○
	Random	○	○	○	○	○	○	×	○
W	Batch	○	○	○	○	○	○	×	○
	Random	○	○	○	○	○	○	×	○
QnA Link Special Relay (on QnA CPU)	Batch	×	×	×	×	×	○	×	×
	Random	×	×	×	×	×	○	×	×
Integrating Timer (Contact Point)	Batch	×	×	×	×	×	○	×	×
	Random	×	×	×	×	×	×	×	×
Integrating Timer (Coil)	Batch	×	×	×	×	×	○	×	×
	Random	×	×	×	×	×	×	×	×
QnA Link Special Register (on QnA CPU)	Batch	×	×	×	×	×	○	×	×
	Random	×	×	×	×	×	○	×	×
QnA Edge Relay (on QnA CPU)	Batch	×	×	×	×	×	○	×	×
	Random	×	×	×	×	×	○	×	×
Own station random access buffer	Batch	×	×	×	×	×	×	×	×
	Random	×	×	×	×	×	×	×	×
Integrating Timer (Current Value)	Batch	×	×	×	×	×	○	×	×
	Random	×	×	×	×	×	○	×	×
Own station link register (For sending)	Batch	×	×	×	×	×	×	×	×
	Random	×	×	×	×	×	×	×	×
Own station link register (For receiving)	Batch	×	×	×	×	×	×	×	×
	Random	×	×	×	×	×	×	×	×
S device of FXCPU	Batch	×	×	×	×	×	×	×	×
	Random	×	×	×	×	×	×	×	×
Own station buffer memory	Batch	×	×	×	×	×	×	×	×
	Random	×	×	×	×	×	×	×	×
QnA SEND function (with confirmation of arrival)	Batch	×	×	×	×	×	×	×	×
	Random	×	×	×	×	×	×	×	×
QnA SEND function (without confirmation of arrival)	Batch	×	×	×	×	×	×	×	×
	Random	×	×	×	×	×	×	×	×

11. ACCESSIBLE DEVICES AND ACCESSIBLE RANGE

MELSEC

Device		Destination							
		A1N	A0J2H A1S(-S1) A1SH A1SJH(-S8) A1SJ(-3) A2C(J) A2N(-S1) A2S(-S1) A2SH(-S1) A1FX	A2A(-S1) A2U(-S1) A2AS(-S1) A2AS-S30 Q02(H)-A Q06H-A	A3N A3A A3U	A4U	Q2A(-S1) Q3A Q4A Q4AR Q2AS(-S1) Q2ASH(-S1) Q02(H) Q06H Q12H Q25H	FX0 FX0S FX0N FX1 FX2 FX2C FX2N FX2NC	A273UH(-S3) A171SH A172SH
Direct Link Input	Batch	×	×	×	×	×	×	×	×
	Random	×	×	×	×	×	×	×	×
Direct Link Output	Batch	×	×	×	×	×	×	×	×
	Random	×	×	×	×	×	×	×	×
Direct Link Relay	Batch	×	×	×	×	×	×	×	×
	Random	×	×	×	×	×	×	×	×
Direct Link Register	Batch	×	×	×	×	×	×	×	×
	Random	×	×	×	×	×	×	×	×
Direct Link Special Relay (on Network Unit)	Batch	×	×	×	×	×	×	×	×
	Random	×	×	×	×	×	×	×	×
Direct Link Special Register (on Network Unit)	Batch	×	×	×	×	×	×	×	×
	Random	×	×	×	×	×	×	×	×
Special Direct Buffer Register	Batch	×	×	×	×	×	×	×	×
	Random	×	×	×	×	×	×	×	×
Other station buffer memory	Batch	×	×	×	×	×	×	×	×
	Random	×	×	×	×	×	×	×	×
Other station random access buffer	Batch	×	×	×	×	×	×	×	×
	Random	×	×	×	×	×	×	×	×
Other station RX	Batch	×	×	×	×	×	×	×	×
	Random	×	×	×	×	×	×	×	×
Other station RY	Batch	×	×	×	×	×	×	×	×
	Random	×	×	×	×	×	×	×	×
Other station link register	Batch	×	×	×	×	×	×	×	×
	Random	×	×	×	×	×	×	×	×
Other station SB	Batch	×	×	×	×	×	×	×	×
	Random	×	×	×	×	×	×	×	×
Other station SW	Batch	×	×	×	×	×	×	×	×
	Random	×	×	×	×	×	×	×	×

11.3.2 Accessible range

The accessible range for Ethernet communication is indicated below.
 During Ethernet communication, only the same segment may be accessed.
 Access cannot be made beyond the router and gateway.

(1) Configuration

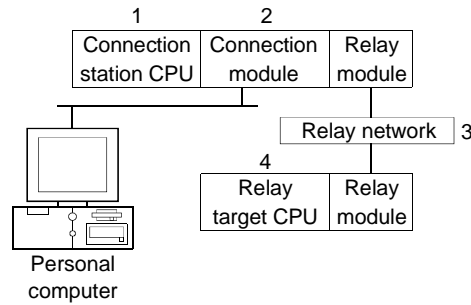

(2) Accessibility list

POINT
 When using the Q series-compatible E71 or QE71 (when using UDP/IP), Ethernet parameter setting must be made in the parameter setting of GPPW.

○: Accessible, ×: Inaccessible

Connection Station		3. Relay Network	4. Relay Target CPU					
1. CPU	2. Connection module		QCPU		QnACPU	ACPU	FXCPU	Motion controller CPU
			Q mode	A mode				
QCPU (Q mode) ○	Q series-compatible E71	MELSECNET/10H *1	○	×	×	×	×	×
		MELSECNET/10 *1	○	○	○	○	×	○
		Ethernet	○*3	×	○*3	×	×	×
		Computer link	○	×	○	×	×	×
		CC-Link	○	○	○	○	×	○
QnACPU ○	QE71	MELSECNET/10H	×	×	×	×	×	×
		MELSECNET/10	×	×	○	×	×	×
		Ethernet	×	×	○*3*4	×	×	×
		Computer link	×	×	○*4	×	×	×
		CC-Link	×	×	×	×	×	×
QCPU (A mode), QnACPU *2, ACPUs ○	E71	MELSECNET/10H	×	×	×	×	×	×
		MELSECNET/10	×	○	○*2	○	×	○
		Ethernet	×	×	×	×	×	×
		Computer link	×	×	×	×	×	×
		CC-Link	×	×	×	×	×	×

*1 In the connection station side (Q series-compatible E71), specify the station number set in the Ethernet parameter.
 *2 Operates as equivalent to A3ACPU.
 *3 As the network number and station number, set the parameter-set values of the QE71 on the relay module side.
 Also, set "Station No. ↔ IP information (MNET/10 routing information)" in the QE71 parameter setting.
 At this time, specify any of the IP address calculation system, table conversion system and combined system as the "Station No. ↔ IP information system (MNET/10 routing system)".
 *4 Access is not allowed when TCP/IP is selected.

11.4 CPU COM Communication

This section describes the accessible devices and accessible range in the CPU COM Communication.

11.4.1 Accessible devices

The following lists the accessible devices in the CPU COM Communication.

Device		Destination							
		A1N	A0J2H A1S(-S1) A1SH A1SJH(-S8) A1SJ(-3) A2C(J) A2N(-S1) A2S(-S1) A2SH(-S1) A1FX	A2A(-S1) A2U(-S1) A2AS(-S1) A2AS-S30 Q02(H)-A Q06H-A	A3N A3A A3U	A4U	Q2A(-S1) Q3A Q4A Q4AR Q2AS(-S1) Q2ASH(-S1) Q02(H) Q06H Q12H Q25H	FX0 FX0S FX0N FX1 FX2 FX2C FX2N FX2NC	A273UH(-S3) A171SH A172SH
X	Batch	○	○	○	○	○	○	○	○
	Random	○	○	○	○	○	○	○	○
Y	Batch	○	○	○	○	○	○	○	○
	Random	○	○	○	○	○	○	○	○
L	Batch	○	○	○	○	○	○	×	○
	Random	○	○	○	○	○	○	×	○
M	Batch	○	○	○	○	○	○	○	○
	Random	○	○	○	○	○	○	○	○
Special M(SM), SB	Batch	○	○	○	○	○	○	Sp.M: ○ SB: ×	○
	Random	○	○	○	○	○	○	Sp.M: ○ SB: ×	○
F	Batch	○	○	○	○	○	○	×	○
	Random	○	○	○	○	○	○	×	○
T(Contact Point)	Batch	○	○	○	○	○	○	○	○
	Random	○	○	○	○	○	○	○	○
T(Coil)	Batch	○	○	○	○	○	○	○	○
	Random	○	○	○	○	○	○	○	○
C (Contact Point)	Batch	○	○	○	○	○	○	○	○
	Random	○	○	○	○	○	○	○	○
C (Coil)	Batch	○	○	○	○	○	○	○	○
	Random	○	○	○	○	○	○	○	○
T (Current Value)	Batch	○	○	○	○	○	○	○	○
	Random	○	○	○	○	○	○	○	○
C (Current Value)	Batch	○	○	○	○	○	○	○	○
	Random	○	○	○	○	○	○	○	○
D	Batch	○	○	○	○	○	○	○	○
	Random	○	○	○	○	○	○	○	○
Special D(SD), SW	Batch	○	○	○	○	○	○	Sp.D: ○ SW: ×	○
	Random	○	○	○	○	○	○	Sp.D: ○ SW: ×	○
T (Main Set Value)	Batch	○	○	○	○	○	×	×	○
	Random	×	×	×	×	×	×	×	×
T (Sub Set Value 1)	Batch	○	○	○ * 1	○	○	×	×	○
	Random	○	○	×	×	×	×	×	×
T (Sub Set Value 2)	Batch	×	×	×	○	○	×	×	×
	Random	×	×	×	○	○	×	×	×
T (Sub Set Value 3)	Batch	×	×	×	×	○	×	×	×
	Random	×	×	×	×	×	×	×	×
C (Main Set Value)	Batch	○	○	○	○	○	×	×	○
	Random	×	×	×	×	×	×	×	×
C (Sub Set Value 1)	Batch	○	○	○ * 1	○	○	×	×	○
	Random	○	○	×	×	×	×	×	×

* 1 A2A(-S1)CPU is not allowed access.

11. ACCESSIBLE DEVICES AND ACCESSIBLE RANGE

MELSEC

Device		Destination							
		A1N	A0J2H A1S(-S1) A1SH A1SJH(-S8) A1SJ(-3) A2C(J) A2N(-S1) A2S(-S1) A2SH(-S1) A1FX	A2A(-S1) A2U(-S1) A2AS(-S1) A2AS-S30 Q02(H)-A Q06H-A	A3N A3A A3U	A4U	Q2A(-S1) Q3A Q4A Q4AR Q2AS(-S1) Q2ASH(-S1) Q02(H) Q06H Q12H Q25H	FX0 FX0S FX0N FX1 FX2 FX2C FX2N FX2NC	A273UH(-S3) A171SH A172SH
C (Sub Set Value 2)	Batch	×	×	×	×	○	×	×	×
	Random	×	×	×	×	×	×	×	×
C (Sub Set Value 3)	Batch	×	×	×	×	○	×	×	×
	Random	×	×	×	×	×	×	×	×
A	Batch	×	×	×	×	×	×	×	×
	Random	×	×	×	×	×	×	×	×
Z	Batch	×	×	×	×	×	×	○	×
	Random	×	×	×	×	×	×	○	×
V (Index Register)	Batch	×	×	×	×	×	×	○	×
	Random	×	×	×	×	×	×	○	×
R (File Register)	Batch	×	○	○	○	○	○	×	○
	Random	×	○	○	○	○	○	×	○
ER (Extended File Register)	Batch	○	○	○	○	○	○	×	○
	Random	○	○	○	○	○	○	×	○
B	Batch	○	○	○	○	○	○	×	○
	Random	○	○	○	○	○	○	×	○
W	Batch	○	○	○	○	○	○	×	○
	Random	○	○	○	○	○	○	×	○
QnA Link Special Relay (on QnA CPU)	Batch	×	×	×	×	×	○	×	×
	Random	×	×	×	×	×	○	×	×
Integrating Timer (Contact Point)	Batch	×	×	×	×	×	○	×	×
	Random	×	×	×	×	×	×	×	×
Integrating Timer (Coil)	Batch	×	×	×	×	×	○	×	×
	Random	×	×	×	×	×	×	×	×
QnA Link Special Register (on QnA CPU)	Batch	×	×	×	×	×	○	×	×
	Random	×	×	×	×	×	○	×	×
QnA Edge Relay (on QnA CPU)	Batch	×	×	×	×	×	○	×	×
	Random	×	×	×	×	×	○	×	×
Own station random access buffer	Batch	×	×	×	×	×	×	×	×
	Random	×	×	×	×	×	×	×	×
Integrating Timer (Current Value)	Batch	×	×	×	×	×	○	×	×
	Random	×	×	×	×	×	○	×	×
Own station link register (For sending)	Batch	×	×	×	×	×	×	×	×
	Random	×	×	×	×	×	×	×	×
Own station link register (For receiving)	Batch	×	×	×	×	×	×	×	×
	Random	×	×	×	×	×	×	×	×
S device of FXCPU	Batch	×	×	×	×	×	×	○	×
	Random	×	×	×	×	×	×	○	×
Own station buffer memory	Batch	×	×	×	×	×	×	×	×
	Random	×	×	×	×	×	×	×	×
QnA SEND function (with confirmation of arrival)	Batch	×	×	×	×	×	×	×	×
	Random	×	×	×	×	×	×	×	×
QnA SEND function (without confirmation of arrival)	Batch	×	×	×	×	×	×	×	×
	Random	×	×	×	×	×	×	×	×

11. ACCESSIBLE DEVICES AND ACCESSIBLE RANGE

MELSEC

Device		Destination							
		A1N	A0J2H A1S(-S1) A1SH A1SJH(-S8) A1SJ(-3) A2C(J) A2N(-S1) A2S(-S1) A2SH(-S1) A1FX	A2A(-S1) A2U(-S1) A2AS(-S1) A2AS-S30 Q02(H)-A Q06H-A	A3N A3A A3U	A4U	Q2A(-S1) Q3A Q4A Q4AR Q2AS(-S1) Q2ASH(-S1) Q02(H) Q06H Q12H Q25H	FX0 FX0S FX0N FX1 FX2 FX2C FX2N FX2NC	A273UH(-S3) A171SH A172SH
Direct Link Input	Batch	×	×	×	×	×	○ *2	×	×
	Random	×	×	×	×	×	○ *2	×	×
Direct Link Output	Batch	×	×	×	×	×	○ *2	×	×
	Random	×	×	×	×	×	○ *2	×	×
Direct Link Relay	Batch	×	×	×	×	×	○ *2	×	×
	Random	×	×	×	×	×	○ *2	×	×
Direct Link Register	Batch	×	×	×	×	×	○ *2	×	×
	Random	×	×	×	×	×	○ *2	×	×
Direct Link Special Relay (on Network Unit)	Batch	×	×	×	×	×	○ *2	×	×
	Random	×	×	×	×	×	○ *2	×	×
Direct Link Special Register (on Network Unit)	Batch	×	×	×	×	×	○ *2	×	×
	Random	×	×	×	×	×	○ *2	×	×
Special Direct Buffer Register	Batch	×	×	×	×	×	○	×	×
	Random	×	×	×	×	×	○	×	×
Other station buffer memory	Batch	×	×	×	×	×	×	×	×
	Random	×	×	×	×	×	×	×	×
Other station random access buffer	Batch	×	×	×	×	×	×	×	×
	Random	×	×	×	×	×	×	×	×
Other station RX	Batch	×	×	×	×	×	×	×	×
	Random	×	×	×	×	×	×	×	×
Other station RY	Batch	×	×	×	×	×	×	×	×
	Random	×	×	×	×	×	×	×	×
Other station link register	Batch	×	×	×	×	×	×	×	×
	Random	×	×	×	×	×	×	×	×
Other station SB	Batch	×	×	×	×	×	×	×	×
	Random	×	×	×	×	×	×	×	×
Other station SW	Batch	×	×	×	×	×	×	×	×
	Random	×	×	×	×	×	×	×	×

*2 Access is not allowed unless there's a network module available.

11.4.2 Accessible range

The accessible range for CPU COM communication is indicated below.

(1) Configuration

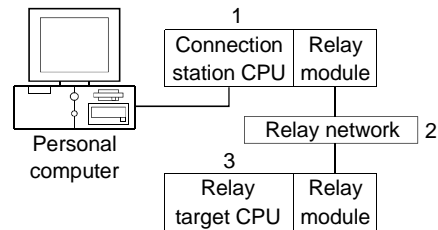

(2) Accessibility list

Please note that the range of the access is different according to setting Target screen of utility.

(When the check box is checked, Logical Station becomes Direct Station)

[Logical Station]

○: Accessible, ×: Inaccessible

1. Connection station CPU	2. Relay Network	3. Relay Target CPU					
		QCPU		QnACPU	ACPU	FXCPU	Motion controller CPU
		Q mode	A mode				
QCPU(Q mode) ○	MELSECNET/10H	○	×	×	×	×	×
	MELSECNET/10	○	○	○	○	×	○
	Ethernet	○*1	×	○*1	×	×	×
	Computer link	○	×	○	×	×	×
	CC-Link	○	○*2	○*2	○*2	×	○*2
QCPU(A mode) ○	MELSECNET/10H	×	×	×	×	×	×
	MELSECNET/10	×	○	×	○	×	○
	Ethernet	×	×	×	×	×	×
	Computer link	×	×	×	×	×	×
	CC-Link	×	×	×	×	×	×
QnACPU ○	MELSECNET/10H	×	×	×	×	×	×
	MELSECNET/10	×	×	○	×	×	×
	Ethernet	×	×	○*1	×	×	×
	Computer link	×	×	○	×	×	×
	CC-Link	×	×	○	×	×	×
ACPU ○	MELSECNET/10H	×	×	×	×	×	×
	MELSECNET/10	×	○	×	○	×	○
	Ethernet	×	×	×	×	×	×
	Computer link	×	×	×	×	×	×
	CC-Link	×	×	×	×	×	×
FXCPU ○	MELSECNET/10H	×	×	×	×	×	×
	MELSECNET/10	×	×	×	×	×	×
	Ethernet	×	×	×	×	×	×
	Computer link	×	×	×	×	×	×
	CC-Link	×	×	×	×	×	×
Motion controller CPU ○	MELSECNET/10H	×	×	×	×	×	×
	MELSECNET/10	×	○	×	○	×	○
	Ethernet	×	×	×	×	×	×
	Computer link	×	×	×	×	×	×
	CC-Link	×	×	×	×	×	×

*1 As the network number and station number, set the parameter-set values of the Q series-compatible E71 or QE71 on the relay module side. Also, set "Station No.↔ IP information (MNET/10 routing information)" in the Q series-compatible E71 or QE71 parameter setting. At this time, specify any of the IP address calculation system, table conversion system and combined system as the "Station No.↔ IP information system (MNET/10 routing system)".

*2 As the CC-Link system master/local module on the relay station CPU side, use the module of software version "S" or later.

[Direct Station]

○: Accessible, ×: Inaccessible

1. Connection station CPU	2. Relay Network	3. Relay Target CPU					
		QCPU		QnACPU	ACPU	FXCPU	Motion controller CPU
		Q mode	A mode				
QCPU(Q mode) ○	MELSECNET/10H	○	×	×	×	×	×
	MELSECNET/10	○	×	×	×	×	×
	Ethernet	×	×	×	×	×	×
	Computer link	×	×	×	×	×	×
	CC-Link	×	×	×	×	×	×
QCPU(A mode) ○	MELSECNET/10H	×	×	×	×	×	×
	MELSECNET/10	×	○	×	×	×	×
	Ethernet	×	×	×	×	×	×
	Computer link	×	×	×	×	×	×
	CC-Link	×	×	×	×	×	×
QnACPU ○	MELSECNET/10H	×	×	×	×	×	×
	MELSECNET/10	×	×	○	×	×	×
	Ethernet	×	×	×	×	×	×
	Computer link	×	×	×	×	×	×
	CC-Link	×	×	×	×	×	×
ACPU ○	MELSECNET/10H	×	×	×	×	×	×
	MELSECNET/10	×	○	×	○	×	○
	Ethernet	×	×	×	×	×	×
	Computer link	×	×	×	×	×	×
	CC-Link	×	×	×	×	×	×
FXCPU ○	MELSECNET/10H	×	×	×	×	×	×
	MELSECNET/10	×	×	×	×	×	×
	Ethernet	×	×	×	×	×	×
	Computer link	×	×	×	×	×	×
	CC-Link	×	×	×	×	×	×
Motion controller CPU ○	MELSECNET/10H	×	×	×	×	×	×
	MELSECNET/10	×	×	×	×	×	○
	Ethernet	×	×	×	×	×	×
	Computer link	×	×	×	×	×	×
	CC-Link	×	×	×	×	×	×

11.5 CPU USB Communication

This section explains the accessible devices and accessible range for CPU USB communication.

11.5.1 Accessible devices

The following table lists the accessible devices in CPU USB communication.

Device		Destination						
		A1N	A0J2H A1S(-S1) A1SH A1SJH(-S8) A1SJ(-3) A2C(J) A2N(-S1) A2S(-S1) A2SH(-S1) A1FX	A2A(-S1) A2U(-S1) A2AS(-S1) A2AS-S30 Q02(H)-A Q06H-A	A3N A3A A3U	A4U	Q2A(-S1) Q3A Q4A Q4AR Q2AS(-S1) Q2ASH(-S1) Q02(H) Q06H Q12H Q25H	A273UH(-S3) A171SH A172SH
X	Batch	○	○	○	○	○	○	○
	Random	○	○	○	○	○	○	○
Y	Batch	○	○	○	○	○	○	○
	Random	○	○	○	○	○	○	○
L	Batch	○	○	○	○	○	○	○
	Random	○	○	○	○	○	○	○
M	Batch	○	○	○	○	○	○	○
	Random	○	○	○	○	○	○	○
Special M(SM), SB	Batch	○	○	○	○	○	○	○
	Random	○	○	○	○	○	○	○
F	Batch	○	○	○	○	○	○	○
	Random	○	○	○	○	○	○	○
T(Contact Point)	Batch	○	○	○	○	○	○	○
	Random	○	○	○	○	○	×	○
T(Coil)	Batch	○	○	○	○	○	○	○
	Random	○	○	○	○	○	×	○
C (Contact Point)	Batch	○	○	○	○	○	○	○
	Random	○	○	○	○	○	×	○
C (Coil)	Batch	○	○	○	○	○	○	○
	Random	○	○	○	○	○	×	○
T (Current Value)	Batch	○	○	○	○	○	○	○
	Random	○	○	○	○	○	○	○
C (Current Value)	Batch	○	○	○	○	○	○	○
	Random	○	○	○	○	○	○	○
D	Batch	○	○	○	○	○	○	○
	Random	○	○	○	○	○	○	○
Special D(SD), SW	Batch	○	○	○	○	○	○	○
	Random	○	○	○	○	○	○	○
T (Main Set Value)	Batch	○	○	○	○	○	×	○
	Random	×	×	×	×	×	×	×
T (Sub Set Value 1)	Batch	○	○	○ * 1	○	○	×	○
	Random	○	○	×	×	×	×	×
T (Sub Set Value 2)	Batch	×	×	×	×	○	×	×
	Random	×	×	×	×	×	×	×
T (Sub Set Value 3)	Batch	×	×	×	×	○	×	×
	Random	×	×	×	×	×	×	×
C (Main Set Value)	Batch	○	○	○	○	○	×	○
	Random	×	×	×	×	×	×	×
C (Sub Set Value 1)	Batch	○	○	○ * 1	○	○	×	○
	Random	○	○	×	×	×	×	×

* 1 A2A(-S1)CPU is not allowed access.

Device		Destination						
		A1N	A0J2H A1S(-S1) A1SH A1SJH(-S8) A1SJ(-3) A2C(J) A2N(-S1) A2S(-S1) A2SH(-S1) A1FX	A2A(-S1) A2U(-S1) A2AS(-S1) A2AS-S30 Q02(H)-A Q06H-A	A3N A3A A3U	A4U	Q2A(-S1) Q3A Q4A Q4AR Q2AS(-S1) Q2ASH(-S1) Q02(H) Q06H Q12H Q25H	A273UH(-S3) A171SH A172SH
C (Sub Set Value 2)	Batch	×	×	×	×	○	×	×
	Random					×		
C (Sub Set Value 3)	Batch	×	×	×	×	○	×	×
	Random					×		
A	Batch	×	×	×	×	×	×	×
	Random							
Z	Batch	×	×	×	×	×	×	×
	Random							
V (Index Register)	Batch	×	×	×	×	×	×	×
	Random							
R (File Register)	Batch	×	○	○	○	○	○	○
	Random							
ER (Extended File Register)	Batch	○	○	○	○	○	○	○
	Random							
B	Batch	○	○	○	○	○	○	○
	Random							
W	Batch	○	○	○	○	○	○	○
	Random							
QnA Link Special Relay (on QnA CPU)	Batch	×	×	×	×	×	○	×
	Random							
Integrating Timer (Contact Point)	Batch	×	×	×	×	×	○	×
	Random						×	
Integrating Timer (Coil)	Batch	×	×	×	×	×	○	×
	Random						×	
QnA Link Special Register (on QnA CPU)	Batch	×	×	×	×	×	○	×
	Random							
QnA Edge Relay (on QnA CPU)	Batch	×	×	×	×	×	○	×
	Random							
Own station random access buffer	Batch	×	×	×	×	×	×	×
	Random							
Integrating Timer (Current Value)	Batch	×	×	×	×	×	○	×
	Random							
Own station link register (For sending)	Batch	×	×	×	×	×	×	×
	Random							
Own station link register (For receiving)	Batch	×	×	×	×	×	×	×
	Random							
S device of FXCPU	Batch	×	×	×	×	×	×	×
	Random							
Own station buffer memory	Batch	×	×	×	×	×	×	×
	Random							
QnA SEND function (with confirmation of arrival)	Batch	×	×	×	×	×	×	×
	Random							
QnA SEND function (without confirmation of arrival)	Batch	×	×	×	×	×	×	×
	Random							

Device		Destination						
		A1N	A0J2H A1S(-S1) A1SH A1SJH(-S8) A1SJ(-3) A2C(J) A2N(-S1) A2S(-S1) A2SH(-S1) A1FX	A2A(-S1) A2U(-S1) A2AS(-S1) A2AS-S30 Q02(H)-A Q06H-A	A3N A3A A3U	A4U	Q2A(-S1) Q3A Q4A Q4AR Q2AS(-S1) Q2ASH(-S1) Q02(H) Q06H Q12H Q25H	A273UH(-S3) A171SH A172SH
Direct Link Input	Batch	×	×	×	×	×	○ * 2	×
	Random							
Direct Link Output	Batch	×	×	×	×	×	○ * 2	×
	Random							
Direct Link Relay	Batch	×	×	×	×	×	○ * 2	×
	Random							
Direct Link Register	Batch	×	×	×	×	×	○ * 2	×
	Random							
Direct Link Special Relay (on Network Unit)	Batch	×	×	×	×	×	○ * 2	×
	Random							
Direct Link Special Register (on Network Unit)	Batch	×	×	×	×	×	○ * 2	×
	Random							
Special Direct Buffer Register	Batch	×	×	×	×	×	×	×
	Random							
Other station buffer memory	Batch	×	×	×	×	×	×	×
	Random							
Other station random access buffer	Batch	×	×	×	×	×	×	×
	Random							
Other station RX	Batch	×	×	×	×	×	×	×
	Random							
Other station RY	Batch	×	×	×	×	×	×	×
	Random							
Other station link register	Batch	×	×	×	×	×	×	×
	Random							
Other station SB	Batch	×	×	×	×	×	×	×
	Random							
Other station SW	Batch	×	×	×	×	×	×	×
	Random							

*2 Access is not allowed unless there's a network module available.

11.5.2 Accessible range

The accessible range for CPU USB communication is indicated below.

(1) Configuration

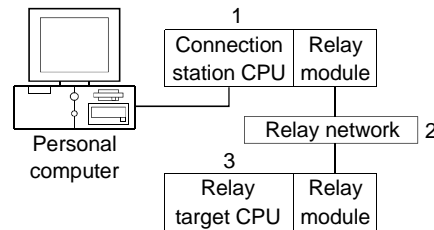

(2) Accessibility list

Please note that the range of the access is different according to setting Target screen of utility.

(When the check box is checked, Logical Station becomes Direct Station.)

[Logical Station]

○: Accessible, ×: Inaccessible

1. Connection station CPU	2. Relay Network	3. Relay Target CPU					
		QCPU		QnACPU	ACPU	FXCPU	Motion controller CPU
		Q mode	A mode				
QCPU(Q mode) ○	MELSECNET/10H	○	×	×	×	×	×
	MELSECNET/10	○	○	○	○	×	○
	Ethernet	○*1	×	○*1	×	×	×
	Computer link	○	×	○	×	×	×
	CC-Link	○	○*2	○*2	○*2	×	○*2

*1 As the network number and station number, set the parameter-set values of the Q series-compatible E71 or QE71 on the relay module side. Also, set "Station No.↔ IP information (MNET/10 routing information)" in the Q series-compatible E71 or QE71 parameter setting. At this time, specify any of the IP address calculation system, table conversion system and combined system as the "Station No.↔ IP information system (MNET/10 routing system)".

*2 As the CC-Link system master/local module on the relay station CPU side, use the module of software version "S" or later.

[Direct Station]

○: Accessible, ×: Inaccessible

1. Connection station CPU	2. Relay Network	3. Relay Target CPU					
		QCPU		QnACPU	ACPU	FXCPU	Motion controller CPU
		Q mode	A mode				
QCPU(Q mode) ○	MELSECNET/10H	○	×	×	×	×	×
	MELSECNET/10	○	×	×	×	×	×
	Ethernet	×	×	×	×	×	×
	Computer link	×	×	×	×	×	×
	CC-Link	×	×	×	×	×	×

11.6 CC-Link G4 Communication

This section explains the accessible devices and accessible range for CC-Link G4 communication.

11.6.1 Accessible devices

The following devices are accessible for CC-Link G4 communication.

Device		Destination							
		A1N	A0J2H A1S(-S1) A1SH A1SJH(-S8) A1SJ(-3) A2C(J) A2N(-S1) A2S(-S1) A2SH(-S1) A1FX	A2A(-S1) A2U(-S1) A2AS(-S1) A2AS-S30 Q02(H)-A Q06H-A	A3N A3A A3U	A4U	Q2A(-S1) Q3A Q4A Q4AR Q2AS(-S1) Q2ASH(-S1) Q02(H) Q06H Q12H Q25H	FX0 FX0S FX0N FX1 FX2 FX2C FX2N FX2NC	A273UH(-S3) A171SH A172SH
X	Batch	○	○	○	○	○	○ * 1	×	×
	Random	○	○	○	○	○	○ * 1	×	×
Y	Batch	○	○	○	○	○	○ * 1	×	×
	Random	○	○	○	○	○	○ * 1	×	×
L	Batch	○	○	○	○	○	○ * 1	×	×
	Random	○	○	○	○	○	○ * 1	×	×
M	Batch	○	○	○	○	○	○ * 1	×	×
	Random	○	○	○	○	○	○ * 1	×	×
Special M(SM), SB	Batch	○	○	○	○	○	○ * 1	×	×
	Random	○	○	○	○	○	○ * 1	×	×
F	Batch	○	○	○	○	○	○ * 1	×	×
	Random	○	○	○	○	○	○ * 1	×	×
T(Contact Point)	Batch	○	○	○	○	○	○ * 1	×	×
	Random	○	○	○	○	○	×	×	×
T(Coil)	Batch	○	○	○	○	○	○ * 1	×	×
	Random	○	○	○	○	○	×	×	×
C (Contact Point)	Batch	○	○	○	○	○	○ * 1	×	×
	Random	○	○	○	○	○	×	×	×
C (Coil)	Batch	○	○	○	○	○	○ * 1	×	×
	Random	○	○	○	○	○	×	×	×
T (Current Value)	Batch	○	○	○	○	○	○ * 1	×	×
	Random	○	○	○	○	○	○ * 1	×	×
C (Current Value)	Batch	○	○	○	○	○	○ * 1	×	×
	Random	○	○	○	○	○	○ * 1	×	×
D	Batch	○	○	○	○	○	○ * 1	×	×
	Random	○	○	○	○	○	○ * 1	×	×
Special D(SD), SW	Batch	○	○	○	○	○	○ * 1	×	×
	Random	○	○	○	○	○	○ * 1	×	×
T (Main Set Value)	Batch	×	×	×	×	×	×	×	×
	Random	×	×	×	×	×	×	×	×
T (Sub Set Value 1)	Batch	×	×	×	×	×	×	×	×
	Random	×	×	×	×	×	×	×	×
T (Sub Set Value 2)	Batch	×	×	×	×	×	×	×	×
	Random	×	×	×	×	×	×	×	×
T (Sub Set Value 3)	Batch	×	×	×	×	×	×	×	×
	Random	×	×	×	×	×	×	×	×
C (Main Set Value)	Batch	×	×	×	×	×	×	×	×
	Random	×	×	×	×	×	×	×	×
C (Sub Set Value 1)	Batch	×	×	×	×	×	×	×	×
	Random	×	×	×	×	×	×	×	×

* 1 Access is not allowed for Q (Q mode).

11. ACCESSIBLE DEVICES AND ACCESSIBLE RANGE

MELSEC

Device		Destination							
		A1N	A0J2H A1S(-S1) A1SH A1SJH(-S8) A1SJ(-3) A2C(J) A2N(-S1) A2S(-S1) A2SH(-S1) A1FX	A2A(-S1) A2U(-S1) A2AS(-S1) A2AS-S30 Q02(H)-A Q06H-A	A3N A3A A3U	A4U	Q2A(-S1) Q3A Q4A Q4AR Q2AS(-S1) Q2ASH(-S1) Q02(H) Q06H Q12H Q25H	FX0 FX0S FX0N FX1 FX2 FX2C FX2N FX2NC	A273UH(-S3) A171SH A172SH
C (Sub Set Value 2)	Batch	×	×	×	×	×	×	×	×
	Random	×	×	×	×	×	×	×	×
C (Sub Set Value 3)	Batch	×	×	×	×	×	×	×	×
	Random	×	×	×	×	×	×	×	×
A	Batch	×	×	×	×	×	×	×	×
	Random	×	×	×	×	×	×	×	×
Z	Batch	×	×	×	×	×	×	×	×
	Random	×	×	×	×	×	×	×	×
V (Index Register)	Batch	×	×	×	×	×	×	×	×
	Random	×	×	×	×	×	×	×	×
R (File Register)	Batch	×	○	○	○	○	○ * 1	×	×
	Random	×	○	○	○	○	○ * 1	×	×
ER (Extended File Register)	Batch	○	○	○	○	○	○ * 1	×	×
	Random	○	○	○	○	○	○ * 1	×	×
B	Batch	○	○	○	○	○	○ * 1	×	×
	Random	○	○	○	○	○	○ * 1	×	×
W	Batch	○	○	○	○	○	○ * 1	×	×
	Random	○	○	○	○	○	○ * 1	×	×
QnA Link Special Relay (on QnA CPU)	Batch	×	×	×	×	×	○ * 1	×	×
	Random	×	×	×	×	×	○ * 1	×	×
Integrating Timer (Contact Point)	Batch	×	×	×	×	×	○ * 1	×	×
	Random	×	×	×	×	×	×	×	×
Integrating Timer (Coil)	Batch	×	×	×	×	×	○ * 1	×	×
	Random	×	×	×	×	×	×	×	×
QnA Link Special Register (on QnA CPU)	Batch	×	×	×	×	×	○ * 1	×	×
	Random	×	×	×	×	×	○ * 1	×	×
QnA Edge Relay (on QnA CPU)	Batch	×	×	×	×	×	○ * 1	×	×
	Random	×	×	×	×	×	○ * 1	×	×
Own station random access buffer	Batch	×	×	×	×	×	×	×	×
	Random	×	×	×	×	×	×	×	×
Integrating Timer (Current Value)	Batch	×	×	×	×	×	○ * 1	×	×
	Random	×	×	×	×	×	○ * 1	×	×
Own station link register (For sending)	Batch	×	×	×	×	×	×	×	×
	Random	×	×	×	×	×	×	×	×
Own station link register (For receiving)	Batch	×	×	×	×	×	×	×	×
	Random	×	×	×	×	×	×	×	×
S device of FXCPU	Batch	×	×	×	×	×	×	×	×
	Random	×	×	×	×	×	×	×	×
Own station buffer memory	Batch	×	×	×	×	×	×	×	×
	Random	×	×	×	×	×	×	×	×
QnA SEND function (with confirmation of arrival)	Batch	×	×	×	×	×	×	×	×
	Random	×	×	×	×	×	×	×	×
QnA SEND function (without confirmation of arrival)	Batch	×	×	×	×	×	×	×	×
	Random	×	×	×	×	×	×	×	×

* 1 Access is not allowed for Q (Q mode).

11. ACCESSIBLE DEVICES AND ACCESSIBLE RANGE

MELSEC

Device		Destination							
		A1N	A0J2H A1S(-S1) A1SH A1SJH(-S8) A1SJ(-3) A2C(J) A2N(-S1) A2S(-S1) A2SH(-S1) A1FX	A2A(-S1) A2U(-S1) A2AS(-S1) A2AS-S30 Q02(H)-A Q06H-A	A3N A3A A3U	A4U	Q2A(-S1) Q3A Q4A Q4AR Q2AS(-S1) Q2ASH(-S1) Q02(H) Q06H Q12H Q25H	FX0 FX0S FX0N FX1 FX2 FX2C FX2N FX2NC	A273UH(-S3) A171SH A172SH
Direct Link Input	Batch	×	×	×	×	×	×	×	×
	Random	×	×	×	×	×	×	×	×
Direct Link Output	Batch	×	×	×	×	×	×	×	×
	Random	×	×	×	×	×	×	×	×
Direct Link Relay	Batch	×	×	×	×	×	×	×	×
	Random	×	×	×	×	×	×	×	×
Direct Link Register	Batch	×	×	×	×	×	×	×	×
	Random	×	×	×	×	×	×	×	×
Direct Link Special Relay (on Network Unit)	Batch	×	×	×	×	×	×	×	×
	Random	×	×	×	×	×	×	×	×
Direct Link Special Register (on Network Unit)	Batch	×	×	×	×	×	×	×	×
	Random	×	×	×	×	×	×	×	×
Special Direct Buffer Register	Batch	×	×	×	×	×	×	×	×
	Random	×	×	×	×	×	×	×	×
Other station buffer memory	Batch	×	×	×	×	×	×	×	×
	Random	×	×	×	×	×	×	×	×
Other station random access buffer	Batch	×	×	×	×	×	×	×	×
	Random	×	×	×	×	×	×	×	×
Other station RX	Batch	×	×	×	×	×	×	×	×
	Random	×	×	×	×	×	×	×	×
Other station RY	Batch	×	×	×	×	×	×	×	×
	Random	×	×	×	×	×	×	×	×
Other station link register	Batch	×	×	×	×	×	×	×	×
	Random	×	×	×	×	×	×	×	×
Other station SB	Batch	×	×	×	×	×	×	×	×
	Random	×	×	×	×	×	×	×	×
Other station SW	Batch	×	×	×	×	×	×	×	×
	Random	×	×	×	×	×	×	×	×

11.6.2 Accessible range

The accessible range for CC-Link G4 communication is indicated below.

(1) Configuration

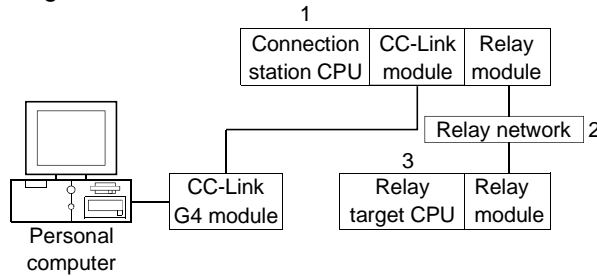

(2) Accessibility list

(a) When CC-Link G4 module is in QnA mode

○: Accessible, ×: Inaccessible

1. Connection station CPU	2. Relay Network	3. Relay Target CPU					
		QCPU		QnACPU	ACPU	FXCPU	Motion controller CPU
		Q mode	A mode				
QnACPU ○	MELSECNET/10H	×	×	×	×	×	×
	MELSECNET/10	×	×	○	×	×	×
	Ethernet	×	×	○	×	×	×
	Computer link	×	×	○	×	×	×
	CC-Link	×	×	×	×	×	×

(b) When CC-Link G4 module is in A mode

○: Accessible, ×: Inaccessible

1. Connection station CPU	2. Relay Network	3. Relay Target CPU					
		QCPU		QnACPU	ACPU	FXCPU	Motion controller CPU
		Q mode	A mode				
QCPU (A mode), ACPUs, Motion controller CPU ○	MELSECNET/10H	×	×	×	×	×	×
	MELSECNET/10	×	×	×	×	×	×
	Ethernet	×	×	×	×	×	×
	Computer link	×	×	×	×	×	×
	CC-Link	×	×	×	×	×	×

Microsoft, Windows, Microsoft Windows NT, Visual Basic and Visual C++ are registered trademarks of Microsoft Corporation in the United States and other countries.

Pentium is a trademark or registered trademark of the Intel Corporation in the United States and other countries.

Ethernet is a registered trademark of Xerox Co., Ltd.

Other company names and product names in this document are trademarks or registered trademarks of the respective owners.

Type SW3D5F-CSKP-E Basic Communication Support Tool Operating Manual

MODEL	SW3D5F-CSKP-E-O-E
MODEL CODE	1LMS50
IB(NA)-0800014-H(0404)MEE	

 **MITSUBISHI ELECTRIC CORPORATION**

HEAD OFFICE : 1-8-12, OFFICE TOWER Z 14F HARUMI CHUO-KU 104-6212, JAPAN
NAGOYA WORKS : 1-14, YADA-MINAMI 5-CHOME, HIGASHI-KU, NAGOYA, JAPAN

When exported from Japan, this manual does not require application to the
Ministry of Economy, Trade and Industry for service transaction permission.

Specifications subject to change without notice.