

GRAPHIC OPERATION TERMINAL

GOT1000 Series

Connection Manual

(Mitsubishi Electric Products)

for GT Works3

- BUS CONNECTION
 - DIRECT CONNECTION TO CPU
 - COMPUTER LINK CONNECTION
 - ETHERNET CONNECTION
 - MELSECNET/H CONNECTION
 - MELSECNET/10 CONNECTION
 - CC-Link IE CONNECTION
 - CC-Link CONNECTION
 - INVERTER CONNECTION
 - SERVO AMPLIFIER CONNECTION
 - ROBOT CONTROLLER CONNECTION
 - CNC CONNECTION
 - ENERGY MEASURING UNIT/ELECTRIC MULTI-MEASURING INSTRUMENT CONNECTION
 - GOT MULTI-DROP CONNECTION
 - MULTIPLE-GT14, GT12, GT11, GT10 CONNECTION FUNCTION
 - MULTI-CHANNEL FUNCTION
 - FA TRANSPARENT FUNCTION
- 

● SAFETY PRECAUTIONS ●

(Always read these precautions before using this equipment.)

Before using this product, please read this manual and the relevant manuals introduced in this manual carefully and pay full attention to safety to handle the product correctly.

The precautions given in this manual are concerned with this product.

In this manual, the safety precautions are ranked as "WARNING" and "CAUTION".



Indicates that incorrect handling may cause hazardous conditions, resulting in death or severe injury.



Indicates that incorrect handling may cause hazardous conditions, resulting in medium or slight personal injury or physical damage.

Note that the  caution level may lead to a serious accident according to the circumstances. Always follow the instructions of both levels because they are important to personal safety.

Please save this manual to make it accessible when required and always forward it to the end user.

[DESIGN PRECAUTIONS]

WARNING

- Some failures of the GOT, communication unit or cable may keep the outputs on or off.
Some failures of a touch panel may cause malfunction of the input objects such as a touch switch.
An external monitoring circuit should be provided to check for output signals which may lead to a serious accident.
Not doing so can cause an accident due to false output or malfunction.
- If a communication fault (including cable disconnection) occurs during monitoring on the GOT, communication between the GOT and PLC CPU is suspended and the GOT becomes inoperative.
For bus connection : The CPU becomes faulty and the GOT becomes inoperative.
For other than bus connection : The GOT becomes inoperative.
A system where the GOT is used should be configured to perform any significant operation to the system by using the switches of a device other than the GOT on the assumption that a GOT communication fault will occur.
Not doing so can cause an accident due to false output or malfunction.
- Do not use the GOT as the warning device that may cause a serious accident.
An independent and redundant hardware or mechanical interlock is required to configure the device that displays and outputs serious warning.
Failure to observe this instruction may result in an accident due to incorrect output or malfunction.

[DESIGN PRECAUTIONS]

WARNING

- Incorrect operation of the touch switch(s) may lead to a serious accident if the GOT backlight is gone out.
When the GOT backlight goes out, the display section dims, while the input of the touch switch(s) remains active.
This may confuse an operator in thinking that the GOT is in "screensaver" mode, who then tries to release the GOT from this mode by touching the display section, which may cause a touch switch to operate.
Note that the following occurs on the GOT when the backlight goes out.
<When using the GT1655-V, Handy GOT, GT15, GT14, GT12, GT11, or GT105□>
The POWER LED blinks (green/orange) and the monitor screen appears blank.
<When using the GT1695, GT1685, GT1675, GT1672, GT1665, or GT1662>
The POWER LED blinks (green/orange) and the monitor screen appears dimmed.
<When using the GT104□>
The monitor screen appears blank.
<When using the GT103□ or GT102□>
The monitor screen appears dimmed.
- The display section of the GT16, GT1595-X, GT14, GT12 or GT1020 are an analog-resistive type touch panel.
If you touch the display section simultaneously in 2 points or more, the switch that is located around the center of the touched point, if any, may operate.
Do not touch the display section in 2 points or more simultaneously.
Doing so may cause an accident due to incorrect output or malfunction.
- When programs or parameters of the controller (such as a PLC) that is monitored by the GOT are changed, be sure to reset the GOT or shut off the power of the GOT at the same time.
Not doing so can cause an accident due to false output or malfunction.
- To maintain the security (confidentiality, integrity, and availability) of the GOT and the system against unauthorized access, DoS*¹ attacks, computer viruses, and other cyberattacks from unreliable networks and devices via network, take appropriate measures such as firewalls, virtual private networks (VPNs), and antivirus solutions.
Mitsubishi Electric shall have no responsibility or liability for any problems involving GOT trouble and system trouble by unauthorized access, DoS attacks, computer viruses, and other cyberattacks.
*¹ DoS: A denial-of-service (DoS) attack disrupts services by overloading systems or exploiting vulnerabilities, resulting in a denial-of-service (DoS) state.

CAUTION

- Do not bundle the control and communication cables with main-circuit, power or other wiring.
Run the above cables separately from such wiring and keep them a minimum of 100mm apart.
Not doing so noise can cause a malfunction.
- Do not press the GOT display section with a pointed material as a pen or driver.
Doing so can result in a damage or failure of the display section.

[DESIGN PRECAUTIONS]

CAUTION

- When the GOT is connected to the Ethernet network, the available IP address is restricted according to the system configuration.
 - When multiple GOTs are connected to the Ethernet network:
Do not set the IP address (192.168.0.18) for the GOTs and the controllers in the network.
 - When a single GOT is connected to the Ethernet network:
Do not set the IP address (192.168.0.18) for the controllers except the GOT in the network.
Doing so can cause the IP address duplication. The duplication can negatively affect the communication of the device with the IP address (192.168.0.18).
The operation at the IP address duplication depends on the devices and the system.
- Turn on the controllers and the network devices to be ready for communication before they communicate with the GOT.
Failure to do so can cause a communication error on the GOT.

[MOUNTING PRECAUTIONS]

WARNING

- Be sure to shut off all phases of the external power supply used by the system before mounting or removing the GOT to/from the panel.
Not switching the power off in all phases can cause a unit failure or malfunction.
- Be sure to shut off all phases of the external power supply used by the system before mounting or removing the communication unit, option function board or multi-color display board onto/from the GOT.
Not doing so can cause the unit to fail or malfunction.
- Before mounting an optional function board or Multi-color display board, wear a static discharge wrist strap to prevent the board from being damaged by static electricity.

CAUTION

- Use the GOT in the environment that satisfies the general specifications described in the User's Manual.
Not doing so can cause an electric shock, fire, malfunction or product damage or deterioration.
- When mounting the GOT to the control panel, tighten the mounting screws in the specified torque range.
Undertightening can cause the GOT to drop, short circuit or malfunction.
Overtightening can cause a drop, short circuit or malfunction due to the damage of the screws or the GOT.
- When loading the communication unit or option unit to the GOT (GT16, GT15), fit it to the extension interface of the GOT and tighten the mounting screws in the specified torque range.
Undertightening can cause the GOT to drop, short circuit or malfunction.
Overtightening can cause a drop, failure or malfunction due to the damage of the screws or unit.

[MOUNTING PRECAUTIONS]

CAUTION

- When mounting the multi-color display board onto the GOT (GT15), connect it to the corresponding connector securely and tighten the mounting screws within the specified torque range. Loose tightening may cause the unit and/or GOT to malfunction due to poor contact. Overtightening may damage the screws, unit and/or GOT; they might malfunction.
- When mounting the option function board onto the GOT (GT16), connect it to the corresponding connector securely and tighten the mounting screws within the specified torque range.
- When mounting an optional function board onto the GOT(GT15), fully connect it to the connector until you hear a click.
- When mounting an optional function board onto the GOT(GT11), fully connect it to the connector.
- When inserting a CF card into the GOT(GT16, GT15, GT11), push it into the CF card interface of GOT until the CF card eject button will pop out. Failure to do so may cause a malfunction due to poor contact.
- When inserting/removing a SD card into/from the GOT(GT14), turn the SD card access switch off in advance. Failure to do so may corrupt data within the SD card.
- When inserting/removing a CF card into/from the GOT(GT16, GT15, GT11), turn the CF card access switch off in advance. Failure to do so may corrupt data within the CF card.
- When removing a SD card from the GOT(GT14), make sure to support the SD card by hand, as it may pop out. Failure to do so may cause the SD card to drop from the GOT and break.
- When removing a CF card from the GOT, make sure to support the CF card by hand, as it may pop out. Failure to do so may cause the CF card to drop from the GOT and break.
- When installing a USB memory to the GOT(GT16, GT14), make sure to install the USB memory to the USB interface firmly. Failure to do so may cause a malfunction due to poor contact.
- Before removing the USB memory from the GOT(GT16, GT14), operate the utility screen for removal. After the successful completion dialog box is displayed, remove the memory by hand carefully. Failure to do so may cause the USB memory to drop, resulting in a damage or failure of the memory.
- For closing the USB environmental protection cover, fix the cover by pushing the Δ mark on the latch firmly to comply with the protective structure.
- Remove the protective film of the GOT. When the user continues using the GOT with the protective film, the film may not be removed.
- Operate and store the GOT in environments without direct sunlight, high temperature, dust, humidity, and vibrations.
- When using the GOT in the environment of oil or chemicals, use the protective cover for oil. Failure to do so may cause failure or malfunction due to the oil or chemical entering into the GOT.

[WIRING PRECAUTIONS]

WARNING

- Be sure to shut off all phases of the external power supply used by the system before wiring. Failure to do so may result in an electric shock, product damage or malfunctions.

CAUTION

- Please make sure to ground FG terminal and LG terminal and protective ground terminal of the GOT power supply section by applying Class D Grounding (Class 3 Grounding Method) or higher which is used exclusively for the GOT.
Not doing so may cause an electric shock or malfunction.
- Be sure to tighten any unused terminal screws with a torque of 0.5 to 0.8N•m.
Failure to do so may cause a short circuit due to contact with a solderless terminal.
- Use applicable solderless terminals and tighten them with the specified torque.
If any solderless spade terminal is used, it may be disconnected when the terminal screw comes loose, resulting in failure.
- Correctly wire the GOT power supply section after confirming the rated voltage and terminal arrangement of the product.
Not doing so can cause a fire or failure.
- Tighten the terminal screws of the GOT power supply section in the specified torque range.
Undertightening can cause a short circuit or malfunction.
Overtightening can cause a short circuit or malfunction due to the damage of the screws or the GOT.
- Exercise care to avoid foreign matter such as chips and wire offcuts entering the GOT.
Not doing so can cause a fire, failure or malfunction.
- The module has an ingress prevention label on its top to prevent foreign matter, such as wire offcuts, from entering the module during wiring.
Do not peel this label during wiring.
Before starting system operation, be sure to peel this label because of heat dissipation.
- Plug the bus connection cable by inserting it into the connector of the connected unit until it "clicks".
After plugging, check that it has been inserted snugly.
Not doing so can cause a malfunction due to a contact fault.
- Plug the communication cable into the connector of the connected unit and tighten the mounting and terminal screws in the specified torque range.
Undertightening can cause a short circuit or malfunction.
Overtightening can cause a short circuit or malfunction due to the damage of the screws or unit.
- Plug the QnA/ACPU/Motion controller (A series) bus connection cable by inserting it into the connector of the connected unit until it "clicks".
After plugging, check that it has been inserted snugly.
Not doing so can cause a malfunction due to a contact fault.

[TEST OPERATION PRECAUTIONS]

WARNING

- Before performing the test operations of the user creation monitor screen (such as turning ON or OFF bit device, changing the word device current value, changing the settings or current values of the timer or counter, and changing the buffer memory current value), read through the manual carefully and make yourself familiar with the operation method.
During test operation, never change the data of the devices which are used to perform significant operation for the system.
False output or malfunction can cause an accident.

[PRECAUTIONS FOR REMOTE CONTROL]

WARNING

- Remote control is available through a network by using GOT functions, including the SoftGOT-GOT link function, the remote personal computer operation function, and the VNC server function.
If these functions are used to perform remote control of control equipment, the field operator may not notice the remote control, possibly leading to an accident.
In addition, a communication delay or interruption may occur depending on the network environment, and remote control of control equipment cannot be performed normally in some cases.
Before using the above functions to perform remote control, fully grasp the circumstances of the field site and ensure safety.

[STARTUP/MAINTENANCE PRECAUTIONS]

WARNING

- When power is on, do not touch the terminals.
Doing so can cause an electric shock or malfunction.
- Correctly connect the battery connector.
Do not charge, disassemble, heat, short-circuit, solder, or throw the battery into the fire.
Doing so will cause the battery to produce heat, explode, or ignite, resulting in injury and fire.
- Before starting cleaning or terminal screw retightening, always switch off the power externally in all phases.
Not switching the power off in all phases can cause a unit failure or malfunction.
Undertightening can cause a short circuit or malfunction.
Overtightening can cause a short circuit or malfunction due to the damage of the screws or unit.

CAUTION

- Do not disassemble or modify the unit.
Doing so can cause a failure, malfunction, injury or fire.
- Do not touch the conductive and electronic parts of the unit directly.
Doing so can cause a unit malfunction or failure.

[STARTUP/MAINTENANCE PRECAUTIONS]

CAUTION

- The cables connected to the unit must be run in ducts or clamped.
Not doing so can cause the unit or cable to be damaged due to the dangling, motion or accidental pulling of the cables or can cause a malfunction due to a cable connection fault.
- When unplugging the cable connected to the unit, do not hold and pull the cable portion.
Doing so can cause the unit or cable to be damaged or can cause a malfunction due to a cable connection fault.
- Do not drop or apply strong impact to the unit.
Doing so may damage the unit.
- Do not drop or give an impact to the battery mounted to the unit.
Doing so may damage the battery, causing the battery fluid to leak inside the battery.
If the battery is dropped or given an impact, dispose of it without using.
- Before touching the unit, always touch grounded metal, etc. to discharge static electricity from human body, etc.
Not doing so can cause the unit to fail or malfunction.
- Replace battery with GT15-BAT(GT16, GT15) or GT11-50BAT(GT14, GT12, GT11, GT10) by Mitsubishi electric Co. only.
Use of another battery may present a risk of fire or explosion.
- Dispose of used battery promptly.
Keep away from children. Do not disassemble and do not dispose of in fire.

[TOUCH PANEL PRECAUTIONS]

CAUTION

- For the analog-resistive film type touch panels, normally the adjustment is not required. However, the difference between a touched position and the object position may occur as the period of use elapses. When any difference between a touched position and the object position occurs, execute the touch panel calibration.
- When any difference between a touched position and the object position occurs, other object may be activated. This may cause an unexpected operation due to incorrect output or malfunction.

[BACKLIGHT REPLACEMENT PRECAUTIONS]

WARNING

- Be sure to shut off all phases of the external power supply of the GOT (and the PLC CPU in the case of a bus topology) and remove the GOT from the control panel before replacing the backlight (when using the GOT with the backlight replaceable by the user).
Not doing so can cause an electric shock.
Replacing a backlight without removing the GOT from the control panel can cause the backlight or control panel to drop, resulting in an injury.

CAUTION

- Wear gloves for the backlight replacement when using the GOT with the backlight replaceable by the user.
Not doing so can cause an injury.
- Before replacing a backlight, allow 5 minutes or more after turning off the GOT when using the GOT with the backlight replaceable by the user.
Not doing so can cause a burn from heat of the backlight.

[DISPOSAL PRECAUTIONS]

CAUTION

- When disposing of the product, handle it as industrial waste.
- When disposing of this product, treat it as industrial waste. When disposing of batteries, separate them from other wastes according to the local regulations.
(For details of the battery directive in EU member states, refer to the User's Manual of the GOT to be used.)

[TRANSPORTATION PRECAUTIONS]

CAUTION

- When transporting lithium batteries, make sure to treat them based on the transport regulations.
(For details on models subject to restrictions, refer to the User's Manual for the GOT you are using.)
- Make sure to transport the GOT main unit and/or relevant unit(s) in the manner they will not be exposed to the impact exceeding the impact resistance described in the general specifications of the User's Manual, as they are precision devices.
Failure to do so may cause the unit to fail.
Check if the unit operates correctly after transportation.

INTRODUCTION

Thank you for choosing Mitsubishi Electric Graphic Operation Terminal (Mitsubishi Electric GOT).
Read this manual and make sure you understand the functions and performance of the GOT thoroughly
in advance to ensure correct use.

CONTENTS

SAFETY PRECAUTIONS	A - 1
INTRODUCTION	A - 9
CONTENTS	A - 9
MANUALS.....	A - 21
QUICK REFERENCE	A - 23
ABBREVIATIONS AND GENERIC TERMS	A - 25
HOW TO READ THIS MANUAL	A - 30

1. PREPARATORY PROCEDURES FOR MONITORING

1.1	Setting the Communication Interface.....	1 - 3
1.1.1	Setting connected equipment (Channel setting).....	1 - 4
1.1.2	I/F communication setting.....	1 - 13
1.1.3	Precautions.....	1 - 15
1.2	Writing the Project Data and OS onto the GOT.....	1 - 16
1.2.1	Writing the project data and OS onto the GOT.....	1 - 16
1.2.2	Checking the project data and OS writing on GOT	1 - 17
1.3	Option Devices for the Respective Connection	1 - 18
1.3.1	Communication module	1 - 18
1.3.2	Option unit	1 - 19
1.3.3	Conversion cables	1 - 19
1.3.4	Connector conversion adapter	1 - 19
1.3.5	Serial Multi-Drop Connection Unit	1 - 19
1.3.6	RS-232/485 signal conversion adapter	1 - 19
1.3.7	Installing a unit on another unit (Checking the unit installation position)	1 - 20
1.4	Connection Cables for the Respective Connection	1 - 27
1.4.1	GOT connector specifications	1 - 27
1.4.2	Coaxial cable connector connection method	1 - 30
1.4.3	Terminating resistors of GOT	1 - 31
1.4.4	Setting the RS-232/485 signal conversion adaptor	1 - 34
1.5	Verifying GOT Recognizes Connected Equipment.....	1 - 35
1.6	Checking for Normal Monitoring	1 - 40
1.6.1	Check on the GOT	1 - 40
1.6.2	Confirming the communication state on the GOT side (For Ethernet connection)	1 - 46
1.6.3	Confirming the communication state to each station (Station monitoring function).....	1 - 48
1.6.4	Check on GX Developer	1 - 51
1.6.5	Check on GX Works2	1 - 55
1.6.6	Check on the PLC	1 - 56

MITSUBISHI ELECTRIC PLC CONNECTIONS

2.DEVICE RANGE THAT CAN BE SET

2.1	MELSEC iQ-R, RnMT	2 - 8
2.2	MELSEC iQ-F	2 - 9
2.3	MELSEC-QnU/DC, Q17nD/M/NC/DR, CRnD-700.....	2 - 10
2.4	MELSEC-L	2 - 11
2.5	MELSEC-QnA/Q/QS, MELDAS C6 *	2 - 12
2.6	MELSEC-Q (Multi)/Q Motion	2 - 13
2.7	MELSEC-A	2 - 14
2.8	MELSEC-FX	2 - 15
2.9	MELSEC-WS	2 - 16

3.ACCESS RANGE FOR MONITORING

3.1	Access Range for Monitoring Stations on Network Systems.....	3 - 2
3.1.1	MELSECNET/H, MELSECNET/10, CC-Link IE Controller Network, CC-Link IE Field Network	3 - 2
3.2	Access Range for Monitoring when Using Ethernet Connection	3 - 13
3.3	CC-Link System Access Range for Monitoring.....	3 - 14
3.4	Data Link System (MELSECNET/B, (II)) Access Range for Monitoring	3 - 17
3.5	Access Range for Monitoring when Connecting FXCPU.....	3 - 18
3.6	Connection to Remote I/O Station in MELSECNET/H Network System.....	3 - 19
3.7	Connection to the Head Module of CC-Link IE Field Network System	3 - 22

4.HOW TO MONITOR REDUNTANT SYSTEM

4.1	Connection to Remote I/O Station in MELSECNET/H Network System.....	4 - 8
4.1.1	Direct CPU connection (Direct CPU connection to the remote I/O station).....	4 - 8
4.1.2	Computer link connection (Connection to serial communication module mounted on remote I/O station)	4 - 9
4.1.3	Ethernet connection (Connection to Ethernet module mounted on remote I/O station)	4 - 10
4.2	Direct CPU Connection.....	4 - 11
4.2.1	When using one GOT	4 - 11
4.2.2	When using two GOTs.....	4 - 12
4.2.3	Precautions when connecting a GOT directly to a PLC CPU in the redundant system without making Q redundant setting	4 - 13
4.3	CC-Link Connection (Intelligent Device Station).....	4 - 18
4.4	CC-Link Connection (Via G4)	4 - 20
4.5	MELSECNET/H and MELSECNET/10 Connections (Network Systems).....	4 - 22
4.6	CC-Link IE Controller Network Connection (Network System).....	4 - 23
4.7	Ethernet Connection	4 - 24
4.8	Connection to the Redundant Type Extension Base Unit.....	4 - 25
4.8.1	Computer link connection (Connection to the Serial communication module mounted on the redundant type extension base unit).....	4 - 25
4.8.2	Ethernet connection (Connection to the Ethernet module mounted on redundant type extension base unit).....	4 - 26

4.8.3	CC-Link connection (intelligent device station) (Connection to the CC-Link module mounted on redundant type extension base unit).....	4 - 27
4.8.4	CC-Link connection (Via G4) (Connection to the CC-Link module mounted on redundant type extension base unit).....	4 - 28
4.9	Q Redundant Setting	4 - 29
4.10	Switch the Monitor Target to the Control System Using the Script Function	4 - 31
4.10.1	Method for using the station number switching function.....	4 - 31
4.10.2	Method for using the screen changing function.....	4 - 38

5. BUS CONNECTION

5.1	Connectable Model List	5 - 2
5.2	System Configuration	5 - 7
5.2.1	Connecting to QCPU	5 - 7
5.2.2	Connecting to QnACPU or AnCPU	5 - 11
5.2.3	Connection to QnASCPU or AnSCPU.....	5 - 14
5.2.4	Connection to A0J2HCPU	5 - 20
5.2.5	Connection to motion controller CPU (A273UCPU, A273UHCPU(-S3), A373UCPU(-S3)).....	5 - 21
5.2.6	Connecting to motion controller CPU (A171SCPU(-S3(N)), A171SHCPU(N), A172SHCPU(N), A173UHCPU(-S1))	5 - 26
5.3	GOT Side Settings.....	5 - 32
5.3.1	Setting communication interface (Communication settings).....	5 - 32
5.3.2	Communication detail settings.....	5 - 32
5.4	Precautions.....	5 - 36
5.4.1	GT15-C [] EXSS-1, GT15-C [] BS	5 - 36
5.4.2	Turning the GOT ON	5 - 36
5.4.3	Powering OFF the GOT, reapplying the power (OFF to ON)	5 - 37
5.4.4	Reset switch on GOT	5 - 37
5.4.5	Powering OFF or resetting the PLC	5 - 37
5.4.6	Position of the GOT	5 - 37
5.4.7	When the GOT is bus-connected to a PLC CPU without the communication driver written	5 - 37
5.4.8	When designing the system	5 - 38
5.4.9	When assigning GOT I/O signals	5 - 38
5.4.10	When connecting to a QCPU (Q mode)	5 - 38
5.4.11	When connecting to a QnA(S)CPU or An(S)CPU type	5 - 39
5.4.12	When connecting multiple GOTs.....	5 - 40
5.4.13	When using a PLC CPU in the direct mode	5 - 40
5.4.14	When connecting to a Q4ARCPU redundant system.....	5 - 41
5.4.15	When monitoring the Q170MCPU	5 - 41
5.4.16	Troubleshooting.....	5 - 41

6. DIRECT CONNECTION TO CPU

6.1	Connectable Model List	6 - 2
6.2	System Configuration	6 - 7
6.2.1	Connecting to QCPU	6 - 7
6.2.2	Connecting to LCPU.....	6 - 8
6.2.3	Connecting to QnACPU.....	6 - 10
6.2.4	Connecting to ACPU	6 - 11
6.2.5	Connecting to MELSEC iQ-F Series	6 - 12

6.2.6	Connecting to FXCPU	6 - 15
6.2.7	Connecting to WSCPU	6 - 25
6.2.8	Connecting to the motion controller CPU	6 - 25
6.3	Connection Diagram	6 - 27
6.3.1	RS-232 cable	6 - 27
6.3.2	RS-422 cable	6 - 28
6.4	GOT Side Settings	6 - 30
6.4.1	Setting communication interface (Communication settings).....	6 - 30
6.4.2	Communication detail settings	6 - 30
6.5	PLC Side Setting	6 - 33
6.5.1	L6ADP-R4 adapter settings	6 - 33
6.5.2	GX Works2 settings	6 - 33
6.6	Precautions	6 - 34

7.COMPUTER LINK CONNECTION

7.1	Connectable Model List	7 - 2
7.1.1	PLC/Motion controller CPU.....	7 - 2
7.1.2	Serial communication module/Computer link module.....	7 - 7
7.2	System Configuration	7 - 8
7.2.1	Connecting to MELSEC iQ-R series.....	7 - 8
7.2.2	Connecting to QCPU (Q mode).....	7 - 9
7.2.3	Connecting to LCPU	7 - 10
7.2.4	Connecting to QCPU (A mode)	7 - 11
7.2.5	Connecting to QnACPU (QnACPU type).....	7 - 12
7.2.6	Connecting to QnACPU (QnASCPU type)	7 - 13
7.2.7	Connecting to ACPU (AnCPU type)	7 - 15
7.2.8	Connecting to ACPU (AnSCPU type, A0J2HCPU, A2CCPUC)	7 - 16
7.3	Connection Diagram	7 - 17
7.3.1	RS-232 cable	7 - 17
7.3.2	RS-422 cable	7 - 19
7.4	GOT Side Settings	7 - 21
7.4.1	Setting communication interface (Communication settings).....	7 - 21
7.4.2	Communication detail settings	7 - 21
7.5	PLC Side Setting	7 - 24
7.5.1	Connecting serial communication module (MELSEC iQ-R Series).....	7 - 24
7.5.2	Connecting serial communication module (Q, L Series).....	7 - 25
7.5.3	Connecting serial communication module (QnA Series)	7 - 26
7.5.4	Connecting computer link module	7 - 28
7.6	Precautions	7 - 31

8.ETHERNET CONNECTION

8.1	Connectable Model List	8 - 2
8.1.1	PLC/Motion controller CPU.....	8 - 2
8.1.2	Ethernet module	8 - 7
8.2	System Configuration	8 - 8
8.2.1	Connection to Ethernet module	8 - 8
8.2.2	Connection to Built-in Ethernet port CPU or C Controller module	8 - 12
8.2.3	Connecting to Display I/F.....	8 - 14
8.2.4	Connection to CC-Link IE Field Network Ethernet Adapter Module	8 - 15

8.2.5	Connecting to PERIPHERAL I/F (Built-in Ethernet port Motion Controller CPU)	8 - 16
8.3	GOT Side Settings	8 - 17
8.3.1	Setting communication interface (Communication settings)	8 - 17
8.3.2	Communication detail settings	8 - 17
8.3.3	Ethernet setting	8 - 19
8.3.4	Routing parameter setting	8 - 20
8.4	PLC Side Setting	8 - 22
8.4.1	Connecting to Built-in Ethernet port CPU (one-to one connection)	8 - 23
8.4.2	Connecting to Built-in Ethernet port CPU (multiple connection)	8 - 24
8.4.3	Connecting to Ethernet module (MELSEC iQ-R Series)	8 - 26
8.4.4	Connection to C Controller module (MELSEC iQ-R Series)	8 - 29
8.4.5	Connecting to Built-in Ethernet port CPU (one-to-one connection)	8 - 31
8.4.6	Connecting to Built-in Ethernet port CPU (multiple connection)	8 - 33
8.4.7	Connecting to Ethernet module (Q/L Series)	8 - 35
8.4.8	Connecting to C Controller module (Q Series)	8 - 38
8.4.9	Connecting to Ethernet module (QnA Series)	8 - 41
8.4.10	Connecting to Ethernet module (A Series)	8 - 44
8.4.11	Connecting to Ethernet module (FX Series)	8 - 49
8.4.12	Connecting to Built-in Ethernet port FXCPU (FX3GE)	8 - 53
8.4.13	Connecting to Display I/F (CNC C70)	8 - 55
8.4.14	Connecting to CC-Link IE Field Network Ethernet Adapter Module	8 - 57
8.4.15	Connecting to PERIPHERAL I/F (Built-in Ethernet port Motion Controller CPU)	8 - 59
8.5	Precautions	8 - 62

9.MELSECNET/H CONNECTION (PLC TO PLC NETWORK)

9.1	Connectable Model List	9 - 2
9.1.1	PLC/Motion controller CPU	9 - 2
9.1.2	MELSECNET/H network module	9 - 7
9.2	System Configuration	9 - 8
9.2.1	Connecting to optical loop system	9 - 8
9.2.2	Connecting to the coaxial bus system	9 - 8
9.3	GOT Side Settings	9 - 10
9.3.1	Setting communication interface (Communication settings)	9 - 10
9.3.2	Communication detail settings	9 - 10
9.3.3	Routing parameter setting	9 - 11
9.4	PLC Side Settings	9 - 12
9.4.1	System configuration	9 - 12
9.4.2	Switch setting of MELSECNET/H network module	9 - 12
9.4.3	Parameter setting	9 - 13
9.4.4	[Controller Setting] of GT Designer3	9 - 16
9.5	Precautions	9 - 17

10.MELSECNET/10 CONNECTION (PLC TO PLC NETWORK)

10.1	Connectable Model List	10 - 2
10.1.1	PLC/Motion controller CPU	10 - 2
10.1.2	MELSECNET/H (NET/10 mode), MELSECNET/10 network module	10 - 7
10.2	System Configuration	10 - 8
10.2.1	Connecting to optical loop system	10 - 8
10.2.2	Connecting to the coaxial bus system	10 - 9

10.3	GOT Side Settings	10 - 10
10.3.1	Setting communication interface (Communication settings).....	10 - 10
10.3.2	Communication detail settings.....	10 - 10
10.3.3	Routing parameter setting	10 - 11
10.3.4	Switch setting (Only when MELSECNET/10 communication unit is used).....	10 - 12
10.4	PLC Side Setting	10 - 13
10.4.1	Connecting to MELSECNET/H network module.....	10 - 13
10.4.2	Connecting to MELSECNET/10 network module (QnA Series)	10 - 18
10.4.3	Connecting to MELSECNET/10 network module (A Series)	10 - 22
10.5	Precautions	10 - 26

11.CC-Link IE CONTROLLER NETWORK CONNECTION

11.1	Connectable Model List	11 - 2
11.1.1	PLC/Motion controller CPU.....	11 - 2
11.1.2	CC-Link IE Controller Network communication unit.....	11 - 7
11.2	System Configuration	11 - 8
11.2.1	Connecting to optical loop system	11 - 8
11.3	GOT side settings	11 - 9
11.3.1	Setting communication interface (Communication settings).....	11 - 9
11.3.2	Communication detail settings.....	11 - 9
11.3.3	Routing parameter setting	11 - 10
11.4	PLC Side Setting	11 - 11
11.4.1	Connecting to MELSEC iQ-R Series	11 - 11
11.4.2	Connecting to C Controller module (MELSEC iQ-R Series).....	11 - 15
11.4.3	Connecting to MELSEC-Q/L.....	11 - 19
11.5	Precautions	11 - 25

12.CC-Link IE FIELD NETWORK CONNECTION

12.1	Connectable Model List	12 - 2
12.1.1	PLC/Motion controller CPU.....	12 - 2
12.1.2	CC-Link IE Field Network communication unit	12 - 7
12.2	System Configuration	12 - 8
12.2.1	Connecting to CC-Link IE Field Network communication unit	12 - 8
12.3	GOT side settings	12 - 9
12.3.1	Setting communication interface (Communication settings).....	12 - 9
12.3.2	Communication detail settings.....	12 - 9
12.3.3	Routing parameter setting	12 - 10
12.4	PLC Side Setting	12 - 11
12.4.1	Connecting to MELSEC iQ-R Series	12 - 11
12.4.2	Connection to C Controller module (MELSEC iQ-R Series).....	12 - 13
12.4.3	Connecting to MELSEC-Q/L.....	12 - 16
12.5	Precautions	12 - 19

13.CC-Link CONNECTION (INTELLIGENT DEVICE STATION)

13.1	Connectable Model List	13 - 2
13.1.1	PLC/Motion controller CPU.....	13 - 2
13.1.2	CC-Link module	13 - 6
13.2	System Configuration	13 - 7

13.2.1	Connecting with CC-Link Ver.1 compatible	13 - 7
13.2.2	Connecting with CC-Link Ver.2 compatible	13 - 9
13.2.3	Connecting with CC-Link Ver.1/Ver.2 compatibles mixed	13 - 10
13.3	GOT Side Settings.....	13 - 11
13.3.1	Setting communication interface (Communication settings).....	13 - 11
13.3.2	Communication detail settings.....	13 - 11
13.3.3	Switch setting (Only when MODEL GT15-75J61BT13-Z CC-Link communication unit is used).....	13 - 13
13.4	PLC Side Setting	13 - 14
13.4.1	Connecting to CC-Link module (MELSEC iQ-R Series) with Ver.1 compatible.....	13 - 15
13.4.2	Connecting to CC-Link module (MELSEC iQ-R Series) with Ver.2 compatible.....	13 - 16
13.4.3	Connecting to CC-Link module (MELSEC iQ-R Series) with Ver.1/Ver.2 compatibles mixed	13 - 18
13.4.4	Connection to C Controller module (MELSEC iQ-R Series).....	13 - 20
13.4.5	Connecting to CC-Link module (Q Series) with Ver.1 compatible	13 - 22
13.4.6	Connecting to CC-Link module (Q Series) with Ver.2 compatible	13 - 25
13.4.7	Connecting to CC-Link module (Q Series) with Ver.1/Ver.2 compatibles mixed	13 - 29
13.4.8	Connecting to MELSEC-L series with CC-Link Ver.1 compatible.....	13 - 33
13.4.9	Connecting to MELSEC-L series with CC-Link Ver.2 compatible.....	13 - 34
13.4.10	Connecting to CC-Link module (QnA Series).....	13 - 36
13.4.11	Connecting to CC-Link module (A Series).....	13 - 40
13.5	Precautions.....	13 - 48

14.CC-Link CONNECTION (Via G4)

14.1	Connectable Model List	14 - 2
14.1.1	PLC/Motion controller CPU	14 - 2
14.1.2	CC-Link module/peripheral module	14 - 6
14.2	System Configuration	14 - 7
14.2.1	Connecting to QCPU (Q mode).....	14 - 7
14.2.2	Connecting to LCPU.....	14 - 8
14.3	Connection Diagram.....	14 - 9
14.3.1	RS-232 cable.....	14 - 9
14.3.2	RS-422 cable.....	14 - 9
14.4	GOT Side Settings.....	14 - 10
14.4.1	Setting communication interface (Communication settings).....	14 - 10
14.4.2	Communication detail settings.....	14 - 10
14.5	PLC Side Settings.....	14 - 12
14.5.1	Connecting AJ65BT-G4-S3	14 - 12
14.5.2	Connecting AJ65BT-R2N	14 - 13
14.5.3	Switch setting of CC-Link module (Q series).....	14 - 15
14.5.4	[Network parameter] of GX Developer	14 - 15
14.5.5	Parameter setting (when connecting to C Controller module (Q Series)).....	14 - 16
14.5.6	[Controller Setting] of GT Designer3	14 - 17
14.6	Precautions.....	14 - 18

MITSUBISHI ELECTRIC FA DEVICE CONNECTIONS

15.INVERTER CONNECTION

15.1	Connectable Model List	15 - 2
------	------------------------------	--------

15.2	System Configuration	15 - 3
15.2.1	Connecting to FREQROL-A500/A500L/F500/F500L/V500/V500L	15 - 3
15.2.2	Connecting to FREQROL-E500/S500/S500E/F500J/D700/F700PJ	15 - 7
15.2.3	Connecting to FREQROL E700/sensorless servo (FREQROL-E700EX).....	15 - 10
15.2.4	Connecting to FREQROL-A700/F700/700P	15 - 14
15.2.5	Connecting to FREQROL-A800/F800	15 - 18
15.2.6	Connecting to MD-CX522-K(-A0)	15 - 21
15.3	Connection Diagram	15 - 24
15.3.1	RS-485 cable	15 - 24
15.4	GOT Side Settings	15 - 32
15.4.1	Setting communication interface (Communication settings).....	15 - 32
15.4.2	Communication detail settings	15 - 32
15.5	FREQROL Series Inverter Side Settings	15 - 34
15.5.1	Connecting FREQROL-S500, S500E, F500J series	15 - 34
15.5.2	Connecting FREQROL-E500 series	15 - 35
15.5.3	Connecting FREQROL-F500, F500L series	15 - 36
15.5.4	Connecting FREQROL-A500, A500L series.....	15 - 37
15.5.5	Connecting FREQROL-V500, V500L series.....	15 - 38
15.5.6	Connecting FREQROL-E700 series	15 - 39
15.5.7	Connecting FREQROL-D700 series.....	15 - 40
15.5.8	Connecting FREQROL-F700/700P series.....	15 - 41
15.5.9	Connecting FREQROL-F700PJ series	15 - 43
15.5.10	Connecting FREQROL-A700 series	15 - 44
15.5.11	Connecting FREQROL-A800/F800 series	15 - 46
15.5.12	Connecting a sensorless servo (FREQROL-E700EX series).....	15 - 47
15.5.13	Connecting MD-CX522-K(-A0)	15 - 48
15.5.14	Station number setting	15 - 49
15.6	Device Range that Can Be Set.....	15 - 50
15.7	Precautions	15 - 53

16.SERVO AMPLIFIER CONNECTION

16.1	Connectable Model List	16 - 2
16.2	System Configuration	16 - 3
16.2.1	Connecting to the MELSERVO-J2-Super Series.....	16 - 3
16.2.2	Connecting to the MELSERVO-J2M Series	16 - 4
16.2.3	Connecting to the MELSERVO-J4, J3 Series.....	16 - 5
16.2.4	Connecting to the MELSERVO-JE Series	16 - 8
16.3	Connection Diagram	16 - 9
16.3.1	RS-232 cable	16 - 9
16.3.2	RS-422 cable	16 - 10
16.4	GOT Side Settings	16 - 15
16.4.1	Setting communication interface (Communication settings).....	16 - 15
16.4.2	Communication detail settings	16 - 15
16.5	Setting on Servo Amplifier Side	16 - 17
16.5.1	Connecting to the MELSERVO-J2-Super Series.....	16 - 17
16.5.2	Connecting to the MELSERVO-J2M Series	16 - 18
16.5.3	Connecting to the MELSERVO-J4,J3,JE Series	16 - 19
16.5.4	Station number setting.....	16 - 19
16.6	Device Range that Can Be Set.....	16 - 20

16.7	Precautions.....	16 - 58
------	------------------	---------

17.ROBOT CONTROLLER CONNECTION

17.1	Connectable Model List	17 - 2
17.2	System Configuration	17 - 2
17.2.1	Connecting to robot controller (CRnD-700).....	17 - 2
17.3	GOT Side Settings.....	17 - 3
17.3.1	Setting communication interface (Communication settings).....	17 - 3
17.3.2	Communication detail settings.....	17 - 3
17.3.3	Ethernet setting	17 - 5
17.4	PLC Side Settings.....	17 - 6
17.4.1	Connecting to robot controller (CRnD-700).....	17 - 6
17.5	Device Range that Can Be Set.....	17 - 8
17.6	Precautions.....	17 - 8

18.CNC CONNECTION

18.1	Connectable Model List	18 - 2
18.2	System Configuration	18 - 3
18.2.1	Direct connection to CPU	18 - 3
18.2.2	MELSECNET/10 connection (PLC to PLC network)	18 - 4
18.2.3	CC-Link connection (intelligent device station).....	18 - 5
18.2.4	Ethernet connection.....	18 - 6
18.3	Connection Diagram	18 - 7
18.3.1	RS-232 cable	18 - 7
18.4	GOT Side Settings.....	18 - 8
18.4.1	Setting communication interface (Communication settings).....	18 - 8
18.4.2	Communication detail settings.....	18 - 8
18.4.3	Ethernet setting	18 - 13
18.4.4	Switch setting	18 - 13
18.5	CNC Side Settings.....	18 - 16
18.5.1	MELSECNET/10 connection	18 - 16
18.5.2	CC-Link (ID) connection	18 - 19
18.5.3	Ethernet connection.....	18 - 21
18.6	Device Range that Can Be Set.....	18 - 23
18.7	Precautions.....	18 - 23
18.7.1	Direct connection to CPU	18 - 23
18.7.2	MELSECNET/10 connection	18 - 23
18.7.3	CC-Link (ID) connection	18 - 23
18.7.4	Ethernet connection.....	18 - 24

19.ENERGY MEASURING UNIT/ELECTRIC MULTI-MEASURING INSTRUMENT CONNECTION

19.1	Connectable Model List	19 - 2
19.2	System Configuration	19 - 3
19.2.1	Connecting to an energy measuring unit/electronic multi-measuring instrument.....	19 - 3
19.3	Connection Diagram.....	19 - 4
19.4	GOT Side Settings.....	19 - 9

19.4.1	Setting communication interface (Communication settings).....	19 - 9
19.4.2	Communication detail settings.....	19 - 9
19.5	Setting of Energy Measuring Unit/Electric Multi-measuring Instrument.....	19 - 10
19.5.1	Connecting to an energy measuring unit/electronic multi-measuring instrument	19 - 10
19.5.2	Station number setting.....	19 - 10
19.6	Device Range that Can Be Set.....	19 - 11
19.7	Precautions.....	19 - 12

MULTIPLE GOT CONNECTIONS

20.GOT MULTI-DROP CONNECTION

20.1	CPU that can be Monitored	20 - 2
20.2	Connectable Model List	20 - 3
20.3	System Configuration	20 - 16
20.4	Connection Diagram	20 - 17
20.4.1	RS-485 cable	20 - 17
20.5	GOT Side Settings.....	20 - 25
20.5.1	Setting communication interface (communication settings).....	20 - 25
20.5.2	Communication detail settings.....	20 - 25
20.6	Setting of Serial Multi-Drop Connection Unit	20 - 26
20.6.1	Write the OS	20 - 26
20.6.2	Setting communication interface (Communication settings).....	20 - 26
20.6.3	Setting switches.....	20 - 30
20.7	Setting of connection conversion adapter.....	20 - 31
20.7.1	Setting switches.....	20 - 31
20.8	Precautions.....	20 - 32

21.MULTIPLE-GT14, GT12, GT11, GT10 CONNECTION FUNCTION

21.1	Connectable Model List	21 - 2
21.2	System Configuration	21 - 2
21.2.1	Connecting the GOT to PLC via RS-232 interface	21 - 2
21.2.2	Connecting the GOT to PLC via RS-422 interface	21 - 4
21.3	Connection Diagram	21 - 5
21.3.1	RS-232 Cable	21 - 5
21.3.2	RS-422 cable	21 - 6
21.4	GOT Side Settings.....	21 - 7
21.4.1	Setting communication interface (Communication settings).....	21 - 7
21.4.2	Communication detail settings.....	21 - 9
21.5	Precautions.....	21 - 11

MULTI-CHANNEL FUNCTION

22.MULTI-CHANNEL FUNCTION

22.1	What is Multi-channel Function?.....	22 - 2
22.2	System Configuration	22 - 4
22.2.1	Bus connection and serial connection	22 - 4
22.2.2	Ethernet multiple connection	22 - 6

22.3	GOT Side Settings.....	22 - 7
22.3.1	Basics of interface selection	22 - 7
22.3.2	General flow from system selection to drawing	22 - 12
22.3.3	Determining the connection type and channel No. (System selection)	22 - 13
22.3.4	Determining the GOT side interface (Interface selection)	22 - 23
22.3.5	Setting for communication settings.....	22 - 35
22.3.6	Items to be checked before starting drawing.....	22 - 39
22.4	Precautions.....	22 - 41
22.4.1	Precautions for hardware	22 - 41
22.4.2	Precautions for use.....	22 - 41
22.5	Multi-channel Function Check Sheet.....	22 - 42

FA TRANSPARENT FUNCTION

23.FA TRANSPARENT FUNCTION

23.1	FA Transparent Function	23 - 2
23.2	Compatible Software	23 - 2
23.3	List of Models that Can Be Monitored.....	23 - 15
23.4	System Configuration	23 - 34
23.4.1	GX Works3, CW Configurator, GX Developer, GX Works2, GX LogViewer, MX Component, MX Sheet, CPU Module Logging Configuration Tool, Setting/Monitoring tool for C Controller module.....	23 - 34
23.4.2	PX Developer, GX Configurator	23 - 38
23.4.3	MT Developer, MT Works2.....	23 - 39
23.4.4	MR Configurator, MR Configurator2.....	23 - 41
23.4.5	FR Configurator	23 - 43
23.4.6	FX Configurator-FP, FX Configurator-EN-L, FX Configurator-EN	23 - 43
23.4.7	RT ToolBox2.....	23 - 44
23.4.8	NC Configurator.....	23 - 44
23.5	GOT Side Settings.....	23 - 45
23.5.1	Setting communication interface	23 - 45
23.6	Personal Computer Side Setting	23 - 48
23.6.1	Accessing by GX Works3	23 - 48
23.6.2	Accessing by CW Configurator.....	23 - 52
23.6.3	Accessing the PLC by the GX Developer, PX Developer, GX Configurator.....	23 - 53
23.6.4	Accessing by GX Works2	23 - 57
23.6.5	Accessing by GX LogViewer	23 - 67
23.6.6	Accessing PLC by GX Configurator-QP	23 - 67
23.6.7	Accessing by the MT Developer.....	23 - 68
23.6.8	Accessing by the MT Works2	23 - 69
23.6.9	Accessing the servo amplifier by the MR Configurator.....	23 - 73
23.6.10	Accessing the servo amplifier by the MR Configurator2.....	23 - 73
23.6.11	Accessing the inverter by the FR Configurator	23 - 73
23.6.12	Accessing PLC by FX Configurator-FP	23 - 74
23.6.13	Accessing by FX Configurator-EN-L or FX Configurator-EN	23 - 74
23.6.14	Accessing by RT ToolBox2	23 - 75
23.6.15	Accessing by NC Configurator	23 - 77
23.6.16	Accessing by MELSOFT Navigator	23 - 78
23.6.17	Accessing by CPU Module Logging Configuration Tool.....	23 - 78
23.6.18	Accessing by Setting/ Monitoring tool for C Controller module	23 - 79

23.6.19	Accessing by MX Component(MX Sheet)	23 - 81
23.7	Precautions	23 - 85
23.7.1	Precautions common to each software.....	23 - 85
23.7.2	When using GX Works3, GX Works2, GX Developer	23 - 87
23.7.3	When using MT Developer, MT Works2.....	23 - 89
23.7.4	When using MR Configurator, MR Configurator2	23 - 90
23.7.5	When using FR Configurator	23 - 90

INDEX

REVISIONS

Intellectual Property Rights

MANUALS

The following table lists the manual relevant to this product.
Refer to each manual for any purpose.

■ Screen creation software manuals

Manual Name	Delivery method	Manual Number
GT Works3 Version1 Installation Procedure Manual	Enclosed in product	-
GT Designer3 Version1 Screen Design Manual (Fundamentals) 1/2, 2/2	*1	SH-080866ENG
GT Designer3 Version1 Screen Design Manual (Functions) 1/2, 2/2	*1	SH-080867ENG
GT Simulator3 Version1 Operating Manual for GT Works3	*1	SH-080861ENG
GT Converter2 Version3 Operating Manual for GT Works3	*1	SH-080862ENG

*1 Contact your local distributor.

■ Connection manuals

Manual Name	Delivery method	Manual Number
GOT1000 Series Connection Manual (Mitsubishi Electric Products) for GT Works3	*1	SH-080868ENG
GOT1000 Series Connection Manual (Non-Mitsubishi Electric Products 1) for GT Works3	*1	SH-080869ENG
GOT1000 Series Connection Manual (Non-Mitsubishi Electric Products 2) for GT Works3	*1	SH-080870ENG
GOT1000 Series Connection Manual (Microcomputer, MODBUS Products, Peripherals) for GT Works3	*1	SH-080871ENG
GOT1000 Series Connection Manual (α2 Connection) for GT Works3	*1	JY997D39201

*1 Contact your local distributor.

■ Extended and option function manuals

Manual Name	Delivery method	Manual Number
GOT1000 Series Gateway Functions Manual for GT Works3	*1	SH-080858ENG
GOT1000 Series MES Interface Function Manual for GT Works3	*1	SH-080859ENG
GOT1000 Series User's Manual (Extended Functions, Option Functions) for GT Works3	*1	SH-080863ENG

*1 Contact your local distributor.

■ GT SoftGOT1000 manuals

Manual Name	Delivery method	Manual Number
GT SoftGOT1000 Version3 Operating Manual for GT Works3	*1	SH-080860ENG

*1 Contact your local distributor.

■ GT16 manuals

Manual Name	Delivery method	Manual Number
GT16 User's Manual (Hardware)	*1	SH-080928ENG
GT16 User's Manual (Basic Utility)	*1	SH-080929ENG
GT16 Handy GOT User's Manual	*1	JY997D41201 JY997D41202

*1 Contact your local distributor.

■ GT15 manuals

Manual Name	Delivery method	Manual Number
GT15 User's Manual	*1	SH-080528ENG

*1 Contact your local distributor.

■ GT14 manuals

Manual Name	Delivery method	Manual Number
GT14 User's Manual	*1	JY997D44801

*1 Contact your local distributor.

■ GT12 manuals

Manual Name	Delivery method	Manual Number
GT12 User's Manual	*1	SH-080977ENG

*1 Contact your local distributor.

■ GT11 manuals

Manual Name	Delivery method	Manual Number
GT11 User's Manual	*1	JY997D17501
GT11 Handy GOT User's Manual	*1	JY997D20101 JY997D20102

*1 Contact your local distributor.

■ GT10 manuals

Manual Name	Delivery method	Manual Number
GT10 User's Manual	*1	JY997D24701

*1 Contact your local distributor.

QUICK REFERENCE

■ Creating a project

Obtaining the specifications and operation methods of GT Designer3	
Setting available functions on GT Designer3	GT Designer3 Version1 Screen Design Manual (Fundamentals) 1/2, 2/2
Creating a screen displayed on the GOT	
Obtaining useful functions to increase efficiency of drawing	
Setting details for figures and objects	GT Designer3 Version1 Screen Design Manual (Functions) 1/2, 2/2
Setting functions for the data collection or trigger action	
Setting functions to use peripheral devices	
Simulating a created project on a personal computer	GT Simulator3 Version1 Operating Manual for GT Works3

■ Connecting a controller to the GOT

Obtaining information of Mitsubishi Electric products applicable to the GOT	GOT1000 Series Connection Manual (Mitsubishi Electric Products) for GT Works3
Connecting Mitsubishi Electric products to the GOT	
Connecting multiple controllers to one GOT (Multi-channel function)	
Establishing communication between a personal computer and a controller via the GOT (FA transparent function)	
Obtaining information of Non-Mitsubishi Electric products applicable to the GOT	• GOT1000 Series Connection Manual (Non-Mitsubishi Electric Products 1) for GT Works3 • GOT1000 Series Connection Manual (Non-Mitsubishi Electric Products 2) for GT Works3
Connecting Non-Mitsubishi Electric products to the GOT	
Obtaining information of peripheral devices applicable to the GOT	GOT1000 Series Connection Manual (Microcomputer, MODBUS Products, Peripherals) for GT Works3
Connecting peripheral devices including a barcode reader to the GOT	
Connecting α2 with GOT	GOT1000 Series Connection Manual (α2 Connection) for GT Works3

■ Transferring data to the GOT

Writing data to the GOT	GT Designer3 Version1 Screen Design Manual (Fundamentals) 1/2, 2/2
Reading data from the GOT	
Verifying a editing project to a GOT project	

■ Others

Obtaining specifications (including part names, external dimensions, and options) of each GOT	<ul style="list-style-type: none">• GT16 User's Manual (Hardware)• GT16 Handy GOT User's Manual• GT15 User's Manual• GT14 User's Manual• GT12 User's Manual• GT11 User's Manual• GT11 Handy GOT User's Manual• GT10 User's Manual
Installing the GOT	
Operating the utility	<ul style="list-style-type: none">• GT16 User's Manual (Basic Utility)• GT16 Handy GOT User's Manual• GT15 User's Manual• GT14 User's Manual• GT12 User's Manual• GT11 User's Manual• GT11 Handy GOT User's Manual• GT10 User's Manual
Configuring the gateway function	GOT1000 Series Gateway Functions Manual for GT Works3
Configuring the MES interface function	GOT1000 Series MES Interface Function Manual for GT Works3
Configuring the extended function and option function	GOT1000 Series User's Manual (Extended Functions, Option Functions) for GT Works3
Using a personal computer as the GOT	GT SoftGOT1000 Version3 Operating Manual for GT Works3

ABBREVIATIONS AND GENERIC TERMS

■ GOT

Abbreviations and generic terms		Description
GT1695	GT1695M-X	Abbreviation of GT1695M-XTBA, GT1695M-XTBD
GT1685	GT1685M-S	Abbreviation of GT1685M-STBA, GT1685M-STBD
GT1675	GT1675M-S	Abbreviation of GT1675M-STBA, GT1675M-STBD
	GT1675M-V	Abbreviation of GT1675M-VTBA, GT1675M-VTBD
	GT1675-VN	Abbreviation of GT1675-VNBA, GT1675-VNBD
GT1672	GT1672-VN	Abbreviation of GT1672-VNBA, GT1672-VNBD
GT1665	GT1665M-S	Abbreviation of GT1665M-STBA, GT1665M-STBD
	GT1665M-V	Abbreviation of GT1665M-VTBA, GT1665M-VTBD
GT1662	GT1662-VN	Abbreviation of GT1662-VNBA, GT1662-VNBD
GT1655	GT1655-V	Abbreviation of GT1655-VTBD
GT16		Abbreviation of GT1695, GT1685, GT1675, GT1672, GT1665, GT1662, GT1655, GT16 Handy GOT
GT1595	GT1595-X	Abbreviation of GT1595-XTBA, GT1595-XTBD
GT1585	GT1585V-S	Abbreviation of GT1585V-STBA, GT1585V-STBD
	GT1585-S	Abbreviation of GT1585-STBA, GT1585-STBD
GT157□	GT1575V-S	Abbreviation of GT1575V-STBA, GT1575V-STBD
	GT1575-S	Abbreviation of GT1575-STBA, GT1575-STBD
	GT1575-V	Abbreviation of GT1575-VTBA, GT1575-VTBD
	GT1575-VN	Abbreviation of GT1575-VNBA, GT1575-VNBD
	GT1572-VN	Abbreviation of GT1572-VNBA, GT1572-VNBD
GT156□	GT1565-V	Abbreviation of GT1565-VTBA, GT1565-VTBD
	GT1562-VN	Abbreviation of GT1562-VNBA, GT1562-VNBD
GT155□	GT1555-V	Abbreviation of GT1555-VTBD
	GT1555-Q	Abbreviation of GT1555-QTBD, GT1555-QSBD
	GT1550-Q	Abbreviation of GT1550-QLBD
GT15		Abbreviation of GT1595, GT1585, GT157□, GT156□, GT155□
GT145□	GT1455-Q	Abbreviation of GT1455-QTBDE, GT1455-QTBD
	GT1450-Q	Abbreviation of GT1450-QMBDE, GT1450-QMBD, GT1450-QLBDE, GT1450-QLBD
GT14		Abbreviation of GT1455-Q, GT1450-Q
GT1275	GT1275-V	Abbreviation of GT1275-VNBA, GT1275-VNBD
GT1265	GT1265-V	Abbreviation of GT1265-VNBA, GT1265-VNBD
GT12		Abbreviation of GT1275, GT1265
GT115□	GT1155-Q	Abbreviation of GT1155-QTBDQ, GT1155-QSBDQ, GT1155-QTBDA, GT1155-QSBDA, GT1155-QTBD, GT1155-QSBD
	GT1150-Q	Abbreviation of GT1150-QLBDQ, GT1150-QLBDA, GT1150-QLBD
GT11		Abbreviation of GT115□, GT11 Handy GOT
GT105□	GT1055-Q	Abbreviation of GT1055-QSBD
	GT1050-Q	Abbreviation of GT1050-QBBD
GT104□	GT1045-Q	Abbreviation of GT1045-QSBD
	GT1040-Q	Abbreviation of GT1040-QBBD
GT1030		Abbreviation of GT1030-LBD, GT1030-LBD2, GT1030-LBL, GT1030-LBDW, GT1030-LBDW2, GT1030-LBLW, GT1030-LWD, GT1030-LWD2, GT1030-LWL, GT1030-LWDW, GT1030-LWDW2, GT1030-LWLW, GT1030-HBD, GT1030-HBD2, GT1030-HBL, GT1030-HBDW, GT1030-HBDW2, GT1030-HBLW, GT1030-HWD, GT1030-HWD2, GT1030-HWL, GT1030-HWDW, GT1030-HWDW2, GT1030-HWLW
GT1020		Abbreviation of GT1020-LBD, GT1020-LBD2, GT1020-LBL, GT1020-LBDW, GT1020-LBDW2, GT1020-LBLW, GT1020-LWD, GT1020LWD2, GT1020-LWL, GT1020-LWDW, GT1020-LWDW2, GT1020-LWLW
GT10		Abbreviation of GT105□, GT104□, GT1030, GT1020

GOT1000
Series

Abbreviations and generic terms			Description	
GOT1000 Series	Handy GOT	GT16 Handy GOT	GT1665HS-V	Abbreviation of GT1665HS-VTBD
		GT11 Handy GOT	GT1155HS-Q	Abbreviation of GT1155HS-QSBD
			GT1150HS-Q	Abbreviation of GT1150HS-QLBD
	GT SoftGOT1000		Abbreviation of GT SoftGOT1000	
GOT900 Series			Abbreviation of GOT-A900 series, GOT-F900 series	
GOT800 Series			Abbreviation of GOT-800 series	

■ Communication unit

Abbreviations and generic terms	Description
Bus connection unit	GT15-QBUS, GT15-QBUS2, GT15-ABUS, GT15-ABUS2, GT15-75QBUSL, GT15-75QBUS2L, GT15-75ABUSL, GT15-75ABUS2L
Serial communication unit	GT15-RS2-9P, GT15-RS4-9S, GT15-RS4-TE
RS-422 conversion unit	GT15-RS2T4-9P, GT15-RS2T4-25P
Ethernet communication unit	GT15-J71E71-100
MELSECNET/H communication unit	GT15-J71LP23-25, GT15-J71BR13
MELSECNET/10 communication unit	GT15-75J71LP23-Z ^{*1} , GT15-75J71BR13-Z ^{*2}
CC-Link IE Controller Network communication unit	GT15-J71GP23-SX
CC-Link IE Field Network communication unit	GT15-J71GF13-T2
CC-Link communication unit	GT15-J61BT13, GT15-75J61BT13-Z ^{*3}
Interface converter unit	GT15-75IF900
Serial multi-drop connection unit	GT01-RS4-M
Connection Conversion Adapter	GT10-9PT5S
RS-232/485 signal conversion adapter	GT14-RS2T4-9P

*1 A9GT-QJ71LP23 + GT15-75IF900 set

*2 A9GT-QJ71BR13 + GT15-75IF900 set

*3 A8GT-J61BT13 + GT15-75IF900 set

■ Option unit

Abbreviations and generic terms	Description	
Printer unit	GT15-PRN	
Video/RGB unit	Video input unit	GT16M-V4, GT15V-75V4
	RGB input unit	GT16M-R2, GT15V-75R1
	Video/RGB input unit	GT16M-V4R1, GT15V-75V4R1
	RGB output unit	GT16M-ROUT, GT15V-75ROUT
Multimedia unit	GT16M-MMR	
CF card unit	GT15-CFCD	
CF card extension unit ^{*1}	GT15-CFEX-C08SET	
External I/O unit	GT15-DIO, GT15-DIOR	
Sound output unit	GT15-SOUT	

*1 GT15-CFEX + GT15-CFEXIF + GT15-C08CF set

■ Option

Abbreviations and generic terms		Description
Memory card	CF card	GT05-MEM-16MC, GT05-MEM-32MC, GT05-MEM-64MC, GT05-MEM-128MC, GT05-MEM-256MC, GT05-MEM-512MC, GT05-MEM-1GC, GT05-MEM-2GC, GT05-MEM-4GC, GT05-MEM-8GC, GT05-MEM-16GC
	SD card	NZ1MEM-2GBSD, NZ1MEM-4GBSD, NZ1MEM-8GBSD, NZ1MEM-16GBSD, L1MEM-2GBSD, L1MEM-4GBSD
Memory card adaptor		GT05-MEM-ADPC
Option function board		GT16-MESB, GT15-FNB, GT15-QFNB, GT15-QFNB16M, GT15-QFNB32M, GT15-QFNB48M, GT11-50FNB, GT15-MESB48M
Battery		GT15-BAT, GT11-50BAT
Protective Sheet	For GT16	GT16-90PSCB, GT16-90PSGB, GT16-90PSCW, GT16-90PSGW, GT16-80PSCB, GT16-80PSGB, GT16-80PSCW, GT16-80PSGW, GT16-70PSCB, GT16-70PSGB, GT16-70PSCW, GT16-70PSGW, GT16-60PSCB, GT16-60PSGB, GT16-60PSCW, GT16-60PSGW, GT16-50PSCB, GT16-50PSGB, GT16-50PSCW, GT16-50PSGW, GT16-90PSCB-012, GT16-80PSCB-012, GT16-70PSCB-012, GT16-60PSCB-012, GT16-50PSCB-012, GT16H-60PSC
	For GT15	GT15-90PSCB, GT15-90PSGB, GT15-90PSCW, GT15-90PSGW, GT15-80PSCB, GT15-80PSGB, GT15-80PSCW, GT15-80PSGW, GT15-70PSCB, GT15-70PSGB, GT15-70PSCW, GT15-70PSGW, GT15-60PSCB, GT15-60PSGB, GT15-60PSCW, GT15-60PSGW, GT15-50PSCB, GT15-50PSGB, GT15-50PSCW, GT15-50PSGW
	For GT14	GT14-50PSCB, GT14-50PSGB, GT14-50PSCW, GT14-50PSGW
	For GT12	GT11-70PSCB, GT11-65PSCB
	For GT11	GT11-50PSCB, GT11-50PSGB, GT11-50PSCW, GT11-50PSGW, GT11H-50PSC
	For GT10	GT10-50PSCB, GT10-50PSGB, GT10-50PSCW, GT10-50PSGW, GT10-40PSCB, GT10-40PSGB, GT10-40PSCW, GT10-40PSGW, GT10-30PSCB, GT10-30PSGB, GT10-30PSCW, GT10-30PSGW, GT10-20PSCB, GT10-20PSGB, GT10-20PSCW, GT10-20PSGW
Protective cover for oil		GT05-90PCO, GT05-80PCO, GT05-70PCO, GT05-60PCO, GT05-50PCO, GT16-50PCO, GT10-40PCO, GT10-30PCO, GT10-20PCO
USB environmental protection cover		GT16-UCOV, GT16-50UCOV, GT15-UCOV, GT14-50UCOV, GT11-50UCOV
Stand		GT15-90STAND, GT15-80STAND, GT15-70STAND, A9GT-50STAND, GT05-50STAND
Attachment		GT15-70ATT-98, GT15-70ATT-87, GT15-60ATT-97, GT15-60ATT-96, GT15-60ATT-87, GT15-60ATT-77, GT15-50ATT-95W, GT15-50ATT-85
Backlight		GT16-90XLTT, GT16-80SLTT, GT16-70SLTT, GT16-70VLTT, GT16-70VLTTA, GT16-70VLTN, GT16-60SLTT, GT16-60VLTT, GT16-60VLTN, GT15-90XLTT, GT15-80SLTT, GT15-70SLTT, GT15-70VLTT, GT15-70VLTN, GT15-60VLTT, GT15-60VLTN
Multi-color display board		GT15-XHNB, GT15-VHNB
Connector conversion box		GT11H-CNB-37S, GT16H-CNB-42S
Emergency stop sw guard cover		GT11H-50ESCOV, GT16H-60ESCOV
With wall-mounting Attachment		GT14H-50ATT
Memory loader		GT10-LDR
Memory board		GT10-50FMB
Panel-mounted USB port extension		GT14-C10EXUSB-4S, GT10-C10EXUSB-5S

■ Software

Abbreviations and generic terms		Description
GT Works3		Abbreviation of the SW□DND-GTWK3-E and SW□DND-GTWK3-EA
GT Designer3		Abbreviation of screen drawing software GT Designer3 for GOT1000 series
GT Simulator3		Abbreviation of screen simulator GT Simulator3 for GOT1000/GOT900 series
GT SoftGOT1000		Abbreviation of monitoring software GT SoftGOT1000
GT Converter2		Abbreviation of data conversion software GT Converter2 for GOT1000/GOT900 series
GT Designer2 Classic		Abbreviation of screen drawing software GT Designer2 Classic for GOT900 series
GT Designer2		Abbreviation of screen drawing software GT Designer2 for GOT1000/GOT900 series
iQ Works		Abbreviation of iQ Platform compatible engineering environment MELSOFT iQ Works
MELSOFT Navigator		Generic term for integrated development environment software included in the SW□DNC-IQWK (iQ Platform compatible engineering environment MELSOFT iQ Works)
MELSOFT iQ AppPortal		SW□DND-IQAPL-M type integrated application management software
GX Works3		Abbreviation of SW□DND-GXW3-E and SW□DND-GXW3-EA type programmable controller engineering software
GX Works2		Abbreviation of SW□DNC-GXW2-E and SW□DNC-GXW2-EA type programmable controller engineering software
Controller simulator	GX Simulator3	Abbreviation of GX Works3 with the simulation function
	GX Simulator2	Abbreviation of GX Works2 with the simulation function
	GX Simulator	Abbreviation of SW□D5C-LLT-E(-EV) type ladder logic test tool function software packages (SW□D5C-LLT (-EV) or later versions)
GX Developer		Abbreviation of SW□D5C-GPPW-E(-EV)/SW D5F-GPPW-E type software package
GX LogViewer		Abbreviation of SW□DNN-VIEWER-E type software package
PX Developer		Abbreviation of SW□D5C-FBDQ-E type FBD software package for process control
MT Works2		Abbreviation of motion controller engineering environment MELSOFT MT Works2 (SW□DND-MTW2-E)
MT Developer		Abbreviation of SW□RNC-GSV type integrated start-up support software for motion controller Q series
MR Configurator2		Abbreviation of SW□DNC-MRC2-E type Servo Configuration Software
MR Configurator		Abbreviation of MRZJW□-SETUP□E type Servo Configuration Software
FR Configurator		Abbreviation of Inverter Setup Software (FR-SW□-SETUP-WE)
NC Configurator		Abbreviation of CNC parameter setting support tool NC Configurator
FX Configurator-FP		Abbreviation of parameter setting, monitoring, and testing software packages for FX3U-20SSC-H (SW□D5C-FXSSC-E)
FX3U-ENET-L Configuration tool		Abbreviation of FX3U-ENET-L type Ethernet module setting software (SW1D5-FXENETL-E)
FX Configurator-EN		Abbreviation of FX3U-ENET type Ethernet module setting software (SW1D5C-FXENET-E)
RT ToolBox2		Abbreviation of robot program creation software (3D-11C-WINE)
MX Component		Abbreviation of MX Component Version□ (SW□D5C-ACT-E, SW□D5C-ACT-EA)
MX Sheet		Abbreviation of MX Sheet Version□ (SW□D5C-SHEET-E, SW□D5C-SHEET-EA)
CPU Module Logging Configuration Tool		Abbreviation of CPU Module Logging Configuration Tool (SW1DNN-LLUTL-E)

■ License key (for GT SoftGOT1000)

Abbreviations and generic terms	Description
License	GT15-SGTKEY-U, GT15-SGTKEY-P

■ Others

Abbreviations and generic terms	Description
IAI	Abbreviation of IAI Corporation
AZBIL	Abbreviation of Azbil Corporation (former Yamatake Corporation)
OMRON	Abbreviation of OMRON Corporation
KEYENCE	Abbreviation of KEYENCE CORPORATION
KOYO EI	Abbreviation of KOYO ELECTRONICS INDUSTRIES CO., LTD.
SHARP	Abbreviation of Sharp Manufacturing Systems Corporation
JTEKT	Abbreviation of JTEKT Corporation
SHINKO	Abbreviation of Shinko Technos Co., Ltd.
CHINO	Abbreviation of CHINO CORPORATION
TOSHIBA	Abbreviation of TOSHIBA CORPORATION
TOSHIBA MACHINE	Abbreviation of TOSHIBA MACHINE CO., LTD.
HITACHI IES	Abbreviation of Hitachi Industrial Equipment Systems Co., Ltd.
HITACHI	Abbreviation of Hitachi, Ltd.
FUJI	Abbreviation of FUJI ELECTRIC CO., LTD.
PANASONIC	Abbreviation of Panasonic Corporation
PANASONIC INDUSTRIAL DEVICES SUNX	Abbreviation of Panasonic Industrial Devices SUNX Co., Ltd.
YASKAWA	Abbreviation of YASKAWA Electric Corporation
YOKOGAWA	Abbreviation of Yokogawa Electric Corporation
ALLEN-BRADLEY	Abbreviation of Allen-Bradley products manufactured by Rockwell Automation, Inc.
GE	Abbreviation of GE Intelligent Platforms
LS IS	Abbreviation of LS Industrial Systems Co., Ltd.
MITSUBISHI INDIA	Mitsubishi Electric India Pvt. Ltd.
SCHNEIDER	Abbreviation of Schneider Electric SA
SICK	Abbreviation of SICK AG
SIEMENS	Abbreviation of Siemens AG
RKC	Abbreviation of RKC INSTRUMENT INC.
HIRATA	Abbreviation of Hirata Corporation
MURATEC	Abbreviation of Muratec products manufactured by Muratec Automation Co., Ltd.
PLC	Abbreviation of programmable controller
Temperature controller	Generic term for temperature controller manufactured by each corporation
Indicating controller	Generic term for indicating controller manufactured by each corporation
Control equipment	Generic term for control equipment manufactured by each corporation
CHINO controller	Abbreviation of indicating controller manufactured by CHINO CORPORATION
PC CPU module	Abbreviation of PC CPU Unit manufactured by CONTEC CO., LTD
GOT (server)	Abbreviation of GOTs that use the server function
GOT (client)	Abbreviation of GOTs that use the client function
Windows® font	Abbreviation of TrueType font and OpenType font available for Windows® (Differs from the True Type fonts settable with GT Designer3)
Intelligent function module	Indicates the modules other than the PLC CPU, power supply module and I/O module that are mounted to the base unit
MODBUS®/RTU	Generic term for the protocol designed to use MODBUS® protocol messages on a serial communication
MODBUS®/TCP	Generic term for the protocol designed to use MODBUS® protocol messages on a TCP/IP network

HOW TO READ THIS MANUAL

Symbols

Following symbols are used in this manual.

BUS CONNECTION

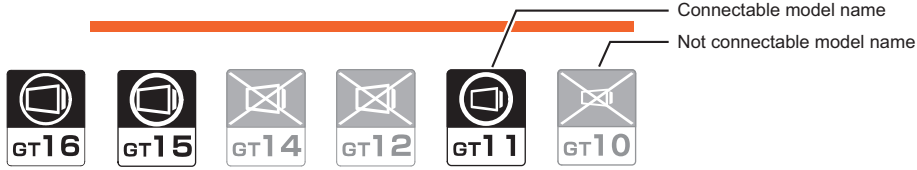

5.1 Connectable Model List 5 - 2

Model name	Computer link module ¹	Communication type	Connection cable		GOT		Number of connectable equipment
			Cable model	Max. distance	Option device	Mode	
MELSEC-Q (A mode)	A1SJ71UC24-R2 A1SJ71C24-R2 A1SJ71UC24-PRF A1SJ71C24-PRF	RS-232C	GT09-C30R2-9P(3m) or RS232C connection diagram 1)	15m	-(Built into GOT)	GT16, GT15, GT11, GT10	1 GOT for 1 computer link module
			RS232C connection diagram 3)	15m	-(Built into GOT)	GT16, GT15, GT10	

Applicable model name

- Shows GT16.
- Shows GT15.
- Shows GT14.
- Shows GT12.
- Shows GT11.
- Shows GT11 (BUS).
- Shows GT11 (SERIAL).
- Shows GT10.
- Shows GT105□, GT104□.
- Shows GT1020, GT1030 (input power supply : 24V).
- Shows GT1020, GT1030 (input power supply : 5V).

5.3 GOT Side Settings

5.3.1 Setting communication interface (Communication settings)

5.3.2 Communication detail settings

Set the channel of the connected equipment.

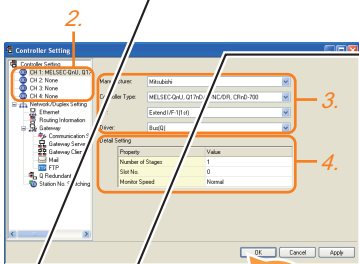

1. Select [Common] → [Controller Setting] from the menu.
2. The Controller Setting window is displayed. Select the channel to be used from the list menu.
3. Select the following.
 - Manufacturer : Mitsubishi
 - Controller Type: Set according to the Controller Type to be connected.
 - I/F: Interface to be used
 - Driver : Set either of the following according to the Controller Type to be connected.
 - BUS (Q)
 - BUS (A/QnA)
4. The detailed setting is displayed after Manufacturer, Controller Type, I/F, and Driver are set. Make the settings according to the usage environment.
 - ☞ 5.3.2 Communication detail settings

(1) Bus(Q)

Property	Value
Number of Stages	1
Slot No.	0
Monitor Speed	Normal

Item	Description	Range
Stage No.	(Default: 1)	1 to 7
Slot No.	(Default: 0)	0 to 9
Monitor	(Default: Normal)	High/Normal/Low

(2) Bus(A/QnA)

Property	Value
Number of Stages	1
Slot No.	0

Item	Description	Range
Stage No.	(Default: 1)	1 to 7
Slot No.	(Default: 0)	0 to 7

POINT

- (1) Communication interface setting by Utility
The communication interface setting can be changed on the Utility's [Communication Settings] after writing [Communication Settings] of project data.
For details on the Utility, refer to the following manual.
- ☞ GT□ User's Manual
- (2) Precedence in communication settings
When settings are made by GT Designer3 or the Utility, the latest setting is effective.
- (3) When changing Stage No. and Slot No.
Change these settings with the PLC CPU turned OFF, and then reapply the power to the PLC CPU and GOT.
Failure to do so may generate a system alarm (No.487).

1. → 2. → 3. ...

Indicates the operation steps.

[]: Indicates the setting items displayed on the software and GOT screen.

POINT Refers to the information required.

HINT Refers to information useful for operation.

Indicates the location of related content.

Since the above page was created for explanation purpose, it differs from the actual page.

■ About system configuration

The following describes the system configuration of each connection included in this manual.

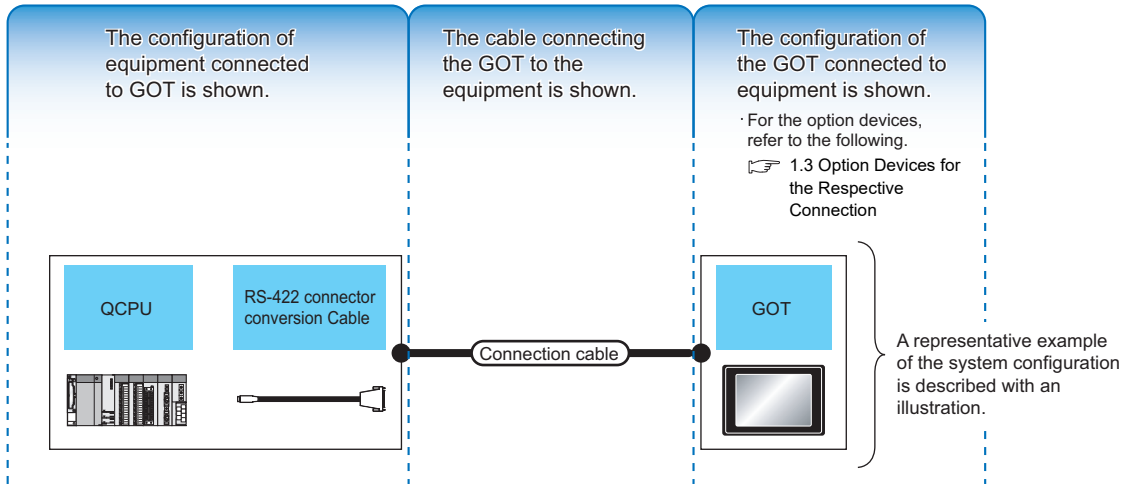

PLC			Connection cable		GOT		Number of connectable equipment
Model name	RS-422 connector conversion cable	Communication type	Cable model	Max. distance	Option device	Model	
MELSEC-Q	-	RS-232	GT01-C30R2-6P(3m)	3m	- (Built into GOT)		1 GOT for 1 PLC
			GT15-RS2-9P		GT15-RS2-9P		
			GT01-RS4-M ⁴		GT01-RS4-M ⁴	-	
			GT10-C30R2-6P(3m)	3m	- (Built into GOT)		
MELSEC-Q	FA-CNV2402CBL(0.2m) FA-CNV2405CBL(0.5m)	RS-422	GT01-C30R4-25P(3m)	30m	GT16-C02R4-9S		1 GOT for 1 PLC
			GT01-C100R4-25P(10m)		GT15-RS2T4-9P ¹		
			GT01-C200R4-25P(20m)		GT15-RS4-9S		
			GT01-C300R4-25P(30m)		- (Built into GOT)		
				30m	- (Built into GOT)		

Indicates the connection diagram number of cables to be prepared by the user. Refer to the connection diagram section in each chapter.

Indicates the commercially available cable models that can be used.

Indicates the maximum distance between the PLC and GOT.

System Configuration Examples
 (When connecting the PLC [MELSEC-Q] and GT16, with RS-422 cable)
 1) Connect the RS-422 conversion cable [FA-CNV2402CBL] to the [MELSEC-Q].
 2) Connect the option [GT16-C02R4-9S] to [GT16].
 3) Connect [MELSEC-Q] and [GT16] with the connection cable [GT01-C30R4-25P].

Since the above page was created for explanation purpose, it differs from the actual page.

1

PREPARATORY PROCEDURES FOR MONITORING

1.1	Setting the Communication Interface	1 - 3
1.2	Writing the Project Data and OS onto the GOT	1 - 16
1.3	Option Devices for the Respective Connection	1 - 18
1.4	Connection Cables for the Respective Connection	1 - 27
1.5	Verifying GOT Recognizes Connected Equipment	1 - 35
1.6	Checking for Normal Monitoring.	1 - 40

1
PREPARATORY PROCEDURES FOR MONITORING

2
DEVICE RANGE THAT CAN BE SET

3
ACCESS RANGE FOR MONITORING

4
HOW TO MONITOR REDUNDANT SYSTEM

5
BUS CONNECTION

6
DIRECT CONNECTION TO CPU

7
COMPUTER LINK CONNECTION

8
ETHERNET CONNECTION

1. PREPARATORY PROCEDURES FOR MONITORING

The following shows the procedures to be taken before monitoring and corresponding reference sections.

Setting the communication interface

Determine the connection type and channel No. to be used, and perform the communication setting.

- ☞ 1.1 Setting the Communication Interface
- ☞ Each chapter GOT Side Settings



Writing the project data and OS

Write the standard monitor OS, communication driver, option OS, project data and communication settings onto the GOT.

- ☞ 1.2.1 Writing the project data and OS onto the GOT



Verifying the project data and OS

Verify the standard monitor OS, communication driver, option OS, project data and communication settings are properly written onto the GOT.

- ☞ 1.2.2 Checking the project data and OS writing on GOT



Attaching the communication unit and connecting the cable

Mount the optional equipment and prepare/connect the connection cable according to the connection type.

- ☞ 1.3 Option Devices for the Respective Connection
- ☞ 1.4 Connection Cables for the Respective Connection
- ☞ Each chapter System Configuration
- ☞ Each chapter Connection Diagram



Verifying GOT recognizes connected equipment

Verify the GOT recognizes controllers on [Communication Settings] of the Utility.

- ☞ 1.5 Verifying GOT Recognizes Connected Equipment



Verifying the GOT is monitoring normally

Verify the GOT is monitoring normally using Utility, Developer, etc.

- ☞ 1.6 Checking for Normal Monitoring

1.1 Setting the Communication Interface

Set the communication interface of GOT and the connected equipment.

When using the GOT at the first time, make sure to set the channel of communication interface and the communication driver before writing to GOT.

Set the communication interface of the GOT at [Controller Setting] and [I/F Communication Setting] in GT Designer3.

POINT

When using the parameter reflection function of MELSOFT Navigator.

The system configuration of MELSOFT Navigator can be reflected to the project of GT Designer3 using the parameter function of MELSOFT Navigator.

For details of the parameter functions of MELSOFT Navigator, refer to the following.

 Help of MELSOFT Navigator

- (1) The color of the cells for the items which are reflected to GT Designer3 from MELSOFT Navigator changes to green. Set items, which are displayed in green cells, from the MELSOFT Navigator. When changing in GT Designer3, refer to the following (3).

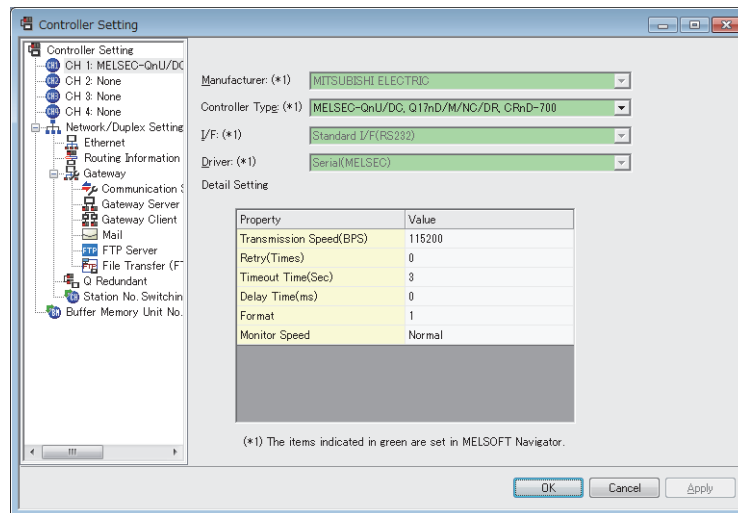

- (2) When setting the communication interface for the connection with the iQ Works untargeted equipment, set [Set with GT Designer3] to the channel connected at [Input Detailed Configuration Information] in MELSOFT Navigator and make the settings at [Controller Setting] in GT Designer3.

- (3) To make the items reflected from MELSOFT Navigator editable on GT Designer3, select the [Option] menu and put a check mark at [Enable an editing of parameters set in MELSOFT Navigator] in the [iQ Works Interaction] tab.

However, when the items set in MELSOFT Navigator are edited in GT Designer3, the interaction function with MELSOFT Navigator is unavailable due to a mismatch with the system configuration of MELSOFT Navigator. Eliminate mismatches using the parameter verification function etc. before using the interaction function of MELSOFT Navigator.

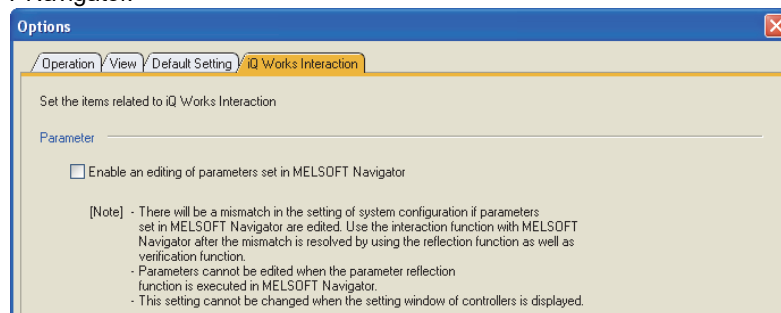

1.1.1 Setting connected equipment (Channel setting)

Set the channel of the equipment connected to the GOT.

■ Setting

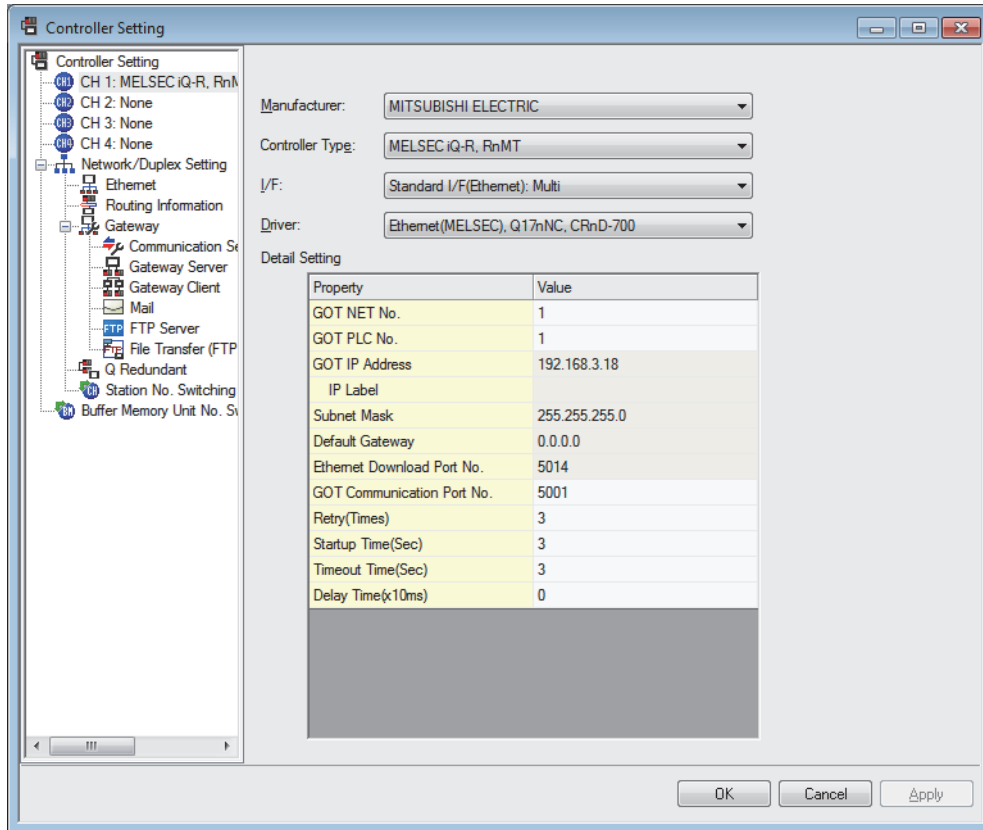

1. Select [Common] → [Controller Setting] from the menu.
2. The Controller Setting dialog box appears. Select the channel No. to be used from the list menu.
3. Refer to the following explanations for the setting.

POINT

Channel No.2 to No.4

Use the channel No.2 to No.4 when using the Multi-channel function.

For details of the Multi-channel function, refer to the following.

 Mitsubishi Electric Products 22. MULTI-CHANNEL FUNCTION

■ Setting item

This section describes the setting items of the Manufacturer, Controller Type, Driver and I/F. When using the channel No.2 to No.4, put a check mark at [Use CH*].

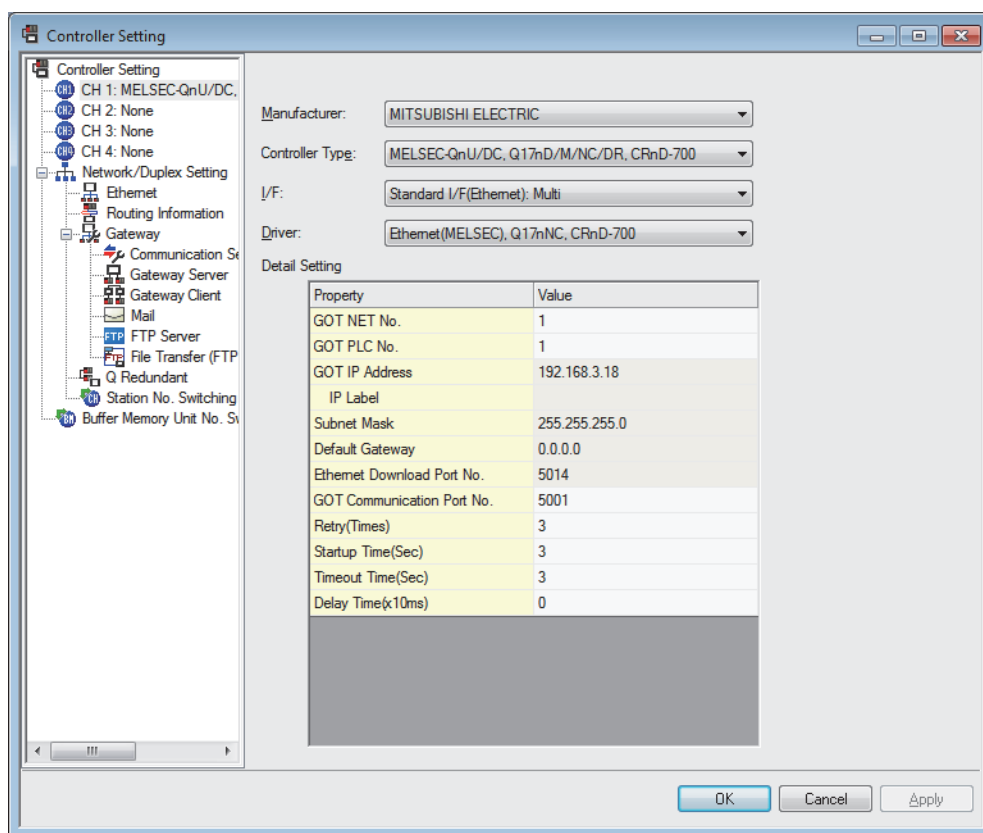

Item	Description
Use CH*	Select this item when setting the channel No.2 to No.4.
Manufacturer	Select the manufacturer of the equipment to be connected to the GOT.
Type	Select the type of the equipment to be connected to the GOT. For the settings, refer to the following. ☞ (2)Setting [Controller Type]
I/F	Select the interface of the GOT to which the equipment is connected.For the settings, refer to the following. ☞ (3)Setting [I/F]
Driver	Select the communication driver to be written to the GOT. For the settings, refer to the following. ☞ (1)Setting [Driver]
Detail Setting	Make settings for the transmission speed and data length of the communication driver. ☞ Refer to each chapter of the equipment to be connected to the GOT.

(1) Setting [Driver]

The displayed items for a driver differ according to the settings [Manufacturer], [Controller Type] and [I/F]. When the driver to be set is not displayed, confirm if [Manufacturer], [Controller Type] and [I/F] are correct. For the settings, refer to the following.

☞ [Setting the communication interface] section in each chapter

(2) Setting [Controller Type]

The types for the selection differs depending on the PLC to be used.
For the settings, refer to the following.

Type	Model name
MELSEC iQ-R, RnMT	R04CPU
	R08CPU
	R16CPU
	R32CPU
	R120CPU
	R16MTCPU
	R32MTCPU
	R08PCPU
	R16PCPU
	R32PCPU
	R120PCPU
	R04ENCPU
	R08ENCPU
	R16ENCPU
R32ENCPU	
R120ENCPU	
R08SFCPU	
R16SFCPU	
R32SFCPU	
R120SFCPU	
R12CCPU-V	
MELSEC iQ-F	FX5U
	FX5UC
For GT16, GT15, GT14, GT12, GT11 MELSEC-Q(MULTI)/Q MOTION	Q00CPU
	Q01CPU
	Q02CPU
	Q02HCPU
	Q06HCPU
	Q12HCPU
	Q25HCPU
	Q02PHCPU
	Q06PHCPU
	Q12PHCPU
	Q25PHCPU
	Q172CPU
	Q173CPU
	Q172CPUN
Q173CPUN	
Q172HCPU	
Q173HCPU	
For GT16, GT15, GT12 ^{*1,2} MELSEC-QnU/DC, Q17nD/M/NC/DR, CRnD-700	Q00UCPU
	Q01UCPU
	Q02UCPU
	Q03UDCPU
	Q04UDHCPU
	Q06UDHCPU
	Q10UDHCPU
	Q13UDHCPU
	Q20UDHCPU
	Q26UDHCPU
	Q03UDECPU
	Q04UDEHCPU
	Q06UDEHCPU
	Q10UDEHCPU
Q13UDEHCPU	
Q20UDEHCPU	
Q26UDEHCPU	
Q50UDEHCPU	
Q100UDEHCPU	

Type	Model name	
For GT16, GT15, GT12 ^{*1,2} MELSEC-QnU/DC, Q17nD/M/NC/DR, CRnD-700	Q03UDVCPU	
	Q04UDVCPU	
	Q06UDVCPU	
	Q13UDVCPU	
	Q26UDVCPU	
	Q12DCCPU-V	
	Q24DHCCPU-V/VG	
	Q24DHCCPU-LS	
	Q26DHCCPU-LS	
	Q172DCPU	
	Q173DCPU	
	Q172DCPU-S1	
	Q173DCPU-S1	
	Q172DSCPU	
Q173DSCPU		
Q170MCP		
Q170MSCPU		
Q170MSCPU-S1		
For GT14, GT11 ^{*1} MELSEC-QnU/DC, Q17nD/M/NC/DR	CNC C70 (Q173NCCPU)	
	CRnQ-700 (Q172DRCPU)	
	CR750-Q (Q172DRCPU)	
	CR751-Q (Q172DRCPU)	
	CRnD-700 CR750-D CR751-D	
	For GT10 ^{*1} MELSEC-QnU/DC	Q00JCPU
		Q00CPU
		Q01CPU
		Q02CPU
		Q02HCPU
		Q06HCPU
		Q12HCPU
		Q25HCPU
		Q02PHCPU
Q06PHCPU		
Q12PHCPU		
Q25PHCPU		
Q12PRHCPU		
Q25PRHCPU		
QS001CPU		
Q2ACPU		
Q2ACPU-S1		
Q3ACPU		
Q4ACPU		
Q4ARCPU		
Q2ASCPU		
Q2ASCPU-S1		
Q2ASHCPU		
Q2ASHCPU-S1		
For GT16, GT15, GT12 ^{*1,2} MELSEC-QnA/Q/QS, MELDAS C6 [*]	MELDAS C6 (FCA C6)	
	MELDAS C64 (FCA C64)	

Type	Model name
MELSEC-L	L02CPU
	L06CPU
	L26CPU
	L26CPU-BT
	L02CPU-P
	L06CPU-P
	L26CPU-P
	L26CPU-PBT
	L02SCPU
	L02SCPU-P
	NZ2GF-ETB

- *1 When using the multiple CPU system
When using the GOT to monitor the multiple CPU system of other station, select [MELSEC-Q(Multi)/Q-Motion], or [MELSEC-QnU/DC, Q17nD/M/NC/DR, CRnD-700] for the type regardless of the host PLC CPU type.
- *2 When connecting to the remote I/O station in the MELSECNET/H network system, set the type to [MELSEC-QnA/Q/QS, MELDAS C6 *].

Type	Model name
MELSEC-A	A2UCPU
	A2UCPU-S1
	A3UCPU
	A4UCPU
	A2ACPU
	A2ACPUP21
	A2ACPUR21
	A2ACPU-S1
	A2ACPUP21-S1
	A2ACPUR21-S1
	A3ACPU
	A3ACPUP21
	A3ACPUR21
	A1NCPUP21
	A1NCPUR21
	A2NCPUP21
	A2NCPUR21
	A2NCPUS1
	A2NCPUP21-S1
	A2NCPUR21-S1
	A3NCPUP21
	A3NCPUR21
	A2USCPU
	A2USCPU-S1
	A2USHCPU-S1
	A1SCPU
	A1SCPUC24-R2
	A1SHCPU
	A2SCPU
	A2SCPU-S1
	A2SHCPU
	A2SHCPU-S1
	A1SJCPU
	A1SJCPU-S3
	A1SJHCPU
	A0J2HCPU
	A0J2HCPUP21
	A0J2HCPUR21
	A0J2HCPU-DC24
	A2CCPU
	A2CCPUP21
	A2CCPUR21
	A2CCPUC24
	A2CCPUC24-PRF
	A2CJCPU-S3
	A1FXCPU
	A273UCPU
A273UHCPU	
A273UHCPU-S3	
A373UCPU	
A373UCPU-S3	

1 PREPARATORY PROCEDURES FOR MONITORING

2 DEVICE RANGE THAT CAN BE SET

3 ACCESS RANGE FOR MONITORING

4 HOW TO MONITOR REDUNDANT SYSTEM

5 BUS CONNECTION

6 DIRECT CONNECTION TO CPU

7 COMPUTER LINK CONNECTION

8 ETHERNET CONNECTION

Type	Model name
MELSEC-A	A171SCPU
	A171SCPU-S3
	A171SCPU-S3N
	A171SHCPU
	A171SHCPUN
	A172SHCPU
	A172SHCPUN
	A173UHCPU
	A173UHCPUS1
MELSEC-FX	FX0
	FX0S
	FX0N
	FX1
	FX2
	FX2C
	FX1S
	FX1N
	FX2N
	FX1NC
	FX2NC
	FX3S
	FX3G
	FX3GC
	FX3GE
	FX3U
	FX3UC
	MELSEC-FX(Ethernet)
FX3G	
FX3GC	
FX3GE	
FX3UC	
MELSEC-WS	WS0-CPU0
	WS0-CPU1
	WS0-CPU3
MELSERVO-J2M-P8A	MELSERVO-J2M-P8A
MELSERVO-J2M-*DU	MELSERVO-J2M-*DU
MELSERVO-J2S-*A	MELSERVO-J2S-*A
MELSERVO-J2S-*CP	MELSERVO-J2S-*CP
MELSERVO-J2S-*CL	MELSERVO-J2S-*CL
MELSERVO-J3-*A	MELSERVO-J3-*A
MELSERVO-J3-*T	MELSERVO-J3-*T
MELSERVO-J4-*A	MELSERVO-J4-*A
MELSERVO-JE-*A	MELSERVO-JE-*A
FREQROL 500/700/800 Series	FREQROL-S500
	FREQROL-S500E
	FREQROL-E500
	FREQROL-F500
	FREQROL-F500L
	FREQROL-F500J
	FREQROL-A500
	FREQROL-A500L
	FREQROL-V500
	FREQROL-V500L
	FREQROL-D700

Type	Model name
FREQROL 500/700/800 Series	FREQROL-E700
	FREQROL-F700
	FREQROL-F700P
	FREQROL-F700PJ
	FREQROL-A700
	FREQROL-A800
Sensorless Servo	FREQROL-F800
	FREQROL-E700EX

(3) Setting [I/F]

The interface differs depending on the GOT to be used.

Set the I/F according to the connection and the position of communication unit to be mounted onto the GOT.

(a) GT16

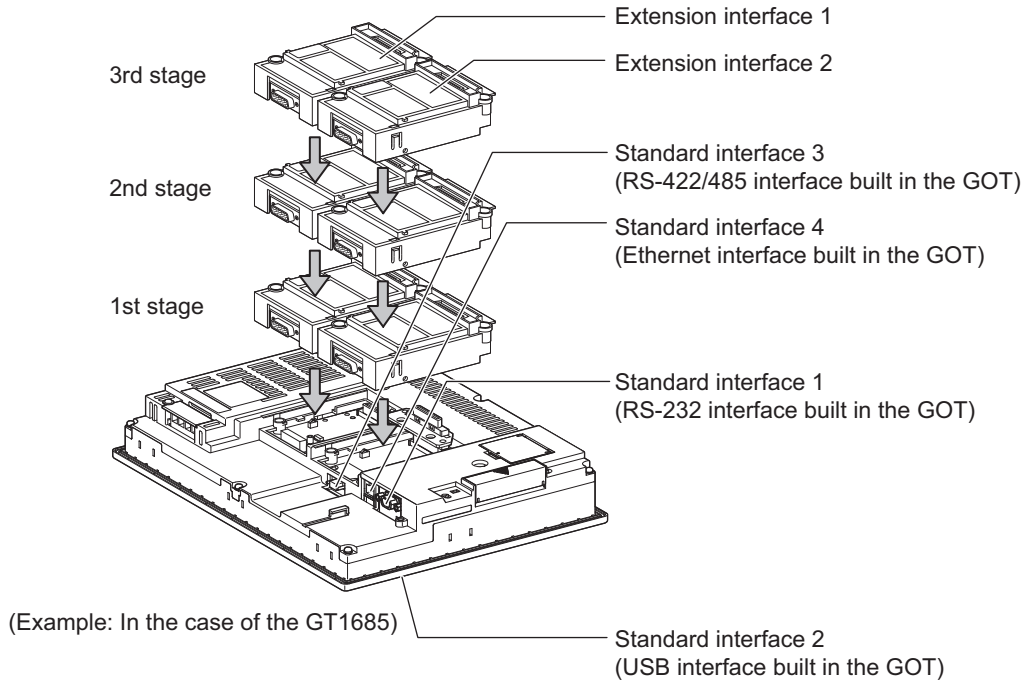

(b) GT15

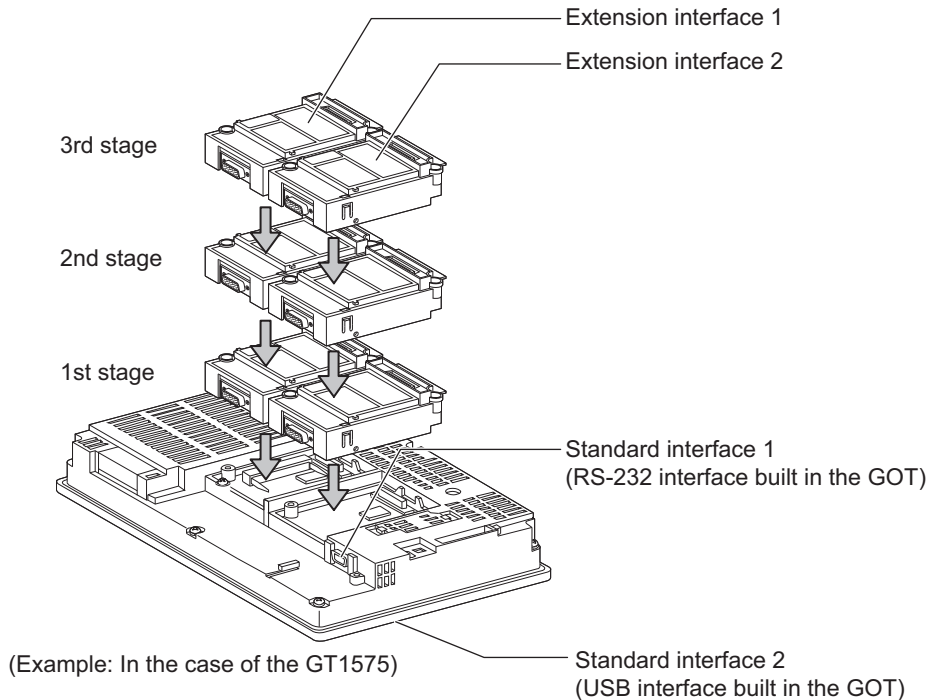

(c) GT14

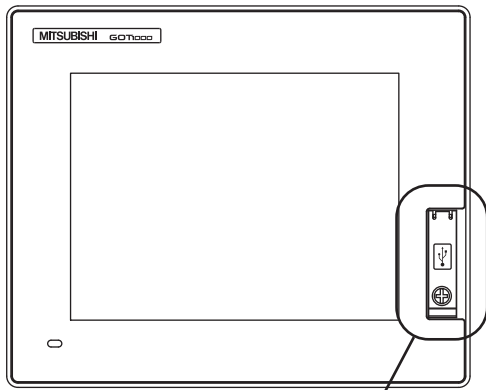

[Front view]]

Standard interface 3
(GOT built-in USB interface)

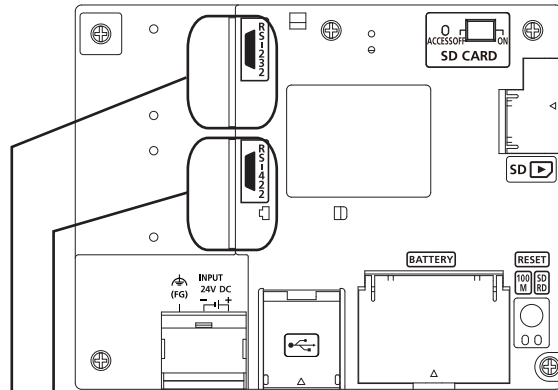

[Rear view]

Standard interface 1
(GOT built-in RS-422 interface)

Standard interface 2
(GOT built-in RS-232 interface)

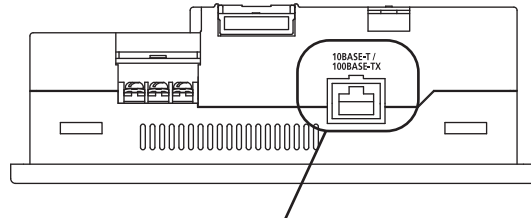

Standard interface 4
(GOT built-in Ethernet interface)

[Under view]

(d) GT12

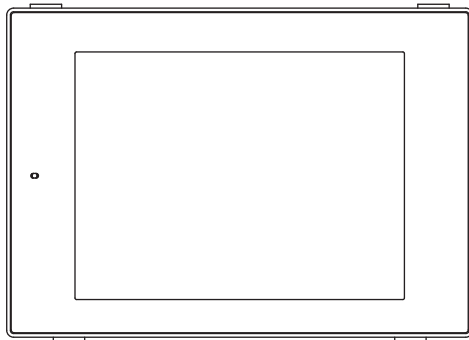

[Front view]

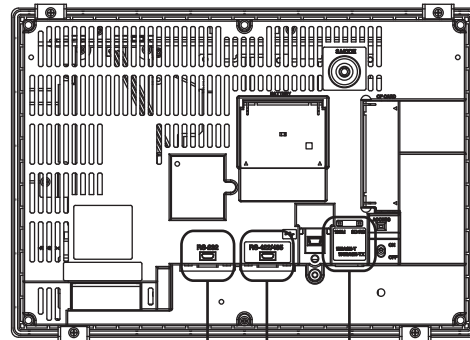

[Rear view]

Standard interface 4
(GOT built-in Ethernet interface)

Standard interface 1
(GOT built-in RS-422 interface)

Standard interface 2
(GOT built-in RS-232 interface)

(e) GT11
 • GT11 Serial

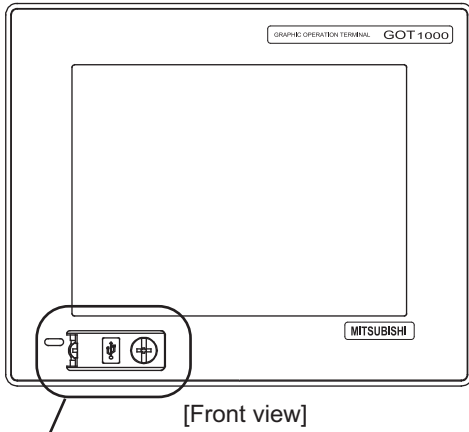

Standard interface 3
 (GOT built-in USB interface)

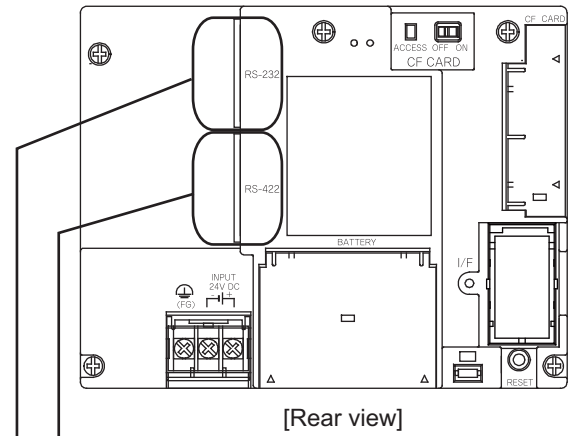

Standard interface 1
 (GOT built-in RS-422 interface)

Standard interface 2
 (GOT built-in RS-232 interface)

• GT11 Bus

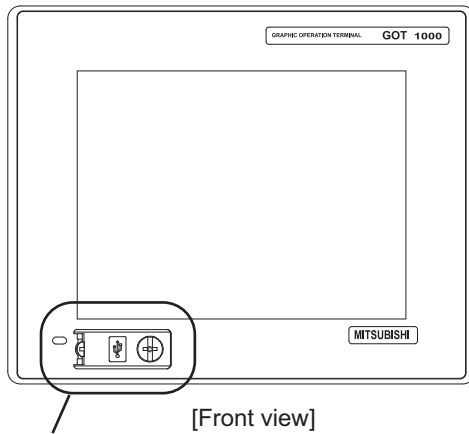

Standard interface 3
 (GOT built-in USB interface)

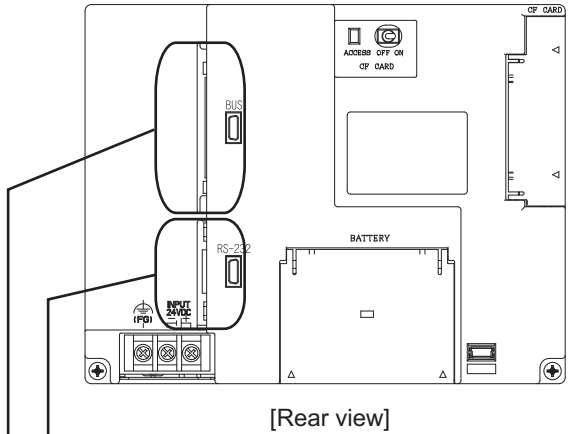

Standard interface 2
 (GOT built-in RS-232 interface)

Standard interface 1
 (GOT built-in Bus interface)

(f) GT105□

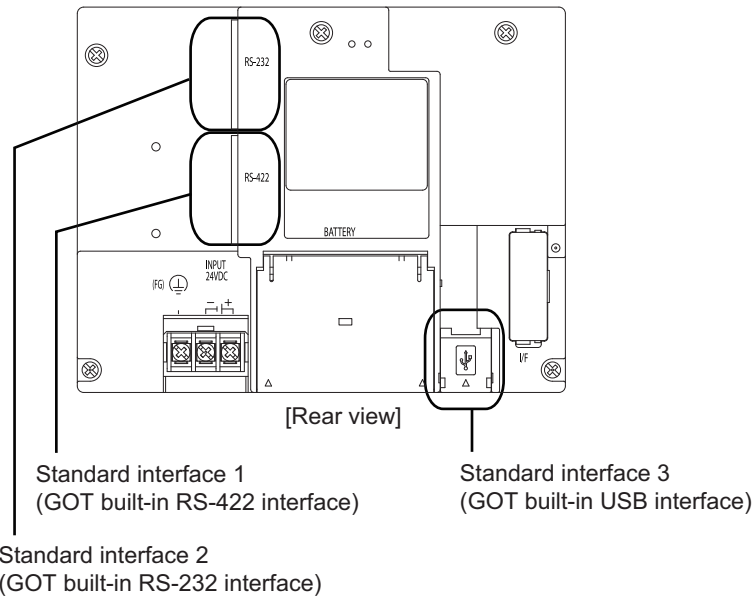

(g) GT104□

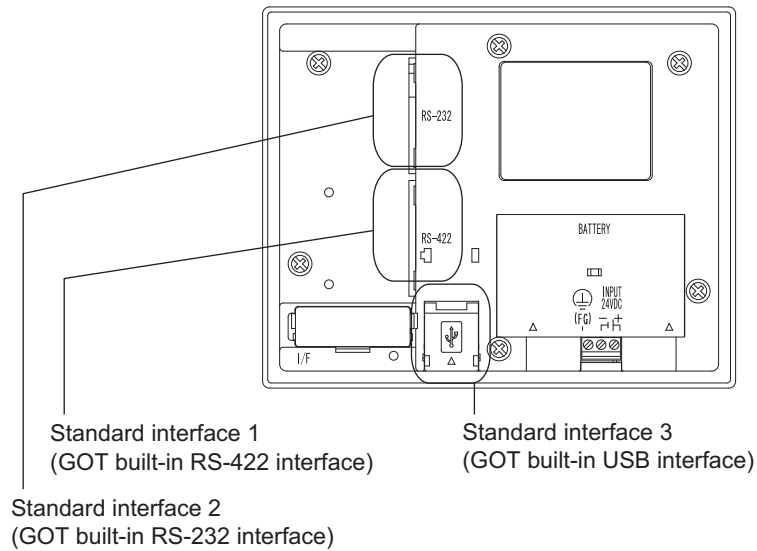

(h) GT1020, GT1030

Standard interface 1
(GOT built-in RS-422 interface)
or (GOT built-in RS-232 interface)

Standard interface 2
(GOT built-in RS-232 interface)

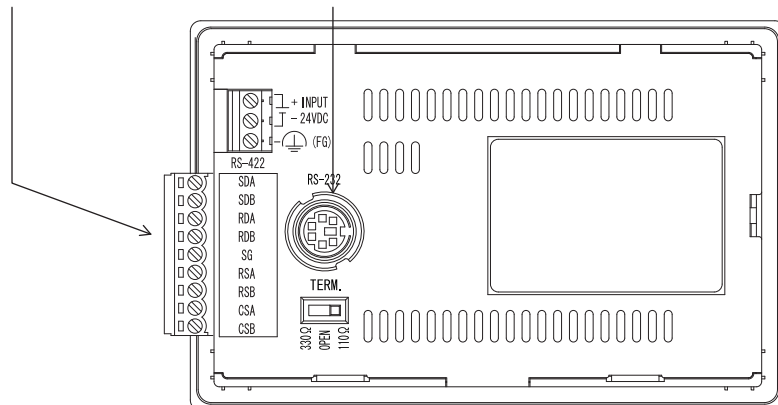

1.1.2 I/F communication setting

This function displays the list of the GOT communication interfaces.
Set the channel and the communication driver to the interface to be used.

■ Setting

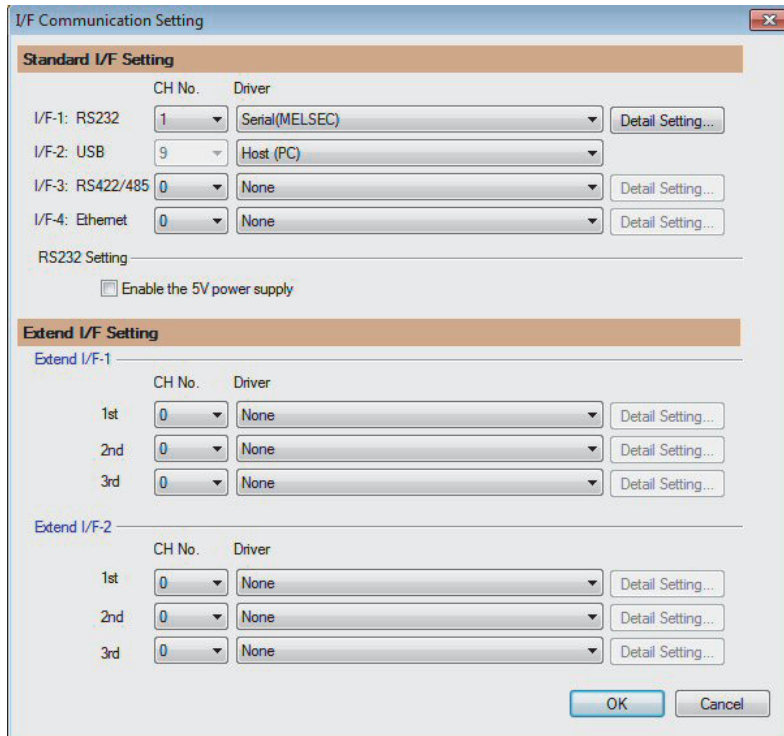

1. Select [Common] → [I/F Communication Setting] from the menu.
2. The I/F Communication Setting dialog box appears. Make the settings with reference to the following explanation.

POINT

When using the parameter reflection function of MELSOFT Navigator.

When setting [Controller Setting] in GT Designer3 using the parameter function of MELSOFT Navigator, all of I/F Communication Setting are grayout and cannot be edited. Set these items at [Controller Setting] or [Peripheral Unit Setting].

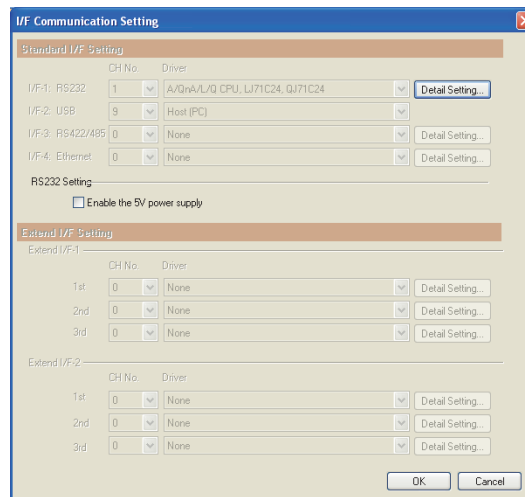

■ Setting item

The following describes the setting items for the standard I/F setting and extension I/F setting.

Item	Description
Standard I/F setting	Set channel No. and drivers to the GOT standard interfaces. GT16, GT14, GT12: Standard I/F-1, Standard I/F-2, Standard I/F-3, Standard I/F-4 GT15, GT1030, GT1020: Standard I/F-1, Standard I/F-2 GT11, GT105□, GT104□: Standard I/F-1, Standard I/F-2, Standard I/F-3
CH No.	Set the CH No. according to the intended purpose. The number of channels differs depending on the GOT to be used. 0: Not used 1 to 4: Used for connecting a controller of channel No. 1 to 4 set in Setting connected equipment (Channel setting) 8: Used for fingerprint authentication, barcode function, RFID function, remote personal computer operation (serial), report function (when using the serial printer), hard copy function (when using the serial printer) or GOT (extended computer) 9: Used for connecting Host (PC) or Host (modem) *: Used for remote personal computer operation (Ethernet), Ethernet download, gateway function or MES interface function Multi: Used for Ethernet multiple connection
I/F	The communication type of the GOT standard interface is displayed.
Driver	Set the driver for the device to be connected. · None · Host (Personal computer) · Each communication driver for connected devices
Detail Setting	Make settings for the transmission speed and data length of the communication driver. Refer to each chapter of the equipment to be connected to the GOT.
RS232 Setting	To validate the 5V power supply function in RS232, mark the [Enable the 5V power supply] checkbox. The RS232 setting is invalid in the following cases. • CH No. of [I/F-1: RS232] is [9] in GT15 and 16. • CH No. of [I/F-1: RS232] is [9] or [8] in GT14. • For GT12, GT11 and GT10

(Continued to next page)

Item	Description
Extension I/F setting	Set the communication unit attached to the extension interface of the GOT.
CH No.	Set the CH No. according to the intended purpose. The number of channels differs depending on the GOT to be used. 0: Not used 1 to 4: Used for connecting a controller of channel No. 1 to 4 set in Setting connected equipment (Channel setting) 5 to 7: Used for barcode function, RFID function, remote personal computer operation (serial), report function (when using the serial printer) or hard copy function (when using the serial printer) *: Used for remote personal computer operation (Ethernet), video display function, multimedia function, operation panel function, external I/O function, RGB display function, report function (when using a PictBridge compatible printer), hard copy function (when using a PictBridge compatible printer), sound output function, functions with the CF card unit or CF card extension unit, Ethernet download, gateway function or MES interface function
Driver	Set the driver for the device to be connected. · None · Each driver for connected devices
Detail Setting	Make settings for the transmission speed and data length of the communication driver.  Refer to each chapter of the equipment to be connected to the GOT.

POINT

Channel No., drivers, [RS232 Setting]

(1) Channel No.2 to No.4

Use the channel No.2 to No.4 when using the Multi-channel function.
For details of the Multi-channel function, refer to the following.

 Mitsubishi Electric Products 22. MULTI-CHANNEL FUNCTION

(2) Drivers

The displayed items for a driver differ according to the settings [Manufacturer], [Controller Type] and [I/F].
When the driver to be set is not displayed, confirm if [Manufacturer], [Controller Type] and [I/F] are correct.

 [Setting the communication] section in each chapter

(3) [RS232 Setting] of GT14

Do not use [RS232 Setting] of GT14 for other than the 5V power feeding to the RS-232/485 signal conversion adaptor.
For details, refer to the following manual.

 GT14 User's Manual 7.11 RS-232/485 Signal Conversion Adaptor

1.1.3 Precautions

(1) When using the multiple CPU system

When using the GOT to monitor the multiple CPU system of other stations, select [MELSEC-Q(Multi)/Q-Motion] or [MELSEC-QnU, Q17nD/M/NC/DR, CRnD-700] for the type, regardless of the host PLC CPU type (QCPU, QnACPU, ACPU). When other models are selected, the setting of the CPU No. becomes unavailable.

(2) Precautions for changing model

(a) When devices that cannot be converted are included.

When setting of [Manufacturer] or [Controller Type] is changed, GT Designer3 displays the device that cannot be converted (no corresponding device type, or excessive setting ranges as [??]). In this case, set the device again.

(b) When the changed Manufacturer or Controller Type does not correspond to the network.

The network will be set to the host station.

(c) When the Manufacturer or Controller Type is changed to [None]

The GT Designer3 displays the device of the changed channel No. as [??]. In this case, set the device again.

Since the channel No. is retained, the objects can be reused in other channel No. in a batch by using the [Device Batch Edit], [CH No. Batch Edit] or [Device List].

1.2 Writing the Project Data and OS onto the GOT

Write the standard monitor OS, communication driver, option OS, project data and communication settings onto the GOT. For details on writing to GOT, refer to the following manual.

 GT Designer3 Version□ Screen Design Manual

1.2.1 Writing the project data and OS onto the GOT

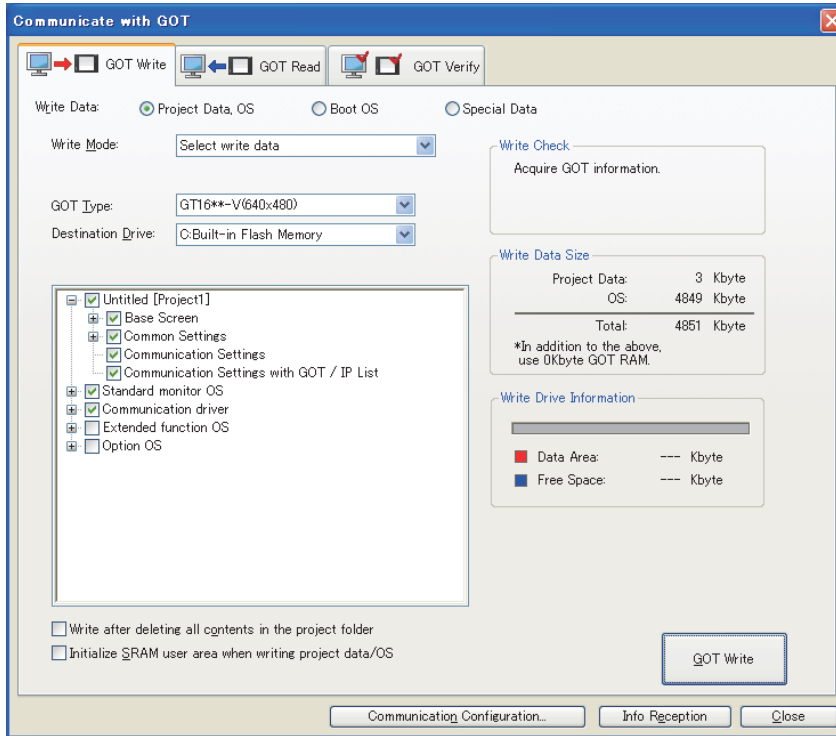

1. Select [Communication] → [Write to GOT...] from the menu.
2. The [Communication configuration] dialog box appears. Set the communication setting between the GOT and the personal computer. Click the [OK] button when settings are completed.
3. The [GOT Write] tab appears on the [Communicate with GOT] dialog box. Select the [Project data, OS] radio button of the Write Data.
4. Check-mark a desired standard monitor OS, communication driver, option OS, extended function OS, and Communication Settings and click the [GOT Write] button.

POINT

Writing communication driver onto GT10

When writing a communication driver onto the GT10 in which a Boot OS Ver. under F or a standard monitor OS Ver. under 01.08.00 is written, turn on the GOT in the OS transfer mode.

For details, refer to the following manual.

 GT10 User's Manual

(Operating of transmission mode)

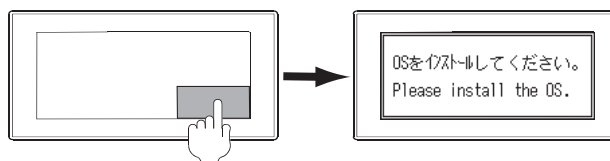

Turn on the GOT while the bottom right corner is touched.

1.2.2 Checking the project data and OS writing on GOT

Confirm if the standard monitor OS, communication driver, option OS, project data and communication settings are properly written onto the GOT by reading from GOT using GT Designer3.
For reading from the GOT, refer to the following manual.

 GT Designer3 Version□ Screen Design Manual

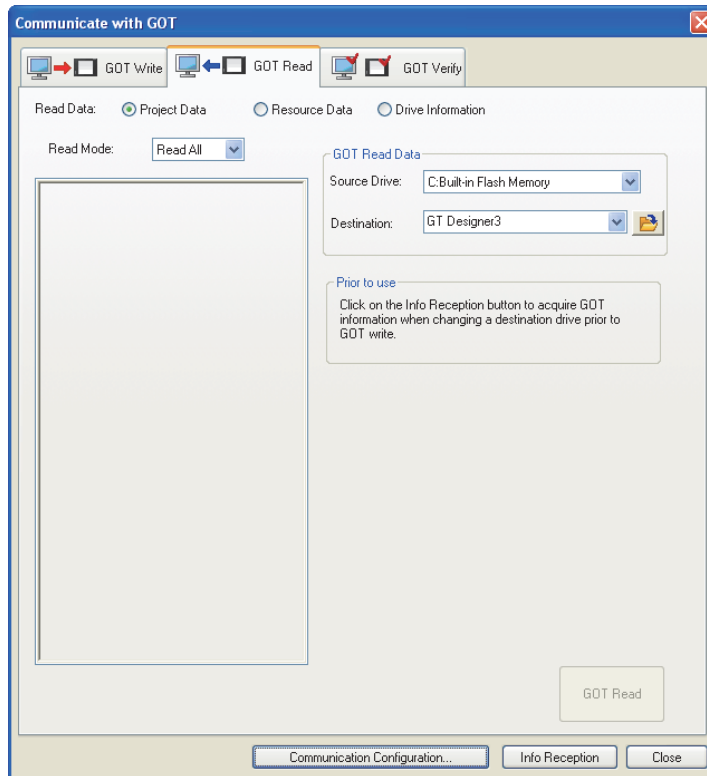

1. Select [Communication] → [Read from GOT...] from the menu.
2. The [Communication configuration] dialog box appears.
Set the communication setting between the GOT and the personal computer.
Click the [OK] button when settings are completed.
3. The [GOT Read] tab appears on the [Communicate with GOT] dialog box.
Select the [Drive information] radio button of the Read Data.
4. Click the [Info Reception] button.
5. Confirm that the project data and OS are written correctly onto the GOT.

1.3 Option Devices for the Respective Connection

The following shows the option devices to connect in the respective connection type.

For the specifications, usage and connecting procedure on option devices, refer to the respective device manual.

1.3.1 Communication module

Product name	Model	Specifications	
Bus connection unit	GT15-QBUS	For QCPU (Q mode), motion controller CPU (Q series) Bus connection (1ch) unit standard model	
	GT15-QBUS2	For QCPU (Q mode), motion controller CPU (Q series) Bus connection (2ch) unit standard model	
	GT15-ABUS	For A/QnACPU, motion controller CPU (A series) Bus connection (1ch) unit standard model	
	GT15-ABUS2	For A/QnACPU, motion controller CPU (A series) Bus connection (2ch) unit standard model	
	GT15-75QBUSL	For QCPU (Q mode), motion controller CPU (Q series) Bus connection (1ch) unit slim model	
	GT15-75QBUS2L	For QCPU (Q mode), motion controller CPU (Q series) Bus connection (2ch) unit slim model	
	GT15-75ABUSL	For A/QnACPU, motion controller CPU (A series) Bus connection (1ch) unit slim model	
	GT15-75ABUS2L	For A/QnACPU, motion controller CPU (A series) Bus connection (1ch) unit slim model	
Serial communication module	GT15-RS2-9P	RS-232 serial communication unit (D-sub 9-pin (male))	
	GT15-RS4-9S	RS-422/485 serial communication unit (D-sub 9-pin (female))	
	GT15-RS4-TE	RS-422/485 serial communication unit (terminal block)	
RS-422 conversion unit	GT15-RS2T4-9P	RS-232 → RS-422 conversion unit	RS-422 side connector 9-pin
	GT15-RS2T4-25P		RS-422 side connector 25-pin
MELSECNET/H Communication module	GT15-J71LP23-25	Optical loop unit	
	GT15-J71BR13	Coaxial bus unit	
MELSECNET/10 Communication module	GT15-75J71LP23-Z	Optical loop unit (A9GT-QJ71LP23 + GT15-75IF900 set)	
	GT15-75J71BR13-Z	Coaxial bus unit (A9GT-QJ71BR13 + GT15-75IF900 set)	
CC-Link IE Controller Network communication unit	GT15-J71GP23-SX	Optical loop unit	
CC-Link IE Field Network communication unit	GT15-J71GF13-T2	CC-Link IE Field Network (1000BASE-T) unit	
CC-Link communication unit	GT15-J61BT13	Intelligent device station unit CC-LINK Ver. 2 compatible	
	GT15-75J61BT13-Z	Intelligent device station unit (A8GT-61BT13 + GT15-75IF900 set)	
Ethernet communication unit	GT15-J71E71-100	Ethernet (100Base-TX) unit	

1.3.2 Option unit

Product name	Model	Specifications
Printer unit	GT15-PRN	USB slave (PictBridge) for connecting printer 1 ch
Multimedia unit	GT16M-MMR	For video input signal (NTSC/PAL) 1 ch, playing movie
Video input unit	GT16M-V4	For video input signal (NTSC/PAL) 4 ch
	GT15V-75V4	
RGB input unit	GT16M-R2	For analog RGB input signal 2 ch
	GT15V-75R1	
Video/RGB input unit	GT16M-V4R1	For video input signal (NTSC/PAL) 4 ch, for analog RGB mixed input signal 1 ch
	GT15V-75V4R1	
RGB output unit	GT16M-ROUT	For analog RGB output signal 1 ch
	GT15V-75ROUT	
CF card unit	GT15-CFCD	For CF card installation (B drive) For GOT back face CF card eject
CF card extension unit	GT15-CFEX-C08SET	For CF card installation (B drive) For control panel front face CF card eject
Sound output unit	GT15-SOUT	For sound output
External I/O unit	GT15-DIOR	For the connection to external I/O device or operation panel (Negative Common Input/Source Type Output)
	GT15-DIO	For the connection to external I/O device or operation panel (Positive Common Input/Sink Type Output)

1.3.3 Conversion cables

Product name	Model	Specifications
RS-422 connector conversion Cable	GT16-C02R4-9S	RS-422/485 (Connector) ↔ RS-422 connector conversion cable (D-sub 9-pin)
RS-485 terminal block conversion modules	FA-LTBGTR4CBL05	RS-422/485 (Connector) ↔ RS-485 (Terminal block) Supplied connection cable dedicated for the conversion unit
	FA-LTBGTR4CBL10	
	FA-LTBGTR4CBL20	

1.3.4 Connector conversion adapter

Product name	Model	Specifications
Connector conversion adapter	GT10-9PT5S	RS-422/485 (D-Sub 9-pin connector) ↔ RS-422/485 (Terminal block)

1.3.5 Serial Multi-Drop Connection Unit

Product name	Model	Specifications
Serial multi-drop connection unit	GT01-RS4-M	GOT multi-drop connection module  Mitsubishi Electric Products 20. GOT MULTI-DROP CONNECTION

1.3.6 RS-232/485 signal conversion adapter

Product name	Model	Specifications
RS-232/485 signal conversion adapter	GT14-RS2T4-9P	RS-232 signal (D-Sub 9-pin connector) → RS-485 signal (Terminal block)

1.3.7 Installing a unit on another unit (Checking the unit installation position)

This section describes the precautions for installing units on another unit.

For the installation method of each unit, refer to the User's Manual for the communication unit and option unit you are using.

For the method for installing a unit on another unit, refer to the following.

 User's Manual of GOT used.

■ Calculating consumed current

For using multiple extension units, a bar code reader, or a RFID controller, the total current for the extension units, bar code reader, or RFID controller must be within the current that the GOT can supply.

For the current that the GOT can supply and the current for the extension units, bar code reader, or RFID controller, refer to the following tables. Make sure that the total of consumed current is within the capacity of the GOT.

(1) Current supply capacity of the GOT

GOT type	Current supply capacity (A)
GT1695M-X	2.4
GT1685M-S	2.4
GT1675M-S	2.4
GT1675M-V	2.4
GT1675-VN, GT1672-VN	2.4
GT1665M-S	2.4
GT1665M-V	2.4
GT1662-VN	2.4
GT1655-V	1.3

GOT type	Current supply capacity (A)
GT1595-X	2.13
GT1585V-S	1.74
GT1585-S	1.74
GT1575V-S	2.2
GT1575-S	2.2
GT1575-V, GT1572-VN	2.2
GT1565-V, GT1562-VN	2.2
GT1555-V	1.3
GT1555-Q, GT1550-Q	1.3

(2) Current consumed by an extension unit/barcode reader/RFID controller

Module type	Consumed current (A)
GT15-QBUS, GT15-75QBUSL, GT15-QBUS, GT15-75QBUS2L	0.275 ^{*1}
GT15-ABUS, GT15-75ABUSL, GT15-ABUS2, GT15-75ABUS2L	0.12
GT15-RS2-9P	0.29
GT15-RS4-9S	0.33
GT15-RS4-TE	0.3
GT15-RS2T4-9P	0.098
GT15-J71E71-100	0.224
GT15-J71GP23-SX	1.07
GT15-J71LP23-25	0.56
GT15-J71BR13	0.77
GT15-J61BT13	0.56
Bar code reader	*2
GT15-PRN	0.09
GT16M-V4	0.12 ^{*1}
GT15V-75V4	0.2 ^{*1}

Module type	Consumed current (A)
GT16M-R2	0 ^{*1}
GT15V-75R1	0.2 ^{*1}
GT16M-V4R1	0.12 ^{*1}
GT15V-75V4R1	0.2 ^{*1}
GT16M-ROUT	0.11 ^{*1}
GT15V-75ROUT	0.11
GT16M-MMR	0.27 ^{*1}
GT15-CFCD	0.07
GT15-CFEX-C08SET	0.15
GT15-SOUT	0.08
GT15-DIO	0.1
GT15-DIOR	0.1
RFID controller	*2
GT15-80FPA	0.22

*1 Value used for calculating the current consumption of the multi-channel function.

For the specifications of the unit, refer to the manual included with the unit.

*2 When the GOT supplies power to a barcode reader or a RFID controller from the standard interface, add their consumed current. (Maximum value is less than 0.3 A)

(3) Calculation example

- (a) When connecting the GT15-J71BR13, GT15-RS4-9S (3 units), GT15-J71E71-100 (For the gateway function) and a bar code reader (0.12 A) to the GT1575-V

Current supply capacity of GOT (A)	Total consumed current (A)
2.2	$0.77+0.33+0.33+0.33+0.224+0.12=2.104$

Since the calculated value is within the capacity of the GOT, they can be connected to the GOT.

- (b) When connecting the GT15-J71BR13, GT15-RS4-9S (2 units), GT15-J71E71-100 (For the gateway function) and a bar code reader (0.12 A) to the GT1585-S

Current supply capacity of GOT (A)	Total consumed current (A)
1.74	$0.77+0.33+0.33+0.224+0.12=1.774$

Since the calculated value exceeds the capacity of the GOT, such configuration is not allowed.

■ When using a bus connection unit

The installation position varies depending on the bus connection unit to be used.

- (1) Wide bus units (GT15-75QBUS(2)L, GT15-75ABUS(2)L, GT15-QBUS2, GT15-ABUS2)
 Install a bus connection unit in the 1st stage of the extension interface.
 If a bus connection unit is installed in the 2nd stage or above, the unit cannot be used.

Example: Installing a bus connection unit and serial communication units

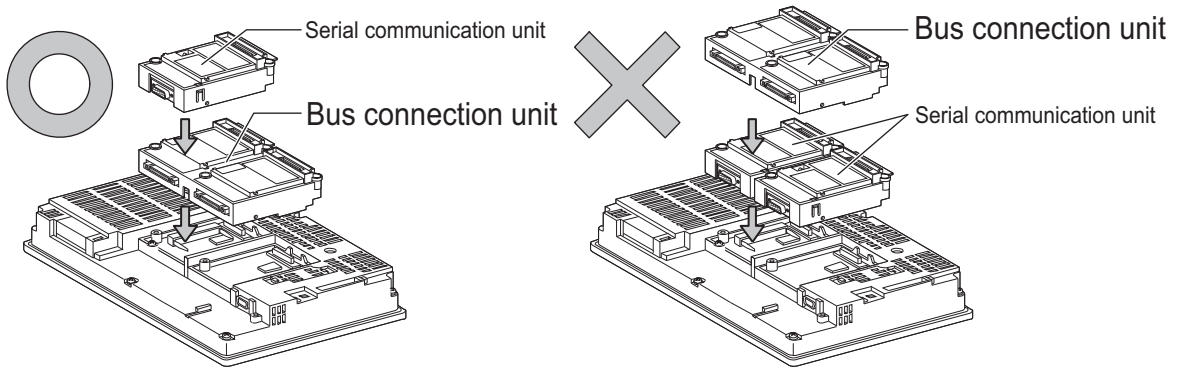

POINT

Cautions for using GT15-QBUS2 and GT15-ABUS2

The stage number of communication units installed on the next stage of GT15-QBUS2 or GT15-ABUS2 are recognized by the GOT differently depending on the extension interface position.

For communication units installed in the extension interface 2 side, even if the communication unit is physically installed in the 2nd stage position, the GOT recognizes the position as the 1st stage.

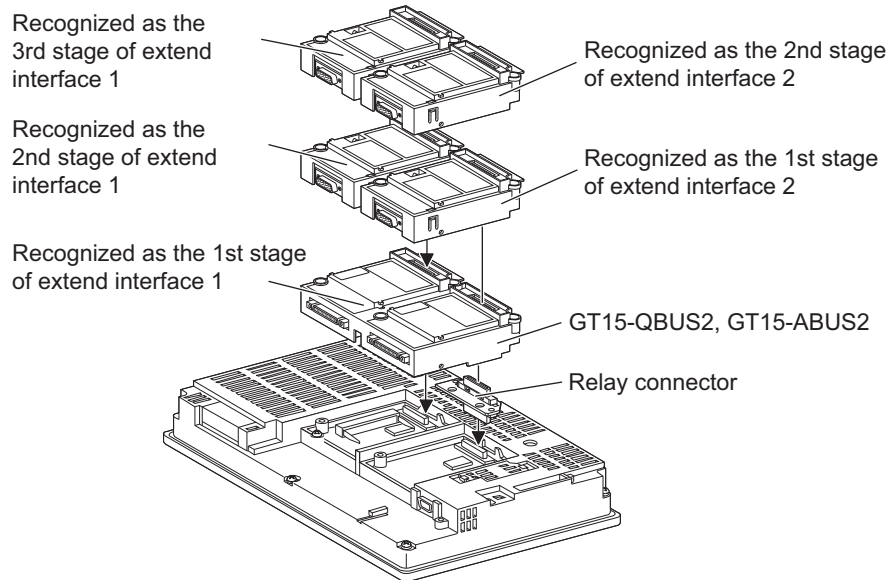

(2) Standard size bus connection unit (GT15-QBUS and GT15-ABUS)

A bus connection unit can be installed in any position (1st to 3rd stage) of the extension interface.

Example: Installing a bus connection unit and serial communication units

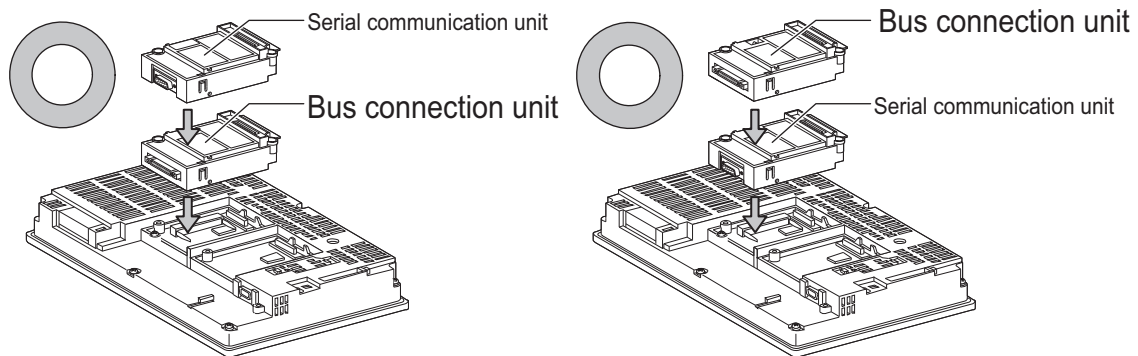

■ When using a MELSECNET/H communication unit, CC-Link IE Controller Network communication unit, CC-Link IE Field Network communication unit, or CC-Link communication unit (GT15-J61BT13)

Install a MELSECNET/H communication unit, CC-Link IE Controller Network communication unit, CC-Link IE Field Network communication unit, or CC-Link communication unit in the 1st stage of an extension interface. These communication units cannot be used if installed in the 2nd or higher stage.

Example: When installing a MELSECNET/H communication unit and a serial communication unit

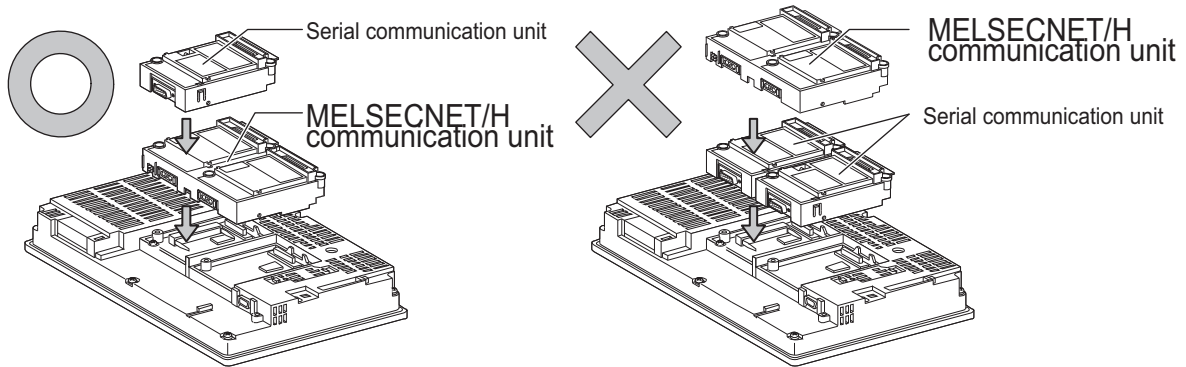

POINT

Precautions for using a MELSECNET/H communication unit, CC-Link IE Controller Network communication unit, CC-Link IE Field Network communication unit, CC-Link communication unit (GT15-J61BT13)

The installed stage number of communication units installed on the next stage of MELSECNET/H communication unit, CC-Link IE Controller Network communication unit, CC-Link IE Field Network communication unit, or CC-Link communication unit are recognized by the GOT differently depending on the extension interface position.

For communication units installed in the extension interface 2 side, even if the communication unit is physically installed in the 2nd stage position, the GOT recognizes the position as the 1st stage.

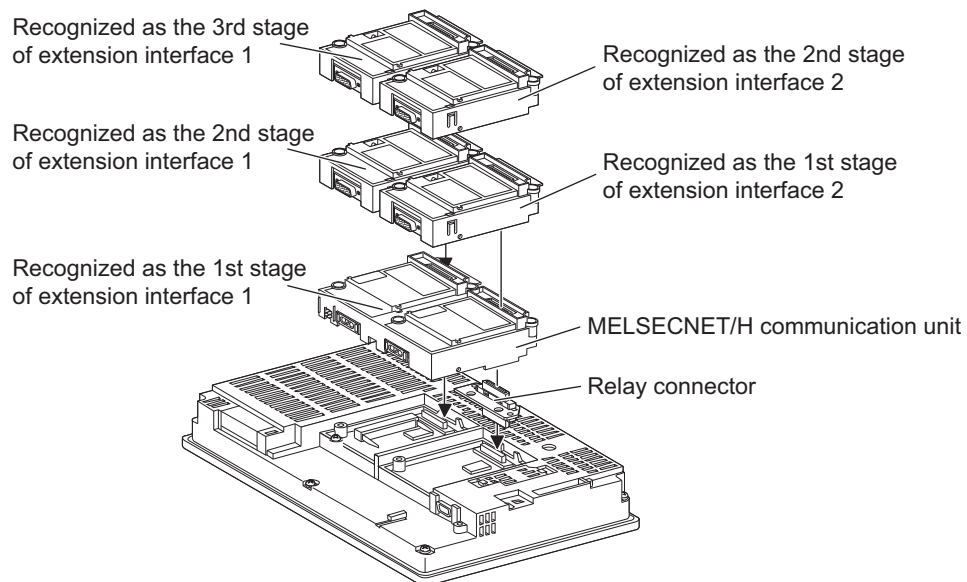

■ When using a MELSECNET/10 communication unit (GT15-75J71LP23-Z, GT15-75J71BR13-Z) or CC-Link communication unit (GT15-75J61BT13-Z)

Install a MELSECNET/10 communication unit (GT15-75J71LP23-Z, GT15-75J71BR13-Z) or CC-Link communication unit (GT15-75J61BT13-Z) at the 1st stage of the extension interface.

These communication units cannot be used if installed in the 2nd or higher stage.

For GT16 and the GT155□, the MELSECNET/10 communication unit (GT15-75J71LP23-Z, GT15-75J71BR13-Z) and the CC-Link communication unit (GT15-75J61BT13-Z) are not applicable.

Example: When installing a MELSECNET/10 communication unit and a serial communication unit

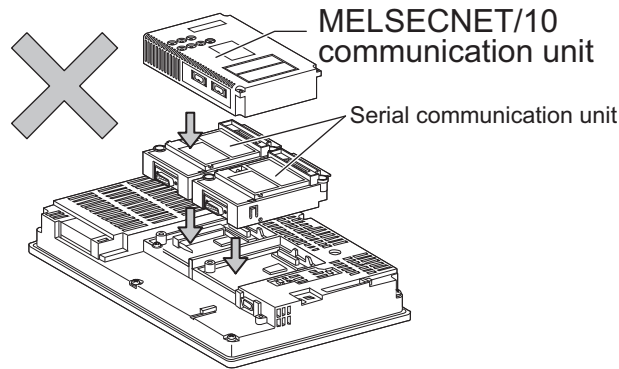

■ When using an Ethernet communication unit

An Ethernet communication unit can be installed in any position (1st to 3rd stage) of the extension interface.

For GT16, the Ethernet communication unit is not applicable.

Use the Ethernet interface built in the GOT.

Example: When installing an Ethernet communication unit and a serial communication unit

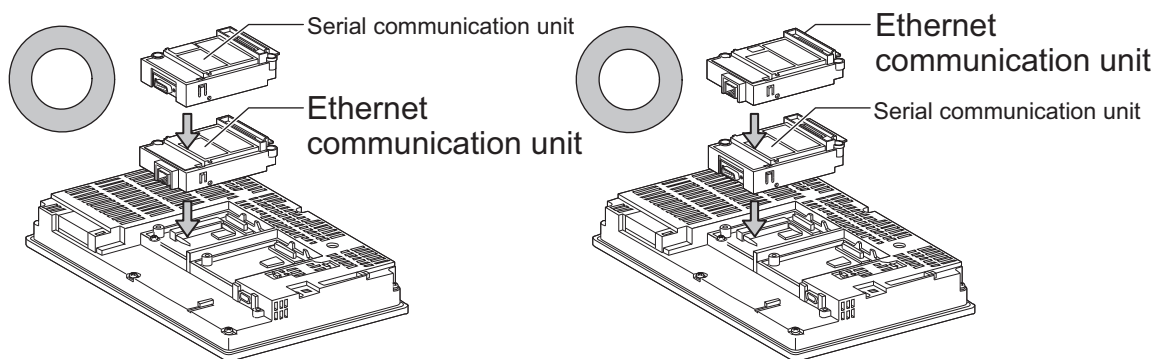

■ When using a serial communication unit

A serial communication unit can be installed in any position (1st to 3rd stage) of the extension interface.

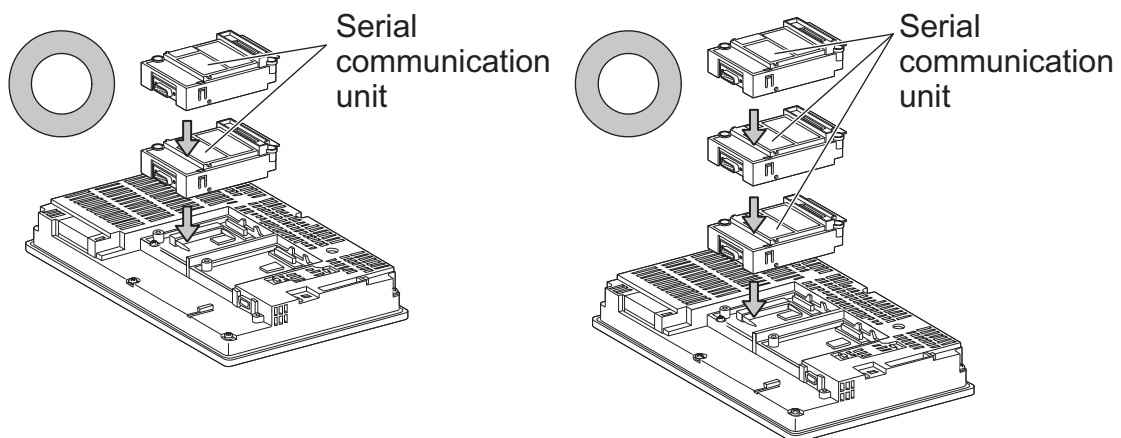

■ When using the printer unit, sound output unit, or external I/O unit

The printer unit, sound output unit, or external I/O unit can be installed in any position (1st to 3rd stage) of the extension interface.

Example: When installing a printer unit

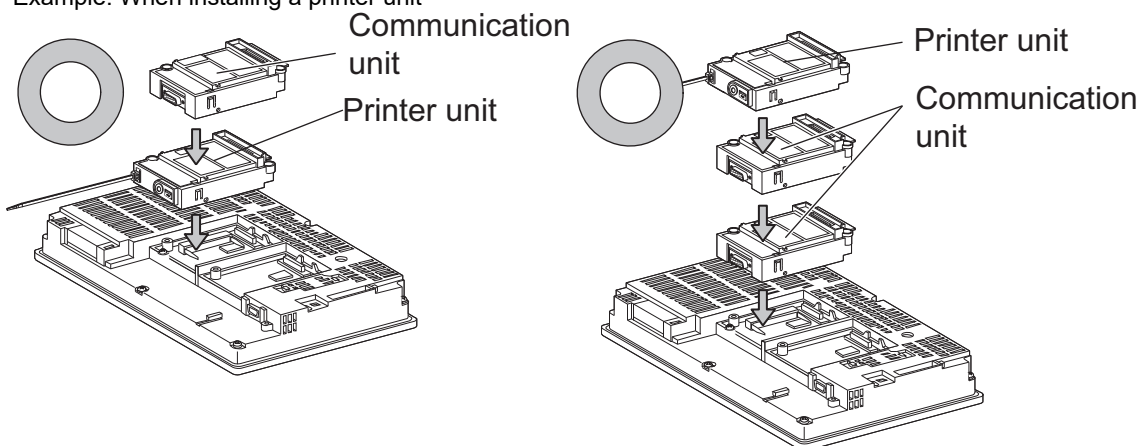

■ When using the video input unit, RGB input unit, video/RGB input unit, RGB output unit, or multimedia unit

Install the video input unit, RGB input unit, video/RGB input unit, RGB output unit, or multimedia unit at the 1st stage of the extension interface. These units cannot be used if installed in the 2nd or higher stage.

When any of these units is used, the communication units indicated below must be installed in the 2nd stage of the extension interface.

Communication unit	Model	
Bus connection unit	GT15-QBUS2,	GT15-ABUS2
MELSECNET/H communication unit	GT15-J71LP23-25,	GT15-J71BR13
CC-Link IE Controller Network communication unit	GT15-J71GP23-SX	
CC-Link communication unit	GT15-J61BT13	

Example: When installing a video input unit and a MELSECNET/H communication unit

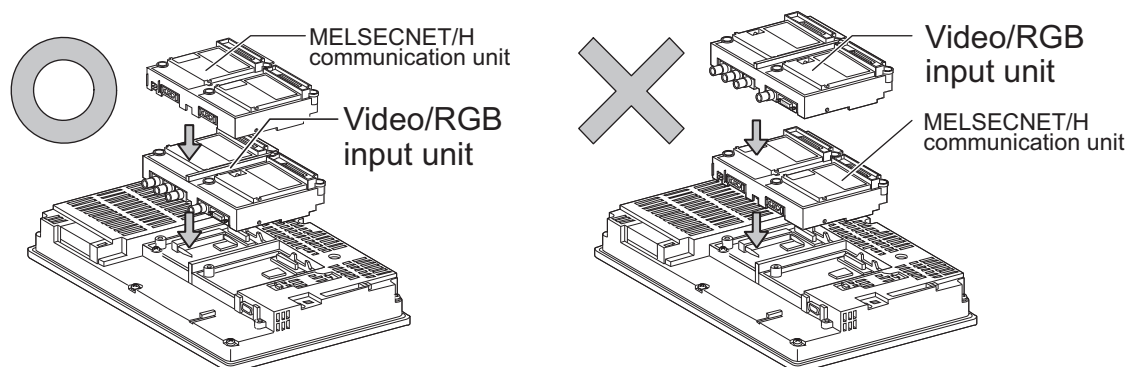

POINT

Precautions for video input unit, RGB input unit, video/RGB input unit, RGB output unit, and multimedia unit

When a communication unit is installed on any of the units above, the stage number of the communication unit recognized by the GOT varies according to the extension interface.

For communication units installed in the extension interface 2 side, even if the communication unit is physically installed in the 2nd stage position, the GOT recognizes the position as the 1st stage.

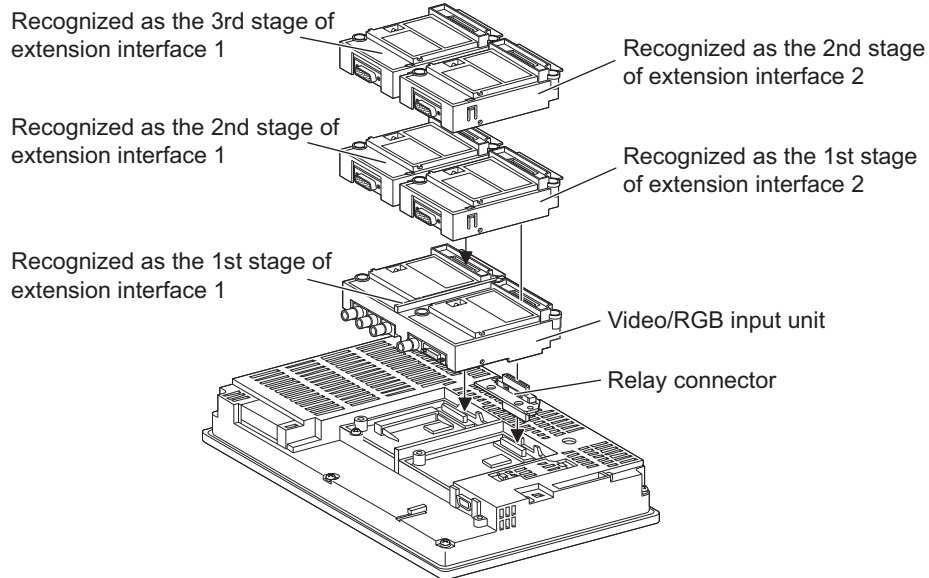

■ When using CF card unit or CF card extension unit

Install the CF card unit or CF card extension unit on the extension interface at the last.

The following figures show how to install the CF card unit.

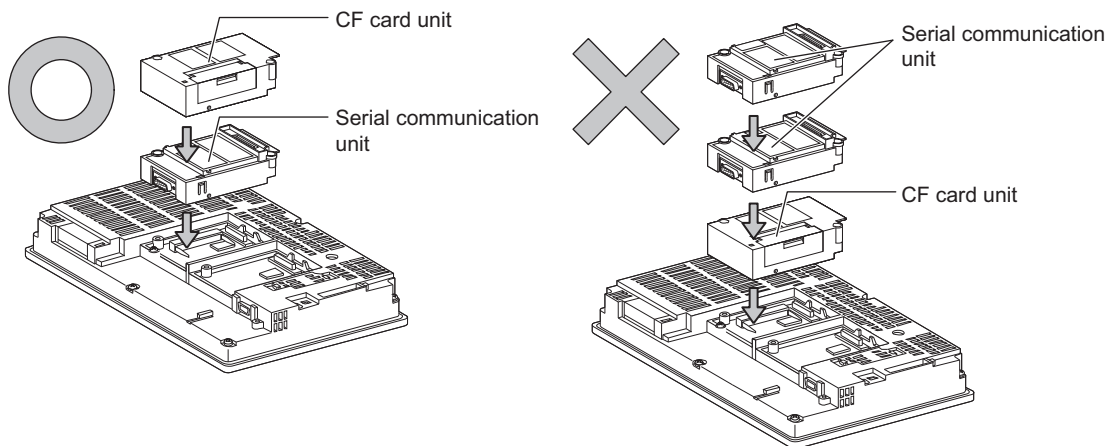

1.4 Connection Cables for the Respective Connection

To connect the GOT to a device in the respective connection type, connection cables between the GOT and a device are necessary.

For cables needed for each connection, refer to each chapter for connection.

1.4.1 GOT connector specifications

The following shows the connector specifications on the GOT side.
Refer to the following table when preparing connection cables by the user.

■ RS-232 interface

Use the following as the RS-232 interface and RS-232 communication unit connector on the GOT. For the GOT side connection cable, use a connector and connector cover applicable to the GOT connector.

(1) Connector specifications

GOT	Hardware version*1	Connector type	Connector model	Manufacturer
GT16	—	9-pin D-sub (male) inch screw fixed type	17LE-23090-27(D4C□)	DDK Ltd.
GT1595-X	—		17LE-23090-27(D4CK)	
GT1585V-S	—		GM-C9RMDU11	Honda Tsushin Kogyo Co., Ltd.
GT1585-STBA	B or later C			
GT1585-STBD	—		17LE-23090-27(D4CK)	DDK Ltd.
GT1575V-S	—		GM-C9RMDU11	Honda Tsushin Kogyo Co., Ltd.
GT1575-STBA	B or later C			
GT1575-STBD	—		17LE-23090-27(D4CK)	DDK Ltd.
GT1575-VTBA	D or later E		GM-C9RMDU11	Honda Tsushin Kogyo Co., Ltd.
GT1575-VTBD	—			
GT1575-VN	—		17LE-23090-27(D4CK)	DDK Ltd.
GT1565-V	—			
GT1562-VN	—			
GT155□	—			
GT14	—			
GT12	—			
GT115□ -Q	—			
GT105□ -Q	—			
GT104□ -Q	—			
GT1030, GT1020	—			
GT15-RS2-9P	—	9-pin D-sub (male) inch screw fixed type	17LE-23090-27(D3CC)	DDK Ltd.
GT01-RS4-M	—			

*1 For the procedure to check the GT15 hardware version, refer to the GT15 User's Manual.

*2 The terminal block (MC1.5/9-ST-3.5 or corresponding product) of the cable side is packed together with the GT1030, GT1020.

(2) Connector pin arrangement

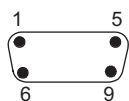
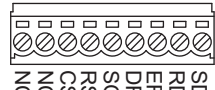
GT16, GT15, GT14, GT12, GT11, GT105□, GT104□, GT01-RS4-M	GT1030, GT1020
<p>GOT main part connector see from the front</p>  <p>9-pin D-sub (male)</p>	<p>See from the back of a GOT main part</p>  <p>9-pin terminal block</p>

■ RS-422 interface

Use the following as the RS-422 interface and the RS-422/485 communication unit connector on the GOT.
For the GOT side of the connection cable, use a connector and connector cover applicable to the GOT connector.

(1) Connector model

GOT	Connector type	Connector model	Manufacturer
RS-422 conversion unit	9-pin D-sub (female) M2.6 millimeter screw fixed type	17LE-13090-27(D2AC)	DDK Ltd.
GT16*1	14-pin (female)	HDR-EC14LFDT1-SLE+	Honda Tsushin Kogyo Co., Ltd.
GT14	9-pin D-sub (female) M2.6 millimeter screw fixed type	17LE-13090-27(D3AC)	DDK Ltd.
GT12			
GT115□ -Q			
GT105□ -Q			
GT104□ -Q			
GT1030, GT1020	9-pin terminal block*2	MC1.5/9-G-3.5BK	PHOENIX CONTACT Inc.
GT16-C02R4-9S	9-pin D-sub (female) M2.6 millimeter screw fixed type	17LE-13090-27(D3AC)	DDK Ltd.
GT15-RS4-9S			
GT01-RS4-M			

*1 When connecting to the RS-422/485 interface, use HDR-E14MAG1+ as a cable connector.
To use HDR-E14MAG1+, a dedicated pressure welding tool is required.

For details on the connector and pressure welding tool, contact Honda Tsushin Kogyo Co., Ltd.

*2 The terminal block (MC1.5/9-ST-3.5 or corresponding product) of the cable side is packed together with the GT1030, GT1020.

(2) Connector pin arrangement

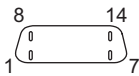
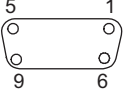
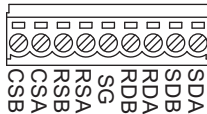
GT16	GT15, GT14, GT12, GT11, GT105□, GT104□, GT01-RS4-M	GT1030, GT1020
GOT main part connector see from the front	GOT main part connector see from the front	See from the back of a GOT main part
		
14-pin (female)	9-pin D-sub (female)	9-pin terminal block

■ RS-485 interface

Use the following as the RS-485 interface and the RS-422/485 communication unit connector on the GOT.
For the GOT side of the connection cable, use a connector and connector cover applicable to the GOT connector.

(1) Connector model

GOT	Hardware version ^{*1}	Connector type	Connector model	Manufacturer
GT16 ^{*2}	—	14-pin (female)	HDR-EC14LFD1-SLE+	Honda Tsushin Kogyo Co., Ltd.
GT14	—	9-pin D-sub (female) M2.6 millimeter screw fixed type	17LE-13090-27(D3AC)	DDK Ltd.
GT12	—			
GT1155-QTBD	C or later			
GT1155-QSBD	F or later			
GT1150-QLBD				
GT105□ -Q	C or later			
GT104□ -Q	A or later			
GT1030	B or later	9-pin terminal block ^{*3}	MC1.5/9-G-3.5BK	PHOENIX CONTACT Inc
GT1020	E or later			
GT15-RS4-9S	—	9-pin D-sub (female) M2.6 millimeter screw fixed type	17LE-13090-27(D3AC)	DDK Ltd.
GT15-RS4-TE	—	—	SL-SMT3.5/10/90F BOX	Weidmuller interconnections inc

*1 For the checking procedure of the hardware version, refer to the User's Manual.

*2 When connecting to the RS-422/485 interface, use HDR-E14MAG1+ as a cable connector.
To use HDR-E14MAG1+, a dedicated pressure welding tool is required.

For details on the connector and pressure welding tool, contact Honda Tsushin Kogyo Co., Ltd..

*3 The terminal block (MC1.5/9-ST-3.5 or corresponding product) of the cable side is packed together with the GT1030, GT1020.

(2) Connector pin arrangement

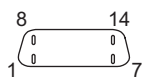
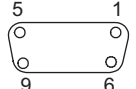
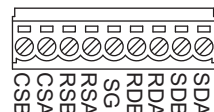
GT16	GT15, GT14, GT12, GT11, GT105□, GT104□	GT1030, GT1020
GOT main part connector see from the front	GOT main part connector see from the front	See from the back of a GOT main part
		
14-pin (female)	9-pin D-sub (female)	9-pin terminal block

1.4.2 Coaxial cable connector connection method

The following describes the method for connecting the BNC connector (connector plug for coaxial cable) and the cable.

⚠ CAUTION

- Solder the coaxial cable connectors properly. Insufficient soldering may result in malfunctions.

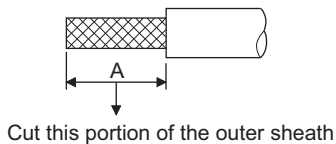
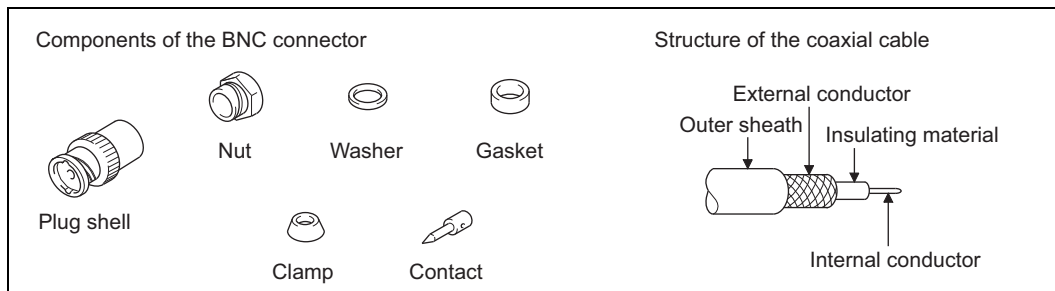

1. Remove the external sheath of the coaxial cable with dimensions as shown below.

Cable in use	A
3C-2V	15mm
5C-2V, 5C-2V-CCY	10mm

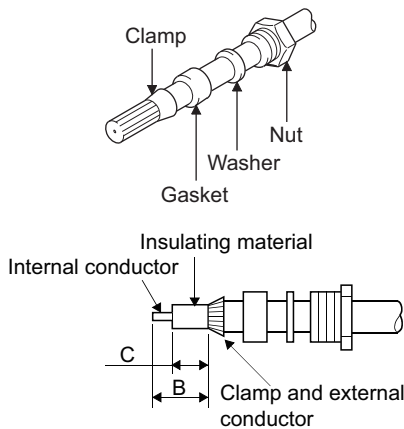

2. Pass the nut, washer, gasket, and clamp through the coaxial cable as shown on the left and loosen the external conductor.

3. Cut the external conductor, insulating material, and internal conductor with the dimensions as shown below. Note that the external conductor should be cut to the same dimension as the tapered section of the clamp and smoothed down to the clamp.

Cable in use	B	C
3C-2V	6mm	3mm
5C-2V, 5C-2V-CCY	7mm	5mm

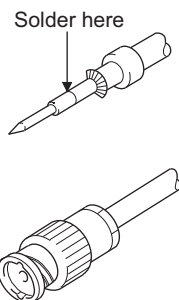

4. Solder the contact to the internal conductor.
5. Insert the connector assembly shown in 4. into the plug shell and screw the nut into the plug shell.

Precautions for soldering

Note the following precautions when soldering the internal conductor and contact.

- Make sure that the solder does not bead up at the soldered section.
- Make sure there are no gaps between the connector and cable insulator or they do not cut into each other.
- Perform soldering quickly so the insulation material does not become deformed.

1.4.3 Terminating resistors of GOT

The following shows the terminating resistor specifications on the GOT side.
When setting the terminating resistor in each connection type, refer to the following.

■ RS-422/485 communication unit

Set the terminating resistor using the terminating resistor setting switch.

Terminating resistor ^{*1}	Switch No.	
	1	2
100 OHM	ON	ON
Disable	OFF	OFF



*1 The default setting is "Disable".

• For RS-422/485 communication unit

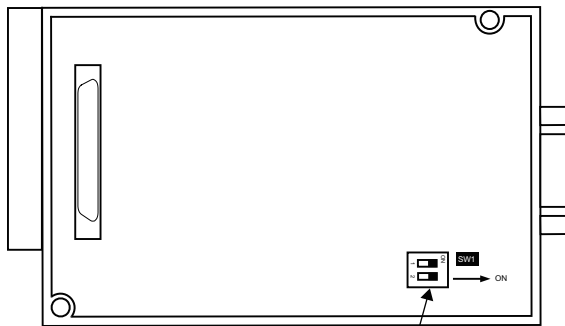

Terminating resistor setting switch

Rear view of RS-422/485 communication unit.

■ RS-232/485 signal conversion adaptor

For details, refer to the following.

➡ 1.4.4 Setting the RS-232/485 signal conversion adaptor

■ GT16

Set the terminating resistor using the terminating resistor setting switch.

Terminating resistor ^{*1}	Switch No.	
	1	2
Enable	ON	ON
Disable	OFF	OFF



*1 The default setting is "Disable".

• For GT1685M-S

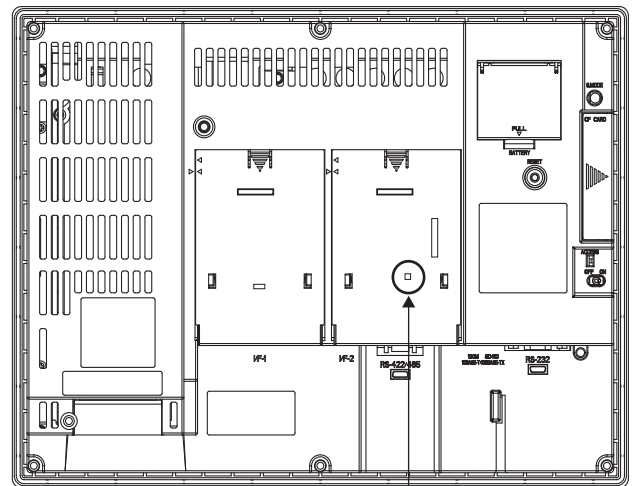

Terminating resistor setting switch (inside the cover)

■ GT14

Set the terminating resistor using the terminating resistor setting switch.

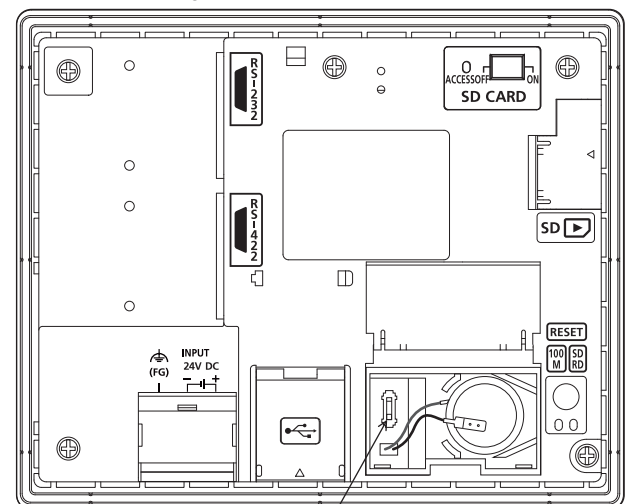

Terminating resistor selector switch

■ GT12

Set the terminating resistor using the terminating resistor setting switch.

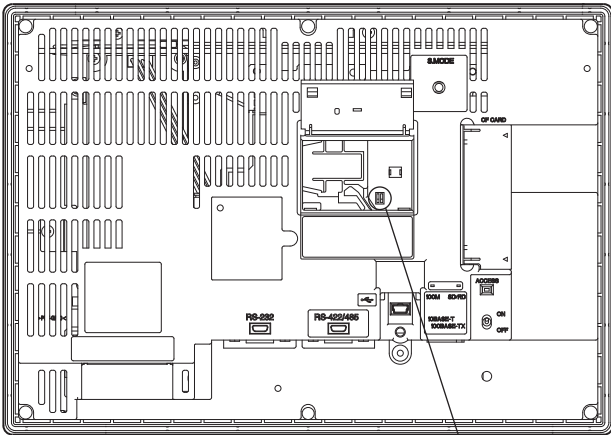

Terminating resistor selector switch

■ GT105□

Set the terminating resistor using the terminating resistor setting switch.

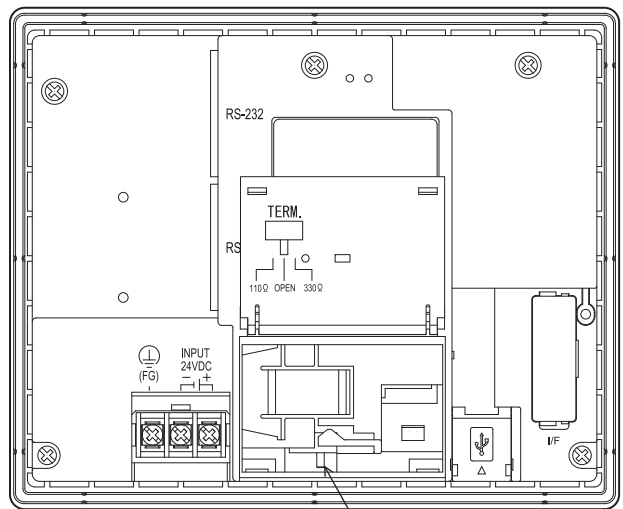

Terminating resistor selector switch

■ GT11

Set the terminating resistor using the terminating resistor setting switch.

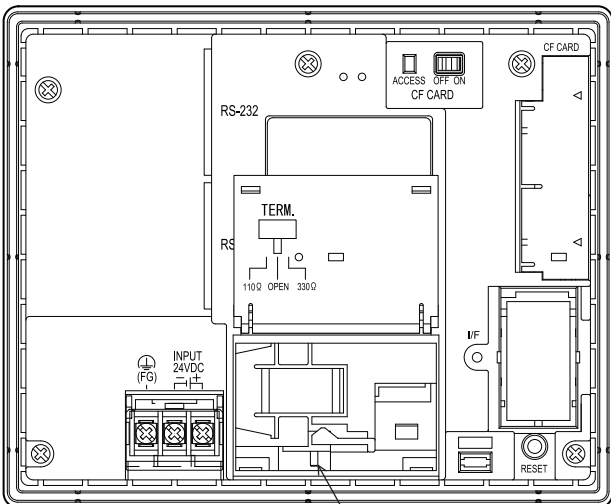

Terminating resistor selector switch

■ GT104□

Set the terminating resistor using the terminating resistor setting switch.

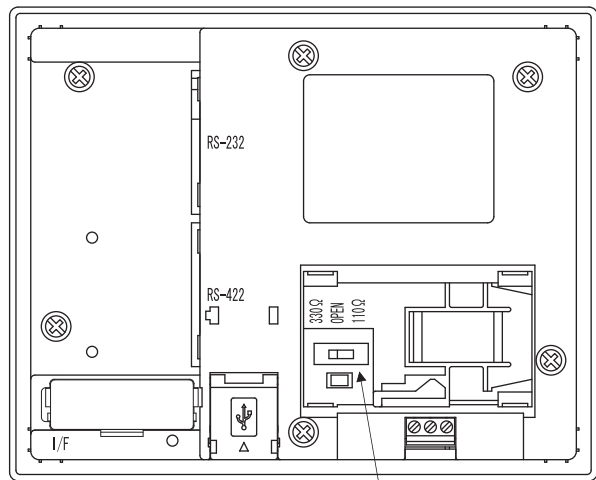

Terminating resistor selector switch

■ GT1030

Set the terminating resistor using the terminating resistor setting switch.

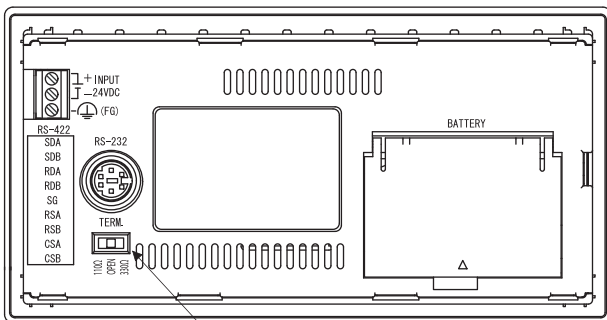

Terminating resistor selector switch

■ GT1020

Set the terminating resistor using the terminating resistor setting switch.

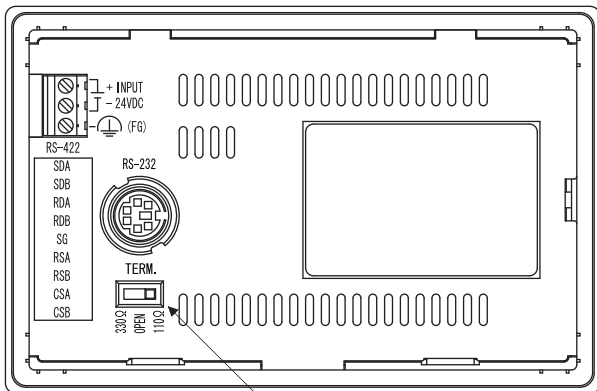

Terminating resistor selector switch

1.4.4 Setting the RS-232/485 signal conversion adaptor

Set the 2-wire/4-wire terminating resistor setting switch according to the connection type.

POINT

Enable the 5V power supply

Make sure to validate "Enable the 5V power supply" in the [RS232 Setting] to operate the RS-232/485 signal conversion adaptor.

☞ 1.1.2 I/F communication setting

When validating the function using the utility function of the GOT main unit, refer to the following manual.

☞ GT14 User's Manual 8.2 Utility Function List

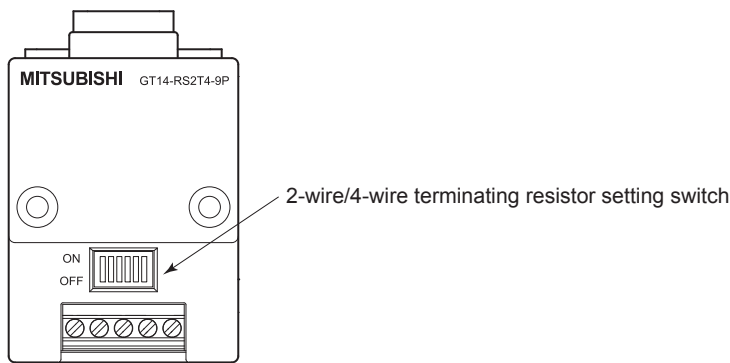

■ Setting the 2-wire/4-wire terminating resistor setting switch

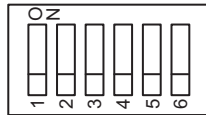

Setting item	Set value	Switch No.					
		1	2	3	4	5	6
2-wire/4-wire	2-wire (1Pair)	ON	ON	-	-	-	OFF
	4-wire (2Pair)	OFF	OFF	-	-	-	OFF
Terminating resistor	110Ω	-	-	ON	OFF	OFF	OFF
	OPEN	-	-	OFF	OFF	OFF	OFF
	330Ω	-	-	OFF	ON	ON	OFF

POINT

RS-232/485 signal conversion adapter

For details on the RS-232/485 signal conversion adapter, refer to the following manual.

☞ GT14-RS2T4-9P RS-232/485 Signal Conversion Adapter User's Manual

1.5 Verifying GOT Recognizes Connected Equipment

Verify the GOT recognizes controllers on [Communication Settings] of the Utility.

- Channel number of communication interface, communication drivers allocation status
- Communication unit installation status

For details on the Utility, refer to the following manual.

 GT□ User's Manual

■ When using GT16, GT12

(For GT16)

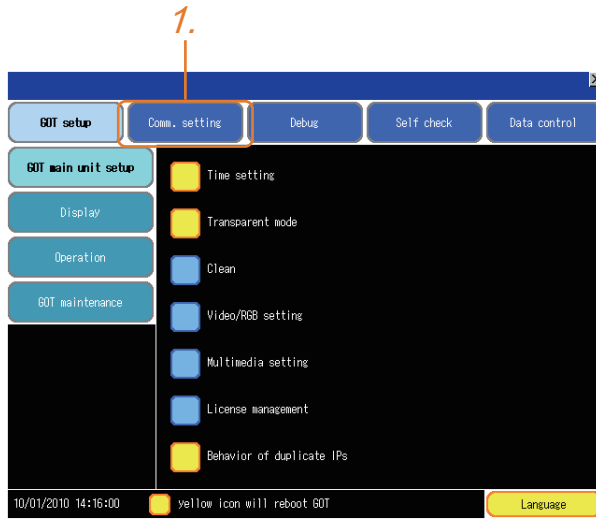

1. After powering up the GOT, touch [Main menu] → [Communication setting] from the Utility.

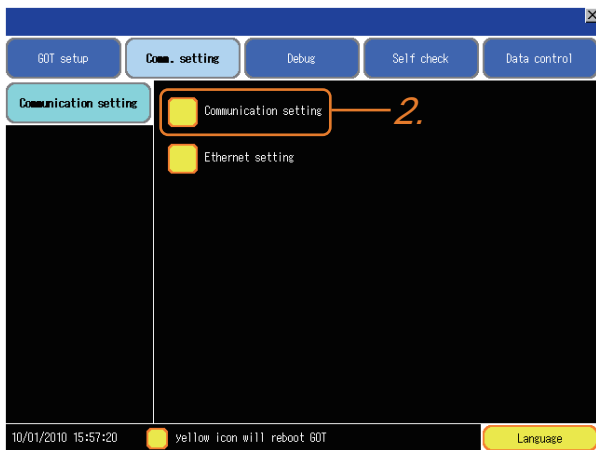

2. Touch [Communication setting].



1
PREPARATORY PROCEDURES FOR MONITORING

2
DEVICE RANGE THAT CAN BE SET

3
ACCESS RANGE FOR MONITORING

4
HOW TO MONITOR REDUNDANT SYSTEM

5
BUS CONNECTION

6
DIRECT CONNECTION TO CPU

7
COMPUTER LINK CONNECTION

8
ETHERNET CONNECTION

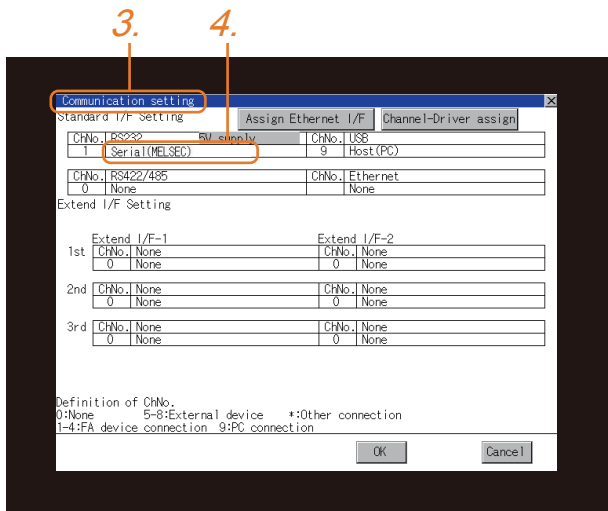

3. The [Communication Settings] appears.

4. Verify that the communication driver name to be used is displayed in the communication interface box to be used.

5. When the communication driver name is not displayed normally, carry out the following procedure again.

➡ 1.1 Setting the Communication Interface

■ For GT15, GT14 or GT11

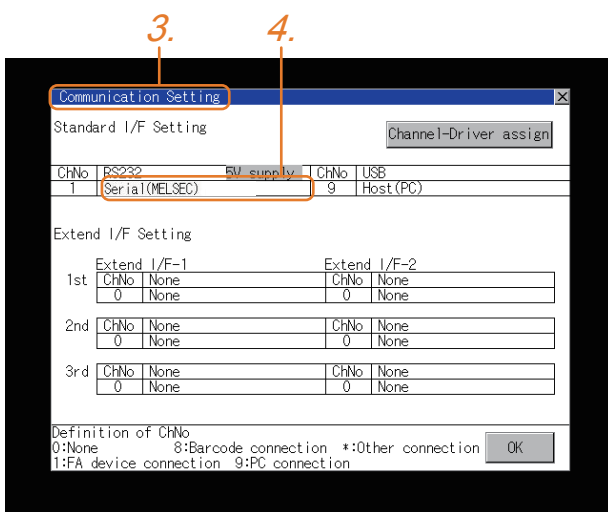
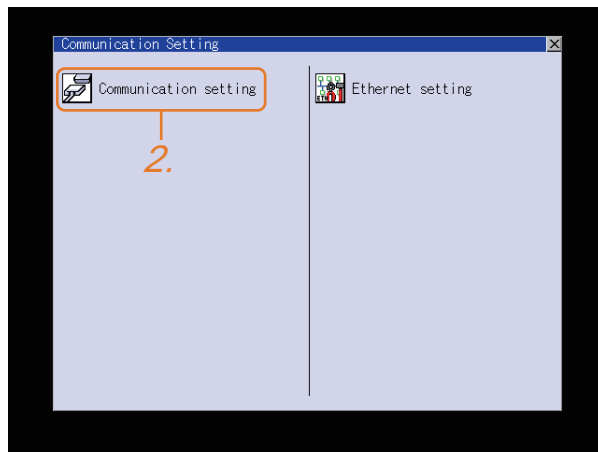

1. After powering up the GOT, touch [Main Menu] → [Communication setting] from the Utility.

2. Touch [Communication setting].
(The screen on the left is not displayed on GT11.)

3. The [Communication Setting] appears.

4. Verify that the communication driver name to be used is displayed in the box for the communication interface to be used.

5. When the communication driver name is not displayed normally, carry out the following procedure again.

☞ 1.1 Setting the Communication Interface

■ For GT10

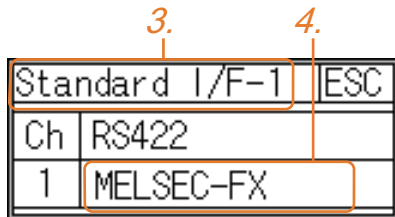
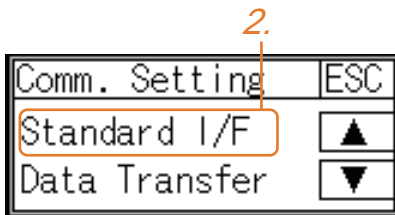
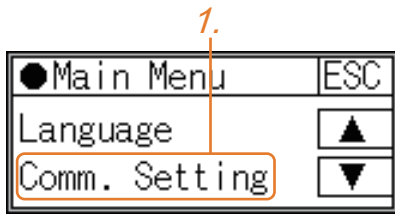

1. After powering up the GOT, touch [Main Menu] → [Comm. Setting] from the Utility.

2. Touch [Standard I/F] on [Comm. Setting].

3. The [Standard I/F] appears.

4. Verify that the communication driver name to be used is displayed in the box for the communication interface to be used.

5. When the communication driver name is not displayed normally, carry out the following procedure again.

☞ 1.1 Setting the Communication Interface

POINT

Utility

(1) How to display Utility (at default)

When using GT16, GT1595, GT14, GT12 or GT1020

Utility call key
1-point press on GOT screen upper-left corner

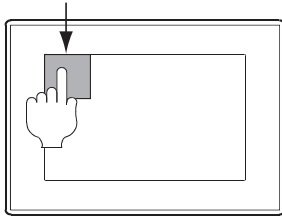

When using GT1585, GT157□, GT156□, GT155□, GT11, GT105□, GT104□ or GT1030

Utility call key
Simultaneous 2-point press

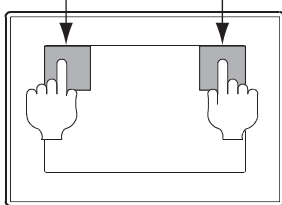

Utility display
(When using GT16, GT12) (When using GT15)

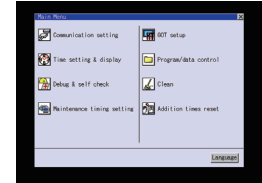
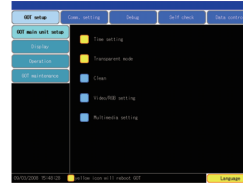

(When using GT14, GT11) (When using GT105□, GT104□)

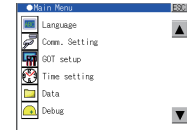

(When using GT1030, GT1020)

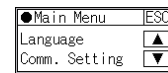

(2) Utility call

When setting [Pressing time] to other than 0 second on the setting screen of the utility call key, press and hold the utility call key until the buzzer sounds. For the setting of the utility call key, refer to the following.

GT□ User's Manual

(3) Communication interface setting by the Utility

The communication interface setting can be changed on the Utility's [Communication setting] after writing [Communication Settings] of project data. For details on the Utility, refer to the following manual.

GT□ User's Manual

(4) Precedence in communication settings

When settings are made by GT Designer3 or the Utility, the latest setting is effective.

1.6 Checking for Normal Monitoring

1.6.1 Check on the GOT

- Check for errors occurring on the GOT







Presetting the system alarm to project data allows you to identify errors occurred on the GOT, PLC CPU, servo amplifier and communications.

For details on the operation method of the GOT Utility screen, refer to the following manual.

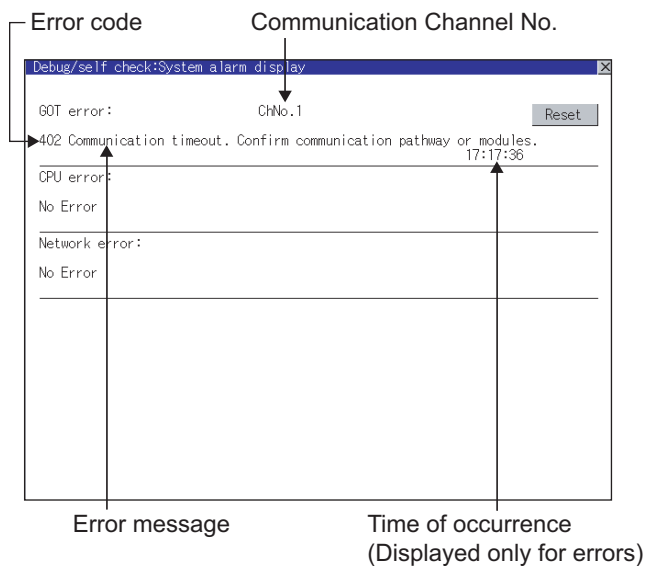
 GT□ User's Manual

(When using GT15)



Advanced alarm popup display   

With the advanced alarm popup display function, alarms are displayed as a popup display regardless of whether an alarm display object is placed on the screen or not (regardless of the display screen).

Since comments can be flown from right to left, even a long comment can be displayed all.

For details of the advanced popup display, refer to the following manual.

 GT Designer3 Screen Design Manual

■ Perform an I/O check



Whether the PLC can communicate with the GOT or not can be checked by the I/O check function. If this check ends successfully, it means correct communication interface settings and proper cable connection. Display the I/O check screen by Main Menu.

- For GT16, GT12
Display the I/O check screen by [Main menu] → [Self check] → [I/O check].
- For GT15, GT14, GT11
Display the I/O check screen by [Main menu] → [Debug & self check] → [Self check] → [I/O check].

For details on the I/O check, refer to the following manual:

 GT□ User's Manual

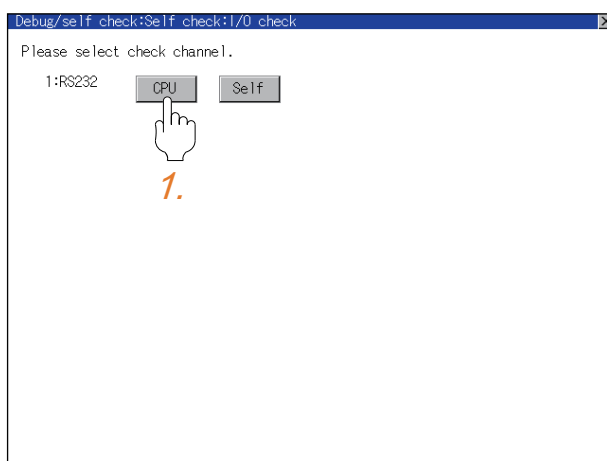

1. Touch [CPU] on the I/O check screen. Touching [CPU] executes the communication check with the connected PLC.

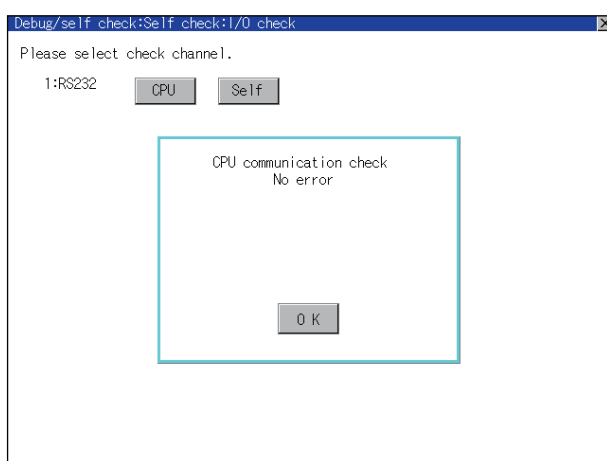

2. When the communication screen ends successfully, the screen on the left is displayed.

■ Communication monitoring function



The communication monitoring is a function that checks whether the PLC can communicate with the GOT. If this check ends successfully, it means correct communication interface settings and proper cable connection. Display the communication monitoring function screen by [Main Menu] → [Comm. Setting] → [Comm. Monitor]. For details on the communication monitoring function, refer to the following manual:

👉 GT10 User's Manual

(Operation of communication monitoring function screen)

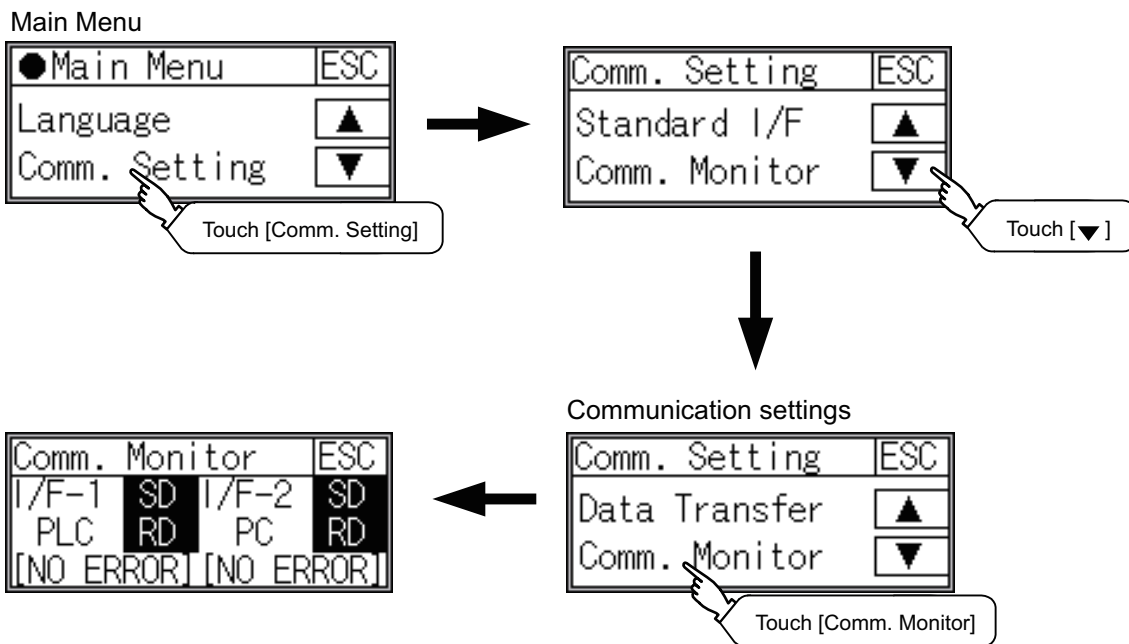

■ Confirming the communication status with network unit by GOT



(1) For MELSECNET/H, MELSECNET/10 network system

The communication status between the GOT and the MELSECNET/H, MELSECNET/10 network system can be confirmed by the Utility screen of the GOT.

For details on the operation method of the GOT Utility screen, refer to the following manual.

GT16 User's Manual (Basic Utility)

GT15 User's Manual

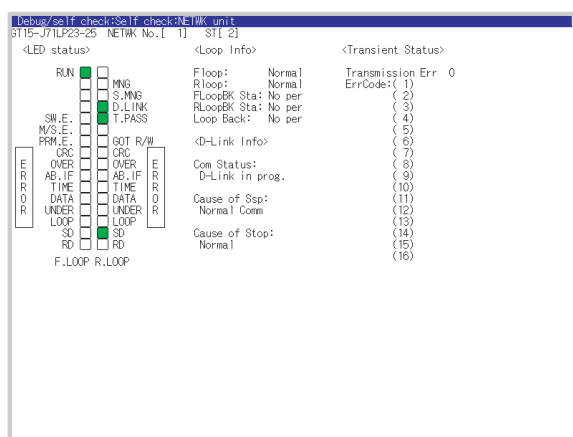

POINT

Communication unit for displaying network module status

Use the GT15-J71LP23-25 or GT15-J71BR13 for displaying the network module status on the GOT.

The GOT cannot display the network module status with GT15-75J71LP23-Z or GT15-75J71BR13-Z.

(2) For CC-Link IE Controller Network system

The communication status between the GOT and CC-Link IE Controller Network can be confirmed by the utility screen of the GOT.

For details on the operation method of the GOT Utility screen, refer to the following manual.

 GT16 User's Manual (Basic Utility)

 GT15 User's Manual

```

Debug/self check:Self check:NETWK unit
ST15-J716P23-SX NETWK No.[ 1] ST[ 1]

<LED status>
RUN 
PC 
ONLINE 
TEST 
OFFLINE 
M/S ERR. 
PARAM.ERR. 
F LOOP ERR. 
SD 
RD 

MANAGER
S.MANAGER
NORMAL
TOKEN PASS
DATA LINK
GOT R/W
R LOOP ERR.

<Loop Info>
IN: Loop Sts.:Normal
IN: LoopBK Sta: ---
IN: LoopBK factor:
No LoopBK Sta.
OUT: Loop Info>
OUT: Loop Sts.: Normal
OUT: LoopBK Sta: ---
OUT: LoopBK factor:
No LoopBK Sta.
<D-Link Info>
Com Status:D-Link in prog.
Cause of Ssp:
Normal Comm
Cause of Stop:
Normal Comm
<Link scan time info.>
Current LS time: 0ms
Max. LS time: 2ms
Min. LS time: 2ms
Constant LS time: 12ms

<Transient Status>
Transmission Err 0
ErrCode:( 1)
( 2)
( 3)
( 4)
( 5)
( 6)
( 7)
( 8)
( 9)
(10)
(11)
(12)
(13)
(14)
(15)
(16)

<Host line sts.>
Connction:Normal
IN: cable disconnct count: 0 OUT: cable disconnct count: 2
IN: line err count: 0 OUT: line err count: 0
  
```

(3) For CC-Link IE Field Network system

The communication status between the GOT and CC-Link IE Field Network can be confirmed by the utility screen of the GOT.

For details on the operation method of the GOT Utility screen, refer to the following manual.

 GT16 User's Manual (Basic Utility)

 GT15 User's Manual

```

Debug/self check:Self check:NETWK unit
ST15-J716F13-T2 NETWK No.[ 1] ST[ 0]

<LED status>
RUN 
MST 
DLINK 
ERR 
LERR 
SD 
RD 
MODE 
LER1 
LER2 
LNK1 
LNK2 
GOT R/W 

<Host PORT1 link info.>
Link up status:Linking down
<Host PORT2 link info.>
Link up status:Linking down
<D-Link Info>
Com Status:B-Pass stopped
Cause of Ssp:
Cable disconnection
Cause of Stop:
Normal Comm
<Link scan time info.>
Current LS time: 0ms
Max. LS time: 0ms
Min. LS time: 0ms
Constant LS time: ---ms

<Unit error info.>
Unit error: 0
ErrCode:( 1)
( 2)
( 3)
( 4)
( 5)
( 6)
( 7)
( 8)
( 9)
(10)
(11)
(12)
(13)
(14)
(15)
(16)

<Host line sts.>
Connction:Disconnect (PORT1: cable disconnected, PORT2: cable disconnected)
PORT1: cable disconnct count: 0 PORT2: cable disconnct count: 0
PORT1: line err count: 0 PORT2: line err count: 0
  
```

(4) For CC-Link system

The communication status between the GOT and the CC-Link System can be confirmed by the Utility screen of the GOT.

For details on the operation method of the GOT Utility screen, refer to the following manual.

 GT16 User's Manual (Basic Utility)

 GT15 User's Manual

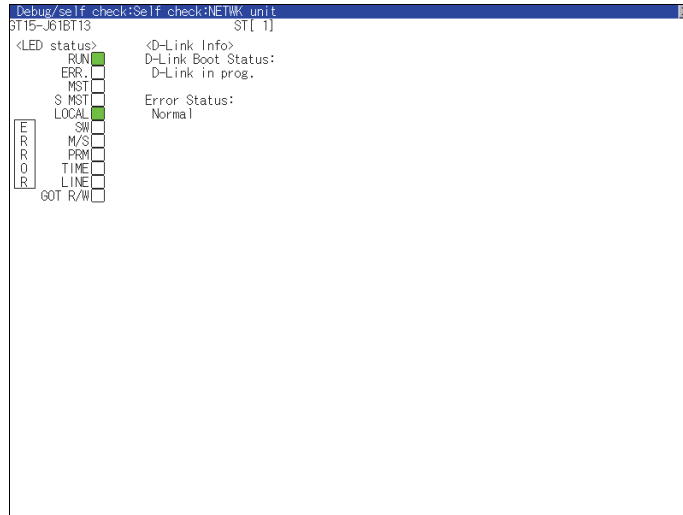

POINT

CC-Link communication unit when network module status display is made

When displaying the network module status, use the CC-Link communication unit of MODEL GT15-J61BT13.

For the MODEL GT15-75J61BT13-Z, the network module status cannot be displayed.

1.6.2 Confirming the communication state on the GOT side (For Ethernet connection)



■ Confirming the communication state on Windows®, GT Designer3

(1) When using the Command Prompt of Windows®

Execute a Ping command at the Command Prompt of Windows®.

(a) When normal communication

```
C:\>Ping 192.168.0.18
```

```
Reply from 192.168.0.18: bytes=32time<1ms TTL=64
```

(b) When abnormal communication

```
C:\>Ping 192.168.0.18
```

```
Request timed out.
```

(2) When using the [PING Test] of GT Designer3

Select [Communication] → [Communication configuration] → [Ethernet] and → [Connection Test] to display [PING Test].

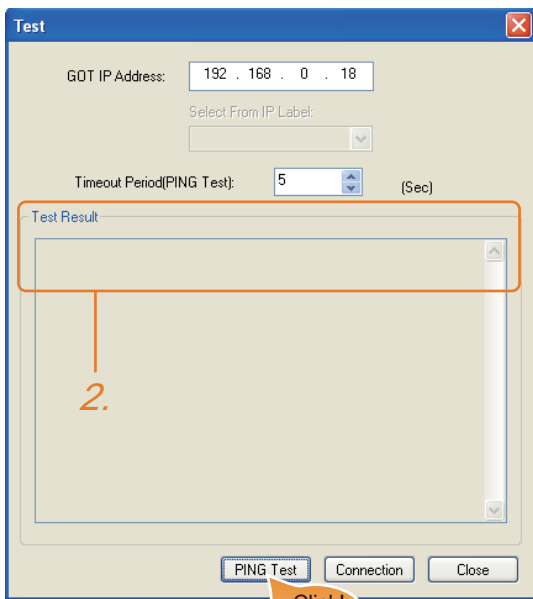

1. Specify the [GOT IP Address] of the [PING Test] and click the [PING Test] button.

2. The [Test Result] is displayed after the [PING Test] is finished.

(3) When abnormal communication

At abnormal communication, check the followings and execute the Ping command again.

- Mounting condition of Ethernet communication unit
- Cable connecting condition
- Confirmation of [Communication Settings]
- IP address of GOT specified by Ping command

POINT

Ethernet diagnostics of GX Developer

Ethernet diagnostics of GX Developer is available to a Ping test from the PLC.

For details of Ethernet diagnostics of GX Developer, refer to the following manual.

 User's manual of the Ethernet module

■ **Confirming the communication state on the GOT (For GT16, GT14)**

[PING Test] can be confirmed by the Utility screen of the GOT.

For details on the operation method of the GOT Utility screen, refer to the following manual.

 [GT16 User's Manual \(Basic Utility\)](#)

[GT14 User's Manual](#)

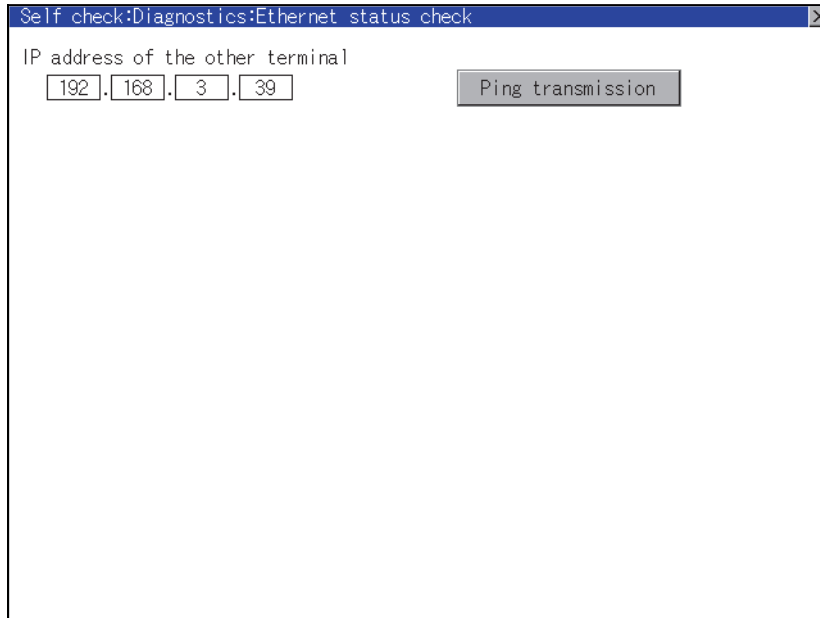

1.6.3 Confirming the communication state to each station (Station monitoring function)



The station monitoring function detects the faults (communication timeout) of the stations monitored by the GOT. When detecting the abnormal state, it allocates the data for the faulty station to the GOT special register (GS).

(1) No. of faulty stations

- (a) Ethernet connection (Except for Ethernet multiple connection)
Total No. of the faulty CPU is stored.

Device	b15 to b8	b7 to b0
GS230	(00H fixed)	No. of faulty stations

- (b) Ethernet multiple connection
Total No. of the faulty connected equipment is stored.

Channel	Device	b15 to b8	b7 to b0
Ch1	GS280	(00H fixed)	No. of faulty stations
Ch2	GS300	(00H fixed)	No. of faulty stations
Ch3	GS320	(00H fixed)	No. of faulty stations
Ch4	GS340	(00H fixed)	No. of faulty stations

POINT

When monitoring GS230 on Numerical Display

When monitoring GS230 on Numerical Display, check [mask processing] with data operation tab as the following. For the data operation, refer to the following manual.

GT Designer3 Screen Design Manual

● Numerical Display (Data Operation tab)

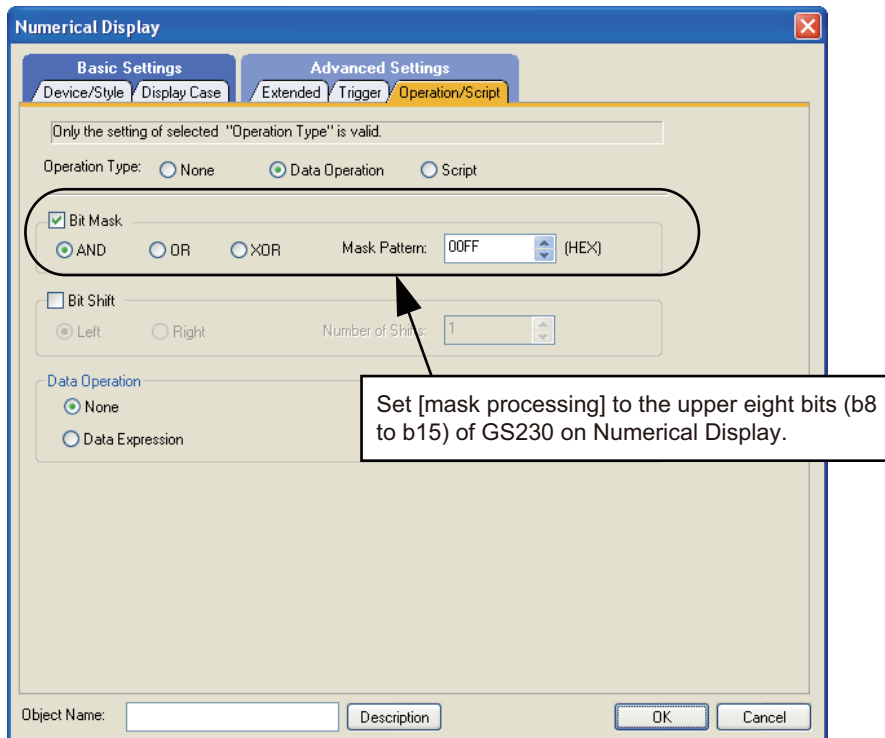

(2) Faulty station information (GS231 to GS238)

The bit corresponding to the faulty station is set.(0: Normal, 1: Abnormal)
The bit is reset after the fault is recovered.

(a) Ethernet connection (Except for Ethernet multiple connection)

GS231 bit 0 . . .
GS231 bit 1 . . .
GS231 bit 2 . . .
GS231 bit 3 . . .

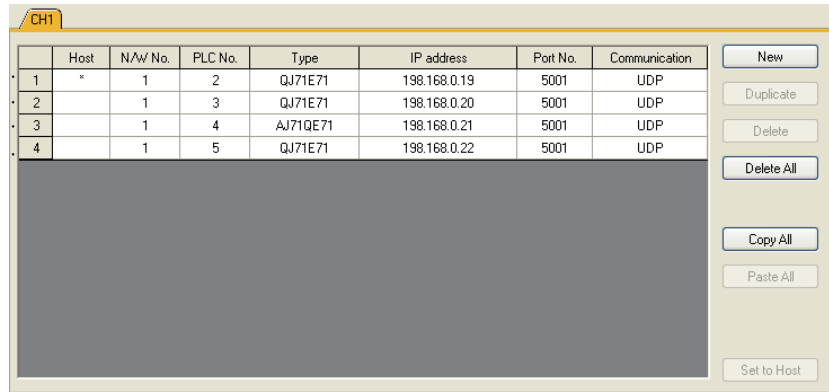

Device	PLC No.															
	b15	b14	b13	b12	b11	b10	b9	b8	b7	b6	b5	b4	b3	b2	b1	b0
GS231	16	15	14	13	12	11	10	9	8	7	6	5	4	3	2	1
GS232	32	31	30	29	28	27	26	25	24	23	22	21	20	19	18	17
GS233	48	47	46	45	44	43	42	41	40	39	38	37	36	35	34	33
GS234	64	63	62	61	60	59	58	57	56	55	54	53	52	51	50	49
GS235	80	79	78	77	76	75	74	73	72	71	70	69	68	67	66	65
GS236	96	95	94	93	92	91	90	89	88	87	86	85	84	83	82	81
GS237	112	111	110	109	108	107	106	105	104	103	102	101	100	99	98	97
GS238	128	127	126	125	124	123	122	121	120	119	118	117	116	115	114	113

(b) Ethernet multiple connection, servo amplifier connection, inverter connection

The station number to which each device corresponds changes according to the connection/non connection with Ethernet.

With Ethernet connection: 1 to 128

With other than Ethernet connection: 0 to 127

Example) With Ethernet connection, when PC No. 100 CPU connecting to Ch3 is faulty, GS327.b3 is set. The following table shows the case with Ethernet connection.

Device				PLC No./Station No.															
Ch1	Ch2	Ch3	Ch4	b15	b14	b13	b12	b11	b10	b9	b8	b7	b6	b5	b4	b3	b2	b1	b0
GS281	GS301	GS321	GS341	16	15	14	13	12	11	10	9	8	7	6	5	4	3	2	1
GS282	GS302	GS322	GS342	32	31	30	29	28	27	26	25	24	23	22	21	20	19	18	17
GS283	GS303	GS323	GS343	48	47	46	45	44	43	42	41	40	39	38	37	36	35	34	33
GS284	GS304	GS324	GS344	64	63	62	61	60	59	58	57	56	55	54	53	52	51	50	49
GS285	GS305	GS325	GS345	80	79	78	77	76	75	74	73	72	71	70	69	68	67	66	65
GS286	GS306	GS326	GS346	96	95	94	93	92	91	90	89	88	87	86	85	84	83	82	81
GS287	GS307	GS327	GS347	112	111	110	109	108	107	106	105	104	103	102	101	100	99	98	97
GS288	GS308	GS328	GS348	128	127	126	125	124	123	122	121	120	119	118	117	116	115	114	113

For details on the GS Device, refer to the following manual.

GT Designer3 Screen Design Manual (Fundamentals) Appendix.2.3 GOT special register (GS)

1 PREPARATORY PROCEDURES FOR MONITORING
 2 DEVICE RANGE THAT CAN BE SET
 3 ACCESS RANGE FOR MONITORING
 4 HOW TO MONITOR REDUNDANT SYSTEM
 5 BUS CONNECTION
 6 DIRECT CONNECTION TO CPU
 7 COMPUTER LINK CONNECTION
 8 ETHERNET CONNECTION

(3) Network No., station No. notification

The network No. and station No. of the GOT in Ethernet connection are stored at GOT startup.
If connected by other than Ethernet, 0 is stored.

Device				Description
CH1	CH2	CH3	CH4	
GS376	GS378	GS380	GS382	Network No. (1 to 239)
GS377	GS379	GS381	GS383	Station No. (1 to 64)

1.6.4 Check on GX Developer

- Check if the PLC CPU recognizes the GOT (For bus connection) (QCPU (Q mode) only)



Using the [System monitor] of GX Developer, check if the PLC CPU recognizes the GOT or not.
For the GX Developer operation method, refer to the following manual.

GX Developer Version Operating Manual

- Check the Module Name, I/O Address and Implementation Position. (The display example is based on GX Developer Version 8)

Startup procedure

GX Developer → [Diagnostics] → [System monitor]

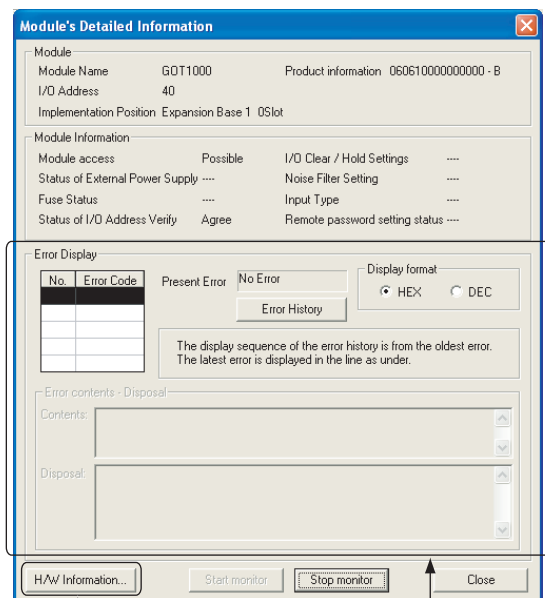

Not displayed

No error displayed
at all times

■ Checking the wiring state (For optical loop system only)



Check if the optical fiber cable is connected correctly in [Loop test] of GX Developer.
For the GX Developer operation method, refer to the following manual.

Q Corresponding MELSECNET/H Network System Reference Manual (PLC to PLC network)

(2) Check the [Receive direction error station] (The display example on GX Developer Version 8)

Startup procedure

GX Developer → [Diagnostics] → [MELSECNET (II)/10/H diagnostics] → **Loop test**

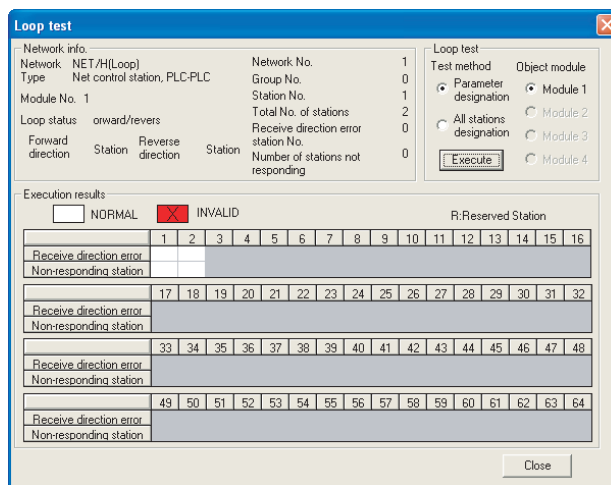

■ Checking if the GOT is performed the data link correctly



- (1) For MELSECNET/H, MELSECNET/10 network system
 Check if the GOT is performed the data link correctly in [Other station information].
 For the GX Developer operation method, refer to the following manual.

☞ Q Corresponding MELSECNET/H Network System Reference Manual (PLC to PLC network)

- (a) Check [Communication status of each station] and [Data-Link status of each station] (The display example on GX Developer Version 8)

Startup procedure

GX Developer → [Diagnostics] → [MELSECNET (II)/10/H diagnostics] → [Other station info.]

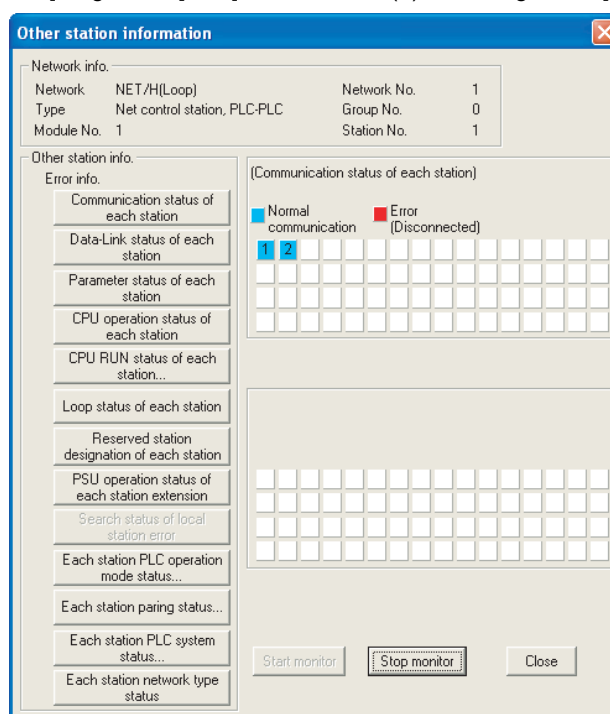

- (2) For CC-Link IE Controller Network system
 Use [CC IE Control diagnostics...] of GX Developer to check if the GOT is correctly performed the data link.
 For the GX Developer operation method, refer to the following manual.

 CC-Link IE Controller Network Reference Manual

- (a) Check the [Select station network device status display] (The display example on GX Developer Version 8)

Startup procedure

GX Developer → [Diagnostics] → [CC IE Control diagnostics...] → [CC IE Control Network Diagnostics]

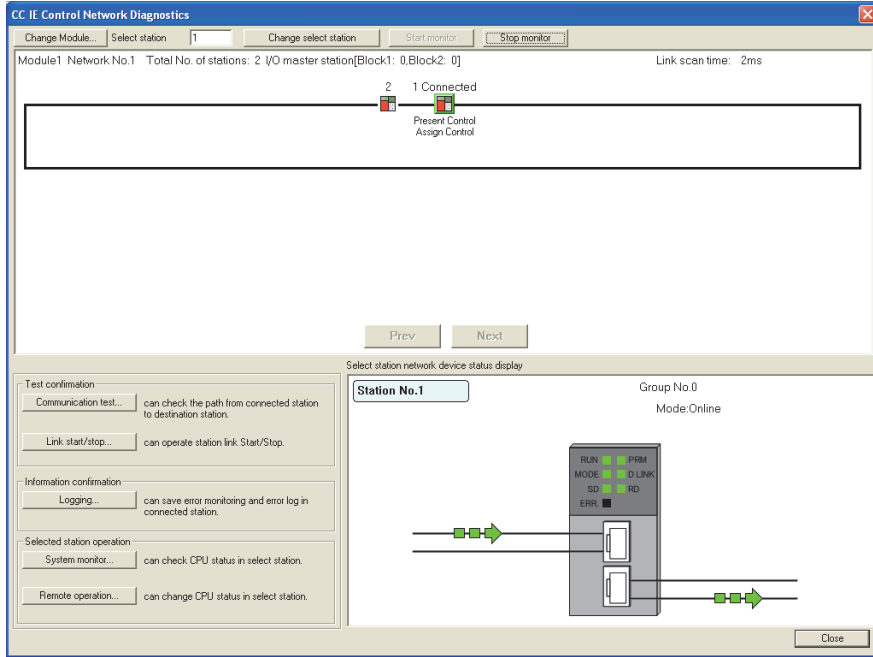

- (3) For CC-Link system
 Use [Monitoring other station] of the GX Developer to check if the GOT is correctly performed the data link.
 For the GX Developer operation method, refer to the following manual.

 CC-Link System Master/Local Module User's Manual QJ61BT11N

- (a) Check the [Status] (The display example on GX Developer Version 8)

Startup procedure

GX Developer → [Diagnostics] → [CC-Link / CC-Link LT diagnostics] → [Monitoring other station]

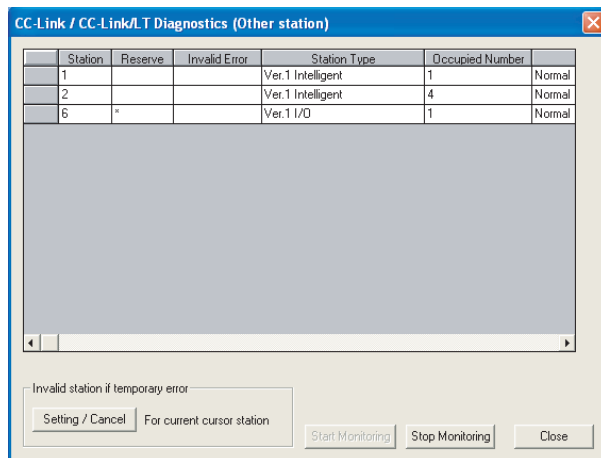

1.6.5 Check on GX Works2

■ For CC-Link IE Field Network system

Use [CC IE Field diagnostics] of GX Works2 to check if the GOT is correctly performed the data link.
For the GX Works2 operation method, refer to the following manual.

 MELSEC-Q CC-Link IE Field Network Master/Local Module User's Manual

Startup procedure

GX Works2 → [diagnostics] → [CC IE Field diagnostics]

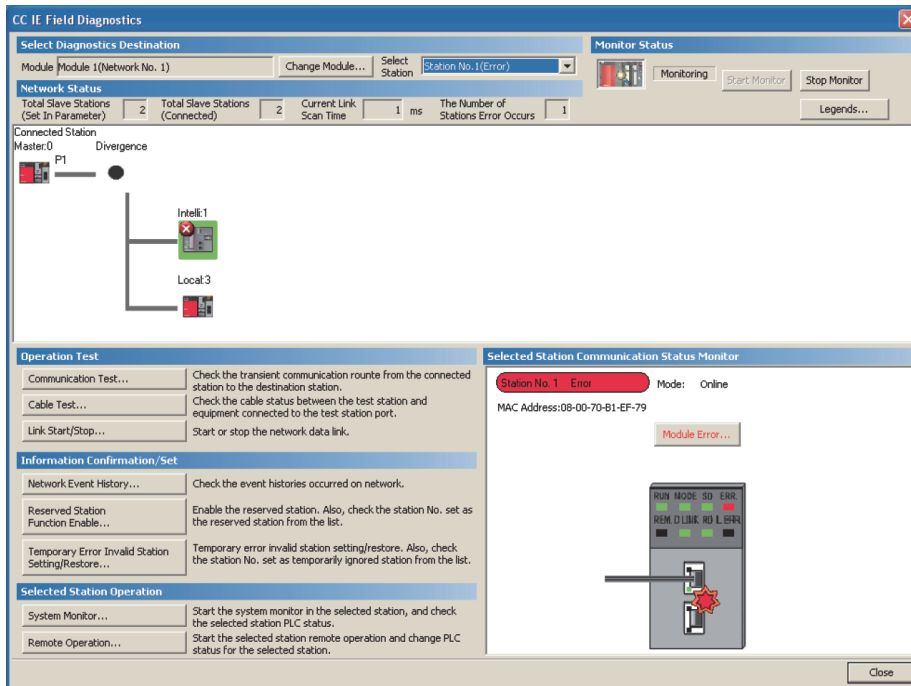

1.6.6 Check on the PLC

■ Checking the wiring state of the optical fiber cable (For CC-Link IE Controller Network only)



Check if the fiber-optic cable is connected correctly to all the modules in the CC-Link IE Controller Network.
Perform the line test from the control station of the CC-Link IE Controller Network to check the wiring state of the fiber-optic cable.

For the line testing method, refer to the following manual.

 CC-Link IE Controller Network Reference Manual

■ Checking the wiring state of the CC-Link dedicated cable (For CC-Link system only)



Check if the CC-Link dedicated cable is connected correctly to all the modules in the CC-Link system.
Perform the line test from the master station of the CC-Link System to check the wiring state of the CC-Link dedicated cable.

For the line testing method, refer to the following manuals.

 CC-Link System Master/Local Module User's Manual QJ61BT11N

 CC-Link System Master/Local Module User's Manual AJ61QBT11, A1SJ61QBT11

 CC-Link System Master/Local Module User's Manual AJ61BT11, A1SJ61BT11

MITSUBISHI ELECTRIC PLC CONNECTIONS

2.	DEVICE RANGE THAT CAN BE SET	2 - 1
3.	ACCESS RANGE FOR MONITORING	3 - 1
4.	HOW TO MONITOR REDUNTANT SYSTEM	4 - 1
5.	BUS CONNECTION.....	5 - 1
6.	DIRECT CONNECTION TO CPU	6 - 1
7.	COMPUTER LINK CONNECTION	7 - 1
8.	ETHERNET CONNECTION.....	8 - 1
9.	MELSECNET/H CONNECTION (PLC TO PLC NETWORK)	9 - 1
10.	MELSECNET/10 CONNECTION (PLC TO PLC NETWORK)	10 - 1
11.	CC-Link IE CONTROLLER NETWORK CONNECTION ...	11 - 1
12.	CC-Link IE FIELD NETWORK CONNECTION	12 - 1
13.	CC-Link CONNECTION (INTELLIGENT DEVICE STATION)	13 - 1
14.	CC-Link CONNECTION (Via G4).....	14 - 1

2

DEVICE RANGE THAT CAN BE SET

2.1	MELSEC iQ-R, RnMT	2 - 8
2.2	MELSEC iQ-F	2 - 9
2.3	MELSEC-QnU/DC, Q17nD/M/NC/DR, CRnD-700	2 - 10
2.4	MELSEC-L	2 - 11
2.5	MELSEC-QnA/Q/QS, MELDAS C6 *	2 - 12
2.6	MELSEC-Q (Multi)/Q Motion	2 - 13
2.7	MELSEC-A	2 - 14
2.8	MELSEC-FX	2 - 15
2.9	MELSEC-WS	2 - 16









2. DEVICE RANGE THAT CAN BE SET

The device ranges that can be set for the Mitsubishi Electric PLCs are as follows.

Note that the device ranges in the following tables are the maximum values that can be set in GT Designer3.

The device specifications of controllers may differ depending on the models, even though belonging to the same series. Please make the setting according to the specifications of the controller actually used.

When a non-existent device or a device number outside the range is set, other objects with correct device settings may not be monitored.

-  2.1 MELSEC iQ-R, RnMT
-  2.2 MELSEC iQ-F
-  2.3 MELSEC-QnU/DC, Q17nD/M/NC/DR, CRnD-700 *¹
-  2.4 MELSEC-L
-  2.5 MELSEC-QnA/Q/QS, MELDAS C6 * *²
-  2.6 MELSEC-Q (Multi)/Q Motion *³
-  2.7 MELSEC-A
-  2.8 MELSEC-FX
-  2.9 MELSEC-WS

*1 The PLC names differ depending on the type of GOT.

- GT11: MELSEC-QnU/DC, Q17nD/M/NC/DR
- GT10: MELSEC-QnU/DC

*2 The PLC names differ depending on the type of GOT.

- GT11: MELSEC-QnA/Q, MELDAS C6 *
- GT10: MELSEC-QnA/Q

*3 The PLC names differ depending on the type of GOT.

- GT10: MELSEC-Q (MULTI)

■ Setting item

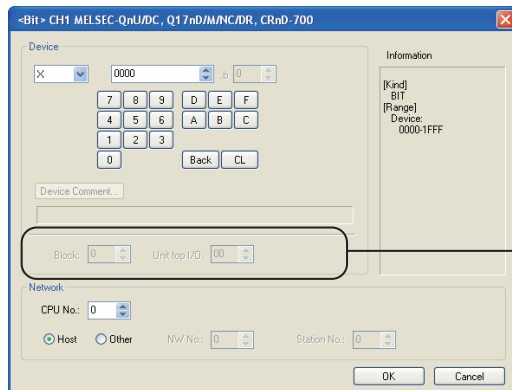

(For MELSEC-QnU/DC, Q17nD/M/NC/DR, CRnD-700)

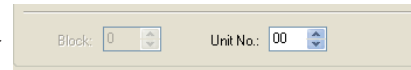

When selecting buffer memory (G) with the following controllers
 MELSEC-QnU/DC, Q17nD/M/NC/DR, CRnD-700
 MELSEC-L
 MELSEC-QnA/Q/QS, MELDAS C6 *
 MELSEC-Q(MULTI)/Q MOTION

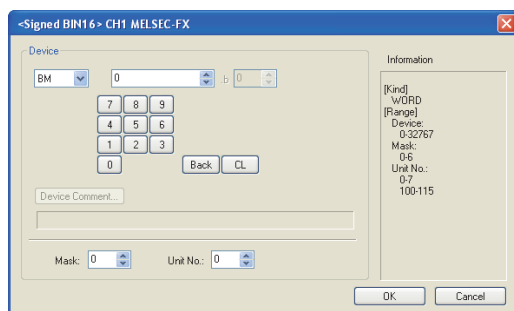

(For MELSEC-FX)

Item	Description		
Device	Set the device name, device number, and bit number. The bit number can be set only by specifying the bit of word device. When setting buffer memory (BM) and (G), set the buffer memory address in the space for the device number.		
	<div style="border: 1px solid black; padding: 2px; display: inline-block;">Device Comment...</div> Reading the device comment data created by GX Developer and confirming the device comment/device name are available during device setting. For details on the procedure to refer to the device comment, refer to the following. GT Designer3 Version□ Screen Design Manual		
	Block Set the block number of the extended file register. This item can be set only when the extended file register (ER) is selected.		
	Intelligent function module	Unit top I/O	Set when the buffer memory (BM) is selected. Set the head I/O number of the buffer memory for the intelligent function module. Set the first 2 digits of the 3-digit head I/O number.
		Unit No.	Set when the buffer memory (G) is selected. Set the head I/O number of the buffer memory for the intelligent function module. Set the first 2 digits of the 3-digit head I/O number.
	MELSEC-FX buffer memory	Mask type	Set for using the buffer memory of MELSEC-FX series. Set the mask type for monitoring or writing only specified bits of the buffer memory. (4) Setting of the mask type (MELSEC-FX)
Unit No.		Set for using the buffer memory of MELSEC-FX series. Set the module No. of the special function unit or special function block to monitor or write. (5) Setting of the module No. (MELSEC-FX)	
Information	Displays the device type and its setting range selected in [Device].		
Network	Set the station number of the controller to be monitored.		
	CPU No.	Set the CPU No. of the controller. (1) Setting of the CPU No.	
	Host	Select this item for monitoring the host controller.	
	Other	Select this for monitoring other controllers. After selecting the item, set the station number and network number of the controller to be monitored. NW No.: Set the network No. Station No.: Set the station No.	

(1) Setting of the CPU No.

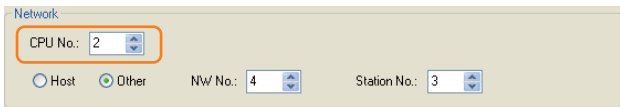

- (a) When monitoring a single CPU system
Set to 0.
- (b) When monitoring a multiple CPU system
Set the CPU No. (0 to 4) in [CPU No.] when monitoring a multiple CPU system.
When [CPU No.] is set to "0", the monitoring target differs depending on the connection method.

Connection method	Monitoring target
• Direct CPU connection	Connected PLC CPU
• Bus connection • Computer link connection • MELSECNET connection • Ethernet connection • CC-Link connection	Control CPU

(2) When monitoring link relay (B) and link register (W) assigned in link parameter and network parameter. Set the device link relay (B) and link register (W) running cyclic communication as [Host]. If it is set as [Other] in the network setting, the cyclic transmission is changed to the transient transmission regardless of the network type, resulting in delay of the object display.

(3) Setting the device by inputting directly from the keyboard
When setting the device by inputting directly from the keyboard, set the items as follows.
(For devices except BM and G)

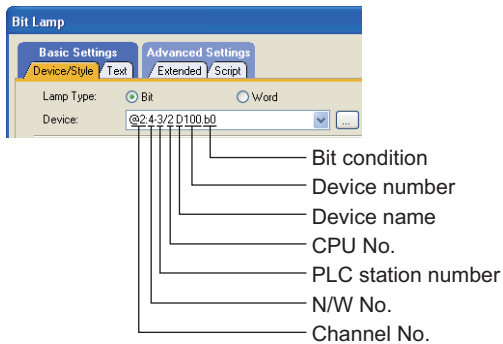

(For device BM and CPU No. 0)

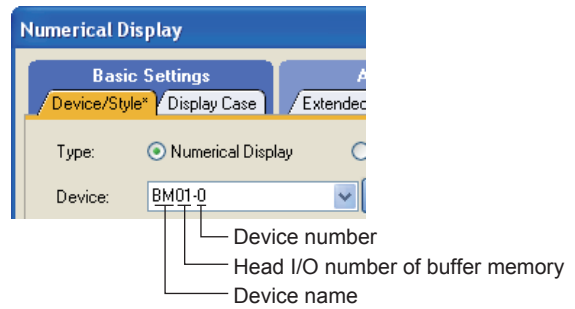

(For device BM and CPU No. 1 to 4)

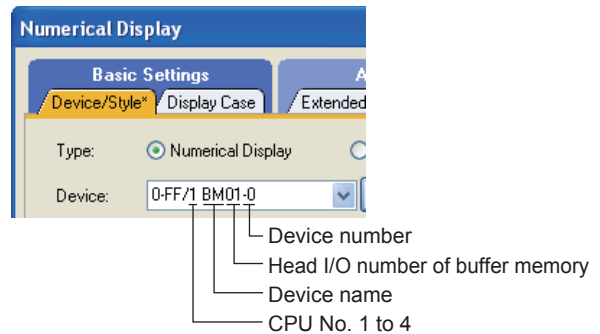

(For device G and CPU No. 0)

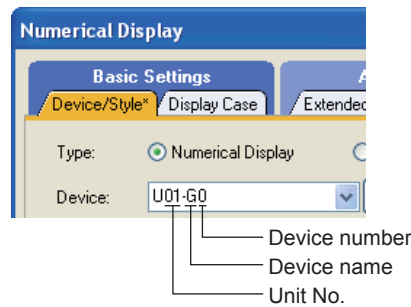

(For device G and CPU No. 1 to 4)

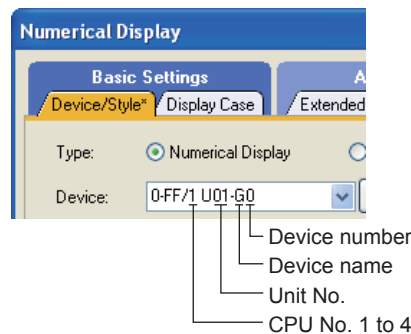

(4) Setting of the mask type (MELSEC-FX)
 Set the item for monitoring or writing only the specified bits of the buffer memory.



Mask type

The mask type is effective when using for the buffer memories divided per 4 bits, such as an analog input block.

(a) Mask type 0

Monitor and write the buffer memory value directly.

(b) Mask type 1

• (For 16 bits)
 Monitor and write only b0 to b3 of the buffer memory.

Example:
 The monitor value is 0001H when monitoring BM=4321H as mask type 1.

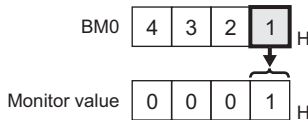

BM0=0001H when writing input value 4321H to BM0=0000H as mask type 1.

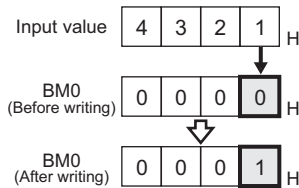

• (For 32 bits)
 Monitor and write only b0 to b3 and b16 to 19 of the buffer memory.

Example:
 The monitor value is 00050001H when monitoring BM0=87654321H as mask type 1.

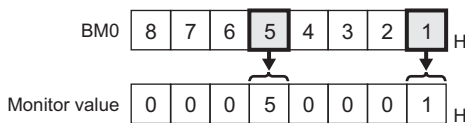

BM0=00050001H when writing input value 87654321H to BM0=00000000H as mask type 1.

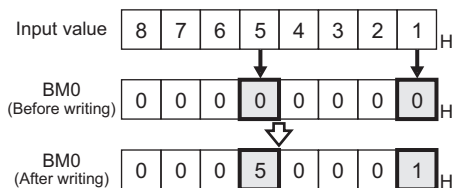

(c) Mask type 2

• (For 16 bits)
 Monitor and write only b4 to b7 of the buffer memory.

Example:
 The monitor value is 0002H when monitoring BM0=4321H as mask type 2.

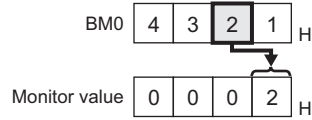

BM0=0010H when writing input value 4321H to BM0=0000H as mask type 2.

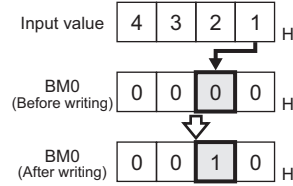

• (For 32 bits)
 Monitor and write only b4 to b7 and b20 to 23 of the buffer memory.

Example:
 The monitor value is 00060002H when monitoring BM0=87654321H as mask type 2.

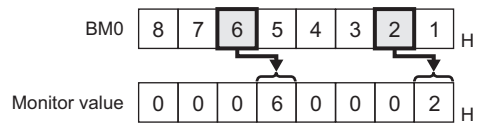

BM0=00500010H when writing input value 87654321H to BM0=00000000H as mask type 2.

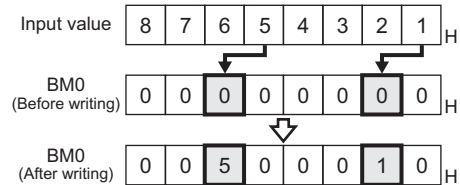

(d) Mask type 3

• (For 16 bits)
 Monitor and write only b8 to b11 of the buffer memory.

Example:
 The monitor value is 0003H when monitoring BM0=4321H as mask type 3.

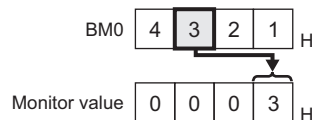

BM0=0100H when writing input value 4321H to BM0=0000H as mask type 3.

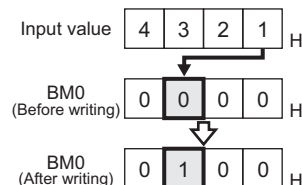

- (For 32 bits)
Monitor and write only b8 to b11 and b28 to 31 of the buffer memory.

Example:

The monitor value is 00070003H when monitoring BM0=87654321H as mask type 3.

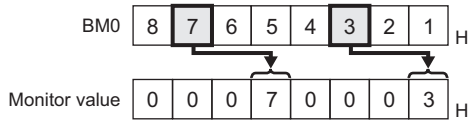

BM0=05000100H when writing input value 87654321H to BM0=00000000H as mask type 3.

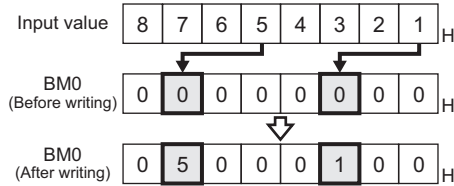

(e) Mask type 4

- (For 16 bits)
Monitor and write only b12 to b15 of the buffer memory.

Example:

The monitor value is 0004H when monitoring BM0=4321H as mask type 4.

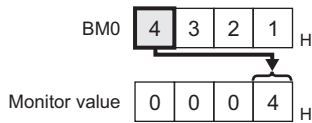

BM0=1000H when writing input value 4321H to BM0=0000H as mask type 4.

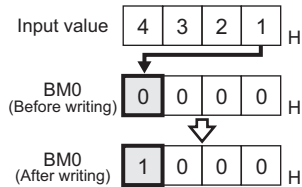

- (For 32 bits)
Monitor and write only b12 to b15 and b28 to 31 of the buffer memory.

Example:

The monitor value is 00080004H when monitoring BM0=87654321H as mask type 4.

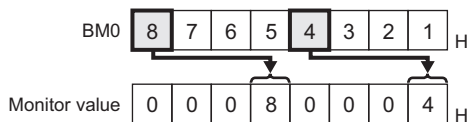

BM0=50001000H for writing input value 87654321H to BM0=00000000H as mask type 4.

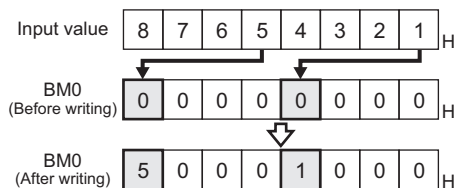

(f) Mask type 5

- (For 16 bits)
Monitor and write only b0 to b7 of the buffer memory.

Example:

The monitor value is 0021H when monitoring BM0=4321H as mask type 5.

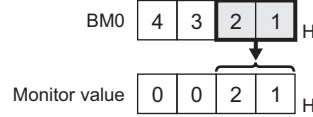

BM0=0021H when writing input value 4321H to BM0=0000H as mask type 5.

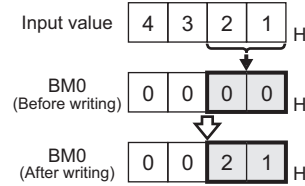

- (For 32 bits)
Monitor and write only b0 to b7 and b16 to 23 of the buffer memory.

Example:

The monitor value is 00650021H when monitoring BM0=87654321H as mask type 5.

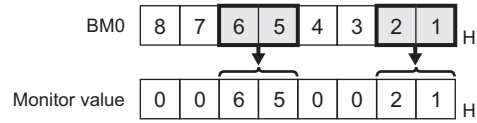

BM0=00650021H when writing input value 87654321H to BM0=00000000H as mask type 5.

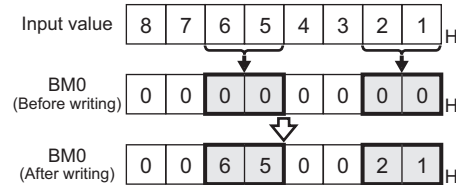

(g) Mask type 6

- (For 16 bits)
Monitor and write only b8 to b15 of the buffer memory.

Example:

The monitor value is 0043H when monitoring BM0=4321H as mask type 6.

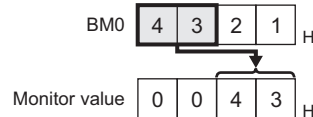

BM0=2100H when writing input value 4321H to BM0=0000H as mask type 6.

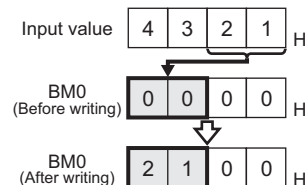

- (For 32 bits)
Monitor and write only b8 to b15 and b24 to 31 of the buffer memory.

Example:

The monitor value is 00870043H when monitoring BM0=87654321H as mask type 6.

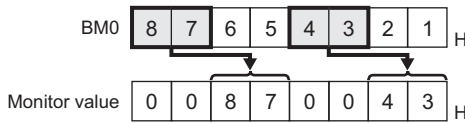

BM0=65002100H when writing input value 87654321H to BM0=00000000H as mask type 6.

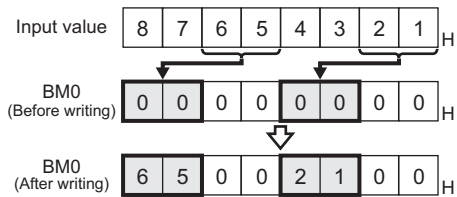

(5) Setting of the module No. (MELSEC-FX)

Set the module No. of the special function unit or special function block to monitor or write.

The module No.0 to No.7 are assigned in order for the nearest module or block from the main unit. For details of the module No., refer to the following.

User's Manual (Hardware) of MELSEC-FX

(a) Direct specification

Specify the module No. (No.0 to No.7) of the special function unit or special function block directly, to monitor or write when setting the devices.

(b) Indirect specification^{*1}

Specify the module No. of the special function unit or special function block indirectly, to monitor or write when setting the devices, by using the 16-bit GOT internal data register (GD10 to GD25). When specifying the station No. from 100 to 115 on GT Designer3, the value of GD10 to GD25 corresponding to the module No. will be the module No. of the special function unit or special function block.

Module No.	Compatible device	Setting range
100	GD10	0 to 7
101	GD11	For the setting other than the above, error (dedicated device is out of range) will occur.
:	:	
114	GD24	If a non-existent module No. is set, a timeout error occurs.
115	GD25	

*1 The module No. cannot be specified indirectly for the multi-drop connection.

2.1 MELSEC iQ-R, RnMT

The table below shows the device ranges in [MELSEC iQ-R, RnMT] as the controller type.

Device name	Setting range	Device No. representation	
Input (X)	X0 to X3FFF	Hexadecimal number	
Output (Y)	Y0 to Y3FFF		
Internal relay (M) ^{*1}	M0 to M161882111	Decimal number	
Latch relay (L)	L0 to L32767		
Step relay (S) ^{*5}	S0 to S16383		
Annunciator (F)	F0 to F131071		
Link relay (B) ^{*1}	B0 to B9A61FFF		
Timer ^{*1}	Contact (TT)	TT0 to TT8993439	Decimal number
	Coil (TC)	TC0 to TC8993439	
Long timer ^{*1*2}	Contact (LTT)	LTT0 to LTT2529407	
	Coil (LTC)	LTC0 to LTC2529407	
Counter ^{*1}	Contact (CT)	CT0 to CT8993439	
	Coil (CC)	CC0 to CC8993439	
Long counter ^{*1}	Contact (LCT)	LCT0 to LCT4761215	
	Coil (LCC)	LCC0 to LCC4761215	
Special relay (SM)	SM0 to SM4095		
Retentive timer ^{*1}	Contact (SS)	SS0 to SS8993439	
	Coil (SC)	SC0 to SC8993439	
Long retentive timer ^{*1*2}	Contact (LSS)	LSS0 to LSS2529407	
	Coil (LSC)	LSC0 to LSC2529407	
SFC block (BL)	BL0 to BL319		
Step relay (block)(BLS)	BLS0 to BLS511		
Link special relay (SB) ^{*1}	SB0 to SB9A61FFF	Hexadecimal number	
Remote input (RX)	RX0 to RX3FFF		
Remote output (RY)	RY0 to RY3FFF		
Link relay (LB)	LB0 to LB7FFF	-	
Bit-specified word device (Except the timer, counter, retentive timer, and index register (Z))	Setting range of each word device		
Data register (D) ^{*1}	D0 to D10117631	Decimal number	
Special data register (SD)	SD0 to SD4095		
Link register (W) ^{*1}	W0 to W9A61FF	Hexadecimal number	
Timer (current value) (TN) ^{*1}	TN0 to TN8993439		
Counter (current value) (CN) ^{*1}	CN0 to CN8993439		
Retentive timer (current value) (SN) ^{*1}	SN0 to SN8993439		
Link special register (SW) ^{*1}	SW0 to SW9A61FF	Hexadecimal number	

Device name	Setting range	Device No. representation	
File register (R)	R0 to R32767	Decimal number	
Extension file register (ER)	Block		0 to 255
	Device		ER0 to ER32767
Extension file register (ZR) ^{*1}	ZR0 to ZR10027007		
Index register (16 bits) (Z)	Z0 to Z23		
Buffer memory (Intelligent function module) (G) ^{*3}	G0 to G268435455		
Ww	Ww0 to Ww1FFF		Hexadecimal number
Wr	Wr0 to Wr1FFF		
Multiple CPU high speed transmission memory (U3E0) ^{*4}	U3E000000 to U3E012287		Decimal number
Multiple CPU high speed transmission memory (U3E1) ^{*4}	U3E100000 to U3E112287		
Multiple CPU high speed transmission memory (U3E2) ^{*4}	U3E200000 to U3E212287		
Multiple CPU high speed transmission memory (U3E3) ^{*4}	U3E300000 to U3E312287		
Motion device (#)	#0 to #108287		
Word-specified bit devices (except timer, long timer, counter, long counter, retentive timer, and long retentive timer)	Setting range of each bit device	-	
Long timer (current value) (LTN) ^{*1*2}	LTN0 to LTN2529407	Decimal number	
Long counter (current value) (LCN) ^{*1}	LCN0 to LCN4761215		
Long retentive timer (current value) (LSN) ^{*1*2}	LSN0 to LSN2529407		
Index register (32 bits) (ZZ) ^{*2}	ZZ0 to ZZ22		
Index register (32 bits) (LZ)	LZ0 to LZ11		

*1 For the maximum number of devices when an extended SRAM cassette is installed, refer to the following.

 MELSEC iQ-R CPU Module User's Manual (Application)

*2 Monitoring or writing is not possible in the continuous device designation mode.

*3 Only the intelligent function module on the station connected to GOT can be specified. Set the buffer memory within the address range of the buffer memory existing in the intelligent function module.

*4 For monitoring the multiple CPU high speed transmission memory, the CPU buffer memory access device (HG) for RCPUI is monitored.

The CPU buffer memory access device (G) is not monitored.

*5 Only reading is possible.

2.2 MELSEC iQ-F

The table below shows the device ranges in [MELSEC iQ-F] as the controller type.

Device name		Setting range	Device No. representation	
Bit device	Input (X)	X0 to X1777	Octal	
	Output (Y)	Y0 to Y1777		
	Internal relay (M)	M0 to M32767	Decimal	
	Latch relay (L)	L0 to L32767		
	Step relay (S)	S0 to S4095		
	Annunciator (F)	F0 to F32767		
	Link relay (B)	B0 to B7FFF	Hexadecimal	
	Timer	Contact (TT)	TT0 to TT1023	Decimal
		Coil (TC)	TC0 to TC1023	
	Counter	Contact (CT)	CT0 to CT1023	
		Coil (CC)	CC0 to CC1023	
	Long counter	Contact (LCT)	LCT0 to LCT1023	
		Coil (LCC)	LCC0 to LCC1023	
	Special relay (SM)	SM0 to SM9999		
	Retentive timer	Contact (SS)	SS0 to SS1023	
		Coil (SC)	SC0 to SC1023	
Link special relay (SB)	SB0 to SB7FFF	Hexadecimal		
The bit specification of the word device (except Timer, Counter, Retentive timer, Index register (Z))		Setting range of each word device	—	
Word device	Data register (D)	D0 to D7999	Decimal	
	Special data register (SD)	SD0 to SD11999		
	Link register (W)	W0 to W7FFF	Hexadecimal	
	Timer (current value) (TN)	TN0 to TN1023	Decimal	
	Counter (current value)(CN)	CN0 to CN1023		
	Retentive timer (current value) (SN)	SN0 to SN1023		
	Link special register (SW)	SW0 to SW7FFF	Hexadecimal	
	File register (R) ^{*1}	R0 to R32767	Decimal	
	Index register (Z)	Z0 to Z23		
	Buffer memory (Intelligent function module) (G) ^{*2}	G0 to G262143		
The word specification of the bit device ^{*3} (except Timer, Counter, Retentive timer)		Setting range of each bit devices	—	
Double word device	Long counter (current value) (LCN) ^{*3}	LCN0 to LCN1023	-	
	Index register (LZ)	LZ0 to LZ11		

*1 Available for file register of block No. switched with the RSET instruction.

*2 Only the intelligent function module on the station connected to GOT can be specified. Set within the address range of the buffer memory existing in the target intelligent function module.

*3 The device No. must be set in multiples of 16.

1
PREPARATORY PROCEDURES FOR MONITORING

2
DEVICE RANGE THAT CAN BE SET

3
ACCESS RANGE FOR MONITORING

4
HOW TO MONITOR REDUNDANT SYSTEM

5
BUS CONNECTION

6
DIRECT CONNECTION TO CPU

7
COMPUTER LINK CONNECTION

8
ETHERNET CONNECTION

2.3 MELSEC-QnU/DC, Q17nD/M/NC/DR, CRnD-700

The table below shows the device ranges in [MELSEC-QnU/DC, Q17nD/M/NC/DR, CRnD-700]^{*9} as the controller type.

Device name ^{*6,12}		Setting range	Device No. representation		
Bit device	Input (X)	X0 to X3FFF	Hexadecimal		
	Output (Y)	Y0 to Y3FFF			
	Internal relay (M) ^{*5,10}	M0 to M61439	Decimal		
	Latch relay (L)	L0 to L32767			
	Annunciator (F)	F0 to F32767			
	Link relay (B)	B0 to B9FFF	Hexadecimal		
	Timer ^{*5}	Contact (TT)	TT0 to TT32767	Decimal	
		Coil (TC)	TC0 to TC32767		
		Counter ^{*5}	Contact (CT)		CT0 to CT32767
			Coil (CC)		CC0 to CC32767
		Special relay (SM)	SM0 to SM2255		
		Retentive timer ^{*5}	Contact (SS)		SS0 to SS32767
	Coil (SC)		SC0 to SC32767		
	Step relay (S)	S0 to S32767			
	Link special relay (SB)	SB0 to SB7FFF	Hexadecimal		
The bit specification of the word device (except Timer, Counter, Retentive timer, Index register)	Setting range of each word device	—			
Word device	Data register (D) ^{*5,10}	D0 to D4910079	Decimal		
	Special data register (SD)	SD0 to SD2255			
	Link register (W)	W0 to W4AEBFF	Hexadecimal		
	Timer (current value) (TN) ^{*5}	TN0 to TN32767	Decimal		
	Counter (current value) (CN) ^{*5}	CN0 to CN32767			
	Retentive timer (current value) (SN) ^{*5}	SN0 to SN32767			
	Link special register (SW)	SW0 to SW7FFF	Hexadecimal		
	File register (R) ^{*1,2}	R0 to R32767	Decimal		
	Extension file register (ER) ^{*1}	Block		0 to 255	
		Device		ER0 to ER32767	
	Extension file register (ZR) ^{*1,3}	ZR0 to ZR4849663			
	Index register (Z)	Z0 to Z19			
	Buffer memory (Intelligent function module) (BM) ^{*4}	BM0 to BM32767			
	Buffer memory (Intelligent function module) (G) ^{*4}	G0 to G65535			
	Ww ^{*7,8}	Ww0 to Ww1FFF	Hexadecimal		
Wr ^{*7,8}	Wr0 to Wr1FFF				
Multiple CPU high speed transmission memory (U3E0)	U3E010000 to U3E024335				
Multiple CPU high speed transmission memory (U3E1)	U3E110000 to U3E124335				
Multiple CPU high speed transmission memory (U3E2)	U3E210000 to U3E224335				
Multiple CPU high speed transmission memory (U3E3)	U3E310000 to U3E324335				

Device name ^{*6,12}		Setting range	Device No. representation
Word device	Motion device (#)	#0 to #12287	Decimal
	The word specification of the bit device ^{*7,11} (except Timer, Counter, Retentive timer)	Setting range of each bit devices	—

- *1 Do not set a file register by GT Designer3 when executing multiple programs with the file of the file register set at [Use the same file name as the program] by the PLC parameter of GX Developer.
Otherwise, read/write at GOT will be erroneous.
- *2 Available for file register of block No. switched with the RSET instruction.
- *3 Available for file register of block No. of file name switched with the QDRSET instruction.
- *4 Only the intelligent function module on the station connected to GOT can be specified.
Set within the address range of the buffer memory existing in the target intelligent function module.
- *5 Do not use local devices set in the MELSEC-Q system.
Otherwise, normal monitoring is not performed.
- *6 Even though Universal model QCPU processes 64-bit data, the GOT cannot monitor 64-bit data.
- *7 This is not supported by GT10.
- *8 This cannot be monitored when in GOT multi-drop connection.
- *9 For GT14, GT11 and GT10, the controller type is as follows.
• GT14, GT11: MELSEC-QnU/DC, Q17nD/M/NC/DR
• GT10: MELSEC-QnU/DC
- *10 For monitoring the internal relay (M) or data register (D) of a C Controller module (Q Series), configure the settings related to the device functions in the device setting tab of the language controller setting utility.
- *11 The device No. must be set in multiples of 16.
- *12 To continuously write the Q172DR (CR750-Q), use the Q172DR (CR750-Q) Ver.R6b or later.

2.4 MELSEC-L

The device ranges that can be set when selecting [MELSEC-L] as the controller type are as follows.

Device name		Setting range	Device No. representation	
Bit device	Input (X)	X0 to X3FFF	Hexadecimal	
	Output (Y)	Y0 to Y3FFF		
	Internal relay (M) ^{*5}	M0 to M61439	Decimal	
	Latch relay (L)	L0 to L32767		
	Annunciator (F)	F0 to F32767		
	Link relay (B)	B0 to BEFFF	Hexadecimal	
	Timer ^{*5}	Contact (TT)	TT0 to TT32767	Decimal
		Coil (TC)	TC0 to TC32767	
	Counter ^{*5}	Contact (CT)	CT0 to CT32767	
		Coil (CC)	CC0 to CC32767	
	Special relay (SM)	SM0 to SM2047		
	Retentive timer ^{*5}	Contact (SS)	SS0 to SS32767	
		Coil (SC)	SC0 to SC32767	
	Step relay (S)	S0 to S8191		
Link special relay (SB)	SB0 to SB7FFF	Hexadecimal		
The bit specification of the word device (except Timer, Counter, Retentive timer, Index register)	Setting range of each word device	—		
Word device	Data register (D) ^{*5}	D0 to D421887	Decimal	
	Special data register (SD)	SD0 to SD2047		
	Link register (W)	W0 to W66FFF	Hexadecimal	
	Timer (current value) (TN) ^{*5}	TN0 to TN32767	Decimal	
	Counter (current value) (CN) ^{*5}	CN0 to CN32767		
	Retentive timer (current value) (SN) ^{*5}	SN0 to SN32767		
	Link special register (SW)	SW0 to SW7FFF	Hexadecimal	
	File register (R) ^{*1*2}	R0 to R32767	Decimal	
	Extension file register (ZR) ^{*1*3}	ZR0 to ZR393215		
	Index register (Z)	Z0 to Z19		
	Buffer memory (Intelligent function module) (BM) ^{*4}	BM0 to BM32767		
	Buffer memory (Intelligent function module) (G) ^{*4}	G0 to G65535		
	Ww ^{*6*7}	Ww0 to Ww1FFF	Hexadecimal	
	Wr ^{*6*7}	Wr0 to Wr1FFF		
The word specification of the bit device ^{*6*8} (except Timer, Counter, Retentive timer)	Setting range of each bit devices	—		

- *1 Do not set a file register by GT Designer3 when executing multiple programs with the file of the file register set at [Use the same file name as the program] by the PLC parameter of GX Developer. Otherwise, read/write at GOT will be erroneous.
- *2 Available for file register of block No. switched with the RSET instruction.
- *3 Available for file register of block No. of file name switched with the QDRSET instruction.
- *4 Only the intelligent function module on the station connected to GOT can be specified. Set within the address range of the buffer memory existing in the target intelligent function module.
- *5 Do not use local devices set in the MELSEC-L system. Otherwise, normal monitoring is not performed. (The data register (D) can be used for D32768 or later.)
- *6 This is not supported by GT10.
- *7 This cannot be monitored when in GOT multi-drop connection.
- *8 The device No. must be set in multiples of 16.

1
PREPARATORY PROCEDURES FOR MONITORING

2
DEVICE RANGE THAT CAN BE SET

3
ACCESS RANGE FOR MONITORING

4
HOW TO MONITOR REDUNDANT SYSTEM

5
BUS CONNECTION

6
DIRECT CONNECTION TO CPU

7
COMPUTER LINK CONNECTION

8
ETHERNET CONNECTION

2.5 MELSEC-QnA/Q/QS, MELDAS C6 *

The device ranges that can be set when selecting [MELSEC-QnA/Q/QS, MELDAS C6*]^{*12} as the controller type are as follows.

Device name ^{*6*7*11}		Setting range	Device No. representation	
Bit device	Input (X)	X0 to X3FFF	Hexadecimal	
	Output (Y)	Y0 to Y3FFF		
	Internal relay (M) ^{*8}	M0 to M32767	Decimal	
	Latch relay (L)	L0 to L32767		
	Annunciator (F)	F0 to F32767		
	Link relay (B)	B0 to B7FFF	Hexadecimal	
	Timer ^{*8}	Contact (TT)	TT0 to TT32767	Decimal
		Coil (TC)	TC0 to TC32767	
	Counter ^{*8}	Contact (CT)	CT0 to CT32767	
		Coil (CC)	CC0 to CC32767	
	Special relay (SM)	SM0 to SM2047		
	Retentive timer ^{*8}	Contact (SS)	SS0 to SS32767	
		Coil (SC)	SC0 to SC32767	
	Step relay (S)	S0 to S32767		
	Link special relay (SB)	SB0 to SB7FFF	Hexadecimal	
The bit specification of the word device (except Timer, Counter, Retentive timer, Index register)		Setting range of each word device	—	
Word device	Data register (D) ^{*8}	D0 to D32767	Decimal	
	Special data register (SD)	SD0 to SD2047		
	Link register (W)	W0 to W7FFF	Hexadecimal	
	Timer (current value) (TN) ^{*8}	TN0 to TN32767	Decimal	
	Counter (current value) (CN) ^{*8}	CN0 to CN32767		
	Retentive timer (current value) (SN) ^{*8}	SN0 to SN32767		
	Link special register (SW)	SW0 to SW7FFF	Hexadecimal	
	File register (R) ^{*11*2}	R0 to R32767	Decimal	
	Extension file register (ER) ^{*1*9*10}	Block		0 to 255
		Device		R0 to R32767
	Extension file register (ZR) ^{*1*3*9*10}	ZR0 to ZR1042431		
	Index register (Z)	Z0 to Z15		
	Buffer memory (Intelligent function module) (BM) ^{*4*9*10}	BM0 to BM32767		
	Buffer memory (Intelligent function module) (G) ^{*4*9*10}	G0 to G65535		
	Ww ^{*9*10}	Ww0 to Ww1FFF	Hexadecimal	
Wr ^{*9*10}	Wr0 to Wr1FFF			
The word specification of the bit device ^{*5*9} (except Timer, Counter, Retentive timer)		Setting range of each bit devices	—	

- *1 Do not set a file register by GT Designer3 when executing multiple programs with the file of the file register set at [Use the same file name as the program] by the PLC parameter of GX Developer. (Except MELSEC-QnA)
Otherwise, read/write at GOT will be erroneous.
- *2 Available for file register of block No. switched with the RSET instruction.
- *3 Available for file register of block No. of file name switched with the QDRSET instruction.
- *4 Only the intelligent function module on the station connected to GOT can be specified.
Set within the address range of the buffer memory existing in the target intelligent function module.
- *5 The device No. must be set in multiples of 16.
- *6 When monitoring MELDAS C6/64, if a word device outside the range is set, the value becomes indefinite.
When a bit device outside the range is set, the object may not be displayed or the set function may fail to operate.
Check the set device using the device list of GT Designer3.
- *7 Devices used by the MELDAS C6/64 system cannot be used.
- *8 Do not use local devices set in the MELSEC-Q system.
Otherwise, normal monitoring is not performed.
- *9 This is not supported by GT10.
- *10 This cannot be monitored when in GOT multi-drop connection.
- *11 Only reading is possible from QS001CPU.
- *12 For GT14, GT11 and GT10, the controller type is as follows.
• GT14, GT11: MELSEC-QnA/Q, MELDAS C6 *
• GT10: MELSEC-QnA/Q

2.6 MELSEC-Q (Multi)/Q Motion

The device ranges that can be set when selecting [MELSEC-Q (Multi)/Q Motion]^{*13} as the controller type are as follows.

Device name		Setting range	Device No. representation	
Bit device	Input (X)	X0 to X1FFF	Hexadecimal	
	Output (Y)	Y0 to Y1FFF		
	Internal relay (M) ^{*12}	M0 to M32767	Decimal	
	Latch relay (L)	L0 to L32767		
	Annunciator (F)	F0 to F32767		
	Link relay (B)	B0 to B7FFF	Hexadecimal	
	Timer ^{*12}	Contact (TT)	TT0 to TT32767	Decimal
		Coil (TC)	TC0 to TC32767	
	Counter ^{*12}	Contact (CT)	CT0 to CT32767	
		Coil (CC)	CC0 to CC32767	
	Special relay (SM) ^{*9}	SM0 to SM2047		
	Retentive timer ^{*12}	Contact (SS)	SS0 to SS32767	
		Coil (SC)	SC0 to SC32767	
	Step relay (S)	S0 to S32767		
Link special relay (SB)	SB0 to SB7FF	Hexadecimal		
The bit specification of the word device (except Timer, Counter, Retentive timer, Index register)		Setting range of each word device	—	
Word device	Data register (D) ^{*10*11*12}	D0 to D32767	Decimal	
	Special data register (SD)	SD0 to SD2047		
	Link register (W)	W0 to W7FFF	Hexadecimal	
	Timer (current value) (TN) ^{*12}	TN0 to TN32767	Decimal	
	Counter (current value) (CN) ^{*12}	CN0 to CN32767		
	Retentive timer (current value) (SN) ^{*12}	SN0 to SN32767		
	Link special register (SW)	SW0 to SW7FF	Hexadecimal	
	File register (R) ^{*1*2}	R0 to R32767	Decimal	
	Extension file register (ER) ^{*1*7*8}	Block		0 to 255
		Device		R0 to R32767
	Extension file register (ZR) ^{*1*3*4*7*8}	ZR0 to ZR1042431		
	Index register (Z)	Z0 to Z15		
	Buffer memory (Intelligent function module) (BM) ^{*5*7*8}	BM0 to BM32767		
	Buffer memory (Intelligent function module) (G) ^{*4*5*7*8}	G0 to G65535		
	Ww ^{*7*8}	Ww0 to Ww7FF		Hexadecimal
	Wr ^{*7*8}	Wr0 to Wr7FF		
	Motion device (#) ^{*7*8}	#0 to #8191	Decimal	
	The word specification of the bit device ^{*6*7} (except Timer, Counter, Retentive timer)		Setting range of each bit devices	—

(When using the QCPU)

* For details of *1 to *6, refer to 2.5 MELSEC-QnA/Q/QS, MELDAS C6*.

*7 This is not supported by GT10.

*8 This cannot be monitored when in GOT multi-drop connection.

(When using the Q Motion)

*9 When setting special internal relay M9000 to M9255, use SM for the device name and set the value subtracted 9000 for the device number (0 to 255).

*10 The setting range is D9000 to D9255 when setting the special data register.

*11 D8192 to D8999 and D9256 to D9999 are out of the valid setting range.

(When using the QCPU/Q Motion)

*12 Do not use local devices set in the MELSEC-Q (Multi)/Q Motion system.

Otherwise, normal monitoring is not performed.

*13 For GT10, the controller type is [MELSEC-Q(Multi)].

2.7 MELSEC-A

The device ranges that can be set when selecting [MELSEC-A] as the controller type are as follows.

(1) For GT16, GT15, GT14, GT12, GT11

Device name	Setting range	Device No. representation	
Input (X)	X0 to X1FFF	Hexadecimal	
Output (Y)	Y0 to Y1FFF		
Internal relay/Special internal relay (M)	M0 to M32767	Decimal	
Latch relay (L)	L0 to L32767		
Annunciator (F)	F0 to F32767		
Link relay (B)	B0 to B7FFF	Hexadecimal	
Timer	Contact (TT)	TT0 to TT32767	Decimal
	Coil (TC)	TC0 to TC32767	
Counter	Contact (CT)	CT0 to CT32767	
	Coil (CC)	CC0 to CC32767	
Link special relay (SB)	SB0 to SB7FF	Hexadecimal	
The bit specification of the word device (except Index register (Z), Buffer memory)	Setting range of each word device	—	
Data register/Special data register (D)	D0 to D32767	Decimal	
Link register (W)	W0 to W7FFF	Hexadecimal	
Timer (current value) (TN)	TN0 to TN32767	Decimal	
Counter (current value) (CN)	CN0 to CN32767		
Link special register (SW)	SW0 to SW7FF	Hexadecimal	
File register (R)	R0 to R32767	Decimal	
Extension file register (ER) ^{*1}	Block		1 to 255
	Device		ER0 to ER32767
Index register ^{*2}	(Z)		Z0 to Z15
	(V)		V0 to V6
Accumulator (A)	A0 to A1		
Buffer memory (Intelligent function module) (BM) ^{*3}	BM0 to BM32767	Decimal	
Ww	Ww0 to Ww7FF	Hexadecimal	
Wr	Wr0 to Wr7FF		
The word specification of the bit device ^{*4*5} (except Timer, Counter)	Setting range of each bit devices	—	

- *1 In the computer link connection, the bit specification writing of the word device to the ER29-0 (block 29 of the extension file register) or later of A3ACPU, A3UCPU, or A4UCPU is not available.
When the bit specification writing of the word device is required, use the range of block No. 0 to 28.
- *2 In the computer link connection, writing to the index register (e.g., the touch switch function, numerical input function) is not available.
- *3 Only the intelligent function module on the station connected to GOT can be specified.
Set within the address range of the buffer memory existing in the target intelligent function module.
- *4 The device No. must be set in multiples of 16.
- *5 If the special internal relay (M) is converted to the word device, treat 9000 of the device No. as 0 and set in multiples of 16.
Example: M9000, M9016, M9240

(2) For GT10, GOT MULTI-DROP CONNECTION

Device name	Setting range	Device No. representation	
Input (X)	X0 to X1FFF	Decimal	
Output (Y)	Y0 to Y1FFF		
Internal relay/Special internal relay (M)	M0 to M9255		
Latch relay (L)	L0 to L8191		
Annunciator (F)	F0 to F2047		
Link relay (B)	B0 to B1FFF	Hexadecimal	
Timer	Contact (TT)	TT0 to TT2047	Decimal
	Coil (TC)	TC0 to TC2047	
Counter	Contact (CT)	CT0 to CT1023	
	Coil (CC)	CC0 to CC1023	
Word device bit	Specified bit of the following word devices (Except Index register)	—	
Data register/Special data register (D)	D0 to D9255	Decimal	
Link register (W)	W0 to W1FFF	Hexadecimal	
Timer (current value) (TN)	TN0 to TN2047	Decimal	
Counter (current value) (CN)	CN0 to CN1023		
File register (R)	R0 to R8191		
Index register ^{*1}	(Z)		Z0 to Z6
	(V)		V0 to V6
Accumulator (A) ^{*2}	A0 to A1		
Bit device word ^{*3*4*5}	Converting the above bit devices into words (Except Timer and Counter)	—	

- *1 In the computer link connection, writing to the index register (e.g., the touch switch function, numerical input function) is not available.
- *2 With the computer link connection, the GOT cannot read/write data from/to the accumulator.
- *3 This is not supported by GT10.
- *4 The device No. must be set in multiples of 16.
If the special internal relay (M) is converted to the word device, treat 9000 of the device No. as 0 and set in multiples of 16.
Example: M9000, M9016, M9240
- *5

2.8 MELSEC-FX

The device ranges that can be set when selecting [MELSEC-FX] as the controller type are as follows.

	Device name	Setting range	Device No. representation
Bit device	Input relay (X)	X0 to X377	Octal
	Output relay (Y)	Y0 to Y377	
	Auxiliary relay (M)	M0 to M7679	
	Special auxiliary relay (M)	M8000 to M8511	Decimal
	State (S)	S0 to S4095	
	Timer contact (T)	T0 to T511	
	Counter contact (C)	C0 to C255	
	The bit specification of the word device ^{*1} (except Timer (set value), Counter (set value))	Setting range of each word device	—
Word device	Data register (D)	D0 to D0999	Decimal
	File register (D)	D1000 to D7999	
	Special data register (D)	D8000 to D8511	
	Timer (current value) (T)	T0 to T511	
	Counter (current value) (C)	C0 to C255	
	Timer (set value) (TS) ^{*3*5}	TS0 to TS511	
	Counter (set value) (CS) ^{*4*5}	CS0 to CS255	
	Extension register (R)	R0 to R32767	
	Index register (V)	V0 to V7	
	Index register (Z)	Z0 to Z7	
	Buffer memory (BM) ^{*7}	BM0 to BM32767	
		The word specification of the bit device ^{*2*6} (except Timer contact, Counter contact)	

- *1 When executing the touch switch function set during the bit specification of the word device, do not write any data to the word device through the sequence program.
- *2 The device No. must be set in multiples of 16.
- *3 Only 16-bit (1-word) designation is allowed.
- *4 For CS0 to CS199, only 16-bit (1-word) designation is allowed.
For CS200 to CS255, only 32-bit (2-word) designation is allowed.
- *5 Monitoring or writing is not possible in the continuous device designation mode.
In addition, setting values of the timer and counter, which are not used for the program, cannot be monitored. If monitoring is executed, a reading error occurs.
- *6 This is not supported by GT10.
- *7 Can be used only for special blocks or special units compatible with FX1N, FX1NC, FX2N, FX2NC, FX3G, FX3GC, FX3U, FX3UC.
(Except FX0N-3A, FX2N-2AD, and FX2N-2DA)

POINT

- Precautions when using the buffer memory
 - When the power supply of the special block or special module is turned off, the contents of the buffer memory are initialized, except for some keeping areas.
 - When the buffer memory is monitored by the GOT, the PLC scan time may increase instantly.
 - Use the 16 bit specification for the buffer memory of 16 bit data. Use the 32 bit

specification for the buffer memory of 32 bit data. If using the 16 bit specification for a buffer memory of 32 bit data, monitoring and writing may not be executed normally.

For the data size of each buffer memory, refer to the following.

 User's Manual of the special block or special module

- When reading from/writing to the special block or special module by interrupt processing of the sequence program, monitoring/writing from GOT to the buffer memory may not be executed normally.
- How to select a keyword protection level
For equipment that are allowed to operate the FX PLC online, 3 levels of protection level can be set. When monitoring or changing settings by any online equipment is required, set a keyword referring to the following.
 - When setting the keyword only
Select a protection level by the initial letter of the keyword.
All operation protect: Set a keyword with the initial letter "A", "D" to "F", or "0" to "9".
Incorrect write/read protect: Set a keyword with the initial letter "B".
Incorrect write protect: Set a keyword with the initial letter "C".
 - When setting the keyword and 2nd keyword
Select a protection level by [Registration condition].
 - Monitoring availability at each keyword protection level
The following shows the device monitoring availability at each keyword protection level.

Item	When registering the keyword only			When registering the keyword and 2nd keyword			Keyword not registered or protection cancelled
	All operation protect	Incorrect write/read protect	Incorrect write protect	All online operation protect	Read/write protect	Write protect	
Monitoring devices	○	○	○	×	○	○	○
Changing devices	T, C set value and file register (D1000 and the following)	× ^{*1}	× ^{*1}	×	○	○	○
	Other than above	○	○	○	×	○	○

- *1 When the T, C set values are specified indirectly, changing devices is available.

- Difference between all online operations prohibition and all operations prohibition
When specifying all online operations prohibition, displaying devices and inputting data with programming tools or GOT are all prohibited. When all operations are prohibited, displaying devices and inputting data with the GOT are enabled while all operations using programming tools are prohibited.

2.9 MELSEC-WS

The device ranges that can be set when selecting [MELSEC-WS] as the controller type are as follows.

	Device	Setting range	Device No. representation
Bit device	Input (I)	I1.1 to I12.8	Decimal +Decimal
	Output (Q)	Q1.1 to Q12.8	
	Logic result (LQ)	LQ0.0 to LQ3.7	
	Logic input (LI)	LI0.0 to LI3.7	
	The bit specification of the word device	Setting range of each word device	-
Word device	Data (byte)(D)	D0 to D99	Decimal
	Data (word)(W)	W0 to W49	
	EFI input (byte)(EI)	EI110 to EI233	Decimal +Decimal +Decimal
	EFI output (byte)(EQ)	EQ10 to EQ22	
	Logic input (byte)(LD)	LD0 to LD3	Decimal
	Logic input (word)(LW)	LW0 to LW1	Decimal

POINT

- (1) Devices of MELSEC-WS
Only reading is possible for all devices.
- (2) Device settings of MELSEC-WS
 - Input(I), Output(Q)

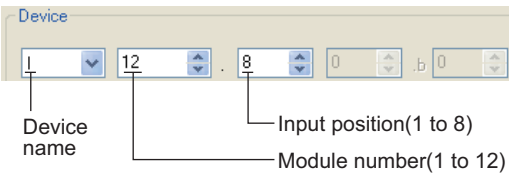

- Logic result(LQ), Logic input(LI)

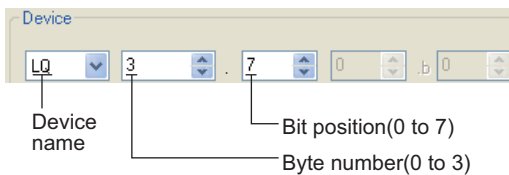

- EFI input(EI)

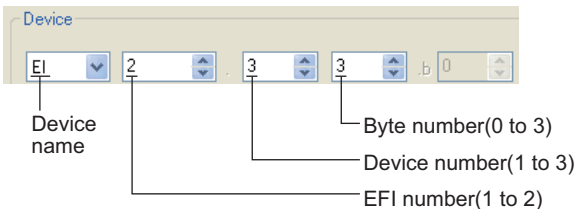

- EFI output(EQ)

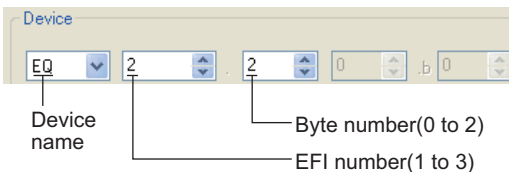

- (3) Engineering software for MELSEC-WS and device representation of GT Designer3
The engineering software for MELSEC-WS and the device representation of GT Designer3 are different. Set the device by referring to the following table.

Device	GT Designer3	Engineering software for MELSEC-WS
I*1	I□□.△ □□(1-12(Dec)): Module number △(1-8): Input position	▲▲▲▲[□□].I△ ▲▲▲▲: I/O model name (such as XTIO) □□(1-12(Dec)): Module number △(1-8): Input position
Q*1	Q□□.△ □□(1-12(Dec)): Module number △(1-8): Output position	▲▲▲▲[□□].Q△ ▲▲▲▲: I/O model name (such as XTIO) □□(1-12(Dec)): Module number △(1-8): Output position
LQ*1	LQ□.△ □(0-3): Byte number △(0-7): Bit position	▲▲□.△ ▲▲: "Result" □(0-3): Byte number △(0-7): Bit position
LI*1	LI□.△ □(0-3): Byte number △(0-7): Bit position	▲▲▲▲[0].□.△ ▲▲▲▲: CPU type (CPU0, CPU1) □(0-3): Byte number △(0-7): Bit position
EI*1	EIO□△ O(1-2): EFI number □(1-3): Device number △(0-3): Byte number	▲▲▲▲[0].EFI□:□, Byte △ ▲▲▲▲: CPU type (CPU0, CPU1) O(1-2): EFI number □(1-3): Device number △(0-3): Byte number
EQ*1	EQO△ O(1-2): EFI number △(0-2): Byte number	▲▲▲▲[0].EFI□:1, Byte △ ▲▲▲▲: CPU type (CPU0, CPU1) O(1-2): EFI number △(0-2): Byte number
D	D△ △(0-99(Dec)): Byte number	RS232 data (Safety controller to RS232)
W	W△ △(0-49(Dec)): Word number Word virtualization of D device W0= (D1(Upper bits), D0(Lower bits))	GOT independent device (Not available)
LD	LD△ △(0-3): Byte number	RS232 data (Safety controller to RS232)
LW	LW△ △(0-1): Word number Word virtualization of LD device LW0= (LD1(Upper bits), LD0(Lower bits))	GOT independent device (Not available)

*1 When the mapping position is changed by the MELSEC-WS engineering software, a mismatch occurs between virtual devices on GOT and MELSEC-WS mapping devices. When mapping is changed, use D devices or LD devices.

- (4) When using offset specification
When setting devices using the offset function, the device values are as follows.

(a) Input(I)

Offset	+0	+1	+2	+3	+4	+5	+6	+7	+8 to +15	
+0	I1.1	I1.2	I1.3	I1.4	I1.5	I1.6	I1.7	I1.8	Fixed to 0 (OFF)	
+16	I2.1	I2.2	I2.3	I2.4	I2.5	I2.6	I2.7	I2.8		
+32	I3.1	I3.2	I3.3	I3.4	I3.5	I3.6	I3.7	I3.8		
+48	I4.1	I4.2	I4.3	I4.4	I4.5	I4.6	I4.7	I4.8		
+64	I5.1	I5.2	I5.3	I5.4	I5.5	I5.6	I5.7	I5.8		
+80	I6.1	I6.2	I6.3	I6.4	I6.5	I6.6	I6.7	I6.8		
+96	I7.1	I7.2	I7.3	I7.4	I7.5	I7.6	I7.7	I7.8		
+112	I8.1	I8.2	I8.3	I8.4	I8.5	I8.6	I8.7	I8.8		
+128	I9.1	I9.2	I9.3	I9.4	I9.5	I9.6	I9.7	I9.8		
+144	I10.1	I10.2	I10.3	I10.4	I10.5	I10.6	I10.7	I10.8		
+160	I11.1	I11.2	I11.3	I11.4	I11.5	I11.6	I11.7	I11.8		
+176	I12.1	I12.2	I12.3	I12.4	I12.5	I12.6	I12.7	I12.8		
+192	Device range error									

(b) Output(Q)

Offset	+0	+1	+2	+3	+4	+5	+6	+7	+8 to +15	
+0	Q1.1	Q1.2	Q1.3	Q1.4	Q1.5	Q1.6	Q1.7	Q1.8	Fixed to 0 (OFF)	
+16	Q2.1	Q2.2	Q2.3	Q2.4	Q2.5	Q2.6	Q2.7	Q2.8		
+32	Q3.1	Q3.2	Q3.3	Q3.4	Q3.5	Q3.6	Q3.7	Q3.8		
+48	Q4.1	Q4.2	Q4.3	Q4.4	Q4.5	Q4.6	Q4.7	Q4.8		
+64	Q5.1	Q5.2	Q5.3	Q5.4	Q5.5	Q5.6	Q5.7	Q5.8		
+80	Q6.1	Q6.2	Q6.3	Q6.4	Q6.5	Q6.6	Q6.7	Q6.8		
+96	Q7.1	Q7.2	Q7.3	Q7.4	Q7.5	Q7.6	Q7.7	Q7.8		
+112	Q8.1	Q8.2	Q8.3	Q8.4	Q8.5	Q8.6	Q8.7	Q8.8		
+128	Q9.1	Q9.2	Q9.3	Q9.4	Q9.5	Q9.6	Q9.7	Q9.8		
+144	Q10.1	Q10.2	Q10.3	Q10.4	Q10.5	Q10.6	Q10.7	Q10.8		
+160	Q11.1	Q11.2	Q11.3	Q11.4	Q11.5	Q11.6	Q11.7	Q11.8		
+176	Q12.1	Q12.2	Q12.3	Q12.4	Q12.5	Q12.6	Q12.7	Q12.8		
+192	Device range error									

(c) Logic result(LQ)

Offset	+0	+1	+2	+3	+4	+5	+6	+7	
+0	LQ0.0	LQ0.1	LQ0.2	LQ0.3	LQ0.4	LQ0.5	LQ0.6	LQ0.7	
+8	LQ1.0	LQ1.1	LQ1.2	LQ1.3	LQ1.4	LQ1.5	LQ1.6	LQ1.7	
+16	LQ2.0	LQ2.1	LQ2.2	LQ2.3	LQ2.4	LQ2.5	LQ2.6	LQ2.7	
+24	LQ3.0	LQ3.1	LQ3.2	LQ3.3	LQ3.4	LQ3.5	LQ3.6	LQ3.7	
+32	Device range error								

(d) Logic input(LI)

Offset	+0	+1	+2	+3	+4	+5	+6	+7	
+0	LI0.0	LI0.1	LI0.2	LI0.3	LI0.4	LI0.5	LI0.6	LI0.7	
+8	LI1.0	LI1.1	LI1.2	LI1.3	LI1.4	LI1.5	LI1.6	LI1.7	
+16	LI2.0	LI2.1	LI2.2	LI2.3	LI2.4	LI2.5	LI2.6	LI2.7	
+24	LI3.0	LI3.1	LI3.2	LI3.3	LI3.4	LI3.5	LI3.6	LI3.7	
+32	Device range error								

(e) EFI input(EI)

Offset	+0	+1	+2	+3	+8 to +15
+0	EI110	EI111	EI112	EI113	Fixed to 0
+16	EI120	EI121	EI122	EI123	
+32	EI130	EI131	EI132	EI133	
+48 : +240	Fixed to 0				
+256	EI210	EI211	EI212	EI213	
+272	EI220	EI221	EI222	EI223	
+288	EI230	EI231	EI232	EI233	
+302	Device range error				

(f) EFI output(EQ)

Offset	+0	+1	+2	+3 to +15
+0	EQ10	EQ11	EQ12	Fixed to 0
+16 : +240	Fixed to 0			
+256	EQ20	EQ21	EQ22	
+272	Device range error			

1
PREPARATORY
PROCEDURES FOR
MONITORING

2
DEVICE RANGE
THAT CAN BE SET

3
ACCESS RANGE
FOR MONITORING

4
HOW TO MONITOR
REDUNDANT SYS-
TEM

5
BUS CONNECTION

6
DIRECT CONNEC-
TION TO CPU

7
COMPUTER LINK
CONNECTION

8
ETHERNET CON-
NECTION



3

ACCESS RANGE FOR MONITORING

3.1	Access Range for Monitoring Stations on Network Systems	3 - 2
3.2	Access Range for Monitoring when Using Ethernet Connection	3 - 13
3.3	CC-Link System Access Range for Monitoring	3 - 14
3.4	Data Link System (MELSECNET/B, (II)) Access Range for Monitoring	3 - 17
3.5	Access Range for Monitoring when Connecting FXCPU	3 - 18
3.6	Connection to Remote I/O Station in MELSECNET/H Network System	3 - 19
3.7	Connection to the Head Module of CC-Link IE Field Network System	3 - 22

1	PREPARATORY PROCEDURES FOR MONITORING
2	DEVICE RANGE THAT CAN BE SET
3	ACCESS RANGE FOR MONITORING
4	HOW TO MONITOR REDUNDANT SYSTEM
5	BUS CONNECTION
6	DIRECT CONNECTION TO CPU
7	COMPUTER LINK CONNECTION
8	ETHERNET CONNECTION

3. ACCESS RANGE FOR MONITORING

3.1 Access Range for Monitoring Stations on Network Systems

3.1.1 MELSECNET/H, MELSECNET/10, CC-Link IE Controller Network, CC-Link IE Field Network



■ Bus connection

- (1) When connecting to multiple CPU system
- The GOT can monitor the control station and all the normal stations on the network.

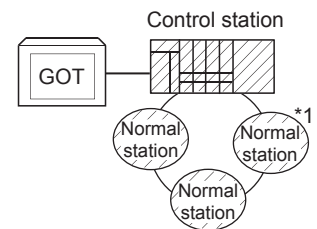

- The GOT can monitor the control station and all the normal stations on other networks.
(For monitoring stations on other networks, be sure to set the routing parameter)
When the Universal model QCPU is used as a relay station, the GOT can monitor stations with the station No.65 or later in the CC-Link IE controller network.
- When connecting to the multiple CPU system, the GOT can monitor CPU No.1 to No.4.

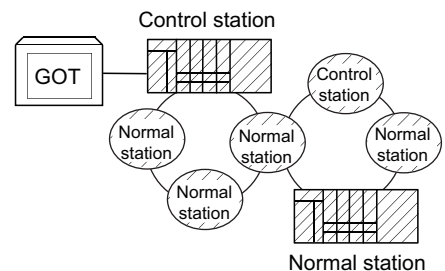
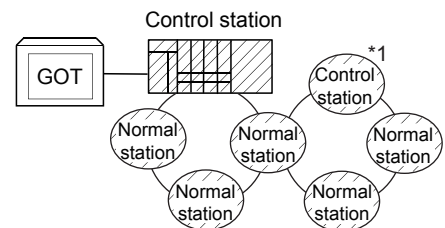

- Devices of other stations (other than devices B and W that are allocated by the network parameter) may not allow monitoring depending on their PLC CPU.

☞ ■ Monitor accessible range of other stations and setting method of monitor devices (Examples 1 to 2)

- The motion controller CPU (Q Series) at other stations cannot be monitored.

*1 The control station and normal station correspond to the master station and local station in the CC-Link IE field network respectively.

(2) When connecting to QCPU (Q mode)/QnACPU/AnUCPU

- The GOT can monitor the control station and all the normal stations on the network.

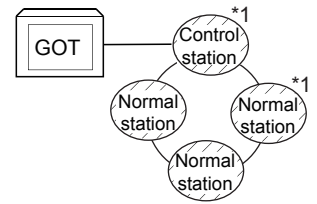

- The GOT can monitor the control station and all the normal stations on other networks.
(For monitoring stations on other networks, be sure to set the routing parameter)

When the Universal model QCPU is used as a relay station, the GOT can monitor stations with the station No.65 or later in the CC-Link IE controller network.

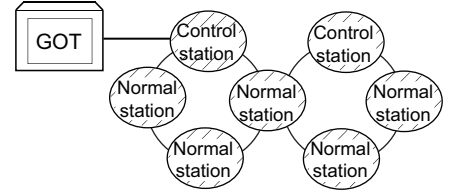

- When connected to a relay station and the data link system is included, the master station and local stations can be monitored.
- When connected to a relay station, it is not necessary to designate the data link parameter [Effective unit number for accessing other stations] for the PLC CPU of the connected station. (Even if designated, the parameter is ignored)

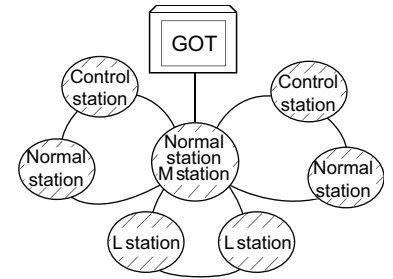

- Devices of other stations (other than devices B and W that are allocated by the network parameter) may not allow monitoring depending on their PLC CPU.

☞ ■ Monitor accessible range of other stations and setting method of monitor devices (Examples 1 to 2)

*1 The control station and normal station correspond to the master station and local station in the CC-Link IE field network respectively.

(3) When connecting to AnACPU/AnNCP

- The GOT can monitor the control station on the network.
When the PLC CPU on the control station is the QCPU (Q mode) or QnACPU, the GOT cannot monitor devices other than B and W assigned for the network parameter.
- The GOT cannot monitor normal stations on the network.
- The GOT cannot monitor any stations on the other networks.

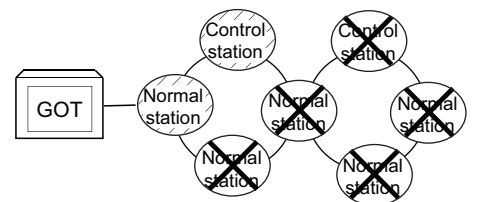
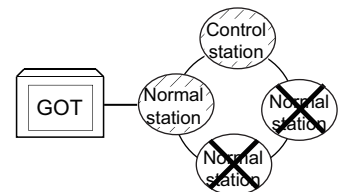

1	PREPARATORY PROCEDURES FOR MONITORING
2	DEVICE RANGE THAT CAN BE SET
3	ACCESS RANGE FOR MONITORING
4	HOW TO MONITOR REDUNDANT SYSTEM
5	BUS CONNECTION
6	DIRECT CONNECTION TO CPU
7	COMPUTER LINK CONNECTION
8	ETHERNET CONNECTION

■ Direct CPU connection/computer link connection

- (1) When connecting to multiple CPU system
 - Corresponding to the access range described in ■ Bus connection (1).
- (2) When connecting to RCPU
 - For the computer link connection, refer to the following.
- (3) When connecting to QCPU (Q mode)/QnACPU
 - Corresponding to the access range described in ■ Bus connection (2).

☞ ■ MELSECNET/H connection, MELSECNET/10 connection, CC-Link IE Controller Network connection, CC-Link IE Field Network connection

- For connections via a MELSECNET (II), computer link, or CC-Link network, the GOT cannot access any CPU on a network via the relay network.

- (4) When connecting to QCPU (A mode)/AnUCPU
 - The GOT can monitor the control station and all the normal stations on the network.
 - For monitoring devices (other than B and W assigned for the network parameter) of other stations, the GOT cannot monitor the devices of the PLC CPU that is the QCPU (Q mode) or QnACPU.

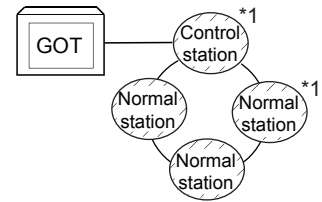

- If connected to a relay station, use data link parameter [Effective unit number for accessing other stations] to designate the unit number that is connected to the network to be monitored.

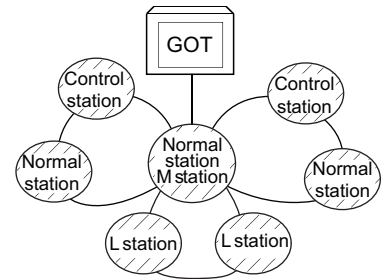

- (5) When connecting to AnACPU/AnNCPU
 - Corresponding to the access range described in ■ Bus connection (3).
- (6) When connecting to motion controller CPU (Q series), CNC (CNC C70), or robot controller (CRnQ-700) via direct CPU connection

Monitor the motion controller CPU (Q series), CNC (CNC C70), or robot controller (CRnQ-700) via the following QCPUs in the multiple CPU system.

	Controller	Relay CPU
Motion controller CPU (Q Series)	Q172HCPU, Q173HCPU	QCPU (Q mode)
	Q172DCPU, Q173DCPU	
CNC (CNC C70)	Q173NCCPU	QnUCPU
Robot controller (CRnQ-700)	Q172DRCPU	

*1 The control station and normal station correspond to the master station and local station in the CC-Link IE field network respectively.

■ CC-Link connection (intelligent device station), CC-Link connection (via G4)

- Only the station connected to the GOT can be monitored.

☞ ■ Monitor accessible range of other stations and setting method of monitor devices Example 6:
When using CC-Link connection (intelligent device station) /CC-Link connection (via G4)

- When the station connected to the GOT is in the multiple CPU system, the GOT can monitor CPU No.1 to No.4.
- The GOT cannot monitor other stations.

- MELSECNET/H connection, MELSECNET/10 connection, CC-Link IE Controller Network connection, CC-Link IE Field Network connection

POINT





Precautions for cyclic transmission

Devices that can be accessed by cyclic transmission differ according to connection type.

Connection type	Devices that can be accessed
MELSECNET/H	B, W, LB, LW, SB, SW
MELSECNET/10	B, W, LB, LW, SB, SW
CC-Link IE Controller Network	B, W, LB, LW, SB, SW
CC-Link IE Field Network	X, Y, RX, RY, Ww, Wr, SB, SW

- The GOT is regarded as a normal station and monitors the control station and all normal stations on the network.
When the monitoring target is a PLC CPU within a multiple CPU system, the GOT can monitor CPU No. 1 to CPU No. 4 by specifying CPU No.
- When monitoring other networks, a CPU on another Ethernet, MELSECNET/H, MELSECNET/10, CC-Link IE Controller Network, or CC-Link field network is accessible via the PLC CPU. (Monitoring other networks via a motion controller CPU (MELSEC iQ-R series) is available by Ethernet only.)
However, the GOT cannot monitor the CNC C70 on other networks.
Only the RCP, QCPU (Q mode), and QnACPU are accessible on Ethernet networks.
- When monitoring other networks in MELSECNET/10 connection, install the MELSECNET/H communication unit on the GOT.
- To monitor other networks, setting of routing parameters is required.
For routing parameter setting, refer to the following manuals.

Routing parameter setting for the GOT

-  9. MELSECNET/H CONNECTION (PLC TO PLC NETWORK)
-  10. MELSECNET/10 CONNECTION (PLC TO PLC NETWORK)
-  11. CC-Link IE CONTROLLER NETWORK CONNECTION
-  12. CC-Link IE FIELD NETWORK CONNECTION

Routing parameter setting for the PLC CPU (MELSECNET/H network system, MELSECNET/10 network system)

-  Q Corresponding MELSECNET/H Network System Reference Manual (PLC to PLC network)

Routing parameter setting for the PLC CPU (When connecting to the CC-Link IE Controller Network)

-  CC-Link IE Controller Network Reference Manual

Routing parameter setting for the PLC CPU (When connecting to the CC-Link IE Field Network)

-  CC-Link IE Field Network Master/Local Module User's Manual

- If devices of other stations (other than devices B and W that are allocated by the network parameter) are monitored, monitoring may not be available depending on the PLC CPU of the network system to be monitored.

-  ■ Monitor accessible range of other stations and setting method of monitor devices Example 5:
When using MELSECNET/10 connection

POINT

Precautions when using the QCPU redundant system

When monitoring other networks, do not set the QCPU redundant system as a relay station.

If the QCPU redundant system is set as a relay station, the GOT cannot switch the monitoring target automatically when the system is switched.

(A timeout error occurs due to failed monitoring)

■ Monitoring devices of other stations on the network

If devices of other stations on the network system are monitored, the display speed will be significantly reduced. Therefore, monitor the link relay (B) and link register (W) that are allocated by the network parameter.

■ Monitoring devices of other networks (Bus connection, CPU direct connection, computer link connection)

- Be sure to designate the routing parameter to the PLC CPU of the connected station.
- If another network is monitored, the display speed of object etc. will be significantly reduced.

■ Monitor accessible range of other stations and setting method of monitor devices

Example 1: When using bus connection

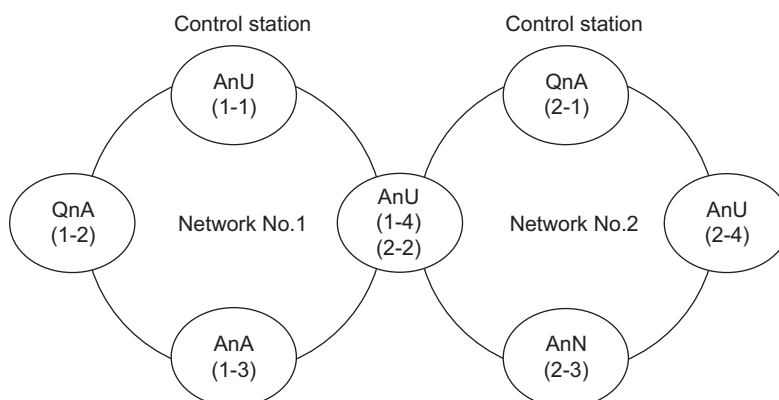

- Monitor accessible range of devices (other than B or W) of other stations or other networks
Specify the accessing network No. or station as shown in the following table.

- (1) To monitor B or W of the connected station (host station) assigned with a network parameter, specify the host station.
- (2) To monitor another station (other than B or W) or another network, specify the station (network No. and station No.).

Station to be accessed Station connected to GOT	Network No.1				Network No.2			
	AnU (1-1)	QnA (1-2)	AnA (1-3)	AnU (1-4)	QnA (2-1)	AnU (2-2)	AnN (2-3)	AnU (2-4)
AnU (1-1)	○	×	○	○	×	○	×	○
	Host	—	Other (1-3)	Other (1-4)	—	Other (2-2)	—	Other (2-4)
QnA (1-2)	○	○	×	○	○	○	×	○
	Other (1-1)	Host	—	Other (1-4)	Other (2-1)	Other (2-2)	—	Other (2-4)
AnA (1-3)	○	×	○	×	×	×	×	×
	Other (0-0)	—	Host	—	—	—	—	—
AnU (1-4)	○	×	×	○	×	○	×	○
	Other (1-1)	—	—	Host	—	Host	—	Other (2-4)
QnA (2-1)	○	○	×	○	○	○	○	○
	Other (1-1)	Other (1-2)	—	Other (1-4)	Host	Other (2-2)	Other (2-3)	Other (2-4)
AnN (2-3)	×	×	×	×	×	×	○	×
	—	—	—	—	—	—	Host	—
AnU (2-4)	○	×	×	○	×	○	×	○
	Other (1-1)	—	—	Other (1-4)	—	Other (2-2)	—	Host

How to read the table

Upper line: Accessibility

○: Accessible

×: Not accessible

Lower line: Network settings

Host

Other (Network No. - Station number)

POINT

Monitoring link device B or W

For monitoring devices B and W that are allocated by the link parameter, use the host device number even when designating devices allocated to another station.

Otherwise, the display speed will be reduced.

Example 2: When using bus connection

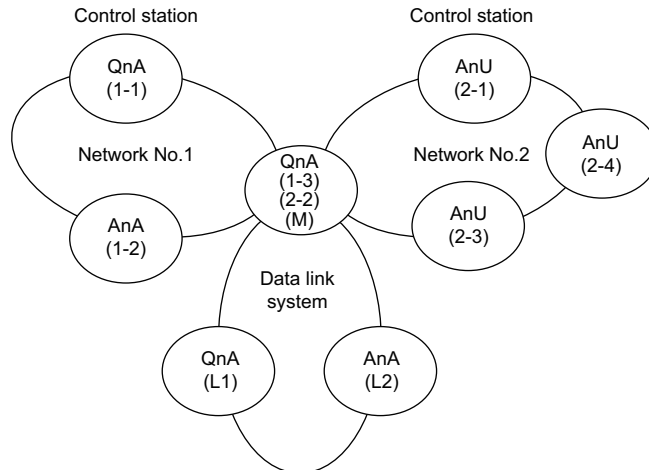

- Monitor accessible range of devices (other than B or W) of other stations or other networks
Specify the accessing network No. or station as shown in the following table.

- (1) To monitor B or W of the connected station (host station) assigned with a network parameter, specify the host station.
- (2) To monitor another station (other than B or W) or another network, specify the station (network No. and station No.).

Station to be accessed Station connected to GOT	Network No.1			Network No.2				Data link system		
	QnA (1-1)	AnA (1-2)	QnA (1-3)	AnU (2-1)	QnA (2-2)	AnU (2-3)	AnU (2-4)	QnA (M)	QnA (L1)	AnA (L2)
QnA (1-1)	○	○	○	○	○	○	○	○	×	×
	Host	Other (1-2)	Other (1-3)	Other (2-1)	Other (2-2)	Other (2-3)	Other (2-4)	Other (1-3) or Other (2-2)	—	—
AnA (1-2)	×	○	×	×	×	×	×	×	×	×
	—	Host	—	—	—	—	—	—	—	—
QnA (1-3) (2-2) (M)	○	×	○	○	○	○	○	○	×	○
	Other (1-1)	—	Host	Other (2-1)	Host	Other (2-3)	Other (2-4)	Host	—	Other (0-2)*1
AnU (2-1)	×	×	×	○	×	○	○	×	×	×
	—	—	—	Host	—	Other (2-3)	Other (2-4)	—	—	—
AnU (2-3)	×	×	×	○	×	○	○	×	×	×
	—	—	—	Other (2-1)	—	Host	Other (2-4)	—	—	—
AnU (2-4)	×	×	×	○	×	○	○	×	×	×
	—	—	—	Other (2-1)	—	Other (2-3)	Host	—	—	—
QnA (L1)	×	×	×	×	×	×	×	×	○	×
	—	—	—	—	—	—	—	—	Host	—
AnA (L2)	×	×	×	×	×	×	×	×	×	○
	—	—	—	—	—	—	—	—	—	Host

*1 When monitoring the data link system, designate the network No. as 0.

How to read the table

Upper line: Accessibility
 ○: Accessible
 ×: Not accessible

Lower line: Network settings
 Host
 Other (Network No. - Station number)

POINT

Monitoring link device B or W
 For monitoring devices B and W that are allocated by the link parameter, use the host device number even when designating devices allocated to another station.
 Otherwise, the display speed will be reduced.

Example 3: When using CPU direct connection or computer link connection

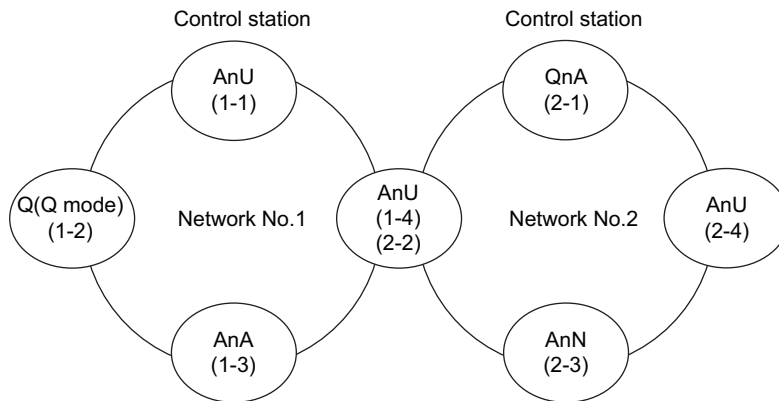

- Monitor accessible range of devices (other than B or W) of other stations or other networks
Specify the accessing network No. or station as shown in the following table.

- (1) To monitor B or W of the connected station (host station) assigned with a network parameter, specify the host station.
- (2) To monitor another station (other than B or W) or another network, specify the station (network No. and station No.).

Station to be accessed Station connected to GOT	Network No.1				Network No.2			
	AnU (1-1)	Q(Q mode) (1-2)	AnA (1-3)	AnU (1-4)	QnA (2-1)	AnU (2-2)	AnN (2-3)	AnU (2-4)
AnU (1-1)	○	×	○	○	×	○	×	×
	Host	—	Other (1-3)	Other (1-4)	—	Other (2-2)	—	—
Q (Q mode) (1-2)	○	○	×	○	○	○	×	○
	Other (1-1)	Host	—	Other (1-4)	Other (2-1)	Other (2-2)	—	Other (2-4)
AnA (1-3)	○	×	○	×	×	×	×	×
	Other (0-0)	—	Host	—	—	—	—	—
AnU (1-4) (2-2)	○	×	×	○	×	○	×	×
	Other (1-1)	—	—	Host	—	Host	—	—
QnA (2-1)	○	○	×	○	○	○	○	○
	Other (1-1)	Other (1-2)	—	Other (1-4)	Host	Other (2-2)	Other (2-3)	Other (2-4)
AnN (2-3)	×	×	×	×	×	×	○	×
	—	—	—	—	—	—	Host	—
AnU (2-4)	×	×	×	×	×	○	×	○
	—	—	—	—	—	Other (2-2)	—	Host

How to read the table

- Upper line: Accessibility
 ○: Accessible
 ×: Not accessible
- Lower line: Network settings
 Host
 Other (Network No. - Station number)

POINT

Monitoring link device B or W

For monitoring devices B and W that are allocated by the link parameter, use the host device number even when designating devices allocated to another station.

Otherwise, the display speed will be reduced.

1 PREPARATORY PROCEDURES FOR MONITORING
 2 DEVICE RANGE THAT CAN BE SET
 3 ACCESS RANGE FOR MONITORING
 4 HOW TO MONITOR REDUNDANT SYSTEM
 5 BUS CONNECTION
 6 DIRECT CONNECTION TO CPU
 7 COMPUTER LINK CONNECTION
 8 ETHERNET CONNECTION

Example 4: When using CPU direct connection or computer link connection

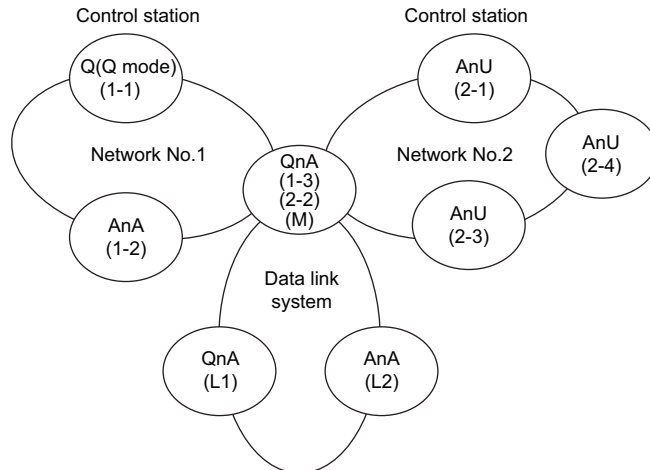

- Monitor accessible range of devices (other than B or W) of other stations or other networks
Specify the accessing network No. or station as shown in the following table.

- (1) To monitor B or W of the connected station (host station) assigned with a network parameter, specify the host station.
- (2) To monitor another station (other than B or W) or another network, specify the station (network No. and station No.).

Station to be accessed Station connected to GOT	Network No.1			Network No.2				Data link system		
	QnA (1-1)	AnA (1-2)	QnA (1-3)	AnU (2-1)	QnA (2-2)	AnU (2-3)	AnU (2-4)	QnA (M)	QnA (L1)	AnA (L2)
Q (Q mode) (1-1)	○	○	○	○	○	○	○	○	×	×
	Host	Other (1-2)	Other (1-3)	Other (2-1)	Other (2-2)	Other (2-3)	Other (2-4)	Other (1-3) or Other (2-2)	—	—
AnA (1-2)	×	○	×	×	×	×	×	×	×	×
	—	Host	—	—	—	—	—	—	—	—
QnA (1-3) (2-2) (M)	○	×	○	○	○	○	○	○	×	○
	Other (1-1)	—	Host	Other (2-1)	Host	Other (2-3)	Other (2-4)	Host	—	*1 Other (0-2)
AnU (2-1)	×	×	×	○	×	○	○	×	×	×
	—	—	—	Host	—	Other (2-3)	Other (2-4)	—	—	—
AnU (2-3)	×	×	×	○	×	○	○	×	×	×
	—	—	—	Other (2-1)	—	Host	Other (2-4)	—	—	—
AnU (2-4)	×	×	×	○	×	○	○	×	×	×
	—	—	—	Other (2-1)	—	Other (2-3)	Host	—	—	—
QnA (L1)	×	×	×	×	×	×	×	×	○	×
	—	—	—	—	—	—	—	—	Host	—
AnA (L2)	×	×	×	×	×	×	×	×	×	○
	—	—	—	—	—	—	—	—	—	Host

*1 When monitoring the data link system, designate the network No. as 0.

How to read the table

Upper line: Accessibility
○: Accessible
×: Not accessible

Lower line: Network settings
Host
Other (Network No. - Station number)

POINT

Monitoring link device B or W

For monitoring devices B and W that are allocated by the link parameter, use the host device number even when designating devices allocated to another station. Otherwise, the display speed will be reduced.

Example 5: When using MELSECNET/10 connection

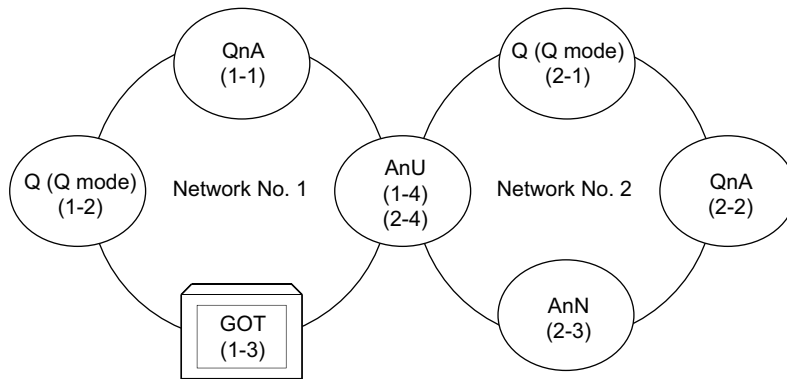

- Monitor access range for other station devices (other than B and W)

Station to be accessed Station connected to GOT	Network No.1				Network No.2			
	QnA (1-1)	Q (Q mode) (1-2)	GOT (1-3)	AnU (1-4)	Q (Q mode) (2-1)	QnA (2-2)	AnN (2-3)	AnU (2-4)
GOT (1-3)	○	○	—	○	○	○	×	○

○: Accessible ×: Not accessible

- Designating network No. and station number for setting monitor device
 - Monitoring devices B and W that are allocated by network parameter
NW No.: 1, Station number: Host

POINT

For monitoring devices B and W that are allocated by the link parameter, use the local device number if designating devices allocated to another station.
Otherwise, the display speed will be reduced.

- Monitoring other stations (other than B and W)

Station to be accessed Station connected to GOT	QnA (1-1)	Q (Q mode) (1-2)	GOT (1-3)	AnU (1-4)
GOT (1-3)	1, Other (1)	1, Other (2)	—	1, Other (4)

How to read the table 1, Other (2)
↑ ↑
NW No. Station number

1 PREPARATORY PROCEDURES FOR MONITORING
2 DEVICE RANGE THAT CAN BE SET
3 ACCESS RANGE FOR MONITORING
4 HOW TO MONITOR REDUNDANT SYSTEM
5 BUS CONNECTION
6 DIRECT CONNECTION TO CPU
7 COMPUTER LINK CONNECTION
8 ETHERNET CONNECTION

Example 6: When using CC-Link connection (intelligent device station) /CC-Link connection (via G4)

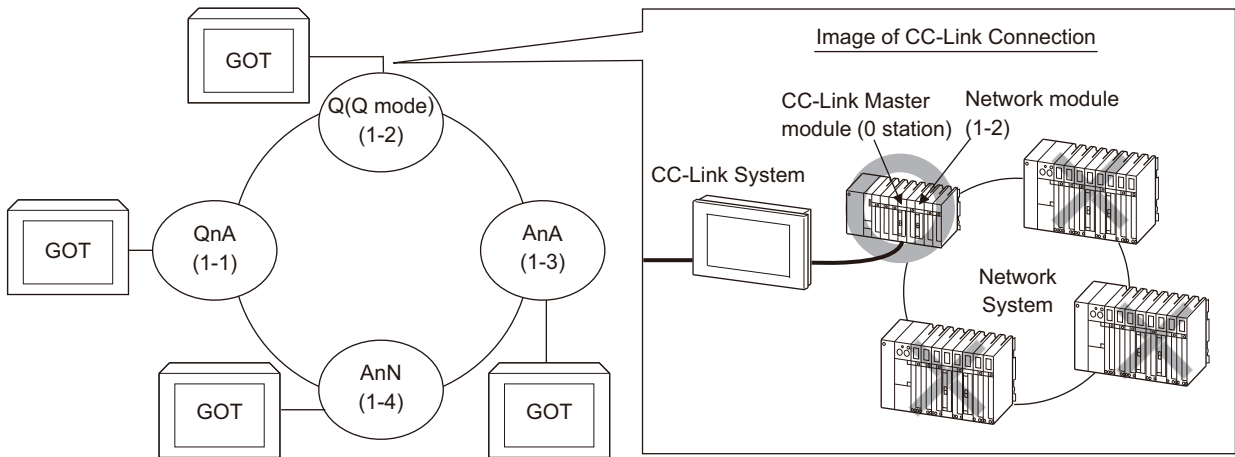

Station to be accessed Station connected to GOT	QnA (1-1)	Q (Q mode) (1-2)	AnA (1-3)	AnN (1-4)
QnA (1-1)	○	×	×	×
Q(Q mode) (1-2)	×	○	×	×
AnA (1-3)	×	×	○	×
AnN (1-4)	×	×	×	○

○: Accessible ×: Not accessible

3.2 Access Range for Monitoring when Using Ethernet Connection

GT 16 GT 15 GT 14 GT 12 GT 11 GT 10

Access range

(1) MITSUBISHI ELECTRIC PLC

The PLC can be monitored via the Ethernet module set in the Ethernet setting on GT Designer3.

The GOT can access CPUs on another Ethernet, MELSECNET/H, MELSECNET/10, CC-Link IE Controller Network, or CC-Link field network via the RCP, QCPU or QnACPU. (Monitoring other networks via a motion controller CPU (MELSEC iQ-R series) is available by Ethernet only.)

However, the GOT cannot monitor the CNC C70 on other networks.

(The GOT cannot monitor the AnNCPU on the CC-Link IE Controller Network, MELSECNET/H, and MELSECNET/10 networks)

For monitoring CPUs on the MELSECNET/H, MELSECNET/10, CC-Link IE Controller Network, and CC-Link field network, set the routing parameter.

For the routing parameter setting, refer to the following manuals.

- Routing parameter setting of the GOT

☞ 8. ETHERNET CONNECTION

- Routing parameter setting for accessing CPUs on the MELSECNET/H network system, or MELSECNET/10 network system

☞ Q corresponding MELSECNET/H Network System Reference Manual (PLC to PLC network)

- Routing parameter setting for accessing CPUs on the CC-Link IE Controller Network

☞ CC-Link IE Controller Network Reference Manual

- Routing parameter setting for accessing CPUs on the CC-Link IE Field Network

☞ MELSEC-Q CC-Link IE Field Network Master/Local Module User's Manual

☞ CC-Link IE Field Network Ethernet Adapter Module User's Manual

Monitoring via the MELSECNET (II) or MELSECNET/B network cannot be performed.

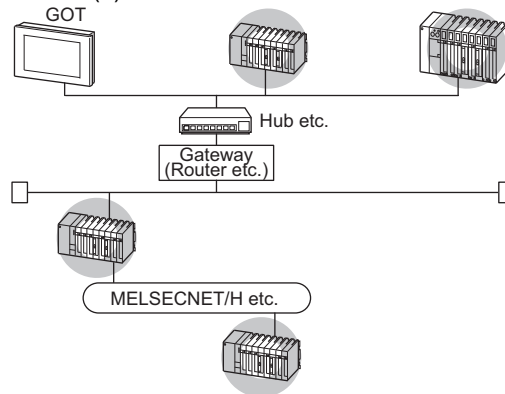

POINT

(1) Host in the Ethernet connection

While the GOT is handled as the host in MELSECNET/H, MELSECNET/10 or CC-Link connection, the station (Ethernet module) set as the host in the Ethernet setting of GT Designer3 is handled as the host in Ethernet connection.

(2) Precautions when using the QCPU redundant system

When monitoring other networks, do not set the QCPU redundant system as a relay station.

If the QCPU redundant system is set as a relay station, the GOT cannot switch the monitoring target automatically when the system is switched.

(A timeout error occurs due to failed monitoring)

Various settings

For the Ethernet setting by GT Designer3, refer to the following.

☞ 8. ETHERNET CONNECTION

1 PREPARATORY PROCEDURES FOR MONITORING
2 DEVICE RANGE THAT CAN BE SET
3 ACCESS RANGE FOR MONITORING
4 HOW TO MONITOR REDUNDANT SYSTEM
5 BUS CONNECTION
6 DIRECT CONNECTION TO CPU
7 COMPUTER LINK CONNECTION
8 ETHERNET CONNECTION

3.3 CC-Link System Access Range for Monitoring

■ When using Bus connection/CPU direct connection/computer link connection

Only connected stations can be monitored.

■ When using CC-Link connection (intelligent device station)



(1) Access range

The master station and local station can be monitored.

○: Can be monitored, ×: Cannot be monitored

Monitor target	Monitoring by cyclic transmission	Monitoring by transient transmission
Master station (Remote network Ver.2 mode)	○	○
Local station Station No.1 (Ver.1 compatible)	○	○
Local station Station No.6 (Ver.2 compatible)	○*1	○

*1 Monitoring is available only when the CC-Link communication module is the GT15-J61BT13.

All devices RX, RY, RWw and RWr that are allocated to the master station by the CC-Link parameter setting can be monitored.

When the monitor target is the multi-PLC system, CPU No. 1 to No. 4 can be monitored.

The device range of RX, RY, RWw, RWr to be allocated to the GOT differs according to the setting of the number of CC-Link communication units (one station/four station) occupied.

For details on the number of CC-Link stations occupied, refer to the following manual .

User's manual of the CC-Link master unit to be connected

(2) Setting device name and device number

(a) Monitoring devices RX, RY, RWw and RWr that are allocated to the master station by CC-Link parameter setting

Use the following device names.

For devices RX, RY, RWw and RWr, designate the addresses allocated by station number setting.

- In the case of CC-Link Ver.2 (Device names to be refreshed automatically are indicated as X, Y, and D.)

Device name on PLC CPU	Automatic refresh	Device name on master station	Link scan	GT Designer3 settings			
				Device name	Set device range		
Input	X	←	Remote input	RX	←	X	X0 to X1FFF
Output	Y	→	Remote output	RY	→	Y	Y0 to Y1FFF
Register (write area)	D	←	Remote register (write area)	RWw	←	Ww	Ww0 to Ww7FF
Register (read area)	D	→	Remote register (read area)	RWr	→	Wr	Wr0 to Wr7FF

- In the case of CC-Link Ver.1 (Device names to be refreshed automatically are indicated as X, Y, and D.)

Device name on PLC CPU	Automatic refresh	Device name on master station	Link scan	GT Designer3 settings			
				Device name	Set device range		
Input	X	←	Remote input	RX	←	X	X0 to X7FF
Output	Y	→	Remote output	RY	→	Y	Y0 to Y7FF
Register (write area)	D	←	Remote register (write area)	RWw	←	Ww	Ww0 to WwFF
Register (read area)	D	→	Remote register (read area)	RWr	→	Wr	Wr0 to WrFF

- (b) Monitoring PLC CPU devices of other stations
Set the device name and device No.

 2. DEVICE RANGE THAT CAN BE SET

(3) Setting NW No. and station number

- (a) When monitoring devices RX, RY, RWw and RWr that are allocated to the master station by CC-Link parameter setting
NW No.: 0, PLC station number: Local
- (b) When monitoring PLC CPU devices of another station
NW No. 0, PLC station number: Other (Station number: n)
(n: Station number of another station to be monitored (0: Master station, 1-64: Local station))

POINT

For monitoring devices RX, RY, RWw and RWr that are allocated by CC-Link parameter, use the local device even if designating devices allocated to another station.
Otherwise, the display speed will be reduced.

■ When using CC-Link connection (via G4) (Q series only)

- (1) Access range
GT16, GT15 and GT14 can monitor the master station and local stations.
GT10 and GT11 can monitor the master station only.
- (2) Setting NW No. and station number
 - (a) When monitoring master station
NW No.: 0, PLC station number: Host/other (station number: 0)
 - (b) When monitoring local station
NW No.: 0, PLC station number: Other (station number: 1 to 64)
- (3) Setting device name and device number
Set the device name and device No.

 2. DEVICE RANGE THAT CAN BE SET

1	PREPARATORY PROCEDURES FOR MONITORING
2	DEVICE RANGE THAT CAN BE SET
3	ACCESS RANGE FOR MONITORING
4	HOW TO MONITOR REDUNDANT SYSTEM
5	BUS CONNECTION
6	DIRECT CONNECTION TO CPU
7	COMPUTER LINK CONNECTION
8	ETHERNET CONNECTION

■ Monitoring overview

The following two methods are available for monitoring by the GOT with CC-Link communication unit.

Monitoring method	Monitoring by transient transmission*2	Monitoring by cyclic transmission*2
Contents	Devices of the PLC CPU on the CC-Link system master and local station are specified and monitored.	All remote inputs/outputs and remote registers assigned to the Master station by CC-Link parameter setting are specified and monitored.
Advantage	The CC-Link parameter setting sequence program is required. However, the GOT communication sequence program is not needed.*1	The data communication processing speed is high.
Disadvantage	The data communication processing speed is lower than that of cyclic transmission.	<ul style="list-style-type: none"> • Writing from the GOT (read command from the master station) can be performed only to remote outputs and remote registers assigned to the GOT of the master station and to the GOT internal registers. • GOT communication sequence program is required.*1

*1 This program is not required if the CC-Link parameter setting sequence program and GOT communication sequence program satisfy the following conditions.

- Use a QCPU (Q mode) or QnACPU whose number given in the DATE field of the rating plate is "9707B" or later as the PLC CPU of the master station.
- Use GX Developer or SW2□-GPPW and make CC-Link parameter setting and batch refresh device setting in the CC-Link setting on the package.

For details of the connection method, refer to the following manual .

 User's manual of the CC-Link master unit to be connected

*2 For whether the data can be sent to/received from the CC-Link Ver. 2 compatible station by transient transmission and cyclic transmission, refer to the following.

 ■ When using CC-Link connection (intelligent device station)

POINT

In transient transmission, connection of several (five or more as a guideline) intelligent device stations (GOTs and intelligent device units) reduces the data communication speed.

To raise the data communication speed, increase the CC-Link system, for example, and do not connect five or more intelligent device stations to a single CC-Link system.

3.4 Data Link System (MELSECNET/B, (II)) Access Range for Monitoring

■ Bus connection, CPU direct connection, Computer link connection

(1) When connecting to the master station

- Local stations can be monitored.
When the PLC CPU of the local station is QnACPU, devices other than B and W that are allocated by the link parameter cannot be monitored.

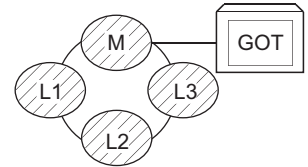

(2) When connecting to the local station

- The master station can be monitored.
However, when the PLC CPU of the local station is QnACPU, devices other than B and W that are allocated by the link parameter cannot be monitored.
- Other local stations cannot be monitored.

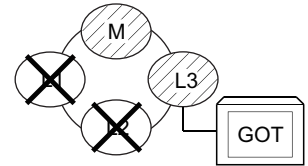

(3) When connecting to the master station on the third layer

- The master station on the second layer and local stations on the third layer can be monitored.
However, when the PLC CPU of the local station is QnACPU, devices other than B and W that are allocated by the link parameter cannot be monitored.
- Local stations on the second layer cannot be monitored.

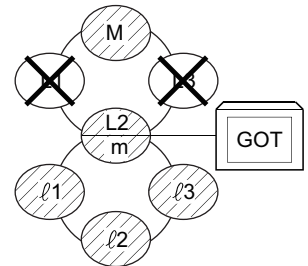

■ Monitoring devices of other stations

If devices of other stations on the data link system are monitored, the display speed will be significantly reduced. Therefore monitor the link relay (B) and link register (W) that are allocated by the link parameter.

GT 16 GT 15 GT 14 GT 12 GT 11 GT 10

1	PREPARATORY PROCEDURES FOR MONITORING
2	DEVICE RANGE THAT CAN BE SET
3	ACCESS RANGE FOR MONITORING
4	HOW TO MONITOR REDUNDANT SYSTEM
5	BUS CONNECTION
6	DIRECT CONNECTION TO CPU
7	COMPUTER LINK CONNECTION
8	ETHERNET CONNECTION

■ Setting method of monitor device

The following example describes the method of setting the network No. and the station numbers when setting monitor devices .

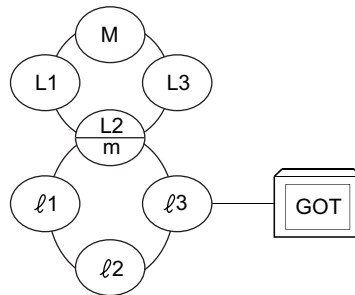

- (1) Monitoring the connected station (host station) and B and W allocated by the link parameter
Specify the host station.
- (2) Monitoring devices of other stations
Network No.: 0, Station number: Refer to the following table.

Setting of the station No.

Station to be accessed Station connected to GOT	M	L1	L2 m	L3	l1	l2	l3
M	Host	Other 1	Other 2	Other 3	—	—	—
L1	Other 0	Host	—	—	—	—	—
L2 m	Other 0	—	Host	—	Other 1	Other 2	Other 3
L3	Other 0	—	—	Host	—	—	—
l1	—	—	Other 0	—	Host	—	—
l2	—	—	Other 0	—	—	Host	—
l3	—	—	Other 0	—	—	—	Host

POINT

Monitoring link device B or W

For monitoring devices B and W that are allocated by the link parameter, use the host device number even when designating devices allocated to another station.

Otherwise, the display speed will be reduced.

3.5 Access Range for Monitoring when Connecting FXCPU



The access range that can be monitored for the direct CPU connection is only the connected CPU. (The GOT cannot monitor other stations.)

The access range that can be monitored for the Ethernet connection is the host and others.

The access range that can be monitored for the multi-drop communication is only the CPU to which the serial multi-drop connection unit (GT01-RS4-M) is connected directly.

3.6 Connection to Remote I/O Station in MELSECNET/H Network System

GT 16 GT 15 GT 14 GT 12 GT 11 GT 10

When connected to the remote I/O station of the MELSECNET/H network system, the GOT can monitor the PLC CPU of the master station.

When connecting the GOT to the remote I/O station, use the following connection methods.

POINT

- (1) Connection to remote I/O station of MELSECNET/B, (II) or /10
The GOT cannot be connected to the remote I/O station on the MELSECNET/B, (II) data link system and MELSECNET/10 network system.
Connect the GOT to the remote I/O station on the MELSECNET/H network system.

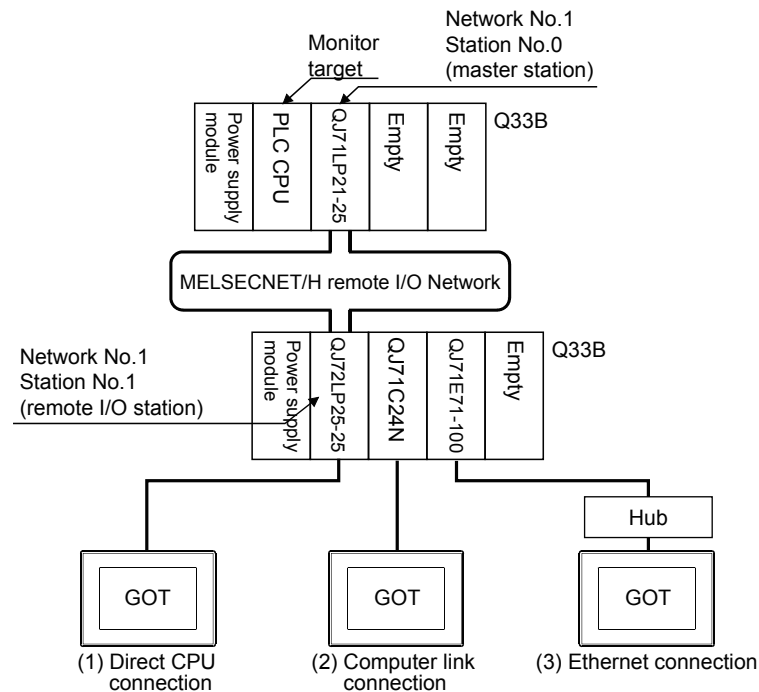

- (2) Connection to GT11 and remote I/O station on MELSECNET/H
GT11 can not access the master station on MELSECNET/H network system.
GT11 can access only the connected host station (remote I/O station).

1 PREPARATORY PROCEDURES FOR MONITORING
2 DEVICE RANGE THAT CAN BE SET
3 ACCESS RANGE FOR MONITORING
4 HOW TO MONITOR REDUNDANT SYSTEM
5 BUS CONNECTION
6 DIRECT CONNECTION TO CPU
7 COMPUTER LINK CONNECTION
8 ETHERNET CONNECTION

■ Direct CPU connection

- (1) The network units (QJ72LP25-25, QJ72LP25G, QP72BR15) of the remote I/O station are handled as PLC CPU. Connect the GOT to the RS-232 interface of the network unit.

For cables required for connection with the network module and other details, refer to the following.

6. DIRECT CONNECTION TO CPU

- (2) Specify a type including MELSEC-Q (including multiple), or MELSEC-QnU for the controller type on GT Designer3. Then, specify [[NW No.] (Network No. of the remote I/O network) to 1, and specify [Station No.] (Master station) to 0.] as the monitoring target in the network setting of the device setting dialog box. (GT16, GT15 only)

The GOT monitors stations on the MELSECNET/H network with the transient transmission.

Therefore, a longer time-lag occurs for displaying objects compared with directly monitoring the PLC CPU.

For displaying objects with a shorter time-lag, execute the cyclic transmission so that the GOT can monitor link devices B and W of the host station set in the MELSECNET/H network.

For settings required for the PLC CPU, refer to the following manual.

Q Corresponding MELSECNET/H Network System Reference Manual (Remote I/Q network)

- (3) To monitor other networks, set the routing parameter to the PLC CPU as necessary. For routing parameter settings of the PLC CPU, refer to the following manual.

Q corresponding MELSECNET/H Network System Reference Manual (PLC to PLC network)

■ Computer link connection

- (1) Connect the GOT to the serial communication module (QJ71C24, QJ71C24-R2, QJ71C24N, QJ71C24N-R2, QJ71C24N-R4) or modem interface module (QJ71CMO) mounted on the remote I/O station.

For the cables required for connection with the serial communication module or modem interface module and other details, refer to the following.

7. COMPUTER LINK CONNECTION

- (2) Specify a type including MELSEC-Q (including multiple), or MELSEC-QnU for the controller type on GT Designer3. Then, specify [[NW No.] (Network No. of the remote I/O network) to 1, and specify [Station No.] (Master station) to 0.] as the monitoring target in the network setting of the device setting dialog box. (GT16, GT15 only)

The GOT monitors stations on the MELSECNET/H network with the transient transmission.

Therefore, a longer time-lag occurs for displaying objects compared with directly monitoring the PLC CPU.

For displaying objects with a shorter time-lag, execute the cyclic transmission so that the GOT can monitor link devices B and W of the host station set in the MELSECNET/H network.

For settings required for the PLC CPU, refer to the following manual.

Q Corresponding MELSECNET/H Network System Reference Manual (Remote I/Q network)

- (3) To monitor other networks, set the routing parameter to the PLC CPU as necessary. For routing parameter settings of the PLC CPU, refer to the following manual.

Q corresponding MELSECNET/H Network System Reference Manual (PLC to PLC network)

■ Ethernet connection

- (1) Connect the GOT to the Ethernet module (QJ71E71-100, QJ71E71-B5, QJ71E71-B2, QJ71E71) mounted on the remote I/O station.
For details of cables and others required for connecting the GOT to the Ethernet module, refer to the following.

 8. ETHERNET CONNECTION

- (2) Specify a type including MELSEC-Q (including multiple), or MELSEC-QnU for the controller type on GT Designer3. Then, specify [[NW No.] (Network No. of the remote I/O network) to 1, and specify [Station No.] (Master station) to 0.] as the monitoring target in the network setting of the device setting dialog box. (GT16, GT15 only)

The GOT monitors stations on the MELSECNET/H network with the transient transmission. Therefore, a longer time-lag occurs for displaying objects compared with directly monitoring the PLC CPU.

For displaying objects with a shorter time-lag, execute the cyclic transmission so that the GOT can monitor link devices B and W of the remote I/O station.

For settings required for the PLC CPU, refer to the following manual.

 Q Corresponding MELSECNET/H Network System Reference Manual (Remote I/Q network)

- (3) To monitor other networks, set the routing parameter to the GOT and PLC CPU as necessary. For routing parameter settings of the GOT, refer to the following manual.

 8. ETHERNET CONNECTION

For routing parameter settings of the PLC CPU, refer to the following manual.

 Q corresponding MELSECNET/H Network System Reference Manual (PLC to PLC network)

■ Restrictions on connection to remote I/O station

The GOT does not allow the clock of the master station to be set in the clock setting of the utility function.

The master station clock will not change even if the clock setting is made.

Use GX Developer or a similar software to set the PLC CPU clock of the master station.

3.7 Connection to the Head Module of CC-Link IE Field Network System

GT 16 GT 15 GT 14 GT 12 GT 11 GT 10

When connected to the head module of the CC-Link IE Field Network, the GOT can monitor the PLC CPUs of the master station and local stations. When connecting the GOT to the head module, use the following connection methods.

■ Computer link connection

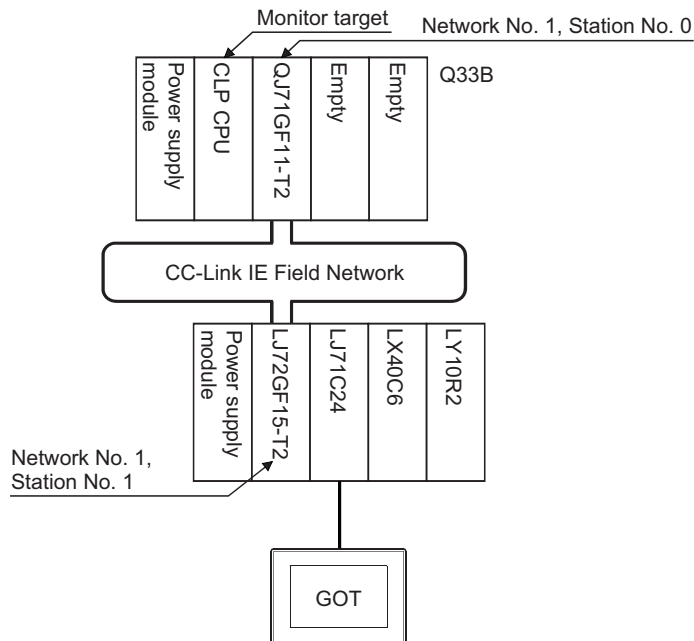

- (1) Connect the GOT to the serial communication module (LJ71C24, LJ71C24-R2) mounted on the head module. For cables required for connection with the serial communication module and other details, refer to the following.

☞ 7. COMPUTER LINK CONNECTION

- (2) Specify a GOT type which includes MELSEC-QnU in the controller type on GT Designer3. Then, specify [Network No. 1 (Network No. of CC-Link IE Field Network), Station No. 0 (Master station)] as the monitoring target in the network setting of the device setting dialog box. (GT16, GT15, GT14 only)
In this case, the GOT monitoring is performed by transient transmission of the CC-Link IE Field Network. Therefore, a longer time-lag occurs for displaying objects compared with directly monitoring the PLC CPU. For displaying objects with a shorter time-lag, execute the cyclic transmission so that the GOT can monitor link devices B and W of the host station set in the CC-Link field network. For settings required for the PLC CPU, refer to the following manual.

☞ MELSEC-L CC-Link IE Field Network Head Module User's Manual

- (3) To monitor other networks, set the routing parameter to the PLC CPU as necessary. For routing parameter setting of the PLC CPU, refer to the following manual.

☞ MELSEC-L CC-Link IE Field Network Head Module User's Manual

POINT

Connection between GT11, GT10 and head module of CC-Link IE Field Network
GT11, GT10 can not access the master station on CC-Link IE Field Network.
GT11, GT10 can access only the connected host station (head module).

■ Restrictions on connection to head module

The GOT does not allow the clock of the master station to be set in the clock setting of the utility function.
The master station clock will not change even if the clock setting is made.
Use GX Works or similar software to set the PLC CPU clock of the master station.

1	PREPARATORY PROCEDURES FOR MONITORING
2	DEVICE RANGE THAT CAN BE SET
3	ACCESS RANGE FOR MONITORING
4	HOW TO MONITOR REDUNDANT SYSTEM
5	BUS CONNECTION
6	DIRECT CONNECTION TO CPU
7	COMPUTER LINK CONNECTION
8	ETHERNET CONNECTION

4

HOW TO MONITOR REDUNDANT SYSTEM

4.1	Connection to Remote I/O Station in MELSECNET/H Network System	4 - 8
4.2	Direct CPU Connection	4 - 11
4.3	CC-Link Connection (Intelligent Device Station)	4 - 18
4.4	CC-Link Connection (Via G4).	4 - 20
4.5	MELSECNET/H and MELSECNET/10 Connections (Network Systems)	4 - 22
4.6	CC-Link IE Controller Network Connection (Network System)	4 - 23
4.7	Ethernet Connection	4 - 24
4.8	Connection to the Redundant Type Extension Base Unit	4 - 25
4.9	Q Redundant Setting	4 - 29
4.10	Switch the Monitor Target to the Control System Using the Script Function	4 - 31

1
PREPARATORY
PROCEDURES FOR
MONITORING

2
DEVICE RANGE
THAT CAN BE SET

3
ACCESS RANGE
FOR MONITORING

4
HOW TO MONITOR
REDUNDANT
SYSTEM

5
BUS CONNECTION

6
DIRECT
CONNECTION TO
CPU

7
COMPUTER LINK
CONNECTION

8
ETHERNET
CONNECTION

4. HOW TO MONITOR REDUNDANT SYSTEM



This section explains the restrictions on the connection methods and other information applicable when the QCPU redundant system is monitored by the GOT.

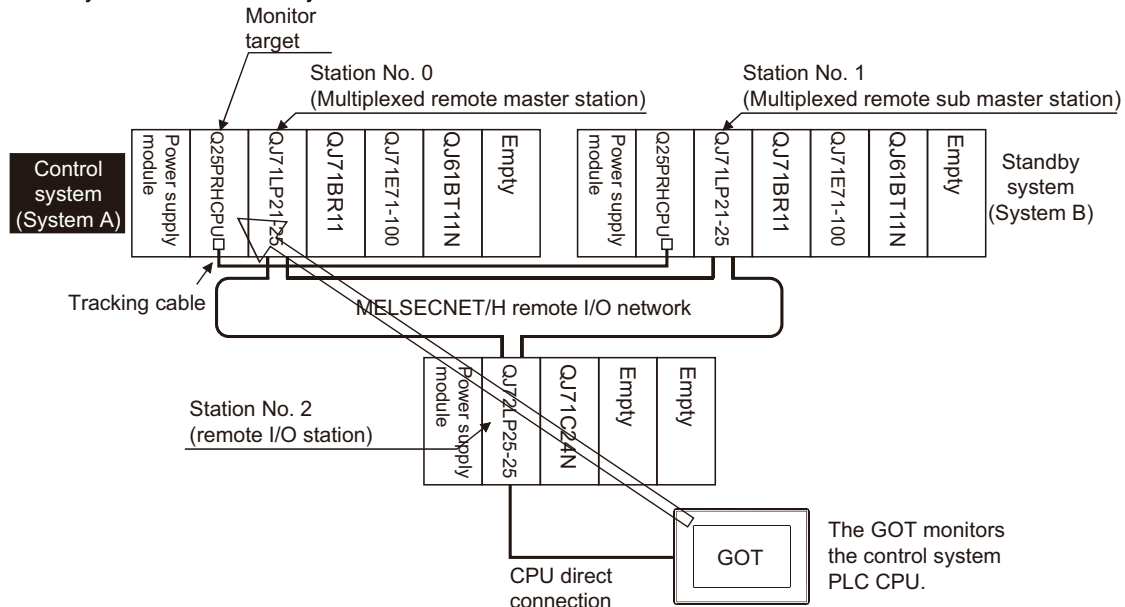

When an error occurs in System A, System B switches from standby system to control system.

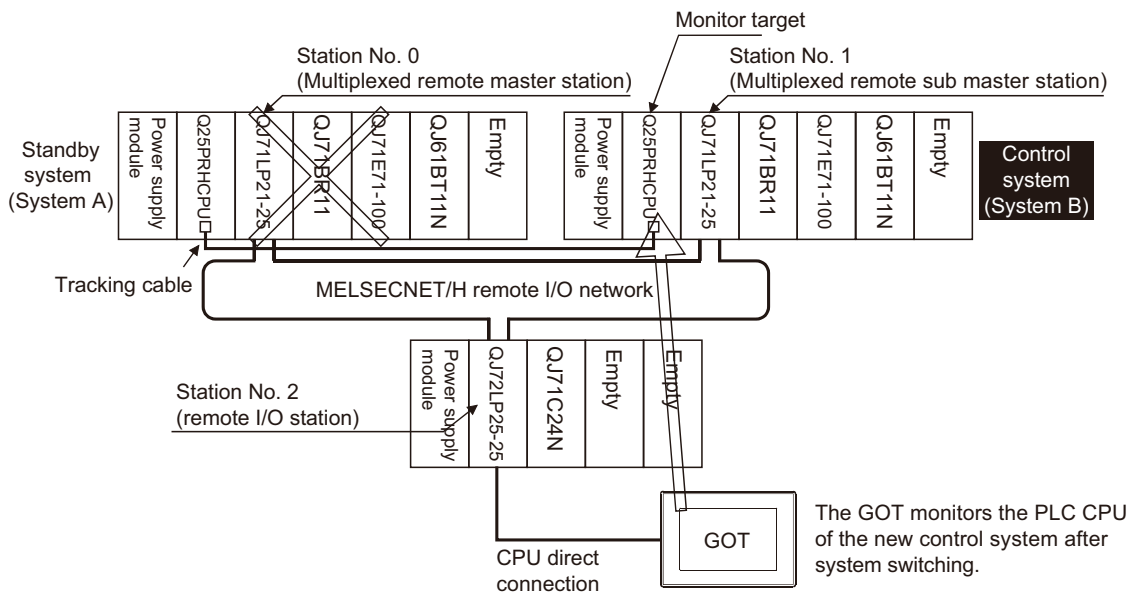













In a redundant system, the monitoring can be performed with the monitoring target specified as the control system or the standby system on the GOT. By specifying the monitoring target PLC CPU as the control system of the redundant system, the monitoring target is automatically changed to the PLC CPU in the control system when system switching occurs.

To enable this automatic changing of the monitoring target at the GOT, settings are required in the GT Designer3.

➡ 4.9 Q Redundant Setting

The following connection methods are available for the QCPU redundant system.

- Connection to remote I/O station in MELSECNET/H network system
 - (1) Direct CPU connection (Remote I/O station of MELSECNET/H network system)
 -  4.1.1 Direct CPU connection (Direct CPU connection to the remote I/O station)
 - (2) Computer link connection (Serial communication module mounted on remote I/O station of MELSECNET/H network system)
 -  4.1.2 Computer link connection (Connection to serial communication module mounted on remote I/O station)
 - (3) Ethernet connection (Ethernet module mounted on the remote I/O station of the MELSECNET/H network system)
 -  4.1.3 Ethernet connection (Connection to Ethernet module mounted on remote I/O station)
- Direct CPU connection
 -  4.2 Direct CPU Connection
- CC-Link connection (intelligent device station)
 -  4.3 CC-Link Connection (Intelligent Device Station)
- CC-Link connection (Via G4)
 -  4.4 CC-Link Connection (Via G4)
- MELSECNET/H connection, MELSECNET/10 connection (Network system)
 -  4.5 MELSECNET/H and MELSECNET/10 Connections (Network Systems)
- CC-Link IE Controller Network connection (Network system)
 -  4.6 CC-Link IE Controller Network Connection (Network System)
- Ethernet connection
 -  4.7 Ethernet Connection
- Connection to the redundant type extension base unit
 - (1) Computer link connection (Serial communication module mounted on the redundant type extension base unit)
 -  4.8.1 Computer link connection (Connection to the Serial communication module mounted on the redundant type extension base unit)
 - (2) Ethernet connection (Ethernet module mounted on the redundant type extension base unit)
 -  4.8.2 Ethernet connection (Connection to the Ethernet module mounted on redundant type extension base unit)
 - (3) CC-Link connection (intelligent device station) (CC-Link module mounted on the redundant type extension base unit)
 -  4.8.3 CC-Link connection (intelligent device station) (Connection to the CC-Link module mounted on redundant type extension base unit)
 - (4) CC-Link connection (Via G4) (CC-Link module mounted on the redundant type extension base unit)
 -  4.8.4 CC-Link connection (Via G4) (Connection to the CC-Link module mounted on redundant type extension base unit)

For details of PLC CPUs that can be monitored in each connection method of GOT, refer to the following.

-  Monitorable controllers of each chapter

1	PREPARATORY PROCEDURES FOR MONITORING
2	DEVICE RANGE THAT CAN BE SET
3	ACCESS RANGE FOR MONITORING
4	HOW TO MONITOR REDUNDANT SYSTEM
5	BUS CONNECTION
6	DIRECT CONNECTION TO CPU
7	COMPUTER LINK CONNECTION
8	ETHERNET CONNECTION

The following table shows the features of each connection method.

Connection type	Before system switching	After system switching
<ul style="list-style-type: none"> • Direct CPU connection (Remote I/O station of MELSECNET/H network system) • Computer link connection (Serial communication module mounted on the remote I/O station on MELSECNET/H network system) • Ethernet connection (Ethernet module mounted on the remote I/O station of the MELSECNET/H network system) 	<p style="text-align: center;">Direct CPU connection Computer link connection Ethernet connection</p>	<p style="text-align: center;">Direct CPU connection Computer link connection Ethernet connection</p> <p>The monitoring target is automatically changed to the control system PLC CPU.</p>
<ul style="list-style-type: none"> • Direct CPU connection 		<p>By the Q redundant setting, the GOT automatically changes the monitoring target to the PLC CPU in the control system.*1</p>
	<p>Monitor the PLC CPU of the control system by GOT1.</p>	<p>Monitor the PLC CPU of the control system by GOT2.</p>

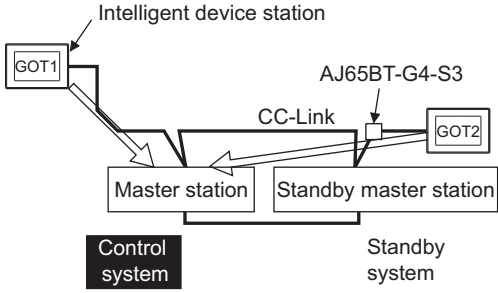
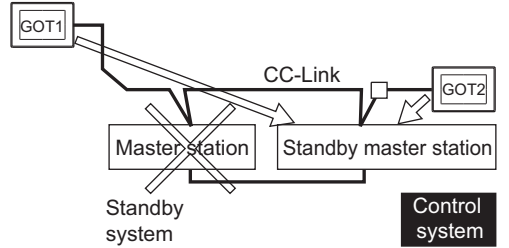
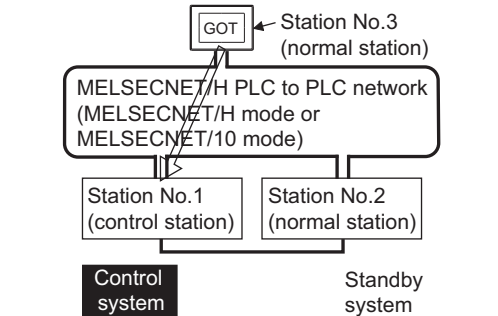
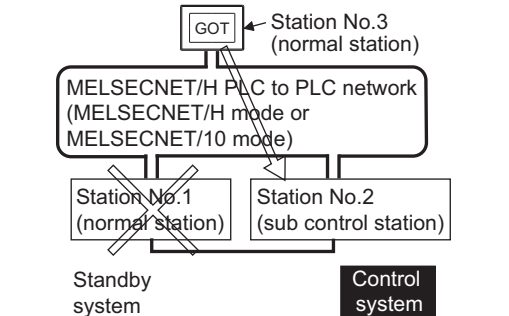
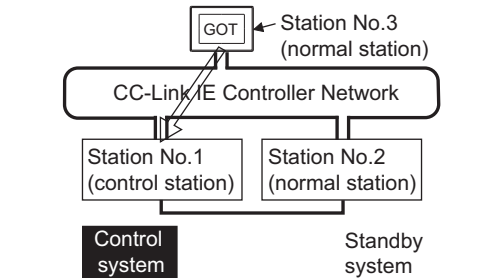
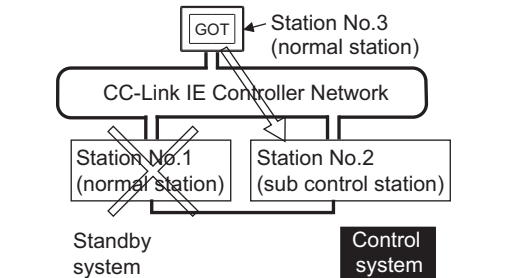
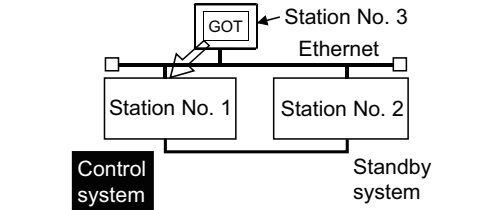
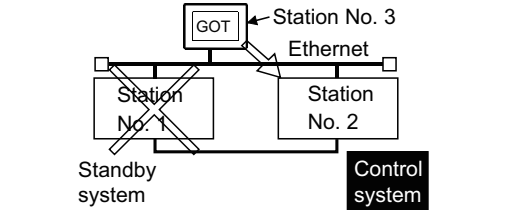
Connection type	Before system switching	After system switching
<ul style="list-style-type: none"> • CC-Link connection (intelligent device station) • CC-Link connection (Via G4) 		 <p>The monitoring target is automatically changed to the control system PLC CPU.</p>
<ul style="list-style-type: none"> • MELSECNET/H connection, MELSECNET/10 connection (Network system) 		 <p>By the Q redundant setting, the GOT automatically changes the monitoring target to the PLC CPU in the control system.*2</p>
<ul style="list-style-type: none"> • CC-Link IE Controller Network connection (Network system) 		 <p>By the Q redundant setting, the GOT automatically changes the monitoring target to the PLC CPU in the control system.*2</p>
<ul style="list-style-type: none"> • Ethernet connection 		 <p>By the Q redundant setting, the GOT automatically changes the monitoring target to the PLC CPU in the control system.*2</p>

1
PREPARATORY PROCEDURES FOR MONITORING

2
DEVICE RANGE THAT CAN BE SET

3
ACCESS RANGE FOR MONITORING

4
HOW TO MONITOR REDUNDANT SYSTEM

5
BUS CONNECTION

6
DIRECT CONNECTION TO CPU

7
COMPUTER LINK CONNECTION

8
ETHERNET CONNECTION

Connection type	Before system switching	After system switching
<ul style="list-style-type: none"> • Computer link connection (Serial communication module mounted on the redundant type extension base unit) • Ethernet connection (Ethernet module mounted on the redundant type extension base unit) • CC-Link connection (intelligent device station) (CC-Link module mounted on the redundant type extension base unit) • CC-Link connection (Via G4) (CC-Link module mounted on the redundant type extension base unit) 		

*1 To monitor the control system after the system switching without the Q redundant setting, change the cable connection from the PLC CPU in the previous control system to the control system after system switching.

*2 To monitor the control system after the system switching without the Q redundancy setting, refer to the following.



4.10 Switch the Monitor Target to the Control System Using the Script Function

POINT

Precautions for monitoring the QCPU redundant system

- (1) A system alarm may be detected when the system is switched in a redundant system.
When Q redundant setting is made : "450 Path has changed or timeout occurred in redundant system."
When Q redundant setting is not made : "402 Communication timeout. Confirm communication pathway or modules."

However, even if the error occurs, the GOT automatically resumes monitoring and there are no problems in the monitoring operation.
- (2) The system alarm is displayed when the system is switched due to cable disconnection etc. (when the path is changed).
The system alarm is not displayed when the system is switched by the user.
- (3) When connected to the remote I/O station, the GOT can monitor only the following GOT functions.
 - Monitoring function
 - System monitoring function
- (4) When connected to the remote I/O station, the GOT does not allow the PLC CPU clock of the master station to be set in the clock setting of the utility.
The master station clock will not change even if the clock setting is made.
Use GX Developer or a similar software to set the PLC CPU clock of the master station.
- (5) When the Q redundant setting is not made, the GOT does not automatically change the monitoring target even if system switching occurs in the redundant system. When the GOT is connected to the standby system, data written to a device are overwritten by the data of the control system, failing to be reflected.
In this case, when data are written to a device in the standby system normally, the system alarm "315 Device writing error. Correct device." is not detected.
- (6) For monitoring the QCPU redundant system when connecting to MELSECNET/H, use QCPU of function version D or later, with the upper five digits later than "07102".
Also, use GX Developer of Version 8.29F or later.
- (7) A message "Unable to communicate with CPU." is displayed when the system switching occurs while an option function such as the ladder monitor is used.
- (8) In the MELSECNET/H connection or MELSECNET/10 connection, when the control station of the MELSECNET/H network or MELSECNET/10 network fails and is taken over by a station outside the QCPU redundant system, the timeout is detected as the system alarm.
If this occurs, the monitor display speed may slow down.
- (9) In the direct CPU connection, the GOT fails to automatically change the monitoring target in the following cases.
 - When the power supply to the CPU where the GOT is connected is OFF
 - When the cable connecting the GOT with the CPU is broken
 - When the tracking is disabled
- (10) If the Q redundant setting is made for a system that is not a QCPU redundant system, no error occurs at the start up of the GOT and the GOT operates normally.
In this case, if an abnormality (such as powering OFF, or communication timeout error) occurs at the PLC CPU for which the Q redundant setting has been made, the PLC CPU may operate in a different way from the monitoring target change mode that was set in the Q redundant setting.
- (11) If the QCPU redundant system is in the debug mode, do not make the Q redundant system setting for the GOT side when connecting the GOT.

4.1 Connection to Remote I/O Station in MELSECNET/H Network System

4.1.1 Direct CPU connection (Direct CPU connection to the remote I/O station)



This section explains the direct CPU connection that connects the GOT to the remote I/O station of the MELSECNET/H network system.

The following shows an example of connecting the GOT to the remote I/O station of the MELSECNET/H network system.

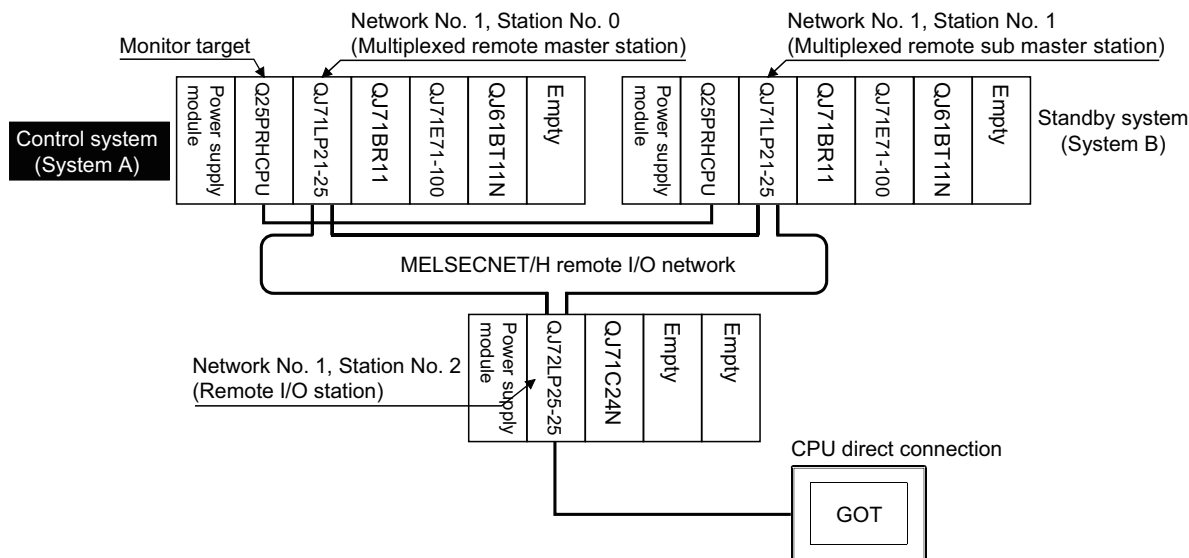

- Connection method**
 Connect the GOT to the RS-232 interface of the network module (QJ72LP25-25, QJ72LP25G, QJ72BR15) on the remote I/O station of the MELSECNET/H network system.
 For details, refer to the following.

6. DIRECT CONNECTION TO CPU

- GT Designer3 setting**
 Set GT Designer3 as follows.

Setting item	Settings	Model
Controller Type	GT16, GT15, GT12: MELSEC-QnA/Q/QS, MELDAS C6* GT14, GT11: MELSEC-QnA/Q, MELDAS C6* *1	
Device setting (Network setting)	Other NW No.: Network No. of MELSECNET/H remote I/O network Station No.: 0 (Master station)	
Q Redundant Setting	Do not set the item.	*2

*1 GT14 and GT11 are not compatible with MELSEC-QS.

*2 Only the CPU which is connected to GT11 directly can be monitored on GT11. The setting of GT Designer3 is not necessary.

In this case, the GOT monitoring is performed by transient transmission of the MELSECNET/H network system. Therefore, a longer time-lag occurs for displaying objects compared with directly monitoring the PLC CPU. For displaying objects with a shorter time-lag or using GT11, set the device for link devices B and W of the host station set in the MELSECNET/H network and execute the cyclic transmission. For details, refer to the following manual.

Q Corresponding MELSECNET/H Network System Reference Manual (Remote I/Q network)

- Monitoring target change when system switching occurs in a redundant system**
 When the system switching occurs, the multiplexed remote sub master station switched to the control system takes over the master operation of MELSECNET/H.
 Since the GOT monitors the master station, the monitoring target is automatically changed to the PLC CPU that is operating as the master.

4.1.2 Computer link connection (Connection to serial communication module mounted on remote I/O station)

GT 16 GT 15 GT 14 GT 12 GT 11 GT 10

This section explains the computer link connection that connects the GOT to the serial communication module mounted on the remote I/O station of the MELSECNET/H network system. The following shows an example of connecting the GOT to the serial communication module mounted on the remote I/O station of the MELSECNET/H network system.

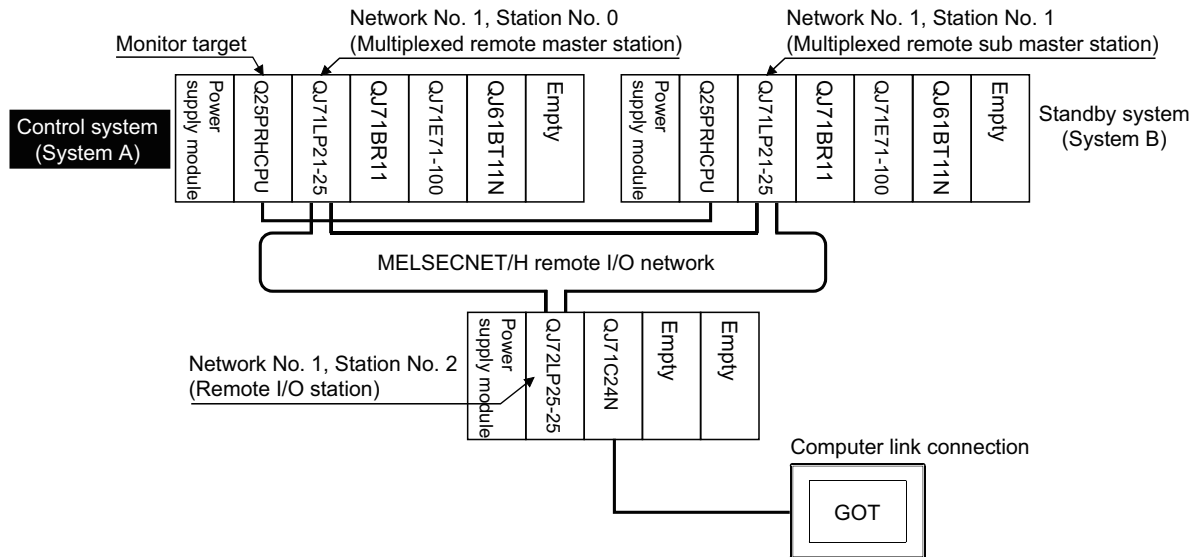

(1) Connection method

Connect the GOT to the serial communication module (QJ71C24, QJ71C24-R2, QJ71C24N, QJ71C24N-R2, QJ71C24N-R4) or modem interface module (QJ71CM0) mounted on the remote I/O station of the MELSECNET/H network system. For details, refer to the following.

7. COMPUTER LINK CONNECTION

(2) GT Designer3 setting

Set GT Designer3 as follows.

Setting item	Settings	Model
Controller Type	GT16, GT15, GT12: MELSEC-QnA/Q/QS, MELDAS C6* GT14, GT11: MELSEC-QnA/Q, MELDAS C6* *1	GT16 GT15 GT14 GT12 GT11 GT10
Device setting (Network setting)	Other NW No.: Network No. of MELSECNET/H remote I/O network Station No.: 0 (Master station)	GT16 GT15 GT14 GT12 GT11 GT10
Q Redundant Setting	Do not set the item.	*2

*1 GT14 and GT11 are not compatible with MELSEC-QS.

*2 Only the CPU which is connected to GT11 in the computer link connection can be monitored on GT11. The setting of GT Designer3 is not necessary.

In this case, the GOT monitoring is performed by transient transmission of the MELSECNET/H network system. Therefore, a longer time-lag occurs for displaying objects compared with directly monitoring the PLC CPU. For displaying objects with a shorter time-lag or using GT11, set the device for link devices B and W of the host station set in the MELSECNET/H network and execute the cyclic transmission. For details, refer to the following manual.

Q Corresponding MELSECNET/H Network System Reference Manual (Remote I/Q network)

(3) Monitoring target change when system switching occurs in a redundant system

When the system switching occurs, the multiplexed remote sub master station switched to the control system takes over the master operation of MELSECNET/H. Since the GOT monitors the master station, the monitoring target is automatically changed to the PLC CPU that is operating as the master.

1 PREPARATORY PROCEDURES FOR MONITORING
2 DEVICE RANGE THAT CAN BE SET
3 ACCESS RANGE FOR MONITORING
4 HOW TO MONITOR REDUNDANT SYSTEM
5 BUS CONNECTION
6 DIRECT CONNECTION TO CPU
7 COMPUTER LINK CONNECTION
8 ETHERNET CONNECTION

4.1.3 Ethernet connection (Connection to Ethernet module mounted on remote I/O station)

GT 16 GT 15 GT 14 GT 12 GT 11 GT 10

This section explains the Ethernet connection for connecting the GOT to the Ethernet module mounted on the remote I/O station of the MELSECNET/H network system.

The following shows an example of connecting the GOT to the Ethernet module mounted on the I/O station of the MELSECNET/H network system.

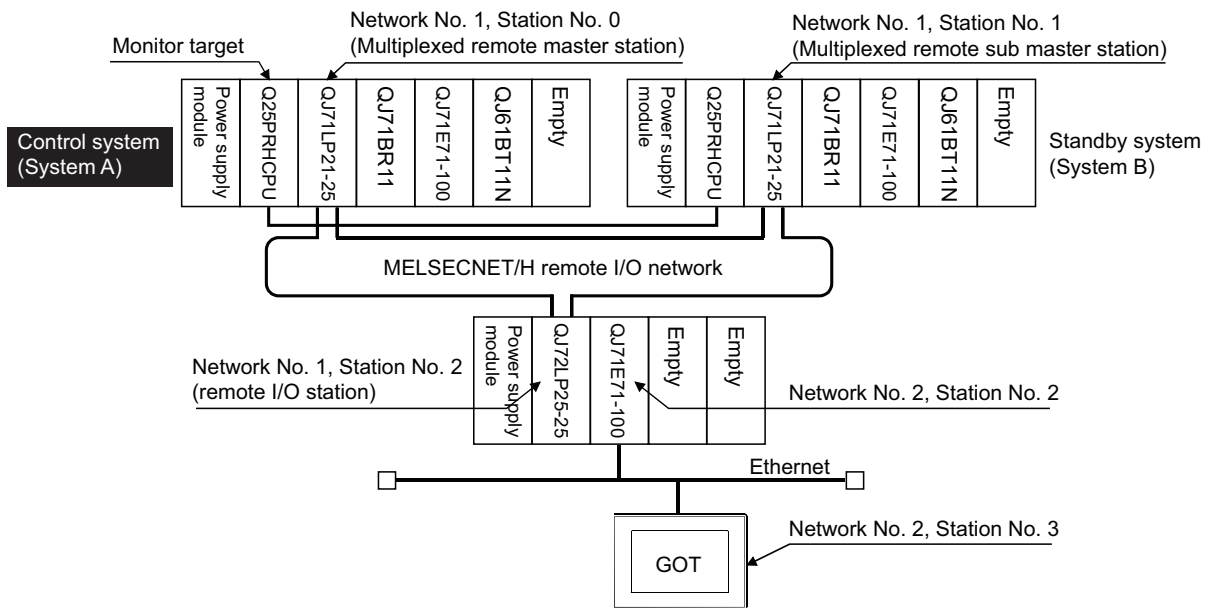

(1) Connection method

Connect the GOT to the Ethernet module (QJ71E71-100, QJ71E71-B5, QJ71E71-B2, QJ71E71) mounted on the remote I/O station of the MELSECNET/H network system.

For details, refer to the following.

☞ 8. ETHERNET CONNECTION

(2) GT Designer3 setting

Set GT Designer3 as follows.

Setting item	Settings	Model
Controller Type	GT16, GT15, GT12: MELSEC-QnA/Q/QS, MELDAS C6* GT14: MELSEC-QnA/Q, MELDAS C6* *1	GT16 GT15 GT14 GT12 GT11 GT10
Device setting (Network setting)	Other NW No.: Network No. of MELSECNET/H remote I/O network Station No.: 0 (Master station)	GT16 GT15 GT14 GT12 GT11 GT10
Q Redundant Setting	Do not set the item.	GT16 GT15 GT14 GT12 GT11 GT10
Routing Information Setting	☞ 8. ETHERNET CONNECTION	

*1 GT14 is not compatible with MELSEC-QS.

In this case, the GOT monitoring is performed by transient transmission of the MELSECNET/H network system. Therefore, a longer time-lag occurs for displaying objects compared with directly monitoring the PLC CPU.

For displaying objects with a shorter time-lag, set the device for link devices B and W of the host station set in the MELSECNET/H network and execute the cyclic transmission.

For details, refer to the following manual.

☞ Q Corresponding MELSECNET/H Network System Reference Manual (Remote I/Q network)

(3) Monitoring target change when system switching occurs in a redundant system

When the system switching occurs, the multiplexed remote sub master station switched to the control system takes over the master operation of MELSECNET/H.

Since the GOT monitors the master station, the monitoring target is automatically changed to the PLC CPU that is operating as the master.

4.2 Direct CPU Connection

GT 16 GT 15 GT 14 GT 12 GT 11 GT 10

This section describes the direct CPU connection by which a GOT is connected to a PLC CPU in the redundant system. Two methods for the CPU direct connection, using one or two GOTs, are available.

4.2.1 When using one GOT

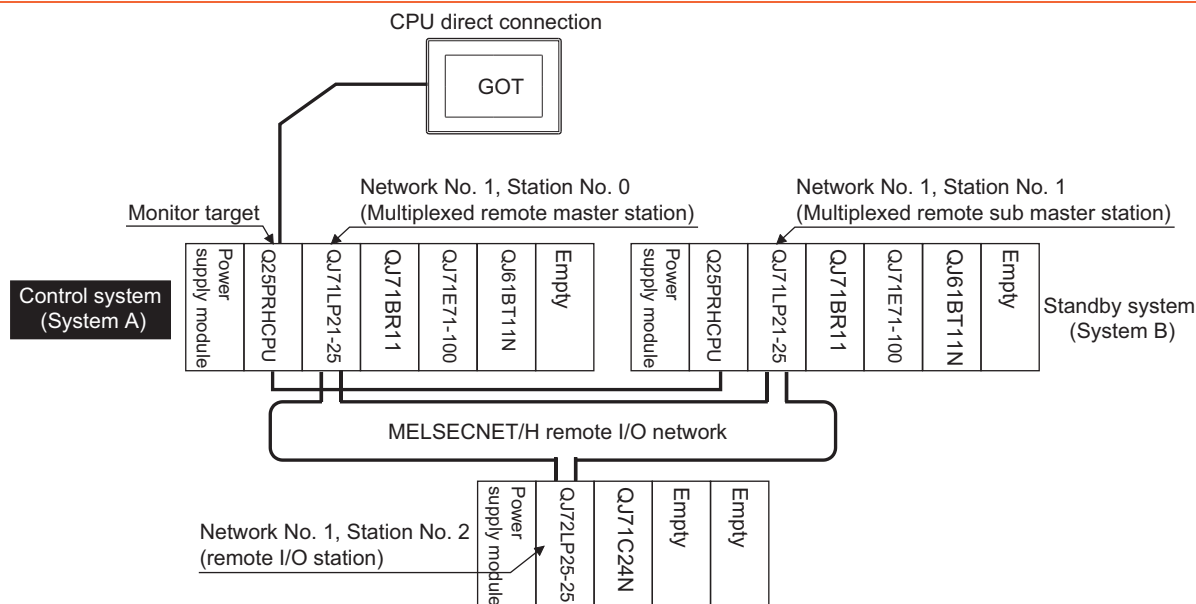

- (1) Connection method
Connect the GOT to the RS-232 interface of the control system CPU module (Q12PRHCPU, Q25PRHCPU) of the redundant system.
For details, refer to the following.

6. DIRECT CONNECTION TO CPU

- (2) GT Designer3 setting
Set GT Designer3 as follows.

Setting item	Settings	Model
Controller Type	GT16, GT15, GT12: MELSEC-QnA/Q/QS, MELDAS C6* GT14, GT11: MELSEC-QnA/Q, MELDAS C6* *1	GT16 GT15 GT14 GT12 GT11 GT10
Device setting (Network setting)	Host	GT16 GT15 GT14 GT12 GT11 GT10
Q Redundant Setting	4.9 Q Redundant Setting	*2

*1 GT14 and GT11 are not compatible with MELSEC-QS.

*2 Only the CPU which is connected to GT11 directly can be monitored on GT11. The setting of GT Designer3 is not necessary.

- (3) Monitoring target change when system switching occurs in a redundant system
When the system switching occurs, the PLC CPU (other station) of the control system after system switching takes over the host station operation.
Since the GOT monitors the control system, the monitoring target is automatically changed to other station.

POINT

To monitor the control system without Q redundant setting

If the system switching occurs when the Q redundant setting is not made, the GOT cannot change the monitoring target at the occurrence of system switching since it monitors the connected PLC CPU (host station).

As a countermeasure, change the cable connection from the PLC CPU in the previous control system to the control system after system switching.

4.2.2 When using two GOTs

Connect a GOT to each PLC CPU to respond to the system switching.

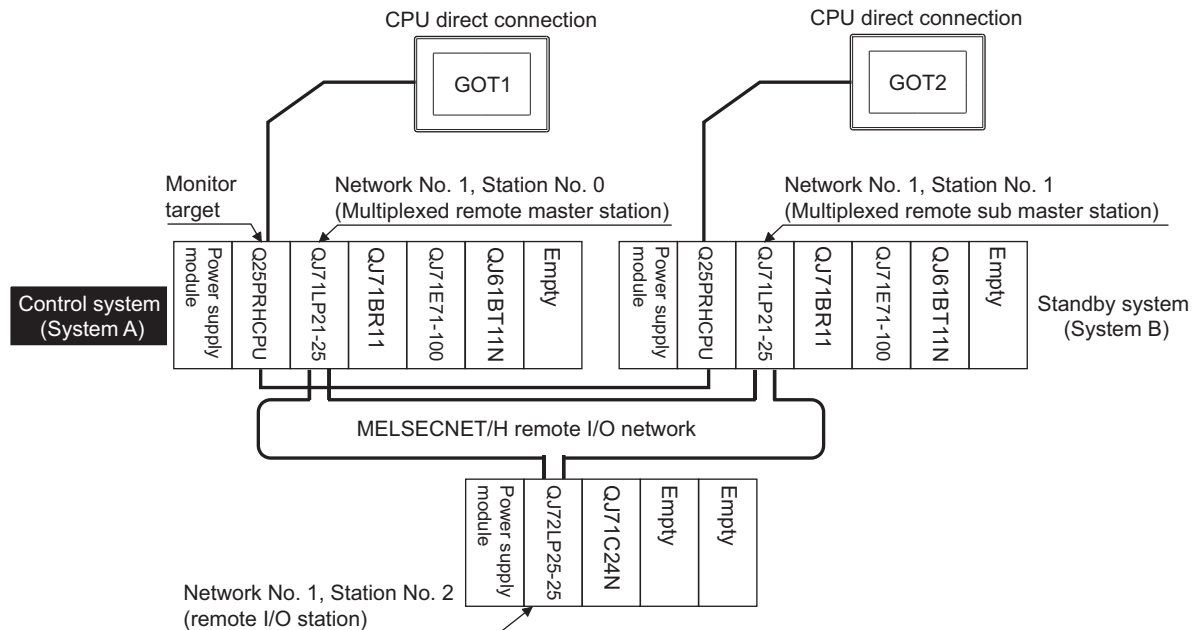

- (1) Connection method
Connect GOTs to the RS-232C interface of the control system and standby system CPU modules (Q12PRHCPU, Q25PRHCPU) of the redundant system.
For details, refer to the following.

6. DIRECT CONNECTION TO CPU

- (2) GT Designer3 setting
Set GT Designer3 as follows.

Setting item	Settings	Model
Controller Type	GT16, GT15, GT12: MELSEC-QnA/Q/QS, MELDAS C6* GT14, GT11: MELSEC-QnA/Q, MELDAS C6* *1	GT16 GT15 GT14 GT12 GT11 GT10
Device setting (Network setting)	Host	GT16 GT15 GT14 GT12 GT11 GT10
Q Redundant Setting	4.9 Q Redundant Setting	GT16 GT15 GT14 GT12 GT11 GT10 *2

*1 GT14 and GT11 are not compatible with MELSEC-QS.

*2 Only the CPU which is connected to GT11 directly can be monitored on GT11. The setting of GT Designer3 is not necessary.

- (3) Monitoring target change when system switching occurs in a redundant system
When the system switching occurs, the GOT cannot change the monitoring target automatically in response to the system switching.
The GOT that is connected to the control system CPU module after system switching continues the monitoring. Different from the case using one GOT, no cable reconnection is required.

POINT

To automatically change the monitoring target after system switching using one GOT, make the Q redundant settings.

4.9 Q Redundant Setting

4.2.3 Precautions when connecting a GOT directly to a PLC CPU in the redundant system without making Q redundant setting

- (1) As the GOT monitors exclusively the PLC CPU that is directly connected to, the monitor target cannot be changed in response to the system switching of the redundant system.
To change the target monitor in response to the system switching, change the target of the connection cable between the GOT and PLC CPU to the other PLC CPU, or configure the system using GOTs connected to each PLC CPU.
- (2) In CPU direct connection, when monitoring a PLC CPU in the redundant system, only the PLC CPU that is directly connected to the GOT can be monitored.
- (3) When connected to the standby system PLC CPU, the writing of the GOT to a device in the connected PLC CPU is not reflected. Design a monitor screen that disables writing to the standby system.
In the redundant system, the tracking function transfers device data from control system to standby system. When the tracking function is enabled, the device value of the standby system PLC CPU is overwritten by the device value transferred from the control system to the standby system even if the GOT writes to the standby system PLC CPU (Numerical input, Ascii input, Script, Recipe, or others).

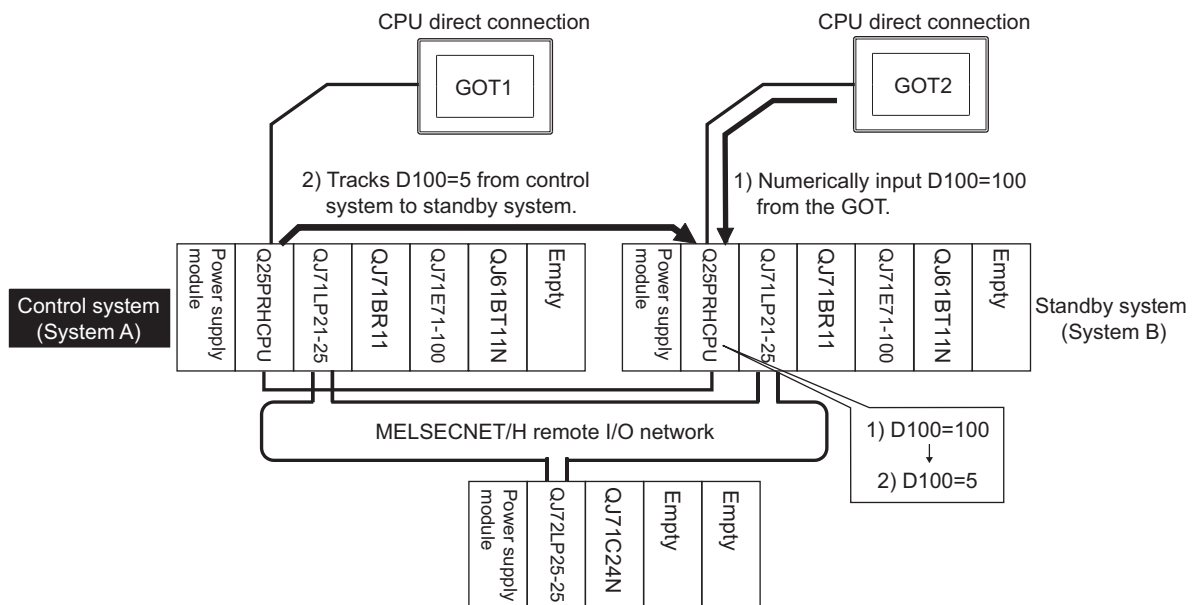

As countermeasures to the above, perform the following.

- Display a monitor screen which indicates that "the connected PLC CPU is the standby system" on a GOT when connecting the GOT to the standby system PLC CPU.
- To display the specified monitor screen when connecting the GOT to the standby system PLC CPU, use the special relay SM1515 (Control status identification flag) of the PLC CPU.
(When the SM1515 is OFF, the connected PLC CPU is the standby system)
- Control the operation of each object by the SM1515, which is set for the operation condition.
- For the screen switching device, use a GOT internal device.

If a device of the PLC CPU is used, the Status Observation operation of the GOT may be disabled since the device data of the PLC CPU will be overwritten by the device value transferred with the redundant system tracking function.

The following diagram shows an example of screen setting using SM1515.
 System configuration example: when using one GOT

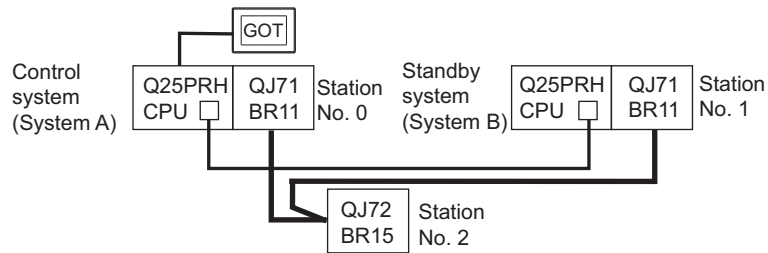

Create a monitor screen on the base screen 1 that performs the following operations for when connecting a GOT to control system and standby system.

- 1) When connecting to the control system, the monitor screen displays a message calling a touch switch operation, by which the screen switches to the next screen.
- 2) When connecting to the standby system, the monitor screen displays a message calling the reconnection of the connection cable.

1) When connecting to the control system

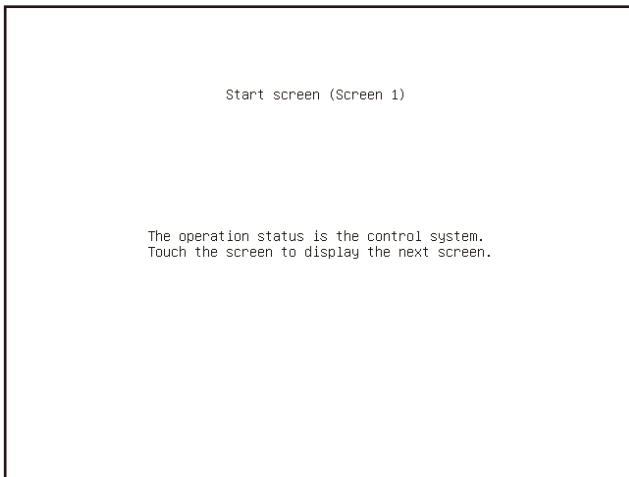

2) When connecting to the standby system

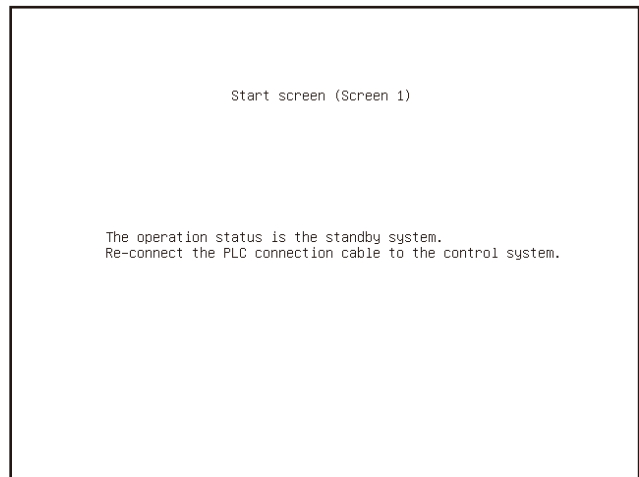

1. Set the screen switching device of the base screen.
 Choose [Common] → [GOT Environmental Setting] → [Screen Switching/Window], and set the internal device GD100 as the base screen switching device.
 (Do not use PLC CPU devices for the screen switching device. If used, the Status Observation operation of the GOT may be disabled since the device data of the PLC CPU is overwritten by the device value transferred with the redundant system tracking function)

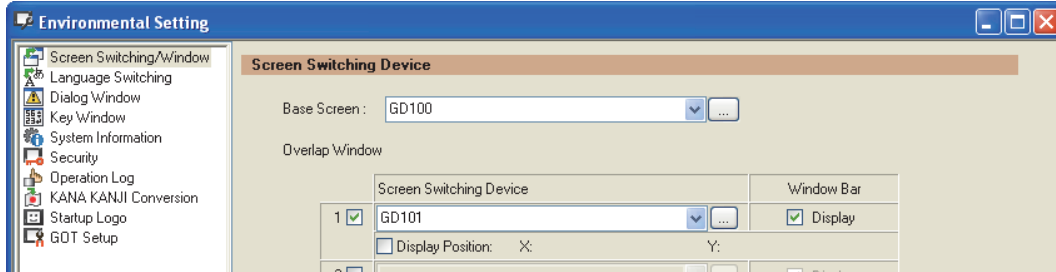

2. Set the Status Observation.
 Make the setting so that the base screen 1 is displayed when the connected PLC CPU is the standby system (SM1515 is OFF) in the project specified by selecting [Common] → [Status Observation].

Condition 1 : SM1515 (while OFF)	←	When the SM1515 is OFF, the connected PLC CPU is the standby system.
Operation : GD100=1	←	The screen switches to the base screen 1.

Create the status observation in the project on the Project tab.

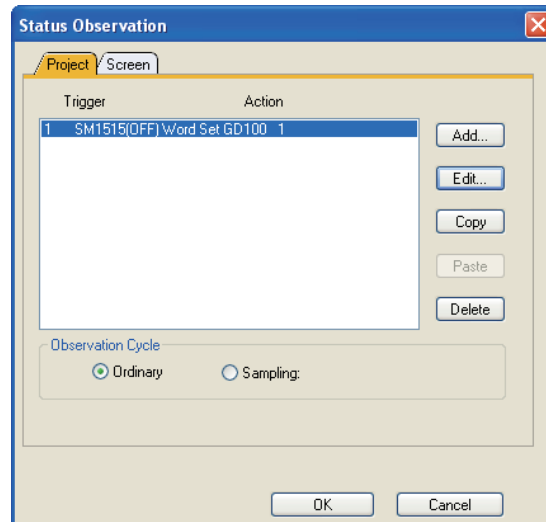

1 PREPARATORY PROCEDURES FOR MONITORING
 2 DEVICE RANGE THAT CAN BE SET
 3 ACCESS RANGE FOR MONITORING
 4 HOW TO MONITOR REDUNDANT SYSTEM
 5 BUS CONNECTION
 6 DIRECT CONNECTION TO CPU
 7 COMPUTER LINK CONNECTION
 8 ETHERNET CONNECTION

3. Set the comment display on the base screen 1.
 Set a comment to be displayed on the base screen 1 depending on the system status (ON/OFF of the SM1515) of the connected PLC CPU using the Comment Display (Bit).
 Select [Object] → [Comment Display] → [Bit Comment] and set Comment Display (Bit).

Device/Style tab	
Device	: SM1515
Shape	: None
Comment tab	
Comment Display Type Text (ON)	: The operation status is control system. Touch the screen to display the next screen.
Comment Display Type Text (OFF)	: The operation status is standby system. Reconnect the PLC connection cable to the control system CPU.

1) Device/Style tab screen

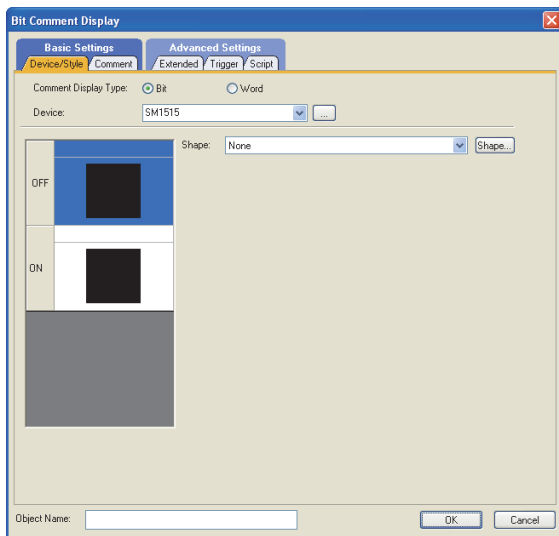

2) Comment tab screen (ON status)

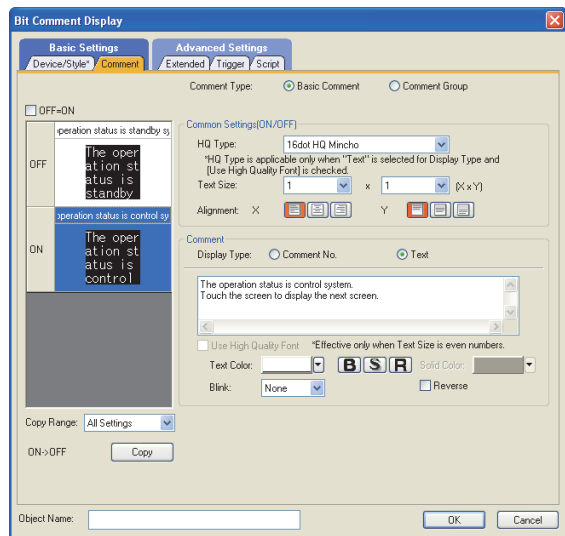

3) Comment tab screen (OFF status)

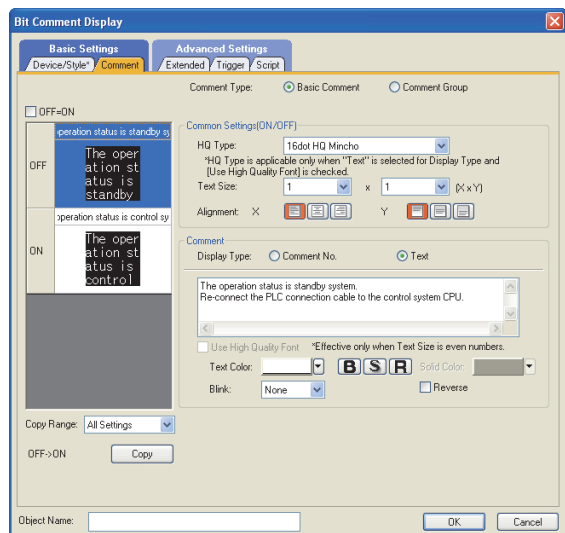

4. Set the touch switches on the base screen 1.

By using the go to screen switch function, set a touch switch for shifting the screen to the next screen with a screen touch, when the connected PLC CPU is the control system (SM1515 is ON).

Select [Object] → [Switch] → [Go To Screen Switch] and set the screen switching function.

Set the same size for the touch switch as the base screen size so that touching any place of the screen enables the switch operation.

Next Screen tab	
Screen Type	: Base
Go To Screen	: Fixed 2
Style tab	
Display Style	: None (Shape)
Trigger tab	
Trigger Type	: ON
Trigger Device	: SM1515

1) Next Screen tab

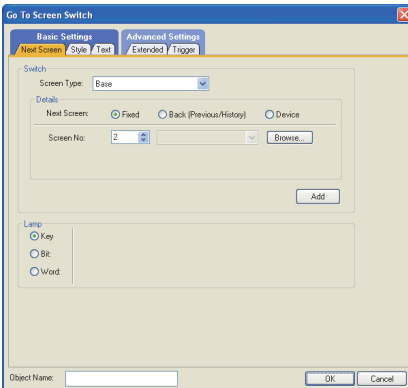

2) Style tab screen

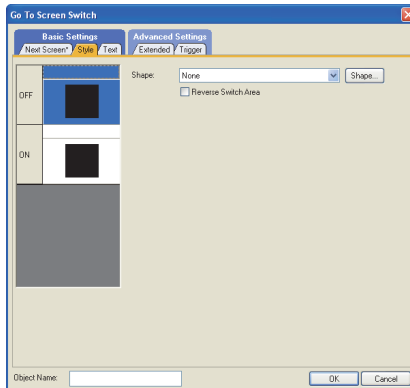

3) Trigger tab screen

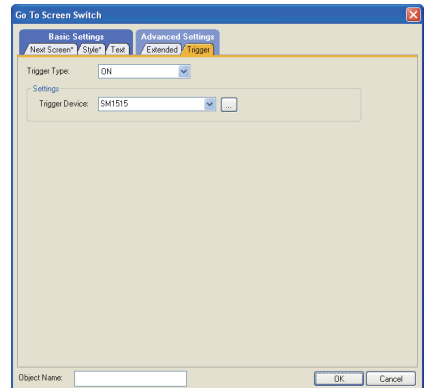

The following shows the created base screen 1.

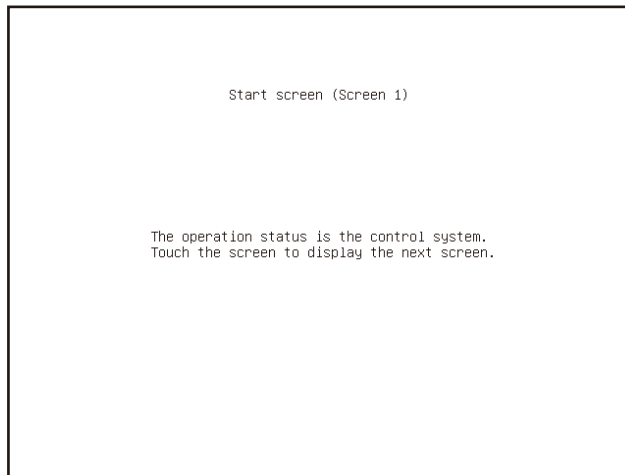

4.3 CC-Link Connection (Intelligent Device Station)

GT 16 GT 15 GT 14 GT 12 GT 11 GT 10

This section describes the CC-Link connection (intelligent device station) that connects the GOT set as the intelligent device station to the CC-Link network.

The following shows an example of connecting the GOT set as the intelligent device station to the CC-Link network.

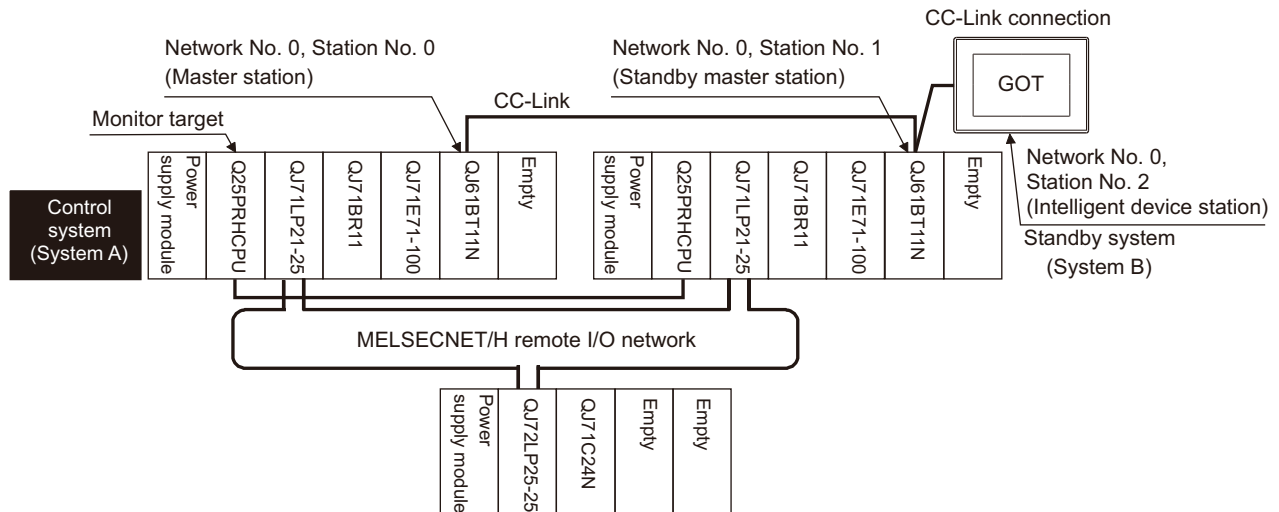

- (1) Connection method
Connect the CC-Link network system to the GOT.
For details, refer to the following.

☞ 13. CC-Link CONNECTION (INTELLIGENT DEVICE STATION)

- (2) GT Designer3 setting
Set GT Designer3 as follows.

Setting item	Settings		Model
Controller Type	MELSEC-QnA/Q/QS, MELDAS C6*		
Device setting (Network setting)	Other	NW No.: 0 (fixed)	GT16 GT15
		Station No.: 0 (Master station)	GT14 GT12 GT11 GT10
Q Redundant Setting	Do not set the item.		

In this case, the GOT monitoring is performed by transient transmission of the CC-Link network system. Therefore, a longer time-lag occurs for displaying objects compared with directly monitoring the PLC CPU. For displaying objects with a shorter time-lag, set the device for RX, RY, RWw, RWr of the host station set in the CC-Link network and execute the cyclic transmission.

For details, refer to the following.

☞ 3.3 CC-Link System Access Range for Monitoring

(3) Monitoring target change when system switching occurs in a redundant system

(a) System switching due to an alarm occurred in the control system

When system switching occurs, the CC-Link switches the station No. 0 of the master station and the station No. 1 of the standby master station on the network.

The CC-Link module of the new control system after system switching takes over the control as the master station.

Since the GOT monitors the master station, the monitoring target is automatically changed to the new control system after system switching.

(b) System switching due to a network communication error occurred in other than the CC-Link of the control system, or due to switching by the user

When system switching occurs, the CC-Link does not switch the station No. 0 of the master station and the station No. 1 of the standby master station on the network.

The CC-Link module of the new control system after system switching takes over the control as the standby master station.

Since the GOT monitors the master station, the monitoring target is not automatically changed to the new control system after system switching.

To automatically change the monitoring target of the GOT to the new control system after system switching, switch the data link control from the standby master station to the master station by the sequence program of the new control system.

For details of the sequence program, refer to the following manual.

 QnPRHCPU User's Manual (Redundant System)
(Sample Programs when Using CC-Link)

POINT

CC-Link network setting

To automatically change the monitoring target in the QCPU redundant system when using the CC-Link connection, set the CC-Link master station as System A and the standby master station as System B.

For details of using the CC-Link network in the redundant system, refer to the following manual.

 CC-Link System Master/Local Module User's Manual

 QnPRHCPU User's Manual (Redundant System)

1	PREPARATORY PROCEDURES FOR MONITORING
2	DEVICE RANGE THAT CAN BE SET
3	ACCESS RANGE FOR MONITORING
4	HOW TO MONITOR REDUNDANT SYSTEM
5	BUS CONNECTION
6	DIRECT CONNECTION TO CPU
7	COMPUTER LINK CONNECTION
8	ETHERNET CONNECTION

4.4 CC-Link Connection (Via G4)

GT 16 GT 15 GT 14 GT 12 GT 11 GT 10

This section explains the CC-Link connection (via G4) that connects the GOT to the AJ65BT-G4-S3 of the CC-Link network.

The following shows an example of connecting the GOT to the AJ65BT-G4-S3 of the CC-Link network.

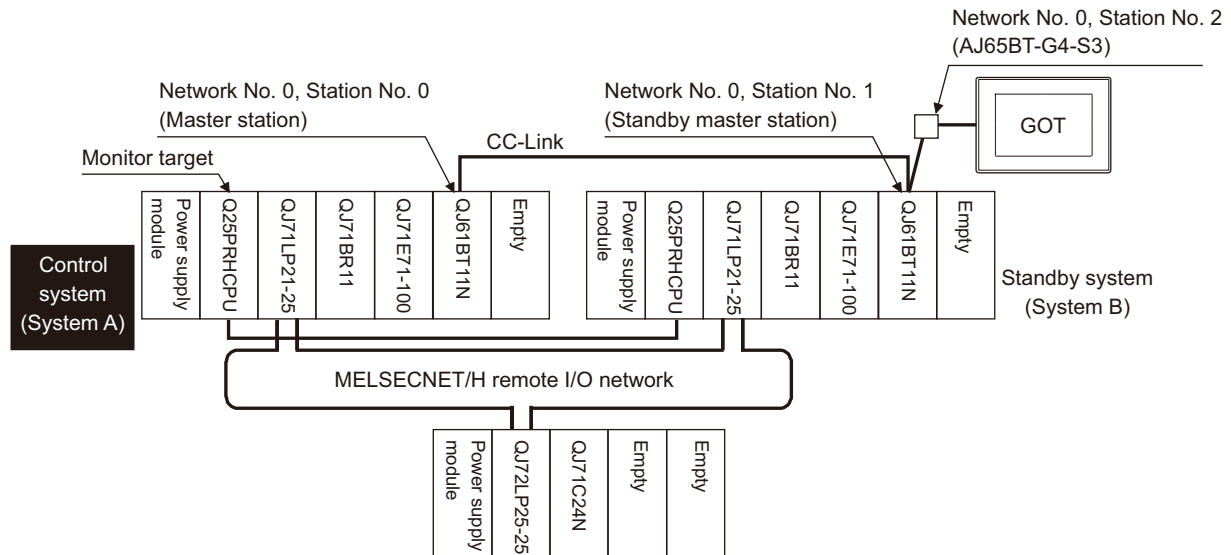

- (1) Connection method
Connect the AJ65BT-G4-S3 of the CC-Link network to the GOT.
For details, refer to the following.

14. CC-Link CONNECTION (Via G4)

- (2) GT Designer3 setting
Set GT Designer3 as follows.

Setting item	Settings	Model
Controller Type	GT16, GT15, GT12: MELSEC-QnA/Q/QS, MELDAS C6* GT14, GT11: MELSEC-QnA/Q, MELDAS C6* *1 GT10: MELSEC-QnA/Q*1	GT16 GT15 GT14 GT12 GT11 GT10
Device setting (Network setting)	Host	GT16 GT15 GT14 GT12 GT11 GT10
Q Redundant Setting	Do not set the item.	GT16 GT15 GT14 GT12 GT11 GT10 *2

*1 GT14, GT11, and GT10 are not compatible with MELSEC-QS.

*2 Only master station can be monitored in GT11 and GT10. The setting of GT Designer3 is not necessary.

(3) Monitoring target change when system switching occurs in a redundant system

(a) System switching due to an alarm occurred in the control system

When system switching occurs, the CC-Link switches the station No. 0 of the master station and the station No. 1 of the standby master station on the network.

The CC-Link module of the new control system after system switching takes over the control as the master station.

Since the GOT monitors the master station, the monitoring target is automatically changed to the new control system after system switching.

(b) System switching due to a network communication error occurred in other than the CC-Link of the control system, or due to switching by the user

When system switching occurs, the CC-Link does not switch the station No. 0 of the master station and the station No. 1 of the standby master station on the network.

The CC-Link module of the new control system after system switching takes over the control as the standby master station.

Since the GOT monitors the master station, the monitoring target is not automatically changed to the new control system after system switching.

To automatically change the monitoring target of the GOT to the new control system after system switching, switch the data link control from the standby master station to the master station by the sequence program of the new control system.

For details of the sequence program, refer to the following manual.

 QnPRHCPU User's Manual (Redundant System)
(Sample Programs when Using CC-Link)

POINT

CC-Link network setting

To automatically change the monitoring target in the QCPU redundant system when using the CC-Link connection, set the CC-Link master station as System A and the standby master station as System B.

For details of using the CC-Link network in the redundant system, refer to the following manual.

 CC-Link System Master/Local Module User's Manual

 QnPRHCPU User's Manual (Redundant System)

1	PREPARATORY PROCEDURES FOR MONITORING
2	DEVICE RANGE THAT CAN BE SET
3	ACCESS RANGE FOR MONITORING
4	HOW TO MONITOR REDUNDANT SYSTEM
5	BUS CONNECTION
6	DIRECT CONNECTION TO CPU
7	COMPUTER LINK CONNECTION
8	ETHERNET CONNECTION

4.5 MELSECNET/H and MELSECNET/10 Connections (Network Systems)

GT 16 GT 15 GT 14 GT 12 GT 11 GT 10

This section explains the MELSECNET/H and MELSECNET/10 connections (network systems) that connect the GOT to the MELSECNET/H and MELSECNET/10 network system.

The following provides an example of connecting the GOT set as a normal station to the MELSECNET/H network system.

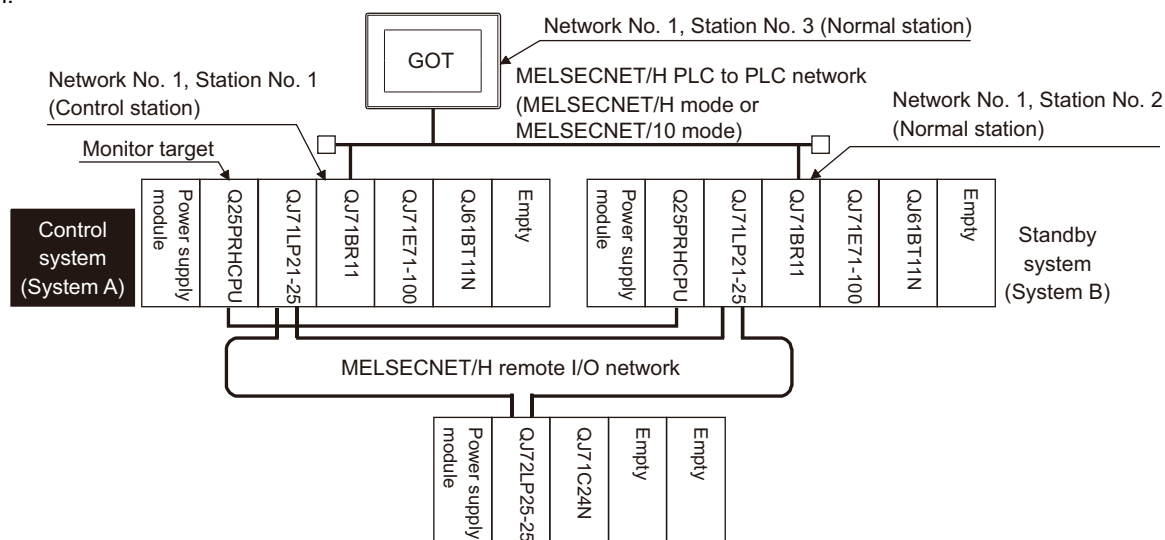

- (1) Connection method
Connect the MELSECNET/H network system to the GOT.
For details, refer to the following.

➡ 9. MELSECNET/H CONNECTION (PLC TO PLC NETWORK)

- (2) GT Designer3 setting
Set GT Designer3 as follows.

Setting item	Settings	Model
Controller Type	MELSEC-QnA/Q/QS, MELDAS C6*	
Device setting (Network setting)	Other	GT 16 GT 15 GT 14 GT 12 GT 11 GT 10
Q Redundant Setting	➡ 4.9 Q Redundant Setting	

- (3) Monitoring target change when system switching occurs in a redundant system
When system switching occurs, the network module station No. 2 changes from the normal station to the sub control station and takes over the control of the MELSECNET/H network system.
Since the GOT monitors the control system, the monitoring target is automatically changed to the network module station No. 2.

POINT

To monitor the control system without Q redundant setting

When system switching occurs, the network module station No. 2 changes from the normal station to the sub control station and takes over the control of the MELSECNET/H network system.

Since the GOT monitors the station of the specified station number, the monitoring target cannot be changed to the station No. 2 in response to the system switching.

As a countermeasure, create a screen to monitor the PLC CPU of the control system by switching the station numbers between System A and System B using the script function.

➡ 4.10 Switch the Monitor Target to the Control System Using the Script Function

4.6 CC-Link IE Controller Network Connection (Network System)



This section explains the CC-Link IE Controller Network connection (network system) that connects the GOT to the CC-Link IE controller network.

The following shows an example of connecting the GOT set as a normal station to the CC-Link IE Controller Network.

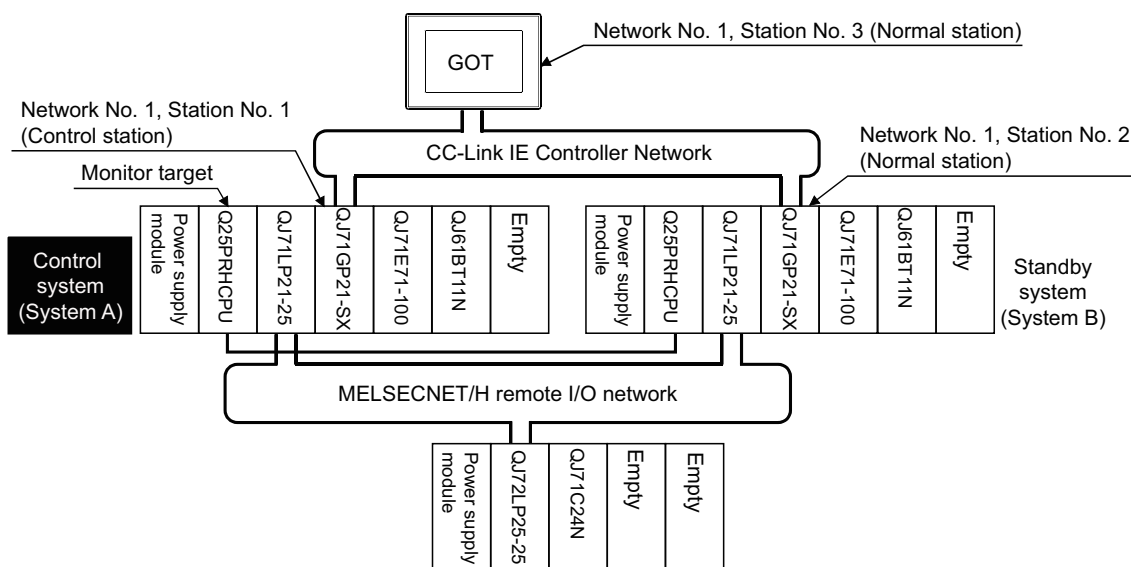

- (1) Connection method
Connect the GOT to the CC-Link IE Controller Network.
For details, refer to the following.

11. CC-Link IE CONTROLLER NETWORK CONNECTION

- (2) GT Designer3 setting
Set GT Designer3 as described below.

Setting item	Settings	Model
Controller Type	MELSEC-QnA/Q/QS, MELDAS C6*	
Device setting (Network setting)	NW No.: Network No. of CC-Link IE Controller Network	GT16 GT15
	Station No.: Station number of the control system	GT14 GT12 GT11 GT10
Q Redundant Setting	4.9 Q Redundant Setting	

*1 GT14 is not compatible with MELSEC-QS.

To specify the station number which was set in the Q redundant setting in the device setting, set the station number as the other station.

- (3) Monitoring target change when system switching occurs in a redundant system
When system switching occurs, the network module station No.2 changes from a normal station to the sub control station, and the system with the module takes over the control of the CC-Link IE Controller Network as the control system.
Since the GOT monitors the control system, the monitoring target is automatically changed to the network module station No. 2.

1 PREPARATORY PROCEDURES FOR MONITORING
 2 DEVICE RANGE THAT CAN BE SET
 3 ACCESS RANGE FOR MONITORING
 4 HOW TO MONITOR REDUNDANT SYSTEM
 5 BUS CONNECTION
 6 DIRECT CONNECTION TO CPU
 7 COMPUTER LINK CONNECTION
 8 ETHERNET CONNECTION

4.7 Ethernet Connection

GT 16 GT 15 GT 14 GT 12 GT 11 GT 10

This section explains the Ethernet connection that connects the GOT to the Ethernet network system. The following shows an example of connecting the GOT to the Ethernet network.

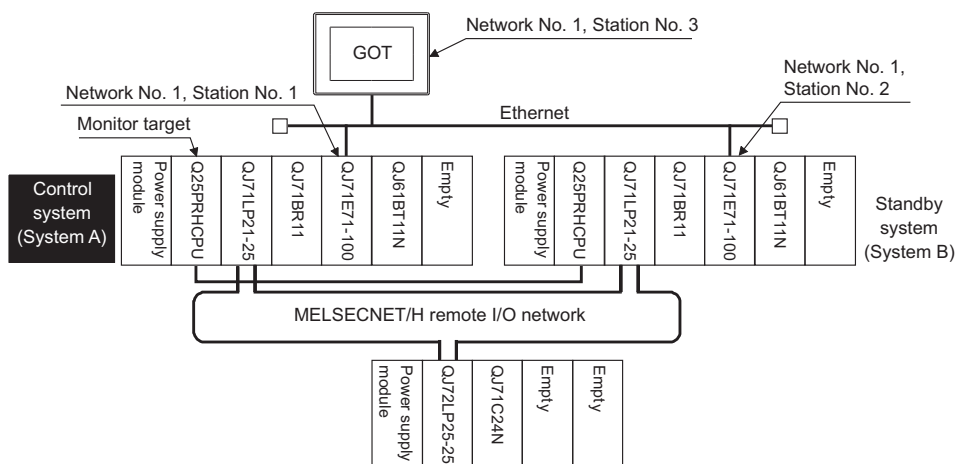

(1) Connection method

Connect the Ethernet network system to the GOT.

Set the Ethernet modules of System A and System B (including NW No., station No, and IP address) to the Ethernet setting of the GOT side.

For details, refer to the following.

8. ETHERNET CONNECTION

(2) GT Designer3 setting

Set GT Designer3 as follows.

Setting item	Settings	Model
Controller Type	GT16, GT15, GT12: MELSEC-QnA/Q/QS, MELDAS C6* GT14: MELSEC-QnA/Q, MELDAS C6* *1	
Device setting (Network setting)	Host	Host (The control system is monitored.)
	Other	NW No.: Network No. of Ethernet Station No.: Station number of the control system
Q Redundant Setting	4.9 Q Redundant Setting	

*1 GT14 is not compatible with MELSEC-QS.

To specify the station number which was set in the Q redundant setting in the device setting, set the station number as the other station.

(3) Monitoring target change when system switching occurs in a redundant system

When system switching occurs, Ethernet module station No. 2 takes over the control of the Ethernet network system as the control system.

Since the GOT monitors the control system, the monitoring target is automatically changed to the Ethernet module station No. 2.

POINT

When monitoring control system without Q redundant setting (Only GT16, GT15 and GT14)

When system switching occurs, Ethernet module station No. 2 takes over the control of the Ethernet network system as the control system.

Since the GOT monitors the station of the specified station number, the monitoring target cannot be changed to the station No. 2 in response to the system switching.

As a countermeasure, create a screen to monitor the PLC CPU of the control system by switching the station numbers between System A and System B using the script function.

4.10 Switch the Monitor Target to the Control System Using the Script Function

4.8 Connection to the Redundant Type Extension Base Unit

4.8.1 Computer link connection (Connection to the Serial communication module mounted on the redundant type extension base unit)



This section explains the computer link connection for connecting the GOT to the serial communication module mounted on the redundant type extension base unit.

The following shows an example of connecting the GOT to the serial communication module mounted on the redundant type extension base unit.

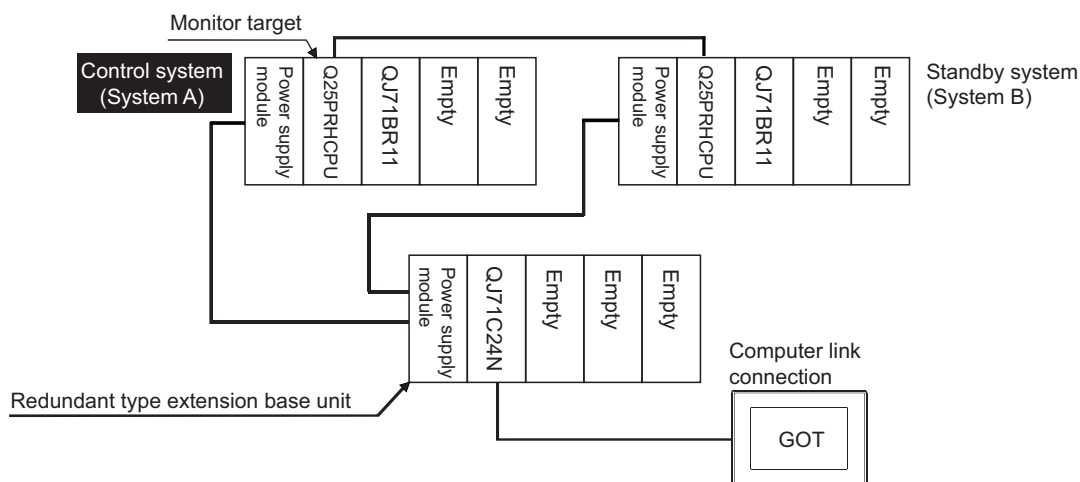

- (1) Connection method
Connect the GOT to the serial communication module (QJ71C24N) mounted on the redundant type extension base unit.
For details, refer to the following.

7. COMPUTER LINK CONNECTION

- (2) GT Designer3 setting
Set GT Designer3 as follows.

Setting item	Settings	Model
Controller Type	GT16, GT15, GT12: MELSEC-QnA/Q/QS, MELDAS C6* GT14, GT11: MELSEC-QnA/Q, MELDAS C6* *1	GT16 GT15 GT14 GT12 GT11 GT10
Device setting (Network setting)	Host	
Q Redundant Setting	Do not set the item.	

*1 GT14 and GT11 are not compatible with MELSEC-QS.

- (3) Monitoring target change when system switching occurs in a redundant system
When the system switching occurs, the GOT automatically changes the monitoring target to the PLC CPU switched to the control system.

4.8.2 Ethernet connection (Connection to the Ethernet module mounted on redundant type extension base unit)

GT 16 GT 15 GT 14 GT 12 GT 11 GT 10

This section explains the Ethernet connection for connecting the GOT to the Ethernet module mounted on the redundant type extension base unit.

The following shows an example of connecting the GOT to the Ethernet module mounted on the redundant type extension base unit.

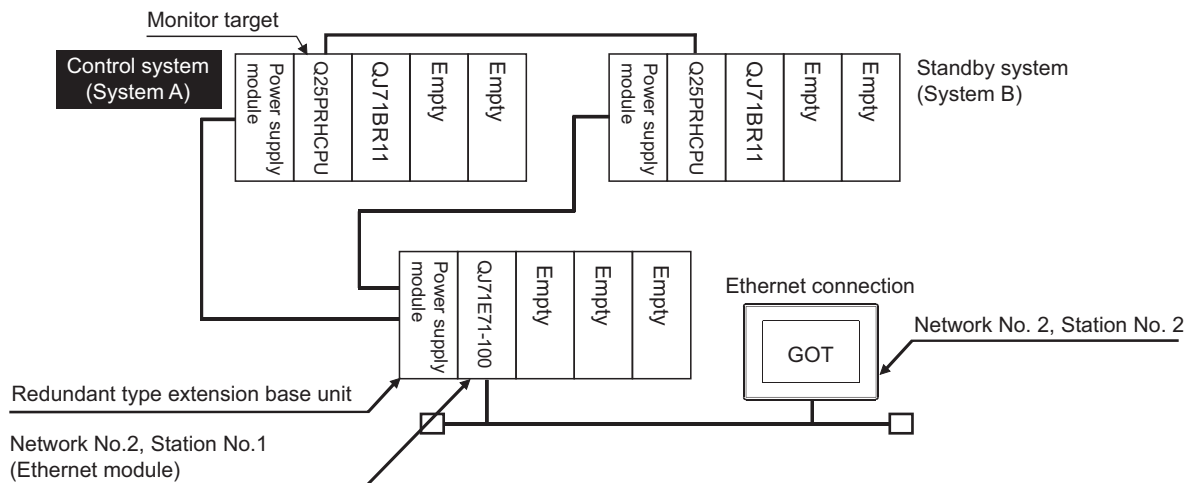

(1) Connection method

Connect the GOT to the Ethernet module (QJ71E71-100, QJ71E71-B5, QJ71E71-B2) mounted on the redundant type extension base unit.

For details, refer to the following.

8. ETHERNET CONNECTION

(2) GT Designer3 setting

Set GT Designer3 as follows.

Setting item	Settings	Model
Controller Type	GT16, GT15, GT12: MELSEC-QnA/Q/QS, MELDAS C6* GT14: MELSEC-QnA/Q, MELDAS C6* *1	GT16 GT15 GT14 GT12 GT11 GT10
Device setting (Network setting)	Host	
Q Redundant Setting	Do not set the item.	

*1 GT14 is not compatible with MELSEC-QS.

(3) Monitoring target change when system switching occurs in a redundant system

When the system switching occurs, the GOT automatically changes the monitoring target to the PLC CPU switched to the control system.

4.8.3 CC-Link connection (intelligent device station) (Connection to the CC-Link module mounted on redundant type extension base unit)



This section explains the CC-Link connection for connecting the GOT to the CC-Link module mounted on the redundant type extension base unit.

The following shows an example of connecting the GOT to the CC-Link module mounted on the redundant type extension base unit.

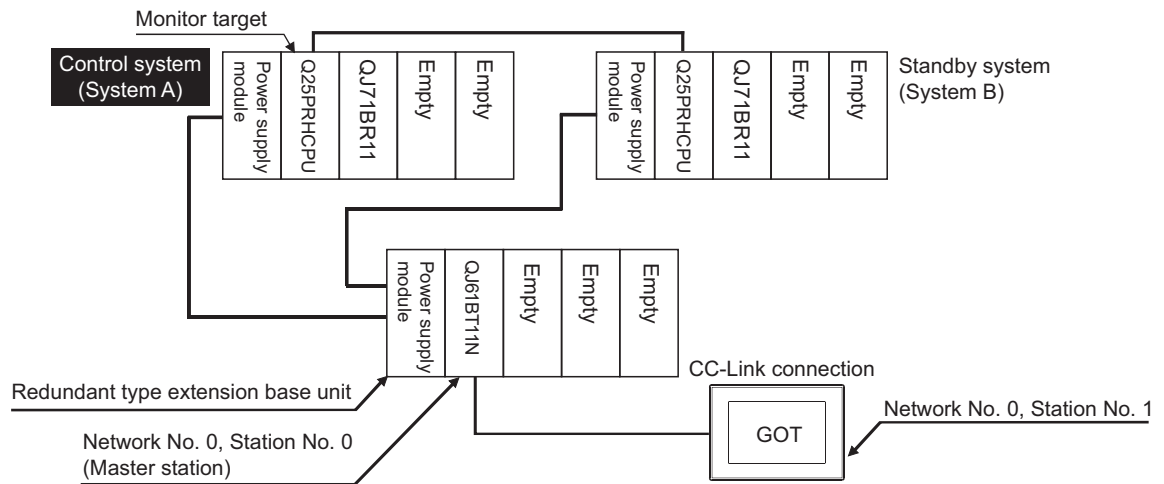

- (1) Connection method
Connect the GOT to the CC-Link module (QJ61BT11N) mounted on the redundant type extension base unit. For details, refer to the following.

13. CC-Link CONNECTION (INTELLIGENT DEVICE STATION)

- (2) GT Designer3 setting
Set GT Designer3 as follows.

Setting item	Settings	Model
Controller Type	MELSEC-QnA/Q/QS, MELDAS C6*	
Device setting (Network setting)	NW No.: 0 (fixed)	GT16 GT15
	Station No.: 0 (Master station)	GT14 GT12 GT11 GT10
Q Redundant Setting	Do not set the item.	

In this case, the GOT monitoring is performed by transient transmission of the CC-Link network system. Therefore, a longer time-lag occurs for displaying objects compared with directly monitoring the PLC CPU. For displaying objects with a shorter time-lag, set the device for RX, RY, RWw, RWr of the host station set in the CC-Link network and execute the cyclic transmission. For details, refer to the following.

3.3 CC-Link System Access Range for Monitoring

- (3) Monitoring target change when system switching occurs in a redundant system
When the system switching occurs, the GOT automatically changes the monitoring target to the PLC CPU switched to the control system.

1 PREPARATORY PROCEDURES FOR MONITORING
 2 DEVICE RANGE THAT CAN BE SET
 3 ACCESS RANGE FOR MONITORING
 4 HOW TO MONITOR REDUNDANT SYSTEM
 5 BUS CONNECTION
 6 DIRECT CONNECTION TO CPU
 7 COMPUTER LINK CONNECTION
 8 ETHERNET CONNECTION

4.8.4 CC-Link connection (Via G4) (Connection to the CC-Link module mounted on redundant type extension base unit)

GT 16 GT 15 GT 14 GT 12 GT 11 GT 10

This section explains the CC-Link connection (Via G4) for connecting the GOT to the CC-Link module mounted on the redundant type extension base unit via the AJ65BT-G4-S3.

The following shows an example of connecting the GOT to the AJ65BT-G4-S3 of the CC-Link network.

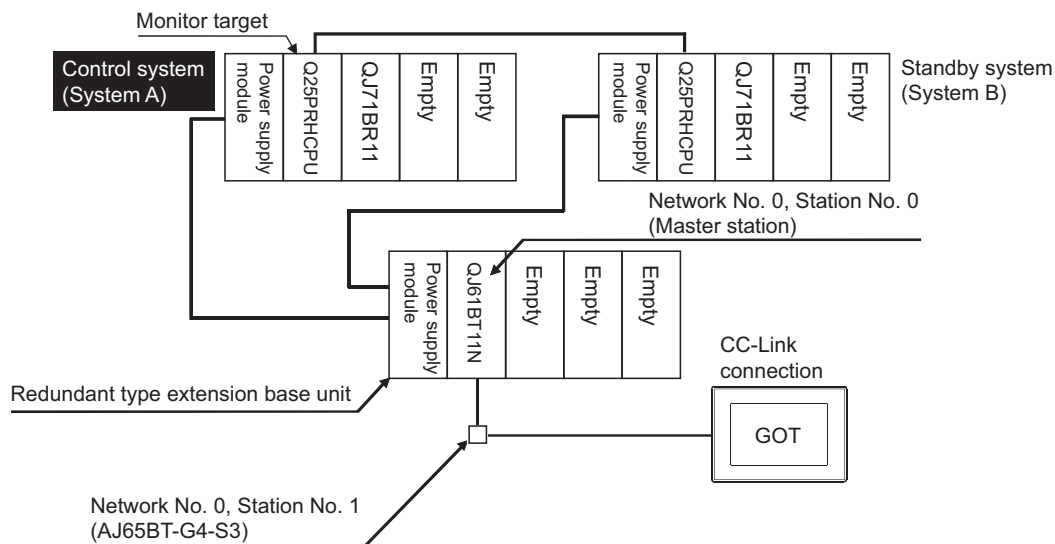

- (1) Connection method
Connect the AJ65BT-G4-S3 of the CC-Link network to the GOT.
For details, refer to the following.

☞ 14. CC-Link CONNECTION (Via G4)

- (2) GT Designer3 setting
Set GT Designer3 as follows.

Setting item	Settings	Model
Controller Type	GT16, GT15, GT12: MELSEC-QnA/Q/QS, MELDAS C6* GT14, GT11: MELSEC-QnA/Q, MELDAS C6* *1	GT16 GT15 GT14 GT12 GT11 GT10
Device setting (Network setting)	Host	
Q Redundant Setting	Do not set the item.	

*1 GT14 and GT11 are not compatible with MELSEC-QS.

- (3) Monitoring target change when system switching occurs in a redundant system
When the system switching occurs, the GOT automatically changes the monitoring target to the PLC CPU switched to the control system.

4.9 Q Redundant Setting



The following explains the setting for automatically change the monitoring target of the GOT when monitoring a QCPU redundant system.

POINT

Before making the Q redundant setting
 In the Q redundant setting, do not set stations other than redundant CPUs.

1. Select [Common] → [Controller Setting] → [Q Redundant] from the menu.
2. The setting dialog box appears. Make the settings with reference to the following explanation.
3. Make the settings for the Q redundant setting.
 In the Q Redundant Setting dialog box, settings can be made for each channel of the controller.

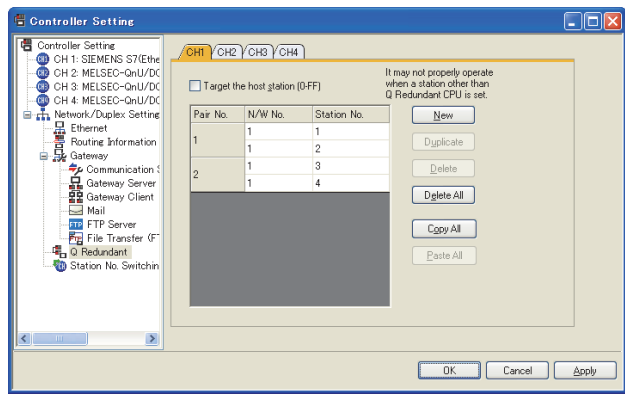

(Example: Ethernet connection (Station No. 5), redundant CPU pair No. 1 and No. 2, redundant CPU station No. 1 to 4)

Item	Contents		Model
CH1 to CH4	Select a tab of the CH No. for the Q redundant setting.		
Target at its own Station (0-FF)	Select this item to monitor the control system as a host station. (In Ethernet connection, not available even when selected)		
Pair No.*1	NW No.	Set the network No. (1 to 225) for each of pair numbers (1 to 64). Upper row: Setting for the first redundant CPU. Lower row: Setting for the second redundant CPU. (The same value as the value set for the first redundant CPU is displayed)	
	Station No.	Set the station No. (1 to 63) of the redundant CPU for each of pair numbers (1 to 64). Upper row: Setting for the first redundant CPU. Lower row: Setting for the second redundant CPU. (The value of "Setting for the first redundant CPU" + 1 is displayed)	GT16 GT15 GT14 GT12 GT11 GT10
New	Create a new pair No.		*2
Duplicate	Copies one setting of the selected pair number to append it at the last line.		
Delete	Deletes one setting of the selected pair. After deletion, the succeeding pair numbers are renumbered to fill the deleted pair number.		
Delete All	Deletes the setting of all pair numbers.		
Copy All	Copies the Q redundant setting on the selected CH No. tab.		
Paste All	Pastes the copied Q redundant setting in the selected CH No. tab.		

For details of *1, refer to the explanation below.

*2 GT14, GT12, GT11 are applicable to built-in serial interface only.

1 PREPARATORY PROCEDURES FOR MONITORING
 2 DEVICE RANGE THAT CAN BE SET
 3 ACCESS RANGE FOR MONITORING
 4 HOW TO MONITOR REDUNDANT SYSTEM
 5 BUS CONNECTION
 6 DIRECT CONNECTION TO CPU
 7 COMPUTER LINK CONNECTION
 8 ETHERNET CONNECTION

*1 Pair number

Redundant CPU pair means the redundant CPUs (System A / System B) in the redundant system configuration. Pair number is the number assigned to each redundant CPU pair.

Example: Ethernet connection (Pair No. 1 and Pair No. 2)

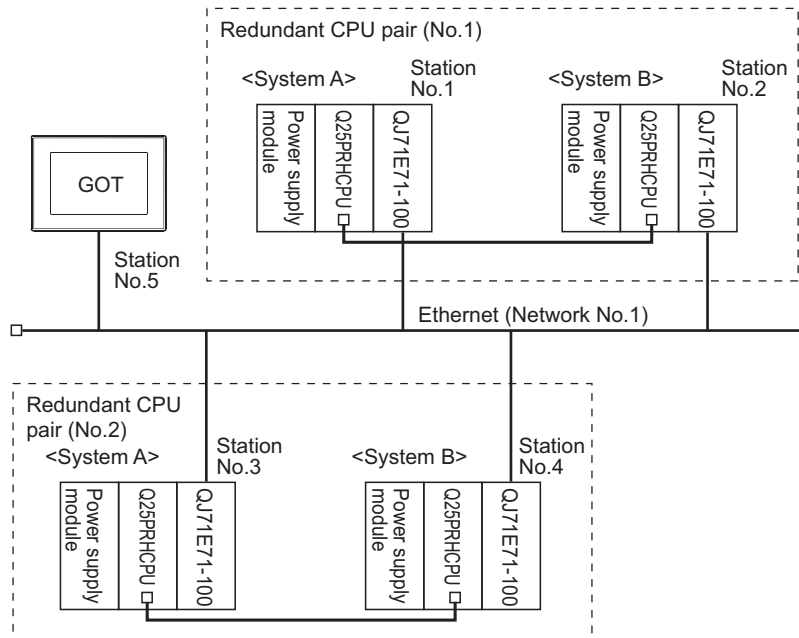

POINT

Precautions for making Q redundant setting

Pay attention to the following items when making the Q redundant setting.

- In the setting, station Nos. of the System A CPU and System B CPU must be adjacent numbers to be set as a pair.
As long as adjacent numbers are used, allocation of them to the System A CPU and System B CPU may be determined as desired.
- Pairing of the last station No. and station No. 1 (Example: Station No. 64 and station No. 1) is not allowed.
- Make sure that the QCPU in the station for which Q redundant setting is made is a redundant CPU.
If any of the QCPU to which the Q redundant setting is made is not a redundant CPU, the GOT fails to automatically change the monitoring target to the control system when the system is switched.
- When making the Q redundant setting for MELSECNET/H, MELSECNET/10, or Ethernet connections, check the station Nos. of network modules before the setting. If the settings of the Q redundant setting and the actual network module station Nos. are not matched, the GOT fails to automatically change the monitoring target to the control system when the system is switched.
- The redundant pair number setting is necessary in the Q redundant setting when the monitoring target changes automatically at the system switching with the host station specified in Ethernet connection. (The "Target at its own Station (0-FF)" function of the Q redundant setting is not valid in Ethernet connection.)
- GOT supports the backup mode (separate mode), which is the operation mode of the QCPU redundant system, and does not support the debug mode.

4.10 Switch the Monitor Target to the Control System Using the Script Function



The following explains how to create a script screen, to be used for the MELSECNET/H or MELSECNET/10 connection (network system), or Ethernet connection, that automatically changes the monitoring target (Station No.) at the occurrence of system switching even if the Q redundant setting is not made. The script executes the station number switching function or screen switching function. The following shows the advantages and disadvantages of the station number switching function and screen switching function.

Function	Advantage	Disadvantage
Station number switching function	The monitor screens for Station No. 1 (control system) and Station No. 2 (standby system) can be created on one screen.	Some objects do not allow the station number to be switched.
Screen switching function	All objects can be used since monitor screens are created for each station number.	Monitor screens must be created separately for Station No. 1 (control system) and Station No. 2 (standby system).

The following explains how to use each function.

4.10.1 Method for using the station number switching function

- As a feature of this function, monitor screens for Station No. 1 (control system) and Station No. 2 (standby system) can be created on one screen.
- If the system switching occurs, the GOT can change the monitoring target to the control system PLC CPU on the same monitor screen.
- To achieve this, the script of the GOT monitors the special relay SM1515 (Control system identification flag) of the PLC CPU and stores the station number of the latest control system into the station number switching device.
- Restrictions: Some objects do not allow the station number to be switched.

GT Designer3 Version Screen Design Manual

■ Setting method (For MELSECNET/H connection, MELSECNET/10 connection)

System configuration example 1: MELSECNET/H connection, MELSECNET/10 connection

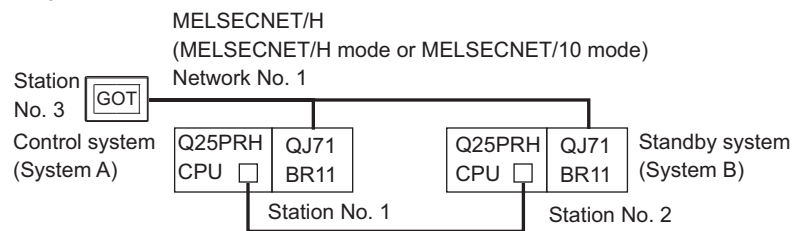

Connected module	Network No.	Station No.
MELSECNET/H network module of control system	1	1
MELSECNET/H network module of standby system		2
GOT connected to MELSECNET/H network or MELSECNET/10 network		3

1 PREPARATORY PROCEDURES FOR MONITORING
 2 DEVICE RANGE THAT CAN BE SET
 3 ACCESS RANGE FOR MONITORING
 4 HOW TO MONITOR REDUNTANT SYSTEM
 5 BUS CONNECTION
 6 DIRECT CONNECTION TO CPU
 7 COMPUTER LINK CONNECTION
 8 ETHERNET CONNECTION

1. Set the station number switching device.
 Select [Common] → [Controller Setting] → [Station No. Switching], and set the internal device GD100 as the station number switching device.
 Do not use a device of PLC CPU as a screen switching device. Since the device information is transferred by the tracking transfer function of the redundant system, the status observation may be disabled.

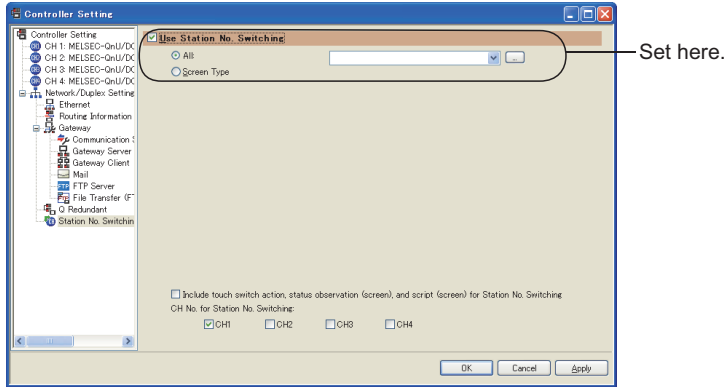

2. Set the status observation.
 Make the settings so that the station number is switched when the faulty station information (SW70) of MELSECNET/H turns ON in the project specified by selecting [Common] → [Status Observation].

Condition 1	: SW70.b0 (while ON)	← When b0 is ON, Station No. 1 is abnormal.
Operation	: GD100=2	← Station No. is changed to 2.

Condition 1	: SW70.b1 (while ON)	← When b1 is ON, Station No. 2 is abnormal.
Operation	: GD100=1	← Station No. is changed to 1.

Create the status observation in the project on the Project tab.

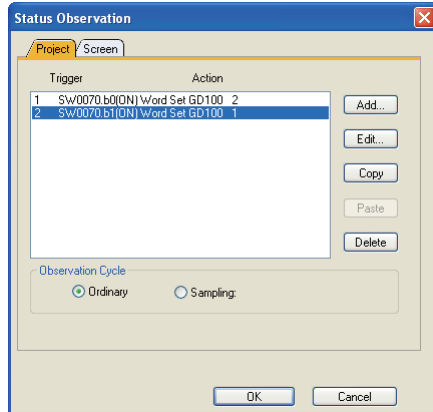

POINT

Setting for the status observation function

For the status observation function, hexadecimal cannot be used.

To use the status observation function, set the N/W No. and the station No. of the PLC CPU in [Unsigned BIN].
 (For the status observation function, set [Unsigned BIN] for [Storing Device])

Example:

When N/W No.: 1 and Station No.: 1 (0101H)

Set "257".

When N/W No.: 10 and Station No.: 10 (0A0AH)

Set "2570".

3. Create a monitor screen.
For MELSECNET/H connection, MELSECNET/10 connection or Ethernet connection: (Common)
In the device setting (network setting) of each object, set Network No. 1 and Station No. 1 of the control system.
4. Validate the station number switching function.
On the Basic tab screen specified by selecting [Screen] → [Screen Property], select the item [Switch Station No.] to validate the station number changing function.
Make this setting for each monitor screen.

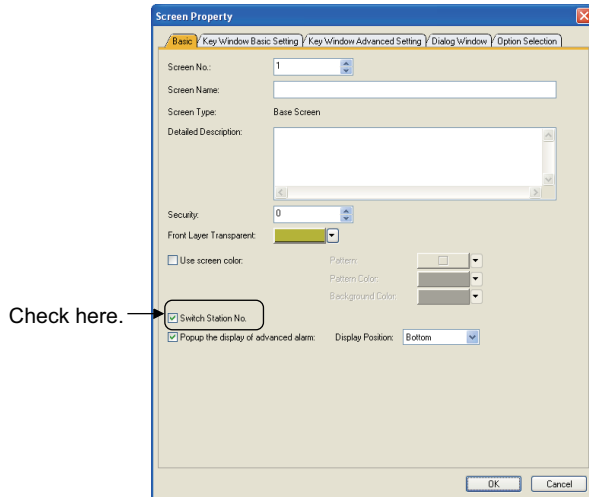

5. Change the station number switching device value in the script.
By selecting [Common] → [Script] → [Script], create a script for each monitor screen that checks the SM1515 status of the current monitor station, and if it is OFF (standby system), changes the station number switching device value.
Set the trigger type of the script as [Ordinary] or [Sampling(about 3s)].

- Screen script for MELSECNET/H connection and MELSECNET/10 connection:

```
// If the host station is not a control station, the station number is switched to that of the other station.
if([b:SM1515]==OFF){
    if([w:GD100]==1){
        [w:GD100]=2;
    }else{
        [w:GD100]=1;
    }
}
```

Set the created script for each screen on the Screen tab.

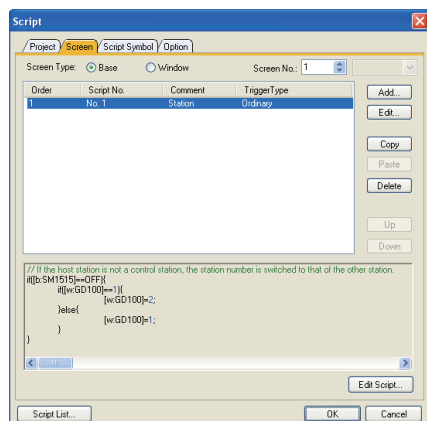



When the MELSECNET/H network is connected to the redundant system only, SW56 (current control station) can be set as the station number switching device.
In this case, even if the system switching occurs, the GOT always monitors the station number that is currently the control station.

■ Setting method (Ethernet connection)

System configuration example 2: Ethernet connection

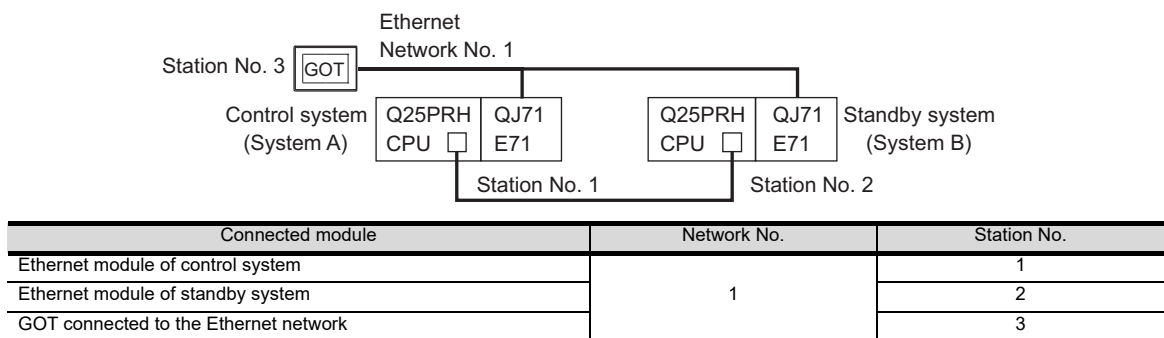

1. Set the station number switching device.
Select [Common] → [Controller Setting] → [Station No. Switching], and set the internal device GD100 as the station number switching device.
Do not use a device of PLC CPU as a screen switching device. Since the device information is transferred by the tracking transfer function of the redundant system, the status observation may be disabled.

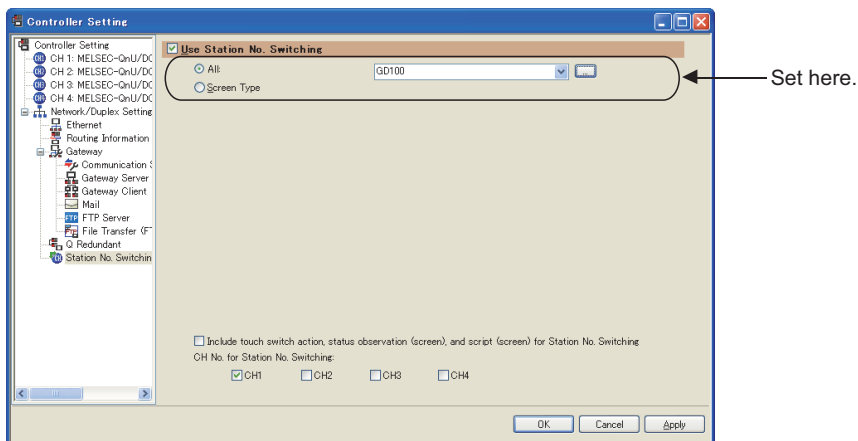

2. Set the status observation.

Make the setting so that the station number is switched when the faulty station information (GS231) from the station monitoring specified by selecting [Common] → [Status Observation] turns ON.

(For Network No. 1 and Station No. 2, set "258"(0102H))

Condition 1	: GS231.b0 (while ON)	← When b0 is ON, Station No. 1 is abnormal.
Operation	: GD100=258(0102H)	← Station No. is changed to 2.

Condition 1	: GS231.b1 (while ON)	← When b1 is ON, Station No. 2 is abnormal.
Operation	: GD100=257(0101H)	← Station No. is changed to 1.

Create the status observation in the project on the Project tab.

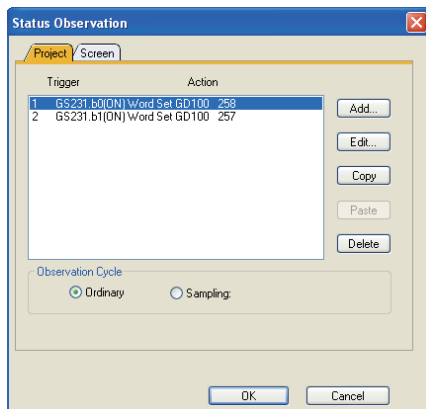

POINT

Setting for the status observation function

For the status observation function, hexadecimals cannot be used.

To use the status observation function, set the N/W No. and the station No. of the PLC CPU in [Unsigned BIN].

(For the status observation function, set [Unsigned BIN] for [Storing Device])

Example:

When N/W No.: 1 and Station No.: 1 (0101H)

Set "257".

When N/W No.: 10 and Station No.: 10 (0A0AH)

Set "2570".

3. Create a monitor screen.

For MELSECNET/H connection, MELSECNET/10 connection or Ethernet connection: (Common)

In the device setting (network setting) of each object, set Network No. 1 and Station No. 1 of the control system.

4. On the screen 1, set the switch for writing the station No. 1 to the station number switching device.
 After the GOT is started up, the station number switching device value of the GOT is "0".
 For Ethernet connection, the monitor becomes abnormal when the station number switching device value is "0".
 Therefore, set the switch for writing the station number to the station number switching device and the switch for shifting to the monitor screen on the screen 1.
 To make this setting, select [Object] → [Switch] → [Switch].

The following shows an example of setting GD100=257 (0101H: Network No. 1, Station No. 1) and base screen=2 to one switch.(Base screen 2 is the actually monitoring screen)

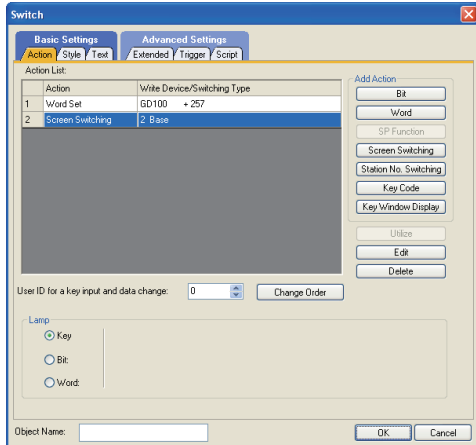

5. Validate the station number switching function.
 On the Basic tab screen specified by selecting [Screen] → [Property], select the item [Switch Station No.] to validate the station number changing function.
 Make this setting for each monitor screen.
 However, do not make this setting on the screen 1 created in the item 4. above.

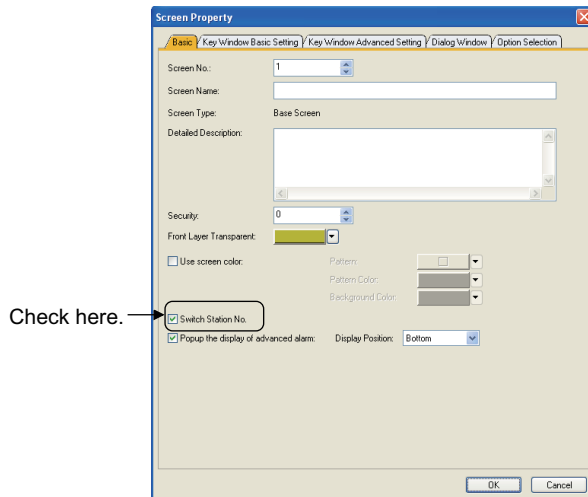

6. Change the station number switching device value in the script.
 By selecting [Common] → [Script] → [Script], create a script for each monitor screen that checks the SM1515 status of the current monitor station, and if it is OFF (standby system), changes the station number switching device value.
 Set the trigger type of the script as [Ordinary] or [Sampling(about 3s)].

- Screen script for Ethernet connection:

```
// If the host station is not a control station, the station number is switched to that of the other station.
if([b:SM1515]==OFF){
    if([w:GD100]==0x0101){                // Station No. 1 to 2
        [w:GD100]=0x0102;
    }else{                                // Station No. 2 to 1
        [w:GD100]=0x0101;
    }
}
```

For the Ethernet connection, create a script so that the network No. and station number are set to the station switching device.

For Network No. 1 and Station No. 2, create "[w:GD100]=0x0102".

Set the created script for each screen on the Screen tab.

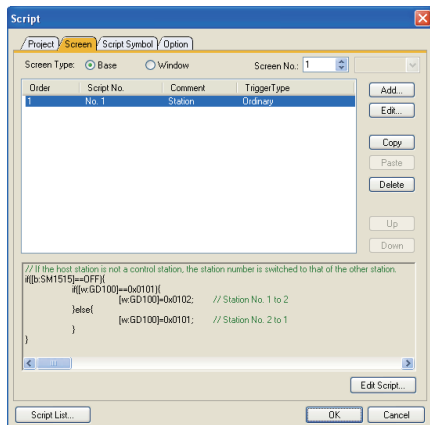

4.10.2 Method for using the screen changing function

- As a feature of this function, monitor screens are created for each station number. When the system switching occurs, the GOT can change the monitoring target to the control system PLC CPU on the other monitor screen.
- To achieve this, the script of the GOT monitors the special relay SM1515 (Control system identification flag) of the PLC CPU and stores the screen number corresponding to the latest station number of the control system into the screen switching devices.
- Precautions:
There are the following 8 different screen switching devices. Set the screen switching devices for all screens to be used.

- (1) Base screen switching device
- (2) Overlap window 1 switching device
- (3) Overlap window 2 switching device
- (4) Overlap window 3 switching device
- (5) Overlap window 4 switching device
- (6) Overlap window 5 switching device
- (7) Superimpose window 1 switching device
- (8) Superimpose window 2 switching device

■ Setting method (For MELSECNET/H connection, MELSECNET/10 connection)

System configuration example 1: MELSECNET/H connection, MELSECNET/10 connection

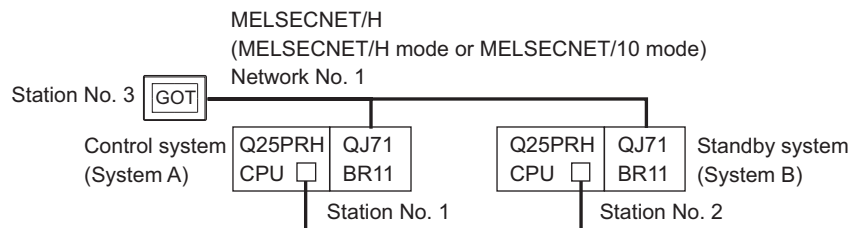

Connected module	Network No.	Station No.
MELSECNET/H network module of control system	1	1
MELSECNET/H network module of standby system		2
GOT connected to MELSECNET/H network or MELSECNET/10 network		3

1. Set the screen switching device of the base screen.
Select [Common] → [GOT Environmental Setting] → [Screen Switching/Window], and set the internal device GD100 as the base screen switching device.

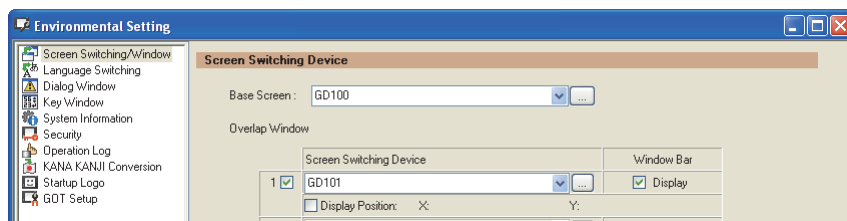

2. Set the status observation.

Set the status observation so that the station number is switched when the faulty station information (SW70) of MELSECNET/H turns ON in the project specified by choosing [Common] → [Status Observation].

Condition 1	: SW70.b0 (while ON)	← When b0 is ON, Station No. 1 is abnormal.
Operation	: GD100=2	← Screen No. is changed to 2.

Condition 1	: SW70.b1 (while ON)	← When b1 is ON, Station No. 2 is abnormal.
Operation	: GD100=1	← Screen No. is changed to 1.

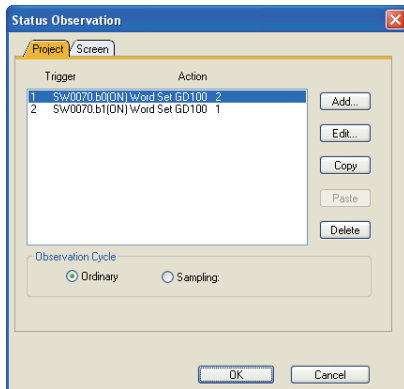

Make the setting so that the station number is switched when the faulty station information (GS231) from the station monitoring specified by selecting [Common] → [Status Observation] turns ON.

Condition 1	: GS231.b0 (while ON)	← When b0 is ON, Station No. 1 is abnormal.
Operation	: GD100=2	← Screen No. is changed to 2.

Condition 1	: GS231.b1 (while ON)	← When b1 is ON, Station No. 2 is abnormal.
Operation	: GD100=1	← Screen No. is changed to 1.

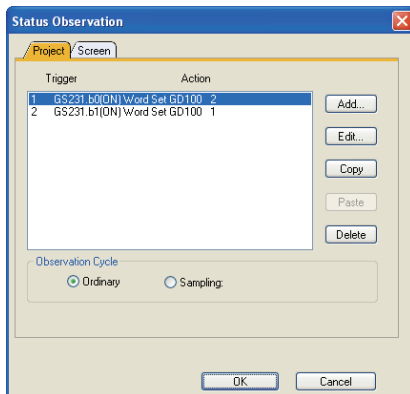

1 PREPARATORY PROCEDURES FOR MONITORING
 2 DEVICE RANGE THAT CAN BE SET
 3 ACCESS RANGE FOR MONITORING
 4 HOW TO MONITOR REDUNDANT SYSTEM
 5 BUS CONNECTION
 6 DIRECT CONNECTION TO CPU
 7 COMPUTER LINK CONNECTION
 8 ETHERNET CONNECTION

3. Set monitor screens.

For MELSECNET/H connection, MELSECNET/10 connection or Ethernet connection: (Common)

- Create a monitor screen with each object whose network setting is Station No. 1 on Screen No. 1 (1-1).
- Create a monitor screen with each object whose network setting is Station No. 2 on Screen No. 2 (1-2).

4. Change the screen switching device value in the script.

By selecting [Common] → [Script] → [Script], create a script for each monitor screen that checks the SM1515 status of the current monitor station, and if it is OFF (standby system), changes the station number switching device value.

Set the trigger type of the script as [Ordinary] or [Sampling(about 3s)].

Screen scripts for MELSECNET/H connection and MELSECNET/10 connection:

The same script can be used for MELSECNET/H connection, MELSECNET/10 connection and Ethernet connection.

```
// Script of Screen No. 1
// If Station 1 is not a control station, the screen is changed to that of Station 2.
if([1-1:b:SM1515]==OFF){
[w:GD100]=2;
}
```

```
// Script of Screen No. 2
// If Station 2 is not a control station, the screen is changed to that of Station 1.
if([1-2:b:SM1515]==OFF){
[w:GD100]=1;
}
```

Script screen of Screen No. 1

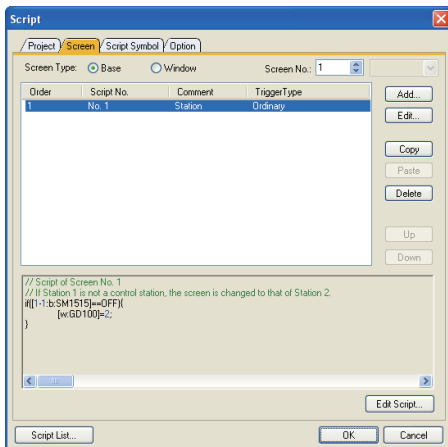

Script screen of Screen No. 2

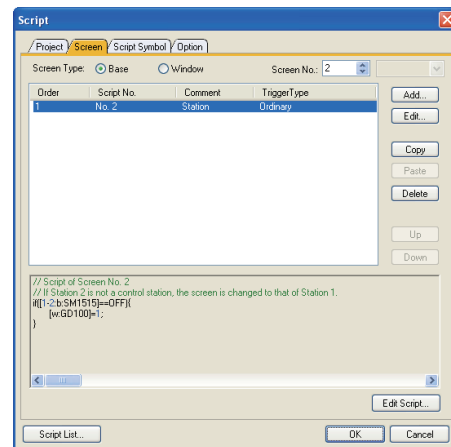

When the MELSECNET/H network is connected to the redundant system only, SW56 (current control station) can be set as the screen switching device.

In this case, even if the system switching occurs, the GOT always monitors the station number that is currently the control station.

■ Setting method (Ethernet connection)

System configuration example 2: Ethernet connection

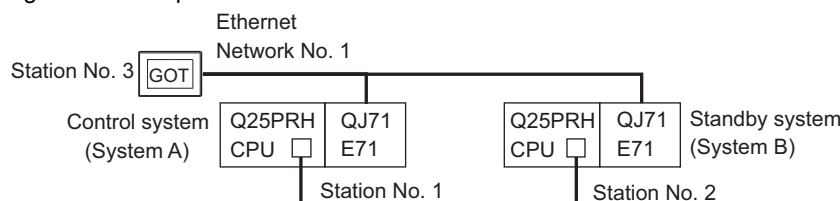

Connected module	Network No.	Station No.
Ethernet module of control system		1
Ethernet module of standby system	1	2
GOT connected to the Ethernet network		3

1. Set the screen switching device of the base screen.
Select [Common] → [GOT Environmental Setting] → [Screen Switching/Window], and set the internal device GD100 as the base screen switching device.

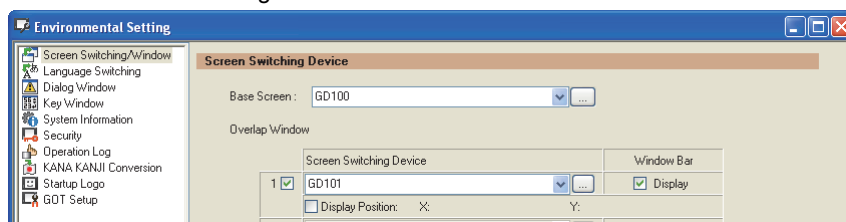

2. Set the status observation.
Make the setting so that the station number is switched when the faulty station information (GS231) from the station monitoring specified by selecting [Common] → [Status Observation] turns ON.

Condition 1	: GS231.b0 (while ON)	← When b0 is ON, Station No. 1 is abnormal.
Operation	: GD100=2	← Screen No. is changed to 2.

Condition 1	: GS231.b1 (while ON)	← When b1 is ON, Station No. 2 is abnormal.
Operation	: GD100=1	← Screen No. is changed to 1.

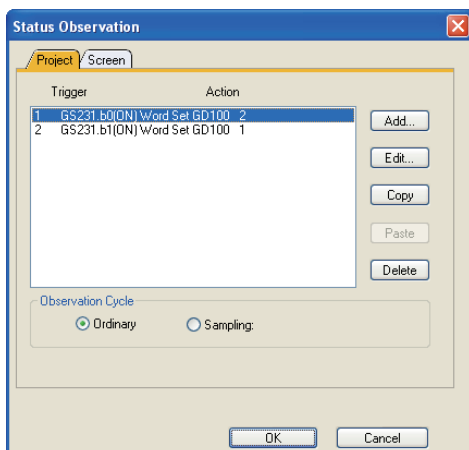

3. Set monitor screens.
For MELSECNET/H connection, MELSECNET/10 connection or Ethernet connection: (Common)
 - Create a monitor screen with each object whose network setting is Station No. 1 on Screen No. 1 (1-1).
 - Create a monitor screen with each object whose network setting is Station No. 2 on Screen No. 2 (1-2).

4. Change the screen switching device value in the script.
By selecting [Common] → [Script] → [Script], create a script for each monitor screen that checks the SM1515 status of the current monitor station, and if it is OFF (standby system), changes the station number switching device value.

Set the trigger type of the script as [Ordinary] or [Sampling(about 3s)].

Screen script for Ethernet connection:

The same script can be used for MELSECNET/H connection, MELSECNET/10 connection and Ethernet connection.

```
// Script of Screen No. 1
// If Station 1 is not a control station, the screen is changed to that of Station 2.
if([1-1:b:SM1515]==OFF){
[w:GD100]=2;
}
```

```
// Script of Screen No. 2
// If Station 2 is not a control station, the screen is changed to that of Station 1.
if([1-2:b:SM1515]==OFF){
[w:GD100]=1;
}
```

Script screen of Screen No. 1

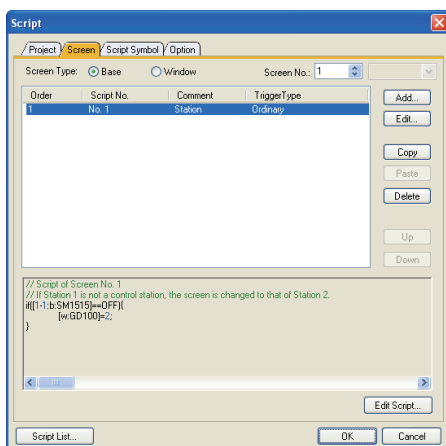

Script screen of Screen No. 2

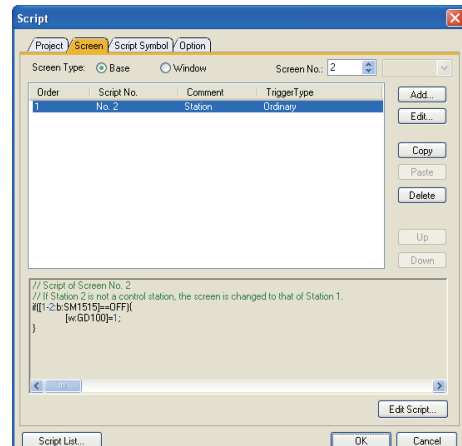

5

BUS CONNECTION



5.1	Connectable Model List	5 - 2
5.2	System Configuration	5 - 7
5.3	GOT Side Settings	5 - 32
5.4	Precautions	5 - 36

5. BUS CONNECTION

5.1 Connectable Model List

The following table shows the connectable models.

Series	Model name	Clock	Communication type	GT 16	GT 15	GT 14	GT 12	GT11 Bus	GT11 Serial	GT10 5□	GT10 30	Refer to
MELSEC iQ-R Series	R04CPU	○	Bus connection	x	x	x	x	x	x	x	x	-
	R08CPU											
	R16CPU											
	R32CPU											
	R120CPU											
	R08PCPU											
	R16PCPU											
	R32PCPU											
	R120PCPU											
	R04ENCPU											
	R08ENCPU											
	R16ENCPU											
	R32ENCPU											
	R120ENCPU											
	R08SFCPU											
	R16SFCPU											
R32SFCPU												
R120SFCPU												
Motion controller CPU (MELSEC iQ-R Series)	R16MTCPU	○	Bus connection	x	x	x	x	x	x	x	x	-
	R32MTCPU											
C Controller module (MELSEC iQ-R Series)	R12CCPU-V	○	Bus connection	x	x	x	x	x	x	x	x	-
MELSEC iQ-F Series	FX5U FX5UC	○	Bus connection	x	x	x	x	x	x	x	x	-

(Continued to next page)

Series	Model name	Clock	Communication type	GT 16	GT 15	GT 14	GT 12	GT11 Bus	GT11 Serial	GT 10□□4□	GT 10□□30	Refer to			
MELSEC-Q (Q mode) ^{*5}	Q00JCPU ^{*1}	○	Bus connection									5.2.1			
	Q00CPU ^{*2}														
	Q01CPU ^{*2}														
	Q02CPU ^{*2}														
	Q02HCPU ^{*2}														
	Q06HCPU ^{*2}														
	Q12HCPU ^{*2}														
	Q25HCPU ^{*2}														
	Q02PHCPU Q06PHCPU Q12PHCPU Q25PHCPU														
	Q12PRHCPU (Main base)	○	-									-			
	Q25PRHCPU (Main base)			×	×	×	×	×	×	×	×				
	Q12PRHCPU (Extension base)			×	×	×	×	×	×	×	×				
	Q25PRHCPU (Extension base)			×	×	×	×	×	×	×	×				
	Q00UJCPU ^{*1}	○	Bus connection										5.2.1		
Q00UCPU Q01UCPU Q02UCPU Q03UDCPU															
Q04UDHCPU Q06UDHCPU Q10UDHCPU Q13UDHCPU Q20UDHCPU Q26UDHCPU															
Q03UDECPU Q04UDEHCPU Q06UDEHCPU Q10UDEHCPU Q13UDEHCPU Q20UDEHCPU Q26UDEHCPU Q50UDEHCPU Q100UDEHCPU															
Q03UDVCPU Q04UDVCPU Q06UDVCPU Q13UDVCPU Q26UDVCPU															
C Controller module (Q Series)	Q12DCCPU-V ^{*4} Q24DHCCPU-V/VG Q24DHCCPU-LS			○	Bus connection										5.2.1
	Q26DHCCPU-LS					○	×	○	×	×	×	○		○	
	MELSEC-QS			QS001CPU	○	-	×	×	×	×	×	×		×	×

(Continued to next page)

- *1 When using the bus extension connector box, attach it to the extension base unit. (Connecting it to the main base unit is not allowed.)
- *2 For the multiple CPU system configuration, use CPU function version B or later.
- *3 Only GT115□-Q□BDQ can be connected.
- *4 Use a module with the upper five digits later than 12042.
- *5 When a slim base is used, a bus connection cannot be established.

1 PREPARATORY PROCEDURES FOR MONITORING
 2 DEVICE RANGE THAT CAN BE SET
 3 ACCESS RANGE FOR MONITORING
 4 HOW TO MONITOR REDUNDANT SYSTEM
 5 BUS CONNECTION
 6 DIRECT CONNECTION TO CPU
 7 COMPUTER LINK CONNECTION
 8 ETHERNET CONNECTION

Series	Model name	Clock	Communication type	GT 16	GT 15	GT 14	GT 12	GT11 Bus	GT11 Serial	GT10 5□4□	GT10 20□30□	Refer to
MELSEC-L	L02CPU	○	-	×	×	×	×	×	×	×	×	-
	L06CPU											
	L26CPU											
	L26CPU-BT											
	L02CPU-P											
	L06CPU-P											
	L26CPU-P											
	L26CPU-PBT											
	L02SCPU											
	L02SCPU-P											
MELSEC-Q (A mode)	Q02CPU-A	○	-	×	×	×	×	×	×	×	×	-
	Q02HCPU-A											
	Q06HCPU-A											
MELSEC-QnA (QnACPU)	Q2ACPU	○	Bus connection	○	○	×	×	○*1	×	×	×	☞ 5.2.2
	Q2ACPU-S1											
	Q3ACPU											
	Q4ACPU											
	Q4ARCPU*2											
MELSEC-QnA (QnASCPU)	Q2ASCPU	○	Bus connection	○	○	×	×	○*1	×	×	×	☞ 5.2.3
	Q2ASCPU-S1											
	Q2ASHCPU											
	Q2ASHCPU-S1											
MELSEC-A (AnCPU)	A2UCPU	○	Bus connection	○	○	×	×	○*1	×	×	×	☞ 5.2.2
	A2UCPU-S1											
	A3UCPU											
	A4UCPU											
	A2ACPU											
	A2ACPUP21											
	A2ACPUR21											
	A2ACPU-S1											
	A2ACPUP21-S1											
	A2ACPUR21-S1											
	A3ACPU											
	A3ACPUP21											
	A3ACPUR21											
	A1NCPUR21											
	A1NCPUP21											
	A2NCPUR21											
	A2NCPUP21											
	A2NCPUR21											
	A2NCPUR21											
	A2NCPUR21-S1											
	A2NCPUP21-S1											
	A2NCPUR21-S1											
	A3NCPUR21											
A3NCPUP21												
A3NCPUR21												
MELSEC-A (AnSCPU)	A2USCPU	○	Bus connection	○	○	×	×	○*1	×	×	×	☞ 5.2.3
	A2USCPU-S1											
	A2USHCPU-S1											
	A1SCPU											
	A1SCPUC24-R2											
	A1SHCPU											
	A2SCPU											
	A2SCPU-S1											
	A2SHCPU											
	A2SHCPU-S1											
	A1SJCPU*3											
	A1SJCPU-S3*3											
	A1SJHCPU*3											
	MELSEC-A											
A0J2HCPUP21												

(Continued to next page)

*1 Only GT115□-Q□BDA can be connected.

*2 Bus-connect the GOT on the last redundant extension base A68RB (version B or later) for the Q4ARCPU redundant system.

*3 When an extension base unit is connected, a bus connection cannot be established.

Series	Model name	Clock	Communication type	GT 16	GT 15	GT 14	GT 12	GT11 Bus	GT11 Serial	GT 10 5□	GT 10 20 30	Refer to
MELSEC-A	A0J2HCPUR21	×	Bus connection	○	○	×	×	○*1	×	×	×	☞ 5.2.4
	A0J2HCPU-DC24			○	○	×	×	○*1	×	×	×	
	A2CCPU	○	-	×	×	×	×	×	×	×	×	-
	A2CCPUP21											
	A2CCPUR21											
	A2CCPUC24											
	A2CCPUC24-PRF											
A2CJCPU-S3												
A1FXCPU												
Motion controller CPU (Q Series)	Q172CPU*3*4	○	Bus connection	○	○	×	×	○*2	×	×	×	☞ 5.2.1
	Q173CPU*3*4											
	Q172CPUN*3											
	Q173CPUN*3											
	Q172HCPU											
	Q173HCPU											
	Q172DCPU											
	Q173DCPU											
	Q172DCPU-S1											
	Q173DCPU-S1											
	Q172DSCPU											
	Q173DSCPU											
	Q170MCPUS*5											
	Q170MSCPU*7											
Q170MSCPU-S1*7												
MR-MQ100	○	-	×	×	×	×	×	×	×	×	-	
Motion controller CPU (A Series)	A273UCPU	○	Bus connection	○	○	×	×	○*1	×	×	×	☞ 5.2.5
	A273UHCPU											
	A273UHCPU-S3											
	A373UCPU											
	A373UCPU-S3	○	Bus connection	○	○	×	×	○*1	×	×	×	☞ 5.2.6
	A171SCPU*6											
	A171SCPU-S3*6											
	A171SCPU-S3N*6											
	A171SHCPU*6											
	A171SHCPUN*6											
	A172SHCPU*6											
	A172SHCPUN*6											
	A173UHCPU*6											
A173UHCPU-S1*6												
MELSEC-WS	WS0-CPU0	×	-	×	×	×	×	×	×	×	-	
WS0-CPU1												
WS0-CPU3												
MELSECNET/H Remote I/O station	QJ72LP25-25	×	-	×	×	×	×	×	×	×	-	
QJ72LP25G												
QJ72BR15												
CC-Link IE Field Network head module	LJ72GF15-T2	×	-	×	×	×	×	×	×	×	×	-
CC-Link IE Field Network Ethernet adapter module	NZ2GF-ETB9	×	-	×	×	×	×	×	×	×	×	-
CNC C70	Q173NCCPU	○	Bus connection	○	○	×	×	○*2	×	×	×	☞ 5.2.1
Robot controller	CRnQ-700 (Q172DRCPU)	○	Bus connection	○	○	×	×	○*2	×	×	×	☞ 5.2.1
	CR750-Q (Q172DRCPU)											
	CR751-Q (Q172DRCPU)											

*1 Only GT115□-Q□BDA can be connected.

*2 Only GT115□-Q□BDQ can be connected.

*3 When using SV13, SV22, or SV43, use the motion controller CPU on which any of the following main OS version is installed.

• SW6RN-SV13Q□: 00E or later

• SW6RN-SV22Q□: 00E or later

• SW6RN-SV43Q□: 00B or later

*4 Use main modules with the following product numbers.

• Q172CPU: Product number K***** or later

• Q173CPU: Product number J***** or later

*5 Connect Q170MCPUS to QC30B directly, or to the extension base unit (Q52B/Q55B).

*6 When using an extension base, use the A168.

*7 Connect Q170MSCPU to QC30B directly, or to the extension base unit (Q5□B/Q6□B).

1 PREPARATORY PROCEDURES FOR MONITORING
2 DEVICE RANGE THAT CAN BE SET
3 ACCESS RANGE FOR MONITORING
4 HOW TO MONITOR REDUNDANT SYSTEM
5 BUS CONNECTION
6 DIRECT CONNECTION TO CPU
7 COMPUTER LINK CONNECTION
8 ETHERNET CONNECTION

POINT

List of the main base or extension base available for the GOT bus connection

○: The GOT bus connection is available. ×: The GOT bus connection is not available.

Main/Extension base	Model	GOT bus connection
Main base	Q3□B	○
	Q3□DB (Multiple CPU high speed main base unit)	○
	Q3□BL (Large type base unit)	○
	Q3□SB (Slim type main base unit)	×
	Q38RB (Redundant power main base unit)	×
Extension base	Q5□B (Model requiring no power supply module)	○
	Q6□B (Model requiring a power supply module)	○
	QA1S6□B (Small type QA base unit)	○
	Q5□BL (Large type base unit, Model requiring no power supply module)	×
	Q6□BL (Large type base unit, Model requiring a power supply module)	○
	QA6□B (Large type QA base unit)	×
	QA6ADP (QA conversion adapter module) + A5□B/A6□B	×
	Q68RB (Redundant power extension base unit)	×
	Q65WRB (Redundant extension base unit)	×

5.2 System Configuration

POINT

When "CONTROL BUS ERR" or "UNIT VERIFY ERR" occurs

It can be considered that noise due to a long bus connection cable causes a malfunction.

Check whether a signal line such as bus cable is placed near the equipment to operate. If the line is close to the equipment, make a distance of 100mm or more from the equipment.

5.2.1 Connecting to QCPU

■ When one GOT is connected

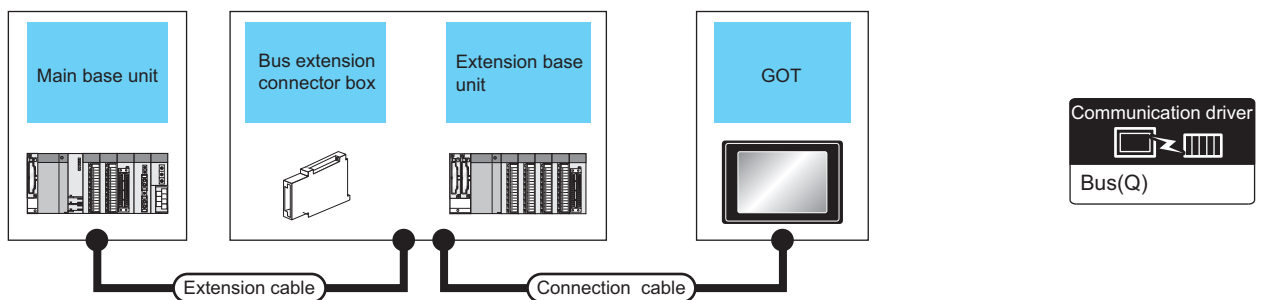

PLC					Connection cable	GOT		Max. distance
Main base		Extension cable*1	Extension base			Option device*4	Model	
Main base	Bus extension connector box*2		Extension base	Bus extension connector box*2				
Main base	-	-	-	-	GT15-QC06B(0.6m) GT15-QC12B(1.2m) GT15-QC30B(3m) GT15-QC50B(5m) GT15-QC100B(10m)	GT15-75QBUSL GT15-75QBUS2L GT15-QBUS GT15-QBUS2	GT16 GT15	Between main base and GOT: 13.2m (Including the extension cable length)
	-	Extension cable (13.2m or less)	Extension base	-	- (Built into GOT)	- (Built into GOT)	GT11 Bus	
	A9GT-QCNB*3	-	-	-	GT15-QC06B(0.6m) GT15-QC12B(1.2m) GT15-QC30B(3m) GT15-QC50B(5m) GT15-QC100B(10m) GT15-QC150BS(15m) GT15-QC200BS(20m) GT15-QC250BS(25m) GT15-QC300BS(30m) GT15-QC350BS(35m)	GT15-75QBUSL GT15-75QBUS2L GT15-QBUS GT15-QBUS2	GT16 GT15	Between main base and GOT: 37m (Including the extension cable length)
	-	Extension cable (13.2m or less)	Extension base	A9GT-QCNB	- (Built into GOT)	- (Built into GOT)	GT11 Bus	

*1 For the extension cables, refer to the MELSEC-Q catalog (L(NA)08032).

*2 When installing the GOT 13.2m or more away from the main base unit, the bus extension connector box is required.

Attach the bus extension connector box to the extension connector of the base unit.

Also, connect the connection cable to the bus extension connector box.

When using no extension base unit: Attach it to the main base unit.

When using the extension base unit: Attach it to the extension base unit on the last stage.

*3 When using Q00JCPU or Q00UJCPU, attach the bus extension connector to the extension base unit. (Connecting it to the main base unit is not allowed)

*4 When using the following functions, use GT15-QBUS(2). GT15-75QBUS(2)L cannot be used.

Used for remote personal computer operation (serial), video display function, multimedia function, operation panel function, external I/O function, RGB display function, report function (when using a PictBridge compatible printer), hard copy function (when using a PictBridge compatible printer), sound output function, functions with the CF card unit or CF card extension unit, Ethernet download, gateway function or MES interface function

However, Ethernet download, gateway function and MES interface function can be used for GT16 by using the Ethernet interface.

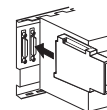

■ When 2 to 5 GOTs are connected

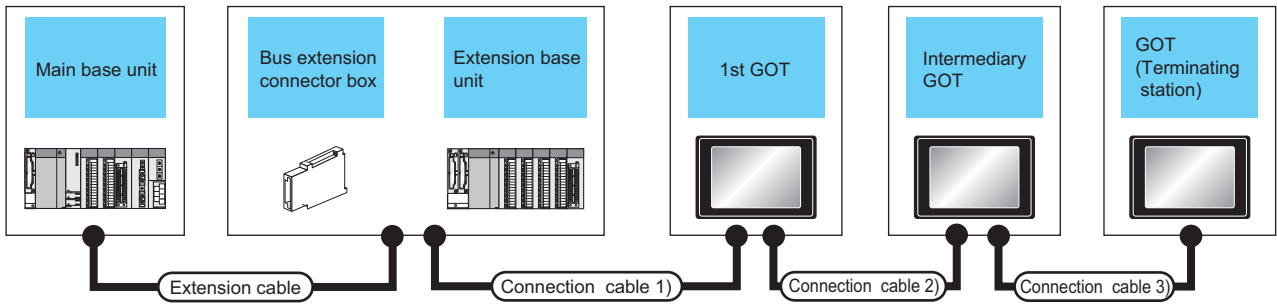

PLC					Connection cable 1)	GOT (1st) ^{*5}		
Main base		Extension cable *1	Extension base			Option device *6*7	Model	
Main base	Bus extension connector box ^{*2}		Extension base	Bus extension connector box ^{*2}				
Main base	-	-	-	-	GT15-QC06B(0.6m) GT15-QC12B(1.2m) GT15-QC30B(3m) GT15-QC50B(5m) GT15-QC100B(10m)	GT15-75QBUS2L GT15-QBUS2	GT16 GT15	
	-	Extension cable (13.2m or less)	Extension base	-		GT15-75QBUS2L GT15-QBUS2	GT16 GT15	
	A9GT-QCNB ^{*3}	-	-	-		GT15-QC06B(0.6m) GT15-QC12B(1.2m) GT15-QC30B(3m) GT15-QC50B(5m) GT15-QC100B(10m) GT15-QC150BS(15m) GT15-QC200BS(20m) GT15-QC250BS(25m) GT15-QC300BS(30m) GT15-QC350BS(35m)	GT15-75QBUS2L GT15-QBUS2	GT16 GT15
	-	Extension cable (13.2m or less)	Extension base	A9GT-QCNB			GT15-75QBUS2L GT15-QBUS2	GT16 GT15

*1 For the extension cables, refer to the MELSEC-Q catalog (L(NA)08032).

*2 When installing the GOT 13.2m or more away from the main base unit, the bus extension connector box is required.

Attach the bus extension connector box to the extension connector of the base unit.
 When using no extension base unit: Attach it to the main base unit.
 When using the extension base unit: Attach it to the extension base unit on the last stage.
 Also, connect the connection cable to the bus extension connector box.
 Set the bus extension connector box to the same Stage No. as that of the GOT unit.
 For details on the Stage No. setting, refer to the following.

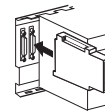

5.3.1 Setting communication interface (Communication settings)

*3 When using Q00JCPU or Q00UJCPU, attach the bus extension connector to the extension base unit. (Connecting it to the main base unit is not allowed)

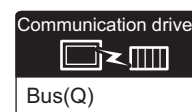

Connection cable 2)	GOT (intermediary)*4*5		Connection cable 3)	GOT (terminal)*4*5		Max. distance	
	Option device *6*7	Model		Option device *6*7	Model		
GT15-QC06B(0.6m) GT15-QC12B(1.2m) GT15-QC30B(3m) GT15-QC50B(5m) GT15-QC100B(10m) GT15-QC150BS(15m) GT15-QC200BS(20m) GT15-QC250BS(25m) GT15-QC300BS(30m) GT15-QC350BS(35m)	GT15-75QBUS2L, GT15-QBUS2	 	GT15-QC06B(0.6m) GT15-QC12B(1.2m) GT15-QC30B(3m) GT15-QC50B(5m) GT15-QC100B(10m) GT15-QC150BS(15m) GT15-QC200BS(20m) GT15-QC250BS(25m) GT15-QC300BS(30m) GT15-QC350BS(35m)	GT15-75QBUSL, GT15-75QBUS2L, GT15-QBUS, GT15-QBUS2	 	Between main base and GOT (1st): 13.2m	
				- (Built into GOT)		Between main base and GOT (terminal): 37m	
	GT15-75QBUS2L, GT15-QBUS2	 		GT15-75QBUSL, GT15-75QBUS2L, GT15-QBUS, GT15-QBUS2	 	Between main base and GOT (1st): 13.2m (Including the extension cable length)	
	- (Built into GOT)			Between main base and GOT (terminal): 37m (Including the extension cable length)			
	GT15-75QBUS2L, GT15-QBUS2	 		GT15-75QBUSL, GT15-75QBUS2L, GT15-QBUS, GT15-QBUS2	 	Between main base and GOT (terminal): 37m	
				- (Built into GOT)			
	GT15-75QBUS2L, GT15-QBUS2	 			GT15-75QBUSL, GT15-75QBUS2L, GT15-QBUS, GT15-QBUS2	 	Between main base and GOT (terminal): 37m (Including the extension cable length)
					- (Built into GOT)		

*4 When connecting 3 or more GOTs, the overall cable length is restricted.

5.4.12 When connecting multiple GOTs

*5 The connection of multiple GOTs

When connecting to multiple GOTs with GT 16, GT15 and GT11 mixed, use GT11 as a terminal.

*6 The bus connection unit

GT15-75QBUSL, GT15-QBUS: Used for a terminal GOT. (Not available for an intermediary GOT)

GT15-75QBUS2L, GT15-QBUS2: Used for an intermediary GOT. (Can be used for a terminal GOT)

*7 When using the following functions, use GT15-QBUS(2). GT15-75QBUS(2)L cannot be used.

Used for remote personal computer operation (serial), video display function, multimedia function, operation panel function, external I/O function, RGB display function, report function (when using a PictBridge compatible printer), hard copy function (when using a PictBridge compatible printer), sound output function, functions with the CF card unit or CF card extension unit, Ethernet download, gateway function or MES interface function

However, Ethernet download, gateway function and MES interface function can be used for GT16 by using the Ethernet interface.

1 PREPARATORY PROCEDURES FOR MONITORING
2 DEVICE RANGE THAT CAN BE SET
3 ACCESS RANGE FOR MONITORING
4 HOW TO MONITOR REDUNDANT SYSTEM
5 BUS CONNECTION
6 CONNECTION TO CPU
7 COMPUTER LINK CONNECTION
8 ETHERNET CONNECTION

5.2.2 Connecting to QnACPU or AnCPU

■ When one GOT is connected

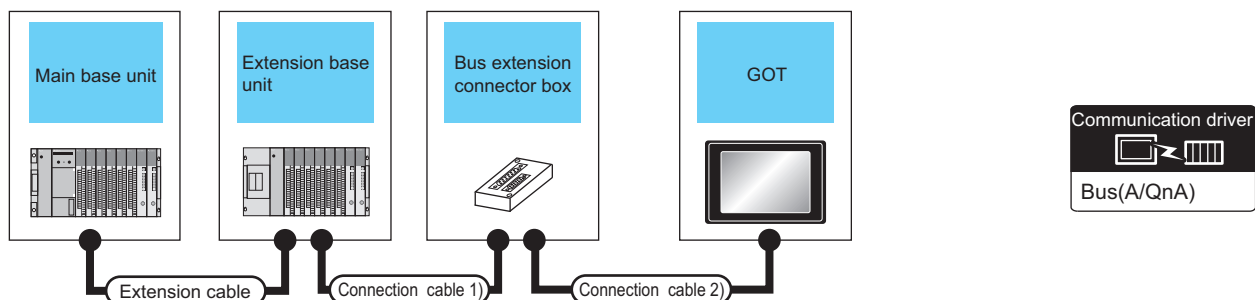

PLC					Connection cable 2)	GOT		Max. distance
Main base	Extension cable *1	Extension base	Connection cable 1)	Bus connector conversion box *2		Option device	Model	
Main base	-	-	-	-	GT15-C12NB(1.2m) GT15-C30NB(3m) GT15-C50NB(5m)	GT15-75ABUSL GT15-75ABUS2L GT15-ABUS GT15-ABUS2	GT16 GT15	Between main base and GOT: 6.6m
	-	-	-	-	- (Built into GOT)	GT11 Bus		
Main base	-	-	GT15-AC06B(0.6m) GT15-AC12B(1.2m) GT15-AC30B(3m) GT15-AC50B(5m)	A7GT -CNB	GT15-C100EXSS-1(10m) GT15-C200EXSS-1(20m) GT15-C300EXSS-1(30m) *3	GT15-75ABUSL GT15-75ABUS2L GT15-ABUS GT15-ABUS2	GT16 GT15	Between main base and GOT: 36.6m (Including between main base and bus connector conversion box)
	-	-	-	-	-	- (Built into GOT)	GT11 Bus	Between main base and bus connector conversion box: 6.6m
Main base	Extension cable	Extension base	-	-	GT15-C12NB(1.2m) GT15-C30NB(3m) GT15-C50NB(5m)	GT15-75ABUSL GT15-75ABUS2L GT15-ABUS GT15-ABUS2	GT16 GT15	Between main base and GOT: 6.6m (Including the extension cable length)
						- (Built into GOT)	GT11 Bus	
Main base	Extension cable	Extension base	GT15-AC06B(0.6m) GT15-AC12B(1.2m) GT15-AC30B(3m) GT15-AC50B(5m)	A7GT -CNB	GT15-C100EXSS-1(10m) GT15-C200EXSS-1(20m) GT15-C300EXSS-1(30m)	GT15-75ABUSL GT15-75ABUS2L GT15-ABUS GT15-ABUS2	GT16 GT15	Between main base and GOT: 36.6m
						- (Built into GOT)	GT11 Bus	Between main base and bus connector conversion box: 6.6m (Including the extension cable length)

*1 For the extension cables, refer to MELSEC-A/QnA catalog (L(NA)08024).

*2 When installing the GOT 6.6m or more away from the main base unit, the bus connector conversion box is required.

*3 When using GT15-C□EXSS-1, follow the precautions below.

☞ 5.4.1 GT15-C [] EXSS-1, GT15-C [] BS

*4 When using the following functions, use GT15-ABUS(2). GT15-75ABUS(2)L cannot be used.

Used for remote personal computer operation (serial), video display function, multimedia function, operation panel function, external I/O function, RGB display function, report function (when using a PictBridge compatible printer), hard copy function (when using a PictBridge compatible printer), sound output function, functions with the CF card unit or CF card extension unit, Ethernet download, gateway function or MES interface function
However, Ethernet download, gateway function and MES interface function can be used for GT16 by using the Ethernet interface.

■ When 2 to 3 GOTs are connected

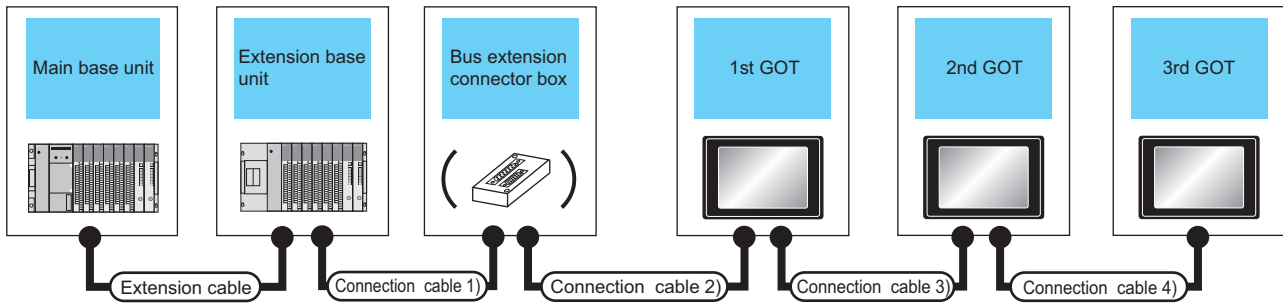

PLC ^{*5}					Connection cable 2)	GOT (1st) ^{*3}	
Main base	Extension cable ^{*1}	Extension base	Connection cable 1)	Bus connector conversion box ^{*2}		Option device ^{*6*7}	Model
Main base	-	-	-	-	GT15-C12NB(1.2m) GT15-C30NB(3m) GT15-C50NB(5m)	GT15-75ABUS2L GT15-ABUS2	GT16 GT15
	Extension cable	Extension base	-	-		GT15-75ABUS2L GT15-ABUS2	GT16 GT15
	-	-	GT15-AC06B(0.6m) GT15-AC12B(1.2m) GT15-AC30B(3m) GT15-AC50B(5m)	A7GT-CNB	GT15-C100EXSS-1(10m) GT15-C200EXSS-1(20m) ^{*4}	GT15-75ABUS2L GT15-ABUS2	GT16 GT15
	Extension cable	Extension base				GT15-75ABUS2L GT15-ABUS2	GT16 GT15
Main base	-	-	-	-	GT15-C12NB(1.2m) GT15-C30NB(3m) GT15-C50NB(5m)	GT15-75ABUS2L GT15-ABUS2	GT16 GT15
	Extension cable	Extension base	-	-		GT15-75ABUS2L GT15-ABUS2	GT16 GT15

*1 For the extension cables, refer to MELSEC-A/QnA catalog (L(NA)08024).

*2 When installing the GOT 6.6m or more away from the main base unit, the bus connector conversion box is required.

*3 When connecting to multiple GOTs with GT 16, GT15 and GT11 mixed, use GT11 as a terminal.

*4 When using GT15-C□EXSS-1 or GT15-C□BS, connect as following precautions.

☞ 5.4.1 GT15-C [] EXSS-1, GT15-C [] BS

*5 The number of connectable GOTs is restricted according to the CPU type and the number of intelligent function modules.

☞ 5.4.12 When connecting multiple GOTs

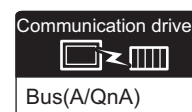

Connection cable 3)	GOT (2nd) ^{*3*5}		Connection cable 4)	GOT (3rd) ^{*3*5}		Max. distance
	Option device ^{*6*7}	Model		Option device ^{*6*7}	Model	
GT15-C07BS(0.7m) GT15-C12BS(1.2m) GT15-C30BS(3m) GT15-C50BS(5m) GT15-C100BS(10m) GT15-C200BS(20m) GT15-C300BS(30m) ^{*4}	GT15-75ABUSL GT15-75ABUS2L GT15-ABUS GT15-ABUS2	 	-	-	-	Between main base and GOT(1st): 6.6m (Including the extension cable length) Between GOT (1st) and GOT (2nd): 30m Between main base and GOT (2nd): 36.6m (Including the extension cable length)
	GT15-75ABUSL GT15-75ABUS2L GT15-ABUS GT15-ABUS2	 				Between main base and bus connector conversion box: 6.6m (Including the extension cable length) Between bus connector conversion box and GOT (2nd): 30m Between main base and GOT (2nd): 36.6m (Including the extension cable length)
GT15-C07BS(0.7m) GT15-C12BS(1.2m) GT15-C30BS(3m) GT15-C50BS(5m) GT15-C100BS(10m) GT15-C200BS(20m) ^{*4}	GT15-75ABUSL GT15-75ABUS2L GT15-ABUS GT15-ABUS2	 	-	-	-	Between main base and bus connector conversion box: 6.6m (Including the extension cable length) Between bus connector conversion box and GOT (2nd): 30m Between main base and GOT (2nd): 36.6m (Including the extension cable length)
	GT15-75ABUSL GT15-75ABUS2L GT15-ABUS GT15-ABUS2	 				Between main base and bus connector conversion box: 6.6m (Including the extension cable length) Between bus connector conversion box and GOT (2nd): 30m Between main base and GOT (2nd): 36.6m (Including the extension cable length)
GT15-C07BS(0.7m) GT15-C12BS(1.2m) GT15-C30BS(3m) GT15-C50BS(5m) GT15-C100BS(10m) GT15-C200BS(20m) ^{*4}	GT15-75ABUS2L GT15-ABUS2	 	GT15-C07BS(0.7m) GT15-C12BS(1.2m) GT15-C30BS(3m) GT15-C50BS(5m) GT15-C100BS(10m) GT15-C200BS(20m) ^{*4}	GT15-75ABUSL GT15-75ABUS2L GT15-ABUS GT15-ABUS2	 	Between main base and GOT(1st): 6.6m (Including the extension cable length)
	GT15-75ABUS2L GT15-ABUS2	 		- (Built into GOT)		Between GOT (1st) and GOT (3rd): 30m
				GT15-75ABUSL GT15-75ABUS2L GT15-ABUS GT15-ABUS2	 	Between main base and GOT (3rd): 36.6m (Including the extension cable length)
				- (Built into GOT)		

^{*6} About the bus connection unit

GT15-75ABUSL, GT15-ABUS: Used for a terminal GOT. (Not available for an intermediary GOT)
 GT15-75ABUS2L, GT15-ABUS2: Used for an intermediary GOT. (Can be used for a terminal GOT)

^{*7} When using the following functions, use GT15-ABUS(2). GT15-75ABUS(2)L cannot be used.

Used for remote personal computer operation (serial), video display function, multimedia function, operation panel function, external I/O function, RGB display function, report function (when using a PictBridge compatible printer), hard copy function (when using a PictBridge compatible printer), sound output function, functions with the CF card unit or CF card extension unit, Ethernet download, gateway function or MES interface function

However, Ethernet download, gateway function and MES interface function can be used for GT16 by using the Ethernet interface.

1
PREPARATORY PROCEDURES FOR MONITORING

2
DEVICE RANGE THAT CAN BE SET

3
ACCESS RANGE FOR MONITORING

4
HOW TO MONITOR REDUNDANT SYSTEM

5
BUS CONNECTION

6
DIRECT CONNECTION TO CPU

7
COMPUTER LINK CONNECTION

8
ETHERNET CONNECTION

5.2.3 Connection to QnASCPU or AnSCPU

■ When one GOT is connected

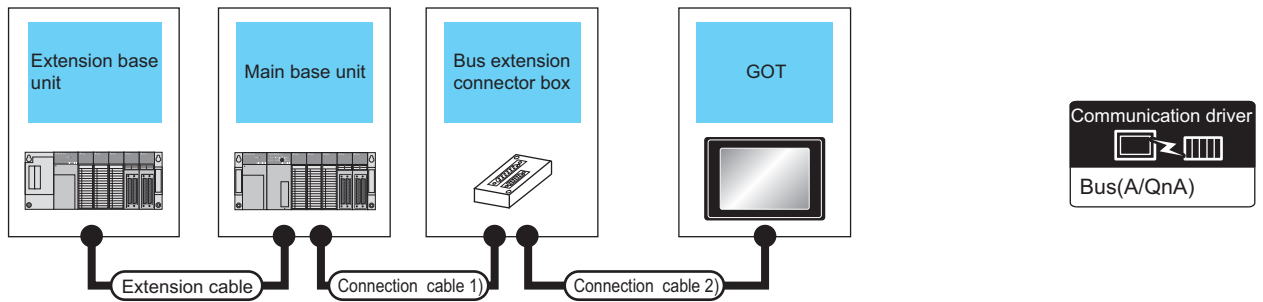

PLC					Connection cable 2)	GOT		Max. distance
Extension base	Extension cable *1	Main base	Connection cable 1)	Bus connector conversion box *2		Option device *4	Model	
-	-	Main base	-	-	GT15-A1SC07B(0.7m) GT15-A1SC12B(1.2m) GT15-A1SC30B(3m) GT15-A1SC50B(5m)	GT15-75ABUSL GT15-75ABUS2L GT15-ABUS GT15-ABUS2	GT16 GT15	Between main base and GOT: 5m
						-(Built into GOT)	GT11 Bus	
			-	-	Main base	-	-	GT15-C100EXSS-1(10m) GT15-C200EXSS-1(20m) GT15-C300EXSS-1(30m) *3
-(Built into GOT)	GT11 Bus							
-	-	Main base	GT15-A1SC05NB(0.45m) GT15-A1SC07NB(0.7m) GT15-A1SC30NB(3m) GT15-A1SC50NB(5m)	A7GT -CNB	GT15-C100EXSS-1(10m) GT15-C200EXSS-1(20m) GT15-C300EXSS-1(30m) *3	GT15-75ABUSL GT15-75ABUS2L GT15-ABUS GT15-ABUS2	GT16 GT15	Between main base and GOT: 35m (Including between main base and bus connector conversion box)
						-(Built into GOT)	GT11 Bus	Between main base and bus connector conversion box: 5m

PLC					GOT		Max. distance	
Extension base	Extension cable *1	Main base	Connection cable 1)	Bus connector conversion box *2	Connection cable 2)	Option device *4		Model
Extension base	Extension cable	Main base	-	-	GT15-A1SC07B(0.7m) GT15-A1SC12B(1.2m) GT15-A1SC30B(3m) GT15-A1SC50B(5m)	GT15-75ABUSL GT15-75ABUS2L GT15-ABUS GT15-ABUS2 - (Built into GOT)	 	Between extension base and GOT: 6m (Including the extension cable length)
			-	-	GT15-C100EXSS-1(10m) GT15-C200EXSS-1(20m) GT15-C300EXSS-1(30m) *3	GT15-75ABUSL GT15-75ABUS2L GT15-ABUS GT15-ABUS2 - (Built into GOT)	 	Between extension base and GOT: 36m (Including the extension cable length)
			GT15-A1SC05NB(0.45m) GT15-A1SC07NB(0.7m) GT15-A1SC30NB(3m) GT15-A1SC50NB(5m)	A7GT -CNB	GT15-C100EXSS-1(10m) GT15-C200EXSS-1(20m) GT15-C300EXSS-1(30m) *3	GT15-75ABUSL GT15-75ABUS2L GT15-ABUS GT15-ABUS2 - (Built into GOT)	 	Between extension base and GOT: 36m Between extension base and bus connector conversion box: 6m (Including the extension cable length)

*1 For details on the extension cables, refer to the MELSEC-A/QnA catalog (L(NA)8024).

*2 When installing the GOT 30m or more away from the main base unit, the bus connector conversion box is required.

*3 When using GT15-C□EXSS-1, connect as the following precautions.

5.4.1 GT15-C [] EXSS-1, GT15-C [] BS

*4 When using the following functions, use GT15-ABUS(2). GT15-75ABUS(2)L cannot be used.

Used for remote personal computer operation (serial), video display function, multimedia function, operation panel function, external I/O function, RGB display function, report function (when using a PictBridge compatible printer), hard copy function (when using a PictBridge compatible printer), sound output function, functions with the CF card unit or CF card extension unit, Ethernet download, gateway function or MES interface function
However, Ethernet download, gateway function and MES interface function can be used for GT16 by using the Ethernet interface.

1 PREPARATORY PROCEDURES FOR MONITORING
2 DEVICE RANGE THAT CAN BE SET
3 ACCESS RANGE FOR MONITORING
4 HOW TO MONITOR REDUNDANT SYSTEM
5 BUS CONNECTION
6 DIRECT CONNECTION TO CPU
7 COMPUTER LINK CONNECTION
8 ETHERNET CONNECTION

■ When two GOTs are connected

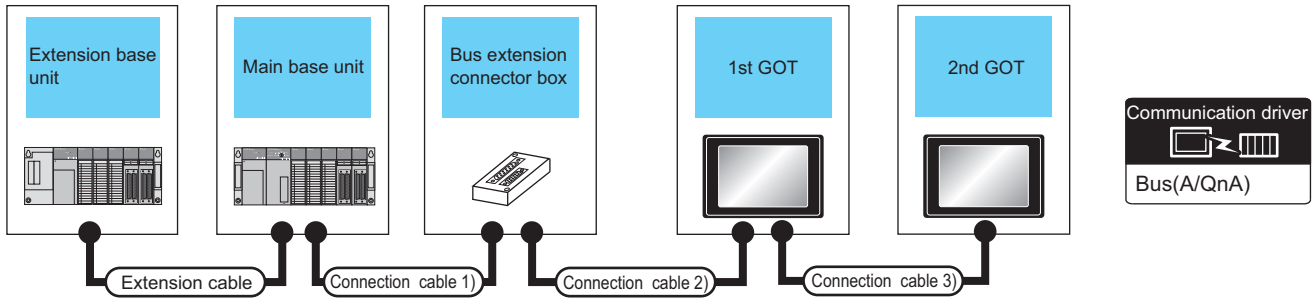

PLC ^{*5}					Connection cable 2)	GOT (1st) ^{*3}	
Extension base	Extension cable ^{*1}	Main base	Connection cable 1)	Bus connector conversion box		Option device ^{*6*7}	Model
-	-	Main base	-	-	GT15-A1SC07B(0.7m) GT15-A1SC12B(1.2m) GT15-A1SC30B(3m) GT15-A1SC50B(5m)	GT15-75ABUS2L GT15-ABUS2	GT 16 GT 15
					GT15-C100EXSS-1(10m) GT15-C200EXSS-1(20m) ^{*4}	GT15-75ABUS2L GT15-ABUS2	GT 16 GT 15
					GT15-A1SC05NB(0.45m) GT15-A1SC07NB(0.7m) GT15-A1SC30NB(3m) GT15-A1SC50NB(5m)	A7GT-CNB ^{*2}	GT15-C100EXSS-1(10m) GT15-C200EXSS-1(20m) ^{*4}
Extension base	Extension cable	Main base	-	-	GT15-A1SC07B(0.7m) GT15-A1SC12B(1.2m) GT15-A1SC30B(3m) GT15-A1SC50B(5m)	GT15-75ABUS2L GT15-ABUS2	GT 16 GT 15
					GT15-C100EXSS-1(10m) GT15-C200EXSS-1(20m) ^{*4}	GT15-75ABUS2L GT15-ABUS2	GT 16 GT 15
					GT15-A1SC05NB(0.45m) GT15-A1SC07NB(0.7m) GT15-A1SC30NB(3m) GT15-A1SC50NB(5m)	A7GT-CNB ^{*2}	GT15-C100EXSS-1(10m) GT15-C200EXSS-1(20m) ^{*4}

*1 For the extension cables, refer to MELSEC-A/QnA catalog (L(NA)08024).

*2 When installing the 1st GOT 30m or more away from the main base unit, the bus connector conversion box is required.

*3 When connecting to multiple GOTs with GT 16, GT15 and GT11 mixed, use GT11 as a terminal.

*4 When using GT15-C□EXSS-1 or GT15-C□BS, connect as following precautions.

☞ 5.4.1 GT15-C [] EXSS-1, GT15-C [] BS

*5 The number of connectable GOTs is restricted according to the CPU type and the number of intelligent function modules.

☞ 5.4.12 When connecting multiple GOTs

Connection cable 3)	GOT (2nd) ^{*3*5}		Max. distance
	Option device ^{*6*7}	Model	
GT15-C07BS(0.7m) GT15-C12BS(1.2m) GT15-C30BS(3m) GT15-C50BS(5m) GT15-C100BS(10m) GT15-C200BS(20m) GT15-C300BS(30m) ^{*4}	GT15-75ABUSL GT15-75ABUS2L GT15-ABUS GT15-ABUS2	 	Between main base and GOT(1st): 5m Between GOT (1st) and GOT (2nd): 30m
	- (Built into GOT)		Between main base and GOT (2nd): 35m
	GT15-75ABUSL GT15-75ABUS2L GT15-ABUS GT15-ABUS2	 	Between main base and GOT (2nd): 30m
GT15-C07BS(0.7m) GT15-C12BS(1.2m) GT15-C30BS(3m) GT15-C50BS(5m) GT15-C100BS(10m) GT15-C200BS(20m) GT15-C300BS(30m) ^{*4}	GT15-75ABUSL GT15-75ABUS2L GT15-ABUS GT15-ABUS2	 	Between main base and bus connector conversion box: 5m Between bus connector conversion box and GOT (2nd): 30m
	- (Built into GOT)		Between main base and GOT (2nd): 35m
	GT15-75ABUSL GT15-75ABUS2L GT15-ABUS GT15-ABUS2	 	Between extension base and GOT (1st): 6m (Including the extension cable length) Between GOT (1st) and GOT (2nd): 30m
GT15-C07BS(0.7m) GT15-C12BS(1.2m) GT15-C30BS(3m) GT15-C50BS(5m) GT15-C100BS(10m) GT15-C200BS(20m) GT15-C300BS(30m) ^{*4}	GT15-75ABUSL GT15-75ABUS2L GT15-ABUS GT15-ABUS2	 	Between extension base and GOT (2nd): 36m (Including the extension cable length)
	- (Built into GOT)		Between main base and GOT (2nd): 30m Between extension base and GOT (2nd): 36m (Including the extension cable length)
	GT15-75ABUSL GT15-75ABUS2L GT15-ABUS GT15-ABUS2	 	Extension base and bus connector conversion box: 6m (Including extension cable length) Between bus connector conversion box and GOT (2nd): 30m
GT15-C07BS(0.7m) GT15-C12BS(1.2m) GT15-C30BS(3m) GT15-C50BS(5m) GT15-C100BS(10m) GT15-C200BS(20m) GT15-C300BS(30m) ^{*4}	- (Built into GOT)		Between extension base and GOT (2nd): 36m (Including the extension cable length)

*6 About the bus connection unit
 GT15-75ABUSL, GT15-ABUS: Used for a terminal GOT. (Not available for an intermediary GOT)
 GT15-75ABUS2L, GT15-ABUS2: Used for an intermediary GOT. (Can be used for a terminal GOT)

*7 When using the following functions, use GT15-ABUS(2). GT15-75ABUS(2)L cannot be used.
 Used for remote personal computer operation (serial), video display function, multimedia function, operation panel function, external I/O function, RGB display function, report function (when using a PictBridge compatible printer), hard copy function (when using a PictBridge compatible printer), sound output function, functions with the CF card unit or CF card extension unit, Ethernet download, gateway function or MES interface function
 However, Ethernet download, gateway function and MES interface function can be used for GT16 by using the Ethernet interface.

■ When three GOTs are connected

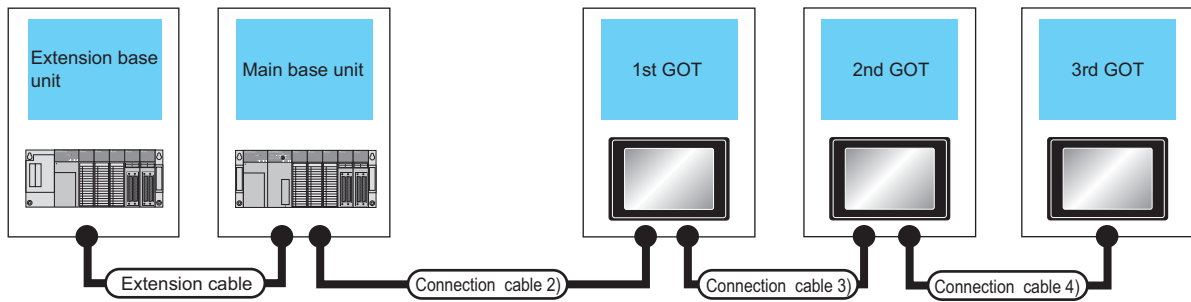

PLC ^{*3}					Connection cable 2)	GOT (1st) ^{*2}		
Extension base	Extension cable ^{*1}	Main base	Connection cable 1)	Bus connector conversion box		Option device ^{*5*6}	Model	
-	-	Main base	-	-	GT15-A1SC07B(0.7m) GT15-A1SC12B(1.2m) GT15-A1SC30B(3m) GT15-A1SC50B(5m)	GT15-75ABUS2L GT15-ABUS2	GT 16 GT 15	
Extension base	Extension cable	Main base	-	-	GT15-A1SC07B(0.7m) GT15-A1SC12B(1.2m) GT15-A1SC30B(3m) GT15-A1SC50B(5m)	GT15-75ABUS2L GT15-ABUS2	GT 16 GT 15	

*1 For the extension cables, refer to MELSEC-A/QnA catalog (L(NA)08024).

*2 The connection of multiple GOTs
When connecting to multiple GOTs with GT 16, GT15 and GT11 mixed, use GT11 as a terminal.

*3 The number of connectable GOTs is restricted according to the CPU type and the number of intelligent function modules.

☞ 5.4.12 When connecting multiple GOTs

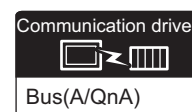

Connection cable 3)	GOT (2nd) ^{*2*3}		Connection cable 4)	GOT (3rd) ^{*2*3}		Max. distance
	Option device ^{*5*6}	Model		Option device ^{*5*6}	Model	
GT15-C07BS(0.7m) GT15-C12BS(1.2m) GT15-C30BS(3m) GT15-C50BS(5m) GT15-C100BS(10m) GT15-C200BS(20m) ^{*4}	GT15-75ABUS2L GT15-ABUS2	 	GT15-C07BS(0.7m) GT15-C12BS(1.2m) GT15-C30BS(3m) GT15-C50BS(5m) GT15-C100BS(10m) GT15-C200BS(20m) ^{*4}	GT15-75ABUSL GT15-75ABUS2L GT15-ABUS GT15-ABUS2 - (Built into GOT)	 	Between main base and GOT(1st): 5m Between GOT (1st) and GOT (3rd): 30m Between main base and GOT (3rd): 35m
GT15-C07BS(0.7m) GT15-C12BS(1.2m) GT15-C30BS(3m) GT15-C50BS(5m) GT15-C100BS(10m) GT15-C200BS(20m) ^{*4}	GT15-75ABUS2L GT15-ABUS2	 	GT15-C07BS(0.7m) GT15-C12BS(1.2m) GT15-C30BS(3m) GT15-C50BS(5m) GT15-C100BS(10m) GT15-C200BS(20m) ^{*4}	GT15-75ABUSL GT15-75ABUS2L GT15-ABUS GT15-ABUS2 - (Built into GOT)	 	Between extension base and GOT (1st): 6m (Including the extension cable length) Between GOT (1st) and GOT (3rd): 30m Between extension base and GOT (3rd): 36m (Including the extension cable length)

*4 When using GT15-C□BS, connect as following precautions.

5.4.1 GT15-C [] EXSS-1, GT15-C [] BS

*5 The bus connection unit

GT15-75ABUSL, GT15-ABUS: Used for a terminal GOT. (Not available for an intermediary GOT)
 GT15-75ABUS2L, GT15-ABUS2: Used for an intermediary GOT. (Can be used for a terminal GOT)

*6 When using the following functions, use GT15-ABUS(2). GT15-75ABUS(2)L cannot be used.

Used for remote personal computer operation (serial), video display function, multimedia function, operation panel function, external I/O function, RGB display function, report function (when using a PictBridge compatible printer), hard copy function (when using a PictBridge compatible printer), sound output function, functions with the CF card unit or CF card extension unit, Ethernet download, gateway function or MES interface function

However, Ethernet download, gateway function and MES interface function can be used for GT16 by using the Ethernet interface.

1 PREPARATORY PROCEDURES FOR MONITORING
 2 DEVICE RANGE THAT CAN BE SET
 3 ACCESS RANGE FOR MONITORING
 4 HOW TO MONITOR REDUNDANT SYSTEM
 5 BUS CONNECTION
 6 DIRECT CONNECTION TO CPU
 7 COMPUTER LINK CONNECTION
 8 ETHERNET CONNECTION

5.2.4 Connection to A0J2HCPU

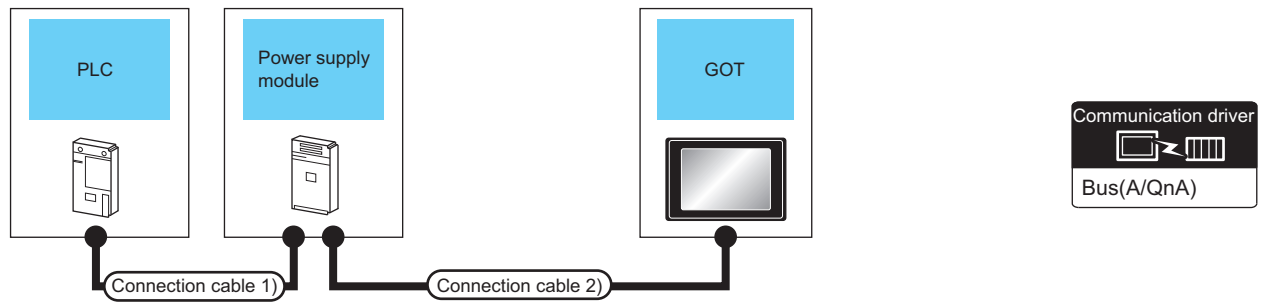

PLC			Connection cable 2)	GOT1000 series ^{*1}		Max. distance
Model name	Connection cable 1)	Power supply module		Option device ^{*2}	Model	
A0J2HCPU	A0J2C03(0.3m) A0J2C06(0.55m) A0J2C10(1m) A0J2C20(2m)	A0J2-PW	GT15-J2C10B(1m)	GT15-75ABUSL GT15-75ABUS2L GT15-ABUS GT15-ABUS2	GT16 GT15	Between PLC and GOT: 6.6m Between power supply module and GOT: 1m
				- (Built into GOT)	GT11 Bus	

*1 The number of connectable GOTs is restricted depending on the number of intelligent function modules mounted to the A0J2HCPU.

☞ 5.4.12 When connecting multiple GOTs

*2 When using the following functions, use GT15-ABUS(2). GT15-75ABUS(2)L cannot be used.

Used for remote personal computer operation (serial), video display function, multimedia function, operation panel function, external I/O function, RGB display function, report function (when using a PictBridge compatible printer), hard copy function (when using a PictBridge compatible printer), sound output function, functions with the CF card unit or CF card extension unit, Ethernet download, gateway function or MES interface function

However, Ethernet download, gateway function and MES interface function can be used for GT16 by using the Ethernet interface.

5.2.5 Connection to motion controller CPU (A273UCPU, A273UHCPU(-S3), A373UCPU(-S3))

■ When one GOT is connected

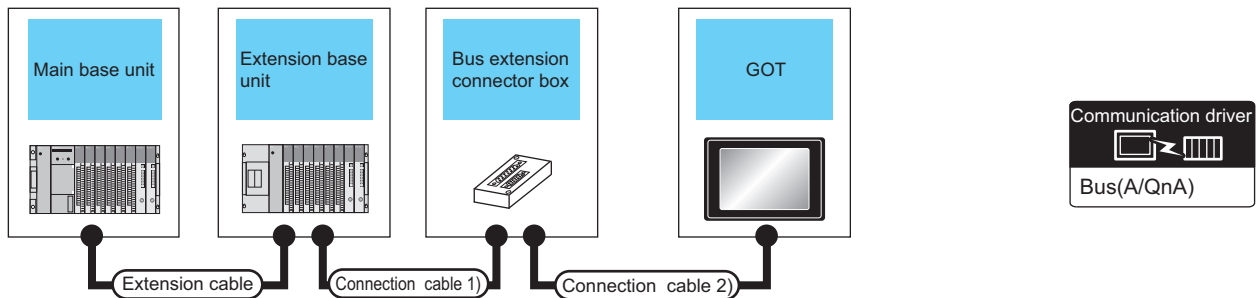

PLC					GOT1000 Series		Max. distance	
Main base	Extension cable	Extension base	Connection cable 1)	Bus connector conversion box ^{*1}	Connection cable 2)	Option device ^{*3}		Model
Main base	-	-	-	-	GT15-A370C12B-S1(1.2m) GT15-A370C25B-S1(2.5m)	GT15-75ABUSL GT15-75ABUS2L GT15-ABUS GT15-ABUS2	GT16 GT15	Between main base and GOT: 2.5m
					(Built into GOT)	GT11 Bus		
Main base	-	-	GT15-A370C12B(1.2m) GT15-A370C25B(2.5m)	A7GT -CNB	GT15-C100EXSS-1(10m) GT15-C200EXSS-1(20m) GT15-C300EXSS-1(30m) ^{*2}	GT15-75ABUSL GT15-75ABUS2L GT15-ABUS GT15-ABUS2	GT16 GT15	Between main base and GOT: 32.5m (Including between main base and bus connector conversion box)
					(Built into GOT)	GT11 Bus	Between main base and bus connector conversion box: 2.5m	
Main base	GT15-A370C12B(1.2m) GT15-A370C25B(2.5m)	Extension base	-	-	GT15-C12NB(1.2m) GT15-C30NB(3m) GT15-C50NB(5m)	GT15-75ABUSL GT15-75ABUS2L GT15-ABUS GT15-ABUS2	GT16 GT15	Between main base and GOT: 6.6m (Including the extension cable length)
					(Built into GOT)	GT11 Bus		
Main base	GT15-A370C12B(1.2m) GT15-A370C25B(2.5m)	Extension base	GT15-AC06B(0.6m) GT15-AC12B(1.2m) GT15-AC30B(3m) GT15-AC50B(5m)	A7GT -CNB	GT15-C100EXSS-1(10m) GT15-C200EXSS-1(20m) GT15-C300EXSS-1(30m) ^{*2}	GT15-75ABUSL GT15-75ABUS2L GT15-ABUS GT15-ABUS2	GT16 GT15	Between main base and GOT: 36.6m
					(Built into GOT)	GT11 Bus	Between main base and bus connector conversion box: 6.6m (Including the extension cable length)	

*1 When installing the GOT 30m or more away from the main base unit, the bus connector conversion box is required.

*2 When using GT15-C□EXSS-1, connect as the following precautions.

☞ 5.4.1 GT15-C [] EXSS-1, GT15-C [] BS

*3 When using the following functions, use GT15-ABUS(2). GT15-75ABUS(2)L cannot be used.

Used for remote personal computer operation (serial), video display function, multimedia function, operation panel function, external I/O function, RGB display function, report function (when using a PictBridge compatible printer), hard copy function (when using a PictBridge compatible printer), sound output function, functions with the CF card unit or CF card extension unit, Ethernet download, gateway function or MES interface function
However, Ethernet download, gateway function and MES interface function can be used for GT16 by using the Ethernet interface.

■ When two GOTs are connected

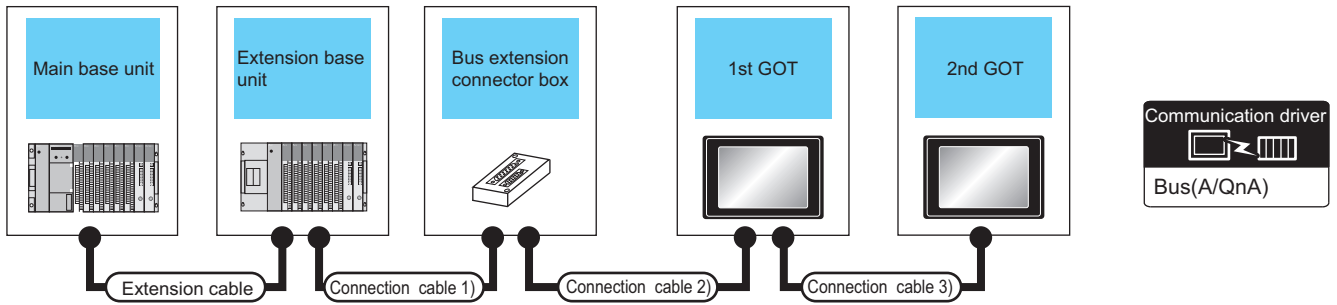

PLC ^{*4}					Connection cable 2)	GOT (1st) ^{*2}	
Main base	Extension cable	Extension base	Connection cable 1)	Bus connector conversion box		Option device ^{*5*6}	Model
Main base	-	-	-	-	GT15-A370C12B-S1(1.2m) GT15-A370C25B-S1(2.5m)	GT15-75ABUS2L GT15-ABUS2	GT16 GT15
			GT15-A370C12B(1.2m) GT15-A370C25B(2.5m)	A7GT-CNB ^{*1}	GT15-C100EXSS-1(10m) GT15-C200EXSS-1(20m) ^{*3}	GT15-75ABUS2L GT15-ABUS2	GT16 GT15
Main base	GT15-A370C12B(1.2m) GT15-A370C25B(2.5m)	Extension base	-	-	GT15-C12NB(1.2m) GT15-C30NB(3m) GT15-C50NB(5m)	GT15-75ABUS2L GT15-ABUS2	GT16 GT15
			GT15-AC06B(0.6m) GT15-AC12B(1.2m) GT15-AC30B(3m) GT15-AC50B(5m)	A7GT-CNB ^{*1}	GT15-C100EXSS-1(10m) GT15-C200EXSS-1(20m) ^{*3}	GT15-75ABUS2L GT15-ABUS2	GT16 GT15

*1 When installing the 1st GOT 30m or more away from the main base unit, the bus connector conversion box is required.

*2 When connecting to multiple GOTs with GT 16, GT15 and GT11 mixed, use GT11 as a terminal.

*3 When using GT15-C□EXSS-1 or GT15-C□BS, connect as following precautions.

☞ 5.4.1 GT15-C [] EXSS-1, GT15-C [] BS

*4 The number of connectable GOTs is restricted according to the CPU type and the number of intelligent function modules.

☞ 5.4.12 When connecting multiple GOTs

Connection cable 3)	GOT (2nd) ^{*2*4}		Max. distance
	Option device ^{*5*6}	Model	
GT15-C07BS(0.7m) GT15-C12BS(1.2m) GT15-C30BS(3m) GT15-C50BS(5m) GT15-C100BS(10m) GT15-C200BS(20m) GT15-C300BS(30m) *3	GT15-75ABUSL GT15-75ABUS2L GT15-ABUS GT15-ABUS2	 	Between main base and GOT(1st): 2.5m Between GOT (1st) and GOT (2nd): 30m
	- (Built into GOT)		Between main base and GOT (2nd): 32.5m
GT15-C07BS(0.7m) GT15-C12BS(1.2m) GT15-C30BS(3m) GT15-C50BS(5m) GT15-C100BS(10m) GT15-C200BS(20m) *3	GT15-75ABUSL GT15-75ABUS2L GT15-ABUS GT15-ABUS2	 	Between main base and bus connector conversion box: 2.5m Between bus connector conversion box and GOT (2nd): 30m
	- (Built into GOT)		Between main base and GOT (2nd): 32.5m
GT15-C07BS(0.7m) GT15-C12BS(1.2m) GT15-C30BS(3m) GT15-C50BS(5m) GT15-C100BS(10m) GT15-C200BS(20m) GT15-C300BS(30m) *3	GT15-75ABUSL GT15-75ABUS2L GT15-ABUS GT15-ABUS2	 	Between main base and GOT (1st): 6.6m (Including the extension cable length) Between GOT (1st) and GOT (2nd): 30m
	- (Built into GOT)		Between main base and GOT (2nd): 36.6m (Including the extension cable length)
GT15-C07BS(0.7m) GT15-C12BS(1.2m) GT15-C30BS(3m) GT15-C50BS(5m) GT15-C100BS(10m) GT15-C200BS(20m) *3	GT15-75ABUSL GT15-75ABUS2L GT15-ABUS GT15-ABUS2	 	Between main base and bus connector conversion box: 6.6m (Including extension cable length) Between bus connector conversion box and GOT (2nd): 30m
	- (Built into GOT)		Between main base and GOT (2nd): 36.6m (Including the extension cable length)

*5 The bus connection unit
 GT15-75ABUSL, GT15-ABUS: Used for a terminal GOT. (Not available for an intermediary GOT)
 GT15-75ABUS2L, GT15-ABUS2: Used for an intermediary GOT. (Can be used for a terminal GOT)

*6 When using the following functions, use GT15-ABUS(2). GT15-75ABUS(2)L cannot be used.
 Used for remote personal computer operation (serial), video display function, multimedia function, operation panel function, external I/O function, RGB display function, report function (when using a PictBridge compatible printer), hard copy function (when using a PictBridge compatible printer), sound output function, functions with the CF card unit or CF card extension unit, Ethernet download, gateway function or MES interface function
 However, Ethernet download, gateway function and MES interface function can be used for GT16 by using the Ethernet interface.

■ When 2 to 3 GOTs are connected^{*2}

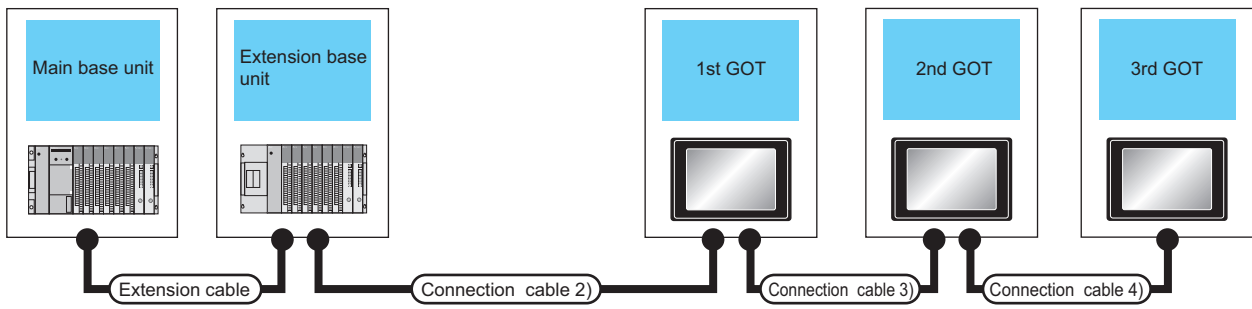

PLC ^{*2}					Connection cable 2)	GOT (1st) ^{*1}		
Extension base	Extension cable	Main base	Connection cable 1)	Bus connector conversion box		Option device ^{*4*5}	Model	
-	-	Main base	-	-	GT15-A370C12B-S1(1.2m) GT15-A370C25B-S1(2.5m)	GT15-75ABUS2L GT15-ABUS2	GT 16 GT 15	
Extension base	GT15-A370C12B(1.2m) GT15-A370C25B(2.5m)	Main base	-	-	GT15-C12NB(1.2m) GT15-C30NB(3m) GT15-C50NB(5m)	GT15-75ABUS2L GT15-ABUS2	GT 16 GT 15	

*1 The connection of multiple GOTs

When connecting to multiple GOTs with GT 16, GT15 and GT11 mixed, use GT11 as a terminal.

*2 The number of connectable GOTs is restricted according to the CPU type and the number of intelligent function modules.

☞ 5.4.12 When connecting multiple GOTs

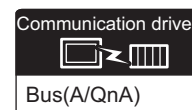

Connection cable 3)	GOT (2nd) ^{*2*3}		Connection cable 4)	GOT (3rd) ^{*2*3}		Max. distance
	Option device ^{*4*5}	Model		Option device ^{*4*5}	Model	
GT15-C07BS(0.7m) GT15-C12BS(1.2m) GT15-C30BS(3m) GT15-C50BS(5m) GT15-C100BS(10m) GT15-C200BS(20m) *3	GT15-75ABUS2L GT15-ABUS2	 	GT15-C07BS(0.7m) GT15-C12BS(1.2m) GT15-C30BS(3m) GT15-C50BS(5m) GT15-C100BS(10m) GT15-C200BS(20m) *3	GT15-75ABUSL GT15-75ABUS2L GT15-ABUS GT15-ABUS2 - (Built into GOT)	 	Between main base and GOT(1st): 2.5m Between GOT (1st) and GOT (3rd): 30m Between main base and GOT (3rd): 32.5m
GT15-C07BS(0.7m) GT15-C12BS(1.2m) GT15-C30BS(3m) GT15-C50BS(5m) GT15-C100BS(10m) GT15-C200BS(20m) *3	GT15-75ABUS2L GT15-ABUS2	 	GT15-C07BS(0.7m) GT15-C12BS(1.2m) GT15-C30BS(3m) GT15-C50BS(5m) GT15-C100BS(10m) GT15-C200BS(20m) *3	GT15-75ABUSL GT15-75ABUS2L GT15-ABUS GT15-ABUS2 - (Built into GOT)	 	Between main base and GOT(1st): 6.6m (Including the extension cable length) Between GOT (1st) and GOT (3rd): 30m Between main base and GOT (3rd): 36.6m (Including the extension cable length)

*3 When using GT15-C□BS, connect as following precautions.

5.4.1 GT15-C [] EXSS-1, GT15-C [] BS

*4 The bus connection unit

GT15-75ABUSL, GT15-ABUS: Used for a terminal GOT. (Not available for an intermediary GOT)
 GT15-75ABUS2L, GT15-ABUS2: Used for an intermediary GOT. (Can be used for a terminal GOT)

*5 When using the following functions, use GT15-ABUS(2). GT15-75ABUS(2)L cannot be used.

Used for remote personal computer operation (serial), video display function, multimedia function, operation panel function, external I/O function, RGB display function, report function (when using a PictBridge compatible printer), hard copy function (when using a PictBridge compatible printer), sound output function, functions with the CF card unit or CF card extension unit, Ethernet download, gateway function or MES interface function
 However, Ethernet download, gateway function and MES interface function can be used for GT16 by using the Ethernet interface.

5.2.6 Connecting to motion controller CPU (A171SCPU(-S3(N)), A171SHCPU(N), A172SHCPU(N), A173UHCPU(-S1))

■ When one GOT is connected

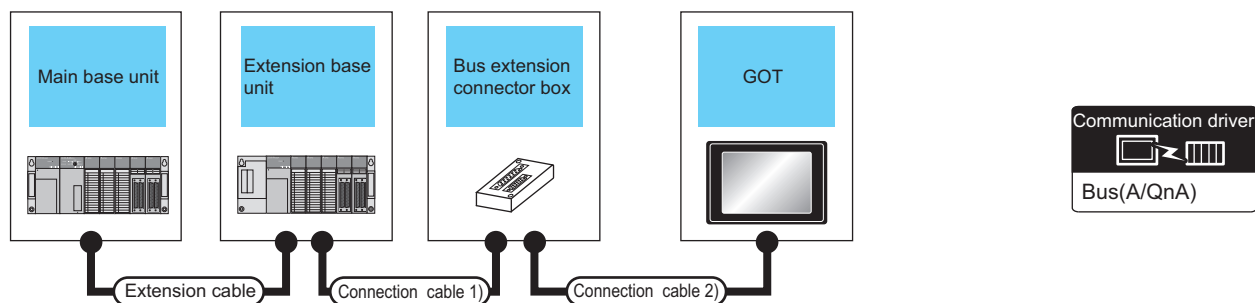

PLC					GOT1000 Series		Max. distance	
Main base	Extension cable *1	Extension base *2	Connection cable 1)	Bus connector conversion box	Connection cable 2)	Option device *5		Model
Main base	-	-	-	-	GT15-A1SC07B(0.7m) GT15-A1SC12B(1.2m) GT15-A1SC30B(3m)	GT15-75ABUSL GT15-75ABUS2L GT15-ABUS GT15-ABUS2	GT16 GT15	Between main base and GOT: 3m
					- (Built into GOT)	GT11 Bus		
					GT15-C100EXSS-1(10m) GT15-C200EXSS-1(20m) GT15-C300EXSS-1(30m) *4	GT15-75ABUSL GT15-75ABUS2L GT15-ABUS GT15-ABUS2	GT16 GT15	Between main base and GOT: 30m
			GT15-A1SC05NB(0.45m) GT15-A1SC07NB(0.7m) GT15-A1SC30NB(3m)	A7GT -CNB*3	GT15-C100EXSS-1(10m) GT15-C200EXSS-1(20m) GT15-C300EXSS-1(30m) *4	GT15-75ABUSL GT15-75ABUS2L GT15-ABUS GT15-ABUS2	GT16 GT15	Between main base and GOT: 33m (Including between main base and bus connector conversion box)
						- (Built into GOT)	GT11 Bus	Between main base and bus connector conversion box: 3m

PLC					Connection cable 2)	GOT1000 Series		Max. distance
Main base	Extension cable ^{*1}	Extension base ^{*2}	Connection cable 1)	Bus connector conversion box		Option device ^{*5}	Model	
Main base	Extension cable	Extension base	-	-	GT15-A1SC07B(0.7m) GT15-A1SC12B(1.2m) GT15-A1SC30B(3m)	GT15-75ABUSL GT15-75ABUS2L GT15-ABUS GT15-ABUS2 - (Built into GOT)	 	Between extension base and GOT: 3m (Including the extension cable length)
			-	-	GT15-C100EXSS-1(10m) GT15-C200EXSS-1(20m) GT15-C300EXSS-1(30m) ^{*4}	GT15-75ABUSL GT15-75ABUS2L GT15-ABUS GT15-ABUS2 - (Built into GOT)	 	Between extension base and GOT: 33m (Including the extension cable length)
			GT15-A1SC05NB(0.45m) GT15-A1SC07NB(0.7m) GT15-A1SC30NB(3m)	A7GT -CNB ^{*3}	GT15-C100EXSS-1(10m) GT15-C200EXSS-1(20m) GT15-C300EXSS-1(30m) ^{*4}	GT15-75ABUSL GT15-75ABUS2L GT15-ABUS GT15-ABUS2 - (Built into GOT)	 	Between extension base and GOT: 33m Between extension base and bus connector conversion box: 3m (Including the extension cable length)

*1 For details on the extension cables, refer to the MELSEC-A/QnA catalog (L(NA)8024).

*2 Use the A168B for the extension base unit.

*3 When installing the GOT 30m or more away from the main base unit, the bus connector conversion box is required.

*4 When using GT15-C□EXSS-1, connect as the following precautions.

5.4.1 GT15-C [] EXSS-1, GT15-C [] BS

*5 When using the following functions, use GT15-ABUS(2). GT15-75ABUS(2)L cannot be used.

Used for remote personal computer operation (serial), video display function, multimedia function, operation panel function, external I/O function, RGB display function, report function (when using a PictBridge compatible printer), hard copy function (when using a PictBridge compatible printer), sound output function, functions with the CF card unit or CF card extension unit, Ethernet download, gateway function or MES interface function
However, Ethernet download, gateway function and MES interface function can be used for GT16 by using the Ethernet interface.

1
PREPARATORY PROCEDURES FOR MONITORING

2
DEVICE RANGE THAT CAN BE SET

3
ACCESS RANGE FOR MONITORING

4
HOW TO MONITOR REDUNDANT SYSTEM

5
BUS CONNECTION

6
DIRECT CONNECTION TO CPU

7
COMPUTER LINK CONNECTION





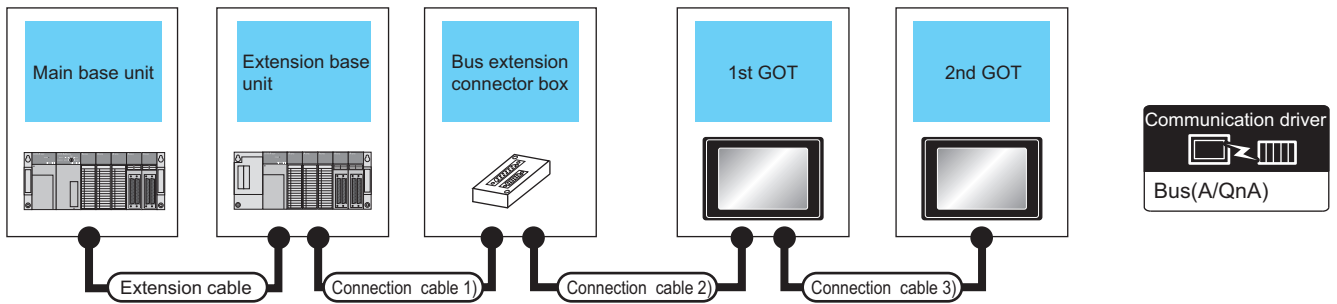











8
ETHERNET CONNECTION

■ When two GOTs are connected



PLC ^{*5}					Connection cable 2)	GOT (1st) ^{*4}	
Main base	Extension cable ^{*1}	Extension base ^{*2}	Connection cable 1)	Bus connector conversion box		Option device ^{*7,8}	Model
Main base	-	-	-	-	GT15-A1SC07B(0.7m) GT15-A1SC12B(1.2m) GT15-A1SC30B(3m)	GT15-75ABUS2L GT15-ABUS2	GT 16 GT 15
			-	-	GT15-C100EXSS-1(10m) GT15-C200EXSS-1(20m) ^{*5}	GT15-75ABUS2L GT15-ABUS2	GT 16 GT 15
			GT15-A1SC05NB(0.45m) GT15-A1SC07NB(0.7m) GT15-A1SC30NB(3m)	A7GT-CNB ^{*3}	GT15-C100EXSS-1(10m) GT15-C200EXSS-1(20m) ^{*5}	GT15-75ABUS2L GT15-ABUS2	GT 16 GT 15
Main base	Extension cable	Extension base	-	-	GT15-A1SC07B(0.7m) GT15-A1SC12B(1.2m) GT15-A1SC30B(3m)	GT15-75ABUS2L GT15-ABUS2	GT 16 GT 15
			-	-	GT15-C100EXSS-1(10m) GT15-C200EXSS-1(20m) ^{*5}	GT15-75ABUS2L GT15-ABUS2	GT 16 GT 15
			GT15-A1SC05NB(0.45m) GT15-A1SC07NB(0.7m) GT15-A1SC30NB(3m)	A7GT-CNB ^{*3}	GT15-C100EXSS-1(10m) GT15-C200EXSS-1(20m) ^{*5}	GT15-75ABUS2L GT15-ABUS2	GT 16 GT 15

*1 For the extension cables, refer to MELSEC-A/QnA catalog (L(NA)08024).
 *2 Use the A168B for the extension base unit.
 *3 When installing the 1st GOT 30m or more away from the main base unit, the bus connector conversion box is required.
 *4 When connecting to multiple GOTs with GT 16, GT15 and GT11 mixed, use GT11 as a terminal.
 *5 When using GT15-C□EXSS-1 or GT15-C□BS, connect as following precautions.
 ➡ 5.4.1 GT15-C [] EXSS-1, GT15-C [] BS
 *6 The number of connectable GOTs is restricted according to the CPU type and the number of intelligent function modules.
 ➡ 5.4.12 When connecting multiple GOTs

Connection cable 3)	GOT (2nd) ^{*4*6}		Max. distance
	Option device ^{*7*8}	Model	
GT15-C07BS(0.7m) GT15-C12BS(1.2m) GT15-C30BS(3m) GT15-C50BS(5m) GT15-C100BS(10m) GT15-C200BS(20m) GT15-C300BS(30m) *5	GT15-75ABUSL GT15-75ABUS2L GT15-ABUS GT15-ABUS2	 	Between main base and GOT(1st): 3m Between GOT (1st) and GOT (2nd): 30m
	- (Built into GOT)		Between main base and GOT (2nd): 33m
	GT15-75ABUSL GT15-75ABUS2L GT15-ABUS GT15-ABUS2	 	Between main base and GOT (2nd): 30m
GT15-C07BS(0.7m) GT15-C12BS(1.2m) GT15-C30BS(3m) GT15-C50BS(5m) GT15-C100BS(10m) GT15-C200BS(20m) *5	- (Built into GOT)		Between main base and bus connector conversion box: 3m Between bus connector conversion box and GOT (2nd): 30m
	GT15-75ABUSL GT15-75ABUS2L GT15-ABUS GT15-ABUS2	 	Between main base and GOT (2nd): 33m
	GT15-75ABUSL GT15-75ABUS2L GT15-ABUS GT15-ABUS2	 	Between main base and GOT (1st): 3m (Including the extension cable length) Between GOT (1st) and GOT (2nd): 30m
GT15-C07BS(0.7m) GT15-C12BS(1.2m) GT15-C30BS(3m) GT15-C50BS(5m) GT15-C100BS(10m) GT15-C200BS(20m) GT15-C300BS(30m) *5	- (Built into GOT)		Between main base and GOT (2nd): 33m (Including the extension cable length)
	GT15-75ABUSL GT15-75ABUS2L GT15-ABUS GT15-ABUS2	 	Between main base and GOT (2nd): 30m
	GT15-75ABUSL GT15-75ABUS2L GT15-ABUS GT15-ABUS2	 	Between main base and bus connector conversion box: 3m (Including extension cable length) Between bus connector conversion box and GOT (2nd): 30m
GT15-C07BS(0.7m) GT15-C12BS(1.2m) GT15-C30BS(3m) GT15-C50BS(5m) GT15-C100BS(10m) GT15-C200BS(20m) *5	- (Built into GOT)		Between main base and GOT (2nd): 33m (Including the extension cable length)

*7 The bus connection unit

GT15-75ABUSL, GT15-ABUS: Used for a terminal GOT. (Not available for an intermediary GOT)
 GT15-75ABUS2L, GT15-ABUS2: Used for an intermediary GOT. (Can be used for a terminal GOT)

*8 When using the following functions, use GT15-ABUS(2). GT15-75ABUS(2)L cannot be used.

Used for remote personal computer operation (serial), video display function, multimedia function, operation panel function, external I/O function, RGB display function, report function (when using a PictBridge compatible printer), hard copy function (when using a PictBridge compatible printer), sound output function, functions with the CF card unit or CF card extension unit, Ethernet download, gateway function or MES interface function
 However, Ethernet download, gateway function and MES interface function can be used for GT16 by using the Ethernet interface.

■ When 2 to 3 GOTs are connected*4

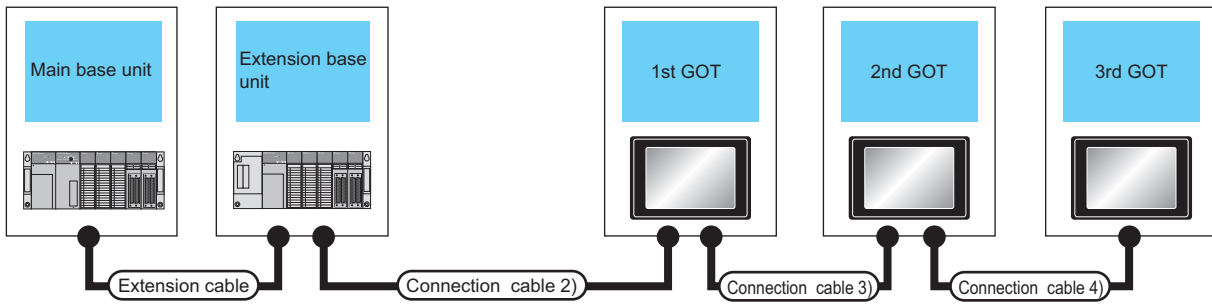

PLC*3					Connection cable 2)	GOT (1st)*3		
Main base	Extension cable*1	Extension base*2	Connection cable 1)	Bus connector conversion box		Option device*6+7	Model	
Main base	-	-	-	-	GT15-A1SC07B(0.7m) GT15-A1SC12B(1.2m) GT15-A1SC30B(3m)	GT15-75ABUS2L GT15-ABUS2	GT 16 GT 15	
Main base	Extension cable	Extension base	-	-	GT15-A1SC07B(0.7m) GT15-A1SC12B(1.2m) GT15-A1SC30B(3m)	GT15-75ABUS2L GT15-ABUS2	GT 16 GT 15	

*1 For the extension cables, refer to MELSEC-A/QnA catalog (L(NA)08024).

*2 Use the A168B for the extension base unit.

*3 The connection of multiple GOTs

When connecting to multiple GOTs with GT 16, GT 15 and GT 11 mixed, use GT 11 as a terminal.

*4 The number of connectable GOTs is restricted according to the CPU type and the number of intelligent function modules.

☞ 5.4.12 When connecting multiple GOTs

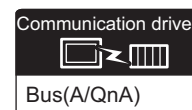

	Connection cable 3)	GOT (2nd) ^{*3*4}		Connection cable 4)	GOT (3rd) ^{*3*4}		Max. distance
		Option device ^{*6*7}	Model		Option device ^{*6*7}	Model	
	GT15-C07BS(0.7m) GT15-C12BS(1.2m) GT15-C30BS(3m) GT15-C50BS(5m) GT15-C100BS(10m) GT15-C200BS(20m) *5	GT15-75ABUS2L GT15-ABUS2	 	GT15-C07BS(0.7m) GT15-C12BS(1.2m) GT15-C30BS(3m) GT15-C50BS(5m) GT15-C100BS(10m) GT15-C200BS(20m) *5	GT15-75ABUSL GT15-75ABUS2L GT15-ABUS GT15-ABUS2 - (Built into GOT)	 	Between main base and GOT(1st): 3m Between GOT (1st) and GOT (3rd): 30m Between main base and GOT (3rd): 33m
	GT15-C07BS(0.7m) GT15-C12BS(1.2m) GT15-C30BS(3m) GT15-C50BS(5m) GT15-C100BS(10m) GT15-C200BS(20m) *5	GT15-75ABUS2L GT15-ABUS2	 	GT15-C07BS(0.7m) GT15-C12BS(1.2m) GT15-C30BS(3m) GT15-C50BS(5m) GT15-C100BS(10m) GT15-C200BS(20m) *5	GT15-75ABUSL GT15-75ABUS2L GT15-ABUS GT15-ABUS2 - (Built into GOT)	 	Between main base and GOT(1st): 3m (Including the extension cable length) Between GOT (1st) and GOT (3rd): 30m Between main base and GOT (3rd): 33m (Including the extension cable length)

*5 When using GT15-C□BS, connect as following precautions.

5.4.1 GT15-C [] EXSS-1, GT15-C [] BS

*6 The bus connection unit

GT15-75ABUSL, GT15-ABUS: Used for a terminal GOT. (Not available for an intermediary GOT)
 GT15-75ABUS2L, GT15-ABUS2: Used for an intermediary GOT. (Can be used for a terminal GOT)

*7 When using the following functions, use GT15-ABUS(2). GT15-75ABUS(2)L cannot be used.

Used for remote personal computer operation (serial), video display function, multimedia function, operation panel function, external I/O function, RGB display function, report function (when using a PictBridge compatible printer), hard copy function (when using a PictBridge compatible printer), sound output function, functions with the CF card unit or CF card extension unit, Ethernet download, gateway function or MES interface function
 However, Ethernet download, gateway function and MES interface function can be used for GT16 by using the Ethernet interface.

5.3 GOT Side Settings

5.3.1 Setting communication interface (Communication settings)

Set the channel of the connected equipment.

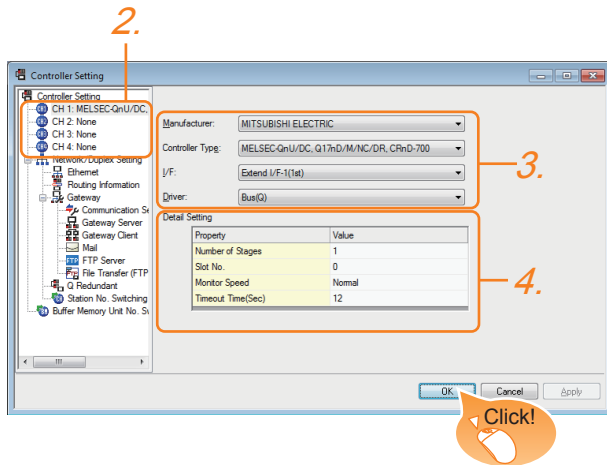

1. Select [Common] → [Controller Setting] from the menu.
2. The Controller Setting window is displayed. Select the channel to be used from the list menu.
3. Set the following items.
 - Manufacturer: MITSUBISHI ELECTRIC
 - Controller Type: Set the option according to the Controller Type to be connected.
 - I/F: Interface to be used
 - Driver: Set either of the following option according to the Controller Type to be connected.
 - BUS (Q)
 - BUS (A/QnA)
4. The detailed setting is displayed after Manufacturer, Controller Type, I/F, and Driver are set. Make the settings according to the usage environment.

5.3.2 Communication detail settings

Click the [OK] button when settings are completed.

POINT

The settings of connecting equipment can be confirmed in [I/F Communication Setting]. For details, refer to the following.

1.1.2 I/F communication setting

5.3.2 Communication detail settings

(1) Bus(Q)

Property	Value
Number of Stages	1
Slot No.	0
Monitor Speed	Normal
Timeout Time(Sec)	12

Item	Description	Range
Number of Stages	(Default: 1)	1 to 7
Slot No.	(Default: 0)	0 to 9
Monitor Speed	Set the monitor speed of the GOT. This setting is not valid in all systems. (Default: Normal)	High ^{*1} /Normal/Low ^{*2}
Timeout Time (Sec.)	Set the time period for a communication to time out. (Default: 12)	12 to 90

- *1 This range is effective when collecting a large amount of data (such as logging and recipe function) on other than the monitor screen. However, the range may affect the sequence scan time when connecting to Q00UJ/Q00U/Q01U/Q02UCPU or Q00J/Q00/Q01CPU. If you want to avoid the influence on the sequence scan time, do not set [High]. (This setting hardly affects QCPUs other than the above.)
- *2 Set this range if you want to avoid the influence on the sequence scan time further than the [Normal] setting when connecting to Q00UJ/Q00U/Q01U/Q02UCPU or Q00J/Q00/Q01CPU. However, the monitor speed may be reduced.

(2) Bus(A/QnA)

Property	Value
Number of Stages	1
Slot No.	0
Timeout Time(Sec)	3

Item	Description	Range
Number of Stages	(Default: 1)	1 to 7
Slot No.	(Default: 0)	0 to 7
Timeout Time (Sec.)	Set the time period for a communication to time out. (Default: 3)	3 to 90

POINT

- (1) Communication interface setting by Utility
 The communication interface setting can be changed on the Utility's [Communication Settings] after writing [Communication Settings] of project data.
 For details on the Utility, refer to the following manual.
 ➔ GT□ User's Manual
- (2) Precedence in communication settings
 When settings are made by GT Designer3 or the Utility, the latest setting is effective.
- (3) When changing Stage No. and Slot No.
 Change these settings with the PLC CPU turned OFF, and then reapply the power to the PLC CPU and GOT.
 Failure to do so may generate a system alarm (No.487).

HINT

Cutting the portion of multiple connection of the controller

By setting GOT internal device, GOT can cut the portion of multiple connection of the controller. For example, faulty station that has communication timeout can be cut from the system.

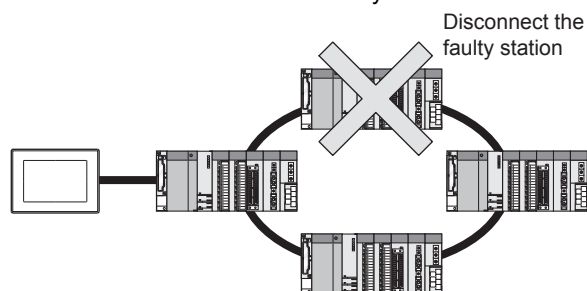

For details of the setting contents of GOT internal device, refer to the following manual.

➔ GT Designer3 Version Screen Design Manual (Fundamentals)

Setting Stage No. and Slot No.

POINT

Before setting Stage No. and Slot No.

The PLC CPU recognizes the GOT as follows.

- QCPU (Q mode)
: Intelligent function module of 16 I/O points
- Other than QCPU (Q mode)
: Intelligent function module of 32 I/O points

At the [Detail setting], assign the GOT to an empty I/O slot on the PLC CPU.

- (1) When connecting to QCPU (Q mode)

Set an additional stage (16 points × 10 slots) for GOT connection, and assign a GOT to one of the I/O slots. (The GOT cannot be assigned to empty slots of the main base unit or extension base unit.)

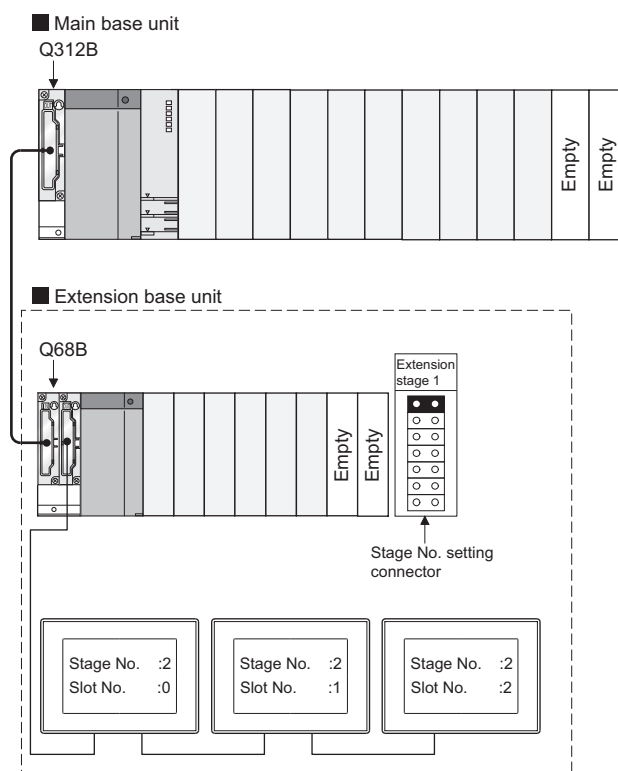

POINT

When using the bus extension connector box

Set the Stage No. switch on the bus extension connector box to the same Stage No. as the GOT.
 For setting details, refer to the following manual:

➔ A9GT-QCNB Bus Extension Connector Box User's Manual

POINT

When connecting to motion controller CPU (Q Series)
In the [Base Setting] on MT Developer, set "10" to the number of slots for the extension base used for GOT connection.

Example: When setting "2" to Stage No. and "0" to Slot No. in the communication interface settings, set "10" to [2nd Stage].

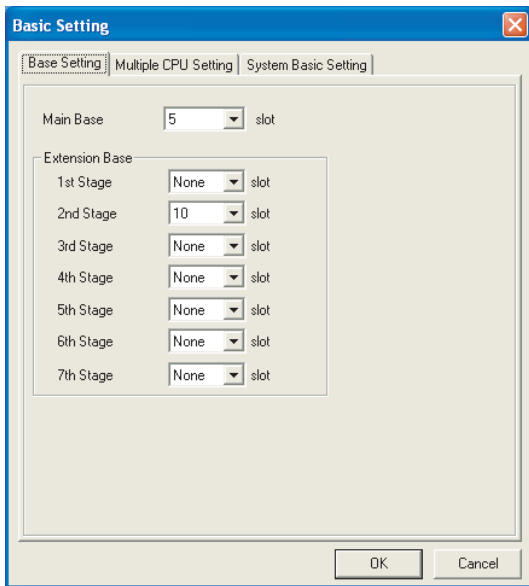

HINT

Setting unused I/O slots to empty (0 points) (only when connecting to QCPU (Q mode))

Setting unused I/O slots as empty slots (0 points) from "PC parameters" "I/O assignments" of GX Developer allows you to use I/O numbers of "16 points × number of empty slots" for other purposes.

For details on I/O assignment settings, refer to the following manual:

- ➔ QnU User's Manual (Function Explanation, Program Fundamentals)
- ➔ Qn(H)/QnPH/QnPRHCPU User's Manual (Function Explanation, Program Fundamentals)

Example: I/O assignment (when 16 points are assigned to each of all modules installed with the PLC CPU)

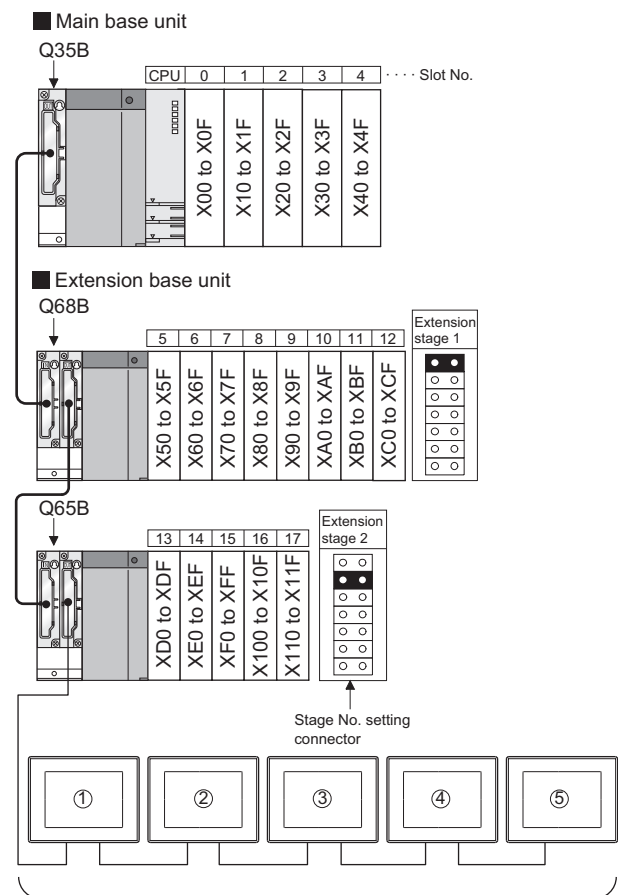

Schematic image of Stage No. for GOT connection viewed from PLC CPU (16 points x 10 slots occupied)

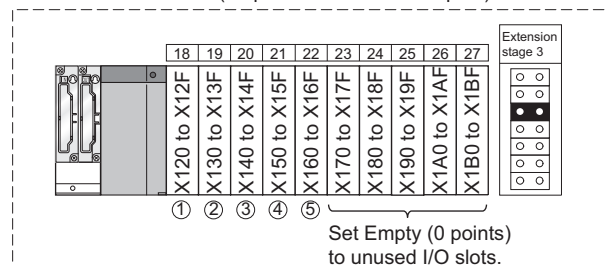

(2) Other than QCPU (Q mode)

Assign the GOT to an empty I/O slot on the extension base unit.

When there is no extension base unit or no empty I/O slots are left on an extension base unit, set an additional stage, and assign the GOT to one of the I/O slots.

(Assigning the GOT to an empty slot on the main base unit is not allowed.)

(a) When there is an empty I/O slot on the extension base unit

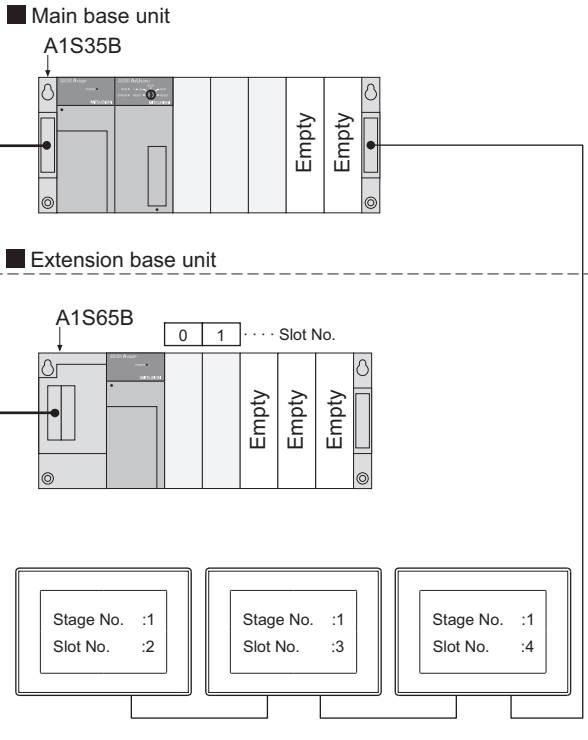

(b) When there are no empty I/O slots on the extension base unit

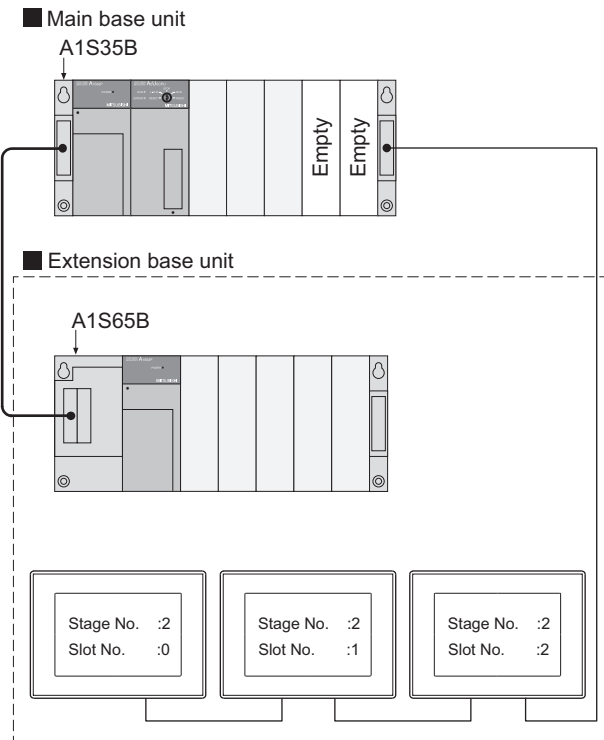

5.4 Precautions

5.4.1 GT15-C [] EXSS-1, GT15-C [] BS

(1) Composition of GT15-C□EXSS-1

It is composed of GT15-EXCNB (0.5m) and GT15-C□BS (10 to 30m).

Calculate the cable length based on GT15-C100EXSS-1(10m), GT15-C200EXSS-1(20m) and GT15-C300EXSS-1(30m).

(2) GT15-C□EXSS-1 connector

Connect the connectors as follows:

GT15-EXCNB → PLC CPU side

GT15-C□BS → GOT side

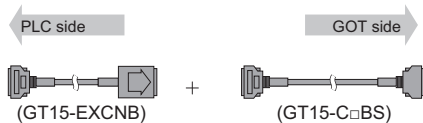

(3) Grounding

(a) When using GT15-C□EXSS-1

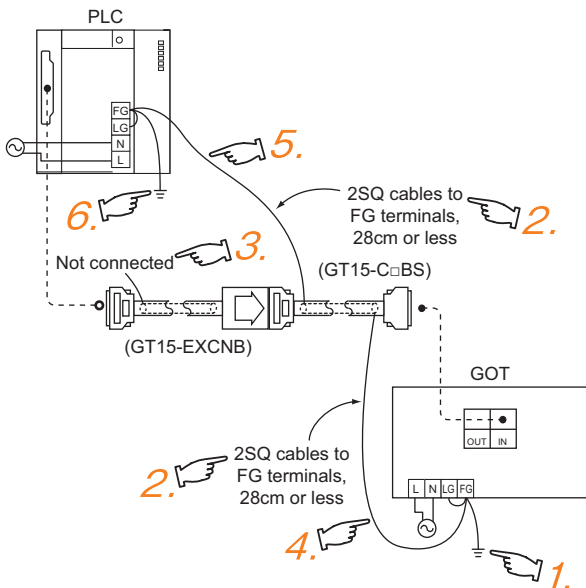

1. Connect the LG and FG terminals of the terminal block on the GOT unit power and ground them with a cable.
2. Use the GT15-C□ BS's FG cable of 28cm or less.
3. Do not connect the GT15-EXCNB's FG ground cable.
4. Connect the GT15-C□ BS's FG cable on the GOT side to FG of the GOT unit power's terminal block.
5. Connect the GT15-C□ BS's FG cable on the PLC side to FG of the PLC's power supply module.
6. Connect the LG and FG terminals of the terminal block on the PLC and ground them with a cable.

(b) When using GT15-C□BS

Follow the GOT side grounding steps in (a) above for both GOTs.

5.4.2 Turning the GOT ON

(1) System configuration

The PLC CPU remains in the reset status until the GOT is started.

Therefore, no sequence program will run until then.

The system configuration, in which the GOT is turned on from a sequence program, is not available.

(2) Time taken until the PLC runs after power-on of the GOT

The following time is taken from when the GOT is powered on until when the PLC runs.

- QCPU (Q mode), motion controller CPU

(Q series): 10 seconds or more

- MELDAS C70: 18 seconds or more

When the GOT starts before the PLC runs, a system alarm occurs. Adjust the opening screen time in the GOT setup so that no system alarm occurs.

➔ GT Designer3 Version□ Screen Design Manual

(3) Power-up sequence for connection of 3 GOTs or more (when connecting QCPU (Q mode))

➔ 5.4.10 (1)Restrictions in overall cable length to No. of GOTs

(4) Power-up sequence for connection of the Q4ARCPU redundant system

➔ 5.4.14 (2)Power-On sequence for GOT and Q4ARCPU redundant system

(5) Power-up sequence for cases other than (3) and (4)

The GOT and PLC can both be started up whichever of these devices is turned ON first. (There is no specific sequence in which they are powered ON)

Note, however, that operation is as follows when the GOT is turned ON followed by the PLC:

When the PLC power is OFF with the GOT turned ON, the system alarm (No.402: timeout error) is generated. Upon power-on of the PLC CPU, the GOT automatically starts monitoring.

Use System Information to reset the alarm.

For the System Information, refer to the following manual:

➔ GT Designer3 Version□ Screen Design Manual

5.4.3 Powering OFF the GOT, reapplying the power (OFF to ON)

- (1) Precautions for reapplying the power to the GOT (OFF to ON)
Do not power-cycle the GOT (OFF to ON) while the PLC is ON.
Before doing so, be sure to turn off the PLC first.



Operations causing automatic reboot of the GOT1000 Series

Since the GOT1000 Series is automatically rebooted in the following cases, the power does not need to be reapplied to the GOT (OFF to ON).

- When an OS is written from GT Designer3 or a CF card
- When utility settings have been changed

- (2) When turning OFF the GOT before display of the user creation screen
When the GOT is turned OFF before the user creation screen is displayed on the GOT, subsequent communications may be no longer possible.
In such a case, reapply the power to the PLC CPU and GOT.
- (3) Precautions for connection of 3 GOTs or more (when connecting QCPU (Q mode))
5.4.10 (1) Restrictions in overall cable length to No. of GOTs

5.4.4 Reset switch on GOT

When bus connection is used, the reset switch on the GOT does not function.

5.4.5 Powering OFF or resetting the PLC

- (1) When turning OFF or resetting the PLC during monitoring
When turning OFF or resetting the PLC during monitoring, the system alarm (No.402: timeout error) is generated.
When the PLC CPU is restored, the GOT automatically resumes monitoring.
Use System Information to reset the alarm.
For the System Information, refer to the following manual:
GT Designer3 Version□ Screen Design Manual
- (2) When turning OFF or resetting the PLC CPU before display of the user creation screen
When the PLC CPU is turned OFF or reset before the user creation screen is displayed on the GOT, subsequent communications may be no longer possible.
In such a case, reapply the power to the PLC CPU and GOT.
- (3) Precautions for connection of 3 GOTs or more (when connecting QCPU (Q mode))
5.4.10 (1) Restrictions in overall cable length to No. of GOTs

5.4.6 Position of the GOT

Always connect the GOT to the last base unit.
Connecting a GOT between base units is not allowed.

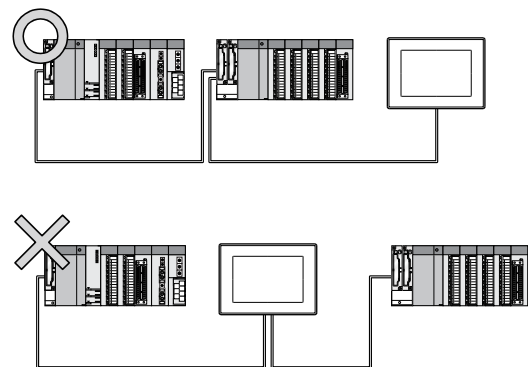

5.4.7 When the GOT is bus-connected to a PLC CPU without the communication driver written

When the GOT is bus-connected to a PLC CPU without the standard monitor OS and the communication driver for the bus connection being written onto the GOT, the PLC CPU is reset. (GX Developer cannot communicate with the PLC CPU)

In this case, disconnecting the bus connection cable from the GOT will cancel the reset status of the PLC CPU.

5.4.8 When designing the system

When the GOT is OFF, the following currents are supplied to the GOT from the PLC CPU side (the power supply module on the main base unit). (The GOT does not operate when it is OFF.)

Design the system so that the 5V DC current consumption of the modules on the main base unit and the total current consumption of the GOTs will not exceed the rated output current of 5V DC of the power supply module in use.

When connecting to	No. of GOTs	Total current consumption
When connecting to QCPU (Q mode)	5	2200mA
	4	1760mA
	3	1320mA
	2	880mA
	1	440mA
Other than QCPU (Q mode)	3	360mA
	2	240mA
	1	120mA

5.4.9 When assigning GOT I/O signals

Do not use the I/O signals assigned to the PLC CPU in sequence programs, as these signals are used by the GOT system.

When these signals are used, GOT functions cannot be assured.

5.4.10 When connecting to a QCPU (Q mode)

- (1) Restrictions in overall cable length to No. of GOTs
The following restrictions apply when 3 or more GOTs are connected:

Number of GOTs	Overall Cable Length	Restriction	Overall Cable Length	Restriction
1	(No restrictions)			
2				
3	Less than 25m	(No restrictions)	25 to 37m	Use the same power supply for the PLC and all GOTs, and turn these devices ON and OFF simultaneously.
4	Less than 20m		20 to 37m	
5	Less than 15m		15 to 37m	

- (2) When using a Q00JCPU, Q00UJCPU
The bus extension connector box can be connected only to the extension base unit. (Connecting it to the main base unit is not allowed)

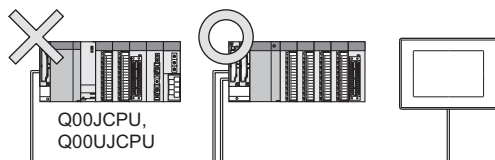

- (3) When using a Q00J/Q00UJ/Q00/Q00U/Q01/Q01U/Q02UCPU

When a GOT is bus-connected to a Q00JCPU or Q00UJCPU, number of extension stages including the GOT must be 2 or less.

When a GOT is bus-connected to a Q00CPU, Q00UCPU, Q01CPU, Q01UCPU or Q02UCPU, number of extension stages including the GOT must be 4 or less.

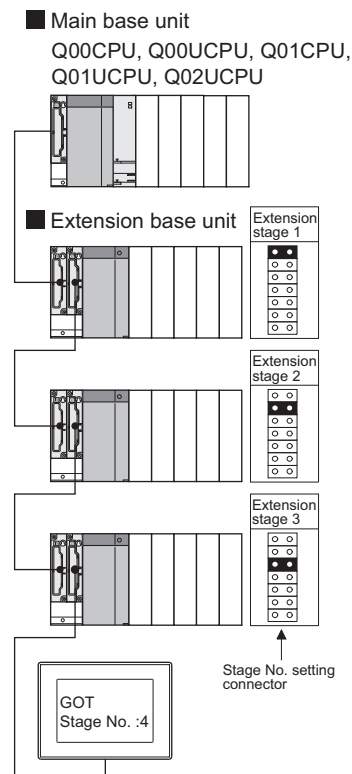
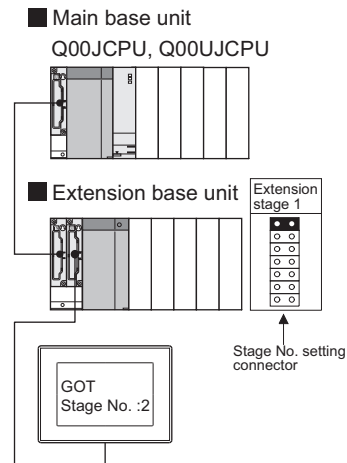

- (4) When using the QA1S6□B extension base unit
 A GOT is physically connected to the last of all extension base units. In the Stage No. setting, however, assign the GOT as a stage next to the last Q□□B type extension base unit.
 Assign the QA1S6□B type extension base unit as a stage next to the GOT.

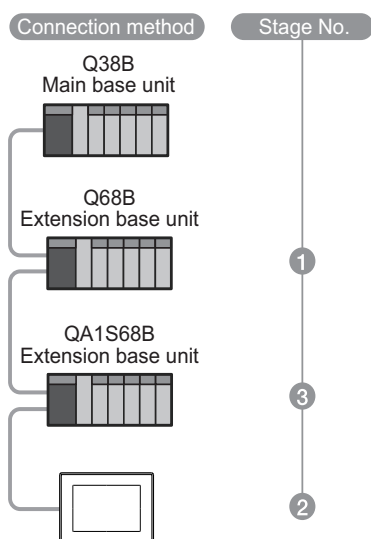

5.4.11 When connecting to a QnA(S)CPU or An(S)CPU type

- (1) When connecting with a QnASCPU type and an AnSCPU type
 A GOT can be connected to an extension connector on only one side of the main base unit.
 (Concurrently connecting GOTs to extension connectors on both sides is not allowed)

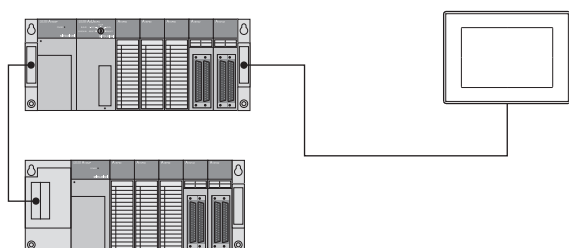

- (2) In the case of Q4A(R)CPU, Q3ACPU, A3□CPU, A4UCPU
 Empty I/O slots are required within the max. number of extension stages.
- (3) For A0J2HCPU
 Assign the GOT to the I/O slots 0 to 3 of extension stage 1.

- (4) In the case of CPUs other than (2) (3) above
 Even if the max. number of stages are used with no empty I/O slots, when there is a free space of 32 I/O points or more, a GOT can be connected under the following communication interface setting.
 For the communication interface setting, refer to the following.

5.3.1 Setting communication interface (Communication settings)

When connecting to	Max. stage No.	Communication interface setting	
		Stage No.	Slot No.
A1□CPU/A2USCPU(-S1) /QnAS(H)CPU(-S1)	1	2	0
A2□CPU/Q2ACPU	3	4	0
A3□CPU/A4□CPU	7	Cannot be used	
Q3ACPU/Q4ACPU	7		
A0J2HCPU	1		

5.4.12 When connecting multiple GOTs

(1) System including different GOT series

The GOT1000 series can be connected with GOT-A900 series in a system.

When using them together, refer to the following Technical News.

 Precautions when Replacing GOT-A900 Series with GOT1000 Series (GOT-A-0009)

The GOT1000 series cannot be used with GOTs other than GOT-A900 series in a system.

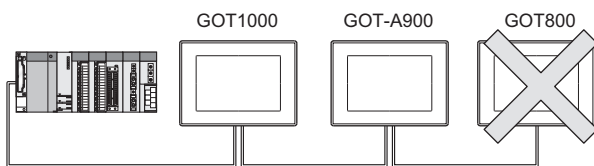

(2) Restrictions on No. of GOTs

The number of connectable GOTs is restricted according to the CPU type and the number of intelligent function modules.

When connecting to		Number of connectable GOTs	Total number of connectable GOTs and intelligent function modules*1
QCPU(Q mode), motion controller CPU (Q Series)		Up to 5	5 GOTs + 6 intelligent function modules*2
QCPU (A mode)		Not connectable	-----
QnACPU		Up to 3	6 in total
ACPU	AnUCPU, AnACPU, A2US(H)CPU	Up to 3	6 in total
	AnNCPU, AnS(H)CPU, A1SJ(H)CPU	Up to 2	2 in total
	A0J2HCPU	Up to 1	2 in total
	A1FXCPU	Not connectable	-----
Motion controller CPU (A Series)	A273UCPU, A273UHCPU(-S3), A373UCPU(-S3), A173UHCPU(-S1)	Up to 3	6 in total
	A171SHCPUN, A172SHCPUN	Up to 2	2 in total

*1 Indicates the following models:
AD51(S3), AD51H(S3), AD51FD(S3), AD57G(S3),
AJ71C21(S1), AJ71C22(S1), AJ71C23, AJ71C24(S3/S6/
S8), AJ71UC24, AJ71E71(-S3), AJ71E71N-B2/B5/T/B5T,
AJ71E71N3-T, AJ61BT11 (in intelligent mode only),
A1SJ71C24(-R2/PRF/R4),
A1SJ71UC24(-R2/PRF/R4),
A1SJ71E71-B2/B5(-S3),
A1SJ71E71N-B2/B5/T/B5T, A1SJ71E71N3-T, A1SD51S,
A1SJ61BT11 (in intelligent mode only)

*2 Only the A1SD51S can be connected to the QCPU (Q Mode).

5.4.13 When using a PLC CPU in the direct mode

Note that when the I/O control mode of the PLC CPU is the direct mode, and if the 1st GOT is connected to the main or extension base unit with a 5m extension cable (GT15-AC50B, GT15-A1SC50NB), the input X of the empty I/O slot cannot be used.

No restrictions apply when the I/O control mode is the refresh mode.

On PLC CPUs whose I/O control mode can be selected by a switch, set the I/O control mode to the refresh mode before use.

POINT

In the cases where input X of an empty I/O slot is used

- (1) When input X is assigned on the MELSECNET/10 network
- (2) When input X of an empty I/O slot is turned ON/OFF by the computer link module
- (3) When input X of the I/O slot is turned ON/OFF by the touch switch function (Bit SET/RST/Alternate/Momentary) of GOT

5.4.14 When connecting to a Q4ARCPU redundant system

- (1) When the GOT is bus-connected to a Q4ARCPU redundant system
 Connect the GOT to the last redundant extension base unit (A68RB) of the Q4ARCPU redundant system.
 For the redundant extension base units, use version B or later.
 The version can be confirmed in the DATE field of the rating plate.

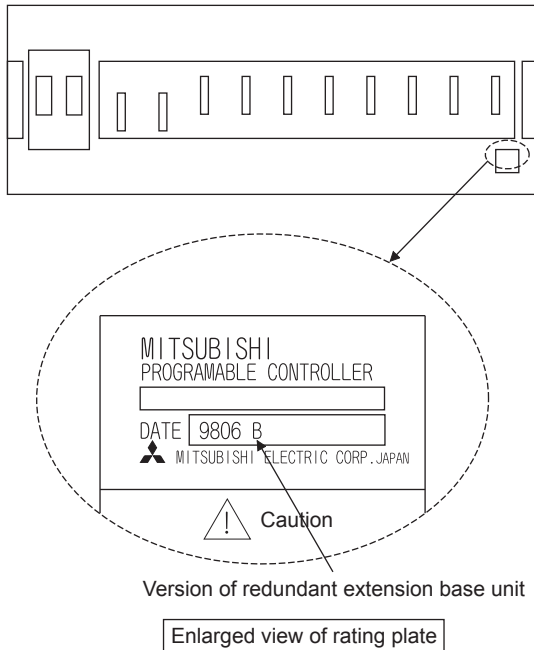

POINT

Precautions for Q4ARCPU redundant system configurations

The GOT does not operate normally in the following system configurations.

- (1) When the GOT is bus connected to the bus switching module (A6RAF) on a redundant main base unit (A32RB/A33RB)
- (2) When the GOT is bus connected to a version-A redundant main base unit (A68RB)

- (2) Power-On sequence for GOT and Q4ARCPU redundant system
 Apply the power to the GOT and Q4ARCPU redundant system in the following sequence.

1. Turn ON the GOT.
2. After the monitor screen is displayed on the GOT, turn ON the Q4ARCPU redundant system.
 At this time, a timeout is displayed on the system alarm. Use System Information to reset the alarm.
 For the system alarm, refer to the following manual:

GT Designer3 Version□ Screen Design Manual

5.4.15 When monitoring the Q170MCPU

Set [CPU No.] to "2" in the device setting to monitor the device of the Motion CPU area (CPU No.2).

When the CPU No. is set to "0" or "1", the device on the PLC CPU area (CPU No.1) is monitored.

When the CPU No. is set to the number other than "0" to "2", a communication error occurs and the monitoring cannot be executed.

For setting the CPU No., refer to the following manual.

GT Designer3 Version□ Screen Design Manual

Example) Setting dialog box of the bit device

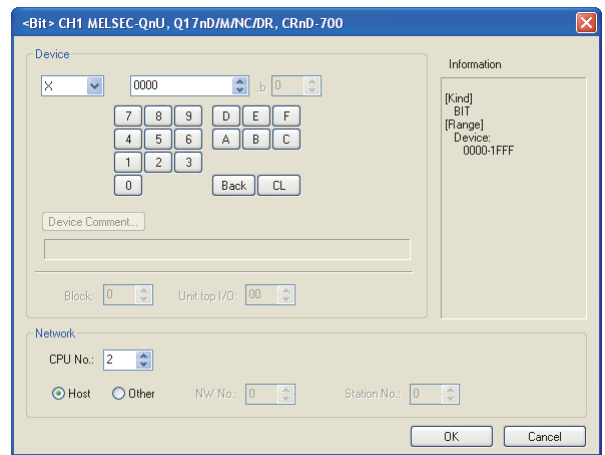

5.4.16 Troubleshooting

For the troubleshooting, refer to the User's Manual for the GOT you are using.

1 PREPARATORY PROCEDURES FOR MONITORING
 2 DEVICE RANGE THAT CAN BE SET
 3 ACCESS RANGE FOR MONITORING
 4 HOW TO MONITOR REDUNDANT SYSTEM
 5 BUS CONNECTION
 6 DIRECT CONNECTION TO CPU
 7 COMPUTER LINK CONNECTION
 8 ETHERNET CONNECTION

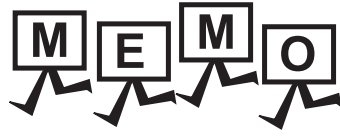

6

DIRECT CONNECTION TO CPU



6.1	Connectable Model List	6 - 2
6.2	System Configuration	6 - 7
6.3	Connection Diagram	6 - 27
6.4	GOT Side Settings	6 - 30
6.5	PLC Side Setting	6 - 33
6.6	Precautions	6 - 34

6. DIRECT CONNECTION TO CPU

6.1 Connectable Model List

The following table shows the connectable models.

Series	Model name	Clock	Communication type	GT 16	GT 15	GT 14	GT 12	GT11 Bus	GT11 Serial	GT 10 ²⁰ ₄₀	GT 10 ²⁰ ₃₀	Refer to
MELSEC iQ-R Series	R04CPU	○	RS-232 RS-422	×	×	×	×	×	×	×	×	-
	R08CPU											
	R16CPU											
	R32CPU											
	R120CPU											
	R08PCPU											
	R16PCPU											
	R32PCPU											
	R120PCPU											
	R04ENCPU											
	R08ENCPU											
	R16ENCPU											
	R32ENCPU											
	R120ENCPU											
	R08SFCPU											
	R16SFCPU											
R32SFCPU												
R120SFCPU												
Motion controller CPU (MELSEC iQ-R Series)	R16MTCPU	○	RS-232 RS-422	×	×	×	×	×	×	×	×	-
	R32MTCPU											
C Controller module (MELSEC iQ-R Series)	R12CCPU-V	○	RS-232 RS-422	×	×	×	×	×	×	×	×	-
MELSEC iQ-F Series	FX5U	○	RS-232 RS-422	○	×	○	×	×	×	○	○	-
	FX5UC											

(Continued to next page)

Series	Model name	Clock	Communication type	GT 16	GT 15	GT 14	GT 12	GT11 Bus	GT11 Serial	GT10 ²⁰ ₄	GT10 ²⁰ ₃₀	Refer to	
MELSEC-Q (Q mode)	Q00JCPU	○	RS-232 RS-422	○	○	○	○	×	○	○	○	6.2.1	
	Q00CPU*1												
	Q01CPU*1												
	Q02CPU*1												
	Q02HCPU*1 Q06HCPU*1 Q12HCPU*1 Q25HCPU*1	○	RS-232 RS-422	○	○	○	○	×	○	×*3	×*3	6.2.1	
	Q02PHCPU Q06PHCPU Q12PHCPU Q25PHCPU												
	Q12PRHCPU (Main base) Q25PRHCPU (Main base)												
	Q12PRHCPU (Extension base) Q25PRHCPU (Extension base)	○	-	×	×	×	×	×	×	×	×	×	-
	Q00UJCPU	○	RS-232 RS-422	○	○	○	○	○	×	○	○	○	6.2.1
	Q00UCPU Q01UCPU Q02UCPU Q03UDCPU												
	Q04UDHCPU Q06UDHCPU Q10UDHCPU Q13UDHCPU Q20UDHCPU Q26UDHCPU												
	Q03UDECPU Q04UDEHCPU Q06UDEHCPU Q10UDEHCPU Q13UDEHCPU Q20UDEHCPU Q26UDEHCPU Q50UDEHCPU Q100UDEHCPU												
	Q03UDVCPU Q04UDVCPU Q06UDVCPU Q13UDVCPU Q26UDVCPU	○	RS-232	○*2	○*2	○*2	○*2	×	○*2	○*2	○*2	○*2	6.2.1
	Q03UDVCPU Q04UDVCPU Q06UDVCPU Q13UDVCPU Q26UDVCPU												
C Controller module (Q Series)	Q12DCCPU-V*4 Q24DHCCPU-V/VG Q24DHCCPU-LS	○	RS-232	○*2	○*2	○*2	○*2	×	○*2	○*2	○*2	6.2.1	
	Q26DHCCPU-LS			○*2	×	○*2	×	×	×	○*2	○*2		
MELSEC-QS	QS001CPU	○	-	×	×	×	×	×	×	×	×	-	

(Continued to next page)

- *1 When in multiple CPU system configuration, use CPU function version B or later.
- *2 Access via the (RS-232) in the multiple CPU system.
- *3 Exclude the GT10 from the multiple CPU system configuration.
- *4 Use a module with the upper five digits of the serial No. later than 12042.

1 PREPARATORY PROCEDURES FOR MONITORING
 2 DEVICE RANGE THAT CAN BE SET
 3 ACCESS RANGE FOR MONITORING
 4 HOW TO MONITOR REDUNDANT SYSTEM
 5 BUS CONNECTION
 6 DIRECT CONNECTION TO CPU
 7 COMPUTER LINK CONNECTION
 8 ETHERNET CONNECTION

Series	Model name	Clock	Communication type	GT 16	GT 15	GT 14	GT 12	GT11 Bus	GT11 Serial	GT10 5□4□	GT10 20□30□	Refer to
MELSEC-L	L02CPU*1	○	RS-232 RS-422	○	○	○	○	×	○	○	○	☞ 6.2.2
	L06CPU*1											
	L26CPU*1											
	L26CPU-BT*1											
	L02CPU-P*1											
	L06CPU-P*1											
	L26CPU-P*1											
	L26CPU-PBT*1											
MELSEC-Q (A mode)	Q02CPU-A	○	RS-232 RS-422	○	○	○	○	×	○	○	○	☞ 6.2.1
	Q02HCPU-A											
	Q06HCPU-A											
MELSEC-QnA (QnACPU)*3	Q2ACPU	○	RS-422	○	○	○	○	×	○	○	○	☞ 6.2.3
	Q2ACPU-S1											
MELSEC-QnA (QnASCPU)*3	Q3ACPU	○	RS-422	○	○	○	○	×	○	○	○	☞ 6.2.3
	Q4ACPU											
MELSEC-A (AnCPU)	Q4ARCPU	○	RS-422	○	○	○	○	×	○	×	×	☞ 6.2.4
	Q2ASCPU	○	RS-422	○	○	○	○	×	○	○	○	
	Q2ASCPU-S1											
	Q2ASHCPU											
	Q2ASHCPU-S1											
	A2UCPU											
	A2UCPU-S1											
	A3UCPU											
	A4UCPU											
	A2ACPU											
	A2ACPUP21											
	A2ACPUR21											
	A2ACPU-S1											
	A2ACPUP21-S1											
	A2ACPUR21-S1											
	A3ACPU											
	A3ACPUP21											
	A3ACPUR21											
	A1NCPU*2											
	A1NCPUP21*2											
A1NCPUR21*2												
A2NCPU*2												
A2NCPUP21*2												
A2NCPUR21*2												
A2NCPU-S1*2												
A2NCPUP21-S1*2												
A2NCPUR21-S1*2												
A3NCPU*2												
A3NCPUP21*2												
A3NCPUR21*2												
MELSEC-A (AnSCPU)	A2USCPU	○	RS-422	○	○	○	○	×	○	○	○	☞ 6.2.4

(Continued to next page)

- *1 When connecting in direct CPU connection, the adapter L6ADP-R2 or L6ADP-R4 is required.
When using L6ADP-R4, use an LCPU whose upper five digits are "15102" or later.
- *2 When monitoring AnNCPU or A2SCPU, only the following or later software version is used to write to the CPU.
- AnNCPU(S1) with link: Version L or later, AnNCPU(S1) without link: Version H or later
 - A2SCPU: Version H or later
- *3 GT10 can be connected to CPUs of the following HW versions or later.

PLC type	HW/SW Version	PLC type	HW/SW Version
Q2ACPU	DA	Q2ASCPU	AL
Q2ACPU-S1	DA	Q2ASCPU-S1	AL
Q3ACPU	DA	Q2ASHCPU	BL
Q4ACPU	EA	Q2ASHCPU-S1	BL
Q4ARCPU	AL	-	-

Series	Model name	Clock	Communication type	GT 16	GT 15	GT 14	GT 12	GT11 Bus	GT11 Serial	GT 10 50	GT 10 30	Refer to	
MELSEC-A (AnSCPU)	A2USCPU-S1	○	RS-422									☞ 6.2.4	
	A2USHCPU-S1												
	A1SCPU												
	A1SCPUC24-R2												
	A1SHCPU												
	A2SCPU*1												
	A2SCPU-S1*1												
	A2SHCPU												
	A2SHCPU-S1												
	A1SJCPU												
	A1SJCPU-S3												
A1SJHCPU													
MELSEC-A	A0J2HCPU*1	×	RS-422									☞ 6.2.4	
	A0J2HCPUP21*1												
	A0J2HCPUR21*1												
	A0J2HCPU-DC24*1												
	MELSEC-A	A2CCPU*1	○	RS-422									☞ 6.2.4
		A2CCPUP21											
		A2CCPUR21											
		A2CCPUC24											
A2CCPUC24-PRF													
A2CJCPU-S3													
A1FXCPU													
Motion controller CPU (Q Series)	Q172CPU*2*3	○	RS-232 RS-422									☞ 6.2.1	
	Q173CPU*2*3												
	Q172CPUN*2												
	Q173CPUN*2												
	Motion controller CPU (Q Series)	Q172HCPU	○	RS-232									☞ 6.2.1
		Q173HCPU											
		Q172DCPU											
		Q173DCPU											
		Q172DCPU-S1											
		Q173DCPU-S1											
		Q172DSCPU											
		Q173DSCPU											
		Q170MCPUCPU											
		Q170MSCPU											
		Q170MSCPU-S1											
	MR-MQ100	○	RS-422								☞ 6.2.8		

(Continued to next page)

- *1 When monitoring A0J2HCPU, A2CCPU or A2SCPU, only the following or later software version is used to write to the CPU.
 - A0J2HCPU (with/without link): Version E or later
 - A0J2HCPU-DC24: Version B or later
 - A2CCPU, A2SCPU: Version H or later
- *2 When using SV13, SV22, or SV43, use the motion controller CPU on which any of the following main OS version is installed.
 - SW6RN-SV13Q□: 00E or later
 - SW6RN-SV22Q□: 00E or later
 - SW6RN-SV43Q□: 00B or later
- *3 Use main modules with the following product numbers.
 - Q172CPU: Product number K***** or later
 - Q173CPU: Product number J***** or later
- *4 Access via QCPU (RS-232) in the multiple CPU system.

1 PREPARATORY PROCEDURES FOR MONITORING
2 DEVICE RANGE THAT CAN BE SET
3 ACCESS RANGE FOR MONITORING
4 HOW TO MONITOR REDUNDANT SYSTEM
5 BUS CONNECTION
6 DIRECT CONNECTION TO CPU
7 COMPUTER LINK CONNECTION
8 ETHERNET CONNECTION

Series	Model name	Clock	Communication type	GT 16	GT 15	GT 14	GT 12	GT11 Bus	GT11 Serial	GT 10 5V 4□	GT 10 20 3□	Refer to
Motion controller CPU (A Series)	A273UCPU	○	RS-422	○	○	○	○	×	○	×	×	6.2.4
	A273UHCPU	○	RS-422	○	○	○	○	×	○	×	×	
	A273UHCPU-S3			○	○	○	○	×	○	×	×	
	A373UCPU	○	RS-422	○	○	○	○	×	○	×	×	
	A373UCPU-S3			○	○	○	○	×	○	×	×	
	A171SCPU			○	○	○	○	×	○	×	×	
	A171SCPU-S3			○	○	○	○	×	○	×	×	
	A171SCPU-S3N	○	RS-422	○	○	○	○	×	○	×	×	
	A171SHCPU			○	○	○	○	×	○	×	×	
	A171SHCPUN			○	○	○	○	×	○	×	×	
	A172SHCPU			○	○	○	○	×	○	×	×	
	A172SHCPUN			○	○	○	○	×	○	×	×	
	A173UHCPU			○	○	○	○	×	○	×	×	
	A173UHCPU-S1	○	○	○	○	×	○	×	×			
MELSEC-WS	WS0-CPU0	×	RS-232	○	○	○	○	×	○	○	○	6.2.7
	WS0-CPU1			○	○	○	○	×	○	○	○	
	WS0-CPU3			○	○	○	○	×	○	○	○	
MELSECNET/H Remote I/O station	QJ72LP25-25	×	RS-232	○	○	○	○	×	○ ^{*1}	×	×	6.2.1
	QJ72LP25G			○	○	○	○	×	○ ^{*1}	×	×	
	QJ72BR15			○	○	○	○	×	○ ^{*1}	×	×	
CC-Link IE Field Network head module	LJ72GF15-T2	×	-	×	×	×	×	×	×	×	-	
CC-Link IE Field Network Ethernet adapter module	NZ2GF-ETB	×	-	×	×	×	×	×	×	×	×	-
CNC C70	Q173NCCPU	○	RS-232	○ ^{*2}	○ ^{*2}	○ ^{*2}	○ ^{*2}	×	○ ^{*2}	×	×	6.2.1
Robot controller	CRnQ-700 (Q172DRCPU) CR750-Q (Q172DRCPU) CR751-Q (Q172DRCPU)	○	RS-232	○ ^{*2}	○ ^{*2}	○ ^{*2}	○ ^{*2}	×	○ ^{*2}	×	×	6.2.1
MELSEC-FX	FX0	×	RS-422	○	○	○	○	×	○	○	○ ^{*4}	6.2.6
	FX0S	×	RS-422	○	○	○	○	×	○	○	○	
	FX0N			○	○	○	○	×	○	○	○	
	FX1	×	RS-422	○	○	○	○	×	○	○	○ ^{*4}	
	FX2	×	RS-422	○	○	○	○	×	○	○	○ ^{*4}	
	FX2C			○	○	○	○	×	○	○	○ ^{*4}	
	FX1S	○	RS-232 RS-422	○	○	○	○	×	○	○	○	
	FX1N			○	○	○	○	×	○	○	○	
	FX2N			○	○	○	○	×	○	○	○	
	FX1NC			○	○	○	○	×	○	○	○	
	FX2NC	×	RS-232 RS-422	○	○	○	○	×	○	○	○	
	FX3S	○	RS-232 RS-422	○	○	○	○	×	○	○	○	
	FX3G			○	○	○	○	×	○	○	○	
	FX3GC			○	○	○	○	×	○	○	○	
FX3GE	○			○	○	○	×	○	○	○		
FX3U	○			○	○	○	×	○	○	○		
FX3UC	○			○	○	○	×	○	○	○		

*1 GT11 can not access the master station on MELSECNET/H network system. GT11 can access only the connected host station (remote I/O station).

*2 Access via QCPU (RS-232) in the multiple CPU system.

*3 It is available by installing the real time clock function board or the EEPROM memory with the real time clock function.

*4 Cannot be connected to products with input voltage 5V.

6.2 System Configuration

6.2.1 Connecting to QCPU

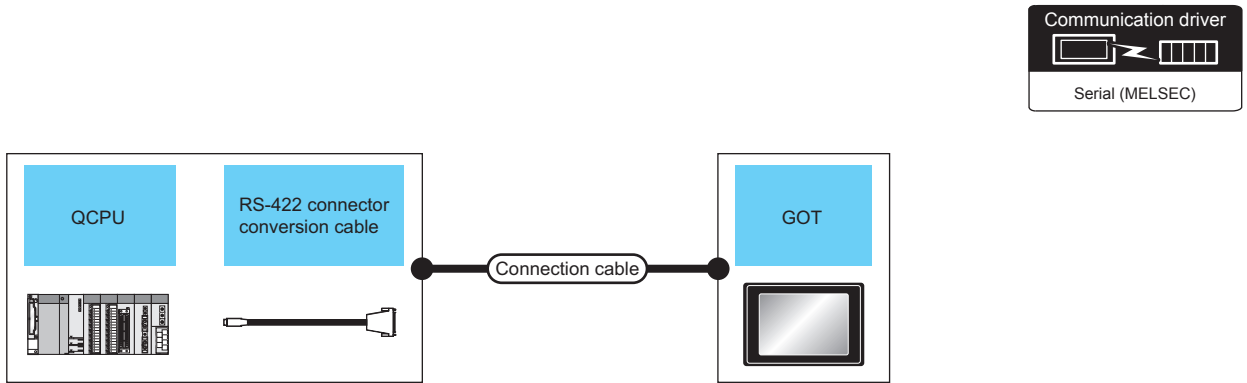

PLC			Connection cable		GOT		Number of connectable equipment*5
Model name	RS-422 connector conversion cable	Communication type	Cable model	Max. distance	Option device	Model	
MELSEC-Q	-	RS-232	GT01-C30R2-6P(3m)	3m	- (Built into GOT)		1 GOT for 1 PLC
					GT15-RS2-9P		
			GT01-RS4-M*4	-			
			GT10-C30R2-6P(3m) *2	3m	- (Built into GOT)		
	FA-CNV2402CBL(0.2m) FA-CNV2405CBL (0.5m)	RS-422	GT01-C30R4-25P(3m) GT01-C100R4-25P(10m) GT01-C200R4-25P(20m) GT01-C300R4-25P(30m)	30m	GT16-C02R4-9S		
					GT15-RS2T4-9P*1		
					GT15-RS4-9S		
					- (Built into GOT)		
		GT01-RS4-M*4	-				
		GT10-C30R4-25P(3m) GT10-C100R4-25P(10m) GT10-C200R4-25P(20m) GT10-C300R4-25P(30m)	30m	- (Built into GOT)			

*1 Connect it to the RS-232 interface (built into GOT). It cannot be mounted on GT1655 and GT155□.

*2 For the connection to GOT, refer to the connection diagram. (☞ RS-232 connection diagram 3))

*3 For the connection to GOT, refer to the connection diagram. (☞ RS-422 connection diagram 2))

*4 For details of the GOT multi-drop connection, refer to the following.

☞ 20. GOT MULTI-DROP CONNECTION

*5 GT14, GT12, GT11 and GT10 are available for the multiple-GT14, GT12, GT11, GT10 connection function to connect up to two GOTs.

☞ 21. MULTIPLE-GT14, GT12, GT11, GT10 CONNECTION FUNCTION

*6 Applicable to the QnUCPU only

*7 Use the RS-232 connection model.

*8 Use the RS-422 connection model.

6.2.2 Connecting to LCPU

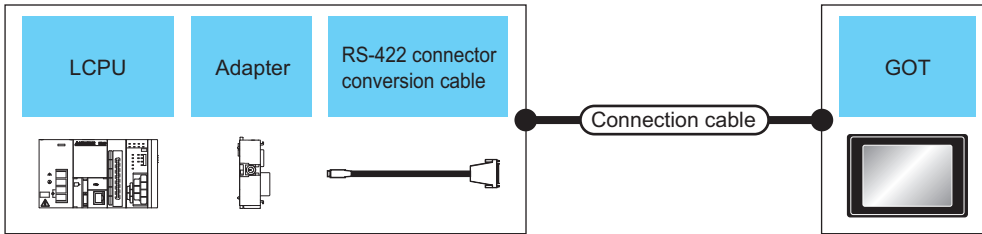

PLC				Connection cable		GOT		Number of connectable equipment*5
Model name	Adapter	RS-422 connector conversion cable	Communication type	Cable model	Max. distance	Option device	Model	
L02CPU L06CPU L26CPU L26CPU-BT L02CPU-P L06CPU-P L26CPU-P L26CPU-PBT	L6ADP-R2	-	RS-232	GT01-C30R2-6P(3m)	3m	- (Built into GOT)		1 GOT for 1 PLC
						GT15-RS2-9P		
						GT01-RS4-M ⁴	-	
	GT10-C30R2-6P(3m) ^{*2}	3m	- (Built into GOT)					
	L6ADP-R2	FA-CNV2402CBL(0.2m) FA-CNV2405CBL(0.5m)	RS-422	GT01-C30R4-25P(3m) GT01-C100R4-25P(10m) GT01-C200R4-25P(20m) GT01-C300R4-25P(30m)	30m	GT16-C02R4-9S		
						GT15-RS2T4-9P ^{*1}		
GT15-RS4-9S								
GT01-RS4-M ⁴	-							
L02CPU L06CPU L26CPU L26CPU-BT L02SCPU L02CPU-P L06CPU-P L26CPU-P L26CPU-PBT	L6ADP-R4	-	RS-422	GT10-C30R4-25P(3m) GT10-C100R4-25P(10m) GT10-C200R4-25P(20m) GT10-C300R4-25P(30m) ^{*3}	30m	- (Built into GOT)		
						GT15-RS2-9S		
						- (Built into GOT)		
RS-422 connection diagram 6)	1200m	- (Built into GOT)						
RS-422 connection diagram 7)	1200m	- (Built into GOT)						

PLC				Connection cable		GOT		Number of connectable equipment*5	
Model name	Adapter	RS-422 connector conversion cable	Communication type	Cable model	Max. distance	Option device	Model		
L02SCPU L02SCPU-P	-	-	RS-232	GT01-C30R2-6P(3m)	3m	- (Built into GOT)	GT16 GT15	1 GOT for 1 PLC	
							GT14		
							GT11 Serial		
				GT10 ⁵ 4□					
				GT15-RS2-9P	GT16 GT15				
				GT01-RS4-M*4	-				
		GT10-C30R2-6P(3m)*2	3m	- (Built into GOT)	GT _{24V} 10 ²⁰ 30				
					GT01-C30R4-25P(3m) GT01-C100R4-25P(10m) GT01-C200R4-25P(20m) GT01-C300R4-25P(30m)	30m	GT16-C02R4-9S		GT16
							GT15-RS2T4-9P*1		GT16 GT15
							GT15-RS4-9S		GT14 Serial
GT10-C30R4-25P(3m) GT10-C100R4-25P(10m) GT10-C200R4-25P(20m) GT10-C300R4-25P(30m)	30m	- (Built into GOT)	GT10 ⁵ 4□						
			GT01-RS4-M*4	-					
GT10-C30R4-25P(3m) GT10-C100R4-25P(10m) GT10-C200R4-25P(20m) GT10-C300R4-25P(30m)	30m	- (Built into GOT)	GT _{24V} 10 ²⁰ 30						
			*3						

- *1 Connect it to the RS-232 interface (built into GOT). It cannot be mounted on GT1655 and GT155□.
- *2 For the connection to GOT, refer to the connection diagram. (☞ RS-232 connection diagram 3))
- *3 For the connection to GOT, refer to the connection diagram. (☞ RS-422 connection diagram 2))
- *4 For details of the GOT multi-drop connection, refer to the following.
☞ 20. GOT MULTI-DROP CONNECTION
- *5 GT14, GT12, GT11 and GT10 are available for the multiple-GT14, GT12, GT11, GT10 connection function to connect up to two GOTs.
☞ 21. MULTIPLE-GT14, GT12, GT11, GT10 CONNECTION FUNCTION
- *6 Use the RS-232 connection model.
- *7 Use the RS-422 connection model.

1 PREPARATORY PROCEDURES FOR MONITORING
 2 DEVICE RANGE THAT CAN BE SET
 3 ACCESS RANGE FOR MONITORING
 4 HOW TO MONITOR REDUNDANT SYSTEM
 5 BUS CONNECTION
 6 DIRECT CONNECTION TO CPU
 7 COMPUTER LINK CONNECTION
 8 ETHERNET CONNECTION

6.2.3 Connecting to QnACPU

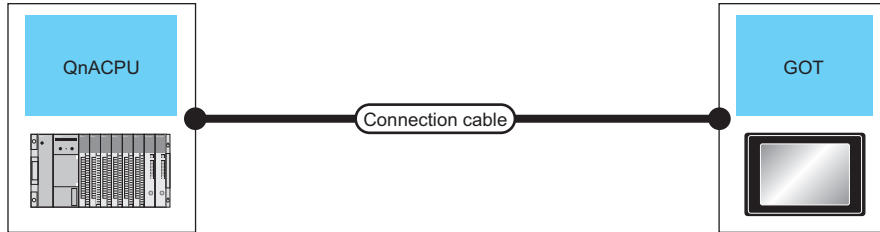

PLC		Connection cable		GOT		Number of connectable equipment ^{*4}
Model name	Communication type	Cable model	Max. distance	Option device	Model	
MELSEC-QnA	RS-422	GT01-C30R4-25P(3m) GT01-C100R4-25P(10m) GT01-C200R4-25P(20m) GT01-C300R4-25P(30m)	30m	GT16-C02R4-9S GT15-RS2T4-9P ^{*1} GT15-RS4-9S - (Built into GOT)	 	1 GOT for 1 PLC
		GT10-C30R4-25P(3m) GT10-C100R4-25P(10m) GT10-C200R4-25P(20m) GT10-C300R4-25P(30m) ^{*2}	30m	- (Built into GOT)	^{*5}	
				GT01-RS4-M ^{*3}	-	

^{*1} Connect it to the RS-232 interface (built into GOT). It cannot be mounted on GT1655 and GT155□.

^{*2} For the connection to GOT, refer to the connection diagram. (→ RS-422 connection diagram 2))

^{*3} For details of the GOT multi-drop connection, refer to the following.

→ 20. GOT MULTI-DROP CONNECTION

^{*4} GT14, GT12, GT11 and GT10 are available for the multiple-GT14, GT12, GT11, GT10 connection function to connect up to two GOTs.

→ 21. MULTIPLE-GT14, GT12, GT11, GT10 CONNECTION FUNCTION

^{*5} Use the RS-422 connection model.

6.2.4 Connecting to ACPU

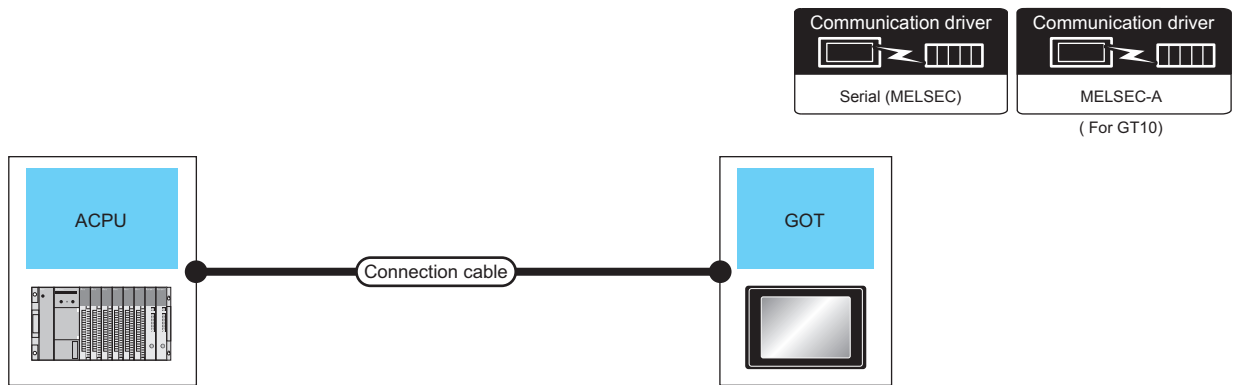

PLC		Connection cable		GOT		Number of connectable equipment*4
Model name	Communication type	Cable model	Max. distance	Option device	Model	
MELSEC-A	RS-422	GT01-C30R4-25P(3m) GT01-C100R4-25P(10m) GT01-C200R4-25P(20m) GT01-C300R4-25P(30m)	30m	GT16-C02R4-9S	GT16	1 GOT for 1 PLC
		GT10-C30R4-25P(3m) GT10-C100R4-25P(10m) GT10-C200R4-25P(20m) GT10-C300R4-25P(30m) *2		30m	- (Built into GOT)	
GT15-RS2T4-9P*1 GT15-RS4-9S	GT16, GT15		-		GT10 20/30*5	
GT01-RS4-M*3	-	-	-	-		

*1 Connect it to the RS-232 interface (built into GOT). It cannot be mounted on GT1655 and GT155□.

*2 For the connection to GOT, refer to the connection diagram. (RS-422 connection diagram 2))

*3 For details of the GOT multi-drop connection, refer to the following.

20. GOT MULTI-DROP CONNECTION

*4 GT14, GT12, GT11 and GT10 are available for the multiple-GT14, GT12, GT11, GT10 connection function to connect up to two GOTs.

21. MULTIPLE-GT14, GT12, GT11, GT10 CONNECTION FUNCTION

*5 Use the RS-422 connection model.





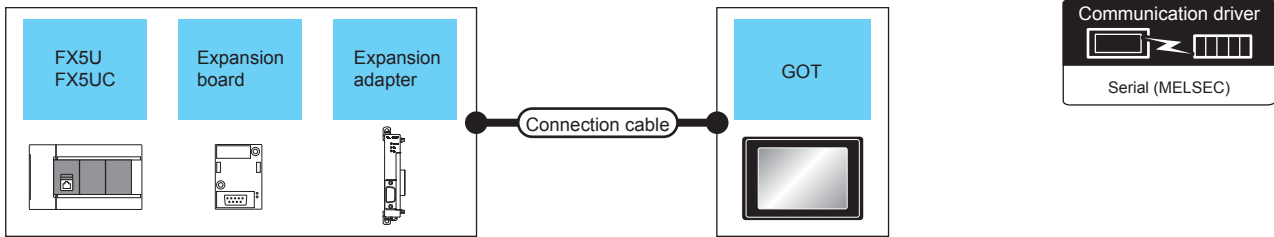





1 PREPARATORY PROCEDURES FOR MONITORING
2 DEVICE RANGE THAT CAN BE SET
3 ACCESS RANGE FOR MONITORING
4 HOW TO MONITOR REDUNDANT SYSTEM
5 BUS CONNECTION
6 DIRECT CONNECTION TO CPU
7 COMPUTER LINK CONNECTION
8 ETHERNET CONNECTION

6.2.5 Connecting to MELSEC iQ-F Series



■ When connecting to FX5U (RS-422 connection)

Model name	PLC			Connection cable		GOT		Number of connectable equipment*3
	Expansion board	Expansion adapter	Communication type	Cable model Connection diagram number	Max. distance	Option device	Model	
FX5U	FX5-422-BD-GOT	-	RS-422	GT01-C10R4-8P(1m) GT01-C30R4-8P(3m) GT01-C100R4-8P(10m) GT01-C200R4-8P(20m) GT01-C300R4-8P(30m)	30m	GT16-C02R4-9S	GT16	1 GOT for 1 Expansion board
						GT15-RS2T4-9P*1	GT16	
						GT15-RS4-9S	GT16	
		-(Built into GOT)	GT14, GT10 ⁵ ₄					
		GT10-C10R4-8P(1m) GT10-C30R4-8P(3m) GT10-C100R4-8P(10m) GT10-C200R4-8P(20m) GT10-C300R4-8P(30m) GT10-C10R4-8PC(1m) GT10-C30R4-8PC(3m) GT10-C100R4-8PC(10m) GT10-C200R4-8PC(20m) GT10-C300R4-8PC(30m) *2	30m	-(Built into GOT)	GT10 ²⁰ _{24V} ³⁰ *4			
		-(Built into GOT)		GT10 ²⁰ _{5V} ³⁰ *4				
	-	-	RS-422	User RS-422 connection diagram 8)	30m	GT16-C02R4-9S	GT16	1 GOT for 1 PLC built-in port
						GT15-RS2T4-9P*1	GT16	
				GT15-RS4-9S	GT16			
				-(Built into GOT)	GT14, GT10 ⁵ ₄			
				User RS-422 connection diagram 9)	30m	-(Built into GOT)	GT10 ²⁰ _{24V} ³⁰ *4	
	FX5-485-BD	-	RS-422	User RS-422 connection diagram 8)	30m	GT16-C02R4-9S	GT16	1 GOT for 1 Expansion board
						GT15-RS2T4-9P*1	GT16	
						GT15-RS4-9S	GT16	
					-(Built into GOT)	GT14, GT10 ⁵ ₄		
				User RS-422 connection diagram 9)	30m	-(Built into GOT)	GT10 ²⁰ _{24V} ³⁰ *4	

PLC				Connection cable		GOT		Number of connectable equipment*3
Model name	Expansion board	Expansion adapter	Communication type	Cable model Connection diagram number	Max. distance	Option device	Model	
FX5U	-	FX5-485ADP	RS-422	 RS-422 connection diagram 8)	30m	GT16-C02R4-9S		1 GOT for 1 Expansion adapter
						GT15-RS2T4-9P*1		
						GT15-RS4-9S	 	
				- (Built into GOT)	 			
				 RS-422 connection diagram 9)	30m	- (Built into GOT)	  *4	

















*1 Connect it to the RS-232 interface (built into GOT). It cannot be mounted on GT1655 and GT155□.

*2 For the connection to GOT, refer to the connection diagram. (☞ RS-422 connection diagram 1))

*3 When the expansion board (communication board) and the expansion adapter are connected, a GOT and a peripheral such as a PC with GX Works3 installed can be connected to them individually.

*4 Use the RS-422 connection model.

■ When connecting to FX5U (RS-232 connection)

PLC				Connection cable		GOT		Number of connectable equipment*2
Model name	Expansion board	Expansion adapter	Communication type	Cable model Connection diagram number	Max. distance	Option device	Model	
FX5U	FX5-232-BD	-	RS-232	GT01-C30R2-9S(3m) or  RS-232 connection diagram 1)	15m	- (Built into GOT)	  	1 GOT for 1 Expansion board
						GT15-RS2-9P		
						GT01-RS4-M*1	-	
				 RS-232 connection diagram 4)	15m	- (Built into GOT)	  *3	
	-	FX5-232ADP	RS-232	GT01-C30R2-9S(3m) or  RS-232 connection diagram 1)	15m	- (Built into GOT)	  	1 GOT for 1 Expansion adapter
						GT15-RS2-9P		
				GT01-RS4-M*1		-		
			 RS-232 connection diagram 4)	15m	- (Built into GOT)	  *3		

*1 For details of the GOT multi-drop connection, refer to the following.

☞ 20. GOT MULTI-DROP CONNECTION

*2 When the expansion board (communication board) and the expansion adapter are connected, a GOT and a peripheral such as a PC with GX Works3 installed can be connected to them individually.

*3 Use the RS-422 connection model.

1
PREPARATORY PROCEDURES FOR MONITORING

2
DEVICE RANGE THAT CAN BE SET

3
ACCESS RANGE FOR MONITORING

4
HOW TO MONITOR REDUNDANT SYSTEM















5
BUS CONNECTION

6
DIRECT CONNECTION TO CPU

7
COMPUTER LINK CONNECTION

8
ETHERNET CONNECTION

■ When connecting to FX5UC (RS-422 connection)







PLC				Connection cable		GOT		Number of connectable equipment*2
Model name	Expansion board	Expansion adapter	Communication type	Cable model Connection diagram number	Max. distance	Option device	Model	
FX5UC	-	-	RS-422	 RS-422 connection diagram 8)	30m	GT16-C02R4-9S		1 GOT for 1 PLC built-in port
						GT15-RS2T4-9P*1		
						GT15-RS4-9S		
				-(Built into GOT)	 			
				 RS-422 connection diagram 9)	30m	-(Built into GOT)	 *3	
FX5UC	-	FX5-485ADP	RS-422	 RS-422 connection diagram 8)	30m	GT16-C02R4-9S		1 GOT for 1 Expansion adapter
						GT15-RS2T4-9P*1		
						GT15-RS4-9S		
				-(Built into GOT)	 			
				 RS-422 connection diagram 9)	30m	-(Built into GOT)	 *3	

*1 Connect it to the RS-232 interface (built into GOT). It cannot be mounted on GT1655 and GT155□.

*2 When the expansion board (communication board) and the expansion adapter are connected, a GOT and a peripheral such as a PC with GX Works3 installed can be connected to them individually.

*3 Use the RS-422 connection model.

■ When connecting to FX5UC (RS-232 connection)

PLC				Connection cable		GOT		Number of connectable equipment*2
Model name	Expansion board	Expansion adapter	Communication type	Cable model Connection diagram number	Max. distance	Option device	Model	
FX5UC	-	FX5-232ADP	RS-232	GT01-C30R2-9S(3m) or  RS-232 connection diagram 1)	15m	-(Built into GOT)	  	1 GOT for 1 Expansion adapter
				GT15-RS2-9P				
				GT01-RS4-M*1	-			
				 RS-232 connection diagram 4)	15m	-(Built into GOT)	 *3	

*1 For details of the GOT multi-drop connection, refer to the following.

 20. GOT MULTI-DROP CONNECTION

*2 When the expansion board (communication board) and the expansion adapter are connected, a GOT and a peripheral such as a PC with GX Works3 installed can be connected to them individually.

*3 Use the RS-422 connection model.

6.2.6 Connecting to FXCPU

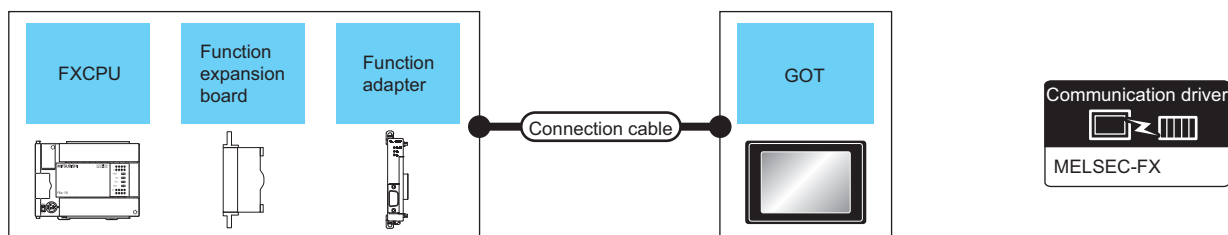

■ When connecting to FX0, FX0s, FX0N, FX1, FX2 or FX2C

PLC				Connection cable		GOT		Number of connectable equipment*4
Model name	Function expansion board*5	Function adapter*5	Communication type	Cable model	Max. distance	Option device	Model	
FX0 FX0s FX0N	-	-	RS-422	GT01-C10R4-8P(1m) GT01-C30R4-8P(3m) GT01-C100R4-8P(10m) GT01-C200R4-8P(20m) GT01-C300R4-8P(30m)	30m	GT16-C02R4-9S GT15-RS2T4-9P*1 GT15-RS4-9S	GT16 GT16 GT15 GT14 GT12 GT11 Serial GT10 5□ 4□	1 GOT for 1 PLC
				GT10-C10R4-8P(1m) GT10-C30R4-8P(3m) GT10-C100R4-8P(10m) GT10-C200R4-8P(20m) GT10-C300R4-8P(30m) GT10-C10R4-8PC(1m) GT10-C30R4-8PC(3m) GT10-C100R4-8PC(10m) GT10-C200R4-8PC(20m) GT10-C300R4-8PC(30m) GT10-C10R4-8PL *2		30m	-(Built into GOT)	
FX0s FX0N	-	-	RS-422	GT10-C10R4-8P(1m) GT10-C30R4-8P(3m) GT10-C10R4-8PC(1m) GT10-C30R4-8PC(3m) GT10-C10R4-8PL *2	3m	-(Built into GOT)	GT10 20 30 *6 5V	
FX1 FX2 FX2C	-	-	RS-422	GT01-C30R4-25P(3m) GT01-C100R4-25P(10m) GT01-C200R4-25P(20m) GT01-C300R4-25P(30m)	30m	GT16-C02R4-9S GT15-RS2T4-9P*1 GT15-RS4-9S	GT16 GT16 GT15 GT14 GT12 GT11 Serial GT10 5□ 4□	1 GOT for 1 PLC
				GT10-C30R4-25P(3m) GT10-C100R4-25P(10m) GT10-C200R4-25P(20m) GT10-C300R4-25P(30m) *7		30m	-(Built into GOT)	

*1 Connect it to the RS-232 interface (built into GOT). It cannot be mounted on GT1655 and GT155□.

*2 For the connection to GOT, refer to the connection diagram. (➡ RS-422 connection diagram 1))

*3 For details of the GOT multi-drop connection, refer to the following.

➡ 20. GOT MULTI-DROP CONNECTION

*4 GT14, GT12, GT11 and GT10 are available for the multiple-GT14, GT12, GT11, GT10 connection function to connect up to two GOTs.

➡ 21. MULTIPLE-GT14, GT12, GT11, GT10 CONNECTION FUNCTION

*5 When using function expansion boards or function adapters, confirm the communication settings.

➡ 6.6 Precautions ■ Connection to FXCPU (2) When connecting with function extension board or communication special adapter

*6 Use the RS-422 connection model.

*7 For the connection to GOT, refer to the connection diagram. (➡ RS-422 connection diagram 2))

■ When connecting to FX1S, FX1N, FX2N, FX1NC, FX2NC (RS-422 connection)

PLC				Connection cable		GOT		Number of connectable equipment *6
Model name	Function expansion board*4,7	Function adapter*7	Communication type	Cable model	Max. distance	Option device	Model	
FX1S FX1N FX2N FX1NC FX2NC	-	-	RS-422	GT01-C10R4-8P(1m) GT01-C30R4-8P(3m) GT01-C100R4-8P(10m) GT01-C200R4-8P(20m) GT01-C300R4-8P(30m)	30m	GT16-C02R4-9S		1 GOT for 1 PLC built-in port
						GT15-RS2T4-9P*1		
						GT15-RS4-9S		
						-(Built into GOT)	 	
				GT01-RS4-M*5	-			
				GT10-C10R4-8P(1m) GT10-C30R4-8P(3m) GT10-C100R4-8P(10m) GT10-C200R4-8P(20m) GT10-C300R4-8P(30m) GT10-C10R4-8PC(1m) GT10-C30R4-8PC(3m) GT10-C100R4-8PC(10m) GT10-C200R4-8PC(20m) GT10-C300R4-8PC(30m) GT10-C10R4-8PL(1m)*2 *3	30m	-(Built into GOT)	*8	
GT10-C10R4-8P(1m) GT10-C30R4-8P(3m) GT10-C10R4-8PC(1m) GT10-C30R4-8PC(3m) GT10-C10R4-8PL(1m)*2 *3	3m	-(Built into GOT)	*8					
FX1S FX1N FX2N	FX1N-422-BD FX2N-422-BD	-	RS-422	GT01-C10R4-8P(1m) GT01-C30R4-8P(3m) GT01-C100R4-8P(10m) GT01-C200R4-8P(20m) GT01-C300R4-8P(30m)	30m	GT16-C02R4-9S		1 GOT for 1 function expansion board
						GT15-RS2T4-9P*1		
						GT15-RS4-9S		
						-(Built into GOT)	 	
				GT01-RS4-M*5	-			
				GT10-C10R4-8P(1m) GT10-C30R4-8P(3m) GT10-C100R4-8P(10m) GT10-C200R4-8P(20m) GT10-C300R4-8P(30m) GT10-C10R4-8PC(1m) GT10-C30R4-8PC(3m) GT10-C100R4-8PC(10m) GT10-C200R4-8PC(20m) GT10-C300R4-8PC(30m) GT10-C10R4-8PL(1m) *3	30m	-(Built into GOT)	*8	
GT10-C10R4-8P(1m) GT10-C30R4-8P(3m) GT10-C10R4-8PC(1m) GT10-C30R4-8PC(3m) GT10-C10R4-8PL(1m) *3	3m	-(Built into GOT)	*8					

*1 Connect it to the RS-232 interface (built into GOT). It cannot be mounted on GT1655 and GT155□.

*2 GT10-C10R4-8PL(1m) can be available for FX1S, FX1N and FX2N.

*3 For the connection to GOT, refer to the connection diagram. (☞ RS-422 connection diagram 1))

*4 The function expansion board to be used differs according to the type of the FXCPU to be connected. Use the applicable function expansion board shown in the following table.

Item	Function expansion board to be used	
	When connecting to FX1N or FX1S Series	When connecting to FX Series
RS-422 communication	FX1N-422-BD	FX2N-422-BD















*5 For details of the GOT multi-drop connection, refer to the following.

☞ 20. GOT MULTI-DROP CONNECTION

- *6 GT14, GT12, GT11 and GT10 are available for the multiple-GT14, GT12, GT11, GT10 connection function to connect up to two GOTs.
- ☞ 21. MULTIPLE-GT14, GT12, GT11, GT10 CONNECTION FUNCTION
- *7 When using function expansion boards or function adapters, confirm the communication settings.
- ☞ 6.6 Precautions ■Connection to FXCPU (2)When connecting with function extension board or communication special adapter
- *8 Use the RS-422 connection model.

1	PREPARATORY PROCEDURES FOR MONITORING
2	DEVICE RANGE THAT CAN BE SET
3	ACCESS RANGE FOR MONITORING
4	HOW TO MONITOR REDUNDANT SYSTEM
5	BUS CONNECTION
6	DIRECT CONNECTION TO CPU
7	COMPUTER LINK CONNECTION
8	ETHERNET CONNECTION

■ When connecting to FX1S, FX1N, FX2N, FX1NC, FX2NC (RS-232 connection)

PLC			Connection cable		GOT		Number of connectable equipment ^{*3}
Model name	Function expansion board ^{*1,4}	Function adapter ^{*4}	Communication type	Cable model Connection diagram number	Max. distance	Option device Model	
FX1S FX1N FX2N	FX1N-232-BD FX2N-232-BD	-	RS-232	GT01-C30R2-9S(3m) or  RS-232 connection diagram 1)	15m	- (Built into GOT) GT15-RS2-9P GT01-RS4-M ^{*2}	1 GOT for 1 function expansion board
				 RS-232 connection diagram 4)	15m	- (Built into GOT)	
				GT01-C30R2-9S(3m) or  RS-232 connection diagram 1)	15m	- (Built into GOT) GT15-RS2-9P GT01-RS4-M ^{*2}	
	FX1N-CNV-BD FX2N-CNV-BD	FX2NC -232ADP	RS-232	GT01-C30R2-9S(3m) or  RS-232 connection diagram 1)	15m	- (Built into GOT) GT15-RS2-9P GT01-RS4-M ^{*2}	1 GOT for 1 function adapter
				 RS-232 connection diagram 4)	15m	- (Built into GOT)	
				GT01-C30R2-25P(3m) or  RS-232 connection diagram 2)	15m	- (Built into GOT) GT15-RS2-9P GT01-RS4-M ^{*2}	
FX0N -232ADP	RS-232	GT01-C30R2-25P(3m) or  RS-232 connection diagram 2)	15m	- (Built into GOT) GT15-RS2-9P GT01-RS4-M ^{*2}	1 GOT for 1 function adapter		
		 RS-232 connection diagram 5)	15m	- (Built into GOT)			
		GT01-C30R2-9S(3m) or  RS-232 connection diagram 1)	15m	- (Built into GOT) GT15-RS2-9P GT01-RS4-M ^{*2}			
FX1NC FX2NC	-	FX2NC -232ADP	GT01-C30R2-9S(3m) or  RS-232 connection diagram 1)	15m		- (Built into GOT) GT15-RS2-9P GT01-RS4-M ^{*2}	1 GOT for 1 function adapter
			 RS-232 connection diagram 4)	15m		- (Built into GOT)	
			GT01-C30R2-25P(3m) or  RS-232 connection diagram 2)	15m		- (Built into GOT) GT15-RS2-9P GT01-RS4-M ^{*2}	
FX0N -232ADP	RS-232	GT01-C30R2-25P(3m) or  RS-232 connection diagram 2)	15m	- (Built into GOT) GT15-RS2-9P GT01-RS4-M ^{*2}	1 GOT for 1 function adapter		
		 RS-232 connection diagram 5)	15m	- (Built into GOT)			
		GT01-C30R2-9S(3m) or  RS-232 connection diagram 1)	15m	- (Built into GOT) GT15-RS2-9P GT01-RS4-M ^{*2}			

*1 The function expansion board to be used differs according to the type of the FXCPU. Select the function expansion board from the following table.

Item	Function expansion board to be used	
	When connecting to FX1N or FX1S Series	When connecting to FX Series
RS-232 communication	FX1N-232-BD	FX2N-232-BD
When the function adapter is used	FX1N-CNV-BD	FX2N-CNV-BD

*2 For details of the GOT multi-drop connection, refer to the following.

 20. GOT MULTI-DROP CONNECTION

*3 GT14, GT12, GT11 and GT10 are available for the multiple-GT14, GT12, GT11, GT10 connection function to connect up to two GOTs.

 21. MULTIPLE-GT14, GT12, GT11, GT10 CONNECTION FUNCTION

*4 When using function expansion boards or function adapters, confirm the communication settings.

 6.6 Precautions ■ Connection to FXCPU (2) When connecting with function extension board or communication special adapter

*5 Use the RS-232 connection model.

































■ When connecting to FX3G, FX3S, FX3GE (RS-422 connection)

PLC			Connection cable		GOT		Number of connectable equipment *5	
Model name	Function expansion board *6	Function adapter *6	Communication type	Cable model	Max. distance	Option device		Model
FX3G FX3S FX3GE	-	-	RS-422	GT01-C10R4-8P(1m) GT01-C30R4-8P(3m) GT01-C100R4-8P(10m) GT01-C200R4-8P(20m) GT01-C300R4-8P(30m)	30m	GT16-C02R4-9S		1 GOT for 1 PLC built-in port
						GT15-RS2T4-9P*1		
						GT15-RS4-9S		
						-(Built into GOT)	 	
				GT01-RS4-M*3	-			
				GT10-C10R4-8P(1m) GT10-C30R4-8P(3m) GT10-C100R4-8P(10m) GT10-C200R4-8P(20m) GT10-C300R4-8P(30m) GT10-C10R4-8PC(1m) GT10-C30R4-8PC(3m) GT10-C100R4-8PC(10m) GT10-C200R4-8PC(20m) GT10-C300R4-8PC(30m) *2	30m	-(Built into GOT)	*7	
GT10-C10R4-8P(1m) GT10-C30R4-8P(3m) GT10-C10R4-8PC(1m) GT10-C30R4-8PC(3m) *2	3m	-(Built into GOT)	*4*7					
FX3G-422-BD	-	-	RS-422	GT01-C10R4-8P(1m) GT01-C30R4-8P(3m) GT01-C100R4-8P(10m) GT01-C200R4-8P(20m) GT01-C300R4-8P(30m)	30m	GT16-C02R4-9S		1 GOT for 1 function expansion board
						GT15-RS2T4-9P*1		
						GT15-RS4-9S		
						-(Built into GOT)	 	
				GT01-RS4-M*3	-			
				GT10-C10R4-8P(1m) GT10-C30R4-8P(3m) GT10-C100R4-8P(10m) GT10-C200R4-8P(20m) GT10-C300R4-8P(30m) GT10-C10R4-8PC(1m) GT10-C30R4-8PC(3m) GT10-C100R4-8PC(10m) GT10-C200R4-8PC(20m) GT10-C300R4-8PC(30m) *2	30m	-(Built into GOT)	*7	
GT10-C10R4-8P(1m) GT10-C30R4-8P(3m) GT10-C10R4-8PC(1m) GT10-C30R4-8PC(3m) *2	3m	-(Built into GOT)	*4					

- *1 Connect it to the RS-232 interface (built into GOT). It cannot be mounted on GT1655 and GT155□.
- *2 For the connection to GOT, refer to the connection diagram. (👉 RS-422 connection diagram 1))
- *3 For details of the GOT multi-drop connection, refer to the following.
👉 20. GOT MULTI-DROP CONNECTION
- *4 When connecting FX3G, FX3S series to GT10 (input power supply: 5V), they cannot be connected to standard built-in port (RS-422) and function expansion board (FX3G-422-BD) simultaneously.
- *5 When the function expansion board (communication board) and the function adapter are connected, a GOT and a peripheral such as a PC with GX Developer installed can be connected to them individually.
GT14, GT12, GT11 and GT10 are available for the multiple-GT14, GT12, GT11, GT10 connection function to connect up to two GOTs.
👉 21. MULTIPLE-GT14, GT12, GT11, GT10 CONNECTION FUNCTION
- *6 When using function expansion boards or function adapters, confirm the communication settings.
👉 6.6 Precautions ■Connection to FXCPU (2)When connecting with function extension board or communication special adapter
- *7 Use the RS-422 connection model.

1 PREPARATORY PROCEDURES FOR MONITORING
 2 DEVICE RANGE THAT CAN BE SET
 3 ACCESS RANGE FOR MONITORING
 4 HOW TO MONITOR REDUNDANT SYSTEM
 5 BUS CONNECTION
 6 DIRECT CONNECTION TO CPU
 7 COMPUTER LINK CONNECTION
 8 ETHERNET CONNECTION

■ When connecting to FX3G, FX3S, FX3GE (RS-232 connection)

PLC			Connection cable		GOT		Number of connectable equipment *2	
Model name	Function expansion board*3	Function adapter*3	Communication type	Cable model Connection diagram number	Max. distance	Option device Model		
FX3G FX3S FX3GE	FX3G-232-BD	-	RS-232	GT01-C30R2-9S(3m) or  RS-232 connection diagram 1)	15m	- (Built into GOT)	     	1 GOT for 1 function expansion board
						GT15-RS2-9P		
				GT01-RS4-M*1	-			
				 RS-232 connection diagram 4)	15m	- (Built into GOT)		
FX3G	-	FX3G-CNV-ADP + FX3U-232ADP FX3U-232ADP-MB	RS-232	GT01-C30R2-9S(3m) or  RS-232 connection diagram 1)	15m	- (Built into GOT)	     	1 GOT for 1 function adapter
						GT15-RS2-9P		
				GT01-RS4-M*1	-			
				 RS-232 connection diagram 4)	15m	- (Built into GOT)		
FX3GE	-	FX3U-232ADP FX3U-232ADP-MB	RS-232	GT01-C30R2-9S(3m) or  RS-232 connection diagram 1)	15m	- (Built into GOT)	     	1 GOT for 1 function adapter
						GT15-RS2-9P		
				GT01-RS4-M*1	-			
				 RS-232 connection diagram 4)	15m	- (Built into GOT)		
FX3S	-	FX3S-CNV-ADP + FX3U-232ADP FX3U-232ADP-MB	RS-232	GT01-C30R2-9S(3m) or  RS-232 connection diagram 1)	15m	- (Built into GOT)	     	1 GOT for 1 function adapter
						GT15-RS2-9P		
				GT01-RS4-M*1	-			
				 RS-232 connection diagram 4)	15m	- (Built into GOT)		

*1 For details of the GOT multi-drop connection, refer to the following.

 20. GOT MULTI-DROP CONNECTION

*2 When the function expansion board (communication board) and the function adapter are connected, a GOT and a peripheral such as a PC with GX Developer installed can be connected to them individually.
GT14, GT12, GT11 and GT10 are available for the multiple-GT14, GT12, GT11, GT10 connection function to connect up to two GOTs.

 21. MULTIPLE-GT14, GT12, GT11, GT10 CONNECTION FUNCTION

*3 When using function expansion boards or function adapters, confirm the communication settings.

 6.6 Precautions ■ Connection to FXCPU (2) When connecting with function extension board or communication special adapter

*4 Use the RS-232 connection model.

■ When connecting to FX3GC (FX3GC-□□/D, FX3GC-□□/DSS) (RS-422 connection)

PLC		Connection cable		GOT		Number of connectable equipment*4					
Model name	Communication type	Cable model	Max. distance	Option device	Model						
FX3GC-□□/D FX3GC-□□/DSS	RS-422	GT01-C10R4-8P(1m) GT01-C30R4-8P(3m) GT01-C100R4-8P(10m) GT01-C200R4-8P(20m) GT01-C300R4-8P(30m)	30m	GT16-C02R4-9S(0.2m)	GT16	1 GOT for 1 PLC built-in port					
				GT15-RS2T4-9P*1	GT16, GT15						
				GT15-RS4-9S	GT14, GT11 Serial, GT10 5□, 4□						
-(Built into GOT)	GT14, GT11 Serial, GT10 5□, 4□										
GT01-RS4-M*3	-										
GT10-C10R4-8P(1m) GT10-C30R4-8P(3m) GT10-C100R4-8P(10m) GT10-C200R4-8P(20m) GT10-C300R4-8P(30m) GT10-C10R4-8PC(1m) GT10-C30R4-8PC(3m) GT10-C100R4-8PC(10m) GT10-C200R4-8PC(20m) GT10-C300R4-8PC(30m) *2	30m	-(Built into GOT)	-	GT10 20, 30, 20, 30 *5	-						
							GT10-C10R4-8P(1m) GT10-C30R4-8P(3m) GT10-C10R4-8PC(1m) GT10-C30R4-8PC(3m) GT10-C10R4-8PC(1m) GT10-C30R4-8PC(3m) *2	3m	-(Built into GOT)	-	GT10 20, 30, 20, 30 *5

- *1 Connect it to the RS-232 interface (built into GOT). It cannot be mounted on GT1655 and GT155□.
- *2 For the connection to GOT, refer to the connection diagram. (☞ RS-422 connection diagram 1))
- *3 For details of the GOT multi-drop connection, refer to the following.
☞ 20. GOT MULTI-DROP CONNECTION
- *4 GT14, GT12, GT11 and GT10 are available for the multiple-GT14, GT12, GT11, GT10 connection function to connect up to two GOTs.
☞ 21. MULTIPLE-GT14, GT12, GT11, GT10 CONNECTION FUNCTION
- *5 Use the RS-422 connection model.

■ When connecting to FX3GC (FX3GC-□□/D, FX3GC-□□/DSS) (RS-232 connection)

PLC		Connection cable		GOT		Number of connectable equipment*2	
Model name	Function adapter*3	Communication type	Cable model Connection diagram number	Max. distance	Option device Model		
FX3GC-□□/D FX3GC-□□/DSS	FX3u-232ADP FX3u-232ADP-MB	RS-232	GT01-C30R2-9S(3m) or ☞ RS-232 connection diagram 1)	15m	-(Built into GOT)	GT16, GT15, GT14, GT11 Serial, GT10 5□, 4□	1 GOT for 1 function adapter
					GT15-RS2-9P	GT16, GT15	
			GT01-RS4-M*1	-			
☞ RS-232 connection diagram 4)	15m	-(Built into GOT)	GT10 20, 30 *4				

- *1 For details of the GOT multi-drop connection, refer to the following.
☞ 20. GOT MULTI-DROP CONNECTION
- *2 A GOT and a peripheral such as a PC with GX Developer installed can be connected to the function adapter and the FXCPU individually.
GT14, GT12, GT11 and GT10 are available for the multiple-GT14, GT12, GT11, GT10 connection function to connect up to two GOTs.
☞ 21. MULTIPLE-GT14, GT12, GT11, GT10 CONNECTION FUNCTION
- *3 When using function expansion boards or function adapters, confirm the communication settings.
☞ 6.6 Precautions ■ Connection to FXCPU (2) When connecting with function extension board or communication special adapter
- *4 Use the RS-232 connection model.

1 PREPARATORY PROCEDURES FOR MONITORING
 2 DEVICE RANGE THAT CAN BE SET
 3 ACCESS RANGE FOR MONITORING
 4 HOW TO MONITOR REDUNDANT SYSTEM
 5 BUS CONNECTION
 6 DIRECT CONNECTION TO CPU
 7 COMPUTER LINK CONNECTION
 8 ETHERNET CONNECTION

■ When connecting to FX3U or FX3UC (FX3UC-□□-LT(-2)) (RS-422 connection)

PLC			Connection cable		GOT		Number of connectable equipment ^{*5}				
Model name	Function expansion board ^{*6}	Function adapter ^{*6}	Communication type	Cable model	Max. distance	Option device		Model			
FX3U FX3UC (FX3UC-□□-LT(-2))	-	-	RS-422	GT01-C10R4-8P(1m) GT01-C30R4-8P(3m) GT01-C100R4-8P(10m) GT01-C200R4-8P(20m) GT01-C300R4-8P(30m)	30m	GT16-C02R4-9S		1 GOT for 1 PLC built-in port			
						GT15-RS2T4-9P ^{*1}					
						GT15-RS4-9S					
						-(Built into GOT)					
				GT01-RS4-M ^{*4}	-						
				GT10-C10R4-8P(1m) GT10-C30R4-8P(3m) GT10-C100R4-8P(10m) GT10-C200R4-8P(20m) GT10-C300R4-8P(30m) GT10-C10R4-8PC(1m) GT10-C30R4-8PC(3m) GT10-C100R4-8PC(10m) GT10-C200R4-8PC(20m) GT10-C300R4-8PC(30m) GT10-C10R4-8PL(1m) ^{*2} ^{*3}	30m	-(Built into GOT)	^{*7}				
GT10-C10R4-8P(1m) GT10-C30R4-8P(3m) GT10-C10R4-8PC(1m) GT10-C30R4-8PC(3m) GT10-C10R4-8PL(1m) ^{*2} ^{*3}	3m	-(Built into GOT)	^{*7}								
								GT10-C10R4-8P(1m) GT10-C30R4-8P(3m) GT10-C10R4-8PC(1m) GT10-C30R4-8PC(3m)	3m	-(Built into GOT)	^{*7}
FX3U-422-BD	-	-	RS-422	GT01-C10R4-8P(1m) GT01-C30R4-8P(3m) GT01-C100R4-8P(10m) GT01-C200R4-8P(20m) GT01-C300R4-8P(30m)	30m	GT16-C02R4-9S		1 GOT for 1 function expansion board			
						GT15-RS2T4-9P ^{*1}					
						GT15-RS4-9S					
						-(Built into GOT)					
				GT01-RS4-M ^{*4}	-						
				GT10-C10R4-8P(1m) GT10-C30R4-8P(3m) GT10-C100R4-8P(10m) GT10-C200R4-8P(20m) GT10-C300R4-8P(30m) GT10-C10R4-8PC(1m) GT10-C30R4-8PC(3m) GT10-C100R4-8PC(10m) GT10-C200R4-8PC(20m) GT10-C300R4-8PC(30m) GT10-C10R4-8PL(1m) ^{*2} ^{*3}	30m	-(Built into GOT)	^{*7}				
GT10-C10R4-8P(1m) GT10-C30R4-8P(3m) GT10-C10R4-8PC(1m) GT10-C30R4-8PC(3m)	3m	-(Built into GOT)	^{*7}								
								GT10-C10R4-8P(1m) GT10-C30R4-8P(3m) GT10-C10R4-8PC(1m) GT10-C30R4-8PC(3m)	3m	-(Built into GOT)	^{*7}

*1 Connect it to the RS-232 interface (built into GOT). It cannot be mounted on GT1655 and GT155□.

*2 GT10-C10R4-8PL can be used for FX3U or FX3UC-□□-LT(-2).

*3 For the connection to GOT, refer to the connection diagram. (☞ RS-422 connection diagram 1))

*4 For details of the GOT multi-drop connection, refer to the following.

☞ 20. GOT MULTI-DROP CONNECTION

*5 When the function expansion board (communication board) and the function adapter are connected, a GOT and a peripheral such as a PC with GX Developer installed can be connected to them individually.
GT14, GT12, GT11 and GT10 are available for the multiple-GT14, GT12, GT11, GT10 connection function to connect up to two GOTs.

☞ 21. MULTIPLE-GT14, GT12, GT11, GT10 CONNECTION FUNCTION

*6 When using function expansion boards or function adapters, confirm the communication settings.

☞ 6.6 Precautions ■Connection to FXCPU (2)When connecting with function extension board or communication special adapter

*7 Use the RS-422 connection model.

■ When connecting to FX3U or FX3UC (FX3UC-□□-LT(-2)) (RS-232 connection)

PLC				Connection cable		GOT		Number of connectable equipment *2
Model name	Function expansion board*3	Function adapter*3	Communication type	Cable model Connection diagram number	Max. distance	Option device	Model	
FX3U FX3UC (FX3UC-□□-LT(-2))	FX3U-232-BD	-	RS-232	GT01-C30R2-9S(3m) or RS-232 connection diagram 1)	15m	- (Built into GOT)		1 GOT for 1 function expansion board
						GT15-RS2-9P		
						GT01-RS4-M*1	-	
				RS-232 connection diagram 4)	15m	- (Built into GOT)		
	FX3U-422-BD FX3U-232-BD FX3U-CNV-BD	FX3U-232ADP FX3U-232ADP-MB	RS-232	GT01-C30R2-9S(3m) or RS-232 connection diagram 1)	15m	- (Built into GOT)		1 GOT for 1 function adapter
					GT15-RS2-9P			
			RS-232 connection diagram 4)	15m	- (Built into GOT)			

*1 For details of the GOT multi-drop connection, refer to the following.

20. GOT MULTI-DROP CONNECTION

*2 When the function expansion board (communication board) and the function adapter are connected, a GOT and a peripheral such as a PC with GX Developer installed can be connected to them individually.
GT14, GT12, GT11 and GT10 are available for the multiple-GT14, GT12, GT11, GT10 connection function to connect up to two GOTs.

21. MULTIPLE-GT14, GT12, GT11, GT10 CONNECTION FUNCTION

*3 When using function expansion boards or function adapters, confirm the communication settings.

6.6 Precautions ■ Connection to FXCPU (2) When connecting with function extension board or communication special adapter

*4 Use the RS-232 connection model.

1	PREPARATORY PROCEDURES FOR MONITORING
2	DEVICE RANGE THAT CAN BE SET
3	ACCESS RANGE FOR MONITORING
4	HOW TO MONITOR REDUNDANT SYSTEM
5	BUS CONNECTION
6	DIRECT CONNECTION TO CPU
7	COMPUTER LINK CONNECTION
8	ETHERNET CONNECTION

■ When connecting to FX3UC (FX3UC-□□/D, FX3UC-□□/DS, FX3UC-□□/DSS) (RS-422 connection)

PLC		Connection cable		GOT		Number of connectable equipment*4
Model name	Communication type	Cable model	Max. distance	Option device	Model	
FX3UC-□□/D FX3UC-□□/DS FX3UC-□□/DSS	RS-422	GT01-C10R4-8P(1m) GT01-C30R4-8P(3m) GT01-C100R4-8P(10m) GT01-C200R4-8P(20m) GT01-C300R4-8P(30m)	30m	GT16-C02R4-9S(0.2m)		1 GOT for 1 PLC built-in port
				GT15-RS2T4-9P*1		
				GT15-RS4-9S		
- (Built into GOT)						
				GT01-RS4-M*3	-	
		GT10-C10R4-8P(1m) GT10-C30R4-8P(3m) GT10-C100R4-8P(10m) GT10-C200R4-8P(20m) GT10-C300R4-8P(30m) GT10-C10R4-8PC(1m) GT10-C30R4-8PC(3m) GT10-C100R4-8PC(10m) GT10-C200R4-8PC(20m) GT10-C300R4-8PC(30m) *2	30m	- (Built into GOT)	*5	
		GT10-C10R4-8P(1m) GT10-C30R4-8P(3m) GT10-C10R4-8PC(1m) GT10-C30R4-8PC(3m) *2	3m	- (Built into GOT)	*5	

*1 Connect it to the RS-232 interface (built into GOT). It cannot be mounted on GT1655 and GT155□.

*2 For the connection to GOT, refer to the connection diagram. (☞ RS-422 connection diagram 1))

*3 For details of the GOT multi-drop connection, refer to the following.

☞ 20. GOT MULTI-DROP CONNECTION

*4 GT14, GT12, GT11 and GT10 are available for the multiple-GT14, GT12, GT11, GT10 connection function to connect up to two GOTs.

☞ 21. MULTIPLE-GT14, GT12, GT11, GT10 CONNECTION FUNCTION

*5 Use the RS-422 connection model.

■ When connecting to FX3UC (FX3UC-□□/D, FX3UC-□□/DS, FX3UC-□□/DSS) (RS-232 connection)

PLC		Connection cable		GOT		Number of connectable equipment*2	
Model name	Function adapter*3	Communication type	Cable model Connection diagram number	Max. distance	Option device		Model
FX3UC-□□/D FX3UC-□□/DS FX3UC-□□/DSS	FX3U-232ADP FX3U-232ADP-MB	RS-232	GT01-C30R2-9S(3m) or RS-232 connection diagram 1)	15m	- (Built into GOT)	 	1 GOT for 1 function adapter
					GT15-RS2-9P		
			RS-232 connection diagram 4)	15m	GT01-RS4-M*1	-	
					- (Built into GOT)	*4	

*1 For details of the GOT multi-drop connection, refer to the following.

☞ 20. GOT MULTI-DROP CONNECTION

*2 A GOT and a peripheral such as a PC with GX Developer installed can be connected to the function adapter and the FXCPU individually.

GT14, GT12, GT11 and GT10 are available for the multiple-GT14, GT12, GT11, GT10 connection function to connect up to two GOTs.

☞ 21. MULTIPLE-GT14, GT12, GT11, GT10 CONNECTION FUNCTION

*3 When using function expansion boards or function adapters, confirm the communication settings.

☞ 6.6 Precautions ■ Connection to FXCPU (2) When connecting with function extension board or communication special adapter

*4 Use the RS-232 connection model.

6.2.7 Connecting to WSCPU

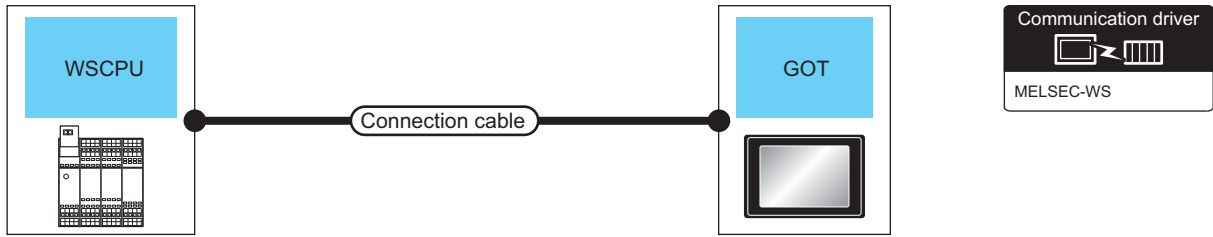

PLC		Connection cable		GOT		Number of connectable equipment
Model name	Communication type	Cable model Connection diagram number	Max. distance	Option device	Model	
MELSEC-WS	RS-232	WS0-C20R2(2m)	2m	- (Built into GOT)		1 GOT for 1 PLC
		WS0-C20R2(2m) + User RS-232 connection diagram 6)	2.3m	- (Built into GOT)		

*1 Use the RS-232 connection model.

6.2.8 Connecting to the motion controller CPU

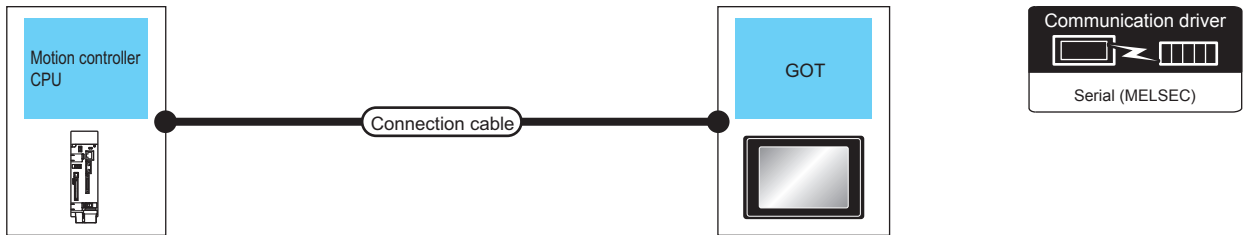

Motion controller CPU		Connection cable		GOT		Number of connectable equipment ^{*4}
Model name	Communication type	Cable model	Max. distance	Option device	Model	
Q170MCPU	RS-232	GT01-C30R2-6P(3m)	3m	- (Built into GOT)		1 GOT for 1 motion controller CPU
		GT10-C30R2-6P(3m) ^{*1}	3m	- (Built into GOT)		
MR-MQ100	RS-422	Q170MIOCBL1M-B(1m) + User RS-422 connection diagram 3)	30m	GT16-C02R4-9S(0.2m)		1 GOT for 1 motion controller CPU
		Q170MIOCBL1M-B(1m) + User RS-422 connection diagram 4)		GT15-RS2T4-9P ^{*2} GT15-RS4-9S		
		Q170MIOCBL1M-A(1m) ^{*3}	1m	- (Built into GOT)		

*1 For the connection to GOT, refer to the connection diagram. (➡ RS-232 connection diagram 3))

*2 Connect it to the RS-232 interface (built into GOT). It cannot be mounted on GT155□.

*3 For the connection to GOT, refer to the connection diagram. (➡ RS-422 connection diagram 5))

*4 GT14, GT12, GT11 and GT10 are available for the multiple-GT14, GT12, GT11, GT10 connection function to connect up to two GOTs.

➡ 21. MULTIPLE-GT14, GT12, GT11, GT10 CONNECTION FUNCTION

*5 Use the RS-232 connection model.

*6 Use the RS-422 connection model.

1 PREPARATORY PROCEDURES FOR MONITORING
2 DEVICE RANGE THAT CAN BE SET
3 ACCESS RANGE FOR MONITORING
4 HOW TO MONITOR REDUNDANT SYSTEM
5 BUS CONNECTION
6 DIRECT CONNECTION TO CPU
7 COMPUTER LINK CONNECTION
8 ETHERNET CONNECTION

POINT

When connecting to the motion controller CPU (Q Series) other than Q170MCP, MR-MQ100

A motion controller CPU (Q Series) mounted to the multiple CPU system of the QCPU (Q mode) can be monitored. The system configuration, connection conditions, and system equipment for connecting a GOT to a motion controller CPU (Q Series) are the same as those for connecting to the QCPU.

 6.2.1 Connecting to QCPU

6.3 Connection Diagram

The following diagram shows the connection between the GOT and the PLC.

6.3.1 RS-232 cable

■ Connection diagram

RS-232 connection diagram 1)

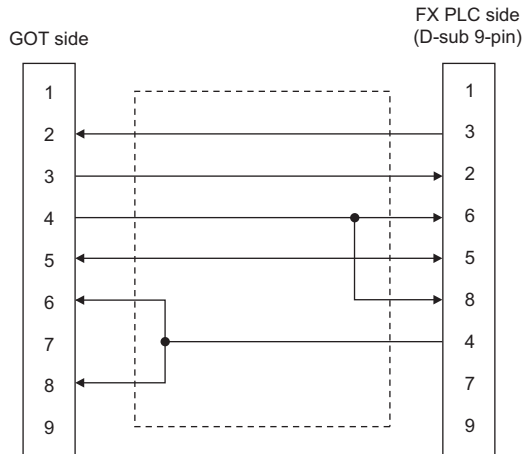

RS-232 connection diagram 2)

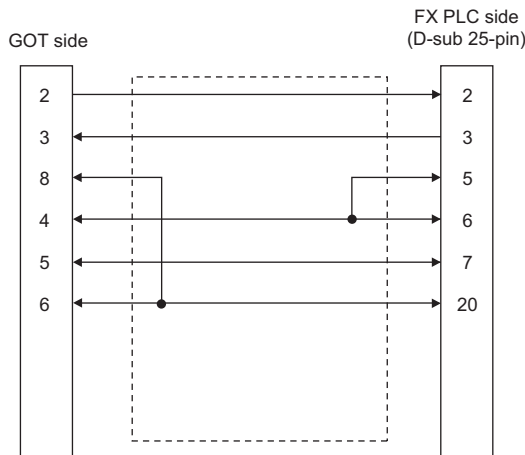

RS-232 connection diagram 3)

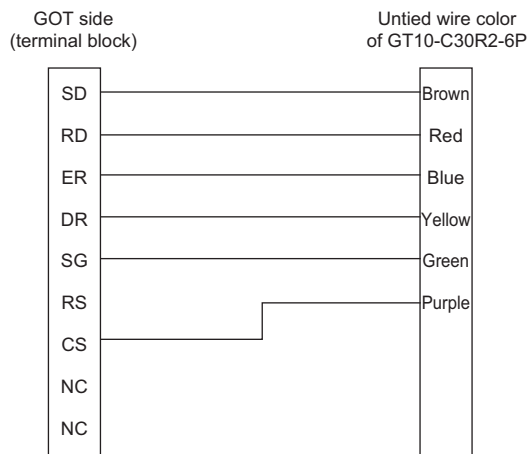

RS-232 connection diagram 4)

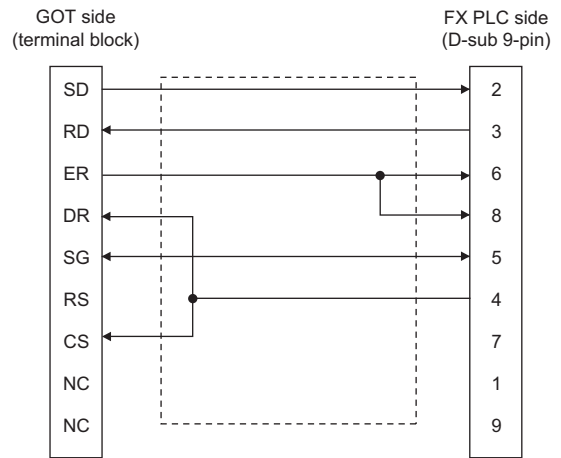

RS-232 connection diagram 5)

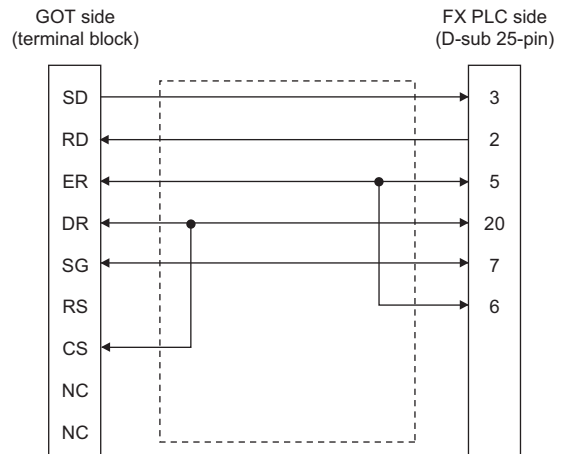

RS-232 connection diagram 6)

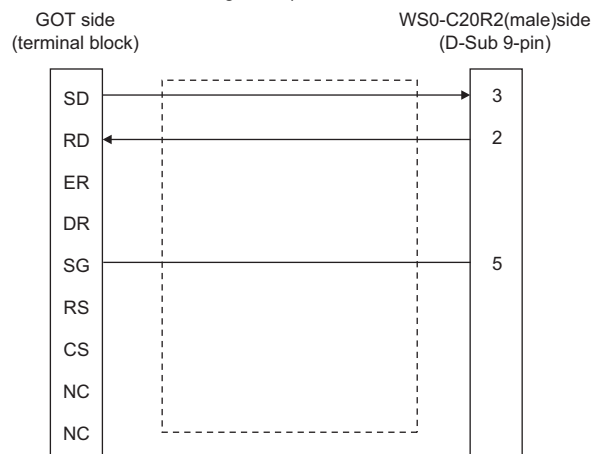

1 PREPARATORY PROCEDURES FOR MONITORING
 2 DEVICE RANGE THAT CAN BE SET
 3 ACCESS RANGE FOR MONITORING
 4 HOW TO MONITOR REDUNDANT SYSTEM
 5 BUS CONNECTION
 6 DIRECT CONNECTION TO CPU
 7 COMPUTER LINK CONNECTION
 8 ETHERNET CONNECTION

■ Precautions when preparing a cable

(1) Cable length

The length of the RS-232 cable must be within the maximum distance specifications.

(2) GOT side connector

For the GOT side connector, refer to the following.

 1.4.1 GOT connector specifications

6.3.2 RS-422 cable

■ Connection diagram

RS-422 connection diagram 1)

GT10 (input power supply : 24V)

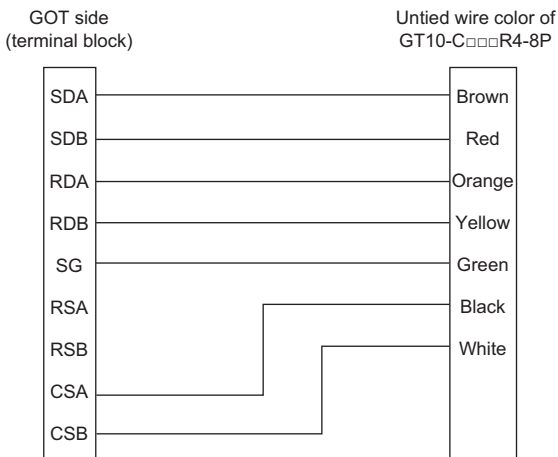

GT10 (input power supply : 5V)

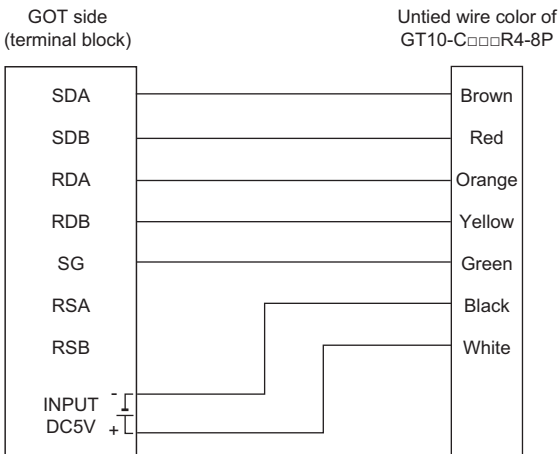

RS-422 connection diagram 2)

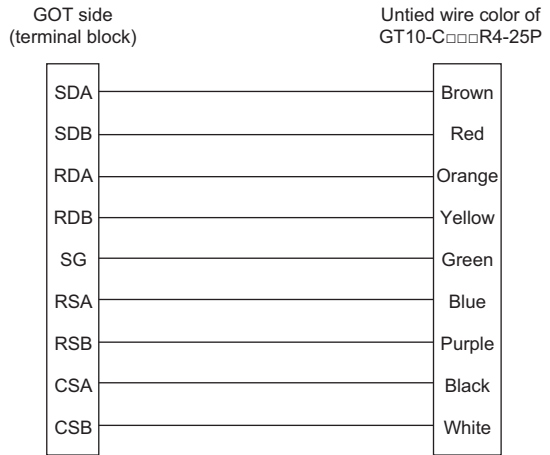

RS-422 connection diagram 3)

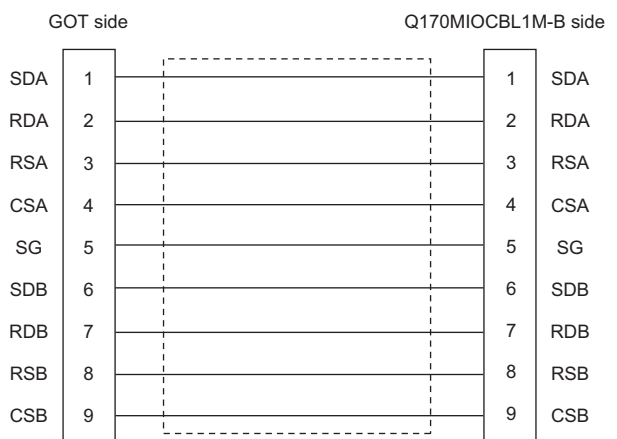

RS-422 connection diagram 4)

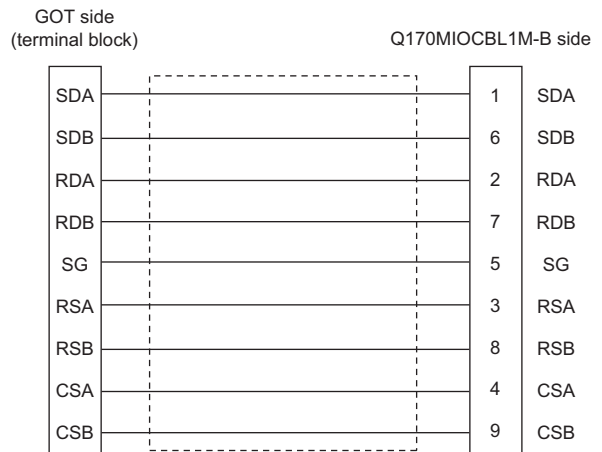

RS-422 connection diagram 5)

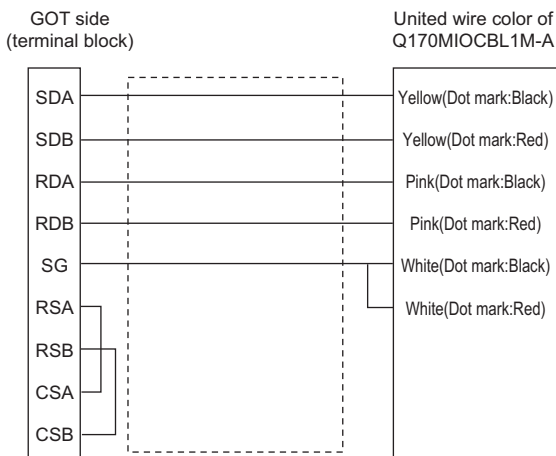

RS-422 connection diagram 6)

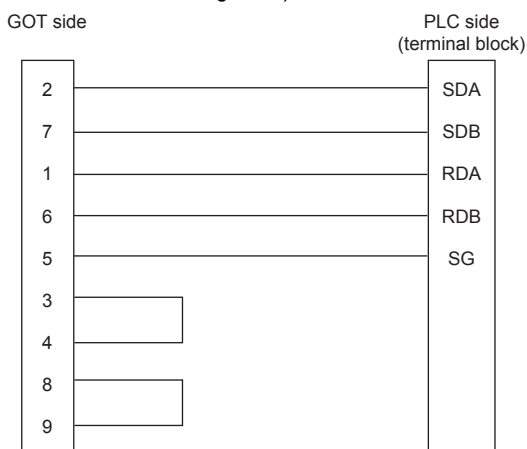

RS-422 connection diagram 7)

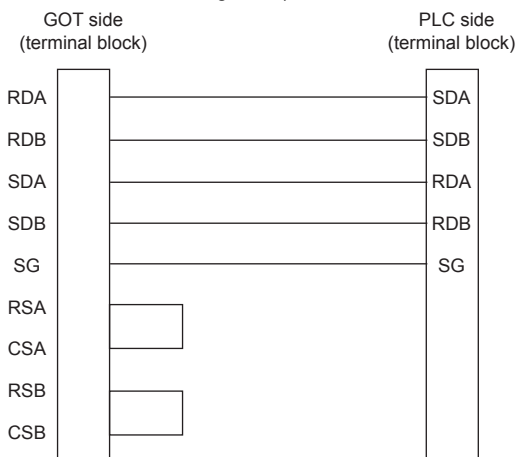

RS-422 connection diagram 8)

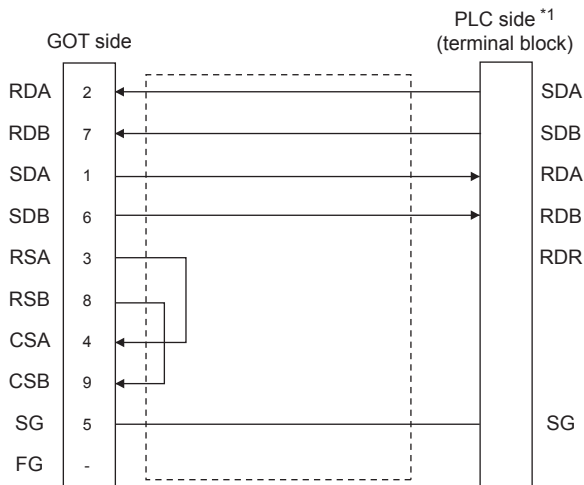

*1 Set the terminating resistor of the PLC side to "330Ω"

RS-422 connection diagram 9)

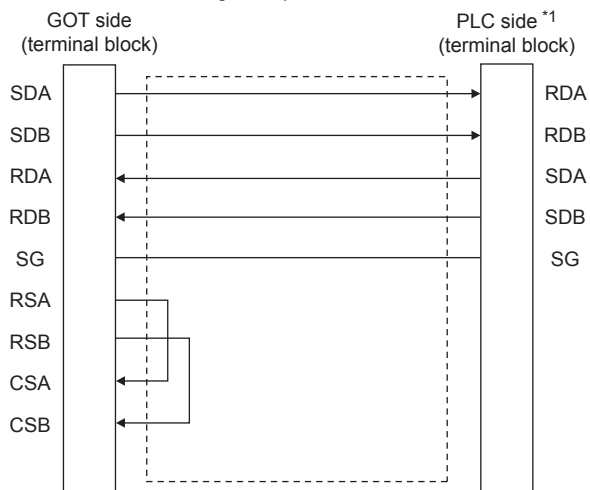

*1 Set the terminating resistor of the PLC side to "330Ω".

■ Precautions when preparing a cable

(1) Cable length

The length of the RS-422 cable must be within the maximum distance specifications.

(2) GOT side connector

For the GOT side connector, refer to the following.

☞ 1.4.1 GOT connector specifications

■ Connecting terminating resistors

(1) GOT side

When connecting a PLC to the GOT, a terminating resistor must be connected to the GOT.

(a) For GT16, GT15, GT12

Set the terminating resistor setting switch of the GOT main unit to "Disable".

(b) For GT14, GT11, GT10

Set the terminating resistor selector to "330Ω".

For the procedure to set the terminating resistor, refer to the following.

☞ 1.4.3 Terminating resistors of GOT

6.4 GOT Side Settings

6.4.1 Setting communication interface (Communication settings)

POINT

GOT Multi- Drop Connection

When using the serial multi-drop connection unit, refer to the following.

☞ 20. GOT MULTI-DROP CONNECTION

Set the channel of the connected equipment.

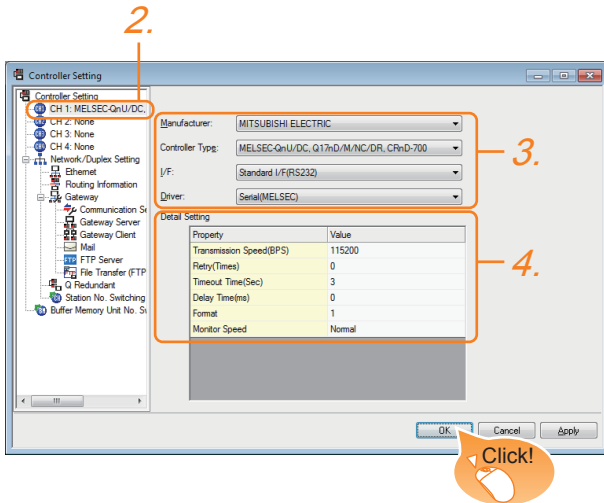

1. Select [Common] → [Controller Setting] from the menu.
2. The Controller Setting window is displayed. Select the channel to be used from the list menu.
3. Set the following items.
 - Manufacturer: MITSUBISHI ELECTRIC
 - Controller Type: Set according to the Controller Type to be connected.
 - I/F: Interface to be used
 - Driver: Set either of the following according to the Controller Type to be connected.
 - For GT16, GT15, GT14, GT12, GT11
 - Serial (MELSEC)
 - MELSEC-FX
 - MELSEC-WS
 - For GT10
 - Serial (MELSEC)
 - MELSEC-A
 - MELSEC-FX
 - MELSEC-WS

4. The detailed setting is displayed after Manufacturer, Controller Type, I/F, and Driver are set. Make the settings according to the usage environment.

☞ 6.4.2 Communication detail settings

Click the [OK] button when settings are completed.

POINT

The settings of connecting equipment can be confirmed in [I/F Communication Setting]. For details, refer to the following:

☞ 1.1.2 I/F communication setting

6.4.2 Communication detail settings

Make the settings according to the usage environment.

(1) Serial (MELSEC)

Property	Value
Transmission Speed(BPS)	115200
Retry(Times)	0
Timeout Time(Sec)	3
Delay Time(ms)	0
Format	1
Monitor Speed	Normal

Item	Description	Range
Transmission Speed	Set this item when change the transmission speed used for communication with the connected equipment. (Default: 115200bps) When the setting exceeds the limit of the connected equipment, communication is performed at the fastest transmission speed supported by the connected equipment.	9600bps, 19200bps, 38400bps, 57600bps, 115200bps
Retry	Set the number of retries to be performed when a communication timeout occurs. (Default: 0time)	0 to 5times
Timeout Time	Set the time period for a communication to time out. (Default: 3sec)	3 to 30sec
Delay Time	Set this item to adjust the transmission timing of the communication request from the GOT. (Default: 0ms)	0 to 300 (ms)

Item	Description	Range
Format*3	Select the communication format. (Default: 1)	1, 2
Monitor Speed (GT16 only)	Set the monitor speed of the GOT. This setting is not valid in all systems. (Default: Normal)	High*1 Normal Low*2

- *1 This is effective when collecting a large data on other than the monitor screen (logging, recipe function, etc.). However, when connecting to Q00J/Q00/Q01CPU, the sequence scan time may be influenced. If you want to avoid the influence on the sequence scan time, do not set "High".
(High performance is hardly affected)
- *2 Set this item if you want to avoid the influence on the sequence scan time further than the "Normal" setting when connecting to Q00J/Q00/Q01CPU. However, the monitor speed may be reduced.
- *3 The format setting differs depending on the controller.
L6ADP-R4 adapter : [2]
Other than L6ADP-R4 adapter: [1]

(2) MELSEC-FX

(a) For GT16, GT15, GT14, GT12, GT11

Property	Value
Transmission Speed(BPS)	115200
Retry(Times)	0
Timeout Time(Sec)	3
Delay Time(ms)	0

Item	Description	Range
Transmission Speed	Set this item when change the transmission speed used for communication with the connected equipment. (Default: 115200bps) When the setting exceeds the limit of the connected equipment, communication is performed at the fastest transmission speed supported by the connected equipment.	9600bps, 19200bps, 38400bps, 57600bps, 115200bps
Retry	Set the number of retries to be performed when a communication timeout occurs. When receiving no response after retries, the communication times out. (Default: 0time)	0 to 5times
Timeout Time	Set the time period for a communication to time out. (Default: 3sec)	3 to 30sec
Delay Time	Set this item to adjust the transmission timing of the communication request from the GOT. (Default: 0ms)	0 to 300 (ms)

(b) For GT10

Property	Value
Transmission Speed(BPS)	115200

Item	Description	Range
Transmission Speed	Set this item when change the transmission speed used for communication with the connected equipment. (Default: 115200bps) When the setting exceeds the limit of the connected equipment, communication is performed at the fastest transmission speed supported by the connected equipment.	9600bps, 19200bps, 38400bps, 57600bps, 115200bps

(3) Serial (MELSEC) (GT10)

Property	Value
Transmission Speed(BPS)	115200

Item	Description	Range
Transmission Speed	Set this item when change the transmission speed used for communication with the connected equipment. (Default: 115200bps) When the setting exceeds the limit of the connected equipment, communication is performed at the fastest transmission speed supported by the connected equipment.	9600bps, 19200bps, 38400bps, 57600bps, 115200bps

1
PREPARATORY PROCEDURES FOR MONITORING

2
DEVICE RANGE THAT CAN BE SET

3
ACCESS RANGE FOR MONITORING

4
HOW TO MONITOR REDUNDANT SYSTEM

5
BUS CONNECTION

6
DIRECT CONNECTION TO CPU

7
COMPUTER LINK CONNECTION

8
ETHERNET CONNECTION

(4) MELSEC-A (GT10)

Property	Value
Transmission Speed(BPS)	9600

Item	Description	Range
Transmission Speed	Set this item when change the transmission speed used for communication with the connected equipment. (Default: 9600bps) When the setting exceeds the limit of the connected equipment, communication is performed at the fastest transmission speed supported by the connected equipment.	9600bps

(5) MELSEC-WS

Property	Value
Transmission Speed(BPS)	115200
Retry(Times)	3
Timeout Time(Sec)	3
Delay Time(ms)	5

Item	Description	Range
Transmission Speed	Set this item when change the transmission speed used for communication with the connected equipment. (Default: 115200bps) When the setting exceeds the limit of the connected equipment, communication is performed at the fastest transmission speed supported by the connected equipment.	9600bps, 19200bps, 38400bps, 57600bps, 115200bps
Retry	Set the number of retries to be performed when a communication timeout occurs. When receiving no response after retries, the communication times out. (Default: 3times)	0 to 5times
Timeout Time	Set the time period for a communication to time out. (Default: 3sec)	1 to 30sec
Delay Time	Set this item to adjust the transmission timing of the communication request from the GOT. (Default: 5ms)	0 to 300 (ms)

POINT

- Communication interface setting by the Utility
The communication interface setting can be changed on the Utility's [Communication Settings] after writing [Communication Settings] of project data.
For details on the Utility, refer to the following manual.
 GT□ User's Manual
- Precedence in communication settings
When settings are made by GT Designer3 or the Utility, the latest setting is effective.

HINT

Cutting the portion of multiple connection of the controller
By setting GOT internal device, GOT can cut the portion of multiple connection of the controller. For example, faulty station that has communication timeout can be cut from the system.

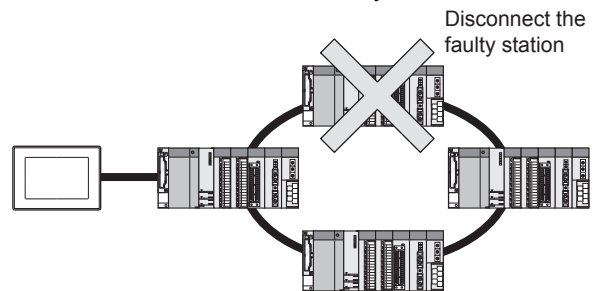

For details of the setting contents of GOT internal device, refer to the following manual.

 GT Designer3 Version Screen Design Manual (Fundamentals)

6.5 PLC Side Setting

When a GOT and an LCPU are connected via an L6ADP-R4 adapter, set the following communication setting.

6.5.1 L6ADP-R4 adapter settings

Set the communication settings by the DIP switches of the L6ADP-R4 adapter.

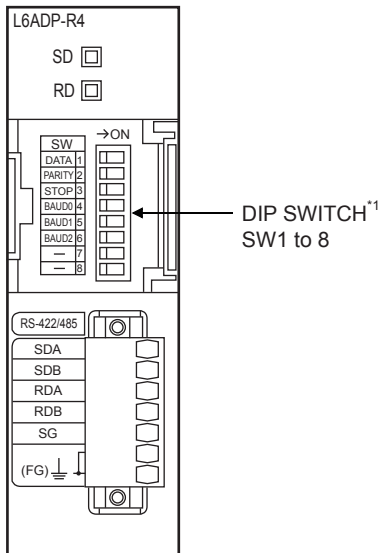

*1 SW7 and SW8 are not used.

(1) DIP switches (SW1 to SW3)
Set the data length, parity bit, and stop bit.

Setting switch	Description	Setting range	
SW1	Data length*1	OFF	7bit
		ON	8bit
SW2	Parity*1	OFF	Disable
		ON	Enable
SW3	Stop bit*1	OFF	1bit
		ON	2bit

*1 Adjust the settings with GOT settings.
 6.4.2 Communication detail settings

(2) DIP switches (SW4 to SW6)
Set the transmission speed.

Setting switch	Transmission speed*1				
	9600 bps	19200 bps	38400 bps	57600 bps	115200 bps
SW4	ON	OFF	ON	OFF	ON
SW5	ON	OFF	OFF	ON	ON
SW6	OFF	ON	ON	ON	ON

*1 Adjust the settings with GOT settings.
 6.4.2 Communication detail settings

6.5.2 GX Works2 settings

Set the communication speed in GX Works2.

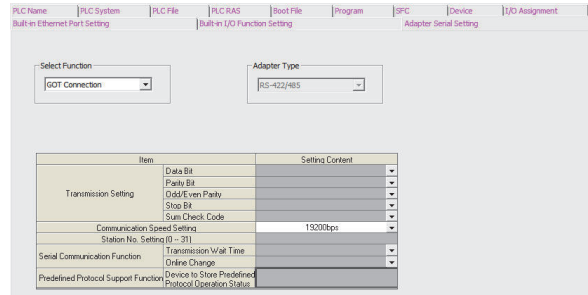

1. Click [PLC parameter] → [Adapter Serial Setting].
2. Set [RS-422/485] in [Adapter Type].
3. Set [GOT Connection] in [Select Function].
4. Adjust [Communication Speed Setting] with the GOT communication setting.

6.4.2 Communication detail settings

POINT

L6ADP-R4 adapter
For details on the L6ADP-R4 adapter, refer to the following manual.

MELSEC-L CPU Module User's Manual (Hardware Design, Maintenance and Inspection)

1 PREPARATORY PROCEDURES FOR MONITORING
 2 DEVICE RANGE THAT CAN BE SET
 3 ACCESS RANGE FOR MONITORING
 4 HOW TO MONITOR REDUNDANT SYSTEM
 5 BUS CONNECTION
 6 DIRECT CONNECTION TO CPU
 7 COMPUTER LINK CONNECTION
 8 ETHERNET CONNECTION

6.6 Precautions

■ Connection to FXCPU

- (1) When connecting to FX3 series
 When the keyword of FXCPU (FX3 series) has been set, GOT may not be able to monitoring. Perform an I/O check again.
 (☞ ■ Perform an I/O check) When the result of the I/O check is normal, check the status of keyword registration.
- (2) When connecting with function extension board or communication special adapter
 When a sequence program and settings that the FXCPU communicates with devices other than the GOT are set with software, including GX Developer, the FXCPU cannot communicate with the GOT.

- (a) Settings with sequence program
 Check the sequence program and delete the following.
 ☞ FX SERIES PROGRAMMABLE CONTROLLERS USER'S MANUAL - Data Communication Edition
 - No protocol communication (RS instruction)
 - Sequence program with the computer link, N:N network, and parallel link
 - Parameter setting
 - Set the following special registers to 0.
 Except FX3U, FX3UC: D8120
 FX3U, FX3UC: D8120, D8400, D8420
 FX3G, FX3GC, FX3GE: D8120, D8400, D8420, D8370
 FX3S: D8120, D8400

- (b) Settings with GX Developer
 Select [PLC parameter] in [Parameter], and then click the PLC system(2) tab on the FX parameter screen.
 Uncheck [Operate communication setting], and then transfer the parameter to the programmable controller. After the transfer, turn off the programmable controller, and then turn on the programmable controller again.

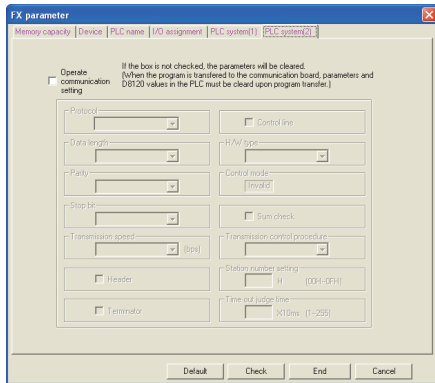

- (3) Connection to GT1020-L□□□, GT1030-□□□□
 When connecting GT1020-L□□□ or GT1030-□□□□ to FX3G, FX3S series, they cannot be connected to standard built-in port (RS-422) and function expansion board (FX3G-422-BD) simultaneously.

■ Connection in the multiple CPU system

When the GOT is connected to multiple CPU system, the following time is taken until when the PLC runs.

- QCPU (Q mode), motion controller CPU (Q series): 10 seconds or more
- MELDAS C70: 18 seconds or more

When the GOT starts before the PLC runs, a system alarm occurs. Adjust the opening screen time in the GOT setup so that no system alarm occurs.

☞ GT Designer3 Version□ Screen Design Manual

■ Connection to LCPUCPU

LCPUCPU may diagnose (check file system, recovering process, etc.) the SD memory card when turning on the power or when resetting. Therefore, it takes time until the SD memory card becomes available. When the GOT starts before the SD card becomes available, a system alarm occurs. Adjust the opening screen time in the GOT setup so that no system alarm occurs.

☞ GT Designer3 Version□ Screen Design Manual

■ Connection to basic model QCPU

Do not set the serial communication function of Q00UJ/Q00U/Q01U/Q02UCPU, Q00/Q01CPU. If the function is set, the communication may not be performed.

■ Connection to Q170MCPUCPU

Set [CPU No.] to "2" in the device setting to monitor the device of the Motion CPU area (CPU No.2).

When the CPU No. is set to "0" or "1", the device on the PLC CPU area (CPU No.1) is monitored.

When the CPU No. is set to the number other than "0" to "2", a communication error occurs and the monitoring cannot be executed.

For setting the CPU No., refer to the following manual.

☞ GT Designer3 Version□ Screen Design Manual

Example) Setting dialog box of the bit device

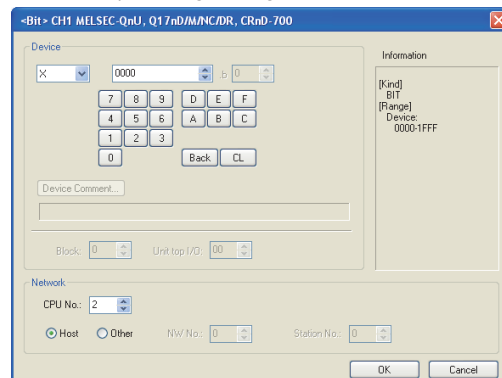

■ Connection to MELSEC iQ-F Series

POINT

MELSEC iQ-F Series communication settings
For details of MELSEC iQ-F Series communication settings, refer to the following manual.

☞ MELSEC iQ-F Series User's Manual

Module parameter settings as a default value (MELSOFT Connection).

If it sets up other than a default value, it becomes impossible to communicate with GOT.

(1) Module parameter setting (When using FX5-485-BD)

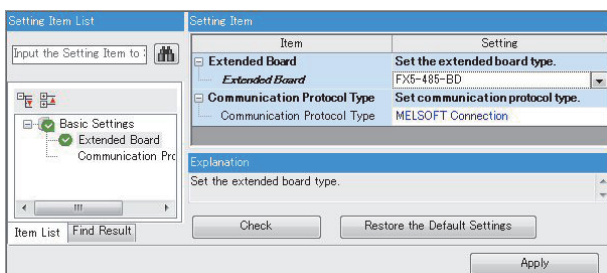

POINT

When changing the module parameter
After writing module parameters to the PLC CPU, turn the PLC CPU OFF then back ON again, or reset the PLC CPU.

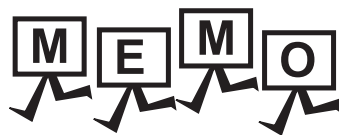

7

COMPUTER LINK CONNECTION



7.1	Connectable Model List	7 - 2
7.2	System Configuration	7 - 8
7.3	Connection Diagram	7 - 17
7.4	GOT Side Settings	7 - 21
7.5	PLC Side Setting	7 - 24
7.6	Precautions	7 - 31

7. COMPUTER LINK CONNECTION

7.1 Connectable Model List

The following table shows the connectable models.

7.1.1 PLC/Motion controller CPU

Series	Model name	Clock	Communication type	GT 16	GT 15	GT 14	GT 12	GT11 Bus	GT11 Serial	GT 10 ₂₄	GT 10 ₃₀	Refer to
MELSEC iQ-R Series	R04CPU	○	RS-232 RS-422	○	×	○	×	×	×	○	○	☞ 7.2.1
	R08CPU											
	R16CPU											
	R32CPU											
	R120CPU											
	R08PCPU											
	R16PCPU											
	R32PCPU											
	R120PCPU											
	R04ENCPU											
	R08ENCPU											
	R16ENCPU											
	R32ENCPU											
	R120ENCPU											
Motion controller CPU (MELSEC iQ-R Series)	R16MTCPU	○	RS-232 RS-422	○	×	○	×	×	×	○	○	☞ 7.2.1
	R32MTCPU											
C Controller module*1 (MELSEC iQ-R Series)	R12CCPU-V	○	RS-232 RS-422	○	×	○	×	×	×	○	○	☞ 7.2.1
MELSEC iQ-F Series	FX5U FX5UC	○	RS-232 RS-422	×	×	×	×	×	×	×	×	-

(Continued to next page)

*1 Use the serial port of a serial communication module controlled by another CPU on the multiple CPU.

*2 Mount a safety function module R6SFM next to the RnSF CPU on the base unit. The RnSF CPU and the safety function module R6SFM must have the same pair version. If their pair versions differ, the RnSF CPU does not operate.

Series	Model name	Clock	Communication	GT 16	GT 15	GT 14	GT 12	GT11 Bus	GT11 Serial	GT10 5□	GT10 20□	Refer to	
MELSEC-Q (Q mode)	Q00JCPU	○	RS-232 RS-422	○	○	○	○	×	○	○	○	☞ 7.2.2	
	Q00CPU*1												
	Q01CPU*1												
	Q02CPU*1												
	Q02HCPU*1												
	Q06HCPU*1												
	Q12HCPU*1												
	Q25HCPU*1												
	Q02PHCPU	○	RS-232 RS-422	○	○	○	○	×	○	×*2	×*2	☞ 7.2.2	
	Q06PHCPU												
	Q12PHCPU												
	Q25PHCPU	○	-	×	×	×	×	×	×	×	×	-	
	Q12PRHCPU (Main base)												
	Q25PRHCPU (Main base)	○	RS-232 RS-422	○	○	○	○	×	○	×	×	×	☞ 7.2.2
	Q12PRHCPU (Extension base)												
	Q25PRHCPU (Extension base)												
	Q00JCPU	○	RS-232 RS-422	○	○	○	○	×	○	○	○	☞ 7.2.2	
	Q00UCPU												
	Q01UCPU												
	Q02UCPU												
	Q03UDCPU												
	Q04UDHCPU												
	Q06UDHCPU												
	Q10UDHCPU												
	Q13UDHCPU												
	Q20UDHCPU												
	Q26UDHCPU												
	Q03UDECPU												
	Q04UDEHCPU												
	Q06UDEHCPU												
Q10UDEHCPU													
Q13UDEHCPU													
Q20UDEHCPU													
Q26UDEHCPU													
Q50UDEHCPU													
Q100UDEHCPU													
Q03UDVCPU	○	RS-232 RS-422	○	○	○	○	×	○	○	○	☞ 7.2.2		
Q04UDVCPU													
Q06UDVCPU													
Q13UDVCPU													
Q26UDVCPU													

(Continued to next page)

*1 When in multiple CPU system configuration, use CPU function version B or later.

*2 For GT10, do not include in the multiple CPU system configuration.

- 1 PREPARATORY PROCEDURES FOR MONITORING
- 2 DEVICE RANGE THAT CAN BE SET
- 3 ACCESS RANGE FOR MONITORING
- 4 HOW TO MONITOR REDUNDANT SYSTEM
- 5 BUS CONNECTION
- 6 DIRECT CONNECTION TO CPU
- 7 COMPUTER LINK CONNECTION
- 8 ETHERNET CONNECTION

Series	Model name	Clock	Communication	GT 16	GT 15	GT 14	GT 12	GT11 Bus	GT11 Serial	GT 10 5□ 4□	GT 10 20 30	Refer to
C Controller module (Q Series)	Q12DCCPU-V ^{*1} *2	○	RS-232 RS-422	○	○	○	○	×	○	○	○	☞ 7.2.2
	Q24DHCCPU-V ^{*2} /VG ^{*2}			○	○	○	○	×	○	○	○	
	Q24DHCCPU-LS			○	×	○	×	×	×	○	○	
	Q26DHCCPU-LS			○	×	○	×	×	×	○	○	
MELSEC-QS	QS001CPU	×	-	×	×	×	×	×	×	×	×	-
MELSEC-L	L02CPU	○	RS-232 RS-422	○	○	○	○	×	○	○	○	☞ 7.2.3
	L06CPU			○	○	○	○	×	○	○	○	
	L26CPU			○	○	○	○	×	○	○	○	
	L26CPU-BT			○	○	○	○	×	○	○	○	
	L02CPU-P			○	○	○	○	×	○	○	○	
	L06CPU-P			○	○	○	○	×	○	○	○	
	L26CPU-P			○	○	○	○	×	○	○	○	
	L26CPU-PBT			○	○	○	○	×	○	○	○	
	L02SCPU			○	○	○	○	×	○	○	○	
L02SCPU-P	○	○	○	○	×	○	○	○				
MELSEC-Q (A mode)	Q02CPU-A	○	RS-232 RS-422	○	○	○	○	×	○	○	○	☞ 7.2.4
	Q02HCPU-A			○	○	○	○	×	○	○	○	
	Q06HCPU-A			○	○	○	○	×	○	○	○	
MELSEC-QnA (QnACPU) ^{*3}	Q2ACPU	○	RS-232 RS-422	○	○	○	○	×	○	○	○	☞ 7.2.5
	Q2ACPU-S1			○	○	○	○	×	○	○	○	
	Q3ACPU			○	○	○	○	×	○	○	○	
	Q4ACPU	○	○	○	○	×	○	○	○	○		
	Q4ARCPU	○	RS-232 RS-422	○	○	○	○	×	○	×	×	
MELSEC-QnA (QnACPU) ^{*3}	Q2ASCPU	○	RS-232 RS-422	○	○	○	○	×	○	○	○	☞ 7.2.6
	Q2ASCPU-S1			○	○	○	○	×	○	○	○	
	Q2ASHCPU			○	○	○	○	×	○	○	○	
	Q2ASHCPU-S1			○	○	○	○	×	○	○	○	
MELSEC-A (AnCPU)	A2UCPU	○	RS-232 RS-422	○	○	○	○	×	○	○	○	☞ 7.2.7
	A2UCPU-S1			○	○	○	○	×	○	○	○	
	A3UCPU			○	○	○	○	×	○	○	○	
	A4UCPU			○	○	○	○	×	○	○	○	
	A2ACPU			○	○	○	○	×	○	○	○	
	A2ACPUP21			○	○	○	○	×	○	○	○	
	A2ACPUR21			○	○	○	○	×	○	○	○	
	A2ACPU-S1			○	○	○	○	×	○	○	○	
	A2ACPUP21-S1			○	○	○	○	×	○	○	○	
	A2ACPUR21-S1			○	○	○	○	×	○	○	○	
	A3ACPU			○	○	○	○	×	○	○	○	
	A3ACPUP21			○	○	○	○	×	○	○	○	
	A3ACPUR21			○	○	○	○	×	○	○	○	
	A1NCPUR21			○	○	○	○	×	○	○	○	
	A2NCPUR21			○	○	○	○	×	○	○	○	
	A2NCPUP21			○	○	○	○	×	○	○	○	
	A2NCPUR21			○	○	○	○	×	○	○	○	
	A2NCPUP21-S1			○	○	○	○	×	○	○	○	
	A2NCPUR21-S1			○	○	○	○	×	○	○	○	
	A3NCPUR21			○	○	○	○	×	○	○	○	
	A3NCPUP21			○	○	○	○	×	○	○	○	
A3NCPUR21	○	○	○	○	×	○	○	○				

(Continued to next page)

*1 Use only modules with the upper five digits of the serial No. later than 12042.

*2 Use the serial port of a serial communication module controlled by another CPU on the multiple CPU.

*3 If the A series computer link module is applied to the QnACPU, the GOT can monitor the devices in the same range on AnACPU. However, the following devices cannot be monitored.

- Devices added to QnACPU
- Latch relays (L) and step relays (S)
(In case of QnACPU, the latch relay (L) and step relay (S) are different from the internal relay. However, whichever is specified, an access is made to the internal relay.)
- File register (R)

Series	Model name	Clock	Communication	GT 16	GT 15	GT 14	GT 12	GT11 Bus	GT11 Serial	GT10 5□	GT10 20 30	Refer to		
MELSEC-A (AnSCPU)	A2USCPU	○	RS-232 RS-422	○	○	○	○	×	○	○	○	☞ 7.2.8		
	A2USCPU-S1													
	A2USHCPU-S1													
	A1SCPU													
	A1SCPUC24-R2*6													
	A1SHCPU*1													
	A2SCPU*1													
	A2SCPU-S1*1													
	A2SHCPU*1													
	A2SHCPU-S1*1													
	A1SJCPU													
	A1SJCPU-S3													
A1SJHCPU*1														
MELSEC-A	A0J2HCPU*1	×	RS-232 RS-422	○	○	○	○	×	○	○	○	☞ 7.2.8		
	A0J2HCPUP21*1													
	A0J2HCPUR21*1													
	A0J2HCPU-DC24*1													
	MELSEC-A	A2CCPU	○	-	×	×	×	×	×	×	×	×	-	
		A2CCPUP21												
		A2CCPUR21												
		MELSEC-A	A2CCPUC24	○	RS-232 RS-422	○	○	○	○	×	○	○	○	☞ 7.2.8
			A2CCPUC24-PRF											
A2CJCPU-S3														
Motion controller CPU (Q Series)	Q172CPU*2*3	○	RS-232 RS-422	○	○	○	○	×	○	○	○	☞ 7.2.2		
	Q173CPU*2*3													
	Q172CPUN*2													
	Q173CPUN*2													
	Q172HCPU													
	Q173HCPU													
	Q172DCPU													
	Q173DCPU													
	Q172DCPU-S1													
	Q173DCPU-S1													
	Q172DSCPU													
	Q173DSCPU													
	Q170MCPUS*4													
	Q170MSCPUS*5													
	Q170MSCPUS-S1*5													
	MR-MQ100													
													○	-

(Continued to next page)

- *1 The computer link module version U or later supports the A2SCPU(S1), A2SHCPU(S1), A1SHCPU, A1SJHCPU and A0J2HCPU. In addition, A0J2-C214-S1 (A0J2HCPU-dedicated computer link module) cannot be used.
- *2 When using SV13, SV22, or SV43, use the motion controller CPU on which any of the following main OS version is installed.
 - SW6RN-SV13Q□: 00H or later
 - SW6RN-SV22Q□: 00H or later
 - SW6RN-SV43Q□: 00B or later
- *3 Use main modules with the following product numbers.
 - Q172CPU: Product number N***** or later
 - Q173CPU: Product number M***** or later
- *4 Only the first step can be used on the extension base unit (Q52B/Q55B).
- *5 The extension base unit (Q5□B/Q6□B) can be used.
- *6 Use hardware version C or later, software version E or later.

Series	Model name	Clock	Communication	GT 16	GT 15	GT 14	GT 12	GT11 Bus	GT11 Serial	GT10 5□4□	GT10 20□30	Refer to
Motion controller CPU (A Series)	A273UCPU	○	RS-232 RS-422	○	○	○	○	×	○	×	×	☞ 7.2.7
	A273UHCPU											
	A273UHCPU-S3											
	A373UCPU											
	A373UCPU-S3											
	A171SCPU	○	RS-232 RS-422	○	○	○	○	×	○	×	×	☞ 7.2.8
	A171SCPU-S3											
	A171SCPU-S3N											
	A171SHCPU*2											
	A171SHCPUN*2											
	A172SHCPU*2											
	A172SHCPUN*2											
	A173UHCPU											
A173UHCPU-S1												
MELSEC-WS	WS0-CPU0	×	-	×	×	×	×	×	×	×	×	-
	WS0-CPU1											
	WS0-CPU3											
MELSECNET/H Remote I/O station	QJ72LP25-25	×	RS-232 RS-422	○	○	○	○	×	○*1	×	×	☞ 7.2.2
	QJ72LP25G											
	QJ72BR15											
CC-Link IE Field Network head module	LJ72GF15-T2	×	RS-232 RS-422	○	○	○	○	×	○*3	○*3	○*3	☞ 7.2.3
CC-Link IE Field Network Ethernet adapter module	NZ2GF-ETB	×	-	×	×	×	×	×	×	×	×	-
CNC C70	Q173NCCPU	○	RS-232 RS-422	○	○	○	○	×	○	×	×	☞ 7.2.2
Robot controller	CRnQ-700 (Q172DRCPU) CR750-Q (Q172DRCPU) CR751-Q (Q172DRCPU)	○	RS-232 RS-422	○	○	○	○	×	○	×	×	☞ 7.2.2
MELSEC-FX	FX0	×	-	×	×	×	×	×	×	×	×	-
	FX0S											
	FX0N											
	FX1											
	FX2											
	FX2C	○	-	×	×	×	×	×	×	×	×	
	FX1S											
	FX1N											
	FX2N	○	-	×	×	×	×	×	×	×	×	
	FX1NC											
	FX2NC											
	FX3S											
	FX3G											
	FX3GC											
	FX3GE											
FX3U												
FX3UC												

*1 GT11 can not access the master station on MELSECNET/H network system. GT11 can access only the connected host station (remote I/O station).

*2 For computer link connection of A171SHCPU(N) and A172SHCPU(N), use the computer link module whose software version is version U or later.

*3 GT11,GT10 can not access the master station on CC-Link IE field network system. GT11,GT10 can access only the connected host station (head module station).

7.1.2 Serial communication module/Computer link module

CPU series	Model name*1
MELSEC iQ-R Series Motion controller CPU (MELSEC iQ-R Series) C Controller module (MELSEC iQ-R Series) ^{*7}	RJ71C24, RJ71C24-R2, RJ71C24-R4
MELSEC-Q (Q mode) Motion controller CPU (Q Series) MELSECNET/H remote I/O station CNC C70 Robot controller (CRnQ-700)	QJ71C24 ^{*2} , QJ71C24-R2 ^{*2} QJ71C24N, QJ71C24N-R2, QJ71C24N-R4 QJ71CMO ^{*3} , QJ71CMON ^{*3}
MELSEC-L	LJ71C24, LJ71C24-R2
MELSEC-Q (A mode)	A1SJ71UC24-R2, A1SJ71UC24-R4, A1SJ71UC24-PRF A1SJ71C24-R2, A1SJ71C24-R4, A1SJ71C24-PRF
MELSEC-QnA (QnACPU) MELSEC-QnA (QnASCPU)	AJ71QC24 ^{*4} , AJ71QC24-R2 ^{*4} , AJ71QC24-R4 ^{*4} AJ71QC24N ^{*4} , AJ71QC24N-R2 ^{*4} , AJ71QC24N-R4 ^{*4} A1SJ71QC24 ^{*4} , A1SJ71QC24-R2 ^{*4} A1SJ71QC24N ^{*4} , A1SJ71QC24N-R2 ^{*4} A1SJ71QC24N1 ^{*4} , A1SJ71QC24N1-R2 ^{*4} AJ71UC24 ^{*4*6} A1SJ71C24-R2 ^{*6} , A1SJ71C24-R4 ^{*6} , A1SJ71C24-PRF ^{*6} A1SJ71UC24-R2 ^{*6} , A1SJ71UC24-R4 ^{*6} , A1SJ71UC24-PRF ^{*6}
MELSEC-A (AnCPU) MELSEC-A (AnSCPU) MELSEC-A Motion controller CPU (A Series)	AJ71UC24 ^{*4*5} A1SJ71UC24-R2 ^{*5} , A1SJ71UC24-R4 ^{*5} , A1SJ71UC24-PRF ^{*5} A1SJ71C24-R2 ^{*5} , A1SJ71C24-R4 ^{*5} , A1SJ71C24-PRF ^{*5} A1SCPUC24-R2 ^{*8} A2CCPUC24 ^{*4} , A2CCPUC24-PRF ^{*4}

*1 Communication cannot be performed with RS-485.

A0J2-C214-S1 cannot be used.

*2 Either CH1 or CH2 can be used for the function version A. Both CH1 and CH2 can be used together for the function version B or later.

*3 Only CH2 can be connected.

*4 Either CH1 or CH2 can be used.

*5 The computer link module version U or later supports the A2SCPU(S1), A2SHCPU(S1), A1SHCPU, A1SJHCPU and A0J2HCPU.

*6 The module operates in the device range on AnACPU.

*7 Use the serial port of a serial communication module controlled by another CPU on the multiple CPU.

*8 Use hardware version C or later, software version E or later.

1
PREPARATORY
PROCEDURES FOR
MONITORING

2
DEVICE RANGE
THAT CAN BE SET

3
ACCESS RANGE
FOR MONITORING

4
HOW TO MONITOR
REDUNDANT
SYSTEM

5
BUS CONNECTION

6
DIRECT
CONNECTION TO
CPU

7
COMPUTER LINK
CONNECTION

8
ETHERNET
CONNECTION

7.2 System Configuration

7.2.1 Connecting to MELSEC iQ-R series

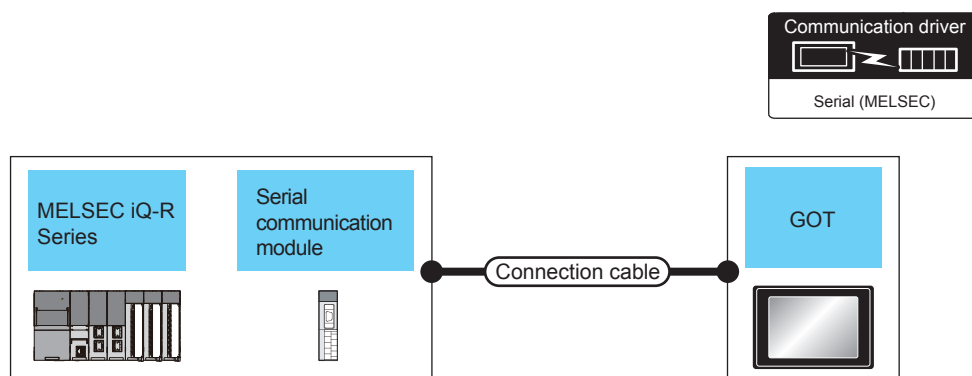

PLC			Connection cable		GOT		Number of connectable equipment
Model name	Serial communication module*1	Communication type	Cable model	Max. distance	Option device	Model	
MELSEC iQ-R Series	RJ71C24 RJ71C24-R2	RS-232	GT09-C30R2-9P(3m) or RS-232 connection diagram 1)	15m	- (Built into GOT)	 	2 GOTs for 1 serial communication module
			RS-232 connection diagram 3)	15m	- (Built into GOT)		
	RJ71C24 RJ71C24-R4	RS-422	RS-422 connection diagram 2)	1200m	- (Built into GOT)		
			GT09-C30R4-6C(3m) GT09-C100R4-6C(10m) GT09-C200R4-6C(20m) GT09-C300R4-6C(30m) or RS-422 connection diagram 1)	1200m	GT16-C02R4-9S		
			RS-422 connection diagram 1)	1200m	GT15-RS2T4-9P*2 GT15-RS4-9S		
			RS-422 connection diagram 3)	1200m	- (Built into GOT)	 	
					- (Built into GOT)	*4	

*1 For details on the system configuration on the serial communication module side, refer to the following manual.

Manuals of MELSEC iQ-R Series

*2 Connect it to the RS-232 interface (built into GOT). It cannot be mounted on GT1655.

*3 Use the RS-232 connection model.

*4 Use the RS-422 connection model.

7.2.2 Connecting to QCPU (Q mode)

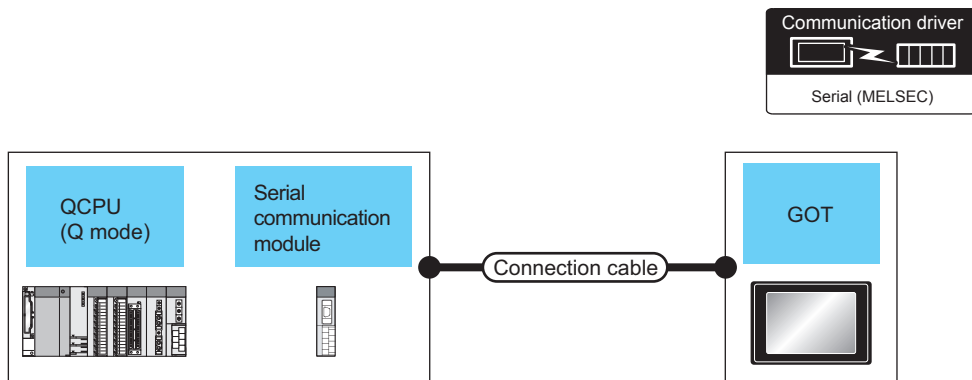

PLC			Connection cable		GOT		Number of connectable equipment*5
Model name	Serial communication module*1	Communication type	Cable model	Max. distance	Option device	Model	
MELSEC-Q (Q mode)	QJ71C24 QJ71C24N QJ71C24-R2 QJ71C24N-R2 QJ71CMO QJ71CMON	RS-232	GT09-C30R2-9P(3m) or User's Manual RS-232 connection diagram 1)	15m	- (Built into GOT)	GT16, GT15, GT14, GT12, GT11, GT10, Serial	2 GOTs for 1 serial communication module*3
					GT15-RS2-9P	GT16, GT15	
			GT01-RS4-M*4	-			
			User's Manual RS-232 connection diagram 3)	15m	- (Built into GOT)	GT24, GT10, GT20, GT30*6	
	QJ71C24 QJ71C24N QJ71C24N-R4	RS-422	User's Manual RS-422 connection diagram 2)	1200m	- (Built into GOT)	GT16	1 GOT for 1 modem interface module
					GT16-C02R4-9S	GT16	
			GT09-C30R4-6C(3m) GT09-C100R4-6C(10m) GT09-C200R4-6C(20m) GT09-C300R4-6C(30m) or User's Manual RS-422 connection diagram 1)	1200m	GT15-RS2T4-9P*2	GT16, GT15	
					GT15-RS4-9S	GT14, GT12, GT11, GT10, Serial	
			GT01-RS4-M*4	-			
			User's Manual RS-422 connection diagram 3)	1200m	- (Built into GOT)	GT24, GT10, GT20, GT30*7	

*1 For details on the system configuration on the serial communication module side, refer to the following manual.

☞ Q Corresponding Serial Communication Module User's Manual (Basic)

For details on the system configuration on the modem interface module side, refer to the following manual.

☞ Modem Interface Module User's Manual

*2 Connect it to the RS-232 interface (built into GOT). It cannot be mounted on GT1655 and GT155□.

*3 Two GOTs can be connected with the function version B or later of the serial communication module.

*4 For details of the GOT multi-drop connection, refer to the following.

☞ 20. GOT MULTI-DROP CONNECTION

*5 GT14, GT12, GT11 and GT10 are available for the multiple-GT14, GT12, GT11, GT10 connection function to connect up to four GOTs.

However, when using modem interface modules or serial communication modules (function version A), up to two GOTs can be connected.

☞ 21. MULTIPLE-GT14, GT12, GT11, GT10 CONNECTION FUNCTION

*6 Use the RS-232 connection model.

*7 Use the RS-422 connection model.

7.2.3 Connecting to LCPU

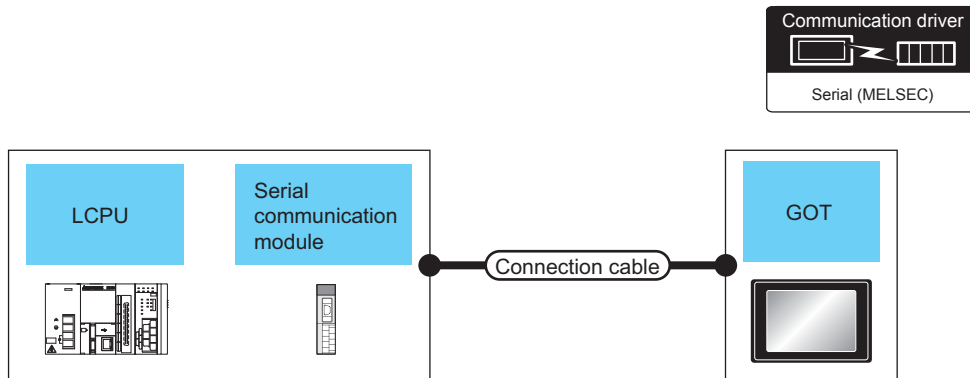

PLC		Connection cable		GOT		Number of connectable equipment		
Model name	Serial communication module ^{*1}	Communication type	Cable model	Max. distance	Option device		Model	
MELSEC-L	LJ71C24 LJ71C24-R2	RS-232	GT09-C30R2-9P(3m) or RS-232 connection diagram 1)	15m	- (Built into GOT)			
					GT15-RS2-9P			
					GT01-RS4-M ^{*3}	-		
	LJ71C24	RS-422	RS-422 connection diagram 3)	15m	- (Built into GOT)	^{*4}		
					RS-422 connection diagram 2)	1200m	- (Built into GOT)	
					GT09-C30R4-6C(3m) GT09-C100R4-6C(10m) GT09-C200R4-6C(20m) GT09-C300R4-6C(30m) or RS-422 connection diagram 1)	1200m	GT16-C02R4-9S	
							GT15-RS2T4-9P ^{*2}	
							GT15-RS4-9S	
					RS-422 connection diagram 1)	500m	- (Built into GOT)	
							GT01-RS4-M ^{*3}	-
RS-422 connection diagram 3)	1200m	- (Built into GOT)	^{*5}					

*1 For details on the system configuration on the serial communication module side, refer to the following manual.

MELSEC-L Serial Communication Module User's Manual (Basic)

*2 Connect it to the RS-232 interface (built into GOT). It cannot be mounted on GT1655 and GT155□.

*3 For details of the GOT multi-drop connection, refer to the following.

20. GOT MULTI-DROP CONNECTION

*4 Use the RS-232 connection model.

*5 Use the RS-422 connection model.

7.2.4 Connecting to QCPU (A mode)

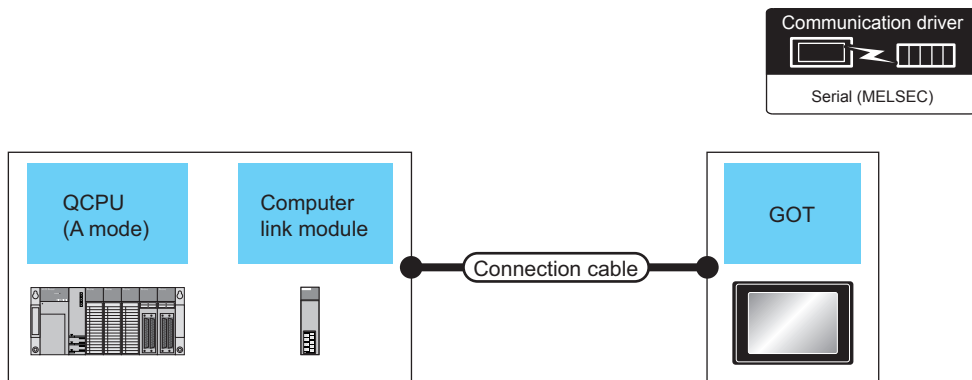

PLC			Connection cable		GOT		Number of connectable equipment	
Model name	Computer link module ^{*1}	Communication type	Cable model	Max. distance	Option device	Model		
MELSEC-Q (A mode)	A1SJ71UC24-R2 A1SJ71C24-R2 A1SJ71UC24-PRF A1SJ71C24-PRF	RS-232	GT09-C30R2-9P(3m) or RS-232 connection diagram 1)	15m	- (Built into GOT)		1 GOT for 1 computer link module	
			RS-232 connection diagram 3)	15m	- (Built into GOT)			
		A1SJ71UC24-R4 A1SJ71C24-R4	RS-422	RS-422 connection diagram 2)	500m	- (Built into GOT)		
				GT09-C30R4-6C(3m) GT09-C100R4-6C(10m) GT09-C200R4-6C(20m) GT09-C300R4-6C(30m) or RS-422 connection diagram 1)	500m	GT16-C02R4-9S GT15-RS2T4-9P ^{*2} GT15-RS4-9S		
	RS-422 connection diagram 1)			500m	- (Built into GOT)			
	RS-422 connection diagram 3)			500m	- (Built into GOT)			

*1 For the system configuration on the computer link module side, refer to the following manual.

Computer Link Module (Com. link func./Print. func.) User's Manual

*2 Connect it to the RS-232 interface (built into GOT). It cannot be mounted on GT1655 and GT155□.

*3 Use the RS-232 connection model.

*4 Use the RS-422 connection model.

1 PREPARATORY PROCEDURES FOR MONITORING
2 DEVICE RANGE THAT CAN BE SET
3 ACCESS RANGE FOR MONITORING
4 HOW TO MONITOR REDUNDANT SYSTEM
5 BUS CONNECTION
6 DIRECT CONNECTION TO CPU
7 COMPUTER LINK CONNECTION
8 ETHERNET CONNECTION

7.2.5 Connecting to QnACPU (QnACPU type)

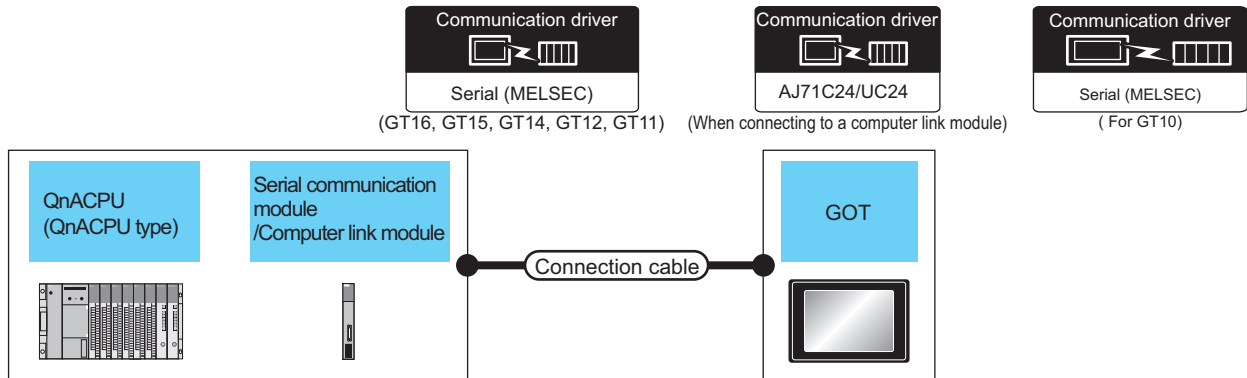

PLC		Connection cable		GOT		Number of connectable equipment		
Model name	Serial communication module ^{*1}	Communication type	Cable model	Max. distance	Option device		Model	
MELSEC-QnA (QnACPU)	AJ71QC24 AJ71QC24N AJ71QC24-R2 AJ71QC24N-R2	RS-232	GT09-C30R2-25P(3m) or User RS-232 connection diagram 2)	15m	-(Built into GOT)	GT 16, GT 15, GT 14, GT 12, GT11 Serial, GT 10		
			GT15-RS2-9P		GT 16, GT 15			
					GT01-RS4-M ^{*3}	-		
			User RS-232 connection diagram 4)	15m	-(Built into GOT)	GT 2W, GT 10, GT 20, GT 30 ^{*4}		
			AJ71QC24-R4 AJ71QC24N-R4	RS-422	GT01-C30R4-25P(3m) GT01-C100R4-25P(10m) GT01-C200R4-25P(20m) GT01-C300R4-25P(30m)	30m	GT16-C02R4-9S	GT 16
							GT15-RS2T4-9P ^{*2}	GT 16, GT 15
	GT15-RS4-9S	GT 14, GT 12, GT11 Serial, GT 10, GT 5, GT 4						
	-(Built into GOT)	GT 14, GT 12, GT11 Serial, GT 10, GT 5, GT 4						
	GT01-RS4-M ^{*3}	-						
	GT10-C30R4-25P(3m) GT10-C100R4-25P(10m) GT10-C200R4-25P(20m) GT10-C300R4-25P(30m) or User RS-422 connection diagram 4)	30m			-(Built into GOT)	GT 2W, GT 10, GT 20, GT 30 ^{*5}		
	AJ71QC24 AJ71QC24N AJ71QC24-R4 AJ71QC24N-R4	RS-422	User RS-422 connection diagram 2)	1200m	-(Built into GOT)	GT 16		
			GT09-C30R4-6C(3m) GT09-C100R4-6C(10m) GT09-C200R4-6C(20m) GT09-C300R4-6C(30m) or User RS-422 connection diagram 1)	1200m	GT16-C02R4-9S	GT 16		
GT15-RS2T4-9P ^{*2}					GT 16, GT 15			
GT15-RS4-9S					GT 14, GT 12, GT11 Serial, GT 10, GT 5, GT 4			
-(Built into GOT)					GT 14, GT 12, GT11 Serial, GT 10, GT 5, GT 4			
GT01-RS4-M ^{*3}			500m	GT01-RS4-M ^{*3}	-			
User RS-422 connection diagram 3)	1200m	-(Built into GOT)	GT 2W, GT 10, GT 20, GT 30 ^{*5}					

^{*1} For details on the system configuration on the serial communication module side, refer to the following manual.

Serial Communications Module User's Manual (Modem Function Additional Version)

^{*2} Connect it to the RS-232 interface (built into GOT). It cannot be mounted on GT1655 and GT155□.

^{*3} For details of the GOT multi-drop connection, refer to the following.

20. GOT MULTI-DROP CONNECTION

^{*4} Use the RS-232 connection model.

^{*5} Use the RS-422 connection model.

PLC			Connection cable		GOT		Number of connectable equipment
Model name	Computer link module*1	Communication type	Cable model	Max. distance	Option device	Model	
MELSEC-QnA (QnACPU)	AJ71UC24	RS-232	GT09-C30R2-25P(3m) or RS-232 connection diagram 2)	15m	- (Built into GOT)		1 GOT for 1 computer link module
			GT15-RS2-9P				
			GT01-RS4-M*3		-		
	RS-232 connection diagram 4)	15m	- (Built into GOT)	*4			
	AJ71UC24	RS-422	RS-422 connection diagram 2)	500m	- (Built into GOT)		
			GT09-C30R4-6C(3m) GT09-C100R4-6C(10m) GT09-C200R4-6C(20m) GT09-C300R4-6C(30m) or RS-422 connection diagram 1)	500m	GT16-C02R4-9S		
GT15-RS2T4-9P*2							
GT15-RS4-9S							
- (Built into GOT)							
GT01-RS4-M*3		-					
RS-422 connection diagram 3)	500m	- (Built into GOT)	*5				

*1 For the system configuration on the computer link module side, refer to the following manual.

Computer Link Module (Com. link func./Print. func.) User's Manual

When connecting to a computer link module, set the communication driver to [AJ71C24/UC24].

*2 Connect it to the RS-232 interface (built into GOT). It cannot be mounted on GT1655 and GT155□.

*3 For details of the GOT multi-drop connection, refer to the following.

20. GOT MULTI-DROP CONNECTION

*4 Use the RS-232 connection model.

*5 Use the RS-422 connection model.

7.2.6 Connecting to QnACPU (QnASCPU type)

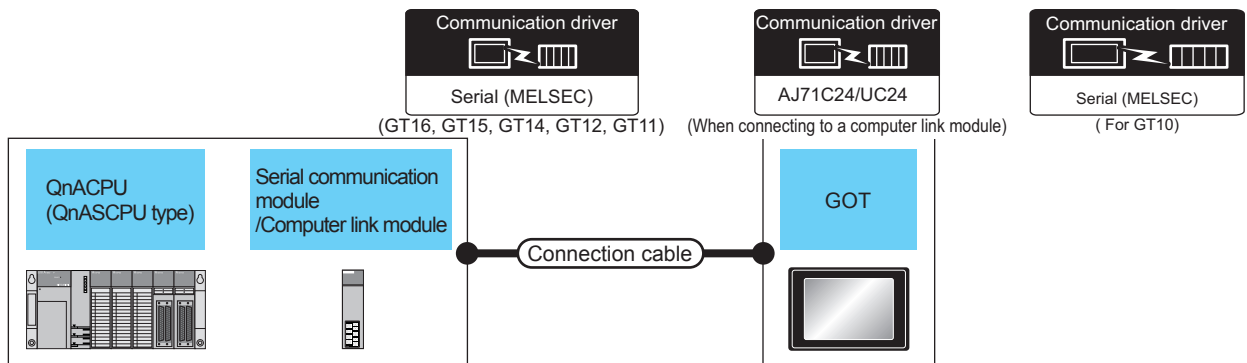

PLC			Connection cable		GOT		Number of connectable equipment
Model name	Serial communication module*1	Communication type	Cable model	Max. distance	Option device	Model	
MELSEC-QnA (QnASCPU)	A1SJ71QC24 A1SJ71QC24N A1SJ71QC24N1 A1SJ71QC24-R2 A1SJ71QC24N-R2 A1SJ71QC24N1-R2	RS-232	GT09-C30R2-9P(3m) or RS-232 connection diagram 1)	15m	- (Built into GOT)		1 GOT for 1 serial communication module
			GT15-RS2-9P				
			GT01-RS4-M*2		-		
RS-232 connection diagram 3)	15m	- (Built into GOT)	*3				







































*1 For details on the system configuration on the serial communication module side, refer to the following manual.

Serial Communication Module User's Manual (Modem Function Additional Version)

*2 For details of the GOT multi-drop connection, refer to the following.

20. GOT MULTI-DROP CONNECTION

*3 Use the RS-232 connection model.

PLC			Connection cable		GOT		Number of connectable equipment
Model name	Serial communication module/Computer link module *1	Communication type	Cable model	Max. distance	Option device	Model	
MELSEC-QnA (QnASCPU)	A1SJ71QC24 A1SJ71QC24N A1SJ71QC24N1	RS-422	 RS-422 connection diagram 2)	1200m	- (Built into GOT)		1 GOT for 1 serial communication module
			GT09-C30R4-6C(3m) GT09-C100R4-6C(10m) GT09-C200R4-6C(20m) GT09-C300R4-6C(30m) or  RS-422 connection diagram 1)	1200m	GT16-C02R4-9S		
					GT15-RS2T4-9P*2	 	
					GT15-RS4-9S	   	
			- (Built into GOT)	500m	GT01-RS4-M*3	-	
 RS-422 connection diagram 3)	1200m	- (Built into GOT)	  *5				
MELSEC-QnA (QnASCPU)	A1SJ71UC24-R2 A1SJ71C24-R2 A1SJ71UC24-PRF A1SJ71C24-PRF	RS-232	GT09-C30R2-9P(3m) or  RS-232 connection diagram 1)	15m	- (Built into GOT)	    	1 GOT for 1 computer link module
			 RS-232 connection diagram 1)	15m	GT15-RS2-9P	 	
					GT01-RS4-M*3	-	
	 RS-232 connection diagram 3)	15m	- (Built into GOT)	  *4			
	A1SJ71UC24-R4 A1SJ71C24-R4	RS-422	 RS-422 connection diagram 2)	500m	- (Built into GOT)		
			GT09-C30R4-6C(3m) GT09-C100R4-6C(10m) GT09-C200R4-6C(20m) GT09-C300R4-6C(30m) or  RS-422 connection diagram 1)	500m	GT16-C02R4-9S		
					GT15-RS2T4-9P*2	 	
					GT15-RS4-9S	   	
			- (Built into GOT)	500m	GT01-RS4-M*3	-	
	 RS-422 connection diagram 3)	500m	- (Built into GOT)	  *5			

*1 For details on the system configuration on the serial communication module side, refer to the following manual.

 Serial Communication Module User's Manual (Modem Function Additional Version)

For the system configuration on the computer link module side, refer to the following manual.

 Computer Link Module (Com. link func./Print. func.) User's Manual

When connecting to a computer link module, set the communication driver to [AJ71C24/UC24].

*2 Connect it to the RS-232 interface (built into GOT). It cannot be mounted on GT1655 and GT155□.

*3 For details of the GOT multi-drop connection, refer to the following.

 20. GOT MULTI-DROP CONNECTION

*4 Use the RS-232 connection model.

*5 Use the RS-422 connection model.

7.2.7 Connecting to ACPU (AnCPU type)

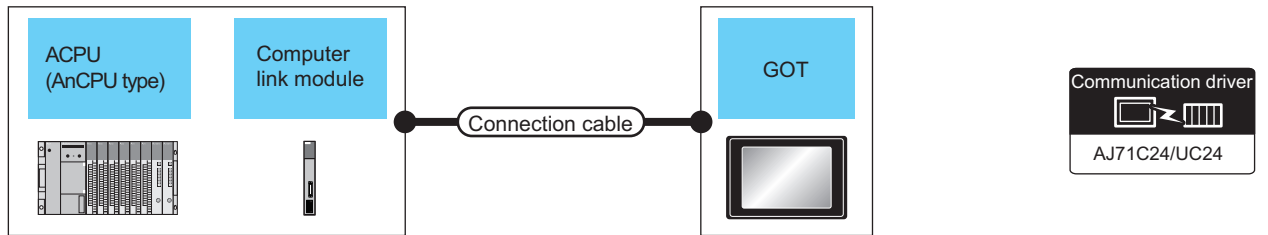

PLC			Connection cable		GOT		Number of connectable equipment
Model name	Computer link module *1	Communication type	Cable model	Max. distance	Option device	Model	
MELSEC-A (AnCPU)	AJ71UC24	RS-232	GT09-C30R2-25P(3m) or RS-232 connection diagram 2)	15m	- (Built into GOT)		1 GOT for 1 computer link module
			RS-232 connection diagram 4)	15m	- (Built into GOT)		
			RS-422 connection diagram 2)	500m	- (Built into GOT)		
			GT09-C30R4-6C(3m) GT09-C100R4-6C(10m) GT09-C200R4-6C(20m) GT09-C300R4-6C(30m) or RS-422 connection diagram 1)	500m	GT16-C02R4-9S GT15-RS2T4-9P*2 GT15-RS4-9S		
	AJ71UC24	RS-422	RS-422 connection diagram 3)	500m	- (Built into GOT)		

*1 For the system configuration on the computer link module side, refer to the following manual.

Computer Link Module (Com. link func./Print. func.) User's Manual

*2 Connect it to the RS-232 interface (built into GOT). It cannot be mounted on GT1655 and GT155□.

*3 Use the RS-232 connection model.

*4 Use the RS-422 connection model.

1 PREPARATORY PROCEDURES FOR MONITORING
2 DEVICE RANGE THAT CAN BE SET
3 ACCESS RANGE FOR MONITORING
4 HOW TO MONITOR REDUNDANT SYSTEM
5 BUS CONNECTION
6 DIRECT CONNECTION TO CPU
7 COMPUTER LINK CONNECTION
8 ETHERNET CONNECTION

7.2.8 Connecting to ACPU (AnSCPU type, A0J2HCPU, A2CCPUC)

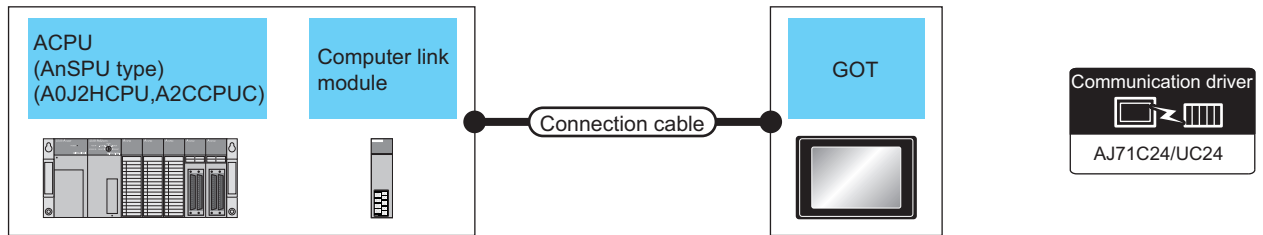

PLC		Connection cable		GOT		Number of connectable equipment	
Model name	Computer link module *1	Communication type	Cable model	Max. distance	Option device		Model
MELSEC-A (AnSCPU) (A0J2H) (A2CCPUC)	A1SJ71UC24-R2 A1SJ71C24-R2 A1SJ71UC24-PRF A1SJ71C24-PRF A1SCPUC24-R2 A2CCPUC24 A2CCPUC24-PRF	RS-232	GT09-C30R2-9P(3m) or User preparing RS-232 connection diagram 1)	15m	- (Built into GOT)	GT 16, GT 15, GT 14, GT 12, GT11 Serial, GT 10 5/4	1 GOT for 1 computer link module
			GT15-RS2-9P		GT 16, GT 15		
			User preparing RS-232 connection diagram 3)	15m	- (Built into GOT)	GT 24W, GT 10 20/30 *3	
			User preparing RS-422 connection diagram 2)	500m	- (Built into GOT)	GT 16	
	A1SJ71UC24-R4 A1SJ71C24-R4	RS-422	GT09-C30R4-6C(3m) GT09-C100R4-6C(10m) GT09-C200R4-6C(20m) GT09-C300R4-6C(30m) or User preparing RS-422 connection diagram 1)	500m	GT16-C02R4-9S GT15-RS2T4-9P*2 GT15-RS4-9S	GT 16, GT 15	
			User preparing RS-422 connection diagram 3)	500m	- (Built into GOT)	GT 14, GT 12, GT11 Serial, GT 10 5/4	
			User preparing RS-422 connection diagram 3)	500m	- (Built into GOT)	GT 24W, GT 10 20/30 *4	

*1 For the system configuration on the computer link module side, refer to the following manual.

Computer Link Module (Com. link func./Print. func.) User's Manual

*2 Connect it to the RS-232 interface (built into GOT). It cannot be mounted on GT1655 and GT155□.

*3 Use the RS-232 connection model.

*4 Use the RS-422 connection model.

7.3 Connection Diagram

The following diagram shows the connection between the GOT and the PLC.

7.3.1 RS-232 cable

Connection diagram

RS-232 connection diagram 1)

PLC side connector D-sub 9-pin

For GT16, GT15

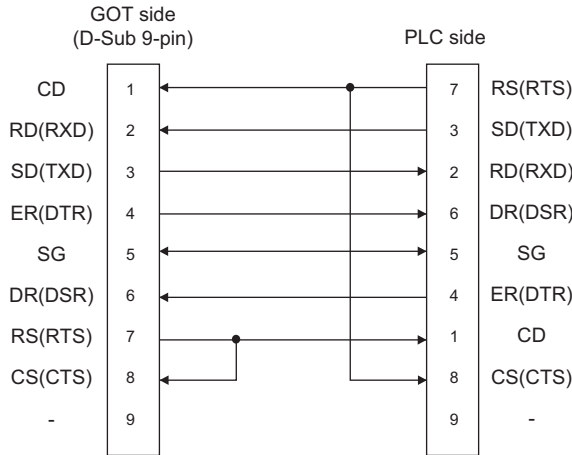

For the GT14, GT12, GT11, GT105□, GT104□, Serial Multi-Drop Unit (When connecting to the Q/QnA/L Serial Communication Module)

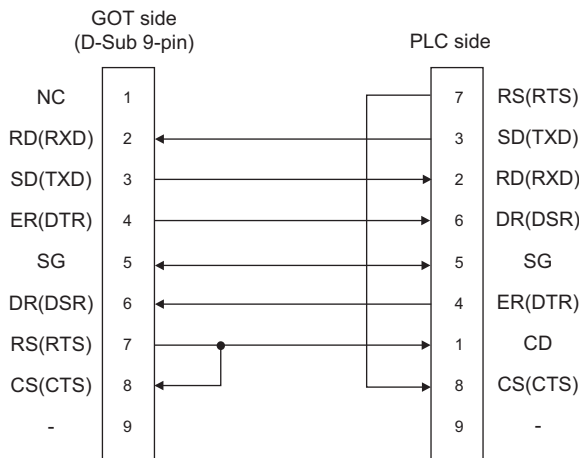

For the GT14, GT12, GT11, GT105□, GT104□ (When connecting to the Computer Link Module)

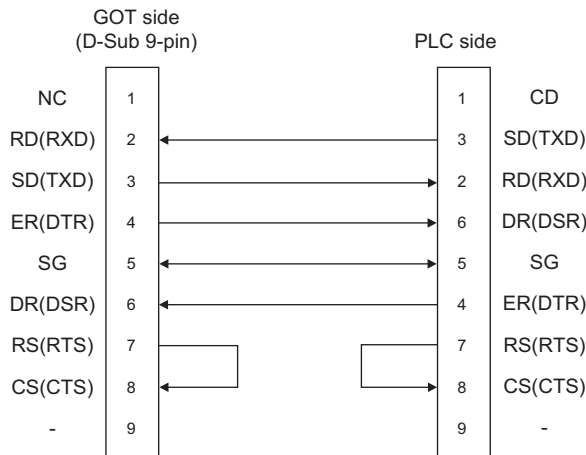

RS-232 connection diagram 2)

PLC side connector D-sub 25-pin

For GT16, GT15

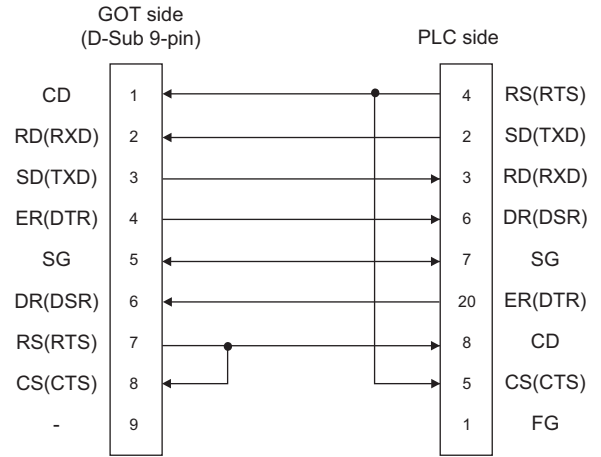

For the GT14, GT12, GT11, GT105□, GT104□, Serial Multi-Drop Unit (When connecting to the Q/QnA Serial Communication Module)

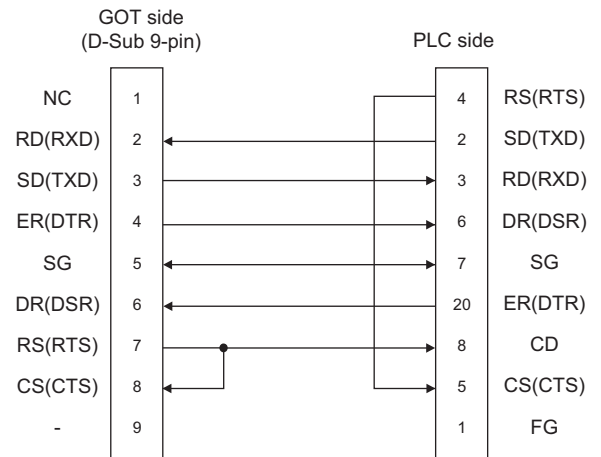

For the GT14, GT12, GT11, GT105□, GT104□ (When connecting to the Computer Link Module)

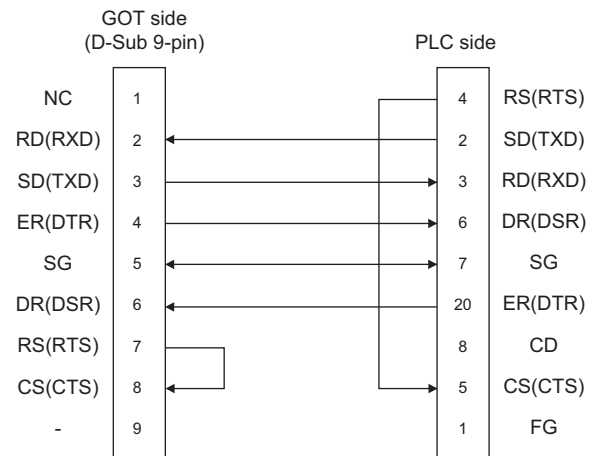

1 PREPARATORY PROCEDURES FOR MONITORING
 2 DEVICE RANGE THAT CAN BE SET
 3 ACCESS RANGE FOR MONITORING
 4 HOW TO MONITOR REDUNDANT SYSTEM
 5 BUS CONNECTION
 6 DIRECT CONNECTION TO CPU
 7 COMPUTER LINK CONNECTION
 8 ETHERNET CONNECTION

RS-232 connection diagram 3)

PLC side connector D-sub 9-pin

For GT1030, GT1020

(When connecting to the Q/QnA/L Serial Communication Module)

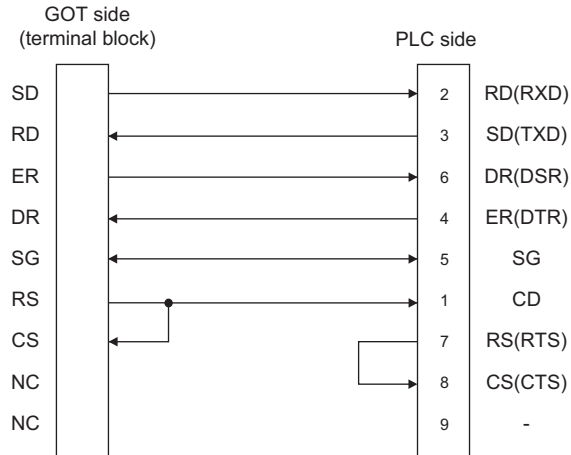

For GT1030, GT1020

(When connecting to the Computer Link Module)

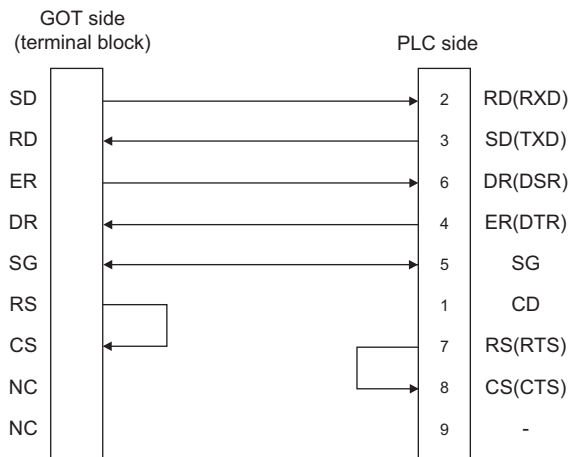

RS-232 connection diagram 4)

PLC side connector D-sub 25-pin

For GT1030, GT1020

(When connecting to the Q/QnA Serial Communication Module)

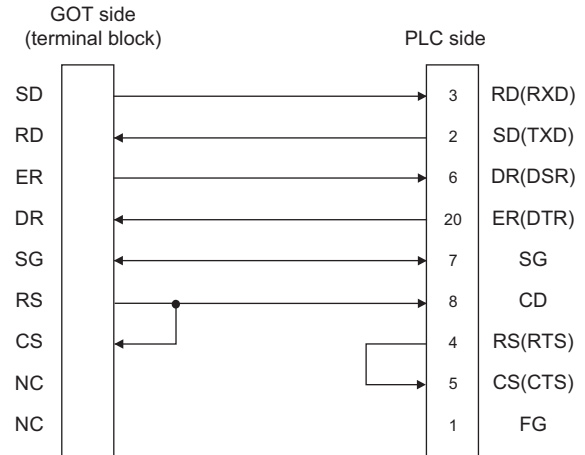

For GT1030, GT1020

(When connecting to the Computer Link Module)

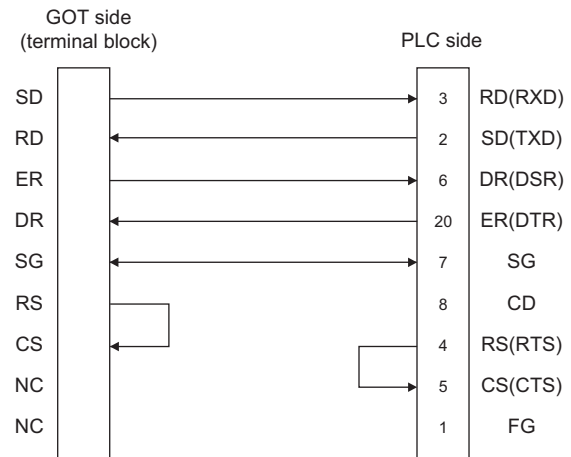

■ Precautions when preparing a cable

(1) Cable length

The length of the RS-232 cable must be 15m or less.

(2) GOT side connector

For the GOT side connector, refer to the following.

 1.4.1 GOT connector specifications

7.3.2 RS-422 cable

■ Connection diagram

RS-422 connection diagram 1)

(For GT16, GT15, GT14, GT12, GT11, GT105□, GT104□), Serial Multi-Drop Unit

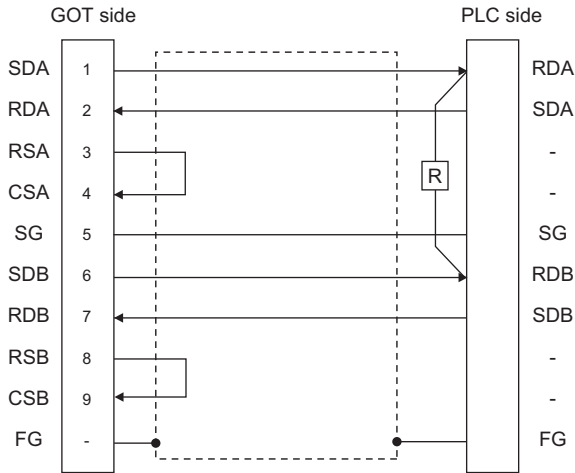

RS-422 connection diagram 2)

(For GT16)

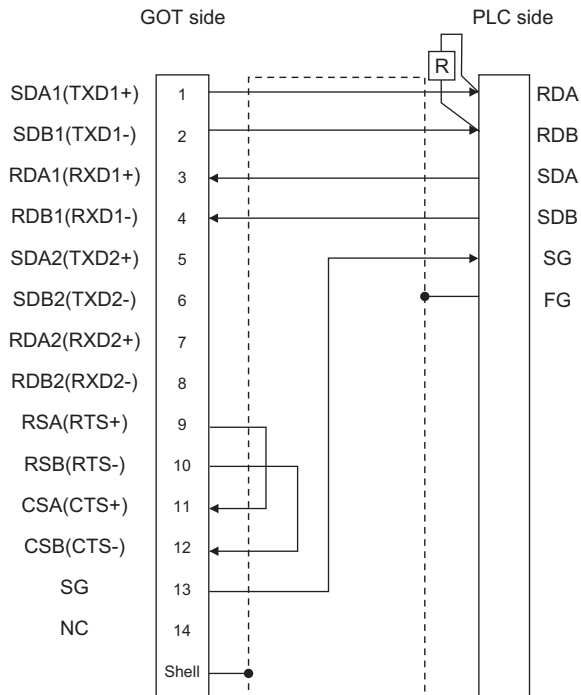

RS-422 connection diagram 3)

(For GT1030, GT1020)

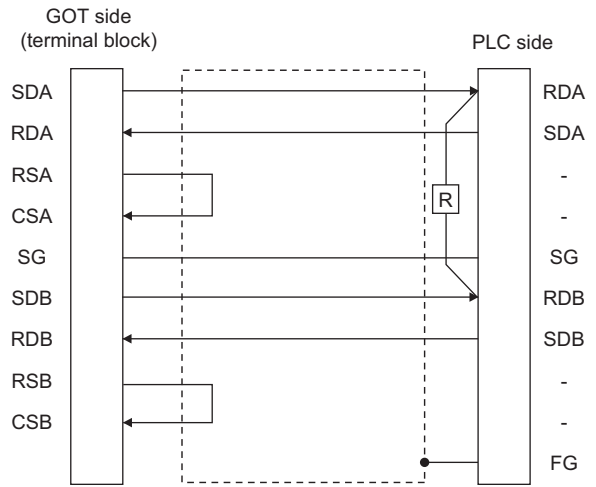

RS-422 connection diagram 4)

(For GT1030, GT1020)

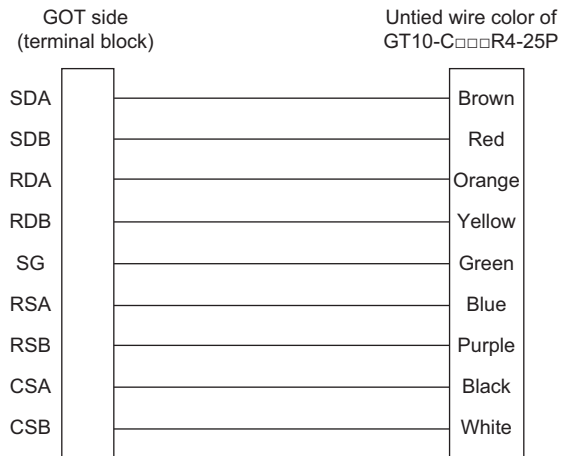

■ Precautions when preparing a cable

- (1) Cable length
The length of the RS-422 cable must be 1200m or less.
- (2) GOT side connector
For the GOT side connector, refer to the following.
 1.4.1 GOT connector specifications

1
PREPARATORY
PROCEDURES FOR
MONITORING

2
DEVICE RANGE
THAT CAN BE SET

3
ACCESS RANGE
FOR MONITORING

4
HOW TO MONITOR
REDUNDANT
SYSTEM

5
BUS CONNECTION

6
DIRECT
CONNECTION TO
CPU

7
COMPUTER LINK
CONNECTION

8
ETHERNET
CONNECTION

■ Connecting terminating resistors

(1) GOT side

When connecting a PLC to the GOT, a terminating resistor must be connected to the GOT.

- (a) For GT16, GT15, GT12
Set the terminating resistor setting switch of the GOT main unit to "Disable".
- (b) For GT14, GT11, GT10
Set the terminating resistor selector to "330Ω".

For the procedure to set the terminating resistor, refer to the following.

 1.4.3 Terminating resistors of GOT

(2) Serial communication module or computer link module side

Connect the terminating resistors (330Ω 1/4W (orange/orange/brown/□)) on the serial communication module or computer link module side. For details, refer to the following manual.

 User's Manual for the serial communication module or computer link module

- (a) Other than A2CCPUC24(-PRF)
Connect the terminating resistors supplied with the module across RDA and RDB.
- (b) A2CCPUC24(-PRF)
Set TXD and RXD on the terminating resistor setting pin to "A".

7.4 GOT Side Settings

7.4.1 Setting communication interface (Communication settings)

Set the channel of the connected equipment.

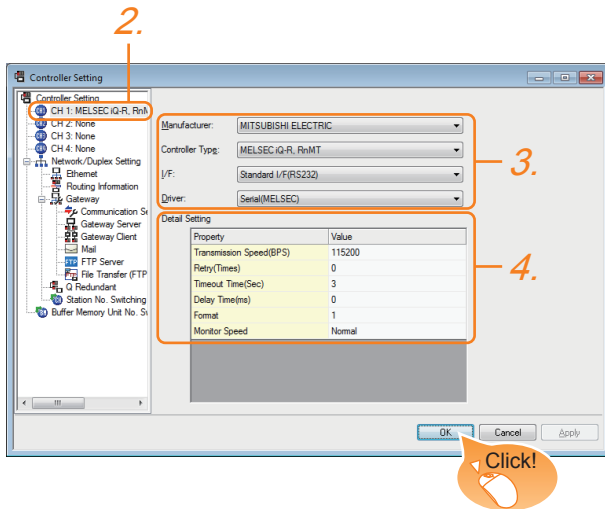

1. Select [Common] → [Controller Setting] from the menu.
2. The Controller Setting window is displayed. Select the channel to be used from the list menu.
3. Set the following items.
 - Manufacturer: MITSUBISHI ELECTRIC
 - Controller Type: Set according to the Controller Type to be connected.
 - I/F: Interface to be used
 - Driver: Set either of the following according to the Controller Type to be connected.
 - For GT16, GT15, GT14, GT12, GT11
 - Serial (MELSEC)
 - AJ71QC24, MELDAS C6*
 - AJ71C24/UC24
 - For GT10
 - Serial (MELSEC)
 - AJ71C24/UC24
4. The detailed setting is displayed after Manufacturer, Controller Type, I/F, and Driver are set. Make the settings according to the usage environment.

☞ 7.4.2 Communication detail settings

Click the [OK] button when settings are completed.

POINT

The settings of connecting equipment can be confirmed in [I/F Communication Setting]. For details, refer to the following.

☞ 1.1.2 I/F communication setting

7.4.2 Communication detail settings

Make the settings according to the usage environment.

(1) Serial (MELSEC)

Property	Value
Transmission Speed(BPS)	115200
Retry(Times)	0
Timeout Time(Sec)	3
Delay Time(ms)	0
Format	1
Monitor Speed	Normal

Item	Description	Range
Transmission Speed	Set this item when change the transmission speed used for communication with the connected equipment. (Default: 115200bps) When the setting exceeds the limit of the connected equipment, communication is performed at the fastest transmission speed supported by the connected equipment.	9600bps, 19200bps, 38400bps, 57600bps, 115200bps
Retry	Set the number of retries to be performed when a communication timeout occurs. When receiving no response after retries, the communication times out. (Default: 0time)	0 to 5times
Timeout Time	Set the time period for a communication to time out. (Default: 3sec)	3 to 30sec
Delay Time	Set this item to adjust the transmission timing of the communication request from the GOT. (Default: 0ms)	0 to 300 (ms)
Format*3	Select the communication format. (Default: 1)	1, 2

Item	Description	Range
Monitor Speed (GT16 only)	Set the monitor speed of the GOT. This setting is not valid in all systems. (Default: Normal)	High* ¹ Normal Low* ²

- *1 This is effective when collecting a large data on other than the monitor screen (logging, recipe function, etc.). However, when connecting to Q00J/Q00/Q01CPU, the sequence scan time may be influenced. If you want to avoid the influence on the sequence scan time, do not set "High". (High performance is hardly affected)
- *2 Set this item if you want to avoid the influence on the sequence scan time further than the "Normal" setting when connecting to Q00J/Q00/Q01CPU. However, the monitor speed may be reduced.
- *3 Refer to the following POINT.

POINT

Setting [Format]

This setting is required for replacement of F900 series with GOT1000 series.

- (1) To change the communication settings of the serial communication module which is connected to F900, set as follows.

The value of Transmission Speed can be set to 115200bps.

- (a) [Intelligent function module switch setting] of PLC

Switch No.	CH1 side	CH2 side
Switch 1	0000H	-
Switch 2	0000H	-
Switch 3	-	0000H
Switch 4	-	0000H
Switch 5	0000H	0000H

7.5 PLC Side Setting

- (b) GOT communication settings

Format
1

- (2) To maintain the communication settings of the serial communication module which is connected to F900, set the communication setting of the GOT as follows.

The value of Transmission Speed remains 38400bps.

Format	Transmission Speed
2	38400bps

(2) AJ71QC24, MELDAS C6*

Property	Value
Transmission Speed(BPS)	19200
Data Bit	8 bit
Stop Bit	1 bit
Parity	Odd
Retry(Times)	0
Timeout Time(Sec)	3
Delay Time(ms)	0

Item	Description	Range
Transmission Speed	Set this item when change the transmission speed used for communication with the connected equipment. (Default: 19200bps)	4800bps, 9600bps, 19200bps, 38400bps, 57600bps, 115200bps
Data Bit	Set this item when change the data length used for communication with the connected equipment. (Default: 8bit)	8bit (fixed)
Stop Bit	Specify the stop bit length for communications. (Default: 1bit)	1bit (fixed)
Parity	Specify whether or not to perform a parity check, and how it is performed during communication. (Default: Odd)	Odd (fixed)
Retry	Set the number of retries to be performed when a communication timeout occurs. When receiving no response after retries, the communication times out. (Default: 0time)	0 to 5times
Timeout Time	Set the time period for a communication to time out. (Default: 3sec)	3 to 30sec
Delay Time	Set this item to adjust the transmission timing of the communication request from the GOT. (Default: 0ms)	0 to 300 (ms)

(3) AJ71C24/UC24

Property	Value
Transmission Speed(BPS)	19200
Data Bit	8 bit
Stop Bit	1 bit
Parity	Odd
Retry(Times)	0
Timeout Time(Sec)	3
Delay Time(ms)	0

Item	Description	Range
Transmission Speed	Set this item when change the transmission speed used for communication with the connected equipment. (Default: 19200bps)	4800bps, 9600bps, 19200bps
Data Bit	Set this item when change the data length used for communication with the connected equipment. (Default: 8bit)	8bit (fixed)
Stop Bit	Specify the stop bit length for communications. (Default: 1bit)	1bit (fixed)
Parity	Specify whether or not to perform a parity check, and how it is performed during communication. (Default: Odd)	Odd (fixed)
Retry	Set the number of retries to be performed when a communication timeout occurs. When receiving no response after retries, the communication times out. (Default: 0time)	0 to 5times
Timeout Time	Set the time period for a communication to time out. (Default: 3sec)	3 to 30sec
Delay Time	Set this item to adjust the transmission timing of the communication request from the GOT. (Default: 0ms)	0 to 300 (ms)

(4) QnA/L/Q CPU (GT10)

Property	Value
Transmission Speed(BPS)	115200

Item	Description	Range
Transmission Speed	Set this item when change the transmission speed used for communication with the connected equipment. (Default: 115200bps) When the setting exceeds the limit of the connected equipment, communication is performed at the fastest transmission speed supported by the connected equipment.	9600bps, 19200bps, 38400bps, 57600bps, 115200bps

POINT

- Communication interface setting by the Utility
The communication interface setting can be changed on the Utility's [Communication Settings] after writing [Communication Settings] of project data.
For details on the Utility, refer to the following manual.
 ➡ GT□ User's Manual
- Precedence in communication settings
When settings are made by GT Designer3 or the Utility, the latest setting is effective.

HINT

Cutting the portion of multiple connection of the controller

By setting GOT internal device, GOT can cut the portion of multiple connection of the controller. For example, faulty station that has communication timeout can be cut from the system.

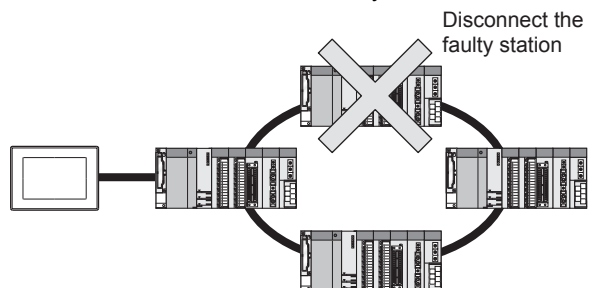

For details of the setting contents of GOT internal device, refer to the following manual.

- ➡ GT Designer3 Version Screen Design Manual (Fundamentals)

7.5 PLC Side Setting

The GOT operates under the following transmission specifications when it is connected to a Mitsubishi Electric PLC in the computer link connection.

Transmission specifications	Setting
Data bit	8bits
Parity bit	Yes (Odd)
Stop bit	1bit
Sum check	Yes
Transmission speed (Baud rate)	Set the same transmission speed on both the GOT and the PLC.

The PLC side settings (the serial communication module, computer link module) are explained in Section 7.5.2 to Section 7.5.4.

Model	Refer to
Serial communication module (MELSEC iQ-R Series)	RJ71C24, RJ71C24-R2, RJ71C24-R4 7.5.1
Serial communication module (Q Series)	QJ71C24N, QJ71C24 7.5.2
	QJ71C24N-R2, QJ71C24-R2
	QJ71C24N-R4
Modem interface module	QJ71CMO, QJ71CMON 7.5.2
Serial communication module (L Series)	LJ71C24, LJ71C24-R2 7.5.2
Serial communication module (QnA Series)	AJ71QC24N, AJ71QC24 7.5.3
	AJ71QC24N-R2, AJ71QC24-R2
	AJ71QC24N-R4, AJ71QC24-R4
	A1SJ71QC24N1, A1SJ71QC24N, A1SJ71QC24
	A1SJ71QC24N1-R2, A1SJ71QC24N-R2, A1SJ71QC24-R2
Computer link module	AJ71UC24 7.5.4
	A1SJ71UC24-R2, A1SJ71UC24-PRF, A1SJ71C24-R2, A1SJ71C24-PRF 7.5.4
	A1SJ71UC24-R4, A1SJ71C24-R4 7.5.4
	A1SCPUC24-R2 7.5.4
	A2CCPUC24, A2CCPUC24-PRF 7.5.4

7.5.1 Connecting serial communication module (MELSEC iQ-R Series)

POINT

Serial communication module (MELSEC iQ-R Series)

For details of the serial communication module (MELSEC iQ-R Series), refer to the following manual.

 Manuals of MELSEC iQ-R Series

■ [Unit parameter] of GX Works3

The PLC can communicate with the GOT with the default unit parameter setting.

(1) Unit parameter

POINT

- (1) When changing the unit parameter
After writing unit parameters to the PLC CPU, turn the PLC CPU OFF then back ON again, or reset the PLC CPU.
- (2) Connection of multiple GOTs
To some serial communication module models, two GOTs can be connected using both CH1 and CH2.

7.5.2 Connecting serial communication module (Q, L Series)

POINT

- (1) Serial communication module (Q, L Series)
For details of the serial communication module (Q, L Series), refer to the following manual.
 - Q Corresponding Serial Communication Module User's Manual (Basic)
 - MELSEC-L Serial Communication Module User's Manual (Basic)
- (2) Modem interface module
For details of the modem interface module, refer to the following manual.
 - Modem Interface Module User's Manual

■ [Intelligent function module switch setting] on GX Developer

[The intelligent function module switch setting] on GX Developer is not necessary. (When no [intelligent function module switch setting] is made, the module runs in the GX Developer connection mode.)

A module can be also connected to a GOT by making the following [intelligent function module switch setting] on GX Developer.

(1) When connecting to the CH1 side

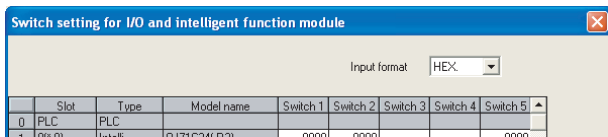

Switch No.	Bit		Description	Set value*3	
	Position	Specified value			
Switch 1	b0	OFF	Operation setting	0000H	
	b1	OFF	Data Bit		
	b2	OFF	Parity Bit		
	b3	OFF	Even/Odd parity		
	b4	OFF	Stop bit		
	b5	OFF	Sum check code		
	b6	OFF	Write during RUN		
	b7	OFF	Setting modifications		
	b8 to b15	—	CH1 transmission speed setting*2		
Switch 2	—	—	CH1 Communication protocol setting	GX Developer connection	0000H
Switch 5	—	—	Station number setting	0th station	0000H

(2) When connecting to the CH2 side

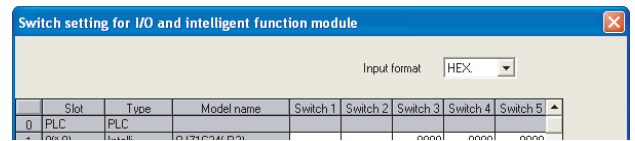

Switch No.	Bit		Description	Set value*3	
	Position	Specified value			
Switch 3	b0	OFF	Operation setting	0000H	
	b1	OFF	Data bit		
	b2	OFF	Parity bit		
	b3	OFF	Even/odd parity		
	b4	OFF	Stop bit		
	b5	OFF	Sum check code		
	b6	OFF	Write during RUN		
	b7	OFF	Setting modifications		
	b8 to b15	—	CH2 transmission speed setting*2		
Switch 4	—	—	CH2 Communication protocol setting	GX Developer connection	0000H
Switch 5	—	—	Station number setting	0th station	0000H

*1 The module operates under the following transmission specifications.

Transmission specifications	Setting details
Operation setting	Independent
Data bit	8bits
Parity bit	Yes
Even/odd parity	Odd
Stop bit	1bit
Sum check code	Yes

*2 The serial communication module operates at the transmission speed set on the GOT.

*3 When the value of switch setting is other than "0", the setting of [Format] and [Transmission Speed] on the GOT side are required to be changed.

7.4.2 Communication detail settings

POINT

- (1) When the [intelligent function module switch setting] has been set
After writing PLC parameters to the PLC CPU, turn the PLC CPU OFF then back ON again, or reset the PLC CPU.
- (2) Connection of multiple GOTs
To some serial communication module models, two GOTs can be connected using both CH1 and CH2.

Model	Connection of 2 GOTs	
	Function version A	Function version B
QJ71C24(-R2)	△	○
QJ71C24N(-R2/R4)	-	○
LJ71C24(-R2)	○	-

○: 2 GOTs connectable, △: 1 GOT connectable, -: Not applicable

- (3) When connecting to the modem interface module
When the modem interface module is connected, only CH2 can be used.

7.5.3 Connecting serial communication module (QnA Series)

POINT

Serial communication module (QnA Series)
For details of the serial communication module (QnA Series), refer to the following manual.

 Serial Communication Module User's Manual (Modem Function Additional Version)

Switch setting on serial communication module

Set the Station number switches, the Mode setting switch for the channel used for GOT connection, and the Transmission specifications switches.

AJ71QC24N, AJ71QC24N-R2, AJ71QC24N-R4, AJ71QC24, AJ71QC24-R2, AJ71QC24-R4
A1SJ71QC24N1, A1SJ71QC24N1-R2, A1SJ71QC24N, A1SJ71QC24N-R2, A1SJ71QC24, A1SJ71QC24-R2

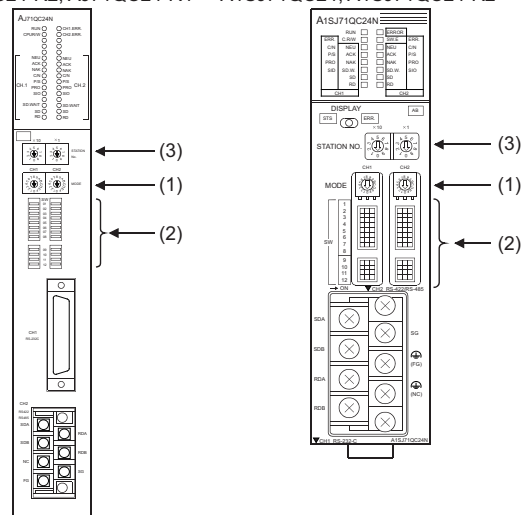

(1) Mode setting switch

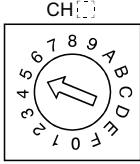
Mode setting switch*1	Description	Set value
	Dedicated protocol (Format 5) (Binary mode)	5

*1 The mode switch in the figure is for the AJ71QC24 (N) (-R2/R4).

POINT

When connecting a GOT to CH2
Set the CH1 side mode switch to any other than "0" (interlocked operation).

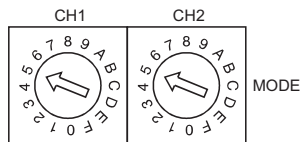

(2) Transmission specifications setting switch

Transmission specifications setting switch	Setting switch	Description	Set value	
	SW01	Operation setting	Independent operation	OFF
	SW02	Data bit setting	8bits	ON
	SW03	Parity bit enable/disable setting	Enable	ON
	SW04	Even/odd parity setting	Odd	OFF
	SW05	Stop bit setting	1bit	OFF
	SW06	Sum check enable/disable setting	Enable	ON
	SW07	Write during RUN enable/disable setting	Enable	ON
	SW08	Setting change enable/disable	Disable (prohibit)	OFF
	SW09 to SW12	Transmission speed setting	(Consistent with the GOT side specifications)	See (a)
	SW13 to SW15	—	The switch is located on the left side of the module. (only on AJ71QC24 (-R2/R4))	All OFF

*1 The following shows the layout of switches in the case of the following hardware versions for the module. Switch settings and switch ON/OFF directions are the same.

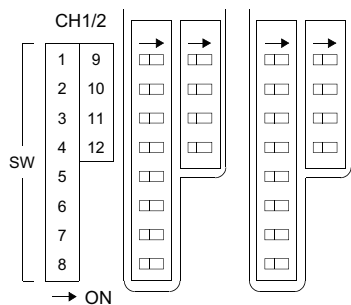

Target unit	Hardware version
A1SJ71QC24	Version E hardware or earlier
A1SJ71QC24-R2	Version D hardware or earlier
A1SJ71QC24N, A1SJ71QC24N-R2	Version A hardware

- (a) Transmission speed setting (SW09 to SW12)
Set the transmission speed (SW09 to SW12) as follows.
The transmission speed setting must be consistent with that of the GOT side.

Setting Switch	Transmission speed ^{*1*2*3}					
	4800 bps	9600 bps	19200 bps	38400 bps ^{*4}	57600 bps ^{*4}	115200 bps ^{*4}
SW09	OFF	ON	OFF	ON	OFF	ON
SW10	OFF	OFF	ON	ON	ON	ON
SW11	ON	ON	ON	ON	OFF	OFF
SW12	OFF	OFF	OFF	OFF	ON	ON

- *1 Only transmission speeds available on the GOT side are shown.
 *2 When the software version of AJ71QC24 (-R2/R4) and A1SJ71QC24 (-R2) is "L" or earlier, and when 2 devices are connected to the two interfaces individually, make the setting so that the total transmission speed of the two interfaces is within 19200bps. When the total transmission speed of the two interfaces is within 19200bps, a controller other than GOT can be connected to the computer link module. When only one device is connected to either of the interfaces, a maximum transmission speed of 19200bps can be set to the one where the device is connected. In this instance, set SW09 to SW12 to "OFF" on the other side.
 *3 When 3 devices are connected to the two interfaces individually in the case of AJ71QC24N(-R2/R4), A1SJ71QC24N(-R2), and A1SJ71QC24N1(-R2), make the setting so that the total transmission speed of the two interfaces is within 115200bps (within 230400bps in the case of A1SJ71QC24N1(-R2)). When the total transmission speed of the two interfaces is within 115200bps (within 230400bps in the case of A1SJ71QC24N1(-R2)), a controller other than GOT can be connected to the computer link module. When only one device is connected to either of the interfaces, a maximum transmission speed of 115200bps can be set to the one where the device is connected. In this instance, set SW09 to SW12 to "OFF" on the other side.
 *4 This can be set only in the case of AJ71QC24N (-R2/R4), A1SJ71QC24N (-R2) or A1SJ71QC24N1 (-R2).

(3) Station number switch (for both CH1 and CH2)

Station number switch ^{*5}	Contents	Set value
	Set the station number of the serial communication module to which an access is made from the GOT.	0

*5 The station number switch in the figure is for the AJ71QC24 (N) (-R2/R4).

POINT

When the switch setting has been changed
Turn the PLC CPU OFF then ON again, or reset the PLC CPU.

7.5.4 Connecting computer link module

POINT

Computer link module

For details of the computer link module, refer to the following manual.

☞ Computer Link Module (Com. link func./Print. func.) User's Manual

Switch setting on the computer link module

Set the Mode setting switch, the Transmission specifications switches and the Station number setting switches.

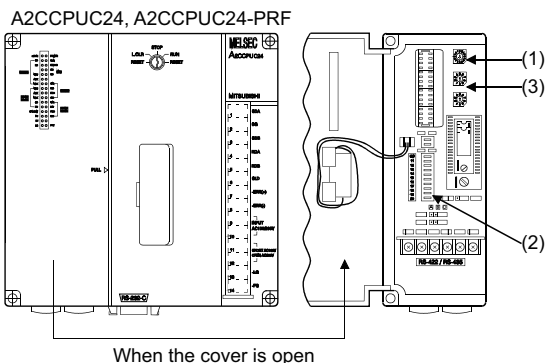
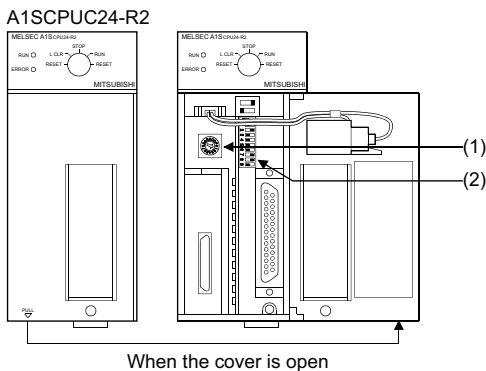
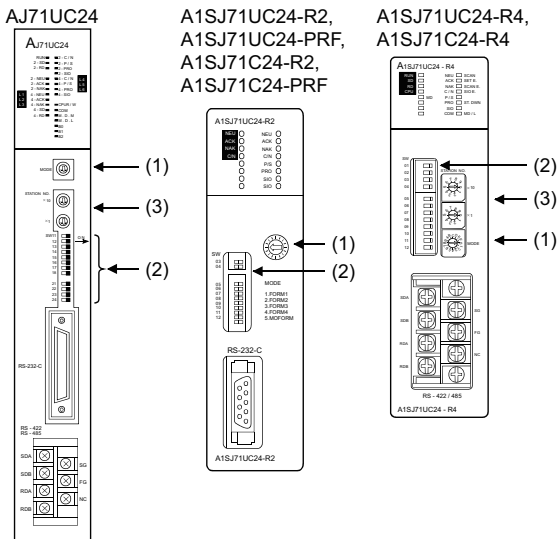

(1) Mode setting switch

Mode setting switch	Contents		Set value
	Dedicated protocol type 1	RS-232 connection	1
		RS-422 connection	5

(2) Transmission specifications switch

(a) AJ71UC24

Transmission specifications switch	Setting switch	Description		Set value
	SW11	Main channel setting	RS-232 connection	OFF
			RS-422 connection	ON
	SW12	Data bit setting	8bits	ON
	SW13	Transmission speed setting	(Consistent with the GOT side specifications)	See descriptions below.
	SW14			
	SW15			
	SW16	Parity bit setting	Set	ON
	SW17	Even/odd parity setting	Odd	OFF
	SW18	Stop bit setting	1bit	OFF
	SW21	Sum check setting	Set	ON
	SW22	Write during RUN enabled/disabled setting	Enabled	ON
	SW23	Computer link/multi-drop selection	Computer link	ON
	SW24	Master station/Local station setting	(Setting ignored)	OFF

- Transmission speed setting (SW13 to SW15)
Set the transmission speed (SW13 to SW15) as follows.
The transmission speed setting must be consistent with that of the GOT side.

Setting switch	Transmission speed ^{*1}		
	4800bps	9600bps	19200bps
SW13	OFF	ON	OFF
SW14	OFF	OFF	ON
SW15	ON	ON	ON

*1 Only transmission speeds available on the GOT side are shown.

(b) A1SJ71UC24-R2, A1SJ71UC24-PRF,
A1SJ71C24-R2, A1SJ71C24-PRF

Transmission specifications switch	Setting switch	Description	Set value	
	SW03	Unused	—	OFF
	SW04	Write during RUN enabled/disabled setting	Enabled	ON
	SW05	Transmission speed setting	(Consistent with the GOT side specifications)	See descriptions below.
	SW06			
	SW07			
	SW08	Data bit setting	8bits	ON
	SW09	Parity bit setting	Set	ON
	SW10	Even/odd parity setting	Odd	OFF
	SW11	Stop bit setting	1bit	OFF
	SW12	Sum check setting	Set	ON

- Transmission speed setting (SW05 to SW07)
Set the transmission speed (SW05 to SW07) as follows.
The transmission speed setting must be consistent with that of the GOT side.

Setting switch	Transmission speed*1		
	4800bps	9600bps	19200bps
SW05	OFF	ON	OFF
SW06	OFF	OFF	ON
SW07	ON	ON	ON

*1 Only transmission speeds available on the GOT side are shown.

(c) A1SJ71UC24-R4, A1SJ71C24-R4

Transmission specifications switch	Setting switch	Description	Set value	
	SW01	Master station/Local station setting	(Setting ignored)	OFF
	SW02	Computer link/multi-drop selection	Computer link	ON
	SW03	Unused	—	OFF
	SW04	Write during RUN enabled/disabled setting	Enabled	ON
	SW05	Transmission speed setting	(Consistent with the GOT side specifications)	See descriptions below.
	SW06			
	SW07			
	SW08	Data bit setting	8bits	ON
	SW09	Parity bit setting	Set	ON
	SW10	Even/odd parity setting	Odd	OFF
	SW11	Stop bit setting	1bit	OFF
	SW12	Sum check setting	Set	ON

- Transmission speed setting (SW05 to SW07)
Set the transmission speed (SW05 to SW07) as follows.
The transmission speed setting must be consistent with that of the GOT side.

Setting switch	Transmission speed*1		
	4800bps	9600bps	19200bps
SW05	OFF	ON	OFF
SW06	OFF	OFF	ON
SW07	ON	ON	ON

*1 Only transmission speeds available on the GOT side are shown.

(d) A1SCPUC24-R2

Transmission specifications switch	Setting switch	Description	Set value	
	1	Write during RUN enabled/disabled setting	Enabled	ON
	2	Transmission speed setting	(Consistent with the GOT side specifications)	See descriptions below.
	3			
	4			
	5	Data bit setting	8bits	ON
	6	Parity bit setting	Set	ON
	7	Even/odd parity setting	Odd	OFF
	8	Stop bit setting	1bit	OFF
	9	Sum check setting	Set	ON

- Transmission speed setting (2 to 4)
Set the transmission speed (2 to 4) as follows.
The transmission speed setting must be consistent with that of the GOT side.

Setting switch	Transmission speed*2		
	4800bps	9600bps	19200bps
2	OFF	ON	OFF
3	OFF	OFF	ON
4	ON	ON	ON

*2 Only transmission speeds available on the GOT side are shown.

(e) A2CCPUC24, A2CCPUC24-PRF

Transmission specifications switch	Setting switch	Description	Set value	
	SW11	Transmission speed setting (Consistent with the GOT side specifications)	See descriptions below.	
	SW12			
	SW13			
	SW14	Data bit setting	8bits	ON
	SW15	Parity bit setting	Set	ON
	SW16	Even/odd parity setting	Odd	OFF
	SW17	Stop bit setting	1bit	OFF
	SW18	Sum check setting	Set	ON
	SW19	Main channel setting	RS-232	OFF
	SW20	Write during RUN enabled/disabled setting	Enabled	ON

- Transmission speed setting (SW11 to SW13)
Set the transmission speed (SW11 to SW13) as follows.
The transmission speed setting must be consistent with that of the GOT side.

Setting switch	Transmission speed*1		
	4800bps	9600bps	19200bps
SW11	OFF	ON	OFF
SW12	OFF	OFF	ON
SW13	ON	ON	ON

*1 Only transmission speeds available on the GOT side are shown.

(3) Station number setting switch

Station number switch*2	Description	Set value
	Set the station number of the computer link module to which an access is made from the GOT.	0

*2 The station number setting switch in the figure is for the A1SJ71UC24-R4.

POINT

When connecting the GT14, GT12, GT11, GT10 and the computer link unit

When the GT14, GT12, GT11, GT10 and the computer link unit are connected via RS-232C, set the buffer memory in the computer link unit using the sequence program so that CD signals are not checked. Examples of the CPU units equipped with built-in computer link are explained below also.

- In the case of A computer link
Refer to the program example below in which the I/O signals of the computer link unit are 80 to 9F (H).

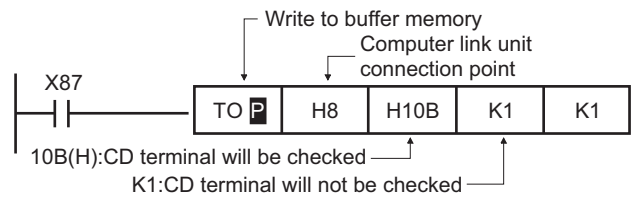

- In the case of CPU equipped with built-in computer link
(a) A1SCPUC24-R2

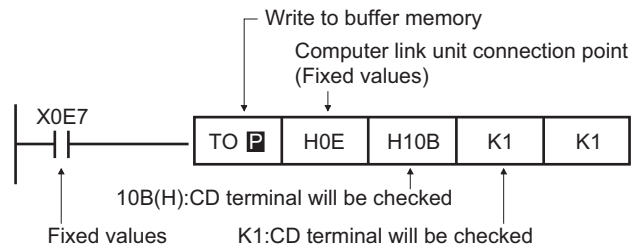

- (b) A2CCPUC2

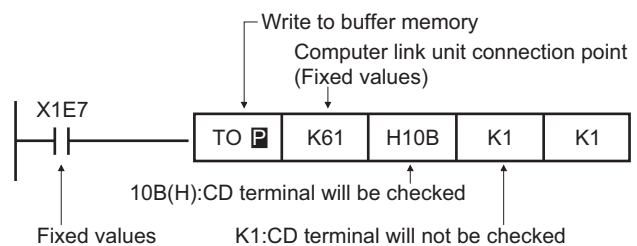

POINT

When the switch setting has been changed
Turn the PLC CPU OFF then ON again, or reset the PLC CPU.

7.6 Precautions

■ Time taken until the PLC runs when connected in the multiple CPU system

The following time is taken until the PLC runs.
QCPU (Q mode), motion controller CPU (Q series): 10 seconds or more

MELDAS C70: 18 seconds or more

When the GOT starts before the PLC runs, a system alarm occurs. Adjust the opening screen time in the GOT setup so that no system alarm occurs.

☞ GT Designer3 Version□ Screen Design Manual

■ Connection to LCPU

LCPU may diagnose (check file system, recovering process, etc.) the SD memory card when turning on the power or when resetting. Therefore, it takes time until the SD memory card becomes available. When the GOT starts before the SD card becomes available, a system alarm occurs. Adjust the opening screen time in the GOT setup so that no system alarm occurs.

☞ GT Designer3 Version□ Screen Design Manual

■ When monitoring the Q170MCP

Set [CPU No.] to "2" in the device setting to monitor the device of the Motion CPU area (CPU No.2).

When the CPU No. is set to "0" or "1", the device on the PLC CPU area (CPU No.1) is monitored.

When the CPU No. is set to the number other than "0" to "2", a communication error occurs and the monitoring cannot be executed.

For setting the CPU No., refer to the following manual.

☞ GT Designer3 Version□ Screen Design Manual

Example) Setting dialog box of the bit device

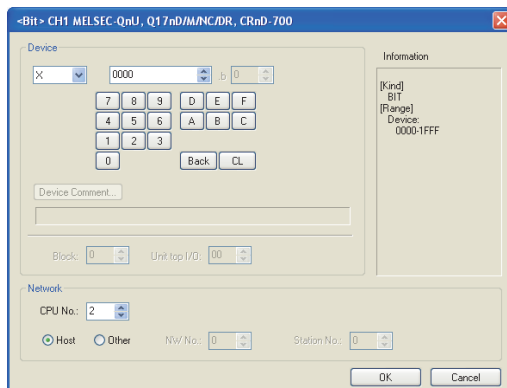

■ Connection to RnSF CPU

The RnSF CPU takes 10 seconds or more to run. If the GOT is started before the RnSF CPU runs, a system alarm occurs.

To prevent a system alarm from occurring, adjust the title display time in the [GOT Setup] dialog.

☞ GT Designer3 (GOT2000) Help

8

ETHERNET CONNECTION



8.1	Connectable Model List	8 - 2
8.2	System Configuration	8 - 8
8.3	GOT Side Settings	8 - 17
8.4	PLC Side Setting	8 - 22
8.5	Precautions	8 - 62

8. ETHERNET CONNECTION

8.1 Connectable Model List

8.1.1 PLC/Motion controller CPU

The following table shows the connectable models.

Series	Model name	Clock	Communication type	GT 16	GT 15	GT 14 *1	GT 12	GT11 Bus	GT11 Serial	GT 10 5/4	GT 10 20/30	Refer to	
MELSEC iQ-R Series	R04CPU	○	Ethernet	○	×	○	×	×	×	×	×	8.2.1	
	R08CPU												
	R16CPU												
	R32CPU												
	R120CPU												
	R08PCPU												
	R16PCPU												
	R32PCPU												
	R120PCPU												
	R04ENCPU												
	R08ENCPU												
	R16ENCPU												
	R32ENCPU												
	R120ENCPU												
Motion controller CPU (MELSEC iQ-R Series)	R16MTCPU	○	Ethernet	○	×	○	×	×	×	×	×	8.2.1	
	R32MTCPU												
	C Controller module (MELSEC iQ-R Series)	R12CCPU-V	○	Ethernet	○	×	○	×	×	×	×	×	8.2.1
	MELSEC iQ-F Series	FX5U	○	Ethernet	○	×	×	×	×	×	×	×	8.2.1
FX5UC													

(Continued to next page)

*1 GT14 models compatible with Ethernet connection are only GT1455-QTBDE, GT1450-QMBDE and GT1450-QLBDE.

*2 Mount a safety function module R6SFM next to the RnSF CPU on the base unit. The RnSF CPU and the safety function module R6SFM must have the same pair version. If their pair versions differ, the RnSF CPU does not operate.

Series	Model name	Clock	Communication type	GT 16	GT 15	GT 14 ^{*3}	GT 12	GT11 Bus	GT11 Serial	GT10 ^{5□} 4□	GT10 ²⁰ 30	Refer to
MELSEC-Q (Q mode)	Q00JCPU	○	Ethernet	○	○	○	○	×	×	×	×	8.2.1
	Q00CPU ^{*1}											
	Q01CPU ^{*1}											
	Q02CPU ^{*1}											
	Q02HCPU ^{*1}											
	Q06HCPU ^{*1}											
	Q12HCPU ^{*1}											
	Q25HCPU ^{*1}											
	Q02PHCPU											
	Q06PHCPU											
	Q12PHCPU											
	Q25PHCPU											
	Q12PRHCPU (Main base)											
	Q25PRHCPU (Main base)											
	Q12PRHCPU (Extension base)											
	Q25PRHCPU (Extension base)											
MELSEC-Q (Q mode)	Q00UJCPU	○	Ethernet	○	○	○	○	×	×	×	×	8.2.1
	Q00UCPU											
	Q01UCPU											
	Q02UCPU											
	Q03UDCPU											
	Q04UDHCPU											
	Q06UDHCPU											
	Q10UDHCPU											
	Q13UDHCPU											
	Q20UDHCPU											
Q26UDHCPU												
MELSEC-Q (Q mode)	Q03UDECPU	○	Ethernet	○	○	○	○	×	×	×	×	8.2.1 8.2.2
	Q04UDEHCPU											
	Q06UDEHCPU											
	Q10UDEHCPU											
	Q13UDEHCPU											
	Q20UDEHCPU											
	Q26UDEHCPU											
	Q50UDEHCPU											
	Q100UDEHCPU											
	Q03UDVCPU											
Q04UDVCPU												
Q06UDVCPU												
Q13UDVCPU												
Q26UDVCPU												
C Controller module (Q Series)	Q12DCCPU-V ^{*2}	○	Ethernet	○	○	○	○	×	×	×	×	8.2.2
	Q24DHCCPU-V/VG											
	Q24DHCCPU-LS											
	Q26DHCCPU-LS			○	×	○	×	×	×	×		

(Continued to next page)

*1 When in multiple CPU system configuration, use CPU function version B or later.

*2 Use a module with the upper five digits later than 12042.

*3 GT14 models compatible with Ethernet connection are only GT1455-QTBDE, GT1450-QMBDE and GT1450-QLBDE.

1	PREPARATORY PROCEDURES FOR MONITORING
2	DEVICE RANGE THAT CAN BE SET
3	ACCESS RANGE FOR MONITORING
4	HOW TO MONITOR REDUNDANT SYSTEM
5	BUS CONNECTION
6	DIRECT CONNECTION TO CPU
7	COMPUTER LINK CONNECTION
8	ETHERNET CONNECTION

Series	Model name	Clock	Communication type	GT 16	GT 15	GT 14 ^{*2}	GT 12	GT11 Bus	GT11 Serial	GT 10 ^{5/4}	GT 10 ^{20/30}	Refer to
MELSEC-QS	QS001CPU	○	Ethernet	○	○	×	○	×	×	×	×	8.2.1
MELSEC-L	L02CPU L06CPU L26CPU L26CPU-BT L02CPU-P L06CPU-P L26CPU-P L26CPU-PBT L02SCPU L02SCPU-P	○	Ethernet	○	○	○	○	×	×	×	×	8.2.2 8.2.1
MELSEC-Q (A mode)	Q02CPU-A ^{*3} Q02HCPU-A ^{*3} Q06HCPU-A ^{*3}	○	Ethernet	○	○	○	○	×	×	×	×	8.2.1
MELSEC-QnA (QnACPU)	Q2ACPU ^{*3} Q2ACPU-S1 ^{*3} Q3ACPU ^{*3} Q4ACPU ^{*3} Q4ARCPU ^{*3}	○	Ethernet	○ ^{*1}	○ ^{*1}	○ ^{*1}	○ ^{*1}	×	×	×	×	8.2.1
MELSEC-QnA (QnASCPU)	Q2ASCPU Q2ASCPU-S1 Q2ASHCPU Q2ASHCPU-S1	○	Ethernet	○ ^{*1}	○ ^{*1}	○ ^{*1}	○ ^{*1}	×	×	×	×	8.2.1
MELSEC-A (AnCPU)	A2UCPU A2UCPU-S1 A3UCPU A4UCPU A2ACPU A2ACPUP21 A2ACPUR21 A2ACPU-S1 A2ACPUP21-S1 A2ACPUR21-S1 A3ACPU A3ACPUP21 A3ACPUR21 A1NCPUR21 A1NCPUR21 A2NCPUR21 A2NCPUR21 A2NCPUR21 A2NCPUR21 A2NCPUR21-S1 A2NCPUR21-S1 A3NCPUR21 A3NCPUR21 A3NCPUR21	○	Ethernet	○	○	○	○	×	×	×	×	8.2.1

(Continued to next page)

- *1 If the A series Ethernet module is applied to the QnACPU, the GOT can monitor the devices as the same as the case of AnACPU. However, the following devices cannot be monitored.
- Devices added to QnACPU
 - Latch relays (L) and step relays (S)
(In case of QnACPU, the latch relay (L) and step relay (S) are different from the internal relay. However, whichever is specified, an access is made to the internal relay.)
 - File register (R)
- *2 GT14 models compatible with Ethernet connection are only GT1455-QTBDE, GT1450-QMBDE and GT1450-QLBDE.
- *3 Combination with the Ethernet module is restricted. 8.1.2 Ethernet module

Series	Model name	Clock	Communication type	GT 16	GT 15	GT 14 *4	GT 12	GT11 Bus	GT11 Serial	GT 10 5□	GT 10 30	Refer to	
MELSEC-A (AnSCPU)	A2USCPU	○	Ethernet	○	○	○	○	×	×	×	×	8.2.1	
	A2USCPU-S1												
	A2USHCPU-S1												
	A1SCPU												
	A1SCPUC24-R2												
	A1SHCPU												
	A2SCPU												
	A2SCPU-S1												
	A2SHCPU												
	A2SHCPU-S1												
	A1SJCPU												
	A1SJCPU-S3												
	A1SJHCPU												
MELSEC-A	A0J2HCPU	×	Ethernet	○	○	○	○	×	×	×	×	8.2.1	
	A0J2HCPUP21												
	A0J2HCPUR21												
	A0J2HCPU-DC24												
	MELSEC-A	A2CCPU	○	-	×	×	×	×	×	×	×	×	-
		A2CCPUP21											
		A2CCPUR21											
		A2CCPUC24											
		A2CCPUC24-PRF											
		A2CJCPU-S3											
A1FXCPU													
Motion controller CPU (Q Series)	Q172CPU*1*2	○	Ethernet	○	○	○	○	×	×	×	×	8.2.1	
	Q173CPU*1*2												
	Q172CPUN*1												
	Q173CPUN*1												
	Q172HCPU												
	Q173HCPU												
	Q172DCPU												
	Motion controller CPU (Q Series)	Q173DCPU	○	Ethernet	○	○	○	○	×	×	×	×	8.2.1 8.2.5
		Q172DCPU-S1											
		Q173DCPU-S1											
		Q172DSCPU											
		Q173DSCPU											
		Q170MCPU*3											
		Q170MSCPU*5											
Q170MSCPU-S1*5													
MR-MQ100													

(Continued to next page)

- *1 When using SV13, SV22, or SV43, use the motion controller CPU on which any of the following main OS version is installed.
 - SW6RN-SV13Q□: 00H or later
 - SW6RN-SV22Q□: 00H or later
 - SW6RN-SV43Q□: 00B or later
- *2 Use main modules with the following product numbers.
 - Q172CPU: Product number N***** or later
 - Q173CPU: Product number M***** or later
- *3 When using Ethernet module, only the first step can be used on the extension base unit (Q52B/Q55B).
- *4 GT14 models compatible with Ethernet connection are only GT1455-QTBDE, GT1450-QMBDE and GT1450-QLBDE.
- *5 When using Ethernet module, the extension base unit (Q5□B/Q6□B) can be used.

1 PREPARATORY PROCEDURES FOR MONITORING
 2 DEVICE RANGE THAT CAN BE SET
 3 ACCESS RANGE FOR MONITORING
 4 HOW TO MONITOR REDUNDANT SYSTEM
 5 BUS CONNECTION
 6 DIRECT CONNECTION TO CPU
 7
 8 COMPUTER LINK CONNECTION
 ETHERNET CONNECTION

Series	Model name	Clock	Communication type	GT 16	GT 15	GT 14 ^{*3}	GT 12	GT11 Bus	GT11 Serial	GT 10 ^{5□}	GT 10 ^{20□}	Refer to		
Motion controller CPU (A Series)	A273UCPU	○	Ethernet	○	○	○	○	×	×	×	×	☞ 8.2.1		
	A273UHCPU													
	A273UHCPU-S3													
	A373UCPU													
	A373UCPU-S3													
	A171SCPU													
	A171SCPU-S3													
	A171SCPU-S3N													
	A171SHCPU													
	A171SHCPUN													
	A172SHCPU													
	A172SHCPUN													
	A173UHCPU													
A173UHCPU-S1														
MELSEC-WS	WS0-CPU0	×	-	×	×	×	×	×	×	×	×	-		
	WS0-CPU1													
	WS0-CPU3													
MELSECNET/H Remote I/O station	QJ72LP25-25	×	Ethernet	○	○	○	○	×	×	×	×	☞ 8.2.1		
	QJ72LP25G													
	QJ72BR15													
CC-Link IE Field Network head module	LJ72GF15-T2	×	-	×	×	×	×	×	×	×	×	-		
CC-Link IE Field Network Ethernet adapter module	NZ2GF-ETB	×	CC-Link IE	×	×	×	×	×	×	×	×	☞ 8.2.4		
		×	Ethernet	○	○	○	○	×	×	×	×			
CNC C70	Q173NCCPU	○	Ethernet	○	○	○	○	×	×	×	×	☞ 8.2.3		
Robot controller	CRnQ-700 (Q172DRCPU) CR750-Q (Q172DRCPU) CR751-Q (Q172DRCPU)	○	Ethernet ^{*2}	○	○	○	○	×	×	×	×	☞ 8.2.1		
MELSEC-FX	FX0	×	-	×	×	×	×	×	×	×	×	-		
	FX0S													
	FX0N													
	FX1													
	FX2	×	-	×	×	×	×	×	×	×	×			
	FX2C													
	FX1S	○	-	×	×	×	×	×	×	×	×			
	FX1N													
	FX2N													
	FX1NC	×	-	×	×	×	×	×	×	×	×			
	FX2NC													
	FX3S ^{*1}	○	Ethernet	○	○	○	○	○	×	×	×		×	☞ 8.2.1
	FX3G ^{*1}													
	FX3GE													
	FX3GC ^{*1}													
FX3U ^{*1}														
FX3UC ^{*1}														

*1 The supported version of the main units varies depending on the Ethernet module to be used as shown below.

Ethernet module	FX3U(C)	FX3G(C)	FX3S
FX3U-ENET-L	Ver. 2.21 or later	FX3U-ENET-L is not supported.	
FX3U-ENET	Ver. 2.21 or later	FX3U-ENET is supported.	
FX3U-ENET-ADP	Ver. 3.10 or later	Ver. 2.00 or later	Ver. 1.00 or later

*2 The Ethernet connection of robot controller can be established only via the Ethernet module (QJ71E71) or Built-in Ethernet port of QnUDE.

*3 GT14 models compatible with Ethernet connection are only GT1455-QTBDE, GT1450-QMBDE and GT1450-QLBDE.

8.1.2 Ethernet module

CPU series	Ethernet module*1			
MELSEC iQ-R Series Motion controller CPU (MELSEC iQ-R Series)	RJ71EN71			
MELSEC-Q (Q mode) MELSEC-QS Motion controller CPU (Q Series) CNC C70 Robot controller (CRnQ-700)	QJ71E71-100	QJ71E71-B5	QJ71E71-B2	QJ71E71
MELSEC-QnA	AJ71QE71N3-T*2 AJ71QE71N-B5T*2 A1SJ71QE71N-B5*2 A1SJ71QE71-B5	AJ71QE71N-B5*2 AJ71QE71 A1SJ71QE71N-B2*2 A1SJ71QE71-B2	AJ71QE71N-B2*2 AJ71QE71-B5 A1SJ71QE71N-T*2 A1SJ71QE71-B2	AJ71QE71N-T*2 A1SJ71QE71N3-T*2 A1SJ71QE71N-B5T*2
MELSEC-Q (A mode) MELSEC-A Motion Controller CPU (A Series)	AJ71E71N3-T AJ71E71N-B5T A1SJ71E71N-B2 A1SJ71E71-B2-S3	AJ71E71N-B5 AJ71E71-S3 A1SJ71E71N-T	AJ71E71N-B2 A1SJ71E71N3-T A1SJ71E71N-B5T	AJ71E71N-T A1SJ71E71N-B5 A1SJ71E71-B5-S3
MELSEC-FX	FX3U-ENET-L	FX3U-ENET	FX3U-ENET-ADP	
CC-Link IE Field Network Ethernet adapter module	NZ2GF-ETB			
MELSEC-L	LJ71E71-100			

*1 If the A series Ethernet module is applied to the QnACPU, the GOT can monitor the devices as the same as the case of AnACPU. However, the following devices cannot be monitored.

- Devices added to QnACPU
- Latch relays (L) and step relays (S)
(In case of QnACPU, the latch relay (L) and step relay (S) are different from the internal relay. However, whichever is specified, an access is made to the internal relay.)
- File register (R)

*2 Use B or a later function version of Ethernet module and PLC CPU.





8.2 System Configuration

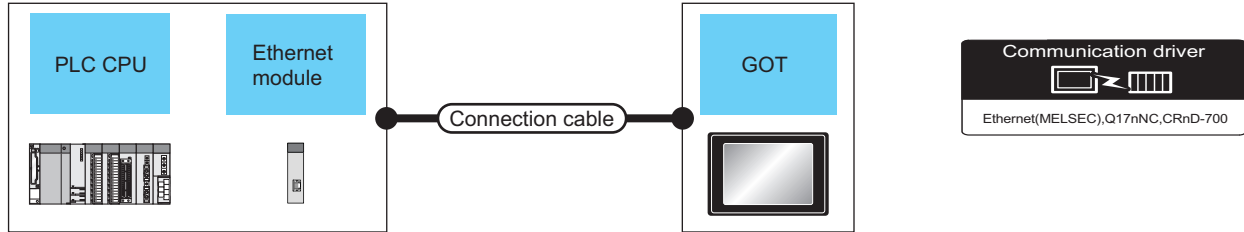





8.2.1 Connection to Ethernet module

- When connecting to MELSEC iQ-R, motion controller CPU (MELSEC iQ-R Series), C Controller module (MELSEC iQ-R Series), MELSEC-Q, QS, QnA, A or motion controller CPU (Q Series)



PLC			Connection cable ^{*1}	Maximum segment length ^{*3}	GOT		Number of connectable equipment
Model name	Ethernet module ^{*4*5}	Communication type	Cable model		Option device	Model	
MELSEC iQ-R Series Motion controller CPU (MELSEC iQ-R Series)	RJ71EN71	Ethernet		100m	- (Built into GOT)	^{*2} ^{*8}	128 GOTs ^{*7} (recommended to 16 units or less)
MELSEC-Q (Q mode) MELSEC-QS Motion controller CPU (Q Series) ^{*6}	QJ71E71-100 QJ71E71-B5 QJ71E71-B2 QJ71E71	Ethernet			- (Built into GOT)	^{*2} ^{*8*9} 	
MELSEC-QnA	AJ71QE71N3-T AJ71QE71N-B5 AJ71QE71N-B2 AJ71QE71N-T AJ71QE71N-B5T AJ71QE71 AJ71QE71-B5 A1SJ71QE71N3-T A1SJ71QE71N-B5 A1SJ71QE71N-B2 A1SJ71QE71N-T A1SJ71QE71N-B5T A1SJ71QE71-B5 A1SJ71QE71-B2	Ethernet			- (Built into GOT)	^{*2} ^{*8} 	
MELSEC-A MELSEC-Q (A mode) Motion controller CPU (A Series)	AJ71E71N3-T AJ71E71N-B5 AJ71E71N-B2 AJ71E71N-T AJ71E71N-B5T AJ71E71-S3 A1SJ71E71N3-T A1SJ71E71N-B5 A1SJ71E71N-B2 A1SJ71E71N-T A1SJ71E71N-B5T A1SJ71E71-B5-S3 A1SJ71E71-B2-S3	Ethernet		- (Built into GOT)	^{*2} ^{*8} 		
			Twisted pair cable	100m	GT15-J71E71-100		
			<ul style="list-style-type: none"> 10BASE-T Shielded twisted pair cable (STP) or unshielded twisted pair cable (UTP): Category 3, 4, and 5 100BASE-TX Shielded twisted pair cable (STP): Category 5 and 5e 		GT15-J71E71-100		

PLC			Connection cable*1	Maximum segment length*3	GOT		Number of connectable equipment
Model name	Ethernet module*4*5	Communication type	Cable model		Option device	Model	
MELSEC-L	LJ71E71-100	Ethernet	Twisted pair cable <ul style="list-style-type: none"> • 10BASE-T Shielded twisted pair cable (STP) or unshielded twisted pair cable (UTP): Category 3, 4, and 5 • 100BASE-TX Shielded twisted pair cable (STP): Category 5 and 5e 	100m	- (Built into GOT)	 *2  *8 	128 GOTs*7 (recommended to 16 units or less)
					GT15-J71E71-100		



- *1 The destination connected with the twisted pair cable varies with the configuration of the applicable Ethernet network system. Connect to the Ethernet module, hub, transceiver, or other system equipment corresponding to the applicable Ethernet network system.
Use cables, connectors, and hubs that meet the IEEE802.3 10BASE-T/100BASE-TX standard.
A cross cable is available for connecting the GOT to the Ethernet module.
- *2 When connecting GT16 of the function version A to an equipment that meets the 10BASE (-T/2/5) standard, use the switching hub and operate in a 10Mbps/100Mbps mixed environment.
For how to check the function version, refer to the following.
 GT16 User's Manual (Hardware)
- *3 A length between a hub and a node.
The maximum distance differs depending on the Ethernet device to be used.
The following shows the number of the connectable nodes when a repeater hub is used.
• 10BASE-T: Max. 4 nodes for a cascade connection (500m)
• 100BASE-TX: Max. 2 nodes for a cascade connection (205m)
When switching hubs are used, the cascade connection between the switching hubs has no logical limit for the number of cascades.
For the limit, contact the switching hub manufacturer.
- *4 For the system configuration of the Ethernet module, refer to the following manuals.
 Q Corresponding Ethernet Interface Module User's Manual (Basic)
 For QnA Ethernet Interface Module User's Manual
 For A Ethernet Interface Module User's Manual
- *5 Select one of the following [Controller Type] in [Ethernet] of GT Designer3.
• Ethernet module (MELSEC iQ-R Series): RJ71EN71
• Ethernet module (Q Series): QJ71E71
• Ethernet module (QnA Series): AJ71QE71
• Ethernet module (A Series): AJ71QE71
For [Ethernet] of GT Designer3, refer to the following.
 8.3.3 Ethernet setting
- *6 When using the peripheral I/F of Q170MCP, Q17nDCPU-S1 or MR-MQ100, refer to the following.
 8.2.5 Connecting to PERIPHERAL I/F (Built-in Ethernet port Motion Controller CPU)
- *7 In case of RJ71EN71, the number of connectable GOTs for one network is 119 units (at most).
Other than RJ71EN71, the number of connectable GOTs for one network is 63 units (at most).
- *8 GT14 models compatible with Ethernet connection are only GT1455-QTBDE, GT1450-QMBDE and GT1450-QLBDE.
- *9 GT14 cannot be connected with MELSEC-QS.

1	PREPARATORY PROCEDURES FOR MONITORING
2	DEVICE RANGE THAT CAN BE SET
3	ACCESS RANGE FOR MONITORING
4	HOW TO MONITOR REDUNDANT SYSTEM
5	BUS CONNECTION
6	DIRECT CONNECTION TO CPU
7	COMPUTER LINK CONNECTION
8	ETHERNET CONNECTION

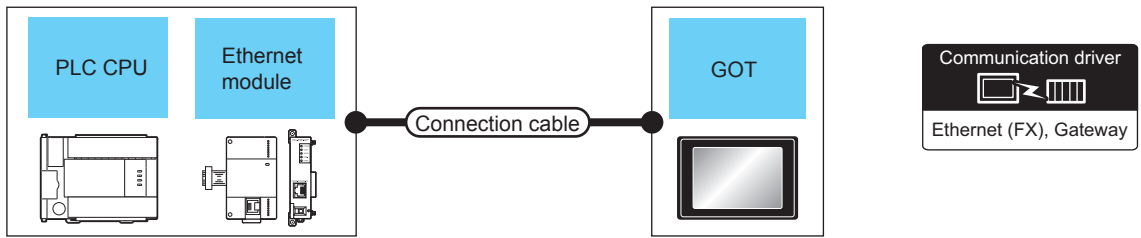
■ When connecting to MELSEC-FX



PLC			Connection cable ^{*1}	Maximum segment length ^{*3}	GOT		Number of connectable equipment
Model name	Ethernet module ^{*4*5}	Communication type	Cable model		Option device	Model	
MELSEC-FX (FX3U, FX3G)	FX3U-ENET-L	Ethernet	Twisted pair cable • 10BASE-T Shielded twisted pair cable (STP) or unshielded twisted pair cable (UTP): Category 3, 4, and 5 • 100BASE-TX Shielded twisted pair cable (STP): Category 5 and 5e	100m	- (Built into GOT)	GT 16 ^{*2} GT 14 ^{*7} GT 12	2 GOTs
					GT15-J71E71-100	GT 15	
MELSEC-FX (FX3U, FX3G)	FX3U-ENET	Ethernet		100m	- (Built into GOT)	GT 16 ^{*2} GT 14 ^{*7} GT 12	4 GOTs
					GT15-J71E71-100	GT 15	
MELSEC-FX (FX3UC, FX3GC)	FX3UC-1PS-5V, FX2NC-CNV-IF + FX3U-ENET-L ^{*6}	Ethernet		100m	- (Built into GOT)	GT 16 ^{*2} GT 14 ^{*7} GT 12	2 GOTs
					GT15-J71E71-100	GT 15	
MELSEC-FX (FX3UC, FX3GC)	FX3UC-1PS-5V, FX2NC-CNV-IF + FX3U-ENET ^{*6}	Ethernet		100m	- (Built into GOT)	GT 16 ^{*2} GT 14 ^{*7} GT 12	4 GOTs
					GT15-J71E71-100	GT 15	
MELSEC-FX (FX3U)	FX3U-CNV-BD, FX3U-422-BD, FX3U-232-BD, + FX3U-ENET-ADP ^{*8*9}	Ethernet		100m	- (Built into GOT)	GT 16 ^{*2} GT 14 ^{*7} GT 12	4 GOTs
					GT15-J71E71-100	GT 15	
MELSEC-FX (FX3UC)	FX3U-ENET-ADP	Ethernet	100m	- (Built into GOT)	GT 16 ^{*2} GT 14 ^{*7} GT 12	4 GOTs	
				GT15-J71E71-100	GT 15		
MELSEC-FX (FX3G)	FX3G-CNV-ADP, + FX3U-ENET-ADP ^{*9}	Ethernet	100m	- (Built into GOT)	GT 16 ^{*2} GT 14 ^{*7} GT 12	4 GOTs	
MELSEC-FX (FX3GC)	FX3U-ENET-ADP ^{*9}	Ethernet		GT15-J71E71-100	GT 15		
MELSEC-FX (FX3S)	FX3S-CNV-ADP + FX3U-ENET-ADP ^{*9}	Ethernet	100m	- (Built into GOT)	GT 16 ^{*2} GT 14 ^{*7} GT 12	4 GOTs	
				GT15-J71E71-100	GT 15		

- *1 The destination connected with the twisted pair cable varies with the configuration of the applicable Ethernet network system. Connect to the Ethernet module, hub, transceiver or other system equipment corresponding to the applicable Ethernet network system.
Use cables, connectors, and hubs that meet the IEEE802.3 10BASE-T/100BASE-TX standard.
A cross cable is available for connecting the GOT to the Ethernet module.
- *2 When connecting GT16 of the function version A to an equipment that meets the 10BASE (-T/2/5) standard, use the switching hub and operate in a 10Mbps/100Mbps mixed environment.
For how to check the function version, refer to the following.
 GT16 User's Manual (Hardware)
- *3 A length between a hub and a node.
The maximum distance differs depending on the Ethernet device to be used.
The following shows the number of the connectable nodes when a repeater hub is used.
 - 10BASE-T: Max. 4 nodes for a cascade connection (500m)
 - 100BASE-TX: Max. 2 nodes for a cascade connection (205m)
 When switching hubs are used, the cascade connection between the switching hubs has no logical limit for the number of cascades.
For the limit, contact the switching hub manufacturer.
- *4 For the system configuration of the Ethernet module, refer to the following manuals.
 For FX Ethernet Interface Module User's Manual
- *5 Select one of the following [Controller Type] in [Ethernet] of GT Designer3.
 - Ethernet module (FX Series): FX
 For [Ethernet] of GT Designer3, refer to the following.
 8.3.3 Ethernet setting
- *6 When using an Ethernet module with the FX3UC series, FX2NC-CNV-IF or FX3UC-1PS-5V is required.
- *7 GT14 models compatible with Ethernet connection are only GT1455-QTBDE, GT1450-QMBDE and GT1450-QLBDE.
- *8 When using an Ethernet module with the FX3U series, FX3U-CNV-BD, FX3U-422-BD, or FX3U-232-BD is required.
- *9 FX3U-ENET-ADP occupies one extension communication adapter CH (Max. 2 CHs) of the FX3U(C) or FX3G(C) and one extension communication adapter CH (Max. 1 CH) of the FX3S. One CPU allows the connection of only one FX3U-ENET-ADP.

1	PREPARATORY PROCEDURES FOR MONITORING
2	DEVICE RANGE THAT CAN BE SET
3	ACCESS RANGE FOR MONITORING
4	HOW TO MONITOR REDUNDANT SYSTEM
5	BUS CONNECTION
6	DIRECT CONNECTION TO CPU
7	COMPUTER LINK CONNECTION
8	ETHERNET CONNECTION

8.2.2 Connection to Built-in Ethernet port CPU or C Controller module

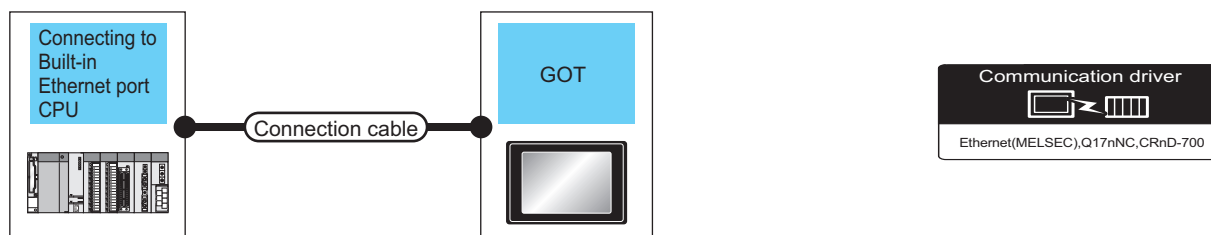



PLC		Connection cable ^{*1*2}	Maximum segment length ^{*4}	GOT		Number of connectable equipment			
Model name	Communication type			Option device	Model				
MELSEC iQ-R Series ^{*10*11}	Ethernet	Twisted pair cable • 10BASE-T Shielded twisted pair cable (STP) or unshielded twisted pair cable (UTP): Category 3, 4, and 5 • 100BASE-TX Shielded twisted pair cable (STP): Category 5 and 5e	100m	- (Built into GOT)	GT 16 ^{*3}	16 GOTs			
Motion controller CPU ^{*10*11} (MELSEC iQ-R Series)	Ethernet				GT 14 ^{*9}				
C Controller module (MELSEC iQ-R Series)	Ethernet				GT 12				
MELSEC-QnUDE(H) ^{*5*6}	Ethernet			- (Built into GOT)	GT 16 ^{*3}		16 GOTs		
MELSEC-QnUDV ^{*5*6}				GT 14 ^{*9}					
				GT 12					
		GT15-J71E71-100	GT 15						
C Controller module (Q Series)	Ethernet	Twisted pair cable • 10BASE-T Shielded twisted pair cable (STP) or unshielded twisted pair cable (UTP): Category 3, 4, and 5 • 100BASE-TX Shielded twisted pair cable (STP): Category 5 and 5e	100m	- (Built into GOT)	GT 16 ^{*3}	*14			
	Ethernet				GT 14 ^{*9}				
	Ethernet				GT 12				
				GT15-J71E71-100	GT 15				
MELSEC-L ^{*7*8}	Ethernet			Twisted pair cable • 10BASE-T Shielded twisted pair cable (STP): Category 3 or higher • 100BASE-TX Shielded twisted pair cable (STP): Category 5 or higher	100m		- (Built into GOT)	GT 16 ^{*3}	16 GOTs
	Ethernet							GT 14 ^{*9}	
	Ethernet	GT 12							
		GT15-J71E71-100	GT 15						
MELSEC-FX (FX3GE)	Ethernet	Twisted pair cable • 10BASE-T Shielded twisted pair cable (STP): Category 3 or higher • 100BASE-TX Shielded twisted pair cable (STP): Category 5 or higher	100m			- (Built into GOT)	GT 16 ^{*3}	4 GOTs	
	Ethernet						GT 14 ^{*9}		
	Ethernet			GT 12					
				GT15-J71E71-100	GT 15				
MELSEC iQ-F Series ^{*12*13}	Ethernet			Twisted pair cable • 10BASE-T Shielded twisted pair cable (STP): Category 3 or higher • 100BASE-TX Shielded twisted pair cable (STP): Category 5 or higher	100m	- (Built into GOT)	GT 16 ^{*3}		8 GOTs
	Ethernet						GT 14 ^{*9}		
	Ethernet	GT 12							
		GT15-J71E71-100	GT 15						

*1 The destination connected with the twisted pair cable varies with the configuration of the applicable Ethernet network system. Connect to the Ethernet module, hub, transceiver, or other system equipment corresponding to the applicable Ethernet network system.

Use cables, connectors, and hubs that meet the IEEE802.3 10BASE-T/100BASE-TX standard.

*2 For a connection via a hub, use the straight cable.

When the GOT is directly connected to the CPU with an Ethernet cable, both the straight cable and cross cable are applicable.

- *3 When connecting GT16 of the function version A to an equipment that meets the 10BASE (-T/2/5) standard, use the switching hub and operate in a 10Mbps/100Mbps mixed environment.
For how to check the function version, refer to the following.
 GT16 User's Manual (Hardware)
- *4 A length between a hub and a node.
The maximum distance differs depending on the Ethernet device to be used.
The following shows the number of the connectable nodes when a repeater hub is used.
- 10BASE-T: Max. 4 nodes for a cascade connection (500m)
 - 100BASE-TX: Max. 2 nodes for a cascade connection (205m)
- When switching hubs are used, the cascade connection between the switching hubs has no logical limit for the number of cascades.
For the limit, contact the switching hub manufacturer.
- *5 For the system configuration of Built-in Ethernet port QCPU, refer to the following manual.
 QCPU User's Manual (Hardware Design, Maintenance and Inspection)
- *6 Select [QnUD(P)V/QnUDEH] for [Controller Type] in [Ethernet] of GT Designer3.
For [Ethernet] of GT Designer3, refer to the following.
 8.3.3 Ethernet setting
- *7 For the system configuration of Built-in Ethernet port LCPU, refer to the following manual.
 MELSEC-L CPU Module User's Manual (Built-In Ethernet Function)
- *8 Select [LCPU] for [Controller Type] in [Ethernet] of GT Designer3.
For [Ethernet] of GT Designer3, refer to the following.
 8.3.3 Ethernet setting
- *9 GT14 models compatible with Ethernet connection are only GT1455-QTBDE, GT1450-QMBDE and GT1450-QLBDE.
- *10 Select [RCPU] for [Controller Type] in [Ethernet] of GT Designer3.
For [Ethernet] of GT Designer3, refer to the following.
 8.3.3 Ethernet setting
- *11 For the system configuration of Built-in Ethernet port RCP, refer to the following manual.
 Manuals of MELSEC iQ-R Series
- *12 Select [FX5CPU] for [Controller Type] in [Ethernet] of GT Designer3.
For [Ethernet] of GT Designer3, refer to the following.
 8.3.3 Ethernet setting
- *13 For the system configuration of MELSEC iQ-F Series, refer to the following manual.
 MELSEC iQ-F User's Manual
- *14 By the controller type of the C Controller module (Q Series) and an operation mode, It's different in number of connectable GOTs.

Controller Type	Operation mode	Number of connectable GOTs
Q12DCCPU-V	Standard monitor mode	1
	Expansion mode	16
Q24DHCCPU-V/VG/LS	-	16

8.2.3 Connecting to Display I/F

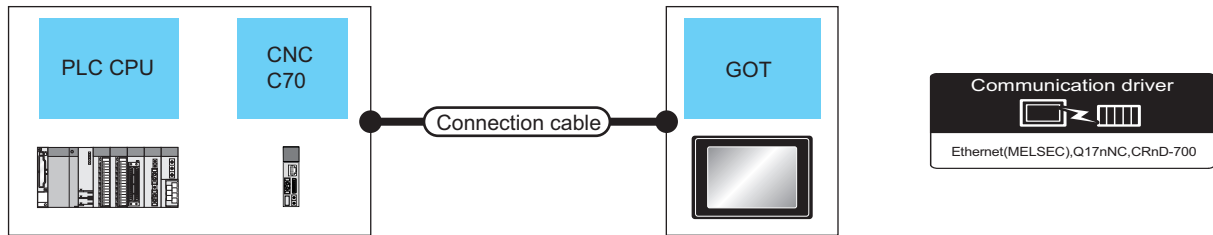

PLC		Connection cable ^{*1}	Maximum segment length ^{*3}	GOT		Number of connectable equipment
Model name	Communication type			Option device	Model	
CNC C70 (Q173NCCPU) ^{*4} ^{*5}	Ethernet	Twisted pair cable <ul style="list-style-type: none"> • 10BASE-T Shielded twisted pair cable (STP) or unshielded twisted pair cable (UTP): Category 3, 4, and 5 • 100BASE-TX Shielded twisted pair cable (STP): Category 5 and 5e 	100m	- (Built into GOT) GT15-J71E71-100	GT 16 ^{*2} GT 14 ^{*6} GT 12 GT 15	16 GOTs for 1 network

- ^{*1} The destination connected with the twisted pair cable varies with the configuration of the applicable Ethernet network system. Connect to the Ethernet module, hub, transceiver or other system equipment corresponding to the applicable Ethernet network system.
Use cables, connectors, and hubs that meet the IEEE802.3 10BASE-T/100BASE-TX standard.
- ^{*2} When connecting GT16 of the function version A to an equipment that meets the 10BASE (-T/2/5) standard, use the switching hub and operate in a 10Mbps/100Mbps mixed environment.
For how to check the function version, refer to the following.
 GT16 User's Manual (Hardware)
- ^{*3} A length between a hub and a node.
The maximum distance differs depending on the Ethernet device to be used.
The following shows the number of the connectable nodes when a repeater hub is used.
 - 10BASE-T: Max. 4 nodes for a cascade connection (500m)
 - 100BASE-TX: Max. 2 nodes for a cascade connection (205m)
 When switching hubs are used, the cascade connection between the switching hubs has no logical limit for the number of cascades.
For the limit, contact the switching hub manufacturer.
- ^{*4} For the system configuration of the CNC C70, refer to the following manual.
 C70 Series SET UP MANUAL
- ^{*5} Select [Q17nNC] for [Controller Type] in [Ethernet] of GT Designer3.
For [Ethernet] of GT Designer3, refer to the following.
 8.3.3 Ethernet setting
- ^{*6} GT14 models compatible with Ethernet connection are only GT1455-QTBDE, GT1450-QMBDE and GT1450-QLBDE.

8.2.4 Connection to CC-Link IE Field Network Ethernet Adapter Module

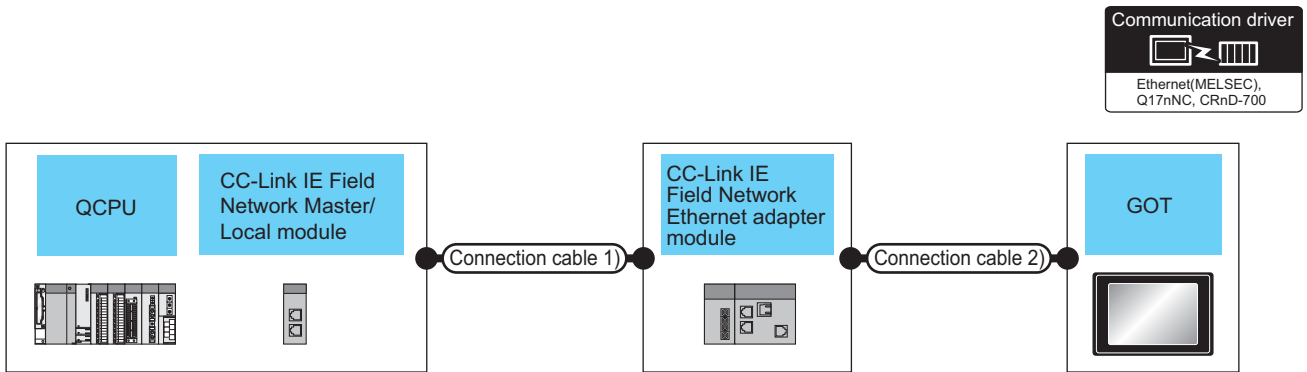

PLC		Connection cable 1)* ⁴		CC-Link IE Field Network Ethernet adapter module			Connection cable 2)* ¹		GOT		Number of connectable equipment
Model name	CC-Link IE Field Network Master/Local module	Cable model	Max. distance	Communication type	Model name	Communication type	Cable model Connection diagram number	Maximum segment length* ³	Option device	Model	
MELSEC-Q (Q mode) C Controller module (Q Series)	QJ71GF11-T2	Double-shielded twisted pair cable* ⁴	100m	CC-Link IE	NZ2G F-ETB	Ethernet	Twisted pair cable • 10BASE-T Shielded twisted pair cable (STP) or unshielded twisted pair cable (UTP): Category 3, 4, and 5 • 100BASE-TX Shielded twisted pair cable (STP): Category 5 and 5e	100m	- (Built into GOT) GT15-J71E71-100	GT16* ² GT14* ⁷ GT12 GT15	128 GOTs* ⁶ (recommended to 16 units or less)

*1 The destination connected with the twisted pair cable varies with the configuration of the applicable Ethernet network system. Connect to the Ethernet module, hub, transceiver, or other system equipment corresponding to the applicable Ethernet network system.
Use cables, connectors, and hubs that meet the IEEE802.3 10BASE-T/100BASE-TX standard.
A cross cable is available for connecting the GOT to the Ethernet module.

*2 When connecting GT16 of the function version A to an equipment that meets the 10BASE (-T/2/5) standard, use the switching hub and operate in a 10Mbps/100Mbps mixed environment.
For how to check the function version, refer to the following.

GT16 User's Manual (Hardware)

*3 A length between a hub and a node.

The maximum distance differs depending on the Ethernet device to be used.

The following shows the number of the connectable nodes when a repeater hub is used.

- 10BASE-T: Max. 4 nodes for a cascade connection (500m)
- 100BASE-TX: Max. 2 nodes for a cascade connection (205m)

When switching hubs are used, the cascade connection between the switching hubs has no logical limit for the number of cascades.

For the limit, contact the switching hub manufacturer.

*4 Use cables with the following specifications.

Connector	Range
Category 5e or higher Shielded RJ-45	Cable that satisfies the following specifications: IEEE802.3 1000BASE-T ANSI/TIA/EIA-568-B(Category 5e)

*5 For the system configuration on the CC-Link IE Field Network module side, refer to the following manual.

CC-Link IE Field Network Ethernet Adapter Module User's Manual

*6 The number of connectable GOTs for one network is 63 units (at most).

*7 GT14 models compatible with Ethernet connection are only GT1455-QTBDE, GT1450-QMBDE and GT1450-QLBDE.

1 PREPARATORY PROCEDURES FOR MONITORING
2 DEVICE RANGE THAT CAN BE SET
3 ACCESS RANGE FOR MONITORING
4 HOW TO MONITOR REDUNDANT SYSTEM
5 BUS CONNECTION
6 DIRECT CONNECTION TO CPU
7 COMPUTER LINK CONNECTION
8 ETHERNET CONNECTION

8.2.5 Connecting to PERIPHERAL I/F (Built-in Ethernet port Motion Controller CPU)

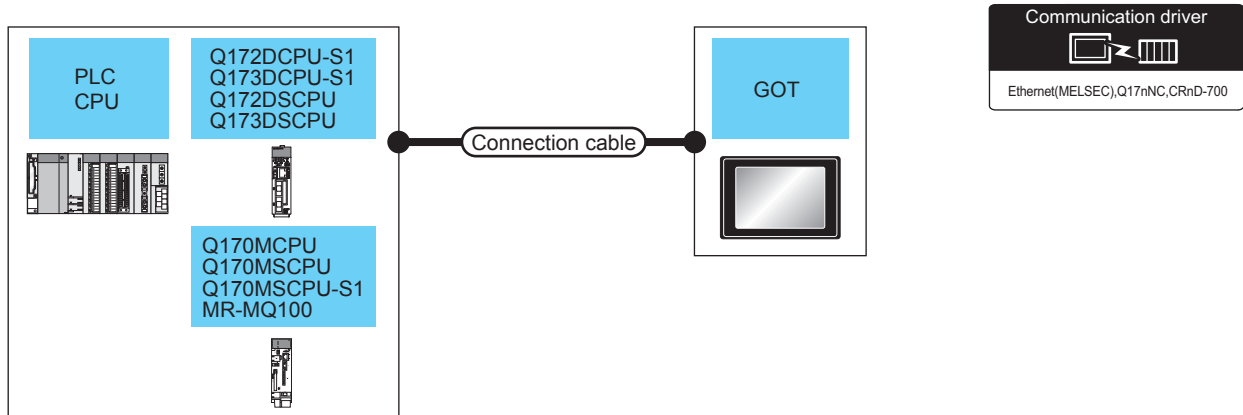

PLC		Connection cable ^{*1}	Maximum segment length ^{*4}	GOT		Number of connectable equipment
Model name ^{*3}	Communication type			Option device	Model	
Motion controller CPU (Q Series) Q172DCPU-S1 Q173DCPU-S1 Q172DSCPU Q173DSCPU Q170MCP Q170MSCPU Q170MSCPU-S1 MR-MQ100	Ethernet	Twisted pair cable • 10BASE-T Shielded twisted pair cable (STP) or unshielded twisted pair cable (UTP): Category 3, 4, and 5 • 100BASE-TX Shielded twisted pair cable (STP): Category 5 and 5e	30m	- (Built into GOT)	GT16 ^{*2} GT14 ^{*5} GT12	16 GOTs for 1 network
				GT15-J71E71-100	GT15	

- ^{*1} The destination connected with the twisted pair cable varies with the configuration of the applicable Ethernet network system. Connect to the Ethernet module, hub, transceiver or other system equipment corresponding to the applicable Ethernet network system.
Use cables, connectors, and hubs that meet the IEEE802.3 10BASE-T/100BASE-TX standard.
- ^{*2} When connecting GT16 of the function version A to an equipment that meets the 10BASE (-T/2/5) standard, use the switching hub and operate in a 10Mbps/100Mbps mixed environment.
For how to check the function version, refer to the following.
👉 GT16 User's Manual (Hardware)
- ^{*3} When using the PERIPHERAL I/F, set as shown below.
• Use the GT Designer3 Version 1.12N or later.
• Select [QnUDE(H)] for [Controller Type] in [Ethernet] of GT Designer3.
For [Ethernet] of GT Designer3, refer to the following.
👉 8.3.3 Ethernet setting
- ^{*4} A length between a hub and a node.
The maximum distance differs depending on the Ethernet device to be used.
The following shows the number of the connectable nodes when a repeater hub is used.
• 10BASE-T: Max. 4 nodes for a cascade connection (500m)
• 100BASE-TX: Max. 2 nodes for a cascade connection (205m)
When switching hubs are used, the cascade connection between the switching hubs has no logical limit for the number of cascades.
For the limit, contact the switching hub manufacturer.
- ^{*5} GT14 models compatible with Ethernet connection are only GT1455-QTBDE, GT1450-QMBDE and GT1450-QLBDE.



Direct connection between PERIPHERAL I/F and GOT

The PERIPHERAL I/F and GOT can be directly connected by using a cross cable for the Ethernet connection cable.

8.3 GOT Side Settings

8.3.1 Setting communication interface (Communication settings)

Set the channel of the connected equipment.

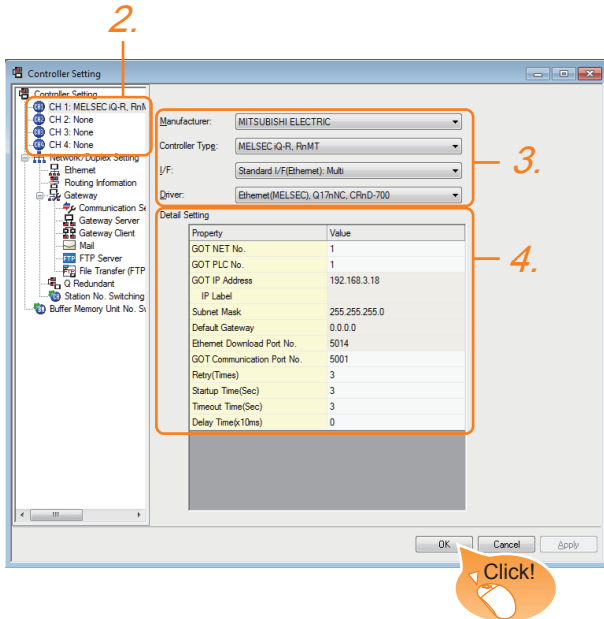

1. Select [Common] → [Controller Setting] from the menu.
2. The Controller Setting window is displayed. Select the channel to be used from the list menu.
3. Set the following items.
 - Manufacturer: MITSUBISHI ELECTRIC
 - Controller Type: Set according to the Controller Type to be connected.
 - I/F: Interface to be used
 - Driver:
 - Ethernet(MELSEC), Q17nNC, CRnD-700
 - Ethernet(FX), Gateway
4. The detailed setting is displayed after Manufacturer, Controller Type, I/F, and Driver are set. Make the settings according to the usage environment.

☞ 8.3.2 Communication detail settings

Click the [OK] button when settings are completed.

POINT

The settings of connecting equipment can be confirmed in [I/F Communication Setting]. For details, refer to the following.

☞ 1.1.2 I/F communication setting

8.3.2 Communication detail settings

Make the settings according to the usage environment.

■ GT16, GT14

Property	Value
GOT NET No.	1
GOT PLC No.	1
GOT IP Address	192.168.3.18
IP Label	
Subnet Mask	255.255.255.0
Default Gateway	0.0.0.0
Ethernet Download Port No.	5014
GOT Communication Port No.	5001
Retry(Times)	3
Startup Time(Sec)	3
Timeout Time(Sec)	3
Delay Time(x10ms)	0

Item	Description	Range
GOT NET No.	Set the network No. of the GOT. (Default: 1)	1 to 239
GOT PLC No. ^{*3}	Set the station No. of the GOT. (Default: 1)	1 to 64
GOT IP Address ^{*2}	Set the IP address of the GOT. (Default: 192.168.3.18)	0.0.0.0 to 255.255.255.255
Subnet Mask ^{*2}	Set the subnet mask for the sub network. (Only for connection via router) If the sub network is not used, the default value is set. (Default: 255.255.255.0)	0.0.0.0 to 255.255.255.255
Default Gateway ^{*2}	Set the router address of the default gateway where the GOT is connected. (Only for connection via router) (Default: 0.0.0.0)	0.0.0.0 to 255.255.255.255
Ethernet Download Port No. ^{*2}	Set the GOT port No. for Ethernet download. (Default: 5014)	1024 to 5010, 5014 to 65534 (Except for 5011, 5012, 5013 and 49153)
GOT Communication Port No. ^{*4}	Set the GOT port No. for the connection with the Ethernet module. • For Ethernet (MELSEC), Q17nNC, and CRnD-700 (Default: 5001) • For Ethernet(FX), Gateway (Default: 5019)	1024 to 5010, 5014 to 65534 (Except for 5011, 5012, 5013 and 49153)
Retry	Set the number of retries to be performed when a communication timeout occurs. When receiving no response after retries, the communication times out. (Default: 3times)	0 to 5times
Startup Time	Specify the time period from the GOT startup until GOT starts the communication with the PLC CPU. (Default: 3sec)	3 to 255sec
Timeout Time ^{*1}	Set the time period for a communication to time out. (Default: 3sec)	1 to 90sec
Delay Time	Set the delay time for reducing the load of the network/destination PLC. (Default: 0ms)	0 to 10000 (× 10ms)

- *1 To connect the GOT with the Ethernet module (Q Series) in the one-on-one relationship using a cross cable, set [Timeout Time] to 6sec. or longer.
- *2 Click the [Setting] button and perform the setting in the [GOT IP Address Setting] screen.

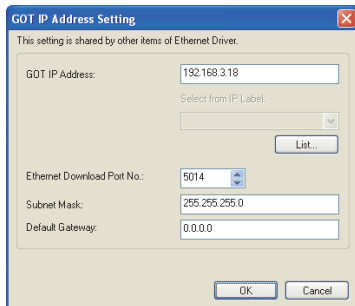

- *3 Each of [GOT PLC No.] set in the communication detail setting and [PLC No.] set in the Ethernet setting must be set to different station numbers.

8.3.3 Ethernet setting

- *4 When connecting to the QCPU, LCPU, do not set [5009] for the port No. Otherwise, monitoring becomes unavailable.

■ GT15

Property	Value
GOT NET No.	1
GOT PLC No.	1
GOT IP Address	192.168.0.18
IP Label	
Subnet Mask	255.255.255.0
Default Gateway	0.0.0.0
Ethernet Download Port No.	5014
GOT Communication Port No.	5001
Retry(Times)	3
Startup Time(Sec)	3
Timeout Time(Sec)	3
Delay Time(x10ms)	0

Item	Description	Range
GOT NET No.	Set the network No. of the GOT. (Default: 1)	1 to 239
GOT PLC No.*2	Set the station No. of the GOT. (Default: 1)	1 to 64
GOT IP address	Set the IP address of the GOT. (Default: 192.168.0.18)	0.0.0.0 to 255.255.255.255
Subnet Mask	Set the subnet mask for the sub network.(Only for connection via router) If the sub network is not used, the default value is set. (Default: 255.255.255.0)	0.0.0.0 to 255.255.255.255
Default Gateway	Set the router address of the default gateway where the GOT is connected.(Only for connection via router) (Default: 0.0.0.0)	0.0.0.0 to 255.255.255.255
Ethernet Download Port No.	Set the GOT port No. for Ethernet download. (Default: 5014)	1024 to 5010, 5014 to 65534 (Except for 5011, 5012, 5013 and 49153)
GOT Communication Port No.*3	Set the GOT port No. for the connection with the Ethernet module. • For Ethernet (MELSEC), Q17nNC, and CRnD-700 (Default: 5001) • For Ethernet(FX), Gateway (Default: 5019)	1024 to 5010, 5014 to 65534 (Except for 5011, 5012, 5013 and 49153)
Retry	Set the number of retries to be performed when a communication timeout occurs. When receiving no response after retries, the communication times out. (Default: 3times)	0 to 5times
Startup Time	Specify the time period from the GOT startup until GOT starts the communication with the PLC CPU. (Default: 3sec)	3 to 255sec
Timeout Time*1	Set the time period for a communication to time out. (Default: 3sec)	3 to 90sec
Delay Time	Set the delay time for reducing the load of the network/destination PLC. (Default: 0ms)	0 to 10000 (x 10ms)

- *1 To connect the GOT with the Ethernet module (Q Series) in the one-on-one relationship using a cross cable, set [Timeout Time] to 6sec. or longer.
- *2 Each of [GOT PLC No.] set in the communication detail setting and [PLC No.] set in the Ethernet setting must be set to different station numbers.
 8.3.3 Ethernet setting
- *3 When connecting to the QCPU, LCPU, do not set [5009] for the port No. Otherwise, monitoring becomes unavailable.

POINT

- (1) Example of [Detail setting].
For examples of [Detail setting], refer to the following.
- ☞ 8.4 PLC Side Setting
- (2) Communication interface setting by Utility
The communication interface setting can be changed on the Utility's [Communication Settings] after writing [Communication Settings] of project data.
For details on the Utility, refer to the following manual.
- ☞ GT□ User's Manual
- (3) Precedence in communication settings
When settings are made by GT Designer3 or the Utility, the latest setting is effective.

8.3.3 Ethernet setting

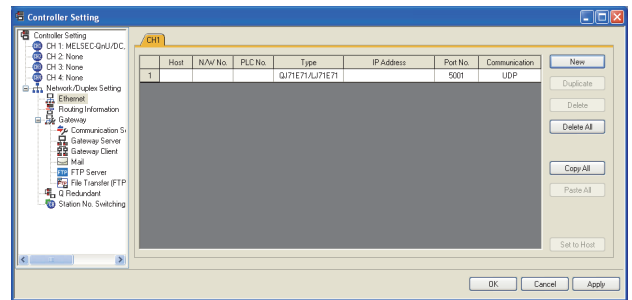

Item	Description	Range
Host	The host is displayed. (The host is indicated with an asterisk (*).))	-
N/W No.	Set the network No. of the connected Ethernet module. (Default: blank)	1 to 239
PLC No.*4	Set the station No. of the connected Ethernet module. (Default: blank)	1 to 64
Type*1	Set the type of the connected Ethernet module. (Default: QJ71E71/LJ71E71)	RCPU, RnCCPU, FX5CPU, QnUD(P)V/QnUDEH, QnD(H)CCPU, LCPU, Q17nNC, RJ71EN71, QJ71E71/LJ71E71, AJ71QE71, AJ71E71, FX, NZ2GF-ETB
IP Address	Set the IP address of the connected Ethernet module. (Default: blank)	0.0.0.0 to 255.255.255.255
Port No.*2	Set the port No. of the connected Ethernet module. (Default: 5001)	1024 to 65534
Communication*3	UDP	UDP, TCP

*1 Select one of the following [Controller Type].

- Built-in Ethernet port (hereafter CPU): RCPU, RnMTCPU, RnPCPU
- C Controller module (MELSEC iQ-R Series): RnCCPU
- Built-in Ethernet port (MELSEC iQ-F Series): FX5CPU
- Connection to Built-in Ethernet port: QnUD(P)V/QnUDEH, QCPU, Q170MCP, Q170MSCPU(-S1), Q173D(S)CPU/ Q172D(S)CPU
- C Controller module (Q Series): QnD(H)CCPU
- Connection to Built-in Ethernet port LCP: LCPU
- Ethernet module (NZ2GF-ETB): NZ2GF-ETB
- Q17nNCCPU: Q17nNC
- The RnENCPU varies in choice of Controller Type by a port name.
 Port CPU P1 : RCPU
 Port P1 : RJ71EN71
 Port P2 : Not applicable to the Ethernet connection.
- Ethernet module (MELSEC iQ-R Series): RJ71EN71
- Ethernet module (Q, L Series): QJ71E71/LJ71E71
- Ethernet module (QnA Series): AJ71QE71
- Ethernet module (A Series): AJ71QE71
- Ethernet module (FX Series): FX
- Built-in Ethernet port FXCPU: FX

For the applicable Ethernet module, refer to the following.

☞ 8.2 System Configuration

1 PREPARATORY PROCEDURES FOR MONITORING
 2 DEVICE RANGE THAT CAN BE SET
 3 ACCESS RANGE FOR MONITORING
 4 HOW TO MONITOR REDUNDANT SYSTEM
 5 BUS CONNECTION
 6 DIRECT CONNECTION TO CPU
 7 COMPUTER LINK CONNECTION
 8 ETHERNET CONNECTION

- *2 Set only when selecting "AJ71E71" in [Controller Type]. When other than [AJ71E71] is selected, the port No. is as follows.
 - [RCPU], [RnCCPU], [QnUDE(H)]: 5006 (fixed)
 - [FX5CPU]: 5562 (fixed)
 - [RJ71EN71][Q17nNC], [QJ71E71], [AJ71QE71]: 5001 (fixed)
 - [FX]: 5551 (When using FX3U-ENET-L or FX3U-ENET) 5556 (When using FX3U-ENET-ADP)
When using built-in Ethernet port FXCPU:5556
- *3 When selecting the FX in [Controller Type], the communication type is the TCP (fixed).
- *4 Each of [GOT PLC No.] set in the communication detail setting and [PLC No.] set in the Ethernet setting must be set to different station numbers.

8.3.2 Communication detail settings

POINT

- (1) Example of [Ethernet setting]
For examples of [Ethernet setting], refer to the following.

8.4 PLC Side Setting

- (2) Parameter reflection function of MELSOFT Navigator
 - (a) The color of the cells for the items which are reflected to GT Designer3 from MELSOFT Navigator changes to green. Set items, which are displayed in green cells, from the MELSOFT Navigator.
 - (b) When the settings of N/W No., PLC No., type or IP address are reflected to the parameter from the MELSOFT Navigator, those settings are added. Items set in advance are not deleted. However, if the combination of the N/W No. and the PLC No. or the IP address overlaps, the item set in advance is overwritten.
- (3) Changing the host on the GOT main unit
The host can be changed by the utility function of the GOT main unit. For the detailed connection method, refer to the following manual.
 User's Manual of GOT used.
(When using GT16)

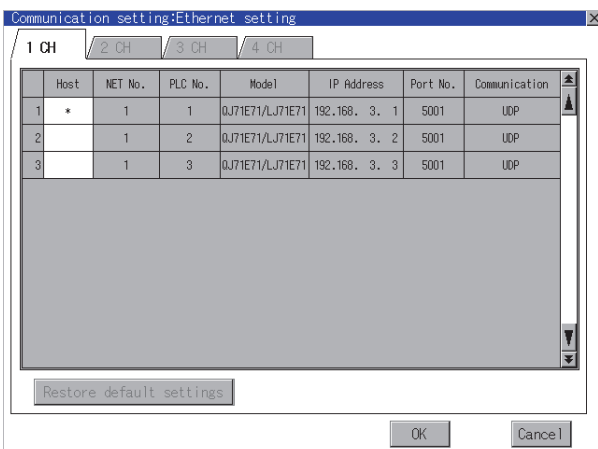

8.3.4 Routing parameter setting

Up to 64 [Transfer Network No.]s can be set.

However, the same transfer network number cannot be set twice or more (multiple times).

Therefore, the one that can access to other station from the request source host GOT is 64 kinds of [Transfer Network No.]s.

POINT

Routing parameter setting

When communicating within the host network, routing parameter setting is unnecessary.

For details of routing parameters, refer to the following manual.

Q Corresponding Ethernet Interface Module User's Manual (Application)

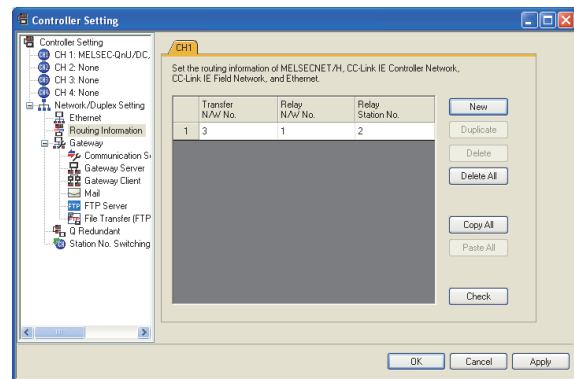

Item	Range
Transfer Network No.	1 to 239
Relay Network No.*1	1 to 239
Relay Station No.*1	1 to 64

*1 When accessing to other networks relaying a Built-in Ethernet port CPU, set the virtual network No. and PLC No. set in the Ethernet settings on GT Designer3.

POINT

- (1) Routing parameter setting of relay station
 - (a) Routing parameter setting may also be necessary for the relay station. For the setting, refer to the following.
☞ 8.4 PLC Side Setting
 - (b) If the routing parameter setting is necessary for the PLC which is set as a relay station when the monitoring target of the GOT is connected to another network via the Ethernet port of the built-in Ethernet port PLC, refer to the following system configuration example. Do not set the network No. of the communication detail settings of the GOT side.
For the setting, refer to the following.
☞ 8.4 PLC Side Setting

(System configuration example)

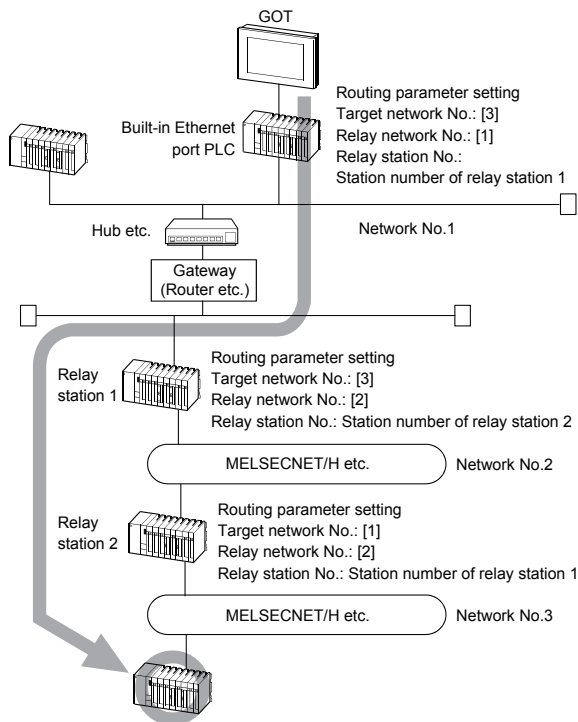

- (2) Parameter reflection function of MELSOFT Navigator
 - (a) The color of the cells for the items which are reflected to GT Designer3 from MELSOFT Navigator changes to green. Set items, which are displayed in green cells, from the MELSOFT Navigator.
 - (b) When the settings of Transfer network No., Relay network No. or Relay station No. are reflected to the parameter from the MELSOFT Navigator, those settings are added. Items set in advance are not deleted. However, if the target network No. overlaps, the item set in advance is overwritten.
 - (c) The routing information is used manually by the user when the data is created. Therefore, after changing the network configuration by MELSOFT Navigator, create a routing information again. For details of the creation of the routing information, refer to the MELSOFT Navigator help.

8.4 PLC Side Setting

	Model	Reference
Built-in Ethernet port RCPU	R04CPU, R08CPU, R16CPU, R32CPU, R120CPU, R16MTCPU, R32MTCPU	8.4.1 8.4.2
	R08PCPU, R16PCPU R32PCPU, R120PCPU R04ENCPU, R08ENCPU, R16ENCPU, R32ENCPU, R120ENCPU, R08SFCPU, R16SFCPU, R32SFCPU, R120SFCPU,	
C Controller module (MELSEC iQ-R Series)	R12CCPU-V	8.4.4
Built-in Ethernet port (MELSEC iQ-F Series)	FX5U FX5UC	8.4.1 8.4.2
	Q03UDEHCPU, Q04UDEHCPU, Q06UDEHCPU, Q10UDEHCPU, Q13UDEHCPU, Q20UDEHCPU, Q26UDEHCPU, Q50UDEHCPU, Q100UDEHCPU, Q03UDVCPU, Q04UDVCPU, Q06UDVCPU, Q13UDVCPU, Q26UDVCPU, Q172DSCPU, Q173DSCPU, Q172DCPU-S1, Q173DCPU-S1, Q170MCPUCPU, Q170MSCPU, Q170MSCPU-S1	8.4.5 8.4.6 8.4.15
C Controller module (Q Series)	Q12DCCPU-V Q24DHCCPU-V/VG Q24DHCCPU-LS Q26DHCCPU-LS	8.4.8
Built-in Ethernet port LCPUCPU	L02CPU L26CPU L26CPU-BT	8.4.5 8.4.6
	L02CPU-P L06CPU-P L26CPU-P L26CPU-PBT L06CPU	
Ethernet module (MELSEC iQ-R Series)	RJ71EN71	8.4.3
Ethernet module (Q Series)	QJ71E71-100, QJ71E71-B5, QJ71E71-B2, QJ71E71	8.4.7
Ethernet module (L Series)	LJ71E71-100	
Ethernet module (QnA Series)	AJ71QE71N3-T, AJ71QE71N-B5, AJ71QE71N-B2, AJ71QE71N-T, AJ71QE71N-B5T, AJ71QE71, AJ71QE71-B5, A1SJ71QE71N3-T, A1SJ71QE71N-B5, A1SJ71QE71N-B2, A1SJ71QE71N-T, A1SJ71QE71N-B5T, A1SJ71QE71-B5, A1SJ71QE71-B2	8.4.9

	Model	Reference
Ethernet module (A Series)	AJ71E71N3-T, AJ71E71N-B5, AJ71E71N-B2, AJ71E71N-T, AJ71E71N-B5T, AJ71E71-S3, A1SJ71E71N3-T, A1SJ71E71N-B5, A1SJ71E71N-B2, A1SJ71E71N-T, A1SJ71E71N-B5T, A1SJ71E71-B5-S3, A1SJ71E71-B2-S3	8.4.10
Ethernet module (FX Series)	FX _{3U} -ENET-L, FX _{3U} -ENET, FX _{3U} -ENET-ADP	8.4.11
Built-in Ethernet port FXCPU	FX _{3GE}	8.4.12
CNC C70	Q173NCCPU	8.4.13
CC-Link IE Field Network Ethernet adapter module	QJ71GF11-T2	8.4.14

8.4.1 Connecting to Built-in Ethernet port CPU (one-to one connection)

This section describes the settings of the GOT and Built-in Ethernet port CPU in the following case of system configuration.

POINT

Built-in Ethernet port CPU

For details of Built-in Ethernet port CPU, refer to the following manual.

- ☞ Manuals of MELSEC iQ-R Series
- ☞ Manuals of MELSEC iQ-F Series

System configuration

For connecting one Built-in Ethernet port CPU to one GOT, the PLC side settings are not required. Set [Ethernet] for [Controller Setting] on GT Designer3, and then connect Built-in Ethernet port CPU to the GOT. (For MELSEC iQ-R Series)

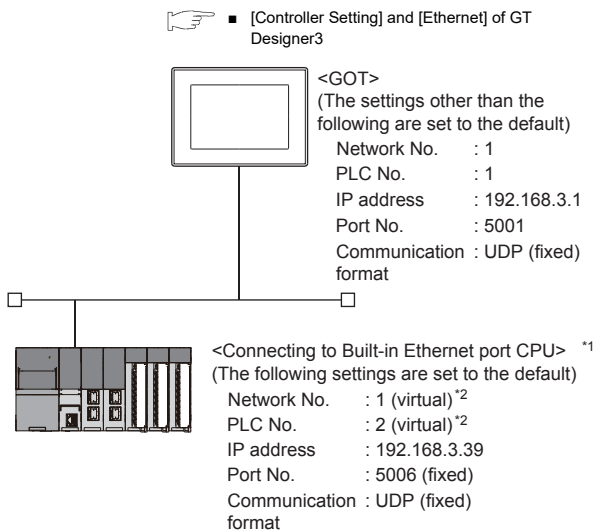

*1 For the settings when using system devices including a hub and a transceiver, refer to the following.

- ☞ 8.4.6 Connecting to Built-in Ethernet port CPU (multiple connection)

*2 These setting items do not exist at the PLC side. However, the virtual values must be set on the GOT side.

- ☞ ■ [Controller Setting] and [Ethernet] of GT Designer3

■ [Controller Setting] and [Ethernet] of GT Designer3

POINT

(1) [Controller Setting] and [Ethernet] of GT Designer3

For [Controller Setting] and [Ethernet] of GT Designer3, refer to the following.

- ☞ 8.3.1 Setting communication interface (Communication settings)

(2) Ethernet setting

When connecting Built-in Ethernet port RCPU to a GOT, the setting items for the network No. and station No. do not exist at the PLC side. However, these virtual values must be set on the GOT side. Therefore, set the network No. and station No. Set the network No. that does not exist on the network system and any station No.

(1) Controller setting

Item	Set value (Use default value)
GOT NET No.	1
GOT PLC No.	1
GOT IP Address	192.168.3.1
GOT Port No. (Communication)	5001
GOT Port No. (Ethernet Download)	5014
Default Gateway	0.0.0.0
Subnet Mask	255.255.255.0
Retry	3times
Startup Time	3sec
Timeout Time	3sec
Delay Time	0ms

(2) Ethernet setting

Item	Set value	
Ethernet setting No.1	Host	*
	N/W No.	1*1
	PLC No.	2*2
	Type	RCPU*3
	IP address	192.168.3.39
	Port No.	5006 (fixed)*4
	Communication	UDP (fixed)*5

- *1 Set the same value as that of GOT N/W No.
- *2 Set a value different from that of GOT PLC No.
- *3 In the case of MELSEC iQ-F series, it is FX5CPU.
- *4 In the case of MELSEC iQ-F series, it is 5562 (fixed).
- *5 In the case of MELSEC iQ-F series, it is TCP (fixed).

■ Checking communication state of Built-in Ethernet port CPU

(1) When using the Command Prompt of Windows®.
Execute a Ping command at the Command Prompt of Windows®.

(a) When normal communication
C:\>Ping 192.168.3.39
Reply from 192.168.3.39: bytes=32 time
<10ms TTL=32

(b) When abnormal communication
C:\>Ping 192.168.3.39
Request timed out.

(2) When abnormal communication
At abnormal communication, check the following and execute the Ping command again.

- Cable connecting condition
- Confirmation of switch and network parameter setting
- Operation state of PLC CPU (faulty or not)
- The IP address of Built-in Ethernet port CPU specified in the ping command

POINT

Ethernet diagnostics of GX Developer

Ethernet diagnostics of GX Developer is available to a Ping test from the PLC.

For details of Ethernet diagnostics of GX Developer, refer to the following manual.

➡ Manuals of MELSEC iQ-R Series

8.4.2 Connecting to Built-in Ethernet port CPU (multiple connection)

This section describes the settings of the GOT and Built-in Ethernet port CPU in the following case of system configuration.

POINT

Built-in Ethernet port CPU

For details of Built-in Ethernet port CPU, refer to the following manual.

➡ Manuals of MELSEC iQ-R Series
➡ Manuals of MELSEC iQ-F Series

■ System configuration

(For MELSEC iQ-R Series)

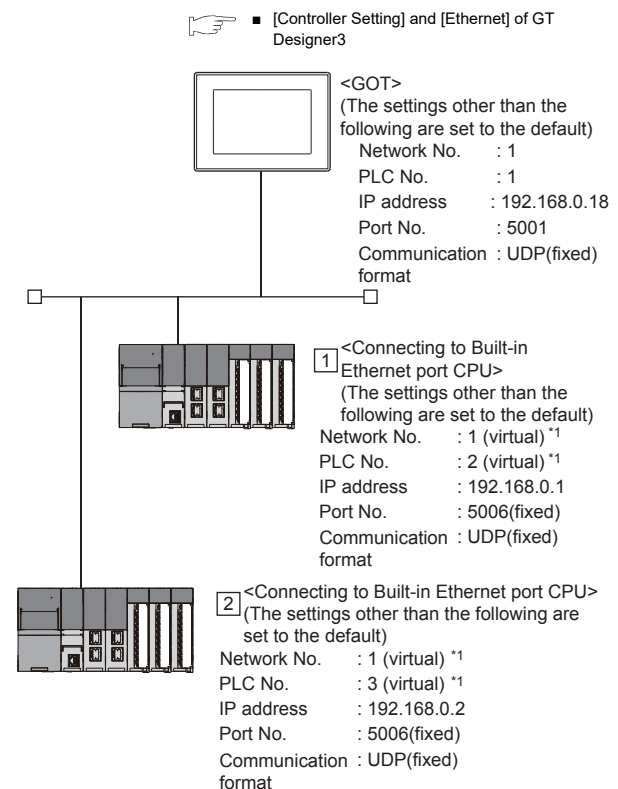

➡ ■ [Module parameter] of GX Works3

*1 These setting items do not exist at the PLC side. However, the virtual values must be set on the GOT side.

➡ ■ [Controller Setting] and [Ethernet] of GT Designer3

■ [Module parameter] of GX Works3

(1) Built-in Ethernet port (For MELSEC iQ-R Series)

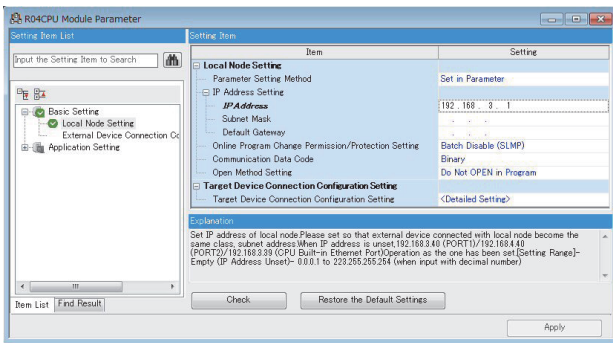

Item	Set value	Setting necessity at GOT connection
IP Address	192.168.0.1	×
Subnet Mask	-	×
Default Gateway	-	×
Online Program Change Permission/Protection Setting	(Use default value)	△
Communication Data Code		△
Open Method Setting		△
Target Device Connection Configuration Setting	-	×

○: Necessary △: As necessary ×: Not necessary

■ [Controller Setting] and [Ethernet] of GT Designer3

POINT

- (1) [Controller Setting] and [Ethernet] of GT Designer3
For [Controller Setting] and [Ethernet] of GT Designer3, refer to the following.

☞ 8.3.1 Setting communication interface
(Communication settings)

- (2) Ethernet setting
When connecting Built-in Ethernet port CPU to a GOT, the setting items for the network No. and station No. do not exist at the PLC side. However, these virtual values must be set on the GOT side. Therefore, set the network No. and station No. Set the network No. that does not exist on the network system and any station No.

(1) Controller setting

Item	Set value (Use default value)
GOT NET No.	1
GOT PLC No.	1
GOT IP Address	192.168.0.18
GOT Port No. (Communication)	5001
GOT Port No. (Ethernet Download)	5014
Default Gateway	0.0.0.0
Subnet Mask	255.255.255.0
Retry	3times
Startup Time	3sec
Timeout Time	3sec
Delay Time	0ms

(2) Ethernet setting

Item	Set value		
	①	②	
Ethernet setting No.1	Host	*	-
	N/W No.	1* ¹	1* ¹
	PLC No.	2* ²	3* ²
	Type	RCPU* ³	RCPU* ³
	IP address	192.168.0.1	192.168.0.2
	Port No.	5006 (fixed)* ⁴	5006 (fixed)* ⁴
	Communication	UDP (fixed)* ⁵	UDP (fixed)* ⁵

*1 Set the same value as that of GOT N/W No.

*2 Set a value different from that of the GOT PLC No. and the PLC No. of other PLCs on the same network.

*3 In the case of MELSEC iQ-F series, it is FX5CPU.

*4 In the case of MELSEC iQ-F series, it is 5562 (fixed).

*5 In the case of MELSEC iQ-F series, it is TCP (fixed).

■ Checking communication state of Built-in Ethernet port CPU

(1) When using the Command Prompt of Windows®.
Execute a Ping command at the Command Prompt of Windows®.

(a) When normal communication

```
C:\>Ping 192.168.0.1
Reply from 192.168.0.1: bytes=32 time
<10ms TTL=32
```

(b) When abnormal communication

```
C:\>Ping 192.168.0.1
Request timed out.
```

(2) When abnormal communication

At abnormal communication, check the following and execute the Ping command again.

- Cable connecting condition
- Confirmation of switch and network parameter setting
- Operation state of PLC CPU (faulty or not)
- The IP address of Built-in Ethernet port CPU specified in the ping command

POINT

Ethernet diagnostics of GX Works3

Ethernet diagnostics of GX Works3 is available to a Ping test from the PLC.

For details of Ethernet diagnostics of GX Works3, refer to the following manual.

☞ Manuals of MELSEC iQ-R Series

8.4.3 Connecting to Ethernet module (MELSEC iQ-R Series)

This section describes the settings of the GOT and Ethernet module (MELSEC iQ-R Series) in the following case of the system configuration.

POINT

Ethernet module (MELSEC iQ-R Series)

For details of the Ethernet module (MELSEC iQ-R Series), refer to the following manual.

☞ Manuals of MELSEC iQ-R Series

■ System configuration

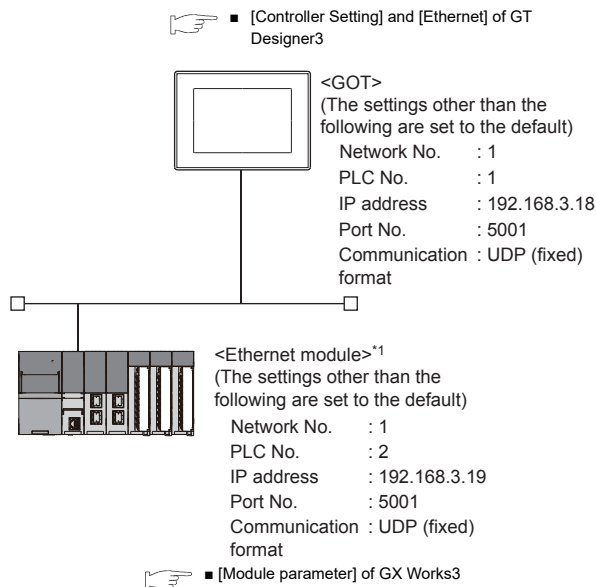

*1 The Ethernet module is mounted on the base unit slot 0.
The Start XY No. of the Ethernet module is set to "0".

■ [Module parameter] of GX Works3

(1) Module parameter of Ethernet module (MELSEC iQ-R Series)*1

*1 Set [Module parameter] of the port under [Module information].

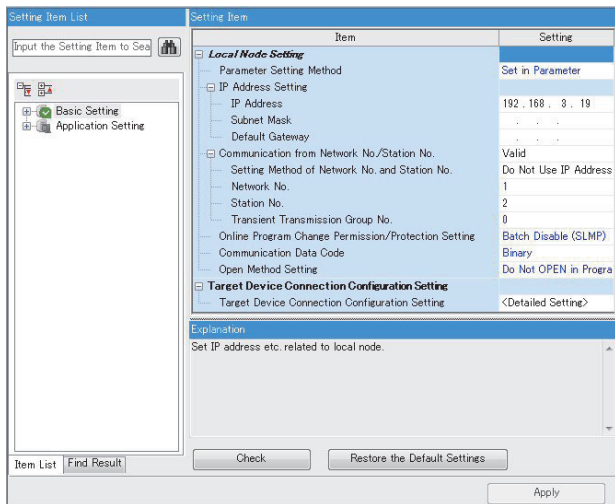

Item	Set value	Setting necessity at GOT connection
IP Address	192.168.3.19	○
Subnet Mask	-	×
Default Gateway	-	×
Setting Method of Network No. and Station No.	Do Not Use IP Address	×
Network No.*2	1	○
Station No.*3	2	○
Transient Transmission Group No.		×
Online Program Change Permission/Protection Setting	(Use default value)	×
Communication Data Code		×
Open Method Setting		×
Target Device Connection Configuration Setting	Refer to (2).	○

○: Necessary △: As necessary ×: Not necessary

*2 Set the same network No. as that of the GOT.

*3 Do not set the same station No. as that of the GOT.

(2) Target Device Connection Configuration Setting

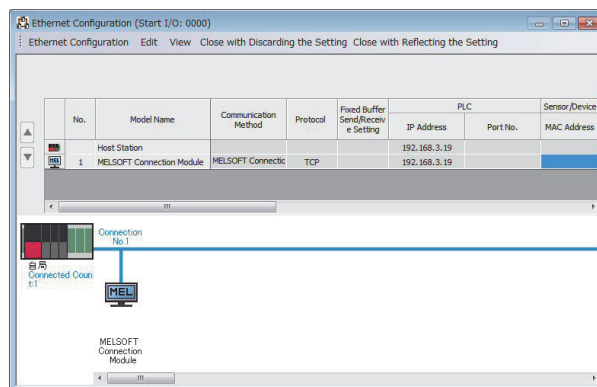

Item	Set value
Protocol	(Use default value)
Open system	MELSOFT connection (fixed)
Host station port No.	(Use default value)

POINT

When changing the module parameter
 After writing module parameters to the PLC CPU, turn the PLC CPU OFF then back ON again, or reset the PLC CPU.

(3) Routing setting

Up to 238 [Target Station Network No.]s can be set. However, the same target station network number cannot be set twice or more (multiple times). Therefore, the one that can access to other station from the request source host GOT is 238 kinds of [Target Station Network No.]s.

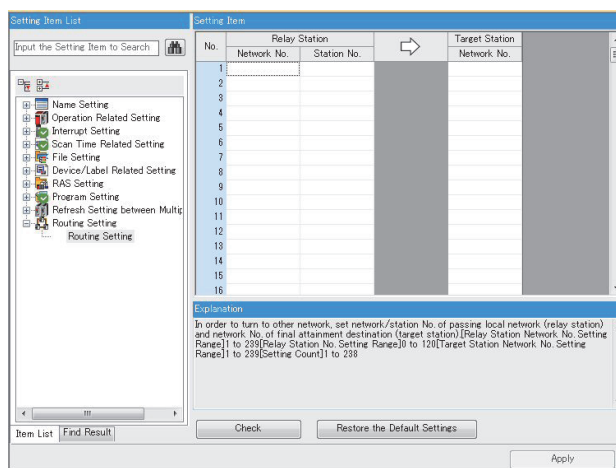

Item	Range
Target Station network No.	1 to 239
Relay Station network No.	1 to 239
Relay station No.	1 to 120

POINT

Routing parameter setting of request source

Routing parameter setting is also necessary for the request source GOT.

For the setting, refer to the following.

 8.3.4 Routing parameter setting

(4) Communication confirmation

The INIT. LED on the Ethernet module turns on when the module is ready to communicate.

For confirming the communication state, refer to the following.

 ■ Confirming the communication state of Ethernet module

RJ71EN71	
RUN <input type="checkbox"/>	<input type="checkbox"/> ERR.
INIT. <input type="checkbox"/>	<input type="checkbox"/> COM.ERR.
OPEN <input type="checkbox"/>	<input type="checkbox"/> 100M
SD <input type="checkbox"/>	<input type="checkbox"/> RD

■ [Controller Setting] and [Ethernet] of GT Designer3

(1) Controller setting

Item	Set value (Use default value)
GOT NET No.	1
GOT PLC No.	1
GOT IP Address	192.168.3.18
GOT Port No. (Communication)	5001
GOT Port No. (Ethernet Download)	5014
Default Gateway	0.0.0.0
Subnet Mask	255.255.255.0
Retry	3times
Startup Time	3sec
Timeout Time	3sec
Delay Time	0ms

(2) Ethernet setting

Item		Set value
Ethernet Ethernet setting No.1	Host	*
	N/W No.	1
	PLC No.	2
	Type	RJ71EN71
	IP address	192.168.3.19
	Port No.	5001 (fixed)
	Communication	UDP (fixed)

POINT

[Controller Setting] and [Ethernet] of GT Designer3

For [Controller Setting] and [Ethernet] of GT Designer3, refer to the following.

 8.3.1 Setting communication interface
(Communication settings)

■ Confirming the communication state of Ethernet module

- (1) When using the Command Prompt of Windows®.
 - Execute a Ping command at the Command Prompt of Windows®.
 - (a) When normal communication
 - C:\>Ping 192.168.3.19
 - Reply from 192.168.3.19: bytes=32 time<1ms TTL=64
 - (b) When abnormal communication
 - C:\>Ping 192.168.3.19
 - Request timed out.
- (2) When abnormal communication
 - At abnormal communication, check the following and execute the Ping command again.
 - Mounting condition of Ethernet communication unit
 - Cable connecting condition
 - Confirmation of switch and network parameter setting
 - Operation state of PLC CPU (faulty or not)
 - IP address of the Ethernet module specified by Ping command

POINT

Ethernet diagnostics of GX Works3
 Ethernet diagnostics of GX Works3 is available to a Ping test from the PLC.
 For details of Ethernet diagnostics of GX Developer, refer to the following manual.
 ➔ Manuals of MELSEC iQ-R Series

8.4.4 Connection to C Controller module (MELSEC iQ-R Series)

This section describes the settings of the GOT and C Controller module (MELSEC iQ-R Series) in the following case of system configuration.
 Use CW Configurator for the C Controller module (MELSEC iQ-R Series) communication settings.

POINT

C Controller module (MELSEC iQ-R Series)
 For details of C Controller module (MELSEC iQ-R Series), refer to the following manual.
 ➔ Manuals of C Controller module (MELSEC iQ-R Series)

■ System configuration

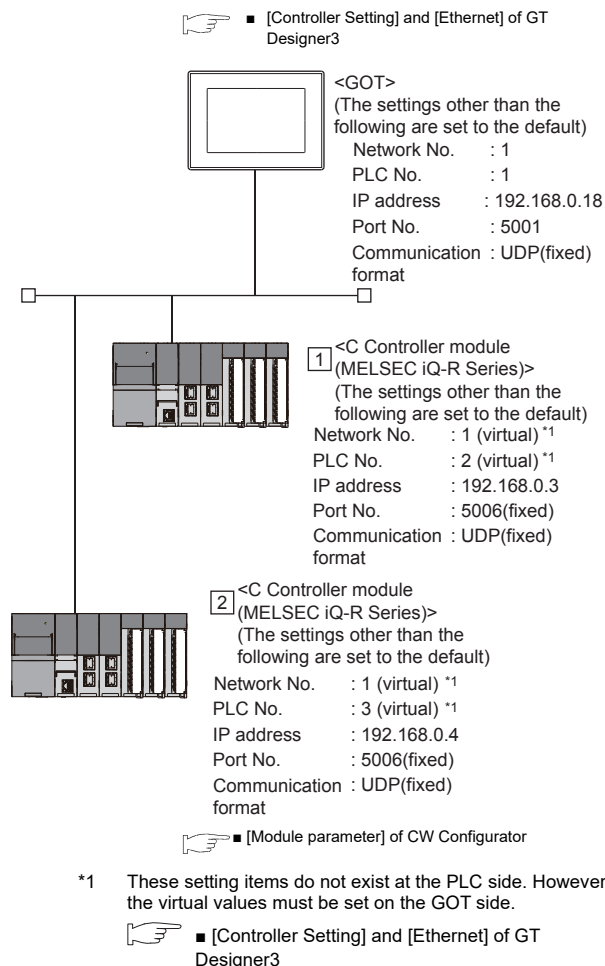

■ [Module parameter] of CW Configurator

(1) Module parameter

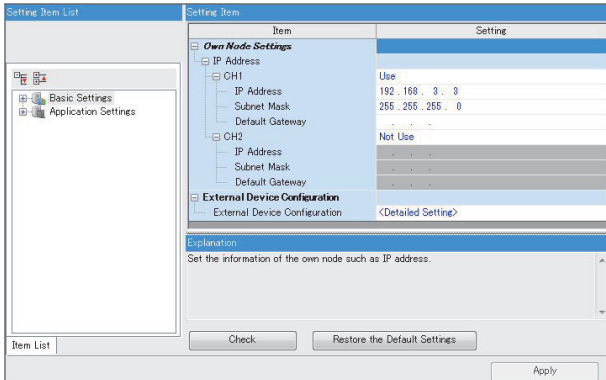

Item ^{*1}	Set value	Setting necessity at GOT connection
CH1	Use	×
IP Address	192.168.3.3	×
Subnet Mask	-	×
Default Gateway	-	×
CH2	Not Use	×
IP Address	-	×
Subnet Mask	-	×
Default Gateway	-	×
External Device Configuration	-	×

○: Necessary △: As necessary ×: Not necessary

*1 Set the IP address corresponding to the CH No. to be used to connect to the GOT.

■ [Controller Setting] and [Ethernet] of GT Designer3

POINT

(1) [Controller Setting] and [Ethernet] of GT Designer3

For [Controller Setting] and [Ethernet] of GT Designer3, refer to the following.

☞ 8.3.1 Setting communication interface (Communication settings)

(2) Ethernet setting

When connecting Built-in Ethernet port CPU to a GOT, the setting items for the network No. and station No. do not exist at the PLC side. However, these virtual values must be set on the GOT side. Therefore, set the network No. and station No. Set the network No. that does not exist on the network system and any station No.

(1) Controller setting

Item	Set value (Use default value)
GOT NET No.	1
GOT PLC No.	1
GOT IP Address	192.168.0.18
GOT Port No. (Communication)	5001
GOT Port No. (Ethernet Download)	5014
Default Gateway	0.0.0.0
Subnet Mask	255.255.255.0
Retry	3times
Startup Time	3sec
Timeout Time	3sec
Delay Time	0ms

(2) Ethernet setting

Item	Set value		
	1	2	
Ethernet setting No.1	Host	*	-
	N/W No.	1 ^{*1}	1 ^{*1}
	PLC No.	2 ^{*2}	3 ^{*2}
	Type	RnCCPU	RnCCPU
	IP address	192.168.0.3	192.168.0.4
	Port No.	5006 (fixed)	5006 (fixed)
	Communication	UDP (fixed)	UDP (fixed)

*1 Set the same value as that of GOT N/W No.

*2 Set a value different from that of the GOT PLC No. and the PLC No. of other PLCs on the same network.

■ Checking communication state of C Controller module (MELSEC iQ-R Series)

- (1) When using the Command Prompt of Windows®. Execute a Ping command at the Command Prompt of Windows®.
 - (a) When normal communication

```
C:\>Ping 192.168.0.3
Reply from 192.168.0.3: bytes=32 time <10ms TTL=32
```
 - (b) When abnormal communication

```
C:\>Ping 192.168.0.3
Request timed out.
```
- (2) When abnormal communication

At abnormal communication, check the following and execute the Ping command again.

 - Cable connecting condition
 - Confirmation of switch and network parameter setting
 - Operation state of PLC CPU (faulty or not)
 - The IP address of C Controller module (MELSEC iQ-R Series) specified in the ping command

POINT

Ethernet diagnostics of CW Configurator
 Ethernet diagnostics of CW Configurator is available to a Ping test from the PLC.
 For details of Ethernet diagnostics of CW Configurator, refer to the following manual.

➔ Manuals of C Controller module (MELSEC iQ-R Series)

8.4.5 Connecting to Built-in Ethernet port CPU (one-to-one connection)

This section describes the settings of the GOT and Built-in Ethernet port CPU in the following case of system configuration.

POINT

Connecting to Built-in Ethernet port CPU
 For details of Built-in Ethernet port CPU, refer to the following manual.

- ➔ QnUCPU User's Manual (Communication via Built-in Ethernet Port)
- ➔ MELSEC-L CPU Module User's Manual (Built-In Ethernet Function)

■ System configuration

For connecting one Built-in Ethernet port QCPU to one GOT, the PLC side settings are not required. Set [Ethernet] for [Controller Setting] on GT Designer3, and then connect Built-in Ethernet port QCPU to the GOT.

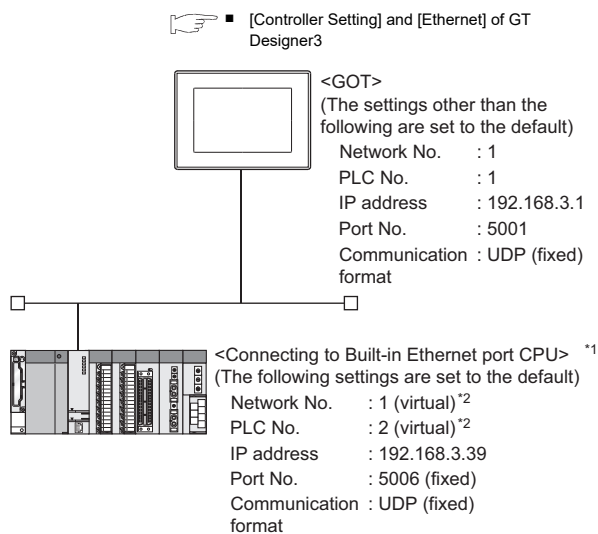

*1 For the settings when using system devices including a hub and a transceiver, refer to the following.

➔ 8.4.6 Connecting to Built-in Ethernet port CPU (multiple connection)

*2 These setting items do not exist at the PLC side. However, the virtual values must be set on the GOT side.

➔ [Controller Setting] and [Ethernet] of GT Designer3

■ [Controller Setting] and [Ethernet] of GT Designer3

POINT

- (1) [Controller Setting] and [Ethernet] of GT Designer3
For [Controller Setting] and [Ethernet] of GT Designer3, refer to the following.

 8.3.1 Setting communication interface (Communication settings)

- (2) Ethernet setting
When connecting Built-in Ethernet port QCPU or LCPU to a GOT, the settings items for the network No. and station No. do not exist at the PLC side. However, these virtual values must be set on the GOT side. Therefore, set the network No. and station No.
Therefore, set the network No. and station No. Set the network No. that is not existed on the network system and any station No..

(3) Controller setting

Item	Set value (Use default value)
GOT NET No.	1
GOT PLC No.	1
GOT IP Address	192.168.3.1
GOT Port No. (Communication)	5001
GOT Port No. (Ethernet Download)	5014
Default Gateway	0.0.0.0
Subnet Mask	255.255.255.0
Retry	3times
Startup Time	3sec
Timeout Time	3sec
Delay Time	0ms

(4) Ethernet setting

Item	Set value	
Ethernet setting No.1	Host	*
	N/W No.	1 ^{*1}
	PLC No.	2 ^{*2}
	Type	QnUDE(H), LCPU
	IP address	192.168.3.39
	Port No.	5006 (fixed)
	Communication	UDP (fixed)



- *1 Set the same value as that of GOT N/W No.
*2 Set a value different from that of GOT PLC No.

■ Checking communication state of Connecting to Built-in Ethernet port CPU

- (1) When using the Command Prompt of Windows®.
Execute a Ping command at the Command Prompt of Windows®.
- (a) When normal communication
C:\>Ping 192.168.3.39
Reply from 192.168.3.39: bytes=32 time <10ms TTL=32
- (b) When abnormal communication
C:\>Ping 192.168.3.39
Request timed out.
- (2) When abnormal communication
At abnormal communication, check the followings and execute the Ping command again.
- Cable connecting condition
 - Confirmation of switch and network parameter setting
 - Operation state of PLC CPU (faulty or not)
 - The IP address of Built-in Ethernet port CPU specified in the ping command

POINT

Ethernet diagnostics of GX Developer
Ethernet diagnostics of GX Developer is available to a Ping test from the PLC.
For details of Ethernet diagnostics of GX Developer, refer to the following manual.



-  QCPU User's Manual (Hardware Design, Maintenance and Inspection)
-  MELSEC-L CPU Module User's Manual (Hardware Design, Maintenance and Inspection)

8.4.6 Connecting to Built-in Ethernet port CPU (multiple connection)

This section describes the settings of the GOT and Built-in Ethernet port CPU in the following case of system configuration.

POINT

Connecting to Built-in Ethernet port CPU
For details of Built-in Ethernet port CPU, refer to the following manual.

-  QnUCPU User's Manual (Communication via Built-in Ethernet Port)
-  MELSEC-L CPU Module User's Manual (Built-In Ethernet Function)

System configuration

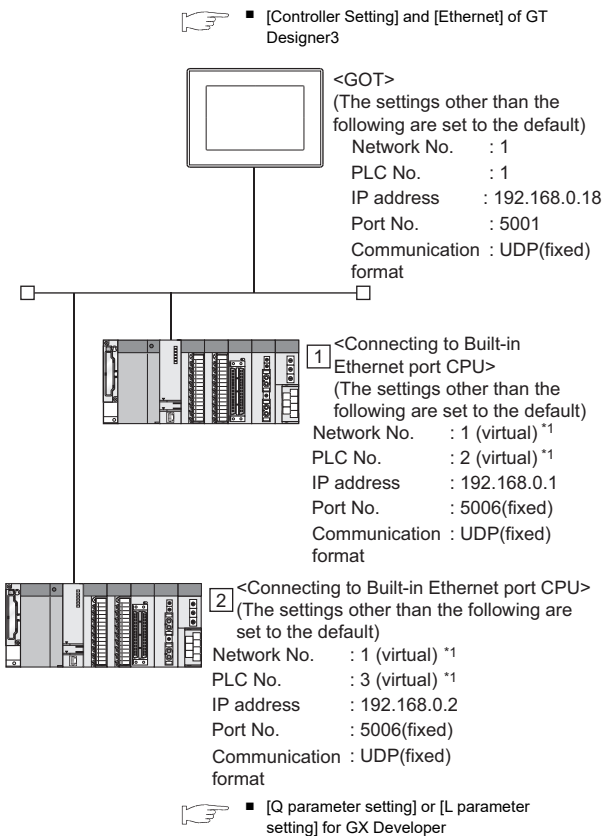

*1 These setting items do not exist at the PLC side. However, the virtual values must be set on the GOT side.

 [Controller Setting] and [Ethernet] of GT Designer3

[Q parameter setting] or [L parameter setting] for GX Developer

(1) Built-in Ethernet port

Example: [Q parameter setting] screen

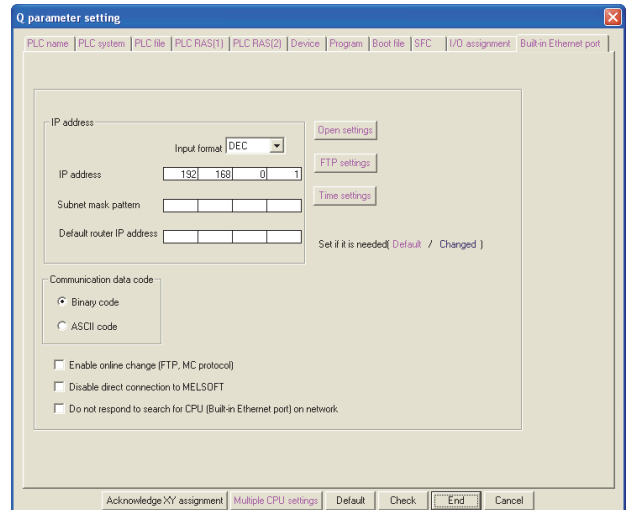

Item	Set value	Setting necessity at GOT connection
IP address	192.168.0.1	○
Subnet mask pattern	-	×
Default router IP address	-	×
Communication data code		△
Enable online change (FTP, MC protocol)		△
Disable direct connection to MELSOFT	(Use default value)	△
Do not respond to search for CPU (Built-in Ethernet port) on network		△
Open settings	Refer to (2).	○
FTP settings	(Use default value)	△
Time settings		△

○: Necessary △: As necessary ×: Not necessary

(2) Open settings

The setting is required for all the connected GOTs.

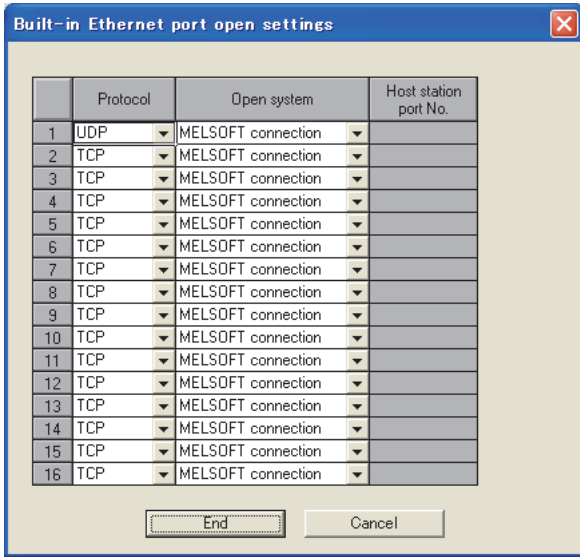

Item	Set value
Protocol	UDP (fixed)
Open system	MELSOFT connection (fixed)
Host station port No.	(Use default value)

■ [Controller Setting] and [Ethernet] of GT Designer3

POINT

- (3) [Controller Setting] and [Ethernet] of GT Designer3
For [Controller Setting] and [Ethernet] of GT Designer3, refer to the following.

☞ 8.3.1 Setting communication interface (Communication settings)

- (4) Ethernet setting
When connecting Built-in Ethernet port CPU to a GOT, the settings items for the network No. and station No. do not exist at the PLC side. However, these virtual values must be set on the GOT side. Therefore, set the network No. and station No. Set the network No. that is not existed on the network system and any station No..

(1) Controller setting

Item	Set value (Use default value)
GOT NET No.	1
GOT PLC No.	1
GOT IP Address	192.168.0.18
GOT Port No. (Communication)	5001
GOT Port No. (Ethernet Download)	5014
Default Gateway	0.0.0.0
Subnet Mask	255.255.255.0
Retry	3times
Startup Time	3sec
Timeout Time	3sec
Delay Time	0ms

(2) Ethernet setting

Item	Set value		
	1	2	
Ethernet setting No.1	Host	*	-
	N/W No.	1* ¹	1* ¹
	PLC No.	2* ²	3* ²
	Type	QnUDE(H), LCPU	QnUDE(H), LCPU
	IP address	192.168.0.1	192.168.0.2
	Port No.	5006 (fixed)	5006 (fixed)
Communication	UDP (fixed)	UDP (fixed)	

*1 Set the same value as that of GOT N/W No.
*2 Set a value different from that of the GOT PLC No. and the PLC No. of other PLCs on the same network.

■ Checking communication state of Connecting to Built-in Ethernet port CPU

- (1) When using the Command Prompt of Windows®.

Execute a Ping command at the Command Prompt of Windows®.

 - (a) When normal communication

```
C:\>Ping 192.168.0.1
          Reply from 192.168.0.1: bytes=32 time <10ms TTL=32
```
 - (b) When abnormal communication

```
C:\>Ping 192.168.0.1
          Request timed out.
```
- (2) When abnormal communication

At abnormal communication, check the followings and execute the Ping command again.

 - Cable connecting condition
 - Confirmation of switch and network parameter setting
 - Operation state of PLC CPU (faulty or not)
 - The IP address of Built-in Ethernet port CPU specified in the ping command

POINT

Ethernet diagnostics of GX Developer
 Ethernet diagnostics of GX Developer is available to a Ping test from the PLC.
 For details of Ethernet diagnostics of GX Developer, refer to the following manual.

- ☞ QCPU User's Manual (Hardware Design, Maintenance and Inspection)
- ☞ MELSEC-L CPU Module User's Manual (Hardware Design, Maintenance and Inspection)

8.4.7 Connecting to Ethernet module (Q/L Series)

This section describes the settings of the GOT and Ethernet module (Q Series) in the following case of the system configuration.

POINT

- Ethernet module (Q/L Series)
 For details of the Ethernet module (Q/L Series), refer to the following manual.
- ☞ Q Corresponding Ethernet Interface Module User's Manual (Basic)
 - ☞ MELSEC-L Ethernet Interface Module User's Manual (Basic)

■ System configuration (for Q series)

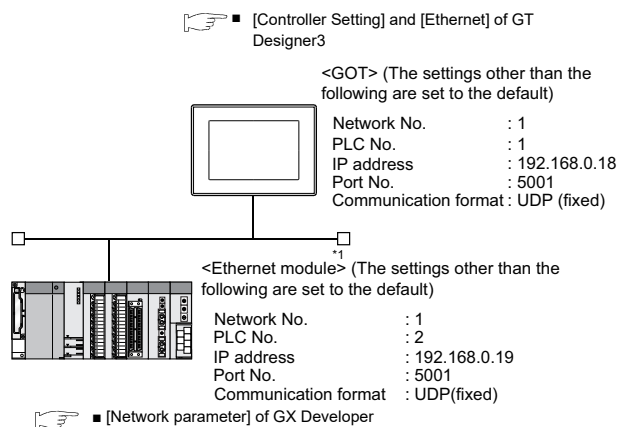

POINT

When connecting to Q170MCP
 When connected to Q170MCP, the start I/O No. of the Ethernet module is set to "70".

■ [Network parameter] of GX Developer

(1) Network parameter

Item	Set value	Setting necessity at GOT connection
Network type	Ethernet (fixed)	○
Starting I/O No.*1	0000H	○
Network No.*2	1	○
Group No.	0 (fixed)	○
Station No.*3	2	○
Mode	Online (fixed)	○
Operation setting	Refer to (2)	○
Initial settings	(Use default value)	△
Open settings		×
Router relay parameter		×
Station No.<->IP information		×
FTP Parameters		×
E-mail settings		×
Interrupt settings		×
Redundant settings*4		△
Routing Parameters	Refer to (3)	△

○: Necessary △: As necessary ×: Not necessary

- *1 When using Q170MCP, set the start I/O to 0070H.
- *2 Specify the same network No. as that of the GOT.
- *3 Do not set the same station No. as that of the GOT.
- *4 Set when using Ethernet module in a redundant QnPRHCPU system.

(2) Operation setting

Item	Set value	Setting necessity at GOT connection
Communication data code*1	(Use default value)	×
IP address	192.168.0.19	○
Initial timing*1	(Use default value)	×
Send frame setting		×
Enable Write at RUN time*1		×
TCP Existence confirmation setting		×

○: Necessary △: As necessary ×: Not necessary

*1 Because port No. 5001 is fixed, these items operate at the following setting without relations to the setting given here.

- Communication date code : [Binary code]
- Initial timing : "Always wait for OPEN" (Communication is applicable while stopping the PLC CPU.)
- Enable Write at RUN time : [Enable Write at RUN time] (Writing Data is applicable while running the PLC CPU.)

POINT

When changing the network parameter
After writing the network parameter to the PLC CPU, operate the PLC CPU ether turning OFF and then ON or resetting.

(3) Routing parameter setting

Up to 64 [Transfer Network No.]s can be set. However, the same transfer network number cannot be set twice or more (multiple times). Therefore, the one that can access to other station from the request source host GOT is 64 kinds of [Transfer Network No.]s.

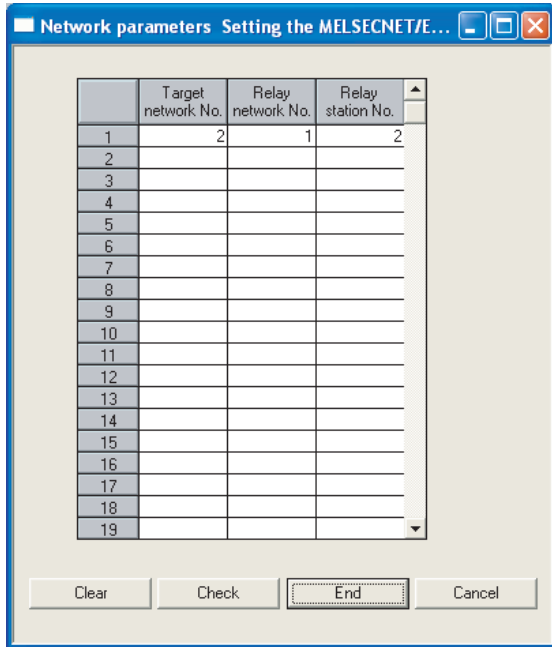

Item	Range
Target network No.	1 to 239
Relay network No.	1 to 239
Relay station No.	1 to 64

POINT

Routing parameter setting of request source
 Routing parameter setting is also necessary for the request source GOT.
 For the setting, refer to the following.
 ➔ 8.3.4 Routing parameter setting

(4) Communication confirmation

The INIT. LED on the Ethernet module turns on when the module is ready to communicate. For confirming the communication state, refer to the following.

➔ ■ Confirming the communication state of Ethernet module

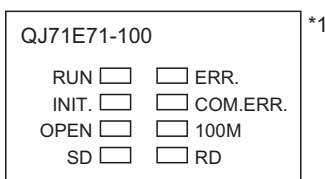

*1 The LEDs layout of QJ71E71-100.

■ [Controller Setting] and [Ethernet] of GT Designer3

(1) Controller setting

Item	Set value (Use default value)
GOT NET No.	1
GOT PLC No.	1
GOT IP Address	192.168.0.18
GOT Port No. (Communication)	5001
GOT Port No. (Ethernet Download)	5014
Default Gateway	0.0.0.0
Subnet Mask	255.255.255.0
Retry	3times
Startup Time	3sec
Timeout Time	3sec
Delay Time	0ms

(2) Ethernet setting

Item	Set value	
Ethernet setting No.1	Host	*
	N/W No.	1
	PLC No.	2
	Type	QJ71E71
	IP address	192.168.0.19
	Port No.	5001 (fixed)
Communication	UDP (fixed)	

POINT

[Controller Setting] and [Ethernet] of GT Designer3
 For [Controller Setting] and [Ethernet] of GT Designer3, refer to the following.
 ➔ 8.3.1 Setting communication interface (Communication settings)

■ Confirming the communication state of Ethernet module

- (1) When using the Command Prompt of Windows®.
Execute a Ping command at the Command Prompt of Windows®.
- (a) When normal communication
C:\>Ping 192.168.0.19
Reply from 192.168.0.19: bytes=32 time<1ms
TTL=64
- (b) When abnormal communication
C:\>Ping 192.168.0.19
Request timed out.
- (2) When abnormal communication
At abnormal communication, check the followings and execute the Ping command again.
- Mounting condition of Ethernet communication unit
 - Cable connecting condition
 - Confirmation of switch and network parameter setting
 - Operation state of PLC CPU (faulty or not)
 - IP address of GOT specified by Ping command

POINT

Ethernet diagnostics of GX Developer
Ethernet diagnostics of GX Developer is available to a Ping test from the PLC.
For details of Ethernet diagnostics of GX Developer, refer to the following manual.

 User's manual of the Ethernet module

8.4.8 Connecting to C Controller module (Q Series)

This section describes the settings of the GOT and C Controller module (Q Series) in the following case of the system configuration.

POINT

C Controller module (Q Series)

For details of C Controller module (Q Series), refer to the following manual.

 C Controller Module (Q Series) User's Manual (Hardware Design, Function Explanation)

■ System configuration

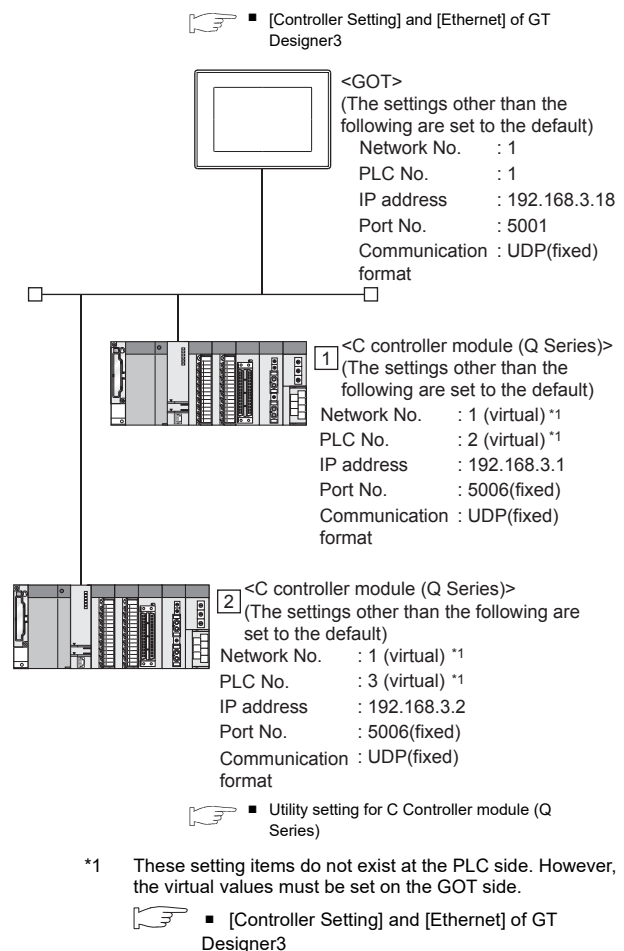

Utility setting for C Controller module (Q Series)

(1) Q12DCCPU-V

Use SW3PVC-CCPU-E Ver.3.05F or later for the C Controller (Q Series) setting utility.

(a) Connection settings

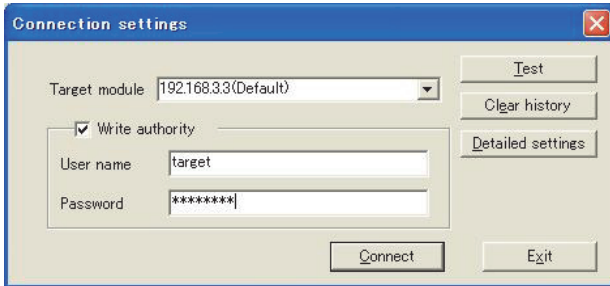

Item	Set value	Setting necessity at GOT connection
Target module*1	192.168.3.3 (Default)	○
Write authority	Mark the checkbox	○
User name*2	target	○
Password*2	password	○
Detailed settings	-	△

○: Necessary △: As necessary ×: Not necessary

- *1 If the IP address of the C Controller module (Q Series) has been changed, input the changed IP address or host name.
- *2 If the account of the C Controller module (Q Series) has been changed, input the changed user name and password.

(b) Online operation

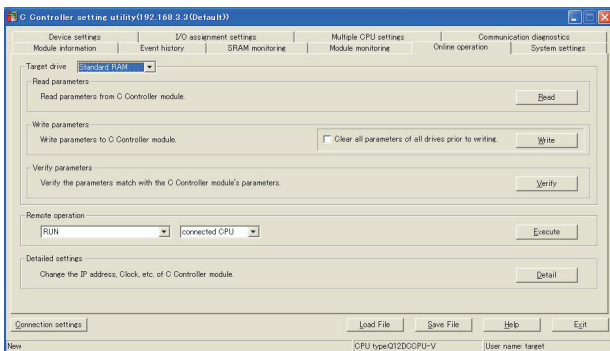

Item	Set value	Setting necessity at GOT connection
Detailed settings	Refer to (3)	○

○: Necessary △: As necessary ×: Not necessary

(c) Detail settings

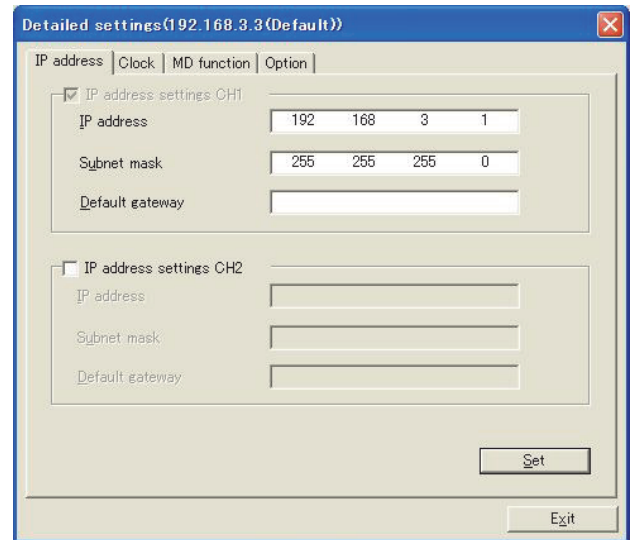

Item	Set value	Setting necessity at GOT connection
IP address	192.168.3.1	○
Subnet mask	255.255.255.0	○
Default gateway	-	×
IP address settings CH2	-	×

○: Necessary △: As necessary ×: Not necessary

(d) System settings

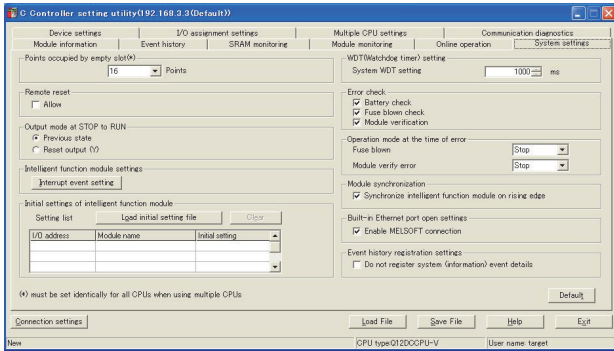

Item	Set value	Setting necessity at GOT connection	
Points occupied by empty slot	(Use default value)	△	
Remote reset		△	
Output mode at STOP to RUN		△	
Intelligent function module settings		△	
Initial settings of intelligent function module		△	
WDT (Watchdog timer) setting		△	
Error check		△	
Operation mode at the time of error		△	
Module synchronization		△	
Built-in Ethernet port open settings		Mark the checkbox	○
Event history registration settings		(Use default value)	△

○: Necessary △: As necessary ×: Not necessary

(2) Q24DHCCPU-V/VG

Use SW4PVC-CCPU-E for the C Controller (Q Series) setting utility.

(a) Connection settings

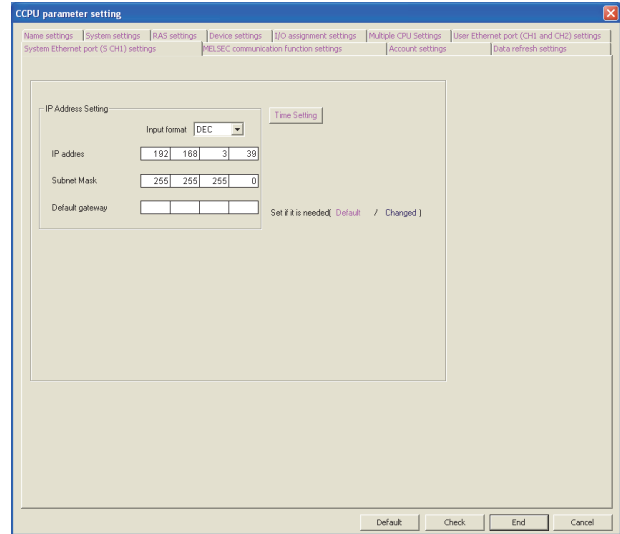

Item	Set value	Setting necessity at GOT connection
IP Address*1	192.168.3.39 (Default)	○
Subnet Mask	255.255.255.0 (Default)	○
Default Gateway	-	×

○: Necessary △: As necessary ×: Not necessary

*1 If the IP address of the C Controller module (Q Series) has been changed, input the changed IP address.

■ [Controller Setting] and [Ethernet] of GT Designer3

POINT

- (1) [Controller Setting] and [Ethernet] of GT Designer3
For [Controller Setting] and [Ethernet] of GT Designer3, refer to the following.

☞ 8.3.1 Setting communication interface (Communication settings)

- (2) Ethernet setting
When connecting C Controller module (Q Series) to a GOT, the setting items for the network No. and station No. do not exist at the PLC side. However, these virtual values must be set on the GOT side. Therefore, set the network No. and station No. Set the network No. that is not existed on the network system and any station No..

(1) Controller setting

Item	Set value (Use default value)
GOT NET No.	1
GOT PLC No.	1
GOT IP Address	192.168.3.18
GOT Port No. (Communication)	5001
GOT Port No. (Ethernet Download)	5014
Default Gateway	0.0.0.0
Subnet Mask	255.255.255.0
Retry	3times
Startup Time	3sec
Timeout Time	3sec
Delay Time	0ms

(2) Ethernet setting

Item	Set value		
	1	2	
Ethernet setting No.1	Host	*	-
	N/W No.	1*1	1*1
	PLC No.	2*2	3*2
	Type	QnD(H)CCPU	QnD(H)CCPU
	IP address	192.168.3.1	192.168.3.2
	Port No.	5006 (fixed)	5006 (fixed)
	Communication	UDP (fixed)	UDP (fixed)

- *1 Set the same value as that of GOT N/W No.
 *2 Set a value different from that of the GOT PLC No. and the PLC No. of other PLCs on the same network.

■ Checking communication state of C Controller module (Q Series)

(1) When using the Command Prompt of Windows®.
 Execute a Ping command at the Command Prompt of Windows®.

- (a) When normal communication
 C:\>Ping 192.168.3.1
 Reply from 192.168.3.1: bytes=32 time <10ms TTL=32
- (b) When abnormal communication
 C:\>Ping 192.168.3.1
 Request timed out.

- (2) When abnormal communication
 At abnormal communication, check the followings and execute the Ping command again.
- Cable connecting condition
 - Confirmation of switch and network parameter setting
 - Operation state of PLC CPU (faulty or not)
 - The IP address of C Controller module (Q Series) specified in the ping command

8.4.9 Connecting to Ethernet module (QnA Series)

This section describes the settings of the GOT and Ethernet module (QnA Series) in the following case of the system configuration.

POINT

Ethernet module (QnA Series)
 For details of the Ethernet module (QnA Series), refer to the following manual.

☞ For QnA Ethernet Interface Module User's Manual

■ System configuration

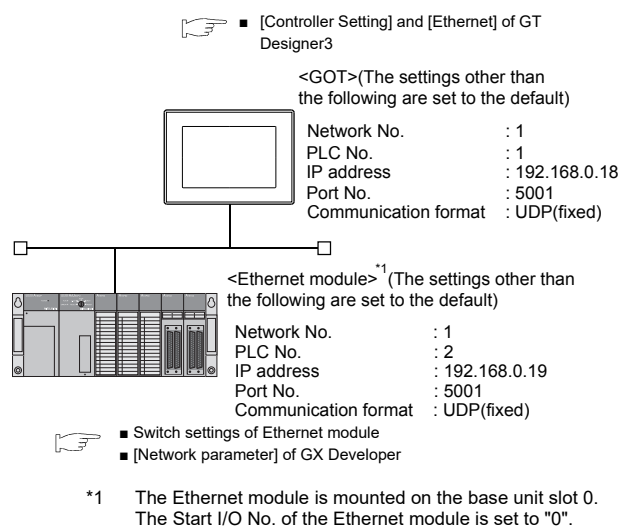

Switch settings of Ethernet module

Set the operation mode setting switch and exchange condition setting switch.

AJ71QE71N3-T, AJ71QE71N-B5, AJ71QE71N-B2, AJ71QE71N-T, AJ71QE71N-B5T, AJ71QE71, AJ71QE71-B5

A1SJ71QE71N3-T, A1SJ71QE71N-B5, A1SJ71QE71N-B2, A1SJ71QE71N-T, A1SJ71QE71N-B5T, A1SJ71QE71-B5, A1SJ71QE71-B2

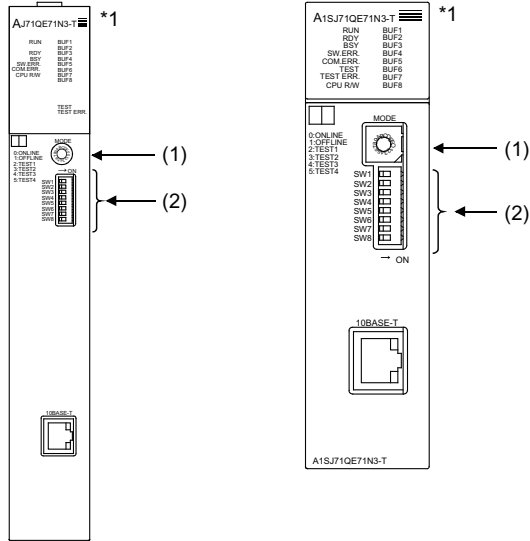

*1 The figure of AJ71QE71N3-T and A1SJ71QE71N3-T.

(1) Operation mode setting switch

Operation mode setting switch	Description	Set value	Setting necessity at GOT connection
	Online	0 (fixed)	○

○: Necessary △: As necessary ×: Not necessary

(2) Exchange condition setting switch

Exchange condition setting switch	Setting switch	Description	Set value	Setting necessity at GOT connection
	SW1	Selection of line processing at TCP timeout error	OFF	△
	SW2	Data code setting ^{*2}	OFF (fixed)	×
	SW3	Self start mode setting ^{*3}	ON	○
	SW4	(Must not to be used)	OFF (fixed)	×
	SW5			
	SW6			
	SW7	CPU exchange timing setting ^{*2}	OFF (fixed)	×
	SW8	Initial timing setting	OFF	△

○: Necessary △: As necessary ×: Not necessary

*2 Because port No. 5001 is fixed, these items operate at the following setting without relations to the setting given here.

- Data code setting : [Binary code]
- Enable Write at : [Enable Write at RUN time] (Writing RUN time Data is applicable while running the PLC CPU.)

*3 When SW3 is ON, the initial processing is executed regardless of the initial request signal (Y19). In addition, communication is applicable while stopping the PLC CPU. For the initial processing by using the initial request signal (Y19), refer to the following manual.

For QnA Ethernet Interface Module User's Manual

POINT

When the switch setting has been changed
Turn the PLC CPU OFF then ON again, or reset the PLC CPU.

■ [Network parameter] of GX Developer

(1) Network parameter

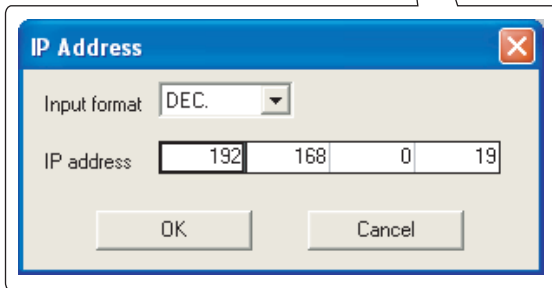
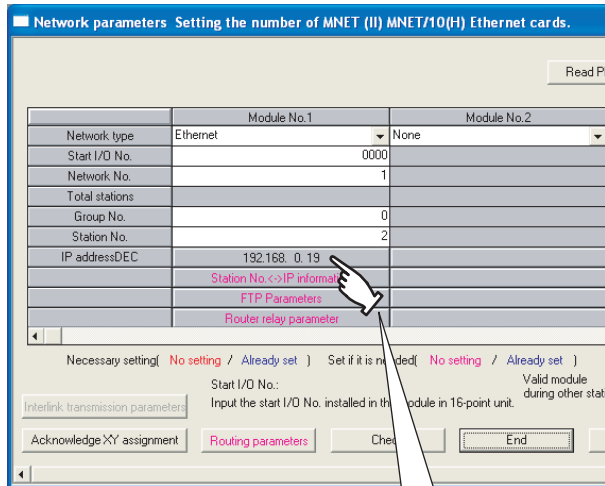

Item	Set value	Setting necessity at GOT connection
Network type	Ethernet (fixed)	○
Start I/O No.	0000H	○
Network No.*1	1	○
Group No.	0 (fixed)	○
Station No.*2	2	○
IP address	192.168.0.19	○
Station No.<->IP information	(Use default value)	×
FTP Parameters		×
Router relay parameter		×
Routing parameters	Refer to (2)	△

○: Necessary △: As necessary ×: Not necessary

- *1 Specify the same network No. as that of the GOT.
 *2 Do not set the same station No. as that of the GOT.

POINT

When changing the network parameter
 After writing the network parameter to the PLC CPU, operate the PLC CPU ether turning OFF and then ON or resetting.

(2) Routing parameter setting

Up to 64 [Transfer Network No.]s can be set. However, the same transfer network number cannot be set twice or more (multiple times). Therefore, the one that can access to other station from the request source host GOT is 64 kinds of [Transfer Network No.]s.

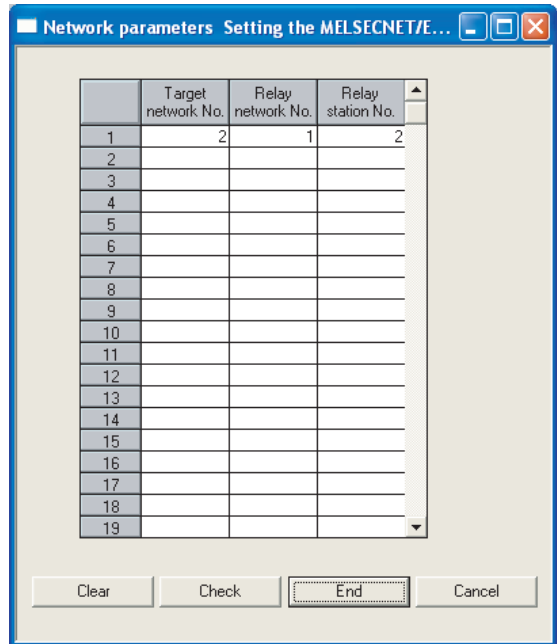

Item	Range
Target network No.	1 to 239
Relay network No.	1 to 239
Relay station No.	1 to 64

POINT

Routing parameter setting of request source
 Routing parameter setting is also necessary for the request source GOT.

For the setting, refer to the following.

☞ 8.3.4 Routing parameter setting

(3) Communication confirmation

The RDY LED on the Ethernet module turn on when the module is ready to communicate.

For confirming the communication state, refer to the following.

8.3.4 ■ Confirming the communication state of Ethernet module

AJ71QE71N3-T, AJ71QE71N-B5,
AJ71QE71N-B2, AJ71QE71N-T,
AJ71QE71N-B5T, AJ71QE71,
AJ71QE71-B5

A1SJ71QE71N3-T, A1SJ71QE71N-B5,
A1SJ71QE71N-B2, A1SJ71QE71N-T,
A1SJ71QE71N-B5T, A1SJ71QE71-B5,
A1SJ71QE71-B2

RUN	BUF1
	BUF2
RDY	BUF3
BSY	BUF4
SW.ERR.	BUF5
COM.ERR.	BUF6
CPU R/W	BUF7
	BUF8
TEST	
TEST ERR.	

RUN	BUF1
RDY	BUF2
BSY	BUF3
SW.ERR.	BUF4
COM.ERR.	BUF5
TEST	BUF6
TEST ERR.	BUF7
CPU R/W	BUF8

■ [Controller Setting] and [Ethernet] of GT Designer3

(1) Controller setting

Item	Set value (Use default value)
GOT NET No.	1
GOT PLC No.	1
GOT IP Address	192.168.0.18
GOT Port No. (Communication)	5001
GOT Port No. (Ethernet Download)	5014
Default Gateway	0.0.0.0
Subnet Mask	255.255.255.0
Retry	3times
Startup Time	3sec
Timeout Time	3sec
Delay Time	0ms

(2) Ethernet setting

Item	Set value	
Ethernet setting No.1	Host	*
	N/W No.	1
	PLC No.	2
	Type	AJ71QE71
	IP address	192.168.0.19
	Port No.	5001 (fixed)
	Communication	UDP (fixed)

POINT

[Controller Setting] and [Ethernet] of GT Designer3
For [Controller Setting] and [Ethernet] of GT Designer3, refer to the following.

8.3.1 Setting communication interface (Communication settings)

8.4.10 Connecting to Ethernet module (A Series)

This section describes the settings of the GOT and Ethernet module (A Series) in the following case of the system configuration.

POINT

Ethernet module (A Series)

For details of the Ethernet module (A Series), refer to the following manual.

For A Ethernet Interface Module User's Manual

■ System configuration

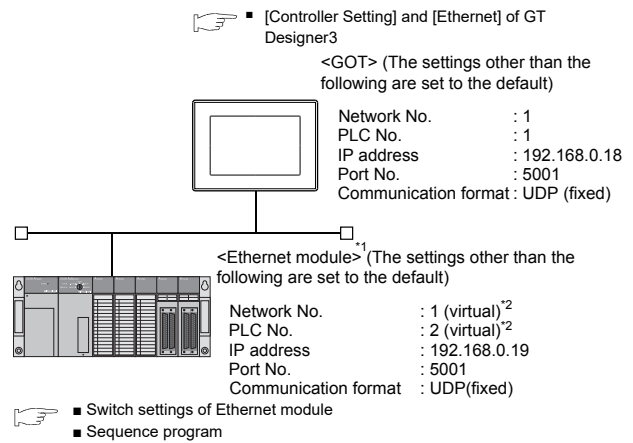

*1 The Ethernet module is mounted on the base unit slot 0.
The Start I/O No. of the Ethernet module is set to "0".

*2 These setting items do not exist at the PLC side. However, the virtual values must be set on the GOT side.

■ [Controller Setting] and [Ethernet] of GT Designer3

Switch settings of Ethernet module

Set the operation mode setting switch and exchange condition setting switch.

AJ71E71N3-T, AJ71E71N-B5,
AJ71E71N-B2, AJ71E71N-T,
AJ71E71N-B5T, AJ71E71-S3

A1SJ71E71N3-T, A1SJ71E71N-B5,
A1SJ71E71N-B2, A1SJ71E71N-T,
A1SJ71E71N-B5T, A1SJ71E71-B5-S3,
A1SJ71E71-B2-S3

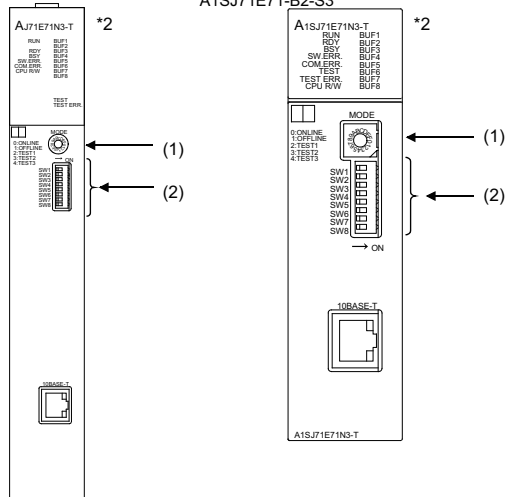

*2 The figure of AJ71E71N3-T and A1SJ71E71N3-T.

(1) Operation mode setting switch

Operation mode setting switch	Description	Set value	Setting necessity at GOT connection
	Online	0 (fixed)	○

○: Necessary △: As necessary ×: Not necessary

(2) Exchange condition setting switch*1

Exchange condition setting switch	Setting switch	Description	Set value	Setting necessity at GOT connection
	SW1	Selection of line processing at TCP timeout error	OFF	△
	SW2	Data code setting (binary code)	OFF (fixed)	○
	SW3	(Must not to be used)	OFF (fixed)	×
	SW4			
	SW5			
	SW6			
	SW7	CPU exchange timing setting (Enable write at RUN time)	ON (fixed)	○
	SW8	Initial timing setting	OFF	△

○: Necessary △: As necessary ×: Not necessary

*1 The exchange condition setting switches of A1SJ71E71-B5-S3 and A1SJ71E71-B2-S3 are specified as the below.

Exchange condition setting switch	Setting switch	Description	Set value	Setting necessity at GOT connection
	SW1	Selection of line processing at TCP timeout error	OFF	△
	SW2	Data code setting (binary code)	OFF (fixed)	○
	SW3	CPU exchange timing setting (Enable write at RUN time)	ON (fixed)	○
	SW4	Initial timing setting	OFF	△

○: Necessary △: As necessary ×: Not necessary

POINT

When the switch setting has been changed
Turn the PLC CPU OFF then ON again, or reset the PLC CPU.

1 PREPARATORY PROCEDURES FOR MONITORING

2 DEVICE RANGE THAT CAN BE SET

3 ACCESS RANGE FOR MONITORING

4 HOW TO MONITOR REDUNDANT SYSTEM

5 BUS CONNECTION

6 DIRECT CONNECTION TO CPU

7 COMPUTER LINK CONNECTION

8 ETHERNET CONNECTION

■ Sequence program

The sequence program for initial processing and communication line opening processing are required.

(1) Programming condition

This program performs the initial processing of the Ethernet module and the opening processing of connection No. 1 when the stopping PLC CPU starts running.

(a) I/O signal of Ethernet module

 For A Ethernet Interface Module User's Manual

(b) Device used by user

Device	Application
M102	COM.ERR turned off command
D100	IP address of Ethernet module
D110	Application setting
D111	Port No. of Ethernet module
D112 to D113	IP address of GOT
D114	Port No. of GOT
D200	Initial fault code

(c) Buffer memory settings used in the present example

Buffer memory address	Item	Set value
Dec (Hex)		
0 to 1 (0 to 1H)	IP address of Ethernet module	C0A80013H (192.168.0.19)
16 (10H)	Application setting ^{*1}	100H
24 (18H)	Port No. of Ethernet module	5001
25 to 26 (19 to 1AH)	IP address of GOT	FFFFFFFFH
27 (1BH)	Port No. of GOT	FFFFH (fixed)
80 (50H)	Initial fault code	—

^{*1} The details of the application setting are shown below. Settings 1), 2) and 3) can be changed by the user. 4), 5) and 6) are fixed.

b15	b14	b13	b12	b11	b10	b9	b8	b7	b6	b5	b4	b3	b2	b1	b0
0	0	0	0	0	0	0	1	0	0	0	0	0	0	0	0
6)						5) 4) 3)			2) 1)						

- 1) Fixed buffer application
0: For sending; no exchange
1: For receiving
- 2) Existence check
0: No
1: Yes
- 3) Pairing open
0: No
1: Yes
- 4) Communication format (Set to "1" (UDP/IP).)
0: TCP/IP
1: UDP/IP
- 5) Fixed buffer exchange (Set to "0" (With procedure).)
0: With procedure
1: Without procedure
- 6) Open method (Set to "00" (Active, UDP/IP).
00: Active, UDP/IP
10: Unpassive
11: Fullpassive

(2) Example of sequence program

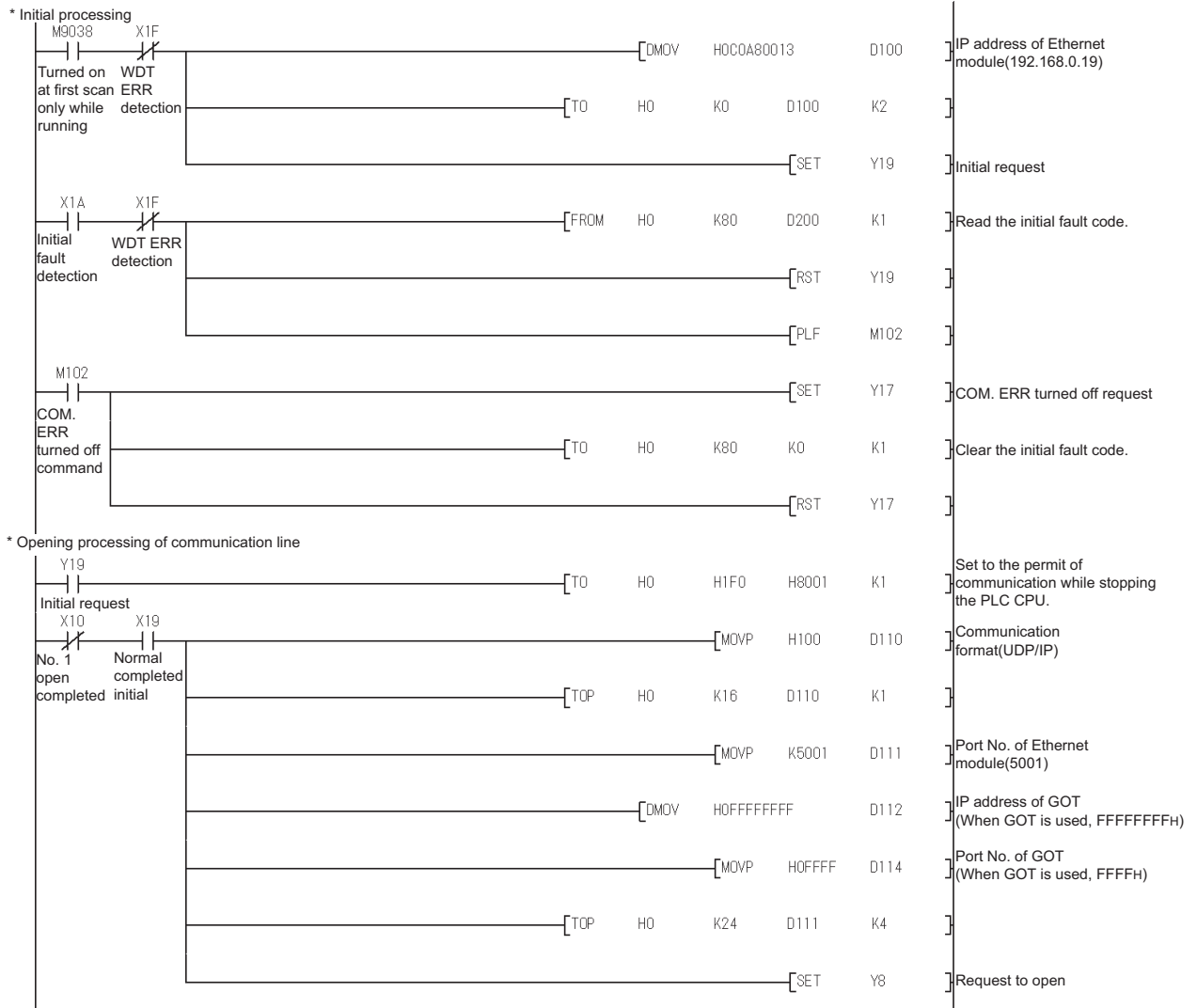

1 PREPARATORY PROCEDURES FOR MONITORING
 2 DEVICE RANGE THAT CAN BE SET
 3 ACCESS RANGE FOR MONITORING
 4 HOW TO MONITOR REDUNDANT SYSTEM
 5 BUS CONNECTION
 6 DIRECT CONNECTION TO CPU
 7 COMPUTER LINK CONNECTION
 8 ETHERNET CONNECTION

POINT

When changing the sequence program

After writing the sequence program to the PLC CPU, operate the PLC CPU either turning OFF and then ON or resetting.

(3) Communication confirmation

The RDY LED on the Ethernet module turn on when the module is ready to communicate.

For confirming the communication state, refer to the following.

 8.4.7 ■Confirming the communication state of Ethernet module

The BUF1 LED turns on when the opening processing of the connection No. 1 is completed in normal at executing of the sequence program example described at (2).

AJ71E71N3-T, AJ71E71N-B5, AJ71E71N-B2, AJ71E71N-T, AJ71E71N-B5T, AJ71E71-S3

A1SJ71E71N3-T, A1SJ71E71N-B5, A1SJ71E71N-B2, A1SJ71E71N-T, A1SJ71E71N-B5T, A1SJ71E71-B5-S3, A1SJ71E71-B2-S3

RUN	BUF1
	BUF2
RDY	BUF3
BSY	BUF4
SW.ERR.	BUF5
COM.ERR.	BUF6
CPU R/W	BUF7
	BUF8
TEST	
TEST ERR.	

RUN	BUF1
RDY	BUF2
BSY	BUF3
SW.ERR.	BUF4
COM.ERR.	BUF5
TEST	BUF6
TEST ERR.	BUF7
CPU R/W	BUF8

■ [Controller Setting] and [Ethernet] of GT Designer3

(1) Controller setting

Item	Set value (Use default value)
GOT NET No.	1
GOT PLC No.	1
GOT IP Address	192.168.0.18
GOT Port No. (Communication)	5001
GOT Port No. (Ethernet Download)	5014
Default Gateway	0.0.0.0
Subnet Mask	255.255.255.0
Retry	3times
Startup Time	3sec
Timeout Time	3sec
Delay Time	0ms

(2) Ethernet setting

Item		Set value
Ethernet setting No.1	Host	*
	N/W No.	1
	PLC No.	2
	Type	AJ71E71
	IP address	192.168.0.19
	Port No.	5001
	Communication	UDP (fixed)

POINT

[Controller Setting] and [Ethernet] of GT Designer3

For [Controller Setting] and [Ethernet] of GT Designer3, refer to the following.

 8.3.1 Setting communication interface (Communication settings)

8.4.11 Connecting to Ethernet module (FX Series)

This section describes the settings of the GOT and Ethernet module (FX Series) in the following case of the system configuration.

POINT

Ethernet module (FX Series)

For details of the Ethernet module (FX Series), refer to the following manual.

- ☞ FX3U-ENET-L User's manual
- ☞ FX3U-ENET User's manual
- ☞ FX3U-ENET-ADP User's manual

System configuration

- ☞ ■ [Controller Setting] and [Ethernet] of GT Designer3

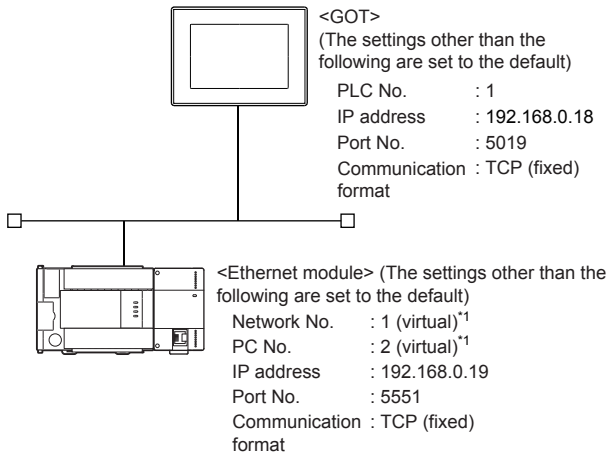

- ☞ ■ Ethernet parameter settings of FX Configurator-EN-L and FX Configurator-EN

*1 These setting items do not exist at the PLC side. However, the virtual values must be set on the GOT side.

- ☞ ■ [Controller Setting] and [Ethernet] of GT Designer3

Ethernet parameter settings of FX Configurator-EN-L and FX Configurator-EN

(1) Ethernet settings

Set the Ethernet parameter using FX Configurator-EN-L or FX Configurator-EN.

For using FX3U-ENET-L Configuration tool, install GX Developer Ver. 8.88S or later on the personal computer.
For using FX Configurator-EN, install GX Developer Ver. 8.25B or later on the personal computer.

For the details of the engineering tools, refer to the following manuals.

- ☞ FX3U-ENET-L Configuration tool
- ☞ FX Configurator-EN Operation manual

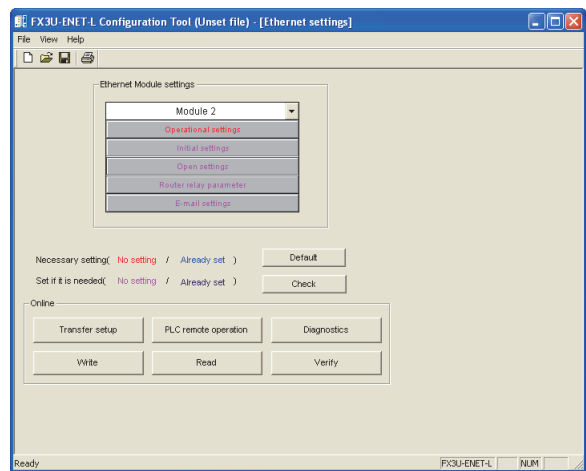

Item	Setting	Setting (with GOT connected)
Module	Module 0*1	○
Operational settings	Refer to (2)	○
Initial settings	(Use default value.)	×
Open settings	Refer to (3)	○
Router relay parameter	(Use default value.)	×
E-mail settings		×

○:Required △:Set if necessary ×:Not required

*1 Set the number of the Ethernet module.

1 PREPARATORY PROCEDURES FOR MONITORING
 2 DEVICE RANGE THAT CAN BE SET
 3 ACCESS RANGE FOR MONITORING
 4 HOW TO MONITOR REDUNDANT SYSTEM
 5 BUS CONNECTION
 6 DIRECT CONNECTION TO CPU
 7 COMPUTER LINK CONNECTION
 8 ETHERNET CONNECTION

(2) Operational settings

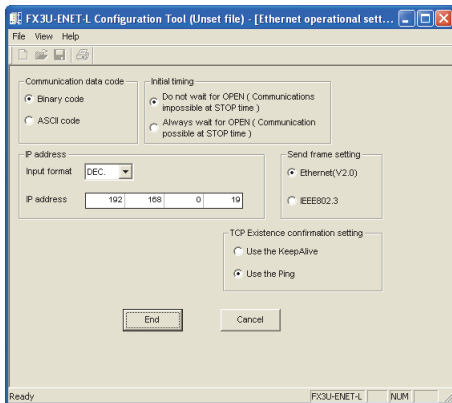

Item	Setting	Setting (with GOT connected)
Communication data code*1	(Use default value.)	×
IP address	192.168.0.19	○
Initial timing*1	(Use default value.)	×
Send frame setting		×
TCP Existence confirmation setting		×

○:Required △:Set if necessary ×:Not required

- *1 Because the port No. 5551 is fixed, the GOT operates as follows, regardless of the setting for the item.
 - Communication data code : [Binary code]
 - Initial timing : [Always wait for OPEN] (Communications are enabled while the programmable controller CPU stops.)
- *2 The default value of IP address is 192.168.1.254. Set the IP address corresponding to the system configuration.

POINT

When changing Ethernet parameter
After writing the Ethernet parameter to the programmable controller CPU, turn off and then on, or reset the programmable controller CPU.

(3) Open settings

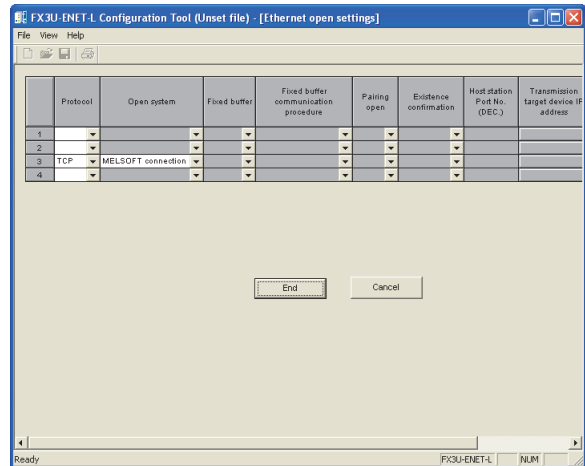

Item	Setting	Setting (with GOT connected)
Protocol	TCP	○
Open system	MELSOFT connection	○
Fixed buffer	(Use default value.)	×
Fixed buffer communication procedure		×
Pairing open		×
Existence confirmation		×
Host station Port No. (DEC.)		×
Transmission target device IP address		×
Transmission target device Port No. (DEC.)		×

○:Required △:Set if necessary ×:Not required

POINT

When connecting to multiple GOTs and peripheral devices
The number of protocols equivalent to that of the GOTs and devices must be set.

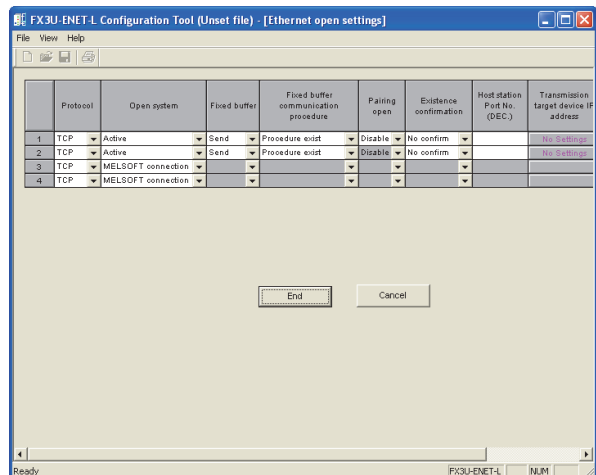

■ Ethernet parameter settings of FX3U-ENET-ADP

(1) Ethernet settings

Set the Ethernet parameter at [FX Parameter] on GX Works2.

To set FX3U-ENET-ADP, GX Works2 Ver.1.90U or later is required.

For details on the setting of FX3U-ENET-ADP, refer to the following manual.

 [FX3U-ENET-ADP User's Manual](#)

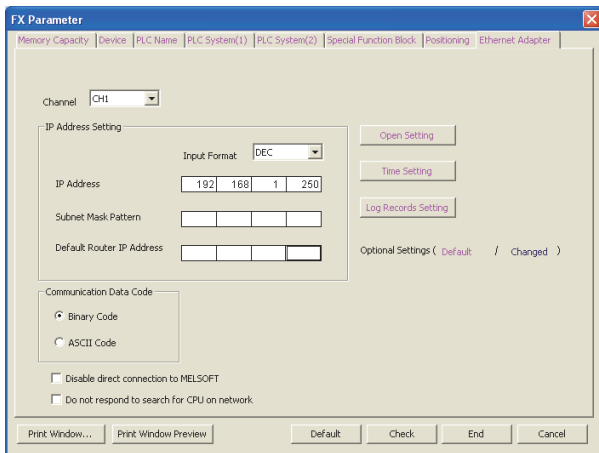

Item	Setting	Setting (with GOT connected)
Channel	CH1 or CH2 ^{*1}	×
IP Address	192.168.1.250 ^{*2}	○
Open Settings	Refer to (2).	○
Communication Data Code	(Use default value.)	×
Disable direct connection to MELSOFT		×
Do not respond to search for CPU on network		×

○:Required △:Set if necessary ×:Not required

*1 Set a channel according to the installation position of FX3U-ENET-ADP on the CPU body.

*2 The default value of IP address is 192.168.1.250. Set the IP address corresponding to the system configuration.

POINT

When changing Ethernet parameter

After writing Ethernet parameters to the PLC CPU, turn the PLC CPU OFF then back ON again.

(2) Open settings

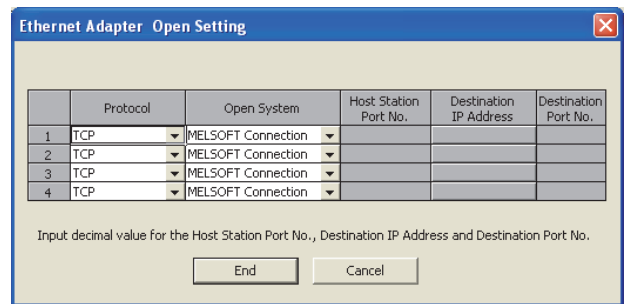

Item	Setting	Setting (with GOT connected)
Protocol	TCP	○
Open System	MELSOFT connection	○

POINT

When connecting to multiple GOTs and peripheral devices

The number of protocols equivalent to that of the GOTs and devices must be set.

■ [Controller Setting] and [Ethernet] of GT Designer3

(1) Controller setting

Item	Setting (Use default value.)
GOT NET No.	1
GOT PLC No.	1
GOT IP Address	192.168.0.18
GOT Port No. (Communication)	5019
GOT Port No. (Ethernet Download)	5014
Default Gateway	0.0.0.0
Subnet Mask	255.255.255.0
Retry	3times
Startup Time	3sec
Timeout Time	3sec
Delay Time	0ms

(2) Ethernet setting

Item	Setting	
Ethernet setting No.1	Host	*
	N/W No.	1
	PLC No.	2
	Type	FX (fixed)
	IP address	192.168.0.19 ^{*1}
	Port No.	5551 ^{*2}
	Communication	TCP (fixed)

*1 Set the value according to the IP address of the connected PLC.

*2 Set the value according to the Port No. of the connected PLC.

For details, refer to the following.

 8.3.3 Ethernet setting

POINT

[Controller Setting] and [Ethernet] of GT Designer3

For [Controller Setting] and [Ethernet] of GT Designer3, refer to the following.

 8.3.1 Setting communication interface (Communication settings)

■ Confirming the communication state of Ethernet module

(1) When using the Command Prompt of Windows®. Execute a Ping command at the Command Prompt of Windows®.

(a) When normal communication

C:\>Ping 192.168.0.19

Reply from 192.168.0.19: bytes=32 time<1ms TTL=64

(b) When abnormal communication

C:\>Ping 192.168.0.19

Request timed out.

(2) When abnormal communication

At abnormal communication, check the followings and execute the Ping command again.

- Mounting condition of Ethernet communication unit
- Cable connecting condition
- Confirmation of switch and network parameter setting
- Operation state of PLC CPU (faulty or not)
- IP address of GOT specified by Ping command

POINT

Ethernet diagnostics of FX Configurator-EN-L and FX Configurator-EN

Ethernet diagnostics of FX Configurator-EN-L and FX Configurator-EN are available to a Ping test from the PLC.

For details of Ethernet diagnostics of the engineering tools, refer to the following manuals.

 FX3U-ENET-L Configuration tool

 FX Configurator-EN Operation manual

8.4.12 Connecting to Built-in Ethernet port FXCPU (FX3GE)

This section describes the settings of the GOT and Ethernet module (FX Series) in the following case of the system configuration.

POINT

FX3GE

For details of the FX3GE, refer to the following manual.

FX3GE SERIES PROGRAMMABLE CONTROLLERS HARDWARE MANUAL

System configuration

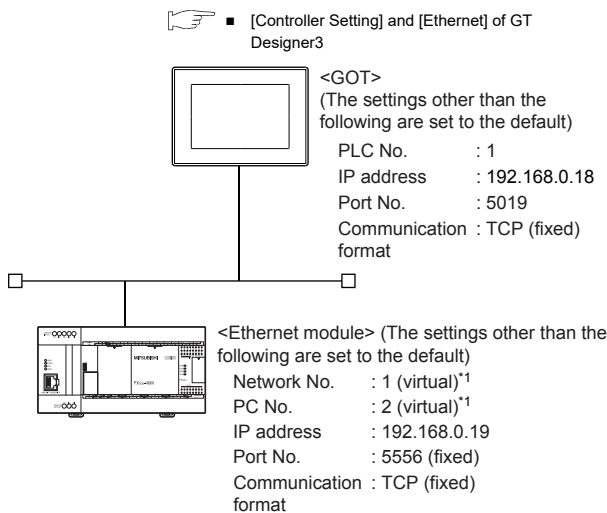

■ Ethernet parameter settings of FX3GE

*1 These setting items do not exist at the PLC side. However, the virtual values must be set on the GOT side.

■ [Controller Setting] and [Ethernet] of GT Designer3

Ethernet parameter settings of FX3GE

(1) Ethernet settings

Set the Ethernet parameter at [FX Parameter] on GX Works2.

To set FX3GE, GX Works2 Ver.1.91V or later is required. For details on the setting of FX3GE, refer to the following manual.

FX3GE SERIES PROGRAMMABLE CONTROLLERS HARDWARE MANUAL

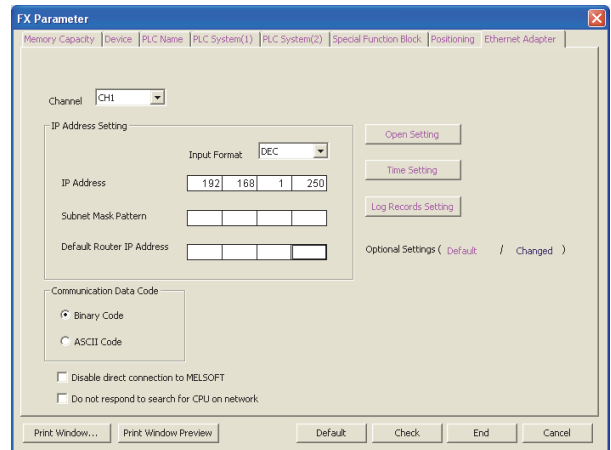

Item	Setting	Setting (with GOT connected)
Channel	CH1	×
IP Address	192.168.1.250*1	○
Open Setting	Refer to (2).	○
Communication Data Code		×
Disable direct connection to MELSOFT	(Use default value.)	×
Do not respond to search for CPU on network		×

○:Required △:Set if necessary ×:Not required

*1 The default value of IP address is 192.168.1.250. Set the IP address corresponding to the system configuration.

POINT

When changing Ethernet parameter
After writing Ethernet parameters to the PLC CPU, turn the PLC CPU OFF then back ON again.

1 PREPARATORY PROCEDURES FOR MONITORING
 2 DEVICE RANGE THAT CAN BE SET
 3 ACCESS RANGE FOR MONITORING
 4 HOW TO MONITOR REDUNDANT SYSTEM
 5 BUS CONNECTION
 6 DIRECT CONNECTION TO CPU
 7 COMPUTER LINK CONNECTION
 8 ETHERNET CONNECTION

(2) Open settings

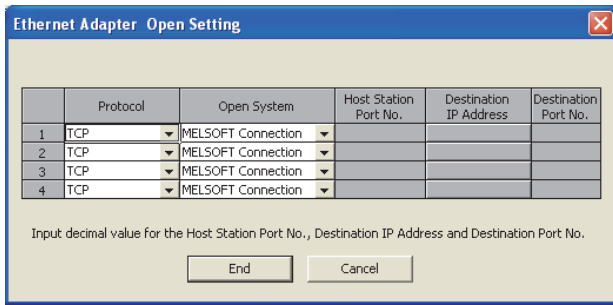

Item	Setting	Setting (with GOT connected)
Protocol	TCP	<input type="radio"/>
Open System	MELSOFT connection	<input type="radio"/>

POINT

When connecting to multiple GOTs and peripheral devices
 The number of protocols equivalent to that of the GOTs and devices must be set.

■ [Controller Setting] and [Ethernet] of GT Designer3

(1) Controller setting

Item	Setting (Use default value.)
GOT NET No.	1
GOT PLC No.	1
GOT IP Address	192.168.0.18
GOT Port No. (Communication)	5019
GOT Port No. (Ethernet Download)	5014
Default Gateway	0.0.0.0
Subnet Mask	255.255.255.0
Retry	3times
Startup Time	3sec
Timeout Time	3sec
Delay Time	0ms

(2) Ethernet setting

Item	Setting	
Ethernet setting No.1	Host	*
	N/W No.	1 (Use default value.)
	PLC No.	2
	Type	FX (fixed)
	IP address	192.168.0.19 ^{*1}
	Port No.	5556 ^{*2}
	Communication	TCP (fixed)

*1 Set the value according to the IP address of the connected PLC.

*2 Set the value according to the Port No. of the connected PLC.

For details, refer to the following.

8.3.3 Ethernet setting

POINT

[Controller Setting] and [Ethernet] of GT Designer3

For [Controller Setting] and [Ethernet] of GT Designer3, refer to the following.

8.3.1 Setting communication interface (Communication settings)

■ Confirming the communication state of Ethernet module

(1) When using the Command Prompt of Windows®. Execute a Ping command at the Command Prompt of Windows®.

- (a) When normal communication
 C:\>Ping 192.168.0.19
 Reply from 192.168.0.19: bytes=32 time<1ms TTL=64
- (b) When abnormal communication
 C:\>Ping 192.168.0.19
 Request timed out.

(2) When abnormal communication
 At abnormal communication, check the followings and execute the Ping command again.

- Mounting condition of Ethernet communication unit
- Cable connecting condition
- Confirmation of switch and network parameter setting
- Operation state of PLC CPU (faulty or not)
- IP address of GOT specified by Ping command

8.4.13 Connecting to Display I/F (CNC C70)

This section describes the settings of the GOT and Display I/F (CNC C70) in the following case of the system configuration.

POINT

Display I/F (CNC C70)

For details of the Display I/F (CNC C70), refer to the following manual.

C70 Series SET UP MANUAL

■ System configuration

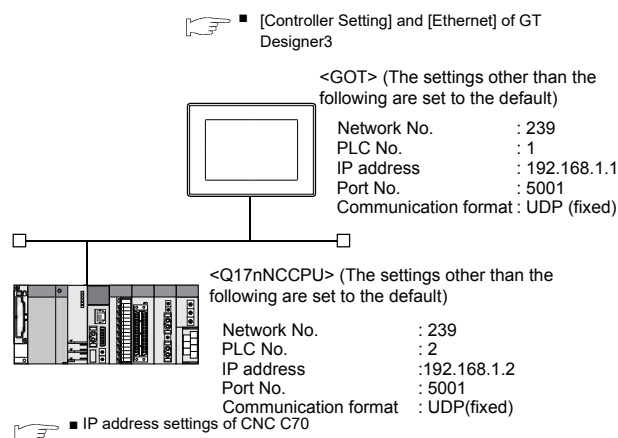

■ IP address settings of CNC C70

(1) Remote monitor tool

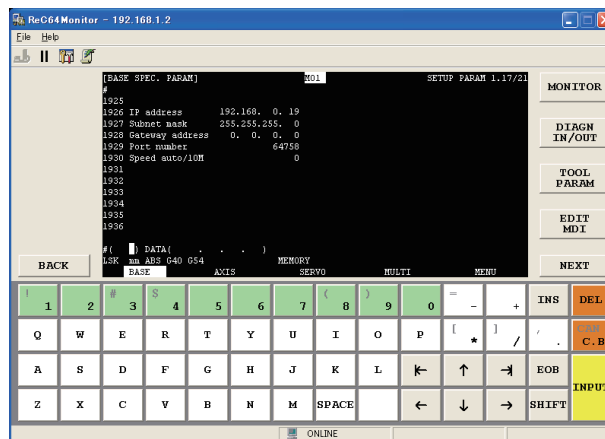

Item	Set value	Setting necessity at GOT connection
IP address	192.168.1.2	○
Subnet mask	255.255.255.0	○
Gateway address	0.0.0.0	○
Port number	64758 (fixed)	○
Speed auto/10M	0 (fixed)	○

○: Necessary △: As necessary ×: Not necessary

(2) CNC monitor

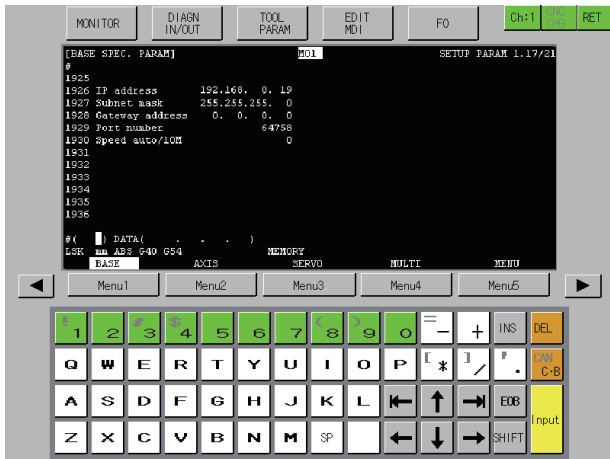

Item	Set value	Setting necessity at GOT connection
IP address	192.168.1.2	○
Subnet mask	255.255.255.0	○
Gateway address	0.0.0.0	○
Port number	64758 (fixed)	○
Speed auto/10M	0 (fixed)	○

○: Necessary △: As necessary ×: Not necessary

(3) Communication check

The CNC C70 can communicate with the GOT when INIT.LED of the CNC C70 is lit. For confirming the communication state, refer to the following.

■ Checking communication state of CNC C70

■ [Controller Setting] and [Ethernet] of GT Designer3

(1) Controller setting

Item	Set value (Use default value)
GOT NET No.	1
GOT PLC No.	1
GOT IP Address	192.168.1.1
GOT Port No. (Communication)	5001
GOT Port No. (Ethernet Download)	5012
Default Gateway	0.0.0.0
Subnet Mask	255.255.255.0
Retry	3times
Startup Time	3sec
Timeout Time	3sec
Delay Time	0ms

(2) Ethernet setting

Item	Set value
Host	*
N/W No.	239
PLC No.	2
Type	Q17nNC
IP address	192.168.1.2
Port No.	5001 (fixed)
Communication	UDP (fixed)

POINT

[Controller Setting] and [Ethernet] of GT Designer3 For [Controller Setting] and [Ethernet] of GT Designer3, refer to the following.

8.3.1 Setting communication interface (Communication settings)

■ Checking communication state of CNC C70

(1) When using the Command Prompt of Windows®. Execute a Ping command at the Command Prompt of Windows®.

- (a) When normal communication
C:\>Ping 192.168.0.19
Reply from 192.168.0.19: bytes=32 time<1ms TTL=64
- (b) When abnormal communication
C:\>Ping 192.168.0.19
Request timed out.

(2) When abnormal communication At abnormal communication, check the followings and execute the Ping command again.

- Mounting condition of CNC C70
- Cable connecting condition
- Switch settings and network parameter settings
- Operation state of PLC CPU (faulty or not)
- IP address of the CNC C70 specified for the Ping command

8.4.14 Connecting to CC-Link IE Field Network Ethernet Adapter Module

This section describes the settings of the GOT, Ethernet adapter module and the PLC in the following system configuration.

System configuration

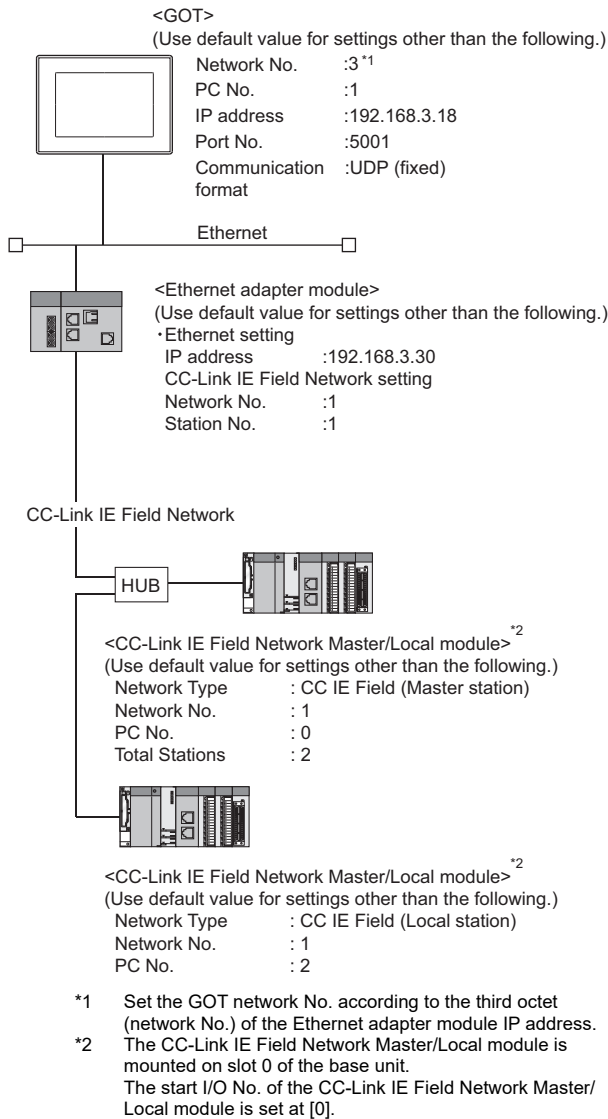

GX Works2 network parameter Ethernet/CC IE/MELSECNET

For details of the setting contents of PLC side, refer to the following manual.

MELSEC-Q CC-Link IE Field Network Master/Local Module User's Manual

(1) Network Type, Network No., Total Stations setting Example: Master station setting

	Module 1	Module 2
Network Type	CC IE Field (Master Station)	None
Start I/O No.	0000	
Network No.	1	
Total Stations	2	
Group No.		
Station No.	0	
Mode	Online (Normal Mode)	
	Network Configuration Setting	
	Network Operation Setting	
	Refresh Parameters	
	Interrupt Setting	
	Specify Station No. by Parameter	

Item	Set value	
	Master station	Local station
Network type	CC IE Field (Master station)	CC IE Field (Local station)
Network No.	1	1
Total Stations	2	-
Station No.	0 (fixed)	2

(2) Routing parameter setting

Set the followings as necessary.

Up to 64 [Transfer Network No.]s can be set.

However, the same transfer network number cannot be set twice or more (multiple times).

Therefore, the one that can access to other station from the request source host GOT is 64 kinds of [Transfer Network No.]s.

	Target Network No.	Relay Network No.	Relay Station No.
1			
2			
3			
4			
5			
6			
7			
8			
9			
10			
11			
12			
13			
14			
15			
16			
17			
18			
19			

Item	Range
Transfer Network No.	1 to 239
Relay Network No.	1 to 239
Relay Station No.	1 to 64

1 PREPARATORY PROCEDURES FOR MONITORING
 2 DEVICE RANGE THAT CAN BE SET
 3 ACCESS RANGE FOR MONITORING
 4 HOW TO MONITOR REDUNDANT SYSTEM
 5 BUS CONNECTION
 6 DIRECT CONNECTION TO CPU
 7 COMPUTER LINK CONNECTION
 8 ETHERNET CONNECTION

■ Ethernet Adapter Module setting

Set the parameter with the Ethernet adapter module setting tool.

For details of the setting method, refer to the following manual.

 CC-Link IE Field Network Ethernet Adapter Module User's Manual

(1) CC-Link IE Field Network setting

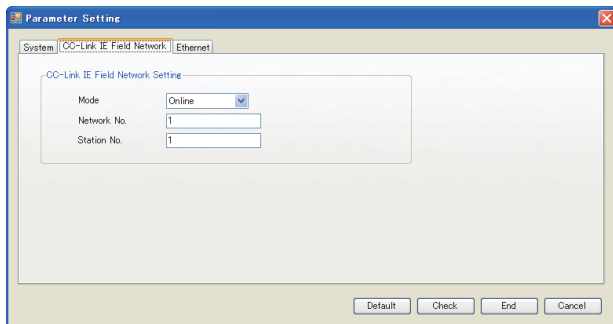

Item	Set value
Network No.	1 ^{*1}
Station No.	1 ^{*2}

- *1 Set the same value as the network No. set on the PLC side.
 *2 Set a value other than the network No. set on the PLC side.

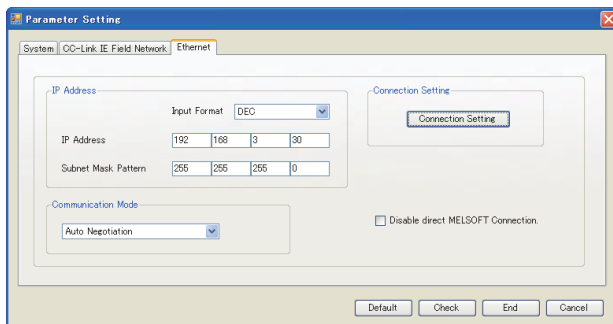

(2) Ethernet setting



Item	Set value
IP address	192.168.3.30 ^{*1}

- *1 Set the IP address within the following range.

192.168.3.30

-  Set the third octet within the range from 1 to 239.
 Set the fourth octet within the range from 1 to 64.

■ [Controller Setting] and [Ethernet] of GT Designer3

POINT

[Controller Setting] and [Ethernet] of GT Designer3
 For [Controller Setting] and [Ethernet] of GT Designer3, refer to the following.

 8.3.1 Setting communication interface (Communication settings)

(1) Controller setting

Item	Set value (Use default value)
GOT NET No.	3 ^{*1}
GOT PC No.	1
GOT IP Address	192.168.3.18
GOT Port No. (Communication)	5001
GOT Port No. (Ethernet Download)	5014
Default Gateway	0.0.0.0
Subnet Mask	255.255.255.0
Retry	3 times
Startup Time	3 sec
Timeout Time	3 sec
Delay Time	0ms

- *1 Set the GOT network No. according to the third octet (network No.) of the Ethernet adapter module IP address.

(2) Ethernet setting

Item	Set value	
Ethernet Setting No.1	Host	*
	N/W No.	3 ^{*1}
	PC No.	30 ^{*2}
	Type	NZ2GF-ETB
	IP address	192.168.3.30 ^{*3}
	Port No.	5001(fixed)
Communication	UDP(fixed)	

- *1 Set according to the third octet (network No.) of the Ethernet adapter module IP address.
 *2 Set according to the fourth octet (PC No.) of the Ethernet adapter module IP address.
 *3 Set according to the Ethernet adapter module IP address.

(3) Routing parameter setting

Item	Set value
Transfer Network No.	1 ^{*1}
Relay Network No.	3 ^{*2}
Relay Station No.	30 ^{*3}

- *1 Set the same value as the Ethernet adapter module network No.
 *2 Set according to the third octet (network No.) of the Ethernet adapter module IP address.
 *3 Set according to the fourth octet (PC No.) of the Ethernet adapter module IP address.

8.4.15 Connecting to PERIPHERAL I/F (Built-in Ethernet port Motion Controller CPU)

This section describes the settings of the GOT and Built-in Ethernet port Motion Controller CPU in the following case of system configuration.

POINT

- (1) GOT type setting
For details, refer to the following.
 - ☞ 1.1.1 Setting connected equipment (Channel setting)
 - (2) Setting [Controller Type]
- (2) CPU No. specification of Q170MCPUCPU
Set whether to monitor the PLC CPU area or the Motion CPU area of Q170MCPUCPU, in the CPU No. specification. For details, refer to the following.
 - ☞ 8.5 Precautions
- (3) PLC type of GX Works2/GX Developer
When creating a program, set the following PLC type:
 - For Q173D(S)CPU/Q172D(S)CPU QnUD(E)(H)CPU
 - For Q170MCPUCPU Q03UDCPU
- (4) Built-in Ethernet port CPU
For details of Built-in Ethernet port CPU, refer to the following manual.
 - ☞ User's Manual of Q173D(S)CPU/ Q172D(S)CPU and Q170MCPUCPU

System configuration

Leave the Built-in Ethernet port Motion Controller CPU settings as default in the following system configuration.

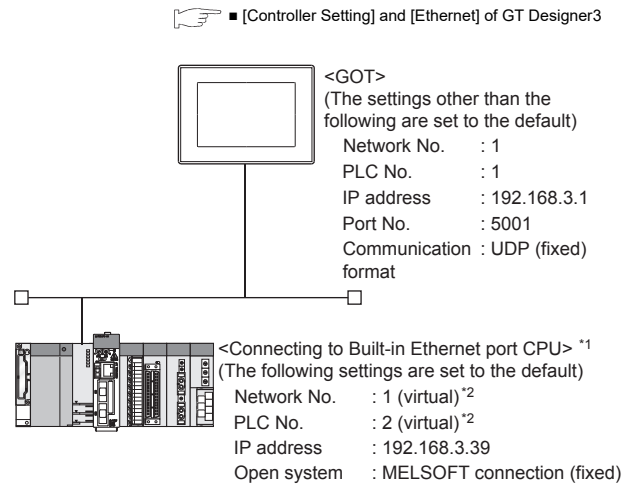

*1 For the settings when using system devices including a hub and a transceiver, refer to the following.

☞ 8.4.6 Connecting to Built-in Ethernet port CPU (multiple connection)

*2 These setting items do not exist at the PLC side. However, the virtual values must be set on the GOT side.

☞ ■ [Controller Setting] and [Ethernet] of GT Designer3

Basic setting of MT Works2

Use the default values of the basic setting for the system configuration above.

(1) Built-in Ethernet port

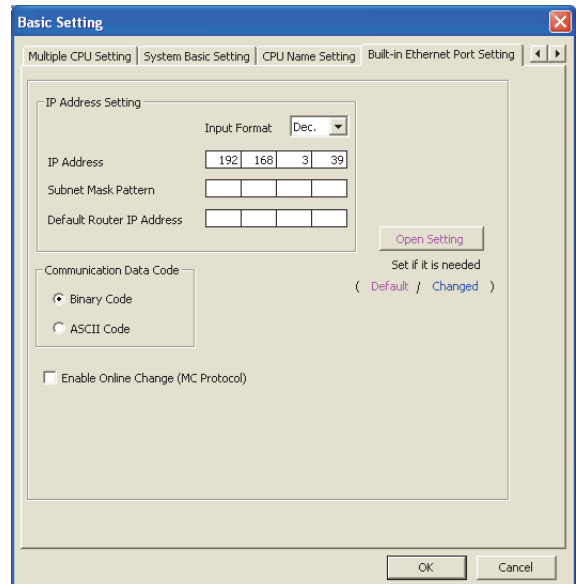

Item	Set value	Setting necessity at GOT connection
IP address	192.168.3.39 (Default)	○
Subnet mask pattern	-	×
Default router IP address	-	×

Item	Set value	Setting necessity at GOT connection
Communication data code	(Use default value)	△
Enable online change (MC protocol)		△
Open settings	Refer to (2)	○

○: Necessary △: As necessary ×: Not necessary

(2) Open settings

The setting is required for all the connected GOTs.

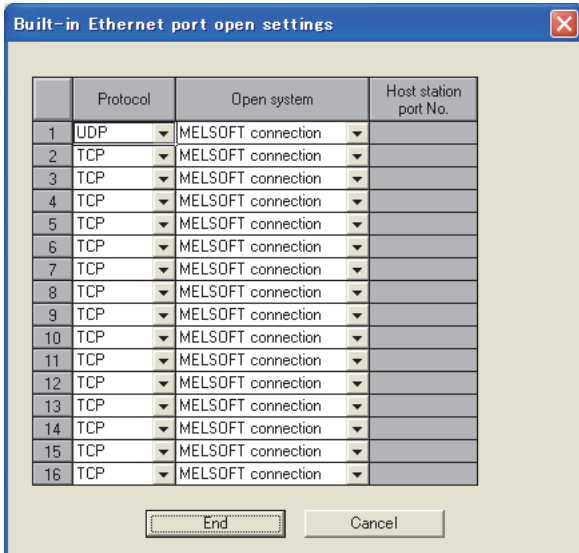

Item	Set value
Protocol	UDP (fixed)
Open system	MELSOFT connection (fixed)
Host station port No.	-

■ [Controller Setting] and [Ethernet] of GT Designer3

POINT

- (1) [Controller Setting] and [Ethernet] of GT Designer3
For [Controller Setting] and [Ethernet] of GT Designer3, refer to the following.

☞ 8.3.1 Setting communication interface (Communication settings)

- (2) Ethernet setting
The settings items for the network No. and station No. do not exist at the Built-in Ethernet port Motion Controller CPU side. However, these virtual values must be set on the GOT side. Therefore, set the network No. and station No. on the GOT side. Set the network No. that is not existed on the network system and any station No..

(3) Controller setting

Item	Setting (Use default value.)
GOT NET No.	1
GOT PC No.	1
GOT IP Address	192.168.3.1
GOT Port No. (Communication)	5001
GOT Port No. (Ethernet Download)	5014
Default Gateway	0.0.0.0
Subnet Mask	255.255.255.0
Retry	3times
Startup Time	3 sec
Timeout time	3 sec
Delay Time	0ms

(4) Ethernet setting

Item	Set value	
Ethernet setting No.1	Host	*
	N/W No.	1 ^{*1}
	PC No.	2 ^{*2}
	Type	QnUDE(H)
	IP address	192.168.3.39 ^{*3}
	Port No.	5006 (fixed)
	Communication	UDP (fixed)

*1 Set the same value as that of GOT N/W No.

*2 Set a value different from that of GOT PLC No.

*3 Set it to the IP address value of the Built-in Ethernet port Motion Controller CPU side.

■ Checking communication state of Connecting to Built-in Ethernet port CPU



- (1) When using the Command Prompt of Windows®
Execute a Ping command at the Command Prompt of Windows®.

- (a) When normal communication
C:\>Ping 192.168.3.39
Reply from 192.168.3.2: bytes=32 time <10ms TTL=32
- (b) When abnormal communication
C:\>Ping 192.168.3.39
Request timed out.

- (2) When abnormal communication
At abnormal communication, check the followings and execute the Ping command again.
 - Cable connecting condition
 - Confirmation of switch and network parameter setting
 - Operation state of PLC CPU (faulty or not)
 - The IP address of Built-in Ethernet port CPU specified in the Ping command

POINT

Ethernet diagnostics of GX Works2/GX Developer
Ethernet diagnostics of GX Works2/GX Developer is available to a Ping test from the PLC.
For details of Ethernet diagnostics of GX Works2/GX Developer, refer to the following manual.

-  GX Works2 Version1 Operating Manual (Common)
-  GX Developer Version8 Operating Manual

1	PREPARATORY PROCEDURES FOR MONITORING
2	DEVICE RANGE THAT CAN BE SET
3	ACCESS RANGE FOR MONITORING
4	HOW TO MONITOR REDUNDANT SYSTEM
5	BUS CONNECTION
6	DIRECT CONNECTION TO CPU
7	COMPUTER LINK CONNECTION
8	ETHERNET CONNECTION

8.5 Precautions

■ Connection to QnA (S) CPU type

Use B or a later function version of Ethernet module (QnA Series) and PLC CPU (QnA/QnASCPU type).

■ Connection to QSCPU

The GOT can only read device data and sequence programs by the ladder monitor function in the QSCPU. The GOT cannot write any data to the QSCPU.

■ Connection to Q170MCP

Set [CPU No.] to "2" in the device setting to monitor the device of the Motion CPU area (CPU No.2).

When the CPU No. is set to "1", the device on the PLC CPU area (CPU No.1) is monitored.

When the CPU No. is set to "0", the monitoring target differs depending on the GOT connection destination. Refer to the following.

GOT connection destination	Monitoring target
QJ71E71 module	PLC CPU area (CPU No.1)
PERIPHERAL I/F	Motion CPU area (CPU No.2)

When the CPU No. is set to the number other than "0" to "2", a communication error occurs and the monitoring cannot be executed.

For setting the CPU No., refer to the following manual.

GT Designer3 Version□ Screen Design Manual

Example) Setting dialog box of the bit device

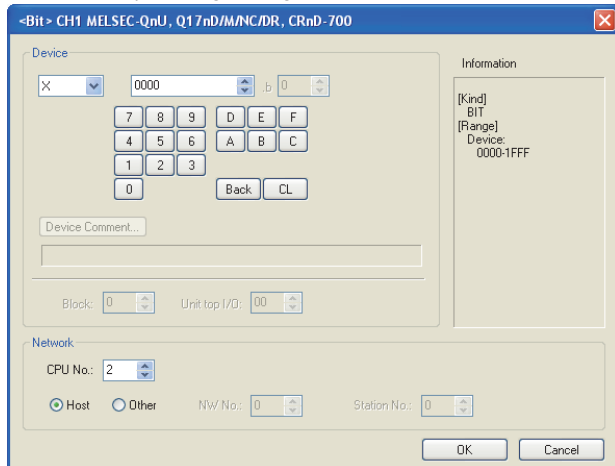

■ Connection in the multiple CPU system

When the GOT is connected to multiple CPU system, the following time is taken until when the PLC runs.

QCPU (Q mode), motion controller CPU (Q series): 10 seconds or more

MELDAS C70: 18 seconds or more

When the GOT starts before the PLC runs, a system alarm occurs. Adjust the opening screen time in the GOT setup so that no system alarm occurs.

GT Designer3 Version□ Screen Design Manual

■ Connection to LCP

LCP may diagnose (check file system, recovering process, etc.) the SD memory card when turning on the power or when resetting. Therefore, it takes time until the SD memory card becomes available. When the GOT starts before the SD card becomes available, a system alarm occurs. Adjust the opening screen time in the GOT setup so that no system alarm occurs.

GT Designer3 Version□ Screen Design Manual

■ When connecting to multiple GOTs

(1) Setting PLC No.

When connecting two or more GOTs in the Ethernet network, set each [PLC No.] to the GOT.

8.3.1 Setting communication interface (Communication settings)

(2) Setting IP address

Do not use the IP address "192.168.0.18" when using multiple GOTs.

A communication error may occur on the GOT with the IP address.

(3) Setting for starting up multiple GOTs simultaneously (When connected to Built-in Ethernet port CPU)

When connecting multiple GOTs to one Built-in Ethernet port CPU, adjust the timing of GOT communication start. When the communication concentrates on the PLC, the communication between GOT and PLC becomes difficult, and the monitoring by GOT may not start. As a method for adjusting the timing, communicating one GOT alone first, and then communicating the other GOTs is effective.

Set the following items on each GOT.

- [Startup Time] of [Controller Setting], or [Title Display Time] of [GOT Setup].

- [Timeout Time] of [Controller Setting]

The following shows a setting example.

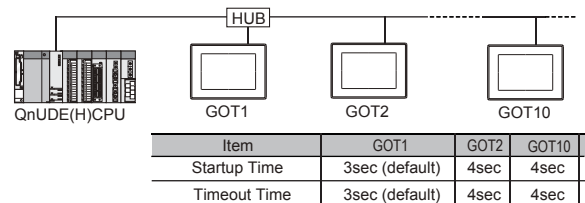

■ When connecting to the multiple network equipment (including GOT) in a segment

By increasing the network load, the transmission speed between the GOT and PLC may be reduced.

The following actions may improve the communication performance.

- Using a switching hub
- More high speed by 100BASE-TX (100Mbps)
- Reduction of the monitoring points on GOT

■ When setting IP address

Do not use "0" and "255" at the end of an IP address.

(Numbers of *.**.0 and *.**.255 are used by the system)

The GOT may not monitor the controller correctly with the above numbers.

Consult with the administrator of the network before setting an IP address to the GOT and controller.

■ When monitoring to another network No. on the same line

When the network No. of the GOT does not match with that of the PLC on the same Ethernet, the PLC cannot be monitored. When monitoring, set the same network No. as that of the GOT, or connect a Ethernet module to the PLC and set the routing setting to monitor as other network.

When the Multi-channel is supported for GT16, set each channel with the networks No. to monitor.

■ Remote password

Do not set a remote password for the following CPUs. Otherwise, monitoring with the GOT becomes unavailable.

RCPU, FX5UCPU, QCPU (Q mode), LCPU

■ When connecting to Built-in Ethernet port of Built-in Ethernet port CPU

Connect to GOT after turning on the network equipment such as Built-in Ethernet port CPU or HUB to enable the communication.

When the communication with Built-in Ethernet port CPU is not available, a communication error may occur on the GOT.

■ The number of connectable CPUs for one GOT

QCPU : 128 CPUs can be set (10 or less CPUs are recommended)

FXCPU : 128 CPUs can be set (10 or less CPUs are recommended)

■ Connection to RnSFCPU

The RnSFCPU takes 10 seconds or more to run.

If the GOT is started before the RnSFCPU runs, a system alarm occurs.

To prevent a system alarm from occurring, adjust the title display time in the [GOT Setup] dialog.

 GT Designer3 (GOT2000) Help

1	PREPARATORY PROCEDURES FOR MONITORING
2	DEVICE RANGE THAT CAN BE SET
3	ACCESS RANGE FOR MONITORING
4	HOW TO MONITOR REDUNDANT SYSTEM
5	BUS CONNECTION
6	DIRECT CONNECTION TO CPU
7	COMPUTER LINK CONNECTION
8	ETHERNET CONNECTION

9

MELSECNET/H CONNECTION (PLC TO PLC NETWORK)



9.1 Connectable Model List	9 - 2
9.2 System Configuration	9 - 8
9.3 GOT Side Settings	9 - 10
9.4 PLC Side Settings	9 - 12
9.5 Precautions	9 - 17

9. MELSECNET/H CONNECTION (PLC TO PLC NETWORK)

9.1 Connectable Model List

POINT

- (1) Connectable network
When using MELSECNET/H in NET/10 mode, refer to MELSECNET/10 CONNECTION.
Connect the GOT to the following network systems as an ordinary station.
 - MELSECNET/H network system (PLC to PLC network) optical loop system
 - MELSECNET/H network system (PLC to PLC network) coaxial bus system
- (2) MELSECNET/H network module
When connecting the MELSECNET/H network module to the MELSECNET/H network system, specify the MELSECNET/H Mode or the MELSECNET/H Extended Mode as a network type.

9.1.1 PLC/Motion controller CPU

The following table shows the connectable models.

Series	Model name	Clock	Communication type	GT 16	GT 15	GT 14	GT 12	GT11 Bus	GT11 Serial	GT 10 40	GT 10 30	Refer to
MELSEC iQ-R Series	R04CPU	○	MELSECNET/H	x	x	x	x	x	x	x	x	-
	R08CPU											
	R16CPU											
	R32CPU											
	R120CPU											
	R08PCPU											
	R16PCPU											
	R32PCPU											
	R120PCPU											
	R04ENCPU											
	R08ENCPU											
	R16ENCPU											
	R32ENCPU											
	R120ENCPU											
	R08SF CPU											
	R16SF CPU											
R32SF CPU												
R120SF CPU												
Motion controller CPU (MELSEC iQ-R Series)	R16MTCPU	○	MELSECNET/H	x	x	x	x	x	x	x	x	-
	R32MTCPU											

(Continued to next page)

Series	Model name	Clock	Communication type	GT 16	GT 15	GT 14	GT 12	GT11 Bus	GT11 Serial	GT 10 5□ 4□	GT 10 20 30	Refer to
C Controller module (MELSEC iQ-R Series)	R12CCPU-V	○	MELSECNE T/H	×	×	×	×	×	×	×	×	-
MELSEC iQ-F Series	FX5U FX5UC	○	MELSECNE T/H	×	×	×	×	×	×	×	×	-
MELSEC-Q (Q mode)	Q00JCPU	○	MELSECNE T/H	○*1	○*1	×	×	×	×	×	×	9.2
	Q00CPU											
	Q01CPU											
	Q02CPU											
	Q02HCPU											
	Q06HCPU											
	Q12HCPU											
	Q25HCPU											
	Q02PHCPU											
	Q06PHCPU											
	Q12PHCPU											
	Q25PHCPU											
	Q12PRHCPU (Main base)											
	Q25PRHCPU (Main base)											
	Q12PRHCPU (Extension base)	○	-	×	×	×	×	×	×	×	×	-
Q25PRHCPU (Extension base)	○	-	×	×	×	×	×	×	×	×	-	
MELSEC-Q (Q mode)	Q00JCPU	○	MELSECNE T/H	○	○	×	×	×	×	×	×	9.2
	Q00UCPU											
	Q01UCPU											
	Q02UCPU											
	Q03UDCPU											
	Q04UDHCPU											
	Q06UDHCPU											
	Q10UDHCPU											
	Q13UDHCPU											
	Q20UDHCPU											
	Q26UDHCPU											

(Continued to next page)

*1 Use CPU function version B or a later version.

9	MELSECNET/H CONNECTION (PLC TO PLC NETWORK)
10	MELSECNET/10 CONNECTION (PLC TO PLC NETWORK)
11	CC-Link IE CONTROLLER NETWORK CONNECTION
12	CC-Link IE FIELD NETWORK CONNECTION
13	CC-Link CONNECTION (INTELLIGENT DEVICE STATION)
14	CC-Link CONNECTION (Via G4)
15	INVERTER CONNECTION
16	SERVO AMPLIFIER CONNECTION

Series	Model name	Clock	Communication type	GT 16	GT 15	GT 14	GT 12	GT11 Bus	GT11 Serial	GT 10 5/4	GT 10 20/30	Refer to
MELSEC-Q (Q mode)	Q03UDEHCPU Q04UDEHCPU Q06UDEHCPU Q10UDEHCPU Q13UDEHCPU Q20UDEHCPU Q26UDEHCPU Q50UDEHCPU Q100UDEHCPU Q03UDVCPU Q04UDVCPU Q06UDVCPU Q13UDVCPU Q26UDVCPU	○	MELSECNET/H	○	○	×	×	×	×	×	×	☞ 9.2
C Controller module (Q Series)	Q12DHCCPU-V ^{*1} Q24DHCCPU-V/VG Q24DHCCPU-LS	○	MELSECNET/H	○	○	×	×	×	×	×	×	☞ 9.2
	Q26DHCCPU-LS			○	×	×	×	×	×	×	×	
MELSEC-QS	QS001CPU	○	MELSECNET/H	○	○	×	×	×	×	×	×	☞ 9.2
MELSEC-L	L02CPU L06CPU L26CPU L26CPU-BT L02CPU-P L06CPU-P L26CPU-P L26CPU-PBT L02SCPU L02SCPU-P	○	-	×	×	×	×	×	×	×	×	-
MELSEC-Q (A mode)	Q02CPU-A Q02HCPU-A Q06HCPU-A	○	-	×	×	×	×	×	×	×	×	-
MELSEC-QnA (QnACPU)	Q2ACPU Q2ACPU-S1 Q3ACPU Q4ACPU Q4ARCPU	○	-	×	×	×	×	×	×	×	×	-
MELSEC-QnA (QnASCPU)	Q2ASCPU Q2ASCPU-S1 Q2ASHCPU Q2ASHCPU-S1	○	-	×	×	×	×	×	×	×	×	-
MELSEC-A (AnCPU)	A2UCPU A2UCPU-S1 A3UCPU A4UCPU A2ACPU A2ACPUP21 A2ACPUR21 A2ACPU-S1 A2ACPUP21-S1 A2ACPUR21-S1 A3ACPU A3ACPUP21 A3ACPUR21 A1NCP A1NCPUP21 A1NCPUR21 A2NCP A2NCPUP21 A2NCPUR21 A2NCPUS1	○	-	×	×	×	×	×	×	×	×	-

(Continued to next page)





*1 Use a module with the upper five digits later than 12042.

Series	Model name	Clock	Communication type	GT 16	GT 15	GT 14	GT 12	GT11 Bus	GT11 Serial	GT 10 5□4□	GT 10 20 30	Refer to	
MELSEC-A (AnSCPU)	A2USCPU	○	-	x	x	x	x	x	x	x	x	-	
	A2USCPU-S1												
	A2USHCPU-S1												
	A1SCPU												
	A1SCPUC24-R2												
	A1SHCPU												
	A2SCPU												
	A2SCPU-S1												
	A2SHCPU												
	A2SHCPU-S1												
	A1SJCPU												
	A1SJCPU-S3												
	A1SJHCPU												
MELSEC-A	A0J2HCPU	x	-	x	x	x	x	x	x	x	x	-	
	A0J2HCPUP21												
	A0J2HCPUR21												
	A0J2HCPU-DC24												
	MELSEC-A	A2CCPU	○	-	x	x	x	x	x	x	x	x	-
		A2CCPUP21											
		A2CCPUR21											
		A2CCPUC24											
		A2CCPUC24-PRF											
		A2CJCPU-S3											
A1FXCPU													
Motion controller CPU (Q Series)	Q172CPU ^{*1*2}	○	MELSECNET/H	○	○	x	x	x	x	x	x	9.2	
	Q173CPU ^{*1*2}												
	Q172CPUN ^{*1}												
	Q173CPUN ^{*1}												
	Q172HCPU												
	Q173HCPU												
	Q172DCPU												
	Q173DCPU												
	Q172DCPU-S1												
	Q173DCPU-S1												
	Q172DSCPU												
	Q173DSCPU												
	Q170MCPU ^{*3}												
	Q170MSCPU ^{*4}												
	Q170MSCPU-S1 ^{*4}												
MR-MQ100	○	-	x	x	x	x	x	x	x	x	-		

(Continued to next page)

- *1 When using SV13, SV22, or SV43, use the motion controller CPU on which any of the following main OS version is installed.
 - SW6RN-SV13Q□: 00H or later
 - SW6RN-SV22Q□: 00H or later
 - SW6RN-SV43Q□: 00B or later
- *2 Use main modules with the following product numbers.
 - Q172CPU: Product number N***** or later
 - Q173CPU: Product number M***** or later
- *3 Only the first step can be used on the extension base unit (Q52B/Q55B).
- *4 The extension base unit (Q5□B/Q6□B) can be used.

9	MELSECNET/H CONNECTION (PLC TO PLC NETWORK)
10	MELSECNET/10 CONNECTION (PLC TO PLC NETWORK)
11	CC-Link IE CONTROLLER NETWORK CONNECTION
12	CC-Link IE FIELD NETWORK CONNECTION
13	CC-Link CONNECTION (INTELLIGENT DEVICE STATION)
14	CC-Link CONNECTION (Via G4)
15	INVERTER CONNECTION
16	SERVO AMPLIFIER CONNECTION

Series	Model name	Clock	Communication type	GT 16	GT 15	GT 14	GT 12	GT11 Bus	GT11 Serial	GT 10 	GT 10 	Refer to
Motion controller CPU (A Series)	A273UCPU	○	-	×	×	×	×	×	×	×	×	-
	A273UHCPU											
	A273UHCPU-S3											
	A373UCPU											
	A373UCPU-S3											
	A171SCPU											
	A171SCPU-S3											
	A171SCPU-S3N											
	A171SHCPU											
	A171SHCPUN											
	A172SHCPU											
	A172SHCPUN											
	A173UHCPU											
	A173UHCPU-S1											
MELSEC-WS	WS0-CPU0	×	-	×	×	×	×	×	×	×	×	-
	WS0-CPU1											
	WS0-CPU3											
MELSECNET/H Remote I/O station	QJ72LP25-25	×	-	×	×	×	×	×	×	×	×	-
	QJ72LP25G											
	QJ72BR15											
CC-Link IE Field Network head module	LJ72GF15-T2	×	-	×	×	×	×	×	×	×	×	-
CC-Link IE Field Network Ethernet adapter module	NZ2GF-ETB	×	-	×	×	×	×	×	×	×	×	-
CNC C70	Q173NCCPU	○	MELSECNET/H	○	○	×	×	×	×	×	×	 9.2
Robot controller	CRnQ-700 (Q172DRCPU)	○	MELSECNET/H	○	○	×	×	×	×	×	×	 9.2
MELSEC-FX	FX0	×	-	×	×	×	×	×	×	×	×	-
	FX0s											
	FX0N											
	FX1											
	FX2	×	-	×	×	×	×	×	×	×	×	
	FX2C											
	FX1S	○	-	×	×	×	×	×	×	×	×	
	FX1N											
	FX2N											
	FX1NC	○	-	×	×	×	×	×	×	×	×	
	FX2NC											
	FX3S											
	FX3G											
	FX3GC											
	FX3GE											
FX3U												
FX3UC												

9.1.2 MELSECNET/H network module

CPU series	Model name	
	Optical loop	Coaxial bus
MELSEC-Q (Q mode) ^{*1} MELSEC-QS Motion controller CPU (Q Series) CNC C70 Robot controller (CRnQ-700)	QJ71LP21 QJ71LP21-25 QJ71LP21S-25	QJ71BR11 ^{*1}
C Controller module (Q Series)	QJ71LP21-25 QJ71LP21S-25	QJ71BR11 ^{*1}

*1 Use function version B or later of the MELSECNET/H network module and CPU.

9	MELSECNET/H CONNECTION (PLC TO PLC NETWORK)
10	MELSECNET/H CONNECTION (PLC TO PLC NETWORK)
11	CC-Link IE CONTROLLER NETWORK CONNECTION
12	CC-Link IE FIELD NETWORK CONNECTION
13	CC-Link CONNECTION (INTELLIGENT DEVICE STATION)
14	CC-Link CONNECTION (Via G4)
15	INVERTER CONNECTION
16	SERVO AMPLIFIER CONNECTION

9.2 System Configuration

9.2.1 Connecting to optical loop system

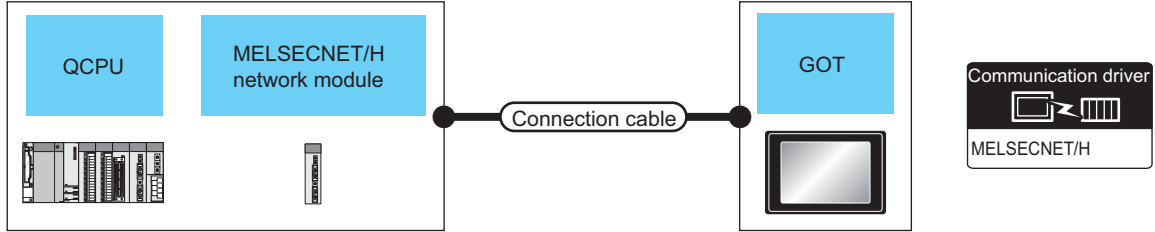

PLC		Connection cable		GOT		Number of connectable equipment	
Model name	MELSECNET/H network module *1	Communication type	Cable model	Max. distance	Option device		Model
MELSEC-Q MELSEC-QS	QJ71LP21 QJ71LP21-25 QJ71LP21S-25	MELSECNET/H	Optical fiber cable *2	*3	GT15-J71LP23-25	GT16 GT15	63 GOTs
C Controller module (Q Series)	QJ71LP21-25 QJ71LP21S-25	MELSECNET/H	Optical fiber cable *2	*3	GT15-J71LP23-25	GT16 GT15	

*1 For the system configuration of the MELSECNET/H network module, refer to the following manual.

Q corresponding MELSECNET/H Network System Reference Manual (PLC to PLC network)

*2 For the optical fiber cable, refer to the following manual.

Q corresponding MELSECNET/H Network System Reference Manual (PLC to PLC network)

*3 The overall extension cable length and the length between stations vary depending on the cable type to be used and the total number of stations.

For details, refer to the following manual.

Q corresponding MELSECNET/H Network System Reference Manual (PLC to PLC network)

9.2.2 Connecting to the coaxial bus system

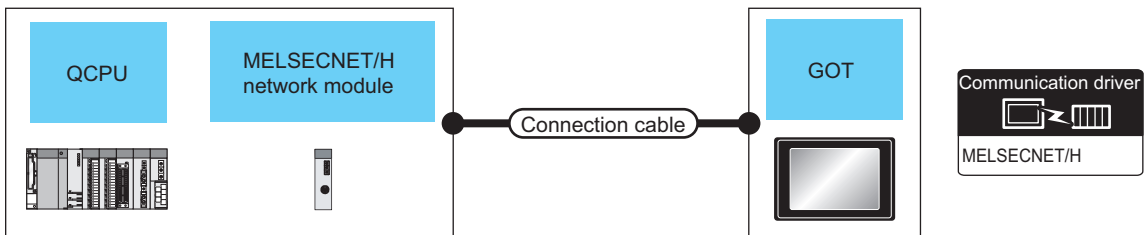

PLC		Connection cable		GOT		Number of connectable equipment	
Model name	MELSECNET/H Network module *2	Communication type	Cable model	Max. distance	Option device		Model
MELSEC-Q *1 C Controller module (Q Series) MELSEC-QS	QJ71BR11	MELSECNET/H	Coaxial cable *3	*4	GT15-J71BR13	GT16 GT15	31 GOTs

*1 Use a PLC CPU of function version B or a later version.

*2 For the system configuration of the MELSECNET/H network module, refer to the following manual.

Q corresponding MELSECNET/H Network System Reference Manual (PLC to PLC network)

Use a MELSECNET/H network module of function version B or a later version.

*3 For the coaxial cable, refer to the following manual.

 Q corresponding MELSECNET/H Network System Reference Manual (PLC to PLC network)
For the coaxial cable connector connection method, refer to the following.

 1.4.2 Coaxial cable connector connection method

*4 The overall extension cable length and the length between stations vary depending on the cable type to be used and the total number of stations.

For details, refer to the following manual.

 Q corresponding MELSECNET/H Network System Reference Manual (PLC to PLC network)

9	MELSECNET/H CONNECTION (PLC TO PLC NETWORK)
10	MELSECNET/10 CONNECTION (PLC TO PLC NETWORK)
11	CC-Link IE CONTROLLER NETWORK CONNECTION
12	CC-Link IE FIELD NETWORK CONNECTION
13	CC-Link CONNECTION (INTELLIGENT DEVICE STATION)
14	CC-Link CONNECTION (Via G4)
15	INVERTER CONNECTION
16	SERVO AMPLIFIER CONNECTION

9.3 GOT Side Settings

9.3.1 Setting communication interface (Communication settings)

Set the channel of the connected equipment.

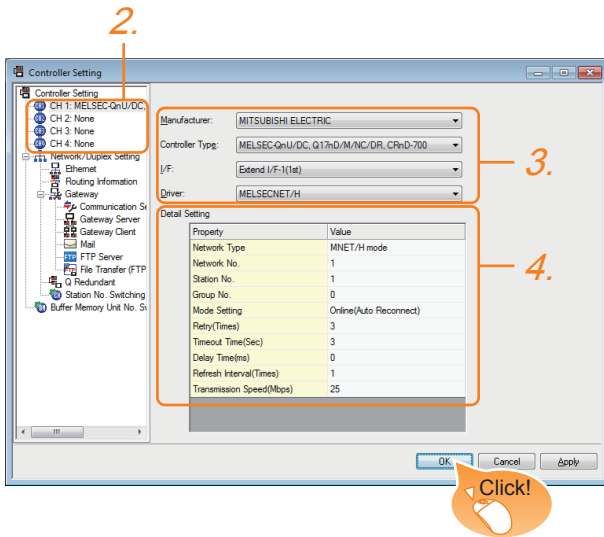

1. Select [Common] → [Controller Setting] from the menu.
2. The Controller Setting window is displayed. Select the channel to be used from the list menu.
3. Set the following items.
 - Manufacturer: MITSUBISHI ELECTRIC
 - Controller Type: Set according to the Controller Type to be connected.
 - I/F: Interface to be used
 - Driver: MELSECNET/H
4. The detailed setting is displayed after Manufacturer, Controller Type, I/F, and Driver are set. Make the settings according to the usage environment.

☞ 9.3.2 Communication detail settings

Click the [OK] button when settings are completed.

POINT

The settings of connecting equipment can be confirmed in [I/F Communication Setting]. For details, refer to the following:

☞ 1.1.2 I/F communication setting

9.3.2 Communication detail settings

Make the settings according to the usage environment.

Property	Value
Network Type	MNET/H mode
Network No.	1
Station No.	1
Group No.	0
Mode Setting	Online(Auto Reconnect)
Retry(Times)	3
Timeout Time(Sec)	3
Delay Time(ms)	0
Refresh Interval(Times)	1
Transmission Speed(Mbps)	25

Item	Description	Range
Network Type	Set the network type. (Default: MNET/H mode)	<ul style="list-style-type: none"> • MNET/H mode • MNET/10 mode • MNET/H Extended mode*1
Network No.	Set the network No. (Default: 1)	1 to 239
Station No.	Set the station No. of the GOT. (Default: 1)	1 to 64
Mode Setting	Set the operation mode of the GOT. (Default: Online (auto. reconnection))	<ul style="list-style-type: none"> • Online (auto. reconnection) • Offline • Test between slave station *2 • Self-loopback test*2 • Internal self-loopback test*2 • H/W test*2
Retry	Set the number of retries to be performed when a communication timeout occurs. When no response is received after retries, a communication times out. (Default: 3times)	0 to 5times
Timeout Time	Set the time period for a communication to time out. (Default: 3sec)	3 to 90sec
Delay Time	Set the delay time for reducing the load of the network/ destination PLC. (Default: 0ms)	0 to 300ms

Item	Description	Range
Refresh Interval	Set the number of refreshes to secure the send/receive data in station units during communication. (Default: 1time) Valid when [Secured data send/ Secured data receive] is marked by the control station side network parameters of the melsecnet/h network system.	1 to 1000times
Transmission Speed	Set the communication transmission speed. (Default: 25Mbps) When specifying [MNET/10 mode] as The network type, only 10Mbps can be set applicable.	10Mbps/25Mbps

- *1 For monitoring the QCPU redundant system, use QCPU of function version D or later, with the upper five digits later than "07102".
Also, use GX Developer of Version 8.29F or later.
- *2 For details, refer to the following manual.
 Q corresponding MELSECNET/H Network System Reference Manual (PLC to PLC network)

POINT

- Communication interface setting by Utility
The communication interface setting can be changed on the Utility's [Communication Settings] after writing [Communication Settings] of project data.
For details on the RS-422 conversion unit and the GOT utility, refer to the following manual:
 GT□ User's Manual
- Precedence in communication settings
When settings are made by GT Designer3 or the Utility, the latest setting is effective.

9.3.3 Routing parameter setting

Up to 64 [Transfer Network No.]s can be set.
However, the same transfer network number cannot be set twice or more (multiple times).
Therefore, the one that can access to other station from the request source host GOT is 64 kinds of [Transfer Network No.]s.

POINT

Routing parameter setting
When communicating within the host network, routing parameter setting is unnecessary.

For details of routing parameters, refer to the following manual.
 Q corresponding MELSECNET/H Network System Reference Manual (PLC to PLC network)

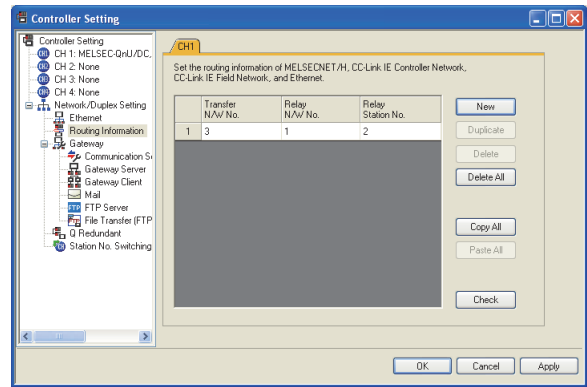

Item	Range
Transfer Network No.	1 to 239
Relay Network No.	1 to 239
Relay Station No.	1 to 64

POINT

- Routing parameter setting of relay station
Routing parameter setting is also necessary for the relay station.
For the setting, refer to the following.
 9.4 PLC Side Settings
- Parameter reflection function of MELSOFT Navigator
 - The color of the cells for the items which are reflected to GT Designer3 from MELSOFT Navigator changes to green. Set items, which are displayed in green cells, from the MELSOFT Navigator.
 - When the settings of Transfer network No., Relay network No. or Relay station No. are reflected to the parameter from the MELSOFT Navigator, those settings are added. Items set in advance are not deleted. However, if the target network No. overlaps, the item set in advance is overwritten.
 - The routing information is used manually by the user when the data is created. Therefore, after changing the network configuration by MELSOFT Navigator, create a routing information again. For details of the creation of the routing information, refer to the MELSOFT Navigator help.

9.4 PLC Side Settings

This section describes the settings of the GOT and MELSECNET/H network module in the case of system configuration shown as 9.4.1.

When connecting the MELSECNET/H network module to the MELSECNET/H network system, specify the MELSECNET/H Mode or the MELSECNET/H Extended Mode as a network type.

POINT

MELSECNET/H network module

For details of the MELSECNET/H network module, refer to the following manual.

- Q corresponding MELSECNET/H Network System Reference Manual (PLC to PLC network)

9.4.1 System configuration

9.4.4 [Controller Setting] of GT Designer3

<GOT>
(Use the default value for settings other than the following.)

Network type	: MNET/H Mode
Network No.	: 1
Station No.	: 2
Mode Setting	: Online (auto,reconnection)
Network range assignment *2:	LB0100H to LB01FFH LW0100H to LW01FFH
Transmission speed	: 10Mbps

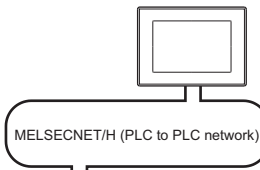

<MELSECNET/H network module> *1
(Use the default value for settings other than the following.)

Station No.	: 1
Mode	: Online (10Mbps)
Network type	: MNET/H mode (Control station)
Network No.	: 1
Total stations	: 2
Network range assignment *2:	LB0000H to LB00FFH LW0000H to LW00FFH

9.4.2 Switch setting of MELSECNET/H network module
(1) [Network parameter] of GX Developer

- *1 The MELSECNET/H network module is mounted at slot 0 of the base unit. The start I/O No. of the MELSECNET/H network module is set at "0".
- *2 The network type must be set according to the number of assignment of send points for each station.
When the number of assignment is 2000 bytes or less: MELSECNET/H mode
When the number of assignment is 2000 bytes or more: MELSECNET/H Extended Mode

POINT

When connecting to Q170MCPU



When connected to Q170MCPU, the start I/O No. of the MELSECNET/H network module is set to "70".

9.4.2 Switch setting of MELSECNET/H network module

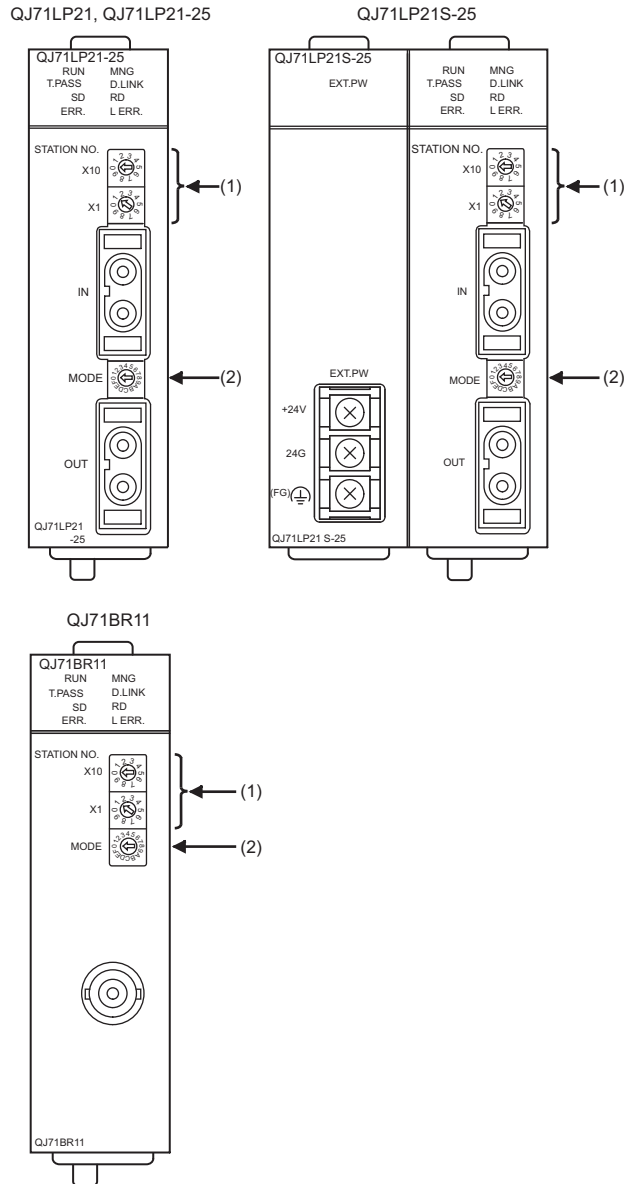
Set the station number setting switch and mode setting switch.



(1) Station number setting switch

Station number setting switch	Description	Set value	Setting necessity at GOT connection
STATION NO. X10  X1 	Station number setting (Station No.1) ^{*1}	1	○

○: Necessary △: As necessary ×: Not necessary
 *1 Do not set the same station No. as that of the GOT.

(2) Mode setting switch

Mode setting switch	Description	Set value	Setting necessity at GOT connection
MODE 	Mode setting (Online: 10Mbps) ^{*2}	0	○

○: Necessary △: As necessary ×: Not necessary
 *2 Set the same mode setting and transmission speed as those of the GOT.

POINT

When the switch setting has been changed
 Turn the PLC CPU OFF then ON again, or reset the PLC CPU.

9.4.3 Parameter setting

■ Connecting to MELSEC-Q or QS series

(1) [Network parameter] of GX Developer
 (a) Network parameter

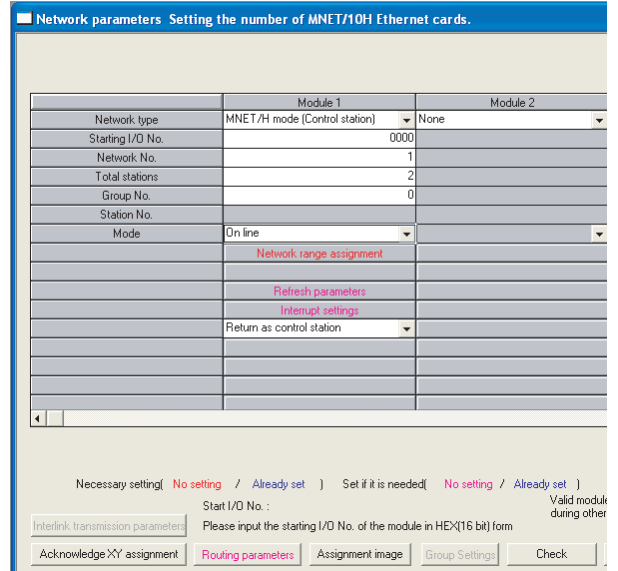

Item	Set value	Setting necessity at GOT connection
Network type	MNET/H mode (Control station) (fixed)	○
Starting I/O No. ^{*1}	0000H	○
Network No. ^{*2}	1	○
Total stations	2	○
Group No.	0 (fixed)	○
Mode ^{*3}	Online	○
Network range assignment	Refer to (b).	△
Refresh parameters	(Use default value)	△
Interrupt settings		×
Control station return setting		△
Redundant settings ^{*4}		△
Interlink transmission parameters		×
Routing parameters	Refer to (c).	△

○: Necessary △: As necessary ×: Not necessary
 *1 When using Q170MCP, set it according to the system configuration.
 *2 Specify the same network No. as that of the GOT.
 *3 Set the same mode setting as that of the GOT.
 *4 Set it when the MELSECNET/H network module is used in the redundant QnPRHCPU system.

9 MELSECNET/H CONNECTION (PLC TO PLC NETWORK)
 10 MELSECNET/10 CONNECTION (PLC TO PLC NETWORK)
 11 CC-Link IE CONTROLLER NETWORK CONNECTION
 12 CC-Link IE FIELD NETWORK CONNECTION
 13 CC-Link CONNECTION (INTELLIGENT DEVICE STATION)
 14 CC-Link CONNECTION (Via G4)
 15 INVERTER CONNECTION
 16 SERVO AMPLIFIER CONNECTION

(b) Network range assignment

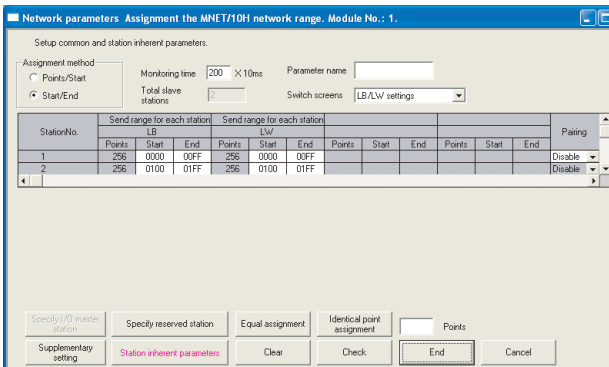

Item		Set value	Setting necessity at GOT connection
Monitoring time		200	△
LB/LW setting ^{*1}	Send range for station (LB)	Station No.1 Start	0000H △
		Station No.1 End	00FFH △
	Station No.2	Start	0100H △
		End	01FFH △
	Send range for station (LW)	Station No.1 Start	0000H △
		Station No.1 End	00FFH △
Station No.2	Start	0100H △	
	End	01FFH △	
Pairing setting ^{*2}		Disable	△
LX/LY setting ^{*1}		No setting	△
Specify I/O master station ^{*1}		No setting	△
Specify reserved station		No setting	△
Supplementary setting		(Use default value)	△
Station inherent parameters			△

○: Necessary △: As necessary ×: Not necessary
^{*1} Be sure to set the setting to perform the cyclic transmission.
^{*2} Set it when the MELSECNET/H network module is used in the redundant QnPRHCPU system.

POINT

When changing the network parameter
 After writing the network parameter to the PLC CPU, operate the PLC CPU ether turning OFF and then ON or resetting.

(c) Routing parameter setting

Up to 64 [Transfer Network No.]s can be set. However, the same transfer network number cannot be set twice or more (multiple times). Therefore, the one that can access to other station from the request source host GOT is 64 kinds of [Transfer Network No.]s.

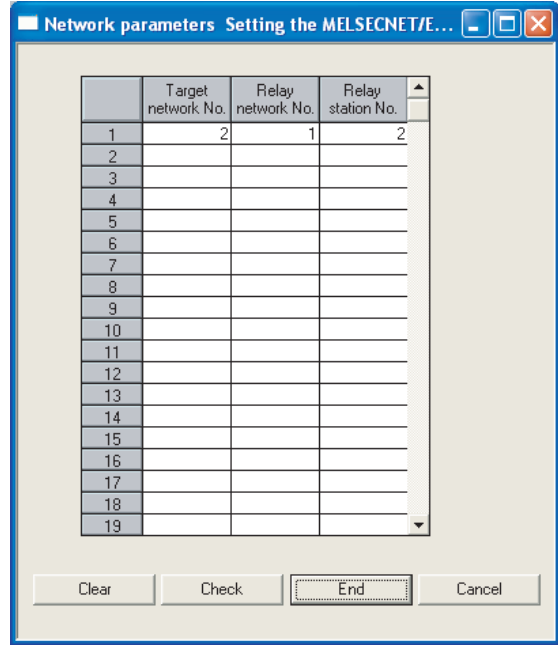

Item	Range
Target network No.	1 to 239
Relay network No.	1 to 239
Relay station No.	1 to 64

POINT

Routing parameter setting of request source
 Routing parameter setting is also necessary for the request source GOT.

For the setting, refer to the following.

➡ 9.3.3 Routing parameter setting

■ Connecting to C Controller module (Q Series)

Use SW3PVC-CCPU-E Ver.3.05F or later for the MELSECNET/H utility.

(1) Connection settings

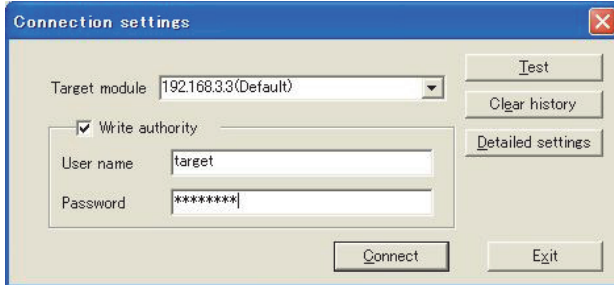

Item	Set value	Setting necessity at GOT connection
Target module *1	192.168.3.3 (Default)	○
Write authority	Mark the checkbox	○
User name *2	target	○
Password *2	password	○
Detailed settings	-	△

○: Necessary △: As necessary ×: Not necessary

- *1 If the IP address of the C Controller module (Q Series) has been changed, input the changed IP address or host name.
- *2 If the account of the C Controller module (Q Series) has been changed, input the changed user name and password.

(2) MELSECNET/H Utility's [Parameter Settings]

(a) Parameter settings

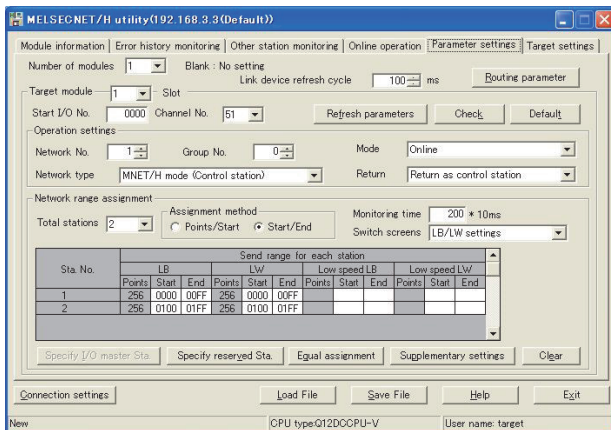

Item	Set value	Setting necessity at GOT connection
Number of modules	1	○
Link device refresh cycle	(Use default value)	△
Routing parameter	Refer to (b).	△
Target module	1	○
Start I/O No.	0000H	○
Channel No.	(Use default value)	○

Item		Set value	Setting necessity at GOT connection		
Operation settings	Network type	MNET/H mode (Control station)	○		
	Network No. *1	1	○		
	Group No.	0	○		
	Mode *2	Online	○		
	Return	(Use default value)	△		
Refresh parameters		(Use default value)	△		
Network range assignment	Total stations	2	○		
	Assignment method		Start/End	○	
	LB/LW settings *3	Send range for each station LB	Sta. No.1 Start	0000H	△
			Sta. No.1 End	00FFH	△
		Send range for each station LW	Sta. No.2 Start	0100H	△
			Sta. No.2 End	01FFH	△
	(LX/LY) settings *3	Sta. No.1	Start	0000H	△
			End	00FFH	△
		Sta. No.2	Start	0100H	△
			End	01FFH	△
	Monitoring time		(Use default value)	△	
	Specify I/O master Sta. *3		No setting	△	
Specify reserved Sta.		No setting	△		
Supplementary settings		(Use default value)	△		

○: Necessary △: As necessary ×: Not necessary

- *1 Specify the same network No. as that of the GOT.
- *2 Set the same mode setting as that of the GOT.
- *3 Be sure to set the setting to perform the cyclic transmission.

POINT

When changing the network parameter After writing the network parameter to the C Controller module (Q Series), either turn the C Controller module (Q Series) OFF and then ON or reset it.

9 MELSECNET/H CONNECTION (PLC TO PLC NETWORK)
 10 MELSECNET/H CONNECTION (PLC TO PLC NETWORK)
 11 MELSECNET/H CONNECTION (PLC TO PLC NETWORK)
 12 CC-Link IE CONTROLLER NETWORK CONNECTION
 13 CC-Link IE FIELD NETWORK CONNECTION
 14 CC-Link CONNECTION (INTELLIGENT DEVICE STATION)
 15 CC-Link CONNECTION (Via G4)
 16 INVERTER CONNECTION
 SERVO AMPLIFIER CONNECTION

- (b) Routing parameter setting
 Up to 64 [Transfer Network No.]s can be set.
 However, the same transfer network number cannot be set twice or more (multiple times).
 Therefore, the one that can access other station from the request source host GOT is 64 kinds of [Transfer Network No.]s.

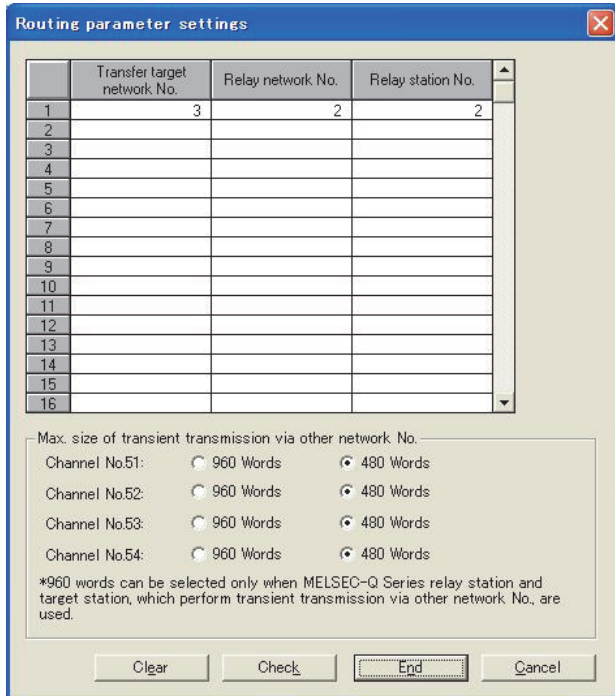

Item	Range
Transfer target network No.	1 to 239
Relay network No.	1 to 239
Relay station No.	1 to 120

POINT

Routing parameter setting of request source
 Routing parameter setting is also necessary for the request source GOT.
 For the setting, refer to the following.
 ➔ 9.3.3 Routing parameter setting

9.4.4 [Controller Setting] of GT Designer3

Item	Set value
Network Type	MNET/H mode
Network No.	1: Network No.1
Station No.	2: Station No.2
Mode Setting	Online (auto. reconnection)
Retry count	3times (Use default value)
Timeout Time	3sec (Use default value)
Delay Time	0sec (Use default value)
Refresh Interval	1time (Use default value)
Monitor Speed	10Mbps

POINT

[Controller Setting] of GT Designer3
 For [Controller Setting], of GT Designer3, refer to the following.

➔ 9.3.1 Setting communication interface
 (Communication settings)

9.5 Precautions

■ Network configuration

Use MELSECNET/H (PLC to PLC network) to configure a network including the GOT.

The following networks including the GOT cannot be configured.

- MELSECNET/H (Remote I/O network)

■ Network type setting

- Specify all the network modules on the same network as the same network type.
(MELSECNET/H Mode and MELSECNET/H Extended Mode cannot be mixed.)
- When connecting to MELSECNET/H in the QCPU redundant system, [MELSECNET/H Extended Mode] cannot be specified as the network type.

■ Monitoring range

Only PLC CPU of the same networks No. can be monitored in GOT.

For details, refer to the following manual.

 GT Designer3 Version□ Screen Design Manual

■ GOT startup in the MELSECNET/H connection

In the MELSECNET/H connection, the data link is started approximately 10 seconds after the GOT startup.

■ When a network error occurs in the system alarm

In the MELSECNET/H connection, when a network error occurs in the system alarm, the system alarm message cannot be canceled even though the causes are removed.

To cancel the system alarm display, restart the GOT.

■ MELSECNET/H network module version

For version restrictions of the MELSECNET/H network module, refer to the following manual.

 Q corresponding MELSECNET/H Network System Reference Manual (PLC to PLC network)

■ Connection in the multiple CPU system

When the GOT is connected to multiple CPU system, the following time is taken until when the PLC runs.

QCPU (Q mode), motion controller CPU (Q series): 10 seconds or more

MELDAS C70: 18 seconds or more

When the GOT starts before the PLC runs, a system alarm occurs. Adjust the opening screen time in the GOT setup so that no system alarm occurs.

 GT Designer3 Version□ Screen Design Manual

■ Connection to QSCPU

The GOT can only read device data and sequence programs by the ladder monitor function in the QSCPU.

The GOT cannot write any data to the QSCPU.

■ Connection to Q170MCPUCPU

Set [CPU No.] to "2" in the device setting to monitor the device of the Motion CPU area (CPU No.2).

When the CPU No. is set to "0" or "1", the device on the PLC CPU area (CPU No.1) is monitored.

When the CPU No. is set to the number other than "0" to "2", a communication error occurs and the monitoring cannot be executed.

For setting the CPU No., refer to the following manual.

 GT Designer3 Version□ Screen Design Manual

Example) Setting dialog box of the bit device

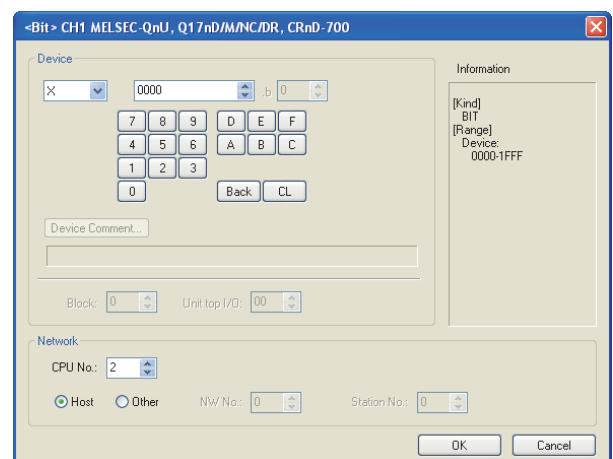

10

MELSECNET/10 CONNECTION (PLC TO PLC NETWORK)



10.1 Connectable Model List	10 - 2
10.2 System Configuration	10 - 8
10.3 GOT Side Settings	10 - 10
10.4 PLC Side Setting	10 - 13
10.5 Precautions	10 - 26

10. MELSECNET/10 CONNECTION (PLC TO PLC NETWORK)

10.1 Connectable Model List

POINT

(1) Connectable network

The MELSECNET/10 connection includes the MELSECNET/H network system used in the MELSECNET/10 mode. The GOT cannot be connected to the remote I/O network.

Connect the GOT to the following network systems as an ordinary station.

- MELSECNET/10 network system (PLC to PLC network) optical loop system
- MELSECNET/10 network system (PLC to PLC network) coaxial bus system

(2) MELSECNET/H network module

When connecting the MELSECNET/H network module to the MELSECNET/10 network system, specify the MELSECNET/10 Mode as a network type.

10.1.1 PLC/Motion controller CPU

The following table shows the connectable models.

Series	Model name	Clock	Communication type	GT 16	GT 15	GT 14	GT 12	GT11 Bus	GT11 Serial	GT10 5□	GT10 20□	Refer to
MELSEC iQ-R Series	R04CPU	○	MELSECNET/10	x	x	x	x	x	x	x	x	-
	R08CPU											
	R16CPU											
	R32CPU											
	R120CPU											
	R08PCPU											
	R16PCPU											
	R32PCPU											
	R120PCPU											
	R04ENCPU											
	R08ENCPU											
	R16ENCPU											
	R32ENCPU											
	R120ENCPU											
	R08SFCPU											
R16SFCPU												
R32SFCPU												
R120SFCPU												
Motion controller CPU (MELSEC iQ-R Series)	R16MTCPU	○	MELSECNET/10	x	x	x	x	x	x	x	x	-
	R32MTCPU											

(Continued to next page)

Series	Model name	Clock	Communication type	GT 16	GT 15	GT 14	GT 12	GT11 Bus	GT11 Serial	GT 10 5□ 4□	GT 10 20 30	Refer to
C Controller module (MELSEC iQ-R Series)	R12CCPU-V	○	MELSECNET/10	×	×	×	×	×	×	×	×	-
MELSEC iQ-F Series	FX5U FX5UC	○	MELSECNET/10	×	×	×	×	×	×	×	×	-
MELSEC-Q (Q mode)	Q00JCPU	○	MELSECNET/10	○*1	○*1	×	×	×	×	×	×	10.2
	Q00CPU											
	Q01CPU											
	Q02CPU											
	Q02HCPU											
	Q06HCPU											
	Q12HCPU											
	Q25HCPU											
	Q02PHCPU											
	Q06PHCPU											
	Q12PHCPU											
	Q25PHCPU											
	Q12PRHCPU (Main base)											
	Q25PRHCPU (Main base)											
	Q12PRHCPU (Extension base)	○	-	×	×	×	×	×	×	×	×	-
	Q25PRHCPU (Extension base)	○	MELSECNET/10	○	○	×	×	×	×	×	×	10.2
Q00JCPU												
Q00UCPU												
Q01UCPU												
Q02UCPU												
Q03UDCPU												

*1 Use CPU function version B or a later version.

(Continued to next page)

9
MELSECNET/H CONNECTION (PLC CONNECTION TO PLC NETWORK)

10
MELSECNET/10 CONNECTION (PLC CONNECTION TO PLC NETWORK)

11
CC-Link IE CONTROLLER NETWORK CONNECTION

12
CC-Link IE FIELD NETWORK CONNECTION

13
CC-Link CONNECTION (INTELLIGENT DEVICE STATION)

14
CC-Link CONNECTION (Via G4)

15
INVERTER CONNECTION

16
SERVO AMPLIFIER CONNECTION

Series	Model name	Clock	Communication type	GT 16	GT 15	GT 14	GT 12	GT11 Bus	GT11 Serial	GT10 5□4□	GT10 20 30	Refer to
MELSEC-Q (Q mode)	Q04UDHCPU Q06UDHCPU Q10UDHCPU Q13UDHCPU Q20UDHCPU Q26UDHCPU	○	MELSECNET/10	○	○	×	×	×	×	×	×	10.2
	Q03UDECPU Q04UDEHCPU Q06UDEHCPU Q10UDEHCPU Q13UDEHCPU Q20UDEHCPU Q26UDEHCPU Q50UDEHCPU Q100UDEHCPU											
	Q03UDVCPU Q04UDVCPU Q06UDVCPU Q13UDVCPU Q26UDVCPU											
C Controller module (Q Series)	Q12DCCPU-V*1 Q24DHCCPU-V/VG Q24DHCCPU-LS	○	MELSECNET/10	○	○	×	×	×	×	×	×	10.2
	Q26DHCCPU-LS			○	×	×	×	×	×	×	×	
MELSEC-QS	QS001CPU	○	MELSECNET/10	○	○	×	×	×	×	×	×	10.2
MELSEC-L	L02CPU L06CPU L26CPU L26CPU-BT L02CPU-P L06CPU-P L26CPU-P L26CPU-PBT L02SCPU L02SCPU-P	○	-	×	×	×	×	×	×	×	×	-
MELSEC-Q (A mode)	Q02CPU-A Q02HCPU-A Q06HCPU-A	○	MELSECNET/10	○	○	×	×	×	×	×	×	10.2
MELSEC-QnA (QnACPU)	Q2ACPU Q2ACPU-S1 Q3ACPU Q4ACPU Q4ARCPU	○	MELSECNET/10	○	○	×	×	×	×	×	×	10.2
MELSEC-QnA (QnASCPU)	Q2ASCPU Q2ASCPU-S1 Q2ASHCPU Q2ASHCPU-S1	○	MELSECNET/10	○	○	×	×	×	×	×	×	10.2

(Continued to next page)

*1 Use a module with the upper five digits later than 12042.

Series	Model name	Clock	Communication type	GT 16	GT 15	GT 14	GT 12	GT11 Bus	GT11 Serial	GT 10 5□	GT 10 20 30	Refer to
MELSEC-A (AnCPU)	A2UCPU	○	MELSECNET/10	○	○	×	×	×	×	×	×	10.2
	A2UCPU-S1											
	A3UCPU											
	A4UCPU											
	A2ACPU	○	-									
	A2ACPUP21											
	A2ACPUR21											
	A2ACPU-S1											
	A2ACPUP21-S1											
	A2ACPUR21-S1											
	A3ACPU											
	A3ACPUP21											
	A3ACPUR21											
	A1NCPUR21											
	A1NCPUP21											
	A1NCPUR21											
	A2NCPUR21											
	A2NCPUP21											
	A2NCPUR21											
	A2NCPUR21-S1											
A2NCPUR21-S1												
A3NCPUR21												
A3NCPUP21												
A3NCPUR21												
MELSEC-A (AnSCPU)	A2USCPU	○	MELSECNET/10	○	○	×	×	×	×	×	×	10.2
	A2USCPU-S1											
	A2USHCPU-S1											
	A1SCPU	○	-									
	A1SCPUC24-R2											
	A1SHCPU											
	A2SCPU											
	A2SCPU-S1											
	A2SHCPU											
	A2SHCPU-S1											
	A1SJCPU											
	A1SJCPU-S3											
	A1SJHCPU											

(Continued to next page)

9
MELSECNET/H
CONNECTION (PLC
TO PLC NETWORK)

10
MELSECNET/10
CONNECTION (PLC
TO PLC NETWORK)

11
CC-Link IE CONTROLLER
NETWORK
CONNECTION



12
CC-Link IE FIELD
NETWORK
CONNECTION

13
CC-Link CONNECTION
(INTELLIGENT DEVICE
STATION)

14
CC-Link
CONNECTION
(Via G4)

15
INVERTER
CONNECTION

16
SERVO AMPLIFIER
CONNECTION

Series	Model name	Clock	Communication type	GT 16	GT 15	GT 14	GT 12	GT11 Bus	GT11 Serial	GT 10 5□/4□	GT 10 20□/30□	Refer to
MELSEC-A	A0J2HCPU	×	-	×	×	×	×	×	×	×	×	-
	A0J2HCPUP21											
	A0J2HCPUR21											
	A0J2HCPU-DC24											
	A2CCPU	○	-	×	×	×	×	×	×	×	-	
	A2CCPUP21											
	A2CCPUR21											
	A2CCPUC24											
	A2CCPUC24-PRF											
	A2CJCPU-S3											
	A1FXCPU											
Motion controller CPU (Q Series)	Q172CPU*1*2	○	MELSECNET/10	○	○	×	×	×	×	×	×	 10.2
	Q173CPU*1*2											
	Q172CPUN*1											
	Q173CPUN*1											
	Q172HCPU											
	Q173HCPU											
	Q172DCPU											
	Q173DCPU											
	Q172DCPU-S1											
	Q173DCPU-S1											
	Q172DSCPU											
	Q173DSCPU											
	Q170MCPU*3											
	Q170MSCPU*4											
	Q170MSCPU-S1*4											
MR-MQ100	○	-	×	×	×	×	×	×	×	×	-	
Motion controller CPU (A Series)	A273UCPU	○	MELSECNET/10	○	○	×	×	×	×	×	×	 10.2
	A273UHCPU											
	A273UHCPU-S3											
	A373UCPU											
	A373UCPU-S3	○	-	×	×	×	×	×	×	×	-	
	A171SCPU											
	A171SCPU-S3											
	A171SCPU-S3N											
	A171SHCPU											
	A171SHCPUN											
	A172SHCPU											
	A172SHCPUN											
	A173UHCPU	○	MELSECNET/10	○	○	×	×	×	×	×	×	 10.2
	A173UHCPU-S1											

(Continued to next page)

*1 When using SV13, SV22 or SV43, use the motion controller CPU on which any of the following main OS version is installed.

- SW6RN-SV13Q□: 00H or later
- SW6RN-SV22Q□: 00H or later
- SW6RN-SV43Q□: 00B or later

*2 Use main modules with the following product numbers.

- Q172CPU: Product number N***** or later
- Q173CPU: Product number M***** or later

*3 Only the first step can be used on the extension base unit (Q52B/Q55B).

*4 The extension base unit (Q5□B/Q6□B) can be used.

Series	Model name	Clock	Communication type	GT 16	GT 15	GT 14	GT 12	GT11 Bus	GT11 Serial	GT10 5□	GT10 20□	Refer to
MELSEC-WS	WS0-CPU0	×	-	×	×	×	×	×	×	×	×	-
	WS0-CPU1											
	WS0-CPU3											
MELSECNET/H remote I/O station	QJ72LP25-25	×	-	×	×	×	×	×	×	×	×	-
	QJ72LP25G											
	QJ72BR15											
CC-Link IE Field Network head module	LJ72GF15-T2	×	-	×	×	×	×	×	×	×	×	-
CC-Link IE Field Network Ethernet adapter module	NZ2GF-ETB	×	-	×	×	×	×	×	×	×	×	-
CNC C70	Q173NCCPU	○	MELSECNET/10	○	○	×	×	×	×	×	×	10.2
Robot controller	CRnQ-700 (Q172DRCPU) CR750-Q (Q172DRCPU) CR751-Q (Q172DRCPU)	○	MELSECNET/10	○	○	×	×	×	×	×	×	10.2
MELSEC-FX	FX0	×	-	×	×	×	×	×	×	×	×	-
	FX0S											
	FX0N											
	FX1	×	-	×	×	×	×	×	×	×		
	FX2											
	FX2C											
	FX1S	○	-	×	×	×	×	×	×	×		
	FX1N											
	FX2N											
	FX1NC	×	-	×	×	×	×	×	×	×		
	FX2NC											
	FX3S											
	FX3G	○	-	×	×	×	×	×	×	×		
	FX3GC											
	FX3GE											
FX3U												
FX3UC												

10.1.2 MELSECNET/H (NET/10 mode), MELSECNET/10 network module

CPU series	Model name	
	Optical loop	Coaxial bus
MELSEC-Q (Q mode)*1 MELSEC-QS Motion controller CPU (Q Series) CNC C70 Robot controller (CRnQ-700)	QJ71LP21, QJ71LP21-25 QJ71LP21S-25	QJ71BR11*1
C Controller module (Q Series)	QJ71LP21-25, QJ71LP21S-25	QJ71BR11*1
MELSEC-QnA	AJ71QLP21, AJ71QLP21S A1SJ71QLP21, A1SJ71QLP21S	AJ71QBR11 A1SJ71QBR11
MELSEC-Q (A mode) MELSEC-A Motion controller CPU (A Series)	AJ71LP21 A1SJ71LP21	AJ71BR11 A1SJ71BR11

*1 Use function version B or later of the CPU and MELSECNET/H network module.

9 MELSECNET/H CONNECTION (PLC CONNECTION TO PLC NETWORK)
10 MELSECNET/10 CONNECTION (PLC CONNECTION TO PLC NETWORK)
11 CC-Link IE CONTROLLER NETWORK CONNECTION
12 CC-Link IE FIELD NETWORK CONNECTION
13 CC-Link CONNECTION (INTELLIGENT DEVICE STATION)
14 CC-Link CONNECTION (Via G4)
15 INVERTER CONNECTION
16 SERVO AMPLIFIER CONNECTION

10.2 System Configuration

10.2.1 Connecting to optical loop system

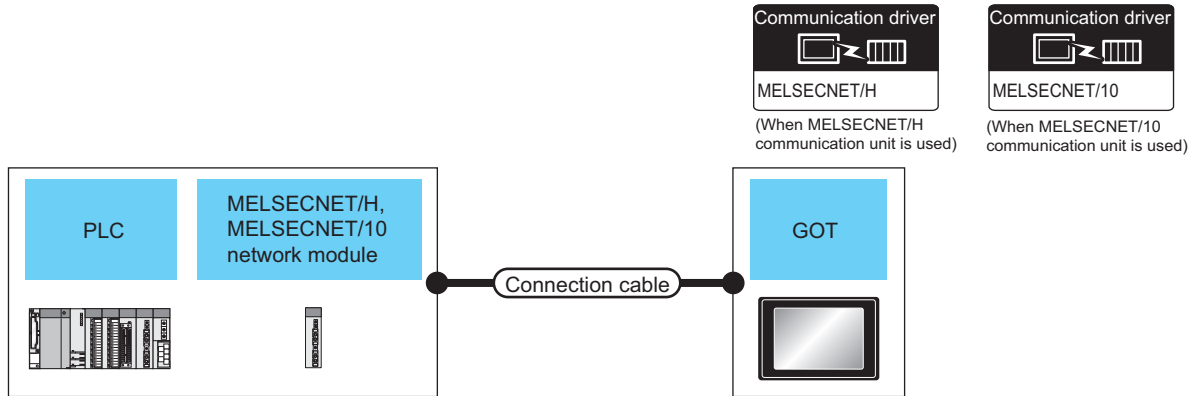

PLC			Connection cable		GOT		Number of connectable equipment
Model name	MELSECNET/H, MELSECNET/10 network module *1	Communication type	Cable model	Max. distance	Option device	Model	
MELSEC-Q	QJ71LP21 QJ71LP21-25 QJ71LP21S-25	MELSECNET/10	Optical fiber cable *2	*3	GT15-J71LP23-25 *4	GT16 GT15	63 GOTs
					GT15-75J71LP23-Z *5	GT15	
C Controller module (Q Series)	QJ71LP21-25 QJ71LP21S-25	MELSECNET/10	Optical fiber cable *2	*3	GT15-75J71LP23-25 *4	GT16 GT15	
MELSEC-QS	QJ71LP21 QJ71LP21-25 QJ71LP21S-25	MELSECNET/10	Optical fiber cable *2	*3	GT15-75J71LP23-25 *4	GT16 GT15	
MELSEC-QnA	AJ71QLP21 AJ71QLP21S A1SJ71QLP21 A1SJ71QLP21S	MELSECNET/10	Optical fiber cable *2	*3	GT15-J71LP23-25 *4	GT16 GT15	
					GT15-75J71LP23-Z *5	GT15	
MELSEC-A	AJ71LP21 A1SJ71LP21	MELSECNET/10	Optical fiber cable *2	*3	GT15-J71LP23-25 *4	GT16 GT15	
					GT15-75J71LP23-Z *5	GT15	

*1 For the system configuration of the MELSECNET/H and MELSECNET/10 network module, refer to the following manuals.

- ☞ Q corresponding MELSECNET/H Network System Reference Manual (PLC to PLC network)
For QnA/Q4AR MELSECNET/10 Network System Reference Manual
Type MELSECNET/10 Network system (PLC to PLC network) Reference Manual

*2 For the optical fiber cable, refer to the following manual.

- ☞ Q corresponding MELSECNET/H Network System Reference Manual (PLC to PLC network)
For QnA/Q4AR MELSECNET/10 Network System Reference Manual
Type MELSECNET/10 Network system (PLC to PLC network) Reference Manual

*3 The overall extension cable length and the length between stations vary depending on the cable type to be used and the total number of stations.

For details, refer to the following manual.

- ☞ Q corresponding MELSECNET/H Network System Reference Manual (PLC to PLC network)
For QnA/Q4AR MELSECNET/10 Network System Reference Manual
Type MELSECNET/10 Network system (PLC to PLC network) Reference Manual

*4 Specify the MELSECNET/10 Mode as the Communication Settings. For the setting, refer to the following.

- ☞ 10.3.1 Setting communication interface (Communication settings)

*5 Not available for the GT15□.

10.2.2 Connecting to the coaxial bus system

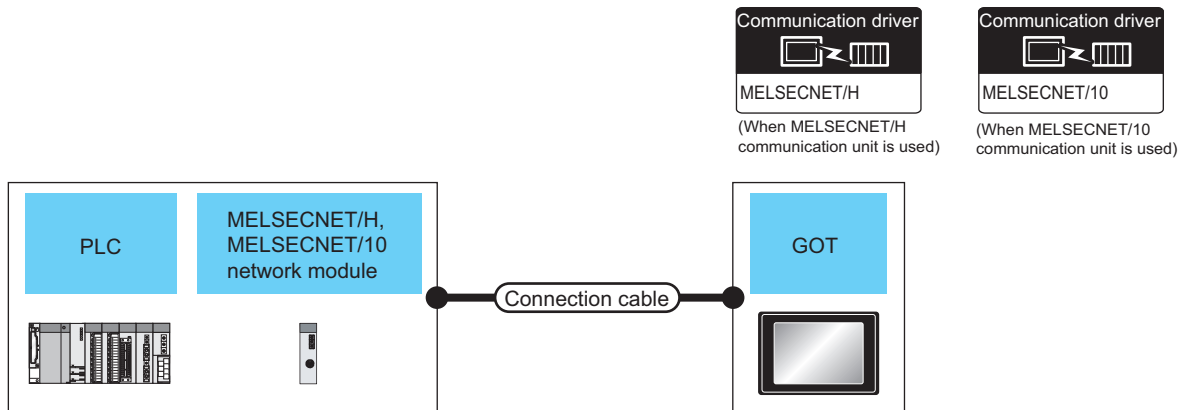

PLC			Connection cable		GOT		Number of connectable equipment
Model name	MELSECNET/H, MELSECNET/10 network module ^{*2}	Communication type	Cable model	Max. distance	Option device	Model	
MELSEC-Q ^{*1}	QJ71BR11 ^{*1}	MELSECNET/10	Coaxial cable ^{*3}	*4	GT15-J71BR13 ^{*5}	GT 16 GT 15	31 GOTs
					GT15-75J71BR13-Z ^{*6}	GT 15	
C Controller module (Q Series) MELSEC-QS	QJ71BR11 ^{*1}	MELSECNET/10	Coaxial cable ^{*3}	*4	GT15-J71BR13 ^{*5}	GT 16 GT 15	
MELSEC-QnA	AJ71QBR11 A1SJ71QBR11	MELSECNET/10	Coaxial cable ^{*3}	*4	GT15-J71BR13 ^{*5}	GT 16 GT 15	
					GT15-75J71BR13-Z ^{*6}	GT 15	
MELSEC-A	AJ71BR11 A1SJ71BR11	MELSECNET/10	Coaxial cable ^{*3}	*4	GT15-J71BR13 ^{*5}	GT 16 GT 15	
					GT15-75J71BR13-Z ^{*6}	GT 15	

*1 Use a PLC CPU and MELSECNET/H network module of function version B or later.

*2 For the system configuration of the MELSECNET/H and MELSECNET/10 network module, refer to the following manuals.

☞ Q corresponding MELSECNET/H Network System Reference Manual (PLC to PLC network)
 For QnA/Q4AR MELSECNET/10 Network System Reference Manual
 Type MELSECNET/10 Network system (PLC to PLC network) Reference Manual

*3 For the coaxial cable, refer to the following manuals.

☞ Q corresponding MELSECNET/H Network System Reference Manual (PLC to PLC network)
 For QnA/Q4AR MELSECNET/10 Network System Reference Manual
 Type MELSECNET/10 Network system (PLC to PLC network) Reference Manual

*4 The overall extension cable length and the length between stations vary depending on the cable type to be used and the total number of stations.

For details, refer to the following manual.

☞ Q corresponding MELSECNET/H Network System Reference Manual (PLC to PLC network)
 For QnA/Q4AR MELSECNET/10 Network System Reference Manual
 Type MELSECNET/10 Network system (PLC to PLC network) Reference Manual

*5 Specify the MELSECNET/10 Mode as the Communication Settings. For the setting, refer to the following.

☞ 10.3.1 Setting communication interface (Communication settings)

*6 Not available for the GT155□.

10.3 GOT Side Settings

10.3.1 Setting communication interface (Communication settings)

Set the channel of the connected equipment.

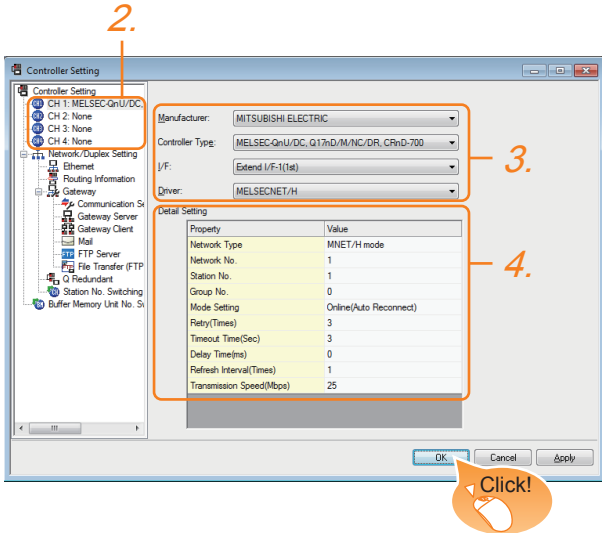

1. Select [Common] → [Controller Setting] from the menu.
2. The Controller Setting window is displayed. Select the channel to be used from the list menu.
3. Set the following items.
 - Manufacturer: MITSUBISHI ELECTRIC
 - Controller Type: Set according to the Controller Type to be connected.
 - I/F: Interface to be used
 - Driver:
 - When using the MELSECNET/H communication unit
 - MELSECNET/H
 - When using the MELSECNET/10 communication unit
 - MELSECNET/10
4. The detailed setting is displayed after Manufacturer, Controller Type, I/F, and Driver are set. Make the settings according to the usage environment.

➡ 10.3.2 Communication detail settings

Click the [OK] button when settings are completed.

POINT

The settings of connecting equipment can be confirmed in [I/F Communication Setting]. For details, refer to the following.

➡ 1.1.2 I/F communication setting

10.3.2 Communication detail settings

Make the settings according to the usage environment.

(1) MELSECNET/H

Property	Value
Network Type	MNET/H mode
Network No.	1
Station No.	1
Group No.	0
Mode Setting	Online(Auto Reconnect)
Retry(Times)	3
Timeout Time(Sec)	3
Delay Time(ms)	0
Refresh Interval(Times)	1
Transmission Speed(Mbps)	25

Item	Description	Range
Network Type	Set the network type. (Default: MNET/H mode)	<ul style="list-style-type: none"> • MNET/H mode • MNET/10 mode • MNET/H Extended mode^{*1}
Network No.	Set the network No. (Default: 1)	1 to 239
Station No.	Set the station No. of the GOT. (Default: 1)	1 to 64
Mode Setting	Set the operation mode of the GOT. (Default: Online (auto. reconnection))	<ul style="list-style-type: none"> • Online (Auto Reconnect) • Offline • Test between slave station^{*2} • Self-loopback test^{*2} • Internal self-loopback test^{*2} • H/W test^{*2}
Retry	Set the number of retries to be performed when a communication timeout occurs. When no response is received after retries, a communication times out. (Default: 3times)	0 to 5times
Timeout Time	Set the time period for a communication to time out. (Default: 3sec)	3 to 90sec
Delay Time	Set the delay time for reducing the load of the network/destination PLC. (Default: 0ms)	0 to 300ms

Item	Description	Range
Refresh Interval	Set the number of refreshes to secure the send/receive data in station units during communication. (Default: 1time) Valid when "Secured data send/ Secured data receive" is marked by the control station side network parameters of the MELSECNET/H network system.	1 to 1000times
Transmission Speed	Set the communication transmission speed. (Default: 25Mbps) When specifying [MNET/10 mode] as the network type, only 10Mbps can be set applicable.	10Mbps/25Mbps

*1 Cannot be set for the QCPU redundant system.
*2 For details, refer to the following manual.

Q corresponding MELSECNET/H Network System Reference Manual (PLC to PLC network)

(2) MELSECNET/10

Property	Value
Retry(Times)	3
Timeout Time(Sec)	3

Item	Description	Range
Retry	Set the number of retries to be performed when a communication timeout occurs. When no response is received after retries, a communication times out. (Default: 3times)	0 to 5times
Timeout Time	Set the time period for a communication to time out. (Default: 3sec)	3 to 90sec

POINT

- When MELSECNET/H communication unit is used
When connecting the MELSECNET/H network module to the MELSECNET/10 network system, specify the [MNET/10 mode] as a [Network Type].
- Communication interface setting by the Utility
The communication interface setting can be changed on the Utility's [Communication Settings] after writing [Communication Settings] of project data.
For details on the Utility, refer to the following manual.

GT□ User's Manual

- Precedence in communication settings
When settings are made by GT Designer3 or the Utility, the latest setting is effective.

10.3.3 Routing parameter setting

Up to 64 [Transfer Network No.]s can be set.

However, the same transfer network number cannot be set twice or more (multiple times).

Therefore, the one that can access to other station from the request source host GOT is 64 kinds of [Transfer Network No.]s.

POINT

- Routing parameter setting
When communicating within the host network, routing parameter setting is unnecessary.
- Selection of communication unit
Routing parameters cannot be set in the GT15-75J71LP23-Z and the GT15-75J71BR13-Z.
When setting routing parameters, use the GT15-J71LP23-25 or the GT15-J71BR13 according to the connection type to be used.

For details of routing parameters, refer to the following manual.

Q corresponding MELSECNET/H Network System Reference Manual (PLC to PLC network)

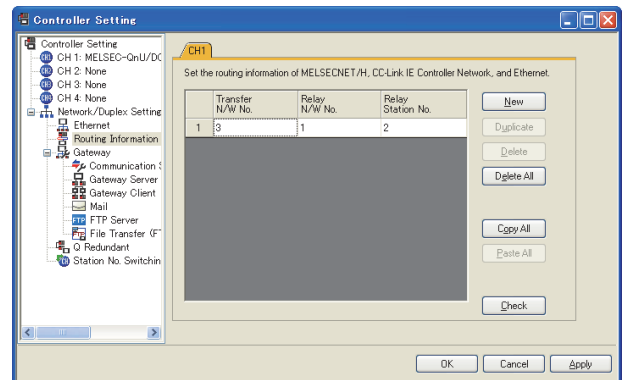

Item	Range
Transfer Network No.	1 to 239
Relay Network No.	1 to 239
Relay Station No.	1 to 64

POINT

Routing parameter setting of relay station

Routing parameter setting is also necessary for the relay station.

For the setting, refer to the following.

10.4 PLC Side Setting

9 MELSECNET/H CONNECTION (PLC TO PLC NETWORK)
 10 MELSECNET/10 CONNECTION (PLC TO PLC NETWORK)
 11 CC-LINK IE CONTROLLER NETWORK CONNECTION
 12 CC-LINK IE FIELD NETWORK CONNECTION
 13 CC-LINK CONNECTION (INTELLIGENT DEVICE STATION)
 14 CC-LINK CONNECTION (Via G4)
 15 INVERTER CONNECTION
 16 SERVO AMPLIFIER CONNECTION

10.3.4 Switch setting (Only when MELSECNET/10 communication unit is used)

POINT

Switch setting of the communication unit
When using the MELSECNET/H communication unit, the switch setting is not needed.

For details of each setting switch and LED, refer to the following manual.

➔ GT15 MELSECNET/10 communication unit User's Manual

GT15-75J71LP23-Z, GT15-75J71BR13-Z

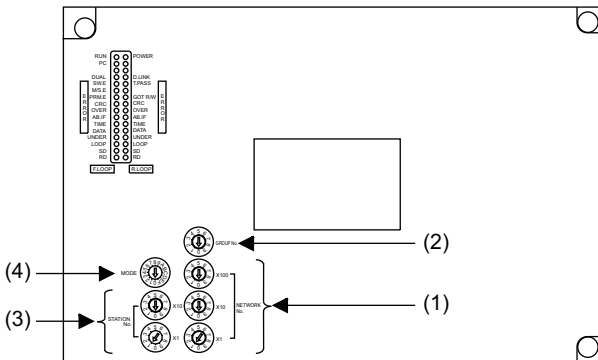

(1) Network number setting switch

Network number setting switch	Description	Set value
	Set the network No. of the MELSECNET/10 communication unit. (Default: 001)	1 to 239

(2) Group number setting switch

Group number setting switch	Description	Set value
	Set the group No. of the MELSECNET/10 communication unit. (Default: 0)	0: No group setting (fixed)*1

*1 The GOT does not use the group number. Specify "0".

(3) Station number setting switch

Station number setting switch	Description	Set value
	Set the station No. of the MELSECNET/10 communication unit. Set to not duplicate other stations in the network. (Default: 01)	1 to 64: GT15-75J71LP23-Z 1 to 32: GT15-75J71BR13-Z

(4) Mode setting switch

Mode setting switch	Description	Set value
	On-line (Default: 0)	0

POINT

(1) Switch setting example

For the switch setting example, refer to the following.

➔ 10.4 PLC Side Setting

(2) When the switch setting is changed

When changing the switch setting after mounting the MELSECNET/10 communication unit to the GOT, reset the GOT.

(3) Self check test

Select "6" to "9" as the mode setting switch to provide a self check test of the MELSECNET/10 communication unit.

For details, refer to the following manual.

➔ GT15 MELSECNET/10 communication unit User's Manual

10.4 PLC Side Setting

Model name	Reference	
MELSECNET/H network module	QJ71LP21, QJ71LP21-25, QJ71LP21S-25, QJ71BR11	10.4.1
MELSECNET/10 network module (QnA Series)	AJ71QLP21, AJ71QLP21S, AJ71QBR11, A1SJ71QLP21, A1SJ71QLP21S, A1SJ71QBR11	10.4.2
MELSECNET/10 network module (A Series)	AJ71LP21, AJ71BR11, A1SJ71LP21, A1SJ71BR1	10.4.3

10.4.1 Connecting to MELSECNET/H network module

This section describes the settings of the GOT and MELSECNET/H network module in the following case of system configuration.

When connecting the MELSECNET/H network module to the MELSECNET/10 network system, specify the MELSECNET/10 Mode as a network type.

POINT

MELSECNET/H network module

For details of the MELSECNET/H network module, refer to the following manual.

➔ Q corresponding MELSECNET/H Network System Reference Manual (PLC to PLC network)

System configuration

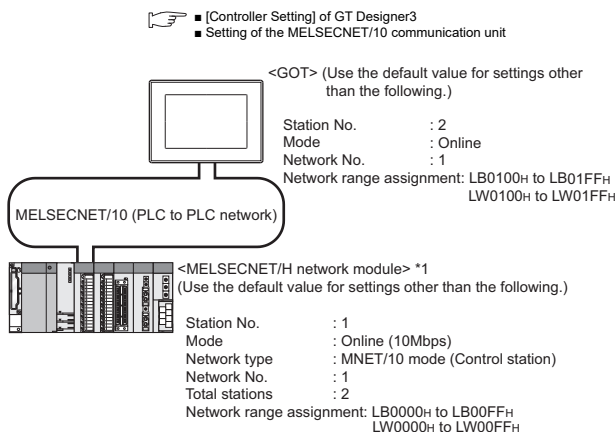

➔ Switch setting of MELSECNET/H network module
 (1)[Network parameter] of GX Developer

*1 The MELSECNET/H network module is mounted at slot 0 of the base unit.
 The start I/O No. of the MELSECNET/H network module is set at "0".

POINT

When connecting to Q170MCPU

When connected to Q170MCPU, the start I/O No. of the MELSECNET/H network module is set to "70".

Switch setting of MELSECNET/H network module

Set the station number setting switch and mode setting switch.

QJ71LP21, QJ71LP21-25

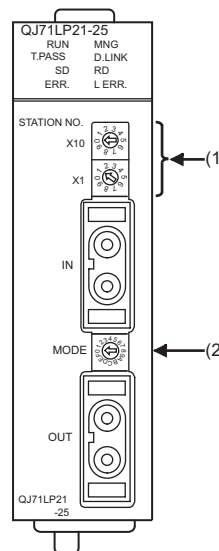

QJ71LP21S-25

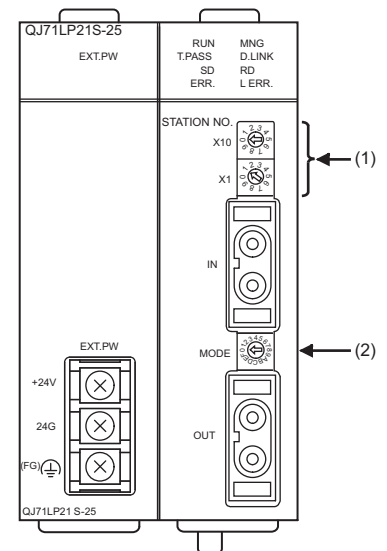

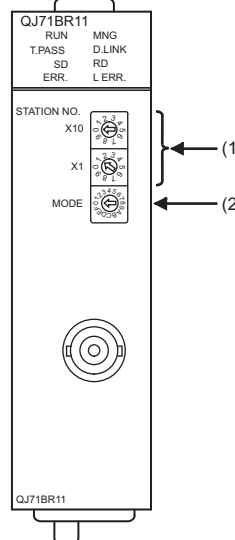

QJ71BR11



9 MELSECNET/H CONNECTION (PLC TO PLC NETWORK)
 10 MELSECNET/10 CONNECTION (PLC TO PLC NETWORK)
 11 CC-Link IE CONTROLLER NETWORK CONNECTION
 12 CC-Link IE FIELD NETWORK CONNECTION
 13 CC-Link CONNECTION (INTELLIGENT DEVICE STATION)
 14 CC-Link CONNECTION (Via G4)
 15 INVERTER CONNECTION
 16 SERVO AMPLIFIER CONNECTION

(1) Station number setting switch

Station number setting switch	Description	Set value	Setting necessity at GOT connection
STATION NO. X10  X1 	Station number setting (Station No.1) ^{*1}	1	○

○: Necessary △: As necessary ×: Not necessary
^{*1} Do not set the same station No. as that of the GOT.

(2) Mode setting switch

Mode setting switch	Description	Set value	Setting necessity at GOT connection
MODE 	Mode setting (Online: 10Mbps)	0 (fixed)	○

○: Necessary △: As necessary ×: Not necessary

POINT

When the switch setting has been changed
 Turn the PLC CPU OFF then ON again, or reset the PLC CPU.

■ Parameter setting (when connecting to MELSEC-Q or QS series)

(1) [Network parameter] of GX Developer

(a) Network parameter

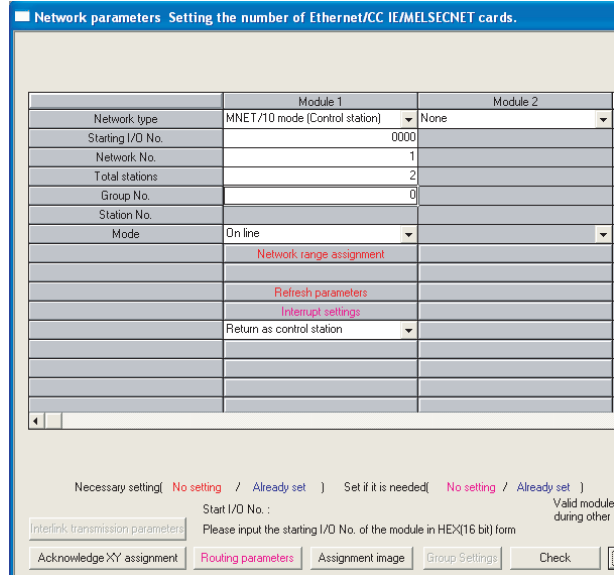

Item	Set value	Setting necessity at GOT connection
Network type	MNET/10 mode (Control station) (fixed)	○
Starting I/O No. ^{*1}	0000H	○
Network No. ^{*2}	1	○
Total stations	2	○
Group No.	0 (fixed)	○
Mode	Online (fixed)	○
Network range assignment	Refer to (b)	△
Refresh parameters	(Use default value)	△
Interrupt settings		×
Control station return setting		△
Redundant settings ^{*3}		△
Interlink transmission parameters		×
Routing parameters	Refer to (c)	△

○: Necessary △: As necessary ×: Not necessary

^{*1} When using Q170MCP, set it according to the system configuration.

^{*2} Specify the same network No. as that of the GOT.

^{*3} Set it when the MELSECNET/H network module is used in the redundant QnPRHCPU system.

(b) Network range assignment

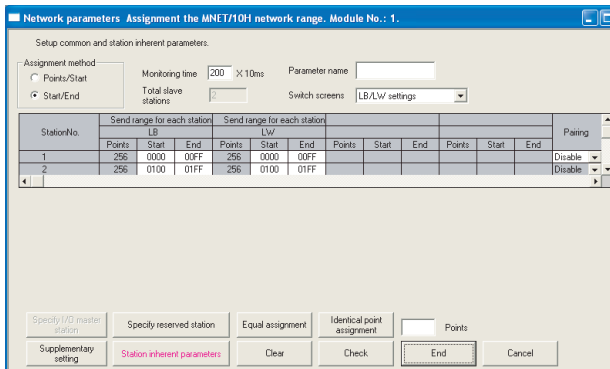

Item		Set value	Setting necessity at GOT connection
Monitoring time		200	△
LB/LW setting*1	Send range for station (LB)	Station No.1 Start	0000H △
		Station No.1 End	00FFH △
	Station No.2	Start	0100H △
		End	01FFH △
	Send range for station (LW)	Station No.1 Start	0000H △
		Station No.1 End	00FFH △
Station No.2	Start	0100H △	
	End	01FFH △	
Pairing setting*2		Disable	△
LX/LY setting*1		No setting	△
Specify I/O master station*1		No setting	△
Specify reserved station		No setting	△
Supplementary setting		(Use default value)	△
Station inherent parameters			△

○: Necessary △: As necessary ×: Not necessary

*1 Be sure to set it to perform the cyclic transmission.

*2 Set it when the MELSECNET/H network module is used in the redundant QnPRH CPU system.

POINT

When changing the network parameter
After writing the network parameter to the PLC CPU, operate the PLC CPU ether turning OFF and then ON or resetting.

(c) Routing parameter setting

Up to 64 [Transfer Network No.]s can be set. However, the same transfer network number cannot be set twice or more (multiple times). Therefore, the one that can access to other station from the request source host GOT is 64 kinds of [Transfer Network No.]s.

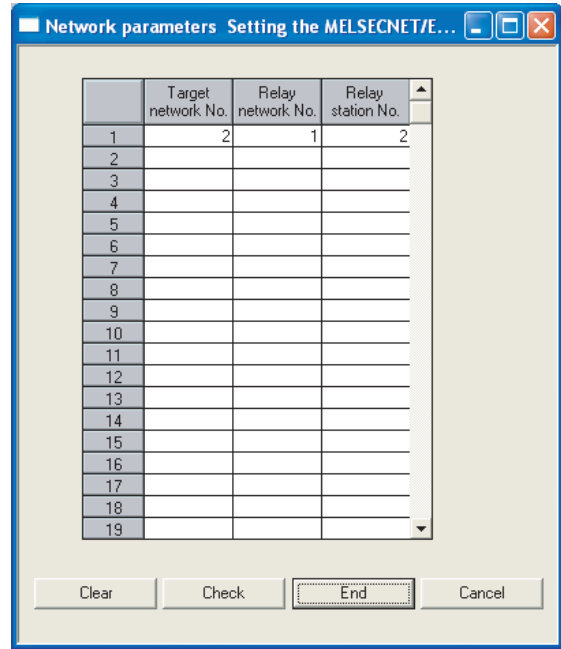

Item	Range
Target network No.	1 to 239
Relay network No.	1 to 239
Relay station No.	1 to 64

POINT

Routing parameter setting of request source
Routing parameter setting is also necessary for the request source GOT.

For the setting, refer to the following.

➡ 10.3.3 Routing parameter setting

9 MELSECNET/H CONNECTION (PLC TO PLC NETWORK)
10 MELSECNET/10 CONNECTION (PLC TO PLC NETWORK)
11 CC-Link IE CONTROLLER NETWORK CONNECTION
12 CC-Link IE FIELD NETWORK CONNECTION
13 CC-Link CONNECTION (INTELLIGENT DEVICE STATION)
14 CC-Link CONNECTION (Via G4)
15 INVERTER CONNECTION
16 SERVO AMPLIFIER CONNECTION

Parameter setting (when connecting to C Controller module (Q Series))

Use SW3PVC-CCPU-E Ver.3.05F or later for the MELSECNET/H utility.

(1) Connection settings

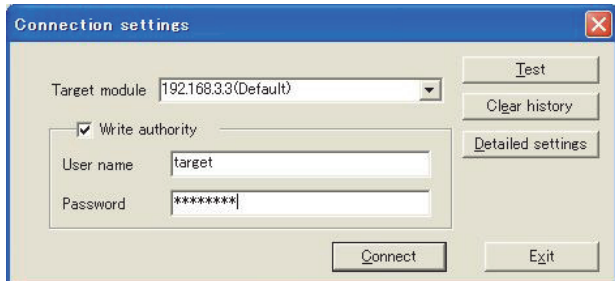

Item	Set value	Setting necessity at GOT connection
Target module*1	192.168.3.3 (Default)	○
Write authority	Mark the checkbox	○
User name*2	target	○
Password*2	password	○
Detailed settings	-	△

○: Necessary △: As necessary ×: Not necessary

- *1 If the IP address of the C Controller module (Q Series) has been changed, input the changed IP address or host name.
 *2 If the account of the C Controller module (Q Series) has been changed, input the changed user name and password.

(2) MELSECNET/H Utility's [Parameter Settings]

(a) Parameter settings

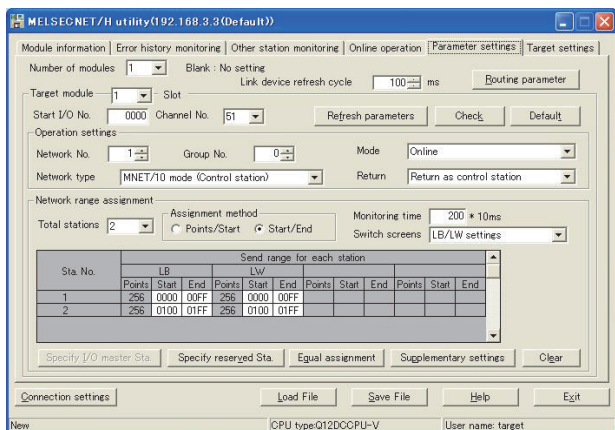

Item	Set value	Setting necessity at GOT connection
Number of modules	1	○
Link device refresh cycle	(Use default value)	△
Routing parameter	Refer to (b).	△
Target module	1	○
Start I/O No.	0000H	○
Channel No.	(Use default value)	○

Item		Set value	Setting necessity at GOT connection		
Operation settings	Network type	MNET/10 mode (Control station)	○		
	Network No.*1	1	○		
	Group No.	0	○		
	Mode	Online	○		
	Return	(Use default value)	△		
Refresh parameters		(Use default value)	△		
Network range assignment	Total stations	2	○		
	Assignment method	Start/End	○		
	LB/LW settings*2	Send range for each station LB	Sta. No.1 Start	0000H	△
			Sta. No.1 End	00FFH	△
		Sta. No.2	Start	0100H	△
			End	01FFH	△
	Send range for each station LW	Sta. No.1	Start	0000H	△
			End	00FFH	△
		Sta. No.2	Start	0100H	△
			End	01FFH	△
	(LX/LY) settings*2		No setting	△	
	Monitoring time		(Use default value)	△	
Specify I/O master Sta.*2		No setting	△		
Specify reserved Sta.		No setting	△		
Supplementary settings		(Use default value)	△		

○: Necessary △: As necessary ×: Not necessary

- *1 Specify the same network No. as that of the GOT.
 *2 Be sure to set the setting to perform the cyclic transmission.

POINT

When changing the network parameter
 After writing the network parameter to the C Controller module (Q Series), either turn the C Controller module (Q Series) OFF and then ON or reset it.

- (b) Routing parameter setting
 Up to 64 [Transfer Network No.]s can be set.
 However, the same transfer network number cannot be set twice or more (multiple times).
 Therefore, the one that can access to other station from the request source host GOT is 64 kinds of [Transfer Network No.]s.

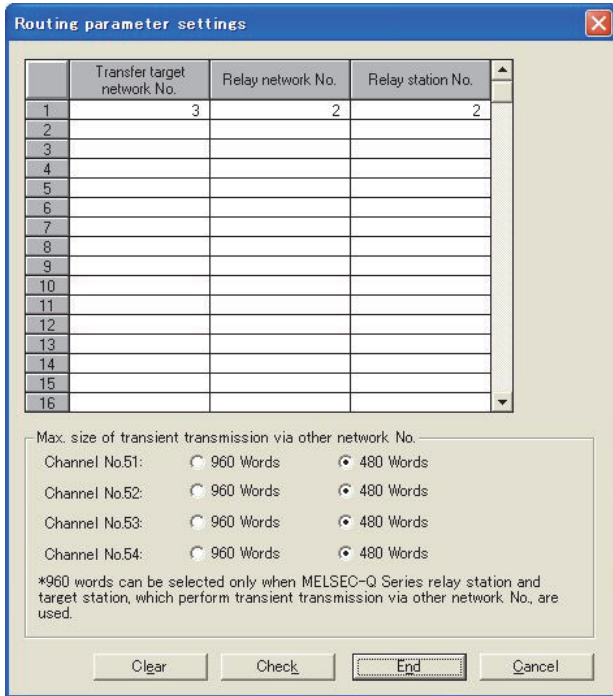

Item	Range
Transfer target network No.	1 to 239
Relay network No.	1 to 239
Relay station No.	1 to 120

POINT

Routing parameter setting of request source
 Routing parameter setting is also necessary for the request source GOT.
 For the setting, refer to the following.
 ➔ 10.3.3 Routing parameter setting

■ [Controller Setting] of GT Designer3

Item	Set value (Use default)
Retry	3times
Timeout Time	3sec

POINT

[Controller Setting] of GT Designer3
 For the setting method of [Controller Setting] of GT Designer3, refer to the following.
 ➔ 10.3.1 Setting communication interface (Communication settings)

■ Setting of the MELSECNET/10 communication unit

Item	Set value
Network number setting switch	1: Network No.1
Group number setting switch	0: No group setting (fixed)
Station number setting switch	2: Station No.2
Mode setting switch	0: Online (fixed)

POINT

Setting of the MELSECNET/10 communication unit
 For the setting method of the MELSECNET/10 communication unit, refer to the following.
 ➔ 10.3.1 Setting communication interface (Communication settings)

9
MELSECNET/H CONNECTION (PLC TO PLC NETWORK)
10
MELSECNET/10 CONNECTION (PLC TO PLC NETWORK)
11
CC-Link IE CONTROLLER NETWORK CONNECTION
12
CC-Link IE FIELD NETWORK CONNECTION
13
CC-Link CONNECTION (INTELLIGENT DEVICE STATION)
14
CC-Link CONNECTION (Via G4)
15
INVERTER CONNECTION
16
SERVO AMPLIFIER CONNECTION

10.4.2 Connecting to MELSECNET/10 network module (QnA Series)

This section describes the settings of the GOT and MELSECNET/10 network module (QnA series) in the following case of system configuration.

In this section, the network parameter (common parameter) of GX Developer is taken as an example to provide explanations.

POINT

MELSECNET/10 network module (QnA Series)

For details of the MELSECNET/10 network module (QnA Series), refer to the following manual.

For QnA/Q4AR MELSECNET/10 Network System Reference Manual

System configuration

- [Controller Setting] of GT Designer3
- Setting of the MELSECNET/10 communication unit

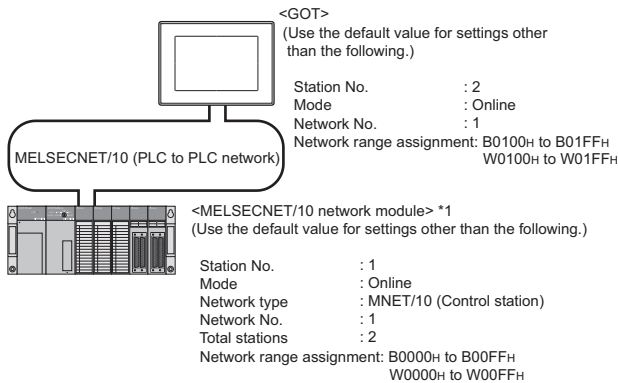

- Switch setting of MELSECNET/10 network module
- [Network parameter] of GX Developer

*1 The MELSECNET/10 network module is mounted at slot 0 of the base unit.
The start I/O No. of the MELSECNET/10 network module is set at "0".

- Switch setting of MELSECNET/10 network module
Set for each setting switch.

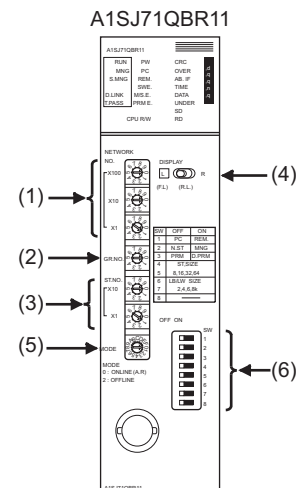
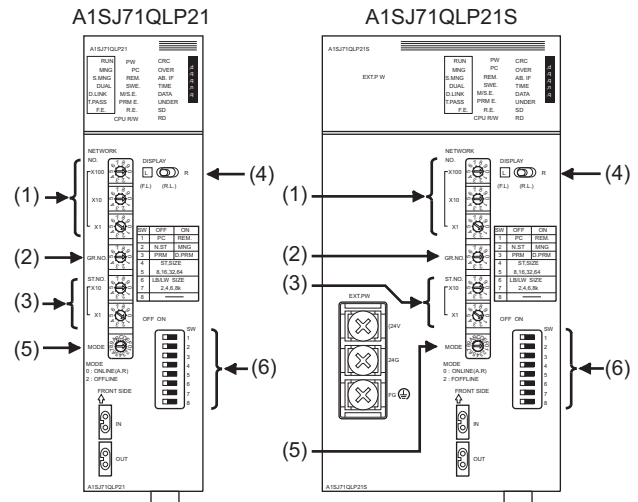
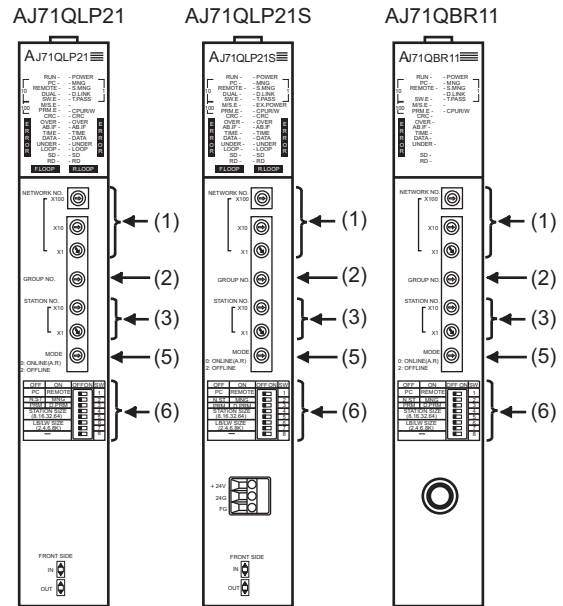

(1) Network number setting switch

Network number setting switch	Description	Set value	Setting necessity at GOT connection
	Network No. setting (Network No.1) ^{*1}	1	○

○: Necessary △: As necessary ×: Not necessary

*1 Specify the same network No. as that of the GOT.

(2) Group number setting switch

Group number setting switch	Description	Set value	Setting necessity at GOT connection
	Group No. setting (No group setting)	0 (fixed)	○

○: Necessary △: As necessary ×: Not necessary

(3) Station number setting switch

Station number setting switch	Description	Set value	Setting necessity at GOT connection
	Station number setting (Station No.1) ^{*2}	1	○

○: Necessary △: As necessary ×: Not necessary

*2 Do not set the same station No. as that of the GOT.

(4) LED indication select switch

LED indication select switch	Description	Set value	Setting necessity at GOT connection
	LED indication select	L (F.L.)	△

○: Necessary △: As necessary ×: Not necessary

(5) Mode setting switch

Mode setting switch	Description	Set value	Setting necessity at GOT connection
	Mode setting (Online)	0 (fixed)	○

○: Necessary △: As necessary ×: Not necessary

(6) Condition setting switches

Condition setting switches	Setting switch	Description	Set value	Setting necessity at GOT connection
	SW1	Network type (PLC to PLC network (PC))	OFF (fixed)	○
	SW2	Station type (Control station (MNG))	ON (fixed)	○
	SW3	Parameter for using ^{*1} (common parameter (PRM))	OFF (fixed)	○
	SW4	No. of stations ^{*1}	OFF (fixed)	×
	SW5			
	SW6	B/W Total BW points ^{*1}	OFF (fixed)	×
	SW7			
	SW8	Not used	OFF (fixed)	×

○: Necessary △: As necessary ×: Not necessary

*1 The MELSECNET/10 network module can be communicated by default parameters. For details, refer to the following manual.

For QnA/Q4AR MELSECNET/10 Network System Reference Manual

POINT

When the switch setting (other than the LED indication select switch) is changed
Turn the PLC CPU OFF then ON again, or reset the PLC CPU.

9
MELSECNET/H CONNECTION (PLC CONNECTION TO PLC NETWORK)
10
MELSECNET/10 CONNECTION (PLC CONNECTION TO PLC NETWORK)
11
CC-Link IE CONTROLLER NETWORK CONNECTION
12
CC-Link IE FIELD NETWORK CONNECTION
13
CC-Link CONNECTION (INTELLIGENT DEVICE STATION)
14
CC-Link CONNECTION (Via G4)
15
INVERTER CONNECTION
16
SERVO AMPLIFIER CONNECTION

■ [Network parameter] of GX Developer

(1) Network parameter

Item	Set value	Setting necessity at GOT connection
Network type	MNET/10 (Control station) (fixed)	○
Start I/O No.	0000H	○
Network No.*1	1	○
Total stations	2	○
Network range assignment	Refer to (2)	△
Refresh parameters	(Use default value)	△
Interlink transmission parameters		×
Routing parameters	Refer to (3)	△

○: Necessary △: As necessary ×: Not necessary

*1 Specify the same network No. as that of the network number setting switch of the MELSECNET/10 network module.

(2) Network range assignment

Item		Set value	Setting necessity at GOT connection	
Monitoring time		200	△	
BW setting*1	Send range for each station (LB)	Station No.1 Start	0000H	△
		Station No.1 End	00FFH	△
	Station No.2	Start	0100H	△
		End	01FFH	△
	Send range for each station (LW)	Station No.1 Start	0000H	△
		Station No.1 End	00FFH	△
XY setting*1		No setting	△	
Specify I/O master station*1		No setting	△	
Specify reserved station		No setting	△	
Supplementary setting		(Use default value)	△	
Station inherent parameters			△	

○: Necessary △: As necessary ×: Not necessary

*1 Be sure to set it to perform the cyclic transmission.

POINT

When changing the network parameter
After writing the network parameter to the PLC CPU, operate the PLC CPU ether turning OFF and then ON or resetting.

(3) Routing parameter setting

Up to 64 [Transfer Network No.]s can be set.
 However, the same transfer network number cannot be set twice or more (multiple times).
 Therefore, the one that can access to other station from the request source host GOT is 64 kinds of [Transfer Network No.]s.

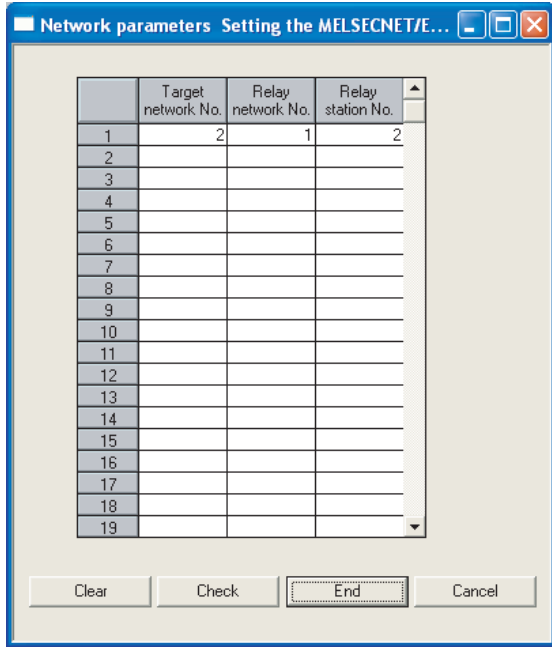

Item	Range
Target network No.	1 to 239
Relay network No.	1 to 239
Relay station No.	1 to 64

POINT

Routing parameter setting of request source
 Routing parameter setting is also necessary for the request source GOT.
 For the setting, refer to the following.
 ➔ 10.3.3 Routing parameter setting

■ [Controller Setting] of GT Designer3

Item	Set value (Use default)
Retry	3times
Timeout Time	3sec

POINT

[Controller Setting] of GT Designer3
 For the setting method of [Controller Setting] of GT Designer3, refer to the following.

➔ 10.3.1 Setting communication interface (Communication settings)

■ Setting of the MELSECNET/10 communication unit

Item	Set value
Network number setting switch	1: Network No.1
Group number setting switch	0: No group setting (fixed)
Station number setting switch	2: Station No.2
Mode setting switch	0: Online (fixed)

POINT

Setting of the MELSECNET/10 communication unit
 For the setting method of the MELSECNET/10 communication unit, refer to the following.

➔ 10.3.1 Setting communication interface (Communication settings)

10.4.3 Connecting to MELSECNET/10 network module (A Series)

This section describes the settings of the GOT and MELSECNET/10 network module (A Series) in the following case of system configuration.

In this section, the network parameter (common parameter) of GX Developer is taken as an example to provide explanations.

POINT

MELSECNET/10 network module (A Series)

For details of the MELSECNET/10 network module (A Series), refer to the following manual.

➡ Type MELSECNET/10 Network system (PLC to PLC network) Reference Manual

System configuration

- ➡ [Controller Setting] of GT Designer3
- Setting of the MELSECNET/10 communication unit

<GOT>
(Use the default value for settings other than the following.)

Station No. : 2
Mode : Online
Network No. : 1
Network range assignment: LB0100H to LB01FFH
LW0100H to LW01FFH

MELSECNET/10 (PLC to PLC network)



<MELSECNET/10 network module> *1
(Use the default value for settings other than the following.)

Station No. : 1
Mode : Online
Network type : MNET/10 (Control station)
Network No. : 1
Total stations : 2
Network range assignment: LB0000H to LB00FFH
LW0000H to LW00FFH

- ➡ Switch setting of MELSECNET/10 network module
- [Network parameter] of GX Developer



*1 The MELSECNET/10 network module is mounted at slot 0 of the base unit.
The start I/O No. of the MELSECNET/10 network module is set at "0".

Switch setting of MELSECNET/10 network module

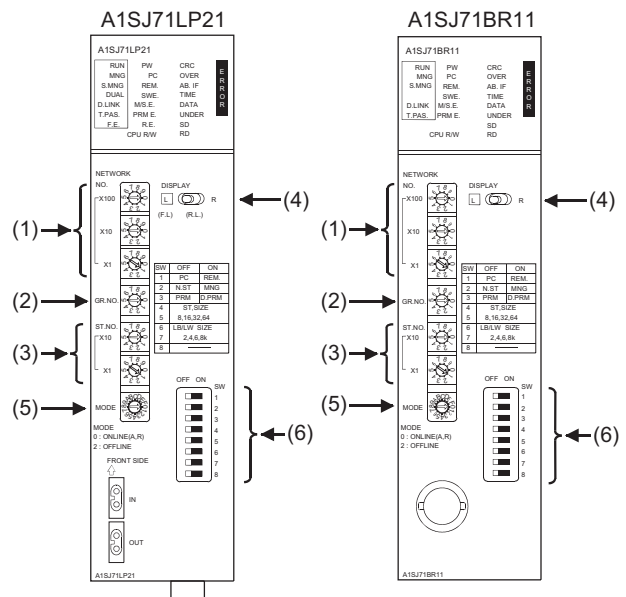
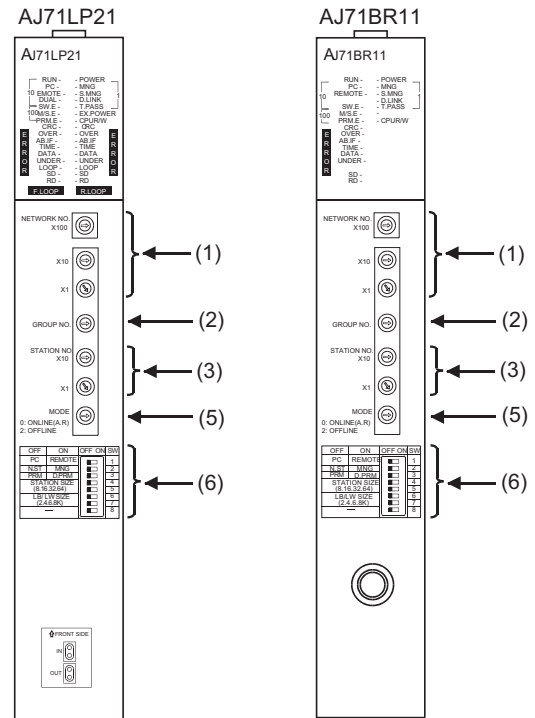
Set for each setting switch.



(1) Network number setting switch

Network number setting switch	Description	Set value	Setting necessity at GOT connection
NETWORK NO. X100  X10  X1 	Network No. setting (Network No.1) ^{*1*2}	1	○

○: Necessary △: As necessary ×: Not necessary

*1 Specify the same network No. as that of the GOT.

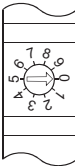

*2 Do not specify a number between 240 and 255.

(2) Group number setting switch

Group number setting switch	Description	Set value	Setting necessity at GOT connection
GROUP.NO. 	Group No. setting (No group setting)	0 (fixed)	○

○: Necessary △: As necessary ×: Not necessary

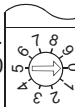
(3) Station number setting switch

Station number setting switch	Description	Set value	Setting necessity at GOT connection
STATION.NO. X10  X1 	Station number setting (Station No.1) ^{*3}	1	○

○: Necessary △: As necessary ×: Not necessary

*3 Do not set the same station No. as that of the GOT.

(4) LED indication select switch

LED indication select switch	Description	Set value	Setting necessity at GOT connection
DISPLAY  R (F.L.) (R.L.)	LED indication select	L (F.L.)	△

○: Necessary △: As necessary ×: Not necessary

(5) Mode setting switch

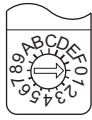
Mode setting switch	Description	Set value	Setting necessity at GOT connection
 MODE 0:ONLINE(A.R) 2:OFFLINE	Mode setting (Online)	0 (fixed)	○

○: Necessary △: As necessary ×: Not necessary

(6) Condition setting switches

Condition setting switches	Setting switch	Description	Set value	Setting necessity at GOT connection
	SW1	Network type (PLC to PLC network (PC))	OFF (fixed)	○
	SW2	Station type (Control station (MNG))	ON (fixed)	○
	SW3	Parameter for using ^{*1} (common parameter (PRM))	OFF (fixed)	○
	SW4	No. of stations ^{*1}	OFF (fixed)	×
	SW5		OFF (fixed)	×
	SW6	Total B/W points ^{*1}	OFF (fixed)	×
	SW7		OFF (fixed)	×
	SW8	Not used	OFF (fixed)	×

○: Necessary △: As necessary ×: Not necessary

*1 The MELSECNET/10 network module can be communicated by default parameters. For details, refer to the following manual.

 Type MELSECNET/10 Network system (PLC to PLC network) Reference Manual

POINT

When the switch setting (other than the LED indication select switch) is changed

Turn the PLC CPU OFF then ON again, or reset the PLC CPU.

9
MELSECNET/H CONNECTION (PLC CONNECTION TO PLC NETWORK)
10
MELSECNET/10 CONNECTION (PLC CONNECTION TO PLC NETWORK)
11
CC-Link IE CONTROLLER NETWORK CONNECTION
12
CC-Link IE FIELD NETWORK CONNECTION
13
CC-Link CONNECTION (INTELLIGENT DEVICE STATION)
14
CC-Link CONNECTION (Via G4)
15
INVERTER CONNECTION
16
SERVO AMPLIFIER CONNECTION

■ [Network parameter] of GX Developer

(1) Network parameter

Item	Set value	Setting necessity at GOT connection
Network type	MNET/10 (Control station) (fixed)	○
Start I/O No.	0000H	○
Network No.*1	1	○
Total stations	2	○
Network range assignment	Refer to (2)	△
Refresh parameters	(Use default value)	△
Interlink transmission parameters		×
Routing parameters	Refer to (3)	△

○: Necessary △: As necessary ×: Not necessary
 *1 Specify the same network No. as that of the network number setting switch of the MELSECNET/10 network module.

(2) Network range assignment

Item		Set value	Setting necessity at GOT connection	
Monitoring time		200	△	
LB/LW setting*1	Send range for each station (LB)	Station No.1 Start	0000H	△
		Station No.1 End	00FFH	△
	Station No.2	Start	0100H	△
		End	01FFH	△
	Send range for each station (LW)	Station No.1 Start	0000H	△
		Station No.1 End	00FFH	△
LX/LY setting*1		No setting	△	
Specify I/O master station*1		No setting	△	
Specify reserved station		No setting	△	
Supplementary setting		(Use default value)	△	
Station inherent parameters			△	

○: Necessary △: As necessary ×: Not necessary
 *1 Be sure to set it to perform the cyclic transmission.

POINT

When changing the network parameter
 After writing the network parameter to the PLC CPU, operate the PLC CPU either turning OFF and then ON or resetting.

(3) Routing parameter setting

Up to 64 [Transfer Network No.]s can be set.
 However, the same transfer network number cannot be set twice or more (multiple times).
 Therefore, the one that can access to other station from the request source host GOT is 64 kinds of [Transfer Network No.]s.

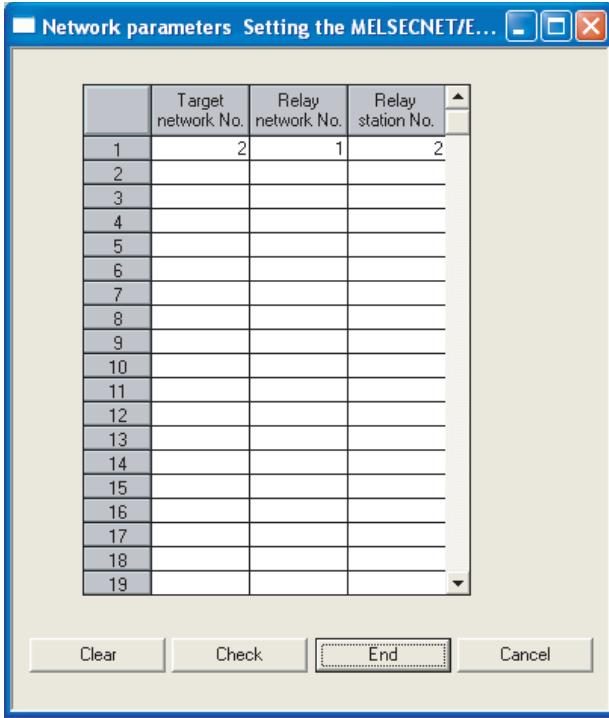

Item	Range
Target network No.	1 to 239
Relay network No.	1 to 239
Relay station No.	1 to 64

POINT

Routing parameter setting of request source
 Routing parameter setting is also necessary for the request source GOT.
 For the setting, refer to the following.
 ➔ 10.3.3 Routing parameter setting

■ [Controller Setting] of GT Designer3

Item	Set value (Use default)
Retry	3times
Timeout Time	3sec

POINT

[Controller Setting] of GT Designer3
 For the setting method of [Controller Setting] of GT Designer3, refer to the following.
 ➔ 10.3.1 Setting communication interface (Communication settings)

■ Setting of the MELSECNET/10 communication unit

Item	Set value
Network number setting switch	1: Network No.1
Group number setting switch	0: No group setting (fixed)
Station number setting switch	2: Station No.2
Mode setting switch	0: Online (fixed)

POINT

Setting of the MELSECNET/10 communication unit
 For the setting method of the MELSECNET/10 communication unit, refer to the following.
 ➔ 10.3.1 Setting communication interface (Communication settings)

10.5 Precautions

■ Network configuration

Use the MELSECNET/10 mode of MELSECNET/H (PLC to PLC network) or MELSECNET/10 (PLC to PLC network) to configure a network including the GOT.

- (1) The following networks including the GOT cannot be configured.
 - MELSECNET/10 (Remote I/O network)
 - MELSECNET/H (Remote I/O network)
- (2) When configuring the network (MELSECNET/H (PLC to PLC network) including the GOT, refer to the following.

 9. MELSECNET/H CONNECTION (PLC TO PLC NETWORK)

■ Monitoring range

Only PLC CPU of the same networks No. can be monitored in GOT.

For details, refer to the following manual.

 GT Designer3 Version□ Screen Design Manual

■ Starting GOT with MELSECNET/10 connection

With the MELSECNET/10 connection, the data link starts approximately 10 seconds after the GOT starts.

■ When a network error occurs in the system alarm

When a system alarm regarding a network error occurs with the MELSECNET/10 connection, the system alarm is kept displaying on the GOT even though the error factor is removed.

To cancel the system alarm display, restart the GOT.

■ Connection in the multiple CPU system

When the GOT is connected to multiple CPU system, the following time is taken until when the PLC runs.

QCPU (Q mode), motion controller CPU (Q series): 10 seconds or more

MELDAS C70: 18 seconds or more

When the GOT starts before the PLC runs, a system alarm occurs. Adjust the opening screen time in the GOT setup so that no system alarm occurs.

 GT Designer3 Version□ Screen Design Manual

■ Connection to QCPU (Q mode)

Use function version B or later of the MELSECNET/H network module and QCPU (Q mode).

■ Connection to Q17nDCPU, Q170MCPUC, CNC C70, CRnQ-700

The Q17nDCPU, Q170MCPUC, CNC C70 and CRnQ-700 are applicable to the MELSECNET/H connection (PLC to PLC network) only.

For connecting the GOT to the MELSECNET/10 network system (PLC to PLC network), set the MELSECNET/H network system (PLC to PLC network) to the MELSECNET/10 mode.

■ Connection to QSCPU

The GOT can only read device data and sequence programs by the ladder monitor function in the QSCPU.

The GOT cannot write any data to the QSCPU.

■ Connection to Q170MCPUC

Set [CPU No.] to "2" in the device setting to monitor the device of the Motion CPU area (CPU No.2).

When the CPU No. is set to "0" or "1", the device on the PLC CPU area (CPU No.1) is monitored.

When the CPU No. is set to the number other than "0" to "2", a communication error occurs and the monitoring cannot be executed.

For setting the CPU No., refer to the following manual.

 GT Designer3 Version□ Screen Design Manual

Example) Setting dialog box of the bit device

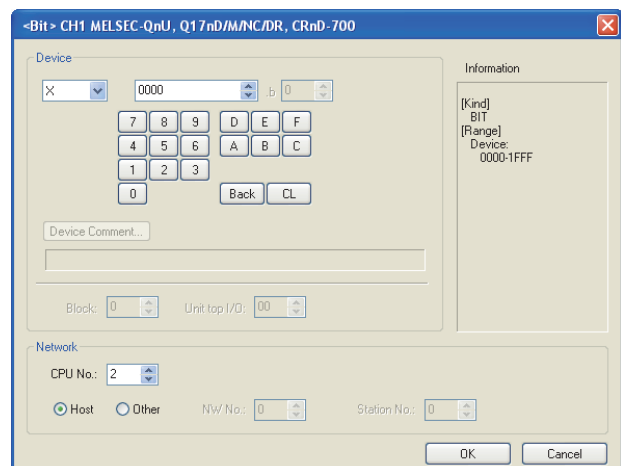

11

CC-Link IE CONTROLLER NETWORK CONNECTION





11.1 Connectable Model List	11 - 2
11.2 System Configuration	11 - 8
11.3 GOT side settings	11 - 9
11.4 PLC Side Setting	11 - 11
11.5 Precautions	11 - 25

11. CC-Link IE CONTROLLER NETWORK CONNECTION

11.1 Connectable Model List

11.1.1 PLC/Motion controller CPU

The following table shows the connectable models.

Series	Model name	Clock	Communication type	GT 16	GT 15	GT 14	GT 12	GT11 Bus	GT11 Serial	GT 10 ₅₀	GT 10 ₃₀	Refer to
MELSEC iQ-R Series	R04CPU	○	CC-Link IE	○	×	×	×	×	×	×	×	 11.2
	R08CPU											
	R16CPU											
	R32CPU											
	R120CPU											
	R08PCPU											
	R16PCPU											
	R32PCPU											
	R120PCPU											
	R04ENCPU											
	R08ENCPU											
	R16ENCPU											
	R32ENCPU											
	R120ENCPU											
Motion controller CPU (MELSEC iQ-R Series)	R16MTCPU	○	CC-Link IE	○	×	×	×	×	×	×	×	 11.2
	R32MTCPU											
C Controller module (MELSEC iQ-R Series)	R12CCPU-V	○	CC-Link IE	○	×	×	×	×	×	×	×	 11.2
MELSEC iQ-F Series	FX5U FX5UC	○	CC-Link IE	×	×	×	×	×	×	×	×	-

(Continued to next page)

*1 Mount a safety function module R6SFM next to the RnSF CPU on the base unit. The RnSF CPU and the safety function module R6SFM must have the same pair version. If their pair versions differ, the RnSF CPU does not operate.

Series	Model name	Clock	Communication type	GT 16	GT 15	GT 14	GT 12	GT11 Bus	GT11 Serial	GT10 5□4□	GT10 20□30	Refer to	
MELSEC-Q (Q mode)	Q00JCPU	○	CC-Link IE	○*1	○*1	×	×	×	×	×	×	11.2	
	Q00CPU*1												
	Q01CPU*1												
	Q02CPU*1												
	Q02HCPU*1												
	Q06HCPU*1												
	Q12HCPU*1												
	Q25HCPU*1												
	Q02PHCPU												
	Q06PHCPU												
	Q12PHCPU												
	Q25PHCPU												
	Q12PRHCPU (Main base)												
	Q25PRHCPU (Main base)												
	Q12PRHCPU (Extension base)	○	-	×	×	×	×	×	×	×	×	-	
	Q25PRHCPU (Extension base)	○	CC-Link IE	○	○	×	×	×	×	×	×	×	11.2
	Q00UCPU												
	Q01UCPU												
	Q02UCPU												
	Q03UDCPU												
	Q04UDHCPU												
	Q06UDHCPU												
	Q10UDHCPU												
	Q13UDHCPU												
	Q20UDHCPU												
	Q26UDHCPU												
	Q03UDECPU												
	Q04UDEHCPU												
Q06UDEHCPU													
Q10UDEHCPU													
Q13UDEHCPU													
Q20UDEHCPU													
Q26UDEHCPU													

(Continued to next page)

*1 When in multiple CPU system configuration, use CPU function version B or later.

9
MELSECNET/H
CONNECTION (PLC
TO PLC NETWORK)

10
MELSECNET/10
CONNECTION (PLC
TO PLC NETWORK)

11
CC-LINK IE CONTROLLER
NETWORK
CONNECTION



12
CC-LINK IE FIELD
NETWORK
CONNECTION

13
CC-LINK CONNECTION
(INTELLIGENT DEVICE
STATION)

14
CC-LINK
CONNECTION
(Via G4)

15
INVERTER
CONNECTION

16
SERVO AMPLIFIER
CONNECTION

Series	Model name	Clock	Communication type	GT 16	GT 15	GT 14	GT 12	GT11 Bus	GT11 Serial	GT10 5□ 4□	GT10 20 30	Refer to
MELSEC-Q (Q mode)	Q50UDEHCPU Q100UDEHCPU Q03UDVCPU Q04UDVCPU Q06UDVCPU Q13UDVCPU Q26UDVCPU	○	CC-Link IE	○	○	×	×	×	×	×	×	 11.2
C Controller module (Q Series)	Q12DCCPU-V*1 Q24DHCCPU-V/VG Q24DHCCPU-LS	○	CC-Link IE	○	○	×	×	×	×	×	×	 11.2
	Q26DHCCPU-LS			○	×	×	×	×	×	×	×	
MELSEC-QS	QS001CPU	○	CC-Link IE	○	○	×	×	×	×	×	×	 11.2
MELSEC-L	L02CPU L06CPU L26CPU L26CPU-BT L02CPU-P L06CPU-P L26CPU-P L26CPU-PBT L02SCPU L02SCPU-P	○	-	×	×	×	×	×	×	×	×	-
MELSEC-Q (A mode)	Q02CPU-A Q02HCPU-A Q06HCPU-A	○	-	×	×	×	×	×	×	×	×	-
MELSEC-QnA (QnACPU)	Q2ACPU Q2ACPU-S1 Q3ACPU Q4ACPU Q4ARCPU	○	-	×	×	×	×	×	×	×	×	-
MELSEC-QnA (QnASCPU)	Q2ASCPU Q2ASCPU-S1 Q2ASHCPU Q2ASHCPU-S1	○	-	×	×	×	×	×	×	×	×	-
MELSEC-A (AnCPU)	A2UCPU A2UCPU-S1 A3UCPU A4UCPU A2ACPU A2ACPUP21 A2ACPUR21 A2ACPU-S1 A2ACPUP21-S1 A2ACPUR21-S1 A3ACPU A3ACPUP21 A3ACPUR21 A1NCPUR21 A1NCPUP21 A1NCPUR21 A2NCPUR21 A2NCPUP21	○	-	×	×	×	×	×	×	×	×	-

(Continued to next page)

*1 Use a module with the upper five digits later than 12042.

Series	Model name	Clock	Communication type	GT 16	GT 15	GT 14	GT 12	GT11 Bus	GT11 Serial	GT 10 5□	GT 10 20 30	Refer to	
MELSEC-A (AnSCPU)	A2USCPU	○	-	x	x	x	x	x	x	x	x	-	
	A2USCPU-S1												
	A2USHCPU-S1												
	A1SCPU												
	A1SCPUC24-R2												
	A1SHCPU												
	A2SCPU												
	A2SCPU-S1												
	A2SHCPU												
	A2SHCPU-S1												
	A1SJCPU												
	A1SJCPU-S3												
	A1SJHCPU												
MELSEC-A	A0J2HCPU	x	-	x	x	x	x	x	x	x	x	-	
	A0J2HCPUP21												
	A0J2HCPUR21												
	A0J2HCPU-DC24												
	MELSEC-A	A2CCPU	○	-	x	x	x	x	x	x	x	x	-
		A2CCPUP21											
		A2CCPUR21											
		A2CCPUC24											
		A2CCPUC24-PRF											
		A2CJCPU-S3											
A1FXCPU													
Motion controller CPU (Q Series)	Q172CPU	○	-	x	x	x	x	x	x	x	x	-	
	Q173CPU												
	Q172CPUN												
	Q173CPUN												
	Q172HCPU												
	Q173HCPU												
	Q172DCPU	○	CC-Link IE	○	○	x	x	x	x	x	x	11.2	
	Q173DCPU												
	Q172DCPU-S1												
	Q173DCPU-S1												
	Q172DSCPU												
	Q173DSCPU												
	Q170MCPU*1												
	Q170MSCPU*2												
	Q170MSCPU-S1*2												
MR-MQ100	○	-	x	x	x	x	x	x	x	x	-		

(Continued to next page)

*1 Only the first step can be used on the extension base unit (Q52B/Q55B).

*2 The extension base unit (Q5□B/Q6□B) can be used.

9
MELSECNET/H
CONNECTION (PLC
TO PLC NETWORK)

10
MELSECNET/10
CONNECTION (PLC
TO PLC NETWORK)

11
CC-LINK IE CONTROLLER
NETWORK
CONNECTION

12
CC-LINK IE FIELD
NETWORK
CONNECTION



13
CC-LINK CONNECTION
(INTELLIGENT DEVICE
STATION)

14

15
CC-LINK
CONNECTION
(Via G4)

16
INVERTER
CONNECTION

SERVO AMPLIFIER
CONNECTION

Series	Model name	Clock	Communication type	GT 16	GT 15	GT 14	GT 12	GT11 Bus	GT11 Serial	GT10 5/4	GT10 20/30	Refer to
Motion controller CPU (A Series)	A273UCPU	○	-	×	×	×	×	×	×	×	×	-
	A273UHCPU											
	A273UHCPU-S3											
	A373UCPU											
	A373UCPU-S3											
	A171SCPU											
	A171SCPU-S3											
	A171SCPU-S3N											
	A171SHCPU											
	A171SHCPUN											
	A172SHCPU											
	A172SHCPUN											
	A173UHCPU											
	A173UHCPU-S1											
MELSEC-WS	WS0-CPU0	×	×	×	×	×	×	×	×	×	×	-
	WS0-CPU1											
	WS0-CPU3											
MELSECNET/H Remote I/O station	QJ72LP25-25	×	-	×	×	×	×	×	×	×	×	-
	QJ72LP25G											
	QJ72BR15											
CC-Link IE Field Network head module	LJ72GF15-T2	×	-	×	×	×	×	×	×	×	×	-
CC-Link IE Field Network Ethernet adapter module	NZ2GF-ETB	×	-	×	×	×	×	×	×	×	×	-
CNC C70	Q173NCCPU	○	CC-Link IE	○	○	×	×	×	×	×	×	 11.2
Robot controller	CRnQ-700 (Q172DRCPU) CR750-Q (Q172DRCPU) CR751-Q (Q172DRCPU)	○	CC-Link IE	○	○	×	×	×	×	×	×	 11.2
MELSEC-FX	FX0	×	-	×	×	×	×	×	×	×	×	-
	FX0s											
	FX0N											
	FX1	×	-	×	×	×	×	×	×	×	×	
	FX2											
	FX2c											
	FX1s	○	-	×	×	×	×	×	×	×	×	
	FX1N											
	FX2N											
	FX1NC	×	-	×	×	×	×	×	×	×	×	
	FX2NC											
	FX3S											
	FX3G	○	-	×	×	×	×	×	×	×	×	
	FX3GC											
	FX3GE											
FX3U												
FX3UC												

11.1.2 CC-Link IE Controller Network communication unit

CPU series	CC-Link IE Controller Network communication unit
MELSEC iQ-R Series Motion controller CPU (MELSEC iQ-R Series) C Controller module (MELSEC iQ-R Series)	RJ71GP21-SX
MELSEC-Q (Q mode) C Controller module (Q Series) MELSEC-QS Motion controller CPU (Q Series) CNC C70 Robot controller (CRnQ-700)	QJ71GP21-SX* ¹ QJ71GP21S-SX* ¹

*¹ When the CC-Link IE Controller Network is in the extended mode, use a unit with the upper five digits of the serial No. 12052 or later.

9	MELSECNET/H CONNECTION (PLC TO PLC NETWORK)
10	MELSECNET/10 CONNECTION (PLC TO PLC NETWORK)
11	CC-LINK IE CONTROLLER NETWORK CONNECTION
12	CC-LINK IE FIELD NETWORK CONNECTION
13	CC-LINK CONNECTION (INTELLIGENT DEVICE STATION)
14	CC-LINK CONNECTION (Via G4)
15	INVERTER CONNECTION
16	SERVO AMPLIFIER CONNECTION

11.2 System Configuration

11.2.1 Connecting to optical loop system

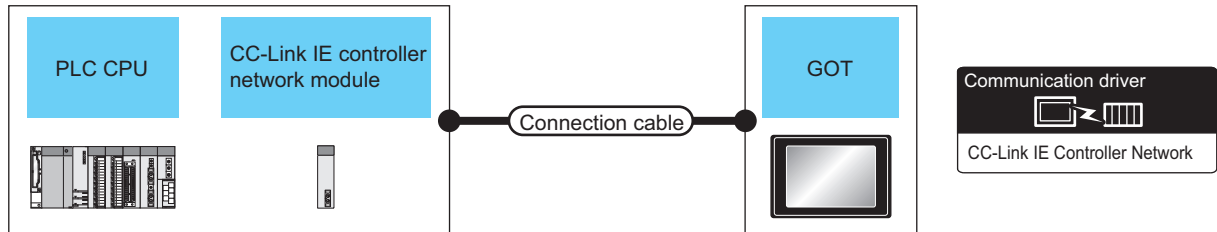

PLC			Connection cable		GOT		Number of connectable equipment
Model name ^{*5}	CC-Link IE controller network communication unit ^{*1}	Communication type	Cable model	Max. distance	Option device	Model	
MELSEC iQ-R Series Motion controller CPU (MELSEC iQ-R Series) C Controller module (MELSEC iQ-R Series)	RJ71GP21-SX	CC-Link IE	Optical fiber cable ^{*2}	*3	GT15-J71GP23-SX ^{*6}		119 GOTs ^{*4}
MELSEC-Q C Controller module (Q Series) MELSEC-QS	QJ71GP21-SX QJ71GP21S-SX	CC-Link IE	Optical fiber cable ^{*2}	*3	GT15-J71GP23-SX ^{*6}		119 GOTs ^{*4}

*1 When the CC-Link IE Controller Network is in the extended mode, use a unit with the upper five digits of the serial No. 12052 or later.

For the system configuration on the CC-Link IE Controller Network module side, refer to the following manual.

CC-Link IE Controller Network Reference Manual

*2 For the optical fiber cable, refer to the following manual.

CC-Link IE Controller Network Reference Manual

*3 The overall extension cable length and the length between stations vary depending on the cable type to be used and the total number of stations.

For details, refer to the following manual.

CC-Link IE Controller Network Reference Manual

*4 When Universal model QCPUs is a control station, up to 119 GOTs can be connected.

When a QCPU other than Universal model QCPU is the control station, the number of connectable GOTs is 63 units (at most). Basic model QCPU and the QSCPU cannot be used as the control station.

*5 When the CC-Link IE Controller Network is in the extended mode, only MELSEC-Q series Universal model QCPU can be used.

*6 When the CC-Link IE Controller Network is in the extended mode, use a module with the serial No. 02910908***** or later.

11.3 GOT side settings

11.3.1 Setting communication interface (Communication settings)

Set the channel of connecting equipment.

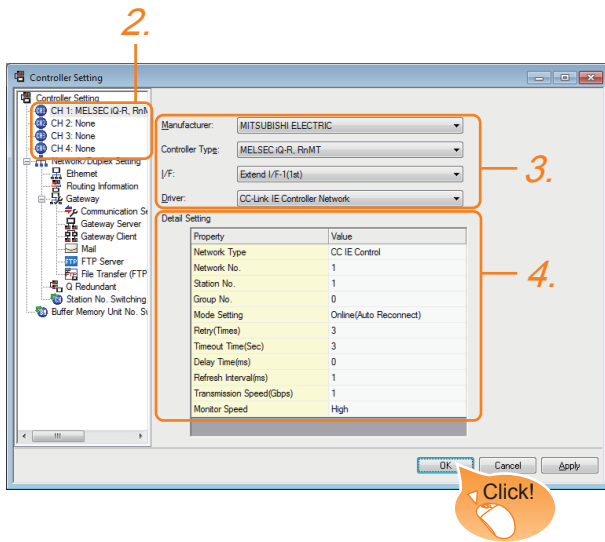

1. Select [Common] → [Controller Setting] from the menu.
2. The Controller Setting window is displayed. Select the channel to be used from the list menu.
3. Set the following items.
 - Manufacturer: MITSUBISHI ELECTRIC
 - Controller Type: Set according to the Controller Type to be connected.
 - I/F: Interface to be used
 - Driver: CC-Link IE Controller Network
4. The detailed setting is displayed after Manufacturer, Controller Type, I/F, and Driver are set. Make the settings according to the usage environment.

☞ 11.3.2 Communication detail settings

Click the [OK] button when settings are completed.

POINT

The settings of connecting equipment can be confirmed in [I/F Communication Setting]. For details, refer to the following.

☞ 1.1.2 I/F communication setting

11.3.2 Communication detail settings

Make the settings according to the usage environment.

Property	Value
Network Type	CC IE Control
Network No.	1
Station No.	1
Group No.	0
Mode Setting	Online(Auto Reconnect)
Retry(Times)	3
Timeout Time(Sec)	3
Delay Time(ms)	0
Refresh Interval(ms)	1
Transmission Speed(Gbps)	1
Monitor Speed	High



Item	Description	Range
Network Type ^{*4}	Set the network Type (Default: CC IE Control)	<ul style="list-style-type: none"> • CC IE Control • CC IE Control extended mode
Network No.	Set the network No. (Default: 1)	1 to 239
Station No.	Set the station No. of the GOT. (Default: 1)	1 to 120
Mode Setting	Set the operation mode of the GOT. (Default: Online (auto. reconnection))	<ul style="list-style-type: none"> • Online (auto. reconnection) • Offline • Test station^{*1} • Self-loopback test^{*1} • Internal self-loopback test^{*1} • Line test^{*1} • H/W test^{*1}
Retry	Set the number of retries to be performed when a communication timeout occurs. When no response is received after retries, a communication times out. (Default: 3times)	0 to 5times
Timeout Time	Set the time period for a communication to time out. (Default: 3sec)	3 to 90sec
Delay Time	Set the delay time for reducing the load of the network/destination PLC. (Default: 0ms)	0 to 300ms
Refresh Interval	Set the number of refreshes to secure the send/receive data in station units during communication. (Default: 1ms) Valid when [Block data assurance per station is available.] is checked by the control station side network parameters of the CC-Link IE Controller Network.	1 to 1000ms

9
 MELSECNET/H CONNECTION (PLC TO PLC NETWORK)
 10
 MELSECNET/IQ CONNECTION (PLC TO PLC NETWORK)
 11
 CC-Link IE CONTROLLER NETWORK CONNECTION
 12
 CC-Link IE FIELD NETWORK CONNECTION
 13
 CC-Link CONNECTION (INTELLIGENT DEVICE STATION)
 14
 CC-Link CONNECTION (Via G4)
 15
 INVERTER CONNECTION
 16
 SERVO AMPLIFIER CONNECTION

Item	Description	Range
Monitor Speed	Set the monitor speed for the CC-Link IE controller network. This setting is not valid in all systems. (Default: High)	High ^{*2} /Normal/Low ^{*3}

- *1 For details, refer to the following manual.
 CC-Link IE Controller Network Reference Manual
- *2 This range is effective when collecting a large amount of data (such as logging and recipe function) on other than the monitor screen. However, the range may affect the sequence scan time when connecting to Q00UJ/Q00U/Q01U/Q02UCPU or Q00J/Q00/Q01CPU. If you want to avoid the influence on the sequence scan time, do not set [High]. (This setting hardly affects QCPUs other than the above.)
- *3 Set this range if you want to avoid the influence on the sequence scan time further than the [Normal] setting when connecting to Q00UJ/Q00U/Q01U/Q02UCPU or Q00J/Q00/Q01CPU. However, the monitor speed may be reduced.
- *4 When the CC-Link IE Controller Network is in the extended mode, set to [CC IE Control extended mode]. The extended mode can be used in GT Designer3 version 1.22Y or later.

POINT

- (1) Switch setting example
For the switch setting example, refer to the following.
 11.4 PLC Side Setting
- (2) Communication interface setting by Utility
The communication interface setting can be changed on the Utility's [Communication Settings] after writing [Communication Settings] of project data. For details on the Utility, refer to the following manual.
 GT□ User's Manual
- (3) Precedence in communication settings
When settings are made by GT Designer3 or the Utility, the latest setting is effective.
- (4) Network type
Be sure to set the same network types for the CPU side and the GOT side. If the net work types of the CPU side and the GOT side are different, an error is displayed in the system alarm of the GOT side.

11.3.3 Routing parameter setting

Up to 64 [Transfer Network No.]s can be set. However, the same transfer network number cannot be set twice or more (multiple times). Therefore, the one that can access to other station from the request source host GOT is 64 kinds of [Transfer Network No.]s.

POINT

Routing parameter setting
When communicating within the host network, routing parameter setting is unnecessary.

For details of routing parameters, refer to the following manual.

 CC-Link IE Controller Network Reference Manual

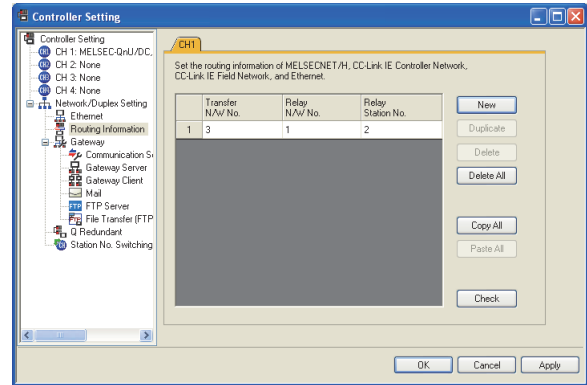

Item	Range
Transfer Network No.	1 to 239
Relay Network No.	1 to 239
Relay Station No.	Universal model QCPU
	QCPU other than Universal model QCPU ^{*1}

*1 Basic model QCPU and the QSCPU are not included.

POINT

- (1) Routing parameter setting of relay station
Routing parameter setting is also necessary for the relay station. For the setting, refer to the following.

 11.4 PLC Side Setting

- (2) Parameter reflection function of MELSOFT Navigator
 - (a) The color of the cells for the items which are reflected to GT Designer3 from MELSOFT Navigator changes to green. Set items, which are displayed in green cells, from the MELSOFT Navigator.
 - (b) When the settings of Transfer network No., Relay network No. or Relay station No. are reflected to the parameter from the MELSOFT Navigator, those settings are added. Items set in advance are not deleted. However, if the target network No. overlaps, the item set in advance is overwritten.
 - (c) The routing information is used manually by the user when the data is created. Therefore, after changing the network configuration by MELSOFT Navigator, create a routing information again. For details of the creation of the routing information, refer to the MELSOFT Navigator help.

11.4 PLC Side Setting

This section describes the settings of the GOT and CC-Link IE controller network module in the following case of system configuration.

POINT

CC-Link IE Controller Network module
 For details of the CC-Link IE Controller Network module, refer to the following manual.
 CC-Link IE Controller Network Reference Manual

11.4.1 Connecting to MELSEC iQ-R Series

System configuration1 (Network Type: CC IE Control)

 ■ GT Designer3 [Communication settings] on System configuration1 (Network Type: CC IE Control)

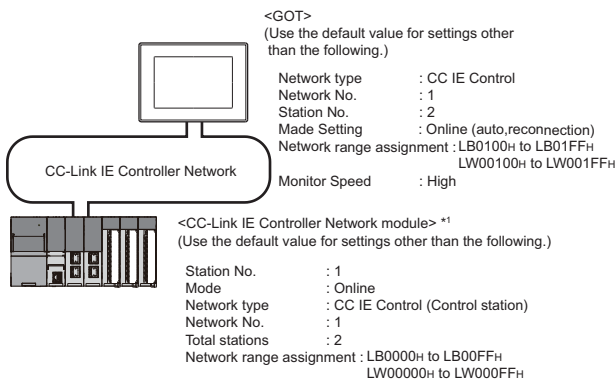

 [Unit parameter] of GX Works3

*1 The CC-Link IE Controller Network module is mounted on slot 0 of the base unit.
 The start I/O No. of the CC-Link IE Controller Network module is set at [0].

System configuration2 (Network Type: CC IE Control extended mode)

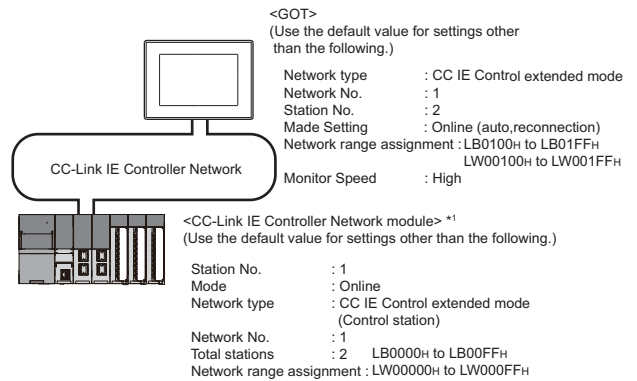

*1 The CC-Link IE Controller Network module is mounted on slot 0 of the base unit.
 The start I/O No. of the CC-Link IE Controller Network module is set at [0].

Parameter settings (Connecting to MELSEC iQ-R series) of System configuration1 (Network Type: CC IE Control)

- (1) [Unit parameter] of GX Works3
 - (a) Unit parameter

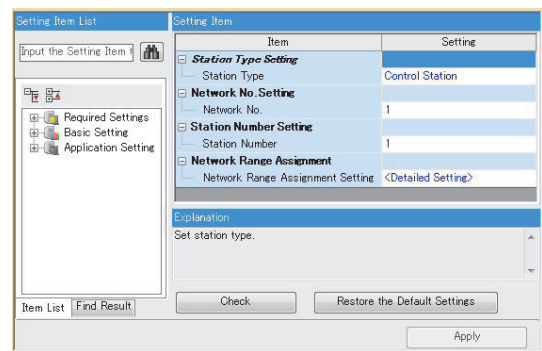

Item	Set value	Setting necessity at GOT connection
Station Type	Control Station (fixed)	○
Network No.*1	1	○
Station Number Setting	1	○
Network Range Assignment	Refer to (b)	△

○: Necessary △: As necessary ×: Not necessary
 *1 Specify the same network No. as that of the GOT.

9 MELSECNET/H CONNECTION (PLC TO PLC NETWORK)
 10 MELSECNET/T/0 CONNECTION (PLC TO PLC NETWORK)
 11 CC-LINK IE CONTROLLER NETWORK CONNECTION
 12 CC-LINK IE FIELD NETWORK CONNECTION
 13 CC-LINK CONNECTION (INTELLIGENT DEVICE STATION)
 14 CC-LINK CONNECTION (Via G4)
 15 INVERTER CONNECTION
 16 SERVO AMPLIFIER CONNECTION

(b) Network range assignment

Station No.	Station Type	LB/LW Setting (1)						Reserved Station	Pairing	Shared Group
		LB			LW					
		Points	Start	End	Points	Start	End			
1	Control Station	256	0000	00FF	256	00000	000FF	No Setting	No Pairs	
2	Normal Station	256	0100	01FF	256	00100	001FF	No Setting	No Pairs	

Item			Set value	Setting necessity at GOT connection	
LB/LW Setting (1)*1	LB	Station No.1	Start	0000H	△
			End	00FFH	△
	Station No.2	Start	0100H	△	
		End	01FFH	△	
	LW	Station No.1	Start	00000H	△
			End	000FFH	△
Station No.2	Start	00100H	△		
End	001FFH	△			
LB/LW Setting (2)*1			No Setting	△	
LX/LY Setting (1)*1			No Setting	△	
LX/LY Setting (2)*1			No Setting	△	
Reserved Station			(Use default value)	△	
Pairing				△	

○: Necessary △: As necessary ×: Not necessary
 *1 Be sure to set it to perform the cyclic transmission.

POINT

When changing the unit parameter
 After writing unit parameters to the PLC CPU, turn the PLC CPU OFF then back ON again, or reset the PLC CPU.

(c) Routing setting

Up to 64 [Target Network No.]s can be set. However, the same transfer network number cannot be set twice or more (multiple times). Therefore, the one that can access to other station from the request source host GOT is 64 kinds of [Target Network No.]s.

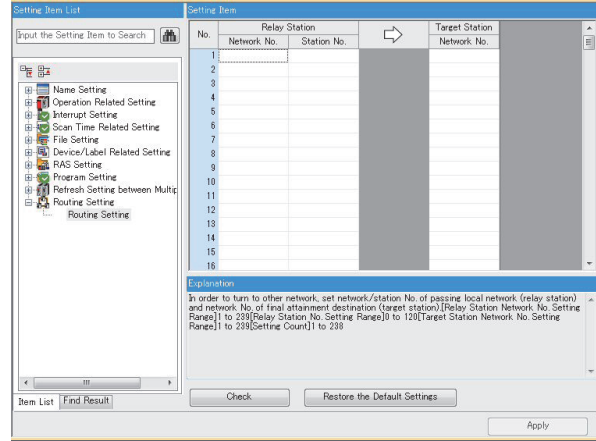

Item	Range
Target Network No.	1 to 239
Relay Network No.	1 to 239
Relay Station No.	1 to 120

POINT

Routing parameter setting of request source
 Routing parameter setting is also necessary for the request source GOT.
 For the setting, refer to the following.
 11.3.3 Routing parameter setting

■ GT Designer3 [Communication settings] on System configuration1 (Network Type: CC IE Control)

Item	Set value
Network Type	CC IE Control
Network No.	1: Network No.1
Station No.	2: Station No.2
Group No.	0 (fixed)
Mode Setting	Online (auto. reconnection)
Transmission Speed	1Gbps (fixed)
Refresh Interval	1ms (Use default value)
Retry	3times (Use default value)
Timeout Time	3sec (Use default value)
Delay Time	0ms (Use default value)
Monitor Speed	High (Normal) (Use default value)

POINT

[Controller Setting] of GT Designer3
For [Controller Setting], of GT Designer3, refer to the following.

☞ 11.3.1 Setting communication interface (Communication settings)

■ Unit parameter settings of System configuration2 (Network Type: Extended mode)

(1) [Unit parameter] of GX Works3

(a) Unit parameter

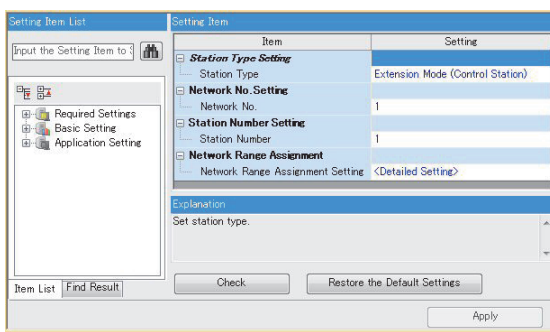

Item	Set value	Setting necessity at GOT connection
Station Type	CC IE Control (Control station)	○
Network No.*1	1	○
Station Number Setting	1	○
Network Range Assignment	Refer to (b)	△

○: Necessary △: As necessary ×: Not necessary

(b) Network range assignment

Item			Set value	Setting necessity at GOT connection	
LB/LW Setting (1)*1	LB	Station No.1	Start	0000H	△
			End	00FFH	△
		Station No.2	Start	0100H	△
			End	01FFH	△
	LW	Station No.1	Start	00000H	△
			End	000FFH	△
		Station No.2	Start	00100H	△
			End	001FFH	△
LB/LW Setting (2)*1			No Setting	△	
LX/LY Setting (1)*1			No Setting	△	
LX/LY Setting (2)*1			No Setting	△	
Reserved Station			(Use default value)	△	
Pairing				△	

○: Necessary △: As necessary ×: Not necessary

*1 Be sure to set it to perform the cyclic transmission.

9
MELSECNET/H CONNECTION (PLC CONNECTION TO PLC NETWORK)
10
MELSECNET/TIO CONNECTION (PLC CONNECTION TO PLC NETWORK)
11
CC-Link IE CONTROLLER NETWORK CONNECTION
12
CC-Link IE FIELD NETWORK CONNECTION
13
CC-Link CONNECTION (INTELLIGENT DEVICE STATION)
14
CC-Link CONNECTION (Via G4)
15
INVERTER CONNECTION
16
SERVO AMPLIFIER CONNECTION

- (c) Routing setting
 Up to 64 [Target Network No.]s can be set.
 However, the same transfer network number cannot be set twice or more (multiple times).
 Therefore, the one that can access other station from the request source host GOT is 64 kinds of [Target Network No.]s.

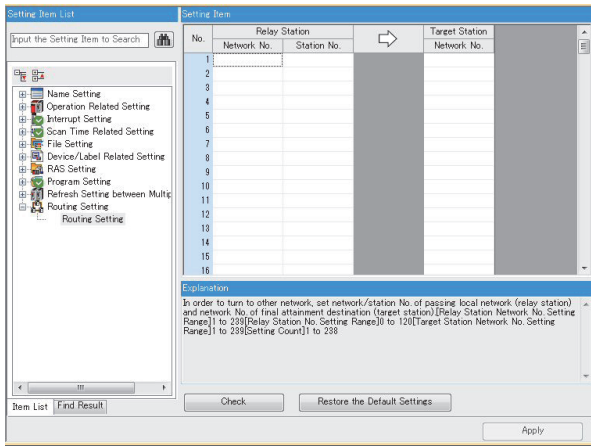

Item	Range
Target Network No.	1 to 239
Relay Network No.	1 to 239
Relay Station No.	1 to 120

POINT

Routing parameter setting of request source
 Routing parameter setting is also necessary for the request source GOT.
 For the setting, refer to the following.
 11.3.3 Routing parameter setting

(2) [Controller Setting] of GT Designer3

Item	Set value
Network type	CC IE Control extended mode
Network No.	1: Network No.1
Station No.	2: Station No.2
Group No.	0 (fixed)
Mode	Online (auto. reconnection)
Refresh Interval	1ms (Use default value)
Retry	3times (Use default value)
Timeout Time	3sec (Use default value)
Delay Time	0ms (Use default value)
Monitor Speed	High (Normal) (Use default value)

POINT

Network type of the GOT side

When the network is in the extended mode, be sure to set the network type of the GOT side to [CC IE Control extended mode].

For [Controller Setting], of GT Designer3, refer to the following.

11.3.1 Setting communication interface
 (Communication settings)

11.4.2 Connecting to C Controller module (MELSEC iQ-R Series)

This section describes the settings of the GOT and C Controller module (MELSEC iQ-R Series) in the following case of system configuration.

Use CW Configurator for the C Controller module (MELSEC iQ-R Series) communication settings.

■ System configuration1 (Network Type: CC IE Control)

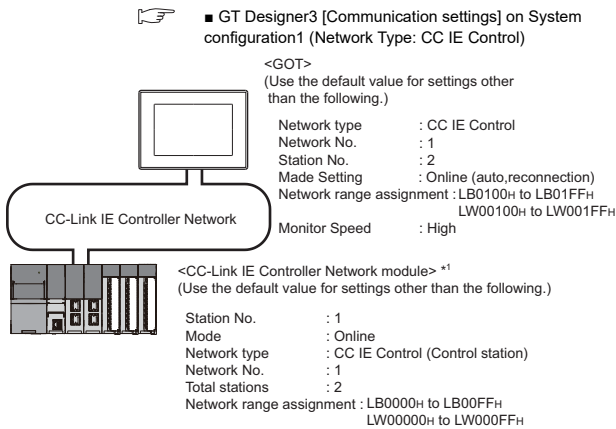

(1) [Module parameter] of CW Configurator

*1 The CC-Link IE Controller Network module is mounted on slot 0 of the base unit.
The start I/O No. of the CC-Link IE Controller Network module is set at [0].

■ System configuration2 (Network Type: CC IE Control extended mode)

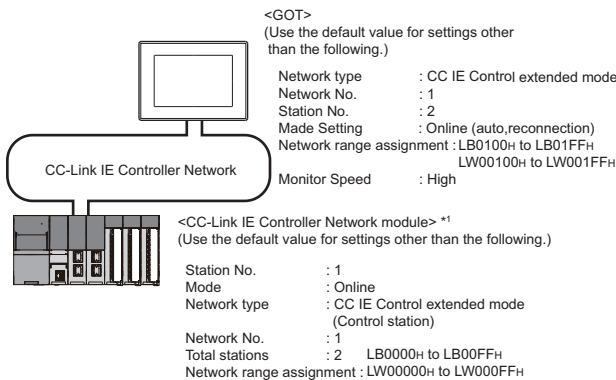

*1 The CC-Link IE Controller Network module is mounted on slot 0 of the base unit.
The start I/O No. of the CC-Link IE Controller Network module is set at [0].

■ Parameter settings (Connecting to MELSEC iQ-R series) of System configuration1 (Network Type: CC IE Control)

(1) [Module parameter] of CW Configurator
(a) Module parameter

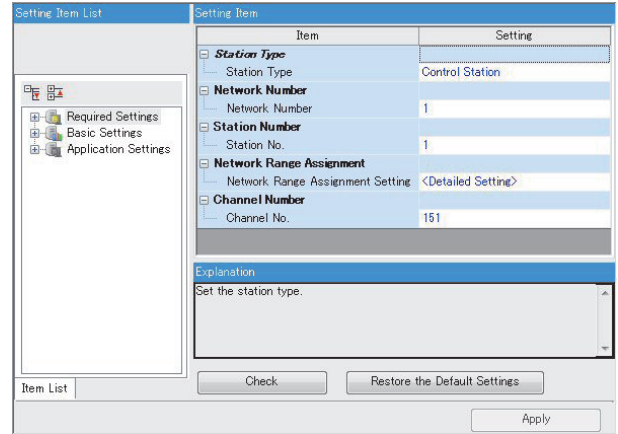

Item	Set value	Setting necessity at GOT connection
Station Type	Control Station (fixed)	○
Network No.*1	1	○
Station Number Setting	1	○
Network Range Assignment	Refer to (b)	△
Channel No.	(Use default value)	×

○: Necessary △: As necessary ×: Not necessary

*1 Specify the same network No. as that of the GOT.

(b) Network range assignment

Station No.	Station Type	LB/LW Setting (1)						Reserved Station	Pairing	Shared Group
		LB			LW					
		Points	Start	End	Points	Start	End			
1	Control Station	256	0000	00FF	256	00000	000FF	No Setting	No Pairs	
2	Normal Station	256	0100	01FF	256	00100	001FF	No Setting	No Pairs	

Item			Set value	Setting necessity at GOT connection	
LB/LW Setting (1)*1	LB	Station No.1	Start	0000H	△
			End	00FFH	△
	Station No.2	Start	0100H	△	
		End	01FFH	△	
	LW	Station No.1	Start	00000H	△
			End	000FFH	△
Station No.2	Start	00100H	△		
	End	001FFH	△		
LB/LW Setting (2)*1			No Setting	△	
LX/LY Setting (1)*1			No Setting	△	
LX/LY Setting (2)*1			No Setting	△	
Reserved Station			(Use default value)	△	
Pairing				△	

○: Necessary △: As necessary ×: Not necessary
 *1 Be sure to set it to perform the cyclic transmission.

POINT

When changing the unit parameter
 After writing unit parameters to the PLC CPU, turn the PLC CPU OFF then back ON again, or reset the PLC CPU.

(c) Routing setting

Up to 64 [Target Network No.]s can be set. However, the same transfer network number cannot be set twice or more (multiple times). Therefore, the one that can access to other station from the request source host GOT is 64 kinds of [Target Network No.]s.

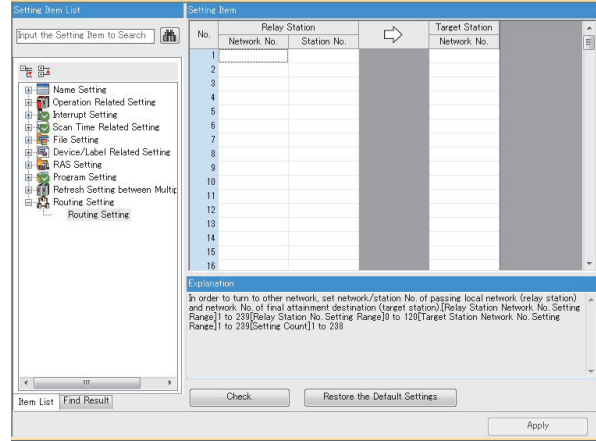

Item	Range
Target Network No.	1 to 239
Relay Network No.	1 to 239
Relay Station No.	1 to 120

POINT

Routing parameter setting of request source
 Routing parameter setting is also necessary for the request source GOT.
 For the setting, refer to the following.
 11.3.3 Routing parameter setting

■ GT Designer3 [Communication settings] on System configuration1 (Network Type: CC IE Control)

Item	Set value
Network Type	CC IE Control
Network No.	1: Network No.1
Station No.	2: Station No.2
Group No.	0 (fixed)
Mode Setting	Online (auto. reconnection)
Transmission Speed	1Gbps (fixed)
Refresh Interval	1ms (Use default value)
Retry	3times (Use default value)
Timeout Time	3sec (Use default value)
Delay Time	0ms (Use default value)
Monitor Speed	High (Normal) (Use default value)

POINT

[Controller Setting] of GT Designer3
 For [Controller Setting], of GT Designer3, refer to the following.
 11.3.1 Setting communication interface (Communication settings)

■ Unit parameter settings of System configuration2 (Network Type: Extended mode)

(1) [Module parameter] of CW Configurator
 (a) Module parameter

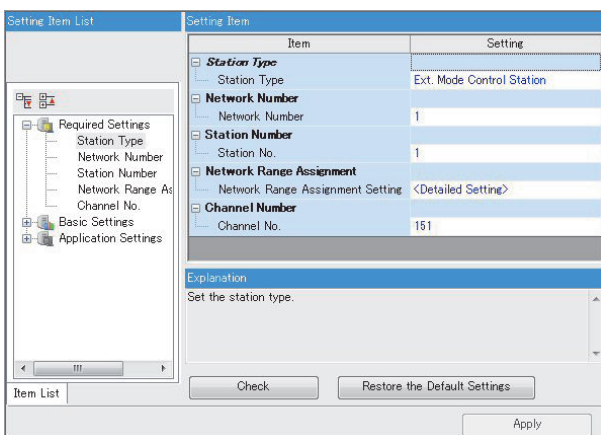

Item	Set value	Setting necessity at GOT connection
Station Type	CC IE Control (Control station)	○
Network No.*1	1	○

Item	Set value	Setting necessity at GOT connection
Station Number Setting	1	○
Network Range Assignment	Refer to (b)	△

○: Necessary △: As necessary ×: Not necessary

(b) Network range assignment

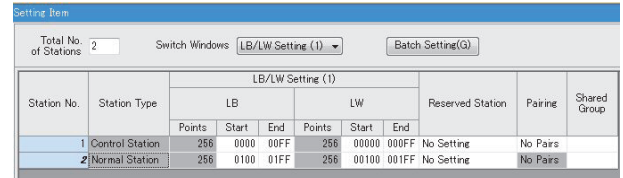

Item			Set value	Setting necessity at GOT connection	
LB/LW Setting (1)*1	LB	Station No.1	Start	0000H	△
			End	00FFH	△
	Station No.2	Start	0100H	△	
		End	01FFH	△	
	LW	Station No.1	Start	00000H	△
			End	000FFH	△
Station No.2		Start	00100H	△	
		End	001FFH	△	
LB/LW Setting (2)*1			No Setting	△	
LX/LY Setting (1)*1			No Setting	△	
LX/LY Setting (2)*1			No Setting	△	
Reserved Station				△	
Pairing			(Use default value)	△	

○: Necessary △: As necessary ×: Not necessary

*1 Be sure to set it to perform the cyclic transmission.

9 MELSECNET/H CONNECTION (PLC CONNECTION TO PLC NETWORK)
 10 MELSECNET/T0 CONNECTION (PLC CONNECTION TO PLC NETWORK)
 11 CC-Link IE CONTROLLER NETWORK CONNECTION
 12 CC-Link IE FIELD NETWORK CONNECTION
 13 CC-Link CONNECTION (INTELLIGENT DEVICE STATION)
 14 CC-Link CONNECTION (Via G4)
 15 INVERTER CONNECTION
 16 SERVO AMPLIFIER CONNECTION

(c) Routing setting

Up to 64 [Target Network No.]s can be set. However, the same transfer network number cannot be set twice or more (multiple times). Therefore, the one that can access other station from the request source host GOT is 64 kinds of [Target Network No.]s.

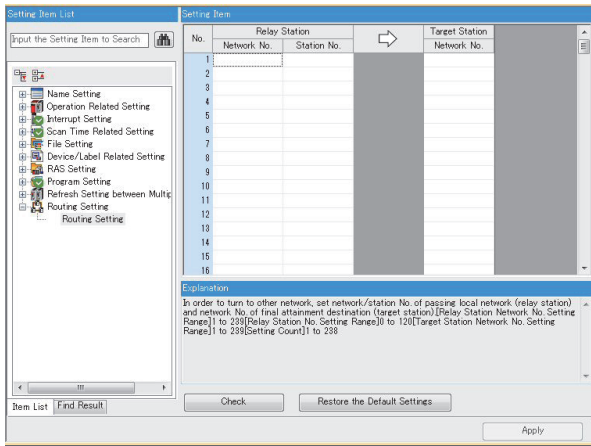

Item	Range
Target Network No.	1 to 239
Relay Network No.	1 to 239
Relay Station No.	1 to 120

POINT

Routing parameter setting of request source
 Routing parameter setting is also necessary for the request source GOT.
 For the setting, refer to the following.
 11.3.3 Routing parameter setting

(2) [Controller Setting] of GT Designer3

Item	Set value
Network type	CC IE Control extended mode
Network No.	1: Network No.1
Station No.	2: Station No.2
Group No.	0 (fixed)
Mode	Online (auto. reconnection)
Refresh Interval	1ms (Use default value)
Retry	3times (Use default value)
Timeout Time	3sec (Use default value)
Delay Time	0ms (Use default value)
Monitor Speed	High (Normal) (Use default value)

POINT

Network type of the GOT side
 When the network is in the extended mode, be sure to set the network type of the GOT side to [CC IE Control extended mode].
 For [Controller Setting], of GT Designer3, refer to the following.

11.3.1 Setting communication interface
 (Communication settings)

11.4.3 Connecting to MELSEC-Q/L

■ System configuration1 (Network Type: CC IE Control)

■ GT Designer3 [Communication settings] of System configuration1 (Network Type: CC IE Control)

<GOT>
(Use the default value for settings other than the following.)

Network type : CC IE Control
 Network No. : 1
 Station No. : 2
 Made Setting : Online (auto,reconnection)
 Network range assignment : LB0100H to LB01FFH
 LW00100H to LW001FFH
 Monitor Speed : High

CC-Link IE Controller Network

<CC-Link IE Controller Network module> *1
(Use the default value for settings other than the following.)

Station No. : 1
 Mode : Online
 Network type : CC IE Control (Control station)
 Network No. : 1
 Total stations : 2
 Network range assignment : LB0000H to LB00FFH
 LW00000H to LW000FFH

■ [Network parameter] of GX Developer

- *1 The CC-Link IE Controller Network module is mounted on slot 0 of the base unit.
 The start I/O No. of the CC-Link IE Controller Network module is set at [0].

POINT

When connecting to Q170MCPU
 When connected to Q170MCPU, the start I/O No. of the CC-Link IE Controller Network module is set to "70".

■ System configuration2 (Network Type: CC IE Control extended mode)

<GOT>
(Use the default value for settings other than the following.)

Network type : CC IE Control extended mode
 Network No. : 1
 Station No. : 2
 Made Setting : Online (auto,reconnection)
 Network range assignment : LB0100H to LB01FFH
 LW00100H to LW001FFH
 Monitor Speed : High

CC-Link IE Controller Network

<CC-Link IE Controller Network module> *1
(Use the default value for settings other than the following.)

Station No. : 1
 Mode : Online
 Network type : CC IE Control extended mode
 (Control station)
 Network No. : 1
 Total stations : 2 LB0000H to LB00FFH
 Network range assignment : LW00000H to LW000FFH

- *1 The CC-Link IE Controller Network module is mounted on slot 0 of the base unit.
 The start I/O No. of the CC-Link IE Controller Network module is set at [0].

■ Parameter settings (Connection to MELSEC-Q, QS series) of System configuration1 (Network Type: CC IE Control)

- (1) [Network parameter] of GX Developer
 (a) Network parameter

Network parameters Setting the number of Ethernet/CC IE/MELSECNET cards.

	Module 1	Module 2
Network type	CC IE Control(Control station)	None
Starting I/O No.	0000	
Network No.	1	
Total stations	2	
Group No.	0	
Station No.	1	
Mode	On line	
Network range assignment		
Refresh parameters		
Interrupt settings		
Specify station No. by parameter.		

Necessary setting(No setting / Already set) Set if it is needed(No setting / Already set)

Start I/O No. : Please input the starting I/O No. of the module in HEX(16 bit) form Valid module during other:

Interlink transmission parameters AcknowledgeXY assignment Routing parameters Assignment image Group Settings Check

Item	Set value	Setting necessity at GOT connection
Network type	CC IE Control (Control station) (fixed)	○
Starting I/O No. *1	0000H	○
Network No. *2	1	○
Total stations	2	○
Group No.	0 (fixed)	○
Station No.	1	○
Mode *3	Online	○
Network range assignment	Refer to (b)	△
Refresh parameters	(Use default value)	△
Interrupt settings		×
Interlink transmission parameters		×
Routing parameters	Refer to (c)	△

○: Necessary △: As necessary ×: Not necessary

- *1 When using Q170MCPU, set it according to the system configuration.
 *2 Specify the same network No. as that of the GOT.
 *3 Set the same mode setting as that of the GOT.

9 MELSECNET/H CONNECTION (PLC CONNECTION TO PLC NETWORK)
 10 MELSECNET/I/O CONNECTION (PLC CONNECTION TO PLC NETWORK)
 11 CC-Link IE CONTROLLER NETWORK CONNECTION
 12 CC-Link IE FIELD NETWORK CONNECTION
 13 CC-Link CONNECTION (INTELLIGENT DEVICE STATION)
 14 CC-Link CONNECTION (Via G4)
 15 INVERTER CONNECTION
 16 SERVO AMPLIFIER CONNECTION

(b) Network range assignment

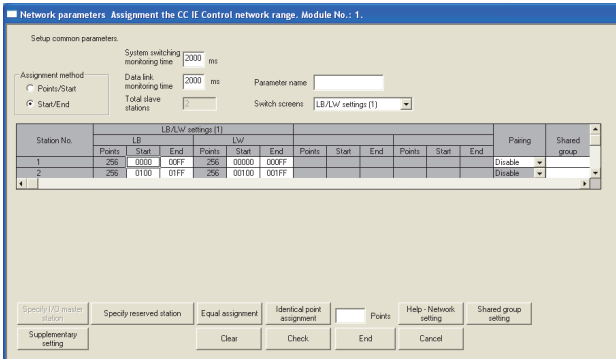

Item			Set value	Setting necessity at GOT connection	
Monitoring time			2000	△	
LB/LW setting(1) *1	LB	Station No.1	Start: 0000H End: 00FFH	△	
		Station No.2	Start: 0100H End: 01FFH	△	
	LW	Station No.1	Start: 00000H End: 000FFH	△	
		Station No.2	Start: 00100H End: 001FFH	△	
	LX/LY setting*1			No setting	△
	Specify I/O master station*1			No setting	△
Specify reserved station			No setting	△	
Supplementary setting			(Use default value)	△	

O: Necessary △: As necessary ×: Not necessary
*1 Be sure to set it to perform the cyclic transmission.

POINT

When changing the network parameter
After writing the network parameter to the PLC CPU, operate the PLC CPU ether turning OFF and then ON or resetting.

(c) Routing parameter setting

Up to 238 [Target Station Network No.]s can be set. However, the same target station network number cannot be set twice or more (multiple times). Therefore, the one that can access to other station from the request source host GOT is 238 kinds of [Target Station Network No.]s.

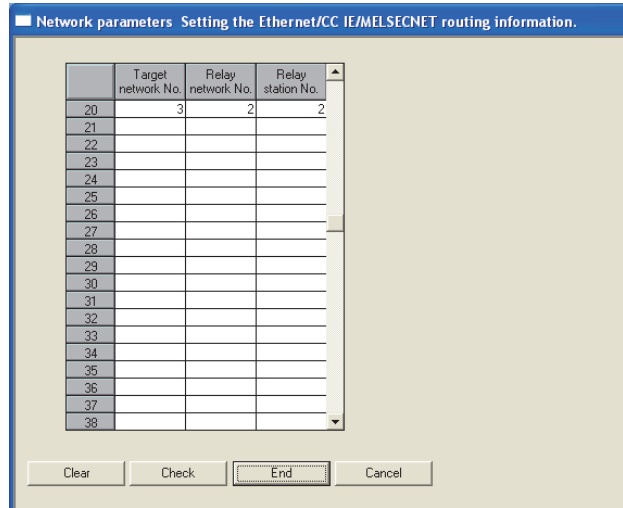

Item	Range
Target Station network No.	1 to 239
Relay Station network No.	1 to 239
Relay station No.	1 to 120

POINT

Routing parameter setting of request source
Routing parameter setting is also necessary for the request source GOT.
For the setting, refer to the following.

☞ 11.3.3 Routing parameter setting

■ Parameter setting (when connecting to C Controller module (Q Series))

Use SW3PVC-CCPU-E Ver.3.05F or later for the CC IE Control utility.

(1) Connection settings between personal computer and C controller module (Q Series)

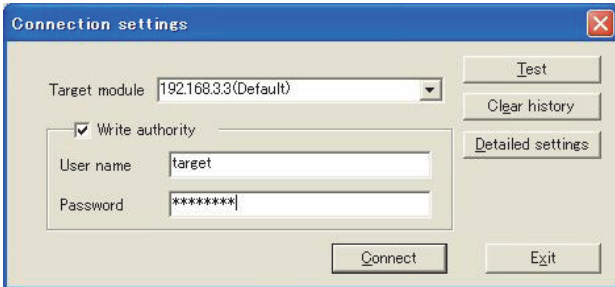

Item	Set value	Setting necessity at GOT connection
Target module*1	192.168.3.3 (Default)	○
Write authority	Mark the checkbox	○
User name*2	target	○
Password*2	password	○
Detailed settings	-	△

○: Necessary △: As necessary ×: Not necessary

- *1 If the IP address of the C Controller module (Q Series) has been changed, input the changed IP address or host name.
 *2 If the account of the C Controller module (Q Series) has been changed, input the changed user name and password.

(2) CC IE Control Utility's [Parameter Settings]

(a) Parameter settings

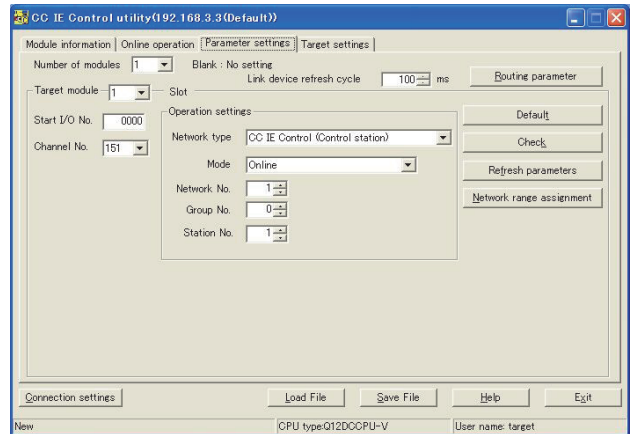

Item	Set value	Setting necessity at GOT connection	
Number of modules	1	○	
Link device refresh cycle	(Use default value)	△	
Routing parameter	Refer to (c)	△	
Target module	1	○	
Start I/O No.	0000H	○	
Channel No.	151	○	
Operation settings	Network type	CC IE Control (Control station)	○
	Mode*1	Online	○
	Network No.*2	1	○
	Group No.	0	○
	Station No.	1	○
Refresh parameters	(Use default value)	△	
Network range assignment	Refer to (b)	△	

○: Necessary △: As necessary ×: Not necessary

- *1 Set the same mode setting as that of the GOT.
 *2 Specify the same network No. as that of the GOT.

(b) Network range assignment

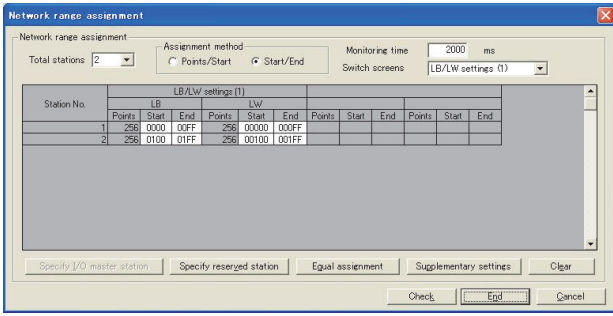

Item			Set value	Setting necessity at GOT connection	
Total stations			2	○	
LB/LW settings (1)	LB	Station No.1	Start	0000H	△
			End	00FFH	△
	LB	Station No.2	Start	0100H	△
			End	01FFH	△
	LW	Station No.1	Start	00000H	△
			End	000FFH	△
LW		Station No.2	Start	00100H	△
			End	001FFH	△
LX/LY settings*1			No setting	△	
Monitoring time			(Use default value)	△	
Specify I/O master station*1			No setting	△	
Specify reserved station			No setting	△	
Supplementary settings			(Use default value)	△	

○: Necessary △: As necessary ×: Not necessary

*1 Be sure to set it to perform the cyclic transmission.

POINT

When changing the network parameter After writing the network parameter to the C Controller module (Q Series), either turn the C Controller module (Q Series) OFF and then ON or reset it.

(c) Routing parameter setting

Up to 238 [Transfer Network No.]s can be set. However, the same transfer network number cannot be set twice or more (multiple times).

Therefore, the one that can access to other station from the request source host GOT is 238 kinds of [Transfer Network No.]s.

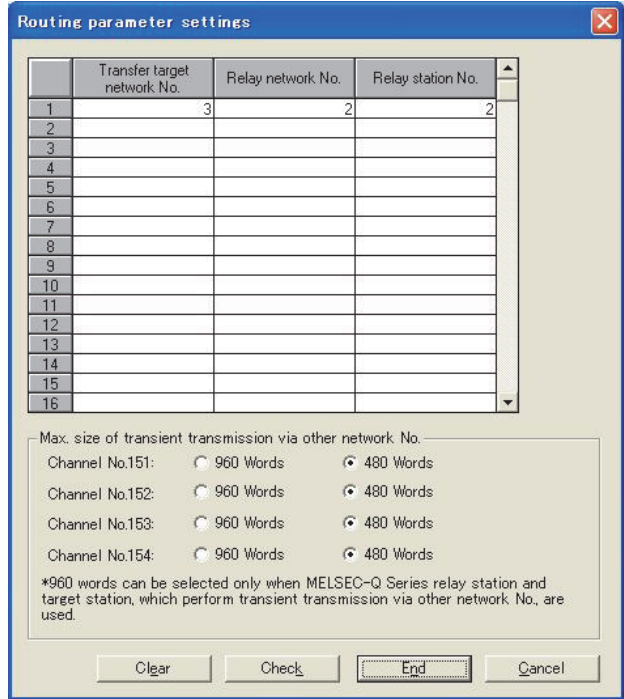

Item	Range
Transfer target network No.	1 to 239
Relay network No.	1 to 239
Relay station No.	1 to 120

POINT

Routing parameter setting of request source Routing parameter setting is also necessary for the request source GOT.

For the setting, refer to the following.

➡ 11.3.3 Routing parameter setting

■ GT Designer3 [Communication settings] of System configuration1 (Network Type: CC IE Control)

Item	Set value
Network Type	CC IE Control
Network No.	1: Network No.1
Station No.	2: Station No.2
Mode Setting	Online (auto. reconnection)
Retry	3times (Use default value)
Timeout Time	3sec (Use default value)
Delay Time	0ms (Use default value)
Refresh Interval	1ms (Use default value)
Monitor Speed	High (Use default value)

POINT

[Controller Setting] of GT Designer3
 For the setting method of [Controller Setting] of GT Designer3, refer to the following.
 11.3.1 Setting communication interface (Communication settings)

■ Parameter settings (Connection to Universal model QCPU) of System configuration2 (Network Type: Extended mode)

(1) [Network parameter] of GX Works2

(a) Network parameter

	Module 1	Module 2
Network Type	CC IE Control Ext. Mode(Control Station)	None
Start I/O No.	0000	
Network No.	1	
Total Stations	2	
Group No.	0	
Station No.	1	
Mode	Online	
	Network Range Assignment	
	Refresh Parameters	
	Interrupt Setting	
	Specify Station No. by Parameter	

Item	Set value	Setting necessity at GOT connection
Network Type	CC IE Control Ext. Mode (Control station) (fixed)	○
Start I/O No.*1	0000H	○
Network No.*2	1	○
Total Stations	2	○
Group No.	0 (Fixed)	○
Station No.	1	○
Mode*3	Online	○
Network Range Assignment	Same as the following setting [Network parameter] of GX Developer	△
Refresh Parameters	(Use default value)	△
Interrupt Setting		×
Interlink transmission parameters		×
Routing parameters	Same as the following setting [Network parameter] of GX Developer	△

○: Necessary △: As necessary ×: Not necessary

(2) [Controller Setting] of GT Designer3

Item	Set value
Network type	CC IE Control extended mode
Network No.	1: Network No.1
Station No.	2: Station No.2
Mode	Online (auto. reconnection)
Retry	3times (Use default value)
Timeout Time	3sec (Use default value)
Delay Time	1ms (Use default value)
Refresh Interval	High (Use default value)
Monitor Speed	High (Use default value)

9 MELSECNET/H CONNECTION (PLC CONNECTION TO PLC NETWORK)
 10 MELSECNET/10 CONNECTION (PLC CONNECTION TO PLC NETWORK)
 11 CC-Link IE CONTROLLER NETWORK CONNECTION
 12 CC-Link IE FIELD NETWORK CONNECTION
 13 CC-Link CONNECTION (INTELLIGENT DEVICE STATION)
 14 CC-Link CONNECTION (Via G4)
 15 INVERTER CONNECTION
 16 SERVO AMPLIFIER CONNECTION

POINT

- (1) Network type of the GOT side
When the network is in the extended mode, be sure to set the network type of the GOT side to [CC IE Control extended mode].
For [Controller Setting], of GT Designer3, refer to the following.
 11.3.1 Setting communication interface
(Communication settings)
 - (2) Network type of the PLC side
Only GX Works2 can set [CC IE Control extended mode (control station)] or [CC IE Control extended mode (ordinary station)]. The CPU which is compatible with the extended mode is Universal model QCPU only.
-

11.5 Precautions

■ GOT startup in CC-Link IE Controller Network connection

For the CC-Link IE Controller Network connection, the data link is started approximately 13 seconds after the GOT startup.

■ When a network error occurs in the system alarm

In the CC-Link IE Controller Network connection, when a network error occurs in the system alarm, the system alarm display cannot be canceled even though the causes are removed.

To cancel the system alarm display, restart the GOT.

■ Connection in the multiple CPU system

When the GOT is connected to multiple CPU system, the following time is taken until when the PLC runs.

QCPU (Q mode), motion controller CPU (Q series): 10 seconds or more

MELDAS C70: 18 seconds or more

When the GOT starts before the PLC runs, a system alarm occurs. Adjust the opening screen time in the GOT setup so that no system alarm occurs.

➡ GT Designer3 Version□ Screen Design Manual

■ CC-Link IE Controller Network module version

For version restrictions of the CC-Link IE Controller Network module, refer to the following manual.

➡ CC-Link IE Controller Network Reference Manual

■ Connection to QSCPU

The GOT can only read device data and sequence programs by the ladder monitor function in the QSCPU.

The GOT cannot write any data to the QSCPU.

■ Connection to Q170MCPUCPU

Set [CPU No.] to "2" in the device setting to monitor the device of the Motion CPU area (CPU No.2).

When the CPU No. is set to "0" or "1", the device on the PLC CPU area (CPU No.1) is monitored.

When the CPU No. is set to the number other than "0" to "2", a communication error occurs and the monitoring cannot be executed.

For setting the CPU No., refer to the following manual.

➡ GT Designer3 Version□ Screen Design Manual

Example) Setting dialog box of the bit device

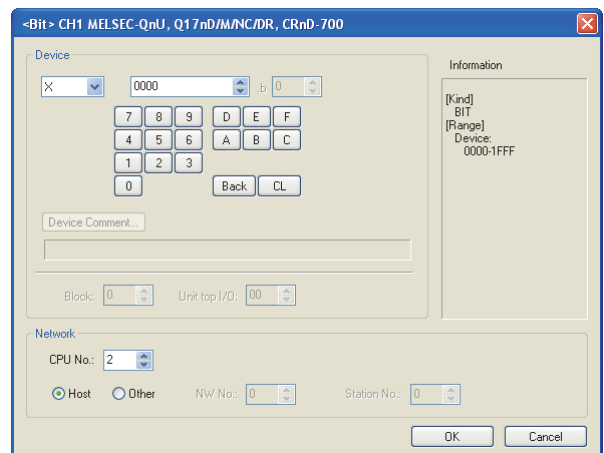

■ Connection to RnSFPCPU

The RnSFPCPU takes 10 seconds or more to run. If the GOT is started before the RnSFPCPU runs, a system alarm occurs.

To prevent a system alarm from occurring, adjust the title display time in the [GOT Setup] dialog.

➡ GT Designer3 (GOT2000) Help

12

CC-Link IE FIELD NETWORK CONNECTION



12.1 Connectable Model List	12 - 2
12.2 System Configuration	12 - 8
12.3 GOT side settings	12 - 9
12.4 PLC Side Setting	12 - 11
12.5 Precautions	12 - 19

12. CC-Link IE FIELD NETWORK CONNECTION

12.1 Connectable Model List

12.1.1 PLC/Motion controller CPU

The following table shows the connectable models.

Series	Model name	Clock	Communication type	GT 16	GT 15	GT 14	GT 12	GT11 Bus	GT11 Serial	GT 10 ₄ ⁵	GT 10 ₃₀ ²⁰	Refer to	
MELSEC iQ-R Series	R04CPU	○	CC-Link IE FIELD NETWORK	○	×	×	×	×	×	×	×	12.2	
	R08CPU												
	R16CPU												
	R32CPU												
	R120CPU												
	R08PCPU												
	R16PCPU												
	R32PCPU												
	R120PCPU												
	R04ENCPU												
	R08ENCPU												
	R16ENCPU												
	R32ENCPU												
	R120ENCPU												
Motion controller CPU (MELSEC iQ-R Series)	R16MTCPU	○	CC-Link IE FIELD NETWORK	○	×	×	×	×	×	×	×	12.2	
	R32MTCPU												
	C Controller module (MELSEC iQ-R Series)	R12CCPU-V	○	CC-Link IE FIELD NETWORK	○	×	×	×	×	×	×	×	12.2
	MELSEC iQ-F Series	FX5U	○	CC-Link IE FIELD NETWORK	×	×	×	×	×	×	×	×	-
FX5UC													

(Continued to next page)

*1 Mount a safety function module R6SFM next to the RnSF CPU on the base unit. The RnSF CPU and the safety function module R6SFM must have the same pair version. If their pair versions differ, the RnSF CPU does not operate.

Series	Model name	Clock	Communication type	GT 16	GT 15	GT 14	GT 12	GT11 Bus	GT11 Serial	GT 10 5□ 4□	GT 10 20 30	Refer to	
MELSEC-Q (Q mode)	Q00JCPU	○	-	x	x	x	x	x	x	x	x	-	
	Q00CPU*1												
	Q01CPU*1												
	Q02CPU*1												
	Q02HCPU*1												
	Q06HCPU*1												
	Q12HCPU*1												
	Q25HCPU*1												
	Q02PHCPU												
	Q06PHCPU												
	Q12PHCPU												
	Q25PHCPU												
	Q12PRHCPU(Main base)												
	Q25PRHCPU(Main base)												
	Q12PRHCPU(Extension base)												○
	Q25PRHCPU(Extension base)	○	-	x	x	x	x	x	x	x	x	-	
	Q00UJCPU	○	CC-Link IE FIELD NETWORK	○	○	x	x	x	x	x	x	x	12.2
	Q00UCPU												
	Q01UCPU												
	Q02UCPU												
	Q03UDCPU												
	Q04UDHCPU												
	Q06UDHCPU												
	Q10UDHCPU												
	Q13UDHCPU												
	Q20UDHCPU												
Q26UDHCPU													
Q03UDECPU													
Q04UDEHCPU													
Q06UDEHCPU													
Q10UDEHCPU													
Q13UDEHCPU													
Q20UDEHCPU													
Q26UDEHCPU													

(Continued to next page)

9	MELSECNET/H CONNECTION (PLC CONNECTION TO PLC NETWORK)
10	MELSECNET/10 CONNECTION (PLC CONNECTION TO PLC NETWORK)
11	CC-Link IE CONTROLLER NETWORK CONNECTION
12	CC-Link IE FIELD NETWORK CONNECTION
13	CC-Link CONNECTION (INTELLIGENT DEVICE STATION)
14	CC-Link CONNECTION (Via G4)
15	INVERTER CONNECTION
16	SERVO AMPLIFIER CONNECTION

Series	Model name	Clock	Communication type	GT 16	GT 15	GT 14	GT 12	GT41 Bus	GT11 Serial	GT 10 5 2 4	GT 10 20 30	Refer to	
MELSEC-Q (Q mode)	Q50UDEHCPU Q100UDEHCPU Q03UDVCPU Q04UDVCPU Q06UDVCPU Q13UDVCPU Q26UDVCPU	○	CC-Link IE FIELD NETWORK	○	○	×	×	×	×	×	×	12.2	
C Controller module (Q Series)	Q12DCCPU-V*1 Q24DHCCPU-V/VG Q24DHCCPU-LS	○		○	○	×	×	×	×	×	×	×	12.2
	Q26DHCCPU-LS			○	×	×	×	×	×	×	×	×	
MELSEC-QS	QS001CPU*3	○		○	○	×	×	×	×	×	×	×	12.2
MELSEC-L	L02CPU*2 L06CPU L26CPU L26CPU-BT*2 L02CPU-P*2 L06CPU-P L26CPU-P L26CPU-PBT*2 L02SCPU L02SCPU-P	○	CC-Link IE FIELD NETWORK	○	○	×	×	×	×	×	×	12.2	
MELSEC-Q (A mode)	Q02CPU-A Q02HCPU-A Q06HCPU-A	○	-	×	×	×	×	×	×	×	×	-	
MELSEC-QnA (QnACPU)	Q2ACPU Q2ACPU-S1 Q3ACPU Q4ACPU Q4ARCPU	○	-	×	×	×	×	×	×	×	×	-	
MELSEC-QnA (QnASCPU)	Q2ASCPU Q2ASCPU-S1 Q2ASHCPU Q2ASHCPU-S1	○	-	×	×	×	×	×	×	×	×	-	
MELSEC-A (AnCPU)	A2UCPU A2UCPU-S1 A3UCPU A4UCPU A2ACPU A2ACPUP21 A2ACPUR21 A2ACPU-S1 A2ACPUP21-S1 A2ACPUR21-S1 A3ACPU A3ACPUP21 A3ACPUR21 A1NCPUR21 A1NCPUR21 A2NCPUR21 A2NCPUR21 A2NCPUR21 A2NCPUR21 A2NCPUR21-S1 A2NCPUR21-S1 A3NCPUR21 A3NCPUR21 A3NCPUR21	○	-	×	×	×	×	×	×	×	×	-	

(Continued to next page)

*1 Use a module with the upper five digits later than 12042.

*2 Use a module with the upper five digits later than 13012.

*3 Use a module with the upper five digits later than "13042". Use GX Developer of Version 8.98C or later.

Series	Model name	Clock	Communication type	GT 16	GT 15	GT 14	GT 12	GT11 Bus	GT11 Serial	GT10 8□	GT10 20 30	Refer to
MELSEC-A (AnSCPU)	A2USCPU	○	-	×	×	×	×	×	×	×	×	-
	A2USCPU-S1											
	A2USHCPU-S1											
	A1SCPU											
	A1SCPUC24-R2											
	A1SHCPU											
	A2SCPU											
	A2SCPU-S1											
	A2SHCPU											
	A2SHCPU-S1											
	A1SJCPU											
	A1SJCPU-S3											
	A1SJHCPU											
MELSEC-A	A0J2HCPU	×	-	×	×	×	×	×	×	×	×	-
	A0J2HCPUP21											
	A0J2HCPUR21											
	A0J2HCPU-DC24											
	A2CCPU	○	-	×	×	×	×	×	×	×	-	
	A2CCPUP21											
	A2CCPUR21											
	A2CCPUC24											
	A2CCPUC24-PRF											
	A2CJCPU-S3											
A1FXCPU												
Motion controller CPU (Q Series)	Q172CPU	○	-	×	×	×	×	×	×	×	×	-
	Q173CPU											
	Q172CPUN											
	Q173CPUN											
	Q172HCPU											
	Q173HCPU											
	Q172DCPU	○	CC-Link IE FIELD NETWORK		×	×	×	×	×	×	×	-
	Q173DCPU											
	Q172DCPU-S1											
	Q173DCPU-S1											
	Q172DSCPU											
	Q173DSCPU											
	Q170MCPU ^{*1}											
Q170MSCPU ^{*3}												
Q170MSCPU-S1 ^{*3}												
				○ ^{*2}	○ ^{*2}	×	×	×	×	×	×	12.2

(Continued to next page)

*1 Only the first step can be used on the extension base unit (Q52B/Q55B).

*2 For the PLC CPU area, use a module with the upper five digits later than 12012. Only the PLC CPU area can be monitored.

*3 The extension base unit (Q5□B/Q6□B) can be used.

9
MELSECNET/H
CONNECTION (PLC
CONNECTION TO
NETWORK)

10
MELSECNET/10
CONNECTION (PLC
CONNECTION TO
NETWORK)

11
CC-Link IE CONTROLLER
NETWORK
CONNECTION





12
CC-Link IE FIELD
NETWORK
CONNECTION

13
CC-Link CONNECTION
(INTELLIGENT DEVICE
STATION)

14
CC-Link
CONNECTION
(Via G4)

15
INVERTER
CONNECTION

16
SERVO AMPLIFIER
CONNECTION

Series	Model name	Clock	Communication type	GT 16	GT 15	GT 14	GT 12	GT 11 Bus	GT 11 Serial	GT 10 5/4	GT 10 20/30	Refer to
Motion controller CPU (A Series)	A273UCPU	○	-	×	×	×	×	×	×	×	×	-
	A273UHCPU											
	A273UHCPU-S3											
	A373UCPU											
	A373UCPU-S3											
	A171SCPU											
	A171SCPU-S3											
	A171SCPU-S3N											
	A171SHCPU											
	A171SHCPUN											
	A172SHCPU											
	A172SHCPUN											
	A173UHCPU											
	A173UHCPU-S1											
MELSEC-WS	WS0-CPU0	×	-	×	×	×	×	×	×	×	×	-
	WS0-CPU1											
	WS0-CPU3											
MELSECNET/H Remote I/O station	QJ72LP25-25	×	-	×	×	×	×	×	×	×	×	-
	QJ72LP25G											
	QJ72BR15											
CC-Link IE Field Network head module	LJ72GF15-T2	×	CC-Link IE FIELD NETWORK	○	○	×	×	×	×	×	×	 12.2
CC-Link IE Field Network Ethernet adapter module	NZ2GF-ETB	×	CC-Link IE FIELD NETWORK	○	○	×	×	×	×	×	×	 12.2
CNC C70	Q173NCCPU	○	CC-Link IE FIELD NETWORK	○	○	×	×	×	×	×	×	 12.2
Robot controller	CRnQ-700 (Q172DRCPU) CR750-Q (Q172DRCPU) CR751-Q (Q172DRCPU)	○	CC-Link IE FIELD NETWORK	○	○	×	×	×	×	×	×	 12.2
MELSEC-FX	FX0	×	-	×	×	×	×	×	×	×	×	-
	FX0S											
	FX0N											
	FX1	×	-	×	×	×	×	×	×	×	×	
	FX2											
	FX2C											
	FX1S	○	-	×	×	×	×	×	×	×	×	
	FX1N											
	FX2N											
	FX1NC	×	-	×	×	×	×	×	×	×	×	
	FX2NC											
	FX3S											
	FX3G											
	FX3GC											
	FX3GE											
FX3U	○	-	×	×	×	×	×	×	×	×		
FX3UC												

12.1.2 CC-Link IE Field Network communication unit

CPU series	CC-Link IE Field Network communication unit
MELSEC iQ-R Series Motion controller CPU (MELSEC iQ-R Series) C Controller module (MELSEC iQ-R Series)	RJ71GF11-T2 RJ71EN71 RD77GF4, RD77GF8, RD77GF16
MELSEC-Q(Universal model) C Controller module (Q Series)	QJ71GF11-T2, QD77GF16
MELSEC-L	LJ71GF11-T2
MELSEC-QS	QS0J71GF11-T2

9	MELSECNET/H CONNECTION (PLC CONNECTION TO PLC NETWORK)
10	MELSECNET/10 CONNECTION (PLC CONNECTION TO PLC NETWORK)
11	CC-Link IE CONTROLLER NETWORK CONNECTION
12	CC-Link IE FIELD NETWORK CONNECTION
13	CC-Link CONNECTION (INTELLIGENT DEVICE STATION)
14	CC-Link CONNECTION (Via G4)
15	INVERTER CONNECTION
16	SERVO AMPLIFIER CONNECTION

12.2 System Configuration

12.2.1 Connecting to CC-Link IE Field Network communication unit

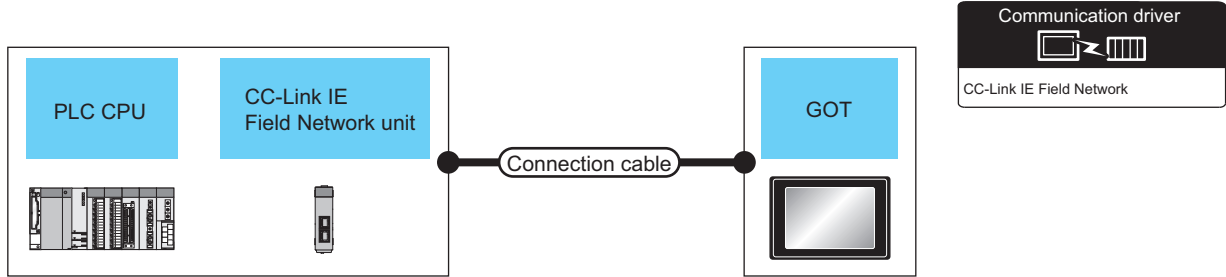

PLC		Connection cable			GOT		Number of connectable equipment
Model name	CC-Link IE Field Network communication unit	Communication type	Cable model*2	Max distance*1	option device	Model	
MELSEC iQ-R Series Motion controller CPU (MELSEC iQ-R Series) C Controller module (MELSEC iQ-R Series)	RJ71GF11-T2 RJ71EN71 RD77GF4*4 RD77GF8*4 RD77GF16*4	CC-Link IE Field Network	Ethernet cable that meets the 1000BASE-T standard: Category 5e or higher, (double-shielded, STP) straight cable.	12100m	GT15-J71GF13-T2	GT16	120 GOTs
R04ENCPU R08ENCPU R16ENCPU R32ENCPU R120ENCPU	-						
MELSEC-Q (Universal model) Q170MCP C Controller module (Q Series)	QJ71GF11-T2 QD77GF16*3				GT15-J71GF13-T2	GT16 GT15	
MELSEC-QS	QS0J71GF11-T2						
MELSEC-L	LJ71GF11-T2						
CC-Link IE Field Network head module	-						
Ethernet adapter module	-						

*1 The overall extension cable length and the length between stations vary depending on the connection method (line, star or ring), the system configuration, etc.

For details, refer to the following manual.

CC-Link IE Field Network Master/Local Module User's Manual

*2 Use hubs that satisfy the following conditions.

- Compliance with the IEEE802.3 (1000BASE-T)
- Supporting the auto MDI/MDI-X function
- Supporting the auto-negotiation function
- Switching hub (A repeater hub is not available.)

Recommended switching hub (Mitsubishi electric products)

Type	Model name
Industrial switching hub	NZ2EHG-T8

For details, refer to the following manual.

CC-Link IE Field Network Master/Local Module User's Manual

*3 When connecting to the QD77GF16, refer to the following manual.

MELSEC-Q QD77GF Simple Motion Module User's Manual

*4 When connecting to the RD77GF4, RD77GF8 and RD77GF16, refer to the following manual.

RD77GF Simple Motion Module User's Manual

12.3 GOT side settings

12.3.1 Setting communication interface (Communication settings)

Set the channel of connecting equipment.

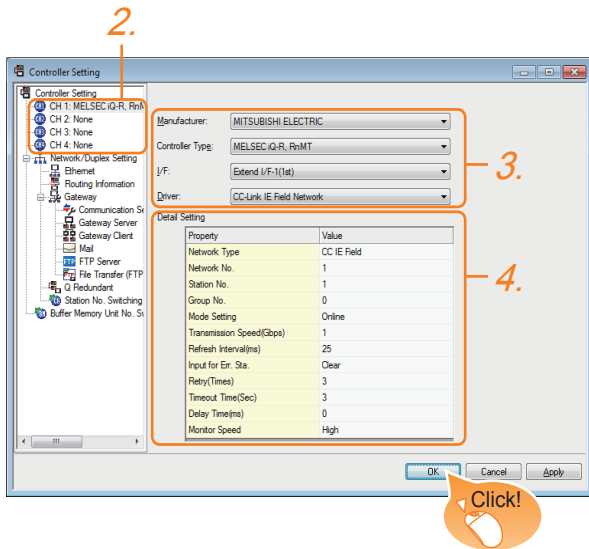

1. Select [Common] → [Controller Setting] from the menu.
2. The Controller Setting window is displayed. Select the channel to be used from the list menu.
3. Set the following items.
 - Manufacturer: MITSUBISHI ELECTRIC
 - Controller Type: Set according to the Controller Type to be connected.
 - I/F: Interface to be used
 - Driver: CC-Link IE Field Network
4. The detailed setting is displayed after Manufacturer, Controller Type, I/F, and Driver are set. Make the settings according to the usage environment.

☞ 12.3.2 Communication detail settings

Click the [OK] button when settings are completed.

POINT

The settings of connecting equipment can be confirmed in [I/F Communication Setting]. For details, refer to the following.

☞ 1.1.2 I/F communication setting

12.3.2 Communication detail settings

Make the settings according to the usage environment.



Property	Value
Network Type	CC IE Field
Network No.	1
Station No.	1
Group No.	0
Mode Setting	Online
Transmission Speed(Gbps)	1
Refresh Interval(ms)	25
Input for Err. Sta.	Clear
Retry(Times)	3
Timeout Time(Sec)	3
Delay Time(ms)	0
Monitor Speed	High

Item	Description	Range
Network Type ⁴	Set the network Type	• CC IE Field
Network No.	Set the network No. of the GOT. (Default: 1)	1 to 239
Station No.	Set the station No. of the GOT. (Default: 1)	1 to 120
Mode Setting	Set the operation mode of the GOT. (Default: Online (auto. reconnection))	• Online • Offline • H/W test ¹ • Self-loopback test ¹
Refresh Interval	Set the number of refreshes to secure the send/receive data in station units during communication. (Default: 25ms)	1 to 1000ms
Input for Error Station	Set the hold/clear of input from the station where the data link is faulty due to some reason such as turning the power OFF. (Default: Clear)	Clear/Hold
Retry	Set the number of retries to be performed when a communication timeout occurs. When receiving no response after retries, the communication times out. (Default: 3times)	0 to 5times
Timeout Time	Set the time period for a communication to time out. (Default: 3sec)	3 to 90sec
Delay Time	Set the delay time for reducing the load of the network/destination PLC. (Default: 0ms)	0 to 300ms
Monitor Speed	Set the monitor speed for the CC-Link IE field network. This setting is not valid in all systems. (Default: High)	High ² /Normal/Low ³

(Continued to next page)

- *1 For details, refer to the following manual.
 CC-Link IE Field Network Master/Local Module User's Manual
- *2 This range is effective when collecting a large amount of data (such as logging and recipe function) on other than the monitor screen.
 However, the range may affect the sequence scan time when connecting to Q00UJ/Q00U/Q01U/Q02UCPU.
 If you want to avoid the influence on the sequence scan time, do not set [High].
 (This setting hardly affects QCPUs other than the above.)
- *3 Set this range if you want to avoid the influence on the sequence scan time further than the [Normal] setting when connecting to Q00UJ/Q00U/Q01U/Q02UCPU.
 However, the monitor speed may be reduced.

POINT

- (1) Switch setting example
 For the switch setting example, refer to the following.
 12.4 PLC Side Setting
- (2) Communication interface setting by Utility
 The communication interface setting can be changed on the Utility's [Communication Settings] after writing [Communication Settings] of project data.
 For details on the Utility, refer to the following manual.
 GT□ User's Manual
- (3) Precedence in communication settings
 When settings are made by GT Designer3 or the Utility, the latest setting is effective.
- (4) Network type
 Be sure to set the same network types for the CPU side and the GOT side. If the network types of the CPU side and the GOT side are different, an error is displayed in the system alarm of the GOT side.

12.3.3 Routing parameter setting

Up to 64 [Transfer Network No.]s can be set.
 However, the same transfer network number cannot be set twice or more (multiple times).
 Therefore, the one that can access to other station from the request source host GOT is 64 kinds of [Transfer Network No.]s.

POINT

Routing parameter setting
 When communicating within the host network, routing parameter setting is unnecessary.
 For details of routing parameters, refer to the following manual.
 CC-Link IE Field Network Reference Manual

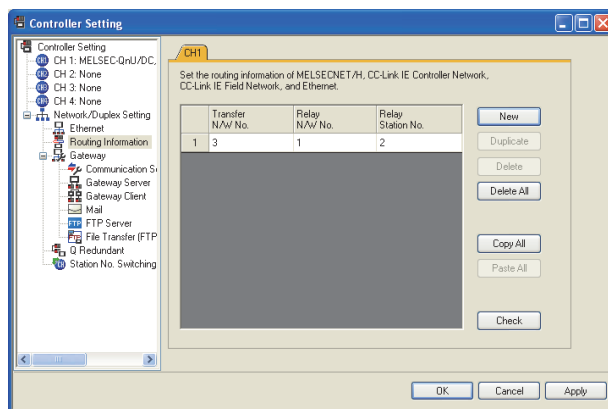

Item		Range
Transfer Network No.		1 to 239
Relay Network No.		1 to 239
Relay Station No.	MELSEC-Q (Universal model) Q170MCPUC Controller Module (Q Series)	0 to 120

*1 Basic model QCPU and the QSCPU are not included.

POINT

- (1) Routing parameter setting of relay station
 Routing parameter setting is also necessary for the relay station.
 For the setting, refer to the following.
 12.4 PLC Side Setting
- (2) Parameter reflection function of MELSOFT Navigator
 - (a) The color of the cells for the items which are reflected to GT Designer3 from MELSOFT Navigator changes to green. Set items, which are displayed in green cells, from the MELSOFT Navigator.
 - (b) When the settings of Transfer network No., Relay network No. or Relay station No. are reflected to the parameter from the MELSOFT Navigator, those settings are added. Items set in advance are not deleted. However, if the target network No. overlaps, the item set in advance is overwritten.
 - (c) The routing information is used manually by the user when the data is created. Therefore, after changing the network configuration by MELSOFT Navigator, create a routing information again. For details of the creation of the routing information, refer to the MELSOFT Navigator help.

12.4 PLC Side Setting

This section describes the settings of the GOT and CC-Link IE controller network module in the following case of system configuration.

POINT

CC-Link IE Field Network Module

For details of the CC-Link IE Field Network module, refer to the following manual.

[CC-Link IE Field Network Master/Local Module User's Manual](#)

12.4.1 Connecting to MELSEC iQ-R Series

System configuration (Network Type: CC IE Field)

System configuration (Network Type: CC IE Field)

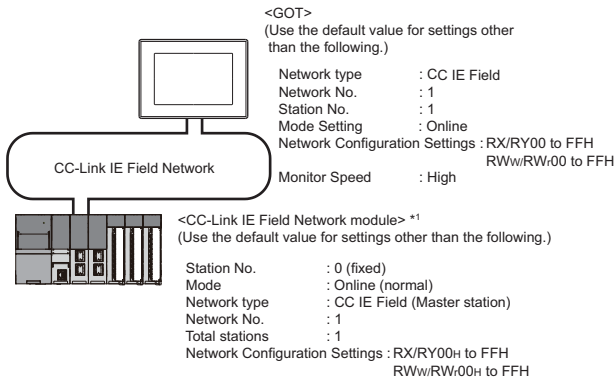

[Unit parameter] of GX Works3

- *1 The CC-Link IE Field Network module is mounted on slot 0 of the base unit. The Start I/O No. of the CC-Link IE Field Network module is set at "0".

Unit parameter settings of System configuration (Network Type: CC IE Field)

(1) [Unit parameter] of GX Works3

(a) Unit parameter

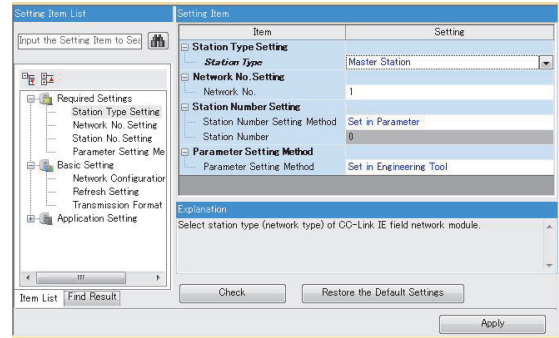

Item	Set value	Setting necessity at GOT connection
Station type	Master station (fixed)	○
Network No.*1	1	○
Station number setting	Parameter	○
Station No.	0 (fixed)	○
Parameter setting	Engineering tool	○
Network Configuration Settings	Refer to (b)	

○: Necessary △: As necessary ×: Not necessary
*1 Specify the same network No. as that of the GOT.

9
MELSECNET/H CONNECTION (PLC CONNECTION TO PLC NETWORK)
10
MELSECNET/10 CONNECTION (PLC CONNECTION TO PLC NETWORK)
11
CC-Link IE CONTROLLER NETWORK CONNECTION
12
CC-Link IE FIELD NETWORK CONNECTION
13
CC-Link CONNECTION (INTELLIGENT DEVICE STATION)
14
CC-Link CONNECTION (Via G4)
15
INVERTER CONNECTION
16
SERVO AMPLIFIER CONNECTION

(b) Network Configuration Settings

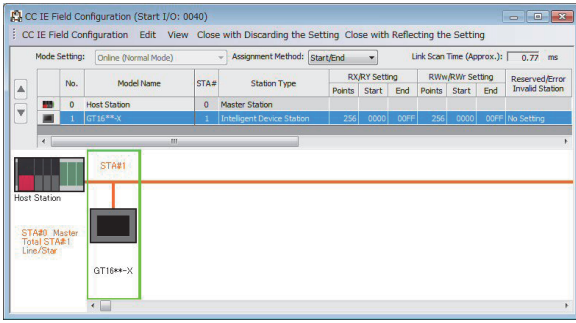

Item			Set value	Setting necessity at GOT connection	
Rx/Ry, RWw/RWr Setting (1)*1	Rx/Ry setting	Station No.1	Start	0000H	△
			End	00FFH	△
	RWw/RWr setting	Station No.1	Start	0000H	△
			End	00FFH	△
Reserved/Error Invalid Station			No setting	△	

○: Necessary △: As necessary ×: Not necessary
 *1 Be sure to set it to perform the cyclic transmission.

POINT

- When changing the unit parameter
 After writing unit parameters to the PLC CPU, turn the PLC CPU OFF then back ON again, or reset the PLC CPU.
- GOT station type
 Set the GOT as an intelligent device station.

(c) Routing setting

Up to 238 [Target Station Network No.]s can be set. However, the same target station network number cannot be set twice or more (multiple times). Therefore, the one that can access to other station from the request source host GOT is 238 kinds of [Target Station Network No.]s.

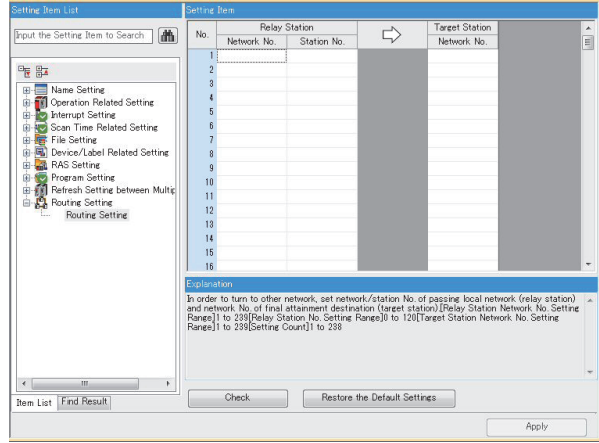

Item	Range
Target Station Network No.	1 to 239
Relay Station Network No.	1 to 239
Relay Station No.	1 to 120

POINT

Routing parameter setting of request source
 Routing parameter setting is also necessary for the request source GOT.
 For the setting, refer to the following.

☞ 11.3.3 Routing parameter setting

■ GT Designer3 [Communication settings] of System configuration (Network Type: CC IE Field)

Item	Set value
Network Type	CC IE Field
Network No.	1: Network No.1
Station No.	1: Station No.1
Group No.	0 (fixed)
Mode Setting	Online
Refresh Interval	25ms (Use default value)
Input for Error Station	Clear (Use default value)
Retry	3times (Use default value)
Timeout Time	3sec (Use default value)
Delay Time	0ms (Use default value)
Monitor Speed	High (Normal) (Use default value)

POINT

[Controller Setting] of GT Designer3
For the setting method of [Controller Setting] of GT Designer3, refer to the following.

☞ 11.3.1 Setting communication interface (Communication settings)

12.4.2 Connection to C Controller module (MELSEC iQ-R Series)

This section describes the settings of the GOT and C Controller module (MELSEC iQ-R Series) in the following case of system configuration.

Use CW Configurator for the C Controller module (MELSEC iQ-R Series) communication settings.

■ System configuration (Network Type: CC IE Field)

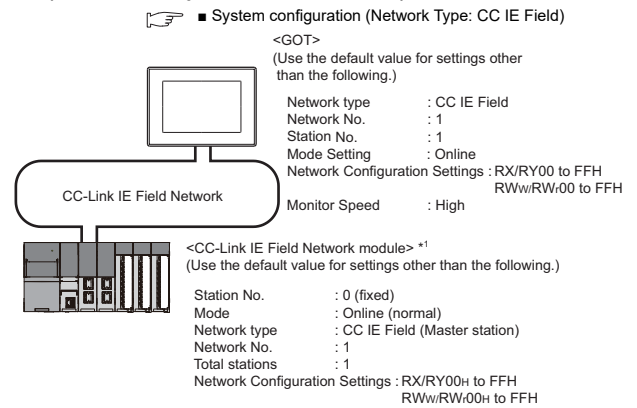

☞ (1) [Module parameter] of CW Configurator

*1 The CC-Link IE Field Network module is mounted on slot 0 of the base unit.
The Start I/O No. of the CC-Link IE Field Network module is set at "0".

■ Unit parameter settings of System configuration (Network Type: CC IE Field)

(1) [Module parameter] of CW Configurator

(a) Module parameter

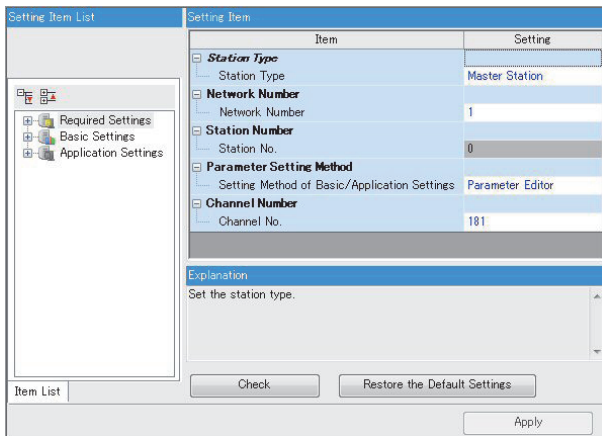

Item	Set value	Setting necessity at GOT connection
Station type	Master station (fixed)	○
Network No.*1	1	○
Station No.	0 (fixed)	○
Parameter setting	Parameter	○
Channel No.	(Use default value)	×
Network Configuration Settings	Refer to (b)	△

○: Necessary △: As necessary ×: Not necessary

*1 Specify the same network No. as that of the GOT.

(b) Network Configuration Settings

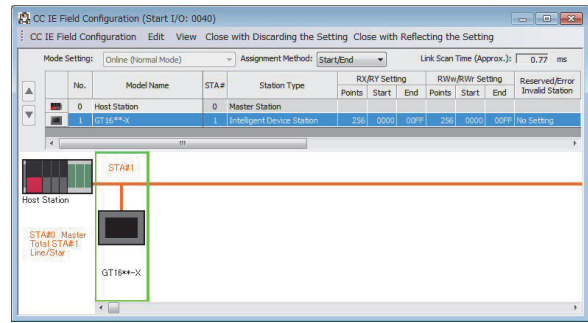

Item			Set value	Setting necessity at GOT connection
Rx/Ry, RWw/RWr Setting (1)*1	Rx/Ry setting	Station No.1	Start 0000H	△
			End 00FFH	△
	RWw/RWr setting	Station No.1	Start 0000H	△
			End 00FFH	△
Reserved/Error Invalid Station			No setting	△

○: Necessary △: As necessary ×: Not necessary

*1 Be sure to set it to perform the cyclic transmission.

POINT

- (1) When changing the unit parameter
After writing unit parameters to the PLC CPU, turn the PLC CPU OFF then back ON again, or reset the PLC CPU.
- (2) GOT station type
Set the GOT as an intelligent device station.

- (c) Routing setting
Up to 238 [Target Station Network No.]s can be set. However, the same target station network number cannot be set twice or more (multiple times). Therefore, the one that can access to other station from the request source host GOT is 238 kinds of [Target Station Network No.]s.

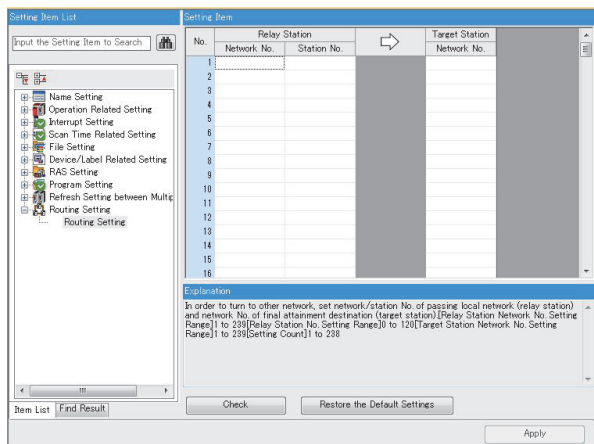

Item	Range
Target Station Network No.	1 to 239
Relay Station Network No.	1 to 239
Relay Station No.	1 to 120

POINT

Routing parameter setting of request source
Routing parameter setting is also necessary for the request source GOT.
For the setting, refer to the following.
☞ 11.3.3 Routing parameter setting

■ GT Designer3 [Communication settings] of System configuration (Network Type: CC IE Field)

Item	Set value
Network Type	CC IE Field
Network No.	1: Network No.1
Station No.	1: Station No.1
Group No.	0 (fixed)
Mode Setting	Online
Refresh Interval	25ms (Use default value)
Input for Error Station	Clear (Use default value)
Retry	3times (Use default value)
Timeout Time	3sec (Use default value)
Delay Time	0ms (Use default value)
Monitor Speed	High (Normal) (Use default value)

POINT

[Controller Setting] of GT Designer3
For the setting method of [Controller Setting] of GT Designer3, refer to the following.
☞ 11.3.1 Setting communication interface (Communication settings)

12.4.3 Connecting to MELSEC-Q/L

System configuration (Network Type: CC IE Field)

■ GT Designer3 [Communication setting] of System configuration1 (Network Type: CC IE Field)

<GOT>
(Use the default value for settings other than the following.)

Network type : CC IE Field
 Network No. : 1
 Station No. : 1
 Mode Setting : Online
 Network Configuration Settings : RX/Ry00 to FFH
 RWw/RW:00 to FFH
 Monitor Speed : High

<CC-Link IE Field Network module> *1
(Use the default value for settings other than the following.)

Station No. : 0 (fixed)
 Mode : Online (normal)
 Network type : CC IE Field (Master station)
 Network No. : 1
 Total stations : 1
 Network Configuration Settings : RX/Ry00H to FFH
 RWw/RW:00H to FFH

■ [Network parameter] of GX Works2

*1 The CC-Link IE Field Network module is mounted on slot 0 of the base unit.
 The start I/O No. of the CC-Link IE Field Network module is set at [0].

POINT

When connecting to Q170MCPU
 When connected to Q170MCPU, the start I/O No. of the CC-Link IE Field Network module is set to "70".

Parameter settings (Connection to MELSEC-Q, QS series) of System configuration (Network Type: CC IE Field)

- (1) Network parameter] of GX Works2
 Use GX Works2 of Version 1.31H or later.
- (a) Network parameter

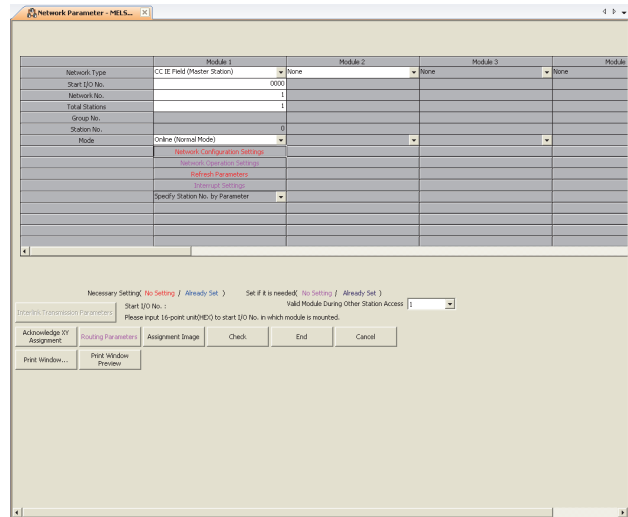

Item	Set value	Setting necessity at GOT connection
Network type	CC IE Field (Master station) (fixed)	○
Starting I/O No.*1	0000H	○
Network No.*2	1	○
Total stations	1	○
Station No.	0 (fixed)	○
Mode*3	Online (Normal mode)	○
Network Configuration Settings	Refer to (b)	△
Refresh parameters	(Use default value)	△
Interrupt settings		×
Interlink transmission parameters		×
Routing parameters	Refer to (c)	△

○: Necessary △: As necessary ×: Not necessary

*1 When using Q170MCPU, set it according to the system configuration.

*2 Specify the same network No. as that of the GOT.

*3 Set the same mode setting as that of the GOT.

(b) Network Configuration Settings

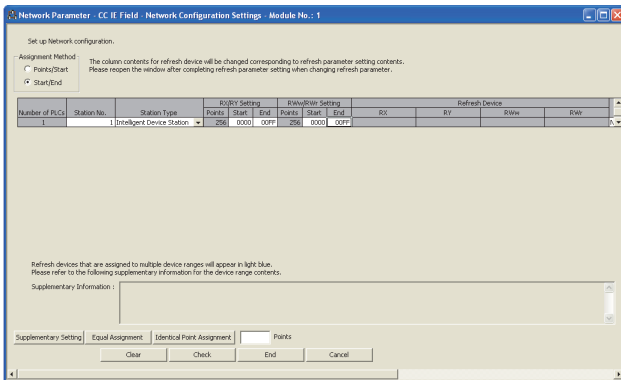

Item		Set value	Setting necessity at GOT connection
Rx/Ry, Rw/Rwr setting(1)*1	Rx/Ry setting	Station No.1 Start	0000H Δ
		Station No.1 End	00FFH Δ
	Rw/Rwr setting	Station No.1 Start	00000H Δ
		Station No.1 End	000FFH Δ
Reserved/Error Invalid Station		No setting	Δ

○: Necessary Δ: As necessary ×: Not necessary

*1 Be sure to set it to perform the cyclic transmission.

POINT

- When changing the network parameter After writing the network parameter to the PLC CPU, operate the PLC CPU ether turning OFF and then ON or resetting.
- GOT station type Set the GOT as an intelligent device station.

(c) Routing parameter setting

Up to 64 [Transfer Network No.]s can be set. However, the same transfer network number cannot be set twice or more (multiple times). Therefore, the one that can access to other station from the request source host GOT is 64 kinds of [Transfer Network No.]s.

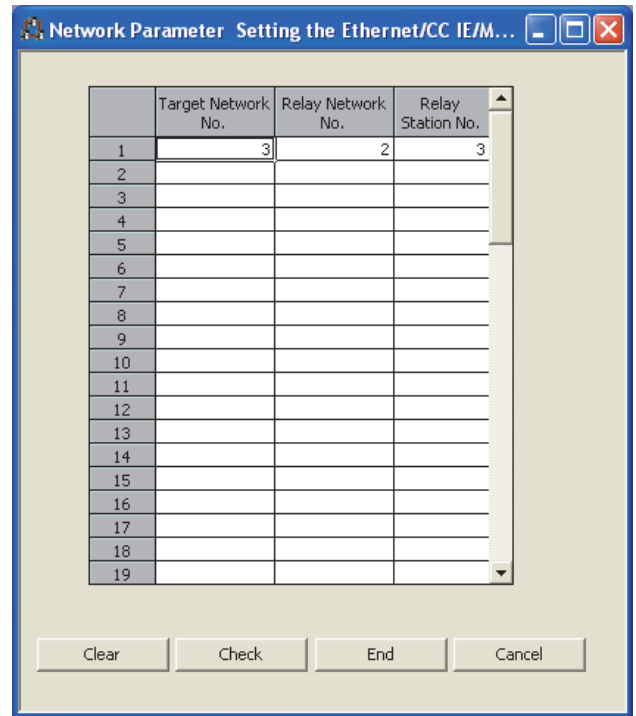

Item	Range
Transfer target network No.	1 to 239
Relay network No.	1 to 239
Relay station No.	0 to 120

POINT

Routing parameter setting of request source Routing parameter setting is also necessary for the request source GOT.

For the setting, refer to the following.

👉 12.3.3 Routing parameter setting

9 MELSECNET/H CONNECTION (PLC CONNECTION TO PLC NETWORK)
10 MELSECNET/10 CONNECTION (PLC CONNECTION TO PLC NETWORK)
11 CC-Link IE CONTROLLER NETWORK CONNECTION
12 CC-Link IE FIELD NETWORK CONNECTION
13 CC-Link CONNECTION (INTELLIGENT DEVICE STATION)
14 CC-Link CONNECTION (Via G4)
15 INVERTER CONNECTION
16 SERVO AMPLIFIER CONNECTION

■ GT Designer3 [Communication settings] of System configuration (Network Type: CC IE Field)

Item	Set value
Network Type	CC IE Field
Network No.	1: Network No.1
Station No.	1: Station No.1
Mode Setting	Online
Retry	3times (Use default value)
Timeout Time	3sec (Use default value)
Delay Time	0ms (Use default value)
Refresh Interval	25ms (Use default value)
Monitor Speed	High (Use default value)

POINT

[Controller Setting] of GT Designer3
For the setting method of [Controller Setting] of GT Designer3, refer to the following.
 12.3.1 Setting communication interface (Communication settings)

12.5 Precautions

■ GOT startup in CC-Link IE Field Network connection

For the CC-Link IE Field Network connection, the data link is started approximately 15 seconds after the GOT startup.

■ When a network error occurs in the system alarm

In the CC-Link IE Field Network connection, when a network error occurs in the system alarm, the system alarm display cannot be canceled even though the causes are removed.

To cancel the system alarm display, restart the GOT.

■ CC-Link IE Field Network module version

For version restrictions of the CC-Link IE Field Network module, refer to the following manual.

 CC-Link IE Field Network Master/Local Module User's Manual

■ Connection to Q170MCPU

The Motion CPU area (CPU No.2) cannot be monitored.

Set the CPU No. to "0" or "1".

The device of the PLC CPU area (CPU No.1) is monitored.

For setting the CPU No., refer to the following manual.

 GT Designer3 Version□ Screen Design Manual

Example) Setting dialog box of the bit device

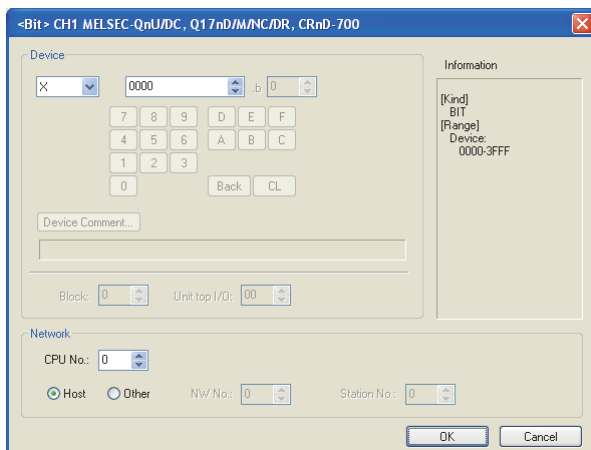

■ Data link failure in other stations at GOT startup

At GOT startup, the data link failure may occur in other stations.

However, after the failure occurrence, the GOT reconnects automatically and monitors the devices properly.

To avoid such data link failure, start up the GOT 10 seconds earlier than the master station.

However, if the master station does not complete startup when GOT starts monitoring (10 seconds after the GOT startup), the communication timeout occurs in the GOT side.

For details, refer to the following manual.

 CC-Link IE Field Network Master/Local Module User's Manual

■ Data link failure in all stations at GOT startup or cable connection/disconnection

At GOT startup, the communication is broken temporarily between PORT1 and PORT2 in the CC-Link IE Field module which is installed on the GOT.

Thus, as the GOT or a station between the GOT and the master station is reconnected, the data link failure may occur on all stations.

POINT

GOT startup

GOT startup indicates the startups after the following operations:

- Turning ON the GOT
- Resetting the GOT main unit
- Operating the utility
- Downloading the project including the communication settings
- Downloading the OS

■ When the output is required to be held at the data link failure

Set the GOT to hold the input from the data link faulty stations in the communication setting. Set "Input for Error Station" to "Hold".

 12.3.2 Communication detail settings

■ Connection to RnSFCPU

The RnSFCPU takes 10 seconds or more to run. If the GOT is started before the RnSFCPU runs, a system alarm occurs.

To prevent a system alarm from occurring, adjust the title display time in the [GOT Setup] dialog.

 GT Designer3 (GOT2000) Help

13

CC-Link CONNECTION (INTELLIGENT DEVICE STATION)



13.1 Connectable Model List	13 - 2
13.2 System Configuration	13 - 7
13.3 GOT Side Settings	13 - 11
13.4 PLC Side Setting	13 - 14
13.5 Precautions	13 - 48

13. CC-Link CONNECTION (INTELLIGENT DEVICE STATION)

13.1 Connectable Model List

13.1.1 PLC/Motion controller CPU

The following table shows the connectable models.

Series	Model name	Clock	Communication type	GT 16	GT 15	GT 14	GT 12	GT11 Bus	GT11 Serial	GT 10 ₅ ₄	GT 10 ₂₀ ₃₀	Refer to
MELSEC iQ-R Series	R04CPU	○	CC-Link (ID)	○	×	×	×	×	×	×	×	👉 13.2
	R08CPU											
	R16CPU											
	R32CPU											
	R120CPU											
	R08PCPU											
	R16PCPU											
	R32PCPU											
	R120PCPU											
	R04ENCPU											
	R08ENCPU											
	R16ENCPU											
	R32ENCPU											
	R120ENCPU											
Motion controller CPU (MELSEC iQ-R Series)	R16MTCPU	○	CC-Link (ID)	○	×	×	×	×	×	×	×	👉 13.2
	R32MTCPU											
C Controller module (MELSEC iQ-R Series)	R12CCPU-V	○	CC-Link (ID)	○	×	×	×	×	×	×	×	👉 13.2
MELSEC iQ-F Series	FX5U FX5UC	○	CC-Link (ID)	×	×	×	×	×	×	×	×	-

(Continued to next page)

*1 Mount a safety function module R6SFM next to the RnSFPCPU on the base unit. The RnSFPCPU and the safety function module R6SFM must have the same pair version. If their pair versions differ, the RnSFPCPU does not operate.

Series	Model name	Clock	Communication type	GT 16	GT 15	GT 14	GT 12	GT11 Bus	GT11 Serial	GT10 5□ 4□	GT10 20 30	Refer to
MELSEC-Q (Q mode)	Q00JCPU	○	CC-Link(ID)									13.2
	Q00CPU*1											
	Q01CPU*1											
	Q02CPU*1											
	Q02HCPU*1											
	Q06HCPU*1											
	Q12HCPU*1											
	Q25HCPU*1											
	Q02PHCPU											
	Q06PHCPU											
	Q12PHCPU											
	Q25PHCPU											
	Q12PRHCPU (Main base)											
	Q25PRHCPU (Main base)											
	Q12PRHCPU (Extension base)											
Q25PRHCPU (Extension base)												
Q00UJCPU	○	CC-Link(ID)									13.2	
Q00UCPU												
Q01UCPU												
Q02UCPU												
Q03UDCPU												
Q04UDHCPU												
Q06UDHCPU												
Q10UDHCPU												
Q13UDHCPU												
Q20UDHCPU												
Q26UDHCPU												
Q03UDECPU												
Q04UDEHCPU												
Q06UDEHCPU												
Q10UDEHCPU												
Q13UDEHCPU												
Q20UDEHCPU												
Q26UDEHCPU												
Q50UDEHCPU												
Q100UDEHCPU												
Q03UDVCPU												
Q04UDVCPU												
Q06UDVCPU												
Q13UDVCPU												
Q26UDVCPU												
C Controller module (Q Series)	Q12DCCPU-V*2	○	CC-Link(ID)									13.2
	Q24DHCCPU-V/VG											
	Q24DHCCPU-LS											
	Q26DHCCPU-LS											

(Continued to next page)

- *1 When in multiple CPU system configuration, use CPU function version B or later.
- *2 Use a module with the upper five digits later than 12042.
- *3 Use GT15-J61BT13 as the CC-Link communication unit.

9
MELSECNET/H
CONNECTION (PLC
TO PLC NETWORK)

10
MELSECNET/10
CONNECTION (PLC
TO PLC NETWORK)

11
CC-Link IE CONTROLLER
NETWORK
CONNECTION







12
CC-Link IE FIELD
NETWORK
CONNECTION

13
CC-Link CONNECTION
(INTELLIGENT DEVICE
STATION)

14
CC-Link CONNECTION
(Via G4)

15
INVERTER
CONNECTION

16
SERVO AMPLIFIER
CONNECTION

Series	Model name	Clock	Communication type	GT 16	GT 15	GT 14	GT 12	GT11 Bus	GT11 Serial	GT 10 5/4	GT 10 20/30	Refer to
MELSEC-QS	QS001CPU	○	-	×	×	×	×	×	×	×	×	-
MELSEC-L	L02CPU	○	CC-Link(ID)	○	○	×	×	×	×	×	×	 13.2.2
	L06CPU											
	L26CPU											
	L26CPU-B											
	L02CPU-P											
	L06CPU-P											
	L26CPU-P											
	L26CPU-PBT											
	L02SCPU											
L02SCPU-P												
MELSEC-Q (A mode)	Q02CPU-A	○	CC-Link(ID)	○	○	×	×	×	×	×	×	 13.2.1
	Q02HCPU-A											
	Q06HCPU-A											
MELSEC-QnA (QnACPU)	Q2ACPU	○	CC-Link(ID)	○	○	×	×	×	×	×	×	 13.2.1
	Q2ACPU-S1											
	Q3ACPU											
	Q4ACPU											
	Q4ARCPU											
MELSEC-QnA (QnASCPU)	Q2ASCPU	○	CC-Link(ID)	○	○	×	×	×	×	×	×	 13.2.1
	Q2ASCPU-S1											
	Q2ASHCPU											
	Q2ASHCPU-S1											
MELSEC-A (AnCPU)	A2UCPU	○	CC-Link(ID)	○	○	×	×	×	×	×	×	 13.2.1
	A2UCPU-S1											
	A3UCPU											
	A4UCPU											
	A2ACPU											
	A2ACPUP21											
	A2ACPUR21											
	A2ACPU-S1											
	A2ACPUP21-S1											
	A2ACPUR21-S1											
	A3ACPU											
	A3ACPUP21											
	A3ACPUR21											
	A1NCPUR21											
	A1NCPUR21											
	A2NCPUR21											
	A2NCPUR21											
	A2NCPUR21											
	A2NCPUR21											
	A2NCPUR21-S1											
	A2NCPUR21-S1											
	A3NCPUR21											
	A3NCPUR21											
A3NCPUR21												
MELSEC-A (AnSCPU)	A2USCPU	○	CC-Link(ID)	○	○	×	×	×	×	×	×	 13.2.1
	A2USCPU-S1											
	A2USHCPU-S1											
	A1SCPU											
	A1SCPUC24-R2											
	A1SHCPU											
	A2SCPU											
	A2SCPU-S1											
	A2SHCPU											
	A2SHCPU-S1											
	A1SJCPU											
	A1SJCPU-S3											
	A1SJHCPU											
	A1SJHCPU											

(Continued to next page)

Series	Model name	Clock	Communication type	GT 16	GT 15	GT 14	GT 12	GT11 Bus	GT11 Serial	GT 10 5□4□	GT 10 20□30	Refer to
MELSEC-A	A0J2HCPU	×	CC-Link(ID)	○	○	×	×	×	×	×	×	13.2.1
	A0J2HCPUP21											
	A0J2HCPUR21											
	A0J2HCPU-DC24											
	A2CCPU	○	-	×	×	×	×	×	×	-		
	A2CCPUP21											
	A2CCPUR21											
	A2CCPUC24											
	A2CCPUC24-PRF											
	A2CJCPU-S3											
A1FXCPU												
Motion controller CPU (Q Series)	Q172CPU ^{*1*2}	○	CC-Link(ID)	○	○	×	×	×	×	×	×	13.2
	Q173CPU ^{*1*2}											
	Q172CPUN ^{*1}											
	Q173CPUN ^{*1}											
	Q172HCPU											
	Q173HCPU											
	Q172DCPU											
	Q173DCPU											
	Q172DCPU-S1											
	Q173DCPU-S1											
	Q172DSCPU											
	Q173DSCPU											
	Q170MCPUS ^{*3}											
	Q170MSCPUS ^{*4}											
	Q170MSCPUS-S1 ^{*4}											
MR-MQ100	○	-	×	×	×	×	×	×	×	×	-	
Motion controller CPU (A Series)	A273UCPU	○	CC-Link(ID)	○	○	×	×	×	×	×	×	13.2.1
	A273UHCPU											
	A273UHCPU-S3											
	A373UCPU											
	A373UCPU-S3											
	A171SCPU											
	A171SCPU-S3											
	A171SCPU-S3N											
	A171SHCPU											
	A171SHCPUN											
	A172SHCPU											
	A172SHCPUN											
	A173UHCPU											
	A173UHCPU-S1											

(Continued to next page)

- *1 When using SV13, SV22, or SV43, use the motion controller CPU on which any of the following main OS version is installed.
- SW6RN-SV13Q□: 00H or later
 - SW6RN-SV22Q□: 00H or later
 - SW6RN-SV43Q□: 00B or later
- *2 Use main modules with the following product numbers.
- Q172CPU: Product number N***** or later
 - Q173CPU: Product number M***** or later
- *3 Only the first step can be used on the extension base unit (Q52B/Q55B).
- *4 The extension base unit (Q5□B/Q6□B) can be used.

9
MELSECNET/H
CONNECTION (PLC
CONNECTION TO PLC NETWORK)

10
MELSECNET/10
CONNECTION (PLC
CONNECTION TO PLC NETWORK)

11
CC-Link IE CONTROLLER
NETWORK
CONNECTION



12
CC-Link IE FIELD
NETWORK
CONNECTION

13
CC-Link CONNECTION
(INTELLIGENT DEVICE
STATION)

14
CC-Link
CONNECTION
(Via G4)

15
INVERTER
CONNECTION

16
SERVO AMPLIFIER
CONNECTION

Series	Model name	Clock	Communication type	GT 16	GT 15	GT 14	GT 12	GT11 Bus	GT11 Serial	GT10 5/4	GT10 3/0	Refer to
MELSEC-WS	WS0-CPU0	×	×	×	×	×	×	×	×	×	×	-
	WS0-CPU1											
	WS0-CPU3											
MELSECNET/H Remote I/O station	QJ72LP25-25	×	-	×	×	×	×	×	×	×	×	-
	QJ72LP25G											
	QJ72BR15											
CC-Link IE Field Network head module	LJ72GF15-T2	×	-	×	×	×	×	×	×	×	×	-
CC-Link IE Field Network Ethernet adapter module	NZ2GF-ETB	×	-	×	×	×	×	×	×	×	×	-
CNC C70	Q173NCCPU	○	CC-Link(ID)	○	○	×	×	×	×	×	×	 13.2
Robot controller	CRnQ-700 (Q172DRCPU) CR750-Q (Q172DRCPU) CR751-Q (Q172DRCPU)	○	CC-Link(ID)	○	○	×	×	×	×	×	×	 13.2
MELSEC-FX	FX0	×	-	×	×	×	×	×	×	×	×	-
	FX0S											
	FX0N											
	FX1	×	-	×	×	×	×	×	×	×		
	FX2											
	FX2C											
	FX1S	○	-	×	×	×	×	×	×	×		
	FX1N											
	FX2N											
	FX1NC	×	-	×	×	×	×	×	×	×		
	FX2NC											
	FX3S											
	FX3G	○	-	×	×	×	×	×	×	×		
	FX3GC											
	FX3GE											
FX3U												
FX3UC												

13.1.2 CC-Link module

CPU series	CC-Link module
MELSEC iQ-R Series Motion controller CPU (MELSEC iQ-R Series) C Controller module (MELSEC iQ-R Series)	RJ61BT11
MELSEC-Q (Q mode) C Controller module (Q Series) Motion controller CPU (Q Series) CNC C70 Robot controller (CRnQ-700)	QJ61BT11 QJ61BT11N
MELSEC-L	LJ61BT11
MELSEC-QnA	AJ61QBT11*1 A1SJ61QBT11*1
MELSEC-Q (A mode) MELSEC-A Motion controller CPU (A Series)	AJ61BT11*1 A1SJ61BT11*1

*1 Transient communication can be performed to only CC-Link modules of function version B or later and software version J or later.



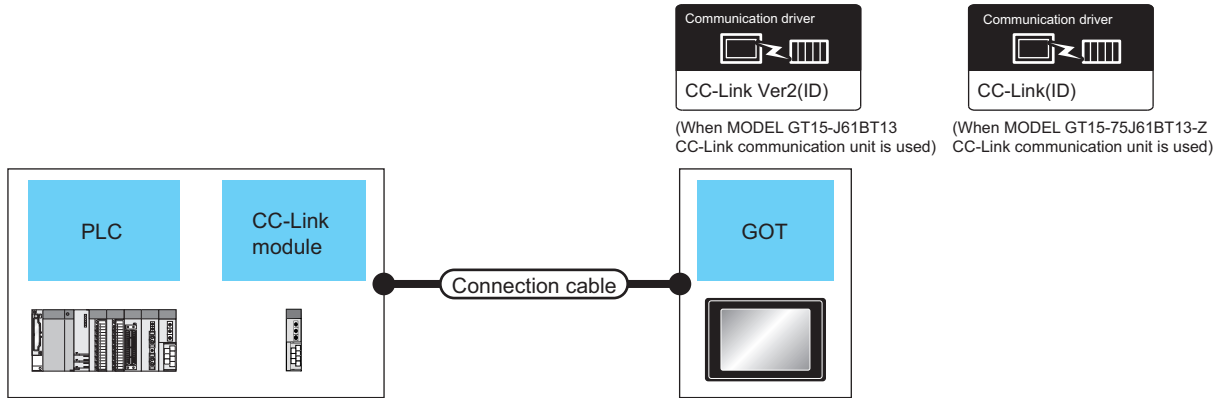

13.2 System Configuration

13.2.1 Connecting with CC-Link Ver.1 compatible



PLC		Connection cable		GOT		Number of connectable equipment	
Model name	CC-Link module *1	Communication type	Cable model	Max. distance	Option device		Model
MELSEC iQ-R Series Motion controller CPU (MELSEC iQ-R Series) C Controller module (MELSEC iQ-R Series)	RJ61BT11	CC-Link (Ver.1)	CC-Link dedicated cable *2	*3	GT15-J61BT13 *5	GT16 GT15	26 GOTs
MELSEC-Q (Q mode) Motion controller CPU (Q Series) CNC C70 Robot controller (CRnQ-700)	QJ61BT11 QJ61BT11N	CC-Link (Ver.1)	CC-Link dedicated cable *2	*3	GT15-J61BT13 *5	GT16 GT15	
C Controller module (Q Series)	QJ61BT11 QJ61BT11N	CC-Link(Ver.1)	CC-Link dedicated cable *2	*3	GT15-J61BT13 *5	GT16 GT15	
MELSEC-L	LJ61BT11	CC-Link(Ver.1)	CC-Link dedicated cable *2	*3	GT15-J61BT13 *5	GT16 GT15	
MELSEC-L (L26CPU-BT)	-	CC-Link(Ver.1)	CC-Link dedicated cable *2	*3	GT15-J61BT13 *5	GT16 GT15	
MELSEC-QnA	AJ61QBT11 A1SJ61QBT11*4	CC-Link (Ver.1)	CC-Link dedicated cable *2	*3	GT15-J61BT13 *5	GT16 GT15	
MELSEC-A	AJ61BT11 A1SJ61BT11*4	CC-Link (Ver.1)	CC-Link dedicated cable *2	*3	GT15-J61BT13 *5	GT16 GT15	
					GT15-75J61BT13-Z	GT15	

9
MELSECNET/H CONNECTION (PLC TO PLC NETWORK)
10
MELSECNET/10 CONNECTION (PLC TO PLC NETWORK)
11
CC-Link IE CONTROLLER NETWORK CONNECTION
12
CC-Link IE FIELD NETWORK CONNECTION
13
CC-Link CONNECTION (INTELLIGENT DEVICE STATION)
14
CC-Link CONNECTION (Via G4)
15
INVERTER CONNECTION
16
SERVO AMPLIFIER CONNECTION

- *1 For the system configuration of the CC-Link module, refer to the following manuals.
-  CC-Link System Master/Local Module User's Manual QJ61BT11N
Control & Communication Link System Master/Local Module Type AJ61QBT11/A1SJ61QBT11 User's Manual
Control & Communication Link System Master/Local Module Type AJ61BT11/A1SJ61BT11 User's Manual
MELSEC-L CC-Link System Master/Local Module User's Manual
- *2 For the specifications and inquiries of the CC-Link dedicated cable, refer to the following.
-  CC-Link Partner Association's home page: <http://www.cc-link.org/>
- *3 The maximum overall extension cable length and the length between stations vary depending on the cable type to be used and the transmission speed.
For details, refer to the following manual.
-  CC-Link System Master/Local Module User's Manual QJ61BT11N
Control & Communication Link System Master/Local Module Type AJ61QBT11/A1SJ61QBT11 User's Manual
Control & Communication Link System Master/Local Module Type AJ61BT11/A1SJ61BT11 User's Manual
MELSEC-L CC-Link System Master/Local Module User's Manual
- *4 Transient transmission can be performed to only CC-Link modules of function version B or later and software version J or later.
- *5 Specify Ver.1 as the mode setting in the Communication Settings to use it.
For details of the settings, refer to the following the manual.
-  13.3.1 Setting communication interface (Communication settings)
- *6 Not available for the universal model QCPU.

13.2.2 Connecting with CC-Link Ver.2 compatible

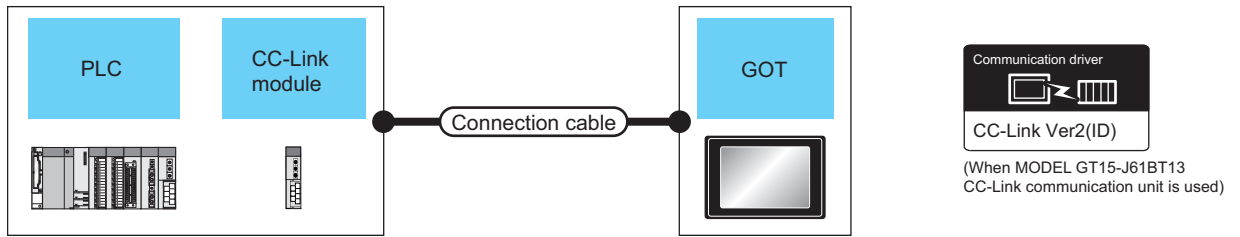

PLC		Connection cable		GOT		Number of connectable equipment	
Model name	CC-Link module *1	Communication type	Cable model	Max. distance	Option device		Model
MELSEC iQ-R Series Motion controller CPU (MELSEC iQ-R Series) C Controller module (MELSEC iQ-R Series)	RJ61BT11	CC-Link (Ver.2)	CC-Link dedicated cable *2	*3	GT15-J61BT13 *4	GT16 GT15	26 GOTs
MELSEC-Q (Q mode) C Controller module (Q Series) Motion controller CPU (Q Series) CNC C70 Robot controller (CRnQ-700)	QJ61BT11N	CC-Link (Ver.2)	CC-Link dedicated cable *2	*3	GT15-J61BT13 *4	GT16 GT15	
MELSEC-L	LJ61BT11						
MELSEC-L (L26CPU-BT) (L26CPU-PBT)	-						

*1 For the system configuration of the CC-Link module, refer to the following manual.

☞ CC-Link System Master/Local Module User's Manual QJ61BT11N
MELSEC-L CC-Link System Master/Local Module User's Manual

*2 For the specifications and inquiries of the CC-Link dedicated cable, refer to the following.

☞ CC-Link Partner Association's home page: <http://www.cc-link.org/>

*3 The maximum overall extension cable length and the length between stations vary depending on the cable type to be used and the transmission speed.

For details, refer to the following manual.

☞ CC-Link System Master/Local Module User's Manual QJ61BT11N
MELSEC-L CC-Link System Master/Local Module User's Manual

*4 Specify Ver.2 as the mode setting in the Communication Settings to use it.
For details of the settings, refer to the following manual.

☞ 13.3.1 Setting communication interface (Communication settings)

13.2.3 Connecting with CC-Link Ver.1/Ver.2 compatibles mixed

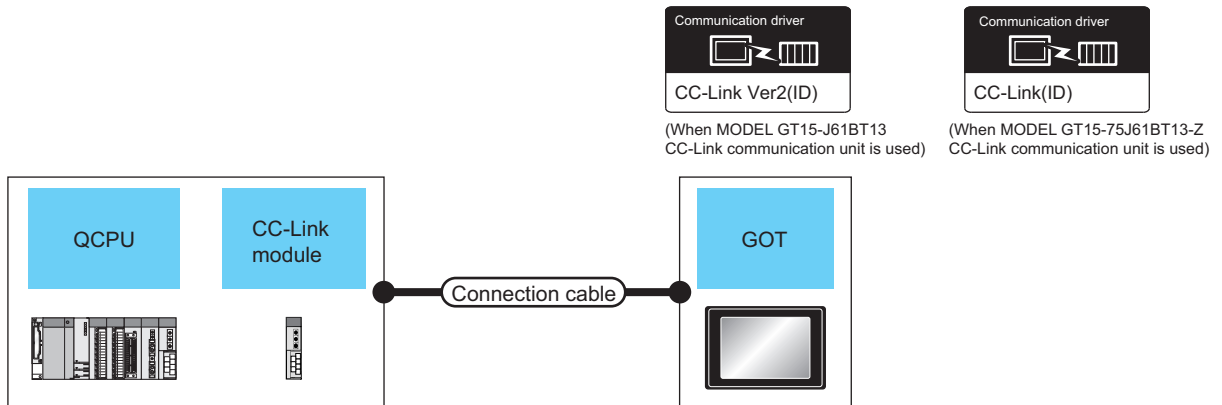

PLC		Connection cable			GOT		Number of connectable equipment
Model name	CC-Link module *1	Communication type	Cable model	Max. distance	Option device	Model	
MELSEC iQ-R Series Motion controller CPU (MELSEC iQ-R Series) C Controller module (MELSEC iQ-R Series)	RJ61BT11	CC-Link (Ver.2)	CC-Link dedicated cable *2	*3	GT15-J61BT13 *4		26 GOTs
		CC-Link (Ver.1)	CC-Link dedicated cable *2	*3	GT15-J61BT13 *5		
MELSEC-Q (Q mode) Motion controller CPU (Q Series) CNC C70 Robot controller (CRnQ-700)	QJ61BT11N	CC-Link (Ver.2)	CC-Link dedicated cable *2	*3	GT15-J61BT13 *4		
		CC-Link (Ver.1)	CC-Link dedicated cable *2	*3	GT15-J61BT13 *5		
			CC-Link dedicated cable *2	*3	GT15-75J61BT13-Z *6		
C Controller module (Q Series)	QJ61BT11N	CC-Link (Ver.2)	CC-Link dedicated cable *2	*3	GT15-J61BT13 *4		
		CC-Link (Ver.1)	CC-Link dedicated cable *2	*3	GT15-J61BT13 *5		

*1 For the system configuration of the CC-Link module, refer to the following manual.

CC-Link System Master/Local Module User's Manual QJ61BT11N

*2 For the specifications and inquiries of the CC-Link dedicated cable, refer to the following.

CC-Link Partner Association's home page: <http://www.cc-link.org/>

*3 The maximum overall extension cable length and the length between stations vary depending on the cable type to be used and the transmission speed.

For details, refer to the following manual.

CC-Link System Master/Local Module User's Manual QJ61BT11N

*4 Specify Ver.2 as the mode setting in the Communication Settings to use it. For details of the settings, refer to the following the manual.

13.3.1 Setting communication interface (Communication settings)

*5 Specify Ver.1 as the mode setting in the Communication Settings to use it. For details of the settings, refer to the following the manual.

13.3.1 Setting communication interface (Communication settings)

*6 Not available for the universal model QCPU.

13.3 GOT Side Settings

13.3.1 Setting communication interface (Communication settings)

Set the channel of the connected equipment.

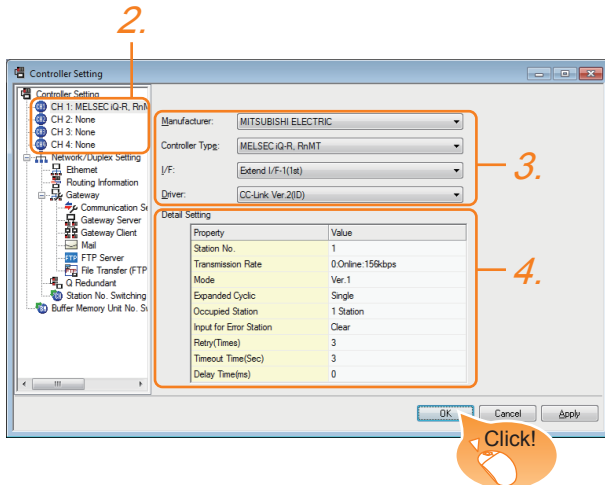

1. Select [Common] → [Controller Setting] from the menu.
2. The Controller Setting window is displayed. Select the channel to be used from the list menu.
3. Set the following items.
 - Manufacturer: MITSUBISHI ELECTRIC
 - Controller Type: Set according to the Controller Type to be connected.
 - I/F: Interface to be used
 - Driver:
 - When MODEL GT15-J61BT13 CC-Link communication unit is used
 - CC-Link Ver2 (ID)
 - When MODEL GT15-75J61BT13-Z CC-Link communication unit is used
 - CC-Link (ID)
4. The detailed setting is displayed after Manufacturer, Controller Type, I/F, and Driver are set. Make the settings according to the usage environment.

☞ 13.3.2 Communication detail settings

Click the [OK] button when settings are completed.

POINT

The settings of connecting equipment can be confirmed in [I/F Communication Setting]. For details, refer to the following.

☞ 1.1.2 I/F communication setting

13.3.2 Communication detail settings

Make the settings according to the usage environment.

(1) CC-Link Ver.2 (ID)

Property	Value
Station No.	1
Transmission Rate	0:Online:156kbps
Mode	Ver.2
Expanded Cyclic	Single
Occupied Station	1 Station
Input for Error Station	Clear
Retry(Times)	3
Timeout Time(Sec)	3
Delay Time(ms)	0

Item	Description	Range
Station No.	Set the station No. of the GOT. (Default: 1)	1 to 64
Transmission Rate ^{*1}	Set the transmission speed and the mode of the GOT. (Default: 0)	0 to E
Mode	Set the mode of CC-Link. (Default: Ver.1)	Ver.1/Ver.2/ Additional/Offline
Expanded Cyclic	Set the cyclic point expansion. (Default: Single)	Single/Double/ Quadruple/Octuple
Occupied Station	Set the number of stations occupied by the GOT. (Default: 1 Station)	1 Station/4 Stations
Input for Error Station	Set Clear/Hold at an error occurrence. (Default: Clear)	Clear/Hold
Retry	Set the number of retries to be performed when a communication timeout occurs. When no response is received after retries, a communication times out. (Default: 3times)	0 to 5times
Timeout Time	Set the time period for a communication to time out. (Default: 3sec)	3 to 90sec
Delay Time	Set the delay time for reducing the load of the network/destination PLC. (Default: 0ms)	0 to 300 (ms)

9 MELSECNET/H CONNECTION (PLC CONNECTION TO PLC NETWORK)
 10 MELSECNET/10 CONNECTION (PLC CONNECTION TO PLC NETWORK)
 11 CC-LINK IE CONTROLLER NETWORK CONNECTION
 12 CC-LINK IE FIELD NETWORK CONNECTION
 13 CC-LINK CONNECTION (INTELLIGENT DEVICE STATION)
 14 CC-LINK CONNECTION (Via G4)
 15 INVERTER CONNECTION
 16 SERVO AMPLIFIER CONNECTION

- *1 Transmission speed settings
The following lists the transmission speed settings of the CC-Link communication.

Set value	Description
0	Online: 156kbps
1	Online: 625kbps
2	Online: 2.5Mbps
3	Online: 5Mbps
4	Online: 10Mbps
A	Hardware test: 156kbps
B	Hardware test: 625kbps
C	Hardware test: 2.5Mbps
D	Hardware test: 5Mbps
E	Hardware test: 10Mbps

For details of the hardware test, refer to the following manual.

 CC-Link System Master/Local Module User's Manual for CC-Link module to be used

(2) CC-Link(ID)

Property	Value
Retry(Times)	3
Timeout Time(Sec)	3

Item	Description	Range
Retry	Set the number of retries to be performed when a communication timeout occurs. When no response is received after retries, a communication times out. (Default: 3times)	0 to 5times
Timeout Time	Set the time period for a communication to time out. (Default: 3sec)	3 to 90sec

POINT

- (1) Communication interface setting by Utility
The communication interface setting can be changed on the Utility's [Communication Settings] after writing [Communication Settings] of project data.
For details on the Utility, refer to the following manual.
 GT□ User's Manual
- (2) Precedence in communication settings
When settings are made by GT Designer3 or the Utility, the latest setting is effective.

13.3.3 Switch setting (Only when MODEL GT15-75J61BT13-Z CC-Link communication unit is used)

POINT

Switch setting of the communication unit
When using the MODEL GT15-J61BT13 CC-Link communication unit, the switch setting is not needed.

For details of each setting switch and LED, refer to the following manual.

GT15 CC-Link communication unit User's Manual

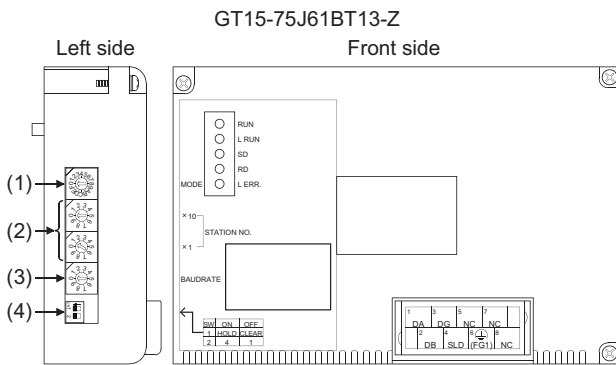

(1) Mode setting switch

Mode setting switch	Description	Set value
	Select the online mode. (Default: 0)	0 (fixed)

(2) Station number setting switch

Station number setting switch	Description	Set value
	Specify the station No. of the CC-Link communication unit. (Default: 01)	1 to 64

(3) Transmission baudrate setting switch

Transmission baudrate setting switch	Description	Set value
	Specify the transmission speed. (Default: 0)	0: 156kbps 1: 625kbps 2: 2.5Mbps 3: 5Mbps 4: 10Mbps

(4) Condition setting switches

Condition setting switches	Setting switch	Description	Set value
	SW1	Specify input data status of the data link error station. (Default: OFF)	OFF: Cleared ON: Held
	SW2	Specify the number of stations occupied. (Default: OFF)	OFF: 1 station ON: 4 stations

POINT

(1) Switch setting example

For the switch setting example, refer to the following.

13.4 PLC Side Setting

(2) When the switch setting is changed

When changing the switch setting after mounting the MODEL GT15-75J61BT13-Z CC-Link communication unit on the GOT, reset the GOT.

13.4 PLC Side Setting

The GOT operates as the stations of which are shown below in the CC-Link system.

Station data	Description
Station type	Intelligent device station, Ver.1 intelligent device station or Ver.2 intelligent device station
Number of stations occupied	Station 1 or Station 4

The switch settings and parameter settings of the PLC side (CC-Link module) are described in 13.4.1 to 13.4.11.

Model name		Refer to	
CC-Link module (MELSEC iQ-R Series)	Connecting with Ver.1 compatible	RJ61BT11	13.4.1
	Connecting with Ver.2 compatible	RJ61BT11	13.4.2
	Connecting with Ver.1/Ver.2 compatibles mixed	RJ61BT11	13.4.3
CC-Link module (Q Series)	Connecting with Ver.1 compatible	QJ61BT11, QJ61BT11N	13.4.5
	Connecting with Ver.2 compatible	QJ61BT11N	13.4.6
	Connecting with Ver.1/Ver.2 compatibles mixed	QJ61BT11N	13.4.7
CC-Link module (QnA Series)	AJ61QBT11, A1SJ61QBT11		13.4.10
CC-Link module (A Series)	AJ61BT11, A1SJ61BT11		13.4.11



Number of stations occupied

The number of stations occupied is setting for determining number of link device points (RX/Ry/RWw/RWr) used by the GOT.

To use multiple numbers of link device points in the case of cyclic transmission between the GOT and CC-Link module, set the number of stations occupied as the exclusive station 4.

The number of link device points at the exclusive station 1 and 4 is shown below.

CC-Link Ver.2

Link device	Expanded cyclic setting							
	Single		Double		Quadruple		Octuple	
	Excl sive statio n 1	Excl sive statio n 4	Excl sive statio n 1	Excl sive statio n 4	Excl sive statio n 1	Excl sive statio n 4	Excl sive statio n 1	Excl sive statio n 4
Remote input (RX)	32 points	128 points	32 points	224 points	64 points	448 points	128 points	896 points
Remote output (RY)	32 points	128 points	32 points	224 points	64 points	448 points	128 points	896 points
Remote register (RWw)	4 points	16 points	8 points	32 points	16 points	64 points	32 points	128 points
Remote register (RWr)	4 points	16 points	8 points	32 points	16 points	64 points	32 points	128 points

CC-Link Ver.1

Link device	Number of stations occupied	
	Exclusive station	Exclusive station 4
Remote input (RX)	32 points	128 points
Remote output (RY)	32 points	128 points
Remote register (RWw)	4 points	16 points
Remote register (RWr)	4 points	16 points

13.4.1 Connecting to CC-Link module (MELSEC iQ-R Series) with Ver.1 compatible

This section describes the settings of the GOT and the CC-Link module (MELSEC iQ-R Series) with Ver.1 compatible in the following system configuration.

POINT

CC-Link module (MELSEC iQ-R Series)
 For details of the CC-Link module (MELSEC iQ-R Series), refer to the following manual.
 Manuals of MELSEC iQ-R Series

System configuration

 ■ [Controller Setting] of GT Designer3

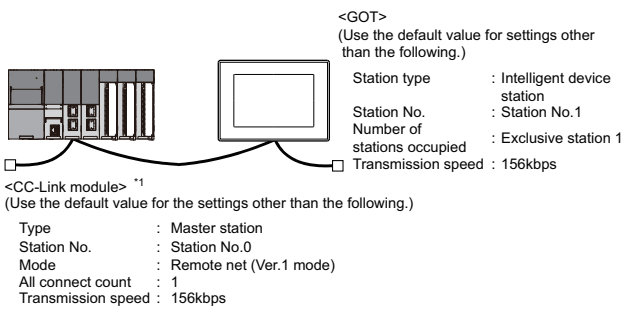

 ■ Unit parameter setting of GX Works3

*1 The CC-Link module is mounted on the base unit slot 0.
 The Start I/O No. of the CC-Link module is set to "0".

POINT

When the switch setting is changed
 Turn the PLC CPU OFF then ON again, or reset the PLC CPU.

Unit parameter setting of GX Works3

(1) Unit parameter

(a) Unit parameter

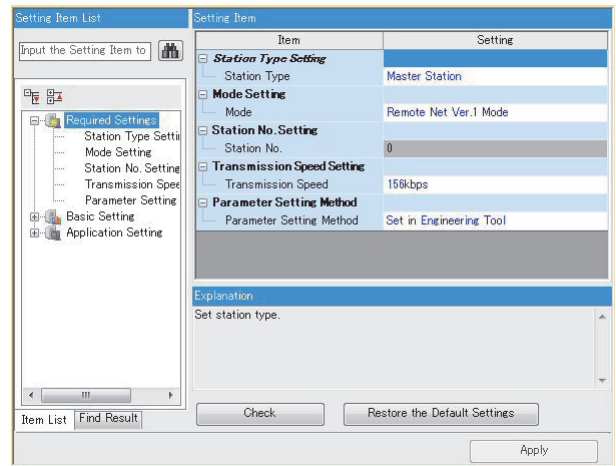

Item	Set value	Setting necessity at GOT connection
Station type	Master station	○
Mode	Remote net (Ver.1 mode)	○
Station No.	0 (fixed)	△
Transmission speed*1	156kbps	○
Parameter setting	Engineering tool	×

○: Necessary △: As necessary ×: Not necessary

*1 Adjust the settings with GOT settings.

(b) Link refresh setting

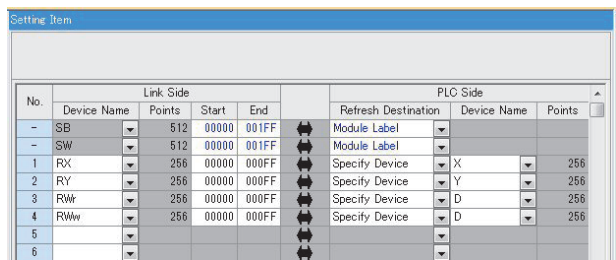

Item	Set value	Setting necessity at GOT connection
Special relay (SB) refresh device	-	△
Special register (SW) refresh device	-	△
Remote input (RX) refresh device	Set as necessary.	△
Remote output (RY) refresh device		△
Remote register (RW _r) refresh device		△

○: Necessary △: As necessary ×: Not necessary

9 MELSECNET/H CONNECTION (PLC CONNECTION TO PLC NETWORK)
 10 MELSECNET/T0 CONNECTION (PLC CONNECTION TO PLC NETWORK)
 11 CC-LINK IE CONTROLLER NETWORK CONNECTION
 12 CC-LINK IE FIELD NETWORK CONNECTION
 13 CC-LINK CONNECTION (INTELLIGENT DEVICE STATION)
 14 CC-LINK CONNECTION (Via G4)
 15 INVERTER CONNECTION
 16 SERVO AMPLIFIER CONNECTION

(c) CC-Link configuration setting

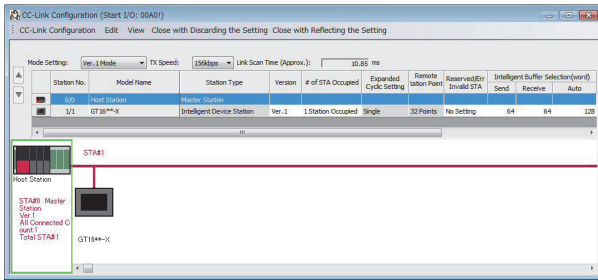

Item ^{*1}	Set value	Setting necessity at GOT connection
Station type	Intelligent device station (fixed)	○
Exclusive station count ^{*2}	Exclusive station 1	○
Reserve/invalid station select	No setting	○
Intelligent buffer select (word)	(Use default value)	×

○: Necessary △: As necessary ×: Not necessary

- *1 When the [Mode] of the CC-Link module is set at [Remote net - (Ver. 1 mode)], [Remote station points] cannot be set.
- *2 Set the same setting as that of the GOT.

POINT

When changing the unit parameter
After writing unit parameters to the PLC CPU, turn the PLC CPU OFF then back ON again, or reset the PLC CPU.

■ [Controller Setting] of GT Designer3

Item	Set value
Station No.	1: Station No.1
Transmission Rate	0: Online 156kbps
Mode	Ver.1: Remote net (Ver.1 mode)
Expanded Cyclic	Single (Use default value)
Number of stations occupied	1 Station
Input for Error Station	0: Clear
Retry	3times (Use default value)
Timeout Time	3sec (Use default value)
Delay Time	0sec (Use default value)

POINT

[Controller Setting] of GT Designer3
For the setting method of [Controller Setting] of GT Designer3, refer to the following.

- ➔ 13.3.1 Setting communication interface (Communication settings)

13.4.2 Connecting to CC-Link module (MELSEC iQ-R Series) with Ver.2 compatible

This section describes the settings of the GOT and the CC-Link module (MELSEC iQ-R Series) with Ver.2 compatible in the following system configuration.

POINT

CC-Link module (MELSEC iQ-R Series)
For details of the CC-Link module (MELSEC iQ-R Series), refer to the following manual.

- ➔ Manuals of MELSEC iQ-R Series

■ System configuration

- ➔ ■ [Communication settings] of GT Designer3

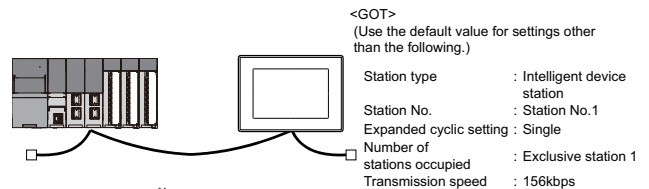

<GOT>
(Use the default value for settings other than the following.)

Station type : Intelligent device station
Station No. : Station No.1
Expanded cyclic setting : Single
Number of stations occupied : Exclusive station 1
Transmission speed : 156kbps

<CC-Link module> *1
(Use the default value for the settings other than the following.)

Type : Master station
Station No. : Station No.0
Mode : Remote net (Ver.2 mode)
All connect count : 1
Transmission speed : 156kbps

- ➔ ■ Unit parameter setting of GX Works3

- *1 The CC-Link module is mounted on the base unit slot 0.
The Start I/O No. of the CC-Link module is set to "0".

■ Unit parameter setting of GX Works3

(1) [Unit parameter] of GX Works3

(a) Unit parameter

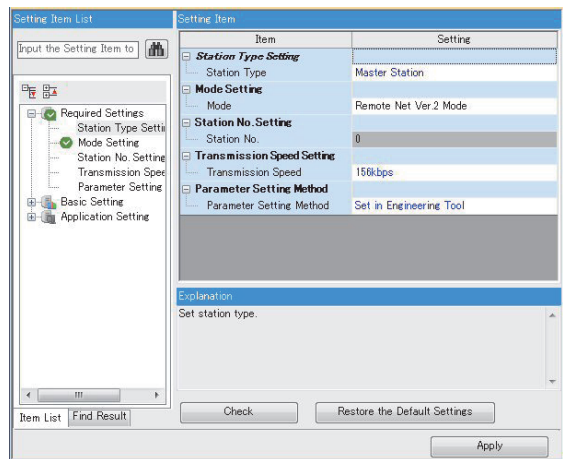

Item	Set value	Setting necessity at GOT connection
Station type	Master station	○
Mode	Remote net (Ver.2 mode)	○

Item	Set value	Setting necessity at GOT connection
Station No.	0 (fixed)	△
Transmission speed*1	156kbps	○
Parameter setting	Engineering tool	×

○: Necessary △: As necessary ×: Not necessary

*1 Adjust the settings with GOT settings.

(b) Link refresh setting

No.	Link Side				Refresh Destination	PLC Side		
	Device Name	Points	Start	End		Device Name	Points	
-	SB	512	00000	001FF	Module Label			
-	SW	512	00000	001FF	Module Label			
1	RX	256	00000	000FF	Specify Device	X		256
2	RY	256	00000	000FF	Specify Device	Y		256
3	RWr	256	00000	000FF	Specify Device	D		256
4	RWw	256	00000	000FF	Specify Device	D		256
5								
6								

Item	Set value	Setting necessity at GOT connection
Special relay (SB) refresh device	-	△
Special register (SW) refresh device	-	△
Remote input (RX) refresh device	Set as necessary.	△
Remote output (RY) refresh device		△
Remote register (RWr) refresh device		△

○: Necessary △: As necessary ×: Not necessary

(c) CC-Link configuration setting

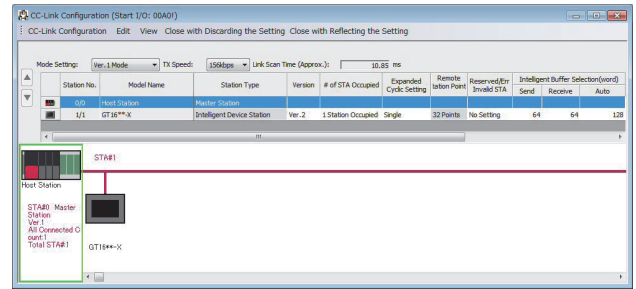

Item*1	Set value	Setting necessity at GOT connection
Station type	Ver.2 Intelligent device station (fixed)	○
Expanded cyclic setting*2	Single	○
Exclusive station count*2	Exclusive station 1	○
Remote station points	32 points (fixed)	○
Reserve/invalid station select	No setting	○
Intelligent buffer select (word)	(Use default value)	×

○: Necessary △: As necessary ×: Not necessary

- *1 When the [Mode] of the CC-Link module is set at [Remote net - (Ver. 2 mode)], [Remote station points] can be set. [Remote station points] is a setting for the remote I/O station. The default value (32 points) must be used on the GOT.
- *2 Set the same setting as that of the GOT.

POINT

When changing the unit parameter
After writing unit parameters to the PLC CPU, turn the PLC CPU OFF then back ON again, or reset the PLC CPU.

■ [Communication settings] of GT Designer3

Item	Set value
Station No.	1: Station No.1
Transmission Rate	0: Online 156kbps
Mode	Ver.2: Remote net (Ver.2 mode)
Expanded Cyclic	Single
Number of stations occupied	1 Station
Input for Error Station	0: Clear
Retry	3times (Use default value)
Timeout Time	3sec (Use default value)
Delay Time	0sec (Use default value)

POINT

[Controller Setting] of GT Designer3
For the setting method of [Controller Setting] of GT Designer3, refer to the following.

☞ 13.3.1 Setting communication interface (Communication settings)

9 MELSECNET/H CONNECTION (PLC CONNECTION TO PLC NETWORK)
10 MELSECNET/10 CONNECTION (PLC CONNECTION TO PLC NETWORK)
11 CC-Link IE CONTROLLER NETWORK CONNECTION
12 CC-Link IE FIELD NETWORK CONNECTION
13 CC-Link CONNECTION (INTELLIGENT DEVICE STATION)
14 CC-Link CONNECTION (Via G4)
15 INVERTER CONNECTION
16 SERVO AMPLIFIER CONNECTION

13.4.3 Connecting to CC-Link module (MELSEC iQ-R Series) with Ver.1/Ver.2 compatibles mixed

This section describes the setting of the GOT and CC-Link module (MELSEC iQ-R Series) with Ver.1/Ver.2 compatibles mixed in the following system configuration.

POINT

CC-Link module (MELSEC iQ-R Series)
For details of the CC-Link module (MELSEC iQ-R Series), refer to the following manual.

➔ Manuals of MELSEC iQ-R Series

System configuration

➔ [Controller Setting] of GT Designer3

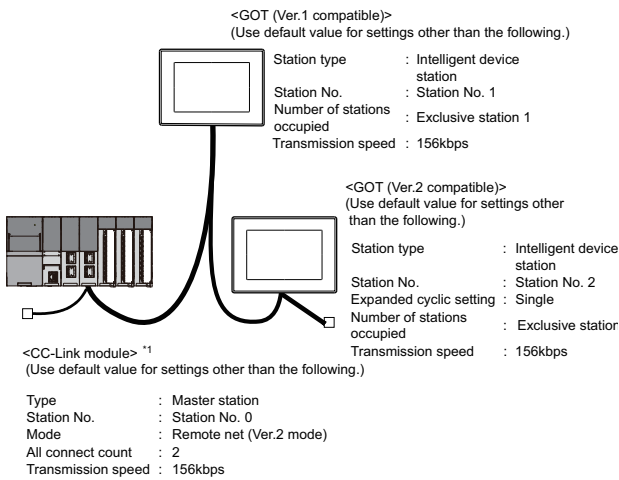

➔ Unit parameter setting of GX Works3

*1 The CC-Link module is mounted on the base unit slot 0.
The Start I/O No. of the CC-Link module is set to "0".

Unit parameter setting of GX Works3

(1) [Unit parameter] of GX Works3

(a) Unit parameter

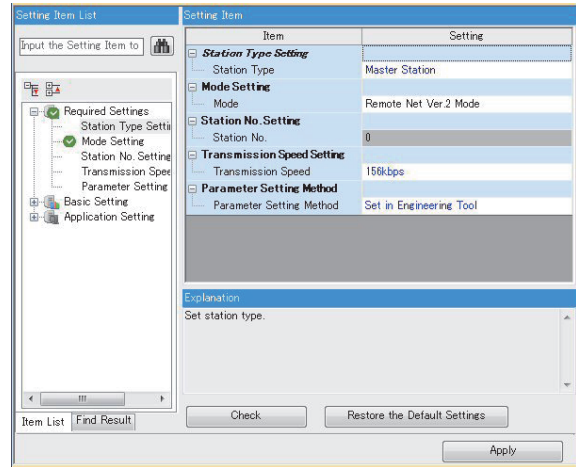

Item	Set value	Setting necessity at GOT connection
Station type	Master station	○
Mode	Remote net (Ver.2 mode)	○
Station No.	0 (fixed)	△
Transmission speed*1	156kbps	○
Parameter setting	Engineering tool	×

○: Necessary △: As necessary ×: Not necessary

*1 Adjust the settings with GOT settings.

(b) Link refresh setting

No.	Link Side					PLC Side		
	Device Name	Points	Start	End		Refresh Destination	Device Name	Points
-	SB	512	00000	001FF	Module Label			
-	SW	512	00000	001FF	Module Label			
1	RX	256	00000	000FF	Specify Device	X	256	
2	RY	256	00000	000FF	Specify Device	Y	256	
3	RWw	256	00000	000FF	Specify Device	D	256	
4	RWw	256	00000	000FF	Specify Device	D	256	
5								
6								

Item	Set value	Setting necessity at GOT connection
Special relay (SB) refresh device	-	△
Special register (SW) refresh device	-	△
Remote input (RX) refresh device	Set as necessary.	△
Remote output (RY) refresh device		△
Remote register (RWw) refresh device		△

○: Necessary △: As necessary ×: Not necessary

(c) CC-Link configuration setting

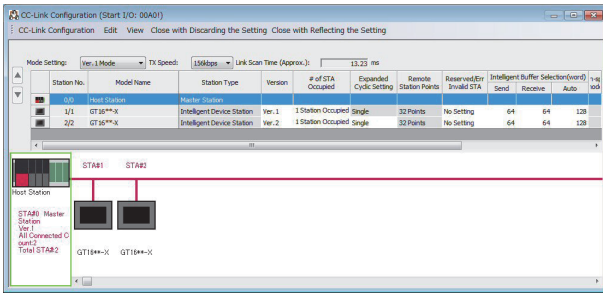

- CC-Link configuration setting of station No.1 (GOT)

Item ^{*1}	Set value	Setting necessity at GOT connection
Station type	Ver.1 intelligent device station (fixed)	○
Exclusive station count ^{*2}	Exclusive station 1	○
Reserve/invalid station select	No setting	○
Intelligent buffer select (word)	(Use default value)	×

○: Necessary △: As necessary ×: Not necessary

- CC-Link configuration setting of station No.2 (GOT)

Item ^{*1}	Set value	Setting necessity at GOT connection
Station type	Ver.2 Intelligent device station (fixed)	○
Expanded cyclic setting ^{*2}	Single	○
Exclusive station count ^{*2}	Exclusive station 1	○
Reserve/invalid station select	No setting	○
Intelligent buffer select (word)	(Use default value)	×

○: Necessary △: As necessary ×: Not necessary

- *1 When the [Mode] of the CC-Link module is set at [Remote net - (Ver. 2 mode)], [Remote station points] can be set. [Remote station points] is a setting for the remote I/O station. The default value (32 points) must be used on the GOT.
- *2 Set the same setting as that of the GOT.

POINT

When changing the unit parameter
After writing unit parameters to the PLC CPU, turn the PLC CPU OFF then back ON again, or reset the PLC CPU.

■ [Controller Setting] of GT Designer3

(1) Communication Settings of station No.1 (GOT)

Item	Set value
Station No.	1: Station No.1
Transmission Rate	0: Online 156kbps
Mode	Ver.1: Remote net (Ver.1 mode)
Expanded Cyclic	Single (Use default value)
Number of stations occupied	1 Station
Input for Error Station	0: Clear
Retry	3times (Use default value)
Timeout Time	3sec (Use default value)
Delay Time	0sec (Use default value)

(2) Communication Settings of station No.2 (GOT)

Item	Set value
Station No.	2: Station No.2
Transmission Rate	0: Online 156kbps
Mode	Ver.2: Remote net (Ver.2 mode)
Expanded Cyclic	Single
Number of stations occupied	1 Station
Input for Error Station	0: Clear
Retry	3times (Use default value)
Timeout Time	3sec (Use default value)
Delay Time	0sec (Use default value)

9
MELSECNET/H CONNECTION (PLC CONNECTION TO PLC NETWORK)
10
MELSECNET/T0 CONNECTION (PLC CONNECTION TO PLC NETWORK)
11
CC-Link IE CONTROLLER NETWORK CONNECTION
12
CC-Link IE FIELD NETWORK CONNECTION
13
CC-Link CONNECTION (INTELLIGENT DEVICE STATION)
14
CC-Link CONNECTION (Via G4)
15
INVERTER CONNECTION
16
SERVO AMPLIFIER CONNECTION

13.4.4 Connection to C Controller module (MELSEC iQ-R Series)

This section describes the settings of the GOT and C Controller module (MELSEC iQ-R Series) in the following case of system configuration.

Use CW Configurator for the C Controller module (MELSEC iQ-R Series) communication settings.

POINT

CC-Link module (MELSEC iQ-R Series)
For details of the CC-Link module (MELSEC iQ-R Series), refer to the following manual.

➡ Manuals of MELSEC iQ-R Series

System configuration

➡ [Controller Setting] of GT Designer3

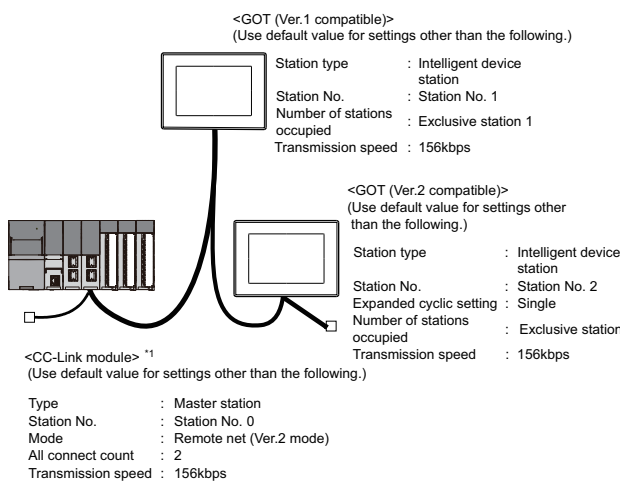

➡ Module parameter setting of CW Configurator

*1 The CC-Link module is mounted on the base unit slot 0.
The Start I/O No. of the CC-Link module is set to "0".

Module parameter setting of CW Configurator

(1) [Module parameter] of CW Configurator

(a) Module parameter

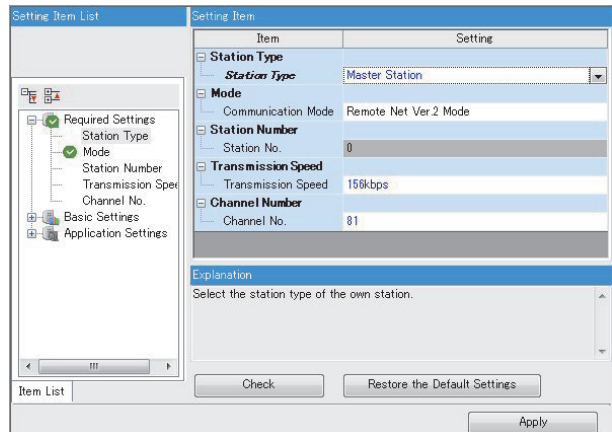

Item	Set value	Setting necessity at GOT connection
Station type	Master station	○
Mode	Remote net (Ver.2 mode)	○
Station No.	0 (fixed)	△
Transmission speed*1	156kbps	○
Channel No.	(Use default value)	×

○: Necessary △: As necessary ×: Not necessary

*1 Adjust the settings with GOT settings.

(b) Link refresh setting

Item	Set value	Setting necessity at GOT connection
Remote input (RX) refresh device	Set as necessary.	△
Remote output (RY) refresh device		△
Remote register (RWr) refresh device		△

○: Necessary △: As necessary ×: Not necessary

(c) CC-Link configuration setting

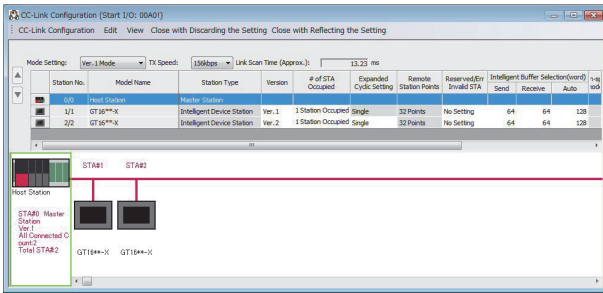

- CC-Link configuration setting of station No.1 (GOT)

Item ^{*1}	Set value	Setting necessity at GOT connection
Station type	Ver.1 intelligent device station (fixed)	○
Exclusive station count ^{*2}	Exclusive station 1	○
Reserve/invalid station select	No setting	○
Intelligent buffer select (word)	(Use default value)	×

○: Necessary △: As necessary ×: Not necessary

- CC-Link configuration setting of station No.2 (GOT)

Item ^{*1}	Set value	Setting necessity at GOT connection
Station type	Ver.2 Intelligent device station (fixed)	○
Expanded cyclic setting ^{*2}	Single	○
Exclusive station count ^{*2}	Exclusive station 1	○
Reserve/invalid station select	No setting	○
Intelligent buffer select (word)	(Use default value)	×

○: Necessary △: As necessary ×: Not necessary

- *1 When the [Mode] of the CC-Link module is set at [Remote net - (Ver. 2 mode)], [Remote station points] can be set. [Remote station points] is a setting for the remote I/O station. The default value (32 points) must be used on the GOT.
- *2 Set the same setting as that of the GOT.

POINT

When changing the unit parameter
After writing unit parameters to the PLC CPU, turn the PLC CPU OFF then back ON again, or reset the PLC CPU.

■ [Controller Setting] of GT Designer3

(1) Communication Settings of station No.1 (GOT)

Item	Set value
Station No.	1: Station No.1
Transmission Rate	0: Online 156kbps
Mode	Ver.1: Remote net (Ver.1 mode)
Expanded Cyclic	Single (Use default value)
Number of stations occupied	1 Station
Input for Error Station	0: Clear
Retry	3times (Use default value)
Timeout Time	3sec (Use default value)
Delay Time	0sec (Use default value)

(2) Communication Settings of station No.2 (GOT)

Item	Set value
Station No.	2: Station No.2
Transmission Rate	0: Online 156kbps
Mode	Ver.2: Remote net (Ver.2 mode)
Expanded Cyclic	Single
Number of stations occupied	1 Station
Input for Error Station	0: Clear
Retry	3times (Use default value)
Timeout Time	3sec (Use default value)
Delay Time	0sec (Use default value)

9 MELSECNET/H CONNECTION (PLC CONNECTION TO PLC NETWORK)
 10 MELSECNET/I/O CONNECTION (PLC CONNECTION TO PLC NETWORK)
 11 CC-Link IE CONTROLLER NETWORK CONNECTION
 12 CC-Link IE FIELD NETWORK CONNECTION
 13 CC-Link CONNECTION (INTELLIGENT DEVICE STATION)
 14 CC-Link CONNECTION (Via G4)
 15 INVERTER CONNECTION
 16 SERVO AMPLIFIER CONNECTION

13.4.5 Connecting to CC-Link module (Q Series) with Ver.1 compatible

This section describes the settings of the GOT and the CC-Link module (Q Series) with Ver.1 compatible in the following system configuration.

POINT

CC-Link module (Q Series)

For details of the CC-Link module (Q Series), refer to the following manual.

☞ CC-Link System Master/Local Module User's Manual QJ61BT11N

System configuration

- ☞ ■ [Controller Setting] of GT Designer3
- Setting of the CC-Link communication unit

<GOT>
(Use the default value for settings other than the following.)

Station type : Intelligent device station
 Station No. : Station No.1
 Number of stations occupied : Exclusive station 1
 Transmission speed : 156kbps

<CC-Link module> *1
(Use the default value for the settings other than the following.)

Type : Master station
 Station No. : Station No.0
 Mode : Remote net (Ver.1 mode)
 All connect count : 1
 Transmission speed : 156kbps

- ☞ ■ Switch setting of CC-Link module (Q Series)
- [Network parameter] of GX Developer

*1 The CC-Link module is mounted on the base unit slot 0.
 The Start I/O No. of the CC-Link module is set to "0"

- Switch setting of CC-Link module (Q Series)
 Set the station number setting switch, transmission speed / mode setting switch.

QJ61BT11, QJ61BT11N

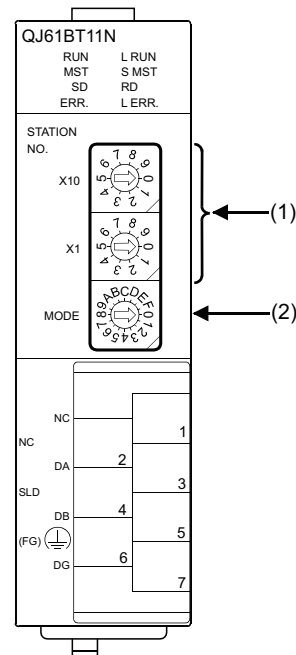

(1) Station number setting switch

Station number setting switch	Description	Set value	Setting necessity at GOT connection
	Station number setting (master station)	0 (fixed)	○

○: Necessary △: As necessary ×: Not necessary

(2) Transmission rate/mode setting switch

Transmission rate/mode setting switch	Description	Set value	Setting necessity at GOT connection
	Transmission rate/mode setting (Online: 156kbps)*1	0	○

○: Necessary △: As necessary ×: Not necessary

*1 Specify the same transmission speed as that of the GOT.

POINT

When the switch setting is changed

Turn the PLC CPU OFF then ON again, or reset the PLC CPU.

Parameter setting (when connecting to MELSEC-Q or QS series)

(1) [Network parameter] of GX Developer

(a) Network parameter

Item	Set value	Setting necessity at GOT connection
No. of boards in module	1	○
Start I/O No.	0000	○
Operational setting	(Use default value)	△
Type	Master station (fixed)	○
Mode	Remote net (Ver.1 mode)	○
All connect count	1	○
Remote input (RX)	X400	△
Remote output (RY)	Y400	△
Remote register (RWr)	D300	△
Remote register (RWw)	D200	△
Special relay (SB)	SB0	△
Special register (SW)	SW0	△
Retry count	3	△
Automatic reconnection station count	1	△
Stand by master station No.	(Use default value)	×
PLC down select	Stop	△
Scan mode setting	Asynchronous	△
Delay information setting	0	△
Station information setting	Refer to (b).	○
Remote device station initial settings	(Use default value)	×
Interrupt setting	(Use default value)	×

Item	Set value	Setting necessity at GOT connection
No. of boards in module	1	○
Start I/O No.	0000H	○
Operation setting	(Use default value)	△
Type	Master station (fixed)	○
Mode	Remote net (Ver.1 mode)	○
All connect count	1	○
Remote input (RX)	X400	△
Remote output (RY)	Y400	△
Remote register (RWr)	D300	△
Remote register (RWw)	D200	△
Special relay (SB)	SB0	△
Special register (SW)	SW0	△
Retry count	(Use default value)	△
Automatic reconnection station count	(Use default value)	△
Stand by master station No.	(Use default value)	×
PLC down select	(Use default value)	△
Scan mode setting	(Use default value)	△
Delay information setting	(Use default value)	△
Station information setting	Refer to (b).	○
Remote device station initial settings	(Use default value)	×
Interrupt setting	(Use default value)	×

○: Necessary △: As necessary ×: Not necessary

(b) Station information setting

Item	Set value	Setting necessity at GOT connection
Station type	Intelligent device station (fixed)	○
Exclusive station count ^{*2}	Exclusive station 1	○
Reserve/invalid station select	No setting	○
Intelligent buffer select (word)	(Use default value)	×

Item ^{*1}	Set value	Setting necessity at GOT connection
Station type	Intelligent device station (fixed)	○
Exclusive station count ^{*2}	Exclusive station 1	○
Reserve/invalid station select	No setting	○
Intelligent buffer select (word)	(Use default value)	×

○: Necessary △: As necessary ×: Not necessary

- *1 When the [Mode] of the CC-Link module is set at [Remote net - (Ver. 1 mode)], [Remote station points] cannot be set.
- *2 Set the same number of occupied stations as that on the GOT.

POINT

When changing the network parameter
After writing the network parameter to the PLC CPU, operate the PLC CPU ether turning OFF and then ON or resetting.

■ Parameter setting (when connecting to C Controller module (Q Series))

Use SW3PVC-CCPU-E Ver.3.05F or later for the CC-Link utility.

(1) Connection settings

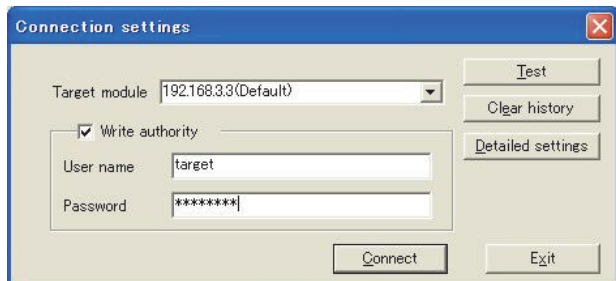

Item	Set value	Setting necessity at GOT connection
Target module ^{*1}	192.168.3.3 (Default)	○
Write authority	Mark the checkbox	○
User name ^{*2}	target	○
Password ^{*2}	password	○
Detailed settings	-	△

○: Necessary △: As necessary ×: Not necessary
^{*1} If the IP address of the C Controller module (Q Series) has been changed, input the changed IP address or host name.
^{*2} If the account of the C Controller module (Q Series) has been changed, input the changed user name and password.

(2) CC-Link Utility's [Parameter Settings]

(a) Parameter settings

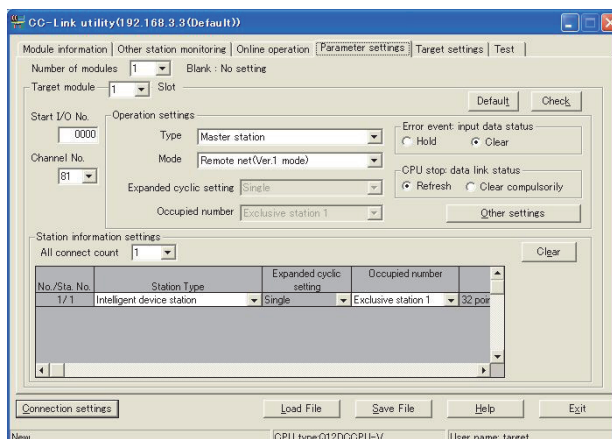

Item ^{*1}	Set value	Setting necessity at GOT connection
Number of modules	1	○
Target module	1	○
Start I/O No.	0000H	○
Channel No.	(Use default value)	○
Operation settings	Type	Master station (fixed) ○
	Mode	Remote net (Ver.1 mode) ○
	Expanded cyclic setting	Single △
	Occupied number	Exclusive station 1 △
	Error event: input data status	Clear △
	CPU stop: data link status	Refresh △
	Other settings	(Use default value) △
Station information settings	All connect count	1 ○
	Station Type	Sta. No.1 Intelligent device station ○
	Occupied number ^{*2}	Sta. No.1 Exclusive station 1 ○
	Reserve/invalid station select	Sta. No.1 No setting ○
	Intelligent buffer select (word)	(Use default value) ×

○: Necessary △: As necessary ×: Not necessary

^{*1} When the [Mode] of the CC-Link module is set at [Remote net - (Ver. 1 mode)], [Remote station points] cannot be set.
^{*2} Set the same number of occupied stations as that on the GOT.

POINT

When changing the network parameter
 After writing the network parameter to the C Controller module (Q Series), either turn the C Controller module (Q Series) OFF and then ON or reset it.

■ [Controller Setting] of GT Designer3

(1) When MODEL GT15-J61BT13 CC-Link communication unit is used

Item	Set value
Station No.	1: Station No.1
Transmission Rate	0: Online 156kbps
Mode	Ver.1: Remote net (Ver.1 mode)
Expanded Cyclic	Single (Use default value)
Number of stations occupied	1 Station
Input for Error Station	0: Clear
Retry	3times (Use default value)
Timeout Time	3sec (Use default value)
Delay Time	0ms (Use default value)

(2) When MODEL GT15-75J61BT13-Z CC-Link communication unit is used

Item	Set value (Use default value)
Retry	3times
Timeout Time	3sec

POINT

[Controller Setting] of GT Designer3

For the setting method of [Controller Setting] of GT Designer3, refer to the following.

➡ 13.3.1 Setting communication interface (Communication settings)

■ Setting of the CC-Link communication unit (Only when MODEL GT15-75J61BT13-Z CC-Link communication unit is used)

Item	Set value	
Mode setting switch	0: Online (fixed)	
Station number setting switch	1: Station No.1	
Transmission baudrate setting switch	0: 156kbps	
Condition setting switches	SW1 (Input data status of the data link error station)	OFF: Cleared
	SW2 (Number of occupied stations)	OFF: 1 station

POINT

Setting of the CC-Link communication unit

For the setting method of the CC-Link communication unit, refer to the following.

➡ 13.3.3 Switch setting (Only when MODEL GT15-75J61BT13-Z CC-Link communication unit is used)

13.4.6 Connecting to CC-Link module (Q Series) with Ver.2 compatible

This section describes the settings of the GOT and CC-Link module (Q Series) in the following case of system configuration.

POINT

CC-Link module (Q Series)

For details of the CC-Link module (Q Series), refer to the following manual.

➡ CC-Link System Master/Local Module User's Manual QJ61BT11N

■ System configuration

➡ [Communication settings] of GT Designer3

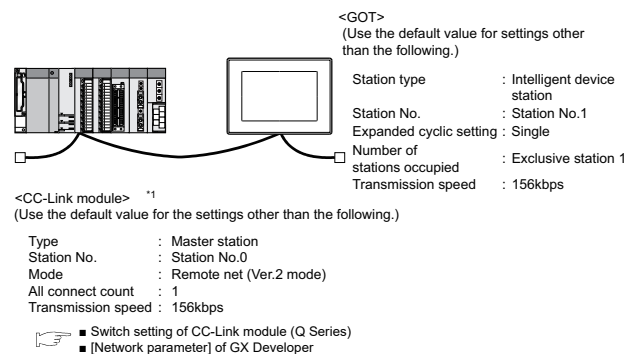

*1 The CC-Link module is mounted on the base unit slot 0.
The Start I/O No. of the CC-Link module is set to "0"

POINT

When connecting to Q170MCPU

When connected to Q170MCPU, the start I/O No. of the CC-Link module is set to "70".

■ Switch setting of CC-Link module (Q Series)
Set the station number setting switch, transmission speed / mode setting switch.

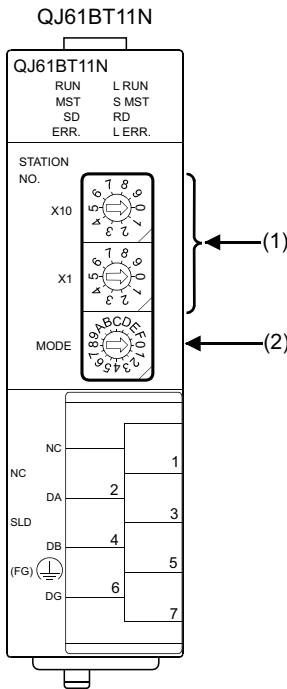

(1) Station number setting switch

Station number setting switch	Description	Set value	Setting necessity at GOT connection
	Station number setting (master station)	0 (fixed)	○

○: Necessary △: As necessary ×: Not necessary

(2) Transmission rate/mode setting switch

Transmission rate/mode setting switch	Description	Set value	Setting necessity at GOT connection
	Transmission rate/mode setting (Online: 156kbps) ^{*1}	0	○

○: Necessary △: As necessary ×: Not necessary

^{*1} Specify the same transmission speed as that of the GOT.

POINT

When the switch setting has been changed
Turn the PLC CPU OFF then ON again, or reset the PLC CPU.

■ Parameter setting (when connecting to MELSEC-Q or QS series)

- (1) [Network parameter] of GX Developer
 - (a) Network parameter

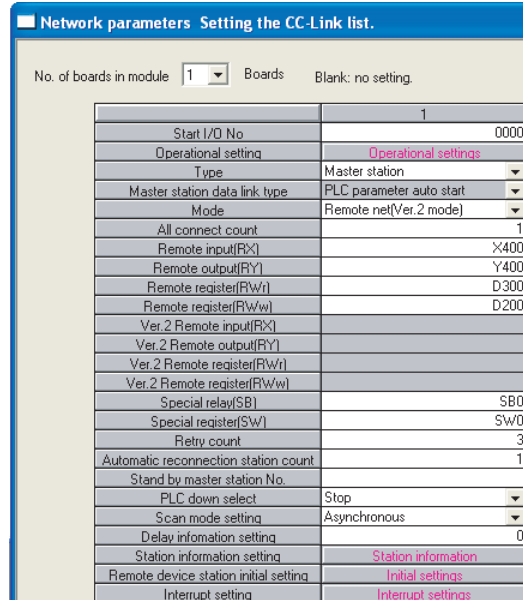

Item	Set value	Setting necessity at GOT connection
No. of boards in module	1	○
Start I/O No. ^{*1}	0000H	○
Operation setting	(Use default value)	△
Type	Master station	○
Mode	Remote net (Ver.2 mode)	○
All connect count	1	○
Remote input (RX)	X400	△
Remote output (RY)	Y400	△
Remote register (RWr)	D300	△
Remote register (RWw)	D200	△
Special relay (SB)	SB0	△
Special register (SW)	SW0	△
Retry count		△
Automatic reconnection station count		△
Stand by master station No.	(Use default value)	×
PLC down select		△
Scan mode setting		△
Delay information setting		△
Station information setting	Refer to (b)	○
Remote device station initial setting	(Use default value)	×
Interrupt setting		×

○: Necessary △: As necessary ×: Not necessary

^{*1} When using Q170MPCPU, set it according to the system configuration.

(b) Station information setting

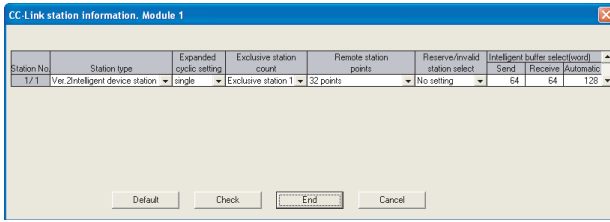

Item ^{*1}	Set value	Setting necessity at GOT connection
Station type	Ver.2 intelligent device station (fixed)	○
Expanded cyclic setting ^{*2}	Single	○
Exclusive station count ^{*2}	Exclusive station 1	○
Remote station points	32 points (fixed)	○
Reserve/invalid station select	No setting	○
Intelligent buffer select (word)	(Use default value)	×

○: Necessary △: As necessary ×: Not necessary

- *1 When the [Mode] of the CC-Link module is set at [Remote net - (Ver. 2 mode)], [Remote station points] can be set. [Remote station points] is a setting for the remote I/O station. The default value (32 points) must be used on the GOT.
- *2 Set the same setting as that of the GOT.

POINT

When changing the network parameter
After writing the network parameter to the PLC CPU, operate the PLC CPU ether turning OFF and then ON or resetting.

■ Parameter setting (when connecting to C Controller module (Q Series))

Use SW3PVC-CCPU-E Ver.3.05F or later for the CC-Link utility.

(1) Connection settings

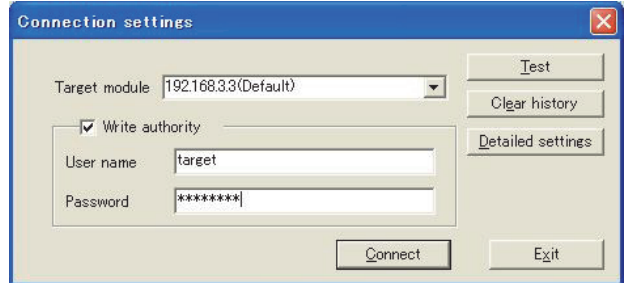

Item	Set value	Setting necessity at GOT connection
Target module ^{*1}	192.168.3.3 (Default)	○
Write authority	Mark the checkbox	○
User name ^{*2}	target	○
Password ^{*2}	password	○
Detailed settings	-	△

○: Necessary △: As necessary ×: Not necessary

- *1 If the IP address of the C Controller module (Q Series) has been changed, input the changed IP address or host name.
- *2 If the account of the C Controller module (Q Series) has been changed, input the changed user name and password.

(2) CC-Link Utility's [Parameter Settings]
 (a) Parameter settings

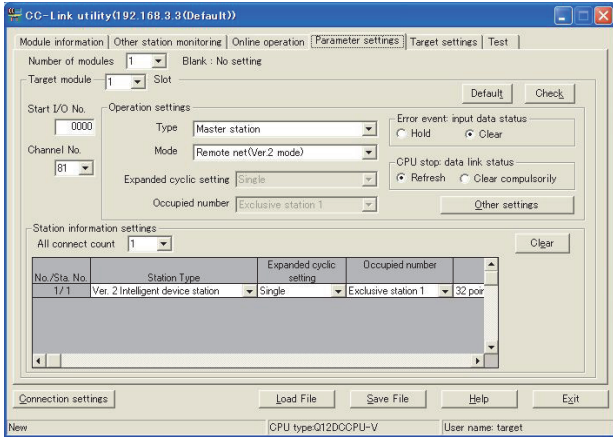

Item*1	Set value	Setting necessity at GOT connection
Number of modules	1	○
Target module	1	○
Start I/O No.	0000H	○
Channel No.	(Use default value)	○
Operation settings	Type	Master station ○
	Mode	Remote net (Ver.2 mode) ○
	Expanded cyclic setting	Single △
	Occupied number	Exclusive station 1 △
	Error event: input data status	Clear △
	CPU stop: data link status	Refresh △
	Other settings	(Use default value) △
	All connect count	1 ○
Station information settings	Station Type	Sta. No.1 Ver.2 intelligent device station ○
	Expanded cyclic setting*2	Sta. No.1 Single ○
	Occupied number*2	Sta. No.1 Exclusive station 1 ○
	Remote station points	Sta. No.1 32 points ○
	Reserve/invalid station select	Sta. No.1 No setting ○
	Intelligent buffer select (word)	(Use default value) ×

○: Necessary △: As necessary ×: Not necessary

*1 When the [Mode] of the CC-Link module is set at [Remote net - (Ver. 2 mode)], [Remote station points] can be set. [Remote station points] is a setting for the remote I/O station. The default value (32 points) must be used on the GOT.
 *2 Set the same setting as that of the GOT.

POINT

When changing the network parameter
 After writing the network parameter to the C Controller module (Q Series), either turn the C Controller module (Q Series) OFF and then ON or reset it.

■ [Communication settings] of GT Designer3

Item	Set value
Station No.	1: Station No.1
Transmission Rate	0: Online 156kbps
Mode	Ver.2: Remote net (Ver.2 mode)
Expanded Cyclic	Single
Number of stations occupied	1 Station
Input for Error Station	Clear
Retry	3times (Use default value)
Timeout Time	3sec (Use default value)
Delay Time	0ms (Use default value)

POINT

[Controller Setting] of GT Designer3
 For the setting method of [Controller Setting] of GT Designer3, refer to the following.
 ➔ 13.3.1 Setting communication interface (Communication settings)

13.4.7 Connecting to CC-Link module (Q Series) with Ver.1/Ver.2 compatibles mixed

This section describes the setting of the GOT and CC-Link module (Q Series) with Ver.1/Ver.2 compatibles mixed in the following system configuration.

POINT

CC-Link module (Q Series)

For details of the CC-Link module (Q Series), refer to the following manual.

☞ CC-Link System Master/Local Module User's Manual QJ61BT11N

System configuration

- ☞ [Controller Setting] of GT Designer3
- Setting of the CC-Link communication unit

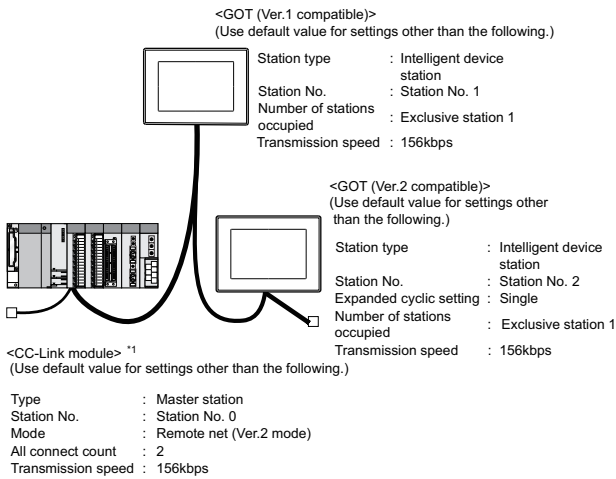

- ☞ Switch setting of CC-Link module (Q Series)
- [Network parameter] of GX Developer

*1 The CC-Link module is mounted on the base unit slot 0. The Start I/O No. of the CC-Link module is set to "0"

POINT

When connecting to Q170MCPU

When connected to Q170MCPU, the start I/O No. of the CC-Link module is set to "70".

- Switch setting of CC-Link module (Q Series)
Set the station number setting switch, transmission speed / mode setting switch.

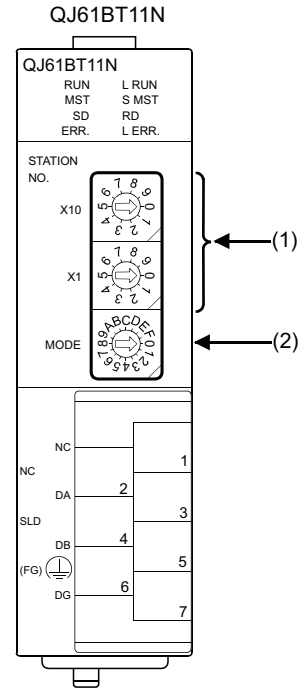

(1) Station number setting switch

Station number setting switch	Description	Set value	Setting necessity at GOT connection
STATION NO. X10	Station number setting (master station)	0 (fixed)	○

○: Necessary △: As necessary ×: Not necessary

(2) Transmission rate/mode setting switch

Transmission rate/mode setting switch	Description	Set value	Setting necessity at GOT connection
MODE	Transmission rate/mode setting (Online: 156kbps)*1	0	○

○: Necessary △: As necessary ×: Not necessary

*1 Specify the same transmission speed as that of the GOT.

POINT

When the switch setting has been changed

Turn the PLC CPU OFF then ON again, or reset the PLC CPU.

9 MELSECNET/H CONNECTION (PLC CONNECTION TO PLC NETWORK)
10 MELSECNET/T0 CONNECTION (PLC CONNECTION TO PLC NETWORK)
11 CC-Link IE CONTROLLER NETWORK CONNECTION
12 CC-Link IE FIELD NETWORK CONNECTION
13 CC-Link CONNECTION (INTELLIGENT DEVICE STATION)
14 CC-Link CONNECTION (Via G4)
15 INVERTER CONNECTION
16 SERVO AMPLIFIER CONNECTION

■ Parameter setting (when connecting to MELSEC-Q or QS series)

(1) [Network parameter] of GX Developer

(a) Network parameter

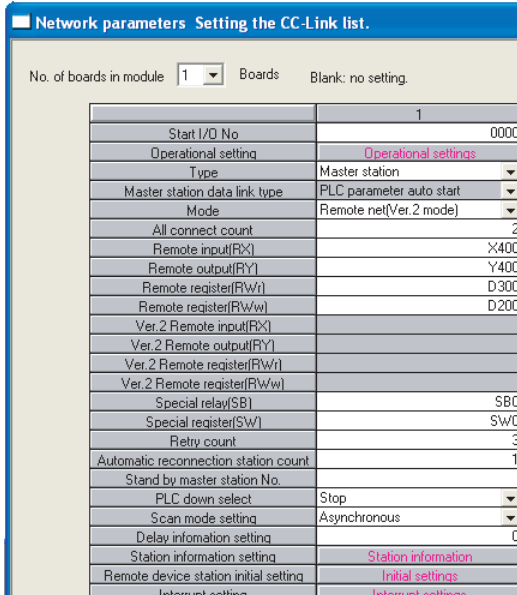

Item	Set value	Setting necessity at GOT connection
No. of boards in module	1	○
Start I/O No.*1	0000H	○
Operation setting	(Use default value)	△
Type	Master station (fixed)	○
Mode	Remote net (Ver.2 mode)	○
All connect count	2	○
Remote input (RX)	X400	△
Remote output (RY)	Y400	△
Remote register (RWr)	D300	△
Remote register (RWw)	D200	△
Special relay (SB)	SB0	△
Special register (SW)	SW0	△
Retry count	3	△
Automatic reconnection station count	1	△
Stand by master station No.	(Use default value)	×
PLC down select	Stop	△
Scan mode setting	Asynchronous	△
Delay information setting	0	△
Station information setting	Refer to (b)	○
Remote device station initial setting	(Use default value)	×
Interrupt setting		×

○: Necessary △: As necessary ×: Not necessary

*1 When using Q170MPCPU, set it according to the system configuration.

(b) Station information setting

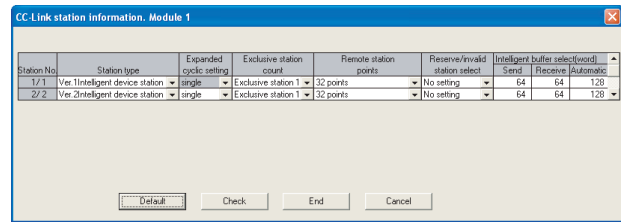

• Station information setting of station No.1 (GOT)

Item*1	Set value	Setting necessity at GOT connection
Station type	Ver.1 intelligent device station (fixed)	○
Exclusive station count*2	Exclusive station 1	○
Reserve/invalid station select	No setting	○
Intelligent buffer select (word)	(Use default value)	×

○: Necessary △: As necessary ×: Not necessary

• Station information setting of station No.2 (GOT)

Item*1	Set value	Setting necessity at GOT connection
Station type	Ver.2 intelligent device station (fixed)	○
Expanded cyclic setting*2	Single	○
Exclusive station count*2	Exclusive station 1	○
Reserve/invalid station select	No setting	○
Intelligent buffer select (word)	(Use default value)	×

○: Necessary △: As necessary ×: Not necessary

*1 When the [Mode] of the CC-Link module is set at [Remote net - (Ver. 2 mode)], [Remote station points] can be set. [Remote station points] is a setting for the remote I/O station. The default value (32 points) must be used on the GOT.
*2 Set the same setting as that of the GOT.

POINT

When changing the network parameter
After writing the network parameter to the PLC CPU, operate the PLC CPU ether turning OFF and then ON or resetting.

■ Parameter setting (when connecting to C Controller module (Q Series))

Use SW3PVC-CCPU-E Ver.3.05F or later for the CC-Link utility.

(1) Connection settings

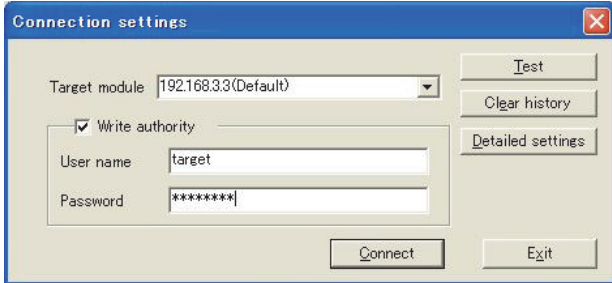

Item	Set value	Setting necessity at GOT connection
Target module*1	192.168.3.3 (Default)	○
Write authority	Mark the checkbox	○
User name*2	target	○
Password*2	password	○
Detailed settings	-	△

○: Necessary △: As necessary ×: Not necessary

- *1 If the IP address of the C Controller module (Q Series) has been changed, input the changed IP address or host name.
- *2 If the account of the C Controller module (Q Series) has been changed, input the changed user name and password.

(2) CC-Link Utility's [Parameter Settings]

(a) Parameter settings

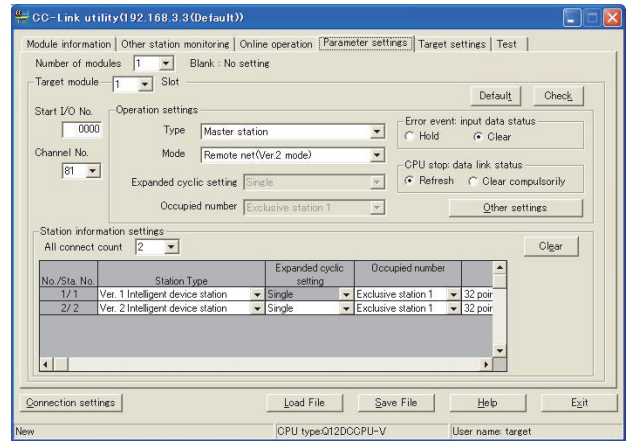

Item*1	Set value	Setting necessity at GOT connection
Number of modules	1	○
Target module	1	○
Start I/O No.	0000H	○
Channel No.	(Use default value)	○
Operation settings	Type	Master station ○
	Mode	Remote net (Ver.2 mode) ○
	Expanded cyclic setting	Single △
	Occupied number	Exclusive station 1 △
	Error event: input data status	Clear △
	CPU stop: data link status	Refresh △
	Other settings	(Use default value) △
All connect count	2	○
Station information settings	Station Type	Sta. No.1 Ver.1 intelligent device station ○
		Sta. No.2 Ver.2 intelligent device station ○
	Expanded cyclic setting*2	Sta. No.1 Single △
		Sta. No.2 Single ○
	Occupied number*2	Sta. No.1 Exclusive station 1 ○
		Sta. No.2 Exclusive station 1 ○
Remote station points	Sta. No.1 32 points ○	
	Sta. No.2 32 points ○	

9 MELSECNET/H CONNECTION (PLC CONNECTION TO PLC NETWORK)
 10 MELSECNET/10 CONNECTION (PLC CONNECTION TO PLC NETWORK)
 11 CC-Link IE CONTROLLER NETWORK CONNECTION
 12 CC-Link IE FIELD NETWORK CONNECTION
 13 CC-Link CONNECTION (INTELLIGENT DEVICE STATION)
 14 CC-Link CONNECTION (Via G4)
 15 INVERTER CONNECTION
 16 SERVO AMPLIFIER CONNECTION

Item ^{*1}		Set value	Setting necessity at GOT connection
Station information settings	Reserve/invalid station select	Sta. No.1	No setting ○
		Sta. No.2	No setting ○
	Intelligent buffer select (word)		(Use default value) ×

○: Necessary △: As necessary ×: Not necessary

*1 When the [Mode] of the CC-Link module is set at [Remote net - (Ver. 2 mode)], [Remote station points] can be set. [Remote station points] is a setting for the remote I/O station. The default value (32 points) must be used on the GOT.

*2 Set the same setting as that of the GOT.

POINT

When changing the network parameter
After writing the network parameter to the C Controller module (Q Series), either turn the C Controller module (Q Series) OFF and then ON or reset it

■ [Controller Setting] of GT Designer3

(1) Communication Settings of station No.1 (GOT)

(a) When MODEL GT15-J61BT13 CC-Link communication unit is used

Item	Set value
Station No.	1: Station No.1
Transmission Rate	0: Online 156kbps
Mode	Ver.1: Remote net (Ver.1 mode)
Expanded Cyclic	Single (Use default value)
Number of stations occupied	1 Station
Input for Error Station	0: Clear
Retry	3times (Use default value)
Timeout Time	3sec (Use default value)
Delay Time	0ms (Use default value)

(b) When MODEL GT15-75J61BT13-Z CC-Link communication unit is used

Item	Set value (Use default value)
Retry	3times
Timeout Time	3sec

(2) Communication Settings of station No.2 (GOT)

Item	Set value (Use default value)
Station No.	2: Station No.2
Transmission Rate	0: Online 156kbps
Mode	Ver.2: Remote net (Ver.2 mode)
Expanded Cyclic	Single
Number of stations occupied	1 Station
Input for Error Station	0: Clear
Retry	3times (Use default value)
Timeout Time	3sec (Use default value)
Delay Time	0ms (Use default value)

■ Setting of the CC-Link communication unit (Only when MODEL GT15-75J61BT13-Z CC-Link communication unit is used)

Item	Set value	
Mode setting switch	0: Online (fixed)	
Station number setting switch	1: Station No.1	
Transmission baudrate setting switch	0: 156kbps	
Condition setting switches	SW1 (Input data status of the data link error station)	OFF: Cleared
	SW2 (Number of occupied stations)	OFF: 1 station

POINT



Setting of the CC-Link communication unit
For the setting method of the CC-Link communication unit, refer to the following.

 13.3.3 Switch setting (Only when MODEL GT15-75J61BT13-Z CC-Link communication unit is used)

13.4.8 Connecting to MELSEC-L series with CC-Link Ver.1 compatible

This section describes the settings of the GOT and MELSEC-L in the following case of the system configuration.

POINT

- (1) CC-Link module (L Series)
For details of the CC-Link module (L Series), refer to the following manual.
 MELSEC-L CC-Link System Master/Local Module User's Manual
- (2) CC-Link function built-in CPU
For details on the CC-Link function built-in CPU, refer to the following manual.
 MELSEC-L CC-Link System Master/Local Module User's Manual

System configuration (Example when using CC-Link module (L Series))

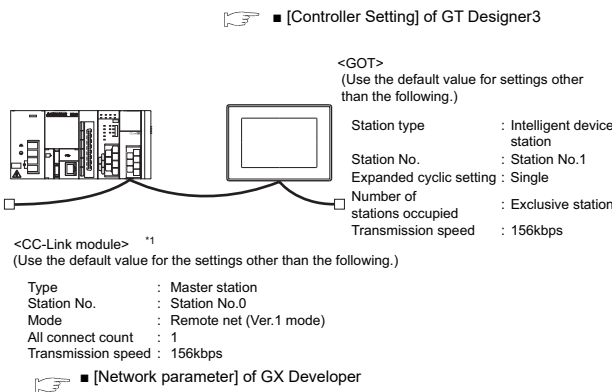

■ [Network parameter] of GX Developer

(1) Network parameter

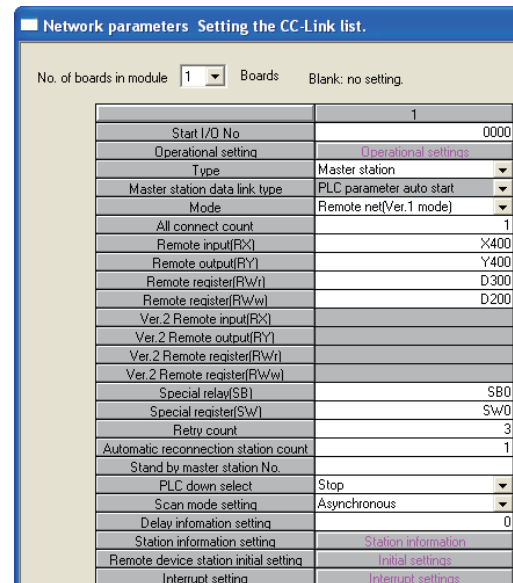

Item	Set value	Setting necessity at GOT connection
No. of boards in module	1	○
Start I/O No.*1	0000H	○
Operation setting	(Use default value)	△
Type	Master station (fixed)	○
Mode	Remote net (Ver.1 mode)	○
All connect count	1	○
Remote input (RX)	X400	△
Remote output (RY)	Y400	△
Remote register (RWr)	D300	△
Remote register (RWw)	D200	△
Special relay (SB)	SB0	△
Special register (SW)	SW0	△
Retry count		△
Automatic reconnection station count		△
Stand by master station No.	(Use default value)	×
PLC down select		△
Scan mode setting		△
Delay information setting		△
Station information setting	Refer to (2)	○
Remote device station initial setting	(Use default value)	×
Interrupt setting		×

○: Necessary △: As necessary ×: Not necessary

*1 Set the Start I/O No. of the CC-Link module according to the system configuration.

9 MELSECNET/H CONNECTION (PLC CONNECTION TO PLC NETWORK)
 10 MELSECNET/I/O CONNECTION (PLC CONNECTION TO PLC NETWORK)
 11 CC-LINK IE CONTROLLER NETWORK CONNECTION
 12 CC-LINK IE FIELD NETWORK CONNECTION
 13 CC-LINK CONNECTION (INTELLIGENT DEVICE STATION)
 14 CC-LINK CONNECTION (Via G4)
 15 INVERTER CONNECTION
 16 SERVO AMPLIFIER CONNECTION

(2) Station information setting

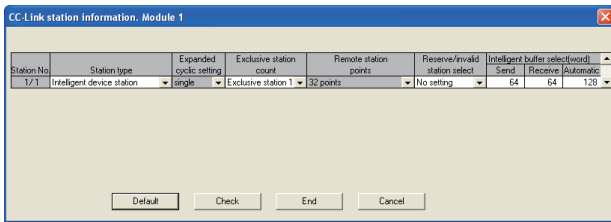

Item ^{*1}	Set value	Setting necessity at GOT connection
Station type	Intelligent device station (fixed)	○
Exclusive station count ^{*2}	Exclusive station 1	○
Reserve/invalid station select	No setting	○
Intelligent buffer select (word)	(Use default value)	×

○: Necessary △: As necessary ×: Not necessary

- *1 When the [Mode] of the CC-Link module is set at [Remote net - (Ver. 1 mode)], [Remote station points] cannot be set.
 *2 Set the same setting as that of the GOT.

POINT

When changing the network parameter
 After writing the network parameter to the PLC CPU, operate the PLC CPU ether turning OFF and then ON or resetting.

■ [Controller Setting] of GT Designer3

Item	Set value
Station No.	1: Station No.1
Transmission Rate	0: Online 156kbps
Mode	Ver.1: Remote net (Ver.1 mode)
Expanded Cyclic	Single (Use default value)
Number of stations occupied	1 Station
Input for Error Station	0: Clear
Retry	3times (Use default value)
Timeout Time	3sec (Use default value)
Delay Time	0ms (Use default value)

POINT

[Controller Setting] of GT Designer3
 For the setting method of [Controller Setting] of GT Designer3, refer to the following.

- ➔ 13.3.1 Setting communication interface (Communication settings)

13.4.9 Connecting to MELSEC-L series with CC-Link Ver.2 compatible

This section describes the settings of the GOT and MELSEC-L in the following case of the system configuration.

POINT

- CC-Link module (L Series)
 For details of the CC-Link module (L Series), refer to the following manual.
 ➔ MELSEC-L CC-Link System Master/Local Module User's Manual
- CC-Link function built-in CPU
 For details on the CC-Link function built-in CPU, refer to the following manual.
 ➔ MELSEC-L CC-Link System Master/Local Module User's Manual

■ System configuration

(Example when using CC-Link module (L Series))

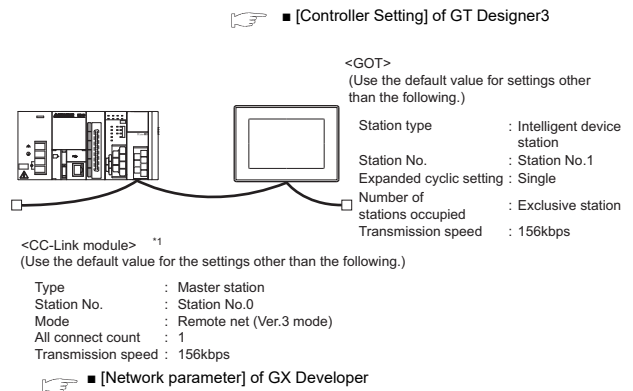

■ [Network parameter] of GX Developer

(1) Network parameter

Item	Set value	Setting necessity at GOT connection
No. of boards in module	1	○
Start I/O No.*1	0000H	○
Operation setting	(Use default value)	△
Type	Master station (fixed)	○
Mode	Remote net (Ver.2 mode)	○
All connect count	1	○
Remote input (RX)	X400	△
Remote output (RY)	Y400	△
Remote register (RWr)	D300	△
Remote register (RWw)	D200	△
Special relay (SB)	SB0	△
Special register (SW)	SW0	△
Retry count	3	△
Automatic reconnection station count	1	△
Stand by master station No.	(Use default value)	×
PLC down select	Stop	△
Scan mode setting	Asynchronous	△
Delay information setting	0	△
Station information setting	Refer to (2)	○
Remote device station initial setting	(Use default value)	×
Interrupt setting		×

○: Necessary △: As necessary ×: Not necessary

*1 Set the Start I/O No. of the CC-Link module according to the system configuration.

(2) Station information setting

Item*1	Set value	Setting necessity at GOT connection
Station type	Ver.2 intelligent device station (fixed)	○
Expanded cyclic setting*2	Single	○
Exclusive station count*2	Exclusive station 1	○
Remote station points	32 points (fixed)	○
Reserve/invalid station select	No setting	○
Intelligent buffer select (word)	(Use default value)	×

○: Necessary △: As necessary ×: Not necessary

*1 When the [Mode] of the CC-Link module is set at [Remote net - (Ver. 2 mode)], [Remote station points] can be set. [Remote station points] is a setting for the remote I/O station. The default value (32 points) must be used on the GOT.

*2 Set the same setting as that of the GOT.

POINT

When changing the network parameter
After writing the network parameter to the PLC CPU, operate the PLC CPU either turning OFF and then ON or resetting.

■ [Controller Setting] of GT Designer3

Item	Set value
Station No.	1: Station No.1
Transmission Rate	0: Online 156kbps
Mode	Ver.2: Remote net (Ver.2 mode)
Expanded Cyclic	Single
Number of stations occupied	1 Station
Input for Error Station	0: Clear
Retry	3times (Use default value)
Timeout Time	3sec (Use default value)
Delay Time	0ms (Use default value)

POINT

[Controller Setting] of GT Designer3
For the setting method of [Controller Setting] of GT Designer3, refer to the following.

☞ 13.3.1 Setting communication interface (Communication settings)

13.4.10 Connecting to CC-Link module (QnA Series)

This section describes the settings of the GOT and CC-Link module (QnA Series) in the following case of system configuration.

POINT

CC-Link module (QnA Series)

For details of the CC-Link module (QnA Series), refer to the following manual.

Control & Communication Link System Master/Local Module Type AJ61QBT11/A1SJ61QBT11 User's Manual

System configuration

- [Controller Setting] of GT Designer3
- Setting of the CC-Link communication unit

<GOT> (Use the default value for settings other than the following.)

Station type : Intelligent device station
 Station No. : Station No.1
 Number of stations occupied : Exclusive station 1
 Transmission speed : 156kbps

<CC-Link module> *1
 (Use the default value for settings other than the following.)

Station type : Master station
 Station No. : Station No.0
 Mode setting : Remote net mode
 All connect count : 1
 Transmission speed : 156kbps

- Switch settings of CC-Link module (QnA Series)
- Parameter setting

*1 The CC-Link module is mounted on the base unit slot 0.
 The Start I/O No. of the CC-Link module is set to "0"

Switch settings of CC-Link module (QnA Series)

Set for each setting switch.

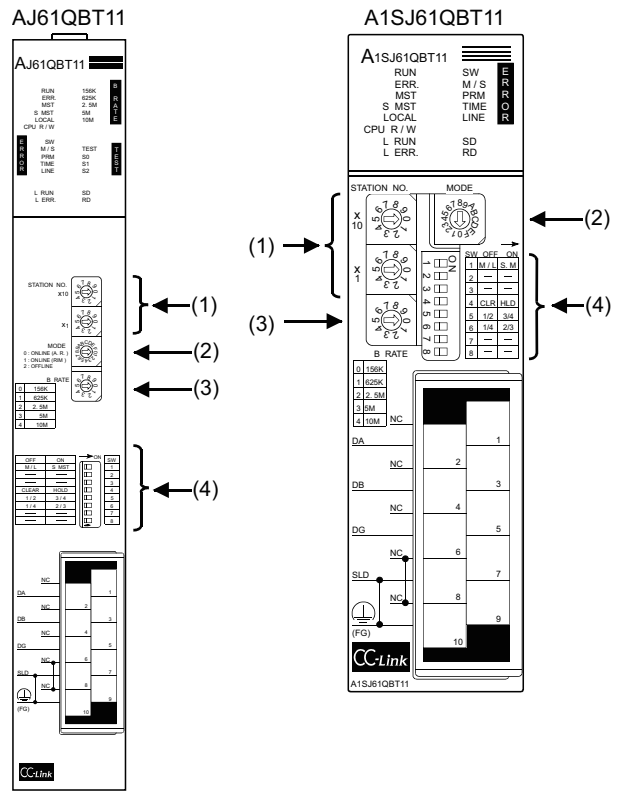

(1) Station number setting switch

Station number setting switch	Description	Set value	Setting necessity at GOT connection
	Station number setting (master station)	0 (fixed)	○

○: Necessary △: As necessary ×: Not necessary

(2) Mode setting switch

Mode setting switch	Description	Set value	Setting necessity at GOT connection
	Mode setting (Online: Remote net mode)	0 (fixed)	○

○: Necessary △: As necessary ×: Not necessary

(3) Transmission speed setting switch

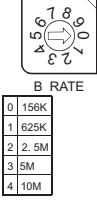
Transmission speed setting switch	Description	Set value	Setting necessity at GOT connection
 B RATE 0 156K 1 625K 2 2.5M 3 5M 4 10M	Transmission speed setting (156kbps)*1	0	○

○: Necessary △: As necessary ×: Not necessary

*1 Specify the same transmission speed as that of the GOT.

(4) Condition setting switches

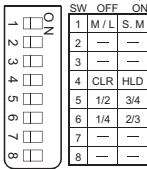
Condition setting switches	Setting switch	Description	Set value	Setting necessity at GOT connection
 SW OFF ON 1 M/L S.M 2 — — — 3 — — — 4 CLR HLD 5 1/2 3/4 6 1/4 2/3 7 — — — 8 — — —	SW1	Station type (Master station/Local station)	OFF (fixed)	○
	SW2	Not used	OFF (fixed)	×
	SW3			
	SW4	Input data status of the data link error station (clear)	OFF	△
	SW5	Number of stations occupied*2	OFF (fixed)	×
	SW6			
	SW7	Not used	OFF (fixed)	×
	SW8			

○: Necessary △: As necessary ×: Not necessary

*2 Will be valid when the CC-Link module is the local station. In the case of the master station, turn off it.

POINT

When the switch setting has been changed Turn the PLC CPU OFF then ON again, or reset the PLC CPU.

Parameter setting

There are two methods for the parameter setting: perform the setting from [Network parameter] of GX Developer and the sequence program.

Performing it from the [Network parameter] of the GX Developer can be set only when the PLC CPU and the CC-Link module use the function version B or later.

- Setting from [Network parameter] of GX Developer
 - Network parameter

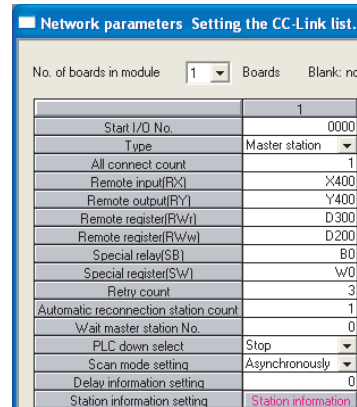

Item	Set value	Setting necessity at GOT connection
No. of boards in module	1	○
Start I/O No.	0000H	○
Type	Master station (fixed)	○
All connect count	1	○
Remote input (RX)	X400	△
Remote output (RY)	Y400	△
Remote register (RW _r)	D300	△
Remote register (RW _w)	D200	△
Special relay (SB)	B0	△
Special register (SW)	W0	△
Retry count	(Use default value)	△
Automatic reconnection station count		△
Wait master station No.		×
PLC down select		△
Scan mode setting		△
Delay information setting		△
Station information setting		Refer to (2)

○: Necessary △: As necessary ×: Not necessary

9 MELSECNET/H CONNECTION (PLC CONNECTION TO PLC NETWORK)
 10 MELSECNET/T/0 CONNECTION (PLC CONNECTION TO PLC NETWORK)
 11 CC-LINK IE CONTROLLER NETWORK CONNECTION
 12 CC-LINK IE FIELD NETWORK CONNECTION
 13 CC-LINK CONNECTION (INTELLIGENT DEVICE STATION)
 14 CC-LINK CONNECTION (Via G4)
 15 INVERTER CONNECTION
 16 SERVO AMPLIFIER CONNECTION

(b) Station information setting

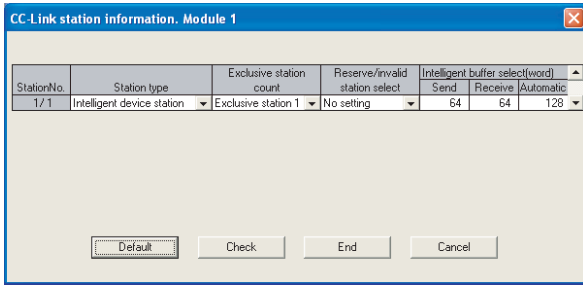

Item	Set value	Setting necessity at GOT connection
Station type	Intelligent device station (fixed)	○
Exclusive station count*1	Exclusive station 1	○
Reserve/invalid station select	No setting	○
Intelligent buffer select (word)	(Use default value)	×

○: Necessary △: As necessary ×: Not necessary

*1 Specify the same number of occupied stations as that of the GOT.

POINT

When changing the network parameter
After writing the network parameter to the PLC CPU, operate the PLC CPU ether turning OFF and then ON or resetting.

(2) Setting from sequence program

The parameter is written to the buffer memory, and the data link is automatically started when PLC CPU status changes from STOP to RUN.

(a) I/O signal of CC-Link module

Control & Communication Link System Master/ Local Module Type AJ61QBT11/A1SJ61QBT11 User's Manual

(b) Device used by user

Device	Application
M100, M101	Flag for parameter setting
M102, M103	Flag for data link startup
D0	Number of connected modules
D1	Number of retry
D2	Automatic reconnection station count
D3	Operation specification in the case of CPU failure
D4	Reserved station specification (Station No. 1 to Station No. 16)
D5	Error invalid station specification (Station No. 1 to Station No. 16)
D6	Station data (first module)
D400	Error code in the case of data link startup failure

(c) Buffer memory settings used in the present example

Buffer memory address	Item	Set value
Decimal (Hex)		
1(11 (1H))	Number of connected modules	1 (1 module)
2(22 (2H))	Number of retry	3 (3times)
3(33 (3H))	Automatic reconnection station count	1 (1 station)
6(66 (6H))	Operation specification in the case of CPU failure	0 (stop)
16(1016 (10H))	Reserved station specification (Station No. 1 to Station No. 16)	0 (No specification)
20(1420 (14H))	Error invalid station specification (Station No. 1 to Station No. 16)	0 (No specification)
32(2032 (20H))	Station data (first module)*1	2101H

*1 Details for the station data are shown below.
For 1) and 2), set the same station No. and number of station occupied as those of the GOT.
For 3), the setting is fixed.

b15 to 3)	b12 b11 to 2)	b8 b7 to 1)	b0
-----------	---------------	-------------	----

- 1) Station No. (Set the same station No. as that of the GOT)
01H to 40H: Station No. 1 to Station No. 64
- 2) Number of stations occupied (Set the number of station occupied as that of the GOT)
1H: Exclusive station 1
2H: Exclusive station 2
3H: Exclusive station 3
4H: Exclusive station 4
- 3) Station type (2H: Set it to intelligent device station)
0H: Remote I/O station
1H: Remote device station
2H: Intelligent device station (Incl. local station)

(d) Example of sequence program

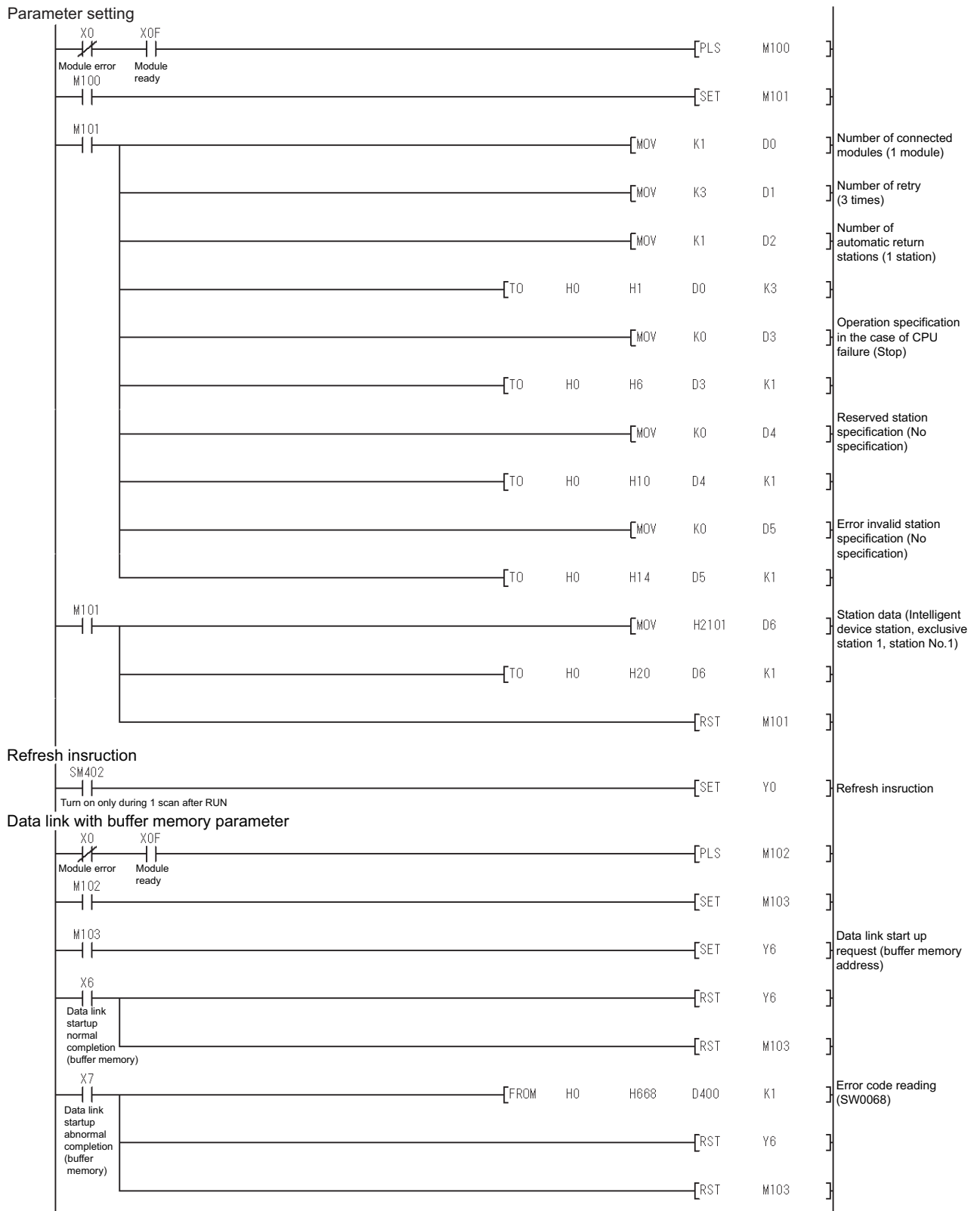

POINT

When changing the sequence program
After writing the sequence program to the PLC CPU, operate the PLC CPU ether turning OFF and then ON or resetting.

9 MELSECNET/H CONNECTION (PLC CONNECTION TO PLC NETWORK)

10 MELSECNET/10 CONNECTION (PLC CONNECTION TO PLC NETWORK)

11 CC-Link IE CONTROLLER NETWORK CONNECTION

12 CC-Link IE FIELD NETWORK CONNECTION

13 CC-Link CONNECTION (INTELLIGENT DEVICE STATION)

14 CC-Link CONNECTION (Via G4)

15 INVERTER CONNECTION

16 SERVO AMPLIFIER CONNECTION

■ [Controller Setting] of GT Designer3

(1) When MODEL GT15-J61BT13 CC-Link communication unit is used

Item	Set value
Station No.	1: Station No.1
Transmission Rate	0: Online 156kbps
Mode	Ver.1: Remote net (Ver.1 mode)
Expanded Cyclic	Single (Use default value)
Number of stations occupied	1 Station
Input for Error Station	0: Clear
Retry	3times (Use default value)
Timeout Time	3sec (Use default value)
Delay Time	0ms (Use default value)

(2) When MODEL GT15-75J61BT13-Z CC-Link communication unit is used

Item	Set value (Use default value)
Retry	3times
Timeout Time	3sec

POINT

[Controller Setting] of GT Designer3

For the setting method of [Controller Setting] of GT Designer3, refer to the following.

☞ 13.3.1 Setting communication interface (Communication settings)

■ Setting of the CC-Link communication unit (Only when MODEL GT15-75J61BT13-Z CC-Link communication unit is used)

Item	Set value	
Mode setting switch	0: Online (fixed)	
Station number setting switch	1: Station No.1	
Transmission baudrate setting switch	0: 156kbps	
Condition setting switches	SW1 (Input data status of the data link error station)	OFF: Cleared
	SW2 (Number of occupied stations)	OFF: 1 station

POINT

Setting of the CC-Link communication unit

For the setting method of the CC-Link communication unit, refer to the following.

☞ 13.3.3 Switch setting (Only when MODEL GT15-75J61BT13-Z CC-Link communication unit is used)

13.4.11 Connecting to CC-Link module (A Series)

This section describes the settings of the GOT and CC-Link module (A Series) in the following case of system configuration.

POINT

CC-Link module (A Series)

For details of the CC-Link module (A Series), refer to the following manual.

☞ Control & Communication Link System Master/Local Module Type AJ61BT11/A1SJ61BT11 User's Manual

■ System configuration

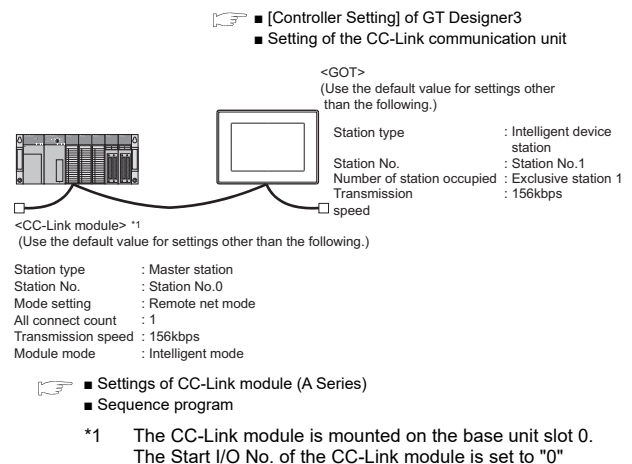

Settings of CC-Link module (A Series)

Set for each setting switch.

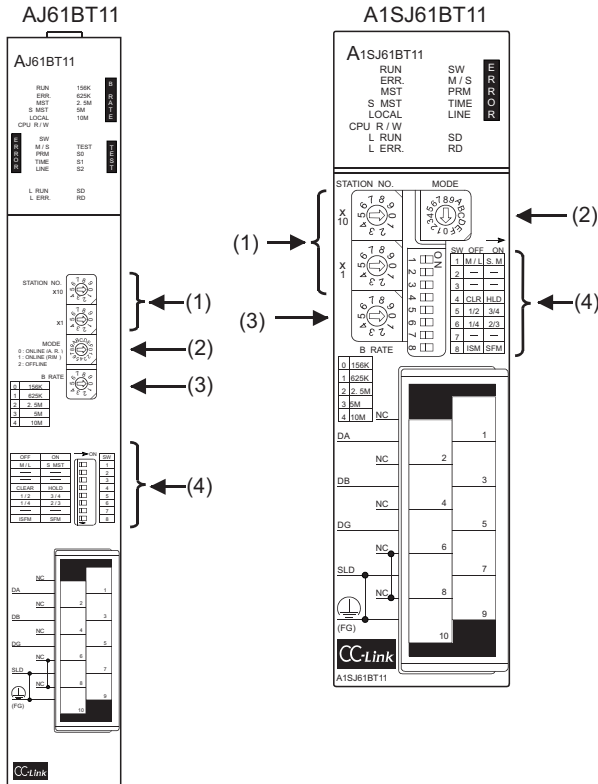

(1) Station number setting switch

Station number setting switch	Description	Set value	Setting necessity at GOT connection
	Station number setting (master station)	0 (fixed)	○

○: Necessary △: As necessary ×: Not necessary

(2) Mode setting switch

Mode setting switch	Description	Set value	Setting necessity at GOT connection
	Mode setting (Online: Remote net mode)	0 (fixed)	○

○: Necessary △: As necessary ×: Not necessary

(3) Transmission speed setting switch

Transmission speed setting switch	Description	Set value	Setting necessity at GOT connection
	Transmission speed setting (156kpbs) ^{*1}	0	○

○: Necessary △: As necessary ×: Not necessary

*1 Specify the same transmission speed as that of the GOT.

(4) Condition setting switches

Condition setting switches	Setting switch	Description	Set value	Setting necessity at GOT connection
	SW1	Station type (Master station/Local station)	OFF (fixed)	○
	SW2	Not used	OFF (fixed)	×
	SW3		OFF (fixed)	×
	SW4	Input data status of the data link error station (clear)	OFF	△
	SW5	Number of stations occupied ^{*2}	OFF (fixed)	×
	SW6		OFF (fixed)	×
	SW7	Not used	OFF (fixed)	×
	SW8	Module mode (Intelligent mode)	OFF (fixed)	○

○: Necessary △: As necessary ×: Not necessary

*2 Will be valid when the CC-Link module is a local station. In the case of the master station, turn off it.

POINT

When the switch setting has been changed Turn the PLC CPU OFF then ON again, or reset the PLC CPU.

9
MELSECNET/H CONNECTION (PLC CONNECTION TO PLC NETWORK)
10
MELSECNET/T0 CONNECTION (PLC CONNECTION TO PLC NETWORK)
11
CC-Link IE CONTROLLER NETWORK CONNECTION
12
CC-Link IE FIELD NETWORK CONNECTION
13
CC-Link CONNECTION (INTELLIGENT DEVICE STATION)
14
CC-Link CONNECTION (Via G4)
15
INVERTER CONNECTION
16
SERVO AMPLIFIER CONNECTION

■ Sequence program

The parameter setting and the sequence program of the data link startup request is required.

(1) Programming condition (with CC-Link dedicated instructions)

The program sets the network parameter and automatic refresh parameter when PLC CPU status changes from STOP to RUN, and automatically starts the data link with CC-Link dedicated instructions.

(a) I/O signal of CC-Link module

 Control & Communication Link System Master/
Local Module Type AJ61BT11/A1SJ61BT11
User's Manual

(b) Device used by user

Device	Application
M0	RLPA instruction normal completion flag
M1	RLPA instruction error completion flag
M100	Network parameter setting flag
M101	Automatic refresh parameter setting flag
D0	Synchronous mode valid/invalid
D1	Number of connected modules
D2	Station data
D3	Send buffer size
D4	Receive buffer size
D5	Automatic update buffer size
D400	Error code in the case of error completion of RLPA instruction
D100 to D103	Automatic refresh setting (RX)
D104 to D107	Automatic refresh setting (RY)
D108 to D111	Automatic refresh setting (RW)
D112 to D115	Automatic refresh setting (SB)
D116 to D119	Automatic refresh setting (SW)

(c) Example of sequence program (CC-Link dedicated instruction)

* Setting of network parameter with dedicated RLPA instruction

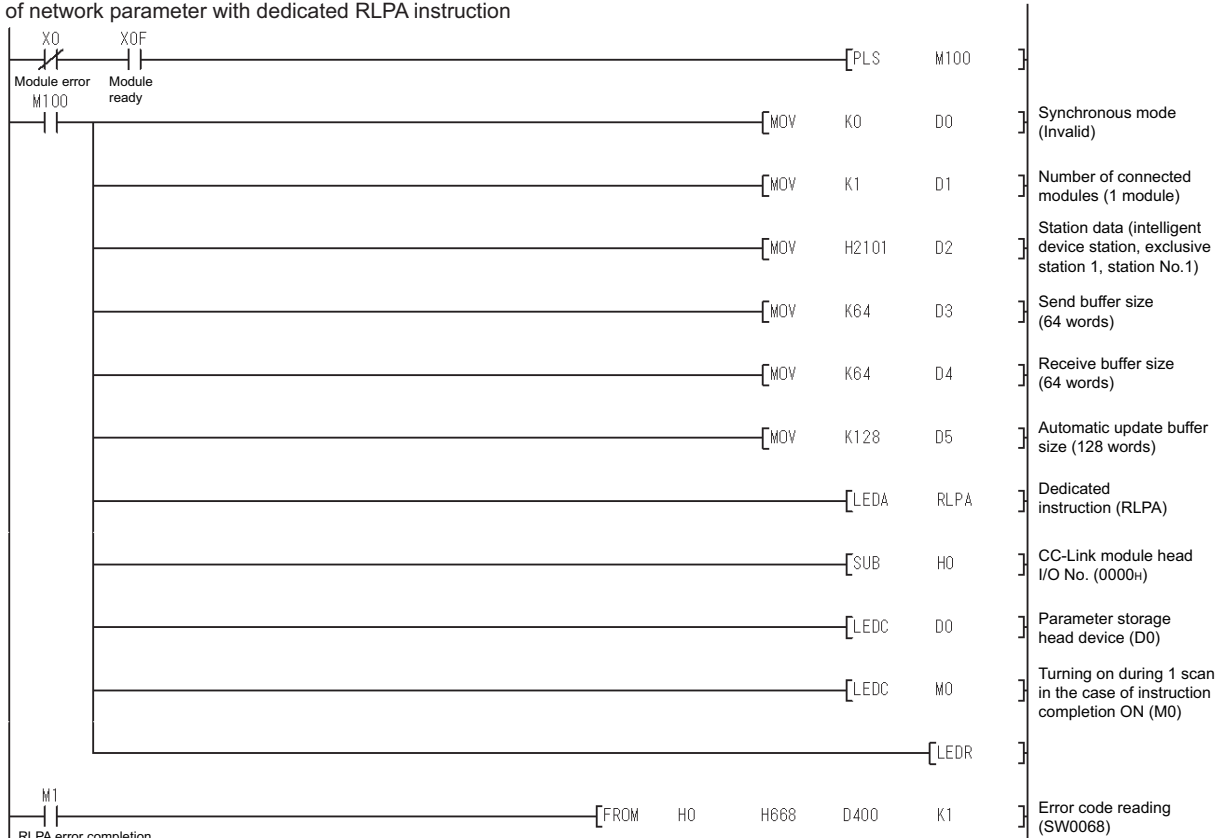

* Setting of automatic refresh parameter with dedicated RRPDA instruction

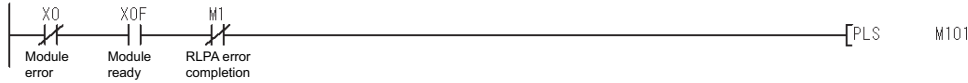

(Continued to next page)

9	MELSECNET/H CONNECTION (PLC CONNECTION TO PLC NETWORK)
10	MELSECNET/10 CONNECTION (PLC CONNECTION TO PLC NETWORK)
11	CC-Link IE CONTROLLER NETWORK CONNECTION
12	CC-Link IE FIELD NETWORK CONNECTION
13	CC-Link CONNECTION (INTELLIGENT DEVICE STATION)
14	CC-Link CONNECTION (Via G4)
15	INVERTER CONNECTION
16	SERVO AMPLIFIER CONNECTION

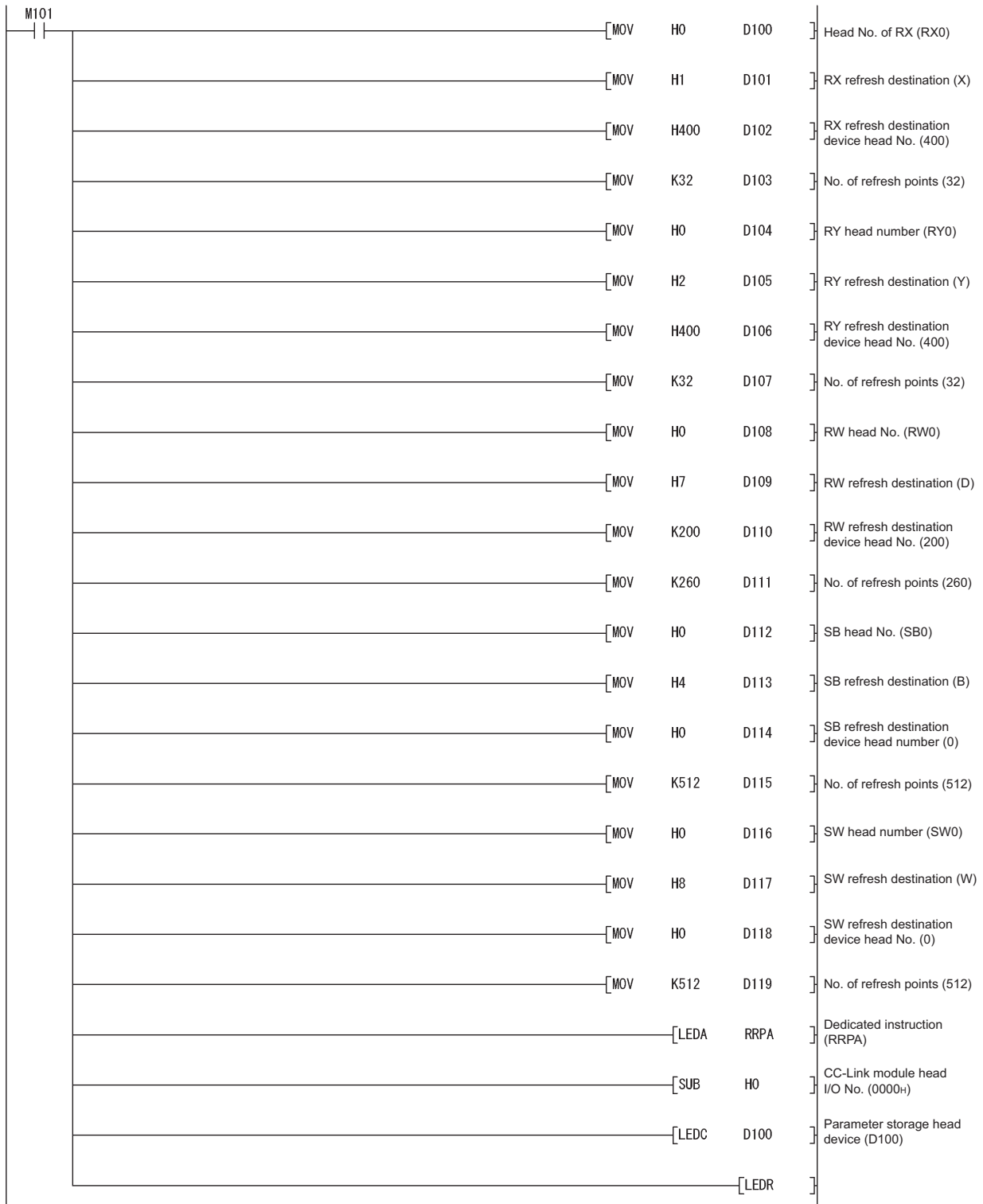

POINT

When changing the sequence program

After writing the sequence program to the PLC CPU, operate the PLC CPU ether turning OFF and then ON or resetting.

(2) Program condition (for FROM/TO instruction)

This program writes parameters to the buffer memory when PLC CPU status changes from STOP to RUN and automatically starts the data link with FROM/TO instruction.

(a) I/O signal of CC-Link module

 Control & Communication Link System Master/ Local Module Type AJ61BT11/A1SJ61BT11 User's Manual

(b) Devices used by user

Device	Application
M100, M101	Flag for parameter setting
M102, M103	Flag for data link startup
D0	Number of connected modules
D1	Number of retry
D2	Automatic reconnection station count
D3	Operation specification in the case of CPU failure
D4	Reserved station specification (Station No. 1 to Station No. 16)
D5	Error invalid station specification (Station No. 1 to Station No. 16)
D6	Station data (first module)
D400	Error code in the case of data link startup failure

(c) Buffer memory settings used in the present example

Buffer memory address	Item	Set value
Decimal (Hex)		
1 (1H)	Number of connected modules	1 (1 module)
2 (2H)	Number of retry	3 (3times)
3 (3H)	Automatic reconnection station count	1 (1 station)
6 (6H)	Operation specification in the case of CPU failure	0 (stop)
16 (10H)	Reserved station specification (Station No. 1 to Station No. 16)	0 (No specification)
20 (14H)	Error invalid station specification (Station No. 1 to Station No. 16)	0 (No specification)
32 (20H)	Station data (first module) ^{*1}	2101H

*1 Details for the station data are shown below.
 For 1) and 2), set the same station No. and number of station occupied settings as those of the GOT.
 For 3), the setting is fixed.

b15 to b12	b11 to b8	b7 to b0
3)	2)	1)

- 1) Station No. (Set the same station No. as that of the GOT.)
 01H to 40H: Station No. 1 to Station No. 64
- 2) Number of stations occupied (Set the same setting of the number of station occupied as that of the GOT.)
 1H: Exclusive station 1
 2H: Exclusive station 2
 3H: Exclusive station 3
 4H: Exclusive station 4
- 3) Station type (2H: Set it to intelligent device station.)
 0H: Remote I/O station
 1H: Remote device station
 2H: Intelligent device station (Incl. local station)

(d) Example of sequence program (FROM/TO instruction)

* Parameter setting

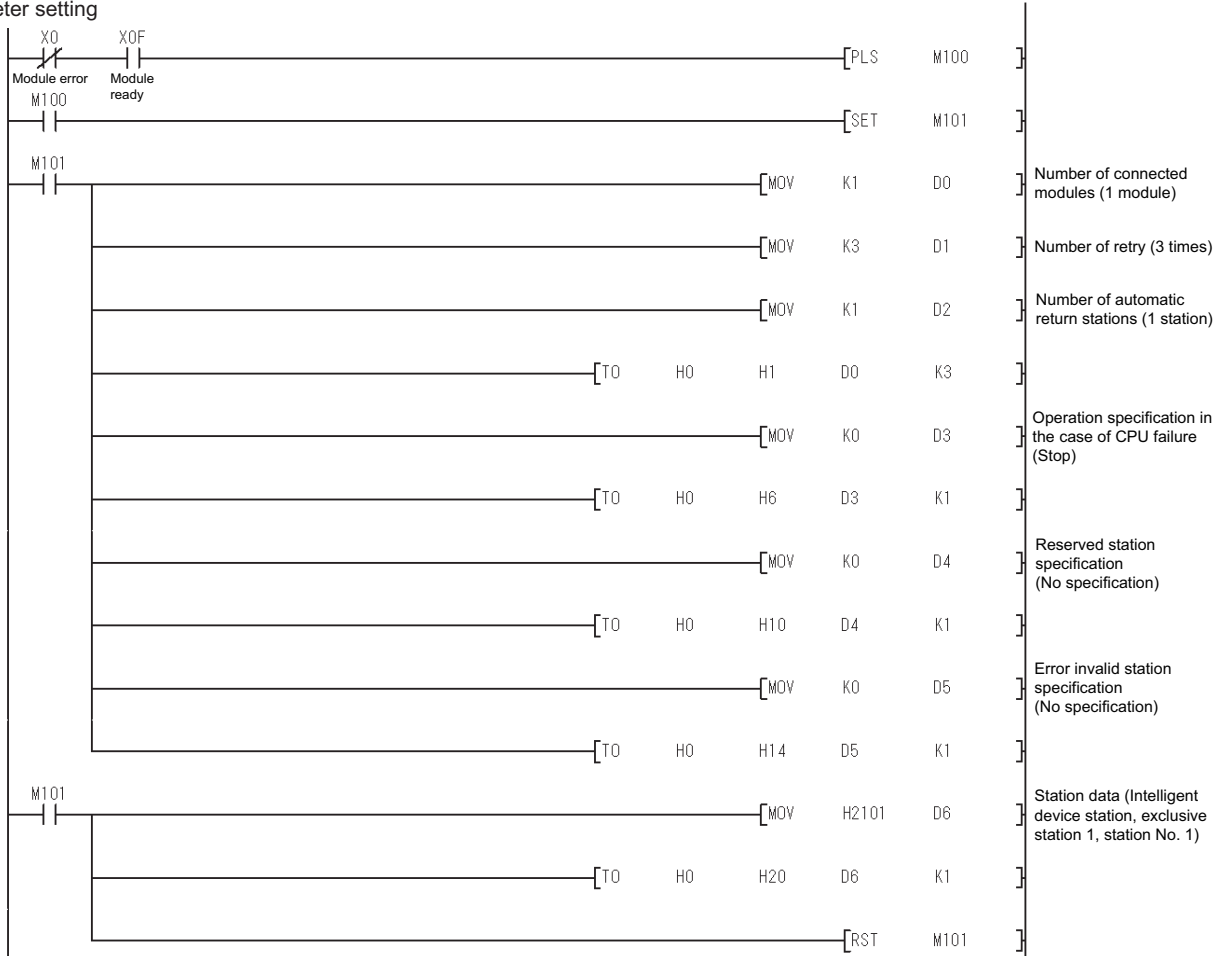

* Refresh instruction



* Data link with buffer memory parameters

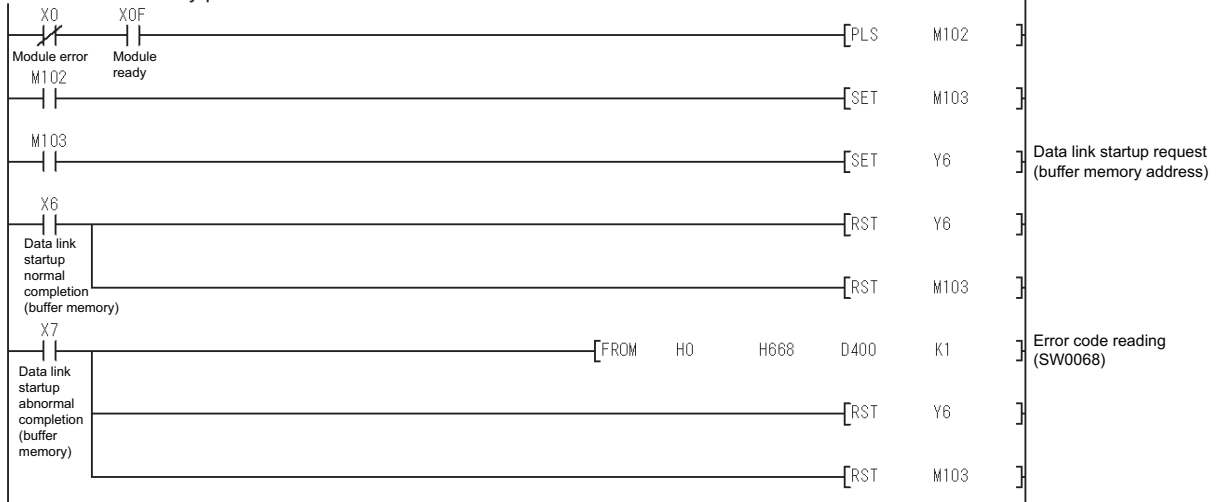

POINT

When changing the sequence program

After writing the sequence program to the PLC CPU, operate the PLC CPU ether turning OFF and then ON or resetting.

■ [Controller Setting] of GT Designer3

(1) When MODEL GT15-J61BT13 CC-Link communication unit is used

Item	Set value
Station No.	1: Station No.1
Transmission Rate	0: Online 156kbps
Mode	Ver.1: Remote net (Ver.1 mode)
Expanded Cyclic	Single (Use default value)
Number of stations occupied	1 Station
Input for Error Station	0: Clear
Retry	3times (Use default value)
Timeout Time	3sec (Use default value)
Delay Time	0ms (Use default value)

(2) When MODEL GT15-75J61BT13-Z CC-Link communication unit is used

Item	Set value (Use default value)
Retry	3times
Timeout Time	3sec

POINT

[Controller Setting] of GT Designer3

For the setting method of [Controller Setting] of GT Designer3, refer to the following.

 13.3.1 Setting communication interface (Communication settings)

■ Setting of the CC-Link communication unit (Only when MODEL GT15-75J61BT13-Z CC-Link communication unit is used)

Item	Set value	
Mode setting switch	0: Online (fixed)	
Station number setting switch	1: Station No.1	
Transmission baudrate setting switch	0: 156kbps	
Condition setting switches	SW1 (Input data status of the data link error station)	OFF: Cleared
	SW2 (Number of occupied stations)	OFF: 1 station

POINT

Setting of the CC-Link communication unit

For the setting method of the CC-Link communication unit, refer to the following.

 13.3.3 Switch setting (Only when MODEL GT15-75J61BT13-Z CC-Link communication unit is used)

13.5 Precautions

■ Using cyclic transmission

(1) I/O signal for master station

Do not turn on the reserved output signals in the output signals (remote output: RY) to the GOT from the master station.

When the reserved output signal is turned on, the PLC system may be malfunctioned.

For the assignment of I/O signals in the GOT, refer to the following manual.

 MODEL GT15-J61BT13 CC-Link communication unit User's Manual

 GT15 CC-Link communication unit User's Manual

(2) Access range that can be monitored

The monitoring range of remote I/O (RX and RY) and that of the remote registers (RW_r and RW_w) vary according to the mode in the master station of the CC-Link system.

Mode of master station	Applicable of monitoring	
	Data for each station compatible with CC-Link ver.1	Data for each station compatible with CC-Link ver.2
Remote net mode	○	-
Remote net ver.1 mode	○	-
Remote net ver.2 mode	○	○*1
Remote net additional mode	○	○*1

○: Applicable ×: N/A(All "0") -: N/A of system configuration

*1 Monitoring is applicable only when MODEL GT15-J61BT13 CC-Link communication unit is used.

(3) When GOT malfunctions, the cyclic output status remains the same as before becoming faulty.

■ For transient transmission

(1) CC-Link module of target station

Mount the CC-Link module of function version B or later and software version J or later to the PLC CPU when performing the following CC-Link modules and transient transmission.

Only cyclic transmission can be communicated with the CC-Link module of function version A or before and software version I or before.

- AJ61BT11
- A1SJ61BT11
- AJ61QBT11
- A1SJ61QBT11

(2) Access range that can be monitored

The GOT can access to the PLC CPU mounting the master and local station of the CC-Link System.

It cannot access another network via the CC-Link module.

■ GOT startup in the CC-Link connection (intelligent device station)

For CC-Link connection (intelligent device station), the data link is started approximately 10 seconds after the GOT startup.

■ When a network error occurs in the system alarm

In the CC-Link connection (intelligent device station), when a network error occurs in the system alarm, the system alarm display cannot be canceled even though the causes are removed.

To cancel the system alarm display, restart the GOT.

■ Connection in the multiple CPU system

When the GOT is connected to multiple CPU system, the following time is taken until when the PLC runs.

QCPU (Q mode), motion controller CPU (Q series): 10 seconds or more

MELDAS C70: 18 seconds or more

When the GOT starts before the PLC runs, a system alarm occurs. Adjust the opening screen time in the GOT setup so that no system alarm occurs.

 GT Designer3 Version□ Screen Design Manual

■ Connection to LCPU

LCPU may diagnose (check file system, execute recovering process, etc.) the SD memory card when turning on the power or when resetting. Therefore, it takes time until the SD memory card becomes available. When the GOT starts before the SD card becomes available, a system alarm occurs. Adjust the opening screen time in the GOT setup so that no system alarm occurs.

 GT Designer3 Version□ Screen Design Manual

■ Connection to Q17nDCPU, Q170MCP, CNC C70, CRnQ-700

The Q17nDCPU, Q170MCP, CNC C70 and CRnQ-700 are applicable to the CC-Link network system Ver.2 only

For connecting to the CC-Link (ID) network system, set the CC-Link (ID) network system to the CC-Link Ver.2 mode.

■ Connection to Q170MCPU

Set [CPU No.] to "2" in the device setting to monitor the device of the Motion CPU area (CPU No.2).

When the CPU No. is set to "0" or "1", the device on the PLC CPU area (CPU No.1) is monitored.

When the CPU No. is set to the number other than "0" to "2", a communication error occurs and the monitoring cannot be executed.

For setting the CPU No., refer to the following manual.

 GT Designer3 Version□ Screen Design Manual

Example) Setting dialog box of the bit device

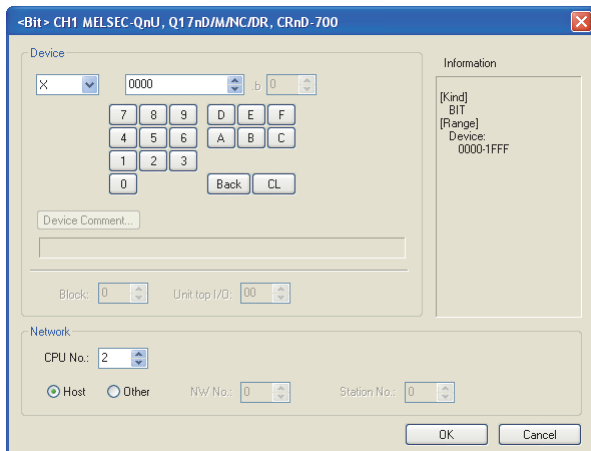

■ Connection to RnSF CPU

The RnSF CPU takes 10 seconds or more to run.

If the GOT is started before the RnSF CPU runs, a system alarm occurs.

To prevent a system alarm from occurring, adjust the title display time in the [GOT Setup] dialog.

 GT Designer3 (GOT2000) Help

9	MELSECNET/H CONNECTION (PLC CONNECTION TO PLC NETWORK)
10	MELSECNET/10 CONNECTION (PLC CONNECTION TO PLC NETWORK)
11	CC-Link IE CONTROLLER NETWORK CONNECTION
12	CC-Link IE FIELD NETWORK CONNECTION
13	CC-Link CONNECTION (INTELLIGENT DEVICE STATION)
14	CC-Link CONNECTION (Via G4)
15	INVERTER CONNECTION
16	SERVO AMPLIFIER CONNECTION

14

CC-Link CONNECTION (Via G4)



14.1 Connectable Model List	14 - 2
14.2 System Configuration	14 - 7
14.3 Connection Diagram	14 - 9
14.4 GOT Side Settings	14 - 10
14.5 PLC Side Settings	14 - 12
14.6 Precautions	14 - 18

14. CC-Link CONNECTION (Via G4)

14.1 Connectable Model List

14.1.1 PLC/Motion controller CPU

The following table shows the connectable models.

Series	Model name	Clock	Communication type	GT 16	GT 15	GT 14	GT 12	GT11 Bus	GT11 Serial	GT 10 ⁵ / ₄	GT 10 ²⁰ / ₃₀	Refer to
MELSEC iQ-R Series	R04CPU	○	CC-Link(G4)									-
	R08CPU											
	R16CPU											
	R32CPU											
	R120CPU											
	R08PCPU											
	R16PCPU											
	R32PCPU											
	R120PCPU											
	R04ENCPU											
	R08ENCPU											
	R16ENCPU											
	R32ENCPU											
	R120ENCPU											
R08SF CPU												
R16SF CPU												
R32SF CPU												
R120SF CPU												
Motion controller CPU (MELSEC iQ-R Series)	R16MTCPU	○	CC-Link(G4)	×	×	×	×	×	×	×	×	-
	R32MTCPU											
C Controller module (MELSEC iQ-R Series)	R12CCPU-V	○	CC-Link(G4)	×	×	×	×	×	×	×	×	-
MELSEC iQ-F Series	FX5U FX5UC	○	CC-Link(G4)	×	×	×	×	×	×	×	×	-

(Continued to next page)

Series	Model name	Clock	Communication type	GT 16	GT 15	GT 14	GT 12	GT11 Bus	GT11 Serial	GT 10 ^{5□} _{4□}	GT 10 ²⁰ ₃₀	Refer to
MELSEC-Q (Q mode)	Q00JCPU	○	CC-Link (G4)	○	○	○	○	×	○ ^{*2}	○ ^{*2}	○ ^{*2}	14.2.1
	Q00CPU ^{*1}											
	Q01CPU ^{*1}											
	Q02CPU ^{*1}											
	Q02HCPU ^{*1}											
	Q06HCPU ^{*1}											
	Q12HCPU ^{*1}											
	Q25HCPU ^{*1}											
	Q02PHCPU	○	CC-Link (G4)	○	○	○	○	×	○ ^{*2}	× ^{*3}	× ^{*3}	
	Q06PHCPU											
	Q12PHCPU											
	Q25PHCPU											
	Q12PRHCPU (Main base)											
	Q25PRHCPU (Main base)											
	Q12PRHCPU (Extension base)	○	CC-Link (G4)	○	○	○	○	×	○ ^{*2}	× ^{*3}	× ^{*3}	
	Q25PRHCPU (Extension base)											
	Q00UJCPU	○	CC-Link (G4)	○	○	○	○	×	○ ^{*2}	○ ^{*2}	○ ^{*2}	
	Q00UCPU											
	Q01UCPU											
	Q02UCPU											
	Q03UDCPU											
	Q04UDHCPU											
	Q06UDHCPU											
	Q10UDHCPU											
Q13UDHCPU												
Q20UDHCPU												
Q26UDHCPU												
Q03UDECPU												
Q04UDEHCPU												
Q06UDEHCPU												
Q10UDEHCPU												
Q13UDEHCPU												
Q20UDEHCPU												
Q26UDEHCPU												
Q50UDEHCPU												
Q100UDEHCPU												
Q03UDVCPU	○	CC-Link (G4)	○	○	○	○	×	○ ^{*2}	○ ^{*2}	○ ^{*2}		
Q04UDVCPU												
Q06UDVCPU												
Q13UDVCPU												
Q26UDVCPU	○	CC-Link (G4)	○	○	○	○	×	○ ^{*2}	○ ^{*2}	○ ^{*2}		
Q03UDVCPU												
Q04UDVCPU												
Q06UDVCPU												

(Continued to next page)

*1 When in multiple CPU system configuration, use CPU function version B or later.

*2 Only master station can be monitored in GT11 and GT10.

*3 For GT10, do not include in the multiple CPU system configuration.

9 MELSECNET/H CONNECTION (PLC CONNECTION TO PLC NETWORK)

10 MELSECNET/10 CONNECTION (PLC CONNECTION TO PLC NETWORK)

11 CC-Link IE CONTROLLER NETWORK CONNECTION

12 CC-Link IE FIELD NETWORK CONNECTION

13 CC-Link CONNECTION (INTELLIGENT DEVICE STATION)

14 CC-Link CONNECTION (Via G4)

15 INVERTER CONNECTION

16 SERVO AMPLIFIER CONNECTION

Series	Model name	Clock	Communication type	GT 16	GT 15	GT 14	GT 12	GT4 Bus	GT11 Serial	GT 10 50	GT 10 20/30	Refer to
C Controller module (Q Series)	Q12DCCPU-V ² Q24DHCCPU-V/VG Q24DHCCPU-LS	○	CC-Link(G4)	○	○	○	○	×	○*1	○*1	○*1	☞ 14.2.1
	Q26DHCCPU-LS			○	×	○	×	×	×	○*1	○*1	
MELSEC-QS	QS001CPU	○	-	×	×	×	×	×	×	×	×	-
MELSEC-L	L02CPU L06CPU L26CPU L26CPU-BT L02CPU-P L06CPU-P L26CPU-P L26CPU-PBT L02SCPU L02SCPU-P	○	CC-Link(G4)	○	○	○	○	×	○*1	○*1	○*1	☞ 14.2.2
MELSEC-Q (A mode)	Q02CPU-A Q02HCPU-A Q06HCPU-A	○	-	×	×	×	×	×	×	×	×	-
MELSEC-QnA (QnACPU)	Q2ACPU Q2ACPU-S1 Q3ACPU Q4ACPU Q4ARCPU	○	-	×	×	×	×	×	×	×	×	-
MELSEC-QnA (QnASCPU)	Q2ASCPU Q2ASCPU-S1 Q2ASHCPU Q2ASHCPU-S1	○	-	×	×	×	×	×	×	×	×	-
MELSEC-A (AnCPU)	A2UCPU A2UCPU-S1 A3UCPU A4UCPU A2ACPU A2ACPUP21 A2ACPUR21 A2ACPU-S1 A2ACPUP21-S1 A2ACPUR21-S1 A3ACPU A3ACPUP21 A3ACPUR21 A1NCPUR21 A1NCPUR21 A2NCPUR21 A2NCPUR21 A2NCPUR21 A2NCPUR21 A2NCPUR21-S1 A2NCPUR21-S1 A3NCPUR21 A3NCPUR21 A3NCPUR21	○	-	×	×	×	×	×	×	×	×	-

(Continued to next page)

*1 Only master station can be monitored in GT11 and GT10.

*2 Use only modules with the upper five digits of the serial No. later than 12042.

Series	Model name	Clock	Communication type	GT 16	GT 15	GT 14	GT 12	GT11 Bus	GT11 Serial	GT 10 5□	GT 10 20 30	Refer to	
MELSEC-A (AnSCPU)	A2USCPU	○	-	x	x	x	x	x	x	x	x	-	
	A2USCPU-S1												
	A2USHCPU-S1												
	A1SCPU												
	A1SCPUC24-R2												
	A1SHCPU												
	A2SCPU												
	A2SCPU-S1												
	A2SHCPU												
	A2SHCPU-S1												
	A1SJCPU												
	A1SJCPU-S3												
	A1SJHCPU												
MELSEC-A	A0J2HCPU	x	-	x	x	x	x	x	x	x	x	-	
	A0J2HCPUP21												
	A0J2HCPUR21												
	A0J2HCPU-DC24												
	MELSEC-A	A2CCPU	○	-	x	x	x	x	x	x	x	x	-
		A2CCPUP21											
		A2CCPUR21											
		A2CCPUC24											
		A2CCPUC24-PRF											
		A2CJCPU-S3											
A1FXCPU													
Motion controller CPU (Q Series)	Q172CPU ^{*1*} 2	○	CC-Link (G4)	○	○	○	○	x	○ ^{*4}	○ ^{*4}	○ ^{*4}	14.2.1	
	Q173CPU ^{*1*} 2												
	Q172CPUN ^{*1}												
	Q173CPUN ^{*1}												
	Q172HCPU												
	Q173HCPU												
	Q172DCPU												
	Q173DCPU												
	Q172DCPU-S1												
	Q173DCPU-S1												
	Q172DSCPU												
	Q173DSCPU												
	Q170MCPUN ^{*3}												
	Q170MSCPU ^{*5}												
	Q170MSCPU-S1 ^{*5}												
	MR-MQ100												

(Continued to next page)

- *1 When using SV13, SV22, or SV43, use the motion controller CPU on which any of the following main OS version is installed.
 - SW6RN-SV13Q□: 00H or later
 - SW6RN-SV22Q□: 00H or later
 - SW6RN-SV43Q□: 00B or later
- *2 Use main modules with the following product numbers.
 - Q172CPU: Product number N***** or later
 - Q173CPU: Product number M***** or later
- *3 Only the first step can be used on the extension base unit (Q52B/Q55B).
- *4 Only master station can be monitored in GT11 and GT10.
- *5 The extension base unit (Q5□B/Q6□B) can be used.

9
MELSECNET/H
CONNECTION (PLC
TO PLC NETWORK)

10
MELSECNET/10
CONNECTION (PLC
TO PLC NETWORK)

11
CC-Link IE CONTROLLER
NETWORK
CONNECTION

12
CC-Link IE FIELD
NETWORK
CONNECTION

13
CC-Link CONNECTION
(INTELLIGENT DEVICE
STATION)

14
CC-Link
CONNECTION
(Via G4)

15
INVERTER
CONNECTION

16
SERVO AMPLIFIER
CONNECTION

Series	Model name	Clock	Communication type	GT 16	GT 15	GT 14	GT 12	GT11 Bus	GT11 Serial	GT 10 5□ 4□	GT 10 20 30	Refer to
Motion controller CPU (A Series)	A273UCPU	○	-	×	×	×	×	×	×	×	×	-
	A273UHCPU											
	A273UHCPU-S3											
	A373UCPU											
	A373UCPU-S3											
	A171SCPU											
	A171SCPU-S3											
	A171SCPU-S3N											
	A171SHCPU											
	A171SHCPUN											
	A172SHCPU											
	A172SHCPUN											
	A173UHCPU											
	A173UHCPU-S1											
MELSEC-WS	WS0-CPU0	×	-	×	×	×	×	×	×	×	×	-
	WS0-CPU1											
	WS0-CPU3											
MELSECNET/H Remote I/O station	QJ72LP25-25	×	-	×	×	×	×	×	×	×	×	-
	QJ72LP25G											
	QJ72BR15											
CC-Link IE Field Network head module	LJ72GF15-T2	×	-	×	×	×	×	×	×	×	×	-
CC-Link IE Field Network Ethernet adapter module	NZ2GF-ETB	×	-	×	×	×	×	×	×	×	×	-
CNC C70	Q173NCCPU	○	CC-Link (G4)	○	○	○	○	×	○*1	×	×	14.2.1
Robot controller	CRnQ-700 (Q172DRCPU) CR750-Q (Q172DRCPU) CR751-Q (Q172DRCPU)	○	CC-Link (G4)	○	○	○	○	×	○*1	×	×	14.2.1
MELSEC-FX	FX0	×	-	×	×	×	×	×	×	×	×	-
	FX0S											
	FX0N											
	FX1	×	-	×	×	×	×	×	×	×	×	
	FX2											
	FX2C											
	FX1S	○	-	×	×	×	×	×	×	×	×	
	FX1N											
	FX2N											
	FX1NC	×	-	×	×	×	×	×	×	×	×	
	FX2NC											
	FX3S											
	FX3G	○	-	×	×	×	×	×	×	×	×	
	FX3GC											
	FX3GE											
FX3U												
FX3UC												

*1 Only master station can be monitored in GT11.

14.1.2 CC-Link module/peripheral module

CPU series	Model name	
	CC-Link module	Peripheral module
MELSEC-Q (Q mode) C Controller module (Q Series) Motion controller CPU (Q Series) CNC C70 Robot controller (CRnQ-700)	QJ61BT11 QJ61BT11N	AJ65BT-G4-S3 AJ65BT-R2N
MELSEC-L	LJ61BT11	

14.2 System Configuration

14.2.1 Connecting to QCPU (Q mode)

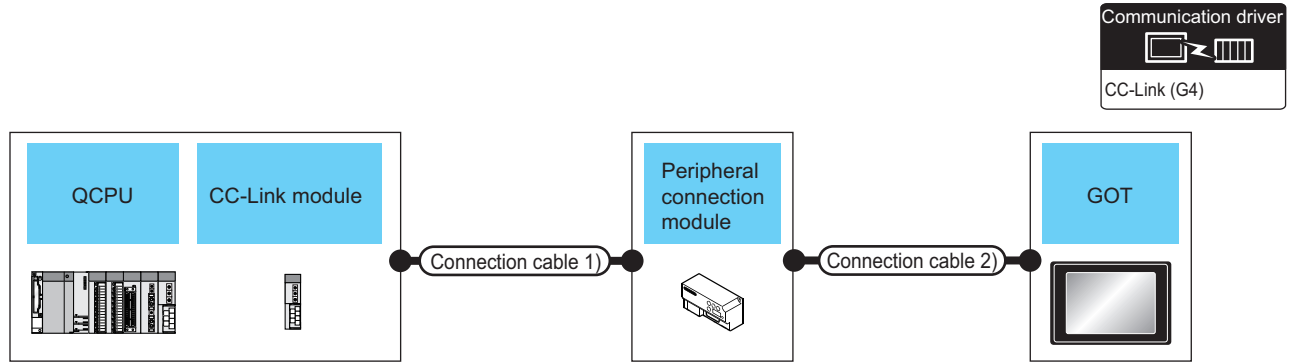

PLC		Connection cable 1)		Peripheral connection module		Connection cable 2)		GOT		Number of connectable equipment
Model name	CC-Link module *1	Cable model	Max. distance	Model name	Communication type	Cable model Connection diagram number	Max. distance	Option device	Model	
MELSEC-Q C Controller module (Q Series)	QJ61BT11 QJ61BT11 N	CC-Link dedicated cable *2	*3	AJ65BT-R2N	RS-232	GT09-C30R2-9P or User RS-232 connection diagram 1)	15m	- (Built into GOT)	GT16, GT15, GT14, GT12, GT11 Serial, GT10 5□/4□	1 GOT for 1 peripheral connection module
						User RS-232 connection diagram 2)	15m	- (Built into GOT)	GT10 2W/30	
				AJ65BT-G4-S3	RS-422	GT01-C30R4-25P(3m) GT01-C100R4-25P(10m) GT01-C200R4-25P(20m) GT01-C300R4-25P(30m)	30m	GT16-C02R4-9S GT15-RS2T4-9P*5 GT15-RS4-9S	GT16, GT15, GT14, GT12, GT11 Serial, GT10 5□/4□	
						GT10-C30R4-25P(3m) GT10-C100R4-25P(10m) GT10-C200R4-25P(20m) GT10-C300R4-25P(30m) *4	30m	- (Built into GOT)	GT10 2W/30	

*1 For the system configuration of the CC-Link module, refer to the following manual.

☞ CC-Link System Master/Local Module User's Manual QJ61BT11N

*2 For the specifications and inquiries of the CC-Link dedicated cable, refer to the following.

☞ CC-Link Partner Association's home page: <http://www.cc-link.org/>

*3 The maximum overall extension cable length and the length between stations vary depending on the cable type to be used and the transmission speed.

For details, refer to the following manual.

☞ CC-Link System Master/Local Module User's Manual QJ61BT11N

*4 For the connection to GOT, refer to the connection diagram.

☞ RS-422 connection diagram 1)

*5 Connect it to the RS-232 interface (built into GOT). It cannot be mounted on GT1655 and GT155□.

9
MELSECNET/H CONNECTION (PLC CONNECTION TO PLC NETWORK)
10
MELSECNET/10 CONNECTION (PLC CONNECTION TO PLC NETWORK)
11
CC-Link IE CONTROLLER NETWORK CONNECTION
12
CC-Link IE FIELD NETWORK CONNECTION
13
CC-Link CONNECTION (INTELLIGENT DEVICE STATION)
14
CC-Link CONNECTION (Via G4)
15
INVERTER CONNECTION
16
SERVO AMPLIFIER CONNECTION

14.2.2 Connecting to LCPU

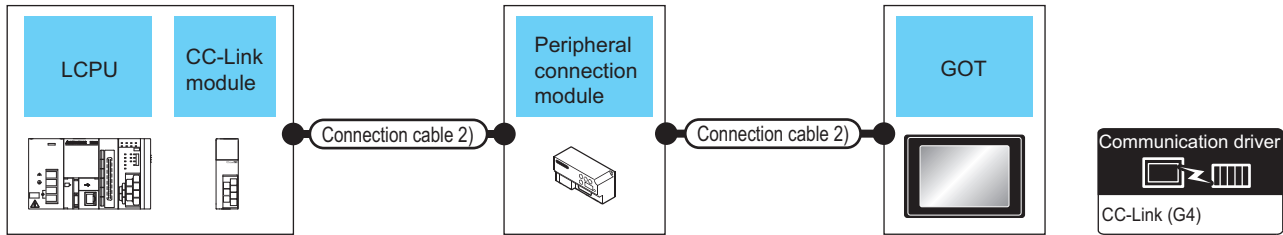

PLC		Connection cable 1)		Peripheral connection module		Connection cable 2)		GOT		Number of connectable equipment
Model name	CC-Link module ^{*1}	Cable model	Max. distance	Model name	Communication type	Cable model Connection diagram number	Max. distance	Option device	Model	
L02CPU L26CPU-BT L02CPU-P L26CPU-PBT	LJ61BT1 1	CC-Link dedicated cable ^{*2}	^{*3}	AJ65B T-R2N	RS-232	GT09-C30R2-9P or RS-232 connection diagram 1)	15m	- (Built into GOT)	 	1 GOT for 1 peripheral connection module
						RS-232 connection diagram 2)	15m	- (Built into GOT)		
				AJ65B T-G4-S3	RS-422	GT01-C30R4-25P(3m) GT01-C100R4-25P(10m) GT01-C200R4-25P(20m) GT01-C300R4-25P(30m)	30m	GT16-C02R4-9S GT15-RS2T4-9P ^{*5} GT15-RS4-9S	 	
						GT10-C30R4-25P(3m) GT10-C100R4-25P(10m) GT10-C200R4-25P(20m) GT10-C300R4-25P(30m) ^{*4}	30m	- (Built into GOT)	 	
L26CPU-BT L26CPU-PBT	-	CC-Link dedicated cable ^{*2}	^{*3}	AJ65B T-R2N	RS-232	GT09-C30R2-9P or RS-232 connection diagram 1)	15m	- (Built into GOT)	 	1 GOT for 1 peripheral connection module
						RS-232 connection diagram 2)	15m	- (Built into GOT)		
				AJ65B T-G4-S3	RS-422	GT01-C30R4-25P(3m) GT01-C100R4-25P(10m) GT01-C200R4-25P(20m) GT01-C300R4-25P(30m)	30m	GT16-C02R4-9S GT15-RS2T4-9P ^{*5} GT15-RS4-9S	 	
						GT10-C30R4-25P(3m) GT10-C100R4-25P(10m) GT10-C200R4-25P(20m) GT10-C300R4-25P(30m) ^{*4}	30m	- (Built into GOT)	 	

^{*1} For the system configuration of the CC-Link module, refer to the following manual.

MELSEC-L CC-Link System Master/Local Module User's Manual

^{*2} For the specifications and inquiries of the CC-Link dedicated cable, refer to the following.

CC-Link Partner Association's home page: <http://www.cc-link.org/>

^{*3} The maximum overall extension cable length and the length between stations vary depending on the cable type to be used and the transmission speed.

For details, refer to the following manual.

MELSEC-L CC-Link System Master/Local Module User's Manual

^{*4} For the connection to GOT, refer to the connection diagram.

RS-422 connection diagram 1)

^{*5} Connect it to the RS-232 interface (built into GOT). It cannot be mounted on GT1655 and GT155□.

14.3 Connection Diagram

The following diagram shows the connection between the GOT and the PLC.

14.3.1 RS-232 cable

■ Connection diagram

RS-232 connection diagram 1)

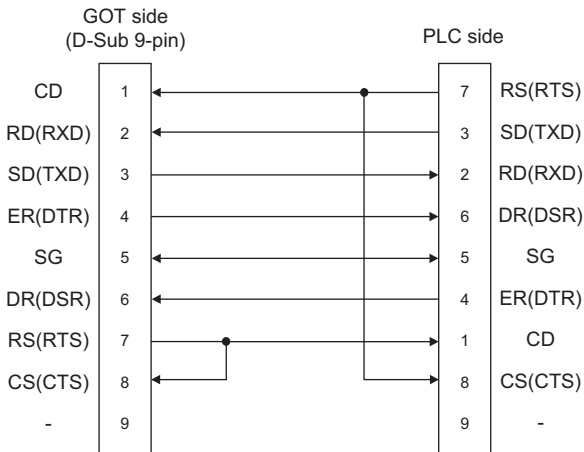

RS-232 connection diagram 2)

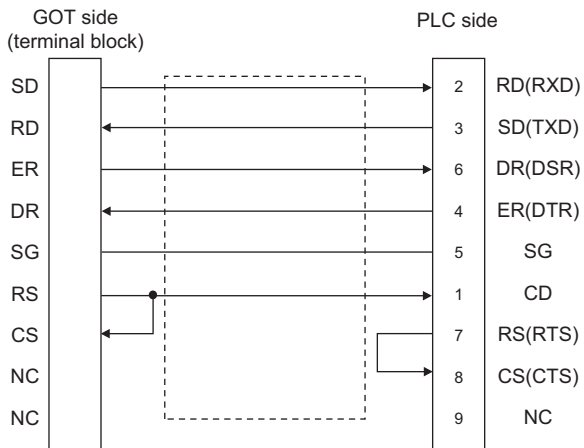

■ Precautions when preparing a cable

- (1) Cable length
The length of the RS-232 cable must be 15m or less.
- (2) GOT side connector
For the GOT side connector, refer to the following.
➡ 1.4.1 GOT connector specifications

14.3.2 RS-422 cable

■ Connection diagram

RS-422 connection diagram 1)

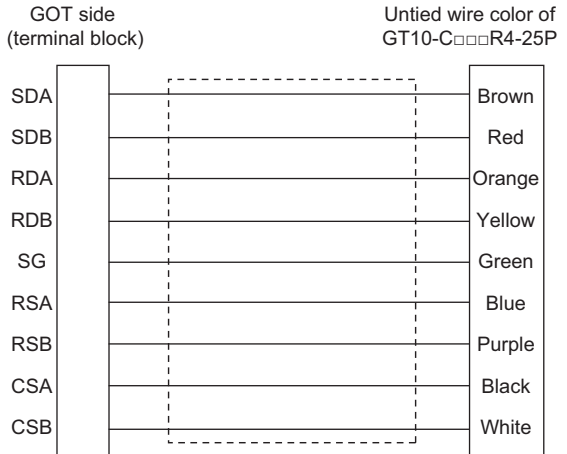

■ Precautions when preparing a cable

- (1) Cable length
The length of the RS-422 cable must be 500m or less.
- (2) GOT side connector
For the GOT side connector, refer to the following.
➡ 1.4.1 GOT connector specifications

■ Connecting terminating resistors

- (1) GOT side
When connecting a PLC to the GOT, a terminating resistor must be connected to the GOT.
 - (a) For GT16, GT15, GT12
Set the terminating resistor setting switch of the GOT main unit to "Disable".
 - (b) For GT14, GT11, GT10
Set the terminating resistor selector to "330Ω".

For the procedure to set the terminating resistor, refer to the following.

➡ 1.4.3 Terminating resistors of GOT

14.4 GOT Side Settings

14.4.1 Setting communication interface (Communication settings)

Set the channel of the connected equipment.

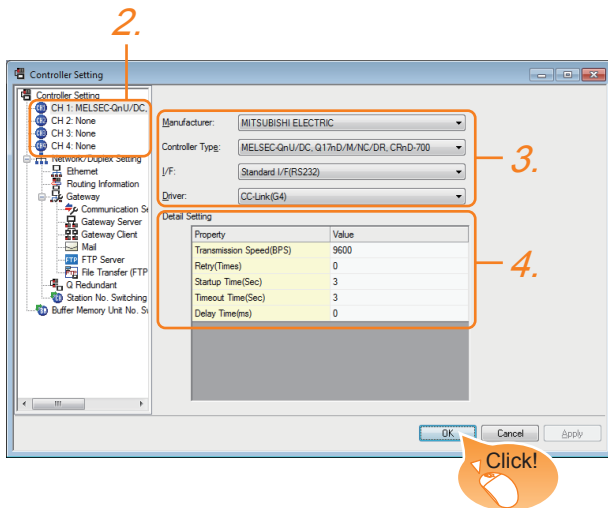

1. Select [Common] → [Controller Setting] from the menu.
2. The Controller Setting window is displayed. Select the channel to be used from the list menu.
3. Set the following items.
 - Manufacturer: MITSUBISHI ELECTRIC
 - Controller Type: Set according to the Controller Type to be connected.
 - I/F: Interface to be used
 - Driver: CC-Link (G4)
4. The detailed setting is displayed after Manufacturer, Controller Type, I/F, and Driver are set. Make the settings according to the usage environment.

☞ 14.4.2 Communication detail settings

Click the [OK] button when settings are completed.

POINT

The settings of connecting equipment can be confirmed in [I/F Communication Setting]. For details, refer to the following:

☞ 1.1.2 I/F communication setting

14.4.2 Communication detail settings

Make the settings according to the usage environment.

Property	Value
Transmission Speed(BPS)	9600
Retry(Times)	0
Startup Time(Sec)	3
Timeout Time(Sec)	3
Delay Time(ms)	0

Item	Description	Range
Transmission Speed	Set this item when change the transmission speed used for communication with the connected equipment. (Default: 9600bps)	9600bps, 19200bps, 38400bps, 57600bps, 115200bps
Retry	Set the number of retries to be performed when a communication timeout occurs. (Default: 0time)	0 to 5times
Timeout Time	Set the time period for a communication to time out.(Default: 3sec)	3 to 30sec
Delay time	Set this item to adjust the transmission timing of the communication request from the GOT. (Default: 0ms)	0 to 300ms

POINT

- (1) Communication interface setting by the Utility
The communication interface setting can be changed on the Utility's [Communication Settings] after writing [Communication Settings] of project data.
For details on the Utility, refer to the following manual.

☞ GT□ User's Manual

- (2) Precedence in communication settings
When settings are made by GT Designer3 or the Utility, the latest setting is effective.

HINT

Cutting the portion of multiple connection of the controller

By setting GOT internal device, GOT can cut the portion of multiple connection of the controller. For example, faulty station that has communication timeout can be cut from the system.

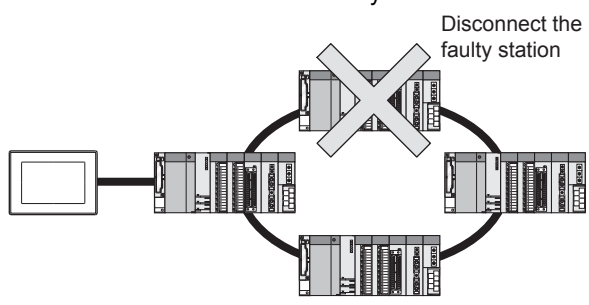

For details of the setting contents of GOT internal device, refer to the following manual.

➡ GT Designer3 Version Screen Design Manual (Fundamentals)

9	MELSECNET/H CONNECTION (PLC CONNECTION TO PLC NETWORK)
10	MELSECNET/10 CONNECTION (PLC CONNECTION TO PLC NETWORK)
11	CC-Link IE CONTROLLER NETWORK CONNECTION
12	CC-Link IE FIELD NETWORK CONNECTION
13	CC-Link CONNECTION (INTELLIGENT DEVICE STATION)
14	CC-Link CONNECTION (Via G4)
15	INVERTER CONNECTION
16	SERVO AMPLIFIER CONNECTION

14.5 PLC Side Settings

Model	Reference
Peripheral connection module	AJ65BT-G4-S3 14.5.1
	AJ65BT-R2N 14.5.2

14.5.1 Connecting AJ65BT-G4-S3

This section describes the settings of the GOT and peripheral connection module in the following case of the system configuration.

POINT

- (1) Peripheral connection module
For details of the peripheral connection module, refer to the following manual.
 - Peripheral Connection Module Type AJ65BT-G4-S3 User's Manual (detail volume)
- (2) CC-Link module
For details of the CC-Link module, refer to the following manual.
 - CC-Link System Master/Local Module User's Manual QJ61BT11N
 - MELSEC-L CC-Link System Master/Local Module User's Manual
- (3) CC-Link function built-in CPU
For details on the CC-Link function built-in CPU, refer to the following manual.
 - MELSEC-L CC-Link System Master/Local Module User's Manual

System configuration

- 14.5.3 Switch setting of CC-Link module (Q series)
- 14.5.4 [Network parameter] of GX Developer

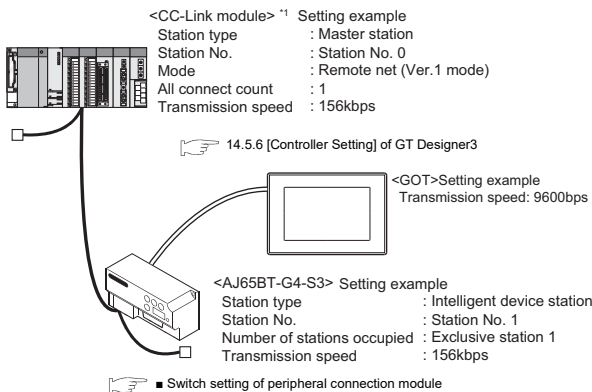

*1 The Start I/O No. of the CC-Link module is set to "0"

Switch setting of peripheral connection module

Set the station number setting switch, data link transmission speed setting switch, and operation setting DIP switch.

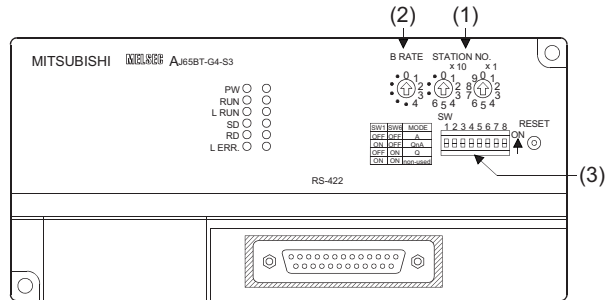

(1) Station number setting switch

Station number setting switch	Description	Set value	Setting necessity at GOT connection
	AJ65BT-G4-S3 station number setting	1 to 64	○

○: Necessary △: As necessary ×: Not necessary

(2) Data link transmission speed setting switch

Data link transmission speed setting switch	Description	Set value	Setting necessity at GOT connection
	Data link transmission speed setting	0: 156kbps 1: 625kbps 2: 2.5Mbps 3: 5Mbps 4: 10Mbps	○

○: Necessary △: As necessary ×: Not necessary

(3) Operation setting DIP switch

Operation setting DIP switch	Setting Switch	Description	Set value	Setting necessity at GOT connection
	SW1, SW6	Operation mode	SW1 = OFF SW6 = ON (fixed) (Q mode)	○
	SW2	Peripheral transmissi on speed*1	OFF (fixed)	×
	SW3			
	SW4	Not used	OFF (fixed)	×
	SW5			
	SW7			
	SW8	Test mode	OFF (fixed) (Online mode)	○

○: Necessary △: As necessary ×: Not necessary

*1 The peripheral connection module operates with the baud rate set in the GOT.

 14.5.6 [Controller Setting] of GT Designer3



POINT

Operation mode of peripheral connection module
Be sure to set the "Q mode" as an operation mode of the peripheral connection module.

14.5.2 Connecting AJ65BT-R2N

This section describes the settings of the GOT and peripheral connection module in the following case of the system configuration.

POINT

- (1) Peripheral connection module
For details of the peripheral connection module, refer to the following manual.
 Peripheral Connection Module Type AJ65BT-R2N User's Manual
- (2) CC-Link module
For details of the CC-Link module, refer to the following manual.
 CC-Link System Master/Local Module User's Manual QJ61BT11N
- (3) CC-Link built-in CPU
For details on the CC-Link function built-in CPU, refer to the following manual.
 MELSEC-L CC-Link System Master/Local Module User's Manual

System configuration

 14.5.3 Switch setting of CC-Link module (Q series)
14.5.4 [Network parameter] of GX Developer

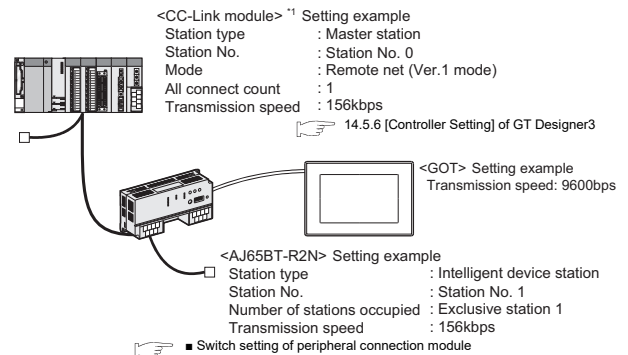

*1 The Start I/O No. of the CC-Link module is set to "0"

Switch setting of peripheral connection module

Set the station number setting switch, data link transmission speed setting switch, and operation setting DIP switch.

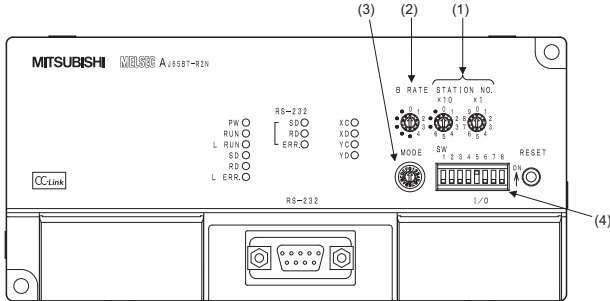

(1) Station number setting switch

Station number setting switch	Description	Set value	Setting necessity at GOT connection
	AJ65BT-R2N station number setting	1 to 64	○

○: Necessary △: As necessary ×: Not necessary

(2) Data link transmission speed setting switch

Data link transmission speed setting switch	Description	Set value	Setting necessity at GOT connection
	Data link transmission speed setting	0: 156kbps 1: 625kbps 2: 2.5Mbps 3: 5Mbps 4: 10Mbps	○

○: Necessary △: As necessary ×: Not necessary

(3) Mode setting switch

Mode setting switch	Description	Set value	Setting necessity at GOT connection
	Mode setting	5 (fixed) (MELSOFT/ connection mode)	○

○: Necessary △: As necessary ×: Not necessary

(4) RS-232 transmission setting switch

RS-232 transmission setting switch	Setting switch	Description	Set value	Setting necessity at GOT connection
	SW1	Peripheral transmission speed*1	OFF (fixed)	○
	SW2			
	SW3			
	SW4			
	SW5	Data bit length	OFF (fixed)	○
	SW6	Parity bit length	OFF (fixed)	○
	SW7			
	SW8	Stop bit length	OFF (fixed)	○

○: Necessary △: As necessary ×: Not necessary

*1 The peripheral connection module operates with the baud rate set in the GOT.

14.5.6 [Controller Setting] of GT Designer3

POINT

Precautions when setting peripheral connection module

- mode setting switch
Be sure to set the Operation mode setting switch to "5" (MELSOFT/connection mode).
- RS-232 transmission setting switch
Turn OFF SW1 through SW8 of the RS-232 transmission setting switch.
If any switch of SW1 through SW8 is ON, setting error will occur (RUN LED turns off).

14.5.3 Switch setting of CC-Link module (Q series)

Set the station number setting switch, transmission speed / mode setting switch.

QJ61BT11, QJ61BT11N

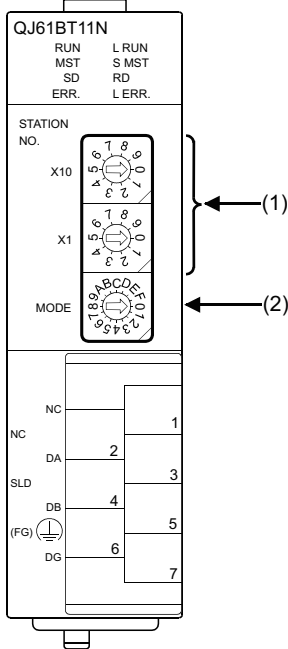

(1) Station number setting switch

Station number setting switch	Description	Set value	Setting necessity at GOT connection
	Station number setting (master station)	0 (fixed)	○

○: Necessary △: As necessary ×: Not necessary

(2) Transmission rate/mode setting switch

Transmission rate/mode setting switch	Description	Set value	Setting necessity at GOT connection
	Transmission rate/mode setting	0: 156kbps 1: 625kbps 2: 2.5Mbps 3: 5Mbps 4: 10Mbps	○

○: Necessary △: As necessary ×: Not necessary

POINT

When the switch setting has been changed
Turn the PLC CPU OFF then ON again, or reset the PLC CPU.

14.5.4 [Network parameter] of GX Developer

(1) Network parameter

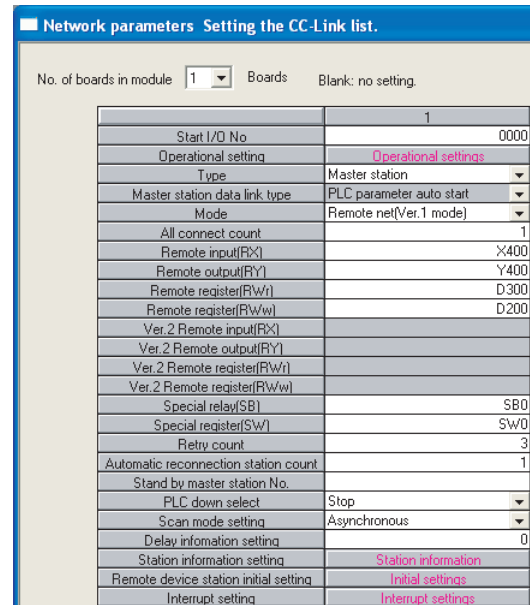

Item	Set value	Setting necessity at GOT connection
No. of boards in module	1	○
Start I/O No.	0000H	○
Operation setting	(Use default value)	△
Type	Master station (fixed)	○
Mode	Remote net (Ver.1 mode)	○
All connect count	1	○
Remote input (RX)	X400	△
Remote output (RY)	Y400	△
Remote register (RW/r)	D300	△
Remote register (RW/w)	D200	△
Special relay (SB)	SB0	△
Special register (SW)	SW0	△
Retry count		△
Automatic reconnection station count		△
Stand by master station No.	(Use default value)	×
PLC down select		△
Scan mode setting		△
Delay information setting		△
Station information setting	Refer to (2)	○
Remote device station initial setting	(Use default value)	×
Interrupt setting		×

○: Necessary △: As necessary ×: Not necessary

9 MELSECNET/H CONNECTION (PLC TO PLC NETWORK)
 10 MELSECNET/T/IO CONNECTION (PLC TO PLC NETWORK)
 11 CC-LINK IE CONTROLLER NETWORK CONNECTION
 12 CC-LINK IE FIELD NETWORK CONNECTION
 13 CC-LINK CONNECTION (INTELLIGENT DEVICE STATION)
 14 CC-LINK CONNECTION (Via G4)
 15 INVERTER CONNECTION
 16 SERVO AMPLIFIER CONNECTION

(2) Station information setting

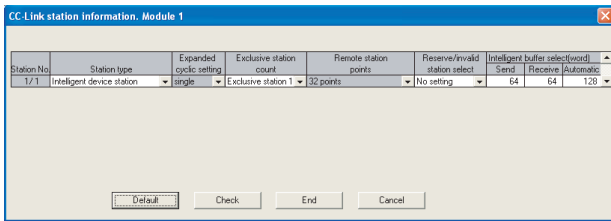

Item*1	Set value	Setting necessity at GOT connection
Station type*2	Intelligent device station (fixed)	○
Number of stations occupied	Exclusive station 1 (fixed)	○
Reserve/invalid station select	No setting	○
Intelligent buffer select (word)	(Use default value)	×

○: Necessary △: As necessary ×: Not necessary

- *1 When the [Mode] of the CC-Link module is set at [Remote net - (Ver. 2 mode)], [Remote station points] can be set. [Remote station points] is a setting for the remote I/O station. The default value (32 points) must be used on the GOT.
- *2 When the [Mode] of the CC-Link module is set at [Remote net - (Ver. 2 mode)] or [Remote net - Additional mode], set to [Ver. 1 Intelligent device station].

POINT

When changing the network parameter
After writing the network parameter to the PLC CPU, operate the PLC CPU ether turning OFF and then ON or resetting.

(3) Completion confirmation

After initial communications of CC-Link are completed, the L RUN LED of AJ65BT-G4-S3 turns on. The GOT starts to monitor after the L-RUN LED of AJ65BT-G4-S3 turns on. It does not monitor while the L RUN LED turns off.

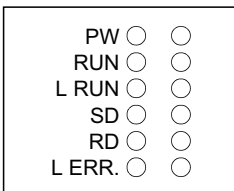

14.5.5 Parameter setting (when connecting to C Controller module (Q Series))

Use SW3PVC-CCPU-E Ver.3.05F or later for the C Controller module setting utility.

(1) Connection settings

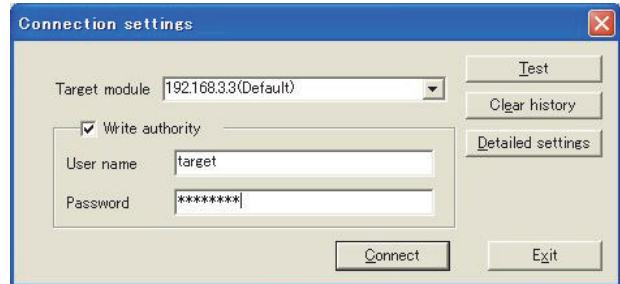

Item	Set value	Setting necessity at GOT connection
Target module*1	192.168.3.3	○
Write authority	Mark the checkbox	○
User name*2	target	○
Password*2	password	○
Detailed settings	-	△

○: Necessary △: As necessary ×: Not necessary

- *1 If the IP address of the C Controller module (Q Series) has been changed, input the changed IP address or host name.
- *2 If the account of the C Controller module (Q Series) has been changed, input the changed user name and password.

(2) [Parameter Setting] of CC-Link utility
 (a) Network parameter

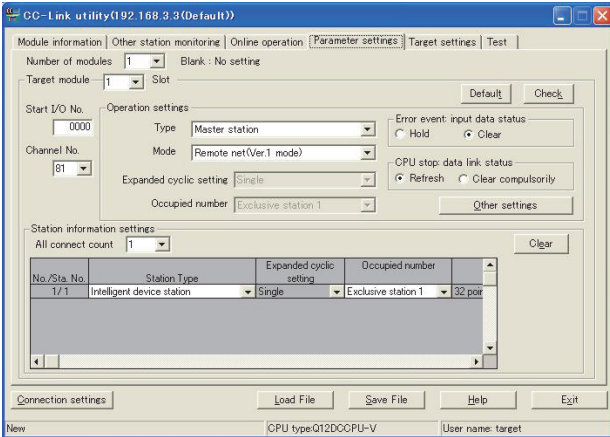

Item	Set value	Setting necessity at GOT connection
Number of modules	1	○
Target module	1	○
Start I/O No.	0000H	○
Channel No.	(Use default value)	○
Operation setting	type	Master station(fixed) ○
	Mode*1	Remote net (Ver.1 mode) ○
	Expanded cyclic station	Single(fixed) △
	Occupied number	Exclusive station 1 (fixed) △
	Error event : input data status	Clear △
	CPU stop: data link status	Refresh △
	Other settings	(Use default value) △
Station information settings	All connect count	1 ○
	Station type	Ver.1 Intelligent device station(fixed) ○
	Expanded cyclic station	Single △
	Occupied number*2	Exclusive station 1 ×
	Remote station points	32 points ○
	Reserve/invalid station select	No setting ○
	Intelligent buffer select (word)	(Use default value) ×

○: Necessary △: As necessary ×: Not necessary

- *1 If the CC-Link module [Mode] is [Remote net -Ver.1 mode], [Remote station points] cannot be set.
- *2 Set the same setting as that of the GOT.

POINT

When changing the network parameter
 After writing the network parameter to the C Controller module (Q Series), either turn the C Controller module (Q Series) OFF and then ON or reset it.

14.5.6 [Controller Setting] of GT Designer3

Item	Set value
Transmission Speed	9600bps
	19200bps
	38400bps
	57600bps
	115200bps
Retry Count	0 to 5times
Timeout Time	3 to 30sec
Delay Time	0 to 300ms

POINT

[Controller Setting] of GT Designer3
 For [Controller Setting], of GT Designer3, refer to the following.

- ➔ 14.4.1 Setting communication interface (Communication settings)

9 MELSECNET/H CONNECTION (PLC CONNECTION TO PLC NETWORK)
 10 MELSECNET/10 CONNECTION (PLC CONNECTION TO PLC NETWORK)
 11 CC-Link IE CONTROLLER NETWORK CONNECTION
 12 CC-Link IE FIELD NETWORK CONNECTION
 13 CC-Link CONNECTION (INTELLIGENT DEVICE STATION)
 14 CC-Link CONNECTION (Via G4)
 15 INVERTER CONNECTION
 16 SERVO AMPLIFIER CONNECTION

14.6 Precautions

■ Connection in the multiple CPU system

When the GOT is connected to multiple CPU system, the following time is taken until when the PLC runs.

QCPU (Q mode), motion controller CPU (Q series): 10 seconds or more

MELDAS C70: 18 seconds or more

When the GOT starts before the PLC runs, a system alarm occurs. Adjust the opening screen time in the GOT setup so that no system alarm occurs.

 GT Designer3 Version□ Screen Design Manual

■ Connection to LCPU

LCPU may diagnose (check file system, execute recovering process, etc.) the SD memory card when turning on the power or when resetting. Therefore, it takes time until the SD memory card becomes available. When the GOT starts before the SD card becomes available, a system alarm occurs. Adjust the opening screen time in the GOT setup so that no system alarm occurs.

 GT Designer3 Version□ Screen Design Manual

■ Connection to Q17nDCPU, Q170MCPUCPU, CNC C70, CRnQ-700

The Q17nDCPU, Q170MCPUCPU, CNC C70 and CRnQ-700 are applicable to the CC-Link network system Ver.2 only.

For connecting to the CC-Link (Via G4) network system, set the CC-Link (G4) network system to the CC-Link Ver.2 mode.

■ Connection to Q170MCPUCPU

Set [CPU No.] to "2" in the device setting to monitor the device of the Motion CPU area (CPU No.2).

When the CPU No. is set to "0" or "1", the device on the PLC CPU area (CPU No.1) is monitored.

When the CPU No. is set to the number other than "0" to "2", a communication error occurs and the monitoring cannot be executed.

For setting the CPU No., refer to the following manual.

 GT Designer3 Version□ Screen Design Manual

Example) Setting dialog box of the bit device

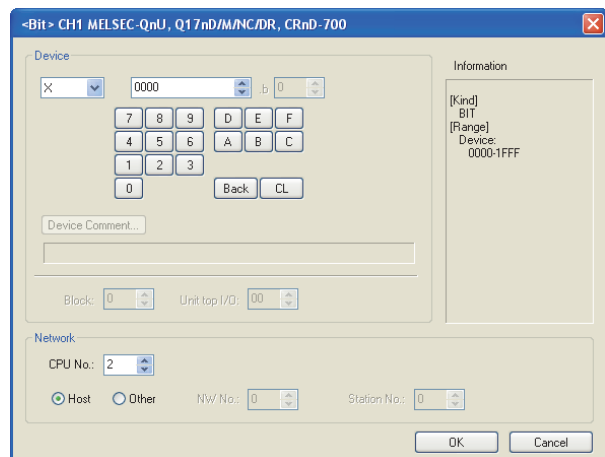

mitsubishi electric fa device connections

15.	INVERTER CONNECTION	15 - 1
16.	SERVO AMPLIFIER CONNECTION	16 - 1
17.	ROBOT CONTROLLER CONNECTION	17 - 1
18.	CNC CONNECTION	18 - 1
19.	ENERGY MEASURING UNIT/ELECTRIC MULTI-MEASURING INSTRUMENT CONNECTION.....	19 - 1

15

INVERTER CONNECTION









15.1 Connectable Model List	15 - 2
15.2 System Configuration	15 - 3
15.3 Connection Diagram	15 - 24
15.4 GOT Side Settings	15 - 32
15.5 FREQROL Series Inverter Side Settings	15 - 34
15.6 Device Range that Can Be Set	15 - 50
15.7 Precautions	15 - 53

15. INVERTER CONNECTION

15.1 Connectable Model List

The following table shows the connectable models.

Series	Model name	Clock	Communication type	GT 16	GT 15	GT 14	GT 12	GT11 Bus	GT11 Serial	GT 10 5/4	GT 10 20/30	Refer to
FREQROL	FREQROL-A500/A500L	×	RS-485	○	○	○	○	×	○	○	○	 15.2.1
	FREQROL-F500/F500L			○	○	○	○	○	○	○		
	FREQROL-V500/V500L			○	○	○	○	○	○	○		
	FREQROL-E500	×	RS-485	○	○	○	○	×	○	○	○	 15.2.2
	FREQROL-S500/S500E											
	FREQROL-F500J											
	FREQROL-D700											
	FREQROL-F700PJ	×	RS-485	○	○	○	○	×	○	○	○	 15.2.3
	FREQROL-E700											
	FREQROL-A700											
	FREQROL-F700	×	RS-485	○	○	○	○	×	○	○	○	 15.2.4
FREQROL-F700P												
FREQROL-A800/F800	×	RS-485	○	○	○	○	×	○	○	○	 15.2.5	
Sensorless servo	FREQROL-E700EX	×	RS-485	○	○	○	○	×	○	○	○	 15.2.3
MELIPM	MD-CX522-□□K(-A0)	×	RS-485	○	○	○	○	×	○	○	○	 15.2.6

15.2 System Configuration

15.2.1 Connecting to FREQROL-A500/A500L/F500/F500L/V500/V500L

■ When connecting to one inverter

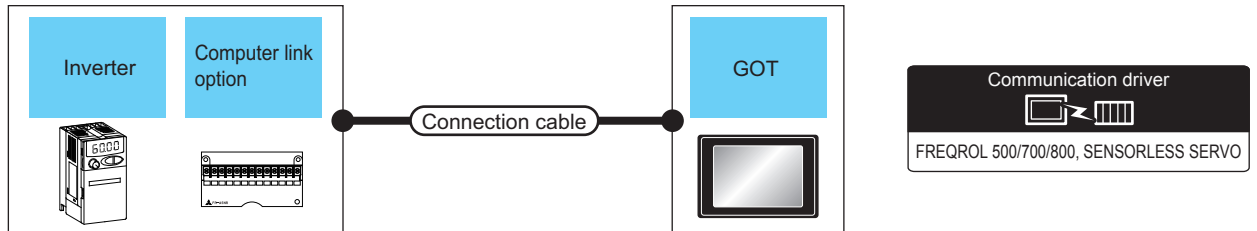

Inverter		Connection cable		GOT		Number of connectable equipment	
Model name	Computer link option	Communication type	Connection diagram number	Max. distance	Option device		Model
FREQROL-A500/A500L F500/F500L V500/V500L *2	-	RS-485		500m	GT16-C02R4-9S (0.2m)		1 GOT for 1 inverter
					GT15-RS2T4-9P*1		
					GT15-RS4-9S		
			- (Built into GOT)				
				500m	- (Built into GOT)		
FREQROL-A500/A500L F500/F500L V500/V500L	FR-A5NR	RS-485		500m	GT16-C02R4-9S (0.2m)		1 GOT for 1 inverter
					GT15-RS2T4-9P*1		
					GT15-RS4-9S		
			- (Built into GOT)				
				500m	- (Built into GOT)		

*1 Connect it to the RS-232 interface (built into GOT). It cannot be mounted on GT1655 and GT155□.

*2 Connect to the PU port of the inverter.

9
MELSECNET/H CONNECTION (PLC CONNECTION TO PLC NETWORK)
10
MELSECNET/T0 CONNECTION (PLC CONNECTION TO PLC NETWORK)
11
CC-Link IE CONTROLLER NETWORK CONNECTION
12
CC-Link IE FIELD NETWORK CONNECTION
13
CC-Link CONNECTION (INTELLIGENT DEVICE STATION)
14
CC-Link CONNECTION (Via G4)
15
INVERTER CONNECTION
16
SERVO AMPLIFIER CONNECTION

■ When connecting to multiple inverters (Max. 31) (Using the distributor)

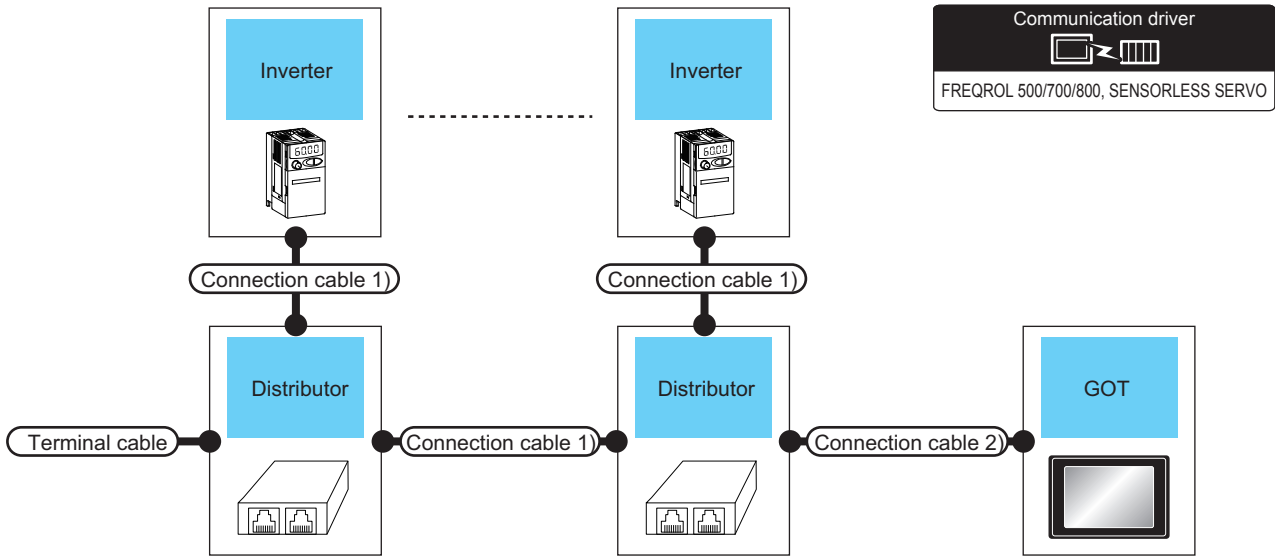

Inverter		Terminal cable	Connection cable 1)	Distributor*3	Connection cable 2)	GOT		Max. distance	Number of connectable equipment
Model name	Communication type					Option device	Model		
FREQROL-A500/A500L F500/F500L V500/V500L *2	RS-485	RS485 connection diagram 9) 	RS485 connection diagram 3) 	BMJ-8 (Recommended)	RS485 connection diagram 1) 	GT16-C02R4-9S (0.2m)		500m	31 inverters for one GOT*4
						GT15-RS2T4-9P*1			
				GT15-RS4-9S					
				- (Built into GOT)	 				
				BMJ-8 (Recommended)	RS485 connection diagram 10) 	- (Built into GOT)			

*1 Connect it to the RS-232 interface (built into GOT). It cannot be mounted on GT1655 and GT155□.

*2 Connect to the PU port of the inverter.

*3 The distributor is a product manufactured by HAKKO ELECTRIC CO., LTD. For details, contact HAKKO ELECTRIC CO., LTD.

*4 For GT11 and GT10, the number of connectable inverters differs according to the hardware version. For the procedure to check the hardware version, refer to the following manual.

GT11 User's Manual
GT10 User's Manual

Model name	Hardware version	Number of connectable Inverter
GT1155-QTBD	C or later	31
	B or earlier	10
GT1155-QSBD GT1150-QLBD	F or later	31
	E or earlier	10
GT1055-QSBD GT1050-QBBD	C or later	31
	B or earlier	10
GT1045-QSBD GT1040-QBBD	A or later	31

Model name	Hardware version	Number of connectable Inverter
GT1030-L□D GT1030-H□D	B or later	31
	A or earlier	10
GT1020-L□D	E or later	31
	D or earlier	10

9	MELSECNET/H CONNECTION (PLC CONNECTION TO PLC NETWORK)
10	MELSECNET/10 CONNECTION (PLC CONNECTION TO PLC NETWORK)
11	CC-Link IE CONTROLLER NETWORK CONNECTION
12	CC-Link IE FIELD NETWORK CONNECTION
13	CC-Link CONNECTION (INTELLIGENT DEVICE STATION)
14	CC-Link CONNECTION (Via G4)
15	INVERTER CONNECTION
16	SERVO AMPLIFIER CONNECTION

■ When connecting to multiple inverters (Max. 31) (Using the computer link option)

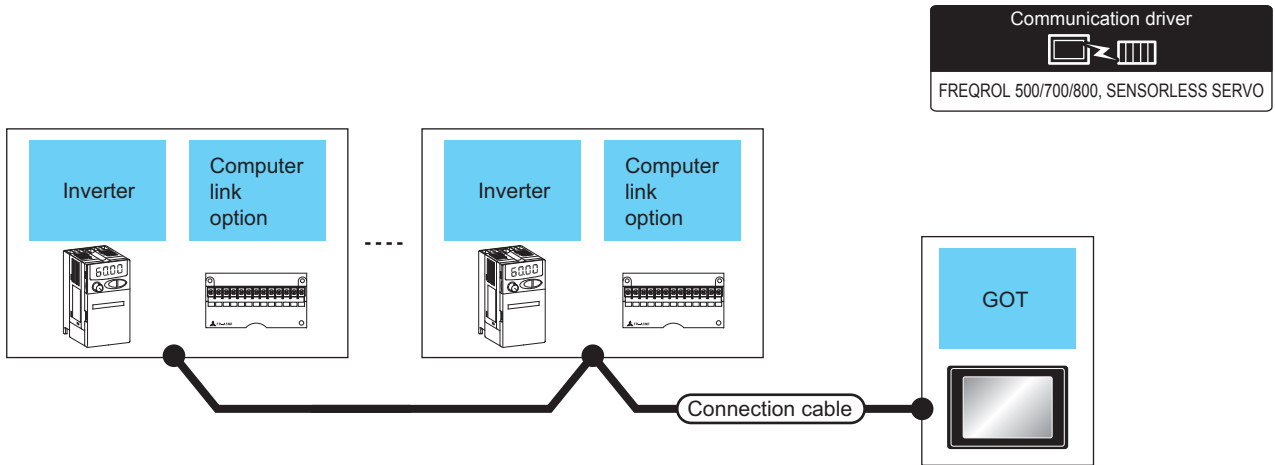

Inverter		Connection cable		GOT		Max. distance	Number of connectable equipment
Model name	Computer link option	Communication type	Connection diagram number	Option device	Model		
FREQROL-A500/A500L F500/F500L V500/V500L	FR-A5NR	RS-485	RS485 connection diagram 4)	GT16-C02R4-9S(0.2m)		500m	31 inverters for one GOT* ²
				GT15-RS2T4-9P* ¹			
				GT15-RS4-9S			
			- (Built into GOT)				
			RS485 connection diagram 12)	- (Built into GOT)			

*1 Connect it to the RS-232 interface (built into GOT). It cannot be mounted on GT1655 and GT155□.

*2 For GT11 and GT10, the number of connectable inverters differs according to the hardware version. For the procedure to check the hardware version, refer to the following manual.

GT11 User's Manual
GT10 User's Manual

Model name	Hardware version	Number of connectable Inverter
GT1155-QTBD	C or later	31
	B or earlier	10
GT1155-QSBD GT1150-QLBD	F or later	31
	E or earlier	10
GT1055-QSBD GT1050-QBBD	C or later	31
	B or earlier	10
GT1045-QSBD GT1040-QBBD	A or later	31
GT1030-L□D GT1030-H□D	B or later	31
	A or earlier	10
GT1020-L□D	E or later	31
	D or earlier	10

15.2.2 Connecting to FREQROL-E500/S500/S500E/F500J/D700/F700PJ

■ When connecting to one inverter

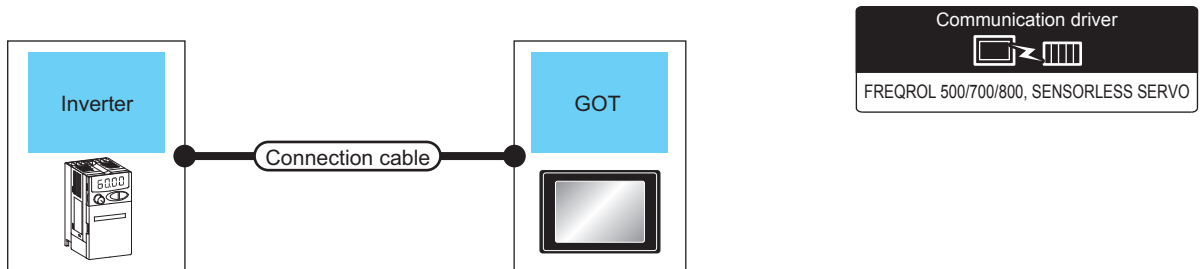

Inverter		Connection cable		GOT		Number of connectable equipment
Model name	Communication type	Connection diagram number	Max. distance	Option device	Model	
FREQROL- E500/S500/S500E F500J/D700/F700PJ *2	RS-485	RS485 connection diagram 1)	500m	GT16-C02R4-9S(0.2m)	GT 16	1 GOT for 1 inverter
				GT15-RS2T4-9P*1	GT 16 GT 15	
				GT15-RS4-9S	GT 14 GT 12	
		- (Built into GOT)	GT 11 Serial GT 10 5□ 4□			
		RS485 connection diagram 10)	500m	- (Built into GOT)	GT 10 20 30	

*1 Connect it to the RS-232 interface (built into GOT). It cannot be mounted on GT1655 and GT155□.

*2 Connect to the PU port of the inverter.

9
MELSECNET/H
CONNECTION (PLC
TO PLC NETWORK)

10
MELSECNET/10
CONNECTION (PLC
TO PLC NETWORK)

11
CC-Link IE CONTROLLER
NETWORK
CONNECTION

12
CC-Link IE FIELD
NETWORK
CONNECTION

13
CC-Link CONNECTION
(INTELLIGENT DEVICE
STATION)

14
CC-Link
CONNECTION
(Via G4)

15
INVERTER
CONNECTION

16
SERVO AMPLIFIER
CONNECTION

■ When connecting to multiple inverters (Max. 31) (Using the distributor)

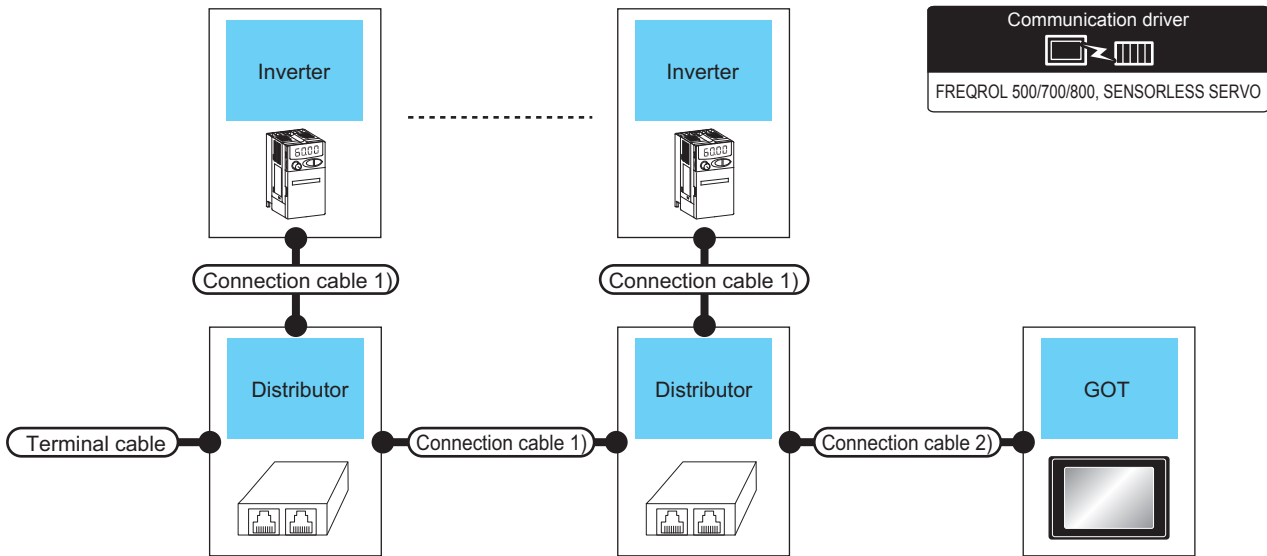

Inverter		Terminal cable	Connection cable 1)	Distributor *3	Connection cable 2)	GOT		Max. distance	Number of connectable equipment
Model name	Communication type					Option device	Model		
FREQROL-E500/S500 S500E/F500J D700 *2	RS-485	RS485 connection diagram 9) 	RS485 connection diagram 3) 	BMJ-8 (Recommended)	RS485 connection diagram 1) 	GT16-C02R4-9S (0.2m)		500m	31 inverters for one GOT*4
						GT15-RS2T4-9P*1			
GT15-RS4-9S									
- (Built into GOT)	 								
- (Built into GOT)	 								
- (Built into GOT)									

*1 Connect it to the RS-232 interface (built into GOT). It cannot be mounted on GT1655 and GT155□.

*2 Connect to the PU port of the inverter.

*3 The distributor is a product manufactured by HAKKO ELECTRIC CO., LTD. For details, contact HAKKO ELECTRIC CO., LTD.

*4 For GT11 and GT10, the number of connectable inverters differs according to the hardware version.

For the procedure to check the hardware version, refer to the following manual.

GT11 User's Manual
GT10 User's Manual

Model name	Hardware version	Number of connectable Inverter
GT1155-QTBD	C or later	31
	B or earlier	10
GT1155-QSBD GT1150-QLBD	F or later	31
	E or earlier	10
GT1055-QSBD GT1050-QBBD	C or later	31
	B or earlier	10
GT1045-QSBD GT1040-QBBD	A or later	31

Model name	Hardware version	Number of connectable Inverter
GT1030-L□D GT1030-H□D	B or later	31
	A or earlier	10
GT1020-L□D	E or later	31
	D or earlier	10

9	MELSECNET/H CONNECTION (PLC CONNECTION TO PLC NETWORK)
10	MELSECNET/10 CONNECTION (PLC CONNECTION TO PLC NETWORK)
11	CC-Link IE CONTROLLER NETWORK CONNECTION
12	CC-Link IE FIELD NETWORK CONNECTION
13	CC-Link CONNECTION (INTELLIGENT DEVICE STATION)
14	CC-Link CONNECTION (Via G4)
15	INVERTER CONNECTION
16	SERVO AMPLIFIER CONNECTION

15.2.3 Connecting to FREQROL E700/sensorless servo (FREQROL-E700EX)

■ When connecting to one inverter

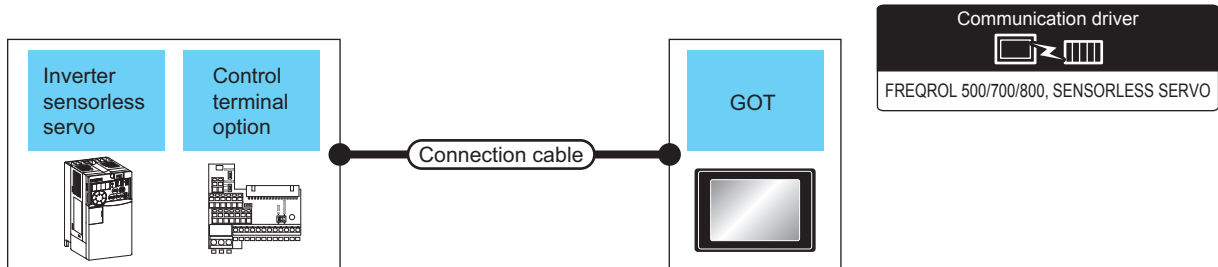

Inverter			Connection cable		GOT		Number of connectable equipment
Model name	Control terminal option	Communication type	Connection diagram number	Max. distance	Option device	Model	
FREQROL-E700/ sensorless servo (FREQROL-E700EX) ^{*2}	-	RS-485	RS485 connection diagram 1)	500m	GT16-C02R4-9S (0.2m)		1 GOT for 1 inverter
					GT15-RS2T4-9P ^{*1}		
					GT15-RS4-9S		
			- (Built into GOT)				
			RS485 connection diagram 10)	500m	- (Built into GOT)		
FREQROL-E700/ sensorless servo (FREQROL-E700EX) ^{*3}	FR-E7TR ^{*3}	RS-485	RS485 connection diagram 7)	500m	GT16-C02R4-9S (0.2m)		
					GT15-RS2T4-9P ^{*1}		
					GT15-RS4-9S		
						RS485 connection diagram 15)	500m

*1 Connect it to the RS-232 interface (built into GOT). It cannot be mounted on GT1655 and GT155□.

*2 Connect to the PU port of the inverter.

*3 The control terminal option and the PU port cannot be used at the same time.

■ When connecting to multiple inverters (Max. 31) (Using the distributor)

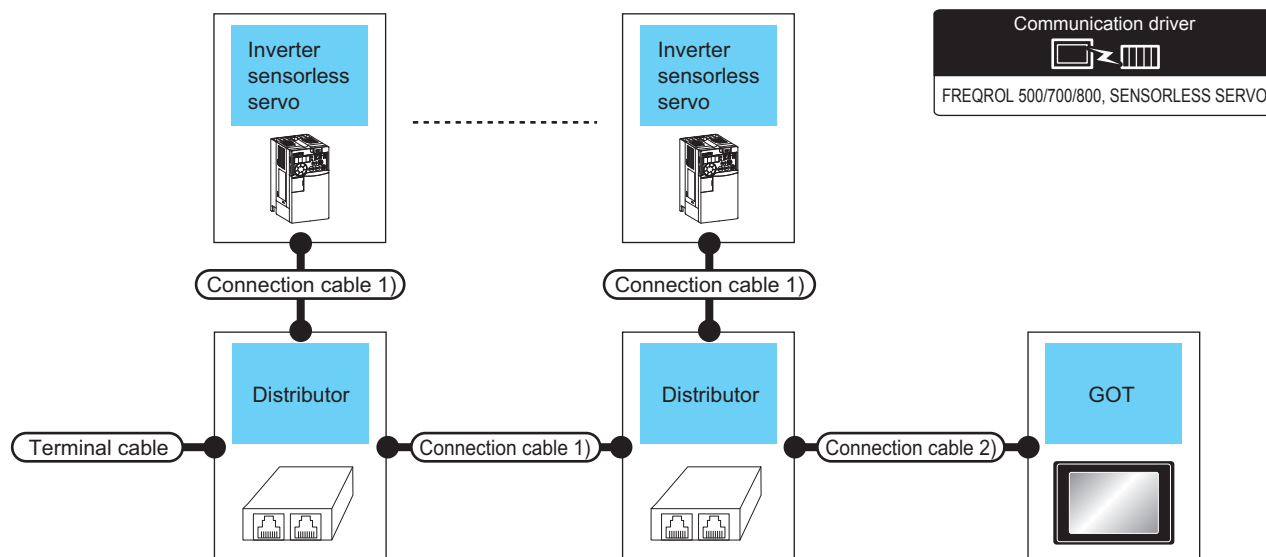

Inverter		Terminating cable	Connection cable 1)	Distributor*3	Connection cable 2)	GOT		Max. distance	Number of connectable equipment
Model name	Communication type					Option device	Model		
FREQROL-E700/ sensorless servo (FREQROL-E700EX)*2	RS-485	RS485 connection diagram 9) <small>User preparing</small>	RS485 connection diagram 3) <small>User preparing</small>	BMJ-8 (Recommended)	RS485 connection diagram 1) <small>User preparing</small>	GT16-C02R4-9S (0.2m)	GT16	500m	31inverters for one GOT*4
						GT15-RS2T4-9P*1	GT16		
				GT15-RS4-9S	GT15				
				- (Built into GOT)	GT14 GT12 GT11 Serial GT10 5□4□				
				BMJ-8 (Recommended)	RS485 connection diagram 10) <small>User preparing</small>	- (Built into GOT)	GT10 20 30 24V		

*1 Connect it to the RS-232 interface (built into GOT). It cannot be mounted on GT1655 and GT155□.

*2 Connect to the PU port of the inverter.

*3 The distributor is a product manufactured by HAKKO ELECTRIC CO., LTD. For details, contact HAKKO ELECTRIC CO., LTD.

*4 For GT11 and GT10, the number of connectable inverters differs according to the hardware version. For the procedure to check the hardware version, refer to the following manual.

👉 GT11 User's Manual
GT10 User's Manual

Model name	Hardware version	Number of connectable Inverter
GT1155-QTBD	C or later	31
	B or earlier	10
GT1155-QSBD GT1150-QLBD	F or later	31
	E or earlier	10
GT1055-QSBD GT1050-QBBD	C or later	31
	B or earlier	10
GT1045-QSBD GT1040-QBBD	A or later	31

9
MELSECNET/H
CONNECTION (PLC
TO PLC NETWORK)

10
MELSECNET/10
CONNECTION (PLC
TO PLC NETWORK)

11
CC-Link IE CONTROLLER
NETWORK
CONNECTION

12
CC-Link IE FIELD
NETWORK
CONNECTION

13
CC-Link CONNECTION
(INTELLIGENT DEVICE
STATION)

14
CC-Link
CONNECTION
(Via G4)

15
INVERTER
CONNECTION

16
SERVO AMPLIFIER
CONNECTION

Model name	Hardware version	Number of connectable Inverter
GT1030-L□D	B or later	31
GT1030-H□D	A or earlier	10
GT1020-L□D	E or later	31
	D or earlier	10

■ When connecting to multiple inverters (Max. 31) (Using the control terminal option)

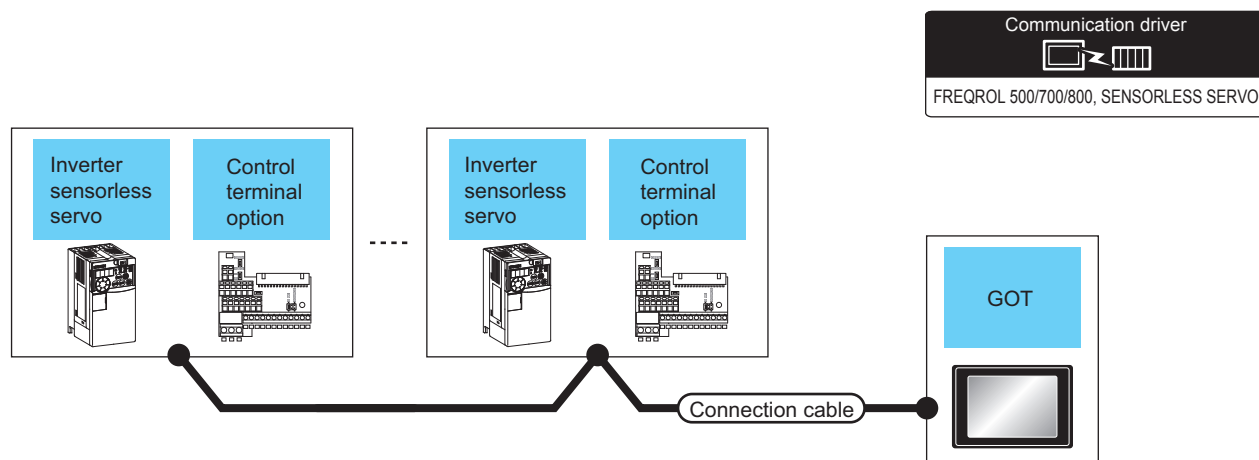

Inverter		Connection cable		GOT		Max. distance	Number of connectable equipment
Model name	Control terminal option	Communication type	Connection diagram number	Option device	Model		
FREQR0L-E700/ sensorless servo (FREQR0L- E700EX) ^{*2}	FR-E7TR ^{*2}	RS-485	RS485 connection diagram 8)	GT16-C02R4-9S(0.2m)		500m	31 inverters for one GOT ^{*3}
				GT15-RS2T4-9P ^{*1}			
				GT15-RS4-9S			
				- (Built into GOT)			
			RS485 connection diagram 16)	- (Built into GOT)			

- *1 Connect it to the RS-232 interface (built into GOT). It cannot be mounted on GT1655 and GT155□.
- *2 The control terminal option and the PU port cannot be used at the same time.
- *3 For GT11 and GT10, the number of connectable inverters differs according to the hardware version. For the procedure to check the hardware version, refer to the following manual.

[GT11 User's Manual](#)
[GT10 User's Manual](#)

Model name	Hardware version	Number of connectable Inverter
GT1155-QTBD	C or later	31
	B or earlier	10
GT1155-QSBD GT1150-QLBD	F or later	31
	E or earlier	10
GT1055-QSBD GT1050-QBBD	C or later	31
	B or earlier	10
GT1045-QSBD GT1040-QBBD	A or later	31
GT1030-L□D GT1030-H□D	B or later	31
	A or earlier	10
GT1020-L□D	E or later	31
	D or earlier	10

15.2.4 Connecting to FREQROL-A700/F700/700P

■ When connecting to one inverter

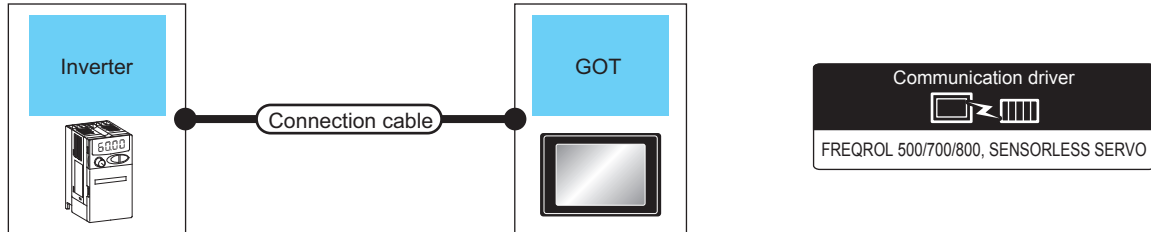

Inverter		Connection cable		GOT		Number of connectable equipment
Model name	Communication type	Connection diagram number	Max. distance	Option device	Model	
FREQROL-A700/F700/F700P (PU port)	RS-485	RS485 connection diagram 1)	500m	GT16-C02R4-9S(0.2m)	GT 16	1 GOT for 1 inverter
				GT15-RS2T4-9P* ¹	GT 16 GT 15	
				GT15-RS4-9S	GT 16	
		- (Built into GOT)	GT 14 GT 12 GT 11 Serial GT 10 5□ 4□			
RS485 connection diagram 10)	500m	- (Built into GOT)	GT 20 24V 30			
FREQROL-A700/F700/F700P (Built-in RS485 terminal block)	RS-485	RS485 connection diagram 5)	500m	GT16-C02R4-9S(0.2m)	GT 16	
				GT15-RS2T4-9P* ¹	GT 16 GT 15	
				GT15-RS4-9S	GT 16	
		- (Built into GOT)	GT 14 GT 12 GT 11 Serial GT 10 5□ 4□			
RS485 connection diagram 13)	500m	- (Built into GOT)	GT 20 24V 30			

*1 Connect it to the RS-232 interface (built into GOT). It cannot be mounted on GT1655 and GT155□.

■ When connecting to multiple inverters (Max. 31) (Using the distributor)

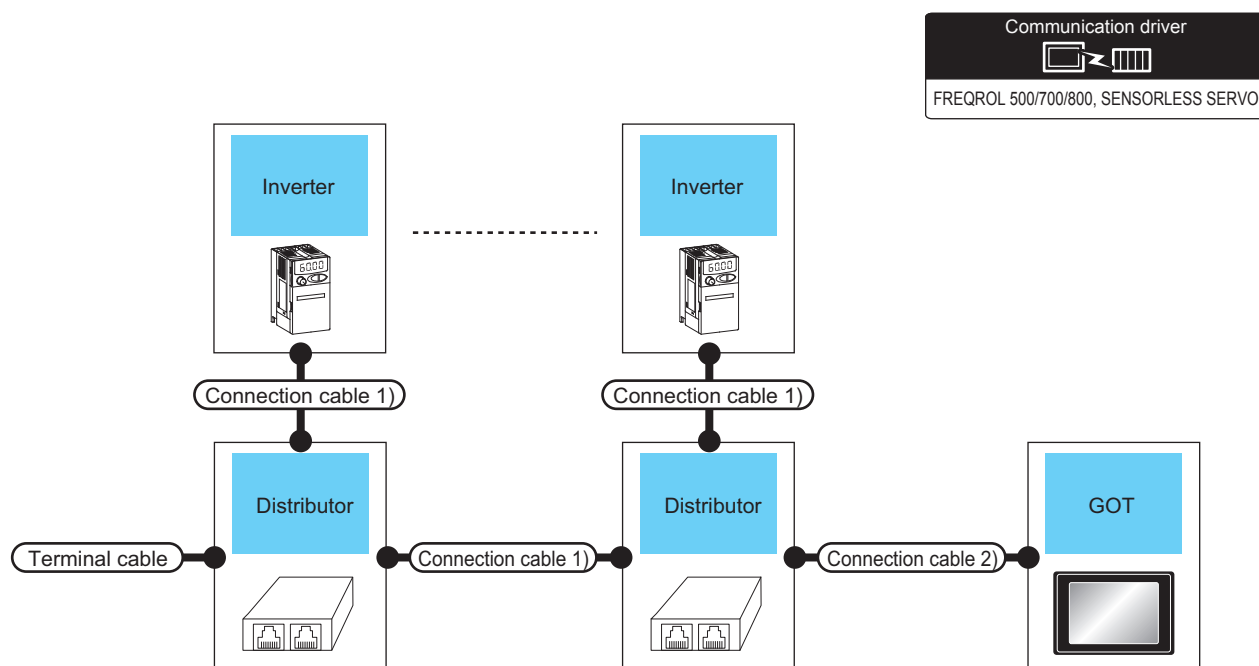

Inverter		Terminal cable	Connection cable 1)	Distributor*2	Connection cable 2)	GOT		Max. distance	Number of connectable equipment
Model name	Communication type		Connection diagram number	Model name	Connection diagram number	Option device	Model		
FREQROL-A700/F700/F700P (PU port)	RS-485	RS485 connection diagram 9) <small>User preparing</small>	RS485 connection diagram 3) <small>User preparing</small>	BMJ-8 (Recommended)	RS485 connection diagram 1) <small>User preparing</small>	GT16-C02R4-9S (0.2m)	GT 16	500m	31 inverters for one GOT*3
						GT15-RS2T4-9P*1	GT 16		
				GT15-RS4-9S	GT 15				
				- (Built into GOT)	GT 14 GT 12 GT11 Serial GT10 5□ 4□				
				BMJ-8 (Recommended)	RS485 connection diagram 10) <small>User preparing</small>	- (Built into GOT)	GT 10 2□ 3□		

*1 Connect it to the RS-232 interface (built into GOT). It cannot be mounted on GT1655 and GT155□.

*2 The distributor is a product manufactured by HAKKO ELECTRIC CO., LTD. For details, contact HAKKO ELECTRIC CO., LTD.

*3 For GT11 and GT10, the number of connectable inverters differs according to the hardware version.

For the procedure to check the hardware version, refer to the following manual.

👉 GT11 User's Manual

GT10 User's Manual

Model name	Hardware version	Number of connectable Inverter
GT1155-QTBD	C or later	31
	B or earlier	10
GT1155-QSBD GT1150-QLBD	F or later	31
	E or earlier	10

9
MELSECNET/H
CONNECTION (PLC
TO PLC NETWORK)

10
MELSECNET/10
CONNECTION (PLC
TO PLC NETWORK)

11
CC-Link IE CONTROLLER
NETWORK
CONNECTION

12

13
CC-Link IE FIELD
NETWORK
CONNECTION

14
CC-Link CONNECTION
(INTELLIGENT DEVICE
STATION)

15
CC-Link
CONNECTION
(Via G4)

16
INVERTER
CONNECTION

SERVO AMPLIFIER
CONNECTION

Model name	Hardware version	Number of connectable Inverter
GT1055-QSBD	C or later	31
GT1050-QBBD	B or earlier	10
GT1045-QSBD	A or later	31
GT1040-QBBD		
GT1030-L□D	B or later	31
GT1030-H□D	A or earlier	10
	E or later	31
GT1020-L□D	D or earlier	10

■ When connecting to multiple inverters (Max. 31) (Using the built-in RS485 terminal block)

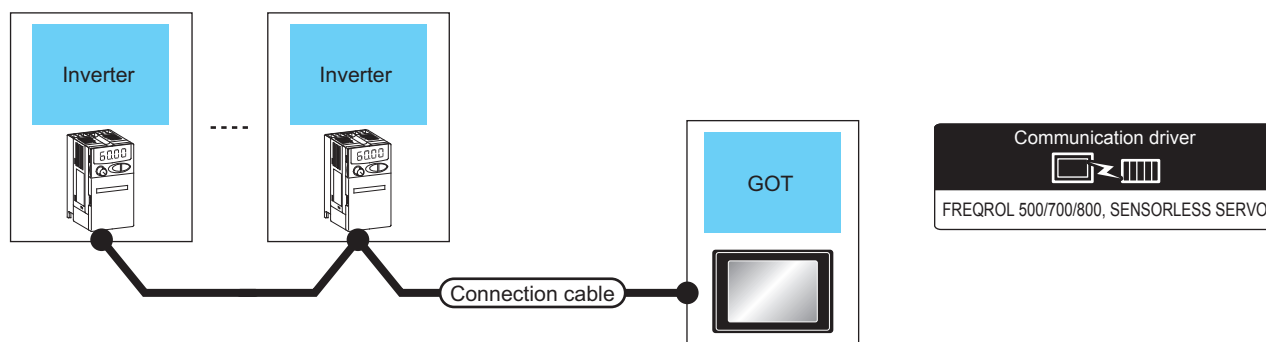

Inverter		Connection cable	GOT		Max. distance	Number of connectable equipment
Model name	Communication type	Connection diagram number	Option device	Model		
FREQROL-A700/F700/F700P (Built-in RS485 terminal block)	RS-485	RS485 connection diagram 6)	GT16-C02R4-9S(0.2m)		500m	31 inverters for one GOT ^{*2}
			GT15-RS2T4-9P ^{*1}			
			GT15-RS4-9S			
			- (Built into GOT)			
		RS485 connection diagram 14)	- (Built into GOT)			

*1 Connect it to the RS-232 interface (built into GOT). It cannot be mounted on GT1655 and GT155□.

*2 For GT11 and GT10, the number of connectable inverters differs according to the hardware version. For the procedure to check the hardware version, refer to the following manual.

GT11 User's Manual
GT10 User's Manual

Model name	Hardware version	Number of connectable Inverter
GT1155-QTBD	C or later	31
	B or earlier	10
GT1155-QSBD GT1150-QLBD	F or later	31
	E or earlier	10
GT1055-QSBD GT1050-QBBD	C or later	31
	B or earlier	10
GT1045-QSBD GT1040-QBBD	A or later	31
GT1030-L□D GT1030-H□D	B or later	31
	A or earlier	10
GT1020-L□D	E or later	31
	D or earlier	10

15.2.5 Connecting to FREQROL-A800/F800

■ When connecting to one inverter

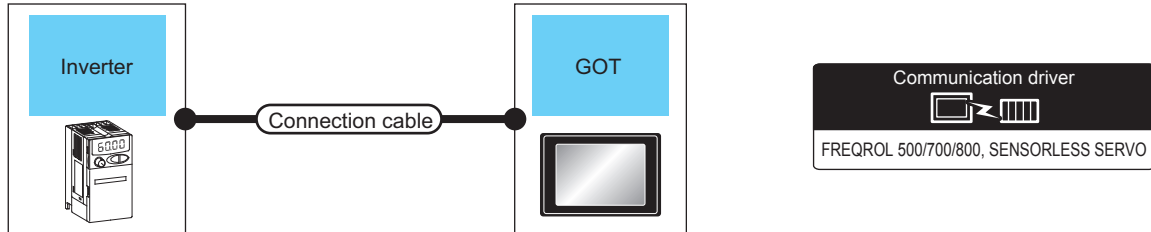

Inverter		Connection cable		GOT		Number of connectable equipment
Model name	Communication type	Connection diagram number	Max. distance	Option device	Model	
FREQROL-A800/F800 (PU port)	RS-485	RS485 connection diagram 1)	500m	GT16-C02R4-9S(0.2m)	GT 16	1 GOT for 1 inverter
				GT15-RS2T4-9P ^{*1}	GT 16 GT 15	
				GT15-RS4-9S	GT 14 GT 11 Serial	
		- (Built into GOT)	GT 10 5 4			
RS485 connection diagram 10)	500m	- (Built into GOT)	GT 24V 10 30			
FREQROL-A800/F800 (Built-in RS485 terminal block)	RS-485	RS485 connection diagram 5)	500m	GT16-C02R4-9S(0.2m)	GT 16	
				GT15-RS2T4-9P ^{*1}	GT 16 GT 15	
				GT15-RS4-9S	GT 14 GT 11 Serial	
		- (Built into GOT)	GT 10 5 4			
RS485 connection diagram 13)	500m	- (Built into GOT)	GT 24V 10 30			

*1 Connect it to the RS-232 interface (built into GOT). Cannot be mounted on GT1655 and GT155□.

■ When connecting to multiple inverters (Max. 31) (Using the distributor)

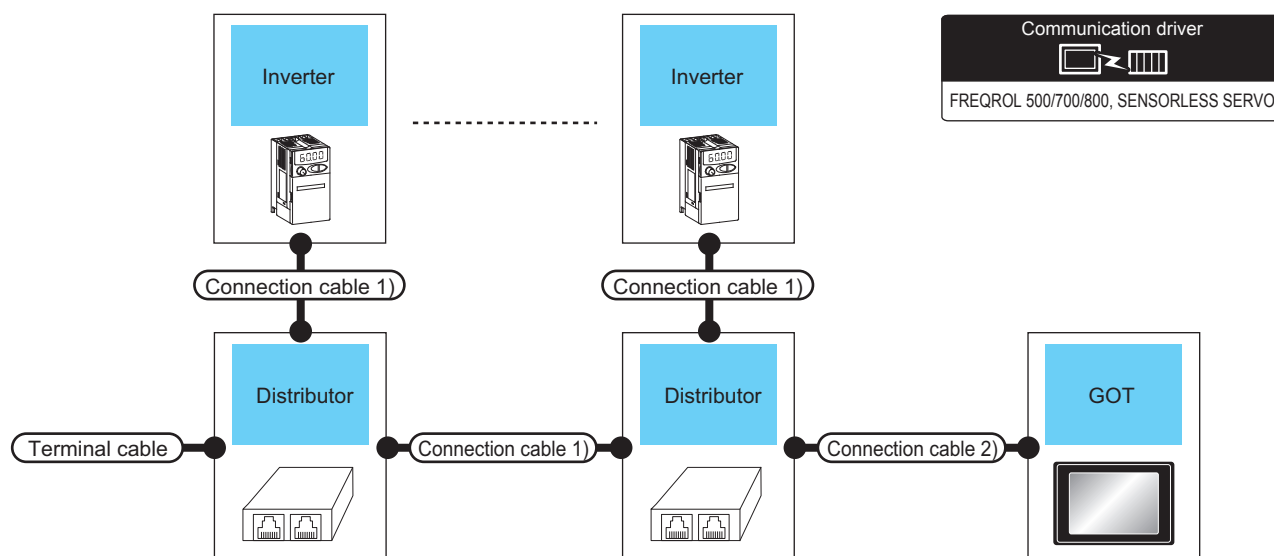

Inverter		Terminal cable	Connection cable 1)	Distributor*2	Connection cable 2)	GOT		Max. distance	Number of connectable equipment
Model name	Communication type					Option device	Model		
FREQROL-A800/F800 (PU port)	RS-485	RS485 connection diagram 9) 	RS485 connection diagram 3) 	BMJ-8 (Recommended)	RS485 connection diagram 1) 	GT16-C02R4-9S (0.2m)		500m	31 inverters for one GOT*3
						GT15-RS2T4-9P*1			
				GT15-RS4-9S					
				- (Built into GOT)	 				
				BMJ-8 (Recommended)	RS485 connection diagram 10) 	- (Built into GOT)			

*1 Connect it to the RS-232 interface (built into GOT). It cannot be mounted on GT1655 and GT155□.

*2 The distributor is a product manufactured by HAKKO ELECTRIC CO., LTD. For details, contact HAKKO ELECTRIC CO., LTD.

*3 For GT11 and GT10, the number of connectable inverters differs according to the hardware version. For the procedure to check the hardware version, refer to the following manual.

GT11 User's Manual
GT10 User's Manual

Model name	Hardware version	Number of connectable Inverter
GT1155-QTBD	C or later	31
	B or earlier	10
GT1155-QSBD GT1150-QLBD	F or later	31
	E or earlier	10
GT1055-QSBD GT1050-QBBD	C or later	31
	B or earlier	10
GT1045-QSBD GT1040-QBBD	A or later	31
GT1030-L□D GT1030-H□D	B or later	31
	A or earlier	10
GT1020-L□D	E or later	31
	D or earlier	10

■ When connecting to multiple inverters (Max. 31) (Using the built-in RS485 terminal block)

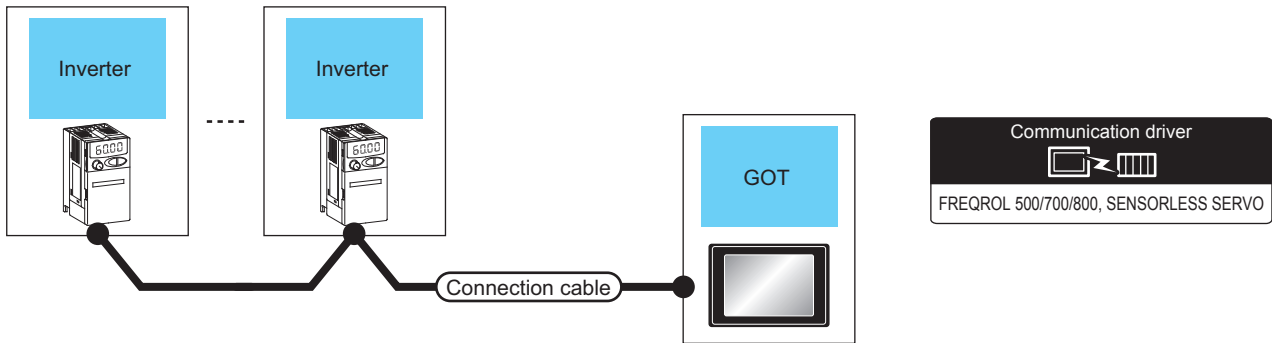

Inverter		Connection cable	GOT		Max. distance	Number of connectable equipment
Model name	Communication type	Connection diagram number	Option device	Model		
FREQROL-A800/F800 (Built-in RS485 terminal block)	RS-485	RS485 connection diagram 6)	GT16-C02R4-9S(0.2m)		500m	31 inverters for one GOT*2
			GT15-RS2T4-9P*1			
			GT15-RS4-9S			
		- (Built into GOT)				
		RS485 connection diagram 14)	- (Built into GOT)			

*1 Connect it to the RS-232 interface (built into GOT). It cannot be mounted on GT1655 and GT155□.

*2 For GT11 and GT10, the number of connectable inverters differs according to the hardware version. For the procedure to check the hardware version, refer to the following manual.

GT11 User's Manual
 GT10 User's Manual

Model name	Hardware version	Number of connectable Inverter
GT1155-QTBD	C or later	31
	B or earlier	10
GT1155-QSBD GT1150-QLBD	F or later	31
	E or earlier	10
GT1055-QSBD GT1050-QBBD	C or later	31
	B or earlier	10
GT1045-QSBD GT1040-QBBD	A or later	31
GT1030-L□D GT1030-H□D	B or later	31
	A or earlier	10
GT1020-L□D	E or later	31
	D or earlier	10

15.2.6 Connecting to MD-CX522-□□K(-A0)

■ When connecting to one inverter

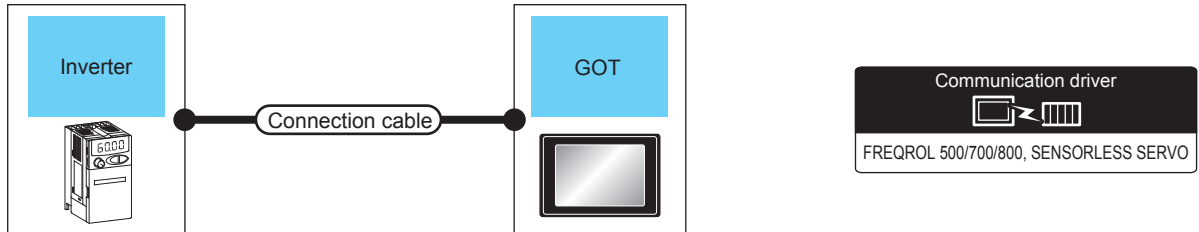

Inverter		Connection cable		GOT		Number of connectable Model name equipment
Model name	Communication type	Connection diagram number	Max. distance	Option device	Model	
MD-CX522-□□K (-A0) ^{*2}	RS-485	RS485 connection diagram 1)	20m	GT16-C02R4-9S(0.2m)	GT 16	1 GOT for 1 inverter
				GT15-RS2T4-9P ^{*1}	GT 16 GT 15	
				GT15-RS4-9S	GT 14 GT 12	
		- (Built into GOT)	GT 11 Serial GT 10 5□ GT 10 20 30			
		RS485 connection diagram 10)	20m	- (Built into GOT)	GT 10 20 30	

*1 Connect it to the RS-232 interface (built into GOT). It cannot be mounted on GT1655 and GT155□.

*2 Connect to the PU port of the inverter.

■ When connecting to multiple inverters (Max. 31) (Using the distributor)

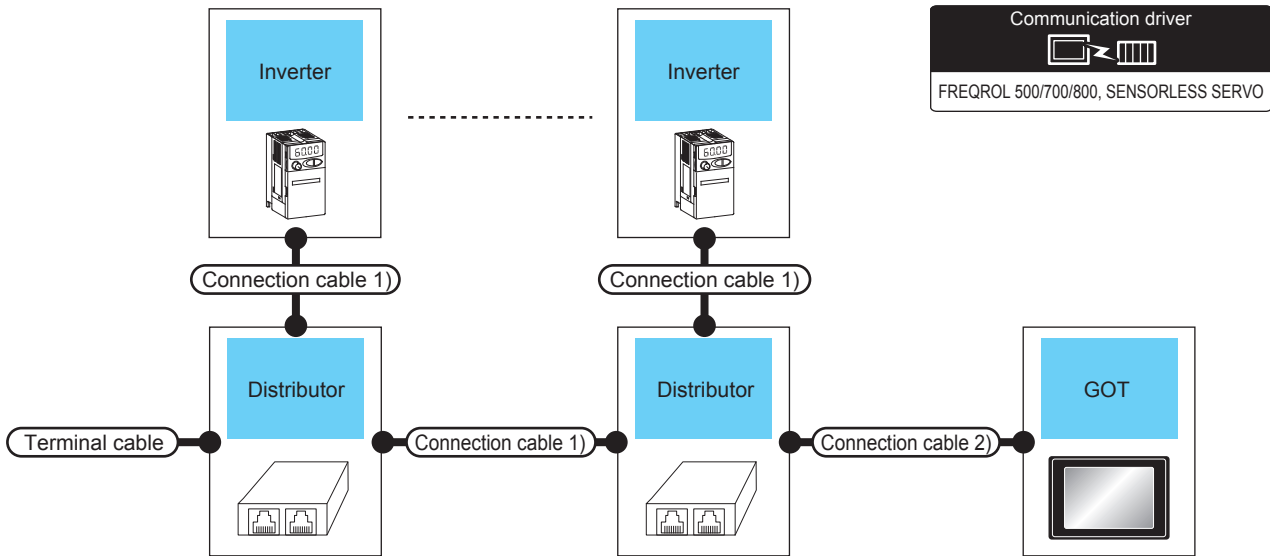

Inverter		Terminating cable	Connection cable 1)	Distributor*3	Connection cable 2)	GOT		Max. distance	Number of connectable Model name equipment
Model name	Communication type		Connection diagram number	Model name	Connection diagram number	Option device	Model		
MD-CX522 -□□K(-A0) *2	RS-485	RS485 connection diagram 9) <small>User preparing</small>	RS485 connection diagram 3) <small>User preparing</small>	BMJ-8 (Recommended)	RS485 connection diagram 1) <small>User preparing</small>	GT16-C02R4-9S (0.2m)	GT 16	20m	31 inverters for one GOT*4
						GT15-RS2T4-9P*1	GT 16		
				GT15-RS4-9S	GT 15				
				- (Built into GOT)	GT 14 GT 12 GT11 Serial GT 10 5□ 4□				
				BMJ-8 (Recommended)	RS485 connection diagram 10) <small>User preparing</small>	- (Built into GOT)	GT 10 20 24V 30		

*1 Connect it to the RS-232 interface (built into GOT). It cannot be mounted on GT1655 and GT155□.

*2 Connect to the PU port of the inverter.

*3 The distributor is a product manufactured by HAKKO ELECTRIC CO., LTD. For details, contact HAKKO ELECTRIC CO., LTD.

*4 For GT11 and GT10, the number of connectable inverters differs according to the hardware version.

For the procedure to check the hardware version, refer to the following manual.

👉 GT11 User's Manual
GT10 User's Manual

Model name	Hardware version	Number of connectable Inverter
GT1155-QTBD	C or later	31
	B or earlier	10
GT1155-QSBD GT1150-QLBD	F or later	31
	E or earlier	10
GT1055-QSBD GT1050-QBBD	C or later	31
	B or earlier	10
GT1045-QSBD GT1040-QBBD	A or later	31

Model name	Hardware version	Number of connectable Inverter
GT1030-L□D GT1030-H□D	B or later	31
	A or earlier	10
GT1020-L□D	E or later	31
	D or earlier	10

9	MELSECNET/H CONNECTION (PLC CONNECTION TO PLC NETWORK)
10	MELSECNET/10 CONNECTION (PLC CONNECTION TO PLC NETWORK)
11	CC-Link IE CONTROLLER NETWORK CONNECTION
12	CC-Link IE FIELD NETWORK CONNECTION
13	CC-Link CONNECTION (INTELLIGENT DEVICE STATION)
14	CC-Link CONNECTION (Via G4)
15	INVERTER CONNECTION
16	SERVO AMPLIFIER CONNECTION

15.3 Connection Diagram

The following diagram shows the connection between the GOT and the inverter.

15.3.1 RS-485 cable

■ Connection diagram

RS485 connection diagram 1)

(For GT16, GT15, GT14, GT12, GT11, GT105□, GT104□)

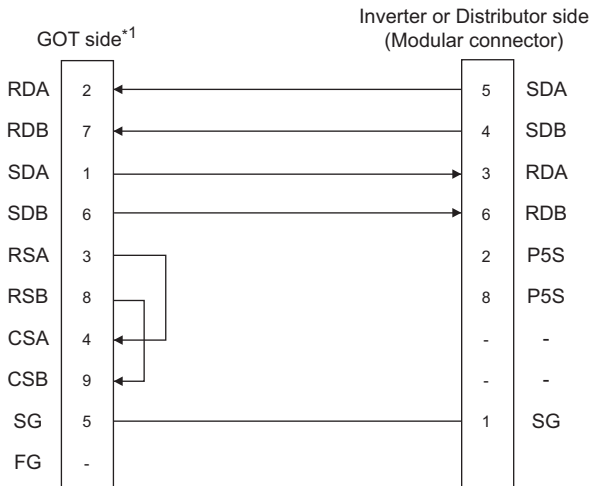

- *1 For GT16, GT15 and GT12, set the terminating resistor to "Disable".
For GT14, GT11 and GT10, set the terminating resistor to "330Ω".

1.4.3 Terminating resistors of GOT

RS485 connection diagram 2)

(For GT16, GT15, GT14, GT12, GT11, GT105□, GT104□)

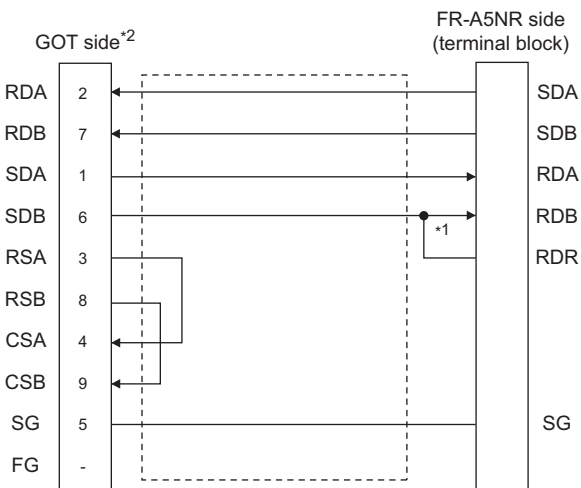

- *1 Connect a terminating resistor jumper to RDB and RDR. The terminating resistor jumper is packed together with the FR-A5NR.
- *2 For GT16, GT15 and GT12, set the terminating resistor to "Disable".
For GT14, GT11 and GT10, set the terminating resistor to "330Ω".

1.4.3 Terminating resistors of GOT

RS485 connection diagram 3)

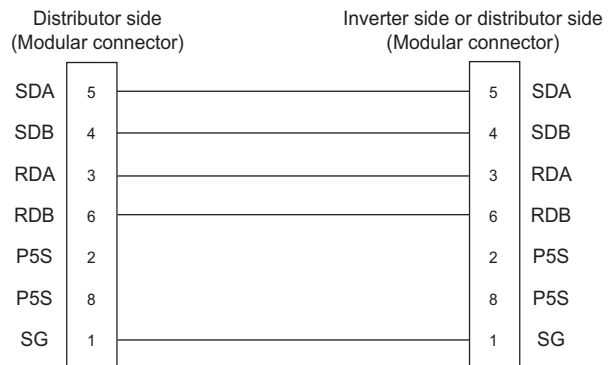

RS485 connection diagram 4)

(For GT16, GT15, GT14, GT12, GT11, GT105□, GT104□)

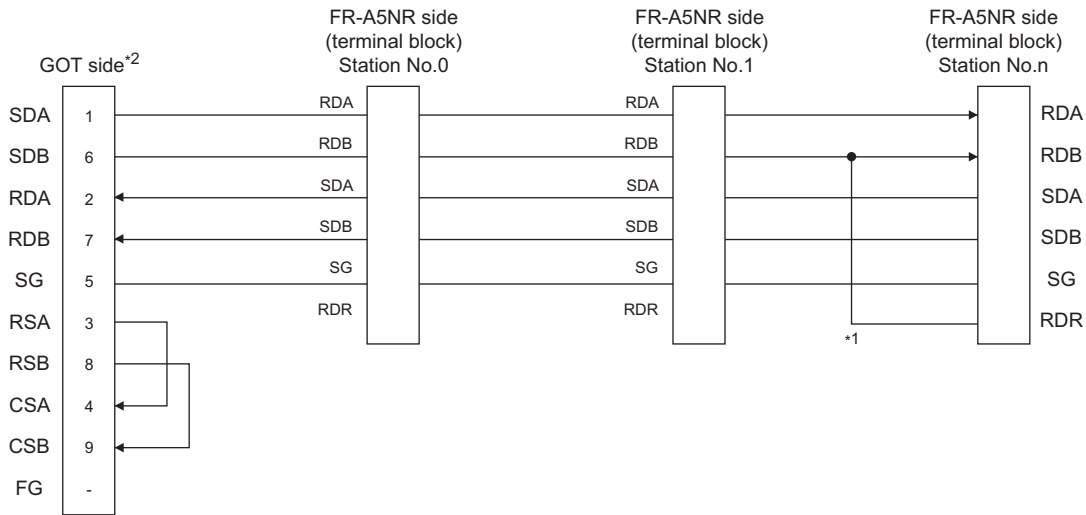

- *1 Connect a terminating resistor jumper to RDB and RDR which are assigned in the FR-A5NR of the inverter located farthest from the GOT.
The terminating resistor jumper is packed together with the FR-A5NR.
- *2 For GT16, GT15 and GT12, set the terminating resistor of GOT side, which will be a terminal, to "Enable".
For GT14, GT11 and GT10, set the terminating resistor of GOT side, which will be a terminal, to "330Ω".

1.4.3 Terminating resistors of GOT

RS485 connection diagram 5)

(For GT16, GT15, GT14, GT12, GT11, GT105□, GT104□)

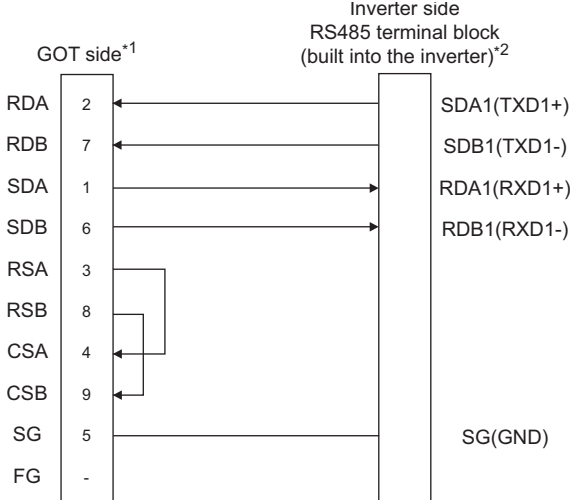

- *1 For GT16, GT15 and GT12, set the terminating resistor to "Disable".
For GT14, GT11 and GT10, set the terminating resistor to "330Ω".

1.4.3 Terminating resistors of GOT

- *2 RDA2, RDB2, SDA2 and SDB2 terminals of the RS485 terminal block (built into the inverter) cannot be used.

RS485 connection diagram 6)

(For GT16, GT15, GT14, GT12, GT11, GT105□, GT104□)

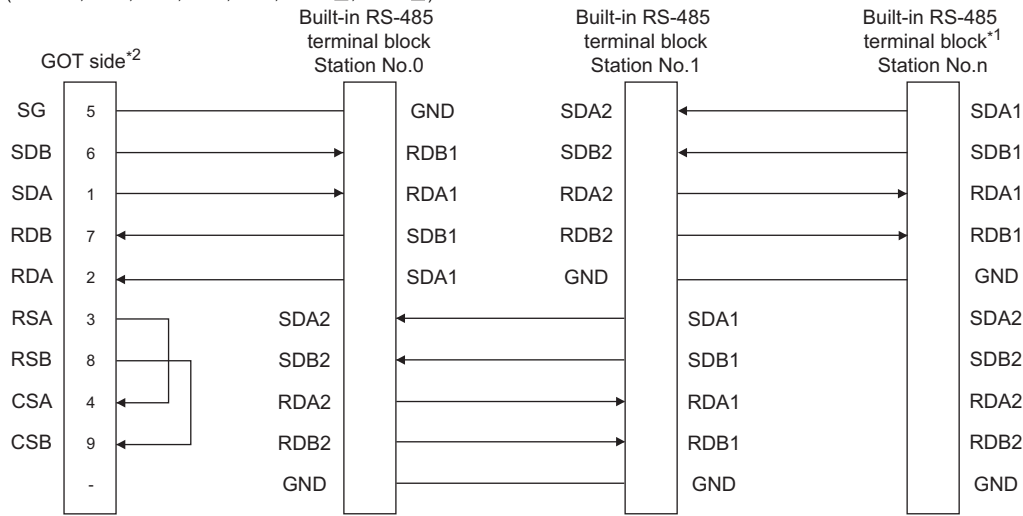

- *1 Set the terminator switch built in the farthest inverter from the GOT to ON (100Ω).
- *2 For GT16, GT15 and GT12, set the terminating resistor of GOT side, which will be a terminal, to "Enable".
For GT14, GT11 and GT10, set the terminating resistor of GOT side, which will be a terminal, to "330Ω".

1.4.3 Terminating resistors of GOT

RS485 connection diagram 7)

(For GT16, GT15, GT14, GT12, GT11, GT105□, GT104□)

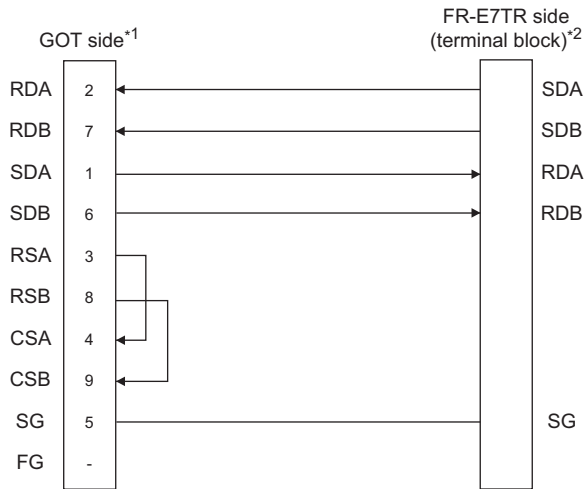

- *1 For GT16, GT15 and GT12, set the terminating resistor to "Disable".
For GT14, GT11 and GT10, set the terminating resistor to "330Ω".

1.4.3 Terminating resistors of GOT

- *2 Turn ON (100Ω) the terminator switch for the FR-E7TR.

RS485 connection diagram 8)

(For GT16, GT15, GT14, GT12, GT11, GT105□, GT104□)

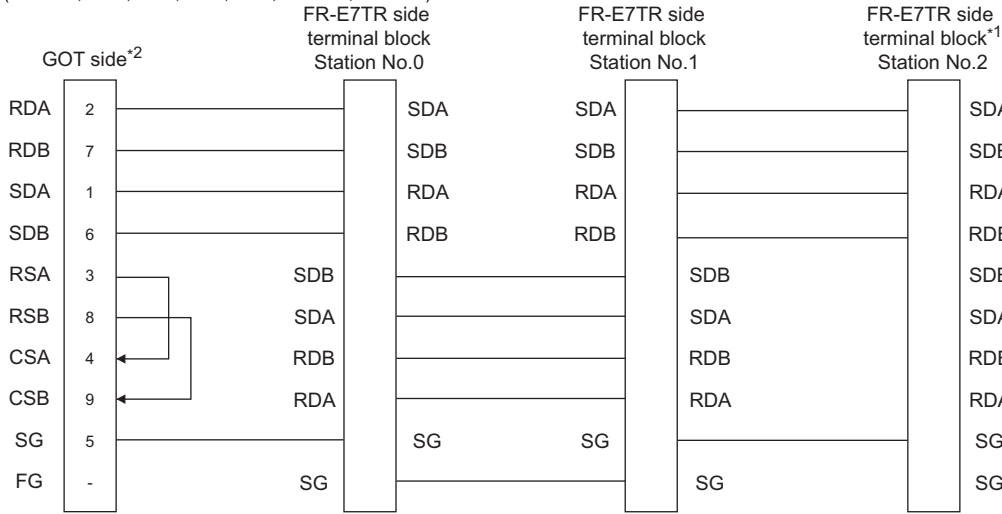

- *1 Turn ON (100Ω) the terminator switch for the most distant FR-E7TR from the GOT.
- *2 For GT16, GT15 and GT12, set the terminating resistor of GOT side, which will be a terminal, to "Enable".
For GT14, GT11 and GT10, set the terminating resistor of GOT side, which will be a terminal, to "330Ω".

☞ 1.4.3 Terminating resistors of GOT

RS485 connection diagram 9)

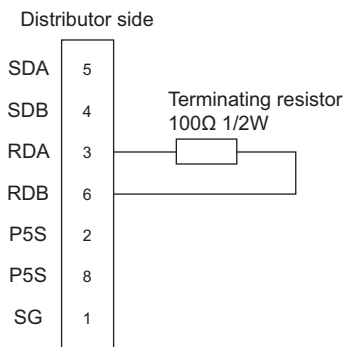

RS485 connection diagram 11)

(For GT1030, GT1020)

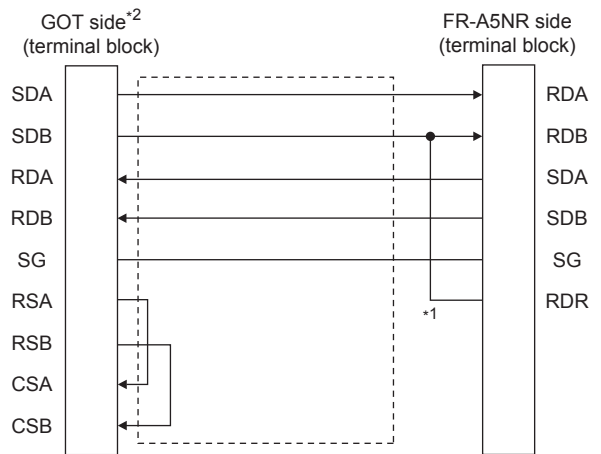

- *1 Connect a terminating resistor jumper to RDB and RDR. The terminating resistor jumper is packed together with the FR-A5NR.
- *2 Set the terminating resistor of the GOT side to "330Ω".

☞ 1.4.3 Terminating resistors of GOT

RS485 connection diagram 10)

(For GT1030, GT1020)

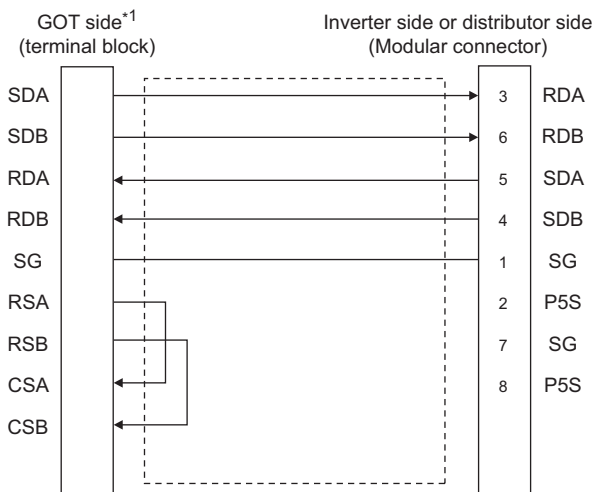

- *1 Set the terminating resistor of the GOT side to "330Ω".

☞ 1.4.3 Terminating resistors of GOT

RS485 connection diagram 12)

(For GT1030, GT1020)

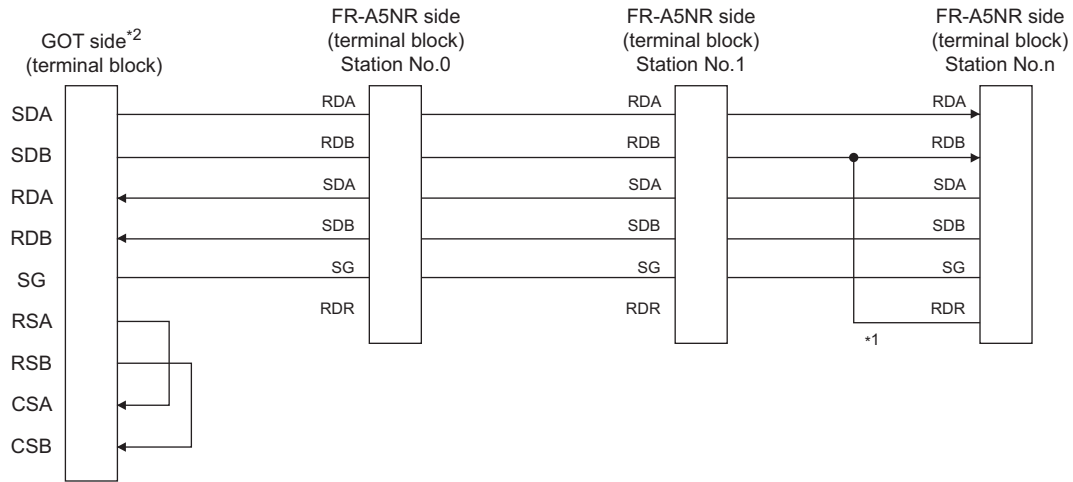

*1 Connect a terminating resistor jumper to RDB and RDR which are assigned in the FR-A5NR of the inverter located farthest from the GOT.

The terminating resistor jumper is packed together with the FR-A5NR.

*2 Set the terminating resistor of GOT side, which will be a terminal, to "330 Ω".

☞ 1.4.3 Terminating resistors of GOT

RS485 connection diagram 13)

(For GT1030, GT1020)

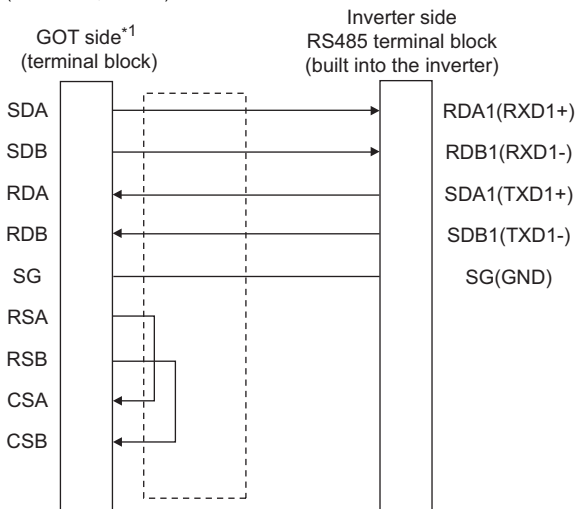

*1 Set the terminating resistor of the GOT side to "330 Ω".

☞ 1.4.3 Terminating resistors of GOT

RS485 connection diagram 14)

(For GT1030, GT1020)

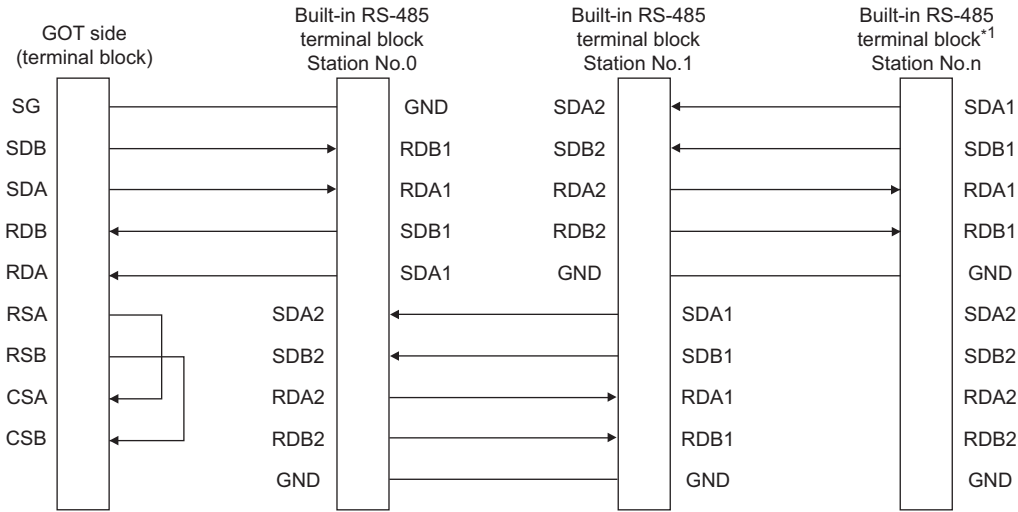

*1 Set the terminator switch built in the farthest inverter from the GOT to ON (100Ω).

*2 Set the terminating resistor of GOT side, which will be a terminal, to "330Ω".

1.4.3 Terminating resistors of GOT

RS485 connection diagram 15)

(For GT1030, GT1020)

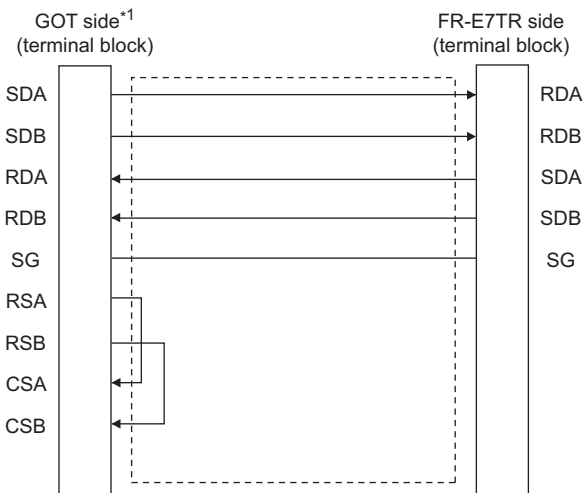

*1 Set the terminating resistor of the GOT side to "330Ω".

1.4.3 Terminating resistors of GOT

RS485 connection diagram 16)

(For GT1030, GT1020)

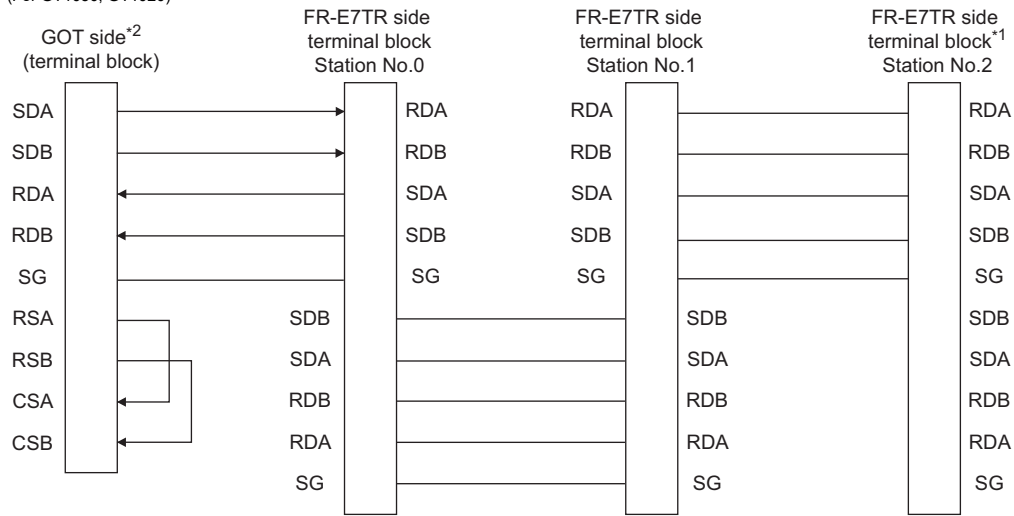

*1 Turn ON (100Ω) the terminator switch for the most distant FR-E7TR from the GOT.

*2 Set the terminating resistor of GOT side, which will be a terminal, to "330Ω".

■ Precautions when preparing a cable

(1) Cable length

The length of the RS-485 cable must be 500m or less.

(2) GOT side connector

For the GOT side connector, refer to the following.

☞ 1.4.1 GOT connector specifications

(3) Inverter connector specifications

(a) Pin layout in the PU port

When seen from the front of the inverter (receptacle side)

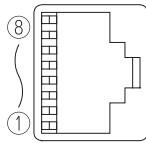

Modular jack

Pin No.	Signal name	Remark
1	GND (SG)	
2	(P5S)	Not used
3	RXD+ (RDA)	
4	TXD- (SDB)	
5	TXD+ (SDA)	
6	RXD- (RDB)	
7	GND (SG)	
8	(P5S)	Not used

The contents inside () indicate symbols described in the inverter manual.

The pins number 2 and 8 (P5S) are connected to the power supply for an operation panel or a parameter unit.

Do not use them in RS-485 communication.

(b) Connector of cable between FREQROL Series inverters

Use the commercial connectors and cables shown in the table below or the comparable products.(Refer to the manual for the inverter.)

Name	Model name	Specifications	Manufacturer
Connector	5-554720-3	RJ45 connector	Tyco International, Ltd
Modular ceiling rosette (Distributor)	BMJ-8	-	HAKKO ELECTRIC CO.,LTD. TEL(03)-3806-9171
Cable	SGLPEV 0.5mm × 4P	Cable conforming to EIA568 (such as cable 10BASE-T)	MITSUBISHI CABLE INDUSTRIES, LTD.

(4) Terminal block layout in the FR-A5NR computer link option

Attach this option to the A500 and F500 Series.

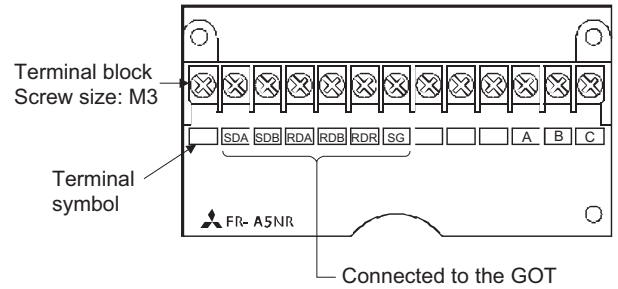

(5) Terminal block layout in the FR-E7TR control terminal option

Mount the FR-E7TR to the E700 series.

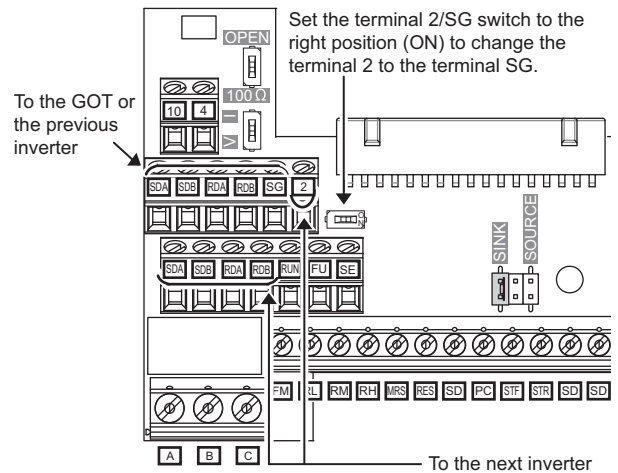

■ Connecting terminating resistors

(1) GOT side

When connecting a PLC to the GOT, a terminating resistor must be connected to the GOT.

(a) For GT16, GT15, GT12

Set the terminating resistor setting switch.

(b) For GT14, GT11, GT10

Set the terminating resistor selector switch.

For the procedure to set the terminating resistor, refer to the following.

☞ 1.4.3 Terminating resistors of GOT

15.4 GOT Side Settings

15.4.1 Setting communication interface (Communication settings)

Set the channel of the connected equipment.

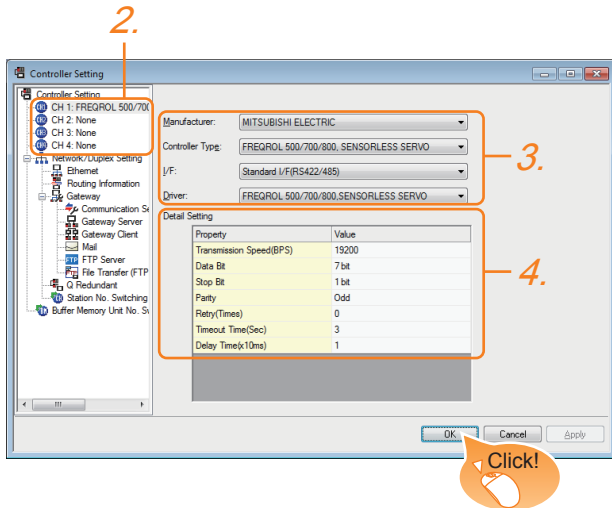

1. Select [Common] → [Controller Setting] from the menu.
2. The Controller Setting window is displayed. Select the channel to be used from the list menu.
3. Set the following items.
 - Manufacturer: MITSUBISHI ELECTRIC
 - Controller Type: Set according to the Controller Type to be connected.
 - I/F: Interface to be used
 - Driver: FREQROL 500/700/800, SENSORLESS SERVO
4. The detailed setting is displayed after Manufacturer, Controller Type, I/F, and Driver are set. Make the settings according to the usage environment.

👉 15.4.2 Communication detail settings

Click the [OK] button when settings are completed.

POINT

The settings of connecting equipment can be confirmed in [I/F Communication Setting]. For details, refer to the following.

👉 1.1.2 I/F communication setting

15.4.2 Communication detail settings

Make the settings according to the usage environment.

Property	Value
Transmission Speed(BPS)	19200
Data Bit	7 bit
Stop Bit	1 bit
Parity	Odd
Retry(Times)	0
Timeout Time(Sec)	3
Delay Time(x10ms)	1

Item	Description	Range
Transmission Speed	Set this item when change the transmission speed used for communication with the connected equipment. (Default: 19200bps)	9600bps, 19200bps, 38400bps, 57600bps, 115200bps
Data Bit	Set this item when change the data length used for communication with the connected equipment. (Default: 7bits)	7bits/8bits
Stop Bit	Specify the stop bit length for communications. (Default: 1bit)	1bit/2bits
Parity	Specify whether or not to perform a parity check, and how it is performed during communication. (Default: Odd)	None Even Odd
Retry	Set the number of retries to be performed when a communication timeout occurs. (Default: 0time)	0 to 5times
Timeout Time	Set the time period for a communication to time out. (Default: 3sec)	1 to 30sec
Delay Time	Set this item to adjust the transmission timing of the communication request from the GOT. (Default: 10ms)	0 to 300ms

POINT

- (1) Communication interface setting by the Utility
The communication interface setting can be changed on the Utility's [Communication Settings] after writing [Communication Settings] of project data.
For details on the Utility, refer to the following manuals.

👉 GT□ User's Manual

- (2) Precedence in communication settings
When settings are made by GT Designer3 or the Utility, the latest setting is effective.

HINT 

Cutting the portion of multiple connection of the controller

By setting GOT internal device, GOT can cut the portion of multiple connection of the controller. For example, faulty station that has communication timeout can be cut from the system.

For details of the setting contents of GOT internal device, refer to the following manual.

 GT Designer3 Version Screen Design Manual (Fundamentals)

9	MELSECNET/H CONNECTION (PLC CONNECTION TO PLC NETWORK)
10	MELSECNET/10 CONNECTION (PLC CONNECTION TO PLC NETWORK)
11	CC-Link IE CONTROLLER NETWORK CONNECTION
12	CC-Link IE FIELD NETWORK CONNECTION
13	CC-Link CONNECTION (INTELLIGENT DEVICE STATION)
14	CC-Link CONNECTION (Via G4)
15	INVERTER CONNECTION
16	SERVO AMPLIFIER CONNECTION

15.5 FREQROL Series Inverter Side Settings

For details of the inverter, refer to the manual of each series.

15.5.1 Connecting FREQROL-S500, S500E, F500J series

■ Communication settings

Make the communication settings of the inverter.

Be sure to perform the inverter reset after updating each parameter.

(1) Communication port and corresponding parameters

GOT connection destination	Parameters corresponding to inverter
RS-485 port	Pr.79, n1 to n7, n10 to n12

(2) Communication settings of inverter

Set the following parameters using the PU (parameter unit). Set Pr.30 (Extended function selection) to 1 [With display] before making the parameter settings.

Do not change these parameters, even though they can be monitored from the GOT. If they are changed, communication with the GOT is disabled.

Setting item ^{*1}	Parameter No. ^{*4}	Set value	Contents of setting
Communication station number	n1 (331)	0 to 31	 15.5.14 Station number setting
Communication speed ^{*2}	n2 (332)	192 ^{*3}	19200bps
Stop bit length ^{*2}	n3 (333)	10	Data length: 7bit Stop bit length: 1bit
Parity check presence/absence ^{*2}	n4 (334)	1	Odd
Number of communication retries	n5 (335)	--- (65535)	The inverter will not come to an alarm stop.
Communication check time interval	n6 (336)	---	Communication check suspension
Wait time setting	n7 (337)	0	0ms
CRLF selection	n11 (341)	1 ^{*3}	With CR, without LF
Protocol selection ^{*5}	—	—	—
Operation mode selection	Pr.79	0 ^{*3}	External operation mode at power on
Link start mode selection	n10 (340)	1	Computer link operation
E ² PROM write selection	n12 (342)	0 ^{*3}	Written to RAM and EEPROM

*1 Setting items are parameter names described in the manual of FREQROL-S500, S500E, and F500J series.

*2 Settings on the GOT can be changed.

When changing the settings on the GOT, be sure to change the parameters on the inverter to correspond with the GOT settings.

*3 Inverter default values (No need to change)

*4 When being monitored from the GOT, the parameter n1 through n7 correspond with Pr.331 through Pr.337, and the parameter n10 through n12 correspond with Pr.340 through Pr.342.

Numbers in brackets show the parameter number when the parameter unit is in use.

*5 There is no Protocol selection setting on the inverter side.

15.5.2 Connecting FREQROL-E500 series

■ Communication settings

Make the communication settings of the inverter.

Be sure to perform the inverter reset after updating each parameter.

(1) Communication port and corresponding parameters

GOT connection destination	Parameters corresponding to inverter
PU connector	Pr.79, Pr.117 to Pr.124, Pr.146, Pr.342

(2) Communication settings of inverter

Set the following parameters using the PU (parameter unit).

Do not change these parameters, even though they can be monitored from the GOT. If they are changed, communication with the GOT is disabled.

Setting item ^{*1}	Parameter No.	Set value	Contents of setting
Communication station number	Pr.117	0 to 31	 15.5.14 Station number setting
Communication speed ^{*2}	Pr.118	192 ^{*3}	19200bps
Stop bit length ^{*2}	Pr.119	10	Data length: 7bit Stop bit length: 1bit
Parity check presence/absence ^{*2}	Pr.120	1	Odd
Number of communication retries	Pr.121	9999 (65535)	The inverter will not come to an alarm stop.
Communication check time interval	Pr.122	9999	Communication check suspension
Wait time setting	Pr.123	0	0ms
CRLF presence/absence selection	Pr.124	1 ^{*3}	With CR, without LF
Protocol selection ^{*4}	—	—	—
Operation mode selection	Pr.79	1 ^{*3}	PU operation mode
Communication startup mode selection ^{*4}	—	—	—
E ² PROM write selection	Pr.342	0 ^{*3}	Written to RAM and EEPROM
Frequency setting command selection ^{*5}	Pr.146	9999	Built-in frequency setting potentiometer invalid

*1 Setting items are parameter names described in the manual of FREQROL-E500 series.

*2 Settings on the GOT can be changed.

When changing the settings on the GOT, be sure to change the parameters on the inverter to correspond with the GOT settings.

*3 Inverter default values (No need to change)

*4 There is no Protocol selection setting on the inverter side.

*5 The setting is required for Frequency setting command selection.

15.5.3 Connecting FREQROL-F500, F500L series

■ Communication settings

Make the communication settings of the inverter.

Be sure to perform the inverter reset after updating each parameter.

(1) Communication port and corresponding parameters

GOT connection destination	Parameters corresponding to inverter
PU connector	Pr.79, Pr.117 to Pr.124
FR-A5NR (Option unit)	Pr.79, Pr.331 to Pr.337, Pr.340 to Pr.342

(2) Communication settings of inverter

Set the following parameters using the PU (parameter unit). Set Pr.160 (user group read selection) to 0 [All parameters can be accessed for reading and writing.] before making the parameter settings.

Do not change these parameters, even though they can be monitored from the GOT. If they are changed, communication with the GOT is disabled.

Setting item ^{*1}	Parameter No.		Set value	Contents of setting	
	PU connector	FR-A5NR			
Communication station number	Pr.117	Pr.331	0 to 31	 15.5.14 Station number setting	
Communication speed ^{*2}	Pr.118	Pr.332	192 ^{*4}	19200bps	
Stop bit length/data length Stop bit length ^{*2}	Pr.119	Pr.333	10	Data length: 7bit Stop bit length: 1bit	
Parity check presence/absence ^{*2}	Pr.120	Pr.334	1	Odd	
Number of communication retries	Pr.121	Pr.335	9999	The inverter will not come to an alarm stop.	
Communication check time interval	Pr.122	Pr.336	9999	Communication check suspension	
Wait time setting	Pr.123	Pr.337	0	0ms	
CRLF presence/ absence selection	Pr.124	Pr.341	1 ^{*3}	With CR, without LF	
Protocol selection ^{*5}	—	—	—	—	
Operation mode selection	Pr.79		PU connector	1	PU operation mode
			FR-A5NR	0 ^{*3}	External operation mode at power on
Link start mode selection ^{*6}	—	Pr.340	1	Computer link operation	
E ² PROM write selection ^{*6}	—	Pr.342	0 ^{*3}	Written to RAM and EEPROM	

*1 Setting items are parameter names described in the manual of FREQROL-F500 and F500L series.

*2 Settings on the GOT can be changed.

When changing the settings on the GOT, be sure to change the parameters on the inverter to correspond with the GOT settings.

*3 Inverter default values (No need to change)

*4 Since the value has been set as a default, no setting is required when connecting to the PU connector on the inverter side.

*5 There is no Protocol selection setting on the inverter side.

*6 The setting is required on the inverter side when FR-A5NR is used.

15.5.4 Connecting FREQROL-A500, A500L series

■ Communication settings

Make the communication settings of the inverter.

Be sure to perform the inverter reset after updating each parameter.

(1) Communication port and corresponding parameters

GOT connection destination	Parameters corresponding to inverter
PU connector	Pr.79, Pr.117 to Pr.124, Pr.342
FR-A5NR (Option unit)	Pr.79, Pr.331 to Pr.337, Pr.340 to Pr.342

(2) Communication settings of inverter

Set the following parameters using the PU (parameter unit). Do not change these parameters, even though they can be monitored from the GOT. If they are changed, communication with the GOT is disabled.

Setting item ^{*1}	Parameter No.		Set value	Contents of setting
	PU connector	FR-A5NR		
Communication station number	Pr.117	Pr.331	0 to 31	 15.5.14 Station number setting
Communication speed ^{*2}	Pr.118	Pr.332	192 ^{*4}	19200bps
Stop bit length ^{*2}	Pr.119	Pr.333	10	Data length: 7bit Stop bit length: 1bit
Parity check presence/absence ^{*2}	Pr.120	Pr.334	1	Odd
Number of communication retries	Pr.121	Pr.335	9999	The inverter will not come to an alarm stop.
Communication check time interval	Pr.122	Pr.336	9999	Communication check suspension
Wait time setting	Pr.123	Pr.337	0	0ms
CRLF presence/ absence selection	Pr.124	Pr.341	1 ^{*3}	With CR, without LF
Protocol selection ^{*5}	—	—	—	—
Operation mode selection	Pr.79	PU connector	1	PU operation mode
		FR-A5NR	0 ^{*3}	External operation mode at power on
Link start mode selection ^{*6}	—	Pr.340	1	Computer link operation
E ² PROM write selection	Pr.342		0 ^{*3}	Written to RAM and EEPROM

*1 Setting items are parameter names described in the manual of FREQROL-A500 and A500L series.

*2 Settings on the GOT can be changed.

When changing the settings on the GOT, be sure to change the parameters on the inverter to correspond with the GOT settings.

*3 Inverter default values (No need to change)

*4 Since the value has been set as a default, no setting is required when connecting to the PU connector on the inverter side.

*5 There is no Protocol selection setting on the inverter side.

*6 The setting is required on the inverter side when FR-A5NR is used.

15.5.5 Connecting FREQROL-V500, V500L series

■ Communication settings

Make the communication settings of the inverter.

Be sure to perform the inverter reset after updating each parameter.

(1) Communication port and corresponding parameters

GOT connection destination	Parameters corresponding to inverter
PU connector	Pr.79, Pr.117 to Pr.124, Pr.342
FR-A5NR (Option unit)	Pr.79, Pr.331 to Pr.337, Pr.340 to Pr.342

(2) Communication settings of inverter

Set the following parameters using the PU (parameter unit). Set Pr.160 (Extended function display selection) to 1 [All parameters can be accessed for reading and writing.] before making the parameter settings.

Do not change these parameters, even though they can be monitored from the GOT. If they are changed, communication with the GOT is disabled.

Setting item ^{*1}	Parameter No.		Set value	Contents of setting	
	PU connector	FR-A5NR			
Communication station number	Pr.117	Pr.331	0 to 31	 15.5.14 Station number setting	
Communication speed ^{*2}	Pr.118	Pr.332	192 ^{*4}	19200bps	
Stop bit length/data length Stop bit length ^{*2}	Pr.119	Pr.333	10	Data length: 7bit Stop bit length: 1bit	
Parity check presence/absence ^{*2}	Pr.120	Pr.334	1	Odd	
Number of communication retries	Pr.121	Pr.335	9999	The inverter will not come to an alarm stop.	
Communication check time interval	Pr.122	Pr.336	9999	Communication check suspension	
Wait time setting	Pr.123	Pr.337	0	0ms	
CRLF presence/ absence selection	Pr.124	Pr.341	1 ^{*3}	With CR, without LF	
Protocol selection ^{*5}	—	—	—	—	
Operation mode selection	Pr.79		PU connector	1	PU operation mode
			FR-A5NR	0 ^{*3}	External operation mode at power on
Link start mode selection ^{*6}	—	Pr.340	1	Computer link operation	
E ² PROM write selection	Pr.342		0 ^{*3}	Written to RAM and EEPROM	

*1 Setting items are parameter names described in the manual of FREQROL-V500 and V500L series.

*2 Settings on the GOT can be changed.

When changing the settings on the GOT, be sure to change the parameters on the inverter to correspond with the GOT settings.

*3 Inverter default values (No need to change)

*4 Since the value has been set as a default, no setting is required when connecting to the PU connector on the inverter side.

*5 There is no Protocol selection setting on the inverter side.

*6 The setting is required on the inverter side when FR-A5NR is used.

15.5.6 Connecting FREQROL-E700 series

■ Communication settings

Make the communication settings of the inverter.

Be sure to perform the inverter reset after updating each parameter.

(1) Communication port and corresponding parameters

GOT connection destination	Parameters corresponding to inverter
PU connector	Pr.79, Pr.117 to Pr.124, Pr.340, Pr.342, Pr.549
FR-E7TR (RS-485 terminal block)	

(2) Communication settings of inverter

Set the following parameters using the PU (parameter unit).

Do not change these parameters, even though they can be monitored from the GOT. If they are changed, communication with the GOT is disabled.

Setting item ^{*1}	Parameter No.	Set value	Contents of setting
PU communication station number	Pr.117	0 to 31	 15.5.14 Station number setting
PU communication speed ^{*2}	Pr.118	192 ^{*3}	19200bps
PU communication stop bit length ^{*2}	Pr.119	10	Data length: 7bit Stop bit length: 1bit
PU communication parity check ^{*2}	Pr.120	1	Odd
Number of PU communication retries	Pr.121	9999	The inverter will not come to an alarm stop.
PU communication check time interval	Pr.122	9999	Communication check suspension
PU communication wait time setting	Pr.123	0	0ms
PU communication CR/LF selection	Pr.124	1 ^{*3}	With CR, without LF
Protocol selection	Pr.549	0 ^{*3}	Mitsubishi Electric inverter protocol
Operation mode selection	Pr.79	0 ^{*3}	PU operation mode
Communication startup mode selection	Pr.340	1	Network operation mode.
Communication EEPROM write selection	Pr.342	0 ^{*3}	Written to RAM and EEPROM

*1 Setting items are parameter names described in the manual of FREQROL-E700 series.

*2 Settings on the GOT can be changed.

When changing the settings on the GOT, be sure to change the parameters on the inverter to correspond with the GOT settings.

*3 Inverter default values (No need to change)

9 MELSECNET/H CONNECTION (PLC CONNECTION TO PLC NETWORK)
 10 MELSECNET/10 CONNECTION (PLC CONNECTION TO PLC NETWORK)
 11 CC-Link IE CONTROLLER NETWORK CONNECTION
 12 CC-Link IE FIELD NETWORK CONNECTION
 13 CC-Link CONNECTION (INTELLIGENT DEVICE STATION)
 14 CC-Link CONNECTION (Via G4)
 15 INVERTER CONNECTION
 16 SERVO AMPLIFIER CONNECTION

15.5.7 Connecting FREQROL-D700 series

■ Communication settings

Make the communication settings of the inverter.

Be sure to perform the inverter reset after updating each parameter.

(1) Communication port and corresponding parameters

GOT connection destination	Parameters corresponding to inverter
PU connector	Pr.79, Pr.117 to Pr.124, Pr.340, Pr.342, Pr.549

(2) Communication settings of inverter

Set the following parameters using the PU (parameter unit). Set Pr.160 (User group read selection) to 0 [The simple mode and extended parameters can be displayed] before making the parameter settings.

Do not change these parameters, even though they can be monitored from the GOT. If they are changed, communication with the GOT is disabled.

Setting item ^{*1}	Parameter No.	Set value	Contents of setting
PU communication station number	Pr.117	0 to 31	 15.5.14 Station number setting
PU communication speed ^{*2}	Pr.118	192 ^{*3}	19200bps
PU communication stop bit length ^{*2}	Pr.119	10	Data length: 7bit Stop bit length: 1bit
PU communication parity check ^{*2}	Pr.120	1	Odd
Number of PU communication retries	Pr.121	9999	The inverter will not come to an alarm stop.
PU communication check time interval	Pr.122	9999	Communication check suspension
PU communication wait time setting	Pr.123	0	0ms
PU communication CR/LF selection	Pr.124	1 ^{*3}	With CR, without LF
Protocol selection	Pr.549	0 ^{*3}	Mitsubishi Electric inverter protocol
Operation mode selection	Pr.79	0 ^{*3}	PU operation mode
Communication startup mode selection	Pr.340	1	Network operation mode.
Communication EEPROM write selection	Pr.342	0 ^{*3}	Written to RAM and EEPROM

*1 Setting items are parameter names described in the manual of FREQROL-D700 series.

*2 Settings on the GOT can be changed.

When changing the settings on the GOT, be sure to change the parameters on the inverter to correspond with the GOT settings.

*3 Inverter default values (No need to change)

15.5.8 Connecting FREQROL-F700/700P series

■ Communication settings

Make the communication settings of the inverter.

Be sure to perform the inverter reset after updating each parameter.

(1) Communication port and corresponding parameters

GOT connection destination	Parameters corresponding to inverter
PU connector	Pr.79, Pr.117 to Pr.124, Pr.340, Pr.342
RS-485 terminal	Pr.79, Pr.331 to Pr.337, Pr.340 to Pr.342, Pr.549

(2) Communication settings of inverter

Set the following parameters using the PU (parameter unit). Set Pr.160 (User group read selection) to 0 [The simple mode and extended parameters can be displayed] before making the parameter settings.

Do not change these parameters, even though they can be monitored from the GOT. If they are changed, communication with the GOT is disabled.

Setting item ^{*1}	Parameter No.		Set value	Contents of setting
	PU connector	RS-485		
PU communication station number/RS-485 communication station number	Pr.117	Pr.331	0 to 31	 15.5.14 Station number setting
PU communication speed/RS-485 communication speed ^{*2}	Pr.118	Pr.332	192 ^{*4}	19200bps
PU communication stop bit length/RS-485 communication stop bit length ^{*2}	Pr.119	Pr.333	10	Data length: 7bit Stop bit length: 1bit
PU communication parity check/RS-485 communication parity check ^{*2}	Pr.120	Pr.334	1	Odd
Number of PU communication retries/RS-485 communication retry count	Pr.121	Pr.335	9999	The inverter will not come to an alarm stop.
PU communication check time interval/RS-485 communication check time interval	Pr.122	Pr.336	9999 ^{*4}	Communication check suspension
PU communication waiting time setting/RS-485 communication waiting time setting	Pr.123	Pr.337	0	0ms
PU communication CR/LF selection/RS-485 communication CR/LF selection	Pr.124	Pr.341	1 ^{*3}	With CR, without LF
Protocol selection	—	Pr.549	0 ^{*3}	Mitsubishi Electric inverter protocol
Operation mode selection	Pr.79	PU connector	1	PU operation mode
		RS-485	0 ^{*3}	External operation mode at power on
Communication startup mode selection	Pr.340	PU connector	0 ^{*3}	Refer to Pr.79 settings.
		RS-485	1	Network operation mode.
Communication EEPROM write selection	Pr.342		0 ^{*3}	Written to RAM and EEPROM

*1 Setting items are parameter names described in the manual of FREQROL-F700 series.

*2 Settings on the GOT can be changed.

When changing the settings on the GOT, be sure to change the parameters on the inverter to correspond with the GOT settings.

*3 Inverter default values (No need to change)

*4 Since the value has been set as a default, no setting is required when connecting to the PU connector on the inverter side.



Automatic setting with Pr.999 (FREQROL-F700P series only)

If Pr.999 is set as the following, the communication settings other than [PU communication station number] and [Communication EEPROM write selection] can be automatically set in a batch to the default communication settings of the GOT side.

Parameter No.	Set value	Description	Operation in parameter setting mode
Pr.999 ^{*1}	10	GOT Initial settings (PU connector)	[AUTO]→[GOT]→[1]Write
	11	GOT Initial settings (RS-485 terminal)	-

*1 When monitoring the value of Pr.999, 9999 is always monitored.

15.5.9 Connecting FREQROL-F700PJ series

■ Communication settings

Make the communication settings of the inverter.

Be sure to perform the inverter reset after updating each parameter.

(1) Communication port and corresponding parameters

GOT connection destination	Parameters corresponding to inverter
PU connector	Pr.79, Pr.117 to Pr.124, Pr.340, Pr.342, Pr.549

(2) Communication settings of inverter

Set the following parameters using the PU (parameter unit). Set Pr.160 (User group read selection) to 0 [The simple mode and extended parameters can be displayed] before making the parameter settings.

Do not change these parameters, even though they can be monitored from the GOT. If they are changed, communication with the GOT is disabled.

Setting item ^{*1}	Parameter No.	Set value	Contents of setting
PU communication station number	Pr.117	0 to 31	 15.5.14 Station number setting
PU communication speed ^{*2}	Pr.118	192 ^{*3}	19200bps
PU communication stop bit length	Pr.119	10	Data length: 7bit Stop bit length: 1bit
PU communication parity check ^{*2}	Pr.120	1	Odd
Number of PU communication retries	Pr.121	9999	The inverter will not come to an alarm stop.
PU communication check time interval	Pr.122	9999	Communication check suspension
PU communication waiting time setting	Pr.123	0	0ms
PU communication CR/LF selection	Pr.124	1 ^{*3}	With CR, without LF
Protocol selection	Pr.549	0 ^{*3}	Mitsubishi Electric inverter protocol
Operation mode selection	Pr.79	0 ^{*3}	External operation mode at power on
Communication startup mode selection	Pr.340	1	Network operation mode.
Communication EEPROM write selection	Pr.342	0 ^{*3}	Written to RAM and EEPROM

*1 Setting items are parameter names described in the manual of FREQROL-F700 series.

*2 Settings on the GOT can be changed.

When changing the settings on the GOT, be sure to change the parameters on the inverter to correspond with the GOT settings.

*3 Inverter default values (No need to change)



Automatic setting with Pr.999

If Pr.999 is set as the following, the communication settings other than [PU communication station number] and [Communication EEPROM write selection] can be automatically set in a batch to the default communication settings of the GOT side.

Parameter No.	Set value	Description	Operation in parameter setting mode
Pr.999 ^{*1}	10	GOT Initial settings (PU connector)	[AUTO] → [GOT] → [1]Write

*1 When monitoring the value of Pr.999, 9999 is always monitored.

9
MELSECNET/H
CONNECTION (PLC
TO PLC NETWORK)

10
MELSECNET/10
CONNECTION (PLC
TO PLC NETWORK)

11
CC-LINK IE CONTROLLER
NETWORK
CONNECTION

12
CC-LINK IE FIELD
NETWORK
CONNECTION

13
CC-LINK CONNECTION
(INTELLIGENT DEVICE
STATION)

14
CC-LINK
CONNECTION
(Via G4)

15
INVERTER
CONNECTION

16
SERVO AMPLIFIER
CONNECTION

15.5.10 Connecting FREQROL-A700 series

■ Communication settings

Make the communication settings of the inverter.

Be sure to perform the inverter reset after updating each parameter.

(1) Communication port and corresponding parameters

GOT connection destination	Parameters corresponding to inverter
PU connector	Pr.79, Pr.117 to Pr.124, Pr.340, Pr.342
RS-485 terminal	Pr.79, Pr.331 to Pr.337, Pr.340 to Pr.342, Pr.549

(2) Communication settings of inverter

Set the following parameters using the PU (parameter unit).

Do not change these parameters, even though they can be monitored from the GOT. If they are changed, communication with the GOT is disabled.

Setting item ^{*1}	Parameter No.		Set value	Contents of setting
	PU connector	RS-485		
PU communication station number/RS-485 communication station number	Pr.117	Pr.331	0 to 31	 15.5.14 Station number setting
PU communication speed/RS-485 communication speed ^{*2}	Pr.118	Pr.332	192 ^{*4}	19200bps
PU communication stop bit length/RS-485 communication stop bit length ^{*2}	Pr.119	Pr.333	10	Data length: 7bit Stop bit length: 1bit
PU communication parity check/RS-485 communication parity check ^{*2}	Pr.120	Pr.334	1	Odd
Number of PU communication retries/RS-485 communication retry count	Pr.121	Pr.335	9999	The inverter will not come to an alarm stop.
PU communication check time interval/RS-485 communication check time interval	Pr.122	Pr.336	9999 ^{*4}	Communication check suspension
PU communication waiting time setting/RS-485 communication waiting time setting	Pr.123	Pr.337	0	0ms
PU communication CR/LF selection/RS-485 communication CR/LF selection	Pr.124	Pr.341	1 ^{*3}	With CR, without LF
Protocol selection	—	Pr.549	0 ^{*3}	Mitsubishi Electric inverter protocol
Operation mode selection	Pr.79	PU connector	1	PU operation mode
		RS-485	0 ^{*3}	External operation mode at power on
Communication startup mode selection	Pr.340	PU connector	0 ^{*3}	Refer to Pr.79 settings.
		RS-485	1	Network operation mode.
Communication EEPROM write selection	Pr.342		0 ^{*3}	Written to RAM and EEPROM

*1 Setting items are parameter names described in the manual of FREQROL-A700 series.

*2 Settings on the GOT can be changed.

When changing the settings on the GOT, be sure to change the parameters on the inverter to correspond with the GOT settings.

*3 Inverter default values (No need to change)

*4 Since the value has been set as a default, no setting is required when connecting to the PU connector on the inverter side.

HINT

(1) Automatic setting with Pr.999

If Pr.999 is set as the following, the communication settings other than [PU communication station number] and [Communication EEPROM write selection] can be automatically set in a batch to the default communication settings of the GOT side.

Parameter No.	Set value	Description	Operation in parameter setting mode
Pr.999 ^{*1}	10	GOT Initial settings (PU connector)	[AUTO] → [GOT] → [1]Write
	11	GOT Initial settings (RS-485)	—

^{*1} When monitoring the value of Pr.999, 9999 is always monitored.

(2) Inverters available for automatic batch setting

Parameters are not automatically set in a batch depending on the SERIAL (production number) symbol of the inverter to be used. For details, contact your local distributor.

15.5.11 Connecting FREQROL-A800/F800 series

■ Communication settings

Make the communication settings of the inverter.

Be sure to perform the inverter reset after updating each parameter.

The GOT1000 series does not support the automatic connection of inverters.

(1) Communication port and corresponding parameters

GOT connection destination	Parameters corresponding to inverter
PU connector	Pr.79, Pr.117 to Pr.124, Pr.340, Pr.342
RS-485 terminal	Pr.79, Pr.331 to Pr.337, Pr.340 to Pr.342, Pr.549

(2) Communication settings of inverter

Set the following parameters using the PU (parameter unit).

Set Pr.160 (User group read selection) to 0 [The simple mode and extended parameters can be displayed] before making the parameter settings.

Do not change these parameters, even though they can be monitored from the GOT. If they are changed, communication with the GOT is disabled.

Setting item ^{*1}	Parameter No.		Set value	Contents of setting
	PU connector	RS-485		
PU communication station number/RS-485 communication station number	Pr.117	Pr.331	0 to 31	 15.5.14 Station number setting
PU communication speed/RS-485 communication speed ^{*2}	Pr.118	Pr.332	192 ^{*4}	19200bps
PU communication stop bit length/RS-485 communication stop bit length ^{*2}	Pr.119	Pr.333	10	Data length: 7bit Stop bit length: 1bit
PU communication parity check/RS-485 communication parity check ^{*2}	Pr.120	Pr.334	1	Odd
Number of PU communication retries/RS-485 communication retry count	Pr.121	Pr.335	9999	The inverter will not come to an alarm stop.
PU communication check time interval/RS-485 communication check time interval	Pr.122	Pr.336	9999 ^{*4}	Communication check suspension
PU communication waiting time setting/RS-485 communication waiting time setting	Pr.123	Pr.337	0	0ms
PU communication CR/LF selection/RS-485 communication CR/LF selection	Pr.124	Pr.341	1 ^{*3}	With CR, without LF
Protocol selection	—	Pr.549	0 ^{*3}	Mitsubishi Electric inverter protocol
Operation mode selection	Pr.79	PU connector	1	PU operation mode
		RS-485	0 ^{*3}	External operation mode at power on
Communication startup mode selection	Pr.340	PU connector	0 ^{*3}	Refer to Pr.79 settings.
		RS-485	1	Network operation mode.
Communication EEPROM write selection	Pr.342		0 ^{*3}	Written to RAM and EEPROM

*1 Setting items are parameter names described in the manual of FREQROL-A800/F800 series.

*2 Settings on the GOT can be changed.

When changing the settings on the GOT, be sure to change the parameters on the inverter to correspond with the GOT settings.

*3 Inverter default values (No need to change)

*4 Since the value has been set as a default, no setting is required when connecting to the PU connector on the inverter side.



Automatic setting with Pr.999

If Pr.999 is set as the following, the communication settings other than [PU communication station number] and [Communication EEPROM write selection] can be automatically set in a batch to the default communication settings of the GOT side.

Parameter No.	Set value	Description	Operation in parameter setting mode
Pr.999*1	10	GOT Initial settings (PU connector)	[AUTO] → [GOT] → [1]Write
	11	GOT Initial settings (RS-485 terminal)	—

*1 When monitoring the value of Pr.999, 9999 is always monitored.

15.5.12 Connecting a sensorless servo (FREQROL-E700EX series)

■ Communication settings

Make the communication settings of the sensorless servo (FREQROL-E700EX series).
Be sure to perform the inverter reset after updating each parameter.

(1) Communication port and corresponding parameters

GOT connection destination	Parameters corresponding to inverter
PU connector	Pr.79, Pr.117 to Pr.124, Pr.340, Pr.342, Pr.549
FR-E7TR (RS-485 terminal block)	

(2) Communication settings of sensorless servo

Set the following parameters using the PU (parameter unit).

Do not change these parameters, even though they can be monitored from the GOT. If they are changed, communication with the GOT is disabled.

Setting item*1	Parameter No.	Set value	Contents of setting
PU communication station number	Pr.117	0 to 31	15.5.14 Station number setting
PU communication speed*2	Pr.118	192*3	19200bps
PU communication stop bit length*2	Pr.119	10	Data length: 7bit Stop bit length: 1bit
PU communication parity check*2	Pr.120	1	Odd
Number of PU communication retries	Pr.121	9999	The inverter will not come to an alarm stop.
PU communication check time interval	Pr.122	9999	Communication check suspension
PU communication wait time setting	Pr.123	0	0ms
PU communication CR/LF selection	Pr.124	1*3	With CR, without LF
Protocol selection	Pr.549	0*3	Mitsubishi Electric inverter protocol
Operation mode selection	Pr.79	0*3	PU operation mode
Communication startup mode selection	Pr.340	1	Network operation mode.
Communication EEPROM write selection	Pr.342	0*3	Written to RAM and EEPROM

*1 Setting items are parameter names described in the manual of FREQROL-E700 series.

*2 Settings on the GOT can be changed.

When changing the settings on the GOT, be sure to change the parameters on the inverter to correspond with the GOT settings.

*3 Sensorless servo (FREQROL-E700EX series) default values (No need to change)

15.5.13 Connecting MD-CX522-□□K(-A0)

■ Communication settings

Make the communication settings of the inverter.

Be sure to perform the inverter reset after updating each parameter.

(1) Communication port and corresponding parameters

GOT connection destination	Parameters corresponding to inverter
PU connector	Pr.79, Pr.117 to Pr.124

(2) Communication settings of inverter

- Set the following parameters using the PU (parameter unit).
- After setting the parameters for the communication settings, reset the inverter.
- Do not change these parameters, even though they can be monitored from the GOT. If they are changed, communication with the GOT is disabled.

Setting item ^{*1}	Parameter No.	Set value	Contents of setting
Communication station number	Pr.117	0 to 31	 15.5.14 Station number setting
Communication speed ^{*2}	Pr.118	192 ^{*3}	19200bps
Stop bit length/data length ^{*2}	Pr.119	10	Data length: 7bit Stop bit length: 1bit
Parity check presence/absence ^{*2}	Pr.120	1	Odd
Number of communication retries	Pr.121	9999	The inverter will not come to an alarm stop.
Communication check time interval	Pr.122	9999	Communication check suspension
Wait time setting	Pr.123	0	0ms
CRLF presence/absence selection	Pr.124	1 ^{*3}	With CR, without LF

*1 Setting items are parameter names described in the manual of MELIPM series.

*2 Settings on the GOT can be changed.

When changing the settings on the GOT, be sure to change the parameters on the inverter to correspond with the GOT settings.

*3 Inverter default values (No need to change)

15.5.14 Station number setting

Set each station number so that no station number overlaps.

The station number can be set without regard to the cable connection order. There is no problem even if station numbers are not consecutive.

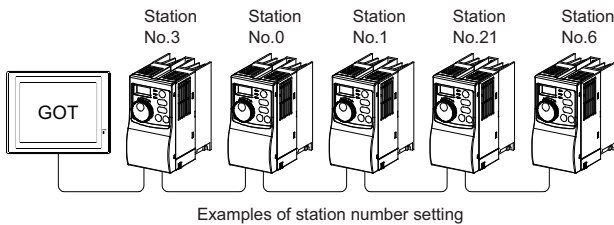

(1) Direct specification

When setting the device, specify the station number of the inverter of which data is to be changed.

Specification range
0 to 31

(2) Indirect specification

When setting the device, indirectly specify the station number of the inverter of which data is to be changed using the 16-bit GOT internal data register (GD10 to GD25).

When specifying the station No. from 100 to 155 on GT Designer3, the value of GD10 to GD25 compatible to the station No. specification will be the station No. of the inverter.

Specification station NO.	Compatible device	Setting range
100	GD10	0 to 31 For the setting other than the above, error (dedicated device is out of range) will occur.
101	GD11	
102	GD12	
103	GD13	
104	GD14	
105	GD15	
106	GD16	
107	GD17	
108	GD18	
109	GD19	
110	GD20	
111	GD21	
112	GD22	
113	GD23	
114	GD24	
115	GD25	

9 MELSECNET/H CONNECTION (PLC CONNECTION TO PLC NETWORK)
 10 MELSECNET/10 CONNECTION (PLC CONNECTION TO PLC NETWORK)
 11 CC-Link IE CONTROLLER NETWORK CONNECTION
 12 CC-Link IE FIELD NETWORK CONNECTION
 13 CC-Link CONNECTION (INTELLIGENT DEVICE STATION)
 14 CC-Link CONNECTION (Via G4)
 15 INVERTER CONNECTION
 16 SERVO AMPLIFIER CONNECTION

15.6 Device Range that Can Be Set

The device ranges of controller that can be used for GOT are as follows.

Note that the device ranges in the following tables are the maximum values that can be set in GT Designer3.

The device specifications of controllers may differ depending on the models, even though belonging to the same series.

Please make the setting according to the specifications of the controller actually used.

When a non-existent device or a device number outside the range is set, other objects with correct device settings may not be monitored.

Setting item

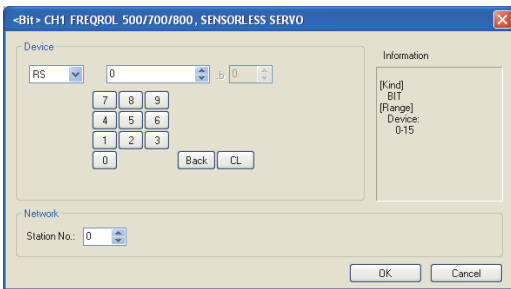

Item	Description	
Device	Set the device name, device number, and bit number. The bit number can be set only by specifying the bit of word device.	
	<table border="1"> <tr> <td>Station No.</td> <td>Monitors the inverter of the specified station No. 0 to 31: To monitor the inverter of the specified station No. 100 to 115: To specify the station No. of the inverter to be monitored by the value of GOT data register (GD).^{*1}</td> </tr> </table>	Station No.
Station No.	Monitors the inverter of the specified station No. 0 to 31: To monitor the inverter of the specified station No. 100 to 115: To specify the station No. of the inverter to be monitored by the value of GOT data register (GD). ^{*1}	
Information	Displays the device type and setting range which are selected in [Device].	

*1 The following shows the relation between the inverter station numbers and the GOT data register.

Station No.	GOT data register (GD)	Setting range
100	GD10	0 to 31 (If setting a value outside the range above, a device range error occurs)
101	GD11	
:	:	
114	GD24	
115	GD25	

(1) Setting the device by inputting directly from the keyboard

When setting the device by inputting directly from the keyboard, set the items as follows.

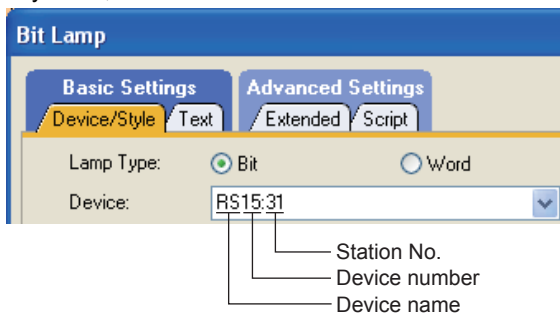

Inverter (FREQROL 500/700/800 series), sensorless servo (FREQROL-E700EX)

	Device name	Setting range	Device No. representation
Bit device	Inverter status monitor (RS) ^{*3}	RS0: 0 to RS15: 31 RS0: 100 to RS15: 115	Decimal
	Run command (WS) ^{*4*5}	WS0: 0 to RS15: 31 WS0: 100 to RS15: 115	
Word device	Alarm definition (A) ^{*2*3}	A0: 0 to A7: 31 A0: 100 to A7: 115	Decimal
	Parameter (Pr) ^{*1*2}	Pr0: 0 to 1500: 31 Pr0: 100 to 1500: 115	
	Programmed operation (PG) ^{*1*2}	PG0: 0 to PG89: 31 PG0: 100 to PG89: 115	
	Special parameter (SP) ^{*2*4*5}	SP108: 0 to SP127: 31 SP108: 100 to SP127: 115	

- *1 When creating the screen, designate only either of programmed operation (PG) device or parameter (Pr) device.
Do not designate both PG (PG0 to PG89) and Pr (Pr900 to Pr905) devices.
- *2 Only 16-bit (1-word) designation is possible.
- *3 Only reading is possible.
- *4 Precautions for PU operation mode
When the GOT is connected to the PU connector and the operation mode is set to the PU operation mode, the multi-speed operation (W3 to W7, SP121, SP122) cannot be used. For using the multi-speed operation, follow either of the operations as below.
 - Connect the GOT to the RS-485 terminal and set the operation mode to the NET operation mode (Computer link operation mode), and then operate the inverter.
 - Change the motor speed with the set frequency (SP109, SP110), and then operate the inverter with the forward or reverse rotation (WS1, WS2, SP121, SP122).
- *5 Precautions for WS devices
Only writing is possible for WS devices.
More than one WS cannot turn on at once.
(Except the turned on WS device, the other WS devices turn off.)
Bits of SP122 (word device) and SP121 (word device) are assigned to WS0 to WS7 and WS8 to WS15 respectively. When more than one WS turns on at once, convert the values for the bit devices that are assigned to the word device into values for the word device. Write the converted values into SP122 or SP121.
 - Setting High speed operation command (WS5), Middle speed operation command (WS4), and Low speed operation command (WS3)
When setting High speed operation command (WS5), Middle speed operation command (WS4), and Low speed operation command (WS3), write numerical values to device SP122 as necessary.
As the following figure shows, each operation mode is assigned to device SP122.
The following shows an example for Forward rotation command (WS1) and Low speed operation command (WS3).

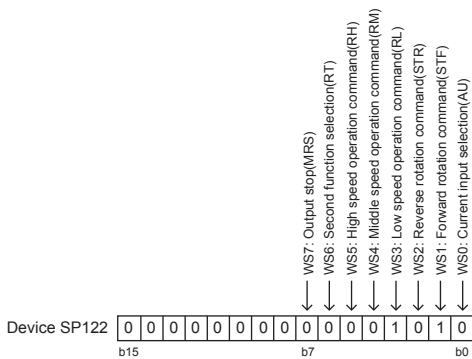

Write 1 to the bits of device SP122 that correspond to the Forward rotation command (WS1) and Low speed operation command (WS3).
 In this example, device SP122 must store 000AH.
 Convert 000AH to a decimal value (10), and then write 10 to device SP122.

- Setting the JOG operation command (WS8), Selection of automatic restart after instantaneous power failure command (WS9), Start self-holding selection command (WS10), and Reset command (WS11)
 When setting the above commands, write values to device SP121 as necessary. As shown in the figure below, each operation mode is assigned to a bit of device SP121. The following shows an example of setting the Reset command (WS11).

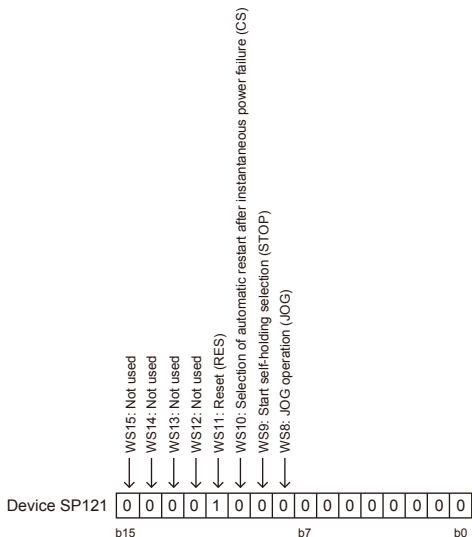

Write 1 to the bit of device SP121 that corresponds to the Reset command (WS11). In this example, device SP121 must store 0800H. Convert 0800H to a decimal value (2048), and then write 2048 to device SP121. When using a WS device, [Alternate] of a bit switch cannot be used.
 Use [Momentary], [Set], and [Reset] for bit switch actions.
 When using a WS device, [Alternate] of a bit switch cannot be used.

Use [Set], [Reset], and [Momentary] of a bit switch.
 The following shows correspondences between virtual inverter devices used in the GOT and data of the inverter.

(1) Inverter status monitor

An example with FREQROL-A700 series is shown below. For the setting items of other than the FREQROL-A700 series, refer to the following manual.

User's Manual of the used inverter (communication function (setting item and set data))

Device name	Description*1
RS0	Inverter running (RUN)
RS1	Forward rotation (STF)
RS2	Reverse rotation (STR)
RS3	Up to frequency (SU)
RS4	Overload (OL)
RS5	Instantaneous power failure (IPF)
RS6	Frequency detection (FU)
RS7	Fault (ABC1)
RS8	ABC2
RS9	-
RS10	-
RS11	-
RS12	-
RS13	-
RS14	-
RS15	Fault occurrence

*1 The description (function of input terminal) may be changed by the parameter of the inverter side. Check the function of the inverter used.

Inverter User's Manual (Application) Communication operation and setting

(2) Run command

An example with FREQROL-A700 series is shown below. For the setting items of other than the FREQROL-A700 series, refer to the following manual.

User's Manual of the used inverter (Communication function (Setting item and set data))

Device name	Description*1
WS0	Current input selection (AU)
WS1	Forward rotation command (STF)
WS2	Reverse rotation command (STR)
WS3	Low speed operation command (RL)
WS4	Middle speed operation command (RM)
WS5	High speed operation command (RH)
WS6	Second function selection (RT)
WS7	Output stop (MRS)
WS8*2	Jog operation (JOG)
WS9*2	Selection of automatic restart after instantaneous power failure (CS)
WS10*2	Start self-holding (STOP)
WS11*2	Reset (RES)
WS12	-
WS13	-
WS14	-
WS15	-

*1 The data (function of input terminal) may be changed by the parameter of the inverter side. Check the function of the inverter used.

Inverter User's Manual (Application) Communication operation and setting

*2 Write a value to parameter Pr.185, Pr.186, Pr.188, or Pr.189 that corresponds to a signal within parentheses. Doing so issues the corresponding run command (WS8 to WS11). For the details of the inverter parameters, refer to the following.

 Manual of the inverter used

(3) Alarm definition

Device name ^{*1}	Description
A0	Second alarm in past
A1	Latest alarm
A2	Fourth alarm in past
A3	Third alarm in past
A4	Sixth alarm in past
A5	Fifth alarm in past
A6	Eighth alarm in past
A7	Seventh alarm in past

*1 Only reading is possible for A0 to A7.
These devices cannot be used for a write object (numerical input etc.).

(4) Parameter

The numbers of virtual devices for inverter (parameter (Pr)), used by GOT, correspond to the inverter parameter numbers.

For the inverter parameters, refer to the following.

 Manual of the inverter being used

POINT

(1) Monitoring Pr.37

GOT cannot monitor the parameter (Pr.37) of FREQROL-E500/S500(E)/F500J/D700/F700PJ/E700.

- (2) When setting "8888" or "9999" to inverter parameter (Pr) "8888" and "9999" designate special function. To set these numbers from GOT, designate a number as shown below.

Set value of inverter side	Value specified by GOT
8888	65520
9999	65535

(3) Precautions for setting calibration parameter (Pr900 to Pr905)

When setting a calibration parameter (Pr900 to Pr905), it is necessary to set the value below for extension second parameter (SP108), depending on the device number to be used and the inverter model.

Value to be set to extension second parameter (SP108)	Description
H00	Offset/gain
H01	Analog
H02	Analog value at terminal

(5) Programmed operation

The devices below correspond to the parameters (Pr.201 to Pr.230) of FREQROL-A500 series.

Device name	Description
PG0 to PG9	Program set 1 (running frequency)
PG10 to PG19 ^{*1}	Program set 1 (time)
PG20 to PG29	Program set 1 (rotation direction)

Device name	Description
PG30 to PG39	Program set 2 (running frequency)
PG40 to PG49 ^{*1}	Program set 2 (time)
PG50 to PG59	Program set 2 (rotation direction)
PG60 to PG69	Program set 3 (running frequency)
PG70 to PG79 ^{*1}	Program set 3 (time)
PG80 to PG89	Program set 3 (rotation direction)

*1 To set the start time (PG10 to PG19, PG40 to PG49, PG70 to PG79), set hour or minute in the upper 8bits, and minute or second in the lower 8bits.
Example) To set 13 hour 35 minute

Time to be set	13H	35M	Remark
Convert "hour" and "minute" into hexadecimal.	H0D	H23	HEX
Combine upper and lower 8-bit values.	Input H0D23 or 3363.		-

(6) Special parameter

The numbers of the inverter's virtual devices (SP) used for the GOT correspond to instruction codes of the inverter communication function.

For instruction details, and values to be read and written, refer to the following.

 Manual of the inverter used

Device name	Description	Instruction code	
		Read	Write
SP108	Second parameter changing	6CH	EC _H
SP109 ^{*1}	Set frequency (RAM)	6DH	ED _H
SP110 ^{*1}	Set frequency (RAM, E ² PROM)	6EH	EE _H
SP111 ^{*1*2}	Output frequency	6FH	-
SP112 ^{*2}	Output current	70H	-
SP113 ^{*2}	Output voltage	71H	-
SP114 ^{*2}	Special monitor	72H	-
SP115	Special monitor selection No.	73H	F3 _H
SP116	Alarm definition all clear	-	F4 _H
	Latest alarm, second alarm in past	74H	-
SP117	Third alarm in past, fourth alarm in past	75H	-
SP118	Fifth alarm in past, sixth alarm in past	76H	-
SP119	Seventh alarm in past, eighth alarm in past	77H	-
SP121	Inverter status monitor (extended)	79H	F9 _H
	Run command (extend)		
SP122	Inverter status monitor	7AH	-
	Run command		
SP123	Communication mode	7BH	FB _H
SP124 ^{*3}	All parameter clear	-	FC _H
SP125 ^{*3}	Inverter reset	-	FD _H
SP127	Link parameter extended setting	7FH	FF _H

*1 GOT cannot monitor SP109 to SP111 if the conditions below are satisfied at the same time.
(Only FREQROL-E500/S500(E)/F500J/D700/F700PJ/E700 series)

- Pr37 ≠ 0
- SP127 = 1

*2 Only reading is possible for SP111 to SP114. These devices cannot be used for a write object (numerical input etc.).

*3 Only writing is possible for SP124 and SP125. These devices cannot be used for read object.

15.7 Precautions

■ Station No. of inverter system

Make sure to establish inverter system with No.0 station.

■ Number of inverter

Up to 31 inverters can be connected.

For GT11 and GT10, refer to the following manual for the procedure to check the connectable inverter depending on the version.

 GT11 User's Manual, GT10 User's Manual

Model name	Hardware version	Number of connectable Inverter
GT1155-QTBD	C or later	31
	B or earlier	10
GT1155-QSBD GT1150-QLBD	F or later	31
	E or earlier	10
GT1055-QSBD GT1050-QBBD	C or later	31
	B or earlier	10
GT1045-QSBD GT1040-QBBD	A or later	31
GT1030-L□D GT1030-H□D	B or later	31
	A or earlier	10
GT1020-L□D	E or later	31
	D or earlier	10

■ Parameter setting

(1) Communication parameter change

Do not make any change for each communication parameter of the inverter side from GOT.
If changed, the communication to the inverter cannot be made.

(2) When setting "8888" or "9999" to inverter parameter (Pr)

"8888" and "9999" designate special function. When specifying from the GOT, it will be as follows.

Set value of inverter side	Value specified by GOT
8888	65520
9999	65535

■ Screen switching devices, system information devices

Make sure to use GD for screen switching devices and system information devices when the GOT is connected to only the inverter.

■ GOT clock control

Since the inverter does not have a clock function, the settings of [time adjusting] or [time broad cast] by GOT clock control will be disabled.

9
MELSECNET/H CONNECTION (PLC CONNECTION TO PLC NETWORK)

10
MELSECNET/10 CONNECTION (PLC CONNECTION TO PLC NETWORK)

11
CC-Link IE CONTROLLER NETWORK CONNECTION

12
CC-Link IE FIELD NETWORK CONNECTION

13
CC-Link CONNECTION (INTELLIGENT DEVICE STATION)

14
CC-Link CONNECTION (Via G4)

15
INVERTER CONNECTION

16
SERVO AMPLIFIER CONNECTION

16

SERVO AMPLIFIER CONNECTION







16.1	Connectable Model List	16 - 2
16.2	System Configuration	16 - 3
16.3	Connection Diagram	16 - 9
16.4	GOT Side Settings	16 - 15
16.5	Setting on Servo Amplifier Side	16 - 17
16.6	Device Range that Can Be Set	16 - 20
16.7	Precautions	16 - 58

16. SERVO AMPLIFIER CONNECTION

16.1 Connectable Model List

The following table shows the connectable models.

Series	Model name	Clock	Communication type	GT 16	GT 15	GT 14	GT 12	GT11 Bus	GT11 Serial	GT 10 5□	GT 10 20 30	Refer to
MELSERVO-J2-Super	MR-J2S-□A	×	RS-232 RS-422	○	○	○	○	×	○	○	○	 16.2.1
	MR-J2S-□CP			○	○	○	○	×	○	○	○	
	MR-J2S-□CL			○	○	○	○	×	○	○	○	
MELSERVO-J2M	MR-J2M-P8A	×	RS-232 RS-422	○	○	○	○	×	○	○	○	 16.2.2
	MR-J2M-□DU			○	○	○	○	×	○	○	○	
MELSERVO-J3	MR-J3-□A	×	RS-232 RS-422	○	○	○	○	×	○	○	○	 16.2.3
	MR-J3-□T			○	○	○	○	×	○	○	○	
MELSERVO-J4*1	MR-J4-□A	×	RS-232 RS-422	○	○*2	○	○	×	○*2	○	○	 16.2.4
	MR-J4-□A-RJ			○	○*2	○	○	×	○*2	○	○	
MELSERVO-JE	MR-JE-□A	×	RS-422	○	○	○	○	×	○	○	○	 16.2.4

*1 For the RS-422 communication, use MELSERVO-J4 of software version A3 or a later version.

*2 The GT15 and GT11 cannot be connected to MR-J4-□A-RJ.

16.2 System Configuration

16.2.1 Connecting to the MELSERVO-J2-Super Series

■ When connecting via RS-232 communication

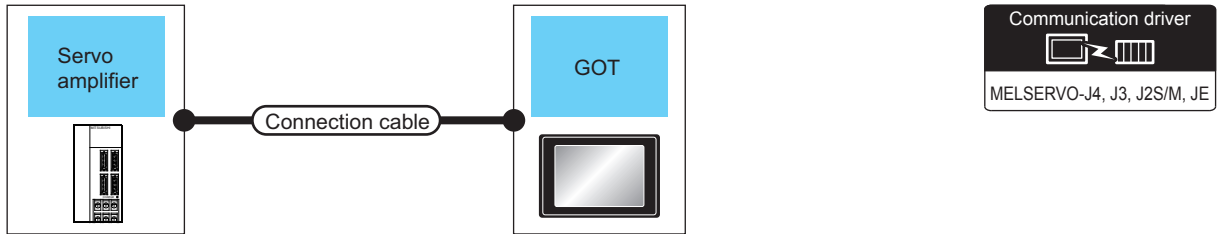

Servo amplifier		Connection cable		GOT		Number of connectable equipment
Series name	Communication type	Cable model Connection diagram number	Max. distance	Option device	Model	
MELSERVO-J2-Super*1	RS-232	MR-CPCATCBL3M(3m) or User RS-232 connection diagram 1)	15m	GT15-RS2-9P	GT 16 GT 15	1 GOT for 1 servo amplifier
		MR-CPCATCBL3M(3m) or User RS-232 connection diagram 1) + User RS-232 connection diagram 2)		(Built into GOT)	GT 16 GT 15 GT 14 GT 12	
			User RS-232 connection diagram 3)	15m	(Built into GOT)	
			15m	(Built into GOT)	GT 10 20 24V 30	

*1 Connect the connector of the servo amplifier to CN3.

■ When connecting via RS-422 communication

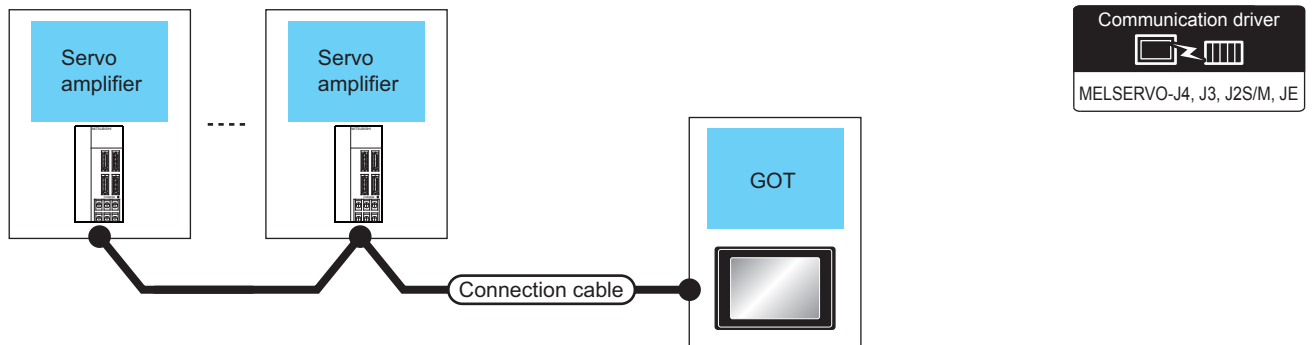

Servo amplifier		Connection cable	GOT		Max. distance	Number of connectable equipment
Series name	Communication type	Connection diagram number	Option device	Model		
MELSERVO-J2-Super*1	RS-422	User RS-422 connection diagram 1)	(Built into GOT)	GT 16	30m	Up to 32 axes for 1 GOT (multi-drop communication)
		User RS-422 connection diagram 2)	GT16-C02R4-9S(0.2m)	GT 16		
			GT15-RS2T4-9P*2	GT 16 GT 15		
		User RS-422 connection diagram 7)	(Built into GOT)	GT 14 GT 12 GT 11 Serial GT 10 5 4		
		User RS-422 connection diagram 7)	(Built into GOT)	GT 10 20 24V 30		

*1 Connect the connector of the servo amplifier to CN3.

*2 Connect it to the RS-232 interface (built into GOT). It cannot be mounted on GT1655 and GT155□.

9
MELSECNET/H CONNECTION (PLC CONNECTION TO PLC NETWORK)
10
MELSECNET/10 CONNECTION (PLC CONNECTION TO PLC NETWORK)
11
CC-Link IE CONTROLLER NETWORK CONNECTION
12
CC-Link IE FIELD NETWORK CONNECTION
13
CC-Link CONNECTION (INTELLIGENT DEVICE STATION)
14
CC-Link CONNECTION (Via G4)
15
INVERTER CONNECTION
16
SERVO AMPLIFIER CONNECTION

16.2.2 Connecting to the MELSERVO-J2M Series

■ When connecting via RS-232 communication

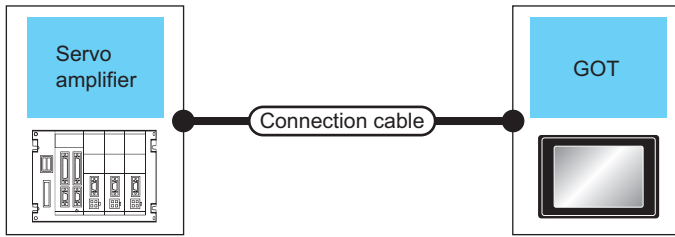

Servo amplifier		Connection cable		GOT		Number of connectable equipment
Series name	Communication type	Cable model Connection diagram number	Max. distance	Option device	Model	
MELSERVO-J2M *1	RS-232	MR-CPCATCBL3M(3m) or RS-232 connection diagram 1)	15m	GT15-RS2-9P		1 GOT for 1 servo amplifier
		MR-CPCATCBL3M(3m) or RS-232 connection diagram 1)		(Built into GOT)	 	
		RS-232 connection diagram 3)	15m	(Built into GOT)		

*1 Connect the connector of the servo amplifier to CN3.

■ When connecting via RS-422 communication

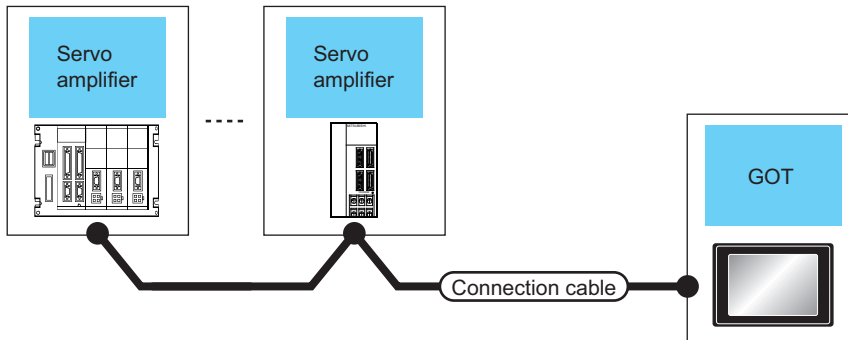

Servo amplifier		Connection cable		GOT		Number of connectable equipment
Series name	Communication type	Connection diagram number	Max. distance	Option device	Model	
MELSERVO-J2M *1	RS-422	RS-422 connection diagram 1)	30m	(Built into GOT)		0 to 31 stations for 1 GOT
		RS-422 connection diagram 2)		GT16-C02R4-9S(0.2m)		
				GT15-RS2T4-9P*2 GT15-RS4-9S		
		RS-422 connection diagram 7)		(Built into GOT)	 	

*1 Connect the connector of the servo amplifier to CN3.

*2 Connect it to the RS-232 interface (built into GOT). It cannot be mounted on GT1655 and GT155□.

16.2.3 Connecting to the MELSERVO-J4, J3 Series

■ When connecting to one servo amplifier

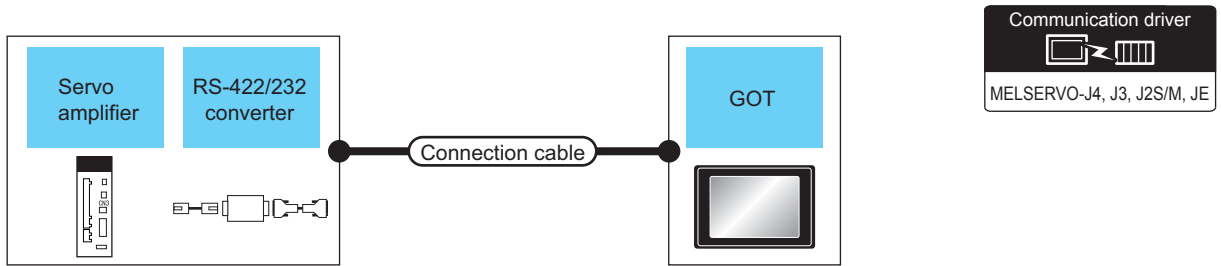

Servo amplifier			Connection cable		GOT		Number of connectable equipment
Series name	RS-422/232 interface converter RS-422/232 conversion cable	Communication type	Cable model Connection diagram number	Max. distance	Option device	Model	
MELSERVO-J4 ^{*1} , J3 ^{*1}	DSV-CABV(1.5m) ^{*2} or FA-T-RS40VS ^{*3}	RS-232	-	15m	GT15-RS2-9P		1 GOT for 1 servo amplifier
					- (Built into GOT)		
			RS-232 connection diagram 2)	15m	- (Built into GOT)		
			-	RS-422	RS-422 connection diagram 3)	30m	
	GT15-RS2T4-9P ^{*4}						
	RS-422 connection diagram 8)	-			- (Built into GOT)		
					- (Built into GOT)		

*1 Connect the connector of the servo amplifier to CN3.

*2 DSV-CABV is a product manufactured by Diatrend Corporation. For details, contact Diatrend Corporation.

*3 FA-T-RS40VS is a product manufactured by MITSUBISHI ELECTRIC ENGINEERING COMPANY LIMITED. For details, contact MITSUBISHI ELECTRIC ENGINEERING COMPANY LIMITED.

The cables (RS-PCATCBL-0.5M(0.5m), RS-422SCBL-2M(2m)) are packed together.

Use the provided cables to connect devices.

* FA-T-RS40VS stopped being produced at the end of March, 2013. The replacement product is not produced.

*4 Connect it to the RS-232 interface (built into GOT). It cannot be mounted on GT1655 and GT155□.

9
MELSECNET/H
CONNECTION (PLC
TO PLC NETWORK)

10
MELSECNET/10
CONNECTION (PLC
TO PLC NETWORK)

11
CC-Link IE CONTROLLER
NETWORK
CONNECTION

12
CC-Link IE FIELD
NETWORK
CONNECTION

13
CC-Link CONNECTION
(INTELLIGENT DEVICE
STATION)

14
CC-Link CONNECTION
(Via G4)

15
INVERTER
CONNECTION

16
SERVO AMPLIFIER
CONNECTION

■ When connecting to multiple servo amplifiers (RS-422 connection)

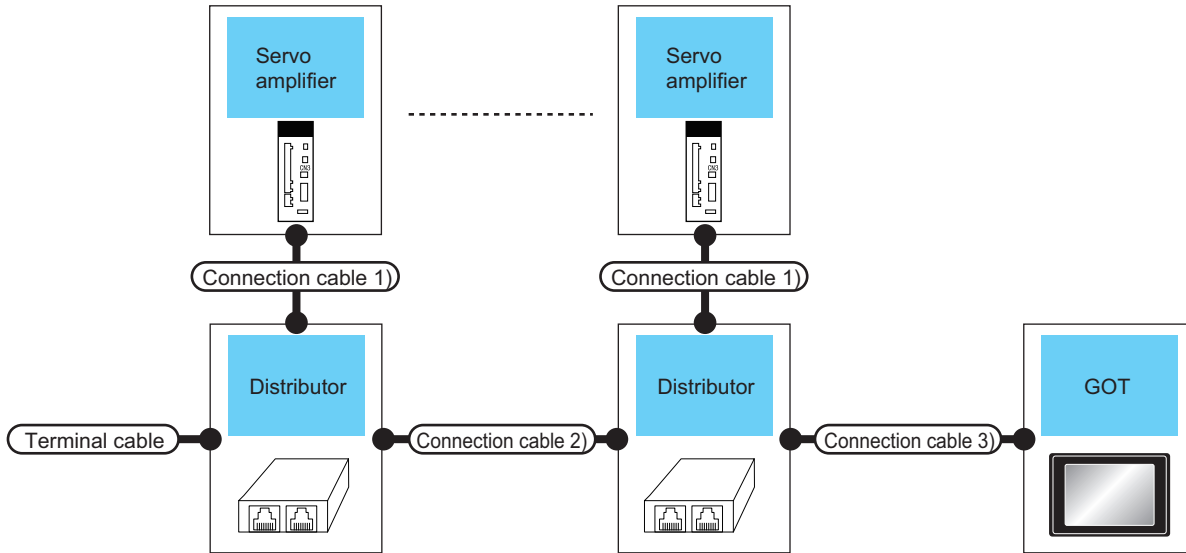

Servo amplifier		Terminating cable	Connection cable 1)	Distributor *2	Connection cable 2)	Distributor *2	Connection cable 3)	GOT		Max. distance	Number of connectable equipment
Series name	Communication type	Connection diagram number	Connection diagram number	Model name	Connection diagram number	Model name	Connection diagram number	Option device	Model		
MELS ERVO-J4*1, J3*1	RS-422	RS-422 connection diagram 6) <small>(User preparing)</small>	RS-422 connection diagram 5) <small>(User preparing)</small>	BMJ-8 (Recommended)	RS-422 connection diagram 4) <small>(User preparing)</small>	BMJ-8 (Recommended)	RS-422 connection diagram 3) <small>(User preparing)</small>	GT16-C02R4-9S(0.2m)	GT16	30m	Up to 32 axes for 1 GOT
								GT15-RS2T4-9P*1	GT15		
								GT15-RS4-9S	GT15		
								- (Built into GOT)	GT14 GT12 GT11 Serial GT10 30/40		
							RS-422 connection diagram 8) <small>(User preparing)</small>	- (Built into GOT)	GT10 20/30		

*1 Connect the connector of the servo amplifier to CN3.

*2 The distributor is a product manufactured by HAKKO ELECTRIC CO., LTD. For details, contact HAKKO ELECTRIC CO., LTD.

■ When connecting to multiple servo amplifiers (RS-232 connection)

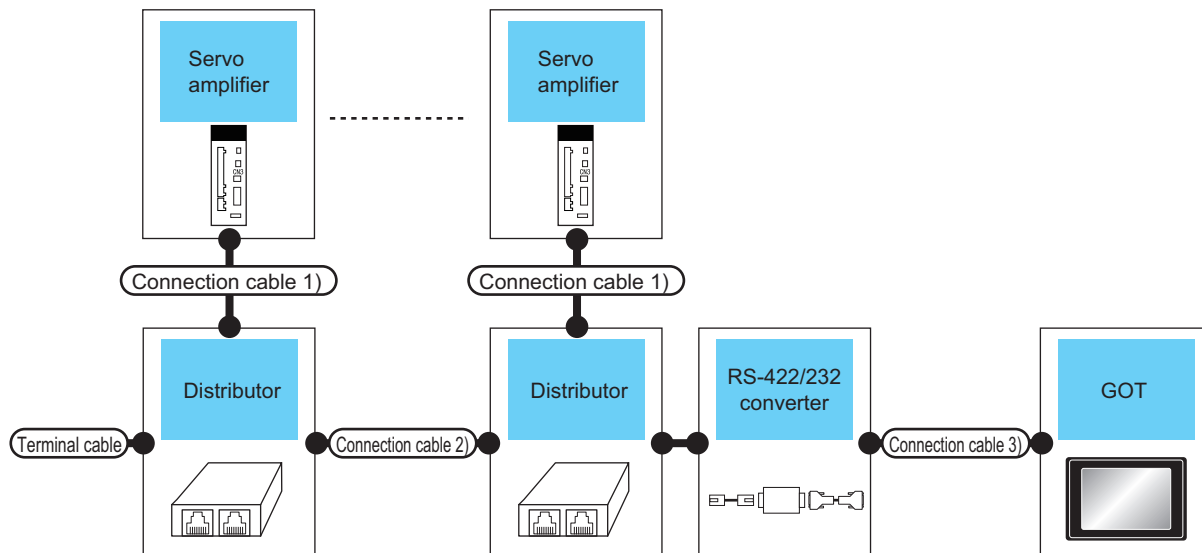

Servo amplifier	Terminating cable	Connection cable 1)	Distributor *3	Connection cable 2)	Distributor *3	RS-422/232 interface converter *2		Connection cable 3)	GOT		Max. distance	Number of connectable equipment
						Model name	Communication type		Option device	Model		
Series name	Connection diagram number	Connection diagram number	Model name	Connection diagram number	Model name	Model name		Connection diagram number	Option device	Model		
MELSE RVO-J4*1, J3*1	RS-422 connection diagram 6) <small>(User preparing)</small>	RS-422 connection diagram 5) <small>(User preparing)</small>	BMJ-8 (Recommended)	RS-422 connection diagram 4) <small>(User preparing)</small>	BMJ-8 (Recommended)	FA-T-RS40 VS	RS-232		GT15-RS2-9P	GT16 GT15 GT14 GT12 GT11 Serial GT10	30m	Up to 32 axes for 1 GOT
									RS-232 connection diagram 2) <small>(User preparing)</small>	- (Built into GOT)		

*1 Connect the connector of the servo amplifier to CN3.

*2 FA-T-RS40VS is a product manufactured by MITSUBISHI ELECTRIC ENGINEERING COMPANY LIMITED. For detail of this product, contact MITSUBISHI ELECTRIC ENGINEERING COMPANY LIMITED.

The cables (RS-PCATCBL-0.5M(0.5m), RS-422SCBL-2M(2m)) are packed together.

Use the cables packed together to connect.

* FA-T-RS40VS stopped being produced at the end of March, 2013. The replacement product is not produced.

*3 The distributor is a product manufactured by HAKKO ELECTRIC CO., LTD. For details, contact HAKKO ELECTRIC CO., LTD.

9
MELSECNET/H CONNECTION (PLC CONNECTION TO PLC NETWORK)

10
MELSECNET/10 CONNECTION (PLC CONNECTION TO PLC NETWORK)

11
CC-Link IE CONTROLLER NETWORK CONNECTION

12
CC-Link IE FIELD NETWORK CONNECTION

13
CC-Link CONNECTION (INTELLIGENT DEVICE STATION)

14
CC-Link CONNECTION (Via G4)

15
INVERTER CONNECTION

16
SERVO AMPLIFIER CONNECTION

16.2.4 Connecting to the MELSERVO-JE Series

■ When connecting via RS-422 communication

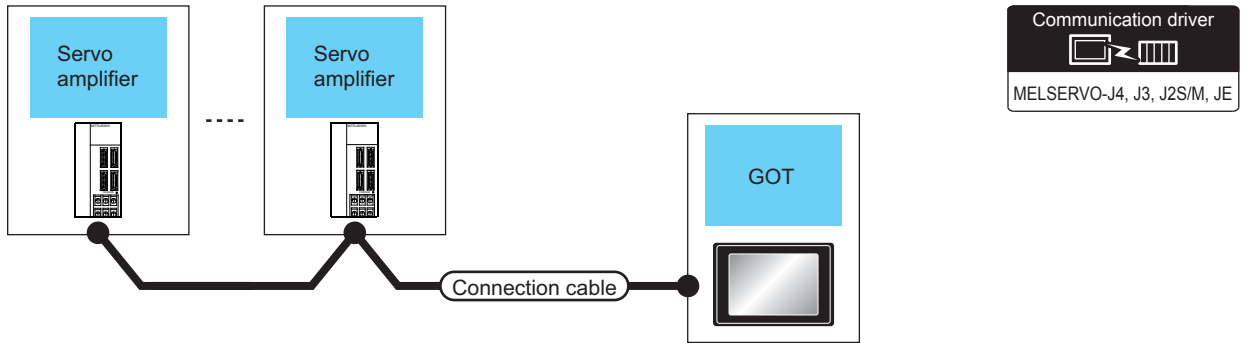

Servo amplifier		Connection cable	GOT		Max. distance	Number of connectable equipment
Series name	Communication type	Connection diagram number	Option device	Model		
MELSERVO-JE ^{*1}	RS-422	RS-422 connection diagram 9)	- (Built into GOT)		30m	Up to 32 axes for 1 GOT (multi-drop communication)
		RS-422 connection diagram 10)	GT16-C02R4-9S(0.2m)			
			GT15-RS2T4-9P ^{*2}			
			GT15-RS4-9S			
RS-422 connection diagram 11)	- (Built into GOT)	 				
		RS-422 connection diagram 11)	- (Built into GOT)			

*1 Connect the connector of the servo amplifier to CN1.

*2 Connect it to the RS-232 interface (built into GOT). It cannot be mounted on GT1655 and GT155□.

16.3 Connection Diagram

The following diagram shows the connection between the GOT and the servo amplifier.

16.3.1 RS-232 cable

■ Connection diagram

RS-232 connection diagram 1)

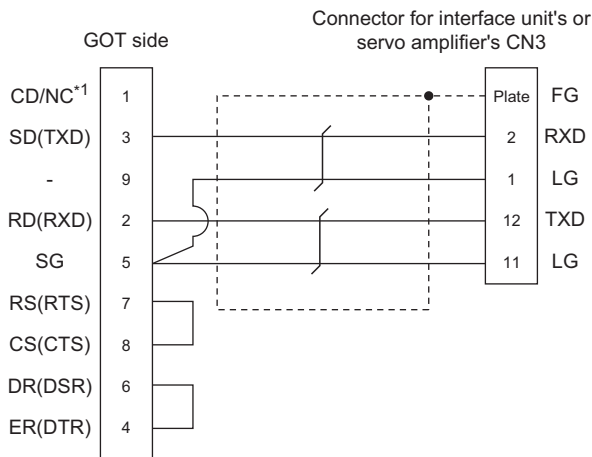

RS-232 connection diagram 2)

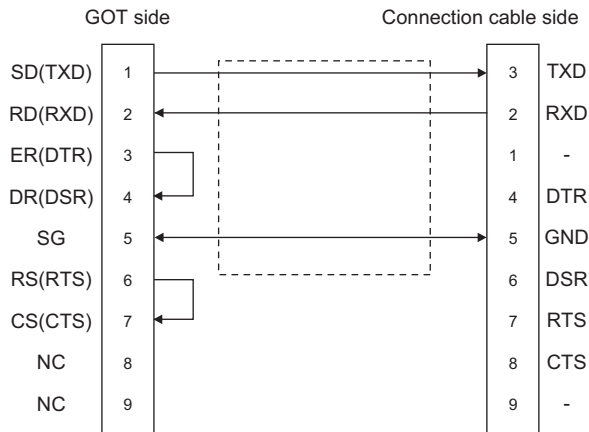

RS-232 connection diagram 3)

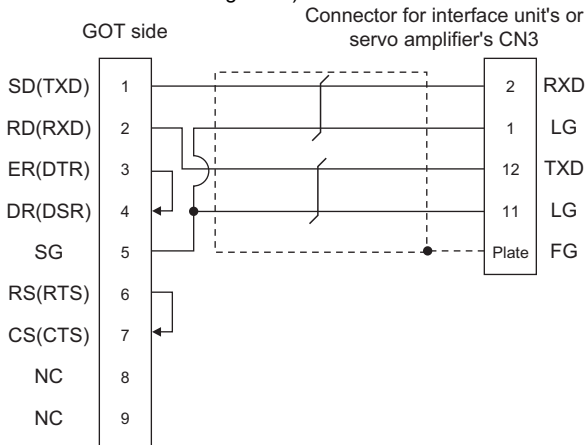

■ Precautions when preparing cable

- (1) Cable length
The length of the cable RS-232 must be 15m or less.
- (2) GOT side connector
For the GOT side connector, refer to the following.
☞ 1.4.1 GOT connector specifications

9
 MELSECNET/H CONNECTION (PLC CONNECTION TO PLC NETWORK)
 10
 MELSECNET/10 CONNECTION (PLC CONNECTION TO PLC NETWORK)
 11
 CC-Link IE CONTROLLER NETWORK CONNECTION
 12
 CC-Link IE FIELD NETWORK CONNECTION
 13
 CC-Link CONNECTION (INTELLIGENT DEVICE STATION)
 14
 CC-Link CONNECTION (Via G4)
 15
 INVERTER CONNECTION
 16
 SERVO AMPLIFIER CONNECTION

16.3.2 RS-422 cable

■ Connection diagram

RS-422 connection diagram 1)

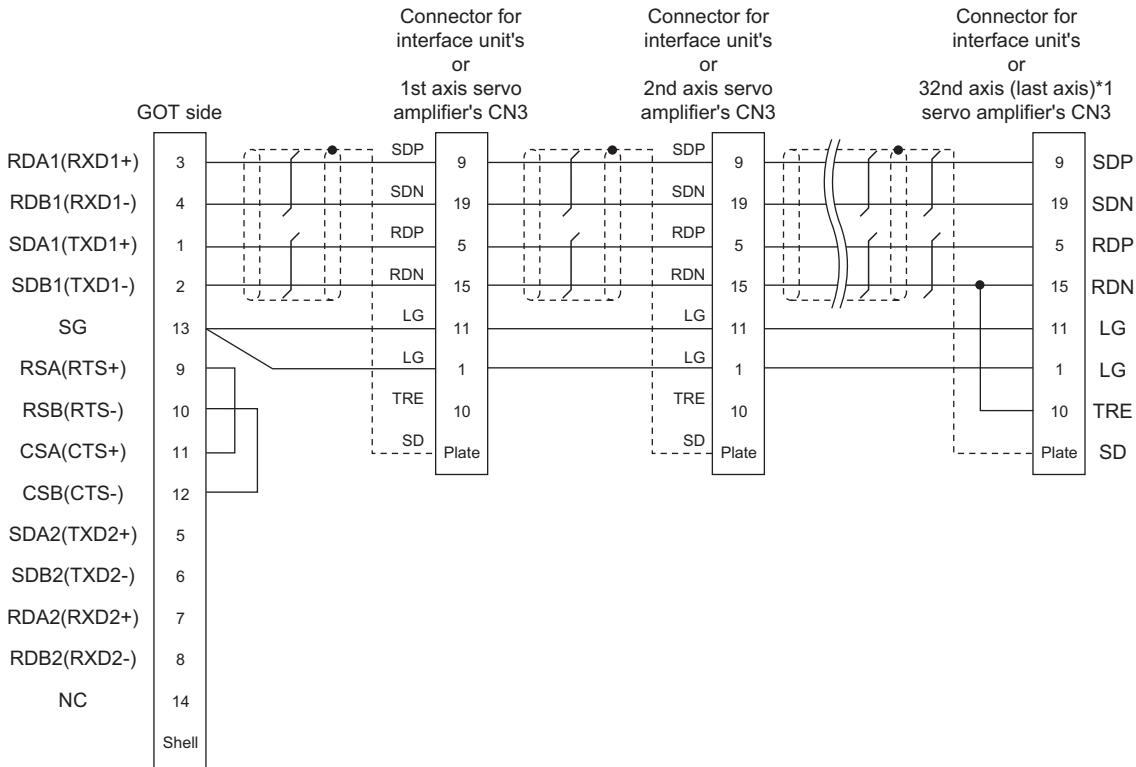

*1 At the last axis, connect TRE to RDN.

RS-422 connection diagram 2)

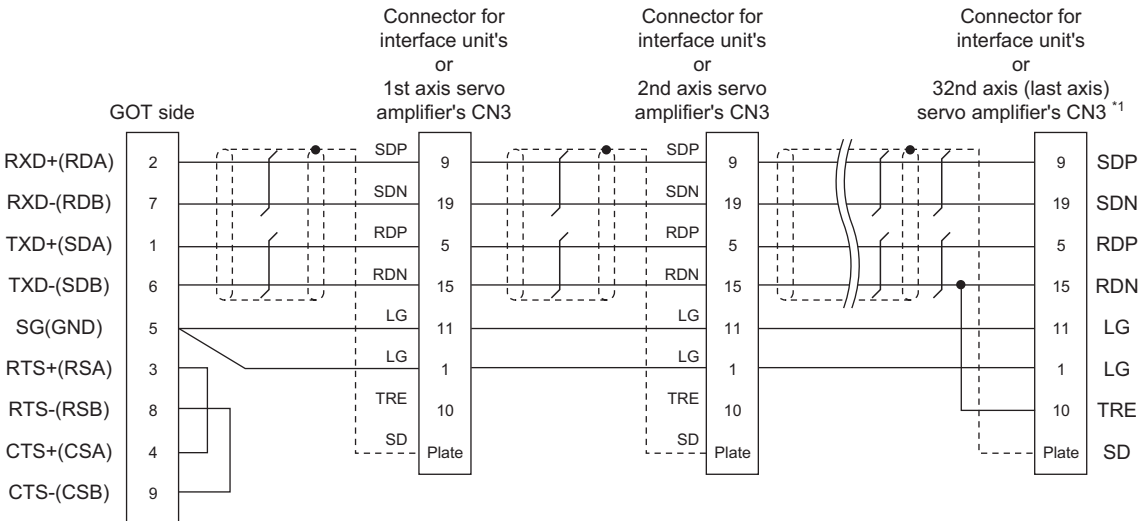

*1 At the last axis, connect TRE to RDN.

RS-422 connection diagram 3)

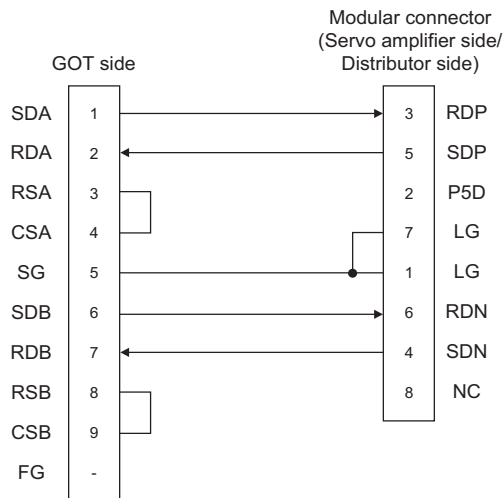

RS-422 connection diagram 6)

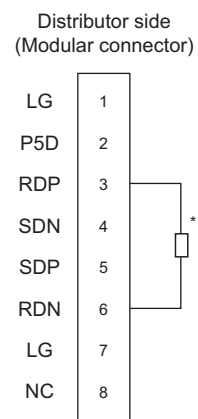

*1 Perform terminal processing on the part between RDP (3-pin) and RDN (6-pin) with a 150Ω resistor.

RS-422 connection diagram 4)

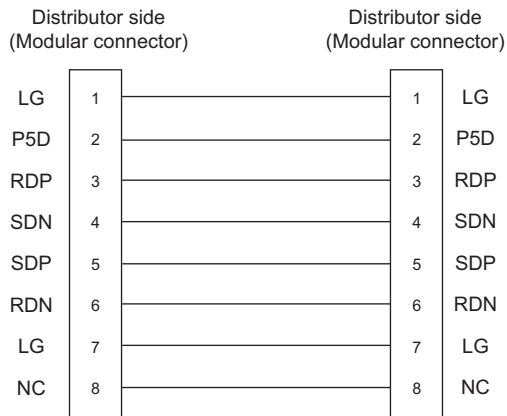

RS-422 connection diagram 5)

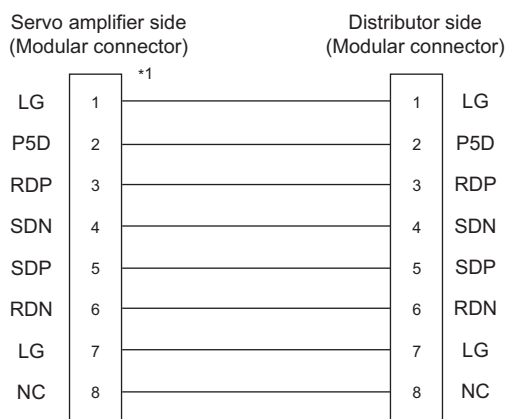

*1 Make the wiring between the distributor and servo amplifier as short as possible.

RS-422 connection diagram 7)

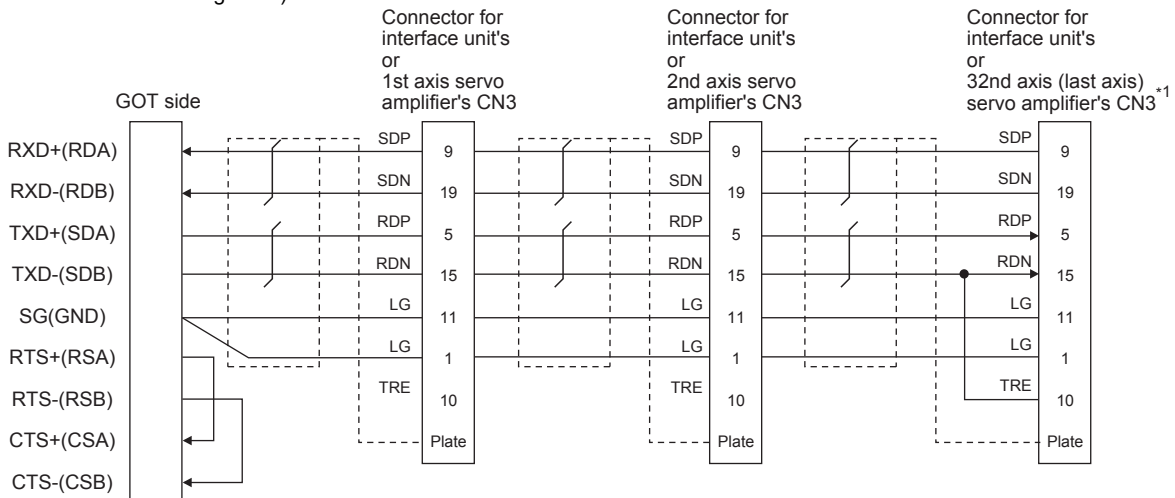

*1 At the last axis, connect TRE to RDN.

RS-422 connection diagram 8)

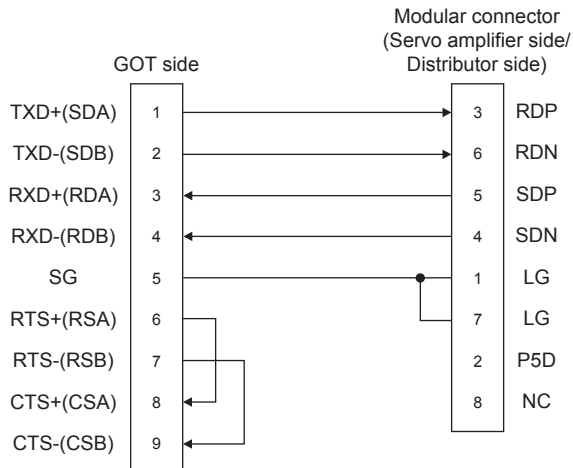

RS-422 connection diagram 9)

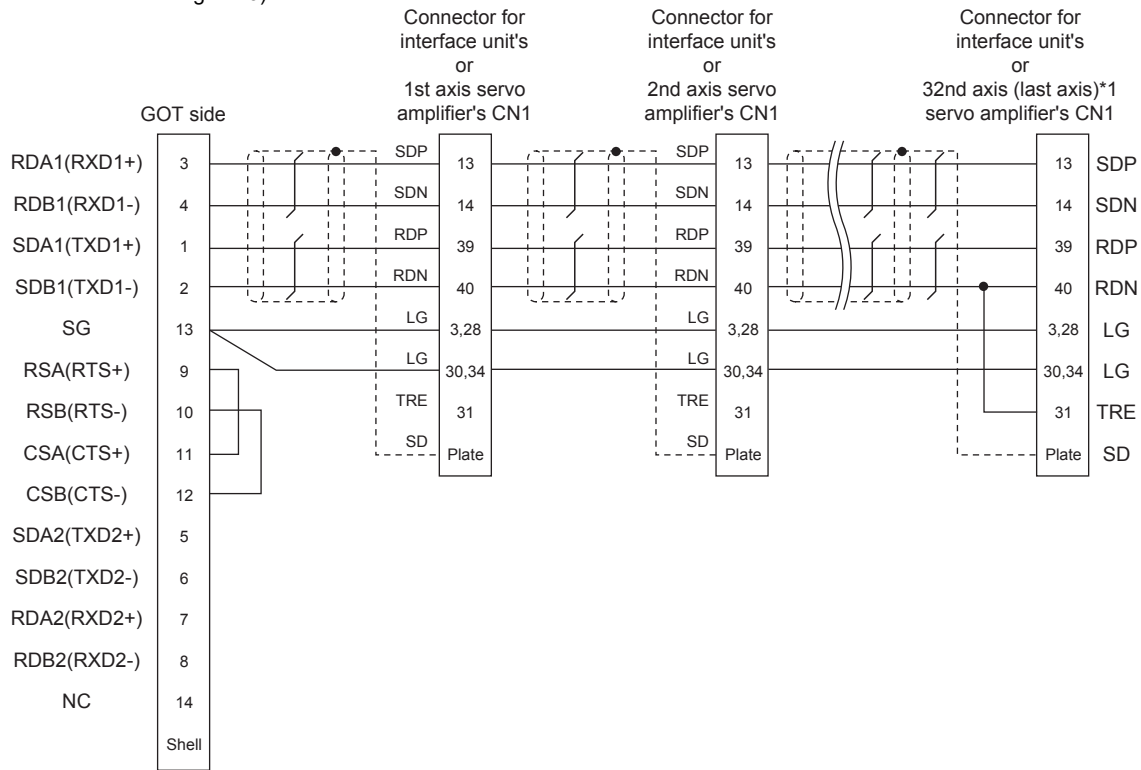

*1 At the last axis, connect TRE to RDN.

RS-422 connection diagram 10)

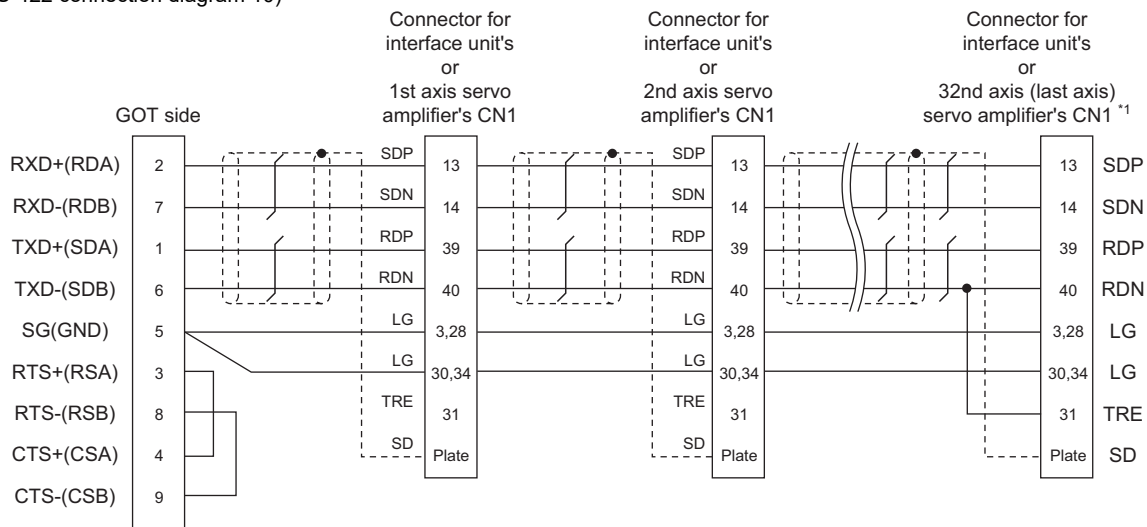

*1 At the last axis, connect TRE to RDN.

RS-422 connection diagram 11)

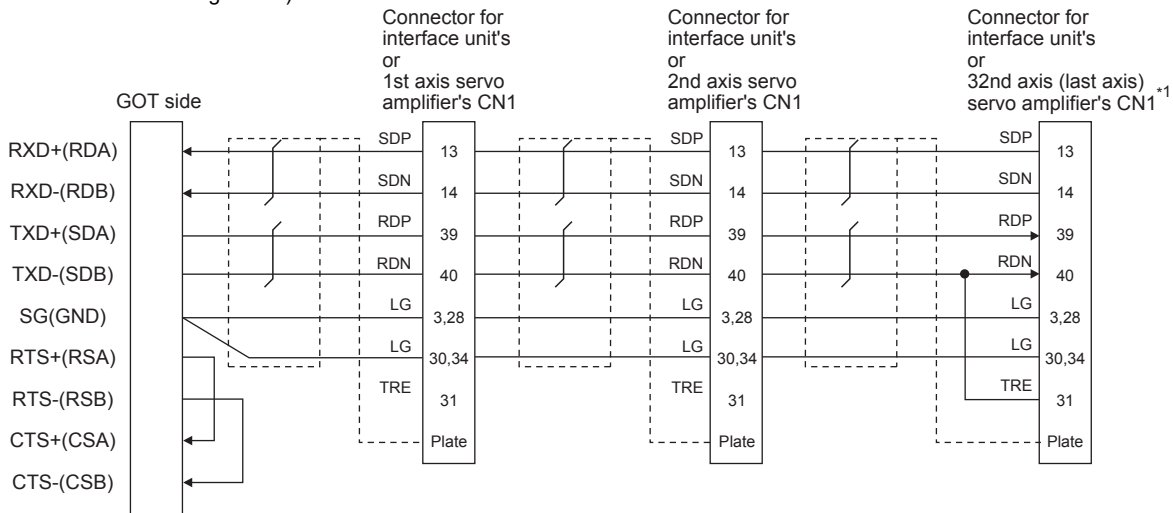

*1 At the last axis, connect TRE to RDN.

■ Precautions when preparing cable

(1) Cable length

The length of the RS-422 cable must be 30m or less.

(2) GOT side connector

For the GOT side connector, refer to the following.

☞ 1.4.1 GOT connector specifications

(3) Servo amplifier connector

Use the connector compatible with the servo amplifier.

For details, refer to the following.

☞ See the technical data of the servo amplifier to be used.

(a) Servo amplifier connector specifications

- Pin layout in the Modular connector

When seen from the front of the servo amplifier (receptacle side)

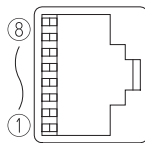

Modular jack

Pin No.	Signal name	Remark
1	LG	
2	P5D	
3	RDP	
4	SDN	
5	SDP	
6	RDN	
7	LG	
8	NC	

- Connector of cable between MELSERVO Series servo amplifiers

Use the commercial connectors and cables shown in the table below or the comparable products.

(Refer to the manual for the servo amplifier.)

Name	Model name	Specifications	Manufacturer
Connector	TM10P-88P (Plug)	RJ45 connector	HIROSE ELECTRIC CO.,LTD.
Modular ceiling rosette (Distributor)	BMJ-8	-	HAKKO ELECTRIC CO.,LTD. TEL.(03)-3806-9171
Cable	-	Cable conforming to EIA568 (such as cable 10BASE-T)	-

■ Connecting terminating resistors

(1) GOT side

When connecting a servo amplifier to the GOT, a terminating resistor must be connected to the GOT.

(a) For GT16, GT15, GT12

Set the terminating resistor setting switch of the GOT main unit to "No".

(b) For GT14, GT11, GT10

Set the terminating resistor selector to "330Ω".

For the procedure to set the terminating resistor, refer to the following.

☞ 1.4.3 Terminating resistors of GOT

16.4 GOT Side Settings

16.4.1 Setting communication interface (Communication settings)

Set the channel of the connected equipment.

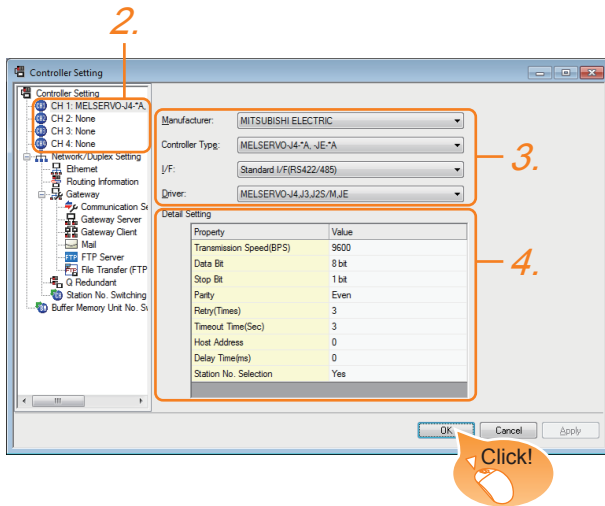

1. Select [Common] → [Controller Setting] from the menu.
2. The Controller Setting window is displayed. Select the channel to be used from the list menu.
3. Set the following items.
 - Manufacturer: MITSUBISHI ELECTRIC
 - Controller Type: Set according to the Controller Type to be connected.
 - I/F: Interface to be used
 - Driver: MELSERVO-J4, J3, J2S/M, JE
4. The detailed setting is displayed after Manufacturer, Controller Type, I/F, and Driver are set. Make the settings according to the usage environment.

☞ 16.4.2 Communication detail settings

Click the [OK] button when settings are completed.

POINT

The settings of connecting equipment can be confirmed in [I/F Communication Setting]. For details, refer to the following.

☞ 1.1.2 I/F communication setting

16.4.2 Communication detail settings

Make the settings according to the usage environment.

Property	Value
Transmission Speed(BPS)	9600
Data Bit	8 bit
Stop Bit	1 bit
Parity	Even
Retry(Times)	3
Timeout Time(Sec)	3
Host Address	0
Delay Time(ms)	0
Station No. Selection	Yes

Item	Description	Range
Transmission Speed	Set this item when change the transmission speed used for communication with the connected equipment. (Default: 9600bps)	9600bps, 19200bps, 38400bps, 57600bps, 115200bps
Data Bit	Set this item when change the data length used for communication with the connected equipment. (Default: 8bit)	8bit (fixed)
Stop Bit	Specify the stop bit length for communications. (Default: 1bit)	1bit (fixed)
Parity	Specify whether or not to perform a parity check, and how it is performed during communication. (Default: Even)	Even (fixed)
Retry	Set the number of retries to be performed when a communication timeout occurs. (Default: 3times)	0 to 5times
Timeout Time	Set the time period for a communication to time out. (Default: 3sec)	3 to 30sec
Host Address	Specify the station number of the servo amplifier in the system configuration. (Default: 0)	0 to 31
Delay Time	Set this item to adjust the transmission timing of the communication request from the GOT. (Default: 0ms)	0 to 300 (ms)
Station No. Selection	Specify whether to use the station No. during communication. If [Yes] is selected, the station No. is fixed to "0." (Default: Yes)	Yes or No

POINT

- (1) Communication interface setting by Utility
The communication interface setting can be changed on the Utility's [Communication Settings] after writing [Communication Settings] of project data.
For details on the Utility, refer to the following manual.
☞ GT User's Manual
- (2) Precedence in communication settings
When settings are made by GT Designer3 or the Utility, the latest setting is effective.

9
 MELSECNET/H CONNECTION (PLC CONNECTION TO PLC NETWORK)
 10
 MELSECNET/T0 CONNECTION (PLC CONNECTION TO PLC NETWORK)
 11
 CC-Link IE CONTROLLER NETWORK CONNECTION
 12
 CC-Link IE FIELD NETWORK CONNECTION
 13
 CC-Link CONNECTION (INTELLIGENT DEVICE STATION)
 14
 CC-Link CONNECTION (Via G4)
 15
 INVERTER CONNECTION
 16
 SERVO AMPLIFIER CONNECTION

HINT

Cutting the portion of multiple connection of the controller

By setting GOT internal device, GOT can cut the portion of multiple connection of the controller. For example, faulty station that has communication timeout can be cut from the system.

For details of the setting contents of GOT internal device, refer to the following manual.

 GT Designer3 Version Screen Design Manual (Fundamentals)

16.5 Setting on Servo Amplifier Side

Model name	Refer to
MELSERVO-J2-Super Series	16.5.1
MELSERVO-J2M Series	16.5.2
MELSERVO-J4, J3 Series	16.5.3

16.5.1 Connecting to the MELSERVO-J2-Super Series

POINT

MELSERVO-J2-Super Series
 For details of the MELSERVO-J2-Super Series, refer to the following manual.

 See the technical manual for the MELSERVO-J2-Super Series servo amplifiers.

Parameters of MELSERVO-J2-Super Series

Enter the parameters of the MELSERVO-J2-Super Series.

Item	Set value
Basic parameter No. 15	Station number setting: 0 to 31 (Default: 0) ^{*1}
Basic parameter No. 16	Serial communication function selection (Default: 0000) Basic parameter No. 16 (3) (2) 0 (1) (1) Serial communication baud rate selection ^{*2} 0: 9600bps 1: 19200bps 2: 38400bps 3: 57600bps (2) Serial communication I/F selection 0: RS-232 1: RS-422 (3) Communication response delay time selection 0: Invalid 1: Valid (Response after 800 μs or longer delay)
In case of MR-J2S-□: Expansion parameter 2 No. 53 In case of MR-J2S-□CP: Expansion parameter 2 No. 57 In case of MR-J2S-□CL: Expansion parameter 2 No. 57	Function selection 8 (Default: 0000) ^{*3} Expansion parameter 2 No. 53 or No. 57 0 (1) 0 0 (1) Station No. selection for protocol 0: With station No. 1: Without station No.

*1 Avoid duplication of the station No. with any of the other axes.
 *2 Specify the same transmission speed as that of the GOT. For the transmission speed setting on the GOT side, refer to the following.
 16.4.1 Setting communication interface (Communication settings)
 *3 To change the set value, enter "000E" to basic parameter No. 19.

POINT

- (1) Parameter setting
 Set the parameter at the pushbutton switch provided on the operation section of the servo amplifier or setup software.

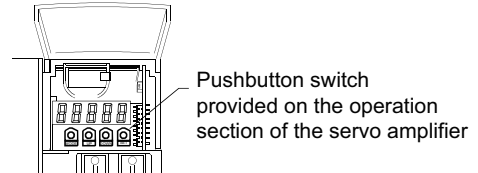

- (2) When changing the parameter
 Turn off then on the servo amplifier to be effective the new parameter.

9
 MELSECNET/H CONNECTION (PLC CONNECTION TO PLC NETWORK)
 10
 MELSECNET/T0 CONNECTION (PLC CONNECTION TO PLC NETWORK)
 11
 CC-Link IE CONTROLLER NETWORK CONNECTION
 12
 CC-Link IE FIELD NETWORK CONNECTION
 13
 CC-Link CONNECTION (INTELLIGENT DEVICE STATION)
 14
 CC-Link CONNECTION (Via G4)
 15
 INVERTER CONNECTION
 16
 SERVO AMPLIFIER CONNECTION

16.5.2 Connecting to the MELSERVO-J2M Series

POINT

MELSERVO-J2M Series

For details of the MELSERVO-J2M Series, refer to the following manual.

 See the technical manual for the MELSERVO-J2M Series servo amplifiers.

Parameter of MELSERVO-J2M Series

Enter the parameters of the MELSERVO-J2M Series.

Item	Set value
Basic IFU parameter No. 0	Serial communication function selection (Default: 0000) Basic IFU parameter No. 0 <input type="text" value="3"/> <input type="text" value="2"/> <input type="text" value="0"/> <input type="text" value="1"/> (1) Serial communication baud rate selection* ¹ 0: 9600bps 1: 19200bps 2: 38400bps 3: 57600bps (2) Serial communication I/F selection 0: RS-232 1: RS-422 (3) Communication response delay time selection 0: Invalid 1: Valid (Response after 800 μs or longer delay)
Basic IFU parameter No. 10	Interface unit serial communication station No. selection: 0 to 31 (Default: 0) * ²
Basic IFU parameter No. 11	Slot 1 serial communication station No. selection: 0 to 31 (Default: 1) * ²
Basic IFU parameter No. 12	Slot 2 serial communication station No. selection: 0 to 31 (Default: 2) * ²
Basic IFU parameter No. 13	Slot 3 serial communication station No. selection: 0 to 31 (Default: 3) * ²
Basic IFU parameter No. 14	Slot 4 serial communication station No. selection: 0 to 31 (Default: 4) * ²
Basic IFU parameter No. 15	Slot 5 serial communication station No. selection: 0 to 31 (Default: 5) * ²
Basic IFU parameter No. 16	Slot 6 serial communication station No. selection: 0 to 31 (Default: 6) * ²
Basic IFU parameter No. 17	Slot 7 serial communication station No. selection: 0 to 31 (Default: 7) * ²
Basic IFU parameter No. 18	Slot 8 serial communication station No. selection: 0 to 31 (Default: 8) * ²

*¹ Specify the same transmission speed as that of the GOT.
For the transmission speed setting on the GOT side, refer to the following.

 16.4.1 Setting communication interface (Communication settings)

*² Avoid duplication of the station No. with any of the other units.

POINT

- (1) Parameter setting
Set the parameter at the pushbutton switch provided on the operation section of the servo amplifier or setup software.

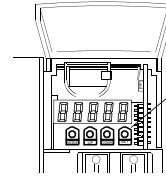

Pushbutton switch provided on the operation section of the servo amplifier

- (2) When changing the parameter
Turn off then on the servo amplifier to be effective the new parameter.

16.5.3 Connecting to the MELSERVO-J4, J3, JE Series

POINT

MELSERVO-J4, J3, JE Series

For details of the MELSERVO-J4, J3, JE Series, refer to the following manual.

☞ See the technical manual for the MELSERVO-J4, J3, JE Series servo amplifiers.

Parameters of MELSERVO-J4, J3, JE Series

Enter the parameters of the MELSERVO-J4, J3, JE Series.

Item	Set value
Basic parameter No. PC20	Station number setting: 0 to 31 (Default: 0) ^{*1}
Basic parameter No. PC21	Serial communication function selection (Default: 0000) Basic parameter No. PC21 <input type="text" value="0"/> <input type="text" value="0"/> <input type="text" value="0"/> (1) Serial communication baud rate selection ^{*2} 0: 9600bps 1: 19200bps 2: 38400bps 3: 57600bps 4: 115200bps (2) Communication response delay time selection 0: Invalid 1: Valid (Response after 800 μs or longer delay)

*1 Avoid duplication of the station No. with any of the other axes.

*2 Specify the same transmission speed as that of the GOT. For the transmission speed setting on the GOT side, refer to the following.

☞ 16.4.1 Setting communication interface (Communication settings)

POINT

(1) Parameter setting

Set the parameter at the pushbutton switch provided on the operation section of the servo amplifier or setup software.

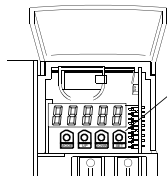

Pushbutton switch provided on the operation section of the servo amplifier

(2) When changing the parameter

Turn off then on the servo amplifier to be effective the new parameter.

16.5.4 Station number setting

Set each station number so that no station number overlaps.

The station number can be set without regard to the cable connection order. There is no problem even if station numbers are not consecutive.

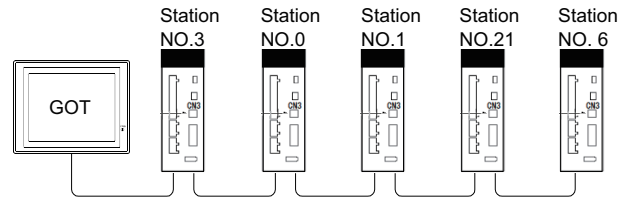

Examples of station number setting

(1) Direct specification

When setting the device, specify the station number of the servo amplifier of which data is to be changed.

Specification range
0 to 31

(2) Indirect specification

When setting the device, indirectly specify the station number of the inverter of which data is to be changed using the 16-bit GOT internal data register (GD10 to GD25).

When specifying the station No. from 100 to 115 on GT Designer3, the value of GD10 to GD25 compatible to the station No. specification will be the station No. of the servo amplifier.

Specification station NO.	Compatible device	Setting range
100	GD10	0 to 31 For the setting other than the above, a communication timeout error will occur.
101	GD11	
102	GD12	
103	GD13	
104	GD14	
105	GD15	
106	GD16	
107	GD17	
108	GD18	
109	GD19	
110	GD20	
111	GD21	
112	GD22	
113	GD23	
114	GD24	
115	GD25	

(3) All station specification

Target station differs depending on write-in operation or read-out operation.

- For write-in operation, all station will be a target.
- For read-out operation, only one station will be a target.

16.6 Device Range that Can Be Set

The device ranges of controller that can be used for GOT are as follows.

Note that the device ranges in the following tables are the maximum values that can be set in GT Designer3.

The device specifications of controllers may differ depending on the models, even though belonging to the same series.

Please make the setting according to the specifications of the controller actually used.

When a non-existent device or a device number outside the range is set, other objects with correct device settings may not be monitored.

(1) Servo amplifier

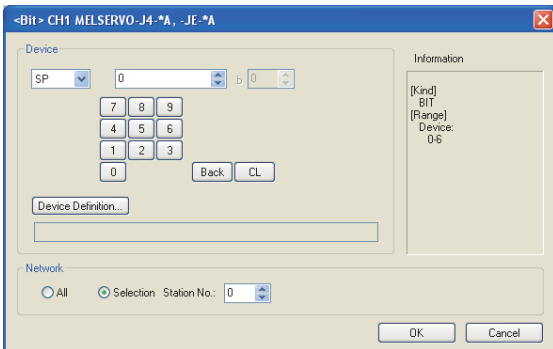

Item	Description
Device	Set the device name, device number, and bit number. The bit number can be set only when specifying the bit of word device.
	Clicking the button displays the dialog box indicating the correspondence between the GOT virtual device for a servo amplifier and the definition of servo amplifier. If selecting an item on the displayed dialog box, remember that the servo amplifier definition is displayed in the text box below.
Information	Displays the device type and setting range which are selected in [Device].
Network	Set the monitor target of the set device. All Select this item when writing data to all servo amplifiers connected. During a monitoring, the servo amplifier of Station No. 0 is monitored. When inputting data by Numerical Input, the data is written to all servo amplifiers connected during inputting; the servo amplifier of Station No. 0 is monitored during other than inputting (displaying).
	Selection Select this item when monitoring the servo amplifier of the Station No. specified. After selecting, set station numbers of servo amplifiers in the following range. 0 to 31: The servo amplifier of the Station No. specified will be monitored. 100 to 115: Specify the Station No. of the servo amplifier to be monitored with a GOT data register (GD). ^{*1}

For details of *1, refer to the following.

Station No.	GOT data register (GD)	Setting range
100	GD10	0 to 31 (If setting a value out of the range above, a timeout error occurs.)
101	GD11	
:	:	
114	GD24	
115	GD25	

- (a) Device Definition dialog box
When setting a device on the Device dialog box and click the [Device Definition...] button, the correspondence between the GOT virtual device for a servo amplifier and the definition of the servo amplifier is displayed.

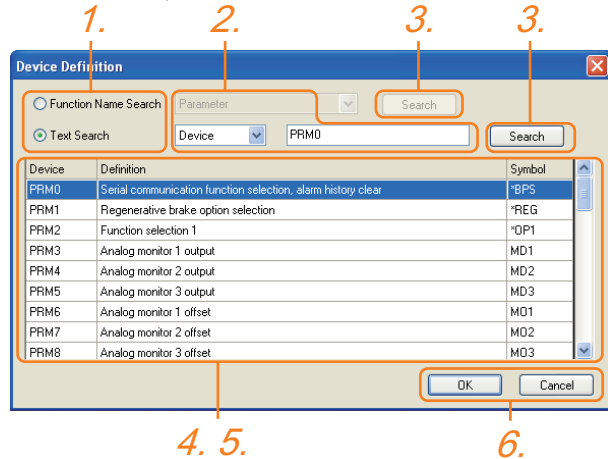

- The device can be searched with the servo definition or other items on this dialog box to set a device.
- Select a key item for searching.
Function Name Search: Select this item when searching a device with the function name.
Text Search: Select this item when searching a device with the character string.
 - Select and input a key item for searching.
 - Click the [Search] button.
 - The items that matches to the specified condition are displayed.
The display contents are as follows.
Device : The GOT virtual device for a servo amplifier is displayed.
Definition : The definition of the servo amplifier is displayed.
Symbol : The abbreviated name for the servo amplifier is displayed.
 - Select a device to be set.
 - Clicking the [OK] button reflects the device selected by step 4 to the Device dialog box.

POINT

When selecting [All] in the Network setting
The network No. 0 and Station No. FF are displayed on Device List and when printing.
(Device List screen)

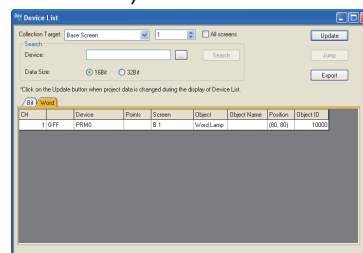

POINT

Monitoring servo amplifier

Carefully read the manual of servo amplifier to be connected and fully understand the operating procedures before monitoring.

Before operation, check the parameter settings. Improper settings may cause some machines to perform unexpected operation.

The parameter settings must not be changed excessively. Operation will be insatiable.

- (1) Parameters with * in front of it's abbreviated name
For the parameter with * in front of it's abbreviated name, powering off the servo amplifier after setting then on makes the parameter valid.

- (2) Data length for setting virtual devices for servo amplifier

Set the following data length for setting devices.

- PRM, ST, AL, PA, PB, PC, PD, POS, SPD, ACT, DCT, DWL, AUX
: 16bits or 32bits (depends on the data of servo amplifier)
- DI, DO, TMI, TMO, TMD: 32bits

If the above data length was not set, data would not be set to the servo amplifier correctly or the GOT can not monitor normally.

- (a) Monitoring

- When the 16-bit data is handled as 32-bit data, the upper 16bits are displayed as 0.
- When the 32-bit data is handled as 16-bit data, the lower 16bits only are displayed as 0.

- (b) Writing

The GOT writes within the range of data length set. Note that the servo amplifier responds correctly while the written data is invalid in the servo amplifier side when the written data is outside the range of values which can be set by the servo amplifier.

- (3) Memory area for writing parameters

Parameters are written to RAM or E²PROM of servo amplifier.

- (a) When written to RAM

Remember that written parameters are cleared when power supply to the servo amplifier is turned off.

- (b) When written to E²PROM

Written parameters are not cleared even when power supply to the servo amplifier is turned off. However, there are limits in the number of writing to E²PROM.

If the data is frequently updated (more than once in an hour), write the parameters to the RAM.

For details, refer to the manual of the servo amplifier used.

(2) MELSERVO-J2M-P8A

	Device name*2	Setting range available	Device No. representation	
Bit device	Servo amplifier request (SP)	SP1 to SP2	Decimal	
	Operation mode selection (OM)	OM0 to OM4		
Word device	Basic parameter Expansion parameter (PRM)*1	PRM0 to PRM29 PRM1000 to PRM1029		
	Status display (ST)	ST0 to ST2		
	Alarm (AL)	AL0 AL11 to AL13 AL200 to AL205 AL210 to AL215 AL230 to AL235		
		External input (DI)*3		DI0 to DI2
		External output (DO)		DO0 to DO1
Double word device		Forced output of signal pin (for test operation) (TMO)		TMO0

*1 Use PRM0 to PRM29 when writing parameters to the servo amplifier RAM. PRM1000 to PRM1029 are used when writing parameters to E²PROM of the servo amplifier. Use PRM1000 to PRM1029 when reading parameters to the servo amplifier RAM.

*2 The GOT cannot read or write data from/to consecutive devices.

*3 Only reading is possible.

POINT

Precautions for SP, OM, and TMO devices

- (1) For bit devices

Only writing is possible.

[Alternate] of a bit switch cannot be used.

Use [Set], [Reset], and [Momentary] of a bit switch.

- (2) For word devices, double word devices

Only writing is possible.

Numerical input cannot be used.

When writing, use [Word Set] of a data set switch.

(a) Servo amplifier request

Device name	Item	Symbol
SP1	Current alarm clear	—
SP2	Alarm history clear	—

(b) Operation mode selection

Device name	Item	Symbol
OM0	Normal mode (not test operation mode)	—
OM4	Output signal (DO) forced output	—

(c) Basic parameter/expansion parameter

Device name	Item	Symbol* ²
PRM0, PRM1000	Serial communication function selection, alarm history clear	*BPS
PRM1, PRM1001	Regenerative brake option selection	*REG
PRM2, PRM1002	Function selection 1	*OP1
PRM3, PRM1003	Analog monitor 1 output	MD1
PRM4, PRM1004	Analog monitor 2 output	MD2
PRM5, PRM1005	Analog monitor 3 output	MD3
PRM6, PRM1006	Analog monitor 1 offset	MO1
PRM7, PRM1007	Analog monitor 2 offset	MO2
PRM8, PRM1008	Analog monitor 3 offset	MO3
PRM9, PRM1009	Function selection 2	*OP2
PRM10, PRM1010	Interface unit serial communication station No. selection	*ISN
PRM11, PRM1011	Slot 1 serial communication station No. selection	*DSN1
PRM12, PRM1012	Slot 2 serial communication station No. selection	*DSM2
PRM13, PRM1013	Slot 3 serial communication station No. selection	*DSM3
PRM14, PRM1014	Slot 4 serial communication station No. selection	*DSN4
PRM15, PRM1015	Slot 5 serial communication station No. selection	*DSN5
PRM16, PRM1016	Slot 6 serial communication station No. selection	*DSN6
PRM17, PRM1017	Slot 7 serial communication station No. selection	*DSN7
PRM18, PRM1018	Slot 8 serial communication station No. selection	*DSN8
PRM19, PRM1019	Parameter write inhibit	*BLK
PRM20, PRM1020	Serial communication time-out selection	SIC
PRM21 to PRM29 PRM1021 to PRM1029	For manufacturer setting	—

2 For the parameters prefixed by an asterisk (), setting becomes effective when the power is turned off once and back on after setting the parameter data.

(d) Status display

Device name	Item	Symbol
ST0	Regenerative load ratio	—
ST1	Bus voltage	—
ST2	Peak bus voltage	—

(e) Alarm

Device name	Item	Symbol
AL0	Current alarm number	—
AL11	Servo status when alarm occurs regenerative load factor	—
AL12	Servo status when alarm occurs bus voltage	—
AL13	Servo status when alarm occurs peak bus voltage	—
AL200	Alarm number from alarm history most recent alarm	—
AL201	Alarm number from alarm history first alarm in past	—
AL202	Alarm number from alarm history second alarm in past	—
AL203	Alarm number from alarm history third alarm in past	—
AL204	Alarm number from alarm history fourth alarm in past	—
AL205	Alarm number from alarm history fifth alarm in past	—
AL210	Alarm occurrence time in alarm history most recent alarm	—
AL211	Alarm occurrence time in alarm history first alarm in past	—
AL212	Alarm occurrence time in alarm history second alarm in past	—
AL213	Alarm occurrence time in alarm history third alarm in past	—
AL214	Alarm occurrence time in alarm history fourth alarm in past	—
AL215	Alarm occurrence time in alarm history fifth alarm in past	—
AL230	Detailed alarm from alarm history most recent alarm	—
AL231	Detailed alarm from alarm history first alarm in past	—
AL232	Detailed alarm from alarm history second alarm in past	—
AL233	Detailed alarm from alarm history third alarm in past	—
AL234	Detailed alarm from alarm history fourth alarm in past	—
AL235	Detailed alarm from alarm history fifth alarm in past	—

(f) External I/O signal

Device name	Item	Symbol
DI0	External input pin statuses CN1A/CN1B	—
DI1	External input pin statuses CN5	—
DI2	External input pin statuses CN4A/CN4B	—
DO0	External output pin statuses CN1A/CN1B	—
DO1	External output pin statuses CN1A/CN1B	—

(g) Forced output of signal pin (for test operation)

Device name	Item	Symbol
TMO0	Forced output of signal pin	—

(3) MELSERVO-J2M-*DU

Device name*2		Setting range	Device No. representation
Bit device	Servo amplifier request (SP)	SP0 to SP6	Decimal
	Operation mode selection (OM)	OM0 to OM4	
	Instruction demand (for test operation) (TMB)	TMB0 to TMB1	
Word device	Basic parameter	PRM0 to PRM84	
	Expansion parameter (PRM)*1	PRM1000 to PRM1084	
	Status display (ST)	ST0 to ST10	
	Alarm (AL)	AL0	
AL200 to AL205		AL210 to AL215	
AL230 to AL235			
Double word device	Input signal for test operation (for test operation) (TMI)	TMI0	
	Forced output of signal pin (for test operation) (TMO)	TMO0	
	Set data (for test operation) (TMD)	TMD0 to TMD2	

- *1 Use PRM0 to PRM84 when writing parameters to the servo amplifier RAM. PRM1000 to PRM1084 are used when writing parameters to E²PROM of the servo amplifier. Use PRM1000 to PRM1084 when reading parameters to the servo amplifier RAM.
- *2 The GOT cannot read or write data from/to consecutive devices.

POINT

Precautions for SP, OM, TMB, TMI, TMO, and TMD devices

- For bit devices
Only writing is possible.
[Alternate] of a bit switch cannot be used.
Use [Set], [Reset], and [Momentary] of a bit switch.
- For word devices, double word devices
Only writing is possible.
Numerical input cannot be used.
When writing, use [Word Set] of a data set switch.

The following shows correspondences between virtual devices for servo amplifier and data of the servo amplifier used with the GOT.

(a) Servo amplifier request

Device name	Item	Symbol
SP0	Status display data clear	—
SP1	Current alarm clear	—
SP2	Alarm history clear	—
SP3	External input signal prohibited	—
SP4	External output signal prohibited	—
SP5	External input signal resumed	—
SP6	External output signal resumed	—

(b) Operation mode selection

Device name	Item	Symbol
OM0	Normal mode (not test operation mode)	—
OM1	JOG operation	—
OM2	Positioning operation	—
OM3	Motorless operation	—
OM4	Output signal (DO) forced output	—

(c) Instruction demand (for test operation)

Device name	Item	Symbol
TMB0	Clears acceleration/ deceleration time constant (test mode)	—
TMB1	Temporary stop command (test mode)	—

(d) Basic parameter/expansion parameter

Device name	Item	Symbol*1
PRM0, PRM1000	For manufacturer setting	—
PRM1, PRM1001	Function selection 1	*OP1
PRM2, PRM1002	Auto tuning	ATU
PRM3, PRM1003	CMX Electronic gear numerator (Command pulse multiplying factor numerator)	CMX
PRM4, PRM1004	Electronic gear denominator (Command pulse multiplying factor denominator)	CDV
PRM5, PRM1005	In-position range	INP
PRM6, PRM1006	Position loop gain 1	PG1
PRM7, PRM1007	Position command acceleration/deceleration time constant (position smoothing)	PST
PRM8 to PRM15, PRM1008 to PRM1015	For manufacturer setting	—
PRM16, PRM1016	Alarm history clear	*BPS
PRM17 to PRM18, PRM1017 to PRM1018	For manufacturer setting	—
PRM19, PRM1019	DRU parameter block	*BLK
PRM20, PRM1020	Function selection 2	*OP2
PRM21, PRM1021	Function selection 3 (Command pulse selection)	*OP3
PRM22, PRM1022	Function selection 4	*OP4
PRM23, PRM1023	Feed forward gain	FFC

(Continued to next page)

Device name	Item	Symbol ^{*1}
PRM24, PRM1024	Zero speed	ZSP
PRM25 to PRM26, PRM1025 to PRM1026	For manufacturer setting	—
PRM27, PRM1027	Encoder output pulses	*ENR
PRM28, PRM1028	Internal torque limit 1	TL1
PRM29 to PRM32, PRM1029 to PRM1032	For manufacturer setting	—
PRM33, PRM1033	Electromagnetic brake sequence output	MBR
PRM34, PRM1034	Ratio of load inertia moment to servo motor inertia moment	GD2
PRM35, PRM1035	Position loop gain 2	PG2
PRM36, PRM1036	Speed loop gain 1	VG1
PRM37, PRM1037	Speed loop gain 2	VG2
PRM38, PRM1038	Speed integral compensation	VIC
PRM39, PRM1039	Speed differential compensation	VDC
PRM40 to PRM41, PRM1040 to PRM1041	For manufacturer setting	—
PRM42, PRM1042	Input signal selection 1	*DI1
PRM43 to PRM50, PRM1043 to PRM1050	For manufacturer setting	—
PRM51, PRM1051	Function selection 6	*OP6
PRM52 to PRM53, PRM1052 to PRM1053	For manufacturer setting	—
PRM54, PRM1054	Function selection 9	*OP9
PRM55, PRM1055	Function selection A	*OPA
PRM56 to PRM57, PRM1056 to PRM1057	For manufacturer setting	—
PRM58, PRM1058	Machine resonance suppression filter 1	NH1
PRM59, PRM1059	Machine resonance suppression filter 2	NH2
PRM60, PRM1060	Low-pass filter, adaptive vibration suppression control	LPF
PRM61, PRM1061	Ratio of load inertia moment to servo motor inertia moment 2	GD2B
PRM62, PRM1062	Position control gain 2 changing ratio	PG2B
PRM63, PRM1063	Speed control gain 2 changing ratio	VG2B
PRM64, PRM1064	Speed integral compensation changing ratio	VICB
PRM65, PRM1065	Gain changing selection	*CDP
PRM66, PRM1066	Gain changing condition	CDS
PRM67, PRM1067	Gain changing time constant	CDT
PRM68, PRM1068	For manufacturer setting	—
PRM69, PRM1069	Command pulse multiplying factor numerator 2	CMX2
PRM70, PRM1070	Command pulse multiplying factor numerator 3	CMX3
PRM71, PRM1071	Command pulse multiplying factor numerator 4	CMX4
PRM72 to PRM75, PRM1072 to PRM1075	For manufacturer setting	—
PRM76, PRM1076	Internal torque limit 2	TL2
PRM77 to PRM84, PRM1077 to PRM1084	For manufacturer setting	—

1 For the parameters prefixed by an asterisk (), setting becomes effective when the power is turned off once and back on after setting the parameter data.

(e) Status display

Device name	Item	Symbol
ST0	Cumulative feedback pulses	—
ST1	Servo motor speed	—
ST2	Droop pulses	—
ST3	Cumulative command pulses	—
ST4	Command pulse frequency	—
ST5	Effective load ratio	—
ST6	Peak load ratio	—
ST7	Instantaneous torque	—
ST8	Within one-revolution position	—
ST9	ABS counter	—
ST10	Load inertia moment ratio	—

(f) Alarm

Device name	Item	Symbol
AL0	Current alarm number	—
AL11	Servo status when alarm occurs cumulative feedback pulses	—
AL12	Servo status when alarm occurs servo motor speed	—
AL13	Servo status when alarm occurs droop pulses	—
AL14	Servo status when alarm occurs cumulative command pulses	—
AL15	Servo status when alarm occurs command pulse frequency	—
AL16	Servo status when alarm occurs effective load ratio	—
AL17	Servo status when alarm occurs peak load ratio	—
AL18	Servo status when alarm occurs instantaneous torque	—
AL19	Servo status when alarm occurs within one- revolution position	—
AL20	Servo status when alarm occurs ABS counter	—
AL21	Servo status when alarm occurs load inertia moment ratio	—
AL200	Alarm number from alarm history most recent alarm	—
AL201	Alarm number from alarm history first alarm in past	—
AL202	Alarm number from alarm history second alarm in past	—
AL203	Alarm number from alarm history third alarm in past	—
AL204	Alarm number from alarm history fourth alarm in past	—
AL205	Alarm number from alarm history fifth alarm in past	—
AL210	Alarm occurrence time in alarm history most recent alarm	—
AL211	Alarm occurrence time in alarm history first alarm in past	—
AL212	Alarm occurrence time in alarm history second alarm in past	—
AL213	Alarm occurrence time in alarm history third alarm in past	—
AL214	Alarm occurrence time in alarm history fourth alarm in past	—

Device name	Item	Symbol
AL215	Alarm occurrence time in alarm history fifth alarm in past	—
AL230	Detailed alarm from alarm history most recent alarm	—
AL231	Detailed alarm from alarm history first alarm in past	—
AL232	Detailed alarm from alarm history second alarm in past	—
AL233	Detailed alarm from alarm history third alarm in past	—
AL234	Detailed alarm from alarm history fourth alarm in past	—
AL235	Detailed alarm from alarm history fifth alarm in past	—

(g) Input signal for test operation (for test operation)

Device name	Item	Symbol
TMI0	Input signal for test operation	—

(h) Forced output of signal pin (for test operation)

Device name	Item	Symbol
TMO0	Forced output of signal pin	—

(i) Set data (for test operation)

Device name	Item	Symbol
TMD0	Writes the speed (test mode)	—
TMD1	Writes the acceleration/deceleration time constant (test mode)	—
TMD2	Writes the moving distance in pulses (test mode)	—

(4) MELSERVO-J2S-*A

Device name*2		Setting range	Device No. representation
Bit device	Servo amplifier request (SP)	SP0 to SP6	Decimal
	Operation mode selection (OM)	OM0 to OM4	
	Instruction demand (for test operation) (TMB)	TMB0 to TMB1	
Word device	Basic parameter /expansion parameter (PRM)*1	PRM0 to PRM84 PRM1000 to PRM1084	
	Status display (ST)	ST0 to ST14	
	Alarm (AL)	AL0 to AL1 AL11 to AL25 AL200 to AL205 AL210 to AL215 AL230 to AL235	
	External input (DI)*3	DI0	
	External output (DO)	DO0	
	Double word device	Input signal for test operation (for test operation) (TMI)	
Forced output of signal pin (for test operation) (TMO)		TMO0	
Set data (for test operation) (TMD)		TMD0 to TMD2	

- *1 Use PRM0 to PRM84 when writing parameters to the servo amplifier RAM. PRM1000 to PRM1084 are used when writing parameters to E²PROM of the servo amplifier. Use PRM1000 to PRM1084 when reading parameters to the servo amplifier RAM.
- *2 The GOT cannot read or write data from/to consecutive devices.
- *3 Only reading is possible.

POINT

Precautions for SP, OM, TMB, TMI, TMO, and TMD devices

- (1) For bit devices
Only writing is possible.
[Alternate] of a bit switch cannot be used.
Use [Set], [Reset], and [Momentary] of a bit switch.
- (2) For word devices, double word devices
Only writing is possible.
Numerical input cannot be used.
When writing, use [Word Set] of a data set switch.

The following shows correspondences between virtual devices for servo amplifier and data of the servo amplifier used with the GOT.

(a) Servo amplifier request

Device name	Item	Symbol
SP0	Status display data clear	—
SP1	Current alarm clear	—
SP2	Alarm history clear	—
SP3	External input signal prohibited	—
SP4	External output signal prohibited	—
SP5	External input signal resumed	—
SP6	External output signal resumed	—

(b) Operation mode selection

Device name	Item	Symbol
OM0	Normal mode (not test operation mode)	—
OM1	JOG operation	—
OM2	Positioning operation	—
OM3	Motorless operation	—
OM4	Output signal (DO) forced output	—

(c) Instruction demand (for test operation)

Device name	Item	Symbol
TMB0	Clears acceleration/ deceleration time constant	—
TMB1	Temporary stop command	—

(d) Basic parameter/expansion parameter

Device name	Item	Symbol ^{*1}
PRM0, PRM1000	Control mode, regenerative brake option selection	*STY
PRM1, PRM1001	Function selection 1	*OP1
PRM2, PRM1002	Auto tuning	ATU
PRM3, PRM1003	Electronic gear numerator (Command pulse multiplying factor numerator)	CMX
PRM4, PRM1004	Electronic gear denominator (Command pulse multiplying factor denominator)	CDV
PRM5, PRM1005	In-position range	INP
PRM6, PRM1006	Position loop gain 1	PG1
PRM7, PRM1007	Position command acceleration/deceleration time constant	PST
PRM8, PRM1008	Internal speed command1/limit1	SC1
PRM9, PRM1009	Internal speed command2/limit2	SC2
PRM10, PRM1010	Internal speed command3/limit3	SC3
PRM11, PRM1011	Acceleration time constant	STA
PRM12, PRM1012	Deceleration time constant	STB
PRM13, PRM1013	S-pattern acceleration/ deceleration time constant	STC
PRM14, PRM1014	Torque command time constant	TQC
PRM15, PRM1015	Station number setting	*SNO
PRM16, PRM1016	Serial communication function selection, alarm history clear	*BPS
PRM17, PRM1017	Analog monitor output	MOD
PRM18, PRM1018	Status display selection	*DMD
PRM19, PRM1019	Parameter block	*BLK
PRM20, PRM1020	Function selection 2	*OP2
PRM21, PRM1021	Function selection 3 (Command pulse selection)	*OP3

Device name	Item	Symbol ^{*1}
PRM22, PRM1022	Function selection 4	*OP4
PRM23, PRM1023	Feed forward gain	FFC
PRM24, PRM1024	Zero speed	ZSP
PRM25, PRM1025	Analog speed command maximum speed /limit maximum speed	VCM
PRM26, PRM1026	Analog torque command maximum output	TLC
PRM27, PRM1027	Encoder output pulses	*ENR
PRM28, PRM1028	Internal torque limit 1	TL1
PRM29, PRM1029	Analog speed command offset /limit offset	VCO
PRM30, PRM1030	Analog torque command offset /limit offset	TLO
PRM31, PRM1031	Analog monitor 1 offset	MO1
PRM32, PRM1032	Analog monitor 2 offset	MO2
PRM33, PRM1033	Electromagnetic brake sequence output	MBR
PRM34, PRM1034	Ratio of load inertia moment to servo motor inertia moment	GD2
PRM35, PRM1035	Position loop gain 2	PG2
PRM36, PRM1036	Speed loop gain 1	VG1
PRM37, PRM1037	Speed loop gain 2	VG2
PRM38, PRM1038	Speed integral compensation	VIC
PRM39, PRM1039	Speed differential compensation	VDC
PRM40, PRM1040	For manufacturer setting	—
PRM41, PRM1041	Input signal automatic ON selection	*DIA
PRM42, PRM1042	Input signal selection 1	*DI1
PRM43, PRM1043	Input signal selection 2 (CN1B-5)	*DI2
PRM44, PRM1044	Input signal selection 3 (CN1B-14)	*DI3
PRM45, PRM1045	Input signal selection 4 (CN1A-8)	*DI4
PRM46, PRM1046	Input signal selection 5 (CN1B-7)	*DI5
PRM47, PRM1047	Input signal selection 6 (CN1B-8)	*DI6
PRM48, PRM1048	Input signal selection 7 (CN1B-9)	*DI7
PRM49, PRM1049	Output signal selection 1	*DO1
PRM50, PRM1050	For manufacturer setting	—
PRM51, PRM1051	Function selection 6	*OP6
PRM52, PRM1052	For manufacturer setting	—
PRM53, PRM1053	Function selection 8	*OP8
PRM54, PRM1054	Function selection 9	*OP9
PRM55, PRM1055	Function selection A	*OPA
PRM56, PRM1056	Serial communication time-out selection	SIC
PRM57, PRM1057	For manufacturer setting	—
PRM58, PRM1058	Machine resonance suppression filter 1	NH1
PRM59, PRM1059	Machine resonance suppression filter 2	NH2
PRM60, PRM1060	Low-pass filter, adaptive vibration suppression control	LPF
PRM61, PRM1061	Ratio of load inertia moment to servo motor inertia moment 2	GD2B
PRM62, PRM1062	Position control gain 2 changing ratio	PG2B
PRM63, PRM1063	Speed control gain 2 changing ratio	VG2B
PRM64, PRM1064	Speed integral compensation changing ratio	VICB
PRM65, PRM1065	Gain changing selection	*CDP
PRM66, PRM1066	Gain changing condition	CDS
PRM67, PRM1067	Gain changing time constant	CDT
PRM68, PRM1068	For manufacturer setting	—
PRM69, PRM1069	Command pulse multiplying factor numerator 2	CMX2

(Continued to next page)

Device name	Item	Symbol*1
PRM70, PRM1070	Command pulse multiplying factor numerator 3	CMX3
PRM71, PRM1071	Command pulse multiplying factor numerator 4	CMX4
PRM72, PRM1072	Internal speed command4/limit4	SC4
PRM73, PRM1073	Internal speed command5/limit5	SC5
PRM74, PRM1074	Internal speed command6/limit6	SC6
PRM75, PRM1075	Internal speed command7/limit7	SC7
PRM76, PRM1076	Internal torque limit 2	TL2
PRM77 to PRM84, PRM1077 to PRM1084	For manufacturer setting	—

1 For the parameters prefixed by an asterisk (), setting becomes effective when the power is turned off once and back on after setting the parameter data.

(e) Status display

Device name	Item	Symbol
ST0	Cumulative feedback pulses	—
ST1	servo motor speed	—
ST2	Droop pulses	—
ST3	Cumulative command pulses	—
ST4	Command pulse frequency	—
ST5	Analog speed command voltage/limit voltage	—
ST6	Analog torque command voltage/limit voltage	—
ST7	Regenerative load ratio	—
ST8	Effective load ratio	—
ST9	Peak load ratio	—
ST10	Instantaneous torque	—
ST11	Within one-revolution position	—
ST12	ABS counter	—
ST13	load inertia moment ratio	—
ST14	Bus voltage	—

(f) Alarm

Device name	Item	Symbol
AL0	Current alarm number	—
AL1	Detailed data of current alarms	—
AL11	Servo status when alarm occurs cumulative feedback pulses	—
AL12	Servo status when alarm occurs servo motor speed	—
AL13	Servo status when alarm occurs droop pulses	—
AL14	Servo status when alarm occurs cumulative command pulses	—
AL15	Servo status when alarm occurs command pulse frequency	—
AL16	Servo status when alarm occurs analog speed command voltage/limit voltage	—
AL17	Servo status when alarm occurs analog torque command voltage/limit voltage	—
AL18	Servo status when alarm occurs regenerative load ratio	—
AL19	Servo status when alarm occurs effective load ratio	—
AL20	Servo status when alarm occurs peak load ratio	—
AL21	Servo status when alarm occurs instantaneous torque	—
AL22	Servo status when alarm occurs within one-revolution position	—
AL23	Servo status when alarm occurs ABS counter	—
AL24	Servo status when alarm occurs load inertia moment ratio	—

Device name	Item	Symbol
AL25	Servo status when alarm occurs bus voltage	—
AL200	Alarm number from alarm history most recent alarm	—
AL201	Alarm number from alarm history first alarm in past	—
AL202	Alarm number from alarm history second alarm in past	—
AL203	Alarm number from alarm history third alarm in past	—
AL204	Alarm number from alarm history fourth alarm in past	—
AL205	Alarm number from alarm history fifth alarm in past	—
AL210	Alarm occurrence time in alarm history most recent alarm	—
AL211	Alarm occurrence time in alarm history first alarm in past	—
AL212	Alarm occurrence time in alarm history second alarm in past	—
AL213	Alarm occurrence time in alarm history third alarm in past	—
AL214	Alarm occurrence time in alarm history fourth alarm in past	—
AL215	Alarm occurrence time in alarm history fifth alarm in past	—
AL230	Detailed alarm from alarm history most recent alarm	—
AL231	Detailed alarm from alarm history first alarm in past	—
AL232	Detailed alarm from alarm history second alarm in past	—
AL233	Detailed alarm from alarm history third alarm in past	—
AL234	Detailed alarm from alarm history fourth alarm in past	—
AL235	Detailed alarm from alarm history fifth alarm in past	—

(g) External I/O signal

Device name	Item	Symbol
DI0	External input pin statuses	—
DO0	External output pin statuses	—

(h) Input signal for test operation (for test operation)

Device name	Item	Symbol
TMI0	Input signal status for test operation	—

(i) Forced output of signal pin (for test operation)

Device name	Item	Symbol
TMO0	Forced output status of signal pin	—

(j) Set data (for test operation)

Device name	Item	Symbol
TMD0	Writes the speed (test mode)	—
TMD1	Writes the acceleration/deceleration time constant (test mode)	—
TMD2	Writes the moving distance in pulses (test mode)	—

9 MELSECNET/H CONNECTION (PLC CONNECTION TO PLC NETWORK)
10 MELSECNET/10 CONNECTION (PLC CONNECTION TO PLC NETWORK)
11 CC-LINK IE CONTROLLER NETWORK CONNECTION
12 CC-LINK IE FIELD NETWORK CONNECTION
13 CC-LINK CONNECTION (INTELLIGENT DEVICE STATION)
14 CC-LINK CONNECTION (Via G4)
15 INVERTER CONNECTION
16 SERVO AMPLIFIER CONNECTION

(5) MELSERVO-J2S-*CP

Device name*3		Setting range		Device No. representation
Bit device	Servo amplifier request (SP)	SP0	to SP6	Decimal
	Operation mode selection (OM)	OM0	to OM4	
	Instruction demand (for test operation) (TMB)	TMB0	to TMB1	
Word device	Basic parameter /expansion parameter (PRM)*1	PRM0	to PRM90 PRM1000 to PRM1090	
	Status display (ST)	ST0	to ST16	
	Alarm (AL)	AL0	to AL1	
		AL11	to AL27	
		AL200	to AL205	
		AL210	to AL215	
	AL230	to AL235		
	External input (DI)*4	DI0	to DI2	
	External output (DO)	DO0	to DO1	
	Point table (position) (POS)*2	POS1	to POS31	
POS1001		to POS1031		
Point table (speed) (SPD)*2		SPD1	to SPD31	
		SPD1001	to SPD1031	
Point table (acceleration time constant) (ACT)*2		ACT1	to ACT31	
	ACT1001	to ACT1031		
Point table (deceleration time constant) (DCT)*2	DCT1	to DCT31		
	DCT1001	to DCT1031		
Point table (dwell) (DWL)*2	DWL1	to DWL31		
	DWL1001	to DWL1031		
Point table (auxiliary function) (AUX)*2	AUX1	to AUX31		
	AUX1001	to AUX1031		
Double word device	Input signal for test operation (for test operation) (TMI)	TMI0		
	Forced output of signal pin (for test operation) (TMO)	TMO0		
	Set data (for test operation) (TMD)	TMD0	to TMD2	

*1 Use PRM0 to PRM90 when writing parameters to the servo amplifier RAM. PRM1000 to PRM1090 are used when writing parameters to E²PROM of the servo amplifier. Use PRM1000 to PRM1090 when reading parameters to the servo amplifier RAM.

*2 When writing to a point table, use the area of 1001 to 1031 (E²PROM area) of POS, SPD, ACT, DCT, DWL, or AUX. If writing to the area of 1 to 31 (RAM area) of POS, SPD, ACT, DCT, DWL, or AUX, the value is not reflected.

*3 The GOT cannot read or write data from/to consecutive devices.

*4 Only reading is possible for DI0 to DI1.

POINT

Precautions for SP, OM, TMB, TMI, TMO, and TMD devices

- (1) For bit devices
Only writing is possible.
[Alternate] of a bit switch cannot be used.
Use [Set], [Reset], and [Momentary] of a bit switch.
- (2) For word devices, double word devices
Only writing is possible.
Numerical input cannot be used.
When writing, use [Word Set] of a data set switch.

The following shows correspondences between virtual devices for servo amplifier and data of the servo amplifier used with the GOT.

(a) Servo amplifier request

Device name	Item	Symbol
SP0	Status display data clear	—
SP1	Current alarm clear	—
SP2	Alarm history clear	—
SP3	External input signal prohibited	—
SP4	External output signal prohibited	—
SP5	External input signal resumed	—
SP6	External output signal resumed	—

(b) Operation mode selection

Device name	Item	Symbol
OM0	Normal mode (not test operation mode)	—
OM1	JOG operation	—
OM2	Positioning operation	—
OM3	Motorless operation	—
OM4	Output signal (DO) forced output	—

(c) Instruction demand (for test operation)

Device name	Item	Symbol
TMB0	Clears the acceleration/deceleration time constant	—
TMB1	Temporary stop command	—

(d) Basic parameter/expansion parameter

Device name	Item	Symbol*1
PRM0, PRM1000	Command system/ regenerative brake option selection	*STY
PRM1, PRM1001	Feeding function selection	*FTY
PRM2, PRM1002	Function selection 1	*OP1
PRM3, PRM1003	Auto tuning	ATU
PRM4, PRM1004	Electronic gear numerator	*CMX
PRM5, PRM1005	Electronic gear denominator	*CDV
PRM6, PRM1006	In-position range	INP
PRM7, PRM1007	Position loop gain 1	PG1
PRM8, PRM1008	Home position return type	*ZTY
PRM9, PRM1009	Home position return speed	ZRF
PRM10, PRM1010	Creep speed	CRF
PRM11, PRM1011	Home position shift distance	ZST
PRM12, PRM1012	Rough match output range	CRP
PRM13, PRM1013	Jog speed	JOG
PRM14, PRM1014	S-pattern acceleration/ deceleration time constant	*STC
PRM15, PRM1015	Station number setting	*SNO
PRM16, PRM1016	Serial communication function selection, alarm history clear	*BPS
PRM17, PRM1017	Analog monitor output	MOD
PRM18, PRM1018	Status display selection	*DMD
PRM19, PRM1019	Parameter block	*BLK
PRM20, PRM1020	Function selection 2	*OP2
PRM21, PRM1021	For manufacturer setting	—
PRM22, PRM1022	Function selection 4	*OP4
PRM23, PRM1023	Serial communication time-out selection	SIC
PRM24, PRM1024	Feed forward gain	FFC
PRM25, PRM1025	Override offset	VCO
PRM26, PRM1026	Torque limit offset	TLO
PRM27, PRM1027	Encoder output pulses	*ENR
PRM28, PRM1028	Internal torque limit 1	TL1
PRM29, PRM1029	Internal torque limit 2	TL2
PRM30, PRM1030	Backlash compensation	*BKC
PRM31, PRM1031	Analog monitor 1 offset	MO1
PRM32, PRM1032	Analog monitor 2 offset	MO2
PRM33, PRM1033	Electromagnetic brake sequence output	MBR
PRM34, PRM1034	Ration of load inertia moment to servo motor inertia moment	GD2
PRM35, PRM1035	Position control gain 2	PG2
PRM36, PRM1036	Speed control gain 1	VG1
PRM37, PRM1037	Position control gain 2	VG2
PRM38, PRM1038	Speed integral compensation	VIC
PRM39, PRM1039	Speed differential compensation	VDC
PRM40 to PRM41, PRM1040 to PRM1041	For manufacturer setting	—
PRM42, PRM1042	Home position return position data	*ZPS
PRM43, PRM1043	Moving distance after proximity dog	DCT
PRM44, PRM1044	Moving distance after proximity dog	ZTM
PRM45, PRM1045	Stopper type home position return torque limit value	ZTT

Device name	Item	Symbol*1
PRM46, PRM1046	Software limit +	*LMP
PRM47, PRM1047	Software limit -	*LMN
PRM48, PRM1048	Software limit -	*LMN
PRM49, PRM1049	Software limit -	*LMN
PRM50, PRM1050	Position range output address +	*LPP
PRM51, PRM1051	Position range output address +	*LPP
PRM52, PRM1052	Position range output address -	*LNP
PRM53, PRM1053	Position range output address -	*LNP
PRM54, PRM1054	For manufacturer setting	—
PRM55, PRM1055	Function selection 6	*OP6
PRM56, PRM1056	For manufacturer setting	—
PRM57, PRM1057	Function selection 8	*OP8
PRM58, PRM1058	Function selection 9	*OP9
PRM59, PRM1059	Function selection A	*OPA
PRM60, PRM1060	For manufacturer setting	—
PRM61, PRM1061	Machine resonance suppression filter 1	NH1
PRM62, PRM1062	Machine resonance suppression filter 2	NH2
PRM63, PRM1063	Low-pass filter, adaptive vibration suppression control	LPF
PRM64, PRM1064	Ratio of load inertia moment to servo motor inertia moment 2	GD2B
PRM65, PRM1065	Position control gain 2 changing ratio	PG2B
PRM66, PRM1066	Speed control gain 2 changing ratio	VG2B
PRM67, PRM1067	Speed integral compensation changing ratio	VICB
PRM68, PRM1068	Gain changing selection	*CDP
PRM69, PRM1069	Gain changing condition	CDS
PRM70, PRM1070	Gain changing time constant	CDT
PRM71 to PRM90, PRM1071 to PRM1090	For manufacturer setting	—

1 For the parameters prefixed by an asterisk (), setting becomes effective when the power is turned off once and back on after setting the parameter data.

(e) Status display

Device name	Item	Symbol
ST0	Current position	—
ST1	Command position	—
ST2	Command remaining distance	—
ST3	Point table No.	—
ST4	Cumulative feedback pulses	—
ST5	Servo motor speed	—
ST6	Droop pulses	—
ST7	Override	—
ST8	Torque limit voltage	—
ST9	Regenerative load ratio	—
ST10	Effective load ratio	—
ST11	Peak load ratio	—
ST12	Instantaneous torque	—
ST13	Within one-revolution position	—
ST14	ABS counter	—
ST15	Load inertia moment ratio	—
ST16	Bus voltage	—

9
MELSECNET/H
CONNECTION (PLC
TO PLC NETWORK)

10
MELSECNET/10
CONNECTION (PLC
TO PLC NETWORK)

11
CC-Link IE CONTROLLER
NETWORK
CONNECTION

12
CC-Link IE FIELD
NETWORK
CONNECTION

13
CC-Link CONNECTION
(INTELLIGENT DEVICE
STATION)

14
CC-Link
CONNECTION
(Via G4)

15
INVERTER
CONNECTION

16
SERVO AMPLIFIER
CONNECTION

(f) Alarm

Device name	Item	Symbol
AL0	Current alarm number	—
AL1	Detailed data of current alarms	—
AL11	Servo status when alarm occurs current position	—
AL12	Servo status when alarm occurs command position	—
AL13	Servo status when alarm occurs command remaining distance	—
AL14	Servo status when alarm occurs point table No.	—
AL15	Servo status when alarm occurs cumulative feedback pulses	—
AL16	Servo status when alarm occurs servo motor speed	—
AL17	Servo status when alarm occurs droop pulses	—
AL18	Servo status when alarm occurs override	—
AL19	Servo status when alarm occurs torque limit voltage	—
AL20	Servo status when alarm occurs regenerative load ratio	—
AL21	Servo status when alarm occurs effective load ratio	—
AL22	Servo status when alarm occurs peak load ratio	—
AL23	Servo status when alarm occurs instantaneous torque	—
AL24	Servo status when alarm occurs within one-revolution position	—
AL25	Servo status when alarm occurs ABS counter	—
AL26	Servo status when alarm occurs Load inertia moment ratio	—
AL27	Servo status when alarm occurs bus voltage	—
AL200	Alarm number from alarm history most recent alarm	—
AL201	Alarm number from alarm history first alarm in past	—
AL202	Alarm number from alarm history second alarm in past	—
AL203	Alarm number from alarm history third alarm in past	—
AL204	Alarm number from alarm history fourth alarm in past	—
AL205	Alarm number from alarm history fifth alarm in past	—
AL210	Alarm occurrence time in alarm history most recent alarm	—
AL211	Alarm occurrence time in alarm history first alarm in past	—
AL212	Alarm occurrence time in alarm history second alarm in past	—
AL213	Alarm occurrence time in alarm history third alarm in past	—
AL214	Alarm occurrence time in alarm history fourth alarm in past	—
AL215	Alarm occurrence time in alarm history fifth alarm in past	—
AL230	Detailed alarm from alarm history most recent alarm	—
AL231	Detailed alarm from alarm history first alarm in past	—
AL232	Detailed alarm from alarm history second alarm in past	—
AL233	Detailed alarm from alarm history third alarm in past	—
AL234	Detailed alarm from alarm history fourth alarm in past	—
AL235	Detailed alarm from alarm history fifth alarm in past	—

(g) External I/O signal

Device name	Item	Symbol
DI0	Input device statuses	—
DI1	External input pin statuses	—
DI2	Statuses of input devices switched on through communication	—
DO0	Output device statuses	—
DO1	External output pin statuses	—

(h) Point table (position)

Device name	Item	Symbol
POS1 to POS31, POS1001 to POS1031	Point table (position) No. 1 to No. 31	—
SPD1 to SPD31, SPD1001 to SPD1031	Point table (speed) No. 1 to No. 31	—
ACT1 to ACT31, ACT1001 to ACT1031	Point table (acceleration time constant) No. 1 to No. 31	—
DCT1 to DCT31, DCT1001 to DCT1031	Point table (deceleration time constant) No. 1 to No. 31	—
DWL1 to DWL31, DWL1001 to DWL1031	Point table (dwell) No. 1 to No. 31	—
AUX1 to AUX31, AUX1001 to AUX1031	Point table (auxiliary function) No. 1 to No. 31	—

(i) Input signal for test operation (for test operation)

Device name	Item	Symbol
TMI0	Input signal for test operation	—

(j) Forced output of signal pin (for test operation)

Device name	Item	Symbol
TMO0	Forced output of signal pin	—

(k) Set data (for test operation)

Device name	Item	Symbol
TMD0	Writes the speed (test mode)	—
TMD1	Writes the acceleration/deceleration time constant (test mode)	—
TMD2	Writes the moving distance in pulses (test mode)	—

(6) MELSERVO-J2S-*CL

Device name*2		Setting range	Device No. representation	
Bit device	Servo amplifier request (SP)	SP0 to SP6	Decimal	
	Operation mode selection (OM)	OM0 to OM4		
	Instruction demand (for test operation) (TMB)	TMB0 to TMB1		
Word device	Basic parameter /expansion parameter (PRM)*1	PRM0 to PRM90 PRM1000 to PRM1090		
	Status display (ST)	ST0 to ST17		
	Alarm (AL)	AL0 to AL1 AL11 to AL28 AL200 to AL205 AL210 to AL215 AL230 to AL235		
		External input (DI)*4		DI0 to DI2
		External output(DO)		DO0 to DO1
		Current position latch data (LD)		LD1
		The value of the general-purpose register (Rx) (RR)*3		RR1 to RR4 RR1001 to RR1004
	The value of the general-purpose register (Dx) (RD)	RD1 to RD4		
	Double word device	Input signal for test operation (for test operation) (TMI)	TMI0	
		Forced output of signal pin (for test operation) (TMO)	TMO0	
Set data (for test operation) (TMD)		TMD0 to TMD2		

- *1 PRM0 to PRM90 are used when writing parameters to the servo amplifier RAM. PRM1000 to PRM1090 are used when writing parameters to E²PROM of the servo amplifier. Use PRM1000 to PRM1090 when reading parameters to the servo amplifier RAM.
- *2 The GOT cannot read or write data from/to consecutive devices.
- *3 Use the integer number when writing parameters to Rx.
- *4 Only reading is possible for DI0 to DI1.

POINT

Precautions for SP, OM, TMB, TMI, TMO, and TMD devices

- (1) For bit devices
Only writing is possible.
[Alternate] of a bit switch cannot be used.
Use [Set], [Reset], and [Momentary] of a bit switch.
- (2) For word devices, double word devices
Only writing is possible.
Numerical input cannot be used.
When writing, use [Word Set] of a data set switch.

The following shows correspondences between virtual devices for servo amplifier and data of the servo amplifier used with the GOT.

(a) Servo amplifier request

Device name	Item	Symbol
SP0	Status display data clear	—
SP1	Current alarm clear	—
SP2	Alarm history clear	—
SP3	External input signal prohibited	—
SP4	External output signal prohibited	—
SP5	External input signal resumed	—
SP6	External output signal resumed	—

(b) Operation mode selection

Device name	Item	Symbol
OM0	Normal mode (not test operation mode)	—
OM1	JOG operation	—
OM2	Positioning operation	—
OM3	Motorless operation	—
OM4	Output signal (DO) forced output	—

(c) Instruction demand (for test operation)

Device name	Item	Symbol
TMB0	Clears the acceleration/ deceleration time constant	—
TMB1	Temporary stop command	—

9 MELSECNET/H CONNECTION (PLC CONNECTION TO PLC NETWORK)
 10 MELSECNET/T0 CONNECTION (PLC CONNECTION TO PLC NETWORK)
 11 CC-Link IE CONTROLLER NETWORK CONNECTION
 12 CC-Link IE FIELD NETWORK CONNECTION
 13 CC-Link CONNECTION (INTELLIGENT DEVICE STATION)
 14 CC-Link CONNECTION (Via G4)
 15 INVERTER CONNECTION
 16 SERVO AMPLIFIER CONNECTION

(d) Basic parameter/expansion parameter

Device name	Item	Symbol*1
PRM0, PRM1000	Command system/ regenerative brake option selection	*STY
PRM1, PRM1001	Feeding function selection	*FTY
PRM2, PRM1002	Function selection 1	*OP1
PRM3, PRM1003	Auto tuning	ATU
PRM4, PRM1004	Electronic gear numerator	*CMX
PRM5, PRM1005	Electronic gear denominator	*CDV
PRM6, PRM1006	In-position range	INP
PRM7, PRM1007	Position loop gain 1	PG1
PRM8, PRM1008	Home position return type	*ZTY
PRM9, PRM1009	Home position return speed	ZRF
PRM10, PRM1010	Creep speed	CRF
PRM11, PRM1011	Home position shift distance	ZST
PRM12, PRM1012	For manufacturer setting	—
PRM13, PRM1013	Jog speed	JOG
PRM14, PRM1014	S-pattern acceleration/ deceleration time constant	*STC
PRM15, PRM1015	Station number setting	*SNO
PRM16, PRM1016	Serial communication function selection, alarm history clear	*BPS
PRM17, PRM1017	Analog monitor output	MOD
PRM18, PRM1018	Status display selection	*DMD
PRM19, PRM1019	Parameter block	*BLK
PRM20, PRM1020	Function selection 2	*OP2
PRM21, PRM1021	For manufacturer setting	—
PRM22, PRM1022	Function selection 4	*OP4
PRM23, PRM1023	Serial communication time-out selection	SIC
PRM24, PRM1024	Feed forward gain	FFC
PRM25, PRM1025	Override offset	VCO
PRM26, PRM1026	Torque limit offset	TLO
PRM27, PRM1027	Encoder output pulses	*ENR
PRM28, PRM1028	Internal torque limit 1	TL1
PRM29, PRM1029	Internal torque limit 2	TL2
PRM30, PRM1030	Backlash compensation	*BKC
PRM31, PRM1031	Analog monitor 1 offset	MO1
PRM32, PRM1032	Analog monitor 2 offset	MO2
PRM33, PRM1033	Electromagnetic brake sequence output	MBR
PRM34, PRM1034	Ratio of load inertia moment to servo motor inertia moment	GD2
PRM35, PRM1035	Position control gain 2	PG2
PRM36, PRM1036	Speed control gain 2	VG1
PRM37, PRM1037	Speed control gain 2	VG2
PRM38, PRM1038	Speed integral compensation	VIC
PRM39, PRM1039	Speed differential compensation	VDC
PRM40, PRM1040	JOG operation acceleration/ deceleration time constant	JTC
PRM41, PRM1041	Home position return operation acceleration/ deceleration time constant	ZTS
PRM42, PRM1042	Home position return position data	*ZPS
PRM43, PRM1043	Moving distance after proximity dog	DCT
PRM44, PRM1044	Stopper type home position return stopper time	ZTM
PRM45, PRM1045	Stopper type home position return torque limit value	ZTT
PRM46, PRM1046	Software limit+	*LMP
PRM47, PRM1047		

Device name	Item	Symbol*1
PRM48, PRM1048	Software limit-	*LMN
PRM49, PRM1049		
PRM50, PRM1050	Position range output address+	*LPP
PRM51, PRM1051	Position range output address-	*LNP
PRM52, PRM1052		
PRM53, PRM1053	For manufacturer setting	—
PRM54, PRM1054	Function selection 6	*OP6
PRM55, PRM1055	For manufacturer setting	—
PRM56, PRM1056	Function selection 8	*OP8
PRM57, PRM1057	Function selection 9	*OP9
PRM58, PRM1058	Function selection A	*OPA
PRM59, PRM1059	For manufacturer setting	—
PRM60, PRM1060	Machine resonance suppression filter 1	NH1
PRM61, PRM1061	Machine resonance suppression filter 2	NH2
PRM62, PRM1062	Low-pass filter, adaptive vibration suppression control	LPF
PRM63, PRM1063	Ratio of load inertia moment to Servo motor inertia moment 2	GD2B
PRM64, PRM1064	Position control gain 2 changing ratio	PG2B
PRM65, PRM1065	Speed control gain 2 changing ratio	VG2B
PRM66, PRM1066	Speed integral compensation changing ratio	VICB
PRM67, PRM1067	Gain changing selection	*CDP
PRM68, PRM1068	Gain changing condition	CDS
PRM69, PRM1069	Gain changing time constant	CDT
PRM70, PRM1070	For manufacturer setting	—
PRM71 to PRM73, PRM1071 to PRM1073	For manufacturer setting	—
PRM74, PRM1074	OUT1 output time selection	OUT1
PRM75, PRM1075	OUT2 output time selection	OUT2
PRM76, PRM1076	OUT3 output time selection	OUT3
PRM77, PRM1077	Selected to program input polarity selection 1	SYC1
PRM78 to PRM90, PRM1078 to PRM1090	For manufacturer setting	—

1 For the parameters prefixed by an asterisk (), setting becomes effective when the power is turned off once and back on after setting the parameter data.

(e) Status display

Device name	Item	Symbol
ST0	Current position	—
ST1	Command position	—
ST2	Command remaining distance	—
ST3	Program Number	—
ST4	Step Number	—
ST5	Cumulative feedback pulses	—
ST6	Servo motor speed	—
ST7	Droop pulses	—
ST8	Override	—
ST9	Torque limit voltage	—
ST10	Regenerative load ratio	—
ST11	Effective load ratio	—
ST12	Peak load ratio	—
ST13	Instantaneous torque	—
ST14	Within one-revolution position	—
ST15	ABS counter	—
ST16	Load inertia moment ratio	—
ST17	Bus voltage	—

(f) Alarm

Device name	Item	Symbol
AL0	Current alarm number	—
AL1	Detailed data of current alarms	—
AL11	Servo status when alarm occurs Current position	—
AL12	Servo status when alarm occurs Command position	—
AL13	Servo status when alarm occurs Command remaining distance	—
AL14	Servo status when alarm occurs Program Number	—
AL15	Servo status when alarm occurs Step Number	—
AL16	Servo status when alarm occurs Cumulative feedback pulses	—
AL17	Servo status when alarm occurs Servo motor speed	—
AL18	Servo status when alarm occurs Droop pulses	—
AL19	Servo status when alarm occurs Override	—
AL20	Servo status when alarm occurs Torque limit voltage	—
AL21	Servo status when alarm occurs Regenerative load ratio	—
AL22	Servo status when alarm occurs Effective load ratio	—
AL23	Servo status when alarm occurs Peak load ratio	—
AL24	Servo status when alarm occurs Instantaneous torque	—
AL25	Servo status when alarm occurs Within one-revolution position	—
AL26	Servo status when alarm occurs ABS counter	—
AL27	Servo status when alarm occurs Load inertia moment ratio	—
AL28	Servo status when alarm occurs Bus voltage	—
AL200	Alarm number from Alarm History most recent alarm	—
AL201	Alarm number from Alarm History first alarm in past	—
AL202	Alarm number from Alarm History second alarm in past	—
AL203	Alarm number from Alarm History third alarm in past	—
AL204	Alarm number from Alarm History fourth alarm in past	—
AL205	Alarm number from Alarm History fifth alarm in past	—
AL210	Alarm occurrence time in alarm history most recent alarm	—
AL211	Alarm occurrence time in alarm history first alarm in past	—
AL212	Alarm occurrence time in alarm history second alarm in past	—
AL213	Alarm occurrence time in alarm history third alarm in past	—
AL214	Alarm occurrence time in alarm history fourth alarm in past	—
AL215	Alarm occurrence time in alarm history fifth alarm in past	—
AL230	Detailed alarm from Alarm History most recent alarm	—
AL231	Detailed alarm from Alarm History first alarm in past	—
AL232	Detailed alarm from Alarm History second alarm in past	—
AL233	Detailed alarm from Alarm History third alarm in past	—

Device name	Item	Symbol
AL234	Detailed alarm from Alarm History fourth alarm in past	—
AL235	Detailed alarm from Alarm History fifth alarm in past	—

(g) External I/O signal

Device name	Item	Symbol
DI0	Input device statuses	—
DI1	External input pin statuses	—
DI2	Statuses of input devices switched on through communication	—
DO0	Output device statuses	—
DO1	External output pin statuses	—

(h) Current position latch data

Device name	Item	Symbol
LD1	Current position latch data	—

(i) The value of the general-purpose register (Rx)

Device name	Item	Symbol
RR1, RR1001	The value of the general-purpose register (R1)	—
RR2, RR1002	The value of the general-purpose register (R2)	—
RR3, RR1003	The value of the general-purpose register (R3)	—
RR4, RR1004	The value of the general-purpose register (R4)	—

(j) The value of the general-purpose register (Dx)

Device name	Item	Symbol
RD1	The value of the general-purpose register (D1)	—
RD2	The value of the general-purpose register (D2)	—
RD3	The value of the general-purpose register (D3)	—
RD4	The value of the general-purpose register (D4)	—

(k) Input signal for test operation (for test operation)

Device name	Item	Symbol
TMI0	Input signal for test operation	—

(l) Forced output of signal pin (for test operation)

Device name	Item	Symbol
TMO0	Forced output of signal pin	—

(m) Set data (for test operation)

Device name	Item	Symbol
TMD0	Writes the speed (test mode)	—
TMD1	Writes the acceleration/deceleration time constant(test mode)	—
TMD2	Writes the moving distance in pulses(test mode)	—

(7) MELSERVO-J3-*A

Device name*2		Setting range	Device No. representation
Bit device	Servo amplifier request (SP)	SP0 to SP6	Decimal
	Operation mode selection (OM)	OM0 to OM4	
	Instruction demand (for test operation) (TMB)	TMB1 to TMB6	
Word device	Basic setting parameter (PA)*1	PA1 to PA19 PA1001 to PA1019	
	Gain filter parameter (PB)*1	PB1 to PB45 PB1001 to PB1045	
	Extension setting parameter (PC)*1	PC1 to PC50 PC1001 to PC1050	
	I/O setting parameter (PD)*1	PD1 to PD30 PD1001 to PD1030	
	Status display (ST)*3	ST0 to ST14	
	Alarm (AL)*3	AL0 to AL1	
		AL11 to AL25	
		AL200 to AL205	
		AL210 to AL215 AL230 to AL235	
	External input (DI)*4	DI0 to DI2	
External output (DO)*3	DO0 to DO1		
Double word device	Input signal for test operation (for test operation) (TMI)	TMI0	
	Forced output of signal pin (for test operation) (TMO)	TMO0	
	Set data (for test operation) (TMD)	TMD0 to TMD1 TMD3	

*1 1 to 50 of PA, PB, PC, and PD are used when writing data to the servo amplifier RAM.
1001 to 1050 of PA, PB, PC, and PD are used when writing data to E²PROM of the servo amplifier.
Use PA, PB, PC, PD 1001 to 1050 when reading parameters to the servo amplifier RAM.

*2 The GOT cannot read or write data from/to consecutive devices.

*3 Only reading is possible.

*4 Only reading is possible for DI0 to DI1.

POINT

Precautions for SP, OM, TMB, TMI, TMO, and TMD devices

- For bit devices
Only writing is possible.
[Alternate] of a bit switch cannot be used.
Use [Set], [Reset], and [Momentary] of a bit switch.
- For word devices, double word devices
Only writing is possible.
Numerical input cannot be used.
When writing, use [Word Set] of a data set switch.

The following shows correspondences between virtual devices for servo amplifier and data of the servo amplifier used with the GOT.

(a) Servo amplifier request

Device name	Item	Symbol
SP0	Status display data clear	—
SP1	Current alarm clear	—
SP2	Alarm history clear	—
SP3	External input signal prohibited	—
SP4	External output signal prohibited	—
SP5	External input signal resumed	—
SP6	External output signal resumed	—

(b) Operation mode selection

Device name	Item	Symbol
OM0	Normal mode (not test operation mode)	—
OM1	JOG operation	—
OM2	Positioning operation	—
OM3	Motorless operation	—
OM4	Output signal (DO) forced output	—

(c) Instruction demand (for test operation)

Device name	Item	Symbol
TMB1	Temporary stop command	—
TMB2	Test operation (positioning operation) start command	—
TMB3	Forward rotation direction	—
TMB4	Reverse rotation direction	—
TMB5	Restart for remaining distance	—
TMB6	Remaining distance clear	—

(d) Basic parameter/expansion parameter

Device name	Item	Symbol*1
PA1, PA1001	Control mode	*STY
PA2, PA1002	Regenerative brake option	*REG
PA3, PA1003	Absolute position detection system	*ABS
PA4, PA1004	Function selection A-1	*AOP1
PA5, PA1005	Number of command input pulses per revolution	*FBP
PA6, PA1006	Electronic gear numerator (command pulse multiplying factor numerator)	CMX
PA7, PA1007	Electronic gear denominator (command pulse multiplying factor denominator)	CDV
PA8, PA1008	Auto tuning mode	ATU
PA9, PA1009	Auto tuning response	RSP
PA10, PA1010	In-position range	INP
PA11, PA1011	Forward torque limit	TLP
PA12, PA1012	Reverses torque limit	TLN
PA13, PA1013	Command pulse input form	*PLSS
PA14, PA1014	Rotation direction selection	*POL
PA15, PA1015	Encoder output pulses	*ENR
PA16 to PA18, PA1016 to PA1018	For manufacturer setting	—
PA19, PA1019	Parameter block	*BLK

1 For the parameters prefixed by an asterisk (), setting becomes effective when the power is turned off once and back on after setting the parameter data.

(e) Gain filter parameter

Device name	Item	Symbol*1
PB1, PB1001	Adaptive tuning mode (Adaptive filter II)	FILT
PA2, PB1002	Vibration suppression control filter tuning mode (Advanced vibration suppression control)	VRFT
PB3, PB1003	Position command acceleration/ deceleration time constant (position smoothing)	PST
PB4, PB1004	Feed forward gain	FFC
PB5, PB1005	For manufacturer setting	—
PB6, PB1006	Ratio of load inertia moment to servo motor inertia moment	GD2
PB7, PB1007	Model control gain	PG1
PB8, PB1008	Position loop gain	PG2
PB9, PB1009	Speed loop gain	VG2
PB10, PB1010	Speed integral compensation	VIC
PB11, PB1011	Speed differential compensation	VDC
PB12, PB1012	For manufacturer setting	—
PB13, PB1013	Machine resonance suppression filter 1	NH1
PB14, PB1014	Notch form selection 1	NHQ1
PB15, PB1015	Machine resonance suppression filter 2	NH2
PB16, PB1016	Notch form selection 2	NHQ2
PB17, PB1017	For manufacturer setting	—
PB18, PB1018	Low-pass filter setting	LPF
PB19, PB1019	Vibration suppression control vibration frequency setting	VRF1
PB20, PB1020	Vibration suppression control resonance frequency setting	VRF2
PB21 to PB22, PB1021 to PB1022	For manufacturer setting	—
PB23, PB1023	Low-pass filter selection	VFBF
PB24, PB1024	Slight vibration suppression control selection	*MVS
PB25, PB1025	Function selection B-1	*BOP1
PB26, PB1026	Gain changing selection	*CDP
PB27, PB1027	Gain changing condition	CDL
PB28, PB1028	Gain changing time constant	CDT
PB29, PB1029	Ratio of load inertia moment to servo motor inertia moment at changing gain	GD2B
PB30, PB1030	Position loop gain at changing gain	PG2B
PB31, PB1031	Speed loop gain at changing gain	VG2B
PB32, PB1032	Speed integral compensation at changing gain	VICB
PB33, PB1033	Vibration suppression control vibration frequency setting for changing gain	VRF1B
PB34, PB1034	Vibration suppression control vibration resonance setting for changing gain	VRF2B
PB35 to PB45, PB1035 to PB1045	For manufacturer setting	—

1 For the parameters prefixed by an asterisk (), setting becomes effective when the power is turned off once and back on after setting the parameter data.

(f) Extension setting parameter

Device name	Item	Symbol*1
PC1, PC1001	Acceleration time constant	STA
PC2, PC1002	Deceleration time constant	STB
PC3, PC1003	S-pattern acceleration/ deceleration time constant	STC
PC4, PC1004	Torque command time constant	TQC
PC5, PC1005	Internal speed command1/limit1	SC1
PC6, PC1006	Internal speed command2/limit2	SC2
PC7, PC1007	Internal speed command3/limit3	SC3
PC8, PC1008	Internal speed command4/limit4	SC4
PC9, PC1009	Internal speed command5/limit5	SC5
PC10, PC1010	Internal speed command6/limit6	SC6
PC11, PC1011	Internal speed command7/limit7	SC7
PC12, PC1012	Analog speed command maximum speed /limit maximum speed	VCM
PC13, PC1013	Analog torque command maximum output	TLC
PC14, PC1014	Analog monitor 1 output	MOD1
PC15, PC1015	Analog monitor 2 output	MOD2
PC16, PC1016	Electromagnetic brake sequence output	MBR
PC17, PC1017	Zero speed	ZSP
PC18, PC1018	Alarm history clear	*BPS
PC19, PC1019	Encoder output pulse selection	*ENRS
PC20, PC1020	Station number setting	*SNO
PC21, PC1021	Communication function selection	*SOP
PC22, PC1022	Function selection C-1	*COP1
PC23, PC1023	Function selection C-2	*COP2
PC24, PC1024	Function selection C-3	*COP3
PC25, PC1025	For manufacturer setting	—
PC26, PC1026	Function selection C-5	*COP5
PC27 to PC29, PC1027 to PC1029	For manufacturer setting	—
PC30, PC1030	Acceleration time constant 2	STA2
PC31, PC1031	Deceleration time constant 2	STB2
PC32, PC1032	Command pulse multiplying factor numerator 2	CMX2
PC33, PC1033	Command pulse multiplying factor numerator 3	CMX3
PC34, PC1034	Command pulse multiplying factor numerator 4	CMX4
PC35, PC1035	Internal torque limit 2	TL2
PC36, PC1036	Status display selection	*DMD
PC37, PC1037	Analog speed command offset /limit offset	VCO
PC38, PC1038	Analog torque command offset /limit offset	TPO
PC39, PC1039	Analog monitor 1 offset	MO1
PC40, PC1040	Analog monitor 2 offset	MO2
PC41 to PC50, PC1041 to PC1050	For manufacturer setting	—

1 For the parameters prefixed by an asterisk (), setting becomes effective when the power is turned off once and back on after setting the parameter data.

(g) I/O setting parameter

Device name	Item	Symbol*1
PD1, PD1001	Input signal automatic ON selection 1	*DIA1
PD2, PD1002	For manufacturer setting	—
PD3, PD1003	Input signal device selection 1 (CN1-15)	*DI1
PD4, PD1004	Input signal device selection 2 (CN1-16)	*DI2
PD5, PD1005	Input signal device selection 3 (CN1-17)	*DI3
PD6, PD1006	Input signal device selection 4 (CN1-18)	*DI4
PD7, PD1007	Input signal device selection 5 (CN1-19)	*DI5
PD8, PD1008	Input signal device selection 6 (CN1-41)	*DI6
PD9, PD1009	For manufacturer setting	—
PD10, D1010	Input signal device selection 8 (CN1-43)	*DI8
PD11, PD1011	Input signal device selection 9 (CN1-44)	*DI9
PD12, PD1012	Input signal device selection 10 (CN1-45)	*DI10
PD13, PD1013	Output signal device selection 1 (CN1-22)	*DO1
PD14, PD1014	Output signal device selection 2 (CN1-23)	*DO2
PD15, PD1015	Output signal device selection 3 (CN1-24)	*DO3
PD16, PD1016	Output signal device selection 4 (CN1-25)	*DO4
PD17, PD1017	For manufacturer setting	—
PD18, PD1018	Output signal device selection 6 (CN1-49)	*DO6
PD19, PD1019	Response level setting	*DIF
PD20, 1020	Function selection D-1	*DOP1
PD21, PD1021	For manufacturer setting	—
PD22, PD1022	Function selection D-3	*DOP3
PD23, PD1023	For manufacturer setting	—
PD24, PD1024	Function selection D-5	*DOP5
PD25 to PD30, PD1025 to PD1030	For manufacturer setting	—

1 For the parameters prefixed by an asterisk (), setting becomes effective when the power is turned off once and back on after setting the parameter data.

(h) Status display

Device name	Item	Symbol
ST0	Cumulative feedback pulses	—
ST1	Servo motor speed	—
ST2	Droop pulses	—
ST3	Cumulative command pulses	—
ST4	Command pulse frequency	—
ST5	Analog speed command voltage/limit voltage	—
ST6	Analog torque command voltage/limit voltage	—
ST7	Regenerative load ratio	—
ST8	Effective load ratio	—
ST9	Peak load ratio	—
ST10	Instantaneous torque	—
ST11	Within one-revolution position	—
ST12	ABS counter	—
ST13	Load inertia moment ratio	—
ST14	Bus voltage	—

(i) Alarm

Device name	Item	Symbol
AL0	Current alarm number	—
AL1	Detailed data of current alarms	—
AL11	Servo status when alarm occurs cumulative feedback pulses	—
AL12	Servo status when alarm occurs servo monitor speed	—
AL13	Servo status when alarm occurs droop pulses	—
AL14	Servo status when alarm occurs cumulative command pulses	—
AL15	Servo status when alarm occurs command pulse frequency	—
AL16	Servo status when alarm occurs analog speed command voltage /limit voltage	—
AL17	Servo status when alarm occurs analog torque command voltage /limit voltage	—
AL18	Servo status when alarm occurs regenerative load ratio	—
AL19	Servo status when alarm occurs effective load ratio	—
AL20	Servo status when alarm occurs peak load ratio	—
AL21	Servo status when alarm occurs instantaneous torque	—
AL22	Servo status when alarm occurs within one-revolution position	—
AL23	Load inertia moment ratio ABS counter	—
AL24	Servo status when alarm occurs load inertia moment ratio	—
AL25	Servo status when alarm occurs bus voltage	—
AL200	Alarm number from alarm history most recent alarm	—
AL201	Alarm number from alarm history first alarm in past	—
AL202	Alarm number from alarm history second alarm in past	—
AL203	Alarm number from alarm history third alarm in past	—
AL204	Alarm number from alarm history fourth alarm in past	—
AL205	Alarm number from alarm history fifth alarm in past	—
AL210	Alarm occurrence time in alarm history most recent alarm	—
AL211	Alarm occurrence time in alarm history first alarm in past	—
AL212	Alarm occurrence time in alarm history second alarm in past	—
AL213	Alarm occurrence time in alarm history third alarm in past	—
AL214	Alarm occurrence time in alarm history fourth alarm in past	—
AL215	Alarm occurrence time in alarm history fifth alarm in past	—
AL230	Detailed alarm from alarm history most recent alarm	—
AL231	Detailed alarm from alarm history first alarm in past	—
AL232	Detailed alarm from alarm history second alarm in past	—
AL233	Detailed alarm from alarm history third alarm in past	—
AL234	Detailed alarm from alarm history fourth alarm in past	—
AL235	Detailed alarm from alarm history fifth alarm in past	—

(j) External input

Device name	Item	Symbol
DI0	Input device statuses	—
DI1	External input pin statuses	—
DI2	Statuses of input devices switched on through communication	—

(k) External output

Device name	Item	Symbol
DO0	Output device statuses	—
DO1	External output pin statuses	—

(l) Input signal for test operation (for test operation)

Device name	Item	Symbol
TMI0	Input signal for test operation	—

(m) Forced output of signal pin (for test operation)

Device name	Item	Symbol
TMO0	Forced output of signal pin	—

(n) Set data (for test operation)

Device name	Item	Symbol
TMD0	Writes the speed (test mode)	—
TMD1	Writes the acceleration/ deceleration time constant (test mode)	—
TMD2	For manufacturer setting	—
TMD3	Writes the moving distance (test mode)	—

(8) MELSERVO-J3-*T

Device name ^{*5}	Setting range	Device No. representation	
Bit device	Servo amplifier request (SP)	SP0 to SP6	Decimal
	Operation mode selection (OM)	OM0 to OM5	
	Instruction demand (for test operation) (TMB)	TMB1 to TMB6	
Word device	Basic setting parameter (PA) ^{*1}	PA1 to PA19 PA1001 to PA1019	Decimal
	Gain filter parameter (PB) ^{*1}	PB1 to PB45 PB1001 to PB1045	
	Extension setting parameter (PC) ^{*1}	PC1 to PC50 PC1001 to PC1050	
	I/O setting parameter (PD) ^{*1}	PD1 to PD30 PD1001 to PD1030	
	Option unit parameter (PO) ^{*1}	PO1 to PO35 PO1001 to PO1035	
	Status display (ST) ^{*4}	ST0 to ST17	
	Alarm (AL) ^{*4}	AL0 to AL1 AL11 to AL28 AL200 to AL205 AL210 to AL215 AL230 to AL235	
	External input (DI) ^{*6}	DI0 to DI7	
	External output (DO) ^{*4}	DO0 to DO4	
	Point table (position) (POS) ^{*2}	POS1 to POS255 POS1001 to POS1255	
	Point table (speed) (SPD) ^{*2}	SPD1 to SPD255 SPD1001 to SPD1255	
	Point table (acceleration time constant) (ACT) ^{*2}	ACT1 to ACT255 ACT1001 to ACT1255	
	Point table (deceleration time constant) (DCT) ^{*2}	DCT1 to DCT255 DCT1001 to DCT1255	
	Point table (dwell) (DWL) ^{*2}	DWL1 to DWL255 DWL1001 to DWL1255	
	Point table (auxiliary function) (AUX) ^{*2}	AUX1 to AUX255 AUX1001 to AUX1255	
Point table (M code) (MCD) ^{*2*3}	MCD1 to MCD255 MCD1001 to MCD1255		
Double word device	Input signal for test operation (for test operation) (TMI0)	TMI0 to TMI2	
	Forced output of signal pin (for test operation) (TMO)	TMO0 to TMO1	
	Set data (for test operation) (TMD)	TMD0 to TMD1 TMD3	

9
MELSECNET/H CONNECTION (PLC CONNECTION TO PLC NETWORK)
10
MELSECNET/10 CONNECTION (PLC CONNECTION TO PLC NETWORK)
11
CC-Link IE CONTROLLER NETWORK CONNECTION
12
CC-Link IE FIELD NETWORK CONNECTION
13
CC-Link CONNECTION (INTELLIGENT DEVICE STATION)
14
CC-Link CONNECTION (Via G4)
15
INVERTER CONNECTION
16
SERVO AMPLIFIER CONNECTION

- *1 Use 1 to 50 of PA, PB, PC, PD, and PO when the GOT writes data to RAM of the servo amplifier.
Use 1001 to 1050 of PA, PB, PC, PD, and PO when the GOT write data to E²PROM of the servo amplifier.
Use PA, PB, PC, PD, PO 1001 to 1050 when reading parameters to the servo amplifier RAM.
- *2 When the GOT writes data to point tables, use 1001 to 1255 of POS, SPD, ACT, DCT, DWL, AUX, and MCD (E²PROM area).
Even if the GOT writes a value to POS, SPD, ACT, DCT, DWL, AUX, or MCD (1 to 255) in the RAM area, the value is not reflected.
- *3 MCD cannot be used as a real number.
- *4 Only reading is possible.
- *5 The GOT cannot read or write data from/to consecutive devices.
- *6 Only reading is possible for DI0 to DI4.

POINT

Precautions for SP, OM, TMB, TMI, TMO, and TMD devices

- (1) For bit devices
Only writing is possible.
[Alternate] of a bit switch cannot be used.
Use [Set], [Reset], and [Momentary] of a bit switch.
- (2) For word devices, double word devices
Only writing is possible.
Numerical input cannot be used.
When writing, use [Word Set] of a data set switch.

The following shows correspondences between virtual devices for servo amplifier and data of the servo amplifier used with the GOT.

(a) Servo amplifier request

Device name	Item	Symbol
SP0	Status display data clear	—
SP1	Current alarm clear	—
SP2	Alarm history clear	—
SP3	External input signal prohibited	—
SP4	External output signal prohibited	—
SP5	External input signal resumed	—
SP6	External output signal resumed	—

(b) Operation mode selection

Device name	Item	Symbol
OM0	Normal mode (not test operation mode)	—
OM1	JOG operation	—
OM2	Positioning operation	—
OM3	Motorless operation	—
OM4	Output signal (DO) forced output	—
OM5	One step sending	—

(c) Instruction demand (for test operation)

Device name	Item	Symbol
TMB1	Temporary stop command	—
TMB2	Test operation (positioning operation) start command	—
TMB3	Forward rotation direction	—
TMB4	Reverse rotation direction	—
TMB5	Restart for remaining distance	—
TMB6	Remaining distance clear	—

(d) Basic setting parameter

Device name	Item	Symbol* ¹
PA1, PA1001	Control mode	*STY
PA2, PA1002	Regenerative brake option	*REG
PA3, PA1003	Absolute position detection system	*ABS
PA4, PA1004	Function selection A-1	*AOP1
PA5, PA1005	Feeding function selection	*FTY
PA6, PA1006	Electronic gear numerator	*CMX
PA7, PA1007	Electronic gear denominator	*CDV
PA8, PA1008	Auto tuning mode	ATU
PA9, PA1009	Auto tuning response	RSP
PA10, PA1010	In-position range	INP
PA11, PA1011	Forward torque limit	TLP
PA12, PA1012	Reverses torque limit	TLN
PA13, PA1013	For manufacturer setting	—
PA14, PA1014	Rotation direction selection	*POL
PA15, PA1015	Encoder output pulses	*ENR
PA16 to PA18, PA1016 to PA1018	For manufacturer setting	—
PA19, PA1019	Parameter block	*BLK

1 For the parameters prefixed by an asterisk (), setting becomes effective when the power is turned off once and back on after setting the parameter data.

(e) Gain filter parameter

Device name	Item	Symbol*1
PB1, PB1001	Adaptive tuning mode (Adaptive filter II)	FILT
PA2, PB1002	Vibration suppression control filter tuning mode (advanced vibration suppression control)	VRFT
PB3, PB1003	For manufacturer setting	—
PB4, PB1004	Feed forward gain	FFC
PB5, PB1005	For manufacturer setting	—
PB6, PB1006	Ratio of load inertia moment to servo motor inertia moment	GD2
PB7, PB1007	Model control gain	PG1
PB8, PB1008	Position loop gain	PG2
PB9, PB1009	Speed loop gain	VG2
PB10, PB1010	Speed integral compensation	VIC
PB11, PB1011	Speed differential compensation	VDC
PB12, PB1012	For manufacturer setting	—
PB13, PB1013	Machine resonance suppression filter 1	NH1
PB14, PB1014	Notch form selection 1	NHQ1
PB15, PB1015	Machine resonance suppression filter 2	NH2
PB16, PB1016	Notch form selection 2	NHQ2
PB17, PB1017	For manufacturer setting	—
PB18, PB1018	Low-pass filter setting	LPF
PB19, PB1019	Vibration suppression control vibration frequency setting	VRF1
PB20, PB1020	Vibration suppression control resonance frequency setting	VRF2
PB21 to PB22, PB1021 to PB1022	For manufacturer setting	—
PB23, PB1023	Low-pass filter selection	VFBF
PB24, PB1024	Slight vibration suppression control selection	*MVS
PB25, PB1025	For manufacturer setting	—
PB26, PB1026	Gain changing selection	*CDP
PB27, PB1027	Gain changing condition	CDL
PB28, PB1028	Gain changing time constant	CDT
PB29, PB1029	Gain changing, Ratio of load inertia moment to servo motor inertia moment	GD2B
PB30, PB1030	Gain changing, Position loop gain	PG2B
PB31, PB1031	Gain changing, Speed loop gain	VG2B
PB32, PB1032	Gain changing, Speed integral compensation	VICB
PB33, PB1033	Gain changing, Vibration suppression control vibration frequency setting	VRF1B
PB34, PB1034	Gain changing, Vibration suppression control resonance frequency setting	VRF2B
PB35 to PB45, PB1035 to PB1045	For manufacturer setting	—

1 For the parameters prefixed by an asterisk (), setting becomes effective when the power is turned off once and back on after setting the parameter data.

(f) Extension setting parameter

Device name	Item	Symbol*1
PC1, PC1001	For manufacturer setting	—
PC2, PC1002	Home position return type	*ZTY
PC3, PC1003	Direction of home position return	*ZDIR
PC4, PC1004	Home position return speed	ZRF
PC5, PC1005	Creep speed	CRF

Device name	Item	Symbol*1
PC6, PC1006	Home position shift distance	ZST
PC7, PC1007	Home position return position data	*ZPS
PC8, PC1008	Moving distance after proximity dog	DCT
PC9, PC1009	Hold time home position return hold time	ZTM
PC10, PC1010	Hold time home position return torque limit value	ZTT
PC11, PC1011	Rough match output range	CRP
PC12, PC1012	Jog speed	JOG
PC13, PC1013	S-pattern acceleration/ deceleration time constant	*STC
PC14, PC1014	Backlash compensation	*BKC
PC15, PC1015	For manufacturer setting	—
PC16, PC1016	Electromagnetic brake sequence output	MBR
PC17, PC1017	Zero speed	ZSP
PC18, PC1018	Alarm history clear	*BPS
PC19, PC1019	Encoder output pulse selection	*ENRS
PC20, PC1020	Station number setting	*SNO
PC21, PC1021	Communication function selection	*SOP
PC22, PC1022	Function selection C-1	*COP1
PC23, PC1023	For manufacturer setting	—
PC24, PC1024	Function selection C-3	*COP3
PC25, PC1025	For manufacturer setting	—
PC26, PC1026	Function selection C-5	*COP5
PC27, PC1027	For manufacturer setting	—
PC28, PC1028	Function selection C-7	*COP7
PC29 to PC30, PC1029 to PC1030	For manufacturer setting	—
PC31, PC1031	Software limit + Low	LMPL
PC32, PC1032	Software limit + High	LMPH
PC33, PC1033	Software limit - Low	LMNL
PC34, PC1034	Software limit - High	LMNH
PC35, PC1035	Internal torque limit 2	TL2
PC36, PC1036	Status display selection	*DMD
PC37, PC1037	Position range output address + Low	*LPPL
PC38, PC1038	Position range output address + High	*LPPH
PC39, PC1039	Position range output address - Low	*LNPL
PC40, PC1040	Position range output address - High	*LNPH
PC41 to PC50, PC1041 to PC1050	For manufacturer setting	—

1 For the parameters prefixed by an asterisk (), setting becomes effective when the power is turned off once and back on after setting the parameter data.

(g) I/O setting parameter

Device name	Item	Symbol*1
PD1, PD1001	Input signal automatic ON selection 1	*DIA1
PD2, PD1002	For manufacturer setting	—
PD3, PD1003	Input signal automatic ON selection 3	*DIA3
PD4, PD1004	Input signal automatic ON selection 4	*DIA4
PD5, PD1005	For manufacturer setting	—
PD6, PD1006	Input signal device selection 2 (CN6-2)	*DI2
PD7, PD1007	Input signal device selection 3 (CN6-3)	*DI3
PD8, PD1008	Input signal device selection 4 (CN6-4)	*DI4
PD9, PD1009	Output signal device selection 1 (CN6-14)	*DO1
PD10, D1010	Output signal device selection 2 (CN6-15)	*DO2

9
MELSECNET/H
CONNECTION (PLC
TO PLC NETWORK)

10
MELSECNET/10
CONNECTION (PLC
TO PLC NETWORK)

11
CC-Link IE CONTROLLER
NETWORK
CONNECTION

12
CC-Link IE FIELD
NETWORK
CONNECTION

13
CC-Link CONNECTION
(INTELLIGENT DEVICE
STATION)

14
CC-Link
CONNECTION
(Via G4)

15
INVERTER
CONNECTION

16
SERVO AMPLIFIER
CONNECTION

Device name	Item	Symbol*1
PD11, PD1011	Output signal device selection 3 (CN6-16)	*DD3
PD12 to PD15, PD1012 to PD1015	For manufacturer setting	—
PD16, PD1016	Input polarity selection	*DIAB
PD17 to PD18, PD1017 to PD1018	For manufacturer setting	—
PD19, PD1019	Response level setting	*DIF
PD20, 1020	Function selection D-1	*DOP1
PD21, PD1021	For manufacturer setting	—
PD22, PD1022	Function selection D-3	*DOP3
PD23, PD1023	For manufacturer setting	—
PD24, PD1024	Function selection D-5	*DOP5
PD25 to PD30, PD1025 to PD1030	For manufacturer setting	—

1 For the parameters prefixed by an asterisk (), setting becomes effective when the power is turned off once and back on after setting the parameter data.

(h) Option unit parameter

Device name	Item	Symbol
PO1, PO1001	For manufacturer setting	—
PO2, PO1002	MR-J3-D01 Input signal device selection 1 (CN10-21, 26)	*ODI1
PO3, PO1003	MR-J3-D01 Input signal device selection 2 (CN10-27, 28)	*ODI2
PO4, PO1004	MR-J3-D01 Input signal device selection 3 (CN10-29, 30)	*ODI3
PO5, PO1005	MR-J3-D01 Input signal device selection 4 (CN10-31, 32)	*ODI4
PO6, PO1006	MR-J3-D01 Input signal device selection 5 (CN10-33, 34)	*ODI5
PO7, PO1007	MR-J3-D01 Input signal device selection 6 (CN10-35, 36)	*ODI6
PO8, PO1008	MR-J3-D01 Output signal device selection 1 (CN10-46, 47)	*ODO1
PO9, PO1009	MR-J3-D01 Output signal device selection 2 (CN10-48, 49)	*ODO2
PO10, PO1010	Function selection 0-1	*OOP1
PO11, PO1011	For manufacturer setting	—
PO12, PO1012	Function selection 0-3	*OOP3
PO13, PO1013	MR-J3-D01 Analog monitor 1 output	MOD1
PO14, PO1014	MR-J3-D01 Analog monitor 2 output	MOD2
PO15, PO1015	MR-J3-D01 Analog monitor 1 offset	M01
PO16, PO1016	MR-J3-D01 Analog monitor 2 offset	M02
PO17 to 20, PO1017 to PO1020	For manufacturer setting	—
PO21, PO1021	MR-J3-D01 Override offset	VCO
PO22, PO1022	MR-J3-D01 Analog torque limitation offset	TLO
PO23 to 35, PO1023 to PO1035	For manufacturer setting	—

(i) Status display

Device name	Item	Symbol
ST0	Current position	—
ST1	Command position	—
ST2	Command remaining distance	—
ST3	Point table No.	—
ST4	Cumulative feedback pulses	—
ST5	Servo monitor speed	—
ST6	Droop pulses	—
ST7	Override voltage	—
ST8	Override	—
ST9	Analog torque command voltage/limit voltage	—
ST10	Regenerative load ratio	—
ST11	Effective load ratio	—
ST12	Peak load ratio	—
ST13	Instantaneous torque	—
ST14	Within one-revolution position	—
ST15	ABS counter	—
ST16	load inertia moment ratio	—
ST17	Bus voltage	—

(j) Alarm

Device name	Item	Symbol
AL0	Current alarm number	—
AL1	Detailed data of current alarms	—
AL11	Servo status when alarm occurs Current position	—
AL12	Servo status when alarm occurs Command position	—
AL13	Servo status when alarm occurs Command remaining distance	—
AL14	Servo status when alarm occurs Point table No.	—
AL15	Servo status when alarm occurs Cumulative feedback pulses	—
AL16	Servo status when alarm occurs Servo motor speed	—
AL17	Servo status when alarm occurs Droop pulses	—
AL18	Servo status when alarm occurs Override voltage	—
AL19	Servo status when alarm occurs Override	—
AL20	Servo status when alarm occurs Analog torque limit voltage	—
AL21	Servo status when alarm occurs Regenerative load ratio	—
AL22	Servo status when alarm occurs Effective load ratio	—
AL23	Servo status when alarm occurs Peak load ratio	—
AL24	Servo status when alarm occurs Instantaneous torque	—
AL25	Servo status when alarm occurs Within one-revolution position	—
AL26	Servo status when alarm occurs ABS counter	—
AL27	Servo status when alarm occurs Load inertia moment ratio	—
AL28	Servo status when alarm occurs Bus voltage	—
AL200	Alarm number from alarm history, Most recent alarm	—
AL201	Alarm number from alarm history First alarm in past	—
AL202	Alarm number from alarm history Second alarm in past	—
AL203	Alarm number from alarm history Third alarm in past	—
AL204	Alarm number from alarm history Fourth alarm in past	—

Device name	Item	Symbol
AL205	Alarm number from alarm history Fifth alarm in past	—
AL210	Alarm occurrence time in alarm history Most recent alarm	—
AL211	Alarm occurrence time in alarm history First alarm in past	—
AL212	Alarm occurrence time in alarm history Second alarm in past	—
AL213	Alarm occurrence time in alarm history Third alarm in past	—
AL214	Alarm occurrence time in alarm history Fourth alarm in past	—
AL215	Alarm occurrence time in alarm history Fifth alarm in past	—
AL230	Detailed alarm from alarm history Most recent alarm	—
AL231	Detailed alarm from alarm history First alarm in past	—
AL232	Detailed alarm from alarm history Second alarm in past	—
AL233	Detailed alarm from alarm history Third alarm in past	—
AL234	Detailed alarm from alarm history Fourth alarm in past	—
AL235	Detailed alarm from alarm history Fifth alarm in past	—

(k) External input

Device name	Item	Symbol
DI0	Input device statuses 1	—
DI1	Input device statuses 2	—
DI2	Input device statuses 3	—
DI3	External input pin statuses 1	—
DI4	External input pin statuses 2	—
DI5	Statuses of input devices switched on through communication 1	—
DI6	Statuses of input devices switched on through communication 2	—
DI7	Statuses of input devices switched on through communication 3	—

(l) External output

Device name	Item	Symbol
DO0	Output device statuses 1	—
DO1	Output device statuses 2	—
DO2	Output device statuses 3	—
DO3	External output pin statuses 1	—
DO4	External output pin statuses 2	—

(m) Point table (position)

Device name	Item	Symbol
POS1 to POS255, POS1001 to POS1255	Point table (position) No.1 to 255	—
SPD1 to SPD255, SPD1001 to SPD1255	Point table (speed) No.1 to 255	—
ACT1 to ACT255, ACT1001 to ACT1255	Point table (acceleration time constant) No.1 to 255	—
DCT1 to DCT255, DCT1001 to DCT1255	Point table (deceleration time constant) No.1 to 255	—
DWL1 to DWL255, DWL1001 to DWL1255	Point table (dwell) (DWL) No.1 to 255	—

Device name	Item	Symbol
AUX1 to AUX255, AUX1001 to AUX1255	Point table (auxiliary function) No.1 to 255	—
MCD1 to MCD255, MCD1001 to MCD1255	Point table (M code) No.1 to 255	—

(n) Input signal for test operation (for test operation)

Device name	Item	Symbol
TMI0	Input signal for test operation 1	—
TMI1	Input signal for test operation 2	—
TMI2	Input signal for test operation 3	—

(o) Forced output of signal pin (for test operation)

Device name	Item	Symbol
TMO0	Forced output from signal pin (CN6)	—
TMO1	Forced output from signal pin (CN10)	—

(p) Set data (for test operation)

Device name	Item	Symbol
TMD0	Writes the speed (test mode)	—
TMD1	Writes the acceleration/deceleration time constant (test mode)	—
TMD3	Writes the moving distance (test mode)	—

9
MELSECNET/H
CONNECTION (PLC
TO PLC NETWORK)

10
MELSECNET/10
CONNECTION (PLC
TO PLC NETWORK)

11
CC-Link IE CONTROLLER
NETWORK
CONNECTION

12

13
CC-Link IE FIELD
NETWORK
CONNECTION

14
CC-Link CONNECTION
(INTELLIGENT DEVICE
STATION)

15
CC-Link
CONNECTION
(Via G4)

16
INVERTER
CONNECTION

SERVO AMPLIFIER
CONNECTION

(9) MELSERVO-J4-*A, JE-*A

Device name*2		Setting range		Device No. representation	
Bit device	Servo amplifier request (SP)	SP0	to SP6	Decimal	
	Operation mode selection (OM)	OM0 OM4	to OM2		
	Instruction demand (for test operation) (TMB)	TMB1	to TMB6		
	One-touch tuning command (OTI)*5	OTI0	to OTI5		
Word device	Basic setting parameter (PA)*1	PA1 PA1001	to PA32 to PA1032		
	Gain filter parameter (PB)*1	PB1 PB1001	to PB64 to PB1064		
	Extension setting parameter (PC)*1	PC1 PC1001	to PC80 to PC1080		
	I/O setting parameter (PD)*1	PD1 PD1001	to PD48 to PD1048		
	Extension setting 2 parameter (PE)*1	PE1 PE1001	to PE64 to PE1064		
	Extension setting 3 parameter (PF)*1	PF1 PF1001	to PF48 to PF1048		
	Linear servo motor/DD motor setting parameter (PL)*2	PL1 PL1001	to PL48 to PL1048		
	Status display (ST)*3	ST0	to ST41		
	Alarm (AL)*3	AL0	to AL1		
		AL11	to AL25		
		AL200	to AL205		
		AL210	to AL215		
	Alarm (ALM)*3	ALM0	to ALM1		
		ALM11	to ALM52		
		ALM200	to ALM215		
		ALM220	to ALM235		
Machine diagnosis data (MD)*3	MD0	to MD11			
One-touch tuning data (OTS)*3	OTS0	to OTS3			
External input (DI)*4	DI0	to DI2			
External output (DO)*3	DO0	to DO1			
Lifetime diagnosis (ALD)*3	ALD0	to ALD1			
Double word device	Input signal for test operation (for test operation) (TM0)	TM10			
	Forced output of signal pin (for test operation) (TMO)	TMO0			
	Set data (for test operation) (TMD)	TMD0	to TMD1 TMD3		

*1 Use 1 to 80 of PA, PB, PC, PD, PE, PF and PL when the GOT writes data to RAM of the servo amplifier.
Use 1001 to 1080 of PA, PB, PC, PD, PE, PF and PL when the GOT write data to E²PROM of the servo amplifier.
Use PA, PB, PC, PD, PE, PF, PL 1001 to 1080 when reading parameters to the servo amplifier RAM.

*2 The GOT cannot read or write data from/to consecutive devices.

*3 Only reading is possible.

*4 Only reading is possible for DI0 to DI1.

*5 Only writing is possible.

POINT

Precautions for SP, OM, TMB, TMI, TMO, and TMD devices

- (1) For bit devices
Only writing is possible.
[Alternate] of a bit switch cannot be used.
Use [Set], [Reset], and [Momentary] of a bit switch.
- (2) For word devices, double word devices
Only writing is possible.
Numerical input cannot be used.
When writing, use [Word Set] of a data set switch.

The following shows correspondences between virtual devices for servo amplifier and data of the servo amplifier used with the GOT.

(a) Servo amplifier request

Device name	Item	Symbol
SP0	Status display data clear	—
SP1	Current alarm clear	—
SP2	Alarm history clear	—
SP3	External input signal prohibited	—
SP4	External output signal prohibited	—
SP5	External input signal resumed	—
SP6	External output signal resumed	—

(b) Operation mode selection

Device name	Item	Symbol
OM0	Normal mode (not test operation mode)	—
OM1	JOG operation	—
OM2	Positioning operation	—
OM4	Output signal (DO) forced output	—

(c) Instruction demand (for test operation)

Device name	Item	Symbol
TMB1	Temporary stop command	—
TMB2	Test operation (positioning operation) start command	—
TMB3	Forward rotation direction	—
TMB4	Reverse rotation direction	—
TMB5	Restart for remaining distance	—
TMB6	Remaining distance clear	—

(d) One-touch tuning

Device name	Item	Symbol
OT10	One-touch tuning start command (Basic mode)	—
OT11	One-touch tuning start command (High mode)	—
OT12	One-touch tuning start command (Low mode)	—
OT13	One-touch tuning stop command	—
OT14	Return to initial value	—
OT15	Return to value before adjustment	—

(e) Basic setting parameter

Device name	Item	Symbol ^{*1}
PA1, PA1001	Operation mode	*STY
PA2, PA1002	Regenerative option	*REG
PA3, PA1003 ^{*2}	Absolute position detection system	*ABS
PA4, PA1004	Function selection A-1	*AOP1
PA5, PA1005	Number of command input pulses per revolution	*FBP
PA6, PA1006	Electronic gear numerator (command pulse multiplication numerator)	CMX
PA7, PA1007	Electronic gear denominator (command pulse multiplication denominator)	CDV
PA8, PA1008	Auto tuning mode	ATU
PA9, PA1009	Auto tuning response	RSP
PA10, PA1010	In-position range	INP
PA11, PA1011	Forward rotation torque limit	TLP
PA12, PA1012	Reverse rotation torque limit	TLN
PA13, PA1013	Command pulse input form	*PLSS
PA14, PA1014	Rotation direction selection	*POL
PA15, PA1015	Encoder output pulses	*ENR
PA16, PA1016	Encoder output pulses 2	*ENR2
PA17 to 18, PA1017 to 1018	For manufacturer setting	—
PA19, PA1019	Parameter writing inhibit	*BLK
PA20, PA1020	Tough drive setting	*TDS
PA21, PA1021	Function selection A-3	*AOP3
PA22, PA1022	For manufacturer setting	—
PA23, PA1023	Drive recorder arbitrary alarm trigger setting	DRAT
PA24, PA1024	Function selection A-4	*AOP4
PA25, PA1025	One-touch tuning - Overshoot permissible level	OTHOV
PA26, PA1026 ^{*2}	Function selection A-5	*AOP5
PA27 to 32, PA1027 to 1032	For manufacturer setting	—

- *1 For the parameters prefixed by an asterisk (*), setting becomes effective when the power is turned off once and back on after setting the parameter data.
- *2 The MELSERVO-JE series is equivalent to the MELSERVO-J4 series, but they are different in parameter functions. When using the MELSERVO-JE series, refer to the following.
-  Technical manual for the MELSERVO-JE series servo amplifiers

(f) Gain filter parameter

Device name	Item	Symbol ^{*1}
PB1, PB1001	Adaptive tuning mode (adaptive filter II)	PB1
PB2, PB1002	Vibration suppression control tuning mode (advanced vibration suppression control II)	VRFT
PB3, PB1003	Position command acceleration/ deceleration time constant (position smoothing)	PST
PB4, PB1004	Feed forward gain	FFC
PB5, PB1005	For manufacturer setting	—
PB6, PB1006	Load to motor inertia ratio	GD2
PB7, PB1007	Model loop gain	PG1
PB8, PB1008	Position loop gain	PG2
PB9, PB1009	Speed loop gain	VG2
PB10, PB1010	Speed integral compensation	VIC
PB11, PB1011	Speed differential compensation	VDC
PB12, PB1012	Overshoot amount compensation	OVA
PB13, PB1013	Machine resonance suppression filter 1	NH1
PB14, PB1014	Notch shape selection 1	NHQ1
PB15, PB1015	Machine resonance suppression filter 2	NH2
PB16, PB1016	Notch shape selection 2	NHQ2
PB17, PB1017	Shaft resonance suppression filter	NHF
PB18, PB1018	Low-pass filter setting	LPF
PB19, PB1019	Vibration suppression control 1 - Vibration frequency	VRF11
PB20, PB1020	Vibration suppression control 1 - Resonance frequency	VRF12
PB21, PB1021	Vibration suppression control 1 - Vibration frequency dumping	VRF13
PB22, PB1022	Vibration suppression control 1 - Resonance frequency dumping	VRF14
PB23, PB1023	Low-pass filter selection	VFBF
PB24, PB1024	Slight vibration suppression control	*MVS
PB25, PB1025	Function selection B-1	*BOP1
PB26, PB1026	Gain switching function	*CDP
PB27, PB1027	Gain switching condition	CDL
PB28, PB1028	Gain switching time constant	CDT
PB29, PB1029	Load to motor inertia ratio after gain switching	GD2B
PB30, PB1030	Position loop gain after gain switching	PG2B
PB31, PB1031	Speed loop gain after gain switching	VG2B
PB32, PB1032	Speed integral compensation after gain switching	VICB
PB33, PB1033	Vibration suppression control 1 - Vibration frequency after gain switching	VRF1B
PB34, PB1034	Vibration suppression control 1 - Resonance frequency after gain switching	VRF2B
PB35, PB1035	Vibration suppression control 1 - Resonance frequency dumping after gain switching	VRF3B
PB36, PB1036	Vibration suppression control 1 - Resonance frequency dumping after gain switching	VRF4B
PB37 to 44, PB1037 to 1044	For manufacturer setting	—
PB45, PB1045	Command notch filter	CNHF
PB46, PB1046	Machine resonance suppression filter 3	NH3
PB47, PB1047	Notch shape selection 3	NHQ3

Device name	Item	Symbol*1
PB48, PB1048	Machine resonance suppression filter 4	NH4
PB49, PB1049	Notch shape selection 4	NHQ4
PB50, PB1050	Machine resonance suppression filter 5	NH5
PB51, PB1051	Notch shape selection 5	NHQ5
PB52, PB1052	Vibration suppression control 2 - Vibration frequency	VRF21
PB53, PB1053	Vibration suppression control 2 - Resonance frequency	VRF22
PB54, PB1054	Vibration suppression control 2 - Vibration frequency dumping	VRF23
PB55, PB1055	Vibration suppression control 2 - Resonance frequency dumping	VRF24
PB56, PB1056	Vibration suppression control 2 - Vibration frequency after gain switching	VRF21B
PB57, PB1057	Vibration suppression control 2 - Resonance frequency after gain switching	VRF22B
PB58, PB1058	Vibration suppression control 2 - Vibration frequency dumping after gain switching	VRF23B
PB59, PB1059	Vibration suppression control 2 - Resonance frequency dumping after gain switching	VRF24B
PB60, PB1060	Model loop gain after gain switching	PG1B
PB61 to 64, PB1061 to 1064	For manufacturer setting	—

1 For the parameters prefixed by an asterisk (), setting becomes effective when the power is turned off once and back on after setting the parameter data.

(g) Extension setting parameter

Device name	Item	Symbol*1
PC1, PC1001	Acceleration time constant	STA
PC2, PC1002	Deceleration time constant	STB
PC3, PC1003	S-pattern acceleration/ deceleration time constant	STC
PC4, PC1004	Torque command time constant	TQC
PC5, PC1005	Internal speed command 1	SC1
	Internal speed limit 1	
PC6, PC1006	Internal speed command 2	SC2
	Internal speed limit 2	
PC7, PC1007	Internal speed command 3	SC3
	Internal speed limit 3	
PC8, PC1008	Internal speed command 4	SC4
	Internal speed limit 4	
PC9, PC1009	Internal speed command 5	SC5
	Internal speed limit 5	
PC10, PC1010	Internal speed command 6	SC6
	Internal speed limit 6	
PC11, PC1011	Internal speed command 7	SC7
	Internal speed limit 7	
PC12, PC1012	Analog speed command - Maximum speed	VCM
	Analog speed limit - Maximum speed	
PC13, PC1013	Analog torque command maximum output	TLC
PC14, PC1014	Analog monitor 1 output	MOD1
PC15, PC1015	Analog monitor 2 output	MOD2
PC16, PC1016	Electromagnetic brake sequence output	MBR
PC17, PC1017	Zero speed	ZSP
PC18, PC1018	Alarm history clear	*BPS

Device name	Item	Symbol*1
PC19, PC1019	Encoder output pulse selection	*ENRS
PC20, PC1020*2	Station number setting	*SNO
PC21, PC1021*2	Communication function selection	*SOP
PC22, PC1022	Function selection C-1	*COP1
PC23, PC1023	Function selection C-2	*COP2
PC24, PC1024	Function selection C-3	*COP3
PC25, PC1025	For manufacturer setting	—
PC26, PC1026	Function selection C-5	*COP5
PC27, PC1027*2	Function selection C-6	*COP6
PC28, PC1028	For manufacturer setting	—
PC29, PC1029	For manufacturer setting	—
PC30, PC1030	Acceleration time constant 2	STA2
PC31, PC1031	Deceleration time constant 2	STB2
PC32, PC1032	Command input pulse multiplication numerator 2	CMX2
PC33, PC1033	Command input pulse multiplication numerator 3	CMX3
PC34, PC1034	Command input pulse multiplication numerator 4	CMX4
PC35, PC1035	Internal torque limit 2	TL2
PC36, PC1036	Status display selection	*DMD
	Analog speed command offset	VCO
Analog speed limit offset		
PC38, PC1038	Analog torque command offset	TPO
	Analog torque limit offset	
PC39, PC1039	Analog monitor 1 offset	MO1
PC40, PC1040	Analog monitor 2 offset	MO2
PC41 to 42, PC1041 to 1042	For manufacturer setting	—
PC43, PC1043	Error excessive alarm detection level	ERZ
PC44 to 50, PC1044 to 1050	For manufacturer setting	—
PC51, PC1051	Forced stop deceleration time constant	RSBR
PC52, PC1052	For manufacturer setting	—
PC53, PC1053	For manufacturer setting	—
PC54, PC1054	Vertical axis freefall prevention compensation amount	RSUP1
PC55 to PC59, PC1055 to PC1059	For manufacturer setting	—
PC60, PC1060	Function selection C-D	*COPD
PC61 to PC80, PC1061 to PC1080	For manufacturer setting	—

1 For the parameters prefixed by an asterisk (), setting becomes effective when the power is turned off once and back on after setting the parameter data.

*2 The MELSERVO-JE series is equivalent to the MELSERVO-J4 series, but they are different in parameter functions. When using the MELSERVO-JE series, refer to the following.

 Technical manual for the MELSERVO-JE series servo amplifiers

(h) I/O setting parameter

Device name	Item	Symbol*1
PD1, PD1001	Input signal automatic on selection 1	*DIA1
PD2, PD1002	For manufacturer setting	—
PD3, PD1003	Input device selection 1L	*DI1L
PD4, PD1004	Input device selection 1H	*DI1H
PD5, PD1005*2	Input device selection 2L	*DI2L
PD6, PD1006*2	Input device selection 2H	*DI2H
PD7, PD1007*2	Input device selection 3L	*DI3L
PD8, PD1008*2	Input device selection 3H	*DI3H
PD9, PD1009*2	Input device selection 4L	*DI4L

Device name	Item	Symbol*1
PD10, PD1010*2	Input device selection 4H	*DI4H
PD11, PD1011	Input device selection 5L	*DI5L
PD12, PD1012	Input device selection 5H	*DI5H
PD13, PD1013	Input device selection 6L	*DI6L
PD14, PD1014	Input device selection 6H	*DI6H
PD15 to 16, PD1015 to 1016	For manufacturer setting	—
PD17, PD1017	Input device selection 8L	*DI8L
PD18, PD1018	Input device selection 8H	*DI8H
PD19, PD1019	Input device selection 9L	*DI9L
PD20, PD1020	Input device selection 9H	*DI9H
PD21, PD1021*2	Input device selection 10L	*DI10L
PD22, PD1022*2	Input device selection 10H	*DI10H
PD23, PD1023*2	Output device selection 1	*DO1
PD24, PD1024	Output device selection 2	*DO2
PD25, PD1025	Output device selection 3	*DO3
PD26, PD1026*2	Output device selection 4	*DO4
PD27, PD1027	For manufacturer setting	—
PD28, PD1028	Output device selection 6	*DO6
PD29, PD1029	Input filter setting	*DIF
PD30, PD1030	Function selection D-1	*DOP1
PD31, PD1031	For manufacturer setting	—
PD32, PD1032	Function selection D-3	*DOP3
PD33, PD1033	For manufacturer setting	—
PD34, PD1034	Function selection D-5	*DOP5
PD35 to 48, PD1035 to 1048	For manufacturer setting	—

- *1 For the parameters prefixed by an asterisk (*), setting becomes effective when the power is turned off once and back on after setting the parameter data.
- *2 The MELSERVO-JE series is equivalent to the MELSERVO-J4 series, but they are different in parameter functions. When using the MELSERVO-JE series, refer to the following.

 Technical manual for the MELSERVO-JE series servo amplifiers

(i) Extension setting 2 parameter

Device name	Item	Symbol
PE1 to 40, PE1000 to 1040	For manufacturer setting	—
PE41, PE1041	Function selection E-3	EOP3
PE42 to 64, PE1042 to 1064	For manufacturer setting	—

(j) Extension setting 3 parameter

Device name	Item	Symbol
PF1 to 8, PF1001 to 1008	For manufacturer setting	—
PF9, PF1009*1	Function selection F-5	*FOP5
PF10 to 14, PF1010 to 1014	For manufacturer setting	—
PF15, PF1015*1	Electronic dynamic brake operating time	DBT
PF16 to 20, PF1016 to 1020	For manufacturer setting	—
PF21, PF1021	Drive recorder switching time setting	DRT
PF22, PF1022	For manufacturer setting	—

Device name	Item	Symbol
PF23, PF1023	Vibration tough drive - Oscillation detection level	OSCL1
PF24, PF1024	Vibration tough drive function selection	OSCL2
PF25, PF1025	Instantaneous power failure tough drive - Detection time	CVAT
PF26 to 30, PF1026 to 1030	For manufacturer setting	—
PF31, PF1031	Machine diagnosis function - Friction judgement speed	FRIC
PF32 to 48, PF1032 to 1048	For manufacturer setting	—

*1 The MELSERVO-JE series is equivalent to the MELSERVO-J4 series, but they are different in parameter functions. When using the MELSERVO-JE series, refer to the following.

 Technical manual for the MELSERVO-JE series servo amplifiers

(k) Linear servo motor/DD motor setting parameter

Device name	Item	Symbol*1
PL1, PL1001	Linear servo motor/DD motor function selection 1	*LIT1
PL2, PL1002	Linear encoder resolution - Numerator	*LIM
PL3, PL1003	Linear encoder resolution - Denominator	*LID
PL4, PL1004	Linear servo motor/DD motor function selection 2	*LIT2
PL5, PL1005	Position deviation error detection level	LB1
PL6, PL1006	Speed deviation error detection level	LB2
PL7, PL1007	Torque/thrust deviation error detection level	LB3
PL8, PL1008	Linear servo motor/DD motor function selection 3	*LIT3
PL9, PL1009	Magnetic pole detection voltage level	LPWM
PL10 to PL16, PL1010 to PL1016	For manufacturer setting	—
PL17, PL1017	Magnetic pole detection - Minute position detection method - Function selection	LTSTS
PL18, PL1018	Magnetic pole detection - Minute position detection method - Identification signal amplitude	IDLV
PL19 to PL48, PL1019 to PL1048	For manufacturer setting	—

1 For the parameters prefixed by an asterisk (), setting becomes effective when the power is turned off once and back on after setting the parameter data.

(l) Status display

Device name	Item	Symbol
ST0	Cumulative feedback pulse	—
ST1	Servo motor speed	—
ST2	Droop pulse	—
ST3	Cumulative command pulse	—
ST4	Command pulse frequency	—
ST5	Analog speed command voltage/limit voltage	—

9
MELSECNET/H CONNECTION (PLC CONNECTION TO PLC NETWORK)
10
MELSECNET/10 CONNECTION (PLC CONNECTION TO PLC NETWORK)
11
CC-Link IE CONTROLLER NETWORK CONNECTION
12
CC-Link IE FIELD NETWORK CONNECTION
13
CC-Link CONNECTION (INTELLIGENT DEVICE STATION)
14
CC-Link CONNECTION (Via G4)
15
INVERTER CONNECTION
16
SERVO AMPLIFIER CONNECTION

Device name	Item	Symbol
ST6	Analog torque command voltage/limit voltage	—
ST7	Regenerative load ratio	—
ST8	Effective load ratio	—
ST9	Peak load ratio	—
ST10	Instantaneous torque	—
ST11	Within one-revolution position(1 pulse unit)	—
ST12	ABS counter	—
ST13	Load inertia moment ratio	—
ST14	Bus voltage	—
ST15 to 31	For manufacturer setting	—
ST32	Internal temperature of encoder	—
ST33	Setting time	—
ST34	Oscillation detection frequency	—
ST35	Number of tough drives	—
ST36 to 39	For manufacturer setting	—
ST40	Unit power consumption 1 (increment of 1 W)	—
ST41	Unit total power consumption 1 (increment of 1 Wh)	—

(m) Alarm (compatible with MELSERVO-J3-*A)

Device name	Item	Symbol
AL0	Current alarm number	—
AL1*1	Detailed data of current alarms	—
AL11	Servo status when alarm occurs Cumulative feedback pulses	—
AL12	Servo status when alarm occurs Servo motor speed	—
AL13	Servo status when alarm occurs Droop pulses	—
AL14	Servo status when alarm occurs cumulative command pulses	—
AL15	Servo status when alarm occurs command pulse frequency	—
AL16	Servo status when alarm occurs analog speed command voltage/limit voltage	—
AL17	Servo status when alarm occurs analog torque command voltage/limit voltage	—
AL18	Servo status when alarm occurs regenerative load ratio	—
AL19	Servo status when alarm occurs effective load ratio	—
AL20	Servo status when alarm occurs peak load ratio	—
AL21	Servo status when alarm occurs Instantaneous torque	—
AL22	Servo status when alarm occurs Within onerevolution position(1 pulse unit)	—
AL23	Servo status when alarm occurs ABS counter	—
AL24	Servo status when alarm occurs load inertia moment ratio	—
AL25	Servo status when alarm occurs Bus voltage	—
AL200	Alarm number from Alarm History most recent alarm	—
AL201	Alarm number from Alarm History first alarm in past	—
AL202	Alarm number from Alarm History second alarm in past	—
AL203	Alarm number from Alarm History third alarm in past	—
AL204	Alarm number from Alarm History fourth alarm in past	—
AL205	Alarm number from Alarm History fifth alarm in past	—

Device name	Item	Symbol
AL210	Alarm occurrence time in alarm history most recent alarm	—
AL211	Alarm occurrence time in alarm history first alarm in past	—
AL212	Alarm occurrence time in alarm history second alarm in past	—
AL213	Alarm occurrence time in alarm history third alarm in past	—
AL214	Alarm occurrence time in alarm history fourth alarm in past	—
AL215	Alarm occurrence time in alarm history fifth alarm in past	—
AL230	Detailed alarm from Alarm History most recent alarm	—
AL231	Detailed alarm from Alarm History first alarm in past	—
AL232	Detailed alarm from Alarm History second alarm in past	—
AL233	Detailed alarm from Alarm History third alarm in past	—
AL234	Detailed alarm from Alarm History fourth alarm in past	—
AL235	Detailed alarm from Alarm History fifth alarm in past	—

*1 The MELSERVO-JE series is equivalent to the MELSERVO-J4 series, but they are different in parameter functions. When using the MELSERVO-JE series, refer to the following.



Technical manual for the MELSERVO-JE series servo amplifiers

(n) Alarm (extended for MELSERVO-J4-*A)

Device name	Item	Symbol
ALM0	Current alarm number	—
ALM1*1	Detailed data of current alarms	—
ALM11	Servo status when alarm occurs Cumulative feedback pulses	—
ALM12	Servo status when alarm occurs Servo motor speed	—
ALM13	Servo status when alarm occurs Droop pulses	—
ALM14	Servo status when alarm occurs cumulative command pulses	—
ALM15	Servo status when alarm occurs command pulse frequency	—
ALM16	Servo status when alarm occurs analog speed command voltage/limit voltage	—
ALM17	Servo status when alarm occurs analog torque command voltage/limit voltage	—
ALM18	Servo status when alarm occurs regenerative load ratio	—
ALM19	Servo status when alarm occurs effective load ratio	—
ALM20	Servo status when alarm occurs peak load ratio	—
ALM21	Servo status when alarm occurs Instantaneous torque	—
ALM22	Servo status when alarm occurs Within onerevolution position(1 pulse unit)	—
ALM23	Servo status when alarm occurs ABS counter	—
ALM24	Servo status when alarm occurs load inertia moment ratio	—
ALM25	Servo status when alarm occurs Bus voltage	—
ALM 26 to 42	For manufacturer setting	—
ALM43	Servo status when alarm occurs Internal temperature of encoder	—
ALM44	Servo status when alarm occurs Setting time	—

Device name	Item	Symbol
ALM45	Servo states when alarm occurs Oscillation detection frequency	—
ALM46	Servo states when alarm occurs Number of tough drives	—
ALM47 to 50	For manufacturer setting	—
ALM51	Servo states when alarm occurs Unit power consumption 1 (increment of 1 W)	—
ALM52	Servo states when alarm occurs Unit total power consumption 1 (increment of 1 Wh)	—
ALM200	Alarm number from Alarm History most recent alarm	—
ALM201	Alarm number from Alarm History 1st alarm in past	—
ALM202	Alarm number from Alarm History 2nd alarm in past	—
ALM203	Alarm number from Alarm History 3rd alarm in past	—
ALM204	Alarm number from Alarm History 4th alarm in past	—
ALM205	Alarm number from Alarm History 5th alarm in past	—
ALM206	Alarm number from Alarm History 6th alarm in past	—
ALM207	Alarm number from Alarm History 7th alarm in past	—
ALM208	Alarm number from Alarm History 8th alarm in past	—
ALM209	Alarm number from Alarm History 9th alarm in past	—
ALM210	Alarm number from Alarm History 10th alarm in past	—
ALM211	Alarm number from Alarm History 11th alarm in past	—
ALM212	Alarm number from Alarm History 12th alarm in past	—
ALM213	Alarm number from Alarm History 13th alarm in past	—
ALM214	Alarm number from Alarm History 14th alarm in past	—
ALM215	Alarm number from Alarm History 15th alarm in past	—
ALM220	Alarm occurrence time in alarm history most recent alarm	—
ALM221	Alarm occurrence time in alarm history 1st alarm in past	—
ALM222	Alarm occurrence time in alarm history 2nd alarm in past	—
ALM223	Alarm occurrence time in alarm history 3rd alarm in past	—
ALM224	Alarm occurrence time in alarm history 4th alarm in past	—
ALM225	Alarm occurrence time in alarm history 5th alarm in past	—
ALM226	Alarm occurrence time in alarm history 6th alarm in past	—
ALM227	Alarm occurrence time in alarm history 7th alarm in past	—
ALM228	Alarm occurrence time in alarm history 8th alarm in past	—
ALM229	Alarm occurrence time in alarm history 9th alarm in past	—
ALM230	Alarm occurrence time in alarm history 10th alarm in past	—
ALM231	Alarm occurrence time in alarm history 11th alarm in past	—
ALM232	Alarm occurrence time in alarm history 12th alarm in past	—

Device name	Item	Symbol
ALM233	Alarm occurrence time in alarm history 13th alarm in past	—
ALM234	Alarm occurrence time in alarm history 14th alarm in past	—
ALM235	Alarm occurrence time in alarm history 15th alarm in past	—
ALM240*1	Detailed alarm from Alarm History most recent alarm	—
ALM241*1	Detailed alarm from Alarm History 1st alarm in past	—
ALM242*1	Detailed alarm from Alarm History 2nd alarm in past	—
ALM243*1	Detailed alarm from Alarm History 3rd alarm in past	—
ALM244*1	Detailed alarm from Alarm History 4th alarm in past	—
ALM245*1	Detailed alarm from Alarm History 5th alarm in past	—
ALM246*1	Detailed alarm from Alarm History 6th alarm in past	—
ALM247*1	Detailed alarm from Alarm History 7th alarm in past	—
ALM248*1	Detailed alarm from Alarm History 8th alarm in past	—
ALM249*1	Detailed alarm from Alarm History 9th alarm in past	—
ALM250*1	Detailed alarm from Alarm History 10th alarm in past	—
ALM251*1	Detailed alarm from Alarm History 11th alarm in past	—
ALM252*1	Detailed alarm from Alarm History 12th alarm in past	—
ALM253*1	Detailed alarm from Alarm History 13th alarm in past	—
ALM254*1	Detailed alarm from Alarm History 14th alarm in past	—
ALM255*1	Detailed alarm from Alarm History 15th alarm in past	—

*1 The MELSERVO-JE series is equivalent to the MELSERVO-J4 series, but they are different in parameter functions. When using the MELSERVO-JE series, refer to the following.

 Technical manual for the MELSERVO-JE series servo amplifiers

(o) Machine diagnosis data

Device name	Item	Symbol
MD0	Machine diagnosis data parameter number	—
MD1	Machine diagnosis data shift judgment (test mode)	—
MD2	Machine diagnosis data status	—
MD3	Machine diagnosis data coulomb friction torque in positive direction	—
MD4	Machine diagnosis data friction torque at rated speed in positive direction	—
MD5	Machine diagnosis data coulomb friction torque in negative direction	—
MD6	Machine diagnosis data friction torque at rated speed in negative direction	—
MD7	Machine diagnosis data oscillation frequency (motor is stopped)	—
MD8	Machine diagnosis data vibration level (motor is stopped)	—
MD9	Machine diagnosis data oscillation frequency (motor is operating)	—
MD10	Machine diagnosis data vibration level (motor is operating)	—
MD11	Machine diagnosis data rated speed	—

9
MELSECNET/H CONNECTION (PLC CONNECTION TO PLC NETWORK)

10
MELSECNET/I/O CONNECTION (PLC CONNECTION TO PLC NETWORK)

11
CC-Link IE CONTROLLER NETWORK CONNECTION

12
CC-Link IE FIELD NETWORK CONNECTION

13
CC-Link CONNECTION (INTELLIGENT DEVICE STATION)

14
CC-Link CONNECTION (Via G4)

15
INVERTER CONNECTION

16
SERVO AMPLIFIER CONNECTION

(p) One-touch tuning data

Device name	Item	Symbol
OTS0	One-touch tuning status confirmation	—
OTS1	Error code list	—
OTS2	Setting time	—
OTS3	Overshoot amount	—

(q) External input

Device name	Item	Symbol
DI0	Input device statuses	—
DI1	External input pin statuses	—
DI2	Statuses of input devices switched on through communication	—

(r) External output

Device name	Item	Symbol
DO0	Output device statuses	—
DO1	External output pin statuses	—

(s) Lifetime diagnosis

Device name	Item	Symbol
ALD0	Cumulative energization time	—
ALD1	Number of ON/OFF times for rush relay	—

(t) Input signal for test operation (for test operation)

Device name	Item	Symbol
TMI0	Input signal for test operation	—

(u) Forced output of signal pin (for test operation)

Device name	Item	Symbol
TMO0	Forced output from signal pin	—

(v) Set data (for test operation)

Device name	Item	Symbol
TMD0	Writes the speed (test mode)	—
TMD1	Writes the acceleration/deceleration time constant (test mode)	—
TMD3	Writes the moving distance (test mode)	—

(10)MELSERVO-J4-*A-RJ

Device name*2	Setting range	Device No. representation
Servo amplifier request (SP)	SP0 to SP6	Decimal
Operation mode selection (OM)	OM0 to OM2 OM4 to OM5	
Instruction demand (for test operation) (TMB)	TMB1 to TMB6	
One-touch tuning command (OTI)*1	OTI0 to OTI5	
Basic setting parameter (PA)*2	PA1 to PA32 PA1001 to PA1032	Decimal
Gain filter parameter (PB)*2	PB1 to PB64 PB1001 to PB1064	
Extension setting parameter (PC)*2	PC1 to PC80 PC1001 to PC1080	
I/O setting parameter (PD)*2	PD1 to PD48 PD1001 to PD1048	
Extension setting No.2 parameter (PE)*2	PE1 to PE64 PE1001 to PE1064	
Extension setting No.3 parameter (PF)*2	PF1 to PF48 PF1001 to PF1048	
Option unit parameter (PO)*2	PO1 to PO32 PO1001 to PO1032	
Linear servo motor/DD motor setting parameter (PL)*2	PL1 to PL48 PL1001 to PL1048	
Positioning control parameter (PT)*2	PT1 to PT48 PT1001 to PT1048	
Status display (ST)*4	ST0 to ST48	
Alarm (current alarm, compatible with J3) (AL)*4	AL0 to AL1 AL11 to AL25	
Alarm (alarm history, compatible with J3) (AL)*4	AL200 to AL205 AL210 to AL215 AL230 to AL235	
Alarm (current alarm, extended for J4) (ALM)*4	ALM0 to ALM1 ALM11 to ALM59	
Alarm (alarm history, extended for J4) (ALM)*4	ALM200 to ALM215 ALM220 to ALM235 ALM240 to ALM255	
Point table (position) (POS)*5	POS1 to POS255 POS1001 to POS1255	
Point table (speed) (SPD)*5	SPD1 to SPD255 SPD1001 to SPD1255	
Point table (acceleration time constant) (ACT)*5	ACT1 to ACT255 ACT1001 to ACT1255	
Point table (deceleration time constant) (DCT)*5	DCT1 to DCT255 DCT1001 to DCT1255	
Point table (dwell) (DWL)*5	DWL1 to DWL255 DWL1001 to DWL1255	
Point table (auxiliary function) (AUX)*5	AUX1 to AUX255 AUX1001 to AUX1255	
Point table (M code) (MCD)*5*6	MCD1 to MCD255 MCD1001 to MCD1255	
Machine diagnosis data (MD)*3	MD0 to MD11	
One-touch tuning data (OTS)*4	OTS0 to OTS3	
External input (DI)*7	DI0 to DI6	
External output (DO)*4	DO0 to DO4	

Device name*2	Setting range	Device No. representation
Current position latch data (LD)*4	LD0 to LD1	Decimal
The value of the general-purpose register (Rx) (RR)*8	RR1 to RR4 RR1001 to RR1004	
The value of the general-purpose register (Dx) (RD)	RD1 to RD4	
Lifetime diagnosis (ALD)*3	ALD0 to ALD1	
Input signal for test operation (for test operation) (TMI)	TMI0 to TMI2	
Forced output of signal pin (for test operation) (TMO)	TMO0	
Set data (for test operation) (TMD)	TMD0 to TMD1 TMD3	

- *1 Only writing is possible.
 *2 Use 1 to 80 of PA, PB, PC, PD, PE, PF, PL, PO, and PT when the GOT writes data to RAM of the servo amplifier. Use 1001 to 1080 of PA, PB, PC, PD, PE, PF, PL, PO, and PT when the GOT writes data to E2PROM of the servo amplifier. Use PA, PB, PC, PD, PE, PF, PL, PO, and PT 1001 to 1080 when reading parameters to the servo amplifier RAM.
 *3 The GOT cannot read or write data from/to consecutive devices.
 *4 Only reading is possible.
 *5 When the GOT writes data to point tables, use 1001 to 1255 of POS, SPD, ACT, DCT, DWL, AUX, and MCD (E2PROM area). Even if the GOT writes a value to POS, SPD, ACT, DCT, DWL, AUX, or MCD (1 to 255) in the RAM area, the value is not reflected.
 *6 MCD cannot be used as a real number.
 *7 Only reading is possible for DI0 to DI3.
 *8 Use the integer number when writing parameters to Rx.

POINT

Precautions for SP, OM, TMB, TMI, TMO, and TMD devices

- For bit devices
 Only writing is possible.
 [Alternate] of a bit switch cannot be used.
 Use [Set], [Reset], and [Momentary] of a bit switch.
- For word devices, double word devices
 Only writing is possible.
 Numerical input cannot be used.
 When writing, use [Word Set] of a data set switch.

The following shows correspondences between virtual devices for servo amplifier and data of the servo amplifier used with the GOT.

(a) Servo amplifier request

Device name	Item	Symbol
SP0	Status display data clear	—
SP1	Current alarm clear	—
SP2	Alarm history clear	—
SP3	External input signal prohibited	—
SP4	External output signal prohibited	—
SP5	External input signal resumed	—
SP6	External output signal resumed	—

(b) Operation mode selection

Device name	Item	Symbol
OM0	Normal mode (not test operation mode)	—
OM1	JOG operation	—
OM2	Positioning operation	—
OM4	Output signal (DO) forced output	—
OM5	Single-step feed operation	—

(c) Instruction demand (for test operation)

Device name	Item	Symbol
TMB1	Temporary stop command	—
TMB2	Test operation (positioning operation) start command	—
TMB3	Forward rotation direction	—
TMB4	Reverse rotation direction	—
TMB5	Restart for remaining distance	—
TMB6	Remaining distance clear	—

(d) One-touch tuning

Device name	Item	Symbol
OT10	One-touch tuning start command (Basic mode)	—
OT11	One-touch tuning start command (High mode)	—
OT12	One-touch tuning start command (Low mode)	—
OT13	One-touch tuning stop command	—
OT14	Return to initial value	—
OT15	Return to value before adjustment	—

(e) Basic setting parameter

Device name	Item	Symbol*1
PA1, PA1001	Operation mode	*STY
PA2, PA1002	Regenerative brake option	*REG
PA3, PA1003	Absolute position detection system	*ABS
PA4, PA1004	Function selection A-1	*AOP1
PA5, PA1005	Number of command input pulses per revolution	*FBP

Device name	Item	Symbol*1
PA6, PA1006	Electronic gear numerator (command pulse multiplication numerator)/Number of gear teeth on machine side	*CMX
PA7, PA1007	Electronic gear denominator (command pulse multiplication denominator)/Number of gear teeth on servo motor side	*CDV
PA8, PA1008	Auto tuning mode	ATU
PA9, PA1009	Auto tuning response	RSP
PA10, PA1010	In-position range	INP
PA11, PA1011	Forward rotation torque limit/ positive direction thrust limit	TLP
PA12, PA1012	Reverse rotation torque limit/ negative direction thrust limit	TLN
PA13, PA1013	Command pulse input form	*PLSS
PA14, PA1014	Rotation direction selection/ travel direction selection	*POL
PA15, PA1015	Encoder output pulses	*ENR
PA16, PA1016	Encoder output pulses 2	*ENR2
PA17, PA1017	Servo motor series setting	*MSR
PA18, PA1018	Servo motor type setting	*MTY
PA19, PA1019	Parameter block	*BLK
PA20, PA1020	Tough drive setting	*TDS
PA21, PA1021	Function selection A-3	*AOP3
PA22, PA1022	For manufacturer setting	—
PA23, PA1023	Drive recorder arbitrary alarm trigger setting	DRAT
PA24, PA1024	Function selection A-4	AOP4
PA25, PA1025	One-touch tuning - Overshoot permissible level	OTHOV
PA26, PA1026	Function selection A-5	*AOP5
PA27 to PA32, PA1027 to PA1032	For manufacturer setting	—

1 For the parameters prefixed by an asterisk (), setting becomes effective when the power is turned off once and back on after setting the parameter data.

(f) Gain filter parameter

Device name	Item	Symbol*1
PB1, PB1001	Adaptive tuning mode (adaptive filter II)	FILT
PB2, PB1002	Vibration suppression control tuning mode (advanced vibration suppression control II)	VRFT
PB3, PB1003	Position command acceleration/ deceleration time constant (position smoothing)	PST
PB4, PB1004	Feed forward gain	FFC
PB5, PB1005	For manufacturer setting	—
PB6, PB1006	Load to motor inertia ratio/load to motor mass ratio	GD2
PB7, PB1007	Model control gain	PG1
PB8, PB1008	Position loop gain	PG2
PB9, PB1009	Speed loop gain	VG2
PB10, PB1010	Speed integral compensation	VIC
PB11, PB1011	Speed differential compensation	VDC
PB12, PB1012	Overshoot amount compensation	OVA
PB13, PB1013	Machine resonance suppression filter 1	NH1
PB14, PB1014	Notch form selection 1	NHQ1

Device name	Item	Symbol*1
PB15, PB1015	Machine resonance suppression filter 2	NH2
PB16, PB1016	Notch form selection 2	NHQ2
PB17, PB1017	Shaft resonance suppression filter	NHF
PB18, PB1018	Low-pass filter setting	LPF
PB19, PB1019	Vibration suppression control 1 - Vibration frequency	VRF11
PB20, PB1020	Vibration suppression control 1 - Resonance frequency	VRF12
PB21, PB1021	Vibration suppression control 1 - Vibration frequency dumping	VRF13
PB22, PB1022	Vibration suppression control 1 - Resonance frequency dumping	VRF14
PB23, PB1023	Low-pass filter selection	VFBF
PB24, PB1024	Slight vibration suppression control selection	*MVS
PB25, PB1025	Function selection B-1	*BOP1
PB26, PB1026	Gain switching function	*CDP
PB27, PB1027	Gain changing condition	CDL
PB28, PB1028	Gain changing time constant	CDT
PB29, PB1029	Load to motor inertia ratio/load to motor mass ratio after gain switching	GD2B
PB30, PB1030	Gain changing, Position loop gain	PG2B
PB31, PB1031	Gain changing, Speed loop gain	VG2B
PB32, PB1032	Gain changing, Speed integral compensation	VICB
PB33, PB1033	Vibration suppression control 1 - Vibration frequency after gain switching	VRF1B
PB34, PB1034	Vibration suppression control 1 - Resonance frequency after gain switching	VRF2B
PB35, PB1035	Vibration suppression control 1 - Vibration frequency damping after gain switching	VRF3B
PB36, PB1036	Vibration suppression control 1 - Resonance frequency damping after gain switching	VRF4B
PB37 to PB44, PB1037 to PB1044	For manufacturer setting	—
PB45, PB1045	Command notch filter	CNHF
PB46, PB1046	Machine resonance suppression filter 3	NH3
PB47, PB1047	Notch form selection 3	NHQ3
PB48, PB1048	Machine resonance suppression filter 4	NH4
PB49, PB1049	Notch form selection 4	NHQ4
PB50, PB1050	Machine resonance suppression filter 5	NH5
PB51, PB1051	Notch form selection 5	NHQ5
PB52, PB1052	Vibration suppression control 2 - Vibration frequency	VRF21
PB53, PB1053	Vibration suppression control 2 - Resonance frequency	VRF22
PB54, PB1054	Vibration suppression control 2 - Vibration frequency dumping	VRF23
PB55, PB1055	Vibration suppression control 2 - Resonance frequency dumping	VRF24
PB56, PB1056	Vibration suppression control 2 - Vibration frequency after gain switching	VRF21B

Device name	Item	Symbol* ¹
PB57, PB1057	Vibration suppression control 2 - Resonance frequency after gain switching	VRF22B
PB58, PB1058	Vibration suppression control 2 - Vibration frequency damping after gain switching	VRF23B
PB59, PB1059	Vibration suppression control 2 - Resonance frequency damping after gain switching	VRF24B
PB60, PB1060	Model loop gain after gain switching	PG1B
PB61 to PB64, PB1061 to PB1064	For manufacturer setting	—

1 For the parameters prefixed by an asterisk (), setting becomes effective when the power is turned off once and back on after setting the parameter data.

(g) Extension setting parameter

Device name	Item	Symbol* ¹
PC1, PC1001	JOG operation acceleration time constant/Acceleration time constant 1	STA
PC2, PC1002	JOG operation deceleration time constant/Deceleration time constant 1	STB
PC3, PC1003	S-pattern acceleration/ deceleration time constant	*STC
PC4, PC1004	Torque command time constant/ thrust command time constant	TQC
PC5, PC1005	Automatic operation speed 1	SC1
PC6, PC1006	Automatic operation speed 2	SC2
PC7, PC1007	Manual operation speed 1	SC3
PC8, PC1008	Internal speed command4/limit4	SC4
PC9, PC1009	Internal speed command5/limit5	SC5
PC10, PC1010	Internal speed command6/limit6	SC6
PC11, PC1011	Internal speed command7/limit7	SC7
PC12, PC1012	Analog speed / limit command - Maximum speed	VCM
PC13, PC1013	Analog torque command maximum output	TLC
PC14, PC1014	Analog monitor 1 output	MOD1
PC15, PC1015	Analog monitor 2 output	MOD2
PC16, PC1016	Electromagnetic brake sequence output	MBR
PC17, PC1017	Zero speed	ZSP
PC18, PC1018	Alarm history clear	*BPS
PC19, PC1019	Encoder output pulses selection	*ENRS
PC20, PC1020	Station number setting	*SNO
PC21, PC1021	RS-422 communication function selection	*SOP
PC22, PC1022	Function selection C-1	*COP1
PC23, PC1023	Function selection C-2	*COP2
PC24, PC1024	Function selection C-3	*COP3
PC25, PC1025	For manufacturer setting	—
PC26, PC1026	Function selection C-5	*COP5
PC27, PC1027	Function selection C-6	*COP6
PC28, PC1028	Function selection C-7	*COP7
PC29, PC1029	For manufacturer setting	—
PC30, PC1030	Home position return acceleration time constant/ Acceleration time constant 2	STA2

Device name	Item	Symbol* ¹
PC31, PC1031	Home position return deceleration time constant/ Deceleration time constant 2	STB2
PC32, PC1032	Command pulse multiplying factor numerator 2	CMX2
PC33, PC1033	Command pulse multiplying factor numerator 3	CMX3
PC34, PC1034	Command pulse multiplying factor numerator 4	CMX4
PC35, PC1035	Internal torque limit 2/internal thrust limit 2	TL2
PC36, PC1036	Status display selection	*DMD
PC37, PC1037	Analog speed command offset/ limit offset	VCO
PC38, PC1038	Analog torque limitation offset	TPO
PC39, PC1039	Analog monitor 1 offset	MO1
PC40, PC1040	Analog monitor 2 offset	MO2
PC41 to PC42, PC1041 to PC1042	For manufacturer setting	—
PC43, PC1043	Error excessive alarm detection level	ERZ
PC44, PC1044	Function selection C-9	*COP9
PC45, PC1045	Function selection C-A	*COPA
PC46 to PC50, PC1046 to PC1050	For manufacturer setting	—
PC51, PC1051	Forced stop deceleration time constant	RSBR
PC52 to PC53, PC1052 to PC1053	For manufacturer setting	—
PC54, PC1054	Vertical axis freefall prevention compensation amount	RSUP1
PC55 to PC59, PC1055 to PC1059	For manufacturer setting	—
PC60, PC1060	Function selection C-D	*COPD
PC61 to PC72, PC1061 to PC1072	For manufacturer setting	—
PC73, PC1073	Error excessive warning level	ERW
PC74 to PC80, PC1074 to PC1080	For manufacturer setting	—

1 For the parameters prefixed by an asterisk (), setting becomes effective when the power is turned off once and back on after setting the parameter data.

(h) I/O setting parameter

Device name	Item	Symbol* ¹
PD1, PD1001	Input signal automatic on selection 1	*DIA1
PD2, PD1002	For manufacturer setting	—
PD3, PD1003	Input device selection 1L	*DI1L
PD4, PD1004	Input device selection 1H	*DI1H
PD5, PD1005	Input device selection 2L	*DI2L
PD6, PD1006	Input device selection 2H	*DI2H
PD7, PD1007	Input device selection 3L	*DI3L
PD8, PD1008	Input device selection 3H	*DI3H
PD9, PD1009	Input device selection 4L	*DI4L
PD10, PD1010	Input device selection 4H	*DI4H
PD11, PD1011	Input device selection 5L	*DI5L
PD12, PD1012	Input device selection 5H	*DI5H
PD13, PD1013	Input device selection 6L	*DI6L
PD14, PD1014	Input device selection 6H	*DI6H

9 MELSECNET/H CONNECTION (PLC TO PLC NETWORK)
10 MELSECNET/10 CONNECTION (PLC TO PLC NETWORK)
11 MELSECNET/10 CONNECTION (PLC TO PLC NETWORK)
12 CC-Link IE CONTROLLER NETWORK CONNECTION
13 CC-Link IE FIELD NETWORK CONNECTION
14 CC-Link CONNECTION (INTELLIGENT DEVICE STATION)
15 CC-Link CONNECTION (Via G4)
16 INVERTER CONNECTION
SERVO AMPLIFIER CONNECTION

Device name	Item	Symbol*1
PD15 to PD16, PD1015 to PD1016	For manufacturer setting	—
PD17, PD1017	Input device selection 8L	*DI8L
PD18, PD1018	Input device selection 8H	*DI8H
PD19, PD1019	Input device selection 9L	*DI9L
PD20, PD1020	Input device selection 9H	*DI9H
PD21, PD1021	Input device selection 10L	*DI10L
PD22, PD1022	Input device selection 10H	*DI10H
PD23, PD1023	Output device selection 1	*DO1
PD24, PD1024	Output device selection 2	*DO2
PD25, PD1025	Output device selection 3	*DO3
PD26, PD1026	Output device selection 4	*DO4
PD27, PD1027	For manufacturer setting	—
PD28, PD1028	Output device selection 6	*DO6
PD29, PD1029	Response level setting	*DIF
PD30, PD1030	Function selection D-1	*DOP1
PD31, PD1031	Function selection D-2	*DOP2
PD32, PD1032	Function selection D-3	*DOP3
PD33, PD1033	Function selection D-4	*DOP4
PD34, PD1034	Function selection D-5	*DOP5
PD35 to PD40, PD1035 to PD1040	For manufacturer setting	—
PD41, PD1041	Input signal automatic on selection 3	*DIA3
PD42, PD1042	Input signal automatic on selection 4	*DIA4
PD43, PD1043	Input device selection 11L	*DI11L
PD44, PD1044	Input device selection 11H	*DI11H
PD45, PD1045	Input device selection 12L	*DI12L
PD46, PD1046	Input device selection 12H	*DI12H
PD47, PD1047	Output device selection 7	*DO7
PD48, PD1048	For manufacturer setting	—

1 For the parameters prefixed by an asterisk (), setting becomes effective when the power is turned off once and back on after setting the parameter data.

(i) Extension setting No.2 parameter

Device name	Item	Symbol*1
PE1, PE1001	Fully closed loop function selection 1	*FCT1
PE2, PE1002	For manufacturer setting	—
PE3, PE1003	Fully closed loop function selection 2	*FCT2
PE4, PE1004	Fully closed loop control - Feedback pulse electronic gear 1 - Numerator	*FBN
PE5, PE1005	Fully closed loop control - Feedback pulse electronic gear 1 - Denominator	*FBD
PE6, PE1006	Fully closed loop control - Speed deviation error detection level	BC1
PE7, PE1007	Fully closed loop control - Position deviation error detection level	BC2
PE8, PE1008	Fully closed loop dual feedback filter	DUF
PE9, PE1009	For manufacturer setting	—
PE10, PE1010	Fully closed loop function selection 3	FCT3
PE11 to PE33, PE1011 to PE1033	For manufacturer setting	—

Device name	Item	Symbol*1
PE34, PE1034	Fully closed loop control - Feedback pulse electronic gear 2 - Numerator	*FBN2
PE35, PE1035	Fully closed loop control - Feedback pulse electronic gear 2 - Denominator	*FBD2
PE36 to PE40, PE1036 to PE1040	For manufacturer setting	—
PE41, PE1041	Function selection E-3	EOP3
PE42 to PE43, PE1042 to PE1043	For manufacturer setting	—
PE44, PE1044	Lost motion compensation positive-side compensation value selection	LMCP
PE45, PE1045	Lost motion compensation negative-side compensation value selection	LMCN
PE46, PE1046	Lost motion filter setting	LMFLT
PE47, PE1047	Torque offset	TOF
PE48, PE1048	Lost motion compensation function selection	*LMOP
PE49, PE1049	Lost motion compensation timing	LMCD
PE50, PE1050	Lost motion compensation non-sensitive band	LMCT
PE51 to PE64, PE1051 to PE1064	For manufacturer setting	—

1 For the parameters prefixed by an asterisk (), setting becomes effective when the power is turned off once and back on after setting the parameter data.

(j) Extension setting No.3 parameter

Device name	Item	Symbol*1
PF1 to 8, PF1001 to PF1008	For manufacturer setting	—
PF9, PF1009	Function selection F-5	*FOP5
PF10 to PF14, PF1010 to PF1014	For manufacturer setting	—
PF15, PF1015	Electronic dynamic brake operating time	DBT
PF16 to PF20, PF1016 to PF1020	For manufacturer setting	—
PF21, PF1021	Drive recorder switching time setting	DRT
PF22, PF1022	For manufacturer setting	—
PF23, PF1023	Vibration tough drive - Oscillation detection level	OSCL1
PF24, PF1024	Vibration tough drive function selection	OSCL2
PF25, PF1025	SEMI-F47 function - Instantaneous power failure detection time	CVAT
PF26 to PF30, PF1026 to PF1030	For manufacturer setting	—
PF31, PF1031	Machine diagnosis function - Friction judgement speed	FRIC
PF32 to PF33, PF1032 to PF1033	For manufacturer setting	—
PF34, PF1034	RS-422 communication function selection 3	*SOP3
PF35 to PF48, PF1035 to PF1048	For manufacturer setting	—

1 For the parameters prefixed by an asterisk (), setting becomes effective when the power is turned off once and back on after setting the parameter data.

(k) Option unit parameter

Device name	Item	Symbol* ¹
PO1 to PO11, PO1001 to PO1011	For manufacturer setting	—
PO12, PO1012	Function selection O-3	*OOP3
PO13 to PO32, PO1013 to PO1032	For manufacturer setting	—

1 For the parameters prefixed by an asterisk (), setting becomes effective when the power is turned off once and back on after setting the parameter data.

(l) Linear servo motor/DD motor setting parameter

Device name	Item	Symbol* ¹
PL1, PL1001	Linear servo motor/DD motor function selection 1	*LIT1
PL2, PL1002	Linear encoder resolution - Numerator	*LIM
PL3, PL1003	Linear encoder resolution - Denominator	*LID
PL4, PL1004	Linear servo motor/DD motor function selection 2	*LIT2
PL5, PL1005	Position deviation error detection level	LB1
PL6, PL1006	Speed deviation error detection level	LB2
PL7, PL1007	Torque/thrust deviation error detection level	LB3
PL8, PL1008	Linear servo motor/DD motor function selection 3	*LIT3
PL9, PL1009	Magnetic pole detection voltage level	LPWM
PL10 to PL16, PL1010 to PL1016	For manufacturer setting	—
PL17, PL1017	Magnetic pole detection - Minute position detection method - Function selection	LTSTS
PL18, PL1018	Magnetic pole detection - Minute position detection method - Identification signal amplitude	IDLV
PL19 to PL48, PL1019 to PL1048	For manufacturer setting	—

1 For the parameters prefixed by an asterisk (), setting becomes effective when the power is turned off once and back on after setting the parameter data.

(m) Positioning control parameter

Device name	Item	Symbol* ¹
PT1, PT1001	Command mode selection	*CTY
PT2, PT1002	Function selection T-1	*TOP1
PT3, PT1003	Feeding function selection	*FTY
PT4, PT1004	Home position return type	*ZTY
PT5, PT1005	Home position return speed	ZRF
PT6, PT1006	Creep speed	GRF
PT7, PT1007	Home position shift distance	ZST
PT8, PT1008	Home position return position data	*ZPS
PT9, PT1009	Moving distance after proximity dog	DCT
PT10, PT1010	Stopper type home position return stopper time	ZTM
PT11, PT1011	Stopper type home position return torque limit value	ZTT

Device name	Item	Symbol* ¹
PT12, PT1012	Rough match output range	CRP
PT13, PT1013	JOG operation	JOG
PT14, PT1014	Backlash compensation	*BKC
PT15, PT1015	Software limit +(Low)	LMPL
PT16, PT1016	Software limit +(High)	LMPH
PT17, PT1017	Software limit +(Low)	LMNL
PT18, PT1018	Software limit +(High)	LMNH
PT19, PT1019	Position range output address +(Low)	*LPPL
PT20, PT1020	Position range output address +(High)	*LPPH
PT21, PT1021	Position range output address +(Low)	*LNPL
PT22, PT1022	Position range output address +(High)	*LNPH
PT23, PT1023	OUT1 output setting time	OUT1
PT24, PT1024	OUT2 output setting time	OUT2
PT25, PT1025	OUT3 output setting time	OUT3
PT26, PT1026	Function selection T-2	*TOP2
PT27, PT1027	Operation mode selection	*ODM
PT28, PT1028	Number of stations per rotation	*STN
PT29, PT1029	Function selection T-3	*TOP3
PT30 to PT33, PT1030 to PT1033	For manufacturer setting	—
PT34, PT1034	Point table/program default	*PDEF
PT35 to PT37, PT1035 to PT1037	For manufacturer setting	—
PT38, PT1038	Function selection T-7	*TOP7
PT39, PT1039	Torque limit delay time	INT
PT40, PT1040	Station home position shift distance	*SZS
PT41, PT1041	Home position return inhibit selection	ORP
PT42, PT1042	Digital override minimum multiplication	*OVM
PT43, PT1043	Digital override pitch width	*OVS
PT44 to PT48, PT1044 to PT1048	For manufacturer setting	—

1 For the parameters prefixed by an asterisk (), setting becomes effective when the power is turned off once and back on after setting the parameter data.

(n) Status display

Device name	Item	Symbol
ST0	Cumulative feedback pulses	—
ST1	Servo motor speed	—
ST2	Droop pulses	—
ST3	Cumulative command pulses	—
ST4	Command pulse frequency	—
ST5	Analog speed command voltage/Analog speed limit voltage	—
ST6	Analog torque limit voltage/Analog torque command voltage	—
ST7	Regenerative load ratio	—
ST8	Effective load ratio	—
ST9	Peak load ratio	—
ST10	Instantaneous torque	—
ST11	Position within one-revolution	—
ST12	ABS counter	—
ST13	Load to motor inertia ratio	—

9
MELSECNET/H
CONNECTION (PLC
TO PLC NETWORK)

10
MELSECNET/10
CONNECTION (PLC
TO PLC NETWORK)

11
CC-Link IE CONTROLLER
NETWORK
CONNECTION

12
CC-Link IE FIELD
NETWORK
CONNECTION

13
CC-Link CONNECTION
(INTELLIGENT DEVICE
STATION)

14
CC-Link CONNECTION
(Via G4)

15
INVERTER
CONNECTION

16
SERVO AMPLIFIER
CONNECTION

Device name	Item	Symbol
ST14	Bus voltage	—
ST15	Load-side cumulative feedback pulses	—
ST16	Load-side droop pulses	—
ST17	Load-side encoder information 1/Z-phase counter	—
ST18	Load-side encoder information 2	—
ST19 to ST21	For manufacturer setting	—
ST22	Temperature of servo motor thermistor	—
ST23	Servo motor-side cumulative feedback pulses (before gear)	—
ST24	Electrical angle	—
ST25 to ST29	For manufacturer setting	—
ST30	Servo motor-side/load-side position deviation	—
ST31	Servo motor-side/load-side speed deviation	—
ST32	Internal temperature of encoder	—
ST33	Settling time	—
ST34	Oscillation detection frequency	—
ST35	Number of tough drive operations	—
ST36 to ST39	For manufacturer setting	—
ST40	Unit power consumption	—
ST41	Unit total power consumption	—
ST42	Current position	—
ST43	Command position	—
ST44	Command remaining distance	—
ST45	Point table No./Program No./Station position No.	—
ST46	Step No.	—
ST47	Analog override voltage	—
ST48	Override level	—

(o) Alarm (compatible with MELSERVO-J3-*A)

Device name	Item	Symbol
AL0	Current alarm number	—
AL1	Detailed data of current alarms	—
AL11	Servo status when alarm occurs cumulative feedback pulses	—
AL12	Servo status when alarm occurs Servo motor speed	—
AL13	Servo status when alarm occurs droop pulses	—
AL14	Servo status when alarm occurs cumulative command pulses	—
AL15	Servo status when alarm occurs command pulse frequency	—
AL16	Servo status (alarm) analog speed command voltage/limit voltage	—
AL17	Servo status (alarm) analog torque command voltage/limit voltage	—
AL18	Servo status when alarm occurs regenerative load ratio	—
AL19	Servo status when alarm occurs effective load ratio	—
AL20	Servo status when alarm occurs peak load ratio	—
AL21	Servo status when alarm occurs instantaneous torque	—

Device name	Item	Symbol
AL22	Servo status (alarm) Within one-revolution position(1 pulse unit)	—
AL23	Servo status when alarm occurs ABS counter	—
AL24	Servo status(alarm) load inertia moment ratio	—
AL25	Servo status when alarm occurs bus voltage	—
AL200	Alarm number from Alarm History most recent alarm	—
AL201	Alarm number from Alarm History first alarm in past	—
AL202	Alarm number from Alarm History second alarm in past	—
AL203	Alarm number from Alarm History third alarm in past	—
AL204	Alarm number from Alarm History fourth alarm in past	—
AL205	Alarm number from Alarm History fifth alarm in past	—
AL210	Alarm occurrence time in alarm history most recent alarm	—
AL211	Alarm occurrence time in alarm history first alarm in past	—
AL212	Alarm occurrence time in alarm history second alarm in past	—
AL213	Alarm occurrence time in alarm history third alarm in past	—
AL214	Alarm occurrence time in alarm history fourth alarm in past	—
AL215	Alarm occurrence time in alarm history fifth alarm in past	—
AL230	Detailed alarm from Alarm History most recent alarm	—
AL231	Detailed alarm from Alarm History first alarm in past	—
AL232	Detailed alarm from Alarm History second alarm in past	—
AL233	Detailed alarm from Alarm History third alarm in past	—
AL234	Detailed alarm from Alarm History fourth alarm in past	—
AL235	Detailed alarm from Alarm History fifth alarm in past	—

(p) Alarm (compatible with MELSERVO-J4-*A)

Device name	Item	Symbol
ALM0	Current alarm number	—
ALM1	Detailed data of current alarms	—
ALM11	Servo status when alarm occurs cumulative feedback pulses	—
ALM12	Servo status when alarm occurs Servo motor speed	—
ALM13	Servo status when alarm occurs droop pulses	—
ALM14	Servo status when alarm occurs cumulative command pulses	—
ALM15	Servo status when alarm occurs command pulse frequency	—
ALM16	Servo status (alarm) analog speed command voltage/limit voltage	—
ALM17	Servo status (alarm) analog torque command voltage/limit voltage	—

Device name	Item	Symbol
ALM18	Servo status when alarm occurs regenerative load ratio	—
ALM19	Servo status when alarm occurs effective load ratio	—
ALM20	Servo status when alarm occurs peak load ratio	—
ALM21	Servo status when alarm occurs instantaneous torque	—
ALM22	Servo status (alarm) Within one-revolution position (1 pulse unit)	—
ALM23	Servo status when alarm occurs ABS counter	—
ALM24	Servo status (alarm) load inertia moment ratio	—
ALM25	Servo status when alarm occurs bus voltage	—
ALM26	Servo status (alarm) Load-side cumulative feedback pulses	—
ALM27	Servo status (alarm) Load-side droop pulses	—
ALM28	Servo status (alarm) Load-side encoder information 1	—
ALM29	Servo status (alarm) Load-side encoder information 2	—
ALM30 to ALM32	For manufacturer setting	—
ALM33	Servo status (alarm) Temperature of servo motor thermistor	—
ALM34	Servo status (alarm) Servo motor-side cumulative feedback pulses (before gear)	—
ALM35	Servo status (alarm) Electrical angle	—
ALM36 to ALM40	For manufacturer setting	—
ALM41	Servo status (alarm) Servo motor-side/load-side position deviation	—
ALM42	Servo status (alarm) Servo motor-side/load-side speed deviation	—
ALM43	Servo status (alarm) Internal temperature of encoder	—
ALM44	Servo status (alarm) Setting time	—
ALM45	Servo status (alarm) Oscillation detection frequency	—
ALM46	Servo status (alarm) Number of tough drives	—
ALM47 to ALM50	For manufacturer setting	—
ALM51	Servo status (alarm) Unit power consumption	—
ALM52	Servo status (alarm) Unit total power consumption	—
ALM53	Servo status when alarm occurs current position	—
ALM54	Servo status when alarm occurs command position	—
ALM55	Servo status when alarm occurs command remaining distance	—
ALM56	Servo status (alarm) Point table No./Program No./Station position No.	—
ALM57	Servo status (alarm) Step No.	—
ALM58	Servo status (alarm) Analog override voltage	—
ALM59	Servo status (alarm) Override level	—
ALM200	Alarm number from Alarm History most recent alarm	—
ALM201	Alarm number from Alarm History 1st alarm in past	—
ALM202	Alarm number from Alarm History 2nd alarm in past	—
ALM203	Alarm number from Alarm History 3rd alarm in past	—

Device name	Item	Symbol
ALM204	Alarm number from Alarm History 4th alarm in past	—
ALM205	Alarm number from Alarm History 5th alarm in past	—
ALM206	Alarm number from Alarm History 6th alarm in past	—
ALM207	Alarm number from Alarm History 7th alarm in past	—
ALM208	Alarm number from Alarm History 8th alarm in past	—
ALM209	Alarm number from Alarm History 9th alarm in past	—
ALM210	Alarm number from Alarm History 10th alarm in past	—
ALM211	Alarm number from Alarm History 11th alarm in past	—
ALM212	Alarm number from Alarm History 12th alarm in past	—
ALM213	Alarm number from Alarm History 13th alarm in past	—
ALM214	Alarm number from Alarm History 14th alarm in past	—
ALM215	Alarm number from Alarm History 15th alarm in past	—
ALM220	Alarm occurrence time in alarm history most recent alarm	—
ALM221	Alarm occurrence time in alarm history 1st alarm in past	—
ALM222	Alarm occurrence time in alarm history 2nd alarm in past	—
ALM223	Alarm occurrence time in alarm history 3rd alarm in past	—
ALM224	Alarm occurrence time in alarm history 4th alarm in past	—
ALM225	Alarm occurrence time in alarm history 5th alarm in past	—
ALM226	Alarm occurrence time in alarm history 6th alarm in past	—
ALM227	Alarm occurrence time in alarm history 7th alarm in past	—
ALM228	Alarm occurrence time in alarm history 8th alarm in past	—
ALM229	Alarm occurrence time in alarm history 9th alarm in past	—
ALM230	Alarm occurrence time in alarm history 10th alarm in past	—
ALM231	Alarm occurrence time in alarm history 11th alarm in past	—
ALM232	Alarm occurrence time in alarm history 12th alarm in past	—
ALM233	Alarm occurrence time in alarm history 13th alarm in past	—
ALM234	Alarm occurrence time in alarm history 14th alarm in past	—
ALM235	Alarm occurrence time in alarm history 15th alarm in past	—
ALM240	Detailed alarm from Alarm History most recent alarm	—
ALM241	Detailed alarm from Alarm History 1st alarm in past	—
ALM242	Detailed alarm from Alarm History 2nd alarm in past	—

9 MELSECNET/H CONNECTION (PLC CONNECTION TO PLC NETWORK)
 10 MELSECNET/10 CONNECTION (PLC CONNECTION TO PLC NETWORK)
 11 CC-Link IE CONTROLLER NETWORK CONNECTION
 12 CC-Link IE FIELD NETWORK CONNECTION
 13 CC-Link CONNECTION (INTELLIGENT DEVICE STATION)
 14 CC-Link CONNECTION (Via G4)
 15 INVERTER CONNECTION
 16 SERVO AMPLIFIER CONNECTION

Device name	Item	Symbol
ALM243	Detailed alarm from Alarm History 3rd alarm in past	—
ALM244	Detailed alarm from Alarm History 4th alarm in past	—
ALM245	Detailed alarm from Alarm History 5th alarm in past	—
ALM246	Detailed alarm from Alarm History 6th alarm in past	—
ALM247	Detailed alarm from Alarm History 7th alarm in past	—
ALM248	Detailed alarm from Alarm History 8th alarm in past	—
ALM249	Detailed alarm from Alarm History 9th alarm in past	—
ALM250	Detailed alarm from Alarm History 10th alarm in past	—
ALM251	Detailed alarm from Alarm History 11th alarm in past	—
ALM252	Detailed alarm from Alarm History 12th alarm in past	—
ALM253	Detailed alarm from Alarm History 13th alarm in past	—
ALM254	Detailed alarm from Alarm History 14th alarm in past	—
ALM255	Detailed alarm from Alarm History 15th alarm in past	—

(q) Point table

Device name	Item	Symbol
POS1 to POS255, POS1001 to POS1255	Point table (position) No. 1 to 255	—
SPD1 to SPD255, SPD1001 to SPD1255	Point table (speed) No. 1 to 255	—
ACT1 to ACT255, ACT1001 to ACT1255	Point table (acceleration time constant) No. 1 to No. 255	—
DCT1 to DCT255, DCT1001 to DCT1255	Point table (deceleration time constant) No. 1 to No. 255	—
DWL1 to DWL255, DWL1001 to DWL1255	Point table (dwell) No. 1 to No. 255	—
AUX1 to AUX255, AUX1001 to AUX1255	Point table (auxiliary function) No. 1 to No. 255	—
MCD1 to MCD255, MCD1001 to MCD1255	Point table (M code) No. 1 to No. 255	—

(r) Machine diagnosis data

Device name	Item	Symbol
MD0	Machine diagnosis data parameter number	—
MD1	Machine diagnosis data shift judgment (test mode)	—
MD2	Machine diagnosis data status	—
MD3	Machine diagnosis data coulomb friction torque in positive direction	—
MD4	Machine diagnosis data friction torque at rated speed in positive direction	—
MD5	Machine diagnosis data coulomb friction torque in negative direction	—
MD6	Machine diagnosis data friction torque at rated speed in positive direction	—

Device name	Item	Symbol
MD7	Machine diagnosis data oscillation frequency (motor is stopped)	—
MD8	Machine diagnosis data vibration level (motor is stopped)	—
MD9	Machine diagnosis data oscillation frequency (motor is operating)	—
MD10	Machine diagnosis data vibration level (motor is operating)	—
MD11	Machine diagnosis data rated speed	—

(s) One-touch tuning data

Device name	Item	Symbol
OTS0	One-touch tuning status confirmation	—
OTS1	Error code list	—
OTS2	Setting time	—
OTS3	Overshoot amount	—

(t) External input

Device name	Item	Symbol
DI0	Input device statuses 1	—
DI1	Input device statuses 2	—
DI2	Input device statuses 3	—
DI3	External input pin statuses	—
DI4	Statuses of input devices switched on through communication 1	—
DI5	Statuses of input devices switched on through communication 2	—
DI6	Statuses of input devices switched on through communication 3	—

(u) External output

Device name	Item	Symbol
DO0	Output device statuses 1	—
DO1	Output device statuses 2	—
DO2	Output device statuses 3	—
DO3	Output device statuses 4	—
DO4	External output pin statuses	—

(v) Current position latch data

Device name	Item	Symbol
LD0	Position data unit	—
LD1	Current position latch data	—

(w) The value of the general-purpose register (Rx)

Device name	Item	Symbol
RR1, RR1001	The value of the general-purpose register (R1)	—
RR2, RR1002	The value of the general-purpose register (R2)	—
RR3, RR1003	The value of the general-purpose register (R3)	—
RR4, RR1004	The value of the general-purpose register (R4)	—

(x) The value of the general-purpose register (Dx)

Device name	Item	Symbol
RD1	The value of the general-purpose register (D1)	—
RD2	The value of the general-purpose register (D2)	—
RD3	The value of the general-purpose register (D3)	—
RD4	The value of the general-purpose register (D4)	—

(y) Lifetime diagnosis

Device name	Item	Symbol
ALD0	Cumulative energization time	—
ALD1	Number of ON/OFF times for rush relay	—

(z) Input signal for test operation (for test operation)

Device name	Item	Symbol
TMI0	Input signal for test operation 1	—
TMI1	Input signal for test operation 2	—
TMI2	Input signal for test operation 3	—

(aa) Forced output of signal pin (for test operation)

Device name	Item	Symbol
TMO0	Forced output of signal pin	—

(ab) Set data (for test operation)

Device name	Item	Symbol
TMD0	Writes the speed (test mode)	—
TMD1	Writes the acceleration/ deceleration time constant (test mode)	—
TMD3	Writes the moving distance (test mode)	—

9	MELSECNET/H CONNECTION (PLC CONNECTION TO PLC NETWORK)
10	MELSECNET/10 CONNECTION (PLC CONNECTION TO PLC NETWORK)
11	CC-Link IE CONTROLLER NETWORK CONNECTION
12	CC-Link IE FIELD NETWORK CONNECTION
13	CC-Link CONNECTION (INTELLIGENT DEVICE STATION)
14	CC-Link CONNECTION (Via G4)
15	INVERTER CONNECTION
16	SERVO AMPLIFIER CONNECTION

16.7 Precautions

■ Station number setting in the servo system

Make sure to establish servo system with the station number set with the host address.

For details of host address setting, refer to the following.

 16.4.1 Setting communication interface
(Communication settings)

■ GOT clock function

Since the servo amplifier does not have a clock function, the settings of [Adjust] or [Broadcast] by GOT clock control will be disabled.

■ Servo amplifier/test operation using the GOT

During the servo amplifier/test operation, when the communication between the GOT and the servo amplifier is interrupted for 0.5[ms] or more, the servo amplifier decelerates, stops, and then gets into the servo lock status. During the servo amplifier/test operation, continue the communication constantly by monitoring the status display of the servo amplifier on the GOT screen, etc.

17

ROBOT CONTROLLER CONNECTION



17.1	Connectable Model List	17 - 2
17.2	System Configuration	17 - 2
17.3	GOT Side Settings	17 - 3
17.4	PLC Side Settings	17 - 6
17.5	Device Range that Can Be Set	17 - 8
17.6	Precautions	17 - 8

17. ROBOT CONTROLLER CONNECTION

17.1 Connectable Model List

The following table shows the connectable models.

Series	Model name	Clock	Communication type	GT 16 *2	GT 15 *2	GT 14 *2	GT 12	GT11 Bus	GT11 Serial	GT 10 50	GT 10 50	Refer to
Robot controller*1	CRnD-700 CR750-D CR751-D	○	Ethernet	○	○	○	○	×	×	×	×	17.2.1

*1 For details on the connection with CRnQ-700/CR750-Q/CR751-Q (Q172DRCPU), refer to Mitsubishi Electric Products (Chapter 5 to 13).

*2 When the robot controller is connected, use the GOT outside the safety fence.

17.2 System Configuration

17.2.1 Connecting to robot controller (CRnD-700)

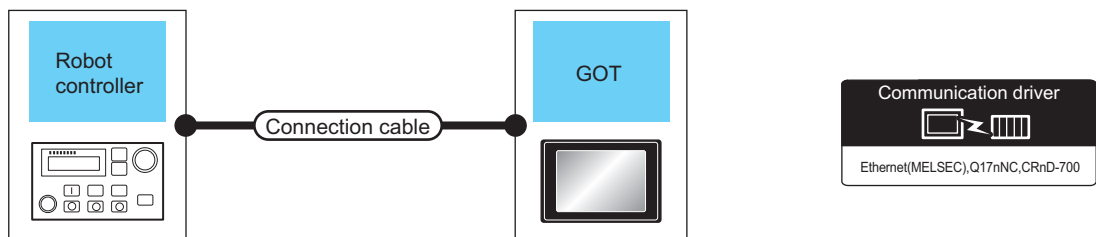

Robot controller		Connection cable *1*2	Maximum segment length*3	GOT		Number of connectable equipment
Model name	Communication type			Option device	Model	
CRnD-700*5*6 CR750-D*5*6 CR751-D*5*6	Ethernet	Twisted pair cable • 10BASE-T Shielded twisted pair cable (STP) or unshielded twisted pair cable (UTP): Category 3, 4, and 5 • 100BASE-TX Shielded twisted pair cable (STP): Category 5 and 5e	100m	- (Built into GOT)	GT 16 *3 GT 12	1 GOT
				GT15-J71E71- 100	GT 15	

*1 The destination connected with the twisted pair cable varies with the configuration of the applicable Ethernet network system. Connect to the Ethernet module, hub, transceiver or other system equipment corresponding to the applicable Ethernet network system.

Use cables, connectors, and hubs that meet the IEEE802.3 10BASE-T/100BASE-TX standard.

*2 A straight cable is available.

When connecting QnUDE(H) and GOT directly with Ethernet cable, remember that the by cross cable is available.

*3 When connecting GT16 of the function version A to an equipment that meets the 10BASE (-T/2/5) standard, use the switching hub and operate in a 10Mbps/100Mbps mixed environment.

For how to check the function version, refer to the following.

GT16 User's Manual (Hardware)

*4 A length between a hub and a node.

The maximum distance differs depending on the Ethernet device to be used.

The following shows the number of the connectable nodes when a repeater hub is used.

- 10BASE-T: Max. 4 nodes for a cascade connection (500m)
- 100BASE-TX: Max. 2 nodes for a cascade connection (205m)

When switching hubs are used, the cascade connection between the switching hubs has no logical limit for the number of cascades.

For the limit, contact the switching hub manufacturer.

*5 For the system configuration of CRnD-700, CR750-D/CR751-D, refer to the following manual.

CRnD-700, CR750-D/CR751-D SET UP MANUAL

*6 Select [CRnD-700] for [Controller Type] in [Ethernet] of GT Designer3.

For [Ethernet] of GT Designer3, refer to the following.

17.3.3 Ethernet setting

17.3 GOT Side Settings

17.3.1 Setting communication interface (Communication settings)

Set the channel of the connected equipment.

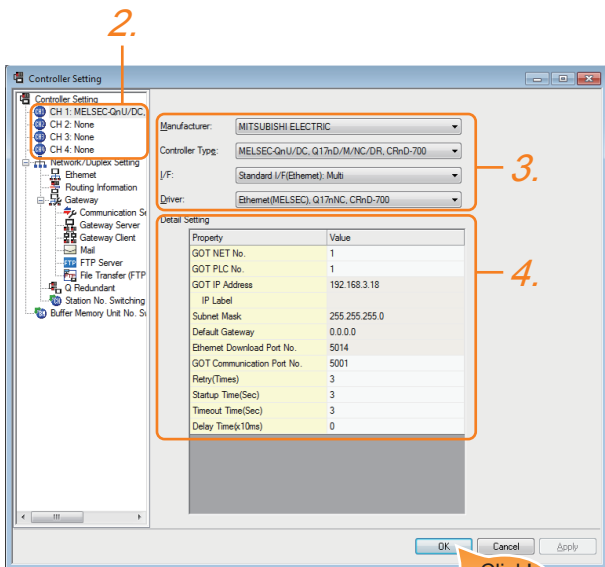

1. Select [Common] → [Controller Setting] from the menu.
2. The Controller Setting window is displayed. Select the channel to be used from the list menu.
3. Set the following items.
 - Manufacturer: MITSUBISHI ELECTRIC
 - Controller Type: Set according to the Controller Type to be connected.
 - I/F: Interface to be used
 - Driver: Ethernet (MELSEC), Q17nNC, CRnD-700
4. The detailed setting is displayed after Manufacturer, Controller Type, I/F, and Driver are set. Make the settings according to the usage environment.

☞ 17.3.2 Communication detail settings

Click the [OK] button when settings are completed.

POINT

The settings of connecting equipment can be confirmed in [I/F Communication Setting]. For details, refer to the following:

☞ 1.1.2 I/F communication setting

17.3.2 Communication detail settings

Make the settings according to the usage environment.

■ GT16, GT14

Property	Value
GOT NET No.	1
GOT PLC No.	1
GOT IP Address	192.168.3.18
IP Label	
Subnet Mask	255.255.255.0
Default Gateway	0.0.0.0
Ethernet Download Port No.	5014
GOT Communication Port No.	5001
Retry(Times)	3
Startup Time(Sec)	3
Timeout Time(Sec)	3
Delay Time(x10ms)	0

Item	Description	Range
GOT NET No.	Set the network No. of the GOT. (Default: 1)	1 to 239
GOT PLC No.*2	Set the station No. of the GOT. (Default: 1)	1 to 64
GOT IP Address*1	Set the IP address of the GOT. (Default: 192.168.3.18)	0.0.0.0 to 255.255.255.255
Subnet Mask*1	Set the subnet mask for the sub network.(Only for connection via router) If the sub network is not used, the default value is set. (Default: 255.255.255.0)	0.0.0.0 to 255.255.255.255
Default Gateway*1	Set the router address of the default gateway where the GOT is connected.(Only for connection via router) (Default: 0.0.0.0)	0.0.0.0 to 255.255.255.255
Ethernet Download Port No.*1	Set the GOT port No. for Ethernet download. (Default: 5014)	1024 to 5010 to 5014 to 65534 (Except for 5011, 5012, 5013 and 49153)
GOT Communication Port No.	Set the GOT port No. for the connection with the Ethernet module. (Default: 5001)	1024 to 5010 to 5014 to 65534 (Except for 5011, 5012, 5013 and 49153)
Retry	Set the number of retries to be performed when a communication timeout occurs. When receiving no response after retries, the communication times out. (Default: 3times)	0 to 5times
Startup Time	Specify the time period from the GOT startup until GOT starts the communication with the PLC CPU. (Default: 3sec)	3 to 255sec
Timeout Time	Set the time period for a communication to time out. (Default: 3sec)	3 to 90sec
Delay Time	Set the delay time for reducing the load of the network/destination PLC. (Default: 0ms)	0 to 10000 (× 10ms)

- *1 Click the [Setting] button and perform the setting in the [GOT IP Address Setting] screen.

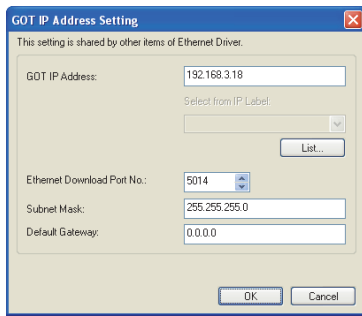

- *2 Each of [GOT PLC No.] set in the communication detail setting and [PLC No.] set in the Ethernet setting must be set to different station numbers.

17.3.3 Ethernet setting

■ GT15, GT12

Property	Value
GOT NET No.	1
GOT PLC No.	1
GOT IP Address	192.168.0.18
IP Label	
Subnet Mask	255.255.255.0
Default Gateway	0.0.0.0
Ethernet Download Port No.	5014
GOT Communication Port No.	5001
Retry(Times)	3
Startup Time(Sec)	3
Timeout Time(Sec)	3
Delay Time(x10ms)	0

Item	Description	Range
GOT NET No.	Set the network No. of the GOT. (Default: 1)	1 to 239
GOT PLC No. ^{*1}	Set the station No. of the GOT. (Default: 1)	1 to 64
GOT IP Address	Set the IP address of the GOT. (Default: 192.168.0.18)	0.0.0.0 to 255.255.255.255
Subnet Mask	Set the subnet mask for the sub network. (Only for connection via router) If the sub network is not used, the default value is set. (Default: 255.255.255.0)	0.0.0.0 to 255.255.255.255
Default Gateway	Set the router address of the default gateway where the GOT is connected. (Only for connection via router) (Default: 0.0.0.0)	0.0.0.0 to 255.255.255.255
Ethernet Download Port No.	Set the GOT port No. for Ethernet download. (Default: 5014)	1024 to 5010 to 5014 to 65534 (Except for 5011, 5012, 5013 and 49153)
GOT Communication Port No.	Set the GOT port No. for the connection with the Ethernet module. (Default: 5001)	1024 to 5010 to 5014 to 65534 (Except for 5011, 5012, 5013 and 49153)
Retry	Set the number of retries to be performed when a communication timeout occurs. When receiving no response after retries, the communication times out. (Default: 3times)	0 to 5times
Startup Time	Specify the time period from the GOT startup until GOT starts the communication with the PLC CPU. (Default: 3sec)	3 to 255sec
Timeout Time ^{*1}	Set the time period for a communication to time out. (Default: 3sec)	3 to 90sec
Delay Time	Set the delay time for reducing the load of the network/destination PLC. (Default: 0ms)	0 to 10000 (× 10ms)

*1 Each of [GOT PLC No.] set in the communication detail setting and [PLC No.] set in the Ethernet setting must be set to different station numbers.

17.3.3 Ethernet setting

POINT

Example of [Detail setting].
For examples of [Detail setting], refer to the following.
☞ 17.4 PLC Side Settings

17.3.3 Ethernet setting

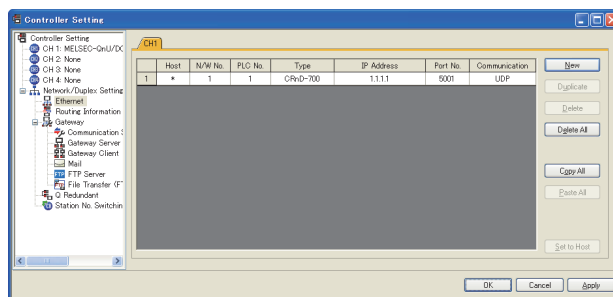

Item	Description	Range
Host	The host is displayed. (The host is indicated with an asterisk (*))	—
N/W No.	Set the network No. of the connected Ethernet module. (Default: blank)	1 to 239
PLC No. *1	Set the station No. of the connected Ethernet module. (Default: blank)	1 to 64
Type *1	Set the type of the connected Ethernet module. CRnD-70(fixed)	CRnD-70(fixed)
IP address	Set the IP address of the connected Ethernet module. (Default: blank)	0.0.0.0 to 255.255.255.255
Port No.	Set the port No. of the connected Ethernet module. (Default: 5001)	1024 to 65534
Communication	UDP (fixed)	UDP (fixed)

*1 Select [CRnD-700] for [Controller Type].

*2 Each of [GOT PLC No.] set in the communication detail setting and [PLC No.] set in the Ethernet setting must be set to different station numbers.

☞ 17.3.2 Communication detail settings

POINT

- (1) Example of [Ethernet]
For examples of [Ethernet], refer to the following.
☞ 17.4 PLC Side Settings
- (2) Communication interface setting by Utility
The communication interface setting can be changed on the Utility's [Communication Settings] after writing [Communication Settings] of project data.
For details on the Utility, refer to the following manual.
☞ GT□ User's Manual
- (3) Precedence in communication settings
When settings are made by GT Designer3 or the Utility, the latest setting is effective.

17.4 PLC Side Settings

Model		Reference
Robot controller	CRnD-700	17.4.1

17.4.1 Connecting to robot controller (CRnD-700)

This section describes the settings of a GOT and a robot controller in the following case of system configuration.

POINT

Robot controller (CRnD-700)

For details of the robot controller (CRnD-700), refer to the following manual.

[CRnD-700 SET UP MANUAL](#)

System configuration

[Controller Setting] and [Ethernet] of GT Designer3

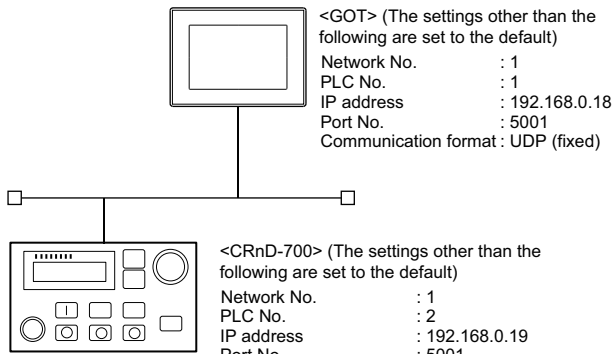

Parameter settings for CRnD-700

Parameter settings for CRnD-700

(1) For RT ToolBox2

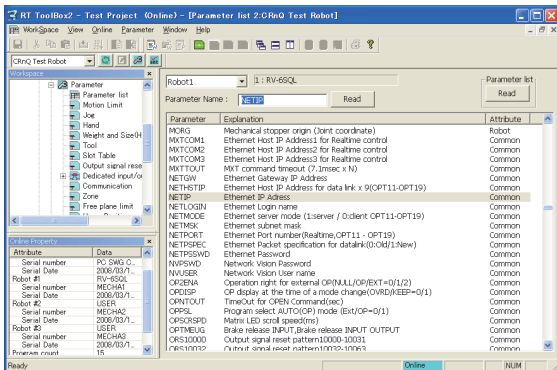

Item	Set value	Setting necessity at GOT connection
NETIP	192.168.0.19	○
GOTPORT	5001	○

○: Necessary △: As necessary ×: Not necessary

(2) For R32TB or R56TB

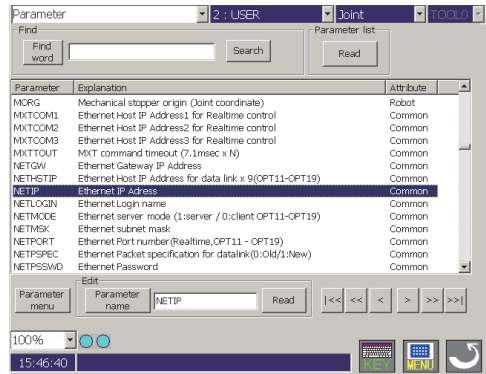

(For R56TB)

Item	Set value	Setting necessity at GOT connection
NETIP	192.168.0.19	○
GOTPORT	5001	○

○: Necessary △: As necessary ×: Not necessary

[Controller Setting] and [Ethernet] of GT Designer3

(1) Communication settings

Item	Set value
GOT NET No.	1
GOT PLC No.	1
GOT IP Address	192.168.0.18
GOT Port No. (Communication)	5001
GOT Port No. (Ethernet Download)	5014
Default Gateway	0.0.0.0
Subnet Mask	255.255.255.0
Retry	3times
Startup Time	3sec
Timeout Time	3sec
Delay Time	0ms

(2) Ethernet setting

Item	Set value	
Ethernet setting No.1	Host	*
	N/W No.	1
	PLC No.	2
	Type	CRnD-700
	IP address	192.168.0.19
	Port No.	5001 (fixed)
Communication	UDP (fixed)	

POINT

[Controller Setting] and [Ethernet] of GT Designer3
For [Controller Setting] and [Ethernet] of GT Designer3, refer to the following.

 17.3.1 Setting communication interface
(Communication settings)

■ **Confirming communication state of CRnD-700**

- (1) When using the Command Prompt of Windows®.
Execute a Ping command at the Command Prompt of Windows®.
 - (a) When normal communication
C:\>Ping 192.168.0.19
Reply from 192.168.0.19: bytes=32 time<1ms
TTL=64
 - (b) When abnormal communication
C:\>Ping 192.168.0.19
Request timed out.
- (2) When abnormal communication
At abnormal communication, check the followings and execute the Ping command again.
 - Cable connecting condition
 - Parameter settings
 - Operation state of the CRnD-700. (faulty or not)
 - The IP address of the CRnD-700 specified for the Ping command.

17.5 Device Range that Can Be Set

For details on the device range that can be used on the GOT, refer to the following.

 2.3 MELSEC-QnU/DC, Q17nD/M/NC/DR, CRnD-700

17.6 Precautions

■ When setting IP address

Do not use "0" and "255" at the end of an IP address.

(Numbers of *.**.0 and *.**.255 are used by the system)

The GOT may not monitor the controller correctly with the above numbers.

Consult with the administrator of the network before setting an IP address to the GOT and controller.

■ When connecting to the multiple network equipment (including GOT) in a segment

By increasing the network load, the transmission speed between the GOT and PLC may be reduced.

The following actions may improve the communication performance.

- Using a switching hub
- More high speed by 100BASE-TX (100Mbps)
- Reduction of the monitoring points on GOT

18

CNC CONNECTION







18.1 Connectable Model List	18 - 2
18.2 System Configuration	18 - 3
18.3 Connection Diagram	18 - 7
18.4 GOT Side Settings	18 - 8
18.5 CNC Side Settings	18 - 16
18.6 Device Range that Can Be Set	18 - 23
18.7 Precautions	18 - 23

18. CNC CONNECTION

18.1 Connectable Model List

The following table shows the connectable models.

Series	Model name	Clock	Communication type	GT 16	GT 15	GT 14	GT 12	GT11 Bus	GT11 Serial	GT 10 5□ 4□	GT 10 20 30	Refer to
MELDAS C6/C64 *1	FCA C6 FCA C64	×	RS-232 RS-422	○	○	○	○	×	○	×	×	 18.2.1
			MELSECNET/10*2	○	○	×	×	×	×	×	×	 18.2.2
			CC-Link(ID)	○	○	×	×	×	×	×	×	 18.2.3
			Ethernet	○	○	○	○	×	×	×	×	 18.2.4

*1 Use the NC system software version D0 or later.

*2 Includes the case on the MELSECNET/H network system in the NET/10 mode. The GOT cannot be connected to the remote I/O network..

For the connection to CNC C70, refer to Mitsubishi Electric Products (Chapter 5 to Chapter 13).

18.2 System Configuration

18.2.1 Direct connection to CPU

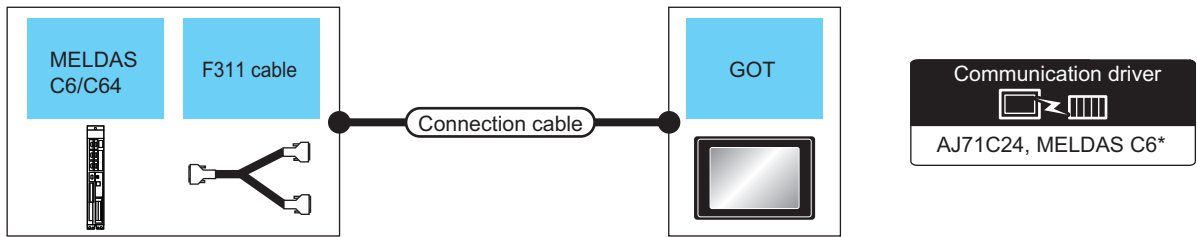

CNC		Connection cable		GOT		Number of connectable equipment
Model name	F311 cable	Communication type	Cable model	Max. distance	Option device	
MELDAS C6/C64 *1	-	RS-232	RS232 connection diagram	15m	- (Built into GOT)	
					GT15-RS2-9P	
MELDAS C6/C64 *2	*3	RS-422	GT01-C30R4-25P(3m) GT01-C100R4-25P(10m) GT01-C200R4-25P(20m) GT01-C300R4-25P(30m)	30.5m	GT16-C02R4-9S(0.2m)	
					GT15-RS2T4-9P ^{*4}	
					GT15-RS4-9S	
					- (Built into GOT)	

*1 Connect the connector of the CNC side to TERMINAL.

*2 Connect the connector of the CNC side to SIO.

*3 To be prepared by the user, referring the following.

MELDAS C6/C64 CONNECTION AND MAINTENANCE MANUAL (BNP-B2255) F311 Cable Production Drawing

*4 Connect it to the RS-232 interface (built into GOT). It cannot be mounted on GT1655 and GT155□.

18.2.2 MELSECNET/10 connection (PLC to PLC network)

POINT

(1) Connectable network

MELSECNET/10 connection includes the case that MELSECNET/H is used in NET/10 mode. The GOT cannot be connected to the remote I/O network.

Connect the GOT to the following network systems as an ordinary station.

- MELSECNET/10 network system (PLC to PLC network) optical loop system
- MELSECNET/10 network system (PLC to PLC network) coaxial bus system

(2) MELSECNET/H network module

When connecting the MELSECNET/H network module to the MELSECNET/10 network system, specify the MELSECNET/10 Mode as a network type.

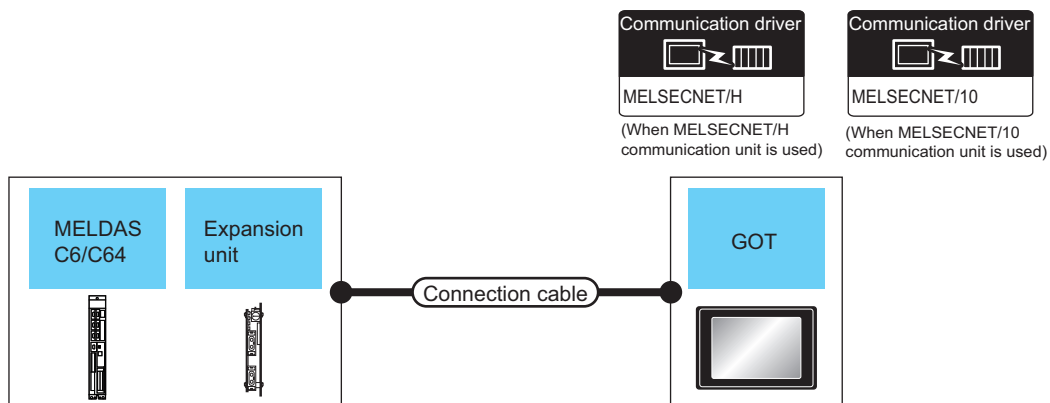

CNC		Connection cable		GOT		Number of connectable equipment	
Model name	Expansion unit	Communication type	Cable model	Max. distance	Option device		Model
MELDAS C6/C64	FCU6-EX878	MELSECNET/10 (Coaxial bus system)	Coaxial cable *3	*1	GT15-J71BR13 ^{*2}	GT 16 GT 15	31 GOTs
					GT15-75J71BR13-Z	GT 15	
	FCU6-EX879	MELSECNET/10 (Optical loop system)	Optical fiber cable *3	*1	GT15-J71LP23-25 ^{*2}	GT 16 GT 15	63 GOTs
					GT15-75J71LP23-Z	GT 15	

*1 The overall extension cable length and the length between stations vary depending on the cable type to be used and the total number of stations.

For details, refer to the following manuals.

☞ C6/C64/C64T CONNECTION AND MAINTENANCE MANUAL BNP-B2255

☞ C6/C64/C64T NETWORK INSTRUCTION MANUAL BNP-B2373

*2 Specify the MELSECNET/10 Mode as the Communication Settings. For the setting, refer to the following.

☞ 18.4.1 Setting communication interface (Communication settings)

*3 For the coaxial cable and optical fiber cable, refer to the following manuals.

☞ C6/C64/C64T CONNECTION AND MAINTENANCE MANUAL BNP-B2255

☞ C6/C64/C64T NETWORK INSTRUCTION MANUAL BNP-B2373

18.2.3 CC-Link connection (intelligent device station)

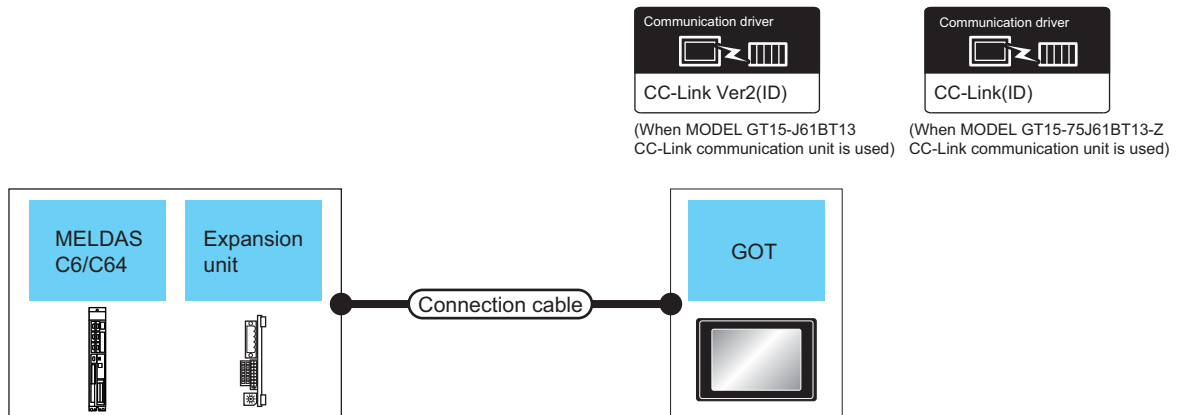

CNC			Connection cable		GOT		Number of connectable equipment
Model name	Expansion unit	Communication type	Cable model	Max. distance	Option device	Model	
MELDAS C6/C64	FUC6-HR865	CC-Link(ID)	CC-Link dedicated cable *3	*1	GT15-J61BT13*2	GT16 GT15	26 GOTs
					GT15-75J61BT13-Z	GT15	

*1 The overall extension cable length and the length between stations vary depending on the cable type to be used and the total number of stations.

For details, refer to the following manuals.

☞ C6/C64/C64T CONNECTION AND MAINTENANCE MANUAL BNP-B2255

☞ C6/C64/C64T NETWORK INSTRUCTION MANUAL BNP-B2373

*2 Specify Ver.1 as the mode setting in the Communication Settings to use it.

For details of the settings, refer to the following manual.

☞ 18.4.1 Setting communication interface (Communication settings)

*3 For the specifications and inquiries of the CC-Link dedicated cable, refer to the following.

☞ CC-Link Partner Association's home page: <http://www.cc-link.org/>

18.2.4 Ethernet connection

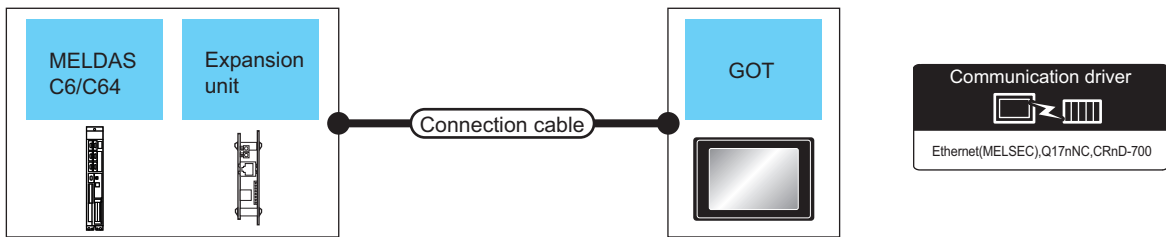

CNC		Connection cable ^{*1}			GOT		Number of connectable equipment
Model name	Expansion unit	Communication type	Cable model	Maximum segment length ^{*3}	Option device	Model	
MELDAS C6/C64	FUC6-EX875 ^{*4*5}	Ethernet	Twisted pair cable <ul style="list-style-type: none"> • 10BASE-T Shielded twisted pair cable (STP) or unshielded twisted pair cable (UTP): Category 3, 4, and 5 • 100BASE-TX Shielded twisted pair cable (STP): Category 5 and 5e 	100m	- (Built into GOT)	GT 16 ^{*2} GT 14 GT 12	128 GOTs (recommended to 16 units or less)
					GT15-J71E71-100	GT 15	

^{*1} The destination connected with the twisted pair cable varies with the configuration of the applicable Ethernet network system. Connect to the Ethernet module, hub, transceiver or other system equipment corresponding to the applicable Ethernet network system.

Use cables, connectors, and hubs that meet the IEEE802.3 10BASE-T/100BASE-TX standards. A cross cable is available for connecting the GOT to the Ethernet module.

^{*2} When connecting GT16 of the function version A to an equipment that meets the 10BASE (-T/2/5) standard, use the switching hub and operate in a 10Mbps/100Mbps mixed environment. For how to check the function version, refer to the following.

☞ GT16 User's Manual

^{*3} A length between a hub and a node.

The maximum distance differs depending on the Ethernet device to be used. The following shows the number of the connectable nodes when a repeater hub is used.

- 10BASE-T: Max. 4 nodes for a cascade connection (500m)
- 100BASE-TX: Max. 2 nodes for a cascade connection (205m)

When switching hubs are used, the cascade connection between the switching hubs has no logical limit for the number of cascades.

For the limit, contact the switching hub manufacturer.

^{*4} For the system configuration of the expansion unit, refer to the following manuals.

☞ C6/C64/C64T CONNECTION AND MAINTENANCE MANUAL BNP-B2255

☞ C6/C64/C64T NETWORK INSTRUCTION MANUAL BNP-B2373

^{*5} Select [AJ71QE71] for [Controller Type] in [Ethernet] of GT Designer3.

For [Ethernet] of GT Designer3, refer to the following.

☞ 18.4.3 Ethernet setting

18.3 Connection Diagram

The following diagram shows the connection between the GOT and the CNC.

18.3.1 RS-232 cable

■ Connection diagram

RS232 connection diagram

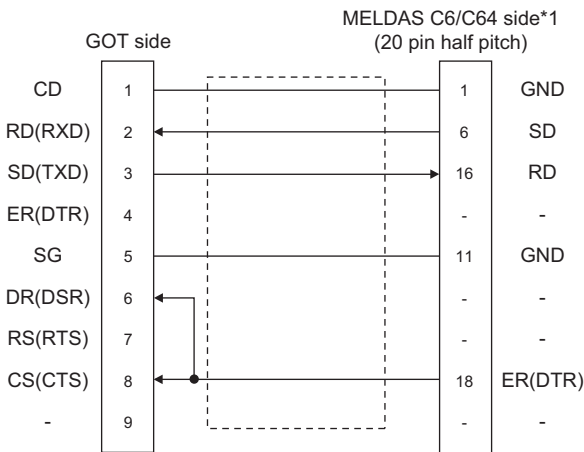

*1 For details of the MELDAS C6/C64 side connection, refer to the following manuals.

➡ MELDAS C6/C64 CONNECTION AND MAINTENANCE MANUAL BNP-B2255

➡ MELDAS C6/C64 NETWORK MANUAL BNP-B2373

■ Precautions when preparing a cable

(1) Cable length

The length of the RS-232 cable must be 15m or less.

(2) GOT side connector

For the GOT side connector, refer to the following.

➡ 1.4.1 GOT connector specifications

18.4 GOT Side Settings

18.4.1 Setting communication interface (Communication settings)

Set the channel of the connected equipment.

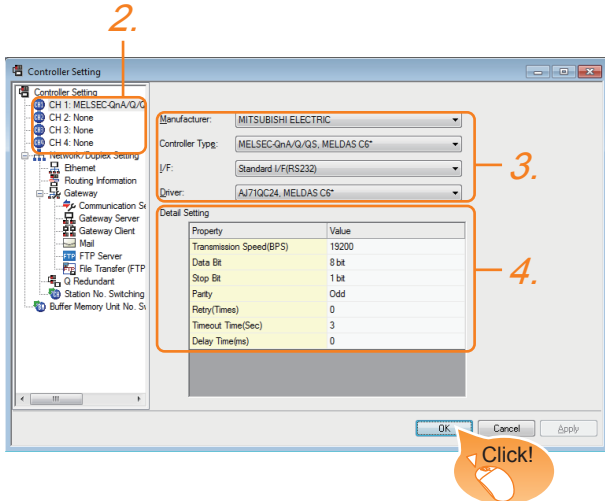

1. Select [Common] → [Controller Setting] from the menu.
2. The Controller Setting window is displayed. Select the channel to be used from the list menu.
3. Set the following items.
 - Manufacturer: MITSUBISHI ELECTRIC
 - Controller Type:
 - For GT16, GT15
 - MELSEC-QnA/Q/QS, MELDAS C6*
 - For GT14, GT11
 - MELSEC-QnA/Q, MELDAS C6*
 - I/F: Interface to be used
 - Driver:
 - For direct connection to CPU
 - AJ71QC24, MELDAS C6*
 - For ELSENET/10 connection
 - MELSENET/H
 - MELSENET/10
 - For CC-Link (ID) connection
 - CC-Link Ver2 (ID)
 - CC-Link (ID)
 - For Ethernet connection
 - Ethernet (MELSEC), Q17nNC, CRnD-700
4. The detailed setting is displayed after Manufacturer, Controller Type, I/F, and Driver are set. Make the settings according to the usage environment.

➡ 18.4.2 Communication detail settings

Click the [OK] button when settings are completed.

POINT

The settings of connecting equipment can be confirmed in [I/F Communication Setting]. For details, refer to the following.

➡ 1.1.2 I/F communication setting

18.4.2 Communication detail settings

Make the settings according to the usage environment.

(1) AJ71QC24, MELDAS C6*

Property	Value
Transmission Speed(BPS)	19200
Data Bit	8 bit
Stop Bit	1 bit
Parity	Odd
Retry(Times)	0
Timeout Time(Sec)	3
Delay Time(ms)	0

Item	Description	Range
Transmission Speed	Set this item when change the transmission speed used for communication with the connected equipment. (Default: 19200bps)	4800bps, 9600bps, 19200bps, 38400bps, 57600bps, 115200bps
Data Bit	Set this item when change the data length used for communication with the connected equipment. (Default: 8bit)	8bit (fixed)
Stop Bit	Specify the stop bit length for communications. (Default: 1bit)	1bit (fixed)
Parity	Specify whether or not to perform a parity check, and how it is performed during communication. (Default: Odd)	Odd (fixed)
Retry	Set the number of retries to be performed when a communication timeout occurs. (Default: 0time)	0 to 5times
Timeout Time	Set the time period for a communication to time out. (Default: 3sec)	3 to 30sec
Delay Time	Set this item to adjust the transmission timing of the communication request from the GOT. (Default: 0ms)	0 to 300ms

(2) MELSECNET/H

Property	Value
Network Type	MNET/H mode
Network No.	1
Station No.	1
Group No.	0
Mode Setting	Online(Auto Reconnect)
Retry(Times)	3
Timeout Time(Sec)	3
Delay Time(ms)	0
Refresh Interval(Times)	1
Transmission Speed(Mbps)	25

Item	Description	Range
Network Type	Set the network type. (Default: MNET/H mode)	<ul style="list-style-type: none"> • MNET/H mode • MNET/10 mode • MNET/H EXT mode
Network No.	Set the network No. (Default: 1)	1 to 239
Station No.	Set the station No. of the GOT. (Default: 1)	1 to 64
Mode Setting	Set the operation mode of the GOT. (Default: Online (auto. reconnection))	<ul style="list-style-type: none"> • Online (auto. reconnection) • Offline • Test between slave station^{*1} • Self-loopback test^{*1} • Internal self-loopback test^{*1} • H/W test^{*1}
Retry	Set the number of retries to be performed when a communication timeout occurs. When receiving no response after retries, the communication times out. (Default: 3times)	0 to 5times
Timeout Time	Set the time period for a communication to time out. (Default: 3sec)	3 to 90sec
Delay Time	Set the delay time for reducing the load of the network/destination PLC. (Default: 0ms)	0 to 300ms
Refresh Interval	Set the number of refreshes to secure the send/receive data in station units during communication. (Default: 1time) Valid when [Secured data send/ Secured data receive] is marked by the control station side network parameters of the MELSECNET/H network system.	1 to 1000times
Transmission Speed	Set the communication transmission speed. (Default: 25Mbps) When specifying [MNET/10 mode] as the network type, only 10Mbps can be set applicable.	10Mbps/25Mbps

*1 For details, refer to the following manual.

 Q corresponding MELSECNET/H Network System Reference Manual (PLC to PLC network)

(3) MELSECNET/10

Property	Value
Retry(Times)	3
Timeout Time(Sec)	3

Item	Description	Range
Retry	Set the number of retries to be performed when a communication timeout occurs. When receiving no response after retries, the communication times out. (Default: 3times)	0 to 5times
Timeout Time	Set the time period for a communication to time out. (Default: 3sec)	3 to 90sec

POINT

When MELSECNET/H communication unit is used
When connecting to the MELSECNET/10 network using the MELSECNET/H communication unit, specify [MELSECNET/10 mode] as [Network Type].

(4) CC-Link Ver.2 (ID)

Property	Value
Station No.	1
Transmission Rate	0:Online:156kbps
Mode	Ver.1
Expanded Cyclic	Single
Occupied Station	1 Station
Input for Error Station	Clear
Retry(Times)	3
Timeout Time(Sec)	3
Delay Time(ms)	0

Item	Description	Range
Station No.	Set the station No. of the GOT. (Default: 1)	1 to 64
Transmission Rate*1	Set the transmission speed and the mode of the GOT. (Default: 0)	0 to E
Mode	Set the mode of CC-Link. (Default: Ver.1)	Ver.1/Ver.2/ Additional/ Offline
Expanded Cyclic	Set the cyclic point expansion. (Default: Single)	Single/ Double/ Quadruple/ Octuple
Occupied Station	Set the number of stations occupied by the GOT. (Default: 1 Station)	1 Station/4 Stations
Input for Error Station	Set Clear/Hold at an error occurrence. (Default: Clear)	Clear/Hold
Retry	Set the number of retries to be performed when a communication timeout occurs. When no response is received after retries, a communication times out. (Default: 3times)	0 to 5times
Timeout Time	Set the time period for a communication to time out. (Default: 3sec)	3 to 90sec
Delay Time	Set the delay time for reducing the load of the network/destination PLC. (Default: 0ms)	0 to 300ms

*1 Transmission speed settings
The following lists the transmission speed settings of the CC-Link communication.

Set value	Description
0	Online: 156kbps
1	Online: 625kbps
2	Online: 2.5Mbps
3	Online: 5Mbps
4	Online: 10Mbps
A	Hardware test: 156kbps
B	Hardware test: 625kbps
C	Hardware test: 2.5Mbps
D	Hardware test: 5Mbps
E	Hardware test: 10Mbps

For details of the hardware test, refer to the following manual.

 CC-Link System Master/Local Module User's Manual for CC-Link module to be used

(5) CC-Link(ID)

Property	Value
Retry(Times)	3
Timeout Time(Sec)	3

Item	Description	Range
Retry	Set the number of retries to be performed when a communication timeout occurs. When receiving no response after retries, the communication times out. (Default: 3times)	0 to 5times
Timeout Time	Set the time period for a communication to time out. (Default: 3sec)	3 to 90sec

(6) Ethernet(MELSEC), Q17nNC, CRnD-700

(a) GT16, GT14

Property	Value
GOT NET No.	1
GOT PLC No.	1
GOT IP Address	192.168.3.18
IP Label	
Subnet Mask	255.255.255.0
Default Gateway	0.0.0.0
Ethernet Download Port No.	5014
GOT Communication Port No.	5001
Retry(Times)	3
Startup Time(Sec)	3
Timeout Time(Sec)	3
Delay Time(x10ms)	0

Item	Description	Range
GOT NET No.	Set the network No. of the GOT. (Default: 1)	1 to 239
GOT PLC No.*2	Set the station No. of the GOT. (Default: 1)	1 to 64
GOT IP Address*1	Set the IP address of the GOT. (Default: 192.168.3.18)	0.0.0.0 to 255.255.255.255
Subnet Mask*1	Set the subnet mask for the sub network.(Only for connection via router) If the sub network is not used, the default value is set. (Default: 255.255.255.0)	0.0.0.0 to 255.255.255.255
Default Gateway*1	Set the router address of the default gateway where the GOT is connected.(Only for connection via router) (Default: 0.0.0.0)	0.0.0.0 to 255.255.255.255
Ethernet Download Port No.*1	Set the GOT port No. for Ethernet download. (Default: 5014)	1024 to 5010, 5014 to 65534 (Except for 5011, 5012, 5013 and 49153)
GOT Communication Port No.	Set the GOT port No. for the connection with the Ethernet module. (Default: 5001)	1024 to 5010 to 5014 to 65534 (Except for 5011, 5012, 5013 and 49153)
Retry	Set the number of retries to be performed when a communication timeout occurs. When receiving no response after retries, the communication times out. (Default: 3times)	0 to 5times
Startup Time	Specify the time period from the GOT startup until GOT starts the communication with the PLC CPU. (Default: 3sec)	3 to 255sec
Timeout Time	Set the time period for a communication to time out. (Default: 3sec)	3 to 90sec
Delay Time	Set the delay time for reducing the load of the network/destination PLC. (Default: 0ms)	0 to 10000 (× 10ms)

*1 Click the [Setting] button and perform the setting in the [GOT IP Address Setting] screen.

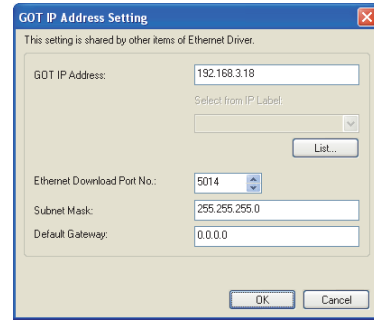

*2 Each of [GOT PLC No.] set in the communication detail setting and [PLC No.] set in the Ethernet setting must be set to different station numbers.

18.4.3 Ethernet setting

(b) GT15, GT12

Property	Value
GOT NET No.	1
GOT PLC No.	1
GOT IP Address	192.168.0.18
IP Label	
Subnet Mask	255.255.255.0
Default Gateway	0.0.0.0
Ethernet Download Port No.	5014
GOT Communication Port No.	5001
Retry(Times)	3
Startup Time(Sec)	3
Timeout Time(Sec)	3
Delay Time(x10ms)	0

Item	Description	Range
GOT NET No.	Set the network No. of the GOT. (Default: 1)	1 to 239
GOT PLC No.*1	Set the station No. of the GOT. (Default: 1)	1 to 64
GOT IP Address	Set the IP address of the GOT. (Default: 192.168.0.18)	0.0.0.0 to 255.255.255.255
Subnet Mask	Set the subnet mask for the sub network.(Only for connection via router) If the sub network is not used, the default value is set. (Default: 255.255.255.0)	0.0.0.0 to 255.255.255.255
Default Gateway	Set the router address of the default gateway where the GOT is connected.(Only for connection via router) (Default: 0.0.0.0)	0.0.0.0 to 255.255.255.255
Ethernet Download Port No.	Set the GOT port No. for Ethernet download. (Default: 5014)	1024 to 5010 to 5014 to 65534 (Except for 5011, 5012, 5013 and 49153)
GOT Communication Port No.	Set the GOT port No. for the connection with the Ethernet module. (Default: 5001)	1024 to 5010 to 5014 to 65534 (Except for 5011, 5012, 5013 and 49153)
Retry	Set the number of retries to be performed when a communication timeout occurs. When receiving no response after retries, the communication times out. (Default: 3times)	0 to 5times
Startup Time	Specify the time period from the GOT startup until GOT starts the communication with the PLC CPU. (Default: 3sec)	3 to 255sec
Timeout Time	Set the time period for a communication to time out. (Default: 3sec)	3 to 90sec
Delay Time	Set the delay time for reducing the load of the network/destination PLC. (Default: 0ms)	0 to 10000 (× 10ms)

*1 Each of [GOT PLC No.] set in the communication detail setting and [PLC No.] set in the Ethernet setting must be set to different station numbers.

 18.4.3 Ethernet setting

POINT

- (1) Communication interface setting by Utility
The communication interface setting can be changed on the Utility's [Communication Settings] after writing [Communication Settings] of project data.
For details on the Utility, refer to the following manual.
-  GT□ User's Manual
- (2) Precedence in communication settings
When settings are made by GT Designer3 or the Utility, the latest setting is effective.

18.4.3 Ethernet setting

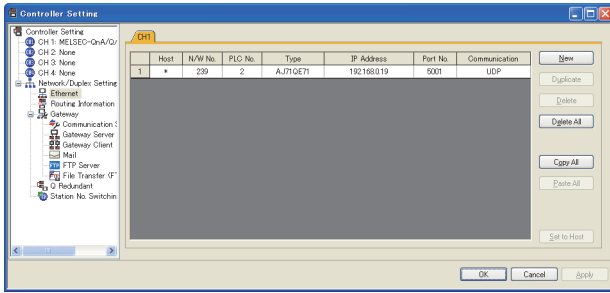

Item	Description	Range
Host	The host is displayed. (The host is indicated with an asterisk (*))	—
N/W No.	Set the network No. of the connected Ethernet module. (Default: blank)	Network No. of CNC*1
PLC No.*2	Set the station No. of the connected Ethernet module. (Default: blank)	Station No. of CNC
Type	Set the type of the connected Ethernet module. (Default: QJ71E71)	AJ71QE71
IP Address	Set the IP address of the connected Ethernet module. (Default: blank)	IP address of CNC
Port No.	Set the port No. of the connected Ethernet module. (Default: 5001)	5001
Communication	UDP (fixed)	UDP (fixed)

- *1 For operating CNC monitor function, set N/W No. to "239".
 *2 Each of [GOT PLC No.] set in the communication detail setting and [PLC No.] set in the Ethernet setting must be set to different station numbers.

➔ 18.4.2 Communication detail settings

18.4.4 Switch setting

Switch setting (GT15-75J71P23-Z, GT15-75JBR13-Z)

POINT

Switch setting of the communication unit
 When using the MELSECNET/H communication unit, the switch setting is not needed.

For details of each setting switch and LED, refer to the following manual.

➔ GT15 MELSECNET/10 communication unit User's Manual

GT15-75J71LP23-Z, GT15-75J71BR13-Z

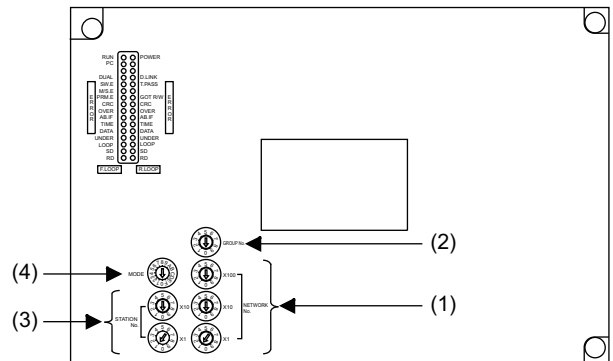

(1) Network number setting switch

Network number setting switch	Description	Set value
	Set the network No. of the MELSECNET/10 communication unit. (Default: 001)	1 to 239

(2) Group number setting switch

Group number setting switch	Description	Set value
	Set the group No. of the MELSECNET/10 communication unit. (Default: 0)	0: No group setting (fixed)*1

*1 The GOT does not use the group number. Specify "0".

(3) Station number setting switch

Station number setting switch	Description	Set value
	Set the station No. of the MELSECNET/10 communication unit. Set to not duplicate other stations in the network. (Default: 01)	1 to 64: GT15-75J71LP23-Z 1 to 32: GT15-75J71BR13-Z

(4) Mode setting switch

Mode setting switch	Description	Set value
	Online (Default: 0)	0

POINT

(1) Switch setting example

For the switch setting example, refer to the following.

18.5.1 MELSECNET/10 connection

(2) When the switch setting is changed

When changing the switch setting after mounting the MELSECNET/10 communication unit to the GOT, reset the GOT.

(3) Self check test

Select "3" to "9" as the mode setting switch to provide a self check test of the MELSECNET/10 communication unit.

For details, refer to the following manual.

GT15 MELSECNET/10 communication unit User's Manual

■ Switch setting (Only when MODEL GT15-75J61BT13-Z CC-Link communication unit is used)

POINT

Switch setting of the communication unit

When using the MODEL GT15-J61BT13 CC-Link communication unit, the switch setting is not needed.

For details of each setting switch and LED, refer to the following manual.

GT15 CC-Link communication unit User's Manual

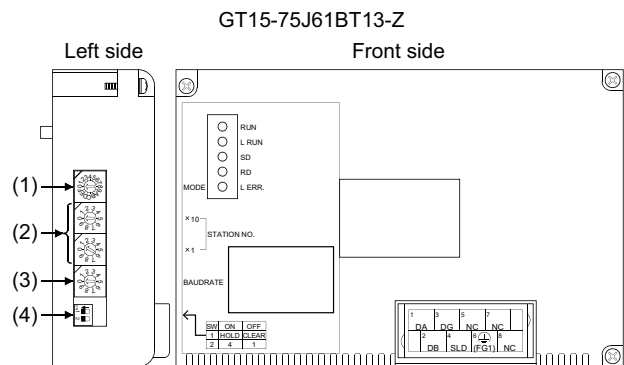

(1) Mode setting switch

Mode setting switch	Description	Set value
	Select the online mode. (Default: 0)	0 (fixed)

(2) Station number setting switch

Station number setting switch	Description	Set value
	Specify the station No. of the CC-Link communication unit. (Default: 01)	1 to 64

(3) Transmission baudrate setting switch

Transmission baudrate setting switch	Description	Set value
	Specify the transmission speed. (Default: 0)	0: 156kbps 1: 625kbps 2: 2.5Mbps 3: 5Mbps 4: 10Mbps

(4) Condition setting switches

Condition setting switches	Setting switch	Description	Set value
	SW1	Specify input data status of the data link error station. (Default: OFF)	OFF: Cleared ON: Held
	SW2	Specify the number of stations occupied. (Default: OFF)	OFF: 1 station ON: 4 stations

POINT

(1) Switch setting example

For the switch setting example, refer to the following.

 18.5.2 CC-Link (ID) connection

(2) When the switch setting is changed

When changing the switch setting after mounting the GT15-75J61BT13-Z type CC-Link communication unit to the GOT, reset the GOT.

18.5 CNC Side Settings

18.5.1 MELSECNET/10 connection

■ Parameter setting

Set parameters related to MELSECNET/10 with MELSEC's peripheral devices in the same way as parameter setting of MELSEC CPU, and write them on CNC by Personal computer. However, in the case of using the default parameters or not requiring separate settings due to normal stations, it is not necessary to set the network

(1) Control Station Parameter

If you wish to place the control station in CNC and set the common parameters, set the network parameters by peripheral device and write them on CNC. An example of parameter setting by GPPW is as follows. Set the first I/O No. as follows according to the expansion slot to which the unit is inserted.

(a) Start I/O No.

Slot	Start I/O No.
EXT1	0200
EXT2	0280

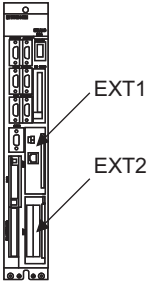

(b) Example of GX Developer setting

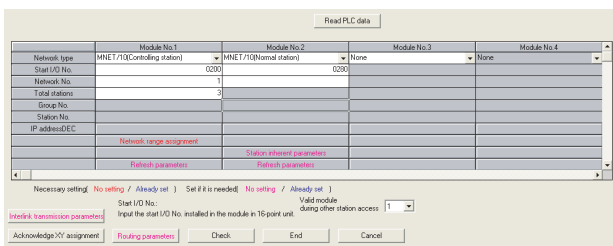

For details of the parameter setting, refer to the following.





 C6/C64/C64T NETWORK INSTRUCTION MANUAL BNP-B2373

(2) Normal Station Parameter

As for normal stations, it is not necessary to set parameters unless separate settings are required. The refresh parameters are set and written as required. In this case, the parameter setting of the first I/O No. is the same as in the case of the control station.

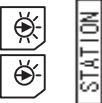
Expansion unit settings

(1) FCU6-EX879 (Optical fiber cable)

No.	Switch name	Settings									
1)	Condition setting switch 	Set the operation condition.									
		SW	Description	OFF	ON						
		1	Network type ^{*1}	Inter-PC net (PC)	Remote I/O net						
		2	Station type ^{*4}	Normal station (N.ST)	Control station (MNG)						
		3	Used parameter ^{*2}	Common parameters (PRM)	Default parameter (D.PRM)						
		4	Number of stations ^{*2} (Valid when SW3 is ON)	OFF	8	ON	16	OFF	32	ON	64
		5		Station	OFF	Station	ON	Station	ON	Station	
		6	B/W total points ^{*2} (Valid when SW3 is ON)	OFF	2K	ON	4K	OFF	6K	ON	8K
		7		points	OFF	points	ON	points	ON	points	
8	Not used	Always OFF									
2)	Station number setting switch 	Station number setting ^{*2*3} (Setting range) 01 to 64: Station number Other than 01 to 64: Setting error									
3)	Setting switch of group number 	Group number setting Not used, fixed to 0									
4)	Setting switch of network number 	Network number setting ^{*2} (Setting range) 001 to 255: Network number Other than 001 to 255: Setting error									
5)	Mode setting switch 	Mode setting ^{*2} 0: Online 1: Cannot be used 2: Offline 3 to F: Test mode									

*1 Set the network type to the PLC to PLC network.

*2 Set as necessary.

*3 Set the station No. not to overlap with that of other units.

*4 Set the station type to the control station.

For details of the parameter setting, refer to the following.

 C6/C64/C64T NETWORK INSTRUCTION MANUAL BNP-B2373

(2) FCU6-EX878 (Coaxial cable)

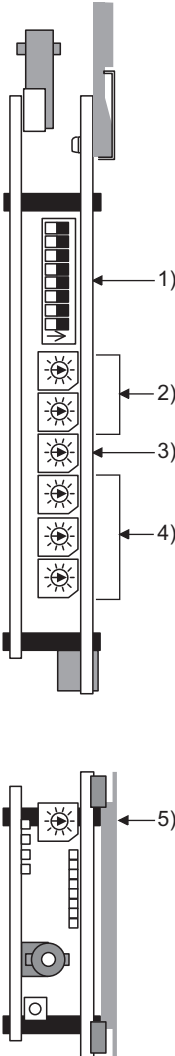
Switch layout	No.	Switch name	Settings							
	1)	Condition setting switch	Set the operation condition.							
			SW	Description	OFF	ON				
			1	Network type ^{*1}	Inter-PC net (PC)	Remote I/O net				
			2	Station type ^{*4}	Normal station (N.ST)	Control station (MNG)				
			3	Used parameter ^{*2}	Common parameters (PRM)	Default parameter (D.PRM)				
	4	Number of stations ^{*2} (Valid when SW3 is ON)	OFF	8 Station	ON	16 Station	OFF	32 Station	ON	64 Station
	5		OFF	2K points	ON	4K points	OFF	6K points	ON	8K points
	6	B/W total points ^{*2} (Valid when SW3 is ON)	OFF	2K points	ON	4K points	OFF	6K points	ON	8K points
	7		OFF	2K points	ON	4K points	OFF	6K points	ON	8K points
	8	Not used	Always OFF							
	2)	Station number setting switch	Station number setting ^{*2*3} (Setting range) 01 to 64: Station number Other than 01 to 64: Setting error							
	3)	Setting switch of group number	Group number setting Not used, fixed to 0							
	4)	Setting switch of network number	Network number setting ^{*2} (Setting range) 001 to 255: Network number Other than 001 to 255: Setting error							
	5)	Mode setting switch	Mode setting ^{*2} 0: Online 1: Cannot be used 2: Offline 3 to F: Test mode							

*1 Set the network type to the PLC to PLC network.

*2 Set as necessary.

*3 Set the station No. not to overlap with that of other units.

*4 Set the station type to the control station.

For details of the parameter setting, refer to the following.

 C6/C64/C64T NETWORK INSTRUCTION MANUAL BNP-B2373

18.5.2 CC-Link (ID) connection

Parameter setting

Set parameters related to CC-Link connection with GX Developer and write them to CNC by PLC. However, in the case of using the local stations, it is not necessary to set the network parameters.

(1) Master station parameter

It is necessary to set and write the network parameters to CNC with GX Developer. The following shows an example of parameter settings. Set the first I/O No. as follows according to the expansion slot to which the unit is inserted.

(a) Start I/O No.

Slot	Start I/O No.
EXT1	0200
EXT2	0280

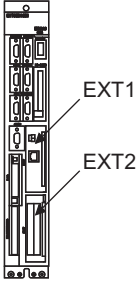

(b) Example of GX Developer setting

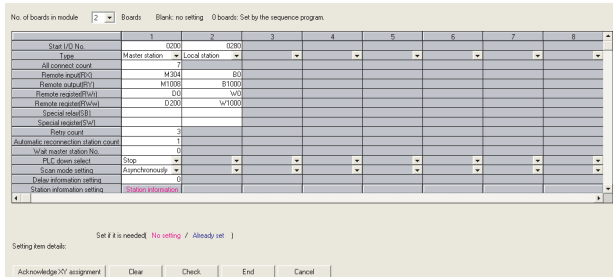

For details of the parameter setting, refer to the following.

 C6/C64/C64T NETWORK INSTRUCTION MANUAL BNP-B2373



Expansion unit settings

Make the communication settings by the setting switch in the expansion unit (FCU6-HR865).

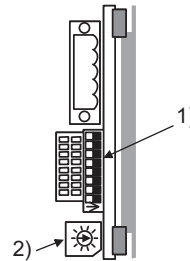
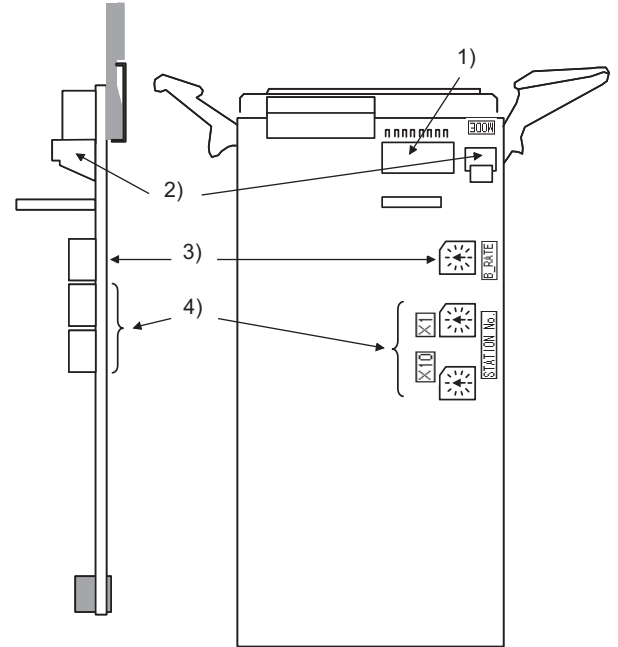
(1) Expansion unit

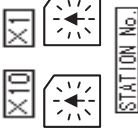

(2) Contents of setting

No.	Switch name	Settings									
1)	Condition setting switch 	Set the operation condition.									
		No.	Description	Switch status			Setting validity				
				OFF	ON		Master station (Standby master station)	Local station (Standby master station)			
		SW1	Station type ^{*1}	Master station/local station		Standby master station		(Valid)	(Valid)		
		SW2	Not used	Always OFF			-	-			
		SW3	Not used	Always OFF			-	-			
		SW4	Data link error station input data status ^{*1}	Clear		Hold		valid	valid		
		SW4	Number of occupied stations ^{*1}	OFF	1 Station	OFF	2 Station	ON	3 Station	Invalid	valid
		SW5		OFF	ON	ON	OFF				
		SW7	Not used	Always OFF			-	-			
SW8	Not used	Always OFF			-	-					
2)	Mode setting switch 	This switch sets the unit operation status.									
		No.	Name	Description			Settability				
							Master station	Local station			
		0	Online ^{*1}	Automatic online return provided when data link is enabled			Yes	Yes			
		1		Link with remote I/O net mode			Yes	No			
		2	Offline ^{*1}	Data link offline state			Yes	Yes			
		3	Line test 1 ^{*1}	Line test 1 in offline state			Yes	No			
		4	Line test 2 ^{*1}	Line test 2 in offline state			Yes	No			
		5	Parameter confirmation test ^{*1}	Checks the parameter details			Yes	No			
		6	Hardware test ^{*1}	Test Expansion unit (FCU6-HR865)			Yes	Yes			
7 to F	Not usable										
3)	Transmission speed setting switch 	This switch sets the unit transmission speed.									
		No.	Description								
		0	156Kbps ^{*1}								
		1	625Kbps ^{*1}								
		2	2.5Mbps ^{*1}								
		3	5Mbps ^{*1}								
		4	10Mbps ^{*1}								
5 to F	Not usable										
4)	Setting switch of station No. 	This switch sets the unit station No. ^{*1*2} (Setting range) Master station: 00 Local station: 01 to 64 Standby master station: 01 to 64									

*1 Set as necessary.

*2 Set the station No. not to overlap with that of other units.
For details of the parameter setting, refer to the following.

 C6/C64/C64T NETWORK INSTRUCTION MANUAL BNP-B2373

18.5.3 Ethernet connection

System configuration

The following shows the example of the system configuration when using the CNC monitor function.

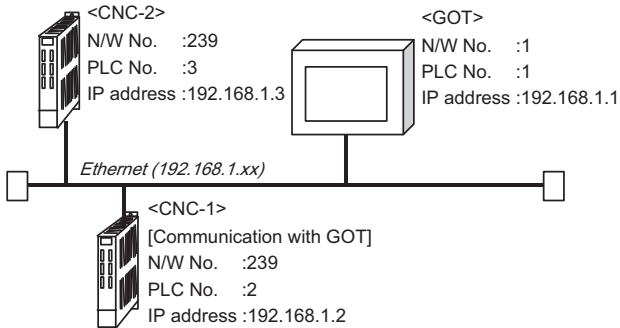

Parameter setting

Set parameters related to Ethernet with MELSEC's peripheral devices in the same way as parameter setting of MELSEC CPU, and write them on CNC by Personal computer.

(1) Network parameter setting

Set the network parameters by peripheral device and write them on CNC. An example of parameter setting by GPPW is as follows. Set the first I/O No. as follows according to the expansion slot to which the unit is inserted.

(a) Unit No.

Slot position	Start I/O No.	Mounting position of extension unit
EXT1	0200	<div style="display: flex; justify-content: space-around;"> <div style="text-align: center;"> <p>[When mounted in EXT1 and EXT2]</p> </div> <div style="text-align: center;"> <p>[When mounted in EXT1 and EXT3]</p> </div> </div>
EXT2	0280	
EXT3	0300	

		<div style="display: flex; justify-content: space-around;"> <div style="text-align: center;"> <p>[When mounted in EXT2 and EXT3]</p> </div> <div style="text-align: center;"> <p>[When mounted in EXT1 only]</p> </div> </div>
		<div style="display: flex; justify-content: space-around;"> <div style="text-align: center;"> <p>[When mounted in EXT2 only]</p> </div> <div style="text-align: center;"> <p>[When mounted in EXT3 only]</p> </div> </div>

(b) Example of GX Developer setting

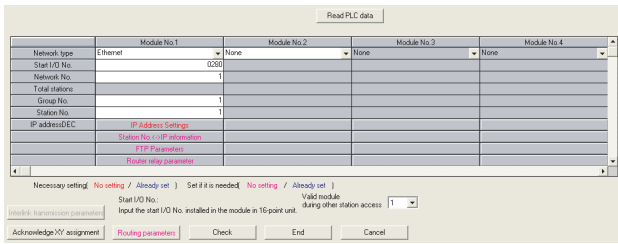

For details of the parameter setting, refer to the following.

C6/C64/C64T NETWORK INSTRUCTION MANUAL BNP-B2373

POINT

IP address setting

IP address setting on GX Developer is invalid. Set the IP address by the 7-segment LED and rotary switch of the CNC side, referring to the next page.

(2) CNC side parameter setting

Confirm the CNC side parameter setting with the settings of IP address, gateway address, subnet mask and port No. by the 7-segment LED and rotary switch of the CNC side. For details of the parameter setting operation, refer to the following.

C6/C64/C64T NETWORK INSTRUCTION MANUAL BNP-B2373 IV Setting the Ethernet IP Address

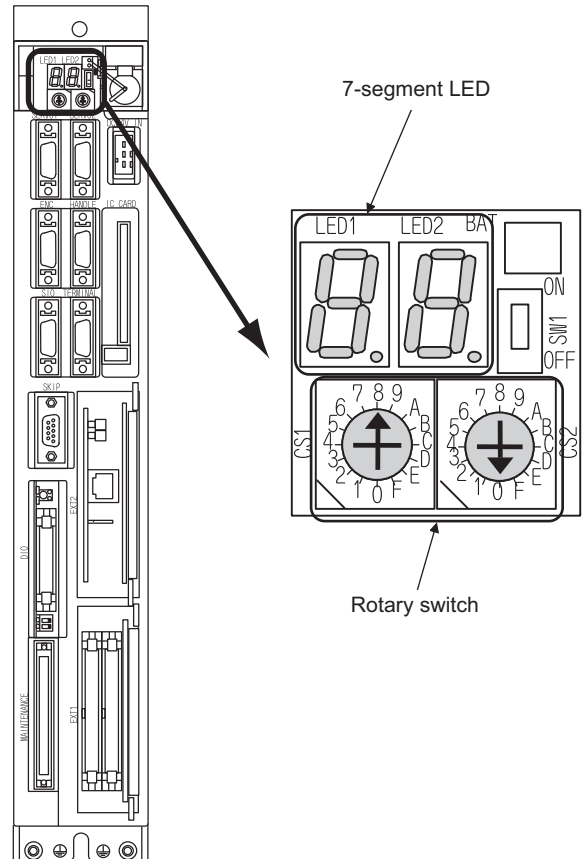

18.6 Device Range that Can Be Set

For details of the device range that can be used on the GOT, refer to the following.

 2.5 MELSEC-QnA/Q/QS, MELDAS C6 *

18.7 Precautions

18.7.1 Direct connection to CPU

■ Version of CNC

For MELDAS C6/C64, use NC system software version D0 or later.

18.7.2 MELSECNET/10 connection

■ Network configuration

Use the MELSECNET/10 mode of MELSECNET/H (PLC to PLC network) or MELSECNET/10 (PLC to PLC network) to configure a network including the GOT.

(1) The following networks including the GOT cannot be configured.

- MELSECNET/10 (Remote I/O network)
- MELSECNET/H (Remote I/O network)

(2) When configuring the network (MELSECNET/H (PLC to PLC network) including the GOT, refer to the following.

 9. MELSECNET/H CONNECTION (PLC TO PLC NETWORK)

■ Monitoring range

Only CNC of the same networks No. can be monitored in GOT.

For details, refer to the following manual.

 3.1 Access Range for Monitoring Stations on Network Systems

■ Starting GOT with CNC connection (MELSECNET/10 connection)

With the CNC connection (MELSECNET/10 connection), the data link starts approximately 10 seconds after the GOT starts.

■ When a network error occurs in the system alarm

When a system alarm regarding a network error occurs with the CNC connection (MELSECNET/10 connection), the system alarm is kept displaying on the GOT even though the error factor is removed.

To cancel the system alarm display, restart the GOT.

■ Version of CNC

For MELDAS C6/C64, use NC system software version E0 or later.

18.7.3 CC-Link (ID) connection

■ Using cyclic transmission

(1) I/O signal for master station

Do not turn on the reserved output signals in the output signals (remote output: RY) to the GOT from the master station.

When the reserved output signal is turned on, the CNC system may be malfunctioned.

For the assignment of I/O signals in the GOT, refer to the following manual.

 MODEL GT15-J61BT13 CC-Link communication unit User's Manual

 GT15 CC-Link communication unit User's Manual

(2) CC-Link Mode

CNC is not compatible with CC-Link Ver.2.

(3) When GOT malfunctions

The cyclic output status remains the same as before becoming faulty.

■ For transient transmission

(1) Access range that can be monitored

The GOT can access to the CNC mounting the master and local station of the CC-Link System.

It cannot access another network via the CC-Link module.

■ GOT startup in CNC connection (CC-Link connection (intelligent device station))

In the CNC connection (CC-Link connection (intelligent device station)), the data link is started approximately 10 seconds after the GOT startup.

■ When a network error occurs in the system alarm

In the CNC connection (CC-Link connection (intelligent device station)), when a network error occurs in the system alarm, the system alarm message cannot be canceled even though the causes are removed.

To cancel the system alarm display, restart the GOT.

■ Version of CNC

For MELDAS C6/C64, use NC system software version D0 or later.

18.7.4 Ethernet connection

■ Via network system

GOT with Ethernet communication cannot access the CNCs in another network via the CNC (network module, Ethernet module, etc.).

■ When connecting to multiple GOTs

When connecting two or more GOTs in the Ethernet network, set each [PLC No.] to the GOT.

☞ 18.4.1 Setting communication interface
(Communication settings)

■ When connecting to the multiple network equipment (including GOT) in a segment

By increasing the network load, the transmission speed between the GOT and CNC may be reduced.

The following actions may improve the communication performance.

- Using a switching hub
- More high speed by 100BASE-TX (100Mbps)
- Reduction of the monitoring points on GOT

■ Ethernet cable connection

Ethernet cable is so susceptible to noise that you should wire power cables and electric supply cables separately. And you need to attach a ferrite core (attachment) on the control unit side.

For details of the Ethernet cable connection, refer to the following

☞ C6/C64/C64T NETWORK INSTRUCTION
MANUAL BNP-B2373 IX Connection Function
with GOT

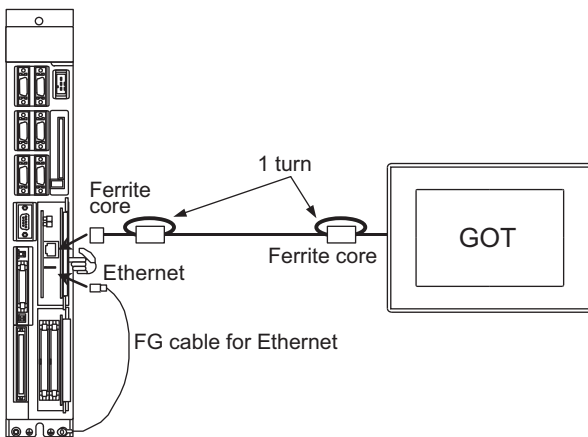

■ Version of CNC

For MELDAS C6/C64, use NC system software version D0 or later.

19

ENERGY MEASURING UNIT/ ELECTRIC MULTI-MEASURING INSTRUMENT CONNECTION



19.1 Connectable Model List	19 - 2
19.2 System Configuration	19 - 3
19.3 Connection Diagram	19 - 4
19.4 GOT Side Settings	19 - 9
19.5 Setting of Energy Measuring Unit/Electric Multi-measuring Instrument	19 - 10
19.6 Device Range that Can Be Set	19 - 11
19.7 Precautions	19 - 12

19. ENERGY MEASURING UNIT/ ELECTRIC MULTI-MEASURING INSTRUMENT CONNECTION

19.1 Connectable Model List

The following table shows the connectable models.

Manufacturer	Series	Model name*1	Clock	Communication type	GT 16	GT 15	GT 14	GT 12	GT11 Bus	GT11 Serial	GT10 5□4□	GT 10 2□3□	Refer to
Mitsubishi Electric	Energy measuring unit	EMU4-BD1-MB	×	RS-485	○	○	○	×	×	○	○	○	19.2.1
		EMU4-HD1-MB			○	○	○	×	×	○	○	○	
	Electric multi-measuring instrument	ME110SSR-MB	×	RS-485	○	○	○	×	×	○	○	○	
		ME96NSR-MB			○	○	○	×	×	○	○	○	

*1 Select a model which is compatible with the communication protocol (MODBUS).
For details, refer to the following catalog.

 Catalog of energy measuring unit/electric multi-measuring instrument

POINT

Versions of GOTs which are compatible with RS-422/485 connection

GOTs can be connected to an energy measuring unit/electric multi-measuring instrument by the RS-422/485 connection.

The following GOT models are compatible with the RS-422/485 connection.

For the confirming method of hardware version, refer to the following.

 GT16 User's Manual

 GT15 User's Manual

 GT14 User's Manual

 GT11 User's Manual

 GT10 User's Manual

GOT	Hardware version	Standard monitor OS
GT16, 15, GT14	Version A or later	-
GT1155-QTBD	Version C or later	
GT1155-QSBD	Version F or later	
GT1150-QLBD	Version F or later	
GT1055-QSBD, GT1050-QBBD	Version C or later	Standard monitor OS [01.32.00] or later Communication driver MODBUS/RTU [01.09.00] or later
GT1045-QSBD, GT1040-QBBD	Version A or later	
GT1030-L□D□, GT1030-H□D□	Version B or later	
GT1020-L□D□	Version E or later	

19.2 System Configuration

19.2.1 Connecting to an energy measuring unit/electronic multi-measuring instrument

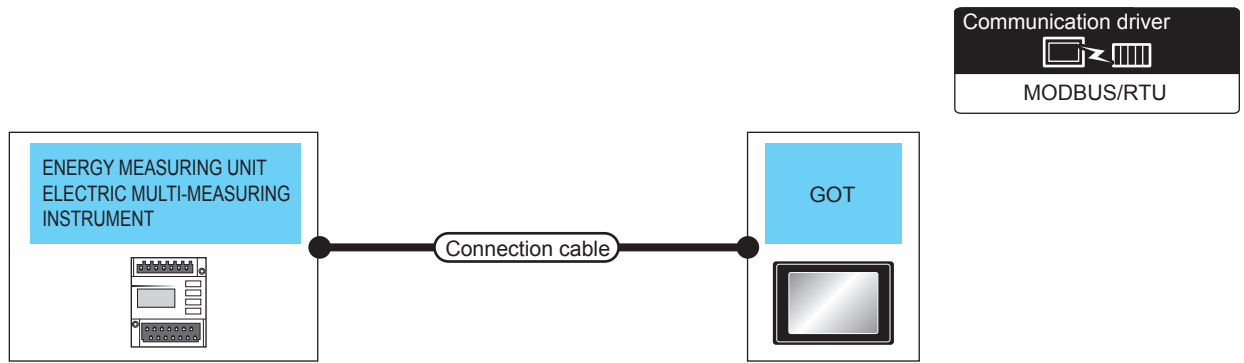

Controller	Communication type	Connection cable		GOT		Number of connectable equipment
		Cable model Connection diagram number	Max. distance	Option device	Model	
Energy measuring unit Electric multi-measuring instrument	RS-422/485	RS-422/485 connection diagram 1)	1000m	FA-LTBGTR4CBL05(0.5m) ^{*1} FA-LTBGTR4CBL10(1m) ^{*1} FA-LTBGTR4CBL20(2m) ^{*1}		Total number of energy measuring units and electric multi-measuring instruments: Up to 31 for 1 GOT
		RS-422/485 connection diagram 2)	1000m	- (Built into GOT)		
		RS-422/485 connection diagram 3)	1000m	- (Built into GOT)		
		RS-422/485 connection diagram 4)	1000m	GT10-9PT5S ^{*2}		
		RS-422/485 connection diagram 5)	1000m	- (Built into GOT)		
		RS-422/485 connection diagram 6)	1000m	GT15-RS4-TE		
		RS-422/485 connection diagram 7)	1000m	GT14-RS2T4-9P ^{*3}		

*1 Product manufactured by MITSUBISHI ELECTRIC ENGINEERING COMPANY LIMITED. For details of the product, contact MITSUBISHI ELECTRIC ENGINEERING COMPANY LIMITED.

*2 Connect it to the RS-422 interface (built into GOT).

*3 Connect it to the RS-232 interface (built into GOT).

17
ROBOT CONTROLLER CONNECTION
18
CNC CONNECTION
19
ENERGY MEASURING UNIT/ELECTRIC MULTI-MEASURING INSTRUMENT CONNECTION
20
GOT MULTI-DROP CONNECTION
21
MULTIPLE-GT14, GT12, GT11, GT10 CONNECTION FUNCTION
22
MULTI-CHANNEL FUNCTION
23
FA TRANSPARENT FUNCTION

19.3 Connection Diagram

The following shows the connection diagrams and connector specifications of the RS-422/485 cable used for connecting the GOT to a PLC.

RS-422/485 connection diagram 1)

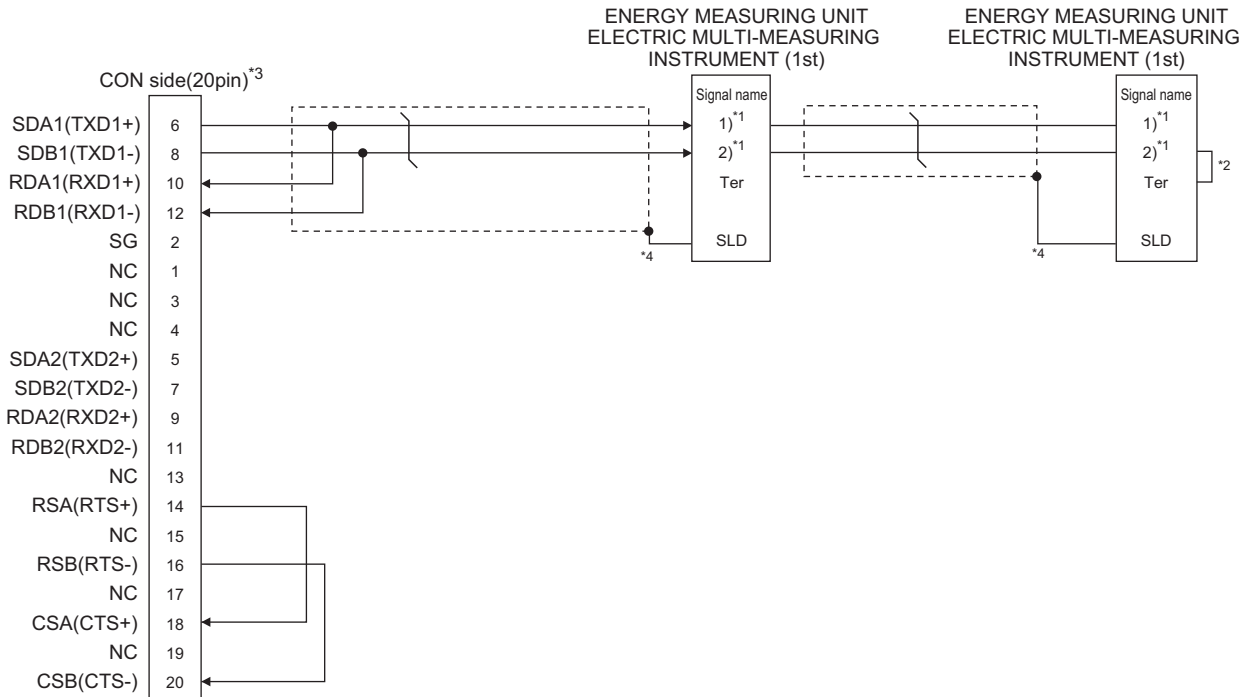

*1 The signal name differs depending on the series name. Refer to the following table.

Series name	Signal name 1)	Signal name 2)
Energy measuring unit	RS485+	RS485-
Electric multi-measuring instrument	T/R+	T/R-

*2 Short-circuit between the following terminals of the energy measuring unit or electric multi-measuring instrument which will be a terminal.

By the short circuit of the following terminals, a terminating resistor with 120Ω is connected.

Series name	Signal name		Signal name
Energy measuring unit	RS485-	< - >	Ter
Electric multi-measuring instrument	T/R-	< - >	Ter

*3 When placing the GOT to the terminal, set the terminating resistor of the GOT to "Enable".
When placing the GOT to the position other than the terminal, set the terminating resistor of the GOT to "Disable".

1.4.3 Terminating resistors of GOT

*4 Ground a shield correctly.

RS-422/485 connection diagram 2)

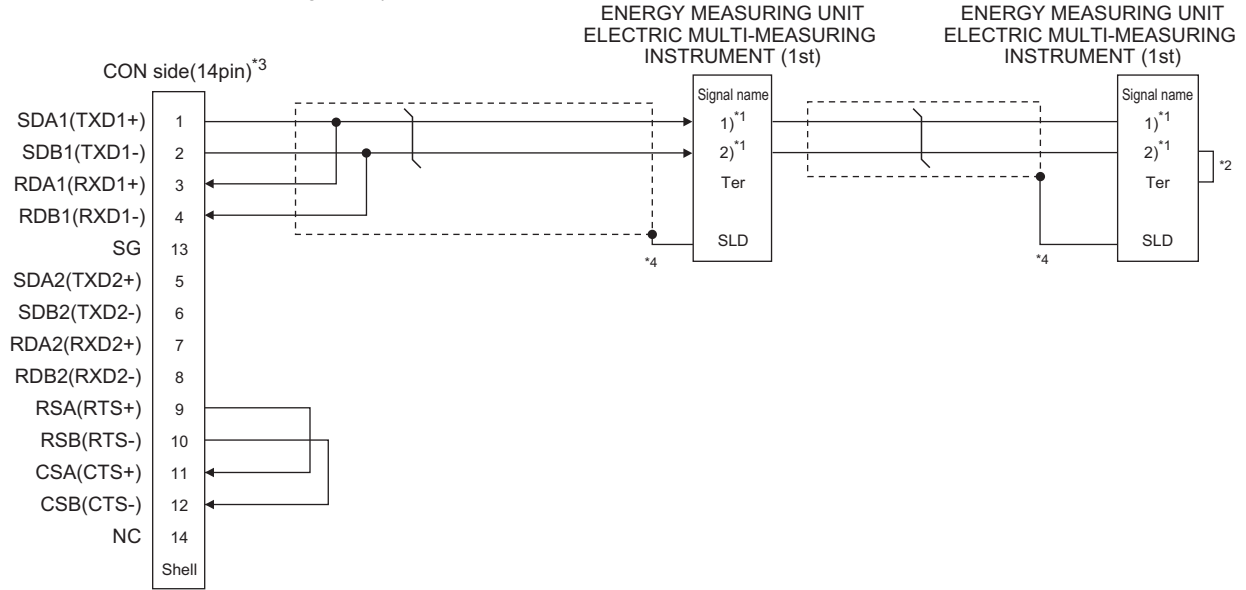

*1 The signal name differs depending on the series name. Refer to the following table.

Series name	Signal name 1)	Signal name 2)
Energy measuring unit	RS485+	RS485-
Electric multi-measuring instrument	T/R+	T/R-

*2 Short-circuit between the following terminals of the energy measuring unit or electric multi-measuring instrument which will be a terminal.

By the short circuit of the following terminals, a terminating resistor with 120Ω is connected.

Series name	Signal name	< - >	Signal name
Energy measuring unit	RS485-	< - >	Ter
Electric multi-measuring instrument	T/R-	< - >	Ter

*3 When placing the GOT to the terminal, set the terminating resistor of the GOT to "Enable".
When placing the GOT to the position other than the terminal, set the terminating resistor of the GOT to "Disable".

☞ 1.4.3 Terminating resistors of GOT

*4 Ground a shield correctly.

RS-422/485 connection diagram 3)

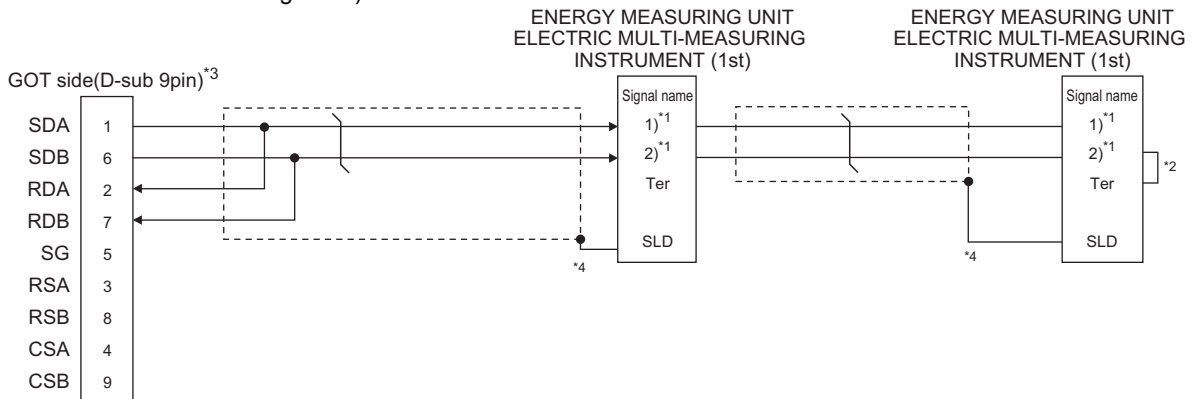

*1 The signal name differs depending on the series name. Refer to the following table.

Series name	Signal name 1)	Signal name 2)
Energy measuring unit	RS485+	RS485-
Electric multi-measuring instrument	T/R+	T/R-

*2 Short-circuit between the following terminals of the energy measuring unit or electric multi-measuring instrument which will be a terminal.

By the short circuit of the following terminals, a terminating resistor with 120Ω is connected.

Series name	Signal name	< - >	Signal name
Energy measuring unit	RS485-	< - >	Ter
Electric multi-measuring instrument	T/R-	< - >	Ter

*3 When placing the GOT to the terminal, set the terminating resistor of the GOT to "110Ω".
When placing the GOT to the position other than the terminal, set the terminating resistor of the GOT to "OPEN".

☞ 1.4.3 Terminating resistors of GOT

*4 Ground a shield correctly.

RS-422/485 connection diagram 4)

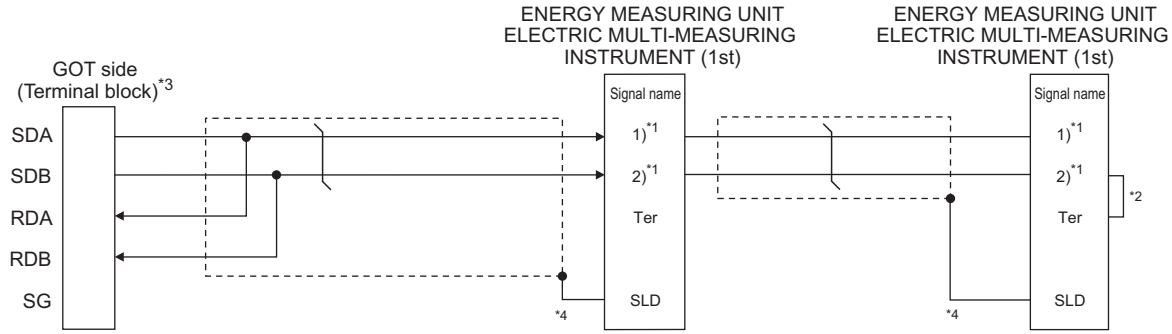

*1 The signal name differs depending on the series name. Refer to the following table.

Series name	Signal name 1)	Signal name 2)
Energy measuring unit	RS485+	RS485-
Electric multi-measuring instrument	T/R+	T/R-

*2 Short-circuit between the following terminals of the energy measuring unit or electric multi-measuring instrument which will be a terminal.

By the short circuit of the following terminals, a terminating resistor with 120Ω is connected.

Series name	Signal name		Signal name
Energy measuring unit	RS485-	< - >	Ter
Electric multi-measuring instrument	T/R-	< - >	Ter

*3 When placing the GOT to the terminal in the system configuration, set the terminating resistor to "110Ω".
When placing the GOT to the position other than the terminal, set the terminating resistor of the GOT to "OPEN".

☞ 1.4.3 Terminating resistors of GOT

Set the 1pair/2pair signal selection switch to "1Pair" when using the connection conversion adapter.

☞ Connection Conversion Adapter User's manual

*4 Ground a shield correctly.

RS-422/485 connection diagram 5)

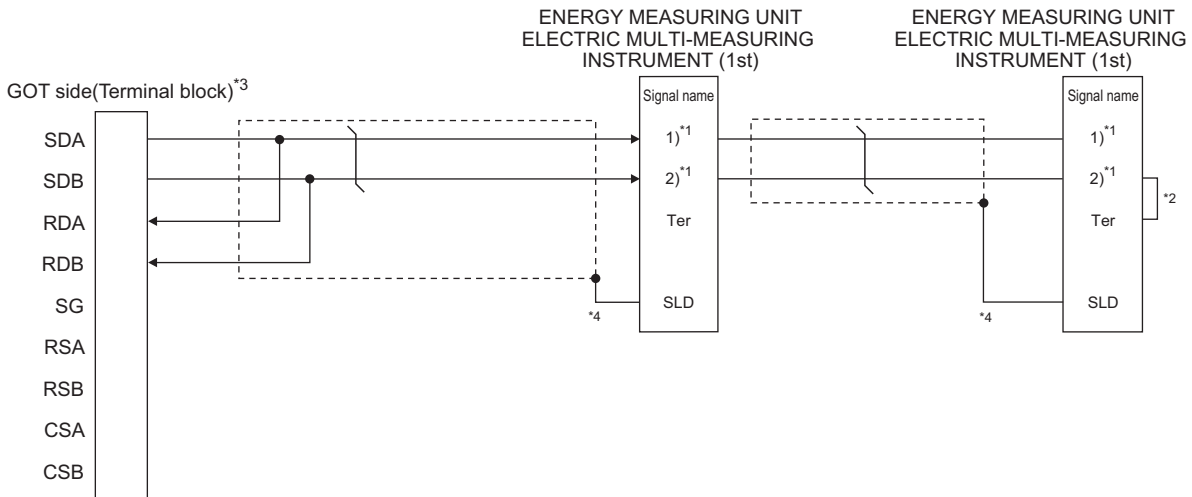

*1 The signal name differs depending on the series name. Refer to the following table.

Series name	Signal name 1)	Signal name 2)
Energy measuring unit	RS485+	RS485-
Electric multi-measuring instrument	T/R+	T/R-

*2 Short-circuit between the following terminals of the energy measuring unit or electric multi-measuring instrument which will be a terminal.

By the short circuit of the following terminals, a terminating resistor with 120Ω is connected.

Series name	Signal name		Signal name
Energy measuring unit	RS485-	< - >	Ter
Electric multi-measuring instrument	T/R-	< - >	Ter

*3 When placing the GOT to the terminal in the system configuration, set the terminating resistor to "110Ω".
When placing the GOT to the position other than the terminal, set the terminating resistor of the GOT to "OPEN".

☞ 1.4.3 Terminating resistors of GOT

*4 Ground a shield correctly.

RS-422/485 connection diagram 6)

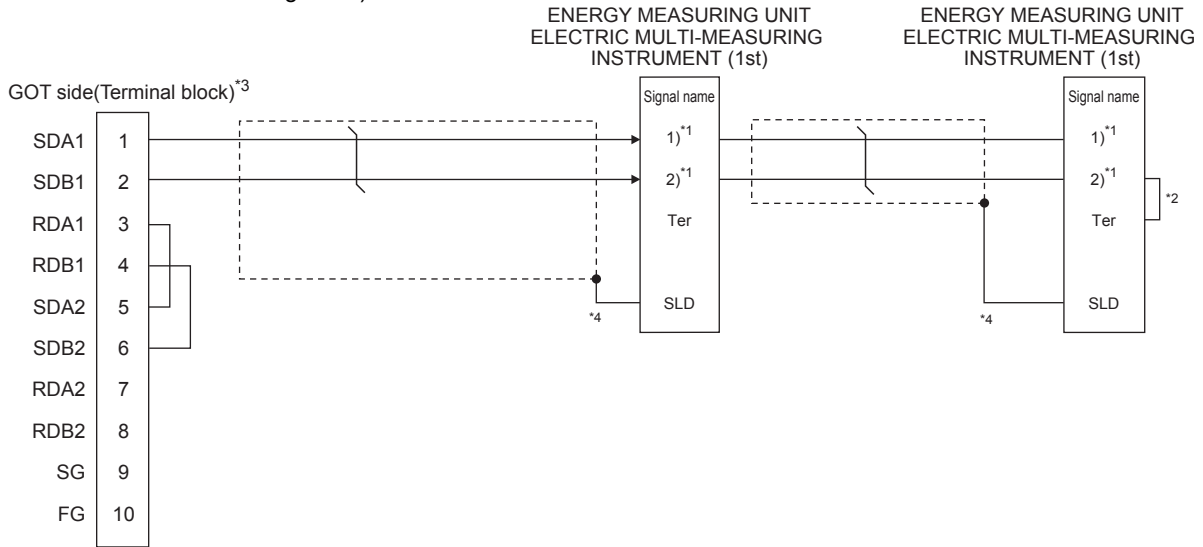

*1 The signal name differs depending on the series name. Refer to the following table.

Series name	Signal name 1)	Signal name 2)
Energy measuring unit	RS485+	RS485-
Electric multi-measuring instrument	T/R+	T/R-

*2 Short-circuit between the following terminals of the energy measuring unit or electric multi-measuring instrument which will be a terminal.

By the short circuit of the following terminals, a terminating resistor with 120Ω is connected.

Series name	Signal name	< - >	Signal name
Energy measuring unit	RS485-	< - >	Ter
Electric multi-measuring instrument	T/R-	< - >	Ter

*3 When placing the GOT to the terminal, set the terminating resistor of the GOT to "Enable".

When placing the GOT to the position other than the terminal, set the terminating resistor of the GOT to "Disable".

1.4.3 Terminating resistors of GOT

*4 Ground a shield correctly.

RS-422/485 connection diagram 7)

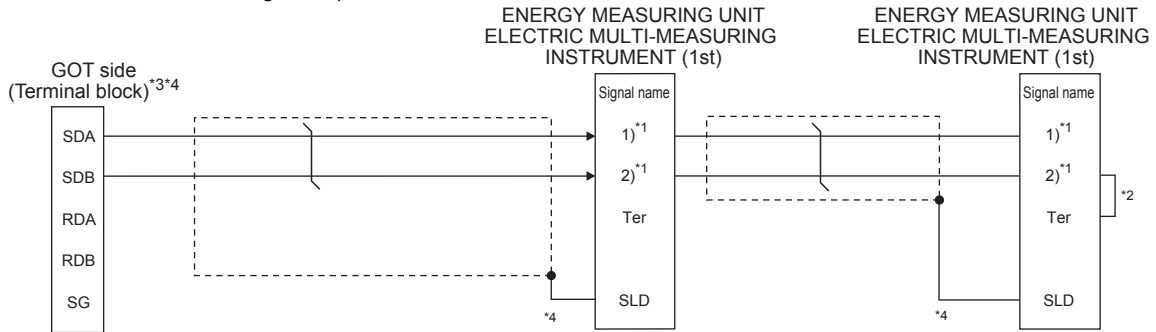

*1 The signal name differs depending on the series name. Refer to the following table.

Series name	Signal name 1)	Signal name 2)
Energy measuring unit	RS485+	RS485-
Electric multi-measuring instrument	T/R+	T/R-

*2 Short-circuit between the following terminals of the energy measuring unit or electric multi-measuring instrument which will be a terminal.

By the short circuit of the following terminals, a terminating resistor with 120Ω is connected.

Series name	Signal name	< - >	Signal name
Energy measuring unit	RS485-	< - >	Ter
Electric multi-measuring instrument	T/R-	< - >	Ter

*3 Set the 2-wire/4-wire terminating resistor setting switch of the RS-232/485 signal conversion adaptor as follows.
2-wire type/4-wire type: 2-wire type (1Pair)

When placing the GOT to the terminal: Set the terminating resistor of the GOT to "110Ω".

When placing the GOT to the position other than the terminal: Set the terminating resistor of the GOT to "OPEN".

1.4.4 Setting the RS-232/485 signal conversion adaptor

*4 For the RS232 setting, check "Enable the 5V power supply".

1.1.2 I/F communication setting

*5 Ground a shield correctly.

■ Precautions when preparing a cable

(1) Cable length

The length of the RS-422/485 cable must be 1,000m or less.

(2) GOT side connector

For the GOT side connector, refer to the following.

 1.4.1 GOT connector specifications

■ Connecting terminating resistors

(1) GOT side

When connecting an energy measuring unit/electric multi-measuring instrument to the GOT, a terminating resistor must be connected to the GOT.

(a) For GT16 body, RS-422/485 communication unit

Set the terminating resistor using the terminating resistor setting switch.

(b) For GT14, GT11, GT10

Set the terminating resistor using the terminating resistor selector.

For the procedure to set the terminating resistor, refer to the following.

 1.4.3 Terminating resistors of GOT

(2) Energy measuring unit/electric multi-measuring instrument side

When connecting an energy measuring unit/electric multi-measuring instrument to the GOT, a terminating resistor must be connected to the energy measuring unit/electric multi-measuring instrument.

For details, refer to the energy measuring unit/electric multi-measuring instrument user's manual.

19.4 GOT Side Settings

19.4.1 Setting communication interface (Communication settings)

Set the channel of the equipment connected to the GOT.

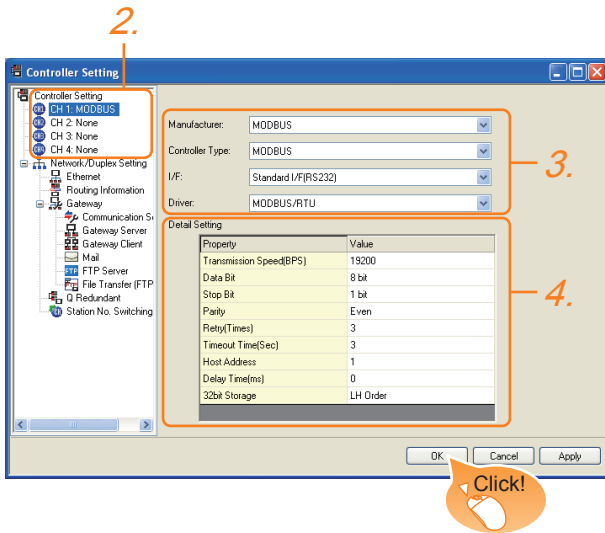

1. Select [Common] → [Controller Setting] from the menu.
2. The Controller Setting window is displayed. Select the channel to be used from the list menu.
3. Set the following items.
 - Manufacturer: MODBUS
 - Controller Type: MODBUS
 - I/F: Interface to be used
 - Driver: MODBUS/RTU
4. The detailed setting is displayed after Manufacturer, Controller Type, I/F, and Driver are set. Make the settings according to the usage environment.

☞ 19.4.2 Communication detail settings

Click the [OK] button when settings are completed.

POINT

The settings of connecting equipment can be set and confirmed in [I/F Communication Setting]. For details, refer to the following.

☞ 1.1.2 I/F communication setting

19.4.2 Communication detail settings

Make the settings according to the setting value of an energy measuring unit/electric multi-measuring instrument to be connected.

Item	Description	Range
Transmission Speed*1	Set this item when change the transmission speed used for communication with the connected equipment. (Default: 19200bps)	9600bps, 19200bps, 38400bps, 57600bps, 115200bps
Data Bit*2	Set this item when change the data length used for communication with the connected equipment. (Default: 8bit)	7bit/8bit
Stop Bit*4	Specify the stop bit length for communications. (Default: 1bit)	1bit/2bit
Parity*4	Specify whether or not to perform a parity check, and how it is performed during communication. (Default: Even)	None Even Odd
Retry	Set the number of retries to be performed when a communication error occurs. (Default: 3times)	0 to 5times
Timeout Time	Set the time period for a communication to time out. (Default: 3sec)	3 to 30sec
Host Address*4	Specify the host address in the connected network. (Default: 1)	1 to 247
Delay Time	Set this item to adjust the transmission timing of the communication request from the GOT. (Default: 0ms)	0 to 300ms
32bit Storage*3	Select the steps to store two words (32-bit data). (Default: LH Order)	LH Order/ HL Order

- *1 Set either of the following values for the transmission speed. [9600bps], [19200bps], [38400bps]
- *2 Set [8bit].
- *3 Set [HL Order].
- *4 Make the settings to match the setting of the energy measuring unit/electronic multi-measuring instrument.

POINT

- (1) Communication interface setting by Utility
The communication interface setting can be changed on the Utility's [Communication setting] after writing [Communication Settings] of project data.
For details on the Utility, refer to the following manual.
☞ User's Manual of GOT used
- (2) Precedence in communication settings
When settings are made by GT Designer3 or the Utility, the latest setting is effective.

19.5 Setting of Energy Measuring Unit/ Electric Multi-measuring Instrument

POINT

Energy measuring unit/electric multi-measuring instrument

For details of the energy measuring unit/electronic multi-measuring instrument, refer to the following manual.

 Energy measuring unit/Electronic multi-measuring instrument User's Manual

Series	Model name	Refer to
Energy measuring unit	EMU4-BD1-MB	19.5.1
	EMU4-HD1-MB	
Electric multi-measuring instrument	ME110SSR-MB	
	ME96NSR-MB	

19.5.1 Connecting to an energy measuring unit/electronic multi-measuring instrument

■ Communication settings

Make the communication settings with the front operation switch on the energy measuring unit/electronic multi-measuring instrument.

Item	Set value
Transmission speed ^{*1*2}	9600bps, 19200bps, 38400bps
Data Bit	8bits (Fixed)
Stop Bit ^{*2}	1bit, 2bits (Default: 1bit)
Parity ^{*2}	NONE/EVEN/ODD (Default: EVEN)
Device address ^{*2}	1 to 247 (Default: 1)

*1 Indicates only the transmission speeds that can be set on the GOT side.

*2 Adjust the settings with GOT settings.

19.5.2 Station number setting

In the MODBUS network, a maximum of 31 energy measuring units/electronic multi-measuring instruments can be connected to 1 GOT.

Assign a non-overlapped station number ranging from 1 to 247 arbitrarily to each energy measuring unit/electronic multi-measuring instrument.

In the system configuration, the energy measuring unit/electric multi-measuring instrument with the station number set with the host address must be included. The station number can be set without regard to the cable connection order. There is no problem even if station numbers are not consecutive.

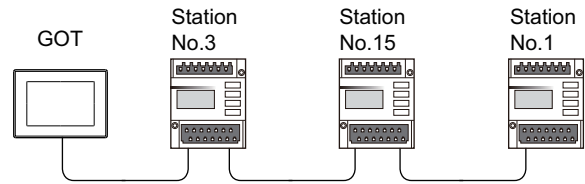

Examples of station number setting

19.6 Device Range that Can Be Set

Device setting items for GT Designer3

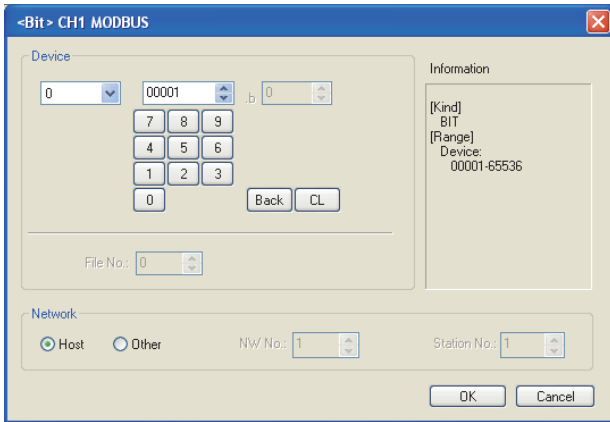

Item	Description			
Device	Set the device name, device number, and bit number. The bit number can be set only when specifying the bit of word device.			
Information	Displays the device type and its setting range selected in [Device].			
Network	Set the station number of the controller to be monitored.			
	<table border="0"> <tr> <td>Host</td> <td>Select this item for monitoring the host controller.</td> </tr> <tr> <td>Other</td> <td>Select this item for monitoring other controllers. After selecting the item, set the station number and network number of the controller to be monitored. NW No.: Set [1]. Station No.: Set the station No.</td> </tr> </table>	Host	Select this item for monitoring the host controller.	Other
Host	Select this item for monitoring the host controller.			
Other	Select this item for monitoring other controllers. After selecting the item, set the station number and network number of the controller to be monitored. NW No.: Set [1]. Station No.: Set the station No.			

Address

GT Designer3 converts the device numbers into decimal format according to the address map of the energy measuring unit/electric multi-measuring instrument to be used.

The table below shows the representations on the MODBUS/RTU communication protocol and GT Designer3.

MODBUS/RTU Communication protocol				Representation on GT Designer3
Device name	Function Code to be used		Address	
	Read	Write		
Holding register	0x03	0x10	0000	400001
			0001	400002
			to	
			FFFE	465535
			FFFF	465536

POINT

Address conversion example

For monitoring the address "031AH" of holding register (Current value of total power) The address of the holding register is displayed as "4*****" on GT Designer3.

GT Designer3 converts the holding register's address "031AH" to "00794" in decimal format.

Then, "+1" is added to this decimal address since the holding register's address on GT Designer3 always starts from "1."

Therefore, the holding register's address "031AH" is displayed as "400795" on GT Designer3.

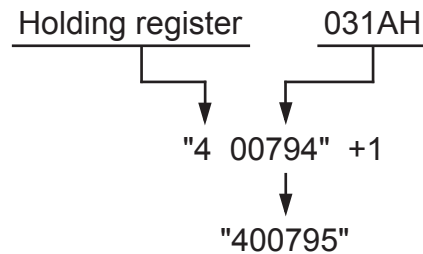

GS device settings

Set the GS device as follows.

$$GS573^{*1} = 2$$

*1 The GS device specifies the maximum number of the holding register read times.

To input the numerical values to the GS device automatically at GOT startup, use the status observation function or the script function. (Setting example of the status observation function)

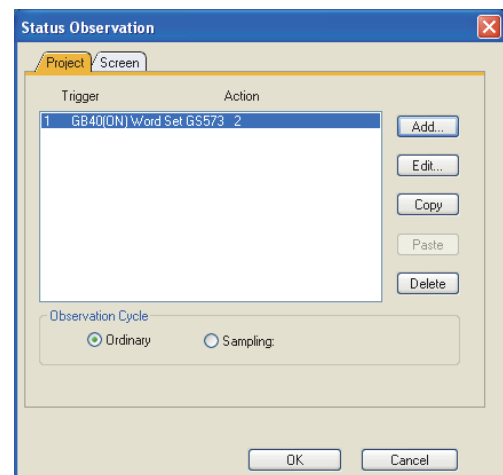

For details of the status observation function or the script function, refer to the following manual.

- GT Designer3 Version1 Screen Design Manual (Drawing)
- 27. STATUS OBSERVATION FUNCTION
- 30. SCRIPT FUNCTION

17
ROBOT CONTROLLER CONNECTION
18
CNC CONNECTION
19
ENERGY MEASURING UNIT/ELECTRIC MULTI-MEASURING INSTRUMENT CONNECTION
20
GOT MULTI-DROP CONNECTION
21
MULTIPLE-GT14, GT12, GT11, GT10 CONNECTION FUNCTION
22
MULTI-CHANNEL FUNCTION
23
FA TRANSPARENT FUNCTION

19.7 Precautions

■ Station number setting of the energy measuring unit/electronic multi-measuring instrument

In the system configuration, the energy measuring unit/electric multi-measuring instrument with the station number set with the host address must be included. For details of host address setting, refer to the following.

 19.4.1 Setting communication interface
(Communication settings)

■ GOT clock control

The settings of "time adjusting" or "time broadcast" made on the GOT will be disabled on the PLC.

■ Cutting the portion of multiple connection of the controller

By setting GOT internal device, GOT can cut the portion of multiple connection of the controller. For example, the faulty station where a communication timeout error occurs can be disconnected from connected equipment. For details of the setting contents of GOT internal device, refer to the following manual.

 GT Designer3 Version1 Screen Design Manual

MULTIPLE GOT CONNECTIONS

20.	GOT MULTI-DROP CONNECTION	20 - 1
21.	MULTIPLE-GT14, GT12, GT11, GT10 CONNECTION FUNCTION CONNECTION	21 - 1

20

GOT MULTI-DROP CONNECTION



20.1 CPU that can be Monitored	20 - 2
20.2 Connectable Model List	20 - 3
20.3 System Configuration	20 - 16
20.4 Connection Diagram	20 - 17
20.5 GOT Side Settings	20 - 25
20.6 Setting of Serial Multi-Drop Connection Unit	20 - 26
20.7 Setting of connection conversion adapter.	20 - 31
20.8 Precautions.	20 - 32

20. GOT MULTI-DROP CONNECTION

20.1 CPU that can be Monitored

The GOT can monitor only a CPU to which a serial multi-drop connection unit (GT01-RS4-M) is connected directly.

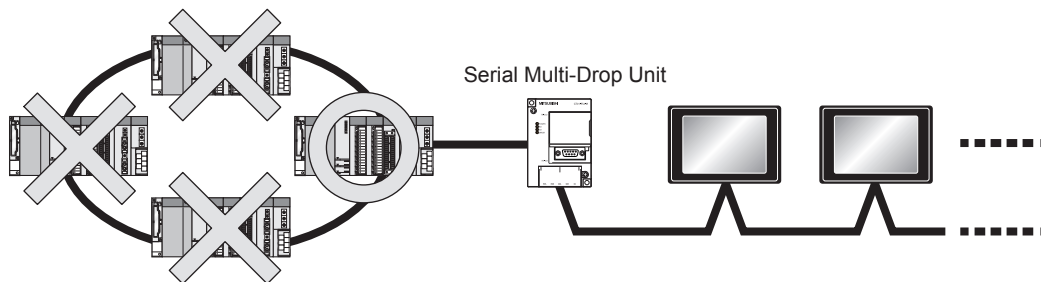

20.2 Connectable Model List

- Connecting the CPU to the Serial Multi-Drop Connection Unit (hereinafter referred to as "master module") directly

The following table shows the connectable models.

Series	Model name	Clock	Communication type		GT 16	GT 15	GT 14	GT 12	GT11 Bus	GT11 Serial	GT 10 5/4	GT 10 20/30
			Between CPU and master module	Between master module and GOT								
MELSEC iQ-R Series	R04CPU	○	RS-232 RS-422	RS-485	x	x	x	x	x	x	x	x
	R08CPU											
	R16CPU											
	R32CPU											
	R120CPU											
	R08PCPU											
	R16PCPU											
	R32PCPU											
	R120PCPU											
	R04ENCPU											
	R08ENCPU											
	R16ENCPU											
	R32ENCPU											
	R120ENCPU											
	R08SF CPU											
R16SF CPU												
R32SF CPU												
R120SF CPU												
Motion controller CPU (MELSEC iQ-R Series)	R16MTCPU	○	RS-232 RS-422	RS-485	x	x	x	x	x	x	x	x
	R32MTCPU											
C Controller module (MELSEC iQ-R Series)	R12CCPU-V	○	RS-232 RS-422	RS-485	x	x	x	x	x	x	x	x
MELSEC iQ-F Series	FX5U	○	RS-232 RS-422	RS-485	x	x	x	x	x	x	x	x
	FX5UC											

(Continued to next page)

Series	Model name	Clock	Communication type		GT 16	GT 15	GT 14	GT 12	GT 11 Bus	GT 11 Serial	GT 10 5□ GT 10 4□	GT 10 20 GT 10 30			
			Between CPU and master module	Between master module and GOT											
MELSEC-Q (Q mode) ⁴	Q00JCPU	○	RS-232 RS-422	RS-485											
	Q00CPU* ¹														
	Q01CPU* ¹														
	Q02CPU* ¹				○		○	○	○	○	×	○	○	○	
	Q02HCPU* ¹														
	Q06HCPU* ¹														
	Q12HCPU* ¹														
	Q25HCPU* ¹														
	Q02PHCPU	○	RS-232 RS-422												
	Q06PHCPU														
	Q12PHCPU				×	×	×	×	×	×	×	×	×	×	
	Q25PHCPU														
	Q12PRHCPU (Main base)	○	-												
	Q25PRHCPU (Main base)														
	Q12PRHCPU (Extension base)	○	-												
	Q25PRHCPU (Extension base)				×	×	×	×	×	×	×	×	×	×	
	Q00UJCPU	○	RS-232 RS-422												
	Q00UCPU														
	Q01UCPU														
	Q02UCPU														
	Q03UDCPU														
	Q04UDHCPU				○			○	○	○	○	×	○	○	○
	Q06UDHCPU														
	Q10UDHCPU														
	Q13UDHCPU														
	Q20UDHCPU														
	Q26UDHCPU														
	Q03UDECPU	○	RS-232												
	Q04UDEHCPU														
	Q06UDEHCPU														
	Q10UDEHCPU														
	Q13UDEHCPU														
	Q20UDEHCPU														
Q26UDEHCPU	○					○	○	○	○	×	○ * ²	○ * ²	○ * ²		
Q50UDEHCPU															
Q100UDEHCPU															
Q03UDVCPU															
Q04UDVCPU															
Q06UDVCPU															
Q13UDVCPU															
Q26UDVCPU															
C Controller module (Q Series)	Q12DCCPU-V ³	○	RS-232												
	Q24DHCCPU-V/VG			○	○	○	○	×	○ * ²	○ * ²	○ * ²				
	Q24DHCCPU-LS														
	Q26DHCCPU-LS			×	×	×	×	×	×	×	×	×			
MELSEC-QS ⁴	QS001CPU	○	-												

(Continued to next page)

- *1 When in multiple CPU system configuration, use CPU function version B or later.
- *2 Access via the (RS-232) in the multiple CPU system.
- *3 Use a module with the upper five digits of the serial No. later than 12042.
- *4 Ww and Wr devices cannot be monitored.

Series	Model name	Clock	Communication type		GT 16	GT 15	GT 14	GT 12	GT 1 Bus	GT 11 Serial	GT 10 5□ 4□	GT 10 20 30
			Between CPU and master module	Between master module and GOT								
MELSEC-L*3	L02CPU*5	○	RS-232 RS-422		○	○	○	○	×	○	○	○
	L06CPU*5											
	L26CPU*5											
	L26CPU-BT*5											
	L02CPU-P*5											
	L06CPU-P*5											
	L26CPU-P*5											
	L26CPU-PBT*5											
MELSEC-Q (A mode)*3	Q02CPU-A	○	RS-232 RS-422		○	○	○	○	×	○	○	○
	Q02HCPU-A											
	Q06HCPU-A											
MELSEC-QnA (QnACPU)*2*3	Q2ACPU	○	RS-422		○	○	○	○	×	○	○	○
	Q2ACPU-S1											
	Q3ACPU	○	RS-422		×	×	×	×	×	×	×	
	Q4ACPU											
MELSEC-QnA (QnASCPU)*2*3	Q2ASCPU	○	RS-422		○	○	○	○	×	○	○	○
	Q2ASCPU-S1											
	Q2ASHCPU											
	Q2ASHCPU-S1											
MELSEC-A (AnCPU)*4	A2UCPU	○	RS-422	RS-485	○	○	○	○	×	○	○	○
	A2UCPU-S1											
	A3UCPU											
	A4UCPU											
	A2ACPU											
	A2ACPUP21											
	A2ACPUR21											
	A2ACPU-S1											
	A2ACPUP21-S1											
	A2ACPUR21-S1											
	A3ACPU											
	A3ACPUP21											
	A3ACPUR21											
	A1NCPU*1											
	A1NCPUP21*1											
	A1NCPUR21*1											
	A2NCPU*1											
	A2NCPUP21*1											
	A2NCPUR21*1											
	A2NCPU-S1*1											
	A2NCPUP21-S1*1											
A2NCPUR21-S1*1												
A3NCPU*1												
A3NCPUP21*1												
A3NCPUR21*1												
MELSEC-A (AnSCPU)*4	A2USCPU	○	RS-422		○	○	○	○	×	○	○	○

(Continued to next page)

*1 When monitoring AnNCPUs or A2SCPU, only the following or later software version is used to write to the CPU.

- AnNCPUs(S1) with link: Version L or later, AnNCPUs(S1) without link: Version H or later
- A2SCPU: Version H or later

*2 GT10 can be connected to CPUs of the following HW versions or later.

PLC type	HW/SW Version	PLC type	HW/SW Version
Q2ACPU	DA	Q2ASCPU	AL
Q2ACPU-S1	DA	Q2ASCPU-S1	AL
Q3ACPU	DA	Q2ASHCPU	BL
Q4ACPU	EA	Q2ASHCPU-S1	BL
Q4ARCPU	AL	-	-

*3 Ww and Wr devices cannot be monitored.

*4 SB, SW, Ww, Wr, ER, and BM devices cannot be monitored.

*5 When connecting in direct CPU connection, the adapter L6ADP-R2 or L6ADP-R4 is required. When using L6ADP-R4, use an LCPU whose upper five digits are "15102" or later.

17 ROBOT CONTROLLER CONNECTION
18 CNC CONNECTION
19 ENERGY MEASURING UNIT/ELECTRIC MULTI-MEASURING INSTRUMENT CONNECTION
20 GOT MULTI-DROP CONNECTION
21 MULTIPLE-GT14, GT12, GT11, GT10 CONNECTION FUNCTION
22 MULTI-CHANNEL FUNCTION
23 FA TRANSPARENT FUNCTION

Series	Model name	Clock	Communication type		GT 16	GT 15	GT 14	GT 12	GT11 Bus	GT11 Serial	GT 10 5□ 4□	GT 10 20 30			
			Between CPU and master module	Between master module and GOT											
MELSEC-A (AnSCPU)*5	A2USCPU-S1	○	RS-422	RS-485											
	A2USHCPU-S1														
	A1SCPU														
	A1SCPUC24-R2														
	A1SHCPU														
	A2SCPU*1							○	○	○	○	×	○	○	○
	A2SHCPU														
	A1SJCPU														
	A1SJCPU-S3														
	A1SJHCPU														
MELSEC-A*5	A0J2HCPU*1	×	RS-422	RS-485											
	A0J2HCPUP21*1														
	A0J2HCPUR21*1														
	A0J2HCPU-DC24*1														
	A2CCPU*1	○	RS-422												
	A2CCPUP21														
	A2CCPUR21														
	A2CCPUC24														
	A2CCPUC24-PRF														
	A2CJCPU-S3														
A1FXCPU															
Motion controller CPU (Q Series)	Q172CPU*2*3	○	RS-232 RS-422	RS-485											
	Q173CPU*2*3														
	Q172CPUN*2														
	Q173CPUN*2														
	Q172HCPU	○	RS-232												
	Q173HCPU														
	Q172DCPU														
	Q173DCPU														
	Q172DCPU-S1														
	Q173DCPU-S1														
	Q172DSCPU														
	Q173DSCPU														
	Q170MCPU	○	RS-232												
	Q170MSCPU														
	Q170MSCPU-S1														
Motion controller CPU (A Series)*5	A273UCPU	○	RS-422												
	A273UHCPU	○	RS-422												
	A273UHCPU-S3														
	A373UCPU	○	RS-422												
	A373UCPU-S3														
	A171SCPU														
	A171SCPU-S3														
	A171SCPU-S3N														

(Continued to next page)

- *1 When monitoring A0J2HCPU or A2CCPU, only the following or later software version is used to write to the CPU.
 - A0J2HCPU (with/without link): Version E or later
 - A0J2HCPU-DC24: Version B or later
 - A2CCPU: Version H or later
- *2 When using SV13, SV22, or SV43, use the motion controller CPU on which any of the following main OS version is installed.
 - SW6RN-SV13Q□: 00E or later
 - SW6RN-SV22Q□: 00E or later
 - SW6RN-SV43Q□: 00B or later
- *3 Use main modules with the following product numbers.
 - Q172CPU: Product number K***** or later
 - Q173CPU: Product number J***** or later
- *4 Access via the (RS-232) in the multiple CPU system.
- *5 SB, SW, Ww, Wr, ER, and BM devices cannot be monitored.

Series	Model name	Clock	Communication type		GT 16	GT 15	GT 14	GT 12	GT11 Bus	GT11 Serial	GT 10 5/4	GT 10 20/30					
			Between CPU and master module	Between master module and GOT													
Motion controller CPU (A Series)*2	A171SHCPU	○	RS-422	RS-485	○	○	○	○	×	○	×	×					
	A171SHCPUN				○	○	○	○	×	○	×	×					
	A172SHCPU				○	○	○	○	×	○	×	×					
	A172SHCPUN				○	○	○	○	×	○	×	×					
	A173UHCPU				○	○	○	○	×	○	×	×					
MELSEC-WS	WS0-CPU0	×	RS-232	RS-485	×	×	×	×	×	×	×	×					
	WS0-CPU1				×	×	×	×	×	×	×	×					
	WS0-CPU3				×	×	×	×	×	×	×	×					
MELSECNET/H remote I/O station	QJ72LP25-25	×	RS-232	RS-485	×	×	×	×	×	×	×	×					
	QJ72LP25G				×	×	×	×	×	×	×	×					
	QJ72BR15				×	×	×	×	×	×	×	×					
CC-Link IE Field Network head module	LJ72GF15-T2	×	-	RS-485	×	×	×	×	×	×	×	×					
CC-Link IE Field Network Ethernet adapter module	NZ2GF-ETB	×	-	RS-485	×	×	×	×	×	×	×	×					
CNC C70	Q173NCCPU	○	RS-232	RS-485	×	×	×	×	×	×	×	×					
Robot controller	CRnQ-700 (Q172DRCPU)	○	RS-232	RS-485	×	×	×	×	×	×	×	×					
	CR750-Q (Q172DRCPU)				×	×	×	×	×	×	×	×					
	CR751-Q (Q172DRCPU)				×	×	×	×	×	×	×	×					
	CR751-Q (Q172DRCPU)				×	×	×	×	×	×	×	×					
MELSEC-FX	FX0	×	RS-422	RS-485	○	○	○	○	×	○	○	○					
	FX0s	×	RS-422	RS-485	○	○	○	○	×	○	○	○					
	FX0N	×	RS-422	RS-485	○	○	○	○	×	○	○	○					
	FX1	×	RS-422	RS-485	○	○	○	○	×	○	○	○					
	FX2	×	RS-422	RS-485	○	○	○	○	×	○	○	○					
	FX2C	*1	RS-422	RS-485	○	○	○	○	×	○	○	○					
	FX1s	○	RS-232 RS-422	RS-485	○	○	○	○	×	○	○	○					
	FX1N				○	○	○	○	×	○	○	○					
	FX2N				○	○	○	○	×	○	○	○					
	FX1NC	○	RS-232 RS-422	RS-485	RS-485	○	○	○	○	×	○	○	○				
	FX2NC					×	*1	RS-232 RS-422	○	○	○	○	×	○	○	○	
	FX3s					○	RS-232 RS-422	RS-485	RS-485	○	○	○	○	×	○	○	○
	FX3G									○	○	○	○	×	○	○	○
	FX3GC									○	○	○	○	×	○	○	○
FX3GE	○									○	○	○	×	○	○	○	
FX3U	○	○	○	○	×					○	○	○					
FX3UC	○	○	○	○	×	○	○	○									

(Continued to next page)

*1 It is available by installing the real time clock function board or the EEPROM memory with the real time clock function.
 *2 SB, SW, Ww, Wr, ER, and BM devices cannot be monitored.

17 ROBOT CONTROLLER CONNECTION
 18 CNC CONNECTION
 19 ENERGY MEASURING UNIT/ELECTRIC MULTI-MEASURING INSTRUMENT CONNECTION
 20 GOT MULTI-DROP CONNECTION
 21 MULTIPLE-GT14, GT12, GT11, GT10 CONNECTION FUNCTION
 22 MULTI-CHANNEL FUNCTION
 23 FA TRANSPARENT FUNCTION

Series	Model name	Clock	Communication type		GT 16	GT 15	GT 14	GT 12	GT11 Bus	GT11 Serial	GT 10 5□4□	GT 10 2□3□
			Between CPU and master module	Between master module and GOT								
FREQROL	FREQROL-A500/A500L	×	RS-485	RS-485								
	FREQROL-F500/F500L											
	FREQROL-V500/V500L											
	FREQROL-E500											
	FREQROL-S500/S500E											
	FREQROL-F500J											
	FREQROL-D700											
	FREQROL-F700PJ											
	FREQROL-E700											
	FREQROL-A700											
	FREQROL-F700											
	FREQROL-F700P											
	FREQROL-A800											
	FREQROL-F800											
Sensorless servo	FREQROL-E700EX											
MELIPM	MD-CX522-□□K(-A0)											
MELSERVO	MR-J2S-□A	×	RS-232 RS-422									
	MR-J2S-□CP											
	MR-J2S-□CL											
	MR-J2M-P8A											
	MR-J2M-□DU											
	MR-J3-□A											
	MR-JE-□A											
	MR-J3-□T											
MR-J4-□A												

■ Connecting the CPU to the Serial Multi-Drop Connection Unit (hereinafter referred to as "master module") in computer link connection

The following table shows the connectable models.

Series	Model name	Clock	Communication type		GT 16	GT 15	GT 14	GT 12	GT 11 Bus	GT 11 Serial	GT 10 5□ 4□	GT 10 20 24□ 30
			Between CPU and master module	Between master module and GOT								
MELSEC iQ-R Series	R04CPU	○	RS-232 RS-422	RS-485	x	x	x	x	x	x	x	x
	R08CPU											
	R16CPU											
	R32CPU											
	R120CPU											
	R08PCPU											
	R16PCPU											
	R32PCPU											
R120PCPU												
Motion controller CPU (MELSEC iQ-R Series)	R16MTCPU	○	RS-232 RS-422	RS-485	x	x	x	x	x	x	x	x
	R32MTCPU											
C Controller module (MELSEC iQ-R Series)	R12CCPU-V	○	RS-232 RS-422	RS-485	x	x	x	x	x	x	x	x
MELSEC iQ-F Series	FX5U	○	RS-232 RS-422	RS-485	x	x	x	x	x	x	x	x
	FX5UC											

(Continued to next page)

Series	Model name	Clock	Communication type		GT 16	GT 15	GT 14	GT 12	GT11 Bus	GT11 Serial	GT 10 5□ 4□	GT 10 20 30		
			Between CPU and master module	Between master module and GOT										
MELSEC-Q (Q mode) ^{*3}	Q00JCPU	○	RS-232 RS-422	RS-485										
	Q00CPU ^{*1}													
	Q01CPU ^{*1}													
	Q02CPU ^{*1}													
	Q02HCPU ^{*1}						○	○	○	○	×	○	○	○
	Q06HCPU ^{*1}													
	Q12HCPU ^{*1}													
	Q25HCPU ^{*1}													
	Q02PHCPU	○	RS-232 RS-422											
	Q06PHCPU													
	Q12PHCPU													
	Q25PHCPU													
	Q12PRHCPU (Main base)	○	-											
	Q25PRHCPU (Main base)													
	Q12PRHCPU (Extension base)	○	-											
	Q25PRHCPU (Extension base)													
	Q00UJCPU	○	RS-232 RS-422											
	Q00UCPU													
	Q01UCPU													
	Q02UCPU													
	Q03UDCPU													
	Q04UDHCPU													
	Q06UDHCPU													
	Q10UDHCPU													
	Q13UDHCPU													
	Q20UDHCPU													
	Q26UDHCPU													
	Q03UDECPU	○	RS-232 RS-422											
	Q04UDEHCPU													
	Q06UDEHCPU													
	Q10UDEHCPU													
	Q13UDEHCPU													
	Q20UDEHCPU													
Q26UDEHCPU														
Q50UDEHCPU														
Q100UDEHCPU														
Q03UDVCPU														
Q04UDVCPU														
Q06UDVCPU														
Q13UDVCPU														
Q26UDVCPU														
C Controller module (Q Series)	Q12DCCPU-V ^{*2}	○	RS-232											
	Q24DHCCPU-V/VG													
	Q24DHCCPU-LS													
	Q26DHCCPU-LS													
MELSEC-QS	○	-												

(Continued to next page)

*1 When in multiple CPU system configuration, use CPU function version B or later.
*2 Use a module with the upper five digits of the serial No. later than 12042.
*3 Ww and Wr devices cannot be monitored.

Series	Model name	Clock	Communication type		GT 16	GT 15	GT 14	GT 12	GT11 Bus	GT11 Serial	GT 10 5□ 4□	GT 10 20 30
			Between CPU and master module	Between master module and GOT								
MELSEC-L*1	L02CPU	○	RS-232 RS-422		○	○	○	○	×	○	○	○
	L06CPU											
	L26CPU											
	L26CPU-BT											
	L02CPU-P											
	L06CPU-P											
	L26CPU-P											
	L26CPU-PBT											
	L02SCPU											
	L02SCPU-P											
MELSEC-Q (A mode)*1	Q02CPU-A	○	RS-232 RS-422		×	×	×	×	×	×	×	×
	Q02HCPU-A											
	Q06HCPU-A											
MELSEC-QnA (QnACPU)*1	Q2ACPU	○	RS-232 RS-422		○	○	○	○	×	○	○	○
	Q2ACPU-S1											
	Q3ACPU											
	Q4ACPU											
MELSEC-QnA (QnASCPU)*1	Q4ARCPU	○	RS-232 RS-422		×	×	×	×	×	×	×	×
	Q2ASCPU											
	Q2ASCPU-S1											
	Q2ASHCPU											
MELSEC-A (AnCPU)	Q2ASHCPU-S1	○	RS-232 RS-422	RS-485	○	○	○	○	×	○	○	○
	A2UCPU											
	A2UCPU-S1											
	A3UCPU											
	A4UCPU											
	A2ACPU											
	A2ACPUP21											
	A2ACPUR21											
	A2ACPU-S1											
	A2ACPUP21-S1											
	A2ACPUR21-S1											
	A3ACPU											
	A3ACPUP21											
	A3ACPUR21											
	A1NCPUR21											
	A1NCPUP21											
	A1NCPUR21											
	A2NCPUR21											
	A2NCPUP21											
	A2NCPUR21											
	A2NCPUR21-S1											
	A2NCPUP21-S1											
	A2NCPUR21-S1											
	A3NCPUR21											
A3NCPUP21												
A3NCPUR21												
MELSEC-A (AnSCPU)	A2USCPU	○	RS-232 RS-422		×	×	×	×	×	×	×	×

*1 Ww and Wr devices cannot be monitored.

(Continued to next page)

17 ROBOT CONTROLLER CONNECTION
18 CNC CONNECTION
19 ENERGY MEASURING UNIT/ELECTRIC MULTI-MEASURING INSTRUMENT CONNECTION
20 GOT MULTI-DROP CONNECTION
21 MULTIPLE-GT14, GT12, GT11, GT10 CONNECTION FUNCTION
22 MULTI-CHANNEL FUNCTION
23 FA TRANSPARENT FUNCTION

Series	Model name	Clock	Communication type		GT 16	GT 15	GT 14	GT 12	GT11 Bus	GT11 Serial	GT 10 5□ 4□	GT 10 20 30		
			Between CPU and master module	Between master module and GOT										
MELSEC-A (AnSCPU)	A2USCPU-S1	○	RS-232 RS-422	RS-485										
	A2USHCPU-S1													
	A1SCPU													
	A1SCPUC24-R2													
	A1SHCPU													
	A2SCPU							x	x	x	x	x	x	x
	A2SHCPU													
	A1SJCPU													
	A1SJCPU-S3													
	A1SJHCPU													
MELSEC-A	A0J2HCPU	x	RS-422	RS-485										
	A0J2HCPUP21													
	A0J2HCPUR21													
	A0J2HCPU-DC24													
	A2CCPU	○	-											
	A2CCPUP21													
	A2CCPUR21													
	A2CCPUC24		RS-232 RS-422		x	x	x	x	x	x	x			
	A2CCPUC24-PRF													
	A2CJCPU-S3													
A1FXCPU	-													
Motion controller CPU (Q Series)	Q172CPU ^{*1*2}	○	RS-232 RS-422	RS-485	○	○	○	○	x	○	○	○		
	Q173CPU ^{*1*2}													
	Q172CPUN ^{*1*2}													
	Q173CPUN ^{*1*2}													
	Q172HCPU	○	RS-232 RS-422											
	Q173HCPU													
	Q172DCPU													
	Q173DCPU													
	Q172DCPU-S1													
	Q173DCPU-S1													
	Q172DSCPU													
	Q173DSCPU													
	Q170MCPU	○	RS-232 RS-422											
Q170MSCPU														
Q170MSCPU-S1														
Motion controller CPU (A Series)	A273UCPU	○	RS-232 RS-422	RS-485	x	x	x	x	x	x	x			
	A273UHCPU	○			x	x	x	x	x	x				
	A273UHCPU-S3													
	A373UCPU	○												
	A373UCPU-S3													
	A171SCPU				x	x	x	x	x	x				
	A171SCPU-S3													
	A171SCPU-S3N													

(Continued to next page)

- *1 When using SV13, SV22, or SV43, use the motion controller CPU on which any of the following main OS version is installed.
 - SW6RN-SV13Q□: 00E or later
 - SW6RN-SV22Q□: 00E or later
 - SW6RN-SV43Q□: 00B or later
- *2 Use main modules with the following product numbers.
 - Q172CPU: Product number K***** or later
 - Q173CPU: Product number J***** or later
- *3 Access via the (RS-232) in the multiple CPU system.

Series	Model name	Clock	Communication type		GT 16	GT 15	GT 14	GT 12	GT11 Bus	GT11 Serial	GT 10 5/4	GT 10 20/30	
			Between CPU and master module	Between master module and GOT									
Motion controller CPU (A Series)	A171SHCPU	○	RS-232 RS-422	RS-485									
	A171SHCPUN												
	A172SHCPU												
	A172SHCPUN												
	A173UHCPU												
A173UHCPU-S1													
MELSEC-WS	WS0-CPU0	×	-	RS-485									
	WS0-CPU1												
	WS0-CPU3												
MELSECNET/H remote I/O station	QJ72LP25-25	×	RS-232 RS-422	RS-485									
	QJ72LP25G												
	QJ72BR15												
CC-Link IE Field Network head module	LJ72GF15-T2	×	-	RS-485									
CC-Link IE Field Network Ethernet adapter module	NZ2GF-ETB	×	-	RS-485									
CNC C70	Q173NCCPU	○	RS-232 RS-422	RS-485									
Robot controller	CRnQ-700 (Q172DRCPU)	○	-	RS-485									
	CR750-Q (Q172DRCPU)												
	CR751-Q (Q172DRCPU)												
	CR751-Q (Q172DRCPU)												
MELSEC-FX	FX0	×	-	RS-485									
	FX0S	×	-	RS-485									
	FX0N	×	-	RS-485									
	FX1	×	-	RS-485									
	FX2	×	-	RS-485									
	FX2C	*1	-	RS-485									
	FX1S	○	-	RS-485									
	FX1N												
	FX2N												
	FX1NC												
	FX2NC	×	-	RS-485									
	FX3S	○	-	RS-485									
	FX3G												
	FX3GC												
FX3GE													
FX3U													
FX3UC													

(Continued to next page)



*1 It is available by installing the real time clock function board or the EEPROM memory with the real time clock function.

17 ROBOT CONTROLLER CONNECTION
18 CNC CONNECTION
19 ENERGY MEASURING UNIT/ELECTRIC MULTI-MEASURING INSTRUMENT CONNECTION
20 GOT MULTI-DROP CONNECTION
21 MULTIPLE-GT14, GT12, GT11, GT10 CONNECTION FUNCTION
22 MULTI-CHANNEL FUNCTION
23 FA TRANSPARENT FUNCTION

Series	Model name	Clock	Communication type		GT 16	GT 15	GT 14	GT 12	GT11 Bus	GT11 Serial	GT 10 5□4□	GT 10 2□3□
			Between CPU and master module	Between master module and GOT								
FREQROL	FREQROL-A500/A500L	×	RS-485	RS-485								
	FREQROL-F500/F500L											
	FREQROL-V500/V500L											
	FREQROL-E500											
	FREQROL-S500/S500E											
	FREQROL-F500J											
	FREQROL-D700											
	FREQROL-F700PJ											
	FREQROL-E700											
	FREQROL-A700											
	FREQROL-F700											
	FREQROL-F700P											
	FREQROL-A800											
	FREQROL-F800											
	Sensorless servo											
MELIPM	MD-CX522-□□K(-A0)											
MELSERVO	MR-J2S-□A	×	RS-232 RS-422									
	MR-J2S-□CP											
	MR-J2S-□CL											
	MR-J2M-P8A											
	MR-J2M-□DU											
	MR-J3-□A											
	MR-JE-□A											
	MR-J3-□T											
	MR-J4-□A											

■ [Controller Type] and [Communication driver] of GT Designer3

The following table shows the [Controller Type] and [Communication driver] of GT Designer3 for which the GOT multi-drop connection is available.

GOT type	PLC ↔ Serial Multi-Drop Connection Unit		
	Connection type	Type	Serial Multi-Drop Connection driver
	DIRECT CONNECTION TO CPU COMPUTER LINK CONNECTION	MELSEC-QnU/DC, Q17nD/M/NC/DR, CRnD-700	Serial(MELSEC)
		MELSEC-QnA/Q/QS, MELDAS C6*	
		MELSEC-Q(MULTI)/Q MOTION	
	DIRECT CONNECTION TO CPU	MELSEC-A	MELSEC-A
		MELSEC-FX	MELSEC-FX
	DIRECT CONNECTION TO CPU COMPUTER LINK CONNECTION	MELSEC-QnU/DC, Q17nD/M/NC/DR	Serial(MELSEC)
		MELSEC-QnA/Q, MELDAS C6*	
		MELSEC-Q(MULTI)/Q MOTION	
	DIRECT CONNECTION TO CPU	MELSEC-A	MELSEC-A
		MELSEC-FX	MELSEC-FX
	DIRECT CONNECTION TO CPU COMPUTER LINK CONNECTION	MELSEC-QnU/DC	Serial(MELSEC)
		MELSEC-QnA/Q	
		MELSEC-Q(MULTI)	
	DIRECT CONNECTION TO CPU	MELSEC-L	MELSEC-A
		MELSEC-FX	MELSEC-FX

POINT

GOT models support the GOT Multi-Drop Connection

The following GOT models support the GOT Multi-Drop Connection.

For the confirming method of hardware version, refer to the following.

 GT□ User's Manual

GOT	Hardware version	Standard monitor OS
GT16, GT15*1, GT14	version A or later	Standard monitor OS[01.12.**]or later
GT1155-QTBD	version C or later	
GT1155-QSBD, GT1150-QLBD	version F or later	
GT1055-QSBD, GT1050-QBBD	version C or later	
GT1045-QSBD, GT1040-QBBD	version A or later	
GT1030-L□D□, GT1030-H□D□	version B or later	
GT1020-L□D□	version E or later	

*1 When connecting GT16/GT15 in multi-drop connection, the writing of the standard monitor OS and communication driver to the GOT from GT Designer3 (Version 1.14Q or later), as well as the writing of the standard monitor OS and communication driver to the serial multi-drop connection unit are required.

For details of the OS installation, refer to the following.

 GT Designer3 Version□ Screen Design Manual (Fundamentals)

20.3 System Configuration

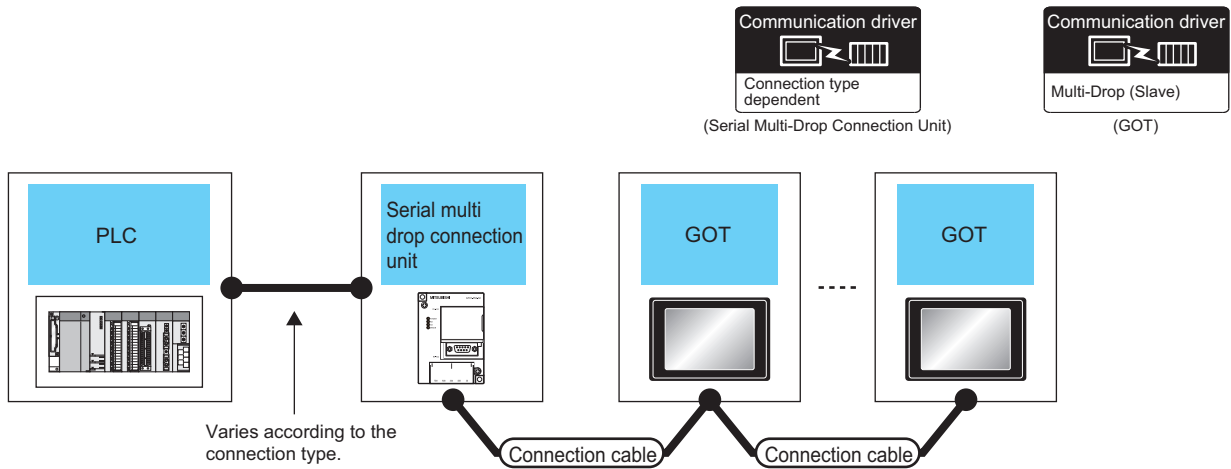

PLC	Serial Multi-Drop Connection Unit		Connection cable	GOT		Max. distance	Number of connectable equipment
	Model	Communication type		Cable model	Option device		
For details of the system configuration between the Serial Multi-Drop Connection Unit and PLC, refer to the corresponding section.	GT01-RS4-M	RS-485	RS485 connection diagram 2)	FA-LTBGTR4CBL05 (0.5m) FA-LTBGTR4CBL10 (1m) FA-LTBGTR4CBL20 (2m)		500m ^{*2}	16 GOTs for Serial Multi-Drop Connection Unit ^{*3}
			RS485 connection diagram 1)	GT15-RS4-9S			
			RS485 connection diagram 3)	GT15-RS4-TE			
			RS485 connection diagram 4)	GT10-9PT5S ^{*1}	 		
				- (Built into GOT)	 		
RS485 connection diagram 5)	GT14-RS2T4-9P ^{*4}						

- *1 Connect it to the RS-422/485 interface (built into GOT).
- *2 The maximum distance from the PLC to the terminal GOT.
- *3 When the number of connected GOTs is increased, the response performance decreases.
- *4 Connect it to the RS-232 interface (built into GOT).
- *5 Cannot be connected to products with input voltage 5V.

20.4 Connection Diagram

The following diagram shows the cable connection between the serial multi-drop connection unit and the GOT.

20.4.1 RS-485 cable

■ Connection diagram

RS485 connection diagram 1)

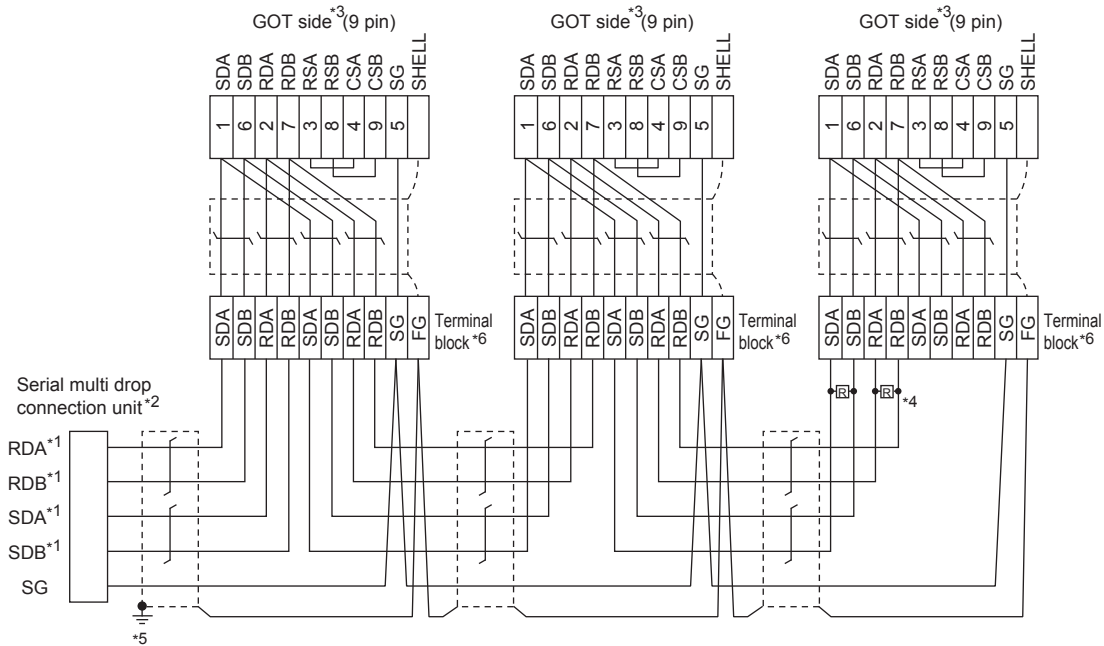

- *1 Use the twisted pair cable for SDA/SDB and RDA/RDB.
- *2 Set the terminating resistor selector to "330Ω".
- *3 Set the terminating resistor setting switch of the GOT main unit to "Disable".
- ☞ 1.4.3 Terminating resistors of GOT
- *4 Connect a 330Ω terminating resistor to the GOT to be a terminal.
- *5 Make sure to ground a cable shield line by applying Class D Grounding.
- *6 For the cable for converting D-sub9 pin connector to terminal block, refer to the following.
- ☞ ■ Precautions when preparing a cable(2)

RS485 connection diagram 2)

(For 1 pair wiring)

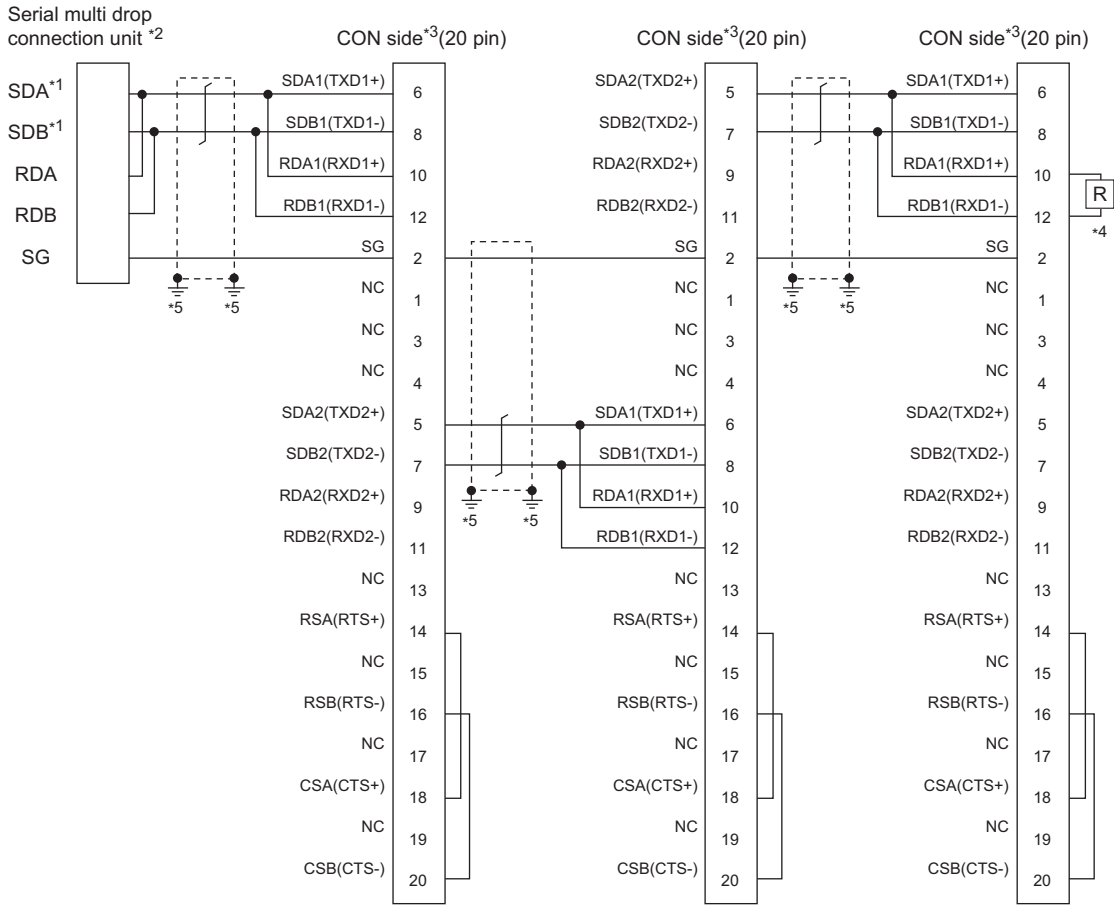

- *1 Use the twisted pair cable for SDA/SDB.
- *2 Set the terminating resistor selector to "110Ω".
- *3 Set the terminating resistor setting switch of the GOT main unit to "Disable".
- ☞ 1.4.3 Terminating resistors of GOT
- *4 Connect a 110Ω terminating resistor to the GOT to be a terminal.
- *5 Make sure to ground a cable shield line by applying Class D Grounding.

RS485 connection diagram 2)

(For 2 pair wiring)

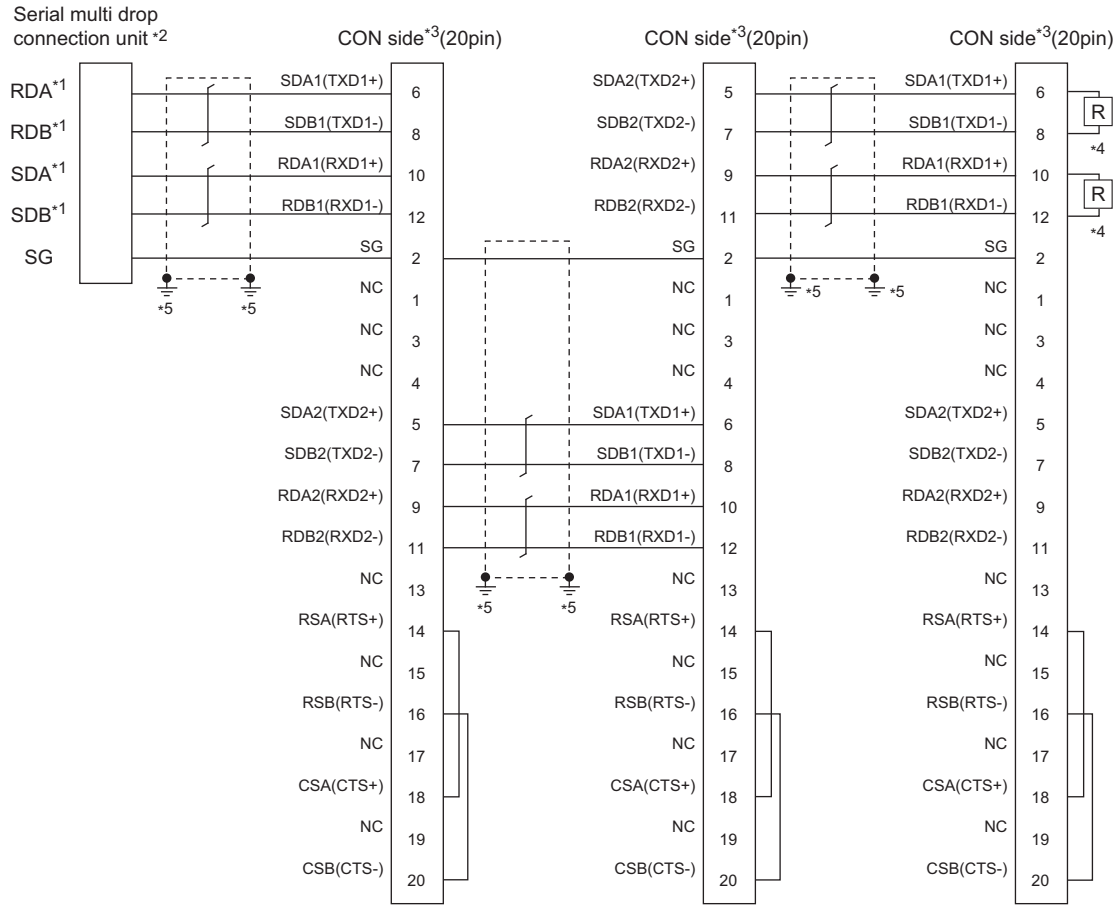

- *1 Use the twisted pair cable for SDA/SDB and RDA/RDB.
 - *2 Set the terminating resistor selector to "330Ω".
 - *3 Set the terminating resistor setting switch of the GOT main unit to "Disable".
- ☞ 1.4.3 Terminating resistors of GOT
- *4 Connect a 330Ω terminating resistor to the GOT to be a terminal.
 - *5 Make sure to ground a cable shield line by applying Class D Grounding.

RS485 connection diagram 3)

(For 1 pair wiring)

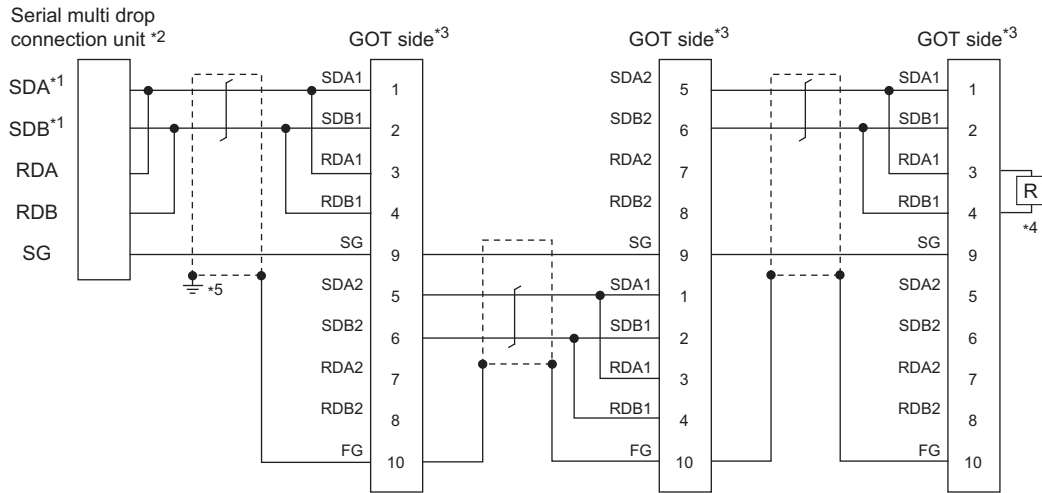

- *1 Use the twisted pair cable for SDA/SDB.
 - *2 Set the terminating resistor selector to "110Ω".
 - *3 Set the terminating resistor setting switch of the GOT main unit to "Disable".
- 1.4.3 Terminating resistors of GOT
- *4 Connect a 110Ω terminating resistor to the GOT to be a terminal.
 - *5 Make sure to ground a cable shield line by applying Class D Grounding.

RS485 connection diagram 3)

(For 2 pair wiring)

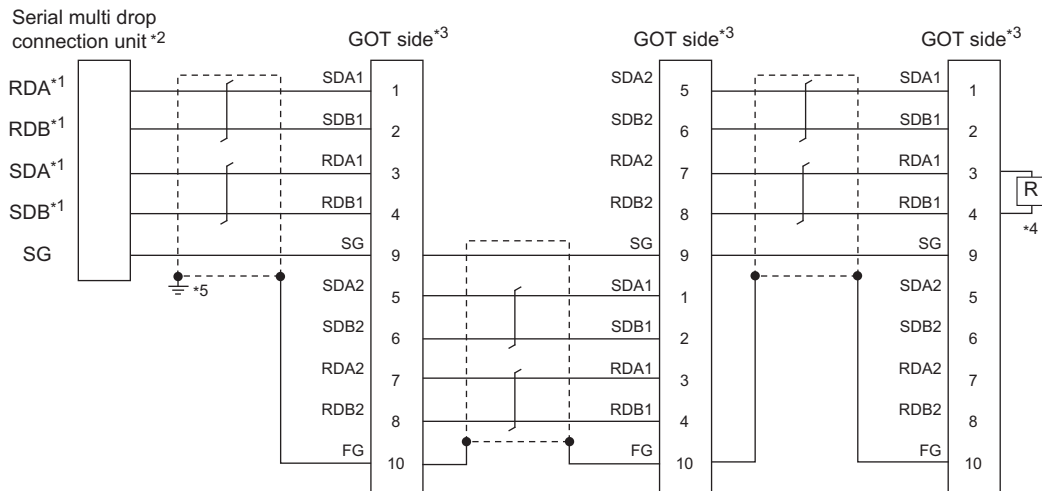

- *1 Use the twisted pair cable for SDA/SDB, RDA/RDB.
 - *2 Set the terminating resistor selector to "330Ω".
 - *3 Set the terminating resistor setting switch of the GOT main unit to "Disable".
- 1.4.3 Terminating resistors of GOT
- *4 Connect a 330Ω terminating resistor to the GOT to be a terminal.
 - *5 Make sure to ground a cable shield line by applying Class D Grounding.

RS485 connection diagram 4)

(For 1 pair wiring)

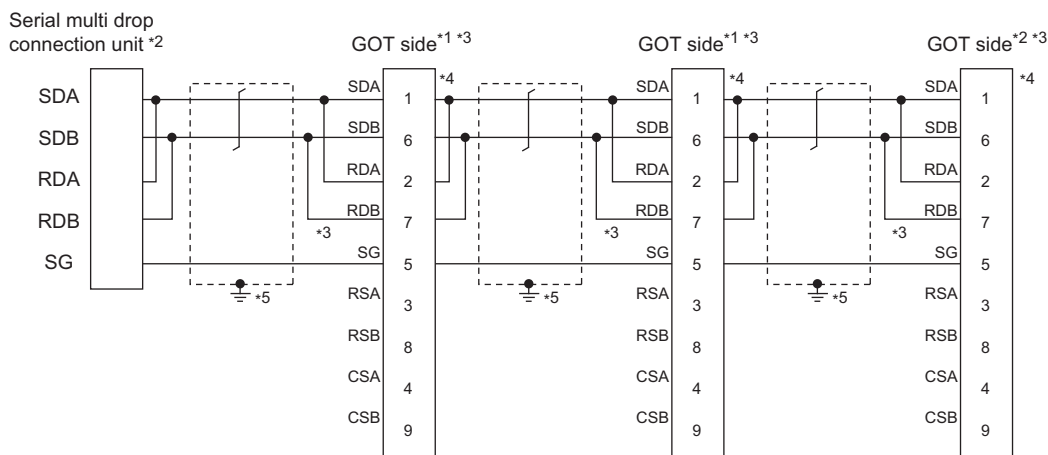

- *1 Set the terminating resistor selector to "OPEN".
- *2 Set the terminating resistor selector to "110Ω".
- 1.4.3 Terminating resistors of GOT
- *3 Set the 1pair/2pair signal selection switch to "1pair" when using the connection conversion adapter. In that case, transition wiring is not necessary between SDA and RDA or SDB and RDB.
- *4 This is the connector pin No. of GT14, GT11, GT105□, or GT104□ main unit.
- *5 Make sure to ground a cable shield line by applying Class D Grounding (100Ω or less).

RS485 connection diagram 4)

(For 2 pair wiring)

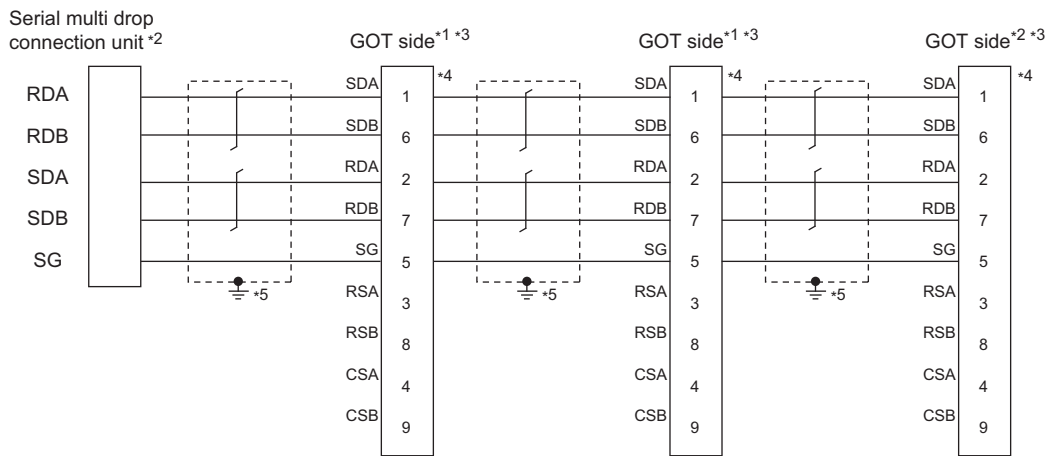

- *1 Set the terminating resistor selector to "OPEN".
- *2 Set the terminating resistor selector to "330Ω".
- 1.4.3 Terminating resistors of GOT
- *3 Set the 1pair/2pair signal selection switch to "2pair" when using the connection conversion adapter.
- *4 This is the connector pin No. of GT14, GT11, GT105□, or GT104□ main unit.
- *5 Make sure to ground a cable shield line by applying Class D Grounding (100Ω or less).

RS485 connection diagram 5)

(For 1 pair wiring)

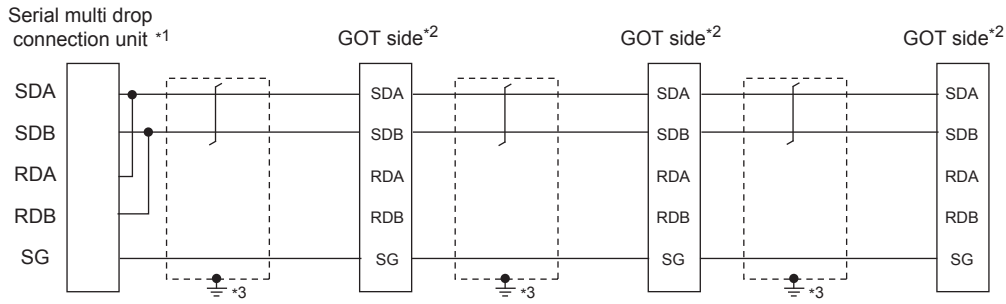

- *1 Set the terminating resistor selector to "110Ω".
 20.6.3 Setting switches
- *2 Set the 2-wire/4-wire terminating resistor setting switch of the RS-232/485 signal conversion adaptor as follows.
 2-wire type/4-wire type: 2-wire type (1Pair)
 - When GOT is a terminal
 Terminating resistor: 110Ω
 - When GOT is not a terminal
 Terminating resistor: OPEN
 1.4.4 Setting the RS-232/485 signal conversion adaptor
- *3 Make sure to ground a cable shield line by applying Class D Grounding (100 or less).

RS485 connection diagram 5)

(For 2 pair wiring)

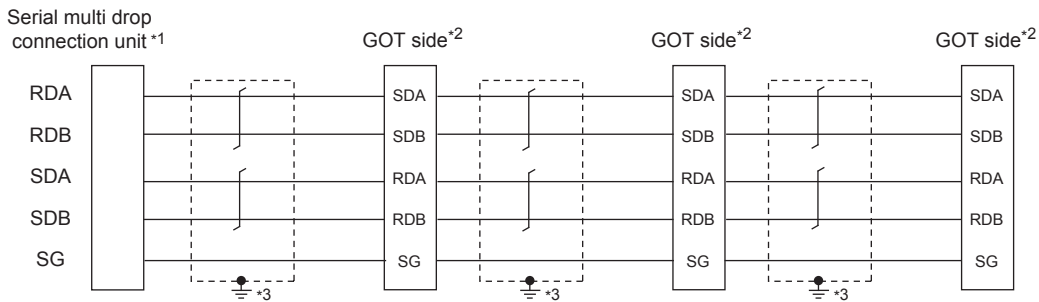

- *1 Set the terminating resistor selector to "110Ω".
 20.6.3 Setting switches
- *2 Set the 2-wire/4-wire terminating resistor setting switch of the RS-232/485 signal conversion adaptor as follows.
 2-wire type/4-wire type: 4-wire type (2Pair)
 - When GOT is a terminal
 Terminating resistor: 330Ω
 - When GOT is not a terminal
 Terminating resistor: OPEN
 1.4.4 Setting the RS-232/485 signal conversion adaptor
- *3 Make sure to ground a cable shield line by applying Class D Grounding (100 or less).

POINT

Mixed wiring with various GOTs

The GOT multi-drop connection can be used with various GOTs mixed.

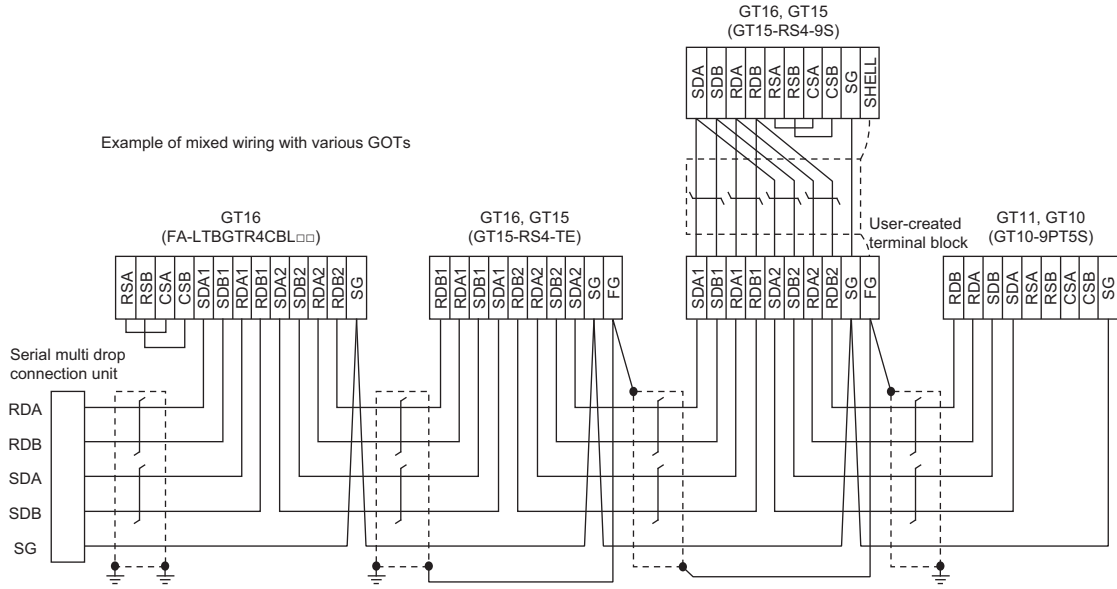

■ Precautions when preparing a cable

(1) Cable

Use a shielded twisted pair cable of 0.3mm² or more as a cable for GOT multi-drop connection. The following shows recommended model names and manufacturers of the cable to be used.

Manufacturer	Model	Remark
MITSUBISHI CABLE INDUSTRIES, LTD.	SPEV(SB)-0.5-2P	Two-pair cable of 0.5mm ²
Showa Electric Wire & Cable Co.,Ltd	KMPEV-SB CWS-178 0.5SQ × 2P	Two-pair cable of 0.5mm ²
Sumitomo Electric Industries.,Ltd	DPEV SB 0.3 × 3P	Three-pair cable of 0.3mm ²
	DPEV SB 0.5 × 3P	Three-pair cable of 0.5mm ²
The Furukawa Electric Co.,Ltd	D-KPEV-SB 0.5 × 3P	Three-pair cable of 0.5mm ²
Fujikura Ltd.	IPEV-SB 2P × 0.3 mm ²	Two-pair cable of 0.3mm ²
	IPEV-SB 2P × 0.5 mm ²	Two-pair cable of 0.5mm ²

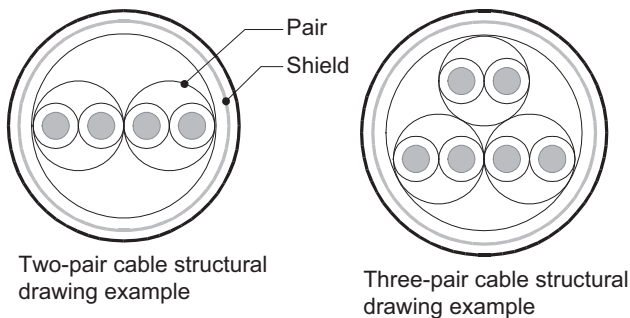

(2) Cable for converting D-sub9 pin connector to terminal block

Create by yourself, referring to the following connection diagram.

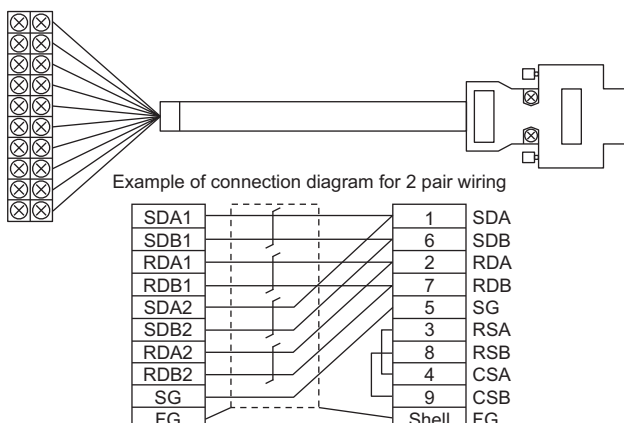

Make sure to connect the wiring branched on the GOT side connector.

Use a shielded twisted pair cable of 0.2mm² or more.

Use an applicable cable to D-sub connector.

Wiring should be the shortest distance.

(3) GOT side connector

For the GOT side connector, refer to the following.

☞ 1.4.1 GOT connector specifications

■ Connecting terminating resistors

When connecting a Serial Multi-Drop Connection Unit to the GOT, a terminating resistor must be connected to the GOT.

(a) For GT16, GT15, GT12

Set the terminating resistor setting switch of the GOT main unit to "Disable".

(b) For GT14, GT11, GT10

Set the terminating resistor selector switch.

For the procedure to set the terminating resistor, refer to the following.

☞ 1.4.3 Terminating resistors of GOT

20.5 GOT Side Settings

20.5.1 Setting communication interface (communication settings)

Set the channel of connecting equipment.

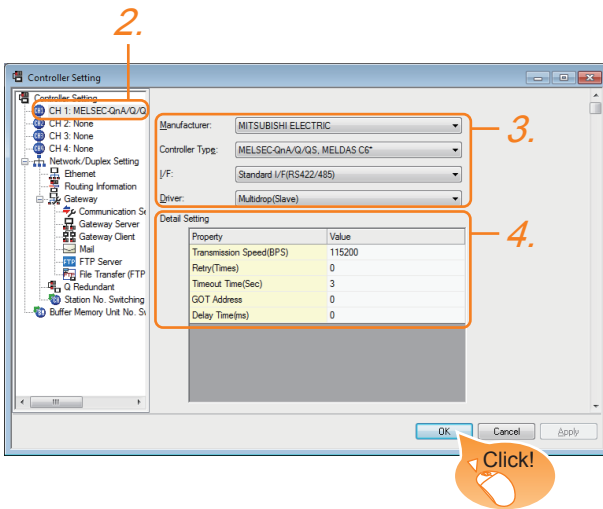

1. Select [Common] → [Controller Setting] from the menu.
2. The Controller Setting window is displayed. Select the channel to be used from the list menu.
3. Set the following items.
 - Manufacturer: Set it according to the connected equipment.
 - Controller Type: Set it according to the connected equipment.
 - I/F: Interface to be used
 - Driver: Multi-Drop (slave)
4. The detailed setting is displayed after Manufacturer, Controller Type, I/F, and Driver are set. Make the settings according to the usage environment.

☞ 20.5.2 Communication detail settings

Click the [OK] button when settings are completed.

POINT

The settings of connecting equipment can be confirmed in [I/F Communication Setting]. For details, refer to the following.

☞ 1.1.2 I/F communication setting

20.5.2 Communication detail settings

Make the settings according to the usage environment.

Property	Value
Transmission Speed(BPS)	115200
Retry(Times)	0
Timeout Time(Sec)	3
GOT Address	0
Delay Time(ms)	0

Item	Description	Range
Transmission Speed	Set this item when change the transmission speed used for communication with the connected equipment. (Default: 115200bps)	4800bps, 9600bps, 19200bps, 38400bps, 57600bps, 115200bps
Retry	Set the number of retries to be performed when a communication timeout occurs. When receiving no response after retries, the communication times out. (Default: 0time)	0 to 5times
Timeout Time	Set the time period for a communication to time out. (Default: 3sec)	3 to 30sec
GOT Address	Specify the station number of the host station in the system configuration. (Default: 0)	0 to 15
Delay Time	Set this item to adjust the transmission timing of the communication request from the GOT. (Default: 0ms)	0 to 300 ms

POINT

- (1) Communication interface setting by Utility
The communication interface setting can be changed on the Utility's [Communication Settings] after writing [Communication Settings] of project data.
For details on the Utility, refer to the following manual.

☞ GT□ User's Manual

- (2) Precedence in communication settings
When settings are made by GT Designer3 or the Utility, the latest setting is effective.

20.6 Setting of Serial Multi-Drop Connection Unit

20.6.1 Write the OS

Write the standard monitor OS and communication driver according to the desired connection type onto the serial multi-drop connection unit.

For the OS writing methods, refer to the following manual.

 GT Designer3 Version□ Screen design manual

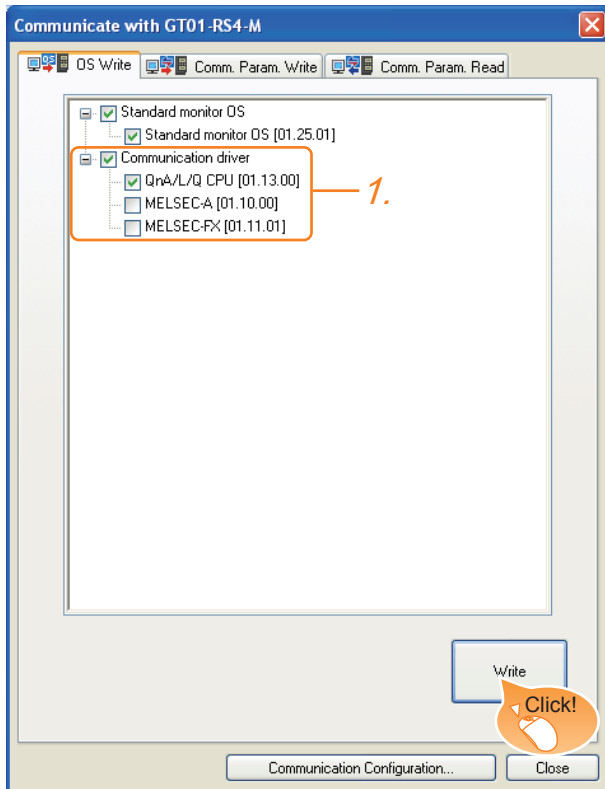

1. Check-mark a communication driver according to the desired connection type and click the [Write] button.

20.6.2 Setting communication interface (Communication settings)

Make the Serial Multi-Drop Connection Unit interface setting on [Communication with GT01-RS4-M] of GT Designer 3.

For the communication interface driver, set the same communication driver as the serial multi-drop connection.

For details on [Communication with GT01-RS4-M] of GT Designer3, refer to the manuals.

 GT Designer3 Version□ Screen design manual

Controller setting

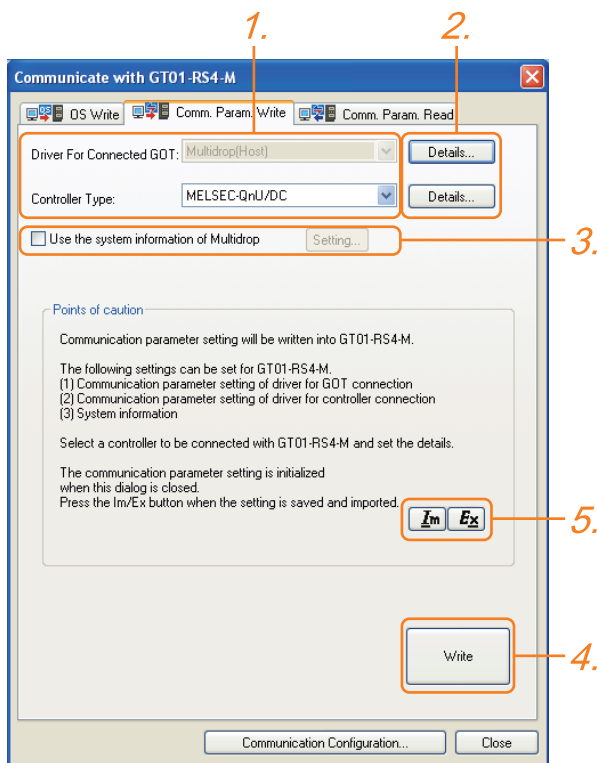

1. Set the following to the driver for the connected equipment.
 - Connection type dependent

The driver for connection with the GOT is fixed to the following one.

 - Multi-drop(Host)
2. Perform the detailed settings for the driver.
 - ☞ ■ Communication detail settings
3. Set [Use the system information of Multidrop] as necessary.
 - ☞ ■ Setting the multi-drop system information function
4. Click the [Write] button when settings are completed.
5. If the [Communication with GT01-RS4-M] dialog box is closed, communication setting contents for GT01-RS4-M does not remain.
 - To maintain the communication setting contents, click **Ex** (export).
 - ☞ ■ Exporting/Importing the communication setting contents
 - To use communication setting contents which are saved previously, click **Im** (import).
 - ☞ ■ Exporting/Importing the communication setting contents

Setting the multi-drop system information function

When checking the connection status of each GOT which is connected to GT01-RS4-M on the PLC side, set the multi-drop system information function. The GOT connection status is stored in the PLC side word device.

(1) Setting on the PLC side word device

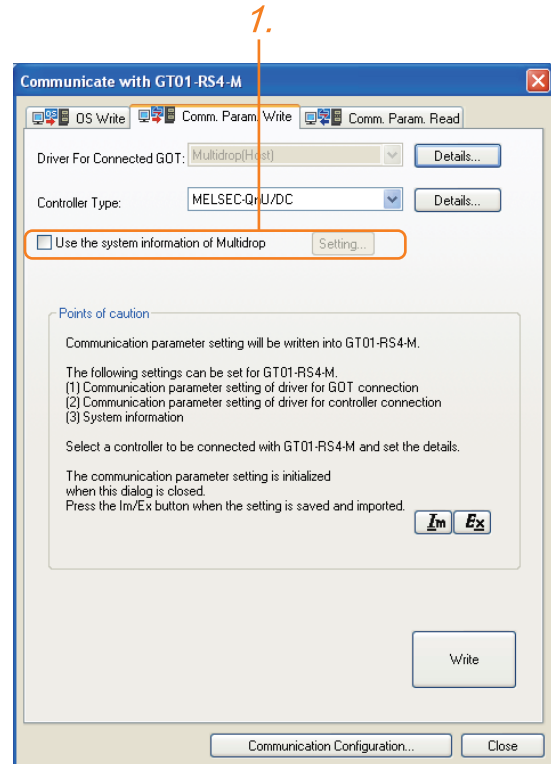

1. Select [Use the system information of Multidrop] and click the [Set] button. The following dialog window is displayed.

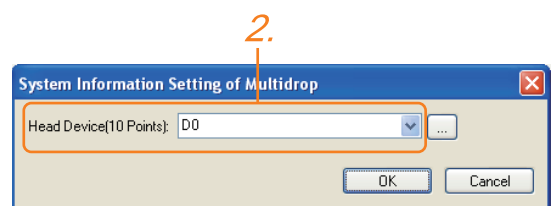

2. Set the PLC side word device to [Head Device (10 Points)]. In this example, "D0" is set.

(2) Assignment contents of the PLC side word device
 The following table shows the device assignment contents when setting [Head Device (10 Points)] to "D0".

Device	Description
D0 (Head device+0)	Control signal 1-1
D1(Head device+1)	Station information notification signal
D2(Head device+2)	(Reserve)
D3(Head device+3)	(Reserve)
D4(Head device+4)	(Reserve)
D5(Head device+5)	Slave station control signal
D6(Head device+6)	(Reserve)
D7(Head device+7)	(Reserve)
D8(Head device+8)	(Reserve)
D9(Head device+9)	(Reserve)

(3) Details on the word device assignment contents

(a) Control signal 1-1

Bit position	Description
bit0	10 second cycle flicker signal
bit1 to 15	(Reserve)

< 10 second cycle flicker signal *1 >

By the repetition of turning ON/OFF every 5 seconds, the connection between GT01-RS4-M and the PLC can be confirmed on the PLC side. When no repetition of this ON/OFF is observed, GT01-RS4-M is not connected to the PLC.

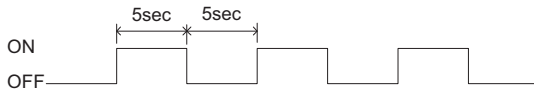

*1 When writing or clearing data on the program area from the personal computer to the PLC using FA transparent function, flicker of the signal as shown above may be temporarily stopped.

(b) Station information notification signal *2

This signal notifies the status of the slave station (GOT) which is connected to the master station (GT01-RS4-M). Only the bit corresponding to the number of connected slave station (GOT) is turned ON and other bits are turned OFF.

bit15	bit14	bit2	bit1	bit0
Station No. 15	Station No. 14	Station No. 2	Station No. 1	Station No. 0

- 1: Connected
- 0: Unconnected (Including communication error status)

*2 When the communication between GT01-RS4-M and the PLC becomes faulty, the station information notification signal is not updated.

(c) Slave station control signal

This signal controls slave stations which are not updated by the master station.

Usually, the master station accesses all stations (up to 16 stations). In addition, if stations are temporarily in communication error due to a power disconnection or screen data transfer during the steady operation, the automatic recovery of the station is executed for one station per ten seconds. Therefore, the automatic recovery may take maximum 2 minutes and 30 seconds.

Using this control signal, the number of slave stations to be monitored by the master station can be reduced to the actual number of slave stations to be used by a user. This makes the automatic recovery processing smooth. If an error occurs in only one station, the time for the station to recover automatically can be reduced within 10 seconds.

Device value	Action												
0	The master station accesses all the slave stations (station 0 to 15). When the multi-drop system information is not used, the operation is the same.												
Other than 0	Turning on the bit corresponding to a station No. disconnects the specified slave station from the master station.												
	<table border="1"> <thead> <tr> <th>bit15</th> <th>bit14</th> <th>.....</th> <th>bit2</th> <th>bit1</th> <th>bit0</th> </tr> </thead> <tbody> <tr> <td>Station No. 15</td> <td>Station No. 14</td> <td>.....</td> <td>Station No. 2</td> <td>Station No. 1</td> <td>Station No. 0</td> </tr> </tbody> </table>	bit15	bit14	bit2	bit1	bit0	Station No. 15	Station No. 14	Station No. 2	Station No. 1	Station No. 0
bit15	bit14	bit2	bit1	bit0								
Station No. 15	Station No. 14	Station No. 2	Station No. 1	Station No. 0								
	1...Connected 0...Unconnected												

When the bits are off and the master station and the slave stations are in communication, the communication with the corresponding slave stations is disconnected if the above corresponding bits are turned on.

■ Exporting/Importing the communication setting contents

(1) **Ex** Export

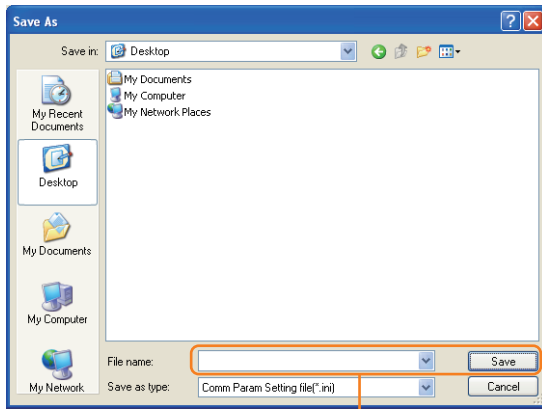

1. After determining the storage location as necessary, name the file and save it. The file format is [*.ini] (fixed).

(2) **Im** Import

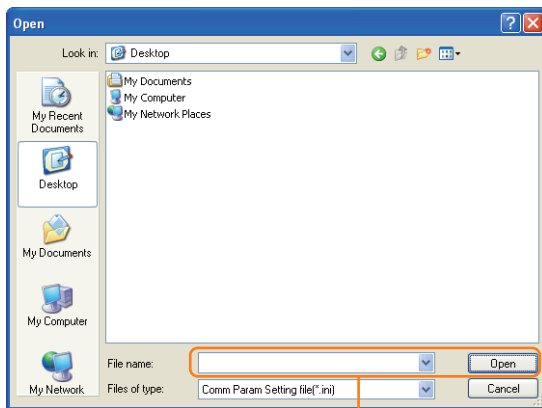

1. Enter the name of the file previously saved and open the file. The file format is [*.ini] (fixed).

■ Communication detail settings

Make the settings according to the usage environment.

(3) For the connection with GOT

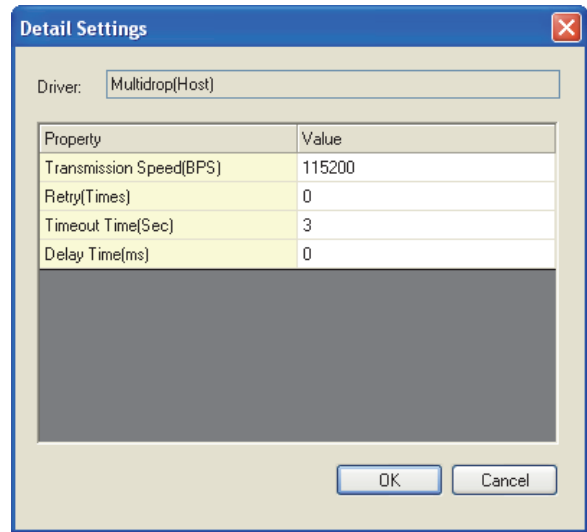

Item	Description	Range
Transmission Speed	Set this item when change the transmission speed used for communication with the connected equipment. (Default: 115200bps)	4800bps, 9600bps, 19200bps, 38400bps, 57600bps, 115200bps
Retry	Set the number of retries to be performed when a communication timeout occurs. When receiving no response after retries, the communication times out. (Default: 0time)	0 to 5times
Timeout Time	Set the time period for a communication to time out. (Default: 3sec)	3 to 30sec
Delay Time	Set this item to adjust the transmission timing of the communication request from the GOT. (Default: 0ms)	0 to 300 ms

(4) For the connected equipment

Set the communication detail settings of the driver for controllers according to the connection type.

☞ Refer to each chapter.

20.6.3 Setting switches

Set the switches according to the connection type.

POINT

Serial Multi-Drop Connection Unit

For details on the Serial Multi-Drop Connection Unit, refer to the following manual.

➔ Serial Multi-Drop Connection Unit User's Manual

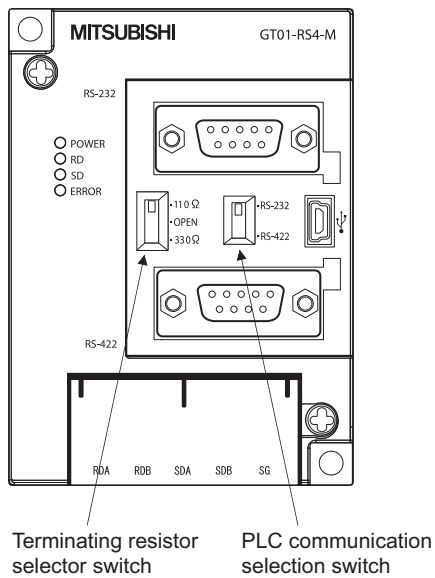

20.7 Setting of connection conversion adapter

20.7.1 Setting switches

Set the switches according to the connection type.

POINT

Connection conversion adapter

For details on the connection conversion adapter, refer to the following manual.

 Connection Conversion Adapter User's manual

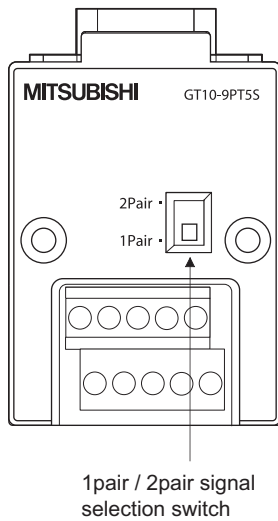

20.8 Precautions

■ Connecting GT16 and GT15 in multi-drop connection

- (1) Standard monitor OS installation, Writing Communication driver
When connecting GT16/GT15 in multi-drop connection, the writing of the standard monitor OS and communication driver to the GOT from GT Designer3 (Version 1.12N or later), as well as the writing of the standard monitor OS and communication driver to the serial multi-drop connection unit are required.
- (2) Device specification
Network No. and station No. are not supported.

■ Station number setting on GOT

Set each station number so that no station number overlaps. When the station No. is duplicated, the GOT whose station No. is duplicated cannot be monitored normally.
The station number can be set without regard to the cable connection order. There is no problem even if station numbers are not consecutive.

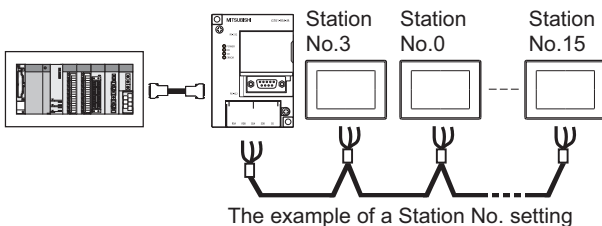

■ Extended/Option function of GOT

The extended/option functions of GOT shown below are not available.
System monitor, Device monitor, Ladder monitor, A list editor, FX list editor, Intelligent unit monitor, Network monitor, Q motion monitor, Servo amplifier monitor, CNC monitor, Backup/restore, CNC data I/O, SFC monitor, Ladder editor, Log viewer, MELSEC-L troubleshoot, Motion SFC, motion program (SV43) editor, Motion program (SV43) I/O

■ System alarm (GT16, GT15, GT14, GT11)

The alarms of the serial multi-drop connection unit are displayed on the system alarm. The alarms of the connected PLC are not displayed.

■ Activating the serial multi-drop connection unit

The master module detects a slave GOT, which is connected, at the startup. It may take time to detect again the slave station which is not detected at this point. Activate the master module in the condition that a communication can be made after the startup of the slave GOT.

■ Using the multi-drop connection in the multi-channel configuration

If a communication timeout error occurs when using the multi-drop connection in the multi-channel configuration, set the send delay time to the serial multi-drop connection unit side.

 ■ Communication detail settings

■ Device update cycle

- When the number of connected slave GOTs and the device points of each GOT increase, the device update cycle on the screen may get slower. In such a case, it is recommended to reduce the device points of each GOT. (Please consider 250 points as a guide of 1 GOT, and 750 points as a guide of the total points.) In addition, when a timeout error occurs, make the timeout time longer in the communication settings of the slave GOT.
- When the device number is set randomly, the device update cycle becomes slower compared to the case that the device number is set consecutively. Therefore, it is recommended to set the device number consecutively.
- Depending on the device points or combination, it may take time to switch the screen. At this time, the device update cycle of other slave station is also affected.

■ FA transparent function

FA transparent function is available for each GOT in the GOT multi-drop connection system.

- (1) Standard monitor OS installation, Writing Communication driver
When using FA transparent function in GOT multi-drop connection, the writing of the standard monitor OS and communication driver to the GOT from GT Designer3 (Version 1.18U or later), as well as the writing of the standard monitor OS and communication driver to the serial multi-drop connection unit are required.
- (2) Number of personal computers
Only one personal computer can be connected to the multi-drop connection system.

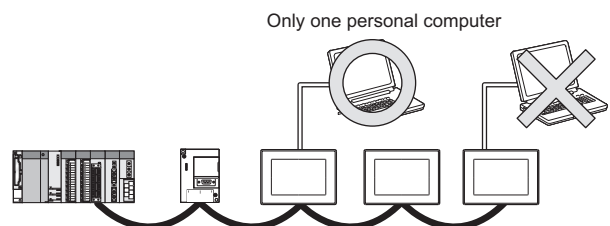

(3) Monitor speed of GOT

The monitoring performance slows down according to the number of monitoring GOTs. While using FA transparent function, the monitoring performance of the whole multi-drop system decreases. As a result, timeout error may occur in GOTs in the system.

21

MULTIPLE-GT14, GT12, GT11, GT10 CONNECTION FUNCTION



21.1 Connectable Model List	21 - 2
21.2 System Configuration	21 - 2
21.3 Connection Diagram	21 - 5
21.4 GOT Side Settings	21 - 7
21.5 Precautions	21 - 11

21. MULTIPLE-GT14, GT12, GT11, GT10 CONNECTION FUNCTION

21.1 Connectable Model List

For details of connectable models, refer to the following.

- ☞ 6. DIRECT CONNECTION TO CPU
- ☞ 7. COMPUTER LINK CONNECTION





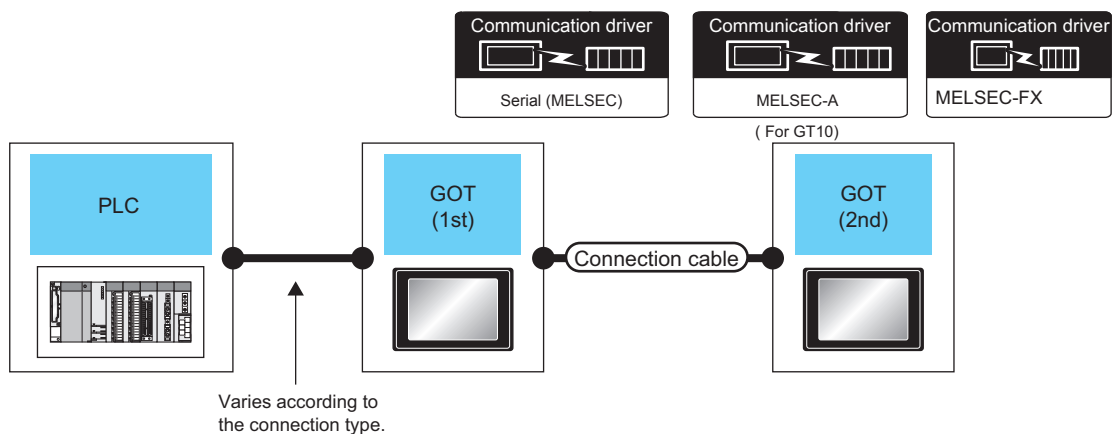



21.2 System Configuration

21.2.1 Connecting the GOT to PLC via RS-232 interface



PLC		GOT (1st) *1		Connection cable			GOT (2nd) *1		Number of connectable equipment
Connection type	Communication type	Option device	Model	Communication type	Cable model	Max. distance	Option device	Model	
For the system configuration between a got and A plc, refer to the following. ☞ DIRECT CONNECTION TO CPU ☞ COMPUTER LINK CONNECTION*4	RS-232	- (Built into GOT)		RS-422	RS-422 connection diagram 1)	30m	- (Built into GOT)		2 GOTs
		- (Built into GOT)		RS-422	RS-422 connection diagram 1)	30m	- (Built into GOT)		
		- (Built into GOT)		RS-422	RS-422 connection diagram 1)	30m	- (Built into GOT)		
		- (Built into GOT)		RS-422	RS-422 connection diagram 1)	30m	- (Built into GOT)		
		- (Built into GOT)		RS-232	GT10-C30R2-6P(3m)*3 GT10-C02H-6PT9P (0.2m) + RS-232 connection diagram 4)	3m 15m	- (Built into GOT)	 *2	

(Continued to next page)

PLC		GOT (1st) *1		Connection cable			GOT (2nd) *1		Number of connectable equipment
Connection type	Communication type	Option device	Model	Communication type	Cable model	Max. distance	Option device	Model	
For the system configuration between a got and A plc, refer to the following.  DIRECT CONNECTION TO CPU  COMPUTER LINK CONNECTION*4	RS-232	- (Built into GOT)		RS-422	 RS-422 connection diagram 2)	30m	- (Built into GOT)	 *5	2 GOTs
		- (Built into GOT)		RS-232	GT01-C30R2-6P(3m) GT10-C02H-6PT9P (0.2m) +  RS-232 connection diagram 5)	3m 15m	- (Built into GOT)		

- *1 When GT14, GT12, GT11 and GT10 are intermingled, the Multiple connection function is not supported.
- *2 The 2nd GOT must be a RS-232 built-in product.
- *3 For the connection to GOT, refer to the connection diagram. ( RS-232 connection diagram 2))
- *4 When connected to the Computer link, the multiple connection function supports only RCPUCPU, QCPU (Q mode), Motion controller CPU (Q mode), LCPUCPU.
- *5 The 2nd GOT must be a GT10 (input power supply: 24V) RS-422 built-in product.

17	ROBOT CONTROLLER CONNECTION
18	CNC CONNECTION
19	ENERGY MEASURING UNIT/ELECTRIC MULTI-MEASURING INSTRUMENT CONNECTION
20	GOT MULTI-DROP CONNECTION
21	MULTIPLE-GT14, GT12, GT11, GT10 CONNECTION FUNCTION
22	MULTI-CHANNEL FUNCTION
23	FA TRANSPARENT FUNCTION

21.2.2 Connecting the GOT to PLC via RS-422 interface

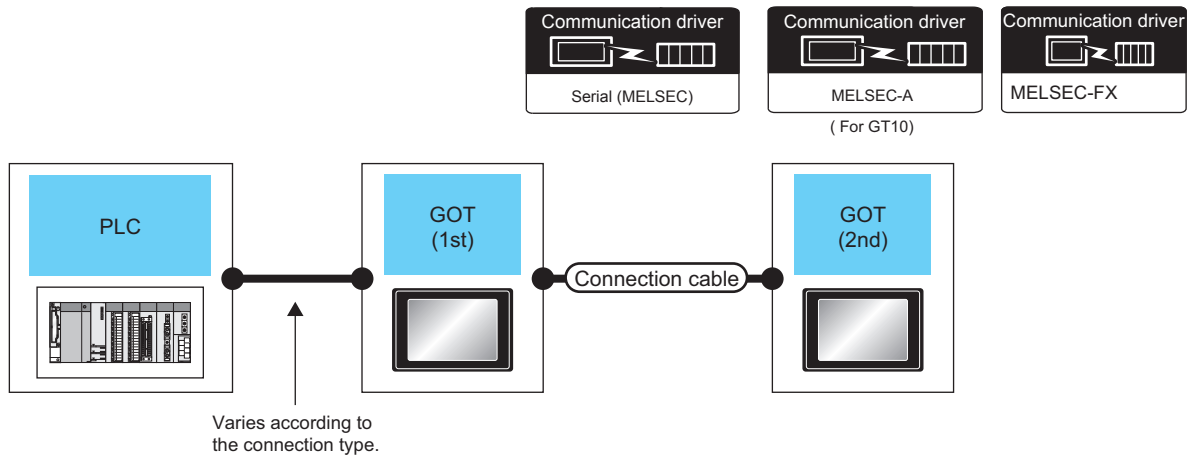

PLC		GOT (1st) *1		Connection cable			GOT (2nd) *1		Number of connectable equipment
Connection type	Communication type	Option device	Model	Communication type	Cable model	Max. distance	Option device	Model	
For the system configuration between a got and A plc, refer to the following. DIRECT CONNECTION TO CPU COMPUTER LINK CONNECTION*4	RS-422	- (Built into GOT)	GT14	RS-232	GT01-C30R2-9S(3m) or User RS-232 connection diagram 1)	15m	- (Built into GOT)	GT14	2 GOTs
		- (Built into GOT)	GT12	RS-232	GT01-C30R2-9S(3m) or User RS-232 connection diagram 1)	15m	- (Built into GOT)	GT12	
		- (Built into GOT)	GT11 Serial	RS-232	GT01-C30R2-9S(3m) or User RS-232 connection diagram 1)	15m	- (Built into GOT)	GT11 Serial	
		- (Built into GOT)	GT10 5□4□	RS-232	GT01-C30R2-9S(3m) or User RS-232 connection diagram 1)	15m	- (Built into GOT)	GT10 5□4□	
		- (Built into GOT)	GT10 20□30□	RS-232	GT10-C30R2-6P(3m) *3 GT10-C02H-6PT9P (0.2m) + User RS-232 connection diagram 4)	3m 15m	- (Built into GOT)	GT10 20□30□ *2	
		- (Built into GOT)	GT10 5□4□	RS-232	User RS-232 connection diagram 3)	15m	- (Built into GOT)	GT10 20□30□ *2	
		- (Built into GOT)	GT10 20□30□	RS-232	GT01-C30R2-6P(3m) GT10-C02H-6PT9P (0.2m) + User RS-232 connection diagram 5)	3m 15m	- (Built into GOT)	GT10 5□4□	

*1 When GT14, GT12, GT11 and GT10 are intermingled, the Multiple connection function is not supported.

*2 The 2nd GOT must be a GT10 (input power supply: 24V) RS-232 built-in product.

*3 For the connection to GOT, refer to the connection diagram. (User RS-232 connection diagram 2))

*4 When connected to the Computer link, the multiple connection function supports only RCPUCPU, QCPU (Q mode), Motion controller CPU (Q mode), LCPUCPU.

21.3 Connection Diagram

The following diagram shows the connection between the GOT and the PLC.

21.3.1 RS-232 Cable

■ Connection diagram

RS-232 connection diagram 1)

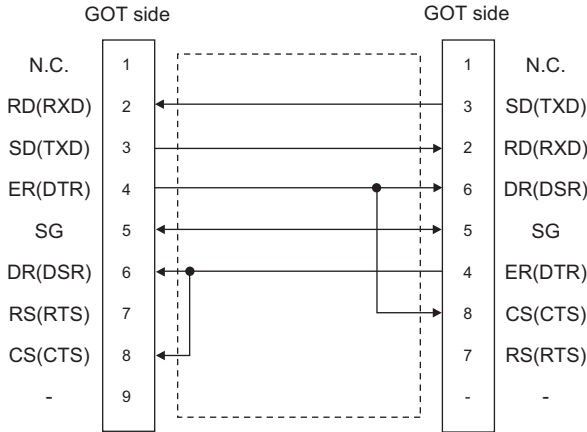

RS-232 connection diagram 2)

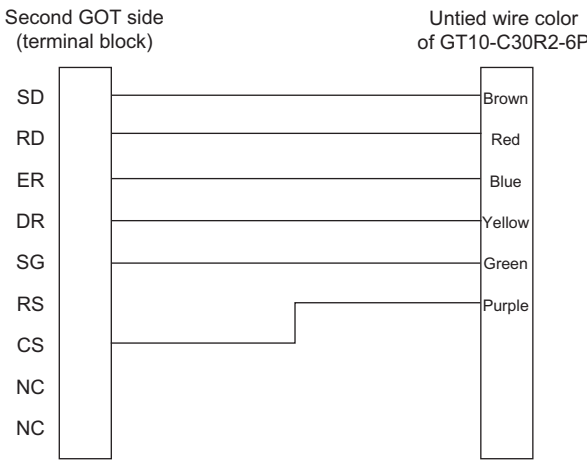

RS-232 connection diagram 3)

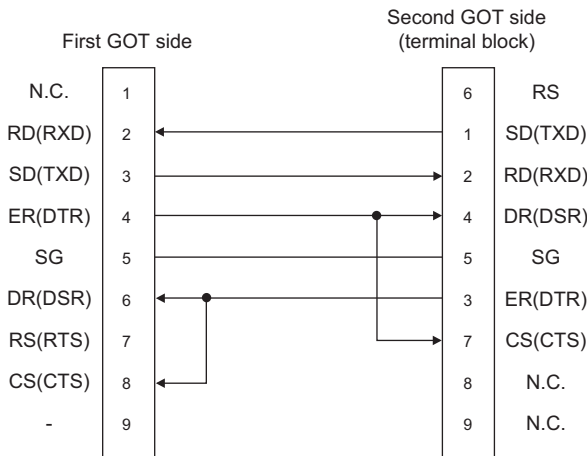

RS-232 connection diagram 4)

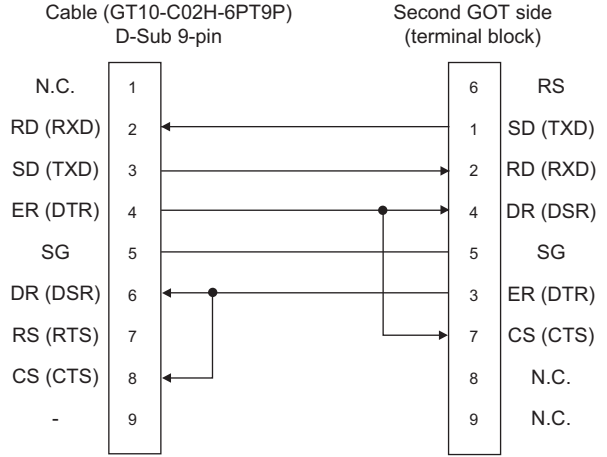

RS-232 connection diagram 5)

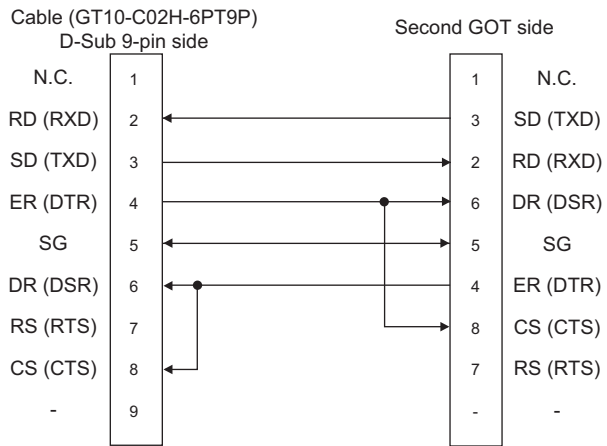

■ Precautions when preparing a cable

- (1) Cable length
The length of the RS-232 cable must be 15m or less.
- (2) GOT side connector
For the GOT side connector, refer to the following.
☞ 1.4.1 GOT connector specifications

17 ROBOT CONTROLLER CONNECTION
 18 CNC CONNECTION
 19 ENERGY MEASURING UNIT/ELECTRIC MULTI-MEASURING INSTRUMENT CONNECTION
 20 GOT MULTI-DROP CONNECTION
 21 MULTIPLE-GT14, GT12, GT11, GT10 CONNECTION FUNCTION
 22 MULTI-CHANNEL FUNCTION
 23 FA TRANSPARENT FUNCTION

21.3.2 RS-422 cable

■ Connection diagram

RS-422 connection diagram 1)

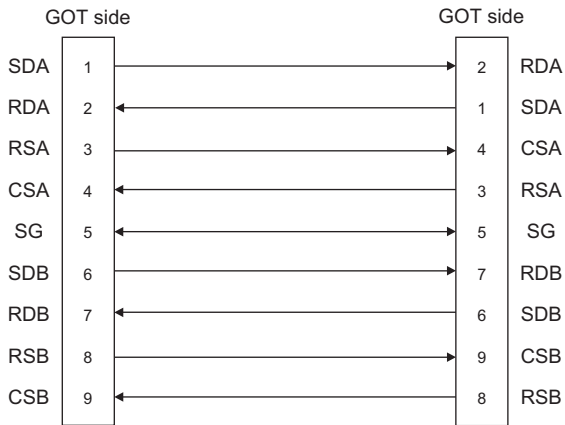

RS-422 connection diagram 2)

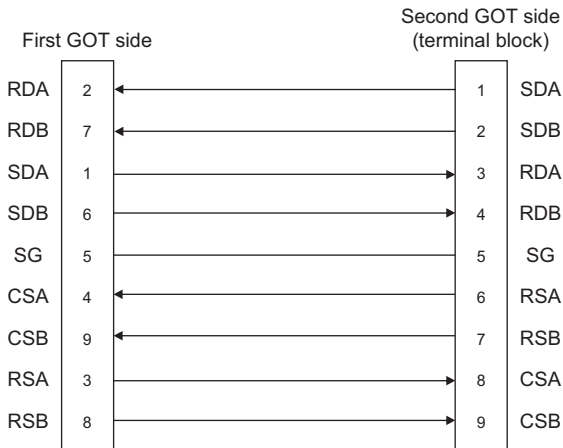

■ Precautions when preparing a cable

(1) Cable length

The length of the RS-422 cable must be 30m or less.

(2) GOT side connector

For the GOT side connector, refer to the following.

1.4.1 GOT connector specifications

■ Connecting terminating resistors

(1) GOT side

When connecting a PLC to the GOT, a terminating resistor must be connected to the GOT.

Set the terminating resistor selector of the GOT main unit to "300 Ω".

For the procedure to set the terminating resistor, refer to the following.

1.4.3 Terminating resistors of GOT

21.4 GOT Side Settings

21.4.1 Setting communication interface (Communication settings)

This section explains with an example of the following system configuration.

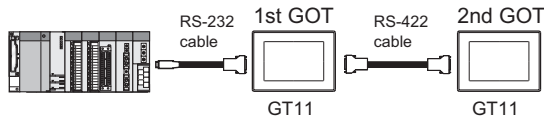

Setting for the first GOT

(1) Settings of communication interface connecting to the PLC

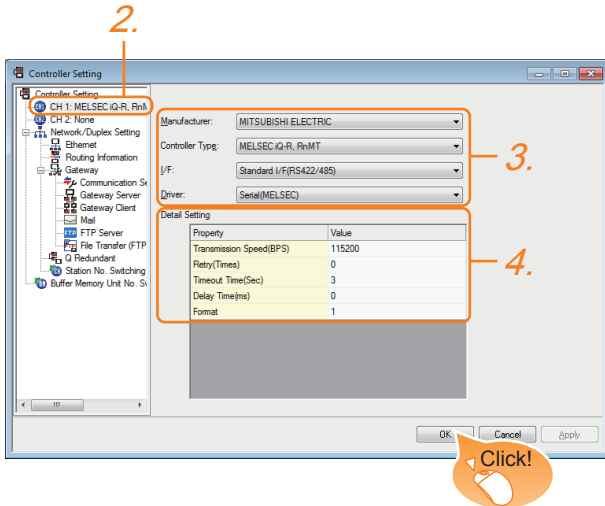

1. Select [Common] → [Controller Setting] from the menu.
2. The Controller Setting window is displayed. Select the channel to be used from the list menu.
3. Set the following items.
 - Manufacturer: MITSUBISHI ELECTRIC
 - Controller Type: Set according to the Controller Type to be connected.
 - I/F: Standard I/F (RS-232)
 - Driver: Set either of the following according to the Controller Type to be connected.
 - For GT14, GT12, GT11
 - Serial (MELSEC)
 - MELSEC-FX
 - For GT10
 - Serial (MELSEC)
 - MELSEC-A
 - MELSEC-FX

4. The detailed setting is displayed after Manufacturer, Controller Type, I/F, and Driver are set. Make the settings according to the usage environment.

☞ 21.4.2 Communication detail settings

Click the [OK] button when settings are completed.

(2) Settings of communication interface connecting to the second GOT

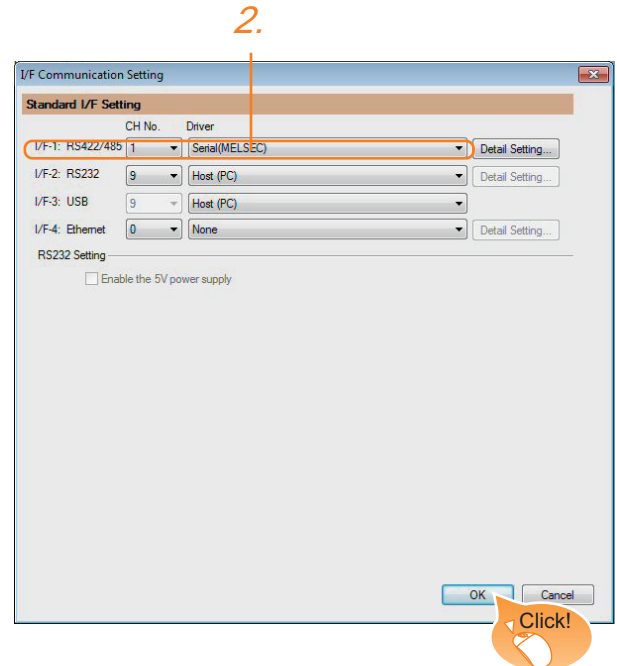

1. Select [Common] → [I/F Communication Setting] from the menu.
2. The I/F Connection list window is displayed. Select the following.
 - I/F-1: RS422/232
 - CH No.: 9
 - Driver: Host (PC)

Click the [OK] button when settings are completed.

(3) [Transparent] setting (GT14 only)

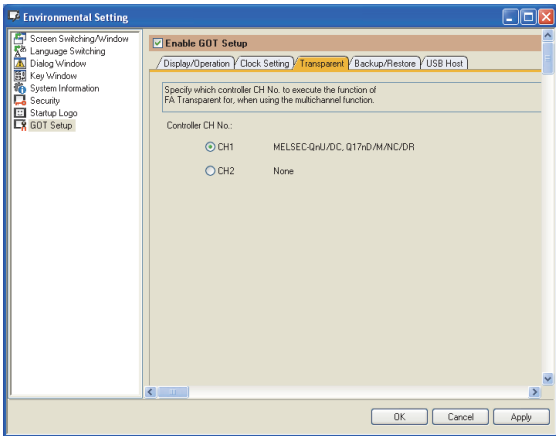

1. Select [Common] → [Environment Setup] → [GOT Setup], check [Enable GOT Setup], and select the [Transparent] menu.
2. After [Controller CH No.] is displayed, check the channel No. connected to the target PLC of multiple GOTs.
For details of connectable models, refer to the following.
 - 6. DIRECT CONNECTION TO CPU
 - 7. COMPUTER LINK CONNECTION

Click the [OK] button when settings are completed.

Setting for the second GOT

Set the communication interface connecting to the first GOT.

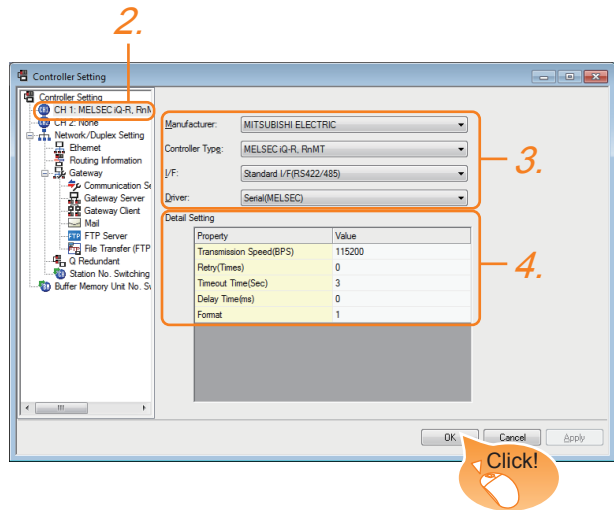

1. Select [Common] → [Controller Setting] from the menu.
2. The Controller Setting window is displayed. Select [CH1] from the list menu.
3. Set the following items.
 - Manufacturer: MITSUBISHI ELECTRIC
 - Controller Type: Set the same setting as the first GOT (communication interface connecting to the PLC)
 - I/F: Standard I/F (RS422/232)
 - Driver: Set the same setting as the first GOT (communication interface connecting to the PLC)
4. The detailed setting is displayed after Manufacturer, Controller Type, I/F, and Driver are set.
Set the same setting as the first GOT (communication interface connecting to the PLC)

Click the [OK] button when settings are completed.

21.4.2 Communication detail settings

Make the settings according to the usage environment.

(1) Serial (MELSEC)

Property	Value
Transmission Speed(BPS)	115200
Retry(Times)	0
Timeout Time(Sec)	3
Delay Time(ms)	0

Item	Description	Range
Transmission Speed	Set this item when change the transmission speed used for communication with the connected equipment. (Default: 115200bps) When the setting exceeds the limit of the connected equipment, communication is performed at the fastest transmission speed supported by the connected equipment.	9600bps, 19200bps, 38400bps, 57600bps, 115200bps
Retry	Set the number of retries to be performed when a communication timeout occurs. (Default: 0time)	0 to 5times
Timeout Time	Set the time period for a communication to time out. (Default: 3sec)	3 to 30sec
Delay Time	Set this item to adjust the transmission timing of the communication request from the GOT. (Default: 0ms)	0 to 300ms

(2) MELSEC-FX

(a) For the GT14, GT12, GT11

Property	Value
Transmission Speed(BPS)	115200
Retry(Times)	0
Timeout Time(Sec)	3
Delay Time(ms)	0

Item	Description	Range
Transmission Speed	Set this item when change the transmission speed used for communication with the connected equipment. (Default: 115200bps) When the setting exceeds the limit of the connected equipment, communication is performed at the fastest transmission speed supported by the connected equipment.	9600bps, 19200bps, 38400bps, 57600bps, 115200bps
Retry	Set the number of retries to be performed when a communication timeout occurs. (Default: 0time)	0 to 5times
Timeout Time	Set the time period for a communication to time out. (Default: 3sec)	3 to 30sec
Delay Time	Set this item to adjust the transmission timing of the communication request from the GOT. (Default: 0ms)	0 to 300ms

(b) For GT10

Property	Value
Transmission Speed(BPS)	115200

Item	Description	Range
Transmission Speed	Set this item when change the transmission speed used for communication with the connected equipment. (Default: 115200bps) When the setting exceeds the limit of the connected equipment, communication is performed at the fastest transmission speed supported by the connected equipment.	9600bps, 19200bps, 38400bps, 57600bps, 115200bps

(3) Serial (MELSEC) (GT10)

Property	Value
Transmission Speed(BPS)	115200

Item	Description	Range
Transmission Speed	Set this item when change the transmission speed used for communication with the connected equipment. (Default: 115200bps) When the setting exceeds the limit of the connected equipment, communication is performed at the fastest transmission speed supported by the connected equipment.	9600bps, 19200bps, 38400bps, 57600bps, 115200bps

(4) MELSEC-A (GT10)

Property	Value
Transmission Speed(BPS)	9600

Item	Description	Range
Transmission Speed	Set this item when change the transmission speed used for communication with the connected equipment. (Default: 9600bps) When the setting exceeds the limit of the connected equipment, communication is performed at the fastest transmission speed supported by the connected equipment.	9600bps

POINT

- (1) Communication interface setting by the Utility
The communication interface setting can be changed on the Utility's [Communication Settings] after writing [Communication Settings] of project data.
For details on the RS-422 conversion unit and the GOT utility, refer to the following manual:
 GT□ User's Manual
- (2) Precedence in communication settings
When settings are made by GT Designer3 or the Utility, the latest setting is effective.

21.5 Precautions

■ GOT's communication timing

(1) GOT's communication timing

Adjust the communication timing so that, after applying the power to the system, the communication with the connected device (MITSUBISHI ELECTRIC PLC) is performed in order starting from the first GOT (from the 1st GOT to the 2nd, and so on).

When the communication is failed, retries are performed. And if the predetermined time has elapsed, a communication error occurs.

- If the first GOT is turned on after a while the second GOT is turned on, because the communication start of the second GOT is delayed, a communication error may be detected at the second GOT.
- If the system power is turned on simultaneously and it takes time to start the communication of the second GOT, a communication error may be developed.

(2) Adjusting communication timing

- (a) When powering up the system simultaneously
Using the utility or selecting [GOT Setup] - [Opening Screen Time] from GT Designer3, set the opening screen time adding a delay to each setting for the GOTs.
During the opening process, communication with the connected device does not start.

Example: Set value of [Opening Screen Time]
(Inside ()): set value
First module (5s) → Second module (10s)

- (b) When powering on devices individually
Turn on the connected device first, and then the first GOT, the second GOT, and so on.

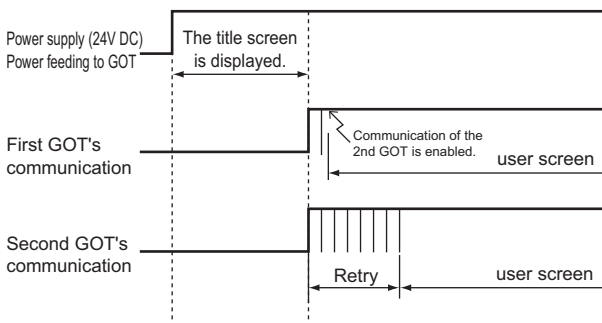

■ Using the FA transparent function

When multiple GOTs are connected, the FA transparent function is not available even if the RS-232 interface or USB interface is used for the connection.

(When connecting a personal computer to the first GOT, the FA transparent function can be used.)

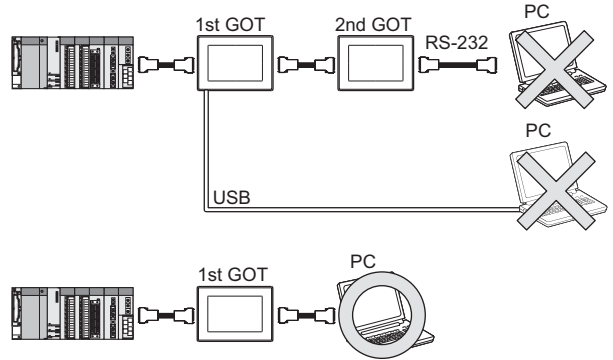

■ Monitoring stop condition for the GOT in the multiple-GT11 connection

In the system where multiple GOTs are connected, performing either of the following monitoring stop operations on the preceding stage (the first GOT) also stops monitoring of the GOT on the next stage (the second GOT).

When the GOT on the preceding stage resumes monitoring, the GOT on the next stage also resumes it.

- When project data or the OS is written/read by GT Designer3^{*1}
- When the GOT is set up^{*1}

*1 A timeout error occurs in GX Developer.

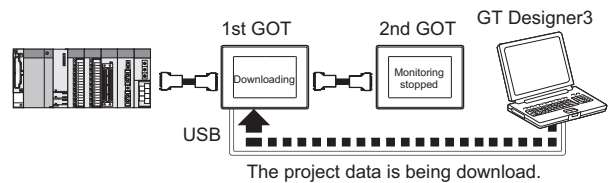

■ When PLC power disconnection occurs in the multiple-GOT connection

In the system where multiple GOTs are connected, when the communication between the PLC and the first GOT is stopped due to PLC power disconnection and a disconnection of the communication cable between the PLC and the first GOT, the GOT waits for timeout against the communication request from the peripheral devices (GX Developer, etc.), and recovery of monitoring between the PLC and the GOT is delayed.

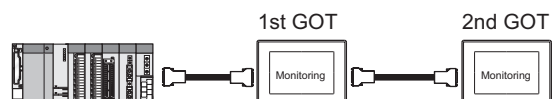

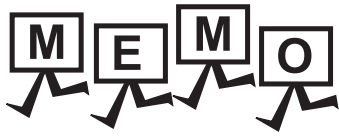

MULTI-CHANNEL FUNCTION

22. MULTI-CHANNEL FUNCTION.....	22 - 1
---------------------------------	--------

22

MULTI-CHANNEL FUNCTION



22.1 What is Multi-channel Function?	22 - 2
22.2 System Configuration	22 - 4
22.3 GOT Side Settings	22 - 7
22.4 Precautions	22 - 41
22.5 Multi-channel Function Check Sheet	22 - 42

22. MULTI-CHANNEL FUNCTION

22.1 What is Multi-channel Function?

Multi-channel Function is a function to monitor up to four FA controllers (PLC CPU, temperature controller, inverter, etc.) on one GOT by writing multiple communication drivers in the GOT.
(For GT155□, up to two controllers (two channels))

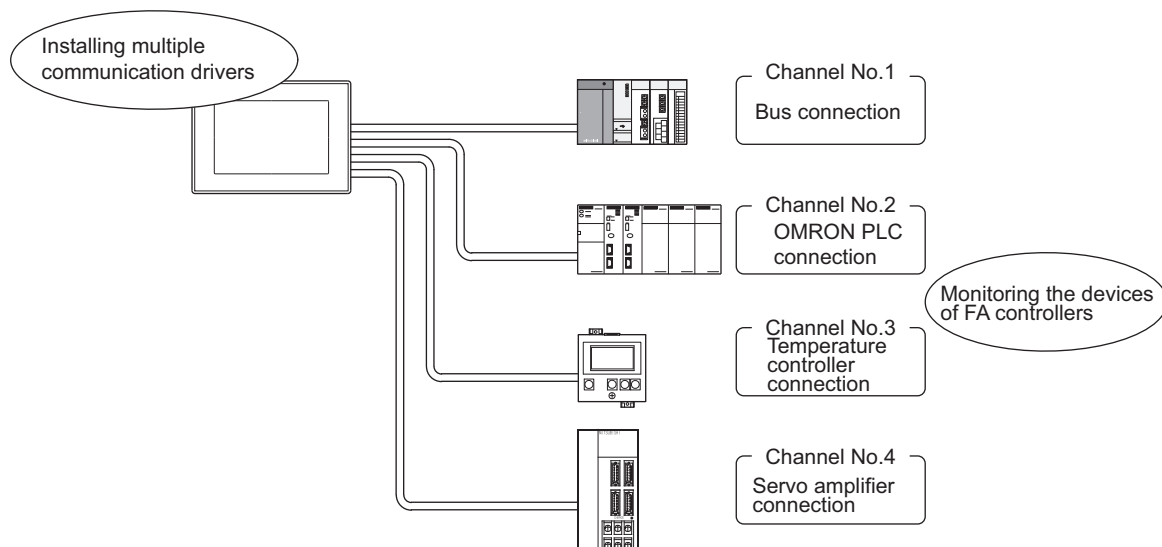

POINT

- (1) Before using the multi-channel function
This manual describes the procedure to use the multi-channel function, based on the following system configuration example.
 - ☞ 22.2.1 Bus connection and serial connection
 - ☞ 22.2.2 Ethernet multiple connection
- (2) System configuration when the multi-channel function is used
The system configuration between GOT and the controllers is the same as that of when not using the multi-channel function.
For the system configuration between GOT and the controllers, refer to the following.
 - ☞ Each chapter indicating the system configuration
- (3) Precautions for hardware
To use the multi-channel function, an option function board is required for some GOTs.
The following table shows the required option function boards.

GOT	Option function board
GT16, GT12	Not necessary
GT15	GT15-QFNB, GT15-QFNB16M, GT15-QFNB32M, GT15-QFNB48M, GT15-MESB48M
GT14	Not necessary

■ Features of the multi-channel function

- (1) With a single unit of GOT, the system consisting of PLC CPU, temperature controller, servo amplifier and other controllers can be configured.
 One GOT can monitor a PLC CPU, temperature controller and servo amplifier, etc. Therefore, the system configuration, in which several controllers are mixed, can be easily established.
 In addition, each system can be monitored on the GOT screen, and the unified management of the information is possible.

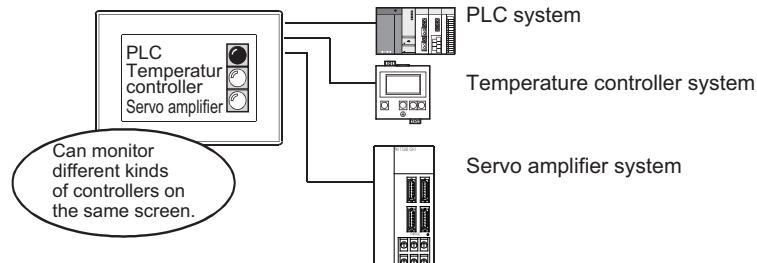

- (2) Controlling FXCPU/third party PLC, etc. through the network (MELSECNET/H, etc.)
 It is possible to control FXCPU/third party PLC, etc. through the network (MELSECNET/H, etc.).
 For example, it is possible to execute read/write of a device such as FXCPU when the condition is satisfied, using the device of the PLC CPU on the network (MELSECNET/H, etc.) as the trigger for action.

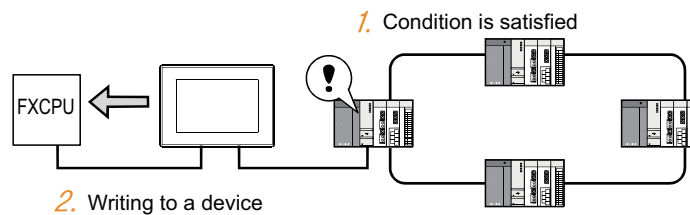

- (3) With one GOT, the Ethernet connection and the bus or network connection are available in combination. (GT16 only)
 One GOT can make the Ethernet connections and the bus or network connection. Therefore, the system configuration, in which several networks are linked, can be established.
 Also, the GOT can monitor multiple controllers on an Ethernet network. (Multi-channel Ethernet connection)

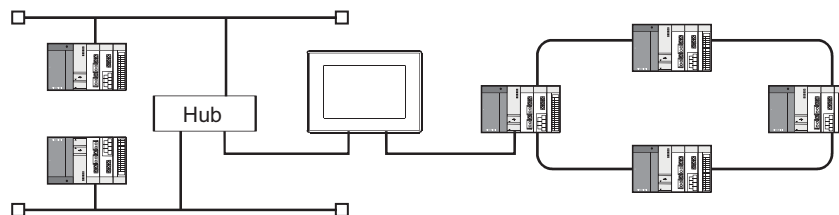

22.2 System Configuration

22.2.1 Bus connection and serial connection



One GOT can monitor a PLC CPU, temperature controller and servo amplifier, etc. Therefore, the system configuration, in which several controllers are mixed, can be easily established.

In addition, each system can be monitored on the GOT screen, and the unified management of the information is possible.

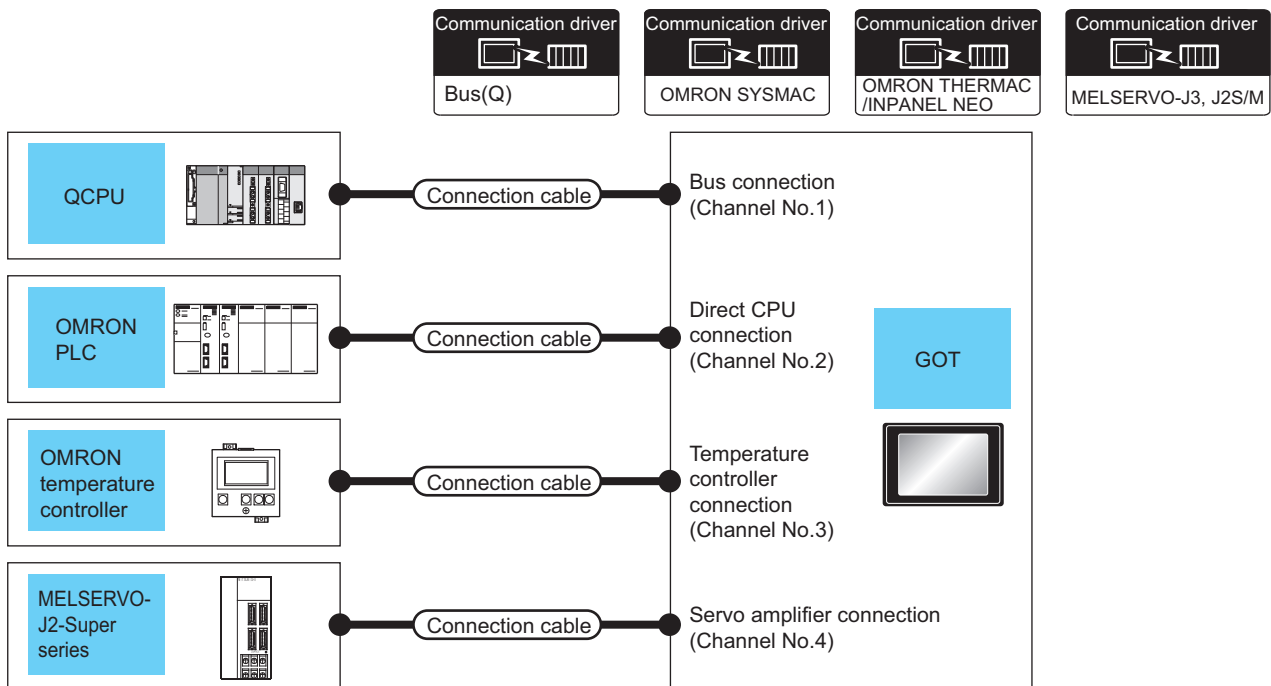





PLC	Connection type	Connection cable	GOT			Number of connectable equipment
			Channel No.	Option device	Model	
MELSEC-Q	Bus connection	For the system configuration between GOT and the controllers, refer to the following. Each chapter indicating the system configuration	1	GT15-QBUS	 4 connected equipment for 1 GOT (4 channels)	
OMRON PLC	Direct CPU connection		2	- (Built into GOT)		
OMRON temperature controller			3	GT15-RS2-9P		
MELSERVO-J2-Super			4	GT15-RS4-9S		
OMRON PLC	Direct CPU connection	For the system configuration between GOT and the controllers, refer to the following. Each chapter indicating the system configuration	1	- (Built into GOT)	 2 connected equipment for 1 GOT (2 channels)	
OMRON temperature controller			2			

POINT

Controllers that use Channels No.5 to 8

The following shows the drivers that can be set to Channels No. 5 to 8.

For the system configuration and connection condition with the controller, refer to the chapter of each controller.

Channel No.	Driver ^{*1}	Reference
5 to 7	Barcode Reader, RFID Controller, PC Remote Operation(Serial), Printer (Serial)	GOT1000 Series Connection Manual (Microcomputer, MODBUS, Products, Peripherals)  FINGERPRINT AUTHENTICATION DEVICE CONNECTION  BAR CODE READER CONNECTION
8	Barcode Reader, RFID Controller, PC Remote Operation(Serial), Fingerprint Authentication, Printer (Serial)	 PC REMOTE CONNECTION  PRINTER CONNECTION  RFID CONNECTION

*1 Only one channel can be assigned to one driver.

22.2.2 Ethernet multiple connection



One GOT can make several Ethernet connections and the bus or network connections. Therefore, the system configuration, in which several networks are linked, can be established.

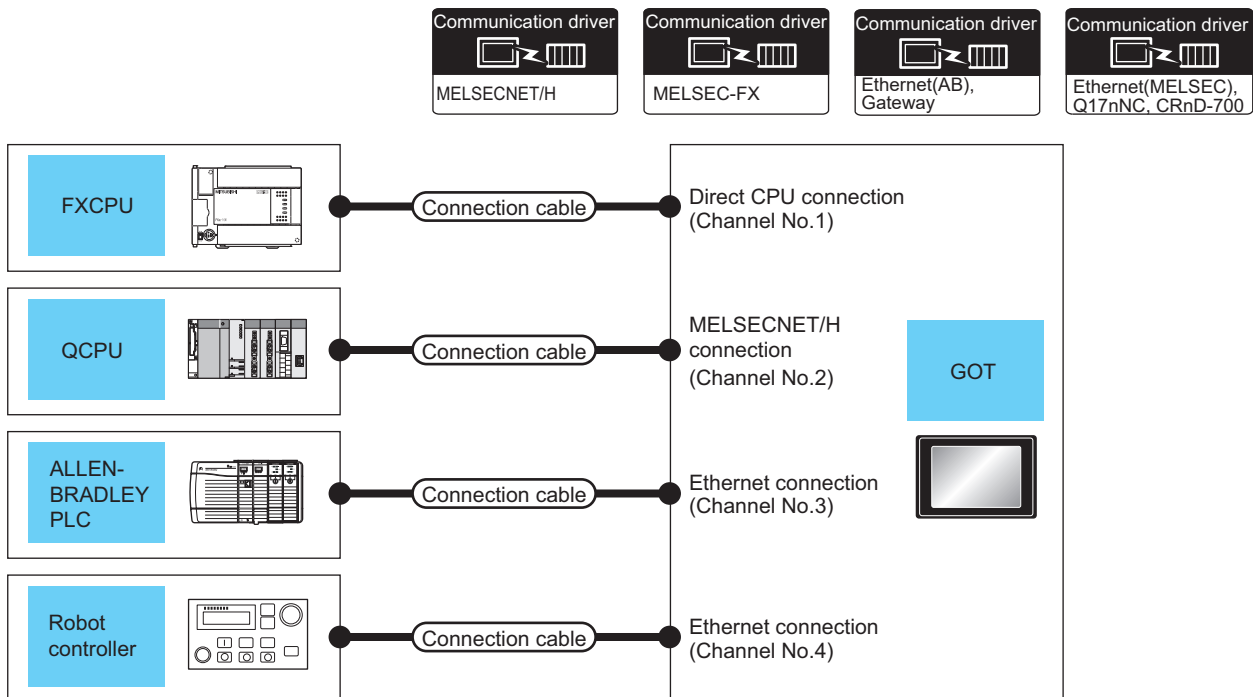

PLC	Connection type	Connection cable	GOT			Number of connectable equipment
			Channel No.	Option device	Model	
MELSEC-FX	Direct CPU connection	For the system configuration between GOT and the controllers, refer to the following. Each chapter indicating the system configuration	1	GT15-RS2T4-9P		4 connected equipment for 1 GOT (4 channels)
QCPU	MELSECNET/H		2	GT15-J71LP23-25		
ALLEN-BRADLEY PLC	Ethernet		3	- (Built into GOT)		
Robot controller			4			
ALLEN-BRADLEY PLC	Ethernet	For the system configuration between GOT and the controllers, refer to the following. Each chapter indicating the system configuration	1	- (Built into GOT)		2 connected equipment for 1 GOT (2 channels)
OMRON PLC			2			

22.3 GOT Side Settings

22.3.1 Basics of interface selection

This section explains basic knowledge of the multi-channel function.

A general flow of operation from system selection for the multi-channel function to drawing is explained in 22.3.2 to 22.3.6.

It is recommended to refer to 22.3.2 to 22.3.6 when making necessary settings using the multi-channel function for the first time.

■ Multi-channel function specifications

How the units are installed and the multi-channel function specifications are described below.

(1) Image drawing of unit installation

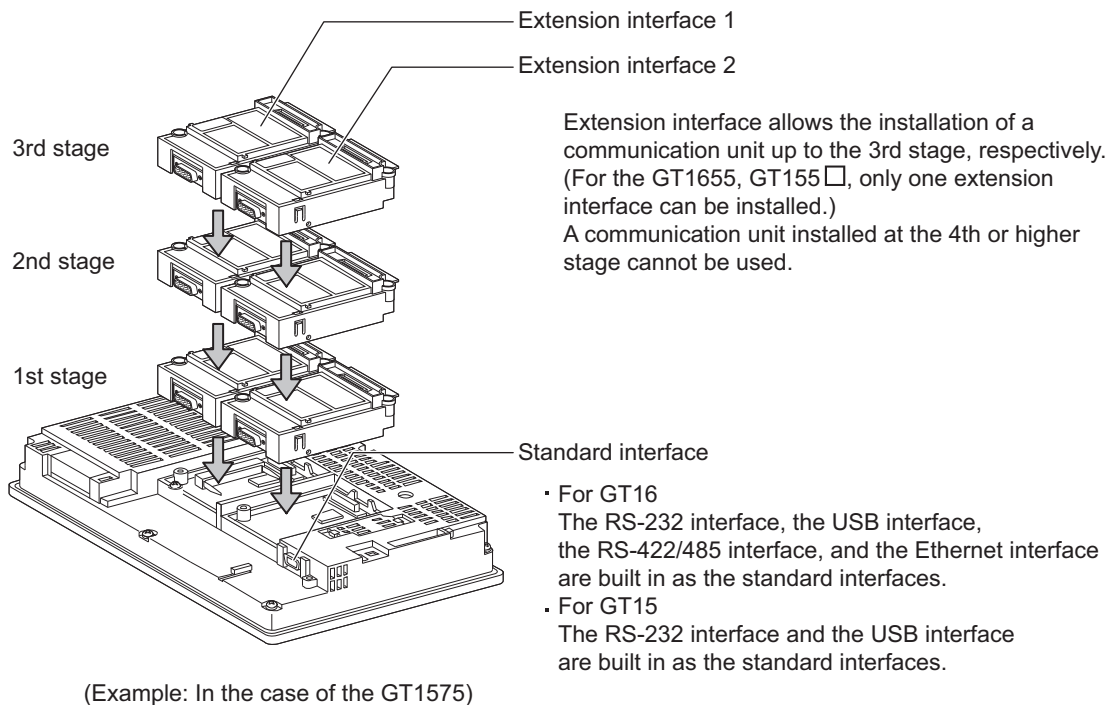

(2) Specifications

Item	Specifications						Description
	GT1695 GT1685 GT1675 GT1672 GT1665 GT1662	GT1655	GT1595 GT1585 GT157□ GT156□	GT155□	GT14	GT12	
Max. number of channels	4 channels		2 channels				<p>GT16</p> <ul style="list-style-type: none"> In bus connection and network connection (*1), only 1 channel can be set for one GOT. For the Ethernet connection (*2), up to 4 channels can be set. When the Ethernet interface built in the GOT is used for connection other than communication with a controller (*3), the connection is not included in the count of the number of channels. The interface used for connecting to an external device (*4) is not included in the count of the number of channels. <p>GT15</p> <ul style="list-style-type: none"> For the bus connection, network connection (*1), and Ethernet connection (*2), only 1 channel can be set for one GOT. When an Ethernet communication unit is used in other than communications with a controller (*3), it is not included in the count of the number of channels. The interface used for connecting to an external device (*4) is not included in the count of the number of channels. <p>GT14</p> <ul style="list-style-type: none"> The interface used for connecting to an external device (*4) is not included in the count of the number of channels. For the Ethernet connection (*2), up to 2 channels can be set. (GT1455-QTBDE, GT1450-QMBDE and GT1450-QLBDE only) When the Ethernet interface built in the GOT is used for connection other than communication with a controller (*3), the connection is not included in the count of the number of channels. (GT1455-QTBDE, GT1450-QMBDE and GT1450-QLBDE only) <p>GT12</p> <ul style="list-style-type: none"> For the Ethernet connection (*2), only 1 channel can be set for one GOT. When an Ethernet communication unit is used in other than communications with a controller (*3), it is not included in the count of the number of channels. The interface used for connecting to an external device (*4) is not included in the count of the number of channels.
Max. installable number of modules	5	3	5	3	-	-	<ul style="list-style-type: none"> Multiple identical units can be installed only for serial communication units. It is necessary to calculate the consumed current. (This section ■ Calculating consumed current) An RS-422 conversion unit is not included in the count of the number of units. (For GT1655, GT155□, the RS-422 conversion unit is not applicable.)
Allowable number of stages	Max. 3 stages (2 slots)	Max. 3 stages (1 slot)	Max. 3 stages (2 slot)	Max. 3 stages (1 slot)	-	-	<ul style="list-style-type: none"> A module that occupies 2 slots (*5, *6, *7) must be installed at the first stage. For the video/RGB display, RGB output, and multimedia function, install the unit indicated in *6 at the first stage and the other units at the second or later stage. When a unit indicated in *7 is used, other extension units cannot be installed. The CF card unit must be installed on the last stage, if used.

*1 MELSECNET/H connection, MELSECNET/10 connection, CC-Link IE Controller Network connection, CC-Link connection (intelligent device station)

*2 Ethernet connection, MODBUS®/TCP connection

*3 Gateway function, MES interface function, Ethernet download

*4 Fingerprint unit, barcode reader, RFID controller, personal computer (writing remote personal computer operation (serial), FA transparent function, OS install, project data) or serial printer

*5 GT15-QBUS2, GT15-ABUS2, GT15-J71GP23-SX, GT15-J71LP23-25, GT15-J71BR13, GT15-J61BT13

*6 GT16M-V4, GT15V-75V4, GT16M-R2, GT15V-75R1, GT16M-V4R1, GT15V-75V4R1, GT16M-ROUT, GT15V-75ROUT, GT16M-MMR

*7 GT15-75QBUSL, GT15-75QBUS2L, GT15-75ABUSL, GT15-75ABUS2L, GT15-75J71LP23-Z, GT15-75J71BR13-Z, GT15-75J61BT13-Z

Usable units differ depending on the GOT.

For units usable with each GOT, refer to the following manuals.

 User's Manual of GOT used.

■ Calculating consumed current

For using multiple extension units, a bar code reader, or a RFID controller, the total current for the extension units, bar code reader, or RFID controller must be within the current that the GOT can supply.

For the current that the GOT can supply and the current for the extension units, bar code reader, or RFID controller, refer to the below tables. For the current that the GOT can supply and the current for the extension units, bar code reader, or RFID controller, refer to the below tables. Make sure that the total of consumed current is within the capacity of the GOT.

(1) Current supply capacity of the GOT

GOT type	Capacity (A)
GT1695M-X	2.4
GT1685M-S	2.4
GT1675M-S	2.4
GT1675M-V	2.4
GT1675-VN, GT1672-VN	2.4
GT1665M-S	2.4
GT1665M-V	2.4
GT1662-VN	2.4
GT1655-V	1.3

GOT type	Capacity (A)
GT1595-X	2.13
GT1585V-S	1.74
GT1585-S	1.74
GT1575V-S	2.2
GT1575-S	2.2
GT1575-V, GT1572-VN	2.2
GT1565-V, GT1562-VN	2.2
GT1555-V	1.3
GT1555-Q, GT1550-Q	1.3

(2) Current consumed by an extension unit/barcode reader/RFID controller

Module type	Consumed current (A)
GT15-QBUS, GT15-75QBUSL, GT15-QBUS2, GT15-75QBUS2L	0.275 ^{*1}
GT15-ABUS, GT15-75ABUSL, GT15-ABUS2, GT15-75ABUS2L	0.12
GT15-RS2-9P	0.29
GT15-RS4-9S	0.33
GT15-RS4-TE	0.3
GT15-RS2T4-9P	0.098
GT15-J71E71-100	0.224
GT15-J71GP23-SX	1.07
GT15-J71GF13-T2	0.96
GT15-J71LP23-25	0.56
GT15-J71BR13	0.77
GT15-J61BT13	0.56
Bar code reader	*2
GT15-PRN	0.09
GT16M-V4	0.12 ^{*1}

Module type	Consumed current (A)
GT15V-75V4	0.2 ^{*1}
GT16M-R2	0 ^{*1}
GT15V-75R1	0.2 ^{*1}
GT16M-V4R1	0.12 ^{*1}
GT15V-75V4R1	0.2 ^{*1}
GT16M-ROUT	0.11 ^{*1}
GT15V-75ROUT	0.11
GT16M-MMR	0.27 ^{*1}
GT15-CFCD	0.07
GT15-CFEX-C08SET	0.15
GT15-SOUT	0.08
GT15-DIO	0.1
GT15-DIOR	0.1
RFID controller	*2
GT15-80FPA	0.22

*1 Value used for calculating the current consumption of the multi-channel function.

For the specifications of the unit, refer to the manual included with the unit.

*2 When the GOT supplies power to a barcode reader or a RFID controller from the standard interface, add their consumed current. (Maximum value is less than 0.3 A)

(3) Calculation example

- (a) When connecting the GT15-J71BR13, GT15-RS4-9S (3 units), GT15-J71E71-100 (for the gateway function) and a bar code reader (0.12 A) to the GT1575-V

Current supply capacity of GOT (A)	Total consumed current (A)
2.2	$0.77+0.33+0.33+0.33+0.224+0.12=2.104$

Since the calculated value is within the capacity of the GOT, they can be connected to the GOT.

- (b) When connecting the GT15-J71BR13, GT15-RS4-9S (2 units), GT15-J71E71-100 (for the gateway function) and a bar code reader (0.12 A) to the GT1585-S

Current supply capacity of GOT (A)	Total consumed current (A)
1.74	$0.77+0.33+0.33+0.224+0.12=1.774$

Since the calculated value exceeds the capacity of the GOT, such configuration is not allowed.

22.3.2 General flow from system selection to drawing

System selection for using the multi-channel function is explained below.

Make selection and setting for the multi-channel function by following the order shown below.

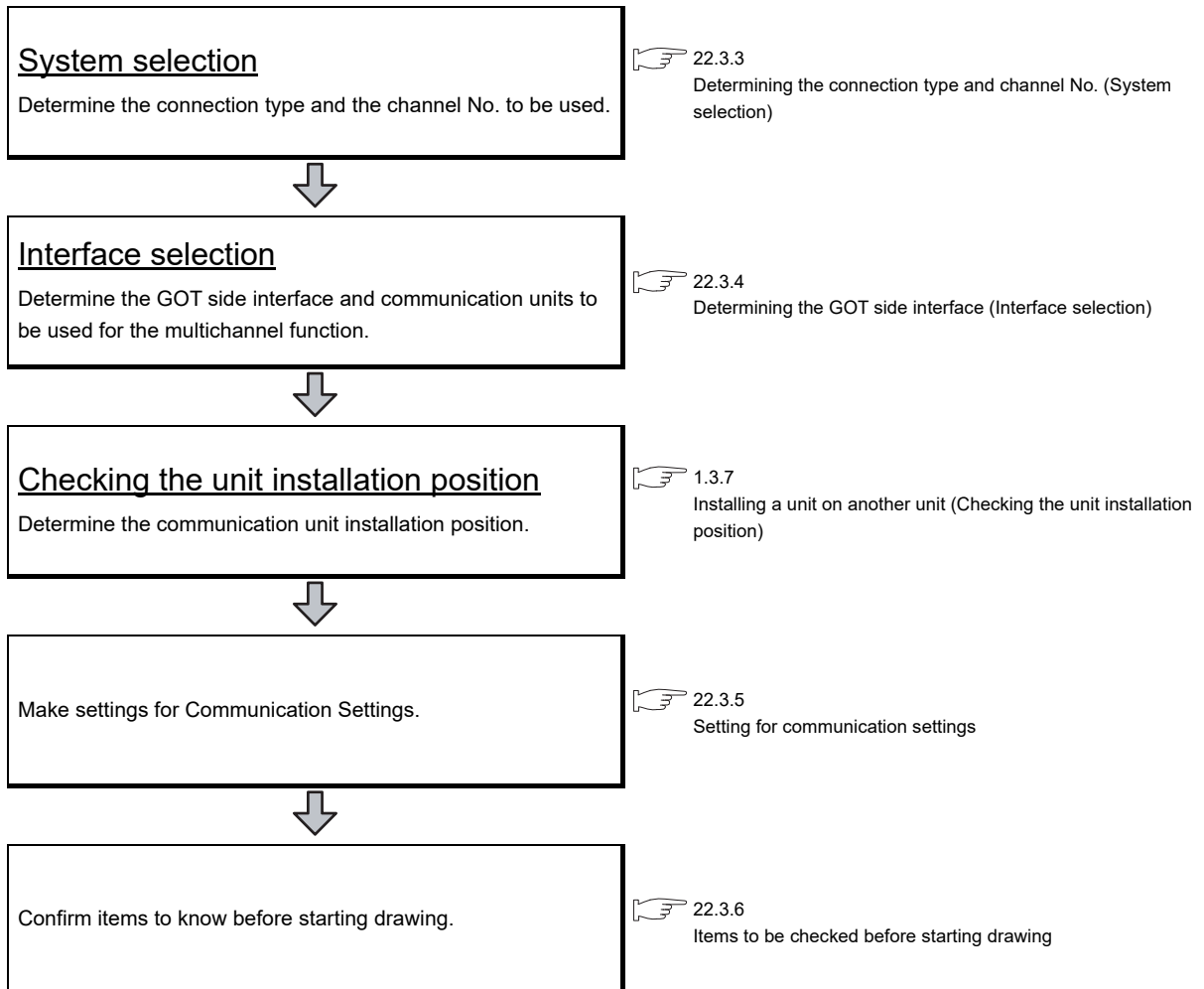

22.3.3 Determining the connection type and channel No. (System selection)

■ Determining the connection type

(1) GT16

For GT16, the combinations of the bus or network connection, the Ethernet connection, and the serial connection are available as shown in the following table.

Connection type		Reference
Bus/network connection	Bus connection	5. BUS CONNECTION
	MELSECNET/H connection (PLC to PLC network)	9. MELSECNET/H CONNECTION (PLC TO PLC NETWORK)
	MELSECNET/10 connection (PLC to PLC network)	10. MELSECNET/10 CONNECTION (PLC TO PLC NETWORK)
	CC-Link IE Controller Network connection	11. CC-Link IE CONTROLLER NETWORK CONNECTION
	CC-Link IE Field Network connection	12. CC-Link IE FIELD NETWORK CONNECTION
	CC-Link connection (intelligent device station)	13. CC-Link CONNECTION (INTELLIGENT DEVICE STATION)
	CNC connection(MELSECNET/10 connection (PLC to PLC network))	18.2.2 MELSECNET/10 connection (PLC to PLC network)
	CNC connection(CC-Link connection (intelligent device station))	18.2.3 CC-Link connection (intelligent device station)
Ethernet connection	Ethernet connection	8. ETHERNET CONNECTION
	Robot controller connection	17. ROBOT CONTROLLER CONNECTION
	CNC connection (Ethernet connection)	18.2.4 Ethernet connection
	Third party PLC connection (Ethernet connection)	Non-Mitsubishi Electric Products 1 • 4. CONNECTION TO OMRON PLC 4.3 Ethernet Connection Non-Mitsubishi Electric Products 2 • 6. CONNECTION TO YASKAWA PLC 6.3 Ethernet Connection • 7. CONNECTION TO YOKOGAWA PLC 7.3 Ethernet Connection • 10. CONNECTION TO ALLEN-BRADLEY PLC 10.3 Ethernet Connection • 14. CONNECTION TO SIEMENS PLC 14.3 Ethernet Connection
	Microcomputer connection (Ethernet)	Microcomputer, MODBUS Products, Peripherals • 3. MICROCOMPUTER CONNECTION (ETHERNET)
	MODBUS [®] /TCP connection	Microcomputer, MODBUS Products, Peripherals • 5. MODBUS(R)/TCP CONNECTION

(Continued to next page)

17

ROBOT CONTROLLER CONNECTION

18

CNC CONNECTION

19

ENERGY MEASURING UNIT/ELECTRIC MULTI-MEASURING INSTRUMENT CONNECTION

20

GOT MULTI-DROP CONNECTION

21

MULTIPLE-GT14, GT12, GT11, GT10 CONNECTION FUNCTION

22

MULTI-CHANNEL FUNCTION

23

FA TRANSPARENT FUNCTION

Connection type		Reference
Serial connection	Direct CPU connection	6. DIRECT CONNECTION TO CPU
	Computer link connection	7. COMPUTER LINK CONNECTION
	CC-Link connection (via G4)	14. CC-Link CONNECTION (Via G4)
	Inverter connection	15. INVERTER CONNECTION
	Servo amplifier connection	16. SERVO AMPLIFIER CONNECTION
	CNC connection (serial connection)	18.2.1 Direct connection to CPU
	GOT Multi- Drop Connection	19. GOT MULTI-DROP CONNECTION
	Third party PLC connection (serial connection)	<p>Non-Mitsubishi Electric Products 1</p> <ul style="list-style-type: none"> • 4. CONNECTION TO OMRON PLC 4.2 Serial Connection • 6. CONNECTION TO KEYENCE PLC • 7. CONNECTION TO KOYO EI PLC • 8. CONNECTION TO JTEKT PLC • 9. CONNECTION TO SHARP PLC • 12. CONNECTION TO TOSHIBA PLC • 13. CONNECTION TO TOSHIBA MACHINE PLC • 15. CONNECTION TO PANASONIC PLC <p>Non-Mitsubishi Electric Products 2</p> <ul style="list-style-type: none"> • 2. CONNECTION TO HITACHI IES PLC • 3. CONNECTION TO HITACHI PLC • 4. CONNECTION TO FUJI FA PLC • 6. CONNECTION TO YASKAWA PLC 6.2 Serial Connection • 7. CONNECTION TO YOKOGAWA PLC 7.2 Serial Connection • 10. CONNECTION TO ALLEN-BRADLEY PLC 10.2 Serial Connection • 11. CONNECTION TO GE FANUC PLC • 12. CONNECTION TO LS INDUSTRIAL SYSTEMS PLC • 14. CONNECTION TO SIEMENS PLC • 16. CONNECTION TO MURATEC CONTROLLER
	Third party safety controller connection	<p>Non-Mitsubishi Electric Products 2</p> <ul style="list-style-type: none"> • 13. CONNECTION TO SICK SAFETY CONTROLLER
	Third party servo amplifier connection	<p>Non-Mitsubishi Electric Products 1</p> <ul style="list-style-type: none"> • 14. CONNECTION TO PANASONIC SERVO AMPLIFIER
	Third party robot controller connection	<p>Non-Mitsubishi Electric Products 1</p> <ul style="list-style-type: none"> • 2. CONNECTION TO IAI ROBOT CONTROLLER <p>Non-Mitsubishi Electric Products 2</p> <ul style="list-style-type: none"> • 15. CONNECTION TO HIRATA CORPORATION HNC CONTROLLER
	Third party temperature controller connection	<p>Non-Mitsubishi Electric Products 1</p> <ul style="list-style-type: none"> • 3. CONNECTION TO AZBIL CONTROL EQUIPMENT • 5. CONNECTION TO OMRON TEMPERATURE CONTROLLER • 10. CONNECTION TO SHINKO TECHNOS INDICATING CONTROLLER • 11. CONNECTION TO CHINO CONTROLLER <p>Non-Mitsubishi Electric Products 2</p> <ul style="list-style-type: none"> • 5. CONNECTION TO FUJI SYS TEMPERATURE CONTROLLER • 8. CONNECTION TO YOKOGAWA TEMPERATURE CONTROLLER • 9. CONNECTION TO RKC TEMPERATURE CONTROLLER
	Microcomputer Connection (Serial)	<p>Microcomputer, MODBUS Products, Peripherals</p> <ul style="list-style-type: none"> • 2. MICROCOMPUTER CONNECTION (SERIAL)
	MODBUS®/RTU connection	<p>Microcomputer, MODBUS Products, Peripherals</p> <ul style="list-style-type: none"> • 4. MODBUS(R)/RTU CONNECTION

The following shows the applicable combinations of connection types, the number of channels, and restricted functions.

○: Allowed △: Restricted

Item	Allowable combination of connection types	GOT to be used		Functions that are restricted by the connection type ^{*1}	
		GT1695 GT1685 GT1675 GT1672 GT1665 GT1662 GT1655		FA transparent function	
				RS-232	USB
(a)	• Bus/network connection: 1 channel • Serial connection: 1 to 3 channels	Max. 4 channels	△ ^{*2}	○	
(b)	• Bus/network connection: 1 channel • Ethernet connection: 1 to 3 channels	Max. 4 channels	△ ^{*2}	○	
(c)	• Ethernet connection: 1 to 3 channels • Serial connection: 1 to 3 channels	Max. 4 channels	△ ^{*2}	○	
(d)	• Bus/network connection: 1 channel • Ethernet connection: 1 to 2 channels • Serial connection: 1 to 2 channels	Max. 4 channels	△ ^{*2}	○	
(e)	• Serial connection: 4 channels	Max. 4 channels	△ ^{*2}	○	
(f)	• Ethernet connection: 4 channels	Max. 4 channels	△ ^{*2}	○	

*1 When the functions below are used, the connectable number of channels may be restricted depending on the combination of the functions to be used.

- Fingerprint authentication
- Remote personal computer operation
- Operation panel function
- Report function
- Functions with the CF card unit or CF card extension unit
- Barcode function
- Video display function
- External I/O function
- Hard copy function(for printer output)
- RFID function
- Multimedia function
- RGB display function
- Sound output function

The video display function, multimedia function and RGB display function cannot be used together.

The CF card unit and the CF card extension unit cannot be used at the same time.

For details, refer to the following.

 22.3.4 Determining the GOT side interface (Interface selection)

*2 For the FA transparent function via the RS-232 connection, the RS-232 interface built in the GOT is available only. When the RS-232 interface built in the GOT is already used, the FA transparent function is not available.

(2) GT15

For GT15, the combinations of the bus, network, or Ethernet connection and the serial connection are available as shown in the following table.

Connection type		Reference
Bus/network/Ethernet connection	Bus connection	5. BUS CONNECTION
	Ethernet connection	8. ETHERNET CONNECTION
	MELSECNET/H connection (PLC to PLC network)	9. MELSECNET/H CONNECTION (PLC TO PLC NETWORK)
	MELSECNET/10 connection (PLC to PLC network)	10. MELSECNET/10 CONNECTION (PLC TO PLC NETWORK)
	CC-Link IE Controller Network connection	11. CC-Link IE CONTROLLER NETWORK CONNECTION
	CC-Link IE Field Network connection	12. CC-Link IE FIELD NETWORK CONNECTION
	CC-Link connection (intelligent device station)	13. CC-Link CONNECTION (INTELLIGENT DEVICE STATION)
	Robot controller connection	17. ROBOT CONTROLLER CONNECTION
	CNC connection(MELSECNET/10 connection (PLC to PLC network))	18.2.2 MELSECNET/10 connection (PLC to PLC network)
	CNC connection(CC-Link connection (intelligent device station))	18.2.3 CC-Link connection (intelligent device station)
	CNC connection (Ethernet connection)	18.2.4 Ethernet connection
	Third party PLC connection (Ethernet connection)	Non-Mitsubishi Electric Products 1 • 4. CONNECTION TO OMRON PLC 3.3 Ethernet Connection Non-Mitsubishi Electric Products 2 • 6. CONNECTION TO YASKAWA PLC 6.3 Ethernet Connection • 7. CONNECTION TO YOKOGAWA PLC 7.3 Ethernet Connection • 10. CONNECTION TO ALLEN-BRADLEY PLC 10.3 Ethernet Connection • 14. CONNECTION TO SIEMENS PLC 14.3 Ethernet Connection
	Microcomputer connection (Ethernet)	Microcomputer, MODBUS Products, Peripherals • 3. MICROCOMPUTER CONNECTION (ETHERNET)
MODBUS [®] /TCP connection	Microcomputer, MODBUS Products, Peripherals • 5. MODBUS(R)/TCP CONNECTION	

(Continued to next page)

Connection type	Reference	
Direct CPU connection	6. DIRECT CONNECTION TO CPU	
Computer link connection	7. COMPUTER LINK CONNECTION	
CC-Link connection (via G4)	14. CC-Link CONNECTION (Via G4)	
Inverter connection	15. INVERTER CONNECTION	
Servo amplifier connection	16. SERVO AMPLIFIER CONNECTION	
CNC connection (serial connection)	18.2.1 Direct connection to CPU	
GOT Multi- Drop Connection	19. GOT MULTI-DROP CONNECTION	
Serial connection	Non-Mitsubishi Electric Products 1 <ul style="list-style-type: none"> • 4. CONNECTION TO OMRON PLC 4.2 Serial Connection • 6. CONNECTION TO KEYENCE PLC • 7. CONNECTION TO KOYO EI PLC • 8. CONNECTION TO JTEKT PLC • 9. CONNECTION TO SHARP PLC • 12. CONNECTION TO TOSHIBA PLC • 13. CONNECTION TO TOSHIBA MACHINE PLC • 15. CONNECTION TO PANASONIC EW PLC Non-Mitsubishi Electric Products 2 <ul style="list-style-type: none"> • 2. CONNECTION TO HITACHI IES PLC • 3. CONNECTION TO HITACHI PLC • 4. CONNECTION TO FUJI FA PLC • 6. CONNECTION TO YASKAWA PLC 6.2 Serial Connection • 7. CONNECTION TO YOKOGAWA PLC 7.2 Serial Connection • 10. CONNECTION TO ALLEN-BRADLEY PLC 10.2 Serial Connection • 11. CONNECTION TO GE FANUC PLC • 12. CONNECTION TO LS INDUSTRIAL SYSTEMS PLC • 14. CONNECTION TO SIEMENS PLC • 16. CONNECTION TO MURATEC CONTROLLER 	
	Third party PLC connection (serial connection)	Non-Mitsubishi Electric Products 2 <ul style="list-style-type: none"> • 13. CONNECTION TO SICK SAFETY CONTROLLER
	Third party safety controller connection	Non-Mitsubishi Electric Products 1 <ul style="list-style-type: none"> • 14. CONNECTION TO PANASONIC SERVO AMPLIFIER
	Third party servo amplifier connection	Non-Mitsubishi Electric Products 1 <ul style="list-style-type: none"> • 2. CONNECTION TO IAI ROBOT CONTROLLER Non-Mitsubishi Electric Products 2 <ul style="list-style-type: none"> • 15. CONNECTION TO HIRATA CORPORATION HNC CONTROLLER
	Third party robot controller connection	Non-Mitsubishi Electric Products 1 <ul style="list-style-type: none"> • 3. CONNECTION TO AZBIL CONTROL EQUIPMENT • 5. CONNECTION TO OMRON TEMPERATURE CONTROLLER • 10. CONNECTION TO SHINKO TECHNOS INDICATING CONTROLLER • 11. CONNECTION TO CHINO CONTROLLER Non-Mitsubishi Electric Products 2 <ul style="list-style-type: none"> • 5. CONNECTION TO FUJI SYS TEMPERATURE CONTROLLER • 8. CONNECTION TO YOKOGAWA TEMPERATURE CONTROLLER • 9. CONNECTION TO RKC TEMPERATURE CONTROLLER
	Third party temperature controller connection	Microcomputer, MODBUS Products, Peripherals <ul style="list-style-type: none"> • 2. MICROCOMPUTER CONNECTION (SERIAL)
	Microcomputer Connection (Serial)	Microcomputer, MODBUS Products, Peripherals <ul style="list-style-type: none"> • 4. MODBUS(R)/RTU CONNECTION
	MODBUS®/RTU connection	

The number of channels and the functions that can be used differ depending on the GOT to be used.
The table below shows the allowable combinations of connection types, the number of channels and restricted functions.

○: Allowed △: Restricted

Item	Allowable combination of connection types	GOT to be used		Functions that are restricted by the connection type ^{*1*2}	
		GT1595 GT1585 GT157□ GT156□	GT155□	FA transparent function	
				RS-232	USB
(a)	• Bus/network/Ethernet connection: 1 channel • Serial connection: 1 to 3 channels	Max. 4 channels	Max. 2 channels	△ ^{*3}	○
(b)	• Serial connection: 4 channels	Max. 4 channels	Max. 2 channels	△ ^{*3}	○

*1 When the functions below are used, the connectable number of channels may be restricted depending on the combination of the functions to be used.

- Fingerprint authentication
- Barcode function
- RFID function
- Remote personal computer operation
- Video display function
- Operation panel function
- External I/O function
- RGB display function
- Report function
- Hard copy function(for printer output)
- Sound output function
- Functions with the CF card unit or CF card extension unit

The video display function and RGB display function cannot be used together.
The CF card unit and the CF card extension unit cannot be used at the same time.
For details, refer to the following.

 22.3.4 Determining the GOT side interface (Interface selection)

*2 When any of the connection methods below is used, Ethernet connection cannot be used although Ethernet download, gateway function, MES interface function and file transfer function (FTP client) can be used.

- Bus connection
- MELSECTNET/H connection
- MELSECTNET/10 connection
- CC-Link IE Controller Network connection
- CC-Link connection
- MODBUS[®]/TCP connection
- CC-Link IE Field Network connection

*3 For the FA transparent function via the RS-232 connection, the RS-232 interface built in the GOT is available only.
When the RS-232 interface built in the GOT is already used, the FA transparent function is not available.

(3) GT14

For GT14, the combinations of the Ethernet connection and the serial connection are available as shown in the following table.

Connection type		Reference
Ethernet connection	Ethernet connection	8.ETHERNET CONNECTION
	CNC connection (Ethernet connection)	18.2.4Ethernet connection
	Third party PLC connection (Ethernet connection)	Non-Mitsubishi Electric Products 1 • 3. CONNECTION TO OMRON PLC 3.3 Ethernet Connection Non-Mitsubishi Electric Products 2 • 6. CONNECTION TO YASKAWA PLC 6.3 Ethernet Connection • 7. CONNECTION TO YOKOGAWA PLC 7.3 Ethernet Connection • 10. CONNECTION TO ALLEN-BRADLEY PLC 10.3 Ethernet Connection • 14. CONNECTION TO SIEMENS PLC 14.3 Ethernet Connection
	Microcomputer connection (Ethernet)	Microcomputer, MODBUS Products, Peripherals • 3. MICROCOMPUTER CONNECTION (ETHERNET)
	MODBUS [®] /TCP connection	Microcomputer, MODBUS Products, Peripherals • 5. MODBUS(R)/TCP CONNECTION
Serial connection	Direct CPU connection	6.DIRECT CONNECTION TO CPU
	Computer link connection	7.COMPUTER LINK CONNECTION
	CC-Link connection (via G4)	14.CC-Link CONNECTION (Via G4)
	Inverter connection	15.INVERTER CONNECTION
	Servo amplifier connection	16.SERVO AMPLIFIER CONNECTION
	CNC connection (serial connection)	18.2.1Direct connection to CPU
	GOT Multi- Drop Connection	20.GOT MULTI-DROP CONNECTION

(Continued to next page)

Connection type		Reference
Serial connection	Third party PLC connection (serial connection)	Non-Mitsubishi Electric Products 1 • 4. CONNECTION TO OMRON PLC 4.2 Serial Connection • 6. CONNECTION TO KEYENCE PLC • 12. CONNECTION TO TOSHIBA PLC • 15. CONNECTION TO PANASONIC EW PLC Non-Mitsubishi Electric Products 2 • 6. CONNECTION TO YASKAWA PLC 6.2 Serial Connection • 7. CONNECTION TO YOKOGAWA PLC 7.2 Serial Connection • 10. CONNECTION TO ALLEN-BRADLEY PLC 11.2 Serial Connection • 14. CONNECTION TO SIEMENS PLC • 16. CONNECTION TO MURATEC CONTROLLER
	Third party safety controller connection	Non-Mitsubishi Electric Products 2 • 13. CONNECTION TO SICK SAFETY CONTROLLER
	Third party robot controller connection	Non-Mitsubishi Electric Products 1 • 2. CONNECTION TO IAI ROBOT CONTROLLER Non-Mitsubishi Electric Products 2 • 15. CONNECTION TO HIRATA CORPORATION HNC CONTROLLER
	Third party temperature controller connection	Non-Mitsubishi Electric Products 1 • 3. CONNECTION TO AZBIL CONTROL EQUIPMENT • 5. CONNECTION TO OMRON TEMPERATURE CONTROLLER • 10. CONNECTION TO SHINKO TECHNOS INDICATING CONTROLLER • 11. CONNECTION TO CHINO CONTROLLER Non-Mitsubishi Electric Products 2 • 8. CONNECTION TO YOKOGAWA TEMPERATURE CONTROLLER • 9. CONNECTION TO RKC TEMPERATURE CONTROLLER
	Microcomputer connection (Serial)	Microcomputer, MODBUS Products, Peripherals • 2. MICROCOMPUTER CONNECTION (SERIAL)
	MODBUS®/RTU connection	Microcomputer, MODBUS Products, Peripherals • 4. MODBUS(R)/RTU CONNECTION

The number of channels and the functions that can be used differ depending on the GOT to be used. The table below shows the allowable combinations of connection types, the number of channels and restricted functions.

○: Allowed △: Restricted

Item	Allowable combination of connection types	GOT to be used		Functions that are restricted by the connection type*1		
		GT1455-QTBDE, GT1450-QMBDE, GT1450-QLBDE	GT1455-QTBD, GT1450-QMBD, GT1450-QLBD	FA transparent function		
				RS-232	USB	Ethernet
(a)	• Ethernet connection: 1 to 2 channels • Serial connection: 1 to 2 channels	Max. 2 channels	-	△*2	○	△*3
(b)	• Serial connection: 2 channels	Max. 2 channels	Max. 2 channels	△*2	○	△*3

*1 When the functions below are used, the connectable number of channels may be restricted depending on the combination of the functions to be used.

- Barcode function
- RFID function

For details, refer to the following.

 22.3.4 Determining the GOT side interface (Interface selection)

*2 For the FA transparent function via the RS-232 connection, the RS-232 interface built in the GOT is available only. When the RS-232 interface built in the GOT is already used, the FA transparent function is not available.

*3 When a GOT and PLC are connected by Ethernet connection, connecting a GOT and a personal computer by Ethernet is not allowed.

(4) GT12

For GT12, the combinations of the Ethernet connection and the serial connection are available as shown in the following table

Connection type		Reference
Ethernet connection	Ethernet connection	8.ETHERNET CONNECTION
	CNC connection (Ethernet connection)	18.2.4Ethernet connection
	Third party PLC connection (Ethernet connection)	Non-Mitsubishi Electric Products 1 <ul style="list-style-type: none"> • 4. CONNECTION TO OMRON PLC 4.3 Ethernet Connection Non-Mitsubishi Electric Products 2 <ul style="list-style-type: none"> • 6. CONNECTION TO YASKAWA PLC 6.3 Ethernet Connection • 7. CONNECTION TO YOKOGAWA PLC 7.3 Ethernet Connection • 10. CONNECTION TO ALLEN-BRADLEY PLC 10.3 Ethernet Connection
	Microcomputer connection (Ethernet)	Microcomputer, MODBUS Products, Peripherals <ul style="list-style-type: none"> • 3. MICROCOMPUTER CONNECTION (ETHERNET)
	MODBUS®/TCP connection	Microcomputer, MODBUS Products, Peripherals <ul style="list-style-type: none"> • 5. MODBUS(R)/TCP CONNECTION
Serial connection	Direct CPU connection	6.DIRECT CONNECTION TO CPU
	Computer link connection	7.COMPUTER LINK CONNECTION
	CC-Link connection (via G4)	14.CC-Link CONNECTION (Via G4)
	Inverter connection	15.INVERTER CONNECTION
	Servo amplifier connection	16.SERVO AMPLIFIER CONNECTION
	CNC connection (serial connection)	18.2.1Direct connection to CPU
	GOT Multi- Drop Connection	20.GOT MULTI-DROP CONNECTION
	Third party PLC connection (serial connection)	Non-Mitsubishi Electric Products 1 <ul style="list-style-type: none"> • 4. CONNECTION TO OMRON PLC 4.2 Serial Connection • 6. CONNECTION TO KEYENCE PLC • 7. CONNECTION TO KOYO EI PLC • 8. CONNECTION TO JTEKT PLC • 9. CONNECTION TO SHARP PLC • 12. CONNECTION TO TOSHIBA PLC • 13. CONNECTION TO TOSHIBA MACHINE PLC • 15. CONNECTION TO PANASONIC PLC Non-Mitsubishi Electric Products 2 <ul style="list-style-type: none"> • 2. CONNECTION TO HITACHI IES PLC • 3. CONNECTION TO HITACHI PLC • 4. CONNECTION TO FUJI FA PLC • 6. CONNECTION TO YASKAWA PLC 6.2 Serial Connection • 7. CONNECTION TO YOKOGAWA PLC 7.2 Serial Connection • 10. CONNECTION TO ALLEN-BRADLEY PLC 11.2 Serial Connection • 11. CONNECTION TO GE FANUC PLC • 12. CONNECTION TO LS INDUSTRIAL SYSTEMS PLC • 14. CONNECTION TO SIEMENS PLC
	Third party safety controller connection	Non-Mitsubishi Electric Products 2 <ul style="list-style-type: none"> • 13. CONNECTION TO SICK SAFETY CONTROLLER
	Third party servo amplifier connection	Non-Mitsubishi Electric Products 1 <ul style="list-style-type: none"> • 14. CONNECTION TO PANASONIC SERVO AMPLIFIER
	Third party robot controller connection	Non-Mitsubishi Electric Products 1 <ul style="list-style-type: none"> • 2. CONNECTION TO IAI ROBOT CONTROLLER Non-Mitsubishi Electric Products 2 <ul style="list-style-type: none"> • 15. CONNECTION TO HIRATA CORPORATION HNC CONTROLLER
	Third party temperature controller connection	Non-Mitsubishi Electric Products 1 <ul style="list-style-type: none"> • 3. CONNECTION TO AZBIL CONTROL EQUIPMENT • 5. CONNECTION TO OMRON TEMPERATURE CONTROLLER • 10. CONNECTION TO SHINKO TECHNOS INDICATING CONTROLLER • 11. CONNECTION TO CHINO CONTROLLER Non-Mitsubishi Electric Products 2 <ul style="list-style-type: none"> • 5. CONNECTION TO FUJI SYS TEMPERATURE CONTROLLER • 8. CONNECTION TO YOKOGAWA TEMPERATURE CONTROLLER • 9. CONNECTION TO RKC TEMPERATURE CONTROLLER
Microcomputer connection (Serial)	Microcomputer, MODBUS Products, Peripherals <ul style="list-style-type: none"> • 2. MICROCOMPUTER CONNECTION (SERIAL) 	
MODBUS®/RTU connection	Microcomputer, MODBUS Products, Peripherals <ul style="list-style-type: none"> • 4. MODBUS(R)/RTU CONNECTION 	

The number of channels and the functions that can be used differ depending on the GOT to be used.
 The table below shows the allowable combinations of connection types, the number of channels and restricted functions.

○: Allowed △: Restricted

Item	Allowable combination of connection types	GOT to be used	Functions that are restricted by the connection type ^{*1*2}	
		GT1275 GT1265	FA transparent function	
			RS-232	USB
(a)	<ul style="list-style-type: none"> Ethernet connection: 1 channel Serial connection: 1 channel 	Max. 2 channels	△ ^{*3}	○
(b)	<ul style="list-style-type: none"> Serial connection: 2 channels 	Max. 2 channels	△ ^{*3}	○

*1 When the functions below are used, the connectable number of channels may be restricted depending on the combination of the functions to be used.

- Barcode function
- RFID function

For details, refer to the following.

 22.3.4 Determining the GOT side interface (Interface selection)

*2 When any of the connection methods below is used, Ethernet connection cannot be used although Ethernet download and gateway function can be used.

- MODBUS[®]/TCP Connection

*3 For the FA transparent function via the RS-232 connection, the RS-232 interface built in the GOT is available only.
 When the RS-232 interface built in the GOT is already used, the FA transparent function is not available.

■ Determining the channel No.

- (1) Channel No. of PLC, motion controller, temperature controller, inverter, servo amplifier, CNC, robot controller
 After determining the connection type to be used, determine the channel Nos. (CH No. 1 to CH No. 4) to be used for the respective connection types.
 There are no special cautions to be attended to for determining channel Nos.
 Set the channel No. by selecting [Common] → [Controller Setting] from the menu.

☞ 1.1.1 Setting connected equipment (Channel setting)

- (2) Channel No. of external devices (fingerprint unit, barcode reader, RFID controller, personal computer and serial printer)
 When connecting a fingerprint unit, barcode reader, RFID controller, personal computer or serial printer, select the channel No. (No.5 to No.8) for each external device.
- (a) Number of external devices that can be connected to the GOT
 One fingerprint unit, barcode reader, RFID controller, personal computer or serial printer can be connected to one GOT.
 One driver must be set for one channel No. (No.5 to No.8) in the communication settings.
- (b) Operator authentication (external authentication or fingerprint authentication)
 When using the operator authentication (external authentication or fingerprint authentication), the RFID controller is available for the channel No.8 only.
- (c) External devices that requires the power supply from the GOT
 When using the barcode reader or RFID controller that requires the power supply from the GOT, set the channel No.8.
 When the channel No.5 to No.7 is set, the GOT cannot supply the power.



Write Check Sheet



22.5
Multi-channel Function
Check Sheet

Write down the following items selected in this section to the check sheet.

- ◆ Selection of connection type
 Write down the name of connection type to be used.

■ Check sheet No.1 (selection of connection type and interface)

- (1) Channel No. of PLC, motion controller CPU, temperature controller, inverter, servo amplifier, CNC, robot controller (No.1 to No.4)

CH No.	◆ Selection of connection type (☞ 20.3.3)	◆ Selection of interface (communication unit) (☞ 20.3.4)
1	Connection name Bus (Q)	
2	Connection name OMRON PLC	
3	Connection name OMRON temp.	
4	Connection name Servo amplifier	

- (2) Channel No. of fingerprint unit, barcode reader, RFID controller, personal computer (No.5 to No.8)

CH No.	◆ Selection of connection type (☞ 20.3.3)	◆ Selection of interface (communication unit) (☞ 20.3.4)
5	Connection name Bar code reader	
6	Connection name	
7	Connection name	
8	Connection name Fingerprint unit	RS-232 interface built in a GOT

22.3.4 Determining the GOT side interface (Interface selection)

To use the multi-channel function, add interfaces to the GOT with the following methods if required.

(1) GT16

- Install communication units on the extension interfaces.
- Use communication units installed on the extension interfaces with the RS-232 interface, the RS422/485 interface, and/or the Ethernet interface built in the GOT.

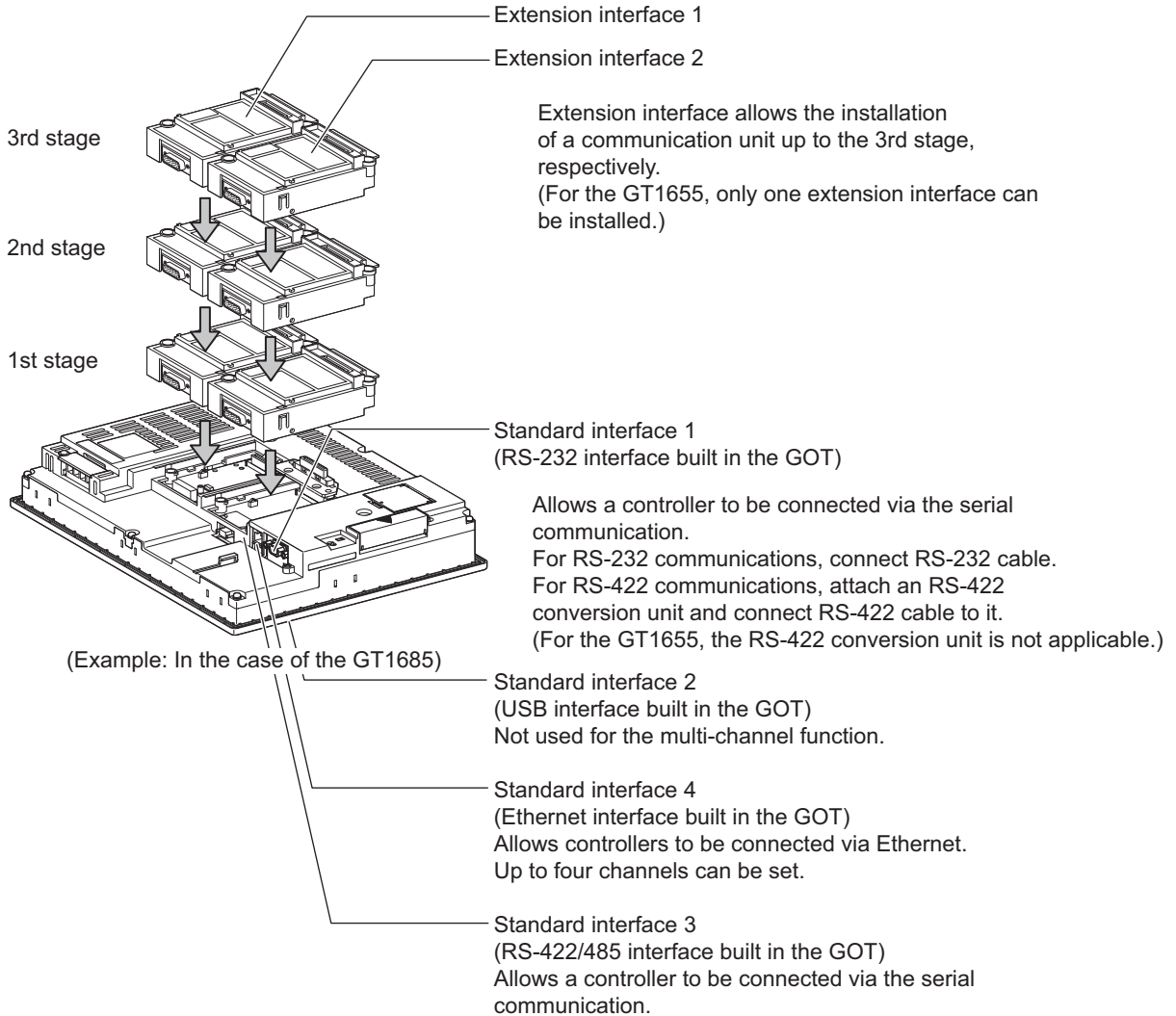

(2) GT15

- Install communication units on the extension interfaces.
- Use communication units installed on the extension interfaces with the RS-232 interface built in the GOT.

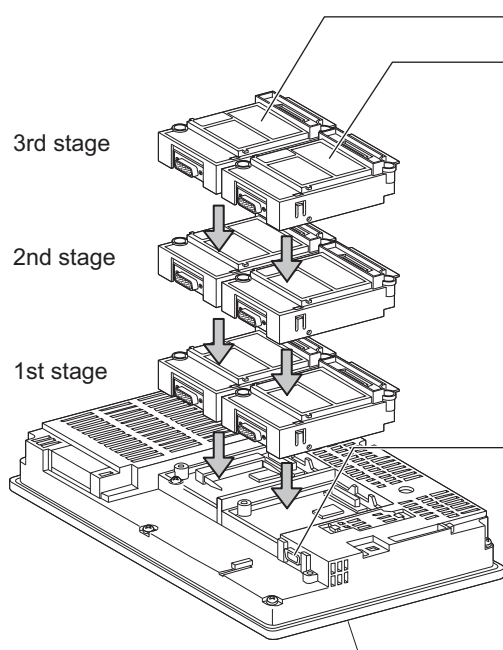





Extension interface allows the installation of a communication unit up to the 3rd stage, respectively.
(For the GT155□, only one extension interface can be installed.)
A communication unit installed at the 4th or higher stage cannot be used.

Allows a controller to be connected via the serial communication.
For RS-232 communications, connect RS-232 cable.
For RS-422 communications, attach an RS-422 conversion unit and connect RS-422 cable to it.
(For the GT155□, the RS-422 conversion unit is not applicable.)

Standard interface 2
(USB interface built in the GOT)
Not used for the multi-channel function.

For the connection via the connection type selected in 22.3.3, select interfaces and communication units to be used. Select the interfaces and communication units according to the connection type by referring to the following.

Selected connection type	Reference for required interface and communication unit
• Bus connection	 This section ■ GOT interface used for bus connection
• MELSECNET/H connection (PLC to PLC network)	 This section ■ GOT interface used for network connection
• MELSECNET/10 connection (PLC to PLC network)	
• CC-Link IE Controller Network connection	
• CC-Link IE Field Network connection	
• CC-Link connection (intelligent device station)	
• CNC connection (MELSECNET/10 connection (PLC to PLC network), CC-Link connection (intelligent device station))	 This section ■ GOT interface used for Ethernet connection
• Ethernet connection	
• Third party PLC connection (Ethernet connection)	
• MODBUS [®] /TCP connection	
• Robot controller connection	
• CNC connection (Ethernet connection)	
• Microcomputer connection (Ethernet)	 This section ■ GOT interface used for serial connection
• Direct CPU connection	
• Computer link connection	
• CC-Link connection (via G4)	
• Third party PLC connection (serial connection)	
• Third party safety controller connection	
• Third party servo amplifier connection	
• Third party robot controller connection	
• Third party temperature controller connection	
• Microcomputer Connection (Serial)	
• GOT Multi- Drop Connection	
• MODBUS [®] /RTU connection	
• Inverter connection	
• Servo amplifier connection	
• CNC connection (serial connection)	
• Other functions	 This section ■ Interfaces and option units used for other functions

POINT

Number of units that can be installed to a GOT

The number of units that can be installed to extension interfaces differs depending on the GOT type.

GOT	Number of units that can be installed
GT1695, GT1685, GT1675, GT1672, GT1665, GT1662, GT1595, GT1585, GT157□, GT156□	Up to 5 units can be installed (up to 4 communication units)
GT1655, GT155□	Up to 3 units can be installed (up to 2 communication units)
GT12	-

■ GOT interface used for bus connection

For the bus connection, use the following communication units.

Interface	Model*1		
Bus connection unit	GT15-75QBUS(2)L, GT15-ABUS(2)	GT15-75ABUS(2)L,	GT15-QBUS(2),

*1 To mount multiple units, the GT15-QBUS(2) or GT15-ABUS(2) is required.

POINT

(1) Bus connection units to be used

GT15-QBUS(2) and GT15-ABUS(2) can be used independent of the number of serial connection channels. When using the multi-channel function for the first time, it is recommended to use GT15-QBUS(2) or GT15-ABUS(2).

(2) Restrictions by bus connection unit installation

For the following functions, use the GT15-QBUS(2) or GT15-ABUS(2), regardless of the number of channels used for the serial connection.

With the GT15-75QBUS(2)L or GT15-75ABUS(2)L, the following functions are not available.

Function		
Remote personal computer operation(serial), Operation panel function, Report function (when using a PictBridge compatible printer), Hard copy function (when using a PictBridge compatible printer), Sound output function, Ethernet download*1,	Video display function, External I/O function, Functions with the CF card unit or CF card extension unit, Gateway function*1,	Multimedia function, RGB display function, MES interface function*1

*1 Since the GT16 has the Ethernet interface, the function is available regardless of the bus connection unit to be used.

■ GOT interface used for network connection

For the network connection, use the following communication units.

Interface	Model	
MELSECNET/H communication unit	GT15-J71LP23-25,	GT15-J71BR13
CC-Link IE Controller Network communication unit	GT15-J71GP23-SX	
CC-Link IE Field Network communication unit	GT15-J71GF13-T2	
CC-Link communication unit	GT15-J61BT13	

POINT

When using GT15-75J71LP23-Z, GT15-75J71BR13-Z, or GT15-75J61BT13-Z

(1) GT16

The GT15-75J71LP23-Z, GT15-75J71BR13-Z, and GT15-75J61BT13-Z are not applicable.

(2) GT15

No unit can be mounted on the GT15-75J71LP23-Z, GT15-75J71BR13-Z, or GT15-75J61BT13-Z. (For the GT155□, the GT15-75J71LP23-Z, GT15-75J71BR13-Z, and GT15-75J61BT13-Z are not applicable)

Therefore, the RS-232 interface built in the GOT is used for the serial connection.

Because of this, the functions using the RS-232 interface, including the barcode function, are not available.

The gateway function, the printer output, and others are also not available since no unit can be mounted on the above models.

■ GOT interface used for Ethernet connection

For the Ethernet connection, use the following interface built in the GOT and communication unit.

(1) GT16

Interface	Name
Interface built in GOT	Ethernet interface*1

*1 Up to four channels can be used.

(2) GT15

Interface	Model
Ethernet communication unit	GT15-J71E71-100

(3) GT14

Interface	Name
Interface built in GOT	Ethernet interface*1

*1 Up to two channels can be used.

(4) GT12

Interface	Name
Interface built in GOT	Ethernet interface

POINT

When using Ethernet download, gateway function, or MES interface function

(1) GT16

The Ethernet download, the gateway function, and the MES interface function are available using the Ethernet interface built in the GOT (one channel).

(2) GT15

For using Ethernet download, the gateway function and MES interface function, only one Ethernet communication unit is required.

(3) GT14

The Ethernet download and the gateway function are available using the Ethernet interface built in the GOT (one channel).

(4) GT12

The Ethernet download and the gateway function are available using the Ethernet interface built in the GOT (one channel).

■ GOT interface used for serial connection

For the serial connection, provide interfaces equivalent to the number of channels by using the following interfaces built in the GOT and communication units in combinations.

(1) GT16

Interface	Name/model
Interface built in GOT	RS-232 interface*1*2, RS-422/485 interface
Serial communication module	GT15-RS2-9P, GT15-RS4-9S, GT15-RS4-TE

*1 The operator authentication (external authentication or fingerprint authentication) or the FA transparent function (RS-232 communication) uses the RS-232 interface built in the GOT.

*2 For the RS-422 communication using the RS-232 interface built in the GOT, the RS-422 conversion unit is required. (For GT 1655, the RS-422 conversion unit is not applicable.)

(2) GT15

Interface	Name/model
Interface built in GOT	RS-232 interface ^{*1*}
Serial communication module	GT15-RS2-9P, GT15-RS4-9S, GT15-RS4-TE

- *1 The operator authentication (external authentication or fingerprint authentication) or the FA transparent function (RS-232 communication) uses the RS-232 interface built in the GOT.
 *2 For the RS-422 communication using the RS-232 interface built in the GOT, the RS-422 conversion unit is required. (For GT15□, the RS-422 conversion unit is not applicable.)

(3) GT14

Interface	Name/model
Interface built in GOT	RS-232 interface ^{*1} , RS-422/485 interface
Serial communication module	-

- *1 The FA transparent function (RS-232 communication) uses the RS-232 interface built in the GOT.

(4) GT12

Interface	Name/model
Interface built in GOT	RS-232 interface ^{*1} , RS-422/485 interface
Serial communication module	-

- *1 The FA transparent function (RS-232 communication) uses the RS-232 interface built in the GOT.

■ Interfaces and option units used for other functions

When the following functions are used in combinations, the number of available channels may vary according to the combinations of units

Function	Reference
Report function (when using a PictBridge compatible printer), Operation panel function, Sound output function	Hard copy function (when using a PictBridge compatible printer), External I/O function, (1) (a)
Remote personal computer operation (serial), Multimedia function,	Video display function, RGB display function (1) (b)
Functions with the CF card unit or CF card extension unit	(1) (c)
Remote personal computer operation(Ethernet), Gateway function ^{*1} ,	Ethernet download ^{*1} , MES interface function ^{*1} (1) (d)
Fingerprint authentication, RFID function, Report function (when using the serial printer),	Barcode function, Remote personal computer operation(serial), Hard copy function (when using the serial printer) (1) (e)

- *1 For GT16, the function is available regardless of the combinations of units because the GOT has the Ethernet interface.
 For GT15, the function is not available when the Ethernet communication unit cannot be mounted because of the combination of units.

Refer to the explanation below to check if the number of channels for the multi-channel function to be used is restricted or not. If it is restricted, review the system configuration.

(1) Number of stages taken up by the individual functions (number of slots)

- (a) Report function (when using a PictBridge compatible printer), hard copy function (when using a PictBridge compatible printer), operation panel function, external I/O function and sound output function

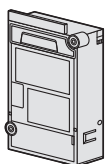

The printer unit, sound output unit, or external I/O unit is required depending on the function to be used.
 Each unit uses one stage (one slot) of an extension interface.

- (b) Remote personal computer operation (serial), video display function, multimedia function and RGB display function

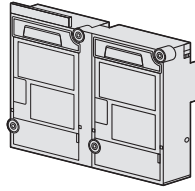

A video input unit, an RGB input unit, a video/RGB input unit, an RGB output unit or a multimedia unit is required corresponding to the function to be used.
Each type of unit uses 1 stage (2 slots) of extension interface.
Only one piece of each type of unit can be installed on a GOT.

- (c) Functions with CF card unit or CF card extension unit

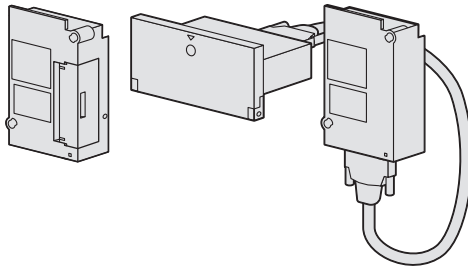

The CF card unit or CF card extension unit is required.
The CF card unit or CF card extension unit uses one stage (one slot) of an extension interface.

- (d) Remote personal computer operation (Ethernet), Ethernet download, gateway and MES interface functions

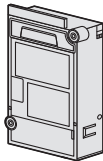

- GT16
Use the interface built in the GOT.
The Ethernet communication unit is not applicable.
- GT15
An Ethernet communication unit is required.
An Ethernet communication unit uses 1 stage (1 slot) of extension interface.
If the GOT is already connected in the Ethernet connection, the Ethernet communication unit installed in the GOT is used.

- (e) Fingerprint authentication, barcode function, RFID function, remote personal computer operation (serial), report function (when using a serial printer) and hard copy function (when using a serial printer)

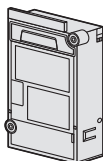

Use the interface built in the GOT or a serial communication unit.
A serial communication unit uses 1 stage (1 slot) of extension interface.

(2) Combinations of units that affect the number of available channels

The following are examples of unit combinations that affect the number of available channels.

POINT

Installing a unit on another unit (Checking the unit installation position)

For details on the precautions for installing units on another unit, refer to the following.

☞ 1.3.7 Installing a unit on another unit (Checking the unit installation position)

For the installation method of each unit, refer to the User's Manual for the communication unit and option unit you are using.

For the method for installing a unit on another unit, refer to the following.

☞ User's Manual of GOT used.

Example 1) To add the printer output (when using a PictBridge compatible printer) and the Ethernet download in a system using the bus connection (1 channel), serial connection (3 channels), and the barcode function

(a) For GT16

Mount the printer unit at the third stage, and use the Ethernet interface built in the GOT. This enables both the printer output of the report function and the Ethernet download.

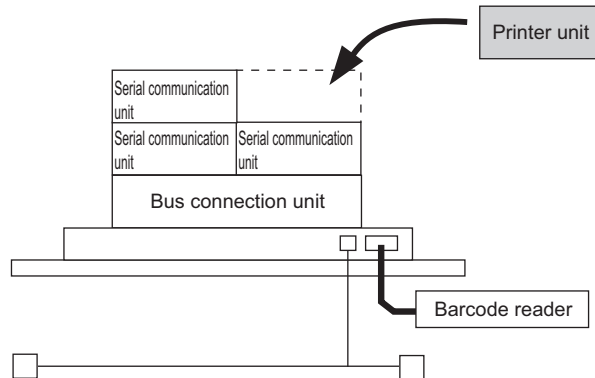

(b) For GT15

Because units can be mounted up to the third stage for GT15, the printer output of the report function and the Ethernet download cannot be used together.

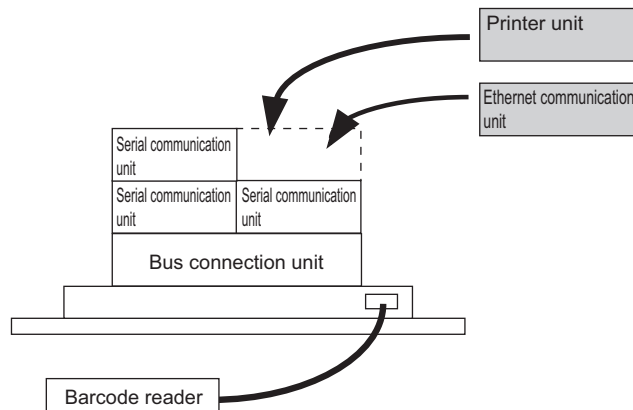

Example 2) To add the serial connection (1 channel) to the system using the bus connection (unit occupying 2 slots: 1 channel), the serial connection (2 channels), the video display, and the barcode function

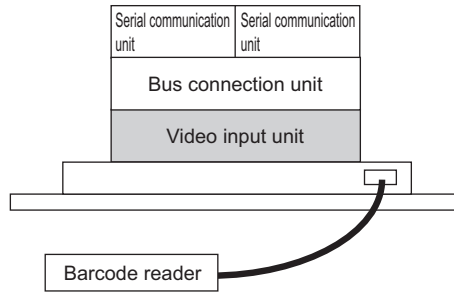

Since there are no available areas left for installing a unit, serial connection can be used for up to 2 channels.



Write Check Sheet



22.5 Multi-channel Function Check Sheet

Write down the following items selected in this section to the check sheet.

2 Selection of interface (communication unit)

Write down the name of interface and the model name of communication unit to be used for each of the connection type.

Check sheet No.1 (selection of connection type and interface)

(1) Channel No. of PLC, motion controller CPU, temperature controller, inverter, servo amplifier, CNC, robot controller (No.1 to No.4)

CH No.	Selection of connection type (20.3.3)	Selection of interface (communication unit) (20.3.4)
1	Connection name <i>Bus (Q)</i>	<i>GT15-QBUS2</i>
2	Connection name <i>OMRON PLC</i>	<i>GT15-RS4-9S</i>
3	Connection name <i>OMRON temp.</i>	<i>GT15-RS2-9P</i>
4	Connection name <i>Servo amplifier</i>	<i>GT15-RS2-9P</i>

(2) Channel No. of fingerprint unit, barcode reader, RFID controller, personal computer (No.5 to No.8)

CH No.	Selection of connection type (20.3.3)	Selection of interface (communication unit) (20.3.4)
5	Connection name <i>Bar code reader</i>	<i>GT15-RS2-9P</i>
6	Connection name	
7	Connection name <i>o</i>	<i>o</i>
8	Connection name <i>Fingerprint unit</i>	RS-232 interface built in a GOT



(Continued to next page)



Write Check Sheet



22.5 Multi-channel Function Check Sheet

Write down the following items to the check sheet.

3 Attaching the communication unit

1. Write down the name of communication unit to be used for each of the connection type.

(2) GT15

* For the GT155 , setting is made only for Extension interface 1.

When GT15-QBUS2/ABUS2 is used, although GT15-RS2-9P is installed physically at the 2nd stage of extend interface 2, the GOT recognizes the position as the 1st stage. Therefore, in the check sheet, the position should be entered as 1st stage.

2. After writing down the names of communication units, write down CH No. to be assigned to respective units based on the entry in ■ Check Sheet No. 1 (selection of connection type and interface).

■ Check sheet No.1 (selection of connection type and interface)

(1) Channel No. of PLC, motion controller CPU, temperature controller, inverter, servo amplifier, CNC, robot controller (No.1 to No.4)

CH No.	Selection of connection type (P. 20.3.3)	Selection of interface (communication unit) (P. 20.3.4)
1	Bus (Q)	GT15-QBUS2
2	OMRON PLC	GT15-RS4-9S
3	OMRON temp.	GT15-RS2-9P
4	Servo amplifier	GT15-RS2-9P

(2) Channel No. of fingerprint unit, barcode reader, RFID controller, personal computer (No.5 to No.8)

CH No.	Selection of connection type (P. 20.3.3)	Selection of interface (communication unit) (P. 20.3.4)
5	Bar code reader	GT15-RS2-9P
6		
7		
8	Fingerprint unit	RS-232 interface built in a GOT

(2) GT15

↓ (Continued to next page)

17 ROBOT CONTROLLER CONNECTION
18 CNC CONNECTION
19 ENERGY MEASURING UNIT/ELECTRIC MULTI-MEASURING INSTRUMENT CONNECTION
20 GOT MULTI-DROP CONNECTION
21 MULTIPLE-GT14, GT12, GT11, GT10 CONNECTION FUNCTION
22 MULTI-CHANNEL FUNCTION
23 FA TRANSPARENT FUNCTION

3. After writing down CH No., write down the communication driver name for each connection type. For the communication drivers used for the respective connection types, refer to the following.

☞ Chapters of each respective connection type

(2) GT15

Extension interface 1

3rd stage	Com. unit name	CH No.	Driver name
(1)	GT15-RS2-9P	5	Barcode
2nd stage	Com. unit name	CH No.	Driver name
(2)	GT15-RS4-9P	2	OMRON SYSMAC
1st stage	Com. unit name	CH No.	Driver name
(3)	GT15-QBus2	1	Bus (Q)

Extension interface 2

3rd stage	Com. unit name	CH No.	Driver name
(4)			
2nd stage	Com. unit name	CH No.	Driver name
(5)	GT15-RS2-9P	4	MELSERVO-J3, J2 S/M
1st stage	Com. unit name	CH No.	Driver name
(6)	GT15-RS2-9P	3	OMRON THERMAC / INPANEL NEO

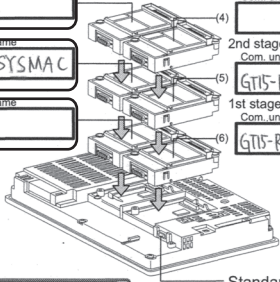

Standard interface 1 (only one connection)

Connecting a controller

Com. unit name	CH No.	Driver name
(7)		

Connecting a fingerprint unit, barcode reader, RFID controller, or personal computer

Com. unit name	CH No.	Driver name
	8	Fingerprint Authentication

Connecting a personal computer

Com. unit name	CH No.	Driver name
	9	Host (PC)

IF Communication Setting

Standard I/F Setting	CH No.	Driver
IF-1 RS232C	0	None
IF-2 USB	0	None

Extended I/F Setting

Extended I/F-1	CH No.	Driver
(3) 1st	0	None
(2) 2nd	0	None
(1) 3rd	0	None

Extended I/F-2	CH No.	Driver
(6) 1st	0	None
(5) 2nd	0	None
(4) 3rd	0	None

* For the GT155, setting is made only for Extension interface 1.

22.3.5 Setting for communication settings

Make communication settings based on the interface and the installation position of the respective communication units.

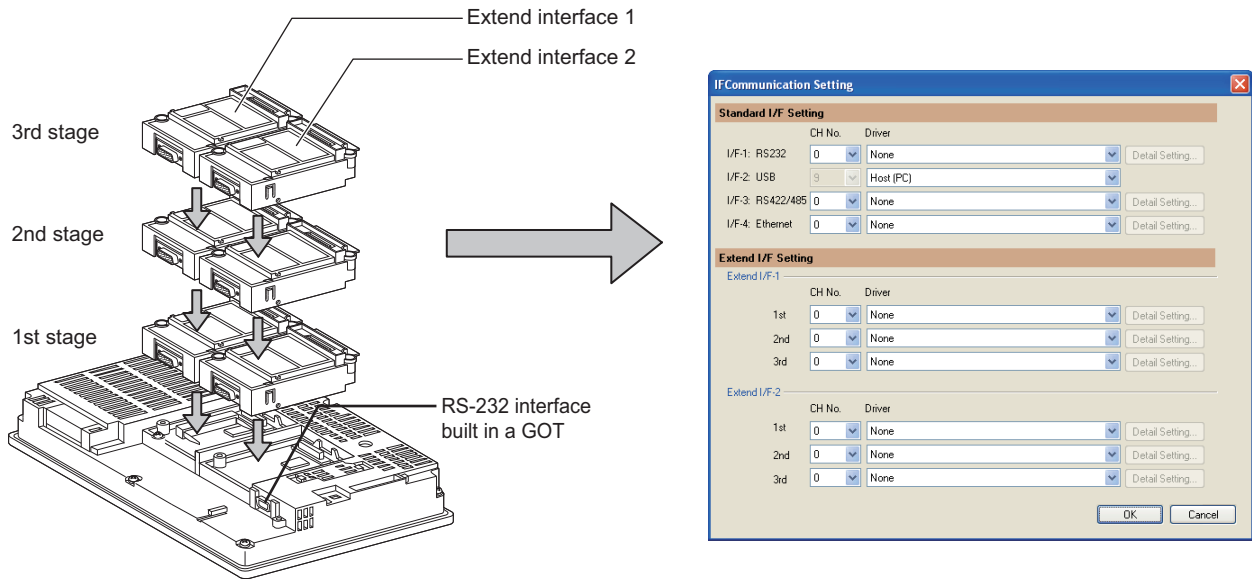

Check



22.5
Multi-channel Function
Check Sheet

Make settings for Communication Settings by GT Designer3 referring to the check sheet where the necessary information has been written.

The positions that the settings should be made on the communication settings screen are specified on the check sheet by numbers (GT16: (1) to (9), GT15: (1) to (7)).

(2) GT15

Extension interface 1			Extension interface 2				
3rd stage	Com. unit name	CH No.	Driver name	3rd stage	Com. unit name	CH No.	Driver name
(1)	GT15-RS2-4P	5	Barcode	(4)			
2nd stage				2nd stage			
(2)	GT15-RS4-4P	2	OMRON SYSMAC	(5)	GT15-RS2-4P	4	MELSERVO-J3, J2 S/M
1st stage				1st stage			
(3)	GT15-BBus2	1	Bus (Q)	(6)	GT15-RS2-4P	3	OMRON THE MAC / INPANEL NEO

Standard interface 1 (only one connection)

(7) Connecting a controller

Com. unit name CH No. Driver name

Connecting a fingerprint unit, barcode reader, RFID controller, or personal computer

8 Fingerprint Authentication

Connecting a personal computer

9 Host (PC)

IF Communication Setting

Standard I/F Setting

I/F-1: RS232 CH No. 0 Driver None

I/F-2: USB CH No. 5 Driver Host (PC)

I/F-3: RS422/485 CH No. 0 Driver None

I/F-4: Ethernet CH No. 0 Driver None

Extend I/F Setting

Extend I/F-1

1st CH No. 0 Driver None

2nd CH No. 0 Driver None

3rd CH No. 0 Driver None

Extend I/F-2

1st CH No. 0 Driver None

2nd CH No. 0 Driver None

3rd CH No. 0 Driver None

* For the GT155, setting is made only for Extension interface 1.

This completes the setting for Communication Settings.

Create a screen with GT Designer3.

Example: Setting example for "Bus connection (1 channel) + Serial connection (3 channels) + Bar code reader"
 (In the case of the GT157□)

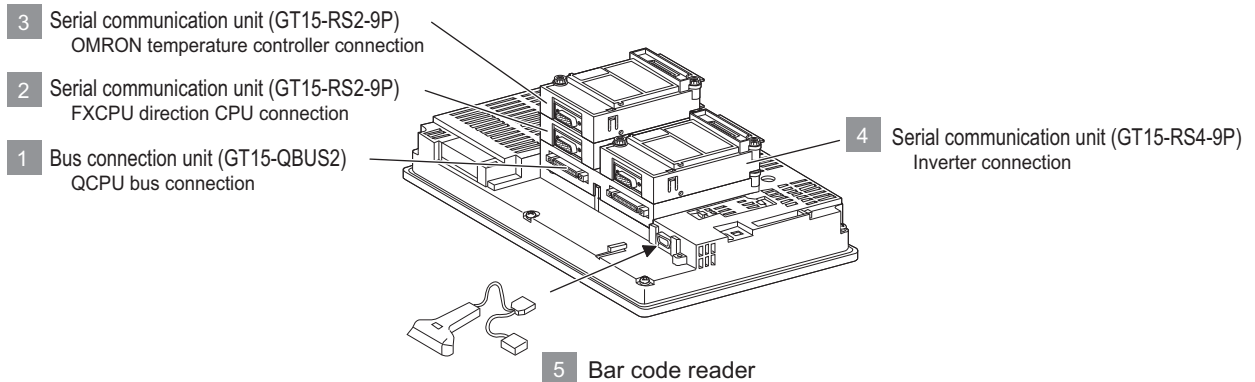

IFCommunication Setting

Standard I/F Setting

I/F	CH No.	Driver
I/F-1: RS232	8	Barcode Reader
I/F-2: USB	9	Host (PC)

Extend I/F Setting

Extend I/F-1

CH No.	Driver
1st	1 Bus(Q)
2nd	2 MELSEC-FX
3rd	3 OMRON THERMAC/INPANEL NEO

Extend I/F-2

CH No.	Driver
1st	4 FREQROL 500/700
2nd	0 None
3rd	0 None

OK Cancel

Example: Setting example for "MELSECNET/H connection (1 channel) + Serial connection (1 channel)"
 (In the case of the GT155□)

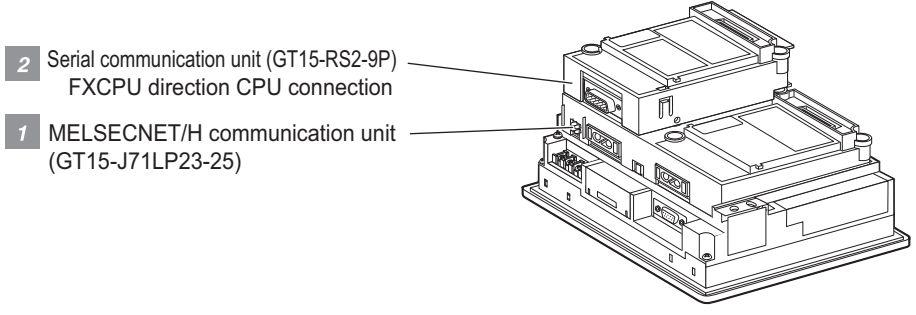

IFCommunication Setting

Standard I/F Setting

	CH No.	Driver	
I/F-1: RS232	9	Host (PC)	Detail Setting...
I/F-2: USB	9	Host (PC)	

Extend I/F Setting

Extend I/F-1

	CH No.	Driver	
1st	1	MELSECNET/H	Detail Setting...
2nd	2	MELSEC-FX	Detail Setting...
3rd	0	None	Detail Setting...

OK Cancel

17 ROBOT CONTROLLER CONNECTION

18 CNC CONNECTION

19 ENERGY MEASURING UNIT/ELECTRIC MULTI-MEASURING INSTRUMENT CONNECTION

20 GOT MULTI-DROP CONNECTION

21 MULTIPLE-GT14, GT12, GT11, GT10 CONNECTION FUNCTION

22 MULTI-CHANNEL FUNCTION

23 FA TRANSPARENT FUNCTION

Example: Setting example for Ethernet connection (4 channels) (In the case of the GT1685)

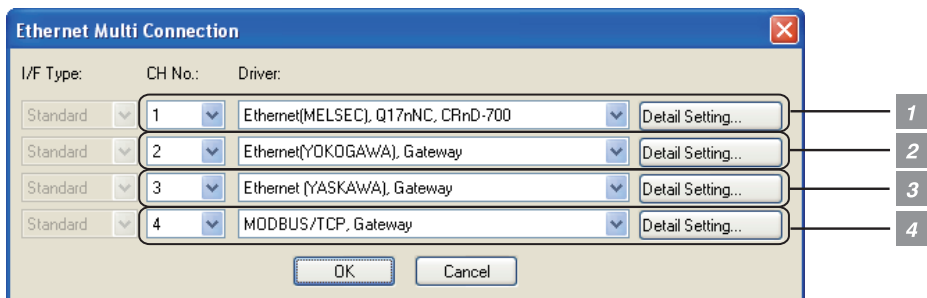
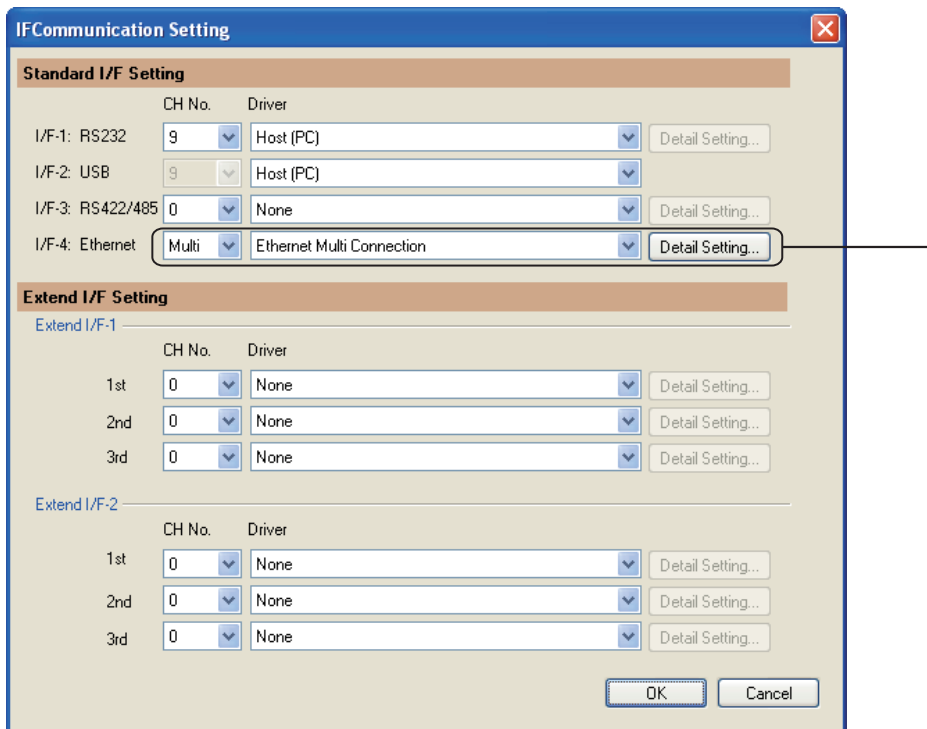
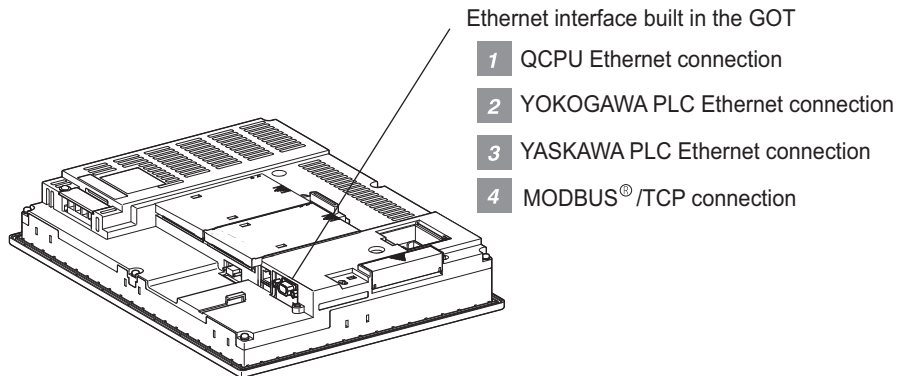

22.3.6 Items to be checked before starting drawing

The following describes that should be understood before starting drawing and the functions that should be set beforehand when using the multi-channel function.

■ Device settings

It is necessary to set the device to be used together with the CH No.

 GT Designer3 Version□ Screen Design Manual

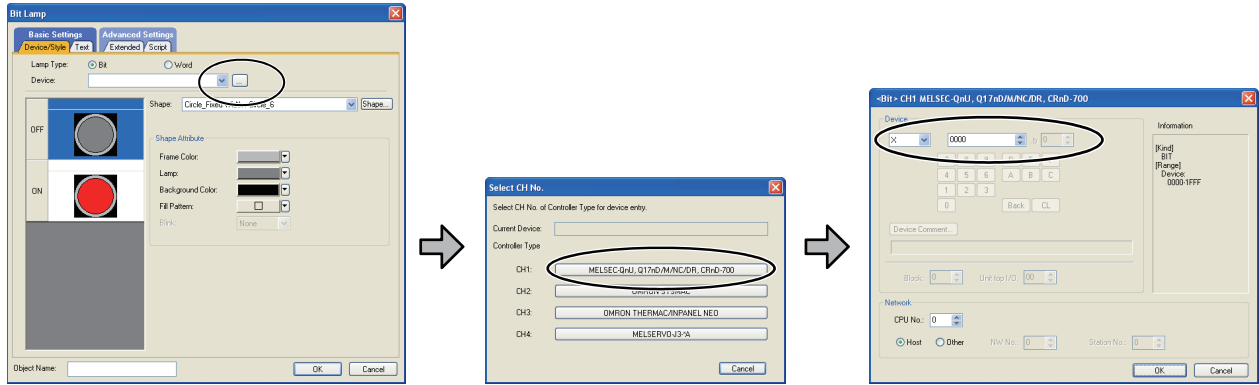

1. Click the device setting button.

2. Click the controller to be set.

3. Set the device.

■ Accessible range for monitoring

The accessible range for monitoring is not changed even when the multi-channel function is used.

 3. ACCESS RANGE FOR MONITORING

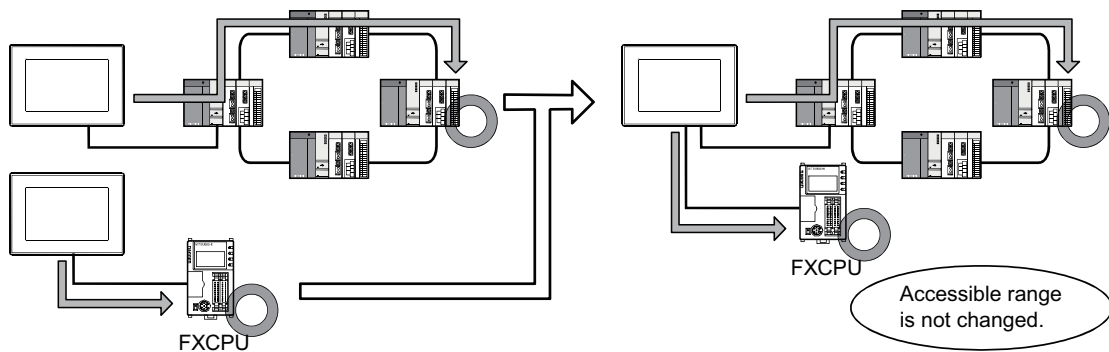

■ Clock function

Set the controller for which adjust/broadcast should be executed by the CH No.

☞ GT Designer3 Version□ Screen Design Manual

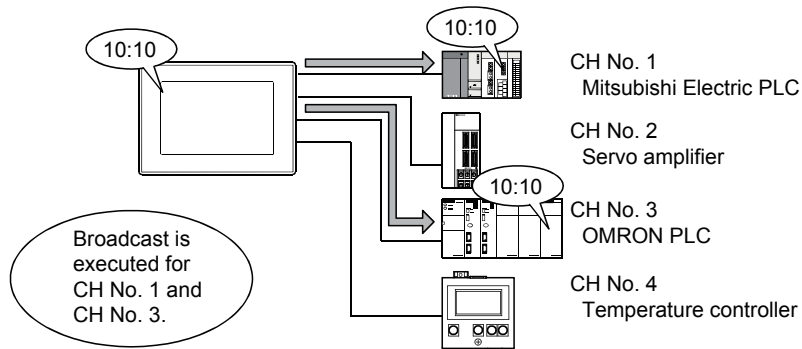

■ FA transparent function

Set the controller for which the FA transparent function should be executed by the CH No.

☞ 23.5.1 Setting communication interface

The set CH No. can be changed by the Utility.

To execute the FA transparent function for other CH No., change the CH No. using the Utility.

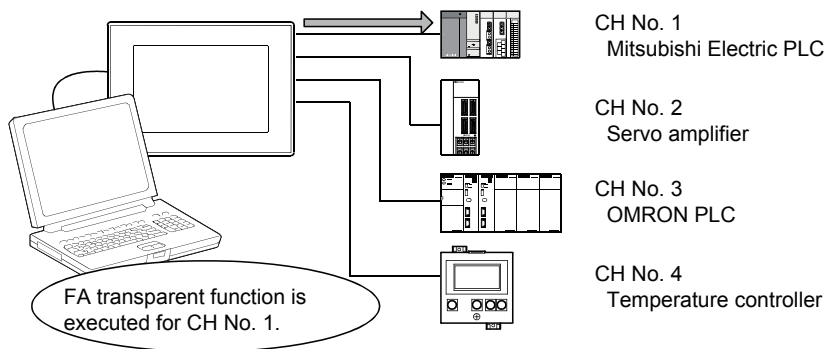

■ Station No. switching function

Set the controller for which the station No. switching function should be executed by the CH No.

☞ GT Designer3 Version□ Screen Design Manual

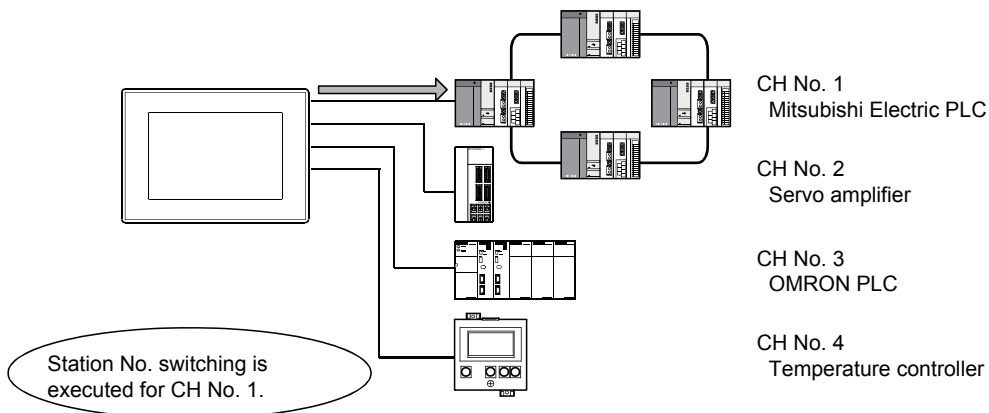

22.4 Precautions

22.4.1 Precautions for hardware

To use the multi-channel function, an option function board is required according to the GOT.
The following shows required option function boards according to the GOT.

GOT	Option function board
GT16	Not necessary
GT15	GT15-QFNB, GT15-MESB48M, GT15-QFNB16M, GT15-QFNB32M, GT15-QFNB48M
GT14	Not necessary
GT12	Not necessary

22.4.2 Precautions for use

■ Occurrence of the same system alarm at different channels

When the advanced system alarm is used, if the system alarms with the same error code occur in different channels the GOT treats the alarms as the same system alarm.

Therefore, if the system alarms with the same error code occur one by one, the time of later system alarm occurrence is not reflected to the GOT.

■ Confirmation of the channel No. at which a system alarm occurred

When a system alarm occurred, confirm the channel No. where the alarm occurred, using the procedure indicated below.

- (1) Check by [System alarm display] of the utility.

 GT16 User's Manual (Basic Utility)

 GT15 User's Manual

 GT14 User's Manual

- (2) Monitor the internal devices of the GOT.

 GT Designer3 Version□ Screen Design Manual

22.5 Multi-channel Function Check Sheet

This section provides the check sheet to be used for Communication Settings when the multi-channel function is used.

Sections 22.3.3 to 22.3.5 contain explanations of the items to be checked on the check sheet.

Checking items explained in these sections using the check sheet on the following page allows you to complete the setting for the multi-channel function.



Write Check Sheet



Section 2.8.10
Multi-channel function
check sheet

Enter the selections having been made in the steps above to the check sheet.

Selection of connection type

Enter the name of connection type to be used.

Shows items and contents to be written on the check sheet. Also describes an example of the check sheet.

■ Check sheet No.1 (selection of connection type and interface)

- (1) Channel No. of PLC, motion controller CPU, temperature controller, inverter, servo amplifier, CNC, robot controller (No.1 to No.4)

CH No.	Selection of connection type (20.3.3)	Selection of interface (communication unit) (20.3.4)
1	Connection name <i>Bus (Q)</i>	
2	Connection name <i>OMRON PLC</i>	
3	Connection name <i>OMRON temp.</i>	
4	Connection name <i>Servo amplifier</i>	

- (2) Channel No. of fingerprint unit, barcode reader, RFID controller, personal computer (No.5 to No.8)

CH No.	Selection of connection type (20.3.3)	Selection of interface (communication unit) (20.3.4)
5	Connection name <i>Bar code reader</i>	
6	Connection name	
7	Connection name	
8	Connection name <i>Fingerprint unit</i>	RS-232 interface built in a GOT

The following symbols are used for each purpose.



Write Check Sheet

Indicates parts where items and details are to be written. Confirm the details and write them to the check sheet.



Check

Indicates parts where written details are to be checked. Confirm the details and perform the Communication Settings.

■ Check sheet No.1 (selection of connection type and interface)

(1) Channel No. of PLC, motion controller CPU, temperature controller, inverter, servo amplifier, CNC, robot controller (No.1 to No.4)

CH No.	① Selection of connection type (☞ 22.3.3)	② Selection of interface (communication unit) (☞ 22.3.4)
1	Connection name	
2	Connection name	
3	Connection name	
4	Connection name	

(2) Channel No. of fingerprint unit, barcode reader, RFID controller, personal computer, serial printer (No.5 to No.8)

CH No.	① Selection of connection type (☞ 22.3.3)	② Selection of interface (communication unit) (☞ 22.3.4)
5	Connection name	
6	Connection name	
7	Connection name	
8	Connection name	RS-232 interface built in a GOT

■ Check sheet No. 2 (selection of GOT side interface)

◆ Attaching the communication unit

☞ 1.3.7

(1) GT16

Extension interface 1

3rd stage
Com. unit name CH No. Driver name

(1)

--	--	--

2nd stage
Com. unit name CH No. Driver name

(2)

--	--	--

1rd stage
Com. unit name CH No. Driver name

(3)

--	--	--

Extension interface 2

3rd stage
Com. unit name CH No. Driver name

(4)

--	--	--

2nd stage
Com. unit name CHNo Driver name

(5)

--	--	--

1rd stage
Com. unit name CHNo Driver name

(6)

--	--	--

Standard interface 3
(only one connection)

Connecting a controller

(8)

--	--	--

Standard interface 1 (only one connection)

Connecting a controller

(7)

--	--	--

Connecting a fingerprint unit, barcode reader, RFID controller, or personal computer

	8	
--	---	--

Connecting a personal computer

	9	Host (PC)
--	---	-----------

Standard interface 4 (only one connection)

Connecting a controller (Without multi-channel Ethernet connection)

(9)

--	--	--

Connecting a controller (With multi-channel Ethernet connection)

	Multi	Multi-channel Ethernet connection
--	-------	-----------------------------------

Standard interface 2 (only one connection)

(9)

--	--	--

Standard interface 3 (only one connection)

(9)

--	--	--

Standard interface 4 (only one connection)

(9)

--	--	--

IFCommunication Setting

Standard I/F Setting			
	CH No.	Driver	
(7) I/F-1: RS232	9	Host (PC)	Detail Setting...
I/F-2: USB	9	Host (PC)	Detail Setting...
(8) I/F-3: RS422/485	0	None	Detail Setting...
(9) I/F-4: Ethernet	0	None	Detail Setting...

Extend I/F Setting			
Extend I/F-1			
	CH No.	Driver	
(3) 1st	0	None	Detail Setting...
(2) 2nd	0	None	Detail Setting...
(1) 3rd	0	None	Detail Setting...

Extend I/F-2			
	CH No.	Driver	
(6) 1st	0	None	Detail Setting...
(5) 2nd	0	None	Detail Setting...
(4) 3rd	0	None	Detail Setting...

Ethernet Multi Connection

I/F Type	CH No.	Driver	
Standard	0	None	Detail Setting...
Standard	0	None	Detail Setting...
Standard	0	None	Detail Setting...
Standard	0	None	Detail Setting...

(2) GT15

Extension interface 1

3rd stage
Com. unit name CH No. Driver name
(1)

--	--	--

2nd stage
Com. unit name CH No. Driver name
(2)

--	--	--

1st stage
Com. unit name CH No. Driver name
(3)

--	--	--

Extension interface 2

3rd stage
Com. unit name CH No. Driver name
(4)

--	--	--

2nd stage
Com. unit name CH No. Driver name
(5)

--	--	--

1st stage
Com. unit name CH No. Driver name
(6)

--	--	--

IFCommunication Setting

Standard I/F Setting

I/F	CH No.	Driver
I/F-1: RS232C	9	Host (PC)
I/F-2: USB	9	Host (PC)

Extend I/F Setting

Extend I/F-1

Stage	CH No.	Driver
1st	0	None
2nd	0	None
3rd	0	None

Extend I/F-2

Stage	CH No.	Driver
1st	0	None
2nd	0	None
3rd	0	None

OK Cancel

Standard interface 1 (only one connection)

Connecting a controller

Com. unit name CH No. Driver name
(7)

--	--	--

Connecting a fingerprint unit, barcode reader, RFID controller, or personal computer

	8	
--	---	--

Connecting a personal computer

	9	Host (PC)
--	---	-----------

* For the GT155□, setting is made only for Extension interface 1.

17 ROBOT CONTROLLER CONNECTION
 18 CNC CONNECTION
 19 ENERGY MEASURING UNIT/ELECTRIC MULTI-MEASURING INSTRUMENT CONNECTION
 20 GOT MULTI-DROP CONNECTION
 21 MULTIPLE-GT14, GT12, GT11, GT10 CONNECTION FUNCTION
 22 MULTI-CHANNEL FUNCTION
 23 FA TRANSPARENT FUNCTION

FA TRANSPARENT FUNCTION

23. FA TRANSPARENT FUNCTION 23 - 1

23

FA TRANSPARENT FUNCTION



23.1 FA Transparent Function	23 - 2
23.2 Compatible Software	23 - 2
23.3 List of Models that Can Be Monitored	23 - 15
23.4 System Configuration	23 - 34
23.5 GOT Side Settings	23 - 45
23.6 Personal Computer Side Setting	23 - 48
23.7 Precautions	23 - 85

23. FA TRANSPARENT FUNCTION

23.1 FA Transparent Function

The FA transparent function allows the sequence programs of the Mitsubishi Electric PLC to be read, written and monitored from a personal computer connected via a GOT.

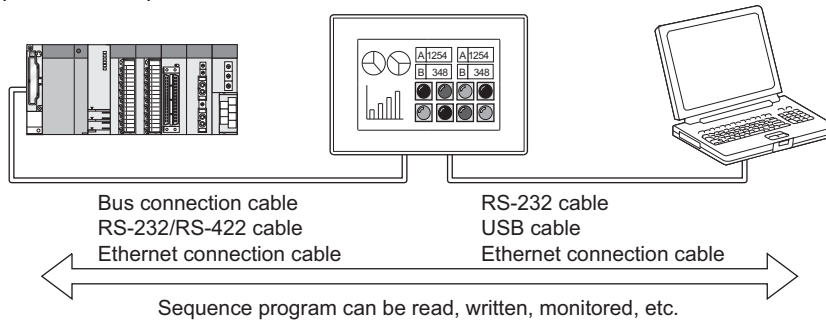

23.2 Compatible Software

The following shows the software compatible with the FA transparent function.

POINT

- (1) The range accessible by software when FA transparent function is used
Use of the FA transparent function does not affect the range accessible by the software.
For details on accessible range, refer to the manual for the respective software.
- (2) The software settings when using FA transparent function
For the software settings, refer to the following when using FA transparent function.

- ☞ 23.6.1 Accessing by GX Works3
- ☞ 23.6.2 Accessing by CW Configurator
- ☞ 23.6.3 Accessing the PLC by the GX Developer, PX Developer, GX Configurator
- ☞ 23.6.4 Accessing by GX Works2
- ☞ 23.6.5 Accessing by GX LogViewer
- ☞ 23.6.6 Accessing PLC by GX Configurator-QP
- ☞ 23.6.7 Accessing by the MT Developer
- ☞ 23.6.8 Accessing by the MT Works2
- ☞ 23.6.9 Accessing the servo amplifier by the MR Configurator
- ☞ 23.6.10 Accessing the servo amplifier by the MR Configurator2
- ☞ 23.6.11 Accessing the inverter by the FR Configurator
- ☞ 23.6.12 Accessing PLC by FX Configurator-FP
- ☞ 23.6.13 Accessing by FX Configurator-EN-L or FX Configurator-EN
- ☞ 23.6.14 Accessing by RT ToolBox2
- ☞ 23.6.15 Accessing by NC Configurator
- ☞ 23.6.16 Accessing by MELSOFT Navigator
- ☞ 23.6.17 Accessing by CPU Module Logging Configuration Tool
- ☞ 23.6.18 Accessing by Setting/ Monitoring tool for C Controller module
- ☞ 23.6.19 Accessing by MX Component(MX Sheet)

■ Connecting the GOT and personal computer with RS-232

(1) When connecting the GOT and PLC in bus connection

The following shows the software and the accessible PLC CPUs.

PLC CPU	Software
QCPU (Q mode), C Controller module (Q Series)	MELSOFT Navigator ^{*9} GX Developer ^{*1} GX Works2 ^{*10} PX Developer ^{*4} GX Configurator ^{*5} -AD/DA/SC/CT/TI/TC/AS/FL/PT GX Configurator-QP ^{*7} MX Component ^{*11} , MX Sheet ^{*12}
Q/QnA/ACPU, motion controller CPU (A Series)	GX Developer ^{*1} GX Works2 ^{*11} MX Component ^{*11} , MX Sheet ^{*12}
Motion controller CPU (Q Series)	MELSOFT Navigator ^{*9} MT Developer ^{*2} SW6RN-GSV13P, SW6RN-GSV22P, SW6RN-GSV43P, SW6RN-GSV54P, SW6RN-DOSCP, SW6RN-SNETP (for user API) MR Configurator ^{*3} MT Works2 ^{*8} , MX Component ^{*16} , MX Sheet ^{*17}
Robot controller (CRnQ-700)	RT ToolBox2 ^{*6}
MELSERVO(MR-J3-B) ^{*15}	MR Configurator ^{*3} , MR Configurator2 ^{*13}
MELSERVO(MR-J4-B) ^{*15}	MR Configurator2 ^{*14}

- *1 GX Developer Version 8 or later is required to use the FA transparent function.
GX Developer Version 8.68W or later is required to use the FA transparent function when connecting the QnUDE(H)CPU to the GOT.
- *2 MT Developer (SW6RNC-GSVE) Version 00N or later is required to use the FA transparent function.
- *3 MR Configurator (MRZJW3-SETUP221E) Version B1 or later is required to use the FA transparent function.
- *4 PX Developer Version 1.09K or later is required to use the FA transparent function.
PX Developer Version 1.18U or later is required to use the FA transparent function when connecting the Q02PHCPU or Q06PHCPU to the GOT.
- *5 Use GX Developer Version 8.30G or later combined with the following GX Configurator version or later to use the FA transparent function.

GX Configurator-AD	: Version 2.03D or later,	GX Configurator-DA	: Version 2.04E or later
GX Configurator-SC	: Version 2.10L or later,	GX Configurator-CT	: Version 1.23Z or later
GX Configurator-TI	: Version 1.22Y or later,	GX Configurator-TC	: Version 1.21X or later
GX Configurator-AS	: Version 1.20W or later,	GX Configurator-FL	: Version 1.21X or later
GX Configurator-PT	: Version 1.20W or later		
- *6 RT ToolBox2 Version 1.1 or later is required to use the FA transparent function.
- *7 GX Configurator-QP Version 2.32J or later is required to use the FA transparent function.
- *8 MT Works2 Version 1.00A or later is required to use the FA transparent function.
- *9 MELSOFT Navigator Version 1.04E or later is required to use the FA transparent function.
- *10 GX Works2 Version 1.03D or later is required to use the FA transparent function.
- *11 MX Component Version 3.14Q or later is required to use the FA transparent function.
- *12 Use MX Component Version 3.14Q or later for MX Sheet.
- *13 Start MR Configurator2 with MT Developer2 Version 1.10L or later.
- *14 MR Configurator2 Version 1.09K or later is required to use the FA transparent function.
- *15 A motion controller is required between the GOT and PLC in bus connection.
- *16 MX Component Version 4.00A or later is required to use the FA transparent function.
- *17 MX Component Version 4.00A or later is required for MX Sheet to use the FA transparent function.

- (2) When connecting the GOT and PLC in direct CPU connection
The following shows the software and the accessible PLC CPUs.

PLC CPU	Software
FX5U, FX5UC	GX Works3 ^{*25} , MX Component ^{*26} , MX Sheet ^{*27}
QCPU (Q mode)	MELSOFT Navigator ^{*10} GX Developer GX Works2 ^{*11} PX Developer ^{*3} GX Configurator ^{*4} -AD/DA/SC/CT/TI/TC/AS/FL/PT GX Configurator-QP ^{*8} MX Component ^{*16} , MX Sheet ^{*17}
LCPU ^{*14}	MELSOFT Navigator ^{*15} GX Developer ^{*12} GX Works2 ^{*13} , GX Logviewer MX Component ^{*16} , MX Sheet ^{*17} , CPU Module Logging Configuration Tool ^{*19}
QCPU (A mode), QnA/ACPU	GX Developer MX Component ^{*16} , MX Sheet ^{*17}
FXCPU	MELSOFT Navigator ^{*10} GX Developer GX Works2 ^{*11} FX-PCS/WIN ^{*5} FX Configurator-FP ^{*6} FX3U-ENET-L Configuration tool FX Configurator-EN ^{*28} MX Component ^{*16} , MX Sheet ^{*17}
Motion controller CPU (Q Series)	MELSOFT Navigator ^{*10} MT Developer SW6RN-GSV13P, SW6RN-GSV22P, SW6RN-GSV43P, SW6RN-GSV54P, SW6RN-DOSCP, SW6RN-SNETP (for user API) MT Works2 ^{*9} MR Configurator ^{*1} , MX Component ^{*22} , MX Sheet ^{*23}
Motion controller CPU (A Series)	GX Developer SW3RN-GSV13P, SW3RN-GSV22P, SW3RN-GSV43P, SW3RN-GSV51P MX Component ^{*16} , MX Sheet ^{*17}
MELSERVO(MR-J3-B) ^{*21}	MR Configurator ^{*1} , MR Configurator2 ^{*18}
MELSERVO(MR-J4-B) ^{*21}	MR Configurator2 ^{*20}
FREQROL A700/F700/E700/D700 Series	FR Configurator ^{*2}
Sensorless servo (FREQROL E700EX)	FR Configurator ^{*24}
Robot controller (CRnQ-700)	RT ToolBox2 ^{*7}

- *1 MR Configurator (MRZJW3-SETUP221E) Version B1 or later is required to use the FA transparent function.
- *2 FR Configurator(FR-SW2-SETUP-WJ) Ver.1.02 or later is required to use the FA transparent function when connecting the A700/F700 series to the GOT.
FR Configurator(FR-SW3-SETUP-WJ) Ver.2.00 or later is required to use the FA transparent function when connecting the E700 series to the GOT.
FR Configurator(FR-SW3-SETUP-WJ) Ver.3.10 or later is required to use the FA transparent function when connecting the F700 series to the GOT.
- *3 PX Developer Version 1.09K or later is required to use the FA transparent function.
PX Developer Version 1.18U or later is required to use the FA transparent function when connecting the Q02PHCPU or Q06PHCPU to the GOT.
- *4 Use GX Developer Version 8.30G or later combined with the following GX Configurator version or later to use the FA transparent function.
GX Configurator-AD : Version 2.03D pr later, GX Configurator-DA : Version 2.04E or later
GX Configurator-SC : Version 2.10L or later, GX Configurator-CT : Version 1.23Zor later
GX Configurator-TI : Version 1.22Y or later, GX Configurator-TC : Version 1.21X or later
GX Configurator-AS : Version 1.20W or later, GX Configurator-FL : Version 1.21X or later
GX Configurator-PT : Version 1.20W or later
- *5 The RS-232/USB conversion adaptor (GT10-RS2TUSB-5S) is not applicable to FX-PCS/WIN.
- *6 FX Configurator-FP Version 1.30 or later is required to use the FA transparent function.
- *7 RT ToolBox2 Version 1.1 or later is required to use the FA transparent function.
- *8 GX Configurator-QP Version2.32J or later is required to use the FA transparent function.
- *9 MT Works2 Version 1.00A or later is required to use the FA transparent function.
- *10 MELSOFT Navigator Version 1.04E or later is required to use the FA transparent function.

- *11 GX Works2 Version 1.03D or later is required to use the FA transparent function.
- *12 GX Developer Version 8.88S or later is required to use the FA transparent function.
- *13 GX Works2 Version 1.11M or later is required to use the FA transparent function.
- *14 The adapter (L6ADP-R2 or L6ADP-R4) is required.
- *15 MELSOFT Navigator Version 1.07H or later is required to use the FA transparent function.
- *16 MX Component Version 4.03D or later is required to use the FA transparent function.
- *17 Use MX Component Version 3.14Q or later for MX Sheet.
- *18 Start MR Configurator2 with MT Developer2 Version 1.10L or later.
- *19 CPU Module Logging Configuration Tool Version 1.04E or later is required to use the FA transparent function.
- *20 MR Configurator2 Version 1.09K or later is required to use the FA transparent function.
- *21 A motion controller is required between the GOT and PLC in direct CPU connection.
- *22 MX Component Version 4.00A or later is required to use the FA transparent function.
- *23 MX Component Version 4.00A or later is required for MX Sheet to use the FA transparent function.
- *24 FR Configurator Version 5.21 or later is required to use the FA transparent function.
- *25 GX Works3 Version 1.005F or later is required to use the FA transparent function.
- *26 MX Component Version 4.11M or later is required to use the FA transparent function.
- *27 MX Sheet, please use the MX Component (Version 4.11M or later).
- *28 FX Configurator-EN Version 1.10A or later is required to use the FA transparent function.

17	ROBOT CONTROLLER CONNECTION
18	CNC CONNECTION
19	ENERGY MEASURING UNIT/ELECTRIC MULTI- MEASURING INSTRUMENT CONNECTION
20	GOT MULTI-DROP CONNECTION
21	MULTIPLE-GT14, GT12, GT11, GT10 CONNECTION FUNCTION
22	MULTI-CHANNEL FUNCTION
23	FA TRANSPARENT FUNCTION

- (3) When connecting the GOT and PLC in computer link connection
The following shows the software and the accessible PLC CPUs.

PLC CPU	Software
RCPU	GX Works3, MX Component ^{*12} , MX Sheet ^{*13}
QCPU (Q mode)	MELSOFT Navigator ^{*4} GX Developer ^{*1} GX Works2 ^{*5} PX Developer ^{*2} GX Configurator-QP ^{*3} MX Component ^{*9} , MX Sheet ^{*10}
LCPU	MELSOFT Navigator ^{*8} GX Developer ^{*6} GX Works2 ^{*7} GX LogViewer MX Component ^{*9} , MX Sheet ^{*10} , CPU Module Logging Configuration Tool ^{*11}

- *1 GX Developer Version 8.62Q or later is required to use the FA transparent function.
GX Developer Version 8.68W or later is required to use the FA transparent function when connecting the QnUDE(H)CPU to the GOT.
- *2 PX Developer Version 1.18U or later is required to use the FA transparent function.
- *3 GX Configurator-QP Version 2.32J or later is required to use the FA transparent function.
- *4 MELSOFT Navigator Version 1.04E or later is required to use the FA transparent function.
- *5 GX Works2 Version 1.03D or later is required to use the FA transparent function.
- *6 GX Developer Version 8.88S or later is required to use the FA transparent function.
- *7 GX Works2 Version 1.11M or later is required to use the FA transparent function.
- *8 MELSOFT Navigator Version 1.07H or later is required to use the FA transparent function.
- *9 MX Component Version 4.03D or later is required to use the FA transparent function.
- *10 Use MX Component Version 3.14Q or later for MX Sheet.
- *11 CPU Module Logging Configuration Tool Version 1.04E or later is required to use the FA transparent function.
- *12 MX Component Version 4.06G or later is required to use the FA transparent function.
- *13 Use MX Component Version 4.06G or later for MX Sheet.

(4) When connecting the GOT and PLC in Ethernet communication
The following shows the software and the accessible PLC CPUs.

PLC CPU	Software
RCPU	GX Works3, MX Component ^{*18} , MX Sheet ^{*19}
Motion controller CPU (MELSEC iQ-R Series)	MT Works2 ^{*17} , MX Component ^{*18} , MX Sheet ^{*19}
C Controller module (MELSEC iQ-R Series)	CW Configurator
FX5U, FX5UC	GX Works3 ^{*20} , MX Component ^{*21} , MX Sheet ^{*22}
QCPU (Q mode) ^{*1} , C Controller module (Q Series)	MELSOFT Navigator ^{*3} GX Developer ^{*2} GX Works2 ^{*4} MX Component ^{*10} , MX Sheet ^{*11}
LCPU	MELSOFT Navigator ^{*9} GX Developer ^{*6} GX Works2 ^{*7} GX LogViewer MX Component ^{*10} , MX Sheet ^{*11} , CPU Module Logging Configuration Tool ^{*12}
FXCPU	GX Works2 ^{*16}
QCPU (A mode), QnA/ACPU ^{*1}	GX Developer ^{*2} MX Component ^{*10} , MX Sheet ^{*11}
Motion controller CPU (Q Series)	MELSOFT Navigator ^{*3} SW6RN-GSV13P, SW6RN-GSV22P, SW6RN-GSV43P, SW6RN-GSV54P, SW6RN-DOSCP, SW6RN-SNETP (for user API) MT Works2 ^{*5*8}
Robot controller (CRnQ-700, CRnD-700)	RT ToolBox2 ^{*13}
MELSERVO(MR-J3-B) ^{*15}	MR Configurator2
MELSERVO(MR-J4-B) ^{*15}	MR Configurator2 ^{*14}

- *1 Only QCPU can be connected. To connect to QnA/ACPU, connect via QCPU.
- *2 GX Developer Version 8.78G or later is required to use the FA transparent function.
- *3 MELSOFT Navigator Version 1.04E or later is required to use the FA transparent function.
- *4 GX Works2 Version 1.10L or later is required to use the FA transparent function.
- *5 MT Works2 Version 1.08J or later is required to use the FA transparent function.
- *6 GX Developer Version 8.88S or later is required to use the FA transparent function.
- *7 GX Works2 Version 1.11M or later is required to use the FA transparent function.
- *8 MT Works2 Version 1.12N or later is required to connect with Q17nDCPU-S1.
- *9 MELSOFT Navigator Version 1.07H or later is required to use the FA transparent function.
- *10 MX Component Version 4.03D or later is required to use the FA transparent function.
- *11 Use MX Component Version 3.14Q or later for MX Sheet.
- *12 CPU Module Logging Configuration Tool Version 1.04E or later is required to use the FA transparent function.
- *13 RT ToolBox2 Version 1.7 or later is required to use the FA transparent function.
- *14 MR Configurator2 Version 1.09K or later is required to use the FA transparent function.
- *15 A motion controller is required between the GOT and PLC in Ethernet connection.
- *16 GX Works2 Version 1.98C or later is required to use the FA transparent function.
- *17 MT Works2 Version 1.100E or later is required to use the FA transparent function.
- *18 MX Component Version 4.06G or later is required to use the FA transparent function.
- *19 Use MX Component Version 4.06G or later for MX Sheet.
- *20 GX Works3 Version 1.005F or later is required to use the FA transparent function.
- *21 MX Component Version 4.11M or later is required to use the FA transparent function.
- *22 MX Sheet, please use the MX Component (Version 4.11M or later).

(5) When connecting the GOT and PLC in CC-Link IE Controller Network connection (GT16 only)
The following shows the software and the accessible PLC CPUs.

PLC CPU	Software
QCPU (Q mode)	GX Works2 ^{*1}
Motion controller CPU (Q Series) (Q170MCP, Q170MSCPU, Q170MSCPU-S1 only)	GX Works2 ^{*1}

- *1 GX Works2 Version 1.525X or later is required to use the FA transparent function.

17
ROBOT CONTROLLER CONNECTION
18
CNC CONNECTION
19
ENERGY MEASURING UNIT/ELECTRIC MULTI-MEASURING INSTRUMENT CONNECTION
20
GOT MULTI-DROP CONNECTION
21
MULTIPLE-GT14, GT12, GT11, GT10 CONNECTION FUNCTION
22
MULTI-CHANNEL FUNCTION
23
FA TRANSPARENT FUNCTION

■ Connecting the GOT and personal computer with USB

(1) When connecting the GOT and PLC in bus connection

The following shows the software and the accessible PLC CPUs.

PLC CPU	Software
QCPU (Q mode), C Controller module (Q Series)	MELSOFT Navigator ^{*9} GX Developer ^{*1} GX Works2 ^{*10} PX Developer ^{*4} GX Configurator ^{*5} -AD/DA/SC/CT/TI/TC/AS/FL/PT GX Configurator-QP ^{*7} MX Component ^{*12} , MX Sheet ^{*13} Setting/Monitoring tool for C Controller module ^{*19}
QCPU (A mode), QnA/ACPU, motion controller CPU (A Series)	GX Developer ^{*1} MX Component ^{*12} , MX Sheet ^{*13}
Motion controller CPU (Q Series)	MELSOFT Navigator ^{*9} MT Developer ^{*2} SW6RN-GSV13P, SW6RN-GSV22P, SW6RN-GSV43P, SW6RN-GSV54P, SW6RN-DOSCP, SW6RN-SNETP (for user API) MR Configurator ^{*3} MT Works2 ^{*8} , MX Component ^{*17} , MX Sheet ^{*18}
CNC CPU(Q173NCCPU)	NC Configurator ^{*11}
Robot controller (CRnQ-700)	RT ToolBox2 ^{*6}
MELSERVO(MR-J3-B) ^{*16}	MR Configurator ^{*3} , MR Configurator2 ^{*14}
MELSERVO(MR-J4-B) ^{*16}	MR Configurator2 ^{*15}

- *1 GX Developer Version 8.22Y or later is required to use the FA transparent function.
GX Developer Version 8.68W or later is required to use the FA transparent function when connecting the QnUDE(H)CPU to the GOT.
- *2 MT Developer (SW6RNC-GSVE) Version 00N or later is required to use the FA transparent function.
- *3 MR Configurator (MRZJW3-SETUP221E) Version B1 or later is required to use the FA transparent function.
- *4 PX Developer Version 1.09K or later is required to use the FA transparent function.
PX Developer Version 1.18U or later is required to use the FA transparent function when connecting the Q02PHCPU or Q06PHCPU to the GOT.
- *5 Use GX Developer Version 8.30G or later combined with the following GX Configurator version or later to use the FA transparent function.
- | | | | |
|--------------------|---------------------------|--------------------|--------------------------|
| GX Configurator-AD | : Version 2.03D or later, | GX Configurator-DA | : Version 2.04E or later |
| GX Configurator-SC | : Version 2.10L or later, | GX Configurator-CT | : Version 1.23Z or later |
| GX Configurator-TI | : Version 1.22Y or later, | GX Configurator-TC | : Version 1.21X or later |
| GX Configurator-AS | : Version 1.20W or later, | GX Configurator-FL | : Version 1.21X or later |
| GX Configurator-PT | : Version 1.20W or later | | |
- *6 RT ToolBox2 Version 1.1 or later is required to use the FA transparent function.
- *7 GX Configurator-QP Version 2.32J or later is required to use the FA transparent function.
- *8 MT Works2 Version 1.00A or later is required to use the FA transparent function.
- *9 MELSOFT Navigator Version 1.04E or later is required to use the FA transparent function.
- *10 GX Works2 Version 1.03D or later is required to use the FA transparent function.
- *11 NC Configurator Version A0 or later is required to use the FA transparent function.
- *12 MX Component Version 3.14Q or later is required to use the FA transparent function.
- *13 Use MX Component Version 3.14Q or later for MX Sheet.
- *14 Start MR Configurator2 with MT Developer2 Version 1.10L or later.
- *15 MR Configurator2 Version 1.09K or later is required to use the FA transparent function.
- *16 A motion controller is required between the GOT and PLC in bus connection.
- *17 MX Component Version 4.00A or later is required to use the FA transparent function.
- *18 MX Component Version 4.00A or later is required for MX Sheet to use the FA transparent function.
- *19 Setting/Monitoring tool for C Controller module Version 4.00A or later is required to use the FA transparent function.

(2) When connecting the GOT and PLC in direct CPU connection
The following shows the software and the accessible PLC CPUs.

PLC CPU	Software
FX5U, FX5UC	GX Works3 ^{*26} , MX Component ^{*27} , MX Sheet ^{*28}
QCPU (Q mode)	MELSOFT Navigator ^{*11} GX Developer ^{*1} GX Works2 ^{*12} PX Developer ^{*5} GX Configurator ^{*6} -AD/DA/SC/CT/TI/TC/AS/FL/PT GX Configurator-QP ^{*9} MX Component ^{*17} , MX Sheet ^{*18}
LCPU ^{*15}	MELSOFT Navigator ^{*16} GX Developer ^{*13} GX Works2 ^{*14} GX Logviewer MX Component ^{*17} , MX Sheet ^{*18} , CPU Module Logging Configuration Tool ^{*20}
QCPU (A mode), QnA/ACPU, motion controller CPU (A Series)	GX Developer ^{*1} MX Component ^{*17} , MX Sheet ^{*18}
FXCPU	MELSOFT Navigator ^{*11} GX Developer ^{*1} GX Works2 ^{*12} FX Configurator-FP ^{*7} FX3U-ENET-L Configuration tool FX Configurator-EN ^{*29} MX Component ^{*17} , MX Sheet ^{*18}
Motion controller CPU (Q Series)	MELSOFT Navigator ^{*11} MT Developer ^{*2} SW6RN-GSV13P, SW6RN-GSV22P, SW6RN-GSV43P, SW6RN-GSV54P, SW6RN-DOSCP, SW6RN-SNETP (for user API) MR Configurator ^{*3} MT Works2 ^{*10} , MX Component ^{*23} , MX Sheet ^{*24}
FREQROL A700/F700/E700/D700 Series	FR Configurator ^{*4}
Sensorless servo (FREQROL E700EX)	FR Configurator ^{*25}
Robot controller (CRnQ-700)	RT ToolBox2 ^{*8}
MELSERVO(MR-J3-B) ^{*22}	MR Configurator ^{*3} , MR Configurator2 ^{*19}
MELSERVO(MR-J4-B) ^{*22}	MR Configurator2 ^{*21}

- *1 GX Developer Version 8.22Y or later is required to use the FA transparent function.
GX Developer Version 8.68W or later is required to use the FA transparent function when connecting the QnUDE(H)CPU to the GOT.
- *2 MT Developer (SW6RNC-GSVE) Version 00N or later is required to use the FA transparent function.
- *3 MR Configurator (MRZJW3-SETUP221E) Version B1 or later is required to use the FA transparent function.
- *4 FR Configurator(FR-SW2-SETUP-WJ) Ver.1.02 or later is required to use the FA transparent function when connecting the A700/F700 series to the GOT.
FR Configurator(FR-SW3-SETUP-WJ) Ver.2.00 or later is required to use the FA transparent function when connecting the E700 series to the GOT.
FR Configurator(FR-SW3-SETUP-WJ) Ver.3.10 or later is required to use the FA transparent function when connecting the F700 series to the GOT.
- *5 PX Developer Version 1.09K or later is required to use the FA transparent function.
PX Developer Version 1.18U or later is required to use the FA transparent function when connecting the Q02PHCPU or Q06PHCPU to the GOT.
- *6 Use GX Developer Version 8.30G or later combined with the following GX Configurator version or later to use the FA transparent function.
- | | | | |
|--------------------|---------------------------|--------------------|--------------------------|
| GX Configurator-AD | : Version 2.03D pr later, | GX Configurator-DA | : Version 2.04E or later |
| GX Configurator-SC | : Version 2.10L or later, | GX Configurator-CT | : Version 1.23Z or later |
| GX Configurator-TI | : Version 1.22Y or later, | GX Configurator-TC | : Version 1.21X or later |
| GX Configurator-AS | : Version 1.20W or later, | GX Configurator-FL | : Version 1.21X or later |
| GX Configurator-PT | : Version 1.20W or later | | |
- *7 FX Configurator-FP Version 1.30 or later is required to use the FA transparent function.
- *8 RT ToolBox2 Version 1.1 or later is required to use the FA transparent function.
- *9 GX Configurator-QP Version 2.32J or later is required to use the FA transparent function.
- *10 MT Works2 Version 1.00A or later is required to use the FA transparent function.
- *11 MELSOFT Navigator Version 1.04E or later is required to use the FA transparent function.
- *12 GX Works2 Version 1.03D or later is required to use the FA transparent function.

17
ROBOT CONTROLLER CONNECTION
18
CNC CONNECTION
19
ENERGY MEASURING UNIT/ELECTRIC MULTI-MEASURING INSTRUMENT CONNECTION
20
GOT MULTI-DROP CONNECTION
21
MULTIPLE-GT14, GT12, GT11, GT10 CONNECTION FUNCTION
22
MULTI-CHANNEL FUNCTION
23
FA TRANSPARENT FUNCTION

- *13 GX Developer Version 8.88S or later is required to use the FA transparent function.
- *14 GX Works2 Version 1.11M or later is required to use the FA transparent function.
- *15 The adapter (L6ADP-R2 or L6ADP-R4) is required.
- *16 MELSOFT Navigator Version 1.07H or later is required to use the FA transparent function.
- *17 MX Component Version 4.03D or later is required to use the FA transparent function.
- *18 Use MX Component Version 3.14Q or later for MX Sheet.
- *19 Start MR Configurator2 with MT Developer2 Version 1.10L or later.
- *20 CPU Module Logging Configuration Tool Version 1.04E or later is required to use the FA transparent function.
- *21 MR Configurator2 Version 1.09K or later is required to use the FA transparent function.
- *22 A motion controller is required between the GOT and PLC in direct CPU connection.
- *23 MX Component Version 4.00A or later is required to use the FA transparent function.
- *24 MX Component Version 4.00A or later is required for MX Sheet to use the FA transparent function.
- *25 FR Configurator Version 5.21 or later is required to use the FA transparent function.
- *26 GX Works3 Version 1.005F or later is required to use the FA transparent function.
- *27 MX Component Version 4.11M or later is required to use the FA transparent function.
- *28 MX Sheet, please use the MX Component (Version 4.11M or later).
- *29 FX Configurator-EN Version 1.10A or later is required to use the FA transparent function.

(3) When connecting the GOT and PLC in computer link connection

The following shows the software and the accessible PLC CPUs.

PLC CPU	Software
RCPU	GX Works3, MX Component ^{*12} , MX Sheet ^{*13}
QCPU (Q mode)	MELSOFT Navigator ^{*4} GX Developer ^{*1} GX Works2 ^{*5} PX Developer ^{*2} GX Configurator-QP ^{*3} MX Component ^{*9} , MX Sheet ^{*10}
LCPU	MELSOFT Navigator ^{*8} GX Developer ^{*6} GX Works2 ^{*7} GX LogViewer MX Component ^{*9} , MX Sheet ^{*10} , CPU Module Logging Configuration Tool ^{*11}

- *1 GX Developer Version 8.62Q or later is required to use the FA transparent function.
GX Developer Version 8.68W or later is required to use the FA transparent function when connecting the QnUDE(H)CPU to the GOT.
- *2 PX Developer Version 1.18U or later is required to use the FA transparent function.
- *3 GX Configurator-QP Version 2.32J or later is required to use the FA transparent function.
- *4 MELSOFT Navigator Version 1.04E or later is required to use the FA transparent function.
- *5 GX Works2 Version 1.03D or later is required to use the FA transparent function.
- *6 GX Developer Version 8.88S or later is required to use the FA transparent function.
- *7 GX Works2 Version 1.11M or later is required to use the FA transparent function.
- *8 MELSOFT Navigator Version 1.07H or later is required to use the FA transparent function.
- *9 MX Component Version 4.03D or later is required to use the FA transparent function.
- *10 Use MX Component Version 3.14Q or later for MX Sheet.
- *11 CPU Module Logging Configuration Tool Version 1.04E or later is required to use the FA transparent function.
- *12 MX Component Version 4.06G or later is required to use the FA transparent function.
- *13 Use MX Component Version 4.06G or later for MX Sheet.

(4) When connecting the GOT and PLC in Ethernet communication
The following shows the software and the accessible PLC CPUs.

PLC CPU	Software
RCPU	GX Works3, MX Component ^{*21} , MX Sheet ^{*22}
Motion controller CPU (MELSEC iQ-R Series)	MT Works2 ^{*20} , MX Component ^{*21} , MX Sheet ^{*22}
C Controller module (MELSEC iQ-R Series)	CW Configurator
FX5U, FX5UC	GX Works3 ^{*23} , MX Component ^{*24} , MX Sheet ^{*25}
QCPU (Q mode) ^{*1} , C Controller module (Q Series)	MELSOFT Navigator ^{*3} GX Developer ^{*2} GX Works2 ^{*4*13} MX Component ^{*11} , MX Sheet ^{*12} Setting/Monitoring tool for C Controller module ^{*18}
LCPU	MELSOFT Navigator ^{*10} GX Developer ^{*7} GX Works2 ^{*8} GX LogViewer MX Component ^{*11} , MX Sheet ^{*12} , CPU Module Logging Configuration Tool ^{*14}
FXCPU	GX Works2 ^{*19}
QCPU (A mode), QnA/ACPU ^{*1}	GX Developer ^{*2} MX Component ^{*11} , MX Sheet ^{*12}
Motion controller CPU (Q Series)	MELSOFT Navigator ^{*3} MT Works2 ^{*5*9}
CNC CPU(Q173NCCPU)	NC Configurator ^{*6}
Robot controller (CRnQ-700, CRnD-700)	RT ToolBox2 ^{*15}
MELSERVO(MR-J3-B) ^{*17}	MR Configurator2
MELSERVO(MR-J4-B) ^{*17}	MR Configurator2 ^{*16}

- *1 Only QCPU can be connected. To connect to QnA/ACPU, connect via QCPU.
- *2 GX Developer Version 8.78G or later is required to use the FA transparent function.
- *3 MELSOFT Navigator Version 1.04E or later is required to use the FA transparent function.
- *4 GX Works2 Version 1.10L or later is required to use the FA transparent function.
- *5 MT Works2 Version 1.08J or later is required to use the FA transparent function.
- *6 NC Configurator Version A1 or later is required to use the FA transparent function.
- *7 GX Developer Version 8.88S or later is required to use the FA transparent function.
- *8 GX Works2 Version 1.11M or later is required to use the FA transparent function.
- *9 MT Works2 Version 1.12N or later is required to connect with Q17nDCPU-S1.
- *10 MELSOFT Navigator Version 1.07H or later is required to use the FA transparent function.
- *11 MX Component Version 4.03D or later is required to use the FA transparent function.
- *12 Use MX Component Version 3.14Q or later for MX Sheet.
- *13 GX Works2 Version 1.34L or later is required to execute the FA transparent function with using CC-Link IE Field Network Ethernet adapter (NZ2GF-ETB).
C controller module (Q Series) does not support CC-Link IE Field Network.
- *14 CPU Module Logging Configuration Tool Version 1.04E or later is required to use the FA transparent function.
- *15 RT ToolBox2 Version 1.7 or later is required to use the FA transparent function.
- *16 MR Configurator2 Version 1.09K or later is required to use the FA transparent function.
- *17 A motion controller is required between the GOT and PLC in Ethernet connection.
- *18 Setting/Monitoring tool for C Controller module Version 4.00A or later is required to use the FA transparent function.
- *19 GX Works2 Version 1.98C or later is required to use the FA transparent function.
- *20 MT Works2 Version 1.100E or later is required to use the FA transparent function.
- *21 MX Component Version 4.06G or later is required to use the FA transparent function.
- *22 Use MX Component Version 4.06G or later for MX Sheet.
- *23 GX Works3 Version 1.005F or later is required to use the FA transparent function.
- *24 MX Component Version 4.11M or later is required to use the FA transparent function.
- *25 MX Sheet, please use the MX Component (Version 4.11M or later).

17
ROBOT CONTROLLER CONNECTION
18
CNC CONNECTION
19
ENERGY MEASURING UNIT/ELECTRIC MULTI-MEASURING INSTRUMENT CONNECTION
20
GOT MULTI-DROP CONNECTION
21
MULTIPLE-GT14, GT12, GT11, GT10 CONNECTION FUNCTION
22
MULTI-CHANNEL FUNCTION
23
FA TRANSPARENT FUNCTION

- (5) When connecting the GOT and PLC in CC-Link IE Controller Network connection (GT16 only)
The following shows the software and the accessible PLC CPUs.

PLC CPU	Software
QCPU (Q mode)	GX Works2 ^{*1}
Motion controller CPU (Q Series) (Q170MCPUCPU, Q170MSCPU, Q170MSCPU-S1 only)	GX Works2 ^{*1}

*1 GX Works2 Version 1.525X or later is required to use the FA transparent function.

■ When connecting the GOT and PC with Ethernet

(1) When connecting the GOT and PLC in Bus connection

The following shows the software and the accessible PLC CPUs.

PLC CPU	Software
QCPU (Q mode), C Controller module (Q Series)	GX Works2 ^{*1} , MX Component ^{*2} , MX Sheet ^{*3} , Setting/Monitoring tool for C Controller module ^{*8}
Motion controller CPU (Q series)	MT Works2 ^{*4}
MELSERVO(MR-J3-B) ^{*5}	MR Configurator2 ^{*6}
MELSERVO(MR-J4-B) ^{*5}	MR Configurator2 ^{*7}

- *1 GX Works2 Version 1.48A or later is required to use the FA transparent function.
- *2 MX Component Version 3.15R or later is required to use the FA transparent function.
- *3 MX Component Version 3.15R or later is required for MX Sheet to use the FA transparent function.
- *4 Use MT Works2 Version 1.25B or later for MT Works2.
- *5 A motion controller is required between the GOT and PLC in bus connection.
- *6 Use MR Configurator2 Version 1.07H or later for MR Configurator2.
- *7 Use MR Configurator2 Version 1.09K or later for MR Configurator2.
- *8 Setting/Monitoring tool for C Controller module Version 4.00A or later is required to use the FA transparent function.

(2) When connecting the GOT and PLC in direct CPU connection

The following shows the software and the accessible PLC CPUs.

PLC CPU	Software
FX5U, FX5UC	GX Works3 ^{*10} , MX Component ^{*11} , MX Sheet ^{*12}
QCPU (Q mode)	GX Works2 ^{*1} , MX Component ^{*3} , MX Sheet ^{*4}
LCPU ^{*2}	GX Works2 ^{*1} , MX Component ^{*3} , MX Sheet ^{*4}
FXCPU	GX Works2 ^{*5}
Motion controller CPU (Q series)	MT Works2 ^{*6}
MELSERVO(MR-J3-B) ^{*9}	MR Configurator2 ^{*7}
MELSERVO(MR-J4-B) ^{*9}	MR Configurator2 ^{*8}

- *1 GX Works2 Version 1.48A or later is required to use the FA transparent function.
- *2 The adapter (L6ADP-R2 or L6ADP-R4) is required.
- *3 MX Component Version 3.15R or later is required to use the FA transparent function.
- *4 MX Component Version 3.15R or later is required for MX Sheet to use the FA transparent function.
- *5 GX Works2 Version 1.73B or later is required for GX Works2 to use the FA transparent function.
- *6 MT Works2 Version 1.25B or later is required for MT Works2 to use the FA transparent function.
- *7 MR Configurator2 Version 1.07H or later is required for MR Configurator2 to use the FA transparent function.
- *8 MR Configurator2 Version 1.09K or later is required to use the FA transparent function.
- *9 A motion controller is required between the GOT and PLC in direct CPU connection.
- *10 GX Works3 Version 1.005F or later is required to use the FA transparent function.
- *11 MX Component Version 4.11M or later is required to use the FA transparent function.
- *12 MX Sheet, please use the MX Component (Version 4.11M or later).

(3) When connecting the GOT and PLC in computer link connection

The following shows the software and the accessible PLC CPUs.

PLC CPU	Software
RCPU	GX Works3, MX Component ^{*4} , MX Sheet ^{*5}
QCPU (Q mode)	GX Works2 ^{*1} , MX Component ^{*2} , MX Sheet ^{*3}
LCPU ^{*2}	GX Works2 ^{*1} , MX Component ^{*2} , MX Sheet ^{*3}

- *1 GX Works2 Version 1.48A or later is required to use the FA transparent function.
- *2 MX Component Version 3.15R or later is required to use the FA transparent function.
- *3 MX Component Version 3.15R or later is required for MX Sheet to use the FA transparent function.
- *4 MX Component Version 4.06G or later is required to use the FA transparent function.
- *5 Use MX Component Version 4.06G or later for MX Sheet.

- (4) When connecting the GOT and PLC in CC-Link IE Controller Network connection (GT16 only)
The following shows the software and the accessible PLC CPUs.

PLC CPU	Software
QCPU (Q mode)	GX Works2 ^{*1}
Motion controller CPU (Q Series) (Q170MCPUCPU, Q170MSCPU, Q170MSCPU-S1 only)	GX Works2 ^{*1}

*1 GX Works2 Version 1.525X or later is required to use the FA transparent function.

■ Connecting the GOT and personal computer with Modem

- (1) When connecting the GOT and PLC in bus connection
The following shows the software and the accessible PLC CPUs.

PLC CPU	Software
QCPU (Q mode)	GX Developer ^{*1} GX Works2 ^{*2}

*1 GX Developer Version 8.78G or later is required to use the FA transparent function.

*2 GX Works2 Version 1.16S or later is required to use the FA transparent function.

- (2) When connecting the GOT and PLC in direct CPU connection
The following shows the software and the accessible PLC CPUs.

PLC CPU	Software
FX5U, FX5UC	GX Works3 ^{*3}
QCPU (Q mode)	GX Developer ^{*1} GX Works2 ^{*2}
FXCPU	GX Developer ^{*1}

*1 GX Developer Version 8.78G or later is required to use the FA transparent function.

*2 GX Works2 Version 1.16S or later is required to use the FA transparent function.

*3 GX Works3 Version 1.005F or later is required to use the FA transparent function.

- (3) When connecting the GOT and PLC in computer link connection
The following shows the software and the accessible PLC CPUs.

PLC CPU	Software
RCPUCPU	GX Works3, MX Component ^{*3} , MX Sheet ^{*4}
QCPU (Q mode)	GX Developer ^{*1} GX Works2 ^{*2}

*1 GX Developer Version 8.78G or later is required to use the FA transparent function.

*2 GX Works2 Version 1.16S or later is required to use the FA transparent function.

*3 MX Component Version 4.06G or later is required to use the FA transparent function.

*4 Use MX Component Version 4.06G or later for MX Sheet.

- (4) When connecting the GOT and PLC in Ethernet connection
The following shows the software and the accessible PLC CPUs.

PLC CPU	Software
RCPUCPU	GX Works3, MX Component ^{*4} , MX Sheet ^{*5}
FX5U, FX5UC	GX Works3 ^{*3}
QCPU (Q mode)	GX Developer ^{*1} GX Works2 ^{*2}

*1 Use GX Developer of Version 8.78G or later.

*2 Use GX Works2 of Version 1.15R or later.

*3 GX Works3 Version 1.005F or later is required to use the FA transparent function.

*4 MX Component Version 4.06G or later is required to use the FA transparent function.

*5 Use MX Component Version 4.06G or later for MX Sheet.

23.3 List of Models that Can Be Monitored

The following models support FA transparent function.

■ When connecting the GOT and personal computer with serial or USB

Series	Model name	Target software	Connection type								
			Bus connection	Direct CPU connection			Computer link connection			Ethernet connection	CC-Link IE Controller Network connection
			GT16 GT15 GT11 Bus	GT16 GT15	GT14 GT12 GT11 Serial	GT10 5□ GT10 20 GT10 4□ GT10 30	GT16 GT15	GT14 GT12 GT11 Serial	GT10 5□ GT10 20 GT10 4□ GT10 30	GT16 GT15 GT14 ^{*1}	GT16
MELSEC iQ-R Series	R04CPU	GX Works3 MX Component MX Sheet									
	R08CPU										
	R16CPU										
	R32CPU										
	R120CPU										
	R08PCPU										
	R16PCPU										
	R32PCPU										
	R120PCPU						○ ^{*2}	○ ^{*2}	○	○ ^{*2}	×
	R04ENCPU ^{*4}										
	R08ENCPU ^{*4}										
	R16ENCPU ^{*4}										
	R32ENCPU ^{*4}										
R120ENCPU ^{*4}											
R08SFPCPU ^{*3*4}											
R16SFPCPU ^{*3*4}											
R32SFPCPU ^{*3*4}											
R120SFPCPU ^{*3*4}											
Motion controller CPU (MELSEC iQ-R Series)	R16MTCPU	MT Works2 MX Component MX Sheet									
	R32MTCPU									○ ^{*2}	×
C Controller module (MELSEC iQ-R Series)	R12CCPU-V	CW Configurator									
MELSEC iQ-F Series	FX5U ^{*4}	GX Works3									
	FX5UC ^{*4}			○ ^{*2}	○ ^{*2}	○ ^{*2}				○ ^{*2}	×

(Continued to next page)

*1 GT14 models compatible with Ethernet connection are only GT1455-QTBDE, GT1450-QMBDE and GT1450-QLBDE.

*2 GT15, GT12 and GT11 do not support the MELSEC iQ-R Series and MELSEC iQ-F Series.

*3 Mount a safety function module R6SFM next to the RnSFPCPU on the base unit. The RnSFPCPU and the safety function module R6SFM must have the same pair version. If their pair versions differ, the RnSFPCPU does not operate.

*4 MX Component Version 4.11M or later is required to use the FA transparent function. MX Sheet, please use the MX Component (Version 4.11M or later).

Series	Model name	Target software	Connection type												
			Bus connection	Direct CPU connection			Computer link connection			Ethernet connection	CC-Link IE Controller Network connection				
			GT 16 GT 15 GT11 Bus	GT 16 GT 15	GT 14 GT 12 GT11 Serial	GT10 5□ GT10 20 4□ 30	GT 16 GT 15	GT 14 GT 12 GT11 Serial	GT10 5□ GT10 20 4□ 30	GT 16 GT 15 GT 14 *2 GT 12	GT 16				
MELSEC-Q (Q mode)	Q00JCPU	GX Developer*4 GX Works2 GX Configurator*4 PX Developer*4 MX Component*4 MX Sheet*4				○			○						
	Q00CPU														
	Q01CPU														
	Q02CPU														
	Q02HCPU														
	Q06HCPU			○	○		○	○		○	○		○	○	
	Q12HCPU														
	Q25HCPU														
	Q02PHCPU														
	Q06PHCPU														
	Q12PHCPU														
	Q25PHCPU														
	Q12PRHCPU (Main base)														
	Q25PRHCPU (Main base)				○		×			×		○		○	
	Q12PRHCPU (Extension base)				×		×			×		×		×	
	Q25PRHCPU (Extension base)					×						×		×	
	Q00JCPU														
	Q00UCPU														
	Q01UCPU														
	Q02UCPU														
	Q03UDCPU														
	Q04UDHCPU					○	○	○							
	Q06UDHCPU														
	Q10UDHCPU														
	Q13UDHCPU														
	Q20UDHCPU														
	Q26UDHCPU														
Q03UDECPU															
Q04UDEHCPU			○					○	○	○		○	○		
Q06UDEHCPU															
Q10UDEHCPU															
Q13UDEHCPU															
Q20UDEHCPU															
Q26UDEHCPU															
Q50UDEHCPU															
Q100UDEHCPU				○*1	○*1	○*1									
Q03UDVCPU*3															
Q04UDVCPU*3															
Q06UDVCPU*3															
Q13UDVCPU*3															
Q26UDVCPU*3															

(Continued to next page)

- *1 Use the serial port of QCPU in the multiple CPU system, since QnUDEHCPU, QnUDVCPU has no direct coupled I/F.
- *2 GT14 models compatible with Ethernet connection are only GT1455-QTBDE, GT1450-QMBDE and GT1450-QLBDE.
- *3 QnUDVCPU is applicable to QnUDVCPU•LCPULogging Configuration Tool and GX LogViewer.
- *4 GX Developer, GX Configurator, PX Developer, MX Component, or MX Sheet does not support the FA transparent function through CC-Link IE Controller Network.

Series	Model name	Target software	Connection type								
			Bus connection	Direct CPU connection			Computer link connection			Ethernet connection	CC-Link IE Controller Network connection
			GT16 GT15 GT11 Bus	GT16 GT15	GT14 GT12 GT11 Serial	GT10 5/4□ GT10 20/30	GT16 GT15	GT14 GT12 GT11 Serial	GT10 5/4□ GT10 20/30	GT16 GT15 GT14 *3 GT12	GT16
C Controller module (Q Series)	Q12DCCPU-V Q24DHCCPU-V/VG Q24DHCCPU-LS Q26DHCCPU-LS*7	GX Developer*6 GX Works2 MX Component*6 MX Sheet*6	○*2	○*1	○*1	○*1	×	×	×	○*2	○
	Q24DHCCPU-V/VG Q24DHCCPU-LS Q26DHCCPU-LS*7	Setting/Monitoring tool for C Controller module*5	○*2	○*1	○*1	○*1	×	×	×	○	×
MELSEC-QS	QS001CPU	-	×	×	×	×	×	×	×	×	×
MELSEC-L	L02CPU L06CPU L26CPU L26CPU-BT L06CPU-P L26CPU-P L02CPU-P L26CPU-PBT L02SCPU L02SCPU-P	GX Developer GX Works2 GX LogViewer MX Component MX Sheet CPU Module Logging Configuration Tool	×	○	○	○	○	○	○	○	×
MELSEC-Q (A mode)	Q02CPU-A Q02HCPU-A Q06HCPU-A	GX Developer MX Component MX Sheet	×	○	○	○	×	×	×	×	×
MELSEC-QnA (QnACPU)	Q2ACPU Q2ACPU-S1 Q3ACPU Q4ACPU	GX Developer MX Component MX Sheet	○	○	○	○	×	×	×	×	×
	Q4ARCPU			○	○	×					
MELSEC-QnA (QnASCPU)	Q2ASCPU Q2ASCPU-S1 Q2ASHCPU Q2ASHCPU-S1	GX Developer MX Component MX Sheet	○	○	○	○	×	×	×	×	×
MELSEC-A (AnCPU)	A2UCPU A2UCPU-S1 A3UCPU A4UCPU A2ACPU A2ACPUP21 A2ACPUR21 A2ACPU-S1 A2ACPUP21-S1 A2ACPUR21-S1 A3ACPU A3ACPUP21 A3ACPUR21 A1NCPUP21 A1NCPUR21 A2NCPUP21 A2NCPUR21	GX Developer MX Component MX Sheet	○*4	○	○	○	×	×	×	×	×

- *1 Use the serial port of QCPU in the multiple CPU system since Q12DCCPU-V1 and Q24DHCCPU-V/VG have no direct coupled I/F.
- *2 When using Q12DCCPU-V1 or Q24DHCCPU-V/VG as the connected CPU, only MX Component can be used. When accessing other CPUs relaying Q12DCCPU-V or Q24DHCCPU-V/VG, GX Developer or GX Works2 can also be used.
- *3 GT14 models compatible with Ethernet connection are only GT1455-QTBDE, GT1450-QMBDE and GT1450-QLBDE.
- *4 Do not execute the write during RUN in the bus connection.
- *5 When the GOT and the personal computer are connected in the serial connection, Setting/Monitoring tool for C Controller module is unavailable.
- *6 GX Developer, GX Configurator, PX Developer, MX Component, or MX Sheet does not support the FA transparent function through CC-Link IE Controller Network.
- *7 GT15, GT12 and GT11 are not applicable to Q26DHCCPU-LS.

(Continued to next page)

17 ROBOT CONTROLLER CONNECTION
 18 CNC CONNECTION
 19 ENERGY MEASURING UNIT/ELECTRIC MULTI-MEASURING INSTRUMENT CONNECTION
 20 GOT MULTI-DROP CONNECTION
 21 MULTIPLE-GT14, GT12, GT11, GT10 CONNECTION FUNCTION
 22 MULTI-CHANNEL FUNCTION
 23 FA TRANSPARENT FUNCTION

Series	Model name	Target software	Connection type									
			Bus connection	Direct CPU connection			Computer link connection			Ethernet connection	CC-Link IE Controller Network connection	
			GT 16 GT 15 GT11 Bus	GT 16 GT 15	GT 14 GT 12 GT11 Serial	GT 10 5□ GT 10 20 GT 10 30	GT 16 GT 15	GT 14 GT 12 GT11 Serial	GT 10 5□ GT 10 20 GT 10 30	GT 16 GT 15 GT 14 *3 GT 12	GT 16	
MELSEC-A (AnSCPU)	A2USCPU	GX Developer MX Component MX Sheet	○	○	○	○	×	×	×	×	×	
	A2USCPU-S1											
	A2USHCPU-S1											
	A1SCPU											
	A1SCPUC24-R2											
	A1SHCPU											
	A2SCPU*1											
	A2SCPU-S1											
	A2SHCPU											
	A2SHCPU-S1											
	A1SJCPU											
	A1SJCPU-S3											
	A1SJHCPU											
MELSEC-A	A0J2HCPU	GX Developer MX Component MX Sheet	○*4	○	○	○	×	×	×	×	×	
	A0J2HCPUP21											
	A0J2HCPUR21											
	A0J2HCPU-DC24											
	MELSEC-A	A2CCCPU	GX Developer MX Component MX Sheet	×	○	○	○	×	×	×	×	×
		A2CCPUP21										
		A2CCPUR21										
		A2CCPUC24										
		A2CCPUC24-PRF										
		A2CJCPU-S3										
A1FXCPU												
Motion controller CPU (Q Series)	Q172CPU	MT Developer	○	○	○	○	×	×	×	×	×	
	Q173CPU											
	Q172CPUN											
	Q173CPUN											
	Q172HCPU	MT Developer MR Configurator		○*1	○*1	○*1	×	×	×	○	○	
	Q173HCPU											
	Q172DCPU	MT Works2		○*2	○*2	○*2	×	×	×	○	×	
	Q173DCPU											
	Q172DCPU-S1											
	Q173DCPU-S1											
	Q172DSCPU											
	Q173DSCPU											
Q170MCPUCPU	MT Works2*5 GX Developer*5 GX Works2	○	○	○	×	×	×	○	○			
Q170MSCPU												
Q170MSCPU-S1												

(Continued to next page)

- *1 Use the serial port of QCPU in the multiple CPU system since only the USB port is available as the direct coupled I/F for Q172H/Q173HCPU.
- *2 Use the serial port of QCPU in the multiple CPU system since Q172H/Q173HCPU has no direct coupled I/F.
- *3 GT14 models compatible with Ethernet connection are only GT1455-QTBDE, GT1450-QMBDE and GT1450-QLBDE.
- *4 Do not execute the write during RUN in the bus connection.
- *5 MT Works2 or GX Developer does not support the FA transparent function through CC-Link IE Controller Network.

Series	Model name	Target software	Connection type								
			Bus connection	Direct CPU connection			Computer link connection			Ethernet connection	CC-Link IE Controller Network connection
			GT16 GT15 GT11 Bus	GT16 GT15	GT14 GT12 GT11 Serial	GT10 5□4□ GT10 20 30	GT16 GT15	GT14 GT12 GT11 Serial	GT10 5□4□ GT10 20 30	GT16 GT15 GT14 *1 GT12	GT16
Motion controller CPU (A Series)	A273UCPU	GX Developer MX Component MX Sheet									
	A273UHCPU										
	A273UHCPU-S3										
	A373UCPU										
	A373UCPU-S3										
	A171SCPU										
	A171SCPU-S3			○ ^{*2}	○	○	×	×	×	×	×
	A171SCPU-S3N										
	A171SHCPU										
	A171SHCPUN										
	A172SHCPU										
	A172SHCPUN										
	A173UHCPU										
	A173UHCPU-S1										
MELSEC-FX	FX0, FX0S, FX0N, FX1, FX2, FX2C, FX1S, FX1N, FX2N, FX1NC, FX2NC	GX Developer GX Works2 MX Component MX Sheet	×	○	○	○	×	×	×	×	×
	FX3G(c), FX3S, FX3GE	GX Developer FX Configurator-FP MX Component MX Sheet	×	○	○	○	×	×	×	×	×
		GX Works2	×	○	○	○	×	×	×	○	×
	FX3U(e)	GX Developer FX Configurator-FP FX3U-ENET-L Configuration tool FX Configurator-EN MX Component MX Sheet	×	○	○	○	×	×	×	×	×
		GX Works2	×	○	○	○	×	×	×	○	×
MELSEC-WS	WS0-CPU0	-									
	WS0-CPU1		×	×	×	×	×	×	×	×	
	WS0-CPU3		×	×	×	×	×	×	×	×	

(Continued to next page)

*1 GT14 models compatible with Ethernet connection are only GT1455-QTBDE, GT1450-QMBDE and GT1450-QLBDE.

*2 Do not execute the write during RUN in the bus connection.

17 ROBOT CONTROLLER CONNECTION
18 CNC CONNECTION
19 ENERGY MEASURING UNIT/ELECTRIC MULTI-MEASURING INSTRUMENT CONNECTION
20 GOT MULTI-DROP CONNECTION
21 MULTIPLE-GT14, GT12, GT11, GT10 CONNECTION FUNCTION
22 MULTI-CHANNEL FUNCTION
23 FA TRANSPARENT FUNCTION

Series	Model name	Target software	Connection type									
			Bus connection	Direct CPU connection			Computer link connection			Ethernet connection	CC-Link IE Controller Network connection	
				GT 16 GT 15 GT 11 Bus	GT 16 GT 15	GT 14 GT 12 GT 11 Serial	GT 10 5□□ GT 10 20 GT 10 30	GT 16 GT 15	GT 14 GT 12 GT 11 Serial			GT 10 5□□ GT 10 20 GT 10 30
MELSECNET/H Remote I/O station	QJ72LP25-25 QJ72LP25G QJ72BR15	-	×	×	×	×	×	×	×	×	×	×
CC-Link IE Field Network head module	LJ72GF15-T2	-	×	×	×	×	×	×	×	×	×	×
CC-Link IE Field Network Ethernet adapter module	NZ2GF-ETB	GX Works2	×	×	×	×	×	×	×	×	○	×
CNC	CNC C70 (Q173NCCPU) CR750-Q (Q172DRCPU) CR751-Q (Q172DRCPU)	GX Developer NC Configurator	○	○ ^{*1}	○ ^{*1}	×	○	○	×	○ ^{*2}	×	×
	MELDAS C6/C64	GX Developer	×	○	○	×	×	×	×	×	×	×
Robot controller	CRnQ-700 (Q172DRCPU)	RT ToolBox2	○	○ ^{*3}	○ ^{*3}	×	×	×	×	○	×	×
	CRnD-700 CR750-D CR751-D		×	×	×	×	×	×	×	○	×	×
FREQROL	FREQROL-A500/A500L	FR Configurator	×	○	○	×	×	×	×	×	×	×
	FREQROL-F500/F500L											
	FREQROL-V500/V500L											
	FREQROL-E500											
	FREQROL-S500/S500E											
	FREQROL-F500J											
	FREQROL-D700											
	FREQROL-E700											
	FREQROL-A700											
FREQROL-F700												
Sensorless servo	FREQROL-E700EX											
MELIPM	MD-CX522-□□K (-A0)	FR Configurator	×	○	○	×	×	×	×	×	×	×

(Continued to next page)

- *1 Use the serial port of QCPU in the multiple CPU system since Q173NCCPU has no direct coupled I/F.
- *2 Connect to the DISPLAY I/F of Q173NCCPU.
GX Developer accesses the PLC CPU which configures the multiple CPU system.
- *3 Use the serial port of QCPU in the multiple CPU system, since CRnQ-700 has no direct coupled I/F.
- *4 GT14 models compatible with Ethernet connection are only GT1455-QTBDE, GT1450-QMBDE and GT1450-QLBDE.

Series	Model name	Target software	Connection type								
			Bus connection	Direct CPU connection			Computer link connection			Ethernet connection	CC-Link IE Controller Network connection
			GT16 GT15 GT11 Bus	GT16 GT15	GT14 GT12 GT11 Serial	GT10 ⁵ ₄ GT10 ²⁰ ₃₀	GT16 GT15	GT14 GT12 GT11 Serial	GT10 ⁵ ₄ GT10 ²⁰ ₃₀	GT16 GT15 GT14 ^{*1} GT12	GT16
MELSERVO	MR-J2S-□A	-									
	MR-J2S-□CP										
	MR-J2S-□CL										
	MR-J2M-P8A		x	x	x	x	x	x	x	x	x
	MR-J2M-□DU										
	MR-JE-□A										
	MR-J3-□A										
	MR-J3-□T										
	MR-J3-□B	MR Configurator	○	○	○	x	x	x	x	x	x
		MR Configurator2	○	○	○	x	x	x	x	○	x
MR-J4-□A	-	x	x	x	x	x	x	x	x	x	
MR-J4-□B MR-J4W2-□B MR-J4W3-□B	MR Configurator2	○	○	○	x	x	x	x	○	x	

*1 GT14 models compatible with Ethernet connection are only GT1455-QTBDE, GT1450-QMBDE and GT1450-QLBDE.

17 ROBOT CONTROLLER CONNECTION
18 CNC CONNECTION
19 ENERGY MEASURING UNIT/ELECTRIC MULTI-MEASURING INSTRUMENT CONNECTION
20 GOT MULTI-DROP CONNECTION
21 MULTIPLE-GT14, GT12, GT11, GT10 CONNECTION FUNCTION
22 MULTI-CHANNEL FUNCTION
23 FA TRANSPARENT FUNCTION

■ When connecting the GOT and PC with Ethernet

Series	Model name	Target software	Connection type								
			Bus connection	Direct CPU connection			Computer link connection			Ethernet connection	CC-Link IE Controller Network connection
			GT16 GT15 GT11 Bus	GT16 GT15	GT14*1 GT12 GT11 Serial	GT10 5□4□ GT10 20 30	GT16 GT15	GT14*1 GT12 GT11 Serial	GT10 5□4□ GT10 20 30	GT16 GT15 GT14*1	GT16
MELSEC iQ-R Series	R04CPU	GX Works3 MX Component MX Sheet	×	×	×	×	○*2	○*2	○	×	×
	R08CPU										
	R16CPU										
	R32CPU										
	R120CPU										
	R08PCPU										
	R16PCPU										
	R32PCPU										
	R120PCPU										
	R04ENCPU*4										
	R08ENCPU*4										
	R16ENCPU*4										
	R32ENCPU*4										
	R120ENCPU*4										
R08SFPCPU*3*4											
R16SFPCPU*3*4											
R32SFPCPU*3*4											
R120SFPCPU*3*4											
Motion controller CPU (MELSEC iQ-R Series)	R16MTCPU	MT Works2 MX Component MX Sheet	×	×	×	×	×	×	×	×	×
	R32MTCPU										
C Controller module (MELSEC iQ-R Series)	R12CCPU-V	CW Configurator	×	×	×	×	×	×	×	×	×
MELSEC iQ-R Series	FX5U*4 FX5UC*4	GX Works3 MX Component MX Sheet	×	○*2	○*2	○*2	×	×	×	×	×

(Continued to next page)

- *1 GT14 models compatible with Ethernet connection are only GT1455-QTBDE, GT1450-QMBDE and GT1450-QLBDE.
- *2 GT15, GT12 and GT11 do not support the MELSEC iQ-R Series and MELSEC iQ-F Series.
- *3 Mount a safety function module R6SFM next to the RnSFPCPU on the base unit. The RnSFPCPU and the safety function module R6SFM must have the same pair version. If their pair versions differ, the RnSFPCPU does not operate.
- *4 MX Component Version 4.11M or later is required to use the FA transparent function. MX Sheet, please use the MX Component (Version 4.11M or later).

Series	Model name	Target software	Connection type												
			Bus connection	Direct CPU connection			Computer link connection			Ethernet connection	CC-Link IE Controller Network connection				
			GT 16 GT 15 GT11 Bus	GT 16 GT 15	GT 14 ^{*2} GT 12 GT11 Serial	GT 10 ^{5□} GT 10 ²⁰ GT 10 ^{4□} GT 10 ³⁰	GT 16 GT 15	GT 14 ^{*2} GT 12 GT11 Serial	GT 10 ^{5□} GT 10 ²⁰ GT 10 ^{4□} GT 10 ³⁰	GT 16 GT 15 GT 14 ^{*2} GT 12	GT 16				
MELSEC-Q (Q mode)	Q00JCPU	GX Works2 MX Component ^{*4} MX Sheet ^{*4}													
	Q00CPU														
	Q01CPU														
	Q02CPU														
	Q02HCPU														
	Q06HCPU			○ ^{*3}	○	○ ^{*3}		○	○ ^{*3}		×		○		
	Q12HCPU														
	Q25HCPU						×								
	Q02PHCPU														
	Q06PHCPU														
	Q12PHCPU														
	Q25PHCPU														
	Q12PRHCPU (Main base)														
	Q25PRHCPU (Main base)				○		×					×		○	
	Q12PRHCPU (Extension base)				×		×		×	×		×			
	Q25PRHCPU (Extension base)					×								×	
	Q00JCPU														
	Q00UCPU														
	Q01UCPU														
	Q02UCPU														
	Q03UDCPU														
	Q04UDHCPU					○	○ ^{*3}		×						
	Q06UDHCPU														
	Q10UDHCPU														
	Q13UDHCPU														
	Q20UDHCPU														
	Q26UDHCPU														
	Q03UDECPU														
Q04UDEHCPU															
Q06UDEHCPU															
Q10UDEHCPU			○ ^{*3}					○	○ ^{*3}	×		×			
Q13UDEHCPU															
Q20UDEHCPU															
Q26UDEHCPU															
Q50UDEHCPU															
Q100UDEHCPU															
Q03UDVCPU				○ ^{*1}	○ ^{*1*3}		×								
Q04UDVCPU															
Q06UDVCPU															
Q13UDVCPU															
Q26UDVCPU															
Q04UDPVCPU															
Q06UDPVCPU															
Q13UDPVCPU															
Q26UDPVCPU															

(Continued to next page)

- *1 Use the serial port of QCPU in the multiple CPU system, since QnUDEHCPU, QnUDVCPU has no direct coupled I/F.
- *2 GT14 models compatible with Ethernet connection are only GT1455-QTBE, GT1450-QMBDE and GT1450-QLBDE.
- *3 GT11 is not supported.
- *4 MX Component or MX Sheet does not support the FA transparent function through CC-Link IE Controller Network.

17 ROBOT CONTROLLER CONNECTION
18 CNC CONNECTION
19 ENERGY MEASURING UNIT/ELECTRIC MULTI-MEASURING INSTRUMENT CONNECTION
20 GOT MULTI-DROP CONNECTION
21 MULTIPLE-GT14, GT12, GT11, GT10 CONNECTION FUNCTION
22 MULTI-CHANNEL FUNCTION
23 FA TRANSPARENT FUNCTION

Series	Model name	Target software	Connection type									
			Bus connection	Direct CPU connection			Computer link connection			Ethernet connection	CC-Link IE Controller Network connection	
				GT 16 GT 15 GT 11 Bus	GT 16 GT 15	GT 14 GT 12 GT 11 Serial	GT 10 5□ GT 10 20 GT 10 30	GT 16 GT 15	GT 14 GT 12 GT 11 Serial			GT 10 5□ GT 10 20 GT 10 30
C controller module (Q Series)	Q12DCCPU-V Q24DHCCPU-V/VG Q24DHCCPU-LS Q26DHCCPU-LS*5	GX Works2 MX Component*4 MX Sheet*4	○*2	○*3	○*3	×	×	×	×	×	×	○
	Q24DHCCPU-V/VG Q24DHCCPU-LS Q26DHCCPU-LS*5	Setting/ Monitoring tool for C Controller module	○*2	○*3	○*3	×	×	×	×	×	×	×
MELSEC-QS	QS001CPU	-	×	×	×	×	×	×	×	×	×	×
MELSEC-L	L02CPU L06CPU L26CPU L26CPU-BT L02CPU-P L06CPU-P L26CPU-P L26CPU-PBT L02SCPU L02SCPU-P	GX Works2 MX Component MX Sheet	×	○	○*2	×	○	○*2	×	×	×	×
MELSEC-Q (A mode)	Q02CPU-A Q02HCPU-A Q06HCPU-A	-	×	×	×	×	×	×	×	×	×	×
MELSEC-QnA (QnACPU)	Q2ACPU Q2ACPU-S1 Q3ACPU Q4ACPU Q4ARCPU	-	×	×	×	×	×	×	×	×	×	×
MELSEC-QnA (QnASCPU)	Q2ASCPU Q2ASCPU-S1 Q2ASHCPU Q2ASHCPU-S1	-	×	×	×	×	×	×	×	×	×	×
MELSEC-A (AnCPU)	A2UCPU A2UCPU-S1 A3UCPU A4UCPU A2ACPU A2ACPUP21 A2ACPUR21 A2ACPU-S1 A2ACPUP21-S1 A2ACPUR21-S1 A3ACPU A3ACPUP21 A3ACPUR21 A1NCPUR21 A1NCPUR21 A1NCPUR21 A2NCPUR21	-	×	×	×	×	×	×	×	×	×	×

(Continued to next page)

*1 GT14 models compatible with Ethernet connection are only GT1455-QTBDE, GT1450-QMBDE and GT1450-QLBDE.

*2 GT11 is not supported.

*3 Use the serial port of QCPU in the multiple CPU system since Q12DCCPU-V1 and Q24DHCCPU-V/VG have no direct coupled I/F.

*4 MX Component or MX Sheet does not support the FA transparent function through CC-Link IE Controller Network.

*5 GT15, GT12 and GT11 are not applicable to Q26DHCCPU-LS.

Series	Model name	Target software	Connection type								
			Bus connection	Direct CPU connection			Computer link connection			Ethernet connection	CC-Link IE Controller Network connection
			GT16 GT15 GT11 Bus	GT16 GT15	GT14 GT12 GT11 Serial	GT10 5/4□ GT10 20/30	GT16 GT15	GT14 GT12 GT11 Serial	GT10 5/4□ GT10 20/30	GT16 GT15 GT14 *1 GT12	GT16
MELSEC-A (AnCPU)	A2NCPUP21	-									
	A2NCPUR21										
	A2NCPU-S1										
	A2NCPUP21-S1		x	x	x	x	x	x	x	x	x
	A2NCPUR21-S1		x	x	x	x	x	x	x	x	x
	A3NCPU										
	A3NCPUP21										
	A3NCPUR21										
MELSEC-A (AnSCPU)	A2USCPU	-									
	A2USCPU-S1										
	A2USHCPU-S1										
	A1SCPU										
	A1SCPUC24-R2										
	A1SHCPU										
	A2SCPU		x	x	x	x	x	x	x	x	x
	A2SCPU-S1		x	x	x	x	x	x	x	x	x
	A2SHCPU										
	A2SHCPU-S1										
	A1SJCPU										
	A1SJCPU-S3										
	A1SJHCPU										
MELSEC-A	A0J2HCPU	-									
	A0J2HCPUP21										
	A0J2HCPUR21		x	x	x	x	x	x	x	x	x
	A0J2HCPU-DC24		x	x	x	x	x	x	x	x	x
	A2CCPU	-									
	A2CCPUP21										
	A2CCPUR21										
	A2CCPUC24		x	x	x	x	x	x	x	x	x
	A2CCPUC24-PRF		x	x	x	x	x	x	x	x	x
	A2CJCPU-S3										
A1FXCPU											
Motion controller CPU (Q Series)	Q172CPU	-									
	Q173CPU										
	Q172CPUN		x	x	x	x	x	x	x	x	x
	Q173CPUN		x	x	x	x	x	x	x	x	x
	Q172HCPU										
	Q173HCPU										

(Continued to next page)

*1 GT14 models compatible with Ethernet connection are only GT1455-QTBDE, GT1450-QMBDE and GT1450-QLBDE.

17 ROBOT CONTROLLER CONNECTION
18 CNC CONNECTION
19 ENERGY MEASURING UNIT/ELECTRIC MULTI-MEASURING INSTRUMENT CONNECTION
20 GOT MULTI-DROP CONNECTION
21 MULTIPLE-GT14, GT12, GT11, GT10 CONNECTION FUNCTION
22 MULTI-CHANNEL FUNCTION
23 FA TRANSPARENT FUNCTION

Series	Model name	Target software	Connection type								
			Bus connection	Direct CPU connection			Computer link connection			Ethernet connection	CC-Link IE Controller Network connection
				GT 16 GT 15 GT11 Bus	GT 16 GT 15	GT 14 GT 12 GT11 Serial	GT 10 5□ GT 10 20 GT 10 30	GT 16 GT 15	GT 14 GT 12 GT11 Serial		
Motion controller CPU (Q Series)	Q172DCPU	MT Works2	○*2	○*3	○*2*3	×	×	×	×	×	×
	Q173DCPU										
	Q172DCPU-S1										
	Q173DCPU-S1										
	Q172DSCPU										
	Q173DSCPU										
	Q170MCPUCPU	MT Works2 ⁴ GX Works2	○*2	○	○*2	×	×	×	×	×	○
	Q170MSCPU										
Q170MSCPU-S1											
Motion controller CPU (A Series)	A273UCPU	-	×	×	×	×	×	×	×	×	×
	A273UHCPU										
	A273UHCPU-S3										
	A373UCPU										
	A373UCPU-S3										
	A171SCPU										
	A171SCPU-S3										
	A171SCPU-S3N										
	A171SHCPU										
	A171SHCPUN										
	A172SHCPU										
	A172SHCPUN										
	A173UHCPU										
	A173UHCPU-S1										
MELSEC-FX	FX0	GX Works2	×	○	○*2	×	×	×	×	×	×
	FX0S										
	FX0N										
	FX1										
	FX2										
	FX2C										
	FX1S										
	FX1N										
	FX2N										
	FX1NC										
	FX2NC										
	FX3S										
	FX3G(C)										
	FX3GE										
	FX3U(C)										
MELSEC-WS	WS0-CPU0	-	×	×	×	×	×	×	×	×	×
	WS0-CPU1										
	WS0-CPU3										

(Continued to next page)









- *1 GT14 models compatible with Ethernet connection are only GT1455-QTBDE, GT1450-QMBDE and GT1450-QLBDE.
- *2 GT11 is not supported.
- *3 Use the serial port of QCPU in the multiple CPU system since Q172D/Q173DCPU has no direct coupled I/F.
- *4 MT Works2 does not support the FA transparent function through CC-Link IE Controller Network.

Series	Model name	Target software	Connection type									
			Bus connection	Direct CPU connection			Computer link connection			Ethernet connection	CC-Link IE Controller Network connection	
			GT 16 GT 15 GT11 Bus	GT 16 GT 15	GT 14 GT 12 GT11 Serial	GT 10 5□ GT 10 20 30	GT 16 GT 15	GT 14 GT 12 GT11 Serial	GT 10 5□ GT 10 20 30	GT 16 GT 15 GT 14 *1 GT 12	GT 16	
MELSECNET/H Remote I/O station	QJ72LP25-25 QJ72LP25G QJ72BR15	-	×	×	×	×	×	×	×	×	×	×
CC-Link IE Field Network head module	LJ72GF15-T2	-	×	×	×	×	×	×	×	×	×	×
CC-Link IE Field Network Ethernet adapter module	NZ2GF-ETB	-	×	×	×	×	×	×	×	×	×	×
CNC	CNC C70 (Q173NCCPU)	-	×	×	×	×	×	×	×	×	×	×
	MELDAS C6/C64	-	×	×	×	×	×	×	×	×	×	×
Robot controller	CRnQ-700 (Q172DRCPU) CR750-Q (Q172DRCPU) CR751-Q (Q172DRCPU)	-	×	×	×	×	×	×	×	×	×	×
	CRnD-700 CR750-D CR751-D	-	×	×	×	×	×	×	×	×	×	×
FREQROL	FREQROL-A500/A500L	-										
	FREQROL-F500/F500L											
	FREQROL-V500/V500L											
	FREQROL-E500											
	FREQROL-S500/S500E											
	FREQROL-F500J		×	×	×	×	×	×	×	×	×	×
	FREQROL-D700											
	FREQROL-E700											
	FREQROL-A700											
	FREQROL-F700											
Sensorless servo	FREQROL-A800/F800											
	FREQROL-E700EX											
MELIPM	MD-CX522-□□K (-A0)											
MELSERVO	MR-J2S-□A	-										
	MR-J2S-□CP											
	MR-J2S-□CL											
	MR-J2M-P8A											
	MR-J2M-□DU		×	×	×	×	×	×	×	×	×	
	MR-J3-□A											
	MR-JE-□A											
	MR-J3-□T											
	MR-J3-□B ^{*3,4}		MR Configurator2	○ ^{*2}	○	○ ^{*2}	×	×	×	×	×	×
MR-J4-□A	-	×	×	×	×	×	×	×	×	×		
MR-J4-□B ^{*3,4}	MR Configurator2	○ ^{*2}	○	○ ^{*2}	×	×	×	×	×	×		
MR-J4W2-□B ^{*3,4}												
	MR-J4W3-□B ^{*3,4}											

*1 GT14 models compatible with Ethernet connection are only GT1455-QTBDE, GT1450-QMBDE and GT1450-QLBDE.
*2 GT11 is not supported.
*3 A motion controller is required between the GOT and PLC in bus connection.
*4 A motion controller is required between the GOT and PLC in direct CPU connection.

17 ROBOT CONTROLLER CONNECTION
18 CNC CONNECTION
19 ENERGY MEASURING UNIT/ELECTRIC MULTI-MEASURING INSTRUMENT CONNECTION
20 GOT MULTI-DROP CONNECTION
21 MULTIPLE-GT14, GT12, GT11, GT10 CONNECTION FUNCTION
22 MULTI-CHANNEL FUNCTION
23 FA TRANSPARENT FUNCTION

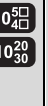
■ When connecting the GOT and personal computer with modem

Series	Model name	Target software	Connection type								
			Bus connection	Direct CPU connection			Computer link connection			Ethernet connection	CC-Link IE Controller Network connection
											
MELSEC iQ-R Series	R04CPU	GX Works3 MX Component MX Sheet	×	×	×	×	○ ^{*2}	○ ^{*2}	○	○ ^{*2}	×
	R08CPU										
	R16CPU										
	R32CPU										
	R120CPU										
	R08PCPU										
	R16PCPU										
	R32PCPU										
	R120PCPU										
	R04ENCPU										
	R08ENCPU										
	R16ENCPU										
	R32ENCPU										
R120ENCPU											
R08SFPCPU ^{*3}											
R16SFPCPU ^{*3}											
R32SFPCPU ^{*3}											
R120SFPCPU ^{*3}											
Motion controller CPU (MELSEC iQ-R Series)	R16MTCPU	MT Works2 MX Component MX Sheet	×	×	×	×	×	×	×	×	×
	R32MTCPU										
C Controller module (MELSEC iQ-R Series)	R12CCPU-V	CW Configurator	×	×	×	×	×	×	×	×	×
MELSEC iQ-F Series	FX5U FX5UC	GX Works3	×	○ ^{*2}	○ ^{*2}	○ ^{*2}	×	×	×	○ ^{*2}	×

(Continued to next page)

- *1 GT14 models compatible with Ethernet connection are only GT1455-QTBDE, GT1450-QMBDE and GT1450-QLBDE.
- *2 GT15, GT12 and GT11 do not support the MELSEC iQ-R Series and MELSEC iQ-F Series.
- *3 Mount a safety function module R6SFM next to the RnSFPCPU on the base unit. The RnSFPCPU and the safety function module R6SFM must have the same pair version. If their pair versions differ, the RnSFPCPU does not operate.

Series	Model name	Target software	Connection type										
			Bus connection	Direct CPU connection			Computer link connection			Ethernet connection	CC-Link IE Controller Network connection		
			GT 16 GT 15 GT11 Bus	GT 16 GT 15	GT 14 GT 12 GT11 Serial	GT 10 5□ GT 10 4□ GT 10 20 GT 10 30	GT 16 GT 15	GT 14 GT 12 GT11 Serial	GT 10 5□ GT 10 4□ GT 10 20 GT 10 30	GT 16 GT 15 GT 14 *2 GT 12	GT 16		
MELSEC-Q (Q mode)	Q00JCPU	GX Developer GX Works2				○			○				
	Q00CPU												
	Q01CPU												
	Q02CPU												
	Q02HCPU												
	Q06HCPU		○	○	○		○	○		○		×	
	Q12HCPU												
	Q25HCPU												
	Q02PHCPU												
	Q06PHCPU												
	Q12PHCPU												
	Q25PHCPU												
	Q12PRHCPU (Main base)												
	Q25PRHCPU (Main base)					×				×			
	Q12PRHCPU (Extension base)		×	×	×		×	×		×	×		
	Q25PRHCPU (Extension base)												
	Q00UJCPU												
	Q00UCPU												
	Q01UCPU												
	Q02UCPU												
	Q03UDCPU				○	○	○						
	Q04UDHCPU												
	Q06UDHCPU												
	Q10UDHCPU												
	Q13UDHCPU												
	Q20UDHCPU												
Q26UDHCPU													
Q03UDECPU	○					○	○	○	○	×			
Q04UDEHCPU													
Q06UDEHCPU													
Q10UDEHCPU													
Q13UDEHCPU													
Q20UDEHCPU													
Q26UDEHCPU													
Q50UDEHCPU			○*1	○*1	○*1								
Q100UDEHCPU													
Q03UDVCPU													
Q04UDVCPU													
Q06UDVCPU													
Q13UDVCPU													
Q26UDVCPU													

(Continued to next page)

*1 Use the serial port of QCPU in the multiple CPU system, since QnUEHCPU has no direct coupled I/F.

*2 GT14 models compatible with Ethernet connection are only GT1455-QTBDE, GT1450-QMBDE and GT1450-QLBDE.

17 ROBOT CONTROLLER CONNECTION
18 CNC CONNECTION
19 ENERGY MEASURING UNIT/ELECTRIC MULTI-MEASURING INSTRUMENT CONNECTION
20 GOT MULTI-DROP CONNECTION
21 MULTIPLE-GT14, GT12, GT11, GT10 CONNECTION FUNCTION
22 MULTI-CHANNEL FUNCTION
23 FA TRANSPARENT FUNCTION

Series	Model name	Target software	Connection type									
			Bus connection	Direct CPU connection			Computer link connection			Ethernet connection	CC-Link IE Controller Network connection	
			GT 16 GT 15 GT 11 Bus	GT 16 GT 15	GT 14 GT 12 GT 11 Serial	GT 10 5/4 GT 10 20/30	GT 16 GT 15	GT 14 GT 12 GT 11 Serial	GT 10 5/4 GT 10 20/30	GT 16 GT 15 GT 14 *1 GT 12	GT 16	
C Controller module (Q Series)	Q12DCCPU-V	-										
	Q24DHCCPU-V/VG		×	×	×	×	×	×	×	×	×	
	Q24DHCCPU-LS		×	×	×	×	×	×	×	×	×	
	Q26DHCCPU-LS		×	×	×	×	×	×	×	×	×	
MELSEC-QS	QS001CPU	-	×	×	×	×	×	×	×	×	×	×
MELSEC-L	L02CPU	-										
	L06CPU											
	L26CPU											
	L26CPU-BT											
	L02CPU-P		×	×	×	×	×	×	×	×	×	×
	L06CPU-P		×	×	×	×	×	×	×	×	×	×
	L26CPU-P		×	×	×	×	×	×	×	×	×	×
	L26CPU-PBT		×	×	×	×	×	×	×	×	×	×
L02SCPU												
L02SCPU-P												
MELSEC-Q (A mode)	Q02CPU-A	-										
	Q02HCPU-A		×	×	×	×	×	×	×	×	×	
	Q06HCPU-A		×	×	×	×	×	×	×	×	×	
MELSEC-QnA (QnACPU)	Q2ACPU	-										
	Q2ACPU-S1		×	×	×	×	×	×	×	×	×	
	Q3ACPU		×	×	×	×	×	×	×	×	×	
	Q4ACPU		×	×	×	×	×	×	×	×	×	
Q4ARCPU												
MELSEC-QnA (QnASCPU)	Q2ASCPU	-										
	Q2ASCPU-S1		×	×	×	×	×	×	×	×	×	
	Q2ASHCPU		×	×	×	×	×	×	×	×	×	
	Q2ASHCPU-S1		×	×	×	×	×	×	×	×	×	
MELSEC-A (AnCPU)	A2UCPU	-										
	A2UCPU-S1											
	A3UCPU											
	A4UCPU											
	A2ACPU											
	A2ACPUP21											
	A2ACPUR21											
	A2ACPU-S1											
	A2ACPUP21-S1											
	A2ACPUR21-S1											
	A3ACPU											
	A3ACPUP21											
	A3ACPUR21		×	×	×	×	×	×	×	×	×	
	A1NCPUR21		×	×	×	×	×	×	×	×	×	
	A1NCPUR21											
	A2NCPUR21											
	A2NCPUR21											
	A2NCPUR21											
	A2NCPUR21-S1											
	A2NCPUR21-S1											
	A3NCPUR21											
	A3NCPUR21											
A3NCPUR21												

(Continued to next page)

*1 GT14 models compatible with Ethernet connection are only GT1455-QTBDE, GT1450-QMBDE and GT1450-QLBDE.

Series	Model name	Target software	Connection type								
			Bus connection	Direct CPU connection			Computer link connection			Ethernet connection	CC-Link IE Controller Network connection
			GT 16 GT 15 GT11 Bus	GT 16 GT 15	GT 14 GT 12 GT11 Serial	GT 10 ⁵ / ₄ GT 10 ²⁰ / ₃₀	GT 16 GT 15	GT 14 GT 12 GT11 Serial	GT 10 ⁵ / ₄ GT 10 ²⁰ / ₃₀	GT 16 GT 15 GT 14 ^{*1} GT 12	GT 16
MELSEC-A (AnSCPU)	A2USCPU	-									
	A2USCPU-S1										
	A2USHCPU-S1										
	A1SCPU										
	A1SCPUC24-R2										
	A1SHCPU										
	A2SCPU ^{*1}		x	x	x	x	x	x	x	x	x
	A2SCPU-S1										
	A2SHCPU										
	A2SHCPU-S1										
	A1SJCPU										
	A1SJCPU-S3										
	A1SJHCPU										
MELSEC-A	A0J2HCPU	-									
	A0J2HCPUP21										
	A0J2HCPUR21										
	A0J2HCPU-DC24										
	A2CCPU										
	A2CCPUP21		x	x	x	x	x	x	x	x	x
	A2CCPUR21										
	A2CCPUC24										
	A2CCPUC24-PRF										
	A2CJCPU-S3										
	A1FXCPU										
Motion controller CPU (Q Series)	Q172CPU	-									
	Q173CPU										
	Q172CPUN										
	Q173CPUN										
	Q172HCPU										
	Q173HCPU										
	Q172DCPU										
	Q173DCPU		x	x	x	x	x	x	x	x	x
	Q172DCPU-S1										
	Q173DCPU-S1										
	Q172DSCPU										
	Q173DSCPU										
	Q170MCPU										
	Q170MSCPU										
	Q170MSCPU-S1										

(Continued to next page)

*1 GT14 models compatible with Ethernet connection are only GT1455-QTBDE, GT1450-QMBDE and GT1450-QLBDE.

17 ROBOT CONTROLLER CONNECTION
18 CNC CONNECTION
19 ENERGY MEASURING UNIT/ELECTRIC MULTI-MEASURING INSTRUMENT CONNECTION
20 GOT MULTI-DROP CONNECTION
21 MULTIPLE-GT14, GT12, GT11, GT10 CONNECTION FUNCTION
22 MULTI-CHANNEL FUNCTION
23 FA TRANSPARENT FUNCTION

Series	Model name	Target software	Connection type									
			Bus connection	Direct CPU connection			Computer link connection			Ethernet connection	CC-Link IE Controller Network connection	
			GT 16 GT 15 GT 11 Bus	GT 16 GT 15	GT 14 GT 12 GT 11 Serial	GT 10 5□ GT 10 20□ GT 10 4□ GT 10 30	GT 16 GT 15	GT 14 GT 12 GT 11 Serial	GT 10 5□ GT 10 20□ GT 10 4□ GT 10 30	GT 16 GT 15 GT 14 *1 GT 12	GT 16	
Motion controller CPU (A Series)	A273UCPU	-										
	A273UHCPU											
	A273UHCPU-S3											
	A373UCPU											
	A373UCPU-S3											
	A171SCPU											
	A171SCPU-S3											
	A171SCPU-S3N			x	x	x	x	x	x	x	x	x
	A171SHCPU											
	A171SHCPUN											
	A172SHCPU											
	A172SHCPUN											
	A173UHCPU											
	A173UHCPU-S1											
MELSEC-FX	FX0	GX Developer										
	FX0S											
	FX0N											
	FX1											
	FX2											
	FX2C											
	FX1S											
	FX1N			x	○	○	○	x	x	x	x	x
	FX2N											
	FX1NC											
	FX2NC											
	FX3S											
	FX3G(C)											
	FX3GE											
	FX3U(C)											
MELSEC-WS	WS0-CPU0	-										
	WS0-CPU1			x	x	x	x	x	x	x	x	
	WS0-CPU3			x	x	x	x	x	x	x	x	

(Continued to next page)

*1 GT14 models compatible with Ethernet connection are only GT1455-QTBDE, GT1450-QMBDE and GT1450-QLBDE.

Series	Model name	Target software	Connection type									
			Bus connection	Direct CPU connection			Computer link connection			Ethernet connection	CC-Link IE Controller Network connection	
			GT 16 GT 15 GT11 Bus	GT 16 GT 15	GT 14 GT 12 GT11 Serial	GT 10 ⁵ ₄ GT 10 ²⁰ ₃₀	GT 16 GT 15	GT 14 GT 12 GT11 Serial	GT 10 ⁵ ₄ GT 10 ²⁰ ₃₀	GT 16 GT 15 GT 14 ^{*1} GT 12	GT 16	
MELSECNET/H Remote I/O station	QJ72LP25-25 QJ72LP25G QJ72BR15	-	x	x	x	x	x	x	x	x	x	x
CC-Link IE Field Network head module	LJ72GF15-T2	-	x	x	x	x	x	x	x	x	x	x
CNC	CNC C70 (Q173NCCPU) MELDAS C6/C64	-	x	x	x	x	x	x	x	x	x	x
Robot controller	CRnQ-700 (Q172DRCPU) CR750-Q (Q172DRCPU) CR751-Q (Q172DRCPU) CRnD-700 CR750-D CR751-D	-	x	x	x	x	x	x	x	x	x	x
FREQROL	FREQROL-A500/A500L FREQROL-F500/F500L FREQROL-V500/V500L FREQROL-E500 FREQROL-S500/S500E FREQROL-F500J FREQROL-D700 FREQROL-E700 FREQROL-A700 FREQROL-F700 FREQROL-A800/F800	-	x	x	x	x	x	x	x	x	x	x
Sensorless servo	FREQROL-E700EX	-										
MELIPM	MD-CX522-□□K(-A0)	-										
MELSERVO	MR-J2S-□A MR-J2S-□CP MR-J2S-□CL MR-J2M-P8A MR-J2M-□DU MR-J3-□A MR-JE-□A MR-J3-□T MR-J3-□B MR-J4-□A MR-J4-□B MR-J4W2-□B MR-J4W3-□B	- - - - - - - - - - - - -	x x x x x x x x x x x x x x	x x x x x x x x x x x x x	x x x x x x x x x x x x x	x x x x x x x x x x x x x	x x x x x x x x x x x x x	x x x x x x x x x x x x x	x x x x x x x x x x x x x			

*1 GT14 models compatible with Ethernet connection are only GT1455-QTBE, GT1450-QMBDE and GT1450-QLBDE.

17 ROBOT CONTROLLER CONNECTION
18 CNC CONNECTION
19 ENERGY MEASURING UNIT/ELECTRIC MULTI-MEASURING INSTRUMENT CONNECTION
20 GOT MULTI-DROP CONNECTION
21 MULTIPLE-GT14, GT12, GT11, GT10 CONNECTION FUNCTION
22 MULTI-CHANNEL FUNCTION
23 FA TRANSPARENT FUNCTION

23.4 System Configuration

23.4.1 GX Works3, CW Configurator, GX Developer, GX Works2, GX LogViewer, MX Component, MX Sheet, CPU Module Logging Configuration Tool, Setting/Monitoring tool for C Controller module

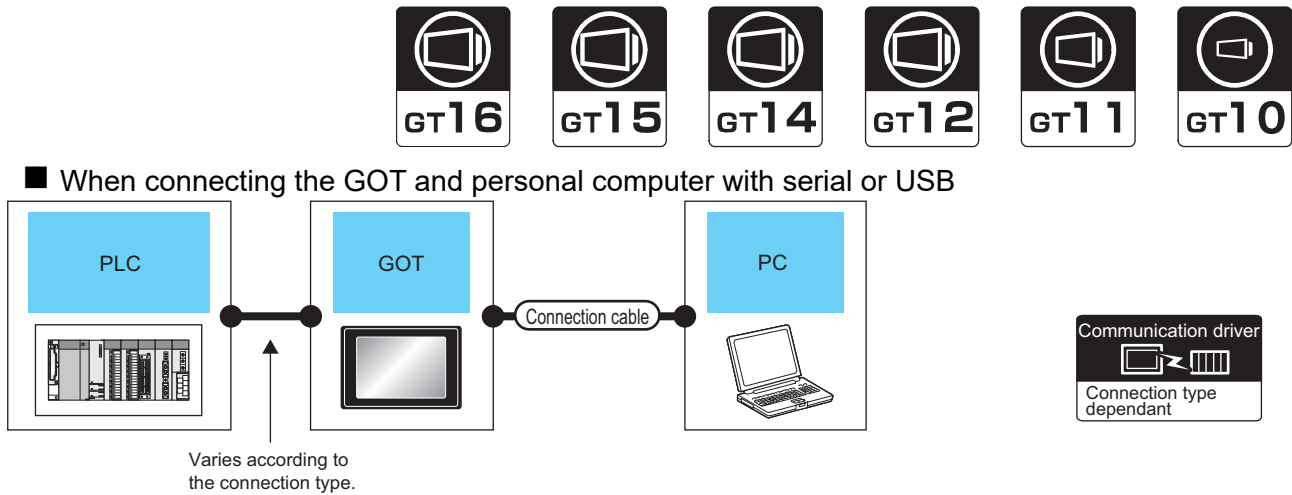

PLC	GOT		Connection cable			Personal computer	Number of connectable equipment
	Connection type	Model	Interface	RS-232/USB conversion adaptor	Cable model		
For the system configuration between the GOT and PLC, refer to the following. COMPUTER LINK CONNECTION ^{*7} ETHERNET CONNECTION ^{*3}		RS-232	-	GT01-C30R2-9S(3m)	3m	GX Works3 CW Configurator MX Component MX Sheet	1 personal computer for 1 GOT
		RS-232	-	GT01-C30R2-6P(3m)			
		RS-232 GT10-RS2TUSB-5S ^{*4}	GT09-C30USB-5P(3m) GT09-C20USB-5P(2m)				
For the system configuration between the GOT and PLC, refer to the following. CC-Link IE CONTROLLER NETWORK CONNECTION		RS-232	-	GT01-C30R2-9S(3m)	3m	GX Works2	1 personal computer for 1 GOT
		USB	-	GT09-C30USB-5P(3m) GT09-C20USB-5P(2m)	3m		
For the system configuration between the GOT and PLC, refer to the following. BUS CONNECTION ^{*2} DIRECT CONNECTION TO CPU ^{*6} COMPUTER LINK CONNECTION ^{*16} ETHERNET CONNECTION ^{*3} GOT MULTI-DROP CONNECTION ^{*5}		RS-232	-	GT01-C30R2-9S(3m)	3m	GX Developer GX Works2 GX LogViewer MX Component MX Sheet CPU Module Logging Configuration Tool Setting/ Monitoring tool for C Controller module	1 personal computer for 1 GOT
		RS-232	-	GT01-C30R2-6P(3m)			
		RS-232 GT10-RS2TUSB-5S ^{*4}	GT09-C30USB-5P(3m) GT09-C20USB-5P(2m)				
		USB	-	GT09-C30USB-5P(3m) GT09-C20USB-5P(2m)	3m		

- *1 Applicable to the QCPU only
- *2 GT10, QnUDVCPULCPU Logging Configuration Tool are not applicable to the bus connection.
- *3 GT11 and GT10 are not applicable to the Ethernet connection.
- *4 The use of RS-232/USB conversion adaptor requires an installation of the dedicated communication driver onto personal computer.
For details, refer to the following manual.
 RS-232/USB Conversion adaptor User's Manual
- *5 GX LogViewer, MX Component, MX Sheet, QnUDVCPULCPU Logging Configuration Tool and Setting/Monitoring tool for C Controller module are not supported.
- *6 Not applicable to Setting/Monitoring tool for C Controller module.
- *7 Not applicable to CW Configurator.

■ When connecting the GOT and PC with Ethernet (For GT16, GT15, GT14, GT12)

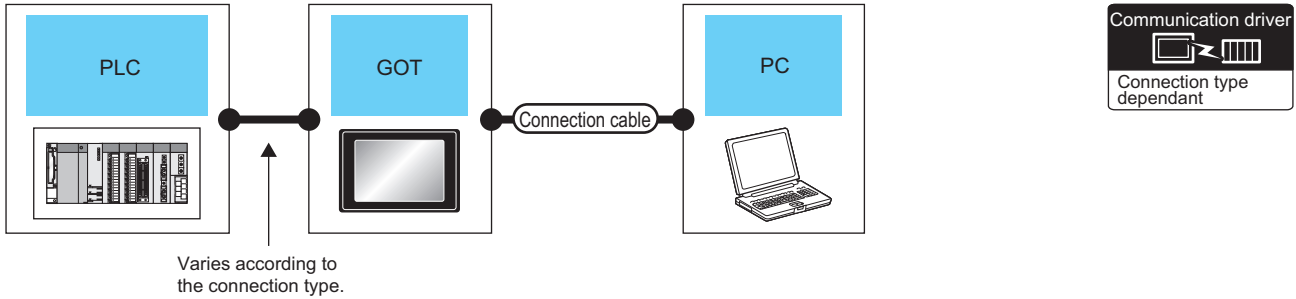

PLC	GOT		Connection cable ^{*1}	Maximum segment length ^{*3}	Personal computer	Number of connectable equipment
	Connection type	Model			Interface	
For the system configuration between the GOT and PLC, refer to the following. COMPUTER LINK CONNECTION	*2 *5	- (Built into GOT)	Twisted pair cable • 10BASE-T Shielded twisted pair cable (STP) or unshielded twisted pair cable (UTP): Category 3, 4, and 5 • 100BASE-TX Shielded twisted pair cable (STP): Category 5 and 5e	100m	GX Works3 MX Component MX Sheet	1 personal computer for 1 GOT
For the system configuration between the GOT and PLC, refer to the following. CC-Link IE CONTROLLER NETWORK CONNECTION	*2	- (Built into GOT)			GX Works2	1 personal computer for 1 GOT
For the system configuration between the GOT and PLC, refer to the following. BUS CONNECTION ^{*4} DIRECT CONNECTION TO CPU ^{*6} COMPUTER LINK CONNECTION ^{*6}	*2 *5 	- (Built into GOT)			GX Works2 Setting/ Monitoring tool for C Controller module	1 personal computer for 1 GOT
		GT15-J71E71-100				

^{*1} The destination connected with the twisted pair cable varies with the configuration of the applicable Ethernet network system. Connect to the Ethernet module, hub, transceiver, or other system equipment corresponding to the applicable Ethernet network system.
Use cables, connectors, and hubs that meet the IEEE802.3 10BASE-T/100BASE-TX standards.
A cross cable is available for connecting the GOT to the Ethernet module.

^{*2} When connecting GT16 of the function version A to an equipment that meets the 10BASE (-T/2/5) standard, use the switching hub and operate in a 10Mbps/100Mbps mixed environment.
For how to check the function version, refer to the following.
 GT16 User's Manual

^{*3} A length between a hub and a node.
The maximum distance differs depending on the Ethernet device to be used.
The following shows the number of the connectable nodes when a repeater hub is used.
• 10BASE-T: Max. 4 nodes for a cascade connection (500m)
• 100BASE-TX: Max. 2 nodes for a cascade connection (205m)
When switching hubs are used, the cascade connection between the switching hubs has no logical limit for the number of cascades.
For the limit, contact the switching hub manufacturer.

^{*4} LCPU is not applicable to the bus connection.

^{*5} GT14 models compatible with Ethernet connection are only GT1455-QTBDE, GT1450-QMBDE and GT1450-QLBDE.

^{*6} Not applicable to Setting/Monitoring tool for C Controller module.

■ When connecting the GOT and personal computer with modem

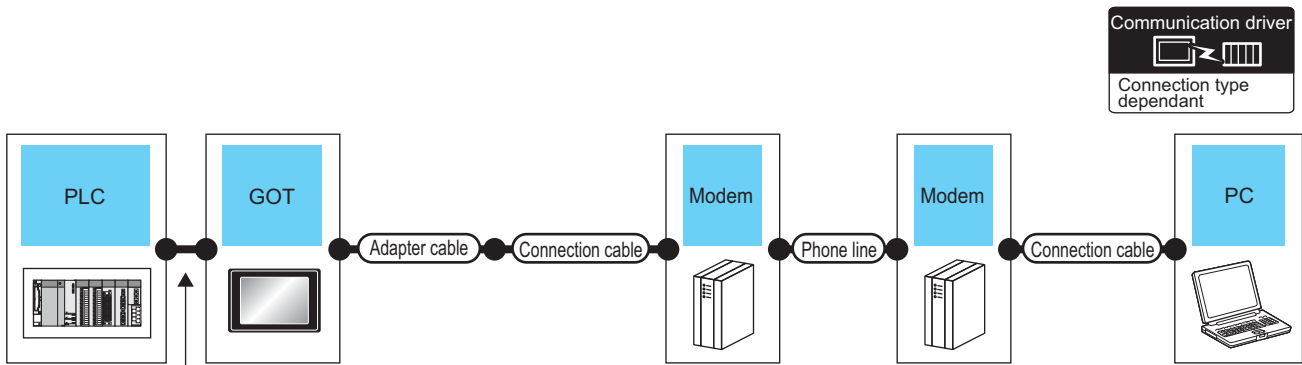

Varies according to the connection type.

PLC	GOT		Adapter cable	Connection cable Cable model	Modem	Phone line	Personal computer ^{*3} Software	Number of connectable equipment
	Connection type	Model						
For the system configuration between the GOT and PLC, refer to the following. COMPUTER LINK CONNECTION ^{*5} ETHERNET CONNECTION ^{*4}		RS-232 (Built into GOT)	-	*1	*1	Public line	GX Works3 CW Configurator MX Component MX Sheet	1 personal computer for 1 GOT
		RS-232	GT10-C02H-6PT9P (0.2m)	*1				
For the system configuration between the GOT and PLC, refer to the following. BUS CONNECTION ^{*2} DIRECT CONNECTION TO CPU COMPUTER LINK CONNECTION ^{*1} ETHERNET CONNECTION ^{*4}		RS-232 (Built into GOT)	-	*1	*1	Public line	GX Developer GX Works2	1 personal computer for 1 GOT
		RS-232	GT10-C02H-6PT9P (0.2m)	*1				

*1 For connectable modems, system equipment and connection cables, refer to the following Technical News.
 List of valid devices applicable for GOT1000 series (T10-0039)

*2 GT10 is not applicable to the bus connection.

*3 Installation of the GOT modem connection tool to the personal computer is required to connect the GOT to a modem. For details, refer to the following manual.
 GT Designer3 Version□ Screen Design Manual

*4 GT11 and GT10 are not applicable to the Ethernet connection.

*5 Not applicable to CW Configurator.

17 ROBOT CONTROLLER CONNECTION
18 CNC CONNECTION
19 ENERGY MEASURING UNIT/ELECTRIC MULTI-MEASURING INSTRUMENT CONNECTION
20 GOT MULTI-DROP CONNECTION
21 MULTIPLE-GT14, GT12, GT11, GT10 CONNECTION FUNCTION
22 MULTI-CHANNEL FUNCTION
23 FA TRANSPARENT FUNCTION

23.4.2 PX Developer, GX Configurator

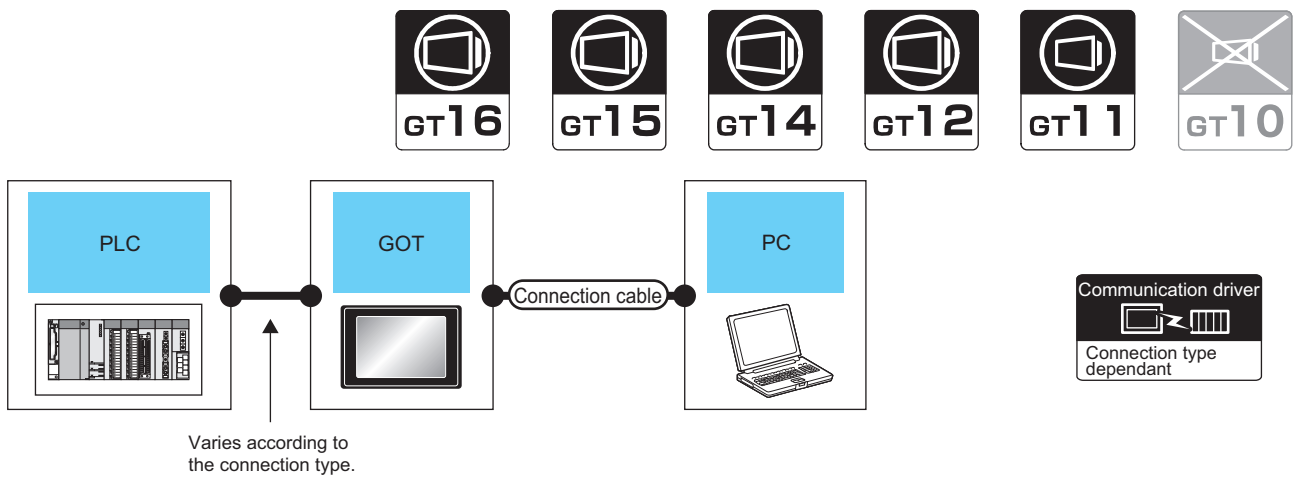

PLC	GOT		Connection cable		Personal computer	Number of connectable equipment
	Connection type	Model	Interface	Cable model	Max. distance	
For the system configuration between the GOT and PLC, refer to the following. ➔ BUS CONNECTION ➔ DIRECT CONNECTION TO CPU ➔ COMPUTER LINK CONNECTION	GT16, GT15, GT14 GT12, GT11 Bus GT11 Serial	RS-232	GT01-C30R2-9S(3m)	3m	PX Developer GX Configurator	1 personal computer for 1 GOT
	GT16, GT15, GT14 GT12, GT11 Bus GT11 Serial	USB	GT09-C30USB-5P(3m) GT09-C20USB-5P(2m)	3m		

23.4.3 MT Developer, MT Works2



■ When connecting the GOT and personal computer with serial or USB

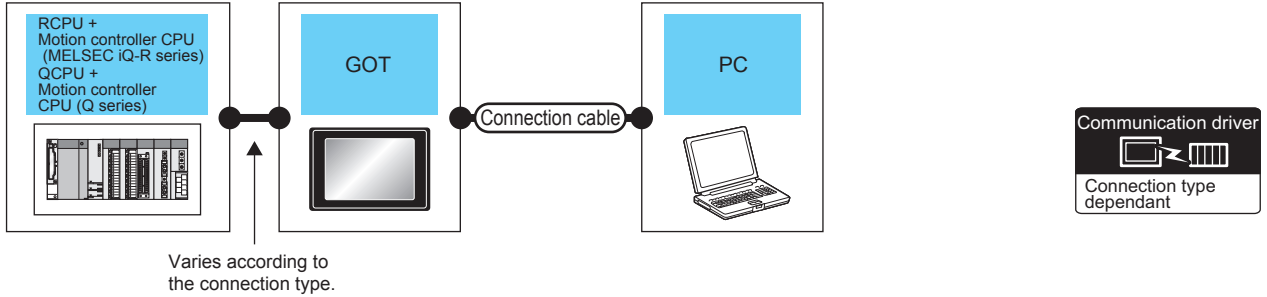

PLC	GOT		Connection cable			Personal computer	Number of connectable equipment
	Connection type	Model ^{*5}	Interface	RS-232/USB conversion adaptor	Cable model	Max. distance	
For the system configuration between the GOT and PLC, refer to the following. ➔ BUS CONNECTION ^{*1*4} ➔ DIRECT CONNECTION TO CPU ^{*4} ➔ ETHERNET CONNECTION ^{*2} ➔ GOT MULTI-DROP CONNECTION ^{*4}	GT16, GT15, GT14, GT12, GT11 Bus, GT11 Serial, GT10 5□, GT10 4□	RS-232	-	GT01-C30R2-9S(3m)	3m	MT Developer MT Works2	1 personal computer for 1 GOT
		RS-232	-	GT01-C30R2-6P(3m)			
	GT10 20, GT10 30	RS-232	GT10-RS2TUSB-5S ^{*3}	GT09-C30USB-5P(3m) GT09-C20USB-5P(2m)			
		USB	-	GT09-C30USB-5P(3m) GT09-C20USB-5P(2m)			

- *1 GT10 is not applicable to the bus connection.
- *2 GT11 and GT10 are not applicable to the Ethernet connection.
- *3 The use of RS-232/USB conversion adaptor requires an installation of the dedicated communication driver onto personal computer.
- ➔ RS-232/USB Conversion adaptor USER'S MANUAL
- *4 The motion controller CPU (MELSEC iQ-R Series) does not support the bus connection, direct CPU connection, and GOT multi-drop connection.
- *5 GT15, GT12 and GT11 do not support the motion controller CPU (MELSEC iQ-R Series).

17 ROBOT CONTROLLER CONNECTION
18 CNC CONNECTION
19 ENERGY MEASURING UNIT/ELECTRIC MULTI-MEASURING INSTRUMENT CONNECTION
20 GOT MULTI-DROP CONNECTION
21 MULTIPLE-GT14, GT12, GT11, GT10 CONNECTION FUNCTION
22 MULTI-CHANNEL FUNCTION
23 FA TRANSPARENT FUNCTION

■ When connecting the GOT and PC with Ethernet (For GT16, GT15, GT14, GT12)

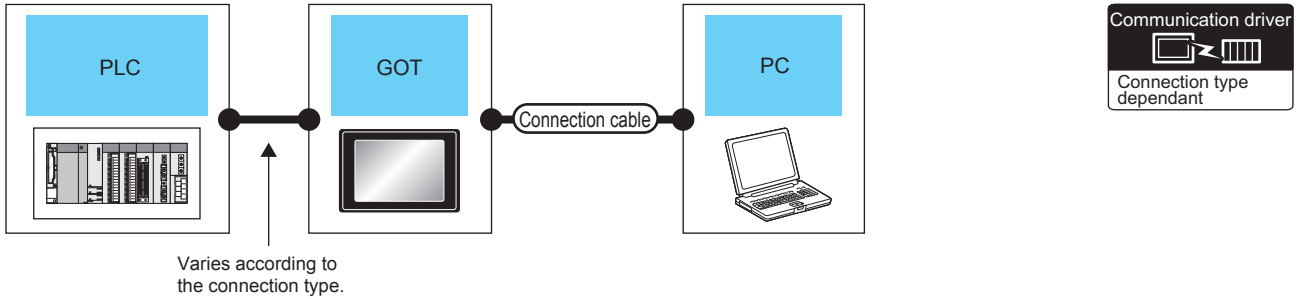

PLC	GOT		Connection cable ^{*1}	Maximum segment length ^{*3}	Personal computer	Number of connectable equipment
	Connection type	Model				
For the system configuration between the GOT and PLC, refer to the following. ➔ BUS CONNECTION ^{*4} ➔ DIRECT CONNECTION TO CPU	GT16 ^{*2} GT14 ^{*5} GT12	- (Built into GOT)	Twisted pair cable • 10BASE-T Shielded twisted pair cable (STP) or unshielded twisted pair cable (UTP): Category 3, 4, and 5 • 100BASE-TX Shielded twisted pair cable (STP): Category 5 and 5e	100m	MT Works2	1 personal computer for 1 GOT
	GT15	GT15-J71E71-100				

*1 The destination connected with the twisted pair cable varies with the configuration of the applicable Ethernet network system. Connect to the Ethernet module, hub, transceiver, or other system equipment corresponding to the applicable Ethernet network system.
Use cables, connectors, and hubs that meet the IEEE802.3 10BASE-T/100BASE-TX standards.
A cross cable is available for connecting the GOT to the Ethernet module.

*2 When connecting GT16 of the function version A to an equipment that meets the 10BASE (-T/2/5) standard, use the switching hub and operate in a 10Mbps/100Mbps mixed environment.
For how to check the function version, refer to the following.
➔ GT16 User's Manual

*3 A length between a hub and a node.
The maximum distance differs depending on the Ethernet device to be used.
The following shows the number of the connectable nodes when a repeater hub is used.
• 10BASE-T: Max. 4 nodes for a cascade connection (500m)
• 100BASE-TX: Max. 2 nodes for a cascade connection (205m)
When switching hubs are used, the cascade connection between the switching hubs has no logical limit for the number of cascades.
For the limit, contact the switching hub manufacturer.

*4 LCPU is not applicable to the bus connection.

*5 GT14 models compatible with Ethernet connection are only GT1455-QTBDE, GT1450-QMBDE and GT1450-QLBDE.

23.4.4 MR Configurator, MR Configurator2



■ When connecting the GOT and personal computer with serial or USB

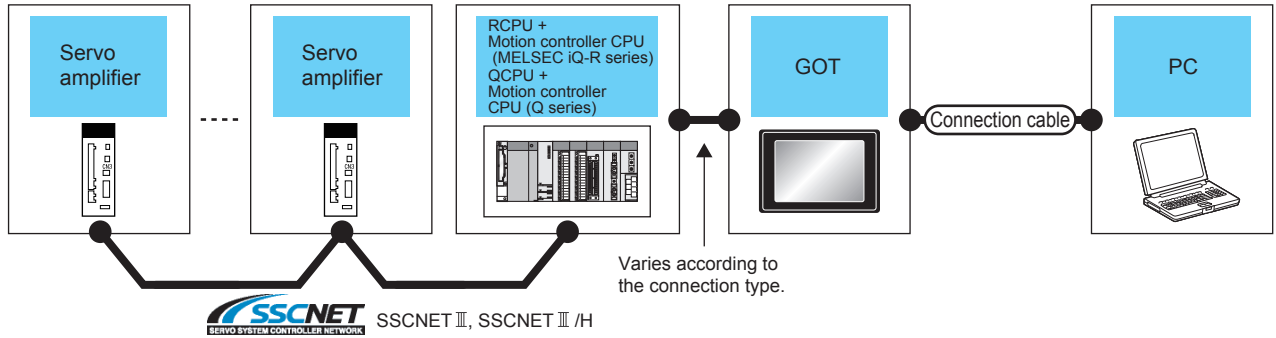

PLC	GOT		Connection cable		Personal computer	Number of connectable equipment
	Model*3	Interface	Cable model	Max. distance	Software	
For the system configuration between the GOT and PLC, refer to the following.	GT16, GT15, GT14, GT12, GT11 Bus, GT11 Serial	RS-232	GT01-C30R2-9S(3m)	3m	MR Configurator MR Configurator2	1 personal computer for 1 GOT
<p>☞ BUS CONNECTION*2</p> <p>☞ DIRECT CONNECTION TO CPU</p> <p>☞ ETHERNET CONNECTION*1*2</p>	GT16, GT15, GT14, GT12, GT11 Bus, GT11 Serial	USB	GT09-C30USB-5P(3m) GT09-C20USB-5P(2m)	3m		

*1 Only MR Configurator2 is compatible with the Ethernet connection.

*2 The motion controller CPU (MELSEC iQ-R Series) does not support the bus connection and direct CPU connection.

*3 GT15, GT12 and GT11 do not support the motion controller CPU (MELSEC iQ-R Series).

17 ROBOT CONTROLLER CONNECTION
18 CNC CONNECTION
19 ENERGY MEASURING UNIT/ELECTRIC MULTI-MEASURING INSTRUMENT CONNECTION
20 GOT MULTI-DROP CONNECTION
21 MULTIPLE-GT14, GT12, GT11, GT10 CONNECTION FUNCTION
22 MULTI-CHANNEL FUNCTION
23 FA TRANSPARENT FUNCTION

■ When connecting the GOT and PC with Ethernet (For GT16, GT15, GT14, GT12)

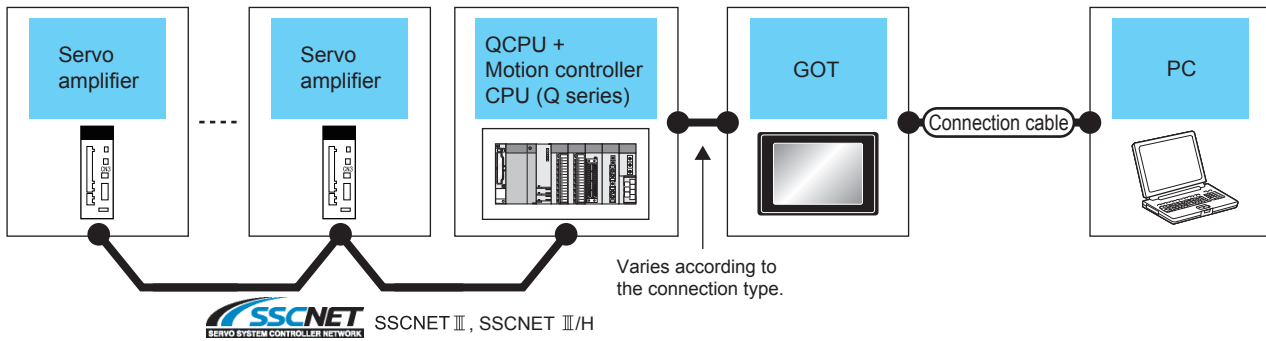

PLC	GOT		Connection cable ^{*1}	Maximum segment length ^{*3}	Personal computer	Number of connectable equipment
Connection type	Model	Interface	Cable model		Software	
For the system configuration between the GOT and PLC, refer to the following. ➔ BUS CONNECTION ^{*4} ➔ DIRECT CONNECTION TO CPU	GT16 ^{*2} GT14 ^{*5} GT12	- (Built into GOT)	Twisted pair cable • 10BASE-T Shielded twisted pair cable (STP) or unshielded twisted pair cable (UTP): Category 3, 4, and 5 • 100BASE-TX Shielded twisted pair cable (STP): Category 5 and 5e	100m	MR Configurator2	1 personal computer for 1 GOT
	GT15	GT15-J71E71-100				

- ^{*1} The destination connected with the twisted pair cable varies with the configuration of the applicable Ethernet network system. Connect to the Ethernet module, hub, transceiver, or other system equipment corresponding to the applicable Ethernet network system.
Use cables, connectors, and hubs that meet the IEEE802.3 10BASE-T/100BASE-TX standards.
A cross cable is available for connecting the GOT to the Ethernet module.
- ^{*2} When connecting GT16 of the function version A to an equipment that meets the 10BASE (-T/2/5) standard, use the switching hub and operate in a 10Mbps/100Mbps mixed environment.
For how to check the function version, refer to the following.
➔ GT16 User's Manual
- ^{*3} A length between a hub and a node.
The maximum distance differs depending on the Ethernet device to be used.
The following shows the number of the connectable nodes when a repeater hub is used.
• 10BASE-T: Max. 4 nodes for a cascade connection (500m)
• 100BASE-TX: Max. 2 nodes for a cascade connection (205m)
When switching hubs are used, the cascade connection between the switching hubs has no logical limit for the number of cascades.
For the limit, contact the switching hub manufacturer.
- ^{*4} LCP is not applicable to the bus connection.
- ^{*5} GT14 models compatible with Ethernet connection are only GT1455-QTBDE, GT1450-QMBDE and GT1450-QLBDE.

23.4.5 FR Configurator

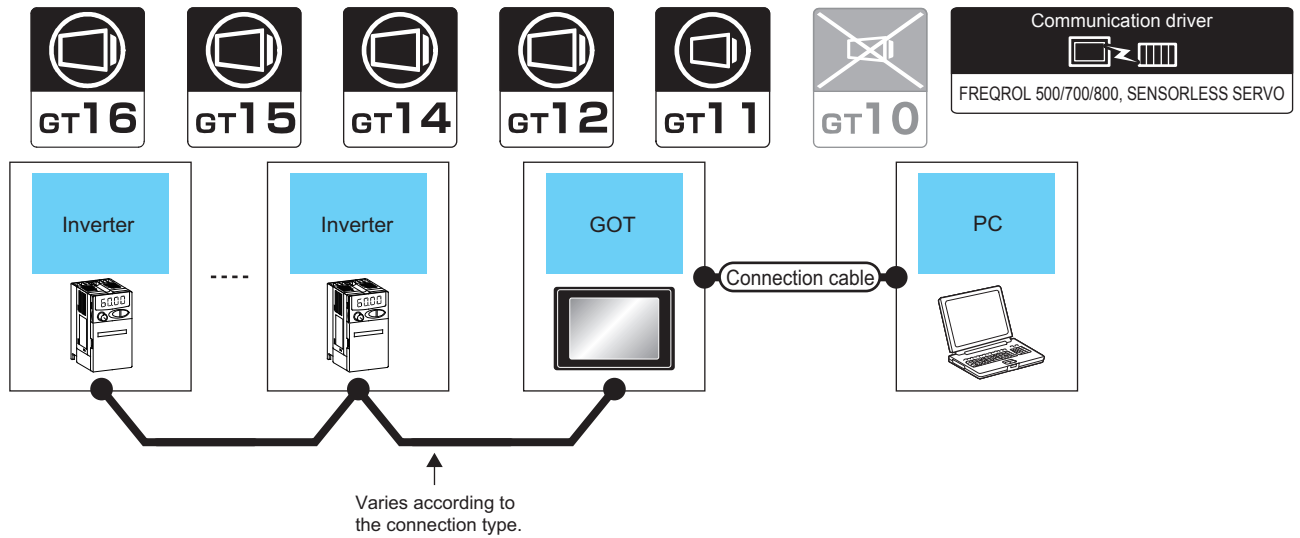

Inverter	GOT		Connection cable		Personal computer	Number of connectable equipment
	Model	Interface	Cable model	Max. distance		
For details on the system configuration between GOT and Mitsubishi Electric inverter, refer to the following. INVERTER CONNECTION	GT16 GT15 GT14 GT12 Serial	RS-232	GT01-C30R2-9S(3m)	3m	FR Configurator	1 personal computer for 1 GOT
	GT16 GT15 GT14 GT12 Serial	USB	GT09-C30USB-5P(3m) GT09-C20USB-5P(2m)	3m		

23.4.6 FX Configurator-FP, FX Configurator-EN-L, FX Configurator-EN

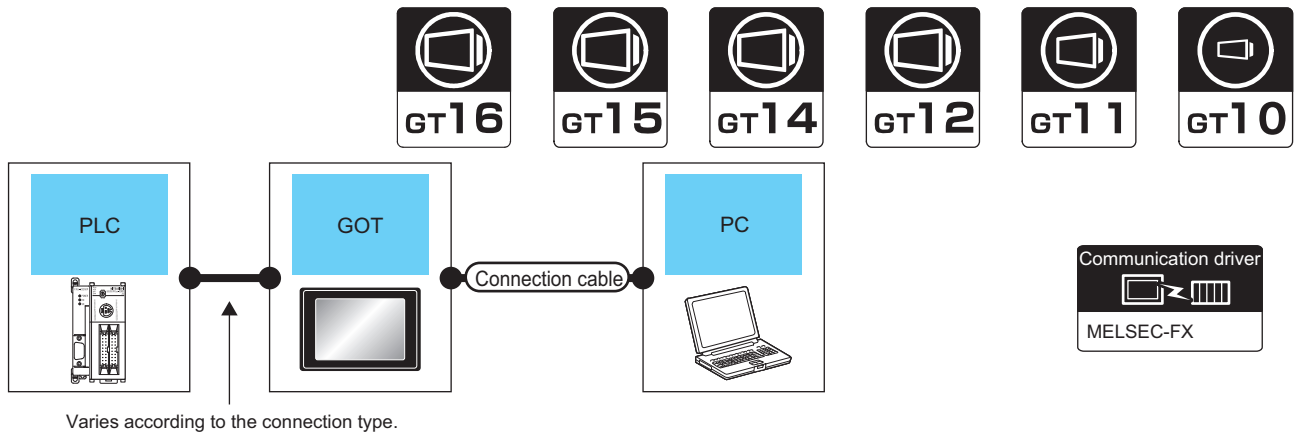

PLC	GOT		Connection cable			Personal computer	Number of connectable equipment
	Model	Interface	RS-232/USB conversion adaptor	Cable model	Max. distance		
For the system configuration between the GOT and PLC, refer to the following. DIRECT CONNECTION TO CPU	GT16 GT15 GT14 GT12 GT11 Serial GT10 5P 4P	RS-232	-	GT01-C30R2-9S(3m)	3m	FX Configurator-FP, FX3U-ENET-L Configuration tool FX Configurator-EN	1 personal computer for 1 GOT
	GT10 20 30	RS-232	-	GT01-C30R2-6P(3m)			
			GT10-RS2TUSB-5S*1	GT09-C30USB-5P(3m) GT09-C20USB-5P(2m)			
	GT16 GT15 GT14 GT12 GT11 Serial GT10 5P 4P	USB	-	GT09-C30USB-5P(3m) GT09-C20USB-5P(2m)			

*1 The use of RS-232/USB conversion adaptor requires an installation of the dedicated communication driver onto personal computer.

RS-232/USB Conversion adaptor User's Manual

23.4.7 RT ToolBox2

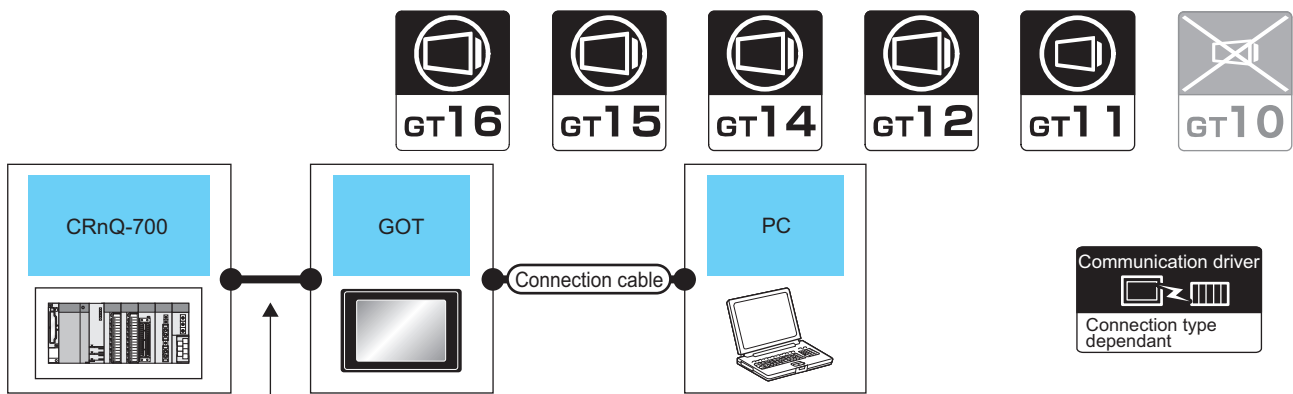

Varies according to the connection type.

PLC	GOT		Connection cable		Personal computer	Number of connectable equipment
	Connection type	Model	Interface	Cable model	Max. distance	
For the system configuration between the GOT and PLC, refer to the following. BUS CONNECTION*1 DIRECT CONNECTION TO CPU*1 ETHERNET CONNECTION	GT16 GT15 GT14 GT12 GT11 Bus GT11 Serial	RS-232	GT01-C30R2-9S(3m)	3m	RT ToolBox2	1 personal computer for 1 GOT
	GT16 GT15 GT14 GT12 GT11 Bus GT11 Serial	USB	GT09-C30USB-5P(3m) GT09-C20USB-5P(2m)	3m		
	*1 CRnD-700 is not applicable to the bus connection, the direct CPU connection.					

23.4.8 NC Configurator

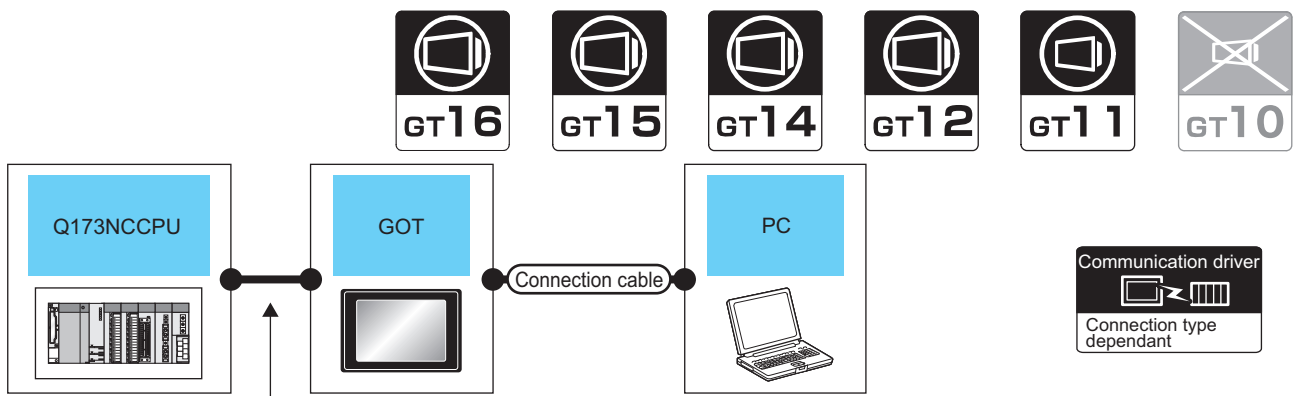

Varies according to the connection type.

PLC	GOT		Connection cable		Personal computer	Number of connectable equipment
	Connection type	Model	Interface	Cable model	Max. distance	
For the system configuration between the GOT and PLC, refer to the following. BUS CONNECTION ETHERNET CONNECTION*1	GT16 GT15 GT14 GT12 GT11 Serial	USB	GT09-C30USB-5P(3m) GT09-C20USB-5P(2m)	3m	NC Configurator	1 personal computer for 1 GOT
	*1 GT11 is not applicable to the Ethernet connection.					

23.5 GOT Side Settings

23.5.1 Setting communication interface

Controller setting

Set the channel of the connected equipment.

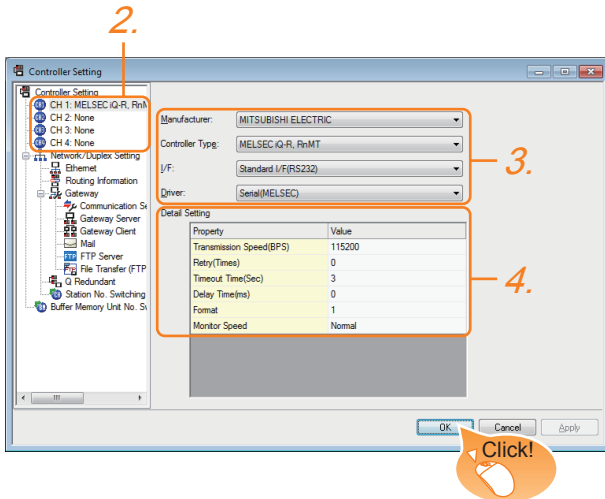

1. Select [Common] → [Controller Setting] from the menu.
2. The Controller Setting window is displayed. Select the channel to be used from the list menu.
3. Set Manufacturer, Controller Type, I/F, and Driver according to the connected equipment to be used.
4. The detailed setting is displayed after Manufacturer, Controller Type, I/F, and Driver are set. Make the settings according to the usage environment.

Click the [OK] button when settings are completed.

POINT

The settings of connecting equipment can be confirmed in [I/F Communication Setting]. For details, refer to the following.

➡ 1.1.2 I/F communication setting

Communication setting with personal computer

Set the communication setting between the GOT and the personal computer.

For details of the setting contents, refer to the following manual.

➡ Screen Design Manual (Fundamentals)
7.1.2 Interface setting of the GOT

Example: For GT16

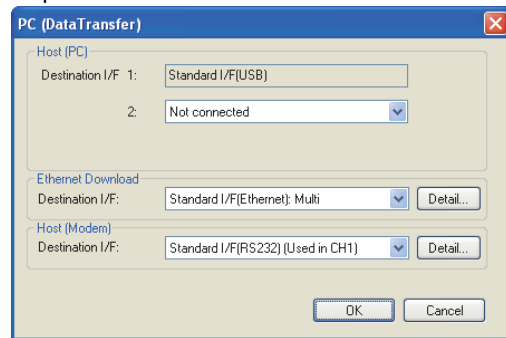

1. Select [Common] → [Peripheral Setting] → [PC(Data Transfer)] from the menu.
2. The [PC (Data Transfer)] is displayed. Set the interface of the GOT to be used in the communication with the personal computer.
 - (a) Host (PC) setting
When communicating the GOT and the personal computer in the direct connection, set the interface of the GOT to be used in the communication with the personal computer.
 - (b) Ethernet download setting
When communicating the GOT via Ethernet, set the interface of the GOT to be used in the communication with the personal computer.

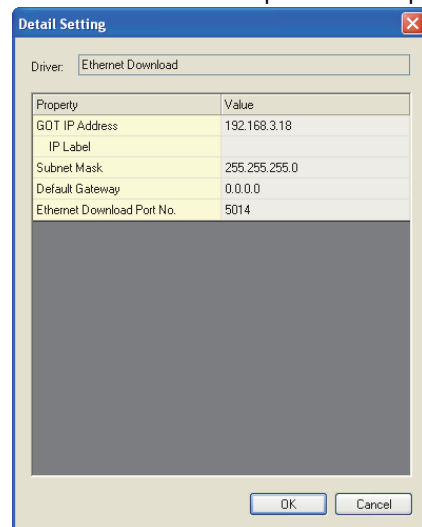

Item	Description	Range
GOT IP Address	Set the IP address of the GOT. (Default: 192.168.3.18)	0.0.0.0 to 255.255.255.255
IP Label	Set the IP Label of detail setting.	-
Subnet Mask*1	Set the subnet mask for the sub network. (Only for connection via router) If the sub network is not used, the default value is set. (Default: 255.255.255.0)	0.0.0.0 to 255.255.255.255
Default Gateway*1	Set the router address of the default gateway where the GOT is connected. (Only for connection via router) (Default: 0.0.0.0)	0.0.0.0 to 255.255.255.255
Ethernet Download Port No.*1	Set the GOT port No. for Ethernet download. (Default: 5014)	1024 to 5010, 5014 to 65534 (Except for 5011, 5012, 5013, 49153)

*1 Click the [Setting] button and perform the setting in the [GOT IP Address Setting] screen.

POINT

Setting the FA transparent function of GX Works2

When connecting the GOT and the personal computer in Ethernet connection, set the GOT IP address and the Ethernet download port No. to the same as the contents of PLC side I/F detailed setting of GOT.

☞ 23.6.4 Accessing by GX Works2

(c) Host (modem) setting

When communicating the GOT via modem, set the interface of the GOT to be used in the communication with the modem.

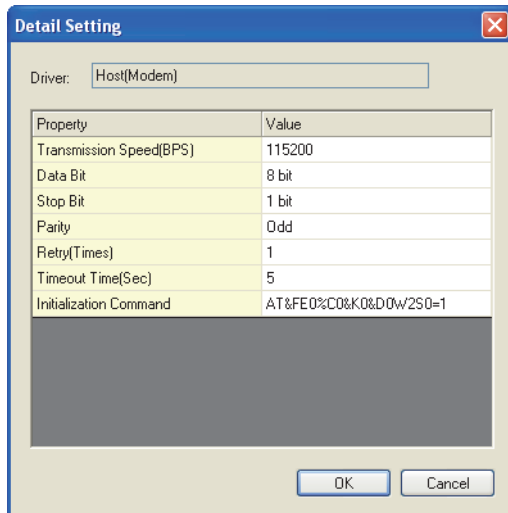

Item	Description	Range
Transmission Speed	Set this item when change the transmission speed used for communication with the connected equipment. (Default: 115200)	9600bps, 19200bps, 38400bps, 57600bps, 115200bps
Data Bit	Set this item when change the data length used for communication with the connected equipment. (Default: 8bit)	7bits/8bits
Stop Bit	Specify the stop bit length for communications. (Default: 1bit)	1bit/2bits

Item	Description	Range
Parity	Specify whether or not to perform a parity check, and how it is performed during communication. (Default: Odd)	None Even Odd
Retry	Set the number of retries to be performed when a communication timeout occurs. (Default: 1time)	1time
Timeout Time	Set the time period for a communication to time out. (Default: 5sec)	5sec
Initialization Command*1	Set the AT command to initialize the modem. (Default: AT&FE0%C0&K0&D0w2S0=1)	Up to 255 one-byte alphanumeric characters

*1 The maximum number of characters of the AT command differs according to the specification of the modem. When the maximum number of characters of the AT command which can be used in the modem is less than 255, set the initialization command according to the specification of the modem.

3. Click the [OK] button when settings are completed.

POINT

- Communication interface setting by Utility
The communication interface setting can be changed on the Utility's [Communication Settings] after downloading [Communication Settings] of project data.
For details on the Utility, refer to the following manual.

☞ GT□ User's Manual

- Precedence in communication settings
When settings are made by GT Designer3 or the Utility, the latest setting is effective.

■ GOT Setup

When using the multi-channel function (only GT16, GT15, GT14, GT12), specify the channel No. on which FA transparent function is executed.

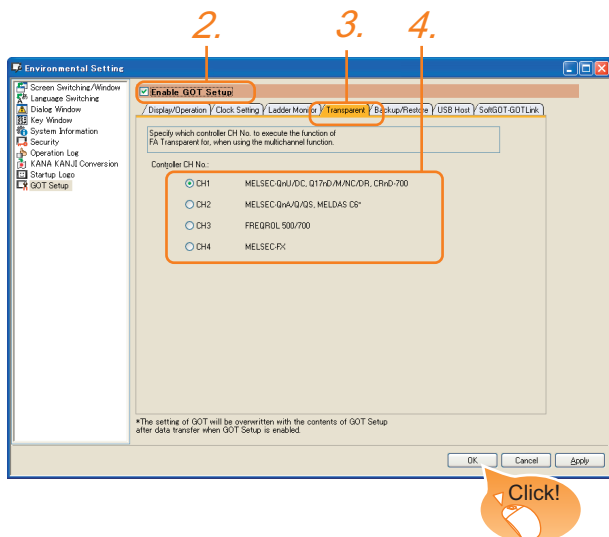

1. Select [Common] → [GOT Environmental Setting] → [GOT Setup] from the menu.
2. Check [Enable GOT Setup].
3. Select the [Transparent] tab.
4. As necessary, check one of [CH1] to [CH4]. (Default: CH1)
 < GT16,GT15 >
 [CH1], [CH2], [CH3], [CH4]
 < GT14,GT12 >
 [CH1], [CH2]

Click the [OK] button when settings are completed.

POINT

Transparent setting on the utility screen

Transparent setting can be performed by the GOT.
For details of the operating, refer to the following.

☞ GT□ User's Manual

23.6 Personal Computer Side Setting

23.6.1 Accessing by GX Works3

The following shows the procedure to set the FA transparent function of GX Works3.

■ When connecting the GOT and personal computer with USB

(1) Connecting the GOT and PLC in Ethernet connection

(a) When connecting to RCPU

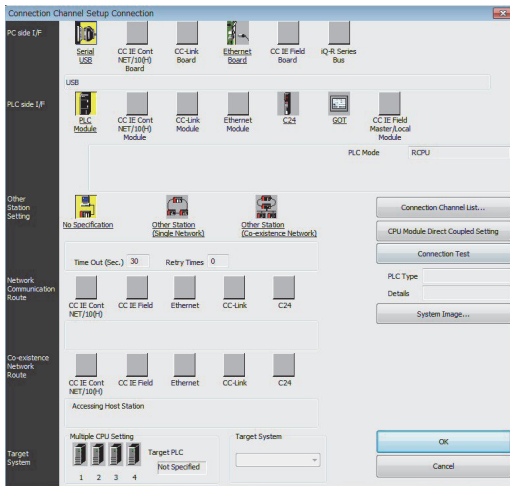

1. Click [Online] → [Connection Destination] on GX Works3.
2. [Connection Channel Setup] is displayed.
3. Set [Connection Channel Setup].
 PC side I/F : USB
 PLC side I/F : GOT
 Other Station Setting : No Specification

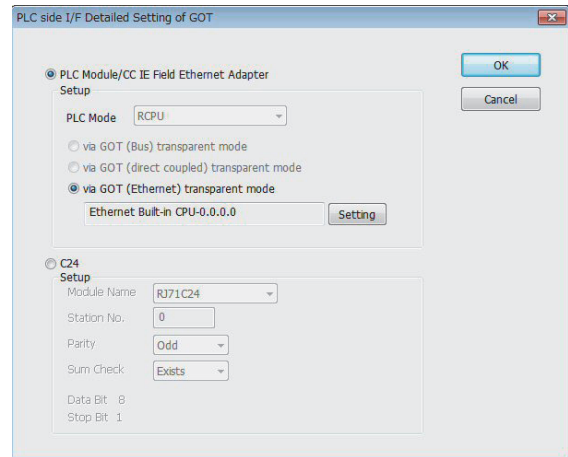
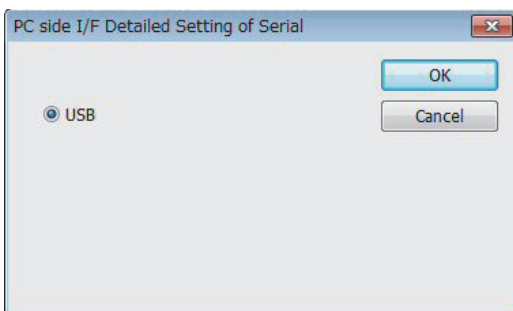

4. Double-click [GOT] of the PLC side I/F to display [PLC side I/F Detailed Setting of GOT].
5. On the [PLC side I/F Detailed Setting of GOT], mark the [via GOT (Ethernet) transparent mode] checkbox and click [Setting].

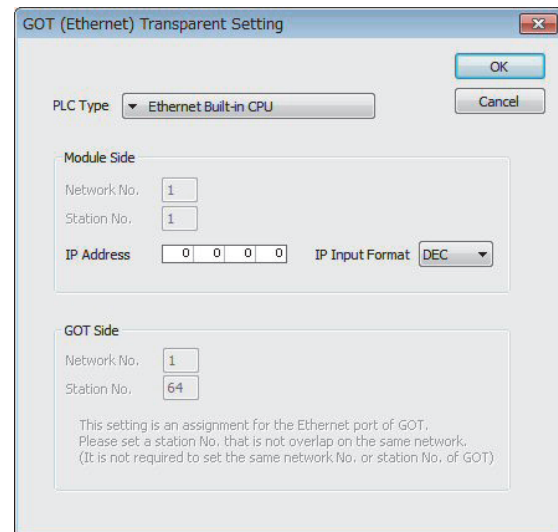

6. By clicking [Setting], the [GOT (Ethernet) Transparent Setting] is displayed. Here, set the built-in Ethernet port CPU or Ethernet module, which is firstly connected via a GOT.
7. Set [RJ71EN71] for [PLC Type].

- ↓
8. Specify the number for [Network No.] and [Station No.] same as the number assigned to the Ethernet module.
 9. Specify the IP address for [IP Address] same as the IP address assigned to the built-in Ethernet port QCPU or Ethernet module.

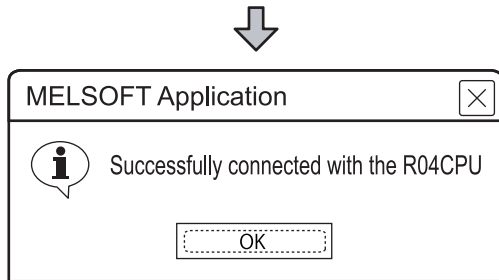

10. The screen returns to the [Connection Channel Setup]. Click [Connection Test] to check if GX Works3 has been connected to the RCP.
 - (b) When connecting to FX5U/FX5UC

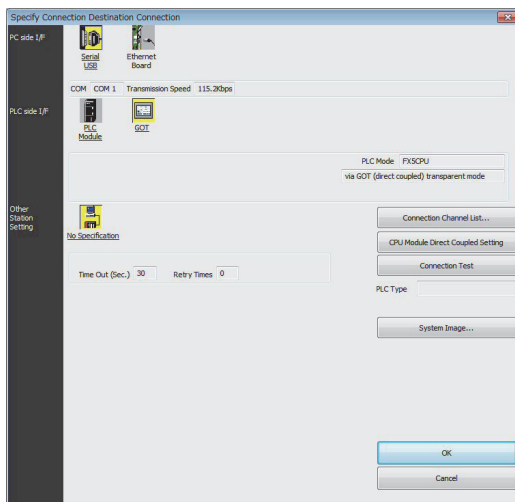

1. Click [Online] → [Specify Connection Destination] in GX Works3.
2. The [Specify Connection Destination 1] is displayed.
3. Set the [Specify Connection Destination 1]:

PC side I/F	: Serial USB
PLC side I/F	: GOT
Other Station Setting	: No Specification

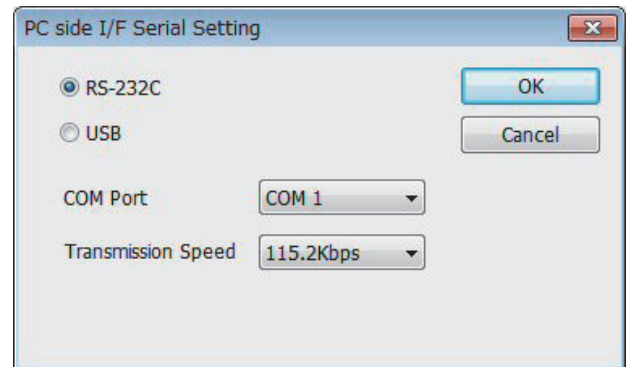

4. Double-click [Serial USB] of the PC side I/F to display [PC side I/F Serial Setting].
5. Check-mark either of the following in [PC side I/F Serial Setting].

When connecting the GOT and PC with serial
Mark the [RS-232C] checkbox.

When connecting the GOT and PC with USB

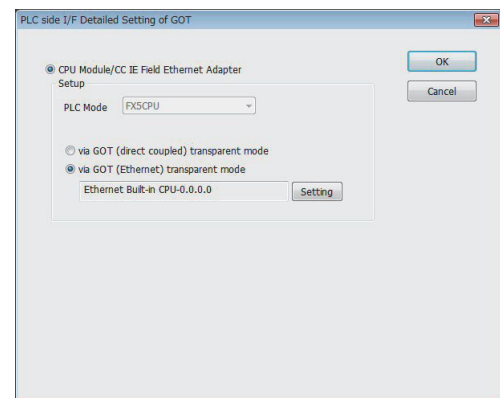

6. Double-click [GOT] of the PLC side I/F to display [PLC side I/F Detailed Setting of GOT].
7. On the [PLC side I/F Detailed Setting of GOT], mark the [via GOT (Ethernet) transparent mode] checkbox and click [Setting...].

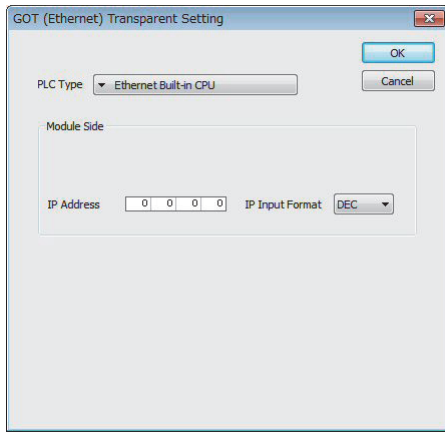

8. By clicking [Setting], the [GOT (Ethernet) transparent setting] is displayed. Here, set the built-in Ethernet port CPU, which is firstly connected via a GOT.
9. Specify the IP address for [IP address] same as the IP address assigned to the built-in Ethernet port CPU.

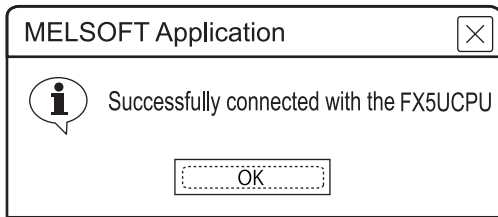

10. The screen returns to Specify Connection Destination Connection1. Click [Connection Test] to check if GX Works3 has been connected to the FX5UCPU.

(2) Connecting the GOT and PLC in direct CPU connection(for FX5U/FX5UC only)

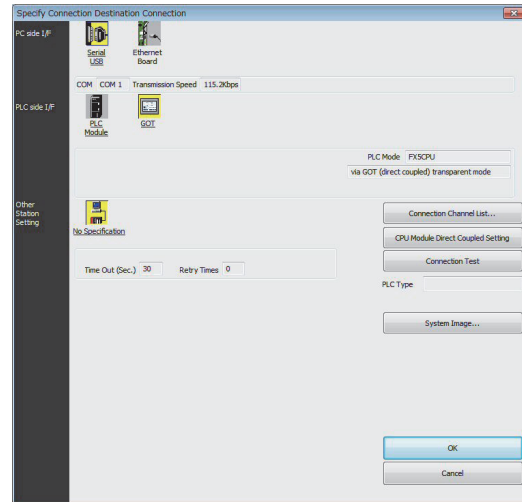

1. Click [Online] → [Specify Connection Destination] on GX Works3.
2. The [Specify Connection Destination 1] is displayed.
3. Set the [Specify Connection Destination 1]:
 PC side I/F : Serial USB
 PLC side I/F : GOT
 Other Station Setting : No Specification:

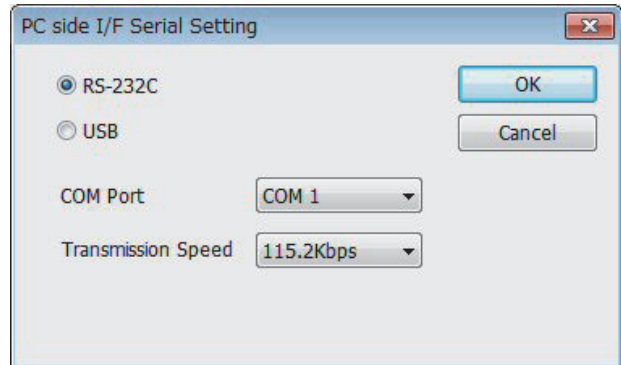

4. Double-click [Serial USB] of the PC side I/F to display [PC side I/F Serial Setting].
5. Check-mark either of the following in [PC side I/F Serial Setting].

When connecting the GOT and PC with serial
 Mark the [RS-232C] checkbox.

When connecting the GOT and PC with USB
 Mark the [USB] checkbox.



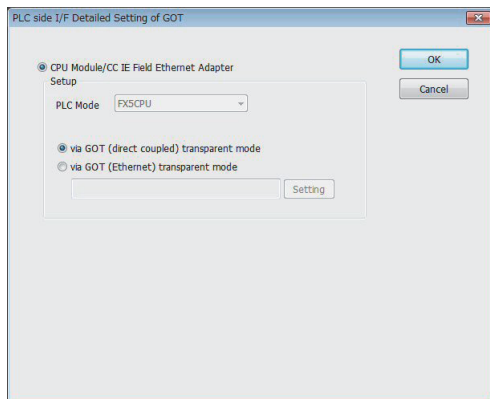

6. Double-click [GOT] of the PLC side I/F to display [PLC side I/F Detailed Setting of GOT].
7. Check-mark [via GOT (direct coupled) transparent mode] in [PLC side I/F Detailed Setting of GOT].

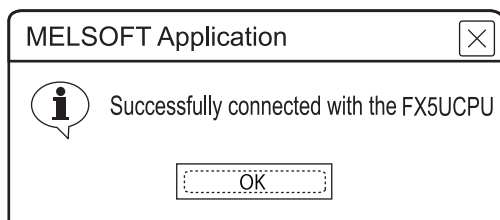

8. The screen returns to Specify Connection Destination Connection1. Click [Connection Test] to check if GX Works3 has been connected to the FX5UCPU.

(3) Connecting the GOT and PLC in computer link connection (when connecting to RJ71C24)

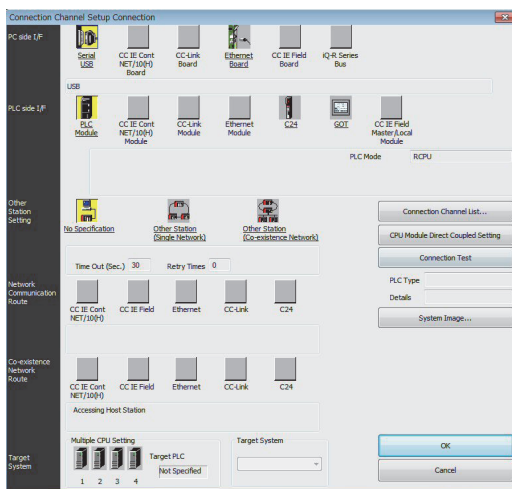

1. Click [Online] → [Connection Destination] on GX Works3.
2. [Connection Channel Setup] is displayed.
3. Set [Connection Channel Setup].
 PC side I/F : USB
 PLC side I/F : GOT
 Other Station Setting : No Specification

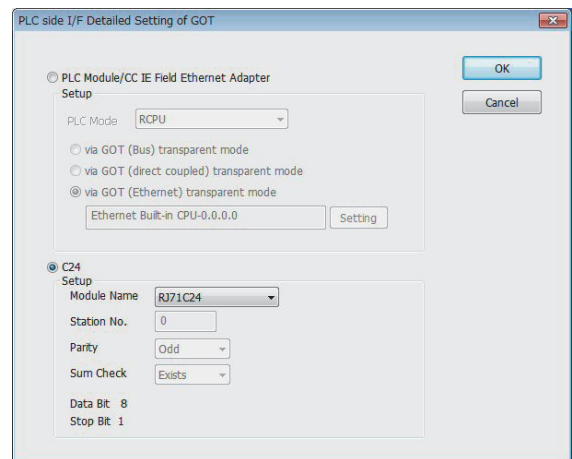
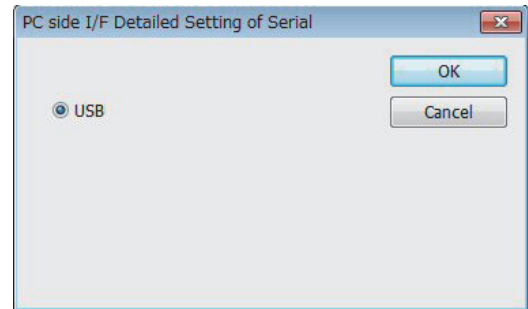

4. Double-click [GOT] of the PLC side I/F to display [PLC side I/F Detailed Setting of GOT].
5. Check-mark [C24] in [PLC side I/F Detailed Setting of GOT].

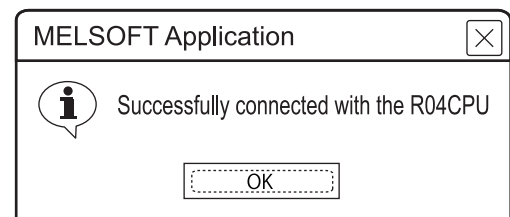

6. The screen returns to the [Connection Channel Setup]. Click [Connection Test] to check if GX Works3 has been connected to the RCPU.

23.6.2 Accessing by CW Configurator

The following shows the procedure to set the FA transparent function of CW Configurator.

■ When connecting the GOT and personal computer with USB

(1) Connecting the GOT and PLC in Ethernet connection

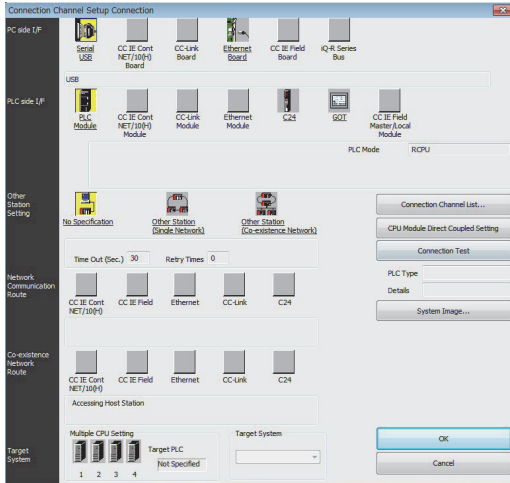

1. Click [Online] → [Connection Destination] on CW Configurator.
2. [Connection Channel Setup] is displayed.
3. Set [Connection Channel Setup].
 PC side I/F : USB
 PLC side I/F : GOT
 Other Station Setting : No Specification

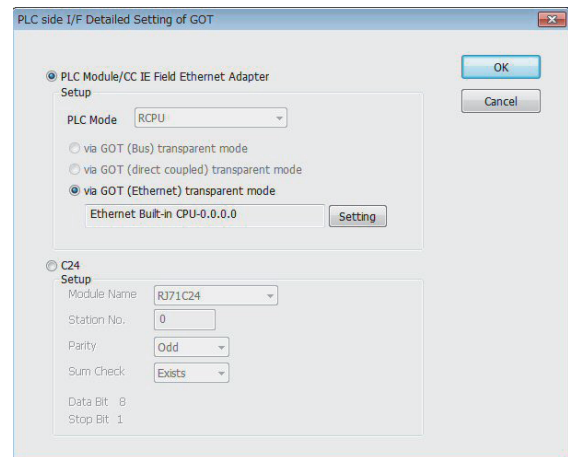
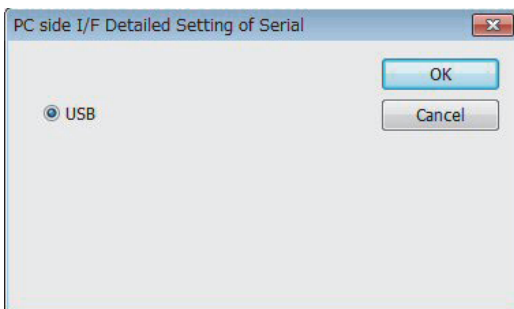

4. Double-click [GOT] of the PLC side I/F to display [PLC side I/F Detailed Setting of GOT].
5. On the [PLC side I/F Detailed Setting of GOT], mark the [via GOT (Ethernet) transparent mode] checkbox and click [Setting].

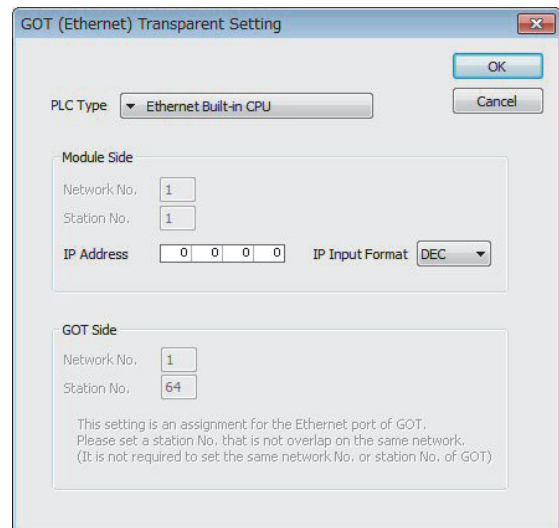

6. By clicking [Setting], the [GOT (Ethernet) Transparent Setting] is displayed. Here, set the built-in Ethernet port CPU or Ethernet module, which is firstly connected via a GOT.
7. Set [Ethernet Built-in CPU] for [PLC Type].





8. Specify the number for [Network No.] and [Station No.] same as the number assigned to the Ethernet module.
9. Specify the IP address for [IP Address] same as the IP address assigned to the built-in Ethernet port QCPU or Ethernet module.

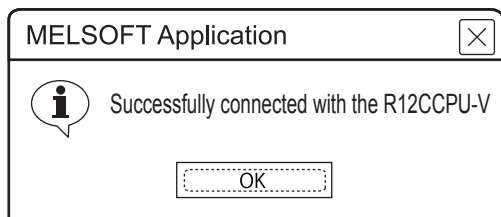

10. The screen returns to the [Connection Channel Setup]. Click [Connection Test] to check if GX Works3 has been connected to the R12CCPU-V.

23.6.3 Accessing the PLC by the GX Developer, PX Developer, GX Configurator

The setting method for the FA transparent function of GX Developer is used as an example.

GX Configurator is an add-on software of GX Developer. (Except for GX Configurator-QP)

- Connecting the GOT and PLC in bus connection or direct CPU connection (when connecting to QCPU (Q mode))

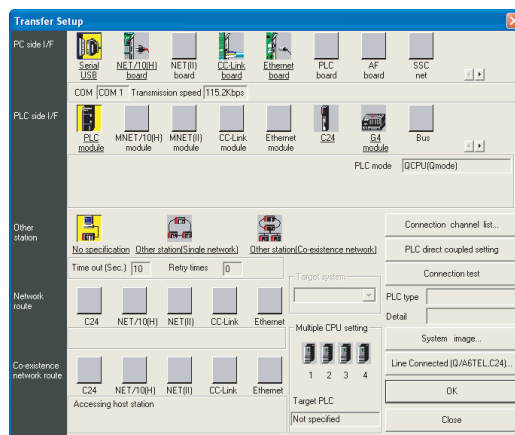

1. Click [Online] → [Transfer Setup] in GX Developer.
2. The [Transfer Setup] is displayed.
3. Set the [Transfer Setup]:
 PC side I/F : Serial USB (COM)
 PLC side I/F : PLC module
 Other station : No specification

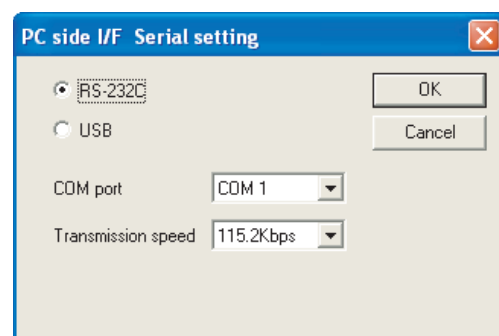

4. Double-click [Serial] of the PC side I/F to display [PC side I/F Serial setting].
5. Check-mark either of the following in [PC side I/F Serial setting].

When connecting the GOT and PC with serial
When connecting the GOT to PC via modem
 Mark the [RS-232C] checkbox.

When connecting the GOT and PC with USB
 Mark the [USB] checkbox.



(For bus connection)

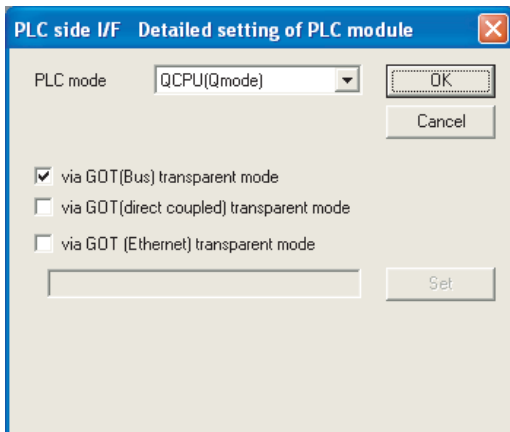

6. Double-click [PLC module] of the PLC side I/F to display [PLC side I/F Detailed setting of PLC module].
7. Check-mark either of the following in [PLC side I/F Detailed setting of PLC module].

Bus connection

[via GOT(Bus) transparent mode]

Direct CPU connection^{*1}

[via GOT (direct coupled) transparent mode]

*1 This is operation required in the case of using GX Developer of which version is 8.22Y and above.

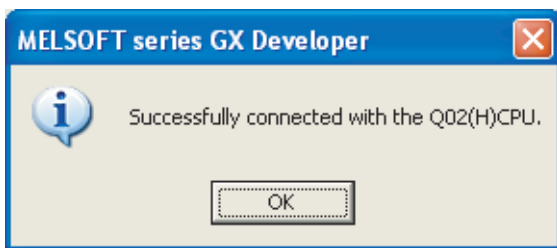

8. The screen returns to [Transfer Setup]. Click [Connection Test] to check if GX Developer has been connected to the QCPU (Q mode).

■ Connecting the GOT and PLC in computer link connection (when connected to the QJ71C24(N)) (GX Configurator is not supported.)

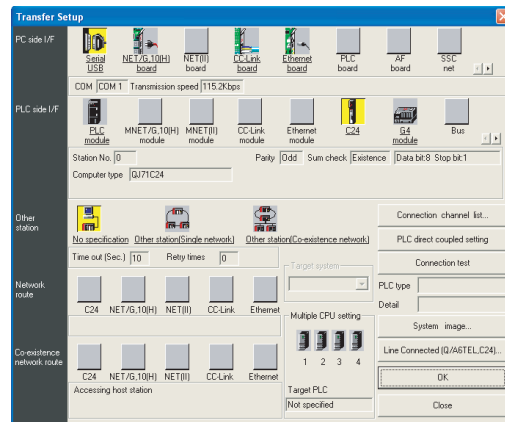

1. Click [Online] → [Transfer Setup] in GX Developer.
2. The [Transfer Setup] is displayed.
3. Set the [Transfer Setup]:
 PC side I/F : Serial
 PLC side I/F : C24
 Other station : No specification

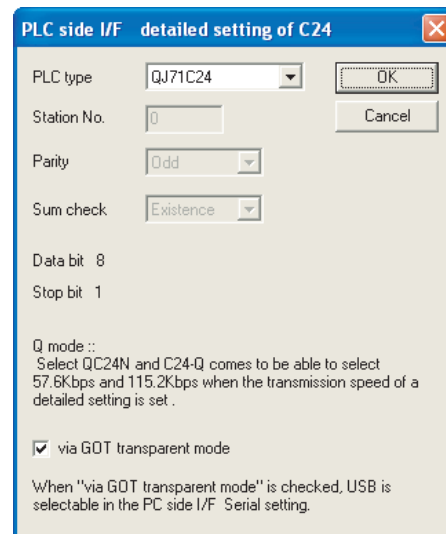

4. Return to [Transfer Setup] and double-click [C24] of the PLC side I/F to display [PLC side I/F detailed setting of C24].
5. Check [via GOT transparent mode] for [PLC side I/F detailed setting of C24].



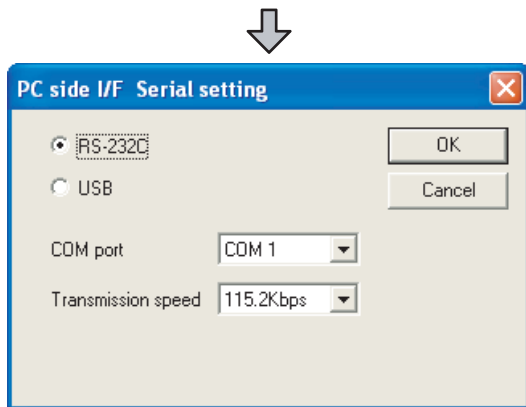

6. Double-click [Serial] of the PC side I/F to display [PC side I/F Serial setting].
7. Check-mark either of the following in [PC side I/F Serial setting].

When connecting the GOT and PC with serial
When connecting the GOT to PC via modem
Mark the [RS-232C] checkbox.

When connecting the GOT and PC with USB
Mark the [USB] checkbox.



8. The screen returns to [Transfer Setup]. Click [Connection Test] to check if GX Developer has been connected to the QCPU (Q mode).

- When connecting the GOT and PLC in Ethernet communication (when connecting to QCPU (Q mode))

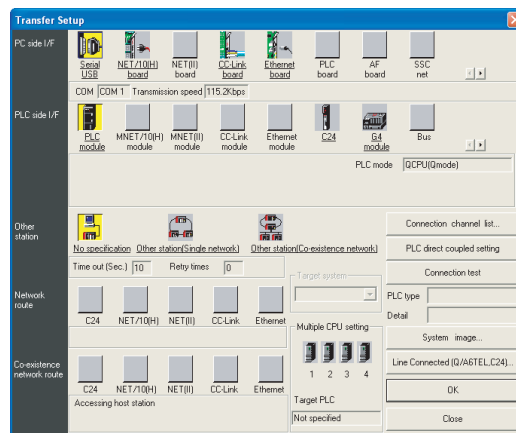

1. Click [Online] → [Transfer Setup] in GX Developer.
2. The [Transfer Setup] is displayed.
3. Set the [Transfer Setup]:
PC side I/F : Serial USB (COM)
PLC side I/F : PLC module
Other station : No specification

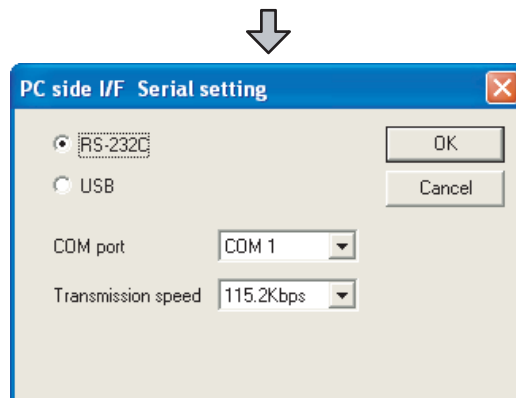

4. Double-click [Serial] of the PC side I/F to display [PC side I/F Serial setting].
5. Check-mark either of the following in [PC side I/F Serial setting].
When connecting the GOT and PC with serial
Mark the [RS-232C] checkbox.
When connecting the GOT and PC with USB
Mark the [USB] checkbox.

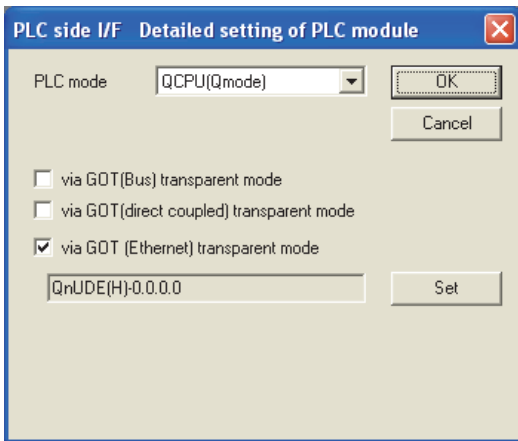

6. Double-click [PLC module] of the PLC side I/F to display [PLC side I/F Detailed setting of PLC module].
7. On the [PLC side I/F Detailed setting of PLC module], mark the [via GOT(Ethernet) transparent mode] checkbox and click [Set].

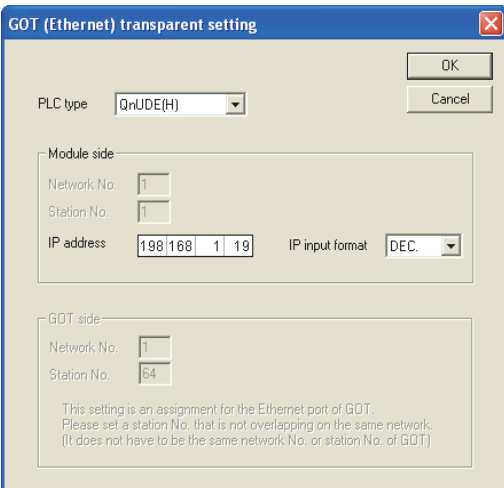

8. By clicking [Set], the [GOT (Ethernet) transparent setting] is displayed. Here, set the built-in Ethernet port QCPU or Ethernet module, which is firstly connected via a GOT.
9. Set [QnUDE(H)] or [QJ71E71] for [Type name]. When connecting the Q173NCCPU, set [QJ71E71].
10. Specify the number for [Network No.] and [Station No.] same as the number assigned to the Ethernet module. When [QnUDE(H)] is set for [Type name], the setting is not required.
11. Specify the IP address for [IP address] same as the IP address assigned to the built-in Ethernet port QCPU or Ethernet module.



12. The screen returns to [Transfer Setup]. Click [Connection Test] to check if GX Developer has been connected to the QCPU (Q mode).

■ Connecting the GOT and PLC in direct CPU connection (when connecting to FXCPU)

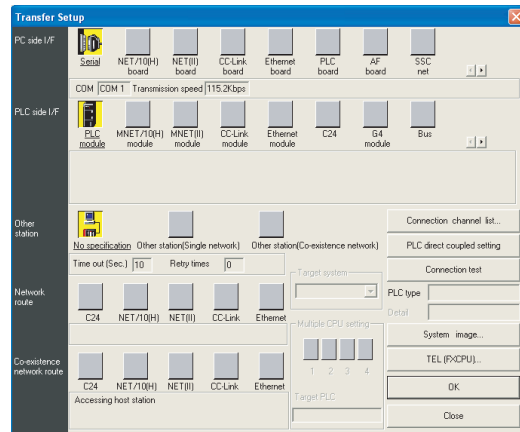

1. Click [Online] → [Transfer Setup] in GX Developer.
2. The [Transfer Setup] is displayed.
3. Set the [Transfer Setup]:
 PC side I/F : Serial
 PLC side I/F : PLC module
 Other station : No specification

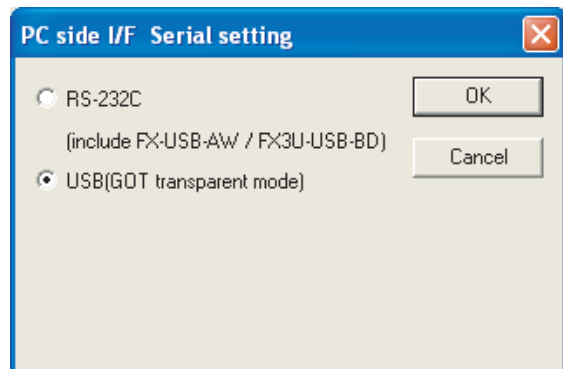

4. Double-click [Serial] of the PC side I/F to display [PC side I/F Serial setting].



5. Check-mark either of the following in [PC side I/F Serial setting].

**When connecting the GOT and PC with serial
When connecting the GOT to PC via modem**
Mark the [RS-232C] checkbox.

When connecting the GOT and PC with USB
Mark the [USB] checkbox.



6. The screen returns to the [Transfer Setup]. Click the [Connection Test] to check if GX Developer has been connected to the FXCPU.

POINT

How to operate GX Developer
For the GX Developer operation method, refer to the following manual.
 GX Developer Version□ Operating Manual

23.6.4 Accessing by GX Works2

The following shows the procedure to set the FA transparent function of GX Works2.

- When connecting the GOT and personal computer with serial or USB

- (1) Connecting the GOT and PLC in bus connection or direct CPU connection (when connecting to QCPU (Q mode))

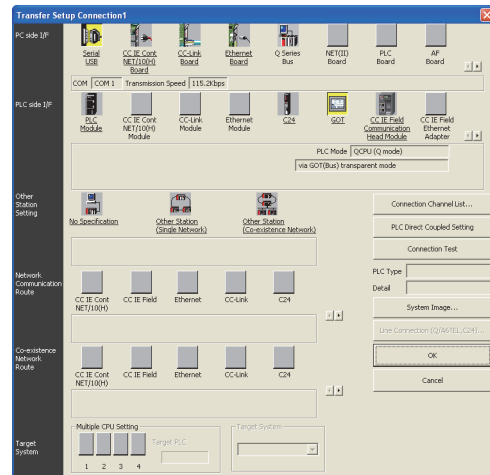

1. Click the Connection Destination view → [Connection Destination] → [(Connection target data name)] in the Navigation window of GX Works2.
2. The [Transfer Setup Connection1] is displayed.
3. Set the [Transfer Setup Connection1]:
PC side I/F : Serial USB
PLC side I/F : GOT
Other Station Setting : No Specification:

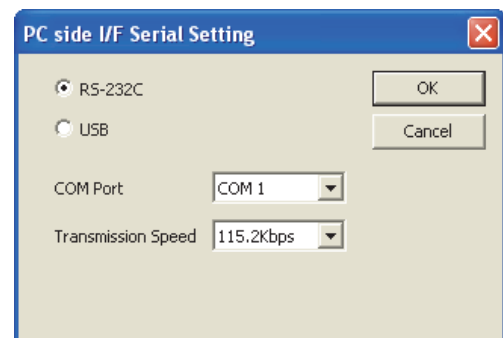

4. Double-click [Serial USB] of the PC side I/F to display [PC side I/F Serial Setting].
5. Check-mark either of the following in [PC side I/F Serial Setting].

**When connecting the GOT and PC with serial
When connecting the GOT to PC via modem**
Mark the [RS-232C] checkbox.

When connecting the GOT and PC with USB
Mark the [USB] checkbox.

(For bus connection)

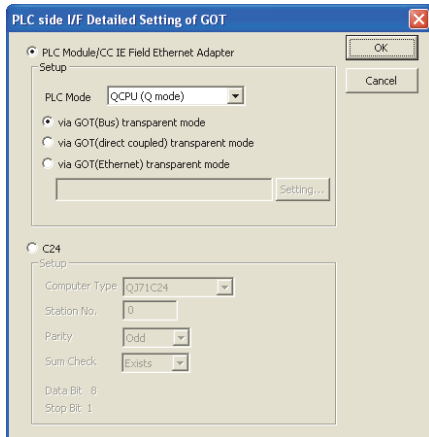

6. Double-click [GOT] of the PLC side I/F to display [PLC side I/F Detailed Setting of GOT].
7. Check-mark either of the following in [PLC side I/F Detailed Setting of GOT].

Bus connection

[via GOT(Bus) transparent mode]

Direct CPU connection

Mark the [via GOT(direct coupled) transparent mode] checkbox.

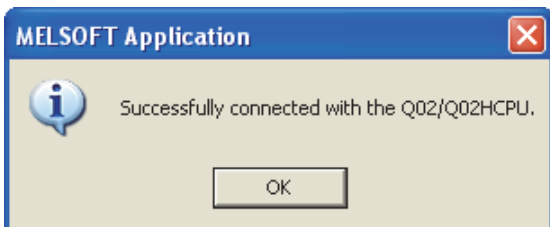

8. The screen returns to [Transfer Setup Connection1]. Click [Connection Test] to check if GX Works2 has been connected to the QCPU (Q mode).

(2) Connecting the GOT and PLC in computer link connection (when connecting to QJ71C24 (N))

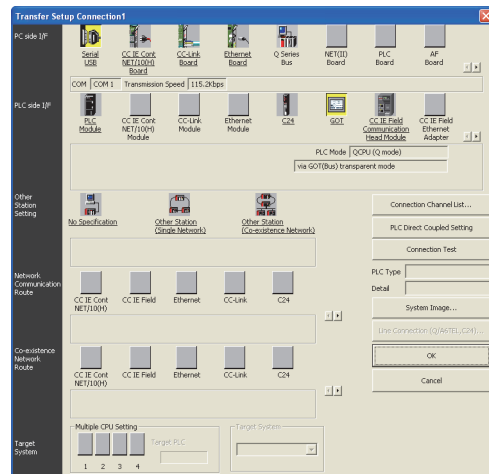

1. Click the Connection Destination view → [Connection Destination] → [(Connection target data name)] in the Navigation window of GX Works2.
2. The [Transfer Setup Connection1] is displayed.
3. Set the [Transfer Setup Connection1]:
 PC side I/F : Serial USB
 PLC side I/F : GOT
 Other Station Setting : No Specification

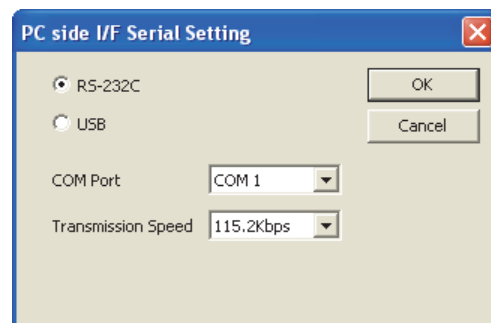

4. Double-click [Serial USB] of the PC side I/F to display [PC side I/F Serial Setting].
5. Check-mark either of the following in [PC side I/F Serial Setting].

When connecting the GOT and PC with serial
When connecting the GOT to PC via modem
 Mark the [RS-232C] checkbox.

When connecting the GOT and PC with USB
 Mark the [USB] checkbox.



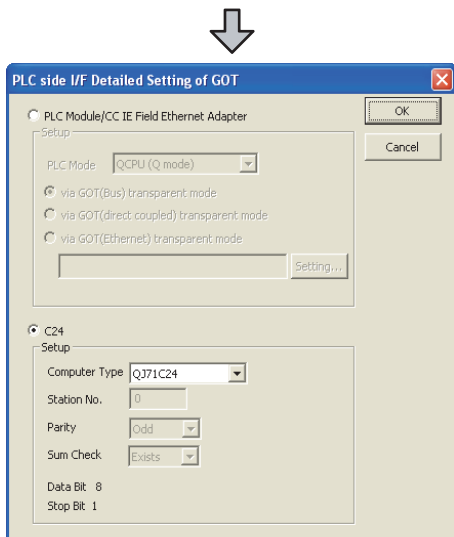

6. Double-click [GOT] of the PLC side I/F to display [PLC side I/F Detailed Setting of GOT].
7. Check-mark [C24] in [PLC side I/F Detailed Setting of GOT].

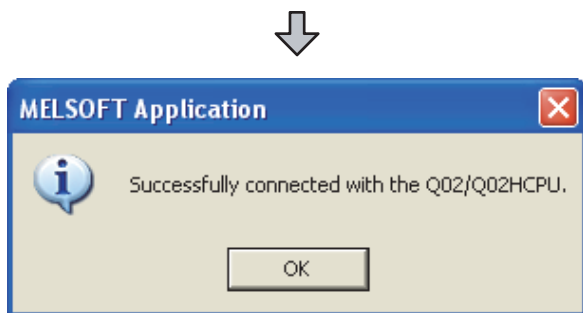

8. The screen returns to [Transfer Setup Connection1]. Click [Connection Test] to check if GX Works2 has been connected to the QCPU (Q mode).

- (3) Connecting the GOT and PLC in Ethernet connection
 - (a) Connecting to QCPU (Q mode)

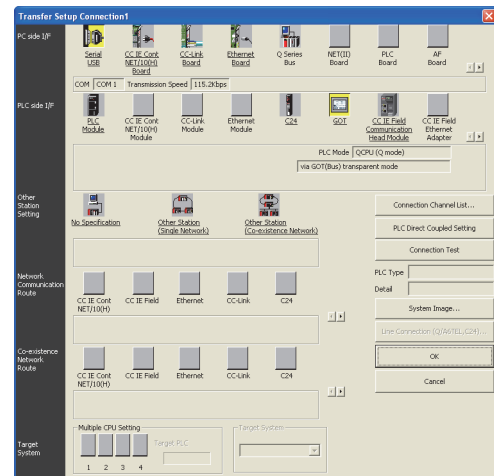

1. Click the Connection Destination view → [Connection Destination] → [(Connection target data name)] in the Navigation window of GX Works2.
2. The [Transfer Setup Connection1] is displayed.
3. Set the [Transfer Setup Connection1]:
 PC side I/F : Serial USB
 PLC side I/F : GOT
 Other Station Setting : Other Station (Single Network)

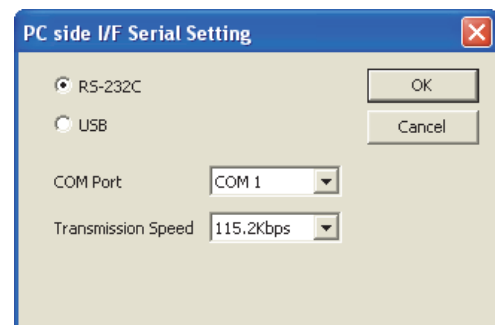

4. Double-click [Serial USB] of the PC side I/F to display [PC side I/F Serial Setting].
5. Check-mark either of the following in [PC side I/F Serial Setting].

When connecting the GOT and PC with serial
 Mark the [RS-232C] checkbox.

When connecting the GOT and PC with USB
 Mark the [USB] checkbox.

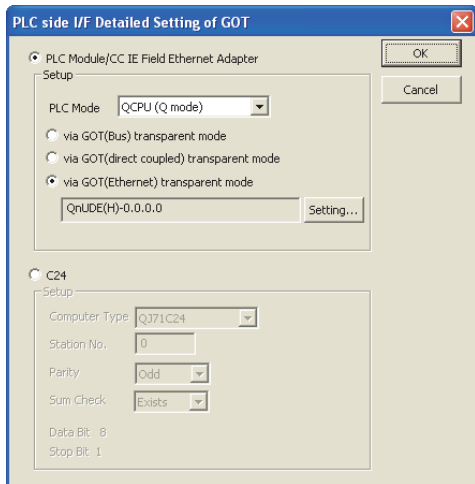

6. Double-click [GOT] of the PLC side I/F to display [PLC side I/F Detailed Setting of GOT].
7. On the [PLC side I/F Detailed Setting of GOT], mark the [via GOT(Ethernet) transparent mode] checkbox and click [Setting...].

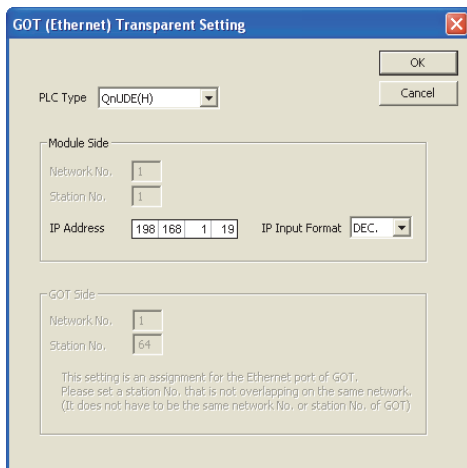

8. By clicking [Set], the [GOT (Ethernet) Transparent Setting] is displayed. Here, set the built-in Ethernet port QCPU or Ethernet module, which is firstly connected via a GOT.
9. Set [QnUDE(H)] or [QJ71E71] for [PLC Type].

10. Specify the number for [Network No.] and [Station No.] same as the number assigned to the Ethernet module. When [QnUDE(H)] is set for [PLC type], the setting is not required.
11. Specify the IP address for [IP Address] same as the IP address assigned to the built-in Ethernet port QCPU or Ethernet module.

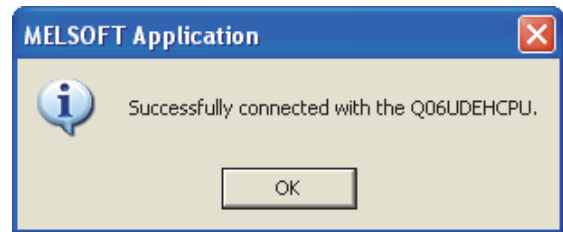

12. The screen returns to [Transfer Setup Connection1]. Click [Connection Test] to check if GX Works2 has been connected to the QCPU (Q mode).

(b) Connecting to FXCPU

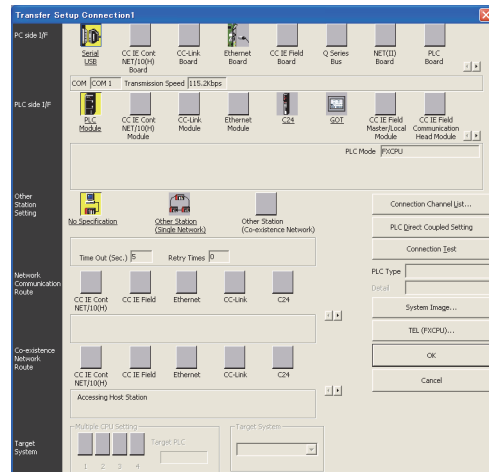

1. Click the Connection Destination view → [Connection Destination] → [(Connection target data name)] in the Navigation window of GX Works2.
2. The [Transfer Setup Connection1] is displayed.
3. Set the [Transfer Setup Connection1]:
 PC side I/F : Serial USB
 PLC side I/F : GOT
 Other Station Setting : No Specification

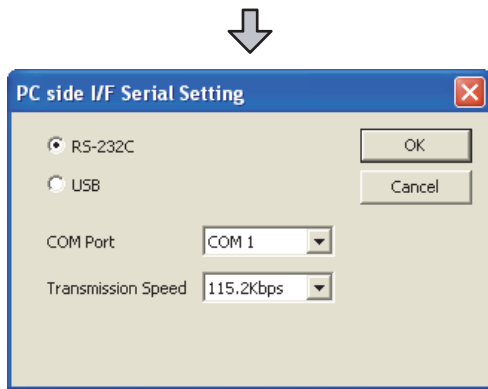

4. Double-click [Serial USB] of the PC side I/F to display [PC side I/F Serial Setting].
5. Check-mark either of the following in [PC side I/F Serial Setting].

When connecting the GOT and PC with serial
Mark the [RS-232C] checkbox.

When connecting the GOT and PC with USB
Mark the [USB] checkbox.

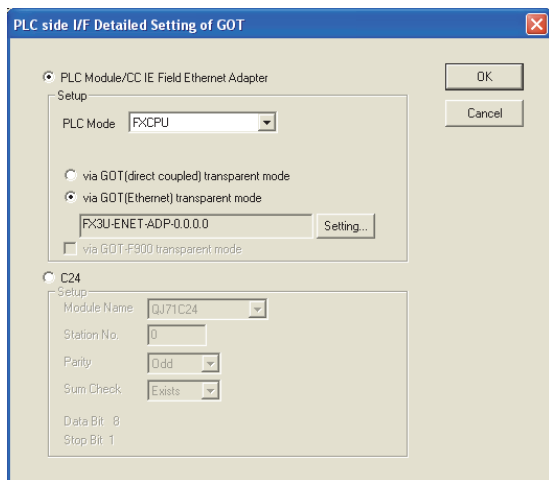

6. Double-click [GOT] of the PLC side I/F to display [PLC side I/F Detailed Setting of GOT].
7. On the [PLC side I/F Detailed Setting of GOT], mark the [via GOT(Ethernet) transparent mode] checkbox and click [Setting...].

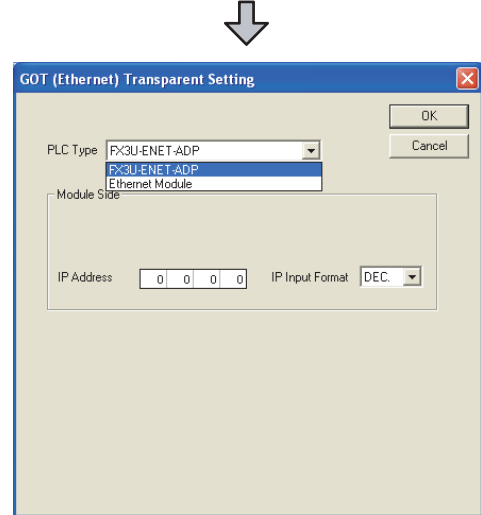

8. By clicking [Set], the [GOT (Ethernet) transparent setting] is displayed. Here, set the [FX3U-ENET-ADP] or [Ethernet Module], which is connected via a GOT.
9. Set [FX3U-ENET-ADP] or [Ethernet Module] for [PLC Type].
10. Specify the IP address for [IP address] same as the IP address assigned to the [FX3U-ENET-ADP] or [Ethernet Module].

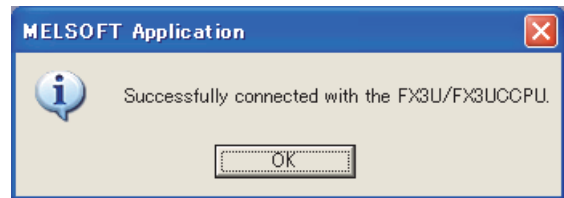

11. The screen returns to [Transfer Setup]. Click [Connection Test] to check if GX Developer has been connected to the FXCPU.

(4) Connecting the GOT and Ethernet adapter (NZ2GF-ETB) in Ethernet connection, and connecting it to a PLC in the CC-Link IE Field Network.
 This section describes the settings of the GX Works2 in the following case of system configuration.

POINT

Version of GX Works2
 GX Works2 Version 1.34L or later is required to execute the FA transparent function with using Ethernet adapter (NZ2GF-ETB).

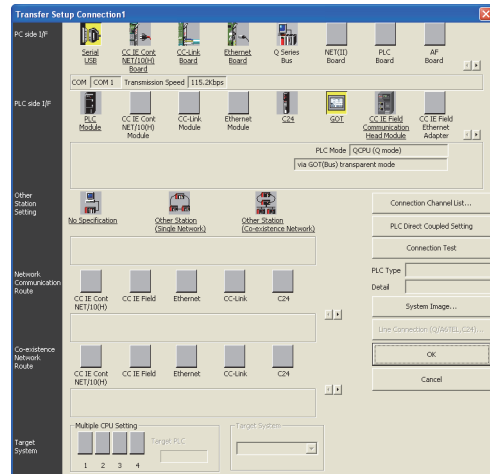
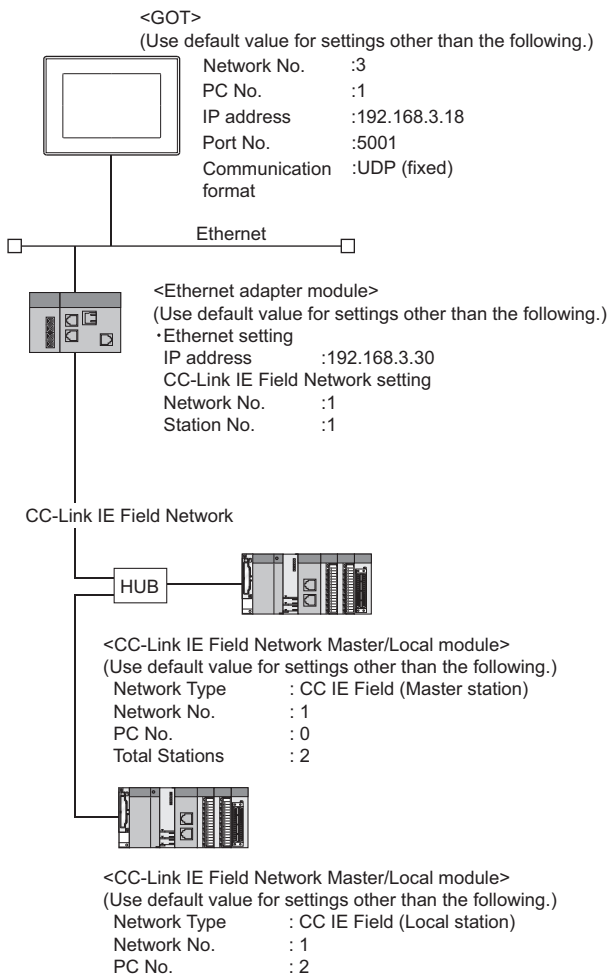

1. Click the Connection Destination view → [Connection Destination] → [(Connection target data name)] in the Navigation window of GX Works2.
2. The [Transfer Setup Connection1] is displayed.
3. Set the [Transfer Setup Connection1].
 PC side I/F : Serial USB
 PLC side I/F : GOT

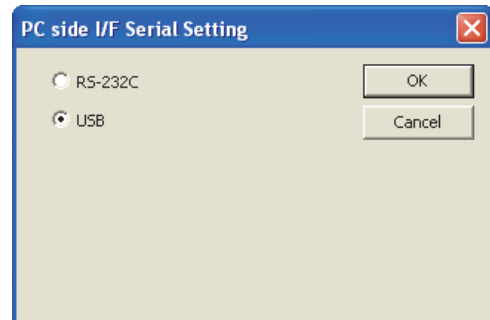

4. Double-click [Serial USB] of the PC side I/F to display [PC side I/F Serial Setting].
5. Check-mark either of the following in [PC side I/F Serial Setting].

When connecting the GOT and PC with serial
 Mark the [RS-232C] checkbox.

When connecting the GOT and PC with USB
 Mark the [USB] checkbox.



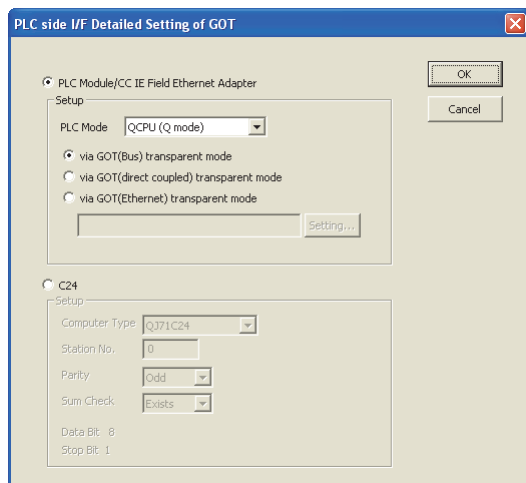

6. Double-click [GOT] of the PLC side I/F to display [PLC side I/F Detailed Setting of GOT].
7. Set the [CPU mode] to [LCPU].

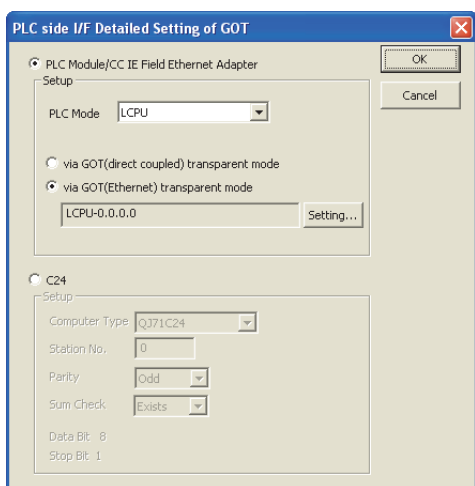

8. On the [PLC side I/F Detailed Setting of GOT], mark the [via GOT(Ethernet) transparent mode] checkbox and click [Setting...].

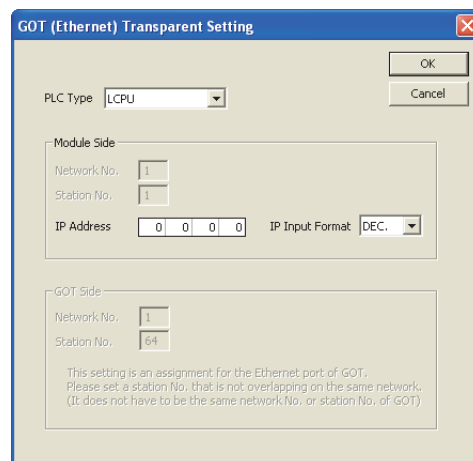

9. [GOT (Ethernet) Transparent Setting] is displayed. Here, set the Ethernet module, which is firstly connected via a GOT.
10. Set [NZ2GF-ETB] for [PLC Type].

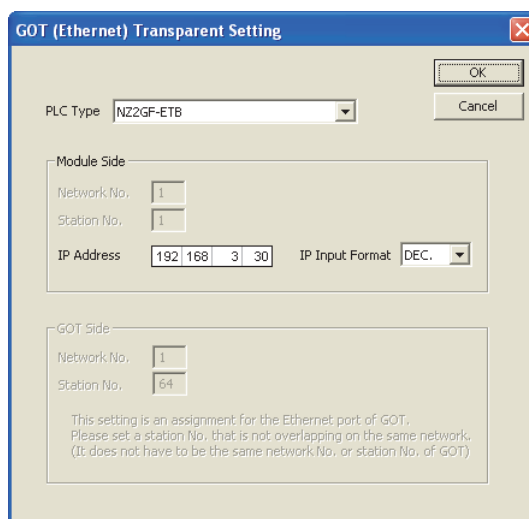

11. Set the same number to [IP address] as the number assigned to NZ2GF-ETB, and click [OK]. In the system configuration example, the setting is as follows.
[IP address]: 192 168 3 30
12. Return to [PLC side I/F Detailed Setting of GOT], and click [OK].

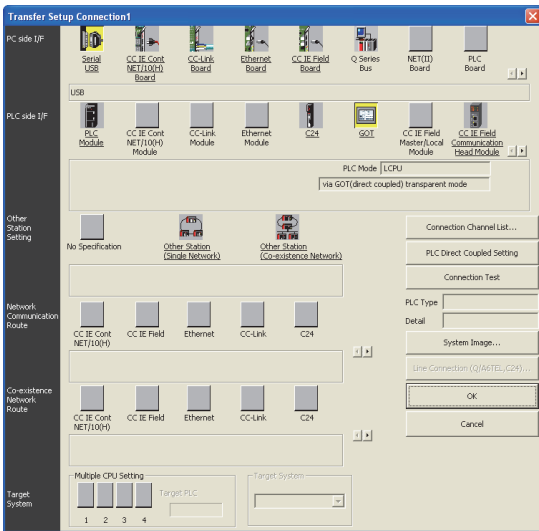

13. The [Transfer Setup Connection1] is displayed.

14. Click [Other station (Single network)].

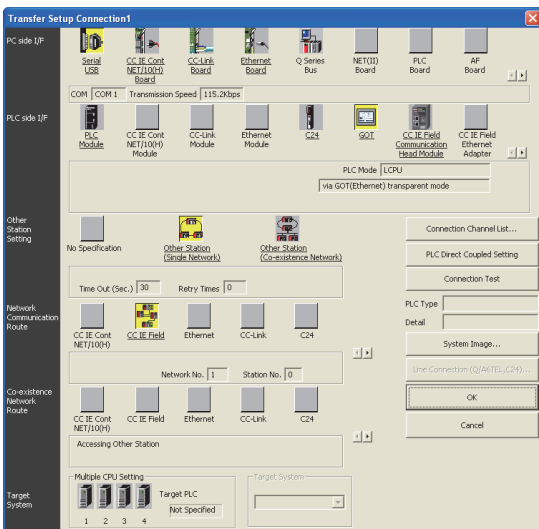

15. Double-click [CC IE Field].

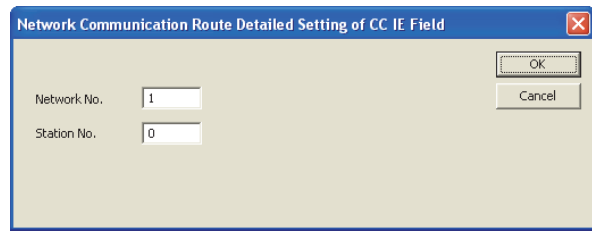

16. Network Communication Route Detailed Setting of CC IE Field is displayed.

17. Set [Network No.] and [Station No.] assigned to CPU, and click [OK].

When connecting to CC-Link IE Field Network Master/Local module of the system configuration example, the setting is as follows.

[Network No.] :1

[Station No.] :0

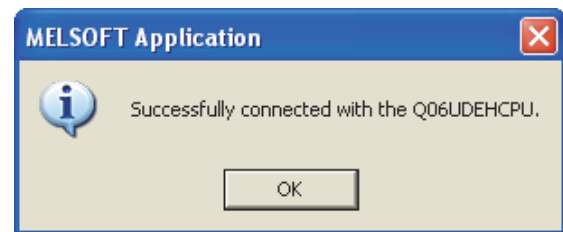

18. The screen returns to [Transfer Setup]. Click [Connection Test] to check if GX Developer has been connected to the QCPU (Q mode).

■ When connecting the GOT and personal computer in Ethernet connection (GT16, GT15 and GT14 only)

(1) Connecting the GOT and PLC in bus connection or direct CPU connection (when connecting to QCPU (Q mode))

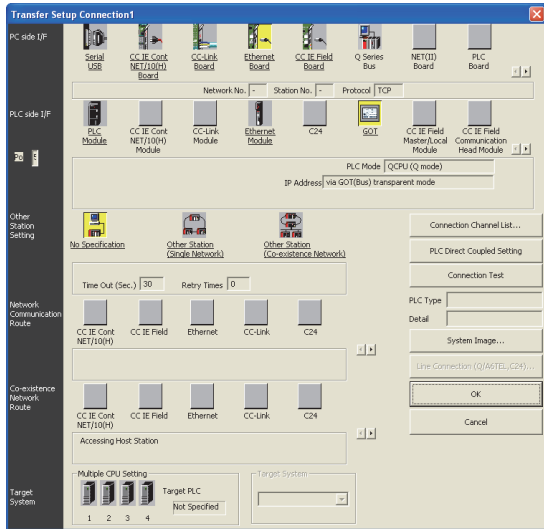

1. Click the Connection Destination view → [Connection Destination] → [(Connection target data name)] in the Navigation window of GX Works2.
2. The [Transfer Setup] is displayed.
3. Set the [Transfer Setup]:
 PC side I/F :Ethernet Board
 PLC side I/F :GOT
 Other Station Setting : No specification

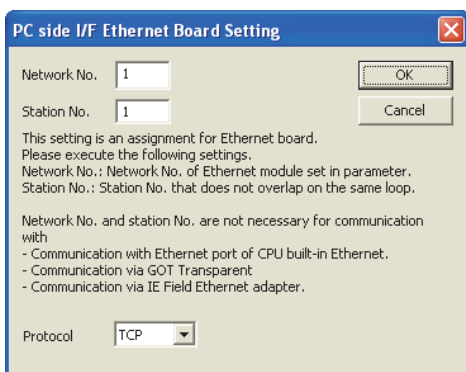

4. Double-click [Ethernet Board] of the PC side I/F to display [PC side I/F Ethernet Board Setting].
5. Set the protocol to TCP. Network No. and Station No. are not required to be changed (default) because they are not used.



(For bus connection)

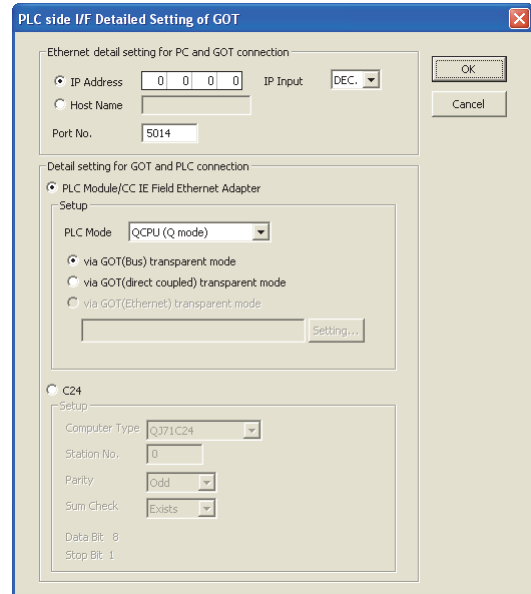

6. Double-click [GOT] of the PLC side I/F to display [PLC side I/F Detailed Setting of GOT].
7. Set the IP address and port No. in [Ethernet detail setting for PC and GOT connection]. Set the IP address and port No. to the same as the Ethernet download setting.
 23.5.1 (b) Ethernet download setting
8. Check either of the followings in [Detail setting for GOT and PLC connection].

Bus connection

[via GOT(Bus) transparent mode]

Direct CPU connection

Mark the [via GOT(direct coupled) transparent mode] checkbox.

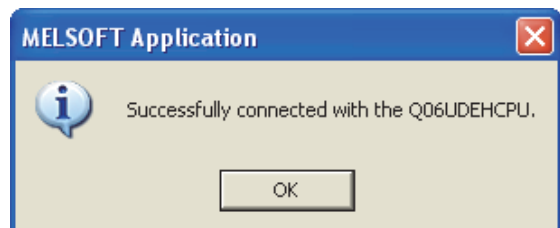

9. The screen returns to [Transfer Setup]. Click [Connection Test] to check if GX Developer has been connected to the QCPU (Q mode).

(2) Connecting the GOT and PLC in computer link connection (when connecting to QJ71C24 (N))

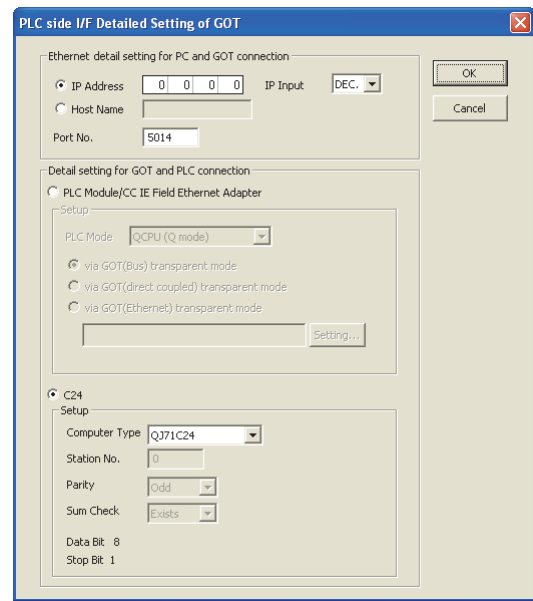
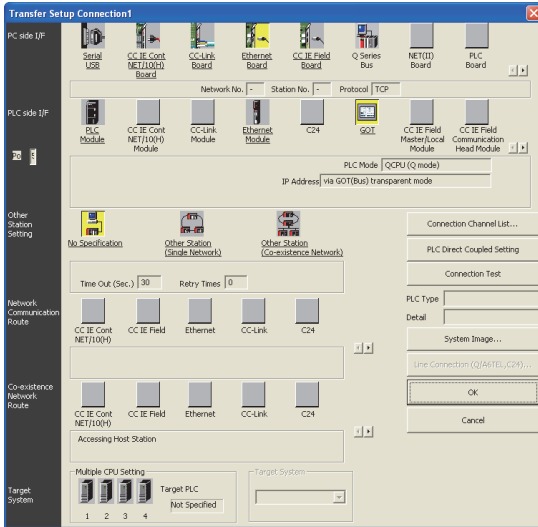

1. Click the Connection Destination view → [Connection Destination] → [(Connection target data name)] in the Navigation window of GX Works2.
2. The [Transfer Setup] is displayed.
3. Set the [Transfer Setup]:
 PC side I/F : Ethernet Board
 PLC side I/F : GOT
 Other Station Setting : No specification

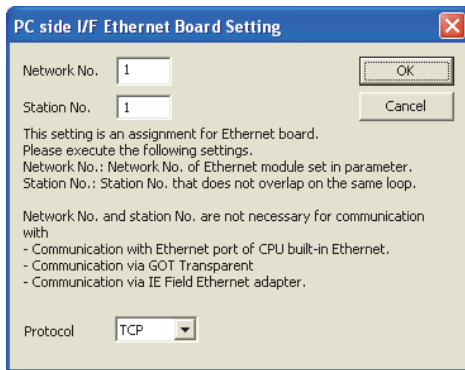

4. Double-click [Ethernet Board] of the PC side I/F to display [PC side I/F Ethernet Board Setting].
5. Set the protocol to TCP. Network No. and Station No. are not required to be changed (default) because they are not used.



6. Double-click [GOT] of the PLC side I/F to display [PLC side I/F Detailed Setting of GOT].
7. Set the IP address and port No. in [Ethernet detail setting for PC and GOT connection]. Set the IP address and port No. to the same as the Ethernet download setting.
 ➔ 23.5.1 (b) Ethernet download setting
8. Check [C24] in [Detail setting for GOT and PLC connection].

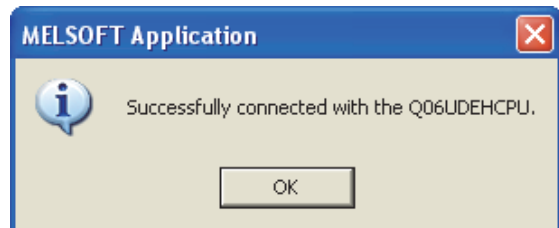

9. The screen returns to [Transfer Setup]. Click [Connection Test] to check if GX Works2 has been connected to the QCPU (Q mode).

23.6.5 Accessing by GX LogViewer

The following shows the procedure to set the FA transparent function of GX LogViewer.

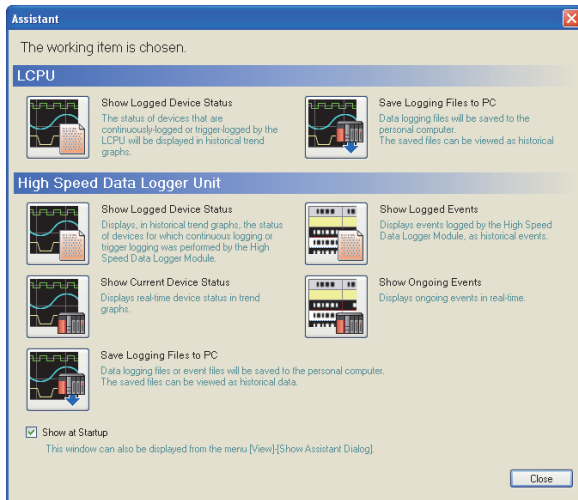

1. Click [Show Assistant Dialog] for [View] on GX LogViewer.
2. The [Assistant] dialog box is displayed.

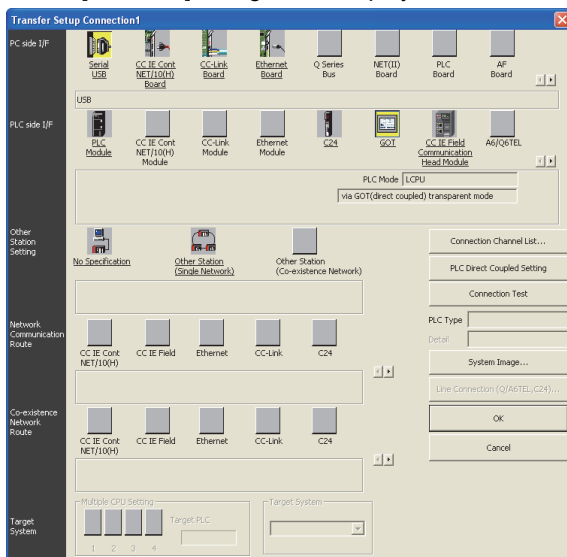

3. Click [LCPU] → [Show Logged Device Status] in the [Assistant] dialog box.
4. The [Transfer Setup Connection 1] dialog box is displayed.
5. Set the [Transfer Setup Connection 1]:
 PC side I/F : Serial USB
 PLC side I/F : GOT
 Other Station Setting : (Select from the system configuration)
6. For [PC side I/F Serial Setting] and [PLC side I/F Detailed Setting of GOT] of [Transfer Setup], refer to the following.

☞ 23.6.4 Accessing by GX Works2

23.6.6 Accessing PLC by GX Configurator-QP

The following shows the procedure to set the FA transparent function of GX Configurator-QP.

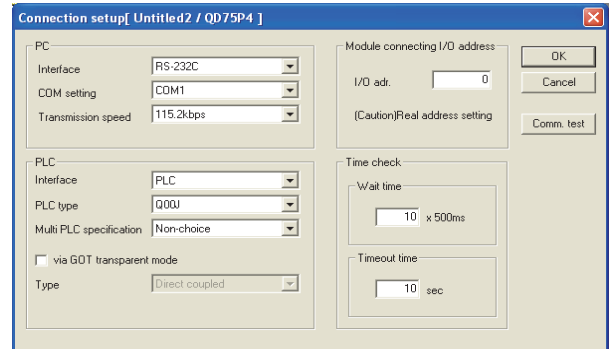

1. Click [Connection setup] for [Online] on GX Configurator-QP.
2. The [Connection setup] is displayed.
3. Set the [PC side] in [Connection setup].

When connecting the GOT and PC with serial
 Interface: (RS-232C)
 COM setting: COM1 to COM10
 Transmission speed: 9.6kbps to 115.2kbps

When connecting the GOT and PC with USB
 Interface: USB



23.6.7 Accessing by the MT Developer

This section explains the procedure to set the FA transparent function of MT Developer with an example of connecting to motion controller CPU (Q series).

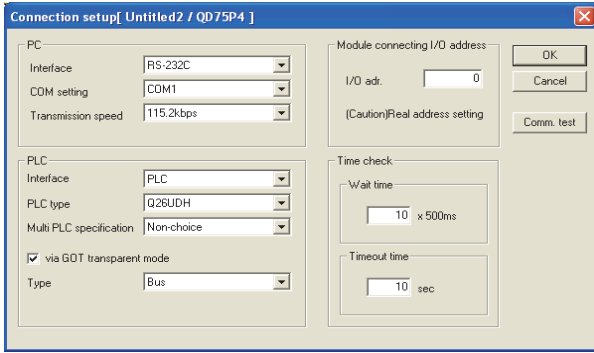

- Set the [PLC side] in [Connection setup].
 PLC type: Q series PLC type
 Multi PLC specification: None/No.1 to 4
 Direct CPU connection, mark the [via GOT transparent mode] checkbox.

Bus connection

Interface: PLC
 Type: Bus

Direct CPU connection

Interface: PLC
 Type: Direct coupled

Computer link connection

Interface: C24

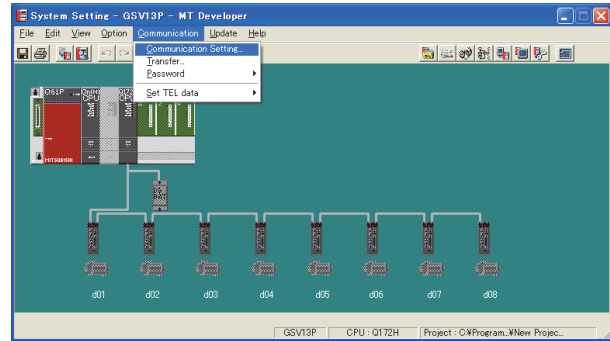

- Click [Communication] → [Communication Setting] in MT Developer.

(For bus connection only)

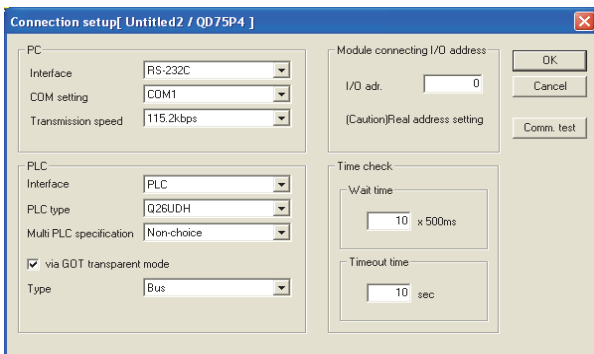

- Set the [Module connecting I/O address] in [Connection setup].
 Specify the actual IP address of the module.

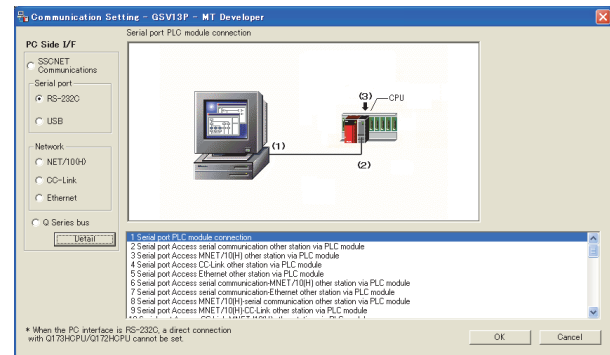

- Check-mark either of the following in [Serial port].
 When connecting the GOT and PC with serial
 Mark the [RS-232C] checkbox.
 When connecting the GOT and PC with USB
 Mark the [USB] checkbox.

- Click [Detail].

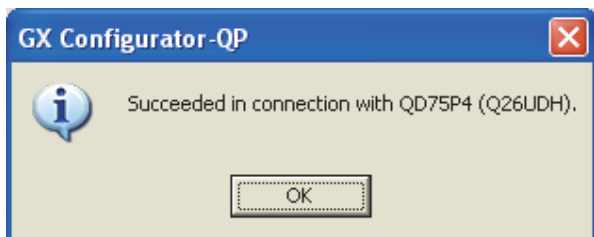

- The screen returns to the [Connection setup]. Click the [Connection Test] to check if GX Developer has been connected to the QD75*** (QnCPU).

23.6.8 Accessing by the MT Works2

This section explains the procedure to set the FA transparent function of MT Works2 with an example of connecting to motion controller CPU (Q series).

■ When connecting the GOT and personal computer with serial or USB

(1) Connecting the GOT and PLC in bus connection or direct CPU connection

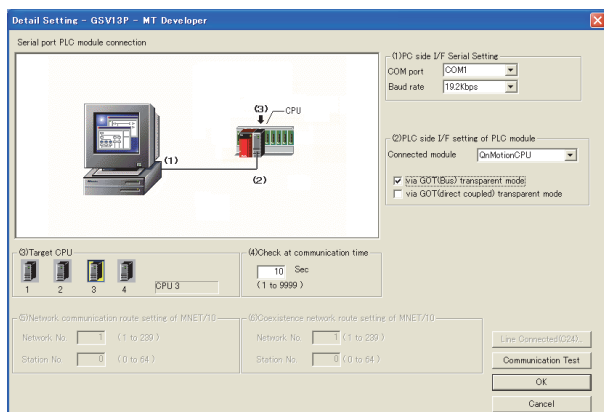

4. Check-mark either of the following in [PLC side I/F setting of PLC module].

Bus connection

[via GOT(Bus) transparent mode]

Direct CPU connection

[via GOT(direct coupled) transparent mode]

5. As necessary, select a CPU that is targeted by using the transparent function in [CPU].

6. Click [Connection Test].

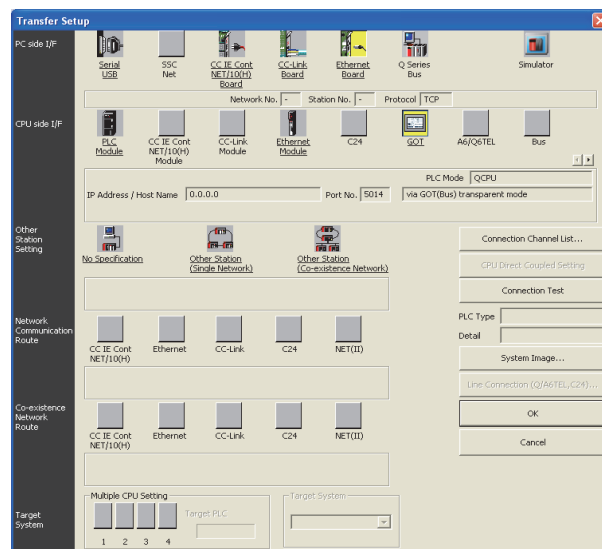

1. Click [Transfer setup] → [Online].

2. The [Transfer setup] is displayed.

3. Set the [Transfer setup]:
 PC side I/F : Serial USB
 CPU side I/F : GOT
 Other Station Setting : No specification

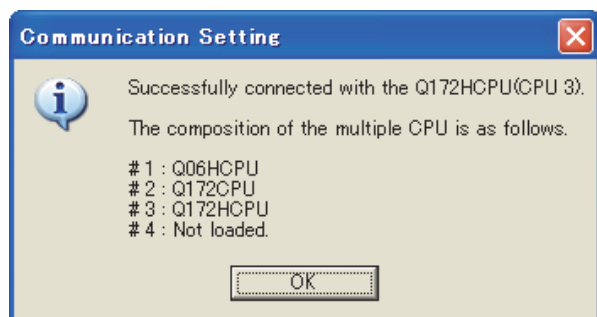

7. Confirm that the personal computer is connected to the motion controller CPU (Q series).

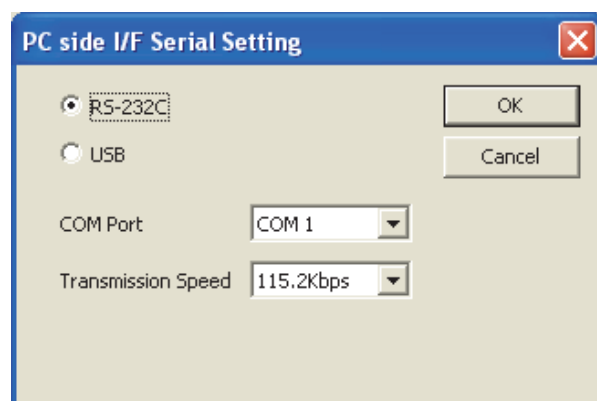

4. Double-click [Serial] of the PLC side I/F to display [PC side I/F Serial setting].

5. Check-mark either of the following in [PC side I/F Serial setting].

When connecting the GOT and PC with serial
 Mark the [RS-232C] checkbox.

When connecting the GOT and PC with USB
 Mark the [USB] checkbox.

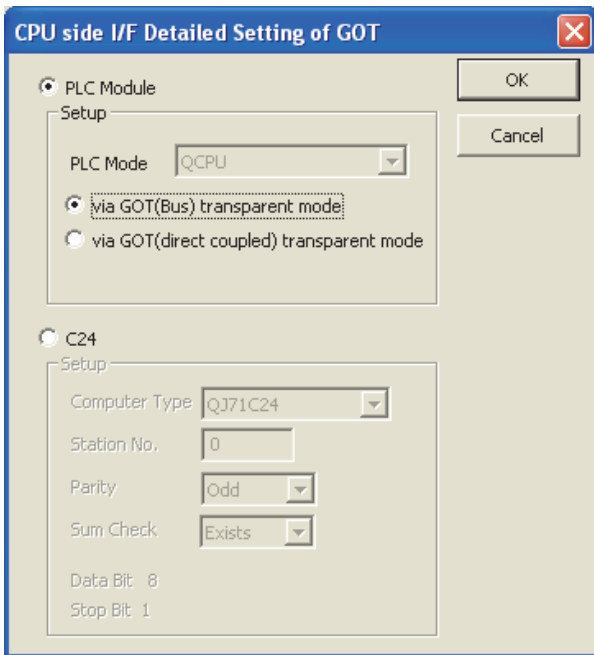

6. Double-click [GOT] of the CPU side I/F to display [CPU side I/F Detailed Setting of GOT].
7. Check-mark either of the following in [CPU side I/F Detailed Setting of GOT].
 - Bus connection**
Mark the [via GOT(Bus) transparent mode] checkbox.
 - Direct CPU connection**
Mark the [via GOT (direct coupled) transparent mode] checkbox.



8. The screen returns to [Transfer setup]. Click [Connection Test] to check if MT Works2 has been connected to the motion controller (Q mode).

(2) When connecting the GOT and PLC in Ethernet communication

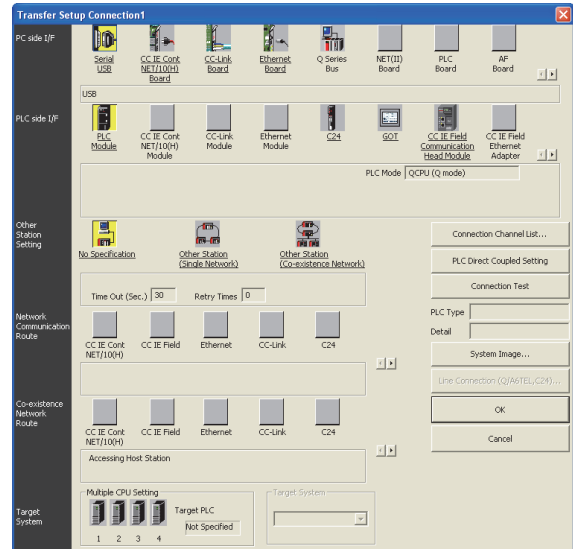

1. Click the Connection Destination view → [Connection Destination] → [(Connection target data name)] in the Navigation window of MT Works2.
2. The [Transfer Setup] is displayed.
3. Set the [Transfer Setup]:
 PC side I/F : Serial USB
 PLC side I/F : GOT
 Other Station Setting : No Specification:

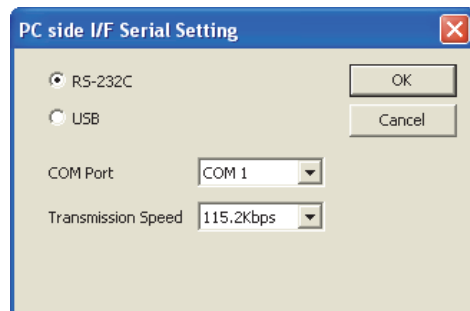

4. Double-click [Serial USB] of the PC side I/F to display [PC side I/F Serial Setting].
5. Check-mark either of the following in [PC side I/F Serial Setting].

When connecting the GOT and PC with serial
Mark the [RS-232C] checkbox.

When connecting the GOT and PC with USB
Mark the [USB] checkbox.



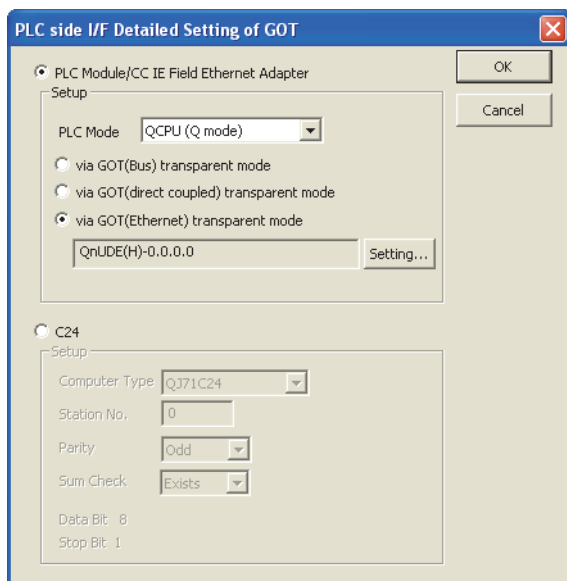

6. Double-click [GOT] of the PLC side I/F to display [PLC side I/F Detailed Setting of GOT].
7. PLC side I/F Detailed Setting of GOT
Mark the [via GOT(Ethernet) transparent mode] checkbox and click [Set].

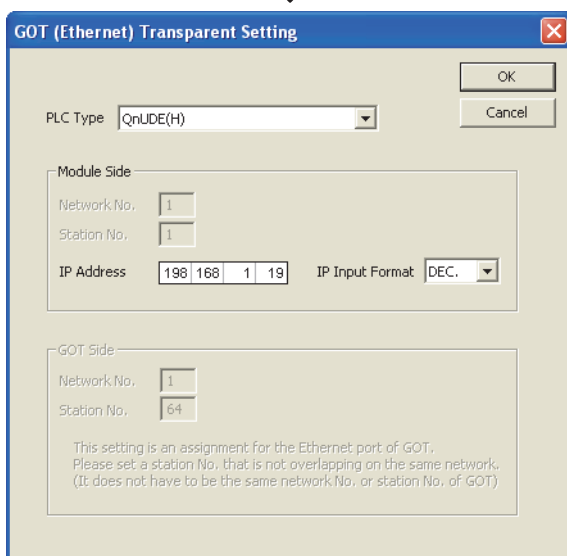

8. By clicking [Set], the [GOT (Ethernet) Transparent Setting] is displayed.
Here, set the built-in Ethernet port QCPU or Ethernet module, which is firstly connected via a GOT.
9. Set [QnUDE(H)] or [QJ71E71] for [Type name].

10. Specify the number for [Network No.] and [Station No.] same as the number assigned to the Ethernet module.
When [QnUDE(H)] is set for [Type name], the setting is not required.
11. Specify the IP address for [IP address] same as the IP address assigned to the built-in Ethernet port QCPU or Ethernet module.

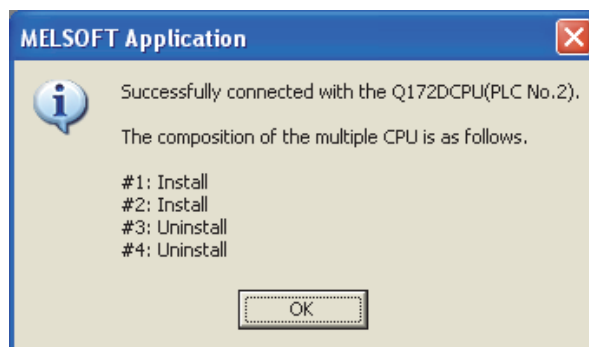

12. The screen returns to [Transfer setup]. Click [Connection Test] to check if GX Developer has been connected to the motion controller (Q mode).

■ When connecting the GOT and personal computer in Ethernet connection (GT16, GT15 and GT14 only)

(1) Connecting the GOT and PLC in bus connection or direct CPU connection

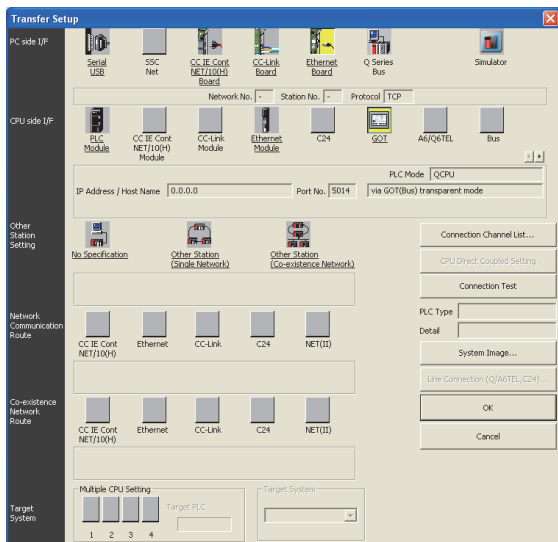

1. Click the Connection Destination view → [Connection Destination] → [(Connection target data name)] in the Navigation window of MT Works2.
2. The [Transfer Setup] is displayed.
3. Set the [Transfer Setup]:
 PC side I/F : Ethernet Board
 PLC side I/F : GOT
 Other Station Setting : No Specification:

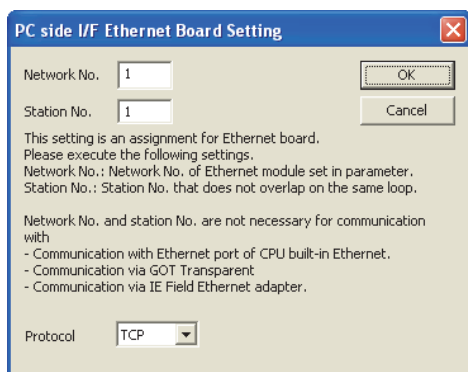

4. Double-click [Ethernet Board] of the PC side I/F to display [PC side I/F Ethernet Board Setting].
5. Set the protocol to TCP. Network No. and Station No. are not required to be changed (default) because they are not used.



(For bus connection)

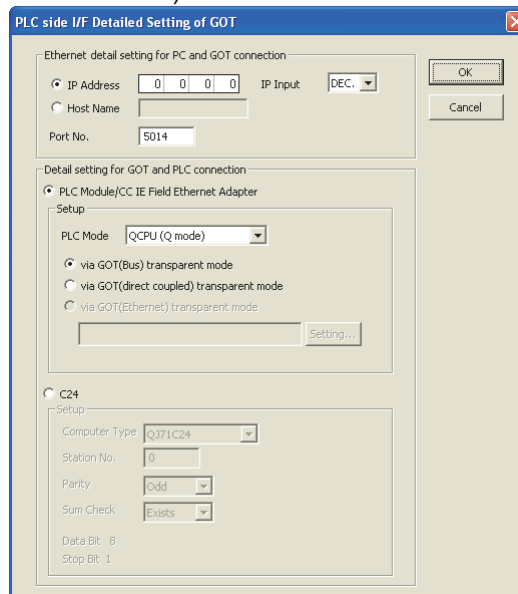

6. Double-click [GOT] of the PLC side I/F to display [PLC side I/F Detailed Setting of GOT].
7. Set the IP address and port No. in [Ethernet detail setting for PC and GOT connection]. Set the IP address and port No. to the same as the Ethernet download setting.
 ➔ 23.5.1 (b) Ethernet download setting
8. Check either of the followings in [Detail setting for GOT and PLC connection].
Bus connection
 [via GOT(Bus) transparent mode]
Direct CPU connection
 Mark the [via GOT(direct coupled) transparent mode] checkbox.



9. The screen returns to [Transfer Setup]. Click [Connection Test] to check if GX Developer has been connected to the Motion controller (Q mode).

23.6.9 Accessing the servo amplifier by the MR Configurator

Make the FA transparent settings with the of MT Developer.

For details, refer to the following:

 23.6.7 Accessing by the MT Developer

23.6.10 Accessing the servo amplifier by the MR Configurator2

Make the FA transparent settings with the of MT Works2.

For details, refer to the following:

 23.6.8 Accessing by the MT Works2

23.6.11 Accessing the inverter by the FR Configurator

This section explains the setting method of the FA transparent function of FR Configurator with an example of connecting to FREQROL A700/F700 series.

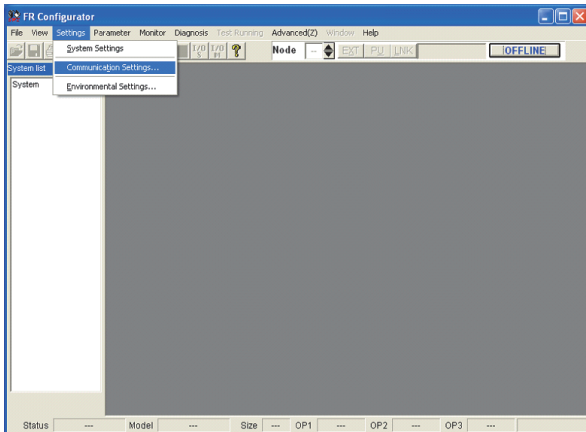

1. Click [Settings] → [Communication Settings...] in FR Configurator.

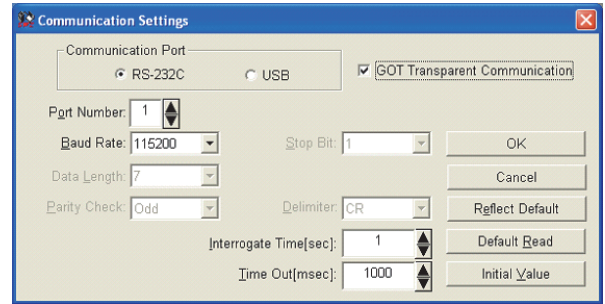

2. Check-mark either of the following in [Communication Port].

When connecting the GOT and PC with serial
Mark the [RS-232C] checkbox.

When connecting the GOT and PC with USB
Mark the [USB] checkbox.

3. Click the [GOT Transparent Communication].
4. Click the [OK].

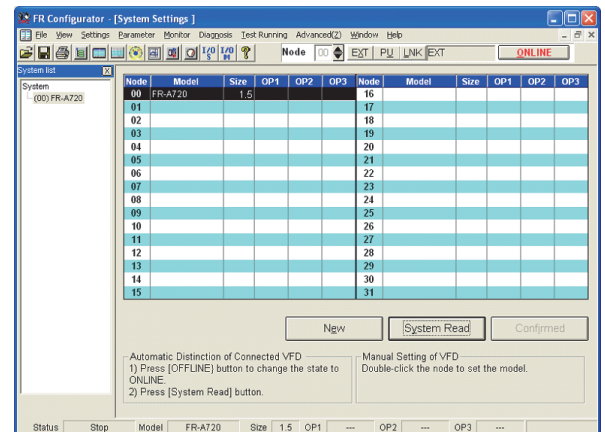

5. Click [OFFLINE] to make it [ONLINE].
6. Click the [System Read], then check if GOT has been connected to FREQROL A700/F700 series normally.

23.6.12 Accessing PLC by FX Configurator-FP

This section explains the procedure to set the FA transparent function of FX Configurator-FP with an example of connecting to FXCPU.

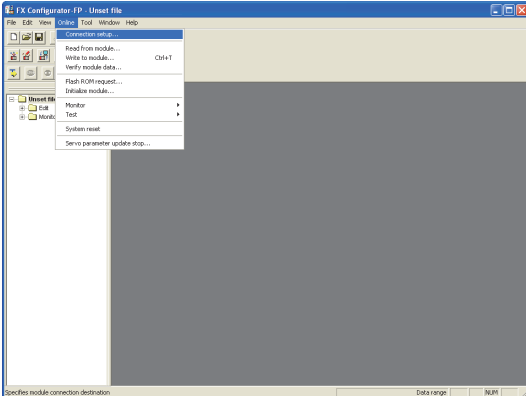

1. Click [Connection setup] for [Online] on FX Configurator-FP.

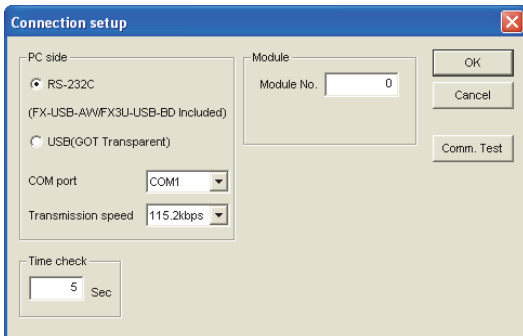

2. Check-mark either of the following in [PC side].
When connecting the GOT and PC with serial
 Mark the [RS-232 (FX-USB-AW/FX3U-USB-BD Included)] checkbox.
When connecting the GOT and PC with USB
 Mark the [USB(GOT Transparent)] checkbox.
3. Click [Comm. Test].

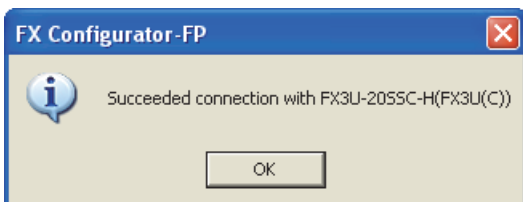

4. After the communication test is completed, check that the GOT is correctly connected to the FXCPU.

23.6.13 Accessing by FX Configurator-EN-L or FX Configurator-EN

This section explains the procedure to set the FA transparent function of FX Configurator-EN-L and FX Configurator-EN.

The following shows an example with FX Configurator-EN-L.

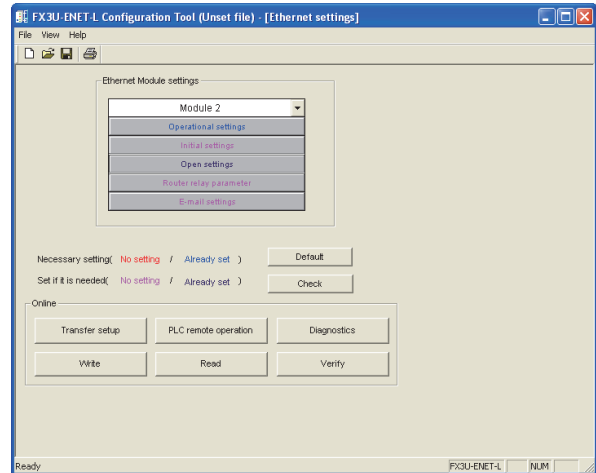

1. Click [Transfer setup] on the FX3U-ENET-L Configuration tool.

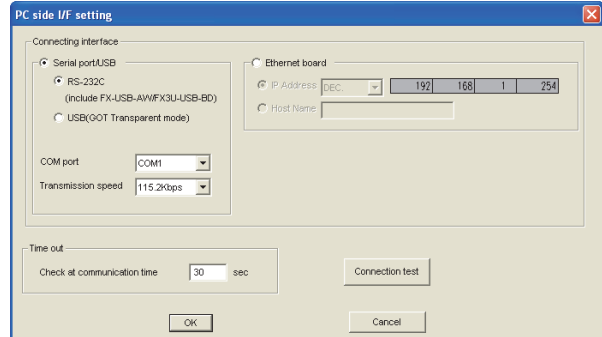

2. Mark the [Serial port/USB] checkbox in [Connecting interface].
3. Check-mark either of the following in [Serial port/USB] of [Connecting interface].
When connecting the GOT and PC with serial
 Mark the [RS-232C (include FX-USB-AW/FX3U-USB-BD)] checkbox.
When connecting the GOT and PC with USB
 Mark the [USB (GOT Transparent mode)] checkbox.
4. Click [Connection test]



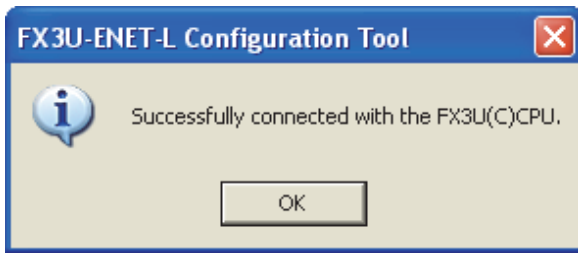

5. After the communication test is completed, check that the GOT is correctly connected to the FXCPU.

23.6.14 Accessing by RT ToolBox2

This section explains the procedure to set the FA transparent function of RT ToolBox2 with an example of connecting to CRnQ-700.

- Connecting the GOT and Controller in bus connection or direct CPU connection (CRnQ-700)

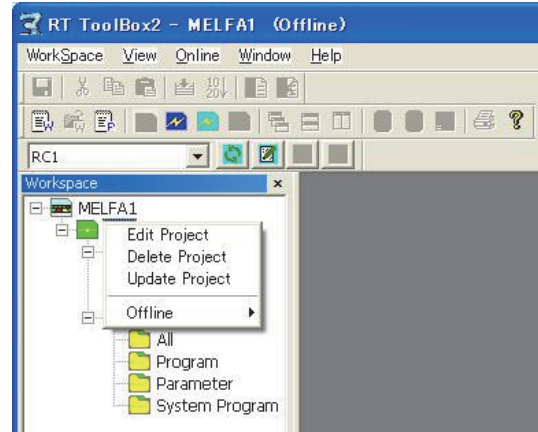

1. Right-click a project name to be a target on the project tree of RT ToolBox2. Click [Edit Project].

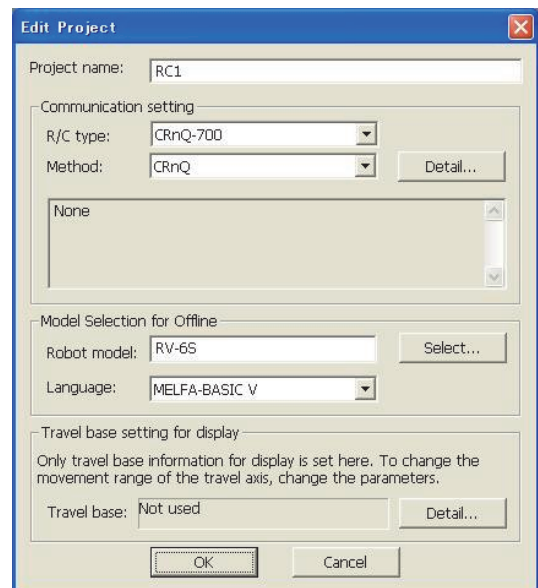

2. Set [Method] to [CRnC].
3. Click [Detail].



17 ROBOT CONTROLLER CONNECTION
 18 CNC CONNECTION
 19 ENERGY MEASURING UNIT/ELECTRIC MULTI-MEASURING INSTRUMENT CONNECTION
 20 GOT MULTI-DROP CONNECTION
 21 MULTIPLE-GT14, GT12, GT11, GT10 CONNECTION FUNCTION
 22 MULTI-CHANNEL FUNCTION
 23 FA TRANSPARENT FUNCTION

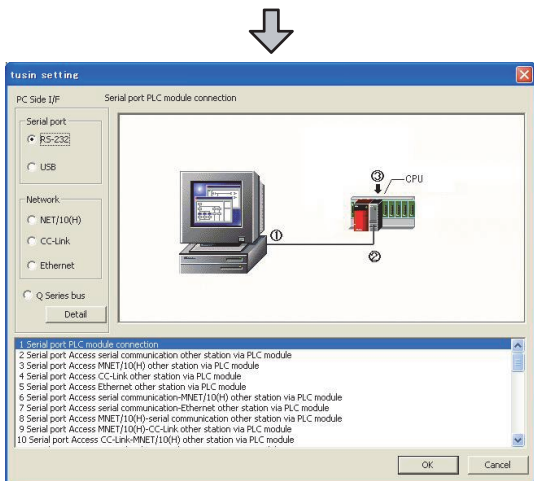

4. Check-mark either of the following in [Serial port].
 When connecting the GOT and PC with serial
 Mark the [RS-232C] checkbox.

When connecting the GOT and PC with USB
 Mark the [USB] checkbox.

5. Click [Detail].

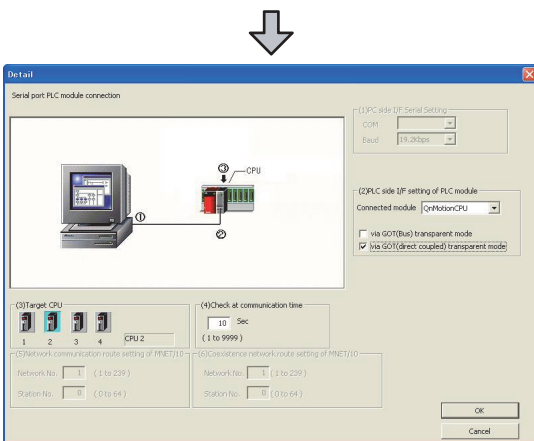

6. Check-mark either of the following in [PLC side I/F setting of PLC module].

Bus connection

[via GOT(Bus) transparent mode]

Direct CPU connection

[via GOT(direct coupled) transparent mode]

7. As necessary, select a CPU that is targeted in [CPU].

Connecting the GOT and Controller in Ethernet connection

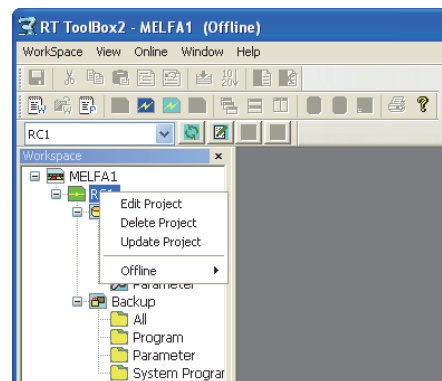

1. Right-click a project name to be a target on the project tree of RT ToolBox2.
 Click [Edit Project].

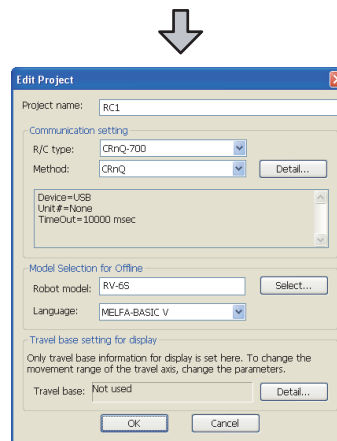

2. Set [Method] to [CRnQ].

3. Click [Detail].

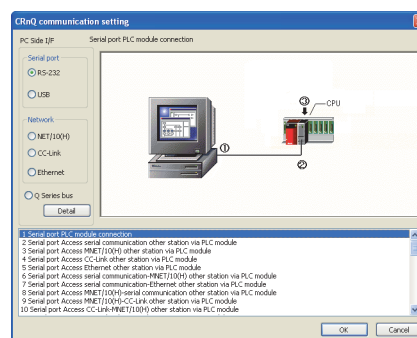

4. Check-mark either of the following in [Serial port].
 When connecting the GOT and PC with serial
 Mark the [RS-232] checkbox.

When connecting the GOT and PC with USB
 Mark the [USB] checkbox.

5. Click [Detail].

23.6.15 Accessing by NC Configurator

The following shows the procedure to set the FA transparent function of NC Configurator.

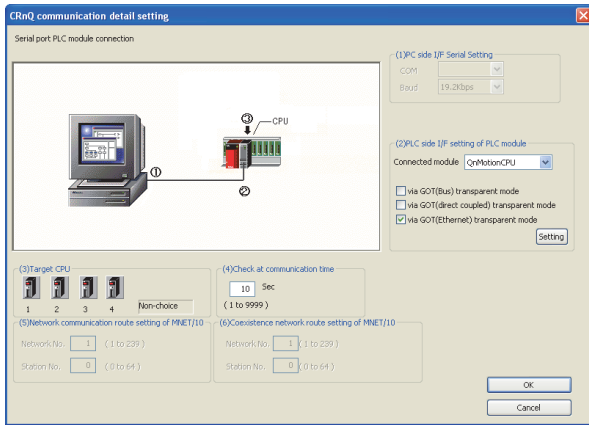

- On the [PLC side I/F setting of PLC module], mark the [via GOT (Ethernet) transparent mode] checkbox and click [Set].

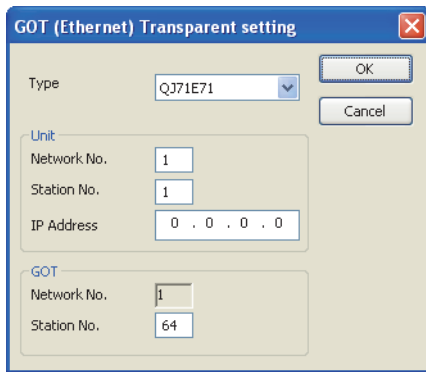

- Set [QJ71E71] for [Type].
- Specify the number assigned to the Ethernet module for [Network No.], [Station No.] and [IP Address] in "Module side".
- Specify the number assigned to the GOT for [Network No.], [Station No.] and [IP Address] in "GOT side".
- As necessary, select a CPU that is targeted in [CPU].

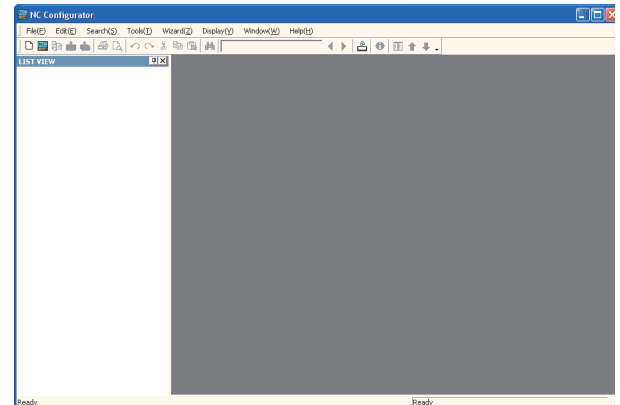

- Click [File] → [Open].
- The [Open] is displayed.

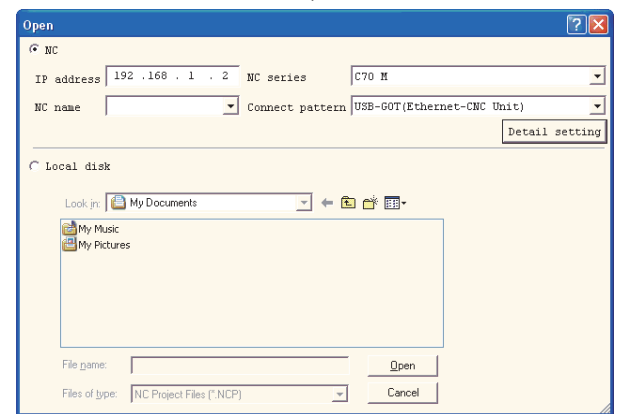

- Select [NC] on the upper left of the screen, and set the following:
 NC series : C70 M or C70 L
 Connect pattern : Set the pattern according to the connect pattern.
 IP address : Set as necessary.
- By clicking [Open], data is read from CNC and displayed.

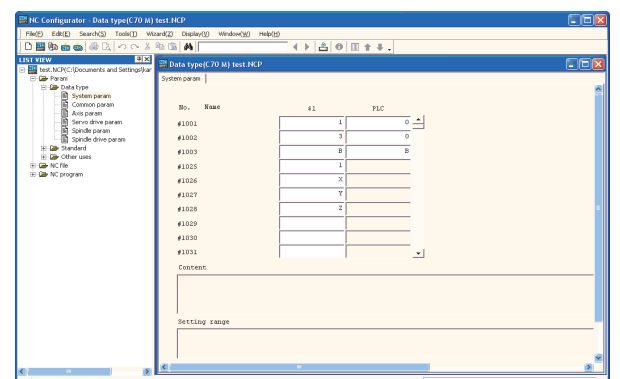

23.6.16 Accessing by MELSOFT Navigator

This section explains the procedure to set the FA transparent function of the MELSOFT Navigator.

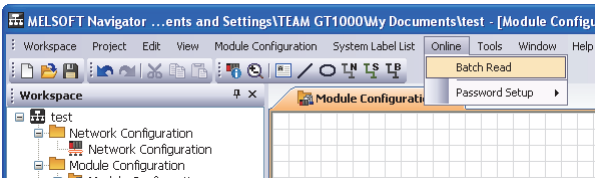

1. Click [Online] → [Batch Read] in MELSOFT Navigator.
2. The [Batch Read] is displayed.

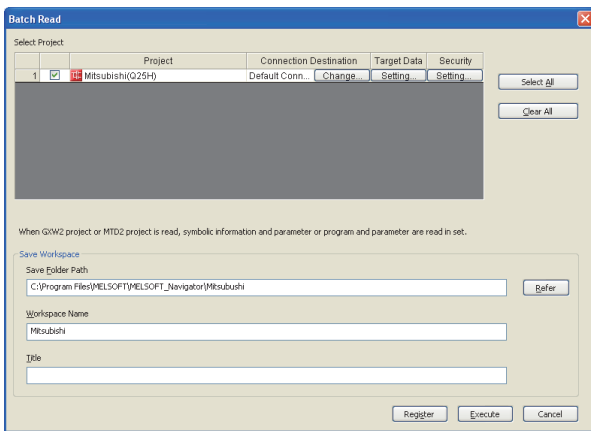

3. Select the projects to be read from [Select Project], and set the storage destination of the workspace in [Save Workspace].
4. Click [Execute] to read and display the specified project.

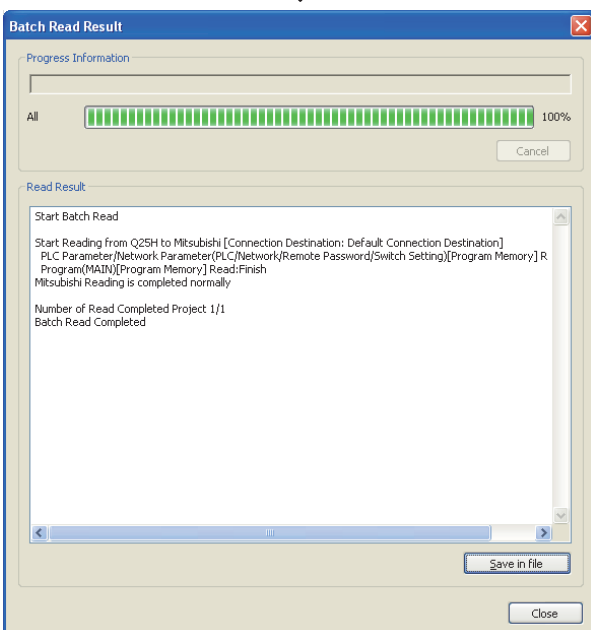

23.6.17 Accessing by CPU Module Logging Configuration Tool

The following shows the procedure to set the FA transparent function of QnUDVCPULCPU Logging Configuration Tool .

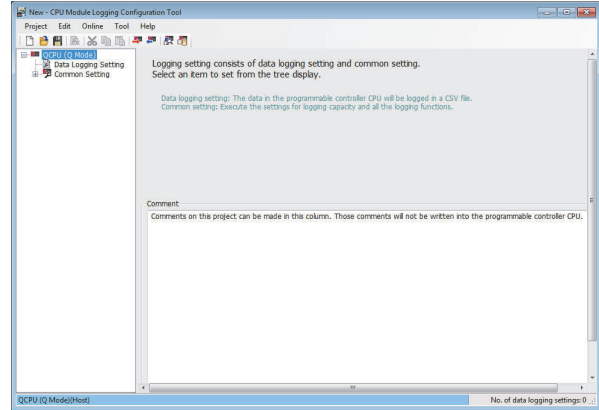

1. Click [Online] → [Transfer Setup...].
2. The [Transfer Setup] is displayed.

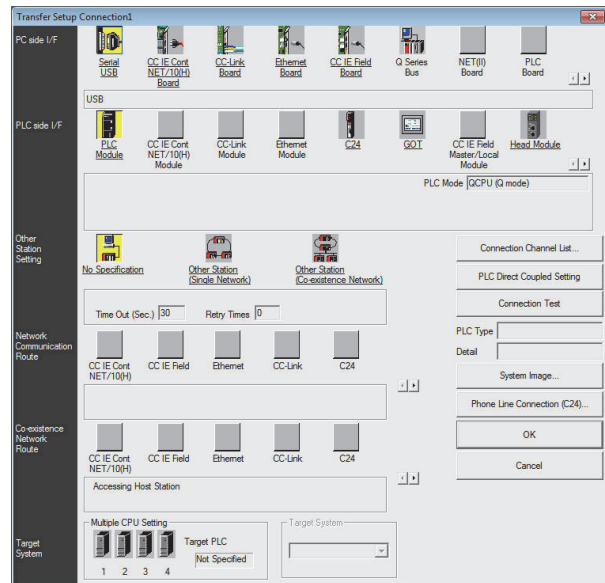

3. Set the [Transfer Setup]:
PC side I/F : Serial USB
PLC side I/F : GOT
Other Station Setting : No specification
4. Set [PC side I/F Serial Setting] and [PLC side I/F Detailed Setting of GOT] in [Transfer Setup]. For details, refer to the following.
 23.6.4 Accessing by GX Works2

23.6.18 Accessing by Setting/ Monitoring tool for C Controller module

The following shows the procedure to set the FA transparent function of Setting/Monitoring tool for C Controller module with the C Controller module (Q Series) (Q24DHCCPU-V) connected.

■ When connecting the GOT and personal computer with USB

(1) When connecting the GOT and PLC in bus connection

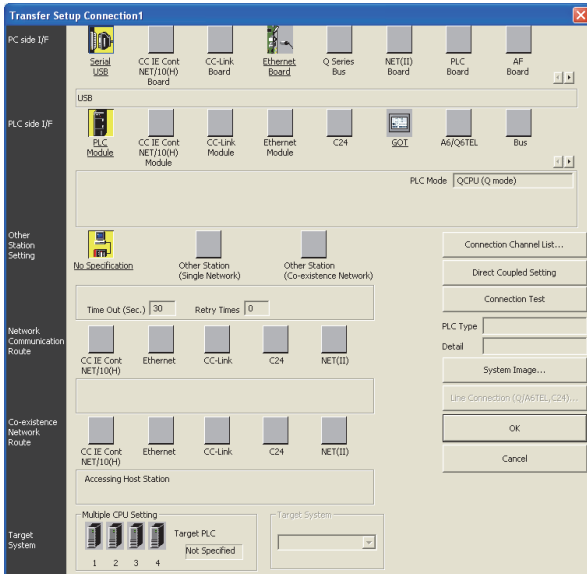

1. Click the Connection Destination view → [Connection Destination] → [(Connection target data name)] in the Navigation window of MT Setting/ Monitoring tool for C Controller module.
2. The [Transfer Setup] is displayed.
3. Set the [Transfer Setup]:
PLC side I/F : GOT
Other station : No specification

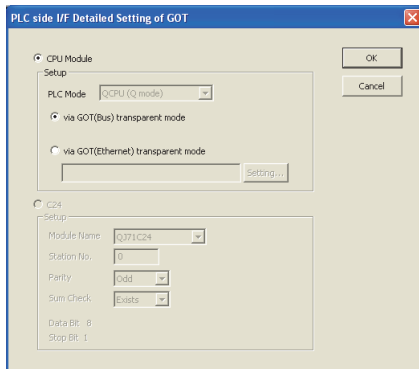

4. Double-click [GOT] of the CPU side I/F to display [CPU side I/F Detailed Setting of GOT].



5. Mark the [via GOT(Bus) transparent mode] checkbox on the [CPU side I/F Detailed Setting of GOT] screen.

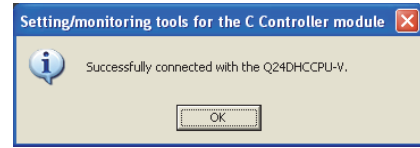

6. The screen returns to [Transfer Setup]. Click [Connection Test] to check if Setting/Monitoring tool for C Controller module has been connected to the motion controller (Q mode).

(2) When connecting the GOT and PLC in Ethernet communication

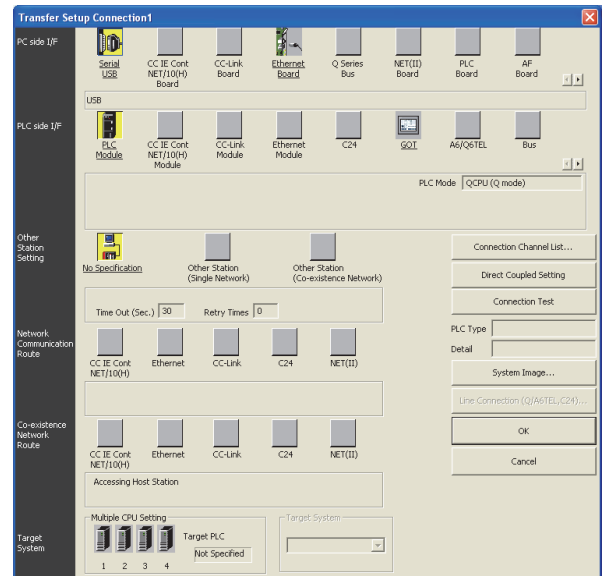

1. Click the Connection Destination view → [Connection Destination] → [(Connection target data name)] in the Navigation window of MT Setting/ Monitoring tool for C Controller module.

2. The [Transfer Setup] is displayed.



3. Set the [Transfer Setup]:
PLC side I/F : GOT
Other station : No specification

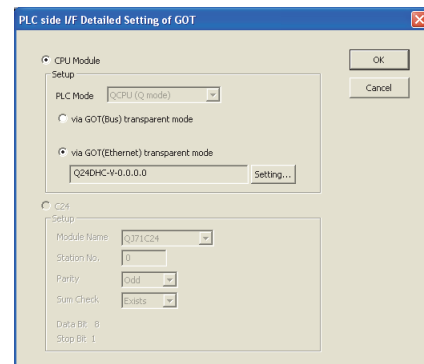

4. Double-click [GOT] of the CPU side I/F to display [CPU side I/F Detailed Setting of GOT].
5. Mark the [via GOT(Ethernet) transparent mode] checkbox on the [CPU side I/F Detailed Setting of GOT] screen.

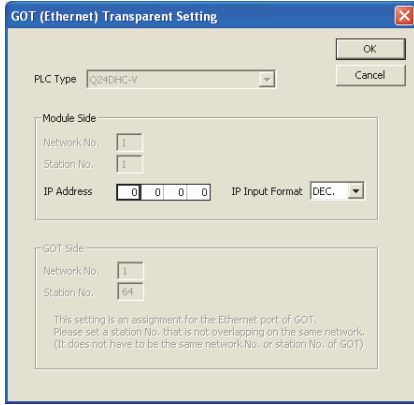

6. By clicking [Set], the [GOT (Ethernet) Transparent Setting] is displayed. Here, set the C Controller module (Q Series) (Q24DHCCPU-V), which is firstly connected via a GOT.
7. Specify the IP address for [IP address] same as the IP address assigned to the C Controller module (Q Series) (Q24DHCCPU-V).

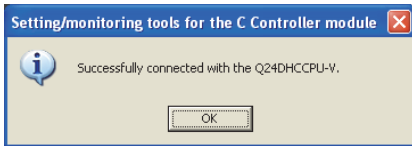

8. The screen returns to [Transfer Setup]. Click [Connection Test] to check if Setting/Monitoring tool for C Controller module has been connected to the C Controller module (Q Series) (Q24DHCCPU-V).

■ When connecting the GOT and personal computer in Ethernet connection (GT16, GT15, and GT14 only)

- (1) When connecting the GOT and PLC in bus connection

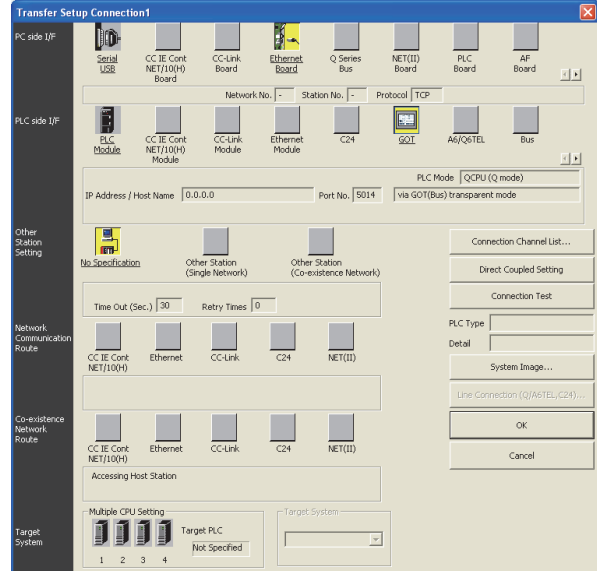

1. Click the Connection Destination view → [Connection Destination] → [(Connection target data name)] in the Navigation window of MT Setting/Monitoring tool for C Controller module.
2. The [Transfer Setup] is displayed.
3. Set the [Transfer Setup]:
 PC side I/F : Ethernet Board
 PLC side I/F : GOT
 Other station : No specification

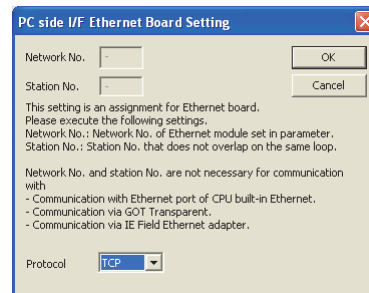

4. Double-click [Ethernet Board] of the PC side I/F to display [PC side I/F Ethernet Board Setting].
5. Set the protocol to TCP. Network No. and Station No. are not required to be changed (default) because they are not used.



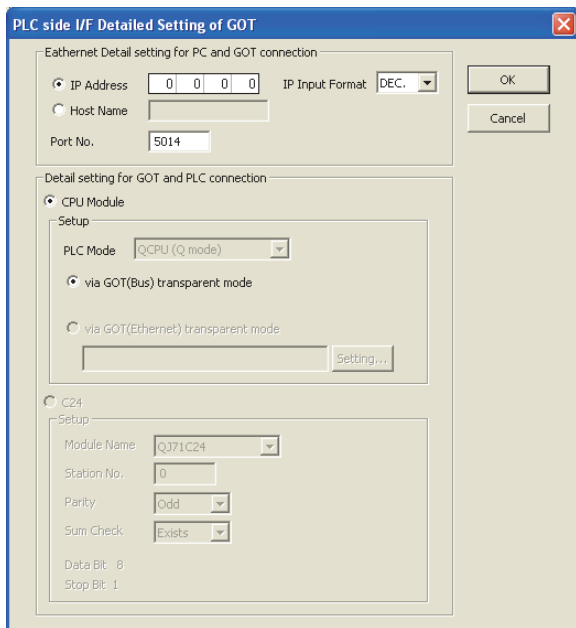

6. Double-click [GOT] of the PLC side I/F to display [PLC side I/F Detailed Setting of GOT].
7. Set the IP address and port No. in [Ethernet detail setting for PC and GOT connection]. Set the IP address and port No. to the same as the Ethernet download setting.

☞ 23.5.1 (b) Ethernet download setting

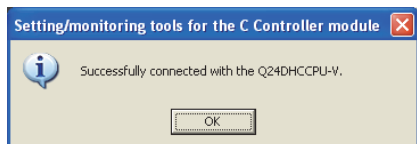

8. The screen returns to [Transfer Setup]. Click [Connection Test] to check if Setting/Monitoring tool for C Controller module has been connected to the motion controller (Q mode).

23.6.19 Accessing by MX Component(MX Sheet)

This section explains the procedure to set the FA transparent function of MX Component(MX Sheet) with an example of MX Sheet Version2.

POINT

MX Component(MX Sheet) manuals
For details of the MX Component(MX Sheet), refer to the following manual.

- ☞ MX Sheet Version 2 Operating Manual (Introduction)
- MX Component Version 4 Operating Manual

When MX Component is used alone
Start [Communication Setting Utility] and start communication setting from the following step 3.

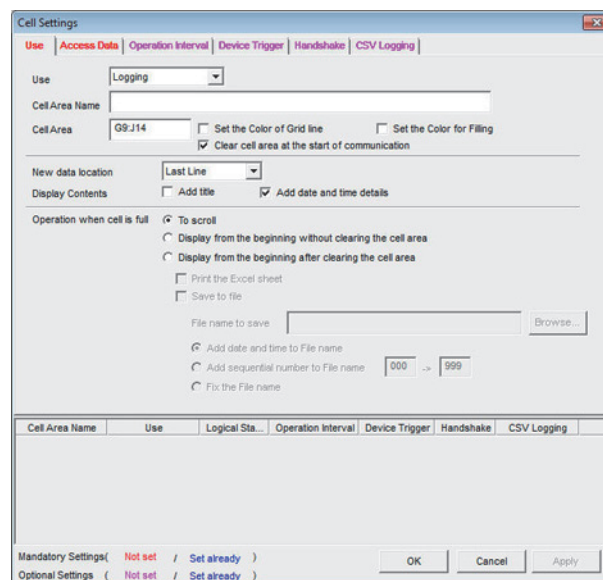

1. Click [MX sheet] of Microsoft Excel →[Cell Settings]. Set [Use] and click [Access Data].



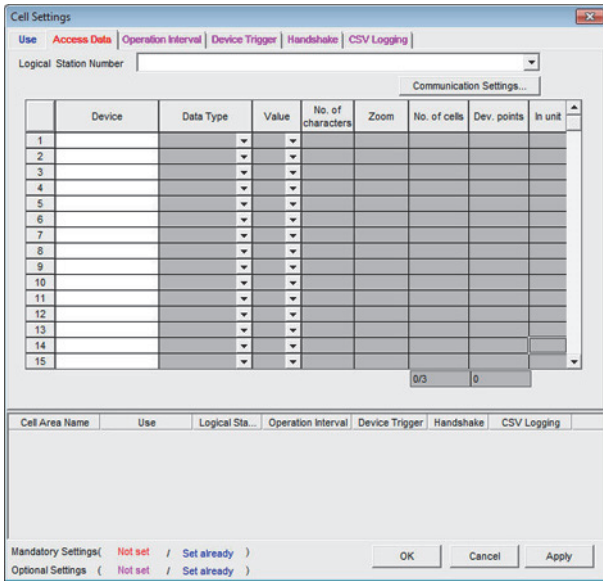

2. Click [Communication Setting].

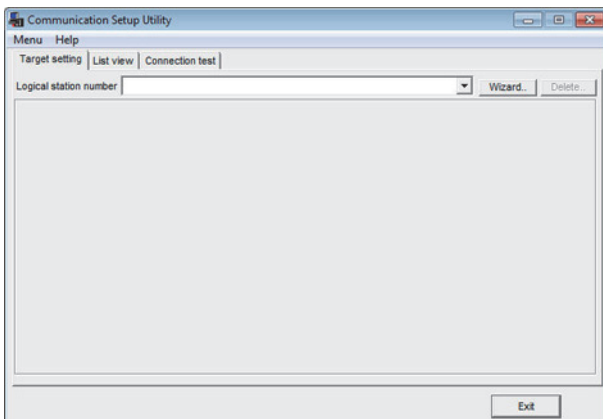

3. Click [Wizard].

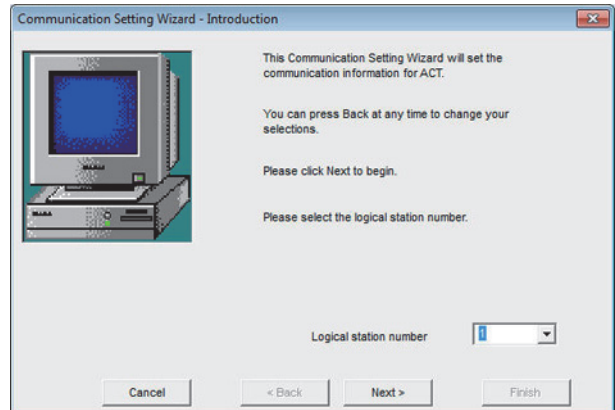

4. Set [Logical station number] and click [Next].

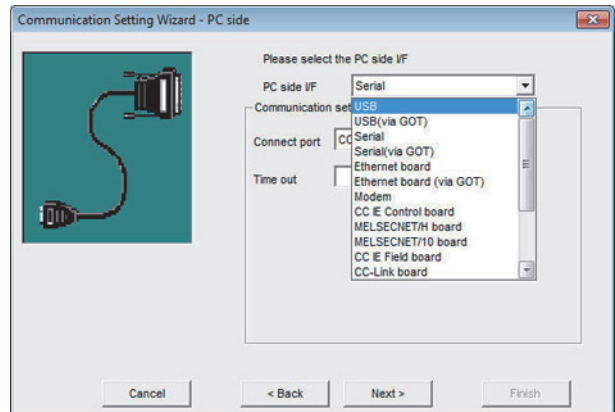

5. Select either of the following option from [PC side I/ F] according to the connection configuration and click [Next].

GOT and USB connection

[USB (Via GOT)]

GOT and Serial connection

[Serial (Via GOT)]

GOT and Ethernet connection

[Ethernet Board (Via GOT)]



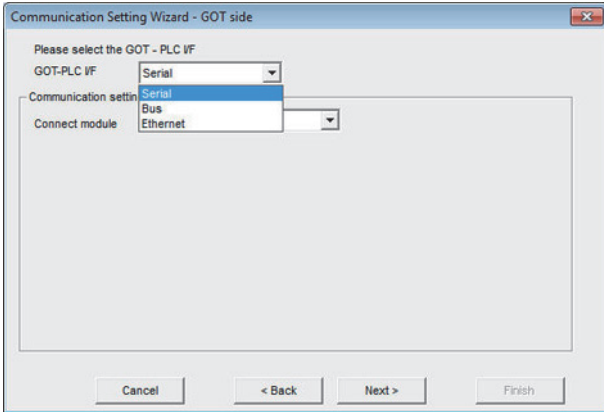

6. Select either of the following option from [GOT PLC I/F] according to the connection configuration.

Direct CPU connection

[Serial]

Bus connection

[Bus connection]

Ethernet connection

[Ethernet]

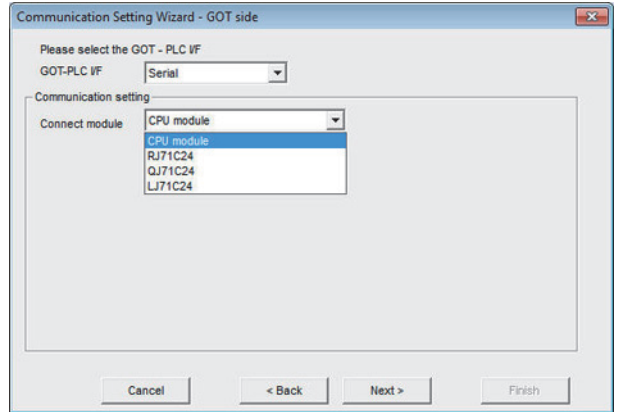

7. Select either of the following option from [Connect module] according to the setting of [GOT PLC I/F] and click [Next].

- For [Serial]
[CPU unit], [RJ71C24], [QJ71C24], [LJ71C24]
- For [Bus connection]
[CPU unit]
- For [Ethernet]
[CPU unit], [QJ71E71], [RJ71E71], [CC IE Field Ethernet adapter], [FX3U-ENET-ADP]
[FX3U-ENET(-L)], [CPU unit(FX5)]

For example, set as shown below and click [Next].
[GOT and PLC I/F]: [Ethernet]
[Connection destination unit type]: [CPU unit]

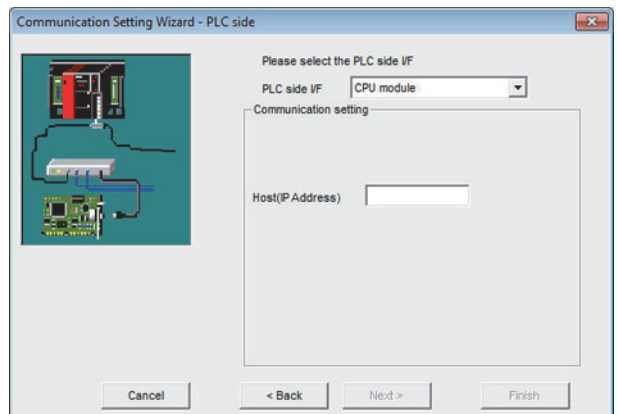

8. Select [Host(IP Address)] according to the connection configuration and click [Next].



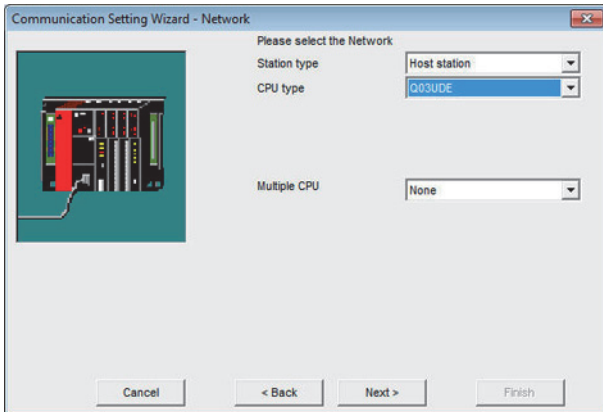

9. Select [Station type], [CPU type], and [Multiple CPU] according to the connection configuration and click [Next].

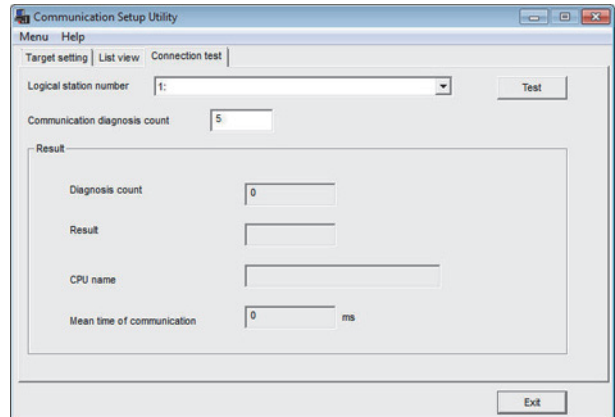

12. Click [Test] and check that normal communication is performed.

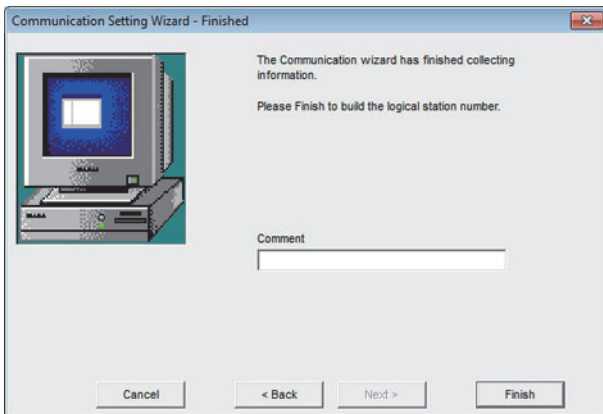

10. Set [Comment] and click [Finish].

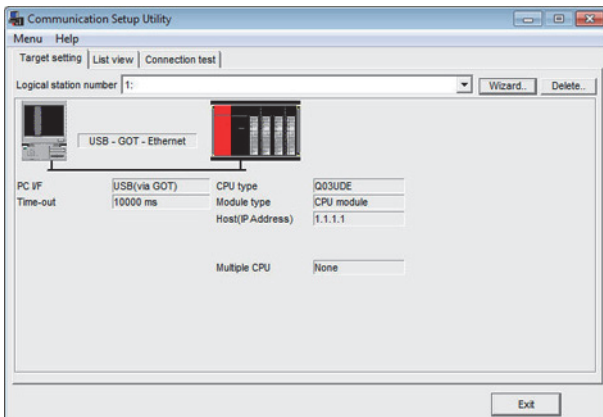

11. Click [Connection test]



23.7 Precautions

23.7.1 Precautions common to each software

■ GOT interface required to use the FA transparent function

Connect the personal computer, to which GX Developer or any other relevant software has been installed, to the RS-232 interface or USB interface of the GOT.

When performing the FA transparent function, use either RS-232 interface or USB interface of the GOT.

Using both of them to perform the FA transparent function concurrently is not allowed.

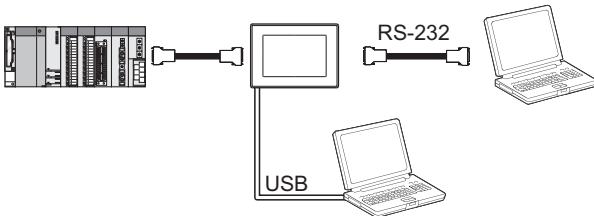

■ Conditions for suspending the FA transparent function

The FA transparent function is also suspended when any of the following operations, which stop the GOT monitor, is performed.

Note that the FA transparent function will not be stopped while using the optional function such as the Utility display or ladder monitor function.

- When project data is written/read, or when the OS is written by GT Designer3^{*1}
- When the GOT is set up^{*1}
- When no communication request (online monitor, etc.) has been issued from GX Developer for 45 minutes

^{*1} A timeout error occurs in GX Developer.

■ When GOT monitoring is faulty

The FA transparent function cannot be used in case that the GOT monitoring is faulty due to PLC CPU errors or faulty communication between the PLC CPU and GOT.

When GOT monitoring is faulty, check the following.

(1) Whether the PLC CPU operates normally

☞ Refer to the User's Manual of the PLC CPU you use.

(2) Whether the PLC CPU and GOT are connected normally

- ☞ 5. BUS CONNECTION
- ☞ 6. DIRECT CONNECTION TO CPU
- ☞ 7. COMPUTER LINK CONNECTION

■ When monitoring the PLC CPU from a personal computer

When monitoring the PLC CPU from a personal computer, the GOT and personal computer refresh the display slower.

■ Software available for the FA transparent function

When multiple kinds of software are activated on one personal computer, only one of them is available for communications using the FA transparent function.

Do not concurrently perform any communications using the FA transparent function.

(Offline operation with each software is available)

Also, do not perform communications with the GOT (e.g. downloading project data) from GT Designer3 during execution of communications using the FA transparent function.

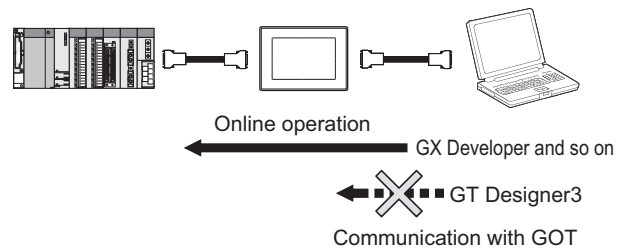

■ When the FA transparent function is used in a bus connection

(1) When multiple GOTs are bus-connected

When multiple GOTs are bus-connected, the FA transparent function can be used on each GOT. However, note that the monitoring performance of each GOT slows down as the number of monitoring GOTs and personal computers increases.

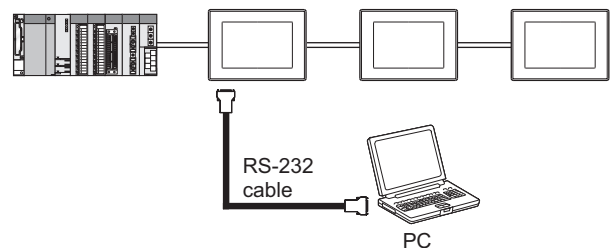

(2) When the FA transparent function is used in a bus connection

When the FA transparent function is used in a bus connection, the following GX Developer functions or GX Works2 functions cannot be executed.

The message [The executed function is not supported. Please check the manual and other documentation.] is displayed on GX Developer or GX Works2.

Unsupported GX Developer functions	Remark
<ul style="list-style-type: none"> Remote Reset Remote system reset 	—
<ul style="list-style-type: none"> Remote RUN Remote STOP Remote PAUSE Remote STEP-RUN Remote latch clear Write clock data Clear malfunction log 	Inexecutable only when specify all stations/groups has been performed.

■ When using together with the Multiple-GT11, GT10 connection function

When multiple GOTs are connected, the FA transparent function is not available even if the RS-232 interface or USB interface is used for the connection.

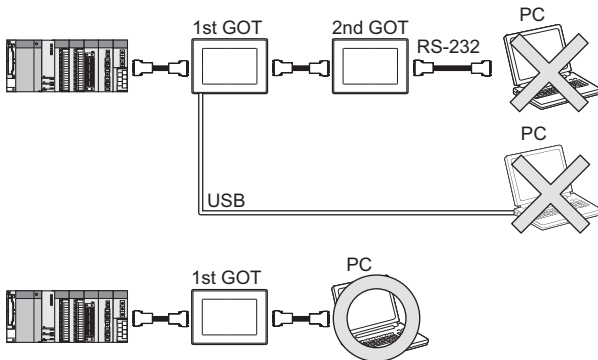

■ When PLC power disconnection occurs with the FA transparent function being used

While the FA transparent function is being used, if the communication between the PLC and the GOT is stopped due to PLC power disconnection or a disconnection of the communication cable between the PLC and the GOT, the GOT waits for timeout against the communication request from the peripheral devices (GX Developer, etc.), and it takes a few minutes to recover the monitoring between the PLC and the GOT.

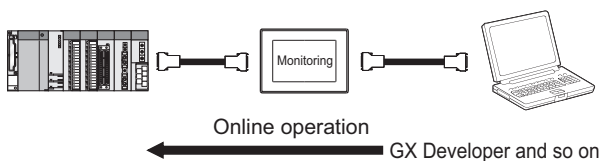

■ When the FA transparent function is used in an Ethernet connection

(1) GX Works3, GX Works2, GX Developer

When the FA transparent function is used in an Ethernet connection, the following GX Works3, GX Works2, GX Developer cannot be executed.

The message [The executed function is not supported. Please check the manual and other documentation.] is displayed on GX Works3, GX Works2, GX Developer.

Unsupported GX Developer functions	Remark
<ul style="list-style-type: none"> Remote Reset Remote system reset 	—
<ul style="list-style-type: none"> Remote RUN Remote STOP Remote PAUSE Remote STEP-RUN Remote latch clear Write clock data Clear malfunction log 	Inexecutable only when specify all stations/groups has been performed.
<ul style="list-style-type: none"> Remote password function MELSECNET diagnostics CC IE Control diagnostics CC IE Field diagnostics Ethernet diagnostics (PING test/loopback test with the Ethernet module (R/Q series)) 	—

(2) GOT station monitoring function

When the FA transparent function is used in an Ethernet connection, GOT station monitoring function cannot be operated.

Therefore, in the cases of [no connection target], [PLC power OFF], etc., the monitoring of the GOT delays for the timeout time.

■ When connecting the GOT multi-drop connection

FA transparent function is available for each GOT in the GOT multi-drop connection system.

- (1) Standard monitor OS installation, Communication driver writing
When using FA transparent function in GOT multi-drop connection, the writing of the standard monitor OS and communication driver to the GOT from GT Designer3 (Version 1.18U or later), as well as the writing of the standard monitor OS and communication driver to the serial multi-drop connection unit are required.
- (2) Number of personal computers
Only one personal computer can be connected to the multi-drop connection system.

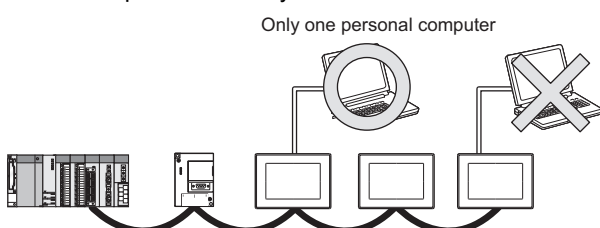

- (3) Monitor speed of GOT
The monitoring performance slows down according to the number of monitoring GOTs. While using FA transparent function, the monitoring performance of the whole multi-drop system decreases. As a result, timeout error may occur in GOTs in the system.

■ When connecting the GOT and personal computer with modem connection

When using the FA transparent function with a modem, the communication settings of compatible software, modem connection tool, modem and GOT must be set correctly to communicate with the GOT. If not correctly set, the communication cannot be performed.

■ When connecting the GOT and personal computer with serial or USB

When the operations shown below are executed, the operation is executed in the PLC. However, the display on the GOT may stop temporarily or the display of timeout may appear on GX Works3, GX Works2.

Operation*1	Remark
<ul style="list-style-type: none"> • Remote Reset 	Applied for the following operations specifying the currently selected station.
<ul style="list-style-type: none"> • Remote RUN • Remote STOP • Remote PAUSE • Remote STEP-RUN • Remote Reset • Remote latch clear • Write clock data 	Applied for the following operations specifying all the station.
<ul style="list-style-type: none"> • CC IE Control diagnostics (Link startup/stop) • CC IE Field diagnostics (Link startup/stop) 	—

*1 The remote operations only of when the connection type between the GOT and CPU is the direct CPU connection or computer link connection are applied.

23.7.2 When using GX Works3, GX Works2, GX Developer

■ When connecting to QCPU (A mode)

When connecting to QCPU (A mode), set the PLC type to "A4UCPU" or "QCPU (A mode)" on GX Works3, GX Works2, GX Developer.

■ When connecting the GOT and PC with RS-232

The [Transmission speed] setting in [PC side I/F Serial setting] in GX Works3, GX Works2, GX Developer must be within the range supported by the connected CPU.

CPU connected	Transmission speed
QCPU, FXCPU	9600bps, 19200bps, 38400bps, 57600bps, 115200bps
QnACPU	9600bps, 19200bps, 38400bps
ACPU	9600, 19200bps
Motion controller CPU (A series)	9600bps

■ When [monitor conditions] have been set on GX Works3, GX Works2, GX Developer

- (1) Monitoring performance of the GOT is temporarily suspended.
- (2) The GOT cannot respond to the touch switch operation and numerical/ascii inputs.
- (3) Writing to PLC results in a system alarm occurrence and displays the message, "315 Device writing error. Correct device."
- (4) While setting the monitor conditions, do not perform any operation which makes the GOT restart (e.g. downloading project data, changing utility data). Doing so may display a system alarm, "402 Communication timeout. Confirm communication pathway or modules." when the GOT restarts. When the monitor conditions setting for the PLC CPU has not been cancelled, reconnect GX Works3, GX Works2, GX Developer to cancel the setting.(An error may be output when the monitor conditions setting is cancelled.)
- (5) When the time check of GX Works3, GX Works2, GX Developer is set to 30 seconds or more in the monitor condition settings, the message "402 Communication timeout. Confirm communication pathway or modules." may appear. Set the time check time of GX Works3, GX Works2, GX Developer to 30 seconds or less.

■ When exiting GX Works3, GX Works2, GX Developer

For 45 seconds after GX Works3, GX Works2, GX Developer has been exited, the GOT continues monitoring at the same speed as when the FA transparent function is working.

■ When performing [Read to PLC], [Write to PLC] and other file operations on GX Works3, GX Works2, GX Developer

If any of the following GOT functions is executed during the file operation such as [Read to PLC] or [Write to PLC], an error may occur on the GOT, GX Works3, GX Works2, GX Developer.

In this case, take the following corrective action:

- File reading in the ladder monitor function for MELSEC-Q

Error messages on GOT	Corrective action on GOT side	Error messages on GX Developer and GX Works2	Corrective action on GX Developer and GX Works2
The file is not found.	With no file operation being executed on GX Developer or GX Works2, re-execute the file reading.	File access failure. Please retry.	With no file reading being executed in the ladder monitor function for MELSEC-Q, re-execute the file operation.

- Read/write of values of the file register specified for the recipe function

Error messages on GOT	Corrective action on GOT side	Error messages on GX Developer and GX Works2	Corrective action on GX Developer and GX Works2
358 PLC file access failure. Confirm PLC drive.*1	With no file operation on GX Works3, GX Works2, GX Developer, turn ON the trigger device for the recipe function again.	File access failure. Please retry. PLC file system error. Unable to communicate with PLC.	Execute the file access operation again with the recipe in-process signal in GOT system information OFF.

- Reading TC monitor set value in the system monitor function

Error messages on GOT	Corrective action on GOT side	Error messages on GX Developer and GX Works2	Corrective action on GX Developer and GX Works2
No message is displayed. (The TC set value space is blank.)	With no file operation being executed on GX Works3, GX Works2, GX Developer, re-execute the TC monitor.	File access failure. Please retry.	With no TC set value being read, re-execute the file operation.

*1 The numerical indicates the system alarm No.

- Reading the special module monitor CPU Malfunction log

Error messages on GOT	Corrective action on GOT side	Error messages on GX Developer and GX Works2	Corrective action on GX Developer and GX Works2
Communication error	With no file operation being executed on GX Works3, GX Works2, GX Developer, re-execute the CPU malfunction log reading.	File access failure. Please retry.	With no special module monitor malfunction log being read, execute the file operation.

- Backup/restore

Error messages on GOT	Corrective action on GOT side	Error messages on GX Developer and GX Works2	Corrective action on GX Developer and GX Works2
Backup	With no file operation being executed on GX Developer or GX Works2, re-execute the backup.	—	With no backup being executed, execute the file operation.
Restore	With no file operation being executed on GX Developer or GX Works2, re-execute the restore.	—	With no restore being executed, execute the file operation.

- SFC monitor file reading

Error messages on GOT	Corrective action on GOT side	Error messages on GX Developer and GX Works2	Corrective action on GX Developer and GX Works2
—	With no file operation being executed on GX Works3, GX Works2, GX Developer, re-execute the file reading.	—	With no special module monitor CPU malfunction log being read, execute the file operation.

• Reading/Writing files of ladder edit

Error messages on GOT	Corrective action on GOT side	Error messages on GX Developer and GX Works2	Corrective action on GX Developer and GX Works2
Read	With no file operation being executed on GX Works3, GX Works2 or GX Developer, re-execute the file reading.	—	With no file reading being executed on ladder edit, execute the file operation.
Write	With no file operation being executed on GX Works3, GX Works2 or GX Developer, re-execute the file writing.	—	With no file writing being executed on ladder edit, execute the file operation.

■ When PLC write is failed while using the FA transparent function

The execution of PLC write using the FA transparent function may be failed due to some reason such as cable disconnection.

When this occurs, re-execute the PLC write from the same personal computer, or reset the PLC CPU.

■ Restrictions on GX Developer during backup/restore execution

- (1) When reading/writing data from/to a PLC, monitoring a PLC, and others are executed with GX Developer or GX Works2 with the FA transparent function during the backup/restore execution with the GOT, the backup/restore is stopped.

Check that reading/writing data from/to the PLC, monitoring the PLC, and others are not executed with GX Developer or GX Works2 with the FA transparent function. Execute the backup/restore with the GOT again.

- (2) When the backup/restore is executed with the GOT while reading/writing data from/to a PLC, monitoring a PLC, and others are executed with GX Developer or GX Works2 with the FA transparent function, errors occur on GX Developer or GX Works2. The backup/restore with the GOT is correctly executed.

■ When connecting the GOT and personal computer with modem connection

(1) Timeout time settings

When the FA transparent function is used with a modem, it takes time for the initial communication with PLC and GX Works2 or GX Developer and a timeout may occur. In that case, set a longer time for the initial communication timeout time for the GOT modem connection tool.

(2) Communication settings

When the FA transparent function is used via modem, the communication setting differs depending on the connection target of the GOT.

Set as follows.

Target of the GOT	Setting item	Setting target				
		GT Designer3	GX Works2 *1	GX Developer *1	GOT modem connection tool	Communication settings of the GOT
FXCPU	Data length	8bits	7bits		8bits	
	Parity	None	Even		None	
	Stop bit	1bit	1bit		1bit	
QCPU	Data length	8bits				
	Parity	Odd				
	Stop bit	1bit				

*1 Communication settings of GX Works2/GX Developer are set automatically, and setting is not required.

■ When connecting the ACPU and motion controller CPU (A series) in bus connection

Do not execute write during RUN with GX Developer. An error may occur in the PLC due to the write during RUN, what may stop the PLC.

23.7.3 When using MT Developer, MT Works2

■ When exiting MT Developer, MT Works2

For 45 seconds after GX Developer, MT Works2 has been exited, the GOT continues monitoring at the same speed as when the FA transparent function is working.

■ When PLC write is failed while using the FA transparent function

The execution of PLC write using the FA transparent function may be failed due to some reasons such as cable disconnection.

When this occurs, re-execute the PLC write from the same personal computer, or reset the motion controller CPU.

■ When a cable disconnection has occurred

When the cable between the GOT and the motion CPU is disconnected, it takes time until a timeout error occurs in MT Developer.

23.7.4 When using MR Configurator, MR Configurator2

■ Unavailable functions and restrictions

For the use via the motion controller, there are unavailable functions and restrictions.

For details on the restrictions, refer to the help screen of MR Configurator.

■ Monitor speed of GOT

Since the FA transparent function is used via the motion CPU, the monitor speed of GOT is slow.

23.7.5 When using FR Configurator

■ GOT monitoring when using FA transparent function

When FA transparent function is used, GOT suspends monitoring on channels supporting FA transparent function.

POINT

Canceling the suspended GOT monitoring immediately

To cancel the suspended (45 seconds) GOT monitoring immediately after FA transparent is executed, input "1" to device GS457. Then GOT resumes monitoring.

If FA transparent is resumed even if "1" is already input to device GS457, an error will occur on FR Configurator.

For the details of the device, refer to the following manual.

 GT Designer3 Version□ Screen Design Manual

■ When using the oscilloscope function specified sampling

Since the monitoring of the inverter data may be not performed at the specified sampling intervals depending on the settings of oscilloscope function, adjust the communication setting, a sampling interval, etc.

■ PU mode operation command source selection

On the setting of PU mode operation command source selection (Pr:551) of the inverter, specify the terminal (1:RS-485 terminals, 2:PU connected) connected to GOT.

INDEX

[A]	
ABBREVIATIONS AND GENERIC TERMS	A-25
ACCESS RANGE FOR MONITORING	3-1
AnCPU type	
Bus connection	5-11
CC-Link connection (intelligent device station)	13-7
Computer link connection	7-15
Direct connection to CPU	6-11
Ethernet connection	8-8
MELSECNET/10 connection (PLC to PLC network)	10-8,10-9
AnSCPU type	
Bus connection	5-14
CC-Link connection (intelligent device station)	13-7
Computer link connection	7-16
Direct connection to CPU	6-11
Ethernet connection	8-8
MELSECNET/10 connection (PLC to PLC network)	10-8,10-9
[B]	
Built-in Ethernet port QCPU	8-12
Bus connection	5-1
[C]	
C Controller module	
Bus connection	5-7
CC-Link connection (intelligent device station)	13-7,13-9
CC-Link connection (via G4)	14-7
CC-Link IE Controller Network connection	11-8
Computer link connection	7-9
Direct connection to CPU	6-7
Ethernet connection	8-12
MELSECNET/10 connection (PLC to PLC network)	10-8,10-9
MELSECNET/H connection (PLC to PLC network)	9-8
CC-Link connection (intelligent device station)	13-1
CC-Link connection (via G4)	14-1
CC-Link IE Controller Network connection	11-1
CC-Link IE Field Network connection	12-1
CNC C70	
Bus connection	5-7
CC-Link connection (intelligent device station)	13-7,13-9
CC-Link connection (via G4)	14-7
CC-Link IE Controller Network connection	11-8
Computer link connection	7-9
Direct connection to CPU	6-7
Ethernet connection	8-14
MELSECNET/10 connection (PLC to PLC network)	10-8,10-9
MELSECNET/H connection (PLC to PLC network)	9-8
CNC connection	
CC-Link connection (intelligent device station)	18-5
Direct connection to CPU	18-3
Ethernet connection	18-6
MELSECNET/10 connection (PLC to PLC network)	18-4
CNC side settings	18-16
Coaxial cable	1-30
Communication module	1-18
Computer link connection	7-1
Connectable Model List	
Bus connection	5-2
CC-Link connection (intelligent device station)	13-2
CC-Link connection (via G4)	14-2
CC-Link IE Controller Network connection	11-2
CC-Link IE Field Network connection	12-2
CNC connection	18-2
Computer link connection	7-2
Direct connection to CPU	6-2
ENERGY MEASURING UNIT/ELECTRIC MULTI-MEASURING INSTRUMENT CONNECTION	19-2
Ethernet connection	8-2
GOT MULTI-DROP CONNECTION	20-2
INVERTER CONNECTION	15-2
MELSECNET/10 connection (PLC to PLC network)	10-2
MELSECNET/H connection (PLC to PLC network)	9-2
Multiple-GT14,GT12,GT11,GT10 connection function	21-2
ROBOT CONTROLLER CONNECTION	17-2
Servo amplifier connection	16-2
Connection Diagram	
CC-Link connection (via G4)	14-9
CNC connection	18-7
Computer link connection	7-17
Direct connection to CPU	6-27
ENERGY MEASURING UNIT/ELECTRIC MULTI-MEASURING INSTRUMENT CONNECTION	19-4
GOT MULTI-DROP CONNECTION	20-17
INVERTER CONNECTION	15-24
Multiple-GT14,GT12,GT11,GT10 connection function	21-5
Servo amplifier connection	16-9
Connector conversion adapter	1-19
Controller Type	1-6
Conversion cables	1-19

[D]	DEVICE RANGE THAT CAN BE SET..... 2-1	[I]	I/F..... 1-9
	Device Range that Can Be Set		I/F communication setting..... 1-13
	CNC connection..... 18-23		Inverter
	ENERGY MEASURING UNIT/ELECTRIC		FREQROL A500/A500L/F500/F500L/V500/
	MULTI-MEASURING INSTRUMENT		V500L..... 15-3
	CONNECTION..... 19-11		FREQROL A700/F700/F700P..... 15-14
	INVERTER CONNECTION..... 15-50		FREQROL E500/S500/S500E/F500J/D700/
	ROBOT CONTROLLER CONNECTION..... 17-8		F700PJ..... 15-7
	Servo amplifier connection..... 16-20		FREQROL E700..... 15-10
	Direct connection to CPU..... 6-1		INVERTER CONNECTION..... 15-1
			Inverter Side Settings..... 15-34
[E]	ENERGY MEASURING UNIT/ELECTRIC	[L]	LCP
	MULTI-MEASURING INSTRUMENT		CC-Link connection..... 14-8
	CONNECTION..... 19-1		Computer link connection..... 7-10
	Ethernet connection..... 8-1		Direct connection to CPU..... 6-8
[F]	FA transparent function..... 23-1,23-2		List of Models that Can Be Monitored..... 23-15
	FXCPU	[M]	MELSECNET/10 connection
	Direct connection to CPU..... 6-15		(PLC to PLC network)..... 10-1
	Ethernet connection..... 8-10		MELSECNET/H connection
[G]	GOT connector specifications..... 1-27		(PLC to PLC network)..... 9-1
	GOT MULTI-DROP CONNECTION..... 20-1,21-1		Motion controller CPU (A series)
	GOT Side Settings		Bus connection..... 5-21,5-26
	Bus connection..... 5-32		CC-Link connection
	CC-Link connection		(intelligent device station)..... 13-7
	(intelligent device station)..... 13-11		Computer link connection..... 7-15,7-16
	CC-Link connection (via G4)..... 14-10		Direct connection to CPU..... 6-11
	CC-Link IE Controller Network connection..... 11-9		Ethernet connection..... 8-8
	CC-Link IE Field Network connection..... 12-9		MELSECNET/10 connection
	CNC connection..... 18-8		(PLC to PLC network)..... 10-8,10-9
	Computer link connection..... 7-21		Motion controller CPU (Q series)
	Direct connection to CPU..... 6-30		Bus connection..... 5-7
	ENERGY MEASURING UNIT/ELECTRIC		CC-Link connection
	MULTI-MEASURING INSTRUMENT		(intelligent device station)..... 13-9
	CONNECTION..... 19-9		CC-Link connection (via G4)..... 14-7
	Ethernet connection..... 8-17		CC-Link IE Controller Network connection..... 11-8
	FA transparent function..... 23-45		Computer link connection..... 7-9
	GOT MULTI-DROP CONNECTION..... 20-25		Direct connection to CPU..... 6-7,6-25
	INVERTER CONNECTION..... 15-32		Ethernet connection..... 8-8
	MELSECNET/10 connection		MELSECNET/10 connection
	(PLC to PLC network)..... 10-10		(PLC to PLC network)..... 10-8,10-9
	MELSECNET/H connection		MELSECNET/H connection
	(PLC to PLC network)..... 9-10		(PLC to PLC network)..... 9-8
	MULTI-CHANNEL FUNCTION..... 22-7		MULTI-CHANNEL FUNCTION..... 22-1
	Multiple-GT14,GT12,GT11,GT10 connection		Multi-channel Function Check Sheet..... 22-42
	function..... 21-7		Multiple-GT14,GT12,GT11,GT10 connection
	ROBOT CONTROLLER CONNECTION..... 17-3		function..... 21-1
	Servo amplifier connection..... 16-15	[O]	Option unit..... 1-19
[H]	HOW TO MONITOR REDUNTANT SYSTEM..... 4-1	[P]	Personal Computer Side Setting..... 23-48

PLC Side Setting	
CC-Link connection	
(intelligent device station)	13-14
CC-Link IE Controller Network connection	11-11
CC-Link IE Field Network connection	12-11
Computer link connection	7-24
Ethernet connection	8-22
MELSECNET/10 connection	
(PLC to PLC network)	10-13
MELSECNET/H connection	
(PLC to PLC network)	9-12
ROBOT CONTROLLER CONNECTION	17-6
PLC Side Settings	
CC-Link connection (via G4).....	14-12
Precautions	
Bus connection	5-36
CC-Link connection	
(intelligent device station)	13-48
CC-Link connection (via G4).....	14-18
CC-Link IE Controller Network connection	11-25
CC-Link IE Field Network connection	12-19
CNC connection	18-23
Computer link connection	7-31
Direct connection to CPU.....	6-34
ENERGY MEASURING UNIT/ELECTRIC	
MULTI-MEASURING INSTRUMENT	
CONNECTION	19-12
Ethernet connection	8-62
FA transparent function.....	23-85
GOT MULTI-DROP CONNECTION.....	20-32
INVERTER CONNECTION.....	15-53
MELSECNET/10 connection	
(PLC to PLC network)	10-26
MELSECNET/H connection	
(PLC to PLC network)	9-17
MULTI-CHANNEL FUNCTION	22-41
Multiple-GT14,GT12,GT11,GT10 connection	
function	21-11
ROBOT CONTROLLER CONNECTION	17-8
Servo amplifier connection.....	16-58
PREPARATORY PROCEDURES FOR	
MONITORING	1-1
[Q]	
QCPU(A mode)	
CC-Link connection	
(intelligent device station)	13-7
Computer link connection	7-11
Direct connection to CPU.....	6-7
Ethernet connection	8-8
MELSECNET/10 connection	
(PLC to PLC network)	10-8,10-9
QCPU(Q mode)	
Bus connection	5-7
CC-Link connection	
(intelligent device station)	13-7,13-9
CC-Link connection (via G4).....	14-7
CC-Link IE Controller Network connection	11-8
CC-Link IE Field Network connection	12-8
Computer link connection	7-9
Direct connection to CPU.....	6-7
Ethernet connection	8-8
MELSECNET/10 connection	
(PLC to PLC network)	10-8,10-9
MELSECNET/H connection	
(PLC to PLC network)	9-8
ROBOT CONTROLLER CONNECTION	17-1
Direct connection to CPU.....	6-7
Ethernet connection	8-8
MELSECNET/10 connection	
(PLC to PLC network)	10-8,10-9
MELSECNET/H connection	
(PLC to PLC network)	9-8
ROBOT CONTROLLER CONNECTION	17-1
[R]	
Remote I/O station of MELSECNET/H network system	
Computer link connection.....	7-9
Direct connection to CPU	6-7
Ethernet connection	8-8
ROBOT CONTROLLER	
Bus connection.....	5-7
CC-Link connection	
(intelligent device station).....	13-7,13-9
CC-Link connection (via G4).....	14-7
CC-Link IE Controller Network connection.....	11-8
Computer link connection.....	7-9
Direct connection to CPU	6-7
Ethernet connection	8-8
MELSECNET/10 connection	
(PLC to PLC network)	10-8,10-9
MELSECNET/H connection	
(PLC to PLC network)	9-8
ROBOT CONTROLLER CONNECTION	17-1
[S]	
Serial Multi-Drop Connection Unit	1-19
Servo amplifier	
MELSERVO-J2M Series	16-4
MELSERVO-J2-Super Series	16-3
MELSERVO-J3 Series	16-5
Servo amplifier connection	16-1

Setting connected equipment	1-4
Setting of connection conversion adapter	20-31
Setting of Energy Measuring Unit/ Electric Multi-measuring Instrument	19-10
Setting of Serial Multi-Drop Connection Unit	20-26
Setting on Servo Amplifier Side	16-17
Station number setting	
ENERGY MEASURING UNIT/ELECTRIC	
MULTI-MEASURING INSTRUMENT	
CONNECTION	19-10
INVERTER CONNECTION	15-49
MELSERVO connection	16-19
System Configuration	
Bus connection	5-7
CC-Link connection	
(intelligent device station)	13-7
CC-Link connection (via G4)	14-7
CC-Link IE Controller Network connection	11-8
CC-Link IE Field Network connection	12-8
CNC connection	18-3
Computer link connection	7-8
Direct connection to CPU	6-7
ENERGY MEASURING UNIT/ELECTRIC	
MULTI-MEASURING INSTRUMENT	
CONNECTION	19-3
Ethernet connection	8-8
FA transparent function	23-34
GOT MULTI-DROP CONNECTION	20-16
INVERTER CONNECTION	15-3
MELSECNET/10 connection	
(PLC to PLC network)	10-8
MELSECNET/H connection	
(PLC to PLC network)	9-8
MULTI-CHANNEL FUNCTION	22-4
Multiple-GT14,GT12,GT11,GT10 connection	
function	21-2
ROBOT CONTROLLER CONNECTION	17-2
Servo amplifier connection	16-3

[T]

Terminating resistors of GOT	1-31
------------------------------------	------

[W]

What is Multi-channel Function?	22-2
---------------------------------------	------

REVISIONS

* The manual number is given on the bottom left of the back cover.

Print Date	* Manual Number	Revision
Oct., 2009	SH(NA)-080868ENG-A	First edition: Compatible with GT Works3 Version1.01B
Nov., 2009	SH(NA)-080868ENG-B	B edition: Compatible with GT Works3 Version1.05F <ul style="list-style-type: none"> • Compatible with iQ Works
Jan., 2010	SH(NA)-080868ENG-C	C edition: Compatible with GT Works3 Version1.10L <ul style="list-style-type: none"> • MELSEC-L compatible, MELSEC-FX (MELSEC-FX buffer memory compatible), FA transparent (GX Works2 compatible, NC Configurator compatible), GT10 motion controller CPU (Q series) connection compatible
May, 2010	SH(NA)-080868ENG-D	D edition: Compatible with GT Works3 Version1.14Q <ul style="list-style-type: none"> • Q50UDEH/Q100UDEH compatible, Q172DCPU-S1/Q173DCPU-S1 compatible, LJ72GF15-T2 compatible • GT16/GT15 GOT multi-drop connection compatible
Jun., 2010	SH(NA)-080868ENG-E	E edition: Compatible with GT Works3 Version1.17T <ul style="list-style-type: none"> • GT1675-VN, GT1672-VN, and GT1662-VN are added. • Q12DCCPU-V compatible, MELSEC-WS compatible, FA transparent (MX Component, MX Sheet and GX LogViewer compatible)
Oct., 2010	SH(NA)-080868ENG-F	F edition: Compatible with GT Works3 Version1.19V <ul style="list-style-type: none"> • Compatible with CC-Link IE Field Network Ethernet adapter module • FA transparent in GOT multi-drop connection compatible • Station monitoring function (Inverter connection) compatible • FA transparent (MR Configurator2 compatible)
Jan., 2011	SH(NA)-080868ENG-G	G edition: Compatible with GT Works3 Version1.23Z <ul style="list-style-type: none"> • CC IE Control extended mode compatible • Inverter connection with 31 modules, device range expansion compatible • FA transparent in LCPU Logging Configuration Tool compatible • FA transparent in Ethernet connection between GOT and personal computer compatible
Apr., 2011	SH(NA)-080868ENG-H	H edition: Compatible with GT Works3 Version1.28E <ul style="list-style-type: none"> • GT1655-V is added.
Jul., 2011	SH(NA)-080868ENG-I	I edition: Compatible with GT Works3 Version1.31H <ul style="list-style-type: none"> • CC-Link IE Field Network compatible • Communication setting storage and error information notification in GOT multi-drop connection compatible • FA transparent (MX Component) in Ethernet connection between personal computer and GOT compatible • Device range expansion (D and W of QCPU and X, Y, Ww, and Wr of LCPU) compatible • Communication setting format 2 compatible
Oct., 2011	SH(NA)-080868ENG-J	J edition: Compatible with GT Works3 Version1.37P <ul style="list-style-type: none"> • GT14, GT12 are added. • Station shutoff function (Inverter connection) compatible • CC-Link IE Field Network compatible model (QS001CPU) are added. • Note about Ethernet connection (FXCPU) are added.
Jan., 2012	SH(NA)-080868ENG-K	K edition: Compatible with GT Works3 Version1.40S <ul style="list-style-type: none"> • "I/F Communication Setting" is compatible with "5V power supply". • CC-Link IE field extended device of QSCPU compatible • Station shutoff function for the network connection via PLC CPU compatible • Station number setting function compatible (multi-drop system information function expanded) • FA transparent in Ethernet connection between GOT and personal computer compatible (FXCPU, motion CPU, MELSERVO) • RS-232/485 signal conversion adaptor is added.
Apr., 2012	SH(NA)-080868ENG-L	L edition: Compatible with GT Works3 Version1.45X <ul style="list-style-type: none"> • FX_{3cc} compatible • Q172DSCPU/Q173DSCPU compatible
Jun., 2012	SH(NA)-080868ENG-M	M edition: Compatible with GT Works3 Version1.54G <ul style="list-style-type: none"> • Ethernet connection; Timeout time setting range is extended. • MELSERVO-J4 series compatible • Ping test at the GT14 main unit compatible
Sep., 2012	SH(NA)-080868ENG-N	N edition: Compatible with GT Works3 Version1.58L <ul style="list-style-type: none"> • Device G compatible

* The manual number is given on the bottom left of the back cover.

Print Date	* Manual Number	Revision
Nov., 2012	SH(NA)-080868ENG-O	Compatible with GT Works3 Version1.63R <ul style="list-style-type: none"> • SAFETY PRECAUTIONS is changed. • C Controller module (Q24DHCCPU-V) compatible • FX_{3U}-ENET-ADP compatible • Inverter connection (MELIPM series) compatible • FA transparent function (MX Component 4.00A) compatible
Feb., 2013	SH(NA)-080868ENG-P	Compatible with GT Works3 Version1.67V <ul style="list-style-type: none"> • High-speed QnU (QnUDVCPU) compatible • MELSEC-L models (L26CPU/L02SCPU, LJ71E71-100) are added. • FA transparent function (Setting/Monitoring tool for C Controller module) compatible • FA transparent function (FXCPU) compatible
May, 2013	SH(NA)-080868ENG-Q	Compatible with GT Works3 Version1.70Y <ul style="list-style-type: none"> • A MELSEC-L model (L06CPU) is added. • A Motion CPU model (Q170MSCPU(-S1)) is added. • The name of LCPU Logging Configuration Tool is changed to QnUDVCPU•LCPU Logging Configuration Tool.
Jun., 2013	SH(NA)-080868ENG-R	Compatible with GT Works3 Version1.74C <ul style="list-style-type: none"> • MELSEC-L models (L06CPU/L26CPU/L02SCPU-P) are added. • FX3S compatible • C Controller module (Q24DHCCPU-LS) compatible • Robot controller (CR750/751-Q, CR750/751-D) compatible • Energy measuring unit/Electric multi-measuring instrument connection compatible
Oct., 2013	SH(NA)-080868ENG-S	Compatible with GT Works3 Version1.105K <ul style="list-style-type: none"> • FX_{3U}-232-ADP-MB compatible • RS-422/485 adapter (L6ADP-R4) compatible • FA transparent function (MX Component 4.03D) compatible
Jan., 2014	SH(NA)-080868ENG-T	Compatible with GT Works3 Version1.108N <ul style="list-style-type: none"> • FX_{3GE} compatible • FREQROL-A800/F800, E700EX compatible • MELSERVO-JE compatible
Apr., 2014	SH(NA)-080868ENG-U	Compatible with GT Works3 Version1.112S <ul style="list-style-type: none"> • Q24DHCCPU-VG is supported.
Jun., 2014	SH(NA)-080868ENG-V	Compatible with GT Works3 Version1.117X <ul style="list-style-type: none"> • MELSEC iQ-R series are supported. • Communication driver (Serial (MELSEC)) is supported.
Jul., 2014	SH(NA)-080868ENG-W	Compatible with GT Works3 Version1.118Y <ul style="list-style-type: none"> • MELSEC-WS (WS0-CPU3) is supported.
Oct., 2014	SH(NA)-080868ENG-X	Compatible with GT Works3 Version1.122C <ul style="list-style-type: none"> • GT14 models (GT1450-QMBDE and GT1450-QMBD) are added. • The name of QnUDVCPU•LCPU Logging Configuration Tool is changed to CPU Module Logging Configuration. • The FA transparent function through CC-Link IE Controller Network is supported.
Jan., 2015	SH(NA)-080868ENG-Y	Compatible with GT Works3 Version1.126G <ul style="list-style-type: none"> • C Controller module (MELSEC iQ-R Series) is supported. • MELSEC iQ-F Series is supported. • FA Transparent Function MELSEC iQ-R Series MX Component, MX Sheet are supported. C Controller module (MELSEC iQ-R Series) CW Configurator is supported. • Servo amplifier connection MELSERVO-J4-*A-RJ compatible
Apr., 2015	SH(NA)-080868ENG-Z	Compatible with GT Works3 Version1.130L <ul style="list-style-type: none"> • Some corrections
Jul., 2015	SH(NA)-080868ENG-AA	Compatible with GT Works3 Version1.136S <ul style="list-style-type: none"> • MELSEC iQ-R Series RnENCPU connection is supported. • MELSEC iQ-R Series Device range extension (extended SRAM cassette is supported).
Oct., 2015	SH(NA)-080868ENG-AB	Compatible with GT Works3 Version1.144A <ul style="list-style-type: none"> • MELSEC iQ-R Series RnSFCPU connection is supported.

Print Date	* Manual Number	Revision
Dec., 2015	SH(NA)-080868ENG-AC	Compatible with GT Works3 Version1.150G <ul style="list-style-type: none"> • Q26DHCCPU-LS is supported. • FA Transparent Function MX Component Ver 4.11M is supported.
May, 2016	SH(NA)-080868ENG-AD	Some corrections
Jun., 2017	SH(NA)-080868ENG-AE	Partial corrections.
Jul., 2018	SH(NA)-080868ENG-AF	Some corrections
Oct., 2020	SH(NA)-080868ENG-AG	Some corrections
Jul., 2022	SH(NA)-080868ENG-AH	Some corrections
Apr., 2023	SH(NA)-080868ENG-AJ	Compatible with GT Works3 Version1.290C <ul style="list-style-type: none"> • The name of the communication driver for Ethernet connection to ALLEN-BRADLEY PLC has been changed.

This manual confers no industrial property rights or any rights of any other kind, nor does it confer any patent licenses. Mitsubishi Electric Corporation cannot be held responsible for any problems involving industrial property rights which may occur as a result of using the contents noted in this manual.

WARRANTY

Please check the following product warranty details before using this product.

■1. **Gratis Warranty Term and Gratis Warranty Range**

If any faults or defects (hereinafter "Failure") found to be the responsibility of Mitsubishi occurs during use of the product within the gratis warranty term, the product shall be repaired at no cost via the sales representative or Mitsubishi Service Company. However, if repairs are required onsite at domestic or overseas location, expenses to send an engineer will be solely at the customer's discretion.

Mitsubishi shall not be held responsible for any re-commissioning, maintenance, or testing on-site that involves replacement of the failed module.

(1) **Gratis Warranty Term**

The gratis warranty term of the product shall be for thirty-six (36) months after the date of purchase or delivery to a designated place.

Note that after manufacture and shipment from Mitsubishi, the maximum distribution period shall be six (6) months, and the longest gratis warranty term after manufacturing shall be forty-two (42) months.

The gratis warranty term of repair parts shall not exceed the gratis warranty term before repairs.

(2) **Gratis Warranty Range**

- (a) The customer shall be responsible for the primary failure diagnosis unless otherwise specified.
If requested by the customer, Mitsubishi Electric Corporation or its representative firm may carry out the primary failure diagnosis at the customer's expense.
The primary failure diagnosis will, however, be free of charge should the cause of failure be attributable to Mitsubishi Electric Corporation.
- (b) The range shall be limited to normal use within the usage state, usage methods, and usage environment, etc., which follow the conditions and precautions, etc., given in the instruction manual, user's manual and caution labels on the product.
- (c) Even within the gratis warranty term, repairs shall be charged in the following cases.
 - Failure occurring from inappropriate storage or handling, carelessness or negligence by the user. Failure caused by the user's hardware or software design.
 - Failure caused by unapproved modifications, etc., to the product by the user.
 - When the Mitsubishi product is assembled into a user's device, Failure that could have been avoided if functions or structures, judged as necessary in the legal safety measures the user's device is subject to or as necessary by industry standards, had been provided.
 - Failure that could have been avoided if consumable parts designated in the instruction manual had been correctly serviced or replaced.
 - Replacing consumable parts such as a battery, backlight, and fuse.
 - Failure caused by external irresistible forces such as fires or abnormal voltages, and Failure caused by force majeure such as earthquakes, lightning, wind and water damage.
 - Failure caused by reasons that could not be predicted by scientific technology standards at the time of shipment from Mitsubishi.
 - Any other failure found not to be the responsibility of Mitsubishi or that admitted not to be so by the user.

■2. **Onerous repair term after discontinuation of production**

- (1) Mitsubishi shall accept onerous product repairs for seven (7) years after production of the product is discontinued. Discontinuation of production shall be notified with Mitsubishi Technical Bulletins, etc.
- (2) Mitsubishi shall not accept a request for product supply (including spare parts) after production is discontinued.

■3. **Overseas service**

Overseas, repairs shall be accepted by Mitsubishi's local overseas FA Center.

Note that the repair conditions at each FA Center may differ.

■4. **Exclusion of loss in opportunity and secondary loss from warranty liability**

Regardless of the gratis warranty term, Mitsubishi shall not be liable for compensation to:

- (1) Damages caused by any cause found not to be the responsibility of Mitsubishi.
- (2) Loss in opportunity, lost profits incurred to the user by Failures of Mitsubishi products.
- (3) Special damages and secondary damages whether foreseeable or not, compensation for accidents, and compensation for damages to products other than Mitsubishi products.
- (4) Replacement by the user, maintenance of on-site equipment, start-up test run and other tasks.

■5. **Changes in product specifications**

The specifications given in the catalogs, manuals, or technical documents are subject to change without prior notice.

■6. **Product application**

- (1) In using the Mitsubishi graphic operation terminal, the usage conditions shall be that the application will not lead to a major accident even if any problem or fault should occur in the graphic operation terminal device, and that backup and fail-safe functions are systematically provided outside of the device for any problem or fault.
- (2) The Mitsubishi graphic operation terminal has been designed and manufactured for applications in general industries, etc. Thus, applications in which the public could be affected such as in nuclear power plants and other power plants operated by respective power companies, and applications in which a special quality assurance system is required, such as for Railway companies or Public service shall be excluded from the graphic operation terminal applications.
In addition, applications in which human life or property could be greatly affected, such as in aircraft, medical, railway applications, incineration and fuel devices, manned transportation equipment, recreation and amusement devices, safety devices, shall also be excluded from the graphic operation terminal.
Even for the above applications, however, Mitsubishi Electric Corporation may consider the possibility of an application, provided that the customer notifies Mitsubishi Electric Corporation of the intention, the application is clearly defined and any special quality is not required, after the user consults the local Mitsubishi representative.

Intellectual Property Rights

■ Trademarks

GOT is a registered trademark of Mitsubishi Electric Corporation.

Microsoft, Microsoft Access, Excel, SQL Server, Visual Basic, Visual C++, Visual C#, Windows, Windows NT, Windows Server, and Windows Vista are trademarks of the Microsoft group of companies.

Adobe and Adobe Reader are registered trademarks of Adobe Systems Incorporated.

Intel, Intel Core, Pentium, and Celeron are trademarks or registered trademarks of Intel Corporation in the United States and other countries.

MODBUS is a trademark of Schneider Electric SA.

VNC is a registered trademark of RealVNC Ltd. in the United States and other countries.

Other company and product names herein are either trademarks or registered trademarks of their respective owners.

■ Copyrights

The screens (screenshots) are used in accordance with the Microsoft Corporation guideline.

GRAPHIC OPERATION TERMINAL

GOT1000 Series

Connection Manual

(Mitsubishi Electric Products)

for GT Works3

MODEL	SW1-GTD3-U(CON1)-E
MODEL CODE	_____
SH(NA)-080868ENG-AJ(2304)MEE	

MITSUBISHI ELECTRIC CORPORATION

HEAD OFFICE: TOKYO BLDG., 2-7-3, MARUNOUCHI, CHIYODA-KU, TOKYO 100-8310, JAPAN
NAGOYA WORKS: 1-14, YADA-MINAMI 5-CHOME, HIGASHI-KU, NAGOYA 461-8670, JAPAN

When exported from Japan, this manual does not require application to the Ministry of Economy, Trade and Industry for service transaction permission.

Specifications subject to change without notice.