

# MITSUBISHI

Mitsubishi Programmable Controller

MELSEC *L*<sub>series</sub>

---

## MELSEC-L LD77MH Simple Motion Module User's Manual

Positioning Control

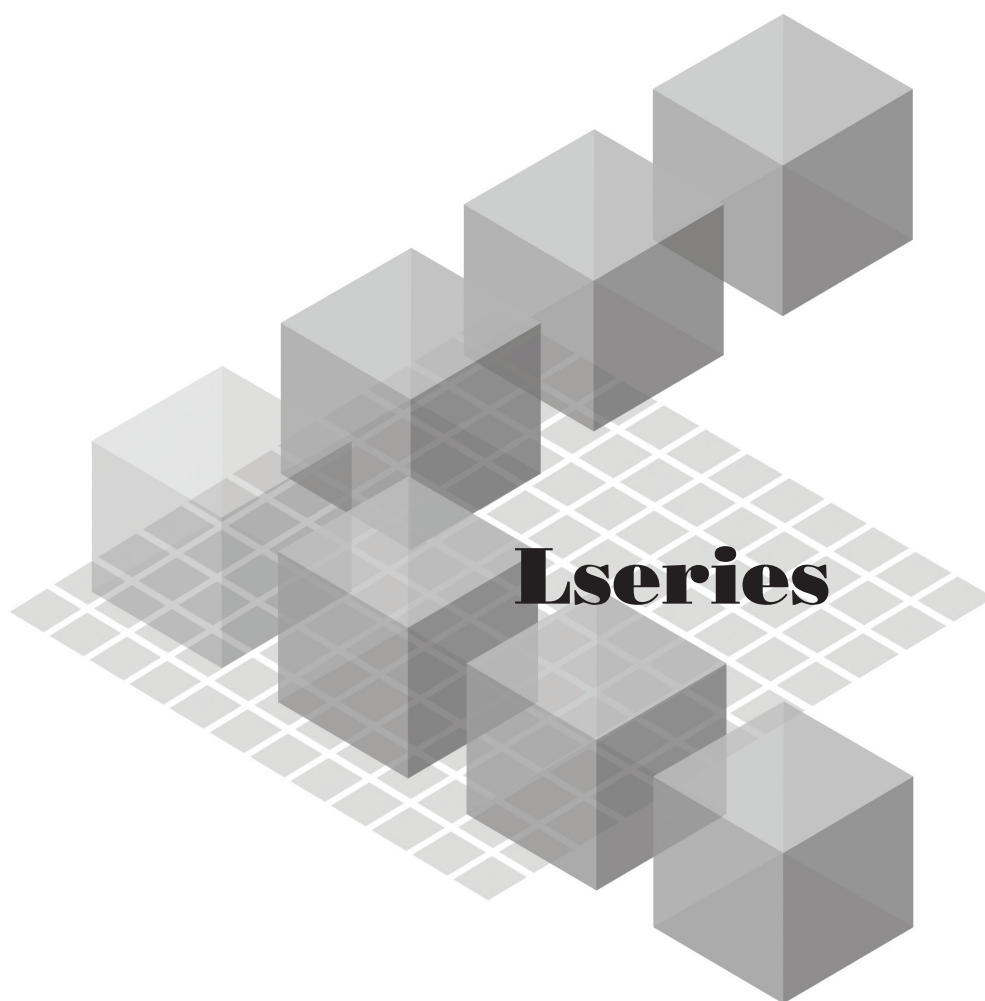

-LD77MH4  
-LD77MH16

MODEL

## ● SAFETY PRECAUTIONS ●

(Please read these instructions before using this equipment.)

Before using this product, please read this manual and the relevant manuals introduced in this manual carefully and pay full attention to safety to handle the product correctly.

Refer to the Users manual of the CPU module to use for a description of the PLC system safety precautions.

In this manual, the safety instructions are ranked as "DANGER" and "CAUTION".



**DANGER**

Indicates that incorrect handling may cause hazardous conditions, resulting in death or severe injury.



**CAUTION**

Indicates that incorrect handling may cause hazardous conditions, resulting in medium or slight personal injury or physical damage.

Depending on circumstances, procedures indicated by  CAUTION may also be linked to serious results.

In any case, it is important to follow the directions for usage.

Please save this manual to make it accessible when required and always forward it to the end user.

## For Safe Operations

### 1. Prevention of electric shocks

#### DANGER

- Never open the front case or terminal covers while the power is ON or the unit is running, as this may lead to electric shocks.
- Never run the unit with the front case or terminal cover removed. The high voltage terminal and charged sections will be exposed and may lead to electric shocks.
- Never open the front case or terminal cover at times other than wiring work or periodic inspections even if the power is OFF. The insides of the module and servo amplifier are charged and may lead to electric shocks.
- Completely turn off the externally supplied power used in the system before mounting or removing the module, performing wiring work, or inspections. Failing to do so may lead to electric shocks.
- When performing wiring work or inspections, turn the power OFF, wait at least ten minutes, and then check the voltage with a tester, etc. Failing to do so may lead to electric shocks.
- Be sure to ground the module, servo amplifier and servomotor (Ground resistance: 100  $\Omega$  or less). Do not ground commonly with other devices.
- The wiring work and inspections must be done by a qualified technician.
- Wire the units after installing the module, servo amplifier and servomotor. Failing to do so may lead to electric shocks or damage.
- Never operate the switches with wet hands, as this may lead to electric shocks.
- Do not damage, apply excessive stress, place heavy things on or sandwich the cables, as this may lead to electric shocks.
- Do not touch the module, servo amplifier, servomotor connector or terminal blocks while the power is ON, as this may lead to electric shocks.
- Do not touch the built-in power supply, built-in grounding or signal wires of the module and servo amplifier, as this may lead to electric shocks.

### 2. For fire prevention

#### CAUTION

- Install the module, servo amplifier, servomotor and regenerative resistor on incombustible. Installing them directly or close to combustibles will lead to fire.
- If a fault occurs in the module or servo amplifier, shut the power OFF at the servo amplifier's power source. If a large current continues to flow, fire may occur.
- When using a regenerative resistor, shut the power OFF with an error signal. The regenerative resistor may abnormally overheat due to a fault in the regenerative transistor, etc., and may lead to fire.
- Always take heat measures such as flame proofing for the inside of the control panel where the servo amplifier or regenerative resistor is installed and for the wires used. Failing to do so may lead to fire.
- Do not damage, apply excessive stress, place heavy things on or sandwich the cables, as this may lead to fire.

### 3. For injury prevention

#### CAUTION

- Do not apply a voltage other than that specified in the instruction manual on any terminal. Doing so may lead to destruction or damage.
- Do not mistake the terminal connections, as this may lead to destruction or damage.
- Do not mistake the polarity ( + / - ), as this may lead to destruction or damage.
- Do not touch the heat radiating fins of module or servo amplifier, regenerative resistor and servomotor, etc., while the power is ON and for a short time after the power is turned OFF. In this timing, these parts become very hot and may lead to burns.
- Always turn the power OFF before touching the servomotor shaft or coupled machines, as these parts may lead to injuries.
- Do not go near the machine during test operations or during operations such as teaching. Doing so may lead to injuries.

### 4. Various precautions

Strictly observe the following precautions. Mistaken handling of the unit may lead to faults, injuries or electric shocks.

#### (1) System structure

#### CAUTION

- Always install a leakage breaker on the module and servo amplifier power source.
- If installation of an electromagnetic contactor for power shut off during an error, etc., is specified in the instruction manual for the servo amplifier, etc., always install the electromagnetic contactor.
- Install the emergency stop circuit externally so that the operation can be stopped immediately and the power shut off.
- Use the module, servo amplifier, servomotor and regenerative resistor with the correct combinations listed in the instruction manual. Other combinations may lead to fire or faults.
- Use the CPU module and Simple Motion module with the correct combinations listed in the instruction manual. Other combinations may lead to faults.
- If safety standards (ex., robot safety rules, etc.,) apply to the system using the module, servo amplifier and servomotor, make sure that the safety standards are satisfied.
- Construct a safety circuit externally of the module or servo amplifier if the abnormal operation of the module or servo amplifier differ from the safety directive operation in the system.
- In systems where coasting of the servomotor will be a problem during the forced stop, emergency stop, servo OFF or power supply OFF, use dynamic brakes.
- Make sure that the system considers the coasting amount even when using dynamic brakes.
- In systems where perpendicular shaft dropping may be a problem during the forced stop, emergency stop, servo OFF or power supply OFF, use both dynamic brakes and electromagnetic brakes.
- The dynamic brakes must be used only on errors that cause the forced stop, emergency stop, or servo OFF. These brakes must not be used for normal braking.
- The brakes (electromagnetic brakes) assembled into the servomotor are for holding applications, and must not be used for normal braking.

## CAUTION

- The system must have a mechanical allowance so that the machine itself can stop even if the stroke limits switch is passed through at the max. speed.
- Use wires and cables that have a wire diameter, heat resistance and bending resistance compatible with the system.
- Use wires and cables within the length of the range described in the instruction manual.
- The ratings and characteristics of the parts (other than module, servo amplifier and servomotor) used in a system must be compatible with the module, servo amplifier and servomotor.
- Install a cover on the shaft so that the rotary parts of the servomotor are not touched during operation.
- There may be some cases where holding by the electromagnetic brakes is not possible due to the life or mechanical structure (when the ball screw and servomotor are connected with a timing belt, etc.). Install a stopping device to ensure safety on the machine side.

### (2) Parameter settings and programming

## CAUTION

- Set the parameter values to those that are compatible with the module, servo amplifier, servomotor and regenerative resistor model and the system application. The protective functions may not function if the settings are incorrect.
- The regenerative resistor model and capacity parameters must be set to values that conform to the operation mode and servo amplifier. The protective functions may not function if the settings are incorrect.
- Set the mechanical brake output and dynamic brake output validity parameters to values that are compatible with the system application. The protective functions may not function if the settings are incorrect.
- Set the stroke limit input validity parameter to a value that is compatible with the system application. The protective functions may not function if the setting is incorrect.
- Set the servomotor encoder type (increment, absolute position type, etc.) parameter to a value that is compatible with the system application. The protective functions may not function if the setting is incorrect.
- Set the servomotor capacity and type (standard, low-inertia, flat, etc.) parameter to values that are compatible with the system application. The protective functions may not function if the settings are incorrect.
- Set the servo amplifier capacity and type parameters to values that are compatible with the system application. The protective functions may not function if the settings are incorrect.
- Use the program commands for the program with the conditions specified in the instruction manual.
- Set the sequence function program capacity setting, device capacity, latch validity range, I/O assignment setting, and validity of continuous operation during error detection to values that are compatible with the system application. The protective functions may not function if the settings are incorrect.

## CAUTION

- Some devices used in the program have fixed applications, so use these with the conditions specified in the instruction manual.
- The input devices and data registers assigned to the link will hold the data previous to when communication is terminated by an error, etc. Thus, an error correspondence interlock program specified in the instruction manual must be used.
- Use the interlock program specified in the intelligent function module's instruction manual for the program corresponding to the intelligent function module.

### (3) Transportation and installation

## CAUTION

- Transport the product with the correct method according to the mass.
- Use the servomotor suspension bolts only for the transportation of the servomotor. Do not transport the servomotor with machine installed on it.
- Do not stack products past the limit.
- When transporting the module or servo amplifier, never hold the connected wires or cables.
- When transporting the servomotor, never hold the cables, shaft or detector.
- When transporting the module or servo amplifier, never hold the front case as it may fall off.
- When transporting, installing or removing the module or servo amplifier, never hold the edges.
- Install the unit according to the instruction manual in a place where the mass can be withstood.
- Do not get on or place heavy objects on the product.
- Always observe the installation direction.
- Keep the designated clearance between the module or servo amplifier and control panel inner surface or the module and servo amplifier, module or servo amplifier and other devices.
- Do not install or operate modules, servo amplifiers or servomotors that are damaged or that have missing parts.
- Do not block the intake/outtake ports of the servo amplifier and servomotor with cooling fan.
- Do not allow conductive matter such as screw or cutting chips or combustible matter such as oil enter the module, servo amplifier or servomotor.
- The module, servo amplifier and servomotor are precision machines, so do not drop or apply strong impacts on them.
- Securely fix the module, servo amplifier and servomotor to the machine according to the instruction manual. If the fixing is insufficient, these may come off during operation.
- Always install the servomotor with reduction gears in the designated direction. Failing to do so may lead to oil leaks.

## ⚠ CAUTION

- Store and use the unit in the following environmental conditions.

Environment	Conditions	
	Module/Servo amplifier	Servomotor
Ambient temperature	According to each instruction manual.	0°C to +40°C (With no freezing) (32°F to +104°F)
Ambient humidity	According to each instruction manual.	80% RH or less (With no dew condensation)
Storage temperature	According to each instruction manual.	-20°C to +65°C (-4°F to +149°F)
Atmosphere	Indoors (where not subject to direct sunlight). No corrosive gases, flammable gases, oil mist or dust must exist	
Altitude	1000m (3280.84ft.) or less above sea level	
Vibration	According to each instruction manual	

- When coupling with the servomotor shaft end, do not apply impact such as by hitting with a hammer. Doing so may lead to detector damage.
- Do not apply a load larger than the tolerable load onto the servomotor shaft. Doing so may lead to shaft breakage.
- When not using the module for a long time, disconnect the power line from the module or servo amplifier.
- Place the module and servo amplifier in static electricity preventing vinyl bags and store.
- When storing for a long time, please contact with our sales representative.  
Also, execute a trial operation.
- Make sure that the connectors for the servo amplifier and peripheral devices have been securely installed until a click is heard.  
Not doing so could lead to a poor connection, resulting in erroneous input and output.

### (4) Wiring

## ⚠ CAUTION

- Correctly and securely wire the wires. Reconfirm the connections for mistakes and the terminal screws for tightness after wiring. Failing to do so may lead to run away of the servomotor.
- After wiring, install the protective covers such as the terminal covers to the original positions.
- Do not install a phase advancing capacitor, surge absorber or radio noise filter (option FR-BIF) on the output side of the servo amplifier.
- Correctly connect the output side (terminal U, V, W). Incorrect connections will lead the servomotor to operate abnormally.
- Do not connect a commercial power supply to the servomotor, as this may lead to trouble.

## ⚠ CAUTION

- Do not mistake the direction of the surge absorbing diode installed on the DC relay for the control signal output of brake signals, etc. Incorrect installation may lead to signals not being output when trouble occurs or the protective functions not functioning.

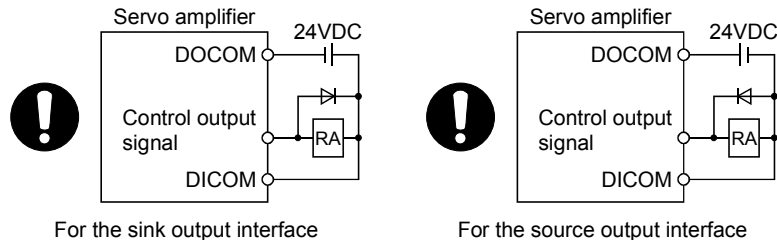

- Do not connect or disconnect the connection cables between each unit, the encoder cable or PLC expansion cable while the power is ON.
- Securely tighten the cable connector fixing screws and fixing mechanisms. Insufficient fixing may lead to the cables coming off during operation.
- Do not bundle the power line or cables.
- Use applicable solderless terminals and tighten them with the specified torque.  
If any solderless spade terminal is used, it may be disconnected when the terminal screw comes loose, resulting in failure.

### (5) Trial operation and adjustment

## ⚠ CAUTION

- Confirm and adjust the program and each parameter before operation. Unpredictable movements may occur depending on the machine.
- Extreme adjustments and changes may lead to unstable operation, so never make them.
- When using the absolute position system function, on starting up, and when the module or absolute value motor has been replaced, always perform a home position return.
- Before starting test operation, set the parameter speed limit value to the slowest value, and make sure that operation can be stopped immediately by the forced stop, etc. if a hazardous state occurs.



(6) Usage methods

**⚠ CAUTION**

- Immediately turn OFF the power if smoke, abnormal sounds or odors are emitted from the module, servo amplifier or servomotor.
- Always execute a test operation before starting actual operations after the program or parameters have been changed or after maintenance and inspection.
- Do not attempt to disassemble and repair the units excluding a qualified technician whom our company recognized.
- Do not make any modifications to the unit.
- Keep the effect or electromagnetic obstacles to a minimum by installing a noise filter or by using wire shields, etc.  
Electromagnetic obstacles may affect the electronic devices used near the module or servo amplifier.
- When using the CE Mark-compliant equipment design, refer to the "EMC Installation Guidelines" (data number IB(NA)-67339) and refer to the corresponding EMC guideline information for the servo amplifiers and other equipment.
- Note that when the reference axis speed is designated for interpolation operation, the speed of the partner axis (2nd axis, 3rd axis and 4th axis) may be larger than the set speed (larger than the speed limit value).
- Use the units with the following conditions.

Item	Conditions	
	L61P	L63P
Input power	100 to 240VAC <sup>+10%</sup> <sub>-15%</sub> (85 to 264VAC)	24VDC <sup>+30%</sup> <sub>-35%</sub> (15.6 to 31.2VDC)
Input frequency	50/60Hz ±5%	
Tolerable momentary power failure	10ms or less	

## (7) Corrective actions for errors

### ⚠ CAUTION

- If an error occurs in the self diagnosis of the module or servo amplifier, confirm the check details according to the instruction manual, and restore the operation.
- If a dangerous state is predicted in case of a power failure or product failure, use a servomotor with electromagnetic brakes or install a brake mechanism externally.
- Use a double circuit construction so that the electromagnetic brake operation circuit can be operated by emergency stop signals set externally.

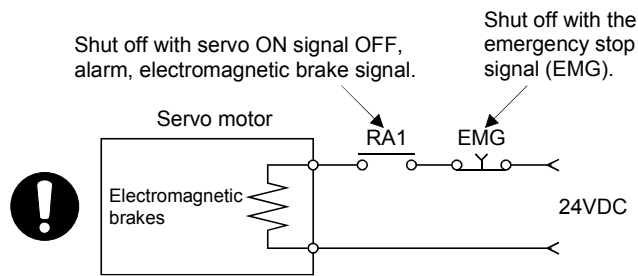

- If an error occurs, remove the cause, secure the safety and then resume operation after alarm release.
- The unit may suddenly resume operation after a power failure is restored, so do not go near the machine. (Design the machine so that personal safety can be ensured even if the machine restarts suddenly.)

## (8) Maintenance, inspection and part replacement

### ⚠ CAUTION

- Perform the daily and periodic inspections according to the instruction manual.
- Perform maintenance and inspection after backing up the program and parameters for the module and servo amplifier.
- Do not place fingers or hands in the clearance when opening or closing any opening.
- Periodically replace consumable parts such as batteries according to the instruction manual.
- Do not touch the lead sections such as ICs or the connector contacts.
- Before touching the module, always touch grounded metal, etc. to discharge static electricity from human body. Failure to do so may cause the module to fail or malfunction.
- Do not directly touch the module's conductive parts and electronic components. Touching them could cause an operation failure or give damage to the module.
- Do not place the module or servo amplifier on metal that may cause a power leakage or wood, plastic or vinyl that may cause static electricity buildup.
- Do not perform a megger test (insulation resistance measurement) during inspection.
- When replacing the module or servo amplifier, always set the new module settings correctly.

## ⚠ CAUTION

- When the module or absolute value motor has been replaced, carry out a home position return operation using one of the following methods, otherwise position displacement could occur.
  - 1) After writing the servo data to the Simple Motion module using programming software, switch on the power again, then perform a home position return operation.
- After maintenance and inspections are completed, confirm that the position detection of the absolute position detector function is correct.
- Do not drop or impact the battery installed to the module.  
Doing so may damage the battery, causing battery liquid to leak in the battery. Do not use the dropped or impacted battery, but dispose of it.
- Do not short circuit, charge, overheat, incinerate or disassemble the batteries.
- The electrolytic capacitor will generate gas during a fault, so do not place your face near the module or servo amplifier.
- The electrolytic capacitor and fan will deteriorate. Periodically replace these to prevent secondary damage from faults. Replacements can be made by our sales representative.
- Lock the control panel and prevent access to those who are not certified to handle or install electric equipment.
- Do not mount/remove the module or terminal block more than 50 times (IEC61131-2-compliant), after the first use of the product. Failure to do so may cause malfunction.
- Do not burn or break a module and servo amplifier. Doing so may cause a toxic gas.

### (9) About processing of waste

When you discard module, servo amplifier, a battery (primary battery) and other option articles, please follow the law of each country (area).

## ⚠ CAUTION

- This product is not designed or manufactured to be used in equipment or systems in situations that can affect or endanger human life.
- When considering this product for operation in special applications such as machinery or systems used in passenger transportation, medical, aerospace, atomic power, electric power, or submarine repeating applications, please contact your nearest Mitsubishi sales representative.
- Although this product was manufactured under conditions of strict quality control, you are strongly advised to install safety devices to forestall serious accidents when it is used in facilities where a breakdown in the product is likely to cause a serious accident.

### (10) General cautions

## ⚠ CAUTION

- All drawings provided in the instruction manual show the state with the covers and safety partitions removed to explain detailed sections. When operating the product, always return the covers and partitions to the designated positions, and operate according to the instruction manual.

## ● CONDITIONS OF USE FOR THE PRODUCT ●

- (1) Mitsubishi programmable controller ("the PRODUCT") shall be used in conditions;
  - i) where any problem, fault or failure occurring in the PRODUCT, if any, shall not lead to any major or serious accident; and
  - ii) where the backup and fail-safe function are systematically or automatically provided outside of the PRODUCT for the case of any problem, fault or failure occurring in the PRODUCT.
- (2) The PRODUCT has been designed and manufactured for the purpose of being used in general industries. MITSUBISHI SHALL HAVE NO RESPONSIBILITY OR LIABILITY (INCLUDING, BUT NOT LIMITED TO ANY AND ALL RESPONSIBILITY OR LIABILITY BASED ON CONTRACT, WARRANTY, TORT, PRODUCT LIABILITY) FOR ANY INJURY OR DEATH TO PERSONS OR LOSS OR DAMAGE TO PROPERTY CAUSED BY the PRODUCT THAT ARE OPERATED OR USED IN APPLICATION NOT INTENDED OR EXCLUDED BY INSTRUCTIONS, PRECAUTIONS, OR WARNING CONTAINED IN MITSUBISHI'S USER, INSTRUCTION AND/OR SAFETY MANUALS, TECHNICAL BULLETINS AND GUIDELINES FOR the PRODUCT.

("Prohibited Application")

Prohibited Applications include, but not limited to, the use of the PRODUCT in;

- Nuclear Power Plants and any other power plants operated by Power companies, and/or any other cases in which the public could be affected if any problem or fault occurs in the PRODUCT.
- Railway companies or Public service purposes, and/or any other cases in which establishment of a special quality assurance system is required by the Purchaser or End User.
- Aircraft or Aerospace, Medical applications, Train equipment, transport equipment such as Elevator and Escalator, Incineration and Fuel devices, Vehicles, Manned transportation, Equipment for Recreation and Amusement, and Safety devices, handling of Nuclear or Hazardous Materials or Chemicals, Mining and Drilling, and/or other applications where there is a significant risk of injury to the public or property.

Notwithstanding the above, restrictions Mitsubishi may in its sole discretion, authorize use of the PRODUCT in one or more of the Prohibited Applications, provided that the usage of the PRODUCT is limited only for the specific applications agreed to by Mitsubishi and provided further that no special quality assurance or fail-safe, redundant or other safety features which exceed the general specifications of the PRODUCTS are required. For details, please contact the Mitsubishi representative in your region.

## INTRODUCTION

Thank you for purchasing the Mitsubishi MELSEC-L series programmable controllers. This manual describes the functions and programming of the Simple Motion module.

Before using this product, please read this manual and the relevant manuals carefully and develop familiarity with the functions and performance of the MELSEC-L series programmable controller to handle the product correctly.

When applying the program examples introduced in this manual to the actual system, ensure the applicability and confirm that it will not cause system control problems.

Please make sure that the end users read this manual.

### REMARK

- Unless otherwise specified, this manual describes the program examples in which the I/O numbers of X/Y00 to X/Y1F are assigned for an L series Simple Motion module. I/O number assignment is required for using the program examples described in the manual.  
For I/O number assignment, refer to the following.  
MELSEC-L CPU Module User's Manual (Function Explanation, Program Fundamentals)
- Operating procedures are explained using GX Works2. When using GX Developer, refer to Appendix 6.



## CONTENTS

SAFETY PRECAUTIONS.....	A- 1
CONDITIONS OF USE FOR THE PRODUCT .....	A-11
INTRODUCTION.....	A-12
REVISIONS .....	A-13
CONTENTS.....	A-14
COMPLIANCE WITH THE EMC AND LOW VOLTAGE DIRECTIVES.....	A-21
RELEVANT MANUALS .....	A-21
MANUAL PAGE ORGANIZATION .....	A-22
TERMS .....	A-23
PACKING LIST.....	A-24

<b>Section 1 Product Specifications and Handling</b>
--

<b>1. Product Outline</b>	<b>1- 1 to 1-30</b>
---------------------------	---------------------

1.1 Positioning control.....	1- 2
1.1.1 Features of LD77MH.....	1- 2
1.1.2 Purpose and applications of positioning control.....	1- 6
1.1.3 Mechanism of positioning control .....	1- 8
1.1.4 Overview of positioning control functions .....	1- 9
1.1.5 Outline design of positioning system .....	1-19
1.1.6 Communicating signals between LD77MH and each module.....	1-20
1.2 Flow of system operation.....	1-24
1.2.1 Flow of all processes.....	1-24
1.2.2 Outline of starting .....	1-26
1.2.3 Outline of stopping .....	1-28
1.2.4 Outline for restarting.....	1-30

<b>2. System Configuration</b>	<b>2- 1 to 2- 6</b>
--------------------------------	---------------------

2.1 General image of system.....	2- 2
2.2 Component list .....	2- 3
2.3 Applicable system .....	2- 4
2.4 How to check the function version and SERIAL No. ....	2- 5
2.5 Restrictions by the SERIAL No. and version .....	2- 5

<b>3. Specifications and Functions</b>	<b>3- 1 to 3-32</b>
--	---------------------

3.1 Performance specifications.....	3- 2
3.2 List of functions .....	3- 4
3.2.1 LD77MH control functions.....	3- 4
3.2.2 LD77MH main functions.....	3- 7
3.2.3 LD77MH sub functions.....	3- 9
3.2.4 LD77MH common functions .....	3-11
3.2.5 Combination of LD77MH main functions and sub functions.....	3-12
3.3 Specifications of input/output signals with PLC CPU .....	3-14
3.3.1 List of input/output signals with PLC CPU.....	3-14

3.3.2 Details of input signals (LD77MH → PLC CPU) .....	3-16
3.3.3 Details of output signals (PLC CPU → LD77MH) .....	3-18
3.4 Specifications of interfaces with external devices .....	3-20
3.4.1 Electrical specifications of input signals .....	3-20
3.4.2 Signal layout for external input signal connector .....	3-23
3.4.3 List of input signal details .....	3-24
3.4.4 Interface internal circuit .....	3-26
3.5 External circuit design .....	3-28

<b>4. Installation, Wiring and Maintenance of the Product</b>	<b>4- 1 to 4-22</b>
---	---------------------

4.1 Outline of installation, wiring and maintenance .....	4- 2
4.1.1 Installation, wiring and maintenance procedures .....	4- 2
4.1.2 Names of each part .....	4- 3
4.1.3 Handling precautions .....	4- 5
4.2 Installation .....	4- 7
4.2.1 Precautions for installation .....	4- 7
4.3 Wiring .....	4- 8
4.3.1 Precautions for wiring .....	4- 8
4.4 Confirming the installation and wiring .....	4-20
4.4.1 Items to confirm when installation and wiring are completed .....	4-20
4.5 Maintenance .....	4-21
4.5.1 Precautions for maintenance .....	4-21
4.5.2 Disposal instructions .....	4-21

<b>5. Data Used for Positioning Control</b>	<b>5- 1 to 5-172</b>
---	----------------------

5.1 Types of data .....	5- 2
5.1.1 Parameters and data required for control .....	5- 2
5.1.2 Setting items for positioning parameters .....	5- 5
5.1.3 Setting items for OPR parameters .....	5- 7
5.1.4 Setting items for expansion parameters .....	5- 8
5.1.5 Setting items for servo parameters .....	5- 8
5.1.6 Setting items for positioning data .....	5- 9
5.1.7 Setting items for block start data .....	5-11
5.1.8 Setting items for condition data .....	5-12
5.1.9 Types and roles of monitor data .....	5-13
5.1.10 Types and roles of control data .....	5-17
5.2 List of parameters .....	5-21
5.2.1 Basic parameters 1 .....	5-21
5.2.2 Basic parameters 2 .....	5-24
5.2.3 Detailed parameters 1 .....	5-25
5.2.4 Detailed parameters 2 .....	5-35
5.2.5 OPR basic parameters .....	5-47
5.2.6 OPR detailed parameters .....	5-54
5.2.7 Expansion parameters .....	5-59
5.2.8 Servo parameters .....	5-61
5.3 List of positioning data .....	5-66
5.4 List of block start data .....	5-82
5.5 List of condition data .....	5-88
5.6 List of monitor data .....	5-98



5.6.1 System monitor data .....	5-98
5.6.2 Axis monitor data.....	5-112
5.7 List of control data .....	5-138
5.7.1 System control data .....	5-138
5.7.2 Axis control data .....	5-142
5.7.3 Expansion axis control data .....	5-170

<b>6. Sequence Program Used for Positioning Control</b>	<b>6- 1 to 6-76</b>
---	---------------------

6.1 Precautions for creating program .....	6- 2
6.2 List of devices used.....	6- 6
6.3 Creating a program .....	6-16
6.3.1 General configuration of program .....	6-16
6.3.2 Positioning control operation program.....	6-17
6.4 Positioning program examples .....	6-21
6.5 Program details .....	6-53
6.5.1 Initialization program .....	6-53
6.5.2 Start details setting program .....	6-54
6.5.3 Start program.....	6-56
6.5.4 Continuous operation interrupt program.....	6-68
6.5.5 Restart program .....	6-70
6.5.6 Stop program.....	6-73

<b>7. Memory Configuration and Data Process</b>	<b>7- 1 to 7-18</b>
---	---------------------

7.1 Configuration and roles of LD77MH memory .....	7- 2
7.1.1 Configuration and roles of LD77MH memory.....	7- 2
7.1.2 Buffer memory area configuration .....	7- 4
7.2 Data transmission process .....	7- 6

## Section 2 Control Details and Setting

### 8. OPR Control 8- 1 to 8-20

8.1 Outline of OPR control .....	8- 2
8.1.1 Two types of OPR control .....	8- 2
8.2 Machine OPR .....	8- 5
8.2.1 Outline of the machine OPR operation .....	8- 5
8.2.2 Machine OPR method .....	8- 6
8.2.3 OPR method (1): Near-point dog method .....	8- 7
8.2.4 OPR method (2): Count method 1) .....	8- 9
8.2.5 OPR method (3): Count method 2) .....	8-11
8.2.6 OPR method (4): Data set method .....	8-13
8.2.7 OPR method (5): Scale origin signal detection method .....	8-14
8.3 Fast OPR .....	8-17
8.3.1 Outline of the fast OPR operation .....	8-17
8.4 Selection of the OPR setting condition .....	8-19
8.4.1 Outline of the OPR setting condition .....	8-19

### 9. Major Positioning Control 9- 1 to 9-126

9.1 Outline of major positioning controls .....	9- 2
9.1.1 Data required for major positioning control .....	9- 4
9.1.2 Operation patterns of major positioning controls .....	9- 5
9.1.3 Designating the positioning address .....	9-15
9.1.4 Confirming the current value .....	9-16
9.1.5 Control unit "degree" handling .....	9-18
9.1.6 Interpolation control .....	9-21
9.2 Setting the positioning data .....	9-26
9.2.1 Relation between each control and positioning data .....	9-26
9.2.2 1-axis linear control .....	9-28
9.2.3 2-axis linear interpolation control .....	9-32
9.2.4 3-axis linear interpolation control .....	9-38
9.2.5 4-axis linear interpolation control .....	9-44
9.2.6 1-axis fixed-feed control .....	9-49
9.2.7 2-axis fixed-feed control (interpolation) .....	9-52
9.2.8 3-axis fixed-feed control (interpolation) .....	9-54
9.2.9 4-axis fixed-feed control (interpolation) .....	9-59
9.2.10 2-axis circular interpolation control with sub point designation .....	9-62
9.2.11 2-axis circular interpolation control with center point designation .....	9-68
9.2.12 1-axis speed control .....	9-76
9.2.13 2-axis speed control .....	9-79
9.2.14 3-axis speed control .....	9-83
9.2.15 4-axis speed control .....	9-87
9.2.16 Speed-position switching control (INC mode) .....	9-92
9.2.17 Speed-position switching control (ABS mode) .....	9-100
9.2.18 Position-speed switching control .....	9-108
9.2.19 Current value changing .....	9-115
9.2.20 NOP instruction .....	9-120

9.2.21 JUMP instruction .....	9-121
9.2.22 LOOP .....	9-123
9.2.23 LEND .....	9-125

<b>10. High-Level Positioning Control</b>	<b>10- 1 to 10-28</b>
---	-----------------------

10.1 Outline of high-level positioning control .....	10- 2
10.1.1 Data required for high-level positioning control.....	10- 3
10.1.2 "Block start data" and "condition data" configuration .....	10- 4
10.2 High-level positioning control execution procedure .....	10- 6
10.3 Setting the block start data .....	10- 7
10.3.1 Relation between various controls and block start data .....	10- 7
10.3.2 Block start (normal start) .....	10- 8
10.3.3 Condition start .....	10-10
10.3.4 Wait start.....	10-11
10.3.5 Simultaneous start .....	10-12
10.3.6 Repeated start (FOR loop) .....	10-13
10.3.7 Repeated start (FOR condition) .....	10-14
10.3.8 Restrictions when using the NEXT start.....	10-15
10.4 Setting the condition data .....	10-16
10.4.1 Relation between various controls and the condition data .....	10-16
10.4.2 Condition data setting examples .....	10-19
10.5 Multiple axes simultaneous start control .....	10-21
10.6 Start program for high-level positioning control .....	10-25
10.6.1 Starting high-level positioning control.....	10-25
10.6.2 Example of a start program for high-level positioning control .....	10-26

<b>11. Manual Control</b>	<b>11- 1 to 11-32</b>
---------------------------	-----------------------

11.1 Outline of manual control .....	11- 2
11.1.1 Three manual control methods.....	11- 2
11.2 JOG operation.....	11- 4
11.2.1 Outline of JOG operation .....	11- 4
11.2.2 JOG operation execution procedure .....	11- 7
11.2.3 Setting the required parameters for JOG operation.....	11- 8
11.2.4 Creating start programs for JOG operation.....	11-10
11.2.5 JOG operation example .....	11-12
11.3 Inching operation.....	11-15
11.3.1 Outline of inching operation .....	11-15
11.3.2 Inching operation execution procedure .....	11-18
11.3.3 Setting the required parameters for inching operation .....	11-19
11.3.4 Creating a program to enable/disable the inching operation.....	11-20
11.3.5 Inching operation example.....	11-22
11.4 Manual pulse generator operation.....	11-24
11.4.1 Outline of manual pulse generator operation.....	11-24
11.4.2 Manual pulse generator operation execution procedure .....	11-28
11.4.3 Setting the required parameters for manual pulse generator operation .....	11-29
11.4.4 Creating a program to enable/disable the manual pulse generator operation.....	11-30

<b>12. Expansion Control</b>	<b>12- 1 to 12-14</b>
------------------------------	-----------------------

12.1 Speed-torque control .....	12- 2
---------------------------------	-------

12.1.1 Outline of speed-torque control .....	12- 2
12.1.2 Setting the required parameters for speed-torque control .....	12- 2
12.1.3 Setting the required data for speed-torque control .....	12- 4
12.1.4 Operation of speed-torque control .....	12- 5

<b>13. Control Sub Functions</b>	<b>13- 1 to 13-104</b>
----------------------------------	------------------------

13.1 Outline of sub functions .....	13- 2
13.1.1 Outline of sub functions .....	13- 2
13.2 Sub functions specifically for machine OPR .....	13- 4
13.2.1 OPR retry function .....	13- 4
13.2.2 OP shift function .....	13- 8
13.3 Functions for compensating the control .....	13-11
13.3.1 Backlash compensation function .....	13-11
13.3.2 Electronic gear function .....	13-13
13.3.3 Near pass function .....	13-20
13.4 Functions to limit the control .....	13-22
13.4.1 Speed limit function .....	13-22
13.4.2 Torque limit function .....	13-24
13.4.3 Software stroke limit function .....	13-28
13.4.4 Hardware stroke limit function .....	13-34
13.4.5 Forced stop function .....	13-37
13.5 Functions to change the control details .....	13-40
13.5.1 Speed change function .....	13-40
13.5.2 Override function .....	13-47
13.5.3 Acceleration/deceleration time change function .....	13-50
13.5.4 Torque change function .....	13-55
13.5.5 Target position change function .....	13-59
13.6 Absolute position system .....	13-63
13.7 Other functions .....	13-65
13.7.1 Step function .....	13-65
13.7.2 Skip function .....	13-70
13.7.3 M code output function .....	13-73
13.7.4 Teaching function .....	13-77
13.7.5 Command in-position function .....	13-83
13.7.6 Acceleration/deceleration processing function .....	13-86
13.7.7 Pre-reading start function .....	13-89
13.7.8 Deceleration start flag function .....	13-92
13.7.9 Stop command processing for deceleration stop function .....	13-95
13.7.10 Speed control 10 x multiplier setting for degree axis function .....	13-98
13.7.11 Operation setting for incompleteness of OPR function .....	13-100
13.8 Servo ON/OFF .....	13-102
13.8.1 Servo ON/OFF .....	13-102
13.8.2 Follow up function .....	13-104

<b>14. Common Functions</b>	<b>14- 1 to 14-36</b>
-----------------------------	-----------------------

14.1 Outline of common functions .....	14- 2
14.2 Parameter initialization function .....	14- 3
14.3 Execution data backup function .....	14- 5
14.4 External signal selection function .....	14- 7
14.5 External I/O signal logic switching function .....	14- 8

14.6 History monitor function .....	14- 9
14.7 Amplifier-less operation function .....	14-10
14.8 Virtual servo amplifier function .....	14-15
14.9 Master-slave operation function .....	14-18
14.10 Mark detection function.....	14-23
14.11 Optional data monitor function.....	14-33
14.12 Module error collection function.....	14-36

<b>15. Dedicated Instructions</b>	<b>15- 1 to 15-18</b>
-----------------------------------	-----------------------

15.1 List of dedicated instructions .....	15- 2
15.2 Interlock during dedicated instruction is executed .....	15- 2
15.3 ZP.PSTR1, ZP.PSTR2, ZP.PSTR3, ZP.PSTR4.....	15- 3
15.4 ZP.TEACH1, ZP.TEACH2, ZP.TEACH3, ZP.TEACH4 .....	15- 7
15.5 ZP.PFWRT .....	15-11
15.6 ZP.PINIT .....	15-15

<b>16. Troubleshooting</b>	<b>16- 1 to 16-66</b>
----------------------------	-----------------------

16.1 Checking errors using GX Works2 .....	16- 2
16.2 Checking errors using a display unit .....	16- 5
16.3 Troubleshooting .....	16- 6
16.4 Error and warning details .....	16- 9
16.5 List of errors .....	16-14
16.5.1 LD77MH detection error.....	16-14
16.5.2 Servo amplifier detection error.....	16-44
16.6 List of warnings .....	16-52
16.6.1 LD77MH detection warning .....	16-52
16.6.2 Servo amplifier detection warning .....	16-62

<b>Appendices</b>	<b>Appendix- 1 to Appendix-72</b>
-------------------	-----------------------------------

Appendix 1 Positioning data (No.1 to 600) List of buffer memory addresses (LD77MH4) .....	Appendix- 2
Appendix 2 Connection with servo amplifiers .....	Appendix-26
Appendix 2.1 Connection of SSCNET III cables .....	Appendix-26
Appendix 2.2 Wiring of SSCNET III cables.....	Appendix-27
Appendix 3 Connection with external device .....	Appendix-31
Appendix 3.1 Connector.....	Appendix-31
Appendix 3.2 External input signal cable.....	Appendix-34
Appendix 4 Comparisons with positioning modules .....	Appendix-37
Appendix 4.1 Comparisons with LD75P/D model .....	Appendix-37
Appendix 4.2 Differences with QD75MH models .....	Appendix-38
Appendix 5 When using GX Works2.....	Appendix-45
Appendix 6 When using GX Developer or GX Configurator-QP .....	Appendix-46
Appendix 6.1 Operation of GX Developer .....	Appendix-46
Appendix 6.2 Operation of GX Configurator -QP .....	Appendix-46
Appendix 7 Positioning control troubleshooting .....	Appendix-47
Appendix 8 List of buffer memory addresses.....	Appendix-53
Appendix 9 External dimension drawing .....	Appendix-71

COMPLIANCE WITH THE EMC AND LOW VOLTAGE DIRECTIVES

(1) For programmable controller system

To configure a system meeting the requirements of the EMC and Low Voltage Directives when incorporating the Mitsubishi programmable controller (EMC and Low Voltage Directives compliant) into other machinery or equipment, refer to the Safety Guidelines provided with the PLC CPU module. Also, refer to "Example of measure against noise for compliance with the EMC directive" of the Section 4.3.1 of this manual.

The CE mark, indicating compliance with the EMC and Low Voltage Directives, is printed on the rating plate of the programmable controller.

(2) For the product

To make this product comply with EMC and Low Voltage Directives, refer to Section 4.3.1 "Precautions for wiring".

RELEVANT MANUALS

(1) Simple motion module user's manual

Manual Name <Manual number (model code)>	Description
MELSEC-L LD77MH Simple Motion Module User's Manual (Positioning Control)  <IB-0300172ENG, 1XB942>	Specifications of the LD77MH and information on how to establish a system, maintenance and inspection, and troubleshooting Functions, programming and buffer memory for the positioning control of the LD77MH
MELSEC-L LD77MH Simple Motion Module User's Manual (Synchronous Control)  <IB-0300174ENG, 1XB943>	Functions, programming and buffer memory for the synchronous control of the LD77MH

(2) CPU module user's manual

Manual Name <Manual number (model code)>	Description
MELSEC-L CPU Module User's Manual (Hardware Design, Maintenance and Inspection)  <SH-080890ENG, 13JZ36>	Specifications of the CPU modules, power supply modules, display unit, SD memory cards, and batteries, information on how to establish a system, maintenance and inspection, and troubleshooting
MELSEC-L CPU Module User's Manual (Function Explanation, Program Fundamentals)  <SH-080889ENG, 13JZ35>	Functions and devices of the CPU module, and programming

### (3) Operating manual

Manual Name <Manual number (model code)>	Description
GX Works2 Version1 Operating Manual (Common) <SH-080779ENG, 13JU63>	System configuration, parameter settings, and online operations (common to Simple project and Structured project) of GX Works2
GX Works2 Version1 Operating Manual (Intelligent Function Module) <SH-080921ENG, 13JU69>	Parameter settings, monitoring, and operations of the predefined protocol support function of intelligent function modules, using GX Works2
GX Developer Version 8 Operating Manual <SH-080373E, 13JU41>	Operating methods of GX Developer, such as programming, printing, monitoring, and debugging
GX Configurator-QP Version 2 Operating Manual <SH-080172, 13JU19>	Data creation (such as parameters and positioning data) and operations of transferring data to modules, positioning monitor, and tests using GX Configurator-QP (sold separately) *1

\*1: The manual is included in the CD-ROM of the software package in a PDF-format file.

For users interested in buying the manual separately, a printed version is available. Please contact us with the manual number (model code) in the list above.

#### MANUAL PAGE ORGANIZATION

■ The symbols used in this manual are shown below.

The following symbols represent the buffer memories supported for each axis.  
(A serial No. is inserted in the "\*" mark.)

Symbol	Description	Reference
Pr. *	Symbol that indicates positioning parameter and OPR parameter item.	Chapter 5
Da. *	Symbol that indicates positioning data, block start data and condition data item.	
Md. *	Symbol that indicates monitor data item.	
Cd. *	Symbol that indicates control data item.	
LD77MH4	Symbol that indicates correspondence to only LD77MH4.	—
LD77MH16	Symbol that indicates correspondence to only LD77MH16.	

■ Representation of numerical values used in this manual.

- Buffer memory addresses, error codes and warning codes are represented in decimal.
- X/Y devices are represented in hexadecimal
- Setting data and monitor data are represented in decimal or hexadecimal. Data ended by "H" or "h" is represented in hexadecimal.

(Example) 10.....Decimal

10H.....Hexadecimal

## TERMS

Unless otherwise specified, this manual uses the following terms.

Term	Description
PLC CPU	Abbreviation for the MELSEC-L series PLC CPU module.
LCPU	Another term for the MELSEC-L series PLC CPU module.
LD77MH	Another term for the MELSEC-L series Simple Motion module.
MR-J3(W)-B	Servo amplifier: Abbreviation for MR-J3(W)-□B. (□ = capacity)
Programming tool	Generic term for GX Works2, GX Developer and MR Configurator2.
GX Works2	Product name of the software package for the MELSEC programmable controllers (Version 1.31H or later).
MR Configurator2	Product name of the setup software for the servo amplifier (Version 1.01B or later).
GX Developer	Product name of the software package for the MELSEC programmable controllers (Version 8.89T or later).
GX Configurator-QP	Product name of the setting and monitoring tool for the Simple Motion module (Version 2.34L or later).
Intelligent function module	A MELSEC-Q/L series module that has functions other than input or output, such as A/D converter module and D/A converter module
Servo amplifier (drive unit)	Abbreviation for SSCNETⅢ compatible servo amplifier (drive unit).
Manual pulse generator	Abbreviation for manual pulse generator (MR-HDP01) (prepared by user).
OPR	Generic term for "Home position return".
OP	Generic term for "Home position".
SSCNETⅢ <sup>(Note)</sup>	High speed synchronous communication network between LD77MH and servo amplifier.

(Note): SSCNET: Servo System Controller NETwork



PACKING LIST

The following items are included in the package of this product. Before use, check that all the items are included.

(1) LD77MH4

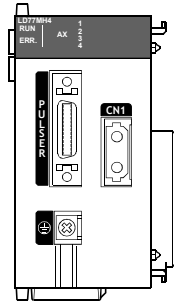

LD77MH4



Before Using the Product

(2) LD77MH16

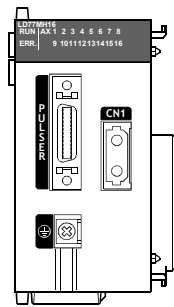

LD77MH16

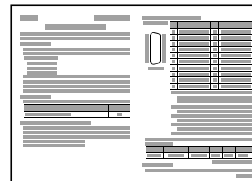

Before Using the Product

# Section 1 Product Specifications and Handling

Section 1 is configured for the following purposes (1) to (5).

- (1) To understand the outline of positioning control, and the LD77MH specifications and functions
- (2) To carry out actual work such as installation and wiring
- (3) To set parameters and data required for positioning control
- (4) To create a sequence program required for positioning control
- (5) To understand the memory configuration and data transmission process

When diverting any of the program examples introduced in this manual to the actual system, fully verify that there are no problems in the controllability of the target system.

Read "Section 2" for details on each control.

Chapter 1	Product Outline .....	1- 1 to 1- 30
Chapter 2	System Configuration.....	2- 1 to 2- 6
Chapter 3	Specifications and Functions.....	3- 1 to 3- 32
Chapter 4	Installation, Wiring and Maintenance of the Product .....	4- 1 to 4- 22
Chapter 5	Data Used for Positioning Control .....	5- 1 to 5-172
Chapter 6	Sequence Program Used for Positioning Control.....	6- 1 to 6- 76
Chapter 7	Memory Configuration and Data Process .....	7- 1 to 7- 18



# Chapter 1 Product Outline

The purpose and outline of positioning control using LD77MH are explained in this chapter. Reading this chapter will help you understand what can be done using the positioning system and which procedure to use for a specific purpose.

By understanding "What can be done", and "Which procedure to use" beforehand, the positioning system can be structured smoothly.

1.1	Positioning control .....	1- 2
1.1.1	Features of LD77MH .....	1- 2
1.1.2	Purpose and applications of positioning control .....	1- 6
1.1.3	Mechanism of positioning control.....	1- 8
1.1.4	Overview of positioning control functions.....	1- 9
1.1.5	Outline design of positioning system .....	1-19
1.1.6	Communicating signals between LD77MH and each module .....	1-20
1.2	Flow of system operation .....	1-24
1.2.1	Flow of all processes .....	1-24
1.2.2	Outline of starting.....	1-26
1.2.3	Outline of stopping.....	1-28
1.2.4	Outline for restarting .....	1-30

## 1.1 Positioning control

### 1.1.1 Features of LD77MH

The LD77MH has the following features.

(1) **High-speed start time**

High-speed start time "0.88ms" (LD77MH4 use) during positioning control is achieved.

(2) **Wide variety of positioning control functions**

The main functions (such as OPR control, positioning control and manual control) which are required for any positioning system and the sub functions which limit and add functions to those controls are supported.

(a) **Enhanced OPR control**

1) **Additional features of OPR control**

Five machine OPR methods are provided: one near-point dog method, two count methods, one data set method and one scale origin signal detection method. Select an applicable method according to the system.

2) **OPR retry function**

The OPR retry function is provided so that the machine OPR control can be performed from any position, regardless of the machine stop position when the system is powered on.

(b) **Wide variety of control methods**

Positioning controls, such as position control, speed control, speed-position switching control, position-speed switching control, and other controls, are provided.

1) **Independent control of each axis**

Controls, such as position control and speed control, can be performed independently for each axis at any given timing.

2) **Interpolation control**

Interpolation controls using multiple axes can be performed. (2- to 4-axis linear interpolation control, 2-axis circular interpolation control, 2- to 4-axis speed control, etc.)

3) **Speed-torque control**

Speed control and torque control not including position loop can be performed.

(c) **Large amount of data**

Up to 600 positioning data (combinations of data, such as control system, positioning address, and command speed) per axis can be set.

- (d) Continuous processing of multiple positioning data  
Multiple positioning data can be processed continuously within one positioning operation.  
Continuous positioning control can be executed over multiple blocks, where each block consists of multiple positioning data.  
This reduces the number of executions of positioning, management of execution status, and others.
  - (e) Acceleration/deceleration processing  
Two acceleration/deceleration processing methods are provided: trapezoidal acceleration/deceleration and S-curve acceleration/deceleration. The acceleration/deceleration curve can be selected according to the machine characteristic.
- (3) Synchronous control  
The synchronous control and electronic cam control can be performed.
- (4) Mark detection function **LD77MH16**  
The mark detection to latch any data by the external command signal [DI1 to DI4] can be performed.
- (5) High maintainability  
Maintainability is enhanced in the LD77MH.
- (a) Data retention without battery  
Data such as the positioning data and parameters can be stored in the flash ROM inside the LD77MH. This feature allows the module retain the data without a battery.
  - (b) Module error collection function **LD77MH16**  
The LD77MH notifies error details to the PLC CPU when an error occurs. Storing the error information in the PLC CPU allows the user to check the error from the programming tool even after the module is powered off or reset.
- (6) Support of intelligent function module dedicated instructions  
Dedicated instructions such as the positioning start instruction (Axis 1 to Axis 4) and teaching instruction (Axis 1 to Axis 4) are provided.  
The use of such dedicated instructions simplifies programs.  
The dedicated instructions are fully compatible with the QD75MH.

(7) Setting, monitoring, and testing through GX Works2

Parameters and positioning data for the LD77MH can be set using GX Works2 (Simple Motion Module Setting).

Moreover, using the test function of GX Works2 (Simple Motion Module Setting), users can check the wiring status and the validity of the preset parameters and positioning data by performing test operation before creating a program for positioning control.

The control monitor function of GX Works2 allows user to debug programs efficiently.

The servo parameters can be set easily by using the GX Works2 in combination with the MR Configurator2.

(8) Compatibility with the QD75MH

The proven programs in QD75MH can be used because the LD77MH is compatible with the QD75MH.

(9) Forced stop function

The batch forced stop is available for all axes of servo amplifier by the forced stop input signal of the external input.

"Valid/Invalid" of the forced stop input signal can be selected by the parameters.

(10) Connection between the LD77MH and servo amplifier with high speed synchronous network by SSCNET III

The LD77MH can be directly connected to the Mitsubishi servo amplifiers of MR-J3-B series using the SSCNET III.

- (a) Because the high speed synchronous network by SSCNET III is used to connect the LD77MH and the servo amplifier, or servo amplifiers, saving wiring can be realized. The maximum distance between the LD77MH and servo amplifier, servo amplifier and servo amplifier of the SSCNET III cable on the same bus was set to 50(164.04)[m(ft.)], and the flexibility will improve at the system design.
- (b) By the use of SSCNET III cable (Optical communication), influence of electromagnetic noise and others from servo amplifier, etc. are reduced.
- (c) The servo parameters can be set on the LD77MH side to write or read them to/from the servo amplifier using the SSCNET III communication.
- (d) The actual current value and error description contained in the servo can be checked by the buffer memory of the LD77MH.
- (e) The communication between the MR Configurator2 and servo amplifiers is possible via the PLC CPU.

(11) Easy application to the absolute position system

- (a) The MR-J3-B series servo amplifiers and servo motors correspond to the absolute position system. It can be realized only at connecting the battery for absolute position system to the servo amplifier.
- (b) Once the OP have been established, the OPR operation is unnecessary at the system's power supply ON.
- (c) With the absolute position system, the data set method OPR is used to establish the OP. The wiring of near-point dog, etc. is unnecessary.
- (d) When the setting unit is "degree", the absolute position system with unlimited length fed can be configured.



### 1.1.2 Purpose and applications of positioning control

"Positioning" refers to moving a moving body, such as a workpiece or tool (hereinafter, generically called "workpiece") at a designated speed, and accurately stopping it at the target position. The main application examples are shown below.

**■ Punch press (X, Y feed positioning)**

The diagram illustrates a punch press system. It features a Y-axis servomotor connected to a gear and ball screw mechanism that moves the press head vertically. The X-axis is driven by an X-axis servomotor connected to a gear and rack & pinion mechanism. Both axes are controlled by servo amplifiers and an LD77MH controller. The press head is used for punching insulation material or leather, etc., at a high yield. The diagram also shows a 'Press punching' operation where the press head is positioned and then punched.

- To punch insulation material or leather, etc., as the same shape at a high yield, positioning is carried out with the X axis and Y axis servos.
- After positioning the table with the X axis servo, the press head is positioned with the Y axis servo, and is then punched with the press.
- When the material type or shape changes, the press head die is changed, and the positioning pattern is changed.

**■ Palletizer**

The diagram shows a palletizer system. A conveyor control system feeds material onto a conveyor. A servomotor with brakes is connected to the conveyor via reduction gears and a ball screw. The servomotor is controlled by a servo amplifier and an LD77MH controller. A position detector is used to accurately position the palletizer. The amount to lower the palletizer according to the material thickness is saved. The diagram also shows a 'Palletizer Unloader control' system.

- Using the servo for one axis, the palletizer is positioned at a high accuracy.
- The amount to lower the palletizer according to the material thickness is saved.

**■ Compact machining center (ATC magazine positioning)**

The diagram illustrates ATC magazine positioning. A servomotor is connected to a coupling and reduction gears, which drive the ATC tool magazine. The tool magazine contains tools (12 pcs., 20 pcs.). A positioning pin is used to accurately position the tool. The system is controlled by a servo amplifier and an LD77MH controller. The diagram also shows two circular diagrams for rotation direction and current value retrieval position.

Rotation direction for calling 11, 12, 1, 2 or 3

Rotation direction for calling 17 to 20, 1 to 5

Current value retrieval position

Rotation direction for calling 5, 6, 7, 8, 9 or 10

Rotation direction for calling 7 to 16

Current value retrieval position

<Number of tools: 12> <Number of tools: 20>

- The ATC tool magazine for a compact machining center is positioned.
- The relation of the magazine's current value and target value is calculated, and positioning is carried out with forward run or reverse run to achieve the shortest access time.

**■ Lifter**

- During the aging process, storage onto the rack is carried out by positioning with the AC servo.
- The up/down positioning of the lifter is carried out with the 1-axis servo, and the horizontal position of the aging rack is positioned with the 2-axis servo.

**■ Index table (High-accuracy indexing of angle)**

- The index table is positioned at a high accuracy using the 1-axis servo.

**■ Inner surface grinder**

(Fix the grinding stone, feed the workpiece, and grind.)

Operation panel

<input type="checkbox"/>	a	<input type="checkbox"/>	d
<input type="checkbox"/>	b	<input type="checkbox"/>	e
<input type="checkbox"/>	c		

a. Total feed amount ( $\mu\text{m}$ )  
 b. Finishing feed amount ( $\mu\text{m}$ )  
 c. Compensation amount ( $\mu\text{m}$ )  
 d. Rough grinding speed ( $\mu\text{m/s}$ )  
 e. Fine grinding speed ( $\mu\text{m/s}$ )

- The grinding of the workpiece's inner surface is controlled with the servo and inverter.
- The rotation of the workpiece is controlled with the 1-axis inverter, and the rotation of the grinding stone is controlled with the 2-axis inverter. The workpiece is fed and ground with the 3-axis servo.

### 1.1.3 Mechanism of positioning control

In the positioning system using the LD77MH, various software and devices are used for the following roles.

The LD77MH realizes complicated positioning control when it reads in various signals, parameters and data and is controlled with the PLC CPU.

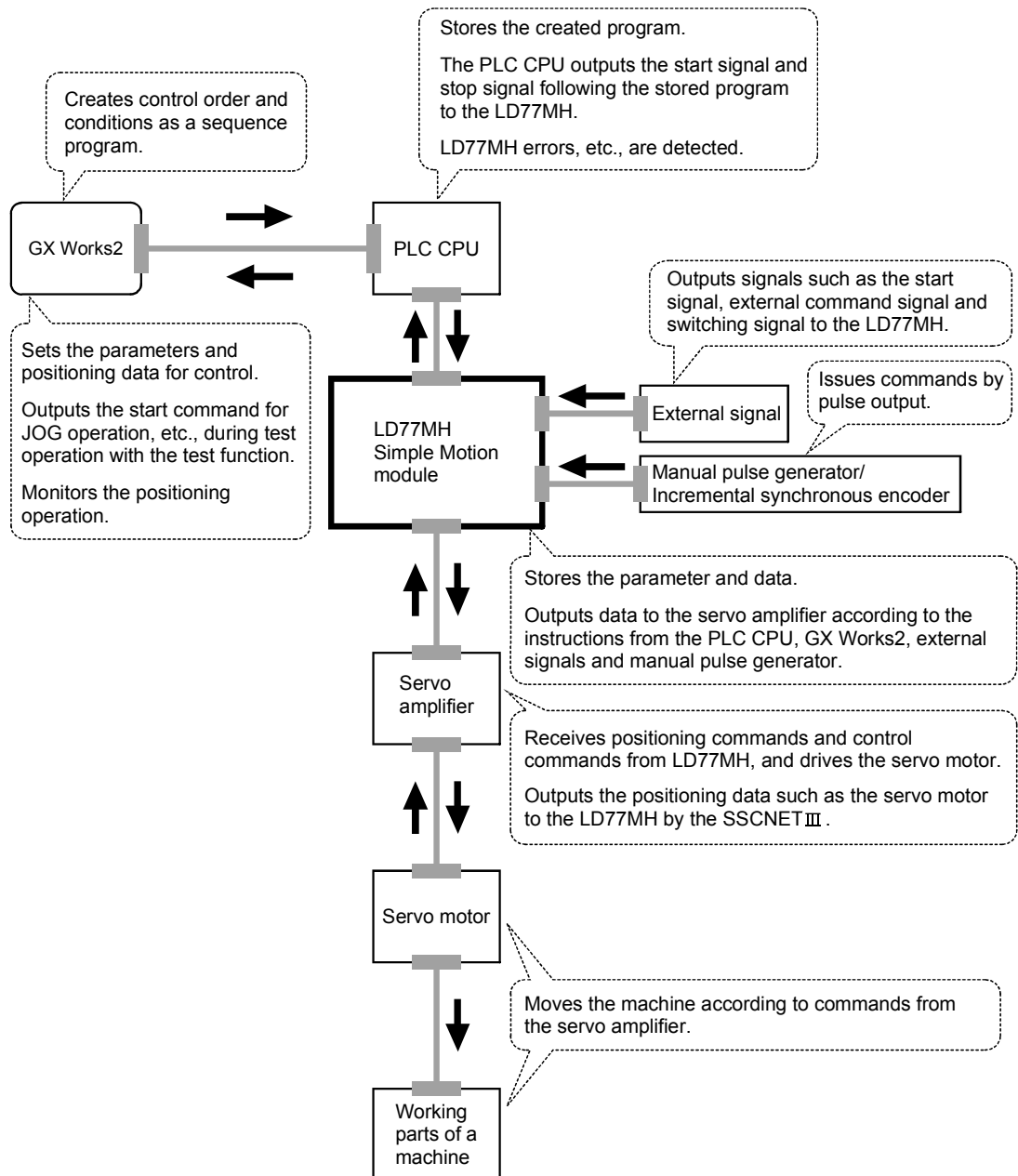

### 1.1.4 Overview of positioning control functions

The outline of the "overview of positioning control" and "overview of individual positioning control and continuous positioning control", "overview of block positioning control" and "overview of acceleration/deceleration processing control" is shown below.

■ Positioning control

An overview of positioning using positioning data described below.

(1) Linear control

(a) 1-axis linear control

This performs positioning from the start point address (location the axis is presently stopped) defined on the specified axis to the specified position.

[Control using the absolute system]

- 1) This performs positioning from the start point address to the specified position.
- 2) The start point address and the specified address determine the movement direction.

[Example]

The following figure shows the operations when the start point address is 5000 and the positioning address are 2000 and 8000:

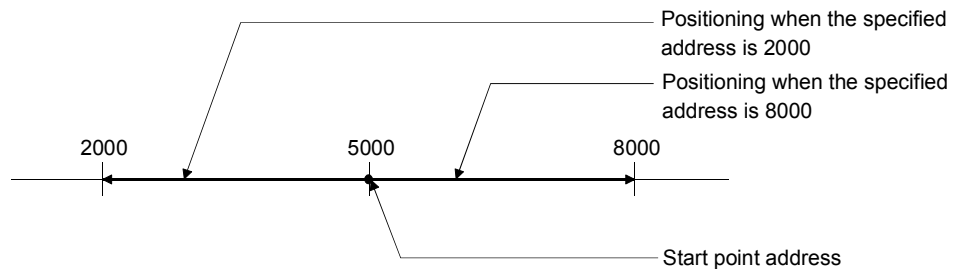

[Control using the increment system]

- 1) This performs positioning from the specified increment of travel from the start point address.
- 2) The sign of the travel increment determines the direction of travel.
  - For positive travel increment.....Positioning in the positive direction (direction of address increase)
  - For negative travel increment.....Positioning in the negative direction (direction of address decrease)

[Example]

The following figure shows the operations when the start point address is 5000 and the travel increments are 3000 and -3000:

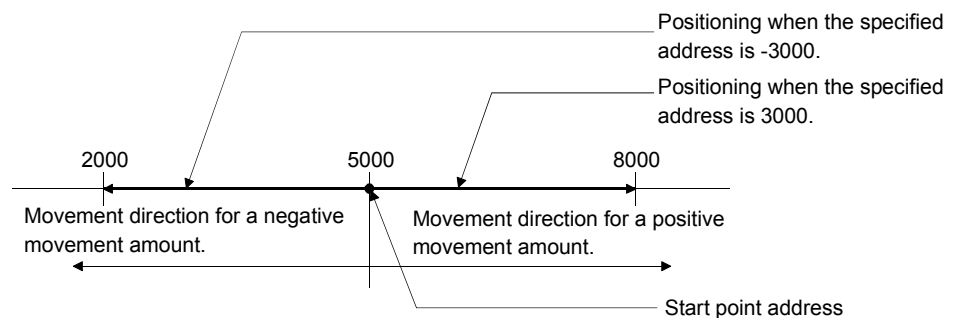

(b) 2-axis linear interpolation control (Note)

This controls interpolation along a linear locus from the start point address (current stop position) defined by two axes.

[Control using the absolute system]

- 1) This performs linear interpolation using two axes from the start point address to the endpoint address.
- 2) The start point address and the specified address determine the direction of travel.

[Example]

The operation when the start point address is 800 for axis 1 and 2000 for axis 2 and the positioning address specified to 2000 for axis 1 and 8000 for axis 2, is shown below.

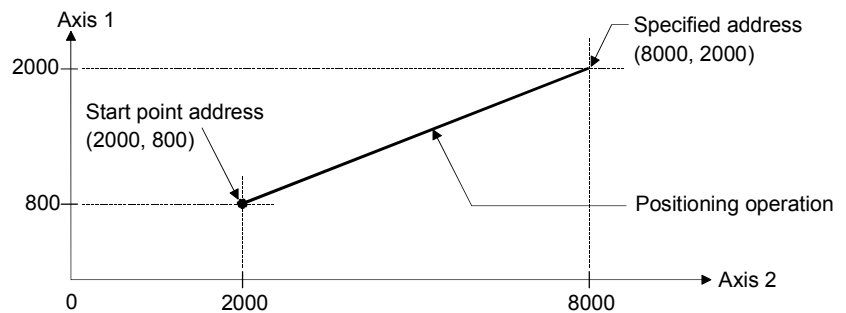

[Control using the increment system]

- 1) This performs positioning from the specified increment of travel from the start point address.
- 2) The sign of the travel increment determines the direction of travel.
  - For positive travel increment.....Positioning in the positive direction (direction of address increase)
  - For negative travel increment.....Positioning in the negative direction (direction of address decrease)

[Example]

The operation when the start point address is 800 for axis 1 and 2000 for axis 2 and the positioning address specified to 1200 for axis 1 and 6000 for axis 2, is shown below.

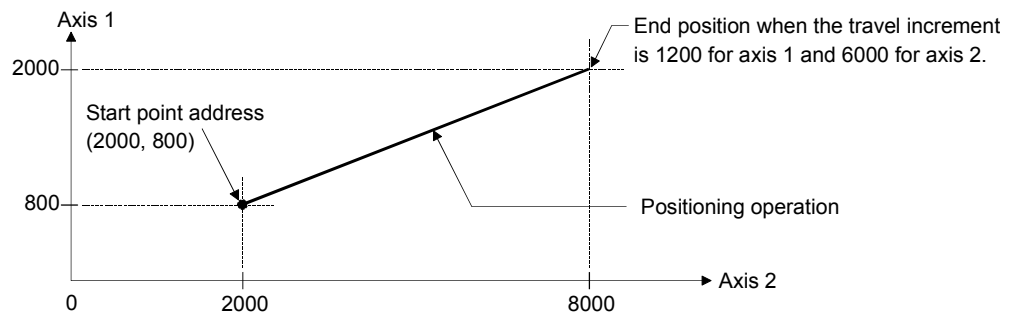

**REMARK**

(Note): The interpolation speed during linear interpolation control can be selected from "composite speed" and "reference axis speed" using the interpolation speed designation method of detailed parameter 1. (Refer to Section 5.2.3 information about setting "Pr.20 Interpolation speed designation method" of the detailed parameter 1.)

## (2) Circular interpolation control (Note)

There are two types of circular interpolation controls: circular interpolation with a specified sub point and circular interpolation with the specified center point.

## (a) Circular interpolation with a specified sub point

Circular interpolation is performed using the specified endpoint address and sub point (passing point) address.

Two methods are available: absolute system and increment system.

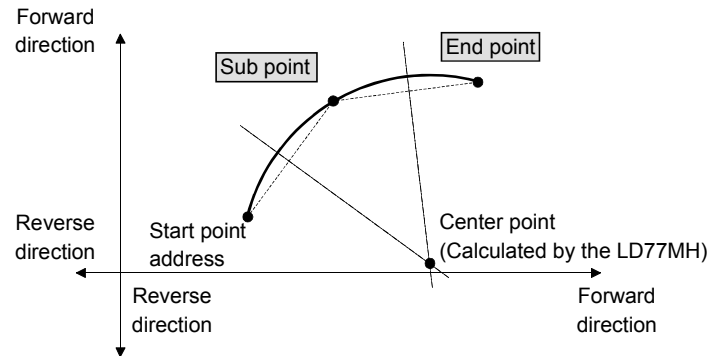

## (b) Circular interpolation with the specified center point

Circular interpolation is performed using the specified endpoint address and center point address.

Two methods are available: absolute system and increment system.

Also, the direction of movement can be selected from clockwise or counterclockwise.

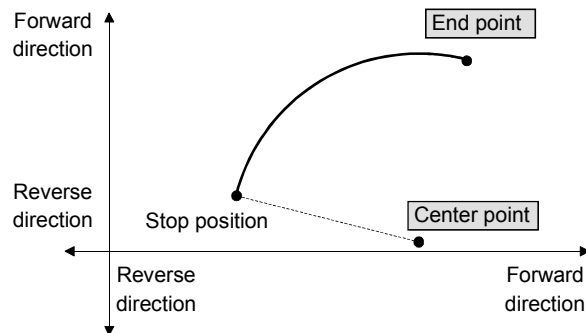
**REMARK**

(Note): The interpolation speed during circular interpolation control may only be set to "composite speed" for the interpolation speed designation method of detailed parameter 1. (Refer to Section 5.2.3 information about setting "Pr.20 Interpolation speed designation method" of the detailed parameter 1.)

### (3) Fixed-feed control

This performs positioning for the specified increment of travel.

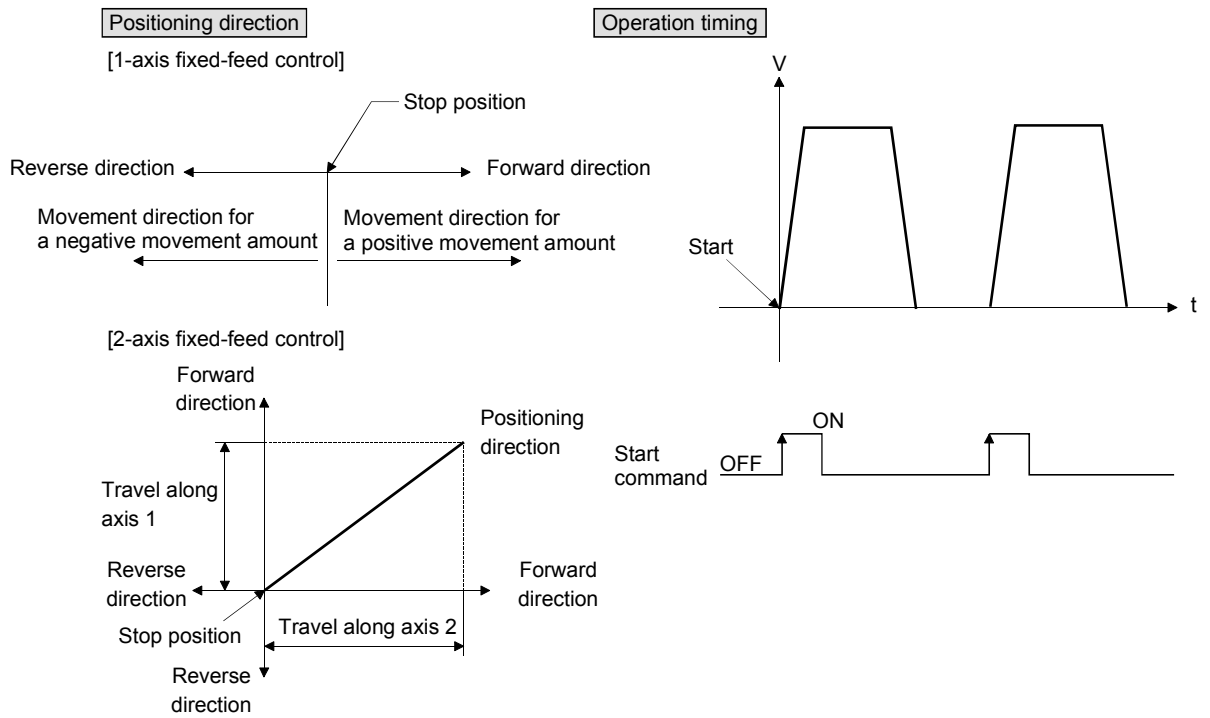

### (4) Speed control

After command is executed, control continues with the command speed until the stop command is input.

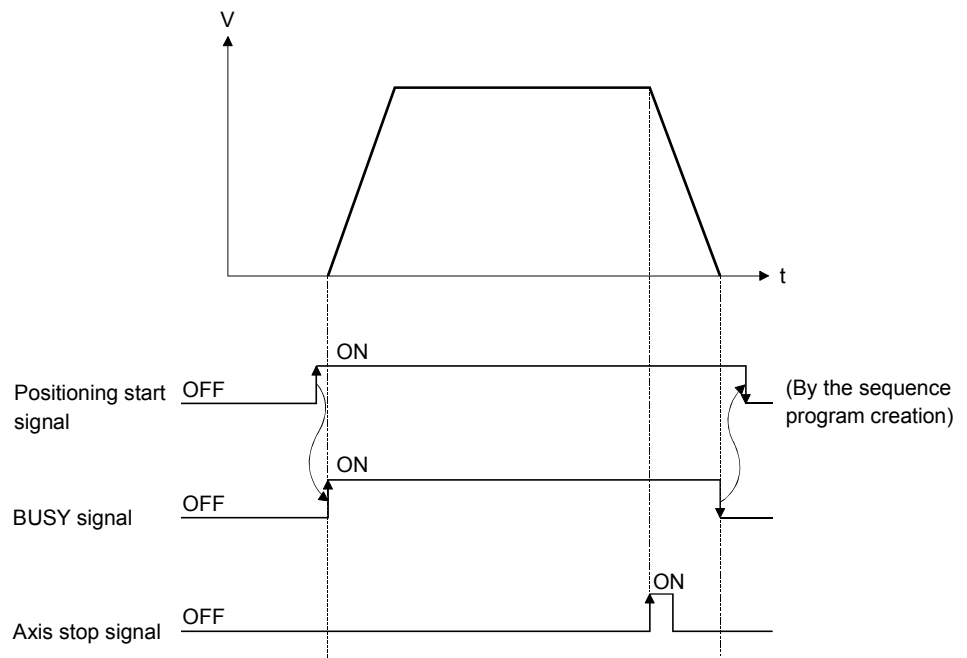

(5) Speed-position switching control

This starts positioning under speed control, and switches to position control according to the input of the LD77MH speed-position switching signal and perform positioning for the specified increment of travel.

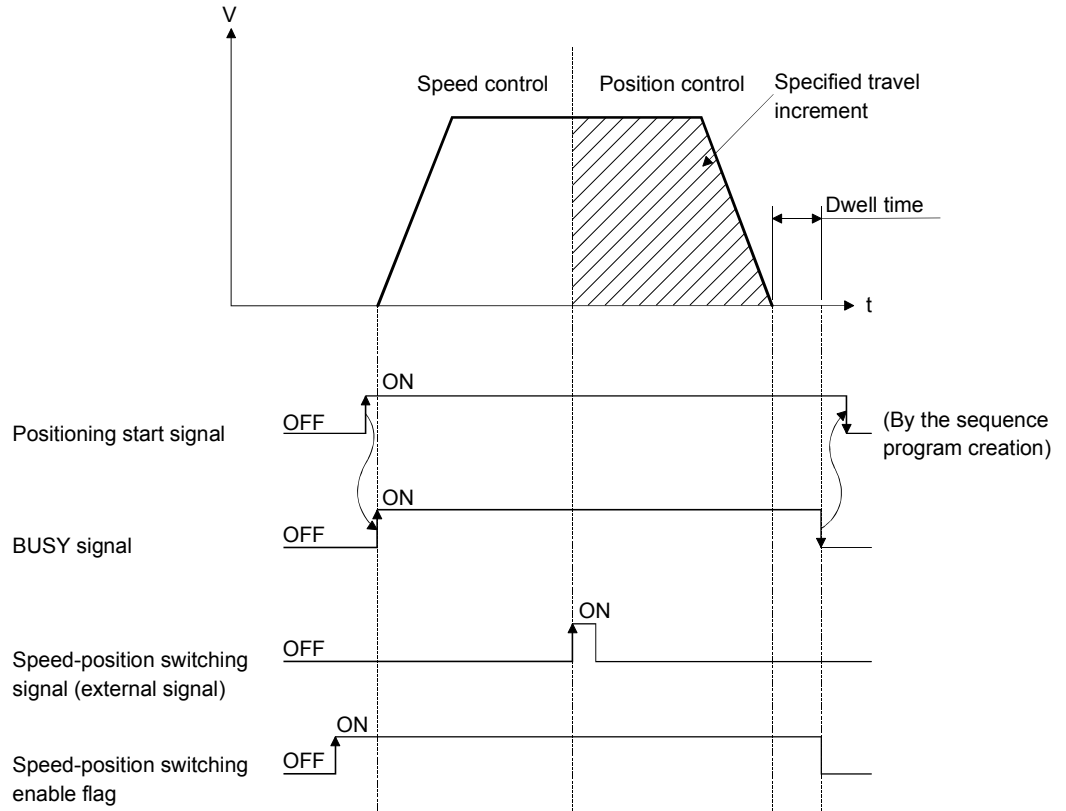



■ Individual positioning control and continuous positioning control

The LD77MH performs positioning according to the user-set positioning data, which is a set of information comprised of the control method (position control, speed control, speed-position switching control), positioning address, operation pattern, and so on. Up to 600 of positioning data are assigned respectively to positioning data Nos. 1 to 600 per axis and registered to the LD77MH.

The operation pattern set in each positioning data by the user determines whether to perform positioning operation with one positioning data item or to perform continuous positioning operation with multiple positioning data items.

(1) Independent positioning control (operation pattern = 00: positioning complete)

The operation completed upon completion of positioning for the specified positioning data. The positioning completion of this operation pattern is also used as the operation pattern for the last positioning data of continuous positioning and continuous-locus positioning.

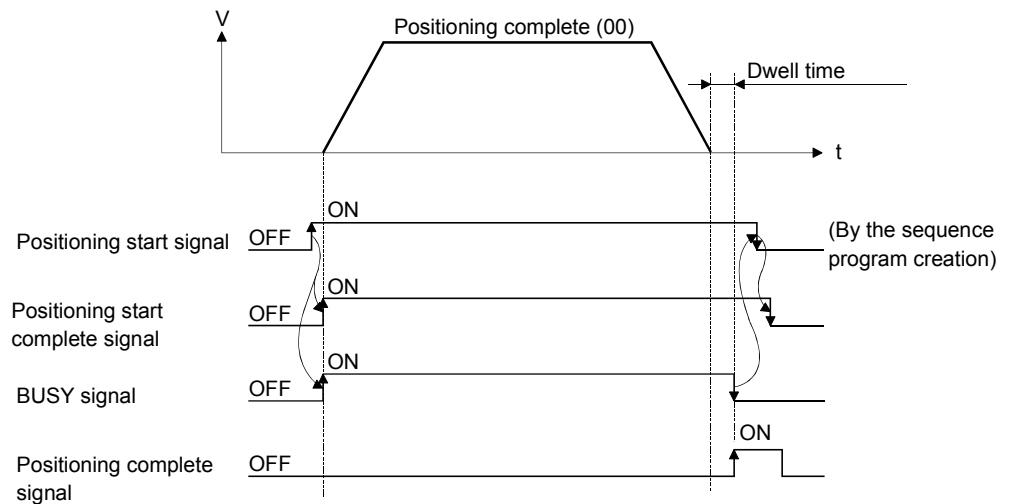

(2) Continuous positioning control (operation pattern = 01: positioning continues)

The operation stops temporarily upon the completion of positioning for the specified positioning data, and then continues with the next positioning data number.

This is specified when performing positioning in which the direction changes because of multiple positioning data items having consecutive positioning data numbers.

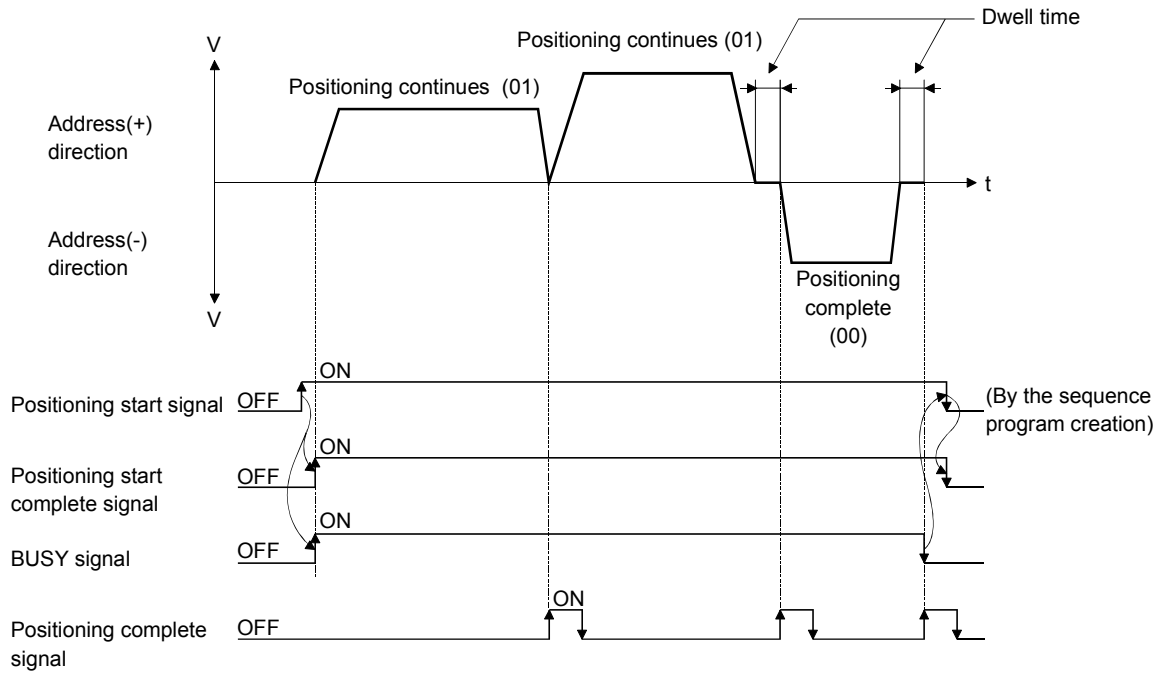

(3) Continuous path control (operation pattern = 11: positioning continue)

After executing positioning using the specified positioning data, the operation changes its speed to that of the next positioning data number and continues positioning.

This is specified when continuously executing multiple positioning data items having consecutive positioning data numbers at a specified speed.

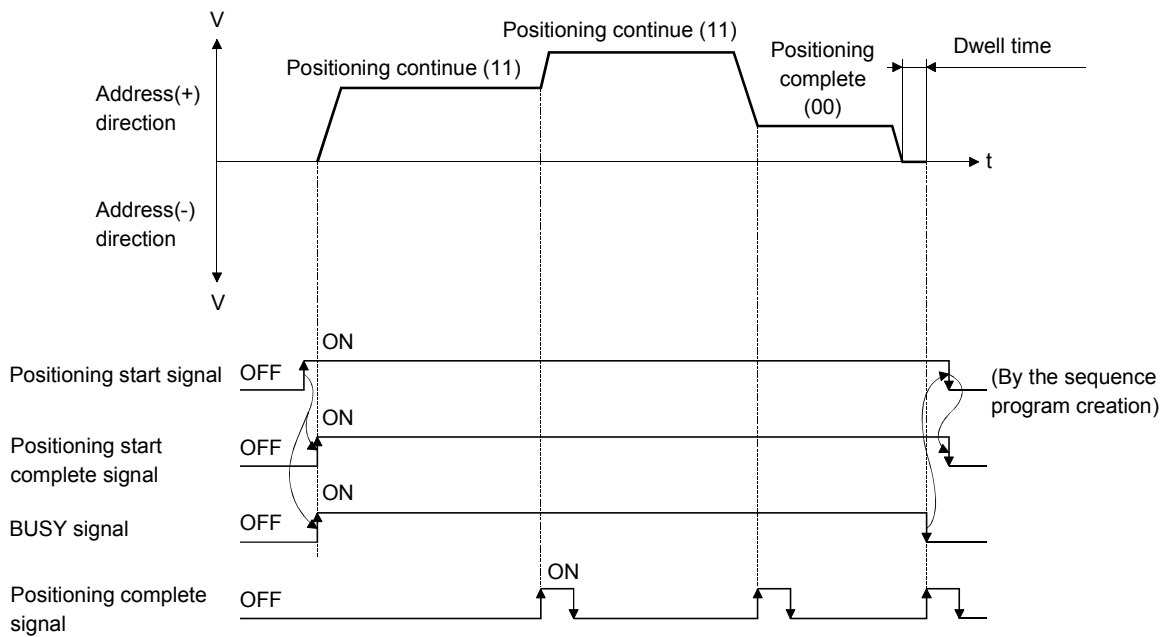

■ Block positioning control

Block positioning is a control that continuously executes the positioning of specified blocks. One block equivalent to a series of positioning data up to the completion of positioning (operation pattern = 00) by Independent or continuous positioning control. A maximum of 50 blocks per axis can be specified.

Using a one-time start command from the PLC CPU or external, complex positioning control can be performed.

The block positioning control can be performed by specifying the positioning start number and positioning start information in the buffer memory.

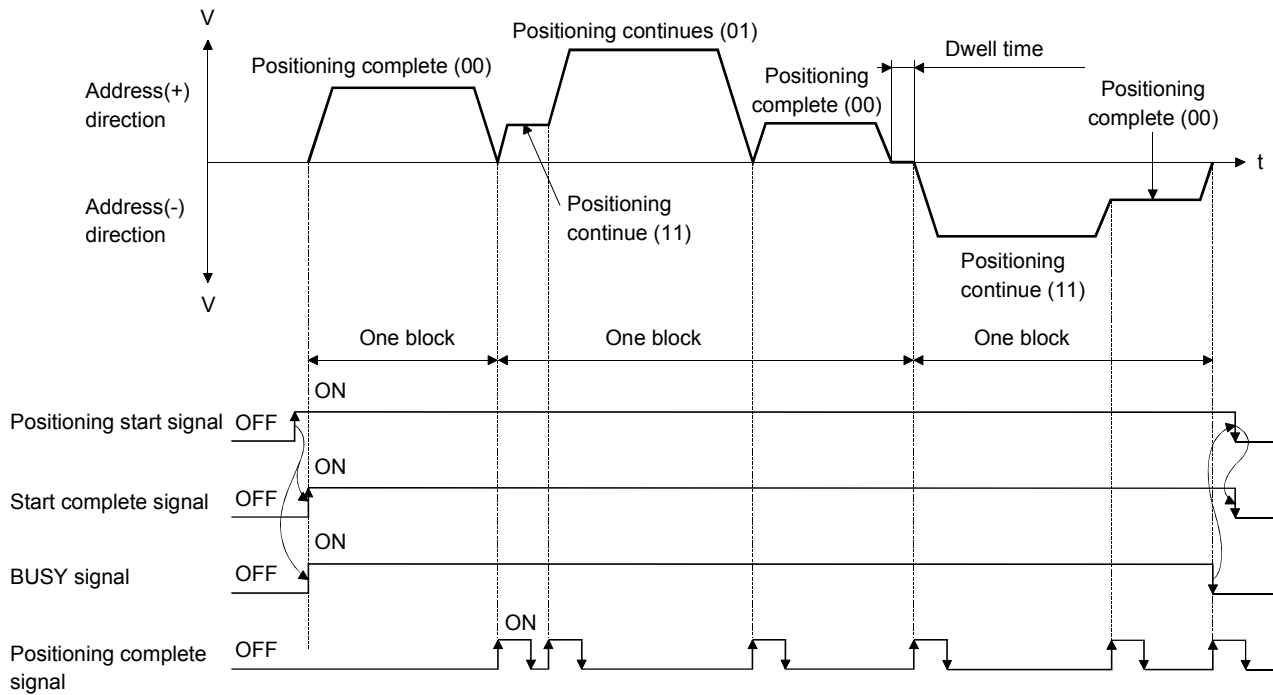

## ■ Overview of acceleration/deceleration processing control

Acceleration/deceleration processing for the positioning processing, manual pulse-generator processing, OPR processing and JOG processing is performed using the user-specified method, acceleration time and deceleration time.

### (1) Acceleration/deceleration method

There are two types of acceleration and deceleration processing: the trapezoidal acceleration/deceleration processing method and S-curve acceleration/deceleration processing method. A detailed parameter is used to set which method is used. The specified acceleration/deceleration method is applied to all accelerations and decelerations when starting and completing positioning processing, OPR processing and JOG processing, as well as when changing the speed.

#### (a) Trapezoidal acceleration/deceleration processing method

This is a method in which linear acceleration/deceleration is carried out based on the acceleration time, deceleration time, and speed limit value set by the user.

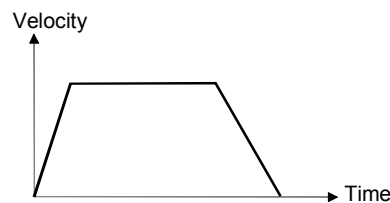

#### (b) S-curve acceleration/deceleration processing method

This method reduces the load on the motor when starting and stopping. This is a method in which acceleration/deceleration is carried out gradually, based on the acceleration time, deceleration time, speed limit value, and "Pr.35 S-curve ratio" (1 to 100%) set by the user.

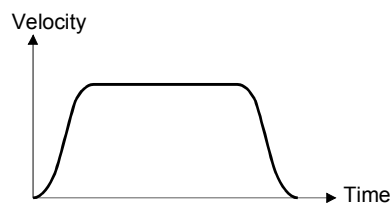

### (2) Acceleration time, deceleration time, sudden-stop deceleration time

(a) For types each of the acceleration time and deceleration time for positioning control can be set using basic parameters 2 and detailed parameters 2.

- Acceleration time.....The time elapses before the speed of 0 reaches the limit value.
- Deceleration time.....The time elapses before the speed at the limit value reaches 0.

(b) The sudden-stop deceleration time (1 to 8388608 ms) is set using the acceleration time/deceleration time setting size selection of detailed parameters 2.

### 1.1.5 Outline design of positioning system

The outline of the positioning system operation and design using the LD77MH is shown below.

#### (1) Positioning system using LD77MH

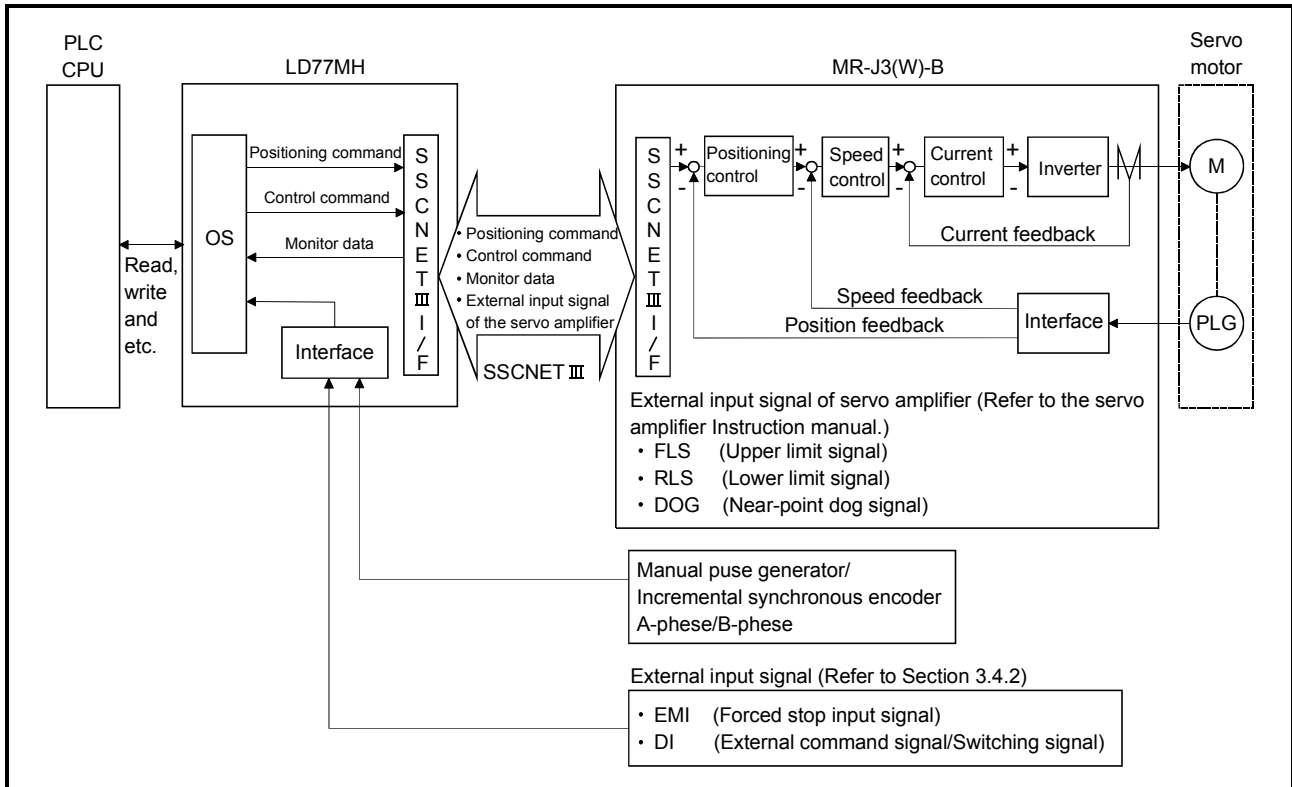

Fig. 1.1 Outline of the operation of positioning system using LD77MH

### 1.1.6 Communicating signals between LD77MH and each module

The outline of the signal communication between the LD77MH and PLC CPU, GX Works2 and servo amplifier, etc., is shown below.

(GX Works2 communicates with the LD77MH via the PLC CPU to which it is connected.)

#### (1) LD77MH4

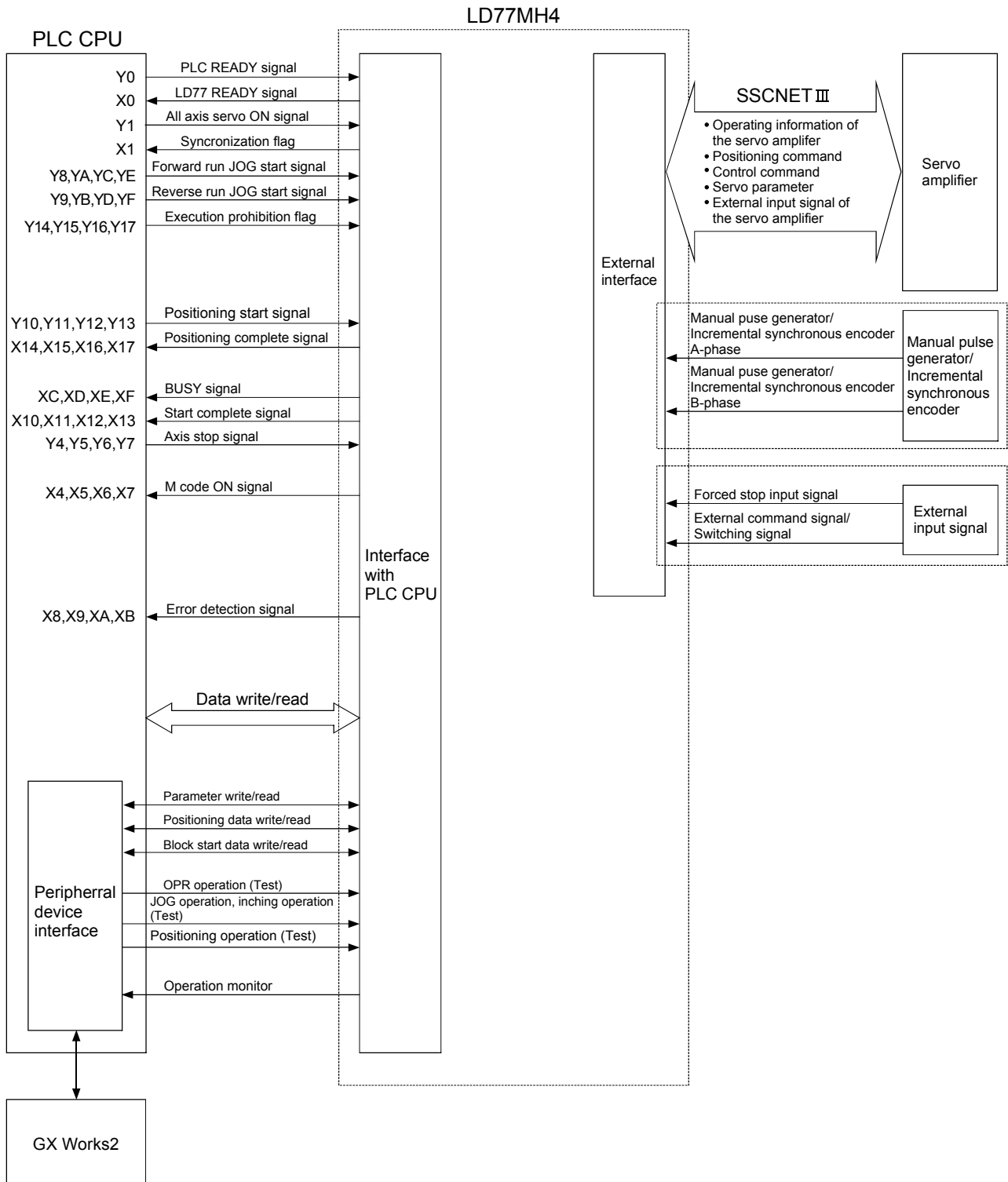

(2) LD77MH16

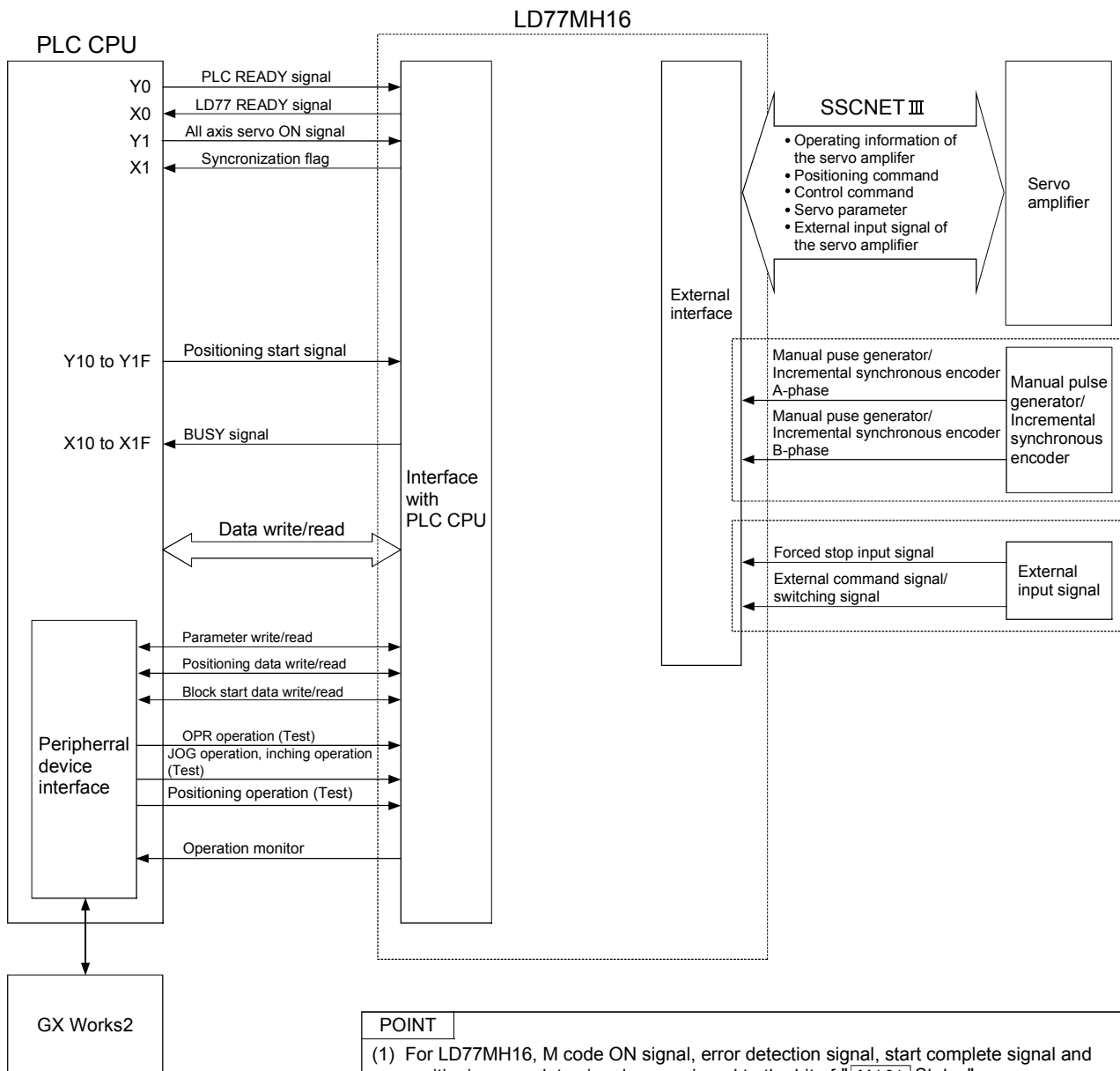

POINT
(1) For LD77MH16, M code ON signal, error detection signal, start complete signal and positioning complete signal are assigned to the bit of "[Md.31] Status".
(2) For LD77MH16, axis stop signal, forward run JOG start signal, reverse run JOG start signal, execution prohibition flag are assigned to the buffer memory [Cd.180] to [Cd.183].



■ LD77MH ↔ PLC CPU

The LD77MH and PLC CPU communicate the following data.

Direction Communication	LD77MH → PLC CPU	PLC CPU → LD77MH
Control signal *	Signal indicating LD77MH state • LD77 READY signal • BUSY signal and etc.	Signal related to commands • PLC READY signal • All axis servo ON signal • Positioning start signal and etc.
Data (read/write)	• Parameter • Positioning data • Block start data • Control data • Monitor data	• Parameter • Positioning data • Block start data • Control data

\* Refer to Section 3.3 "Specifications of input/output signals with PLC CPU" for details.

■ LD77MH ↔ GX Works2

The LD77MH and GX Works2 communicate the following data via the PLC CPU:

Direction Communication	LD77MH → GX Works2	GX Works2 → LD77MH
Data (read/write)	• Parameter • Positioning data	• Parameter • Positioning data
Test operation	—	• OPR control start command • Positioning control start command • JOG/Inching operation start command • Teaching start command • Manual pulse generator operation enable/disable command
Operation monitor	• Monitor data	—

■ LD77MH ↔ Servo amplifier

The LD77MH and servo amplifier communicate the following data via the SSCNET III.

Direction Communication	LD77MH → Servo amplifier	Servo amplifier → LD77MH
SSCNET III	• Positioning commands • Control commands • Servo parameter	• Operating information of the servo amplifier • Servo parameter • External input signal of the servo amplifier

■ LD77MH ↔ Manual pulse generator/Incremental synchronous encoder

The LD77MH and manual pulse generator/incremental synchronous encoder communicate the following data via the external input signal connector.

Direction	LD77MH → Manual pulse generator/Incremental synchronous encoder	Manual pulse generator/Incremental synchronous encoder → LD77MH
Communication		
Pulse signal	–	<ul style="list-style-type: none"> <li>• Manual pulse generator/Incremental synchronous encoder A-phase</li> <li>• Manual pulse generator/Incremental synchronous encoder B-phase</li> </ul>

■ LD77MH ↔ External signal

The LD77MH and external signal communicate the following data via the external input signal connector.

Direction	LD77MH → External signal	External signal → LD77MH
Communication		
Control signal	–	<ul style="list-style-type: none"> <li>• Forced stop input signal</li> <li>• External command signal/switching signal</li> </ul>

1.2 Flow of system operation

1.2.1 Flow of all processes

The positioning control processes, using the LD77MH, are shown below.

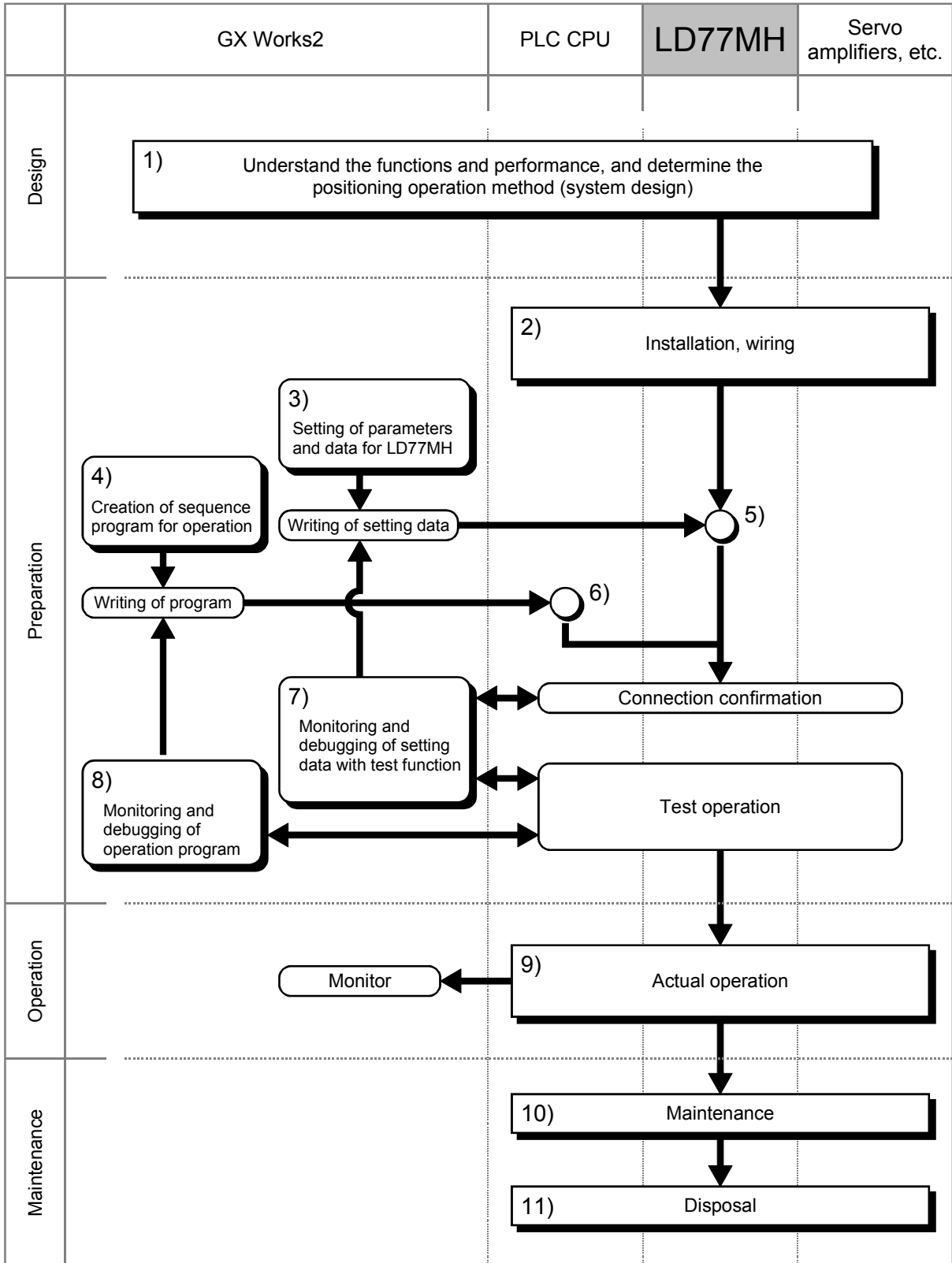

The following work is carried out with the processes shown on the previous page.

	Details	Reference
1)	Understand the product functions and usage methods, the configuration devices and specifications required for positioning control, and design the system.	<ul style="list-style-type: none"> <li>• Chapter 1</li> <li>• Chapter 2</li> <li>• Chapter 3</li> <li>• Chapter 8 to Chapter 14</li> </ul>
2)	Install the LD77MH onto the PLC CPU, wire the LD77MH and external connection devices (servo amplifier, etc.) and wire the PLC CPU and peripheral devices.	<ul style="list-style-type: none"> <li>• Chapter 4</li> </ul>
3)	Using GX Works2, set the parameter, servo parameters, positioning data, block start data and condition data required for the positioning control to be executed.	<ul style="list-style-type: none"> <li>• Chapter 5</li> <li>• Chapter 8 to Chapter 14</li> <li>• Simple Motion Module Setting Tool Help</li> </ul>
4)	Using GX Works2, create the sequence program required for positioning operation.	<ul style="list-style-type: none"> <li>• Chapter 6</li> <li>• GX Works2 Version1 Operating Manual (Common)</li> </ul>
5)	Write the parameters and positioning data, etc., created with GX Works2 into the LD77MH.	<ul style="list-style-type: none"> <li>• Chapter 7</li> <li>• Simple Motion Module Setting Tool Help</li> </ul>
6)	Using GX Works2, write the created sequence program into the PLC CPU.	<ul style="list-style-type: none"> <li>• Chapter 7</li> <li>• GX Works2 Version1 Operating Manual (Common)</li> </ul>
7)	Carry out test operation and adjustments in the test function of GX Works2 to check the connection with the LD77MH and external connection device, and to confirm that the designated positioning operation is executed correctly. (Debug the set "parameters" and "positioning data", etc.)	<ul style="list-style-type: none"> <li>• Chapter 14</li> <li>• Simple Motion Module Setting Tool Help</li> </ul>
8)	Carry out test operation and adjustment to confirm that the designated positioning operation is executed correctly. (Debug the created sequence program.)	<ul style="list-style-type: none"> <li>• GX Works2 Version1 Operating Manual (Common)</li> </ul>
9)	Actually operate the positioning operation. At this time, monitor the operation state as required. If an error or warning occurs, remedy.	<ul style="list-style-type: none"> <li>• Chapter 5</li> <li>• Chapter 16</li> <li>• Simple Motion Module Setting Tool Help</li> <li>• GX Works2 Version1 Operating Manual (Common)</li> </ul>
10)	Service the LD77MH as required.	<ul style="list-style-type: none"> <li>• Chapter 4</li> </ul>
11)	Dispose of the LD77MH.	<ul style="list-style-type: none"> <li>• Chapter 4</li> </ul>

### 1.2.2 Outline of starting

The outline for starting each control is shown with the following flowchart.  
 \*It is assumed that each module is installed, and the required system configuration, etc., has been prepared.

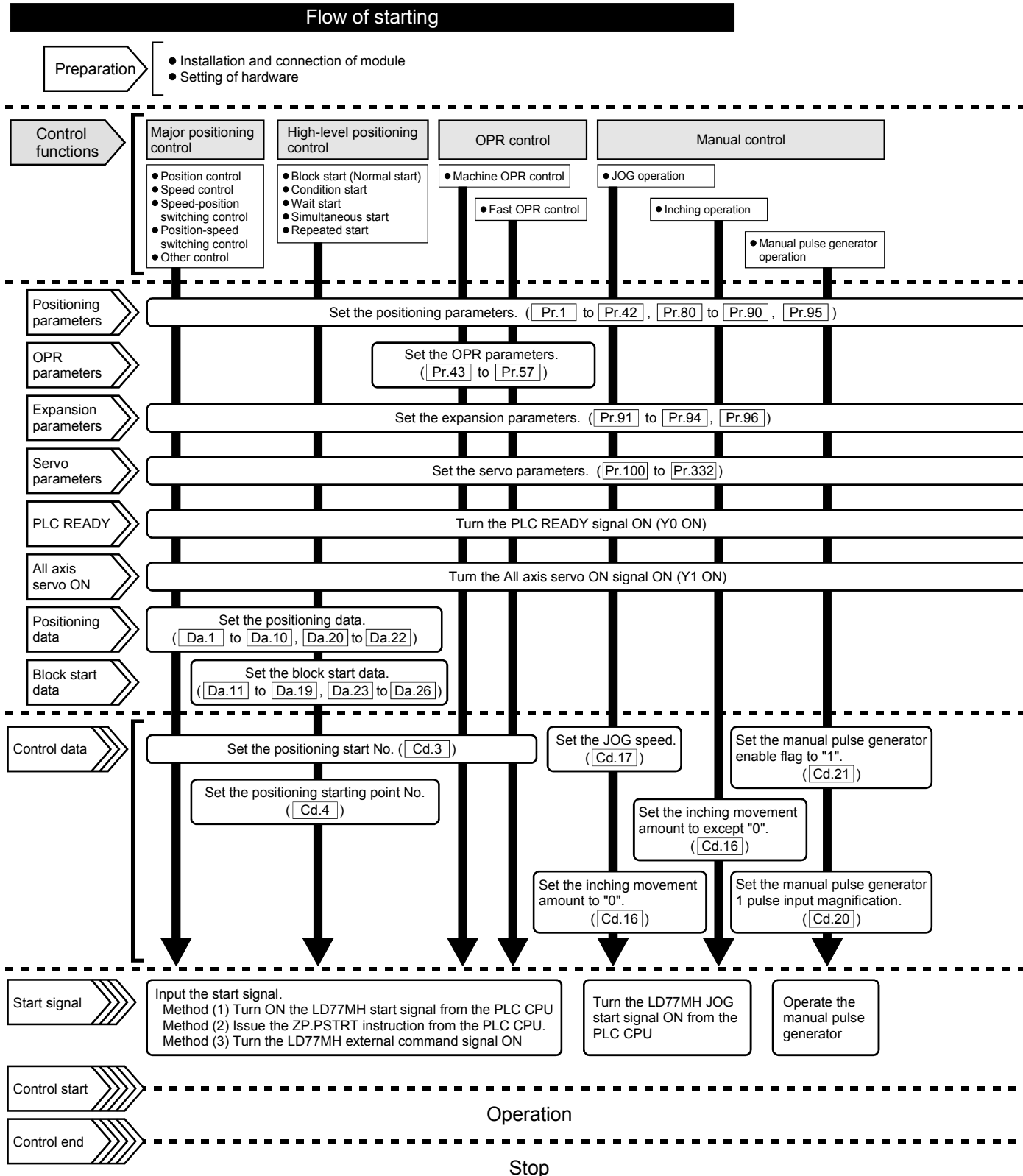

### Setting method

 : Indicates the sequence program that must be created.

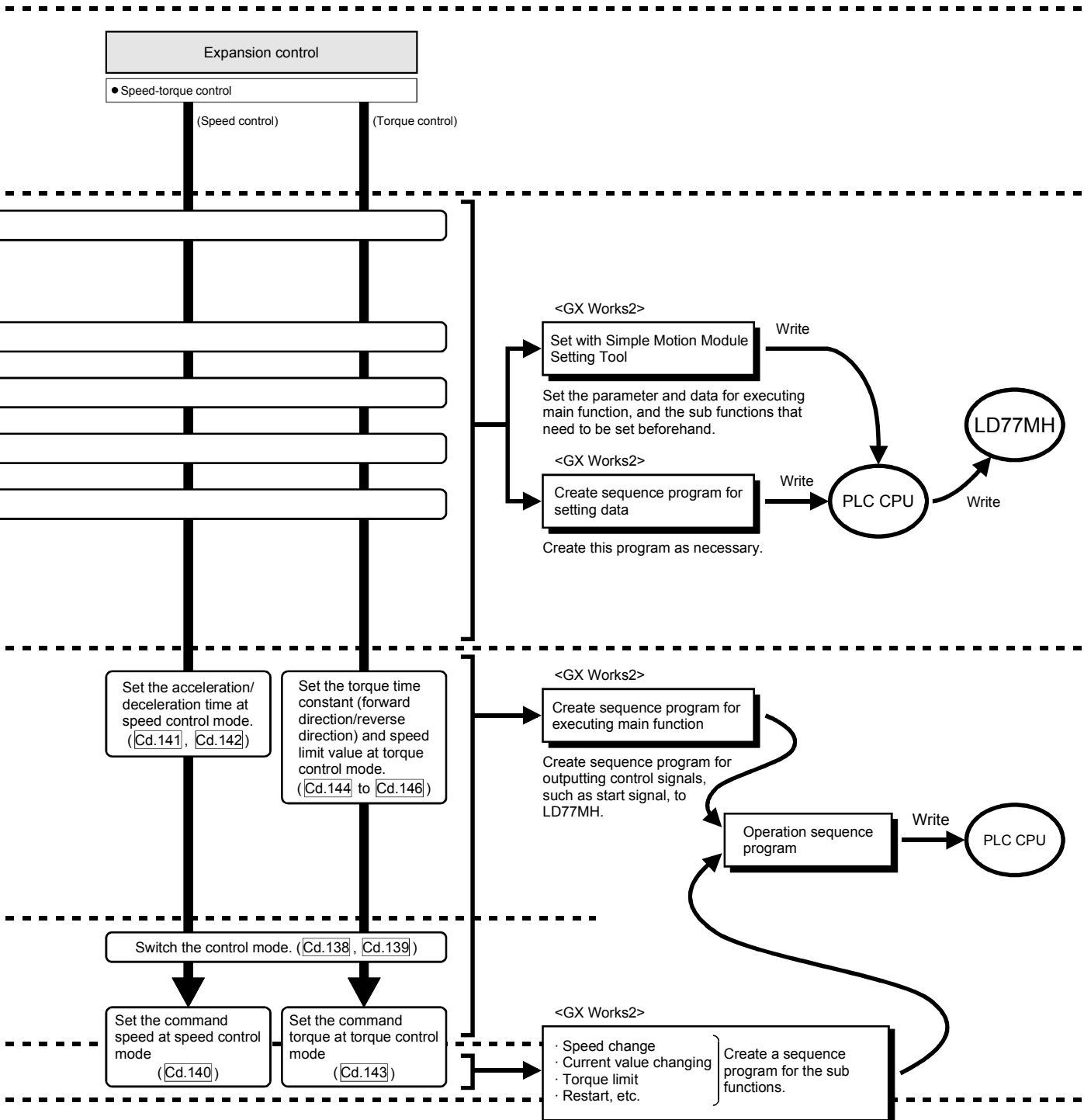

## 1.2.3 Outline of stopping

Each control is stopped in the following cases.

- (1) When each control is completed normally.
- (2) When the Servo READY signal is turned OFF.
- (3) When a PLC CPU error occurs.
- (4) When the PLC READY signal is turned OFF.
- (5) When an error occurs in the LD77MH.
- (6) When control is intentionally stopped (Stop signal from PLC CPU turned ON, etc.).

The outline for the stopping process in these cases is shown below. (Excluding (1) for normal stopping.)

Refer to Section 12.1 "Speed-torque control" for the stop processing during the speed control mode or torque control mode.

Stop cause		Stop axis	M code ON signal after stop	Axis operation status after stopping ( Md.26 )	Stop process					
					OPR control		Major positioning control	High-level positioning control	Manual control	
					Machine OPR control	Fast OPR control			JOG/Inching operation	Manual pulse generator operation
Forced stop	"Forced stop input signal from external device" OFF	All axes	No change	Servo OFF	Servo OFF or free run (The operation stops with dynamic brake or electromagnetic brake.)					
	Servo READY OFF	Each axis	No change	Servo amplifier has not been connected						
	• Servo amplifier power supply OFF			Error						
	• Servo alarm			Servo OFF						
Fatal stop (Stop group 1)	Hardware stroke limit upper/lower limit error occurrence	Each axis	No change	Error	Deceleration stop/sudden stop (Select with " Pr.37 Stop group 1 sudden stop selection".)				Deceleration stop	
Emergency stop (Stop group 2)	Error occurs in PLC CPU	All axes	No change	Error	Deceleration stop/sudden stop (Select with " Pr.38 Stop group 2 sudden stop selection".)				Deceleration stop	
	PLC READY signal OFF		Turns OFF							
	Error in test mode		No change							

Stop cause		Stop axis	M code ON signal after stop	Axis operation status after stopping ( Md.26 )	Stop process					
					OPR control		Major positioning control	High-level positioning control	Manual control	
					Machine OPR control	Fast OPR control			JOG/ Inching operation	Manual pulse generator operation
Relatively safe stop (Stop group 3)	Axis error detection (Error other than stop group 1 or 2) (Note-1) "Stop signal" from GX Works2	Each axis	No change	Error	Deceleration stop/sudden stop (Select with " Pr.39 Stop group 3 sudden stop selection".)					Deceleration stop
Intentional stop (Stop group 3)	"Axis stop signal" ON from PLC CPU	Each axis	No change	Stopped (Standby)						

(Note-1): If an error occurs in a positioning data due to an invalid setting value, when the continuous positioning control uses multiple positioning successively, it automatically decelerates at the previous positioning data. It does not stop suddenly even the setting value is sudden stop in stop group 3. If any of the following error occurs, the operation is performed up to the positioning data immediately before the positioning data where an error occurred, and then stops immediately.

- No command speed (Error code 503)
- Outside linear movement amount range (Error code 504)
- Large arc error deviation (Error code 506)
- Software stroke limit + (Error code 507)
- Software stroke limit - (Error code 508)
- Sub point setting error (Error code 525)
- End point setting error (Error code 526)
- Center point setting error (Error code 527)
- Outside radius range (Error code 544)
- Illegal setting of ABS direction in unit of degree (Error code 546)

**REMARK**

Provide the emergency stop circuits external to the servo system to prevent cases where danger may result from abnormal operation of the overall in the event of a power supply fault or servo system failure.



### 1.2.4 Outline for restarting

When a stop cause has occurred during operation with position control causing the axis to stop, positioning to the end point of the positioning data can be restarted from the stopped position by using the "Cd.6 Restart command".

If issued during a continuous positioning or continuous path control operation, the restart command will cause the positioning to be re-executed using the current position (pointed by the positioning data No. associated with the moment when the movement was interrupted) as the start point.

#### ■ When "Cd.6 Restart command" is ON

- (1) If the "Md.26 Axis operation status" is stopped, positioning to the end point of the positioning data will be restarted from the stopped position regardless of the absolute system or incremental system.
- (2) When "Md.26 Axis operation status" is not stopped, the warning "Restart not possible" (warning code: 104) will be applied, and the restart command will be ignored.

[Example for incremental system]

- (a) The restart operation when the axis 1 movement amount is 300, and the axis 2 movement amount is 600 is shown below.

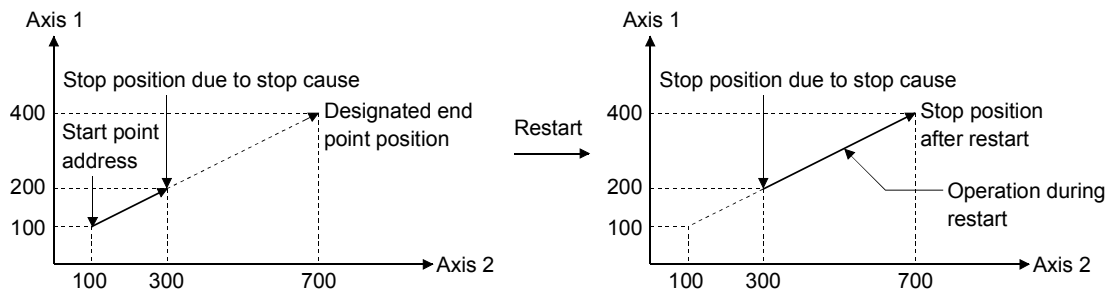

#### REMARK

If the positioning start signal/external command signal \* is turned ON while the "Md.26 Axis operation status" is standby or stopped, positioning will be restarted from the start of the positioning start data regardless of the absolute system or incremental system. (\*: When the external command signal is set to "External positioning start") (Same as normal positioning.)

[Example for incremental system]

- (a) The positioning start operation when the axis 1 movement amount is 300 and the axis 2 movement amount is 600 is shown below.

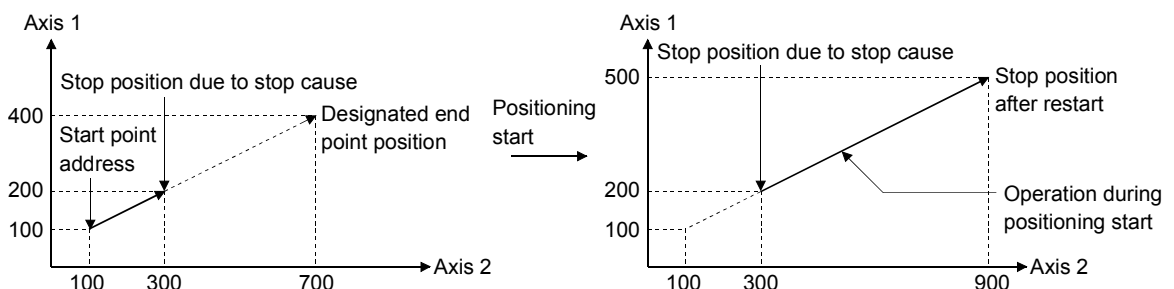

# Chapter 2 System Configuration

In this chapter, the general image of the system configuration of the positioning control using LD77MH, the configuration devices, applicable CPU and the precautions of configuring the system are explained.  
 Prepare the required configuration devices to match the positioning control system.

- 2.1 General image of system .....2- 2
- 2.2 Component list .....2- 3
- 2.3 Applicable system .....2- 4
- 2.4 How to check the function version and SERIAL No. ....2- 5
- 2.5 Restrictions by the SERIAL No. and version .....2- 5

2.1 General image of system

The general image of the system, including such as the LD77MH, PLC CPU and peripheral devices is shown below.

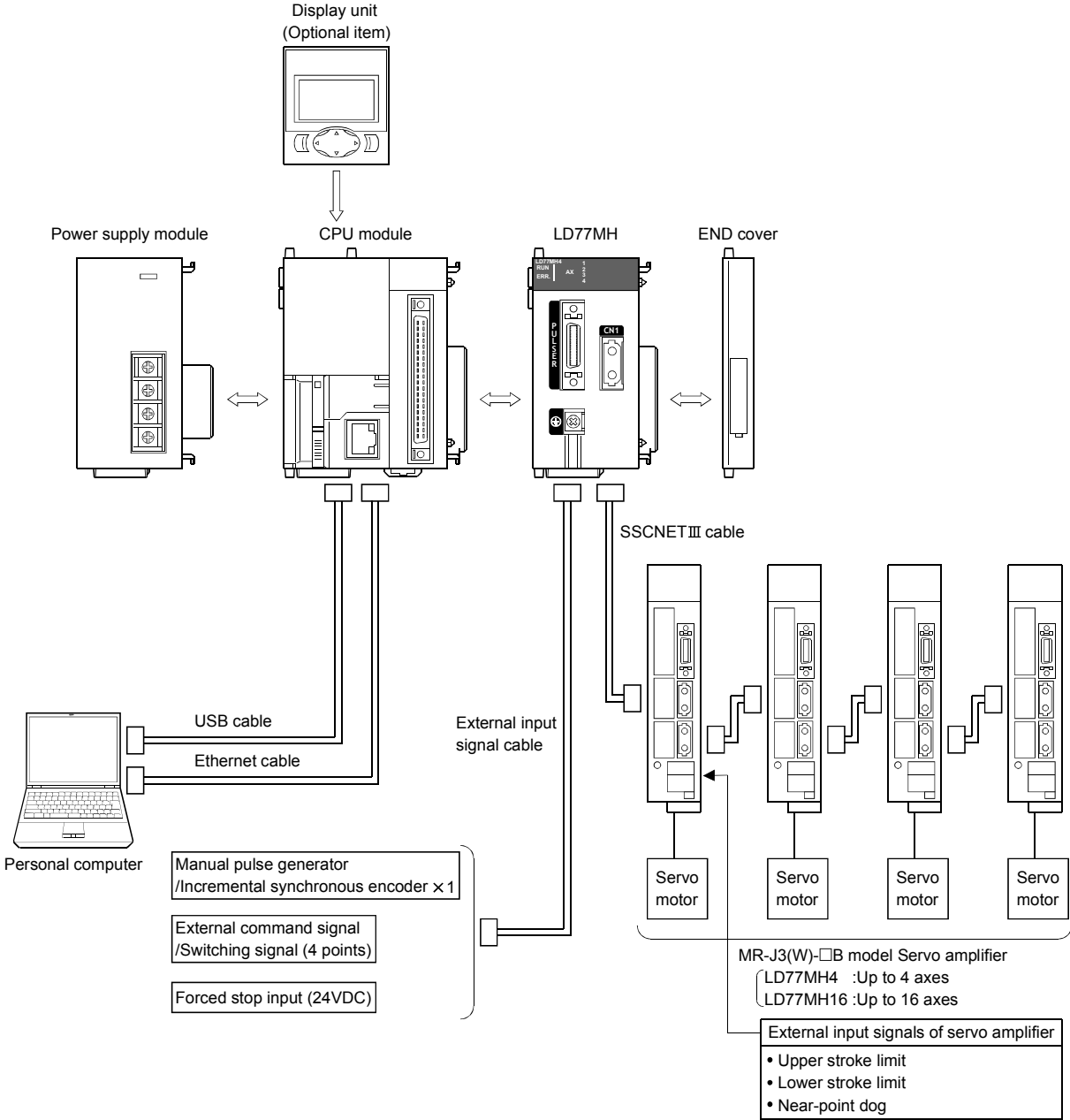

## 2.2 Component list

The positioning system using the LD77MH is configured of the following devices.

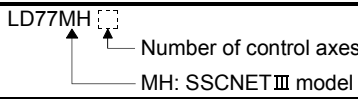
No.	Part name	Type	Remarks
1	Simple Motion module	LD77MH4	
		LD77MH16	
2	GX Works2	–	Refer to the "GX Works2 Version1 Operating Manual (Common)" for details.
3	MR Configurator2	–	Refer to the help of MR Configurator2 for details.
4	Personal computer	Personal computer which supports Windows®	(Prepared by user) Refer to the "GX Works2 Version1 Operating Manual (Common)" for details.
5	USB cable	–	(Prepared by user) A USB cable is needed for connecting the CPU module with a personal computer. Refer to the "GX Works2 Version1 Operating Manual (Common)" for details.
6	Ethernet cable	–	(Prepared by user) An Ethernet cable is needed for connecting the CPU module with a personal computer.
7	Servo amplifier	–	(Prepared by user)
8	Manual pulse generator	–	(Prepared by user) Recommended: MR-HDP01 (Mitsubishi Electric)
9	SSCNET III cable (Note-1)	–	(Prepared by user) Cables are needed to connect the LD77MH with the servo amplifier, or between servo amplifiers.
10	External input signal cable (Note-1)	–	(Prepared by user) Cables are needed to connect the LD77MH with the external device. (Prepare them referring to the manuals for the connected devices and information given in 3.4.2 of this manual.)

(Note-1): The SSCNET III cable connecting the LD77MH and servo amplifier, or between servo amplifiers, external input signal connector has been prepared.

[SSCNET III cable]

Model name	Cable length [m(ft.)]	Description
MR-J3BUS□M (Note-2) (Standard cord for inside panel)	MR-J3BUS015M	0.15 (0.49)
	MR-J3BUS03M	0.3 (0.98)
	MR-J3BUS05M	0.5 (1.64)
	MR-J3BUS1M	1 (3.28)
	MR-J3BUS3M	3 (9.84)
MR-J3BUS□M-A (Note-2) (Standard cable for outside panel)	MR-J3BUS5M-A	5 (16.40)
	MR-J3BUS10M-A	10 (32.81)
	MR-J3BUS20M-A	20 (65.62)
MR-J3BUS□M-B (Note-2) (Long distance cable)	MR-J3BUS30M-B	30 (98.43)
	MR-J3BUS40M-B	40 (131.23)
	MR-J3BUS50M-B	50 (164.04)

• LD77MH ↔ MR-J3(W)-□B  
• MR-J3(W)-□B ↔ MR-J3(W)-□B

(Note-2): □ = Cable length

(015: 0.15m (0.49ft.), 03: 0.3m (0.98ft.), 05: 0.5m (1.64ft.), 1: 1m (3.28ft.), 3: 3m (9.84ft.), 5: 5m (16.40ft.), 10: 10m (32.81ft.), 20: 20m (65.62ft.), 30: 30m (98.43ft.), 40: 40m (131.23ft.), 50: 50m (164.04ft.) )

[External input signal connector]

Part name	Specification
Applicable connector	LD77MHIOCON
Applicable wire size	AWG24 to AWG30 (0.2 to 0.05mm <sup>2</sup> ) (Note-3)

(Note-3): AWG24 (0.2mm<sup>2</sup>) is recommended.

### ■ Specifications of recommended manual pulse generator

Item	Specification
Model name	MR-HDP01
Ambient temperature	-10 to 60°C (14 to 140°F)
Pulse resolution	25PLS/rev (100 PLS/rev after magnification by 4)
Output method	Voltage-output (power supply voltage -1V or more), Output current Max. 20mA
Power supply voltage	4.5 to 13.2VDC
Current consumption	60mA
Output level	"H" level : Power supply voltage <sup>(Note-1)</sup> -1V or more (in no load) "L" level : 0.5V or less (with maximum leading-in)
Life time	1000000 revolutions (at 200r/min)
Permitted axial loads	Radial load: Max. 19.6N
	Thrust load: Max. 9.8N
Weight	0.4 (0.88) [kg(lb)]
Number of max. revolution	Instantaneous Max. 600r/min. normal 200r/min
Pulse signal status	2 signals: A phase, B phase, 90° phase difference
Start friction torque	0.06N·m (20°C (68°F))

(Note-1): If a separate power supply is used, use a stabilized power supply of voltage 5VDC ± 0.25V.

## 2.3 Applicable system

### (1) Number of applicable modules

The LD77MH is regarded as two modules by the CPU module.

The number of maximum applicable modules is five.

Pay attention to the power supply capacity before mounting modules because power supply capacity may be insufficient depending on the combination with other modules or the number of mounted modules.

If the power supply capacity is insufficient, change the combination of the modules.

For the number of applicable modules, refer to the "MELSEC-L CPU Module User's Manual (Hardware Design, Maintenance and Inspection)".

### (2) Programming tool

The applicable programming tool's versions of the LD77MH are shown below.

(For the applicable programming tool's versions of the CPU module, refer to the "MELSEC-L CPU Module User's Manual (Hardware Design, Maintenance and Inspection)".)

	Version	
	GX Works2	MR Configurator2
LD77MH4	Version 1.31H or later	Version 1.01B or later
LD77MH16	Version 1.48A or later	

### REMARK

Refer to APPENDIX 6 to use GX Developer and GX Configurator-QP.

LD77MH16 cannot be supported with GX Developer and GX Configurator-QP.

Use GX Works2 to use LD77MH16.

## 2.4 How to check the function version and SERIAL No.

For how to check the function version and the SERIAL No. of the LD77MH, refer to the "MELSEC-L CPU Module User's Manual (Hardware Design, Maintenance and Inspection)".

## 2.5 Restrictions by the SERIAL No. and version

There are restrictions in the function that can be used by the version of the SERIAL No. and software of LD77MH.

The combination of each version and function is shown below.

Function	LD77MH4		LD77MH16		Reference section
	Five digits of SERIAL NO.	MELSOFT GX Works2	Five digits of SERIAL NO.	MELSOFT GX Works2	
Mark detection function	/	/	—	Version 1.48A or later	Section 14.10
Optional data monitor function	/	/	—	Version 1.48A or later	Section 14.11
Module error collection function	/	/	—	Version 1.48A or later	Section 14.12
Manual pulse generator input multiplied by 1	/	/	—	Version 1.48A or later	/
Condition selection function of position-torque control mode switching	/	/	—	Version 1.48A or later	/
Start history of speed-torque control	/	/	—	Version 1.48A or later	/
High speed input request of external command function selection	/	/	—	Version 1.48A or later	/

—: There is no restriction by the version.

MEMO

---

---

---

---

---

---

---

---

---

---

---

---

---

---

---

---

---

---

---

---

---

---

---

---

---

---

---

---

# Chapter 3 Specifications and Functions

The various specifications of the LD77MH are explained in this chapter.

The "General specifications", "Performance specifications", "List of functions", "Specifications of input/output signals with PLC CPU", and the "Specifications of input/output interfaces with external devices", etc., are described as information required when designing the positioning system.

Confirm each specification before designing the positioning system.

3.1	Performance specifications .....	3- 2
3.2	List of functions .....	3- 4
3.2.1	LD77MH control functions.....	3- 4
3.2.2	LD77MH main functions.....	3- 7
3.2.3	LD77MH sub functions.....	3- 9
3.2.4	LD77MH common functions.....	3-11
3.2.5	Combination of LD77MH main functions and sub functions.....	3-12
3.3	Specifications of input/output signals with PLC CPU.....	3-14
3.3.1	List of input/output signals with PLC CPU .....	3-14
3.3.2	Details of input signals (LD77MH → PLC CPU) .....	3-16
3.3.3	Details of output signals (PLC CPU → LD77MH) .....	3-18
3.4	Specifications of interfaces with external devices.....	3-20
3.4.1	Electrical specifications of input signals.....	3-20
3.4.2	Signal layout for external input signal connector .....	3-23
3.4.3	List of input signal details.....	3-24
3.4.4	Interface internal circuit.....	3-26
3.5	External circuit design .....	3-28



3.1 Performance specifications

Model		LD77MH4	LD77MH16
Item			
Number of control axes		4 axes	16 axes
Operation cycle		0.88ms	0.88ms/1.77ms
Interpolation function		2-, 3-, or 4-axis linear interpolation, 2-axis circular interpolation	
Control system		PTP (Point To Point) control, path control (both linear and arc can be set), speed control, speed-position switching control, position-speed switching control, Speed-torque control	
Control unit		mm, inch, degree, PLS	
Positioning data		600 data/axis (Can be set with GX Works2 or sequence program.)	
Backup		Parameters, positioning data, and block start data can be saved on flash ROM (battery-less backup)	
Positioning	Positioning system	PTP control: Incremental system/absolute system Speed-position switching control: Incremental system/absolute system <sup>(Note-1)</sup> Position-speed switching control: Incremental system Path control: Incremental system/absolute system	
	Positioning range	<div style="border: 1px solid black; padding: 2px;">In absolute system</div> <ul style="list-style-type: none"> <li>• -214748364.8 to 214748364.7 (μm)</li> <li>• -21474.83648 to 21474.83647 (inch)</li> <li>• 0 to 359.99999 (degree)</li> <li>• -2147483648 to 2147483647 (PLS)</li> </ul> <div style="border: 1px solid black; padding: 2px;">In incremental system</div> <ul style="list-style-type: none"> <li>• -214748364.8 to 214748364.7 (μm)</li> <li>• -21474.83648 to 21474.83647 (inch)</li> <li>• -21474.83648 to 21474.83647 (degree)</li> <li>• -2147483648 to 2147483647 (PLS)</li> </ul> <div style="border: 1px solid black; padding: 2px;">In speed-position switching control (INC mode) / position-speed switching control</div> <ul style="list-style-type: none"> <li>• 0 to 214748364.7 (μm)</li> <li>• 0 to 21474.83647 (inch)</li> <li>• 0 to 21474.83647 (degree)</li> <li>• 0 to 2147483647 (PLS)</li> </ul> <div style="border: 1px solid black; padding: 2px;">In speed-position switching control (ABS mode) <sup>(Note-1)</sup></div> <ul style="list-style-type: none"> <li>• 0 to 359.99999 (degree)</li> </ul>	
	Speed command	0.01 to 20000000.00 (mm/min) 0.001 to 2000000.000 (inch/min) 0.001 to 2000000.000 (degree/min) <sup>(Note-2)</sup> 1 to 50000000 (PLS/s)	
	Acceleration/ deceleration process	Trapezoidal acceleration/deceleration, S-curve acceleration/deceleration	
	Acceleration/ deceleration time	1 to 8388608 (ms) Four patterns can be set for each of acceleration time and deceleration time	
	Sudden stop deceleration time	1 to 8388608 (ms)	

Item	Model	LD77MH4	LD77MH16
Starting time (ms) (Note-3)		0.88	1.77
1-axis linear control			
1-axis speed control			
2-axis linear interpolation control (Composite speed)			
2-axis linear interpolation control (Reference axis speed)			
2-axis circular interpolation control			
2-axis speed control			
3-axis linear interpolation control (Composite speed)			
3-axis linear interpolation control (Reference axis speed)			
3-axis speed control			
4-axis linear interpolation control			
4-axis speed control			
External wiring connection system	26-pin connector		
Applicable wire size	AWG24 to AWG30 (0.2 to 0.05mm <sup>2</sup> ) (Note-4)		
Applicable connector for external input signal	LD77MHIOCON		
SSCNET III cable	MR-J3BUS□M (Note-5)	<ul style="list-style-type: none"> <li>• LD77MH ↔ MR-J3(W)-□B/MR-J3(W)-□B ↔ MR-J3(W)-□B</li> <li>• Standard cord for inside panel 0.15m(0.49ft.), 0.3m(0.98ft.), 0.5m(1.64ft.), 1m(3.28ft.), 3m(9.84ft.)</li> </ul>	
	MR-J3BUS□M-A (Note-5)	<ul style="list-style-type: none"> <li>• LD77MH ↔ MR-J3(W)-□B/MR-J3(W)-□B ↔ MR-J3(W)-□B</li> <li>• Standard cable for outside panel 5m(16.40ft.), 10m(32.81ft.), 20m(65.62ft.)</li> </ul>	
	MR-J3BUS□M-B (Note-5), (Note-6)	<ul style="list-style-type: none"> <li>• LD77MH ↔ MR-J3(W)-□B/MR-J3(W)-□B ↔ MR-J3(W)-□B</li> <li>• Long distance cable 30m(98.43ft.), 40m(131.23ft.), 50m(164.04ft.)</li> </ul>	
5VDC internal current consumption [A]		0.55	0.70
Flash ROM write count		Max. 100000 times	
Number of occupied I/O points [points]		32 (I/O assignment: Intelligent function module 32 points)	
Number of applicable modules		Up to 5 modules	
External dimensions [mm(inch)]		90.0 (3.54) (H) × 45.0 (1.77) (W) × 95.0 (3.74) (D)	
Mass [kg]		0.22	

(Note-1): In speed-position switching control (ABS mode), the control unit available is "degree" only. (For details, refer to Section 9.2.17)

(Note-2): When "Speed control 10 x multiplier setting for degree axis function" is valid, this will be the setting range 0.01 to 20000000.00 (degree/min). (For details, refer to Section 13.7.10.)

(Note-3): Time from accepting the positioning start signal until BUSY signal turns ON.

(Note-4): AWG24 (0.2mm<sup>2</sup>) is recommended.

(Note-5): □ = Cable length

(015: 0.15m (0.49ft.), 03: 0.3m (0.98ft.), 05: 0.5m (1.64ft.), 1: 1m (3.28ft.), 3: 3m (9.84ft.), 5: 5m (16.40ft.), 10: 10m (32.81ft.), 20: 20m (65.62ft.), 30: 30m (98.43ft.), 40: 40m (131.23ft.), 50: 50m (164.04ft.)

(Note-6): For the cable of less than 30[m](98.43[ft.]), contact your nearest Mitsubishi sales representative.

## 3.2 List of functions

### 3.2.1 LD77MH control functions

The LD77MH has several functions. In this manual, the LD77MH functions are categorized and explained as follows.

#### ■ Main functions

##### (1) OPR control

"OPR control" is a function (Fast OPR) that established the start point for carrying out positioning control, and carries out positioning toward that start point (Machine OPR). This is used to return a workpiece, located at a position other than the OP when the power is turned ON or after positioning stop, to the OP. The "OPR control" is pre-registered in the LD77MH as the "Positioning start data No. 9001 (Machine OPR)", and "Positioning start data No. 9002 (Fast OPR)". (Refer to Chapter 8 "OPR Control".)

##### (2) Major positioning control

This control is carried out using the "Positioning data" stored in the LD77MH. Positioning control, such as position control and speed control, is executed by setting the required items in this "positioning data" and starting that positioning data. An "operation pattern" can be set in this "positioning data", and with this whether to carry out control with continuous positioning data (ex.: positioning data No. 1, No. 2, No. 3, ...) can be set. (Refer to Chapter 9 "Major Positioning Control".)

##### (3) High-level positioning control

This control executes the "positioning data" stored in the LD77MH using the "block start data". The following types of applied positioning control can be carried out.

- Random blocks, handling several continuing positioning data items as "blocks", can be executed in the designated order.
- "Condition judgment" can be added to position control and speed control.
- The operation of the designated positioning data No. that is set for multiple axes can be started simultaneously. (Command is output simultaneously to multiple servo amplifiers.)
- The designated positioning data can be executed repeatedly, etc., (Refer to Chapter 10 "High-Level Positioning Control".)

##### (4) Manual control

This control executes the random positioning operation by inputting a signal into the LD77MH from an external device. Use this manual control to move the workpiece to a random position (JOG operation), and to finely adjust the positioning (inching operation, manual pulse generator operation), etc. (Refer to Chapter 11 "Manual Control".)

##### (5) Expansion control

The following controls other than the positioning control can be executed.

- Speed control and torque control not including position loop for the command to servo amplifier (Speed-torque control). (Refer to Section 12 "Expansion Control".)
- Synchronous control with gear, shaft, change gear and cam not by mechanical, but by software use "synchronous control parameter", and is synchronized with input axis (Synchronous control).

■ Sub functions

When executing the main functions, control compensation, limits and functions can be added. (Refer to Chapter 13 "Control Sub Functions".)

■ Common functions

Common control using the LD77MH for "parameter initialization" or "backup of execution data" can be carried out. (Refer to Chapter 14 "Common Functions".)

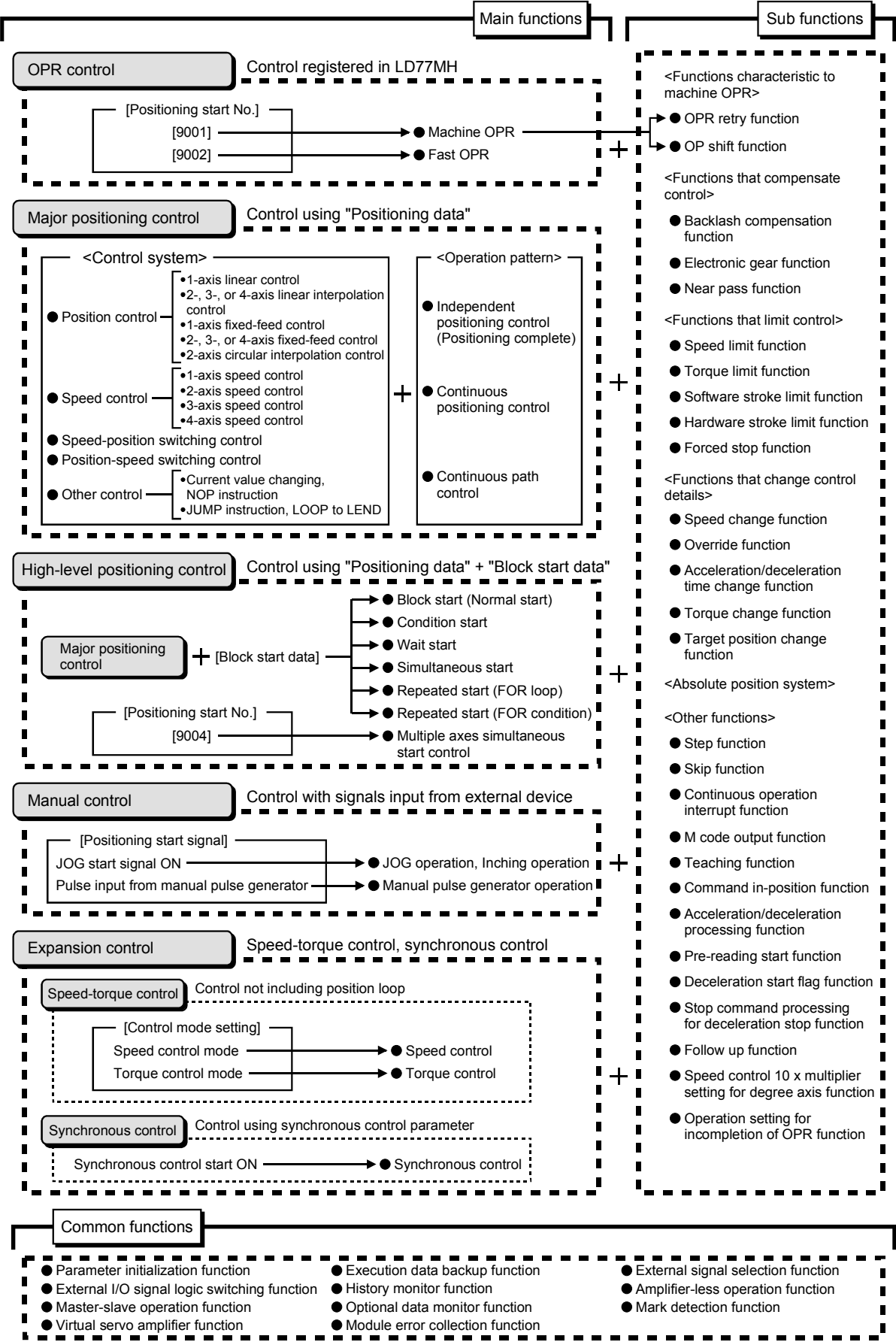

## 3.2.2 LD77MH main functions

The outline of the main functions for positioning control with the LD77MH is described below. (Refer to "Section 2" for details on each function.)

Main functions		Details	Reference section	
OPR control	Machine OPR control	Mechanically establishes the positioning start point using a near-point dog. (Positioning start No. 9001)	8.2	
	Fast OPR control	Positions a target to the OP address ( <u>Md.21</u> Machine feed value) stored in the LD77MH using machine OPR. (Positioning start No. 9002)	8.3	
Major positioning control	Position control	Linear control (1-axis linear control) (2-axis linear interpolation control) (3-axis linear interpolation control) (4-axis linear interpolation control)	9.2.2 9.2.3 9.2.4 9.2.5	
		Fixed-feed control (1-axis fixed-feed control) (2-axis fixed-feed control) (3-axis fixed-feed control) (4-axis fixed-feed control)	9.2.6 9.2.7 9.2.8 9.2.9	
		2-axis circular interpolation control	9.2.10 9.2.11	
		Speed control (1-axis speed control) (2-axis speed control) (3-axis speed control) (4-axis speed control)	9.2.12 9.2.13 9.2.14 9.2.15	
	Speed-position switching control	First, carries out speed control, and then carries out position control (positioning with designated address or movement amount) by turning the "speed-position switching signal" ON.	9.2.16 9.2.17	
	Position-speed switching control	First, carries out position control, and then carries out speed control (continuous output of the command corresponding to the designated command speed) by turning the "position-speed switching signal" ON.	9.2.18	
	Other control	Current value changing	Changes the Current feed value ( <u>Md.20</u> ) to the address set in the positioning data. The following two methods can be used. (The machine feed value ( <u>Md.21</u> ) cannot be changed.) • Current value changing using positioning data • Current value changing using current value changing start No. (No. 9003)	9.2.19
		NOP instruction	No execution control system. When NOP instruction is set, this instruction is not executed and the operation of the next data is started.	9.2.20
		JUMP instruction	Unconditionally or conditionally jumps to designated positioning data No.	9.2.21
		LOOP	Carries out loop control with repeated LOOP to LEND.	9.2.22
		LEND	Returns to the beginning of the loop control with repeated LOOP to LEND.	9.2.23

Main functions		Details	Reference section
High-level positioning control	Block start (Normal start)	With one start, executes the positioning data in a random block with the set order.	10.3.2
	Condition start	Carries out condition judgment set in the "condition data" for the designated positioning data, and then executes the "block start data". When the condition is established, the "block start data" is executed. When not established, that "block start data" is ignored, and the next point's "block start data" is executed.	10.3.3
	Wait start	Carries out condition judgment set in the "condition data" for the designated positioning data, and then executes the "block start data". When the condition is established, the "block start data" is executed. When not established, stops the control until the condition is established. (Waits.)	10.3.4
	Simultaneous start	Simultaneously executes the positioning data having the No. for the axis designated with the "condition data". (Outputs commands at the same timing.)	10.3.5
	Repeated start (FOR loop)	Repeats the program from the block start data set with the "FOR loop" to the block start data set in "NEXT" for the designated number of times.	10.3.6
	Repeated start (FOR condition)	Repeats the program from the block start data set with the "FOR condition" to the block start data set in "NEXT" until the conditions set in the "condition data" are established.	10.3.7
	Multiple axes simultaneous start control	Starts the operation of multiple axes simultaneously according to the command output level. (Positioning start No. 9004, same as the "simultaneous start" above)	10.5
Manual control	JOG operation	Outputs a command to servo amplifier while the JOG start signal is ON.	11.2
	Inching operation	Outputs commands corresponding to minute movement amount by manual operation to servo amplifier. (Performs fine adjustment with the JOG start signal.)	11.3
	Manual pulse generator operation	Outputs pulses commanded with the manual pulse generator to servo amplifier.	11.4
Expansion control	Speed-torque control	Carries out the speed control or torque control that does not include the position loop for the command to servo amplifier by switching control mode.	12.1
	Synchronous control	Carries out the synchronous control that synchronizes with input axis by setting the system such as gear, shaft change gear and cam to the "synchronous control parameter".	-

With the "major positioning control" ("high-level positioning control"), whether or not to continuously execute the positioning data can be set with the "operation pattern".

Outlines of the "operation patterns" are given below.

Da.1 Operation pattern	Details	Reference section
Independent positioning control (positioning complete)	When "independent positioning control" is set for the operation pattern of the started positioning data, only the designated positioning data will be executed, and then the positioning will end.	9.1.2
Continuous positioning control	When "continuous positioning control" is set for the operation pattern of the started positioning data, after the designated positioning data is executed, the program will stop once, and then the next following positioning data will be executed.	
Continuous path control	When "continuous path control" is set for the operation pattern of the started positioning data, the designated positioning data will be executed, and then without decelerating, the next following positioning data will be executed.	

## 3.2.3 LD77MH sub functions

The functions that assist positioning control using the LD77MH are described below.  
(Refer to "Section 2" for details on each function.)

Sub function		Details	Reference section
Functions characteristic to machine OPR	OPR retry function	This function retries the machine OPR with the upper/lower limit switches during OPR. This allows machine OPR to be carried out even if the axis is not returned to before the near-point dog with JOG operation, etc.	13.2.1
	OP shift function	After returning to the machine OP, this function compensates the position by the designated distance from the machine OP position and sets that position as the OP address.	13.2.2
Functions that compensate control	Backlash compensation function	This function compensates the mechanical backlash amount. Feed commands equivalent to the set backlash amount are output each time the movement direction changes.	13.3.1
	Electronic gear function	By setting the movement amount per pulse, this function can freely change the machine movement amount per commanded pulse. When the movement amount per pulse is set, a flexible positioning system that matches the machine system can be structured.	13.3.2
	Near pass function * 1	This function suppresses the machine vibration when the positioning data is switched during continuous path control in the interpolation control.	13.3.3
Functions that limit control	Speed limit function	If the command speed exceeds " [Pr.8] Speed limit value" during control, this function limits the commanded speed to within the " [Pr.8] Speed limit value" setting range.	13.4.1
	Torque limit function	If the torque generated by the servomotor exceeds " [Pr.17] Torque limit setting value" during control, this function limits the generated torque to within the " [Pr.17] Torque limit setting value" setting range.	13.4.2
	Software stroke limit function	If a command outside of the upper/lower limit stroke limit setting range, set in the parameters, is issued, this function will not execute positioning for that command.	13.4.3
	Hardware stroke limit function	This function carries out deceleration stop with the hardware stroke limit switch.	13.4.4
	Forced stop function	This function is stopped the all axis of the servo amplifier when the forced stop input signal of the LD77MH external input signal connector is turned ON.	13.4.5
Functions that change control details	Speed change function	This function changes the speed during positioning. Set the new speed in the speed change buffer memory ( [Cd.14] New speed value), and change the speed with the Speed change request ( [Cd.15] ).	13.5.1
	Override function	This function changes the speed within a percentage of 1 to 300% during positioning. This is executed using " [Cd.13] Positioning operation speed override".	13.5.2
	Acceleration/deceleration time change function	This function changes the acceleration/deceleration time during speed change. (Functions added to the speed change function and override function)	13.5.3
	Torque change function	This function changes the "torque limit value" during control.	13.5.4
	Target position change function	This function changes the target position during positioning. Position and speed can be changed simultaneously.	13.5.5



Sub function		Details	Reference section
Absolute position system		This function restores the absolute position of designated axis. If the OPR is executed at the start of system, after that, it is unnecessary to carry out the OPR when the power is turned ON.	13.6
Other functions	Step function	This function temporarily stops the operation to confirm the positioning operation during debugging, etc. The operation can be stopped at each "automatic deceleration" or "positioning data".	13.7.1
	Skip function	This function stops (decelerates to a stop) the positioning being executed when the skip signal is input, and carries out the next positioning.	13.7.2
	M code output function	This function issues a command for a sub work (clamp or drill stop, tool change, etc.) corresponding to the M code No. (0 to 65535) that can be set for each positioning data.	13.7.3
	Teaching function	This function stores the address positioned with manual control into the "[Da.6]Positioning address/movement amount" having the designated positioning data No. ([Cd.39]).	13.7.4
	Command in-position function	At each automatic deceleration, this function calculates the remaining distance for the LD77MH to reach the positioning stop position. When the value is less than the set value, the "command in-position flag" is set to "1". When using another auxiliary work before ending the control, use this function as a trigger for the sub work.	13.7.5
	Acceleration/deceleration processing function	This function adjusts the acceleration/deceleration.	13.7.6
	Continuous operation interrupt function	This function interrupts continuous operation. When this request is accepted, the operation stops when the execution of the current positioning data is completed.	6.5.4
	Pre-reading start function	This function shortens the virtual start time.	13.7.7
	Deceleration start flag function	Function that turns ON the flag when the constant speed status or acceleration status switches to the deceleration status during position control, whose operation pattern is "Positioning complete", to make the stop timing known.	13.7.8
	Stop command processing for deceleration stop function	Function that selects a deceleration curve when a stop cause occurs during deceleration stop processing to speed 0.	13.7.9
Follow up function	This function monitors the motor rotation amount with the servo turned OFF, and reflects it on the current feed value.	13.8.2	
Speed control 10 x multiplier setting for degree axis function	This function is executed the positioning control by the 10 x speed of the command speed and the speed limit value when the setting unit is "degree".	13.7.10	
Operation setting for incompleteness of OPR function	This function is provided to select whether positioning control is operated or not, when OPR request flag is ON.	13.7.11	

\* 1: The near pass function is featured as standard and is valid only for position control. It cannot be set to be invalid with parameters.

## 3.2.4 LD77MH common functions

The outline of the functions executed as necessary are described below.  
(Refer to "Section 2" for details on each function.)

Common functions	Details	Reference section
Parameter initialization function	This function returns the "parameters" stored in the LD77MH buffer memory and flash ROM to the default values. The following two methods can be used. 1) Method using sequence program 2) Method using GX Works2	14.2
Execution data backup function	This function stores the "setting data", currently being executed, into the flash ROM. 1) Method using sequence program 2) Method using GX Works2	14.3
External signal selection function	This function is used to the external input signal of servo amplifier as the upper/lower limit signal and the Near-point dog signal.	14.4
External I/O signal logic switching function	This function switches I/O signal logic according to externally connected devices. This function enables the use of the system that does not use b (N.C.)-contact signals, such as Upper/lower limit signal, by setting parameters to positive logic.	14.5
History monitor function	This function monitors errors, warnings, and start history of all axes.	14.6
Amplifier-less operation function	This function executes the positioning control of LD77MH without connecting to the servo amplifiers. It is used to debug the program at the start-up of the device or simulate the positioning operation.	14.7
Virtual servo amplifier function	This function executes the operation as the axis (virtual servo amplifier axis) that operates only command (instruction) virtually without servo amplifiers.	14.8
Master-slave operation function	This function uses the master-slave operation function of servo amplifier. The positioning control of master axis is executed with LD77MH, and the slave axis is controlled by data communication (driver communication) between servo amplifiers without LD77MH.	14.9
Mark detection function	This function is used to latch any data at the input timing of the mark detection signal (DI1 to DI4).	14.10
Optional data monitor function	This function is used to store the data selected by user up to 4 data per axis to buffer memory and monitor them.	14.11
Module error collection function	This function collects errors occurred in the LD77MH in the PLC CPU. Holding the error contents in the PLC CPU, this function enables to check the error history even after the PLC CPU in powered off or reset.	14.12

### 3.2.5 Combination of LD77MH main functions and sub functions

With positioning control using the LD77MH, the main functions and sub functions can be combined and used as necessary. A list of the main function and sub function combinations is given below.

Main functions			Sub functions	Functions characteristic to machine OPR		Functions that compensate control			
				OPR retry function	OP shift function	Backlash compensation function	Electronic gear function	Near pass function	
OPR control			Machine OPR control	×	△ *11	○	○	○	
			Fast OPR control	×	×	×	○	○	
Major positioning control	Position control	1-axis linear control	○	×	×	○	○	*2	
		2-, 3-, or 4-axis linear interpolation control	○	×	×	○	○		
		1-axis fixed-feed control	△ (Continuous path control cannot be set)	×	×	○	○		
		2-, 3-, or 4-axis fixed-feed control (interpolation)	△ (Continuous path control cannot be set)	×	×	○	○		
		2-axis circular interpolation control	○	×	×	○	○		
	Speed control (1- to 4-axis)		△ (Only independent positioning control can be set)	×	×	○	○		
	Speed-position switching control		△ (Continuous path control cannot be set)	×	×	○	○		
	Position-speed switching control		△ (Only independent positioning control can be set)	×	×	○	○		
	Other control	Current value changing		△ (Continuous path control cannot be set)	×	×	×		×
		NOP instruction		×	×	×	×		
JUMP instruction		×	×	×	×				
LOOP to LEND		×	×	×	×				
Manual control	JOG operation, inching operation		×	×	×	○	○	×	
	Manual pulse generator operation		×	×	×	○	○	×	
Expansion control	Speed-torque control		×	×	×	×	○	×	

\*1: The operation pattern is one of the "positioning data" setting items.

\*2: The near pass function is featured as standard and is valid only for setting continuous path control for position control.

\*3: Invalid during creep speed.

\*4: Invalid during continuous path control.

\*5: Combination with the inching operation is not available. (Inching operation does not perform acceleration/deceleration processing.)

\*6: Valid for the reference axis only.

\*7: Valid for only the case where a deceleration start is made during position control.

\*8: Change the current value using the positioning data. Disabled for a start of positioning start No. 9003.

\*9: Valid for "[Md.22] Feedrate" and "[Md.28] Axis feedrate".

\*10: Valid for a start of positioning start No.9003, but invalid for a start of positioning data (No. 1 to 600).

\*11: OPR retry function cannot be used during the scale origin signal detection method machine OPR.

\*12: Refer to Section 12.1 "Speed-torque control" for acceleration/deceleration processing in the speed-torque control.

	Functions that limit control					Functions that change control details					Other functions										
	Speed limit function	Torque limit function	Software stroke limit function	Hardware stroke limit function	Forced stop function	Speed change function	Override function	Acceleration/ deceleration time change function	Torque change function	Target position change function	Step function	Skip function	M code output function	Teaching function	Command in-position function	Acceleration/deceleration processing function	Pre-reading start function	Deceleration start flag function	Stop command processing for deceleration stop function	Speed control 10 x multiplier setting for degree axis function	Operation setting for incompletion of OPR function
	○	○	×	◎	○	△ *3	△ *3	△ *3	○	×	×	×	×	×	○	×	×	○	○	○	×
	○	○	×	◎	○	○	○	○	○	×	×	×	×	×	○	×	×	○	○	○	×
	○	○	○	◎	○	○	○	○	○	△ *4	○	○	○	×	○	○	○	○	○	○	○
	○	○	○	◎	○	○	○	○	○	×	○	○	○	×	○	○	○	△ *6	○	○	○
	○	○	○	◎	○	○	○	○	○	×	○	○	○	×	○	○	○	△ *6	○	○	○
	○	○	○	◎	○	○	○	○	○	×	○	○	○	×	○	○	○	×	○	×	○
	○	○	○	◎	○	○	○	○	○	×	×	×	○	×	○	○	○	×	○	○	○
	○	○	○	◎	○	○	○	○	○	×	○	○	×	○	○	○	○	△ *7	○	○	○
	×	×	×	◎ ×	○	×	×	×	×	×	○	○	△ *8	×	×	×	×	×	×	×	△ *10 ×
	×	×	×	×	○	×	×	×	×	×	×	×	×	×	×	×	×	×	×	×	×
	○	○	○	◎	○	△ *5	△ *5	△ *5	○	×	×	×	×	○	×	△ *5	×	×	×	○	×
	×	○	○	◎	○	×	×	×	○	×	×	×	○	×	×	×	×	×	×	△ *9	×
	○	○	○	◎	○	×	×	×	○	×	×	×	×	×	△ *12	×	×	×	×	○	○

◎: Always combine, ○: Combination possible, △: Combination limited, ×: Combination not possible

### 3.3 Specifications of input/output signals with PLC CPU

#### 3.3.1 List of input/output signals with PLC CPU

The LD77MH uses 32 input points and 32 output points for exchanging data with the PLC CPU.

The input/output signals when the head I/O number of LD77MH is set to "0H" are shown below.

If it is set to other than "0H", change the I/O number according to setting of head I/O number.

Device X refers to the signals input from the LD77MH to the PLC CPU, and device Y refers to the signals output from the PLC CPU to the LD77MH.

##### (1) LD77MH4

Signal direction: LD77MH4 → PLC CPU			Signal direction: PLC CPU → LD77MH4		
Device No.	Signal name		Device No.	Signal name	
X0	LD77 READY		Y0	PLC READY	
X1	Synchronization flag		Y1	All axis servo ON	
X2	Use prohibited		Y2	Use prohibited	
X3			Y3		
X4	Axis 1	M code ON	Y4	Axis 1	Axis stop
X5	Axis 2		Y5	Axis 2	
X6	Axis 3		Y6	Axis 3	
X7	Axis 4		Y7	Axis 4	
X8	Axis 1	Error detection	Y8	Axis 1	Forward run JOG start
X9	Axis 2		Y9		Reverse run JOG start
XA	Axis 3		YA	Axis 2	Forward run JOG start
XB	Axis 4		YB		Reverse run JOG start
XC	Axis 1	BUSY	YC	Axis 3	Forward run JOG start
XD	Axis 2		YD		Reverse run JOG start
XE	Axis 3		YE	Axis 4	Forward run JOG start
XF	Axis 4		YF		Reverse run JOG start
X10	Axis 1	Start complete	Y10	Axis 1	Positioning start
X11	Axis 2		Y11	Axis 2	
X12	Axis 3		Y12	Axis 3	
X13	Axis 4		Y13	Axis 4	
X14	Axis 1	Positioning complete	Y14	Axis 1	Execution prohibition flag
X15	Axis 2		Y15	Axis 2	
X16	Axis 3		Y16	Axis 3	
X17	Axis 4		Y17	Axis 4	
X18	Use prohibited		Y18	Use prohibited	
X19			Y19		
X1A			Y1A		
X1B			Y1B		
X1C			Y1C		
X1D			Y1D		
X1E			Y1E		
X1F			Y1F		

#### Important

[Y2, Y3], [Y18 to Y1F], [X2, X3], and [X18 to X1F] are used by the system, and cannot be used by the user.

If these devices are used, the operation of the LD77MH4 will not be guaranteed.

(2) LD77MH16

Signal direction: LD77MH16 → PLC CPU			Signal direction: PLC CPU → LD77MH16		
Device No.	Signal name		Device No.	Signal name	
X0	LD77 READY		Y0	PLC READY	
X1	Synchronization flag		Y1	All axis servo ON	
X2	Use prohibited		Y2	Use prohibited	
X3					
X4					
X5					
X6					
X7					
X8					
X9					
XA					
XB					
XC					
XD					
XE					
XF					
X10			Axis 1		
X11	Axis 2	Y11	Axis 2		
X12	Axis 3	Y12	Axis 3		
X13	Axis 4	Y13	Axis 4		
X14	Axis 5	Y14	Axis 5		
X15	Axis 6	Y15	Axis 6		
X16	Axis 7	Y16	Axis 7		
X17	Axis 8	Y17	Axis 8		
X18	Axis 9	Y18	Axis 9		
X19	Axis 10	Y19	Axis 10		
X1A	Axis 11	Y1A	Axis 11		
X1B	Axis 12	Y1B	Axis 12		
X1C	Axis 13	Y1C	Axis 13		
X1D	Axis 14	Y1D	Axis 14		
X1E	Axis 15	Y1E	Axis 15		
X1F	Axis 16	Y1F	Axis 16		

**POINT**

- (1) For LD77MH16, M code ON signal, error detection signal, start complete signal and positioning complete signal are assigned to the bit of "[Md.31] Status".
- (2) For LD77MH16, axis stop signal, forward run JOG start signal, reverse run JOG start signal, execution prohibition flag are assigned to the buffer memory [Cd.180] to [Cd.183].

**Important**

[Y2 to YF] and [X2 to XF] are used by the system, and cannot be used by the user. If these devices are used, the operation of the LD77MH16 will not be guaranteed.

3.3.2 Details of input signals (LD77MH → PLC CPU)

The ON/OFF timing and conditions of the input signals are shown below.  
 (1) LD77MH4

Device No.	Signal name		Details
X0	LD77 READY		<p>ON: READY                      OFF: Not READY/                      Watch dog timer error</p> <ul style="list-style-type: none"> <li>When the PLC READY signal [Y0] turns from OFF to ON, the parameter setting range is checked. If no error is found, this signal turns ON.</li> <li>When the PLC READY signal [Y0] turns OFF, this signal turns OFF.</li> <li>When watch dog timer error occurs, this signal turns OFF.</li> <li>This signal is used for interlock in a sequence program, etc.</li> </ul>
X1	Synchronization flag		<p>OFF: Module access disabled                      ON: Module access enabled</p> <ul style="list-style-type: none"> <li>After the PLC is turned ON or the CPU module is reset, this signal turns ON if the access from the CPU module to the LD77MH is possible.</li> <li>When "Asynchronous" is selected in the module synchronization setting of the CPU module, this signal can be used as interlock for the access from a sequence program to the LD77MH.</li> </ul>
X4 X5 X6 X7	Axis 1 Axis 2 Axis 3 Axis 4	M code ON	<p>OFF: M code is not set                      ON: M code is set</p> <ul style="list-style-type: none"> <li>In the WITH mode, this signal turns ON when the positioning data operation is started. In the AFTER mode, this signal turns ON when the positioning data operation is completed.</li> <li>This signal turns OFF with the "Cd.7" M code OFF request".</li> <li>When M code is not designated (when "Da.10" M code" is "0"), this signal will remain OFF.</li> <li>With using continuous path control for the positioning operation, the positioning will continue even when this signal does not turn OFF. However, a warning will occur. (Warning code: 503)</li> <li>When the PLC READY signal [Y0] turns OFF, the M code ON signal will also turn OFF.</li> <li>If operation is started while the M code is ON, an error will occur.</li> </ul>
X8 X9 XA XB	Axis 1 Axis 2 Axis 3 Axis 4	Error detection	<p>OFF: No error                      ON: Error occurrence</p> <ul style="list-style-type: none"> <li>This signal turns ON when an error listed in Section 16.4 occurs, and turns OFF when the error is reset on "Cd.5" Axis error reset".</li> </ul>
XC XD XE XF	Axis 1 Axis 2 Axis 3 Axis 4	BUSY (Note-1)	<p>OFF: Not BUSY                      ON: BUSY</p> <ul style="list-style-type: none"> <li>This signal turns ON at the start of positioning, OPR or JOG operation. It turns OFF when the "Da.9" Dwell time" has passed after positioning stops. (This signal remains ON during positioning.) This signal turns OFF when the positioning is stopped with step operation.</li> <li>During manual pulse generator operation, this signal turns ON while the "Cd.21" Manual pulse generator enable flag" is ON.</li> <li>This signal turns OFF at error completion or positioning stop.</li> </ul>
X10 X11 X12 X13	Axis 1 Axis 2 Axis 3 Axis 4	Start complete	<p>OFF: Start incomplete                      ON: Start complete</p> <ul style="list-style-type: none"> <li>This signal turns ON when the positioning start signal turns ON and the LD77MH starts the positioning process. (The start complete signal also turns ON during OPR control.)</li> </ul>
X14 X15 X16 X17	Axis 1 Axis 2 Axis 3 Axis 4	Positioning complete (Note-2)	<p>OFF: Positioning incomplete                      ON: Positioning complete</p> <ul style="list-style-type: none"> <li>This signal turns ON for the time set in "Pr.40" Positioning complete signal output time" from the instant when the positioning control for each positioning data No. is completed. For the interpolation control, the positioning completed signal of interpolation axis turns ON during the time set to the reference axis. (It does not turn ON when "Pr.40" Positioning complete signal output time" is "0".)</li> <li>If positioning (including OPR), JOG/Inching operation, or manual pulse generator operation is started while this signal is ON, the signal will turn OFF.</li> <li>This signal will not turn ON when speed control or positioning is canceled midway.</li> </ul>

**Important**

(Note-1): The BUSY signal turns ON even when position control of movement amount 0 is executed. However, since the ON time is short, the ON status may not to be detected in the sequence program.

(Note-2): "Positioning complete" of the LD77MH4 refers to the point when the pulse output from LD77MH4 is completed. Thus, even if the LD77MH4's positioning complete signal turns ON, the system may continue operation.

(2) LD77MH16

Device No.	Signal name		Details
X0	LD77 READY		<p>ON: READY OFF: Not READY/ Watch dog timer error</p> <ul style="list-style-type: none"> <li>When the PLC READY signal [Y0] turns from OFF to ON, the parameter setting range is checked. If no error is found, this signal turns ON.</li> <li>When the PLC READY signal [Y0] turns OFF, this signal turns OFF.</li> <li>When watch dog timer error occurs, this signal turns OFF.</li> <li>This signal is used for interlock in a sequence program, etc.</li> </ul>
X1	Synchronization flag		<p>OFF: Module access disabled ON: Module access enabled</p> <ul style="list-style-type: none"> <li>After the PLC is turned ON or the CPU module is reset, this signal turns ON if the access from the CPU module to the LD77MH is possible.</li> <li>When "Asynchronous" is selected in the module synchronization setting of the CPU module, this signal can be used as interlock for the access from a sequence program to the LD77MH.</li> </ul>
X10 X11 X12 X13 X14 X15 X16 X17 X18 X19 X1A X1B X1C X1D X1E X1F	Axis 1 Axis 2 Axis 3 Axis 4 Axis 5 Axis 6 Axis 7 Axis 8 Axis 9 Axis 10 Axis 11 Axis 12 Axis 13 Axis 14 Axis 15 Axis 16	BUSY (Note-1)	<p>OFF: Not BUSY ON: BUSY</p> <ul style="list-style-type: none"> <li>This signal turns ON at the start of positioning, OPR or JOG operation. It turns OFF when the " [Da.9] Dwell time" has passed after positioning stops. (This signal remains ON during positioning.) This signal turns OFF when the positioning is stopped with step operation.</li> <li>During manual pulse generator operation, this signal turns ON while the " [Cd.21] Manual pulse generator enable flag" is ON.</li> <li>This signal turns OFF at error completion or positioning stop.</li> </ul>

**Important**

(Note-1): The BUSY signal turns ON even when position control of movement amount 0 is executed. However, since the ON time is short, the ON status may not to be detected in the sequence program.



## 3.3.3 Details of output signals (PLC CPU → LD77MH)

The ON/OFF timing and conditions of the output signals are shown below.

## (1) LD77MH4

Device No.	Signal name		Details
Y0	PLC READY		OFF: PLC READY OFF ON: PLC READY ON  (a) This signal notifies the LD77MH that the PLC CPU is normal. • It is turned ON/OFF with the sequence program. • The PLC READY signal is turned ON during positioning control, OPR control, JOG operation, inching operation, manual pulse generator operation and speed-torque control etc. unless the system is in the GX Works2 test function. (b) When the data (parameter etc.) are changed, the PLC READY signal is turned OFF depending on the parameter (Refer to Chapter 7.). (c) The following processes are carried out when the PLC READY signal turns from OFF to ON. • The parameter setting range is checked. • The LD77 READY signal [X0] turns ON. (d) The following processes are carried out when the PLC READY signal turns from ON to OFF. In these cases, the OFF time should be set to 100ms or more. • The LD77 READY signal [X0] turns OFF. • The operating axis stops. • The M code ON signal [X4 to X7] for each axis turns OFF, and "0" is stored in "Md.25" Valid M code". (e) When parameters or positioning data (No. 1 to 600) are written from the GX Works2 or PLC CPU to the flash ROM, the PLC READY signal will turn OFF.
Y1	All axis servo ON		OFF: Servo OFF ON: Servo ON  • The servo for all the servo amplifiers connected to the LD77MH is turned ON or OFF.
Y4 Y5 Y6 Y7	Axis 1 Axis 2 Axis 3 Axis 4	Axis stop	OFF: Axis stop not requested ON: Axis stop requested  • When the axis stop signal turns ON, the OPR control, positioning control, JOG operation, inching operation, manual pulse generator operation and speed-torque control etc. will stop. • By turning the axis stop signal ON during positioning operation, the positioning operation will be "stopped". • Whether to decelerate stop or suddenly stop can be selected with "Pr.39" Stop group 3 sudden stop selection". • During interpolation control of the positioning operation, if the axis stop signal of any axis turns ON, all axes in the interpolation control will decelerate and stop.
Y8 Y9 YA YB YC YD YE YF	Axis 1 Axis 1 Axis 2 Axis 2 Axis 3 Axis 3 Axis 4 Axis 4	Forward run JOG start Reverse run JOG start Forward run JOG start Reverse run JOG start Forward run JOG start Reverse run JOG start Forward run JOG start Reverse run JOG start	OFF: JOG not started ON: JOG started  • When the JOG start signal is ON, JOG operation will be carried out at the "Cd.17" JOG speed". When the JOG start signal turns OFF, the operation will decelerate and stop. • When inching movement amount is set, the designated movement amount is output for one operation cycle and then the operation stops.
Y10 Y11 Y12 Y13	Axis 1 Axis 2 Axis 3 Axis 4	Positioning start	OFF: Positioning start not requested ON: Positioning start requested  • OPR operation or positioning operation is started. • The positioning start signal is valid at the rising edge, and the operation is started. • When the positioning start signal turns ON during BUSY, the operation starting warning will occur (warning code: 100).
Y14 Y15 Y16 Y17	Axis 1 Axis 2 Axis 3 Axis 4	Execution prohibition flag	OFF: Not during execution prohibition ON: During execution prohibition  • If the execution prohibition flag is ON when the positioning start signal turns ON, positioning control does not start until the execution prohibition flag turns OFF. Used with the "Pre-reading start function". (Refer to Section 13.7.7)

## (2) LD77MH16

Device No.	Signal name		Details
Y0	PLC READY		OFF: PLC READY OFF ON: PLC READY ON  (a) This signal notifies the LD77MH that the PLC CPU is normal. <ul style="list-style-type: none"> <li>• It is turned ON/OFF with the sequence program.</li> <li>• The PLC READY signal is turned ON during positioning control, OPR control, JOG operation, inching operation, manual pulse generator operation and speed-torque control etc. unless the system is in the GX Works2 test function.</li> </ul> (b) When the data (parameter etc.) are changed, the PLC READY signal is turned OFF depending on the parameter (Refer to Chapter 7.). (c) The following processes are carried out when the PLC READY signal turns from OFF to ON. <ul style="list-style-type: none"> <li>• The parameter setting range is checked.</li> <li>• The LD77 READY signal [X0] turns ON.</li> </ul> (d) The following processes are carried out when the PLC READY signal turns from ON to OFF. In these cases, the OFF time should be set to 100ms or more. <ul style="list-style-type: none"> <li>• The LD77 READY signal [X0] turns OFF.</li> <li>• The operating axis stops.</li> <li>• The M code ON signal (<a href="#">Md.31</a> Status: b12) for each axis turns OFF, and "0" is stored in "<a href="#">Md.25</a> Valid M code".</li> </ul> (e) When parameters or positioning data (No. 1 to 600) are written from the GX Works2 or PLC CPU to the flash ROM, the PLC READY signal will turn OFF.
Y1	All axis servo ON		OFF: Servo OFF ON: Servo ON  • The servo for all the servo amplifiers connected to the LD77MH is turned ON or OFF.
Y10 Y11 Y12 Y13 Y14 Y15 Y16 Y17 Y18 Y19 Y1A Y1B Y1C Y1D Y1E Y1F	Axis 1 Axis 2 Axis 3 Axis 4 Axis 5 Axis 6 Axis 7 Axis 8 Axis 9 Axis 10 Axis 11 Axis 12 Axis 13 Axis 14 Axis 15 Axis 16	Positioning start	OFF: Positioning start not requested ON: Positioning start requested  • OPR operation or positioning operation is started. • The positioning start signal is valid at the rising edge, and the operation is started. • When the positioning start signal turns ON during BUSY, the operation starting warning will occur (warning code: 100).

## 3.4 Specifications of interfaces with external devices

## 3.4.1 Electrical specifications of input signals

## (1) External command signal/Switching signal

## (a) Specifications of external command signal/switching signal

Item		Specifications
Number of input points		4 points
Input method		Positive common/Negative common shared
Common terminal arrangement		4 points/common (Common contact: COM)
Isolation method		Photocoupler
Rated input voltage		24VDC
Rated input current (I <sub>IN</sub> )		Approx. 5mA
Operating voltage range		21.6 to 26.4VDC (24VDC ±10%, ripple ratio 5% or less)
ON voltage/current		17.5VDC or more/3.5mA or more
OFF voltage/current		5VDC or less/0.9mA or less
Input resistance		Approx. 5.6kΩ
Response time	OFF to ON	1ms or less
	ON to OFF	
Recommended wire size		AWG24 (0.2mm <sup>2</sup> )

## (2) Forced stop input

## (a) Specifications of forced stop input signal

Item		Specifications
Number of input points		1 point
Input method		Positive common/Negative common shared
Common terminal arrangement		1 point/common (Common contact: EMI.COM)
Isolation method		Photocoupler
Rated input voltage		24VDC
Rated input current (I <sub>IN</sub> )		Approx. 2.4mA
Operating voltage range		20.4 to 26.4VDC (24VDC +10/-15%, ripple ratio 5% or less)
ON voltage/current		17.5VDC or more/2.0mA or more
OFF voltage/current		1.8VDC or less/0.18mA or less
Input resistance		Approx. 10kΩ
Response time	OFF to ON	1ms or less
	ON to OFF	
Recommended wire size		AWG24 (0.2mm <sup>2</sup> )

(3) Manual pulse generator/Incremental synchronous encoder input

(a) Specifications of manual pulse generator/incremental synchronous encoder

Item		Specifications
Signal input form <sup>(Note-1)</sup>		Phase A/Phase B (Magnification by 4/ Magnification by 1 <sup>(Note-2)</sup> ), PLS/SIGN
Differential-output type (26LS31 or equivalent)	Maximum input pulse frequency	1Mpps (After magnification by 4, up to 4Mpps) <sup>(Note-3)</sup>
	Pulse width	1μs or more
	Leading edge/trailing edge time	0.25μs or less
	Phase difference	0.25μs or more
	High-voltage	2.0 to 5.25VDC
	Low-voltage	0 to 0.8VDC
	Differential voltage	±0.2V
	Cable length	Up to 30m (98.43ft.)
Example of waveform		<p>(Note): Duty ratio 50%</p>
Voltage-output/ Open-collector type (5VDC)	Maximum input pulse frequency	200kpps (After magnification by 4, up to 800kpps) <sup>(Note-3)</sup>
	Pulse width	5μs or more
	Leading edge/trailing edge time	1.2μs or less
	Phase difference	1.2μs or more
	High-voltage	3.0 to 5.25 VDC
	Low-voltage	0 to 1.0VDC
	Cable length	Up to 10m (32.81ft.)
	Example of waveform	

(Note-1): Set the signal input form in "[Pr.24] Manual pulse generator/Incremental synchronous encoder input selection".

[Pr.24] Manual pulse generator/ Incremental synchronous encoder input selection	[Pr.22] Input signal logic selection			
	Positive logic		Negative logic	
	Forward run	Reverse run	Forward run	Reverse run
Phase A/Phase B				
PLS/SIGN				

(Note-2): LD77MH16 only.

(Note-3): Maximum input pulse frequency is magnified by 4, when "Phase A/Phase B Magnification by 4" is set in "[Pr.24] Manual pulse generator/Incremental synchronous encoder input selection".



### 3.4.2 Signal layout for external input signal connector

The specifications of the connector section, which is the input/output interface for the LD77MH and external device, are shown below.

The signal layout for the LD77MH external input signal connector is shown.

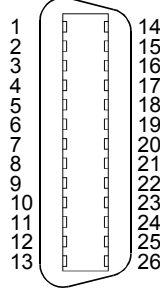
Pin layout	Pin No.	Signal name	Pin No.	Signal name
 <p>Front view of the module</p>	1	5V	14	5V
	2	SG	15	SG
	3	HA <sup>(Note-1), (Note-2), (Note-3)</sup>	16	HB <sup>(Note-1), (Note-2), (Note-3)</sup>
	4	HAH <sup>(Note-1), (Note-2), (Note-4)</sup>	17	HBH <sup>(Note-1), (Note-2), (Note-4)</sup>
	5	HAL <sup>(Note-1), (Note-2), (Note-4)</sup>	18	HBL <sup>(Note-1), (Note-2), (Note-4)</sup>
	6	No connect <sup>(Note-5)</sup>	19	No connect <sup>(Note-5)</sup>
	7		20	
	8		21	
	9		22	
	10	EMI	23	EMI.COM
	11	DI1 <sup>(Note-6)</sup>	24	DI2 <sup>(Note-6)</sup>
	12	DI3 <sup>(Note-6)</sup>	25	DI4 <sup>(Note-6)</sup>
	13	COM <sup>(Note-7)</sup>	26	COM <sup>(Note-7)</sup>

(Note-1): Input type from manual pulse generator/incremental synchronous encoder is switched in "[Pr.89] Manual pulse generator/Incremental synchronous encoder input type selection". (Only the value specified against the axis 1 is valid.)

- 0: Differential-output type (Default value)
- 1: Voltage-output/open-collector type

(Note-2): Set the signal input form in "[Pr.24] Manual pulse generator/Incremental synchronous encoder input selection".

(Note-3): Voltage-output/open-collector type  
Connect the A-phase/PLS signal to HA, and the B-phase/SIGN signal to HB.

(Note-4): Differential-output type  
Connect the A-phase/PLS signal to HAH, and the A-phase/PLS inverse signal to HAL.  
Connect the B-phase/SIGN signal to HBH, and the B-phase/SIGN inverse signal to HBL.

(Note-5): Do not connect to any of the terminal is explained as "No connect".

(Note-6): Set the external command signal [DI] in "[Pr.95] External command signal selection" at LD77MH16 use.

(Note-7): "COM" is the common terminal of DI1, DI2, DI3 and DI4.

3.4.3 List of input signal details

The details of each LD77MH external input signal connector are shown below.

Signal name		Pin No.	Signal details
Differential type	Manual pulse generator/Incremental synchronous encoder A phase/PLS	(+) (HAH) 4	<p>(1) Phase A/Phase B</p> <ul style="list-style-type: none"> <li>Input the pulse signal from the manual pulse generator/incremental synchronous encoder A phase and B phase.</li> <li>If the A phase leads the B phase, the positioning address will increase at the rising and falling edges of each phase.</li> <li>If the B phase leads the A phase, the positioning address will decrease at the rising and falling edges of each phase.</li> </ul> <p>(a) Magnification by 4</p> <p>[When increased]</p> <p>[When decreased]</p> <p>(b) Magnification by 1 <b>LD77MH16</b></p> <p>1) Positive logic</p> <p>[When increased]</p> <p>[When decreased]</p> <p>2) Negative logic</p> <p>[When increased]</p> <p>[When decreased]</p> <p>(2) PLS/SIGN</p> <p>Input the pulse signal for counting the increased/decreased pulse in the pulse input (PLS). Input the signal for controlling forward run and reverse run in the direction sign (SIGN).</p> <p>1) "[Pr.22] Input signal logic selection" is positive logic</p> <ul style="list-style-type: none"> <li>The motor will forward run when the direction sign is HIGH.</li> <li>The motor will reverse run when the direction sign is LOW.</li> </ul> <p>2) "[Pr.22] Input signal logic selection" is negative logic</p> <ul style="list-style-type: none"> <li>The motor will forward run when the direction sign is LOW.</li> <li>The motor will reverse run when the direction sign is HIGH.</li> </ul> <p>[When increased]</p> <p>[When decreased]</p> <p>Negative logic</p> <p>[When increased]</p> <p>[When decreased]</p>
		(-) (HAL) 5	
	Manual pulse generator/Incremental synchronous encoder B phase/SIGN	(+) (HBH) 17	
		(-) (HBL) 18	
Voltage-output/open-collector type	Manual pulse generator/Incremental synchronous encoder A phase/PLS	(HA) 3	<p>1) "[Pr.22] Input signal logic selection" is positive logic</p> <ul style="list-style-type: none"> <li>The motor will forward run when the direction sign is HIGH.</li> <li>The motor will reverse run when the direction sign is LOW.</li> </ul> <p>2) "[Pr.22] Input signal logic selection" is negative logic</p> <ul style="list-style-type: none"> <li>The motor will forward run when the direction sign is LOW.</li> <li>The motor will reverse run when the direction sign is HIGH.</li> </ul> <p>[When increased]</p> <p>[When decreased]</p> <p>Negative logic</p> <p>[When increased]</p> <p>[When decreased]</p>
	Manual pulse generator/Incremental synchronous encoder B phase/SIGN	(HB) 16	

Signal name		Pin No.	Signal details
External command signal/ switching signal	(D1)	11	<ul style="list-style-type: none"> <li>Input a control switching signal during speed-position or position-speed switching control.</li> <li>Use this signal as the input signal of positioning start, speed change request, skip request and mark detection from an external device.</li> </ul> Set the function to use this signal in "[Pr.42] External command function selection". (Note): Set the signal in "[Pr.95] External command signal selection" at LD77MH16 use.
	(D2)	24	
	(D3)	12	
	(D4)	25	
Common (COM)		13 26	<ul style="list-style-type: none"> <li>Common for external command signal/switching signals.</li> </ul>
Forced stop input signal (EMI)		10	<ul style="list-style-type: none"> <li>This signal is input when batch forced stop is available for all axes of servo amplifier.</li> </ul> EMI ON (Opened) : Forced stop EMI OFF (24VDC input) : Forced stop release
Forced stop input signal common (EMI.COM)		23	
Manual pulse generator power supply output (+ 5VDC) (5V)		1 14	<ul style="list-style-type: none"> <li>Power supply for manual pulse generator. (+ 5VDC)</li> </ul>
Manual pulse generator power supply output (GND) (SG)		2 15	<ul style="list-style-type: none"> <li>Power supply for manual pulse generator. (GND)</li> </ul>



3.4.4 Interface internal circuit

The outline diagrams of the internal circuits for the LD77MH external device connection interface are shown below.

(1) Interface between external command signal/switching signal

Input or output	Signal name		Pin No.				Wiring example	Internal circuit	Description
			1	2	3	4			
Input	External command/ Switching	DI□ <sup>(Note-1)</sup>	11	24	12	25			External command signal, Switching signal
		COM	13		26	24VDC <sup>(Note-2)</sup>			

(Note-1): □=1 to 4  
 (Note-2): As for the 24VDC sign, both "+" and "-" are possible.

(2) Interface between forced stop input signal

Input or output	Signal name		Pin No.	Wiring example	Internal circuit	Description
Output	Forced stop input	EMI	10			Forced stop input signal
		EMI.COM	23			

(Note-1): As for the 24VDC sign, both "+" and "-" are possible.

(3) Manual pulse generator/Incremental synchronous encoder input  
 (a) Interface between manual pulse generator/incremental synchronous encoder (Differential-output type)

Input or Output	Signal name	Pin No.	Wiring example	Internal circuit	Specification	Description	
Input (Note-1), (Note-2)	Manual pulse generator, phase A/ PLS	A+ HAH	4			•Rated input voltage 5.5VDC or less	For connection manual pulse generator/incremental synchronous encoder •Pulse width  •Leading edge, Trailing edge time •••0.25µs or less •Phase difference (Phases A, B)  (1) Positioning address increases if Phase A leads Phase B. (2) Positioning address decreases if Phase B leads Phase A.
		A- HAL	5			•HIGH level 2.0 to 5.25VDC	
	Manual pulse generator, phase B/ SIGN	B+ HBH	17			•LOW level 0.8VDC or less	
		B- HBL	18			•26LS31 or equivalent	
Power supply	5V(Note-3)	1 14		Power supply 5VDC			
	SG	2 15					

(Note-1): Set "0: Differential-output type" in " Pr.89 Manual pulse generator/Incremental synchronous encoder input type selection" if the manual pulse generator/Incremental synchronous encoder of differential-output type is used. The default value is "0: Differential-output type".

(Note-2): Set the signal input from in " Pr.24 Manual pulse generator/Incremental synchronous encoder input selection".

(Note-3): The 5VDC power supply from the LD77MH must not be used if a separate power supply is applied to the manual pulse generator/incremental synchronous encoder.  
 If a separate power supply is used, use a stabilized power supply of voltage 5VDC.  
 Anything else may cause a failure.

(b) Interface between manual pulse generator/Incremental synchronous encoder (Voltage-output/open-collector type)

Input or Output	Signal name	Pin No.	Wiring example	Internal circuit	Specification	Description
Input (Note-1), (Note-2)	Manual pulse generator, phase A/PLS HA	3			•Rated input voltage 5.5VDC or less	For connection manual pulse generator/incremental synchronous encoder •Pulse width  •Leading edge, Trailing edge time •••1.2µs or less •Phase difference (Phases A, B)  (1) Positioning address increases if Phase A leads Phase B. (2) Positioning address decreases if Phase B leads Phase A.
	Manual pulse generator, phase B/SIGN HB	16			•HIGH level 3 to 5.25VDC/ 2mA or less	
Power supply	5V(Note-3)	1 14		Power supply 5VDC		
	SG	2 15				

(Note-1): Set "1: Voltage-output/open-collector type" in " Pr.89 Manual pulse generator/Incremental synchronous encoder input type selection" if the manual pulse generator/Incremental synchronous encoder of voltage-output/open-collector type is used. The default value is "0: Differential-output type".

(Note-2): Set the signal input from in " Pr.24 Manual pulse generator/Incremental synchronous encoder input selection".

(Note-3): The 5VDC power supply from the LD77MH must not be used if a separate power supply is applied to the manual pulse generator/Incremental synchronous encoder.  
 If a separate power supply is used, use a stabilized power supply of voltage 5VDC.  
 Anything else may cause a failure.

3.5 External circuit design

Configure up the power supply circuit and main circuit which turn off the power supply after detection alarm occurrence and servo forced stop. When designing the main circuit of the power supply, make sure to use a no fuse breaker (NFB). The outline diagrams of the internal circuits for the external device connection interface are shown below.

(1) Example when using the forced stop of the LD77MH

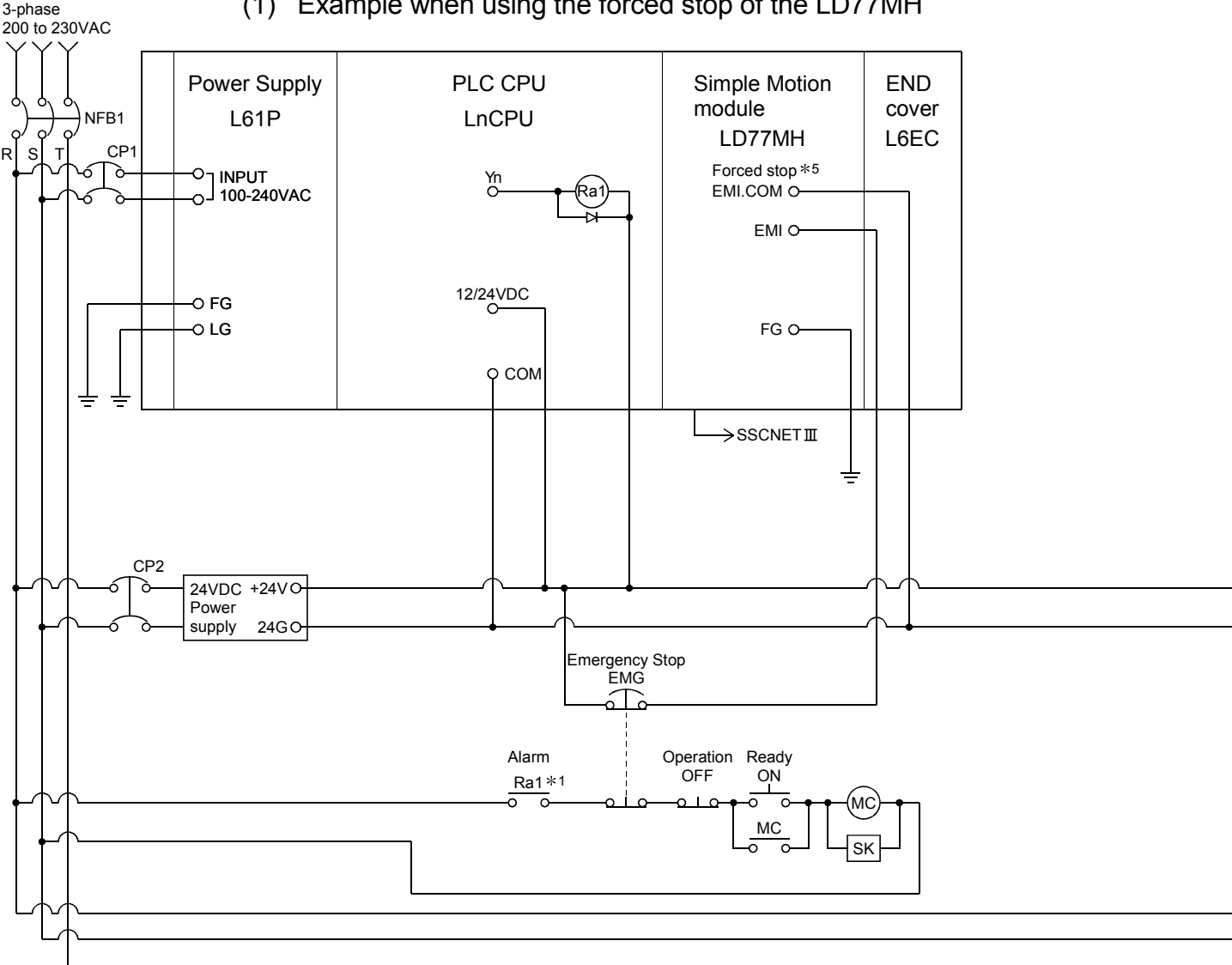

**POINT**

- (1) \*1: Configure up the power supply circuit which switch off the electromagnetic contactor (MC) after detection alarm occurrence on the PLC CPU.
- (2) \*2: It is also possible to use a full wave rectified power supply as the power supply for the electromagnetic brake.
- (3) \*3: It is also possible to use forced stop signal of the servo amplifier.
- (4) \*4: Set the rotary axis setting switch of servo amplifier as follows to set the axis No. of servo amplifier.
 

• Axis 1: 0	• Axis 5: 4	• Axis 9: 8	• Axis 13: C
• Axis 2: 1	• Axis 6: 5	• Axis 10: 9	• Axis 14: D
• Axis 3: 2	• Axis 7: 6	• Axis 11: A	• Axis 15: E
• Axis 4: 3	• Axis 8: 7	• Axis 12: B	• Axis 16: F
- (5) \*5: The status of forced stop input signal can be confirmed with "Md.50 Forced stop input".
- (6) \*6: It recommends using one leakage breaker for one servo amplifier. When electric power is supplied to multiple servo amplifiers for one leakage breaker, select the wire connected to the servo amplifier according to the capacity of the leakage breaker.

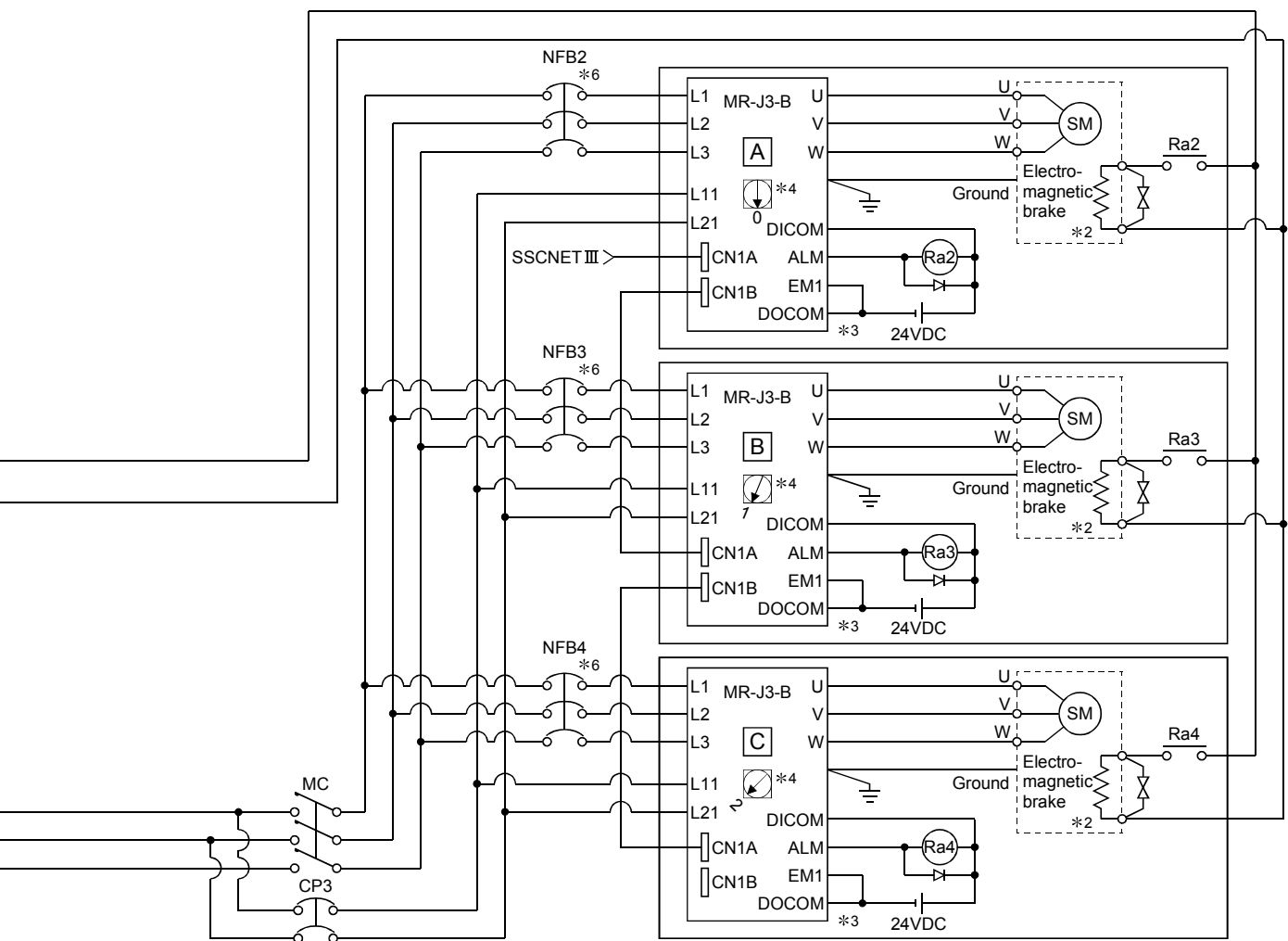

- (Note-1) : When the control power supply of servo amplifier is shut off, it is not possible to communicate with the servo amplifier after that.  
 Example) When the control power supply L11/L21 of servo amplifier in above [B] figure is shut off, it is also not possible to communicate with the servo amplifier [C].  
 If only a specific servo amplifier control power supply is shut off, be sure to shut off the main circuit power supply L1/L2/L3, and do not shut off the control power supply L11/L21.
- (Note-2) : Be sure to shut off the both of main circuit power supply L1/L2/L3 and control power supply L11/L21 at the time of exchange of servo amplifier. At this time, it is not possible to communicate between the servo amplifier and LD77MH. Therefore, be sure to exchange the servo amplifier after stopping the operating of machine beforehand.
- (Note-3): If the emergency stop signal of LD77MH turns OFF when setting of "[Pr.82] Forced stop valid/invalid selection" to "0 : Valid", servomotor is stopped with dynamic brake. (The LED display of servo amplifier indicates "E7" (Controller forced stop warning).)

(2) Example when using the forced stop of the LD77MH and MR-J3-B

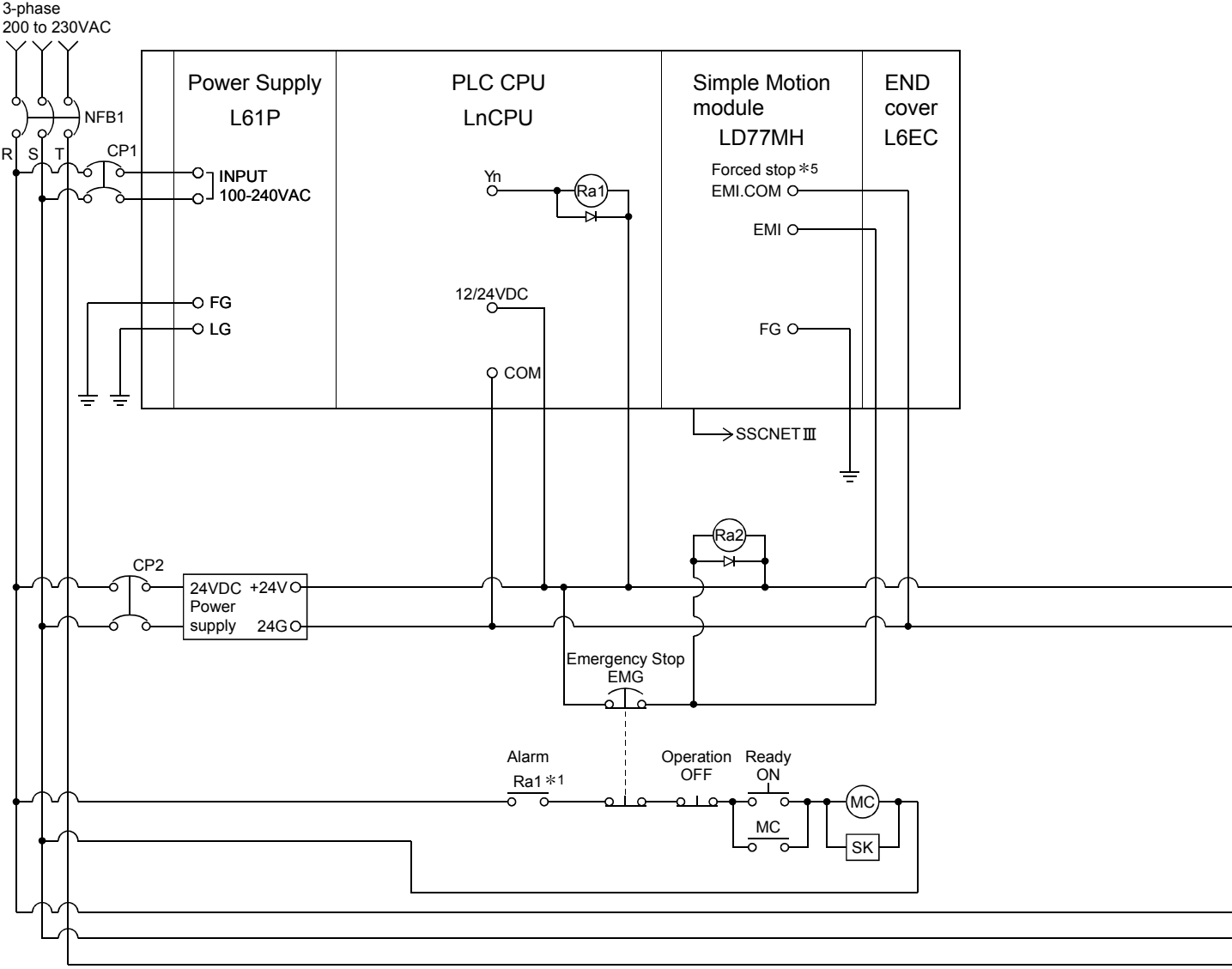

**POINT**

- (1) \*1: Configure up the power supply circuit which switch off the electromagnetic contactor (MC) after detection alarm occurrence on the PLC CPU.
- (2) \*2: It is also possible to use a full wave rectified power supply as the power supply for the electromagnetic brake.
- (3) \*3: Set the rotary axis setting switch of servo amplifier as follows to set the axis No. of servo amplifier.
 

• Axis 1: 0	• Axis 5: 4	• Axis 9: 8	• Axis 13: C
• Axis 2: 1	• Axis 6: 5	• Axis 10: 9	• Axis 14: D
• Axis 3: 2	• Axis 7: 6	• Axis 11: A	• Axis 15: E
• Axis 4: 3	• Axis 8: 7	• Axis 12: B	• Axis 16: F
- (4) \*4: It recommends using one leakage breaker for one servo amplifier. When electric power is supplied to multiple servo amplifiers for one leakage breaker, select the wire connected to the servo amplifier according to the capacity of the leakage breaker.
- (5) \*5: The status of forced stop input signal can be confirmed with "[Md.50] Forced stop input".

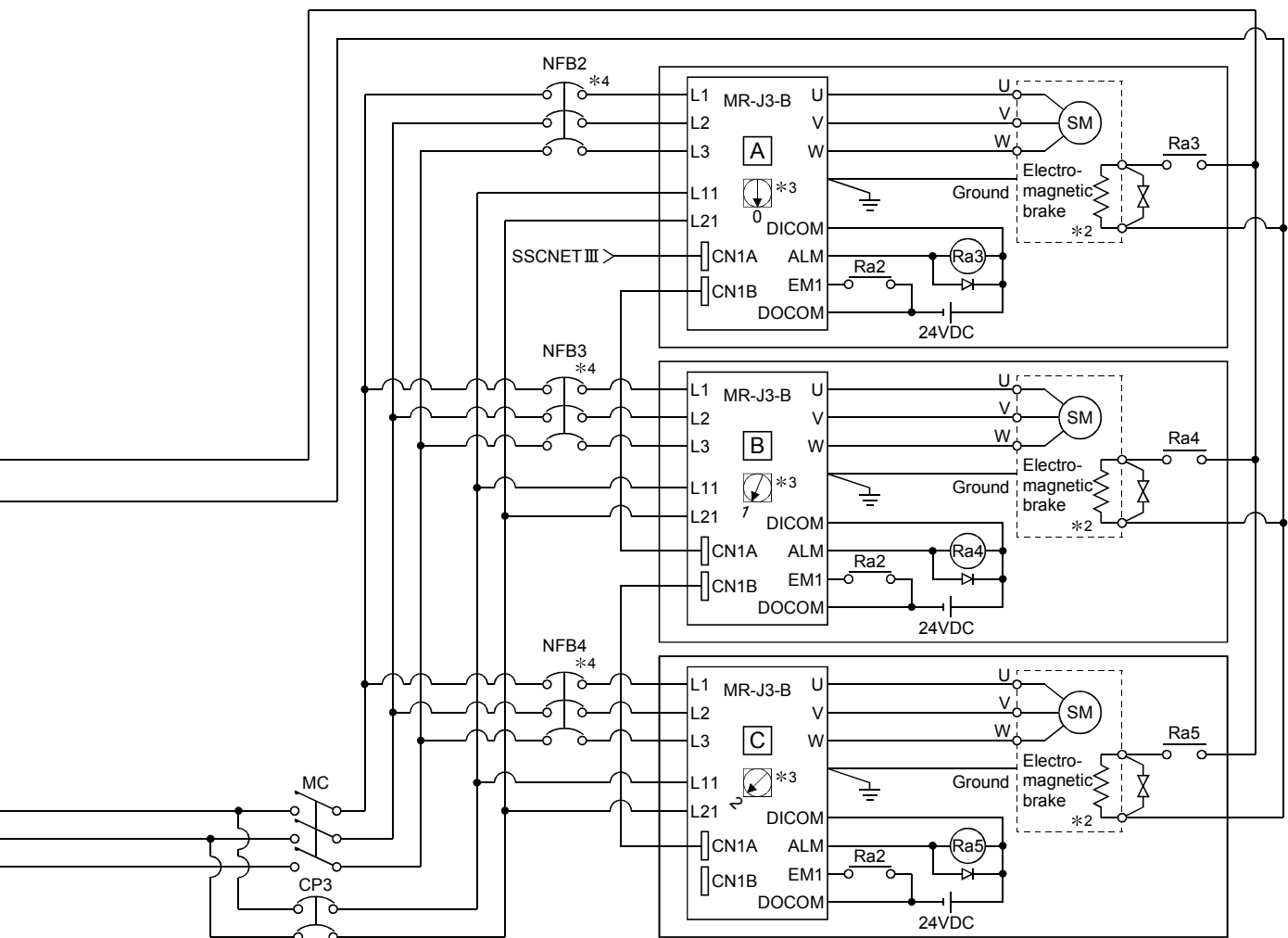

(Note-1) : When the control power supply of servo amplifier is shut off, it is not possible to communicate with the servo amplifier after that.  
 Example) When the control power supply L11/L21 of servo amplifier in above [B] figure is shut off, it is also not possible to communicate with the servo amplifier [C].

If only a specific servo amplifier control power supply is shut off, be sure to shut off the main circuit power supply L1/L2/L3, and do not shut off the control power supply L11/L21.

(Note-2) : Be sure to shut off the both of main circuit power supply L1/L2/L3 and control power supply L11/L21 at the time of exchange of servo amplifier. At this time, it is not possible to communicate between the servo amplifier and LD77MH. Therefore, be sure to exchange the servo amplifier after stopping the operating of machine beforehand.

(Note-3): The dynamic brake is operated, and servomotor occurs to the free run when EM1 (forced stop) of servo amplifier turn OFF. At the time, the display shows the servo forced stop warning (E6).

During ordinary operation, do not used forced stop signal to alternate stop and run.

The service life of the servo amplifier may be shortened.

# MEMO

---

---

---

---

---

---

---

---

---

---

---

---

---

---

---

---

---

---

---

---

---

---

---

---

---

---

---

# Chapter 4 Installation, Wiring and Maintenance of the Product

The installation, wiring and maintenance of the LD77MH are explained in this chapter.

Important information such as precautions to prevent malfunctioning of the LD77MH, accidents and injuries as well as the proper work methods are described. Read this chapter thoroughly before starting installation, wiring or maintenance, and always following the precautions.

4.1	Outline of installation, wiring and maintenance .....	4- 2
4.1.1	Installation, wiring and maintenance procedures .....	4- 2
4.1.2	Names of each part .....	4- 3
4.1.3	Handling precautions .....	4- 5
4.2	Installation .....	4- 7
4.2.1	Precautions for installation .....	4- 7
4.3	Wiring .....	4- 8
4.3.1	Precautions for wiring .....	4- 8
4.4	Confirming the installation and wiring .....	4-20
4.4.1	Items to confirm when installation and wiring are completed.....	4-20
4.5	Maintenance .....	4-21
4.5.1	Precautions for maintenance.....	4-21
4.5.2	Disposal instructions.....	4-21



## 4.1 Outline of installation, wiring and maintenance

### 4.1.1 Installation, wiring and maintenance procedures

The outline and procedures for LD77MH installation, wiring and maintenance are shown below.

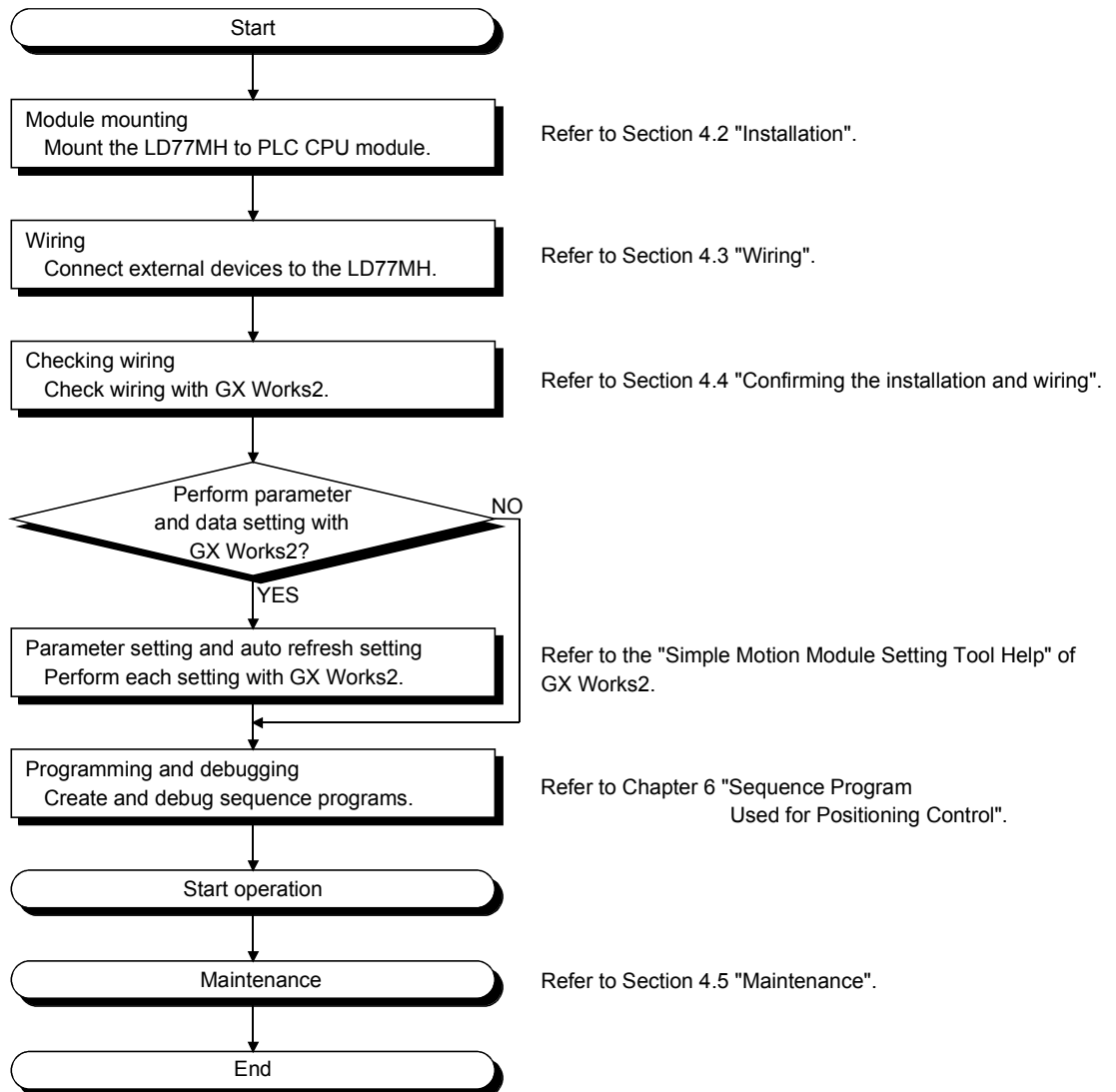

### 4.1.2 Names of each part

(1) The part names of the LD77MH are shown below.

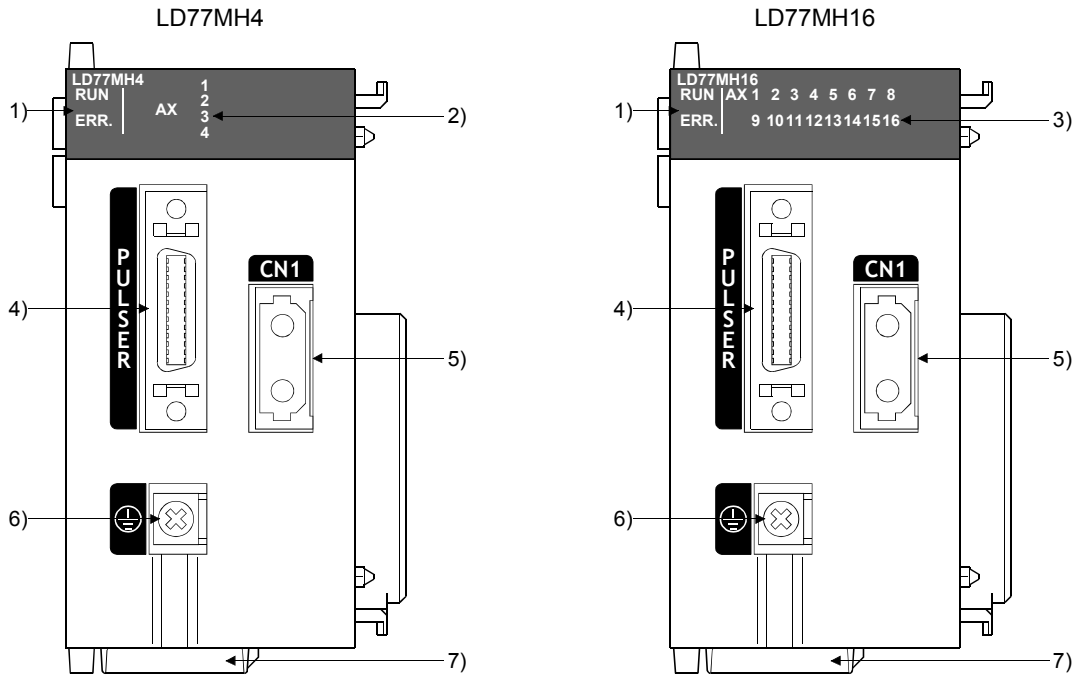

No.	Name	Description
1)	RUN indicator LED, ERR indicator LED	Refer to this section (2).
2)	Axis display LED (AX1 to AX4)	
3)	Axis display LED (AX1 to AX16)	
4)	External input signal connector	Connector to connect the mechanical system input, manual pulse generator/incremental synchronous encoder, or forced stop input. (26-pin connector) Refer to Section 3.4.2 for details.
5)	SSCNET III cable connector	Connector to connect the servo amplifier.
6)	FG terminal block	Earth terminal block (with M3 × 6 screw) <sup>(Note-1)</sup>
7)	Serial number plate	Indicates the serial number written on the rating plate.

(Note-1): Ground the FG terminal block by using the wire AWG16 to AWG20 (1.31 to 0.517mm<sup>2</sup>) with crimping terminal RAV1.25-3 for wiring.

(2) The LED display indicates the following operation statuses of the LD77MH and axes.

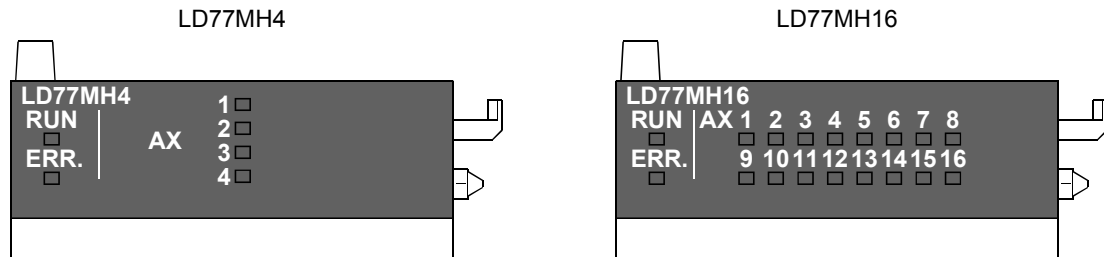

	LED Display		Description
	LD77MH4	LD77MH16	
RUN LED is OFF.	RUN <input type="checkbox"/> ERR. <input type="checkbox"/> AX 1 <input type="checkbox"/> 2 <input type="checkbox"/> 3 <input type="checkbox"/> 4 <input type="checkbox"/>	RUN <input type="checkbox"/> ERR. <input type="checkbox"/> AX 1 <input type="checkbox"/> 2 <input type="checkbox"/> 3 <input type="checkbox"/> 4 <input type="checkbox"/> 5 <input type="checkbox"/> 6 <input type="checkbox"/> 7 <input type="checkbox"/> 8 <input type="checkbox"/> 9 <input type="checkbox"/> 10 <input type="checkbox"/> 11 <input type="checkbox"/> 12 <input type="checkbox"/> 13 <input type="checkbox"/> 14 <input type="checkbox"/> 15 <input type="checkbox"/> 16 <input type="checkbox"/>	Hardware failure, watch dog timer error
Steady RUN LED display. ERR. LED is OFF.	RUN <input checked="" type="checkbox"/> ERR. <input type="checkbox"/> AX 1 <input type="checkbox"/> 2 <input type="checkbox"/> 3 <input type="checkbox"/> 4 <input type="checkbox"/>	RUN <input checked="" type="checkbox"/> ERR. <input type="checkbox"/> AX 1 <input type="checkbox"/> 2 <input type="checkbox"/> 3 <input type="checkbox"/> 4 <input type="checkbox"/> 5 <input type="checkbox"/> 6 <input type="checkbox"/> 7 <input type="checkbox"/> 8 <input type="checkbox"/> 9 <input type="checkbox"/> 10 <input type="checkbox"/> 11 <input type="checkbox"/> 12 <input type="checkbox"/> 13 <input type="checkbox"/> 14 <input type="checkbox"/> 15 <input type="checkbox"/> 16 <input type="checkbox"/>	The module operates normally.
Steady ERR. LED display.	RUN <input checked="" type="checkbox"/> ERR. <input checked="" type="checkbox"/> AX 1 <input type="checkbox"/> 2 <input type="checkbox"/> 3 <input type="checkbox"/> 4 <input type="checkbox"/>	RUN <input checked="" type="checkbox"/> ERR. <input checked="" type="checkbox"/> AX 1 <input type="checkbox"/> 2 <input type="checkbox"/> 3 <input type="checkbox"/> 4 <input type="checkbox"/> 5 <input type="checkbox"/> 6 <input type="checkbox"/> 7 <input type="checkbox"/> 8 <input type="checkbox"/> 9 <input type="checkbox"/> 10 <input type="checkbox"/> 11 <input type="checkbox"/> 12 <input type="checkbox"/> 13 <input type="checkbox"/> 14 <input type="checkbox"/> 15 <input type="checkbox"/> 16 <input type="checkbox"/>	System error
AX1 LED to AX4 LED are OFF.	RUN <input checked="" type="checkbox"/> ERR. <input type="checkbox"/> AX 1 <input type="checkbox"/> 2 <input type="checkbox"/> 3 <input type="checkbox"/> 4 <input type="checkbox"/>	RUN <input checked="" type="checkbox"/> ERR. <input type="checkbox"/> AX 1 <input type="checkbox"/> 2 <input type="checkbox"/> 3 <input type="checkbox"/> 4 <input type="checkbox"/> 5 <input type="checkbox"/> 6 <input type="checkbox"/> 7 <input type="checkbox"/> 8 <input type="checkbox"/> 9 <input type="checkbox"/> 10 <input type="checkbox"/> 11 <input type="checkbox"/> 12 <input type="checkbox"/> 13 <input type="checkbox"/> 14 <input type="checkbox"/> 15 <input type="checkbox"/> 16 <input type="checkbox"/>	During axis stop, during axis standby.
Steady AX1 (or other axis) LED display.	RUN <input checked="" type="checkbox"/> ERR. <input type="checkbox"/> AX 1 <input checked="" type="checkbox"/> 2 <input type="checkbox"/> 3 <input type="checkbox"/> 4 <input type="checkbox"/>	RUN <input checked="" type="checkbox"/> ERR. <input type="checkbox"/> AX 1 <input checked="" type="checkbox"/> 2 <input type="checkbox"/> 3 <input type="checkbox"/> 4 <input type="checkbox"/> 5 <input type="checkbox"/> 6 <input type="checkbox"/> 7 <input type="checkbox"/> 8 <input type="checkbox"/> 9 <input type="checkbox"/> 10 <input type="checkbox"/> 11 <input type="checkbox"/> 12 <input type="checkbox"/> 13 <input type="checkbox"/> 14 <input type="checkbox"/> 15 <input type="checkbox"/> 16 <input type="checkbox"/>	During axis operation.
ERR. LED remains flashing. AX1 (or other axis) remains flashing.	RUN <input checked="" type="checkbox"/> ERR. <input checked="" type="checkbox"/> AX 1 <input checked="" type="checkbox"/> 2 <input type="checkbox"/> 3 <input type="checkbox"/> 4 <input type="checkbox"/>	RUN <input checked="" type="checkbox"/> ERR. <input checked="" type="checkbox"/> AX 1 <input checked="" type="checkbox"/> 2 <input type="checkbox"/> 3 <input type="checkbox"/> 4 <input type="checkbox"/> 5 <input type="checkbox"/> 6 <input type="checkbox"/> 7 <input type="checkbox"/> 8 <input type="checkbox"/> 9 <input type="checkbox"/> 10 <input type="checkbox"/> 11 <input type="checkbox"/> 12 <input type="checkbox"/> 13 <input type="checkbox"/> 14 <input type="checkbox"/> 15 <input type="checkbox"/> 16 <input type="checkbox"/>	Axis error
Steady all LEDs display.	RUN <input checked="" type="checkbox"/> ERR. <input checked="" type="checkbox"/> AX 1 <input checked="" type="checkbox"/> 2 <input checked="" type="checkbox"/> 3 <input checked="" type="checkbox"/> 4 <input checked="" type="checkbox"/>	RUN <input checked="" type="checkbox"/> ERR. <input checked="" type="checkbox"/> AX 1 <input checked="" type="checkbox"/> 2 <input checked="" type="checkbox"/> 3 <input checked="" type="checkbox"/> 4 <input checked="" type="checkbox"/> 5 <input checked="" type="checkbox"/> 6 <input checked="" type="checkbox"/> 7 <input checked="" type="checkbox"/> 8 <input checked="" type="checkbox"/> 9 <input checked="" type="checkbox"/> 10 <input checked="" type="checkbox"/> 11 <input checked="" type="checkbox"/> 12 <input checked="" type="checkbox"/> 13 <input checked="" type="checkbox"/> 14 <input checked="" type="checkbox"/> 15 <input checked="" type="checkbox"/> 16 <input checked="" type="checkbox"/>	Hardware failure

The symbols in the Display column indicate the following LED statuses:  
: OFF, : ON, : Flashing

### 4.1.3 Handling precautions

Handle the LD77MH and cable while observing the following precautions.

#### [1] Handling precautions

## CAUTION

- Use the programmable controller in an environment that meets the general specifications in the "MELSEC-L CPU module User's Manual (Hardware Design, Maintenance and Inspection)". Using the programmable controller in an environment outside the range of the general specifications could result in electric shock, fire, operation failure, and damage to or deterioration of the product.
- Do not directly touch the module's conductive parts and electronic components. Doing so may cause an operation failure or give damage to the module.
- Be sure there are no foreign matters such as sawdust or wiring debris inside the module. Such debris could cause fire, damage, or operation failure.
- Never try to disassemble or modify the modules. It may cause product failure, operation failure, injury or fire.
- Completely turn off the externally supplied power used in the system before installation or removing the module. Not doing so could result in damage to the module.
- Because the connector has its orientation, check it before attaching or detaching the connector straight from the front.  
Unless it is properly installed, a poor contact may occur, resulting in erroneous input and output.

[2] Other precautions

(1) Main body

- The main body case is made of plastic. Take care not to drop or apply strong impacts onto the case.
- Do not remove the LD77MH PCB from the case. Failure to observe this could lead to faults.
- Handle the module carefully. In order to protect the module, place the module in a horizontal position when the module is on a desk or cart.

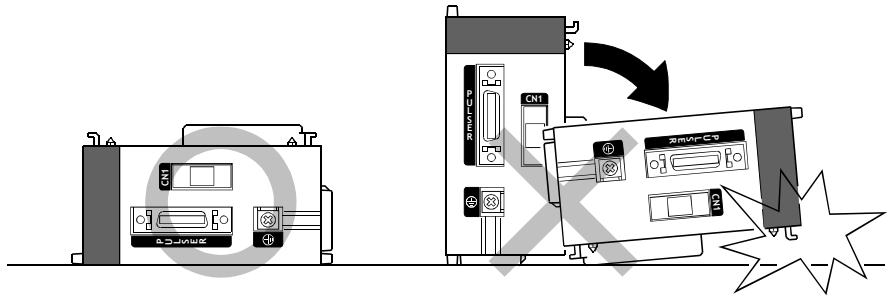

(2) Cable

- Do not press on the cable with a sharp object.
- Do not twist the cable with force.
- Do not forcibly pull on the cable.
- Do not step on the cable.
- Do not place objects on the cable.
- Do not damage the cable sheath.

(3) Installation environment

Do not install the module in the following type of environment.

- Where the ambient temperature exceeds the 0 to 55°C range.
- Where the ambient humidity exceeds the 5 to 95%RH range.
- Where there is sudden temperature changes, or where dew condenses.
- Where there is corrosive gas or flammable gas.
- Where there are high levels of dust, conductive powder, such as iron chips, oil mist, salt or organic solvents.
- Where the module will be subject to direct sunlight.
- Where there are strong electric fields or magnetic fields.
- Where vibration or impact could be directly applied onto the main body.

## 4.2 Installation

### 4.2.1 Precautions for installation

The precautions for installing the LD77MH are given below. Refer to this section as well as Section 4.1.3 "Handling precautions" when carrying out the work.

#### Precautions for installation

### DANGER

- Completely turn off the externally supplied power used in the system before installing or removing the module.  
Not doing so could result in electric shocks, an operation failure or damage to the module.

### CAUTION

- Never try to disassemble or modify the modules. It may cause product failure, operation failure, injury or fire.
- Completely turn off the externally supplied power used in the system before installation or removing the module.  
Not doing so could result in an operation failure or damage to the module.
- After the first use of the module, the number of connections/disconnections is limited to 50 times (in accordance with IEC 61131-2). Exceeding the limit may cause malfunction.
- Use the programmable controller in an environment that meets the general specifications in the "MELSEC-L CPU module User's Manual (Hardware Design, Maintenance and Inspection)".  
Using the programmable controller in an environment outside the range could result in electric shock, fire, operation failure, and damage to or deterioration of the product.
- Do not directly touch the module's conductive parts and electronic components. Doing so may could cause an operation failure or give damage to the module.
- To interconnect modules, engage the respective connectors and securely lock the module joint levers. Incorrect installation of the module can cause an operation failure, damage or drop.
- Lock the control panel and prevent access to those who are not certified to handle or install electric equipment.

## 4.3 Wiring

The precautions for wiring the LD77MH are given below. Refer to this section as well as Section 4.1.3 "Handling precautions" when carrying out the work.

### 4.3.1 Precautions for wiring

#### DANGER

- Completely turn off the externally supplied power used in the system before installation or wiring. Not doing so could result in electric shock or damage to the product.

#### CAUTION

- Be sure to ground the earth terminal FG and LG. (Ground resistance: 100Ω or less)  
Not doing so could result in electric shock or operation failure. Securely tighten the screw of FG terminal.
- Check the layout of the terminals and then properly route the wires to the module.
- Connectors for external input signal must be crimped with the tool specified by the manufacturer, or must be correctly soldered. Insufficient connections may cause short circuit, fire, or malfunction.
- Be careful not to let foreign matter such as sawdust or wire chips get inside the module. These may cause fires, failure or malfunction.
- The top surface of the module is covered with protective films to prevent foreign objects such as cable off cuts from entering the module when wiring. Do not remove this film until the wiring is complete. Before operating the system, be sure to remove the film to provide adequate ventilation.
- Securely connect the connector for SSCNET III cable to the front connector on the module.
- When removing the cable from the module, do not pull the cable. Hold the connector that is connected to the module. Pulling the cable that is still connected to the module may cause malfunction or damage to the module or cable.
- The external input/output signal cable of the LD77MH and the communication cable should not be routed near or bundled with the main circuit cable, power cable and/or other such load – carrying cables other than those for the PLC. These cables should be separated by at least 100mm (3.94inch) or more. They can cause electrical interference, surges and inductance that can lead to mis-operation.
- The shielded cable for connecting LD77MH can be secured in place. If the shielded cable is not secured, unevenness or movement of the shielded cable or careless pulling on it could result in damage to the LD77MH, servo amplifier or shielded cable or defective cable connections could cause mis-operation of the unit.
- If the cable connected to the LD77MH and the power line must be adjacently laid (less than 100mm (3.94inch)), use a shielded cable. Ground the shield of the cable securely to the control panel on the LD77MH side. (A wiring example is given on this section "[1] Precautions for wiring").

## ⚠ CAUTION

- Forcibly removal the SSCNET III cable from the LD77MH will damage the LD77MH and SSCNET III cables.
- After removal of the SSCNET III cable, be sure to put a cap on the SSCNET III connector. Otherwise, adhesion of dirt deteriorates in characteristic and it may cause malfunctions.
- Do not remove the SSCNET III cable while turning on the power supply of LD77MH and servo amplifier. Do not see directly the light generated from SSCNET III connector and the end of SSCNET III cable. When the light gets into eye, may feel something is wrong for eye. (The light source of SSCNET III cable complies with class1 defined in JISC6802 or IEC60825-1.)
- If the SSCNET III cable is added a power such as a major shock, lateral pressure, haul, sudden bending or twist, its inside distorts or breaks, and optical transmission will not be available. Be sure to take care enough so that the short SSCNET III cable is added a twist easily.
- Be sure to use the SSCNET III cable within the range of operating temperature described in this manual. Especially, as optical fiber for MR-J3BUS□M and MR-J3BUS□M-A are made of synthetic resin, it melts down if being left near the fire or high temperature. Therefore, do not make it touched the part which becomes high temperature, such as radiator or regenerative option of servo amplifier, or servomotor.
- When laying the SSCNET III cable, be sure to secure the minimum cable bend radius or more. (Refer to this Section [2] Precautions for SSCNET III cable wiring.)
- Put the SSCNET III cable in the duct or fix the cable at the closest part to the LD77MH with bundle material in order to prevent SSCNET III cable from putting its own weight on SSCNET III connector. When laying cable, the optical cord should be given loose slack to avoid from becoming smaller than the minimum bend radius, and it should not be twisted. Also, fix and hold it in position with using cushioning such as sponge or rubber which does not contain plasticizing material.
- Migrating plasticizer is used for vinyl tape. Keep the MR-J3BUS□M, and MR-J3BUS□M-A cables away from vinyl tape because the optical characteristic may be affected.

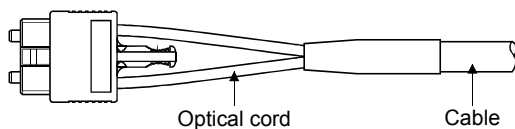

SSCNET III cable	Cord	Cable
MR-J3BUS□M	△	/
MR-J3BUS□M-A	△	△
MR-J3BUS□M-B	○	○

○: Normally, cable is not affected by plasticizer.

△: Phthalate ester plasticizer such as DBP and DOP may affect optical characteristic of cable.

Generally, soft polyvinyl chloride (PVC), polyethylene resin (PE) and fluorine resin contain non-migrating plasticizer and they do not affect the optical characteristic of SSCNET III cable.

However, some wire sheaths and cable ties, which contain migrating plasticizer (phthalate ester), may affect MR-J3BUS□M and MR-J3BUS□M-A cables (made of plastic).

In addition, MR-J3BUS□M-B cable (made of quartz glass) is not affected by plasticizer.



## CAUTION

- If the adhesion of solvent and oil to the cord part of SSCNET III cable may lower the optical characteristic and machine characteristic. If it is used such an environment, be sure to do the protection measures to the cord part.
- When keeping the LD77MH or servo amplifier, be sure to put on a cap to connector part so that a dirt should not adhere to the end of SSCNET III connector.
- SSCNET III connector to connect the SSCNET III cable is put a cap to protect light device inside connector from dust. For this reason, do not remove a cap until just before connecting SSCNET III cable. Then, when removing SSCNET III cable, make sure to put a cap.
- Keep the cap and the tube for protecting light cord end of SSCNET III cable in a plastic bag with a zipper of SSCNET III cable to prevent them from becoming dirty.
- When exchanging the LD77MH or servo amplifier, make sure to put cap on SSCNET III connector. When asking repair of LD77MH or servo amplifier for some troubles, make also sure to put a cap on SSCNET III connector. When the connector is not put a cap, the light device may be damaged at the transit. In this case, exchange and repair of light device is required.

[1] Precautions for wiring

- (1) Use separate cables for connecting to the LD77MH and for the power cable that create surge and inductance.
- (2) The cable for connecting LD77MH can be placed in the duct or secured in place by clamps. If the cable is not placed in the duct or secured by clamps, unevenness or movement of the cable or careless pulling on it could result in damage to the unit or cable or defective cable connections could cause mis-operation of the unit.
- (3) If a duct is being used and cables to connect to LD77MH are separated from the power line duct, use metal piping. Ground the pipes securely after metal piping.
- (4) Use the twisted pair shielded cable (wire size AWG24 to AWG30 (0.2 to 0.05 mm<sup>2</sup>)). The shielded must be grounded in the cable connector shell. (The following figure shows a wiring example.)
- (5) Use separate shielded cables of the forced stop input signal (EMI, EMI.COM), external command signal/switching signal (DI1, DI2, DI3, DI4, COM), and manual pulse generator/incremental synchronous encoder input signal (HAH, HAL, HBH, HBL, HA, HB, 5V, SG) for connecting to the LD77MH. They can cause electrical interference, surges and inductance that can lead to mis-operation.

[Wiring example of shielded cable]

The following shows a wiring example for noise reduction in the case when the connector (LD77MHIOCON) is used.

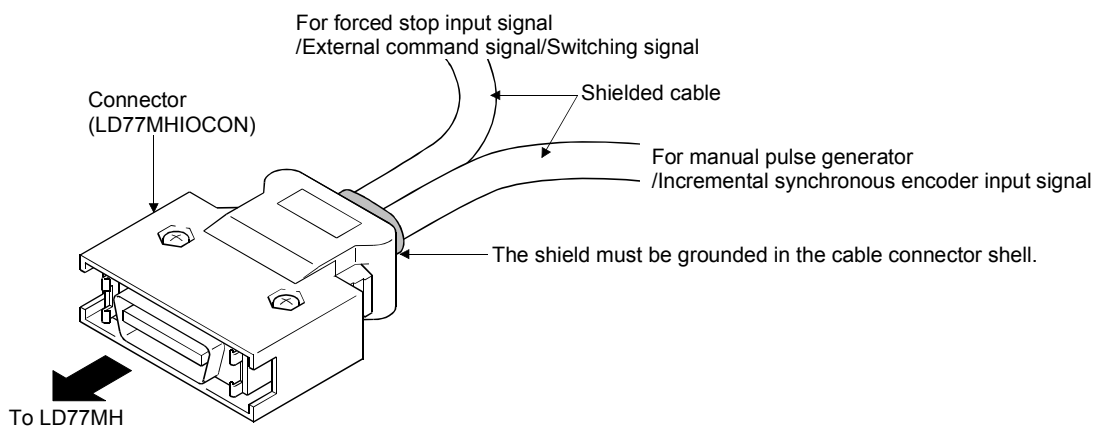

[Processing example of shielded cables]

Connections of FG wire and each shielded cable

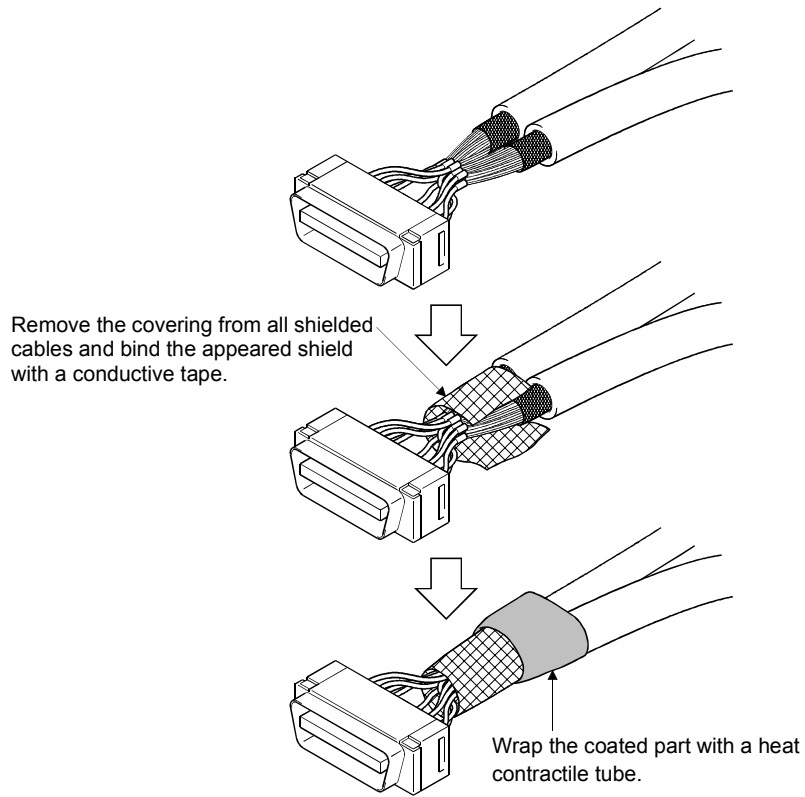

Assembling of connector (LD77MHIOCON)

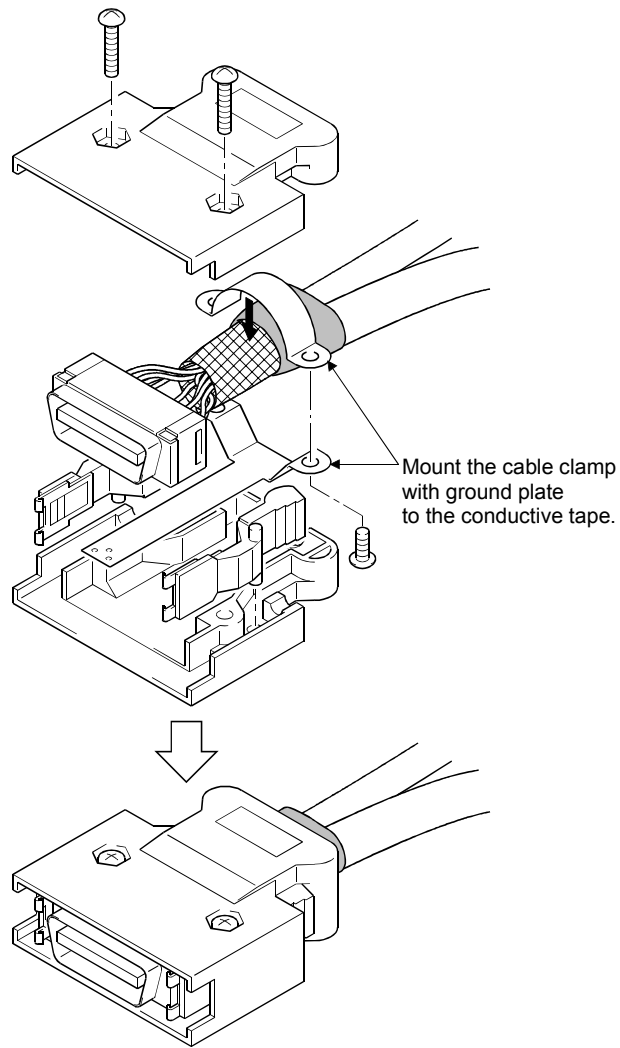

- (6) To make this product conform to the EMC directive instruction and Low Voltage Directives, be sure to use of a AD75CK type cable clamp (manufactured by Mitsubishi Electric) for grounding connected to the control box and the shielded cable.

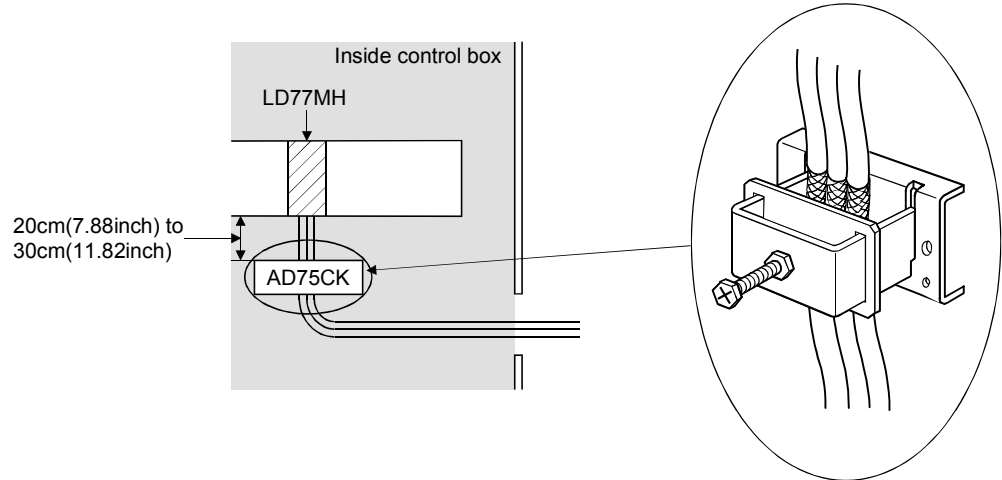

[How to ground shielded cable using AD75CK]

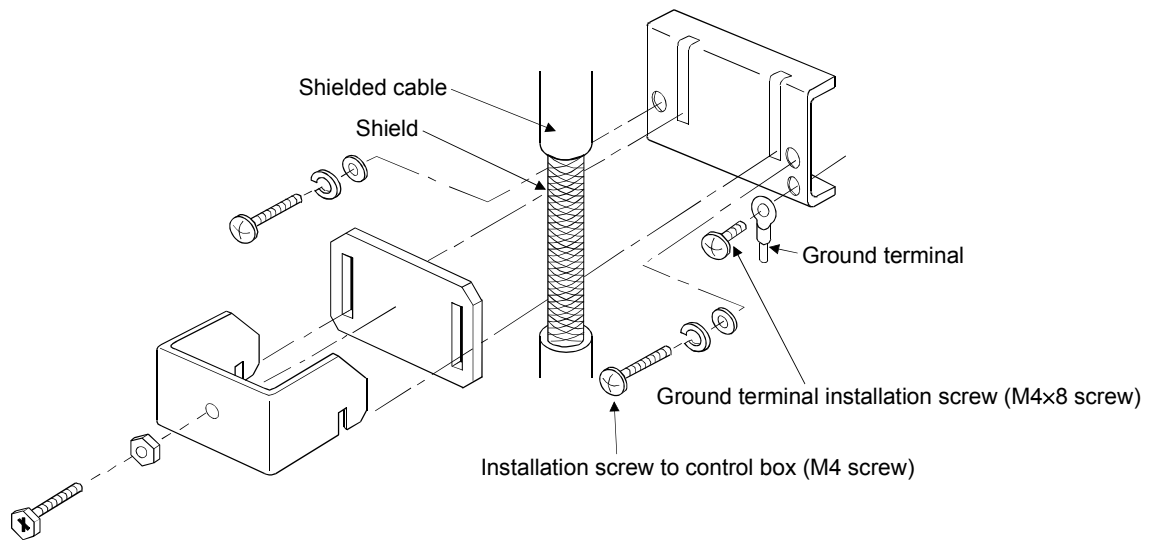

Using the AD75CK, you can tie four cables of about 7mm outside diameter together for grounding.  
(Refer to the "AD75CK-type Cable Clamping Instruction Manual" (IB-68682).)

**⚠ CAUTION**

Do not ground the cable clamp to the top of control panel. Doing so may lead to damage by damage of screws, etc. during installation or removing the cable clamp.

[2] Precautions for SSCNET III cable wiring

SSCNET III cable is made from optical fiber. If optical fiber is added a power such as a major shock, lateral pressure, haul, sudden bending or twist, its inside distorts or breaks, and optical transmission will not be available. Especially, as optical fiber for MR-J3BUS□M, MR-J3BUS□M-A is made of synthetic resin, it melts down if being left near the fire or high temperature. Therefore, do not make it touched the part which becomes high temperature, such as radiator or regenerative option of servo amplifier and servomotor. Be sure to use optical fiber within the range of operating temperature described in this manual. Read described item of this section carefully and handle it with caution.

(1) Minimum bend radius

Make sure to lay the cable with greater radius than the minimum bend radius.

Do not press the cable to edges of equipment or others. For SSCNET III cable, the appropriate length should be selected with due consideration for the dimensions and arrangement of LD77MH or servo amplifier. When closing the door of control panel, pay careful attention for avoiding the case that SSCNET III cable is hold down by the door and the cable bend becomes smaller than the minimum bend radius.

Model name of SSCNET III cable	Minimum bend radius [mm] ([inch])
MR-J3BUS □ M	25 (0.98)
MR-J3BUS □ M-A	Enforced covering cord: 50 (1.97), Cord: 25 (0.98)
MR-J3BUS □ M-B	Enforced covering cord: 50 (1.97), Cord: 30 (1.18)

(2) Tension

If tension is added on the SSCNET III cable, the increase of transmission loss occurs because of external force which concentrates on the fixing part of SSCNET III cable or the connecting part of SSCNET III connector. At worst, the breakage of SSCNET III cable or damage of SSCNET III connector may occur. For cable laying, handle without putting forced tension. (Refer to Section Appendix 2.2 "Wiring of SSCNET III cables" for the tension strength.)

(3) Lateral pressure

If lateral pressure is added on the SSCNET III cable, the cable itself distorts, internal optical fiber gets stressed, and then transmission loss will increase. At worst, the breakage of SSCNET III cable may occur. As the same condition also occurs at cable laying, do not tighten up SSCNET III cable with a thing such as nylon band (TY-RAP).

Do not trample it down or tuck it down with the door of control box or others.

(4) Twisting

If the SSCNET III cable is twisted, it will become the same stress added condition as when local lateral pressure or bend is added. Consequently, transmission loss increases, and the breakage of SSCNET III cable may occur at worst.

(5) Disposal

When incinerating optical cable (cord) used for SSCNET III cable, hydrogen fluoride gas or hydrogen chloride gas which is corrosive and harmful may be generated. For disposal of SSCNET III cable, request for specialized industrial waste disposal services who has incineration facility for disposing hydrogen fluoride gas or hydrogen chloride gas.

(6) Wiring process of SSCNET III cable

Put the SSCNET III cable in the duct or fix the cable at the closest part to the LD77MH with bundle material in order to prevent SSCNET III cable from putting its own weight on SSCNET III connector. Leave the following space for wiring.

- Putting in the duct

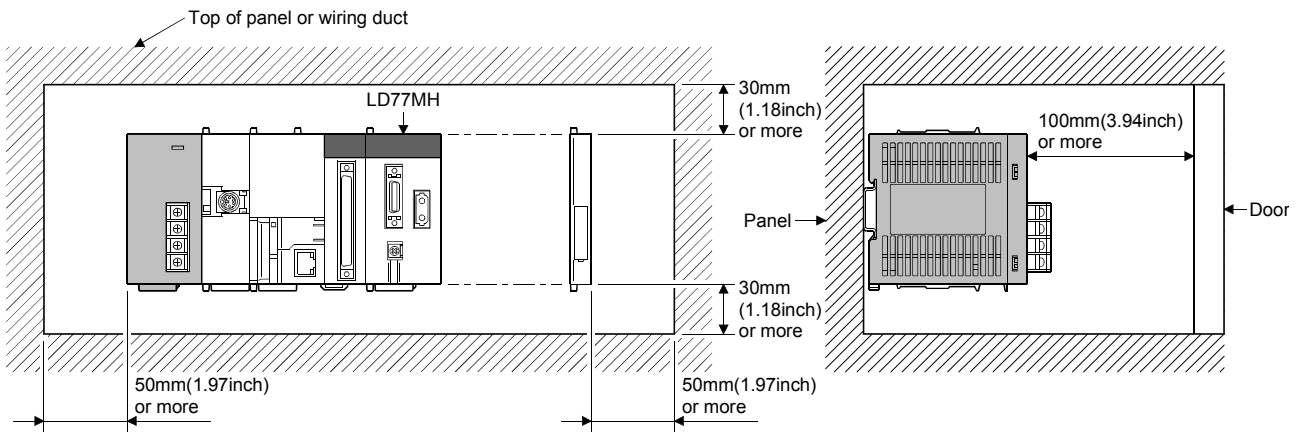

- Bundle fixing

Optical cord should be given loose slack to avoid from becoming smaller than the minimum bend radius, and it should not be twisted. When laying cable, fix and hold it in position with using cushioning such as sponge or rubber which does not contain plasticizing material.

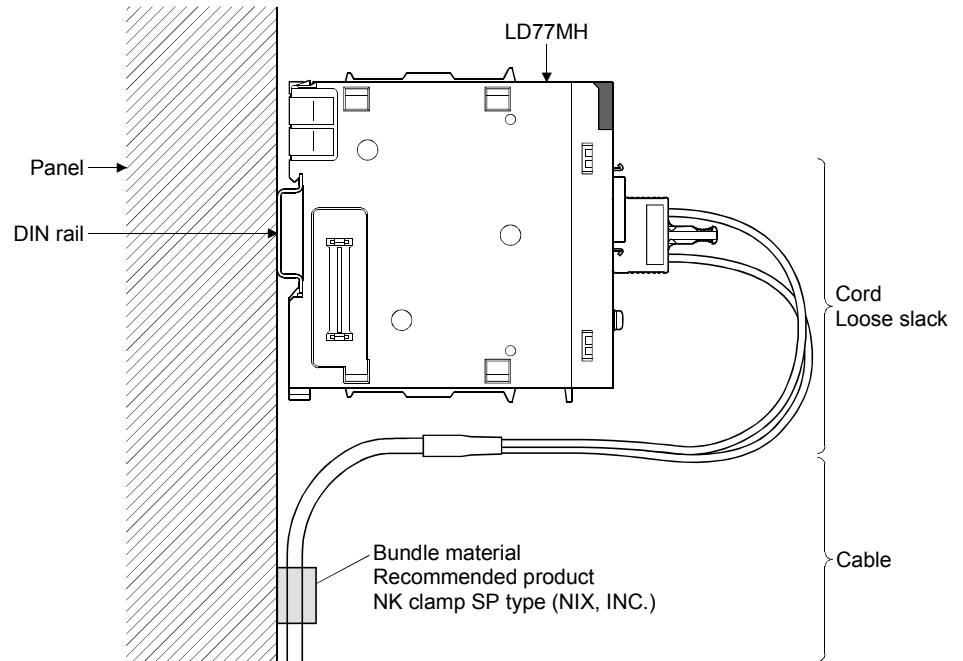



[3] Precautions for FG terminal wiring

(1) Wiring

Use the thickest wires (Up to 1.31mm<sup>2</sup>) possible to reduce the voltage drop to the minimum for the FG cable of the LD77MH.

Use the wires of the following core size and crimping terminal for wiring.

(a) Ground wire

Application	Recommended core size	AWG <sup>(Note-1)</sup>
Ground wire	1.31 to 0.517mm <sup>2</sup>	AWG16 to AWG20

(b) Crimping terminal

Applicable name	Recommended core size	AWG <sup>(Note-1)</sup>
RAV1.25-3	1.31 to 0.517mm <sup>2</sup>	AWG16 to AWG20

(Note-1): AWG stands for "American Wire Gauge". AWG is a unit of the thickness of conducting wire.

(2) Grounding

For grounding, follow the steps (a) to (c) shown below.

(a) Use a dedicated grounding wire as far as possible.

(Ground resistance: 100Ω or less)

(b) When a dedicated grounding cannot be performed, use 2) Common grounding shown below.

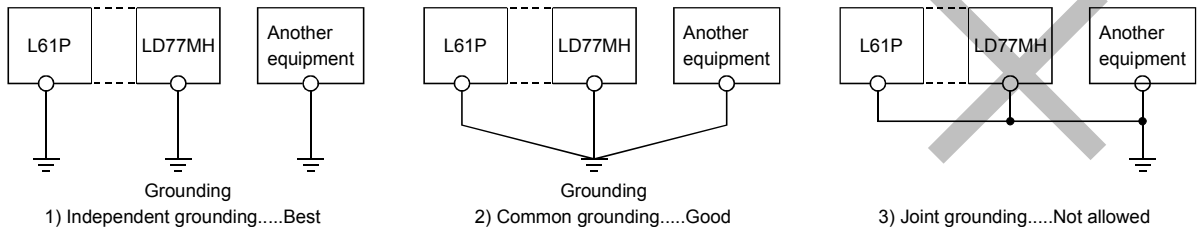

(c) For grounding a cable, use the cable of AWG16 to AWG20 (1.31 to 0.517mm<sup>2</sup>).

Position the ground-contact point as nearly to the LD77MH as possible, and reduce the length of the grounding cable as much as possible.

[4] Example of measure against noise for compliance with the EMC directive.

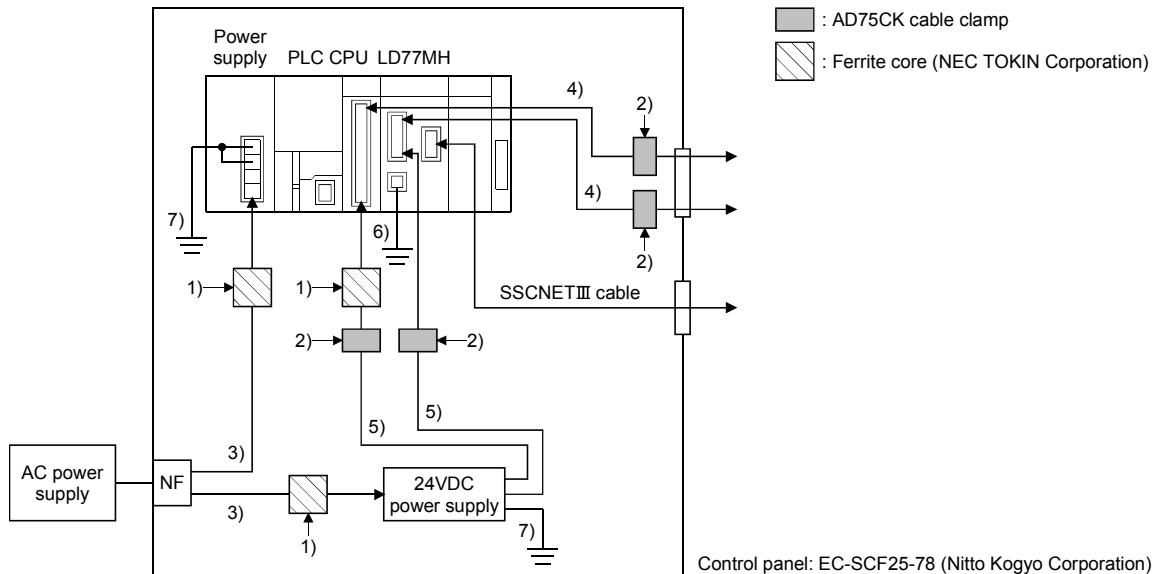

- 1) Install a ferrite core. (Approx. 2 turn)
- 2) Ground the cables at a position 10 to 20cm (3.94 to 7.87inch) away from the module, or at a position 5 to 10cm (1.97 to 3.94inch) away from the exit/entrance of the control panel with the cable clamp, etc.
- 3) Wire the power supply cable as short as possible using the twisted cable (2mm<sup>2</sup> or more).
- 4) Use the shielded twisted cable (cable length: 30m (98.43ft.) or less) for each I/O signal cable.
- 5) Wire the cable connected to secondary side of 24VDC power supply module as short as possible using the shielded twisted cable.
- 6) Wire the cable connected to FG terminal of LD77MH as short as possible using the cable of 0.517 to 1.31mm<sup>2</sup>, and ground to the control panel.
- 7) Wire the power supply and 24VDC power supply as short as possible using the cable of approx. 2mm<sup>2</sup>, and ground to the control panel.

- (1) Refer to this chapter or "EMC and Low Voltage Directives" of "MELSEC-L CPU Module User's Manual (Hardware Design, Maintenance and Inspection)" for basic wire. We examined LD77MH by the above example.
- (2) In wiring inside the panel, the power line connected to the power or servo amplifier and the communication cable such as bus connection cable or network cable must not be mixed. If the cables are installed closely with each other for wiring reasons, using a separator (made of metal) can make the cables less influenced by noise.  
Mixing the power line and communication cable may cause malfunction due to noise.

## 4.4 Confirming the installation and wiring

### 4.4.1 Items to confirm when installation and wiring are completed

Check the following points when completed with the LD77MH installation and wiring.

- Is the module correctly wired?

The following four points are confirmed using the positioning test function of GX Works2.

With this function, "whether the direction that the LD77MH recognizes as forward run matches the address increment direction in the actual positioning work", and "whether the LD77MH recognizes the external input signals such as the manual pulse generator and forced stop", etc., can be checked.

- Are the LD77MH and servo amplifier correctly connected?
- Are the servo amplifier and servomotor correctly connected?
- Are the LD77MH and external devices (input signals) correctly connected?
- Are the servo amplifier and external wiring (FLS, RLS, DOG) correctly connected?

Refer to the "Simple Motion Module Setting Tool Help" of GX Works2 for details of "Positioning test function".

Note that the monitor data of the " [Md.30](#) External input signal" in the GX Works2 may also be used to "confirm the connection between the LD77MH and external devices (input signals)".

<b>Important</b>
------------------

<p>If the LD77MH is faulty, or when the required signals such as the near-point dog signal and forced stop signal are not recognized, unexpected accidents such as "not decelerating at the near-point dog during machine OPR and colliding with the stopper", or "not being able to stop with the forced stop signal" may occur. Execute a checking wiring of external input signal. The connection confirmation by positioning test function must be carried out not only when structuring the positioning system, but also when the system has been changed with module replacement or rewiring, etc.</p>
--

## 4.5 Maintenance

### 4.5.1 Precautions for maintenance

The precautions for servicing the LD77MH are given below. Refer to this section as well as Section 4.1.3 "Handling precautions" when carrying out the work.

#### DANGER

- Completely turn off the externally supplied power used in the system before clearing or tightening the connector screws.  
Not doing so could result in electric shocks.

#### CAUTION

- Never try to disassemble or modify the modules.  
It may cause product failure, operation failure, injury or fires.
- Completely turn off the externally supplied power used in the system before installation or removing the module.  
Not doing so could result in electric shock, damage to the module or operation failure.

### 4.5.2 Disposal instructions

When you discard LD77MH, servo amplifier, a battery (primary battery) and other option articles, please follow the law of each country (area).

#### CAUTION

- This product is not designed or manufactured to be used in equipment or systems in situations that can affect or endanger human life.
- When considering this product for operation in special applications such as machinery or systems used in passenger transportation, medical, aerospace, atomic power, electric power, or submarine repeating applications, please contact your nearest Mitsubishi sales representative.
- Although this product was manufactured under conditions of strict quality control, you are strongly advised to install safety devices to forestall serious accidents when it is used in facilities where a breakdown in the product is likely to cause a serious accident.

# MEMO

---

---

---

---

---

---

---

---

---

---

---

---

---

---

---

---

---

---

---

---

---

---

---

---

---

---

# Chapter 5 Data Used for Positioning Control

The parameters and data used to carry out positioning control with the LD77MH are explained in this chapter.

With the positioning system using the LD77MH, the various parameters and data explained in this chapter are used for control. The parameters and data include parameters set according to the device configuration, such as the system configuration, and parameters and data set according to each control. Read this section thoroughly and make settings according to each control or application.

\*: Refer to "Section 2" for details on each control.

5.1	Types of data .....	5- 2
5.1.1	Parameters and data required for control .....	5- 2
5.1.2	Setting items for positioning parameters.....	5- 5
5.1.3	Setting items for OPR parameters .....	5- 7
5.1.4	Setting items for expansion parameters .....	5- 8
5.1.5	Setting items for servo parameters .....	5- 8
5.1.6	Setting items for positioning data .....	5- 9
5.1.7	Setting items for block start data .....	5-11
5.1.8	Setting items for condition data .....	5-12
5.1.9	Types and roles of monitor data.....	5-13
5.1.10	Types and roles of control data .....	5-17
5.2	List of parameters.....	5-21
5.2.1	Basic parameters 1 .....	5-21
5.2.2	Basic parameters 2 .....	5-24
5.2.3	Detailed parameters 1 .....	5-25
5.2.4	Detailed parameters 2 .....	5-35
5.2.5	OPR basic parameters .....	5-47
5.2.6	OPR detailed parameters .....	5-54
5.2.7	Expansion parameters.....	5-59
5.2.8	Servo parameters .....	5-61
5.3	List of positioning data.....	5-66
5.4	List of block start data .....	5-82
5.5	List of condition data .....	5-88
5.6	List of monitor data .....	5-98
5.6.1	System monitor data.....	5-198
5.6.2	Axis monitor data .....	5-112
5.7	List of control data .....	5-138
5.7.1	System control data .....	5-138
5.7.2	Axis control data .....	5-142
5.7.3	Expansion axis control data .....	5-170

## 5.1 Types of data

### 5.1.1 Parameters and data required for control

The parameters and data required to carry out control with the LD77MH include the "setting data", "monitor data" and "control data" shown below.

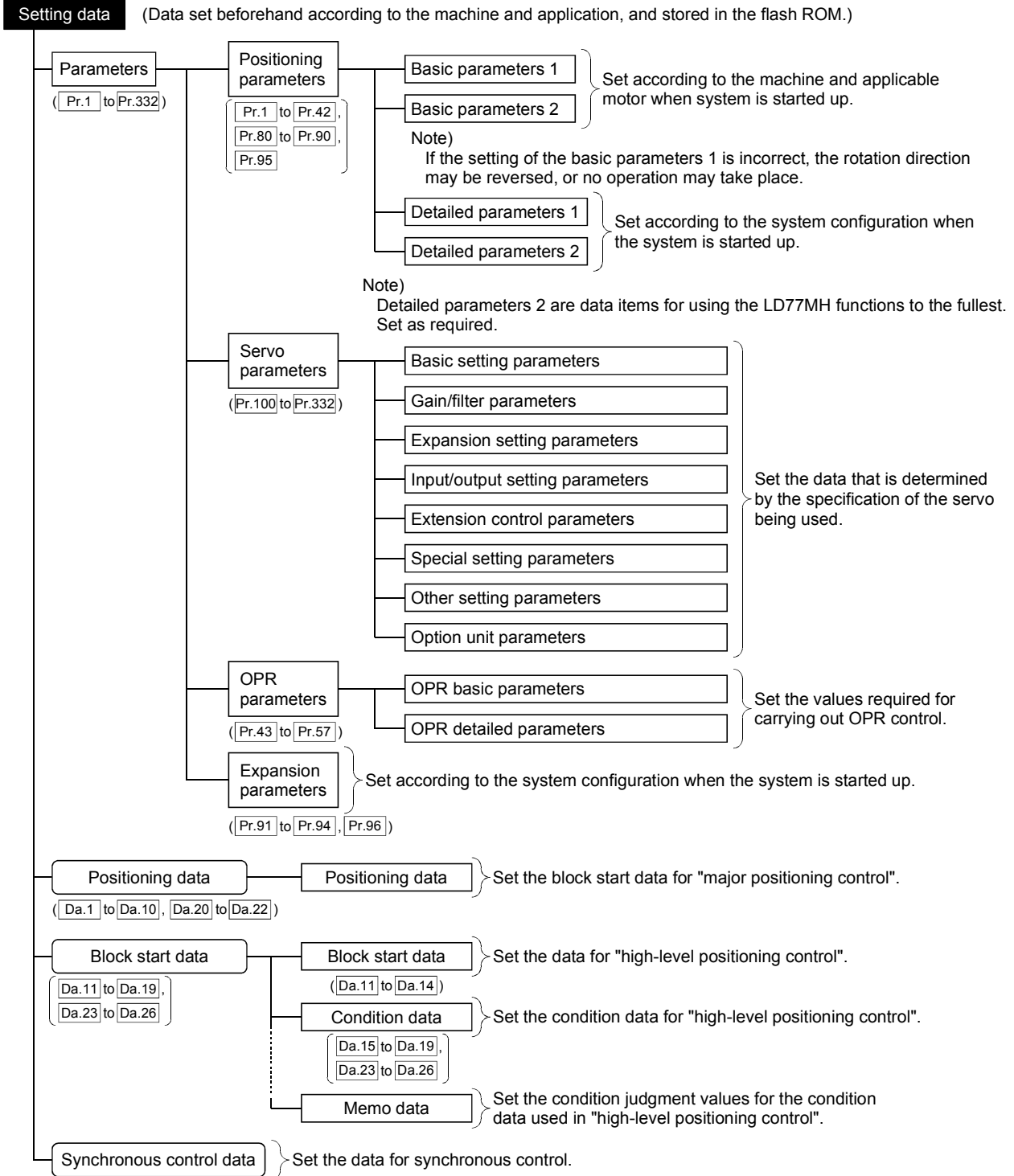

- ◇ The following methods are available for data setting:
  - Set using GX Works2.
  - Create the sequence program for data setting using GX Works2 and execute it. In this manual, the method using the GX Works2 will be explained. (Refer to "Point" on the next page.)
- ◇ The basic parameters 1, detailed parameters 1, OPR parameters, and "[Pr.83] Speed control 10 x multiplier setting for degree axis", "[Pr.89] Manual pulse generator/Incremental synchronous encoder input type selection", "[Pr.90] Operation setting for speed-torque control mode" and "[Pr.95] External command signal selection" become valid when the PLC READY signal [Y0] turns from OFF to ON.
- ◇ The basic parameters 2, detailed parameters 2 (Note that this excludes "[Pr.83] Speed control 10 x multiplier setting for degree axis", "[Pr.89] Manual pulse generator/Incremental synchronous encoder input type selection", "[Pr.90] Operation setting for speed-torque control mode" and "[Pr.95] External command signal selection".) become valid immediately when they are written to the buffer memory, regardless of the state of the PLC READY signal [Y0].
- ◇ Even when the PLC READY signal [Y0] is ON, the values or contents of the following can be changed: basic parameters 2, detailed parameters 2, positioning data, and block start data.
- ◇ The expansion parameter and servo parameter is transmitted from LD77MH to the servo amplifier when the initialized communication carried out after the power supply is turned ON or the PLC CPU is reset.
 

The power supply is turned ON or the PLC CPU is reset after writing servo parameter in flash ROM of LD77MH if the servo parameter is transmitted to the servo amplifier.

The following servo parameter in the buffer memory is transmitted to the servo amplifier when the PLC READY [Y0] turns from OFF to ON.

  - [Pr.108] Auto tuning mode (Basic setting parameters)
  - [Pr.109] Auto tuning response (Basic setting parameters)
  - [Pr.122] Feed forward gain (Gain/filter parameters)
  - [Pr.124] Ratio of load inertia moment to servo motor inertia moment (Gain/filter parameters)
  - [Pr.125] Model loop gain (Gain/filter parameters)
  - [Pr.126] Position loop gain (Gain/filter parameters)
  - [Pr.127] Speed loop gain (Gain/filter parameters)
  - [Pr.128] Speed integral compensation (Gain/filter parameters)
  - [Pr.129] Speed differential compensation (Gain/filter parameters)
- ◇ The only valid data assigned to basic parameter 2, detailed parameter 2, positioning data or block start data are the data read at the moment when a positioning or JOG operation is started. Once the operation has started, any modification to the data is ignored.
 

Exceptionally, however, modifications to the following are valid even when they are made during a positioning operation: acceleration time 0 to 3, deceleration time 0 to 3, and external start command.

  - Acceleration time 0 to 3 and deceleration time 0 to 3:
 

Positioning data are pre-read and pre-analyzed. Modifications to the data four or more steps after the current step are valid.
  - External command function selection: The value at the time of detection is valid.



**Monitor data** (Data that indicates the control state. Stored in the buffer memory, and monitors as necessary.)

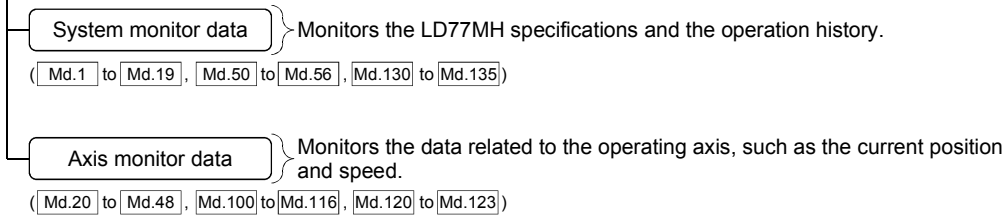

- ◇ The following methods are available for data monitoring:
  - Set using GX Works2.
  - Create the sequence program for monitoring using GX Works2 and execute it.
 In this manual, the method using the GX Works2 will be explained.

**Control data** (Data for user to control positioning system.)

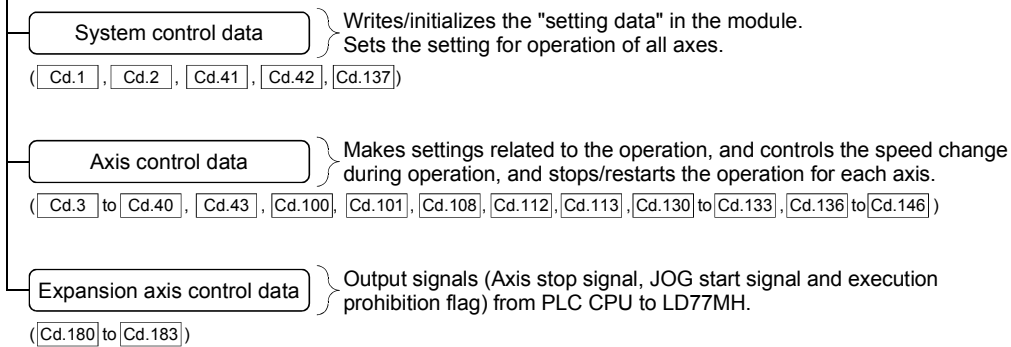

- ◇ Control using the control data is carried out with the sequence program.
  - " Cd.41 Deceleration start flag valid" is valid for only the value at the time when the PLC READY signal [Y0] turns from OFF to ON.

POINT
(1) The "setting data" is created for each axis.
(2) The "setting data" parameters have determined default values, and are set to the default values before shipment from the factory. (Parameters related to axes that are not used are left at the default value.)
(3) The "setting data" can be initialized with GX Works2 or the sequence program.
(4) It is recommended to set the "setting data" with GX Works2. The sequence program for data setting is complicated and many devices must be used. This will increase the scan time.

5.1.2 Setting items for positioning parameters

The table below lists items set to the positioning parameters. Setting of positioning parameters is similarly done for individual axes for all controls achieved by the LD77MH.

For details of controls, refer to "Section 2". For details of setting items, refer to Section 5.2 "List of parameters".

Positioning parameter	Control	Major positioning control								Manual control			Expansion control	Related sub function	
		OPR control	Position control			Speed-position or position-speed control	Other control		Manual pulse generator operation	Inching operation	JOG operation	Speed-torque control			
			1-axis linear control	2/3/4-axis linear interpolation control	1-axis fixed-feed control		2/3/4-axis fixed-feed control	2-axis circular interpolation control					1 to 4 axis speed control		Current value changing
Basic parameters 1	Pr.1	Unit setting	⊙	⊙	⊙	△	⊙	⊙	⊙	⊙	⊙	⊙	⊙	-	
	Pr.2	Number of pulses per rotation (AP) (Unit: PLS)	⊙	⊙	⊙	⊙	⊙	⊙	⊙	⊙	⊙	⊙	⊙	13.3.2	
	Pr.3	Movement amount per rotation (AL)	⊙	⊙	⊙	⊙	⊙	⊙	⊙	⊙	⊙	⊙	⊙		
	Pr.4	Unit magnification (AM)	⊙	⊙	⊙	⊙	⊙	⊙	⊙	⊙	⊙	⊙	⊙		
	Pr.7	Bias speed at start	○	○	○	○	○	-	-	-	-	○	×	-	
Basic parameters 2	Pr.8	Speed limit value	⊙	⊙	⊙	⊙	⊙	⊙	-	-	-	⊙	⊙	13.4.1	
	Pr.9	Acceleration time 0	⊙	⊙	⊙	⊙	⊙	⊙	-	-	-	⊙	-	13.7.6	
	Pr.10	Deceleration time 0	⊙	⊙	⊙	⊙	⊙	⊙	-	-	-	⊙	-		
Detailed parameters 1	Pr.11	Backlash compensation amount	○	○	○	○	○	○	-	-	○	○	○	13.3.1	
	Pr.12	Software stroke limit upper limit value	-	○	○	○	○	○	-	-	○	○	○	13.4.3	
	Pr.13	Software stroke limit lower limit value	-	○	○	○	○	○	-	-	○	○	○		
	Pr.14	Software stroke limit selection	-	○	○	○	○	○	-	-	○	○	○		
	Pr.15	Software stroke limit valid/invalid setting	-	-	-	-	-	○	○	○	○	○	-		
	Pr.16	Command in-position width	-	○	○	○	-	○	-	-	-	-	-		13.7.5
	Pr.17	Torque limit setting value	△	○	○	○	○	○	-	-	△	△	△	○	13.4.2
	Pr.18	M code ON signal output timing	-	○	○	○	○	○	○	-	-	-	-	-	13.7.3
	Pr.19	Speed switching mode	-	○	○	○	-	-	-	-	-	-	-	-	-
	Pr.20	Interpolation speed designation method	-	△	△	△	△	-	-	-	-	-	-	-	-
	Pr.21	Current feed value during speed control	-	-	-	-	○	○	-	-	-	-	-	-	-
	Pr.22	Input signal logic selection	⊙	⊙	⊙	⊙	⊙	⊙	⊙	⊙	⊙	⊙	⊙	⊙	-
	Pr.24	Manual pulse generator/incremental synchronous encoder input selection	-	-	-	-	-	-	-	-	⊙	-	-	-	-
	Pr.80	External input signal selection	○	○	○	○	○	○	○	○	○	○	○	○	14.4
	Pr.81	Speed-position function selection	-	-	-	-	-	⊙	-	-	-	-	-	-	-
Pr.82	Forced stop valid/invalid selection	○	○	○	○	○	○	○	○	○	○	○	○	13.4.5	

- ⊙ : Always set
- : Set as required (Read "-" when not required.)
- ×
- △ : Setting restricted
- : Setting not required. (This is an irrelevant item, so the set value will be ignored. If the value is the default value or within the setting range, there is no problem.)

Positioning parameter		Control											Expansion control	Related sub function		
		Major positioning control								Manual control						
		Position control				Other control				Manual pulse generator operation	Inching operation	JOG operation				
		OPR control	1-axis linear control	2/3/4-axis linear interpolation control	1-axis fixed-feed control	2/3/4-axis fixed-feed control	2-axis circular interpolation control	1 to 4 axis speed control	Speed-position or position-speed control						Current value changing	JUMP instruction, NOP instruction, LOOP to LEND
Detailed parameters 2	Pr.25	Acceleration time 1	○	○	○	○	○	○	○	-	-	-	-	○	-	
	Pr.26	Acceleration time 2	○	○	○	○	○	○	○	-	-	-	-	○	-	
	Pr.27	Acceleration time 3	○	○	○	○	○	○	○	-	-	-	-	○	-	
	Pr.28	Deceleration time 1	○	○	○	○	○	○	○	-	-	-	-	○	-	
	Pr.29	Deceleration time 2	○	○	○	○	○	○	○	-	-	-	-	○	-	
	Pr.30	Deceleration time 3	○	○	○	○	○	○	○	-	-	-	-	○	-	
	Pr.31	JOG speed limit value	-	-	-	-	-	-	-	-	-	◎	◎	-	13.4.1	
	Pr.32	JOG operation acceleration time selection	-	-	-	-	-	-	-	-	-	-	◎	-	-	
	Pr.33	JOG operation deceleration time selection	-	-	-	-	-	-	-	-	-	-	◎	-	-	
	Pr.34	Acceleration/deceleration process selection	○	○	○	○	○	○	-	-	-	-	○	-	-	
	Pr.35	S-curve ratio	○	○	○	○	○	○	-	-	-	-	○	-	13.7.6	
	Pr.36	Sudden stop deceleration time	○	○	○	○	○	○	-	-	-	-	○	-	-	
	Pr.37	Stop group 1 sudden stop selection	○	○	○	○	○	○	-	-	-	-	○	-	-	
	Pr.38	Stop group 2 sudden stop selection	○	○	○	○	○	○	-	-	-	-	○	-	-	
	Pr.39	Stop group 3 sudden stop selection	○	○	○	○	○	○	-	-	-	-	○	-	-	
	Pr.40	Positioning complete signal output time	-	○	○	○	○	○	○	-	-	-	-	-	-	
	Pr.41	Allowable circular interpolation error width	-	-	-	○	-	-	-	-	-	-	-	-	-	
	Pr.42	External command function selection	○	○	○	○	○	○	◎	○	-	-	-	○	-	13.5.1 13.7.2
	Pr.83	Speed control 10 x multiplier setting for degree axis	○	○	○	○	○	○	-	-	○	○	○	○	-	13.7.10
	Pr.84	Restart allowable range when servo OFF to ON	○	○	○	○	○	○	○	○	○	○	○	-	-	5.2.4
Pr.89	Manual pulse generator/Incremental synchronous encoder input type selection	-	-	-	-	-	-	-	-	◎	-	-	-	-	5.2.4	
Pr.90	Operation setting for speed-torque control mode	-	-	-	-	-	-	-	-	-	-	-	○	-	12.1	
Pr.95	External command signal selection <b>LD77MH16</b>	○	○	○	○	○	○	◎	○	-	-	-	○	-	-	

◎: Always set

○: Set as required ("-" when not set)

-: Setting not required (This is an irrelevant item, so the setting value will be ignored. If the value is the default value or within the setting range, there is no problem.)

### ■ Checking the positioning parameters

Pr.1 to Pr.90, Pr.95 are checked with the following timing.

- When the "PLC READY signal [Y0]" output from the PLC CPU to the LD77MH changes from OFF to ON.
- When the positioning test of GX Works2 is executed.

### REMARK

"High-level positioning control" is carried out in combination with the "major positioning control".

Refer to the "major positioning control" parameter settings for details on the parameters required for "high-level positioning control".

## 5.1.3 Setting items for OPR parameters

When carrying out "OPR control", the "OPR parameters" must be set. The setting items for the "OPR parameters" are shown below.

The "OPR parameters" are set commonly for each axis.

Refer to Chapter 8 "OPR control" for details on the "OPR control", and refer to Section 5.2 "List of parameters" for details on each setting item.

OPR parameters		OPR control	Machine OPR control					Fast OPR control
			Near-point dog method	Count method 1)	Count method 2)	Data set method	Scale origin signal detection method	
OPR basic parameters	Pr.43	OPR method						Preset parameters are used for machine OPR control.
	Pr.44	OPR direction	◎	◎	◎	◎	◎	
	Pr.45	OP address	◎	◎	◎	◎	◎	
	Pr.46	OPR speed	◎	◎	◎	-	◎	
	Pr.47	Creep speed	◎	◎	◎	-	◎	
	Pr.48	OPR retry	R	R	R	-	-	
OPR detailed parameters	Pr.50	Setting for the movement amount after near-point dog ON	-	◎	◎	-	-	Preset parameters are used for machine OPR control.
	Pr.51	OPR acceleration time selection	◎	◎	◎	-	◎	
	Pr.52	OPR deceleration time selection	◎	◎	◎	-	◎	
	Pr.53	OP shift amount	S	S	S	-	S	
	Pr.54	OPR torque limit value	○	○	○	-	○	
	Pr.55	Operation setting for incompleteness of OPR	○	○	○	○	○	-
	Pr.56	Speed designation during OP shift	S	S	S	-	S	Preset parameters are used for machine OPR control.
	Pr.57	Dwell time during OPR retry	R	R	R	-	-	

◎ : Always set

○ : Set as required

- : Setting not required (This is an irrelevant item, so the setting value will be ignored. If the value is the default value or within the setting range, there is no problem.)

R : Set when using the "13.2.1 OPR retry function". ("-" when not set.)

S : Set when using the "13.2.2 OP shift function". ("-" when not set.)

#### ■ Checking the OPR parameters.

Pr.43 to Pr.57 are checked with the following timing.

- When the "PLC READY signal [Y0]" output from the PLC CPU to the LD77MH changes from OFF to ON.
- When the positioning test of GX Works2 is executed.

### 5.1.4 Setting items for expansion parameters

The setting items for the "expansion parameters" are shown below. The "expansion parameters" are set commonly for each axis.

Refer to "Section 2" for details on the each control, and refer to Section 5.2 "List of parameters" for details on each setting item.

Expansion parameter		Related sub function
Optional data monitor: Data type setting parameter LD77MH16	Pr.91	Optional data monitor: Data type setting 1
	Pr.92	Optional data monitor: Data type setting 2
	Pr.93	Optional data monitor: Data type setting 3
	Pr.94	Optional data monitor: Data type setting 4
	Pr.96	Operation cycle setting
		14.11
		—

### 5.1.5 Setting items for servo parameters

The servo parameters are used to control the servo motor and the data that is determined by the specification of the servo amplifier being used.

The setting item is different depending on the servo amplifier being used.

Refer to Section 5.2.8 "Servo parameters" for details.

Servo parameter		Remark
Pr.100	Servo series	Set the servo series connected to LD77MH.
Pr.101 to Pr.118, Pr.332	Basic setting parameters	Setting items are different according to the servo series.
Pr.119 to Pr.163	Gain/filter parameters	
Pr.164 to Pr.195	Expansion setting parameters	
Pr.196 to Pr.227	Input/output setting parameters	
Pr.228 to Pr.267	Extension control parameters	
Pr.268 to Pr.299	Special setting parameters	
Pr.300 to Pr.315	Other setting parameters	
Pr.316 to Pr.331	Option unit parameters	

5.1.6 Setting items for positioning data

Positioning data must be set for carrying out any "major positioning control". The table below lists the items to be set for producing the positioning data.

One to 600 positioning data items can be set for each axis.

For details of the major positioning controls, refer to Chapter 9 "Major Positioning Control". For details of the individual setting items, refer to Section 5.3 "List of positioning data".

Major positioning control			Position control					Other control					
			1-axis linear control 2/3/4-axis linear interpolation control	1-axis fixed-feed control 2/3/4-axis fixed-feed control	2-axis circular interpolation control	1 to 4 axis speed control	Speed-position switching control	Position-speed switching control	NOP instruction	Current value changing	JUMP instruction	LOOP	LEND
Positioning data													
Da.1	Operation pattern	Independent positioning control	⊙	⊙	⊙	⊙	⊙	⊙	-	⊙	-	-	-
		Continuous positioning control	⊙	⊙	⊙	×	⊙	×	-	⊙	-	-	-
		Continuous path control	⊙	×	⊙	×	×	×	-	×	-	-	-
Da.2	Control system	Linear 1 Linear 2 Linear 3 Linear 4 *	Fixed-feed 1 Fixed-feed 2 Fixed-feed 3 Fixed-feed 4	Circular sub Circular right Circular left *	Forward run speed 1 Reverse run speed 1 Forward run speed 2 Reverse run speed 2 Forward run speed 3 Reverse run speed 3 Forward run speed 4 Reverse run speed 4	Forward run speed/position Reverse run speed/position	Forward run position/speed Reverse run position/speed	NOP instruction	Current value changing	JUMP instruction	LOOP	LEND	
Da.3	Acceleration time No.	○	○	○	○	○	○	-	-	-	-	-	
Da.4	Deceleration time No.	○	○	○	○	○	○	-	-	-	-	-	
Da.5	Axis to be interpolated <b>LD77MH4</b>	⊙: 2 axes - : 1 axis, 3 axes, 4 axes					-	-	-	-	-	-	-
Da.6	Positioning address/movement amount	⊙	⊙	⊙	-	⊙	⊙	-	New address	-	-	-	
Da.7	Arc address	-	-	⊙	-	-	-	-	-	-	-	-	
Da.8	Command speed	⊙	⊙	⊙	⊙	⊙	⊙	-	-	-	-	-	
Da.9	Dwell time (JUMP destination positioning data No.)	○	○	○	○	○	○	-	-	JUMP destination positioning data No.	-	-	
Da.10	M code (JUMP condition data No.)	○	○	○	○	○	○	-	○	JUMP condition data No.	Number of LOOP to LEND repetitions	-	

⊙ : Always set

○ : Set as required (Read "-" when not required.)

×

- : Setting not required.

(This is an irrelevant item, so the set value will be ignored. If the value is the default value or within the setting range, there is no problem.)

\* : Two control systems are available: the absolute (ABS) system and incremental (INC) system.

Major positioning control		Position control			1 to 4 axis speed control	Speed-position switching control	Position-speed switching control	Other control					
		1-axis linear control 2/3/4-axis linear interpolation control	1-axis fixed-feed control 2/3/4-axis fixed-feed control	2-axis circular interpolation control				NOP instruction	Current value changing	JUMP instruction	LOOP	LEND	
Positioning data													
Da.20	Axis to be interpolated 1 LD77MH16	◎: 2 axes, 3 axes, 4 axes —: 1 axis											
Da.21	Axis to be interpolated 2 LD77MH16	◎: 3 axes, 4 axes —: 1 axis, 2 axes											
Da.22	Axis to be interpolated 3 LD77MH16	◎: 4 axes —: 1 axis, 2 axes, 3 axes											

◎ : Always set

○ : Set as required (Read "-" when not required.)

× : Setting not possible

- : Setting not required.

(This is an irrelevant item, so the set value will be ignored. If the value is the default value or within the setting range, there is no problem.)

\* : Two control systems are available: the absolute (ABS) system and incremental (INC) system.

### ■ Checking the positioning data

The items Da.1 to Da.10, Da.20 to Da.22 are checked at the following timings:

- Startup of a positioning operation

### 5.1.7 Setting items for block start data

The "block start data" must be set when carrying out "high-level positioning control".

The setting items for the "block start data" are shown below.

Up to 50 points of "block start data" can be set for each axis.

Refer to Chapter 10 "High-Level Positioning Control" for details on the "high-level positioning control", and to Section 5.4 "List of block start data" for details on each setting item.

High-level positioning control		Block start (Normal start)	Condition start	Wait start	Simultaneous start	Repeated start (FOR loop)	Repeated start (FOR condition)
Block start data							
Da.11	Shape (end/continue)	<input type="radio"/>	<input type="radio"/>	<input type="radio"/>	<input type="radio"/>	<input type="radio"/>	<input type="radio"/>
Da.12	Start data No.	<input type="radio"/>	<input type="radio"/>	<input type="radio"/>	<input type="radio"/>	<input type="radio"/>	<input type="radio"/>
Da.13	Special start instruction	-	<input type="radio"/>	<input type="radio"/>	<input type="radio"/>	<input type="radio"/>	<input type="radio"/>
Da.14	Parameter	-	<input type="radio"/>	<input type="radio"/>	<input type="radio"/>	<input type="radio"/>	<input type="radio"/>

: Set as required ("-" when not set)

- : Setting not required (This is an irrelevant item, so the setting value will be ignored. If the value is the default value or within the setting range, there is no problem.)

#### ■ Checking the block start data

Da.11 to Da.14 are checked with the following timing.

- When the "Block start data" starts



### 5.1.8 Setting items for condition data

When carrying out "high-level positioning control" or using the JUMP instruction in the "major positioning control", the "condition data" must be set as required. The setting items for the "condition data" are shown below.

Up to 10 "condition data" items can be set for each axis.

Refer to Chapter 10 "High-Level Positioning Control" for details on the "high-level positioning control", and to Section 5.5 "List of condition data" for details on each setting item.

Control		Major positioning control		High-level positioning control					
		Other than JUMP instruction	JUMP instruction	Block start (Normal start)	Condition start	Wait start	Simultaneous start	Repeated start (FOR loop)	Repeated start (FOR condition)
Da.15	Condition target	—	○	—	○	○	○	—	○
Da.16	Condition operator	—	○	—	○	○	○	—	○
Da.17	Address	—	△	—	△	△	—	—	△
Da.18	Parameter 1	—	○	—	○	○	△	—	○
Da.19	Parameter 2	—	△	—	△	△	△	—	△
Da.23	Number of simultaneously starting axes <b>LD77MH16</b>	—	—	—	—	—	○	—	—
Da.24	Simultaneously starting axis No.1 <b>LD77MH16</b>	—	—	—	—	—	○	—	—
Da.25	Simultaneously starting axis No.2 <b>LD77MH16</b>	—	—	—	—	—	○	—	—
Da.26	Simultaneously starting axis No.3 <b>LD77MH16</b>	—	—	—	—	—	○	—	—

○ : Set as required ("—" when not set)

△ : Setting limited

— : Setting not required (This is an irrelevant item, so the setting value will be ignored. If the value is the default value or within the setting range, there is no problem.)

#### ■ Checking the condition data

Da.15 to Da.19, Da.23 to Da.26 are checked with the following timing.

- When the "Block start data" starts
- When "JUMP instruction" starts

### 5.1.9 Types and roles of monitor data

The monitor data area in the buffer memory stores data relating to the operating state of the positioning system, which are monitored as required while the positioning system is operating.

The following data are available for monitoring.

- System monitoring:

Monitoring of the LD77MH configuration and operation history (through the system monitor data [Md.1] to [Md.19], [Md.50] to [Md.56], [Md.130] to [Md.135])

- Axis operation monitoring:

Monitoring of the current position and speed, and other data related to the movements of axes (through the axis monitor data [Md.20] to [Md.48], [Md.100] to [Md.116], [Md.120] to [Md.123])

#### [1] Monitoring the system

##### ■ Monitoring the positioning system operation history

Monitoring details		Corresponding item		
Whether the system is in the test mode or not		[Md.1]	In test mode flag	
History of data that started an operation	Start information	[Md.3]	Start information	
	Start No.	[Md.4]	Start No.	
	Start	Year: month	[Md.54]	Start Year: month
		Day: hour	[Md.5]	Start Day: hour
		Minute: second	[Md.6]	Start Minute: second
	Error upon starting		[Md.7]	Error judgment
Pointer No. next to the pointer No. where the latest history is stored		[Md.8]	Start history pointer	
History of all errors	Axis in which the error occurred		[Md.9] Axis in which the error occurred	
	Axis error No.		[Md.10] Axis error No.	
	Axis error occurrence	Year: month	[Md.55]	Axis error occurrence (Year: month)
		Day: hour	[Md.11]	Axis error occurrence (Day: hour)
		Minute: second	[Md.12]	Axis error occurrence (Minute: second)
Pointer No. next to the pointer No. where the latest history is stored		[Md.13]	Error history pointer	
History of all warnings	Axis in which the warning occurred		[Md.14] Axis in which the warning occurred	
	Axis warning No.		[Md.15] Axis warning No.	
	Axis warning occurrence	Year: month	[Md.56]	Axis warning occurrence (Year: month)
		Day: hour	[Md.16]	Axis warning occurrence (Day: hour)
		Minute: second	[Md.17]	Axis warning occurrence (Minute: second)
Pointer No. next to the pointer No. where the latest history is stored		[Md.18]	Warning history pointer	

Monitoring details		Corresponding item	
Number of write accesses to the flash ROM after the power is switched ON	Number of write accesses to flash ROM	Md.19	Number of write accesses to flash ROM
Forced stop input signal turn ON/OFF	Forced stop input signal (EMI) information	Md.50	Forced stop input
Monitor whether the system is in amplifier-less operation		Md.51	Amplifier-less operation mode status
Monitor the detection status of axis that set communication between amplifiers		Md.52	Communication between amplifiers axes searching flag
Monitor the first five digits of product information		Md.130	OS version
Monitor the RUN status of digital oscilloscope		Md.131	Digital oscilloscope executing
Monitor the current operation cycle.		Md.132	Operation cycle setting <b>LD77MH16</b>
Monitor whether the operation cycle time exceeds operation cycle.		Md.133	Operation cycle over flag <b>LD77MH16</b>
Monitor the time that took for operation every operation cycle.		Md.134	Operation time
Monitor the maximum value of operation time after each module's power supply ON.		Md.135	Maximum operation time

[2] Monitoring the axis operation state

■ Monitoring the position

Monitor details		Corresponding item	
Monitor the current machine feed value		Md.21	Machine feed value
Monitor the current "current feed value"		Md.20	Current feed value
Monitor the current target value		Md.32	Target value

■ Monitoring the speed

Monitor details			Corresponding item	
Monitor the current speed	During independent axis control		Indicates the speed of each axis	
	During interpolation control	When "0: Composite speed" is set for " [Pr.20] Interpolation speed designation method"	Indicates the composite speed	
		When "1: Reference axis speed" is set for " [Pr.20] Interpolation speed designation method"	Indicates the reference axis speed	
	Monitor " [Da.8] Command speed" currently being executed.		Md.27	Current speed
	Constantly indicates the speed of each axis		Md.28	Axis feedrate
Monitor the current target speed			Md.33	Target speed
Monitor the command speed at speed control mode in the speed-torque control			Md.122	Speed during command

### ■ Monitoring the status of servo amplifier

Monitor details	Corresponding item
Monitor the real current value (current feed value - deviation counter).	<a href="#">Md.101</a> Real current value
Monitor the difference between current feed value and real current value.	<a href="#">Md.102</a> Deviation counter value
Monitor the motor speed of servo motor.	<a href="#">Md.103</a> Motor rotation speed
Monitor the current value of servo motor.	<a href="#">Md.104</a> Motor current value
Monitor the software No. of servo amplifier.	<a href="#">Md.106</a> Servo amplifier software No.
Monitor the parameter No. that an error occurred.	<a href="#">Md.107</a> Parameter error No.
Monitor the status (servo status) of servo amplifier.	<a href="#">Md.108</a> Servo status
<ul style="list-style-type: none"> <li>Monitor the percentage of regenerative power to permissible regenerative value.</li> <li>Monitor the content of "<a href="#">Pr.91</a> Optional data monitor: Data type setting 1" at optional data monitor data type setting. <b>LD77MH16</b></li> </ul>	<a href="#">Md.109</a> Regenerative load ratio/Optional data monitor output 1
<ul style="list-style-type: none"> <li>Monitor the continuous effective load torque.</li> <li>Monitor the content of "<a href="#">Pr.92</a> Optional data monitor: Data type setting 2" at optional data monitor data type setting. <b>LD77MH16</b></li> </ul>	<a href="#">Md.110</a> Effective load torque/Optional data monitor output 2
<ul style="list-style-type: none"> <li>Monitor the maximum generated torque.</li> <li>Monitor the content of "<a href="#">Pr.93</a> Optional data monitor: Data type setting 3" at optional data monitor data type setting. <b>LD77MH16</b></li> </ul>	<a href="#">Md.111</a> Peak torque ratio/Optional data monitor output 3
Monitor the content of " <a href="#">Pr.94</a> Optional data monitor: Data type setting 4" at optional data monitor data type setting.	<a href="#">Md.112</a> Optional data monitor output 4 <b>LD77MH16</b>
Monitor the status of semi closed loop control/fully closed loop control.	<a href="#">Md.113</a> Semi/Fully closed loop status
Monitor the alarm of servo amplifier.	<a href="#">Md.114</a> Servo alarm
Monitor the option information of encoder.	<a href="#">Md.116</a> Encoder option information

### ■ Monitoring the state

Monitor details	Corresponding item
Monitor the axis operation state	<a href="#">Md.26</a> Axis operation status
Monitor the latest error code that occurred with the axis	<a href="#">Md.23</a> Axis error No.
Monitor the latest warning code that occurred with the axis	<a href="#">Md.24</a> Axis warning No.
Monitor the external input/output signal and flag	<a href="#">Md.30</a> <a href="#">Md.31</a> External input signal Status
Monitor the valid M codes	<a href="#">Md.25</a> Valid M code
Monitor whether the speed is being limited	<a href="#">Md.39</a> In speed limit flag
Monitor whether the speed is being changed	<a href="#">Md.40</a> In speed change processing flag
Monitor the "start data" point currently being executed	<a href="#">Md.43</a> Start data pointer being executed
Monitor the "positioning data No." currently being executed	<a href="#">Md.44</a> Positioning data No. being executed
Monitor the remaining number of repetitions (special start)	<a href="#">Md.41</a> Special start repetition counter
Monitor the remaining number of repetitions (control system)	<a href="#">Md.42</a> Control system repetition counter
Monitor the block No.	<a href="#">Md.45</a> Block No. being executed

Monitor details	Corresponding item
Monitor the current torque limit value	Md.35 Torque limit stored value/forward torque limit stored value
	Md.120 Reverse torque limit stored value
Monitor the command torque at torque control mode in the speed-torque control.	Md.123 Torque during command
Monitor the "instruction code" of the special start data when using special start	Md.36 Special start data instruction code setting value
Monitor the "instruction parameter" of the special start data when using special start	Md.37 Special start data instruction parameter setting value
Monitor the "start data No." of the special start data when using special start	Md.38 Start positioning data No. setting value
Monitor the "positioning data No." executed last	Md.46 Last executed positioning data No.
Monitor the positioning data currently being executed	Md.47 Positioning data being executed
Monitor the movement amount after the current position control switching when using "speed-position switching control".	Md.29 Speed-position switching control positioning amount
Monitor switching from the constant speed status or acceleration status to the deceleration status during position control whose operation pattern is "Positioning complete"	Md.48 Deceleration start flag
Monitor the movement amount from near-point dog ON to machine OPR completion.	Md.34 Movement amount after near-point dog ON
Monitor the distance that travels to zero point after stop once at OPR.	Md.100 OPR re-travel value

### 5.1.10 Types and roles of control data

Operation of the positioning system is achieved through the execution of necessary controls. (Data required for controls are given through the default values when the power is switched ON, which can be modified as required by the sequence program.) Controls are performed over system data or machine operation.

- Controlling the system data :

Setting and resetting LD77MH setting data (through the system control data [Cd.1](#), [Cd.2](#))

- Controlling the operation :

Setting operation parameters, changing speed during operation, interrupting or restarting operation (through the system control data [Cd.41](#), [Cd.42](#), [Cd.137](#), axis control data [Cd.3](#) to [Cd.40](#), [Cd.43](#), [Cd.100](#), [Cd.101](#), [Cd.108](#), [Cd.112](#), [Cd.113](#), [Cd.130](#) to [Cd.133](#), [Cd.136](#) to [Cd.146](#), expansion axis control data [Cd.180](#) to [Cd.183](#))

#### [1] Controlling the system data

##### ■ Setting and resetting the setting data

Control details	Controlled data item
Write setting data from buffer memory to flash ROM.	<a href="#">Cd.1</a> Flash ROM write request
Reset (initialize) parameters.	<a href="#">Cd.2</a> Parameter initialization request

## [2] Controlling the operation

## ■ Controlling the operation

Control details	Corresponding item	
Set which positioning to execute (start No.).	Cd.3	Positioning start No.
Clear (reset) the axis error ( [Md.23] ) and warning ( [Md.24] ).	Cd.5	Axis error reset
Issue instruction to restart (When axis operation is stopped).	Cd.6	Restart command
Stop axis in control.	Cd.180	Axis stop <b>LD77MH16</b>
Execute start request of JOG operation or inching operation.	Cd.181	Forward run JOG start <b>LD77MH16</b>
	Cd.182	Reverse run JOG start <b>LD77MH16</b>
Execute pre-reading at positioning start.	Cd.183	Execution prohibition flag <b>LD77MH16</b>
Set start point No. for executing block start.	Cd.4	Positioning starting point No.
Stop continuous control.	Cd.18	Interrupt request during continuous operation
Set number of simultaneous starting axes and target axis.	Cd.43	Simultaneous starting axis <b>LD77MH16</b>
Set axis 1 start data Nos. for axes that start up simultaneously.	Cd.30	Simultaneous starting axis start data No. (axis 1 start data No.) <b>LD77MH4</b>
Set start data No. of own axis at multiple axes simultaneous starting.		Simultaneous starting own axis start data No. <b>LD77MH16</b>
Set axis 2 start data Nos. for axes that start up simultaneously.	Cd.31	Simultaneous starting axis start data No. (axis 2 start data No.) <b>LD77MH4</b>
Set start data No.1 for axes that start up simultaneously.		Simultaneous starting axis start data No.1 <b>LD77MH16</b>
Set axis 3 start data Nos. for axes that start up simultaneously.	Cd.32	Simultaneous starting axis start data No. (axis 3 start data No.) <b>LD77MH4</b>
Set start data No.2 for axes that start up simultaneously.		Simultaneous starting axis start data No.2 <b>LD77MH16</b>
Set axis 4 start data Nos. for axes that start up simultaneously.	Cd.33	Simultaneous starting axis start data No. (axis 4 start data No.) <b>LD77MH4</b>
Set start data No.3 for axes that start up simultaneously.		Simultaneous starting axis start data No.3 <b>LD77MH16</b>
Specify write destination for teaching results.	Cd.38	Teaching data selection
Specify data to be taught.	Cd.39	Teaching positioning data No.

## ■ Controlling operation per step

Control details	Corresponding item	
Stop positioning operation after each operation.	Cd.35	Step valid flag
Set unit to carry out step.	Cd.34	Step mode
Continuous operation from stopped step.	Cd.36	Step start information

### ■ Controlling the speed

Control details	Corresponding item
Set new speed when changing speed during operation.	Cd.14 New speed value
Issue instruction to change speed in operation to Cd.14 value. (Only during positioning operation and JOG operation).	Cd.15 Speed change request
Change positioning operation speed between 1 and 300% range.	Cd.13 Positioning operation speed override
Set inching movement amount.	Cd.16 Inching movement amount
Set JOG speed.	Cd.17 JOG speed
When changing acceleration time during speed change, set new acceleration time.	Cd.10 New acceleration time value
When changing deceleration time during speed change, set new deceleration time.	Cd.11 New deceleration time value
Set acceleration/deceleration time validity during speed change.	Cd.12 Acceleration/deceleration time change during speed change, enable/disable selection

### ■ Making settings related to operation

Control details	Corresponding item
Turn M code ON signal OFF.	Cd.7 M code OFF request
Set new value when changing current value.	Cd.9 New current value
Validate speed-position switching signal from external device.	Cd.24 Speed-position switching enable flag
Change movement amount for position control during speed-position switching control (INC mode).	Cd.23 Speed-position switching control movement amount change register
Validate external position-speed switching signal.	Cd.26 Position-speed switching enable flag
Change speed for speed control during position-speed switching control.	Cd.25 Position-speed switching control speed change register
Set up a flag when target position is changed during positioning.	Cd.29 Target position change request flag
Set new positioning address when changing target position during positioning.	Cd.27 Target position change value(new address)
Set new speed when changing target position during positioning.	Cd.28 Target position change value(new speed)
Set absolute (ABS) moving direction in degrees.	Cd.40 ABS direction in degrees
Set manual pulse generator operation validity.	Cd.21 Manual pulse generator enable flag
Set scale per pulse of number of input pulses from manual pulse generator.	Cd.20 Manual pulse generator 1 pulse input magnification
Change OPR request flag from "ON to OFF".	Cd.19 OPR request flag OFF request
Validate external command signal.	Cd.8 External command valid
Set "same setting/individual setting" of the forward torque limit value or reverse torque limit value in the torque change function.	Cd.112 Torque change function switching request
Change "Md.35 Torque limit stored value/forward torque limit stored value".	Cd.22 New torque value/forward new torque value
Change "Md.120 Reverse torque limit stored value".	Cd.113 Reverse new torque value
Set whether "Md.48 Deceleration start flag" is valid or invalid	Cd.41 Deceleration start flag valid



Control details		Corresponding item	
Set the stop command processing for deceleration stop function (deceleration curve re-processing/deceleration curve continuation)		Cd.42	Stop command processing for deceleration stop selection
Turn Servo ON/OFF command ON by the buffer memory ON.		Cd.100	Servo OFF command
Set torque limit value		Cd.101	Torque output setting value
Set whether gain changing is execution or not.		Cd.108	Gain changing command
Set the semi closed loop control/fully closed loop control.		Cd.133	Semi/Fully closed loop switching request
Set the PI-PID switching to servo amplifier.		Cd.136	PI-PID switching request
Speed-torque control	Switch the control mode.	Cd.138	Control mode switching request
	Set the control mode to switch.	Cd.139	Control mode setting
	Set the command speed during speed control mode.	Cd.140	Command speed at speed control mode
	Set the acceleration time during speed control mode.	Cd.141	Acceleration time at speed control mode
	Set the deceleration time during speed control mode.	Cd.142	Deceleration time at speed control mode
	Set the command torque during torque control mode.	Cd.143	Command torque at torque control mode
	Set the time constant to torque forward direction during torque control mode.	Cd.144	Torque time constant at torque control mode (Forward direction)
	Set the time constant to torque reverse direction during torque control mode.	Cd.145	Torque time constant at torque control mode (Reverse direction)
	Set the speed limit value during torque control mode.	Cd.146	Speed limit value at torque control mode

#### ■ Change operation mode

Control details		Corresponding item	
Change operation mode.		Cd.137	Amplifier-less operation mode switching request

## 5.2 List of parameters

The setting items of the positioning parameter, OPR parameter or servo parameter are explained in this section.

- Guide to buffer memory address

In the buffer memory address, "n" in "1+150n", etc. indicates a value corresponding to axis No. such as the following table.

Axis No.	n	Axis No.	n	Axis No.	n	Axis No.	n
1	0	5	4	9	8	13	12
2	1	6	5	10	9	14	13
3	2	7	6	11	10	15	14
4	3	8	7	12	11	16	15

(Note-1): Calculate as follows for the buffer memory address corresponding to each axis.

(Example) For axis No. 16

$$1+150n (\text{Pr.4 Unit magnification (AM)})=1+150 \times 15=2251$$

$$53+150n (\text{Pr.35 S-curve ratio})=53+150 \times 15=2303$$

(Note-2): The range (n=0 to 3) of axis No.1 to 4 is valid in the LD77MH4.

### 5.2.1 Basic parameters 1

Item	Setting value, setting range		Default value	Setting value buffer memory address		
	Value set with GX Works2	Value set with sequence program		LD77MH4	LD77MH16	
<b>Pr.1</b> Unit setting	0 : mm 1 : inch 2 : degree 3 : PLS	0 1 2 3	3	0+150n		
Movement amount per pulse	<b>Pr.2</b> Number of pulses per rotation (AP) (Unit : PLS)	1 to 200000000	20000	2+150n 3+150n		
	<b>Pr.3</b> Movement amount per rotation (AL)	The setting value range differs according to the " <b>Pr.1</b> Unit setting".		4+150n 5+150n		
	<b>Pr.4</b> Unit magnification (AM)	1 : 1 times	1	1	1+150n	
		10 : 10 times	10			
100 : 100 times		100				
1000 : 1000 times		1000				
<b>Pr.7</b> Bias speed at start	The setting value range differs according to the " <b>Pr.1</b> Unit setting".		0	6+150n 7+150n		

n: Axis No.-1

**Pr.1** Unit setting

Set the unit used for defining positioning operations. Choose from the following units depending on the type of the control target: mm, inch, degree, or PLS. Different units can be defined for different axes.

(Example) Different units (mm, inch, degree, and PLS) are applicable to different systems:

- mm or inch ..... X-Y table, conveyor (Select mm or inch depending on the machine specifications.)
- degree ..... Rotating body (360 degrees/rotation)
- PLS..... X-Y table, conveyor

\*: When you change the unit, note that the values of other parameters and data will not be changed automatically.

After changing the unit, check if the parameter and data values are within the allowable range.

Set "degree" to exercise speed-position switching control (ABS mode).

**Pr.2** to **Pr.4** Electronic gear

Mechanical system value used when the LD77MH performs positioning control.

The settings are made using **Pr.2** to **Pr.4**.

The electronic gear is expressed by the following equation.

$$\text{Electronic gear} = \frac{\text{Number of pulses per rotation (AP)}}{\text{Movement amount per rotation (AL)} \times \text{Unit magnification (AM)}}$$

\*: When positioning has been performed, an error (mechanical system error) may be produced between the specified movement amount and the actual movement amount. (Refer to Section 13.3.2 "Electronic gear function".)

**POINT**

(1) Set the electronic gear within the following range.

If the value outside the setting range is set, the "Outside electronic gear setting range (error code: 907)" will occur.

$$0.001 \leq \text{Electronic gear} \left( \frac{\text{AP}}{\text{AL} \times \text{AM}} \right) \leq 20000$$

(2) The result of below calculation (round up after decimal point) is a minimum pulse when the current feed value is updated at follow-up processing. (The movement amount for droop pulse is reflected as the current feed value when the droop pulse becomes more than above calculated value in pulse unit of motor end.)

$$\text{Number of pulses per rotation (AP)} \div (\text{Movement amount per rotation (AL)} \times \text{Unit magnification (AM)} \times 3375) [\text{PLS}]$$

Refer to Section 13.8.2 for the follow-up processing.

**Pr.2** Number of pulses per rotation (AP)

Set the number of pulses required for a complete rotation of the motor shaft. If you are using the Mitsubishi servo amplifier MR-J3(W)-B set the value given as the "resolution per servomotor rotation" in the speed/position detector specifications.

$$\text{Number of pulses per rotation (AP)} = \text{Resolution per servomotor rotation}$$

**Pr.3** Movement amount per rotation (AL), **Pr.4** Unit magnification (AM)

The amount how the workpiece moves with one motor rotation is determined by the mechanical structure.

If the worm gear lead ( $\mu\text{m}/\text{rev}$ ) is PB and the deceleration rate is  $1/n$ , then

$$\text{Movement amount per rotation (AL)} = \text{PB} \times 1/n$$

However, the maximum value that can be set for this "movement amount per rotation (AL)" parameter is 20000000.0 $\mu\text{m}$  (20m). Set the "movement amount per rotation (AL)" as shown below so that the "movement amount per rotation (AL)" does not exceed this maximum value.

$$\begin{aligned} \text{Movement amount per rotation (AL)} &= \text{PB} \times 1/n \\ &= \text{Movement amount per rotation (AL)} \times \text{Unit magnification (AM)} \end{aligned}$$

Note) The unit magnification (AM) is a value of 1, 10, 100 or 1000. If the "PB  $\times$  1/n" value exceeds 20000000.0 $\mu\text{m}$  (20m), adjust with the unit magnification so that the "movement amount per rotation (AL)" does not exceed 20000000.0 $\mu\text{m}$  (20m).

\*1: Refer to Section 13.3.2 "Electric gear function" information about electric gear.

<b>Pr.1</b> setting value	Value set with GX Works2 (unit)	Value set with sequence program (unit)*1
0 : mm	0.1 to 2000000.0 ( $\mu\text{m}$ )	1 to 200000000 ( $\times 10^{-1}\mu\text{m}$ )
1 : inch	0.00001 to 2000.00000 (inch)	1 to 200000000 ( $\times 10^{-5}\text{inch}$ )
2 : degree	0.00001 to 2000.00000 (degree)	1 to 200000000 ( $\times 10^{-5}\text{degree}$ )
3 : PLS	1 to 200000000 (PLS)	1 to 200000000 (PLS)

**Pr.7** Bias speed at start

Set the bias speed (minimum speed) upon starting.

The specified "bias speed at start" will be valid during the following operations:

- Positioning operation
- OPR operation
- JOG operation

Set the value that the bias speed should not exceed "**Pr.8** Speed limit value".

<b>Pr.1</b> setting value	Value set with sequence program (unit)
0 : mm	0 to 2000000000 ( $\times 10^{-2}\text{mm}/\text{min}$ )
1 : inch	0 to 2000000000 ( $\times 10^{-3}\text{inch}/\text{min}$ )
2 : degree	0 to 2000000000 ( $\times 10^{-3}\text{degree}/\text{min}$ ) *1
3 : PLS	0 to 50000000 (PLS/s)

\*1: Range of speed limit value when "**Pr.83** Speed control 10 x multiplier setting for degree axis" is set to valid: 0 to 2000000000 ( $\times 10^{-2}\text{degree}/\text{min}$ )

## 5.2.2 Basic parameters 2

Item	Setting value, setting range		Default value	Setting value buffer memory address	
	Value set with GX Works2	Value set with sequence program		LD77MH4	LD77MH16
<b>Pr.8</b> Speed limit value	The setting range differs depending on the " <b>Pr.1</b> Unit setting".		200000	10+150n	11+150n
<b>Pr.9</b> Acceleration time 0	1 to 8388608 (ms)	1 to 8388608 (ms)	1000	12+150n	13+150n
<b>Pr.10</b> Deceleration time 0	1 to 8388608 (ms)	1 to 8388608 (ms)	1000	14+150n	15+150n

n: Axis No.-1

**Pr.8** Speed limit value

Set the maximum speed during positioning, OPR and speed-torque operations.

<b>Pr.1</b> setting value	Value set with GX Works2 (unit)	Value set with sequence program (unit)
0 : mm	0.01 to 20000000.00 (mm/min)	1 to 2000000000 ( $\times 10^{-2}$ mm/min)
1 : inch	0.001 to 2000000.000 (inch/min)	1 to 2000000000 ( $\times 10^{-3}$ inch/min)
2 : degree	0.001 to 2000000.000 (degree/min) *1	1 to 2000000000 ( $\times 10^{-3}$ degree/min) *2
3 : PLS	1 to 50000000 (PLS/s)	1 to 50000000 (PLS/s)

\*1: Range of speed limit value when "**Pr.83** Speed control 10 x multiplier setting for degree axis" is set to valid: 0.01 to 20000000.00 (degree/min).

\*2: Range of speed limit value when "**Pr.83** Speed control 10 x multiplier setting for degree axis" is set to valid: 1 to 2000000000 ( $\times 10^{-2}$  degree/min)

**Pr.9** Acceleration time 0, **Pr.10** Deceleration time 0

"**Pr.9** Acceleration time 0" specifies the time for the speed to increase from zero to the "**Pr.8** Speed limit value" ("**Pr.31** JOG speed limit value" at JOG operation control).

"**Pr.10** Deceleration time 0" specifies the time for the speed to decrease from the "**Pr.8** Speed limit value" ("**Pr.31** JOG speed limit value" at JOG operation control) to zero.

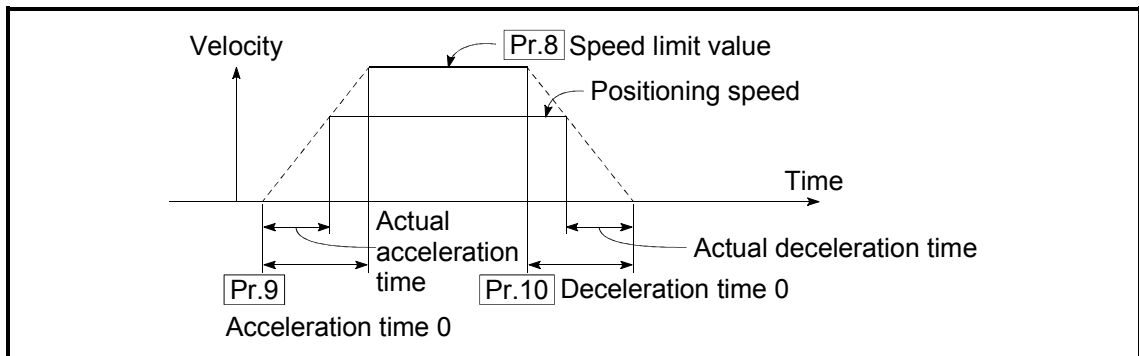

- 1) If the positioning speed is set lower than the parameter-defined speed limit value, the actual acceleration/deceleration time will be relatively short. Thus, set the maximum positioning speed equal to or only a little lower than the parameter-defined speed limit value.
- 2) These settings are valid for OPR, positioning and JOG operations.
- 3) When the positioning involves interpolation, the acceleration/deceleration time defined for the reference axis is valid.

## 5.2.3 Detailed parameters 1

Item	Setting value, setting range		Default value	Setting value buffer memory address	
	Value set with GX Works2	Value set with sequence program		LD77MH4	LD77MH16
Pr.11 Backlash compensation amount			0	17+150n	
Pr.12 Software stroke limit upper limit value	The setting value range differs according to the " Pr.1 Unit setting".		2147483647	18+150n 19+150n	
Pr.13 Software stroke limit lower limit value			-2147483648	20+150n 21+150n	
Pr.14 Software stroke limit selection	0 : Apply software stroke limit on current feed value	0	0	22+150n	
	1 : Apply software stroke limit on machine feed value	1			
Pr.15 Software stroke limit valid/invalid setting	0 : Software stroke limit valid during JOG operation, inching operation and manual pulse generator operation	0	0	23+150n	
	1 : Software stroke limit invalid during JOG operation, inching operation and manual pulse generator operation	1			
Pr.16 Command in-position width	The setting value range differs depending on the " Pr.1 Unit setting".		100	24+150n 25+150n	
Pr.17 Torque limit setting value	1 to 1000 (%)	1 to 1000 (%)	300	26+150n	
Pr.18 M code ON signal output timing	0 : WITH mode	0	0	27+150n	
	1 : AFTER mode	1			
Pr.19 Speed switching mode	0 : Standard speed switching mode	0	0	28+150n	
	1 : Front-loading speed switching mode	1			
Pr.20 Interpolation speed designation method	0 : Composite speed	0	0	29+150n	
	1 : Reference axis speed	1			
Pr.21 Current feed value during speed control	0 : Do not update current feed value	0	0	30+150n	
	1 : Update current feed value	1			
	2 : Clear current feed value to zero	2			

n: Axis No.-1

Item	Setting value, setting range			Default value	Setting value buffer memory address	
	Value set with GX Works2		Value set with sequence program		LD77MH4	LD77MH16
<b>Pr.22</b> Input signal logic selection	b0 Lower limit b1 Upper limit b2 Not used b3 Not used b4 External command/switching signal (Note-1) b5 Not used b6 Near-point dog signal b7 Not used b8 Manual pulse generator input b9 to b15 Not used	0: Negative logic 1: Positive logic  (Note-1): Only the value specified against the axis 1 is valid.		0	31+150n	
<b>Pr.80</b> External input signal selection	1: External input signal of servo amplifier		1	1	32+150n	
<b>Pr.24</b> Manual pulse generator/Incremental synchronous encoder input selection	0: A-phase/B-phase multiplied by 4 2: A-phase/B-phase multiplied by 1 3: PLS/SIGN		0 2 3	0	33	
<b>Pr.81</b> Speed-position function selection	0: Speed-position switching control (INC mode) 2: Speed-position switching control (ABS mode)		0 2	0	34+150n	
<b>Pr.82</b> Forced stop valid/invalid selection	0: Valid 1: Invalid		0 1	0	35	

n: Axis No.-1

**Pr.11** Backlash compensation amount

The error that occurs due to backlash when moving the machine via gears can be compensated.

When the backlash compensation amount is set, commands equivalent to the compensation amount will be output each time the direction changes during positioning.

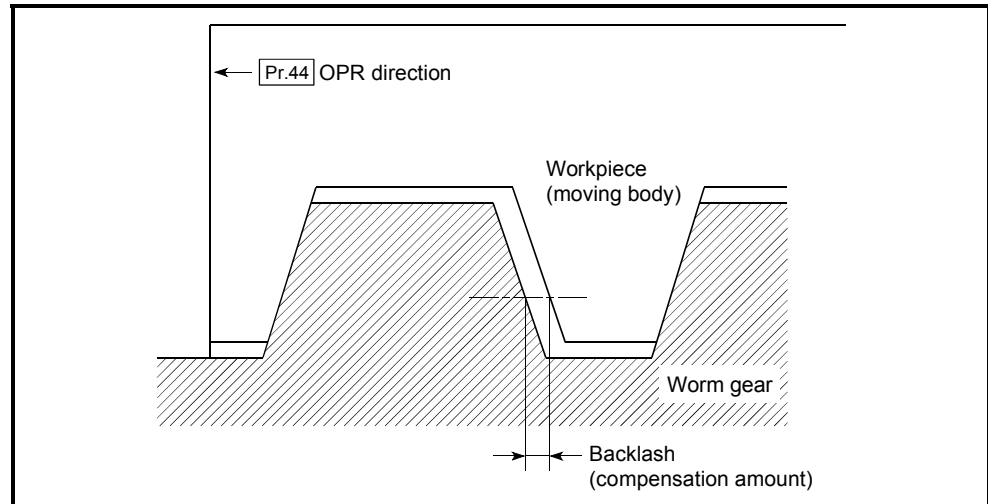

- 1) The backlash compensation is valid after machine OPR. Thus, if the backlash compensation amount is set or changed, always carry out machine OPR once.
- 2) "Pr.2 Number of pulses per rotation", "Pr.3 Movement amount per rotation", "Pr.4 Unit magnification" and "Pr.11 Backlash compensation amount" which satisfies the following (1) can be set up.

$$0 \leq \frac{(\text{Pr.11 Backlash compensation amount}) \times (\text{Pr.2 Number of pulses per rotation})}{(\text{Pr.3 Movement amount per rotation}) \times (\text{Pr.4 Unit magnification})} (= A) \leq 65535 \text{ (PLS) } \dots(1)$$

An error (error code: 920) occurs when "Pr.2 Number of pulses per rotation", "Pr.3 Movement amount per rotation", "Pr.4 Unit magnification" and "Pr.11 Backlash compensation amount" setting range is lower 0, or 65536 or more. (the calculation result of the following (1) )

A servo alarm (error code: 2031, 2035 etc.) may be made to occur by kinds of servo amplifier (servomotor), load inertia and the amount of command of a cycle time (LD77MH) is set so that the calculation result of the following (1) may satisfy "Pr.2 Number of pulses per rotation", "Pr.3 Movement amount per rotation", "Pr.4 Unit magnification" and "Pr.11 Backlash compensation amount" setting range is 0 to 65535.

Reduce the setting value of "Pr.11 Backlash compensation amount" if a servo alarm occurs. Use the value of the following (2) as a measure that a servo alarm does not occur.

$$A \leq \frac{(\text{Maximum motor speed (r/min)}) \times 1.2 \times (\text{Encoder resolution (PLS/r)}) \times (\text{Operation cycle (ms)})}{60(\text{s}) \times 1000 \text{ (ms)}} \text{ (PLS) } \dots(2)$$



Pr.1 setting value	Value set with GX Works2 (unit)	Value set with sequence program (unit) *
0 : mm	0 to 6553.5 (μm)	0 to 65535 ( $\times 10^{-1}\mu\text{m}$ )
1 : inch	0 to 0.65535 (inch)	0 to 65535 ( $\times 10^{-5}\text{inch}$ )
2 : degree	0 to 0.65535 (degree)	0 to 65535 ( $\times 10^{-5}\text{degree}$ )
3 : PLS	0 to 65535 (PLS)	0 to 65535 (PLS)

\* 0 to 32767 : Set as a decimal  
 32768 to 65535 : Convert into hexadecimal and set

**Pr.12** Software stroke limit upper limit value

Set the upper limit for the machine's movement range during positioning control.

Pr.1 setting value	Value set with GX Works2 (unit)	Value set with sequence program (unit)
0 : mm	-214748364.8 to 214748364.7 (μm)	-2147483648 to 2147483647 ( $\times 10^{-1}\mu\text{m}$ )
1 : inch	-21474.83648 to 21474.83647(inch)	-2147483648 to 2147483647 ( $\times 10^{-5}\text{inch}$ )
2 : degree	0 to 359.99999 (degree)	0 to 35999999 ( $\times 10^{-5}\text{degree}$ )
3 : PLS	-2147483648 to 2147483647(PLS)	-2147483648 to 2147483647 (PLS)

**Pr.13** Software stroke limit lower limit value

Set the lower limit for the machine's movement range during positioning control.

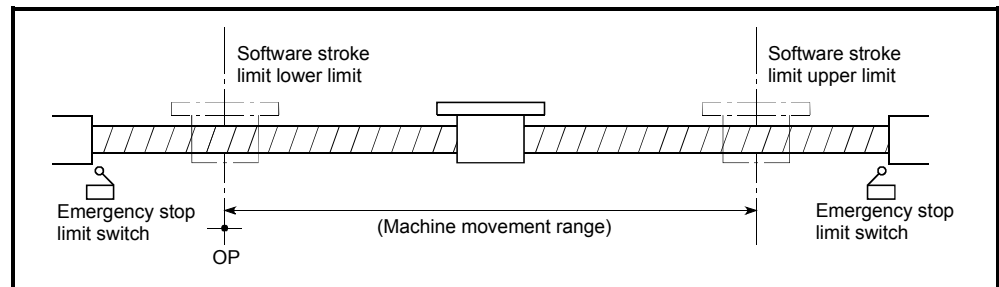

- 1) Generally, the OP is set at the lower limit or upper limit of the stroke limit.
- 2) By setting the upper limit value or lower limit value of the software stroke limit, overrun can be prevented in the software. However, an emergency stop limit switch must be installed nearby outside the range.  
 To invalidate the software stroke limit, set the setting value to "upper limit value = lower limit value". (If it is within the setting range, the setting value can be anything.)  
 When the unit is "degree", the software stroke limit check is invalid during speed control (including speed-position switching control, position-speed switching control) or during manual control.

**Pr.14** Software stroke limit selection

Set whether to apply the software stroke limit on the "current feed value" or the "machine feed value". The software stroke limit will be validated according to the set value.

To invalidate the software stroke limit, set the setting value to "current feed value". When "2: degree" is set in "**Pr.1** Unit setting", set the setting value of software stroke limit to "current feed value".

The "Software stroke limit error" (error code: 923) will occur if "machine feed value" is set.

**Pr.15** Software stroke limit valid/invalid setting

Set whether to validate the software stroke limit during JOG/Inching operation and manual pulse generator operation.

**Pr.16** Command in-position width

Set the remaining distance that turns the command in-position ON. The command in-position signal is used as a front-loading signal of the positioning complete signal. When positioning control is started, the "Command in-position flag (**Md.31** Status: b2)" turns OFF, and the "command in-position flag" turns ON at the set position of the command in-position signal.

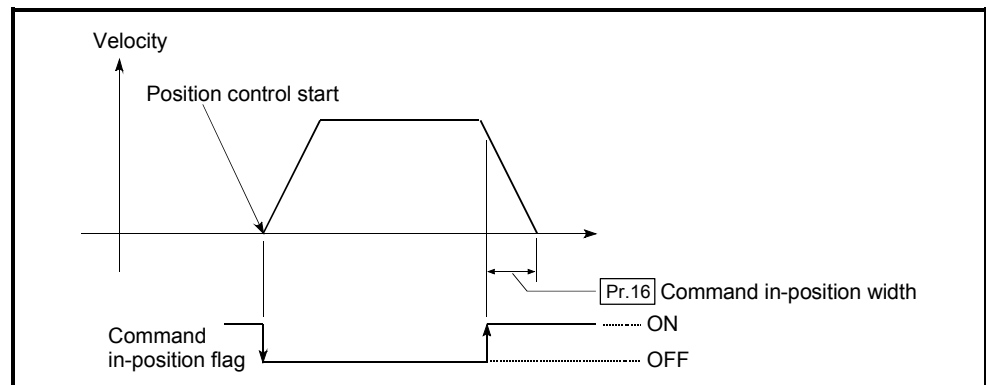

<b>Pr.1</b> setting value	Value set with GX Works2 (unit)	Value set with sequence program (unit)
0 : mm	0.1 to 214748364.7 (μm)	1 to 2147483647 (×10 <sup>-1</sup> μm)
1 : inch	0.00001 to 21474.83647 (inch)	1 to 2147483647 (×10 <sup>-5</sup> inch)
2 : degree	0.00001 to 21474.83647 (degree)	1 to 2147483647 (×10 <sup>-5</sup> degree)
3 : PLS	1 to 2147483647 (PLS)	1 to 2147483647 (PLS)

**Pr.17** Torque limit setting value

Set the maximum value of the torque generated by the servomotor as a percentage between 1 and 1000%.

\* The torque limit function limits the torque generated by the servomotor within the set range.

If the torque required for control exceeds the torque limit value, it is controlled with the set torque limit value.

(Refer to Section 13.4.2 "Torque limit function".)

**Pr.18** M code ON signal output timing

This parameter sets the M code ON signal output timing.  
Choose either WITH mode or AFTER mode as the M code ON signal output timing.

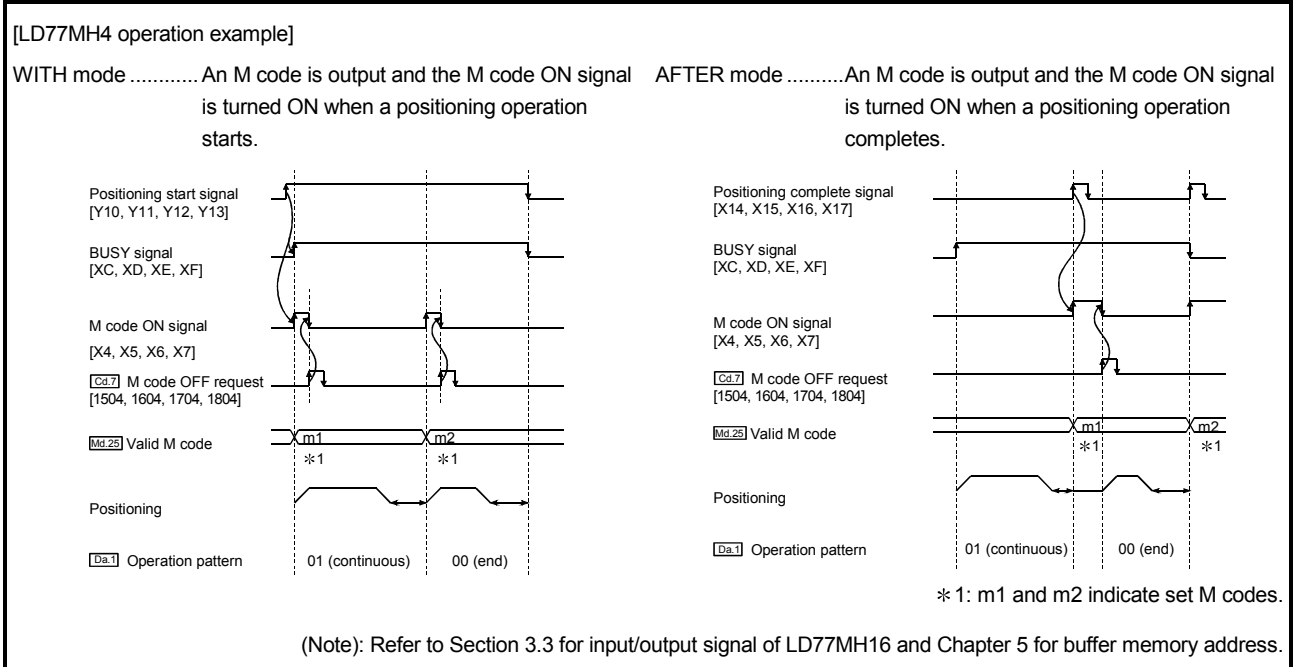

Note: If AFTER mode is used with speed control, an M code will not be output and the M code ON signal will not be turned ON.

An M code is a number between 0 and 65535 that can be assigned to each positioning data ( **Da.10** ).

The sequence program can be coded to read an M code from the buffer memory address specified by " **Md.25** Valid M code" whenever the M code ON signal turns ON so that a command for the sub work (e.g. clamping, drilling, tool change) associated with the M code can be issued.

**Pr.19** Speed switching mode

Set whether to switch the speed switching mode with the standard switching or front-loading switching mode.

- 0 : Standard switching ..... Switch the speed when executing the next positioning data.
- 1 : Front-loading switching ..... The speed switches at the end of the positioning data currently being executed.

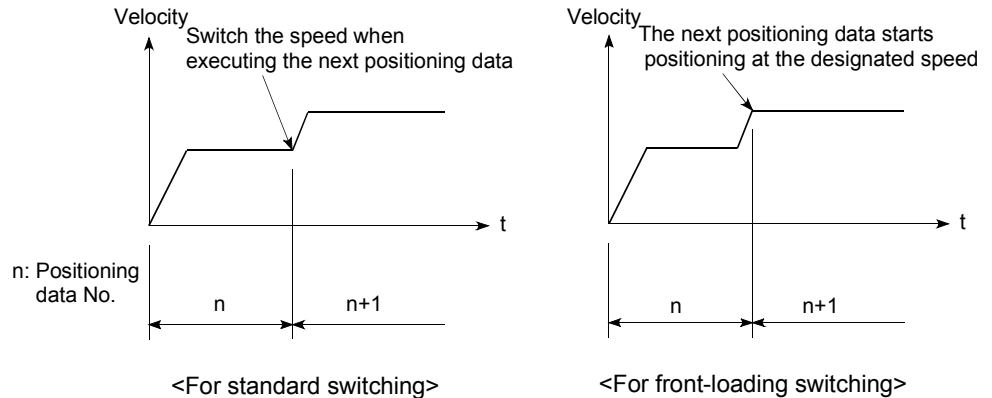

**Pr.20** Interpolation speed designation method

When carrying out linear interpolation/circular interpolation, set whether to designate the composite speed or reference axis speed.

- 0: Composite speed ..... The movement speed for the control target is designated, and the speed for each axis is calculated by the LD77MH.
- 1: Reference axis speed ..... The axis speed set for the reference axis is designated, and the speed for the other axis carrying out interpolation is calculated by the LD77MH.

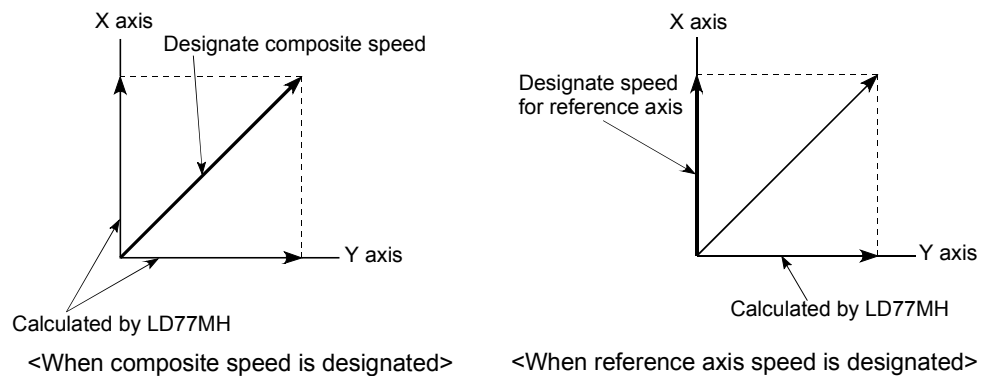

Note: Always specify the reference axis speed if the 4-axis linear interpolation or 2 to 4 axis speed control has to be performed.  
 If you specify the composite speed for a positioning operation that involves the 4-axis linear interpolation or 2 to 4 axis speed control, the error code 523 "interpolation mode error" will be output when the positioning operation is attempted.  
 For a positioning operation that involves the circular interpolation, specify the composite speed always.

**Pr.21** Current feed value during speed control

Specify whether you wish to enable or disable the update of " **Md.20** Current feed value" while operations are performed under the speed control (including the speed-position and position-speed switching control).

0: The update of the current feed value is disabled

The current feed value will not change.  
(The value at the beginning of the speed control will be kept.)

1: The update of the current feed value is enabled

The current feed value will be updated.  
(The current feed value will change from the initial.)

2: The current feed value is cleared to zero

The current feed will be set initially to zero and change from zero while the speed control is in effect.

Note1: When the speed control is performed over two to four axes, the choice between enabling and disabling the update of " **Md.20** Current feed value" depends on how the reference axis is set.

Note2: Set "1" to exercise speed-position switching control (ABS mode).

**Pr.22** Input signal logic selection

Set the input signal logic that matches the signaling specification of the connected external device.

Negative logic

(1) When the input signal contact is not flowed with the current.

(a) FLS, RLS → ON (Limit signal turn ON)

(b) DOG, DI → OFF

(2) When the input signal contact is flowed with the current.

(a) FLS, RLS → OFF (Limit signal turn OFF)

(b) DOG, DI → ON

Positive logic

Opposite the concept of negative logic.

Note1: A mismatch in the signal logic will disable normal operation. Be careful of this when you change from the default value.

Note2: Set the manual pulse generator input logic selection (b8) to axis 1. (Setting of any of other than axis 1 is invalid.)

Note3: The lower limit switch logic selection (b0), the upper limit switch logic selection (b1), and the near-point dog signal logic selection (b3) become valid when the external input signal of servo amplifier is set to the " **Pr.80** External input signal selection".

Note4: Only the value specified against the axis 1 is valid for the logic selection of external signal/switching signal (b4).

**Pr.80** External input signal selection

Do not set except default value "1: External input signal of servo amplifier".

**Pr.24** Manual pulse generator/Incremental synchronous encoder input selection

Set the manual pulse generator/incremental synchronous encoder input pulse mode. (Only the value specified against the axis 1 is valid.)

- 0: A-phase/B-phase multiplied by 4
- 2: A-phase/B-phase; multiplied by 1 **LD77MH16**
- 3: PLS/SIGN

Set the positive logic or negative logic in "**Pr.22** Input signal logic selection".

(1) A-phase/B-phase mode

- When the A-phase is 90° ahead of the B-phase, the motor will forward run.
- When the B-phase is 90° ahead of the A-phase, the motor will reverse run.

(a) A-phase/B-phase multiplied by 4

The positioning address increases or decreases at rising or falling edges of A-phase/B-phase.

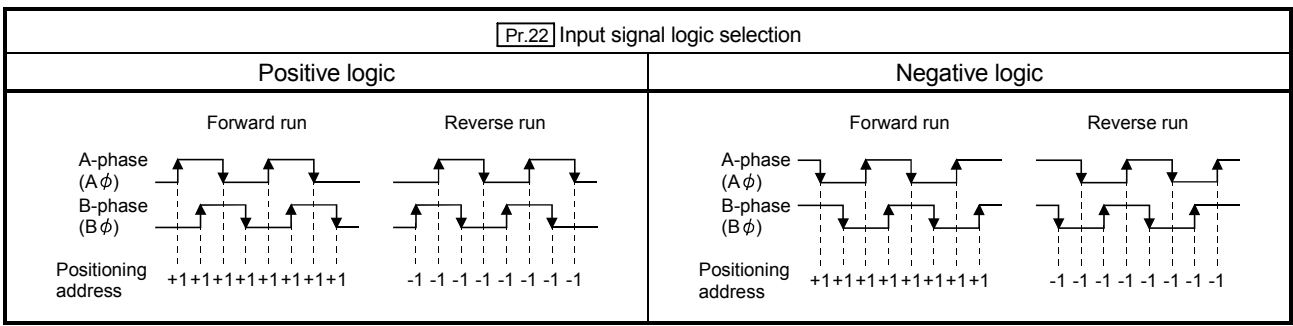

(b) A-phase/B-phase multiplied by 1

The positioning address increases or decreases at twice rising or twice falling edges of A-phase/B-phase.

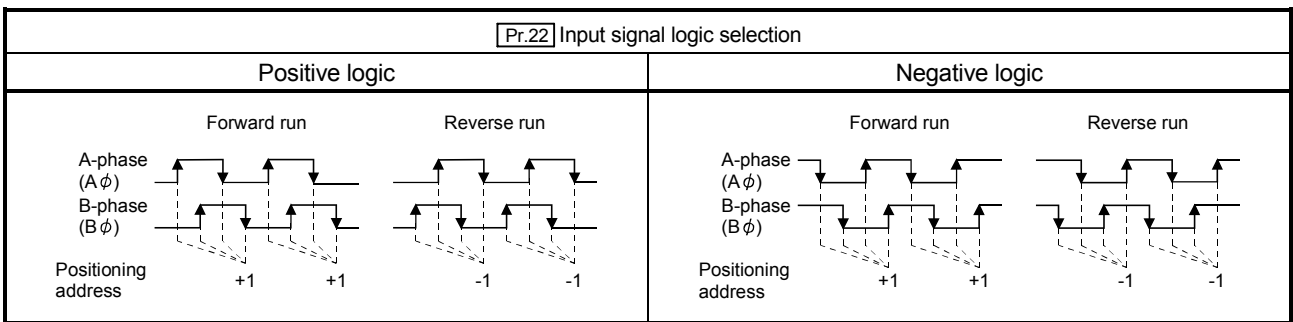

## (2) PLS/SIGN

Pr.22 Input signal logic selection	
Positive logic	Negative logic
<p>Forward run and reverse run are controlled with the ON/OFF of the direction sign (SIGN).</p> <ul style="list-style-type: none"> <li>• The motor will forward run when the direction sign is HIGH.</li> <li>• The motor will reverse run when the direction sign is LOW.</li> </ul>	<p>Forward run and reverse run are controlled with the ON/OFF of the direction sign (SIGN).</p> <ul style="list-style-type: none"> <li>• The motor will forward run when the direction sign is LOW.</li> <li>• The motor will reverse run when the direction sign is HIGH.</li> </ul>

**Pr.81** Speed-position function selection

Select the mode of speed-position switching control.

0: INC mode

2: ABS mode

Note1: If the setting is other than 0 and 2, operation is performed in the INC mode with the setting regarded as 0.

**Pr.82** Forced stop valid/invalid selection

Set the forced stop valid/invalid. (Only the value specified against the axis 1 is valid.)

All axis of the servo amplifier are made to batch forced stop when the forced stop input signal is turned on.

But "Servo READY signal OFF during operation" (error code: 102) does not occur even if the forced input signal is turned on the during operation.

0: Valid (Forced stop is used)

1: Invalid (Forced stop is not used)

Note1: If the setting is other than 0 and 1, "Forced stop valid/invalid setting error" (error code: 937) occurs.

Note2: The "Md.50 Forced stop input" is stored "1" by setting "Forced stop valid/invalid selection" to invalid.

## 5.2.4 Detailed parameters 2

Item	Setting value, setting range		Default value	Setting value buffer memory address	
	Value set with GX Works2	Value set with sequence program		LD77MH4	LD77MH16
[Pr.25] Acceleration time 1	1 to 8388608 (ms)	1 to 8388608 (ms)	1000	36+150n 37+150n	
[Pr.26] Acceleration time 2				38+150n 39+150n	
[Pr.27] Acceleration time 3				40+150n 41+150n	
[Pr.28] Deceleration time 1				42+150n 43+150n	
[Pr.29] Deceleration time 2				44+150n 45+150n	
[Pr.30] Deceleration time 3				46+150n 47+150n	
[Pr.31] JOG speed limit value	The setting range differs depending on the " [Pr.1] Unit setting".		20000	48+150n 49+150n	
[Pr.32] JOG operation acceleration time selection	0: [Pr.9] Acceleration time 0	0	0	50+150n	
	1: [Pr.25] Acceleration time 1	1			
	2: [Pr.26] Acceleration time 2	2			
	3: [Pr.27] Acceleration time 3	3			
[Pr.33] JOG operation deceleration time selection	0: [Pr.10] Deceleration time 0	0	0	51+150n	
	1: [Pr.28] Deceleration time 1	1			
	2: [Pr.29] Deceleration time 2	2			
	3: [Pr.30] Deceleration time 3	3			
[Pr.34] Acceleration/deceleration process selection	0 : Trapezoid acceleration/ deceleration process	0	0	52+150n	
	1 : S-curve acceleration/ deceleration process	1			
[Pr.35] S-curve ratio	1 to 100 (%)	1 to 100 (%)	100	53+150n	
[Pr.36] Sudden stop deceleration time	1 to 8388608 (ms)	1 to 8388608 (ms)	1000	54+150n 55+150n	
[Pr.37] Stop group 1 sudden stop selection	0 : Normal deceleration stop	0	0	56+150n	
[Pr.38] Stop group 2 sudden stop selection				57+150n	
[Pr.39] Stop group 3 sudden stop selection	1 : Sudden stop	1		58+150n	
[Pr.40] Positioning complete signal output time	0 to 65535 (ms)	0 to 65535 (ms) 0 to 32767 : Set as a decimal 32768 to 65535 : Convert into hexadecimal and set	300	59+150n	

n: Axis No.-1



Item	Setting value, setting range		Default value	Setting value buffer memory address	
	Value set with GX Works2	Value set with sequence program		LD77MH4	LD77MH16
<b>Pr.41</b> Allowable circular interpolation error width	The setting value range differs depending on the " <b>Pr.1</b> Unit setting".		100	60+150n 61+150n	
<b>Pr.42</b> External command function selection	0: External positioning start 1: External speed change request 2: Speed-position, position-speed switching request 3: Skip request 4: High speed input request LD77MH16	0 1 2 3 4	0	62+150n	
<b>Pr.83</b> Speed control 10 x multiplier setting for degree axis	0: Invalid 1: Valid	0 1	0	63+150n	
<b>Pr.84</b> Restart allowable range when servo OFF to ON	0, 1 to 327680 [PLS] 0: restart not allowed		0	64+150n 65+150n	
<b>Pr.89</b> Manual pulse generator/ Incremental synchronous encoder input type selection	0: Differential output type 1: Voltage output/open collector type	0 1	0	67	
<b>Pr.90</b> Operation setting for speed-torque control mode	b0 to b3 Not used b4 to b7 Not used b8 to b11 Speed initial value selection 0: Command speed 1: Feedback speed b12 to b15 Condition selection at mode switching 0: Switching conditions valid (for switching control mode) 1: Zero speed ON condition invalid (when switching between position and torque modes)	0 1	0	68+150n	
<b>Pr.95</b> External command signal selection LD77MH16	0: Not used 1: DI1 2: DI2 3: DI3 4: DI4	0 1 2 3 4	0	69+150n	

n: Axis No.-1

**Pr.25** Acceleration time 1 to **Pr.27** Acceleration time 3

These parameters set the time for the speed to increase from zero to the " **Pr.8** Speed limit value" (" **Pr.31** JOG speed limit value" at JOG operation control) during a positioning operation.

**Pr.28** Deceleration time 1 to **Pr.30** Deceleration time 3

These parameters set the time for the speed to decrease from the "**Pr.8** Speed limit value" ("**Pr.31** JOG speed limit value" at JOG operation control) to zero during a positioning operation.

**Pr.31** JOG speed limit value

Set the maximum speed for JOG operation.

Note) • Set the "JOG speed limit value" to less than "**Pr.8** Speed limit value".  
If the "speed limit value" is exceeded, the "JOG speed limit value error" (error code: 956) will occur.

<b>Pr.1</b> setting value	Value set with GX Works2 (unit)	Value set with sequence program (unit)
0 : mm	0.01 to 20000000.00 (mm/min)	1 to 2000000000 ( $\times 10^{-2}$ mm/min)
1 : inch	0.001 to 2000000.000 (inch/min)	1 to 2000000000 ( $\times 10^{-3}$ inch/min)
2 : degree	0.001 to 2000000.000 (degree/min) *1	1 to 2000000000 ( $\times 10^{-3}$ degree/min) *2
3 : PLS	1 to 50000000 (PLS/s)	1 to 50000000 (PLS/s)

\*1: The JOG speed limit value setting range is 0.001 to 2000000.000[degree/min], but it will be decupled and become 0.01 to 20000000.00[degree/min] by setting "**Pr.83** Speed control 10 x multiplier setting for degree axis" to valid.

\*2: The JOG speed limit value setting range is 1 to 2000000000( $\times 10^{-3}$ degree/min), but it will be decupled and become 1 to 2000000000 ( $\times 10^{-2}$ degree/min) by setting "**Pr.83** Speed control 10 x multiplier setting for degree axis" to valid.

**Pr.32** JOG operation acceleration time selection

Set which of "acceleration time 0 to 3" to use for the acceleration time during JOG operation.

- 0 : Use value set in "**Pr.9** Acceleration time 0".
- 1 : Use value set in "**Pr.25** Acceleration time 1".
- 2 : Use value set in "**Pr.26** Acceleration time 2".
- 3 : Use value set in "**Pr.27** Acceleration time 3".

**Pr.33** JOG operation deceleration time selection

Set which of "deceleration time 0 to 3" to use for the deceleration time during JOG operation.

- 0 : Use value set in "**Pr.10** Deceleration time 0".
- 1 : Use value set in "**Pr.28** Deceleration time 1".
- 2 : Use value set in "**Pr.29** Deceleration time 2".
- 3 : Use value set in "**Pr.30** Deceleration time 3".

**Pr.34** Acceleration/deceleration process selection

Set whether to use trapezoid acceleration/deceleration or S-curve acceleration/deceleration for the acceleration/deceleration process.

Note) Refer to Section 13.7.6 "Acceleration/deceleration processing function" for details.

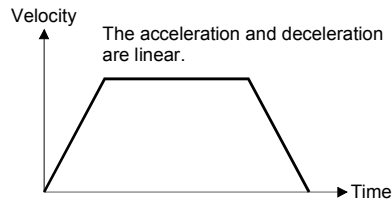

<Trapezoid acceleration/deceleration>

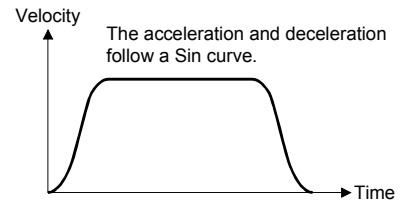

<S-curve acceleration/deceleration>

**Pr.35** S-curve ratio

Set the S-curve ratio (1 to 100%) for carrying out the S-curve acceleration/deceleration process.

The S-curve ratio indicates where to draw the acceleration/deceleration curve using the Sin curve as shown below.

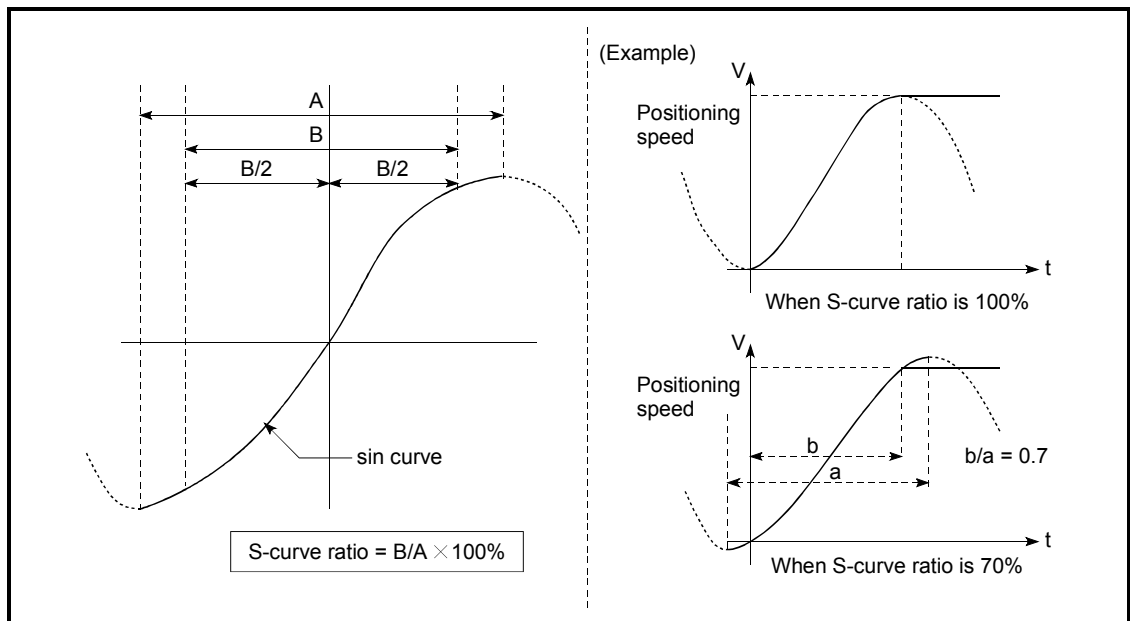

**Pr.36** Sudden stop deceleration time

Set the time to reach speed 0 from " Pr.8 Speed limit value" (" Pr.31 JOG speed limit value" at JOG operation control) during the sudden stop. The illustration below shows the relationships with other parameters.

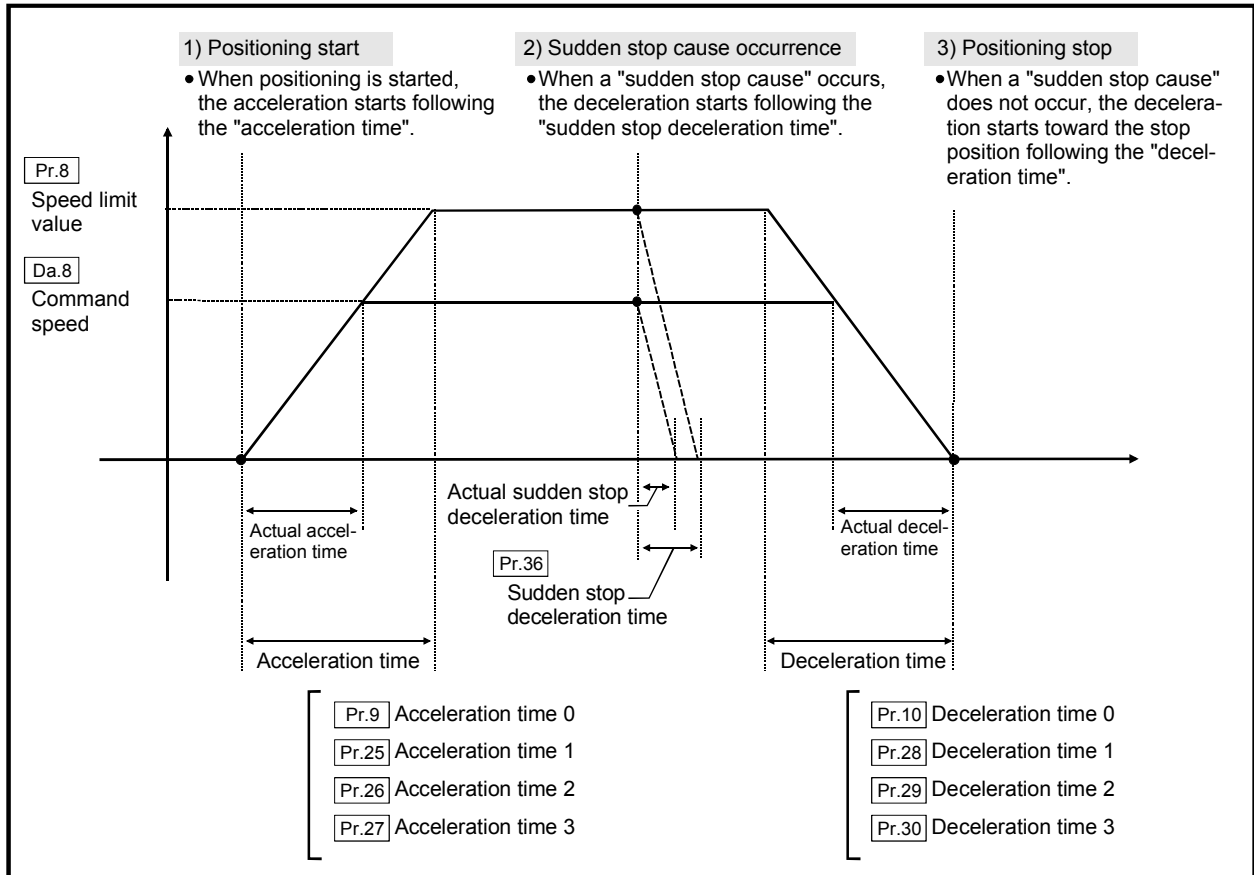

**Pr.37** Stop group 1 sudden stop selection

to

**Pr.39** Stop group 3 sudden stop selection

Set the method to stop when the stop causes in the following stop groups occur.

- Stop group 1 ..... Stop with hardware stroke limit
- Stop group 2 ..... Error occurrence of the PLC CPU, PLC READY signal [Y0] OFF, Fault in test mode
- Stop group 3 ..... Axis stop signal from PLC CPU  
Stop signal from test function of GX Works2  
Error occurrence (excludes errors in stop groups 1 and 2: includes only the software stroke limit errors during JOG operation, speed control, speed-position switching control, and position-speed switching control)

The methods of stopping include "0: Normal deceleration stop" and "1: Sudden stop".

If "1: Sudden stop" is selected, the axis will suddenly decelerate to a stop when the stop cause occurs.

**Pr.40** Positioning complete signal output time

Set the output time of the positioning complete signal output from the LD77MH.  
 A positioning completes when the specified dwell time has passed after the LD77MH had terminated the command output.  
 For the interpolation control, the positioning completed signal of interpolation axis is output only during the time set to the reference axis.

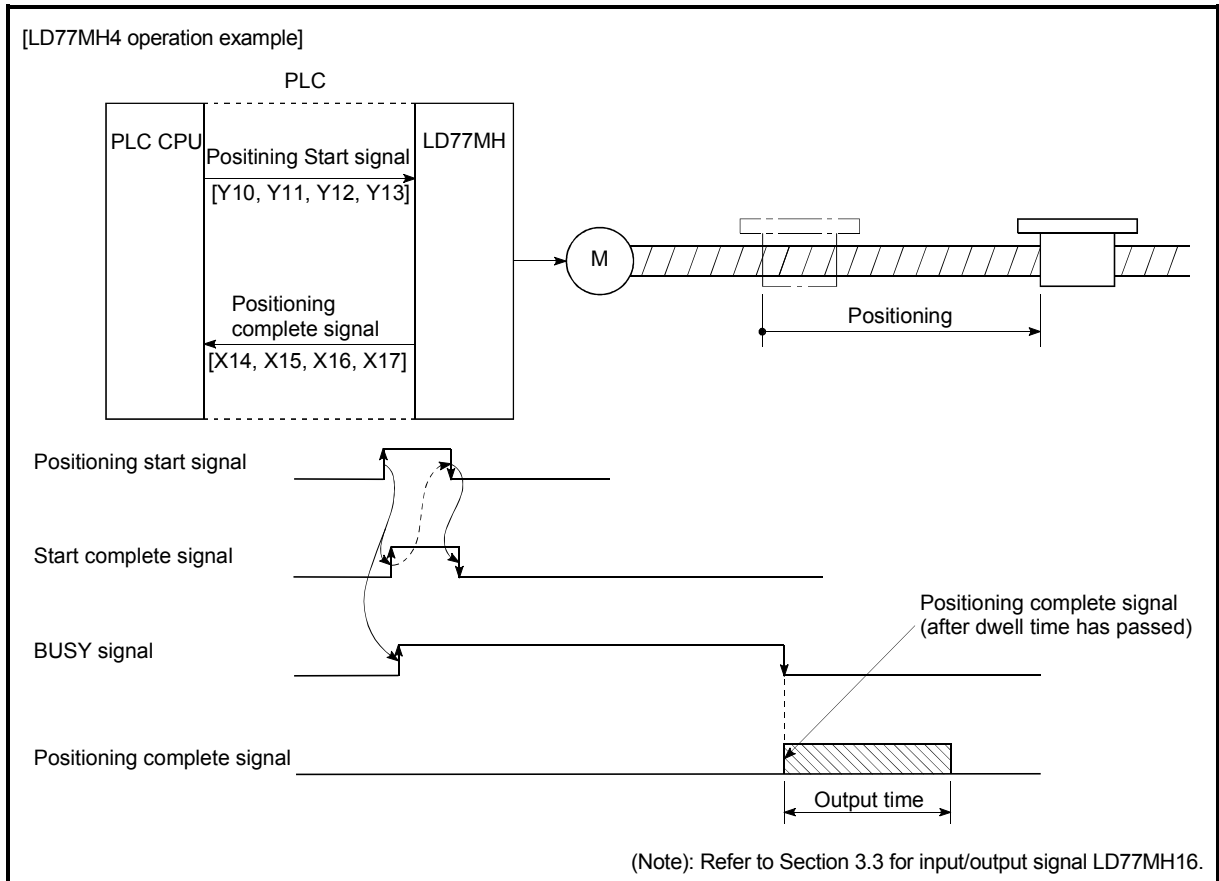

Positioning complete signal output time

**Pr.41** Allowable circular interpolation error width

The allowable error range of the calculated arc path and end point address is set.

\*1 If the error of the calculated arc path and end point address is within the set range, circular interpolation will be carried out to the set end point address while compensating the error with spiral interpolation.

The allowable circular interpolation error width is set in the following axis buffer memory addresses.

- (Example)
- If axis 1 is the reference axis, set in the axis 1 buffer memory address [60, 61].
  - If axis 4 is the reference axis, set in the axis 4 buffer memory address [510, 511].

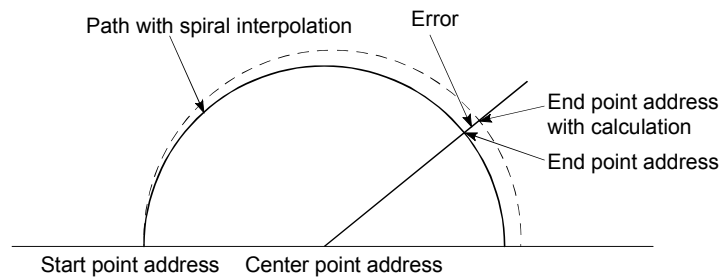

\*1: With circular interpolation control using the center point designation, the arc path calculated with the start point address and center point address and the end point address may deviate.

Pr.1 setting value	Value set with GX Works2 (unit)	Value set with sequence program (unit)
0 : mm	0 to 10000.0 (μm)	0 to 100000 (×10 <sup>-1</sup> μm)
1 : inch	0 to 1.00000 (inch)	0 to 100000 (×10 <sup>-5</sup> inch)
2 : degree	0 to 1.00000 (degree)	0 to 100000 (×10 <sup>-5</sup> degree)
3 : PLS	0 to 100000 (PLS)	0 to 100000 (PLS)

**Pr.42** External command function selection

Select a command with which the external command signal should be associated.

## 0: External positioning start

The external command signal input is used to start a positioning operation.

## 1: External speed change request

The external command signal input is used to change the speed in the current positioning operation. The new speed should be set in the "Cd.14 New speed value"

## 2: Speed-position, position-speed switching request

The external command signal input is used to switch from the speed control to the position control while in the speed-position switching control mode, or from the position control to the speed control while in the position-speed switching control mode.

To enable the speed-position switching control, set the

"Cd.24 Speed-position switching enable flag" to "1".

To enable the position-speed switching control, set the

"Cd.26 Position-speed switching enable flag" to "1".

## 3: Skip request

The external command signal input is used skip the current positioning operation.

4: High speed input request **LD77MH16**

The external command signal input is used to execute the mark detection. And, also set to use the external command signal in the synchronous control.

**POINT**

To enable the external command signal, set the "Cd.8 External command valid" to "1".

**Pr.83** Speed control 10 x multiplier setting for degree axis

Set the speed control 10 x multiplier setting for degree axis when you use command speed and speed limit value set by the positioning data and the parameter at "Pr.1 Unit setting" setup degree by ten times at the speed.

## 0: Invalid

## 1: Valid

Normally, the speed specification range is 0.001 to 2000000.000[degree/min], but it will be decupled and become 0.01 to 20000000.00[degree/min] by setting "Pr.83 Speed control 10 x multiplier setting for degree axis" to valid.

Note) The speed control 10 x multiplier setting for degree axis is included in detailed parameters 2, but it will be valid at the rising edge (OFF to ON) of the PLC READY signal [Y0].

\*1: Refer to Section 13.7.10 "Speed control 10 x multiplier setting for degree axis function" about speed control 10 x multiplier setting for degree axis.

Pr.83 setting value	Value set with GX Works2 (unit)	Value set with sequence program (unit)
0 : Invalid	0.001 to 2000000.000 (degree/min)	1 to 2000000000 ( $\times 10^{-3}$ degree/min)
1 : Valid	0.01 to 20000000.00 (degree/min)	1 to 2000000000 ( $\times 10^{-2}$ degree/min)

**Pr.84** Restart allowable range when servo OFF to ON

(1) What is the restart function when servo OFF to ON ?

The LD77MH restart function when servo OFF changes to ON, performs continuous positioning operation (positioning start, restart) when the servo is switched from OFF to ON in the stopped state (including LD77MH's forced stop, servo forced stop).

Restart when servo OFF changes to ON can be performed when the difference between the last command position of LD77MH when it stopped and the present value when servo OFF changed to ON, is less than the value set in the buffer memory for the restart allowable range setting.

(a) Servo emergency stop processing

- 1) The positioning operation is judged as stopped and can be restarted if the difference between the last command position of LD77MH at the LD77MH's forced stop input or servo forced stop input and the present value at LD77MH's forced stop release or servo forced stop release is lower than the value set in the buffer memory for the restart allowable range setting.
- 2) When the difference between the last command position of the LD77MH at the time the servo stop signal turned ON and the present value at the time the servo stop signal turned OFF is greater than the value set in the buffer memory for the restart allowable range setting, the positioning operation is judged as on-standby and cannot be restarted.

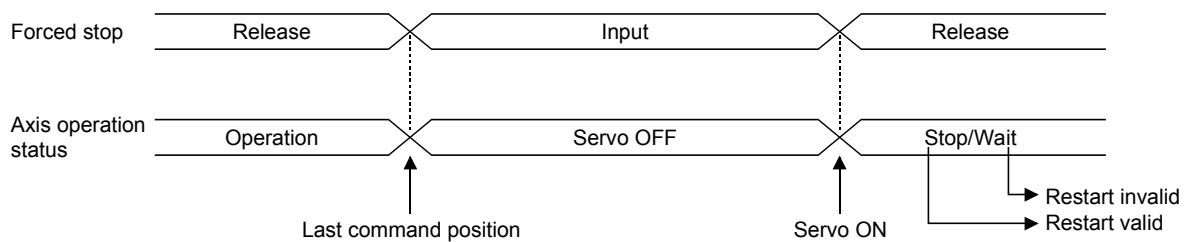

(b) Processing when the servo ON signal changes from OFF to ON.

- 1) The positioning operation is stopped and restart can be performed when the difference between the last command position of the LD77MH when the servo ON signal went from OFF to ON is lower than the value set in the buffer memory for restart allowable range setting.
- 2) When the difference between the last command position of the LD77MH at the time the servo ON signal when from ON to OFF and the present value at the time the servo ON signal went from OFF to ON is greater than the value set in the buffer memory for the restart allowable range setting, the positioning operation is judged as on-standby and cannot be restarted.

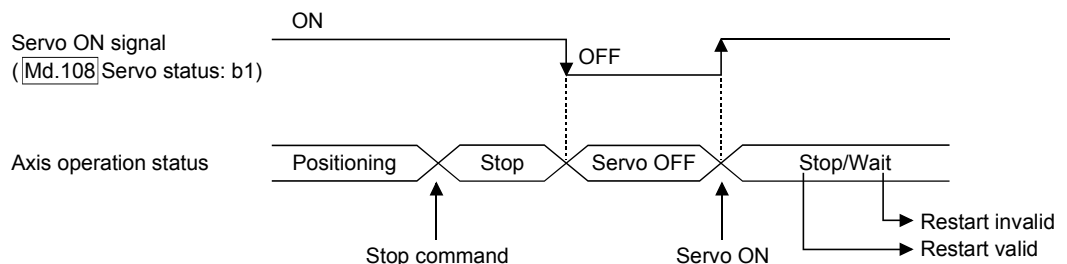



## (2) Setting method

When performing restart at the time servo OFF changes to ON, set the restart allowable range in the following buffer memory.

Setting value buffer memory address		Item	Setting range	Default value
LD77MH4	LD77MH16			
64+150n	65+150n	Pr.84 Restart allowable range when servo OFF to ON	0, 1 to 327680 (PLS) 0: restart not allowed	0

## [Setting example]

A program in which the restart allowable range for axis 1 is set to 10000 PLS is shown below.

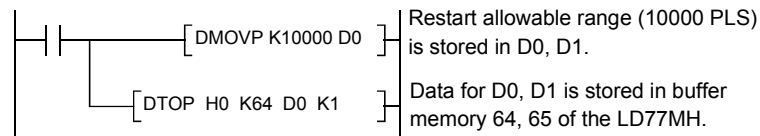

## (3) Precautionary notes

- (a) The difference between the last command position when the servo turned OFF and the present value when the servo turned ON, is output at the first operation of restart. If the restart allowable range is large at this time, an overload may occur on the servo side.  
Set the "restart allowable range when servo OFF changes to ON" to a value where the mechanical system will not be affected by a signal output.
- (b) The restart servo OFF changes to ON is valid only for the first time servo OFF changes to ON. From the second time servo OFF changes to ON, the setting for restart allowable range when servo OFF changes to ON is disregarded.
- (c) Execute servo OFF when the mechanical system is in complete stop state. The restart when servo OFF changes to ON cannot be applied to a system in which the mechanical system operated by external pressure or other force while the servo is OFF.
- (d) Restart can only be executed while the operating status of the axis is "stop". Restart cannot be executed when the operation status of the axis is other than "stop".
- (e) If the PLC READY signal is changed from OFF to ON while servo is OFF, restarting is not possible.  
If restart is requested, a warning "Restart not possible" (warning code: 104) will occur.
- (f) Do not restart while a stop command is ON.  
If restart is executed while stopped, an error (error code 106: Stop signal ON at start) is generated, and the operating status of the axis becomes "ERR".  
Therefore, restart cannot be performed even if the error is reset.

- (g) Restart can also be executed while the positioning starts signal is ON. However do not set the positioning start signal from OFF to ON while stopped.  
If the positioning start signal switches ON from OFF, positioning is performed from the positioning data number set in "[Cd.3] Positioning start No." or from the positioning data number of the specified point.
- (h) If positioning is terminated by a continuous-operation interrupt request, restart cannot be performed.  
If a restart request is made, a warning (warning code 104: Restart disabled) is generated.

[Operation at the time an emergency stop is input]

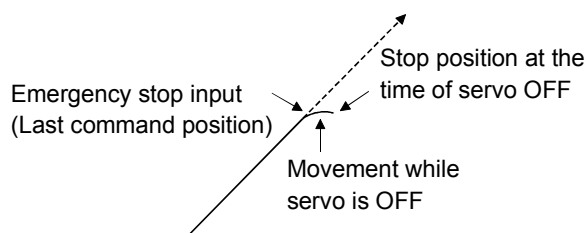

[Operation when a restart is performed]

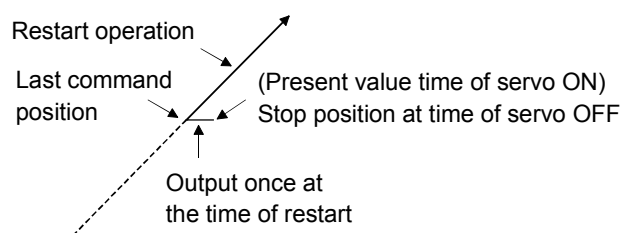

**Pr.89** Manual pulse generator/Incremental synchronous encoder input type selection

Set the input type from the manual pulse generator/incremental synchronous encoder. (Only the value specified against the axis 1 is valid.)

- 0: Differential output type
- 1: Voltage output/open collector type

Note) The "Manual pulse generator/Incremental synchronous encoder input type selection" is included in detailed parameters 2, but it will be valid at the rising edge (OFF to ON) of the PLC READY signal [Y0].

Refer to Section 3.4 "Specifications of interfaces with external devices" for details.

**Pr.90** Operation setting for speed-torque control mode

Operation setting of the speed control mode or torque control mode at the speed-torque control use is executed.

(1) Speed initial value selection

Set the initial speed at switching from position control mode to speed control mode.

0: Command speed .....Speed that position command at switching is converted into the motor speed.

1: Feedback speed .....Motor speed received from servo amplifier at switching

(2) Condition selection at mode switching **LD77MH16**

Set to switch the control mode to torque control mode without stop of servomotor during positioning in position control mode.

0: Switching conditions valid (for switching control mode)

1: Zero speed ON condition invalid (when switching between position and torque modes)

Note) The "Operation setting for speed-torque control mode" is included in detailed parameters 2, but it will be valid at the rising edge (OFF to ON) of the PLC READY signal [Y0].

<b>POINT</b>	Set normally "0". Set "1" to shift to torque control without waiting for stop of servo motor immediately after positioning completion, in the case of stopper, etc.
--------------	---

**Pr.95** External command signal selection **LD77MH16**

Set the external command signal.

0: Not used ..... External command signal is not used.

1: DI1 ..... DI1 is used as external command signal.

2: DI2 ..... DI2 is used as external command signal.

3: DI3 ..... DI3 is used as external command signal.

4: DI4 ..... DI4 is used as external command signal.

Note) The "External command signal selection" is included in detailed parameters 2, but it will be valid at the rising edge (OFF to ON) of the PLC READY signal [Y0].

<b>POINT</b>	Same external command signal can be used in the multiple axes.
--------------	--

## 5.2.5 OPR basic parameters

Item	Setting value, setting range		Default value	Setting value buffer memory address	
	Value set with GX Works2	Value set with sequence program		LD77MH4	LD77MH16
Pr.43 OPR method	0 : Near-point dog method	0	0	70+150n	
	4 : Count method 1)	4			
	5 : Count method 2)	5			
	6 : Data set method	6			
	7 : Scale origin signal detection method	7			
Pr.44 OPR direction	0 : Positive direction (address increment direction)	0	0	71+150n	
	1 : Negative direction (address decrement direction)	1			
Pr.45 OP address			0	72+150n 73+150n	
Pr.46 OPR speed	The setting value range differs depending on the " Pr.1 Unit setting".		1	74+150n 75+150n	
Pr.47 Creep speed			1	76+150n 77+150n	
Pr.48 OPR retry	0 : Do not retry OPR with limit switch	0	0	78+150n	
	1 : Retry OPR with limit switch	1			

n: Axis No.-1

## Pr.43 OPR method

Set the "OPR method" for carrying out machine OPR.

- 0 : Near-point dog method ..... After decelerating at the near-point dog ON, stop at the zero signal and complete the machine OPR.
- 4 : Count method 1) ..... After decelerating at the near-point dog ON, move the designated distance, and complete the machine OPR with the zero signal.
- 5 : Count method 2) ..... After decelerating at the near-point dog ON, move the designated distance, and complete the machine OPR.
- 6 : Data set method ..... The position where the machine OPR has been made will be the OP.
- 7: Scale origin signal  
detection method ..... If it moves in the opposite direction against of OPR direction after deceleration stop at the near-point dog ON, And it moves in OPR direction after deceleration stop once at the detection of the first zero signal. Then, it stops at the detected nearest zero signal, and complete the machine OPR.

Note) Refer to Section 8.2 "Machine OPR" for details on the OPR methods.

OPR method

0 : Near-point dog method

- (1) Start machine OPR.  
(Start movement at the " Pr.46 OPR speed" in the " Pr.44 OPR direction".)
- (2) Detect the near-point dog ON, and start deceleration.
- (3) Decelerate to " Pr.47 Creep speed", and move with the creep speed.  
(At this time, the near-point dog must be ON. If the near-point dog is OFF, the axis will decelerate to a stop.)
- (4) At the first zero signal after the near-point dog turned OFF, machine OPR is completed.

Note) After the home position return (OPR) has been started, the zero point of the encoder must be passed at least once before point A is reached.  
However, if selecting "1: Not need to pass motor Z-phase after the power supply is switched on." with " Pr.180 Function selection C-4", it is possible to carried out the home position return (OPR).

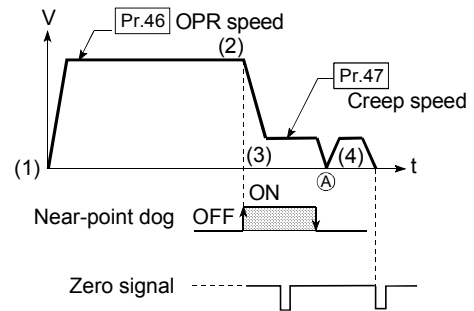

4 : Count method 1)

- (1) Start machine OPR.  
(Start movement at the " Pr.46 OPR speed" in the " Pr.44 OPR direction".)
- (2) Detect the near-point dog ON, and start deceleration.
- (3) Decelerate to " Pr.47 Creep speed", and move with the creep speed.
- (4) After the near-point dog turns ON and the movement amount set in " Pr.50 Setting for the movement amount after near-point dog ON" has passed, the LD77MH stops with the first zero signal, and the machine OPR is completed.

Note) After the home position return (OPR) has been started, the zero point of the encoder must be passed at least once before point A is reached.  
However, if selecting "1: Not need to pass motor Z-phase after the power supply is switched on." with " Pr.180 Function selection C-4", it is possible to carried out the home position return (OPR).

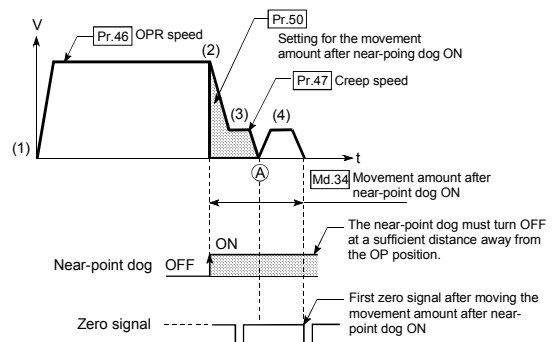

5 : Count method 2)

- (1) Start machine OPR.  
(Start movement at the " Pr.46 OPR speed" in the " Pr.44 OPR direction".)
- (2) Detect the near-point dog ON, and start deceleration.
- (3) Decelerate to " Pr.47 Creep speed", and move with the creep speed.
- (4) After the near-point dog turns ON and the movement amount set in " Pr.50 Setting for the movement amount after near-point dog ON" has passed, machine OPR is completed.

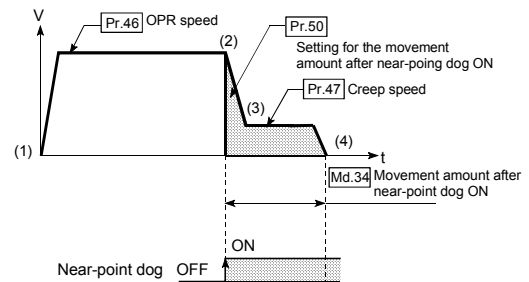

6 : Data set method

The position where the machine OPR has been made will be the OP.  
(Perform after the servo amplifier has been turned ON and the servomotor has been rotated at least once using the JOG or similar operation. However, if selecting "1: Not need to pass motor Z-phase after the power supply is switched on." with " Pr.180 Function selection C-4", it is possible to carried out the home position return (OPR).)

7 : Scale origin signal detection method

- (1) Start machine OPR.  
(Start movement at the " Pr.46 OPR speed" in the " Pr.44 OPR direction".)
- (2) Detect the near-point dog ON, and start deceleration.
- (3) After deceleration stop, it moves in the opposite direction against of OPR at the " Pr.46 OPR speed".
- (4) During movement, the machine begins decelerating when the first zero signal is detected.
- (5) After deceleration stop, it moves in direction of OPR at the speed set in " Pr.47 Creep speed", and stops at the detected nearest zero signal to complete the machine OPR.

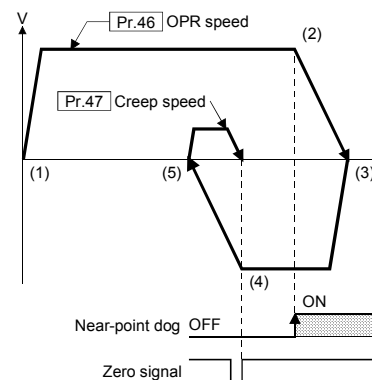

**Pr.44** OPR direction

Set the direction to start movement when starting machine OPR.

0: Positive direction (address increment direction)

Moves in the direction that the address increments. (Arrow 2))

1: Negative direction (address decrement direction)

Moves in the direction that the address decrements. (Arrow 1))

Normally, the OP is set near the lower limit or the upper limit, so "Pr.44 OPR direction" is set as shown below.

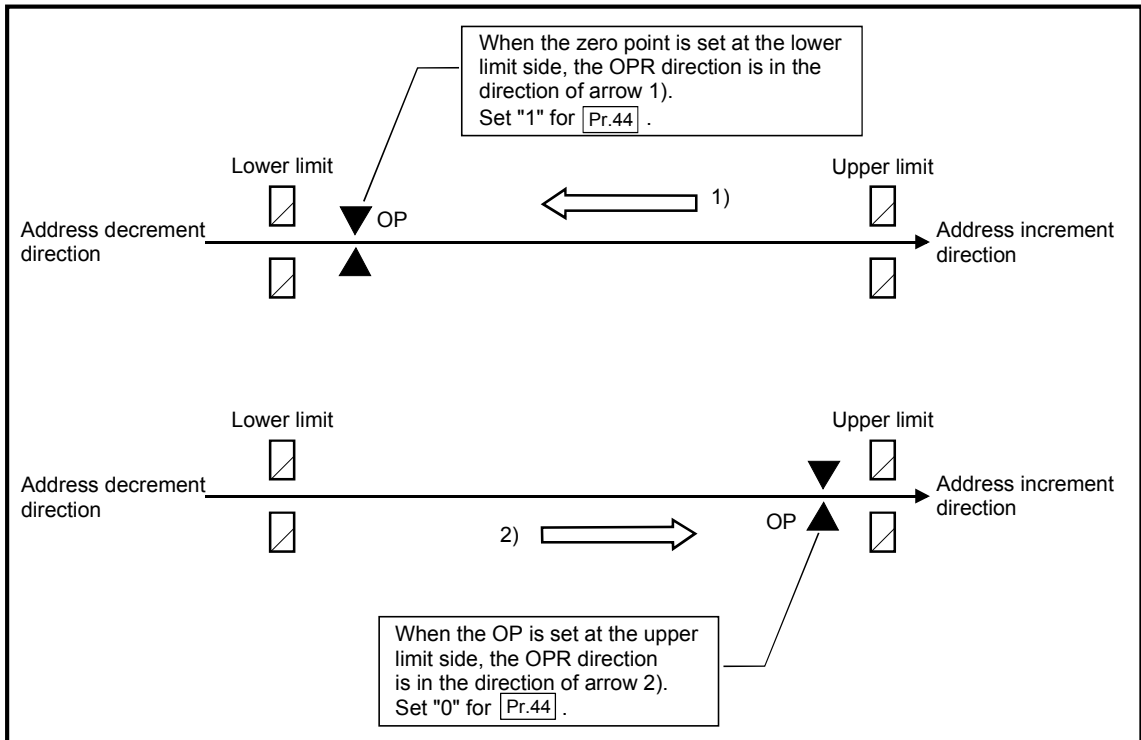

**Pr.45** OP address

Set the address used as the reference point for positioning control (ABS system).  
 (When the machine OPR is completed, the stop position address is changed to the address set in "Pr.45 OP address". At the same time, the "Pr.45 OP address" is stored in "Md.20 Current feed value" and "Md.21 Machine feed value".)

Pr.1 setting value	Value set with GX Works2 (unit)	Value set with sequence program (unit)
0 : mm	-214748364.8 to 214748364.7 ( $\mu\text{m}$ )	-2147483648 to 2147483647 ( $\times 10^{-1}\mu\text{m}$ )
1 : inch	-21474.83648 to 21474.83647 (inch)	-2147483648 to 2147483647 ( $\times 10^{-5}\text{inch}$ )
2 : degree	0 to 359.99999 (degree)	0 to 359999999 ( $\times 10^{-5}\text{degree}$ )
3 : PLS	-2147483648 to 2147483647 (PLS)	-2147483648 to 2147483647 (PLS)

**Pr.46** OPR speed

Set the speed for OPR.

Note) Set the "OPR speed" to less than "Pr.8 Speed limit value". If the "speed limit value" is exceeded, the error "outside speed limit value range" (error code: 910) will occur, and OPR will not be executed.

The "OPR speed" should be equal to or faster than the "Pr.7 Bias speed at start" and "Pr.47 Creep speed".

Pr.1 setting value	Value set with GX Works2 (unit)	Value set with sequence program (unit)
0 : mm	0.01 to 20000000.00 (mm/min)	1 to 2000000000 ( $\times 10^{-2}\text{mm/min}$ )
1 : inch	0.001 to 2000000.000 (inch/min)	1 to 2000000000 ( $\times 10^{-3}\text{inch/min}$ )
2 : degree	0.001 to 2000000.000 (degree/min) * 1	1 to 2000000000 ( $\times 10^{-3}\text{degree/min}$ ) * 2
3 : PLS	1 to 50000000 (PLS/s)	1 to 50000000 (PLS/s)

\*1: The OPR speed setting range is 0.001 to 2000000.000[degree/min], but it will be decupled and become 0.01 to 20000000.00[degree/min] by setting "Pr.83 Speed control 10 x multiplier setting for degree axis" to valid.

\*2: The OPR speed setting range is 1 to 2000000000( $\times 10^{-3}\text{degree/min}$ ), but it will be decupled and become 1 to 2000000000 ( $\times 10^{-2}\text{degree/min}$ ) by setting "Pr.83 Speed control 10 x multiplier setting for degree axis" to valid.



**Pr.47** Creep speed

Set the creep speed after near-point dog ON (the low speed just before stopping after decelerating from the OPR speed).

The creep speed is set within the following range.

$$(\text{Pr.46 OPR speed}) \geq (\text{Pr.47 Creep speed}) \geq (\text{Pr.7 Bias speed at start})$$

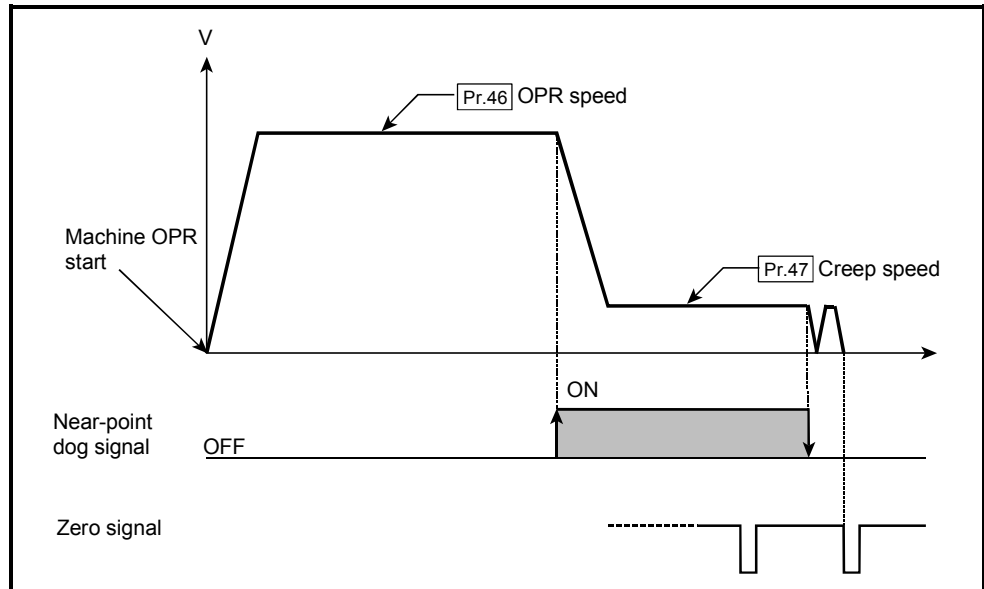

Pr.1 setting value	Value set with GX Works2 (unit)	Value set with sequence program (unit)
0 : mm	0.01 to 20000000.00 (mm/min)	1 to 200000000 ( $\times 10^{-2}$ mm/min)
1 : inch	0.001 to 2000000.000 (inch/min)	1 to 200000000 ( $\times 10^{-3}$ inch/min)
2 : degree	0.001 to 2000000.000 (degree/min) *1	1 to 200000000 ( $\times 10^{-3}$ degree/min) *2
3 : PLS	1 to 50000000 (PLS/s)	1 to 50000000 (PLS/s)

\*1: The creep speed setting range is 0.001 to 2000000.000[degree/min], but it will be decupled and become 0.01 to 20000000.00[degree/min] by setting "Pr.83 Speed control 10 x multiplier setting for degree axis" to valid.

\*2: The creep speed setting range is 1 to 200000000( $\times 10^{-3}$ degree/min), but it will be decupled and become 1 to 200000000 ( $\times 10^{-2}$ degree/min) by setting "Pr.83 Speed control 10 x multiplier setting for degree axis" to valid.

**Pr.48** OPR retry

Set whether to carry out OPR retry.

When the OPR retry function is validated and the machine OPR is started, first the axis will move in the OPR direction (1)). If the upper/lower limit signal turns OFF before the near-point dog signal ON is detected (2)), the axis will decelerate to a stop, and then will move in the direction opposite the OPR direction (3)). If the following edge of the near-point dog signal is detected during movement in the opposite direction, the axis will decelerate to a stop (4)), and then will carry out machine OPR again (5), 6)).

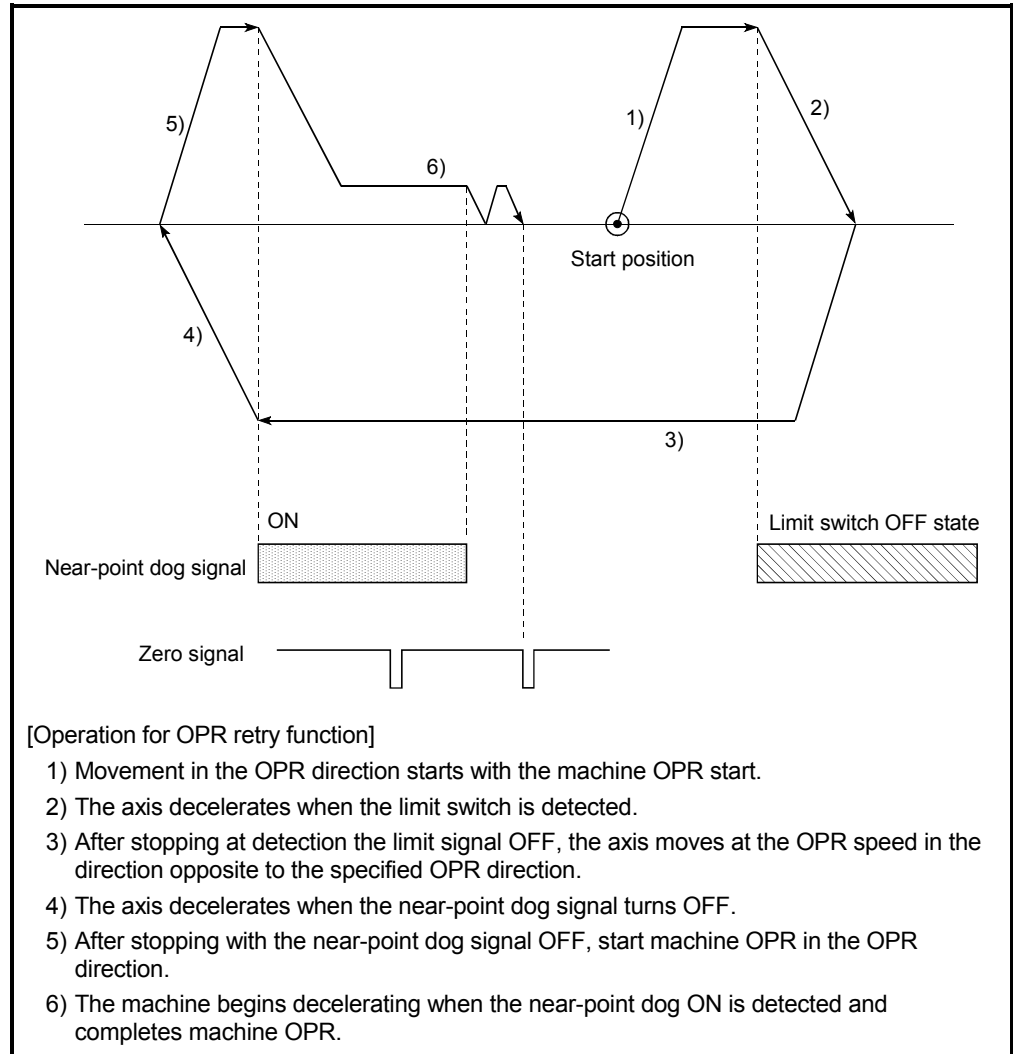

## 5.2.6 OPR detailed parameters

Item	Setting value, setting range		Default value	Setting value buffer memory address	
	Value set with GX Works2	Value set with sequence program		LD77MH4	LD77MH16
<b>Pr.50</b> Setting for the movement amount after near-point dog ON	The setting value range differs depending on the " <b>Pr.1</b> Unit setting".		0	80+150n	81+150n
<b>Pr.51</b> OPR acceleration time selection	0 : <b>Pr.9</b> Acceleration time 0	0	0	82+150n	
	1 : <b>Pr.25</b> Acceleration time 1	1			
	2 : <b>Pr.26</b> Acceleration time 2	2			
	3 : <b>Pr.27</b> Acceleration time 3	3			
<b>Pr.52</b> OPR deceleration time selection	0 : <b>Pr.10</b> Deceleration time 0	0	0	83+150n	
	1 : <b>Pr.28</b> Deceleration time 1	1			
	2 : <b>Pr.29</b> Deceleration time 2	2			
	3 : <b>Pr.30</b> Deceleration time 3	3			
<b>Pr.53</b> OP shift amount	The setting value range differs depending on the " <b>Pr.1</b> Unit setting".		0	84+150n	85+150n
<b>Pr.54</b> OPR torque limit value	1 to 1000 (%)	1 to 1000 (%)	300	86+150n	
<b>Pr.55</b> Operation setting for incompleteness of OPR	0 : Positioning control is not executed.	0	0	87+150n	
	1 : Positioning control is executed.	1			
<b>Pr.56</b> Speed designation during OP shift	0 : OPR speed	0	0	88+150n	
	1 : Creep speed	1			
<b>Pr.57</b> Dwell time during OPR retry	0 to 65535 (ms)	0 to 65535 (ms) 0 to 32767 : Set as a decimal 32768 to 65535 : Convert into hexadecimal and set	0	89+150n	

n: Axis No.-1

**Pr.50** Setting for the movement amount after near-point dog ON

When using the count method 1) or 2), set the movement amount to the OP after the near-point dog signal turns ON.

(The movement amount after near-point dog ON should be equal to or greater than the sum of the "distance covered by the deceleration from the OPR speed to the creep speed" and "distance of movement in 10 ms at the OPR speed".)

Example of setting for "Pr. 50" Setting for the movement amount after near-point dog ON"

Assuming that the "Pr. 8" Speed limit value" is set to 200 kPLS/s, "Pr. 46" OPR speed" to 10 kPLS/s, "Pr. 47" Creep speed" to 1 kPLS/s, and deceleration time to 300 ms, the minimum value of "Pr. 50" Setting for the movement amount after near-point dog ON" is calculated as follows:

[OPR operation]

Pr.8 Speed limit value:  $V_p=200$  kPLS/s

Pr.46 OPR speed:  $V_z=10$  kPLS/s

Pr.47 Creep speed:  $V_c=1$  kPLS/s

$$\text{Actual deceleration time: } t = T_b \times \frac{V_z}{V_p}$$

$$[\text{Deceleration distance}] = \frac{1}{2} \times \frac{V_z}{1000} \times t + \frac{0.01 \times V_z}{1000} \times 10$$

Movement amount for 10ms at OPR speed.

$$= \frac{V_z}{2000} \times \frac{T_b \times V_z}{V_p} + 0.01 \times V_z$$

$$= \frac{10 \times 10^3}{2000} \times \frac{300 \times 10 \times 10^3}{200 \times 10^3} + 0.01 \times 10 \times 10^3$$

$$= 75 + 100$$

$$= 175$$

\* : "Pr.50" Setting for the movement amount after near-point dog ON" should be equal to or larger than 175.

Deceleration time:  $T_b=300$  ms

Pr.1 setting value	Value set with GX Works2 (unit)	Value set with sequence program (unit)
0 : mm	0 to 214748364.7 (μm)	0 to 2147483647 (×10 <sup>-1</sup> μm)
1 : inch	0 to 21474.83647 (inch)	0 to 2147483647 (×10 <sup>-5</sup> inch)
2 : degree	0 to 21474.83647 (degree)	0 to 2147483647 (×10 <sup>-5</sup> degree)
3 : PLS	0 to 2147483647 (PLS)	0 to 2147483647 (PLS)

**Pr.51** OPR acceleration time selection

Set which of "acceleration time 0 to 3" to use for the acceleration time during OPR.

- 0 : Use the value set in "Pr.9" Acceleration time 0".
- 1 : Use the value set in "Pr.25" Acceleration time 1".
- 2 : Use the value set in "Pr.26" Acceleration time 2".
- 3 : Use the value set in "Pr.27" Acceleration time 3".

**Pr.52** OPR deceleration time selection

Set which of "deceleration time 0 to 3" to use for the deceleration time during OPR.

0 : Use the value set in " **Pr.10** Deceleration time 0".

1 : Use the value set in " **Pr.28** Deceleration time 1".

2 : Use the value set in " **Pr.29** Deceleration time 2".

3 : Use the value set in " **Pr.30** Deceleration time 3".

**Pr.53** OP shift amount

Set the amount to shift (move) from the position stopped at with machine OPR.

\* The OP shift function is used to compensate the OP position stopped at with machine OPR.

If there is a physical limit to the OP position, due to the relation of the near-point dog installation position, use this function to compensate the OP to an optimum position.

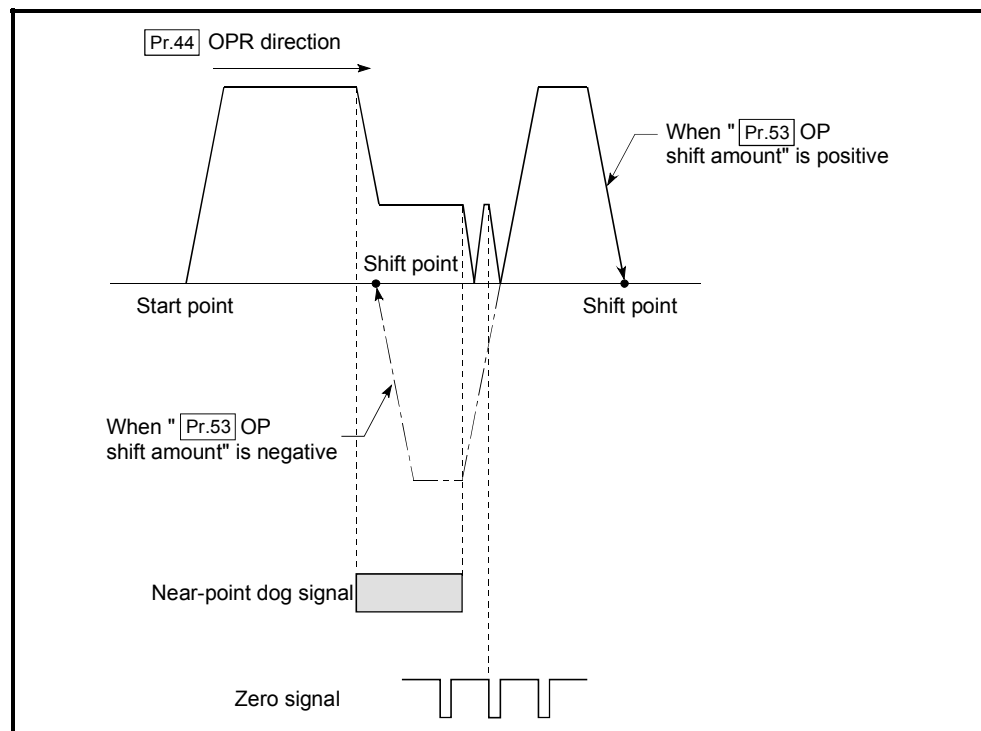

<b>Pr.1</b> setting value	Value set with GX Works2 (unit)	Value set with sequence program (unit)
0 : mm	-214748364.8 to 214748364.7 ( $\mu\text{m}$ )	-2147483648 to 2147483647 ( $\times 10^{-1}\mu\text{m}$ )
1 : inch	-21474.83648 to 21474.83647 (inch)	-2147483648 to 2147483647 ( $\times 10^{-5}\text{inch}$ )
2 : degree	-21474.83648 to 21474.83647 (degree)	-2147483648 to 2147483647 ( $\times 10^{-5}\text{degree}$ )
3 : PLS	-2147483648 to 2147483647 (PLS)	-2147483648 to 2147483647 (PLS)

**Pr.54** OPR torque limit value

Set the value to limit the servomotor torque after reaching the creep speed during machine OPR.

Refer to Section 13.4.2 "Torque limit function" for details on the torque limits.

**Pr.55** Operation setting for incompleteness of OPR

Set whether the positioning control is executed or not (When the OPR request flag is ON.).

0: Positioning control is not executed.

1: Positioning control is executed.

- (1) When OPR request flag is ON, selecting "0: Positioning control is not executed" will result in an "Operation starting at incompleteness of OPR" error (error code: 547), and positioning control will not be performed. At this time, operation with the manual control (JOG operation, inching operation, manual pulse generator operation) is available.  
The positioning control can be executed even if the OPR request flag is ON when selecting "1: Positioning control is executed".
- (2) The following shows whether the positioning control is possible to start/restart or not when selecting "0: Positioning control is not executed".
  - (a) Start possible  
Machine OPR, JOG operation, inching operation, manual pulse generator operation, current value changing using current value changing start No. (9003).
  - (b) Start/restart impossible control  
The positioning control is impossible to start/restart in the following case. 1-axis linear control, 2/3/4-axis linear interpolation control, 1/2/3/4-axis fixed-feed control, 2-axis circular interpolation control with sub point designation, 2-axis circular interpolation control with center point designation, 1/2/3/4-axis speed control, Speed-position switching control (INC mode/ ABS mode), Position-speed switching control, current value changing using current value changing (No.1 to 600).
- (3) When OPR request flag is ON, starting Fast OPR will result in an "Home positioning return (OPR) request flag ON" error (error code: 207) despite the setting value of "Operation setting incompleteness of OPR", and Fast OPR will not be executed.

**⚠ CAUTION**

- Do not execute the positioning control in home position return request signal ON for the axis which uses in the positioning control.  
Failure to observe this could lead to an accident such as a collision.

**Pr.56** Speed designation during OP shift

Set the operation speed for when a value other than "0" is set for "Pr.53 OP shift amount". Select the setting from "Pr.46 OPR speed" or "Pr.47 Creep speed".

0 : Designate "Pr.46 OPR speed" as the setting value.

1 : Designate "Pr.47 Creep speed" as the setting value.

**Pr.57** Dwell time during OPR retry

When OPR retry is validated (when "1" is set for Pr.48 ), set the stop time after decelerating in 2) and 4) in the following drawing.

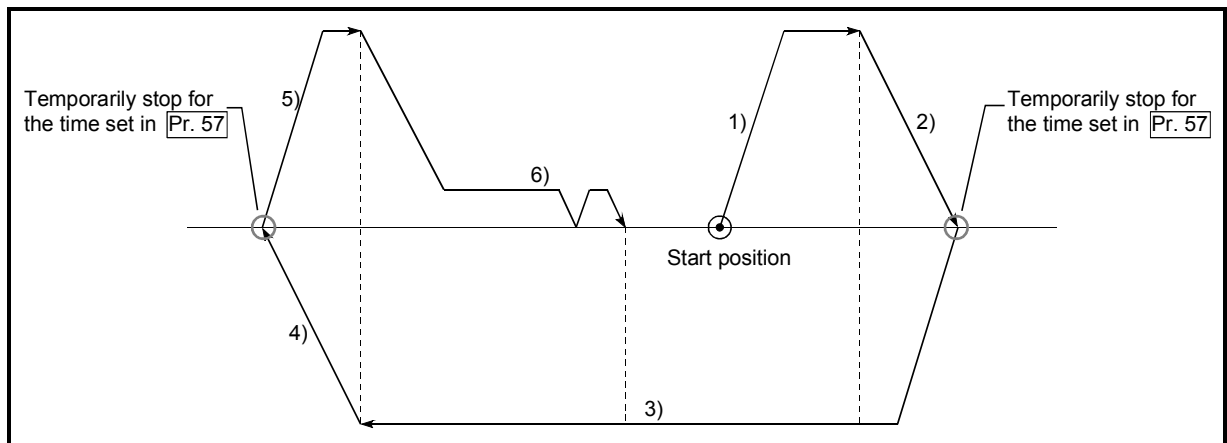

## 5.2.7 Expansion parameters

Item	Setting value, setting range		Default value	Setting value buffer memory address	
	Value set with GX Works2	Value set with sequence program		LD77MH4	LD77MH16
<b>Pr.91</b> Optional data monitor: Data type setting 1 <b>LD77MH16</b>	0 : No setting 1 : Effective load ratio 2 : Regenerative load ratio	0	0	/	100+150n
<b>Pr.92</b> Optional data monitor: Data type setting 2 <b>LD77MH16</b>	3 : Peak load factor 4 : Load inertia ratio 5 : Position loop gain 1 6 : Bus voltage	0	0	/	101+150n
<b>Pr.93</b> Optional data monitor: Data type setting 3 <b>LD77MH16</b>	7 : Servo motor rotation speed 20 : Position feed back <sup>(Note-1)</sup>	0	0	/	102+150n
<b>Pr.94</b> Optional data monitor: Data type setting 4 <b>LD77MH16</b>	21 : Absolute position encoder single revolution position <sup>(Note-1)</sup> 22 : Select synchronous position droop <sup>(Note-1)</sup>	0	0	/	103+150n
<b>Pr.96</b> Operation cycle setting <b>LD77MH16</b>	0: 0.88ms 1: 1.77ms	0 1	1	/	105 <sup>(Note-2)</sup>

n: Axis No. -1

(Note-1): Used point: 2 words

(Note-2): Only the value specified against the axis 1 is valid.

**Pr.91** Optional data monitor: Data type setting 1 to **Pr.94** Optional data monitor: Data type setting 4 **LD77MH16**

Set the data type monitored in optional data monitor function.

- 0 : No setting <sup>(Note)</sup>
- 1 : Effective load ratio
- 2 : Regenerative load ratio
- 3 : Peak load factor
- 4 : Load inertia ratio
- 5 : Position loop gain 1
- 6 : Bus voltage
- 7 : Servo motor rotation speed
- 20 : Position feed back (Used point: 2 words)
- 21 : Absolute position encoder single revolution position (Used point: 2 words)
- 22 : Select synchronous position droop (Used point: 2 words)
- Others : No monitor ("0" is stored.)

(Note): The stored value of "**Md.109** Regenerative load ratio/Optional data monitor output 1" to "**Md.112** Optional data monitor output 4" is different every data type setting 1 to 4. (Refer to Section 5.6.2)



## POINT

- (1) The monitor address of optional data monitor is registered to servo amplifier with initialized communication after power supply ON or PLC CPU reset.
- (2) Set the data type of "used point: 2 words" in "[Pr.91] Optional data monitor: Data type setting 1" or "[Pr.93] Optional data monitor: Data type setting 3". If it is set in "[Pr.92] Optional data monitor: Data type setting 2" or "[Pr.94] Optional data monitor: Data type setting 4", the warning (warning code: 116) will occur with initialized communication to servo amplifier, and "0" is set in [Md.109] to [Md.112].
- (3) Set "0" in "[Pr.92] Optional data monitor: Data type setting 2" when the data type of "used point: 2 words" is set in "[Pr.91] Optional data monitor: Data type setting 1", and set "0" in "[Pr.94] Optional data monitor: Data type setting 4" when the data type of "used point: 2 words" is set in "[Pr.93] Optional data monitor: Data type setting 3". When other than "0" is set, the warning (warning code: 116) will occur with initialized communication to servo amplifier, and "0" is set in [Md.109] to [Md.112].
- (4) When the data type of "used point: 2 words" is set, the monitor data of low-order is "[Md.109] Regenerative load ratio/Optional data monitor output 1" or "[Md.111] Peak torque ratio/Optional data monitor output 3".

[Pr.96] Operation cycle setting **LD77MH16**

Set the operation cycle. (Only the value specified against the axis 1 is valid.)

0: 0.88ms

1: 1.77ms

## POINT

- (1) In this parameter, the value set in flash ROM of LD77MH is valid at power supply ON or PLC CPU reset. Fetch by PLC READY signal OFF to ON is not executed. Execute flash ROM writing to change after setting a value to buffer memory. Confirm the current operation cycle in "[Md.132] Operation cycle setting".
- (2) When "0: 0.88ms" is set, confirm that "[Md.133] Operation cycle over flag" does not turn ON. If the flag is ON, the operation cycle over has been generated. Correct the positioning content or set "1: 1.77ms".

## 5.2.8 Servo parameters

## (1) Servo series

Item	Setting details	Setting range	Default value	Setting value buffer memory address	
				LD77MH4	LD77MH16
Pr.100	<p>Used to select the servo amplifier series, which is connected to the LD77MH.</p> <p><b>POINT</b></p> <p>Be sure to set up servo series. Communication with servo amplifier isn't started by the initial value "0" in default value. (The LED indication of servo amplifier indicates "Ab".)</p>	<p>0: Servo series is not set</p> <p>1: MR-J3-□B MR-J3W-□B (For 2-axis type)</p> <p>3: MR-J3-□B-RJ006 (For fully closed loop control)</p> <p>MR-J3-□BS (For safety servo)</p> <p>4: MR-J3-□B-RJ004 (For liner servo)</p> <p>6: MR-J3-□B-RJ080 (For direct drive motor)</p> <p>4097: Virtual servo amplifier</p>	0	30100+200n	28400+100n

n: Axis No. -1

## (2) Parameters of MR-J3(W)-□B

The parameter list for MR-J3(W)-□B is shown below.

Refer to the "Servo amplifier Instruction Manual" for details of setting items.

Do not change other than the buffer memory addresses of the parameters described in "Servo amplifier Instruction Manual".

Servo amplifier type	Instruction manual name
MR-J3-□B	SSCNETⅢ Compatible MR-J3-□B Servo amplifier Instruction Manual (SH-030051)
MR-J3W-□B	SSCNETⅢ interface 2-axis AC Servo amplifier MR-J3W-□B Servo amplifier Instruction Manual (SH-030073)
MR-J3-□B-RJ004	SSCNETⅢ Compatible Linear Servo MR-J3-□B-RJ004 Instruction Manual (SH-030054)
MR-J3-□B-RJ006	SSCNETⅢ Compatible Fully Closed Loop Control MR-J3-□B-RJ006 Servo amplifier Instruction Manual (SH-030056)
MR-J3-□BS	SSCNETⅢ interface Drive Safety integrated MR-J3-□B Safety Servo amplifier Instruction Manual (SH-030084)

**POINT**

Set the parameter value and switch power off once (The parameter is transferred to servo amplifier from LD77MH), and then switch it on again to make that parameter setting valid.

## (a) Basic setting parameters

Item	Servo amplifier parameter No.	Buffer memory address	
		LD77MH4	LD77MH16
Pr.101	PA01	30101+200n	28401+100n
Pr.102	PA02	30102+200n	28402+100n
Pr.103	PA03	30103+200n	28403+100n
Pr.104	PA04	30104+200n	28404+100n
Pr.105	PA05	30105+200n	28405+100n
Pr.106	PA06	30106+200n	28406+100n
Pr.107	PA07	30107+200n	28407+100n
Pr.108	PA08	30108+200n	28408+100n
Pr.109	PA09	30109+200n	28409+100n
Pr.110	PA10	30110+200n	28410+100n

Item	Servo amplifier parameter No.	Buffer memory address	
		LD77MH4	LD77MH16
Pr.111	PA11	30111+200n	28411+100n
Pr.112	PA12	30112+200n	28412+100n
Pr.113	PA13	30113+200n	28413+100n
Pr.114	PA14	30114+200n	28414+100n
Pr.115	PA15	30115+200n	28415+100n
Pr.116	PA16	30116+200n	28416+100n
Pr.117	PA17	30117+200n	28417+100n
Pr.118	PA18	30118+200n	28418+100n
Pr.332	PA19	30932+50n	Set with GX Works2

n: Axis No.-1

## (b) Gain/filter parameters

Item	Servo amplifier parameter No.	Buffer memory address	
		LD77MH4	LD77MH16
Pr.119	PB01	30119+200n	28419+100n
Pr.120	PB02	30120+200n	28420+100n
Pr.121	PB03	30121+200n	28421+100n
Pr.122	PB04	30122+200n	28422+100n
Pr.123	PB05	30123+200n	28423+100n
Pr.124	PB06	30124+200n	28424+100n
Pr.125	PB07	30125+200n	28425+100n
Pr.126	PB08	30126+200n	28426+100n
Pr.127	PB09	30127+200n	28427+100n
Pr.128	PB10	30128+200n	28428+100n
Pr.129	PB11	30129+200n	28429+100n
Pr.130	PB12	30130+200n	28430+100n
Pr.131	PB13	30131+200n	28431+100n
Pr.132	PB14	30132+200n	28432+100n
Pr.133	PB15	30133+200n	28433+100n
Pr.134	PB16	30134+200n	28434+100n
Pr.135	PB17	30135+200n	28435+100n
Pr.136	PB18	30136+200n	28436+100n
Pr.137	PB19	30137+200n	28437+100n
Pr.138	PB20	30138+200n	28438+100n
Pr.139	PB21	30139+200n	28439+100n
Pr.140	PB22	30140+200n	28440+100n
Pr.141	PB23	30141+200n	28441+100n

Item	Servo amplifier parameter No.	Buffer memory address	
		LD77MH4	LD77MH16
Pr.142	PB24	30142+200n	28442+100n
Pr.143	PB25	30143+200n	28443+100n
Pr.144	PB26	30144+200n	28444+100n
Pr.145	PB27	30145+200n	28445+100n
Pr.146	PB28	30146+200n	28446+100n
Pr.147	PB29	30147+200n	28447+100n
Pr.148	PB30	30148+200n	28448+100n
Pr.149	PB31	30149+200n	28449+100n
Pr.150	PB32	30150+200n	28450+100n
Pr.151	PB33	30151+200n	28451+100n
Pr.152	PB34	30152+200n	28452+100n
Pr.153	PB35	30153+200n	28453+100n
Pr.154	PB36	30154+200n	28454+100n
Pr.155	PB37	30155+200n	28455+100n
Pr.156	PB38	30156+200n	28456+100n
Pr.157	PB39	30157+200n	28457+100n
Pr.158	PB40	30158+200n	28458+100n
Pr.159	PB41	30159+200n	28459+100n
Pr.160	PB42	30160+200n	28460+100n
Pr.161	PB43	30161+200n	28461+100n
Pr.162	PB44	30162+200n	28462+100n
Pr.163	PB45	30163+200n	28463+100n

n: Axis No.-1

## (c) Expansion setting parameters

Item	Servo amplifier parameter No.	Buffer memory address	
		LD77MH4	LD77MH16
Pr.164	PC01	30164+200n	28464+100n
Pr.165	PC02	30165+200n	28465+100n
Pr.166	PC03	30166+200n	28466+100n
Pr.167	PC04	30167+200n	28467+100n
Pr.168	PC05	30168+200n	28468+100n
Pr.169	PC06	30169+200n	28469+100n
Pr.170	PC07	30170+200n	28470+100n
Pr.171	PC08	30171+200n	28471+100n
Pr.172	PC09	30172+200n	28472+100n
Pr.173	PC10	30173+200n	28473+100n
Pr.174	PC11	30174+200n	28474+100n
Pr.175	PC12	30175+200n	28475+100n
Pr.176	PC13	30176+200n	28476+100n
Pr.177	PC14	30177+200n	28477+100n
Pr.178	PC15	30178+200n	28478+100n
Pr.179	PC16	30179+200n	28479+100n

Item	Servo amplifier parameter No.	Buffer memory address	
		LD77MH4	LD77MH16
Pr.180	PC17	30180+200n	28480+100n
Pr.181	PC18	30181+200n	28481+100n
Pr.182	PC19	30182+200n	28482+100n
Pr.183	PC20	30183+200n	28483+100n
Pr.184	PC21	30184+200n	28484+100n
Pr.185	PC22	30185+200n	28485+100n
Pr.186	PC23	30186+200n	28486+100n
Pr.187	PC24	30187+200n	28487+100n
Pr.188	PC25	30188+200n	28488+100n
Pr.189	PC26	30189+200n	28489+100n
Pr.190	PC27	30190+200n	28490+100n
Pr.191	PC28	30191+200n	28491+100n
Pr.192	PC29	30192+200n	28492+100n
Pr.193	PC30	30193+200n	28493+100n
Pr.194	PC31	30194+200n	28494+100n
Pr.195	PC32	30195+200n	28495+100n

n: Axis No.-1

## (d) Input/output setting parameters

Item	Servo amplifier parameter No.	Buffer memory address	
		LD77MH4	LD77MH16
Pr.196	PD01	30196+200n	Set with GX Works2
Pr.197	PD02	30197+200n	
Pr.198	PD03	30198+200n	
Pr.199	PD04	30199+200n	
Pr.200	PD 05	30200+200n	
Pr.201	PD06	30201+200n	
Pr.202	PD07	30202+200n	
Pr.203	PD08	30203+200n	
Pr.204	PD09	30204+200n	
Pr.205	PD10	30205+200n	
Pr.206	PD11	30206+200n	
Pr.207	PD12	30207+200n	
Pr.208	PD13	30208+200n	
Pr.209	PD14	30209+200n	
Pr.210	PD15	30210+200n	
Pr.211	PD16	30211+200n	

Item	Servo amplifier parameter No.	Buffer memory address	
		LD77MH4	LD77MH16
Pr.212	PD17	30212+200n	Set with GX Works2
Pr.213	PD18	30213+200n	
Pr.214	PD19	30214+200n	
Pr.215	PD20	30215+200n	
Pr.216	PD21	30216+200n	
Pr.217	PD22	30217+200n	
Pr.218	PD23	30218+200n	
Pr.219	PD24	30219+200n	
Pr.220	PD25	30220+200n	
Pr.221	PD26	30221+200n	
Pr.222	PD27	30222+200n	
Pr.223	PD28	30223+200n	
Pr.224	PD29	30224+200n	
Pr.225	PD30	30225+200n	
Pr.226	PD31	30226+200n	
Pr.227	PD32	30227+200n	

n: Axis No.-1

(e) Extension control parameters

Item	Servo amplifier parameter No.	Buffer memory address	
		LD77MH4	LD77MH16
Pr.228	PE01	30228+200n	Set with GX Works2
Pr.229	PE02	30229+200n	
Pr.230	PE03	30230+200n	
Pr.231	PE04	30231+200n	
Pr.232	PE05	30232+200n	
Pr.233	PE06	30233+200n	
Pr.234	PE07	30234+200n	
Pr.235	PE08	30235+200n	
Pr.236	PE09	30236+200n	
Pr.237	PE10	30237+200n	
Pr.238	PE11	30238+200n	
Pr.239	PE12	30239+200n	
Pr.240	PE13	30240+200n	
Pr.241	PE14	30241+200n	
Pr.242	PE15	30242+200n	
Pr.243	PE16	30243+200n	
Pr.244	PE17	30244+200n	
Pr.245	PE18	30245+200n	
Pr.246	PE19	30246+200n	
Pr.247	PE20	30247+200n	

Item	Servo amplifier parameter No.	Buffer memory address	
		LD77MH4	LD77MH16
Pr.248	PE21	30248+200n	Set with GX Works2
Pr.249	PE22	30249+200n	
Pr.250	PE23	30250+200n	
Pr.251	PE24	30251+200n	
Pr.252	PE25	30252+200n	
Pr.253	PE26	30253+200n	
Pr.254	PE27	30254+200n	
Pr.255	PE28	30255+200n	
Pr.256	PE29	30256+200n	
Pr.257	PE30	30257+200n	
Pr.258	PE31	30258+200n	
Pr.259	PE32	30259+200n	
Pr.260	PE33	30260+200n	
Pr.261	PE34	30261+200n	
Pr.262	PE35	30262+200n	
Pr.263	PE36	30263+200n	
Pr.264	PE37	30264+200n	
Pr.265	PE38	30265+200n	
Pr.266	PE39	30266+200n	
Pr.267	PE40	30267+200n	

n: Axis No.-1

(f) Special setting parameters

Item	Servo amplifier parameter No.	Buffer memory address	
		LD77MH4	LD77MH16
Pr.268	PS01	30268+200n	Set with GX Works2
Pr.269	PS02	30269+200n	
Pr.270	PS03	30270+200n	
Pr.271	PS04	30271+200n	
Pr.272	PS05	30272+200n	
Pr.273	PS06	30273+200n	
Pr.274	PS07	30274+200n	
Pr.275	PS08	30275+200n	
Pr.276	PS09	30276+200n	
Pr.277	PS10	30277+200n	
Pr.278	PS11	30278+200n	
Pr.279	PS12	30279+200n	
Pr.280	PS13	30280+200n	
Pr.281	PS14	30281+200n	
Pr.282	PS15	30282+200n	
Pr.283	PS16	30283+200n	

Item	Servo amplifier parameter No.	Buffer memory address	
		LD77MH4	LD77MH16
Pr.284	PS17	30284+200n	Set with GX Works2
Pr.285	PS18	30285+200n	
Pr.286	PS19	30286+200n	
Pr.287	PS20	30287+200n	
Pr.288	PS21	30288+200n	
Pr.289	PS22	30289+200n	
Pr.290	PS23	30290+200n	
Pr.291	PS24	30291+200n	
Pr.292	PS25	30292+200n	
Pr.293	PS26	30293+200n	
Pr.294	PS27	30294+200n	
Pr.295	PS28	30295+200n	
Pr.296	PS29	30296+200n	
Pr.297	PS30	30297+200n	
Pr.298	PS31	30298+200n	
Pr.299	PS32	30299+200n	

n: Axis No.-1

## (g) Other setting parameters

Item	Servo amplifier parameter No.	Buffer memory address	
		LD77MH4	LD77MH16
Pr.300	PF01	30900+50n	Set with GX Works2
Pr.301	PF02	30901+50n	
Pr.302	PF03	30902+50n	
Pr.303	PF04	30903+50n	
Pr.304	PF05	30904+50n	
Pr.305	PF06	30905+50n	
Pr.306	PF07	30906+50n	
Pr.307	PF08	30907+50n	

Item	Servo amplifier parameter No.	Buffer memory address	
		LD77MH4	LD77MH16
Pr.308	PF09	30908+50n	Set with GX Works2
Pr.309	PF10	30909+50n	
Pr.310	PF11	30910+50n	
Pr.311	PF12	30911+50n	
Pr.312	PF13	30912+50n	
Pr.313	PF14	30913+50n	
Pr.314	PF15	30914+50n	
Pr.315	PF16	30915+50n	

n: Axis No.-1

## (h) Option unit parameters

Item	Servo amplifier parameter No.	Buffer memory address	
		LD77MH4	LD77MH16
Pr.316	Po01	30916+50n	Set with GX Works2
Pr.317	Po02	30917+50n	
Pr.318	Po03	30918+50n	
Pr.319	Po04	30919+50n	
Pr.320	Po05	30920+50n	
Pr.321	Po06	30921+50n	
Pr.322	Po07	30922+50n	
Pr.323	Po08	30923+50n	

Item	Servo amplifier parameter No.	Buffer memory address	
		LD77MH4	LD77MH16
Pr.324	Po09	30924+50n	Set with GX Works2
Pr.325	Po10	30925+50n	
Pr.326	Po11	30926+50n	
Pr.327	Po12	30927+50n	
Pr.328	Po13	30928+50n	
Pr.329	Po14	30929+50n	
Pr.330	Po15	30930+50n	
Pr.331	Po16	30931+50n	

n: Axis No.-1

### 5.3 List of positioning data

Before explaining the positioning data setting items **Da.1** to **Da.10**, **Da.20** to **Da.22** the configuration of the positioning data will be shown below.

The positioning data stored in the LD77MH buffer memory has the following type of configuration.

• LD77MH4

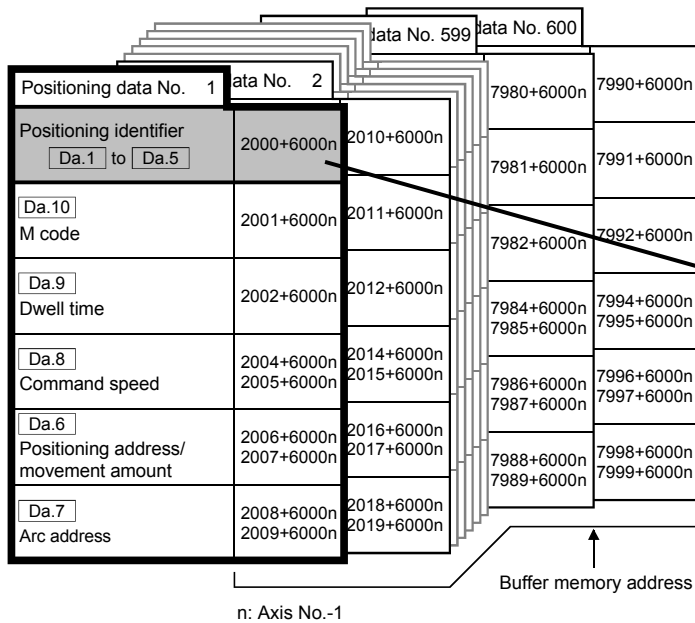

- Up to 600 positioning data items can be set (stored) for each axis in the buffer memory address shown on the left. Data is controlled as positioning data No. 1 to 600 for each axis.
- One positioning data item is configured of the items shown in the bold box.

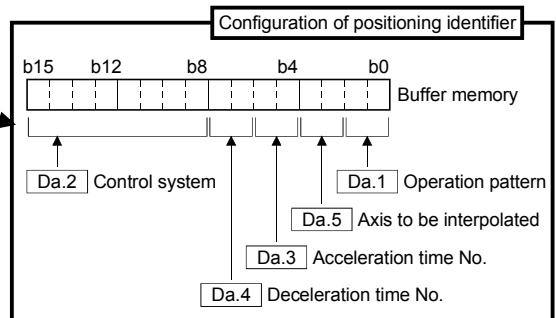

• LD77MH16

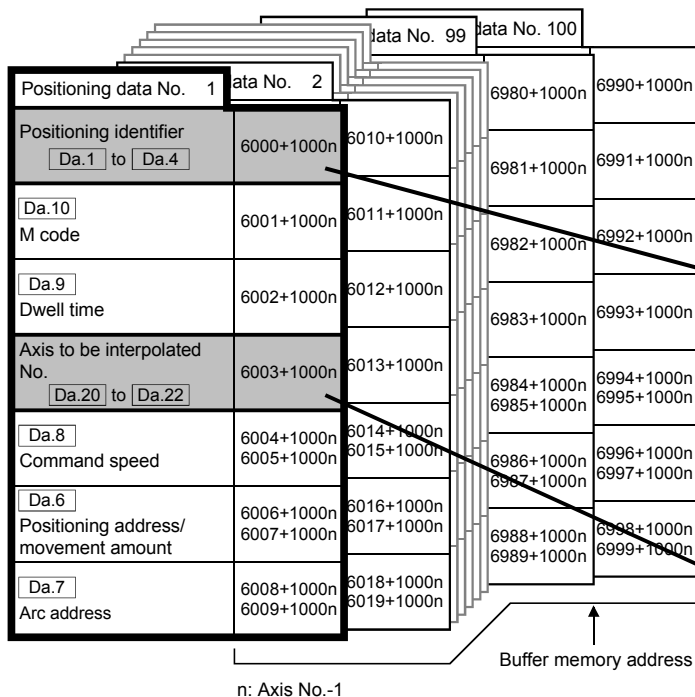

- Up to 100 positioning data items can be set (stored) for each axis in the buffer memory address shown on the left. No.101 to No.600 are not allocated to buffer memory. Set with GX Works2. Data is controlled as positioning data No. 1 to 600 for each axis.
- One positioning data item is configured of the items shown in the bold box.

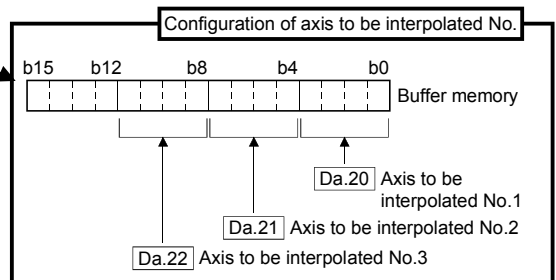
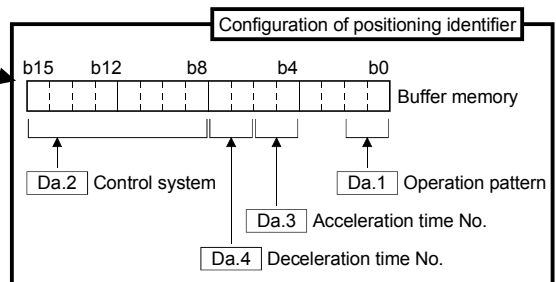

The descriptions that follow relate to the positioning data set items Da.1 to Da.10, Da.20 to Da.22.

(The buffer memory addresses shown are those of the "positioning data No. 1".)

- Guide to buffer memory address

In the buffer memory address, "n" in "6001+1000n", etc. indicates a value corresponding to axis No. such as the following table.

Axis No.	n	Axis No.	n	Axis No.	n	Axis No.	n
1	0	5	4	9	8	13	12
2	1	6	5	10	9	14	13
3	2	7	6	11	10	15	14
4	3	8	7	12	11	16	15

(Note-1): Calculate as follows for the buffer memory address corresponding to each axis.

(Example) For axis No. 16

$$6001+1000n (\text{Da.10 M code})=6001+1000 \times 15=21001$$

$$6009+1000n (\text{Da.7 Arc address})= 6009+1000 \times 15=21009$$

(Note-2): The range (n=0 to 3) of axis No.1 to 4 is valid in the LD77MH4.



Item	Setting value		Default value	Setting value buffer memory address	
	Value set with GX Works2	Value set with sequence program		LD77MH4	LD77MH16
Da.1 Operation pattern  Da.2 Control system  Positioning identifier	00: Positioning complete	00	● Operation pattern  ● Control system  ● Acceleration time  ● Deceleration time  ● Axis to be interpolated (in 2-axis interpolation only)	0000H 2000+6000n 6000+1000n	
	01: Continuous positioning control	01			
	11: Continuous path control	11			
	ABS1 : 1-axis linear control (ABS)	01H			
	INC1 : 1-axis linear control (INC)	02H			
	FEED1: 1-axis fixed-feed control	03H			
	VF1 : 1-axis speed control (forward run)	04H			
	VR1 : 1-axis speed control (reverse run)	05H			
	VPF : Speed-position switching control (forward run)	06H			
	VPR : Speed-position switching control (reverse run)	07H			
	PVF : Position-speed switching control (forward run)	08H			
	PVR : Position-speed switching control (reverse run)	09H			
	ABS2 : 2-axis linear interpolation control (ABS)	0AH			
	INC2 : 2-axis linear interpolation control (INC)	0BH			
	FEED2: Fixed-feed control by 2-axis linear interpolation	0CH			
	ABS $\frown$ : Circular interpolation control with sub point specified (ABS)	0DH			
	INC $\frown$ : Circular interpolation control with sub point specified (INC)	0EH			
	ABS $\cdot$ : Circular interpolation control with center point specified (ABS, CW)	0FH			
	ABS $\cdot$ : Circular interpolation control with center point specified (ABS, CCW)	10H			
	INC $\cdot$ : Circular interpolation control with center point specified (INC, CW)	11H			
	INC $\cdot$ : Circular interpolation control with center point specified (INC, CCW)	12H			
	VF2 : 2-axis speed control (forward run)	13H			
	VR2 : 2-axis speed control (reverse run)	14H			
	ABS3 : 3-axis linear interpolation control (ABS)	15H			
	INC3 : 3-axis linear interpolation control (INC)	16H			
	FEED3: Fixed-feed control by 3-axis linear interpolation control	17H			
	VF3 : 3-axis speed control (forward run)	18H			
	VR3 : 3-axis speed control (reverse run)	19H			
	ABS4 : 4-axis linear interpolation control (ABS)	1AH			
	INC4 : 4-axis linear interpolation control (INC)	1BH			
	FEED4: Fixed-feed control by 4-axis linear interpolation control	1CH			
	VF4 : 4-axis speed control (forward run)	1DH			
	VR4 : 4-axis speed control (reverse run)	1EH			
	NOP : NOP instruction	80H			
POS : Current value changing	81H				
JUMP : JUMP instruction	82H				
LOOP : Declares the beginning of LOOP to LEND section	83H				
LEND : Declares the end of LOOP to LEND section	84H				
Da.3 Acceleration time No.	0: [Pr.9] Acceleration time 0	00			
	1: [Pr.25] Acceleration time 1	01			
	2: [Pr.26] Acceleration time 2	10			
	3: [Pr.27] Acceleration time 3	11			
Da.4 Deceleration time No.	0: [Pr.10] Deceleration time 0	00			
	1: [Pr.28] Deceleration time 1	01			
	2: [Pr.29] Deceleration time 2	10			
	3: [Pr.30] Deceleration time 3	11			
Da.5 Axis to be interpolated LD77MH4	0: Axis1	00			
	1: Axis 2	01			
	2: Axis 3	10			
	3: Axis 4	11			

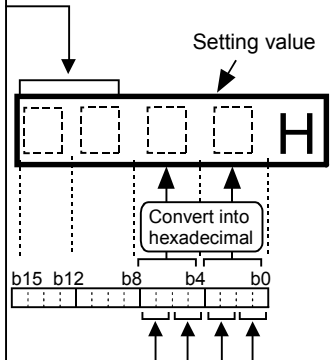

n: Axis No.-1

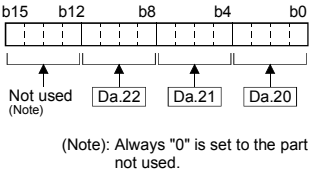
Item	Setting value, setting range		Default value	Setting value buffer memory address		
	Value set with GX Works2	Value set with sequence program		LD77MH4	LD77MH16	
Da.6 Positioning address/ movement amount	The setting value range differs according to the " Da.2 Control system".		0	2006+6000n 2007+6000n	6006+1000n 6007+1000n	
Da.7 Arc address			0	2008+6000n 2009+6000n	6008+1000n 6009+1000n	
Da.8 Command speed	The setting value range differs depending on the " Pr.1 Unit setting". -1: Current speed (Speed set for previous positioning data No.)		0	2004+6000n 2005+6000n	6004+1000n 6005+1000n	
Da.9 Dwell time/ JUMP destination positioning data No.	Dwell time JUMP destination positioning data No.	The setting value range differs according to the " Da.2 Control system".	0	2002+6000n	6002+1000n	
Da.10 M code	M code Condition data No. Number of LOOP to LEND repetitions		0	2001+6000n	6001+1000n	
Axis to be interpolated	Da.20 Axis to be interpolated No.1 LD77MH16	0: Axis 1 selected	0H		0000H	6003+1000n
	Da.21 Axis to be interpolated No.2 LD77MH16	1: Axis 2 selected	1H			
	Da.22 Axis to be interpolated No.3 LD77MH16	2: Axis 3 selected	2H			
		3: Axis 4 selected	3H			
		4: Axis 5 selected	4H			
		5: Axis 6 selected	5H			
		6: Axis 7 selected	6H			
		7: Axis 8 selected	7H			
		8: Axis 9 selected	8H			
		9: Axis 10 selected	9H			
		A: Axis 11 selected	AH			
		B: Axis 12 selected	BH			
		C: Axis 13 selected	CH			
		D: Axis 14 selected	DH			
		E: Axis 15 selected	EH			
		F: Axis 16 selected	FH			

n: Axis No.-1

**Da.1** Operation pattern

The operation pattern designates whether positioning of a certain data No. is to be ended with just that data, or whether the positioning for the next data No. is to be carried out in succession.

[Operation pattern]

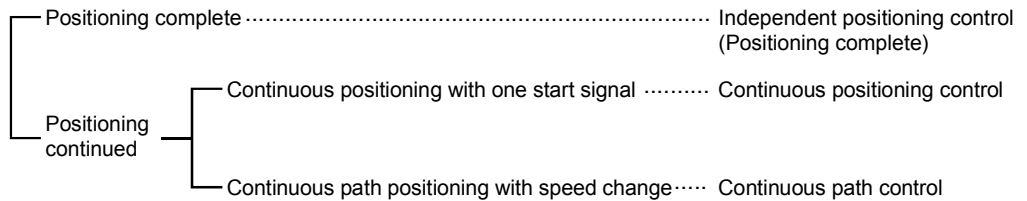

- 1) Positioning complete ..... Set to execute positioning to the designated address, and then complete positioning.
- 2) Continuous positioning control ..... Positioning is carried out successively in order of data Nos. with one start signal. The operation halts at each position indicated by a positioning data.
- 3) Continuous path control..... Positioning is carried out successively in order of data Nos. with one start signal. The operation does not stop at each positioning data.

**Da.2** Control system

Set the "control system" for carrying out positioning control.

- Note)
- When "JUMP instruction" is set for the control system, the " **Da.9** Dwell time" and " **Da.10** M code" setting details will differ.
  - In case you selected "LOOP" as the control system, the " **Da.10** M code" should be set differently from other cases.
  - Refer to Chapter 9 "Major Positioning Control" for details on the control systems.
  - If "degree" is set for " **Pr.1** Unit setting", circular interpolation control cannot be carried out. (The "Circular interpolation not possible error" will occur when executed (error code: 535).)

**Da.3** Acceleration time No.

Set which of "acceleration time 0 to 3" to use for the acceleration time during positioning.

- 0 : Use the value set in " **Pr.9** Acceleration time 0".
- 1 : Use the value set in " **Pr.25** Acceleration time 1".
- 2 : Use the value set in " **Pr.26** Acceleration time 2".
- 3 : Use the value set in " **Pr.27** Acceleration time 3".

**Da.4** Deceleration time No.

Set which of "deceleration time 0 to 3" to use for the deceleration time during positioning.

0 : Use the value set in " **Pr.10** Deceleration time 0".

1 : Use the value set in " **Pr.28** Deceleration time 1".

2 : Use the value set in " **Pr.29** Deceleration time 2".

3 : Use the value set in " **Pr.30** Deceleration time 3".

**Da.5** Axis to be interpolated **LD77MH4**

Set the target axis (partner axis) for operations under the 2-axis interpolation control.

0 : Selects the axis 1 as the target axis (partner axis).

1 : Selects the axis 2 as the target axis (partner axis).

2 : Selects the axis 3 as the target axis (partner axis).

3 : Selects the axis 4 as the target axis (partner axis).

- Note)
- Do not specify the own axis number or any number except the above. (If you do, the "Illegal interpolation description command error" will occur during the program execution (error code: 521).)
  - This item does not need to be set in case 3 or 4-axis interpolation is selected.

**Da.6** Positioning address/movement amount

Set the address to be used as the target value for positioning control.

The setting value range differs according to the " **Da.2** Control system".

((1) to (4))

(1) Absolute (ABS) system, current value changing

- The setting value (positioning address) for the ABS system and current value changing is set with an absolute address (address from OP).

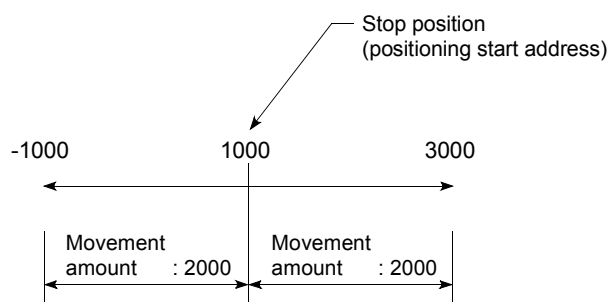

(2) Incremental (INC) system, fixed-feed 1, fixed-feed 2, fixed-feed 3, fixed-feed 4

- The setting value (movement amount) for the INC system is set as a movement amount with sign.

When movement amount is positive: Moves in the positive direction (address increment direction)

When movement amount is negative: Moves in the negative direction (address decrement direction)

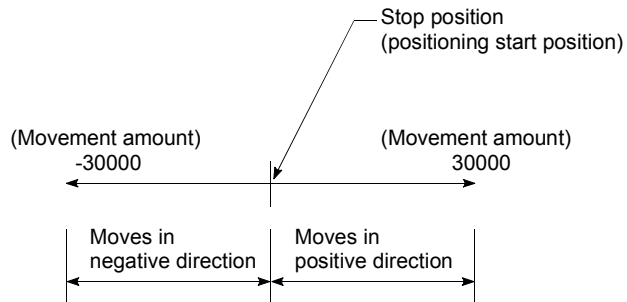

(3) Speed-position switching control

- INC mode:  
Set the amount of movement after the switching from speed control to position control.
- ABS mode:  
Set the absolute address which will be the target value after speed control is switched to position control. (The unit is "degree" only)

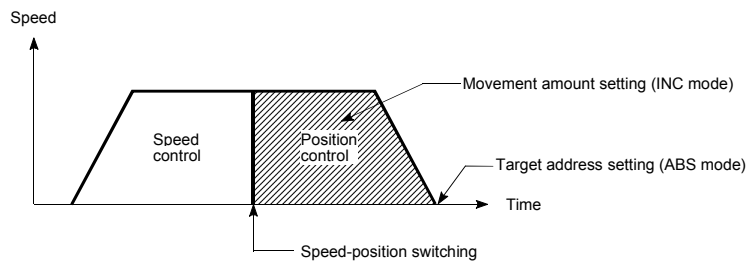

(4) Position-speed switching control

- Set the amount of movement before the switching from position control to speed control.

■ When " Pr.1 Unit Setting" is "mm"

The table below lists the control systems that require the setting of the positioning address or movement amount and the associated setting ranges.

(With any control system excluded from the table below, neither the positioning address nor the movement amount needs to be set.)

Da.2 setting value	Value set with GX Works2 ( $\mu\text{m}$ )	Value set with sequence program *1 ( $\times 10^{-1}\mu\text{m}$ )
ABS Linear 1 : 01H ABS Linear 2 : 0AH ABS Linear 3 : 15H ABS Linear 4 : 1AH Current value changing : 81H	◇ Set the address -214748364.8 to 214748364.7	◇ Set the address -2147483648 to 2147483647
INC Linear 1 : 02H INC Linear 2 : 0BH INC Linear 3 : 16H INC Linear 4 : 1BH Fixed-feed 1 : 03H Fixed-feed 2 : 0CH Fixed-feed 3 : 17H Fixed-feed 4 : 1CH	◇ Set the movement amount -214748364.8 to 214748364.7	◇ Set the movement amount -2147483648 to 2147483647
Forward run speed/position : 06H Reverse run speed/position : 07H Forward run position/speed : 08H Reverse run position/speed : 09H	◇ Set the movement amount 0 to 214748364.7	◇ Set the movement amount 0 to 2147483647
ABS circular sub : 0DH ABS circular right : 0FH ABS circular left : 10H	◇ Set the address -214748364.8 to 214748364.7	◇ Set the address -2147483648 to 2147483647
INC circular sub : 0EH INC circular right : 11H INC circular left : 12H	◇ Set the movement amount -214748364.8 to 214748364.7	◇ Set the movement amount -2147483648 to 2147483647

\*1: Set an integer because the sequence program cannot handle fractions.  
(The value will be converted properly within the system.)

■ When " [Pr.1] Unit Setting" is "degree"

The table below lists the control systems that require the setting of the positioning address or movement amount and the associated setting ranges.

(With any control system excluded from the table below, neither the positioning address nor the movement amount needs to be set.)

[Da.2] setting value	Value set with GX Works2 (degree)	Value set with sequence program *1 ( $\times 10^{-5}$ degree)
ABS Linear 1 : 01H ABS Linear 2 : 0AH ABS Linear 3 : 15H ABS Linear 4 : 1AH Current value changing : 81H	◇ Set the address 0 to 359.99999	◇ Set the address 0 to 35999999
INC Linear 1 : 02H INC Linear 2 : 0BH INC Linear 3 : 16H INC Linear 4 : 1BH Fixed-feed 1 : 03H Fixed-feed 2 : 0CH Fixed-feed 3 : 17H Fixed-feed 4 : 1CH	◇ Set the movement amount -21474.83648 to 21474.83647	◇ Set the movement amount -2147483648 to 2147483647 *2
Forward run speed/position : 06H Reverse run speed/position : 07H	In INC mode ◇ Set the movement amount 0 to 21474.83647 In ABS mode ◇ Set the address 0 to 359.99999	In INC mode ◇ Set the movement amount 0 to 2147483647 In ABS mode ◇ Set the address 0 to 35999999
Forward run position/speed : 08H Reverse run position/speed : 09H	◇ Set the movement amount 0 to 21474.83647	◇ Set the movement amount 0 to 2147483647

\*1: Set an integer because the sequence program cannot handle fractions.  
(The value will be converted properly within the system.)

\*2: When the software stroke limit is valid, -35999999 to 35999999 is set.

■ When " Pr.1 Unit Setting" is "PLS"

The table below lists the control systems that require the setting of the positioning address or movement amount and the associated setting ranges.

(With any control system excluded from the table below, neither the positioning address nor the movement amount needs to be set.)

Da.2 setting value	Value set with GX Works2 (PLS)	Value set with sequence program *1 (PLS)
ABS Linear 1 : 01H ABS Linear 2 : 0AH ABS Linear 3 : 15H ABS Linear 4 : 1AH Current value changing : 81H	◇ Set the address -2147483648 to 2147483647	◇ Set the address -2147483648 to 2147483647
INC Linear 1 : 02H INC Linear 2 : 0BH INC Linear 3 : 16H INC Linear 4 : 1BH Fixed-feed 1 : 03H Fixed-feed 2 : 0CH Fixed-feed 3 : 17H Fixed-feed 4 : 1CH	◇ Set the movement amount -2147483648 to 2147483647	◇ Set the movement amount -2147483648 to 2147483647
Forward run speed/position : 06H Reverse run speed/position : 07H Forward run position/speed : 08H Reverse run position/speed : 09H	◇ Set the movement amount 0 to 2147483647	◇ Set the movement amount 0 to 2147483647
ABS circular sub : 0DH ABS circular right : 0FH ABS circular left : 10H	◇ Set the address -2147483648 to 2147483647	◇ Set the address -2147483648 to 2147483647
INC circular sub : 0EH INC circular right : 11H INC circular left : 12H	◇ Set the movement amount -2147483648 to 2147483647	◇ Set the movement amount -2147483648 to 2147483647



■ When " [Pr.1] Unit Setting" is "inch"

The table below lists the control systems that require the setting of the positioning address or movement amount and the associated setting ranges.

(With any control system excluded from the table below, neither the positioning address nor the movement amount needs to be set.)

[Da.2] setting value	Value set with GX Works2 (inch)	Value set with sequence program *1 ( $\times 10^{-5}$ inch)
ABS Linear 1 : 01H ABS Linear 2 : 0AH ABS Linear 3 : 15H ABS Linear 4 : 1AH Current value changing : 81H	◇ Set the address -21474.83648 to 21474.83647	◇ Set the address -2147483648 to 2147483647
INC Linear 1 : 02H INC Linear 2 : 0BH INC Linear 3 : 16H INC Linear 4 : 1BH Fixed-feed 1 : 03H Fixed-feed 2 : 0CH Fixed-feed 3 : 17H Fixed-feed 4 : 1CH	◇ Set the movement amount -21474.83648 to 21474.83647	◇ Set the movement amount -2147483648 to 2147483647
Forward run speed/position : 06H Reverse run speed/position : 07H Forward run position/speed : 08H Reverse run position/speed : 09H	◇ Set the movement amount 0 to 21474.83647	◇ Set the movement amount 0 to 2147483647
ABS circular sub : 0DH ABS circular right : 0FH ABS circular left : 10H	◇ Set the address -21474.83648 to 21474.83647	◇ Set the address -2147483648 to 2147483647
INC circular sub : 0EH INC circular right : 11H INC circular left : 12H	◇ Set the movement amount -21474.83648 to 21474.83647	◇ Set the movement amount -2147483648 to 2147483647

\*1: Set an integer because the sequence program cannot handle fractions.  
(The value will be converted properly within the system.)

### [Da.7] Arc address

The arc address is data required only when carrying out circular interpolation control.

- (1) When carrying out circular interpolation with sub point designation, set the sub point (passing point) address as the arc address.
- (2) When carrying out circular interpolation with center point designation, set the center point address of the arc as the arc address.

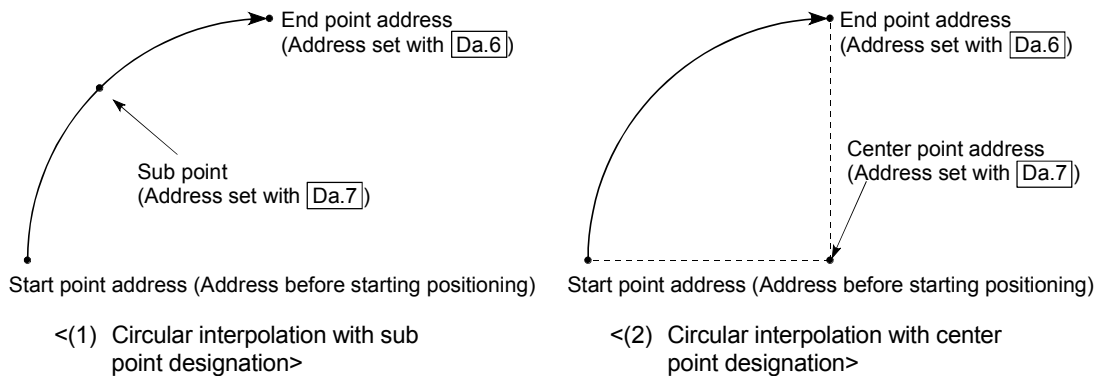

When not carrying out circular interpolation control, the value set in " [Da.7] Arc address" will be invalid.

■ When " [Pr.1] Unit Setting" is "mm"

The table below lists the control systems that require the setting of the arc address and shows the setting range.

(With any control system excluded from the table below, the arc address does not need to be set.)

[Da.2] setting value	Value set with GX Works2 ( $\mu\text{m}$ )	Value set with sequence program *1 ( $\times 10^{-1}\mu\text{m}$ )
ABS circular sub : 0DH ABS circular right : 0FH ABS circular left : 10H	◇ Set the address -214748364.8 to 214748364.7 *2	◇ Set the address -2147483648 to 2147483647
INC circular sub : 0EH INC circular right : 11H INC circular left : 12H	◇ Set the movement amount -214748364.8 to 214748364.7 *2	◇ Set the movement amount -2147483648 to 2147483647 *2

\*1: Set an integer because the sequence program cannot handle fractions.  
(The value will be converted properly within the system.)

\*2: Note that the maximum radius that circular interpolation control is possible is  $536870912 (\times 10^{-1}\mu\text{m})$ , although the setting value can be input within the range shown in the above table, as an arc address.

■ When " [Pr.1] Unit Setting" is "degree"

No control system requires the setting of the arc address by "degree".

■ When " [Pr.1] Unit Setting" is "PLS"

The table below lists the control systems that require the setting of the arc address and shows the setting range.

(With any control system excluded from the table below, the arc address does not need to be set.)

[Da.2] setting value	Value set with GX Works2 (PLS)	Value set with sequence program *1 (PLS)
ABS circular sub : 0DH ABS circular right : 0FH ABS circular left : 10H	◇ Set the address -2147483648 to 2147483647 *1	◇ Set the address -2147483648 to 2147483647
INC circular sub : 0EH INC circular right : 11H INC circular left : 12H	◇ Set the movement amount -2147483648 to 2147483647 *1	◇ Set the movement amount -2147483648 to 2147483647 *1

\*1: Note that the maximum radius that circular interpolation control is possible is 536870912 (PLS), although the setting value can be input within the range shown in the above table, as an arc address.

■ When " [Pr.1] Unit Setting" is "inch"

The table below lists the control systems that require the setting of the arc address and shows the setting range.

(With any control system excluded from the table below, the arc address does not need to be set.)

[Da.2] setting value	Value set with GX Works2 (inch)	Value set with sequence program *1 ( $\times 10^{-5}$ inch)
ABS circular sub : 0DH ABS circular right : 0FH ABS circular left : 10H	◇ Set the address -21474.83648 to 21474.83647 *2	◇ Set the address -2147483648 to 2147483647
INC circular sub : 0EH INC circular right : 11H INC circular left : 12H	◇ Set the movement amount -21474.83648 to 21474.83647 *2	◇ Set the movement amount -2147483648 to 2147483647 *2

\*1: Set an integer because the sequence program cannot handle fractions.  
(The value will be converted properly within the system.)

\*2: Note that the maximum radius that circular interpolation control is possible is  $536870912 (\times 10^{-5}$  inch), although the setting value can be input within the range shown in the above table, as an arc address.

[Da.8] Command speed

Set the command speed for positioning.

- (1) If the set command speed exceeds " [Pr.8] Speed limit value", positioning will be carried out at the speed limit value.
- (2) If "-1" is set for the command speed, the current speed (speed set for previous positioning data No.) will be used for positioning control. Use the current speed for uniform speed control, etc. If "-1" is set for continuing positioning data, and the speed is changed, the following speed will also change.

(Note that when starting positioning, if the "-1" speed is set for the positioning data that carries out positioning control first, the error "Command speed is not set"(error code: 503) will occur, and the positioning will not start. Refer to Section 16.5 "List of errors" for details on the errors.)

[Pr.1] setting value	Value set with GX Works2 (unit)	Value set with sequence program (unit)
0 : mm	0.01 to 20000000.00 (mm/min)	1 to 2000000000 ( $\times 10^{-2}$ mm/min)
1 : inch	0.001 to 2000000.000 (inch/min)	1 to 2000000000 ( $\times 10^{-3}$ inch/min)
2 : degree	0.001 to 2000000.000 (degree/min) *1	1 to 2000000000 ( $\times 10^{-3}$ degree/min) *2
3 : PLS	1 to 50000000 (PLS/s)	1 to 50000000 (PLS/s)

\*1: The command speed setting range is 0.001 to 2000000.000[degree/min], but it will be decupled and become 0.01 to 20000000.00[degree/min] by setting " [Pr.83] Speed control 10 x multiplier setting for degree axis" to valid.

\*2: The command speed setting range is 1 to 2000000000( $\times 10^{-3}$ degree/min), but it will be decupled and become 1 to 2000000000 ( $\times 10^{-2}$ degree/min) by setting " [Pr.83] Speed control 10 x multiplier setting for degree axis" to valid.

**Da.9** Dwell time/JUMP designation positioning data No.

Set the "dwell time" or "positioning data No." corresponding to the "**Da.2** Control system".

- When a method other than "JUMP instruction" is set for "**Da.2** Control system" ..... Set the "dwell time".
- When "JUMP instruction" is set for "**Da.2** Control system" ..... Set the "positioning data No." for the JUMP destination.

When the "dwell time" is set, the setting details of the "dwell time" will be as follows according to "**Da.1** Operation pattern".

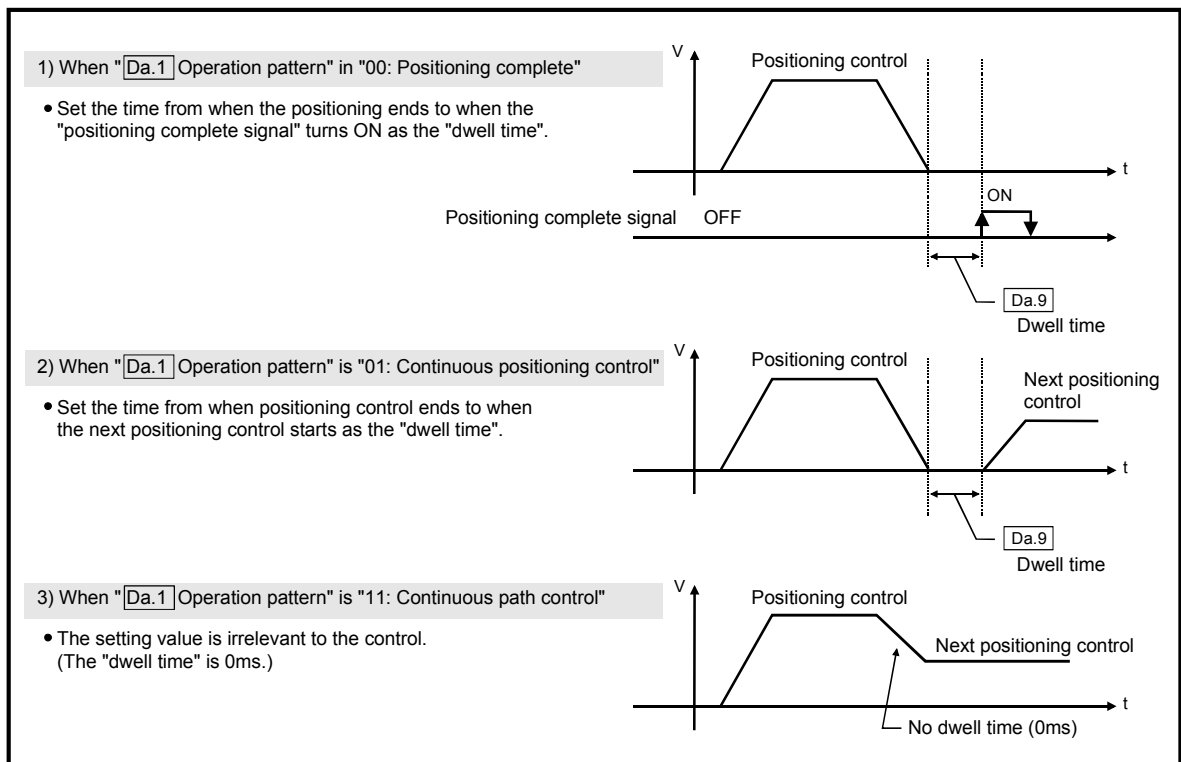

<b>Da.2</b> setting value	Setting item	Value set with GX Works2	Value set with sequence program
JUMP instruction: 82H	Positioning data No.	1 to 600	1 to 600
Other than JUMP instruction	Dwell time	0 to 65535 (ms)	0 to 65535 (ms)

**Da.10** M code (or condition data No./Number of LOOP to LEND repetitions)

Set an "M code", a "condition data No.", or the "Number of LOOP to LEND repetitions" depending on how the " **Da.2** Control system" is set. \*1

- If a method other than "JUMP instruction" and "LOOP" is selected as the " **Da.2** Control system"

..... Set an "M code".  
 If no "M code" needs to be output, set "0" (default value).

- If "JUMP instruction" or "LOOP" is selected as the " **Da.2** Control system"

..... Set the "condition data No." for JUMP.  
 0 : Unconditional JUMP to the positioning data specified by **Da.9** .

1 to 10 : JUMP performed according to the condition data No. specified (a number between 1 and 10).

Make sure that you specify the number of LOOP to LEND repetitions by a number other than "0". The "Control system LOOP setting error" will occur if you specify "0". (error code: 545)

\*1: The condition data specifies the condition for the JUMP instruction to be executed.

(A JUMP will take place when the condition is satisfied.)

<b>Da.2</b> setting value	Setting item	Value set with GX Works2	Value set with sequence program
JUMP instruction: 82H	Condition data No.	0 to 10	0 to 10
Other than JUMP instruction	M code	0 to 65535	0 to 65535
LOOP: 83H	Repetition count	1 to 65535	1 to 65535

[Da.20] Axis to be interpolated No.1 to [Da.22] Axis to be interpolated No.3

**LD77MH16**

Set the axis to be interpolated to execute the 2 to 4-axis interpolation operation.

- 2-axis interpolation ..... Set the target axis number in "[Da.20] Axis to be interpolated No.1".
- 3-axis interpolation ..... Set the target axis number in "[Da.20] Axis to be interpolated No.1" and "[Da.21] Axis to be interpolated No.2".
- 4-axis interpolation ..... Set the target axis number in "[Da.20] Axis to be interpolated No.1" to "[Da.22] Axis to be interpolated No.3".

Set the axis set as axis to be interpolated.

0: Axis 1	8: Axis 9
1: Axis 2	9: Axis 10
2: Axis 3	A: Axis 11
3: Axis 4	B: Axis 12
4: Axis 5	C: Axis 13
5: Axis 6	D: Axis 14
6: Axis 7	E: Axis 15
7: Axis 8	F: Axis 16

- Note)
- Do not specify the own axis number. (If you do, the "Illegal interpolation description command error" will occur during the program execution (error code: 521).)
  - When the same axis number or axis number of own axis is set to multiple axis to be interpolated number, the "Illegal interpolation description command error" will occur during the program execution (error code: 521).
  - Do not specify the axis to be interpolated No.2 and axis to be interpolated No.3 for 2-axis interpolation, and do not specify the axis to be interpolated No.3 for 3-axis interpolation. The setting value is ignored.

### 5.4 List of block start data

The illustrations below show the organization of the block start data stored in the LD77MH buffer memory. The block start data setting items **Da.11** to **Da.14** are explained in the pages that follow.

• LD77MH4

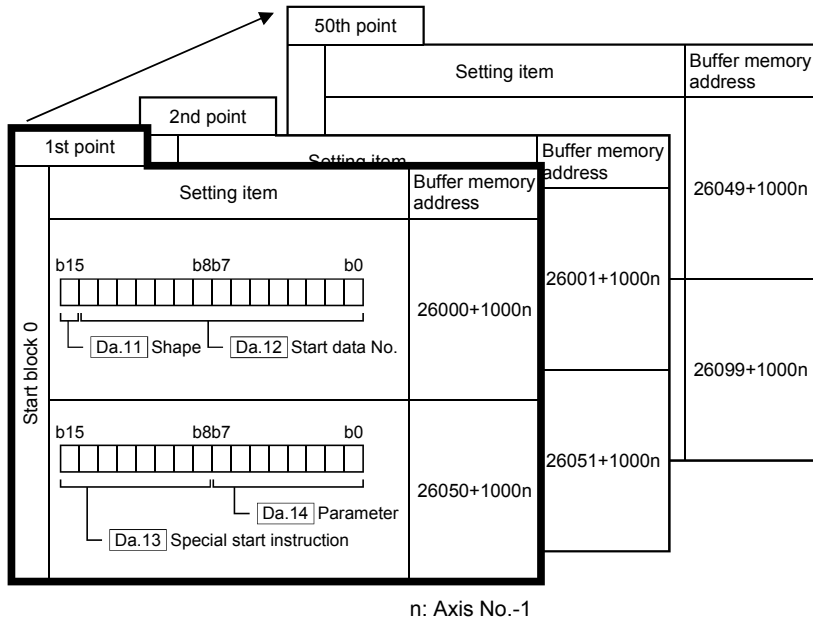

- Up to 50 block start data points can be set (stored) for each axis in the buffer memory addresses shown on the left.
- Items in a single unit of block start data are shown included in a bold frame.
- Each axis has five start blocks (block Nos. 0 to 4).

(Note): For information on the organization of the buffer memory addresses assigned to the start blocks 1 to 4, refer to Appendix 8 "List of buffer memory addresses".

• LD77MH16

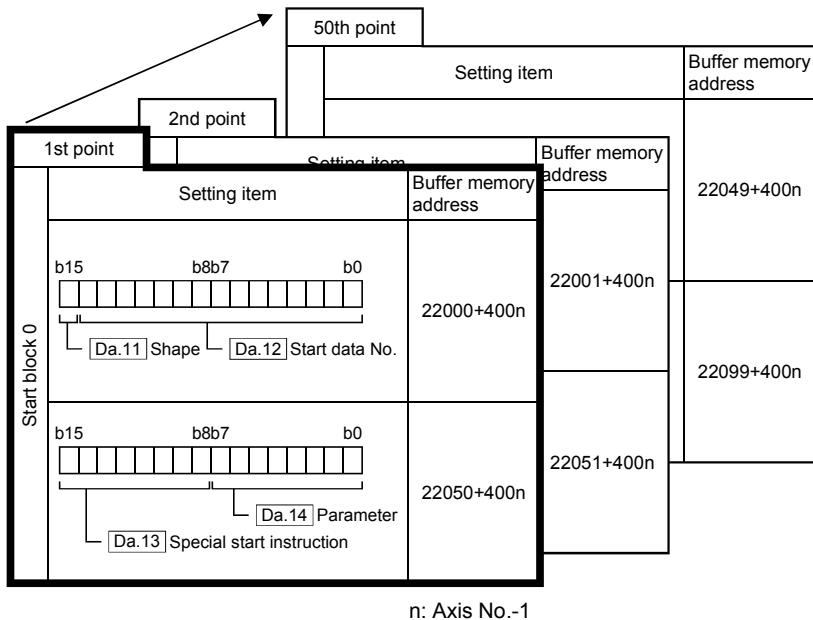

- Up to 50 block start data points can be set (stored) for each axis in the buffer memory addresses shown on the left.
- Items in a single unit of block start data are shown included in a bold frame.
- Each axis has five start blocks (block Nos. 0 to 4). Start block 2 to 4 are not allocated to buffer memory. Set with GX Works2.

(Note): For information on the organization of the buffer memory addresses assigned to the start block 1, refer to Appendix 8 "List of buffer memory addresses".

The pages that follow explain the block start data setting items [Da.11] to [Da.14].  
 (The buffer memory addresses shown are those of the "1st point block start data (block No. 7000)".)

• Guide to buffer memory address

In the buffer memory address, "n" in "22000+400n", etc. indicates a value corresponding to axis No. such as the following table.

Axis No.	n	Axis No.	n	Axis No.	n	Axis No.	n
1	0	5	4	9	8	13	12
2	1	6	5	10	9	14	13
3	2	7	6	11	10	15	14
4	3	8	7	12	11	16	15

(Note-1): Calculate as follows for the buffer memory address corresponding to each axis.

(Example) For axis No. 16

$$22000+400n \text{ ([Da.11] Shape)}=22000+400 \times 15=28000$$

$$22050+400n \text{ ([Da.13] Special start instruction)}=22050+400 \times 15=28050$$

(Note-2): The range (n=0 to 3) of axis No.1 to 4 is valid in the LD77MH4.



**REMARK**

To perform an high-level positioning control using block start data, set a number between 7000 and 7004 to the " **Cd.3** Positioning start No." and use the " **Cd.4** Positioning starting point No." to specify a point number between 1 and 50, a position counted from the beginning of the block.

The number between 7000 and 7004 specified here is called the "block No."

With the LD77MH, up to 50 "block start data" points and up to 10 "condition data" items can be assigned to each "block No."

• LD77MH4

Block No. *1	Axis	Block start data	Condition	Buffer memory	GX Works2
7000	Axis 1	Start block 0	Condition data (1 to 10)	Supports the settings	Supports the settings
	Axis 2		Condition data (1 to 10)		
	Axis 3		Condition data (1 to 10)		
	Axis 4		Condition data (1 to 10)		
7001	Axis 1	Start block 1	Condition data (1 to 10)		
	Axis 2		Condition data (1 to 10)		
	Axis 3		Condition data (1 to 10)		
	Axis 4		Condition data (1 to 10)		
7002	Axis 1	Start block 2	Condition data (1 to 10)		
	Axis 2		Condition data (1 to 10)		
	Axis 3		Condition data (1 to 10)		
	Axis 4		Condition data (1 to 10)		
7003	Axis 1	Start block 3	Condition data (1 to 10)		
	Axis 2		Condition data (1 to 10)		
	Axis 3		Condition data (1 to 10)		
	Axis 4		Condition data (1 to 10)		
7004	Axis 1	Start block 4	Condition data (1 to 10)		
	Axis 2		Condition data (1 to 10)		
	Axis 3		Condition data (1 to 10)		
	Axis 4		Condition data (1 to 10)		

\*1: Setting cannot be made when the "Pre-reading start function" is used. If you set any of Nos. 7000 to 7004 and perform the Pre-reading start function, "Outside start No. range error (error code: 543)" will occur.

(For details, refer to Section 13.7.7 "Pre-reading start function".)

• LD77MH16

Block No. *1	Axis	Block start data	Condition	Buffer memory	GX Works2
7000	Axis 1	Start block 0	Condition data (1 to 10)	Supports the settings	
	to		to		
	Axis 16		Condition data (1 to 10)		
7001	Axis 1	Start block 1	Condition data (1 to 10)		
	to		to		
	Axis 16		Condition data (1 to 10)		
7002	Axis 1	Start block 2	Condition data (1 to 10)		
	to		to		
	Axis 16		Condition data (1 to 10)		
7003	Axis 1	Start block 3	Condition data (1 to 10)		
	to		to		
	Axis 16		Condition data (1 to 10)		
7004	Axis 1	Start block 4	Condition data (1 to 10)		
	to		to		
	Axis 16		Condition data (1 to 10)		

\*1: Setting cannot be made when the "Pre-reading start function" is used. If you set any of Nos. 7000 to 7004 and perform the Pre-reading start function, "Outside start No. range error (error code: 543)" will occur.  
 (For details, refer to Section 13.7.7 "Pre-reading start function".)

Item	Setting value		Default value	Setting value buffer memory address	
	Value set with GX Works2	Value set with sequence program		LD77MH4	LD77MH16
Da.11 Shape	0 : End	0	0000H	26000+1000n	22000+400n
	1 : Continue	1			
Da.12 Start data No.	Positioning data No.: 1 to 600 (01H to 258H)	01H to 258H			
Da.13 Special start instruction	0 : Block start (normal start)	00H	0000H	26050+1000n	22050+400n
	1 : Condition start	01H			
	2 : Wait start	02H			
	3 : Simultaneous start	03H			
	4 : FOR loop	04H			
	5 : FOR condition	05H			
	6 : NEXT start	06H			
Da.14 Parameter	Condition data No.: 1 to 10 (01H to 0AH) Number of repetitions: 0 to 255 (00H to FFH)	00H to FFH			

**Da.11** Shape

Set whether to carry out only the local "block start data" and then end control, or to execute the "block start data" set in the next point.

Setting value	Setting details
0 : End	Execute the designated point's "block start data", and then complete the control.
1 : Continue	Execute the designated point's "block start data", and after completing control, execute the next point's "block start data".

**Da.12** Start data No.

Set the "positioning data No." designated with the "block start data".

**Da.13** Special start instruction

Set the "special start instruction " for using "high-level positioning control". (Set how to start the positioning data set in " **Da.12** Start data No.".)

Setting value	Setting details
00H: Block start (Normal start)	Execute the random block positioning data in the set order with one start.
01H: Condition start	Carry out the condition judgment set in "condition data" for the designated positioning data, and when the conditions are established, execute the "block start data". If not established, ignore that "block start data", and then execute the next point's "block start data".
02H: Wait start	Carry out the condition judgment set in "condition data" for the designated positioning data, and when the conditions are established, execute the "block start data". If not established, stop the control (wait) until the conditions are established.
03H: Simultaneous start	Simultaneous execute (output command at same timing) the positioning data with the No. designated for the axis designated in the "condition data". Up to four axes can start simultaneously.
04H: Repeated start (FOR loop)	Repeat the program from the block start data with the "FOR loop" to the block start data with "NEXT" for the designated number of times.
05H: Repeated start (FOR condition)	Repeat the program from the block start data with the "FOR condition" to the block start data with "NEXT" until the conditions set in the "condition data" are established.
06H: NEXT start	Set the end of the repetition when "04H: Repetition start (FOR loop)" or "05H: Repetition start (FOR condition)" is set.

Refer to Chapter 10 "High-Level Positioning Control" for details on the control.

**Da.14** Parameter

Set the value as required for " **Da.13** Special start instruction ".

<b>Da.13</b> Special start instruction	Setting value	Setting details
Block start (Normal start)	–	Not used. (There is no need to set.)
Condition start	1 to 10	Set the condition data No. (Data No. of "condition data" is set up for the condition judgment.)
Wait start		
Simultaneous start		
Repeated start (FOR loop)	0 to 255	Set the number of repetitions.
Repeated start (FOR condition)	1 to 10	Set the condition data No. (Data No. of "condition data" is set up for the condition judgment.)

5.5 List of condition data

The illustrations below show the organization of the condition data stored in the LD77MH buffer memory. The condition data setting items **Da.15** to **Da.19**, **Da.23** to **Da.26** are explained in the pages that follow.

• LD77MH4

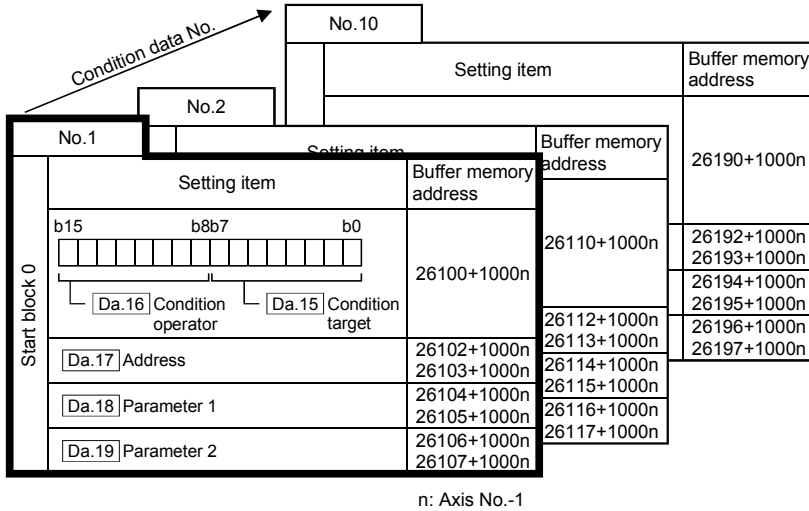

- Up to 10 condition data points can be set (stored) for each axis in the buffer memory addresses shown on the left.
  - Items in a single unit of condition data are shown included in a bold frame.
  - Each axis has five start blocks (block Nos. 0 to 4).
- (Note): For information on the organization of the buffer memory addresses assigned to the start blocks 1 to 4, refer to Appendix 8 "List of buffer memory addresses".

• LD77MH16

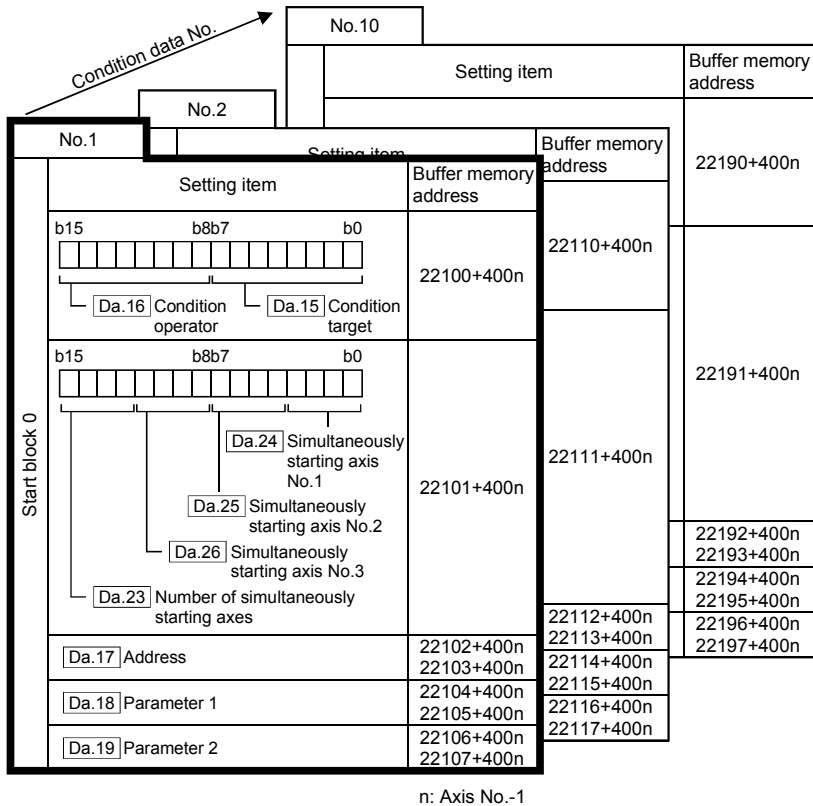

- Up to 10 condition data points can be set (stored) for each axis in the buffer memory addresses shown on the left.
  - Items in a single unit of condition data are shown included in a bold frame.
  - Each axis has five start blocks (block Nos. 0 to 4). Start block 2 to 4 are not allocated to buffer memory. Set with GX Works2.
- (Note): For information on the organization of the buffer memory addresses assigned to the start block 1, refer to Appendix 8 "List of buffer memory addresses".

The pages that follow explain the condition data setting items [Da.15] to [Da.19], [Da.23] to [Da.26].

(The buffer memory addresses shown are those of the "condition data No. 1 (block No. 7000)".)

- Guide to buffer memory address

In the buffer memory address, "n" in "22100+400n", etc. indicates a value corresponding to axis No. such as the following table.

Axis No.	n	Axis No.	n	Axis No.	n	Axis No.	n
1	0	5	4	9	8	13	12
2	1	6	5	10	9	14	13
3	2	7	6	11	10	15	14
4	3	8	7	12	11	16	15

(Note-1): Calculate as follows for the buffer memory address corresponding to each axis.

(Example) For axis No. 16

$$22100+400n \text{ ([Da.16] Condition operator)}=22100+400 \times 15=28100$$

$$22106+400n \text{ ([Da.19] Parameter 2)}=22106+400 \times 15=28106$$

(Note-2): The range (n=0 to 3) of axis No.1 to 4 is valid in the LD77MH4.

**REMARK**

To perform an high-level positioning control using block start data, set a number between 7000 and 7004 to the " **Cd.3** Positioning start No." and use the " **Cd.4** Positioning starting point No." to specify a point number between 1 and 50, a position counted from the beginning of the block.

The number between 7000 and 7004 specified here is called the "block No."

With the LD77MH, up to 50 "block start data" points and up to 10 "condition data" items can be assigned to each "block No."

• LD77MH4

Block No. *1	Axis	Block start data	Condition	Buffer memory	GX Works2
7000	Axis 1	Start block 0	Condition data (1 to 10)	Supports the settings	Supports the settings
	Axis 2		Condition data (1 to 10)		
	Axis 3		Condition data (1 to 10)		
	Axis 4		Condition data (1 to 10)		
7001	Axis 1	Start block 1	Condition data (1 to 10)		
	Axis 2		Condition data (1 to 10)		
	Axis 3		Condition data (1 to 10)		
	Axis 4		Condition data (1 to 10)		
7002	Axis 1	Start block 2	Condition data (1 to 10)		
	Axis 2		Condition data (1 to 10)		
	Axis 3		Condition data (1 to 10)		
	Axis 4		Condition data (1 to 10)		
7003	Axis 1	Start block 3	Condition data (1 to 10)		
	Axis 2		Condition data (1 to 10)		
	Axis 3		Condition data (1 to 10)		
	Axis 4		Condition data (1 to 10)		
7004	Axis 1	Start block 4	Condition data (1 to 10)		
	Axis 2		Condition data (1 to 10)		
	Axis 3		Condition data (1 to 10)		
	Axis 4		Condition data (1 to 10)		

\*1: Setting cannot be made when the "Pre-reading start function" is used. If you set any of Nos. 7000 to 7004 and perform the Pre-reading start function, "Outside start No. range error (error code: 543)" will occur.

(For details, refer to Section 13.7.7 "Pre-reading start function".)

• LD77MH16

Block No. *1	Axis	Block start data	Condition	Buffer memory	GX Works2
7000	Axis 1	Start block 0	Condition data (1 to 10)	Supports the settings	Supports the settings
	to		to		
	Axis 16		Condition data (1 to 10)		
7001	Axis 1	Start block 1	Condition data (1 to 10)		
	to		to		
	Axis 16		Condition data (1 to 10)		
7002	Axis 1	Start block 2	Condition data (1 to 10)		
	to		to		
	Axis 16		Condition data (1 to 10)		
7003	Axis 1	Start block 3	Condition data (1 to 10)		
	to		to		
	Axis 16		Condition data (1 to 10)		
7004	Axis 1	Start block 4	Condition data (1 to 10)		
	to		to		
	Axis 16		Condition data (1 to 10)		

\*1: Setting cannot be made when the "Pre-reading start function" is used. If you set any of Nos. 7000 to 7004 and perform the Pre-reading start function, "Outside start No. range error (error code: 543)" will occur.  
 (For details, refer to Section 13.7.7 "Pre-reading start function".)



Item	Setting value		Default value	Setting value buffer memory address		
	Value set with GX Works2	Value set with sequence program		LD77MH4	LD77MH16	
Condition identifier	Da.15 Condition target	01 : Device X 02 : Device Y 03 : Buffer memory (1-word) 04 : Buffer memory (2-word) 05 : Positioning data No.	01H 02H 03H 04H 05H	0000H	26100+1000n	22100+400n
	Da.16 Condition operator	01 : **=P1 02 : **≠P1 03 : **≤P1 04 : **≥P1 05 : P1≤**≤P2 06 : **≤P1, P2≤** 07 : DEV=ON 08 : DEV=OFF 10 : Axis 1 selected 20 : Axis 2 selected 30 : Axis 1 and 2 selected 40 : Axis 3 selected 50 : Axis 1 and 3 selected 60 : Axis 2 and 3 selected 70 : Axis 1, 2, and 3 selected 80 : Axis 4 selected 90 : Axis 1 and 4 selected A0 : Axis 2 and 4 selected B0 : Axis 1, 2, and 4 selected C0 : Axis 3 and 4 selected D0 : Axis 1, 3, and 4 selected E0 : Axis 2, 3, and 4 selected	01H 02H 03H 04H 05H 06H 07H 08H 10H 20H 30H 40H 50H 60H 70H 80H 90H A0H B0H C0H D0H E0H			
Da.17 Address	Buffer memory address	Example) 	0000H	26102+1000n 26103+1000n	22102+400n 22103+400n	
Da.18 Parameter 1	Value	Example) 	0000H	26104+1000n 26105+1000n	22104+400n 22105+400n	
Da.19 Parameter 2	Value	Example) 	0000H	26106+1000n 26107+1000n	22106+400n 22107+400n	

n: Axis No.-1

Item	Setting value		Default value	Setting value buffer memory address		
	Value set with GX Works2	Value set with sequence program		LD77MH4	LD77MH16	
Simultaneously starting axis	Da.23 Number of simultaneously starting axes LD77MH16	2: 2 axes 3: 3 axes 4: 4 axes	2H 3H 4H	0000H	22101+400n	
	Da.24 Simultaneously starting axis No.1 LD77MH16	0: Axis 1 selected 1: Axis 2 selected 2: Axis 3 selected 3: Axis 4 selected 4: Axis 5 selected	0H 1H 2H 3H 4H			
	Da.25 Simultaneously starting axis No.2 LD77MH16	5: Axis 6 selected 6: Axis 7 selected 7: Axis 8 selected 8: Axis 9 selected 9: Axis 10 selected	5H 6H 7H 8H 9H			
	Da.26 Simultaneously starting axis No.3 LD77MH16	A: Axis 11 selected B: Axis 12 selected C: Axis 13 selected D: Axis 14 selected E: Axis 15 selected F: Axis 16 selected	AH BH CH DH EH FH			

n: Axis No.-1

**Da.15** Condition target

Set the condition target as required for each control.

Setting value	Setting details
01H : Device X	Set the input/output signal ON/OFF as the conditions.
02H : Device Y	
03H : Buffer memory (1-word)	Set the value stored in the buffer memory as the condition. 03H: The target buffer memory is "1-word (16 bits)" 04H: The target buffer memory is "2-word (32 bits)"
04H : Buffer memory (2-word)	
05H : Positioning data No.	Select only for "simultaneous start".

**Da.16** Condition operatorSet the condition operator as required for the " **Da.15** Condition target".

<b>Da.15</b> Condition target	Setting value	Setting details
01H: Device X 02H: Device Y	07H: DEV=ON 08H: DEV=OFF	The state (ON/OFF) of an I/O signal is defined as the condition. Select ON or OFF as the trigger.
03H: Buffer memory (1-word) 04H: Buffer memory (2-word)	01H: **=P1 02H: **≠P1 03H: **≤P1 04H: **≥P1 05H: P1≤**≤P2 06H: **≤P1, P2≤**	Select how to use the value (**) in the buffer memory as a part of the condition.
05H: Positioning data No.	10H: Axis 1 selected 20H: Axis 2 selected 30H: Axis 1 and 2 selected 40H: Axis 3 selected 50H: Axis 1 and 3 selected 60H: Axis 2 and 3 selected 70H: Axis 1, 2, and 3 selected 80H: Axis 4 selected 90H: Axis 1 and 4 selected A0H: Axis 2 and 4 selected B0H: Axis 1, 2, and 4 selected C0H: Axis 3 and 4 selected D0H: Axis 1, 3, and 4 selected E0H: Axis 2, 3, and 4 selected	If "simultaneous start" is specified, select the axis (or axes) that should start simultaneously. <b>LD77MH4</b>

**Da.17** AddressSet the address as required for the " **Da.15** Condition target".

<b>Da.15</b> Condition target	Setting value	Setting details
01H : Device X 02H : Device Y	–	Not used. (There is no need to set.)
03H : Buffer memory (1-word) 04H : Buffer memory (2-word)	Value (Buffer memory address)	Set the target "buffer memory address". (For 2 word, set the low-order buffer memory address.)
05H : Positioning data No.	–	Not used. (There is no need to set.)

**Da.18** Parameter 1

## • LD77MH4

Set the parameters as required for the "**Da.16** Condition operator".

<b>Da.16</b> Condition operator	Setting value	Setting details
01H : $==P1$	Value	The value of P1 should be equal to or smaller than the value of P2. ( $P1 \leq P2$ ) If P1 is greater than P2 ( $P1 > P2$ ), the "condition data error" (error code 533) will occur.
02H : $\neq P1$		
03H : $\leq P1$		
04H : $\geq P1$		
05H : $P1 \leq P2$		
06H : $P1 \leq P1, P2 \leq P2$		
07H : DEV=ON	Value (bit No.)	Set the device bit No. X: 0H, 1H, 4H to 17H Y: 0H, 1H, 4H to 17H
08H : DEV=OFF		
10H : Axis 1 selected	Value (positioning data No.)	Set the positioning data No. for starting axis 1 and/or axis 2. Low-order 16-bit : Axis 1 positioning data No. 1 to 600 (01H to 258H) High-order 16-bit : Axis 2 positioning data No. 1 to 600 (01H to 258H)
↓		
E0H : Axis 2, 3, and 4 selected		

## • LD77MH16

Set the parameters as required for the "**Da.16** Condition operator" and "**Da.23** Number of simultaneously starting axes".

<b>Da.16</b> Condition operator	<b>Da.23</b> Number of simultaneously starting axes	Setting value	Setting details
01H : $==P1$	/	Value	The value of P1 should be equal to or smaller than the value of P2. ( $P1 \leq P2$ ) If P1 is greater than P2 ( $P1 > P2$ ), the "condition data error" (error code 533) will occur.
02H : $\neq P1$			
03H : $\leq P1$			
04H : $\geq P1$			
05H : $P1 \leq P2$			
06H : $P1 \leq P1, P2 \leq P2$			
07H : DEV=ON		Value (bit No.)	Set the device bit No. X: 0H to 1H, 10H to 1FH Y: 0H, 1H, 10H to 1FH
08H : DEV=OFF			
	2 to 4	Value (positioning data No.)	Set the positioning data No. for starting axis set in " <b>Da.24</b> Simultaneously starting axis No.1" and/or " <b>Da.25</b> Simultaneously starting axis No.2". Low-order 16-bit : Simultaneously starting axis No.1 positioning data No.1 to 600 (01H to 258H) High-order 16-bit : Simultaneously starting axis No.2 positioning data No.1 to 600 (01H to 258H)

## Da.19 Parameter 2

## • LD77MH4

Set the parameters as required for the "[Da.16] Condition operator".

[Da.16] Condition operator	Setting value	Setting details
01H : **=P1	—	Not used. (No need to be set.)
02H : **≠P1		
03H : **≤P1		
04H : **≥P1		
05H : P1≤**≤P2	Value	The value of P2 should be equal to or greater than the value of P1. (P1≤P2) If P1 is greater than P2 (P1>P2), the "condition data error" (error code 533) will occur.
06H : **≤P1, P2≤**		
07H : DEV=ON	—	Not used. (No need to be set.)
08H : DEV=OFF		
10H : Axis 1 selected		
20H : Axis 2 selected		
30H : Axis 1 and 2 selected		
40H : Axis 3 selected	Value (positioning data No.)	Set the positioning data No. for starting axis 3 and/or axis 4. Low-order 16-bit : Axis 3 positioning data No. 1 to 600 (01H to 258H) High-order 16-bit : Axis 4 positioning data No. 1 to 600 (01H to 258H)
50H : Axis 1 and 3 selected		
60H : Axis 2 and 3 selected		
70H : Axis 1, 2, and 3 selected		
80H : Axis 4 selected		
90H : Axis 1 and 4 selected		
A0H : Axis 2 and 4 selected		
B0H : Axis 1, 2, and 4 selected		
C0H : Axis 3 and 4 selected		
D0H : Axis 1, 3, and 4 selected		
E0H : Axis 2, 3, and 4 selected		

## • LD77MH16

Set the parameters as required for the "[Da.16] Condition operator" and "[Da.23]

Number of simultaneously starting axes".

[Da.16] Condition operator	[Da.23] Number of simultaneously starting axes	Setting value	Setting details
01H : **=P1	/	—	Not used. (No need to be set.)
02H : **≠P1			
03H : **≤P1			
04H : **≥P1			
05H : P1≤**≤P2		Value	The value of P2 should be equal to or greater than the value of P1. (P1≤P2) If P1 is greater than P2 (P1>P2), the "condition data error" (error code 533) will occur.
06H : **≤P1, P2≤**			
07H : DEV=ON		—	Not used. (No need to be set.)
08H : DEV=OFF			
	2 to 3	Value (positioning data No.)	Set the positioning data No. for starting axis set in "[Da.26] Simultaneously starting axis No.3" Low-order 16-bit : Simultaneously starting axis No.3 positioning data No. 1 to 600 (01H to 258H) High-order 16-bit : Not used (Set "0")
	4		

**Da.23** Number of simultaneously starting axes **LD77MH16**

Set the number of simultaneously starting axes to execute the simultaneous start.

- 2: Simultaneous start by 2 axes of the starting axis and axis set in "Da.24" Simultaneously starting axis No.1".
- 3: Simultaneous start by 3 axes of the starting axis and axis set in "Da.24" Simultaneously starting axis No.1" and "Da.25" Simultaneously starting axis No.2".
- 4: Simultaneous start by 4 axes of the starting axis and axis set in "Da.24" Simultaneously starting axis No.1" to "Da.26" Simultaneously starting axis No.3".

**Da.24** Simultaneously starting axis No.1 to **Da.26** Simultaneously starting axis No.3 **LD77MH16**

Set the simultaneously starting axis to execute the 2 to 4-axis simultaneous start.

- 2-axis interpolation ..... Set the target axis number in "Da.24" Simultaneously starting axis No.1".
- 3-axis interpolation ..... Set the target axis number in "Da.24" Simultaneously starting axis No.1" and "Da.25" Simultaneously starting axis No.2".
- 4-axis interpolation ..... Set the target axis number in "Da.24" Simultaneously starting axis No.1" to "Da.26" Simultaneously starting axis No.3".

Set the axis set as simultaneously starting axis.

- |           |            |
|-----------|------------|
| 0: Axis 1 | 8: Axis 9  |
| 1: Axis 2 | 9: Axis 10 |
| 2: Axis 3 | A: Axis 11 |
| 3: Axis 4 | B: Axis 12 |
| 4: Axis 5 | C: Axis 13 |
| 5: Axis 6 | D: Axis 14 |
| 6: Axis 7 | E: Axis 15 |
| 7: Axis 8 | F: Axis 16 |

- Note)
- Do not specify the own axis number. (If you do, the "Condition data error" will occur during the program execution (error code: 533).)
  - When the same axis number or axis number of own axis is set to multiple simultaneously starting axis number, the "Condition data error" will occur during the program execution (error code: 533).
  - Do not specify the simultaneously starting axis No.2 and simultaneously starting axis No.3 for 2-axis simultaneously start, and not specify the simultaneously starting axis No.3 for 3-axis simultaneously start. The setting value is ignored.

## 5.6 List of monitor data

The setting items of the monitor data are explained in this section.

- Guide to buffer memory address

In the buffer memory address, "n" in "2406+100n", etc. indicates a value corresponding to axis No. such as the following table.

Axis No.	n	Axis No.	n	Axis No.	n	Axis No.	n
1	0	5	4	9	8	13	12
2	1	6	5	10	9	14	13
3	2	7	6	11	10	15	14
4	3	8	7	12	11	16	15

(Note-1): Calculate as follows for the buffer memory address corresponding to each axis.

(Example) For axis No. 16

$$2406+100n (\text{Md.23} \text{ Axis error No.})=2406+100 \times 15=3906$$

$$2494+100n (\text{Md.123} \text{ Torque during command})=2494+100 \times 15=3994$$

(Note-2): The range (n=0 to 3) of axis No.1 to 4 is valid in the LD77MH4.

### 5.6.1 System monitor data

Storage item	Storage details
<u>Md.1</u> In test mode flag	<p>Whether the mode is the test mode from the GX Works2 or not is stored.</p> <ul style="list-style-type: none"> <li>• When not in test mode : OFF</li> <li>• When in test mode : ON</li> </ul> <p><u>Refresh cycle: Immediate</u></p>

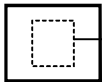
	Reading the monitor value	Default value	Storage buffer memory address (common for all axes)	
			LD77MH4	LD77MH16
	<p>■ Monitoring is carried out with a decimal.</p> <p>Monitor value </p> <p>● Storage value 0: Not in test mode 1: In test mode</p>	0	1200	4000



(Unless noted in particular, the monitor value is saved as binary data.)



Storage item	Storage details	Reading the monitor value																																																																																																																																			
Starting history (Up to 16 records can be stored)	<p><b>Md.3</b></p> <p>Start information</p> <p>[Storage details] This area stores the start information (restart flag, start origin, and start axis):</p> <ul style="list-style-type: none"> <li>Restart flag: Indicates whether the operation has or has not been halted and restarted.</li> <li>Start origin : Indicates the source of the start signal.</li> <li>Start axis : Indicates the started axis.</li> </ul> <p><u>Refresh cycle: At start</u></p> <p>[Reading the monitor value] ■ Monitoring is carried out with a hexadecimal display.</p> <table border="1" style="margin-left: 20px;"> <thead> <tr> <th>Stored contents</th> <th>Storage value</th> </tr> </thead> <tbody> <tr> <td>Restart flag OFF</td> <td>0</td> </tr> <tr> <td>Restart flag ON</td> <td>1</td> </tr> </tbody> </table> <table border="1" style="margin-left: 20px;"> <thead> <tr> <th>Stored contents</th> <th>Storage value</th> </tr> </thead> <tbody> <tr> <td>Axis 1</td> <td>1</td> </tr> <tr> <td>Axis 2</td> <td>2</td> </tr> <tr> <td>Axis 3</td> <td>3</td> </tr> <tr> <td>Axis 4</td> <td>4</td> </tr> <tr> <td>Axis 5</td> <td>LD77MH16</td> </tr> <tr> <td>...</td> <td>...</td> </tr> <tr> <td>Axis 16</td> <td>LD77MH16</td> </tr> </tbody> </table>	Stored contents	Storage value	Restart flag OFF	0	Restart flag ON	1	Stored contents	Storage value	Axis 1	1	Axis 2	2	Axis 3	3	Axis 4	4	Axis 5	LD77MH16	...	...	Axis 16	LD77MH16																																																																																																														
	Stored contents	Storage value																																																																																																																																			
Restart flag OFF	0																																																																																																																																				
Restart flag ON	1																																																																																																																																				
Stored contents	Storage value																																																																																																																																				
Axis 1	1																																																																																																																																				
Axis 2	2																																																																																																																																				
Axis 3	3																																																																																																																																				
Axis 4	4																																																																																																																																				
Axis 5	LD77MH16																																																																																																																																				
...	...																																																																																																																																				
Axis 16	LD77MH16																																																																																																																																				
<p><b>Md.4</b></p> <p>Start No.</p> <p>The starting No. is stored.</p> <p><u>Refresh cycle: At start</u></p> <p>■ Monitoring is carried out with a hexadecimal display.</p> <table border="1" style="margin-left: 20px;"> <thead> <tr> <th rowspan="2">Stored contents</th> <th colspan="4">Storage value</th> <th rowspan="2">Reference (Decimal)</th> </tr> <tr> <th>A</th> <th>B</th> <th>C</th> <th>D</th> </tr> </thead> <tbody> <tr> <td></td> <td>0</td> <td>0</td> <td>0</td> <td>1</td> <td>001</td> </tr> <tr> <td></td> <td colspan="4" style="text-align: center;">to</td> <td></td> </tr> <tr> <td></td> <td>0</td> <td>2</td> <td>5</td> <td>8</td> <td>600</td> </tr> <tr> <td rowspan="6">Positioning operation</td> <td>1</td> <td>B</td> <td>5</td> <td>8</td> <td>7000</td> </tr> <tr> <td>1</td> <td>B</td> <td>5</td> <td>9</td> <td>7001</td> </tr> <tr> <td>1</td> <td>B</td> <td>5</td> <td>A</td> <td>7002</td> </tr> <tr> <td>1</td> <td>B</td> <td>5</td> <td>B</td> <td>7003</td> </tr> <tr> <td>1</td> <td>B</td> <td>5</td> <td>C</td> <td>7004</td> </tr> <tr> <td>JOG operation</td> <td>2</td> <td>3</td> <td>3</td> <td>2</td> <td>9010</td> </tr> <tr> <td>Manual pulse generator</td> <td>2</td> <td>3</td> <td>3</td> <td>3</td> <td>9011</td> </tr> <tr> <td>Machine OPR</td> <td>2</td> <td>3</td> <td>2</td> <td>9</td> <td>9001</td> </tr> <tr> <td>Fast OPR</td> <td>2</td> <td>3</td> <td>2</td> <td>A</td> <td>9002</td> </tr> <tr> <td>Current value changing</td> <td>2</td> <td>3</td> <td>2</td> <td>B</td> <td>9003</td> </tr> <tr> <td>Simultaneous start</td> <td>2</td> <td>3</td> <td>2</td> <td>C</td> <td>9004</td> </tr> <tr> <td>Position control mode → speed control mode switching</td> <td>2</td> <td>3</td> <td>4</td> <td>6</td> <td>9030</td> </tr> <tr> <td>Position control mode → torque control mode switching</td> <td>2</td> <td>3</td> <td>4</td> <td>7</td> <td>9031</td> </tr> <tr> <td>Speed control mode → torque control mode switching</td> <td>2</td> <td>3</td> <td>4</td> <td>8</td> <td>9032</td> </tr> <tr> <td>Torque control mode → speed control mode switching</td> <td>2</td> <td>3</td> <td>4</td> <td>9</td> <td>9033</td> </tr> <tr> <td>Speed control mode → position control mode switching</td> <td>2</td> <td>3</td> <td>4</td> <td>A</td> <td>9034</td> </tr> <tr> <td>Torque control mode → position control mode switching</td> <td>2</td> <td>3</td> <td>4</td> <td>B</td> <td>9035</td> </tr> <tr> <td>Outside the range of control mode setting</td> <td>2</td> <td>3</td> <td>4</td> <td>C</td> <td>9036</td> </tr> </tbody> </table>	Stored contents	Storage value				Reference (Decimal)	A	B	C	D		0	0	0	1	001		to						0	2	5	8	600	Positioning operation	1	B	5	8	7000	1	B	5	9	7001	1	B	5	A	7002	1	B	5	B	7003	1	B	5	C	7004	JOG operation	2	3	3	2	9010	Manual pulse generator	2	3	3	3	9011	Machine OPR	2	3	2	9	9001	Fast OPR	2	3	2	A	9002	Current value changing	2	3	2	B	9003	Simultaneous start	2	3	2	C	9004	Position control mode → speed control mode switching	2	3	4	6	9030	Position control mode → torque control mode switching	2	3	4	7	9031	Speed control mode → torque control mode switching	2	3	4	8	9032	Torque control mode → speed control mode switching	2	3	4	9	9033	Speed control mode → position control mode switching	2	3	4	A	9034	Torque control mode → position control mode switching	2	3	4	B	9035	Outside the range of control mode setting	2	3	4	C	9036	
Stored contents		Storage value					Reference (Decimal)																																																																																																																														
	A	B	C	D																																																																																																																																	
	0	0	0	1	001																																																																																																																																
	to																																																																																																																																				
	0	2	5	8	600																																																																																																																																
Positioning operation	1	B	5	8	7000																																																																																																																																
	1	B	5	9	7001																																																																																																																																
	1	B	5	A	7002																																																																																																																																
	1	B	5	B	7003																																																																																																																																
	1	B	5	C	7004																																																																																																																																
	JOG operation	2	3	3	2	9010																																																																																																																															
Manual pulse generator	2	3	3	3	9011																																																																																																																																
Machine OPR	2	3	2	9	9001																																																																																																																																
Fast OPR	2	3	2	A	9002																																																																																																																																
Current value changing	2	3	2	B	9003																																																																																																																																
Simultaneous start	2	3	2	C	9004																																																																																																																																
Position control mode → speed control mode switching	2	3	4	6	9030																																																																																																																																
Position control mode → torque control mode switching	2	3	4	7	9031																																																																																																																																
Speed control mode → torque control mode switching	2	3	4	8	9032																																																																																																																																
Torque control mode → speed control mode switching	2	3	4	9	9033																																																																																																																																
Speed control mode → position control mode switching	2	3	4	A	9034																																																																																																																																
Torque control mode → position control mode switching	2	3	4	B	9035																																																																																																																																
Outside the range of control mode setting	2	3	4	C	9036																																																																																																																																



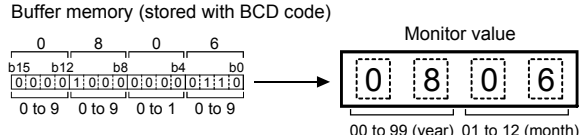
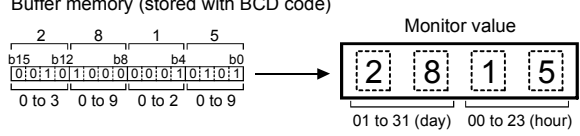
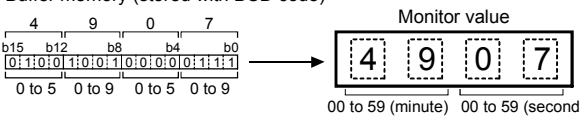
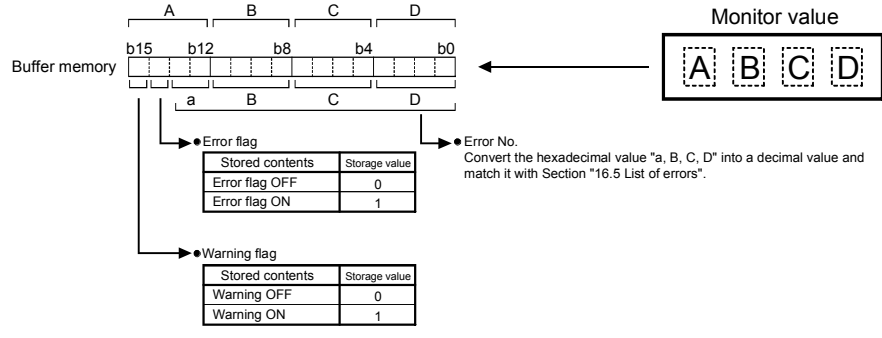

Note: If a start signal is issued against an operating axis, a record relating to this event may be output before a record relating to an earlier start signal is output.

Default value	Storage buffer memory address (common for all axes)																																																																																																																																																																																																																																																									
	LD77MH4	LD77MH16																																																																																																																																																																																																																																																								
0000H	<p>● LD77MH4</p> <table border="1"> <tr> <td>Md.8</td> <td>1292</td> </tr> <tr> <td>Start history pointer</td> <td></td> </tr> </table> <p>Indicates a pointer No. that is next to the Pointer No. assigned to the latest of the existing starting history records.</p> <table border="1"> <thead> <tr> <th>Pointer No.</th> <th>0</th> <th>1</th> <th>2</th> <th>3</th> <th>4</th> <th>5</th> <th>6</th> <th>7</th> <th>8</th> <th>9</th> <th>10</th> <th>11</th> <th>12</th> <th>13</th> <th>14</th> <th>15</th> </tr> </thead> <tbody> <tr> <td rowspan="7">Item</td> <td>Md.3 Start information</td> <td>1212</td> <td>1217</td> <td>1222</td> <td>1227</td> <td>1232</td> <td>1237</td> <td>1242</td> <td>1247</td> <td>1252</td> <td>1257</td> <td>1262</td> <td>1267</td> <td>1272</td> <td>1277</td> <td>1282</td> <td>1287</td> </tr> <tr> <td>Md.4 Start No.</td> <td>1213</td> <td>1218</td> <td>1223</td> <td>1228</td> <td>1233</td> <td>1238</td> <td>1243</td> <td>1248</td> <td>1253</td> <td>1258</td> <td>1263</td> <td>1268</td> <td>1273</td> <td>1278</td> <td>1283</td> <td>1288</td> </tr> <tr> <td>Md.54 Start Year: month</td> <td>1440</td> <td>1441</td> <td>1442</td> <td>1443</td> <td>1444</td> <td>1445</td> <td>1446</td> <td>1447</td> <td>1448</td> <td>1449</td> <td>1450</td> <td>1451</td> <td>1452</td> <td>1453</td> <td>1454</td> <td>1455</td> </tr> <tr> <td>Md.5 Start Day: hour</td> <td>1214</td> <td>1219</td> <td>1224</td> <td>1229</td> <td>1234</td> <td>1239</td> <td>1244</td> <td>1249</td> <td>1254</td> <td>1259</td> <td>1264</td> <td>1269</td> <td>1274</td> <td>1279</td> <td>1284</td> <td>1289</td> </tr> <tr> <td>Md.6 Start Minute: second</td> <td>1215</td> <td>1220</td> <td>1225</td> <td>1230</td> <td>1235</td> <td>1240</td> <td>1245</td> <td>1250</td> <td>1255</td> <td>1260</td> <td>1265</td> <td>1270</td> <td>1275</td> <td>1280</td> <td>1285</td> <td>1290</td> </tr> <tr> <td>Md.7 Error judgment</td> <td>1216</td> <td>1221</td> <td>1226</td> <td>1231</td> <td>1236</td> <td>1241</td> <td>1246</td> <td>1251</td> <td>1256</td> <td>1261</td> <td>1266</td> <td>1271</td> <td>1276</td> <td>1281</td> <td>1286</td> <td>1291</td> </tr> </tbody> </table> <ul style="list-style-type: none"> <li>Each group of buffer memory addresses storing a complete starting history record is assigned a pointer No. Example: Pointer No. 0 = Buffer memory addresses 1212 to 1216, 1440 Pointer No. 1 = Buffer memory addresses 1217 to 1221, 1441 Pointer No. 2 = Buffer memory addresses 1222 to 1226, 1442 ⋮ Pointer No. 15 = Buffer memory addresses 1287 to 1291, 1455</li> <li>Each history record is assigned a pointer No. in the range between 0 and 15. If the pointer No. 15 has been assigned to a new record, the next record will be assigned the pointer number 0. (A new record replaces an older record when a pointer No. is reassigned.)</li> </ul>	Md.8	1292	Start history pointer		Pointer No.	0	1	2	3	4	5	6	7	8	9	10	11	12	13	14	15	Item	Md.3 Start information	1212	1217	1222	1227	1232	1237	1242	1247	1252	1257	1262	1267	1272	1277	1282	1287	Md.4 Start No.	1213	1218	1223	1228	1233	1238	1243	1248	1253	1258	1263	1268	1273	1278	1283	1288	Md.54 Start Year: month	1440	1441	1442	1443	1444	1445	1446	1447	1448	1449	1450	1451	1452	1453	1454	1455	Md.5 Start Day: hour	1214	1219	1224	1229	1234	1239	1244	1249	1254	1259	1264	1269	1274	1279	1284	1289	Md.6 Start Minute: second	1215	1220	1225	1230	1235	1240	1245	1250	1255	1260	1265	1270	1275	1280	1285	1290	Md.7 Error judgment	1216	1221	1226	1231	1236	1241	1246	1251	1256	1261	1266	1271	1276	1281	1286	1291	<p>● LD77MH16</p> <table border="1"> <tr> <td>Md.8</td> <td>4092</td> </tr> <tr> <td>Start history pointer</td> <td></td> </tr> </table> <p>Indicates a pointer No. that is next to the Pointer No. assigned to the latest of the existing starting history records.</p> <table border="1"> <thead> <tr> <th>Pointer No.</th> <th>0</th> <th>1</th> <th>2</th> <th>3</th> <th>4</th> <th>5</th> <th>6</th> <th>7</th> <th>8</th> <th>9</th> <th>10</th> <th>11</th> <th>12</th> <th>13</th> <th>14</th> <th>15</th> </tr> </thead> <tbody> <tr> <td rowspan="7">Item</td> <td>Md.3 Start information</td> <td>4012</td> <td>4017</td> <td>4022</td> <td>4027</td> <td>4032</td> <td>4037</td> <td>4042</td> <td>4047</td> <td>4052</td> <td>4057</td> <td>4062</td> <td>4067</td> <td>4072</td> <td>4077</td> <td>4082</td> <td>4087</td> </tr> <tr> <td>Md.4 Start No.</td> <td>4013</td> <td>4018</td> <td>4023</td> <td>4028</td> <td>4033</td> <td>4038</td> <td>4043</td> <td>4048</td> <td>4053</td> <td>4058</td> <td>4063</td> <td>4068</td> <td>4073</td> <td>4078</td> <td>4083</td> <td>4088</td> </tr> <tr> <td>Md.54 Start Year: month</td> <td>4240</td> <td>4241</td> <td>4242</td> <td>4243</td> <td>4244</td> <td>4245</td> <td>4246</td> <td>4247</td> <td>4248</td> <td>4249</td> <td>4250</td> <td>4251</td> <td>4252</td> <td>4253</td> <td>4254</td> <td>4255</td> </tr> <tr> <td>Md.5 Start Day: hour</td> <td>4014</td> <td>4019</td> <td>4024</td> <td>4029</td> <td>4034</td> <td>4039</td> <td>4044</td> <td>4049</td> <td>4054</td> <td>4059</td> <td>4064</td> <td>4069</td> <td>4074</td> <td>4079</td> <td>4084</td> <td>4089</td> </tr> <tr> <td>Md.6 Start Minute: second</td> <td>4015</td> <td>4020</td> <td>4025</td> <td>4030</td> <td>4035</td> <td>4040</td> <td>4045</td> <td>4050</td> <td>4055</td> <td>4060</td> <td>4065</td> <td>4070</td> <td>4075</td> <td>4080</td> <td>4085</td> <td>4090</td> </tr> <tr> <td>Md.7 Error judgment</td> <td>4016</td> <td>4021</td> <td>4026</td> <td>4031</td> <td>4036</td> <td>4041</td> <td>4046</td> <td>4051</td> <td>4056</td> <td>4061</td> <td>4066</td> <td>4071</td> <td>4076</td> <td>4081</td> <td>4086</td> <td>4091</td> </tr> </tbody> </table> <ul style="list-style-type: none"> <li>Each group of buffer memory addresses storing a complete starting history record is assigned a pointer No. Example: Pointer No. 0 = Buffer memory addresses 4012 to 4016, 4240 Pointer No. 1 = Buffer memory addresses 4017 to 4021, 4241 Pointer No. 2 = Buffer memory addresses 4022 to 4026, 4242 ⋮ Pointer No. 15 = Buffer memory addresses 4087 to 4091, 4255</li> <li>Each history record is assigned a pointer No. in the range between 0 and 15. If the pointer No. 15 has been assigned to a new record, the next record will be assigned the pointer number 0. (A new record replaces an older record when a pointer No. is reassigned.)</li> </ul>	Md.8	4092	Start history pointer		Pointer No.	0	1	2	3	4	5	6	7	8	9	10	11	12	13	14	15	Item	Md.3 Start information	4012	4017	4022	4027	4032	4037	4042	4047	4052	4057	4062	4067	4072	4077	4082	4087	Md.4 Start No.	4013	4018	4023	4028	4033	4038	4043	4048	4053	4058	4063	4068	4073	4078	4083	4088	Md.54 Start Year: month	4240	4241	4242	4243	4244	4245	4246	4247	4248	4249	4250	4251	4252	4253	4254	4255	Md.5 Start Day: hour	4014	4019	4024	4029	4034	4039	4044	4049	4054	4059	4064	4069	4074	4079	4084	4089	Md.6 Start Minute: second	4015	4020	4025	4030	4035	4040	4045	4050	4055	4060	4065	4070	4075	4080	4085	4090	Md.7 Error judgment	4016	4021	4026	4031	4036	4041	4046	4051	4056	4061	4066	4071	4076	4081	4086	4091
	Md.8	1292																																																																																																																																																																																																																																																								
Start history pointer																																																																																																																																																																																																																																																										
Pointer No.	0	1	2	3	4	5	6	7	8	9	10	11	12	13	14	15																																																																																																																																																																																																																																										
Item	Md.3 Start information	1212	1217	1222	1227	1232	1237	1242	1247	1252	1257	1262	1267	1272	1277	1282	1287																																																																																																																																																																																																																																									
	Md.4 Start No.	1213	1218	1223	1228	1233	1238	1243	1248	1253	1258	1263	1268	1273	1278	1283	1288																																																																																																																																																																																																																																									
	Md.54 Start Year: month	1440	1441	1442	1443	1444	1445	1446	1447	1448	1449	1450	1451	1452	1453	1454	1455																																																																																																																																																																																																																																									
	Md.5 Start Day: hour	1214	1219	1224	1229	1234	1239	1244	1249	1254	1259	1264	1269	1274	1279	1284	1289																																																																																																																																																																																																																																									
	Md.6 Start Minute: second	1215	1220	1225	1230	1235	1240	1245	1250	1255	1260	1265	1270	1275	1280	1285	1290																																																																																																																																																																																																																																									
	Md.7 Error judgment	1216	1221	1226	1231	1236	1241	1246	1251	1256	1261	1266	1271	1276	1281	1286	1291																																																																																																																																																																																																																																									
	Md.8	4092																																																																																																																																																																																																																																																								
Start history pointer																																																																																																																																																																																																																																																										
Pointer No.	0	1	2	3	4	5	6	7	8	9	10	11	12	13	14	15																																																																																																																																																																																																																																										
Item	Md.3 Start information	4012	4017	4022	4027	4032	4037	4042	4047	4052	4057	4062	4067	4072	4077	4082	4087																																																																																																																																																																																																																																									
	Md.4 Start No.	4013	4018	4023	4028	4033	4038	4043	4048	4053	4058	4063	4068	4073	4078	4083	4088																																																																																																																																																																																																																																									
	Md.54 Start Year: month	4240	4241	4242	4243	4244	4245	4246	4247	4248	4249	4250	4251	4252	4253	4254	4255																																																																																																																																																																																																																																									
	Md.5 Start Day: hour	4014	4019	4024	4029	4034	4039	4044	4049	4054	4059	4064	4069	4074	4079	4084	4089																																																																																																																																																																																																																																									
	Md.6 Start Minute: second	4015	4020	4025	4030	4035	4040	4045	4050	4055	4060	4065	4070	4075	4080	4085	4090																																																																																																																																																																																																																																									
	Md.7 Error judgment	4016	4021	4026	4031	4036	4041	4046	4051	4056	4061	4066	4071	4076	4081	4086	4091																																																																																																																																																																																																																																									



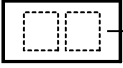

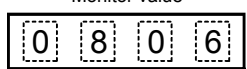
Storage item	Storage details	Reading the monitor value	
Starting history (Up to 16 records can be stored)	<p><b>Md.54</b></p> <p>Start Year: month</p> <p><u>Refresh cycle: At start</u></p>	<p>■ Monitoring is carried out with a hexadecimal display.</p> <p>Buffer memory (stored with BCD code)</p>  <p>Monitor value</p> <p>00 to 99 (year) 01 to 12 (month)</p>	
	<p><b>Md.5</b></p> <p>Start Day: hour</p> <p><u>Refresh cycle: At start</u></p>	<p>■ Monitoring is carried out with a hexadecimal display.</p> <p>Buffer memory (stored with BCD code)</p>  <p>Monitor value</p> <p>01 to 31 (day) 00 to 23 (hour)</p>	
	<p><b>Md.6</b></p> <p>Start Minute: second</p> <p><u>Refresh cycle: At start</u></p>	<p>■ Monitoring is carried out with a hexadecimal display.</p> <p>Buffer memory (stored with BCD code)</p>  <p>Monitor value</p> <p>00 to 59 (minute) 00 to 59 (second)</p>	
<p><b>Md.7</b></p> <p>Error judgment</p>	<p>[Storage details]</p> <p>This area stores the following results of the error judgment performed upon starting:</p> <ul style="list-style-type: none"> <li>Warning flag                     <ul style="list-style-type: none"> <li>BUSY start</li> <li>Control mode switching during BUSY</li> <li>Control mode switching during zero speed OFF</li> <li>Outside control mode range</li> <li>Control mode switching</li> </ul> </li> <li>Error flag</li> <li>Error No.</li> </ul> <p><u>Refresh cycle: At start</u></p> <p>[Reading the monitor value]</p> <p>■ Monitoring is carried out with a hexadecimal display.</p> 		
<p><b>Md.8</b></p> <p>Start history pointer</p> <p><u>Refresh cycle: At start</u></p>	<p>■ Monitoring is carried out with a decimal display.</p> <p>Monitor value</p>  <p>Storage value (Pointer number) 0 to 15</p>		

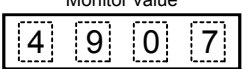
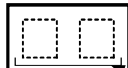
Note: If a start signal is issued against an operating axis, a record relating to this event may be output before a record relating to an earlier start signal is output.

Default value	Storage buffer memory address (common for all axes)																																																																																																																												
	LD77MH4	LD77MH16																																																																																																																											
0000H	<p>● LD77MH4</p> <table border="1"> <tr> <td>Md.8</td> <td>1292</td> </tr> <tr> <td>Start history pointer</td> <td></td> </tr> </table> <p>Indicates a pointer No. that is next to the Pointer No. assigned to the latest of the existing starting history records.</p> <table border="1"> <thead> <tr> <th>Pointer No.</th> <th>0</th> <th>1</th> <th>2</th> <th>3</th> <th>4</th> <th>5</th> <th>6</th> <th>7</th> <th>8</th> <th>9</th> <th>10</th> <th>11</th> <th>12</th> <th>13</th> <th>14</th> <th>15</th> </tr> </thead> <tbody> <tr> <td>Md.3 Start information</td> <td>1212</td> <td>1217</td> <td>1222</td> <td>1227</td> <td>1232</td> <td>1237</td> <td>1242</td> <td>1247</td> <td>1252</td> <td>1257</td> <td>1262</td> <td>1267</td> <td>1272</td> <td>1277</td> <td>1282</td> <td>1287</td> </tr> <tr> <td>Md.4 Start No.</td> <td>1213</td> <td>1218</td> <td>1223</td> <td>1228</td> <td>1233</td> <td>1238</td> <td>1243</td> <td>1248</td> <td>1253</td> <td>1258</td> <td>1263</td> <td>1268</td> <td>1273</td> <td>1278</td> <td>1283</td> <td>1288</td> </tr> <tr> <td>Md.54 Start Year: month</td> <td>1440</td> <td>1441</td> <td>1442</td> <td>1443</td> <td>1444</td> <td>1445</td> <td>1446</td> <td>1447</td> <td>1448</td> <td>1449</td> <td>1450</td> <td>1451</td> <td>1452</td> <td>1453</td> <td>1454</td> <td>1455</td> </tr> <tr> <td>Md.5 Start Day: hour</td> <td>1214</td> <td>1219</td> <td>1224</td> <td>1229</td> <td>1234</td> <td>1239</td> <td>1244</td> <td>1249</td> <td>1254</td> <td>1259</td> <td>1264</td> <td>1269</td> <td>1274</td> <td>1279</td> <td>1284</td> <td>1289</td> </tr> <tr> <td>Md.6 Start Minute: second</td> <td>1215</td> <td>1220</td> <td>1225</td> <td>1230</td> <td>1235</td> <td>1240</td> <td>1245</td> <td>1250</td> <td>1255</td> <td>1260</td> <td>1265</td> <td>1270</td> <td>1275</td> <td>1280</td> <td>1285</td> <td>1290</td> </tr> <tr> <td>Md.7 Error judgment</td> <td>1216</td> <td>1221</td> <td>1226</td> <td>1231</td> <td>1236</td> <td>1241</td> <td>1246</td> <td>1251</td> <td>1256</td> <td>1261</td> <td>1266</td> <td>1271</td> <td>1276</td> <td>1281</td> <td>1286</td> <td>1291</td> </tr> </tbody> </table> <ul style="list-style-type: none"> <li>Each group of buffer memory addresses storing a complete starting history record is assigned a pointer No. Example: Pointer No. 0 = Buffer memory addresses 1212 to 1216, 1440 Pointer No. 1 = Buffer memory addresses 1217 to 1221, 1441 Pointer No. 2 = Buffer memory addresses 1222 to 1226, 1442 ⋮ Pointer No. 15 = Buffer memory addresses 1287 to 1291, 1455</li> <li>Each history record is assigned a pointer No. in the range between 0 and 15. If the pointer No. 15 has been assigned to a new record, the next record will be assigned the pointer number 0. (A new record replaces an older record when a pointer No. is reassigned.)</li> </ul>		Md.8	1292	Start history pointer		Pointer No.	0	1	2	3	4	5	6	7	8	9	10	11	12	13	14	15	Md.3 Start information	1212	1217	1222	1227	1232	1237	1242	1247	1252	1257	1262	1267	1272	1277	1282	1287	Md.4 Start No.	1213	1218	1223	1228	1233	1238	1243	1248	1253	1258	1263	1268	1273	1278	1283	1288	Md.54 Start Year: month	1440	1441	1442	1443	1444	1445	1446	1447	1448	1449	1450	1451	1452	1453	1454	1455	Md.5 Start Day: hour	1214	1219	1224	1229	1234	1239	1244	1249	1254	1259	1264	1269	1274	1279	1284	1289	Md.6 Start Minute: second	1215	1220	1225	1230	1235	1240	1245	1250	1255	1260	1265	1270	1275	1280	1285	1290	Md.7 Error judgment	1216	1221	1226	1231	1236	1241	1246	1251	1256	1261	1266	1271	1276	1281	1286	1291
Md.8	1292																																																																																																																												
Start history pointer																																																																																																																													
Pointer No.	0	1	2	3	4	5	6	7	8	9	10	11	12	13	14	15																																																																																																													
Md.3 Start information	1212	1217	1222	1227	1232	1237	1242	1247	1252	1257	1262	1267	1272	1277	1282	1287																																																																																																													
Md.4 Start No.	1213	1218	1223	1228	1233	1238	1243	1248	1253	1258	1263	1268	1273	1278	1283	1288																																																																																																													
Md.54 Start Year: month	1440	1441	1442	1443	1444	1445	1446	1447	1448	1449	1450	1451	1452	1453	1454	1455																																																																																																													
Md.5 Start Day: hour	1214	1219	1224	1229	1234	1239	1244	1249	1254	1259	1264	1269	1274	1279	1284	1289																																																																																																													
Md.6 Start Minute: second	1215	1220	1225	1230	1235	1240	1245	1250	1255	1260	1265	1270	1275	1280	1285	1290																																																																																																													
Md.7 Error judgment	1216	1221	1226	1231	1236	1241	1246	1251	1256	1261	1266	1271	1276	1281	1286	1291																																																																																																													
0000H	<p>● LD77MH16</p> <table border="1"> <tr> <td>Md.8</td> <td>4092</td> </tr> <tr> <td>Start history pointer</td> <td></td> </tr> </table> <p>Indicates a pointer No. that is next to the Pointer No. assigned to the latest of the existing starting history records.</p> <table border="1"> <thead> <tr> <th>Pointer No.</th> <th>0</th> <th>1</th> <th>2</th> <th>3</th> <th>4</th> <th>5</th> <th>6</th> <th>7</th> <th>8</th> <th>9</th> <th>10</th> <th>11</th> <th>12</th> <th>13</th> <th>14</th> <th>15</th> </tr> </thead> <tbody> <tr> <td>Md.3 Start information</td> <td>4012</td> <td>4017</td> <td>4022</td> <td>4027</td> <td>4032</td> <td>4037</td> <td>4042</td> <td>4047</td> <td>4052</td> <td>4057</td> <td>4062</td> <td>4067</td> <td>4072</td> <td>4077</td> <td>4082</td> <td>4087</td> </tr> <tr> <td>Md.4 Start No.</td> <td>4013</td> <td>4018</td> <td>4023</td> <td>4028</td> <td>4033</td> <td>4038</td> <td>4043</td> <td>4048</td> <td>4053</td> <td>4058</td> <td>4063</td> <td>4068</td> <td>4073</td> <td>4078</td> <td>4083</td> <td>4088</td> </tr> <tr> <td>Md.54 Start Year: month</td> <td>4240</td> <td>4241</td> <td>4242</td> <td>4243</td> <td>4244</td> <td>4245</td> <td>4246</td> <td>4247</td> <td>4248</td> <td>4249</td> <td>4250</td> <td>4251</td> <td>4252</td> <td>4253</td> <td>4254</td> <td>4255</td> </tr> <tr> <td>Md.5 Start Day: hour</td> <td>4014</td> <td>4019</td> <td>4024</td> <td>4029</td> <td>4034</td> <td>4039</td> <td>4044</td> <td>4049</td> <td>4054</td> <td>4059</td> <td>4064</td> <td>4069</td> <td>4074</td> <td>4079</td> <td>4084</td> <td>4089</td> </tr> <tr> <td>Md.6 Start Minute: second</td> <td>4015</td> <td>4020</td> <td>4025</td> <td>4030</td> <td>4035</td> <td>4040</td> <td>4045</td> <td>4050</td> <td>4055</td> <td>4060</td> <td>4065</td> <td>4070</td> <td>4075</td> <td>4080</td> <td>4085</td> <td>4090</td> </tr> <tr> <td>Md.7 Error judgment</td> <td>4016</td> <td>4021</td> <td>4026</td> <td>4031</td> <td>4036</td> <td>4041</td> <td>4046</td> <td>4051</td> <td>4056</td> <td>4061</td> <td>4066</td> <td>4071</td> <td>4076</td> <td>4081</td> <td>4086</td> <td>4091</td> </tr> </tbody> </table> <ul style="list-style-type: none"> <li>Each group of buffer memory addresses storing a complete starting history record is assigned a pointer No. Example: Pointer No. 0 = Buffer memory addresses 4012 to 4016, 4240 Pointer No. 1 = Buffer memory addresses 4017 to 4021, 4241 Pointer No. 2 = Buffer memory addresses 4022 to 4026, 4242 ⋮ Pointer No. 15 = Buffer memory addresses 4087 to 4091, 4255</li> <li>Each history record is assigned a pointer No. in the range between 0 and 15. If the pointer No. 15 has been assigned to a new record, the next record will be assigned the pointer number 0. (A new record replaces an older record when a pointer No. is reassigned.)</li> </ul>		Md.8	4092	Start history pointer		Pointer No.	0	1	2	3	4	5	6	7	8	9	10	11	12	13	14	15	Md.3 Start information	4012	4017	4022	4027	4032	4037	4042	4047	4052	4057	4062	4067	4072	4077	4082	4087	Md.4 Start No.	4013	4018	4023	4028	4033	4038	4043	4048	4053	4058	4063	4068	4073	4078	4083	4088	Md.54 Start Year: month	4240	4241	4242	4243	4244	4245	4246	4247	4248	4249	4250	4251	4252	4253	4254	4255	Md.5 Start Day: hour	4014	4019	4024	4029	4034	4039	4044	4049	4054	4059	4064	4069	4074	4079	4084	4089	Md.6 Start Minute: second	4015	4020	4025	4030	4035	4040	4045	4050	4055	4060	4065	4070	4075	4080	4085	4090	Md.7 Error judgment	4016	4021	4026	4031	4036	4041	4046	4051	4056	4061	4066	4071	4076	4081	4086	4091
Md.8	4092																																																																																																																												
Start history pointer																																																																																																																													
Pointer No.	0	1	2	3	4	5	6	7	8	9	10	11	12	13	14	15																																																																																																													
Md.3 Start information	4012	4017	4022	4027	4032	4037	4042	4047	4052	4057	4062	4067	4072	4077	4082	4087																																																																																																													
Md.4 Start No.	4013	4018	4023	4028	4033	4038	4043	4048	4053	4058	4063	4068	4073	4078	4083	4088																																																																																																													
Md.54 Start Year: month	4240	4241	4242	4243	4244	4245	4246	4247	4248	4249	4250	4251	4252	4253	4254	4255																																																																																																													
Md.5 Start Day: hour	4014	4019	4024	4029	4034	4039	4044	4049	4054	4059	4064	4069	4074	4079	4084	4089																																																																																																													
Md.6 Start Minute: second	4015	4020	4025	4030	4035	4040	4045	4050	4055	4060	4065	4070	4075	4080	4085	4090																																																																																																													
Md.7 Error judgment	4016	4021	4026	4031	4036	4041	4046	4051	4056	4061	4066	4071	4076	4081	4086	4091																																																																																																													
0	1292	4092																																																																																																																											

Storage item	Storage details	Reading the monitor value																	
Error history (Up to 16 records can be stored)	<p><b>Md.9</b></p> <p>Axis in which the error occurred</p> <p>Stores a number (Axis No.) that indicates the axis that encountered an error.</p> <p><u>Refresh cycle: Immediate</u></p>	<p>Monitoring is carried out with a decimal display.</p> <p>Monitor value </p> <p>Storage value</p> <table border="0"> <tr> <td>1: Axis 1</td> <td>5: Axis 5</td> <td>9: Axis 9</td> <td>13: Axis 13</td> </tr> <tr> <td>2: Axis 2</td> <td>6: Axis 6</td> <td>10: Axis 10</td> <td>14: Axis 14</td> </tr> <tr> <td>3: Axis 3</td> <td>7: Axis 7</td> <td>11: Axis 11</td> <td>15: Axis 15</td> </tr> <tr> <td>4: Axis 4</td> <td>8: Axis 8</td> <td>12: Axis 12</td> <td>16: Axis 16</td> </tr> </table> <p style="text-align: right;"><b>LD77MH16</b></p>	1: Axis 1	5: Axis 5	9: Axis 9	13: Axis 13	2: Axis 2	6: Axis 6	10: Axis 10	14: Axis 14	3: Axis 3	7: Axis 7	11: Axis 11	15: Axis 15	4: Axis 4	8: Axis 8	12: Axis 12	16: Axis 16	
	1: Axis 1	5: Axis 5	9: Axis 9	13: Axis 13															
	2: Axis 2	6: Axis 6	10: Axis 10	14: Axis 14															
	3: Axis 3	7: Axis 7	11: Axis 11	15: Axis 15															
	4: Axis 4	8: Axis 8	12: Axis 12	16: Axis 16															
<p><b>Md.10</b></p> <p>Axis error No.</p> <p>Stores an axis error No.</p> <p><u>Refresh cycle: Immediate</u></p>	<p>Monitoring is carried out with a decimal display.</p> <p>Monitor value </p> <p>Error No.</p> <p>For details on the error Nos. (Error codes), refer to Section 16.5 "List of errors".</p>																		
<p><b>Md.55</b></p> <p>Axis error occurrence (Year: month)</p> <p>Stores the time (Year: month) at which an axis error was detected.</p> <p><u>Refresh cycle: Immediate</u></p>	<p>Monitoring is carried out with a hexadecimal display.</p> <p>Buffer memory (stored with BCD code)</p> <table border="0"> <tr> <td>0</td> <td>8</td> <td>0</td> <td>6</td> </tr> <tr> <td>b15</td> <td>b12</td> <td>b8</td> <td>b4</td> </tr> <tr> <td colspan="4">0:0:0:0:1:0:0:0:0:0:0:0:0:0:1:1:0</td> </tr> <tr> <td colspan="2">0 to 9</td> <td colspan="2">0 to 9</td> </tr> </table> <p>Monitor value </p> <p>00 to 99 (year) 01 to 12 (month)</p>	0	8	0	6	b15	b12	b8	b4	0:0:0:0:1:0:0:0:0:0:0:0:0:0:1:1:0				0 to 9		0 to 9			
0	8	0	6																
b15	b12	b8	b4																
0:0:0:0:1:0:0:0:0:0:0:0:0:0:1:1:0																			
0 to 9		0 to 9																	
<p><b>Md.11</b></p> <p>Axis error occurrence (Day: hour)</p> <p>Stores the time (Day: hour) at which an axis error was detected.</p> <p><u>Refresh cycle: Immediate</u></p>	<p>Monitoring is carried out with a hexadecimal display.</p> <p>Buffer memory (stored with BCD code)</p> <table border="0"> <tr> <td>2</td> <td>8</td> <td>1</td> <td>5</td> </tr> <tr> <td>b15</td> <td>b12</td> <td>b8</td> <td>b4</td> </tr> <tr> <td colspan="4">0:0:1:0:1:0:0:0:0:0:0:0:1:0:1:1:0</td> </tr> <tr> <td colspan="2">0 to 3</td> <td colspan="2">0 to 9</td> </tr> </table> <p>Monitor value </p> <p>01 to 31 (day) 00 to 23 (hour)</p>	2	8	1	5	b15	b12	b8	b4	0:0:1:0:1:0:0:0:0:0:0:0:1:0:1:1:0				0 to 3		0 to 9			
2	8	1	5																
b15	b12	b8	b4																
0:0:1:0:1:0:0:0:0:0:0:0:1:0:1:1:0																			
0 to 3		0 to 9																	
<p><b>Md.12</b></p> <p>Axis error occurrence (Minute: second)</p> <p>Stores the time (Minute: second) at which an axis error was detected.</p> <p><u>Refresh cycle: Immediate</u></p>	<p>Monitoring is carried out with a hexadecimal display.</p> <p>Buffer memory (stored with BCD code)</p> <table border="0"> <tr> <td>4</td> <td>9</td> <td>0</td> <td>7</td> </tr> <tr> <td>b15</td> <td>b12</td> <td>b8</td> <td>b4</td> </tr> <tr> <td colspan="4">0:1:0:0:1:0:0:1:0:0:0:0:0:1:1:1:0</td> </tr> <tr> <td colspan="2">0 to 5</td> <td colspan="2">0 to 9</td> </tr> </table> <p>Monitor value </p> <p>00 to 59 (minute) 00 to 59 (second)</p>	4	9	0	7	b15	b12	b8	b4	0:1:0:0:1:0:0:1:0:0:0:0:0:1:1:1:0				0 to 5		0 to 9			
4	9	0	7																
b15	b12	b8	b4																
0:1:0:0:1:0:0:1:0:0:0:0:0:1:1:1:0																			
0 to 5		0 to 9																	
<p><b>Md.13</b></p> <p>Error history pointer</p> <p>Indicates a pointer No. that is next to the Pointer No. assigned to the latest of the existing records.</p> <p><u>Refresh cycle: Immediate</u></p>	<p>Monitoring is carried out with a decimal display.</p> <p>Monitor value </p> <p>Storage value (Pointer number) 0 to 15</p>																		

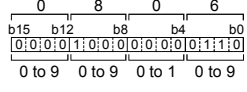
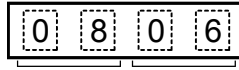
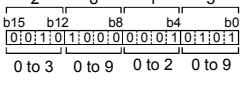

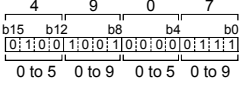
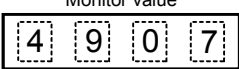
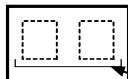



Default value	Storage buffer memory address (common for all axes)	
	LD77MH4	LD77MH16
0	<p>● LD77MH4</p> <div style="border: 1px solid black; padding: 2px; display: inline-block;">Md.13 Error history pointer</div> 1357	

Storage item	Storage details	Reading the monitor value	
<p><b>Md.14</b> Axis in which the warning occurred</p>	<p>Stores a number (Axis No.) that indicates the axis that encountered a warning. <u>Refresh cycle: Immediate</u></p>	<p>■ Monitoring is carried out with a decimal display. Monitor value  → ● Storage value 1: Axis 1    5: Axis 5    9: Axis 9    13: Axis 13 2: Axis 2    6: Axis 6    10: Axis 10    14: Axis 14 3: Axis 3    7: Axis 7    11: Axis 11    15: Axis 15 4: Axis 4    8: Axis 8    12: Axis 12    16: Axis 16 <b>LD77MH16</b></p>	
<p><b>Md.15</b> Axis warning No.</p>	<p>Stores an axis warning No. <u>Refresh cycle: Immediate</u></p>	<p>■ Monitoring is carried out with a decimal display. Monitor value  → ● Warning No. For details of warning Nos. (warning codes), refer to Section 16.6 "List of warnings".</p>	
<p><b>Md.56</b> Axis warning occurrence (Year: month)</p>	<p>Stores the time (Year: month) at which an axis warning was detected. <u>Refresh cycle: Immediate</u></p>	<p>■ Monitoring is carried out with a hexadecimal display. Buffer memory (stored with BCD code)  → Monitor value  00 to 99 (year) 01 to 12 (month)</p>	
<p><b>Md.16</b> Axis warning occurrence (Day: hour)</p>	<p>Stores the time (Day: hour) at which an axis warning was detected. <u>Refresh cycle: Immediate</u></p>	<p>■ Monitoring is carried out with a hexadecimal display. Buffer memory (stored with BCD code)  → Monitor value  01 to 31 (day) 00 to 23 (hour)</p>	
<p><b>Md.17</b> Axis warning occurrence (Minute: second)</p>	<p>Stores the time (Minute: second) at which an axis warning was detected. <u>Refresh cycle: Immediate</u></p>	<p>■ Monitoring is carried out with a hexadecimal display. Buffer memory (stored with BCD code)  → Monitor value  00 to 59 (minute) 00 to 59 (second)</p>	
<p><b>Md.18</b> Warning history pointer</p>	<p>Indicates a pointer No. that is next to the Pointer No. assigned to the latest of the existing records. <u>Refresh cycle: Immediate</u></p>	<p>■ Monitoring is carried out with a decimal display. Monitor value  → ● Storage value (Pointer number) 0 to 15</p>	

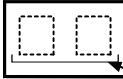

Warning history (Up to 16 records can be stored)

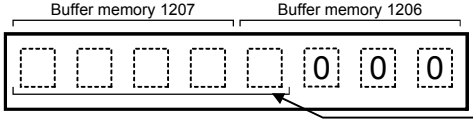
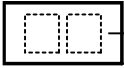
Default value	Storage buffer memory address (common for all axes)																																																																																																											
	LD77MH4	LD77MH16																																																																																																										
0	<p>● LD77MH4</p> <table border="1"> <tr> <td>Md.18</td> <td>1422</td> </tr> <tr> <td>Warning history pointer</td> <td></td> </tr> </table> <p>Indicates a pointer No. that is next to the Pointer No. assigned to the latest of the existing warning history records.</p> <table border="1"> <thead> <tr> <th>Pointer No.</th> <th>0</th> <th>1</th> <th>2</th> <th>3</th> <th>4</th> <th>5</th> <th>6</th> <th>7</th> <th>8</th> <th>9</th> <th>10</th> <th>11</th> <th>12</th> <th>13</th> <th>14</th> <th>15</th> </tr> </thead> <tbody> <tr> <td>Md.14 Axis in which the warning occurred</td> <td>1358</td> <td>1362</td> <td>1366</td> <td>1370</td> <td>1374</td> <td>1378</td> <td>1382</td> <td>1386</td> <td>1390</td> <td>1394</td> <td>1398</td> <td>1402</td> <td>1406</td> <td>1410</td> <td>1414</td> <td>1418</td> </tr> <tr> <td>Md.15 Axis warning No.</td> <td>1359</td> <td>1363</td> <td>1367</td> <td>1371</td> <td>1375</td> <td>1379</td> <td>1383</td> <td>1387</td> <td>1391</td> <td>1395</td> <td>1399</td> <td>1403</td> <td>1407</td> <td>1411</td> <td>1415</td> <td>1419</td> </tr> <tr> <td>Md.56 Axis warning occurrence (Year: month)</td> <td>1472</td> <td>1473</td> <td>1474</td> <td>1475</td> <td>1476</td> <td>1477</td> <td>1478</td> <td>1479</td> <td>1480</td> <td>1481</td> <td>1482</td> <td>1483</td> <td>1484</td> <td>1485</td> <td>1486</td> <td>1487</td> </tr> <tr> <td>Md.16 Axis warning occurrence (Day: hour)</td> <td>1360</td> <td>1364</td> <td>1368</td> <td>1372</td> <td>1376</td> <td>1380</td> <td>1384</td> <td>1388</td> <td>1392</td> <td>1396</td> <td>1400</td> <td>1404</td> <td>1408</td> <td>1412</td> <td>1416</td> <td>1420</td> </tr> <tr> <td>Md.17 Axis warning occurrence (Minute: second)</td> <td>1361</td> <td>1365</td> <td>1369</td> <td>1373</td> <td>1377</td> <td>1381</td> <td>1385</td> <td>1389</td> <td>1393</td> <td>1397</td> <td>1401</td> <td>1405</td> <td>1409</td> <td>1413</td> <td>1417</td> <td>1421</td> </tr> </tbody> </table> <ul style="list-style-type: none"> <li>Each group of buffer memory addresses storing a complete warning history record is assigned a pointer No. Example: Pointer No. 0 = Buffer memory addresses 1358 to 1361, 1472 Pointer No. 1 = Buffer memory addresses 1362 to 1365, 1473 Pointer No. 2 = Buffer memory addresses 1366 to 1369, 1474 ⋮ Pointer No. 15 = Buffer memory addresses 1418 to 1421, 1487</li> <li>Each history record is assigned a pointer No. in the range between 0 and 15. If the pointer No. 15 has been assigned to a new record, the next record will be assigned the pointer number 0. (A new record replaces an older record when a pointer No. is reassigned.)</li> </ul>		Md.18	1422	Warning history pointer		Pointer No.	0	1	2	3	4	5	6	7	8	9	10	11	12	13	14	15	Md.14 Axis in which the warning occurred	1358	1362	1366	1370	1374	1378	1382	1386	1390	1394	1398	1402	1406	1410	1414	1418	Md.15 Axis warning No.	1359	1363	1367	1371	1375	1379	1383	1387	1391	1395	1399	1403	1407	1411	1415	1419	Md.56 Axis warning occurrence (Year: month)	1472	1473	1474	1475	1476	1477	1478	1479	1480	1481	1482	1483	1484	1485	1486	1487	Md.16 Axis warning occurrence (Day: hour)	1360	1364	1368	1372	1376	1380	1384	1388	1392	1396	1400	1404	1408	1412	1416	1420	Md.17 Axis warning occurrence (Minute: second)	1361	1365	1369	1373	1377	1381	1385	1389	1393	1397	1401	1405	1409	1413	1417	1421
Md.18	1422																																																																																																											
Warning history pointer																																																																																																												
Pointer No.	0	1	2	3	4	5	6	7	8	9	10	11	12	13	14	15																																																																																												
Md.14 Axis in which the warning occurred	1358	1362	1366	1370	1374	1378	1382	1386	1390	1394	1398	1402	1406	1410	1414	1418																																																																																												
Md.15 Axis warning No.	1359	1363	1367	1371	1375	1379	1383	1387	1391	1395	1399	1403	1407	1411	1415	1419																																																																																												
Md.56 Axis warning occurrence (Year: month)	1472	1473	1474	1475	1476	1477	1478	1479	1480	1481	1482	1483	1484	1485	1486	1487																																																																																												
Md.16 Axis warning occurrence (Day: hour)	1360	1364	1368	1372	1376	1380	1384	1388	1392	1396	1400	1404	1408	1412	1416	1420																																																																																												
Md.17 Axis warning occurrence (Minute: second)	1361	1365	1369	1373	1377	1381	1385	1389	1393	1397	1401	1405	1409	1413	1417	1421																																																																																												
0000H	<p>● LD77MH16</p> <table border="1"> <tr> <td>Md.18</td> <td>4222</td> </tr> <tr> <td>Warning history pointer</td> <td></td> </tr> </table> <p>Indicates a pointer No. that is next to the Pointer No. assigned to the latest of the existing warning history records.</p> <table border="1"> <thead> <tr> <th>Pointer No.</th> <th>0</th> <th>1</th> <th>2</th> <th>3</th> <th>4</th> <th>5</th> <th>6</th> <th>7</th> <th>8</th> <th>9</th> <th>10</th> <th>11</th> <th>12</th> <th>13</th> <th>14</th> <th>15</th> </tr> </thead> <tbody> <tr> <td>Md.14 Axis in which the warning occurred</td> <td>4158</td> <td>4162</td> <td>4166</td> <td>4170</td> <td>4174</td> <td>4178</td> <td>4182</td> <td>4186</td> <td>4190</td> <td>4194</td> <td>4198</td> <td>4202</td> <td>4206</td> <td>4210</td> <td>4214</td> <td>4218</td> </tr> <tr> <td>Md.15 Axis warning No.</td> <td>4159</td> <td>4163</td> <td>4167</td> <td>4171</td> <td>4175</td> <td>4179</td> <td>4183</td> <td>4187</td> <td>4191</td> <td>4195</td> <td>4199</td> <td>4203</td> <td>4207</td> <td>4211</td> <td>4215</td> <td>4219</td> </tr> <tr> <td>Md.56 Axis warning occurrence (Year: month)</td> <td>4272</td> <td>4273</td> <td>4274</td> <td>4275</td> <td>4276</td> <td>4277</td> <td>4278</td> <td>4279</td> <td>4280</td> <td>4281</td> <td>4282</td> <td>4283</td> <td>4284</td> <td>4285</td> <td>4286</td> <td>4287</td> </tr> <tr> <td>Md.16 Axis warning occurrence (Day: hour)</td> <td>4160</td> <td>4164</td> <td>4168</td> <td>4172</td> <td>4176</td> <td>4180</td> <td>4184</td> <td>4188</td> <td>4192</td> <td>4196</td> <td>4200</td> <td>4204</td> <td>4208</td> <td>4212</td> <td>4216</td> <td>4220</td> </tr> <tr> <td>Md.17 Axis warning occurrence (Minute: second)</td> <td>4161</td> <td>4165</td> <td>4169</td> <td>4173</td> <td>4177</td> <td>4181</td> <td>4185</td> <td>4189</td> <td>4193</td> <td>4197</td> <td>4201</td> <td>4205</td> <td>4209</td> <td>4213</td> <td>4217</td> <td>4221</td> </tr> </tbody> </table> <ul style="list-style-type: none"> <li>Each group of buffer memory addresses storing a complete warning history record is assigned a pointer No. Example: Pointer No. 0 = Buffer memory addresses 4158 to 4161, 4272 Pointer No. 1 = Buffer memory addresses 4162 to 4165, 4273 Pointer No. 2 = Buffer memory addresses 4166 to 4169, 4274 ⋮ Pointer No. 15 = Buffer memory addresses 4218 to 4221, 4287</li> <li>Each history record is assigned a pointer No. in the range between 0 and 15. If the pointer No. 15 has been assigned to a new record, the next record will be assigned the pointer number 0. (A new record replaces an older record when a pointer No. is reassigned.)</li> </ul>		Md.18	4222	Warning history pointer		Pointer No.	0	1	2	3	4	5	6	7	8	9	10	11	12	13	14	15	Md.14 Axis in which the warning occurred	4158	4162	4166	4170	4174	4178	4182	4186	4190	4194	4198	4202	4206	4210	4214	4218	Md.15 Axis warning No.	4159	4163	4167	4171	4175	4179	4183	4187	4191	4195	4199	4203	4207	4211	4215	4219	Md.56 Axis warning occurrence (Year: month)	4272	4273	4274	4275	4276	4277	4278	4279	4280	4281	4282	4283	4284	4285	4286	4287	Md.16 Axis warning occurrence (Day: hour)	4160	4164	4168	4172	4176	4180	4184	4188	4192	4196	4200	4204	4208	4212	4216	4220	Md.17 Axis warning occurrence (Minute: second)	4161	4165	4169	4173	4177	4181	4185	4189	4193	4197	4201	4205	4209	4213	4217	4221
Md.18	4222																																																																																																											
Warning history pointer																																																																																																												
Pointer No.	0	1	2	3	4	5	6	7	8	9	10	11	12	13	14	15																																																																																												
Md.14 Axis in which the warning occurred	4158	4162	4166	4170	4174	4178	4182	4186	4190	4194	4198	4202	4206	4210	4214	4218																																																																																												
Md.15 Axis warning No.	4159	4163	4167	4171	4175	4179	4183	4187	4191	4195	4199	4203	4207	4211	4215	4219																																																																																												
Md.56 Axis warning occurrence (Year: month)	4272	4273	4274	4275	4276	4277	4278	4279	4280	4281	4282	4283	4284	4285	4286	4287																																																																																												
Md.16 Axis warning occurrence (Day: hour)	4160	4164	4168	4172	4176	4180	4184	4188	4192	4196	4200	4204	4208	4212	4216	4220																																																																																												
Md.17 Axis warning occurrence (Minute: second)	4161	4165	4169	4173	4177	4181	4185	4189	4193	4197	4201	4205	4209	4213	4217	4221																																																																																												
0	1422	4222																																																																																																										



Storage item	Storage details	Reading the monitor value	
<p><b>Md.19</b></p> <p>Number of write accesses to flash ROM</p>	<p>Stores the number of write accesses to the flash ROM after the power is switched ON.</p> <p>The count is cleared to "0" when the number of write accesses reach 26 and an error reset operation is performed.</p> <p><u>Refresh cycle: Immediate</u></p>	<p>■ Monitoring is carried out with a decimal display.</p> <p>Monitor value </p> <p>● Storage value 0 to 25</p>	
<p><b>Md.50</b></p> <p>Forced stop input</p>	<p>This area stores the states (ON/OFF) of forced stop input.</p> <p><u>Refresh cycle: Operation cycle</u></p>	<p>■ Monitoring is carried out with a decimal display.</p> <p>Monitor value </p> <p>● Storage value 0 : Forced stop input ON (Forced stop) 1 : Forced stop input OFF (Forced stop release)</p>	
<p><b>Md.51</b></p> <p>Amplifier-less operation mode status</p>	<p>Indicates a current operation mode.</p> <p><u>Refresh cycle: Immediate</u></p>	<p>■ Monitoring is carried out with a decimal display.</p> <p>Monitor value </p> <p>● Storage value 0 : Normal operation mode 1 : Amplifier-less operation mode</p>	
<p><b>Md.52</b></p> <p>Communication between amplifiers axes searching flag</p>	<p>Stores the detection status of axis that set communication between amplifiers.</p> <p><u>Refresh cycle: Immediate</u></p>	<p>■ Monitoring is carried out with a decimal display.</p> <p>Monitor value </p> <p>● Storage value 0 : Search end 1 : Searching</p>	
<p><b>Md.130</b></p> <p>OS version</p>	<p>Stores the first five digits of LD77MH product information.</p> <p><u>Refresh cycle: At power supply ON</u></p>	<p>■ Monitoring is carried out with a hexadecimal display.</p> <p>Buffer memory (stored with BCD code)</p> <p>Monitor value </p> <p>● Storage value First five digits of product information</p>	
<p><b>Md.131</b></p> <p>Digital oscilloscope executing</p>	<p>Stores the RUN status of digital oscilloscope.</p> <p><u>Refresh cycle: Main cycle</u></p>	<p>■ Monitoring is carried out with a decimal display.</p> <p>Monitor value </p> <p>● Storage value 0 : Stop 1 : Run -1 : Stop by error</p>	
<p><b>Md.132</b></p> <p>Operation cycle setting</p> <p><b>LD77MH16</b></p>	<p>Stores the current operation cycle.</p> <p><u>Refresh cycle: At power supply ON</u></p>	<p>■ Monitoring is carried out with a decimal display.</p> <p>Monitor value </p> <p>● Storage value 0 : 0.88ms 1 : 1.77ms</p>	
<p><b>Md.133</b></p> <p>Operation cycle over flag</p> <p><b>LD77MH16</b></p>	<p>This flag turns ON when the operation cycle time exceeds operation cycle.</p> <p><u>Refresh cycle: Immediate</u></p>	<p>■ Monitoring is carried out with a decimal display.</p> <p>Monitor value </p> <p>● Storage value 0 : OFF 1 : ON (Operation cycle over occurred.)</p> <p><b>POINT</b> Latch status of operation cycle over is indicated. When this flag turns ON, correct the positioning detail or change the operation cycle longer than current setting.</p>	

	Default value	Storage buffer memory address (common for all axes)	
		LD77MH4	LD77MH16
	0	1424 1425	4224 4225
	0	1431	4231
	0	1432	4232
	0	1434	4234
	Factory-set product information	1206 1207	4006 4007
	0	1211	4011
	0		4238
	0		4239

Storage item	Storage details	Reading the monitor value	
<p><b>Md.134</b></p> <p>Operation time</p>	<p>Stores the time that took for operation every operation cycle.</p> <p><u>Refresh cycle: Operation cycle</u></p>	<p>■ Monitoring is carried out with a decimal display.</p> <p>Monitor value  ● Storage value Unit: <math>\mu</math>s</p>	
<p><b>Md.135</b></p> <p>Maximum operation time</p>	<p>Stores the maximum value of operation time after each module's power supply ON.</p> <p><u>Refresh cycle: Immediate</u></p>	<p>■ Monitoring is carried out with a decimal display.</p> <p>Monitor value  ● Storage value Unit: <math>\mu</math>s</p>	

	Default value	Storage buffer memory address (common for all axes)	
		LD77MH4	LD77MH16
	0	1208	4008
	0	1209	4009

## 5.6.2 Axis monitor data

Storage item	Storage details
Md.20 Current feed value	<p>The currently commanded address is stored. (Different from the actual motor position during operation)</p> <p>The current position address is stored.</p> <p>If "degree" is selected as the unit, the addresses will have a ring structure for values between 0 and 359.99999 degrees.</p> <ul style="list-style-type: none"> <li>• The OP address is stored when the machine OPR is completed.</li> <li>• When the current value is changed with the current value changing function, the changed value is stored.</li> </ul> <p><u>Refresh cycle: Operation cycle</u></p>
Md.21 Machine feed value	<p>The address of the current position according to the machine coordinates will be stored. (Different from the actual motor position during operation)</p> <p>Note that the current value changing function will not change the machine feed value.</p> <p>Under the speed control mode, the machine feed value is constantly updated always, irrespective of the parameter setting.</p> <p>The value will not be cleared to "0" at the beginning of fixed-feed control.</p> <p>Even if "degree" is selected as the unit, the addresses will not have a ring structure for values between 0 and 359.99999 degrees.</p> <ul style="list-style-type: none"> <li>• Machine coordinates: Characteristic coordinates determined with machine</li> </ul> <p><u>Refresh cycle: Operation cycle</u></p>
Md.22 Feedrate	<p>The speed of the operating workpiece is stored. (May be different from the actual motor speed during operation)</p> <ul style="list-style-type: none"> <li>• During interpolation operation, the speed is stored in the following manner. Reference axis : Composite speed or reference axis speed (Set with Pr.20 ) Interpolation axis : 0</li> </ul> <p><u>Refresh cycle: Operation cycle</u></p> <p><b>POINT</b></p> <p>In case of the single axis operation, " Md.22 Feedrate" and " Md.28 Axis feedrate" are identical.</p> <p>In the composite mode of the interpolation operation, " Md.22 Feedrate" is a speed in a composite direction and " Md.28 Axis feedrate" is that in each axial direction.</p>
Md.23 Axis error No.	<p>When an axis error is detected, the error code corresponding to the error details is stored.</p> <ul style="list-style-type: none"> <li>• The latest error code is always stored. (When a new axis error occurs, the error code is overwritten.)</li> <li>• When " Cd.5 Axis error reset" (axis control data) turns ON, the axis error No. is cleared (set to 0).</li> </ul> <p><u>Refresh cycle: Immediate</u></p>

	Reading the monitor value	Default value	Storage buffer memory address																										
			LD77MH4	LD77MH16																									
<p>■ Monitoring is carried out with a hexadecimal.</p> <p>Low-order buffer memory Example) 800 b15 b12 b8 b4 b0 E F G H</p> <p>High-order buffer memory Example) 801 b31 b28 b24 b20 b16 A B C D</p> <p>Monitor value</p> <p>◇ Sorting</p> <p>(High-order buffer memory) (Low-order buffer memory) A B C D E F G H</p> <p>◇ Converted from hexadecimal to decimal</p> <p>Decimal integer value R</p> <p>◇ Unit conversion <math>R \times 10^m</math></p> <p>Actual value</p> <table border="1"> <tr><td>Md.20</td><td>Current feed value</td></tr> <tr><td>Md.21</td><td>Machine feed value</td></tr> <tr><td>Md.22</td><td>Feedrate</td></tr> </table> <p>• Unit conversion table ([Md.20] [Md.21])</p> <table border="1"> <thead> <tr><th>m</th><th>Unit</th></tr> </thead> <tbody> <tr><td>-1</td><td>μm</td></tr> <tr><td>-5</td><td>inch</td></tr> <tr><td>-5</td><td>degree</td></tr> <tr><td>0</td><td>PLS</td></tr> </tbody> </table> <p>• Unit conversion table ([Md.22])</p> <table border="1"> <thead> <tr><th>m</th><th>Unit</th></tr> </thead> <tbody> <tr><td>-2</td><td>mm/min</td></tr> <tr><td>-3</td><td>inch/min</td></tr> <tr><td>-3 *</td><td>degree/min</td></tr> <tr><td>0</td><td>PLS/s</td></tr> </tbody> </table> <p>* : When "[Pr.83] Speed control 10 x multiplier setting for degree axis" is valid : "-2"</p>	Md.20	Current feed value	Md.21	Machine feed value	Md.22	Feedrate	m	Unit	-1	μm	-5	inch	-5	degree	0	PLS	m	Unit	-2	mm/min	-3	inch/min	-3 *	degree/min	0	PLS/s	0000H	800+100n 801+100n	2400+100n 2401+100n
	Md.20	Current feed value																											
	Md.21	Machine feed value																											
Md.22	Feedrate																												
m	Unit																												
-1	μm																												
-5	inch																												
-5	degree																												
0	PLS																												
m	Unit																												
-2	mm/min																												
-3	inch/min																												
-3 *	degree/min																												
0	PLS/s																												
		0000H	802+100n 803+100n	2402+100n 2403+100n																									
		0000H	804+100n 805+100n	2404+100n 2405+100n																									
<p>■ Monitoring is carried out with a decimal.</p> <p>Monitor value</p> <p>• Error code Refer to Section 16.5 "List of errors" for details on the error Nos. (error codes).</p>	0	806+100n	2406+100n																										

Storage item	Storage details	
Md.24 Axis warning No.	<p>Whenever an axis warning is reported, a related warning code is stored.</p> <ul style="list-style-type: none"> <li>• This area stores the latest warning code always. (Whenever an axis warning is reported, a new warning code replaces the stored warning code.)</li> <li>• When the " Cd.5 Axis error reset" (axis control data) is set to ON, the axis warning No. is cleared to "0".</li> </ul> <p><u>Refresh cycle: Immediate</u></p>	
Md.25 Valid M code	<p>This area stores an M code that is currently active (i.e. set to the positioning data relating to the current operation).</p> <p>When the PLC READY signal [Y0] goes OFF, the value is set to "0".</p> <p><u>Refresh cycle: Immediate</u></p>	
Md.26 Axis operation status	<p>This area stores the axis operation status.</p> <p><u>Refresh cycle: Immediate</u></p>	
Md.27 Current speed	<p>The " Da.8 Command speed" used by the positioning data currently being executed is stored.</p> <ul style="list-style-type: none"> <li>• If " Da.8 Command speed" is set to "-1", this area stores the command speed set by the positioning data used one step earlier.</li> <li>• If " Da.8 Command speed" is set to a value other than "-1", this area stores the command speed set by the current positioning data.</li> <li>• When speed change function is executed, this area stores " Cd.14 New speed value". (For details of change speed function, refer to Section 13.5.1.)</li> </ul> <p><u>Refresh cycle: Immediate</u></p>	

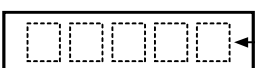
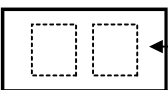
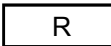
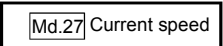
	Reading the monitor value	Default value	Storage buffer memory address										
			LD77MH4	LD77MH16									
<p>■ Monitoring is carried out with a decimal display.</p> <p>Monitor value  ● Warning No. For details of warning Nos. (warning codes), refer to Section 16.6 "List of warnings".</p>	0	807+100n	2407+100n										
<p>■ Monitoring is carried out with a decimal display.</p> <p>Monitor value  ● M code No. (0 to 65535)</p>	0	808+100n	2408+100n										
<p>■ Monitoring is carried out with a decimal display.</p> <p>Monitor value  ● Axis operation status</p> <ul style="list-style-type: none"> <li>-2: Step standby</li> <li>-1: Error</li> <li>0: Standby</li> <li>1: Stopped</li> <li>2: Interpolation</li> <li>3: JOG operation</li> <li>4: Manual pulse generator operation</li> <li>5: Analyzing</li> <li>6: Special start standby</li> <li>7: OPR</li> <li>8: Position control</li> <li>9: Speed control</li> <li>10: Speed control in speed-position switching control</li> <li>11: Position control in speed-position switching control</li> <li>12: Position control in position-speed switching control</li> <li>13: Speed control in position-speed switching control</li> <li>20: Servo amplifier has not been connected/ servo amplifier power OFF</li> <li>21: Servo OFF</li> <li>30: Control mode switch</li> <li>31: Speed control</li> <li>32: Torque control</li> </ul>	0	809+100n	2409+100n										
<p>■ Monitoring is carried out with a decimal display.</p> <p>Monitor value  (Decimal integer value)</p> <p>◇ Unit conversion <math>R \times 10^m</math></p> <p>Actual value  ● Unit conversion table (Md.27)</p> <table border="1" data-bbox="718 1601 941 1758"> <thead> <tr> <th>m</th> <th>Unit</th> </tr> </thead> <tbody> <tr> <td>-2</td> <td>mm/min</td> </tr> <tr> <td>-3</td> <td>inch/min</td> </tr> <tr> <td>-3*</td> <td>degree/min</td> </tr> <tr> <td>0</td> <td>PLS/s</td> </tr> </tbody> </table> <p>*: When "[Pr.83] Speed control 10 x multiplier setting for degree axis" is valid: "-2"</p>	m	Unit	-2	mm/min	-3	inch/min	-3*	degree/min	0	PLS/s	0	810+100n 811+100n	2410+100n 2411+100n
m	Unit												
-2	mm/min												
-3	inch/min												
-3*	degree/min												
0	PLS/s												

n: Axis No.-1



Storage item	Storage details
<p><b>Md.28</b> Axis feedrate</p>	<ul style="list-style-type: none"> <li>The speed which is actually output as a command at that time in each axis is stored. (May be different from the actual motor speed) "0" is stored when the axis is at a stop.</li> </ul> <p><u>Refresh cycle: Operation cycle</u></p> <p><b>POINT</b> Refer to " <b>Md.22</b> Feedrate"</p>
<p><b>Md.29</b> Speed-position switching control positioning amount</p>	<ul style="list-style-type: none"> <li>The movement amount for the position control to end after changing to position control with the speed-position switching control is stored. When the control method is "Reverse run: position/speed", the negative value is stored.</li> </ul> <p><u>Refresh cycle: Immediate</u></p>
<p><b>Md.30</b> External input signal</p>	<p>The ON/OFF state of the external input signal is stored. The following items are stored.</p> <ul style="list-style-type: none"> <li>Lower limit signal *</li> <li>Upper limit signal *</li> <li>External command signal/switching signal</li> <li>Near-point dog signal *</li> </ul> <p>*: This area stores the states of the external input signal (servo amplifier) set by "<b>Pr.80</b> External input signal selection".</p> <p><u>Refresh cycle: Operation cycle</u></p>

	Reading the monitor value	Default value	Storage buffer memory address																				
			LD77MH4	LD77MH16																			
<p>■ Monitoring is carried out with a hexadecimal.</p> <p>Low-order buffer memory Example) 812 b15 b12 b8 b4 b0 E F G H</p> <p>High-order buffer memory Example) 813 b31 b28 b24 b20 b16 A B C D</p> <p>Monitor value E F G H A B C D</p> <p>◇ Sorting</p> <p>(High-order buffer memory) (Low-order buffer memory) A B C D E F G H</p> <p>◇ Converted from hexadecimal to decimal</p> <p>Decimal integer value R</p> <p>◇ Unit conversion <math>R \times 10^m</math></p> <p>Actual value Md.28 Axis feedrate Md.29 Speed-position switching control positioning amount</p> <p>• Unit conversion table (Md.28)</p> <table border="1"> <thead> <tr> <th>m</th> <th>Unit</th> </tr> </thead> <tbody> <tr> <td>-2</td> <td>mm/min</td> </tr> <tr> <td>-3</td> <td>inch/min</td> </tr> <tr> <td>-3 *</td> <td>degree/min</td> </tr> <tr> <td>0</td> <td>PLS/s</td> </tr> </tbody> </table> <p>*: When "Pr.83 Speed control 10 x multiplier setting for degree axis" is valid : "-2"</p> <p>• Unit conversion table (Md.29)</p> <table border="1"> <thead> <tr> <th>m</th> <th>Unit</th> </tr> </thead> <tbody> <tr> <td>-1</td> <td><math>\mu</math>m</td> </tr> <tr> <td>-5</td> <td>inch</td> </tr> <tr> <td>-5</td> <td>degree</td> </tr> <tr> <td>0</td> <td>PLS</td> </tr> </tbody> </table>	m	Unit	-2	mm/min	-3	inch/min	-3 *	degree/min	0	PLS/s	m	Unit	-1	$\mu$ m	-5	inch	-5	degree	0	PLS	0000H	812+100n 813+100n	2412+100n 2413+100n
	m	Unit																					
-2	mm/min																						
-3	inch/min																						
-3 *	degree/min																						
0	PLS/s																						
m	Unit																						
-1	$\mu$ m																						
-5	inch																						
-5	degree																						
0	PLS																						
<p>■ Monitoring is carried out with a hexadecimal.</p> <p>Monitor value 0 0 0 0</p> <p>Buffer memory b15 b12 b8 b4 b0 Not used</p> <table border="1"> <thead> <tr> <th>Stored items</th> <th>Default value</th> <th>Meaning</th> </tr> </thead> <tbody> <tr> <td>b0 Lower limit signal</td> <td>0</td> <td rowspan="8">0: OFF 1: ON</td> </tr> <tr> <td>b1 Upper limit signal</td> <td>0</td> </tr> <tr> <td>b2 Not used</td> <td>0</td> </tr> <tr> <td>b3 Not used</td> <td>0</td> </tr> <tr> <td>b4 External command signal/switching signal</td> <td>0</td> </tr> <tr> <td>b5 Not used</td> <td>0</td> </tr> <tr> <td>b6 Near-point dog signal</td> <td>0</td> </tr> <tr> <td>b7 Not used</td> <td>0</td> </tr> </tbody> </table>	Stored items	Default value	Meaning	b0 Lower limit signal	0	0: OFF 1: ON	b1 Upper limit signal	0	b2 Not used	0	b3 Not used	0	b4 External command signal/switching signal	0	b5 Not used	0	b6 Near-point dog signal	0	b7 Not used	0	0000H	816+100n	2416+100n
	Stored items	Default value	Meaning																				
b0 Lower limit signal	0	0: OFF 1: ON																					
b1 Upper limit signal	0																						
b2 Not used	0																						
b3 Not used	0																						
b4 External command signal/switching signal	0																						
b5 Not used	0																						
b6 Near-point dog signal	0																						
b7 Not used	0																						

n: Axis No.-1

Storage item	Storage details
Md.31 Status	<p>This area stores the states (ON/OFF) of various flags. Information on the following flags is stored.</p> <ul style="list-style-type: none"> <li>● In speed control flag This signal that comes ON under the speed control can be used to judge whether the operation is performed under the speed control or position control. The signal goes OFF when the power is switched ON, under the position control, and during JOG operation or manual pulse generator operation. During the speed-position or position-speed switching control, this signal comes ON only when the speed control is in effect. During the speed-position switching control, this signal goes OFF when the speed-position switching signal executes a switching over from speed control to position control. During the position-speed switching control, this signal comes ON when the position-speed switching signal executes a switching over from position control to speed control.</li> <li>● Speed-position switching latch flag This signal is used during the speed-position switching control for interlocking the movement amount change function. During the speed-position switching control, this signal comes ON when position control takes over. This signal goes OFF when the next positioning data is processed, and during JOG operation or manual pulse generator operation.</li> <li>● Command in-position flag This signal is ON when the remaining distance is equal to or less than the command in-position range (set by a detailed parameter). This signal remains OFF with data that specify the continuous path control (P11) as the operation pattern. The state of this signal is monitored every operation cycle except when the monitoring is canceled under the speed control or while the speed control is in effect during the speed-position or position-speed switching control. While operations are performed with interpolation, this signal comes ON only in respect of the starting axis. (This signal goes OFF in respect of all axes upon starting.)</li> <li>● OPR request flag This signal comes ON when the power is switched ON, when the absolute system has not been set, when the machine OPR has not been executed at the absolute position system, when a machine OPR operation starts. This signal goes OFF when a machine OPR operation completes. (For details of OPR request flag, refer to the remark of Section 8.1.1.)</li> <li>● OPR complete flag This signal comes ON when a machine OPR operation completes normally. This signal goes OFF when the operation start.</li> <li>● Position-speed switching latch flag This signal is used during the position-speed switching control for interlocking the command speed change function. During the position-speed switching control, this signal comes ON when speed control takes over. This signal goes OFF when the next positioning data is processed, and during JOG operation or manual pulse generator operation.</li> <li>● Axis warning detection flag This signal comes On when an axis warning is reported and goes OFF when the axis error reset signal comes ON.</li> <li>● Speed change 0 flag This signal comes ON when a speed change request that specifies 0 as the new speed value is issued. This signal comes ON when a speed change request that specifies a new speed value other than 0 is issued.</li> <li>● M code ON <b>LD77MH16</b> In the WITH mode, this signal turns ON when the positioning data operation is started. In the AFTER mode, this signal turns ON when the positioning data operation is completed. This signal turns OFF with the "[Cd.7] M code OFF request". When M code is not designated (when "[Da.10] M code" is "0"), this signal will remain OFF. With using continuous path control for the positioning operation, the positioning will continue even when this signal does not turn OFF. However, a warning will occur. (Warning code: 503) When the PLC READY signal [Y0] turns OFF, the M code ON signal will also turn OFF. If operation is started while the M code is ON, an error will occur. (Error code: 536)</li> <li>● Error detection <b>LD77MH16</b> This signal turns ON when an error listed in Section 16.4 occurs, and turns OFF when the error is reset on "[Cd.5] Axis error reset".</li> <li>● Start complete <b>LD77MH16</b> This signal turns ON when the positioning start signal turns ON and the LD77MH starts the positioning process. (The start complete signal also turns ON during OPR control.)</li> <li>● Positioning complete <b>LD77MH16</b> This signal turns ON for the time set in "[Pr.40] Positioning complete signal output time" from the instant when the positioning control for each positioning data No. is completed. For the interpolation control, the positioning complete signal of interpolation axis turns ON during the time set to the reference axis. (It does not turn ON when "[Pr.40] Positioning complete signal output time" is "0".) If positioning (including OPR), JOG/Inching operation, or manual pulse generator operation is started while this signal is ON, the signal will turn OFF. This signal will not turn ON when speed control or positioning is canceled midway.</li> </ul> <p><u>Refresh cycle: Immediate</u></p>

	Reading the monitor value	Default value	Storage buffer memory address																															
			LD77MH4	LD77MH16																														
	<p>■ Monitoring is carried out with a hexadecimal display.</p> <table border="1"> <thead> <tr> <th>Stored items</th> <th>Default value</th> <th>Meaning</th> </tr> </thead> <tbody> <tr> <td>b0</td> <td>0</td> <td rowspan="10">0: OFF 1: ON</td> </tr> <tr> <td>b1</td> <td>0</td> </tr> <tr> <td>b2</td> <td>0</td> </tr> <tr> <td>b3</td> <td>1</td> </tr> <tr> <td>b4</td> <td>0</td> </tr> <tr> <td>b5</td> <td>0</td> </tr> <tr> <td>b9</td> <td>0</td> </tr> <tr> <td>b10</td> <td>0</td> </tr> <tr> <td>b12</td> <td>0</td> </tr> <tr> <td>b13</td> <td>0</td> </tr> <tr> <td>b14</td> <td>0</td> <td>LD77MH16</td> </tr> <tr> <td>b15</td> <td>0</td> <td></td> </tr> </tbody> </table>	Stored items	Default value	Meaning	b0	0	0: OFF 1: ON	b1	0	b2	0	b3	1	b4	0	b5	0	b9	0	b10	0	b12	0	b13	0	b14	0	LD77MH16	b15	0		0008H	817+100n	2417+100n
Stored items	Default value	Meaning																																
b0	0	0: OFF 1: ON																																
b1	0																																	
b2	0																																	
b3	1																																	
b4	0																																	
b5	0																																	
b9	0																																	
b10	0																																	
b12	0																																	
b13	0																																	
b14	0	LD77MH16																																
b15	0																																	

Storage item	Storage details
<p><b>Md.32</b> Target value</p>	<p>This area stores the target value ( <b>Da.6</b> Positioning address/movement amount) for a positioning operation.</p> <ul style="list-style-type: none"> <li>• At the beginning of positioning control and current value changing: Stores the value of " <b>Da.6</b> Positioning address/movement amount".</li> <li>• At the OP shift operation of OPR control : Stores the value of OP shift amount.</li> <li>• At other times : Stores "0".</li> </ul> <p><u>Refresh cycle: Immediate</u></p>
<p><b>Md.33</b> Target speed</p>	<ul style="list-style-type: none"> <li>• During operation with positioning data : The actual target speed, considering the override and speed limit value, etc., is stored. "0" is stored when positioning is completed.</li> <li>• During interpolation of position control : The composite speed or reference axis speed is stored in the reference axis address, and "0" is stored in the interpolation axis address.</li> <li>• During interpolation of speed control : The target speeds of each axis are stored in the monitor of the reference axis and interpolation axis.</li> <li>• During JOG operation : The actual target speed, considering the JOG speed limit value for the JOG speed, is stored.</li> <li>• During manual pulse generator operation : "0" is stored.</li> </ul> <p><u>Refresh cycle: Immediate</u></p> <p><b>POINT</b> The target speed is when an override is made to the command speed. When the speed limit value is overridden, the target speed is restricted to the speed limit value. The target speed changes every time data is switched, but does not change in an acceleration/deceleration state inside each piece of data (changes with the speed change because the target speed changes.)</p>
<p><b>Md.34</b> Movement amount after near-point dog ON</p>	<ul style="list-style-type: none"> <li>• "0" is stored when machine OPR starts.</li> <li>• After machine OPR starts, the movement amount from the near-point dog ON to the machine OPR completion is stored. (Movement amount: Movement amount to machine OPR completion using near-point dog ON as "0".)</li> </ul> <p><u>Refresh cycle: Immediate</u></p>

	Reading the monitor value	Default value	Storage buffer memory address																				
			LD77MH4	LD77MH16																			
<p>■ Monitoring is carried out with a decimal display.</p> <p>Monitor value <b>R</b> (Decimal integer value)</p> <p>◇ Unit conversion <math>R \times 10^m</math></p> <p>Actual value <b>Md.32 Target value</b></p> <p>• Unit conversion table (Md.32)</p> <table border="1"> <thead> <tr> <th>m</th> <th>Unit</th> </tr> </thead> <tbody> <tr> <td>-1</td> <td>μm</td> </tr> <tr> <td>-5</td> <td>inch</td> </tr> <tr> <td>-5</td> <td>degree</td> </tr> <tr> <td>0</td> <td>PLS</td> </tr> </tbody> </table>	m	Unit	-1	μm	-5	inch	-5	degree	0	PLS	0	818+100n 819+100n	2418+100n 2419+100n										
m	Unit																						
-1	μm																						
-5	inch																						
-5	degree																						
0	PLS																						
<p>■ Monitoring is carried out with a hexadecimal display.</p> <p>Monitor value <b>E F G H</b> (Low-order buffer memory Example) 820</p> <p>Monitor value <b>A B C D</b> (High-order buffer memory Example) 821</p> <p>◇ Sorting</p> <p>(High-order buffer memory) (Low-order buffer memory)</p> <p><b>A B C D E F G H</b></p> <p>◇ Converted from hexadecimal to decimal</p> <p>Decimal integer value <b>R</b></p> <p>◇ Unit conversion <math>R \times 10^m</math></p> <p>Actual value <b>Md.33 Target speed</b> <b>Md.34 Movement amount after near-point dog ON</b></p> <p>• Unit conversion table (Md.33)</p> <table border="1"> <thead> <tr> <th>m</th> <th>Unit</th> </tr> </thead> <tbody> <tr> <td>-2</td> <td>mm/min</td> </tr> <tr> <td>-3</td> <td>inch/min</td> </tr> <tr> <td>-3*</td> <td>degree/min</td> </tr> <tr> <td>0</td> <td>PLS/s</td> </tr> </tbody> </table> <p>*: When "[Pr.83] Speed control 10 x multiplier setting for degree axis" is valid: "-2"</p> <p>• Unit conversion table (Md.34)</p> <table border="1"> <thead> <tr> <th>m</th> <th>Unit</th> </tr> </thead> <tbody> <tr> <td>-1</td> <td>μm</td> </tr> <tr> <td>-5</td> <td>inch</td> </tr> <tr> <td>-5</td> <td>degree</td> </tr> <tr> <td>0</td> <td>PLS</td> </tr> </tbody> </table>	m	Unit	-2	mm/min	-3	inch/min	-3*	degree/min	0	PLS/s	m	Unit	-1	μm	-5	inch	-5	degree	0	PLS	0000H	820+100n 821+100n	2420+100n 2421+100n
m	Unit																						
-2	mm/min																						
-3	inch/min																						
-3*	degree/min																						
0	PLS/s																						
m	Unit																						
-1	μm																						
-5	inch																						
-5	degree																						
0	PLS																						
		0000H	824+100n 825+100n	2424+100n 2425+100n																			

n: Axis No.-1



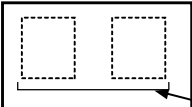
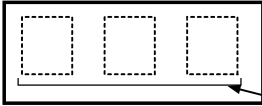
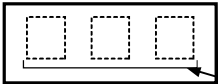



Storage item	Storage details	
<p><b>Md.35</b> Torque limit stored value/ forward torque limit stored value</p>	<p>The " <b>Pr.17</b> Torque limit setting value", " <b>Cd.101</b> Torque output setting value" or " <b>Cd.22</b> New torque value/forward new torque value", " <b>Pr.54</b> OPR torque limit value" is stored.</p> <ul style="list-style-type: none"> <li>• During positioning start, JOG operation start, manual pulse generator operation : The " <b>Pr.17</b> Torque limit setting value" or " <b>Cd.101</b> Torque output setting value" is stored.</li> <li>• When value is changed to " <b>Cd.22</b> New torque value/forward new torque value " during operation : The " <b>Cd.22</b> New torque value/forward new torque value " is stored.</li> <li>• When OPR : The " <b>Pr.17</b> Torque limit setting value" or " <b>Cd.101</b> Torque output setting value" is stored. But " <b>Pr.54</b> OPR torque limit value" is stored after the " <b>Pr.47</b> Creep speed" completion.</li> </ul> <p><u>Refresh cycle: Immediate</u></p>	
<p><b>Md.36</b> Special start data instruction code setting value</p>	<ul style="list-style-type: none"> <li>• The " instruction code" used with special start and indicated by the start data pointer currently being executed is stored.</li> </ul> <p><u>Refresh cycle: Immediate</u></p>	
<p><b>Md.37</b> Special start data instruction parameter setting value</p>	<p>The "instruction parameter" used with special start and indicated by the start data pointer currently being executed is stored.</p> <p>The stored value differs according to the value set for <b>Md.36</b> .</p> <p><u>Refresh cycle: Immediate</u></p>	
<p><b>Md.38</b> Start positioning data No. setting value</p>	<ul style="list-style-type: none"> <li>• The "positioning data No." indicated by the start data pointer currently being executed is stored.</li> </ul> <p><u>Refresh cycle: Immediate</u></p>	

	Reading the monitor value	Default value	Storage buffer memory address													
			LD77MH4	LD77MH16												
	<p>■ Monitoring is carried out with a decimal display.</p> <p>Monitor value </p> <p>● Storage value 1 to 1000 (%)</p>	0	826+100n	2426+100n												
	<p>■ Monitoring is carried out with a decimal display.</p> <p>Monitor value </p> <p>● Storage value 00: Block start (Normal start) 01: Condition start 02: Wait start 03: Simultaneous start 04: FOR loop 05: FOR condition 06: NEXT</p>	0	827+100n	2427+100n												
	<p>■ Monitoring is carried out with a decimal display.</p> <p>Monitor value </p> <p>● Storage value</p> <table border="1" data-bbox="539 1335 992 1599"> <thead> <tr> <th>[Md.36] setting value</th> <th>Stored contents</th> <th>Storage value</th> </tr> </thead> <tbody> <tr> <td>00 06</td> <td>None</td> <td>None</td> </tr> <tr> <td>01 02 03 05</td> <td>Condition data No.</td> <td>1 to 10</td> </tr> <tr> <td>04</td> <td>Number of repetitions</td> <td>0 to 255</td> </tr> </tbody> </table>	[Md.36] setting value	Stored contents	Storage value	00 06	None	None	01 02 03 05	Condition data No.	1 to 10	04	Number of repetitions	0 to 255	0	828+100n	2428+100n
[Md.36] setting value	Stored contents	Storage value														
00 06	None	None														
01 02 03 05	Condition data No.	1 to 10														
04	Number of repetitions	0 to 255														
	<p>■ Monitoring is carried out with a decimal display.</p> <p>Monitor value </p> <p>● Storage value 1 to 600</p>	0	829+100n	2429+100n												

n: Axis No.-1



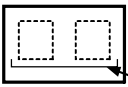

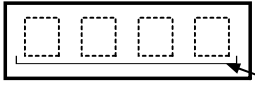
Storage item	Storage details	
Md.39 In speed limit flag	<ul style="list-style-type: none"> <li>• If the speed exceeds the " Pr.8 Speed limit value" ("Pr.31 JOG speed limit value" at JOG operation control) due to a speed change or override, the speed limit functions, and the in speed limit flag turns ON.</li> <li>• When the speed drops to less than " Pr.8 Speed limit value" ("Pr.31 JOG speed limit value" at JOG operation control), or when the axis stops, the in speed limit flag turns OFF.</li> </ul> <p><u>Refresh cycle: Immediate</u></p>	
Md.40 In speed change processing flag	<ul style="list-style-type: none"> <li>• The speed change process flag turns ON when the speed is changed during positioning control.</li> <li>• After the speed change process is completed or when deceleration starts with the stop signal during the speed change process, the in speed change process flag turns OFF.</li> </ul> <p><u>Refresh cycle: Immediate</u></p>	
Md.41 Special start repetition counter	<ul style="list-style-type: none"> <li>• This area stores the remaining number of repetitions during "repetitions" specific to special starting.</li> <li>• The count is decremented by one (-1) at the loop end.</li> <li>• The control comes out of the loop when the count reaches "0".</li> <li>• This area stores "0" within an infinite loop.</li> </ul> <p><u>Refresh cycle: Immediate</u></p>	
Md.42 Control system repetition counter	<ul style="list-style-type: none"> <li>• This area stores the remaining number of repetitions during "repetitions" specific to control system.</li> <li>• The count is decremented by one (-1) at the loop start.</li> <li>• The loop is terminated with the positioning data of the control method "LEND", after the counter becomes "0".</li> </ul> <p><u>Refresh cycle: Immediate</u></p>	
Md.43 Start data pointer being executed	<ul style="list-style-type: none"> <li>• This area stores a point No. (1 to 50) attached to the start data currently being executed.</li> <li>• This area stores "0" after completion of a positioning operation.</li> </ul> <p><u>Refresh cycle: Immediate</u></p>	
Md.44 Positioning data No. being executed	<ul style="list-style-type: none"> <li>• This area stores a positioning data No. attached to the positioning data currently being executed.</li> <li>• This area stores "0" when the JOG/inching operation is executed.</li> </ul> <p><u>Refresh cycle: Immediate</u></p>	
Md.45 Block No. being executed	<ul style="list-style-type: none"> <li>• When the operation is controlled by "block start data", this area stores a block number (7000 to 7004) attached to the block currently being executed.</li> <li>• At other times, this area stores "0".</li> </ul> <p><u>Refresh cycle: At start</u></p>	

	Reading the monitor value	Default value	Storage buffer memory address	
			LD77MH4	LD77MH16
<p>■ Monitoring is carried out with a decimal display.</p> <p>Monitor value  ● Storage value 0: Not in speed limit (OFF) 1: In speed limit (ON)</p>	0	830+100n	2430+100n	
<p>■ Monitoring is carried out with a decimal display.</p> <p>Monitor value  ● Storage value 0: Not in speed change (OFF) 1: In speed change (ON)</p>	0	831+100n	2431+100n	
<p>■ Monitoring is carried out with a decimal display.</p> <p>Monitor value  ● Storage value 0 to 255</p>	0	832+100n	2432+100n	
<p>■ Monitoring is carried out with a hexadecimal display.</p> <p>Monitor value  ● Storage value 0 to FFFF</p>	0000H	833+100n	2433+100n	
<p>■ Monitoring is carried out with a decimal display.</p> <p>Monitor value  ● Storage value 1 to 50</p>	0	834+100n	2434+100n	
<p>■ Monitoring is carried out with a decimal display.</p> <p>Monitor value  ● Storage value 1 to 600, 9001 to 9003</p>	0	835+100n	2435+100n	
<p>■ Monitoring is carried out with a decimal display.</p> <p>Monitor value  ● Storage value 7000 to 7004</p>	0	836+100n	2436+100n	

n: Axis No.-1

Storage item	Storage details
<p><b>Md.46</b> Last executed positioning data No.</p>	<ul style="list-style-type: none"> <li>• This area stores the positioning data No. attached to the positioning data that was executed last time.</li> <li>• The value is retained until a new positioning operation is executed.</li> <li>• This area stores "0" when the JOG/inching operation is executed.</li> </ul> <p><u>Refresh cycle: Immediate</u></p>
<p><b>Md.47</b> Positioning data being executed</p>	<ul style="list-style-type: none"> <li>• The addresses shown to the right store details of the positioning data currently being executed (positioning data No. given by <b>Md.44</b> ).</li> </ul> <p><u>Refresh cycle: Immediate</u></p>
<p><b>Md.48</b> Deceleration start flag *</p>	<ul style="list-style-type: none"> <li>• "1" is stored when the constant speed status or acceleration status switches to the deceleration status during position control whose operation pattern is "Positioning complete".</li> <li>• "0" is stored at the next operation start or manual pulse generator operation enable.</li> </ul> <p><u>Refresh cycle: Immediate</u></p> <p><b>POINT</b>  This parameter is possible to monitor when " <b>Cd.41</b> Deceleration start flag valid " is valid.</p>

	Reading the monitor value	Default value	Storage buffer memory address																																																									
			LD77MH4	LD77MH16																																																								
<p>■ Monitoring is carried out with a decimal display.</p> <p>Monitor value </p> <p>● Storage value 1 to 600, 9001 to 9003</p>		0	837+100n	2437+100n																																																								
<p>Information is stored in the following addresses:</p> <table border="1" data-bbox="172 611 1002 1205"> <thead> <tr> <th colspan="2">Stored address (Monitor value)</th> <th rowspan="2">Stored item</th> <th colspan="2">Reference</th> </tr> <tr> <th>LD77MH4</th> <th>LD77MH16</th> <th>LD77MH4</th> <th>LD77MH16</th> </tr> </thead> <tbody> <tr> <td>838+100n</td> <td>2438+100n</td> <td>Positioning identifier</td> <td>Da.1 to Da.5</td> <td>Da.1 to Da.4</td> </tr> <tr> <td>839+100n</td> <td>2439+100n</td> <td>M code</td> <td>Da.10</td> <td>Da.10</td> </tr> <tr> <td>840+100n</td> <td>2440+100n</td> <td>Dwell time</td> <td>Da.9</td> <td>Da.9</td> </tr> <tr> <td>—</td> <td>2441+100n</td> <td>Axis to be interpolated</td> <td>—</td> <td>Da.20 to Da.22</td> </tr> <tr> <td>842+100n</td> <td>2442+100n</td> <td rowspan="2">Command speed</td> <td>Da.8</td> <td>Da.8</td> </tr> <tr> <td>843+100n</td> <td>2443+100n</td> <td></td> <td></td> </tr> <tr> <td>844+100n</td> <td>2444+100n</td> <td rowspan="2">Positioning address</td> <td>Da.6</td> <td>Da.6</td> </tr> <tr> <td>845+100n</td> <td>2445+100n</td> <td></td> <td></td> </tr> <tr> <td>846+100n</td> <td>2446+100n</td> <td rowspan="2">Arc address</td> <td>Da.7</td> <td>Da.7</td> </tr> <tr> <td>847+100n</td> <td>2447+100n</td> <td></td> <td></td> </tr> </tbody> </table>	Stored address (Monitor value)		Stored item	Reference		LD77MH4	LD77MH16	LD77MH4	LD77MH16	838+100n	2438+100n	Positioning identifier	Da.1 to Da.5	Da.1 to Da.4	839+100n	2439+100n	M code	Da.10	Da.10	840+100n	2440+100n	Dwell time	Da.9	Da.9	—	2441+100n	Axis to be interpolated	—	Da.20 to Da.22	842+100n	2442+100n	Command speed	Da.8	Da.8	843+100n	2443+100n			844+100n	2444+100n	Positioning address	Da.6	Da.6	845+100n	2445+100n			846+100n	2446+100n	Arc address	Da.7	Da.7	847+100n	2447+100n				0	838+100n to 847+100n	2438+100n to 2447+100n
Stored address (Monitor value)		Stored item		Reference																																																								
LD77MH4	LD77MH16		LD77MH4	LD77MH16																																																								
838+100n	2438+100n	Positioning identifier	Da.1 to Da.5	Da.1 to Da.4																																																								
839+100n	2439+100n	M code	Da.10	Da.10																																																								
840+100n	2440+100n	Dwell time	Da.9	Da.9																																																								
—	2441+100n	Axis to be interpolated	—	Da.20 to Da.22																																																								
842+100n	2442+100n	Command speed	Da.8	Da.8																																																								
843+100n	2443+100n																																																											
844+100n	2444+100n	Positioning address	Da.6	Da.6																																																								
845+100n	2445+100n																																																											
846+100n	2446+100n	Arc address	Da.7	Da.7																																																								
847+100n	2447+100n																																																											
<p>■ Monitoring is carried out with a decimal display.</p> <p>Monitor value </p> <p>● Storage value 0: Status other than below 1: Status from deceleration start to next operation start or manual pulse generator operation enable</p>		0	899+100n	2499+100n																																																								

n: Axis No.-1

Storage item	Storage details	
Md.100 OPR re-travel value	<ul style="list-style-type: none"> <li>This area stores the travel distance during the OPR travel to the zero point that was executed last time. For setting units</li> </ul> <p>Example) mm (Buffer memory <math>\times</math> 0.1) <math>\mu</math>m</p> <p><u>Refresh cycle: Immediate</u></p>	
Md.101 Real current value	<ul style="list-style-type: none"> <li>This area stores the current value (feed current value – deviation counter droop pulses).</li> </ul> <p>Example) mm (Buffer memory <math>\times</math> 0.1) <math>\mu</math>m</p> <p><u>Refresh cycle: Operation cycle</u></p>	
Md.102 Deviation counter value	<ul style="list-style-type: none"> <li>This area stores the difference between the feed current and the real current value. (Buffer memory details) PLS</li> </ul> <p><u>Refresh cycle: Operation cycle</u></p>	
Md.103 Motor rotation speed	<ul style="list-style-type: none"> <li>This area stores the motor speed updated in real time. (Buffer memory <math>\times</math> 0.1) r/min *1</li> </ul> <p>*1: The unit is mm/s at linear servo use.</p> <p><u>Refresh cycle: Operation cycle</u></p>	
Md.104 Motor current value	<ul style="list-style-type: none"> <li>This area stores the present motor current value of the motor. (Buffer memory <math>\times</math> 0.1) %</li> </ul> <p><u>Refresh cycle: Operation cycle</u></p>	
Md.106 Servo amplifier software No.	<ul style="list-style-type: none"> <li>This area stores the software No. of the servo amplifier used.</li> <li>This area is update when the control power of the servo amplifier is turned ON.</li> </ul> <p><u>Refresh cycle: Servo amplifier's power supply ON</u></p>	

	Reading the monitor value	Default value	Storage buffer memory address																		
			LD77MH4	LD77MH16																	
<p>■ Monitoring is carried out with a hexadecimal display.</p> <p>Low-order buffer memory Example) 848 b15 b12 b8 b4 b0 E F G H</p> <p>High-order buffer memory Example) 849 b31 b28 b24 b20 b16 A B C D</p> <p>Monitor value: E F G H (top row), A B C D (bottom row)</p> <p>◇ Sorting</p> <p>(High-order buffer memory) (Low-order buffer memory) A B C D E F G H</p> <p>◇ Converted from hexadecimal to decimal</p> <p>Decimal integer value: R</p> <p>◇ Unit conversion <math>R \times 10^m</math></p> <p>Actual value: [Md.100] OPR re-travel value [Md.101] Real current value [Md.102] Deviation counter value [Md.103] Motor rotation speed</p> <p>Unit conversion table ([Md.100] [Md.101])</p> <table border="1"> <thead> <tr><th>m</th><th>Unit</th></tr> </thead> <tbody> <tr><td>-1</td><td>μm</td></tr> <tr><td>-5</td><td>inch</td></tr> <tr><td>-5</td><td>degree</td></tr> <tr><td>0</td><td>PLS</td></tr> </tbody> </table> <p>Unit conversion table ([Md.102])</p> <table border="1"> <thead> <tr><th>m</th><th>Unit</th></tr> </thead> <tbody> <tr><td>0</td><td>PLS</td></tr> </tbody> </table> <p>Unit conversion table ([Md.103])</p> <table border="1"> <thead> <tr><th>m</th><th>Unit</th></tr> </thead> <tbody> <tr><td>-1</td><td>r/min * 1</td></tr> </tbody> </table>	m	Unit	-1	μm	-5	inch	-5	degree	0	PLS	m	Unit	0	PLS	m	Unit	-1	r/min * 1	0000H	848+100n 849+100n	2448+100n 2449+100n
	m	Unit																			
	-1	μm																			
-5	inch																				
-5	degree																				
0	PLS																				
m	Unit																				
0	PLS																				
m	Unit																				
-1	r/min * 1																				
0000H	850+100n 851+100n	2450+100n 2451+100n																			
0000H	852+100n 853+100n	2452+100n 2453+100n																			
<p>■ Monitoring is carried out with a decimal display.</p> <p>Decimal integer value: R</p> <p>◇ Converted from hexadecimal to decimal</p> <p>◇ Unit conversion <math>R \times 10^m</math></p> <p>Actual value: [Md.104] Motor current value</p> <p>Unit conversion table ([Md.104])</p> <table border="1"> <thead> <tr><th>m</th><th>Unit</th></tr> </thead> <tbody> <tr><td>-1</td><td>%</td></tr> </tbody> </table>	m	Unit	-1	%	0	856+100n	2456+100n														
	m	Unit																			
	-1	%																			
<p>■ Monitoring is carried out with a decimal display.</p> <p>Monitor value: [ ] [ ] [ ] [ ]</p> <p>The monitor value is character code (ASCII format).</p> <p>Software No.</p> <p>Example) -B35W200...A0... Address Monitor value Stored value 864 422D - B 865 3533 3 5 866 3257 W 2 867 3030 0 0 868 4120 SPACE A 869 2030 0 SPACE</p>	0	864+100n to 869+100n	2464+100n to 2469+100n																		

n: Axis No.-1

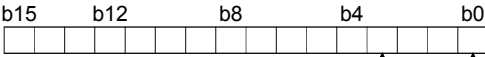
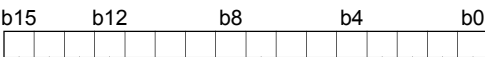

Storage item	Storage details
Md.107 Parameter error No.	<ul style="list-style-type: none"> <li>• When a servo parameter error occurs, the area that corresponds to the parameter number affected by the error comes ON.</li> </ul> <p><u>Refresh cycle: Immediate</u></p>
Md.108 Servo status	<p>This area stores the servo status.</p> <ul style="list-style-type: none"> <li>• Zero point pass Turns ON if the zero point of the encoder has been passed even once.</li> <li>• Zero speed Turns ON when the motor speed is lower than the servo parameter "zero speed."</li> <li>• Speed limit Turn ON during the speed limit in torque control mode.</li> <li>• PID control Turn ON when the servo amplifier is PID control.</li> <li>• READY ON Indicates the ready ON/OFF.</li> <li>• Servo ON Indicates the servo ON/OFF.</li> <li>• Control mode Indicates the control mode of servo amplifier.</li> <li>• Servo alarm Turn ON during the servo alarm.</li> <li>• In-position The dwell pulse turns ON within the servo parameter "in-position".</li> <li>• Torque limit Turns ON when the servo amplifier is having the torque restricted.</li> <li>• Absolute position lost Turns ON when the servo amplifier is lost the absolute position.</li> <li>• Servo warning Turn ON during the servo warning.</li> </ul> <p><u>Refresh cycle: Operation cycle</u></p>

	Reading the monitor value	Default value	Storage buffer memory address																															
			LD77MH4	LD77MH16																														
<p>■ Monitoring is carried out with a decimal display.</p>  <table border="1" data-bbox="662 414 925 716"> <thead> <tr> <th>Storage value</th> <th>Parameter No.</th> </tr> </thead> <tbody> <tr><td>1 to 18</td><td>PA01 to PA18</td></tr> <tr><td>19 to 63</td><td>PB01 to PB45</td></tr> <tr><td>64 to 95</td><td>PC01 to PC32</td></tr> <tr><td>96 to 127</td><td>PD01 to PD32</td></tr> <tr><td>128 to 167</td><td>PE01 to PE40</td></tr> <tr><td>168 to 183</td><td>PF01 to PF16</td></tr> <tr><td>184 to 199</td><td>Po01 to Po16</td></tr> <tr><td>200 to 231</td><td>PS01 to PS32</td></tr> <tr><td>232</td><td>PA19</td></tr> </tbody> </table>	Storage value	Parameter No.	1 to 18	PA01 to PA18	19 to 63	PB01 to PB45	64 to 95	PC01 to PC32	96 to 127	PD01 to PD32	128 to 167	PE01 to PE40	168 to 183	PF01 to PF16	184 to 199	Po01 to Po16	200 to 231	PS01 to PS32	232	PA19	0	870+100n	2470+100n											
Storage value	Parameter No.																																	
1 to 18	PA01 to PA18																																	
19 to 63	PB01 to PB45																																	
64 to 95	PC01 to PC32																																	
96 to 127	PD01 to PD32																																	
128 to 167	PE01 to PE40																																	
168 to 183	PF01 to PF16																																	
184 to 199	Po01 to Po16																																	
200 to 231	PS01 to PS32																																	
232	PA19																																	
<p>■ Monitoring is carried out with a hexadecimal display.</p>  <table border="1" data-bbox="654 862 1013 1019"> <thead> <tr> <th>Stored items</th> <th>Meaning</th> </tr> </thead> <tbody> <tr><td>b0</td><td>Zero point pass</td></tr> <tr><td>b3</td><td>Zero speed</td></tr> <tr><td>b4</td><td>Speed limit</td></tr> <tr><td>b8</td><td>PID control</td></tr> </tbody> </table>	Stored items	Meaning	b0	Zero point pass	b3	Zero speed	b4	Speed limit	b8	PID control	0000H	876+100n	2476+100n																					
Stored items	Meaning																																	
b0	Zero point pass																																	
b3	Zero speed																																	
b4	Speed limit																																	
b8	PID control																																	
<p>■ Monitoring is carried out with a hexadecimal display.</p>  <table border="1" data-bbox="654 1164 1013 1467"> <thead> <tr> <th>Stored items</th> <th>Meaning</th> </tr> </thead> <tbody> <tr><td>b0</td><td>READY ON</td></tr> <tr><td>b1</td><td>Servo ON</td></tr> <tr><td>b2</td><td rowspan="2">Control mode*</td></tr> <tr><td>b3</td></tr> <tr><td>b7</td><td>Servo alarm</td></tr> <tr><td>b12</td><td>In-position</td></tr> <tr><td>b13</td><td>Torque limit</td></tr> <tr><td>b14</td><td>Absolute position lost</td></tr> <tr><td>b15</td><td>Servo warning</td></tr> </tbody> </table> <p>*: Control mode</p> <table border="1" data-bbox="710 1500 1013 1624"> <thead> <tr> <th>b2</th> <th>b3</th> <th>Control mode</th> </tr> </thead> <tbody> <tr><td>0</td><td>0</td><td>Position control mode</td></tr> <tr><td>1</td><td>0</td><td>Speed control mode</td></tr> <tr><td>0</td><td>1</td><td>Torque control mode</td></tr> </tbody> </table>	Stored items	Meaning	b0	READY ON	b1	Servo ON	b2	Control mode*	b3	b7	Servo alarm	b12	In-position	b13	Torque limit	b14	Absolute position lost	b15	Servo warning	b2	b3	Control mode	0	0	Position control mode	1	0	Speed control mode	0	1	Torque control mode	0000H	877+100n	2477+100n
Stored items	Meaning																																	
b0	READY ON																																	
b1	Servo ON																																	
b2	Control mode*																																	
b3																																		
b7	Servo alarm																																	
b12	In-position																																	
b13	Torque limit																																	
b14	Absolute position lost																																	
b15	Servo warning																																	
b2	b3	Control mode																																
0	0	Position control mode																																
1	0	Speed control mode																																
0	1	Torque control mode																																
<p><b>POINT</b></p> <p>When the forced stop of LD77MH and servo amplifier occurs, the servo warning is turned ON. When the forced stop is reset, the servo warning is turned OFF.</p>																																		

n: Axis No.-1

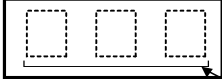
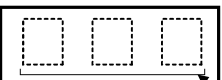
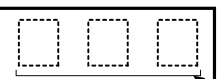
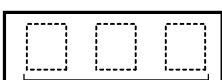

Storage item	Storage details	
<p><b>Md.109</b> Regenerative load ratio/ Optional data monitor output 1</p>	<ul style="list-style-type: none"> <li>The rate of regenerative power to the allowable regenerative power is indicated as a percentage.</li> <li>When the regenerative option is used, the rate to the allowable regenerative power of the option is indicated. (Buffer memory) %</li> <li>This area stores the content set in "<b>Pr.91</b> Optional data monitor: Data type setting 1" at optional data monitor data type setting. <b>LD77MH16</b></li> </ul> <p><u>Refresh cycle: Operation cycle</u></p>	
<p><b>Md.110</b> Effective load torque/ Optional data monitor output 2</p>	<ul style="list-style-type: none"> <li>The continuous effective load torque is indicated.</li> <li>The average value of the load rates for the past 15 seconds to the rated torque is stored as a percentage, rated torque being 100%. (Buffer memory) %</li> <li>This area stores the content set in "<b>Pr.92</b> Optional data monitor: Data type setting 2" at optional data monitor data type setting. <b>LD77MH16</b></li> </ul> <p><u>Refresh cycle: Operation cycle</u></p>	
<p><b>Md.111</b> Peak torque ratio/ Optional data monitor output 3</p>	<ul style="list-style-type: none"> <li>The maximum torque is indicated. (Holding value)</li> <li>The peak values for the past 15 seconds are indicated, rated torque being 100%. (Buffer memory) %</li> <li>This area stores the content set in "<b>Pr.93</b> Optional data monitor: Data type setting 3" at optional data monitor data type setting. <b>LD77MH16</b></li> </ul> <p><u>Refresh cycle: Operation cycle</u></p>	
<p><b>Md.112</b> Optional data monitor output 4 <b>LD77MH16</b></p>	<ul style="list-style-type: none"> <li>This area stores the content set in "<b>Pr.94</b> Optional data monitor: Data type setting 4" at optional data monitor data type setting. ("0" is stored when the optional data monitor data type is not set.)</li> </ul> <p><u>Refresh cycle: Operation cycle</u></p>	
<p><b>Md.113</b> Semi/Fully closed loop status</p>	<ul style="list-style-type: none"> <li>The switching status of semi closed loop control/fully closed loop control is indicated.</li> </ul> <p><u>Refresh cycle: Operation cycle</u></p>	
<p><b>Md.114</b> Servo alarm</p>	<ul style="list-style-type: none"> <li>This area stores the error codes displayed in LED of servo amplifier.</li> </ul> <p><u>Refresh cycle: Immediate</u></p>	

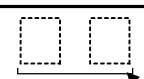
	Reading the monitor value	Default value	Storage buffer memory address	
			LD77MH16	LD77MH16
<p>■ Monitoring is carried out with a decimal display.</p> <p>Monitor value  Regenerative load ratio/ Optional data monitor output 1</p>	0	878+100n	2478+100n	
<p>■ Monitoring is carried out with a decimal display.</p> <p>Monitor value  Effective load torque ratio/ Optional data monitor output 2</p>	0	879+100n	2479+100n	
<p>■ Monitoring is carried out with a decimal display.</p> <p>Monitor value  Peek torque ratio/ Optional data monitor output 3</p>	0	880+100n	2480+100n	
<p>■ Monitoring is carried out with a decimal display.</p> <p>Monitor value  Optional data monitor output 4</p>	0	/	2481+100n	
<p>■ Monitoring is carried out with a decimal display.</p> <p>Monitor value  • Semi/Fully closed loop status 0: In semi closed loop control 1: In fully closed loop control</p>	0	887+100n	2487+100n	
<p>■ Monitoring is carried out with a hexadecimal display.</p> <p>Monitor value  Error code</p>	00H	888+100n	2488+100n	

n: Axis No.-1

Storage item	Storage details	
<p><b>Md.116</b> Encoder option information</p>	<ul style="list-style-type: none"> <li>The option information of encoder is indicated. (This information differs by the connected servo amplifier. Refer to the "Servo amplifier Instruction Manual" for details of storage item.)</li> </ul> <p><u>Refresh cycle: Servo amplifier's power supply ON</u></p>	
<p><b>Md.120</b> Reverse torque limit stored value</p>	<p>" <b>Pr.17</b> Torque limit setting value", " <b>Cd.101</b> Torque output setting value" or " <b>Cd.113</b> Reverse new torque value", " <b>Pr.54</b> OPR torque limit value" is stored.</p> <ul style="list-style-type: none"> <li>At the positioning start/JOG operation start/ manual pulse generator operation : The " <b>Pr.17</b> Torque limit setting value" or " <b>Cd.101</b> Torque output setting value" is stored.</li> <li>When a value is set in " <b>Cd.22</b> New torque value/forward new torque value" or " <b>Cd.113</b> Reverse new torque value" during operation. : " <b>Cd.22</b> New torque value/forward new torque value" is stored when "0" is set in " <b>Cd.112</b> Torque change function switching request". " <b>Cd.113</b> Reverse new torque value" is stored when "1" is set in " <b>Cd.112</b> Torque change function switching request".</li> <li>At the OPR : " <b>Pr.17</b> Torque limit setting value" or " <b>Cd.101</b> Torque output setting value" is stored. However, " <b>Pr.54</b> OPR torque limit value" is stored after it reach to " <b>Pr.47</b> Creep speed" completion.</li> </ul> <p><u>Refresh cycle: Immediate</u></p>	

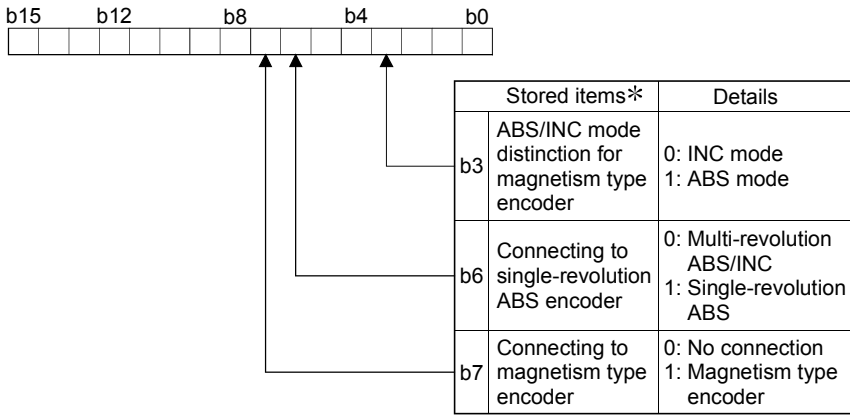
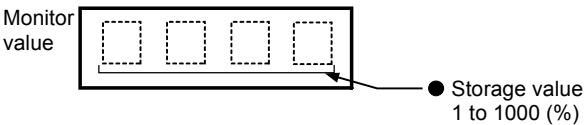
	Reading the monitor value	Default value	Storage buffer memory address								
			LD77MH4	LD77MH16							
<p>■ Monitoring is carried out with a hexadecimal display.</p>  <table border="1" data-bbox="614 459 1013 795"> <thead> <tr> <th>Stored items*</th> <th>Details</th> </tr> </thead> <tbody> <tr> <td>b3 ABS/INC mode distinction for magnetism type encoder</td> <td>0: INC mode 1: ABS mode</td> </tr> <tr> <td>b6 Connecting to single-revolution ABS encoder</td> <td>0: Multi-revolution ABS/INC 1: Single-revolution ABS</td> </tr> <tr> <td>b7 Connecting to magnetism type encoder</td> <td>0: No connection 1: Magnetism type encoder</td> </tr> </tbody> </table> <p>*: Servo amplifier compatible with direct drive motor use</p>	Stored items*	Details	b3 ABS/INC mode distinction for magnetism type encoder	0: INC mode 1: ABS mode	b6 Connecting to single-revolution ABS encoder	0: Multi-revolution ABS/INC 1: Single-revolution ABS	b7 Connecting to magnetism type encoder	0: No connection 1: Magnetism type encoder	0000H	890+100n	2490+100n
Stored items*	Details										
b3 ABS/INC mode distinction for magnetism type encoder	0: INC mode 1: ABS mode										
b6 Connecting to single-revolution ABS encoder	0: Multi-revolution ABS/INC 1: Single-revolution ABS										
b7 Connecting to magnetism type encoder	0: No connection 1: Magnetism type encoder										
<p>■ Monitoring is carried out with a decimal display.</p>  <p>Monitor value</p> <p>● Storage value 1 to 1000 (%)</p>	0	891+100n	2491+100n								

n: Axis No.-1

Storage item	Storage details	
<p><span data-bbox="161 454 233 479">Md.122</span> Speed during command</p>	<ul style="list-style-type: none"> <li>• This area stores the command speed during speed control mode.</li> <li>• "0" is stored other than during speed control mode.</li> </ul> <p><u>Refresh cycle: Operation cycle (Speed control mode only)</u></p>	
<p><span data-bbox="161 734 233 759">Md.123</span> Torque during command</p>	<ul style="list-style-type: none"> <li>• This area stores the command torque during torque control mode. (Buffer memory <math>\times 0.1</math>)%</li> <li>• "0" is stored other than during torque control mode.</li> </ul> <p><u>Refresh cycle: Operation cycle (Torque control mode only)</u></p>	

	Reading the monitor value	Default value	Storage buffer memory address														
			LD77MH4	LD77MH16													
<p>■ Monitoring is carried out with a decimal display.</p> <p>Monitor value <b>R</b></p> <p>◇ Unit conversion <math>R \times 10^m</math></p> <p>Actual value</p> <p>[Md.122] Speed during command [Md.123] Torque during command</p> <p>• Unit conversion table ([Md.122])</p> <table border="1"> <thead> <tr> <th>m</th> <th>Unit</th> </tr> </thead> <tbody> <tr> <td>-2</td> <td>mm/min</td> </tr> <tr> <td>-3</td> <td>inch/min</td> </tr> <tr> <td>-3*</td> <td>degree/min</td> </tr> <tr> <td>0</td> <td>PLS/s</td> </tr> </tbody> </table> <p>*: When "[Pr.83] Speed control 10 x multiplier setting for degree axis" is valid: "-2"</p> <p>• Unit conversion table ([Md.123])</p> <table border="1"> <thead> <tr> <th>m</th> <th>Unit</th> </tr> </thead> <tbody> <tr> <td>-1</td> <td>%</td> </tr> </tbody> </table>	m	Unit	-2	mm/min	-3	inch/min	-3*	degree/min	0	PLS/s	m	Unit	-1	%	0	892+100n 893+100n	2492+100n 2493+100n
	m	Unit															
-2	mm/min																
-3	inch/min																
-3*	degree/min																
0	PLS/s																
m	Unit																
-1	%																
		0	894+100n	2494+100n													

n: Axis No.-1

## 5.7 List of control data

The setting items of the control data are explained in this section.

- Guide to buffer memory address

In the buffer memory address, "n" in "4303+100n", etc. indicates a value corresponding to axis No. such as the following table.

Axis No.	n	Axis No.	n	Axis No.	n	Axis No.	n
1	0	5	4	9	8	13	12
2	1	6	5	10	9	14	13
3	2	7	6	11	10	15	14
4	3	8	7	12	11	16	15

(Note-1): Calculate as follows for the buffer memory address corresponding to each axis.

(Example) For axis No. 16

$$4303+100n \text{ ([Cd.6] Restart command)}=4303+100 \times 15=5803$$

$$4351+100n \text{ ([Cd.100] Servo OFF command)}=4351+100 \times 15=5851$$

(Note-2): The range (n=0 to 3) of axis No.1 to 4 is valid in the LD77MH4.

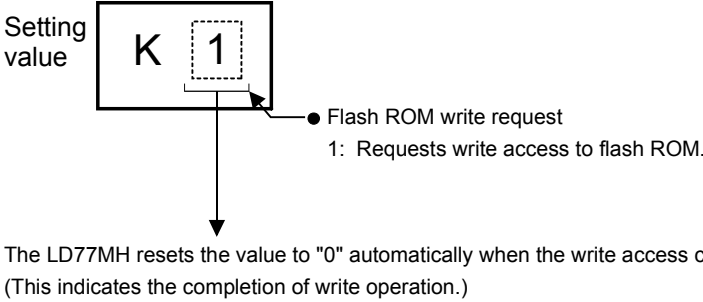
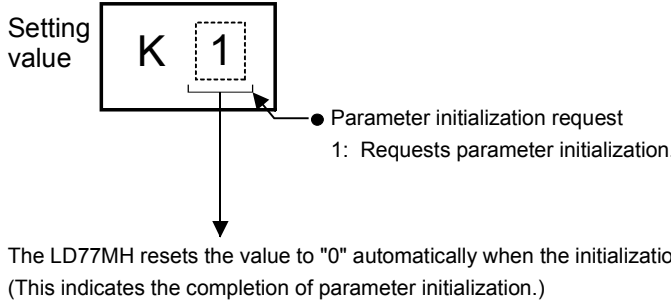

## 5.7.1 System control data

Setting item	Setting details
[Cd.1] Flash ROM write request	<ul style="list-style-type: none"> <li>• Requests writing of data (parameters, positioning data, and block start data) from the buffer memory to the flash ROM.</li> </ul> <p>Fetch cycle: 103[ms]</p> <p><b>POINT</b></p> <p>(1) Do not turn the power OFF or reset the PLC CPU while writing to the flash ROM. If the power is turned OFF or the PLC CPU is reset to forcibly end the process, the data backed up in the flash ROM will be lost.</p> <p>(2) Do not write the data to the buffer memory before writing to the flash ROM is completed.</p> <p>(3) The number of writes to the flash ROM with the sequence program is 25 max. while the power is turned ON. Writing to the flash ROM beyond 25 times will cause an error (error code: 805). Refer to Section 16.5 "List of errors" for details.</p> <p>(4) Monitoring is the number of writes to the flash ROM after the power is switched ON by the " [Md.19] Number of write accesses to flash ROM".</p>
[Cd.2] Parameter initialization request	<ul style="list-style-type: none"> <li>• Requests initialization of setting data. Refer to Section 14.2 for initialized setting data. Initialization: Resetting of setting data to default values</li> </ul> <p>Fetch cycle: 103[ms]</p> <p>Note: After completing the initialization of setting data, reset the PLC CPU or reboot the PLC power.</p>

	Setting value	Default value	Storage buffer memory address (common for all axes)	
			LD77MH4	LD77MH16
<p>■ Set with a decimal.</p> <p>Setting value</p>  <p>● Flash ROM write request 1: Requests write access to flash ROM.</p> <p>The LD77MH resets the value to "0" automatically when the write access completes. (This indicates the completion of write operation.)</p>	0	1900	5900	
<p>■ Set with a decimal.</p> <p>Setting value</p>  <p>● Parameter initialization request 1: Requests parameter initialization.</p> <p>The LD77MH resets the value to "0" automatically when the initialization completes. (This indicates the completion of parameter initialization.)</p>	0	1901	5901	

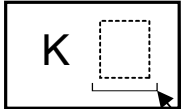

Setting item	Setting details	
<p><b>Cd.41</b> Deceleration start flag valid</p>	<ul style="list-style-type: none"> <li>• Set whether " <b>Md.48</b> Deceleration start flag" is made valid or invalid.</li> </ul> <p><u>Fetch cycle: At PLC READY ON</u></p> <p><b>POINT</b></p> <p>The " <b>Cd.41</b> Deceleration start flag valid" become valid when the PLC READY signal [Y0] turns from OFF to ON.</p>	
<p><b>Cd.42</b> Stop command processing for deceleration stop selection</p>	<ul style="list-style-type: none"> <li>• Set the stop command processing for deceleration stop function (deceleration curve re-processing/deceleration curve continuation).</li> </ul> <p><u>Fetch cycle: At deceleration stop causes occurrence</u></p>	
<p><b>Cd.137</b> Amplifier-less operation mode switching request</p>	<ul style="list-style-type: none"> <li>• Set the switching request of the normal operation mode and amplifier-less operation mode.</li> </ul> <p><u>Fetch cycle: 3.5[ms]</u></p>	

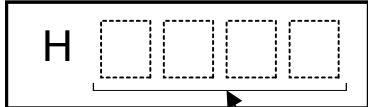
Setting value	Default value	Storage buffer memory address (common for all axes)	
		LD77MH4	LD77MH16
<p>■ Set with a decimal.</p> <p>Setting value </p> <p>● Deceleration start flag valid 0: Deceleration start flag invalid 1: Deceleration start flag valid</p>	0	1905	5905
<p>■ Set with a decimal.</p> <p>Setting value </p> <p>● Stop command processing for deceleration stop selection 0: Deceleration curve re-processing 1: Deceleration curve continuation</p>	0	1907	5907
<p>■ Set with a hexadecimal.</p> <p>Setting value </p> <p>● Amplifier-less operation mode switching request ABCDh: Change from normal operation mode to amplifier-less operation mode 0000h : Change from amplifier-less operation mode to normal operation mode</p>	0000H	1926	5926

## 5.7.2 Axis control data

Setting item	Setting details
Cd.3 Positioning start No.	<ul style="list-style-type: none"> <li>Set the positioning start No. (Only 1 to 600 for the Pre-reading start function. For details, refer to Section 13.7.7 "Pre-reading start function".)</li> </ul> <p>Fetch cycle: At start</p>
Cd.4 Positioning starting point No.	<ul style="list-style-type: none"> <li>Set a "starting point No." (1 to 50) if block start data is used for positioning. (Handled as "1" if the value of other than 1 to 50 is set.)</li> </ul> <p>Fetch cycle: At start</p>
Cd.5 Axis error reset	<ul style="list-style-type: none"> <li>Clears the axis error detection, axis error No., axis warning detection and axis warning No.</li> <li>When the LD77MH axis operation state is "in error occurrence", the error is cleared and the LD77MH is returned to the "waiting" state.</li> <li>Clears the both of LD77MH errors and servo amplifier errors by axis error reset. (Some servo amplifier errors cannot be reset even if error reset is requested, "0" is not stored in Cd.5 .It remains "1". Set "0" in Cd.5 and then set "1" to execute the error reset again by user side. Refer to the "Servo amplifier Instruction Manual" for details.)</li> </ul> <p>Fetch cycle: 56.8[ms]</p>
Cd.6 Restart command	<ul style="list-style-type: none"> <li>When positioning is stopped for any reason (when axis operation state is "stopped"), set "1" in Cd.6 . Positioning will be carried out again from the stopped position to the end point of the stopped positioning data.</li> </ul> <p>Fetch cycle: 56.8[ms]</p>

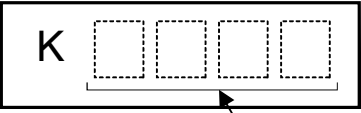
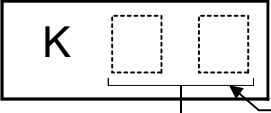
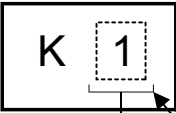
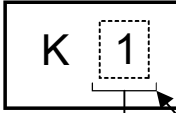
	Setting value	Default value	Storage buffer memory address	
			LD77MH4	LD77MH16
<p>■ Set with a decimal.</p> <p>Setting value</p>  <ul style="list-style-type: none"> <li>● Positioning data No.</li> <li>● 1 to 600 : Positioning data No.</li> <li>● 7000 to 7004 : Block start designation</li> <li>● 9001 : Machine OPR</li> <li>● 9002 : Fast-OPR</li> <li>● 9003 : Current value changing</li> <li>● 9004 : Simultaneous starting of multiple axes</li> </ul>	0	1500+100n	4300+100n	
<p>■ Set with a decimal.</p> <p>Setting value</p>  <ul style="list-style-type: none"> <li>● Positioning starting point No.</li> <li>1 to 50</li> </ul> <p>The LD77MH resets the value to "0" automatically when the continuous operation is interrupted.</p>	0	1501+100n	4301+100n	
<p>■ Set with a decimal.</p> <p>Setting value</p>  <ul style="list-style-type: none"> <li>● Error reset request</li> <li>1: Axis error is reset.</li> </ul> <p>The LD77MH resets the value to "0" automatically after the axis error reset is completed. (Indicates that the axis error reset is completed.)</p>	0	1502+100n	4302+100n	
<p>■ Set with a decimal.</p> <p>Setting value</p>  <ul style="list-style-type: none"> <li>● Restart command</li> <li>1: Restarts</li> </ul> <p>The LD77MH resets the value to "0" automatically after restart acceptance is completed. (Indicates that the restart acceptance is completed.)</p>	0	1503+100n	4303+100n	

n: Axis No.-1

Setting item	Setting details											
<p><b>Cd.7</b> M code OFF request</p>	<ul style="list-style-type: none"> <li>The M code ON signal turns OFF.</li> </ul> <p><u>Fetch cycle: Operation cycle</u></p>											
<p><b>Cd.8</b> External command valid</p>	<ul style="list-style-type: none"> <li>Validates or invalidates external command signals.</li> </ul> <p><u>Fetch cycle: At request by external command signal</u></p>											
<p><b>Cd.9</b> New current value</p>	<ul style="list-style-type: none"> <li>When changing the "current feed value" using the start No. "9003", use this data item to specify a new feed value.</li> <li>Set a value within the following range:</li> </ul> <table border="1" data-bbox="584 1028 1409 1202"> <thead> <tr> <th><b>Pr.1</b> Unit setting</th> <th>mm (<math>\times 10^{-1} \mu\text{m}</math>)</th> <th>inch (<math>\times 10^{-5} \text{inch}</math>)</th> <th>degree (<math>\times 10^{-5} \text{degree}</math>)</th> <th>PLS (PLS)</th> </tr> </thead> <tbody> <tr> <td>Setting range</td> <td>-2147483648 to +2147483647</td> <td>-2147483648 to +2147483647</td> <td>0 to 35999999</td> <td>-2147483648 to +2147483647</td> </tr> </tbody> </table> <p><u>Fetch cycle: At change request</u></p>	<b>Pr.1</b> Unit setting	mm ( $\times 10^{-1} \mu\text{m}$ )	inch ( $\times 10^{-5} \text{inch}$ )	degree ( $\times 10^{-5} \text{degree}$ )	PLS (PLS)	Setting range	-2147483648 to +2147483647	-2147483648 to +2147483647	0 to 35999999	-2147483648 to +2147483647	
<b>Pr.1</b> Unit setting	mm ( $\times 10^{-1} \mu\text{m}$ )	inch ( $\times 10^{-5} \text{inch}$ )	degree ( $\times 10^{-5} \text{degree}$ )	PLS (PLS)								
Setting range	-2147483648 to +2147483647	-2147483648 to +2147483647	0 to 35999999	-2147483648 to +2147483647								
<p><b>Cd.10</b> New acceleration time value</p>	<ul style="list-style-type: none"> <li>When changing the acceleration time during a speed change, use this data item to specify a new acceleration time.</li> </ul> <table border="1" data-bbox="584 1364 1007 1482"> <tr> <td><b>Cd.10</b> setting range (unit)</td> </tr> <tr> <td>0 to 8388608 (ms)</td> </tr> </table> <p><u>Fetch cycle: At change request</u></p>	<b>Cd.10</b> setting range (unit)	0 to 8388608 (ms)									
<b>Cd.10</b> setting range (unit)												
0 to 8388608 (ms)												
<p><b>Cd.11</b> New deceleration time value</p>	<ul style="list-style-type: none"> <li>When changing the deceleration time during a speed change, use this data item to specify a new deceleration time.</li> </ul> <table border="1" data-bbox="584 1644 1007 1762"> <tr> <td><b>Cd.11</b> setting range (unit)</td> </tr> <tr> <td>0 to 8388608 (ms)</td> </tr> </table> <p><u>Fetch cycle: At change request</u></p>	<b>Cd.11</b> setting range (unit)	0 to 8388608 (ms)									
<b>Cd.11</b> setting range (unit)												
0 to 8388608 (ms)												

	Setting value	Default value	Storage buffer memory address										
			LD77MH4	LD77MH16									
<p>■ Set with a decimal.</p> <p>Setting value</p> <div style="border: 1px solid black; padding: 5px; display: inline-block;"> <span style="font-size: 2em; font-weight: bold;">K</span> <span style="border: 1px dashed black; padding: 2px 5px; font-size: 1.5em; font-weight: bold;">1</span> </div> <p>● M code OFF request 1: M code ON signal turns OFF</p> <p>After the M code ON signal turns OFF, "0" is stored by the LD77MH automatically. (Indicates that the OFF request is completed.)</p>	0	1504+100n	4304+100n										
<p>■ Set with a decimal.</p> <p>Setting value</p> <div style="border: 1px solid black; padding: 5px; display: inline-block;"> <span style="font-size: 2em; font-weight: bold;">K</span> <span style="border: 1px dashed black; padding: 2px 5px; font-size: 1.5em; font-weight: bold;"> </span> </div> <p>● External command valid 0: Invalidates an external command. 1: Validates an external command.</p>	0	1505+100n	4305+100n										
<p>■ Set with a decimal.</p> <p>Actual value <span style="border: 1px solid black; padding: 2px;">Cd.9</span> New current value</p> <p>◇ Conversion into an integer value</p> <p>× 10<sup>m</sup> → ● Unit conversion table ((Cd.9))</p> <table border="1" style="margin-left: auto; margin-right: auto;"> <thead> <tr> <th>m</th> <th>Unit</th> </tr> </thead> <tbody> <tr> <td>1</td> <td>μm</td> </tr> <tr> <td>5</td> <td>inch</td> </tr> <tr> <td>5</td> <td>degree</td> </tr> <tr> <td>0</td> <td>PLS</td> </tr> </tbody> </table> <p>Setting value (Decimal) <span style="border: 1px solid black; padding: 2px 10px; font-size: 1.5em; font-weight: bold;">R</span></p>	m	Unit	1	μm	5	inch	5	degree	0	PLS	0	1506+100n 1507+100n	4306+100n 4307+100n
m	Unit												
1	μm												
5	inch												
5	degree												
0	PLS												
<p>■ Set with a decimal.</p> <p>Setting value</p> <div style="border: 1px solid black; padding: 2px; display: inline-block;"> <span style="border: 1px solid black; padding: 2px;">Cd.10</span> New acceleration time value  <span style="border: 1px solid black; padding: 2px;">Cd.11</span> New deceleration time value         </div>	0	1508+100n 1509+100n	4308+100n 4309+100n										
<p>Example: When the "<span style="border: 1px solid black; padding: 2px;">Cd. 10</span> New acceleration time value" is set as "60000 ms", the buffer memory stores "60000".</p>	0	1510+100n 1511+100n	4310+100n 4311+100n										

n: Axis No.-1

Setting item	Setting details											
<p><b>Cd.12</b> Acceleration/deceleration time change during speed change, enable/disable selection</p>	<ul style="list-style-type: none"> <li>Enables or disables modifications to the acceleration/deceleration time during a speed change.</li> </ul> <p>Fetch cycle: <u>At change request</u></p>											
<p><b>Cd.13</b> Positioning operation speed override</p>	<ul style="list-style-type: none"> <li>To use the positioning operation speed override function, use this data item to specify an "override" value.</li> <li>*: For details of the override function, refer to Section 13.5.2 "Override function".</li> </ul> <p>If the speed resulting from a small override value (e.g. 1%) includes fractions below the minimum unit, the speed is raised to make a complete unit and the warning No. 110 is output.</p> <p>Fetch cycle: <u>Operation cycle</u></p>											
<p><b>Cd.14</b> New speed value</p>	<ul style="list-style-type: none"> <li>When changing the speed, use this data item to specify a new speed.</li> <li>The operation halts if you specify "0".</li> <li>Set a value within the following range:</li> </ul> <table border="1" data-bbox="587 1216 1426 1359"> <thead> <tr> <th data-bbox="587 1216 740 1301"><b>Pr.1</b> Unit setting</th> <th data-bbox="740 1216 922 1301">mm (<math>\times 10^{-2}</math> mm/min)</th> <th data-bbox="922 1216 1075 1301">inch (<math>\times 10^{-3}</math> inch/min)</th> <th data-bbox="1075 1216 1262 1301">degree* (<math>\times 10^{-3}</math> degree/min)</th> <th data-bbox="1262 1216 1426 1301">PLS (PLS/s)</th> </tr> </thead> <tbody> <tr> <td data-bbox="587 1301 740 1359">Setting range</td> <td data-bbox="740 1301 922 1359">0 to 2000000000</td> <td data-bbox="922 1301 1075 1359">0 to 2000000000</td> <td data-bbox="1075 1301 1262 1359">0 to 2000000000</td> <td data-bbox="1262 1301 1426 1359">0 to 50000000</td> </tr> </tbody> </table> <p>*: When "<b>Pr.83</b> Speed control 10 x multiplier setting for degree axis" is valid, this will be the setting range 0 to 2000000000 (<math>\times 10^{-2}</math> degree/min).</p> <p>Fetch cycle: <u>At change request</u></p>	<b>Pr.1</b> Unit setting	mm ( $\times 10^{-2}$ mm/min)	inch ( $\times 10^{-3}$ inch/min)	degree* ( $\times 10^{-3}$ degree/min)	PLS (PLS/s)	Setting range	0 to 2000000000	0 to 2000000000	0 to 2000000000	0 to 50000000	
<b>Pr.1</b> Unit setting	mm ( $\times 10^{-2}$ mm/min)	inch ( $\times 10^{-3}$ inch/min)	degree* ( $\times 10^{-3}$ degree/min)	PLS (PLS/s)								
Setting range	0 to 2000000000	0 to 2000000000	0 to 2000000000	0 to 50000000								
<p><b>Cd.15</b> Speed change request</p>	<ul style="list-style-type: none"> <li>After setting the "<b>Cd.14</b> New speed value", set this data item to "1" to execute the speed change (through validating the new speed value).</li> </ul> <p>Fetch cycle: <u>Operation cycle</u></p>											

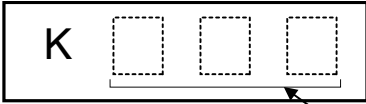
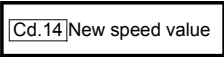
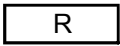
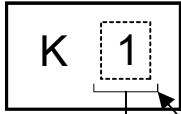
	Setting value	Default value	Storage buffer memory address										
			LD77MH4	LD77MH16									
<p>■ Set with a decimal.</p> <p>Setting value </p> <ul style="list-style-type: none"> <li>● Acceleration/deceleration time change during speed change, enable/disable selection</li> <li>1 : Enables modifications to acceleration/deceleration time</li> <li>Other than 1: Disables modifications to acceleration/deceleration time</li> </ul>	0	1512+100n	4312+100n										
<p>■ Set with a decimal.</p> <p>Setting value </p> <ul style="list-style-type: none"> <li>● Override value (%)</li> <li>1 to 300</li> </ul>	100	1513+100n	4313+100n										
<p>■ Set with a decimal.</p> <p>Actual value </p> <p>↓ Conversion into an integer value</p> <p>◇ Conversion into an integer value</p> <p>× 10<sup>m</sup></p> <p>● Unit conversion table ([Cd.14])</p> <table border="1" data-bbox="735 1205 956 1364"> <thead> <tr> <th>m</th> <th>Unit</th> </tr> </thead> <tbody> <tr> <td>2</td> <td>mm/min</td> </tr> <tr> <td>3</td> <td>inch/min</td> </tr> <tr> <td>3*</td> <td>degree/min</td> </tr> <tr> <td>0</td> <td>PLS/s</td> </tr> </tbody> </table> <p>Setting value (Decimal) </p> <p>Example: When the "[Cd. 14] New speed value" is set as "20000.00mm/min", the buffer memory stores "2000000".</p> <p>* When "[Pr.83] Speed control 10 x multiplier setting for degree axis" is valid : "2"</p>	m	Unit	2	mm/min	3	inch/min	3*	degree/min	0	PLS/s	0	1514+100n 1515+100n	4314+100n 4315+100n
m	Unit												
2	mm/min												
3	inch/min												
3*	degree/min												
0	PLS/s												
<p>■ Set with a decimal.</p> <p>Setting value </p> <ul style="list-style-type: none"> <li>● Speed change request</li> <li>1: Executes speed change.</li> </ul> <p>The LD77MH resets the value to "0" automatically when the speed change request has been processed. (This indicates the completion of speed change request.)</p>	0	1516+100n	4316+100n										

n: Axis No.-1



Setting item	Setting details										
<p><b>Cd.16</b> Inching movement amount</p>	<ul style="list-style-type: none"> <li>• Use this data item to set the amount of movement by inching.</li> <li>• The machine performs a JOG operation if "0" is set.</li> <li>• Set a value within the following range:</li> </ul> <table border="1" data-bbox="587 548 1426 689"> <thead> <tr> <th>Pr.1 Unit setting</th> <th>mm (<math>\times 10^{-1}</math> <math>\mu</math>m)</th> <th>inch (<math>\times 10^{-5}</math> inch)</th> <th>degree (<math>\times 10^{-5}</math> degree)</th> <th>PLS (PLS)</th> </tr> </thead> <tbody> <tr> <td>Setting range</td> <td>0 to 65535</td> <td>0 to 65535</td> <td>0 to 65535</td> <td>0 to 65535</td> </tr> </tbody> </table> <p>Fetch cycle: At start</p>	Pr.1 Unit setting	mm ( $\times 10^{-1}$ $\mu$ m)	inch ( $\times 10^{-5}$ inch)	degree ( $\times 10^{-5}$ degree)	PLS (PLS)	Setting range	0 to 65535	0 to 65535	0 to 65535	0 to 65535
Pr.1 Unit setting	mm ( $\times 10^{-1}$ $\mu$ m)	inch ( $\times 10^{-5}$ inch)	degree ( $\times 10^{-5}$ degree)	PLS (PLS)							
Setting range	0 to 65535	0 to 65535	0 to 65535	0 to 65535							
<p><b>Cd.17</b> JOG speed</p>	<ul style="list-style-type: none"> <li>• Use this data item to set the JOG speed.</li> <li>• Set a value within the following range:</li> </ul> <table border="1" data-bbox="587 1171 1426 1312"> <thead> <tr> <th>Pr.1 Unit setting</th> <th>mm (<math>\times 10^{-2}</math> mm/min)</th> <th>inch (<math>\times 10^{-3}</math> inch/min)</th> <th>Degree * (<math>\times 10^{-3}</math> degree/min)</th> <th>PLS (PLS/s)</th> </tr> </thead> <tbody> <tr> <td>Setting range</td> <td>1 to 200000000</td> <td>1 to 200000000</td> <td>1 to 200000000</td> <td>1 to 50000000</td> </tr> </tbody> </table> <p>*: When "Pr.83 Speed control 10 x multiplier setting for degree axis" is valid, this will be the setting range 1 to 200000000 (<math>\times 10^{-2}</math> degree/min).</p> <p>Fetch cycle: At start</p>	Pr.1 Unit setting	mm ( $\times 10^{-2}$ mm/min)	inch ( $\times 10^{-3}$ inch/min)	Degree * ( $\times 10^{-3}$ degree/min)	PLS (PLS/s)	Setting range	1 to 200000000	1 to 200000000	1 to 200000000	1 to 50000000
Pr.1 Unit setting	mm ( $\times 10^{-2}$ mm/min)	inch ( $\times 10^{-3}$ inch/min)	Degree * ( $\times 10^{-3}$ degree/min)	PLS (PLS/s)							
Setting range	1 to 200000000	1 to 200000000	1 to 200000000	1 to 50000000							
<p><b>Cd.18</b> Interrupt request during continuous operation</p>	<ul style="list-style-type: none"> <li>• To interrupt a continuous operation, set "1" to this data item.</li> <li>• After processing the interruption request ("1"), the LD77MH automatically resets the value to "0".</li> </ul> <p>Fetch cycle: Operation cycle</p>										

	Setting value	Default value	Storage buffer memory address										
			LD77MH4	LD77MH16									
<p>■ Set with a decimal.</p> <p>Actual value <span style="border: 1px solid black; padding: 2px;">Cd.16</span> Inching movement amount</p> <p style="text-align: center;">↓ Conversion into an integer value</p> <p style="text-align: center;"><math>\times 10^m</math></p> <p>Setting value (Decimal) <span style="border: 1px solid black; padding: 2px;">R</span></p> <p>● Unit conversion table (Cd.16)</p> <table border="1" style="margin-left: auto; margin-right: auto;"> <thead> <tr> <th>m</th> <th>Unit</th> </tr> </thead> <tbody> <tr> <td>1</td> <td><math>\mu\text{m}</math></td> </tr> <tr> <td>5</td> <td>inch</td> </tr> <tr> <td>5</td> <td>degree</td> </tr> <tr> <td>0</td> <td>PLS</td> </tr> </tbody> </table> <p style="border: 1px dashed black; padding: 5px; margin-top: 10px;">Example: When the "Cd. 16 Inching movement amount" is set as "1.0 <math>\mu\text{m}</math>", the buffer memory stores "10".</p>	m	Unit	1	$\mu\text{m}$	5	inch	5	degree	0	PLS	0	1517+100n	4317+100n
m	Unit												
1	$\mu\text{m}$												
5	inch												
5	degree												
0	PLS												
<p>■ Set with a decimal.</p> <p>Actual value <span style="border: 1px solid black; padding: 2px;">Cd.17</span> JOG speed</p> <p style="text-align: center;">↓ Conversion into an integer value</p> <p style="text-align: center;"><math>\times 10^m</math></p> <p>Setting value (Decimal) <span style="border: 1px solid black; padding: 2px;">R</span></p> <p>● Unit conversion table (Cd.17)</p> <table border="1" style="margin-left: auto; margin-right: auto;"> <thead> <tr> <th>m</th> <th>Unit</th> </tr> </thead> <tbody> <tr> <td>2</td> <td>mm/min</td> </tr> <tr> <td>3</td> <td>inch/min</td> </tr> <tr> <td>3*</td> <td>degree/min</td> </tr> <tr> <td>0</td> <td>PLS/s</td> </tr> </tbody> </table> <p style="font-size: small; margin-top: 5px;">*: When "Pr.83 Speed control 10 x multiplier setting for degree axis" is valid : "2"</p> <p style="border: 1px dashed black; padding: 5px; margin-top: 10px;">Example: When the "Cd. 17 JOG speed" is set as "20000.00mm/min", the buffer memory stores "2000000".</p>	m	Unit	2	mm/min	3	inch/min	3*	degree/min	0	PLS/s	0	1518+100n 1519+100n	4318+100n 4319+100n
m	Unit												
2	mm/min												
3	inch/min												
3*	degree/min												
0	PLS/s												
<p>■ Set with a decimal.</p> <p>Setting value <span style="border: 1px solid black; padding: 2px;">K</span> <span style="border: 1px solid black; padding: 2px; margin-left: 10px;">1</span></p> <p>● Interruption request continuous operation 1: Interrupts continuous operation control or continuous path control.</p> <p style="margin-top: 10px;">The LD77MH resets the value to "0" automatically when the continuous control interruption request is processed. (This indicates the completion of continuous operation interruption request.)</p>	0	1520+100n	4320+100n										

n: Axis No.-1

Setting item	Setting details	
<p><b>Cd.19</b> OPR request flag OFF request</p>	<ul style="list-style-type: none"> <li>The sequence program can use this data item to forcibly turn the OPR request flag from ON to OFF.</li> </ul> <p><u>Fetch cycle: 56.8[ms]</u></p> <p><b>POINT</b></p> <p>This parameter is made valid when the increment system is valid.</p>	
<p><b>Cd.20</b> Manual pulse generator 1 pulse input magnification</p>	<ul style="list-style-type: none"> <li>This data item determines the factor by which the number of pulses from the manual pulse generator is magnified.</li> <li>Value "0" : read as "1".</li> <li>Value "10001 or more" or negative value : read as "10000".</li> </ul> <p><u>Fetch cycle: Operation cycle (At manual pulse generator enabled)</u></p>	
<p><b>Cd.21</b> Manual pulse generator enable flag</p>	<ul style="list-style-type: none"> <li>This data item enables or disables operations using a manual pulse generator.</li> </ul> <p><u>Fetch cycle: Operation cycle</u></p>	
<p><b>Cd.22</b> New torque value/ forward new torque value</p>	<ul style="list-style-type: none"> <li>When "0" is set to "<b>Cd.112</b> Torque change function switching request", a new torque limit value is set. (This value is set to the forward torque limit value and reverse torque limit value.)</li> <li>When "1" is set to "<b>Cd.112</b> Torque change function switching request", a new forward torque limit value is set.</li> <li>Set a value within "0" to "<b>Pr.17</b> Torque limit setting value". (The new torque value is invalid when "0" is set, and "<b>Pr.17</b> Torque limit setting value" or "<b>Cd.101</b> Torque output setting value" becomes valid. The range of torque change is 1 to "<b>Pr.17</b> Torque limit setting value".)</li> </ul> <p><u>Fetch cycle: Operation cycle</u></p>	

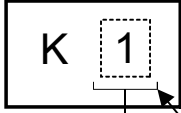
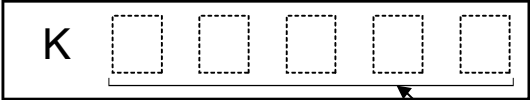
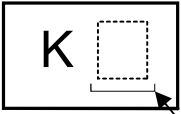
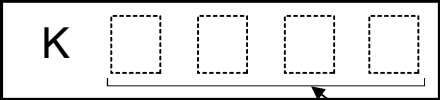
	Setting value	Default value	Storage buffer memory address	
			LD77MH4	LD77MH16
<p>■ Set with a decimal.</p> <p>Setting value</p>  <ul style="list-style-type: none"> <li>● OPR request flag OFF request 1: Turns the "OPR request flag" from ON to OFF.</li> </ul> <p>The LD77MH resets the value to "0" automatically when the OPR request flag is turned OFF. (This indicates the completion of OPR request flag OFF request.)</p>	0	1521+100n	4321+100n	
<p>■ Set with a decimal.</p> <p>Setting value</p>  <ul style="list-style-type: none"> <li>● Manul pulse generator 1 pulse input magnification 1 to 10000</li> </ul>	1	1522+100n 1523+100n	4322+100n 4323+100n	
<p>■ Set with a decimal.</p> <p>Setting value</p>  <ul style="list-style-type: none"> <li>● Manual pulse generator enable flag 0: Disable manual pulse generator operation. 1: Enable manual pulse generator operation.</li> </ul>	0	1524+100n	4324+100n	
<p>■ Set with a decimal.</p> <p>Setting value</p>  <ul style="list-style-type: none"> <li>● New torque value/forward new torque value 0 to [Pr.17] Torque limit setting value (%)</li> </ul>	0	1525+100n	4325+100n	

n: Axis No.-1

Setting item	Setting details												
<p>Cd.23 Speed-position switching control movement amount change register</p>	<ul style="list-style-type: none"> <li>• During the speed control stage of the speed-position switching control (INC mode), it is possible to change the specification of the movement amount during the position control stage. For that, use this data item to specify a new movement amount.</li> <li>• The new movement amount has to be set during the speed control stage of the speed-position switching control (INC mode).</li> <li>• The value is reset to "0" when the next operation starts.</li> <li>• Set a value within the following range:</li> </ul> <table border="1" data-bbox="587 629 1426 770"> <thead> <tr> <th>Pr.1 setting</th> <th>Unit</th> <th>mm (<math>\times 10^{-1} \mu\text{m}</math>)</th> <th>inch (<math>\times 10^{-5} \text{inch}</math>)</th> <th>degree (<math>\times 10^{-5} \text{degree}</math>)</th> <th>PLS (PLS)</th> </tr> </thead> <tbody> <tr> <td>Setting range</td> <td></td> <td>0 to 2147483647</td> <td>0 to 2147483647</td> <td>0 to 2147483647</td> <td>0 to 2147483647</td> </tr> </tbody> </table> <p>Fetch cycle: At switching request</p>	Pr.1 setting	Unit	mm ( $\times 10^{-1} \mu\text{m}$ )	inch ( $\times 10^{-5} \text{inch}$ )	degree ( $\times 10^{-5} \text{degree}$ )	PLS (PLS)	Setting range		0 to 2147483647	0 to 2147483647	0 to 2147483647	0 to 2147483647
Pr.1 setting	Unit	mm ( $\times 10^{-1} \mu\text{m}$ )	inch ( $\times 10^{-5} \text{inch}$ )	degree ( $\times 10^{-5} \text{degree}$ )	PLS (PLS)								
Setting range		0 to 2147483647	0 to 2147483647	0 to 2147483647	0 to 2147483647								
<p>Cd.24 Speed-position switching enable flag</p>	<ul style="list-style-type: none"> <li>• Set whether the external control signal (external command signal [DI]: "speed-position, position-speed switching request" is selected) is enabled or not.</li> </ul> <p>Fetch cycle: At switching request</p>												
<p>Cd.25 Position-speed switching control speed change register</p>	<ul style="list-style-type: none"> <li>• During the position control stage of the position-speed switching control, it is possible to change the specification of the speed during the speed control stage. For that, use this data item to specify a new speed.</li> <li>• The new speed has to be set during the position control stage of the position-speed switching control.</li> <li>• The value is reset to "0" when the next operation starts.</li> <li>• Set a value within the following range:</li> </ul> <table border="1" data-bbox="587 1576 1426 1718"> <thead> <tr> <th>Pr.1 setting</th> <th>Unit</th> <th>mm (<math>\times 10^{-2} \text{mm/min}</math>)</th> <th>inch (<math>\times 10^{-3} \text{inch/min}</math>)</th> <th>degree* (<math>\times 10^{-3} \text{degree/min}</math>)</th> <th>PLS (PLS/s)</th> </tr> </thead> <tbody> <tr> <td>Setting range</td> <td></td> <td>0 to 2000000000</td> <td>0 to 2000000000</td> <td>0 to 2000000000</td> <td>0 to 50000000</td> </tr> </tbody> </table> <p>*: When "[Pr.83] Speed control 10 x multiplier setting for degree axis" is valid, this will be the setting range 0 to 2000000000 (<math>\times 10^{-2} \text{degree/min}</math>).</p> <p>Fetch cycle: At switching request</p>	Pr.1 setting	Unit	mm ( $\times 10^{-2} \text{mm/min}$ )	inch ( $\times 10^{-3} \text{inch/min}$ )	degree* ( $\times 10^{-3} \text{degree/min}$ )	PLS (PLS/s)	Setting range		0 to 2000000000	0 to 2000000000	0 to 2000000000	0 to 50000000
Pr.1 setting	Unit	mm ( $\times 10^{-2} \text{mm/min}$ )	inch ( $\times 10^{-3} \text{inch/min}$ )	degree* ( $\times 10^{-3} \text{degree/min}$ )	PLS (PLS/s)								
Setting range		0 to 2000000000	0 to 2000000000	0 to 2000000000	0 to 50000000								

	Setting value	Default value	Storage buffer memory address											
			LD77MH4	LD77MH16										
<p>■ Set with a decimal.</p> <p>Actual value <span style="border: 1px solid black; padding: 2px;">Cd.23 Speed-position switching control movement amount change register</span></p> <p>↓ Conversion into an integer value</p> <p>Setting value (Decimal) <span style="border: 1px solid black; padding: 2px;">R</span></p> <p>◇ Conversion into an integer value <math>\times 10^m</math></p> <p>● Unit conversion table (Cd.23)</p> <table border="1" style="display: inline-table; vertical-align: middle;"> <thead> <tr> <th>m</th> <th>Unit</th> </tr> </thead> <tbody> <tr> <td>1</td> <td><math>\mu\text{m}</math></td> </tr> <tr> <td>5</td> <td>inch</td> </tr> <tr> <td>5</td> <td>degree</td> </tr> <tr> <td>0</td> <td>PLS</td> </tr> </tbody> </table> <p>Example: If "Cd. 23 Speed-position switching control movement amount change register" is set as "20000.0 <math>\mu\text{m}</math>", the buffer memory stores "200000".</p>	m	Unit	1	$\mu\text{m}$	5	inch	5	degree	0	PLS		0	1526+100n 1527+100n	4326+100n 4327+100n
m	Unit													
1	$\mu\text{m}$													
5	inch													
5	degree													
0	PLS													
<p>■ Set with a decimal.</p> <p>Setting value <span style="border: 1px solid black; padding: 2px;">K</span></p> <p>● Speed-position switching enable flag</p> <p>0: Speed control will not be taken over by position control even when the external command signal [DI] comes ON.</p> <p>1: Speed control will be taken over by position control when the external command signal [DI] comes ON.</p>		0	1528+100n	4328+100n										
<p>■ Set with a decimal.</p> <p>Actual value <span style="border: 1px solid black; padding: 2px;">Cd.25 Position-speed switching control speed change register</span></p> <p>↓ Conversion into an integer value</p> <p>Setting value (Decimal) <span style="border: 1px solid black; padding: 2px;">R</span></p> <p>◇ Conversion into an integer value <math>\times 10^m</math></p> <p>● Unit conversion table (Cd.25)</p> <table border="1" style="display: inline-table; vertical-align: middle;"> <thead> <tr> <th>m</th> <th>Unit</th> </tr> </thead> <tbody> <tr> <td>2</td> <td>mm/min</td> </tr> <tr> <td>3</td> <td>inch/min</td> </tr> <tr> <td>3*</td> <td>degree/min</td> </tr> <tr> <td>0</td> <td>PLS/s</td> </tr> </tbody> </table> <p>*: When "[Pr.83] Speed control 10 x multiplier setting for degree axis" is valid : "2"</p> <p>Example: If "Cd. 25 Position-speed switching control speed change register" is set as "2000.00 mm/min", the buffer memory stores "200000".</p>	m	Unit	2	mm/min	3	inch/min	3*	degree/min	0	PLS/s		0	1530+100n 1531+100n	4330+100n 4331+100n
m	Unit													
2	mm/min													
3	inch/min													
3*	degree/min													
0	PLS/s													

n: Axis No.-1

Setting item	Setting details															
<p><b>Cd.26</b> Position-speed switching enable flag</p>	<ul style="list-style-type: none"> <li>Set whether the external control signal (external command signal [DI]: "speed-position, position-speed switching request" is selected) is enabled or not.</li> </ul> <p><u>Fetch cycle: At switching request</u></p>															
<p><b>Cd.27</b> Target position change value (New address)</p>	<ul style="list-style-type: none"> <li>When changing the target position during a positioning operation, use this data item to specify a new positioning address.</li> <li>Set a value within the following range:</li> </ul> <table border="1" data-bbox="587 815 1426 1070"> <thead> <tr> <th>Pr.1 Unit setting</th> <th>mm (<math>\times 10^{-1} \mu\text{m}</math>)</th> <th>inch (<math>\times 10^{-5} \text{inch}</math>)</th> <th>degree (<math>\times 10^{-5} \text{degree}</math>)</th> <th>PLS (PLS)</th> </tr> </thead> <tbody> <tr> <td>ABS</td> <td>-2147483648 to +2147483647</td> <td>-2147483648 to +2147483647</td> <td>0 to 35999999</td> <td>-2147483648 to +2147483647</td> </tr> <tr> <td>INC</td> <td>-2147483648 to +2147483647</td> <td>-2147483648 to +2147483647</td> <td>-2147483648 to +2147483647</td> <td>-2147483648 to +2147483647</td> </tr> </tbody> </table> <p><u>Fetch cycle: At change request</u></p>	Pr.1 Unit setting	mm ( $\times 10^{-1} \mu\text{m}$ )	inch ( $\times 10^{-5} \text{inch}$ )	degree ( $\times 10^{-5} \text{degree}$ )	PLS (PLS)	ABS	-2147483648 to +2147483647	-2147483648 to +2147483647	0 to 35999999	-2147483648 to +2147483647	INC	-2147483648 to +2147483647	-2147483648 to +2147483647	-2147483648 to +2147483647	-2147483648 to +2147483647
Pr.1 Unit setting	mm ( $\times 10^{-1} \mu\text{m}$ )	inch ( $\times 10^{-5} \text{inch}$ )	degree ( $\times 10^{-5} \text{degree}$ )	PLS (PLS)												
ABS	-2147483648 to +2147483647	-2147483648 to +2147483647	0 to 35999999	-2147483648 to +2147483647												
INC	-2147483648 to +2147483647	-2147483648 to +2147483647	-2147483648 to +2147483647	-2147483648 to +2147483647												
<p><b>Cd.28</b> Target position change value (New speed)</p>	<ul style="list-style-type: none"> <li>When changing the target position during a positioning operation, use this data item to specify a new speed.</li> <li>The speed will not change if "0" is set.</li> <li>Set a value within the following range:</li> </ul> <table border="1" data-bbox="587 1317 1426 1458"> <thead> <tr> <th>Pr.1 Unit setting</th> <th>mm (<math>\times 10^{-2} \text{mm/min}</math>)</th> <th>inch (<math>\times 10^{-3} \text{inch/min}</math>)</th> <th>Degree * (<math>\times 10^{-3} \text{degree/min}</math>)</th> <th>PLS (PLS/s)</th> </tr> </thead> <tbody> <tr> <td>Setting range</td> <td>0 to 2000000000</td> <td>0 to 2000000000</td> <td>0 to 2000000000</td> <td>0 to 50000000</td> </tr> </tbody> </table> <p>*: When "[Pr.83] Speed control 10 x multiplier setting for degree axis" is valid, this will be the setting range 0 to 2000000000 (<math>\times 10^{-2} \text{degree/min}</math>).</p> <p><u>Fetch cycle: At change request</u></p>	Pr.1 Unit setting	mm ( $\times 10^{-2} \text{mm/min}$ )	inch ( $\times 10^{-3} \text{inch/min}$ )	Degree * ( $\times 10^{-3} \text{degree/min}$ )	PLS (PLS/s)	Setting range	0 to 2000000000	0 to 2000000000	0 to 2000000000	0 to 50000000					
Pr.1 Unit setting	mm ( $\times 10^{-2} \text{mm/min}$ )	inch ( $\times 10^{-3} \text{inch/min}$ )	Degree * ( $\times 10^{-3} \text{degree/min}$ )	PLS (PLS/s)												
Setting range	0 to 2000000000	0 to 2000000000	0 to 2000000000	0 to 50000000												
<p><b>Cd.29</b> Target position change request flag</p>	<ul style="list-style-type: none"> <li>Requests a change in the target position during a positioning operation.</li> </ul> <p><u>Fetch cycle: Operation cycle</u></p>															

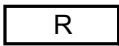
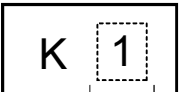
Setting value	Default value	Storage buffer memory address																									
		LD77MH4	LD77MH16																								
<p>■ Set with a decimal.</p> <p>Setting value </p> <p>● Position-speed switching enable flag            0: Position control will not be taken over by speed control even when the external command signal [DI] comes ON.            1: Position control will be taken over by speed control when the external command signal [DI] comes ON.</p>	0	1532+100n	4332+100n																								
<p>■ Set with a decimal.</p> <p>Actual value <table border="1" data-bbox="347 846 865 922"> <tr><td>Cd. 27</td><td>Target position change value (new address)</td></tr> <tr><td>Cd. 28</td><td>Target position change value (new speed)</td></tr> </table></p> <p>◇ Conversion into an integer value</p> <p>Setting value (Decimal) </p> <p>× 10<sup>m</sup> → ● Unit conversion table (Cd.27)</p> <table border="1" data-bbox="737 1012 960 1169"> <thead> <tr><th>m</th><th>Unit</th></tr> </thead> <tbody> <tr><td>1</td><td>μm</td></tr> <tr><td>5</td><td>inch</td></tr> <tr><td>5</td><td>degree</td></tr> <tr><td>0</td><td>PLS</td></tr> </tbody> </table> <p>Example: If "Cd. 28" Target position change value (new speed) is set as "10000.00 mm/min", the buffer memory stores "1000000".</p> <p>● Unit conversion table (Cd.28)</p> <table border="1" data-bbox="737 1214 960 1384"> <thead> <tr><th>m</th><th>Unit</th></tr> </thead> <tbody> <tr><td>2</td><td>mm/min</td></tr> <tr><td>3</td><td>inch/min</td></tr> <tr><td>3*</td><td>degree/min</td></tr> <tr><td>0</td><td>PLS/s</td></tr> </tbody> </table> <p>* : When "[Pr.83] Speed control 10 x multiplier setting for degree axis" is valid : "2"</p>	Cd. 27	Target position change value (new address)	Cd. 28	Target position change value (new speed)	m	Unit	1	μm	5	inch	5	degree	0	PLS	m	Unit	2	mm/min	3	inch/min	3*	degree/min	0	PLS/s	0	1534+100n 1535+100n	4334+100n 4335+100n
Cd. 27	Target position change value (new address)																										
Cd. 28	Target position change value (new speed)																										
m	Unit																										
1	μm																										
5	inch																										
5	degree																										
0	PLS																										
m	Unit																										
2	mm/min																										
3	inch/min																										
3*	degree/min																										
0	PLS/s																										
<p>■ Set with a decimal.</p> <p>Setting value </p> <p>● Target position change request flag            1: Requests a change in the target position</p> <p>The LD77MH resets the value to "0" automatically when the new target position value has been written.            (This indicates the completion of target position change request.)</p>	0	1538+100n	4338+100n																								

n: Axis No.-1





Setting item		Setting details		
Cd.30	Simultaneous starting axis start data No. (axis 1 start data No.) <b>LD77MH4</b>	<ul style="list-style-type: none"> <li>Use these data items to specify an axis 1 start data No. for each axis that has to start simultaneously.</li> <li>Set "0" to any axis that should not start simultaneously.</li> </ul>	<u>Fetch: At start</u>	
	Simultaneous starting own axis start data No. <b>LD77MH16</b>	<ul style="list-style-type: none"> <li>Use these data items to specify a start data No. of own axis at multiple axes simultaneous starting.</li> </ul>		
Cd.31	Simultaneous starting axis start data No. (axis 2 start data No.) <b>LD77MH4</b>	<ul style="list-style-type: none"> <li>Use these data items to specify an axis 2 start data No. for each axis that has to start simultaneously.</li> <li>Set "0" to any axis that should not start simultaneously.</li> </ul>	<u>Fetch: At start</u>	
	Simultaneous starting axis start data No.1 <b>LD77MH16</b>	<ul style="list-style-type: none"> <li>Use these data items to specify a start data No.1 for each axis that has to start simultaneously.</li> </ul>		
Cd.32	Simultaneous starting axis start data No. (axis 3 start data No.) <b>LD77MH4</b>	<ul style="list-style-type: none"> <li>Use these data items to specify an axis 3 start data No. for each axis that has to start simultaneously.</li> <li>Set "0" to any axis that should not start simultaneously.</li> </ul>	<u>Fetch: At start</u>	
	Simultaneous starting axis start data No.2 <b>LD77MH16</b>	<ul style="list-style-type: none"> <li>Use these data items to specify a start data No.2 for each axis that has to start simultaneously.</li> </ul> <p>Note) For 2 axis simultaneous starting, the axis setting is not required. (Setting value is ignored.)</p>		
Cd.33	Simultaneous starting axis start data No. (axis 4 start data No.) <b>LD77MH4</b>	<ul style="list-style-type: none"> <li>Use these data items to specify an axis 4 start data No. for each axis that has to start simultaneously.</li> <li>Set "0" to any axis that should not start simultaneously.</li> </ul>	<u>Fetch: At start</u>	
	Simultaneous starting axis start data No.3 <b>LD77MH16</b>	<ul style="list-style-type: none"> <li>Use these data items to specify a start data No.3 for each axis that has to start simultaneously.</li> </ul> <p>Note) For 2 axis simultaneous starting and 3 axis simultaneous starting, the axis setting is not required. (Setting value is ignored.)</p>		
Cd.34	Step mode	<ul style="list-style-type: none"> <li>To perform a step operation, use this data item to specify the units by which the stepping should be performed.</li> </ul> <p><u>Fetch cycle: At start</u></p>		

Setting value	Default value	Storage buffer memory address		
		LD77MH4	LD77MH16	
<p>■ Set with a decimal.</p> <p>Setting value</p> <div style="border: 1px solid black; padding: 5px; display: inline-block;"> <span style="font-size: 2em; margin-right: 10px;">K</span> <span style="border: 1px dashed black; padding: 2px 10px;">  </span> <span style="border: 1px dashed black; padding: 2px 10px;">  </span> <span style="border: 1px dashed black; padding: 2px 10px;">  </span> </div> <ul style="list-style-type: none"> <li>● LD77MH4 use               <ul style="list-style-type: none"> <li><span style="border: 1px solid black; padding: 1px;">Cd.30</span>   to <span style="border: 1px solid black; padding: 1px;">Cd.33</span></li> <li>Simultaneous starting axis start data No. 1 to 600</li> </ul> </li> <li>● LD77MH16 use               <ul style="list-style-type: none"> <li><span style="border: 1px solid black; padding: 1px;">Cd.30</span></li> <li>Simultaneous starting own axis start data No.</li> <li><span style="border: 1px solid black; padding: 1px;">Cd.31</span>   to <span style="border: 1px solid black; padding: 1px;">Cd.33</span></li> <li>Simultaneous starting axis start data No. 1 to 600</li> </ul> </li> </ul>	0	1540+100n	/	
	0	1541+100n	/	4340+100n
	0	1542+100n	/	4341+100n
	0	1543+100n	/	4342+100n
<p>■ Set with a decimal.</p> <p>Setting value</p> <div style="border: 1px solid black; padding: 5px; display: inline-block;"> <span style="font-size: 2em; margin-right: 10px;">K</span> <span style="border: 1px dashed black; padding: 2px 10px;">  </span> </div> <ul style="list-style-type: none"> <li>● Step mode               <ul style="list-style-type: none"> <li>0: Stepping by deceleration units</li> <li>1: Stepping by data No. units</li> </ul> </li> </ul>	0	1544+100n	4344+100n	

n: Axis No.-1

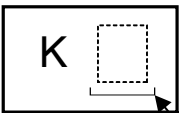
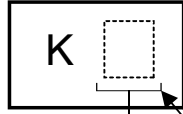
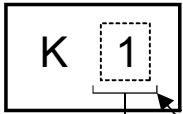
Setting item	Setting details	
Cd.35 Step valid flag	<ul style="list-style-type: none"> <li>This data item validates or invalidates step operations.</li> </ul> <p><u>Fetch cycle: At start</u></p>	
Cd.36 Step start information	<ul style="list-style-type: none"> <li>To continue the step operation when the step function is used, set "1" in the data item.</li> </ul> <p><u>Fetch cycle: 56.8[ms]</u></p>	
Cd.37 Skip command	<ul style="list-style-type: none"> <li>To skip the current positioning operation, set "1" in this data item.</li> </ul> <p><u>Fetch cycle: Operation cycle (During positioning operation)</u></p>	
Cd.38 Teaching data selection	<ul style="list-style-type: none"> <li>This data item specifies the teaching result write destination.</li> <li>Data are cleared to zero when the teaching ends.</li> </ul> <p><u>Fetch cycle: At operation request</u></p>	
Cd.39 Teaching positioning data No.	<ul style="list-style-type: none"> <li>This data item specifies data to be produced by teaching.</li> <li>If a value between 1 and 600 is set, a teaching operation is done.</li> <li>The value is cleared to "0" when the LD77MH is initialized, when a teaching operation completes, and when an illegal value (601 or higher) is entered.</li> </ul> <p><u>Fetch cycle: 103[ms]</u></p>	

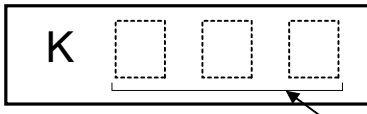
Setting value	Default value	Storage buffer memory address	
		LD77MH4	LD77MH16
<p>■ Set with a decimal.</p> <p>Setting value</p>  <ul style="list-style-type: none"> <li>● Step valid flag</li> <li>0: Invalidates step operations</li> <li>1: Validates step operations</li> </ul>	0	1545+100n	4345+100n
<p>■ Set with a decimal.</p> <p>Setting value</p>  <ul style="list-style-type: none"> <li>● Step start information</li> <li>1: Continues step operation</li> <li>2: Restarts operation</li> </ul> <p>The LD77MH resets the value to "0" automatically when processing of the step start request completes.</p>	0	1546+100n	4346+100n
<p>■ Set with a decimal.</p> <p>Setting value</p>  <ul style="list-style-type: none"> <li>● Skip request</li> <li>1: Issues a skip request to have the machine decelerate, stop, and then start the next positioning operation.</li> </ul> <p>The LD77MH resets the value to "0" automatically when processing of the skip request completes.</p>	0	1547+100n	4347+100n
<p>■ Set with a decimal.</p> <p>Setting value</p>  <ul style="list-style-type: none"> <li>● Teaching data selection</li> <li>0: Takes the current feed value as a positioning address.</li> <li>1: Takes the current feed value as an arc data.</li> </ul>	0	1548+100n	4348+100n
<p>■ Set with a decimal.</p> <p>Setting value</p>  <ul style="list-style-type: none"> <li>● Teaching positioning data No.</li> <li>1 to 600</li> </ul>	0	1549+100n	4349+100n

n: Axis No.-1

Setting item	Setting details
<p><b>Cd.40</b> ABS direction in degrees</p>	<ul style="list-style-type: none"> <li>This data item specifies the ABS moving direction carrying out the position control when "degree" is selected as the unit.</li> </ul> <p><u>Fetch cycle: At start</u></p>
<p><b>Cd.43</b> Simultaneous starting axis</p> <p><b>LD77MH16</b></p>	<ul style="list-style-type: none"> <li>Set the number of simultaneous starting axes and target axis. When "2" is set to the number of simultaneous starting axes, set the target axis No. to the simultaneous starting axis No. 1. When "3" is set to the number of simultaneous starting axes, set the target axis No. to the simultaneous starting axis No.1 and 2. When "4" is set to the number of simultaneous starting axes, set the target axis No. to the simultaneous starting axis No.1 to 3.</li> <li>When the same axis No. or axis No. of own axis is set to the multiple simultaneous starting axis No, or the value outside the range is set to the number of simultaneous starting axes, "Error before simultaneous start" (error code: 501) will occur, and the operation is not executed.</li> </ul> <p>Note) Do not set the simultaneous starting axis No.2 and 3 for 2-axis interpolation, and do not set the simultaneous starting axis No.3 for 3-axis interpolation. The setting value is ignored.</p> <p><u>Fetch cycle: At start</u></p>
<p><b>Cd.100</b> Servo OFF command</p>	<ul style="list-style-type: none"> <li>Turns OFF each axis servo.</li> </ul> <p><u>Fetch cycle: Operation cycle</u></p> <p><b>POINT</b></p> <p>When you want to turn ON the servo for other than axis 1 with only the servo for axis 1 turned OFF, write "1" to storage buffer memory address of axis 1 and then turn ON all axis servo ON [Y1] signal.</p>
<p><b>Cd.101</b> Torque output setting value</p>	<ul style="list-style-type: none"> <li>Sets the torque output value.</li> </ul> <p><u>Fetch cycle: At start</u></p> <p><b>POINT</b></p> <ul style="list-style-type: none"> <li>If the " <b>Cd.101</b> Torque output setting value" is "0", the " <b>Pr.17</b> Torque limit setting value" will be its value.</li> <li>If a value beside "0" is set in the " <b>Cd.101</b> Torque output setting value", the torque generated by the servomotor will be limited by that value.</li> <li>The " <b>Pr.17</b> Torque limit setting value" of the detailed parameter becomes effective at the PLC ready signal rising edge.</li> <li>The " <b>Cd.101</b> Torque output setting value" (refer to the start) axis control data can be changed at all times. Therefore in the " <b>Cd.101</b> Torque output setting value" is used when you must change. (Refer to Section 13.5.4 "Torque change function".)</li> </ul>

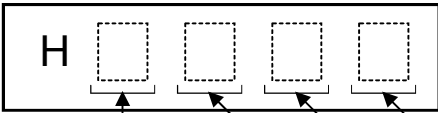
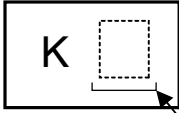
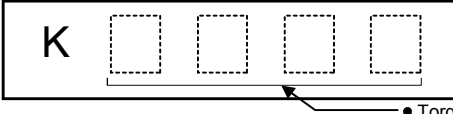
Setting value	Default value	Storage buffer memory address	
		LD77MH4	LD77MH16
<p>■ Set with a decimal.</p> <p>Setting value</p>  <ul style="list-style-type: none"> <li>● ABS direction in degrees 0: Takes a shortcut. (Specified direction ignored.) 1: ABS circular right 2: ABS circular left</li> </ul>	0	1550+100n	4350+100n
<p>■ Set with a hexadecimal.</p> <p>Setting value</p>  <ul style="list-style-type: none"> <li>● Simultaneous starting axis No.1 0 to F: Axis 1 to Axis 16</li> <li>● Simultaneous starting axis No.2 0 to F: Axis 1 to Axis 16</li> <li>● Simultaneous starting axis No.3 0 to F: Axis 1 to Axis 16</li> <li>● Number of simultaneous starting axes 2 to 4: 2 axes to 4 axes</li> </ul>	0000H	/	4339+100n
<p>■ Set with a decimal.</p> <p>Setting value</p>  <ul style="list-style-type: none"> <li>● Servo OFF command 0: Servo ON 1: Servo OFF</li> </ul> <p>When all axis servo ON is valid.</p>	0		1551+100n
<p>■ Set with a decimal.</p> <p>Setting value</p>  <ul style="list-style-type: none"> <li>● Torque output setting 0 to 1000 (%)</li> </ul>	0	1552+100n	4352+100n

n: Axis No.-1

Setting item	Setting details	
<p><u>Cd.108</u> Gain changing command</p>	<ul style="list-style-type: none"> <li>The command required to carry out "gain changing" of the servo amplifier from LD77MH.</li> </ul> <p><u>Fetch cycle: Operation cycle</u></p> <p><u>POINT</u></p> <ul style="list-style-type: none"> <li>If the setting is other than "0" and "1", operation is performed in the "gain changing" with the setting regard as "0". (Refer to the Servo amplifier Instruction Manual.)</li> </ul>	
<p><u>Cd.112</u> Torque change function switching request</p>	<ul style="list-style-type: none"> <li>Sets "same setting/individual setting" of the forward torque limit value or reverse torque limit value in the torque change function.</li> </ul> <p><u>Fetch cycle: Operation cycle</u></p> <p><u>POINT</u></p> <ul style="list-style-type: none"> <li>Set "0" normally. (when the forward torque limit value and reverse torque limit value are not divided.)</li> <li>When a value except "1" is set, it operates as "forward/reverse torque limit value_ same setting".</li> </ul>	
<p><u>Cd.113</u> Reverse new torque value</p>	<ul style="list-style-type: none"> <li>"1" is set in "<u>Cd.112</u> Torque change function switching request", a new reverse torque limit value is set. (when "0" is set in "<u>Cd.112</u> Torque change function switching request ", the setting value is invalid.)</li> <li>Set a value within "0" to "<u>Pr.17</u> Torque limit setting value". (The new torque value is invalid when "0" is set, and "<u>Pr.17</u> Torque limit setting value" or "<u>Cd.101</u>"Torque output setting value" becomes valid. The range of torque change is 1 to "<u>Pr.17</u> Torque limit setting value".</li> </ul> <p><u>Fetch cycle: Operation cycle</u></p>	

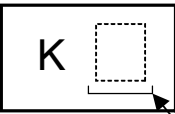
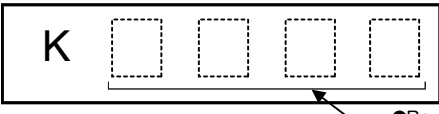
Setting value	Default value	Storage buffer memory address	
		LD77MH4	LD77MH16
<p>■ Set with a decimal.</p> <p>Setting value</p>  <p>● Gain changing command 0: Gain changing command OFF 1: Gain changing command ON</p>	0	1559+100n	4359+100n
<p>■ Set with a decimal.</p> <p>Setting value</p>  <p>● Torque change function switching request 0: Forward/reverse torque limit value_same setting 1: Forward/reverse torque limit value_individual setting</p>	0	1563+100n	4363+100n
<p>■ Set with a decimal.</p> <p>Setting value</p>  <p>● Reverse new torque value 0 to [Pr.17] Torque limit setting value (%)</p>	0	1564+100n	4364+100n

n: Axis No.-1

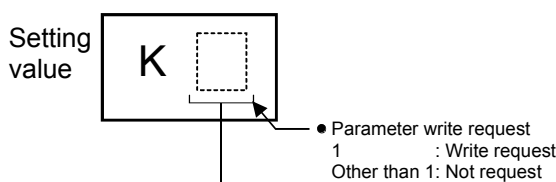
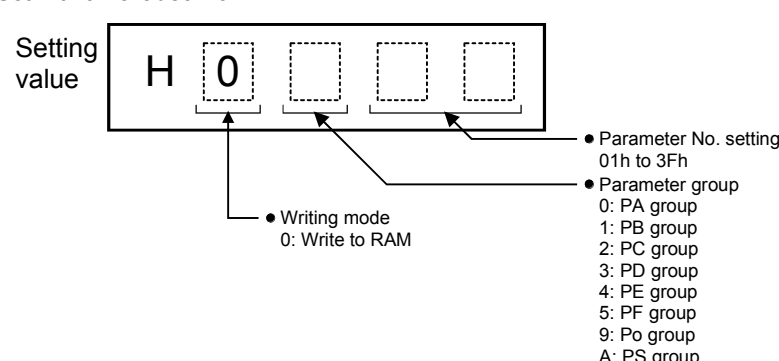
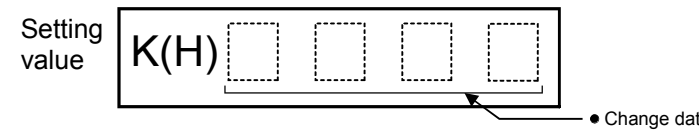
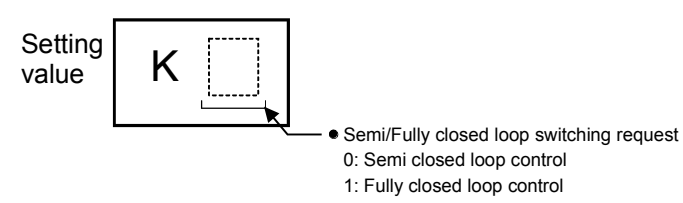
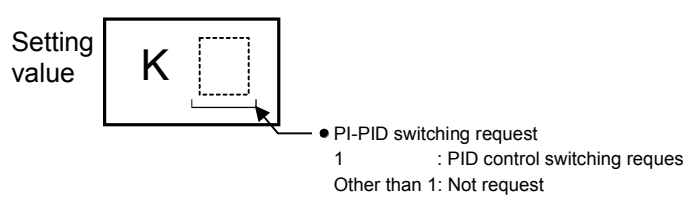

Setting item	Setting details	
<p>[Cd.130] Parameter write request</p>	<ul style="list-style-type: none"> <li>• Set the write request of servo parameter. Set "1" after setting "[Cd.131] Parameter No." and "[Cd.132] Change data".</li> </ul> <p><u>Fetch cycle: Main cycle</u> <sup>(Note-1)</sup></p> <p>(Note-1): Cycle of processing executed at free time except the positioning control. It changes by status of axis start.</p>	
<p>[Cd.131] Parameter No.</p>	<ul style="list-style-type: none"> <li>• Set the servo parameter to be changed.</li> </ul> <p><u>Fetch cycle: At change request</u></p>	
<p>[Cd.132] Change data</p>	<ul style="list-style-type: none"> <li>• Set the change value of servo parameter set in "[Cd.131] Parameter No.".</li> </ul> <p><u>Fetch cycle: At change request</u></p>	
<p>[Cd.133] Semi/Fully closed loop switching request</p>	<ul style="list-style-type: none"> <li>• Set the switching semi closed control and fully closed control.</li> </ul> <p><u>Fetch cycle: Operation cycle (Fully closed loop control servo amplifier only)</u></p>	
<p>[Cd.136] PI-PID switching request</p>	<ul style="list-style-type: none"> <li>• Set the PI-PID switching to servo amplifier.</li> </ul> <p><u>Fetch cycle: Operation cycle</u></p>	

	Setting value	Default value	Storage buffer memory address	
			LD77MH4	LD77MH16
<p>■ Set with a decimal.</p> <p>Setting value</p>  <ul style="list-style-type: none"> <li>Parameter write request 1 : Write request Other than 1: Not request</li> </ul> <p>The LD77MH resets the value to "0" automatically when the parameter write access completes. (The LD77MH resets the value to "3" at writing failure.)</p>	0	1554+100n	4354+100n	
<p>■ Set with a hexadecimal.</p> <p>Setting value</p>  <ul style="list-style-type: none"> <li>Parameter No. setting 01h to 3Fh</li> <li>Parameter group 0: PA group 1: PB group 2: PC group 3: PD group 4: PE group 5: PF group 9: Po group A: PS group</li> <li>Writing mode 0: Write to RAM</li> </ul>	0000H	1555+100n	4355+100n	
<p>■ Set with a decimal or hexadecimal.</p> <p>Setting value</p>  <ul style="list-style-type: none"> <li>Change data</li> </ul>	0	1556+100n	4356+100n	
<p>■ Set with a decimal.</p> <p>Setting value</p>  <ul style="list-style-type: none"> <li>Semi/Fully closed loop switching request 0: Semi closed loop control 1: Fully closed loop control</li> </ul>	0	1558+100n	4358+100n	
<p>■ Set with a decimal.</p> <p>Setting value</p>  <ul style="list-style-type: none"> <li>PI-PID switching request 1 : PID control switching request Other than 1: Not request</li> </ul>	0	1565+100n	4365+100n	

n: Axis No.-1

Setting item	Setting details											
<p>[Cd.138] Control mode switching request</p>	<ul style="list-style-type: none"> <li>Request the control mode switching in the speed-torque control. Set "1" after setting "[Cd.139] Control mode setting".</li> <li>LD77MH sets "0" at completion of control mode switching.</li> </ul> <p>Fetch cycle: Operation cycle</p>											
<p>[Cd.139] Control mode setting</p>	<ul style="list-style-type: none"> <li>Set the control mode to be changed in the speed-torque control.</li> </ul> <p>Fetch cycle: At mode switching</p>											
<p>[Cd.140] Command speed at speed control mode</p>	<ul style="list-style-type: none"> <li>Set the command speed at speed control mode in the speed-torque control.</li> <li>Set a value within the following range:</li> </ul> <table border="1" data-bbox="584 1032 1426 1200"> <thead> <tr> <th data-bbox="584 1032 751 1115">[Pr.1] Unit setting</th> <th data-bbox="751 1032 919 1115">mm (<math>\times 10^{-2}</math> mm/min)</th> <th data-bbox="919 1032 1086 1115">inch (<math>\times 10^{-3}</math> inch/min)</th> <th data-bbox="1086 1032 1270 1115">degree* (<math>\times 10^{-3}</math> degree/min)</th> <th data-bbox="1270 1032 1426 1115">PLS (PLS/s)</th> </tr> </thead> <tbody> <tr> <td data-bbox="584 1115 751 1200">Setting range</td> <td data-bbox="751 1115 919 1200">-2000000000 to +2000000000</td> <td data-bbox="919 1115 1086 1200">-2000000000 to +2000000000</td> <td data-bbox="1086 1115 1270 1200">-2000000000 to +2000000000</td> <td data-bbox="1270 1115 1426 1200">-500000000 to +500000000</td> </tr> </tbody> </table> <p>* : When "[Pr.83] Speed control 10 x multiplier setting for degree axis" is valid, this will be the setting range -2000000000 to 2000000000 (<math>\times 10^{-2}</math> degree/min).</p> <p>Fetch cycle: Operation cycle (At speed control mode)</p>	[Pr.1] Unit setting	mm ( $\times 10^{-2}$ mm/min)	inch ( $\times 10^{-3}$ inch/min)	degree* ( $\times 10^{-3}$ degree/min)	PLS (PLS/s)	Setting range	-2000000000 to +2000000000	-2000000000 to +2000000000	-2000000000 to +2000000000	-500000000 to +500000000	
[Pr.1] Unit setting	mm ( $\times 10^{-2}$ mm/min)	inch ( $\times 10^{-3}$ inch/min)	degree* ( $\times 10^{-3}$ degree/min)	PLS (PLS/s)								
Setting range	-2000000000 to +2000000000	-2000000000 to +2000000000	-2000000000 to +2000000000	-500000000 to +500000000								
<p>[Cd.141] Acceleration time at speed control mode</p>	<ul style="list-style-type: none"> <li>Set the acceleration time at speed control mode in the speed-torque control. (Set the time for the speed to increase from "0" to "[Pr.8] Speed limit value".) 0 to 65535 (ms)</li> </ul> <p>Fetch cycle: At mode switching</p>											

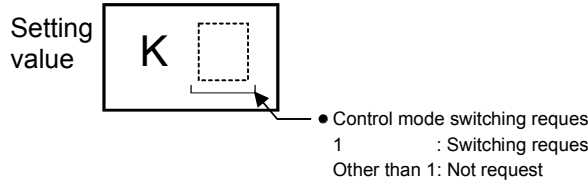
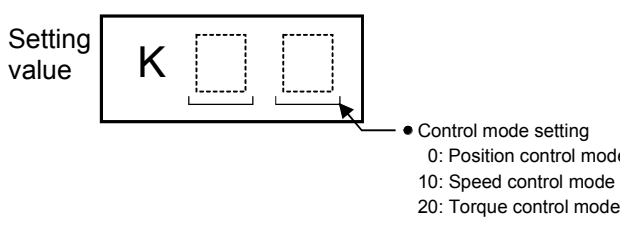
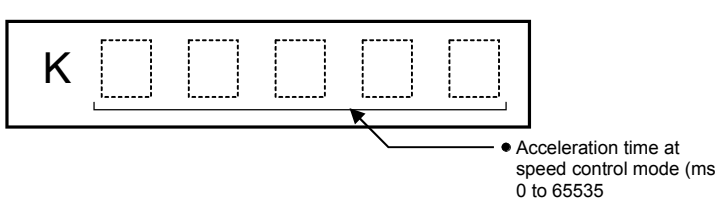
	Setting value	Default value	Storage buffer memory address										
			LD77MH4	LD77MH16									
<p>■ Set with a decimal.</p> <p>Setting value</p> 	0	1574+100n	4374+100n										
<p>■ Set with a decimal.</p> <p>Setting value</p> 	0	1575+100n	4375+100n										
<p>■ Set with a decimal.</p> <p>Actual value</p> <p>Cd.140 Command speed at speed control mode</p> <p>◇ Conversion into an integer value</p> <p>Setting value</p> <p>R</p> <p>× 10<sup>m</sup></p> <p>Unit conversion table (Cd.140)</p> <table border="1" data-bbox="718 1097 941 1254"> <thead> <tr> <th>m</th> <th>Unit</th> </tr> </thead> <tbody> <tr> <td>2</td> <td>mm/min</td> </tr> <tr> <td>3</td> <td>inch/min</td> </tr> <tr> <td>3*</td> <td>degree/min</td> </tr> <tr> <td>0</td> <td>PLS/s</td> </tr> </tbody> </table> <p>*: When " Pr.83 Speed control 10 x multiplier setting for degree axis" is valid: "2"</p>	m	Unit	2	mm/min	3	inch/min	3*	degree/min	0	PLS/s	0	1576+100n 1577+100n	4376+100n 4377+100n
m	Unit												
2	mm/min												
3	inch/min												
3*	degree/min												
0	PLS/s												
<p>■ Set with a decimal.</p> <p>Setting value</p> 	1000	1578+100n	4378+100n										

n: Axis No.-1



Setting item	Setting details										
<p>[Cd.142] Deceleration time at speed control mode</p>	<ul style="list-style-type: none"> <li>Set the deceleration time at speed control mode in the speed-torque control. (Set the time for the speed to decrease from "[Pr.8] Speed limit value" to "0".) 0 to 65535 (ms)</li> </ul> <p>Fetch cycle: At mode switching</p>										
<p>[Cd.143] Command torque at torque control mode</p>	<ul style="list-style-type: none"> <li>Set the command torque at torque control mode in the speed-torque control. -10000 to 10000 (<math>\times 0.1\%</math>)</li> </ul> <p>Fetch cycle: Operation cycle (At torque control mode)</p>										
<p>[Cd.144] Torque time constant at torque control mode (Forward direction)</p>	<ul style="list-style-type: none"> <li>Set the time constant to torque forward direction at torque control mode in the speed-torque control. (Set the time for the torque to increase from "0" to "[Pr.17] Torque limit setting value".) 0 to 65535 (ms)</li> </ul> <p>Fetch cycle: At mode switching</p>										
<p>[Cd.145] Torque time constant at torque control mode (Reverse direction)</p>	<ul style="list-style-type: none"> <li>Set the time constant to torque reverse direction at torque control mode in the speed-torque control. (Set the time for the torque to decrease from "[Pr.17] Torque limit setting value" to "0".) 0 to 65535 (ms)</li> </ul> <p>Fetch cycle: At mode switching</p>										
<p>[Cd.146] Speed limit value at torque control mode</p>	<ul style="list-style-type: none"> <li>Set the speed limit value at torque control mode in the speed-torque control.</li> <li>Set a value within the following range:</li> </ul> <table border="1" data-bbox="584 1565 1426 1709"> <thead> <tr> <th>[Pr.1] Unit setting</th> <th>mm (<math>\times 10^{-2}</math> mm/min)</th> <th>inch (<math>\times 10^{-3}</math> inch/min)</th> <th>degree* (<math>\times 10^{-3}</math> degree/min)</th> <th>PLS (PLS/s)</th> </tr> </thead> <tbody> <tr> <td>Setting range</td> <td>0 to 2000000000</td> <td>0 to 2000000000</td> <td>0 to 2000000000</td> <td>0 to 50000000</td> </tr> </tbody> </table> <p>* : When "[Pr.83] Speed control 10 x multiplier setting for degree axis" is valid, this will be the setting range 0 to 2000000000 (<math>\times 10^{-2}</math> degree/min).</p> <p>Fetch cycle: Operation cycle (At torque control mode)</p>	[Pr.1] Unit setting	mm ( $\times 10^{-2}$ mm/min)	inch ( $\times 10^{-3}$ inch/min)	degree* ( $\times 10^{-3}$ degree/min)	PLS (PLS/s)	Setting range	0 to 2000000000	0 to 2000000000	0 to 2000000000	0 to 50000000
[Pr.1] Unit setting	mm ( $\times 10^{-2}$ mm/min)	inch ( $\times 10^{-3}$ inch/min)	degree* ( $\times 10^{-3}$ degree/min)	PLS (PLS/s)							
Setting range	0 to 2000000000	0 to 2000000000	0 to 2000000000	0 to 50000000							

	Setting value	Default value	Storage buffer memory address										
			LD77MH4	LD77MH16									
<p>■ Set with a decimal.</p> <p>Setting value</p> <div style="border: 1px solid black; padding: 5px; display: inline-block;"> <p>K <span style="border: 1px dashed black; padding: 2px 10px;"> </span> <span style="border: 1px dashed black; padding: 2px 10px;"> </span> <span style="border: 1px dashed black; padding: 2px 10px;"> </span> <span style="border: 1px dashed black; padding: 2px 10px;"> </span> <span style="border: 1px dashed black; padding: 2px 10px;"> </span></p> </div> <p>• Deceleration time at speed control mode (ms) 0 to 65535</p>	1000	1579+100n	4379+100n										
<p>■ Set with a decimal.</p> <p>Setting value</p> <div style="border: 1px solid black; padding: 5px; display: inline-block;"> <p>K <span style="border: 1px dashed black; padding: 2px 10px;"> </span> <span style="border: 1px dashed black; padding: 2px 10px;"> </span> <span style="border: 1px dashed black; padding: 2px 10px;"> </span> <span style="border: 1px dashed black; padding: 2px 10px;"> </span> <span style="border: 1px dashed black; padding: 2px 10px;"> </span> <span style="border: 1px dashed black; padding: 2px 10px;"> </span></p> </div> <p>• Command torque at torque control mode(×0.1%) -10000 to 10000</p>	0	1580+100n	4380+100n										
<p>■ Set with a decimal.</p> <p>Setting value</p> <div style="border: 1px solid black; padding: 5px; display: inline-block;"> <p>K <span style="border: 1px dashed black; padding: 2px 10px;"> </span> <span style="border: 1px dashed black; padding: 2px 10px;"> </span> <span style="border: 1px dashed black; padding: 2px 10px;"> </span> <span style="border: 1px dashed black; padding: 2px 10px;"> </span> <span style="border: 1px dashed black; padding: 2px 10px;"> </span></p> </div> <p>• Torque time constant at torque control mode (Forward direction) (ms) 0 to 65535</p>	1000	1581+100n	4381+100n										
<p>■ Set with a decimal.</p> <p>Setting value</p> <div style="border: 1px solid black; padding: 5px; display: inline-block;"> <p>K <span style="border: 1px dashed black; padding: 2px 10px;"> </span> <span style="border: 1px dashed black; padding: 2px 10px;"> </span> <span style="border: 1px dashed black; padding: 2px 10px;"> </span> <span style="border: 1px dashed black; padding: 2px 10px;"> </span> <span style="border: 1px dashed black; padding: 2px 10px;"> </span></p> </div> <p>• Torque time constant at torque control mode (Reverse direction) (ms) 0 to 65535</p>	1000	1582+100n	4382+100n										
<p>■ Set with a decimal.</p> <p>Actual value</p> <div style="border: 1px solid black; padding: 5px; display: inline-block;"> <p>Cd.146 Speed limit value at torque control mode</p> </div> <p>◇ Conversion into an integer value</p> <p>Setting value</p> <div style="border: 1px solid black; padding: 5px; display: inline-block;"> <p>R</p> </div> <p>× 10<sup>m</sup></p> <p>• Unit conversion table (Cd.146)</p> <table border="1" style="margin-left: 20px;"> <thead> <tr> <th>m</th> <th>Unit</th> </tr> </thead> <tbody> <tr> <td>2</td> <td>mm/min</td> </tr> <tr> <td>3</td> <td>inch/min</td> </tr> <tr> <td>3*</td> <td>degree/min</td> </tr> <tr> <td>0</td> <td>PLS/s</td> </tr> </tbody> </table> <p>*: When " Pr.83 Speed control 10 x multiplier setting for degree axis" is valid: "2"</p>	m	Unit	2	mm/min	3	inch/min	3*	degree/min	0	PLS/s	1	1584+100n 1585+100n	4384+100n 4385+100n
m	Unit												
2	mm/min												
3	inch/min												
3*	degree/min												
0	PLS/s												

n: Axis No.-1

## 5.7.3 Expansion axis control data

Setting item	Setting details
<p><b>Cd.180</b> Axis stop</p> <p><b>LD77MH16</b></p>	<ul style="list-style-type: none"> <li>• When the axis stop signal turns ON, the OPR control, positioning control, JOG operation, inching operation, manual pulse generator operation and speed-torque control etc. will stop.</li> <li>• By turning the axis stop signal ON during positioning operation, the positioning operation will be "stopped".</li> <li>• Whether to decelerate stop or suddenly stop can be selected with "<b>Pr.39</b> Stop group 3 sudden stop selection".</li> <li>• During interpolation control of the positioning operation, if the axis stop signal of any axis turns ON, all axes in the interpolation control will decelerate and stop.</li> </ul> <p><u>Fetch cycle: Operation cycle</u></p>
<p><b>Cd.181</b> Forward run JOG start</p> <p><b>LD77MH16</b></p>	<ul style="list-style-type: none"> <li>• When the JOG start signal is ON, JOG operation will be carried out at the "<b>Cd.17</b> JOG speed". When the JOG start signal turns OFF, the operation will decelerate and stop.</li> </ul>
<p><b>Cd.182</b> Reverse run JOG start</p> <p><b>LD77MH16</b></p>	<ul style="list-style-type: none"> <li>• When inching movement amount is set, the designated movement amount is output for one operation cycle and then the operation stops.</li> </ul> <p><u>Fetch cycle: Operation cycle</u></p>
<p><b>Cd.183</b> Execution prohibition flag</p> <p><b>LD77MH16</b></p>	<ul style="list-style-type: none"> <li>• If the execution prohibition flag is ON when the positioning start signal turns ON, positioning control does not start until the execution prohibition flag turns OFF. Used with the "Pre-reading start function". (Refer to Section 13.7.7)</li> </ul> <p><u>Fetch cycle: At start</u></p>

Setting value	Default value	Storage buffer memory address	
		LD77MH4	LD77MH16
<p>■ Set with a decimal.</p> <p>Setting value</p>  <ul style="list-style-type: none"> <li>• Axis stop 1 : Axis stop requested Other than 1: Axis stop not requested</li> </ul>	0		30100+10n
<p>■ Set with a decimal.</p> <p>Setting value</p>  <ul style="list-style-type: none"> <li>• Forward run JOG start/Reverse run JOG start 1 : JOG started Other than 1: JOG not started</li> </ul>	0		30101+10n
	0		30102+10n
<p>■ Set with a decimal.</p> <p>Setting value</p>  <ul style="list-style-type: none"> <li>• Execution prohibition flag 1 : During execution prohibition Other than 1: Not during execution prohibition</li> </ul>	0		30103+10n

n: Axis No.-1





# Chapter 6 Sequence Program Used for Positioning Control

The programs required to carry out positioning control with the LD77MH are explained in this chapter.

The sequence program required for control is created allowing for the "start conditions", "start time chart", "device settings" and general control configuration. (The parameters, positioning data, block start data and condition data, etc., must be set in the LD77MH according to the control to be executed, and program for setting the control data or a program for starting the various control must be created.)

The first half of this chapter explains the program configuration of general control, and the latter half explains the program details. Create the required program while referring to the various control details explained in "Section 2", and to Chapter 5 "Data Used for Positioning Control".

6.1	Precautions for creating program .....	6- 2
6.2	List of devices used .....	6- 6
6.3	Creating a program .....	6-16
6.3.1	General configuration of program .....	6-16
6.3.2	Positioning control operation program .....	6-17
6.4	Positioning program examples.....	6-21
6.5	Program details .....	6-53
6.5.1	Initialization program.....	6-53
6.5.2	Start details setting program .....	6-54
6.5.3	Start program .....	6-56
6.5.4	Continuous operation interrupt program .....	6-68
6.5.5	Restart program .....	6-70
6.5.6	Stop program .....	6-73

## 6.1 Precautions for creating program

The common precautions to be taken when writing data from the PLC CPU to the LD77MH buffer memory are described below.

When diverting any of the program examples introduced in this manual to the actual system, fully verify that there are no problems in the controllability of the target system.

### (1) Reading/writing the data

Setting the data explained in this chapter (various parameters, positioning data, block start data) should be set using GX Works2.

When set with the sequence program, many sequence programs and devices must be used. This will not only complicate the program, but will also increase the scan time.

When rewriting the positioning data during continuous path control or continuous positioning control, rewrite the data four positioning data items before the actual execution. If the positioning data is not rewritten before the positioning data four items earlier is executed, the process will be carried out as if the data was not rewritten.

### (2) Restrictions to speed change execution interval

Provide an interval of 100ms or more when changing the speed or performing override function with the LD77MH.

### (3) Process during overrun

Overrun is prevented by the setting of the upper and lower stroke limits with the detailed parameter 1.

However, this applies only when the LD77MH is operating correctly.

It is recommended to create an external circuit including a boundary limit switch to ensure the whole system safety as follows: the external circuit powers OFF the motor when the boundary limit switch operates.

(4) System configuration

Unless particularly designated, the sequence program for the following system using LD77MH4 is shown in this chapter and subsequent.

Refer to Section 6.2 for the application of the devices to be used.

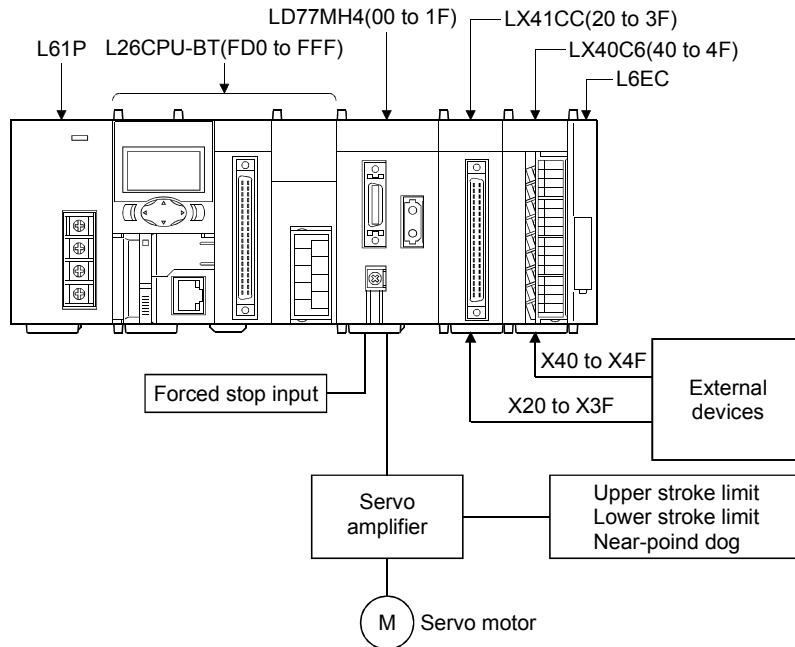

(5) Control unit

In the program, the unit of "0: mm, 2: degree" is set for the basic parameter 1.

(6) Communication with LD77MH

There are two methods for communication with LD77MH using the sequence program: a method using an "intelligent function device" and a method using a FROM/TO command.

In the sequence program in this chapter and subsequent, the program example using the "intelligent function device" is shown without using an FROM/TO command for communication with LD77MH.

When using the FROM/TO command for communication with LD77MH, change the circuit incorporating the "intelligent function device" as follows.

- (a) When the circuit uses the "intelligent function device" on the destination (D) side of a MOV command, change the command to a TO command.

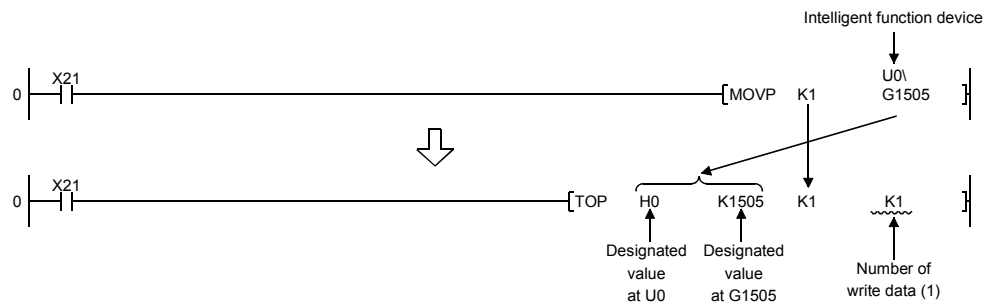

(b) When the circuit uses the "intelligent function device" on the source(s) side and the destination (D) side of a MOV command, change the command to a FROM command and a TO command.

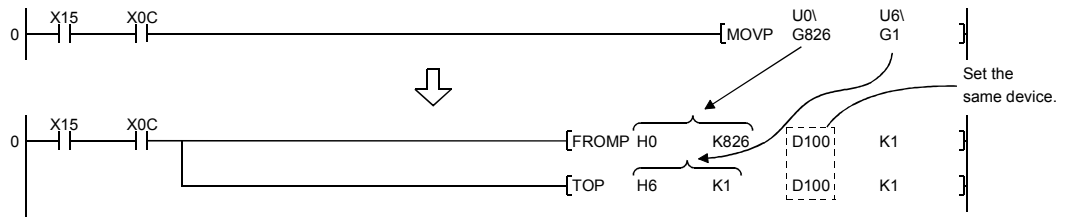

(c) When the circuit uses the "intelligent function device" for a COMPARISON command, change the command to a FROM command and a COMPARISON command.

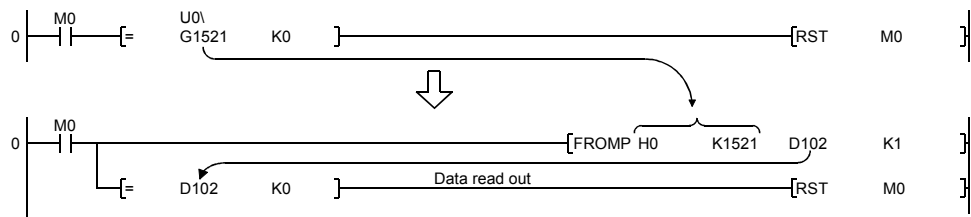

(d) When the circuit uses the "intelligent function device" for a WAND command, change the command to a FROM command and a WAND command.

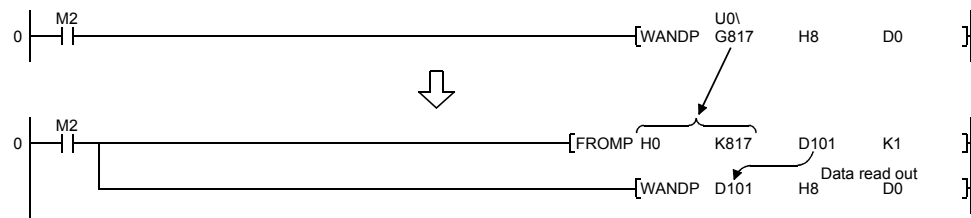

(7) Conversion of sequence program from LD77MH4 to LD77MH16

When the sequence program is changed from LD77MH4 to LD77MH16, change the I/O signals with different arrangement as follows.

(a) When not using index modification

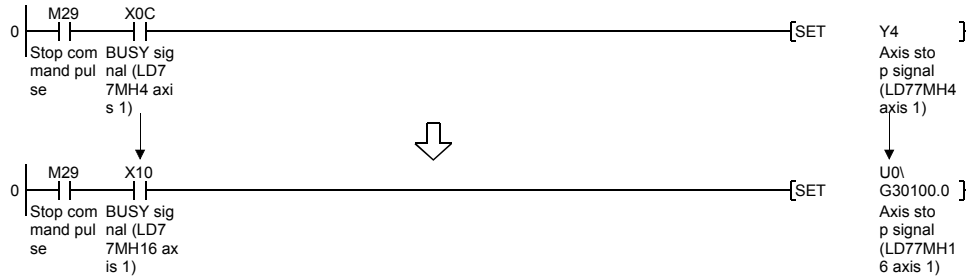

(b) When using index modification

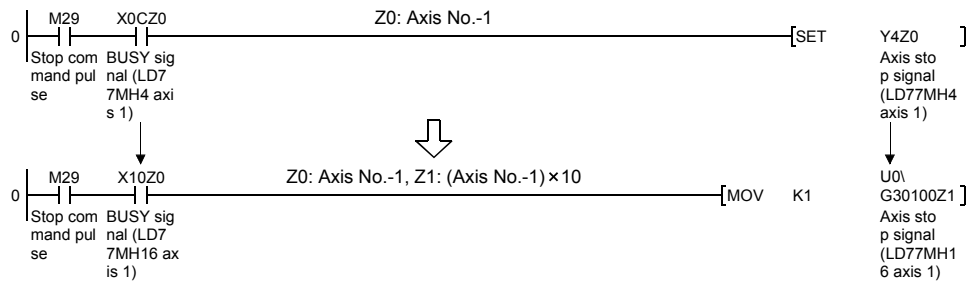

**REMARK**

Refer to the "MELSEC-L CPU Module User's Manual (Function Explanation, Program Fundamentals)" for the intelligent function devices.

Refer to the "MELSEC-Q/L Programming Manual (Common Instructions)" for detail commands used in those programs shown in this chapter and subsequent.

6.2 List of devices used

In the sequence programs using LD77MH4 shown in this chapter and subsequent, the application of the devices used are as follows.

The I/O numbers for LD77MH indicate those when the head I/O number is set to "0H". If it is set to other than "0H", change the I/O number according to setting of head I/O number.

In addition, change the external inputs, external outputs, internal relays, data registers, and timers according to the system used.

(1) Inputs/outputs, external inputs/external outputs, and internal relays of LD77MH4

Device name		Device				Application	Details when ON
		Axis 1	Axis 2	Axis 3	Axis 4		
Inputs/ outputs of LD77MH4	Input	X0				LD77 READY signal	LD77MH preparation completed
		X1				Synchronization flag	LD77MH buffer memory accessible
		X4	X5	X6	X7	M code ON signal	M code outputting
		X8	X9	XA	XB	Error detection signal	Error detected
		XC	XD	XE	XF	BUSY signal	BUSY (operating)
		X10	X11	X12	X13	Start complete signal	Start completed
		X14	X15	X16	X17	Positioning complete signal	Positioning completed
	Out- put	Y0				PLC READY signal	PLC CPU preparation completed
		Y1				All axis servo ON signal	All axis servo ON signal
		Y4	Y5	Y6	Y7	Axis stop signal	Requesting stop
		Y8	YA	YC	YE	Forward run JOG start signal	Starting forward run JOG
		Y9	YB	YD	YF	Reverse run JOG start signal	Starting reverse run JOG
		Y10	Y11	Y12	Y13	Positioning start signal	Requesting start
		Y14	Y15	Y16	Y17	Execution prohibition request	Execution prohibition
External input (command)	X20	—				OPR request OFF command	Commanding OPR request OFF
	X21					External command valid command	Commanding external command valid setting
	X22					External command invalid command	Commanding external command invalid
	X23					Machine OPR command	Commanding machine OPR
	X24					Fast OPR command	Commanding fast OPR
	X25					Positioning start command	Commanding positioning start
	X26					Speed-position switching operation command	Commanding speed-position switching operation
	X27					Speed-position switching enable command	Commanding speed-position switching enable
	X28					Speed-position switching prohibit command	Commanding speed-position switching prohibit
	X29					Movement amount change command	Commanding movement amount change
	X2A					High-level positioning control start command	Commanding high-level positioning control start
	X2B					Positioning start command (dedicated instruction)	Commanding positioning start

Device name	Device				Application	Details when ON			
	Axis 1	Axis 2	Axis 3	Axis 4					
External input (command)	X2C	—	—	—	M code OFF command	Commanding M code OFF			
	X2D				JOG operation speed setting command	Commanding JOG operation speed setting			
	X2E				Forward run JOG/inching command	Commanding forward run JOG/inching operation			
	X2F				Reverse run JOG/inching command	Commanding reverse run JOG/inching operation			
	X30				Manual pulse generator operation enable command	Commanding manual pulse generator operation enable			
	X31				Manual pulse generator operation disable command	Commanding manual pulse generator operation disable			
	X32				Speed change command	Commanding speed change			
	X33				Override command	Commanding override			
	X34				Acceleration/deceleration time change command	Commanding acceleration/deceleration time change			
	X35				Acceleration/deceleration time change disable command	Commanding acceleration/deceleration time change disable			
	X36				Torque change command	Commanding torque change			
	X37				Step operation command	Commanding step operation			
	X38				Skip command	Commanding skip			
	X39				Teaching command	Commanding teaching			
	X3A				Continuous operation interrupt command	Commanding continuous operation interrupt			
	X3B				Restart command	Commanding restart			
					X3C			Parameter initialization command	Commanding parameter initialization
					X3D			Flash ROM write command	Commanding flash ROM write
	X3E	—	—	—	Error reset command	Commanding error reset			
	X3F				Stop command	Commanding stop			
	X40				Position-speed switching operation command	Position-speed switching operation command			
	X41				Position-speed switching enable command	Position-speed switching enable command			
	X42				Position-speed switching prohibit command	Position-speed switching prohibit command			
	X43				Speed change command	Speed change command			
	X44				Inching movement amount setting command	Inching movement amount setting command			
	X45				Target position change command	Target position change command			
	X46				Step start information command	Step start information command			
	X47				Positioning start command k10	Positioning start command k10			
	X48				Override initialization value command	Override initialization value command			
	X49				Unused	—			
	X4A				Unused	—			
	X4B				PLC READY ON	PLC READY ON			
X4D	For unit (degree)	For unit (degree)							
X4E	Positioning start command (Y start)	Positioning start command being given							
X4F	All axis servo ON command	All axis servo ON command							



Device name	Device				Application	Details when ON			
	Axis 1	Axis 2	Axis 3	Axis 4					
Internal relay	M0	—	—	—	OPR request OFF command	Commanding OPR request OFF			
	M1				OPR request OFF command pulse	OPR request OFF commanded			
	M2				OPR request OFF command storage	OPR request OFF command held			
	M3				Fast OPR command	Commanding fast OPR			
	M4				Fast OPR command storage	Fast OPR command held			
	M5				Positioning start command pulse	Positioning start commanded			
	M6				Positioning start command storage	Positioning start command held			
	M7				In-JOG/Inching operation flag	In-JOG/Inching operation flag			
	M8				Manual pulse generator operation enable command	Commanding manual pulse generator operation enable			
	M9				Manual pulse generator operating flag	Manual pulse generator operating flag			
	M10				Manual pulse generator operation disable command	Commanding manual pulse generator operation disable			
	M11				Speed change command pulse	Speed change commanded			
	M12				Speed change command storage	Speed change command held			
	M13				Override command	Requesting override			
	M14				Acceleration/deceleration time change command	Requesting acceleration/deceleration time change			
	M15				Torque change command	Requesting torque change			
	M16				Step operation command pulse	Step operation commanded			
	M17				Skip command pulse	Skip commanded			
	M18				Skip command storage	Skip command held			
	M19				Teaching command pulse	Teaching commanded			
	M20				Teaching command storage	Teaching command held			
	M21				Continuous operation interrupt command	Requesting continuous operation interrupt			
	M22				Restart command	Requesting restart			
	M23				Restart command storage	Restart command held			
					M24			Parameter initialization command pulse	Parameter initialization commanded
					M25			Parameter initialization command storage	Parameter initialization command held
					M26			Flash ROM write command pulse	Flash ROM write commanded
					M27			Flash ROM write command storage	Flash ROM write command held
					M28			Error reset	Error reset completed
					M29			Stop command pulse	Stop commanded
					M30			Target position change command pulse	Target position change commanded
					M31			Target position change command storage	Target position change command held
					M32			ZP.PSTR1 instruction complete device	ZP.PSTR1 instruction completed
	M33			ZP.PSTR1 instruction error complete device	ZP.PSTR1 instruction error completed				

Device name	Device				Application	Details when ON
	Axis 1	Axis 2	Axis 3	Axis 4		
Internal relay	M34	—			ZP.TEACH1 instruction complete device	ZP.TEACH1 instruction completed
	M35				ZP.TEACH1 instruction error complete device	ZP.TEACH1 instruction error completed
	M36				ZP.PINIT instruction complete device	ZP.PINIT instruction completed
	M37				ZP.PINIT instruction error complete device	ZP.PINIT instruction error completed
	M38				ZP.PFWRT instruction complete device	ZP.PFWRT instruction completed
	M39				ZP.PFWRT instruction error complete device	ZP.PFWRT instruction error completed
	M40				Override initialization value	Override initialization value
	M41				Unused	—
	M42				Unused	—
	M50				Parameter setting complete device	Parameter setting completed

(2) Data registers and timers

Device name	Device				Application	Details of storage
	Axis 1	Axis 2	Axis 3	Axis 4		
Data register	D0	—			OPR request flag	<a href="#">Md.31</a> Status: b3
	D1				Speed (low-order 16 bits)	<a href="#">Cd.25</a> Position-speed switching control speed change register
	D2				Speed (high-order 16 bits)	
	D3				Movement amount (low-order 16 bits)	<a href="#">Cd.23</a> Speed-position switching control movement amount change register
	D4				Movement amount (high-order 16 bits)	
	D5				Inching movement amount	<a href="#">Cd.16</a> Inching movement amount
	D6				JOG operation speed (low-order 16 bits)	<a href="#">Cd.17</a> JOG speed
	D7				JOG operation speed (high-order 16 bits)	
	D8				Manual pulse generator 1 pulse input magnification (low-order)	<a href="#">Cd.20</a> Manual pulse generator 1 pulse input magnification
	D9				Manual pulse generator 1 pulse input magnification (high-order)	
	D10				Manual pulse generator operation enable	<a href="#">Cd.21</a> Manual pulse generator enable flag
	D11				Speed change value (low-order 16 bits)	<a href="#">Cd.14</a> New speed value
	D12				Speed change value (high-order 16 bits)	
	D13				Speed change request	<a href="#">Cd.15</a> Speed change request
	D14				Override value	<a href="#">Cd.13</a> Positioning operation speed override

Device name	Device				Application	Details of storage
	Axis 1	Axis 2	Axis 3	Axis 4		
Data register	D15	—	—	—	Acceleration time setting (low-order 16 bits)	Cd.10 New acceleration time value
	D16				Acceleration time setting (high-order 16 bits)	
	D17				Deceleration time setting (low-order 16 bits)	Cd.11 New deceleration time value
	D18				Deceleration time setting (high-order 16 bits)	
	D19				Acceleration/deceleration time change enable	Cd.12 Acceleration/deceleration time change during speed change, enable/disable selection
	D20				Step mode	Cd.34 Step mode
	D21				Step valid flag	Cd.35 Step valid flag
	D22				Step start information	—
	D23				Target position (low-order 16 bits)	Cd.27 Target position change value (new address)
	D24				Target position (high-order 16 bits)	
	D25				Target speed (low-order 16 bits)	Cd.28 Target position change value (new speed)
	D26				Target speed (high-order 16 bits)	
	D27				Target position change request	Cd.29 Target position change request flag
	D28				Unused	—
	D29				Unused	—
	D30				ZP.PSTRT1 instruction control data	—
	D31				Completion status	—
	D32				Start number	—
	D33				ZP.TEACH1 instruction control data	—
	D34				Completion status	—
	D35				Teaching data	—
	D36				Positioning data No.	—
	D37				ZP.PINIT instruction control data	—
	D38				Completion status	—
	D39				ZP.PFWRT instruction control data	—
	D40				Completion status	—
	D50				Unit setting	Pr.1 Unit setting
	D51				Unit magnification	Pr.4 Unit magnification (AM)

Device name	Device				Application	Details of storage	
	Axis 1	Axis 2	Axis 3	Axis 4			
Data register	D52	—	—	—	Number of pulses per rotation (low-order 16 bits)	Pr.2 Number of pulses per rotation (AP)	
	D53				Number of pulses per rotation (high-order 16 bits)		
	D54				Movement amount per rotation (low-order 16 bits)	Pr.3 Movement amount per rotation (AL)	
	D55				Movement amount per rotation (high-order 16 bits)		
	D56				Bias speed at start (low-order 16 bits)	Pr.7 Bias speed at start	
	D57				Bias speed at start (high-order 16 bits)		
	D68				Block start data (Block 0)	Point 1 (shape, start No.)	Da.11 Shape
	D69					Point 2 (shape, start No.)	
	D70					Point 3 (shape, start No.)	
	D71					Point 4 (shape, start No.)	
	D72					Point 5 (shape, start No.)	
	D73					Point 1 (special start instruction)	Da.13 Special start instruction
	D74					Point 2 (special start instruction)	Da.14 Parameter
	D75					Point 3 (special start instruction)	
	D76					Point 4 (special start instruction)	
	D77					Point 5 (special start instruction)	
	D78				—	Torque change value	—
	D79				Error code	Md.23 Axis error No.	
	D80				Servo series	Pr.100 Servo series	
	D81				Absolute position system valid/invalid	Pr.103 Absolute position detection system	
	D82				Unused	—	
	D85				Return home position method	Pr.43 OPR method	
	D100				Positioning identifier	Data No.1	
	D101				M code	Da.1 Operation pattern	
	D102				Dwell time	Da.2 Control system	
	D103				Unused	Da.3 Acceleration time No.	
	D104				Command speed (low-order 16 bits)	Da.4 Deceleration time No.	
	D105				Command speed (high-order 16 bits)	Da.5 Axis to be interpolated	
	D106				Positioning address (low-order 16 bits)	Da.6 Positioning address/ movement amount	
	D107				Positioning address (high-order 16 bits)		
	D108				Arc address (low-order 16 bits)	Da.7 Arc address	
					Arc address (high-order 16 bits)	Da.8 Command speed	
	D109				Arc address (low-order 16 bits)	Da.9 Dwell time	
Arc address (high-order 16 bits)		Da.10 M code					

Device name	Device				Application	Details of storage
	Axis 1	Axis 2	Axis 3	Axis 4		
Data register	D110	—	—	—	Positioning identifier	Data No.2
	D111				M code	Da.1 Operation pattern
	D112				Dwell time	Da.2 Control system
	D113				Unused	Da.3 Acceleration time No.
	D114				Command speed (low-order 16 bits)	Da.4 Deceleration time No.
	D115				Command speed (high-order 16 bits)	Da.5 Axis to be interpolated
	D116				Positioning address (low-order 16 bits)	Da.6 Positioning address/ movement amount
	D117				Positioning address (high-order 16 bits)	Da.7 Arc address
	D118				Arc address (low-order 16 bits)	Da.8 Command speed
	D119				Arc address (high-order 16 bits)	Da.9 Dwell time
	D120				Positioning identifier	Da.10 M code
	D121				M code	Data No.3
	D122				Dwell time	Da.1 Operation pattern
	D123				Unused	Da.2 Control system
	D124				Command speed (low-order 16 bits)	Da.3 Acceleration time No.
	D125				Command speed (high-order 16 bits)	Da.4 Deceleration time No.
	D126				Positioning address (low-order 16 bits)	Da.5 Axis to be interpolated
	D127				Positioning address (high-order 16 bits)	Da.6 Positioning address/ movement amount
	D128				Arc address (low-order 16 bits)	Da.7 Arc address
	D129				Arc address (high-order 16 bits)	Da.8 Command speed
	D130				Positioning identifier	Da.9 Dwell time
	D131				M code	Da.10 M code
	D132				Dwell time	Data No.4
	D133				Unused	Da.1 Operation pattern
	D134				Command speed (low-order 16 bits)	Da.2 Control system
	D135				Command speed (high-order 16 bits)	Da.3 Acceleration time No.
	D136				Positioning address (low-order 16 bits)	Da.4 Deceleration time No.
	D137				Positioning address (high-order 16 bits)	Da.5 Axis to be interpolated
	D138				Arc address (low-order 16 bits)	Da.6 Positioning address/ movement amount
	D139				Arc address (high-order 16 bits)	Da.7 Arc address

Device name	Device				Application	Details of storage
	Axis 1	Axis 2	Axis 3	Axis 4		
Data register	D140	—	—	—	Positioning identifier	Data No.5
	D141				M code	Da.1 Operation pattern
	D142				Dwell time	Da.2 Control system
	D143				Unused	Da.3 Acceleration time No.
	D144				Command speed (low-order 16 bits)	Da.4 Deceleration time No.
	D145				Command speed (low-order 16 bits)	Da.5 Axis to be interpolated
	D146				Positioning address (low-order 16 bits)	Da.6 Positioning address/ movement amount
	D147				Positioning address (high-order 16 bits)	Da.7 Arc address
	D148				Arc address (low-order 16 bits)	Da.8 Command speed
	D149				Arc address (high-order 16 bits)	Da.9 Dwell time
	D150				Positioning identifier	Da.10 M code
	D151				M code	Data No.6
	D152				Dwell time	Da.1 Operation pattern
	D153				Unused	Da.2 Control system
	D154				Command speed (low-order 16 bits)	Da.3 Acceleration time No.
	D155				Command speed (high-order 16 bits)	Da.4 Deceleration time No.
	D156				Positioning address (low-order 16 bits)	Da.5 Axis to be interpolated
	D157				Positioning address (high-order 16 bits)	Da.6 Positioning address/ movement amount
	D158				Arc address (low-order 16 bits)	Da.7 Arc address
	D159				Arc address (high-order 16 bits)	Da.8 Command speed
	D190				Positioning identifier	Da.9 Dwell time
	D191				M code	Da.10 M code
	D192				Dwell time	Data No.10
	D193				Unused	Da.1 Operation pattern
	D194				Command speed (low-order 16 bits)	Da.2 Control system
	D195				Command speed (high-order 16 bits)	Da.3 Acceleration time No.
	D196				Positioning address (low-order 16 bits)	Da.4 Deceleration time No.
	D197				Positioning address (high-order 16 bits)	Da.5 Axis to be interpolated
	D198				Arc address (low-order 16 bits)	Da.6 Positioning address/ movement amount
	D199				Arc address (high-order 16 bits)	Da.7 Arc address

Device name	Device				Application	Details of storage
	Axis 1	Axis 2	Axis 3	Axis 4		
Data register	D200	—	—	—	Positioning identifier	Data No.11
	D201				M code	Da.1 Operation pattern
	D202				Dwell time	Da.2 Control system
	D203				Unused	Da.3 Acceleration time No.
	D204				Command speed (low-order 16 bits)	Da.4 Deceleration time No.
	D205				Command speed (high-order 16 bits)	Da.5 Axis to be interpolated
	D206				Positioning address (low-order 16 bits)	Da.6 Positioning address/ movement amount
	D207				Positioning address (high-order 16 bits)	Da.7 Arc address
	D208				Arc address (low-order 16 bits)	Da.8 Command speed
	D209				Arc address (high-order 16 bits)	Da.9 Dwell time
	D240	—	—	—	Positioning identifier	Data No.15
	D241				M code	Da.1 Operation pattern
	D242				Dwell time	Da.2 Control system
	D243				Unused	Da.3 Acceleration time No.
	D244				Command speed (low-order 16 bits)	Da.4 Deceleration time No.
	D245				Command speed (high-order 16 bits)	Da.5 Axis to be interpolated
	D246				Positioning address (low-order 16 bits)	Da.6 Positioning address/ movement amount
	D247				Positioning address (high-order 16 bits)	Da.7 Arc address
	D248				Arc address (low-order 16 bits)	Da.8 Command speed
	D249				Arc address (high-order 16 bits)	Da.9 Dwell time
Timer	T0	—	—	—	PLC READY signal OFF confirmation	PLC READY signal OFF
	T1				PLC READY signal OFF confirmation	

Device name	Device	Application	Details of storage
Code	U0\G806	Error code	Md.23 Axis error No.
	U0\G809	Axis operation status	Md.26 Axis operation status
	U0\G817	Status	Md.31 Status
	U0\G1500	Positioning start No.	Cd.3 Positioning start No.
	U0\G1502	Axis error reset	Cd.5 Axis error reset
	U0\G1503	Restart command	Cd.6 Restart command
	U0\G1504	M code OFF request (Buffer memory)	Cd.7 M code OFF request
	U0\G1505	External command valid	Cd.8 External command valid
	U0\G1513	Override request	Cd.13 Positioning operation speed override
	U0\G1516	Speed change request	Cd.15 Speed change request
	U0\G1517	Inching movement amount	Cd.16 Inching movement amount
	U0\G1520	Interrupt request during continuous operation	Cd.18 Interrupt request during continuous operation
	U0\G1521	OPR request flag OFF request	Cd.19 OPR request flag OFF request
	U0\G1524	Manual pulse generator enable flag	Cd.21 Manual pulse generator enable flag
	U0\G1526	Speed-position switching control movement amount	Cd.23 Speed-position switching control movement amount change register
	U0\G1528	Speed-position switching enable flag	Cd.24 Speed-position switching enable flag
	U0\G1530	Position-speed switching control speed change	Cd.25 Position-speed switching control speed change register
	U0\G1532	Position-speed switching enable flag	Cd.26 Position-speed switching enable flag
	U0\G1538	Target position change request flag	Cd.29 Target position change request flag
	U0\G1544	Step mode	Cd.34 Step mode
U0\G1547	Skip command	Cd.37 Skip command	



### 6.3 Creating a program

The "positioning control operation program" actually used is explained in this chapter. The functions and programs explained in "Section 2" are assembled into the "positioning control operation program" explained here. (To monitor the control, add the required monitor program that matches the system. Refer to Section 5.6 "List of monitor data" for details on the monitor items.)

#### 6.3.1 General configuration of program

The general configuration of the "positioning control operation program" is shown below.

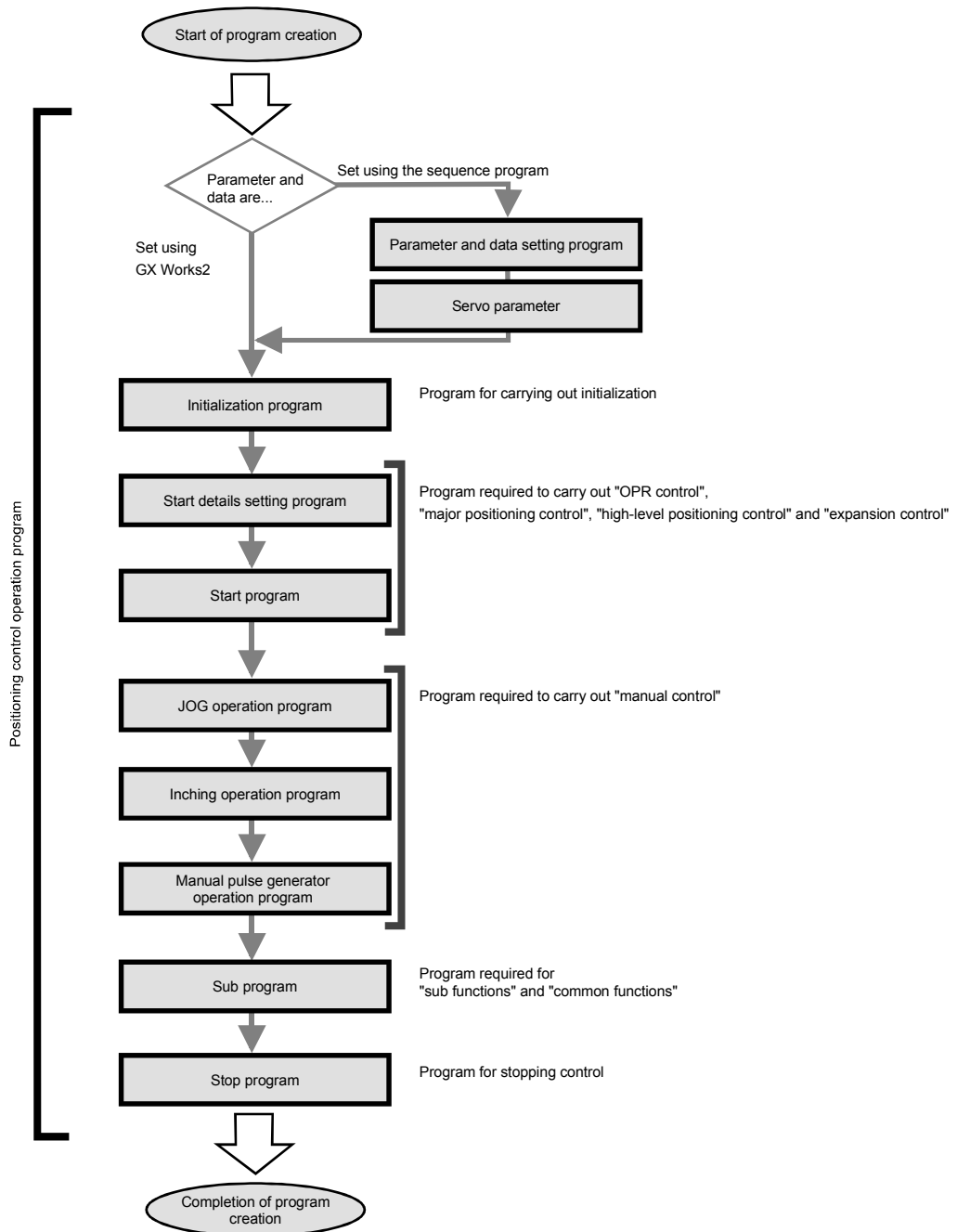

### 6.3.2 Positioning control operation program

The various programs that configure the "positioning control operation program" are shown below. When creating the program, refer to the explanation of each program and Section 6.4 "Positioning program examples", and create an operation program that matches the positioning system. (Numbers are assigned to the following programs. Configuring the program in the order of these numbers is recommended.)

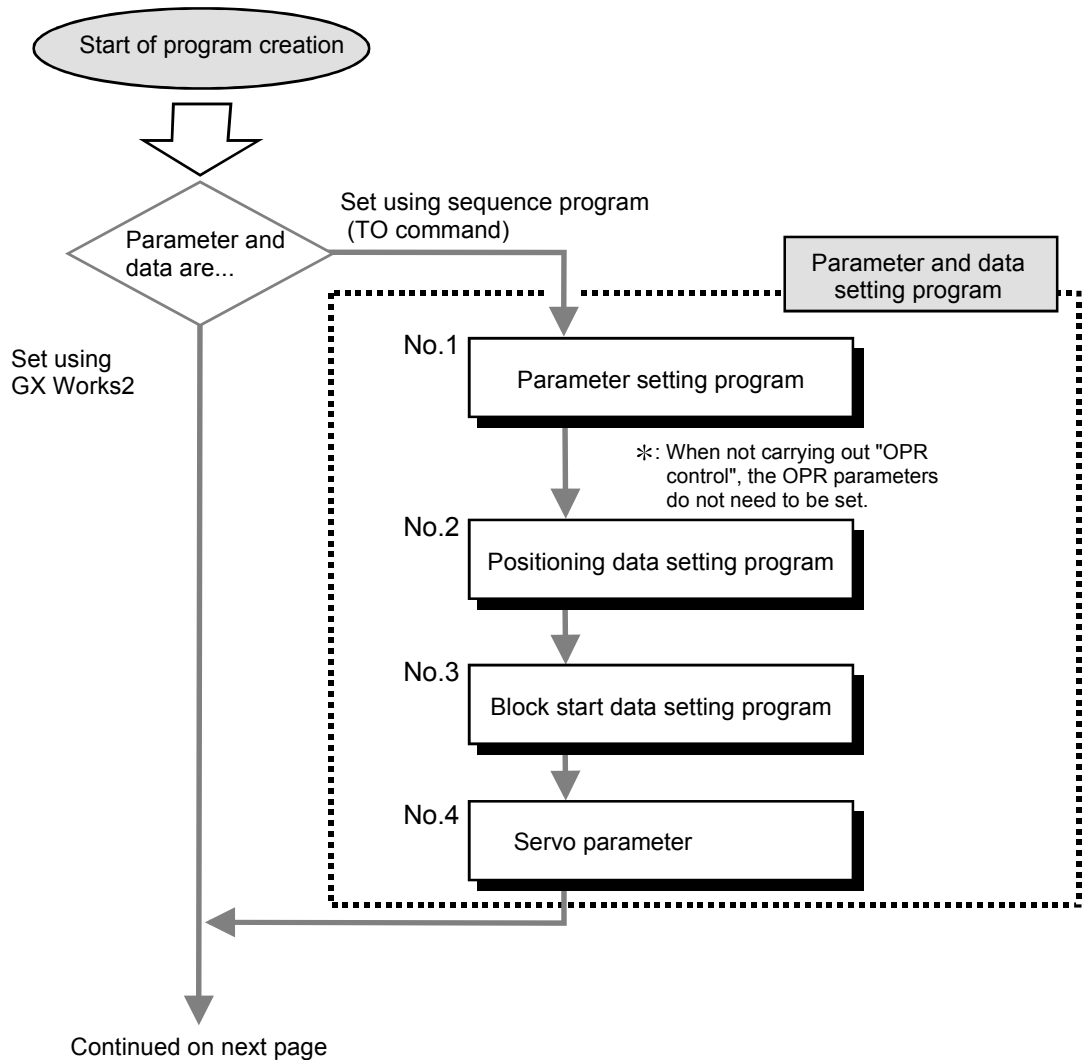

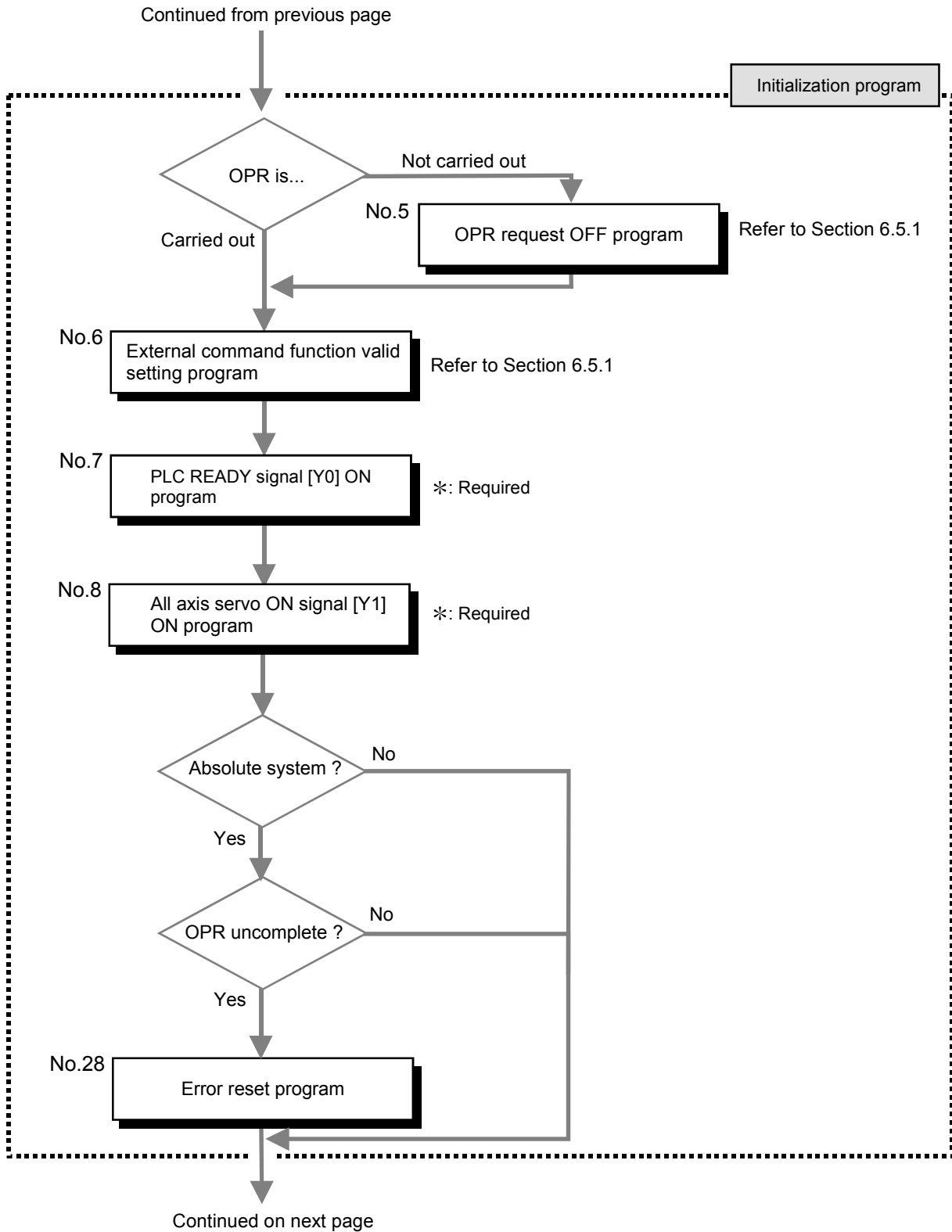

Continued from previous page

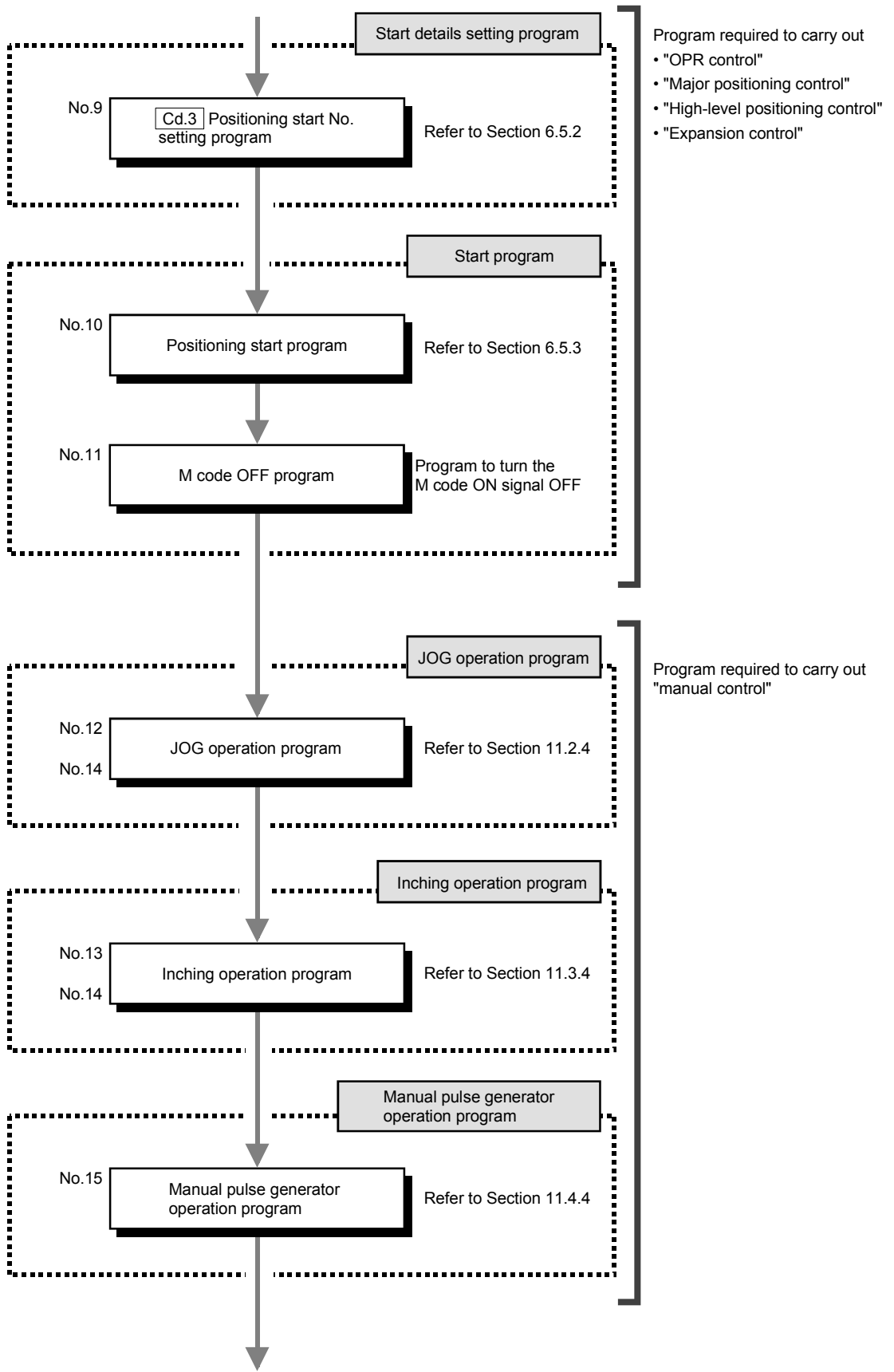

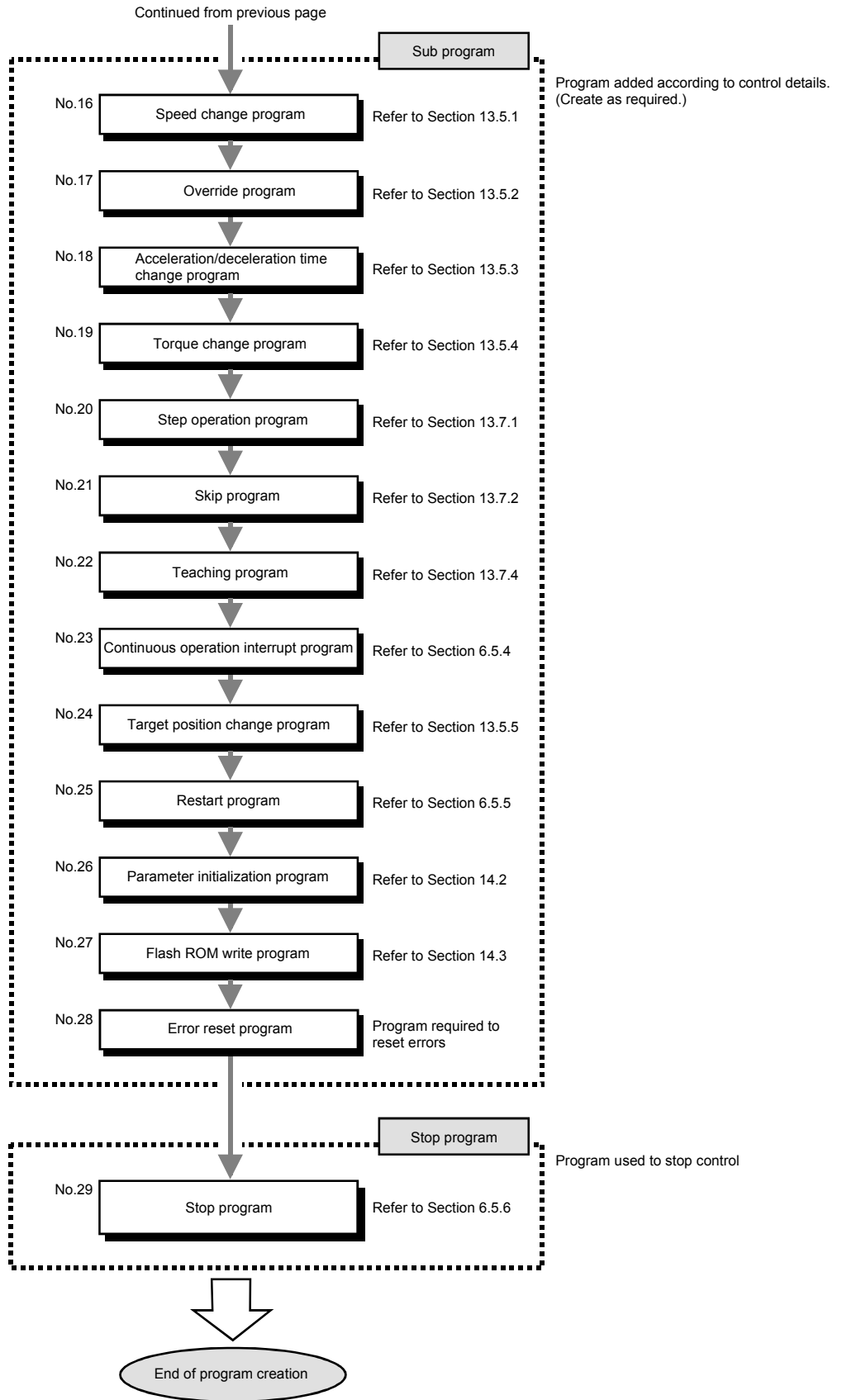

### 6.4 Positioning program examples

An example of the "Axis 1" positioning program using LD77MH4 is given in this section.

[No. 1] to [No. 4] parameter and data setting program  
 \* When setting the parameters or data with the sequence program, set them in the LD77MH using the TO command from the PLC CPU. (Carry out the settings while the PLC READY signal [Y0] is OFF.)  
 \* When setting the parameters or data with GX Works2, the [No. 1] to [No. 4] program is not necessary.

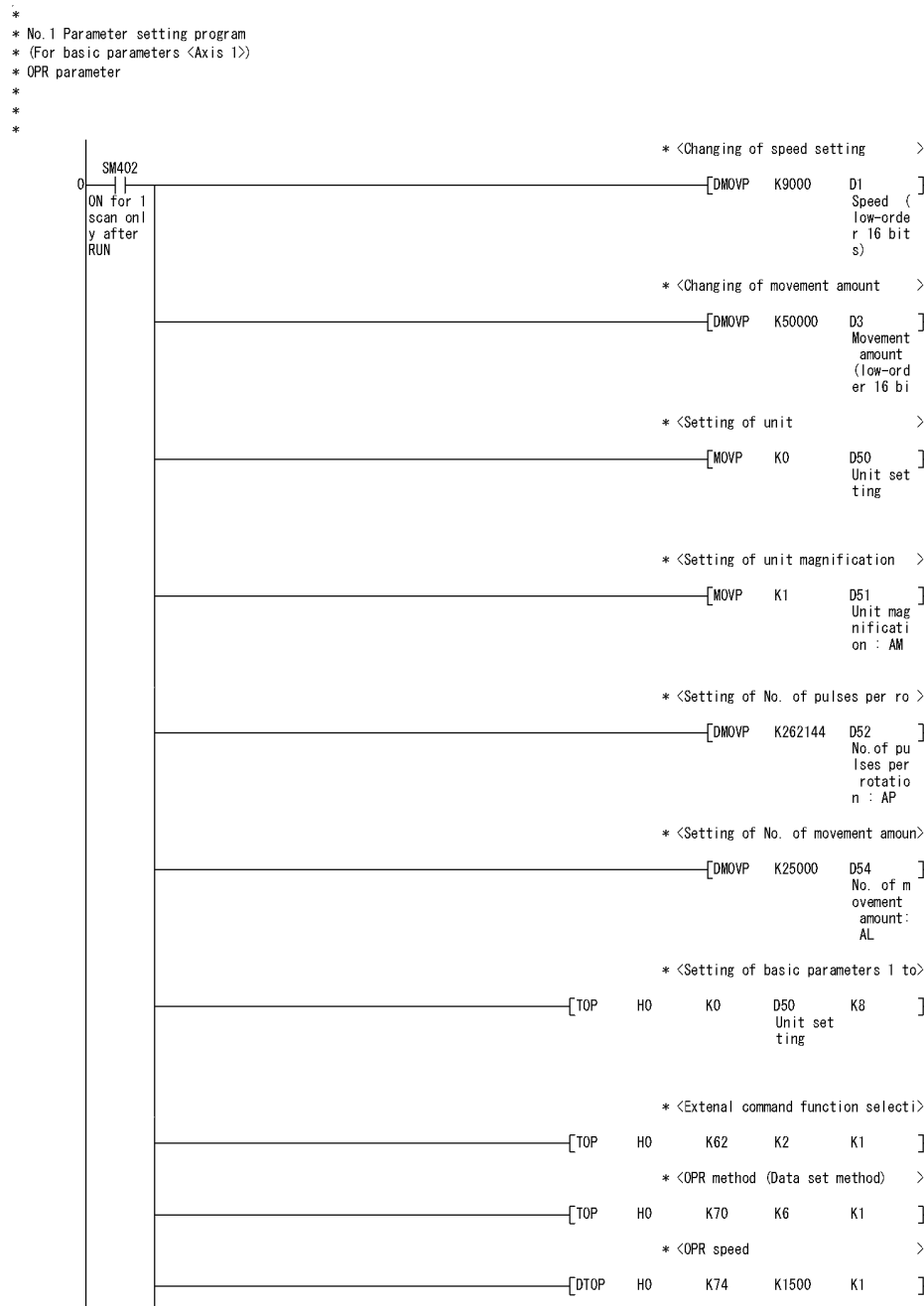

## Chapter 6 Sequence Program Used for Positioning Control

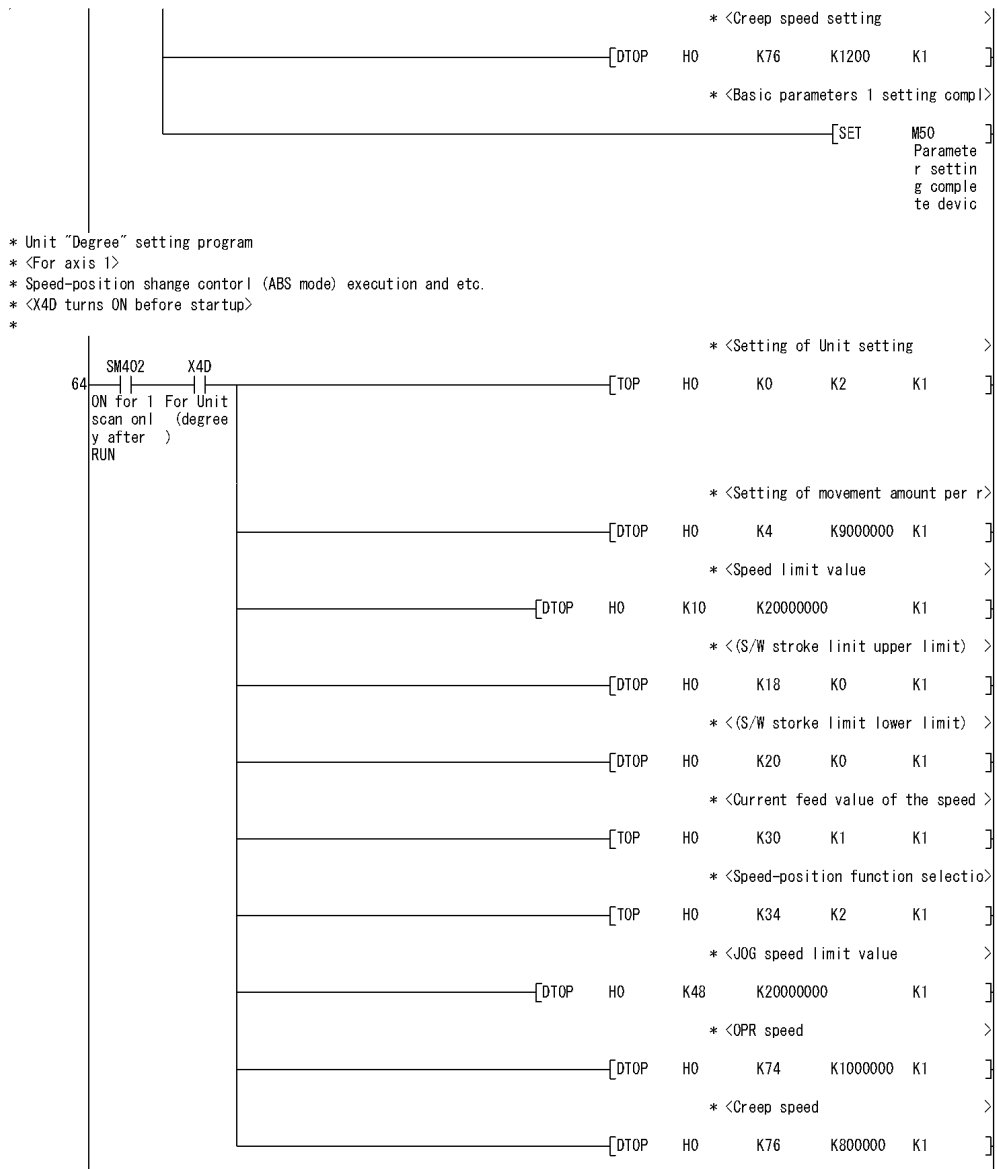

## Chapter 6 Sequence Program Used for Positioning Control

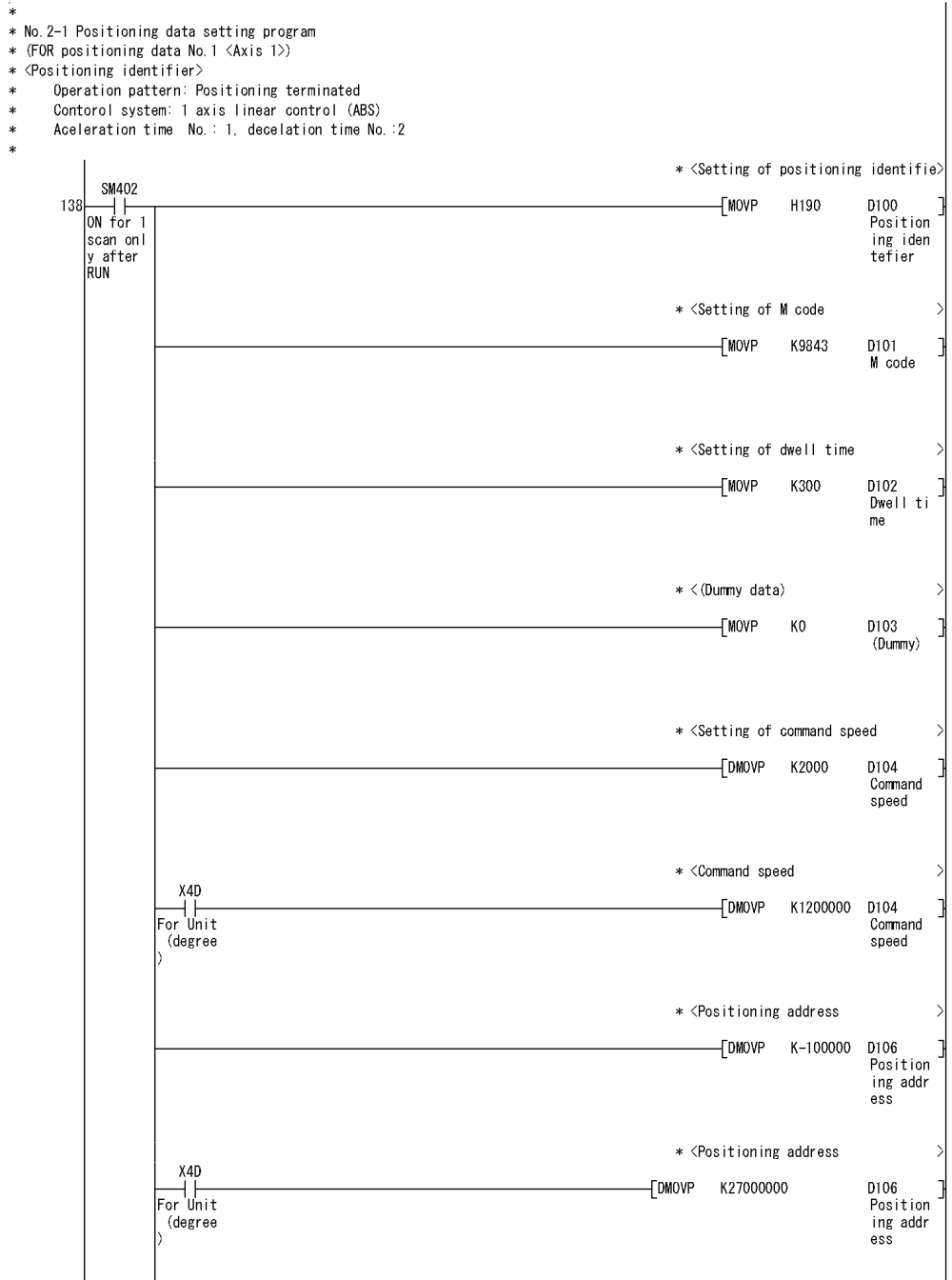



## Chapter 6 Sequence Program Used for Positioning Control

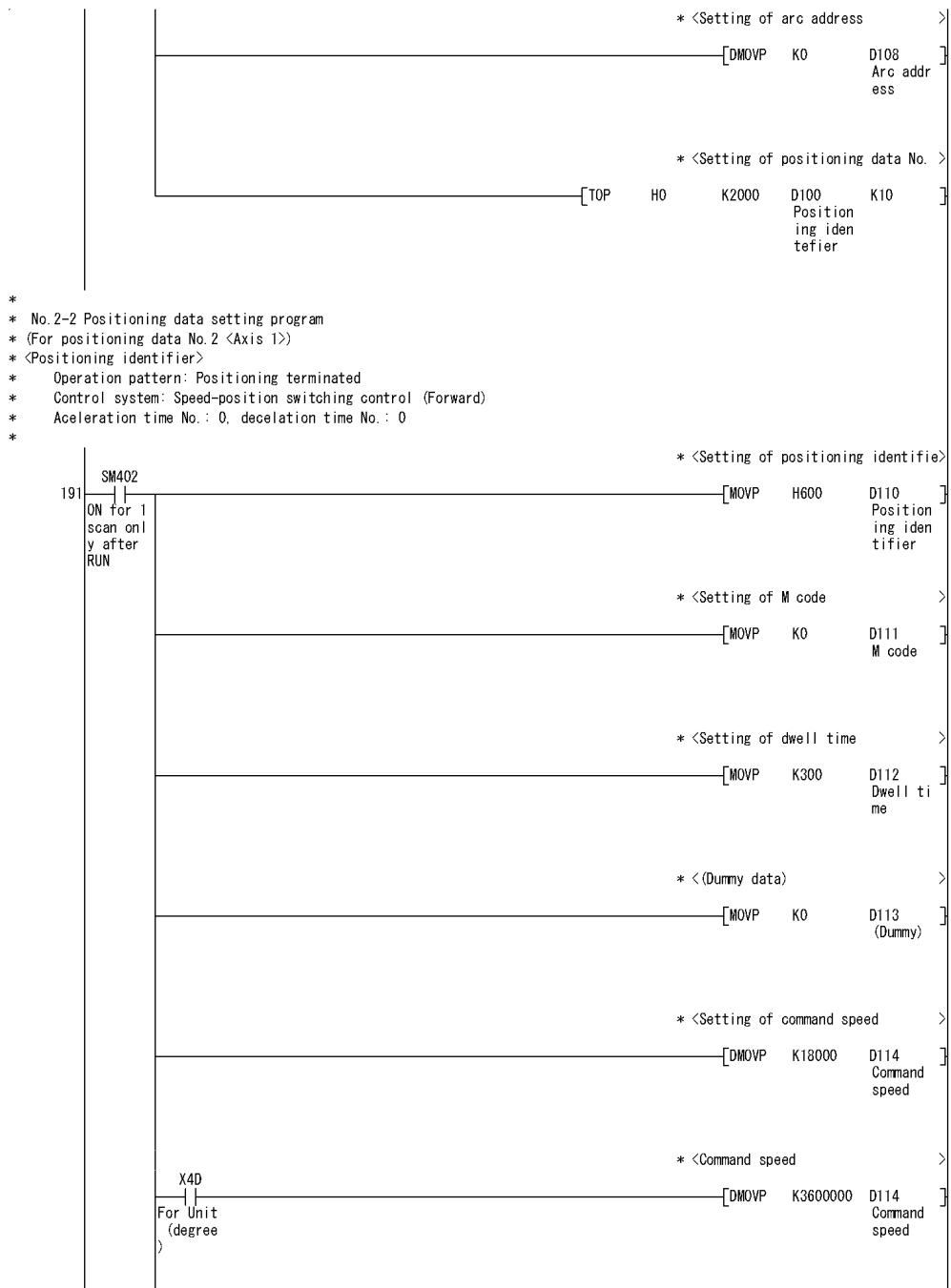

## Chapter 6 Sequence Program Used for Positioning Control

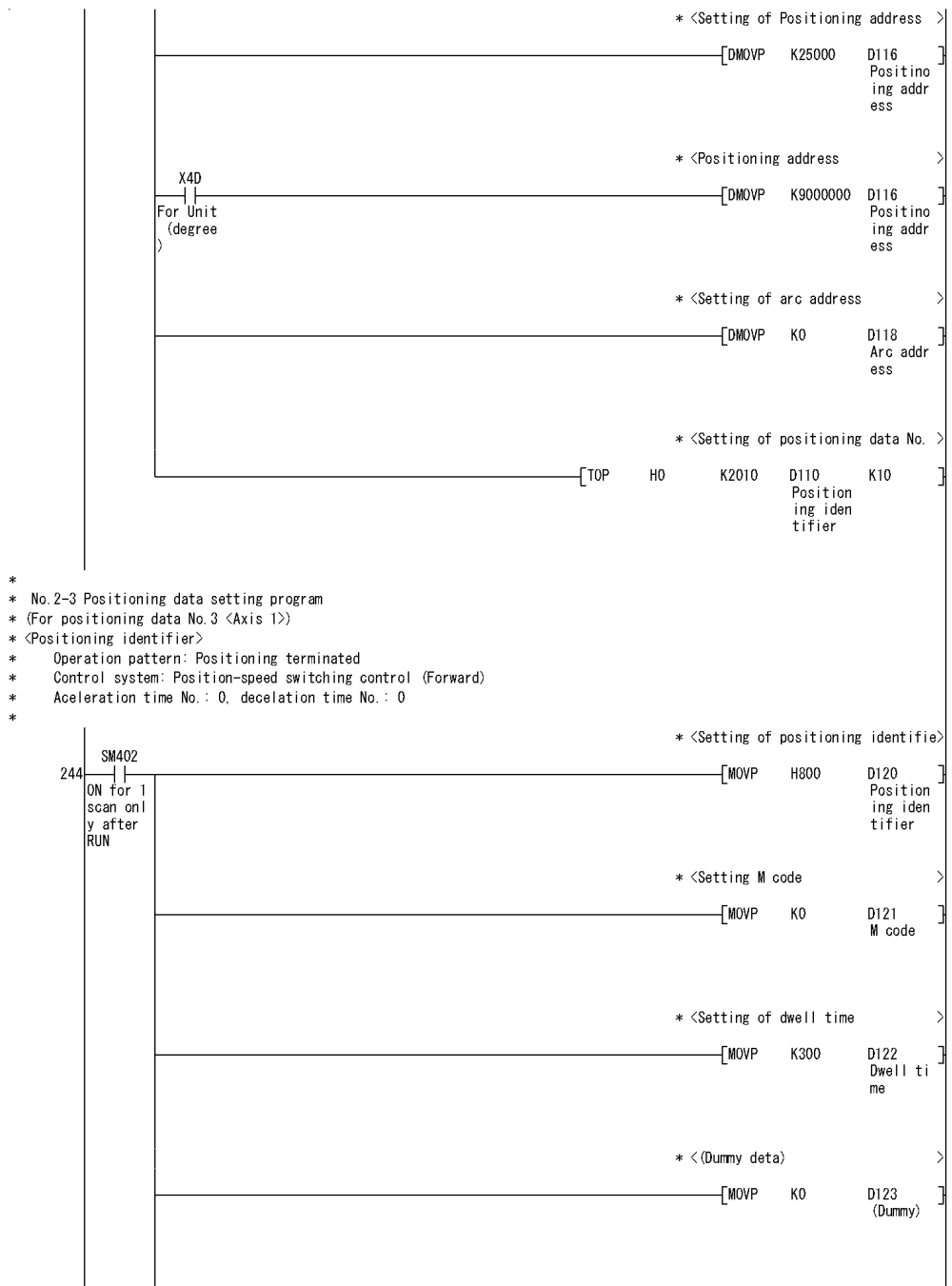

## Chapter 6 Sequence Program Used for Positioning Control

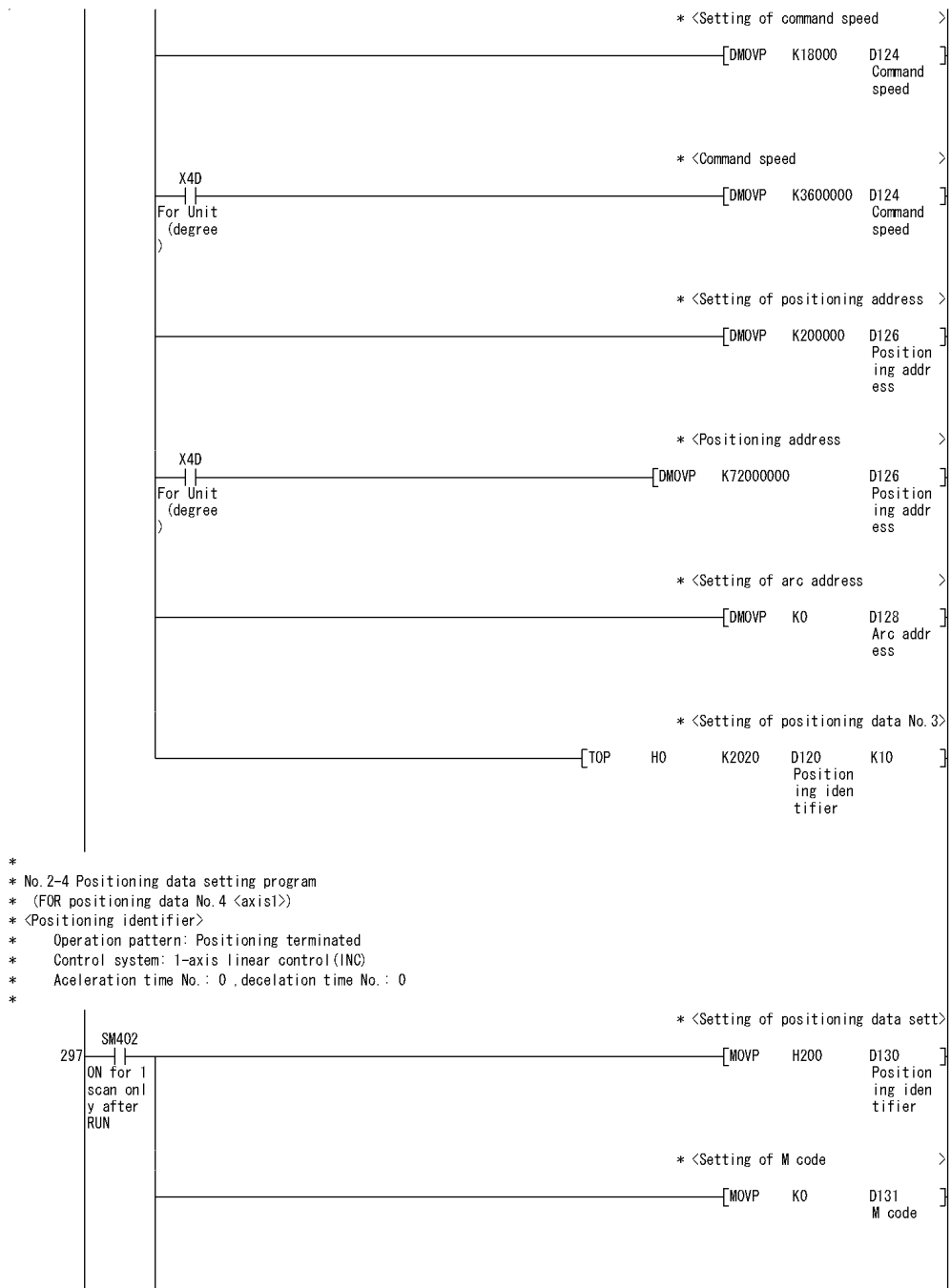

Chapter 6 Sequence Program Used for Positioning Control

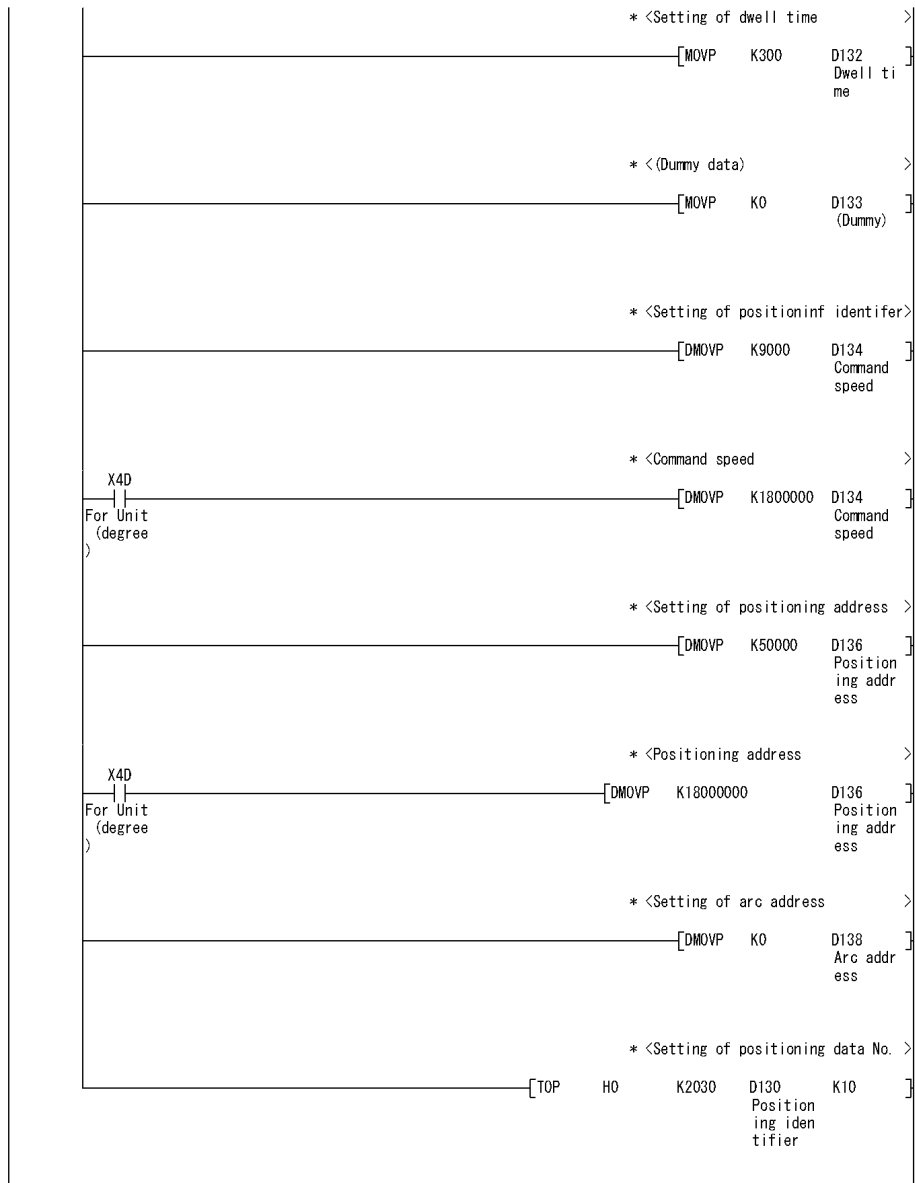

## Chapter 6 Sequence Program Used for Positioning Control

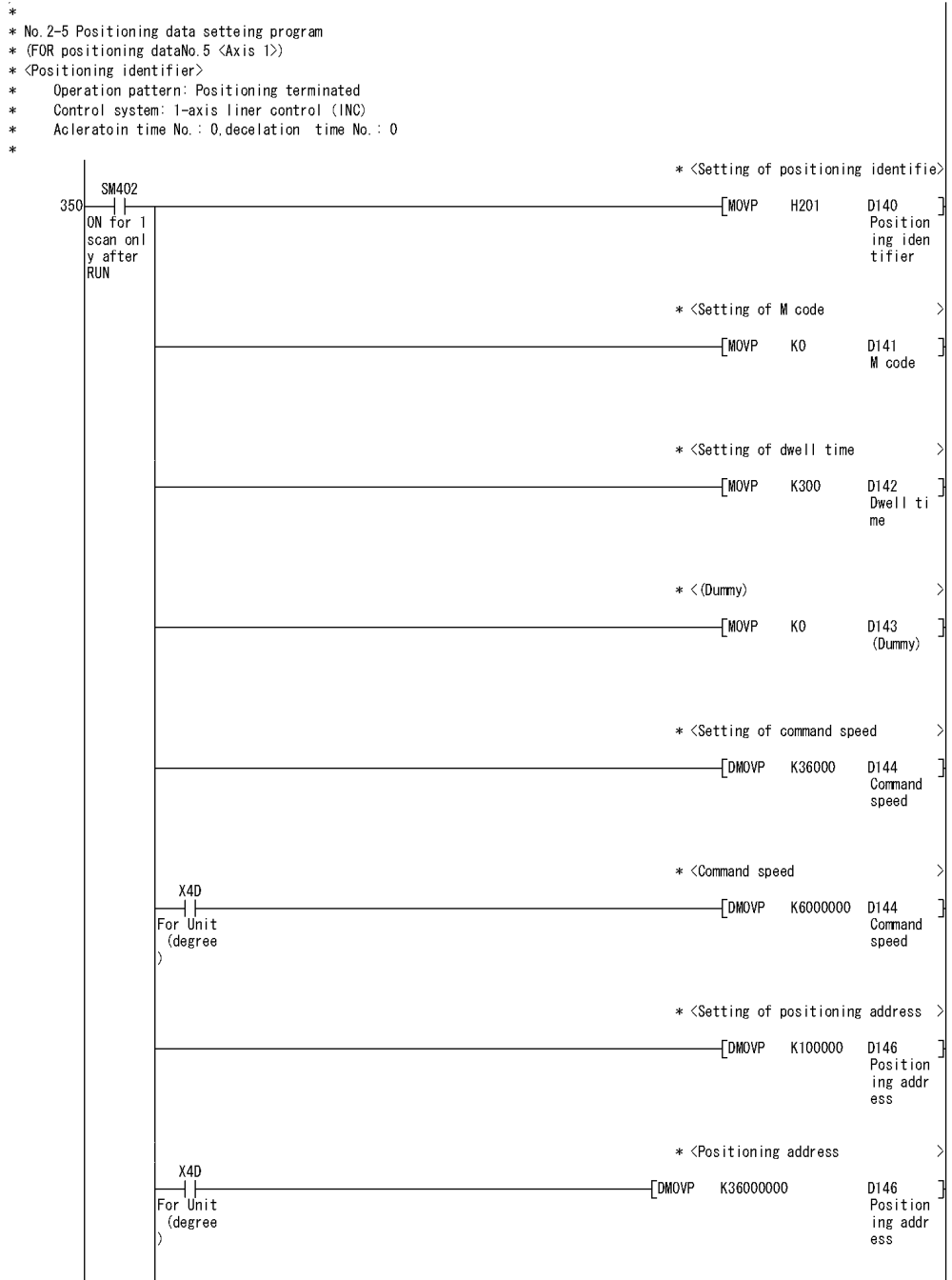

## Chapter 6 Sequence Program Used for Positioning Control

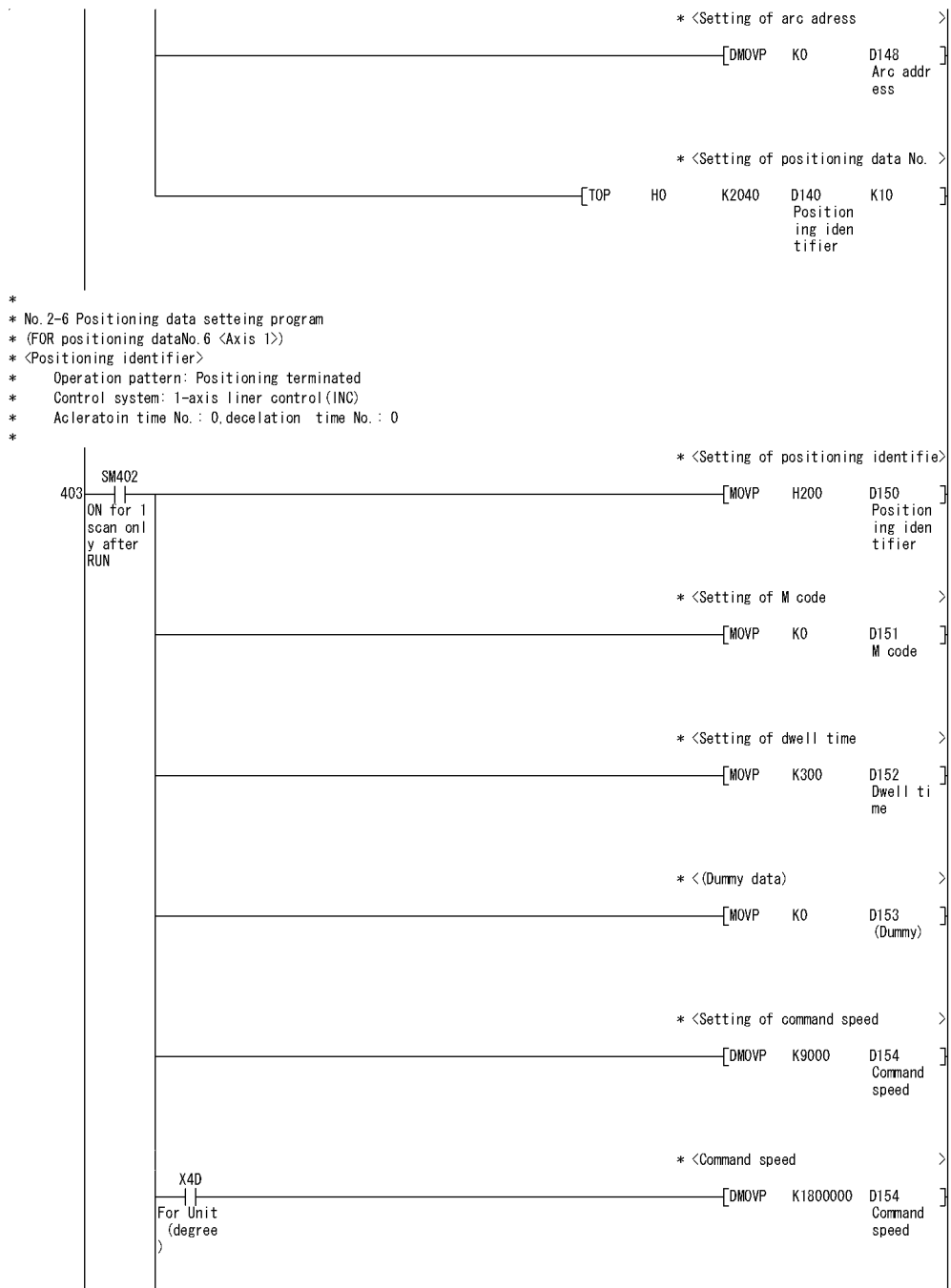

## Chapter 6 Sequence Program Used for Positioning Control

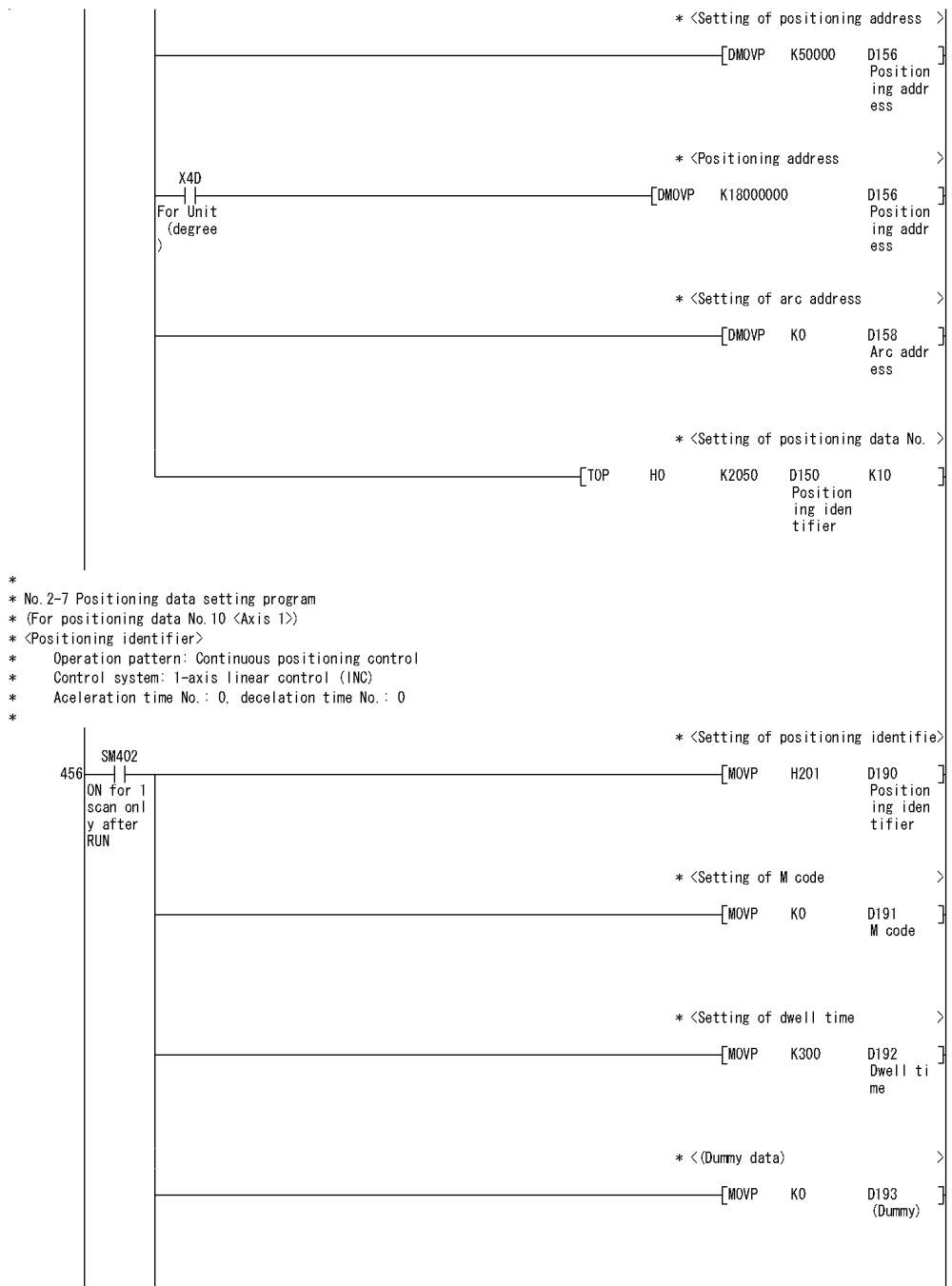

## Chapter 6 Sequence Program Used for Positioning Control

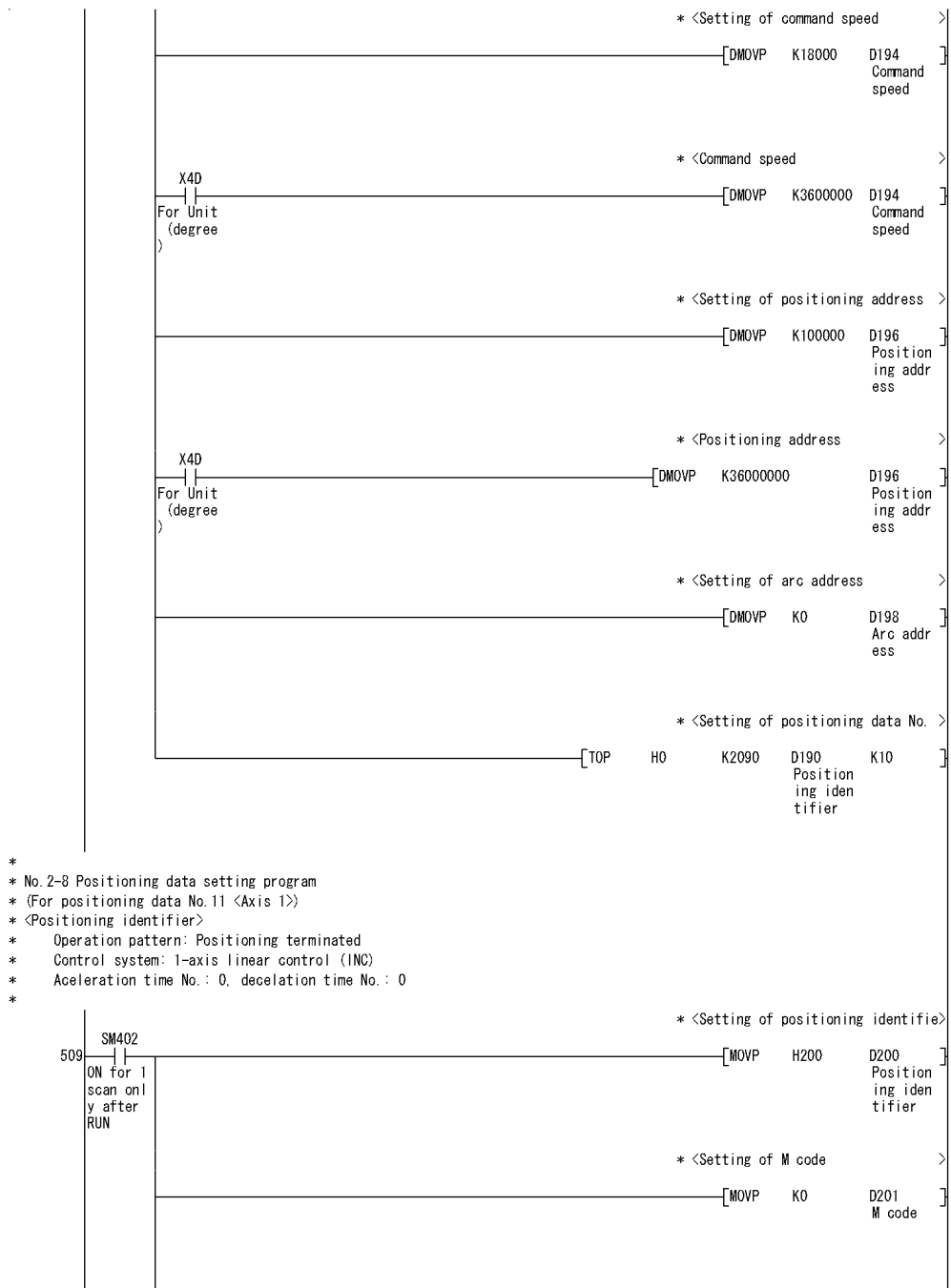



Chapter 6 Sequence Program Used for Positioning Control

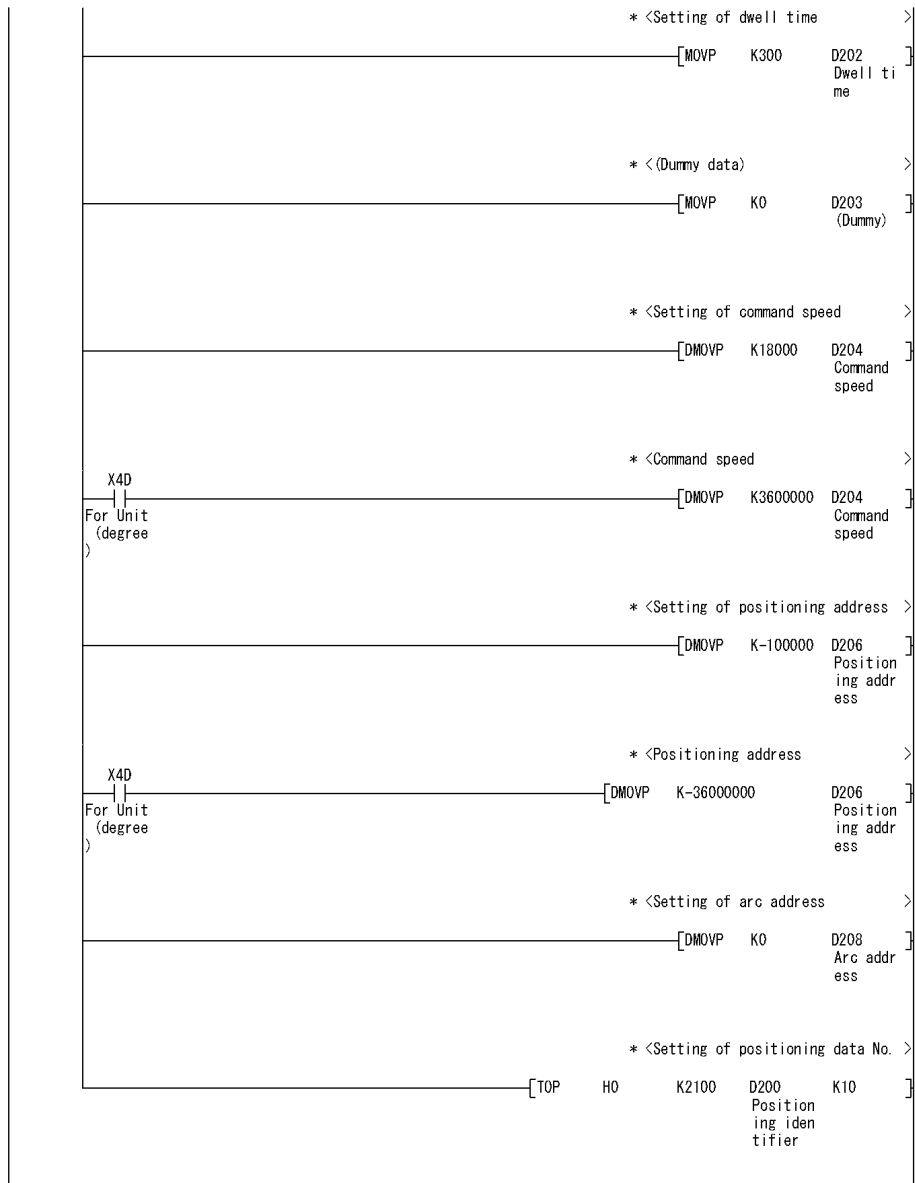

## Chapter 6 Sequence Program Used for Positioning Control

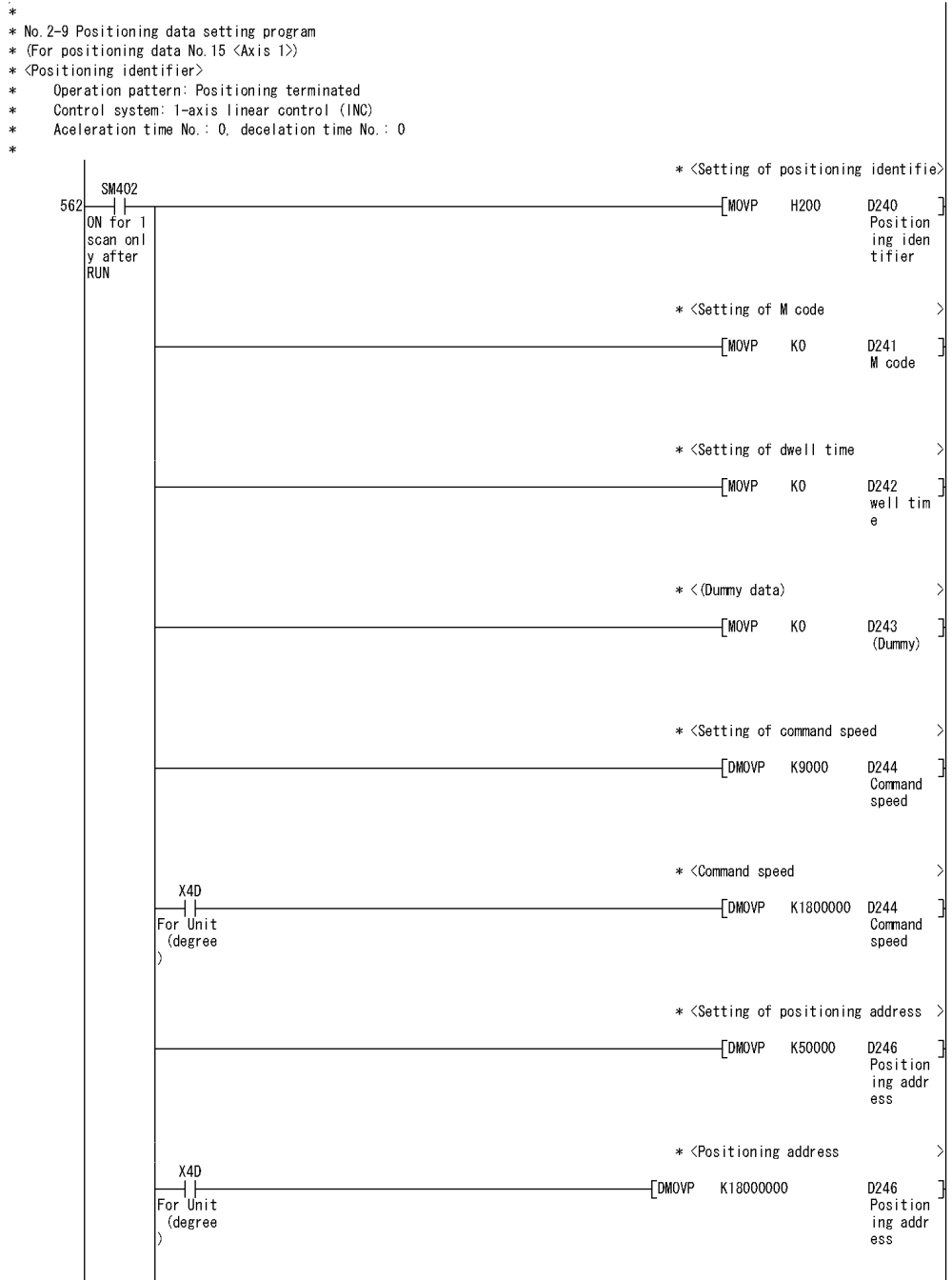

## Chapter 6 Sequence Program Used for Positioning Control

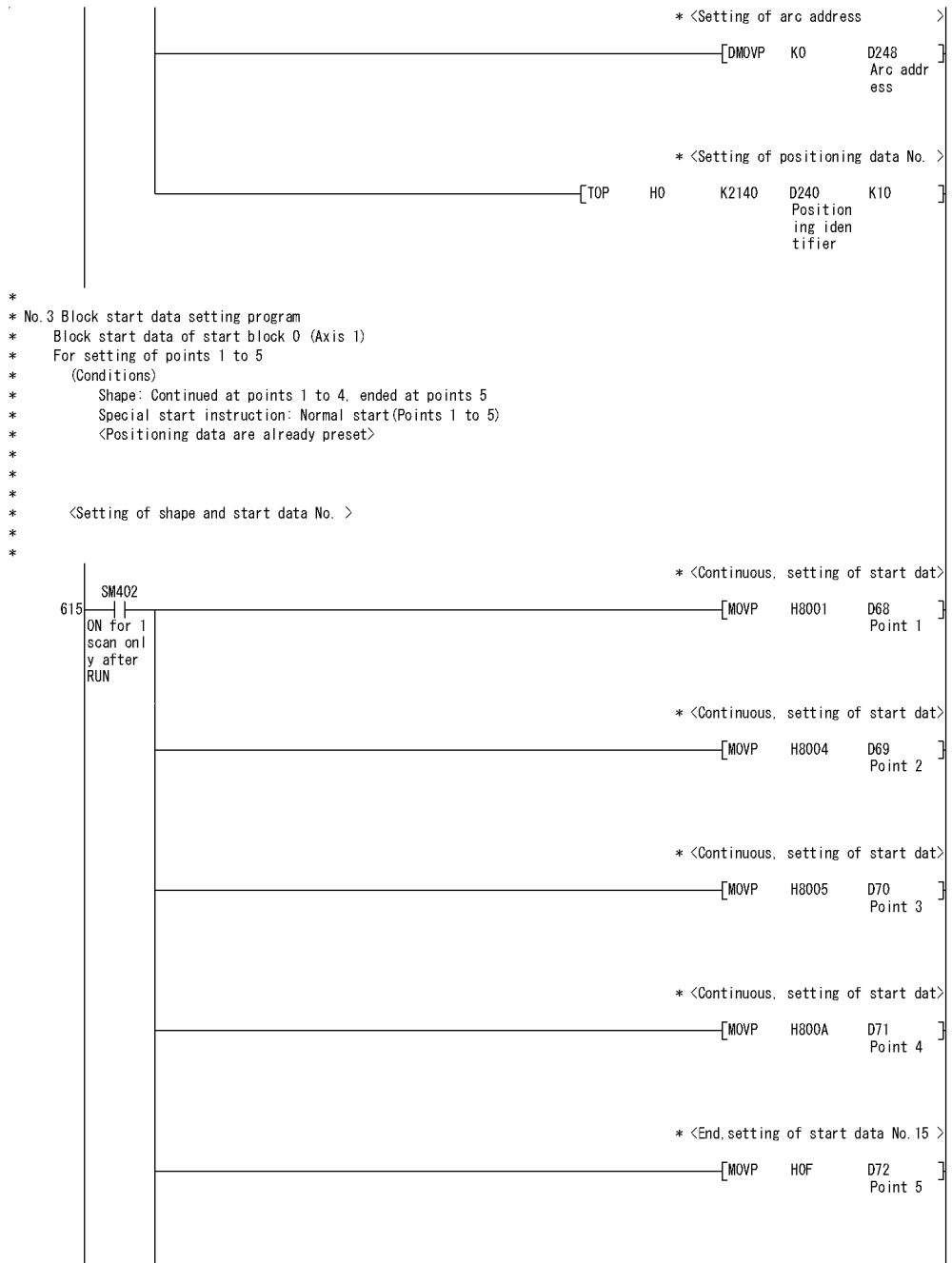

## Chapter 6 Sequence Program Used for Positioning Control

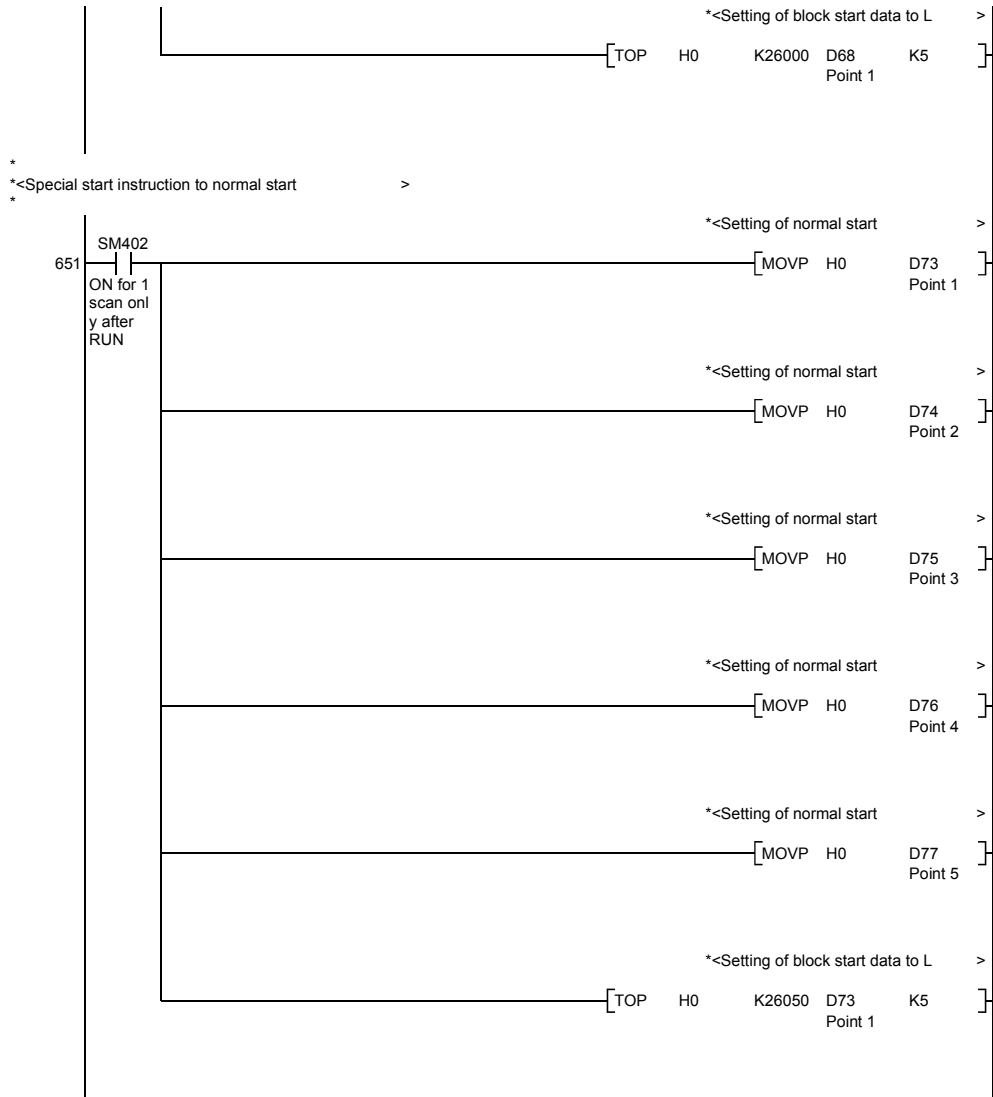

## Chapter 6 Sequence Program Used for Positioning Control

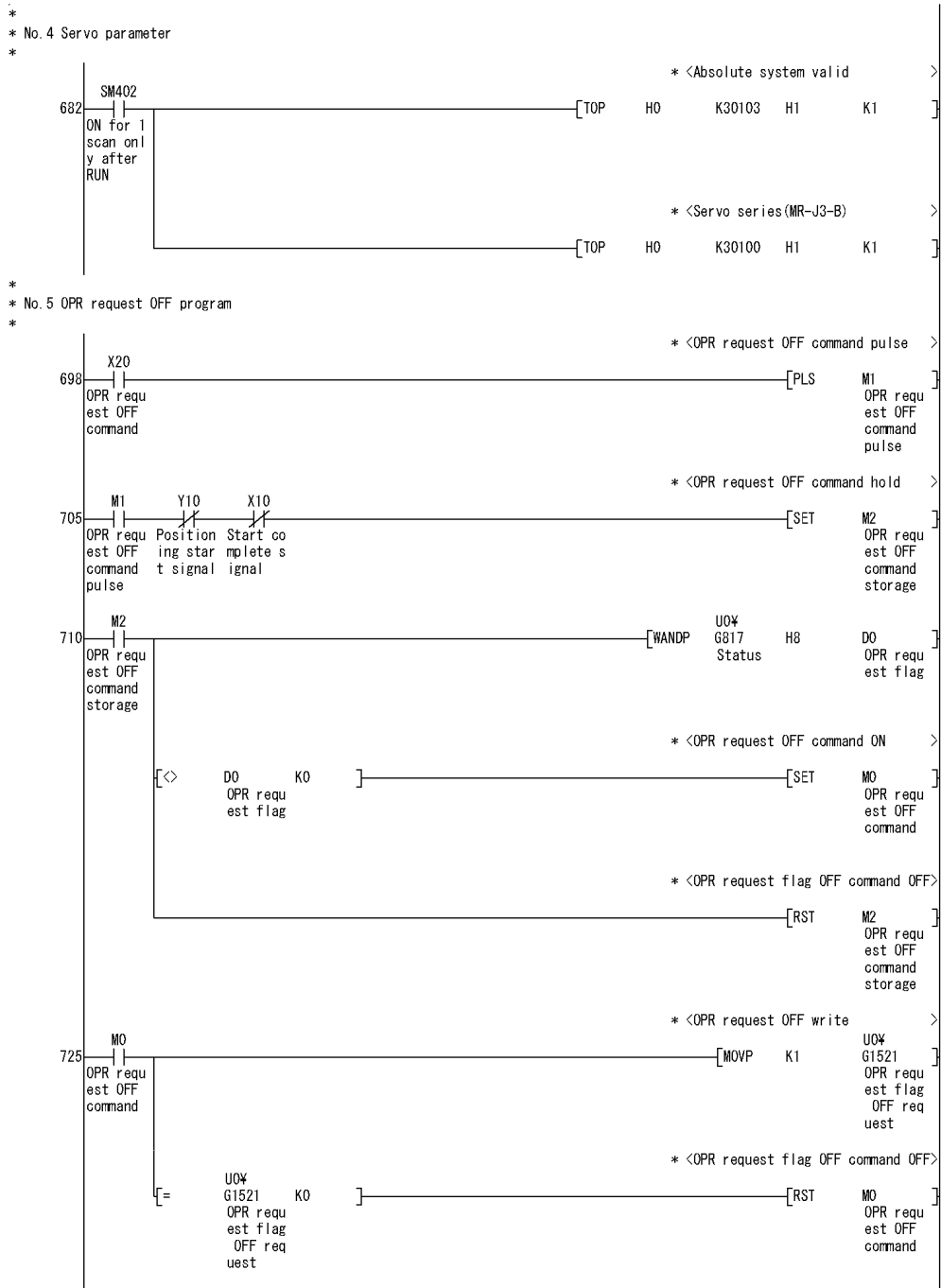

## Chapter 6 Sequence Program Used for Positioning Control

\*  
\*No.6 External command function valid setting program  
\*

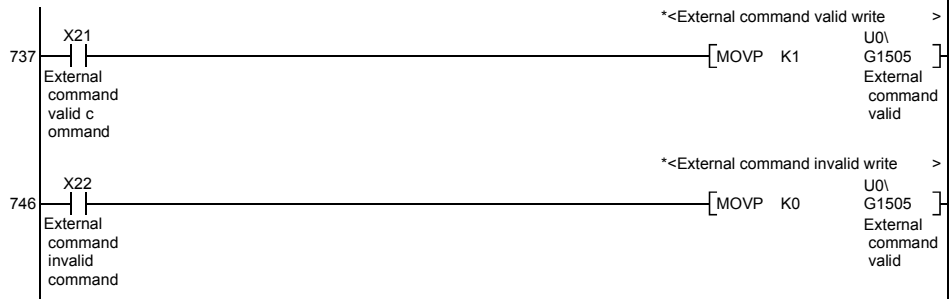

\*  
\*No.7 PLC READY signal [Y0] ON program  
\* (In the synchronization mode, contact of M50 is not needed)  
\*

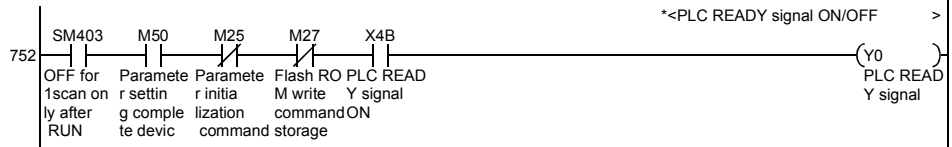

\*  
\*No.8 All axis servo ON signal [Y1] ON program  
\*

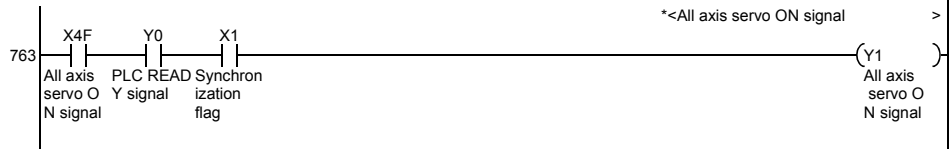

\*  
\*No.9 Positioning start No. setting program  
\*

\*(1) Machine OPR

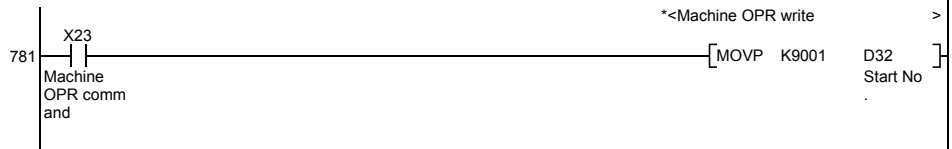

\*(2) Fast OPR

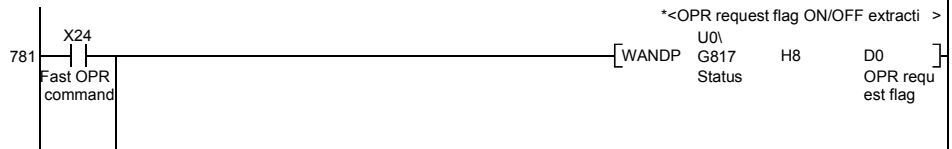

## Chapter 6 Sequence Program Used for Positioning Control

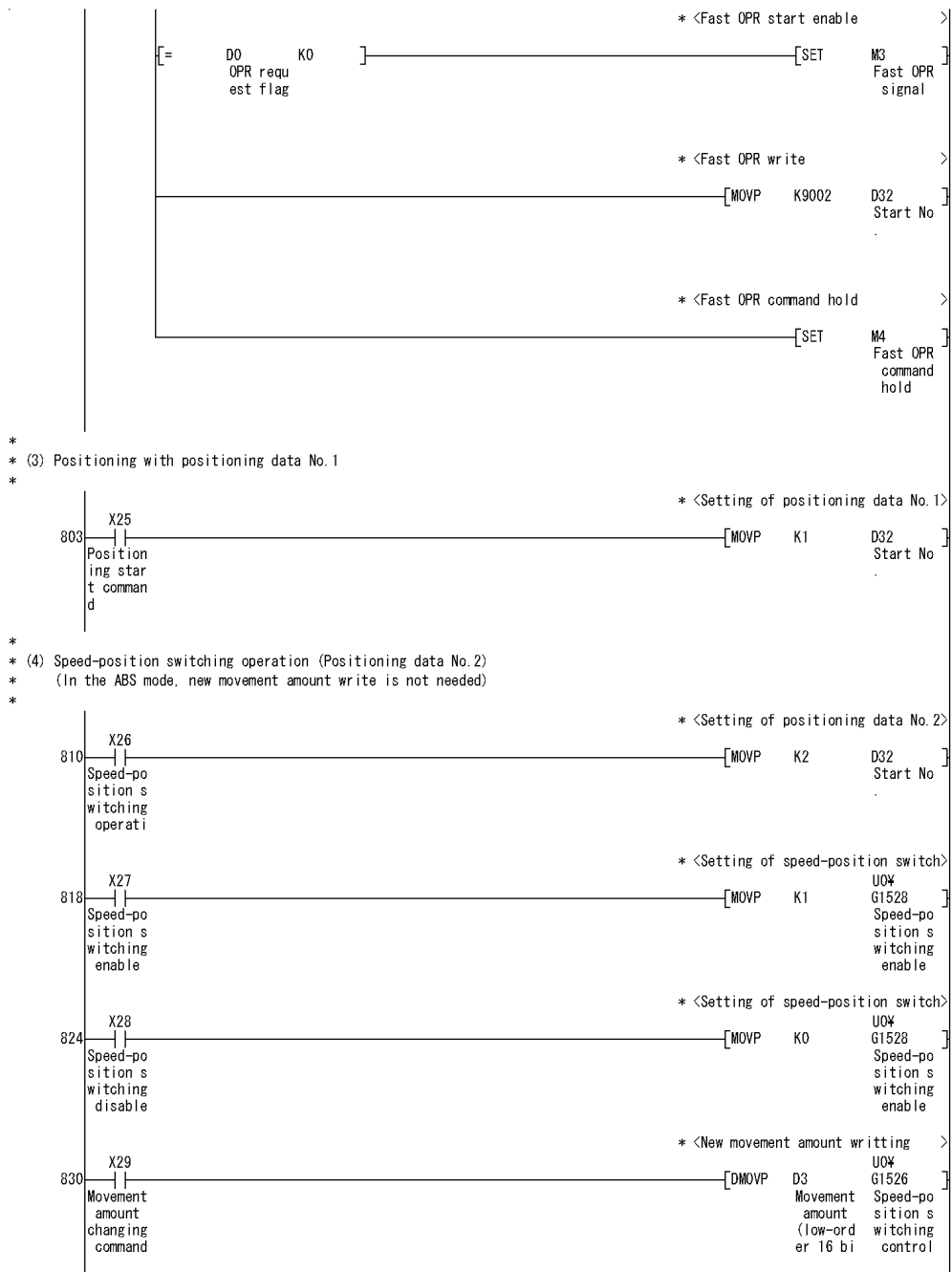

## Chapter 6 Sequence Program Used for Positioning Control

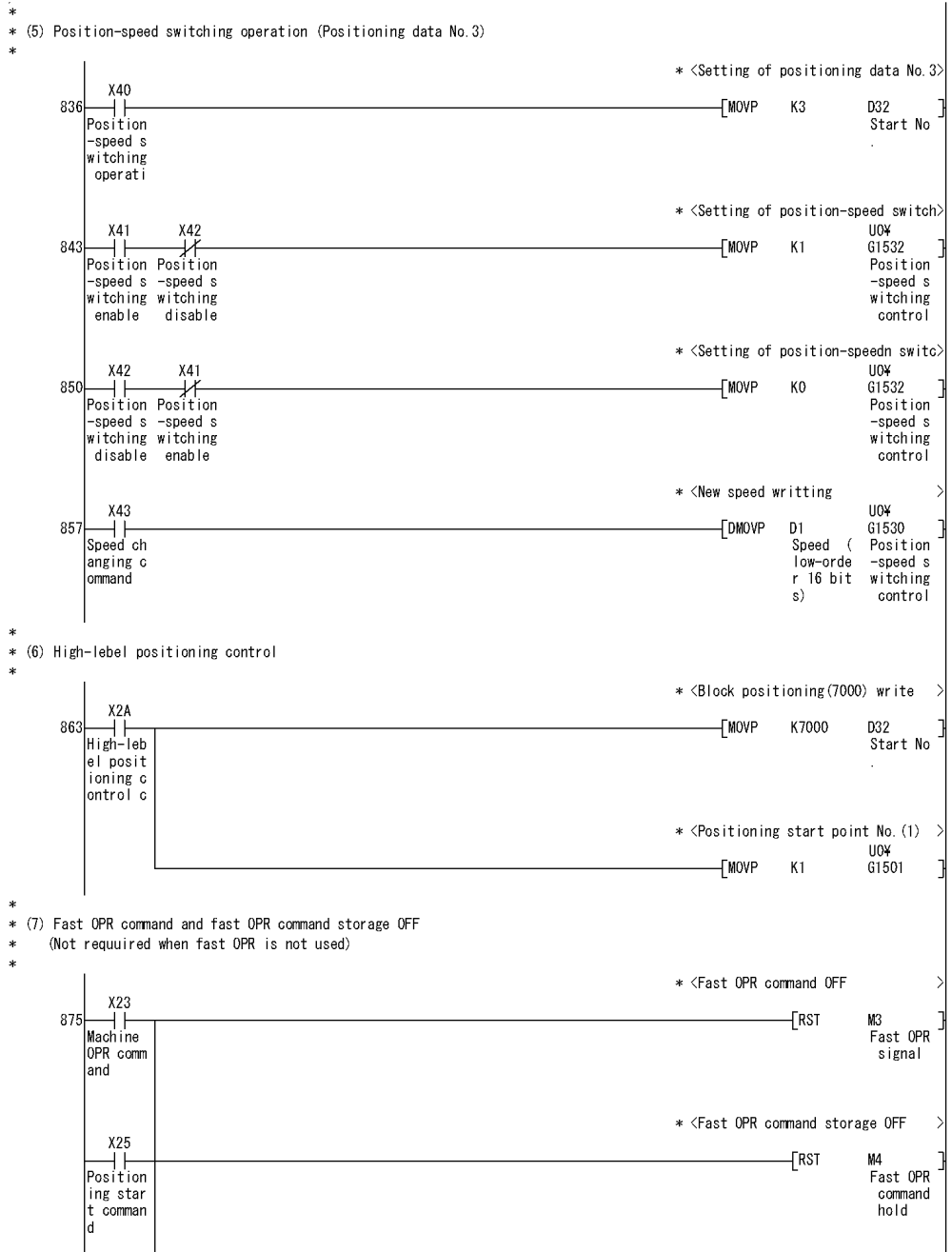





\*  
\* No.10 Positioning start program  
\*

- \* (1) When dedicated instruction (ZP.PSTRT1) is used
- \* (When fast OPR is not made, contacts of M3 and M4 are not needed)
- \* (When M code is not used, contact of X04 is not needed)
- \* (When JOG operation/inching operation is not performed, contact of M7 is not needed)
- \* (When manual pulse generator is not performed, contacts of M9 is not needed)
- \*  
\*

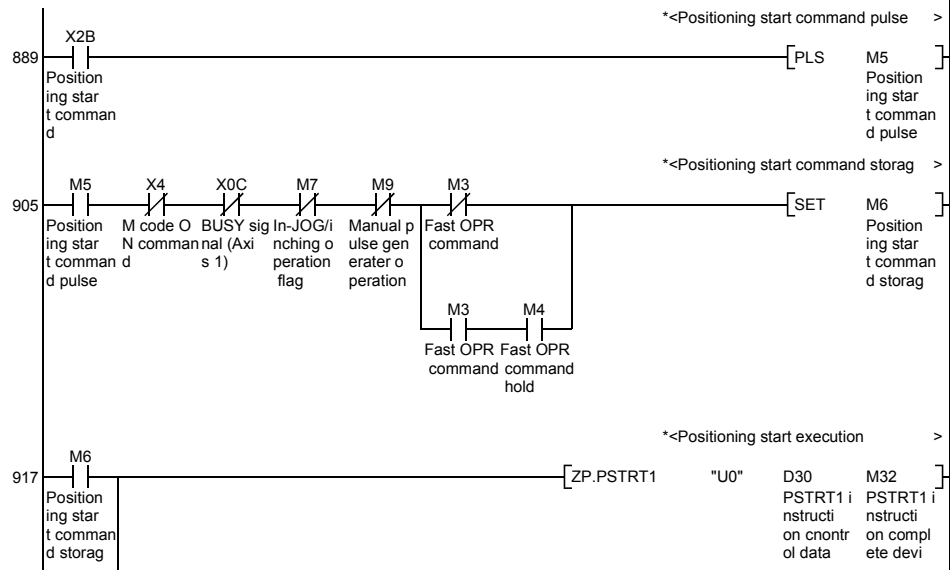

## Chapter 6 Sequence Program Used for Positioning Control

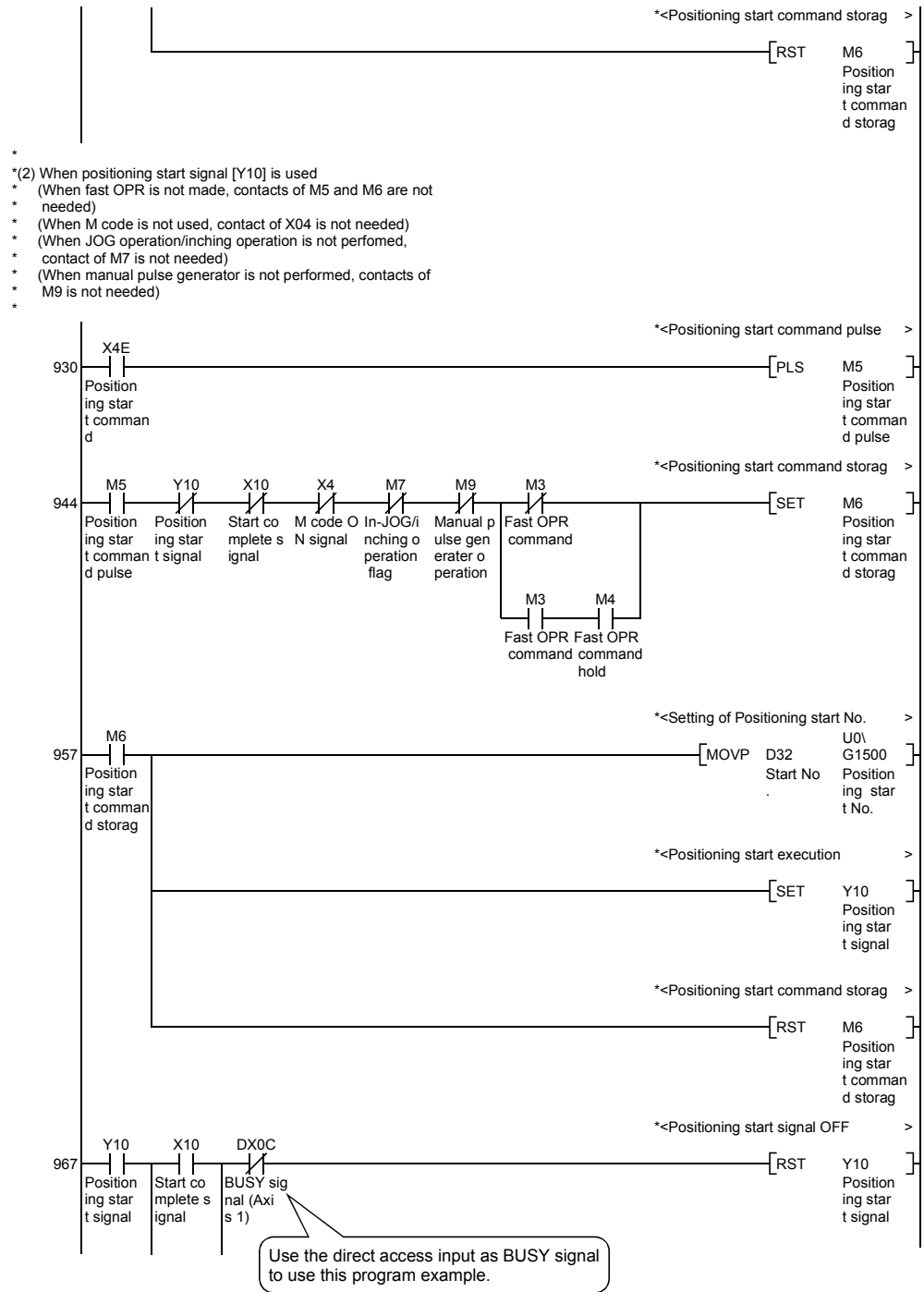

- \* (2) When positioning start signal [Y10] is used
- \* (When fast OPR is not made, contacts of M5 and M6 are not needed)
- \* (When M code is not used, contact of X04 is not needed)
- \* (When JOG operation/inching operation is not performed, contact of M7 is not needed)
- \* (When manual pulse generator is not performed, contacts of M9 is not needed)

## Chapter 6 Sequence Program Used for Positioning Control

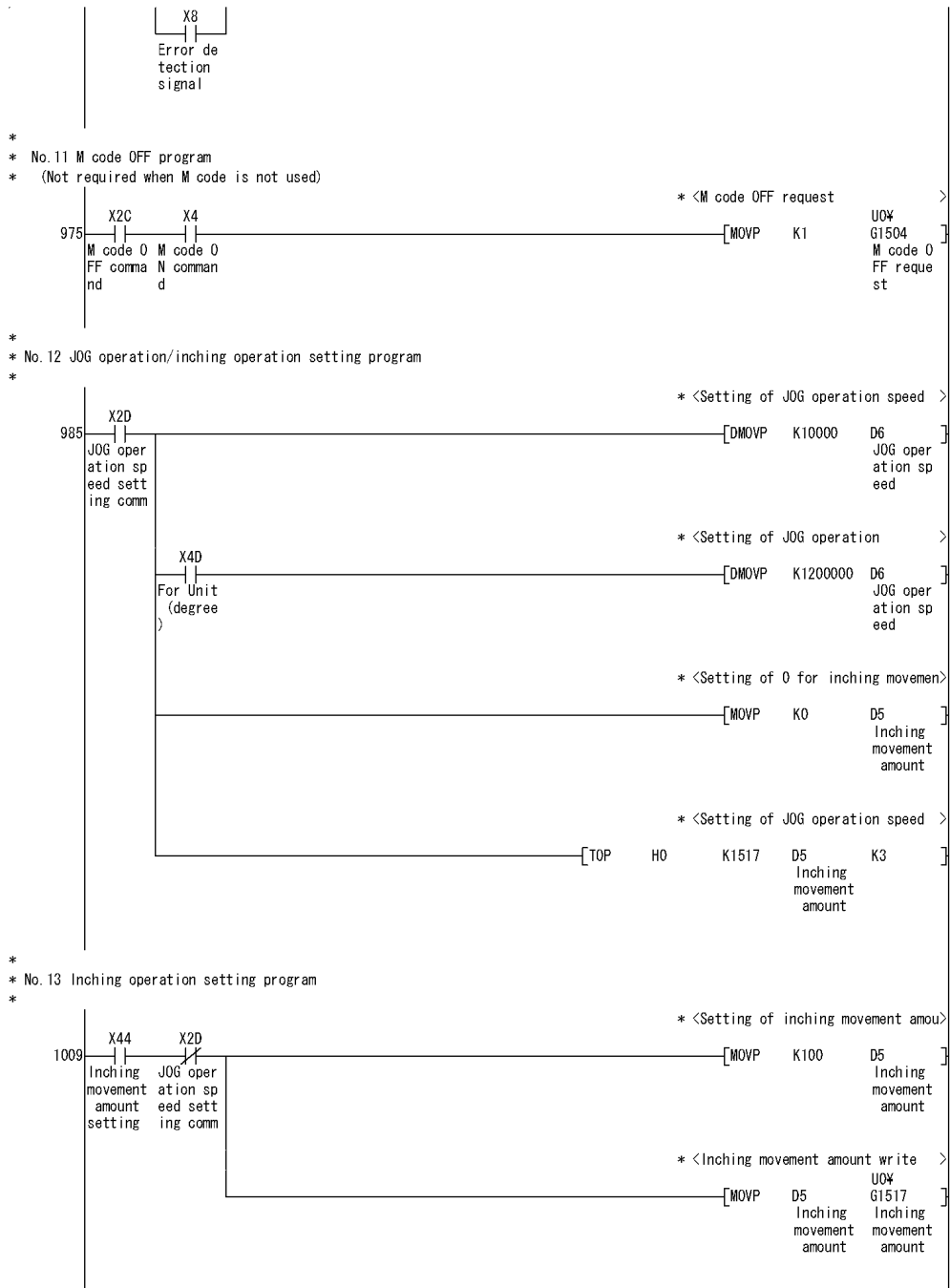

\*No. 14 JOG operation/inching operation program

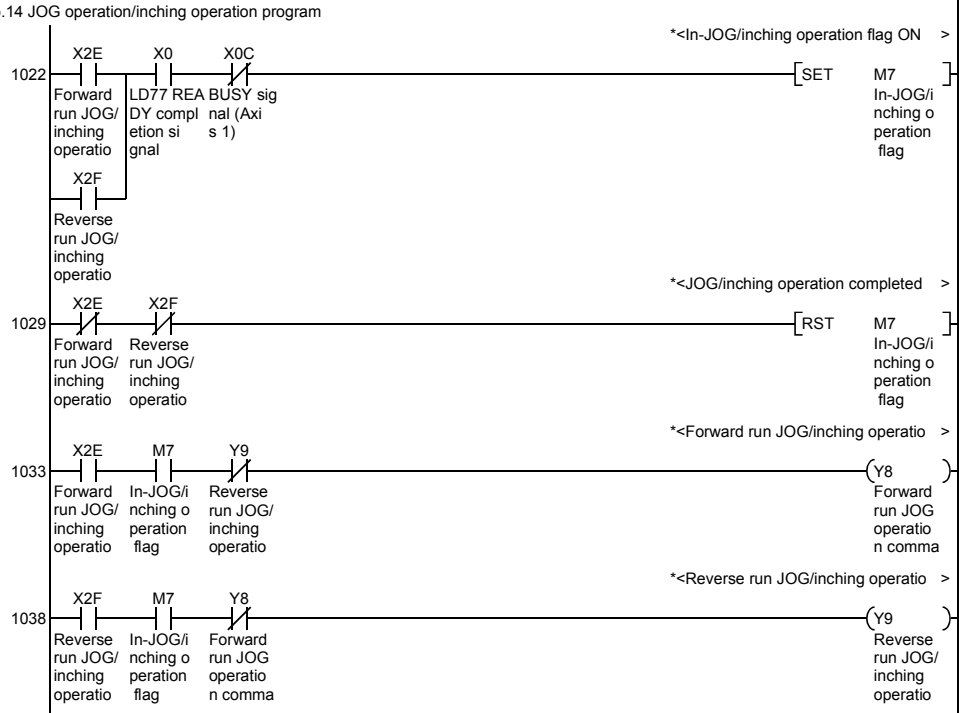

\*No. 15 Manual pulse generator operation program

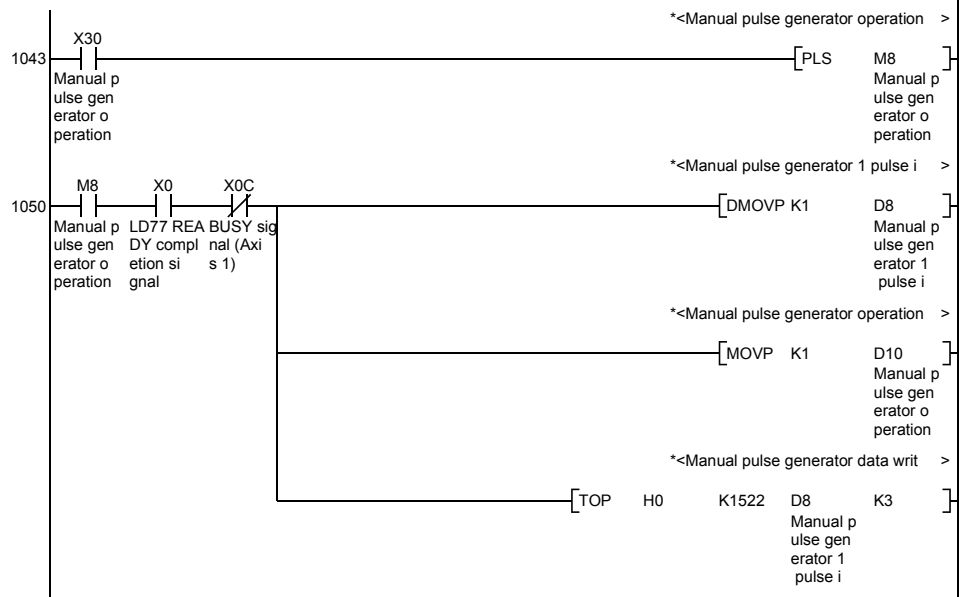

## Chapter 6 Sequence Program Used for Positioning Control

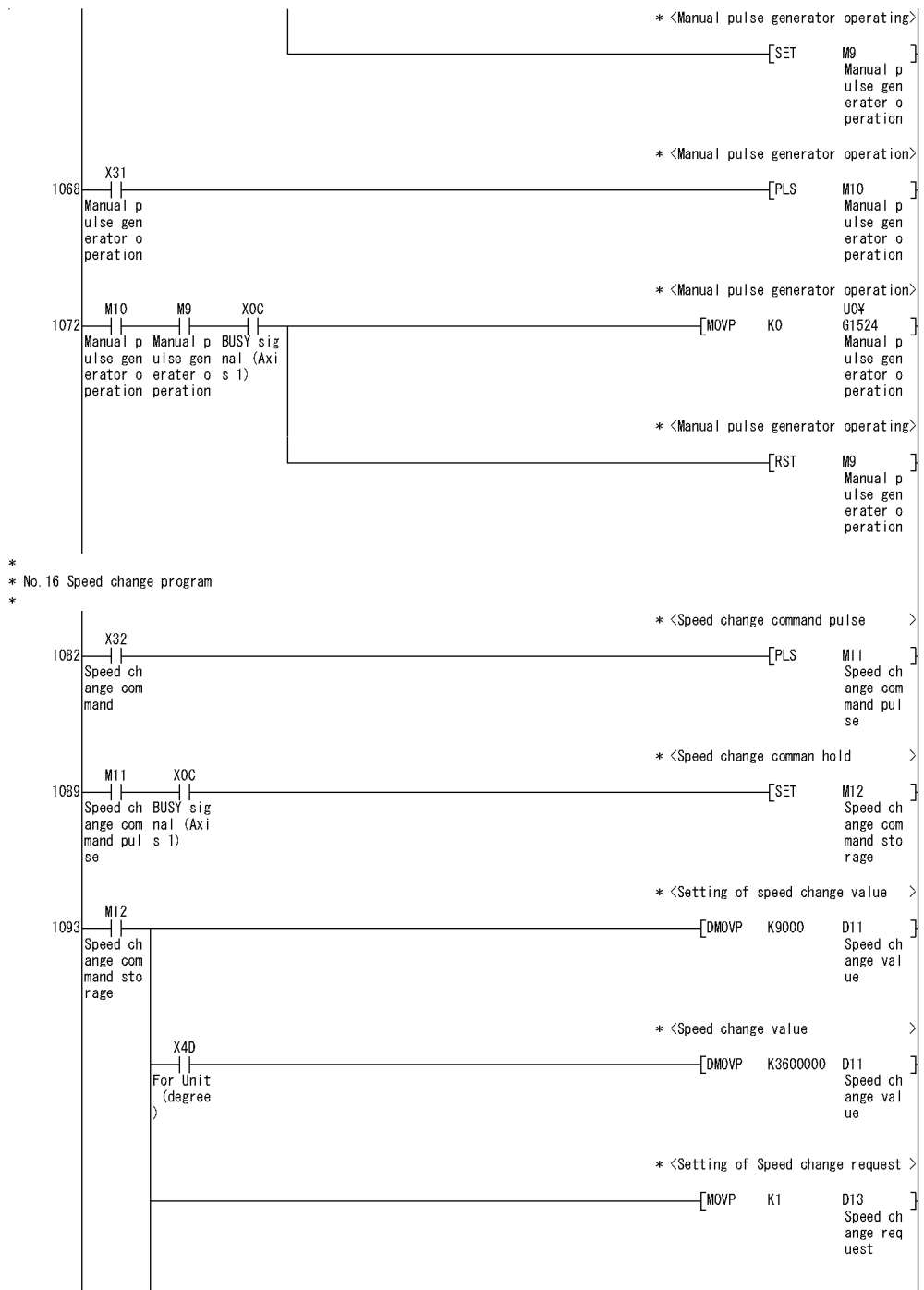

## Chapter 6 Sequence Program Used for Positioning Control

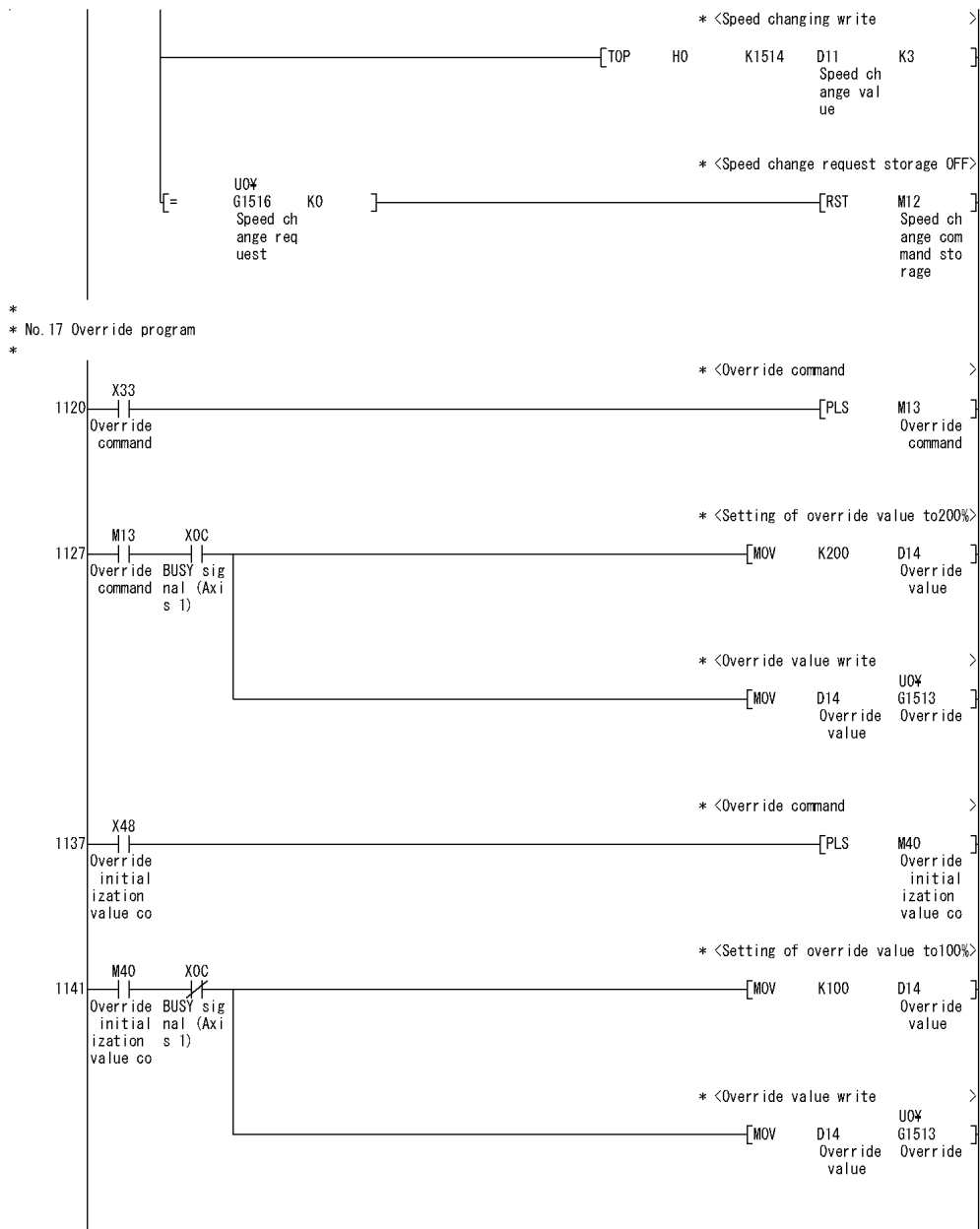

## Chapter 6 Sequence Program Used for Positioning Control

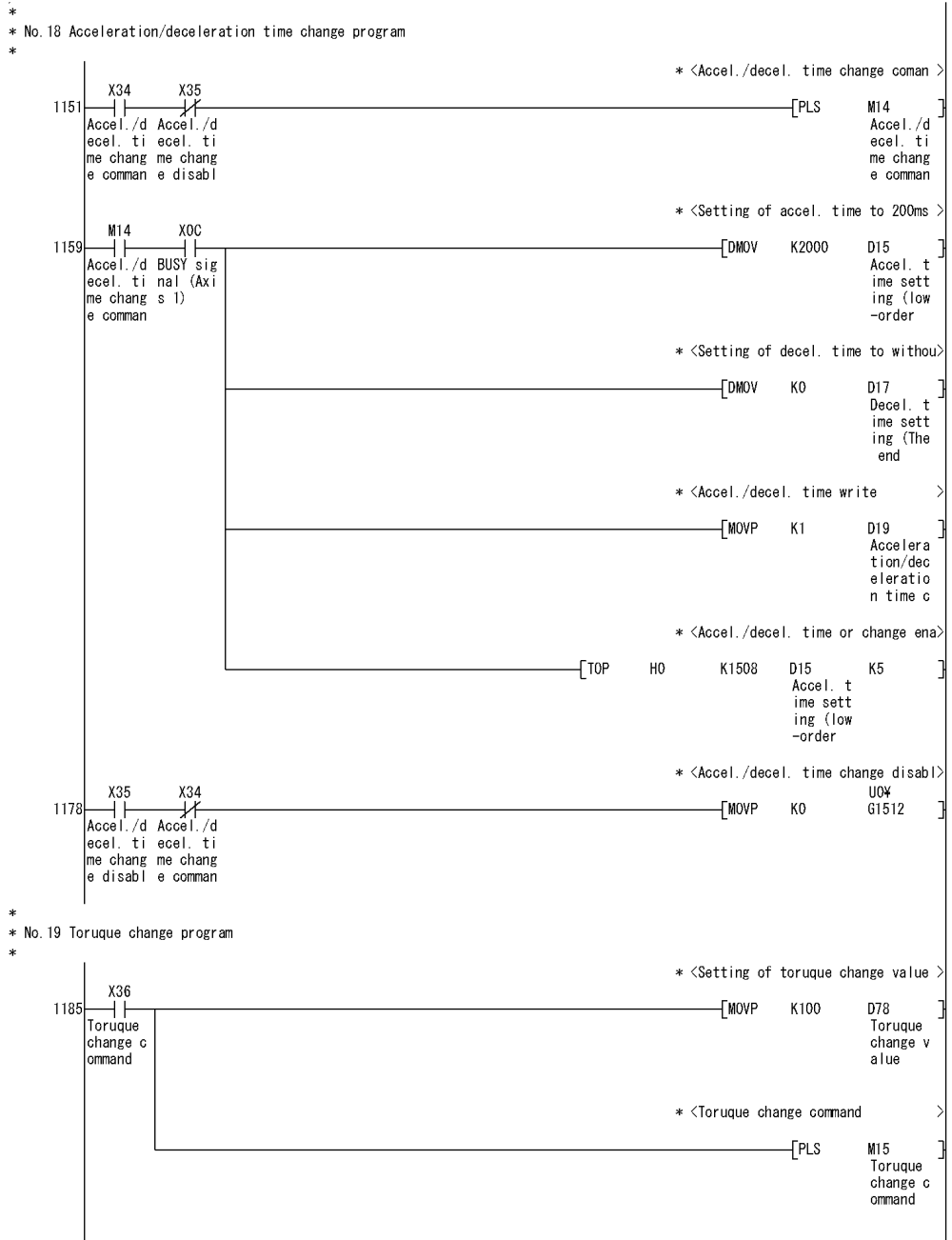

## Chapter 6 Sequence Program Used for Positioning Control

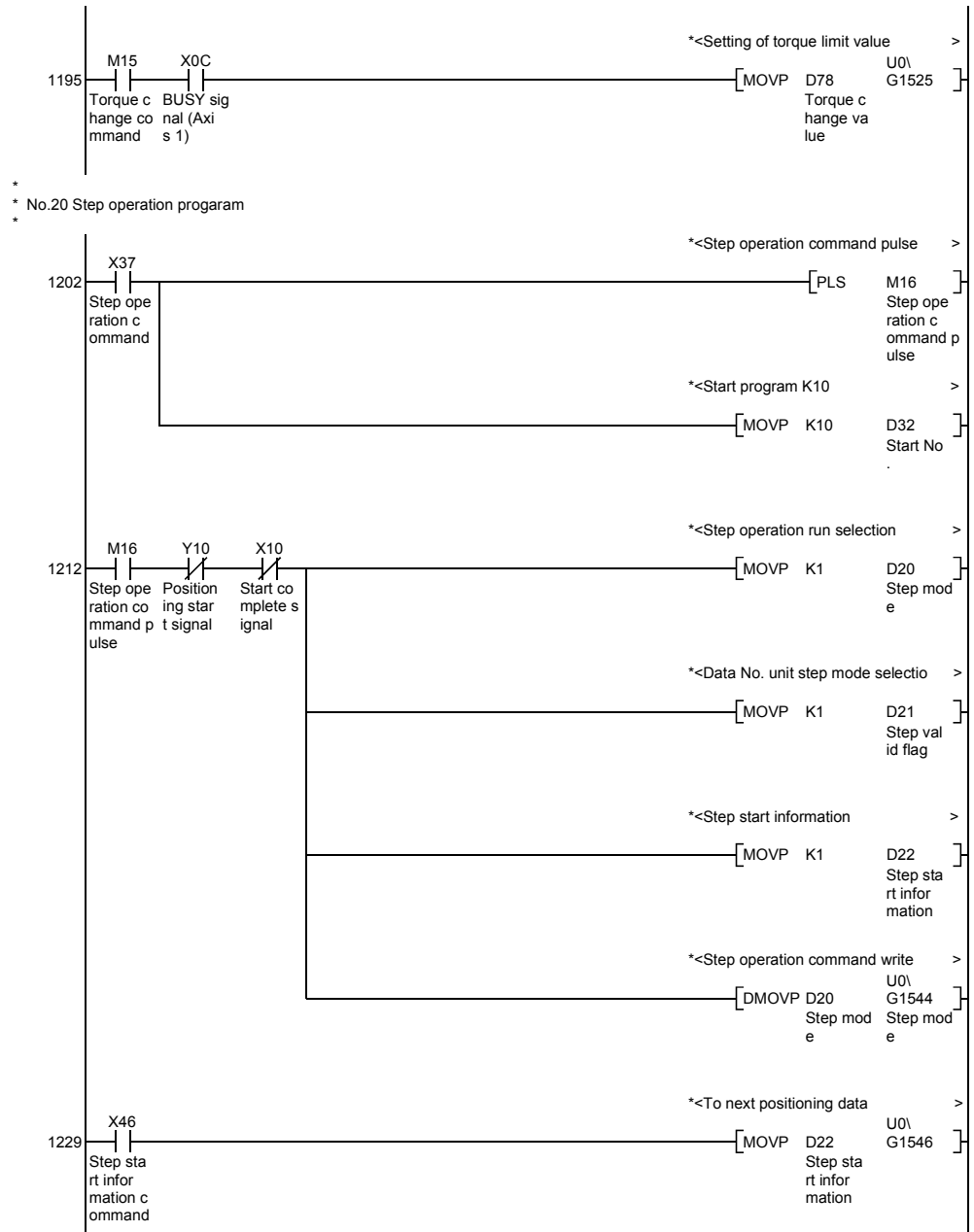



## Chapter 6 Sequence Program Used for Positioning Control

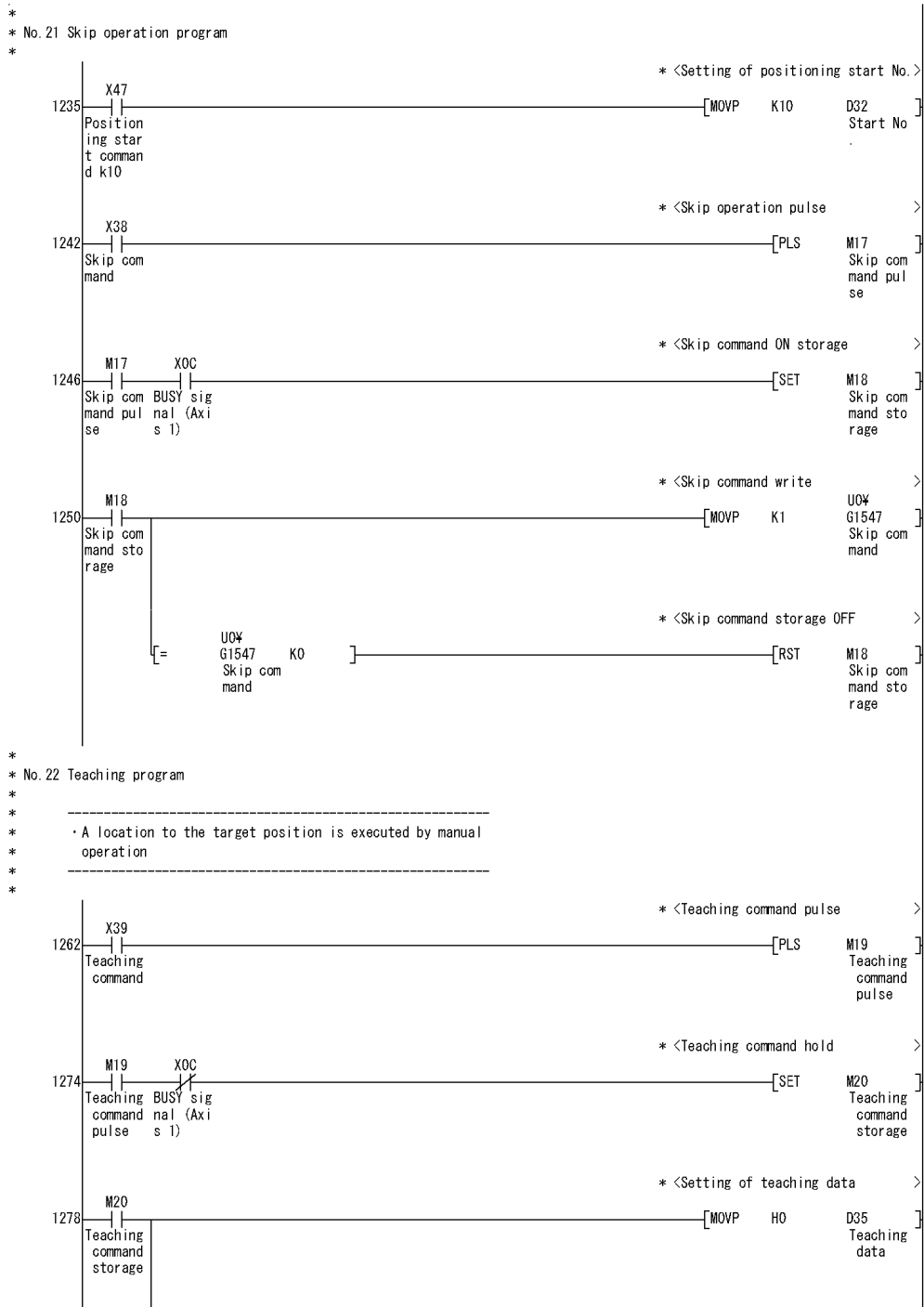

## Chapter 6 Sequence Program Used for Positioning Control

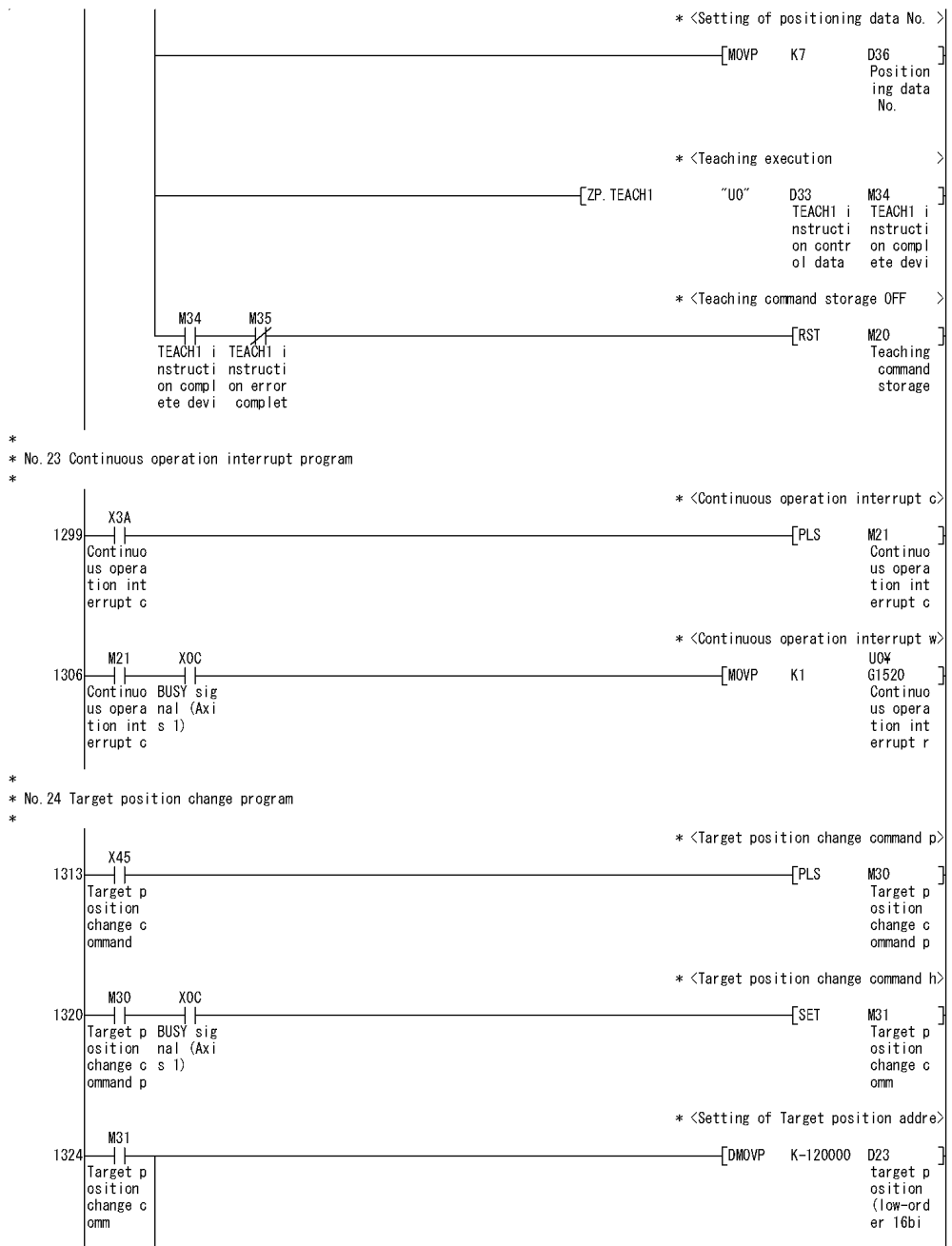

## Chapter 6 Sequence Program Used for Positioning Control

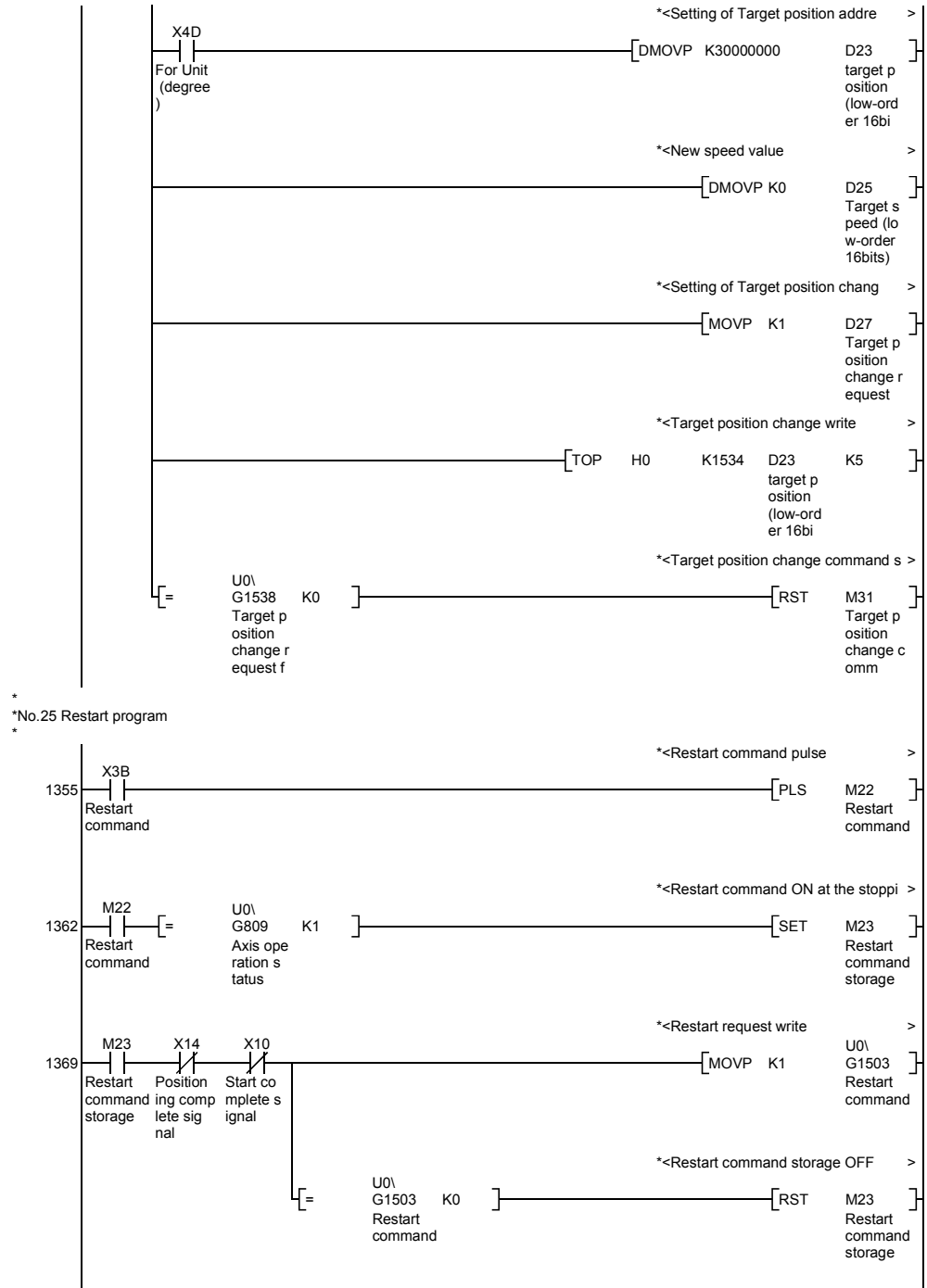

## Chapter 6 Sequence Program Used for Positioning Control

\*  
\*No.26 Parameter initialization program  
\*

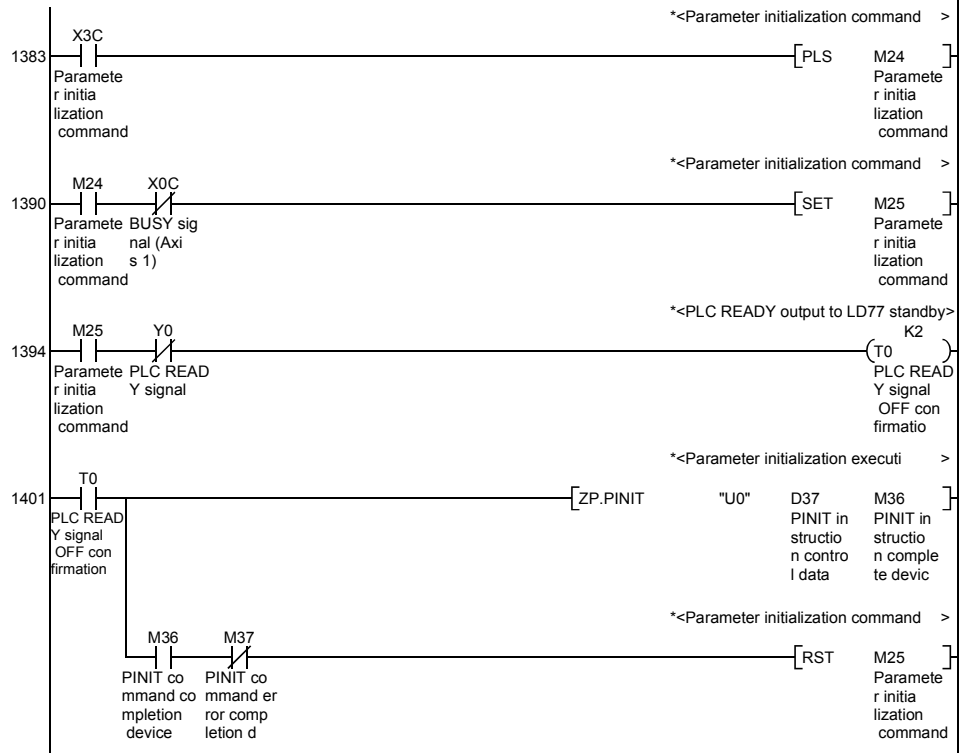

\*  
\*No.27 Flash ROM write program  
\*

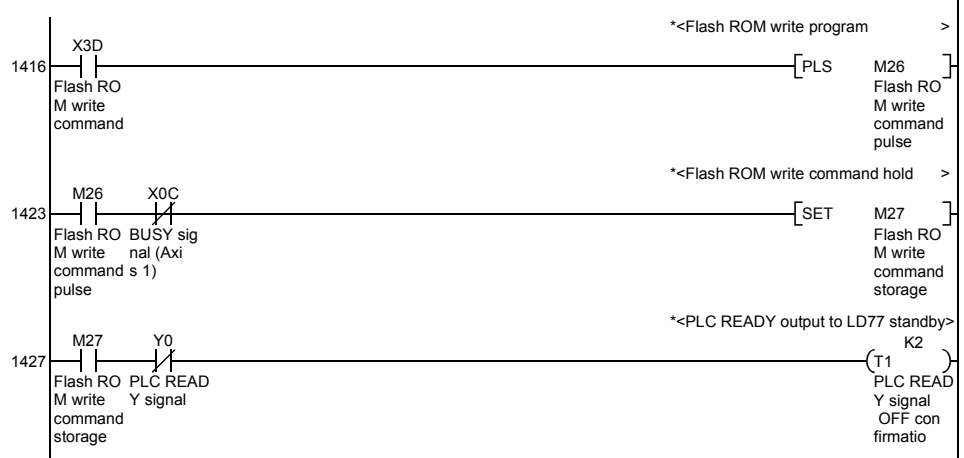

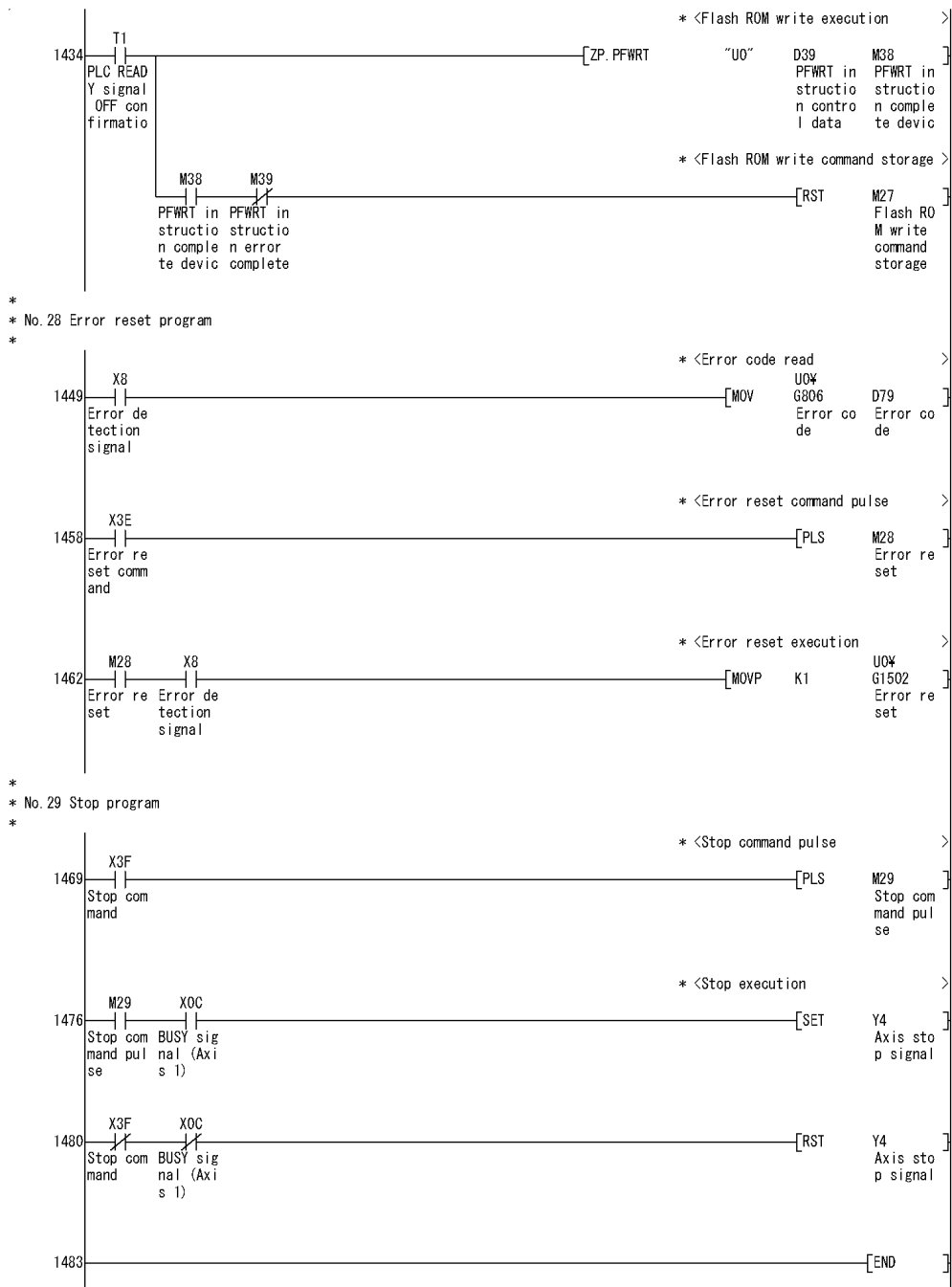

## 6.5 Program details

### 6.5.1 Initialization program

#### [1] OPR request OFF program

This program forcibly turns OFF the "OPR request flag" ( [Md.31] Status: b3) which is ON.

When using a system that does not require OPR, assemble the program to cancel the "OPR request" made by the LD77MH when the power is turned ON, etc.

#### ■ Data requiring setting

Set the following data to use the OPR request flag OFF request.

Setting item	Setting value	Setting details	Buffer memory address	
			LD77MH4	LD77MH16
[Cd.19] OPR request flag OFF request	1	Set to "1: Turn OPR request flag OFF".	1521+100n	4321+100n

\*: Refer to Section 5.7 "List of control data" for details on the setting details.

#### ■ Time chart for OPR OFF request

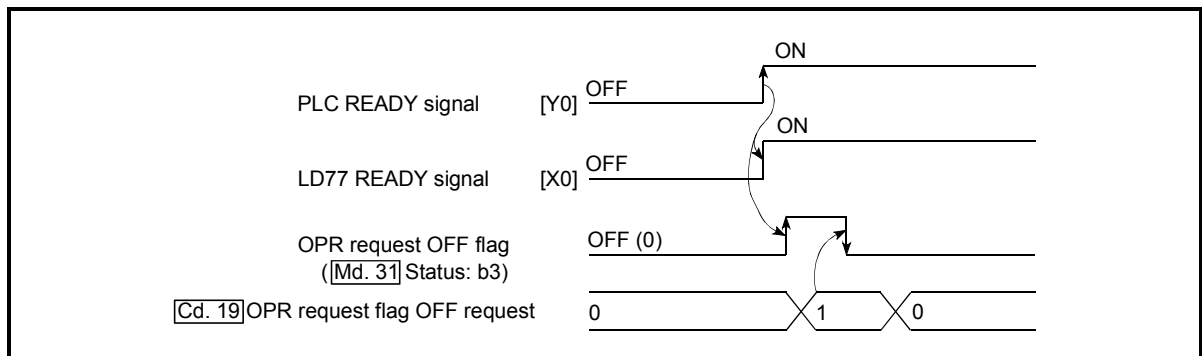

Fig. 6.1 Time chart for OPR OFF request

#### [2] External command function valid setting program

This program is used to validate the "external command signal" beforehand when using the external command functions (external start, speed change, speed-position switching, position-speed switching, skip). Set which function to use beforehand in " [Pr.42] External command function selection".

(Set the external command signal [DI] in " [Pr.95] External command signal selection" at LD77MH16 use.)

Set the following data to validate the "external command signal".

Setting item	Setting value	Setting details	Buffer memory address	
			LD77MH4	LD77MH16
[Cd.8] External command valid	1	Set to "1: Validate external command".	1505+100n	4305+100n

\*: Refer to Section 5.7 "List of control data" for details on the setting details.

## 6.5.2 Start details setting program

This program sets which control, out of "OPR", "major positioning control", "high-level positioning control" or "expansion control" to execute. For "high-level positioning control", "fast OPR", "speed-position switching control" and "position-speed switching control", add the respectively required sequence program.  
(Refer to "Chapter 10" for details of "high-level positioning control" and "Chapter 12" for details on the "expansion control".)

■ Procedures for setting the starting details

- (1) Set the "positioning start No." corresponding to the control to be started in "Cd.3 Positioning start No."

Setting item	Setting value	Setting details	Buffer memory address	
			LD77MH4	LD77MH16
Cd.3 Positioning start No.	→	1 to 600 : Positioning data No. 9001 : Machine OPR 9002 : Fast OPR 9003 : Current value changing 9004 : Simultaneous start 7000 to 7004 : Block No. (For "high-level positioning control")	1500+100n	4300+100n

\*: Refer to Section 5.7 "List of control data" for details on the setting details.

- (2) For "high-level positioning control", set the "positioning start point No." of the block to be started in "Cd.4 Positioning starting point No."

Setting item	Setting value	Setting details	Buffer memory address	
			LD77MH4	LD77MH16
Cd.4 Positioning starting point No.	→	1 to 50 : Point No. of block start data	1501+100n	4301+100n

\*: Refer to Section 5.7 "List of control data" for details on the setting details.

- (3) Set the following control data for "speed-position switching control (INC mode)".

(Set "Cd.23 Speed-position switching control movement amount change register" as required. Setting is not required in the ABS mode.)

Setting item	Setting value	Setting details	Buffer memory address	
			LD77MH4	LD77MH16
Cd.23 Speed-position switching control movement amount change register	→	Set the new value when the position control's movement amount is to be changed during speed control.	1526+100n 1527+100n	4326+100n 4327+100n
Cd.24 Speed-position switching enable flag	1	When "1" is set, the speed-position switching signal will be validated.	1528+100n	4328+100n

\*: Refer to Section 5.7 "List of control data" for details on the setting details.

- (4) For "position-speed switching control", set the control data shown below.  
 (As required, set the " Cd.25 Position-speed switching control speed change register ".)

Setting item		Setting value	Setting details	Buffer memory address	
				LD77MH4	LD77MH16
Cd.25	Position-speed switching control speed change register	→	Used to set a new value when speed is changed during positioning control.	1530+100n 1531+100n	4330+100n 4331+100n
Cd.26	Position-speed switching enable flag	1	To validate position-speed switching signal, this is set to 1.	1532+100n	4332+100n

\*: Refer to Section 5.7 "List of control data" for details on the setting details.



### 6.5.3 Start program

This program is used to start the control with start commands.

The control can be started with the following two methods.

- [1] Starting by inputting positioning start signal
- [2] Starting by inputting external command signal

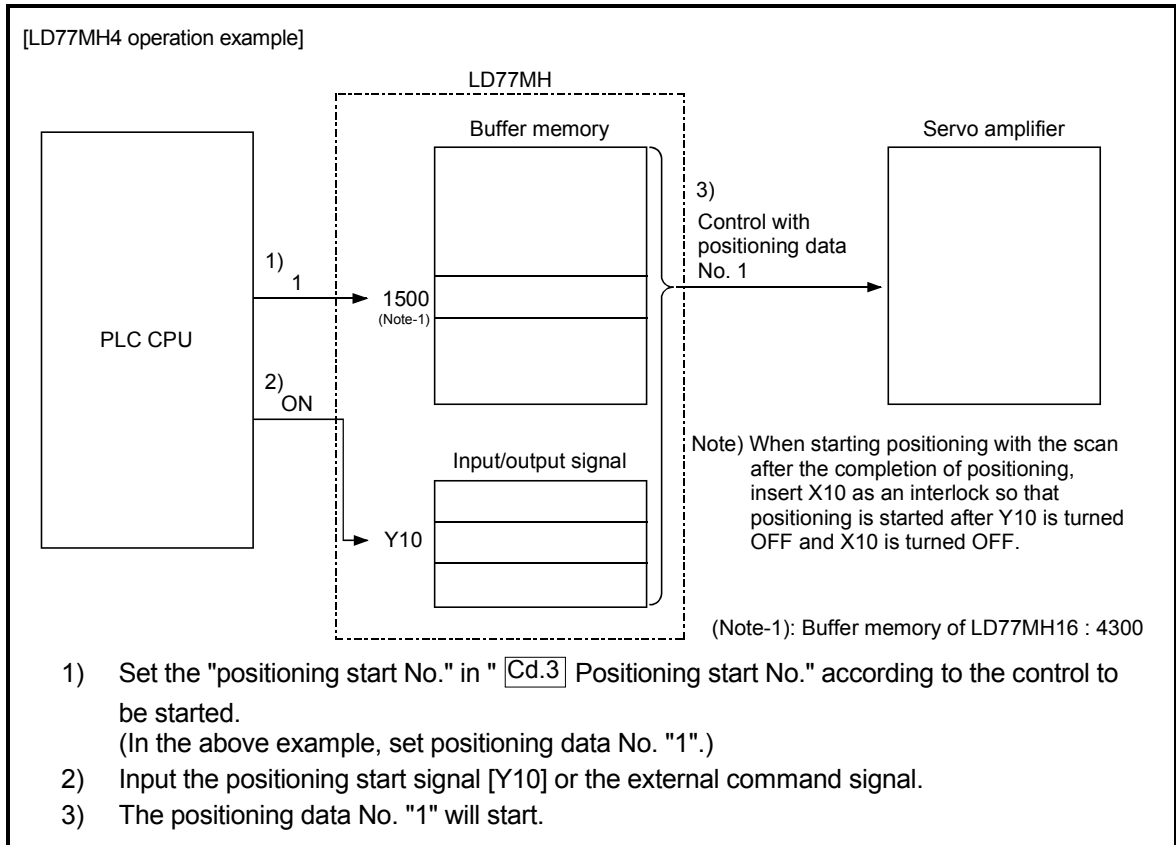

Fig. 6.2 Procedures for starting control (for axis 1)

■ Servo ON conditions

Setting of servo parameter



PLC READY signal Y0 ON



All axis servo ON Y1 ON

■ Starting conditions

To start the control, the following conditions must be satisfied.

The necessary start conditions must be incorporated in the sequence program so that the control is not started when the conditions are not satisfied.

(1) Operation state

Monitor item	Operation state	Buffer memory address	
		LD77MH4	LD77MH16
<b>Md.26</b> Axis operation status	"0: Standby" or "1: Stopped"	809+100n	2409+100n

(2) Signal state

Signal name	Signal state	Device			
		LD77MH4	LD77MH16		
Interface signal	PLC READY signal	ON	PLC CPU preparation completed	Y0	
	LD77 READY signal	ON	LD77MH preparation completed	X0	
	All axis servo ON	ON	All axis servo ON	Y1	
	Synchronization flag *	ON	LD77MH buffer memory Accessible	X1	
	Axis stop signal	OFF	Axis stop signal is OFF	Y4 to Y7	<b>[Cd.180]</b> Axis stop
	M code ON signal	OFF	M code ON signal is OFF	X4 to X7	<b>[Md.31]</b> Status: b12
	Error detection signal	OFF	There is no error	X8 to XB	<b>[Md.31]</b> Status: b13
	BUSY signal	OFF	BUSY signal is OFF	XC to XF	X10 to X1F
	Start complete signal	OFF	Start complete signal is OFF	X10 to X13	<b>[Md.31]</b> Status: b14
External signal	Forced stop input signal	ON	There is no forced stop input	-	
	Upper limit (FLS)	ON	Within limit range	-	
	Lower limit (RLS)	ON	Within limit range	-	

\*: When the synchronous setting of the PLC CPU is made in the nonsynchronous mode, this must be provided as an interlock.

When it is made in the synchronous mode, no interlock must be provided in the program because the flag is turned ON when calculation is run on the PLC CPU.

[1] Starting by inputting positioning start signal

■ Operation when starting

- (1) When the positioning start signal turns ON, the start complete signal and BUSY signal turn ON, and the positioning operation starts.  
It can be seen that the axis is operating when the BUSY signal is ON.
- (2) When the positioning start signal turns OFF, the start complete signal also turns OFF.  
If the positioning start signal is ON even after positioning is completed, the start complete signal will remain ON.
- (3) If the positioning start signal turns ON again while the BUSY signal is ON, the warning "operating start (warning code: 100)" will occur.
- (4) The process taken when positioning is completed will differ according to case (a) and (b) below.
  - (a) When next positioning is not to be carried out
    - If a dwell time is set, the system will wait for the set time to pass, and then positioning will be completed.
    - When positioning is completed, the BUSY signal will turn OFF and the positioning complete signal will turn ON. However, when using speed control or when the positioning complete signal ON time is "0", the signal will not turn ON.
    - When the positioning complete signal ON time is passed, the positioning complete signal will turn OFF.
  - (b) When next positioning is to be carried out
    - If a dwell time is set, the system will wait for the set time to pass.
    - When the set dwell time is passed, the next positioning will start.

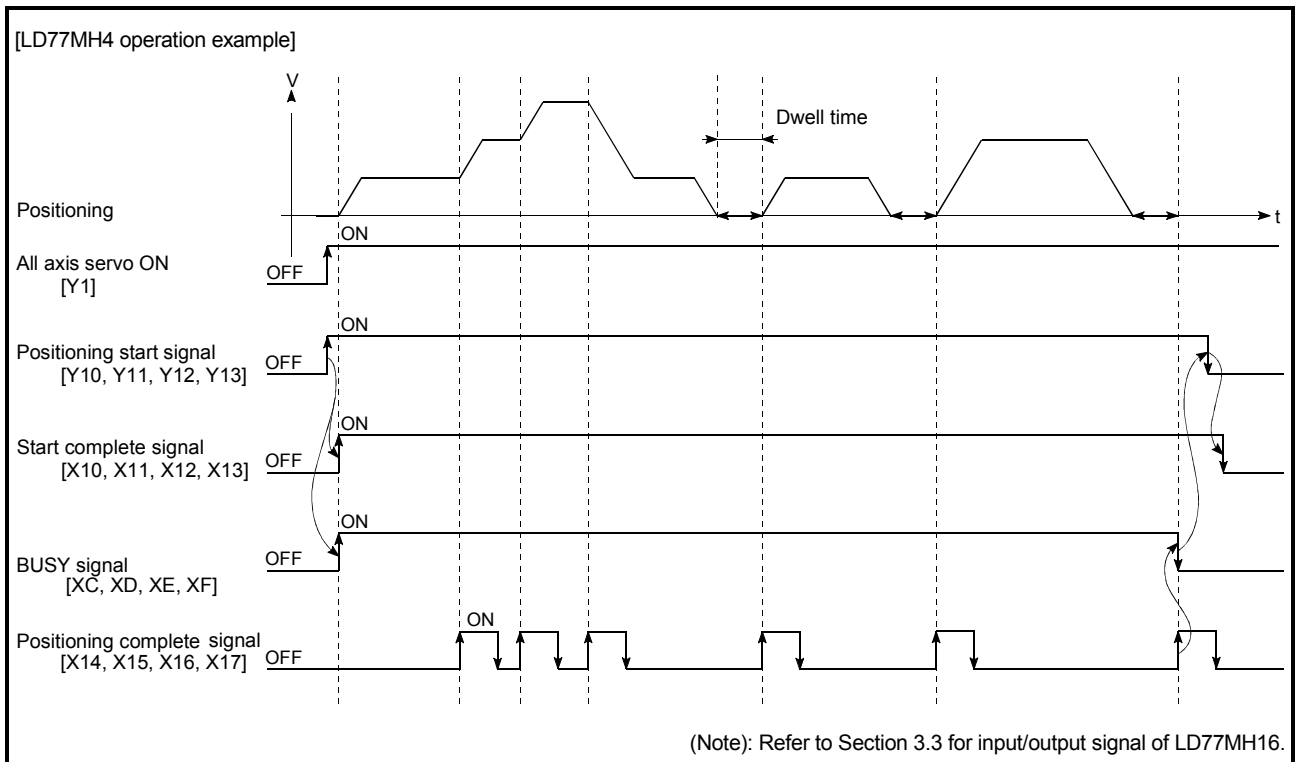

Fig. 6.3 ON/OFF timing of each signal at start of positioning

**POINT**

The BUSY signal turns ON even when position control of movement amount 0 is executed. However, since the ON time is short, the ON status may not be detected in the sequence program.

(The ON status of the start complete signal, positioning complete signal and M code ON signal can be detected in the sequence program.)

■ Starting time chart

The time chart for starting each control is shown below.

(1) Time chart for starting "machine OPR"

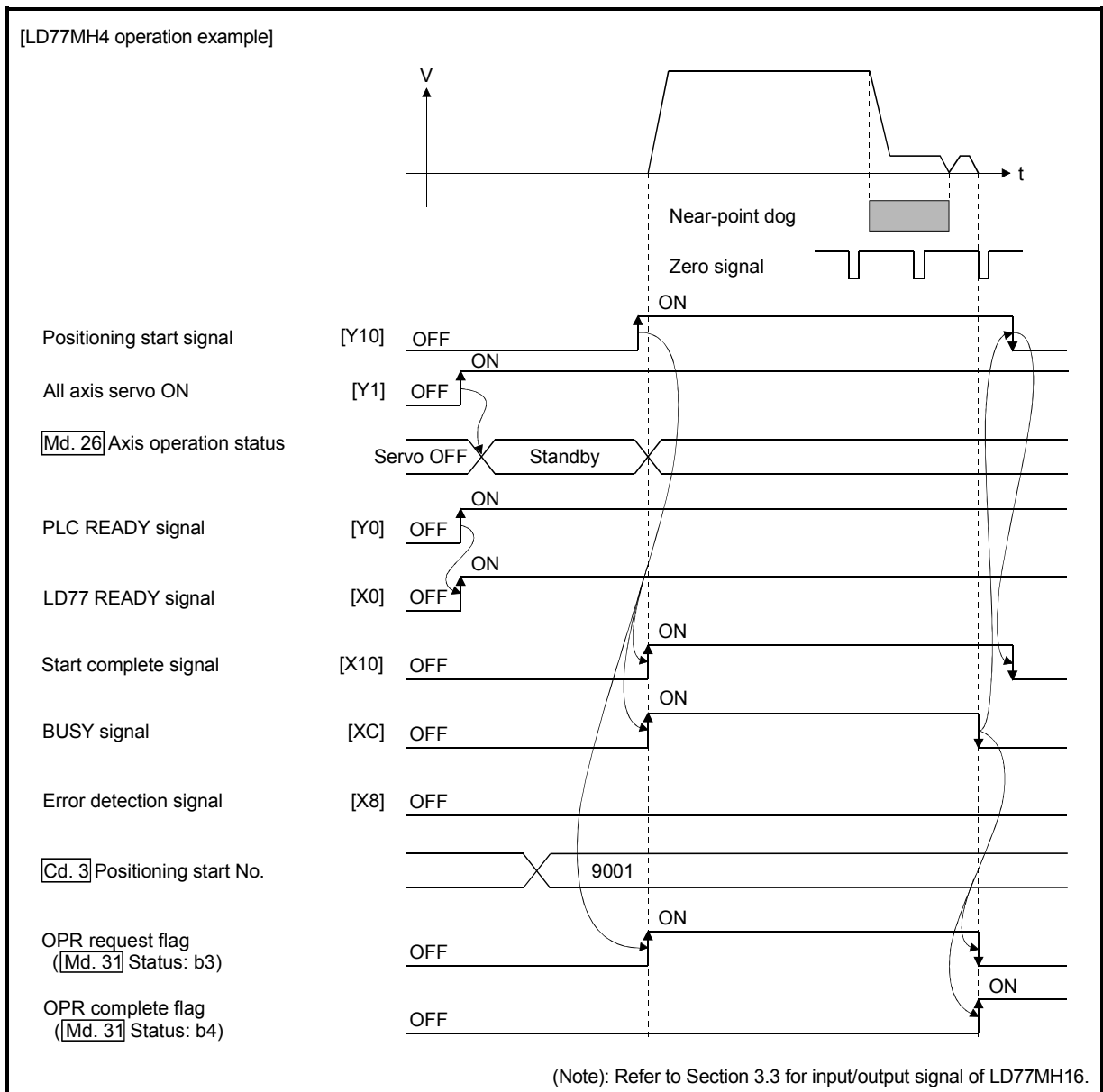

Fig. 6.4 Time chart for starting "machine OPR"

(2) Time chart for starting "fast OPR"

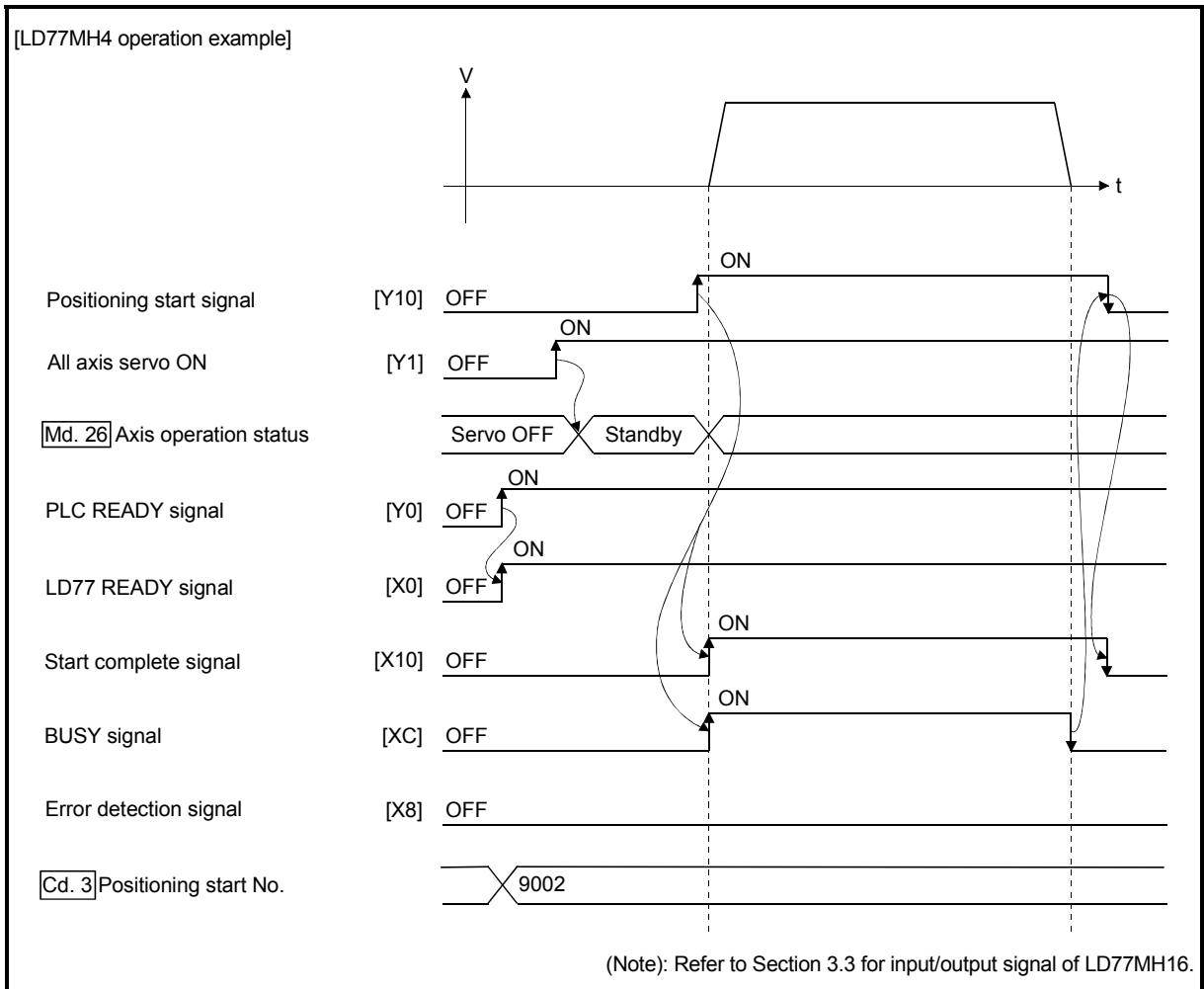

Fig. 6.5 Time chart for starting "fast OPR"

(3) Time chart for starting "major positioning control"

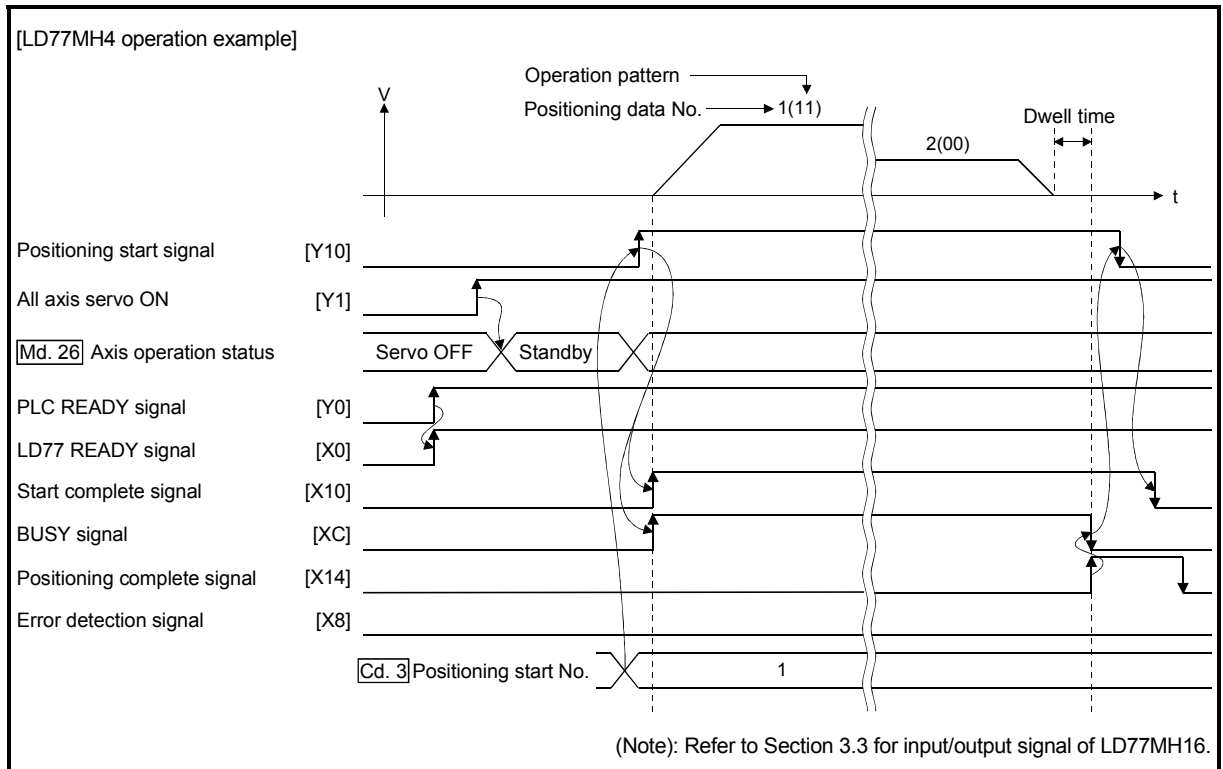

Fig. 6.6 Time chart for starting "major positioning control"

(4) Time chart for starting "speed-position switching control"

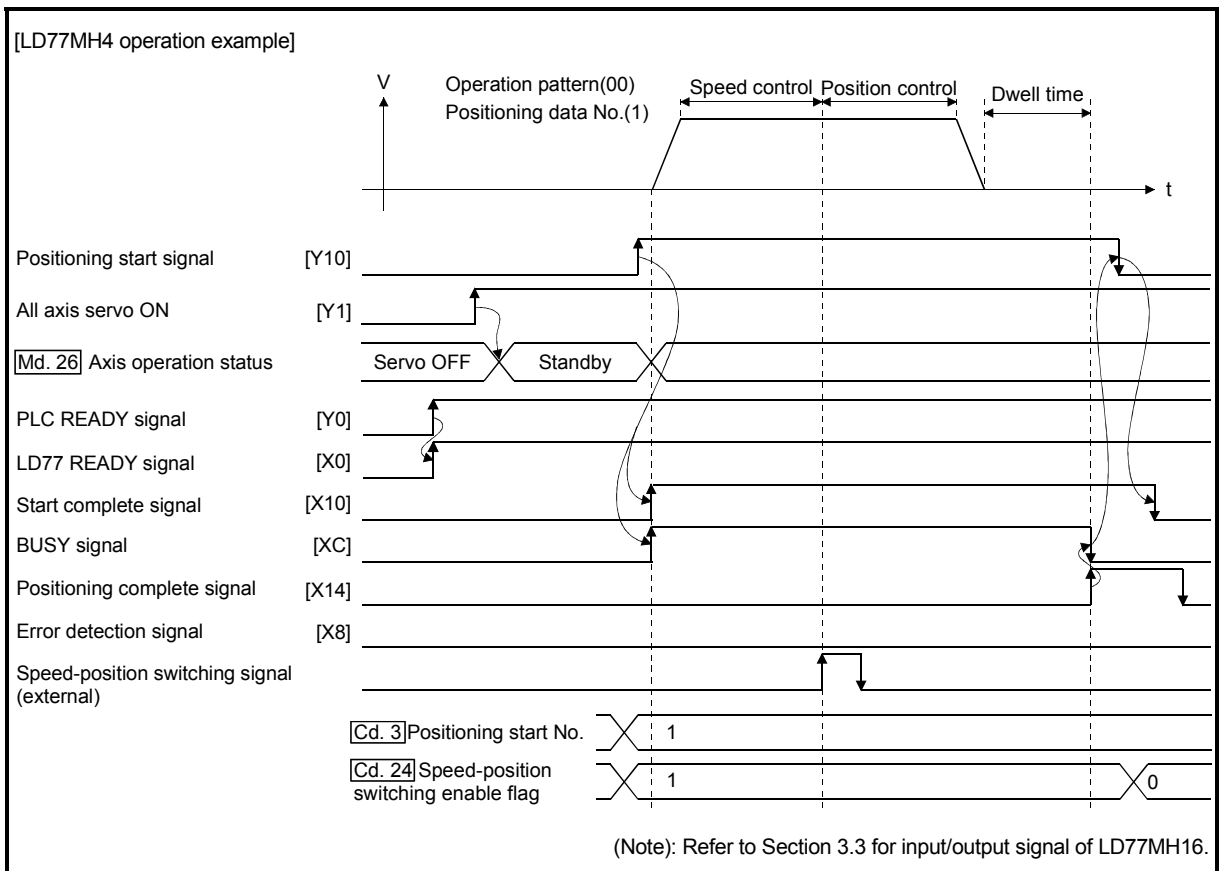

Fig. 6.7 Time chart for starting "speed-position switching control"

(5) Time chart for starting "position-speed switching control"

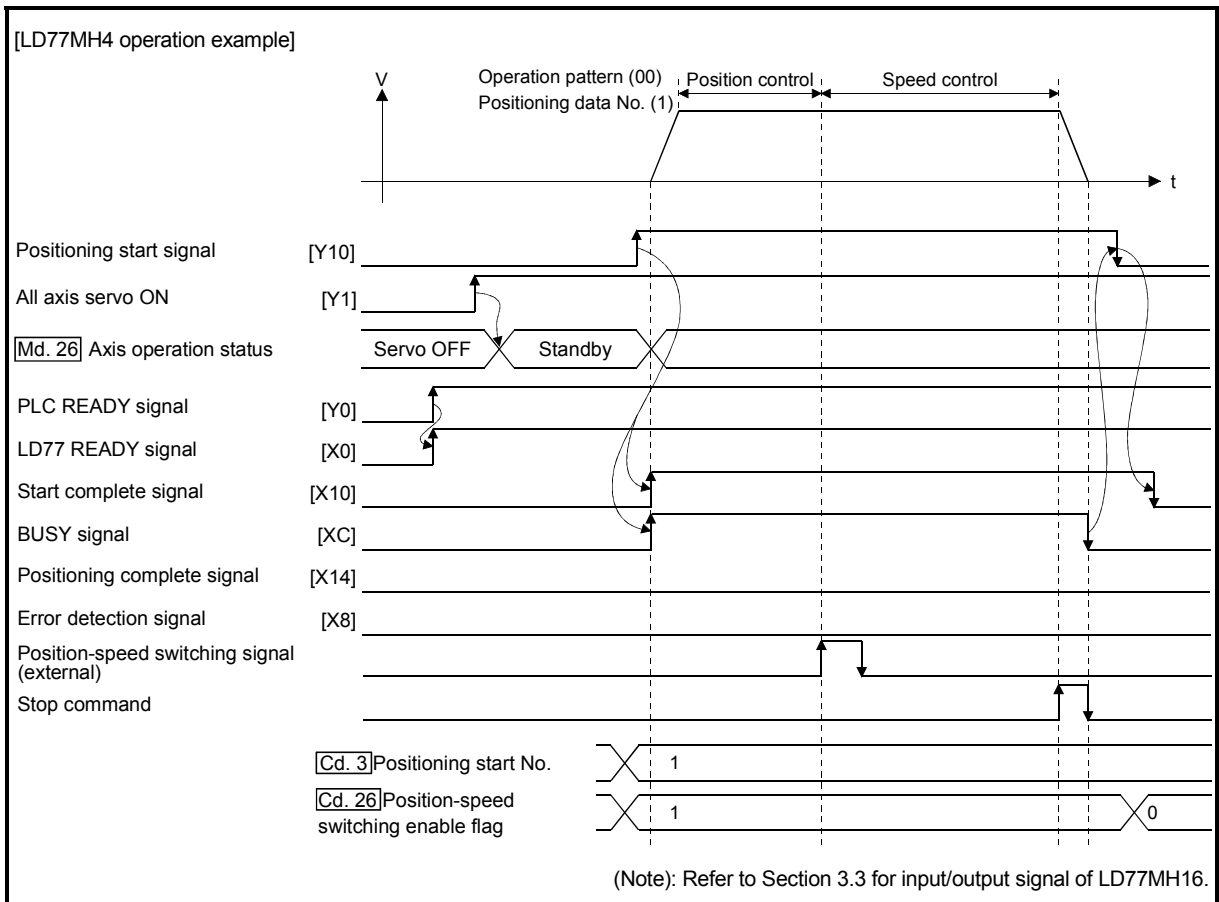

Fig. 6.8 Time chart for starting "position-speed switching control"



■ Machine OPR operation timing and process time

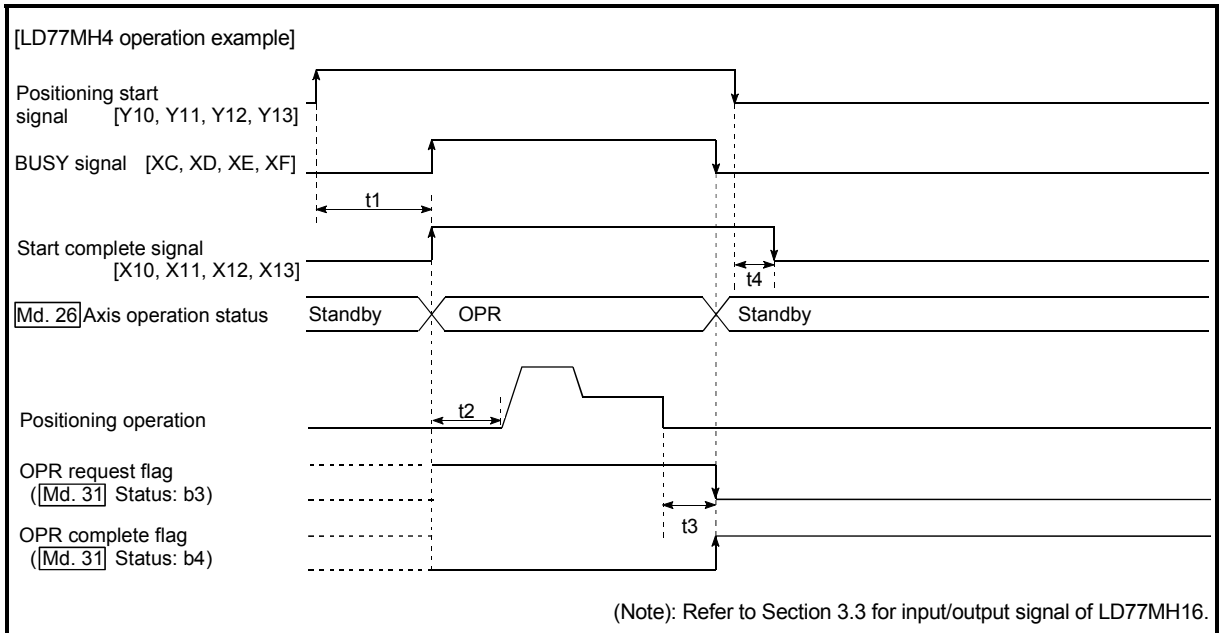

Fig. 6.9 Machine OPR operation timing and process time

Normal timing time

Unit: [ms]

	Operation cycle	t1	t2	t3	t4
LD77MH4	0.88	0.2 to 0.3	2.2 to 2.7	0 to 0.9	0 to 0.9
LD77MH16	0.88	0.3 to 1.4	2.2 to 2.7	0 to 0.9	0 to 0.9
	1.77	0.3 to 1.4	3.2 to 3.9	0 to 1.8	0 to 1.8

- The t1 timing time could be delayed depending on the operating conditions of the other axis.

■ Position control operation timing and process time

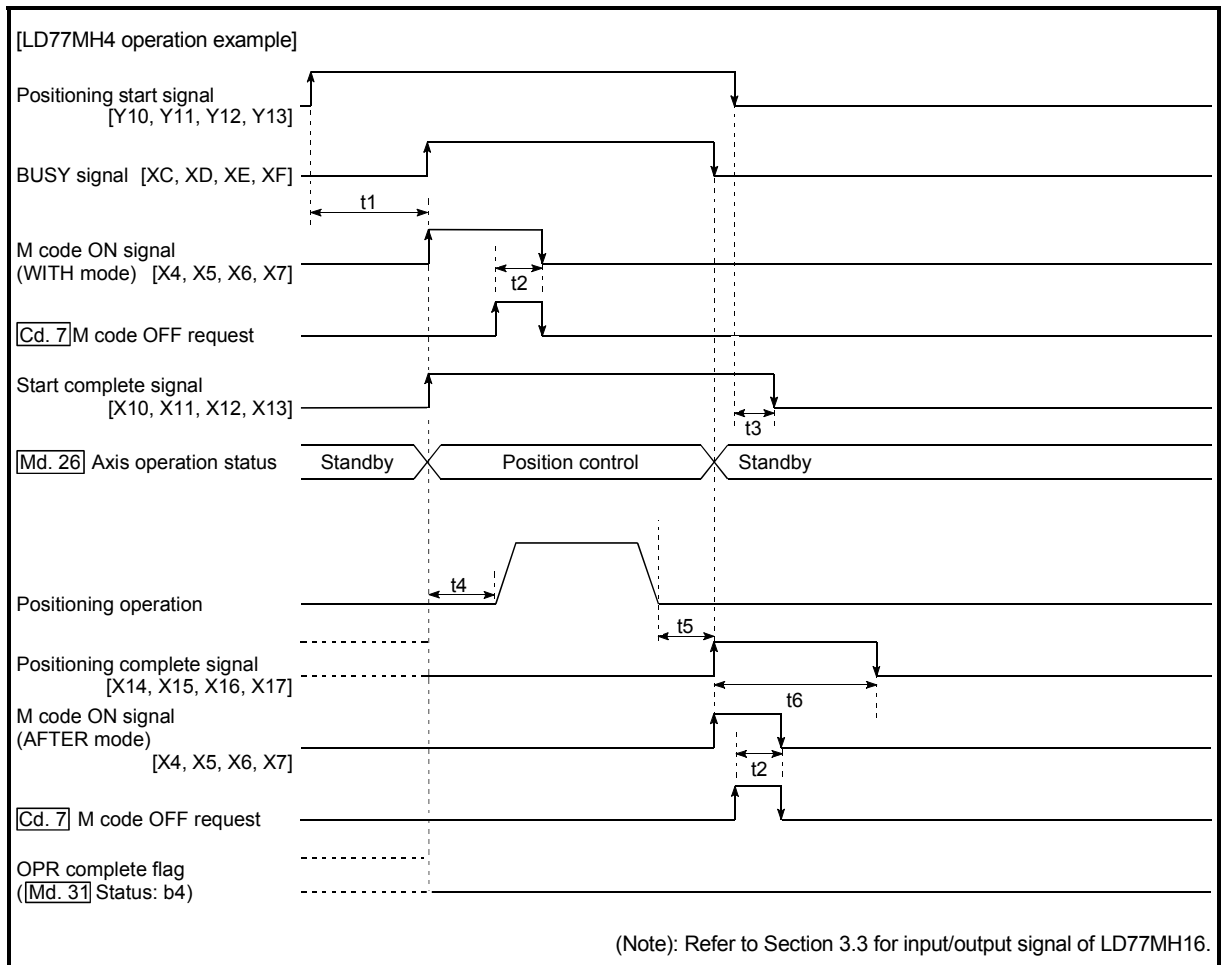

Fig. 6.10 Position control operation timing and process time

When the positioning start signal turns ON, if the "positioning complete signal" or "OPR complete flag" are already ON, the "positioning complete signal" or "OPR complete flag" will turn OFF when the positioning start signal turns ON.

Normal timing time		Unit: [ms]					
	Operation cycle	t1	t2	t3	t4	t5	t6
LD77MH4	0.88	0.2 to 0.3	0 to 0.9	0 to 0.9	2.2 to 2.7	0 to 0.9	Follows parameters
LD77MH16	0.88	0.3 to 1.4	0 to 0.9	0 to 0.9	2.2 to 2.7	0 to 0.9	Follows parameters
	1.77	0.3 to 1.4	0 to 1.8	0 to 1.8	3.2 to 3.9	0 to 1.8	Follows parameters

- The t1 timing time could be delayed depending on the operating conditions of the other axis.

## [2] Starting by inputting external command signal

When starting positioning control by inputting the external command signal, the start command can be directly input into the LD77MH. This allows the variation time equivalent to one scan time of the PLC CPU to be eliminated. This is an effective procedure when operation is to be started as quickly as possible with the start command or when the starting variation time is to be suppressed. To start positioning control by inputting the external command signal, set the "data required to be set" and then turn ON the external command signal.

### ■ Restrictions

When starting by inputting the external command signal, the start complete signal will not turn ON.

### ■ Data required to be set

To execute positioning start with the external command signal, set parameter ( [Pr.42] ) beforehand, and validate the "external command signal" with the "external command signal validity setting program (program No.5).

Setting item		Setting value	Setting details	Buffer memory address	
				LD77MH4	LD77MH16
[Pr.42]	External command function selection	0	Set to "0: External positioning start".	62+150n	
[Cd.8]	External command valid	1	Set to "1: Validate external command".	1505+100n	4305+100n

\*: Set the external command signal [D1] in "[Pr.95] External command signal selection" at LD77MH16 use.  
Refer to Chapter 5 "Data Used for Positioning Control" for details on the setting details.

■ Starting time chart

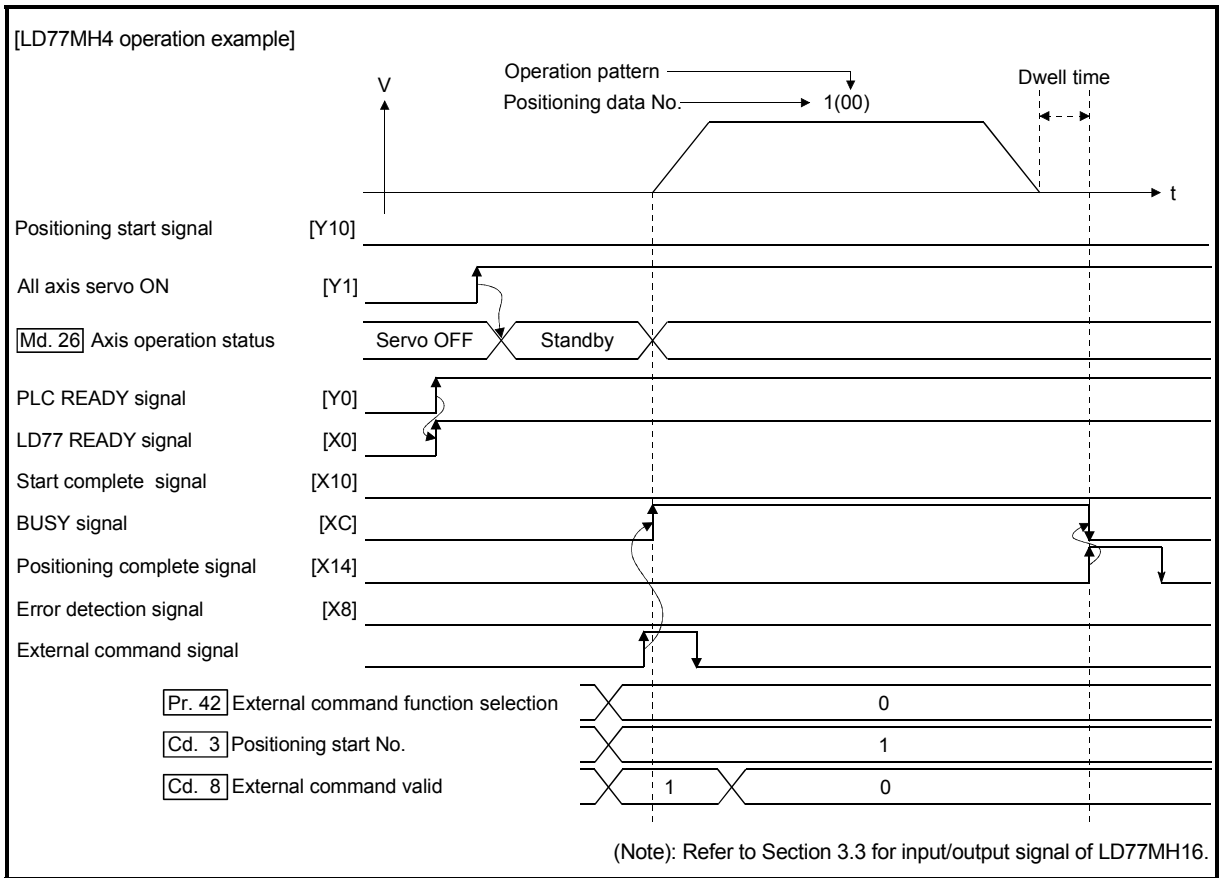

Fig. 6.11 Time chart for starting with external start signal

### 6.5.4 Continuous operation interrupt program

During positioning control, the control can be interrupted during continuous positioning control and continuous path control (continuous operation interrupt function). When "continuous operation interruption" is execution, the control will stop when the operation of the positioning data being executed ends. To execute continuous operation interruption, set "1: Continuous operation interrupt request" for " Cd.18 Interrupt request during continuous operation".

#### [1] Operation during continuous operation interruption

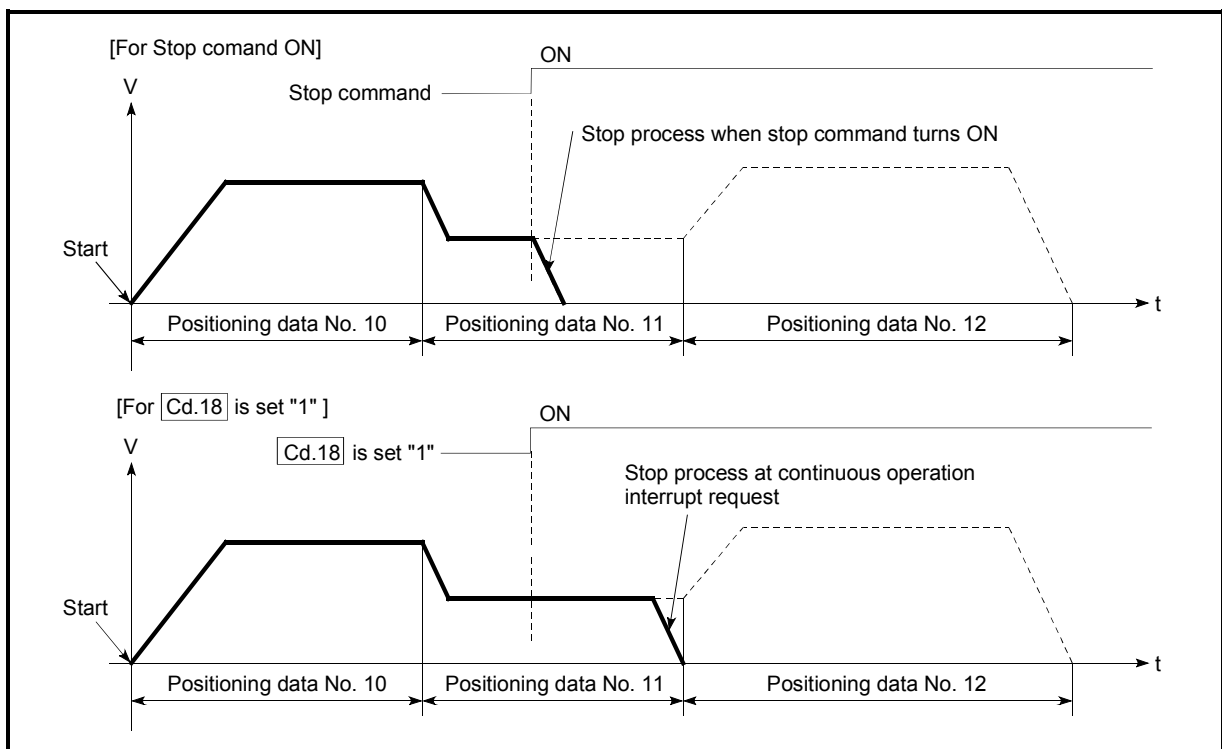

Fig. 6.12 Operation during continuous operation interruption

#### [2] Restrictions

- (1) When the "continuous operation interrupt request" is executed, the positioning will end.  
Thus, after stopping, the operation cannot be "restarted".  
When " Cd.6 Restart command" is issued, a warning "Restart not possible" (warning code: 104) will occur.

- (2) Even if the stop command is turned ON after executing the "continuous operation interrupt request", the "continuous operation interrupt request" cannot be canceled.

Thus, if "restart" is executed after stopping by turning the stop command ON, the operation will stop when the positioning data No. where "continuous operation interrupt request" was executed is completed.

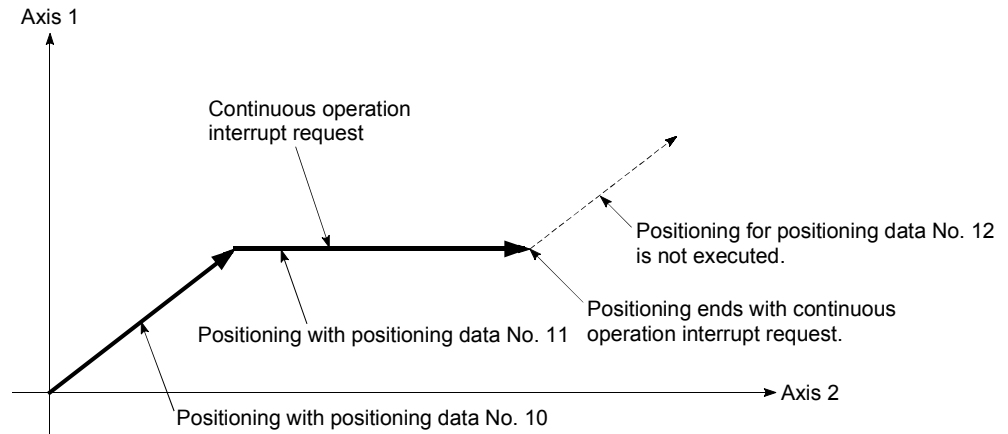

- (3) If the operation cannot be decelerated to a stop because the remaining distance is insufficient when "continuous operation interrupt request" is executed with continuous path control, the interruption of the continuous operation will be postponed until the positioning data shown below.

- Positioning data No. have sufficient remaining distance
- Positioning data No. for positioning complete (pattern: 00)
- Positioning data No. for continuous positioning control (pattern: 01)

Even when the continuous operation interrupt is requested, the remaining distance is insufficient, and thus, the operation cannot stop at the positioning No. being executed.

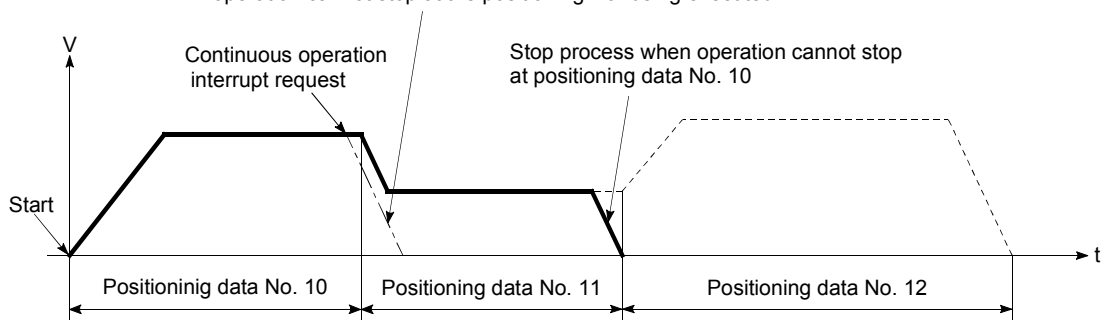

- (4) When operation is not performed (BUSY signal is OFF), the interrupt request during continuous operation is not accepted. It is cleared to 0 at a start or restart.

### [3] Control data requiring settings

Set the following data to interrupt continuous operation.

Setting item	Setting value	Setting details	Buffer memory address	
			LD77MH4	LD77MH16
Cd.18 Interrupt request during continuous operation	1	Set "1: Interrupt request during continuous operation".	1520+100n	4320+100n

※: Refer to Section 5.7 "List of control data" for details on the setting details.

### 6.5.5 Restart program

When a stop factor occurs during position control and the operation stops, the positioning can be restarted from the stopped position to the position control end point by using the "restart command" ( Cd.6 Restart command).

("Restarting" is not possible when "continuous operation is interrupted.")

This instruction is efficient when performing the remaining positioning from the stopped position in the positioning control of incremental method such as INC linear 1.

(Calculation of remaining distance is not required.)

#### [1] Restart operation

After a deceleration stop by the stop command is completed, write "1" to the "Cd.6 Restart command" with "Md.26 Axis operation status" is "stopped" and the positioning restarts.

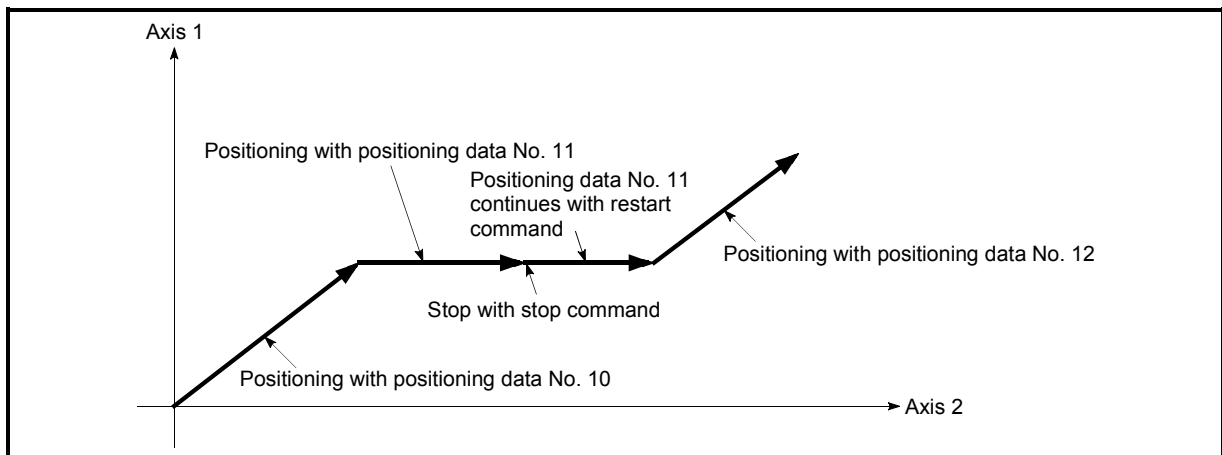

Fig. 6.13 Restart operation

#### [2] Restrictions

- (1) Restarting can be executed only when the "Md.26 Axis operation status" is "stopped (the deceleration stop by stop command is completed)".  
If the axis operation is not "stopped", restarting is not possible.  
In this case, a warning "Restart not possible" (warning code: 104) will occur, and the process at that time will be continued.
- (2) Do not execute restart while the stop command is ON.  
If restart is executed while stopped, an error "Stop signal ON at start" (error code: 106) will occur, and the "Md.26 Axis operation status" will change to "Error".  
Thus, even if the error is reset, the operation cannot be restarted.
- (3) Restarting can be executed even while the positioning start signal is ON.  
However, make sure that the positioning start signal does not change from OFF to ON while stopped.
- (4) If the positioning start signal is changed from OFF to ON while "Md.26 Axis operation status" is "stopped", the normal positioning (the positioning data set in "Cd.3 Positioning start signal") is started.
- (5) If positioning is ended with the continuous operation interrupt request, the operation cannot be restarted.  
If restart is requested, a warning "Restart not possible" (warning code: 104) will occur.

- (6) When stopped with interpolation operation, write "1: Restarts" into " [Cd.6] Restart command" for the reference axis, and then restart.
- (7) If the PLC READY signal is changed from OFF to ON while stopped, restarting is not possible.  
If restart is requested, a warning "Restart not possible" (warning code: 104) will occur.
- (8) When the machine OPR and fast OPR is stopped, a error "OPR restart not possible" (error code: 209) will occur and the positioning cannot restarts.
- (9) If any of reference partner axes executes the positioning operation once after interpolation operation stop, a warning "Restart not possible" (warning code: 104) will occur, and the positioning cannot restarts.

### [3] Control data requiring setting

Set the following data to execute restart.

Setting item	Setting value	Setting details	Buffer memory address	
			LD77MH4	LD77MH16
[Cd.6] Restart command	1	Set "1: Restarts".	1503+100n	4303+100n

※: Refer to Section 5.7 "List of control data" for details on the setting details.

### [4] Starting conditions

The following conditions must be satisfied when restarting. (Assemble the required conditions into the sequence program as an interlock.)

#### (1) Operation state

- " [Md.26] Axis operation status" is "1: Stopped"

#### (2) Signal state

Signal name	Signal state	Device			
		LD77MH4	LD77MH16		
Interface signal	PLC READY signal	ON	PLC CPU preparation completed	Y0	
	LD77 READY signal	ON	LD77MH preparation completed	X0	
	All axis servo ON	ON	All axis servo ON	Y1	
	Synchronization flag ※	ON	LD77MH buffer memory Accessible	X1	
	Axis stop signal	OFF	Axis stop signal is OFF	Y4 to Y7	[Cd.180] Axis stop
	M code ON signal	OFF	M code ON signal is OFF	X4 to X7	[Md.31] Status: b12
	Error detection signal	OFF	There is no error	X8 to XB	[Md.31] Status: b13
	BUSY signal	OFF	BUSY signal is OFF	XC to XF	X10 to X1F
	Start complete signal	OFF	Start complete signal is OFF	X10 to X13	[Md.31] Status: b14
External signal	Forced stop input signal	ON	There is no forced stop input	-	
	Upper limit (FLS)	ON	Within limit range	-	
	Lower limit (RLS)	ON	Within limit range	-	

※: When the synchronous setting of the PLC CPU is made in the nonsynchronous mode, this must be provided as an interlock.

When it is made in the synchronous mode, no interlock must be provided in the program because the flag is turned ON when calculation is run on the PLC CPU.



[5] Time chart for restarting

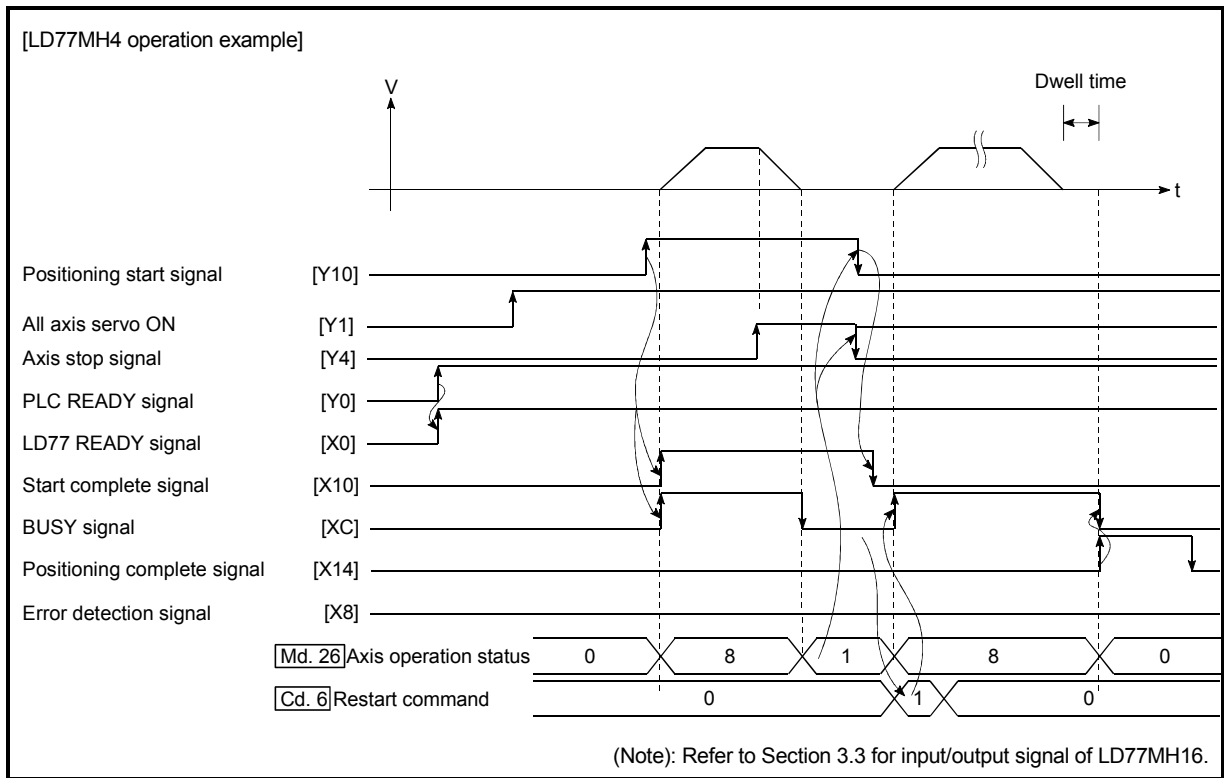

Fig. 6.14 Time chart for restarting

### 6.5.6 Stop program

The axis stop signal is used to stop the control.

Create a program to turn ON the axis stop signal as the stop program.

Signal	LD77MH4	LD77MH16
Axis stop signal	Y4, Y5, Y6, Y7	[Cd.180] Axis stop

The process for stopping control is explained below.

Each control is stopped in the following cases.

- (1) When each control is completed normally.
- (2) When the Servo READY signal is turned OFF.
- (3) When a PLC CPU error occurs.
- (4) When the PLC READY signal is turned OFF.
- (5) When an error occurs in LD77MH.
- (6) When control is intentionally stopped  
(Stop signal from PLC CPU turned ON, etc.)

The stop process for the above cases is shown below.

(Excluding item (1) above "When each control is completed normally".)

#### [1] Stop process

Stop cause	Stop axis	M code ON signal after stop	Axis operation status after stopping ( [Md.26] )	Stop process					
				OPR control		Major positioning control	High-level positioning control	Manual control	
				Machine OPR control	Fast OPR control			JOG/ Inching operation	Manual pulse generator operation
Forced stop	"Forced stop input signal from an external device" OFF	All axes	No change	Servo OFF	Servo OFF or free run (The operation stops with dynamic brake)				
	Servo READY OFF	Each axis	No change	Servo amplifier has not been connected					
	• Servo amplifier power supply OFF			Error					
	• Servo alarm			Servo OFF					
• Forced stop input to servo amplifier									
Fatal stop (Stop group 1)	Hardware stroke limit upper/lower limit error occurrence	Each axis	No change	Error	Deceleration stop/sudden stop (Select with " [Pr.37] Stop group 1 sudden stop selection".)				
Emergency stop (Stop group 2)	Error occurs in PLC CPU	All axes	No change	Error	Delegation stop/sudden stop (Select with " [Pr.38] Stop group 2 sudden stop selection".)				
	PLC READY signal OFF		Turns OFF						
	Error in test mode		No change						
Relatively safe stop (Stop group 3)	Axis error detection (Error other than stop group 1 or 2) "Stop" input from GX Works2	Each axis	No change	Error	Deceleration stop/sudden stop (Select with " [Pr.39] Stop group 3 sudden stop selection".)				
Intentional stop (Stop group 3)	"Axis stop signal" ON from PLC CPU	Each axis	No change	Stopped (Standby)					

[2] Types of stop processes

The operation can be stopped with deceleration stop, sudden stop or immediate stop.

(1) Deceleration stop \*1

The operation stops with "deceleration time 0 to 3" ( [Pr.10] , [Pr.28] , [Pr.29] , [Pr.30] ).

Which time from "deceleration time 0 to 3" to use for control is set in positioning data ( [Da.4] ).

(2) Sudden stop

The operation stops with " [Pr.36] Sudden stop deceleration time".

(3) Servo OFF or free run (The operation stops with dynamic brake or electromagnetic brake.)

The operation does not decelerate.

The LD77MH immediately stops the command, but the operation will coast for the droop pulses accumulated in the servo amplifier deviation counter.

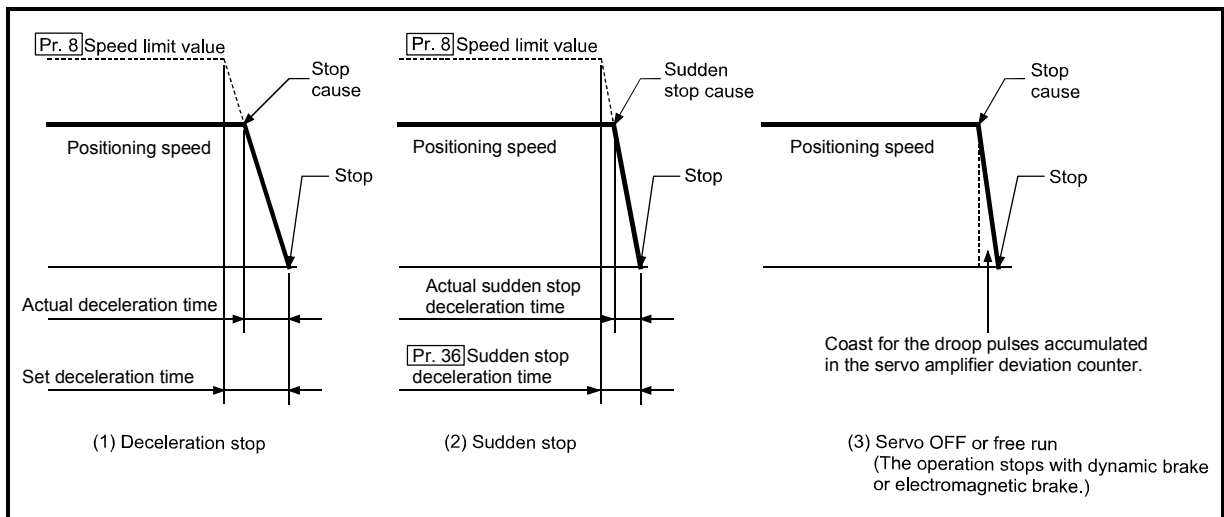

Fig. 6.15 Types of stop processes

**REMARK**

\*1 "Deceleration stop" and "sudden stop" are selected with the detailed parameter 2 "stop group 1 to 3 sudden stop selection". (The default setting is "deceleration stop".)

[3] Order of priority for stop process

The order of priority for the LD77MH stop process is as follows.

Deceleration stop < Sudden stop < Servo OFF

- (1) If the deceleration stop command ON (stop signal ON) or deceleration stop cause occurs during deceleration to speed 0 (including automatic deceleration), operation changes depending on the setting of "Cd.42 Stop command processing for deceleration stop selection".

(a) Manual control

Independently of the Cd.42 setting, a deceleration curve is re-processed from the speed at stop cause occurrence.

(b) OPR control, positioning control

- When Cd.42 = 0 (deceleration curve re-processing):

A deceleration curve is re-processed from the speed at stop cause occurrence.

- When Cd.42 = 1 (deceleration curve continuation):

The current deceleration curve is continued after stop cause occurrence. (For details, refer to Section 13.7.9 "Stop command processing for deceleration stop function".)

- (2) If the stop signal designated for sudden stop turns ON or a stop cause occurs during deceleration, the sudden stop process will start from that point. However, if the sudden stop deceleration time is longer than the deceleration time, the deceleration stop process will be continued even if a sudden stop cause occurs during the deceleration stop process.

Example

The process when a sudden stop cause occurs during deceleration stop is shown below.

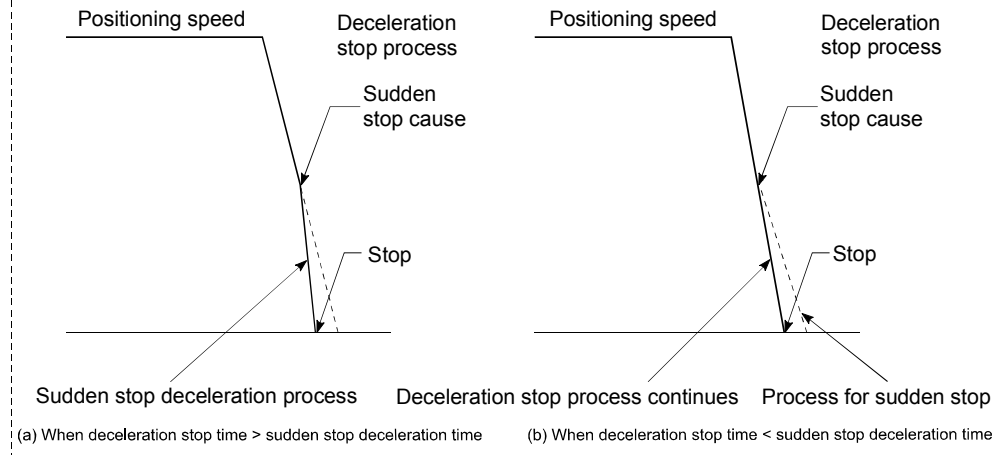

[4] Inputting the stop signal during deceleration

- (1) Even if stop is input during deceleration (including automatic deceleration), the operation will stop at that deceleration speed.
- (2) If stop is input during deceleration for OPR, the operation will stop at that deceleration speed. If input at the creep speed, the operation will stop immediately.
- (3) If a stop cause, designated for sudden stop, occurs during deceleration, the sudden stop process will start from that point.  
The sudden stop process during deceleration is carried out only when the sudden stop time is shorter than the deceleration stop time.

# Chapter 7 Memory Configuration and Data Process

The LD77MH memory configuration and data transmission are explained in this chapter.

The LD77MH is configured of three memories. By understanding the configuration and roles of two memories, the LD77MH internal data transmission process, such as "when the power is turned ON" or "when the PLC READY signal changes from OFF to ON" can be easily understood. This also allows the transmission process to be carried out correctly when saving or changing the data.

7.1	Configuration and roles of LD77MH memory.....	7- 2
7.1.1	Configuration and roles of LD77MH memory.....	7- 2
7.1.2	Buffer memory area configuration.....	7- 4
7.2	Data transmission process.....	7- 6

## 7.1 Configuration and roles of LD77MH memory

### 7.1.1 Configuration and roles of LD77MH memory

The LD77MH is configured of the following three memories.

Model	Memory configuration	Role	Area configuration									Backup	
			Parameter area	Monitor data area	Control data area	Positioning data area		Block start data area		PLC CPU memo area	Servo parameter area		
						(No. 1 to 100)	(No. 101 to 600)	(No.7000 to 7001)	(No.7002 to 7004)		(Pr.100) to (Pr.195)		(Pr.196) to (Pr.332)
LD77MH4	Buffer memory	Area that can be directly accessed with sequence program with PLC CPU.	○	○	○	○	○	○	○	○	○	○	Not possible
	Internal memory	Area that can be set only with GX Works2	-	-	-	-	-	-	-	-	-	-	Not possible
	Flash ROM	Area for backing up data required for positioning.	○	-	-	○	○	○	○	-	○	○	Possible
LD77MH16	Buffer memory	Area that can be directly accessed with sequence program with PLC CPU.	○	○	○	○	-	○	-	○	○	-	Not possible
	Internal memory	Area that can be set only with GX Works2	-	-	-	-	○	-	○	-	-	○	Not possible
	Flash ROM	Area for backing up data required for positioning.	○	-	-	○	○	○	○	-	○	○	Possible

○ : Setting and storage area provided, Not possible: Data is lost when power is turned OFF

- : Setting and storage area not provided, Possible: Data is held even when power is turned OFF

#### ■ Details of areas

- Parameter area

Area where parameters, such as positioning parameters and OPR parameters, required for positioning control are set and stored.

(Set the items indicated with **Pr.1** to **Pr.57**, **Pr.80** to **Pr.96**, **Pr.800** to **Pr.807** for each axis.)

- Monitor data area

Area where positioning system or LD77MH operation state is stored.

(Set the items indicated with **Md.1** to **Md.56**, **Md.100** to **Md.116**, **Md.120** to **Md.123**, **Md.130** to **Md.135**, **Md.800**, **Md.801**.)

- Control data area  
Area where data for operating and controlling positioning system is set and stored.  
(Set the items indicated with **Cd.1** to **Cd.43**, **Cd.100**, **Cd.101**, **Cd.108**, **Cd.112**, **Cd.113**, **Cd.130** to **Cd.133**, **Cd.136** to **Cd.146**, **Cd.180** to **Cd.183**, **Cd.800**, **Cd.801**.)
- Positioning data area (No.1 to 600)  
Area where positioning data No.1 to 600 is set and stored.  
(Set the items indicated with **Da.1** to **Da.10**, **Da.20** to **Da.22** for each positioning data.)
- Block start data area (No.7000 to 7004)  
Area where information required only when carrying out block No. 7000 to 7004 high-level positioning is set and stored.  
(Set the items indicated with **Da.11** to **Da.19**, **Da.23** to **Da.26**.)
- PLC CPU memo area  
Area where condition judgment values required for special positioning, etc., are set and stored.
- Servo parameter area  
Area where parameters, such as servo parameters, required for positioning control on servo amplifier are set and stored.  
(Set the items indicated with **Pr.100** to **Pr.332** for each axis.)

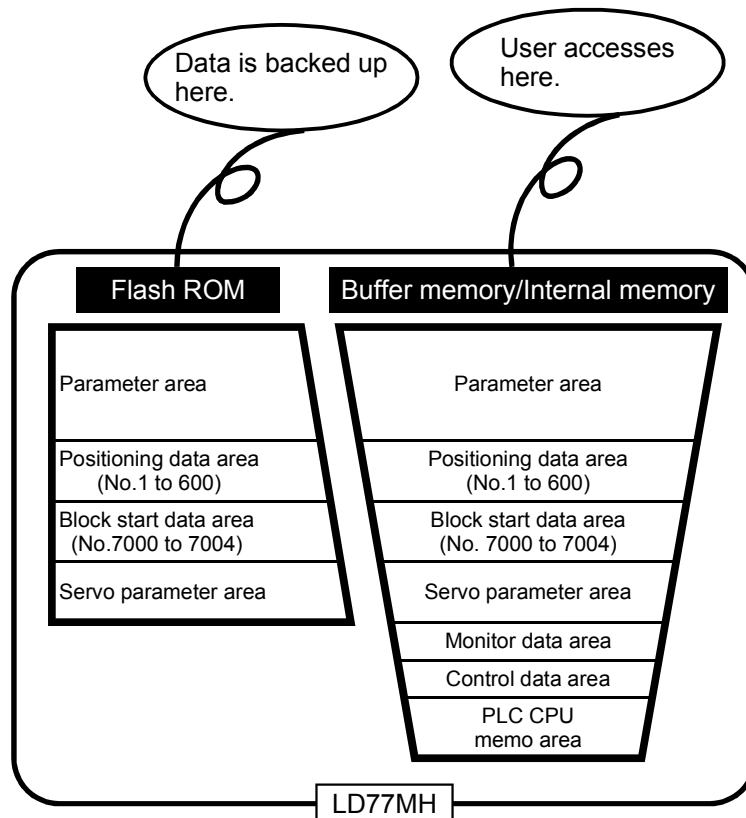



7.1.2 Buffer memory area configuration

The LD77MH buffer memory is configured of the following types of areas.

Buffer memory area configuration		Buffer memory address		Writing possibility
		LD77MH4	LD77MH16	
Parameter area	Basic parameter area	0+150n to 15+150n		Possible
	Detailed parameter area	17+150n to 69+150n		
	OPR basic parameter area	70+150n to 78+150n		
	OPR detailed parameter area	79+150n to 89+150n		
	Expansion parameter area	100+150n to 149+150n		
	Mark detection setting parameter area	54000+20k to 54019+20k		
Monitor data area	System monitor area	1200 to 1499	4000 to 4299	Not possible
	Axis monitor area	800+100n to 899+100n	2400+100n to 2499+100n	
	Mark detection monitor data area	54960+80k to 55039+80k		
Control data area	System control data area	1900 to 1999	5900 to 5999	Possible
	Axis control data area	1500+100n to 1599+100n	4300+100n to 4399+100n	
	Expansion axis control data area	30100+10n to 30109+10n		
	Mark detection control data area	54640+10k to 54649+10k		
Positioning data area (No.1 to 100)	Positioning data area	2000+6000n to 2999+6000n	6000+1000n to 6999+1000n	Possible
Positioning data area (No.101 to 600)		3000+6000n to 7999+6000n	Set with GX Works2	
Block start data area (No.7000)	Block start data area	26000+1000n to 26049+1000n	22000+400n to 22049+400n	Possible
		26050+1000n to 26099+1000n	22050+400n to 22099+400n	
Block start data area (No.7001)	Block start data area	26100+1000n to 26199+1000n	22100+400n to 22199+400n	
		26200+1000n to 26249+1000n	22200+400n to 22249+400n	
		26250+1000n to 26299+1000n	22250+400n to 22299+400n	
Block start data area (No.7002)	Block start data area	26300+1000n to 26399+1000n	22300+400n to 22399+400n	
		26400+1000n to 26449+1000n	Set with GX Works2	
Block start data area (No.7003)	Block start data area	26450+1000n to 26499+1000n		
		26500+1000n to 26599+1000n		
		26600+1000n to 26649+1000n		
Block start data area (No.7004)	Block start data area	26650+1000n to 26699+1000n		
		26700+1000n to 26799+1000n		
Block start data area (No.7004)	Block start data area	26800+1000n to 26849+1000n		
		26850+1000n to 26899+1000n		
Block start data area (No.7004)	Condition data area	26900+1000n to 26999+1000n		
		26700+1000n to 26799+1000n		
PLC CPU memo area	PLC CPU memo area	30000 to 30099		
Servo parameter area	Basic setting parameter area	Pr.100 to Pr.118	30100+200n to 30118+200n	28400+100n to 28418+100n
		Pr.332	30932+50n	
	Gain/filter parameter area	30119+200n to 30163+200n		28419+100n to 28463+100n
	Expansion setting parameter area	30164+200n to 30195+200n		28464+100n to 28495+100n
	Input/output setting parameter area	30196+200n to 30227+200n		Set with GX Works2
	Extension control parameter area	30228+200n to 30267+200n		
	Special setting parameter area	30268+200n to 30299+200n		
	Other setting parameter area	30900+50n to 30915+50n		
Option unit parameter area	30916+50n to 30931+50n			

n: Axis No.-1  
k: Mark detection setting No.-1

\*: Use of address Nos. skipped above is prohibited. If used, the system may not operate correctly.

**POINT**

When the parameter of the servo amplifier side is changed by the following method, it is transmitted to the servo parameter area in the buffer memory/internal memory after the LD77MH is read automatically with parameters.

- (1) When changing the servo parameters by the auto tuning.
- (2) When the servo parameter is changing after the MR Configurator2 is connected directly with the servo amplifier.

However, the data of servo parameter area is not transmitted to the flash ROM.

Use the execution data backup function to hold the data of servo parameter area in the buffer memory/internal memory. (Refer to Section 14.3 for details of the execution data backup function.)

7.2 Data transmission process

The data is transmitted between the LD77MH memories with steps (1) to (10) shown below.

\*: The data transmission patterns numbered (1) to (10) on the right page correspond to the numbers (1) to (10) on the left page.

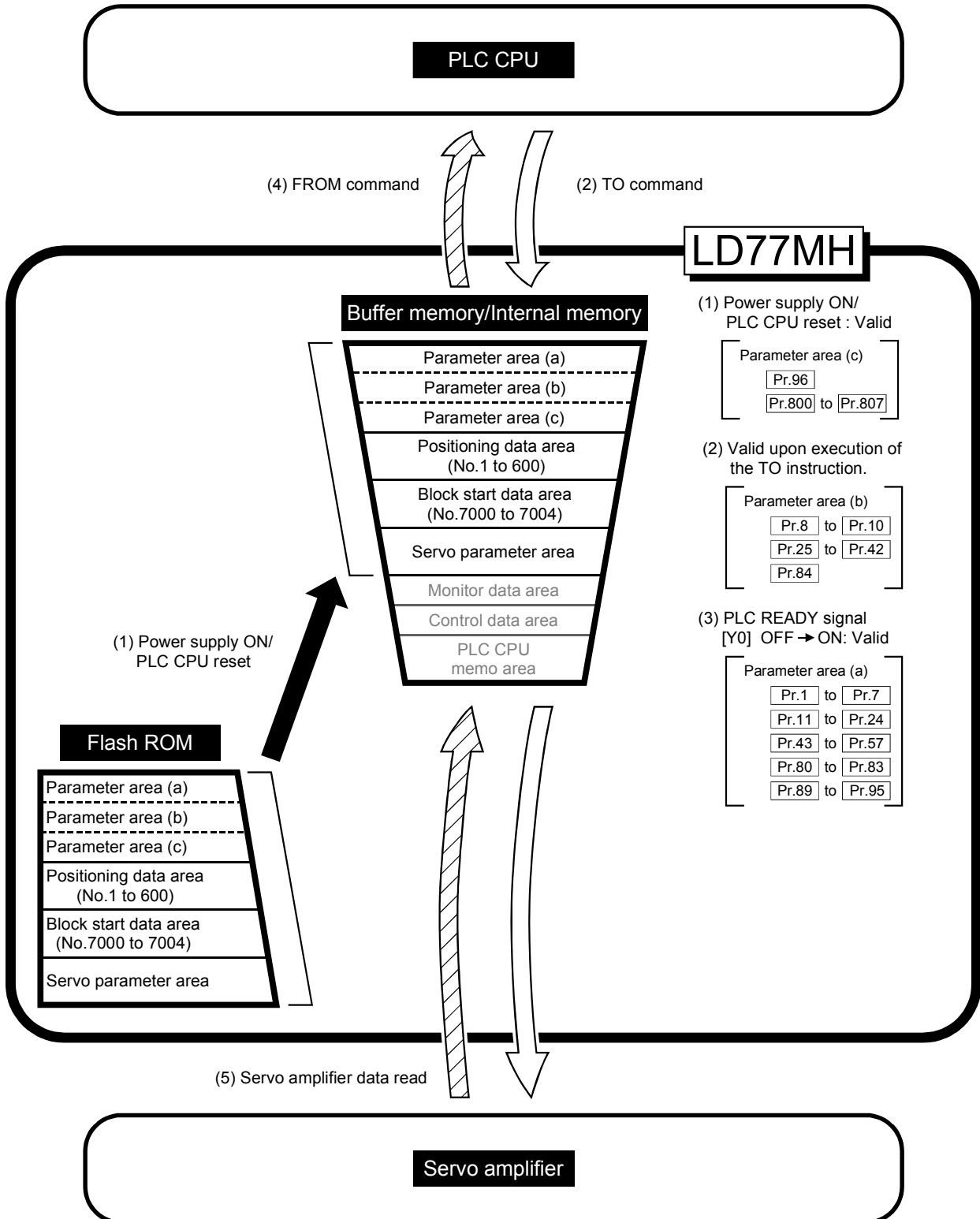

(1) Transmitting data when power is turned ON or PLC CPU is reset (  )

When the power is turned ON or the PLC CPU is reset, the "parameter area (c)<sup>\*1</sup>", "positioning data", "block start data" and "servo parameter" stored (backed up) in the flash ROM is transmitted to the buffer memory and internal memory.

The value stored in the flash ROM is valid for "[Pr.96] Operation cycle setting" in LD77MH16.

\*1: Parameter area (c)..... Parameters validated with power supply ON/ PLC CPU reset.

([Pr.96], [Pr.800] to [Pr.807])

(2) Transmitting data with TO command from PLC CPU (  )

The parameters or data is written from the PLC CPU to the buffer memory using the TO command<sup>\*2</sup>. At this time, when the "parameter area (b)<sup>\*3</sup>", "positioning data", "block start data", "control data" and "PLC CPU memo area" are written into the buffer memory with the TO command, it is simultaneously valid.

\*2: "Servo parameter area ([Pr.196] to [Pr.332]), "Positioning data (No.101 to 600)" and "Block start data (No.7002 to 7004)" can be set with only GX Works2.

\*3 Parameter area (b)..... Parameters validated with next each positioning control is started.

([Pr.8] to [Pr.10], [Pr.25] to [Pr.42], [Pr.84])

**POINT**

When a value other than "0" has been set to the servo parameter "[Pr.100] Servo series" inside the flash ROM, the power is turned ON or PLC CPU is reset to transmit the servo parameter inside the flash ROM to the servo amplifier (servo amplifier LED indicates "b□").

After that, the TO instruction writes the servo parameter from the PLC CPU to the buffer memory so that the servo parameter in the buffer memory is not transmitted to the servo amplifier even if the PLC READY signal [Y0] is turned OFF then ON.

Change the servo parameter with the above method, after setting the servo parameter "[Pr.100] Servo series" inside the flash ROM, to "0".

(3) Validate parameters when PLC READY signal [Y0] changes from OFF to ON

When the PLC READY signal [Y0] changes from OFF to ON, the data stored in the buffer memory's "parameter area (a)<sup>\*4</sup>" is validated.

\*4: Parameter area (a) ..... Parameters validated when PLC READY signal [Y0] changes from OFF to ON.

([Pr.1] to [Pr.7], [Pr.11] to [Pr.24], [Pr.43] to [Pr.57], [Pr.80] to [Pr.83], [Pr.89] to [Pr.95])

**POINT**

The setting values of the parameters that correspond to parameter area (b) are valid when written into the buffer memory with the TO command.  
However, the setting values of the parameters that correspond to parameter area (a) are not validated until the PLC READY signal [Y0] changes from OFF to ON.

(4) Accessing with FROM command from PLC CPU (  )

The data is read from the buffer memory to the PLC CPU using the FROM command\*5.

\*5: "Servo parameter area ([Pr.196] to [Pr.332]), "Positioning data (No.101 to 600)" and "Block start data (No.7002 to 7004)" can be read with only GX Works2.

(5) Reading the servo parameter from the servo amplifier (  )

When the parameter of the servo amplifier side is changed, the servo parameter is read automatically from the servo amplifier to the buffer memory/internal memory.

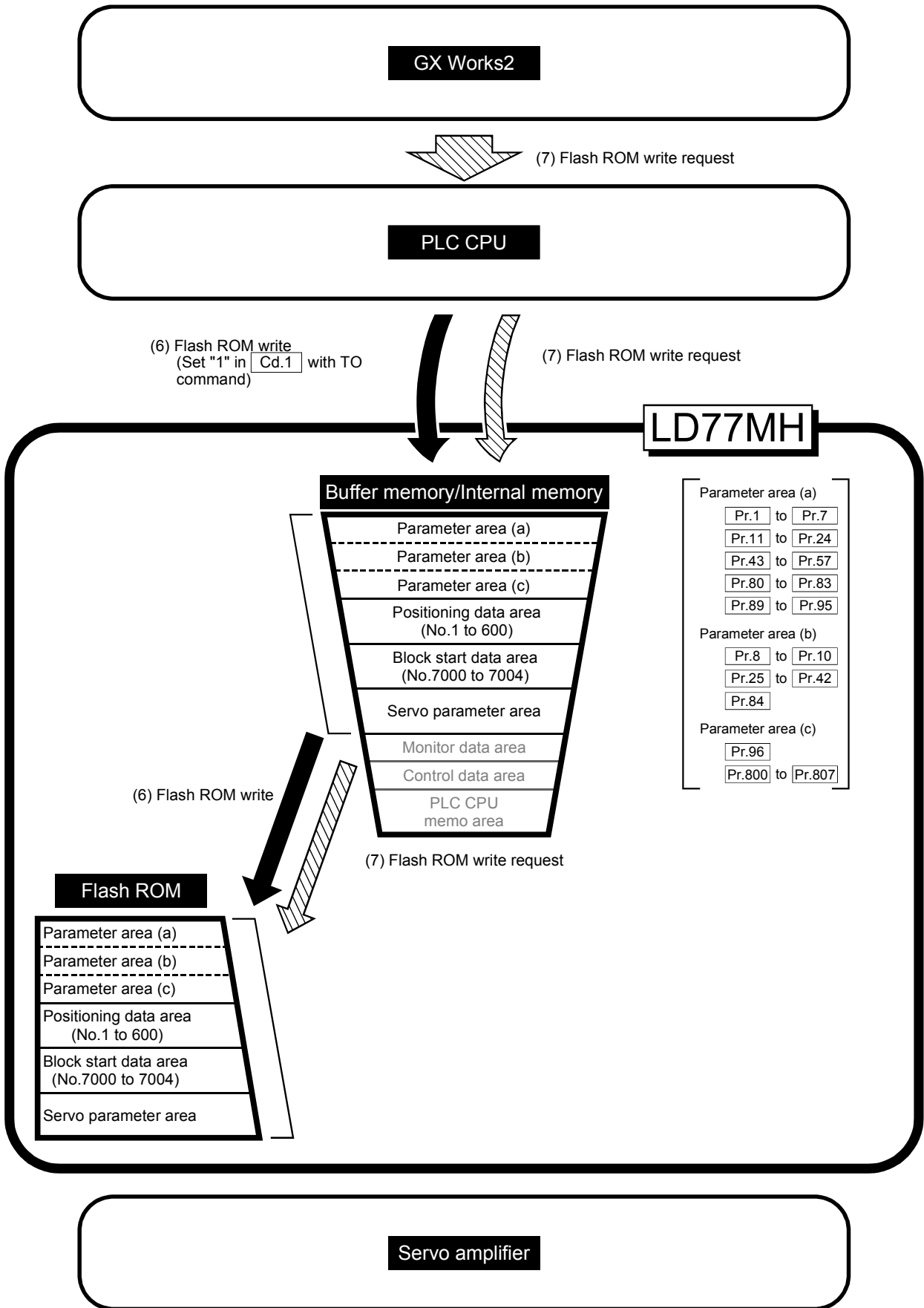

(6) Writing the flash ROM by a PLC CPU request (  )

The following transmission process is carried out by setting "1" in "[Cd.1] Flash ROM write request".

- 1) The "parameters", "positioning data (No. 1 to 600)", "block start data (No. 7000 to 7004)" and "servo parameter" in the buffer memory/internal memory area are transmitted to the flash ROM.

The writing to the flash ROM may also be carried out using a dedicated instruction "ZP.PFWRT". (Refer to Chapter 15 "Dedicated Instructions" for details.)

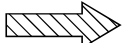
(7) Writing the flash ROM by a GX Works2 request (  )

The following transmission processes are carried out with the [flash ROM write request] from the GX Works2.

- 1) The "parameters", "positioning data (No. 1 to 600)", "block start data (No. 7000 to 7004)" and "servo parameter" in the buffer memory/internal memory area are transmitted to the flash ROM.

Note) This transmission process is the same as (6) above.

**IMPORTANT**

- (1) Do not turn the power OFF or reset the PLC CPU while writing to the flash ROM. If the power is turned OFF or the PLC CPU is reset to forcibly end the process, the data backed up in the flash ROM will be lost.
- (2) Do not write the data to the buffer memory/internal memory before writing to the flash ROM is completed.
- (3) The number of writes to the flash ROM with the sequence program is 25 max. while the power is turned ON.  
Writing to the flash ROM beyond 25 times will cause an error (error code: 805). Refer to Section 16.5 "List of errors" for details.
- (4) Monitoring is the number of writes to the flash ROM after power supply ON by the "[Md.19] Number of write accesses to flash ROM".

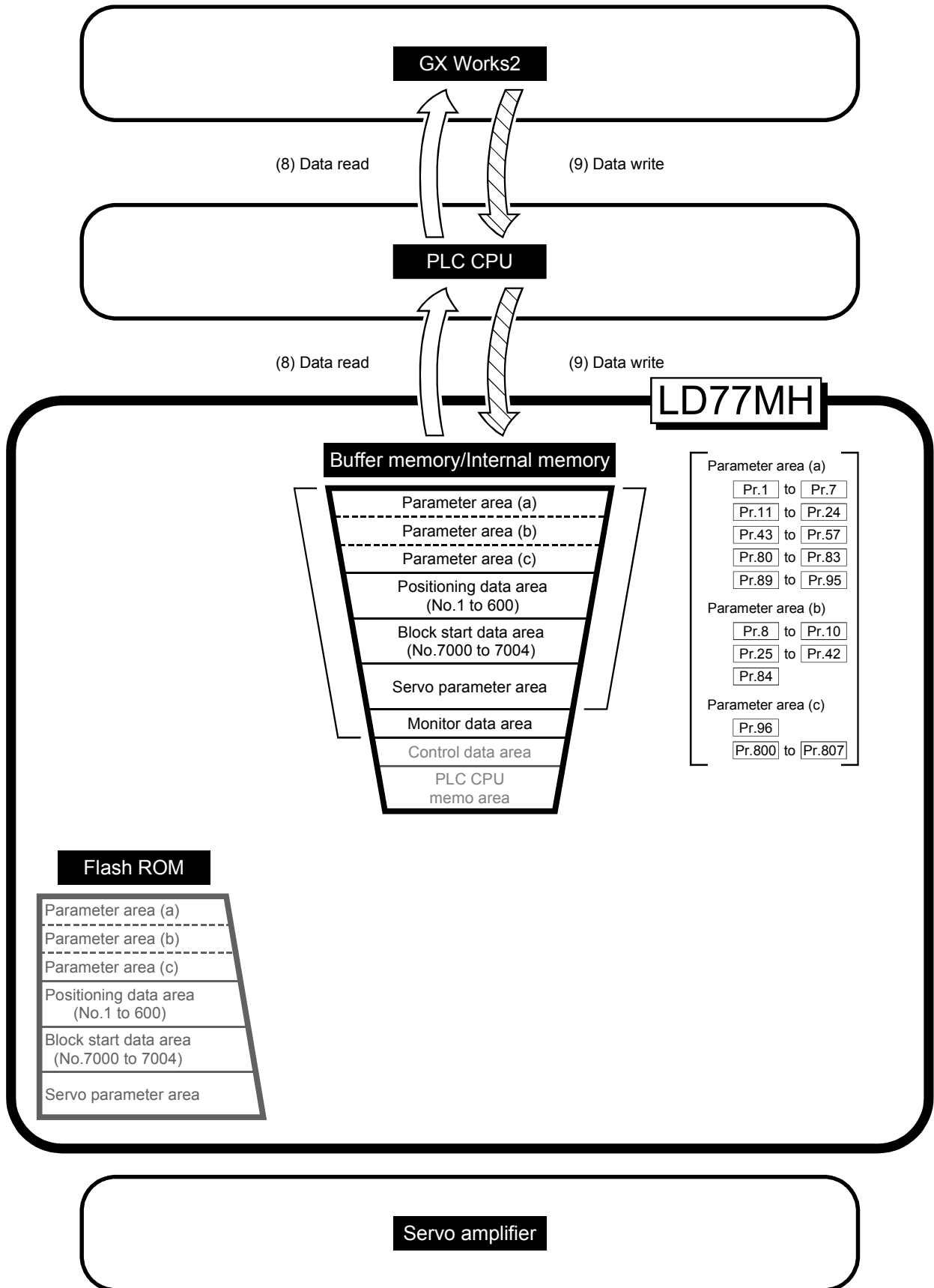



(8) Reading data from buffer memory/internal memory to GX Works2



The following transmission processes are carried out with the [Read from module] from the GX Works2.

- 1) The "parameters", "positioning data (No. 1 to 600)", "block start data (No. 7000 to 7004)" and "servo parameter" in the buffer memory/internal memory area are transmitted to the GX Works2 via the PLC CPU.

The following transmission processes are carried out with the [monitor] from the GX Works2.

- 2) The "monitor data" in the buffer memory area is transmitted to the GX Works2 via the PLC CPU.

(9) Writing data from GX Works2 to buffer memory/internal memory

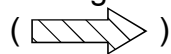



The following transmission processes are carried out with the [Write to module] from the GX Works2.

- 1) The "parameters", "positioning data (No. 1 to 600)", "block start data (No. 7000 to 7004)" and "servo parameter" in the GX Works2 are transmitted to the buffer memory/internal memory via the PLC CPU.

At this time, when [Flash ROM automatic write] is set with the GX Works2, the transmission processes indicated with the following are carried out.

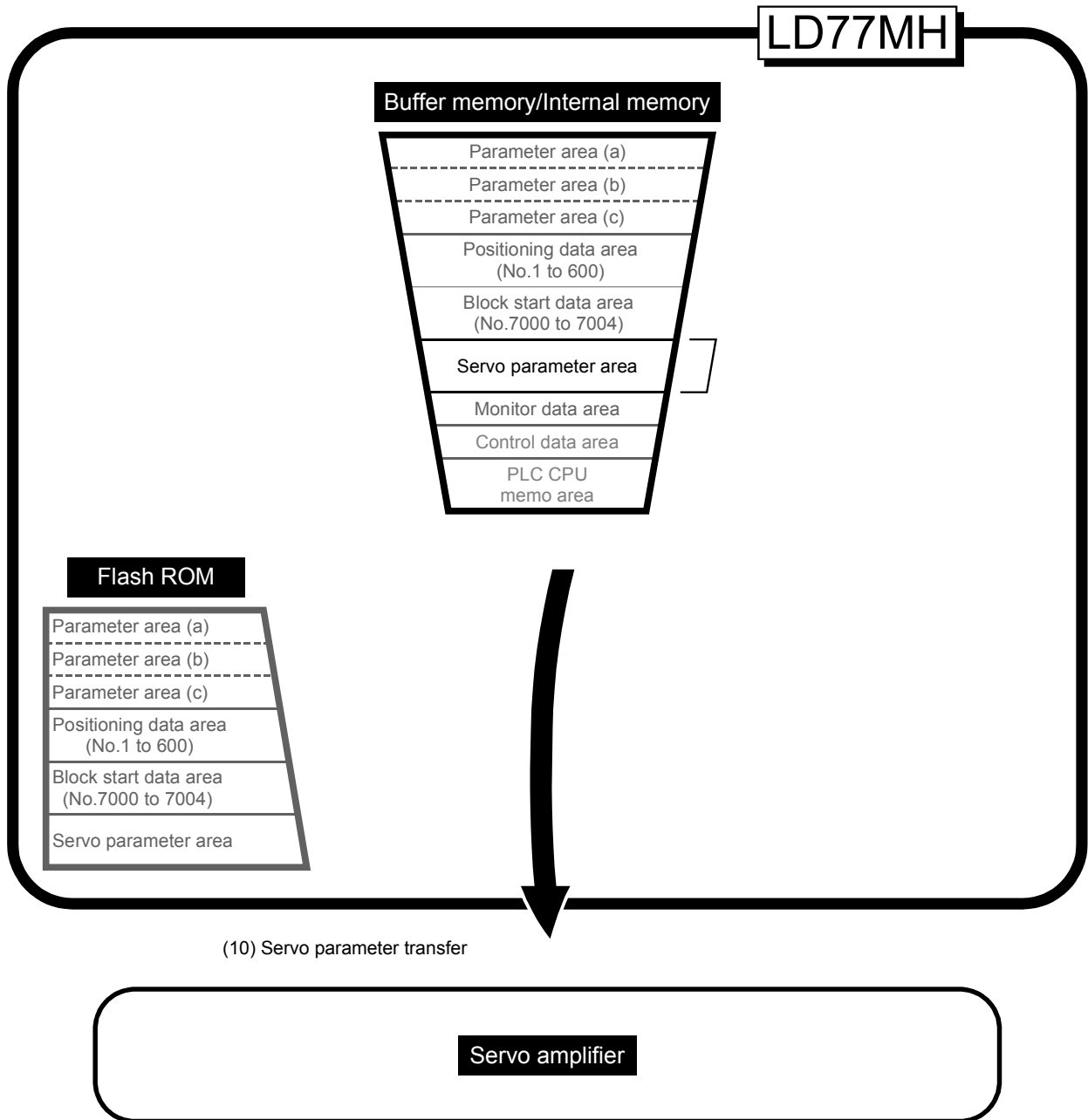
- (7) Flash ROM write



(10) Transmitting servo parameter from the buffer memory/internal memory area to servo amplifier (  )

The servo parameter in the buffer memory/internal memory area is transmitted to the servo amplifier by the following timing.

- 1) The servo parameter transmitted to the servo amplifier when communications with servo amplifier start.  
The "expansion parameter" and "servo parameter" in the buffer memory area is transmitted to the servo amplifier.
- 2) The following servo parameter in the buffer memory area are transmitted to the servo amplifier when the PLC READY signal [Y0] turns from OFF to ON.
  - "[Pr.108] Auto tuning mode" (Basic setting parameters)
  - "[Pr.109] Auto tuning response" (Basic setting parameters)
  - "[Pr.122] Feed forward gain" (Gain/filter parameters)
  - "[Pr.124] Ratio of load inertia moment to servo motor inertia moment" (Gain/filter parameters)
  - "[Pr.125] Model loop gain" (Gain/filter parameters)
  - "[Pr.126] Position loop gain" (Gain/filter parameters)
  - "[Pr.127] Speed loop gain" (Gain/filter parameters)
  - "[Pr.128] Speed integral compensation" (Gain/filter parameters)
  - "[Pr.129] Speed differential compensation" (Gain/filter parameters)

**POINT**

When the PLC READY signal [Y0] is turned ON, an error (error code: 1205) occurs, "[Pr.114] Rotation direction selection" is changed by sequence program or the GX Works2 after the servo parameter is transmitted to servo amplifier (LED of the servo amplifier is indicated b□, C□, or d□).

When "[Pr.114] Rotation direction selection" is changed, transmit the servo parameter to servo amplifier.

**■ About the communication start with servo amplifier**

Communication with servo amplifier is valid when following condition is realized together.

- 1) The power of LD77MH and servo amplifier is turned ON.
- 2) When the servo parameter "[Pr.100] Servo series" inside the buffer memory area is set to the value other than "0" in LD77MH.

When the power is turned ON or the PLC CPU is reset, the data stored in the flash ROM is transmitted to the buffer memory/internal memory.

Therefore the servo parameter "[Pr.100] Servo series" inside the flash ROM is stored to the value other than "0", and communication with servo amplifier is started when the power is turn ON in order of the servo amplifier, LD77MH. After the servo parameter stored in the flash ROM is transmitted to the servo amplifier.

■ How to transfer the servo parameter setup from sequence program/GX Works2 to the servo amplifier

The servo series of servo parameter "[Pr.100] Servo series" inside the flash ROM set to "0". (Initial value: "0")

The setting value of the parameters that correspond to the servo parameter "[Pr.100] Servo series" inside the flash ROM becomes valid when the power is turned ON or the PLC CPU is reset, after the communication with servo amplifier is not started.

However, the PLC READY signal [Y0] is changed from OFF to ON after setting the servo parameters ("[Pr.100] Servo series": except 0) with sequence program/GX Works2 the communication with servo amplifier starts.

■ How to transfer the servo parameter which wrote it in the flash ROM to servo amplifier

Flash ROM writing carried out after the servo parameter is set up in the buffer memory/internal memory.

After that, when the power is turned ON or the PLC CPU is reset, the servo parameters stored in the flash ROM is transmitted to the buffer memory/internal memory.

When the servo parameter is written in the flash ROM, it is unnecessary to use a setup from the sequence program/GX Works2.

■ Servo parameter of the buffer memory/internal memory

The following shows details about the operation timing and details the servo parameter transfer of the buffer memory/internal memory.

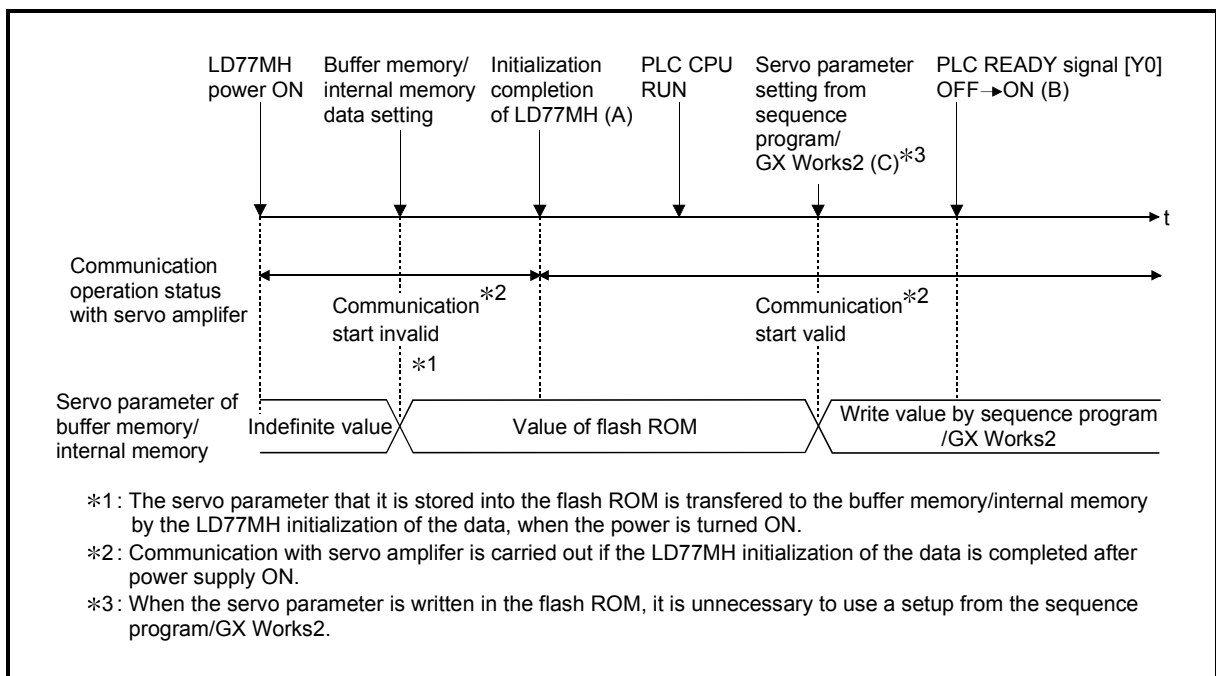

Fig. 7.1 Operation timing in the servo parameter transfer of the buffer memory

■ Operation details

- (1) Servo parameter transfers when servo amplifier had started and the system's power supply is turned ON.
- (a) When the servo parameter "Pr.100 Servo series" ≠ "0" is stored flash ROM.  
Communication start timing to the servo amplifier: Initialization completion (Fig. 7.1 A)
- Transfer the servo parameter : The data stored (backed up) in the flash ROM.
- (b) When the servo parameter "Pr.100 Servo series" = "0" is stored flash ROM.  
Communication start timing to the servo amplifier: The data written from sequence program before the PLC READY signal [Y0] ON (Fig. 7.1 B).
- Transfer the servo parameter : The data written from sequence program/ GX Works2 before the PLC READY signal [Y0] ON (Fig. 7.1 C).
- (2) Servo parameter transfers when servo amplifier had started after the PLC READY signal [Y0] is turned OFF to ON (Fig. 7.1 B)  
Communication start timing to the servo amplifier: when servo amplifier had started
- Transfer the servo parameter : The data written from sequence program/ GX Works2 before the PLC READY signal [Y0] ON (Fig. 7.1 C).

■ How to change individually the servo parameter after transfer of servo parameter

The servo parameters can be individually changed from LD77MH with the following axis control data.

Setting item		Setting details	Buffer memory address	
			LD77MH4	LD77MH16
Cd.130	Parameter write request	Set the write request of servo parameter. Set "1" after setting "Cd.131 Parameter No." and "Cd.132 Change data". 1 : Write request Other than 1 : Not request	1554+100n	4354+100n
Cd.131	Parameter No.	Set the servo parameter to be changed.	1555+100n	4355+100n
Cd.132	Change data	Set the change value of servo parameter set in "Cd.131 Parameter No.".	1556+100n	4356+100n

n: Axis No.-1

POINT
<p>(1) Both of the servo parameter area (buffer memory/internal memory) of LD77MH's and the parameter of servo amplifier are changed.</p> <p>(2) The servo parameter area of LD77MH's flash ROM is not changed. Execute the flash ROM writing to back up the parameters.</p> <p>(3) When the servo parameters that become valid by turning ON the servo amplifier's power supply are changed, be sure to turn ON <sup>(Note)</sup> twice the servo amplifier's power supply after change.</p> <p>(Note): The servo amplifier's RAM data are changed by parameter setting, but the servo amplifier's EEPROM data are not changed. The EEPROM data before the change are overwritten to RAM by the servo amplifier's power supply ON again, and then the servo amplifier starts. After that, the changed data are written to the servo amplifier's EEPROM in an initial communication with LD77MH. Therefore, the changed data are overwritten to the RAM data by turning the servo amplifier's power supply ON again.</p>

# MEMO

---

---

---

---

---

---

---

---

---

---

---

---

---

---

---

---

---

---

---

---

---

---

---

---

---

---

---

---

---

---

## Section 2 Control Details and Setting

Section 2 is configured for the following purposes shown in (1) to (3).

- (1) Understanding of the operation and restrictions of each control.
- (2) Carrying out the required settings in each control
- (3) Dealing with errors

The required settings in each control include parameter setting, positioning data setting, control data setting by a sequence program, etc.

Carry out these settings while referring to "Chapter 5 Data Used for Positioning Control". Also refer to "Chapter 6 Sequence Program Used for Positioning Control" when creating the sequence programs required in each control, and consider the entire control program configuration when creating each program.

Chapter 8	OPR Control .....	8- 1 to 8- 20
Chapter 9	Major Positioning Control.....	9- 1 to 9-126
Chapter 10	High-Level Positioning Control .....	10-1 to 10- 28
Chapter 11	Manual Control.....	11-1 to 11- 32
Chapter 12	Expansion Control.....	12-1 to 12- 14
Chapter 13	Control Sub Functions .....	13-1 to 13-104
Chapter 14	Common Functions.....	14-1 to 14- 36
Chapter 15	Dedicated Instructions .....	15-1 to 15- 18
Chapter 16	Troubleshooting .....	16-1 to 16- 66





# Chapter 8 OPR Control

The details and usage of "OPR control" are explained in this chapter.

OPR control includes "machine OPR" that establish a machine OP without using address data, and "fast OPR" that store the coordinates established by the machine OPR, and carry out positioning to that position.

OPR carried out by sequence programs from the PLC CPU are explained in this chapter. Refer to the "Simple Motion Module Setting Tool Help" of GX Works2 for details on OPR using the GX Works2.

8.1	Outline of OPR control .....	8- 2
8.1.1	Two types of OPR control.....	8- 2
8.2	Machine OPR .....	8- 5
8.2.1	Outline of the machine OPR operation .....	8- 5
8.2.2	Machine OPR method .....	8- 6
8.2.3	OPR method (1): Near-point dog method.....	8- 7
8.2.4	OPR method (2): Count method 1).....	8- 9
8.2.5	OPR method (3): Count method 2).....	8-11
8.2.6	OPR method (4): Data set method .....	8-13
8.2.7	OPR method (5): Scale origin signal detection method .....	8-14
8.3	Fast OPR .....	8-17
8.3.1	Outline of the fast OPR operation .....	8-17
8.4	Selection of the OPR setting condition .....	8-19
8.4.1	Outline of the OPR setting condition.....	8-19

## 8.1 Outline of OPR control

### 8.1.1 Two types of OPR control

In "OPR control" a position is established as the starting point (or "OP") when carrying out positioning control, and positioning is carried out toward that starting point. It is used to return a machine system at any position other than the OP to the OP when the LD77MH issues a "OPR request" <sup>(Note-1)</sup> with the power turned ON or others, or after a positioning stop.

In the LD77MH, the two types of controls shown below are defined as "OPR control", following the flow of the OPR work.

These two types of OPR control can be executed by setting the "OPR parameters" setting "Positioning start No. 9001" and "positioning start No. 9002" prepared beforehand in the LD77MH to "[Cd.3] Positioning start No.", and turning ON the positioning start signal.

The ZP.PSTRT□ start numbers of the dedicated instruction can also be set to 9001 or 9002 to execute the OPR control. (For details, refer to Chapter 15 "Dedicated Instructions".)

- (1) Establish a positioning control OP
  - "Machine OPR" (positioning start No. 9001)
- (2) Carry out positioning toward the OP
  - "Fast OPR" (positioning start No. 9002).

The "machine OPR" above must always be carried out before executing the "fast OPR".

### CAUTION

- When using the absolute position system function, on starting up, and when the LD77MH or absolute value motor has been replaced, always perform an OPR. In the case of the absolute position system, use the sequence program to check the OPR request before performing the positioning control. Failure to observe this could lead to an accident such as a collision.

**REMARK**OPR request <sup>(Note-1)</sup>

The "OPR request flag" ( **[Md.31]** Status: b3) must be turned ON in the LD77MH, and a machine OPR must be executed in the following cases.

(1) When not using an absolute position system

(a) This flag turns on in the following cases:

- System's power supply on or reset
- Servo amplifier power supply on
- Machine OPR start

(Unless a machine OPR is completed normally, the OPR request flag does not turn off.)

(b) This flag turns off by the completion of machine OPR.

(2) When using an absolute position system

(a) This flag turns on in the following cases:

- When not executing a machine OPR once after system start.
- Machine OPR start

(Unless a machine OPR is completed normally, the OPR request flag does not turn off.)

- Erase of an absolute data in LD77MH according to causes, such as battery error (error [1201] occurrence)

- Error [2025] (absolute position erase) occurrence

(**[Md.108]** Servo status (high-order buffer memory address) b14 ON)

- Warning [2143] (absolute position counter warning) occurrence

(**[Md.108]** Servo status (high-order buffer memory address) b14 ON)

	Buffer memory address (high-order)	
	LD77MH4	LD77MH16
<b>[Md.108]</b> Servo status: b14	877+100n	2477+100n

- When the "**[Pr.114]** Rotation direction selection" of servo parameter is changed.

(b) This flag turns off by the completion of the machine OPR.

The address information stored in the LD77MH cannot be guaranteed while the "OPR request flag" is ON.

The "OPR request flag" turns OFF and the "OPR complete flag" ( **[Md.31]** Status: b4) turns ON if the machine OPR is executed and is completed normally.

### ■ Wiring the near-point dog

The external input signal of the servo amplifier is used as the near-point dog.

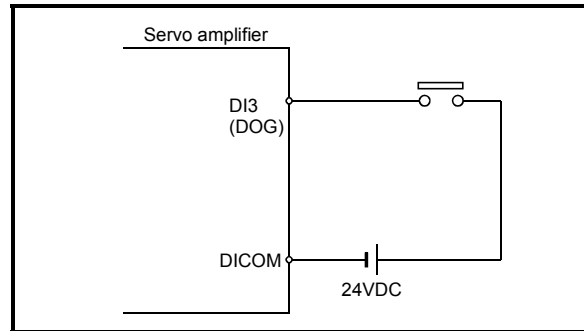

Fig. 8.1 Wiring when using the near-point dog

### ■ OPR sub functions

Refer to Section 3.2.5 "Combination of LD77MH main functions and sub functions" for details on "sub functions" that can be combined with OPR control. Also refer to Chapter 13 "Control Sub Functions" for details on each sub function.

[Remarks]

The following two sub functions are only related to machine OPR.

Sub function name	Machine OPR	Fast OPR	Reference
OPR retry function	△	×	Section 13.2.1
OP shift function	○	×	Section 13.2.2

○ : Combination possible, △: Restricted, ×: Combination not possible

### ■ When an OPR is not required

Control can be carried out ignoring the "OPR request flag" ( [Md.31](#) Status: b3) in systems that do not require an OPR.

In this case, the "OPR parameters ( [Pr.43](#) to [Pr.57](#) )" must all be set to their initial values or a value at which an error does not occur.

### ■ OPR from GX Works2

"Machine OPR" and "fast OPR" can be executed from the test function of the GX Works2.

Refer to the "Simple Motion Module Setting Tool Help" of GX Works2 for details on OPR from the GX Works2.

## 8.2 Machine OPR

### 8.2.1 Outline of the machine OPR operation

#### Important

Use the OPR retry function when the OP position is not always in the same direction from the workpiece operation area (when the OP is not set near the upper or lower limit of the machine).

The machine OPR may not complete unless the OPR retry function is used.

#### ■ Machine OPR operation

In a machine OPR, OP is established.

None of the address information stored in the LD77MH, PLC CPU, or servo amplifier is used at this time. The position mechanically established after the machine OPR is regarded as the "OP" to be the starting point for positioning control.

The method for establishing an "OP" by a machine OPR differs according to the method set in " [Pr.43] OPR method".

The following shows the operation when starting a machine OPR.

1)	The "machine OPR" is started.
2)	The operation starts according to the speed and direction set in the OPR parameters ( [Pr.43] to [Pr.57] ).
3)	The "OP" is established by the method set in " [Pr.43] OPR method", and the machine stops. (Refer to Sections 8.2.2 to 8.2.7)
4)	If "a" is set as " [Pr.45] OP address", "a" will be stored as the current position in the " [Md.20] Current feed value" and " [Md.21] Machine feed value" which are monitoring the position.
5)	The machine OPR is completed.

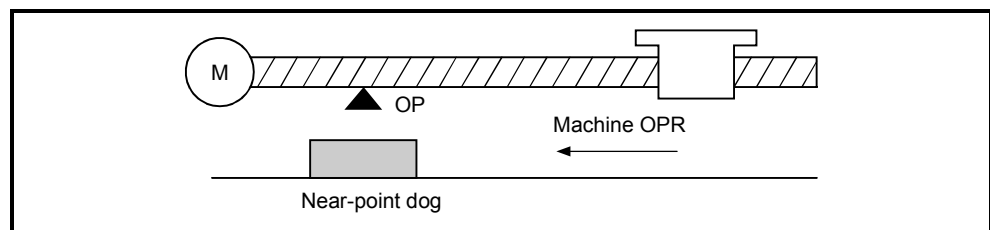

Fig. 8.2 Example of a machine OPR

## 8.2.2 Machine OPR method

The method by which the machine OP is established (method for judging the OP position and machine OPR completion) is designated in the machine OPR according to the configuration and application of the positioning method.

The following table shows the methods that can be used for this OPR method.

(The OPR method is one of the items set in the OPR parameters. It is set in " [Pr.43] OPR method" of the basic parameters for OPR.)

[Pr.43] OPR method	Operation details
Near-point dog method (Note-1)	Deceleration starts by the OFF → ON of the near-point dog. (Speed is reduced to "[Pr.47] Creep speed".) The operation stops once after the near-point dog turns ON and then OFF. Later the operation restarts and then stops at the first zero signal to complete the OPR.
Count method 1) (Note-1)	The deceleration starts by the OFF → ON of the near-point dog, and the machine moves at the "[Pr.47] Creep speed". The machine stops once after moving the distance set in the "[Pr.50] Setting for the movement amount after near-point dog ON" from the OFF → ON position. Later the operation restarts and then stops at the first zero point to complete the machine OPR.
Count method 2) (Note-1)	The deceleration starts by the OFF → ON of the near-point dog, and the machine moves at the "[Pr.47] Creep speed". The machine moves the distance set in the "[Pr.50] Setting for the movement amount after near-point dog ON" from the near-point dog OFF → ON position, and stops at that position. The machine OPR is then regarded as completed.
Data set method	The position where the machine OPR has been performed becomes an OP. The current feed value and feed machine value are overwritten to the OP address.
Scale origin signal detection method (Note-1)	The machine moves in the opposite direction against of "[Pr.44] OPR direction" at the "[Pr.46] OPR speed" by the OFF → ON of the near-point dog, and a deceleration stop is carried out once at the first zero signal. Later the operation moves in direction of "[Pr.44] OPR direction" at the "[Pr.47] Creep speed", and then stops at the detected nearest zero point to complete the machine OPR.

(Note-1): The external input signal of the servo amplifier is used as the near-point dog.

### REMARK

#### Creep speed

The stopping accuracy is poor when the machine suddenly stops from fast speeds.

To improve the machine's stopping accuracy, its must change over to a slow speed before stopping. This speed is set in the "[Pr.47] Creep speed".

The following shows the signals as required for machine OPR.

[Pr.43] OPR method	Signals required for control		
	Near-point dog	Zero signal	Upper/lower limit
Near-point dog method	◎	◎	○
Count method 1)	◎	◎	○
Count method 2)	◎	—	○
Data set method	—	—	—
Scale origin signal detection method	◎	◎	—

◎: Necessary, ○: Necessary as required, —: Unnecessary

### 8.2.3 OPR method (1): Near-point dog method

The following shows an operation outline of the "near-point dog method" OPR method.

#### ■ Operation chart

1)	The machine OPR is started. (The machine begins the acceleration designated in " [Pr.51] OPR acceleration time selection", in the direction designated in " [Pr.44] OPR direction". It then moves at the " [Pr.46] OPR speed" when the acceleration is completed.)
2)	The machine begins decelerating when the near-point dog ON is detected.
3)	The machine decelerates to the " [Pr.47] Creep speed", and subsequently moves at that speed. (At this time, the near-point dog must be ON. The workpiece will continue decelerating and stop if the near-point dog is OFF.)
4)	After the near-point dog turns OFF, the machine stops. It then restarts and stops at the first zero point.
5)	The OPR complete flag ( [Md.31] Status: b4) turns from OFF to ON and the OPR request flag ( [Md.31] status: b3) turns from ON to OFF.

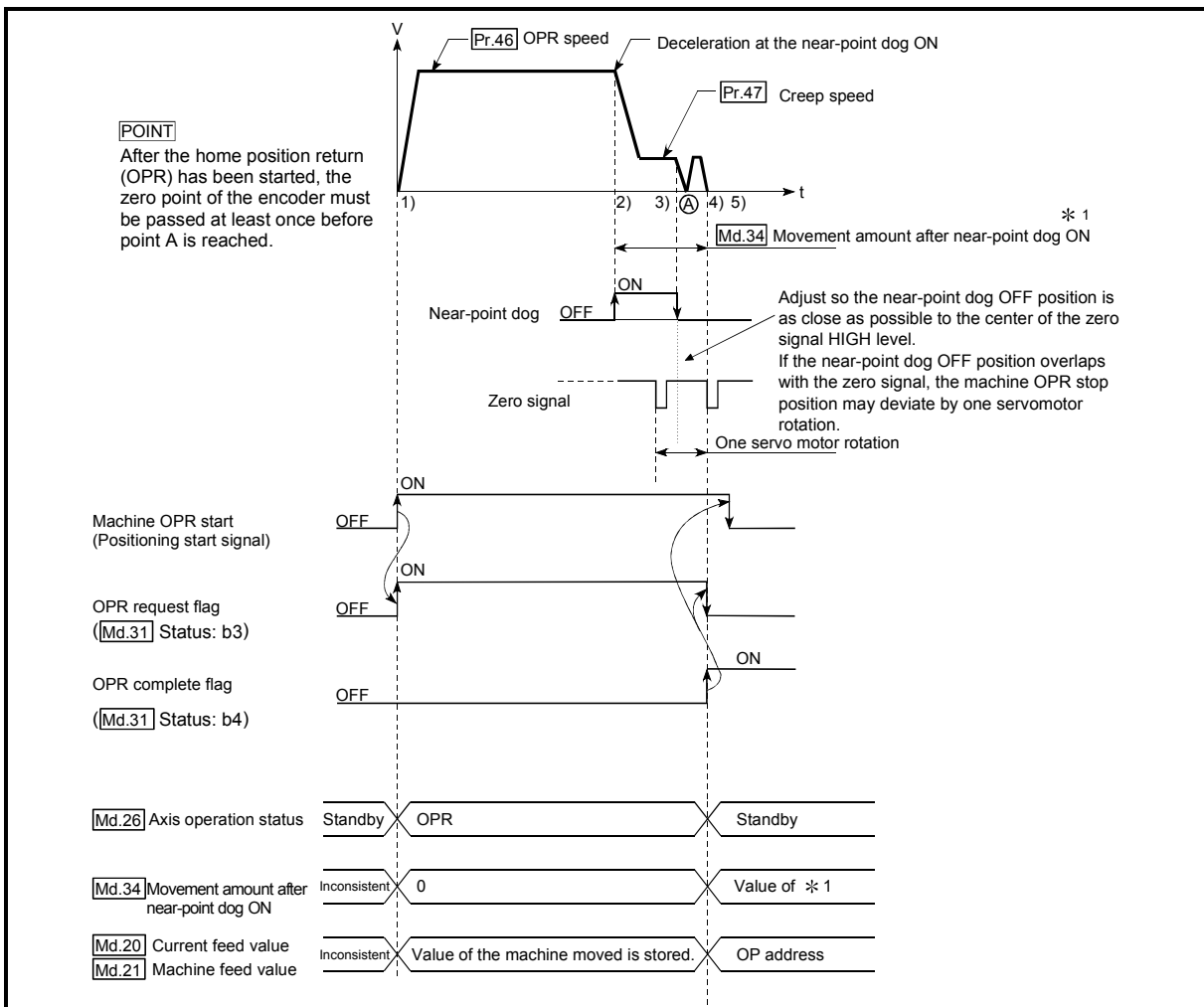

Fig. 8.3 Near-point dog method machine OPR



■ Precautions during operation

- (1) An error "Start at home position (OP) fault (error code: 201)" will occur if another machine OPR is attempted after a machine OPR completion when the OPR retry function is not set ("0" is set in " Pr.48 OPR retry").
- (2) Machine OPR carried out from the near-point dog ON position will start at the " Pr.47 Creep speed".
- (3) The near-point dog must be ON during deceleration from the OPR speed " Pr.47 Creep speed".
- (4) When the stop signal stops the machine OPR, carry out the machine OPR again. When restart command is turned ON after the stop signal stops the OPR, the error "OPR restart impossible (error code: 209)" will occur.
- (5) After the home position return (OPR) has been started, the zero point of the encoder must be passed at least once before point A is reached.  
 However, if selecting "1: Not need to pass motor Z-phase after the power supply is switched on." with " Pr.180 Function selection C-4", it is possible to carried out the home position return (OPR) without passing the zero point. The workpiece will continue decelerating and stop if the near-point dog is turned OFF before it has decelerated to the creep speed, thus causing an error "Dog detection timing fault (error code: 203)".

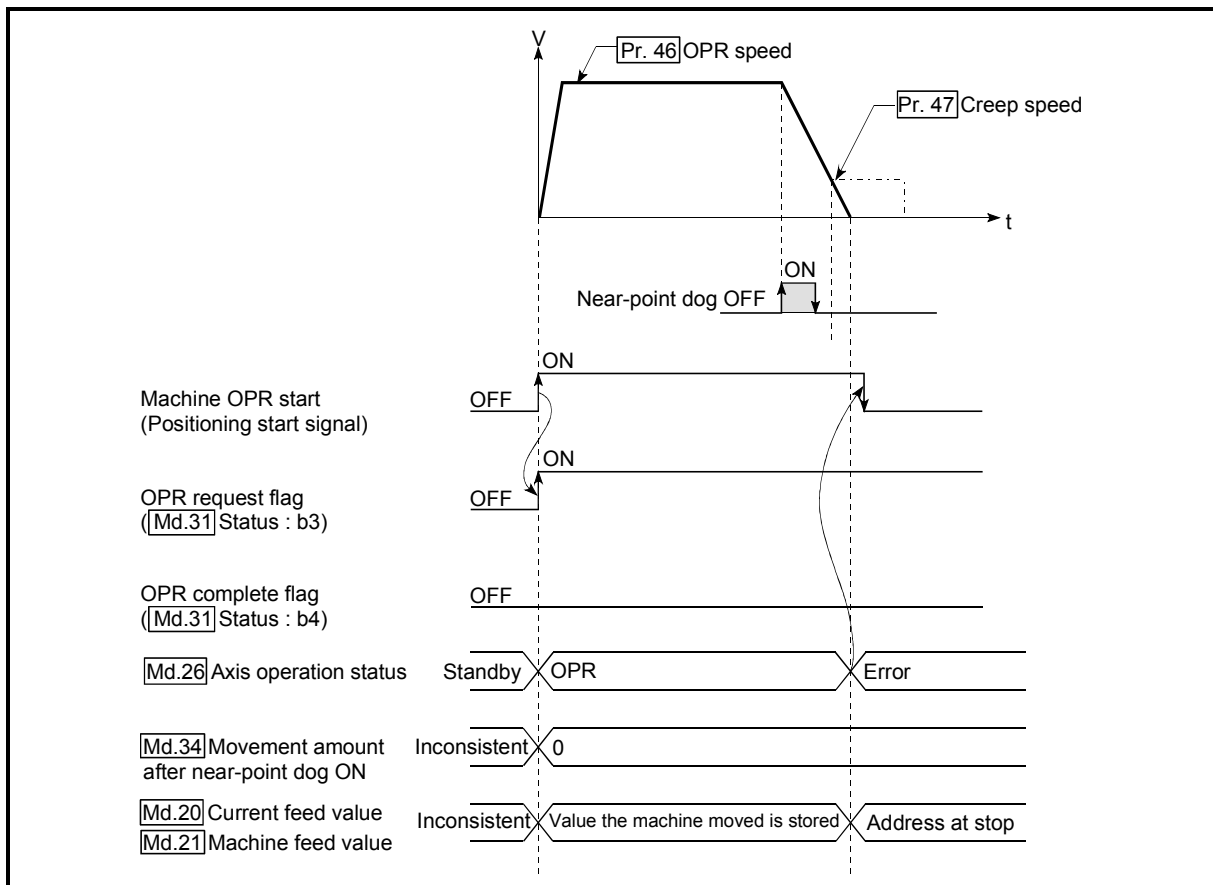

Fig. 8.4 Operation when the near-point dog is turned OFF before the creep speed is reached

### 8.2.4 OPR method (2): Count method 1)

The following shows an operation outline of the "count method 1)" OPR method.

In the "count method 1)" OPR, the following can be performed:

- Machine OPR on near-point dog
- Second machine OPR after completion of first machine OPR

The external input signal of the servo amplifier is used as the near-point dog.

#### ■ Operation chart

1)	The machine OPR is started. (The machine begins the acceleration designated in " [Pr.51] OPR acceleration time selection", in the direction designated in " [Pr.44] OPR direction". It then moves at the " [Pr.46] OPR speed" when the acceleration is completed.)
2)	The machine begins decelerating when the near-point dog ON is detected.
3)	The machine decelerates to the " [Pr.47] Creep speed", and subsequently moves at that speed.
4)	The machine stops after the workpiece has been moved the amount set in the " [Pr.50] Setting for the movement amount after near-point dog ON" after the near-point dog turned ON. It then restarts and stops at the first zero point.
5)	The OPR complete flag [Md.31] Status: b4) turns from OFF to ON, and the OPR request flag ([Md.31] Status: b3) turns from ON to OFF.

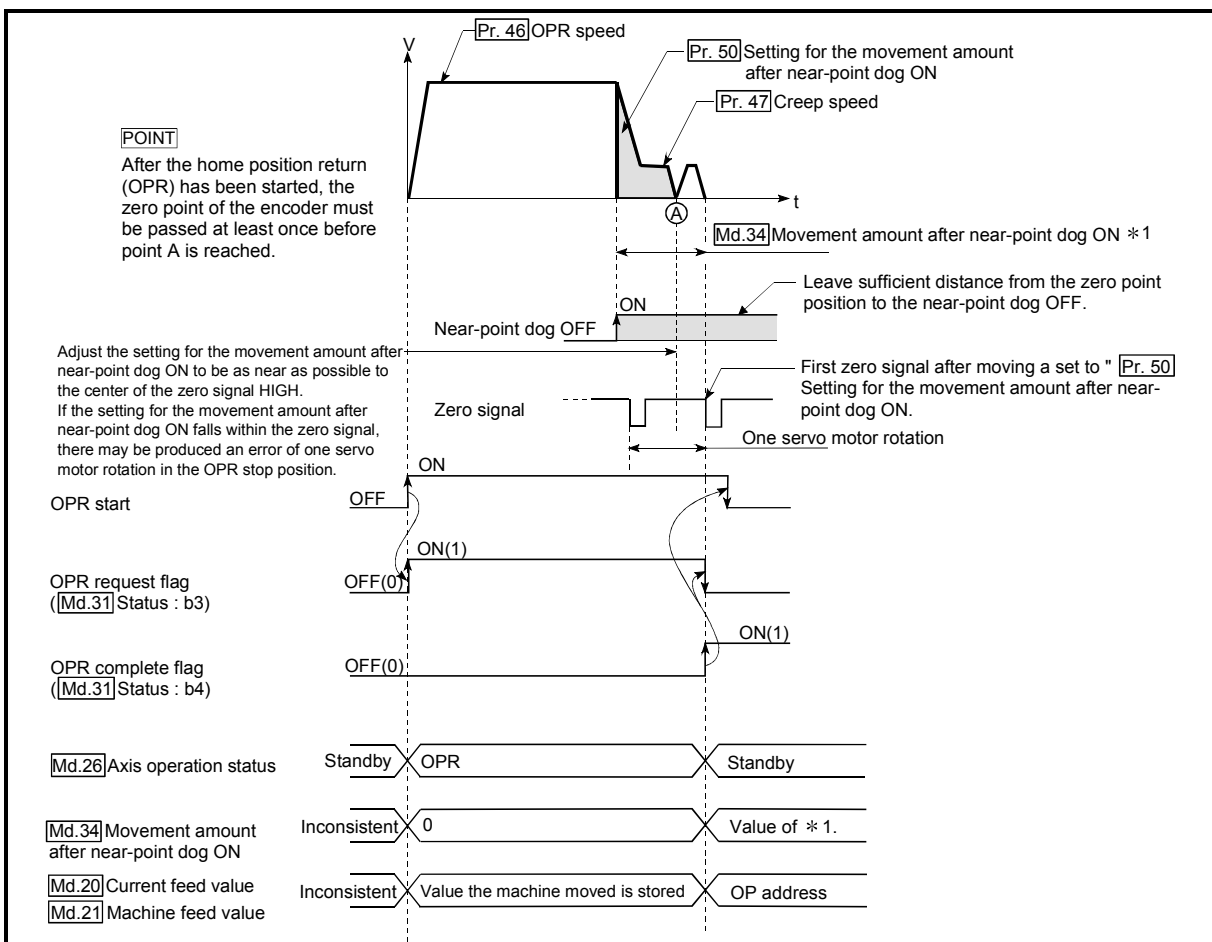

Fig. 8.5 Count method1) machine OPR

### ■ Precautions during operation

- (1) An error "Count method movement amount fault (error code: 206)" will occur if the " [Pr.50] Setting for the movement amount after near-point dog ON" is smaller than the deceleration distance from the " [Pr.46] OPR speed" to " [Pr.47] Creep speed".
- (2) If the speed is changed to a speed faster than "[Pr.46] OPR speed" by the speed change function (refer to "13.5.1 Speed change function".) during a machine OPR, the distance to decelerate to "[Pr.47] Creep speed" may not be ensured, depending on the setting value of "[Pr.50] Setting for the movement amount after near-point dog ON". In this case, the error "Count method movement amount fault" (error code: 206) occurs and the machine OPR is stopped.
- (3) The following shows the operation when a machine OPR is started while the near-point dog is ON.
- (4) Turn OFF the near-point dog at a sufficient distance from the OP.  
Although there is no harm in operation if the near-point dog is turned OFF during a machine OPR, it is recommended to leave a sufficient distance from the OP when the near-point dog is turned OFF for the following reason.  
If machine OPRs are performed consecutively after the near-point dog is turned OFF at the time of machine OPR completion, operation will be performed at the OPR speed until the hardware stroke limit (upper/lower limit) is reached.  
If a sufficient distance cannot be kept, consider the use of the OPR retry function.
- (5) When the stop signal stops the machine OPR, carry out the machine OPR again. When restart command is turned ON after the stop signal stops the OPR, the error "OPR restart impossible (error code: 209)" will occur.
- (6) After the home position return (OPR) has been started, the zero point of the encoder must be passed at least once before point A is reached.  
However, if selecting "1: Not need to pass motor Z-phase after the power supply is switched on." with "[Pr.180] Function selection C-4", it is possible to carry out the home position return (OPR) without passing the zero point.

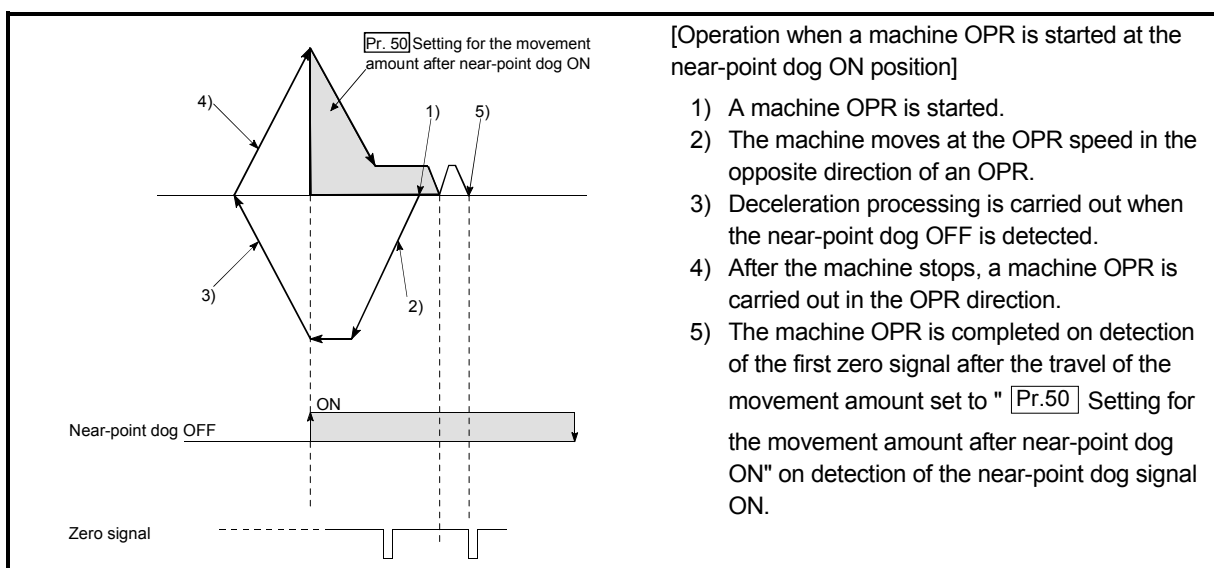

Fig. 8.6 Count method 1) machine OPR on the near-point dog ON position

### 8.2.5 OPR method (3): Count method 2)

The following shows an operation outline of the "method 2)" OPR method.  
 The "count method 2)" method is effective when a "zero signal" cannot be received.  
 (Note that compared to the "count method 1)" method, using this method will result in more deviation in the stop position during machine OPR.)  
 The external input signal of the servo amplifier is used as the near-point dog.

#### ■ Operation chart

1)	The machine OPR is started. (The machine begins the acceleration designated in " Pr.51 OPR acceleration time selection", in the direction designated in " Pr.44 OPR direction". It then moves at the " Pr.46 OPR speed" when the acceleration is completed.)
2)	The machine begins decelerating when the near-point dog ON is detected.
3)	The machine decelerates to the " Pr.47 Creep speed", and subsequently moves at that speed.
4)	The command from the LD77MH will stop and the machine OPR will be completed when the machine moves the movement amount set in " Pr.50 Setting for the movement amount after near-point dog ON " from the near-point dog ON position.

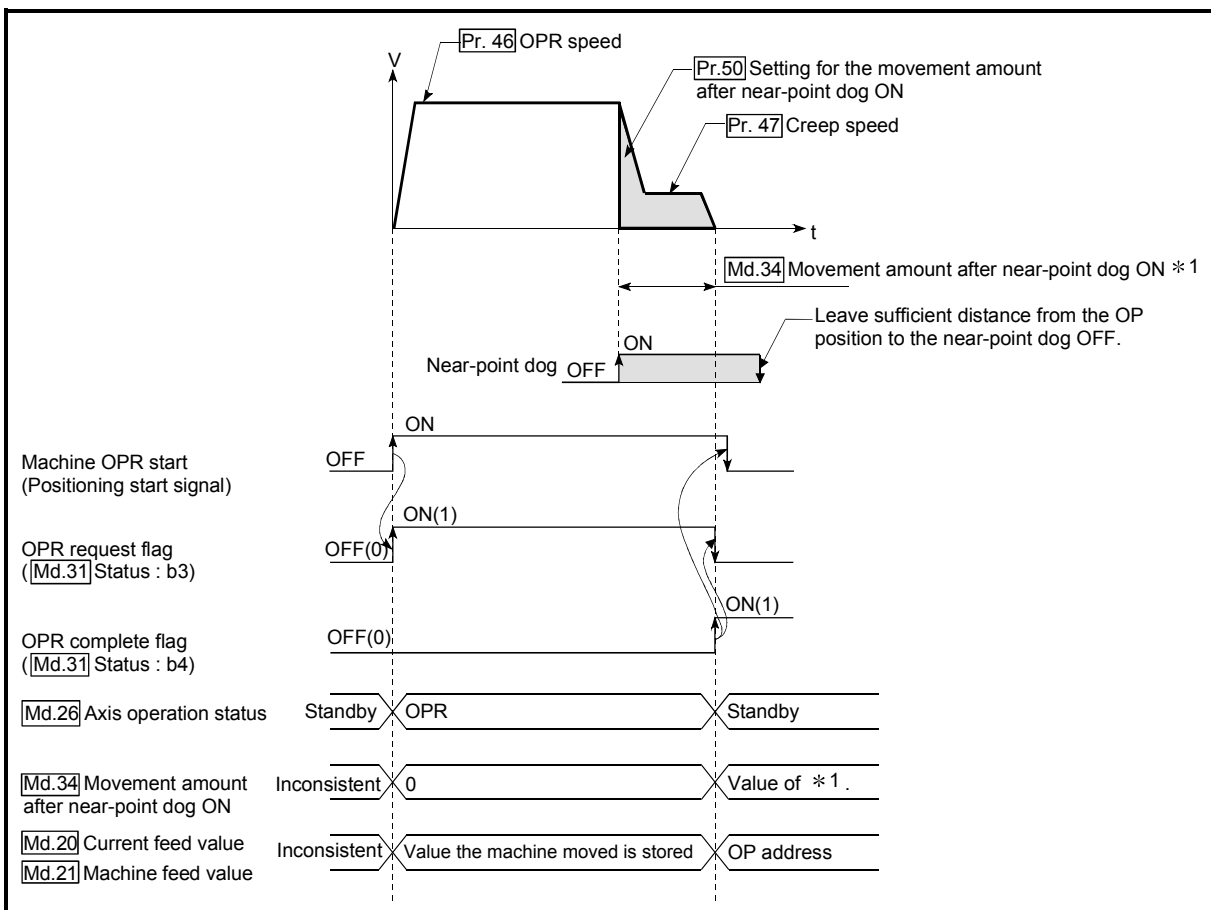

Fig. 8.7 Count method 2) machine OPR

### ■ Restrictions

When this method is used, a deviation will occur in the stop position (OP) compared to other OPR methods because an error of about 1 ms occurs in taking in the near-point dog ON.

### ■ Precautions during operation

- (1) An error "Count method movement amount fault (error code: 206)" will occur and the operation will not start if the " Pr.50 Setting for the movement amount after near-point dog ON" is smaller than the deceleration distance from the " Pr.46 OPR speed" to " Pr.47 Creep speed".
- (2) If the speed is changed to a speed faster than " Pr.46 OPR speed" by the speed change function (refer to "13.5.1 Speed change function".) during a machine OPR, the distance to decelerate to " Pr.47 Creep speed" may not be ensured, depending on the setting value of " Pr.50 Setting for the movement amount after near-point dog ON". In this case, the error "Count method movement amount fault" (error code: 206) occurs and the machine OPR is stopped.
- (3) The following shows the operation when a machine OPR is started while the near-point dog is ON.
- (4) Turn OFF the near-point dog at a sufficient distance from the OP. Although there is no harm in operation if the near-point dog is turned OFF during a machine OPR, it is recommended to leave a sufficient distance from the OP when the near-point dog is turned OFF for the following reason. If machine OPRs are performed consecutively after the near-point dog is turned OFF at the time of machine OPR completion, operation will be performed at the OPR speed until the hardware stroke limit (upper/lower limit) is reached. If a sufficient distance cannot be kept, consider the use of the OPR retry function.
- (5) When the stop signal stops the machine OPR, carry out the machine OPR again. When restart command is turned ON after the stop signal stops the OPR, the error "OPR restart impossible (error code: 209)" will occur.

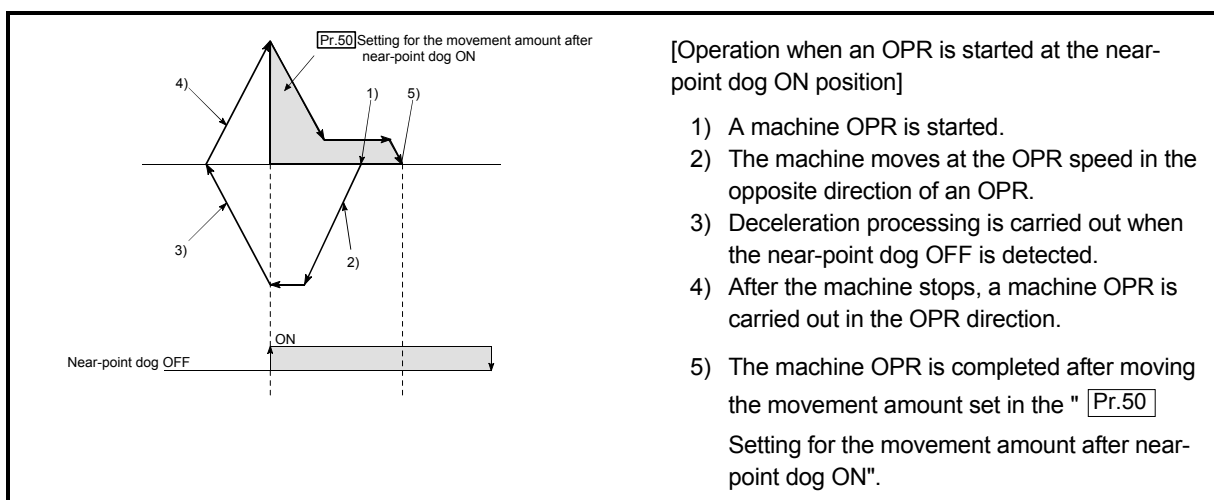

Fig. 8.8 Count method 2) machine OPR on the near-point dog ON position

## 8.2.6 OPR method (4): Data set method

The following shows an operation outline of the "data set method" OPR method.

The "Data set method" method is effective when a "Near-point dog" does not used.

It can be used with absolute position system.

With the data set method OPR, the position where the machine OPR has been carried out, is registered into the LD77MH as the OP, and the current feed value and feed machine value is overwritten to an OP address.

Use the JOG or manual pulse generator operation to move the OP.

### ■ Operation chart

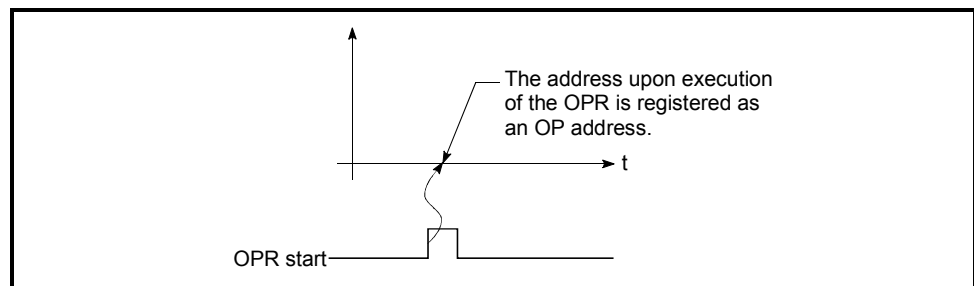

Fig. 8.9 Data set method OPR

### ■ Precautions during operation

- (1) The zero point must have been passed before the OPR is carried out after the power supply is turned ON. If the OPR is carried out without passing the zero point even once, the "OPR restart zero point not passed error" will occur. When the "Home positioning return (OPR) restart zero point not passed error" occurs, perform the JOG or similar operation so that the servomotor makes more than one revolution after an error reset, before carrying out the machine OPR again.  
However, if selecting "1: Not need to pass motor Z-phase after the power supply is switched on." with "Pr.180" Function selection C-4", it is possible to carried out the home position return (OPR).
- (2) When it is not the case of the absolute position system, starting the data set method OPR will be identical to the function of the current value change.
- (3) The OPR data used for the data set method is the "OPR direction" and "OP address".  
The OPR data other than that for the OPR direction and OP address is not used for the data set method OPR method, but if a value is set the outside the setting range, an error will occur when the PLC READY signal [Y0] is turned ON so that the LD77 READY signal [X0] is not turned OFF.  
With the OPR data other than that for the OPR direction and OP address, set an arbitrary value (default value can be allowed) within each data setting range so that an error will not occur upon receiving the PLC READY signal [Y0] ON.

### 8.2.7 OPR method (5): Scale origin signal detection method

The following shows an operation outline of the "scale origin signal detection method" OPR method.

POINT
Set "0: Need to pass motor Z-phase after the power supply is switched on." in "[Pr.180] Function selection C-4". If "1: Not need to pass motor Z-phase after the power supply is switched on." is set, the error "Z-phase passing parameter invalid" (error code: 231) will occur at the start of scale origin signal detection method OPR.

#### ■ Operation chart

1)	The machine OPR is started. (The machine begins the acceleration designated in "[Pr.51] OPR acceleration time selection", in the direction designated in "[Pr.44] OPR direction". It then moves at the "[Pr.46] OPR speed" when the acceleration is completed.)
2)	The machine begins decelerating when the near-point dog ON is detected.
3)	After deceleration stop, the machine moves in the opposite direction against of OPR at the "[Pr.46] OPR speed".
4)	During movement, the machine begins decelerating when the first zero signal is detected.
5)	After deceleration stop, the operation moves in direction of OPR at the "[Pr.47] Creep speed", and then stops at the detected nearest zero signal.
6)	The OPR complete flag ([Md.31] Status: b4) turns from OFF to ON, and the OPR request flag ([Md.31] Status: b3) turns from ON to OFF.

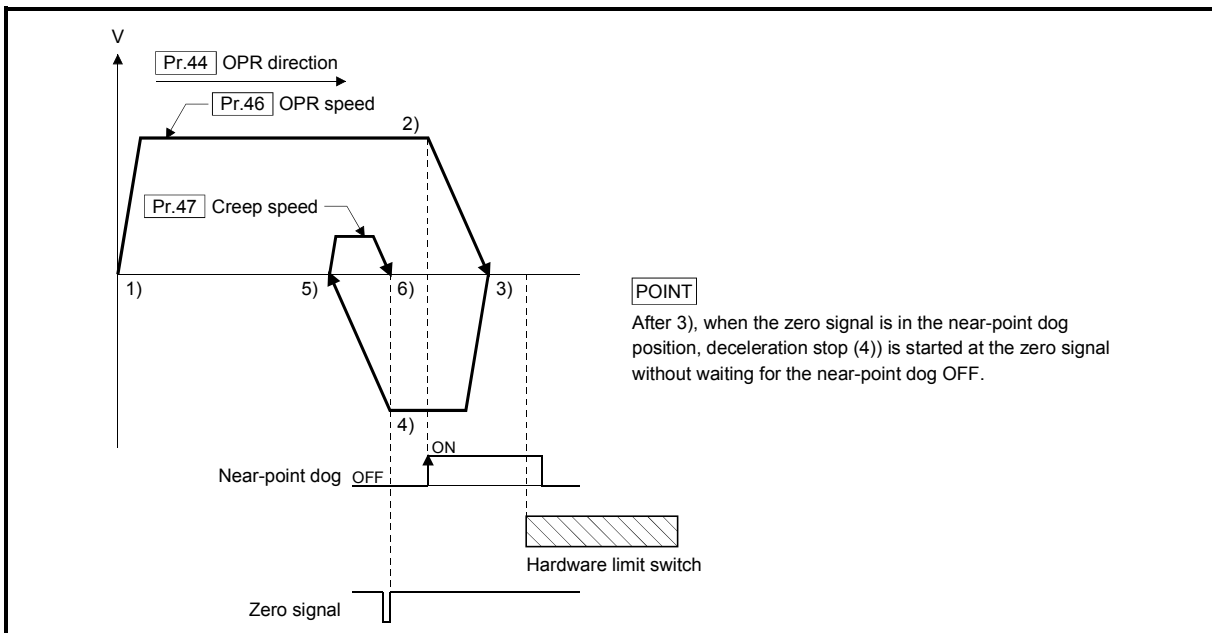

Fig. 8.10 Scale origin signal detection method machine OPR

■ Precautions during operation

- (1) An error "Start at OP (error code: 201)" will occur if another machine OPR is attempted immediately after a machine OPR completion when the OP is in the near-point dog ON position.
- (2) The following shows the operation when a machine OPR is started from the near-point dog ON position.

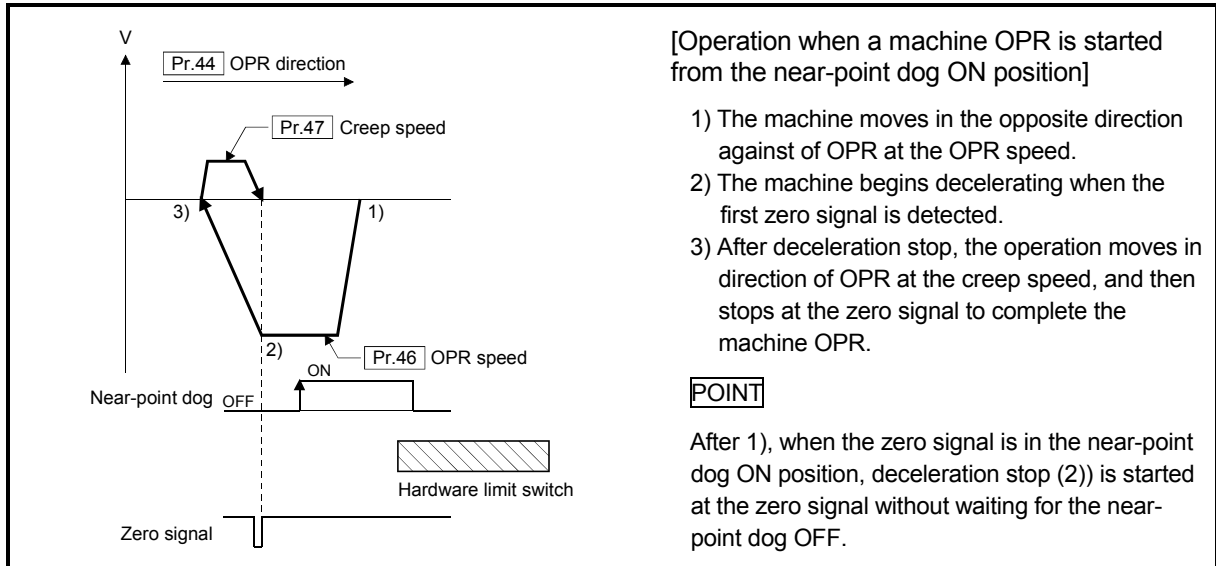
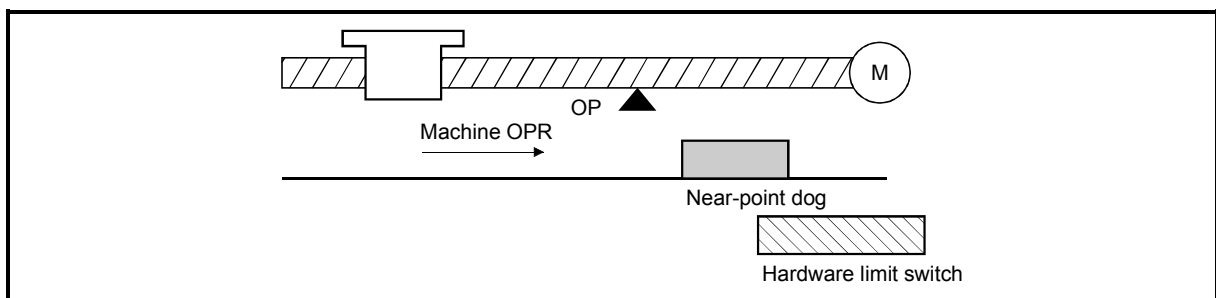

Fig. 8.11 Operation when a machine OPR is started from the near-point dog ON position

- (3) When the stop signal stops the machine OPR, carry out the machine OPR again. When restart command is turned ON after the stop signal stops the OPR, the error "OPR restart not possible (error code: 209)" will occur.
- (4) The OPR retry will not be performed regardless of setting set in "[Pr.48] OPR retry" in the scale origin signal detection method. When a hardware limit switch is detected during machine OPR, the error "Hardware stroke limit (+) (error code: 104)" or "Hardware stroke limit (-) (error code: 105)" will occur.
- (5) Position the near-point dog forward to overlaps with the hardware limit switch in direction of OPR. When the near-point dog is in the opposite direction against of OPR from the machine OPR start position, the error "Hardware stroke limit (+) (error code: 104)" or "Hardware stroke limit (-) (error code: 105)" will occur.





- (6) When the zero signal is detected again during deceleration ( 4) of Fig. 8.12) with detection of zero signal, the operation stops at the zero signal detected lastly to complete the OPR.

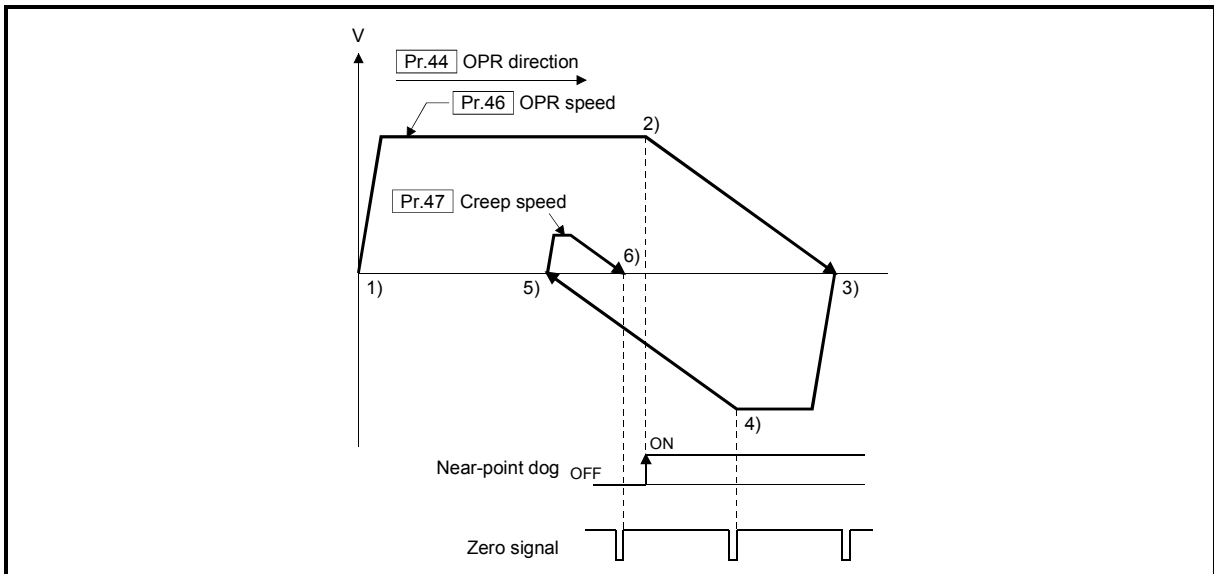

Fig. 8.12 Operation when the zero signal is detected again during deceleration with detection of zero signal

- (7) Do not use the scale origin signal detection method OPR for the machine with the backlash.
- (8) When using the direct drive motor, make it passed the Z phase once before reaching 3) of Fig. 8.10.

## 8.3 Fast OPR

### 8.3.1 Outline of the fast OPR operation

#### ■ Fast OPR operation

After establishing OP position by a machine OPR, positioning control to the OP position is executed without using a near-point dog or a zero signal. The following shows the operation during a basic fast OPR start.

- 1) The fast OPR is started.
- 2) Positioning control to the OP position established by a machine OPR begins at speed set in the OPR parameters ( [Pr.43] to [Pr.57] ).
- 3) The fast OPR is completed.

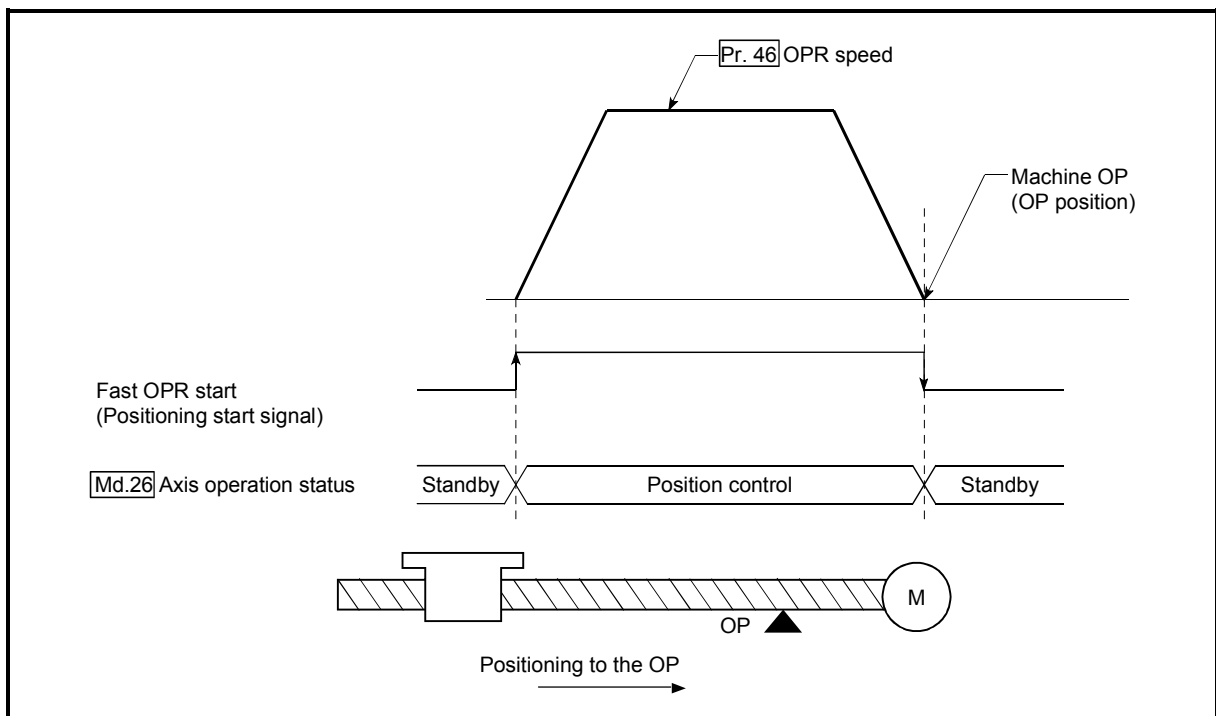

Fig. 8.13 Fast OPR

### ■ Operation timing and processing time of fast OPR

The following shows details about the operation timing and time during fast OPR.

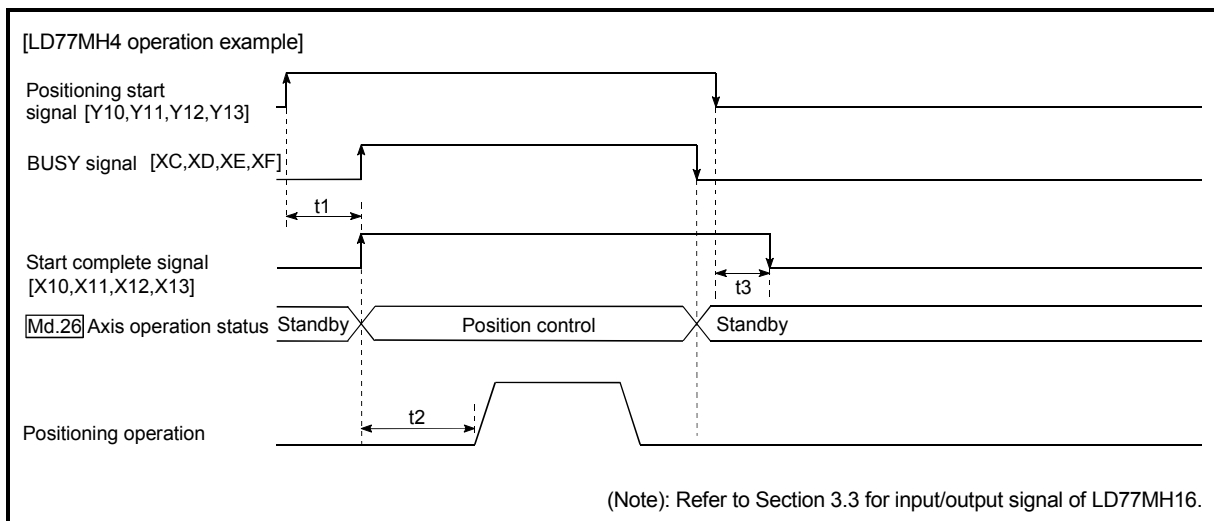

Fig. 8.14 Operation timing and processing time of fast OPR

Normal timing time

Unit: [ms]

	Operation cycle	t1	t2	t3
LD77MH4	0.88	0.1 to 0.3	2.2 to 2.7	0 to 0.9
LD77MH16	0.88	0.3 to 1.4	2.2 to 2.7	0 to 0.9
	1.77	0.3 to 1.4	3.2 to 3.9	0 to 1.8

•The t1 timing time could be delayed by the operation state of other axes.

### ■ Operating restrictions

- (1) The fast OPR can only be executed after the OP position is established by executing the Machine OPR.  
If not, the error "OPR request ON" (error code: 207) will occur.  
(OPR request flag ([Md.31] Status: b3) must be turned OFF).
- (2) If the fraction pulse is cleared to zero using current value changing or fixed-feed control, execute the fast OPR and an error will occur by a cleared amount.
- (3) When unlimited length feed is executed by speed control and the machine feed value overflows or underflows once, the fast OPR cannot be executed normally.
- (4) The OPR complete flag ([Md.31] Status: b4) is not turned ON.
- (5) The axis operation status during fast OPR is "in position control".

## 8.4 Selection of the OPR setting condition

### 8.4.1 Outline of the OPR setting condition

If executing the home position return (OPR), it is necessary to make sure that the servomotor has been rotated more than one revolution and passed the Z phase (Motor reference position signal) and that the zero point pass signal ( [Md.108](#) Servo status (low-order buffer memory address): b0) has turned ON.

However, if selecting "1: Not need to pass motor Z-phase after the power supply is switched on." with " [Pr.180](#) Function selection C-4", it is possible to turn the zero point pass signal ( [Md.108](#) Servo status (low-order buffer memory address): b0) ON without passing the zero point.

	Buffer memory address (low-order)	
	LD77MH4	LD77MH16
<a href="#">Md.108</a> Servo status: b0	876+100n	2476+100n

#### ■ Data setting

To select the "OPR setting condition", set the data shown in the following table to the LD77MH.

Servo parameters are set for each axis.

The "OPR setting condition" is stored into the following buffer memory addresses.

Setting item	Setting value	Setting details	Buffer memory address	
			LD77MH4	LD77MH16
<a href="#">Pr.180</a> Function selection C-4 (PC17)	0	0 : Need to pass motor Z-phase after the power supply is switched on. 1 : Not need to pass motor Z-phase after the power supply is switched on.	30180+200n	28480+100n

\*: Refer to Section 5.2.8 "Servo parameters" for information on the storage details.

#### ■ Precautions during operation

- (1) If setting the above servo parameter to "1: Not need to pass motor Z-phase after the power supply is switched on.", the restriction, "If executing the home position return (OPR), it is necessary to execute OPR after rotating the servomotor more than one revolution and letting it pass through the Z phase (Motor reference position signal).", will be invalid.
- (2) Set the parameter value and switch power off once (The parameter is transferred to servo amplifier from LD77MH), then switch it on again to make that parameter setting valid.



# Chapter 9 Major Positioning Control

The details and usage of the major positioning controls (control functions using the "positioning data") are explained in this chapter.

The major positioning controls include such controls as "positioning control" in which positioning is carried out to a designated position using the address information, "speed control" in which a rotating object is controlled at a constant speed, "speed-position switching control" in which the operation is shifted from "speed control" to "position control" and "position-speed switching control" in which the operation is shifted from "position control" to "speed control".

Carry out the required settings to match each control.

9.1	Outline of major positioning controls.....	9- 2
9.1.1	Data required for major positioning control.....	9- 4
9.1.2	Operation patterns of major positioning controls.....	9- 5
9.1.3	Designating the positioning address.....	9- 15
9.1.4	Confirming the current value.....	9- 16
9.1.5	Control unit "degree" handling.....	9- 18
9.1.6	Interpolation control.....	9- 21
9.2	Setting the positioning data.....	9- 26
9.2.1	Relation between each control and positioning data.....	9- 26
9.2.2	1-axis linear control.....	9- 28
9.2.3	2-axis linear interpolation control.....	9- 32
9.2.4	3-axis linear interpolation control.....	9- 38
9.2.5	4-axis linear interpolation control.....	9- 44
9.2.6	1-axis fixed-feed control.....	9- 49
9.2.7	2-axis fixed-feed control (interpolation).....	9- 52
9.2.8	3-axis fixed-feed control (interpolation).....	9- 54
9.2.9	4-axis fixed-feed control (interpolation).....	9- 59
9.2.10	2-axis circular interpolation control with sub point designation.....	9- 62
9.2.11	2-axis circular interpolation control with center point designation.....	9- 68
9.2.12	1-axis speed control.....	9- 76
9.2.13	2-axis speed control.....	9- 79
9.2.14	3-axis speed control.....	9- 83
9.2.15	4-axis speed control.....	9- 87
9.2.16	Speed-position switching control (INC mode).....	9- 92
9.2.17	Speed-position switching control (ABS mode).....	9-100
9.2.18	Position-speed switching control.....	9-108
9.2.19	Current value changing.....	9-115
9.2.20	NOP instruction.....	9-120
9.2.21	JUMP instruction.....	9-121
9.2.22	LOOP.....	9-123
9.2.23	LEND.....	9-125

### 9.1 Outline of major positioning controls

"Major positioning controls" are carried out using the "positioning data" stored in the LD77MH.

The basic controls such as position control and speed control are executed by setting the required items in this "positioning data", and then starting that positioning data.

The control system for the "major positioning controls" is set in setting item "[Da.2] Control system" of the positioning data.

Control defined as a "major positioning control" carries out the following types of control according to the "[Da.2] Control system" setting.

However, the position loop is included for commanding to servo amplifier in the speed control set in "[Da.2] Control system".

Use the "speed-torque control" (Refer to Section 12.1 "Speed-torque control") to execute the speed control not including position loop.

Major positioning control		[Da.2] Control system		Details
Position control	Linear control	1-axis linear control	ABS Linear 1 INC Linear 1	Positioning of the designated 1 axis is carried out from the start address (current stop position) to the designated position.
		2-axis linear interpolation control (Note-1)	ABS Linear 2 INC Linear 2	Using the designated 2 axes, linear interpolation control is carried out from the start address (current stop position) to the designated position.
		3-axis linear interpolation control (Note-1)	ABS Linear 3 INC Linear 3	Using the designated 3 axes, linear interpolation control is carried out from the start address (current stop position) to the designated position.
		4-axis linear interpolation control (Note-1)	ABS Linear 4 INC Linear 4	Using the designated 4 axes, linear interpolation control is carried out from the start address (current stop position) to the designated position.
	Fixed-feed control	1-axis fixed-feed control	Fixed-feed 1	Positioning of the designated 1 axis is carried out for a designated movement amount from the start address (current stop position). (The "[Md.20] Current feed value" is set to "0" at the start.)
		2-axis fixed-feed control (Note-1)	Fixed-feed 2	Using the designated 2 axes, linear interpolation control is carried out for a designated movement amount from the start address (current stop position). (The "[Md.20] Current feed value" is set to "0" at the start.)
		3-axis fixed-feed control (Note-1)	Fixed-feed 3	Using the designated 3 axes, linear interpolation control is carried out for a designated movement amount from the start address (current stop position). (The "[Md.20] Current feed value" is set to "0" at the start.)
		4-axis fixed-feed control (Note-1)	Fixed-feed 4	Using the designated 4 axes, linear interpolation control is carried out for a designated movement amount from the start address (current stop position). (The "[Md.20] Current feed value" is set to "0" at the start.)
	2-axis circular interpolation control (Note-1)	Sub point designation	ABS Circular sub INC Circular sub	Using the designated 2 axes, positioning is carried out in an arc path to a position designated from the start point address (current stop position).
		Center point designation	ABS Circular right ABS Circular left INC Circular right INC Circular left	

Major positioning control		Da.2 Control system	Details
Speed control	1-axis speed control	Forward run speed 1 Reverse run speed 1	The speed control of the designated 1 axis is carried out.
	2-axis speed control <sup>(Note-1)</sup>	Forward run speed 2 Reverse run speed 2	The speed control of the designated 2 axes is carried out.
	3-axis speed control <sup>(Note-1)</sup>	Forward run speed 3 Reverse run speed 3	The speed control of the designated 3 axes is carried out.
	4-axis speed control <sup>(Note-1)</sup>	Forward run speed 4 Reverse run speed 4	The speed control of the designated 4 axes is carried out.
Speed-position switching control		Forward run speed/position Reverse run speed/position	The control is continued as position control (positioning for the designated address or movement amount) by turning ON the "speed-position switching signal" after first carrying out speed control.
Position-speed switching control		Forward run position/speed Reverse run position/speed	The control is continued as speed control by turning ON the "position-speed switching signal" after first carrying out position control.
Other control	NOP instruction	NOP instruction	A nonexecutable control system. When this instruction is set, the operation is transferred to the next data operation, and the instruction is not executed.
	Current value changing	Current value changing	"Md.20 Current feed value" is changed to an address set in the positioning data. This can be carried out by either of the following 2 methods. (("Md.21 Machine feed value" cannot be changed.) <ul style="list-style-type: none"> <li>• Current value changing using the control system</li> <li>• Current value changing using the current value changing start No. (No. 9003).</li> </ul>
	JUMP instruction	JUMP instruction	An unconditional or conditional JUMP is carried out to a designated positioning data No.
	LOOP	LOOP	A repeat control is carried out by repeat LOOP to LEND.
	LEND	LEND	Control is returned to the top of the repeat control by repeat LOOP to LEND. After the repeat operation is completed specified times, the next positioning data is run.

(Note-1): Control is carried out so that linear and arc paths are drawn using a motor set in two or more axes directions. This kind of control is called "interpolation control". (Refer to Section 9.1.6 "Interpolation control" for details.)



## 9.1.1 Data required for major positioning control

The following table shows an outline of the "positioning data" configuration and setting details required to carry out the "major positioning controls".

Setting item		Setting details
Positioning data No. 1	Da.1 Operation pattern	Set the method by which the continuous positioning data (Ex: positioning data No.1, No.2, No.3) will be controlled. (Refer to Section "9.1.2".)
	Da.2 Control system	Set the control system defined as a "major positioning control". (Refer to Section "9.1".)
	Da.3 Acceleration time No.	Select and set the acceleration time at control start. (Select one of the four values set in Pr.9 , Pr.25 , Pr.26 , and Pr.27 for the acceleration time.)
	Da.4 Deceleration time No.	Select and set the deceleration time at control stop. (Select one of the four values set in Pr.10 , Pr.28 , Pr.29 , and Pr.30 for the deceleration time.)
	Da.5 Axis to be interpolated LD77MH4	Set an axis to be interpolated (partner axis) during the 2-axis interpolation operation (Refer to Section 9.1.6.).
	Da.6 Positioning address/ movement amount	Set the target value during position control. (Refer to Section "9.1.3".)
	Da.7 Arc address	Set the sub point or center point address during circular interpolation control.
	Da.8 Command speed	Set the speed during the control execution.
	Da.9 Dwell time	The time between the command pulse output is completed to the positioning completed signal is turned ON. Set it for absorbing the delay of the mechanical system to the instruction, such as the delay of the servo system (deviation).
	Da.10 M code	Set this item when carrying out sub work (clamp and drill stops, tool replacement, etc.) corresponding to the code No. related to the positioning data execution.
	Da.20 Axis to be interpolated No.1 LD77MH16	Set an axis to be interpolated during the 2- to 4-axis interpolation operation. (Refer to Section 9.1.6.)
	Da.21 Axis to be interpolated No.2 LD77MH16	
	Da.22 Axis to be interpolated No.3 LD77MH16	

(Note): The settings and setting requirement for the setting details of Da.1 to Da.10 and Da.20 to Da.22 differ according to the "Da.2 Control system". (Refer to Section 9.2 "Setting the positioning data".)

#### ■ Major positioning control sub functions

Refer to Section 3.2.5 "Combination of LD77MH main functions and sub functions" for details on "sub functions" that can be combined with the major positioning control.

Also refer to Chapter 13 "Control Sub Functions" for details on each sub function.

#### ■ Major positioning control from GX Works2

"Major positioning control" can be executed by test function of GX Works2.

Refer to "Simple Motion Module Setting Tool Help" of GX Works2 for details on carrying out major positioning control from the GX Works2.

#### REMARK

600 positioning data (positioning data No. 1 to 600) items can be set per axis.

9.1.2 Operation patterns of major positioning controls

In "major positioning control" (high-level positioning control), "Da.1" Operation pattern" can be set to designate whether to continue executing positioning data after the started positioning data. The "operation pattern" includes the following 3 types.

- Positioning complete — (1) Independent positioning control (operation pattern: 00)
- Positioning continue — (2) Continuous positioning control (operation pattern: 01)
- (3) Continuous path control (operation pattern: 11)

The following shows examples of operation patterns when "1-axis linear control (ABS linear 1)" is set in positioning data No. 1 to No. 6 of axis 1. Details of each operation pattern are shown on the following pages.

< Operation example when "1-axis linear positioning" is set in the positioning data of axis 1 >

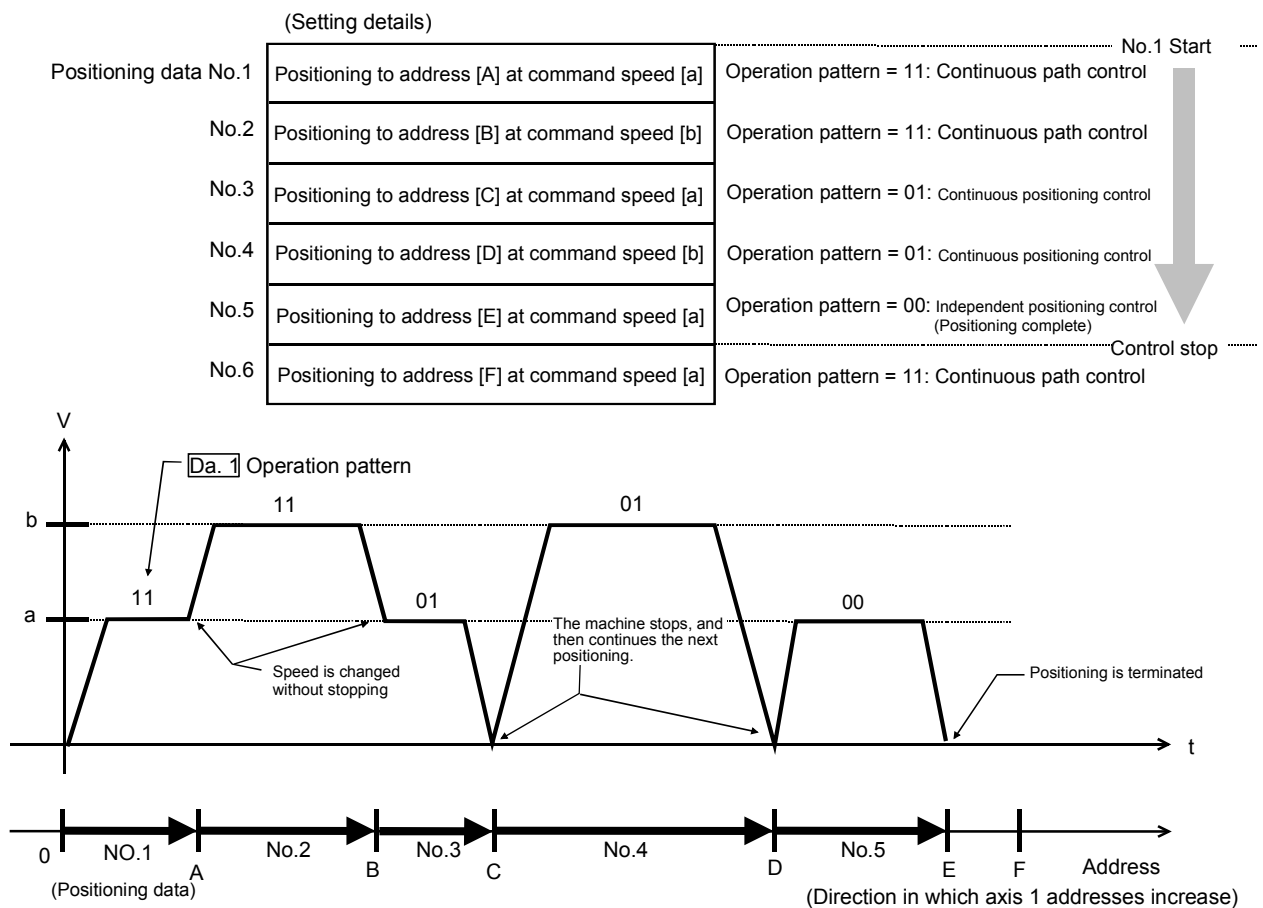

For 1-axis linear control

(One motor is driven, and positioning is carried out to an addresses designated in one direction.)

POINT
(1) When the operation pattern is continuous positioning control or continuous path control, the same address as the last value is specified in absolute system or the movement amount 0 is specified in incremental system, positioning control of movement amount 0 is executed.
(2) The BUSY signal turns ON even when position control of movement amount 0 is executed. However, since the ON time is short, the ON status may not be detected in the PLC program.
(3) The positioning complete signal turns ON even when position control of movement amount 0 is executed. ON time is determined by "Pr.40 Positioning complete signal output time".

[1] Independent positioning control (Positioning complete)

This control is set when executing only one designated data item of positioning. If a dwell time is designated, the positioning will complete after the designated time elapses.

This data (operation pattern [00] data) becomes the end of block data when carrying out block positioning. (The positioning stops after this data is executed.)

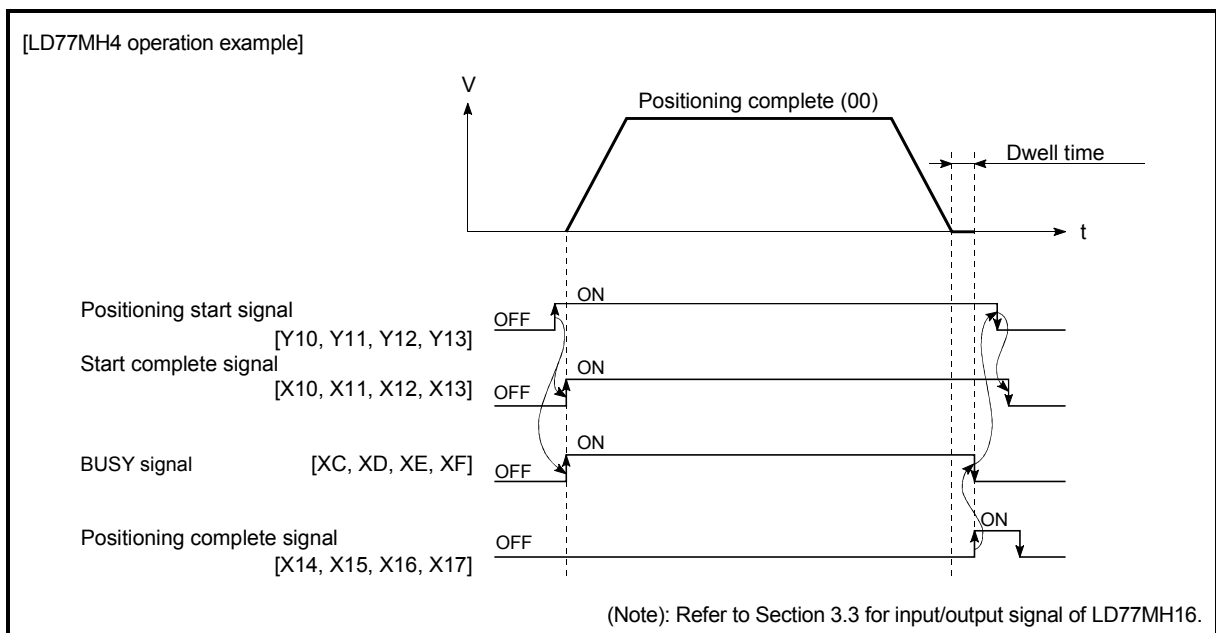

Fig. 9.1 Operation during independent positioning control

[2] Continuous positioning control

- (1) The machine always automatically decelerates each time the positioning is completed. Acceleration is then carried out after the LD77MH command speed reaches 0 to carry out the next positioning data operation. If a dwell time is designated, the acceleration is carried out after the designated time elapses.
- (2) In operation by continuous positioning control (operation pattern "01"), the next positioning No. is automatically executed. Always set operation pattern "00" in the last positioning data to complete the positioning. If the operation pattern is set to positioning continue ("01" or "11"), the operation will continue until operation pattern "00" is found. If the operation pattern "00" cannot be found, the operation may be carried out until the positioning data No. 600. If the operation pattern of the positioning data No. 600 is not completed, the operation will be started again from the positioning data No. 1.

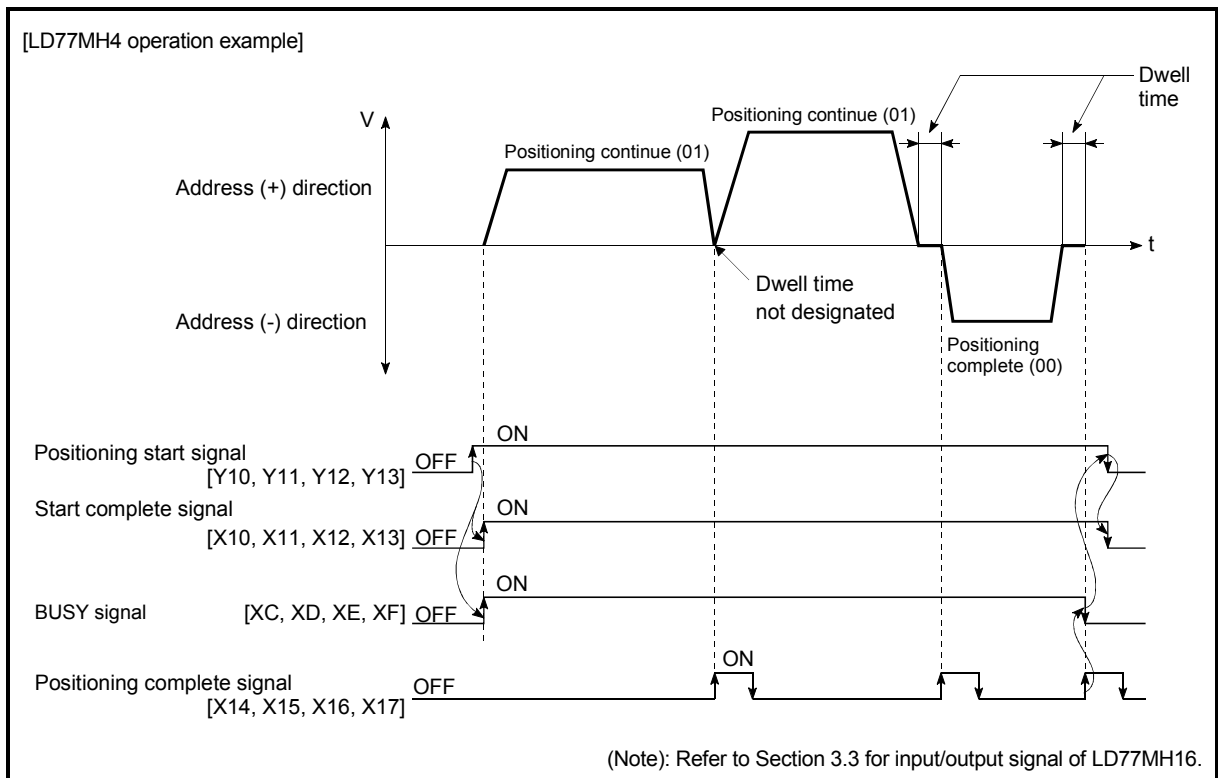
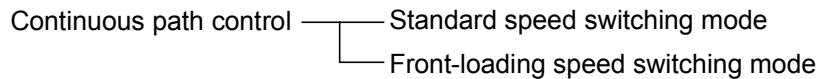

Fig. 9.2 Operation during continuous positioning control

[3] Continuous path control

(1) Continuous path control

- (a) The speed is changed without deceleration stop between the command speed of the positioning data currently being run and the speed of the positioning data that will be run next.  
The speed is not changed if the current speed and the next speed are equal.
- (b) The speed will become the speed used in the previous positioning operation if the command speed is set to "-1".
- (c) Dwell time will be ignored, even if set.
- (d) The next positioning No. is executed automatically in operations by continuous path control (operation pattern "11"). Always complete the positioning by setting operation pattern "00" in the last positioning data. If the operation pattern is set to positioning continue ("01" or "11"), the operation will continue until operation pattern "00" is found. If the operation pattern "00" cannot be found, the operation may be carried out until the positioning data No. 600. If the operation pattern of the positioning data No. 600 is not complete, the operation will be started again from the positioning data No. 1.
- (e) The speed switching patterns include the "front-loading speed switching pattern" in which the speed is changed at the end of the current positioning side, and the "standard speed switching pattern" in which the speed is at the start of the next positioning side. (Refer to " Pr.19 Speed switching mode".)



- (f) In the continuous path control, the positioning may be completed before the set address/movement amount and the current data may be switched to the "positioning data that will be run next".  
This is because a preference is given to the positioning at a command speed. In actuality, the positioning is completed before the set address/movement amount by an amount of remaining distance at speeds less than the command speed. The remaining distance ( $\Delta \ell$ ) at speeds less than the command speed is  $0 \leq \Delta \ell \leq$  (distance moved in operation cycle at a speed at the time of completion of the positioning).  
The remaining distance ( $\Delta \ell$ ) is output at the next positioning data No.

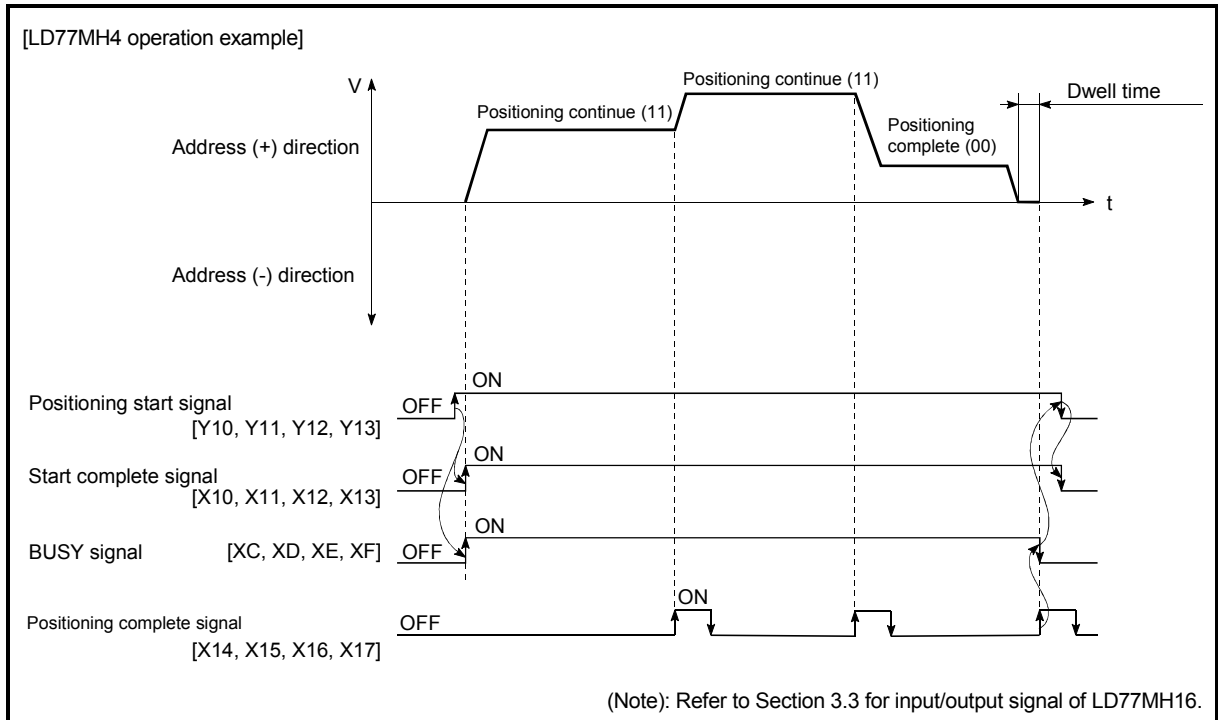

Fig. 9.3 Operation during continuous path control (Standard speed switching mode)

**POINT**

In the continuous path control, a speed variation will not occur using the near-pass function when the positioning data No. is switched (Refer to Section 13.3.3 "Near pass function").

(2) Deceleration stop conditions during continuous path control

Deceleration stops are not carried out in continuous path control, but the machine will carry out a deceleration stop to speed "0" in the following cases (a) to (c).

- (a) When the operation pattern of the positioning data currently being executed is "continuous path control: 11", and the movement direction of the positioning data currently being executed differs from that of the next positioning data. (Only for 1-axis positioning control (Refer to the "Points" in the next page.))

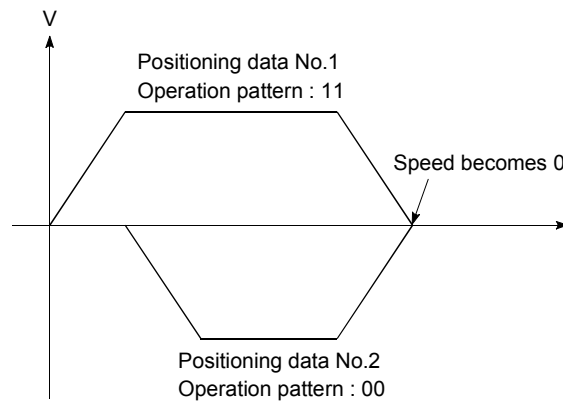

- (b) During operation by step operation. (Refer to Section 13.7.1 "Step function".)
- (c) When there is an error in the positioning data to carry out the next operation.

**POINTS**

(1) The movement direction is not checked during interpolation operations. Thus, automatic deceleration to a stop will not be carried out even if the movement direction is changed (See the figures below). Because of this, the interpolation axis may suddenly reverse direction. To avoid this sudden direction reversal in the interpolation axis, set the pass point to continuous positioning control "01" instead of setting it to continuous path control "11".

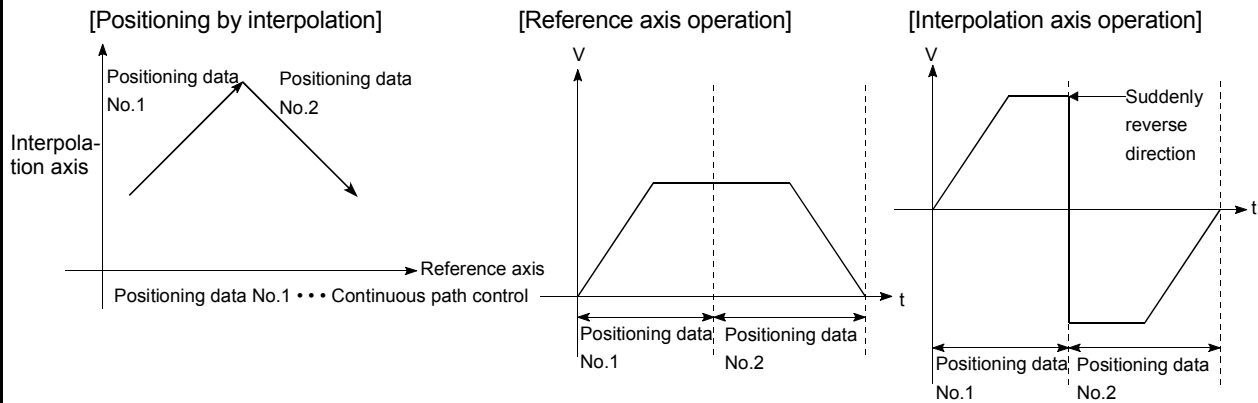

- (2) When a "0" is set in the " **Da.6** Positioning address/movement amount" of the continuous path control positioning data, the command speed of about 2 ms is reduced to 0. When a "0" is set in the " **Da.6** Positioning address/movement amount" to increase the number of speed change points in the future, change the " **Da.2** Control system" to the "NOP instruction" to make the control nonexecutable. (Refer to Section 9.2.20 "NOP instruction".)
- (3) In the continuous path control positioning data, assure a movement distance so that the execution time with that data is 100 ms or longer, or lower the command speed.

(3) Speed handling

- (a) Continuous path control command speeds are set with each positioning data.  
The LD77MH then carries out the positioning at the speed designated with each positioning data.
- (b) The command speed can be set to "-1" in continuous path control.  
The control will be carried out at the speed used in the previous positioning data No. if the command speed is set to "-1".  
(The "current speed" will be displayed in the command speed when the positioning data is set with a GX Works2. The current speed is the speed of the positioning control being executed currently.)
  - 1) The speed does not need to be set in each positioning data when carrying out uniform speed control if "-1" is set beforehand in the command speed.
  - 2) If the speed is changed or the override function is executed, in the previous positioning data when "-1" is set in the command speed, the operation can be continued at the new speed.
  - 3) An error "no command speed error (error code: 503)" occurs and positioning cannot be started if "-1" is set in the command speed of the first positioning data at start.

[Relation between the command speed and current speed]

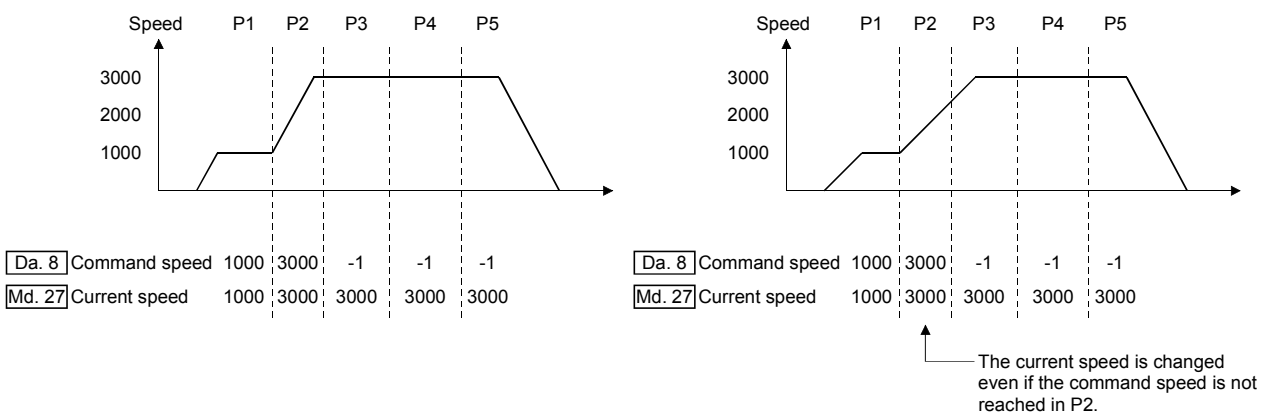

**POINTS**

- (1) In the continuous path control, a speed variation will not occur using the near-pass function when the positioning data is switched (Refer to Section 13.3.3 "Near pass function").
- (2) The LD77MH holds the command speed set with the positioning data, and the latest value of the speed set with the speed change request as the "Md.27" Current speed". It controls the operation at the "current speed" when "-1" is set in the command speed.  
(Depending on the relation between the movement amount and the speed, the feedrate may not reach the command speed value, but even then the current speed will be updated.)
- (3) When the address for speed change is identified beforehand, generate and execute the positioning data for speed change by the continuous path control to carry out the speed change without requesting the speed change with a sequence program.



(4) Speed switching

(Refer to " Pr.19 Speed switching mode".)

The two modes for changing the speed are shown below.

- Standard speed switching.....Switch the speed when executing the next positioning data.
- Front-loading speed switching....The speed switches at the end of the positioning data currently being executed.

(a) Standard speed switching mode

- 1) If the respective command speeds differ in the "positioning data currently being executed" and the "positioning data to carry out the next operation", the machine will accelerate or decelerate after reaching the positioning point set in the "positioning data currently being executed" and the speed will change over to the speed set in the "positioning data to carry out the next operation".
- 2) The parameters used in acceleration/deceleration to the command speed set in the "positioning data to carry out the next operation" are those of the positioning data to carry out acceleration/deceleration.  
Speed switching will not be carried out if the command speeds are the same.

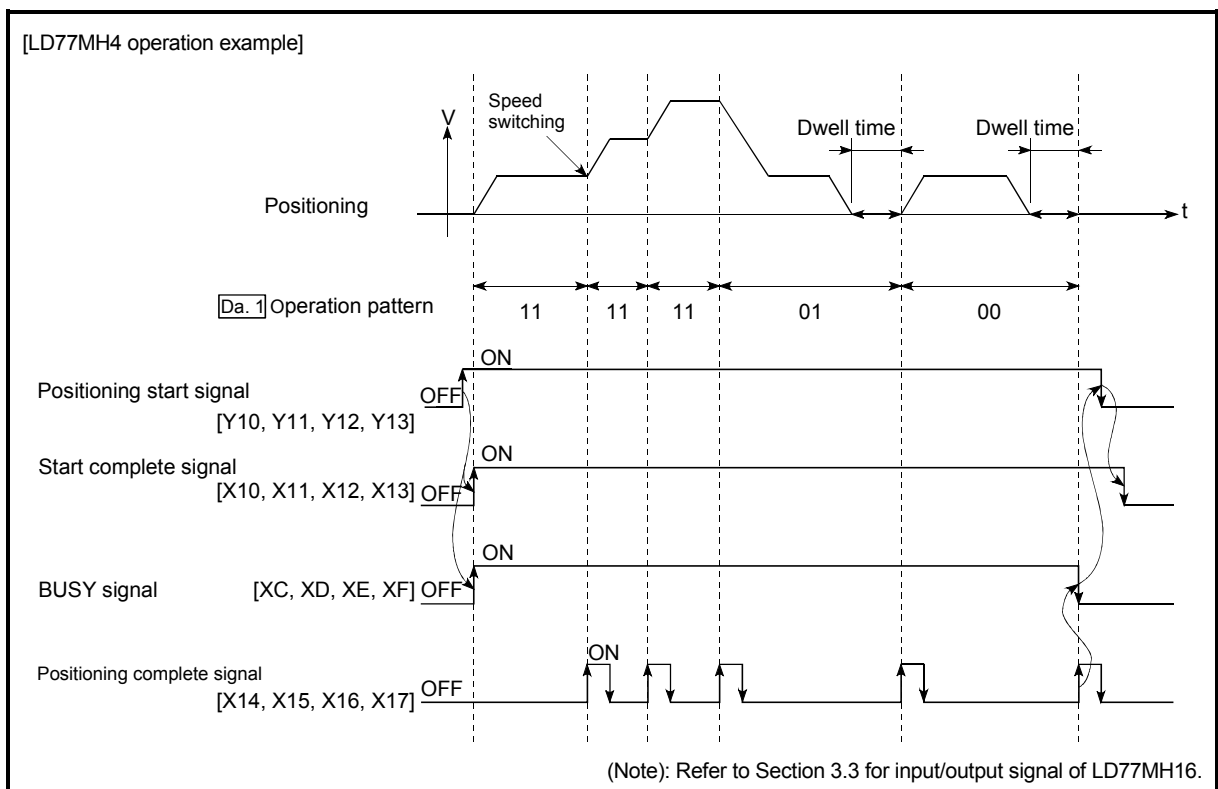

Fig. 9.4 Operation for the standard speed switching mode

3) Speed switching condition

If the movement amount is small in regard to the target speed, the current speed may not reach the target speed even if acceleration/deceleration is carried out. In this case, the machine is accelerated/decelerated so that it nears the target speed.

If the movement amount will be exceeded when automatic deceleration is required (Ex. Operation patterns "00", "01", etc.), the machine will immediately stop at the designated positioning address, and a "insufficient movement amount" (warning code: 513) will occur.

[When the speed cannot change over in P2]

For the following relation of the speed

$$P1 = P4, P2 = P3, P1 < P2$$

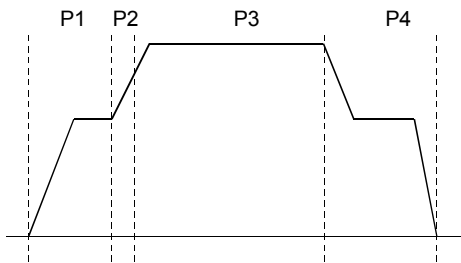

[When the movement amount is small during automatic deceleration]

The movement amount required to carry out the automatic deceleration cannot be secured, so the machine immediately stops in a speed  $\neq 0$  status.

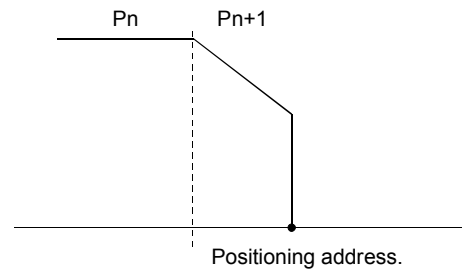

(b) Front-loading speed switching mode

- 1) If the respective command speeds differ in the "positioning data currently being executed" and the "positioning data to carry out the next operation", the speed will change over to the speed set in the "positioning data to carry out the next operation" at the end of the "positioning data currently being executed".
- 2) The parameters used in acceleration/deceleration to the command speed set in the "positioning data to carry out the next operation" are those of the positioning data to carry out acceleration/deceleration.  
Speed switching will not be carried out if the command speeds are the same.

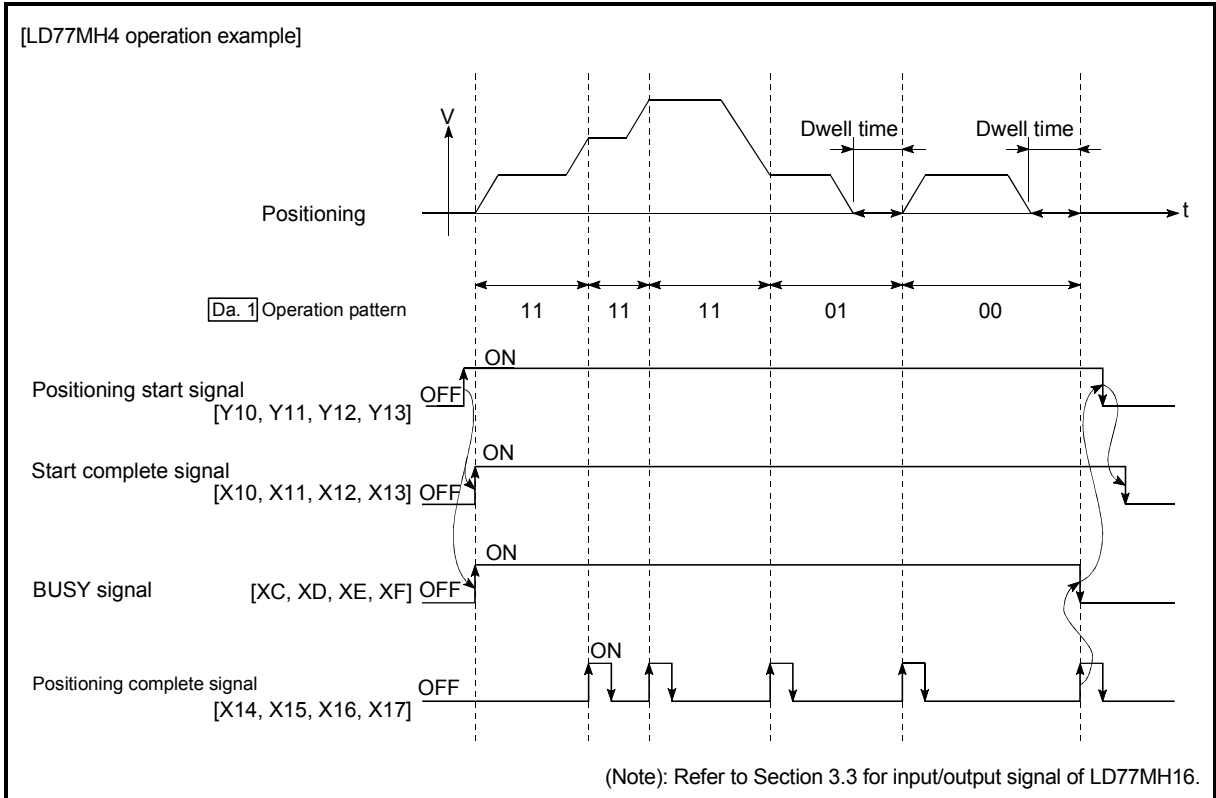

Fig. 9.5 Operation for the front-loading speed switching mode

3) Speed switching condition

If the movement amount is small in regard to the target speed, the current speed may not reach the target speed even if acceleration/deceleration is carried out. In this case, the machine is accelerated/decelerated so that it nears the target speed. If the movement amount will be exceeded when automatic deceleration is required (Ex. Operation patterns "00", "01", etc.), the machine will immediately stop at the designated positioning address, and a "insufficient movement amount" (warning code: 513) will occur.

[When the speed cannot change over to the P2 speed in P1]

For the following relation of the speed  
 $P1 = P4, P2 = P3, P1 < P2$

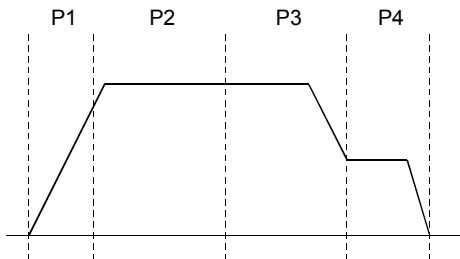

[When the movement amount is small during automatic deceleration]

The movement amount required to carry out the automatic deceleration cannot be secured, so the machine immediately stops in a speed  $\neq 0$  status.

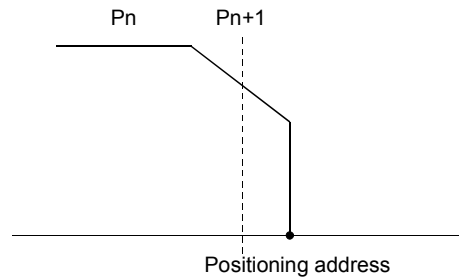

### 9.1.3 Designating the positioning address

The following shows the two methods for commanding the position in control using positioning data.

#### ■ Absolute system

Positioning is carried out to a designated position (absolute address) having the OP as a reference. This address is regarded as the positioning address. (The start point can be anywhere.)

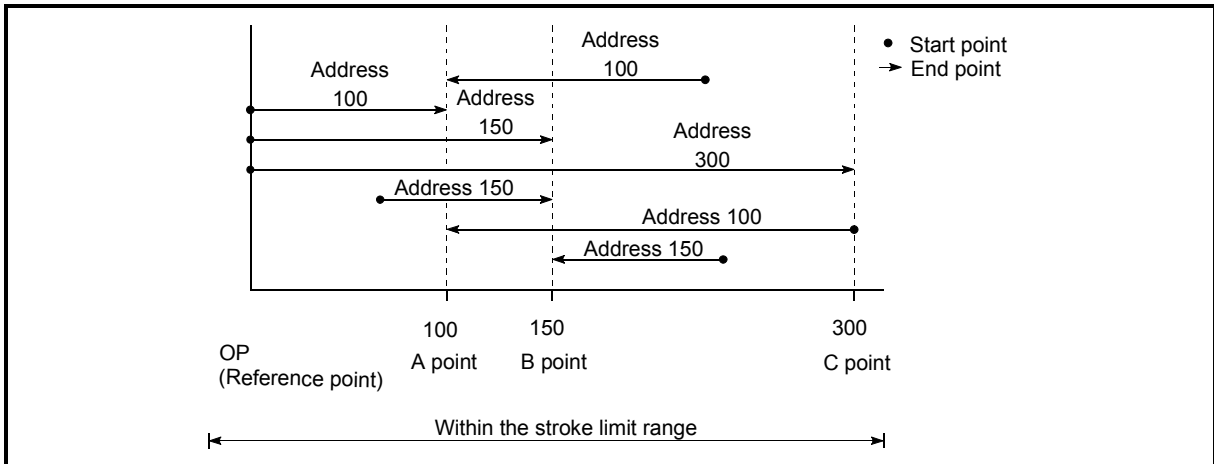

Fig. 9.6 Absolute system positioning

#### ■ Incremental system

The position where the machine is currently stopped is regarded as the start point, and positioning is carried out for a designated movement amount in a designated movement direction.

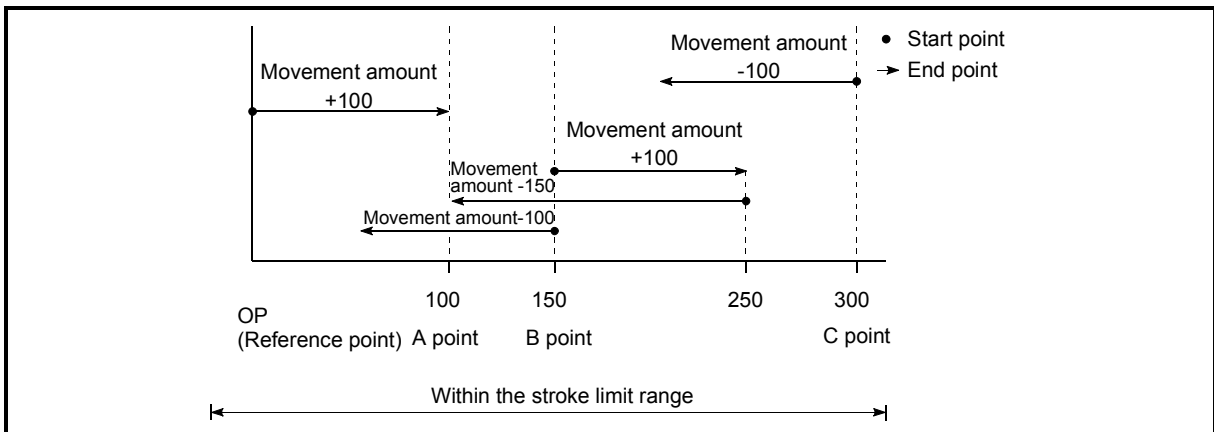

Fig. 9.7 Incremental system positioning

### 9.1.4 Confirming the current value

#### ■ Values showing the current value

The following two types of addresses are used as values to show the position in the LD77MH.

These addresses ("current feed value" and "machine feed value") are stored in the monitor data area, and used in monitoring the current value display, etc.

Current feed value	<ul style="list-style-type: none"> <li>This is the value stored in "Md.20 Current feed value".</li> <li>This value has an address established with a "machine OPR" as a reference, but the address can be changed by changing the current value to a new value.</li> </ul>
Machine feed value	<ul style="list-style-type: none"> <li>This is the value stored in "Md.21 Machine feed value".</li> <li>This value always has an address established with a "machine OPR" as a reference. The address cannot be changed, even if the current value is changed to a new value.</li> </ul>

The "current feed value" and "machine feed value" are used in monitoring the current value display, etc.

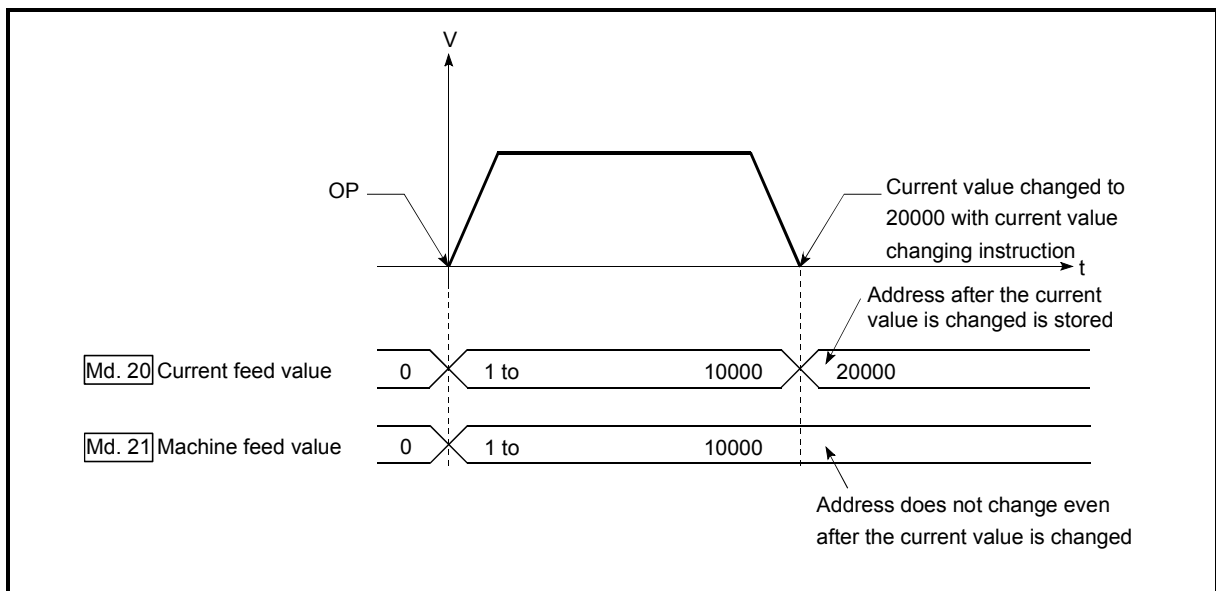

Fig. 9.8 Current feed value and machine feed value

#### ■ Restrictions

- (1) Operation cycle error will occur in the current value refresh cycle when the stored "current feed value" and "machine feed value" are used in the control.

■ Monitoring the current value

The "current feed value" and "machine feed value" are stored in the following buffer memory addresses, and can be read using a "DFRO(P) instruction" or "DMOV(P) instruction" from the PLC CPU.

	Buffer memory addresses	
	LD77MH4	LD77MH16
<b>Md.20</b> Current feed value	800+100n 801+100n	2400+100n 2401+100n
<b>Md.21</b> Machine feed value	802+100n 803+100n	2402+100n 2403+100n

(1) The following shows the examples of programs to read out the current feed value of the LD77MH4 [axis 1] to D104 and D105 when X40 is turned ON.

(a) For the DFRO(P) instruction

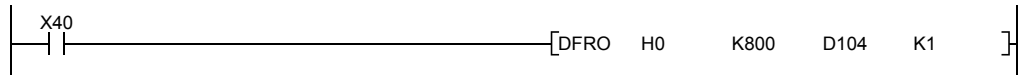

(b) For the DMOV(P) instruction

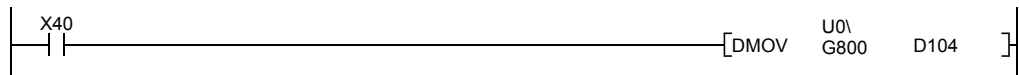

### 9.1.5 Control unit "degree" handling

When the control unit is set to "degree", the following items differ from when other control units are set.

#### [1] Current feed value and machine feed value addresses

The address of "Md.20" Current feed value" becomes a ring address from 0 to 359.99999°.

But the address of "Md.21" Machine feed value" doesn't become a ring address.

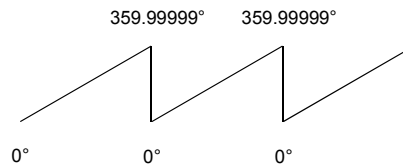

#### [2] Software stroke limit valid/invalid setting

With the control unit set to "degree", the software stroke limit upper and lower limit values are 0 to 359.99999.

##### (a) Setting to validate software stroke limit

To validate the software stroke limit, set the software stroke limit lower limit value and the upper limit value in a clockwise direction.

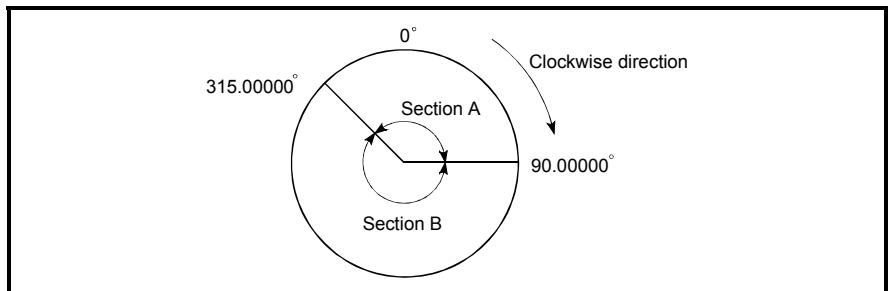

##### 1) To set the movement range A, set as follows.

- Software stroke limit lower limit value ..... 315.00000°
- Software stroke limit upper limit value ..... 90.00000°

##### 2) To set the movement range B, set as follows.

- Software stroke limit lower limit value ..... 90.00000°
- Software stroke limit upper limit value ..... 315.00000°

##### (b) Setting to invalidate software stroke limit

To invalidate the software stroke limit, set the software stroke limit lower limit value equal to the software stroke limit upper limit value.

The control can be carried out irrespective of the setting of the software stroke limit.

<b>POINT</b>
<p>(1) When the upper/lower limit value of the axis which set the software stroke limit as valid are changed, perform the machine OPR after that.</p> <p>(2) When the software stroke limit is set as valid in the incremental data system, perform the machine OPR after power supply on.</p>

[3] Positioning control method when the control unit is set to "degree"

1) Absolute system

(a) When the software stroke limit is invalid

Positioning is carried out in the nearest direction to the designated address, using the current value as a reference.

(This is called "shortcut control".)

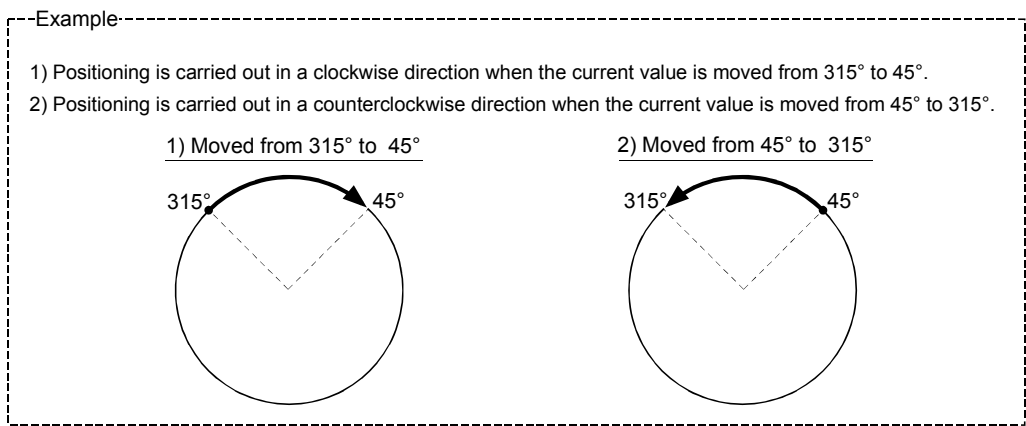

To designate the positioning direction (not carrying out the shortcut control), the shortcut control is invalidated and positioning in a designated direction is carried out by the "Cd.40 ABS direction in degrees".

This function can perform only when the software stroke limit is invalid. When the software stroke limit is valid, an error "ABS direction in degrees illegal" (error code: 546) occurs and positioning is not started.

To designate the movement direction in the ABS control, a "1" or "2" is written to the "Cd.40 ABS direction in degrees" of the buffer memory (initial value: 0).

The value written to the "Cd.40 ABS direction in degrees" becomes valid only when the positioning control is started.

In the continuous positioning control and continuous path control, the operation is continued with the setting set at the time of start even if the setting is changed during the operation.

Name	Function	Buffer memory address		Initial value
		LD77MH4	LD77MH16	
Cd.40 ABS direction in degrees	The ABS movement direction in the unit of degree is designated. 0: Shortcut (direction setting invalid) 1: ABS clockwise 2: ABS counterclockwise	1550+100n	4350+100n	0



## (b) When the software stroke limit is valid

The positioning is carried out in a clockwise/counterclockwise direction depending on the software stroke limit range setting method. Because of this, positioning with "shortcut control" may not be possible.

Example

When the current value is moved from  $0^\circ$  to  $315^\circ$ , positioning is carried out in the clockwise direction if the software stroke limit lower limit value is  $0^\circ$  and the upper limit value is  $345^\circ$ .

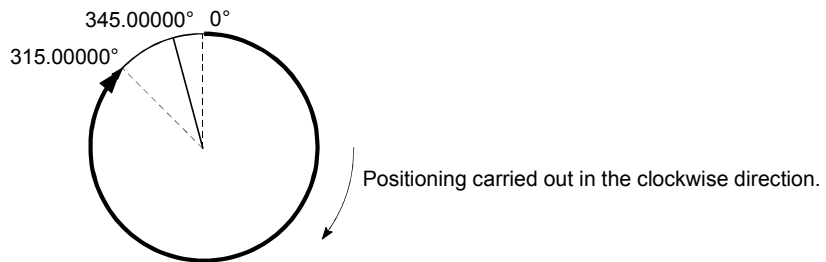
**POINT**

Positioning addresses are within a range of  $0^\circ$  to  $359.99999^\circ$ .  
Use the incremental system to carry out positioning of one rotation or more.

## 2) Incremental system

Positioning is carried out for a designated movement amount in a designated movement direction when in the incremental system of positioning.

The movement direction is determined by the sign (+, -) of the movement amount.

- For a positive (+) movement direction .....Clockwise
- For a negative (-) movement direction .....Counterclockwise

**POINT**

Positioning of  $360^\circ$  or more can be carried out with the incremental system.  
At this time, set as shown below to invalidate the software stroke limit.

[Software stroke limit upper limit value = Software stroke limit lower limit value]

Set the value within the setting range ( $0^\circ$  to  $359.99999^\circ$ ).

9.1.6 Interpolation control

■ Meaning of interpolation control

In "2-axis linear interpolation control", "3-axis linear interpolation control", "4-axis linear interpolation control", "2-axis fixed-feed control", "3-axis fixed-feed control", "4-axis fixed-feed control", "2-axis speed control", "3-axis speed control", "4-axis speed control", and "2-axis circular interpolation control", control is carried out so that linear and arc paths are drawn using a motor set in two to four axis directions. This kind of control is called "interpolation control".

In interpolation control, the axis in which the control system is set is defined as the "reference axis", and the other axis is defined as the "interpolation axis".

The LD77MH controls the "reference axis" following the positioning data set in the "reference axis", and controls the "interpolation axis" corresponding to the reference axis control so that a linear or arc path is drawn.

The following table shows the reference axis and interpolation axis combinations.

Interpolation of "Da.2" Control system	Axis definition	LD77MH4		LD77MH16					
		Reference axis	Interpolation axis	Reference axis	Interpolation axis				
2-axis linear interpolation control 2-axis fixed-feed control 2-axis circular interpolation control 2-axis speed control	Any of axes 1 to 4		"Axis to be interpolated" set in reference axis	Any of axes 1 to 16	"Axis to be interpolated No.1" set in reference axis				
	Axis 1	Axis 2, Axis 3	Any of axes 1 to 16		"Axis to be interpolated No.1" and "Axis to be interpolated No.2" set in reference axis				
	Axis 2	Axis 3, Axis 4							
	Axis 3	Axis 4, Axis 1							
Axis 4	Axis 1, Axis 2								
3-axis linear interpolation control 3-axis fixed-feed control 3-axis speed control	Axis 1	Axis 2, Axis 3, Axis 4				Any of axes 1 to 16	"Axis to be interpolated No.1", "Axis to be interpolated No.2" and "Axis to be interpolated No.3" set in reference axis		
	Axis 2	Axis 3, Axis 4, Axis 1							
	Axis 3	Axis 4, Axis 1, Axis 2							
	Axis 4	Axis 1, Axis 2, Axis 3							
4-axis linear interpolation control 4-axis fixed-feed control 4-axis speed control	Axis 1	Axis 2, Axis 3, Axis 4						Any of axes 1 to 16	"Axis to be interpolated No.1", "Axis to be interpolated No.2" and "Axis to be interpolated No.3" set in reference axis
	Axis 2	Axis 3, Axis 4, Axis 1							
	Axis 3	Axis 4, Axis 1, Axis 2							
	Axis 4	Axis 1, Axis 2, Axis 3							

### ■ Setting the positioning data during interpolation control

When carrying out interpolation control, the same positioning data Nos. are set for the "reference axis" and the "interpolation axis".

The following table shows the "positioning data" setting items for the reference axis and interpolation axis.

Setting item		Axis	Reference axis setting item	Interpolation axis setting item	
Same positioning data Nos	Da.1	Operation pattern	◎	—	
	Da.2	Control system	Linear 2, 3, 4, Fixed-feed 2, 3, 4, Circular sub, Circular right, Circular left Forward run speed 2, 3, 4 Reverse run speed 2, 3, 4	—	
	Da.3	Acceleration time No.	◎	—	
	Da.4	Deceleration time No.	◎	—	
	Da.5	Axis to be interpolated <b>LD77MH4</b>	○ *1	—	
	Da.6	Positioning address/ movement amount	△	(Forward run speed 2, 3, and 4. Reverse run speed 2, 3, and 4 not required.)	△ (Forward run speed 2, 3, and 4. Reverse run speed 2, 3, and 4 not required.)
	Da.7	Arc address	△	(Only during circular sub, circular right, and circular left).	△ (Only during circular sub, circular right, and circular left).
	Da.8	Command speed	◎		△ (Only during forward run speed 2, 3, 4 and reverse run speed 2, 3, 4).
	Da.9	Dwell time	○		—
	Da.10	M code	○		—
	Da.20	Axis to be interpolated No.1 <b>LD77MH16</b>	○ *2		—
	Da.21	Axis to be interpolated No.2 <b>LD77MH16</b>	○ *2		—
	Da.22	Axis to be interpolated No.3 <b>LD77MH16</b>	○ *2		—

◎ : Setting always required

○ : Set according to requirements (Set to "—" when not used.)

△ : Setting restrictions exist

— : Setting not required (Setting value is invalid. Use the initial value or a value within the setting range.)

\*1: For 2-axis interpolation, the partner axis is set. If the self-axis is set, an error "Illegal interpolation description command (error code: 521)" will occur. For 3- and 4-axis interpolation, the axis setting is not required.

\*2: The axis No. is set to axis to be interpolated No.1 for 2-axis linear interpolation, to axis to be interpolated No.1 and No.2 for 3-axis linear interpolation, and to axis to be interpolated No.1 to No.3 for 4-axis linear interpolation.

If the self-axis is set, an error "Illegal interpolation description command (error code: 521)" will occur. The axes that are not used are not required.

\*: Refer to Section 5.3 "List of positioning data" for information on the setting details.

### ■ Starting the interpolation control

The positioning data Nos. of the reference axis (axis in which interpolation control was set in "Da.2 Control system") are started when starting the interpolation control. (Starting of the interpolation axis is not required.)

The following errors or warnings will occur and the positioning will not start if both reference axis and the interpolation axis are started.

- Reference axis : Interpolation while interpolation axis BUSY (error code: 519)
- Interpolation axis : Control system setting error (error code: 524), start during operation (warning code: 100).

### ■ Interpolation control continuous positioning

When carrying out interpolation control in which "continuous positioning control" and "continuous path control" are designated in the operation pattern, the positioning method for all positioning data from the started positioning data to the positioning data in which "positioning complete" is set must be set to interpolation control.

The number of the interpolation axes and axes to be interpolated cannot be changed from the intermediate positioning data. When the number of the interpolation axes and axes to be interpolated are changed, an error "Control system setting error" (error code: 524) will occur and the positioning will stop.

### ■ Speed during interpolation control

Either the "composite speed" or "reference axis speed" can be designated as the speed during interpolation control.

(Pr.20 Interpolation speed designation method.)

Only the "Reference axis speed" can be designated in the following interpolation control.

When a "composite speed" is set and positioning is started, the "Interpolation mode error (error code: 523)" occurs, and the system will not start.

- 4-axis linear interpolation
- 2-axis speed control
- 3-axis speed control
- 4-axis speed control

### ■ Cautions in interpolation control

(1) If either of the axes exceeds the "Pr.8 Speed limit value" in the 2- to 4-axes speed control, the axis which exceeded the speed limit value is controlled by the speed limit value.

For the other axes which perform interpolation, the speed can be suppressed by the ratio of a command speed.

If the reference axis exceeds "Pr.8 Speed limit value" during 2- to 4-axis linear interpolation control, 2- to 4-axis fixed-feed control or 2-axis circular interpolation control, the reference axis is controlled at the speed limit value. (The speed limit does not function on the interpolation axis side.)

(2) In 2-axis interpolation, you cannot change the combination of interpolated axes midway through operation.

**POINT**

When the "reference axis speed" is set during interpolation control, set so the major axis side becomes the reference axis. If the minor axis side is set as the reference axis, the major axis side speed may exceed the " [Pr.8] Speed limit value".

**■ Limits to interpolation control**

There are limits to the interpolation control that can be executed and speed ( [Pr.20] Interpolation speed designation method) that can be set, depending on the " [Pr.1] Unit setting" of the reference axis and interpolation axis. (For example, circular interpolation control cannot be executed if the reference axis and interpolation axis units differ.)

The following table shows the interpolation control and speed designation limits.

" [Da.2] Control system" interpolation control	[Pr.20] Interpolation speed designation method	[Pr.1] Unit setting *1	
		Reference axis and interpolation axis units are the same, or a combination of "mm" and "inch". *3	Reference axis and interpolation axis units differ *3
Linear 2 (ABS, INC) Fixed-feed 2	Composite speed	○	×
	Reference axis speed	○	○
Circular sub (ABS, INC) Circular right (ABS, INC) Circular left (ABS, INC)	Composite speed	○ *2	×
	Reference axis speed	×	×
Linear 3 (ABS, INC) Fixed-feed 3	Composite speed	○	×
	Reference axis speed	○	○
Linear 4 (ABS, INC) Fixed-feed 4	Composite speed	×	×
	Reference axis speed	○	○

○ : Setting possible, × : Setting not possible.

\*1: "mm" and "inch" unit mix possible.

When "mm" and "inch" are mixed, convert as follows for the positioning.

- If interpolation control units are "mm", positioning is controlled by calculating position commands from the address, travel value, positioning speed and electronic gear, which have been converted to "mm" using the formula: inch setting value  $\times$  25.4 = mm setting value.
- If interpolation control units are "inch", positioning is controlled by calculating position commands from the address, travel value, positioning speed and electronic gear, which have been converted to "inch" using the formula: mm setting value  $\div$  25.4 = inch setting value.

\*2:"degree" setting not possible. A "Circular interpolation not possible (error code: 535)" will occur and the position cannot start if circular interpolation control is set when the unit is "degree". The machine will immediately stop if "degree" is set during positioning control.

\*3: The unit set in the reference axis will be used for the speed unit during control if the units differ or if "mm" and "inch" are combined.

**■ Axis operation status during interpolation control**

"Interpolation" will be stored in the " [Md.26] Axis operation status" during interpolation control. "Standby" will be stored when the interpolation operation is terminated. Both the reference axis and interpolation axis will carry out a deceleration stop if an error occurs during control, and "Error" will be stored in the operation status.



## 9.2 Setting the positioning data

### 9.2.1 Relation between each control and positioning data

The setting requirements and details for the setting items of the positioning data to be set differ according to the "[Da.2] Control system".

The following table shows the positioning data setting items corresponding to the different types of control. Details and settings for the operation of each control are shown in Section 9.2.2 and subsequent sections.

(In this section, it is assumed that the positioning data setting is carried out using GX Works2.)

Major positioning control			Position control			Speed control
			1-axis linear control 2-axis linear interpolation control 3-axis linear interpolation control 4-axis linear interpolation control	1-axis fixed-feed control 2-axis fixed-feed control 3-axis fixed-feed control 4-axis fixed-feed control	2-axis circular interpolation control	1-axis, 2-axis, 3-axis, 4-axis Speed control
Positioning data setting items						
Da.1	Operation pattern	Independent positioning control (Positioning complete)	◎	◎	◎	◎
		Continuous positioning control	◎	◎	◎	×
		Continuous path control	◎	×	◎	×
Da.2	Control system	Linear 1 Linear 2 Linear 3 Linear 4 *	Fixed-feed 1 Fixed-feed 2 Fixed-feed 3 Fixed-feed 4	Circular sub Circular right Circular left *	Forward run speed 1 Reverse run speed 1 Forward run speed 2 Reverse run speed 2 Forward run speed 3 Reverse run speed 3 Forward run speed 4 Reverse run speed 4	
Da.3	Acceleration time No.	◎	◎	◎	◎	
Da.4	Deceleration time No.	◎	◎	◎	◎	
Da.5	Axis to be interpolated <b>LD77MH4</b>	◎: 2-axis –: 1, 3, 4-axis				
Da.6	Positioning address/movement amount	◎	◎	◎	–	
Da.7	Arc address	–	–	◎	–	
Da.8	Command speed	◎	◎	◎	◎	
Da.9	Dwell time	○	○	○	–	
Da.10	M code	○	○	○	○	
Da.20	Axis to be interpolated No.1 <b>LD77MH16</b>	◎: 2, 3, 4-axis –: 1-axis				
Da.21	Axis to be interpolated No.2 <b>LD77MH16</b>	◎: 3, 4-axis –: 1, 2-axis				
Da.22	Axis to be interpolated No.3 <b>LD77MH16</b>	◎: 4-axis –: 1, 2, 3 -axis				

	Speed-position switching control	Position- speed switching control	Other control				
			NOP instruction	Current value changing	JUMP instruction	LOOP instruction	LEND instruction
	◎	◎	-	◎	-	-	-
	◎	×	-	◎	-	-	-
	×	×	-	×	-	-	-
	Forward run speed/position	Forward run position/speed	NOP instruction	Current value changing	JUMP instruction	LOOP instruction	LEND instruction
	Reverse run speed/position *	Reverse run position/speed	NOP instruction	Current value changing	JUMP instruction	LOOP instruction	LEND instruction
	◎	◎	-	-	-	-	-
	◎	◎	-	-	-	-	-
	-	-	-	-	-	-	-
	◎	◎	-	Change destination address	-	-	-
	-	-	-	-	-	-	-
	◎	◎	-	-	-	-	-
	○	○	-	-	JUMP destination-positioning data No.	-	-
	○	○	-	○	Condition data No. at JUMP	Number of repetition	-
	-	-	-	-	-	-	-
	-	-	-	-	-	-	-
	-	-	-	-	-	-	-

◎ : Always set

○ : Set according to requirements ("-" when not set)

× : Setting not possible (If setting is made, an error (error code: 516) will occur at a start.)

- : Setting not required (Setting value is invalid. Use the initial values or setting values within a range.)

\* : The "ABS (absolute) system" or "INC (incremental) system" can be used for the control system.

**REMARK**

- It is recommended that the "positioning data" be set whenever possible with GX Works2. Execution by sequence program uses many sequence programs and devices. The execution becomes complicated, and the scan times will increase.



## 9.2.2 1-axis linear control

In "1-axis linear control" ("Da.2" Control system" = ABS linear 1, INC linear 1), one motor is used to carry out position control in a set axis direction.

## [1] 1-axis linear control (ABS linear 1)

## ■ Operation chart

In absolute system 1-axis linear control, positioning is carried out from the current stop position (start point address) to the address (end point address) set in "Da.6 Positioning address/movement amount".

## Example

When the start point address (current stop position) is 1000, and the end point address (positioning address) is 8000, positioning is carried out in the positive direction for a movement amount of 7000 (8000-1000)

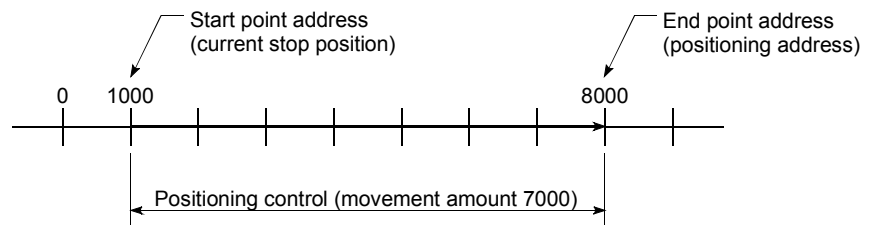

### ■ Positioning data setting example

[When "1-axis linear control (ABS linear 1)" is set in positioning data No. 1 of axis 1.]

Setting item		Setting example		Setting details	
		LD77MH4	LD77MH16		
Axis 1 Positioning data No. 1	Da.1	Operation pattern	Positioning complete		Set "Positioning complete" assuming the next positioning data will not be executed.
	Da.2	Control system	ABS linear 1		Set absolute system 1-axis linear control.
	Da.3	Acceleration time No.	1		Designate the value set in " [Pr.25] Acceleration time 1" as the acceleration time at start.
	Da.4	Deceleration time No.	0		Designate the value set in " [Pr.10] Deceleration time 0" as the deceleration time at deceleration.
	Da.5	Axis to be interpolated LD77MH4	-	/	Setting not required (setting value is ignored).
	Da.6	Positioning address/ movement amount	8000.0μm		Set the positioning address. (Assuming "mm" is set in " [Pr.1] Unit setting".)
	Da.7	Arc address	-		Setting not required (setting value is ignored).
	Da.8	Command speed	6000.00mm/min		Set the speed during movement to the positioning address.
	Da.9	Dwell time	500ms		Set the time the machine dwells after the positioning stop (command stop) to the output of the positioning complete signal.
	Da.10	M code	10		Set this when other sub operation commands are issued in combination with the No.1 positioning data.
	Da.20	Axis to be interpolated No.1 LD77MH16	/	-	Setting not required (setting value is ignored).
	Da.21	Axis to be interpolated No.2 LD77MH16	/	-	
	Da.22	Axis to be interpolated No.3 LD77MH16	/	-	

(Note): Refer to Section 5.3 "List of positioning data" for information on the setting details.

[2] 1-axis linear control (INC linear 1)

■ Operation chart

In incremental system 1-axis linear control, positioning is carried out from the current stop position (start point address) to a position at the end of the movement amount set in "Da.6 Positioning address/movement amount". The movement direction is determined by the sign of the movement amount.

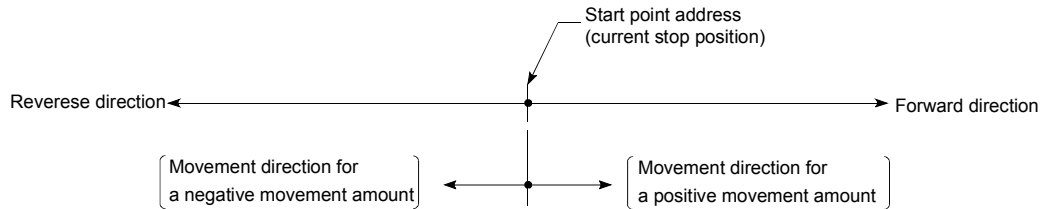

-Example-

When the start point address is 5000, and the movement amount is -7000, positioning is carried out to the -2000 position.

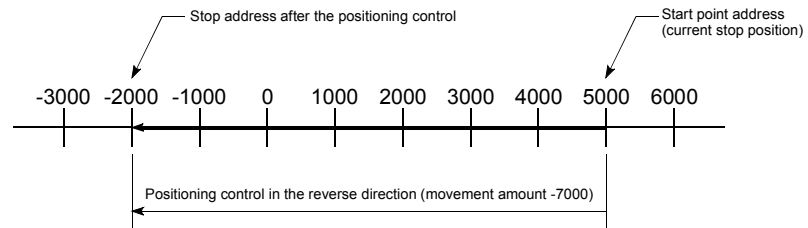

### ■ Positioning data setting example

[When "1-axis linear control (INC linear 1)" is set in positioning data No. 1 of axis 1]

Setting item		Setting example		Setting details	
		LD77MH4	LD77MH16		
Axis 1 Positioning data No. 1	Da.1	Operation pattern	Positioning complete		Set "Positioning complete" assuming the next positioning data will not be executed.
	Da.2	Control system	INC linear 1		Set incremental system 1-axis linear control.
	Da.3	Acceleration time No.	1		Designate the value set in " Pr.25 Acceleration time 1" as the acceleration time at start.
	Da.4	Deceleration time No.	0		Designate the value set in " Pr.10 Deceleration time 0" as the deceleration time at deceleration.
	Da.5	Axis to be interpolated LD77MH4	-		Setting not required (setting value is ignored).
	Da.6	Positioning address/ movement amount	-7000.0μm		Set the movement amount. (Assuming "mm" is set in " Pr.1 Unit setting".)
	Da.7	Arc address	-		Setting not required (setting value is ignored).
	Da.8	Command speed	6000.00mm/min		Set the speed during movement.
	Da.9	Dwell time	500ms		Set the time the machine dwells after the positioning stop (command stop) to the output of the positioning complete signal.
	Da.10	M code	10		Set this when other sub operation commands are issued in combination with the No.1 positioning data.
	Da.20	Axis to be interpolated No.1 LD77MH16		-	Setting not required (setting value is ignored).
	Da.21	Axis to be interpolated No.2 LD77MH16		-	
	Da.22	Axis to be interpolated No.3 LD77MH16		-	

(Note): Refer to Section 5.3 "List of positioning data" for information on the setting details.

### 9.2.3 2-axis linear interpolation control

In "2-axis linear interpolation control" ("Da.2 Control system" = ABS linear 2, INC linear 2), two motors are used to carry out position control in a linear path while carrying out interpolation for the axis directions set in each axis.  
 (Refer to Section 9.1.6 "Interpolation control" for details on interpolation control.)

#### [1] 2-axis linear interpolation control (ABS linear 2)

##### ■ Operation chart

In absolute system 2-axis linear interpolation control, the designated 2 axes are used. Linear interpolation positioning is carried out from the current stop position (start point address) to the address (end point address) set in "Da.6 Positioning address/movement amount".

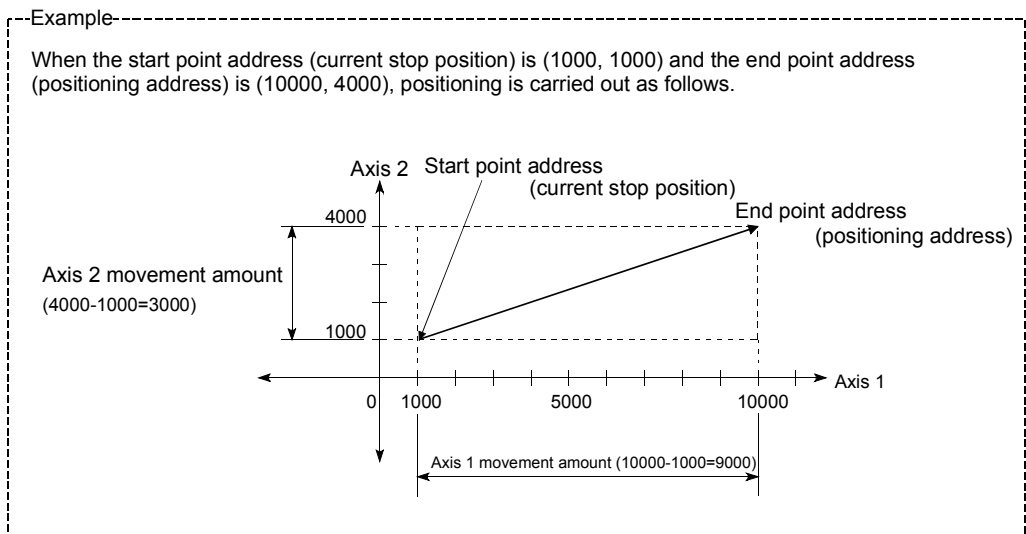
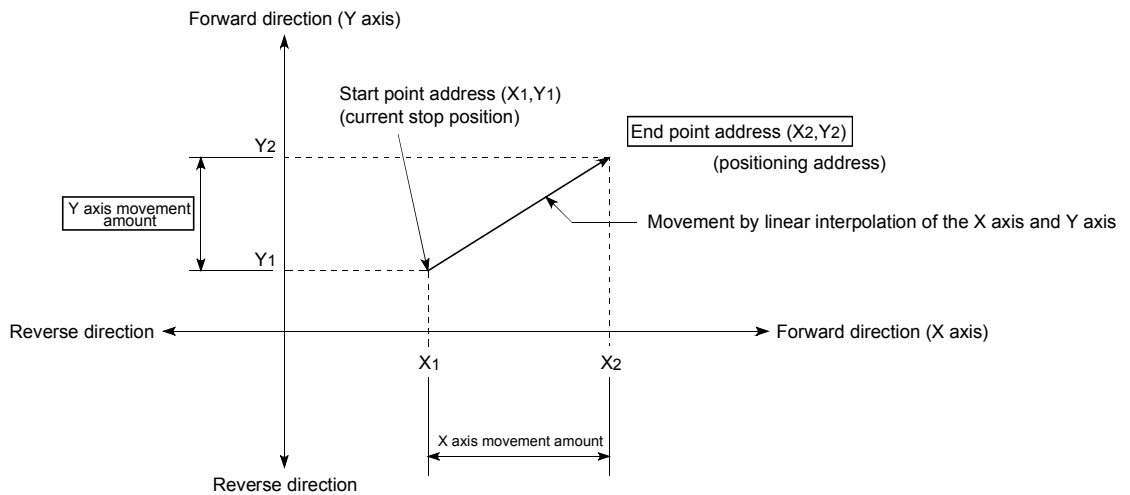

■ Restrictions

An error will occur and the positioning will not start in the following cases. The machine will immediately stop if the error is detected during a positioning control.

- If the movement amount of each axis exceeds "1073741824 (=2<sup>30</sup>)" when "0: Composite speed" is set in "Pr.20 Interpolation speed designation method" The "Outside linear movement amount range error (error code: 504)" occurs at a positioning start.  
(The maximum movement amount that can be set in "Da.6 Positioning address/movement amount" is "1073741824 (=2<sup>30</sup>).")

■ Positioning data setting example

[When "2-axis linear interpolation control (ABS linear 2)" is set in positioning data No. 1 of axis 1]

- Reference axis..... Axis 1
- Interpolation axis..... Axis 2 (The required values are also set in positioning data No. 1 of axis 2.)

Setting item	Axis	LD77MH4 setting example		LD77MH16 setting example		Setting details
		Axis 1 (reference axis)	Axis 2 (interpolation axis)	Axis 1 (reference axis)	Axis 2 (interpolation axis)	
Da.1	Operation pattern	Positioning complete	-	Positioning complete	-	Set "Positioning complete" assuming the next positioning data will not be executed.
Da.2	Control system	ABS linear 2	-	ABS linear 2	-	Set absolute system 2-axis linear interpolation control.
Da.3	Acceleration time No.	1	-	1	-	Designate the value set in "Pr.25 Acceleration time 1" as the acceleration time at start.
Da.4	Deceleration time No.	0	-	0	-	Designate the value set in "Pr.10 Deceleration time 0" as the deceleration time at deceleration.
Da.5	Axis to be interpolated LD77MH4	Axis 2	-	/		Set the axis to be interpolated (partner axis). If the self-axis is set, an error will occur.
Da.6	Positioning address/movement amount	10000.0 μm	4000.0 μm	10000.0 μm	4000.0 μm	Set the end point address. (Assuming "mm" is set in "Pr.1 Unit setting".)
Da.7	Arc address	-	-	-	-	Setting not required (setting value is ignored).
Da.8	Command speed	6000.00 mm/min	-	6000.00 mm/min	-	Set the speed during movement to the end point address.
Da.9	Dwell time	500ms	-	500ms	-	Set the time the machine dwells after the positioning stop (command stop) to the output of the positioning complete signal.
Da.10	M code	10	-	10	-	Set this when other sub operation commands are issued in combination with the No.1 positioning data.
Da.20	Axis to be interpolated No.1 LD77MH16	/		Axis 2	-	Set the axis to be interpolated. If the self-axis is set, an error will occur.
Da.21	Axis to be interpolated No.2 LD77MH16	/		-	-	Setting not required (setting value is ignored).
Da.22	Axis to be interpolated No.3 LD77MH16	/		-	-	

(Note): Refer to Section 5.3 "List of positioning data" for information on the setting details.

POINT

- When the "reference axis speed" is set during 2-axis linear interpolation control, set so the major axis side becomes the reference axis. If the minor axis side is set as the reference axis, the major axis side speed may exceed the " Pr.8 Speed limit value".

[2] 2-axis linear interpolation control (INC linear 2)

■ Operation chart

In incremental system 2-axis linear interpolation control, the designated 2 axes are used. Linear interpolation positioning is carried out from the current stop position (start point address) to a position at the end of the movement amount set in "Da.6 Positioning address/movement amount". The movement direction is determined by the sign of the movement amount.

- Positive movement amount ..... Positioning control to forward direction (Address increase direction)
- Negative movement amount ..... Positioning control to reverse direction (Address decrease direction)

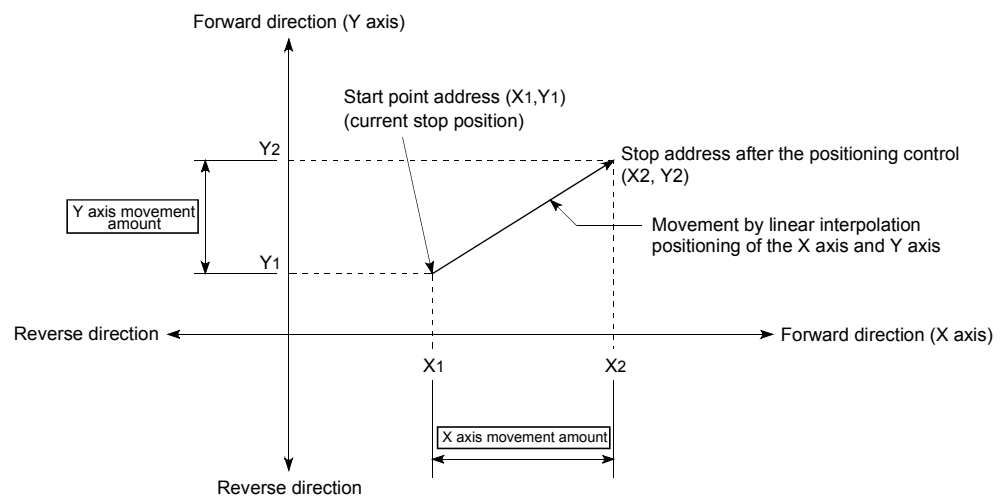

Example

When the axis 1 movement amount is 9000 and the axis 2 movement amount is -3000, positioning address (10000, 4000) is carried out as follows.

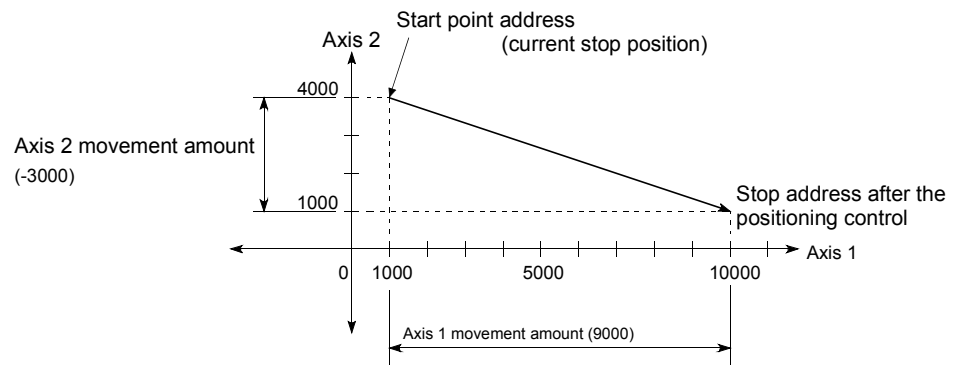



■ Restrictions

An error will occur and the positioning will not start in the following cases. The machine will immediately stop if the error is detected during a positioning operation.

- If the movement amount of each axis exceeds "1073741824 (=2<sup>30</sup>)" when "0: Composite speed" is set in "[Pr.20] Interpolation speed designation method" The "Outside linear movement amount range error (error code: 504)" occurs at a positioning start.  
(The maximum movement amount that can be set in "[Da.6] Positioning address/movement amount" is "1073741824 (=2<sup>30</sup>).")

■ Positioning data setting example

[When "2-axis linear interpolation control (INC linear 2)" is set in positioning data No. 1 of axis 1]

- Reference axis..... Axis 1
- Interpolation axis..... Axis 2 (The required values are also set in positioning data No. 1 of axis 2.)

Setting item	Axis	LD77MH4 setting example		LD77MH16 setting example		Setting details
		Axis 1 (reference axis)	Axis 2 (interpolation axis)	Axis 1 (reference axis)	Axis 2 (interpolation axis)	
[Da.1] Operation pattern		Positioning complete	–	Positioning complete	–	Set "Positioning complete" assuming the next positioning data will not be executed.
[Da.2] Control system		INC linear 2	–	INC linear 2	–	Set incremental system 2-axis linear interpolation control.
[Da.3] Acceleration time No.		1	–	1	–	Designate the value set in "[Pr.25] Acceleration time 1" as the acceleration time at start.
[Da.4] Deceleration time No.		0	–	0	–	Designate the value set in "[Pr.10] Deceleration time 0" as the deceleration time at deceleration.
[Da.5] Axis to be interpolated <b>LD77MH4</b>		Axis 2	–	/		Set the axis to be interpolated (partner axis). If the self-axis is set, an error will occur.
[Da.6] Positioning address/movement amount		9000.0 μm	-3000.0 μm	9000.0 μm	-3000.0 μm	Set the movement amount. (Assuming "mm" is set in "[Pr.1] Unit setting".)
[Da.7] Arc address		–	–	–	–	Setting not required (setting value is ignored).
[Da.8] Command speed		6000.00 mm/min	–	6000.00 mm/min	–	Set the speed during movement.
[Da.9] Dwell time		500ms	–	500ms	–	Set the time the machine dwells after the positioning stop (command stop) to the output of the positioning complete signal.
[Da.10] M code		10	–	10	–	Set this when other sub operation commands are issued in combination with the No.1 positioning data.
[Da.20] Axis to be interpolated No.1 <b>LD77MH16</b>		/		Axis 2	–	Set the axis to be interpolated. If the self-axis is set, an error will occur.
[Da.21] Axis to be interpolated No.2 <b>LD77MH16</b>		/		–	–	Setting not required (setting value is ignored).
[Da.22] Axis to be interpolated No.3 <b>LD77MH16</b>		/		–	–	

(Note): Refer to Section 5.3 "List of positioning data" for information on the setting details.

POINT

- When the "reference axis speed" is set during 2-axis linear interpolation control, set so the major axis side becomes the reference axis. If the minor axis side is set as the reference axis, the major axis side speed may exceed the "Pr.8 Speed limit value".

9.2.4 3-axis linear interpolation control

In "3-axis linear interpolation control" ("Da.2 Control system" = ABS linear 3, INC linear 3), three motors are used to carry out position control in a linear path while carrying out interpolation for the axis directions set in each axis.  
 (Refer to Section 9.1.6 "Interpolation control" for details on interpolation control.)

[1] 3-axis linear interpolation control (ABS linear 3)

■ Operation chart

In the absolute system 3-axis linear interpolation control, the designated 3 axes are used. Linear interpolation positioning is carried out from the current stop position (start point address) to the address (end point address) set in the "Da.6 Positioning address/movement amount".

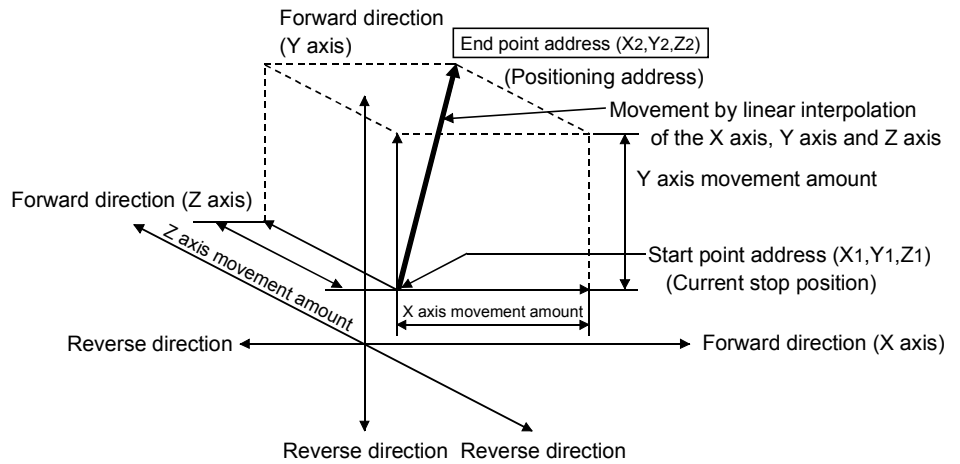

Example

When the start point address (current stop position) is (1000, 2000, 1000) and the end point address (positioning address) is (4000, 8000, 4000), positioning is carried out as follows.

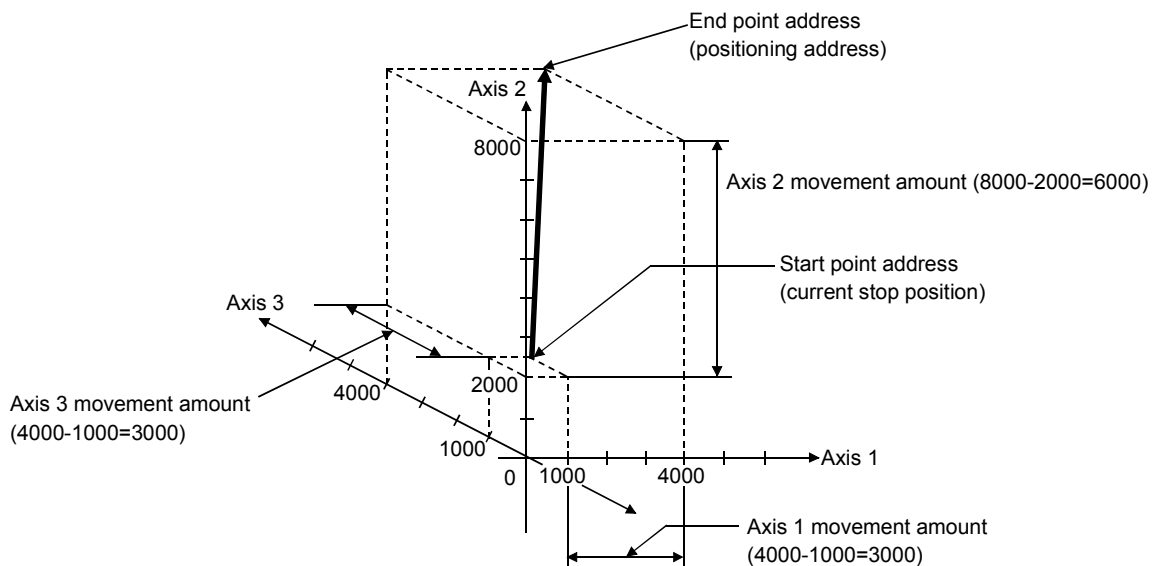

■ Restrictions

An error will occur and the positioning will not start in the following cases. The machine will immediately stop if the error is detected during a positioning control.

- If the movement amount of each axis exceeds "1073741824 (=2<sup>30</sup>)" when "0: Composite speed" is set in "[Pr.20] Interpolation speed designation method" The "Outside linear movement amount range error (error code: 504)" occurs at a positioning start.  
(The maximum movement amount that can be set in "[Da.6] Positioning address/movement amount" is "1073741824 (=2<sup>30</sup>).")

■ Positioning data setting example

[When "3-axis linear interpolation control (ABS linear 3)" is set in positioning data No. 1 of axis 1]

- Reference axis..... Axis 1
- Interpolation axis..... Axis 2, Axis3 (The required values are also set in positioning data No. 1 of axis 2 and axis 3.)

Setting item	Axis	LD77MH4 setting example			LD77MH16 setting example			Setting details
		Axis 1 (reference axis)	Axis 2 (interpolation axis)	Axis 3 (interpolation axis)	Axis 1 (reference axis)	Axis 2 (interpolation axis)	Axis 3 (interpolation axis)	
[Da.1] Operation pattern		Positioning complete	-	-	Positioning complete	-	-	Set "Positioning complete" assuming the next positioning data will not be executed.
[Da.2] Control system		ABS linear 3	-	-	ABS linear 3	-	-	Set absolute system 3-axis linear interpolation control.
[Da.3] Acceleration time No.		1	-	-	1	-	-	Designate the value set in "[Pr.25] Acceleration time 1" as the acceleration time at start.
[Da.4] Deceleration time No.		0	-	-	0	-	-	Designate the value set in "[Pr.10] Deceleration time 0" as the deceleration time at deceleration.
[Da.5] Axis to be interpolated LD77MH4		-	-	-	/			Setting not required (setting value is ignored). When axis 1 is used as a reference axis, the interpolation axes are axes 2 and 3.
[Da.6] Positioning address/ movement amount		4000.0 μm	8000.0 μm	4000.0 μm	4000.0 μm	8000.0 μm	4000.0 μm	Set the end point address. (Assuming "mm" is set in "[Pr.1] Unit setting".)
[Da.7] Arc address		-	-	-	-	-	-	Setting not required (setting value is ignored).
[Da.8] Command speed		6000.00 mm/min	-	-	6000.00 mm/min	-	-	Set the speed during movement to the end point address.
[Da.9] Dwell time		500ms	-	-	500ms	-	-	Set the time the machine dwells after the positioning stop (command stop) to the output of the positioning complete signal.
[Da.10] M code		10	-	-	10	-	-	Set this when other sub operation commands are issued in combination with the No. 1 positioning data.
[Da.20] Axis to be interpolated No.1 LD77MH16		/			Axis 2			Set the axis to be interpolated. If the self-axis is set, an error will occur.
[Da.21] Axis to be interpolated No.2 LD77MH16		/			Axis 3			
[Da.22] Axis to be interpolated No.3 LD77MH16		/			-	-	-	Setting not required (setting value is ignored).

(Note): Refer to Section 5.3 "List of positioning data" for information on the setting details.

POINTS

- When the "reference axis speed" is set during 3-axis linear interpolation control, set so the major axis side becomes the reference axis. If the minor axis side is set as the reference axis, the major axis side speed may exceed the " Pr.8 Speed limit value".
- Refer to Section 9.1.6 "Interpolation control" for the reference axis and interpolation axis combinations.

[2] 3-axis linear interpolation control (INC linear 3)

■ Operation chart

In the incremental system 3-axis linear interpolation control, the designated 3 axes are used. Linear interpolation positioning is carried out from the current stop position (start point address) to a position at the end of the movement amount set in the "Da.6 Positioning address/movement amount". The movement direction is determined the sign of the movement amount.

- Positive movement amount ..... Positioning control to forward direction (Address increase direction)
- Negative movement amount..... Positioning control to reverse direction (Address decrease direction)

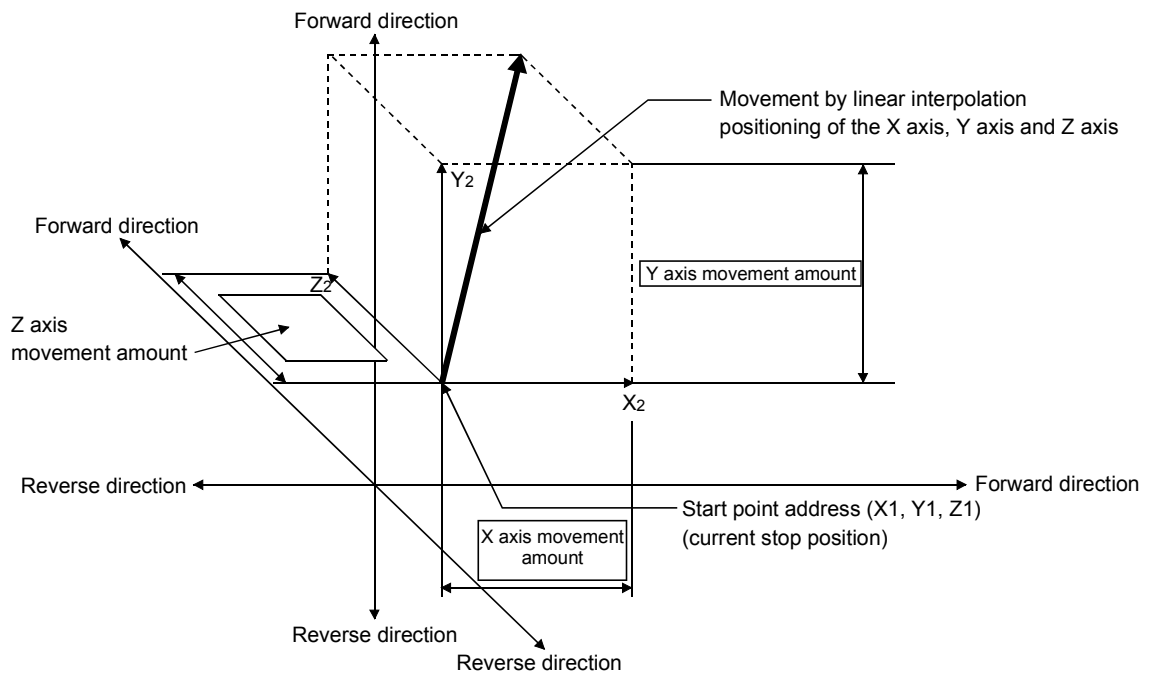

-Example-

When the axis 1 movement amount is 10000, the axis 2 movement amount is 5000 and the axis 3 movement amount is 6000, positioning is carried out as follows.

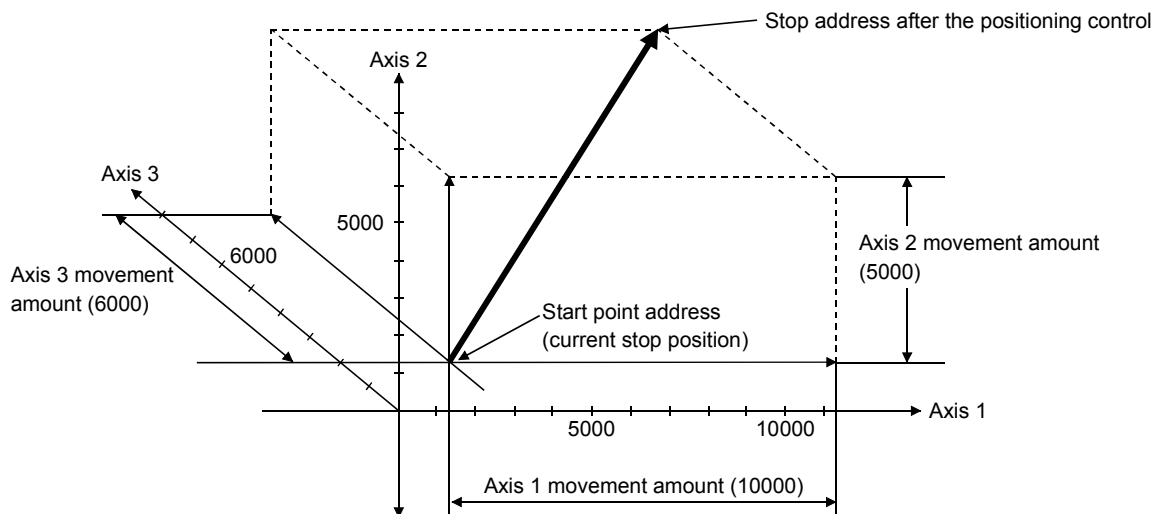

■ Restrictions

An error will occur and the positioning will not start in the following cases. The machine will immediately stop if the error is detected during a positioning operation.

- If the movement amount of each axis exceeds "1073741824 (=2<sup>30</sup>)" when "0: Composite speed" is set in " [Pr.20] Interpolation speed designation method" The "Outside linear movement amount range error (error code: 504)" occurs at a positioning start.  
(The maximum movement amount that can be set in " [Da.6] Positioning address/movement amount" is "1073741824 (=2<sup>30</sup>).")

■ Positioning data setting example

[When "3-axis linear interpolation control (INC linear 3)" is set in positioning data No. 1 of axis 1]

- Reference axis..... Axis 1
- Interpolation axis..... Axis 2, Axis3 (The required values are also set in positioning data No. 1 of axis 2 and axis 3.)

Setting item	Axis	LD77MH4 setting example			LD77MH16 setting example			Setting details
		Axis 1 (reference axis)	Axis 2 (interpolation axis)	Axis 3 (interpolation axis)	Axis 1 (reference axis)	Axis 2 (interpolation axis)	Axis 3 (interpolation axis)	
[Da.1] Operation pattern		Positioning complete	-	-	Positioning complete	-	-	Set "Positioning complete" assuming the next positioning data will not be executed.
[Da.2] Control system		INC linear 3	-	-	INC linear 3	-	-	Set incremental system 3-axis linear interpolation control.
[Da.3] Acceleration time No.		1	-	-	1	-	-	Designate the value set in " [Pr.25] Acceleration time 1" as the acceleration time at start.
[Da.4] Deceleration time No.		0	-	-	0	-	-	Designate the value set in " [Pr.10] Deceleration time 0" as the deceleration time at deceleration.
[Da.5] Axis to be interpolated LD77MH4		-	-	-	/			Setting not required (setting value is ignored). When axis 1 is used as a reference axis, the interpolation axes are axes 2 and 3.
[Da.6] Positioning address/movement amount		10000.0 μm	5000.0 μm	6000.0 μm	10000.0 μm	5000.0 μm	6000.0 μm	Set the movement amount. (Assuming "mm" is set in " [Pr.1] Unit setting".)
[Da.7] Arc address		-	-	-	-	-	-	Setting not required (setting value is ignored).
[Da.8] Command speed		6000.00 mm/min	-	-	6000.00 mm/min	-	-	Set the speed during movement to the end point address.
[Da.9] Dwell time		500ms	-	-	500ms	-	-	Set the time the machine dwells after the positioning stop (command stop) to the output of the positioning complete signal.
[Da.10] M code		10	-	-	10	-	-	Set this when other sub operation commands are issued in combination with the No. 1 positioning data.
[Da.20] Axis to be interpolated No.1 LD77MH16		/			Axis 2			Set the axis to be interpolated.
[Da.21] Axis to be interpolated No.2 LD77MH16		/			Axis 3			If the self-axis is set, an error will occur.
[Da.22] Axis to be interpolated No.3 LD77MH16		/			-	-	-	Setting not required (setting value is ignored).

(Note): Refer to Section 5.3 "List of positioning data" for information on the setting details.

POINTS

- When the "reference axis speed" is set during 3-axis linear interpolation control, set so the major axis side becomes the reference axis. If the minor axis side is set as the reference axis, the major axis side speed may exceed the " Pr.8 Speed limit value".
- Refer to Section 9.1.6 "Interpolation control" for the reference axis and interpolation axis combinations.



### 9.2.5 4-axis linear interpolation control

In "4-axis linear interpolation control" ("Da.2 Control system" = ABS linear 4, INC linear 4), four motors are used to carry out position control in a linear path while carrying out interpolation for the axis directions set in each axis.  
(Refer to Section 9.1.6 "Interpolation control" for details on interpolation control.)

#### [1] 4-axis linear interpolation control (ABS linear 4)

In the absolute system 4-axis linear interpolation control, the designated 4 axes are used. Linear interpolation positioning is carried out from the current stop position (start point address) to the address (end point address) set in the "Da.6 Positioning address/movement amount".

#### ■ Restrictions

An error will occur and the positioning will not start in the following cases. The machine will immediately stop if the error is detected during a positioning control.

- When the movement amount for each axis exceeds "1073741824 ( $=2^{30}$ )"  
An "outside linear movement amount range error (error code: 504)" will occur at the positioning start.

(The maximum movement amount that can be set in "Da.6 Positioning address/movement amount" is "1073741824 ( $=2^{30}$ )".)

■ Positioning data setting example

[When "4-axis linear interpolation control (ABS linear 4)" is set in positioning data No. 1 of axis 1]

- Reference axis..... Axis 1
- Interpolation axis..... Axis 2, Axis3, Axis4 (The required values are also set in positioning data No. 1 of axis 2, axis 3 and axis 4.)

Setting item		LD77MH4 setting example				LD77MH16 setting example				Setting details	
		Axis 1 (reference axis)	Axis 2 (interpolation axis)	Axis 3 (interpolation axis)	Axis 4 (interpolation axis)	Axis 1 (reference axis)	Axis 2 (interpolation axis)	Axis 3 (interpolation axis)	Axis 4 (interpolation axis)		
Axis 1 Positioning data No. 1	Da.1	Operation pattern	Positioning complete	-	-	-	Positioning complete	-	-	-	Set "Positioning complete" assuming the next positioning data will not be executed.
	Da.2	Control system	ABS linear 4	-	-	-	ABS linear 4	-	-	-	Set absolute system 4-axis linear interpolation control.
	Da.3	Acceleration time No.	1	-	-	-	1	-	-	-	Designate the value set in "[Pr.25] Acceleration time 1" as the acceleration time at start.
	Da.4	Deceleration time No.	0	-	-	-	0	-	-	-	Designate the value set in "[Pr.10] Deceleration time 0" as the deceleration time at deceleration.
	Da.5	Axis to be interpolated LD77MH4	-	-	-	-	/				Setting not required (setting value is ignored). When axis 1 is used as a reference axis, the interpolation axes are axes 2, 3 and 4.
	Da.6	Positioning address/movement amount	4000.0 μm	8000.0 μm	4000.0 μm	3000.0 μm	4000.0 μm	8000.0 μm	4000.0 μm	3000.0 μm	Set the end point address. (Assuming "mm" is set in "[Pr.1] Unit setting".)
	Da.7	Arc address	-	-	-	-	-	-	-	-	Setting not required (setting value is ignored).
	Da.8	Command speed	6000.00 mm/min	-	-	-	6000.00 mm/min	-	-	-	Set the speed during movement to the end point address.
	Da.9	Dwell time	500ms	-	-	-	500ms	-	-	-	Set the time the machine dwells after the positioning stop (command stop) to the output of the positioning complete signal.
	Da.10	M code	10	-	-	-	10	-	-	-	Set this when other sub operation commands are issued in combination with the No. 1 positioning data.
	Da.20	Axis to be interpolated No.1 LD77MH16	/				Axis 2	-	-	-	Set the axis to be interpolated. If the self-axis is set, an error will occur.
	Da.21	Axis to be interpolated No.2 LD77MH16	/				Axis 3	-	-	-	
	Da.22	Axis to be interpolated No.3 LD77MH16	/				Axis 4	-	-	-	

(Note): Refer to Section 5.3 "List of positioning data" for information on the setting details.

**POINTS**

- When the "reference axis speed" is set during 4-axis linear interpolation control, set so the major axis side becomes the reference axis. If the minor axis side is set as the reference axis, the major axis side speed may exceed the "Pr.8 Speed limit value".
- Refer to Section 9.1.6 "Interpolation control" for the reference axis and interpolation axis combinations.

**[2] 4-axis linear interpolation control (INC linear 4)**

In the incremental system 4-axis linear interpolation control, the designated 4 axes are used. Linear interpolation positioning is carried out from the current stop position (start point address) to a position at the end of the movement amount set in the "Da.6 Positioning address/movement amount". The movement direction is determined by the sign of the movement amount.

**■ Restrictions**

An error will occur and the positioning will not start in the following cases. The machine will immediately stop if the error is detected during a positioning operation.

- When the movement amount for each axis exceeds "1073741824 (=2<sup>30</sup>)" An "outside linear movement amount range error (error code: 504)" will occur at the positioning start.

(The maximum movement amount that can be set in "Da.6 Positioning address/movement amount" is "1073741824 (=2<sup>30</sup>).")

■ Positioning data setting example

[When "4-axis linear interpolation control (INC linear 4)" is set in positioning data No. 1 of axis 1]

- Reference axis..... Axis 1
- Interpolation axis..... Axis 2, Axis3, Axis4 (The required values are also set in positioning data No. 1 of axis 2, axis 3 and axis 4.)

Setting item		LD77MH4 setting example				LD77MH16 setting example				Setting details	
		Axis 1 (reference axis)	Axis 2 (interpolation axis)	Axis 3 (interpolation axis)	Axis 4 (interpolation axis)	Axis 1 (reference axis)	Axis 2 (interpolation axis)	Axis 3 (interpolation axis)	Axis 4 (interpolation axis)		
Axis 1 Positioning data No. 1	Da.1	Operation pattern	Positioning complete	-	-	-	Positioning complete	-	-	-	Set "Positioning complete" assuming the next positioning data will not be executed.
	Da.2	Control system	INC linear 4	-	-	-	INC linear 4	-	-	-	Set incremental system 4-axis linear interpolation control.
	Da.3	Acceleration time No.	1	-	-	-	1	-	-	-	Designate the value set in "[Pr.25] Acceleration time 1" as the acceleration time at start.
	Da.4	Deceleration time No.	0	-	-	-	0	-	-	-	Designate the value set in "[Pr.10] Deceleration time 0" as the deceleration time at deceleration.
	Da.5	Axis to be interpolated <b>LD77MH4</b>	-	-	-	-	/				Setting not required (setting value is ignored). When axis 1 is used as a reference axis, the interpolation axes are axes 2, 3 and 4.
	Da.6	Positioning address/movement amount	4000.0 μm	8000.0 μm	4000.0 μm	3000.0 μm	4000.0 μm	8000.0 μm	4000.0 μm	3000.0 μm	Set the movement amount. (Assuming "mm" is set in "[Pr.1] Unit setting".)
	Da.7	Arc address	-	-	-	-	-	-	-	-	Setting not required (setting value is ignored).
	Da.8	Command speed	6000.00 mm/min	-	-	-	6000.00 mm/min	-	-	-	Set the speed during movement.
	Da.9	Dwell time	500ms	-	-	-	500ms	-	-	-	Set the time the machine dwells after the positioning stop (command stop) to the output of the positioning complete signal.
	Da.10	M code	10	-	-	-	10	-	-	-	Set this when other sub operation commands are issued in combination with the No. 1 positioning data.
Da.20	Axis to be interpolated No.1 <b>LD77MH16</b>	/				Axis 2	-	-	-	Set the axis to be interpolated. If the self-axis is set, an error will occur.	
Da.21	Axis to be interpolated No.2 <b>LD77MH16</b>	/				Axis 3	-	-	-		
Da.22	Axis to be interpolated No.3 <b>LD77MH16</b>	/				Axis 4	-	-	-		

(Note): Refer to Section 5.3 "List of positioning data" for information on the setting details.

POINT

- When the "reference axis speed" is set during 4-axis linear interpolation control, set so the major axis side becomes the reference axis. If the minor axis side is set as the reference axis, the major axis side speed may exceed the " Pr.8 Speed limit value".
- Refer to Section 9.1.6 "Interpolation control" for the reference axis and interpolation axis combinations.

### 9.2.6 1-axis fixed-feed control

In "1-axis fixed-feed control" ("Da.2 Control system" = fixed-feed 1), one motor is used to carry out fixed-feed control in a set axis direction.

In fixed-feed control, any remainder of below control accuracy is rounded down to convert the movement amount designated in the positioning data into the command value to servo amplifier.

#### ■ Operation chart

In 1-axis fixed-feed control, the address (Md.20 Current feed value) of the current stop position (start point address) is set to "0". Positioning is then carried out to a position at the end of the movement amount set in "Da.6 Positioning address/movement amount".

The movement direction is determined by the movement amount sign.

- Positive movement amount ..... Positioning control to forward direction (Address increase direction)
- Negative movement amount..... Positioning control to reverse direction (Address decrease direction)

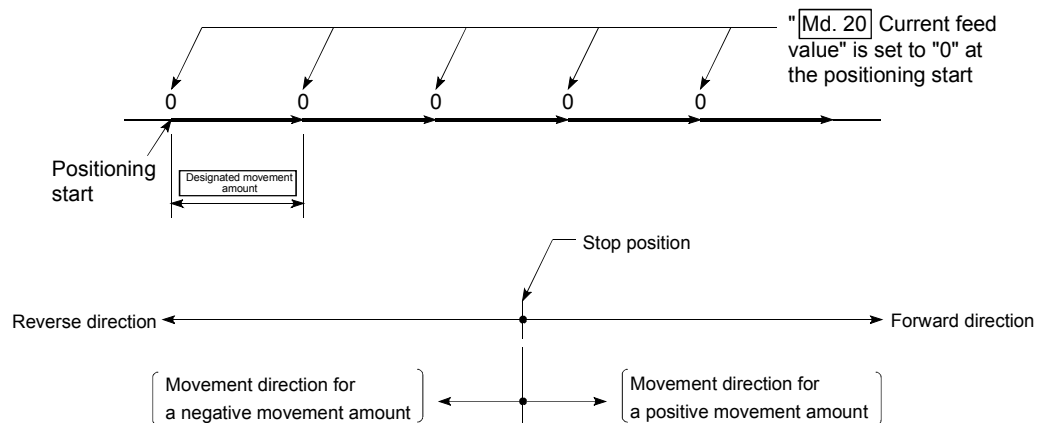

#### ■ Restrictions

- (1) An axis error "Continuous path control invalid (error code: 516)" will occur and the operation cannot start if "continuous path control" is set in "Da.1 Operation pattern". ("Continuous path control" cannot be set in fixed-feed control.)
- (2) "Fixed-feed" cannot be set in "Da.2 Control system" in the positioning data when "continuous path control" has been set in "Da.1 Operation pattern" of the immediately prior positioning data. (For example, if the operation pattern of positioning data No. 1 is "continuous path control", fixed-feed control cannot be set in positioning data No. 2.) An axis error "Continuous path control invalid (error code: 516)" will occur and the machine will carry out a deceleration stop if this type of setting is carried out.

**POINT**

- When the movement amount is converted to the actual number of command pulses, a fraction appears after the decimal point, according to the movement amount per pulse. This fraction is normally retained in the LD77MH and reflected at the next positioning.

For the fixed-feed control, since the movement distance is maintained constant (= the command number of pulses is maintained constant), the control is carried out after the fraction pulse is cleared to zero at start.

[Accumulation/cutoff for fractional pulses]

When movement amount per pulse is 1.0 [μm] and movement for 2.5 [μm] is executed two times.

→ Conversion to command pulses:  $2.5 [\mu\text{m}] \div 1.0 = 2.5 [\text{PLS}]$

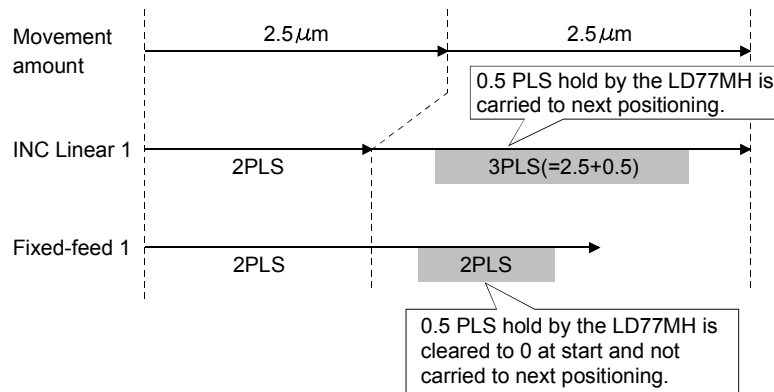

### ■ Positioning data setting example

[When "1-axis fixed-feed control (fixed-feed 1)" is set in positioning data No.1 of axis 1]

Setting item		Setting example		Setting details	
		LD77MH4	LD77MH16		
Axis 1 Positioning data No. 1	Da.1	Operation pattern	Positioning complete		Set "Positioning complete" assuming the next positioning data will not be executed.
	Da.2	Control system	Fixed-feed 1		Set 1-axis fixed-feed control.
	Da.3	Acceleration time No.	1		Designate the value set in " Pr.25 Acceleration time 1" as the acceleration time at start.
	Da.4	Deceleration time No.	0		Designate the value set in " Pr.10 Deceleration time 0" as the deceleration time at deceleration.
	Da.5	Axis to be interpolated LD77MH4	-	/	Setting not required (setting value is ignored).
	Da.6	Positioning address/ movement amount	8000.0μm		Set the positioning address. (Assuming "mm" is set in " Pr.1 Unit setting".)
	Da.7	Arc address	-		Setting not required (setting value is ignored).
	Da.8	Command speed	6000.00mm/min		Set the speed during movement to the positioning address.
	Da.9	Dwell time	500ms		Set the time the machine dwells after the positioning stop (command stop) to the output of the positioning complete signal.
	Da.10	M code	10		Set this when other sub operation commands are issued in combination with the No. 1 positioning data.
	Da.20	Axis to be interpolated No.1 LD77MH16	/	-	Setting not required (setting value is ignored).
	Da.21	Axis to be interpolated No.2 LD77MH16	/	-	
	Da.22	Axis to be interpolated No.3 LD77MH16	/	-	

(Note): Refer to Section 5.3 "List of positioning data" for information on the setting details.



### 9.2.7 2-axis fixed-feed control (interpolation)

In "2-axis fixed-feed control" ("Da.2 Control system" = fixed-feed 2), two motors are used to carry out fixed-feed control in a linear path while carrying out interpolation for the axis directions set in each axis.

In fixed-feed control, any remainder of below control accuracy is rounded down to convert the movement amount designated in the positioning data into the command value to servo amplifier.

(Refer to Section 9.1.6 "Interpolation control" for details on interpolation control.)

#### ■ Operation chart

In incremental system 2-axis fixed-feed control, the addresses (Md.20 Current feed value) of the current stop position (start addresses) of both axes are set to "0". Linear interpolation positioning is then carried out from that position to a position at the end of the movement amount set in "Da.6 Positioning address/movement amount". The movement direction is determined by the sign of the movement amount.

- Positive movement amount ..... Positioning control to forward direction  
(Address increase direction)
- Negative movement amount..... Positioning control to reverse direction  
(Address decrease direction)

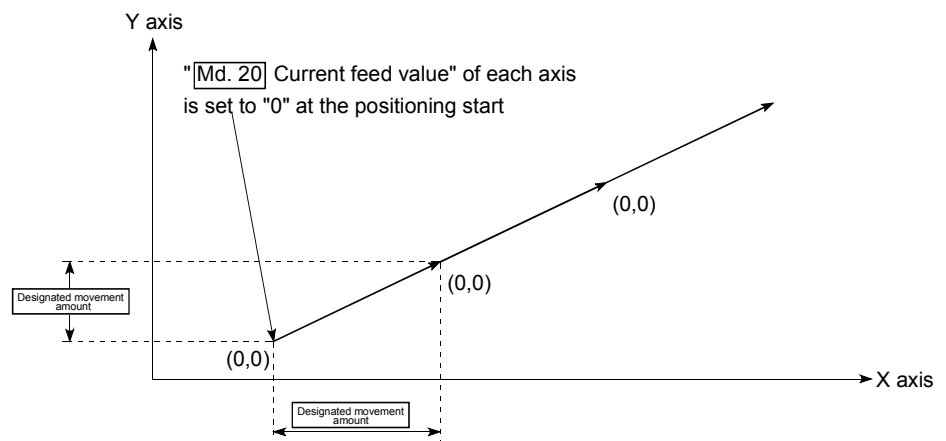

#### ■ Restrictions

- (1) An axis error "Continuous path control not possible (error code: 516)" will occur and the operation cannot start if "continuous path control" is set in "Da.1 Operation pattern". ("Continuous path control" cannot be set in fixed-feed control.)
- (2) "Fixed-feed" cannot be set in "Da.2 Control system" in the positioning data when "continuous path control" has been set in "Da.1 Operation pattern" of the immediately prior positioning data. (For example, if the operation pattern of positioning data No. 1 is "continuous path control", fixed-feed control cannot be set in positioning data No. 2.) An axis error "Continuous path control not possible (error code: 516)" will occur and the machine will carry out a deceleration stop if this type of setting is carried out.

■ Positioning data setting example

[When "2-axis fixed-feed control (fixed-feed 2)" is set in positioning data No. 1 of axis 1]

- Reference axis..... Axis 1
- Interpolation axis..... Axis 2 (The required values are also set in positioning data No. 1 of axis 2.)

Setting item		LD77MH4 setting example		LD77MH16 setting example		Setting details	
		Axis 1 (reference axis)	Axis 2 (interpolation axis)	Axis 1 (reference axis)	Axis 2 (interpolation axis)		
Axis 1 Positioning data No. 1	Da.1	Operation pattern	Positioning complete	–	Positioning complete	–	Set "Positioning complete" assuming the next positioning data will not be executed.
	Da.2	Control system	Fixed-feed 2	–	Fixed-feed 2	–	Set 2-axis fixed-feed control.
	Da.3	Acceleration time No.	1	–	1	–	Designate the value set in "[Pr.25] Acceleration time 1" as the acceleration time at start.
	Da.4	Deceleration time No.	0	–	0	–	Designate the value set in "[Pr.10] Deceleration time 0" as the deceleration time at deceleration.
	Da.5	Axis to be interpolated LD77MH4	Axis 2	–	/		Set the axis to be interpolated (partner axis). If the self-axis is set, an error will occur.
	Da.6	Positioning address/ movement amount	8000.0 μm	6000.0 μm	8000.0 μm	6000.0 μm	Set the positioning address. (Assuming "mm" is set in "[Pr.1] Unit setting".)
	Da.7	Arc address	–	–	–	–	Setting not required (setting value is ignored).
	Da.8	Command speed	6000.00 mm/min	–	6000.00 mm/min	–	Set the speed during movement. (Designate the composite speed of reference axis speed in "[Pr.20] Interpolation speed designation method".)
	Da.9	Dwell time	500ms	–	500ms	–	Set the time the machine dwells after the positioning stop (command stop) to the output of the positioning complete signal.
	Da.10	M code	10	–	10	–	Set this when other sub operation commands are issued in combination with the No. 1 positioning data.
	Da.20	Axis to be interpolated No.1 LD77MH16	/		Axis 2	–	Set the axis to be interpolated. If the self-axis is set, an error will occur.
	Da.21	Axis to be interpolated No.2 LD77MH16	/		–	–	Setting not required (setting value is ignored).
	Da.22	Axis to be interpolated No.3 LD77MH16	/		–	–	

(Note): Refer to Section 5.3 "List of positioning data" for information on the setting details.

## POINTS

- When the movement amount is converted to the actual number of command pulses, a fraction appears after the decimal point, according to the movement amount per pulse. This fraction is normally retained in the LD77MH and reflected at the next positioning.  
For the fixed-feed control, since the movement distance is maintained constant (= the command number of pulses is maintained constant), the control is carried out after the fraction pulse is cleared to zero at start.

[Accumulation/cutoff for fractional pulses]

When movement amount per pulse is 1.0 [ $\mu\text{m}$ ] and movement for 2.5 [ $\mu\text{m}$ ] is executed two times.

→ Conversion to command pulses:  $2.5 [\mu\text{m}] \div 1.0 = 2.5 [\text{PLS}]$

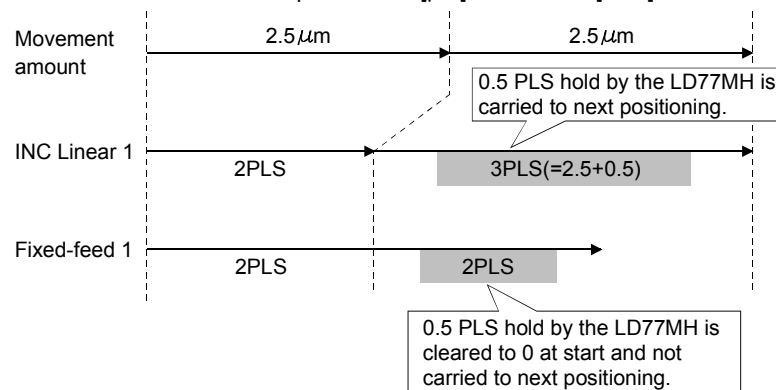

- When the "reference axis speed" is set during 2-axis fixed-feed control, set so the major axis side becomes the reference axis. If the minor axis side is set as the reference axis, the major axis side speed may exceed the "Pr.8 Speed limit value".

### 9.2.8 3-axis fixed-feed control (interpolation)

In "3-axis fixed-feed control" ("Da.2 Control system" = fixed-feed 3), three motors are used to carry out fixed-feed control in a linear path while carrying out interpolation for the axis directions set in each axis.

In fixed-feed control, any remainder of below control accuracy is rounded down to convert the movement amount designated in the positioning data into the command value to servo amplifier.

(Refer to Section 9.1.6 "Interpolation control" for details on interpolation control.)

■ Operation chart

In incremental system 3-axis fixed-feed control, the addresses ( [Md.20] Current feed value) of the current stop position (start addresses) of every axes are set to "0". Linear interpolation positioning is then carried out from that position to a position at the end of the movement amount set in " [Da.6] Positioning address/ movement amount". The movement direction is determined by the sign of the movement amount.

- Positive movement amount ..... Positioning control to forward direction (Address increase direction)
- Negative movement amount..... Positioning control to reverse direction (Address decrease direction)

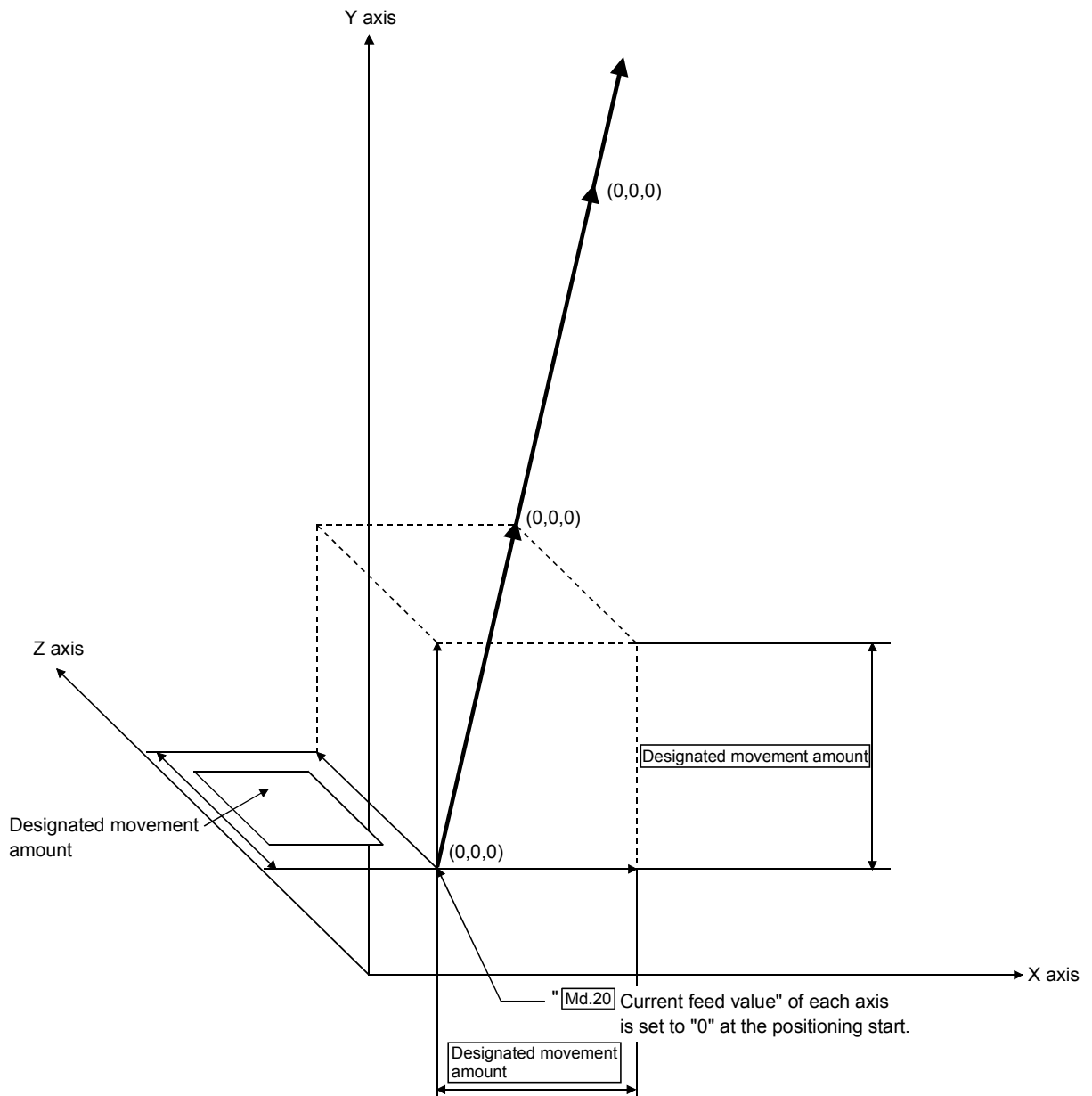

**■ Restrictions**

- (1) An axis error "Continuous path control not possible (error code: 516)" will occur and the operation cannot start if "continuous path control" is set in "[Da.1] Operation pattern". ("Continuous path control" cannot be set in fixed-feed control.)
- (2) If the movement amount of each axis exceeds "1073741824 (=2<sup>30</sup>)" when "0: Composite speed" is set in "[Pr.20] Interpolation speed designation method", the "Outside linear movement amount range" (error code: 504) occurs at a positioning start and positioning cannot be started. (The maximum movement amount that can be set in "[Da.6] Positioning address/movement amount" is "1073741824 (= 2<sup>30</sup>)".)
- (3) "Fixed-feed" cannot be set in "[Da.2] Control system" in the positioning data when "continuous path control" has been set in "[Da.1] Operation pattern" of the immediately prior positioning data. (For example, if the operation pattern of positioning data No. 1 is "continuous path control", fixed-feed control cannot be set in positioning data No. 2.) An axis error "Continuous path control not possible" (error code: 516) will occur and the machine will carry out a deceleration stop if this type of setting is carried out.

■ Positioning data setting example

[When "3-axis fixed-feed control (fixed-feed 3)" is set in positioning data No. 1 of axis 1]

- Reference axis..... Axis 1
- Interpolation axis..... Axis 2, Axis3 (The required values are also set in positioning data No. 1 of axis 2 and axis 3.)

Setting item	Axis	LD77MH4 setting example			LD77MH16 setting example			Setting details
		Axis 1 (reference axis)	Axis 2 (interpolation axis)	Axis 3 (interpolation axis)	Axis 1 (reference axis)	Axis 2 (interpolation axis)	Axis 3 (interpolation axis)	
Da.1	Operation pattern	Positioning complete	-	-	Positioning complete	-	-	Set "Positioning complete" assuming the next positioning data will not be executed.
Da.2	Control system	Fixed-feed 3	-	-	Fixed-feed 3	-	-	Set 3-axis fixed-feed control.
Da.3	Acceleration time No.	1	-	-	1	-	-	Designate the value set in "[Pr.25] Acceleration time 1" as the acceleration time at start.
Da.4	Deceleration time No.	0	-	-	0	-	-	Designate the value set in "[Pr.10] Deceleration time 0" as the deceleration time at deceleration.
Da.5	Axis to be interpolated LD77MH4	-	-	-	/			Setting not required (setting value is ignored). When axis 1 is used as a reference axis, the interpolation axes are axes 2 and 3.
Da.6	Positioning address/ movement amount	10000.0 μm	5000.0 μm	6000.0 μm	10000.0 μm	5000.0 μm	6000.0 μm	Set the positioning address. (Assuming "mm" is set in "[Pr.1] Unit setting".)
Da.7	Arc address	-	-	-	-	-	-	Setting not required (setting value is ignored).
Da.8	Command speed	6000.00 mm/min	-	-	6000.00 mm/min	-	-	Set the speed during movement.
Da.9	Dwell time	500ms	-	-	500ms	-	-	Set the time the machine dwells after the positioning stop (command stop) to the output of the positioning complete signal.
Da.10	M code	10	-	-	10	-	-	Set this when other sub operation commands are issued in combination with the No. 1 positioning data.
Da.20	Axis to be interpolated No.1 LD77MH16	/			Axis 2			Set the axis to be interpolated.
Da.21	Axis to be interpolated No.2 LD77MH16	/			Axis 3			If the self-axis is set, an error will occur.
Da.22	Axis to be interpolated No.3 LD77MH16	/			-	-	-	Setting not required (setting value is ignored).

(Note): Refer to Section 5.3 "List of positioning data" for information on the setting details.

## POINTS

- When the movement amount is converted to the actual number of command pulses, a fraction appears after the decimal point, according to the movement amount per pulse. This fraction is normally retained in the LD77MH and reflected at the next positioning.

For the fixed-feed control, since the movement distance is maintained constant (= the command number of pulses is maintained constant), the control is carried out after the fraction pulse is cleared to zero at start.

## [Accumulation/cutoff for fractional pulses]

When movement amount per pulse is  $1.0\ [\mu\text{m}]$  and movement for  $2.5\ [\mu\text{m}]$  is executed two times.

→ Conversion to command pulses:  $2.5\ [\mu\text{m}] \div 1.0 = 2.5\ [\text{PLS}]$

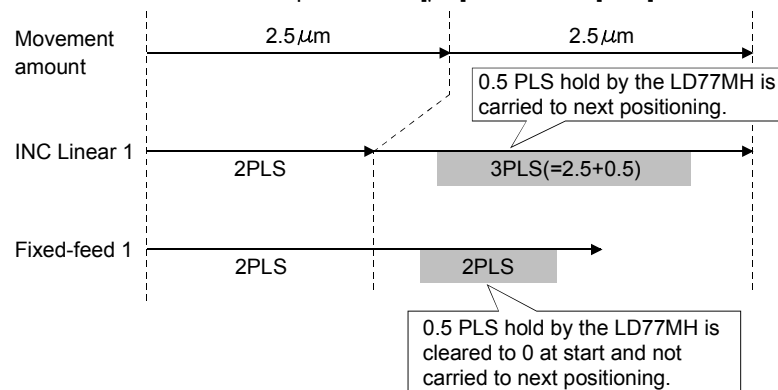

- When the "reference axis speed" is set during 3-axis fixed-feed control, set so the major axis side becomes the reference axis. If the minor axis side is set as the reference axis, the major axis side speed may exceed the "Pr.8 Speed limit value".
- Refer to Section 9.1.6 "Interpolation control" for the reference axis and interpolation axis combinations.

### 9.2.9 4-axis fixed-feed control (interpolation)

In "4-axis fixed-feed control" ("Da.2 Control system" = fixed-feed 4), four motors are used to carry out fixed-feed control in a linear path while carrying out interpolation for the axis directions set in each axis.

In fixed-feed control, any remainder of below control accuracy is rounded down to convert the movement amount designated in the positioning data into the command value to servo amplifier.

(Refer to Section 9.1.6 "Interpolation control" for details on interpolation control.)

#### ■ Operation chart

In incremental system 4-axis fixed-feed control, the addresses (Md.20 Current feed value) of the current stop position (start addresses) of every axes are set to "0". Linear interpolation positioning is then carried out from that position to a position at the end of the movement amount set in "Da.6 Positioning address/movement amount". The movement direction is determined by the sign of the movement amount.

- Positive movement amount ..... Positioning control to forward direction  
(Address increase direction)
- Negative movement amount..... Positioning control to reverse direction  
(Address decrease direction)

#### ■ Restrictions

- (1) An axis error "Continuous path control not possible (error code: 516)" will occur and the operation cannot start if "continuous path control" is set in "Da.1 Operation pattern". ("Continuous path control" cannot be set in fixed-feed control.)
- (2) "Fixed-feed" cannot be set in "Da.2 Control system" in the positioning data when "continuous path control" has been set in "Da.1 Operation pattern" of the immediately prior positioning data. (For example, if the operation pattern of positioning data No. 1 is "continuous path control", fixed-feed control cannot be set in positioning data No. 2.) An axis error "Continuous path control not possible (error code: 516)" will occur and the machine will carry out a deceleration stop if this type of setting is carried out.



■ Positioning data setting example

[When "4-axis fixed-feed control (fixed-feed 4)" is set in positioning data No.1 of axis 1]

- Reference axis..... Axis 1
- Interpolation axis..... Axis 2, Axis3, Axis4 (The required values are also set in positioning data No. 1 of axis 2, axis 3 and axis 4.)

Setting item		LD77MH4 setting example				LD77MH16 setting example				Setting details	
		Axis 1 (reference axis)	Axis 2 (interpolation axis)	Axis 3 (interpolation axis)	Axis 4 (interpolation axis)	Axis 1 (reference axis)	Axis 2 (interpolation axis)	Axis 3 (interpolation axis)	Axis 4 (interpolation axis)		
Axis 1 Positioning data No. 1	Da.1	Operation pattern	Positioning complete	-	-	-	Positioning complete	-	-	-	Set "Positioning complete" assuming the next positioning data will not be executed.
	Da.2	Control system	Fixed-feed 4	-	-	-	Fixed-feed 4	-	-	-	Set 4-axis fixed-feed control.
	Da.3	Acceleration time No.	1	-	-	-	1	-	-	-	Designate the value set in "[Pr.25] Acceleration time 1" as the acceleration time at start.
	Da.4	Deceleration time No.	0	-	-	-	0	-	-	-	Designate the value set in "[Pr.10] Deceleration time 0" as the deceleration time at deceleration.
	Da.5	Axis to be interpolated LD77MH4	-	-	-	-	/				Setting not required (setting value is ignored). When axis 1 is used as a reference axis, the interpolation axes are axes 2, 3 and 4.
	Da.6	Positioning address/movement amount	4000.0 μm	8000.0 μm	4000.0 μm	3000.0 μm	4000.0 μm	8000.0 μm	4000.0 μm	3000.0 μm	Set the positioning address. (Assuming "mm" is set in "[Pr.1] Unit setting".)
	Da.7	Arc address	-	-	-	-	-	-	-	-	Setting not required (setting value is ignored).
	Da.8	Command speed	6000.00 mm/min	-	-	-	6000.00 mm/min	-	-	-	Set the speed during movement.
	Da.9	Dwell time	500ms	-	-	-	500ms	-	-	-	Set the time the machine dwells after the positioning stop (command stop) to the output of the positioning complete signal.
	Da.10	M code	10	-	-	-	10	-	-	-	Set this when other sub operation commands are issued in combination with the No. 1 positioning data.
Da.20	Axis to be interpolated No.1 LD77MH16	/				Axis 2	-	-	-	Set the axis to be interpolated. If the self-axis is set, an error will occur.	
Da.21	Axis to be interpolated No.2 LD77MH16	/				Axis 3	-	-	-		
Da.22	Axis to be interpolated No.3 LD77MH16	/				Axis 4	-	-	-		

(Note): Refer to Section 5.3 "List of positioning data" for information on the setting details.

## POINTS

- When the movement amount is converted to the actual number of command pulses, a fraction appears after the decimal point, according to the movement amount per pulse. This fraction is normally retained in the LD77MH and reflected at the next positioning.

For the fixed-feed control, since the movement distance is maintained constant (= the command number of pulses is maintained constant), the control is carried out after the fraction pulse is cleared to zero at start.

## [Accumulation/cutoff for fractional pulses]

When movement amount per pulse is  $1.0 [\mu\text{m}]$  and movement for  $2.5 [\mu\text{m}]$  is executed two times.

→ Conversion to command pulses:  $2.5 [\mu\text{m}] \div 1.0 = 2.5 [\text{PLS}]$

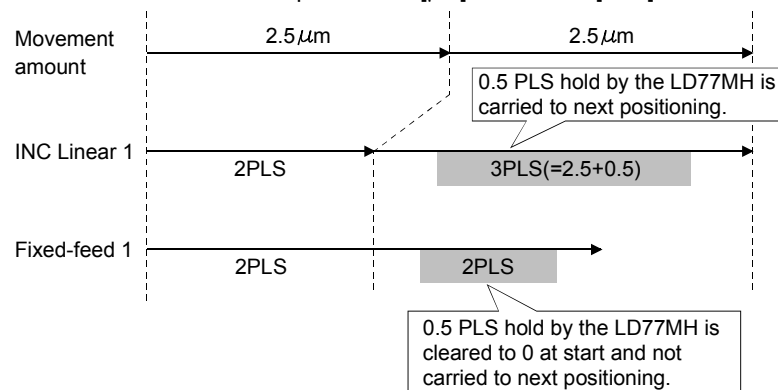

- When the "reference axis speed" is set during 4-axis fixed-feed control, set so the major axis side becomes the reference axis. If the minor axis side is set as the reference axis, the major axis side speed may exceed the "Pr.8 Speed limit value".
- Refer to Section 9.1.6 "Interpolation control" for the reference axis and interpolation axis combinations.

### 9.2.10 2-axis circular interpolation control with sub point designation

In "2-axis circular interpolation control" ("  $\overline{Da.2}$  Control system" = ABS circular sub, INC circular sub), two motors are used to carry out position control in an arc path passing through designated sub points, while carrying out interpolation for the axis directions set in each axis.

(Refer to Section 9.1.6 "Interpolation control" for details on interpolation control.)

#### [1] 2-axis circular interpolation control with sub point designation (ABS circular sub)

##### ■ Operation chart

In the absolute system, 2-axis circular interpolation control with sub point designation, positioning is carried out from the current stop position (start point address) to the address (end point address) set in "  $\overline{Da.6}$  Positioning address/movement amount", in an arc path that passes through the sub point address set in "  $\overline{Da.7}$  Arc address".

The resulting control path is an arc having as its center the intersection point of perpendicular bisectors of a straight line between the start point address (current stop position) and sub point address (arc address), and a straight line between the sub point address (arc address) and end point address (positioning address).

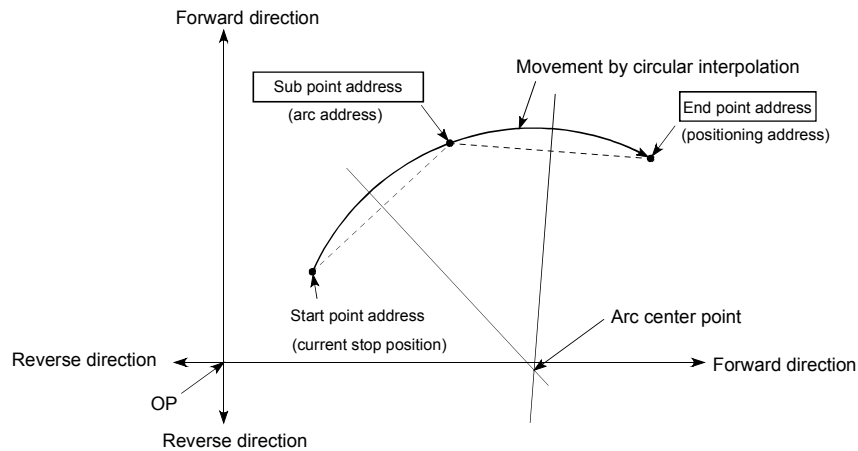

## ■ Restrictions

- (1) 2-axis circular interpolation control cannot be set in the following cases.
  - When "degree" is set in " Pr.1 Unit setting"
  - When the units set in " Pr.1 Unit setting" are different for the reference axis and interpolation axis. ("mm" and "inch" combinations are possible.)
  - When "reference axis speed" is set in " Pr.20 Interpolation speed designation method"
- (2) An error will occur and the positioning start will not be possible in the following cases. The machine will immediately stop if the error is detected during positioning control.
  - When the radius exceeds "536870912 ( $=2^{29}$ )". (The maximum radius for which circular interpolation control is possible is "536870912 ( $=2^{29}$ )"  
 ... An error "Outside radius range (error code: 544)" will occur at positioning start.
  - When the center point address is outside the range of " $-2147483648 (-2^{31})$  to  $2147483647 (2^{31}-1)$ "  
 ... A "Sub point setting error" (error code: 525) will occur at positioning start.
  - When the start point address is the same as the end point address  
 ... An "End point setting error" (error code: 526) will occur.
  - When the start point address is the same as the sub point address  
 ... A "Sub point setting error" (error code: 525) will occur.
  - When the end point address is the same as the sub point address  
 ... A "Sub point setting error" (error code: 525) will occur.
  - When the start point address, sub point address, and end point address are in a straight line  
 ... A "Sub point setting error" (error code: 525) will occur.

■ Positioning data setting example

[When "2-axis circular interpolation control with sub point designation (ABS circular sub)" is set in positioning data No. 1 of axis 1]

- Reference axis..... Axis 1
- Interpolation axis..... Axis 2 (The required values are also set in positioning data No. 1 of axis 2.)

Setting item		LD77MH4 setting example		LD77MH16 setting example		Setting details	
		Axis 1 (reference axis)	Axis 2 (interpolation axis)	Axis 1 (reference axis)	Axis 2 (interpolation axis)		
Axis 1 Positioning data No. 1	Da.1	Operation pattern	Positioning complete	–	Positioning complete	–	Set "Positioning complete" assuming the next positioning data will not be executed.
	Da.2	Control system	ABS circular sub	–	ABS circular sub	–	Set absolute system, 2-axis circular interpolation control with sub point designation.
	Da.3	Acceleration time No.	1	–	1	–	Designate the value set in "[Pr.25] Acceleration time 1" as the acceleration time at start.
	Da.4	Deceleration time No.	0	–	0	–	Designate the value set in "[Pr.10] Deceleration time 0" as the deceleration time at deceleration.
	Da.5	Axis to be interpolated LD77MH4	Axis 2	–	/		Set the axis to be interpolated (partner axis). If the self-axis is set, an error will occur.
	Da.6	Positioning address/ movement amount	8000.0 μm	6000.0 μm	8000.0 μm	6000.0 μm	Set the positioning address. (Assuming "mm" is set in "[Pr.1] Unit setting".)
	Da.7	Arc address	4000.0 μm	3000.0 μm	4000.0 μm	3000.0 μm	Set the sub point address. (Assuming that the "[Pr.1] Unit setting" is set to "mm".)
	Da.8	Command speed	6000.00 mm/min	–	6000.00 mm/min	–	Set the speed when moving to the end point address. (Designate the composite speed in "[Pr.20] Interpolation speed designation method".)
	Da.9	Dwell time	500ms	–	500ms	–	Set the time the machine dwells after the positioning stop (command stop) to the output of the positioning complete signal.
	Da.10	M code	10	–	10	–	Set this when other sub operation commands are issued in combination with the No. 1 positioning data.
	Da.20	Axis to be interpolated No.1 LD77MH16	/		Axis 2	–	Set the axis to be interpolated. If the self-axis is set, an error will occur.
	Da.21	Axis to be interpolated No.2 LD77MH16	/		–	–	Setting not required (setting value is ignored).
	Da.22	Axis to be interpolated No.3 LD77MH16	/		–	–	

(Note): Refer to Section 5.3 "List of positioning data" for information on the setting details.

<b>POINT</b>
Set a value in " Da.8 Command speed" so that the speed of each axis does not exceed the " Pr.8 Speed limit value". (The speed limit does not function for the speed calculated by the LD77MH during interpolation control.)

[2] 2-axis circular interpolation control with sub point designation (INC circular sub)

■ Operation chart

In the incremental system, 2-axis circular interpolation control with sub point designation, positioning is carried out from the current stop position (start point address) to a position at the end of the movement amount set in "Da.6

Positioning address/movement amount" in an arc path that passes through the sub point address set in "Da.7 Arc address". The movement direction depends on the sign (+ or -) of the movement amount.

The resulting control path is an arc having as its center the intersection point of perpendicular bisectors of the straight line between the start point address (current stop position) and sub point address (arc address) calculated from the movement amount to the sub point, and a straight line between the sub point address (arc address) and end point address (positioning address) calculated from the movement amount to the end point.

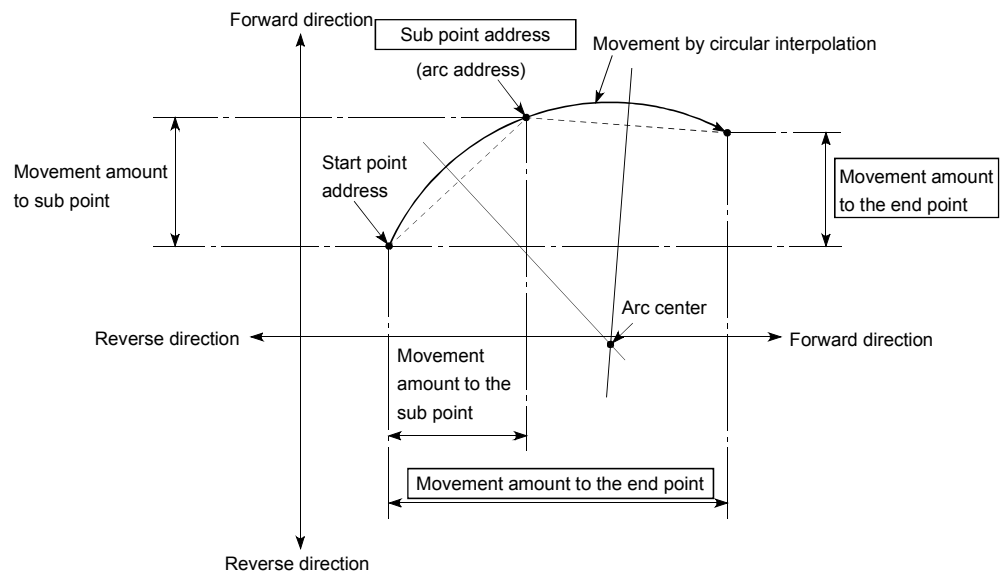

## ■ Restrictions

- (1) 2-axis circular interpolation control cannot be set in the following cases.
  - When "degree" is set in " Pr.1 Unit setting"
  - When the units set in " Pr.1 Unit setting" are different for the reference axis and interpolation axis. ("mm" and "inch" combinations are possible.)
  - When "reference axis speed" is set in " Pr.20 Interpolation speed designation method"
- (2) An error will occur and the positioning start will not be possible in the following cases. The machine will immediately stop if the error is detected during positioning control.
  - When the radius exceeds "536870912 ( $=2^{29}$ )". (The maximum radius for which circular interpolation control is possible is "536870912 ( $=2^{29}$ )"  
 ... An error "Outside radius range (error code: 544)" will occur at positioning start.
  - When the sub point address is outside the range of " $-2147483648 (-2^{31})$  to  $2147483647 (2^{31}-1)$ "  
 ... A "Sub point setting error" (error code: 525) will occur.
  - When the end point address is outside the range of " $-2147483648 (-2^{31})$  to  $2147483647 (2^{31}-1)$ "  
 ... An "End point setting error" (error code: 526) will occur.
  - When the center point address is outside the range of " $-2147483648 (-2^{31})$  to  $2147483647 (2^{31}-1)$ "  
 ... An "Sub point setting error" (error code: 525) will occur at positioning start.
  - When the start point address is the same as the end point address  
 ... An "End point setting error" (error code: 526) will occur.
  - When the start point address is the same as the sub point address  
 ... A "Sub point setting error" (error code: 525) will occur.
  - When the end point address is the same as the sub point address  
 ... A "Sub point setting error" (error code: 525) will occur.
  - When the start point address, sub point address, and end point address are in a straight line  
 ... A "Sub point setting error" (error code: 525) will occur.

■ Positioning data setting example

[When "2-axis circular interpolation control with sub point designation (INC circular sub)" is set in positioning data No. 1 of axis 1]

- Reference axis..... Axis 1
- Interpolation axis..... Axis 2 (The required values are also set in positioning data No. 1 of axis 2.)

Setting item		LD77MH4 setting example		LD77MH16 setting example		Setting details	
		Axis 1 (reference axis)	Axis 2 (interpolation axis)	Axis 1 (reference axis)	Axis 2 (interpolation axis)		
Axis 1 Positioning data No. 1	Da.1	Operation pattern	Positioning complete	–	Positioning complete	–	Set "Positioning complete" assuming the next positioning data will not be executed.
	Da.2	Control system	INC circular sub	–	INC circular sub	–	Set incremental system, 2-axis circular interpolation control with sub point designation.
	Da.3	Acceleration time No.	1	–	1	–	Designate the value set in "[Pr.25] Acceleration time 1" as the acceleration time at start.
	Da.4	Deceleration time No.	0	–	0	–	Designate the value set in "[Pr.10] Deceleration time 0" as the deceleration time at deceleration.
	Da.5	Axis to be interpolated LD77MH4	Axis 2	–	/		Set the axis to be interpolated (partner axis). If the self-axis is set, an error will occur.
	Da.6	Positioning address/ movement amount	8000.0 μm	6000.0 μm	8000.0 μm	6000.0 μm	Set the movement amount. (Assuming that the "[Pr.1] Unit setting" is set to "mm".)
	Da.7	Arc address	4000.0 μm	3000.0 μm	4000.0 μm	3000.0 μm	Set the sub point address. (Assuming that the "[Pr.1] Unit setting" is set to "mm".)
	Da.8	Command speed	6000.00 mm/min	–	6000.00 mm/min	–	Set the speed during movement. (Designate the composite speed in "[Pr.20] Interpolation speed designation method".)
	Da.9	Dwell time	500ms	–	500ms	–	Set the time the machine dwells after the positioning stop (command stop) to the output of the positioning complete signal.
	Da.10	M code	10	–	10	–	Set this when other sub operation commands are issued in combination with the No. 1 positioning data.
	Da.20	Axis to be interpolated No.1 LD77MH16	/		Axis 2	–	Set the axis to be interpolated. If the self-axis is set, an error will occur.
	Da.21	Axis to be interpolated No.2 LD77MH16	/		–	–	Setting not required (setting value is ignored).
	Da.22	Axis to be interpolated No.3 LD77MH16	/		–	–	

(Note): Refer to Section 5.3 "List of positioning data" for information on the setting details.

<b>POINT</b>
Set a value in " Da.8 Command speed" so that the speed of each axis does not exceed the " Pr.8 Speed limit value". (The speed limit does not function for the speed calculated by the LD77MH during interpolation control.)



9.2.11 2-axis circular interpolation control with center point designation

In "2-axis circular interpolation control" ("Da.2 Control system" = ABS circular right, INC circular right, ABS circular left, INC circular left), two motors are used to carry out position control in an arc path having an arc address as a center point, while carrying out interpolation for the axis directions set in each axis.  
 (Refer to Section 9.1.6 "Interpolation control" for details on interpolation control.)

The following table shows the rotation directions, arc center angles that can be controlled, and positioning paths for the different control systems.

Control system	Rotation direction	Arc center angle that can be controlled	Positioning path
ABS circular right	Clockwise	$0^\circ < \theta \leq 360^\circ$	
INC circular right			
ABS circular left	Counterclockwise		
INC circular left			

### ■ Circular interpolation error compensation

In circular interpolation control with center point designation, the arc path calculated from the start point address and center point address may deviate from the position of the end point address set in "Da.6 Positioning address/movement amount".

(Refer to "Pr.41 Allowable circular interpolation error width".)

#### (1) Calculated error < "Pr.41 Allowable circular interpolation error width"

Circular interpolation control to the set end point address is carried out while the error compensation is carried out. (This is called "spiral interpolation".)

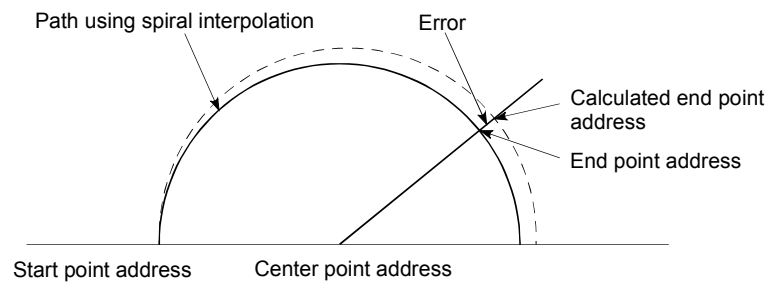

In circular interpolation control with center point designation, an angular velocity is calculated on the assumption that operation is carried out at a command speed on the arc using the radius calculated from the start point address and center point address, and the radius is compensated in proportion to the angular velocity deviated from that at the start point.

Thus, when there is a difference (error) between a radius calculated from the start point address and center point address (start point radius) and a radius calculated from the end point address and center point address (end point radius), the composite speed differs from the command speed as follows.

- \* Start point radius > End point radius: As compared with the speed without error, the speed becomes slower as end point address is reached.
- \* Start point radius < End point radius: As compared with the speed without error, the speed becomes faster as end point address is reached.

#### (2) Calculated error > "Pr.41 Allowable circular interpolation error width"

At the positioning start, an error "Outside circular interpolation error allowable limit" (error code: 506) will occur and the control will not start. The machine will immediately stop if the error is detected during positioning control.

[1] 2-axis circular interpolation control with center point designation  
(ABS circular right, ABS circular left)

■ Operation chart

In the absolute system, 2-axis circular interpolation control with center point designation positioning is carried out from the current stop position (start point address) to the address (end point address) set in "Da.6" Positioning address/movement amount", in an arc path having as its center the address (arc address) of the center point set in "Da.7" Arc address".

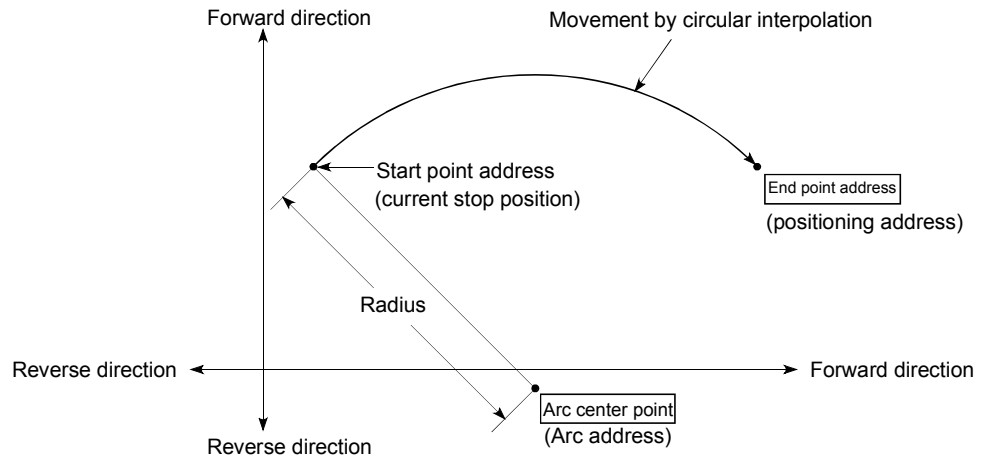

Positioning of a complete round with a radius from the start point address to the arc center point can be carried out by setting the end point address (positioning address) to the same address as the start point address.

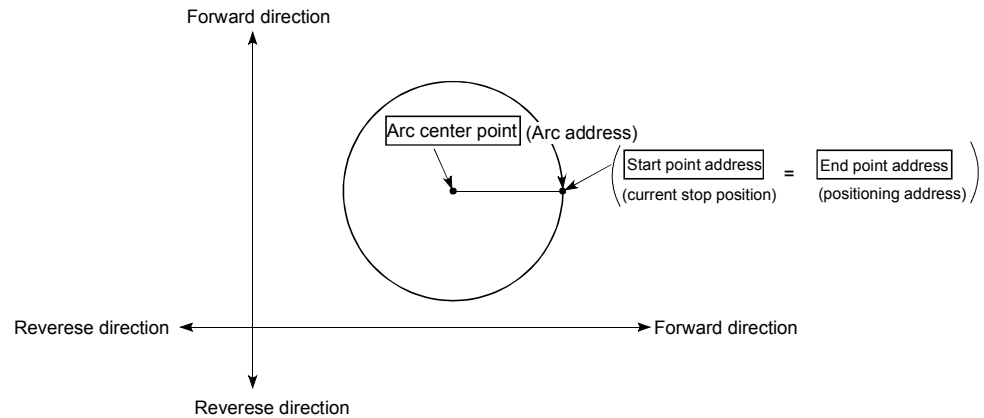

In circular interpolation control with center point designation, an angular velocity is calculated on the assumption that operation is carried out at a command speed on the arc using the radius calculated from the start point address and center point address, and the radius is compensated in proportion to the angular velocity deviated from that at the start point.

Thus, when there is a difference (error) between a radius calculated from the start point address and center point address (start point radius) and a radius calculated from the end point address and center point address (end point radius), the composite speed differs from the command speed as follows.

- \* Start point radius > End point radius: As compared with the speed without error, the speed becomes slower as end point address is reached.
- \* Start point radius < End point radius: As compared with the speed without error, the speed becomes faster as end point address is reached.

### ■ Restrictions

- (1) 2-axis circular interpolation control cannot be set in the following cases.
  - When "degree" is set in " [Pr.1] Unit setting"
  - When the units set in " [Pr.1] Unit setting" are different for the reference axis and interpolation axis. ("mm" and "inch" combinations are possible.)
  - When "reference axis speed" is set in " [Pr.20] Interpolation speed designation method"
- (2) An error will occur and the positioning start will not be possible in the following cases. The machine will immediately stop if the error is detected during positioning control.
  - When the radius exceeds "536870912 ( $=2^{29}$ )". (The maximum radius for which circular interpolation control is possible is "536870912 ( $=2^{29}$ )"  
... An error "Outside radius range" (error code: 544)" will occur at positioning start.
  - When the start point address is the same as the center point address  
... A "Center point setting error" (error code: 527) will occur.
  - When the end point address is the same as the center point address  
... A "Center point setting error" (error code: 527) will occur.
  - When the center point address is outside the range of  $-2147483648 (-2^{31})$  to  $2147483647 (2^{31}-1)$   
... A "Center point setting error" (error code: 527) will occur.

■ Positioning data setting examples

[When "2-axis circular interpolation control with center point designation (ABS circular right, ABS circular left)" is set in positioning data No. 1 of axis 1]

- Reference axis..... Axis 1
- Interpolation axis..... Axis 2 (The required values are also set in positioning data No. 1 of axis 2.)

Setting item		LD77MH4 setting example		LD77MH16 setting example		Setting details	
		Axis 1 (reference axis)	Axis 2 (interpolation axis)	Axis 1 (reference axis)	Axis 2 (interpolation axis)		
Axis 1 Positioning data No. 1	Da.1	Operation pattern	Positioning complete	-	Positioning complete	-	Set "Positioning complete" assuming the next positioning data will not be executed.
	Da.2	Control system	ABS circular right ABS circular left	-	ABS circular right ABS circular left	-	Set absolute system, 2-axis circular interpolation control with center point designation. (Select clockwise or counterclockwise according to the control.)
	Da.3	Acceleration time No.	1	-	1	-	Designate the value set in "[Pr.25] Acceleration time 1" as the acceleration time at start.
	Da.4	Deceleration time No.	0	-	0	-	Designate the value set in "[Pr.10] Deceleration time 0" as the deceleration time at deceleration.
	Da.5	Axis to be interpolated LD77MH4	Axis 2	-	/		Set the axis to be interpolated (partner axis). If the self-axis is set, an error will occur.
	Da.6	Positioning address/movement amount	8000.0 μm	6000.0 μm			8000.0 μm
	Da.7	Arc address	4000.0 μm	3000.0 μm	4000.0 μm	3000.0 μm	Set the arc address (center point address). (Assuming that the "[Pr.1] Unit setting" is set to "mm".)
	Da.8	Command speed	6000.00 mm/min	-	6000.00 mm/min	-	Set the speed when moving to the end point address. (Designate the composite speed in "[Pr.20] Interpolation speed designation method".)
	Da.9	Dwell time	500ms	-	500ms	-	Set the time the machine dwells after the positioning stop (command stop) to the output of the positioning complete signal.
	Da.10	M code	10	-	10	-	Set this when other sub operation commands are issued in combination with the No.1 positioning data.
	Da.20	Axis to be interpolated No.1 LD77MH16	/		Axis 2	-	Set the axis to be interpolated. If the self-axis is set, an error will occur.
	Da.21	Axis to be interpolated No.2 LD77MH16			-	-	
	Da.22	Axis to be interpolated No.3 LD77MH16			-	-	

(Note): Refer to Section 5.3 "List of positioning data" for information on the setting details.

<b>POINT</b>
Set a value in " Da.8 Command speed" so that the speed of each axis does not exceed the " Pr.8 Speed limit value". (The speed limit does not function for the speed calculated by the LD77MH during interpolation control.)

[2] 2-axis circular interpolation control with center point designation (INC circular right, INC circular left)

■ Operation chart

In the incremental system, 2-axis circular interpolation control with center point designation, positioning is carried out from the current stop position (start point address) to a position at the end of the movement amount set in "Da.6" Positioning address/movement amount", in an arc path having as its center the address (arc address) of the center point set in "Da.7" Arc address".

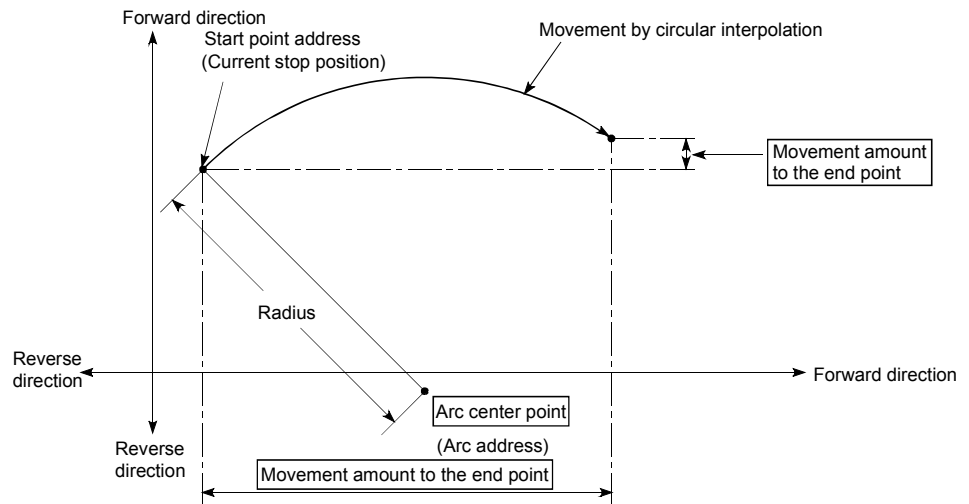

Positioning of a complete round with a radius of the distance from the start point address to the arc center point can be carried out by setting the movement amount to "0".

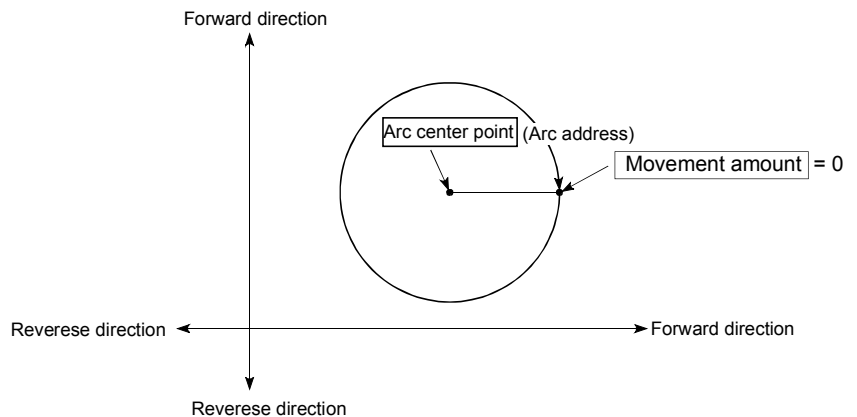

In circular interpolation control with center point designation, an angular velocity is calculated on the assumption that operation is carried out at a command speed on the arc using the radius calculated from the start point address and center point address, and the radius is compensated in proportion to the angular velocity deviated from that at the start point.

Thus, when there is a difference (error) between a radius calculated from the start point address and center point address (start point radius) and a radius calculated from the end point address and center point address (end point radius), the composite speed differs from the command speed as follows.

- \* Start point radius > End point radius: As compared with the speed without error, the speed becomes slower as end point address is reached.
- \* Start point radius < End point radius: As compared with the speed without error, the speed becomes faster as end point address is reached.

### ■ Restrictions

(1) 2-axis circular interpolation control cannot be set in the following cases.

- When "degree" is set in " [Pr.1] Unit setting"
- When the units set in " [Pr.1] Unit setting" are different for the reference axis and interpolation axis. ("mm" and "inch" combinations are possible.)
- When "reference axis speed" is set in " [Pr.20] Interpolation speed designation method"

(2) An error will occur and the positioning start will not be possible in the following cases. The machine will immediately stop if the error is detected during positioning control.

- When the radius exceeds "536870912 (=2<sup>29</sup>)". (The maximum radius for which circular interpolation control is possible is "536870912 (=2<sup>29</sup>)"  
... An "Outside radius range" (error code: 544) will occur at positioning start.
- When the end point address is outside the range of  $-2147483648 (-2^{31})$  to  $2147483647 (2^{31}-1)$   
... An "End point setting error" (error code: 526) will occur.
- When the start point address is the same as the center point address  
... A "Center point setting error" (error code: 527) will occur.
- When the end point address is the same as the center point address  
... A "Center point setting error" (error code: 527) will occur.
- When the center point address is outside the range of  $-2147483648 (-2^{31})$  to  $2147483647 (2^{31}-1)$   
... A "Center point setting error" (error code: 527) will occur.

■ Positioning data setting examples

[When "2-axis circular interpolation control with center point designation (INC circular right, INC circular left)" is set in positioning data No. 1 of axis 1]

- Reference axis..... Axis 1
- Interpolation axis..... Axis 2 (The required values are also set in positioning data No. 1 of axis 2.)

Setting item		LD77MH4 setting example		LD77MH16 setting example		Setting details	
		Axis 1 (reference axis)	Axis 2 (interpolation axis)	Axis 1 (reference axis)	Axis 2 (interpolation axis)		
Axis 1 Positioning data No. 1	Da.1	Operation pattern	Positioning complete	-	Positioning complete	-	Set "Positioning complete" assuming the next positioning data will not be executed.
	Da.2	Control system	INC circular right INC circular left	-	INC circular right INC circular left	-	Set incremental system, 2-axis circular interpolation control with center point designation. (Select clockwise or counterclockwise according to the control.)
	Da.3	Acceleration time No.	1	-	1	-	Designate the value set in "[Pr.25] Acceleration time 1" as the acceleration time at start.
	Da.4	Deceleration time No.	0	-	0	-	Designate the value set in "[Pr.10] Deceleration time 0" as the deceleration time at deceleration.
	Da.5	Axis to be interpolated LD77MH4	Axis 2	-	/		Set the axis to be interpolated (partner axis). If the self-axis is set, an error will occur.
	Da.6	Positioning address/ movement amount	8000.0 μm	6000.0 μm	8000.0 μm	6000.0 μm	Set the movement amount. (Assuming that the "[Pr.1] Unit setting" is set to "mm".)
	Da.7	Arc address	4000.0 μm	3000.0 μm	4000.0 μm	3000.0 μm	Set the center point address (center point address). (Assuming that the "[Pr.1] Unit setting" is set to "mm".)
	Da.8	Command speed	6000.00 mm/min	-	6000.00 mm/min	-	Set the speed when moving to the end point address. (Designate the composite speed in "[Pr.20] Interpolation speed designation method".)
	Da.9	Dwell time	500ms	-	500ms	-	Set the time the machine dwells after the positioning stop (command stop) to the output of the positioning complete signal.
	Da.10	M code	10	-	10	-	Set this when other sub operation commands are issued in combination with the No.1 positioning data.
	Da.20	Axis to be interpolated No.1 LD77MH16	/		Axis 2	-	Set the axis to be interpolated. If the self-axis is set, an error will occur.
	Da.21	Axis to be interpolated No.2 LD77MH16	/		-	-	Setting not required (setting value is ignored).
	Da.22	Axis to be interpolated No.3 LD77MH16	/		-	-	

(Note): Refer to Section 5.3 "List of positioning data" for information on the setting details.

<b>POINT</b>
Set a value in "Da.8 Command speed" so that the speed of each axis does not exceed the "Pr.8 Speed limit value". (The speed limit does not function for the speed calculated by the LD77MH during interpolation control.)



9.2.12 1-axis speed control

In "1-axis speed control" ("Da.2 Control system" = Forward run: speed 1, Reverse run: speed 1), control is carried out in the axis direction in which the positioning data has been set by continuously outputting pulses for the speed set in "Da.8 Command speed" until the input of a stop command.

The two types of 1-axis speed control are "Forward run: speed 1" in which the control starts in the forward run direction, and "Reverse run: speed 1" in which control starts in the reverse run direction.

■ Operation chart

The following chart shows the operation timing for 1-axis speed control with axis 1 as the reference axis.

The "in speed control" flag (Md.31 Status: b0) is turned ON during speed control. The "Positioning complete signal" is not turned ON.

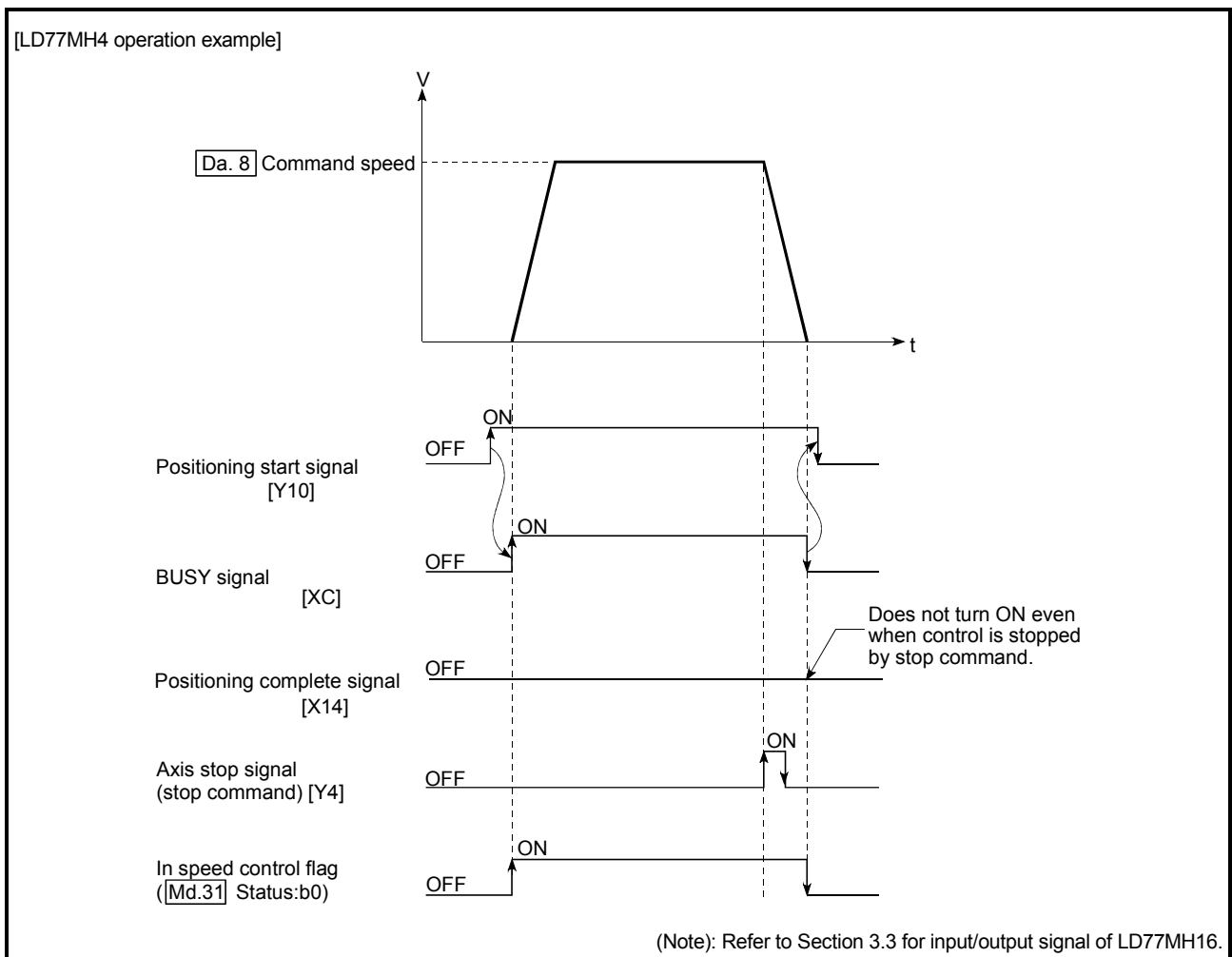
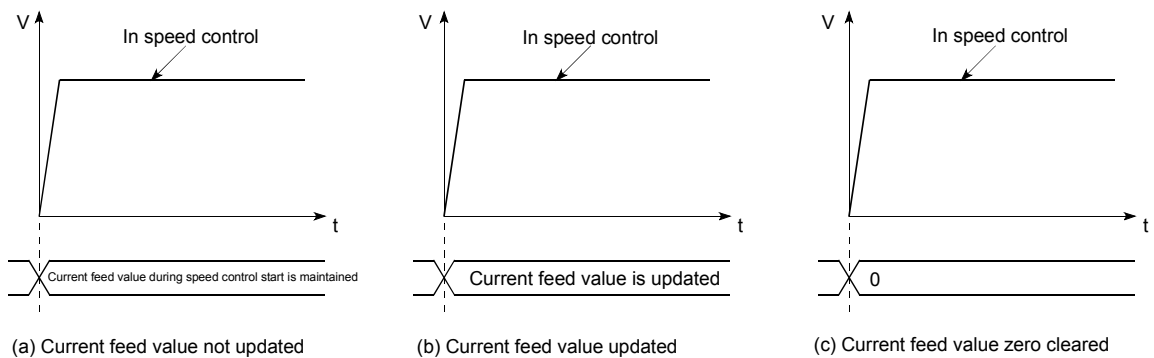

Fig.9.9 1-axis speed control operation timing

### ■ Current feed value during 1-axis speed control

The following table shows the "Md.20 Current feed value" during 1-axis speed control corresponding to the "Pr.21 Current feed value during speed control" settings.

Pr.21 Current feed value during speed control" setting	Md.20 Current feed value
0: Do not update current feed value	The current feed value at speed control start is maintained.
1: Update current feed value	The current feed value is updated.
2: Zero clear current feed value	The current feed value is fixed at 0.



### ■ Restrictions

- (1) Set "Positioning complete" in "Da.1 Operation pattern". An axis error "Continuous path control not possible (error code: 516)" will occur and the operation cannot start if "continuous positioning control" or "continuous path control" is set in "Da.1 Operation pattern". ("Continuous positioning control" and "continuous path control" cannot be set in speed control.)
- (2) Set the WITH mode in "Pr.18 M code ON signal output timing" when using an M code. The M code will not be output, and the M code ON signal will not turn ON if the AFTER mode is set.
- (3) An error "No command speed (error code: 503)" will occur if the current speed (-1) is set in "Da.8 Command speed".
- (4) The software stroke limit check will not be carried out if the control unit is set to "degree".

■ Positioning data setting examples

[When "1-axis speed control (forward run: speed 1)" is set in the positioning data No. 1 of axis 1]

Setting item		Setting example		Setting details	
		LD77MH4	LD77MH16		
Axis 1 Positioning data No. 1	Da.1	Operation pattern	Positioning complete		Setting other than "Positioning complete" is not possible in speed control.
	Da.2	Control system	Forward run speed 1		Set 1-axis speed control.
	Da.3	Acceleration time No.	1		Designate the value set in " Pr.25 Acceleration time 1" as the acceleration time at start.
	Da.4	Deceleration time No.	0		Designate the value set in " Pr.10 Deceleration time 0" as the deceleration time at deceleration.
	Da.5	Axis to be interpolated LD77MH4	-	/	Setting not required (setting value is ignored).
	Da.6	Positioning address/ movement amount	-		
	Da.7	Arc address	-		
	Da.8	Command speed	6000.00mm/min		Set the speed to be commanded.
	Da.9	Dwell time	-		Setting not required (setting value is ignored).
	Da.10	M code	10		Set this when other sub operation commands are issued in combination with the No. 1 positioning data. (" Pr.18 M code ON signal output timing" setting only possible in the WITH mode.)
	Da.20	Axis to be interpolated No.1 LD77MH16	/	-	Setting not required (setting value is ignored).
	Da.21	Axis to be interpolated No.2 LD77MH16	/	-	
	Da.22	Axis to be interpolated No.3 LD77MH16	/	-	

(Note): Refer to Section 5.3 "List of positioning data" for information on the setting details.

### 9.2.13 2-axis speed control

In "2-axis speed control" ("Da.2 Control system" = Forward run: speed 2, Reverse run: speed 2), control is carried out in the 2-axis direction in which the positioning data has been set by continuously outputting pulses for the speed set in "Da.8 Command speed" until the input of a stop command.

The two types of 2-axis speed control are "Forward run: speed 2" in which the control starts in the forward run direction, and "Reverse run: speed 2" in which control starts in the reverse run direction.

(Refer to Section 9.1.6 "Interpolation control" for the combination of the reference axis with the interpolation axis.)

#### ■ Operation chart

The following chart shows the operation timing for 2-axis (axes 1 and 2) speed control with axis 1 as the reference axis. The "in speed control" flag (Md.31 Status: b0) is turned ON during speed control.

The "positioning complete signal" is not turned ON.

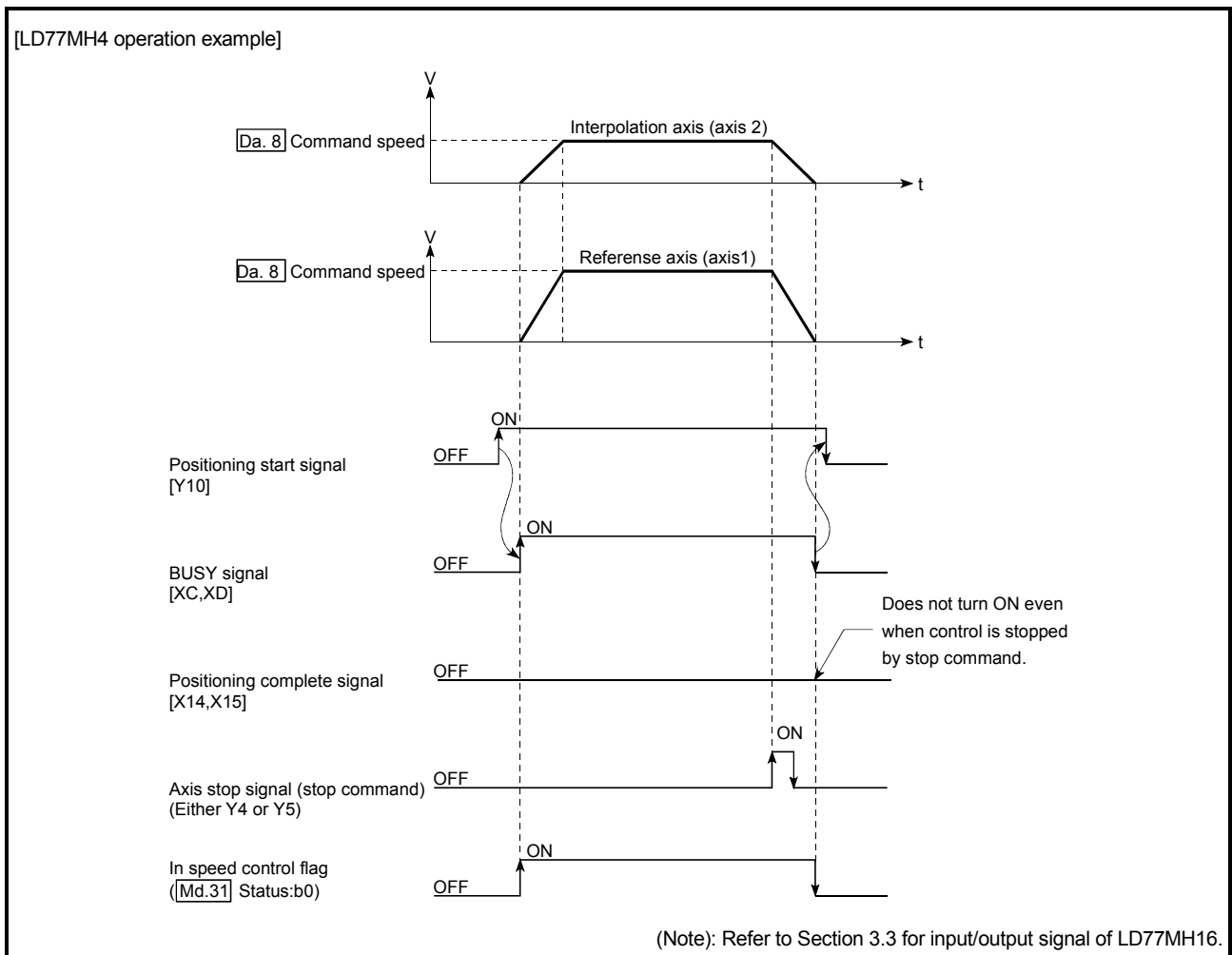
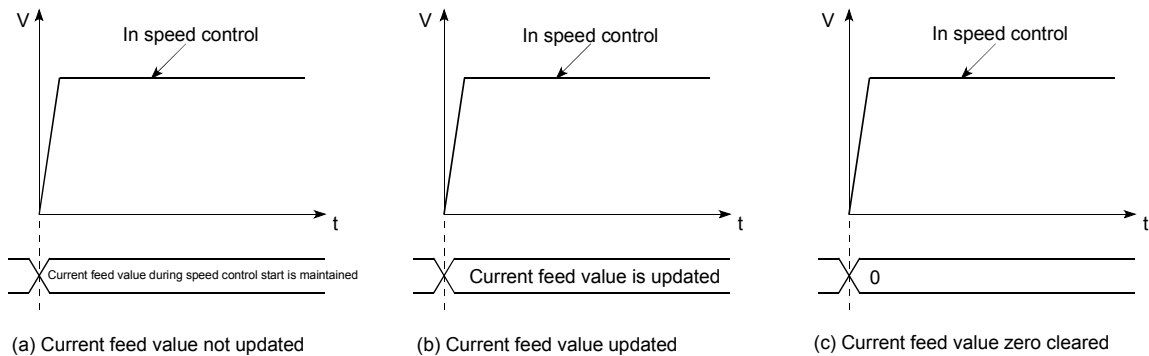

Fig. 9.10 2-axis speed control operation timing

■ Current feed value during 2-axis speed control

The following table shows the "Md.20 Current feed value" during 2-axis speed control corresponding to the "Pr.21 Current feed value during speed control" settings. (Note that the reference axis setting values are used for parameters.)

"Pr.21 Current feed value during speed control" setting	Md.20 Current feed value
0: Do not update current feed value	The current feed value at speed control start is maintained.
1: Update current feed value	The current feed value is updated.
2: Zero clear current feed value	The current feed value is fixed at 0.



■ Restrictions

- (1) Set "Positioning complete" in "Da.1 Operation pattern". An axis error "Continuous path control not possible (error code: 516)" will occur and the operation cannot start if "continuous positioning control" or "continuous path control" is set. ("Continuous positioning control" and "continuous path control" cannot be set in speed control.)
- (2) Set the WITH mode in "Pr.18 M code ON signal output timing" when using an M code. The M code will not be output, and the M code ON signal will not turn ON if the AFTER mode is set.
- (3) Set the "reference axis speed" in "Pr.20 Interpolation speed designation method". An "Interpolation mode error (error code: 523)" will occur and the operation cannot start if a composite speed is set.

- (4) When either of two axes exceeds the speed limit, that axis is controlled with the speed limit value. The speeds of the other axes are limited at the ratios of "[Da.8] Command speed".

(Examples)

Setting item		Axis	
		Axis 1 setting	Axis 2 setting
[Pr.8]	Speed limit value	4000.00mm/min	5000.00mm/min
[Da.8]	Command speed	8000.00mm/min	6000.00mm/min

With the settings shown above, the operation speed in speed control is as follows.

Axis 1: 4000.00 mm/min (Speed is limited by [Pr.8]).

Axis 2: 3000.00 mm/min (Speed is limited at an ratio of an axis 1 command speed to an axis 2 command speed).

(Note): Operation runs at speed 1 when a reference axis speed is less than 1 as a result of speed limit.

In addition, when "[Pr.7] Bias speed at start" is set, the set value will be the minimum speed.

- (5) An error "No command speed (error code: 503)" occurs if a current speed (-1) is set in "[Da.8] Command speed".
- (6) The software stroke limit check is not carried out when the control unit is set to "degree".

■ Positioning data setting examples

[When "2-axis speed control (forward run: speed 2)" is set in the positioning data No. 1 of axis 1]

- Reference axis..... Axis 1
- Interpolation axis..... Axis 2 (The required values are also set in positioning data No.1 of axis 2.)

Setting item		LD77MH4 setting example		LD77MH16 setting example		Setting details	
		Axis 1 (reference axis)	Axis 2 (interpolation axis)	Axis 1 (reference axis)	Axis 2 (interpolation axis)		
Axis 1 Positioning data No. 1	Da.1	Operation pattern	Positioning complete	-	Positioning complete	-	Setting other than "Positioning complete" is not possible in speed control.
	Da.2	Control system	Forward run speed 2	-	Forward run speed 2	-	Set 2-axis speed control.
	Da.3	Acceleration time No.	1	-	1	-	Designate the value set in "[Pr.25] Acceleration time 1" as the acceleration time at start.
	Da.4	Deceleration time No.	0	-	0	-	Designate the value set in "[Pr.10] Deceleration time 0" as the deceleration time at deceleration.
	Da.5	Axis to be interpolated LD77MH4	Axis 2	-	/		Set the axis to be interpolated (partner axis). If the self-axis is set, an error will occur.
	Da.6	Positioning address/ movement amount	-	-	-	-	Setting not required (setting value is ignored).
	Da.7	Arc address	-	-	-	-	Setting not required (setting value is ignored).
	Da.8	Command speed	6000.00 mm/min	3000.00 mm/min	6000.00 mm/min	3000.00 mm/min	Set the speed to be commanded.
	Da.9	Dwell time	-	-	-	-	Setting not required (setting value is ignored).
	Da.10	M code	10	-	10	-	Set this when other sub operation commands are issued in combination with the No. 1 positioning data. (" [Pr.18] M code ON signal output timing" setting only possible in the WITH mode.)
	Da.20	Axis to be interpolated No.1 LD77MH16	/		Axis 2	-	Set the axis to be interpolated. If the self-axis is set, an error will occur.
	Da.21	Axis to be interpolated No.2 LD77MH16	/		-	-	Setting not required (setting value is ignored).
Da.22	Axis to be interpolated No.3 LD77MH16	/		-	-		

(Note): Refer to Section 5.3 "List of positioning data" for information on the setting details.

### 9.2.14 3-axis speed control

In "3-axis speed control" ("Da.2 Control system" = Forward run: speed 3, Reverse run: speed 3), control is carried out in the 3-axis direction in which the positioning data has been set by continuously outputting pulses for the speed set in "Da.8 Command speed" until the input of a stop command.

The two types of 3-axis speed control are "Forward run: speed 3" in which the control starts in the forward run direction, and "Reverse run: speed 3" in which control starts in the reverse run direction.

(Refer to Section 9.1.6 "Interpolation control" for the combination of the reference axis with the interpolation axes.)

#### ■ Operation chart

The following chart shows the operation timing for 3-axis (axes 1, 2, and 3) speed control with axis 1 as the reference axis.

The "in speed control" flag (Md.31 Status: b0) is turned ON during speed control.

The "positioning complete signal" is not turned ON.

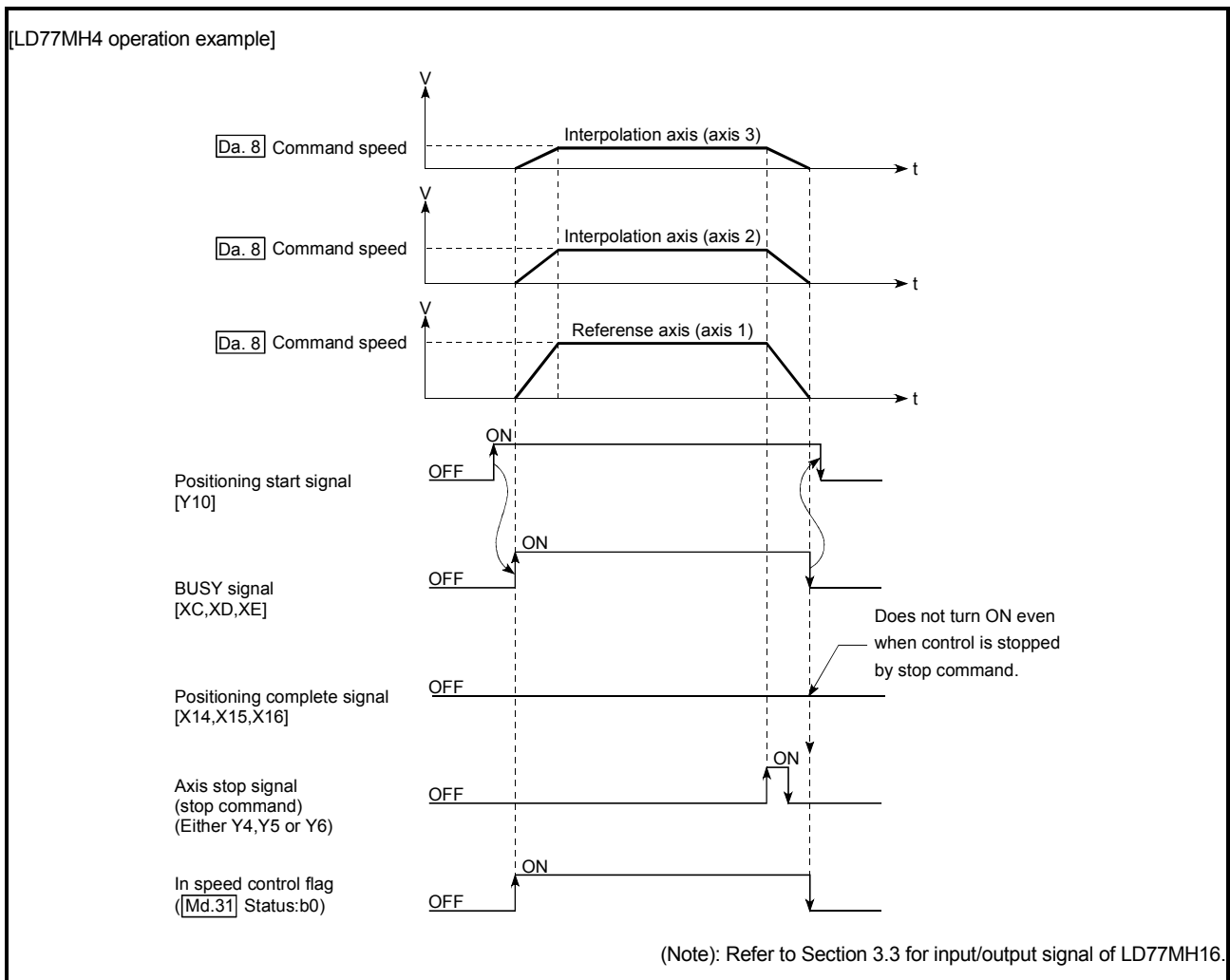

Fig. 9.11 3-axis speed control operation timing



### ■ Current feed value during 3-axis speed control

The following table shows the "Md.20 Current feed value" during 3-axis speed control corresponding to the "Pr.21 Current feed value during speed control" settings. (Note that the reference axis setting values are used for parameters.)

Pr.21 Current feed value during speed control" setting	Md.20 Current feed value
0: Do not update current feed value	The current feed value at speed control start is maintained.
1: Update current feed value	The current feed value is updated.
2: Zero clear current feed value	The current feed value is fixed at 0.

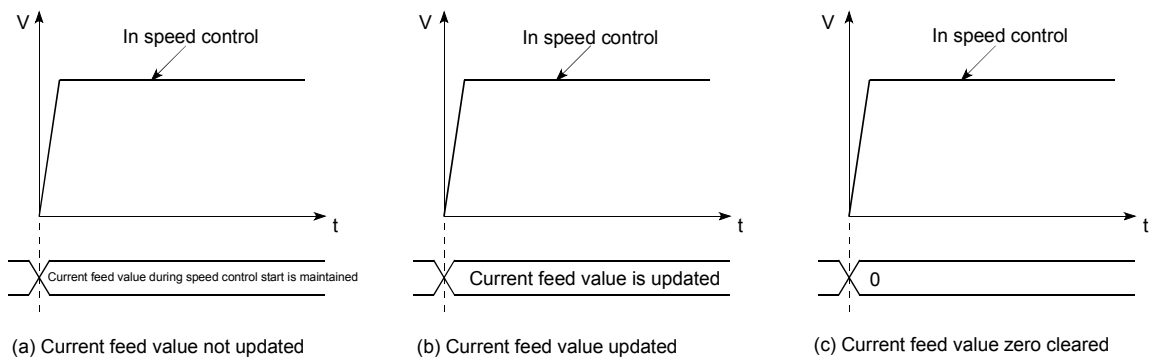

### ■ Restrictions

- (1) Set "Positioning complete" in "Da.1 Operation pattern". An axis error "Continuous path control not possible (error code: 516)" will occur and the operation cannot start if "continuous positioning control" or "continuous path control" is set. ("Continuous positioning control" and "continuous path control" cannot be set in speed control.)
- (2) Set the WITH mode in "Pr.18 M code ON signal output timing" when using an M code. The M code will not be output, and the M code ON signal will not turn ON if the AFTER mode is set.
- (3) Set the "reference axis speed" in "Pr.20 Interpolation speed designation method". An "Interpolation mode error (error code: 523)" will occur and the operation cannot start if a composite speed is set.

- (4) When either of three axes exceeds the speed limit, that axis is controlled with the speed limit value. The speeds of the other axes are limited at the ratios of "[Da.8] Command speed".

(Examples)

Setting item		Axis		
		Axis 1 setting	Axis 2 setting	Axis 3 setting
[Pr.8]	Speed limit value	4000.00mm/min	5000.00mm/min	6000.00mm/min
[Da.8]	Command speed	8000.00mm/min	6000.00mm/min	4000.00mm/min

With the settings shown above, the operation speed in speed control is as follows.

Axis 1: 4000.00 mm/min (Speed is limited by [Pr.8]).

Axis 2: 3000.00 mm/min (Speed is limited at ratios in axes 1, 2, and 3 command speeds).

Axis 3: 2000.00 mm/min (Speed is limited at ratios in axes 1, 2, and 3 command speeds).

(Note): Operation runs at speed 1 when a reference axis speed is less than 1 as a result of speed limit.

In addition, when "[Pr.7] Bias speed at start" is set, the set value will be the minimum speed.

- (5) An error "No command speed (error code: 503)" will occur if a current speed (-1) is set in "[Da.8] Command speed".
- (6) The software stroke limit check is not carried out when the control unit is set to "degree".

■ Positioning data setting examples

[When "3-axis speed control (forward run: speed 3)" is set in the positioning data No. 1 of axis 1]

- Reference axis..... Axis 1
- Interpolation axis..... Axis 2, Axis 3 (The required values are also set in positioning data No.1 of axis 2 and axis 3.)

Setting item	Axis	LD77MH4 setting example			LD77MH16 setting example			Setting details	
		Axis 1 (reference axis)	Axis 2 (interpolation axis)	Axis 3 (interpolation axis)	Axis 1 (reference axis)	Axis 2 (interpolation axis)	Axis 3 (interpolation axis)		
Axis 1 Positioning data No. 1	Da.1	Operation pattern	Positioning complete	-	-	Positioning complete	-	-	Setting other than "Positioning complete" is not possible in speed control.
	Da.2	Control system	Forward run speed 3	-	-	Forward run speed 3	-	-	Set 3-axis speed control.
	Da.3	Acceleration time No.	1	-	-	1	-	-	Designate the value set in "[Pr.25] Acceleration time 1" as the acceleration time at start.
	Da.4	Deceleration time No.	0	-	-	0	-	-	Designate the value set in "[Pr.10] Deceleration time 0" as the deceleration time at deceleration.
	Da.5	Axis to be interpolated LD77MH4	-	-	-	/			Setting not required (setting value is ignored). When axis 1 is used as a reference axis, the interpolation axes are axes 2 and 3.
	Da.6	Positioning address/ movement amount	-	-	-	-	-	-	Setting not required (setting value is ignored).
	Da.7	Arc address	-	-	-	-	-	-	Setting not required (setting value is ignored).
	Da.8	Command speed	6000.00 mm/min	3000.00 mm/min	2000.00 mm/min	6000.00 mm/min	3000.00 mm/min	2000.00 mm/min	Set the speed to be commanded.
	Da.9	Dwell time	-	-	-	-	-	-	Setting not required (setting value is ignored).
	Da.10	M code	10	-	-	10	-	-	Set this when other sub operation commands are issued in combination with the No. 1 positioning data. ("[Pr.18] M code ON signal output timing" setting only possible in the WITH mode.)
	Da.20	Axis to be interpolated No.1 LD77MH16	/			Axis 2			Set the axis to be interpolated.
	Da.21	Axis to be interpolated No.2 LD77MH16	/			Axis 3			If the self-axis is set, an error will occur.
	Da.22	Axis to be interpolated No.3 LD77MH16	/			-	-	-	Setting not required (setting value is ignored).

(Note): Refer to Section 5.3 "List of positioning data" for information on the setting details.

### 9.2.15 4-axis speed control

In "4-axis speed control" ("Da.2 Control system" = Forward run: speed 4, Reverse run: speed 4), control is carried out in the 4-axis direction in which the positioning data has been set by continuously outputting pulses for the speed set in "Da.8 Command speed" until the input of a stop command.

The two types of 4-axis speed control are "Forward run: speed 4" in which the control starts in the forward run direction, and "Reverse run: speed 4" in which control starts in the reverse run direction.

(Refer to Section 9.1.6 "Interpolation control" for the combination of the reference axis with the interpolation axes.)

■ Operation chart

The following chart shows the operation timing for 4-axis speed control with axis 1 as the reference axis.

The "in speed control" flag ( [Md.31] Status: b0) is turned ON during speed control.

The "positioning complete signal" is not turned ON.

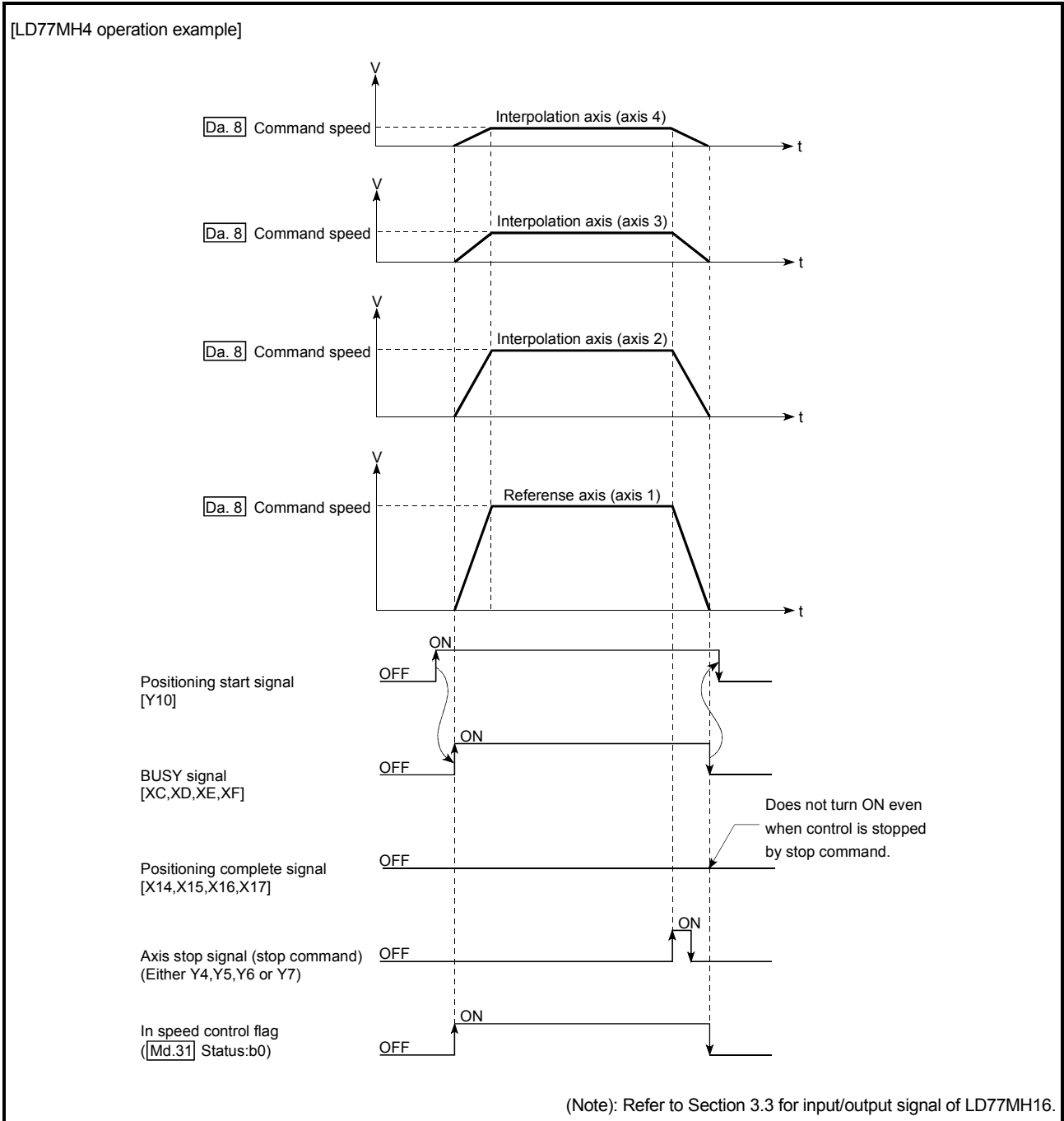
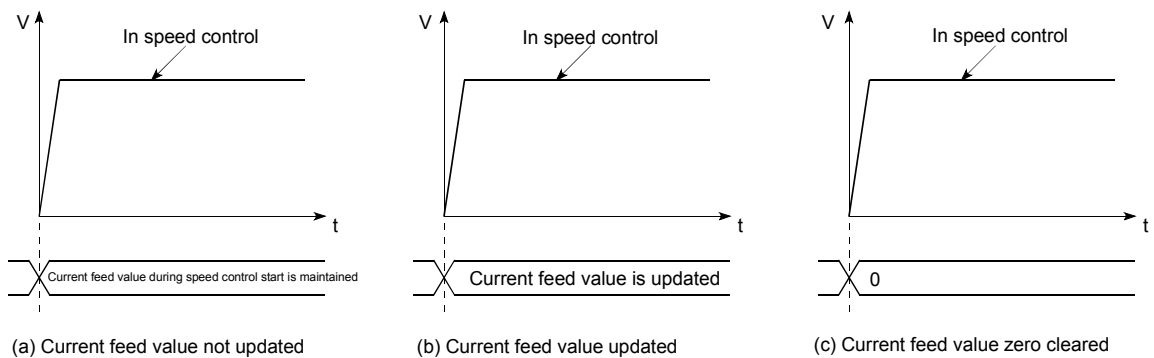

Fig. 9.12 4-axis speed control operation timing

### ■ Current feed value during 4-axis speed control

The following table shows the "Md.20 Current feed value" during 4-axis speed control corresponding to the "Pr.21 Current feed value during speed control" settings. (Note that the reference axis setting values are used for parameters.)

Pr.21 Current feed value during speed control" setting	Md.20 Current feed value
0: Do not update current feed value	The current feed value at speed control start is maintained.
1: Update current feed value	The current feed value is updated.
2: Zero clear current feed value	The current feed value is fixed at 0.



### ■ Restrictions

- (1) Set "Positioning complete" in "Da.1 Operation pattern". An axis error "Continuous path control not possible (error code: 516)" will occur and the operation cannot start if "continuous positioning control" or "continuous path control" is set. ("Continuous positioning control" and "continuous path control" cannot be set in speed control.)
- (2) Set the WITH mode in "Pr.18 M code ON signal output timing" when using an M code. The M code will not be output, and the M code ON signal will not turn ON if the AFTER mode is set.
- (3) Set the "reference axis speed" in "Pr.20 Interpolation speed designation method". An "Interpolation mode error (error code: 523)" will occur and the operation cannot start if a composite speed is set.

- (4) When either of four axes exceeds the speed limit, that axis is controlled with the speed limit value. The speeds of the other axes are limited at the ratios of "[Da.8] Command speed".

(Examples)

Setting item		Axis			
		Axis 1 setting	Axis 2 setting	Axis 3 setting	Axis 4 setting
[Pr.8]	Speed limit value	4000.00mm/min	5000.00mm/min	6000.00mm/min	8000.00mm/min
[Da.8]	Command speed	8000.00mm/min	6000.00mm/min	4000.00mm/min	1500.00mm/min

With the settings shown above, the operation speed in speed control is as follows.

Axis 1: 4000.00 mm/min (Speed is limited by [Pr.8]).

Axis 2: 3000.00 mm/min (Speed is limited at ratios in axes 1, 2, 3 and 4 command speeds).

Axis 3: 2000.00 mm/min (Speed is limited at ratios in axes 1, 2, 3 and 4 command speeds).

Axis 4: 750.00 mm/min (Speed is limited at ratios in axes 1, 2, 3 and 4 command speeds).

(Note): Operation runs at speed 1 when a reference axis speed is less than 1 as a result of speed limit.

In addition, when "[Pr.7] Bias speed at start" is set, the set value will be the minimum speed.

- (5) An error "No command speed (error code: 503)" will occur if a current speed (-1) is set in "[Da.8] Command speed".
- (6) The software stroke limit check is not carried out when the control unit is set to "degree".

■ Positioning data setting examples

[When "4-axis speed control (forward run: speed 4)" is set in the positioning data No. 1 of axis 1]

- Reference axis..... Axis 1
- Interpolation axis..... Axis 2 to Axis 4 (The required values are also set in positioning data No. 1 of axis 2 to axis 4.)

Setting item		LD77MH4 setting example				LD77MH16 setting example				Setting details	
		Axis 1 (reference axis)	Axis 2 (interpolation axis)	Axis 3 (interpolation axis)	Axis 4 (interpolation axis)	Axis 1 (reference axis)	Axis 2 (interpolation axis)	Axis 3 (interpolation axis)	Axis 4 (interpolation axis)		
Axis 1 Positioning data No. 1	Da.1	Operation pattern	Positioning complete	-	-	-	Positioning complete	-	-	-	Setting other than "Positioning complete" is not possible in speed control.
	Da.2	Control system	Forward run speed 4	-	-	-	Forward run speed 4	-	-	-	Set 4-axis speed control.
	Da.3	Acceleration time No.	1	-	-	-	1	-	-	-	Designate the value set in "[Pr.25] Acceleration time 1" as the acceleration time at start.
	Da.4	Deceleration time No.	0	-	-	-	0	-	-	-	Designate the value set in "[Pr.10] Deceleration time 0" as the deceleration time at deceleration.
	Da.5	Axis to be interpolated <b>LD77MH4</b>	-	-	-	-	/				Setting not required (setting value is ignored). When axis 1 is used as a reference axis, the interpolation axes are axes 2, 3 and 4.
	Da.6	Positioning address/movement amount	-	-	-	-	-	-	-	-	Setting not required (setting value is ignored).
	Da.7	Arc address	-	-	-	-	-	-	-	-	Setting not required (setting value is ignored).
	Da.8	Command speed	6000.00 mm/min	3000.00 mm/min	2000.00 mm/min	1000.00 mm/min	6000.00 mm/min	3000.00 mm/min	2000.00 mm/min	1000.00 mm/min	Set the speed to be commanded.
	Da.9	Dwell time	-	-	-	-	-	-	-	-	Setting not required (setting value is ignored).
	Da.10	M code	10	-	-	-	10	-	-	-	Set this when other sub operation commands are issued in combination with the No. 1 positioning data. (" [Pr.18] M code ON signal output timing " setting only possible in the WITH mode.)
Da.20	Axis to be interpolated No.1 <b>LD77MH16</b>	/				Axis 2	-	-	-	Set the axis to be interpolated. If the self-axis is set, an error will occur.	
Da.21	Axis to be interpolated No.2 <b>LD77MH16</b>	/				Axis 3	-	-	-		
Da.22	Axis to be interpolated No.3 <b>LD77MH16</b>	/				Axis 4	-	-	-		

(Note): Refer to Section 5.3 "List of positioning data" for information on the setting details.



### 9.2.16 Speed-position switching control (INC mode)

In "speed-position switching control (INC mode)" ("Da.2] Control system = Forward run: speed/position, Reverse run: speed/position), the pulses of the speed set in "Da.8] Command speed" are kept output on the axial direction set to the positioning data. When the "speed-position switching signal" is input, position control of the movement amount set in "Da.6] Positioning address/movement amount" is exercised.

"Speed-position switching control (INC mode)" is available in two different types: "forward run: speed/position" which starts the axis in the forward run direction and "reverse run: speed/position" which starts the axis in the reverse run direction.

Use the detailed parameter 1 "Pr.81] Speed-position function selection" with regard to the choice for "speed-position switching control (INC mode)".

Setting item		Setting value	Setting details	Buffer memory address	
				LD77MH4	LD77MH16
Pr.81]	Speed-position function selection	0	Speed-position switching control (INC mode)	34+150n	

(Note): If the set value is other than 0 and 2, it is regarded as 0 and operation is performed in the INC mode. For details of the setting, refer to Section 5.2 "List of parameters".

#### ■ Switching over from speed control to position control

- (1) The control is switched over from speed control to position control by executing the external command signal set in "speed-position switching signal".
- (2) Besides setting the positioning data, the "Cd.24] Speed-position switching enable flag" must also be turned ON to switch over from speed control to position control. (If the "Cd.24] Speed-position switching enable flag" turns ON after the speed-position switching signal turns ON, the control will continue as speed control without switching over to position control. The control will be switched over from position control to speed control when the external command signal turns from OFF to ON again. Only position control will be carried out when the "Cd.24] Speed-position switching enable flag" and speed-position switching signal are ON at the operation start.)

Setting item		Setting value	Setting details	Buffer memory address	
				LD77MH4	LD77MH16
Cd.24]	Speed-position switching enable flag	1	Set "1: Speed control will be taken over by position control when the external command signal [DI] comes ON."	1528+100n	4328+100n

■ Operation chart

The following chart (Fig.9.13) shows the operation timing for speed-position switching control (INC mode). The "in speed control flag" ( [Md.31] Status: b0) is turned ON during speed control of speed-position switching control (INC mode).

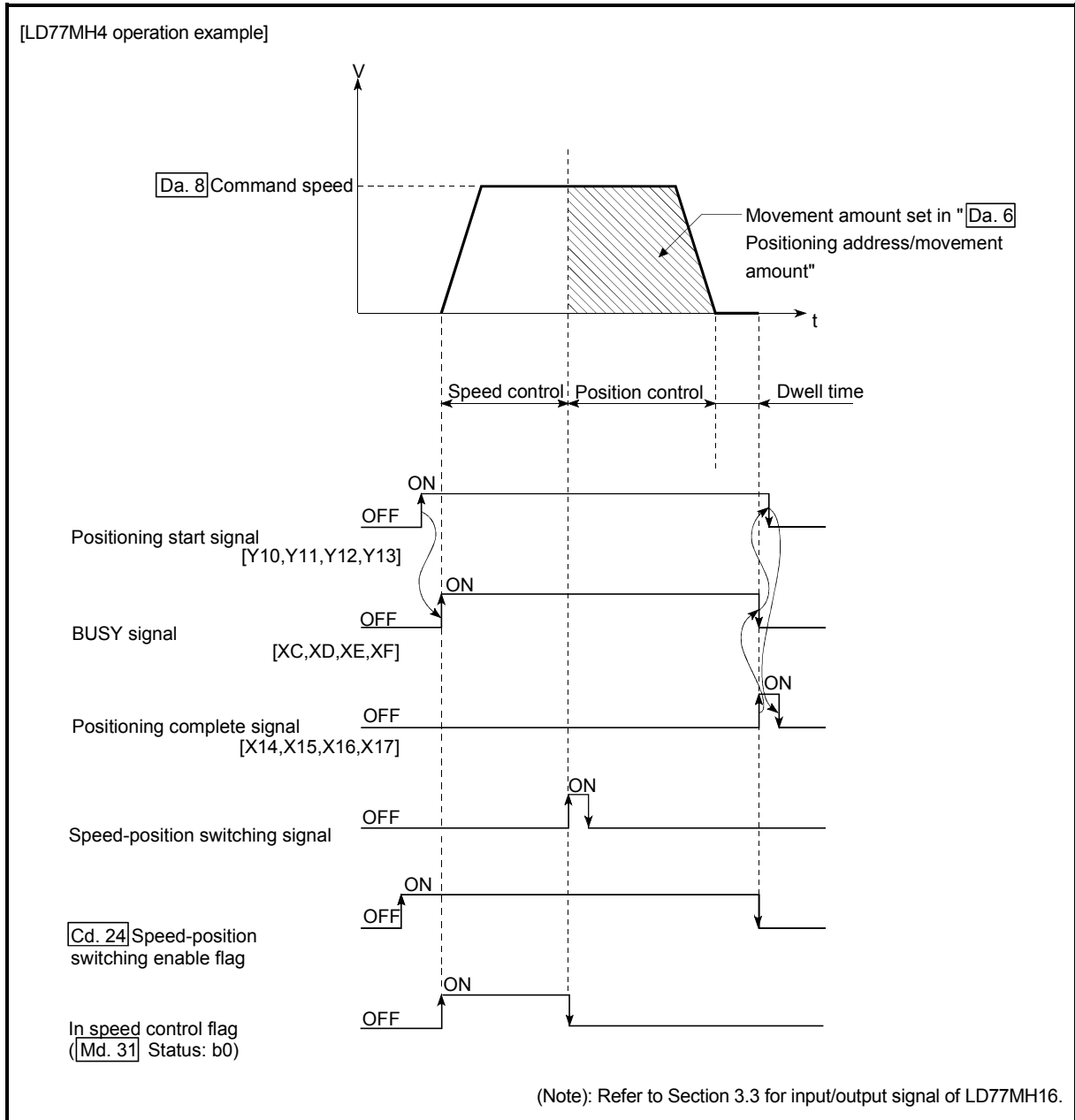
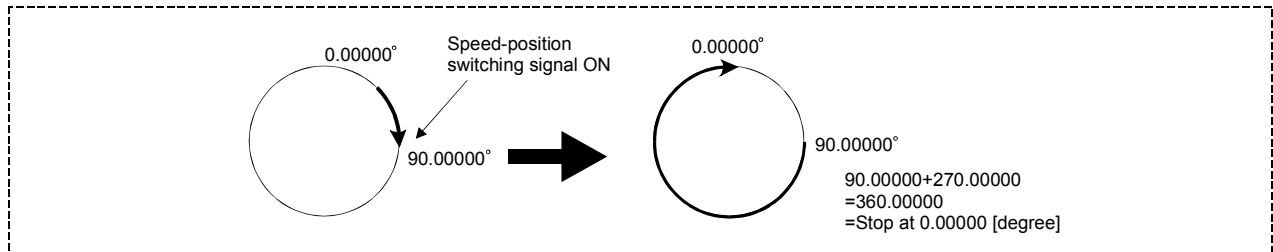

Fig. 9.13 Speed-position switching control (INC mode) operation timing

## [Operation example]

The following operation assumes that the speed-position switching signal is input at the position of the current feed value of 90.00000 [degree] during execution of "Da.2 Control system" "Forward run: speed/position" at "Pr.1 Unit setting" of "2: degree" and "Pr.21 Current feed value during speed control" setting of "1: Update current feed value".

(The value set in "Da.6 Positioning address/movement amount" is 270.00000 [degree])



■ Operation timing and processing time during speed-position switching control (INC mode)

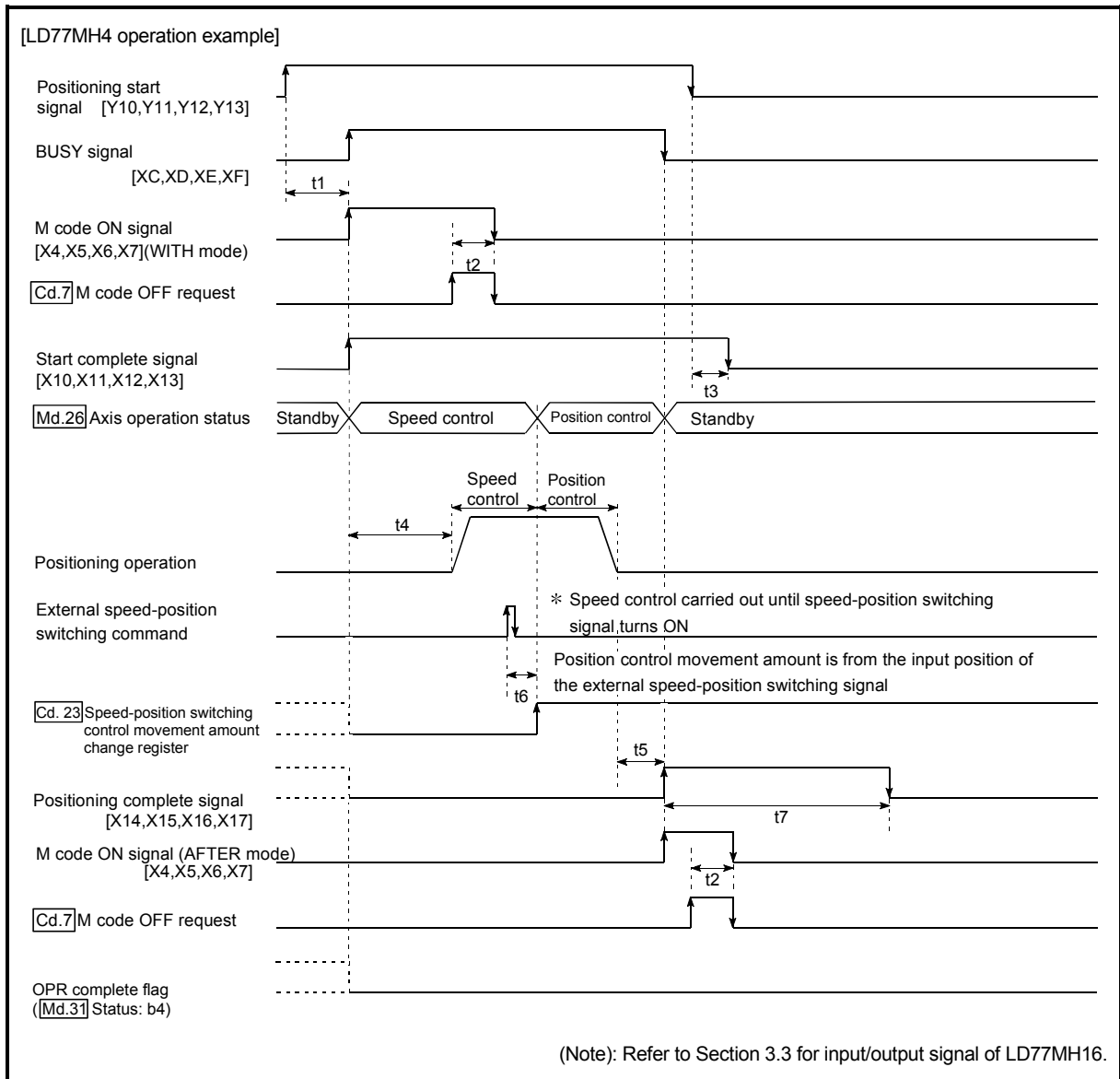

Fig. 9.14 Operation timing and processing time during speed-position switching control (INC mode)

Normal timing time

Unit: [ms]

	Operation cycle	t1	t2	t3	t4	t5	t6	t7
LD77MH4	0.88	0.2 to 0.3	0 to 0.9	0 to 0.9	2.2 to 2.7	0 to 0.9	0.2	Follows parameters
LD77MH16	0.88	0.3 to 1.4	0 to 0.9	0 to 0.9	2.2 to 2.7	0 to 0.9	0.2	Follows parameters
	1.77	0.3 to 1.4	0 to 1.8	0 to 1.8	3.2 to 3.9	0 to 1.8	0.2	Follows parameters

- The t1 timing time could be delayed by the operation state of other axes.

■ Current feed value during speed-position switching control (INC mode)

The following table shows the "Md.20 Current feed value" during speed-position switching control (INC mode) corresponding to the "Pr.21 Current feed value during speed control" settings.

Pr.21 Current feed value during speed control" setting	Md.20 Current feed value
0: Do not update current feed value	The current feed value at control start is maintained during speed control, and updated from the switching to position control.
1: Update current feed value	The current feed value is updated during speed control and position control.
2: Zero clear current feed value	The current feed value is cleared (set to "0") at control start, and updated from the switching to position control.

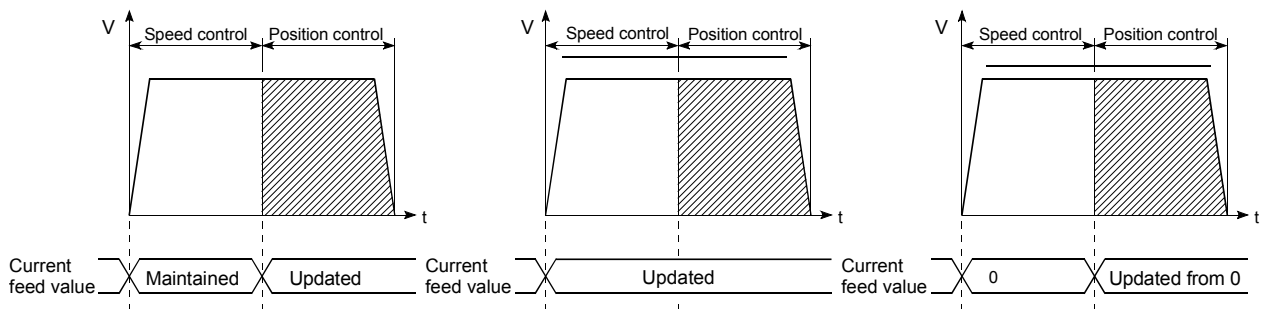

(a) Current feed value not updated

(b) Current feed value updated

(c) Current feed value zero cleared

■ Switching time from speed control to position control

There is 1ms from the time the speed-position switching signal is turned ON to the time the speed-position switching latch flag (Md.31 Status: b1) turns ON.

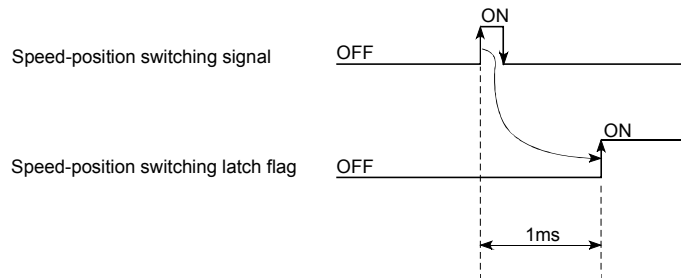

■ Speed-position switching signal setting

The following table shows the items that must be set to use the external command signals [DI] as speed-position switching signals.

Setting item	Setting value	Setting details	Buffer memory address	
			LD77MH4	LD77MH16
Pr.42 External command function selection	2	Set the "2: speed-position and position-speed switching requests".	62+150n	
Cd.8 External command valid	1	Set "1: Validate external command".	1505+100n	4305+100n

(Note): Set the external command signal [DI] in "Pr.95 External command signal selection" at LD77MH16 use. Refer to Section 5.2 "List of parameters" and Section 5.7 "List of control data" for information on the setting details.

### ■ Changing the position control movement amount

In "speed-position switching control (INC mode)", the position control movement amount can be changed during the speed control section.

- (1) The position control movement amount can be changed during the speed control section of speed-position switching control (INC mode).  
A movement amount change request will be ignored unless issued during the speed control section of the speed-position switching control (INC mode).
- (2) The "new movement amount" is stored in "Cd.23 Speed-position switching control movement amount change register" by the sequence program during speed control.

When the speed-position switching signal is turned ON, the movement amount for position control is stored in "Md.29 Speed-position switching control movement amount change register".

- (3) The movement amount is stored in the "Md.29 Speed-position switching control positioning amount" of the axis monitor area from the point where the control changes to position control by the input of a speed-position switching signal from an external device.

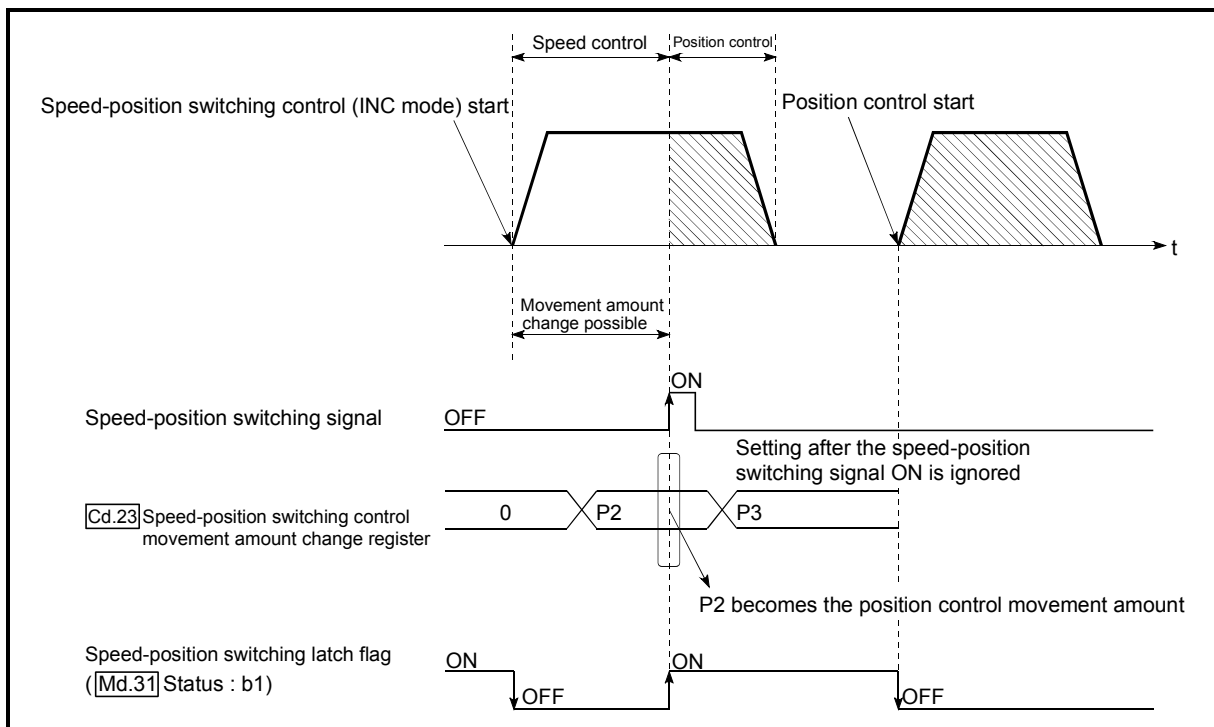

Fig. 9.15 Position control movement amount change timing

#### POINT

- The machine recognizes the presence of a movement amount change request when the data is written to "Cd.23 Speed-position switching control movement amount change register" with the sequence program.
- The new movement amount is validated after execution of the speed-position switching control (INC mode), before the input of the speed-position switching signal.
- The movement amount change can be enable/disable with the interlock function in position control using the "speed-position switching latch flag" (Md.31 Status : b1) of the axis monitor area.

## ■ Restrictions

- (1) An axis error (error code: 516) will occur and the operation cannot start if "continuous positioning control" or "continuous path control" is set in "Da.1 Operation pattern".
- (2) "Speed-position switching control" cannot be set in "Da.2 Control system" of the positioning data when "continuous path control" has been set in "Da.1 Operation pattern" of the immediately prior positioning data. (For example, if the operation pattern of positioning data No. 1 is "continuous path control", "speed-position switching control" cannot be set in positioning data No. 2.) An axis error (error code: 516) will occur and the machine will carry out a deceleration stop if this type of setting is carried out.
- (3) An error (error code: 503) will occur if "current speed (-1)" is set in "Da.8 Command speed".
- (4) The software stroke limit range check during speed control is made only when the following (a) and (b) are satisfied:
  - (a) "Pr.21 Current feed value during speed control" is "1: Update current feed value".  
If the movement amount exceeds the software stroke limit range during speed control in case of the setting of other than "1: Update current feed value", an error (error code: 507 or 508) will occur as soon as speed control is changed to position control and the axis will decelerate to a stop.
  - (b) When "Pr.1 Unit setting" is other than "2: degree"  
If the unit is "degree", the software stroke limit range check is not performed.
- (5) If the value set in "Da.6 Positioning address/movement amount" is negative, an error (error code: 530) will occur.
- (6) Deceleration processing is carried out from the point where the speed-position switching signal is input if the position control movement amount set in "Da.6 Positioning address/movement amount" is smaller than the deceleration distance from the "Da.8 Command speed".
- (7) Turn ON the speed-position switching signal in the speed stabilization region (constant speed status). A warning (warning code: 508) will occur because of large deviation in the droop pulse amount if the signal is turned ON during acceleration.  
During use of the servo motor, the actual movement amount after switching of speed control to position control is the "preset movement amount + droop pulse amount". If the signal is turned ON during acceleration/deceleration, the stop position will vary due to large variation of the droop pulse amount. Even though "Md.29 Speed-position switching control positioning amount" is the same, the stop position will change due to a change in droop pulse amount when "Da.8 Command speed" is different.

### ■ Positioning data setting examples

[When "speed-position switching control (INC mode) by forward run" is set in positioning data No. 1 of axis 1]

Setting item	Setting example		Setting details
	LD77MH4	LD77MH16	
Da.1	Operation pattern	Positioning complete	Set "Positioning complete" assuming the next positioning data will not be executed. ("Continuous path control" cannot be set in "speed-position switching control (INC mode)".)
Da.2	Control system	Forward run: speed/position	Set speed-position switching control by forward run.
Da.3	Acceleration time No.	1	Designate the value set in " [Pr.25] Acceleration time 1" as the acceleration time at start.
Da.4	Deceleration time No.	0	Designate the value set in " [Pr.10] Deceleration time 0" as the deceleration time at deceleration.
Da.5	Axis to be interpolated LD77MH4	—	Setting not required. (Setting value is ignored.)
Da.6	Positioning address/ movement amount	10000.0μm	INC mode ( [Pr.81] = 0) Set the movement amount after the switching to position control. (Assuming that the " [Pr.1] Unit setting" is set to "mm".)
Da.7	Arc address	—	Setting not required. (Setting value is ignored.)
Da.8	Command speed	6000.00mm/min	Set the speed to be controlled.
Da.9	Dwell time	500ms	Set a time from the positioning stop (command stop) by position control until the positioning complete signal is output. When the system is stopped by speed control, ignore the setting value.
Da.10	M code	10	Set this when other sub operation commands are issued in combination with the No.1 positioning data.
Da.20	Axis to be interpolated No.1 LD77MH16	/	Setting not required (setting value is ignored).
Da.21	Axis to be interpolated No.2 LD77MH16	/	
Da.22	Axis to be interpolated No.3 LD77MH16	/	

(Note): Refer to Section 5.3 "List of positioning data" for information on the setting details.



## 9.2.17 Speed-position switching control (ABS mode)

In case of "speed-position switching control (ABS mode)" ("Da.2 Control system = Forward run: speed/position, Reverse run: speed/position), the pulses of the speed set in "Da.8 Command speed" are kept output in the axial direction set to the positioning data. When the "speed-position switching signal" is input, position control to the address set in "Da.6 Positioning address/movement amount" is exercised.

"Speed-position switching control (ABS mode)" is available in two different types: "forward run: speed/position" which starts the axis in the forward run direction and "reverse run: speed/position" which starts the axis in the reverse run direction.

"Speed-position switching control (ABS mode)" is valid only when "Pr.1 Unit setting" is "2: degree".

Speed-position function selection	Pr.1 Unit setting			
	mm	inch	degree	PLS
INC mode	○	○	○	○
ABS mode	×	×	○	×

○: Setting allowed,

×: Setting disallowed (If setting is made, an error (error code: 935) will occur when the PLC READY signal [Y0] turns ON.)

Use the detailed parameter 1 "Pr.81 Speed-position function selection" to choose "speed-position switching control (ABS mode)".

Setting item	Setting value	Setting details	Buffer memory address	
			LD77MH4	LD77MH16
Pr.81 Speed-position function selection	2	Speed-position switching control (ABS mode)	34+150n	

(Note): If the set value is other than 0 and 2, it is regarded as 0 and operation is performed in the INC mode.

For details of the setting, refer to Section 5.2 "List of parameters".

■ Switching over from speed control to position control

- (1) The control is switched over from speed control to position control by executing the external command signal set in "speed-position switching signal".
- (2) Besides setting the positioning data, the "Cd.24 Speed-position switching enable flag" must also be turned ON to switch over from speed control to position control. (If the "Cd.24 Speed-position switching enable flag" turns ON after the speed-position switching signal turns ON, the control will continue as speed control without switching over to position control. The control will be switched over from speed control to position control when the external command signal turns from OFF to ON again. Only position control will be carried out when the "Cd.24 Speed-position switching enable flag" and speed-position switching signal are ON at the operation start.)

Setting item		Setting value	Setting details	Buffer memory address	
				LD77MH4	LD77MH16
Cd.24	Speed-position switching enable flag	1	Set "1: Speed control will be taken over by position control when the external command signal [DI] comes ON."	1528+100n	4328+100n

■ Operation chart

The following chart (Fig.9.16) shows the operation timing for speed-position switching control (ABS mode). The "in speed control flag" ( [Md.31] Status: b0) is turned ON during speed control of speed-position switching control (ABS mode).

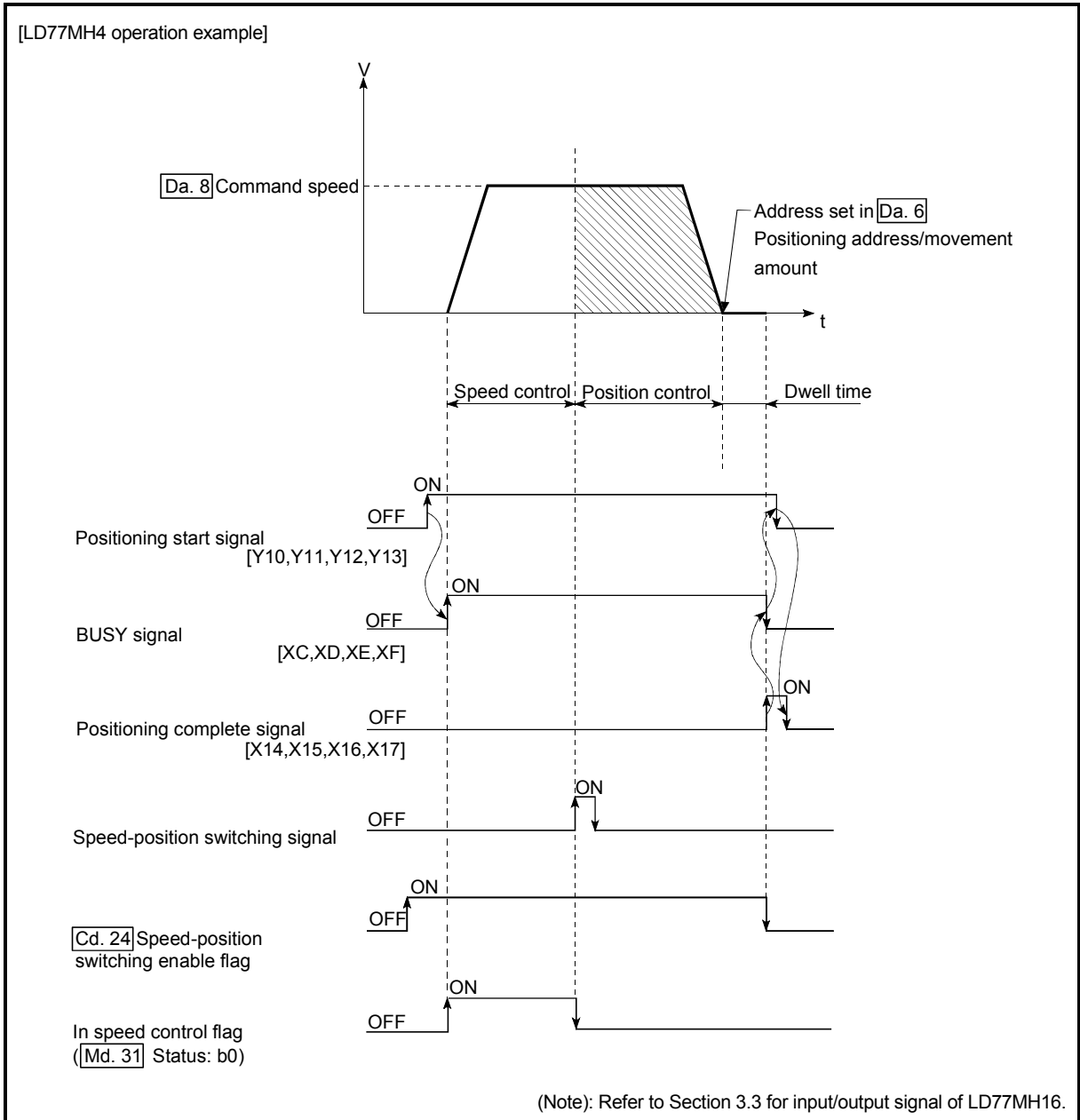
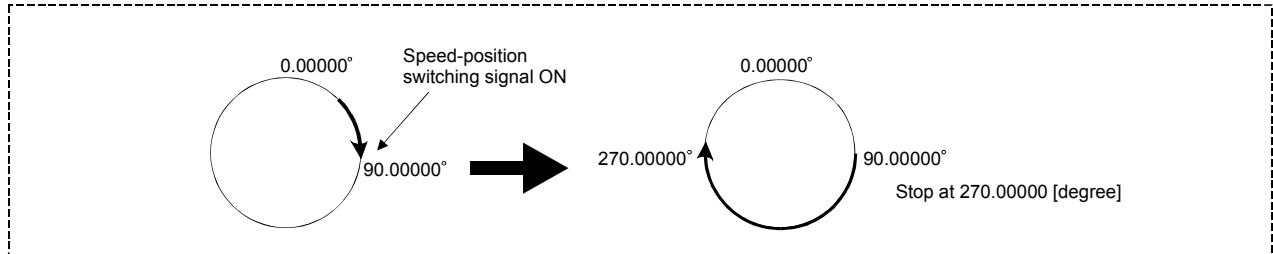

Fig. 9.16 Speed-position switching control (ABS mode) operation timing

## [Operation example]

The following operation assumes that the speed-position switching signal is input at the position of the current feed value of 90.00000 [degree] during execution of "Da.2 Control system" "Forward run: speed/position" at "Pr.1 Unit setting" of "2: degree" and "Pr.21 Current feed value during speed control" setting of "1: Update current feed value".

(The value set in "Da.6 Positioning address/movement amount" is 270.00000 [degree])



■ Operation timing and processing time during speed-position switching control (ABS mode)

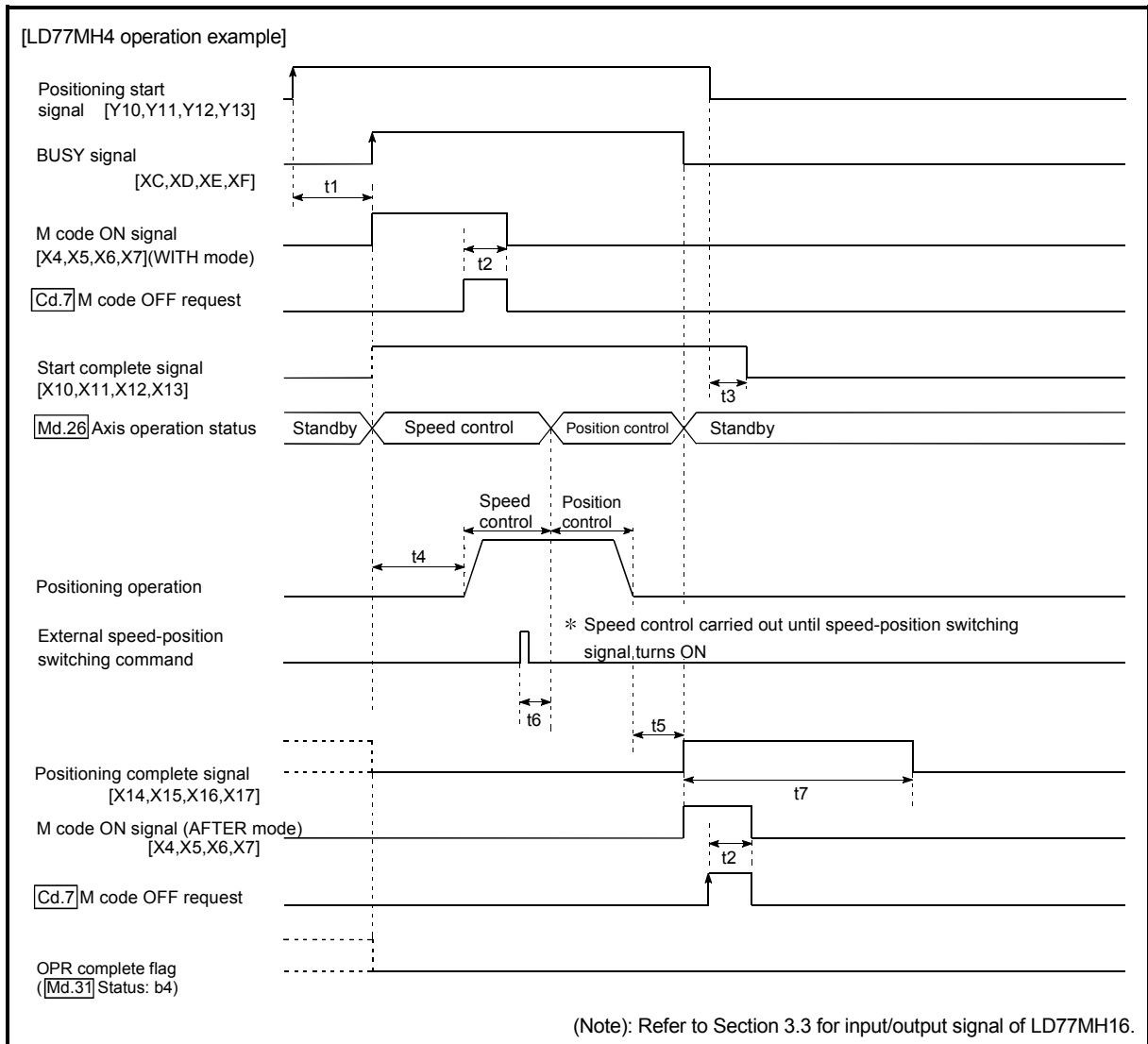

Fig. 9.17 Operation timing and processing time during speed-position switching control (ABS mode)

Normal timing time

Unit: [ms]

	Operation cycle	t1	t2	t3	t4	t5	t6	t7
LD77MH4	0.88	0.2 to 0.3	0 to 0.9	0 to 0.9	2.2 to 2.7	0 to 0.9	0.2	Follows parameters
LD77MH16	0.88	0.3 to 1.4	0 to 0.9	0 to 0.9	2.2 to 2.7	0 to 0.9	0.2	Follows parameters
	1.77	0.3 to 1.4	0 to 1.8	0 to 1.8	3.2 to 3.9	0 to 1.8	0.2	Follows parameters

- The t1 timing time could be delayed by the operation state of other axes.

■ Current feed value during speed-position switching control (ABS mode)

The following table shows the "Md.20 Current feed value" during speed-position switching control (ABS mode) corresponding to the "Pr.21 Current feed value during speed control" settings.

"Pr.21 Current feed value during speed control" setting	Md.20 Current feed value
1: Update current feed value	The current feed value is updated during speed control and position control.

Only "1: Update current value" is valid for the setting of "Pr.21 Current feed value during speed control" in speed-position switching control (ABS mode).

An error (error code: 935) will occur if the "Pr.21 Current feed value during speed control" setting is other than 1.

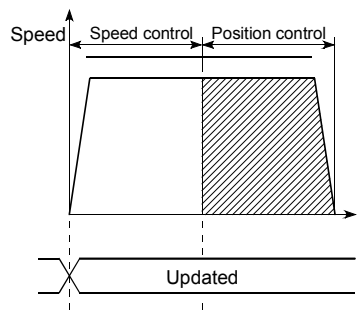

Current feed value updated

■ Switching time from speed control to position control

There is 1ms from the time the speed-position switching signal is turned ON to the time the speed-position switching latch flag (Md.31 Status: b1) turns ON.

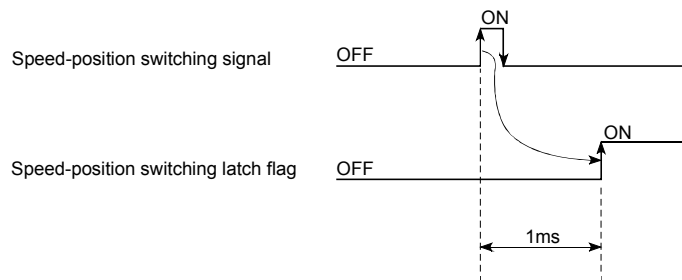

### Speed-position switching signal setting

The following table shows the items that must be set to use the external command signals [DI] as speed-position switching signals.

Setting item		Setting value	Setting details	Buffer memory address	
				LD77MH4	LD77MH16
<b>Pr.42</b>	External command function selection	2	Set the "2: speed-position and position-speed switching requests".	62+150n	
<b>Cd.8</b>	External command valid	1	Set "1: Validate external command".	1505+100n	4305+100n

(Note): Set the external command signal [DI] in "**Pr.95** External command signal selection" at LD77MH16 use. Refer to Section 5.2 "List of parameters" and Section 5.7 "List of control data" for information on the setting details.

### Restrictions

- (1) An axis error (error code: 516) will occur and the operation cannot start if "continuous positioning control" or "continuous path control" is set in "**Da.1** Operation pattern".
- (2) "Speed-position switching control" cannot be set in "**Da.2** Control system" of the positioning data when "continuous path control" has been set in "**Da.1** Operation pattern" of the immediately prior positioning data. (For example, if the operation pattern of positioning data No. 1 is "continuous path control", "speed-position switching control" cannot be set in positioning data No. 2.) An axis error (error code: 516) will occur and the machine will carry out a deceleration stop if this type of setting is carried out.
- (3) An error (error code: 503) will occur if "current speed (-1)" is set in "**Da.8** Command speed".
- (4) If the value set in "**Da.6** Positioning address/movement amount" is negative, an error (error code: 530) will occur.
- (5) Even though the axis control data "**Cd.23** Speed-position switching control movement amount change register" was set in speed-position switching control (ABS mode), it would not function. The set value is ignored.
- (6) To exercise speed-position switching control (ABS mode), the following conditions must be satisfied:
  - (a) "**Pr.1** Unit setting" is "2: degree"
  - (b) The software stroke limit function is invalid (upper limit value = lower limit value)
  - (c) "**Pr.21** Current feed value during speed control" is "1: Update current feed value"
  - (d) The "**Da.6** Positioning address/movement amount" setting range is 0 to 359.99999 (degree)  
If the value is outside of the range 0 to 359.99999 (degree), an error (error code: 530) will occur at a start.
  - (e) The "**Pr.81** Speed-position function selection" setting is "2: Speed-position switching control (ABS mode)".
- (7) If any of the conditions in (6)(a) to (6)(c) is not satisfied in the case of (6)(e), an error (error code: 935) will occur when the PLC READY signal [Y0] turns from OFF to ON.

- (8) If the axis reaches the positioning address midway through deceleration after automatic deceleration started at the input of the speed-position switching signal, the axis will not stop immediately at the positioning address. The axis will stop at the positioning address after N revolutions so that automatic deceleration can always be made. (N: Natural number)

In the following example, since making deceleration in the path of dotted line will cause the axis to exceed the positioning addresses twice, the axis will decelerate to a stop at the third positioning address.

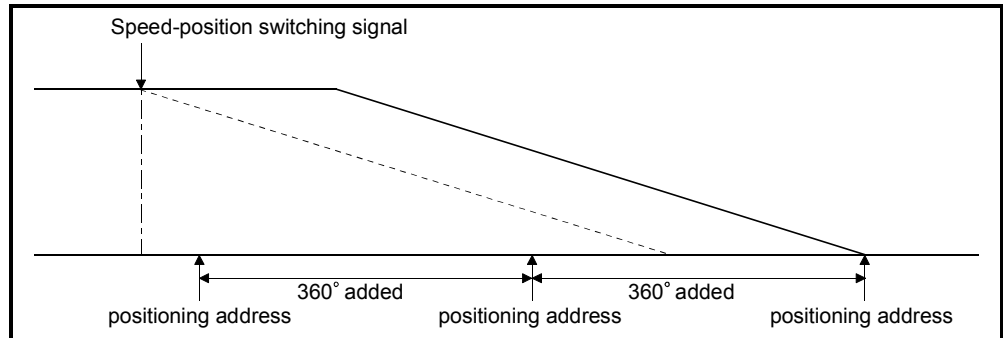

■ Positioning data setting examples

[When "speed-position switching control (ABS mode) by forward run" is set in positioning data No. 1 of axis 1]

Setting item		Setting example		Setting details	
		LD77MH4	LD77MH16		
Axis 1 Positioning data No. 1	Da.1	Operation pattern	Positioning complete		Set "Positioning complete" assuming the next positioning data will not be executed. ("Continuous path control" cannot be set in "speed-position switching control (ABS mode)".)
	Da.2	Control system	Forward run: speed/position		Set speed-position switching control by forward run.
	Da.3	Acceleration time No.	1		Designate the value set in " [Pr.25] Acceleration time 1" as the acceleration time at start.
	Da.4	Deceleration time No.	0		Designate the value set in " [Pr.10] Deceleration time 0" as the deceleration time at deceleration.
	Da.5	Axis to be interpolated LD77MH4	-		Setting not required. (Setting value is ignored.)
	Da.6	Positioning address/ movement amount	270.00000degree		ABS mode ( [Pr.81] = 2) Set the address after the switching to position control. (Assuming that the " [Pr.1] Unit setting" is set to "mm".)
	Da.7	Arc address	-		Setting not required. (Setting value is ignored.)
	Da.8	Command speed	6000.00mm/min		Set the speed to be controlled.
	Da.9	Dwell time	500ms		Set a time from the positioning stop (command stop) by position control until the positioning complete signal is output. When the system is stopped by speed control, ignore the setting value.
	Da.10	M code	10		Set this when other sub operation commands are issued in combination with the No. 1 positioning data.
	Da.20	Axis to be interpolated No.1 LD77MH16		-	Setting not required (setting value is ignored).
	Da.21	Axis to be interpolated No.2 LD77MH16		-	
	Da.22	Axis to be interpolated No.3 LD77MH16		-	

(Note): Refer to Section 5.3 "List of positioning data" for information on the setting details.



## 9.2.18 Position-speed switching control

In "position-speed switching control" (" [Da.2] Control system" = Forward run: position/speed, Reverse run: position/speed), before the position-speed switching signal is input, position control is carried out for the movement amount set in " [Da.6] Positioning address/movement amount" in the axis direction in which the positioning data has been set. When the position-speed switching signal is input, the position control is carried out by continuously outputting the pulses for the speed set in " [Da.8] Command speed" until the input of a stop command.

The two types of position-speed switching control are "Forward run: position/speed" in which the control starts in the forward run direction, and "Reverse run: position/speed" in which control starts in the reverse run direction.

#### ■ Switching over from position control to speed control

- (1) The control is switched over from position control to speed control by executing the external command signal set in "position-speed switching signal".
- (2) Besides setting the positioning data, the " [Cd.26] Position-speed switching enable flag" must also be turned ON to switch over from position control to speed control. (If the " [Cd.26] Position-speed switching enable flag" turns ON after the position-speed switching signal turns ON, the control will continue as position control without switching over to speed control. The control will be switched over from position control to speed control when the external command signal turns from OFF to ON again. Only speed control will be carried out when the " [Cd.26] Position-speed switching enable flag" and position-speed switching signal are ON at the operation start.)

Setting item		Setting value	Setting details	Buffer memory address	
				LD77MH4	LD77MH16
[Cd.26]	Position-speed switching enable flag	1	Set "1: Position control will be taken over by speed control when the external command signal [DI] comes ON."	1532+100n	4332+100n

■ Operation chart

The following chart shows the operation timing for position-speed switching control.

The "in speed control" flag (Md.31) Status: b0) is turned ON during speed control of position-speed switching control.

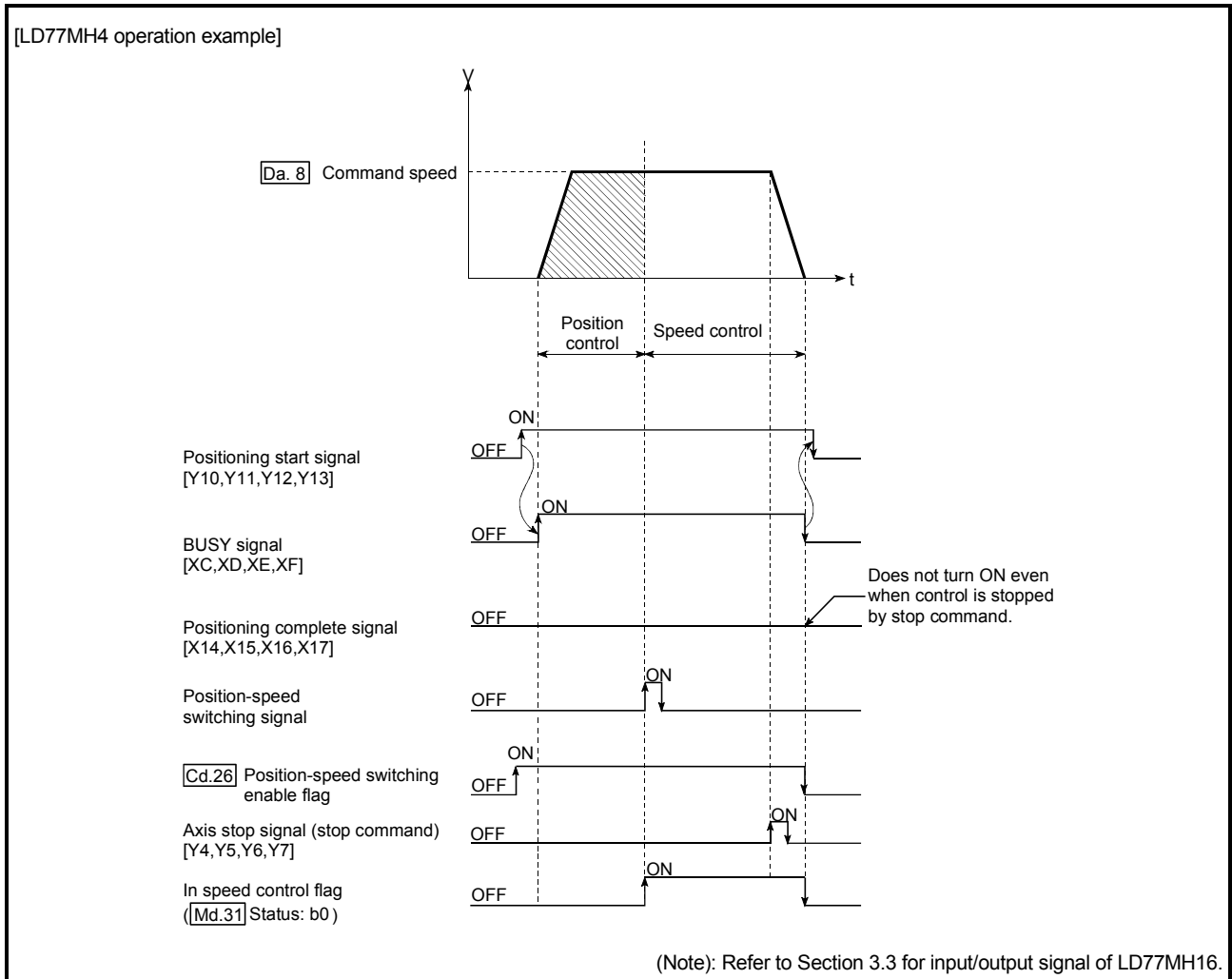

Fig. 9.18 Position-speed switching control operation timing

■ Operation timing and processing time during position-speed switching control

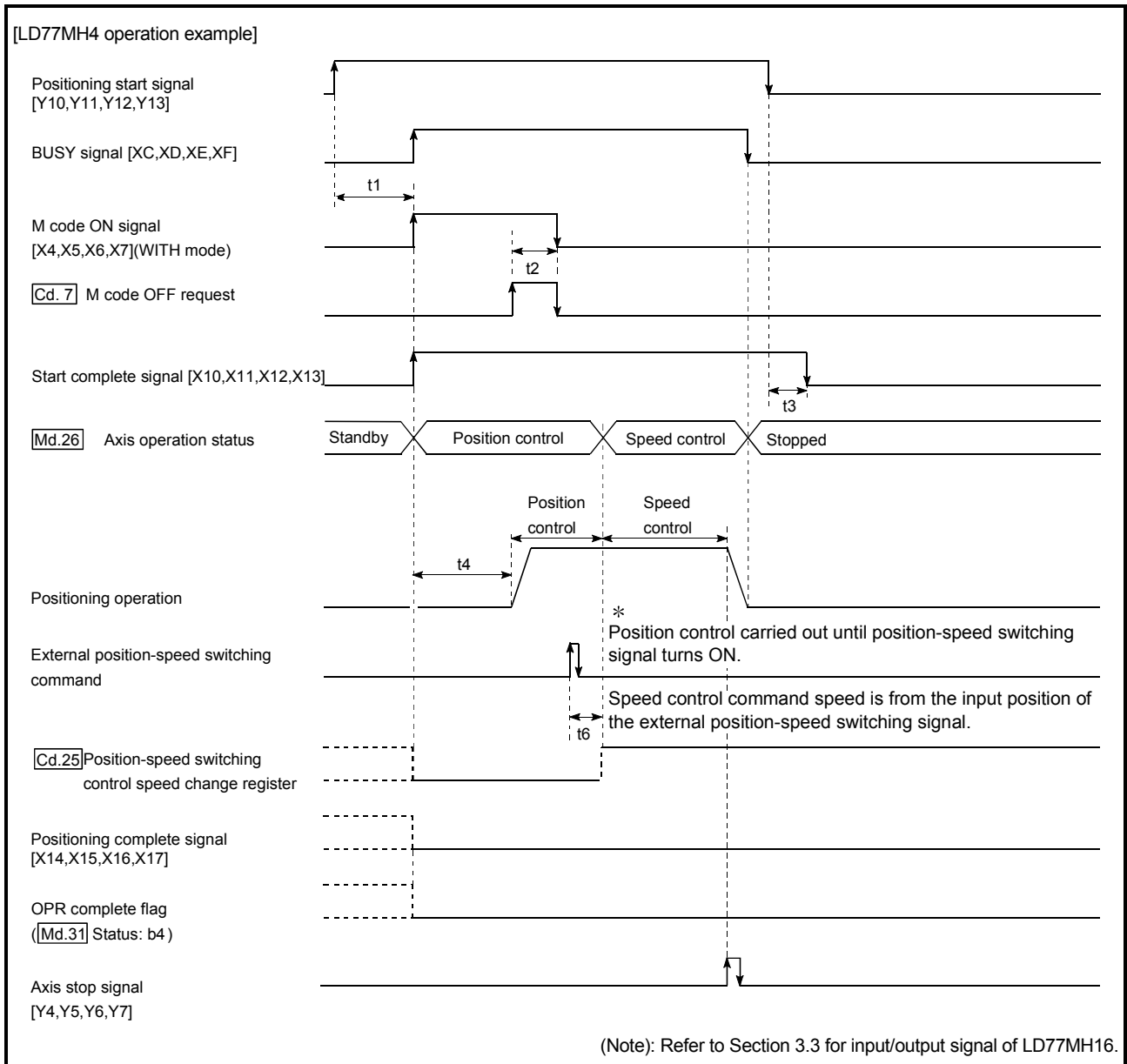

Fig. 9.19 Operation timing and processing time during position-speed switching control

Normal timing time Unit: [ms]

	Operation cycle	t1	t2	t3	t4	t5	t6
LD77MH4	0.88	0.2 to 0.3	0 to 0.9	0 to 0.9	2.2 to 2.7	–	0.2
LD77MH16	0.88	0.3 to 1.4	0 to 0.9	0 to 0.9	2.2 to 2.7	–	0.2
	1.77	0.3 to 1.4	0 to 1.8	0 to 1.8	3.2 to 3.9	–	0.2

- The t1 timing time could be delayed by the operation state of other axes.

■ Current feed value during position-speed switching control

The following table shows the "Md.20 Current feed value" during position-speed switching control corresponding to the "Pr.21 Current feed value during speed control" settings.

"Pr.21 Current feed value during speed control" setting	Md.20 Current feed value
0: Do not update current feed value	The current feed value is updated during position control, and the current feed value at the time of switching is maintained as soon as position control is switched to speed control.
1: Update current feed value	The current feed value is updated during position control and speed control.
2: Zero clear current feed value	The current feed value is updated during position control, and the current feed value is cleared (to "0") as soon as position control is switched to speed control.

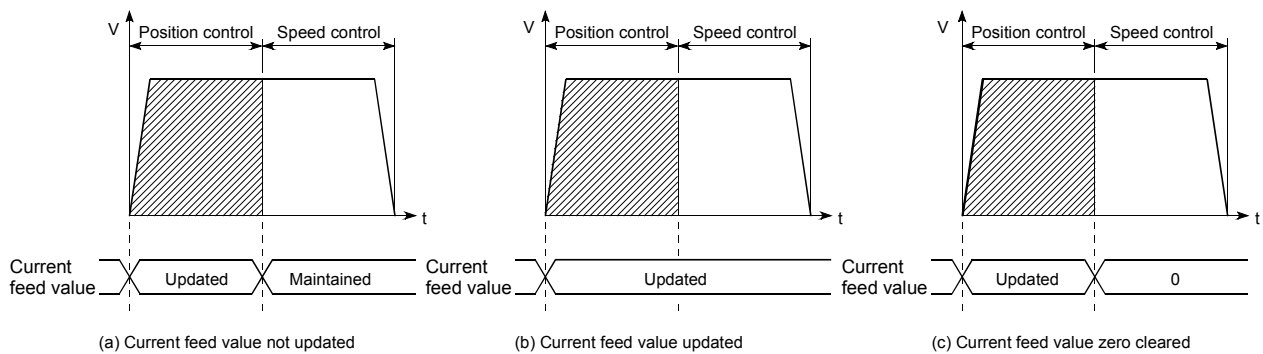

■ Switching time from position control to speed control

There is 1ms from the time the position-speed switching signal is turned ON to the time the position-speed switching latch flag (Md.31 Status: b5) turns ON.

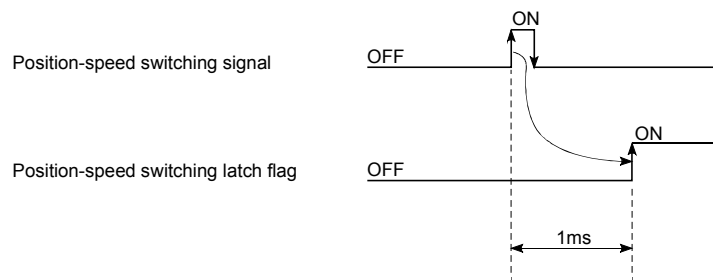

■ Position-speed switching signal setting

The following table shows the items that must be set to use the external command signals [DI] as position-speed switching signals.

Setting item		Setting value	Setting details	Buffer memory address	
				LD77MH4	LD77MH16
[Pr.42]	External command function selection	2	Set the "2: speed-position and position-speed switching requests".	62+150n	
[Cd.8]	External command valid	1	Set "1: Validate external command".	1505+100n	4305+100n

(Note): Set the external command signal [DI] in "[Pr.95] External command signal selection" at LD77MH16 use. Refer to Section 5.2 "List of parameters" and Section 5.7 "List of control data" for information on the setting details.

■ Changing the speed control command speed

In "position-speed switching control", the speed control command speed can be changed during the position control.

- (1) The speed control command speed can be changed during the position control of position-speed switching control.  
A command speed change request will be ignored unless issued during the position control of the position-speed switching control.
- (2) The "new command speed" is stored in "[Cd.25] Position-speed switching control speed change register" by the sequence program during position control.

This value then becomes the speed control command speed when the position-speed switching signal turns ON.

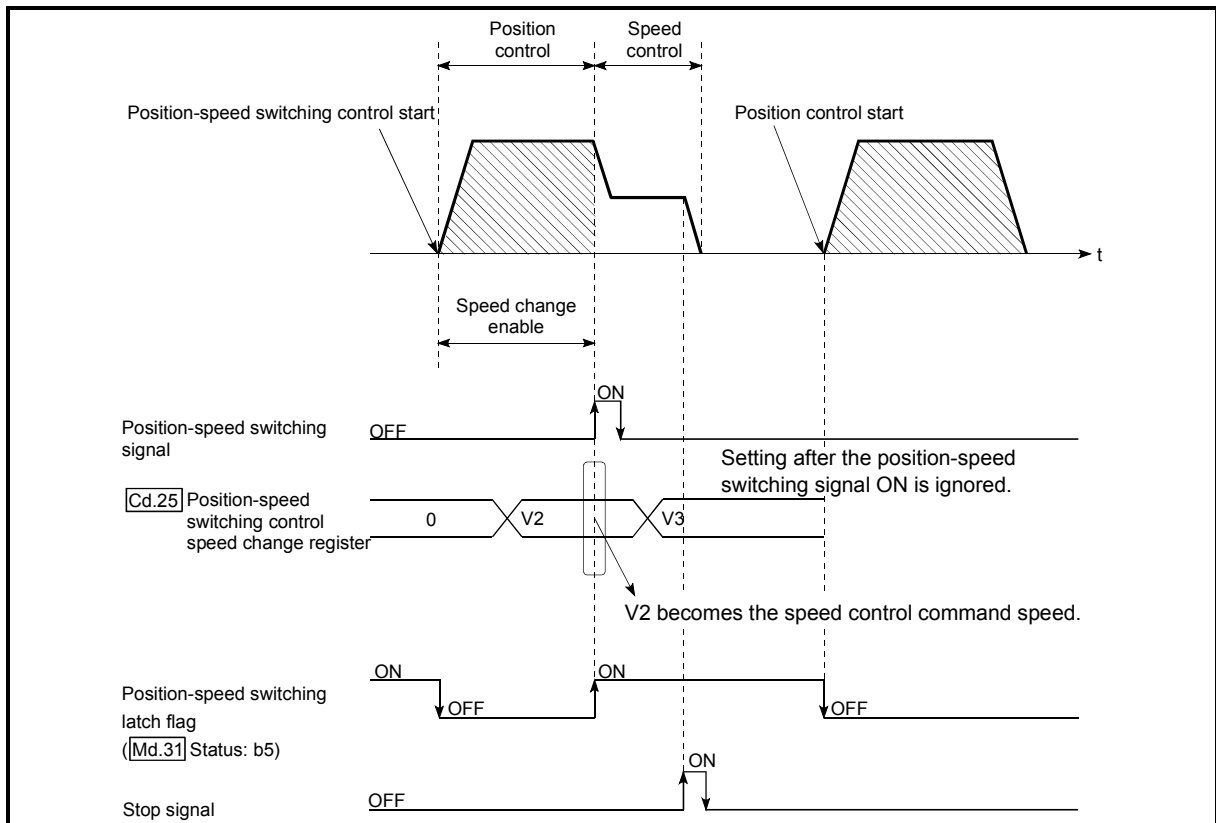

Fig. 9.20 Speed control speed change timing

## POINTS

- The machine recognizes the presence of a command speed change request when the data is written to " [Cd.25] Position-speed switching control speed change register" with the sequence program.
- The new command speed is validated after execution of the position-speed switching control before the input of the position-speed switching signal.
- The command speed change can be enabled/disabled with the interlock function in speed control using the "position-speed switching latch flag" ( [Md.31] Status: b5) of the axis monitor area.

### ■ Restrictions

- (1) An axis error (error code: 516) will occur and the operation cannot start if "continuous positioning control" or "continuous path control" is set in " [Da.1] Operation pattern".
- (2) "Position-speed switching control" cannot be set in " [Da.2] Control system" of the positioning data when "continuous path control" has been set in " [Da.1] Operation pattern" of the immediately prior positioning data. (For example, if the operation pattern of positioning data No. 1 is "continuous path control", "position-speed switching control" cannot be set in positioning data No. 2.) An axis error (error code: 516) will occur and the machine will carry out a deceleration stop if this type of setting is carried out.
- (3) The software stroke limit range is only checked during speed control if the "1: Update current feed value" is set in " [Pr.21] Current feed value during speed control".  
The software stroke limit range is not checked when the control unit is set to "degree".
- (4) An error (error code: 507 or 508) will occur and the operation cannot start if the start point address or end point address for position control exceeds the software stroke limit range.
- (5) Deceleration stop will be carried out if the position-speed switching signal is not input before the machine is moved by a specified movement amount. When the position-speed switching signal is input during automatic deceleration by positioning control, acceleration is carried out again to the command speed to continue speed control.  
When the position-speed switching signal is input during deceleration to a stop with the stop signal, the control is switched to the speed control to stop the machine.  
Restart is carried out by speed control using the restart command.
- (6) A warning (warning code: 501) will occur and control is continued by " [Pr.8] Speed limit value" if a new speed exceeds " [Pr.8] Speed limit value" at the time of change of the command speed.
- (7) If the value set in " [Da.6] Positioning address/movement amount" is negative, an error (error code: 530) will occur.
- (8) Set WITH mode in " [Pr.18] M code ON signal output timing" at M code use. The M code will not be output, and the M code ON signal will not turn ON if the AFTER mode is set.

### ■ Positioning data setting examples

[When "position-speed switching control (forward run: position/speed)" is set in positioning data No. 1 of axis 1]

Setting item		Setting example		Setting details	
		LD77MH4	LD77MH16		
Axis 1 Positioning data No. 1	Da.1	Operation pattern	Positioning complete		Set "Positioning complete" assuming the next positioning data will not be executed. ("Continuous positioning control" and "Continuous path control" cannot be set in "position/speed changeover control".)
	Da.2	Control system	Forward run: position/speed		Set position-speed switching control.
	Da.3	Acceleration time No.	1		Designate the value set in " [Pr.25] Acceleration time 1" as the acceleration time at start.
	Da.4	Deceleration time No.	0		Designate the value set in " [Pr.10] Deceleration time 0" as the deceleration time at deceleration.
	Da.5	Axis to be interpolated LD77MH4	-		Setting not required. (Setting value is ignored.)
	Da.6	Positioning address/ movement amount	10000.0μm		Set the movement amount at the time of position control before the switching to speed control. (Assuming that the " [Pr.1] Unit setting" is set to "mm".)
	Da.7	Arc address	-		Setting not required. (Setting value is ignored.)
	Da.8	Command speed	6000.00mm/min		Set the speed to be controlled.
	Da.9	Dwell time	500ms		Set the time the machine dwells after the positioning stop (command stop) by position control to the output of the positioning complete signal. If the machine is stopped by speed control, the setting value is ignored.
	Da.10	M code	10		Set this when other sub operation commands are issued in combination with the No.1 positioning data.
	Da.20	Axis to be interpolated No.1 LD77MH16		-	Setting not required (setting value is ignored).
	Da.21	Axis to be interpolated No.2 LD77MH16		-	
	Da.22	Axis to be interpolated No.3 LD77MH16		-	

(Note): Refer to Section 5.3 "List of positioning data" for information on the setting details.

## 9.2.19 Current value changing

When the current value is changed to a new value, control is carried out in which the "Md.20 Current feed value" of the stopped axis is changed to a random address set by the user. (The "Md.21 Machine feed value" is not changed when the current value is changed.)

The two methods for changing the current value are shown below.

- [1] Changing to a new current value using the positioning data
- [2] Changing to a new current value using the start No. (No. 9003) for a current value changing

The current value changing using method [1] is used during continuous positioning of multiple blocks, etc.

### [1] Changing to a new current value using the positioning data

#### ■ Operation chart

The following chart shows the operation timing for a current value changing. The "Md.20 Current feed value" is changed to the value set in "Da.6 Positioning address/movement amount" when the positioning start signal turns ON.

[LD77MH4 operation example]

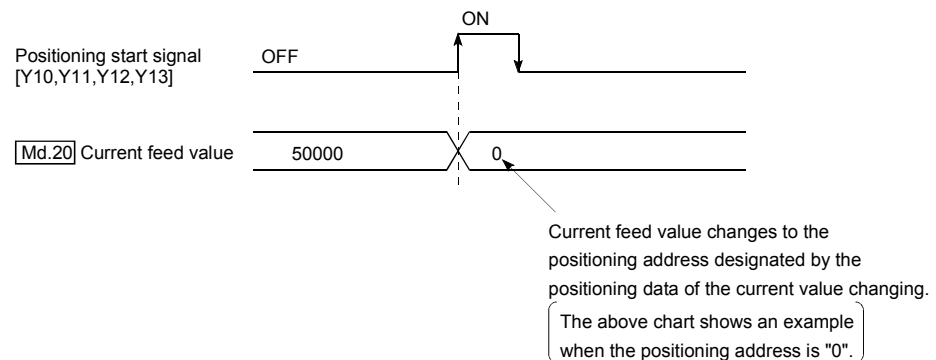

(Note): Refer to Section 3.3 for input/output signal of LD77MH16.

#### ■ Restrictions

- (1) An axis error "New current value not possible (error code: 515)" will occur and the operation cannot start if "continuous path control" is set in "Da.1 Operation pattern". ("Continuous path control" cannot be set in current value changing.)
- (2) "Current value changing" cannot be set in "Da.2 Control system" of the positioning data when "continuous path control" has been set in "Da.1 Operation pattern" of the immediately prior positioning data. (For example, if the operation pattern of positioning data No. 1 is "continuous path control", "current value changing" cannot be set in positioning data No. 2.) An axis error "New current value invalid (error code: 515)" will occur and the machine will carry out a deceleration stop if this type of setting is carried out.



- (3) An axis error "Outside new current value range (error code: 514)" will occur and the operation cannot start if "degree" is set in " [Pr.1] Unit setting" and the value set in " [Da.6] Positioning address/movement amount (0 to 359.99999 [degree])" is outside the setting range.
- (4) If the value set in " [Da.6] Positioning address/movement amount" is outside the software stroke limit ( [Pr.12] , [Pr.13] ) setting range, an error "Software stroke limit +, - (error code: 507 or 508)" will occur at the positioning start, and the operation will not start.
- (5) An error (error code: 507 or 508) will occur if the new current value is outside the software stroke limit range.
- (6) The new current value using the positioning data (No.1 to 600) cannot be changed, if "0: Positioning control is not executed" is set in " [Pr.55] Operation setting for incompleteness of OPR" and "OPR request flag" ON. A warning "Operation setting for incompleteness of OPR at positioning start error" (error code: 547) will occur.

#### ■ Positioning data setting examples

[When "current value changing" is set in the positioning data No. 1 of axis 1]

Setting item		Setting example		Setting details
		LD77MH4	LD77MH16	
Axis 1 Positioning data No. 1	[Da.1] Operation pattern	Positioning complete		Set "Positioning complete" assuming that the next positioning data will be executed. ("Continuous path control" cannot be set by current value change.)
	[Da.2] Control system	Current value changing		Set the current value changing.
	[Da.3] Acceleration time No.	-		Setting not required (Setting value is ignored.)
	[Da.4] Deceleration time No.	-		
	[Da.5] Axis to be interpolated LD77MH4	-	/	
	[Da.6] Positioning address/ movement amount	10000.0μm		
	[Da.7] Arc address	-		Setting not required (Setting value is ignored.)
	[Da.8] Command speed	-		
	[Da.9] Dwell time	-		
	[Da.10] M code	10		Set this when other sub operation commands are issued in combination with the No.1 positioning data.
	[Da.20] Axis to be interpolated No.1 LD77MH16	/	-	Setting not required (setting value is ignored).
	[Da.21] Axis to be interpolated No.2 LD77MH16	/	-	
[Da.22] Axis to be interpolated No.3 LD77MH16	/	-		

(Note): Refer to Section 5.3 "List of positioning data" for information on the setting details.

## [2] Changing to a new current value using the start No. (No. 9003) for a current value changing

### ■ Operation chart

The current value is changed by setting the new current value in the current value changing buffer memory "Cd.9 New current value", setting "9003" in the "Cd.3 Positioning start No.", and turning ON the positioning start signal.

[LD77MH4 operation example]

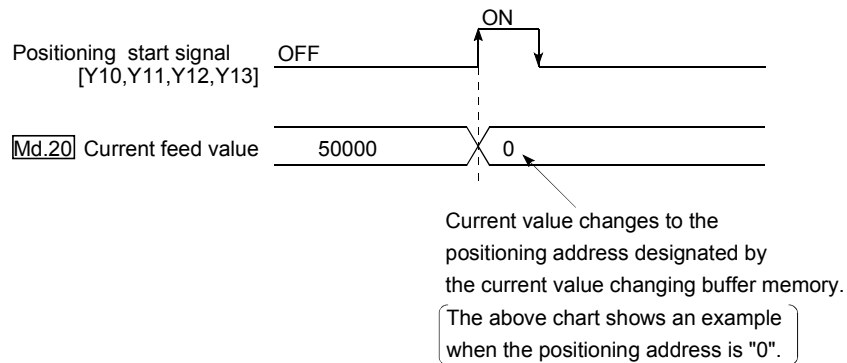

(Note): Refer to Section 3.3 for input/output signal of LD77MH16.

### ■ Restrictions

- (1) An axis error "Outside new current value range (error code: 514)" will occur if the designated value is outside the setting range when "degree" is set in "Unit setting".
- (2) An error "Software stroke limit +, - (error code: 507 or 508)" will occur if the designated value is outside the software stroke limit range.
- (3) The current value cannot be changed during stop commands and while the M code ON signal is ON.
- (4) The M code output function is made invalid.

### POINTS

The new current value using the current value changing start No. (No. 9003) can be changed, if "0: Positioning control is not executed" is set in "Pr.55 Operation setting for incompleteness of OPR" and "OPR request flag" ON.

### ■ Current value changing procedure

The following shows the procedure for changing the current value to a new value.

- 1) Write the current value to "Cd. 9 New current value"
- 2) Write "9003" in "Cd. 3 Positioning start No."
- 3) Turn ON the positioning start signal.

■ Setting method for the current value changing function

The following shows an example of a sequence program and data setting to change the current value to a new value with the positioning start signal. (The "Md.20 Current feed" value is changed to "5000.0μm" in the example shown.)

- (1) Set the following data.  
(Set with the sequence program shown in (3), while referring to the start time chart shown in (2).)

Setting item	Setting value	Setting details	Buffer memory address	
			LD77MH4	LD77MH16
Cd.3	Positioning start No.	9003	Set the start No. "9003" for the new current value.	
Cd.9	New current value	50000	1506+100n	4306+100n
			1507+100n	4307+100n

(Note): Refer to Section 5.7 "List of control data" for details on the setting details.

- (2) The following shows a start time chart.

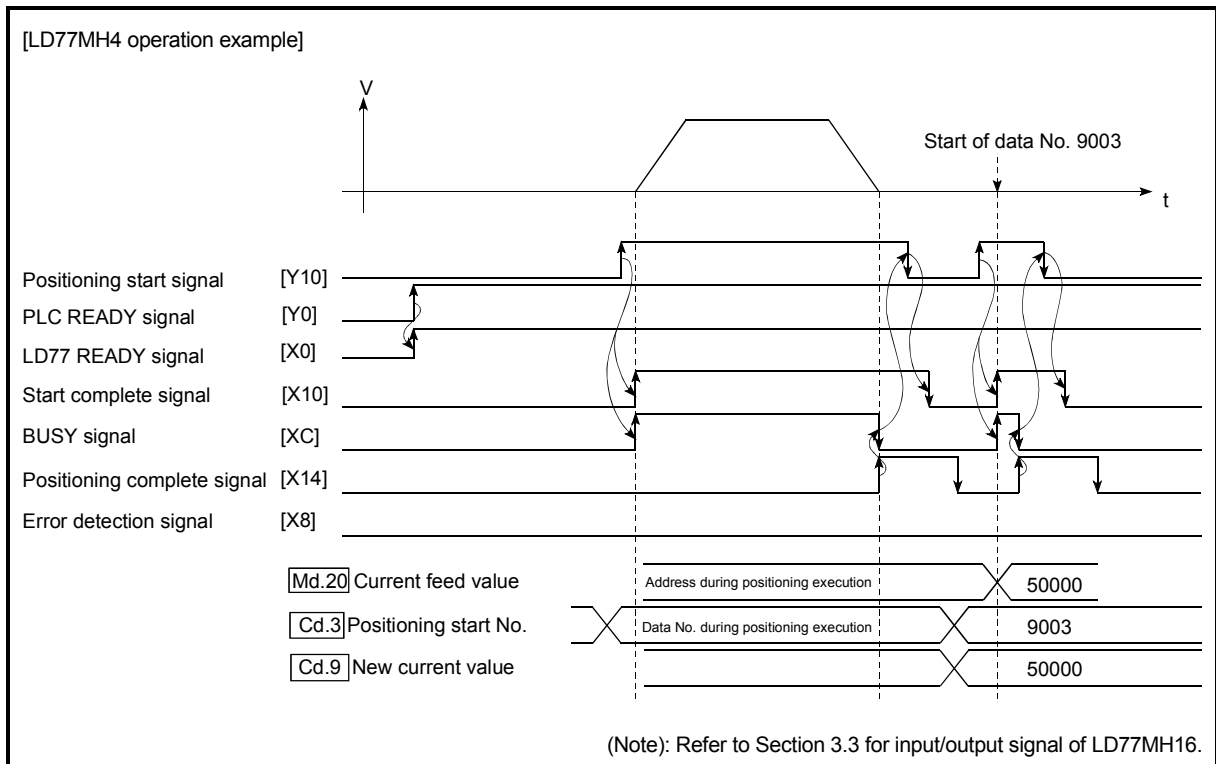
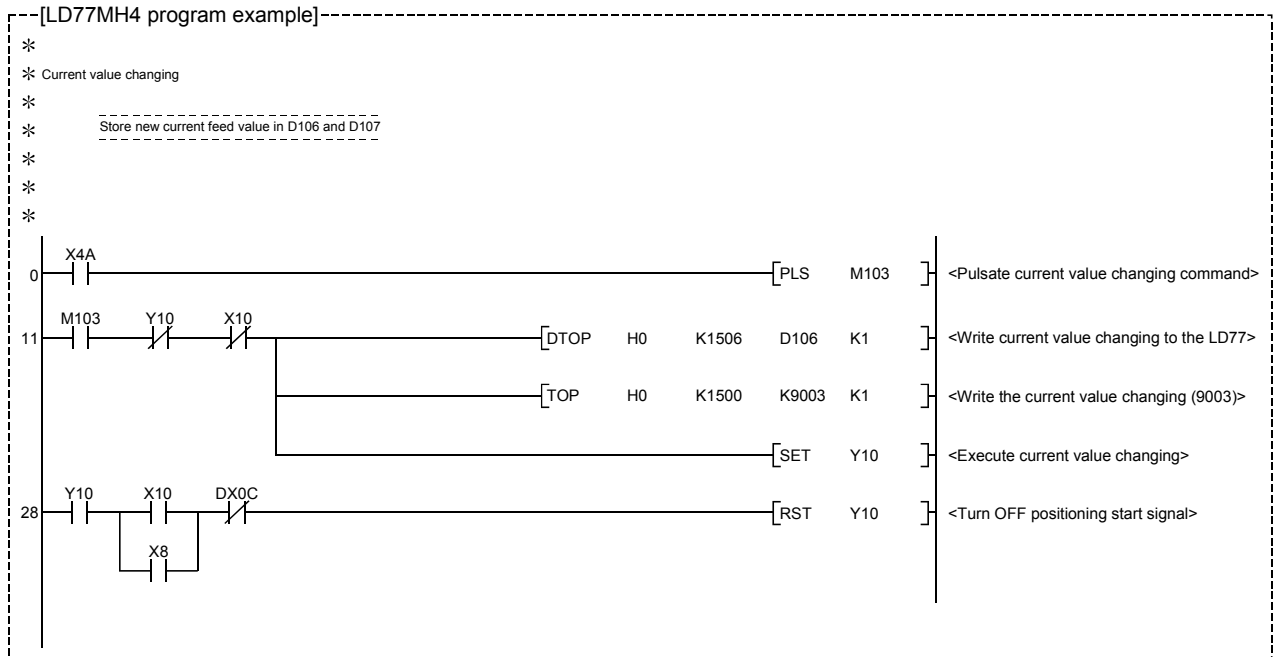

Fig. 9.21 Changing to a new current value using the start No. (No. 9003) for a current value changing

(3) Add the following sequence program to the control program, and write it to the PLC CPU.



## 9.2.20 NOP instruction

The NOP instruction is used for the nonexecutable control system.

### ■ Operation

The positioning data No. to which the NOP instruction is set transfers, without any processing, to the operation for the next positioning data No.

### ■ Positioning data setting examples

[When "NOP instruction" is set in positioning data No.1 of axis 1]

Setting item		Setting example		Setting details	
		LD77MH4	LD77MH16		
Axis 1 Positioning data No. 1	Da.1	Operation pattern	-		Setting not required (Setting value is ignored.)
	Da.2	Control system	NOP instruction		Set the NOP instruction
	Da.3	Acceleration time No.	-		Setting not required (Setting value is ignored.)
	Da.4	Deceleration time No.	-		
	Da.5	Axis to be interpolated LD77MH4	-		
	Da.6	Positioning address/ movement amount	-		
	Da.7	Arc address	-		
	Da.8	Command speed	-		
	Da.9	Dwell time	-		
	Da.10	M code	10		
	Da.20	Axis to be interpolated No.1 LD77MH16		-	
	Da.21	Axis to be interpolated No.2 LD77MH16		-	
	Da.22	Axis to be interpolated No.3 LD77MH16		-	

(Note): Refer to Section 5.3 "List of positioning data" for information on the setting details.

### ■ Restrictions

An error "Control system setting error (error code: 524)" will occur if the "NOP instruction" is set for the control system of the positioning data No. 600.

POINT
<p>&lt;Use example of NOP instruction&gt;</p> <p>If there is a possibility of speed switching or temporary stop (automatic deceleration) at a point between two points during positioning, that data can be reserved with the NOP instruction to change the data merely by the replacement of the identifier.</p>

### 9.2.21 JUMP instruction

The JUMP instruction is used to control the operation so it jumps to a positioning data No. set in the positioning data during "continuous positioning control" or "continuous path control".

JUMP instruction include the following two types of JUMP.

- (1) Unconditional JUMP  
When no execution conditions are set for the JUMP instruction  
(When "0" is set as the condition data No.)
- (2) Conditional JUMP  
When execution conditions are set for the JUMP instruction  
(The conditions are set in the "condition data" used with "high-level positioning control".)

Using the JUMP instruction enables repeating of the same positioning control, or selection of positioning data by the execution conditions during "continuous positioning control" or "continuous path control".

#### ■ Operation

- (1) Unconditional JUMP  
The JUMP instruction is unconditionally executed. The operation jumps to the positioning data No. set in " [Da.9] Dwell time".
- (2) Conditional JUMP  
The block start condition data is used as the JUMP instruction execution conditions.
  - When block positioning data No. 7000 to 7004 is started:  
Each block condition data is used.
  - When positioning data No. 1 to 600 is started:  
Start block 0 condition data is used.
  - When the execution conditions set in " [Da.10] M code" of the JUMP instruction have been established:  
the JUMP instruction is executed to jump the operation to the positioning data No. set in " [Da.9] Dwell time".
  - When the execution conditions set in " [Da.10] M code" of the JUMP instruction have not been established:  
the JUMP instruction is ignored, and the next positioning data No. is executed.

#### ■ Restrictions

- (1) When using a conditional JUMP instruction, establish the JUMP instruction execution conditions by the 4th positioning data No. before the JUMP instruction positioning data No..  
If the JUMP instruction execution conditions are not established by the time the 4th positioning control is carried out before the JUMP instruction positioning data No., the operation will be processed as an operation without established JUMP instruction execution conditions.  
(During execution of continuous path control/continuous positioning control, the LD77MH calculates the positioning data of the positioning data No. four items ahead of the current positioning data.)

- (2) Set JUMP instruction to positioning data No. that "continuous positioning control" or "continuous path control" is set in operation pattern.  
It cannot set to positioning data No. that "positioning complete" is set in operation pattern.
- (3) Positioning control such as loops cannot be executed by conditional JUMP instructions alone until the conditions have been established.  
When loop control is executed using JUMP instruction, an axis operation status is "analyzing" during loop control, and the positioning data analysis (start) for other axes are not executed. As the target of the JUMP instruction, specify a positioning data that is controlled by other than JUMP and NOP instructions.

### ■ Positioning data setting example

[When "JUMP instruction" is set in positioning data No. 1 of axis 1]

	Setting item	Setting example		Setting details		
		LD77MH4	LD77MH16			
Axis 1 Positioning data No. 1	Da.1	Operation pattern	-		Setting not required. (Setting value is ignored.)	
	Da.2	Control system	JUMP instruction		Set the JUMP instruction.	
	Da.3	Acceleration time No.	-		Setting not required. (Setting value is ignored.)	
	Da.4	Deceleration time No.	-			
	Da.5	Axis to be interpolated LD77MH4	-			
	Da.6	Positioning address/ movement amount	-			
	Da.7	Arc address	-			
	Da.8	Command speed	-			
	Da.9	Dwell time	500			Set the positioning data No. 1 to 600 for the JUMP destination. (The positioning data No. of the JUMP instruction cannot be set. Setting its own positioning data No. will result in an error "Illegal data No." (error code: 502).)
	Da.10	M code	1			Set the JUMP instruction execution conditions with the condition data No. 0 : Unconditional JUMP 1 to 10 : Condition data No. ("Simultaneous start" condition data cannot be set.)
	Da.20	Axis to be interpolated No.1 LD77MH16		-	Setting not required (setting value is ignored).	
	Da.21	Axis to be interpolated No.2 LD77MH16		-		
Da.22	Axis to be interpolated No.3 LD77MH16		-			

(Note): Refer to Section 5.3 "List of positioning data" for information on the setting details.

## 9.2.22 LOOP

The LOOP is used for loop control by the repetition of LOOP to LEND.

■ Operation

The LOOP to LEND loop is repeated by set repeat cycles.

■ Positioning data setting examples

[When "LOOP" is set in positioning data No. 1 of axis 1]

Setting item		Setting example		Setting details	
		LD77MH4	LD77MH16		
Axis 1 Positioning data No. 1	Da.1	Operation pattern	-		Setting not required. (Setting value is ignored.)
	Da.2	Control system	LOOP		Set the LOOP.
	Da.3	Acceleration time No.	-		Setting not required. (Setting value is ignored.)
	Da.4	Deceleration time No.	-		
	Da.5	Axis to be interpolated LD77MH4	-	/	
	Da.6	Positioning address/ movement amount	-		
	Da.7	Arc address	-		
	Da.8	Command speed	-		
	Da.9	Dwell time	-		
	Da.10	M code	5		Set the LOOP to LEND repeat cycles.
	Da.20	Axis to be interpolated No.1 LD77MH16	/	-	Setting not required (setting value is ignored).
	Da.21	Axis to be interpolated No.2 LD77MH16	/	-	
	Da.22	Axis to be interpolated No.3 LD77MH16	/	-	

(Note): Refer to Section 5.3 "List of positioning data" for information on the setting details.

■ Restrictions

- (1) An error "Control system LOOP setting error (error code: 545)" will occur if a "0" is set for the repeat cycles.
- (2) Even if LEND is absent after LOOP, no error will occur, but repeat processing will not be carried out.
- (3) Nesting is not allowed between LOOP-LEND's. If such setting is made, only the inner LOOP-LEND is processed repeatedly.



POINT

The setting by this control system is easier than that by the special start "FOR loop" of "High-level Positioning Control" (refer to Chapter 10).

<Setting data>

- For special start: Positioning start data, special start data, condition data, and positioning data
- For control system : Positioning data

For the special start FOR to NEXT, the positioning data is required for each of FOR and NEXT points. For the control system, loop can be executed even only by one data.

Also, nesting is enabled by using the control system LOOP to LEND in combination with the special start FOR to NEXT.

However LOOP to LEND cannot be set across block. Always set LOOP to LEND so that the processing ends within one block.

(For details of the "block", refer to Section 10.1 "Outline of high-level positioning control".)

## 9.2.23 LEND

The LEND is used to return the operation to the top of the repeat (LOOP to LEND) loop.

### ■ Operation

When the repeat cycle designated by the LOOP becomes 0, the loop is terminated, and the next positioning data No. processing is started. (The operation pattern, if set to "Positioning complete", will be ignored.)

When the operation is stopped after the repeat operation is executed by designated cycles, the dummy positioning data (for example, incremental positioning without movement amount) is set next to LEND.

Positioning data No.	Operation pattern	Control system	Conditions	Operation
1	Continuous control	ABS2		Executed in the order of the positioning data No. 1 → 2 → 3 → 4 → 5 → 2 → 3 → 4 → 5 → 6. (The operation patterns of the positioning data Nos. 2 and 5 are ignored.)
2	Positioning complete	LOOP	Number of loop cycles: 2	
3	Continuous path control	ABS2		
4	Continuous control	ABS2		
5	Positioning complete	LEND		
6	Positioning complete	ABS2		

### ■ Positioning data setting examples

[When "LEND" is set in positioning data No. 8 of axis 1]

Setting item	Setting example		Setting details
	LD77MH4	LD77MH16	
Da.1 Operation pattern	-		Setting not required. (Setting value is ignored.)
Da.2 Control system	LEND		Set the LEND.
Da.3 Acceleration time No.	-		Setting not required. (Setting value is ignored.)
Da.4 Deceleration time No.	-		
Da.5 Axis to be interpolated	-		
Da.6 Positioning address/movement amount	-		
Da.7 Arc address	-		
Da.8 Command speed	-		
Da.9 Dwell time	-		
Da.10 M code	-		
Da.20 Axis to be interpolated No.1 <b>LD77MH16</b>		-	
Da.21 Axis to be interpolated No.2 <b>LD77MH16</b>		-	
Da.22 Axis to be interpolated No.3 <b>LD77MH16</b>		-	

(Note): Refer to Section 5.3 "List of positioning data" for information on the setting details.

### ■ Restrictions

(1) Ignore the "LEND" before the "LOOP" is executed.



# Chapter 10 High-Level Positioning Control

The details and usage of high-level positioning control (control functions using the "block start data") are explained in this chapter.

High-level positioning control is used to carry out applied control using the "positioning data". Examples of applied control are using conditional judgment to control "positioning data" set with the major positioning control, or simultaneously starting "positioning data" for several different axes.

Read the execution procedures and settings for each control, and set as required.

10.1	Outline of high-level positioning control .....	10- 2
10.1.1	Data required for high-level positioning control.....	10- 3
10.1.2	"Block start data" and "condition data" configuration .....	10- 4
10.2	High-level positioning control execution procedure .....	10- 6
10.3	Setting the block start data .....	10- 7
10.3.1	Relation between various controls and block start data .....	10- 7
10.3.2	Block start (normal start) .....	10- 8
10.3.3	Condition start .....	10- 10
10.3.4	Wait start .....	10- 11
10.3.5	Simultaneous start .....	10- 12
10.3.6	Repeated start (FOR loop) .....	10- 13
10.3.7	Repeated start (FOR condition) .....	10- 14
10.3.8	Restrictions when using the NEXT start.....	10- 15
10.4	Setting the condition data .....	10- 16
10.4.1	Relation between various controls and the condition data .....	10- 16
10.4.2	Condition data setting examples .....	10- 19
10.5	Multiple axes simultaneous start control.....	10- 21
10.6	Start program for high-level positioning control .....	10- 25
10.6.1	Starting high-level positioning control.....	10- 25
10.6.2	Example of a start program for high-level positioning control .....	10- 26

## 10.1 Outline of high-level positioning control

In "high-level positioning control" the execution order and execution conditions of the "positioning data" are set to carry out more applied positioning. (The execution order and execution conditions are set in the "block start data" and "condition data".) The following applied positioning controls can be carried out with "high-level positioning control".

High-level positioning control	Details
Block <sup>(Note-1)</sup> start (Normal start)	With one start, executes the positioning data in a random block with the set order.
Condition start	Carries out condition judgment set in the "condition data" for the designated positioning data, and then executes the "block start data". <ul style="list-style-type: none"> <li>• When the condition is established, the "block start data" is executed.</li> <li>• When not established, that "block start data" is ignored, and the next point's "block start data" is executed.</li> </ul>
Wait start	Carries out condition judgment set in the "condition data" for the designated positioning data, and then executes the "block start data". <ul style="list-style-type: none"> <li>• When the condition is established, the "block start data" is executed.</li> <li>• When not established, stops the control until the condition is established. (Waits.)</li> </ul>
Simultaneous start (Note-2)	Simultaneously executes the positioning data having the No. for the axis designated with the "condition data". (Outputs command at the same timing.)
Repeated start (FOR loop)	Repeats the program from the "block start data" set with the "FOR loop" to the "block start data" set in "NEXT" for the designated number of times.
Repeated start (FOR condition)	Repeats the program from the "block start data" set with the "FOR condition" to the "block start data" set in "NEXT" until the conditions set in the "condition data" are established.

### ■ High-level positioning control sub functions

"High-level positioning control" uses the "positioning data" set with the "major positioning control". Refer to Section 3.2.5 "Combination of LD77MH main functions and sub functions" for details on sub functions that can be combined with the major positioning control.

Note that the sub function Section 13.7.7 "Pre-reading start function" cannot be used together with "high-level positioning control".

### ■ High-level positioning control from GX Works2

"High-level positioning control" (start of the "block start data") can be executed using the test function of GX Works2.

Refer to the "Simple Motion Module Setting Tool Help" of GX Works2 for details on starting of the "block start data" using GX Works2.

### REMARK

(Note-1): Block

"1 block" is defined as all the data continuing from the positioning data in which "continuous positioning control" or "continuous path control" is set in the "[Da.1] Operation pattern" to the positioning data in which "independent positioning control (Positioning complete)" is set.

(Note-2): Simultaneous start

Besides the simultaneous start of "block start data" system, the "simultaneous starts" include the "multiple axes simultaneous start control" of control system.

Refer to Section 10.5 "Multiple axis simultaneous start control" for details.

10.1.1 Data required for high-level positioning control

"High-level positioning control" is executed by setting the required items in the "block start data" and "condition data", then starting that "block start data". Judgment about whether execution is possible, etc., is carried out at execution using the "condition data" designated in the "block start data".

"Block start data" can be set for each No. from 7000 to 7004 (called "block Nos."), and up to 50 points can be set for each axis. (This data is controlled with Nos. called "points" to distinguish it from the positioning data. For example, the 1st block start data item is called the "1st point block start data" or "point No. 1 block start data".)

"Condition data" can be set for each No. from 7000 to 7004 (called "block Nos."), and up to 10 data items can be set for each axis.

The "block start data" and "condition data" are set as 1 set for each block No.

The following table shows an outline of the "block start data" and "condition data" stored in the LD77MH.

Setting item		Setting details	
Block start data	Da.11	Shape	Set whether to end the control after executing only the "block start data" of the shape itself, or continue executing the "block start data" set in the next point.
	Da.12	Start data No.	Set the "positioning data No." to be executed.
	Da.13	Special start instruction	Set the method by which the positioning data set in Da.12 will be started.
	Da.14	Parameter	Set the conditions by which the start will be executed according to the commands set in Da.13. (Designate the "condition data No." and "Number of repetitions".)

Setting item		Setting details		
Condition data	Da.15	Condition target	Designate the "device", "buffer memory storage details", and "positioning data No." elements for which the conditions are set.	
	Da.16	Condition operator	Set the judgment method carried out for the target set in Da.15.	
	Da.17	Address	Set the buffer memory address in which condition judgment is carried out (only when the details set in Da.15 are "buffer memory storage details").	
	Da.18	Parameter 1	Set the required conditions according to the details set in Da.15, Da.16 and Da.23 <b>LD77MH16</b> .	
	Da.19	Parameter 2		
	Da.23	Number of simultaneously starting axes	Set the number of axes to be started simultaneously in the simultaneously start.	
	Da.24	Simultaneously starting axis No.1		<b>LD77MH16</b>
	Da.25	Simultaneously starting axis No.2		
Da.26	Simultaneously starting axis No.3	Set the simultaneously starting axis in the simultaneously start on 2 to 4 axes.		

10.1.2 "Block start data" and "condition data" configuration

The "block start data" and "condition data" corresponding to "block No. 7000" can be stored in the buffer memory.

• LD77MH4

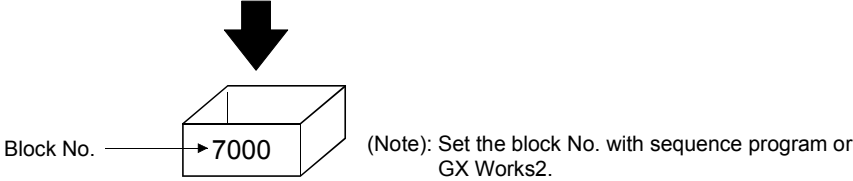
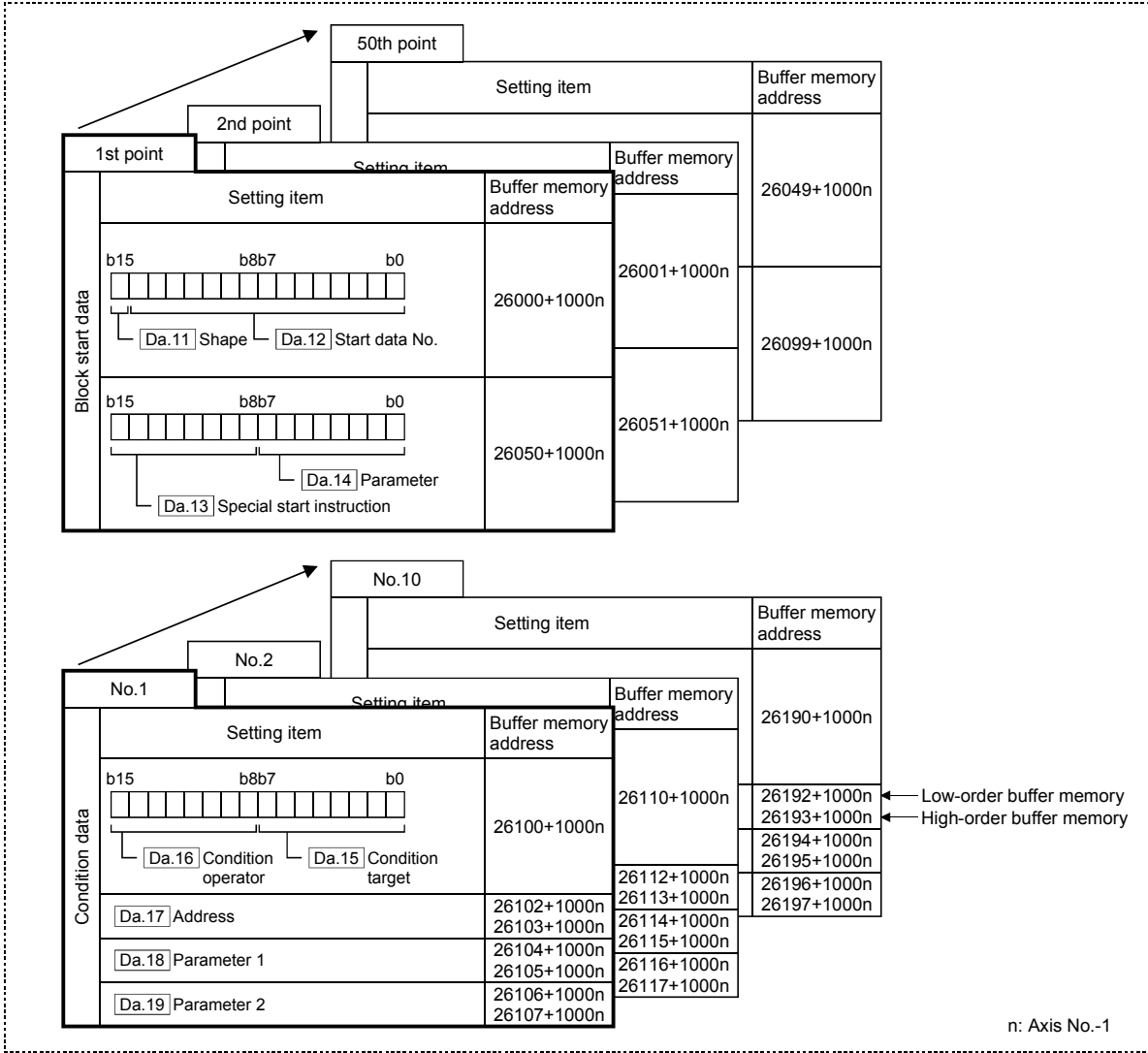

• LD77MH16

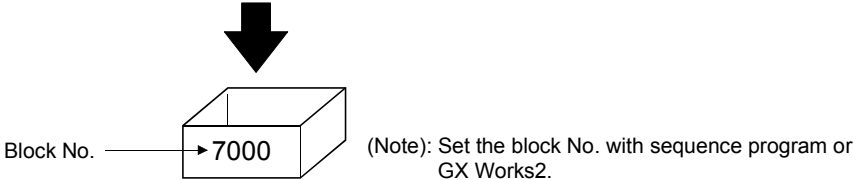
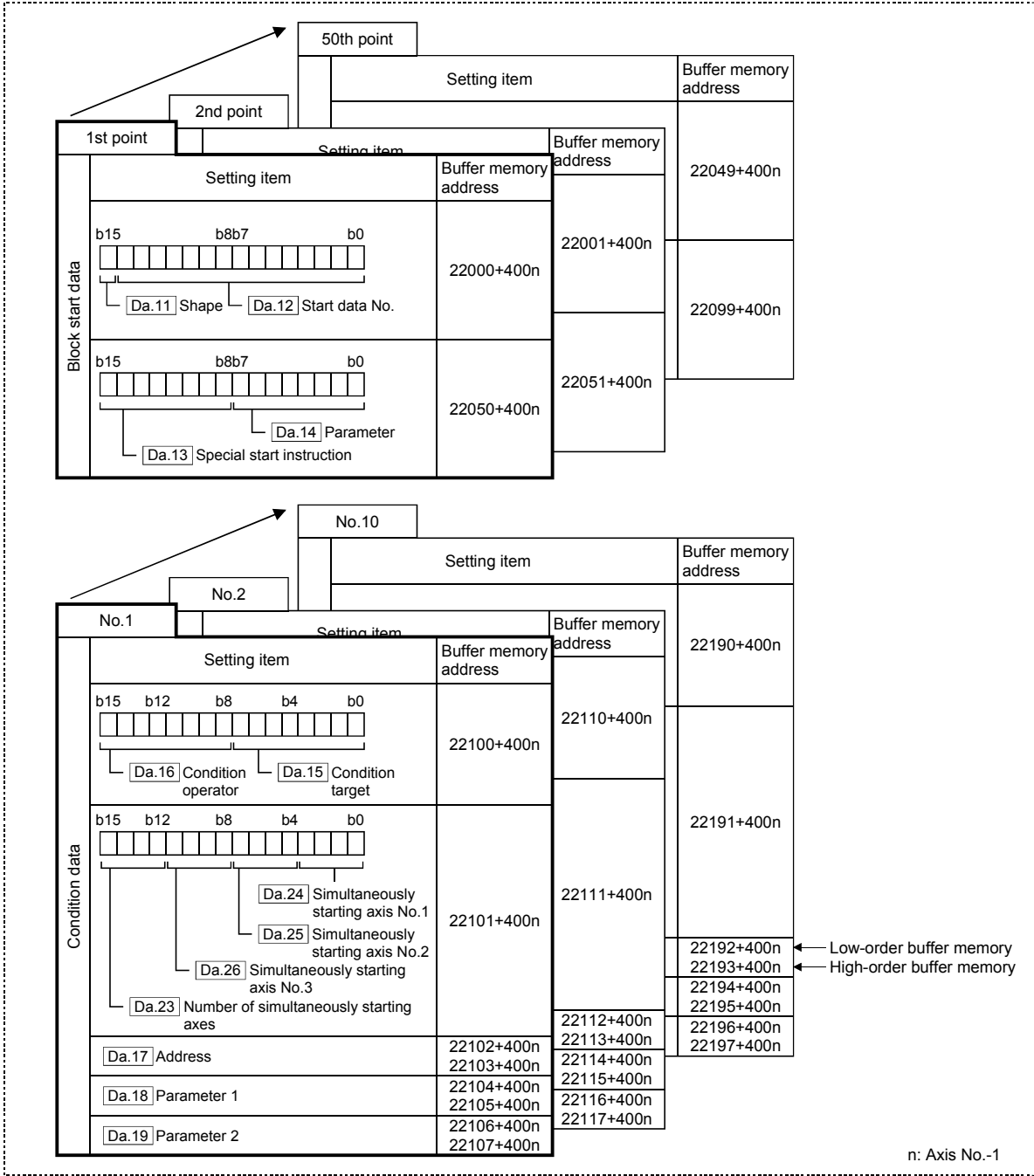

Set the "block start data" and "condition data" corresponding to the following "block Nos. 7001 to 7004" using sequence program or GX Works2 to LD77MH. For LD77MH16, the "block start data" and "condition data" corresponding to "block No. 7002 to 7004" are not allocated. Set the data with GX Works2.



## 10.2 High-level positioning control execution procedure

High-level positioning control is carried out using the following procedure.

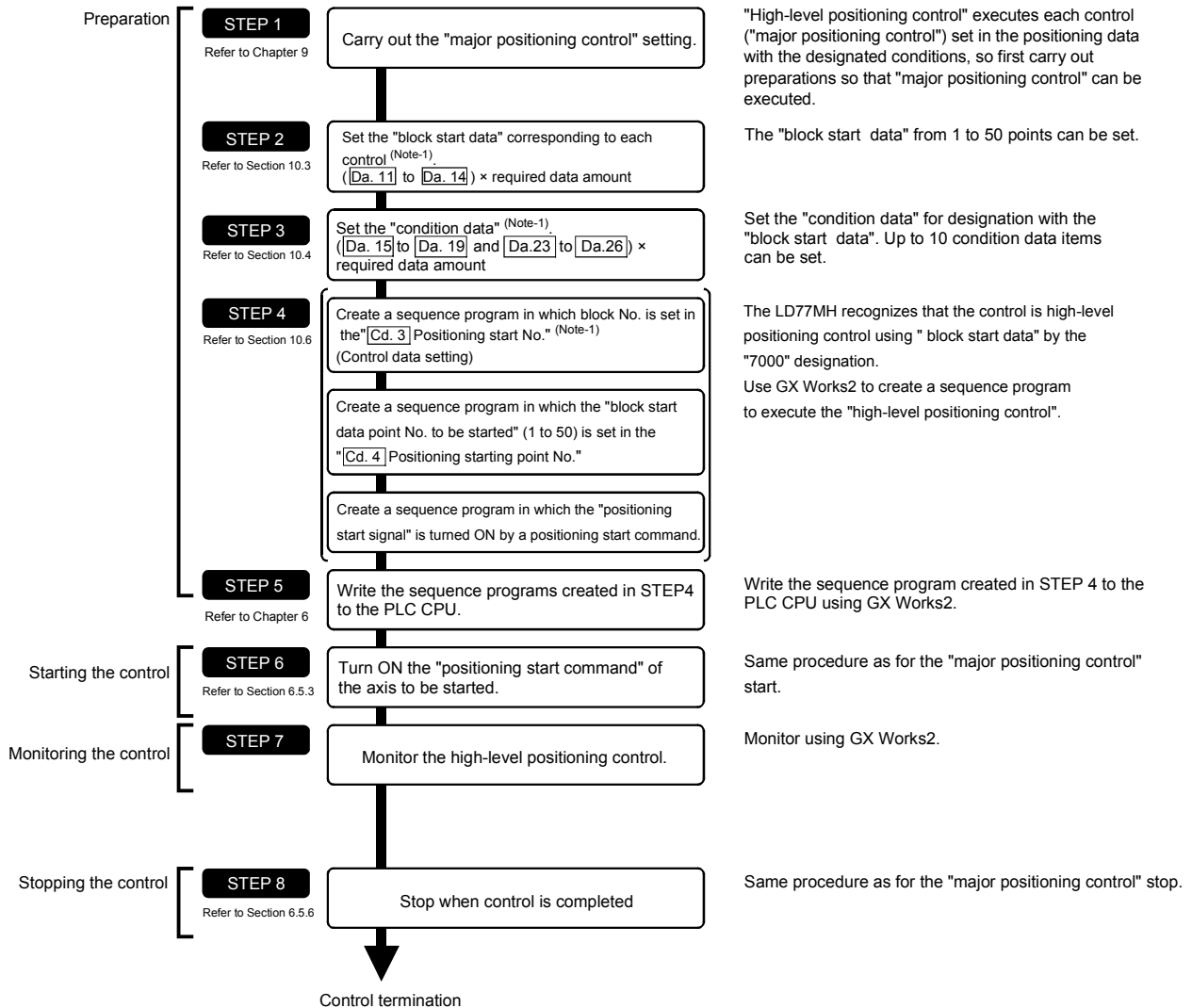

### REMARK

(Note-1): Five sets of "block start data (50 points)" and "condition data (10 items)" corresponding to block No. "7000" to "7004" are set with GX Works2 or sequence program.  
"7000 to 7004" can be set in "Cd.3 Positioning start No." on STEP4 when the above is set.

## 10.3 Setting the block start data

### 10.3.1 Relation between various controls and block start data

The "block start data" must be set to carry out "high-level positioning control". The setting requirements and details of each "block start data" item to be set differ according to the "Da.13 Special start instruction" setting.

The following shows the "block start data" setting items corresponding to various control systems. The operation details of each control type are explained starting in Section 10.3.2. Also refer to Section 10.4 "Setting the condition data" for details on "condition data" with which control execution is judged.

(The "block start data" settings in this chapter are assumed to be carried out using GX Works2.)

High-level positioning control		Block start (Normal start)	Condition start	Wait start	Simultaneous start	Repeated start (FOR loop)	Repeated start (FOR condition)	NEXT start *	
Da.11	Shape	0 : End	◎	◎	◎	◎	×	×	◎
		1 : Continue	◎	◎	◎	◎	◎	◎	◎
Da.12	Start data No.	1 to 600							
Da.13	Special start instruction	0	1	2	3	4	5	6	
Da.14	Parameter	–	Condition data No.			Number of repetitions	Condition data No.	–	

◎ : One of the two setting items must be set.

○ : Set as required (Set to "–" when not used.)

× : Setting not possible

– : Setting not required (Setting value will be ignored. Use the initial value or a value within the setting range.)

\* The "NEXT start" instruction is used in combination with "repeated start (FOR loop)" and "repeated start (FOR condition)". Control using only the "NEXT start" will not be carried out.

#### REMARK

It is recommended that the "block start data" be set whenever possible with GX Works2. Execution by sequence program uses many sequence programs and devices. The execution becomes complicated, and the scan times will increase.

## 10.3.2 Block start (normal start)

In a "block start (normal start)", the positioning data groups of a block are continuously executed in a set PLC starting from the positioning data set in "[Da.12] Start data No." by one start.

Section [2] shows a control example where the "block start data" and "positioning data" are set as shown in section [1].

## [1] Setting examples

## (1) Block start data setting example

Axis 1 block start data	[Da.11] Shape	[Da.12] Start data No.	[Da.13] Special start instruction	[Da.14] Parameter
1st point	1: Continue	1	0: Block start	—
2nd point	1: Continue	2	0: Block start	—
3rd point	1: Continue	5	0: Block start	—
4th point	1: Continue	10	0: Block start	—
5th point	0: End	15	0: Block start	—
•				
•				

## (2) Positioning data setting example

Axis 1 positioning data No.	[Da.1] Operation pattern	
1	00: Positioning complete	} 1 block (Note-1)
2	11: Continuous path control	
3	01: Continuous positioning control	
4	00: Positioning complete	} 1 block
5	11: Continuous path control	
6	00: Positioning complete	
•		
10	00: Positioning complete	
•		
15	00: Positioning complete	
•		

**REMARK**

(Note-1): Block

"1 block" is defined as all the data continuing from the positioning data in which "continuous positioning control" or "continuous path control" is set in the "[Da.1] Operation pattern" to the positioning data in which "independent positioning control (Positioning complete)" is set.

[2] Control examples

The following shows the control executed when the "block start data" of the 1st point of axis 1 is set as shown in section [1] and started.

<1> The positioning data is executed in the following order before stopping.  
 Axis 1 positioning data No. 1 → 2 → 3 → 4 → 5 → 6 → 10 → 15.

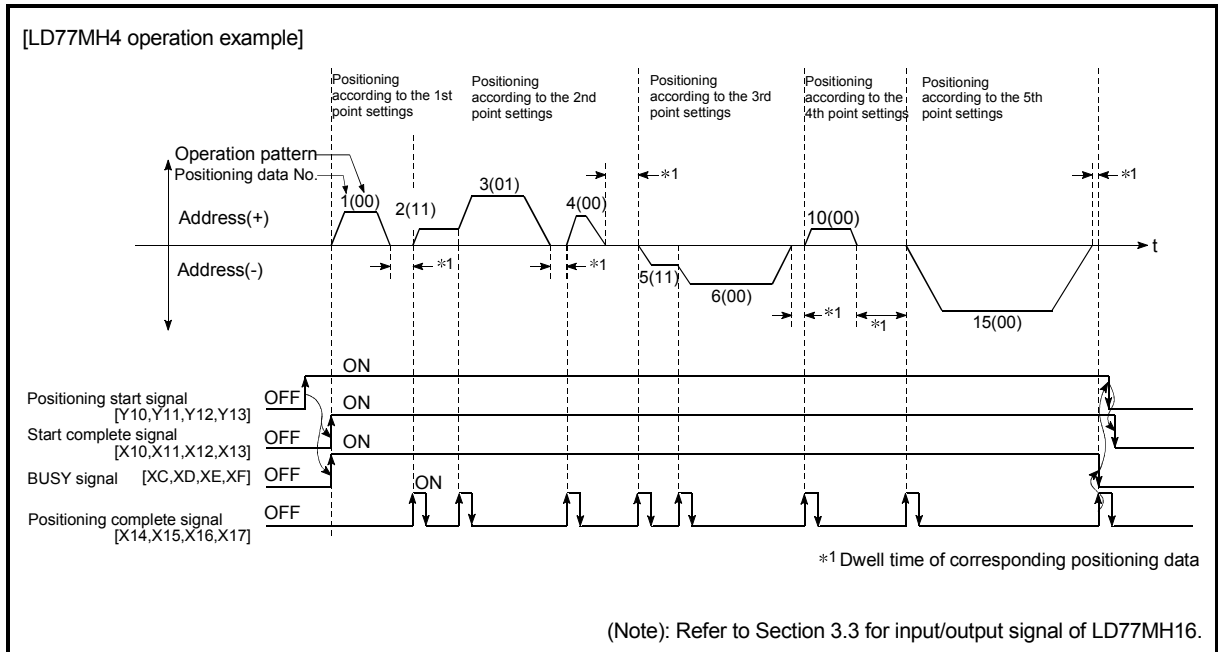

Fig. 10.1 Block start control example

### 10.3.3 Condition start

In a "condition start", the "condition data" conditional judgment designated in "[Da.14] Parameter" is carried out for the positioning data set in "[Da.12] Start data No.". If the conditions have been established, the "block start data" set in "1: condition start" is executed. If the conditions have not been established, that "block start data" will be ignored, and the "block start data" of the next point will be executed.

Section [2] shows a control example where the "block start data" and "positioning data" are set as shown in section [1].

#### [1] Setting examples

##### (1) Block start data setting example

Axis 1 block start data	[Da.11] Shape	[Da.12] Start data No.	[Da.13] Special start instruction	[Da.14] Parameter
1st point	1: Continue	1	1: Condition start	1
2nd point	1: Continue	10	1: Condition start	2
3rd point	0: End	50	0: Block start	–
•				
•				

(Note): The "condition data Nos." have been set in "[Da.14] Parameter".

##### (2) Positioning data setting example

Axis 1 positioning data No.	[Da.1] Operation pattern
1	01: Continuous positioning control
2	01: Continuous positioning control
3	00: Positioning complete
•	
10	11: Continuous path control
11	11: Continuous path control
12	00: Positioning complete
•	
50	00: Positioning complete
•	

#### [2] Control examples

The following shows the control executed when the "block start data" of the 1st point of axis 1 is set as shown in section [1] and started.

<1> The conditional judgment set in "condition data No. 1" is carried out before execution of the axis 1 "positioning data No.1".

→ Conditions established → Execute positioning data No. 1, 2, and 3 → Go to <2>.

→ Conditions not established → Go to <2>.

<2> The conditional judgment set in "condition data No.2" is carried out before execution of the axis 1 "positioning data No. 10".

→ Conditions established → Execute positioning data No.10, 11, and 12 → Go to <3>.

→ Conditions not established → Go to <3>.

<3> Execute axis 1 "positioning data No.50" and stop the control.

## 10.3.4 Wait start

In a "wait start", the "condition data" conditional judgment designated in "[Da.14] Parameter" is carried out for the positioning data set in "[Da.12] Start data No.". If the conditions have been established, the "block start data" is executed. If the conditions have not been established, the control stops (waits) until the conditions are established.

Section [2] shows a control example where the "block start data" and "positioning data" are set as shown in section [1].

## [1] Setting examples

## (1) Block start data setting example

Axis 1 block start data	[Da.11] Shape	[Da.12] Start data No.	[Da.13] Special start instruction	[Da.14] Parameter
1st point	1: Continue	1	2: Wait start	3
2nd point	1: Continue	10	0: Block start	–
3rd point	0: End	50	0: Block start	–
•				
•				

(Note): The "condition data Nos." have been set in "[Da.14] Parameter".

## (2) Positioning data setting example

Axis 1 positioning data No.	[Da.1] Operation pattern
1	01: Continuous positioning control
2	01: Continuous positioning control
3	00: Positioning complete
•	
10	11: Continuous path control
11	11: Continuous path control
12	00: Positioning complete
•	
50	00: Positioning complete
•	

## [2] Control examples

The following shows the control executed when the "block start data" of the 1st point of axis 1 is set as shown in section [1] and started.

- <1> The conditional judgment set in "condition data No. 3" is carried out before execution of the axis 1 "positioning data No. 1".
- Conditions established → Execute positioning data No. 1, 2, and 3 → Go to <2>.
  - Conditions not established → Control stops (waits) until conditions are established → Go to <1>.
- <2> Execute the axis 1 "positioning data No. 10, 11, 12, and 50" and stop the control.

### 10.3.5 Simultaneous start

In a "simultaneous start", the positioning data set in the "[Da.12] Start data No." and positioning data of other axes set in the "condition data" are simultaneously executed (commands are output with the same timing).

(The "condition data" is designated with "[Da.14] Parameter".)

Section [2] shows a control example where the "block start data" and "positioning data" are set as shown in section [1].

#### [1] Setting examples

##### (1) Block start data setting example

Axis 1 block start data	[Da.11] Shape	[Da.12] Start data No.	[Da.13] Special start instruction	[Da.14] Parameter
1st point	0: End	1	3: Simultaneous start	4
•				
•				
•				
•				

(Note): It is assumed that the "axis 2 positioning data" for simultaneous starting is set in the "condition data" designated with "[Da.14] Parameter".

##### (2) Positioning data setting example

Axis 1 positioning data No.	[Da.1] Operation pattern
1	01: Continuous positioning control
2	01: Continuous positioning control
3	00: Positioning complete
•	
•	
•	
•	
•	

#### [2] Control examples

The following shows the control executed when the "block start data" of the 1st point of axis 1 is set as shown in section [1] and started.

<1> Check the axis operation status of axis 2 which is regarded as the simultaneously started axis.

→ Axis 2 is standing by → Go to <2>.

→ Axis 2 is carrying out positioning. → An error occurs and simultaneous start will not be carried out.

<2> Simultaneously start the axis 1 "positioning data No. 1" and axis 2 positioning data set in "condition data No. 4.

#### [3] Precautions

Positioning data No. executed by simultaneously started axes is set to condition data ("[Da.18] Parameter 1", "[Da.19] Parameter 2"), but the setting value of start axis (the axis which carries out positioning start) should be "0". If the setting value is set to other than "0", the positioning data set in "[Da.18] Parameter 1", "[Da.19] Parameter 2" is given priority to be executed rather than "[Da.12] Start data No.". (For details, refer to Section 5.5 "List of condition data".)

### 10.3.6 Repeated start (FOR loop)

In a "repeated start (FOR loop)", the data between the " block start data" in which "4: FOR loop" is set in " [Da.13] Special start instruction" and the "block start data" in which "6: NEXT start" is set in " [Da.13] Special start instruction " is repeatedly executed for the number of times set in " [Da.14] Parameter". An endless loop will result if the number of repetitions is set to "0".

(The number of repetitions is set in " [Da.14] Parameter" of the " block start data" in which "4: FOR loop" is set in " [Da.13] Special start instruction".)

Section [2] shows a control example where the " block start data" and "positioning data" are set as shown in section [1].

#### [1] Setting examples

##### (1) Block start data setting example

Axis 1 block start data	[Da.11] Shape	[Da.12] Start data No.	[Da.13] Special start instruction	[Da.14] Parameter
1st point	1: Continue	1	4: FOR loop	2
2nd point	1: Continue	10	0: Block start	–
3rd point	0: End	50	6: NEXT start	–
•				
•				

(Note): The "condition data Nos." have been set in " [Da.14] Parameter".

##### (2) Positioning data setting example

Axis 1 positioning data No.	[Da.1] Operation pattern
1	01: Continuous positioning control
2	01: Continuous positioning control
3	00: Positioning complete
•	
10	11: Continuous path control
11	00: Positioning complete
•	
50	01: Continuous positioning control
51	00: Positioning complete
•	

#### [2] Control examples

The following shows the control executed when the " block start data" of the 1st point of axis 1 is set as shown in section [1] and started.

<1> Execute the axis 1 "positioning data No.1, 2, 3, 10, 11, 50, and 51".

<2> Return to the axis 1 "1st point block start data". Again execute the axis 1 "positioning data No.1, 2, 3, 10, 11, 50 and 51", and then stop the control.

(Repeat for the number of times (2 times) set in [Da.14].)



### 10.3.7 Repeated start (FOR condition)

In a "repeated start (FOR condition)", the data between the " block start data" in which "5: FOR condition" is set in "[Da.13] Special start instruction" and the " block start data" in which "6: NEXT start" is set in "[Da.13] Special start instruction" is repeatedly executed until the establishment of the conditions set in the "condition data".

Conditional judgment is carried out as soon as switching to the point of "6: NEXT start" (before positioning of NEXT start point).

(The "condition data" designation is set in "[Da.14] Parameter" of the " block start data" in which "5: FOR condition" is set in "[Da.13] Special start instruction".)

Section [2] shows a control example where the " block start data" and "positioning data" are set as shown in section [1].

#### [1] Setting examples

##### (1) Block start data setting example

Axis 1 block start data	[Da.11] Shape	[Da.12] Start data No.	[Da.13] Special start instruction	[Da.14] Parameter
1st point	1: Continue	1	5: FOR condition	5
2nd point	1: Continue	10	0: Block start	–
3rd point	0: End	50	6: NEXT start	–
•				
•				

(Note): The "condition data Nos." have been set in "[Da.14] Parameter".

##### (2) Positioning data setting example

Axis 1 positioning data No.	[Da.1] Operation pattern
1	01: Continuous positioning control
2	01: Continuous positioning control
3	00: Positioning complete
•	
10	11: Continuous path control
11	00: Positioning complete
•	
50	01: Continuous positioning control
51	00: Positioning complete
•	

#### [2] Control examples

The following shows the control executed when the " block start data" of the 1st point of axis 1 is set as shown in section [1] and started.

<1> Execute axis 1 "positioning data No.1, 2, 3, 10, and 11.

<2> Carry out the conditional judgment set in axis 1 "condition data No.5" <sup>(Note-1)</sup>.

→ Conditions not established → Execute "Positioning data No.50, 51". Go to <1>.

→ Conditions established → Execute "Positioning data No.50, 51" and complete the positioning.

(Note-1): Conditional judgment is carried out as soon as switching to NEXT start point (before positioning of NEXT start point).

### 10.3.8 Restrictions when using the NEXT start

The "NEXT start" is a instruction indicating the end of the repetitions when executing Section 10.3.6 "Repeated start (FOR loop)" and Section 10.3.7 "Repeated start (FOR condition)".

The following shows the restrictions when setting "6: NEXT start" in the " block start data".

- (1) The processing when "6: NEXT start" is set before execution of "4: FOR loop" or "5: FOR condition" is the same as that for a "0: block start".
- (2) Repeated processing will not be carried out if there is no "6: NEXT start" instruction after the "4: FOR loop" or "5: FOR condition" instruction. (Note that an "error" will not occur.)
- (3) Nesting is not possible between "4: FOR loop" and "6: NEXT start", or between "5: FOR condition" and "6: NEXT start". A warning "FOR to NEXT nest construction (warning code: 506)" will occur if nesting is attempted.

[Operating examples without nesting structure]

Start block data	Da.13 Special start instruction
1st point	Normal start
2nd point	FOR ←
3rd point	Normal start
4th point	NEXT —
5th point	Normal start
6th point	Normal start
7th point	FOR ←
8th point	Normal start
9th point	NEXT —
•	
•	

[Operating examples with nesting structure]

Start block data	Da.13 Special start instruction
1st point	Normal start
2nd point	FOR
3rd point	Normal start
4th point	FOR ←
5th point	Normal start
6th point	Normal start
7th point	NEXT —
8th point	Normal start
9th point	NEXT
•	
•	

A warning will occur when starting the 4th point "FOR". The JUMP destination of the 7th point "NEXT" is the 4th point. The 9th point "NEXT" is processed as normal start.

## 10.4 Setting the condition data

### 10.4.1 Relation between various controls and the condition data

"Condition data" is set in the following cases.

- (1) When setting conditions during execution of Section 9.2.21 "JUMP instruction" (major positioning control)
- (2) When setting conditions during execution of "high-level positioning control"

The "condition data" to be set includes the setting items from [Da.15](#) to [Da.19](#) and [Da.23](#) to [Da.26](#), but the setting requirements and details differ according to the control system and setting conditions.

The following shows the "condition data" "[Da.15](#) Condition target" corresponding to the different types of control.

(The "condition data" settings in this chapter are assumed to be carried out using GX Works2.)

Control type <a href="#">Da.15</a> Setting item	High-level positioning control				Major positioning control
	Block start	Wait start	Simultaneous start	Repeated start (For condition)	JUMP instruction
01: Device X <sup>(Note-1)</sup>	◎	◎	×	◎	◎
02: Device Y <sup>(Note-1)</sup>	◎	◎	×	◎	◎
03: Buffer memory (1 word)	◎	◎	×	◎	◎
04: Buffer memory (2 words)	◎	◎	×	◎	◎
05: Positioning data No.	×	×	◎	×	×

◎ : One of the setting items must be set.

× : Setting not possible

(Note-1): Refer to devices X/Y which belongs to LD77MH.

#### REMARK

It is recommended that the "condition data" be set whenever possible with GX Works2. Execution by sequence program uses many sequence programs and devices. The execution becomes complicated, and the scan times will increase.

The setting requirements and details of the following "condition data" [Da.16] to [Da.19] and [Da.23] setting items differ according to the "[Da.15] Condition target" setting.

The following shows the [Da.16] to [Da.19] and [Da.23] setting items corresponding to the "[Da.15] Condition target".

• LD77MH4

Other setting item [Da.15] Condition target	[Da.16] Condition operator	[Da.17] Address	[Da.18] Parameter 1	[Da.19] Parameter 2
01H: Device X	07H: DEV=ON	-	0 to 1FH (bit No.)	-
02H: Device Y	08H: DEV=OFF		0 to 1FH (bit No.)	
03H: Buffer memory (1 word) (Note-1)	01H: **=P1 02H: **≠P1	Buffer memory address	P1 (numeric value)	P2 (numeric value) (Set only when "[Da.16]" is [05H] or [06H].)
04H: Buffer memory (2 words) (Note-1)	03H: **≤P1 04H: **≥P1			
	05H: P1≤**≤P2 06H: **≤P1, P2≤**			
05H: Positioning data No.	10H: Axis 1 selected 20H: Axis 2 selected 30H: Axis 1 and 2 selected 40H: Axis 3 selected 50H: Axis 1 and 3 selected 60H: Axis 2 and 3 selected 70H: Axis 1, 2, and 3 selected 80H: Axis 4 selected 90H: Axis 1 and 4 selected A0H: Axis 2 and 4 selected B0H: Axis 1, 2, and 4 selected C0H: Axis 3 and 4 selected D0H: Axis 1, 3, and 4 selected E0H: Axis 2, 3, and 4 selected	—	Low-order 16 bits: Axis 1 positioning data No. (Note-2) High-order 16 bits: Axis 2 positioning data No. (Note-2)	Low-order 16 bits: Axis 3 positioning data No. (Note-2) High-order 16 bits: Axis 4 positioning data No. (Note-2)

- : Setting not required (Setting value will be ignored. Use the initial value or a value within the setting range.)

\*\* : Value stored in buffer memory designated in [Da.17]

(Note-1): Comparison of ≤ and ≥ is judged as signed values.

Refer to Section 5.5 "List of condition data" for the setting contents.

(Note-2): The setting value of start axis (the axis which executes positioning start) should be "0". If the setting value is set to other than "0", the positioning data set in "[Da.18] Parameter 1", "[Da.19] Parameter 2" is given priority to be executed rather than "[Da.12] Start data No.".

• LD77MH16

Other setting item [Da.15] Condition target	[Da.16] Condition operator	[Da.23] Number of simultaneously starting axes	[Da.17] Address	[Da.18] Parameter 1	[Da.19] Parameter 2
01H: Device X	07H: DEV=ON	—	—	0 to 1FH (bit No.)	—
02H: Device Y	08H: DEV=OFF			0 to 1FH (bit No.)	
03H: Buffer memory (1 word) (Note-1)	01H: **=P1 02H: **≠P1	—	Buffer memory address	P1 (numeric value)	P2 (numeric value) (Set only when "[Da.16]" is [05H] or [06H].)
04H: Buffer memory (2 words) (Note-1)	03H: **≤P1 04H: **≥P1 05H: P1≤** ≤P2 06H: **≤P1, P2≤**				
05H: Positioning data No.	/	2	—	Low-order 16 bits: "[Da.24]" Simultaneously starting axis No.1" positioning data No. High-order 16 bits: "[Da.25]" Simultaneously starting axis No.2" positioning data No.	—
		3			
		4			

— : Setting not required (Setting value will be ignored. Use the initial value or a value within the setting range.)

\*\* : Value stored in buffer memory designated in [Da.17]

(Note-1): Comparison of ≤ and ≥ is judged as signed values.

Refer to Section 5.5 "List of condition data" for the setting contents.

Judgment whether the condition operator is "=" or "≠" at the start of wait.

Judgment on data is carried out for each operation cycle of the LD77MH. Thus, in the judgment on the data such as current feed value which varies continuously, the operator "=" may not be detected. If this occurs, use a range operator.

**REMARK**

The "PLC CPU memo area" can be designated as the buffer memory address to be designated in [Da.17]. (Refer to Section 7.1.1 "Configuration and roles of LD77MH memory".)

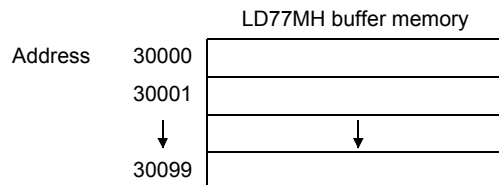

## 10.4.2 Condition data setting examples

The following shows setting examples for "condition data".

## (1) LD77MH4

- (a) Setting the device ON/OFF as a condition

[Condition]

Device "XC" (Axis 1 BUSY signal) is OFF

Da.15 Condition target	Da.16 Condition operator	Da.17 Address	Da.18 Parameter 1	Da.19 Parameter 2
01H: Device X	08H: DEV=OFF	—	0CH	—

- (b) Setting the numeric value stored in the "buffer memory" as a condition

[Condition]

The value stored in buffer memory addresses "800, 801" ("Md.20 Current feed value") is "1000" or larger.

Da.15 Condition target	Da.16 Condition operator	Da.17 Address	Da.18 Parameter 1	Da.19 Parameter 2
04H: Buffer memory (2 words)	04H: * * ≥ P1	800	1000	—

- (c) Designating the axis and positioning data No. to be simultaneously started in "simultaneous start"

[Condition]

Simultaneously starting "axis 2 positioning data No.3".

Da.15 Condition target	Da.16 Condition operator	Da.17 Address	Da.18 Parameter 1	Da.19 Parameter 2
05H: Positioning data No.	20H: Axis 2 selected	—	High-order 16 bits "0003H" (Note-1)	— (Note-1)

(Note-1): The setting value of start axis (the axis which executes positioning start) should be "0000H".

## (2) LD77MH16

(a) Setting the device ON/OFF as a condition

[Condition]

Device "X10" (Axis 1 BUSY signal) is OFF

Da.15 Condition target	Da.16 Condition operator	Da.17 Address	Da.18 Parameter 1	Da.19 Parameter 2	Da.23 Number of simultaneously starting axes	Da.24 Simultaneously starting axis No.1	Da.25 Simultaneously starting axis No.2	Da.26 Simultaneously starting axis No.3
01H: Device X	08H: DEV=OFF	—	10H	—	—	—	—	—

(b) Setting the numeric value stored in the "buffer memory" as a condition

[Condition]

The value stored in buffer memory addresses "2400, 2401" ("Md.20 Current feed value") is "1000" or larger.

Da.15 Condition target	Da.16 Condition operator	Da.17 Address	Da.18 Parameter 1	Da.19 Parameter 2	Da.23 Number of simultaneously starting axes	Da.24 Simultaneously starting axis No.1	Da.25 Simultaneously starting axis No.2	Da.26 Simultaneously starting axis No.3
04H: Buffer memory (2 words)	04H: ** ≥ P1	2400	1000	—	—	—	—	—

(c) Designating the axis and positioning data No. to be simultaneously started in "simultaneous start"

[Condition]

Simultaneously starting "axis 2 positioning data No.3".

Da.15 Condition target	Da.16 Condition operator	Da.17 Address	Da.18 Parameter 1	Da.19 Parameter 2	Da.23 Number of simultaneously starting axes	Da.24 Simultaneously starting axis No.1	Da.25 Simultaneously starting axis No.2	Da.26 Simultaneously starting axis No.3
05H: Positioning data No.	—	—	Low-order 16 bits "0003H"	—	2H: 2 axes	1H: Axis 2	0H	0H

## 10.5 Multiple axes simultaneous start control

The "multiple axes simultaneous start control" starts and controls the multiple axes simultaneously by outputting command to the axis to be started at the same timing as the start axis.

The maximum of four axes can be started simultaneously.

### [1] Control details

The multiple axes simultaneous start control is carried out by setting the simultaneous start setting data to the multiple axes simultaneous start control buffer memory of the axis control data, and the "9004" to "[Cd.3] Positioning start No." of the start axis, and then turning ON the positioning start signal.

- LD77MH4 ..... Set the start data No. of simultaneous starting axis (positioning data No. to be started simultaneously for each axis) in "[Cd.30] Simultaneous starting axis start data No. (axis 1 start data No.)" to "[Cd.33] Simultaneous starting axis start data No. (axis 4 start data No.)".
- LD77MH16 ..... Set the number of axes to be started simultaneously and axis No. in "[Cd.43] Simultaneous starting axis", and the start data No. of simultaneous starting axis (positioning data No. to be started simultaneously for each axis) in "[Cd.30] Simultaneous starting own axis start data No." and "[Cd.31] Simultaneous starting axis start data No.1" to "[Cd.33] Simultaneous starting axis start data No.3".

### [2] Restrictions

- (1) An error will occur and all simultaneously started axes will not start (error code: 501) if the simultaneously started axis start data No. is not set to the axis control data on the start axis or set outside the setting range.
- (2) An error will occur and all simultaneously started axes will not start (error code: 501) if either of the simultaneously started axes is BUSY.
- (3) An error will occur and all simultaneously started axes will not start (error code: 501) if an error occurs during the analysis of the positioning data on the simultaneously started axes.
- (4) No error or warning will occur if only the start axis is the simultaneously started axis.
- (5) This function cannot be used with the sub function Section 13.7.7 "Pre-reading start function".



### [3] Multiple axes simultaneous start control procedure

The procedure for multiple axes simultaneous start control is as follows.

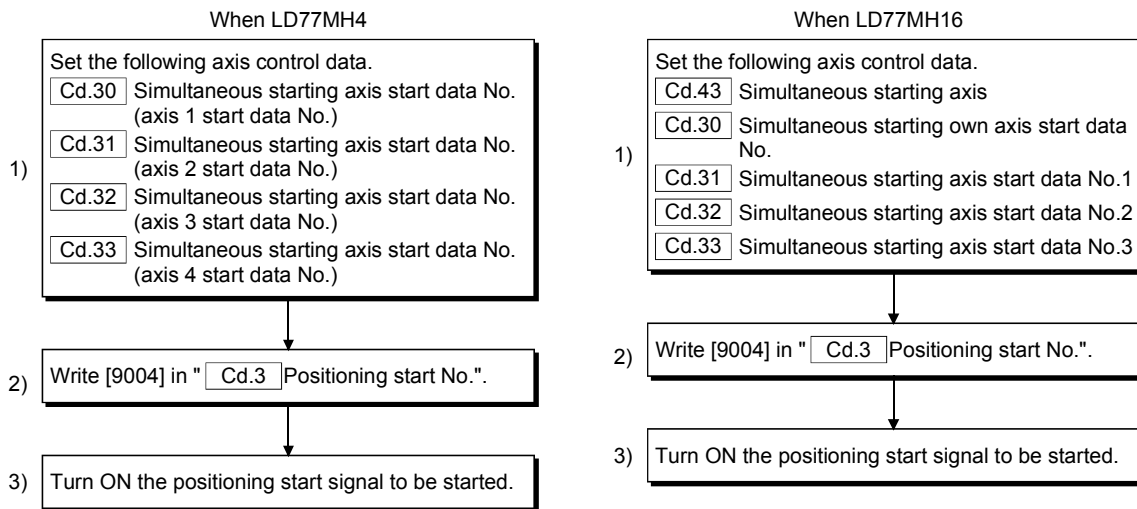

### [4] Multiple axes simultaneous start control function setting method

The following shows the setting of the data used to execute the multiple axes simultaneous start control with positioning start signals (The axis control data on the start axis is set).

Setting item	Setting value	Setting details	Buffer memory address	
			LD77MH4	LD77MH16
Cd.3	9004	Positioning start No.	1500+100n	4300+100n
Cd.43		Simultaneous starting axis <b>LD77MH16</b>		4339+100n
Cd.30		Simultaneous starting axis start data No. (axis 1 start data No.) <b>LD77MH4</b>	1540+100n	
		Simultaneous starting own axis start data No. <b>LD77MH16</b>		4340+100n
Cd.31		Simultaneous starting axis start data No. (axis 2 start data No.) <b>LD77MH4</b>	1541+100n	
		Simultaneous starting axis start data No.1 <b>LD77MH16</b>		4341+100n
Cd.32		Simultaneous starting axis start data No. (axis 3 start data No.) <b>LD77MH4</b>	1542+100n	
		Simultaneous starting axis start data No.2 <b>LD77MH16</b>		4342+100n
Cd.33		Simultaneous starting axis start data No. (axis 4 start data No.) <b>LD77MH4</b>	1543+100n	
		Simultaneous starting axis start data No.3 <b>LD77MH16</b>		4343+100n

n: Axis No.-1

(Note): Refer to Section 5.7 "List of control data" for information on setting details.

## [5] Setting examples

- (1) The following shows the setting examples in which the LD77MH4 [axis 1] is used as the start axis and the simultaneously started axes are used as the axes 2 and 4.

Setting item	Setting value	Setting details	Buffer memory address (Axis 1)
<span style="border: 1px solid black; padding: 2px;">Cd.3</span> Positioning start No.	9004	Set the multiple axes simultaneous start control start No. "9004".	1500
<span style="border: 1px solid black; padding: 2px;">Cd.30</span> Simultaneous starting axis start data No. (axis 1 start data No.)	100	The axis 1 starts the positioning data No. 100.	1540
<span style="border: 1px solid black; padding: 2px;">Cd.31</span> Simultaneous starting axis start data No. (axis 2 start data No.)	200	Immediately after the start of the axis 1, the axis 2 starts the axis 2 positioning data No. 200.	1541
<span style="border: 1px solid black; padding: 2px;">Cd.32</span> Simultaneous starting axis start data No. (axis 3 start data No.)	0	Will not start simultaneously.	1542
<span style="border: 1px solid black; padding: 2px;">Cd.33</span> Simultaneous starting axis start data No. (axis 4 start data No.)	300	Immediately after the start of the axis 1, the axis 4 starts the axis 4 positioning data No. 300.	1543

- (2) The following shows the setting examples in which the LD77MH16 [axis 10] is used as the start axis and the simultaneously started axes are used as the axes 12 and 14.

Setting item	Setting value	Setting details	Buffer memory address (Axis 10)
<span style="border: 1px solid black; padding: 2px;">Cd.3</span> Positioning start No.	9004	Set the multiple axes simultaneous start control start No. "9004".	5200
<span style="border: 1px solid black; padding: 2px;">Cd.43</span> Simultaneous starting axis	30DBH	Set the axis 12 (0BH) to the simultaneously starting axis No.1, and the axis 14 (0DH) to the simultaneously starting axis No.2.	5239
<span style="border: 1px solid black; padding: 2px;">Cd.30</span> Simultaneous starting own axis start data No.	100	The axis 10 starts the positioning data No. 100.	5240
<span style="border: 1px solid black; padding: 2px;">Cd.31</span> Simultaneous starting axis start data No.1	200	Immediately after the start of the axis 10, the axis 12 starts the axis 12 positioning data No. 200.	5241
<span style="border: 1px solid black; padding: 2px;">Cd.32</span> Simultaneous starting axis start data No.2	300	Immediately after the start of the axis 10, the axis 14 starts the axis 14 positioning data No. 300.	5242
<span style="border: 1px solid black; padding: 2px;">Cd.33</span> Simultaneous starting axis start data No.3	0	Will not start simultaneously.	5243

POINTS

- (1) The "multiple axes simultaneous start control" carries out an operation equivalent to the "simultaneous start" using the "block start data".
- (2) The setting of the "multiple axes simultaneous start control" is easier than that of the "simultaneous start" using the "block start data".
  - Setting items for "simultaneous start" using "block start data"  
Positioning start data, block start data, condition data, and positioning data
  - Setting items for "multiple axes simultaneous start control"  
Positioning data and axis control data

## 10.6 Start program for high-level positioning control

### 10.6.1 Starting high-level positioning control

To execute high-level positioning control, a sequence program must be created to start the control in the same method as for major positioning control.

The following shows the procedure for starting the "1st point block start data" (regarded as block No. 7000) set in axis 1.

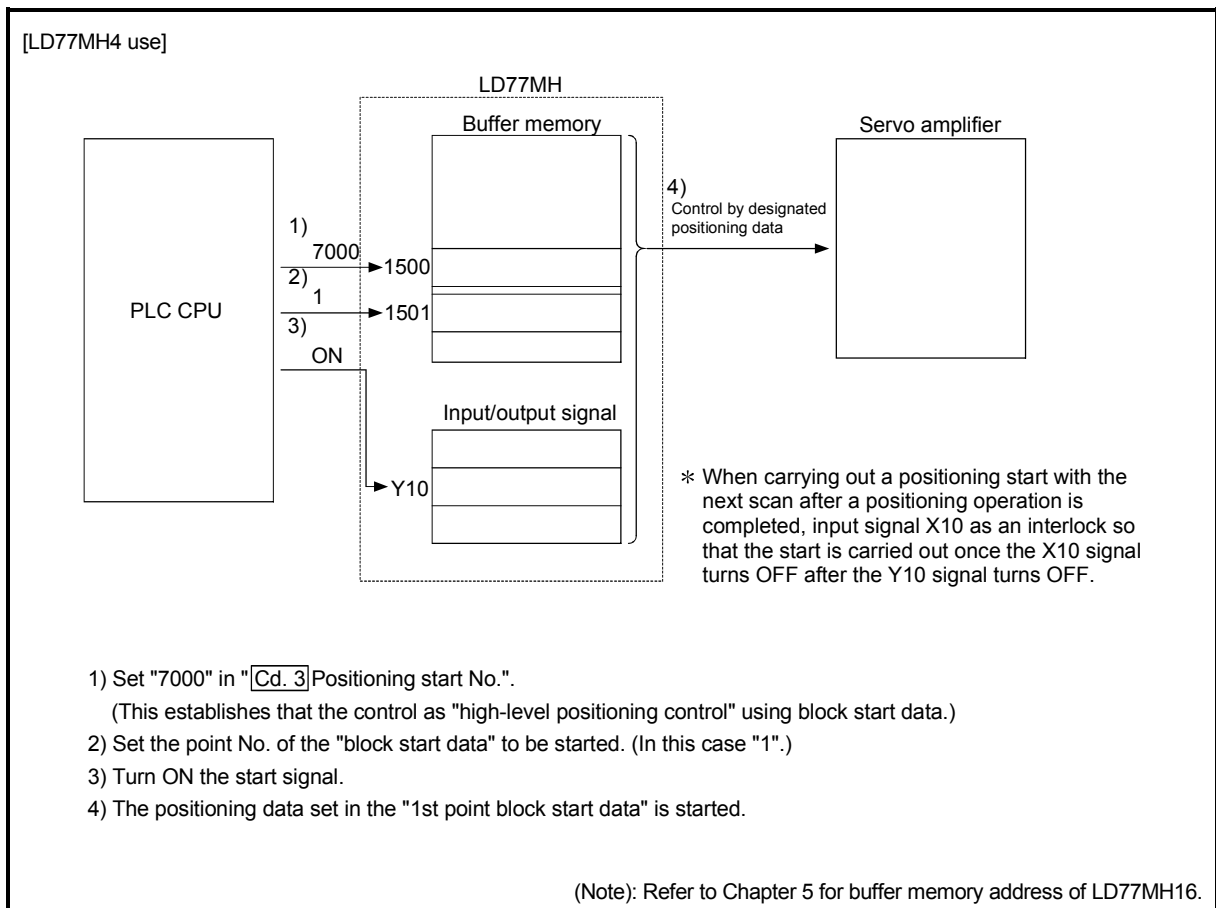

Fig. 10.2 High-level positioning control start procedure

## 10.6.2 Example of a start program for high-level positioning control

The following shows an example of a start program for high-level positioning control in which the 1st point "block start data" of axis 1 is started. (The block No. is regarded as "7000".)

■ Control data that require setting

The following control data must be set to execute high-level positioning control. The setting is carried out using a sequence program.

Setting item	Setting value	Setting details	Buffer memory address		
			LD77MH4	LD77MH16	
Cd.3	Positioning start No.	7000	Set "7000" to indicate control using "block start data".	1500+100n	4300+100n
Cd.4	Positioning starting point No.	1	Set the point No. of the "block start data" to be started.	1501+100n	4301+100n

(Note): Refer to Section 5.7 "List of control data" for details on the setting details.

■ Start conditions

The following conditions must be fulfilled when starting the control. The required conditions must also be integrated into the sequence program, and configured so the control does not start unless the conditions are fulfilled.

Signal name	Signal state	Device			
		LD77MH4	LD77MH16		
Interface signal	PLC READY signal	ON	PLC CPU preparation completed	Y0	
	LD77 READY signal	ON	LD77MH preparation completed	X0	
	All axis servo ON	ON	All axis servo ON	Y1	
	Synchronization flag	ON	LD77MH buffer memory The access is possible.	X1	
	Axis stop signal	OFF	Axis stop signal is OFF	Y4 to Y7	Cd.180 Axis stop
	Start complete signal	OFF	Start complete signal is OFF	X10 to X13	Md.31 Status: b14
	BUSY signal	OFF	BUSY signal is OFF	XC to XF	X10 to X1F
	Error detection signal	OFF	There is no error	X8 to XB	Md.31 Status: b13
M code ON signal	OFF	M code ON signal is OFF	X4 to X7	Md.31 Status: b12	
External signal	Forced stop input signal	ON	There is no forced stop input	-	
	Upper limit (FLS)	ON	Within limit range	-	
	Lower limit (RLS)	ON	Within limit range	-	

■ Start time chart

The following chart shows a time chart in which the positioning data No. 1, 2, 10, 11, and 12 of LD77MH4 [axis 1] are continuously executed as an example.

(1) Block start data setting example

Axis 1 block start data	Da.11 Shape	Da.12 Start data No.	Da.13 Special start instruction	Da.14 Parameter
1st point	1: Continue	1	0: Block start	—
2nd point	0: End	10	0: Block start	—
•				
•				

(2) Positioning data setting example

Axis 1 positioning data No.	Da.1 Operation pattern
1	11: Continuous path control
2	00: Positioning complete
•	
10	11: Continuous path control
11	11: Continuous path control
12	00: Positioning complete
•	

(3) Start time chart

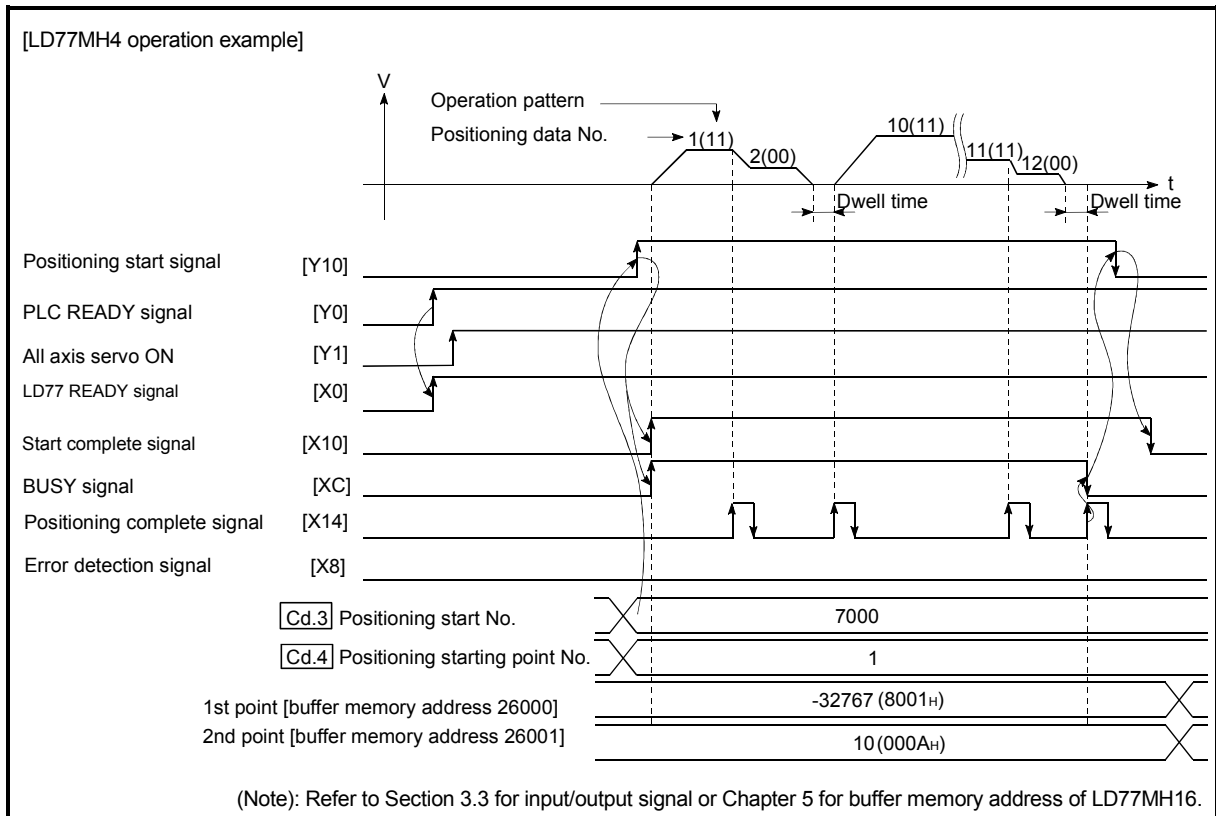
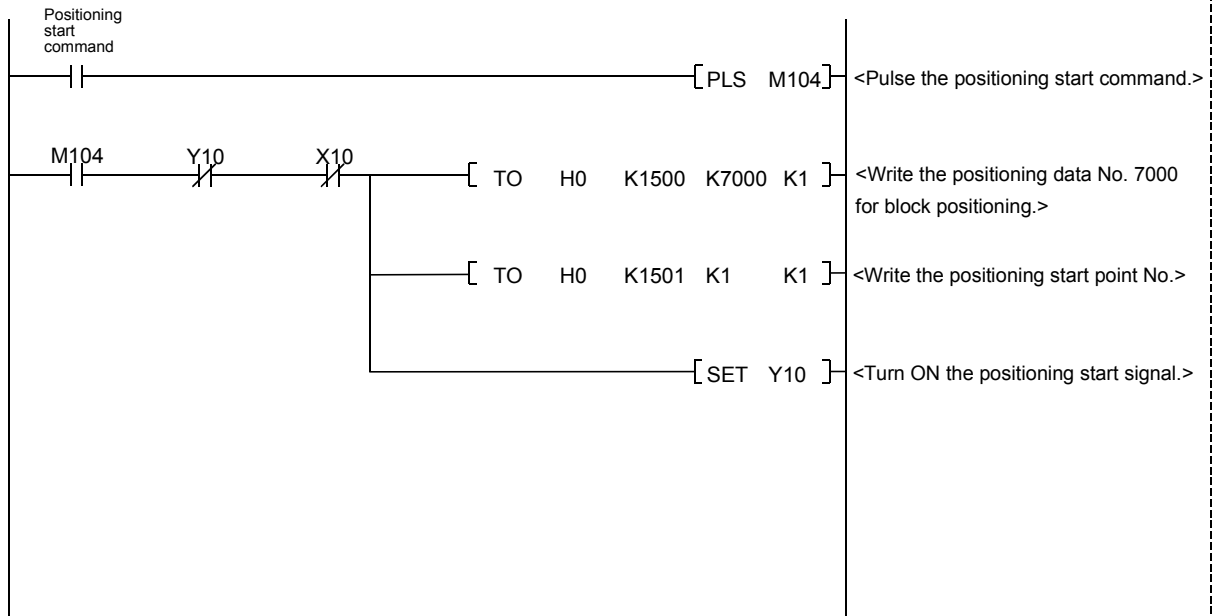

Fig. 10.3 Start time chart for high-level positioning control (block start)

■ Creating the program

[LD77MH4 program example]

Set the block start data beforehand.



Y10: Positioning start signal  
 X10: Start complete signal  
 M104: Positioning start command pulse

# Chapter 11 Manual Control

The details and usage of manual control are explained in this chapter. In manual control, commands are issued during a JOG operation and an inching operation executed by the turning ON of the JOG START signal, or from a manual pulse generator connected to the LD77MH.

Manual control using a sequence program from the PLC CPU is explained in this chapter. Refer to the "Simple Motion Module Setting Tool Help" of GX Works2 for an explanation of manual control (JOG operation, inching operation and manual pulse generator operation) using the GX Works2.

11.1	Outline of manual control .....	11- 2
11.1.1	Three manual control methods.....	11- 2
11.2	JOG operation.....	11- 4
11.2.1	Outline of JOG operation .....	11- 4
11.2.2	JOG operation execution procedure .....	11- 7
11.2.3	Setting the required parameters for JOG operation .....	11- 8
11.2.4	Creating start programs for JOG operation.....	11- 10
11.2.5	JOG operation example .....	11- 12
11.3	Inching operation .....	11- 15
11.3.1	Outline of inching operation .....	11- 15
11.3.2	Inching operation execution procedure .....	11- 18
11.3.3	Setting the required parameters for inching operation .....	11- 19
11.3.4	Creating a program to enable/disable the inching operation.....	11- 20
11.3.5	Inching operation example.....	11- 22
11.4	Manual pulse generator operation .....	11- 24
11.4.1	Outline of manual pulse generator operation.....	11- 24
11.4.2	Manual pulse generator operation execution procedure .....	11- 28
11.4.3	Setting the required parameters for manual pulse generator operation.....	11- 29
11.4.4	Creating a program to enable/disable the manual pulse generator operation.....	11- 30



## 11.1 Outline of manual control

### 11.1.1 Three manual control methods

"Manual control" refers to control in which positioning data is not used, and a positioning operation is carried out in response to signal input from an external device. The three types of this "manual control" are explained below.

#### [1] JOG operation

"JOG operation" is a control method in which the machine is moved by only a movement amount (commands are continuously output while the JOG START signal is ON). This operation is used to move the workpiece in the direction in which the limit signal is ON, when the operation is stopped by turning the limit signal OFF to confirm the positioning system connection and obtain the positioning data address (refer to Section 13.7.4 "Teaching function").

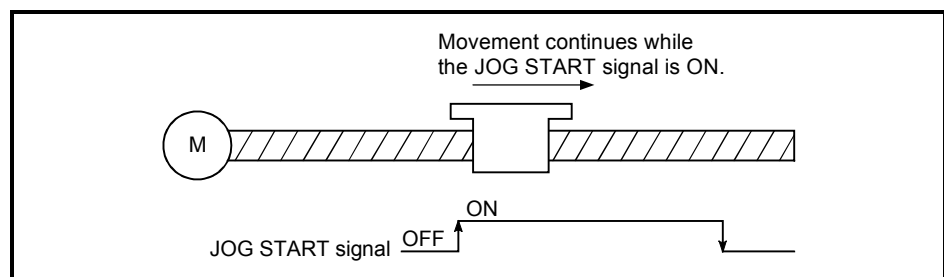

Fig. 11.1 JOG operation

#### [2] Inching operation

"Inching operation" is a control method in which a minute movement amount of command is output manually in operation cycle.

When the "inching movement amount" of the axis control data is set by JOG operation, the workpiece is moved by a set movement amount. (When the "inching movement amount" is set to "0", the machine functions as JOG operation.)

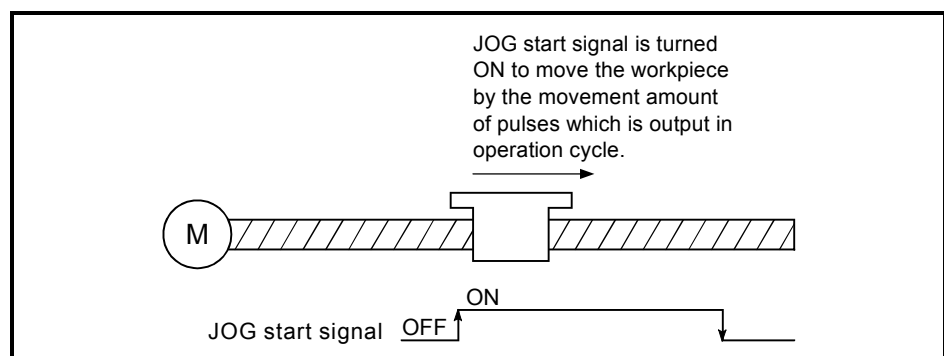

Fig. 11.2 Inching operation

### [3] Manual pulse generator operation

"Manual pulse generator operation" is a control method in which positioning is carried out in response to the number of pulses input from a manual pulse generator (the number of input command is output). This operation is used for manual fine adjustment, etc., when carrying out accurate positioning to obtain the positioning address.

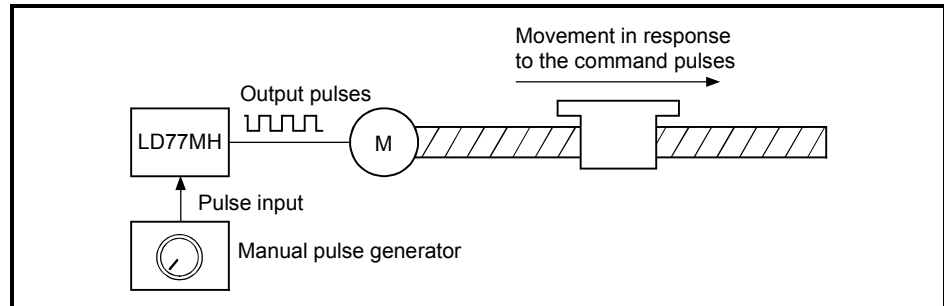

Fig. 11.3 Manual pulse generator control

#### ■ Manual control sub functions

Refer to Section 3.2.5 "Combination of LD77MH main functions and sub functions" for details on "sub functions" that can be combined with manual control. Also refer to Chapter 13 "Control Sub Functions" for details on each sub function.

#### ■ Carrying out manual control from GX Works2

"JOG operation", "Inching operation" and enabling/disabling of the "manual pulse generator operation" can be executed from GX Works2 test function. Refer to the "Simple Motion Module Setting Tool Help" of GX Works2 for details on manual control from GX Works2.

#### ■ Monitoring manual control

Refer to Section 5.6 "List of monitor data" when directly monitoring the buffer memory using GX Works2. Also refer to the "Simple Motion Module Setting Tool Help" of GX Works2 when monitoring with the monitor functions of GX Works2.

## 11.2 JOG operation

### 11.2.1 Outline of JOG operation

#### ■ JOG operation

In JOG operation, the forward run JOG start signal or reverse run JOG start signal turns ON, causing pulses to be output to the servo amplifier from the LD77MH while the signal is ON. The workpiece is then moved in the designated direction.

Signal	LD77MH4	LD77MH16
Forward run JOG start signal	Y8, YA, YC, YE	[Cd.181] Forward run JOG start
Reverse run JOG start signal	Y9, YB, YD, YF	[Cd.182] Reverse run JOG start

The following shows examples of JOG operation.

1)	When the START signal turns ON, acceleration begins in the direction designated by the START signal, and continues for the acceleration time designated in "[Pr.32] JOG operation acceleration time selection". At this time, the BUSY signal changes from OFF to ON.
2)	When the workpiece being accelerated reaches the speed set in "[Cd.17] JOG speed", the movement continues at this speed. The constant speed movement takes place at 2) and 3).
3)	When the START signal is turned OFF, deceleration begins from the speed set in "[Cd.17] JOG speed", and continues for the deceleration time designated in "[Pr.33] JOG operation deceleration time selection".
4)	The operation stops when the speed becomes "0". At this time, the BUSY signal changes from ON to OFF.

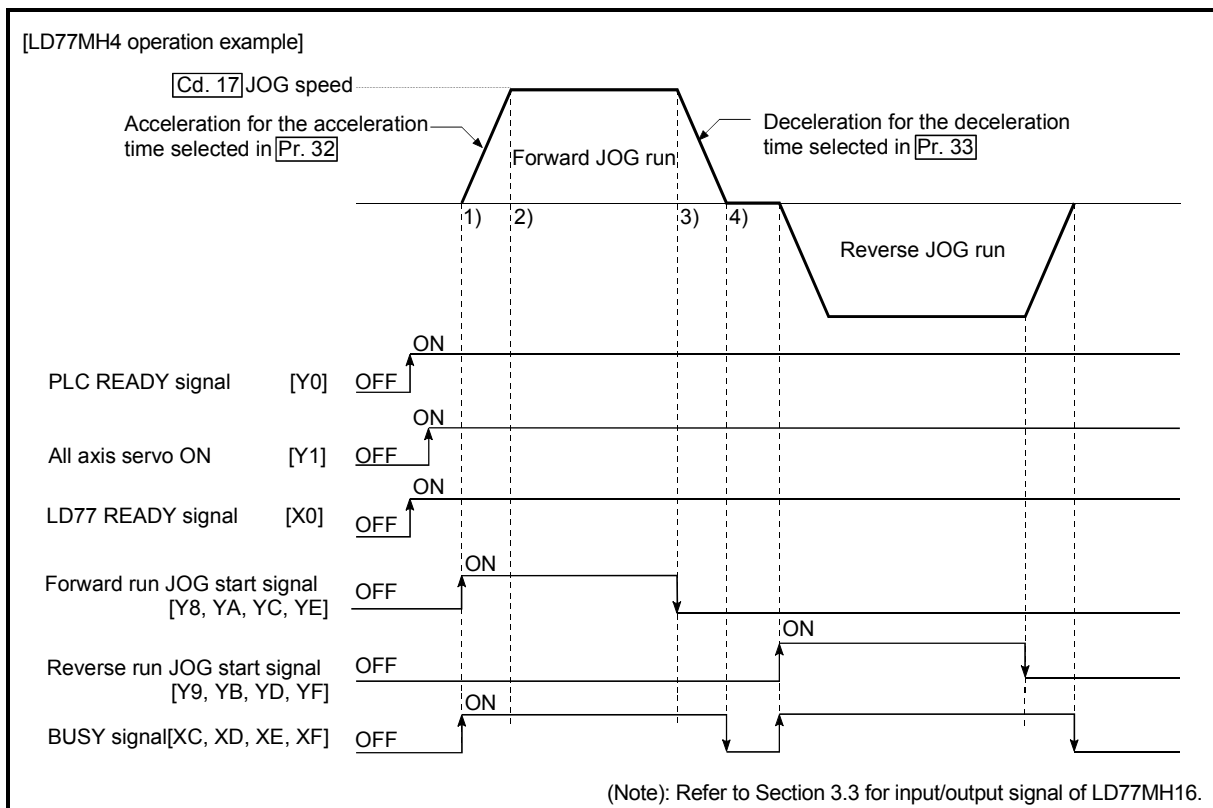

Fig. 11.4 JOG operation

**Important**

Use the hardware stroke limit function when carrying out JOG operation near the upper or lower limits. (Refer to Section "13.4.4").

If the hardware stroke limit function is not used, the workpiece may exceed the moving range, causing an accident.

**■ Precautions during operation**

The following details must be understood before carrying out JOG operation.

- (1) For safety, first set " [Cd.17] JOG speed" to a smaller value and check the movement. Then gradually increase the value.
- (2) An axis error will occur and the operation will not start (error code: 300) if the "JOG speed" is outside the setting range at the JOG start.
- (3) An axis error will occur and the operation will not start (error code: 956) if " [Pr.31] JOG speed limit value" is set to a value larger than " [Pr.8] speed limit value".
- (4) If " [Cd.17] JOG speed" exceeds the speed set in " [Pr.31] JOG speed limit value", the workpiece will move at the " [Pr.31] JOG speed limit value" and an "Axis warning" will occur in the LD77MH (warning code: 301).
- (5) The JOG operation can be continued even if an "Axis warning" has occurred.
- (6) Set a "0" in " [Cd.16] Inching movement amount". If a value other than "0" is set, the operation will become an inching operation (Refer to Section 11.3 "Inching operation").

**■ Operations when stroke limit error occurs**

When the operation is stopped by hardware stroke limit error or software stroke limit error, the JOG operation can execute in an opposite way (direction within normal limits) after an error reset. (An error will occur again if JOG start signal is turned ON in a direction to outside the stroke limit.)

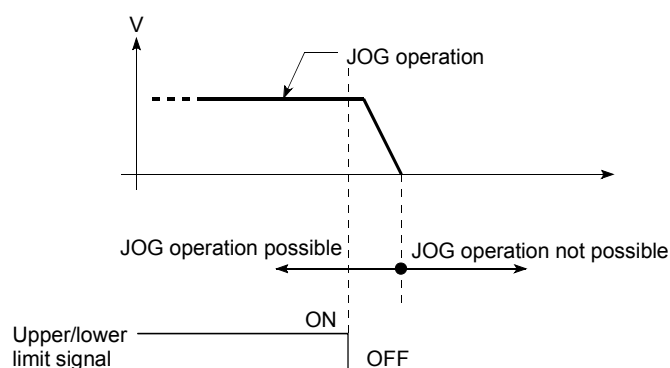

■ JOG operation timing and processing time

The following drawing shows details of the JOG operation timing and processing time.

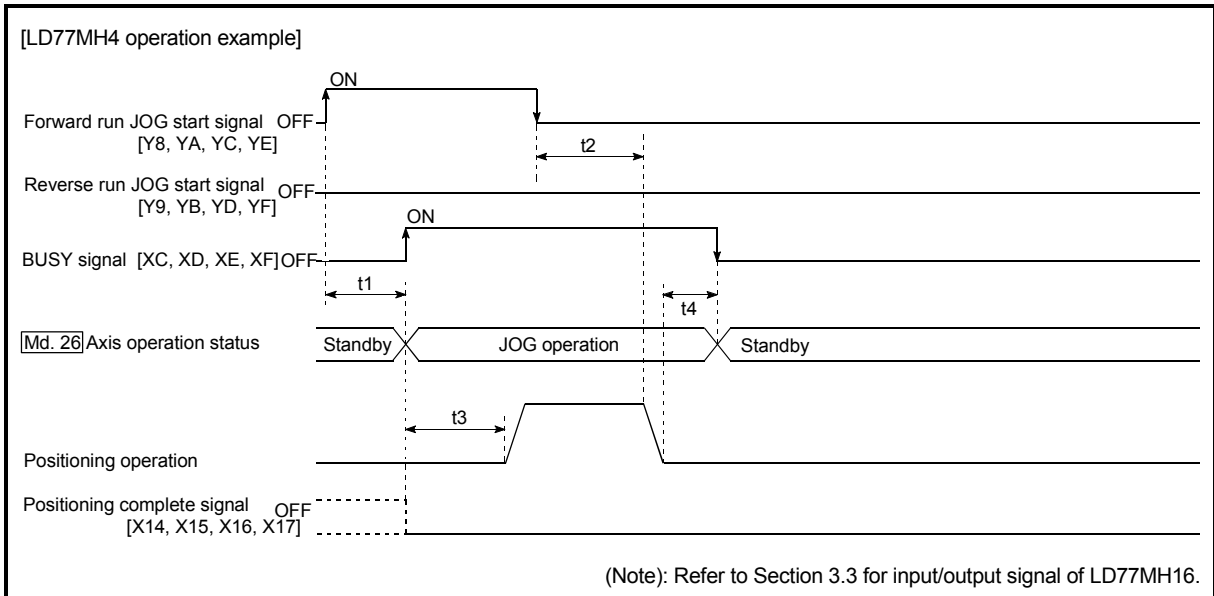

Fig. 11.5 JOG operation timing and processing times

Normal timing times

Unit: [ms]

	Operation cycle	t1	t2	t3	t4
LD77MH4	0.88	0.8 to 1.1	0 to 0.9	2.2 to 2.7	0 to 0.9
LD77MH16	0.88	0.8 to 1.1	0 to 0.9	2.2 to 2.7	0 to 0.9
	1.77	0.8 to 2.2	0 to 1.8	3.2 to 3.9	0 to 1.8

- Delays may occur in the t1 timing time due to the operation status of other axes.

### 11.2.2 JOG operation execution procedure

The JOG operation is carried out by the following procedure.

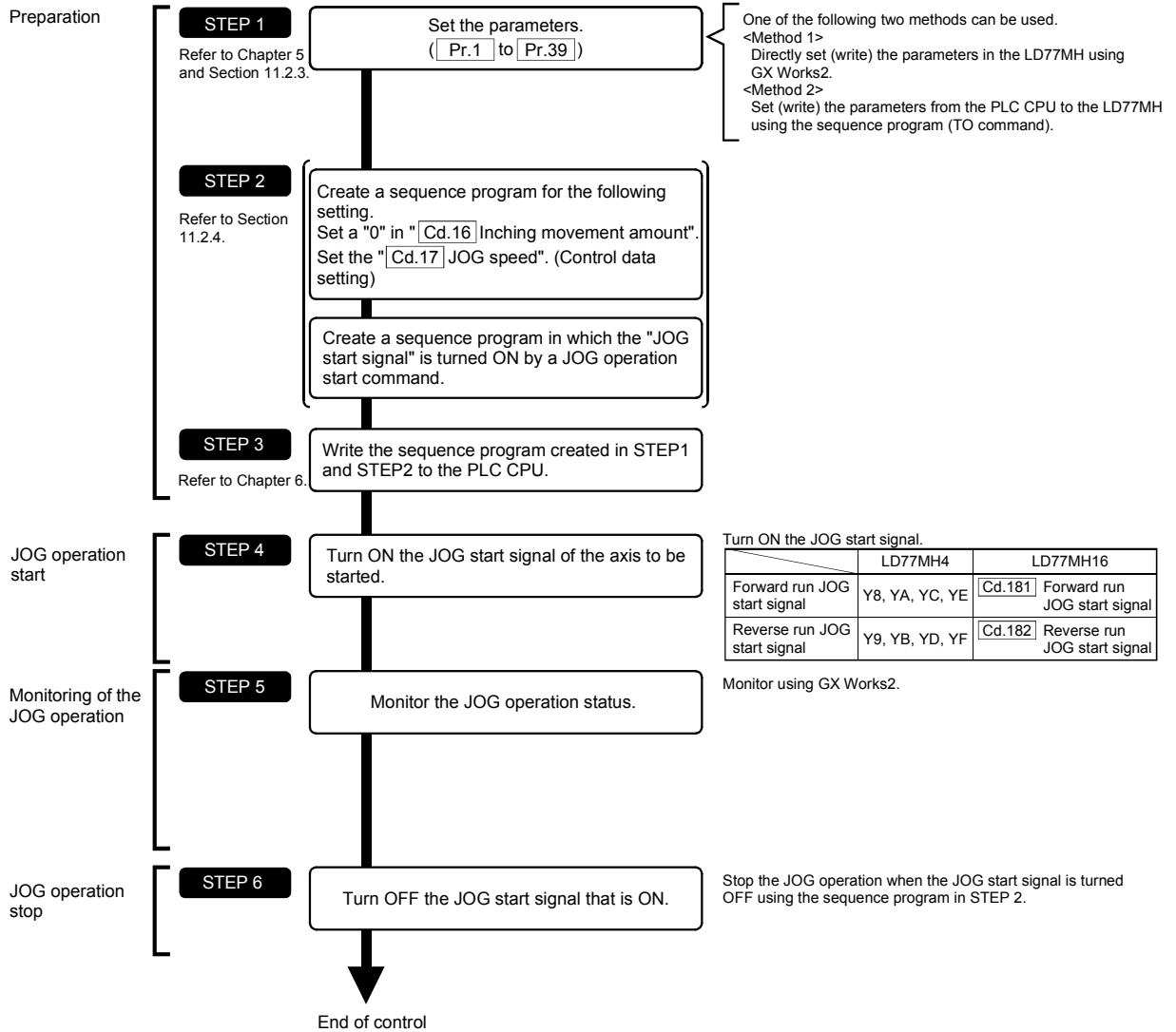

**REMARK**

- Mechanical elements such as limit switches are considered as already installed.
- Parameter settings work in common for all control using the LD77MH.

## 11.2.3 Setting the required parameters for JOG operation

The "Positioning parameters" must be set to carry out JOG operation.

The following table shows the setting items of the required parameters for carrying out JOG operation. When only JOG operation will be carried out, no parameters other than those shown below need to be set. (Use the initial values or setting values within a range where no error occurs for trouble-free operation.)

Setting item		Setting requirement	Factory-set initial value (setting details)	
Positioning parameters	Pr.1	Unit setting	◎	3 (PLS)
	Pr.2	Number of pulses per rotation (AP) (Unit: PLS)	◎	20000
	Pr.3	Movement amount per rotation (AL) (Unit: PLS)	◎	20000
	Pr.4	Unit magnification (AM)	◎	1 (1 times)
	Pr.7	Bias speed at start (Unit: PLS/s)	○	0
	Pr.8	Speed limit value (Unit: PLS/s)	◎	200000
	Pr.9	Acceleration time 0 (Unit: PLS/s)	◎	1000
	Pr.10	Deceleration time 0 (Unit: PLS/s)	◎	1000
	Pr.11	Backlash compensation amount (Unit: PLS)	○	0
	Pr.12	Software stroke limit upper limit value (Unit: PLS)	○	2147483647
	Pr.13	Software stroke limit lower limit value (Unit: PLS)	○	-2147483648
	Pr.14	Software stroke limit selection	○	0 (current feed value)
	Pr.15	Software stroke limit valid/invalid setting	○	0 (valid)
	Pr.17	Torque limit setting value (Unit: %)	○	300
	Pr.25	Acceleration time 1 (Unit: ms)	○	1000
	Pr.26	Acceleration time 2 (Unit: ms)	○	1000
	Pr.27	Acceleration time 3 (Unit: ms)	○	1000
	Pr.28	Deceleration time 1 (Unit: ms)	○	1000
	Pr.29	Deceleration time 2 (Unit: ms)	○	1000
	Pr.30	Deceleration time 3 (Unit: ms)	○	1000
	Pr.31	JOG speed limit value (Unit: PLS/s)	◎	20000
	Pr.32	JOG operation acceleration time selection	◎	0 (acceleration time 0)
	Pr.33	JOG operation deceleration time selection	◎	0 (deceleration time 0)
	Pr.34	Acceleration/deceleration process selection	○	0 (trapezoidal acceleration/ deceleration processing)
	Pr.35	S-curve ratio (Unit: %)	○	100
	Pr.36	Sudden stop deceleration time (Unit: ms)	○	1000
	Pr.37	Stop group 1 sudden stop selection	○	0 (deceleration stop)
	Pr.38	Stop group 2 sudden stop selection	○	0 (deceleration stop)
	Pr.39	Stop group 3 sudden stop selection	○	0 (deceleration stop)

◎ : Setting always required.

○ : Set according to requirements (Leave set to the initial value when not used.)

**REMARK**

- Parameter settings work in common for all control using the LD77MH. When carrying out other control ("major positioning control", "high-level positioning control", "OPR positioning control"), the respective setting items must also be matched and set.
- Parameters are set for each axis.
- Refer to Chapter 5 "Data Used for Positioning Control" for setting details.



### 11.2.4 Creating start programs for JOG operation

A sequence program must be created to execute a JOG operation. Consider the "required control data setting", "start conditions" and "start time chart" when creating the program.

The following shows an example when a JOG operation is started for axis 1. ("Cd.17 JOG speed" is set to "100.00mm/min" in the example shown.)

#### ■ Required control data setting

The control data shown below must be set to execute a JOG operation. The setting is carried out with the sequence program.

Setting item	Setting value	Setting details	Buffer memory address	
			LD77MH4	LD77MH16
Cd.16 Inching movement amount	0	Set "0".	1517+100n	4317+100n
Cd.17 JOG speed	10000	Set a value equal to or below the "Pr.31 JOG speed limit value".	1518+100n 1519+100n	4318+100n 4319+100n

※: Refer to Section 5.7 "List of control data" for details on the setting details.

#### ■ Start conditions

The following conditions must be fulfilled when starting. The required conditions must also be assembled in the sequence program, and the sequence program must be configured so the operation will not start if the conditions are not fulfilled.

Signal name	Signal state	Device			
		LD77MH4	LD77MH16		
Interface signal	PLC READY signal	ON	PLC CPU preparation completed	Y0	
	LD77 READY signal	ON	LD77MH preparation completed	X0	
	All axis servo ON	ON	All axis servo ON	Y1	
	Synchronization flag *	ON	LD77MH buffer memory The access is possible.	X1	
	Axis stop signal	OFF	Axis stop signal is OFF	Y4 to Y7	Cd.180 Axis stop
	Start complete signal	OFF	Start complete signal is OFF	X10 to X13	Md.31 Status: b14
	BUSY signal	OFF	LD77MH is not operating	XC to XF	X10 to X1F
	Error detection signal	OFF	There is no error	X8 to XB	Md.31 Status: b13
	M code ON signal	OFF	M code ON signal is OFF	X4 to X7	Md.31 Status: b12
External signal	Forced stop input signal	ON	There is no forced stop input	—	
	Upper limit (FLS)	ON	Within limit range	—	
	Lower limit (RLS)	ON	Within limit range	—	

※: If the PLC CPU is set to the asynchronous mode in the synchronization setting, this must be inserted in the program for interlocking. If it is set to the synchronous mode, it must not be inserted in the program for interlocking because it is turned ON when the PLC CPU executes calculation.

■ Start time chart

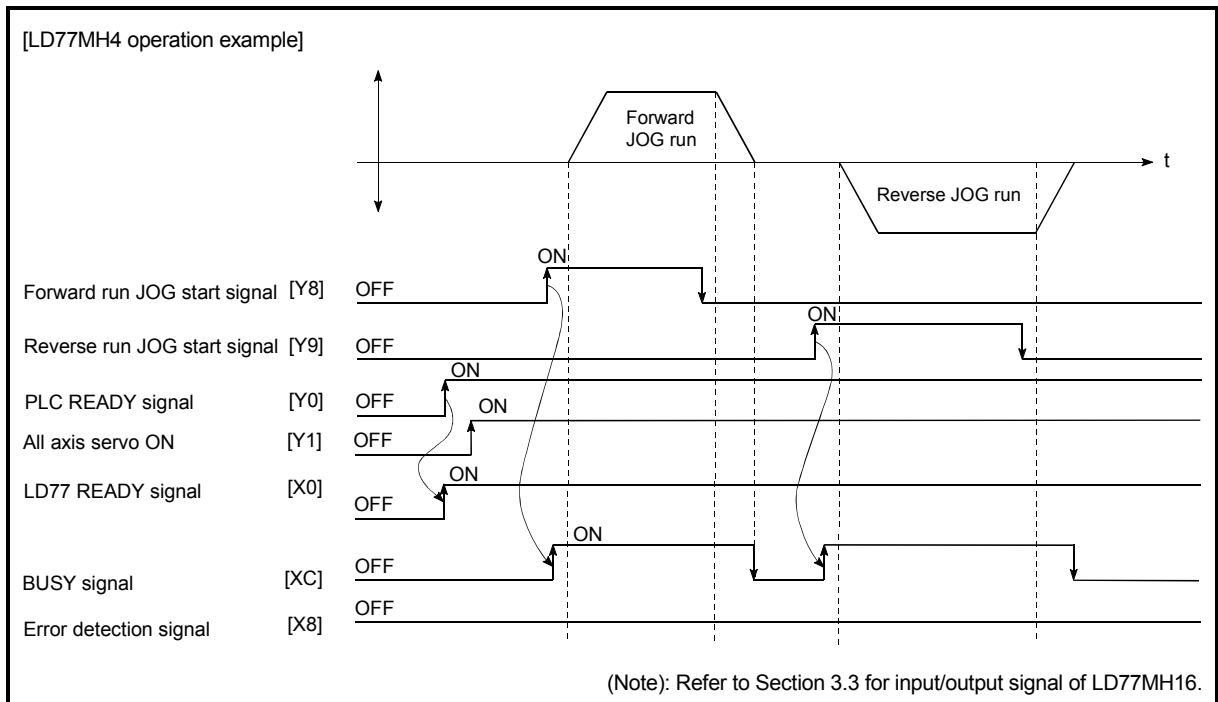
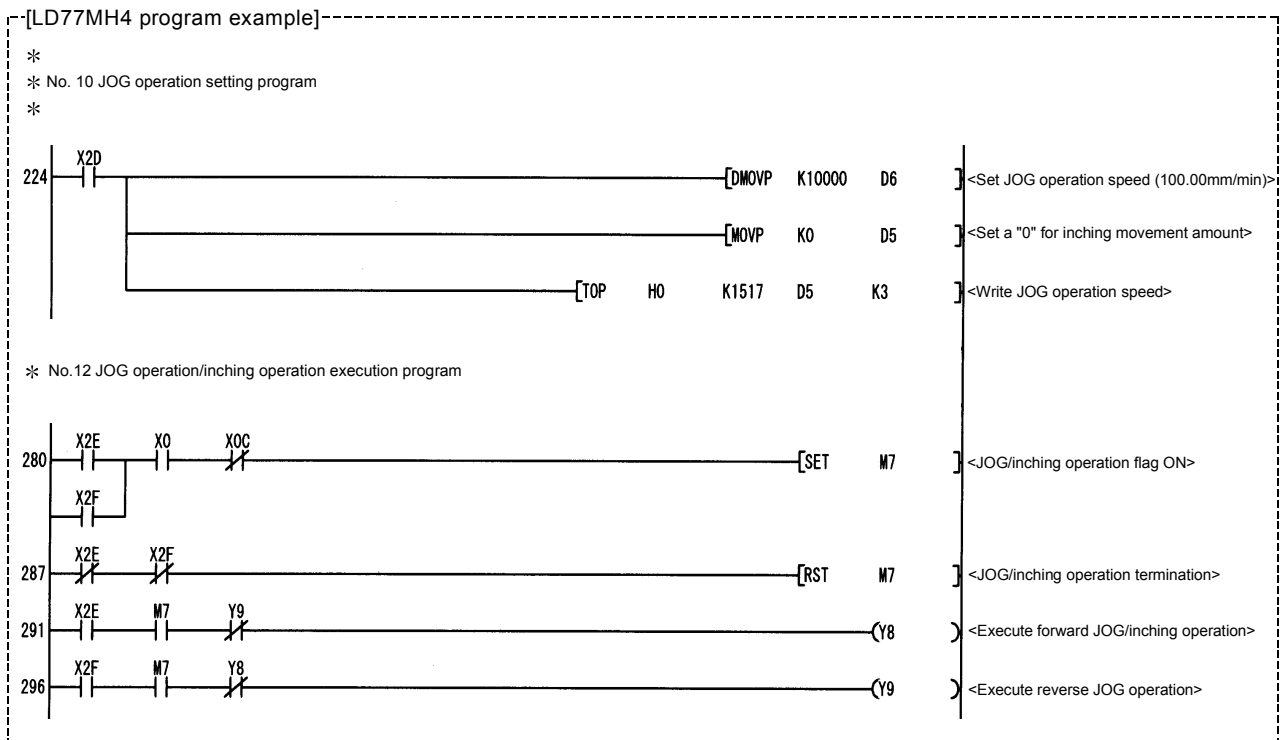

Fig. 11.6 JOG operation start time chart

■ Creating the program



### 11.2.5 JOG operation example

■ When the "stop signal" is turned ON during JOG operation

When the "stop signal" is turned ON during JOG operation, the JOG operation will stop by the "deceleration stop" method.

If the JOG start signal is turned ON while the stop signal is ON, an error "Stop signal ON at start" (error code: 106) will occur.

The operation can be started by turning the stop signal OFF, and turning the JOG start signal from OFF to ON again.

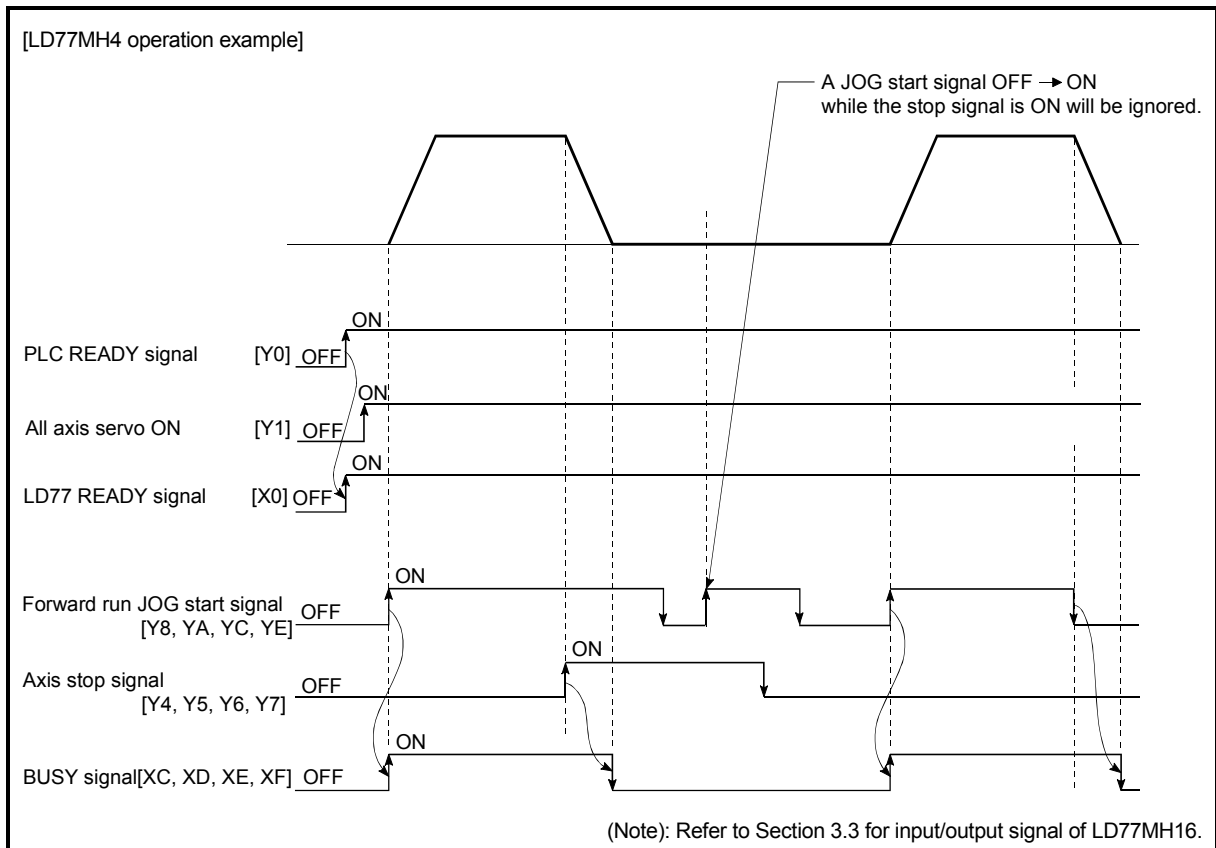

Fig. 11.7 Operation when the stop signal is turned ON during JOG operation

- When both the "forward run JOG start signal" and "reverse run JOG start signal" are turned ON simultaneously for one axis

When both the "forward run JOG start signal" and "reverse run JOG start signal" are turned ON simultaneously for one axis, the "forward run JOG start signal" is given priority. In this case, the "reverse run JOG start signal" is validated when the LD77MH BUSY signal is turned OFF.

If the forward run JOG operation is stopped due to stop by a stop signal or axis error, the reverse run JOG operation will not be executed even if the "reverse run JOG start signal" turns ON.

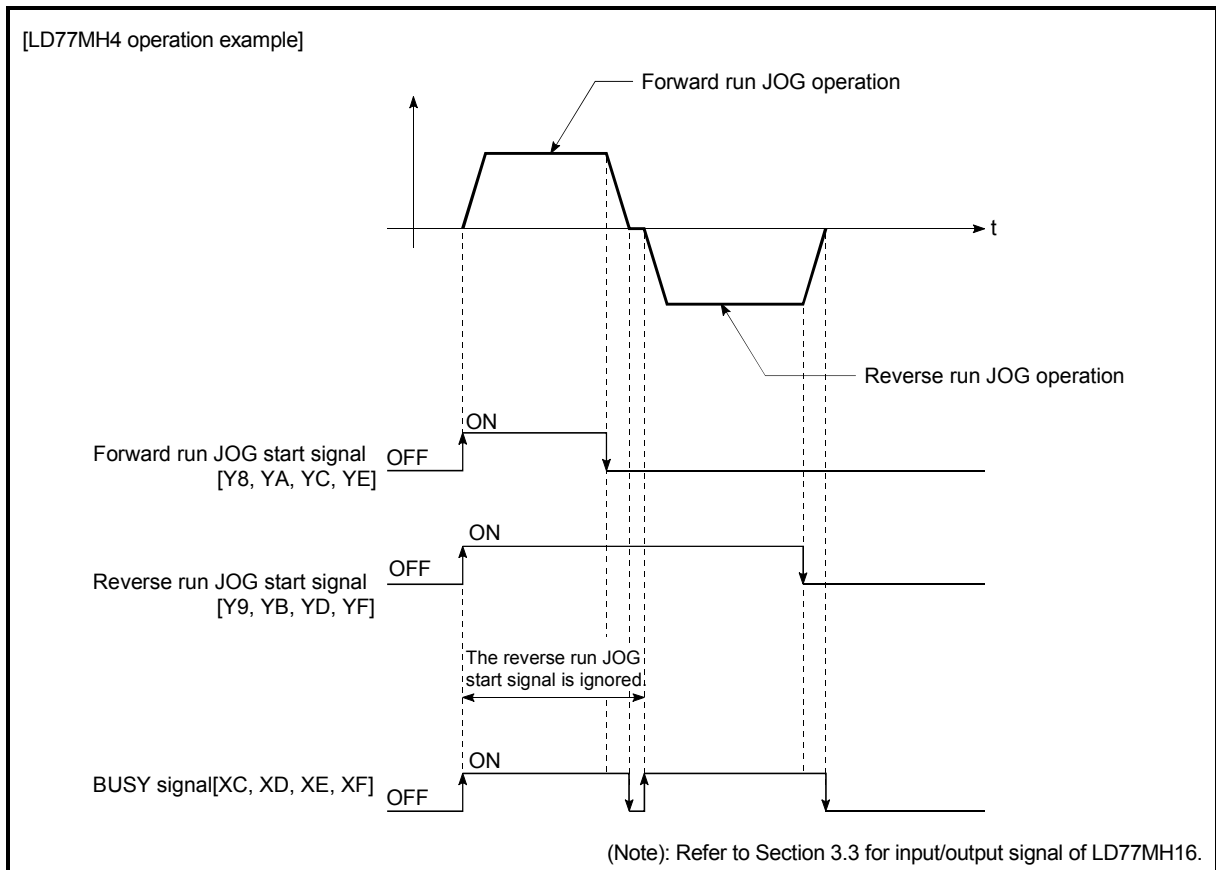

Fig. 11.8 Operation when both the forward run JOG start signal and reverse run JOG start signal are turned ON simultaneously

- When the "JOG start signal" is turned ON again during deceleration caused by the ON → OFF of the "JOG start signal"

When the "JOG start signal" is turned ON again during deceleration caused by the ON → OFF of the "JOG start signal", the JOG operation will be carried out from the time the "JOG start signal" is turned ON.

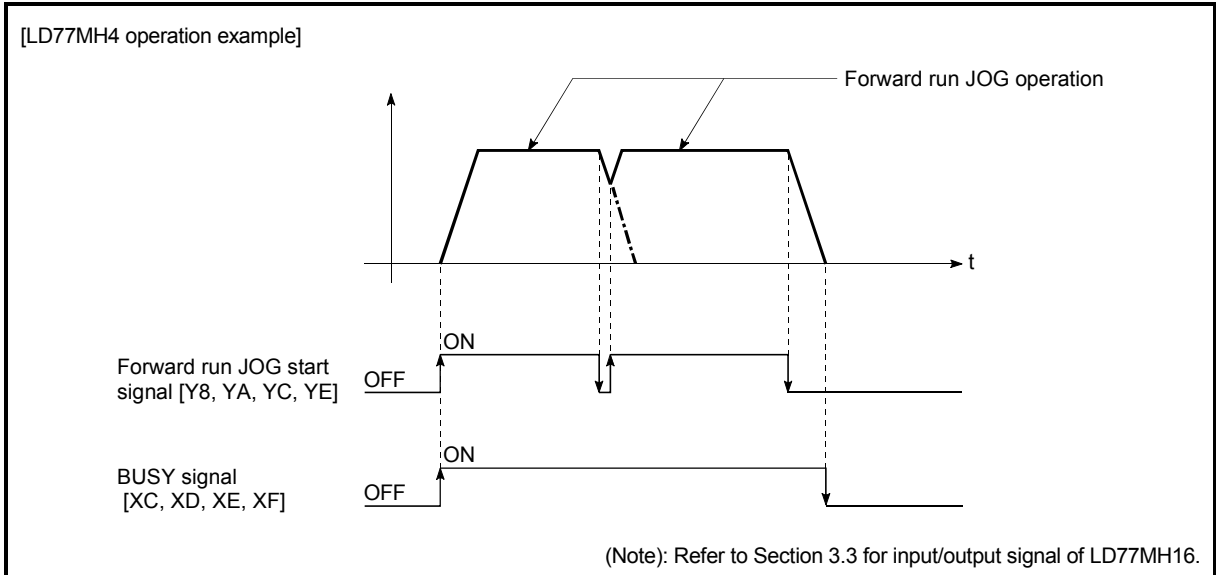

Fig. 11.9 Operation when the JOG start signal is turned ON during deceleration

- When the "JOG start signal" is turned ON while the test function of GX Works2 is used

When the "JOG start signal" is turned ON while the test function of GX Works2 is used, it will be ignored and the JOG operation will not be carried out.

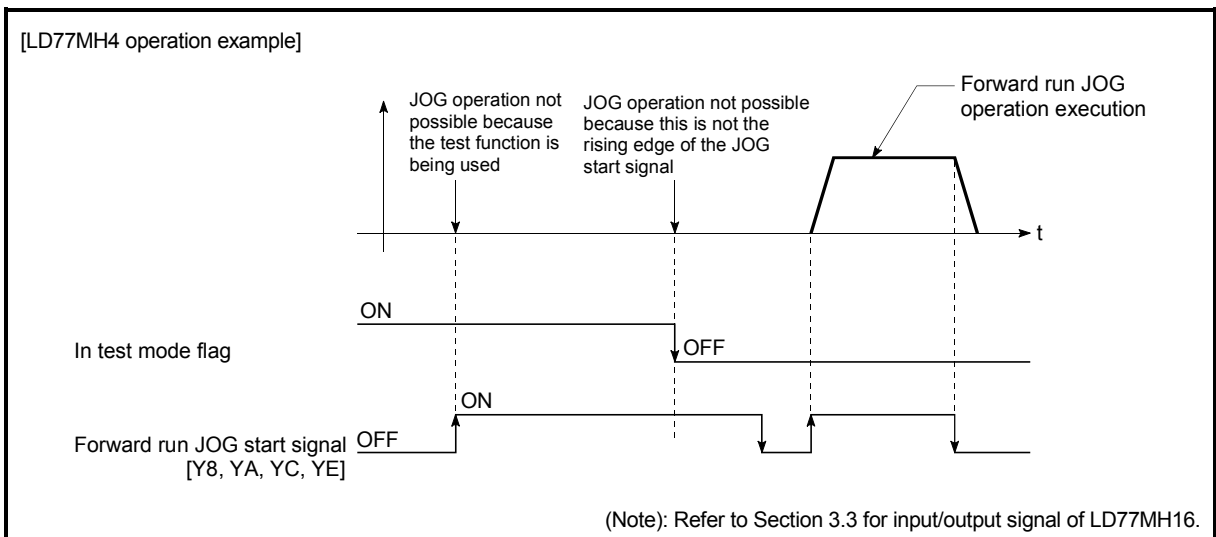

Fig. 11.10 Operation when the JOG start signal is turned ON while the test function is used

### 11.3 Inching operation

#### 11.3.1 Outline of inching operation

##### ■ Inching operation

In inching operation, pulses are output to the servo amplifier at operation cycle to move the workpiece by a designated movement amount after the forward run JOG start signal or reverse JOG start signal is turned ON.

Signal	LD77MH4	LD77MH16
Forward run JOG start signal	Y8, YA, YC, YE	[Cd.181] Forward run JOG start
Reverse run JOG start signal	Y9, YB, YD, YF	[Cd.182] Reverse run JOG start

The following shows the example of inching operation.

1)	When the start signal is turned ON, inching operation is carried out in the direction designated by the start signal. In this case, BUSY signal is turned from OFF to ON.
2)	The workpiece is moved by a movement amount set in " [Cd.16] Inching movement amount".
3)	The workpiece movement stops when the speed becomes "0". In this case, BUSY signal is turned from ON to OFF. The positioning complete signal is turned from OFF to ON.
4)	The positioning complete signal is turned from ON to OFF after a time set in " [Pr.40] Positioning complete signal output time" has been elapsed.

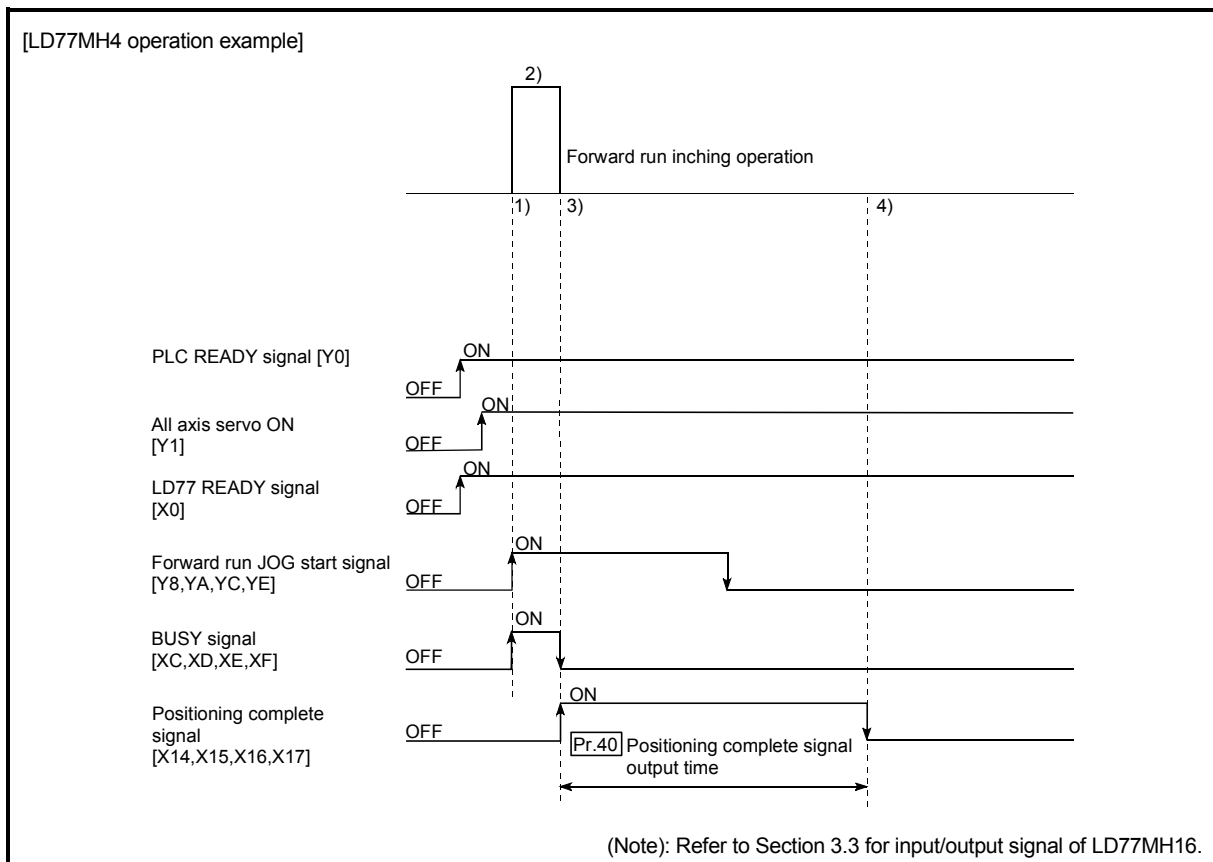

Fig. 11.11 Inching operation

**Important**

When the inching operation is carried out near the upper or lower limit, use the hardware stroke limit function (Refer to Section 13.4.4).

If the hardware stroke limit function is not used, the workpiece may exceed the movement range, and an accident may result.

**■ Precautions during operation**

The following details must be understood before inching operation is carried out.

- (1) Acceleration/deceleration processing is not carried out during inching operation.

(Commands corresponding to the designated inching movement amount are output at operation cycle. The movement direction of inching operation is reversed and, when a backlash compensation is carried out, first command corresponding to the backlash amount are output at operation cycle and then commands corresponding to the designated inching movement amount are output in the subsequent operation cycles.)

The " [Cd.17] JOG speed" is ignored even if it is set. An error will occur in the following cases (error code: 301).

( [Cd.16] Inching movement amount) x (A) > ( [Pr.31] JOG speed limit value)

Where (A) is as follows.

	Operation cycle	
	0.88	1.77
When the unit setting is PLS.	1125	562.5
When the unit setting is degree and the " [Pr.83] Speed control 10 x multiplier setting for degree axis" is valid.	67.5	33.75
When the unit setting is other than the above.	675	337.5

- (2) Set a value other than a "0" in " [Cd.16] Inching movement amount".

If a "0" is set, the operation will become JOG operation (Refer to Section 11.2 "JOG operation").

**■ Operations when stroke limit error occurs**

When the operation is stopped by hardware stroke limit error or software stroke limit error, the inching operation can be performed in an opposite way (direction within normal limits.) after an error reset.

(An error will occur again if JOG start signal is turned ON in a direction to outside the stroke limit.)

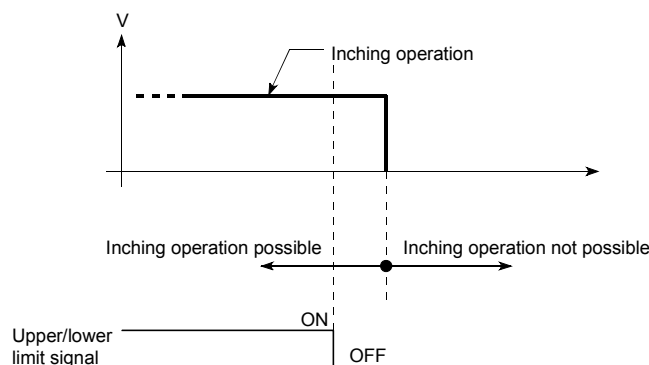

■ Inching operation timing and processing times

The following drawing shows the details of the inching operation timing and processing time.

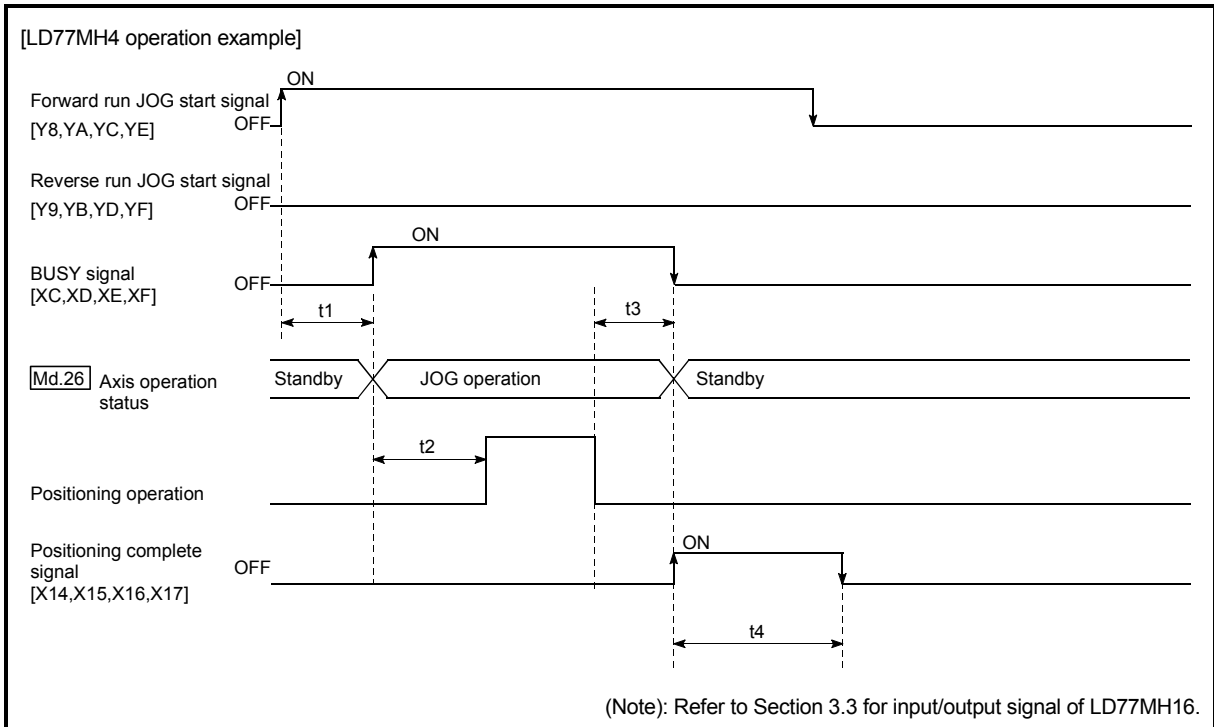

Fig. 11.12 Inching operation timing and processing times

Normal timing times

Unit : [ms]

	Operation cycle	t1	t2	t3	t4
LD77MH4	0.88	0.8 to 1.1	2.2 to 2.7	0 to 0.9	Depending on parameters
LD77MH16	0.88	0.8 to 1.1	2.2 to 2.7	0 to 0.9	Depending on parameters
	1.77	0.8 to 2.2	3.2 to 3.9	0 to 1.8	Depending on parameters

- Depending on the operating statuses of the other axes, delay may occur in the t1 timing time.



### 11.3.2 Inching operation execution procedure

The inching operation is carried out by the following procedure.

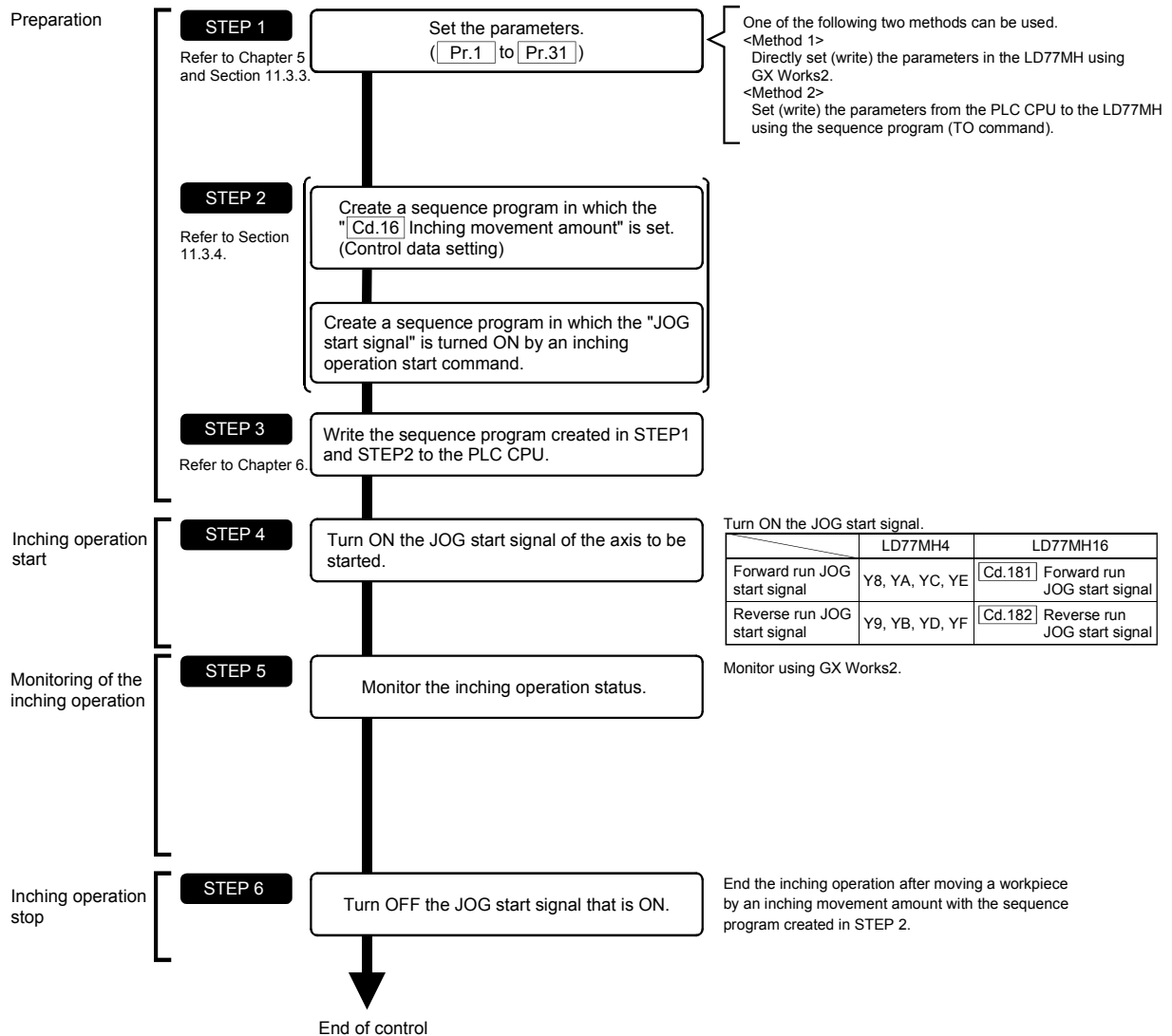

**REMARK**

- Mechanical elements such as limit switches are considered as already installed.
- Parameter settings work in common for all control using the LD77MH.

### 11.3.3 Setting the required parameters for inching operation

The "Positioning parameters" must be set to carry out inching operation.

The following table shows the setting items of the required parameters for carrying out inching operation. When only inching operation will be carried out, no parameters other than those shown below need to be set. (Use the initial values or setting values within a range where no error occurs for trouble-free operation.)

		Setting item	Setting requirement	Factory-set initial value (setting details)
Positioning parameters	Pr.1	Unit setting	◎	3 (PLS)
	Pr.2	Number of pulses per rotation (AP) (Unit: PLS)	◎	20000
	Pr.3	Movement amount per rotation (AL) (Unit: PLS)	◎	20000
	Pr.4	Unit magnification (AM)	◎	1 (1 times)
	Pr.11	Backlash compensation amount (Unit: PLS)	○	0
	Pr.12	Software stroke limit upper limit value (Unit: PLS)	○	2147483647
	Pr.13	Software stroke limit lower limit value (Unit: PLS)	○	-2147483648
	Pr.14	Software stroke limit selection	○	0 (current feed value)
	Pr.15	Software stroke limit valid/invalid setting	○	0 (valid)
	Pr.17	Torque limit setting value (Unit: %)	○	300
	Pr.31	JOG speed limit value (Unit: PLS/s)	◎	20000

◎ : Setting always required.

○ : Set according to requirements (Leave set to the initial value when not used.)

#### REMARK

- Positioning parameter settings work in common for all control using the LD77MH. When carrying out other controls ("major positioning control", "high-level positioning control", and "OPR control"), the respective setting items must also be set.
- Parameters are set for each axis.
- Refer to Chapter 5 "Data Used for Positioning Control" for setting details.

### 11.3.4 Creating a program to enable/disable the inching operation

A sequence program must be created to execute an inching operation. Consider the "required control data setting", "start conditions", and "start time chart" when creating the program.

The following shows an example when an inching operation is started for axis 1. (The example shows the inching operation when a "10.0 μm" is set in "[Cd.16] Inching movement amount".)

#### ■ Required control data setting

The control data shown below must be set to execute an inching operation. The setting is carried out with the sequence program.

Setting item	Setting value	Setting details	Buffer memory address	
			LD77MH4	LD77MH16
[Cd.16] Inching movement amount	100	Set the setting value so that the JOG speed limit value is not increased larger than the maximum output pulse	1517+100n	4317+100n

※: Refer to Section 5.7 "List of control data" for information on setting details.

#### ■ Start conditions

The following conditions must be fulfilled when starting. The required conditions must also be assembled in the sequence program, and the sequence program must be configured so the operation will not start if the conditions are not fulfilled.

Signal name	Signal state	Device			
		LD77MH4	LD77MH16		
Interface signal	PLC READY signal	ON	PLC CPU preparation completed	Y0	
	LD77 READY signal	ON	LD77MH preparation completed	X0	
	All axis servo ON	ON	All axis servo ON	Y1	
	Synchronization flag *	ON	Accessible to LD77MH buffer memory	X1	
	Axis stop signal	OFF	Axis stop signal is OFF	Y4 to Y7	[Cd.180] Axis stop
	Start complete signal	OFF	Start complete signal is OFF	X10 to X13	[Md.31] Status: b14
	BUSY signal	OFF	LD77MH is not operating	XC to XF	X10 to X1F
	Positioning complete signal	OFF	Positioning complete signal is OFF	X14 to X17	[Md.31] Status: b15
	Error detection signal	OFF	There is no error	X8 to XB	[Md.31] Status: b13
External signal	M code ON signal	OFF	M code ON signal is OFF	X4 to X7	[Md.31] Status: b12
	Forced stop input signal	ON	There is no forced stop input	—	
	Upper limit (FLS)	ON	Within limit range	—	
Lower limit (RLS)	ON	Within limit range	—		

※: If the PLC CPU is set to the asynchronous mode in the synchronization setting, this must be inserted in the program for interlocking. If it is set to the synchronous mode, it must not be inserted in the program for interlocking because it is turned ON when the PLC CPU executes calculation.

■ Start time chart

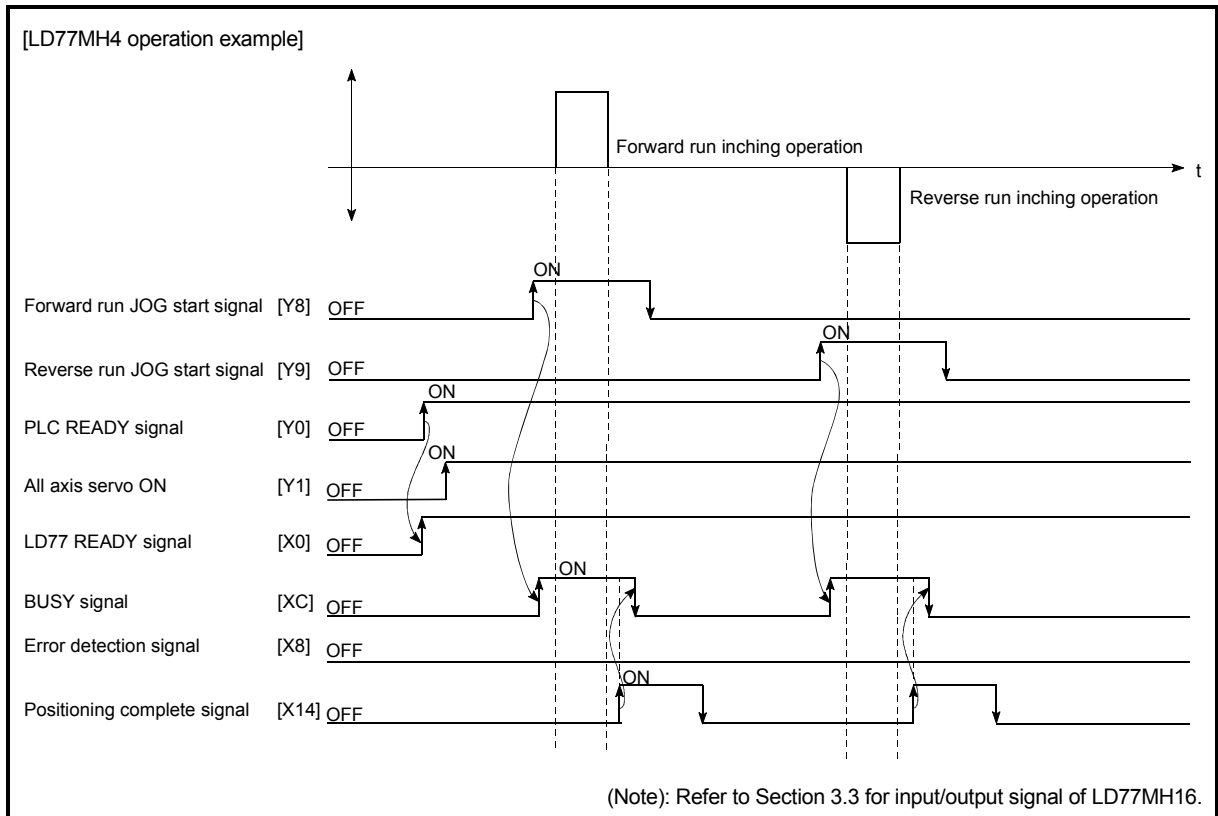
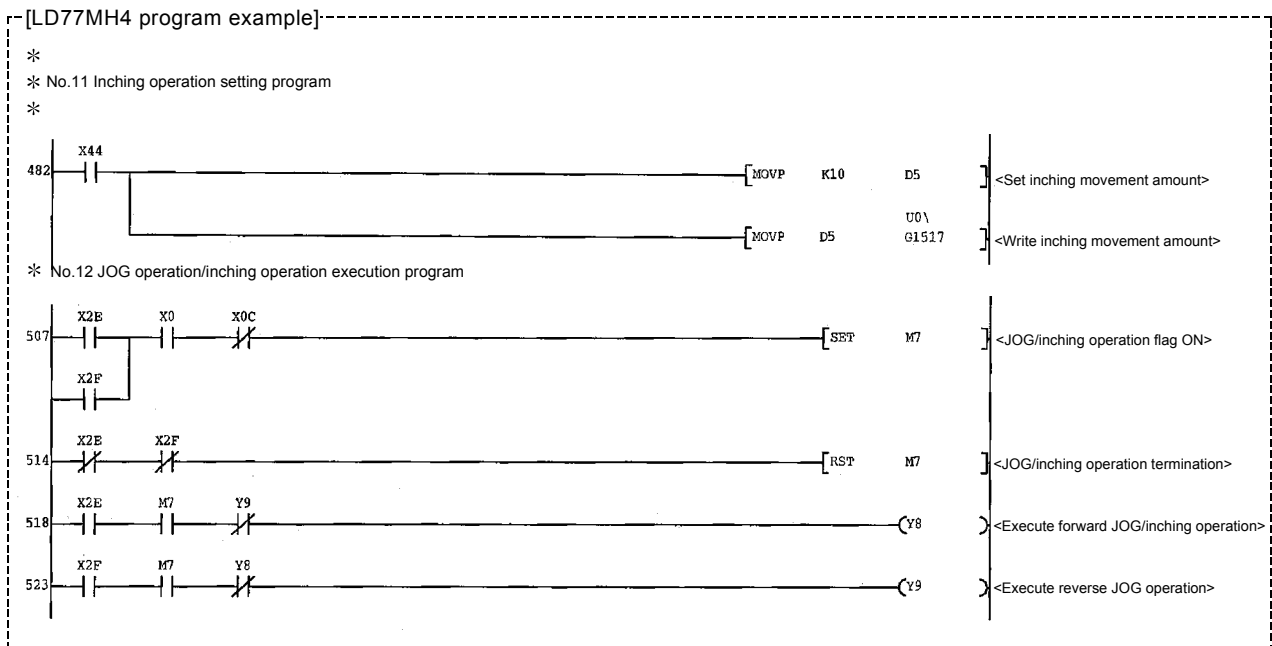

Fig. 11.13 Inching operation start time chart

■ Creating the program



### 11.3.5 Inching operation example

■ When executing inching operation while stop signal is turned ON

If the JOG start signal is turned ON while the stop signal is ON, an error "Stop signal ON at start" (error code: 106) will occur.

The inching operation can be re-started when the stop signal is turned OFF and then re-turned ON.

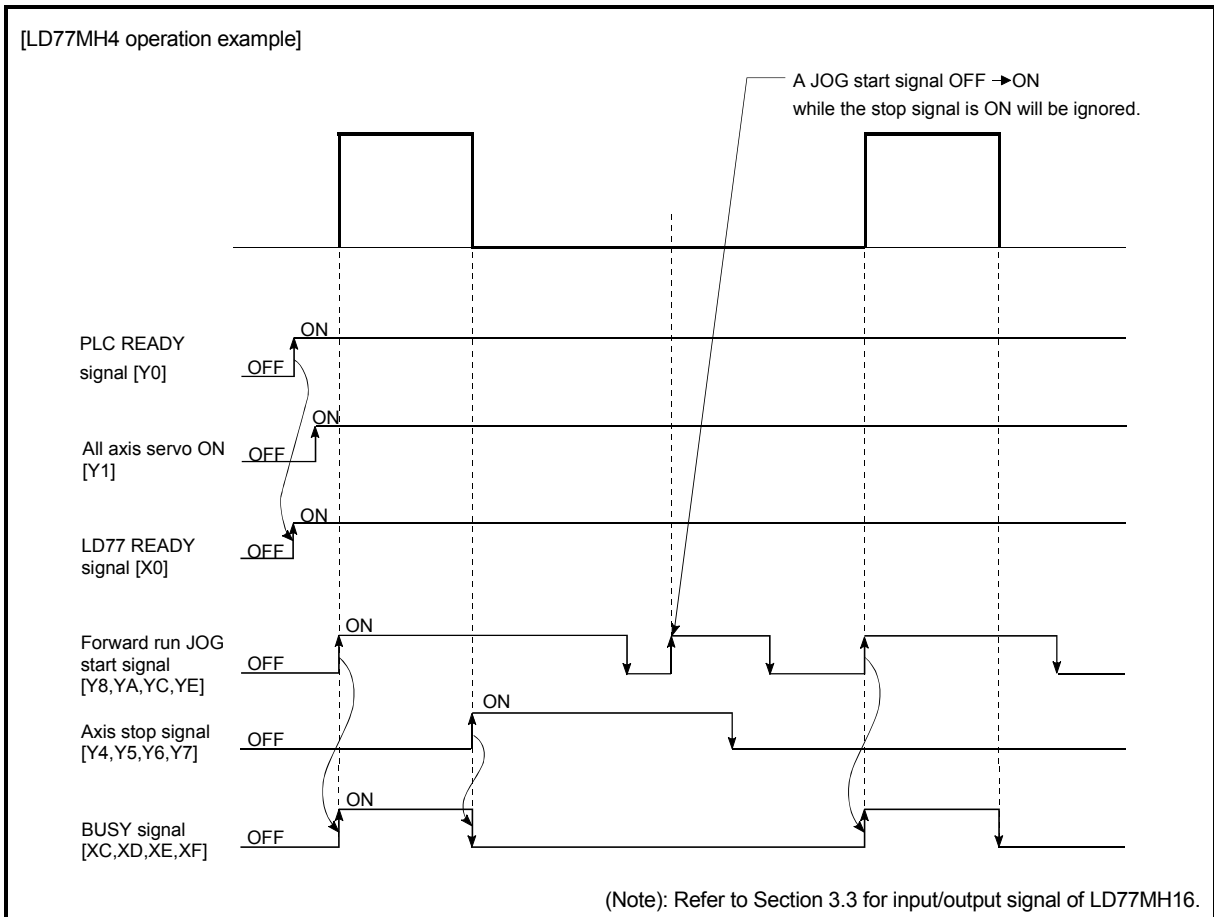

Fig. 11.14 Operation when executing inching operation while stop signal is turned ON

■ When the "JOG start signal" is turned ON while the test function of GX Works2 is used

When the "JOG start signal" is turned ON while the test function is used, it will be ignored and the inching operation will not be carried out.

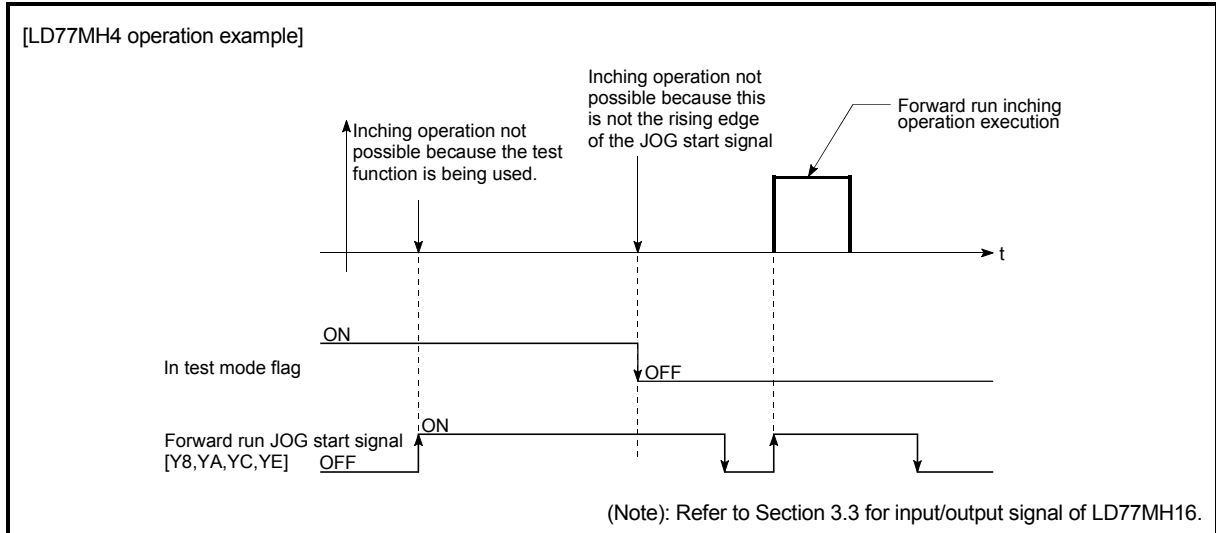

Fig. 11.15 Operation when the JOG start signal is turned ON while the test function is used

## 11.4 Manual pulse generator operation

### 11.4.1 Outline of manual pulse generator operation

#### ■ Manual pulse generator operation

In manual pulse generator operations, pulses are input to the LD77MH from the manual pulse generator. This causes the same number of input command to be output from the LD77MH to the servo amplifier, and the workpiece is moved in the designated direction.

The following shows an example of manual pulse generator operation.

1)	When the " [Cd.21] Manual pulse generator enable flag" is set to "1", the BUSY signal turns ON and the manual pulse generator operation is enabled.
2)	The workpiece is moved corresponding to the number of pulses input from the manual pulse generator.
3)	The workpiece movement stops when no more pulses are input from the manual pulse generator.
4)	When the " [Cd.21] Manual pulse generator enable flag" is set to "0", the BUSY signal turns OFF and the manual pulse generator operation is disabled.

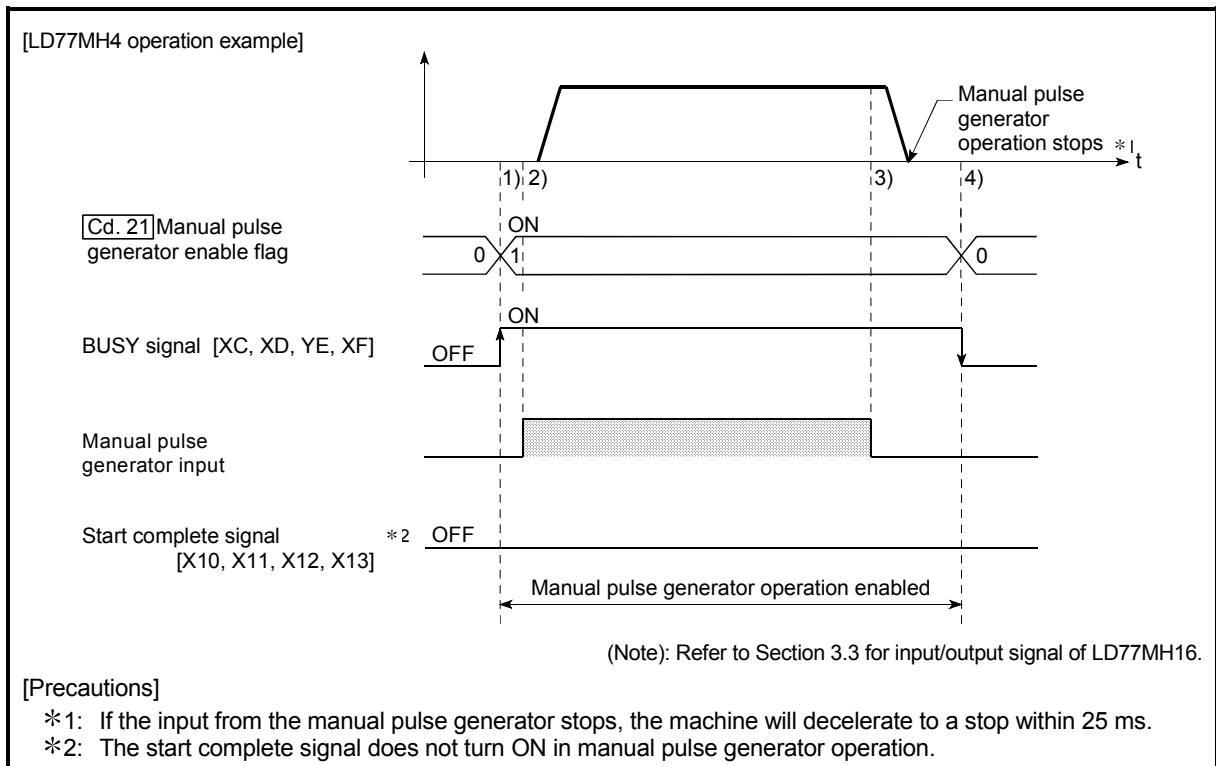

Fig. 11.16 Manual pulse generator operation

#### Important

Create the sequence program so that " [Cd.21] Manual pulse generator enable flag" is always set to "0" (disabled) when a manual pulse generator operation is not carried out.

Mistakenly touching the manual pulse generator when the manual pulse generator enable flag is set to "1" (enable) can cause accidents or incorrect positioning.

### ■ Restricted items

A manual pulse generator is required to carry out manual pulse generator operation.

### ■ Precautions during operation

The following details must be understood before carrying out manual pulse generator operation.

- (1) The speed during manual pulse generator operation is not limited by the " [Pr.8] Speed limit value".
- (2) If the " [Cd.21] Manual pulse generator enable flag" is turned ON while the LD77MH is BUSY (BUSY signal ON), a warning will occur (warning code 100: start during operation).
- (3) If a stop factor occurs during manual pulse generator operation, the operation will stop, and the BUSY signal will turn OFF.  
At this time, the " [Cd.21] Manual pulse generator enable flag" will be left ON, but manual pulse generator operation will not be possible. To carry out manual pulse generator operation again, measures must be carried out to eliminate the stop factor. Once eliminated, the operation can be carried out again by turning the " [Cd.21] Manual pulse generator enable flag" ON → OFF → ON.  
(Note that this excludes hardware/software stroke limit error.)
- (4) Command will not be output if an error occurs when the manual pulse generator operation starts.

### Important

The speed command is issued according to the input from the manual pulse generator irrelevant of the speed limit setting.

When the speed command is larger than 62914560pps (63Mpps), a servo error "Command frequency error (error code: 2035)" will occur.

The following calculation formula is used to judge whether or not an error will occur.

$$(\text{Speed command}) = \left( \begin{array}{c} \text{Number of} \\ \text{input pulses} \\ \text{for one} \\ \text{second} \end{array} \right) \times \left( \begin{array}{c} \text{Manual pulse} \\ \text{generator 1} \\ \text{pulse input} \\ \text{magnification} \end{array} \right) \times \left( \begin{array}{c} \text{Manual pulse} \\ \text{generator 1} \\ \text{pulse movement} \\ \text{amount} \end{array} \right) \times \left( \begin{array}{c} \text{Number of pulses per rotation} \\ \text{Movement amount per rotation} \end{array} \right)$$

If a large value is set to the manual pulse generator 1 pulse input magnification, there is a high possibility of a servo error "Command frequency error (error code: 2035)" occurrence. Note that the servomotor does not work rapidly by sudden pulse input even if the servo error will not occur.

### REMARK

- One LD77MH module can be connected to one manual pulse generator.
- The LD77MH module can simultaneously command to servo amplifier (LD77MH4: Axis 1 to 4, LD77MH16: Axis 1 to 16) by one manual pulse generator.  
(Simultaneous operation (LD77MH4: 1 axis to 4 axes, LD77MH16: 1 axis to 16 axes) is possible.)



■ Operations when stroke limit error occurs

When the hardware stroke limit error or the software stroke limit error is detected (Note-1) during operation, the operation will decelerate to a stop. However, in case of "[Md.26] Axis operation status", "Manual pulse generator operation" will continue (Note-1). After stopping, manual pulse generator input pulses to the outside direction of the limit range are not accepted, but operation can be executed within the range.

(Note-1): Only when the current feed value or the machine feed value overflows or underflows during deceleration, the manual pulse generator operation will terminate as "error occurring". To carry out manual pulse generator operation again, "[Cd.21] Manual pulse generator enable flag" must be turned OFF once and turn ON.

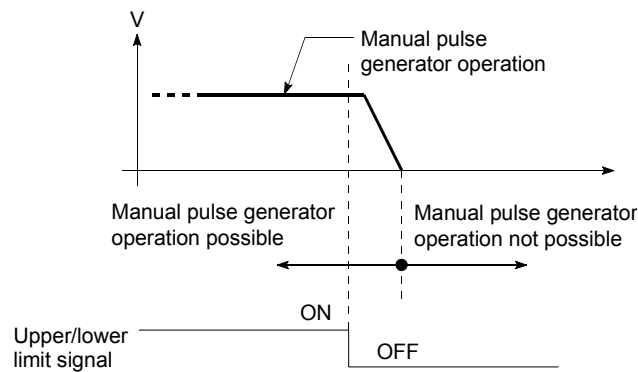

■ Manual pulse generator operation timing and processing time

The following drawing shows details of the manual pulse generator operation timing and processing time.

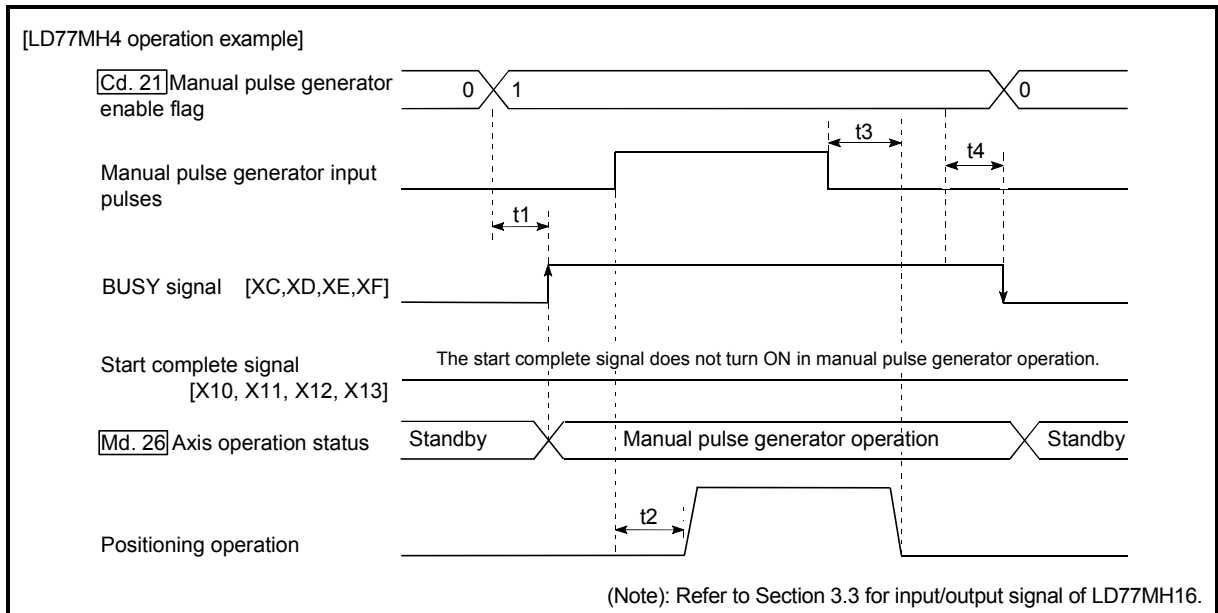

Fig. 11.17 Manual pulse generator operation timing and processing times

Normal timing times

Unit : [ms]

	Operation cycle	t1	t2	t3	t4
LD77MH4	0.88	0.6 to 0.9	9.0 to 13.0	18.0 to 25.0	8.9
LD77MH16	0.88	0.6 to 0.9	9.0 to 13.0	18.0 to 25.0	8.9
	1.77	0.8 to 2.2	9.0 to 14.7	18.0 to 25.0	8.9

- Delays may occur in the t1 timing time due to the operation status of other axes.

### ■ Position control by manual pulse generator operation

In manual pulse generator operation, the position is moved by a "manual pulse generator 1 pulse movement amount" per pulse.

The current feed value in the positioning control by manual pulse generator operation can be calculated using the expression shown below.

$$\text{Current feed value} = \text{Number of input pulses} \times \text{Cd.20 Manual pulse generator 1 pulse input magnification} \times \text{Manual pulse generator 1 pulse movement amount}$$

Pr.1 Unit setting	mm	inch	degree	PLS
Manual pulse generator 1 pulse movement amount	0.1 $\mu$ m	0.00001inch	0.00001degree	1PLS

For example, when "Pr.1 Unit setting" is mm and "Cd.20 Manual pulse generator 1 pulse input magnification" is 2, and 100 pulses are input from the manual pulse generator, the current feed value is as follows.

$$100 \times 2 \times 0.1 = 20 [\mu\text{m}] \quad (\text{"Md.20 Current feed value"}=200)$$

The number of pulses output actually to the servo amplifier is "Manual pulse generator 1 pulse movement amount/movement amount per pulse<sup>(Note)</sup>". For example, when "Pr.1 Unit setting" is mm and the movement amount per pulse is 1 $\mu$ m,  $0.1/1 = 1/10$ , i.e., the output to the servo amplifier per pulse from the manual pulse generator is 1/10pulse. Thus, the LD77MH outputs 1pulse to the servo amplifier after receiving 10pulses from the manual pulse generator.

$$\text{(Note): Movement amount per pulse} = \frac{\text{"Pr.3 Movement amount per rotation(AL)"}}{\text{"Pr.2 Number of pulses per rotation(AP)"}} \times \text{"Pr.4 Unit magnification(AM)"}$$

### ■ Speed control by manual pulse generation operation

The speed during positioning control by manual pulse generator operation is a speed corresponding to the number of input pulses per unit time, and can be obtained using the following equation.

$$\text{Output command frequency} = \text{Input frequency} \times \text{Cd.20 Manual pulse generator 1 pulse input magnification}$$

### 11.4.2 Manual pulse generator operation execution procedure

The manual pulse generator operation is carried out by the following procedure.

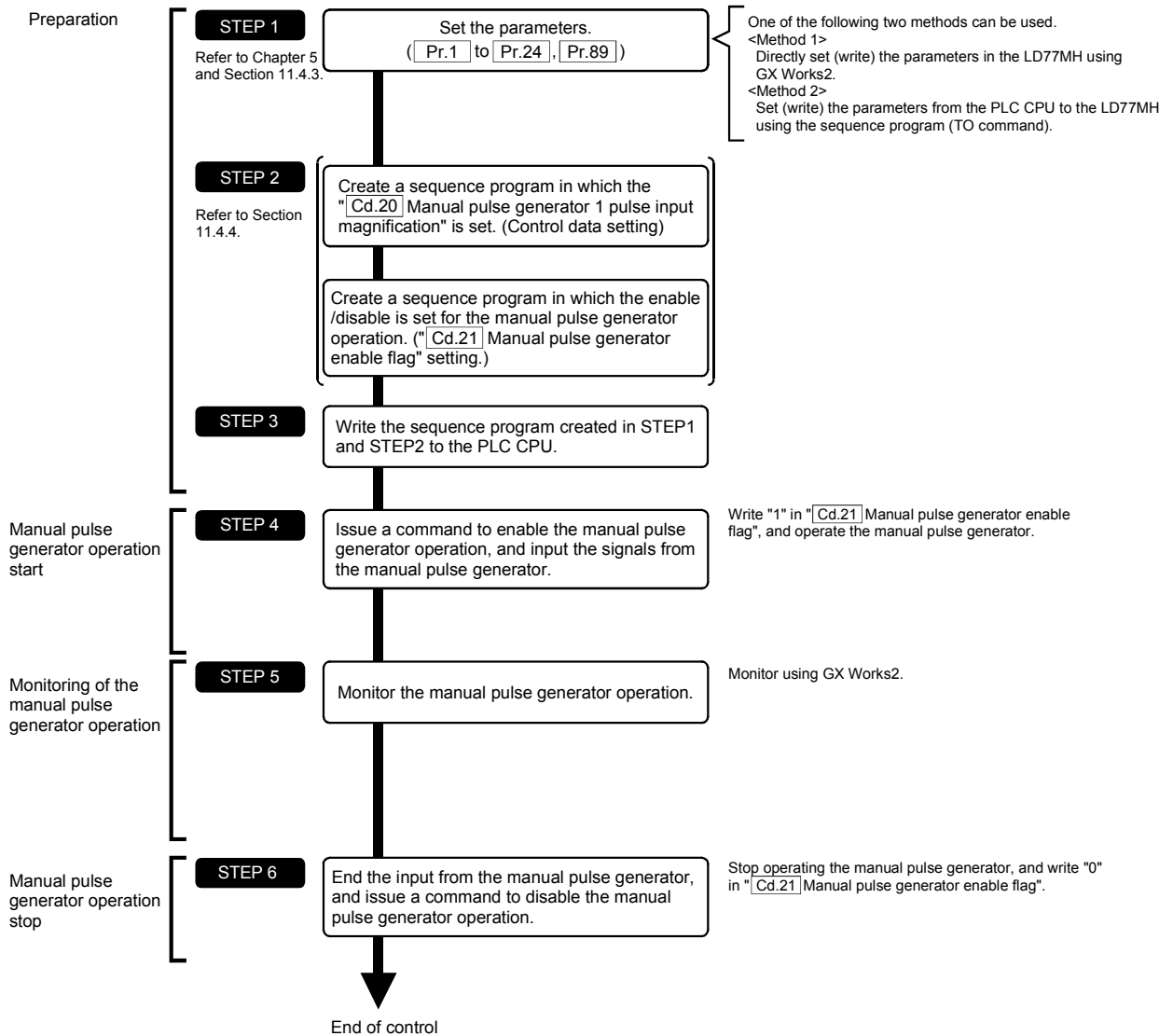

**REMARK**

- Mechanical elements such as limit switches are considered as already installed.
- Parameter settings work in common for all control using the LD77MH.

### 11.4.3 Setting the required parameters for manual pulse generator operation

The "Positioning parameters" must be set to carry out manual pulse generator operation.

The following table shows the setting items of the required parameters for carrying out manual pulse generator operation. When only manual pulse generator operation will be carried out, no parameters other than those shown below need to be set. (Use the initial values or setting values within a range where no error occurs for trouble-free operation.)

Setting item		Setting requirement	Factory-set initial value (setting details)	
Positioning parameters	Pr.1	Unit setting	⊙	3 (PLS)
	Pr.2	Number of pulses per rotation (AP) (Unit: PLS)	⊙	20000
	Pr.3	Movement amount per rotation (AL) (Unit: PLS)	⊙	20000
	Pr.4	Unit magnification (AM)	⊙	1 (1 times)
	Pr.8	Speed limit value (Unit: PLS/s)	⊙	200000
	Pr.11	Backlash compensation amount (Unit: PLS)	○	0
	Pr.12	Software stroke limit upper limit value (Unit: PLS)	○	2147483647
	Pr.13	Software stroke limit lower limit value (Unit: PLS)	○	-2147483648
	Pr.14	Software stroke limit selection	○	0 (current feed value)
	Pr.15	Software stroke limit valid/invalid setting	○	0 (valid)
	Pr.17	Torque limit setting value (Unit: %)	○	300
	Pr.22	Input signal logic selection	○	0 (Manual pulse generator input is negative logic.)
	Pr.24	Manual pulse generator/Incremental synchronous encoder input selection	○	0 (4 times multiplication of A phase/B phase)
	Pr.89	Manual pulse generator/Incremental synchronous encoder input type selection	⊙	0 (Differential output type)

⊙ : Setting always required.

○ : Set according to requirements (Leave set to the initial value when not used.)

#### REMARK

- Positioning parameter settings work in common for all control using the LD77MH. When carrying out other control ("major positioning control", "high-level positioning control", "OPR control"), the respective setting items must also be matched and set.
- Parameters are set for each axis. But Pr.22 Manual pulse generator input (b8), Pr.24, Pr.89 is set only for axis 1. (The setting for other than axis 1 is ignored.)
- Refer to Chapter 5 "Data Used for Positioning Control" for setting details.

### 11.4.4 Creating a program to enable/disable the manual pulse generator operation

A sequence program must be created to execute a manual pulse generator operation. Consider the "required control data setting", "start conditions" and "start time chart" when creating the program.

The following shows an example when a manual pulse generator operation is started for axis 1.

#### ■ Required control data setting

The control data shown below must be set to execute a manual pulse generator operation. The setting is carried out with the sequence program.

Setting item	Setting value	Setting details	Buffer memory address	
			LD77MH4	LD77MH16
<a href="#">Cd.20</a> Manual pulse generator 1 pulse input magnification	1	Set the manual pulse generator 1 pulse input magnification. (1 to 10000 times)	1522+100n 1523+100n	4322+100n 4323+100n
<a href="#">Cd.21</a> Manual pulse generator enable flag	1 (0)	Set "1: Enable manual pulse generator operation". (Set "0: Disable manual pulse generator operation" when finished with the manual pulse generator operation.)	1524+100n	4324+100n

\*: Refer to Section 5.7 "List of control data" for details on the setting details.

#### ■ Start conditions

The following conditions must be fulfilled when starting. The required conditions must also be assembled in the sequence program, and the sequence program must be configured so the operation will not start if the conditions are not fulfilled.

Signal name	Signal state	Signal state	Device		
			LD77MH4	LD77MH16	
Interface signal	PLC READY signal	ON	PLC CPU preparation completed		
	LD77 READY signal	ON	LD77MH preparation completed		
	All axis servo ON	ON	All axis servo ON		
	Synchronization flag *	ON	LD77MH buffer memory The access is possible.		
	Axis stop signal	OFF	Axis stop signal is OFF	Y4 to Y7	<a href="#">Cd.180</a> Axis stop
	Start complete signal	OFF	Start complete signal is OFF	X10 to X13	<a href="#">Md.31</a> Status: b14
	BUSY signal	OFF	LD77MH is not operating	XC to XF	X10 to X1F
	Error detection signal	OFF	There is no error	X8 to XB	<a href="#">Md.31</a> Status: b13
M code ON signal	OFF	M code ON signal is OFF	X4 to X7	<a href="#">Md.31</a> Status: b12	
External signal	Forced stop input signal	ON	There is no forced stop input		
	Upper limit (FLS)	ON	Within limit range		
	Lower limit (RLS)	ON	Within limit range		

\*: If the PLC CPU is set to the asynchronous mode in the synchronization setting, this must be inserted in the program for interlocking. If it is set to the synchronous mode, it must not be inserted in the program for interlocking because it is turned ON when the PLC CPU executes calculation.

■ Start time chart

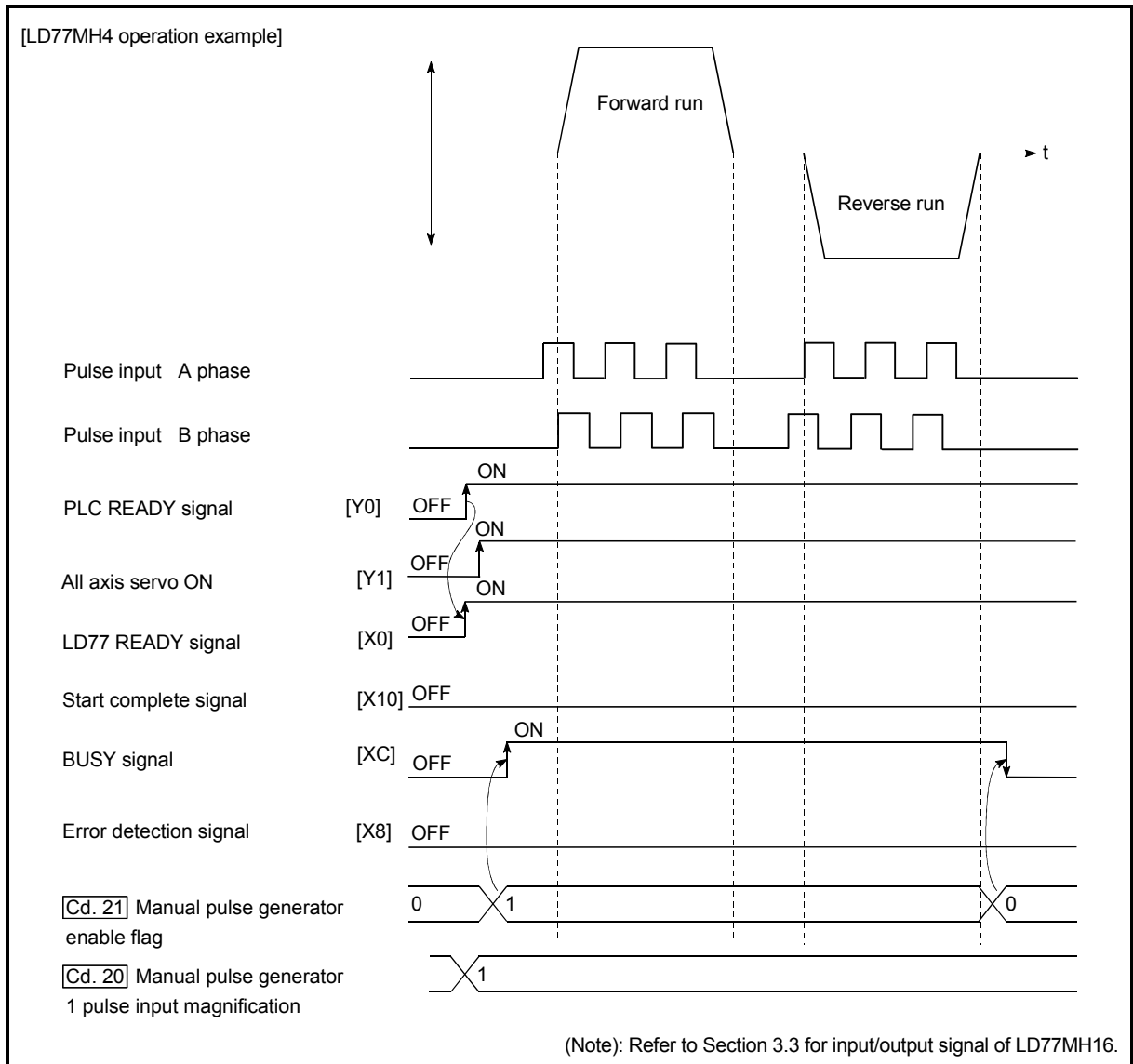
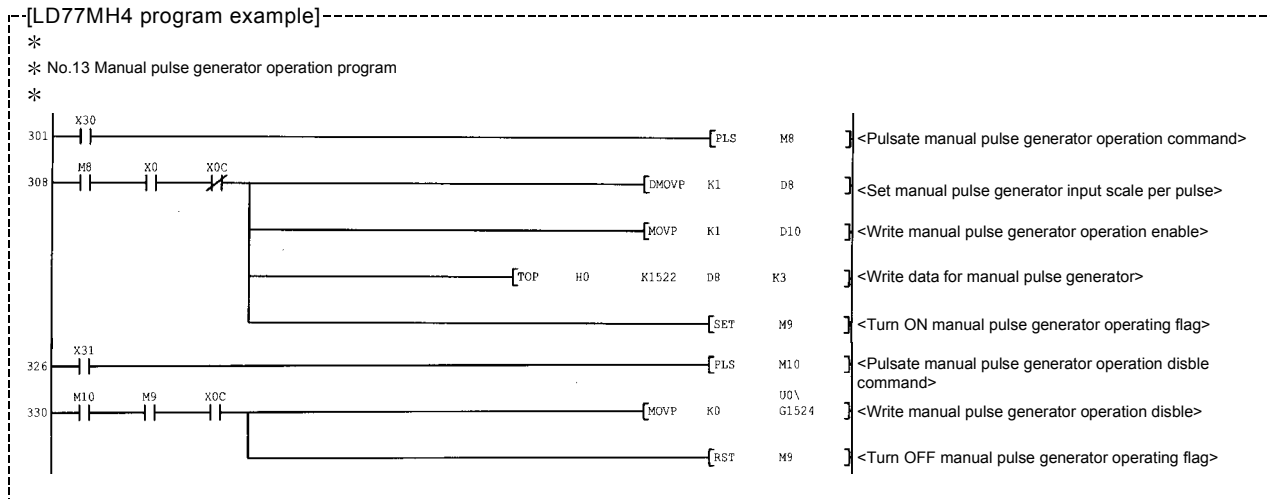

Fig. 11.18 Manual pulse generator operation start time chart

■ Creating the program





# Chapter 12 Expansion Control

The details and usage of expansion control are explained in this chapter.

In expansion control, the speed-torque control to execute the speed control and torque control not including position loop can be performed.  
Execute the required setting to match the control.

12.1	Speed-torque control .....	12- 2
12.1.1	Outline of speed-torque control .....	12- 2
12.1.2	Setting the required parameters for speed-torque control.....	12- 2
12.1.3	Setting the required data for speed-torque control .....	12- 4
12.1.4	Operation of speed-torque control.....	12- 5



## 12.1 Speed-torque control

### 12.1.1 Outline of speed-torque control

This function is used to execute the speed control or torque control that does not include the position loop for the command to servo amplifier.

Switch the control mode from "position control mode" to "speed control mode" or from "torque control mode" to execute the speed control or torque control.

Control mode	Control	Remark
Position control mode	Positioning control, OPR control, JOG operation, Inching operation and Manual pulse generator operation	Control that include the position loop for the command to servo amplifier
Speed control mode	Speed-torque control	Control that does not include the position loop for the command to servo amplifier
Torque control mode		

Use the servo amplifiers compatible with the control mode switching to execute the "Speed-torque control".

### 12.1.2 Setting the required parameters for speed-torque control

The "Positioning parameters" must be set to carry out speed-torque control.

The following table shows the setting items of the required parameters for carrying out speed-torque control. When only speed-torque control will be carried out, no parameters other than those shown below need to be set. (Use the initial values or setting values within a range where no error occurs for trouble-free operation.)

Setting item		Setting requirement	
Positioning parameters	Pr.1	Unit setting	◎
	Pr.2	Number of pulses per rotation (AP)	◎
	Pr.3	Movement amount per rotation (AL)	◎
	Pr.4	Unit magnification (AM)	◎
	Pr.8	Speed limit value	◎
	Pr.12	Software stroke limit upper limit value	○
	Pr.13	Software stroke limit lower limit value	○
	Pr.14	Software stroke limit selection	○
	Pr.22	Input signal logic selection	◎
	Pr.82	Forced stop valid/invalid selection	○
	Pr.83	Speed control 10 x multiplier setting for degree axis	○
	Pr.90	Operation setting for speed-torque control mode	○

◎ : Setting always required.

○ : Set according to requirements (Leave set to the initial value when not used.)

**REMARK**

- Positioning parameter settings work in common for all control using the LD77MH. When carrying out other control ("major positioning control", "high-level positioning control", "OPR control"), the respective setting items must also be matched and set.
- Parameters are set for each axis.
- Refer to Chapter 5 "Data Used for Positioning Control" for setting details.

## 12.1.3 Setting the required data for speed-torque control

■ Required control data setting for the control mode switching

The control data shown below must be set to execute the control mode switching.

Setting item	Setting value	Setting details	Buffer memory address	
			LD77MH4	LD77MH16
Cd.138	1	Set "1: Switching request" after setting in "Cd.139 Control mode setting".	1574+100n	4374+100n
Cd.139	→	Set the control mode to switch. 0: Position control mode 10: Speed control mode 20: Torque control mode	1575+100n	4375+100n

n: Axis No.-1

\*: Refer to Section 5.7 "List of control data" for details on the setting details.

■ Required control data setting for the speed control mode

The control data shown below must be set to execute the speed control.

Setting item	Setting value	Setting details	Buffer memory address	
			LD77MH4	LD77MH16
Cd.140	→	Set the command speed at speed control mode.	1576+100n 1577+100n	4376+100n 4377+100n
Cd.141	→	Set the acceleration time at speed control mode.	1578+100n	4378+100n
Cd.142	→	Set the deceleration time at speed control mode.	1579+100n	4379+100n

n: Axis No.-1

\*: Refer to Section 5.7 "List of control data" for details on the setting details.

■ Required control data setting for the torque control mode

The control data shown below must be set to execute the torque control.

Setting item	Setting value	Setting details	Buffer memory address	
			LD77MH4	LD77MH16
Cd.143	→	Set the command torque at torque control mode.	1580+100n	4380+100n
Cd.144	→	Set the time constant to torque forward direction at torque control mode.	1581+100n	4381+100n
Cd.145	→	Set the time constant to torque reverse direction at torque control mode.	1582+100n	4382+100n
Cd.146	→	Set the speed limit value at torque control mode.	1584+100n 1585+100n	4384+100n 4385+100n

n: Axis No.-1

\*: Refer to Section 5.7 "List of control data" for details on the setting details.

### 12.1.4 Operation of speed-torque control

#### [1] Switching of control mode

##### ■ Switching method of control mode

Set "1" in "[Cd.138] Control mode switching request" after setting the control mode in "[Cd.139] Control mode setting".

When the mode is switched to the speed control mode or torque control mode, the control data used in each control mode must be set before setting "1" in "[Cd.138] Control mode switching request".

When the switching condition is satisfied at control mode switching request, "30: Control mode switch" is set in "[Md.26] Axis operation status", and the BUSY signal turns ON. "0" is automatically stored in "[Cd.138] Control mode switching" after completion of switching.

A warning (warning code 120: Control mode switching during BUSY or warning code 121: Control mode switching during zero speed OFF) will occur if the switching condition is not satisfied, and the switching mode does not switched.

The following shows the switching condition of each control mode.

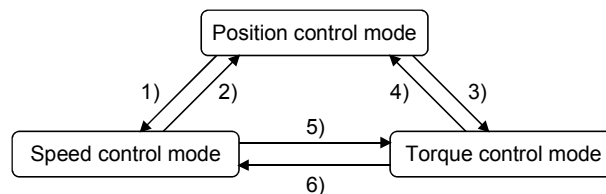

Switching operation		Switching condition
1)	Position control mode → Speed control mode	Not during positioning <sup>(Note-2)</sup> and during motor stop <sup>(Note-3)</sup>
2)	Seed control mode → Position control mode	During motor stop <sup>(Note-3)</sup>
3)	Position control mode → Torque control mode <sup>(Note-1)</sup>	Not during positioning <sup>(Note-2)</sup> and during motor stop <sup>(Note-3)</sup>
4)	Torque control mode → Position control mode <sup>(Note-1)</sup>	During motor stop <sup>(Note-3)</sup>
5)	Speed control mode → Torque control mode	None
6)	Torque control mode → Speed control mode	

(Note-1): The control mode can be changed without checking the switching condition in LD77MH of "during motor stop" by setting "1: Zero speed ON condition invalid (when switching between position and torque modes)" in "Condition selection at mode switching" of "[Pr.90] Operation setting for speed-torque control mode". However, set "1: Zero speed ON condition invalid (when switching between position and torque modes)" to switch to torque control mode without waiting for stop of servomotor immediately after positioning completion, in the case of stopper, etc. Set "0: Switching conditions valid (for switching control mode)" in the other cases.

(Note-2): BUSY signal is OFF.

(Note-3): ZERO speed is ON. (Low-order buffer memory address: b3 of "[Md.108] Servo status")

	Buffer memory address (Low-order)	
	LD77MH4	LD77MH16
[Md.108] Servo status: b3	876+100n	2476+100n

The history of control mode switching is stored to the starting history at request of control mode switching. (Refer to Section 5.6.1 "System monitor data".)

Confirm the control mode with "control mode (high-order buffer memory address: b2, b3)" of "[Md.108] Servo status". (Refer to Section 5.6.2 "Axis monitor data".)

	Buffer memory address (High-order)	
	LD77MH4	LD77MH16
[Md.108] Servo status: b2, b3	877+100n	2477+100n

■ Precautions at control mode switching

- (1) The start complete signal and positioning complete signal does not turn ON at control mode switching.
- (2) "30: Control mode switch", "31: Speed control", or "32: Torque control" is set in "[Md.26] Axis operation status", the BUSY signal turns ON.
- (3) The motor speed might change momentarily at switching from the speed control mode to torque control mode. Therefore, it recommended to switch from the speed control mode to torque control mode after the servomotors are stopped.
- (4) Set "2" in the Servo parameter "[Pr.143] Maker setting (PB25)" to use the speed control mode.

■ Operation for "Position control mode ↔ Speed control mode switching"

When the mode is switched from position control mode to speed control mode, the command speed immediately after switching is the speed set in "speed initial value selection (b8 to b11)" of "[Pr.90] Operation setting for speed-torque control mode".

Speed initial value selection ([Pr.90]: b8 to b11)	Command speed to servo amplifier immediately after switching from position control mode to speed control mode
0: Command speed	Speed that position command at switching is converted into the motor speed. (When the positioning does not start at switching, the speed to servo amplifier immediately after switching is "0".)
1: Feedback speed	Motor speed received from servo amplifier at switching. <b>CAUTION</b> The motor speed changes even when the positioning does not start (current feed value does not change) or positioning starts at constant speed. Therefore, normally set "0: Command speed" as "speed initial value selection".

When the mode is switched from speed control mode to position control mode, the command position immediately after switching is the current feed value at switching.

The following chart shows the operation timing for axis 1.

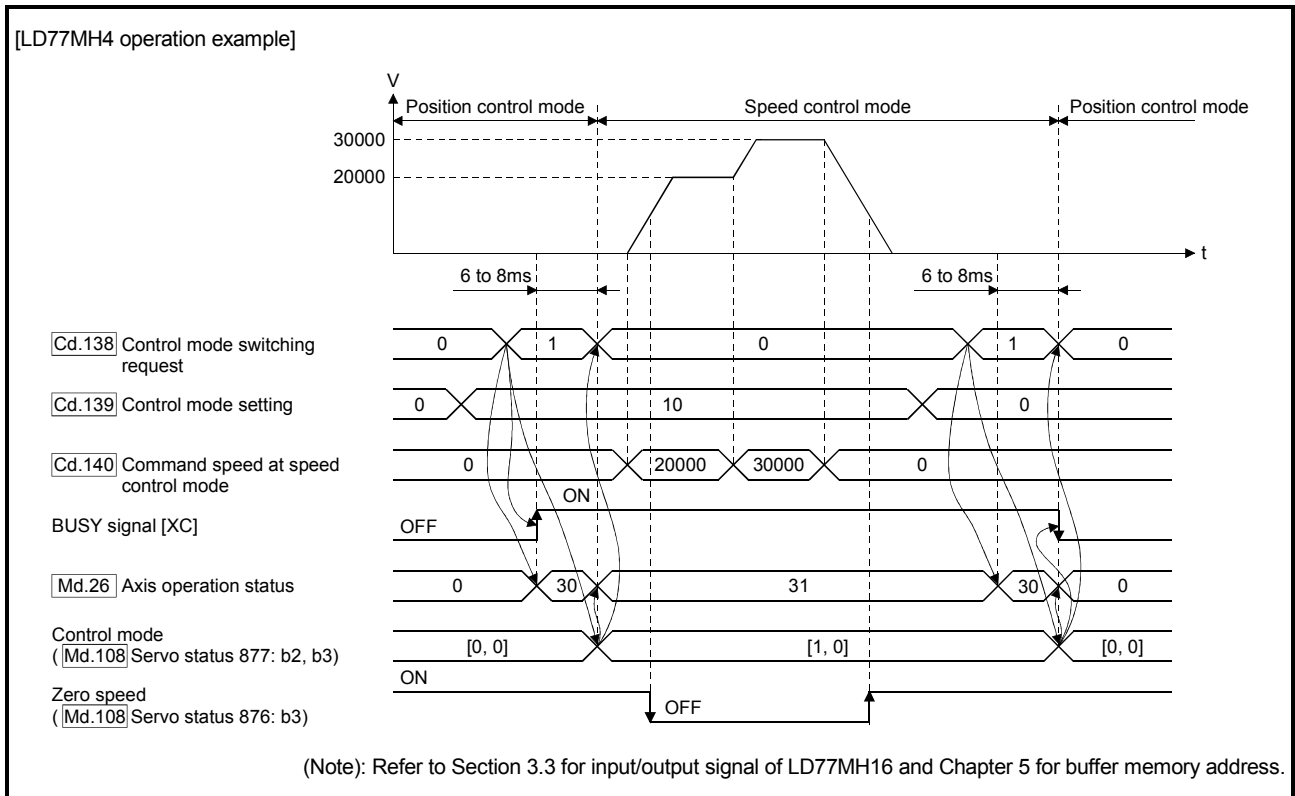

■ Operation for "Position control mode ↔ Torque control mode switching"

When the mode is switched from position control mode to torque control mode, the command torque immediately after switching is the motor current value at switching. When the mode is switched from torque control mode to position control mode, the command position immediately after switching is the current feed value at switching.

The following chart shows the operation timing for axis 1.

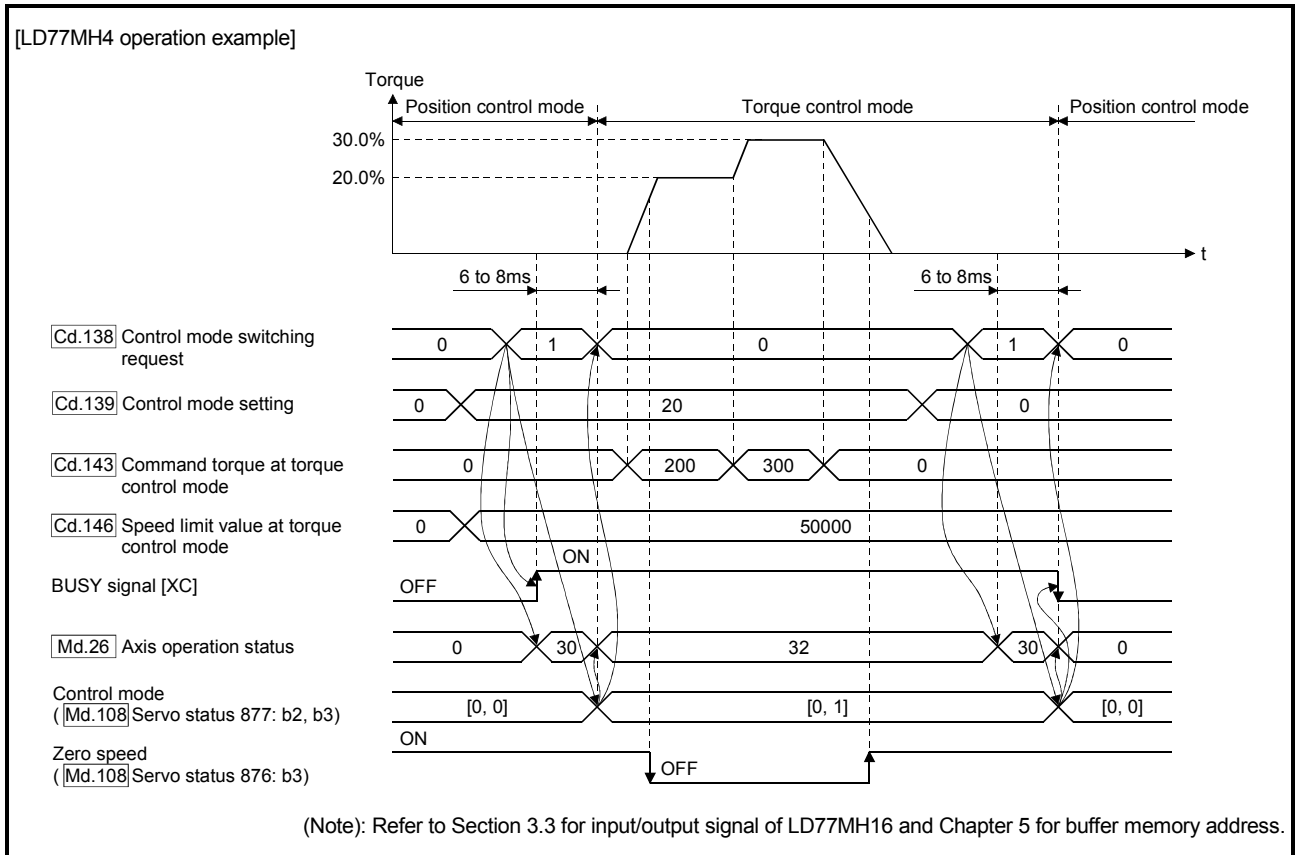

■ Operation for "Speed control mode ↔ Torque control mode switching"

When the mode is switched from speed control mode to torque control mode, the command torque immediately after switching is the motor current value at switching.

When the mode is switched from torque control mode to speed control mode, the command speed immediately after switching is the motor speed at switching.

The following chart shows the operation timing for axis 1.

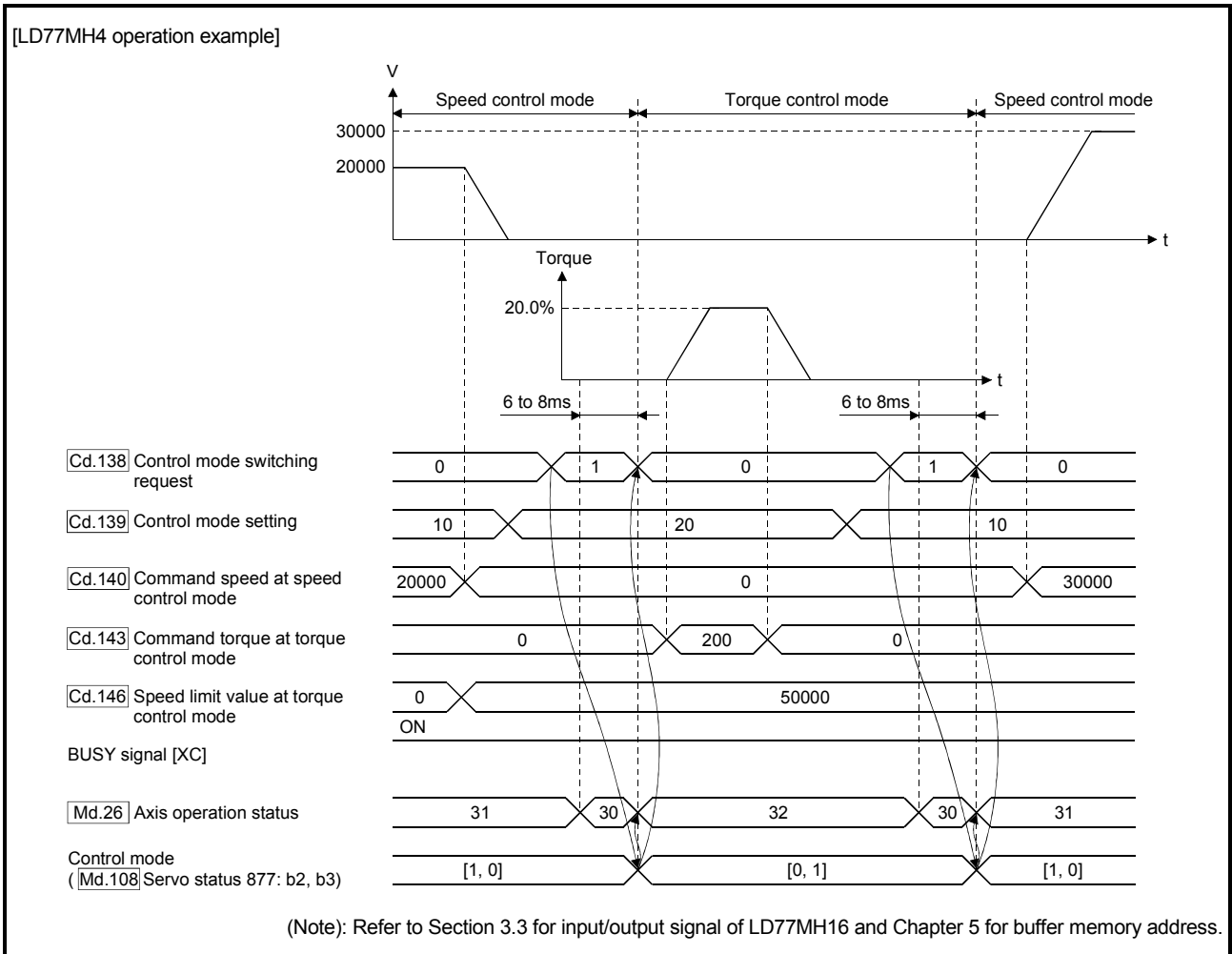



## [2] Speed control mode

## ■ Operation for speed control mode

The speed control is executed at speed set in "[Cd.140] Command speed at speed control mode" in the speed control mode. Set a positive value for forward rotation and a negative value for reverse rotation in "[Cd.140]". "[Cd.140]" can be changed any time during speed control mode.

Acceleration/deceleration is a trapezoidal acceleration/deceleration processing.

Set acceleration/deceleration time toward "[Pr.8] Speed limit value" in "[Cd.141] Acceleration time at speed control mode" and "[Cd.142] Deceleration time at speed control mode". The value at speed control mode switching request is valid for "[Cd.141]" and "[Cd.142]".

The command speed during speed control mode is limited with "[Pr.8] Speed limit value". If the speed exceeds speed limit value is set, a warning (warning code 501: Speed limit value over) will occur, the operation is controlled with speed limit value. Confirm the command speed to servo amplifier with "[Md.122] Speed during command".

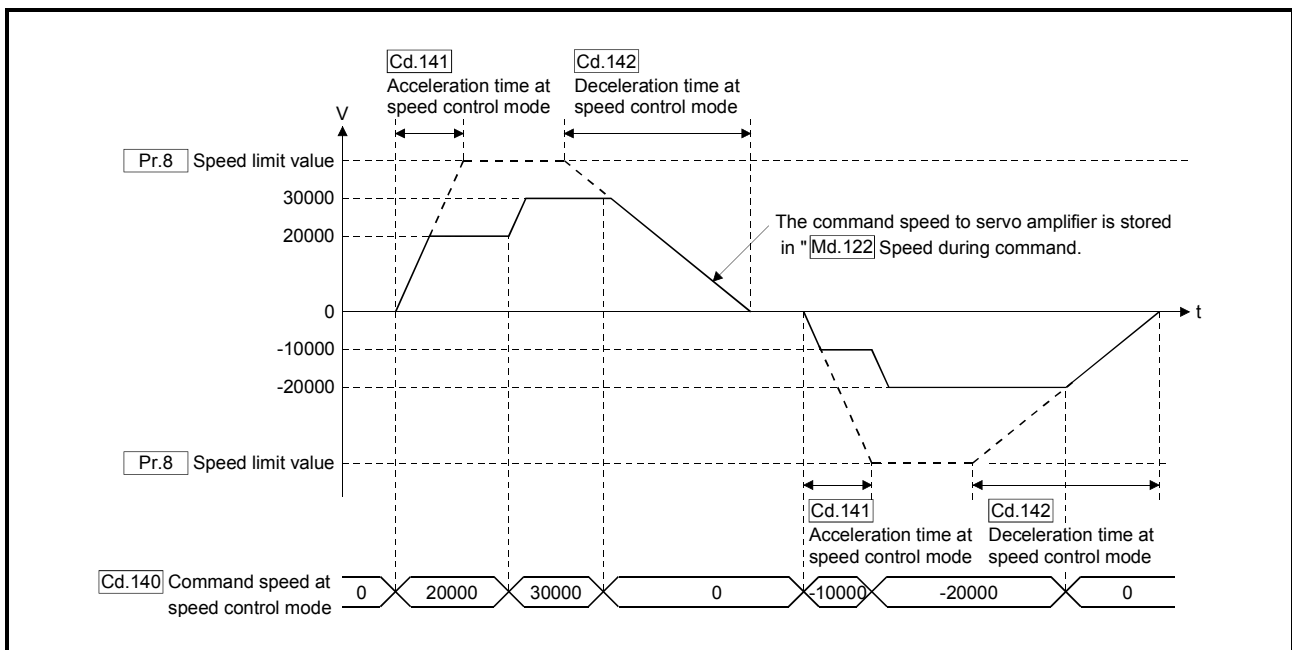

## ■ Current feed value during speed control mode

"[Md.20] Current feed value", "[Md.21] Machine feed value" and "[Md.101] Real current value" are updated.

If the current feed value exceeds the software stroke limit, an error (error code: 507, 508) will occur and the operation is switched to position control mode.

Invalidate the software stroke limit to execute one-way feed.

### ■ Stop cause during speed control mode

The operation for stop cause during speed control mode is shown below.

Item	Operation during speed control mode
The Axis stop [Y4 to Y7] turned ON. <b>LD77MH4</b>	The motor decelerates to speed "0" by setting value of "[Cd.142] Deceleration time at speed control mode". The mode is switched to position control mode when "Zero speed" of "[Md.108] Servo status" turns ON, and the operation stops.
The "[Cd.180] Axis stop" turned ON. <b>LD77MH16</b>	
The All axis servo ON [Y1] turned OFF. "[Cd.100] Servo OFF command" turned ON.	The servo OFF is not executed during speed control mode or torque control mode. The command status at that time becomes valid at position control mode switching.
The current value reached to software stroke limit. The position of motor reached to hardware stroke limit	The error (error code: 507, 508, 104, 105, 101) will occur. The mode is switched to position control mode at current position, and the operation immediately stops. (Deceleration processing is not executed.)
The PLC READY [Y0] turned OFF.	
The forced stop input to LD77MH. The emergency stop input to servo amplifier.	
The servo error occurred.	The mode is switched to position control mode when the servo OFF (Servo ON of "[Md.108] Servo status" turns OFF) is executed. (While the servo amplifier is servo OFF, even if the mode is switched to position control mode, the servomotor occurs to the free run.)
The servo amplifier's power supply turned OFF.	The mode is switched to position control mode. (The mode is to position control mode at the servo amplifier's power supply ON again.)

### [3] Torque control mode

#### ■ Operation for torque control mode

The torque control is executed at torque set in "[Cd.143] Command torque at torque control mode" in the torque control mode. Set a positive value for forward direction of torque generation direction of servo motor and a negative value for reverse direction in "[Cd.143]". "[Cd.143]" can be changed any time during torque control mode. The relation between setting of command torque and torque generation direction of servomotor differs from the setting of servo parameter "[Pr.114] Rotation direction selection".

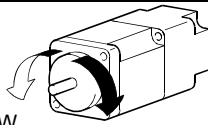
"[Pr.114] Rotation direction selection"	"[Cd.143] Command torque at torque control mode"	Torque generation direction of servo motor	
0: Forward rotation (CCW) with the increase of the positioning address	Positive value (Forward direction)	CCW direction	 CCW direction      CW direction
	Negative value (Reverse direction)	CW direction	
1: Reverse rotation (CW) with the increase of the positioning address	Positive value (Forward direction)	CW direction	
	Negative value (Reverse direction)	CCW direction	

Set time that reaches "[Pr.17] Torque limit setting value" from 0% in "[Cd.144] Torque time constant at torque control mode (Forward direction)" and time that decreases 0% from "[Pr.17] Torque limit setting value" in "[Cd.145] Torque time constant at torque control mode (Reverse direction)". The value at torque control mode switching request is valid for "[Cd.144]" and "[Cd.145]".

The command torque during torque control mode is limited with "[Pr.17] Torque limit setting value". If the torque exceed torque limit setting value is set, a warning (warning code 520: Torque limit value over) will occur, the operation is controlled with torque limit setting value.

Confirm the command torque to servo amplifier with "[Md.123] Torque during command".

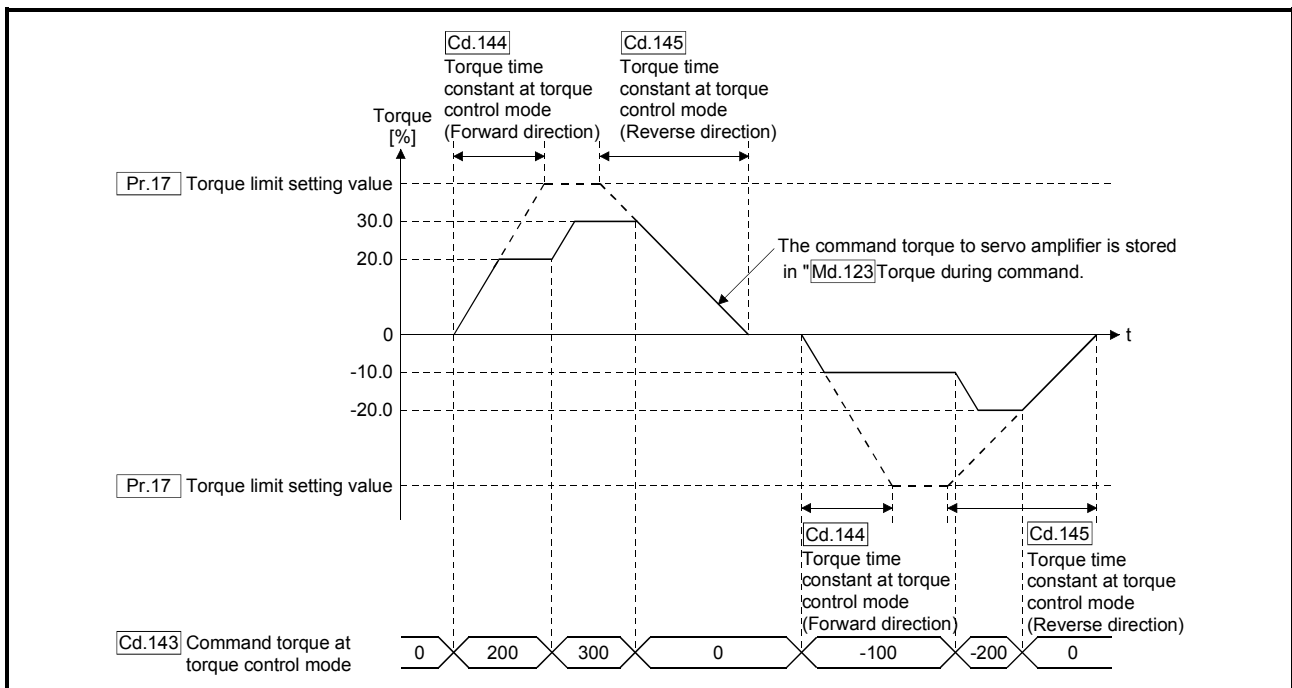

■ Speed during torque control mode

The speed during torque control mode is limited with "[Cd.146] Speed limit value at torque control mode". At this time, "low-order buffer memory address: b4 Speed limit" of "[Md.108] Servo status" turns ON.

	Buffer memory address (Low-order)	
	LD77MH4	LD77MH16
[Md.108] Servo status: b4	876+100n	2476+100n

And, "[Cd.146] Speed limit value at torque control mode" is limited with "[Pr.8] Speed limit value". If the speed exceeds speed limit value is set, a warning (warning code 501: Speed limit value over) will occur, the operation is controlled with speed limit value. The acceleration/deceleration processing is invalid for "[Cd.146] Speed limit value at torque control mode".

■ Current feed value during torque control mode

"[Md.20] Current feed value", "[Md.21] Machine feed value" and "[Md.101] Real current value" are updated. If the current feed value exceeds the software stroke limit, an error (error code: 507, 508) will occur and the operation is switched to position control mode. Invalidate the software stroke limit to execute one-way feed.

■ Stop cause during torque control mode

The operation for stop cause during torque control mode is shown below.

Item	Operation during torque control mode
The Axis stop [Y4 to Y7] turned ON. <b>LD77MH4</b>	The speed limit value commanded to servo amplifier is "0" regardless of the setting value of "[Cd.146] Speed limit value at torque control mode". The mode is switched to position control mode when "Zero speed" of "[Md.108] Servo status" turns ON, and the operation stops immediately. (Deceleration processing is not executed.)
The "[Cd.180] Axis stop" turned ON. <b>LD77MH16</b>	
The All axis servo ON [Y1] turned OFF. "[Cd.100] Servo OFF command" turned ON.	The servo OFF is not executed during speed control mode or torque control mode. The command status at that time becomes valid at position control mode switching.
The current value reached to software stroke limit.	The error (error code: 507, 508, 104, 105, 101) will occur. The mode is switched to position control mode at current position, and the operation immediately stops. (Deceleration processing is not executed.)
The position of motor reached to hardware stroke limit	
The PLC READY [Y0] turned OFF.	
The forced stop input to LD77MH.	The mode is switched to position control mode when the servo OFF (Servo ON of "[Md.108] Servo status" turns OFF) is executed. (While the servo amplifier is servo OFF, even if the mode is switched to position control mode, the servomotor occurs to the free run.)
The emergency stop input to servo amplifier.	
The servo error occurred.	The mode is switched to position control mode. (The mode is to position control mode at the servo amplifier's power supply ON again.)
The servo amplifier's power supply turned OFF.	

# MEMO

---

---

---

---

---

---

---

---

---

---

---

---

---

---

---

---

---

---

---

---

---

---

---

---

---

---

---

# Chapter 13 Control Sub Functions

The details and usage of the "sub functions" added and used in combination with the main functions are explained in this chapter.

A variety of sub functions are available, including functions specifically for machine OPR and generally related functions such as control compensation, etc. More appropriate, finer control can be carried out by using these sub functions. Each sub function is used together with a main function by creating matching parameter settings and sequence programs. Read the execution procedures and settings for each sub function, and set as required.

13.1	Outline of sub functions .....	13- 2
13.1.1	Outline of sub functions .....	13- 2
13.2	Sub functions specifically for machine OPR .....	13- 4
13.2.1	OPR retry function.....	13- 4
13.2.2	OP shift function .....	13- 8
13.3	Functions for compensating the control.....	13- 11
13.3.1	Backlash compensation function.....	13- 11
13.3.2	Electronic gear function .....	13- 13
13.3.3	Near pass function .....	13- 20
13.4	Functions to limit the control.....	13- 22
13.4.1	Speed limit function.....	13- 22
13.4.2	Torque limit function.....	13- 24
13.4.3	Software stroke limit function.....	13- 28
13.4.4	Hardware stroke limit function .....	13- 34
13.4.5	Forced stop function .....	13- 37
13.5	Functions to change the control details .....	13- 40
13.5.1	Speed change function .....	13- 40
13.5.2	Override function.....	13- 47
13.5.3	Acceleration/deceleration time change function .....	13- 50
13.5.4	Torque change function .....	13- 55
13.5.5	Target position change function .....	13- 59
13.6	Absolute position system.....	13- 63
13.7	Other functions.....	13- 65
13.7.1	Step function .....	13- 65
13.7.2	Skip function .....	13- 70
13.7.3	M code output function.....	13- 73
13.7.4	Teaching function.....	13- 77
13.7.5	Command in-position function.....	13- 83
13.7.6	Acceleration/deceleration processing function .....	13- 86
13.7.7	Pre-reading start function .....	13- 89
13.7.8	Deceleration start flag function .....	13- 92
13.7.9	Stop command processing for deceleration stop function.....	13- 95
13.7.10	Speed control 10 x multiplier setting for degree axis function .....	13- 98
13.7.11	Operation setting for incompleteness of OPR function.....	13- 100
13.8	Servo ON/OFF.....	13- 102
13.8.1	Servo ON/OFF .....	13- 102
13.8.2	Follow up function .....	13- 104

### 13.1 Outline of sub functions

"Sub functions" are functions that compensate, limit, add functions, etc., to the control when the main functions are executed. These sub functions are executed by parameter settings, operation from GX Works2, sub function sequence programs, etc.

#### 13.1.1 Outline of sub functions

The following table shows the types of sub functions available.

Sub function		Details
Functions characteristic to machine OPR	OPR retry function	This function retries the OPR with the upper/lower limit switches during machine OPR. This allows machine OPR to be carried out even if the axis is not returned to before the near-point dog with JOG operation, etc.
	OP shift function	After returning to the machine OP, this function offsets the position by the designated distance from the machine OP position and sets that position as the OP address.
Functions that compensate control	Backlash compensation function	This function compensates the mechanical backlash. Feed command equivalent to the set backlash amount are output each time the movement direction changes.
	Electronic gear function	By setting the movement amount per pulse, this function can freely change the machine movement amount per commanded pulse. When the movement amount per pulse is set, a flexible positioning system that matches the machine system can be structured.
	Near pass function *1	This function suppresses the machine vibration when the positioning data is switched during continuous path control in the interpolation control.
Functions that limit control	Speed limit function	If the command speed exceeds " [Pr.8] Speed limit value" during control, this function limits the commanded speed to within the " [Pr.8] Speed limit value" setting range.
	Torque limit function	If the torque generated by the servomotor exceeds " [Pr.17] Torque limit setting value" during control, this function limits the generated torque to within the " [Pr.17] Torque limit setting value" setting range.
	Software stroke limit function	If a command outside of the upper/lower limit stroke limit setting range, set in the parameters, is issued, this function will not execute positioning for that command.
	Hardware stroke limit function	This function carries out deceleration stop with the hardware stroke limit switch.
	Forced stop function	This function is stopped the all axes of the servo amplifier when the forced stop input signal of the LD77MH external input signal connector is turned ON.
Functions that change control details	Speed change function	This function changes the speed during positioning. Set the changed speed in the speed change buffer memory ( [Cd.14] New speed value), and change the speed with the speed change request ( [Cd.15] Speed change request).
	Override function	This function changes the speed within a percentage of 1 to 300% during positioning. This is executed using " [Cd.13] Positioning operation speed override".
	Acceleration/deceleration time change function	This function changes the acceleration/deceleration time during speed change. (Functions added to the speed change function and override function.)
	Torque change function	This function changes the "torque limit value" during control.
	Target position change function	This function changes the target position during the execution of positioning. At the same time, this also can change the speed.

\*1: The near pass function is validated only when the machine of the standard specification carries out the position control with the continuous path control mode. It cannot be invalidated with parameters.

Sub function	Details	
Absolute position system function	This function restores the absolute position of designated axis. By this function, the OPR after power ON from OFF is not required once the OPR is executed when the system operation is started.	
Other functions	Step function	This function temporarily stops the operation to confirm the positioning operation during debugging, etc. The operation can be stopped at each "automatic deceleration" or "positioning data".
	Skip function	This function stops the positioning being executed (decelerates to a stop) when the skip signal is input, and carries out the next positioning.
	M code output function	This function issues a sub work (clamp or drill stop, tool change, etc.) according to the code No. (0 to 65535) set for each positioning data.
	Teaching function	This function stores the address positioned with manual control into the positioning address ( [Da.6] Positioning address/movement amount) having the designated positioning data No.
	Command in-position function	At each automatic deceleration, this function calculates the remaining distance for the LD77MH to reach the positioning stop position, and when the value is less than the set value, sets the "command in-position flag". When using another sub work before ending the control, use this function as a trigger for the sub work.
	Acceleration/deceleration processing function	This function adjusts the control acceleration/deceleration.
	Pre-reading start function	This function shortens the virtual start time.
	Deceleration start flag function	Function that turns ON the flag when the constant speed status or acceleration status switches to the deceleration status during position control, whose operation pattern is "Positioning complete", to make the stop timing known.
	Stop command processing for deceleration stop function	Function that selects a deceleration curve when a stop cause occurs during deceleration stop processing to speed 0.
	Follow up function	This function monitors the motor rotation amount with the servo turned OFF, and reflects it on the current feed value.
Speed control 10 x multiplier setting for degree axis function	This function is executed the positioning control by the 10 x speed of the command speed and the speed limit value when the setting unit is "degree".	
Operation setting for incompleteness of OPR function	This function is provided to select whether positioning control is operated or not, when OPR request flag is ON.	



## 13.2 Sub functions specifically for machine OPR

The sub functions specifically for machine OPR include the "OPR retry function" and "OP shift function". Each function is executed by parameter setting.

### 13.2.1 OPR retry function

When the workpiece goes past the OP without stopping during positioning control, it may not move back in the direction of the OP although a machine OPR is commanded, depending on the workpiece position. This normally means the workpiece has to be moved to a position before the near-point dog by a JOG operation, etc., to start the machine OPR again. However, by using the OPR retry function, a machine OPR can be carried out regardless of the workpiece position.

The details shown below explain about the "OPR retry function".

- [1] Control details
- [2] Precautions during control
- [3] Setting the OPR retry function

#### [1] Control details

The following drawing shows the operation of the OPR retry function.

- (1) OPR retry point return retry operation when the workpiece is within the range between the upper and lower limits.

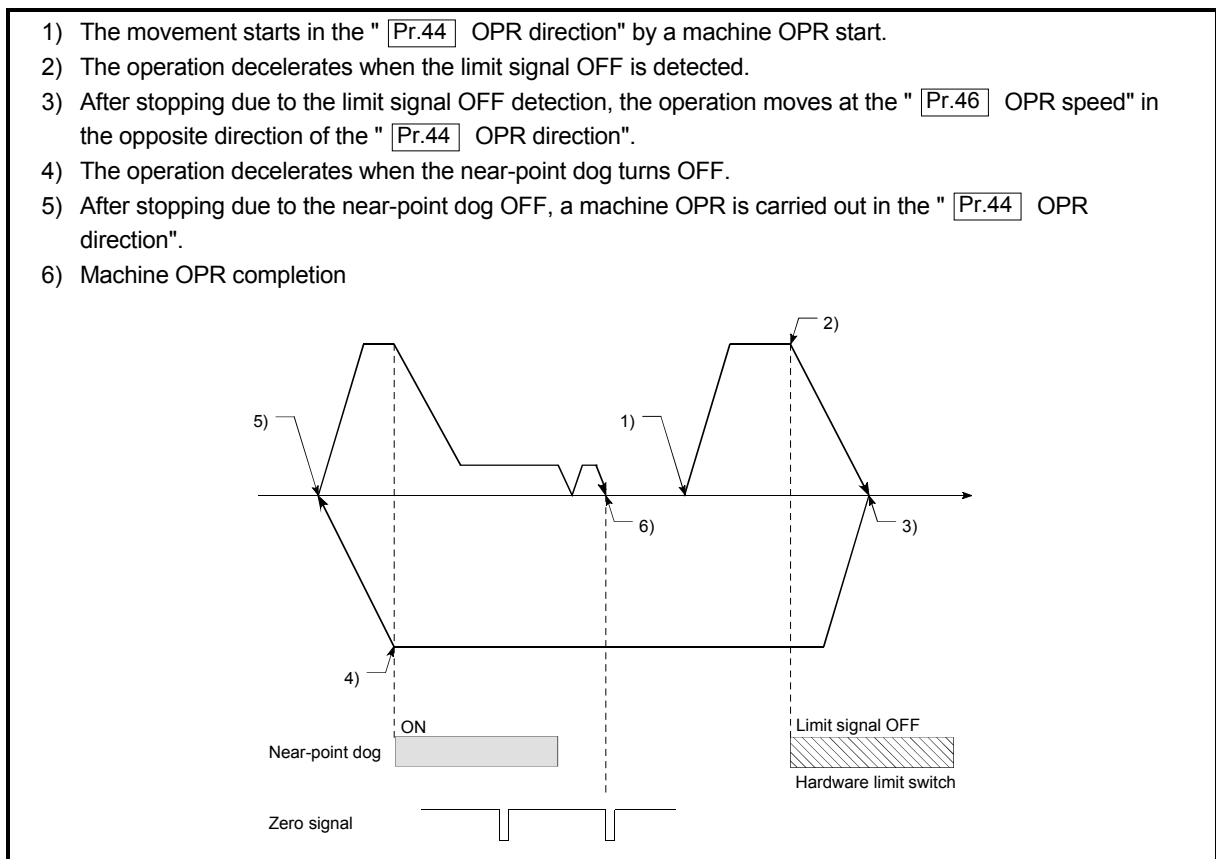
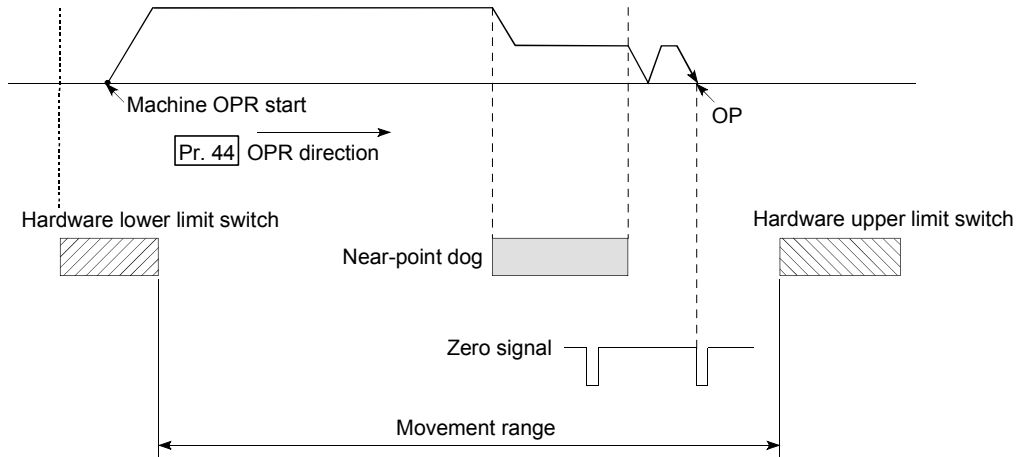

Fig. 13.1 OPR retry operation by limit signal detection

(2) OPR retry operation when the workpiece is outside the range between the upper and lower limits.

1) When the direction from the workpiece to the OP is the same as the " [Pr.44] OPR direction", a normal machine OPR is carried out.



2) When the direction from the workpiece to the OP is the opposite direction from the " [Pr.44] OPR direction", the operation carries out a deceleration stop when the near-point dog turns OFF, and then carries out a machine OPR in the direction set in " [Pr.44] OPR direction".

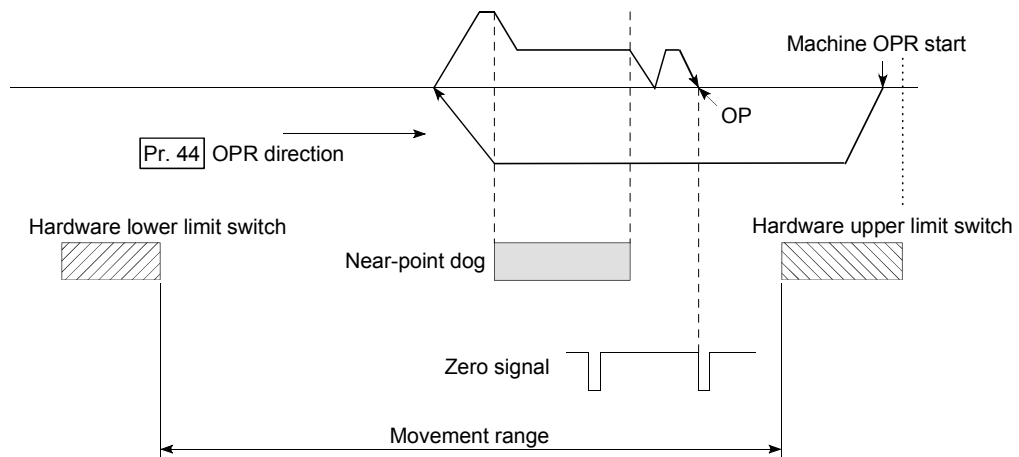

\* In the above example 1) and 2), "0: Positive direction" is set in " [Pr.44] OPR direction"

**REMARK**

- When the "0: Positive direction" is selected in " [Pr.44] OPR direction", the upper limit switch is set to the limit switch in the OPR direction.
- When the "1: Negative direction" is selected in " [Pr.44] OPR direction", the lower limit switch is set to the limit switch in the OPR direction.
- If inverting the install positions of upper/lower limit switches, hardware stroke limit function cannot be operated properly.  
If problem is found when "[Pr.114] Rotation direction selection" and the wiring for the upper/lower limit switch are checked.

Fig. 13.2 OPR retry operation from on limit (limit signal OFF)

(3) Setting the dwell time during an OPR retry

The OPR retry function can perform such function as the dwell time using "Pr.57 Dwell time during OPR retry" when the reverse run operation is carried out due to detection by the limit signal for upper and lower limits and when the machine OPR is executed after the near point dog is turned OFF to stop the operation.

"Pr.57 Dwell time during OPR retry" is validated when the operation stops at the "A" and "B" positions in the following drawing. (The dwell time is the same value at both positions "A" and "B".)

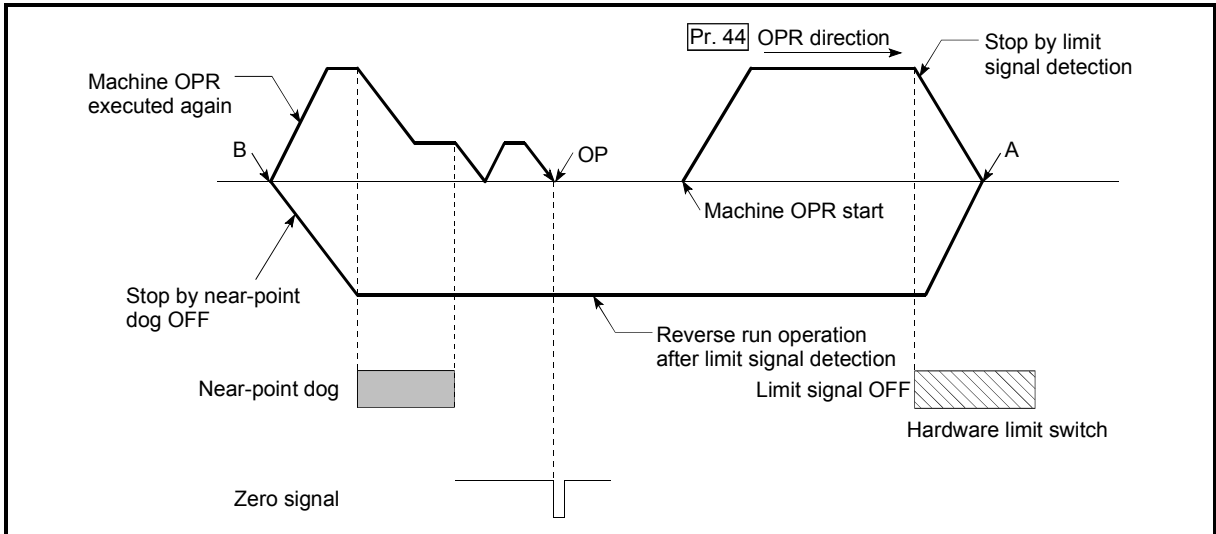

Fig. 13.3 Setting the dwell time during an OPR retry

## [2] Precaution during control

- (1) The following table shows whether the OPR retry function may be executed by the " **Pr.43** OPR method".

<b>Pr.43</b> OPR method	Execution status of OPR retry function
Near-point dog method	○ : Execution possible
Count method 1)	○ : Execution possible
Count method 2)	○ : Execution possible
Data set method	— :
Scale origin signal detection method	× : Execution not possible

- (2) Always establish upper/lower limit switches at the upper/lower limit positions of the machine, and connect an LD77MH module. If the OPR retry function is used without hardware stroke limit switches, the motor will continue rotation until a hardware stroke limit signal is detected.
- (3) Do not configure a system so that the servo amplifier power turns OFF by the upper/lower limit switches connected to the LD77MH. If the servo amplifier power is turned OFF, the OPR retry cannot be carried out.
- (4) The operation decelerates upon detection of the hardware limit signal, and the movement starts in the opposite direction. In this case, however, an error (104, 105) is not produced.

## [3] Setting the OPR retry function

To use the "OPR retry function", set the required details in the parameters shown in the following table, and write them to the LD77MH.

When the parameters are set, the OPR retry function will be added to the machine OPR control. The set details are validated at the rising edge (OFF → ON) of the PLC READY signal [Y0]. Set " **Pr.57** Dwell time during OPR retry" according to the user's requirements.

Setting item	Setting value	Setting details	Factory-set initial value
<b>Pr.48</b> OPR retry	1	Set "1: Carry out OPR retry by limit switch".	0
<b>Pr.57</b> Dwell time during OPR retry	→	Set the deceleration stop time during OPR retry. (Random value between 0 and 65535 (ms))	0

\*: Refer to Section 5.2 "List of parameters" for setting details.

### REMARK

- Parameters are set for each axis.
- It is recommended that the parameters be set whenever possible with GX Works2. Execution by sequence program uses many sequence programs and devices. The execution becomes complicated, and the scan times will increase.

### 13.2.2 OP shift function

When a machine OPR is carried out, the OP is normally established using the near-point dog, stopper, and zero signal. However, by using the OP shift function, the machine can be moved a designated movement amount from the position where the zero signal was detected. A mechanically established OP can then be interpreted at that point.

The details shown below explain about the "OP shift function".

- [1] Control details
- [2] Setting range for the OP shift amount
- [3] Movement speed during OP shift
- [4] Precautions during control
- [5] Setting the OP shift function

#### [1] Control details

The following drawing shows the operation of the OP shift function.

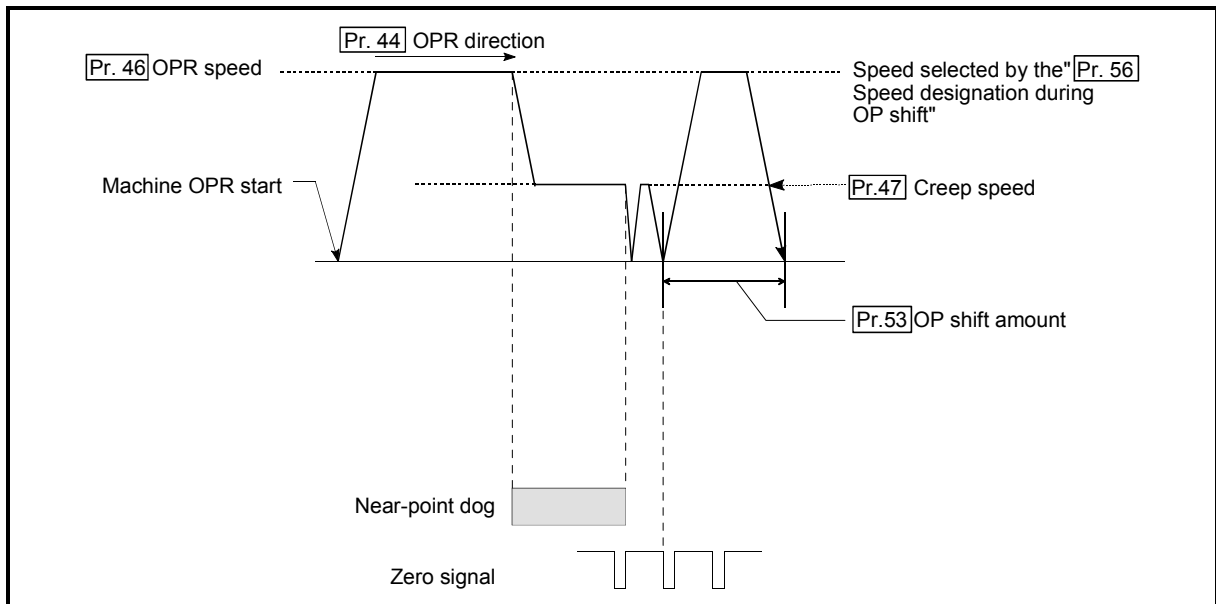

Fig. 13.4 OP shift operation

[2] Setting range for the OP shift amount

Set the OP shift amount within the range from the detected zero signal to the upper/lower limit switches.

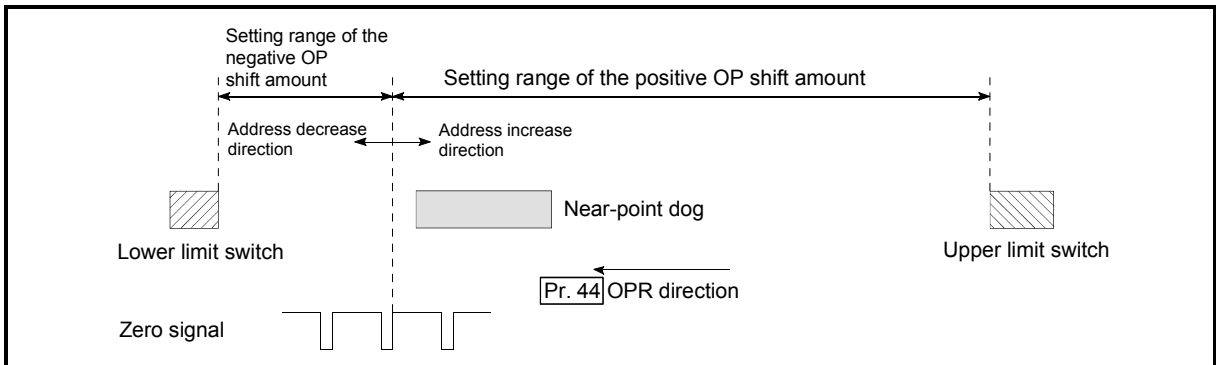

Fig. 13.5 Setting range for the OP shift amount

[3] Movement speed during OP shift

When using the OP shift function, the movement speed during the OP shift is set in "Pr.56 Speed designation during OP shift". The movement speed during the OP shift is selected from either the "Pr.46 OPR speed" or the "Pr.47 Creep speed".

The following drawings show the movement speed during the OP shift when a mechanical OPR is carried out by the near-point dog method.

(1) OP shift operation at the "Pr.46 OPR speed"

(When "Pr.56 speed designation during OP shift" is 0)

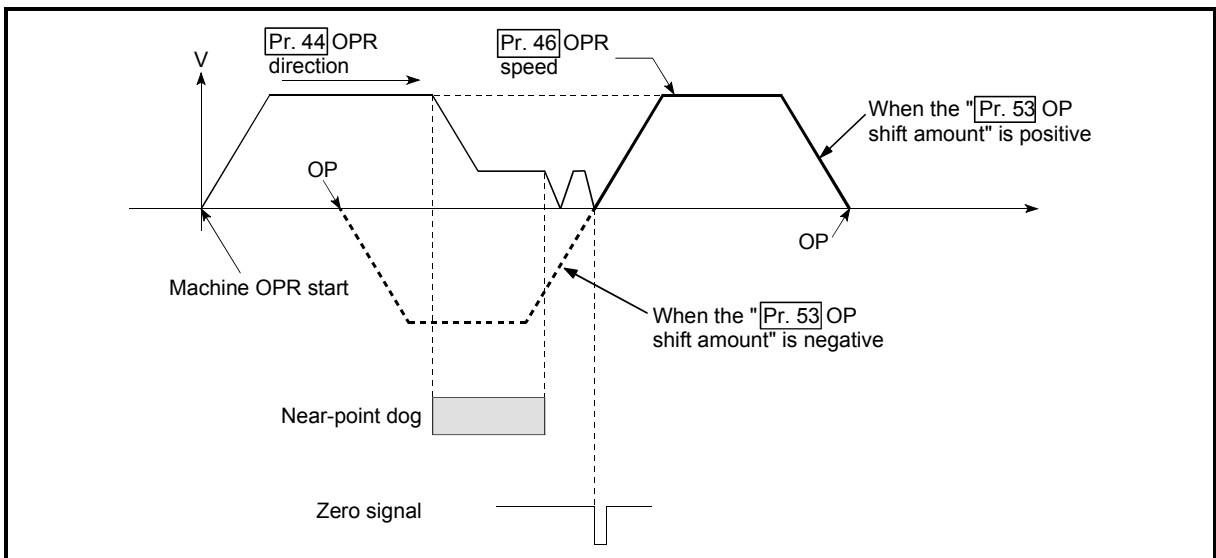

Fig. 13.6 OP shift operation at the OPR speed

- (2) OP shift operation at the " Pr.47 Creep speed"  
 (When " Pr.56 Speed designation during OP shift" is 1)

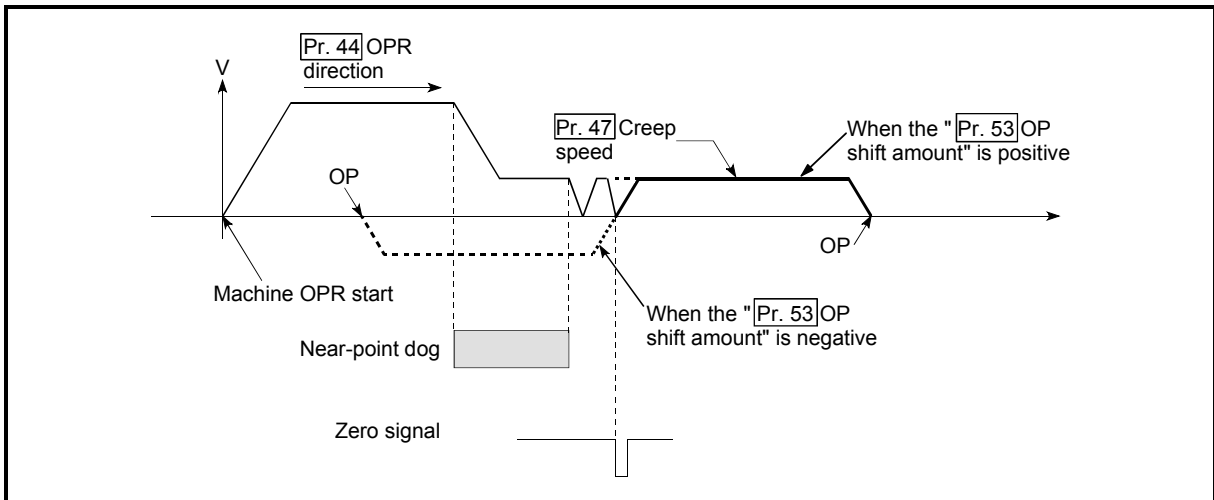

Fig. 13.7 OP shift operation at the creep speed

[4] Precautions during control

(1) The following data are set after the OP shift amount is complete.

- OPR complete flag ( Md.31 Status: b4)
- Md.20 Current feed value
- Md.21 Machine feed value
- Md.26 Axis operation status

OPR request flag ( Md.31 Status: b3) is reset after completion of the OP shift.

(2) "Pr.53 OP shift amount" is not added to "Md.34 Movement amount after near-point dog ON". The movement amount immediately before the OP shift operation, considering near-point dog ON as "0", is stored.

[5] Setting the OP shift function

To use the "OP shift function", set the required details in the parameters shown in the following table, and write them to the LD77MH.

When the parameters are set, the OP shift function will be added to the machine OPR control. The set details are validated at the rising edge (OFF → ON) of the PLC READY signal [Y0].

Setting item	Setting value	Setting details	Factory-set initial value
Pr.53	OP shift amount	→ Set the shift amount during the OP shift.	0
Pr.56	Speed designation during OP shift	→ Select the speed during the OP shift 0: Pr.46 OPR speed 1: Pr.47 Creep speed	0

\*: Refer to Section 5.2 "List of parameters" for setting details.

**REMARK**

- Parameters are set for each axis.
- It is recommended that the parameters be set whenever possible with GX Works2. Execution by sequence program uses many sequence programs and devices. The execution becomes complicated, and the scan times will increase.

### 13.3 Functions for compensating the control

The sub functions for compensating the control include the "backlash compensation function", "electronic gear function", and "near pass function". Each function is executed by parameter setting or sequence program creation and writing.

#### 13.3.1 Backlash compensation function

The "backlash compensation function" compensates the backlash amount in the mechanical system. When the backlash compensation amount is set, an extra amount of command equivalent to the set backlash amount is output every time the movement direction changes.

The details shown below explain about the "backlash compensation function".

- [1] Control details
- [2] Precautions during control
- [3] Setting the backlash compensation function

#### [1] Control details

The following drawing shows the operation of the backlash compensation function.

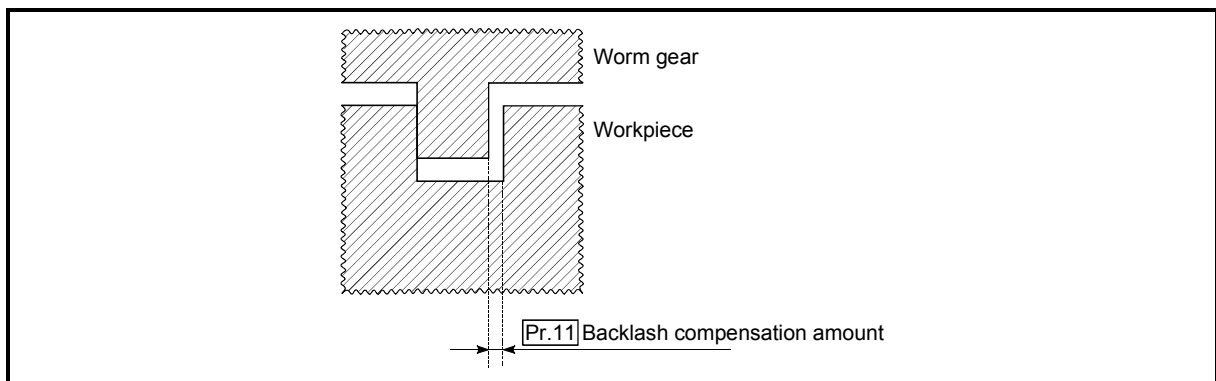

Fig. 13.8 Backlash compensation amount



**[2] Precautions during control**

- (1) The feed command of the backlash compensation amount are not added to the "  **Md.20**  Current feed value" or "  **Md.21**  Machine feed value".
- (2) Always carry out a machine OPR before starting the control when using the backlash compensation function (when "  **Pr.11**  Backlash compensation amount" is set). The backlash in the mechanical system cannot be correctly compensated if a machine OPR is not carried out.
- (3) Backlash compensation, which includes the movement amount and "  **Pr.11**  Backlash compensation amount", is output the moment at the moving direction changes.
- (4) Backlash compensation cannot be made when the speed control mode and torque control mode.

**[3] Setting the backlash compensation function**

To use the "backlash compensation function", set the "backlash compensation amount" in the parameter shown in the following table, and write it to the LD77MH.

The set details are validated at the rising edge (OFF → ON) of the PLC READY signal [Y0].

Setting item		Setting value	Setting details	Factory-set initial value
<b> Pr.11 </b>	Backlash compensation amount	→	Set the backlash compensation amount.	0

\*: Refer to Section 5.2 "List of parameters" for setting details.

**REMARK**

- Parameters are set for each axis.
- It is recommended that the parameters be set whenever possible with GX Works2. Execution by sequence program uses many sequence programs and devices. The execution becomes complicated, and the scan times will increase.

### 13.3.2 Electronic gear function

The "electronic gear function" adjusts the actual machine movement amount and number of pulse output to servo amplifier according to the parameters set in the LD77MH.

The "electronic gear function" has the following three functions ( [A] to [C] ).

- [A] During machine movement, the function increments in the LD77MH values less than one pulse that could not be output, and outputs the incremented amount when the total incremented value reached one pulse or more.
- [B] When machine OPR is completed, current value changing is completed, speed control is started (except when current feed value change is present), or fixed-feed control is started, the function clears to "0" the cumulative values of less than one pulse which could not be output. (If the cumulative value is cleared, an error will occur by a cleared amount in the feed machine value. Control can be constantly carried out at the same machine movement amount, even when the fixed-feed control is continued.)
- [C] The function compensates the mechanical system error of the command movement amount and actual movement amount by adjusting the "electronic gear".  
(The "movement amount per pulse" value is defined by " [Pr.2] Number of pulses per rotation (AP)", " [Pr.3] Movement amount per rotation (AL)" and " [Pr.4] Unit magnification (AM)".)

The LD77MH automatically carries out the processing for [A] and [B].

The details shown below explain about the "electronic gear function", including the method for compensating the error in [C] above, etc.

[1] Basic concept of the electronic gear

[2] The method for compensating the error

[1] Basic concept of the electronic gear

The electronic gear is an item which determines how many rotations (rotations by how many pulses) the motor must make in order to move the machine according to the programmed movement amount.

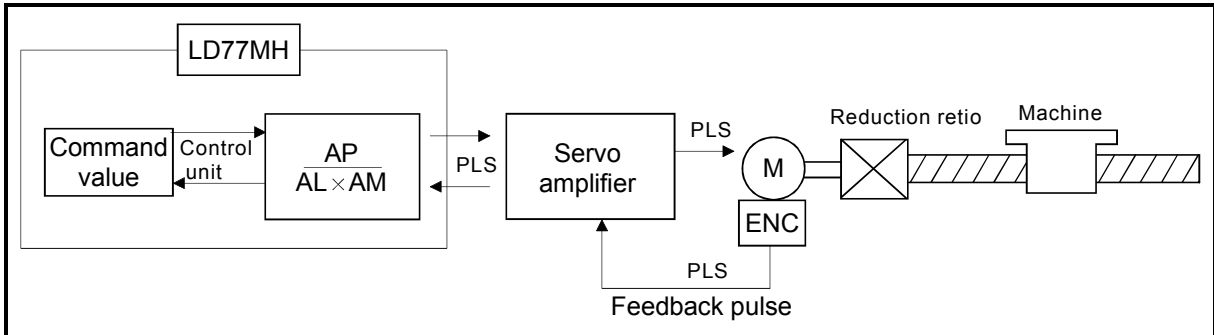

The basic concept of the electronic gear is represented by the following expression.

- Pr.2 (Number of pulses per rotation) = AP
- Pr.3 (Movement amount per rotation) = AL
- Pr.4 (Unit magnification) = AM
- Movement amount per rotation that considered unit magnification = ΔS

$$\text{Electronic gear} = \frac{AP}{\Delta S} = \frac{AP}{AL \times AM} \dots(1)$$

Set values for AP, AL and AM so that this related equation is established. However, because values to be set for AP, AL and AM have the settable range, values calculated (reduced) from the above related equation must be contained in the setting range for AP, AL and AM.

(1) For "Ball screw" + "Reduction gear"

When the ball screw pitch is 10mm, the motor is the HF-KP (262144 PLS/rev) and the reduction ratio of the reduction gear is 9/44.

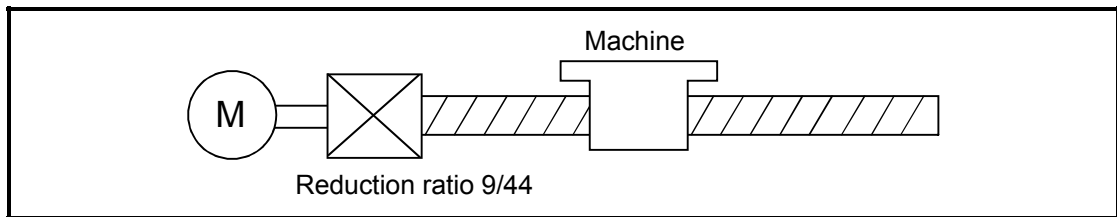

First, find how many millimeters the load (machine) will travel ( $\Delta S$ ) when the motor turns one revolution (AP).

- AP (Number of pulses per rotation) = 262144 [PLS]
- $\Delta S$  (Movement amount per rotation)
  - = Ball screw pitch  $\times$  Reduction ratio
  - = 10 [mm]  $\times$  9/44
  - = 10000.0 [ $\mu$ m]  $\times$  9/44

Substitute this for the above expression (1).

At this time, make calculation with the reduction ratio 9/44 remaining as a fraction.

$$\begin{aligned}
 \frac{AP}{\Delta S} &= \frac{262144}{10000.0 [\mu\text{m}] \times 9/44} \\
 &= \frac{262144 \times 44}{10000.0 \times 9} \\
 &= \frac{11534336}{90000.0} \\
 &= \frac{1441792}{11250.0} = \frac{1441792 (AP)}{11250.0 (AL) \times 1 (AM)} \\
 &= \frac{1441792 (AP)}{1125.0 (AL) \times 10 (AM)}
 \end{aligned}$$

Thus, AP, AL and AM to be set are as follows.

$$\begin{aligned}
 AP &= 1441792 \dots \boxed{\text{Pr.2}} & AP &= 1441792 \dots \boxed{\text{Pr.2}} \\
 AL &= 11250.0 \dots \boxed{\text{Pr.3}} & \text{or} & AL &= 1125.0 \dots \boxed{\text{Pr.3}} \\
 AM &= 1 \dots \boxed{\text{Pr.4}} & AM &= 10 \dots \boxed{\text{Pr.4}}
 \end{aligned}$$

Note): These two examples of settings are only examples. There are settings other than these examples.

(2) When "PLS (pulse)" is set as the control unit

When using PLS (pulse) as the control unit, set the electronic gear as follows.

- AP = "Number of pulses per rotation"
- AL = "Movement amount per rotation"
- AM = 1

Example) When the motor is the HF-KP (262144PLS/rev)

- AP = 262144 .. Pr.2
- AL = 262144 .. Pr.3
- AM = 1 ..... Pr.4

(3) When "degree" is set as the control unit for a rotary axis

When the rotary axis is used, the motor is HF-KP (262144PLS/rev) and the reduction ratio of the reduction gear is 3/11

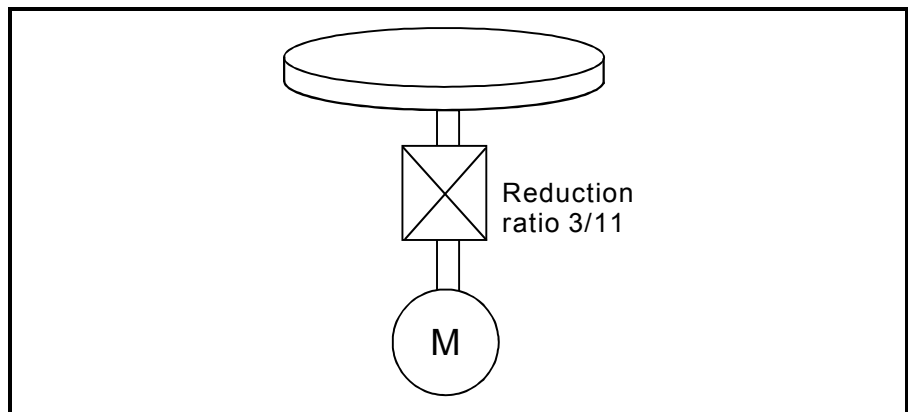

First, find how many degrees the load (machine) will travel ( $\Delta S$ ) when the motor turns one revolution (AP).

- AP (Number of pulses per rotation) = 262144 [PLS]
- $\Delta S$  (Movement amount per rotation)
  - = 360.00000 [degree]  $\times$  Reduction ratio
  - = 360.00000  $\times$  3/11

Substitute this for the above expression (1).

$$\begin{aligned} \frac{AP}{\Delta S} &= \frac{262144 \text{ [PLS]}}{360.00000 \text{ [degree]} \times 3/11} \\ &= \frac{262144 \text{ [PLS]} \times 11}{360.00000 \times 3} \\ &= \frac{2883584}{1080.00000} \\ &= \frac{180224}{67.50000} = \frac{180224 \text{ (AP)}}{67.50000 \text{ (AL)} \times 1 \text{ (AM)}} \\ &= \frac{180224 \text{ (AP)}}{0.06750 \text{ (AL)} \times 1000 \text{ (AM)}} \end{aligned}$$

Thus, AP, AL and AM to be set are as follows.

$$\begin{aligned} AP &= 180224 \dots \text{Pr.2} & AP &= 180224 \dots \text{Pr.2} \\ AL &= 67.50000 \dots \text{Pr.3} & \text{or} & AL &= 0.06750 \dots \text{Pr.3} \\ AM &= 1 \dots \text{Pr.4} & AM &= 1000 \dots \text{Pr.4} \end{aligned}$$

Note): These two examples of settings are only examples. There are settings other than these examples.)

(4) When "mm" is set as the control unit for conveyor drive (calculation including  $\pi$ )

When the belt conveyor drive is used, the conveyor diameter is 135mm, the pulley ratio is 1/3, the motor is HF-KP (262144PLS/rev) and the reduction ratio of the reduction gear is 7/53.

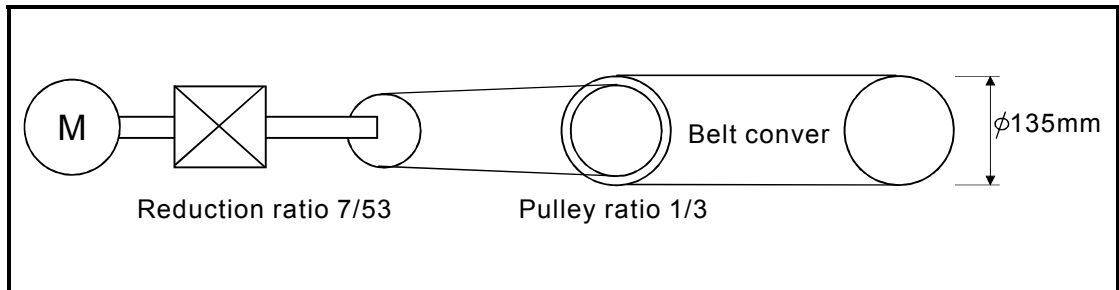

As the travel value of the conveyor is used to exercise control, set "mm" as the control unit.

First, find how many millimeters the load (machine) will travel ( $\Delta S$ ) when the motor turns one revolution (AP).

- AP (Number of pulses per rotation) = 262144 [PLS]
- $\Delta S$  (Movement amount per rotation)
  - =  $135000.0 [\mu\text{m}] \times \pi \times \text{Reduction ratio}$
  - =  $135000.0 [\mu\text{m}] \times \pi \times 7/53 \times 1/3$

Substitute this for the above expression (1).

At this time, make calculation with the reduction ratio  $7/53 \times 1/3$  remaining as a fraction.

$$\begin{aligned} \frac{AP}{\Delta S} &= \frac{AP}{AL \times AM} = \frac{262144 \text{ [PLS]}}{135000.0 [\mu\text{m}] \times \pi \times 7/53 \times 1/3} \\ &= \frac{262144 \times 53 \times 3}{135000.0 \times \pi \times 7} \end{aligned}$$

Here, make calculation on the assumption that  $\pi$  is equal to 3.141592654.

$$\frac{AP}{\Delta S} = \frac{AP}{AL \times AM} = \frac{41680896}{2968805.058}$$

AL has a significant number to first decimal place, round down numbers to two decimal places.

$$\frac{\Delta S}{AP} = \frac{AP}{AL \times AM} = \frac{41680896}{2968805.0} = \frac{41680896 (AP)}{2968805.0 (AL) \times 1(AM)}$$

Thus, AP, AL and AM to be set are as follows.

AP = 41680896 ..... Pr.2

AL = 2968805.0 ..... Pr.3

AM = 1 ..... Pr.4

This setting will produce an error for the true machine value, but it cannot be helped. This error is as follows.

$$\left( \frac{29688050/41680896}{9450000 \pi \times 41680896} - 1 \right) \times 100 = -1.95 \times 10^{-6} [\%]$$

It is equivalent to an about 19.5 [μm] error in continuous 1km feed.

(5) Number of pulses/ movement amount at linear servo use

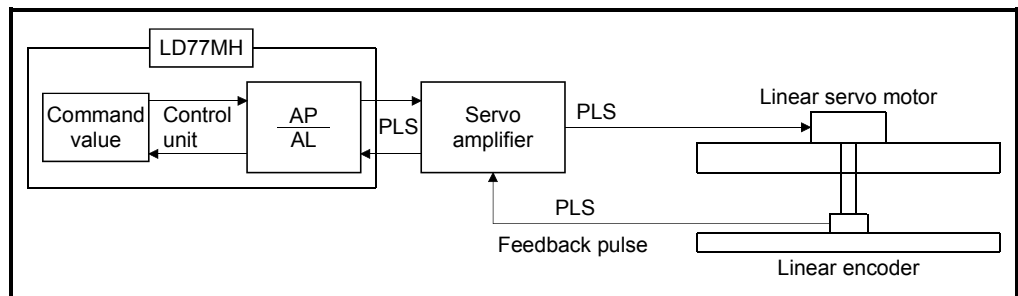

Calculate the number of pulses (AP) and movement amount (AL) for the linear encoder in the following conditions.

$$\text{Linear encoder resolution} = \frac{\text{Number of pulses (AP)}}{\text{Movement amount (AL)}}$$

Linear encoder resolution: 0.05[μm]

$$\frac{\text{Number of pulses (AP) [PLS]}}{\text{Movement amount (AL) [μm]}} = \frac{1}{0.05} = \frac{20}{1.0}$$

Set the number of pulses in " Pr.2 Number of pulses per rotation (AP)", and the movement amount in " Pr.3 Movement amount per rotation (AL)" in the actual setting.

(Note): Set the same value as the value set in the fixed parameter to the servo parameter " Pr.269 Linear encoder resolution setting Numerator" and " Pr.270 Linear encoder resolution setting Denominator".

Refer to the "Servo amplifier Instruction Manual" for details.

Servo amplifier type	Instruction manual name
MR-J3-□B-RJ004	Compatible Linear Servo MR-J3-□B-RJ004 Instruction Manual (SH-030054)

[2] The method for compensating the error

When the position control is carried out using the "Electronic gear" set in a parameter, this may produce an error between the command movement amount (L) and the actual movement amount (L'). With LD77MH, this error is compensated by adjusting the electronic gear. The "Error compensation amount", which is used for error compensation, is defined as follows:

$$\text{Error compensation amount} = \frac{\text{Command movement amount (L)}}{\text{Actual movement amount (L')}} \dots(2)$$

The electronic gear including an error compensation amount is shown below.

$$\frac{AP}{AL \times AM} \times \frac{L}{L'} = \frac{AP'}{AL' \times AM'}$$

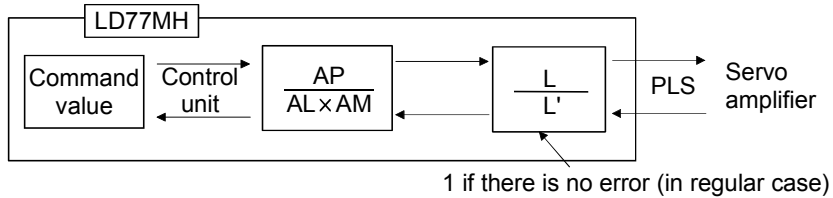

Electronic gear taking an error into consideration

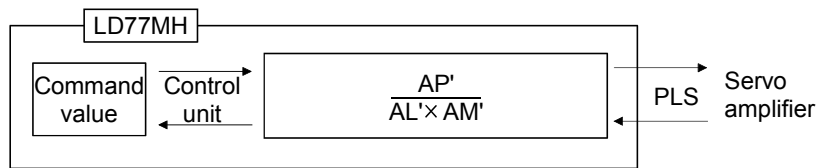

--- Calculation example ---

(Conditions)

- Number of pulses per rotation (AP) : 262144 [PLS]
- Movement amount per rotation (AL) : 5000.0 [μm]
- Unit magnification (AM) : 1

(Positioning results)

- Command movement amount (L) : 100 [mm]
- Actual movement amount (L') : 101 [mm]

(Compensation value)

$$\frac{AP}{AL \times AM} \times \frac{L}{L'} = \frac{262144}{5000.0 \times 1} \times \frac{100}{101} = \frac{262144 (AP')}{5050 (AL') \times 1 (AM')}$$

- Number of pulses per rotation (AP') : 262144 ... [Pr.2]
- Movement amount per rotation (AL') : 5050.0 .... [Pr.3]
- Unit magnification (AM') : 1 ..... [Pr.4]

Set the post-compensation " [Pr.2] Number of pulses per rotation (AP')", " [Pr.3] Movement amount per rotation (AL')", and " [Pr.4] Unit magnification (AM')" in the parameters, and write them to the LD77MH. The set details are validated at the rising edge (OFF → ON) of the PLC READY signal [Y0].



### 13.3.3 Near pass function

When continuous pass control is carried out using interpolation control, the near pass function is carried out.

The "near pass function" is a function to suppress the mechanical vibration occurring at the time of switching the positioning data when continuous pass control is carried out using interpolation control.

[Near pass function]

The extra movement amount occurring at the end of each positioning data unit being continuously executed is carried over to the next positioning data unit. Alignment is not carried out, and thus the output speed drops are eliminated, and the mechanical vibration occurring during speed changes can be suppressed. Because alignment is not carried out, the operation is controlled on a path that passes near the position set in "Da.6] Positioning address/movement amount".

The details shown below explain about the "near pass function".

- [1] Control details
- [2] Precautions during control

#### [1] Control details

The following drawing shows the path of the continuous path control by the 2-axis linear interpolation control.

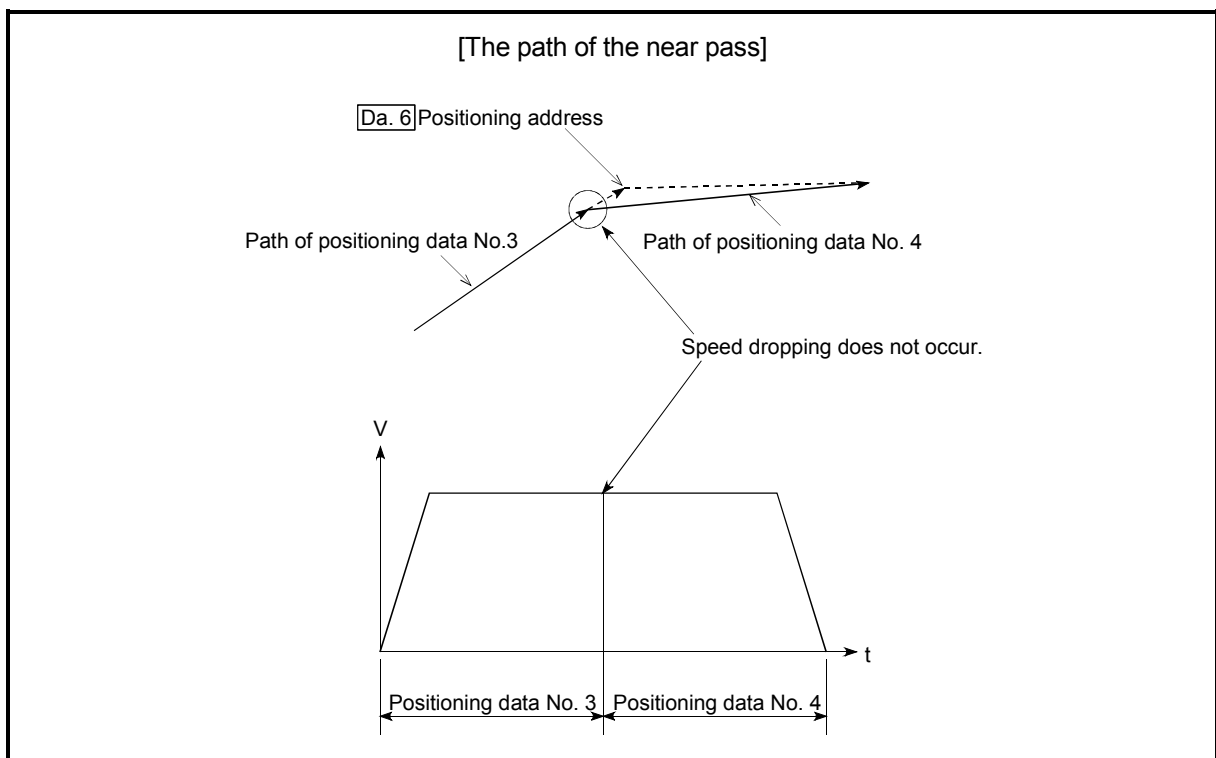

Fig. 13.9 The path of the continuous path control

[2] Precautions during control

- (1) If the movement amount designated by the positioning data is small when the continuous path control is executed, the output speed may not reach the designated speed.
- (2) The movement direction is not checked during interpolation operation. Therefore, a deceleration stops are not carried out even if the movement direction changes. (See below) For this reason, the output will suddenly reverse when the reference axis movement direction changes. To prevent the sudden output reversal, assign not the continuous path control "11", but the continuous positioning control "01" to the positioning data of the passing point.

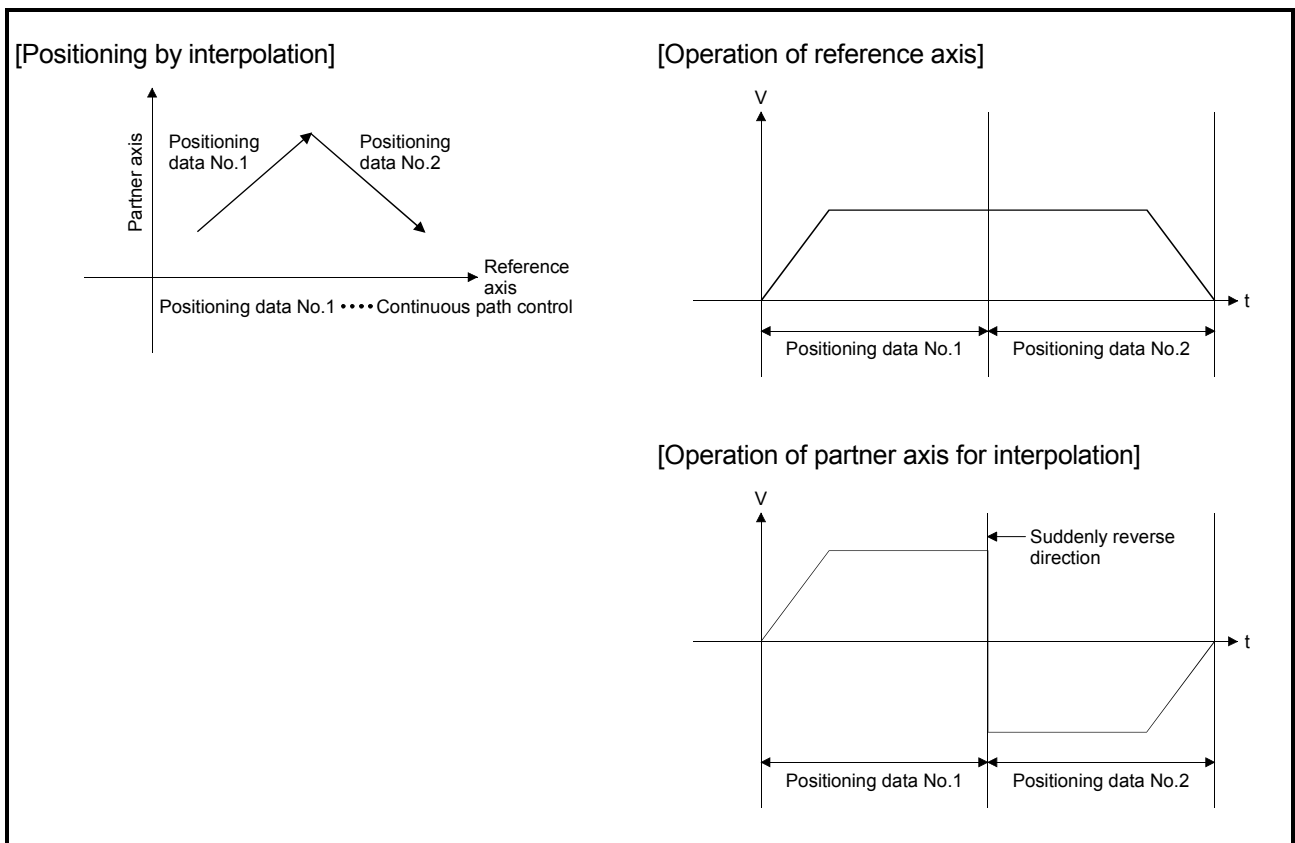

Fig. 13.10 Path and output speed of various axes when movement direction varies during continuous path control

## 13.4 Functions to limit the control

Functions to limit the control include the "speed limit function", "torque limit function", "software stroke limit function", "hardware stroke limit function", and "forced stop function". Each function is executed by parameter setting or sequence program creation and writing.

### 13.4.1 Speed limit function

The speed limit function limits the command speed to a value within the "speed limit value" setting range when the command speed during control exceeds the "speed limit value".

The details shown below explain about the "speed limit function".

[1] Relation between the speed limit function and various controls

[2] Precautions during control

[3] Setting the speed limit function

#### [1] Relation between the speed limit function and various controls

The following table shows the relation of the "speed limit function" and various controls.

Control type		Speed limit function	Speed limit value	
OPR control	Machine OPR control	◎	[Pr.8] Speed limit value	
	Fast OPR control	◎		
Major positioning control	Position control	1-axis linear control		◎
		2 to 4-axes linear interpolation control		◎
		1-axis fixed-feed control		◎
		2 to 4-axes fixed-feed control (interpolation)		◎
		2-axis circular interpolation control		◎
	1 to 4-axes Speed control	◎		
	Speed-position switching control, Position-speed switching control	◎		
Other control	Current value changing	—		Setting value invalid
	JUMP instruction, NOP instruction, LOOP to LEND	—		
Manual control	JOG operation, Inching operation	◎	[Pr.31] JOG speed limit value	
	Manual pulse generator operation	—	Setting is invalid	
Expansion control	Speed-torque control	◎	[Pr.8] Speed limit value	

◎ : Always set

— : Setting not required (Setting value is invalid. Use the initial value or a value within the setting range.)

**[2] Precautions during control**

If any axis exceeds " [Pr.8] Speed limit value" during 2- to 4-axis speed control, the axis in excess of the speed limit value is controlled at the speed limit value. The speeds of the other axes interpolated are suppressed depending on their command speed ratios.

If the reference axis exceeds " [Pr.8] Speed limit value" during 2- to 4-axis linear interpolation control, 2- to 4-axis fixed-feed control or 2-axis circular interpolation control, the reference axis is controlled at the speed limit value (The speed limit does not function on the interpolation axis side.)

**[3] Setting the speed limit function**

To use the "speed limit function", set the "speed limit value" in the parameters shown in the following table, and write them to the LD77MH.

The set details are validated after they are written to the LD77MH.

Setting item		Setting value	Setting details	Factory-set initial value
[Pr.8]	Speed limit value	→	Set the speed limit value (max. speed during control).	200000
[Pr.31]	JOG speed limit value	→	Set the speed limit value during JOG operation (max. speed during control). (Note that [Pr.31] JOG speed limit value shall be less than or equal to [Pr.8] Speed limit value.)	20000

\*: Refer to Section 5.2 "List of parameters" for setting details.

**REMARK**

- Parameters are set for each axis.
- It is recommended that the parameters be set whenever possible with GX Works2. Execution by sequence program uses many sequence programs and devices. The execution becomes complicated, and the scan times will increase.

### 13.4.2 Torque limit function

The "torque limit function" limits the generated torque to a value within the "torque limit value" setting range when the torque generated in the servomotor exceeds the "torque limit value".

The "torque limit function" protects the deceleration function, limits the power of the operation pressing against the stopper, etc. It controls the operation so that unnecessary force is not applied to the load and machine.

The details shown below explain about the "torque limit function".

[1] Relation between the torque limit function and various controls

[2] Control details

[3] Precautions during control

[4] Setting the torque limit function

#### [1] Relation between the torque limit function and various controls

The following table shows the relation of the "torque limit function" and various controls.

Control type		Torque limit function	Torque limit value *
OPR control	Machine OPR control	○	" [Pr.17] Torque limit setting value" or " [Cd.101] Torque output setting value". *: After the " [Pr.47] Creep speed" is reached, this value becomes the " [Pr.54] OPR torque limit value".
	Fast OPR control	○	
Major positioning control	Position control	1-axis linear control	○
		2 to 4-axes linear interpolation control	○
		1-axis fixed-feed control	○
		2 to 4-axes fixed-feed control (interpolation)	○
		2-axis circular interpolation control	○
	1 to 4-axes speed control	○	
	Speed-position switching control	○	
	Position-speed switching control	○	
Other control	Current value changing	–	Setting value is invalid.
	JUMP instruction, NOP instruction, LOOP to LEND	–	
Manual control	JOG operation, Inching operation	○	" [Pr.17] Torque limit setting value" or " [Cd.101] Torque output setting value".
	Manual pulse generator operation	○	
Expansion control	Speed-torque control	○	Torque limit value is continued after control mode switching.

○ : Set when required (Set to " – " when not used.)

– : Setting not required (Setting value is invalid. Use the initial value or a value within the setting range.)

\* : Shows the torque limit value when " [Cd.22] New torque value/forward new torque value" or " [Cd.113] Reverse new torque value" is set to "0".

## [2] Control details

The following drawing shows the operation of the torque limit function.

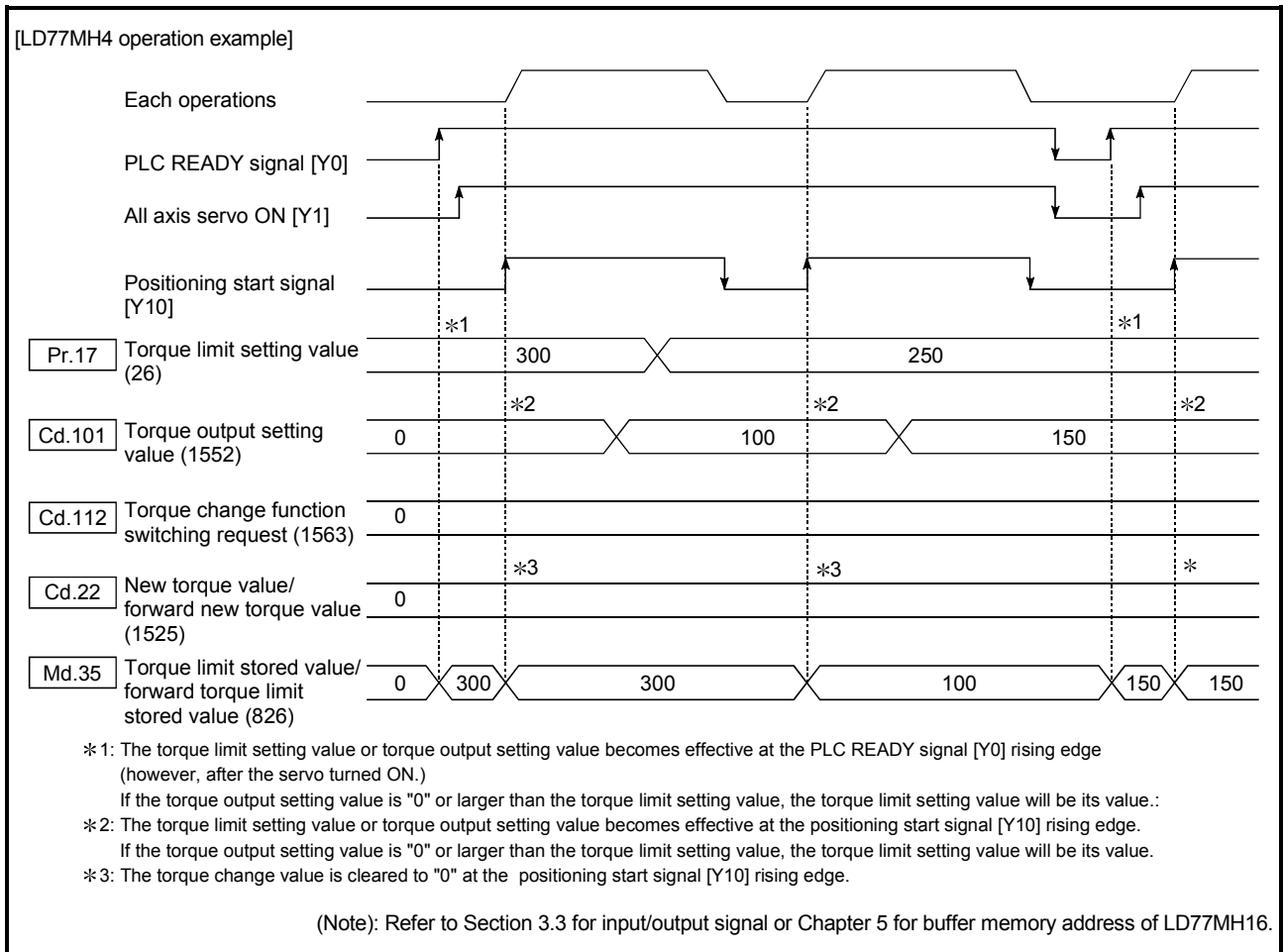

Fig. 13.11 Torque limit function operation

## [3] Precautions during control

- (1) When limiting the torque at the " Pr.17 Torque limit setting value", confirm that " Cd.22 New torque value/forward new torque value" or "Cd.113 Reverse new torque value" is set to "0". If this parameter is set to a value besides "0", the setting value will be validated, and the torque will be limited at that value. (Refer to Section 13.5.4 "Torque change function" for details about the "new torque value".)
- (2) When the " Pr.54 OPR torque limit value "exceeds the " Pr.17 Torque limit setting value", an error occurs. (Error code: 995)
- (3) When the operation is stopped by torque limiting, the droop pulse will remain in the deviation counter. If the load torque is eliminated, operation for the amount of droop pulses will be carried out.

[4] Setting the torque limit function

(1) To use the "torque limit function", set the "torque limit value" in the parameters shown in the following table, and write them to the LD77MH.

a) The set details are validated at the rising edge (OFF → ON) of the PLC READY signal [Y0].

Setting item	Setting value	Setting details	Factory-set initial value
Pr.17 Torque limit setting value	→	Set the torque limit value as a percentage.	300
Pr.54 OPR torque limit value	→	Set the torque limit value after the " Pr.47 Creep speed" is reached. Set as a percentage.	300

b) The set details are validated at the rising edge (OFF → ON) of the positioning start signal [Y10].

Setting item	Setting value	Setting details	Factory-set initial value
Cd.101 Torque output setting value	→	Set the torque output setting value as a percentage.	0

- \*: Refer to Section 5.2 "List of parameters" or Section 5.7 "List of control data" for setting details.
- \*: Torque limit value: Will be an upper limit value of the torque change value. Even if a larger value has been mistakenly input for the torque change value, it is restricted within the torque limit setting values to prevent an erroneous entry. (Even if a value larger than the torque limit setting value has been input to the torque change value, the torque value is not changed.)
- \*: Torque output setting value: to be taken at the start of positioning, and used as a torque limit value. If the value is "0" or larger than the torque limit setting value, the parameter "torque limit setting value" is taken at the start.

(2) The "torque limit value" set in the LD77MH is set in the " Md.35 Torque limit stored value/forward torque limit stored value" or "Md.120 Reverse torque limit stored value".

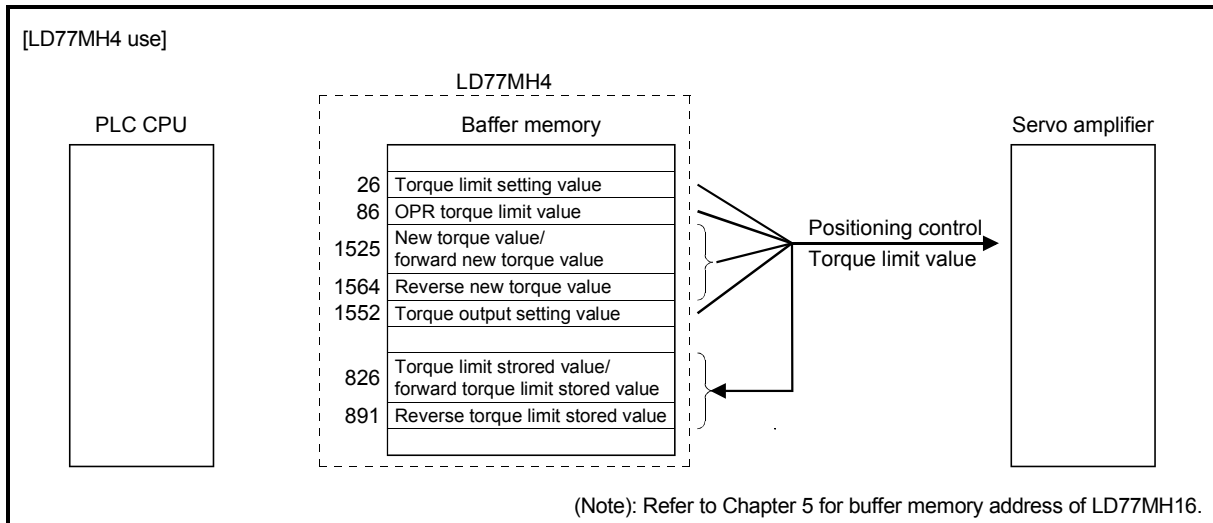

Fig. 13.12 Limiting the torque to the servo amplifier (Axis 1)

The following table shows the "Md.35 Torque limit stored value/forward torque limit stored value" and "Md.120 Reverse torque limit stored value" of the buffer memory address.

Monitor item		Monitor value	Storage details	Buffer memory address	
				LD77MH4	LD77MH16
Md.35	Torque limit stored value/forward torque limit stored value	→	The "torque limit value/forward torque limit stored value" valid at that time is stored. ( Pr.17 , Pr.54 , Cd.22 or Cd.101 )	826+100n	2426+100n
Md.120	Reverse torque limit stored value	→	The "reverse torque limit stored value" is stored depending on the control status. ( Pr.17 , Pr.54 , Cd.22 , Cd.101 or Cd.113 )	891+100n	2491+100n

\*: Refer to Section 5.6 "List of monitor data" for information on the storage details.

### REMARK

- Parameters are set for each axis.
- It is recommended that the parameters be set whenever possible with GX Works2. Execution by sequence program uses many sequence programs and devices. The execution becomes complicated, and the scan times will increase.
- Use "Md.120 Reverse torque limit stored value" and "Cd.113 Reverse new torque value" only when "1: Forward/reverse torque limit value\_individual setting" is set in "Cd.112 Torque change function switching request".  
(Refer to Section 13.5.4 "Torque change function".)



### 13.4.3 Software stroke limit function

In the "software stroke limit function" the address established by a machine OPR is used to set the upper and lower limits of the moveable range of the workpiece. Movement commands issued to addresses outside that setting range will not be executed.

In the LD77MH, the "current feed value" and "machine feed value" are used as the addresses indicating the current position. However, in the "software stroke limit function", the address used to carry out the limit check is designated in the " [Pr.14](#) Software stroke limit selection". (Refer to Section 9.1.4 "Confirming the current value" or details on the "current feed value" and "machine feed value".)

The upper and lower limits of the moveable range of the workpiece are set in " [Pr.12](#) Software stroke limit upper limit value"/" [Pr.13](#) Software stroke limit lower limit value".

The details shown below explain about the "software stroke limit function".

- [1] Differences in the moveable range when "current feed value" and "machine feed value" are selected.
- [2] Software stroke limit check details
- [3] Relation between the software stroke limit function and various controls
- [4] Precautions during software stroke limit check
- [5] Setting the software stroke limit function
- [6] Invalidating the software stroke limit
- [7] Setting when the control unit is "degree"

#### [1] Differences in the moveable range when "current feed value" and "machine feed value" are selected.

The following drawing shows the moveable range of the workpiece when the software stroke limit function is used.

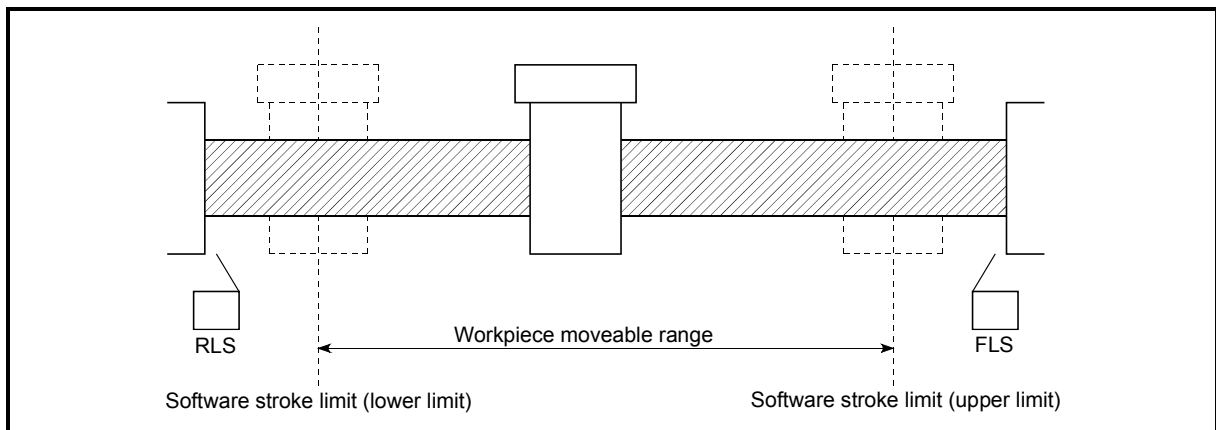

Fig. 13.13 Workpiece moveable range

The following drawing shows the differences in the operation when " Md.20 Current feed value" and " Md.21 Machine feed value" are used in the moveable range limit check.

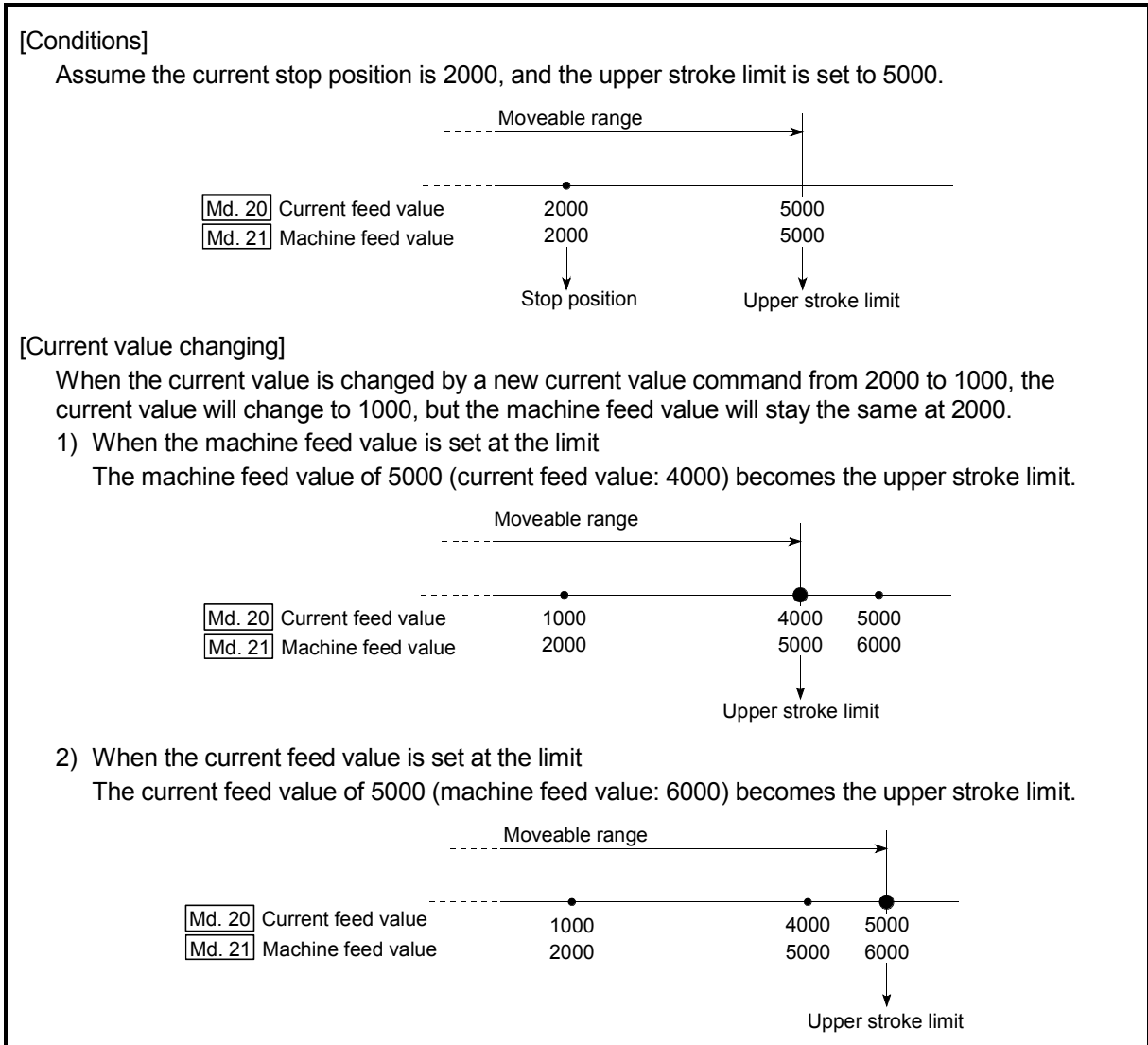

Fig. 13.14 Software stroke limits of the current feed value and machine feed value

**POINT**  
When "machine feed value" is set in " Pr.14 Software stroke limit selection", the moveable range becomes an absolute range referenced on the OP. When "current feed value" is set, the moveable range is the relative range from the "current feed value".

[2] Software stroke limit check details

Check details		Processing when an error occurs
1)	An error shall occur if the current value *1 is outside the software stroke limit range *2. (Check " [Md.20] Current feed value" or " [Md.21] Machine feed value".)	An "axis error" will occur (error code: 507, 508)
2)	An error shall occur if the command address is outside the software stroke limit range. (Check " [Da.6] Positioning address/movement amount".)	

\*1: Check whether the " [Md.20] Current feed value" or " [Md.21] Machine feed value" is set in " [Pr.14] Software stroke limit selection".

\*2: Moveable range from the " [Pr.12] Software stroke limit upper limit value" to the " [Pr.13] Software stroke limit lower limit value".

[3] Relation between the software stroke limit function and various controls

Control type		Limit check	Processing at check
OPR control	Machine OPR control	Data set method	Check not carried out.
		Other than "Data set method"	
	Fast OPR control	—	
Major positioning control	Position control	1-axis linear control	Checks 1) and 2) in the previous section [2] are carried out. For speed control: The axis decelerates to a stop when it exceeds the software stroke limit range. For position control: The axis comes to an immediate stop when it exceeds the software stroke limit range.
		2 to 4-axes axis linear interpolation control	
		1-axis fixed-feed control	
		2 to 4-axes fixed-feed control (interpolation)	
		2-axis circular interpolation control	
	1 to 4-axes speed control	○ *3, *4	
	Speed-position switching control	○	
	Position-speed switching control	*3, *4	
Other control	Current value changing	◎	The current value will not be changed if the new current value is outside the software stroke limit range.
	JUMP instruction, NOP instruction, LOOP to LEND	—	Check not carried out.
Manual control	JOG operation, Inching operation	△ *5	Check 1) in the previous section [2] is carried out. The machine will carry out a deceleration stop when the software stroke limit range is exceeded. If the address is outside the software stroke limit range, the operation can only be started toward the moveable range.
	Manual pulse generator operation	△ *5	
Expansion control	Speed-torque control	◎	Check 1) in the previous section [2] is carried out. The mode is switched to position control mode when the software stroke limit range is exceeded, then the operation is immediately stop.

◎ : Check valid

○ : Check is not made when the current feed value is not updated (Refer to [Pr.21] ) at the setting of " current feed value" in " [Pr.14] Software stroke limit selection" during speed control.

— : Check not carried out (check invalid).

△ : Valid only when "0: valid" is set in the " [Pr.15] Software stroke limit valid/invalid setting".

\*3: The value in " [Md.20] Current feed value" will differ according to the " [Pr.21] Current feed value during speed control" setting.

\*4: When the unit is "degree", check is not made during speed control.

\*5: When the unit is "degree", check is not carried out.

[4] Precautions during software stroke limit check

- (1) A machine OPR must be executed beforehand for the "software stroke limit function" to function properly.
- (2) During interpolation control, a stroke limit check is carried out for the every current value of both the reference axis and the interpolation axis. Every axis will not start if an error occurs, even if it only occurs in one axis.
- (3) During circular interpolation control, the " [Pr.12] Software stroke limit upper limit value"/" [Pr.13] Software stroke limit lower limit value" may be exceeded.

In this case, a deceleration stop will not be carried out even if the stroke limit is exceeded. Always install an external limit switch if there is a possibility the stroke limit will be exceeded.

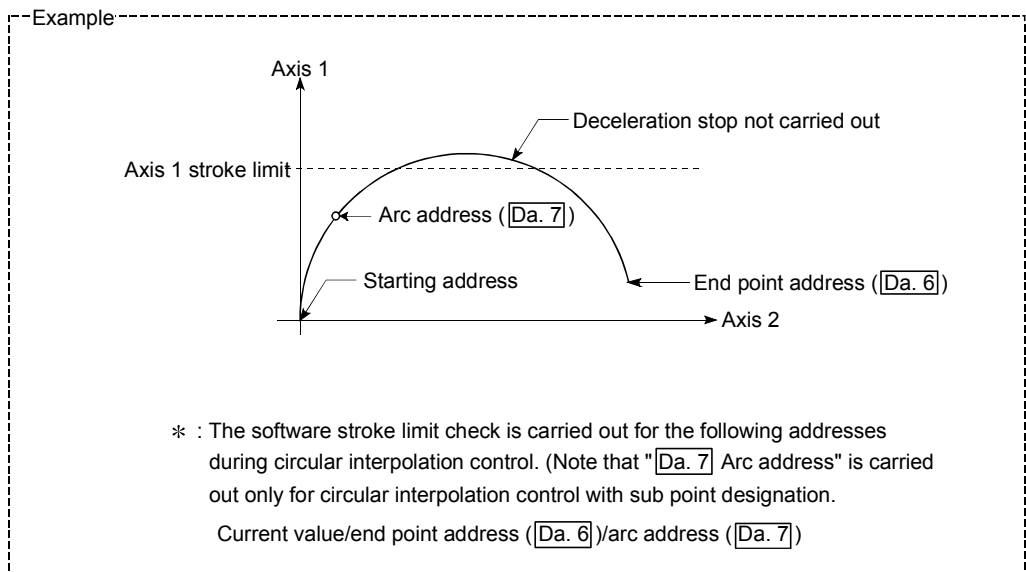

- (4) If an error is detected during continuous path control, the axis stops immediately on completion of execution of the positioning data located right before the positioning data in error.

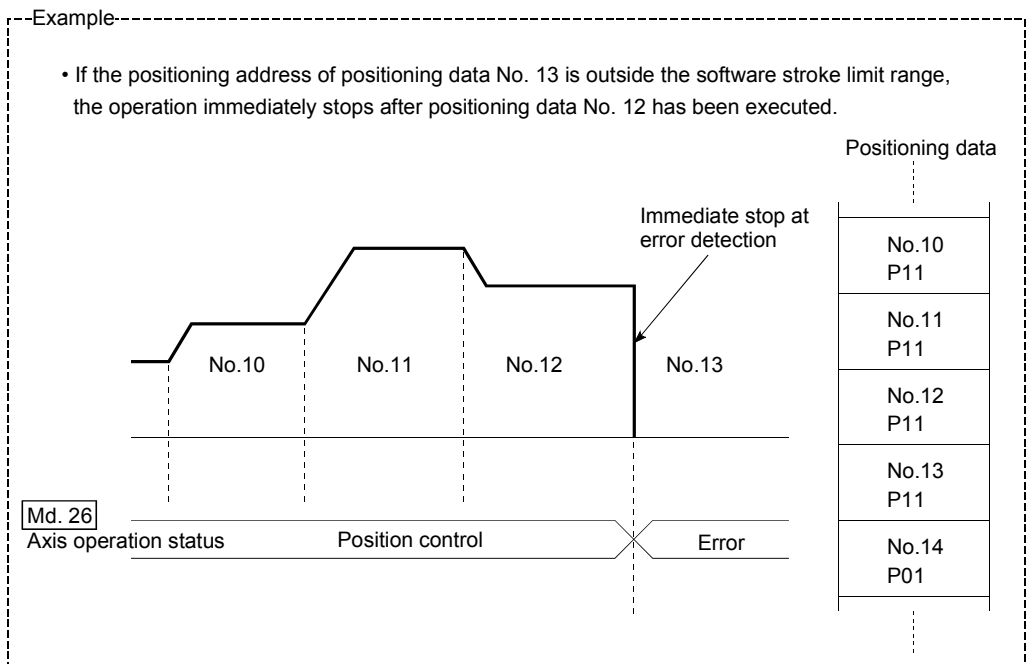

- (5) During simultaneous start, a stroke limit check is carried out for the current values of every axis to be started. Every axis will not start if an error occurs, even if it only occurs in one axis.

### [5] Setting the software stroke limit function

To use the "software stroke limit function", set the required values in the parameters shown in the following table, and write them to the LD77MH.

The set details are validated at the rising edge (OFF → ON) of the PLC READY signal [Y0].

Setting item	Setting value	Setting details	Factory-set initial value
Pr.12 Software stroke limit upper limit value	→	Set the upper limit value of the moveable range.	2147483647
Pr.13 Software stroke limit lower limit value	→	Set the lower limit value of the moveable range.	-2147483648
Pr.14 Software stroke limit selection	→	Set whether to use the "Md.20 Current feed value" or "Md.21 Machine feed value" as the "current value".	0: Current feed value
Pr.15 Software stroke limit valid/invalid setting	0: Valid	Set whether the software stroke limit is validated or invalidated during manual control (JOG operation, Inching operation, manual pulse generator operation).	0: valid

\*: Refer to Section 5.2 "List of parameters" for setting details.

### [6] Invalidating the software stroke limit

To invalidate the software stroke limit, set the following parameters as shown, and write them to the LD77MH. (Set the value within the setting range.)

Pr.12 Software stroke limit upper limit value	=	Pr.13 Software stroke limit lower limit value
---	---	---

(To invalidate only the manual operation, set "1: software stroke limit invalid" in the "Pr.15 Software stroke limit valid/invalid setting".)

The set details are validated at the rising edge (OFF → ON) of the PLC READY signal [Y0].

When the unit is "degree", the software stroke limit check is not performed during speed control (including speed control in speed-position switching control or position-speed switching control) or during manual control, independently of the values set in Pr.12, Pr.13 and Pr.15.

#### REMARK

- Parameters are set for each axis.
- It is recommended that the parameters be set whenever possible with GX Works2. Execution by sequence program uses many sequence programs and devices. The execution becomes complicated, and the scan times will increase.

[7] Setting when the control unit is "degree"

■ Current value address

The "Md.20 Current feed value" address is a ring address between 0 and 359.99999° .

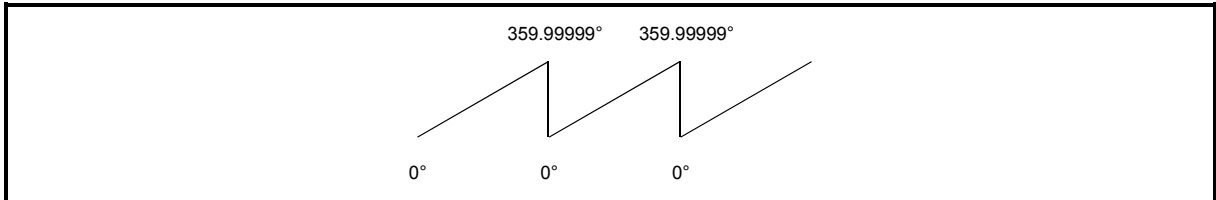

Fig. 13.15 Current value address when the control unit is "degree".

■ Setting the software stroke limit

The upper limit value/lower limit value of the software stroke limit is a value between 0 and 359.99999° .

(1) Setting when the software stroke limit is to be validated.

When the software stroke limit is to be validated, set the upper limit value in a clockwise direction from the lower limit value.

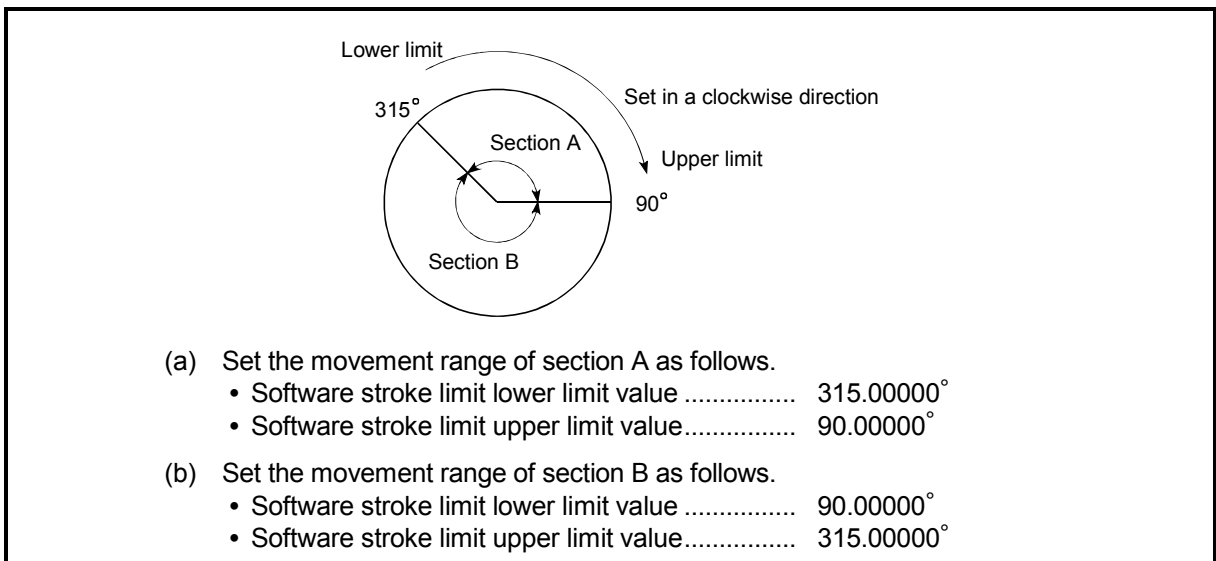

Fig. 13.16 Software stroke limit when the control unit is "degree"

## 13.4.4 Hardware stroke limit function

## ⚠ DANGER

- When the hardware stroke limit is required to be wired, ensure to wire it in the negative logic using b-contact. If it is set in positive logic using a-contact, a serious accident may occur.

In the "hardware stroke limit function", limit switches are set at the upper/lower limit of the physical moveable range, and the control is stopped (by deceleration stop) by the input of a signal from the limit switch. Damage to the machine can be prevented by stopping the control before the upper/lower limit of the physical moveable range is reached.

The hardware stroke limit is able to use "external input connector" of the servo amplifier. (Refer to the "[Pr.80] External input signal selection".)

The details shown below explain about the "hardware stroke limit function".

- [1] Control details
- [2] Wiring the hardware stroke limit
- [3] Precautions during control
- [4] When the hardware stroke limit function is not used

### [1] Control details

The following drawing shows the operation of the hardware stroke limit function.

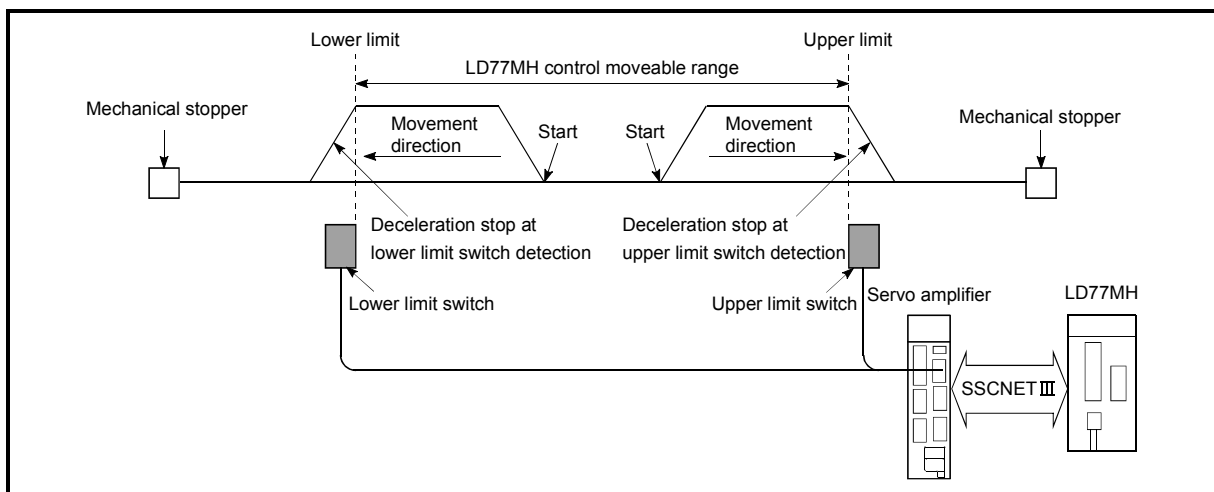

Fig. 13.17 Hardware stroke limit function operation

## [2] Wiring the hardware stroke limit

When using the hardware stroke limit function, wire the terminals of the servo amplifier upper/lower limit stroke limit as shown in the following drawing.

(When " Pr.22 Input signal logic selection" is set to the initial value)

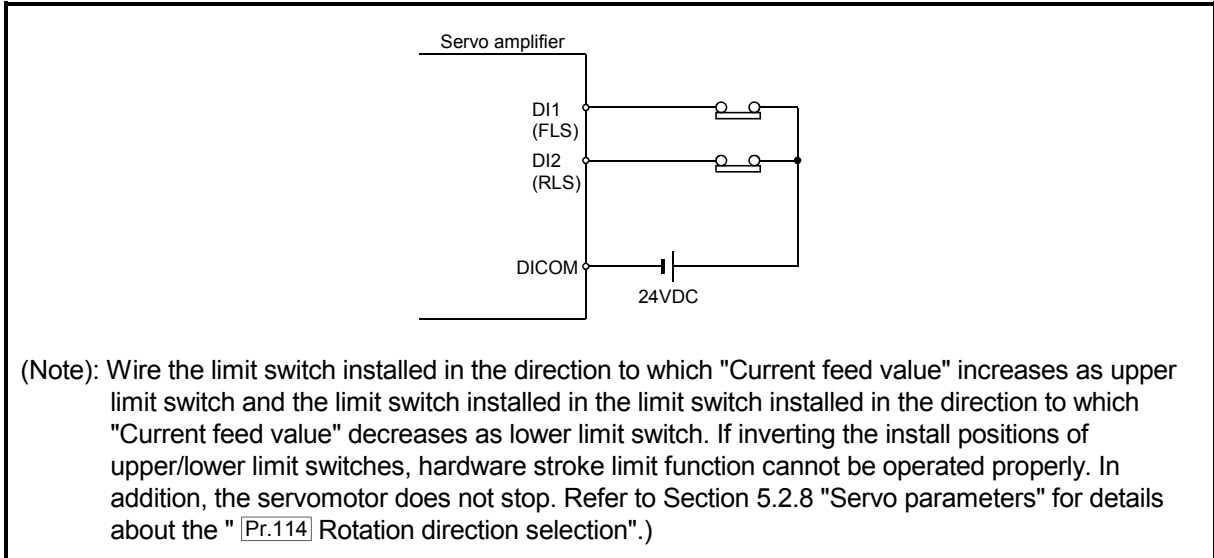

Fig. 13.18 Wiring when using the hardware stroke limit

## [3] Precautions during control

- (1) If the machine is stopped outside the LD77MH control range (outside the upper/lower limit switches), or if stopped by hardware stroke limit detection, the starting for the "OPR control", "major positioning control", and "high-level positioning control" and the control mode switching cannot be executed. To carry out these types of control again, return the workpiece to the LD77MH control range by a "JOG operation", "inching operation" or "manual pulse generator operation".
- (2) When " Pr.22 Input signal logic selection" is set to the initial value, the LD77MH cannot carry out the positioning control if FLS (limit switch for upper limit) is separated from DICOM or RLS (limit switch for lower limit) is separated from DICOM (including when wiring is not carried out).



**[4] When the hardware stroke limit function is not used**

When not using the hardware stroke limit function, wire the terminals of the servo amplifier upper/lower limit stroke limit as shown in the following drawing.

When the logic of FLS and RLS is set to "positive logic" using "Pr.22 Input signal logic selection", positioning control can be carried out even if FLS and RLS are not wired. (For details, refer to Section 14.5 "External I/O signal logic switching function".)

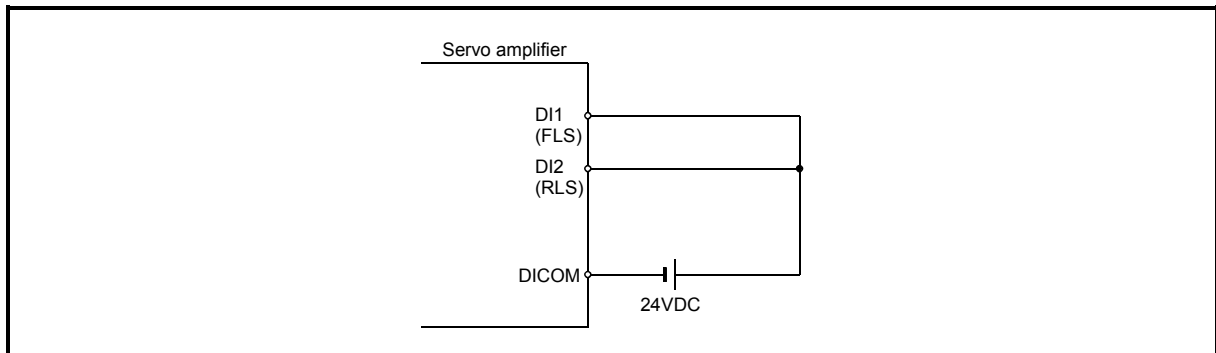

Fig. 13.19 Wiring when not using the hardware stroke limit function  
(When "Pr.22 Input signal logic selection" is the initial value)

### 13.4.5 Forced stop function

## ⚠ DANGER

- When the forced stop is required to be wired, ensure to wire it in the negative logic using b-contact.
- Provided safety circuit outside the LD77MH so that the entire system will operate safety even when the "[Pr.82] Forced stop valid/invalid selection" is set "1: Invalid". Be sure to use the forced stop signal (EMI) of the servo amplifier.

By the LD77MH external input signal connector is connected forced stop, this function is available for all axes of servo amplifier. (The initial value is "0: Valid".)

The forced stop input valid/invalid is selected by "[Pr.82] Forced stop valid/invalid selection".

The details shown below explain about the "forced stop function".

- [1] Control details
- [2] Wiring the forced stop
- [3] Setting the forced stop
- [4] How to check the forced stop
- [5] Precautions during control

#### [1] Control details

A warning "controller forced stop warning (warning code: 2147)" will occur if turned on the forced stop input signal when the "[Pr.82] Forced stop valid/invalid selection" is set "0: Valid". And then it is available for all axes of servo amplifier.

The outline of the forced stop process is shown below.

Stop cause		Stop axis	M code ON signal after stop	Axis operation status ( [Md.26] ) after stopping	Stop process					
					OPR control		Major positioning control	High-level positioning control	Manual control	
					Machine OPR control	Fast OPR control			JOG/Inching operation	Manual pulse generator operation
Forced stop	"Forced stop input signal" OFF	All axes	No change	Servo OFF	Servo OFF or free run (The operation stops with dynamic brake)				—	

The following drawing shows the operation of the forced stop function.

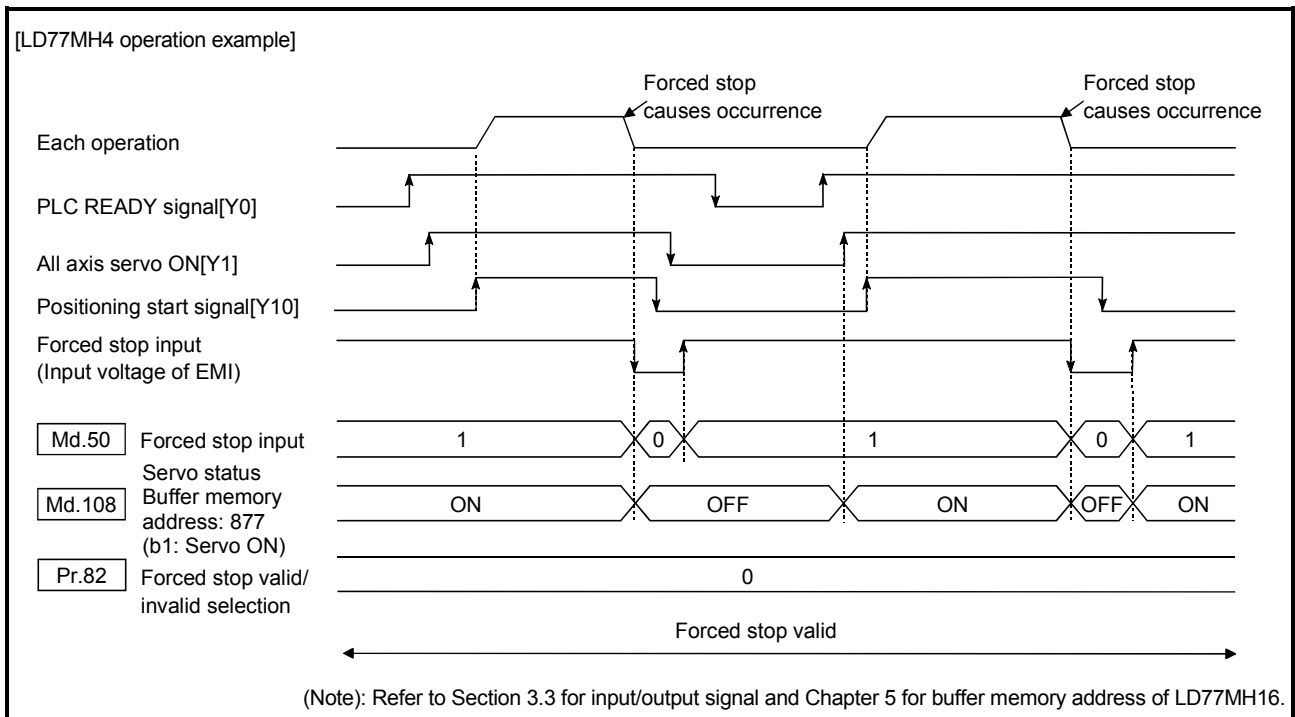

Fig. 13.20 Operation for the forced stop function

## [2] Wiring the forced stop

When using the forced stop function, wire the terminals of the LD77MH forced stop input as shown in the following drawing. (Either polarity can be connected to the forced stop input (EMI, EMI.COM)).

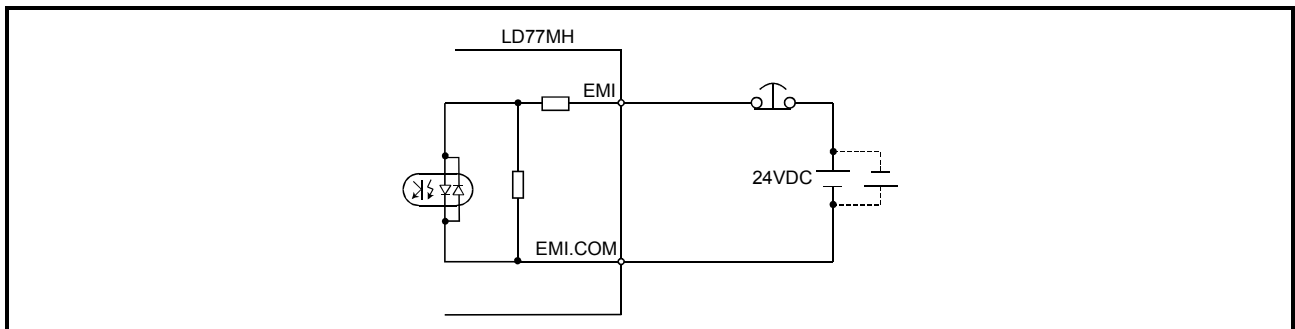

Fig. 13.21 Wiring when using the forced stop

### [3] Setting the forced stop

To use the "Forced stop function", set the following data using a sequence program.

The set details are validated at the rising edge (OFF → ON) of the PLC READY signal [Y0].

Setting item	Setting value	Setting details	Buffer memory address	
			LD77MH4	LD77MH16
<span style="border: 1px solid black; padding: 2px;">Pr.82</span> Forced stop valid/ invalid selection	→	Set the forced stop function. 0 : Valid (Forced stop is used) 1 : Invalid (Forced stop is not used)	35	

\*: Refer to Section 5.2.3 "Detailed parameters 1" for details on the setting details.

### [4] How to check the forced stop

To use the states (ON/OFF) of forced stop input, set the parameters shown in the following table.

Monitor item	Monitor value	Storage details	Buffer memory address	
			LD77MH4	LD77MH16
<span style="border: 1px solid black; padding: 2px;">Md.50</span> Forced stop input	→	Stores the states (ON/OFF) of forced stop input. 0 : Forced stop input ON (Forced stop) 1 : Forced stop input OFF (Forced stop release)	1431	4231

\*: Refer to Section 5.6.1 "System monitor data" for details on the storage details.

### [5] Precautions during control

- (1) After the "Forced stop input" is released, the servo ON/OFF is valid for the status of all axis servo ON [Y1].
- (2) If the setting is other than 0 and 1, "Forced stop valid/invalid setting error" (error code: 937) occurs.
- (3) The "Md.50 Forced stop input" is stored "1" by setting "Pr.82 Forced stop valid/invalid selection" to "1: invalid".
- (4) When the "Forced stop input" is turned ON during operation, the "Servo READY signal OFF during operation error (error code: 102)" will not occur.

## 13.5 Functions to change the control details

Functions to change the control details include the "speed change function", "override function", "acceleration/deceleration time change function", "torque change function" and "target position change function". Each function is executed by parameter setting or sequence program creation and writing.

Refer to Section 3.2.5 "Combination of LD77MH main functions and sub functions" for combination with main function.

Both the "speed change function" or "override function" change the speed, but the differences between the functions are shown below. Use the function that corresponds to the application.

"Speed change function"

- The speed is changed at any time, only in the control being executed.
- The new speed is directly set.

"Override function"

- The speed is changed for all control to be executed.
- The new speed is set as a percent (%) of the command speed.

<b>POINT</b>
"Speed change function" and "Override function" cannot be used in the manual pulse generator operation and speed-torque control.

### 13.5.1 Speed change function

The speed control function is used to change the speed during control to a newly designated speed at any time.

The new speed is directly set in the buffer memory, and the speed is changed by a speed change command ( [Cd.15](#) Speed change request) or external command signal.

During the machine OPR, a speed change to the creep speed cannot be carried out after deceleration start because the near point dog ON is detected.

The details shown below explain about the "speed change function".

[1] Control details

[2] Precautions during control

[3] Setting the speed change function from the PLC CPU

[4] Setting the speed change function using an external command signal

[1] Control details

The following drawing shows the operation during a speed change.

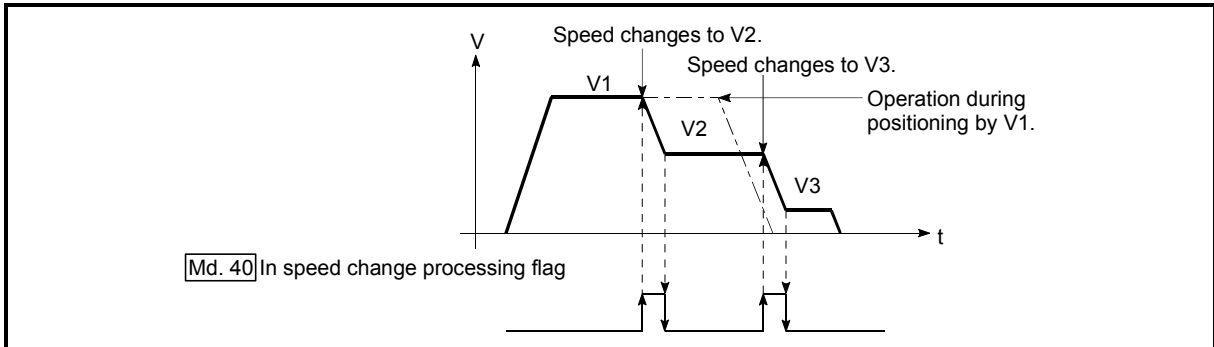

Fig. 13.22 Speed change operation

[2] Precautions during control

(1) Control is carried out as follows at the speed change during continuous path control.

- a) When no speed designation (current speed) is provided in the next positioning data:
  - The next positioning data is controlled at the "Cd.14 New speed value".
- b) When a speed designation is provided in the next positioning data:
  - The next positioning data is controlled at its "Da.8 Command speed".

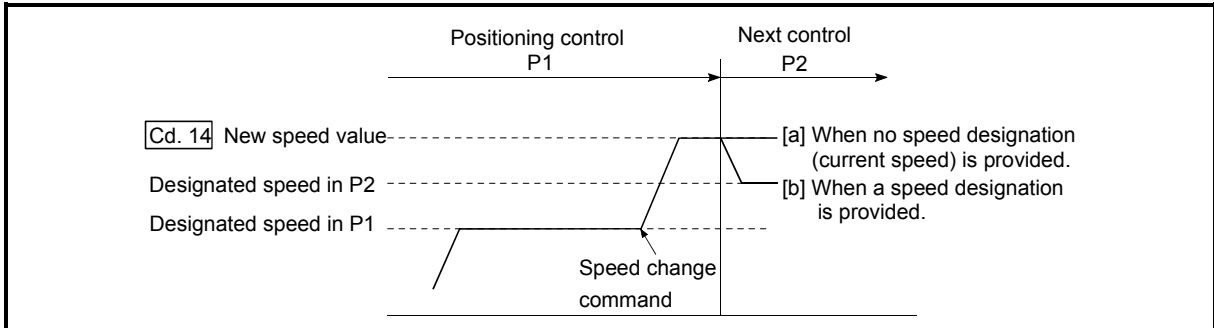

Fig. 13.23 Speed change during continuous path control

(2) When changing the speed during continuous path control, the speed change will be ignored if there is not enough distance remaining to carry out the change.

- (3) When the stop command was given to make a stop after a speed change that had been made during position control, the restarting speed depends on the "Cd.14 New speed value".

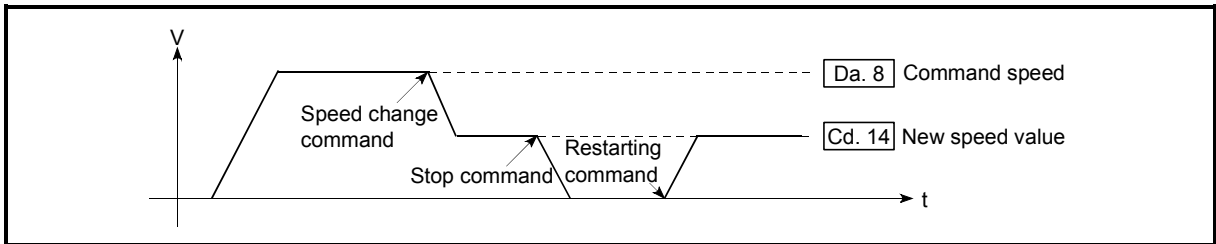
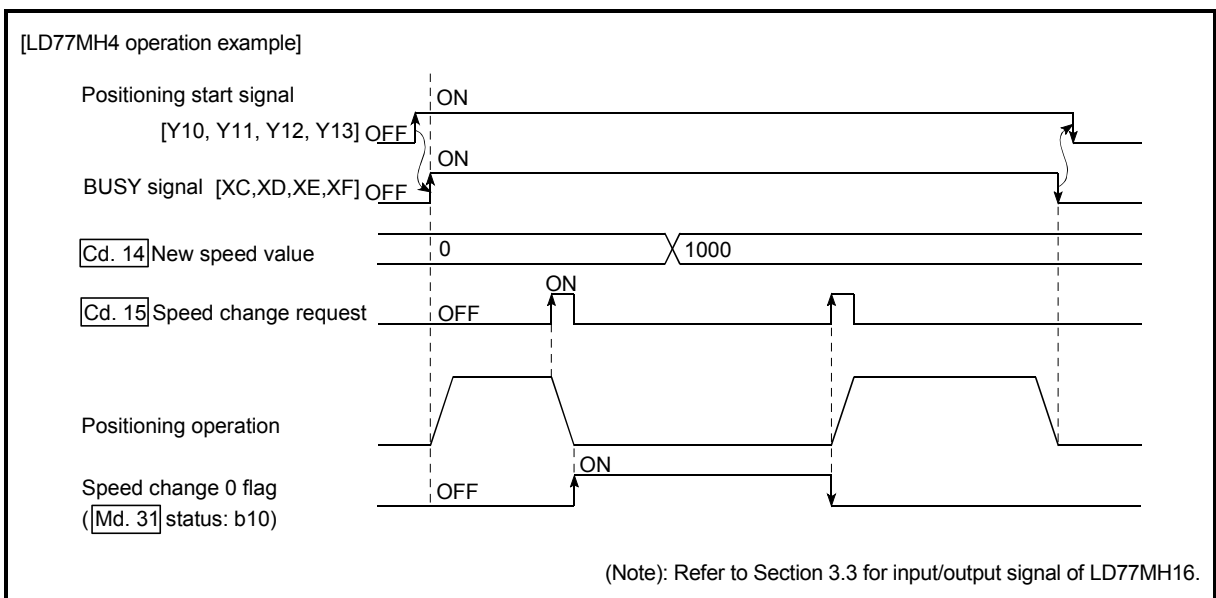

Fig. 13.24 Restarting speed after speed change made during position control

- (4) When the speed is changed by setting "Cd.14 New speed value" to "0", the operation is carried out as follows.
- When "Cd.15 Speed change request" is turned ON, the speed change 0 flag (Md.31 Status: b10) turns ON. (During interpolation control, the speed change 0 flag on the reference axis side turns ON.)
  - The axis stops, but "Md.26 Axis operation status" does not change, and the BUSY signal remains ON. (If a stop signal is input, the BUSY signal will turn OFF, and "Md.26 Axis operation status" will change to "stopped".)

In this case, setting the "Cd.14 New speed value" to a value besides "0" will turn OFF the speed change 0 flag (Md.31 Status: b10), and enable continued operation.



(Note): Refer to Section 3.3 for input/output signal of LD77MH16.

Fig. 13.25 Speed change at new speed value "0"

- (5) A warning "Deceleration/stop speed change (warning code: 500)" occurs and the speed cannot be changed in the following cases.
  - During deceleration by a stop command
  - During automatic deceleration during positioning control
- (6) A warning "Speed limit value over (warning code: 501)" occurs and the speed is controlled at the " Pr.8 Speed limit value" when the value set in " Cd.14 New speed value" is larger than the " Pr.8 Speed limit value".
- (7) When the speed is changed during interpolation control, the required speed is set in the reference axis.
- (8) When carrying out consecutive speed changes, be sure there is an interval between the speed changes of 100ms or more.  
(If the interval between speed changes is short, the LD77MH will not be able to track, and it may become impossible to carry out commands correctly.)
- (9) When a speed change is requested simultaneously for multiple axes, change the speed one by one.  
Therefore, the start timing of speed change is different for each axis.
- (10) Speed change cannot be carried out during the machine OPR. A request for speed change is ignored.
- (11) When deceleration is started by the speed change function, the deceleration start flag does not turn ON.
- (12) The speed change function cannot be used during speed control mode and torque control mode.  
Refer to Section 12.1 "Speed-torque control" for the speed change during speed control mode.

[3] Setting the speed change function from the PLC CPU

The following shows the data settings and sequence program example for changing the control speed of axis 1 from the PLC CPU. (In this example, the control speed is changed to "20.00mm/min".)

- (1) Set the following data.  
(Use the start time chart shown in section (2) below as a reference, and set using the sequence program shown in section (3).)

Setting item		Setting value	Setting details	Buffer memory address	
				LD77MH4	LD77MH16
Cd.14	New speed value	2000	Set the new speed.	1514+100n 1515+100n	4314+100n 4315+100n
Cd.15	Speed change request	1	Set "1: Change the speed".	1516+100n	4316+100n

\*: Refer to Section 5.7 "List of control data" for details on the setting details.



(2) The following shows the speed change time chart.

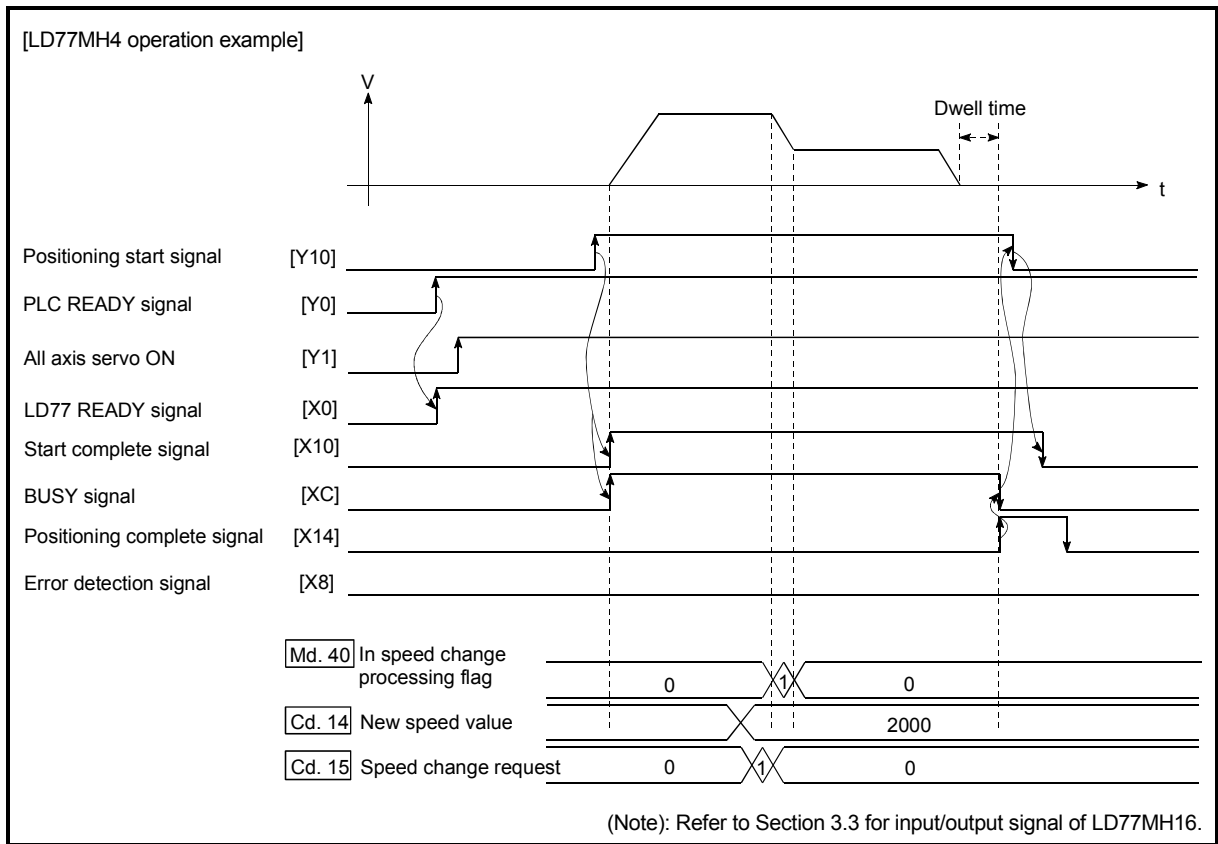
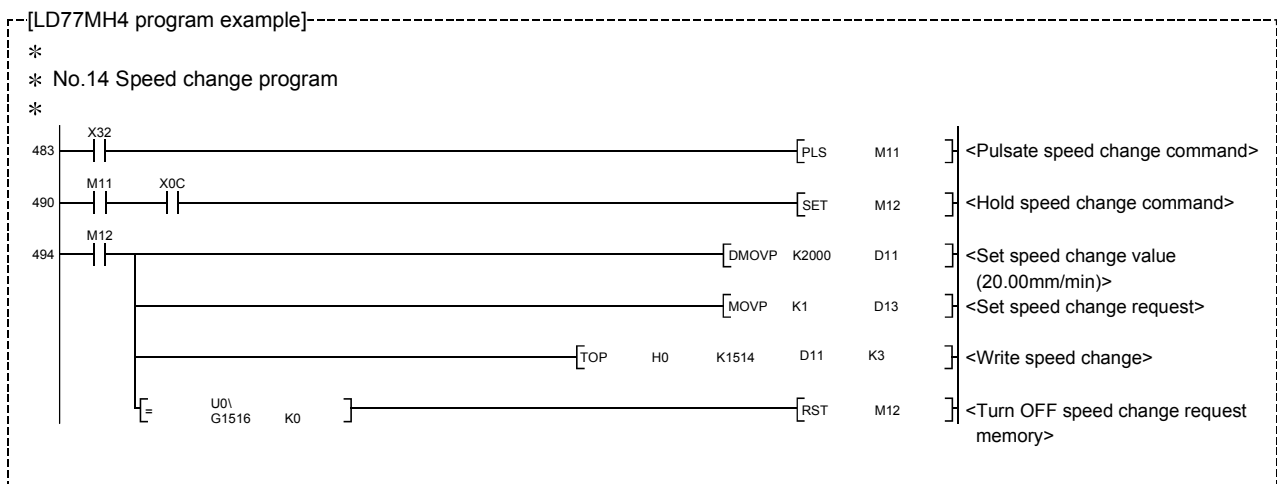

Fig. 13.26 Time chart for changing the speed from the PLC CPU

(3) Add the following sequence program to the control program, and write it to the PLC CPU.



**[4] Setting the speed change function using an external command signal**

The speed can also be changed using an "external command signal".

The following shows the data settings and sequence program example for changing the control speed of axis 1 using an "external command signal". (In this example, the control speed is changed to "10000.00mm/min".)

- (1) Set the following data to change the speed using an external command signal.  
(Use the start time chart shown in section (2) below as a reference, and set using the sequence program shown in section (3).)

Setting item	Setting value	Setting details	Buffer memory address	
			LD77MH4	LD77MH16
Pr.42 External command function selection	1	Set "1: External speed change request".	62+150n	
Cd.8 External command valid	1	Set "1: Validate the external command".	1505+100n	4305+100n
Cd.14 New speed value	1000000	Set the new speed.	1514+100n	4314+100n
			1515+100n	4315+100n

\*: Set the external command signal [D1] in "Pr.95 External command signal selection" at LD77MH16 use.  
Refer to Section 5.2 "List of parameters" and Section 5.7 "List of control data" for details on the setting details.

- (2) The following shows the speed change time chart.

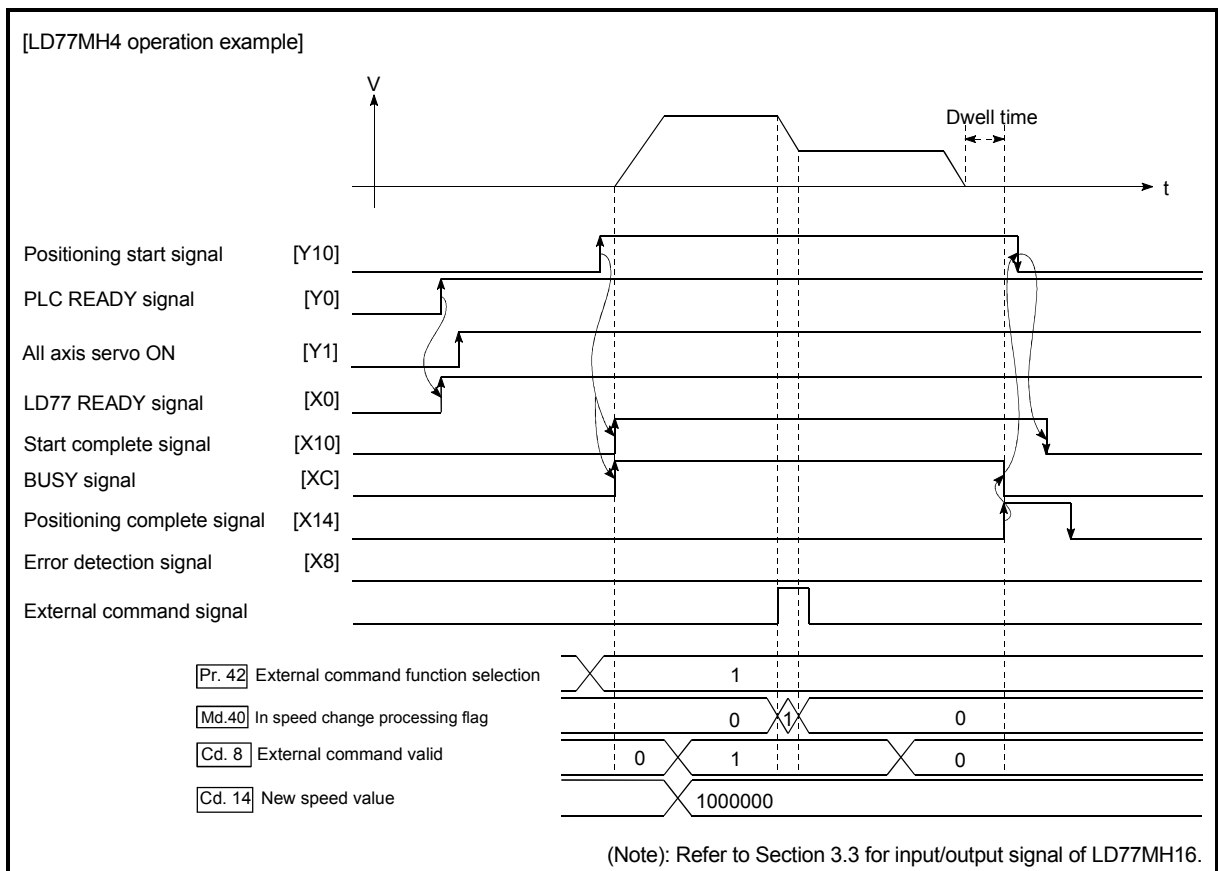
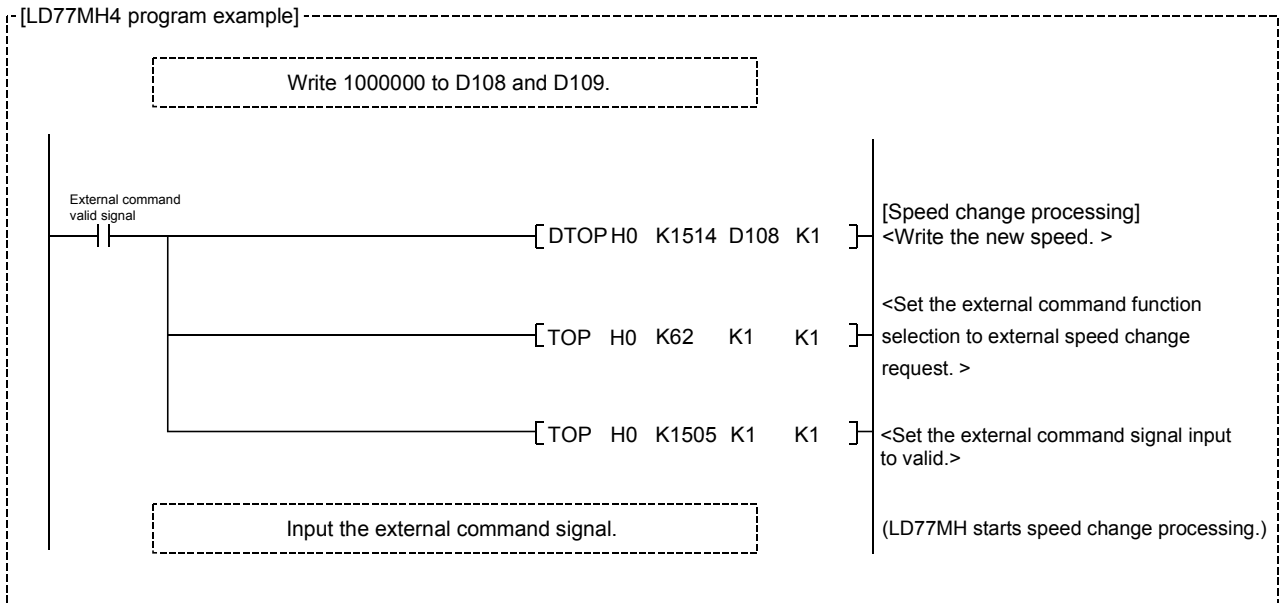

Fig. 13.27 Time chart for changing the speed using an external command signal

(3) Add the following sequence program to the control program, and write it to the PLC CPU.



### 13.5.2 Override function

The override function changes the command speed by a designated percentage (1 to 300%) for all control to be executed.

The speed can be changed by setting the percentage (%) by which the speed is changed in "Cd.13 Positioning operation speed override".

- [1] Control details
- [2] Precautions during control
- [3] Setting the override function

#### [1] Control details

The following shows that operation of the override function.

- 1) A value changed by the override function is monitored by "Md.22 Feedrate".
- 2) If "Cd.13 Positioning operation speed override" is set to 100%, the speed will not change.
- 3) If "Cd.13 Positioning operation speed override" is set a value less than 100%, the warning "Less than minimum speed (warning code: 110)" is generated, and control will be carried out at speed unit "1" at the time "Md.22 Feedrate" becomes a value of "1" or less.
- 4) If there is not enough remaining distance to change the speed due to the "override function", when the speed is changed during the position control of speed-position switching control or position-speed switching control, the operation will be carried out at the speed that could be changed.
- 5) If the speed changed by the override function is greater than the "Pr.8 Speed limit value", a warning "Speed limit value over (warning code: 501)" will occur and the speed will be controlled at the "Pr.8 Speed limit value".  
The "Md.39 In speed limit flag" will turn ON.

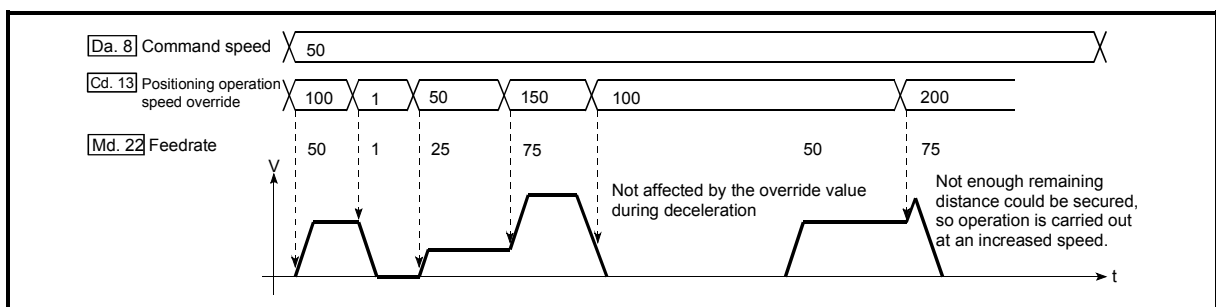

Fig. 13.28 Override function operation

## [2] Precaution during control

- (1) When changing the speed by the override function during continuous path control, the speed change will be ignored if there is not enough distance remaining to carry out the change.
- (2) A warning "Deceleration/stop speed change (warning code: 500)" occurs and the speed cannot be changed by the override function in the following cases.  
(The value set in " [Cd.13] Positioning operation speed override" is validated after a deceleration stop.)
  - During deceleration by a stop command
  - During automatic deceleration during positioning control
- (3) When the speed is changed by the override function during interpolation control, the required speed is set in the reference axis.
- (4) When carrying out consecutive speed change by the override function, be sure there is an interval between the speed change of 100ms or more.  
(If the interval between speed change is short, the LD77MH will not be able to track, and it may become impossible to carry out commands correctly.)
- (5) When a machine OPR is performed, the speed change by the override function cannot be carried out after a deceleration start to the creep speed following the detection of near-point dog ON. In this case, a request for speed change is ignored.
- (6) When deceleration is started by the override function, the deceleration start flag does not turn ON.
- (7) The override function cannot be used during speed control mode and torque control mode.

## [3] Setting the override function

The following shows the data settings and sequence program example for setting the override value of axis 1 to "200%".

- (1) Set the following data. (Use the start time chart shown in section (2) below as a reference, and set using the sequence program shown in section (3).)

Setting item		Setting value	Setting details	Buffer memory address	
				LD77MH4	LD77MH16
[Cd.13]	Positioning operation speed override	200	Set the new speed as a percentage (%).	1513+100n	4313+100n

\*: Refer to Section 5.7 "List of control data" for details on the setting details.

(2) The following shows a time chart for changing the speed using the override function.

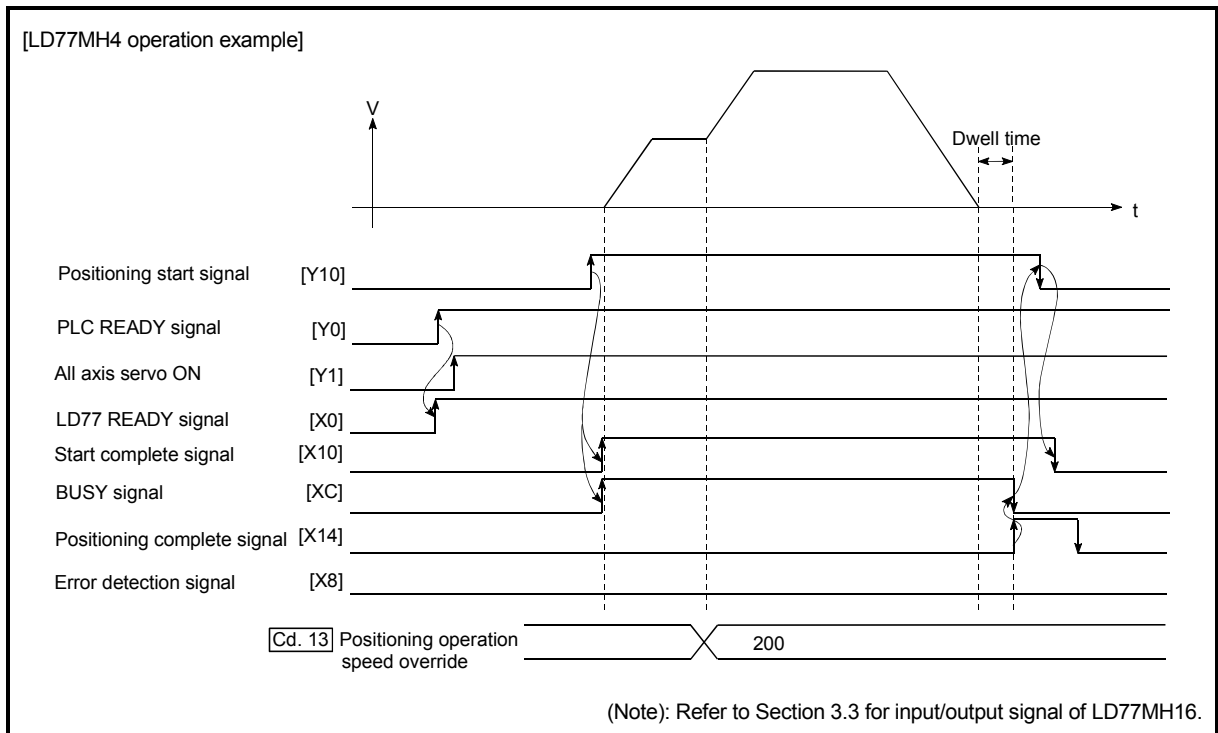
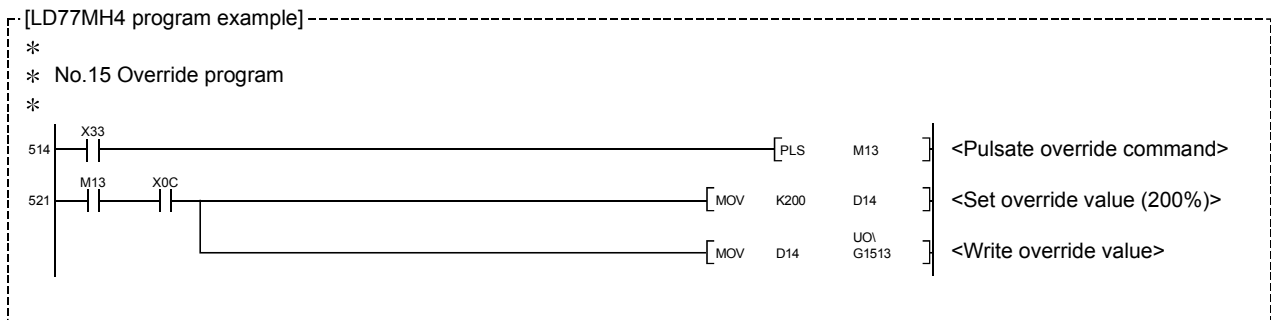

Fig.13.29 Time chart for changing the speed using the override function

(3) Add the following sequence program to the control program, and write it to the PLC CPU.



### 13.5.3 Acceleration/deceleration time change function

The "acceleration/deceleration time change function" is used to change the acceleration/deceleration time during a speed change to a random value when carrying out the speed change by the "speed change function" and "override function". In a normal speed change (when the acceleration/deceleration time is not changed), the acceleration/deceleration time previously set in the parameters ( [Pr.9] , [Pr.10] , and [Pr.25] to [Pr.30] values) is set in the positioning parameter data items [Da.3] and [Da.4], and control is carried out with that acceleration/deceleration time. However, by setting the new acceleration/deceleration time ( [Cd.10] , [Cd.11] ) in the control data, and issuing an acceleration/deceleration time change enable command ( [Cd.12] Acceleration/deceleration time change during speed change, enable/disable selection) to change the speed when the acceleration/deceleration time change is enabled, the speed will be changed with the new acceleration/deceleration time ( [Cd.10] , [Cd.11] ).

The details shown below explain about the "acceleration/deceleration time change function".

[1] Control details

[2] Precautions during control

[3] Setting the acceleration/deceleration time change function

[1] Control details

After setting the following two items, carry out the speed change to change the acceleration/deceleration time during the speed change.

- Set change value of the acceleration/deceleration time ("Cd.10 New acceleration time value", "Cd.11 New deceleration time value")
- Setting acceleration/deceleration time change to enable ("Cd.12 Acceleration/deceleration time change during speed change, enable/disable selection")

The following drawing shows the operation during an acceleration/deceleration time change.

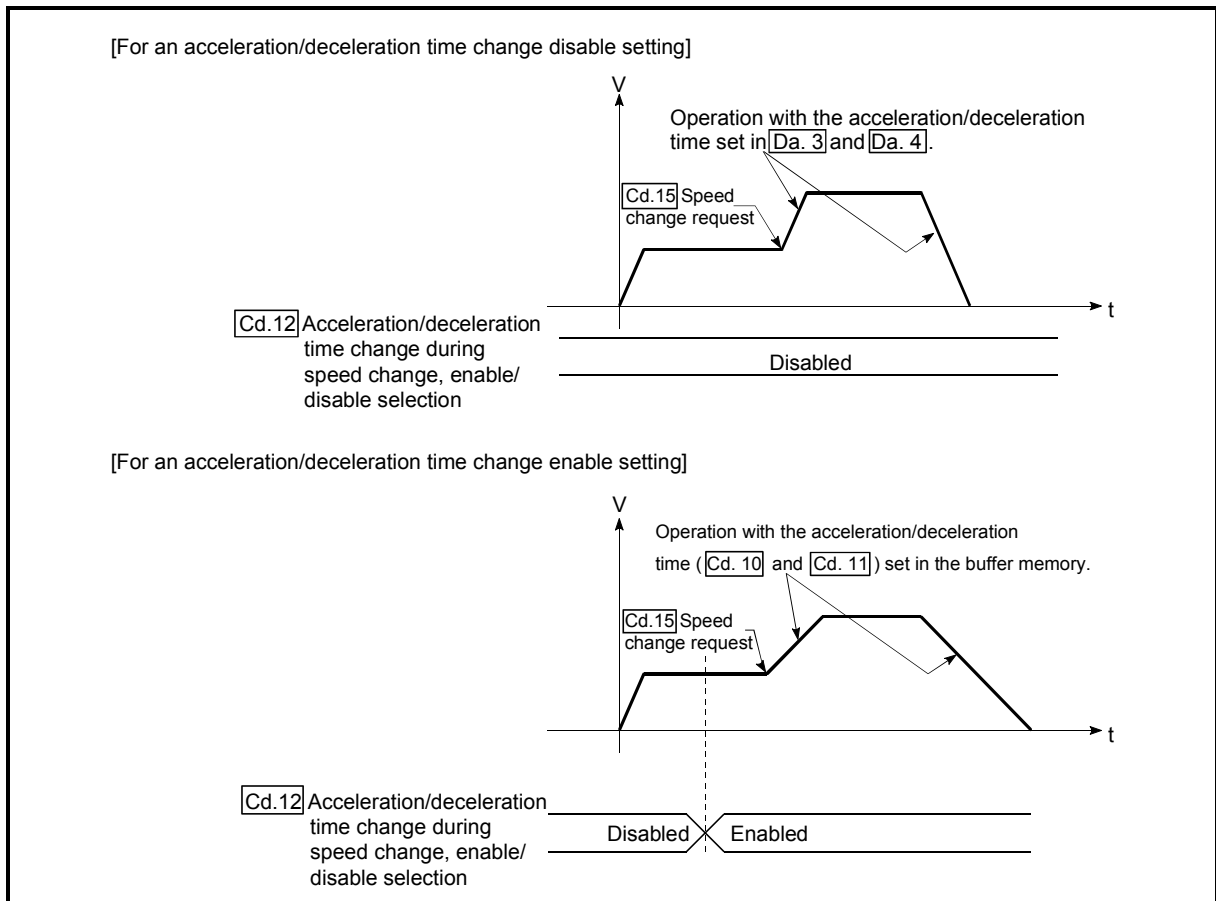
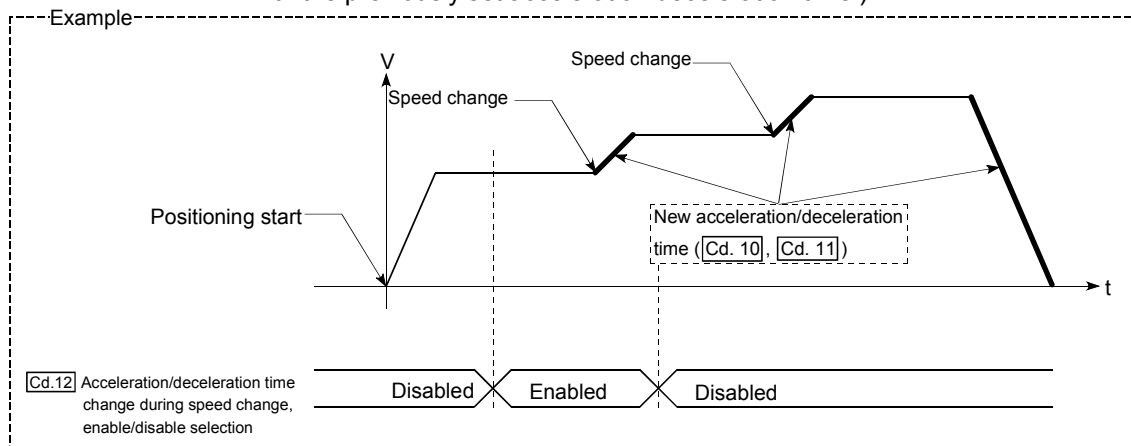

Fig. 13.30 Operation during an acceleration/deceleration time change



## [2] Precautions during control

- (1) When "0" is set in "[Cd.10] New acceleration time value" and "[Cd.11] New deceleration time value", the acceleration/deceleration time will not be changed even if the speed is changed. In this case, the operation will be controlled at the acceleration/deceleration time previously set in the parameters.
- (2) The "new acceleration/deceleration time" is valid during execution of the positioning data for which the speed was changed. In continuous positioning control and continuous path control, the speed is changed and control is carried out with the previously set acceleration/deceleration time at the changeover to the next positioning data, even if the acceleration/deceleration time is changed to the "new acceleration/deceleration time ([Cd.10], [Cd.11])".
- (3) Even if the acceleration/deceleration time change is set to disable after the "new acceleration/deceleration time" is validated, the positioning data for which the "new acceleration/deceleration time" was validated will continue to be controlled with that value. (The next positioning data will be controlled with the previously set acceleration/deceleration time.)



- (4) If the "new acceleration/deceleration time" is set to "0" and the speed is changed after the "new acceleration/deceleration time" is validated, the operation will be controlled with the previous "new acceleration/deceleration time".

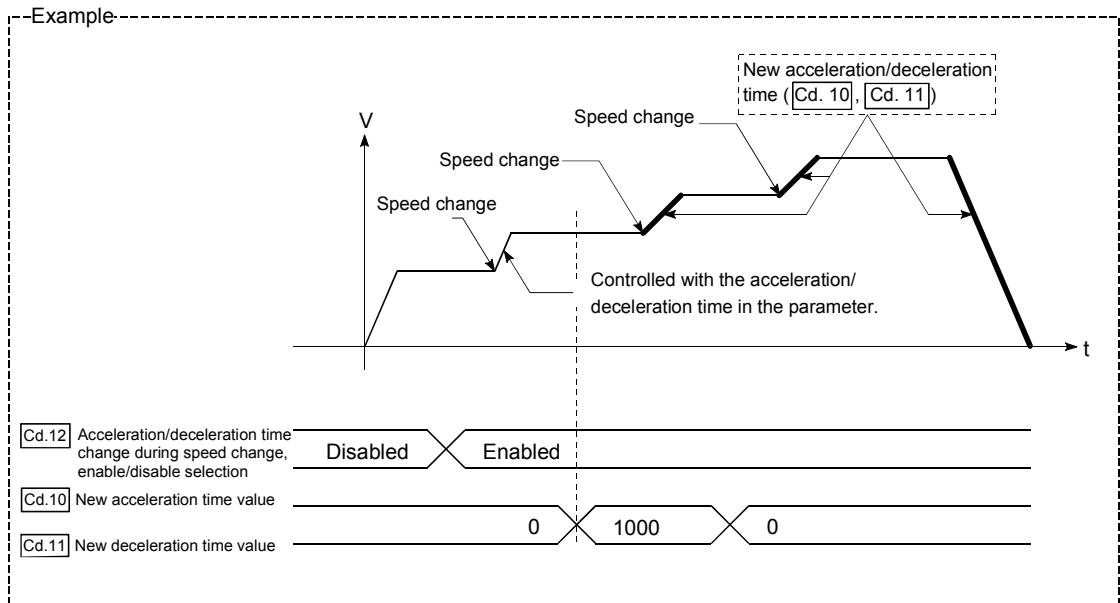

- (5) The acceleration/deceleration change function cannot be used during speed control mode and torque control mode. Refer to Section 12.1 "Speed-torque control" for the acceleration/deceleration processing during speed control mode.

**POINT**

If the speed is changed when an acceleration/deceleration change is enabled, the "new acceleration/deceleration time" will become the acceleration/deceleration time of the positioning data being executed. The "new acceleration/deceleration time" remains valid until the changeover to the next positioning data. (The automatic deceleration processing at the completion of the positioning will also be controlled by the "new acceleration/deceleration time".)

[3] Setting the acceleration/deceleration time change function

To use the "acceleration/deceleration time change function", write the data shown in the following table to the LD77MH using the sequence program.

The set details are validated when a speed change is executed after the details are written to the LD77MH.

Setting item	Setting value	Setting details	Buffer memory address	
			LD77MH4	LD77MH16
Cd.10 New acceleration time value	→	Set the new acceleration time.	1508+100n 1509+100n	4308+100n 4309+100n
Cd.11 New deceleration time value	→	Set the new deceleration time.	1510+100n 1511+100n	4310+100n 4311+100n
Cd.12 Acceleration/deceleration time change during speed change, enable/disable selection	1	Set "1: Acceleration/deceleration time change enable".	1512+100n	4312+100n

\*: Refer to Section 5.7 "List of control data" for details on the setting details.

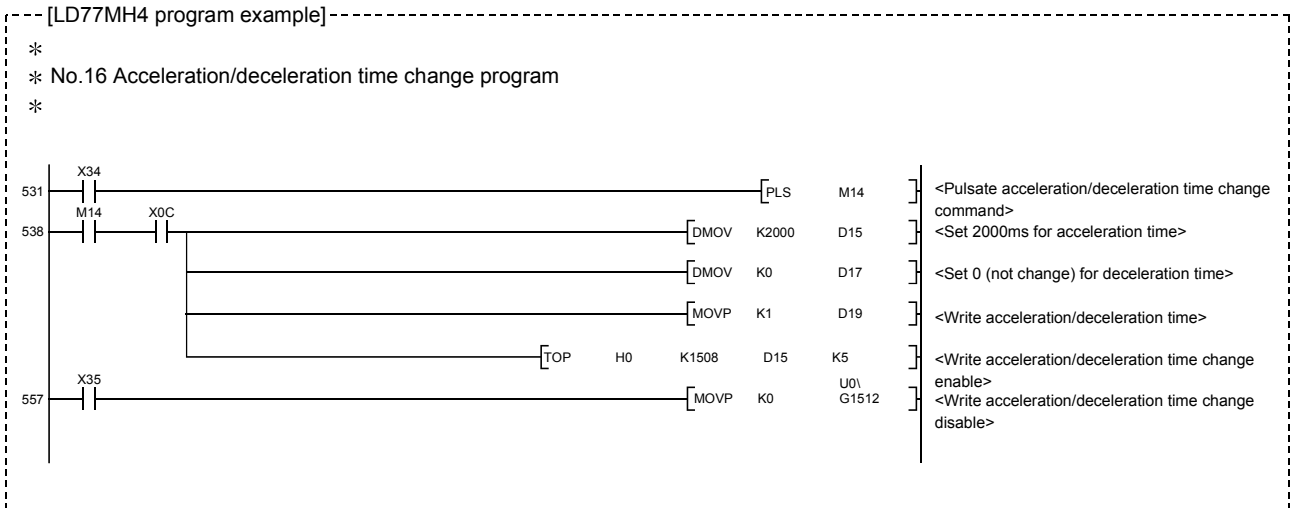

### 13.5.4 Torque change function

The "torque change function" is used to change the torque limit value during torque limiting.

The torque limit value at the control start is the value set in the " [Pr.17](#) Torque limit setting value" or " [Cd.101](#) Torque output setting value"

The following two change methods in the torque change function.

Torque change function	Details
Forward/reverse new torque value_same setting	The forward torque limit value and reverse torque limit value are changed to the same value by the new torque value. (Use this method when they need not be separately set.)
Forward/reverse new torque value_individual setting	The forward torque limit value and reverse torque limit value are individually changed respectively by the forward new torque value and reverse new torque value.

\*: Forward new torque value: The limit value to the generated torque during CCW regeneration at the CCW driving of the servo motor.

Reverse new torque value The limit value to the generated torque during CW regeneration at the CW driving of the servo motor.

Set previously "same setting" or "individual setting" of the forward/reverse new torque in "[Cd.112](#) Torque change function switching request".

Torque change function	Setting items	
	Torque change function switching request ( <a href="#">Cd.112</a> )	New torque value ( <a href="#">Cd.22</a> , <a href="#">Cd.113</a> )
Forward/reverse new torque value_same setting	0: Forward/reverse new torque value: same setting	<a href="#">Cd.22</a> New torque value/ forward new torque value
		<a href="#">Cd.113</a> Setting invalid
Forward/reverse new torque value_individual setting	1: Forward/reverse new torque value: individual setting	<a href="#">Cd.22</a> New torque value/ forward new torque value
		<a href="#">Cd.113</a> Reverse new torque value

The details shown below explain about the "torque change function".

[1] Control details

[2] Precautions during control

[3] Setting the torque change function start signal

[1] Control details

The torque value (forward new torque value/reverse new torque value) of the axis control data can be changed at all times. The torque can be limited with a new torque value from the time the new torque value has been written to the LD77MH.

Note that the delay time until a torque control is executed is max. operation cycle after torque change value was written.

The torque limiting is not carried out from the time the power supply is turned ON to the time the PLC READY signal [Y0] is turned ON.

The new torque value ( Cd.22, Cd.113 ) is cleared to zero at the leading edge (OFF to ON) of the positioning start signal [Y10].

The torque setting range is from 0 to " Pr.17 Torque limit setting value".

(When the setting value is 0, a torque change is considered not to be carried out, and it becomes to the value set in " Pr.17 Torque limit setting value" or " Cd.101 Torque output setting value".)

Cd.101 Torque output setting value".)

The torque change range is 1 to " Pr.17 Torque limit setting value".

The following drawing shows the operation at the same setting (Figure 13.31) and the operation at the individual setting (Figure 13.32) for the forward new torque value and reverse new torque value.

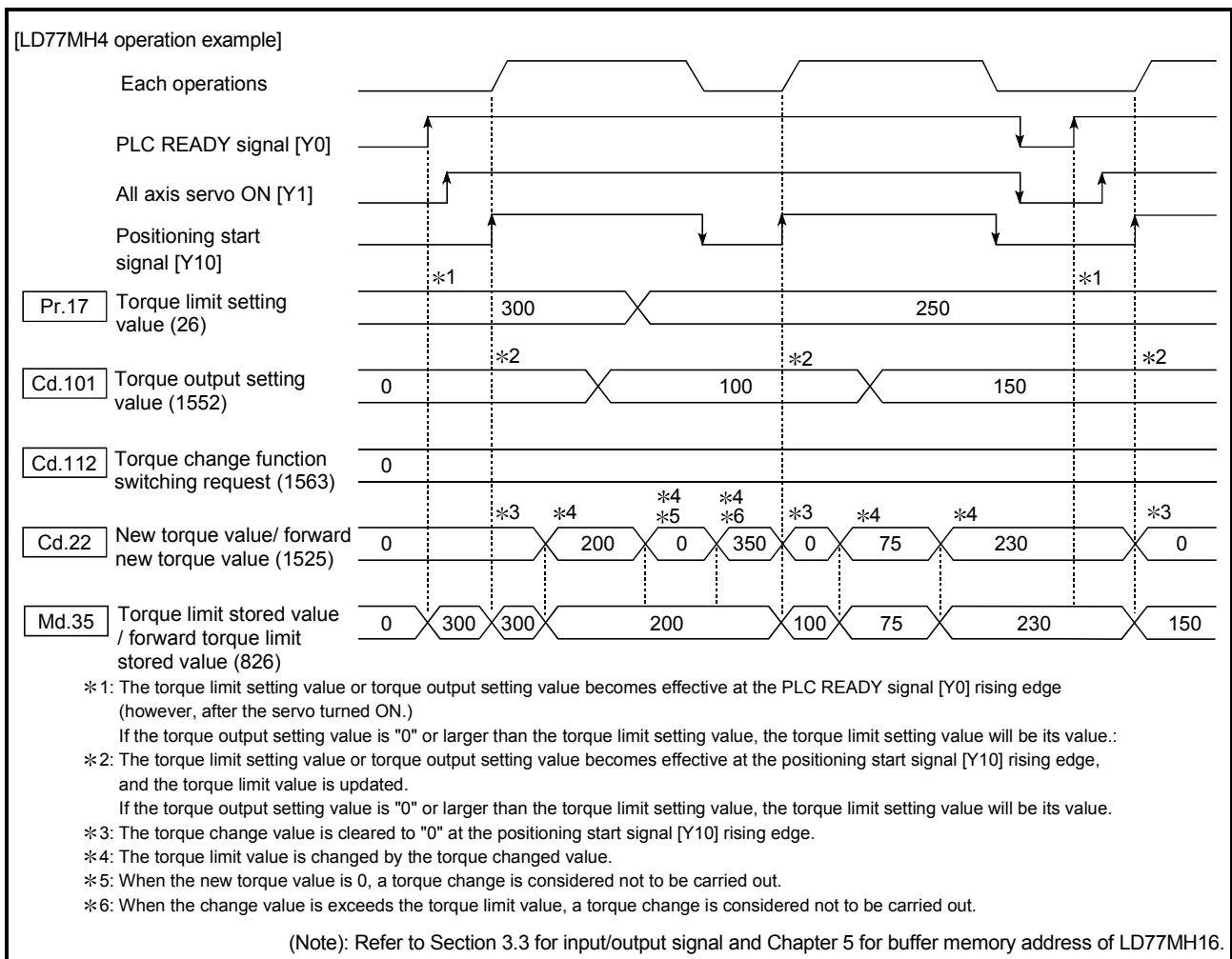

Fig. 13.31 Torque change operation (forward/reverse new torque value: same setting) (Axis 1)

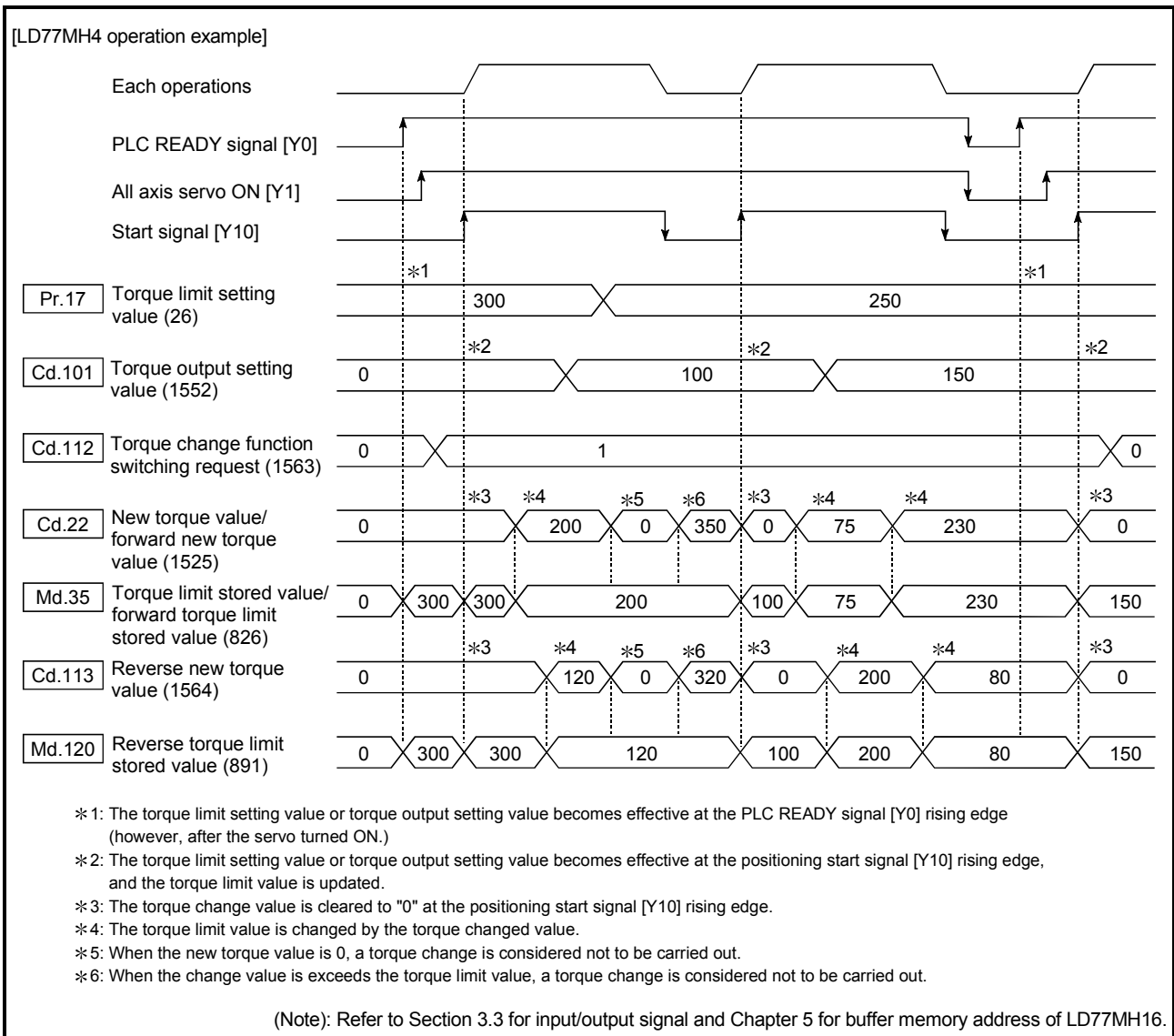

Fig. 13.32 Torque change operation (forward/reverse new torque value: individual setting) (Axis 1)

[2] Precautions during control

- (1) If a value besides "0" is set in the new torque value, the torque generated by the servomotor will be limited by the setting value. To limit the torque with the value set in " Pr.17 Torque limit setting value" or " Cd.101 Torque output setting value", set "0" to the new torque value.

Setting value of "Cd.112 Torque change function switching request"	Setting item (New Torque value)
0: Forward/reverse new torque value _same setting	Cd.22 New torque value/forward new torque value
1: Forward/reverse new torque value _individual setting	Cd.22 New torque value/forward new torque value
	Cd.113 Reverse new torque value

- (2) The " **Cd.22** New torque value/forward new torque value" or "**Cd.113** Reverse new torque value" is validated when written to the LD77MH.  
(Note that it is not validated from the time the power supply is turned ON to the time the PLC READY signal [Y0] is turned ON.)
- (3) If the setting value of " **Cd.22** New torque value/forward new torque value" is outside the setting range, an axis warning "Outside new torque value range/outside forward new torque value range" (warning code: 113) will occur and the torque will not be changed.  
If the setting value of "**Cd.113** Reverse new torque value" is outside the setting range, an axis warning "Outside reverse new torque value range" (warning code: 115) will occur and the torque will not be changed.
- (4) If the time to hold the new torque value is not more than 100ms, a torque change may not be executed.
- (5) When changing from "0: Forward/reverse new torque value\_same setting" to "1: Forward/reverse new torque value\_individual setting" by the torque change function, set "0" or same value set in " **Cd.22** New torque value/forward new torque value" in "**Cd.113**Reverse new torque value" before change.

**[3] Setting the torque change function start signal**

To use the "torque change function", write the data shown in the following table to the LD77MH using the sequence program.

The set details are validated when written to the LD77MH.

Setting item		Setting value	Setting details	Buffer memory address	
				LD77MH4	LD77MH16
<b>Cd.112</b>	Torque change function switching request	0: Forward/reverse new torque value_same setting 1: Forward/reverse new torque value_individual setting	Sets "same setting/individual setting" of the forward torque limit value and reverse torque limit value. *: Set "0" normally. (When the forward torque limit value and reverse torque limit value are not divided.) *: When a value except "1" is set, it operates as "forward/reverse torque limit value_same setting".	1563+100n	4363+100n
<b>Cd.22</b>	New torque value/forward new torque value	0 to <b>Pr.17</b> Torque limit setting value	When "0" is set to " <b>Md.35</b> Torque change function switching request", a new torque limit value is set. (This value is set to the forward torque limit value and reverse torque limit value.) When "1" is set to " <b>Cd.112</b> Torque change function switching request", a new forward torque limit value is set.	1525+100n	4325+100n
<b>Cd.113</b>	Reverse new torque value	0 to <b>Pr.17</b> Torque limit setting value	"1" is set in " <b>Cd.112</b> Torque change function switching request", a new reverse torque limit value is set. *: When "0" is set in " <b>Cd.112</b> Torque change function switching request", the setting value is invalid.	1564+100n	4364+100n

\*: Refer to Section 5.7 "List of control data" for details on the setting details.

### 13.5.5 Target position change function

The "target position change function" is a function to change a target position to a newly designated target position at any timing during the position control (1-axis linear control). A command speed can also be changed simultaneously.

The target position and command speed changed are set directly in the buffer memory, and the target position change is executed by "Cd.29 Target position change request flag".

The following shows the details of the "target position change function".

[1] Details of control

[2] Precaution during operation

[3] Method of setting target position change function from PLC CPU

#### [1] Details of control

The following charts show the details of control of the target position change function.

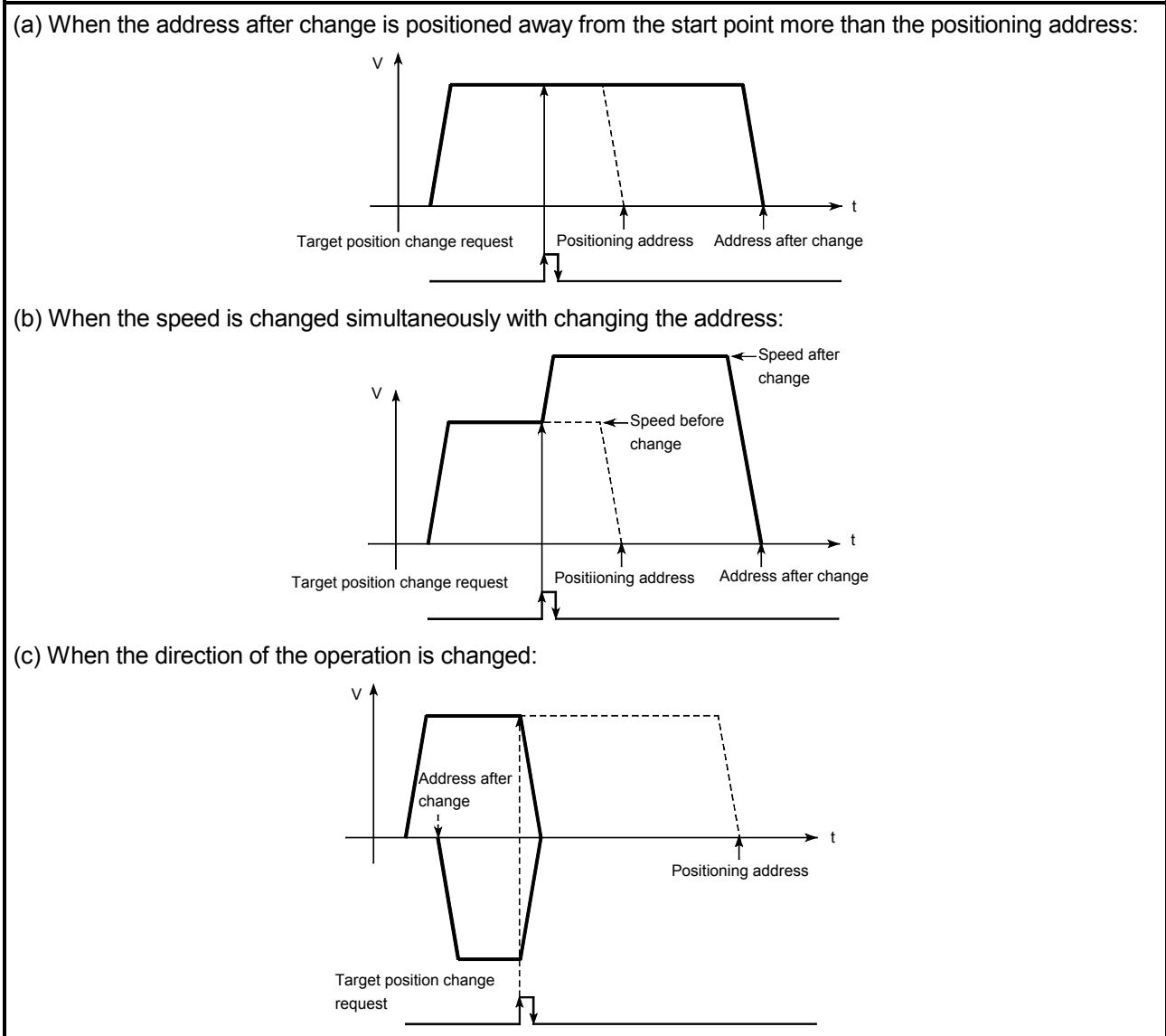

Fig. 13.33 Target position change operation



## [2] Precautions during operation

- (1) If the positioning movement direction from the stop position to a new target position is reversed, stop the operation once and then position to the new target position. (Refer to Fig. 13.33 (c).)
- (2) If a command speed exceeding the speed limit value is set to change the command speed, a warning will be given, and the new command speed will be the speed limit value (warning code: 501).  
Also, if the command speed change disables the remaining distance to the target value from being assured, a warning will be given (warning code: 509).
- (3) In the following cases, a target position change request given is ignored and a warning occurs. (warning code: 518)
  - During interpolation control
  - A new target position value (address) is outside the software stroke limit range.
  - The axis is decelerating to a stop by a stop cause.
  - While the positioning data whose operation pattern is continuous path control is executed.
  - When the speed change 0 flag ([Md.31](#) Status: b10) is ON.
- (4) When a command speed is changed, the current speed is also changed. When the next positioning speed uses the current speed in the continuous positioning, the next positioning operation is carried out at the new speed value. When the speed is set with the next positioning data, that speed becomes the current speed and the operation is carried out at the current speed.
- (5) When a target position change request is given during automatic deceleration in position control, positioning control to a new position is exercised after the axis has stopped once if the moving direction is reversed. If the moving direction is not reversed, the axis is accelerated to the command speed again and positioned to the new position.
- (6) If the constant speed status is regained or the output is reversed by a target position change made while "[Md.48](#) Deceleration start flag" is ON, the deceleration start flag remains ON. (For details, refer to Section 13.7.8.)
- (7) Carrying out the target position change to the ABS linear 1 in degrees may carry out the positioning to the new target position after the operation decelerates to stop once, even the movement direction is not reversed.

**POINT**

When carrying out the target position change continuously, take an interval of 100 ms or longer between the times of the target position changes. Also, take an interval of 100 ms or longer when the speed change and override is carried out after changing the target position or the target position change is carried out after the speed change and override.

[3] Method of setting target position change function from PLC CPU

The following table and chart show the example of a data setting and sequence program used to change the target position of the axis 1 by the command from the PLC CPU, respectively. (example in which the target position value and command speed are changed to a new target position of "300.0 μm" and a new command speed of "10000.00 mm/min".)

(1) The following data is set.

(Referring to the starting time chart shown in item (2) below, carry out the setting with the sequence program shown in item (3).)

Setting item	Setting value	Setting details	Buffer memory address	
			LD77MH4	LD77MH16
Cd.27 Target position change value (new address)	3000	Set the new address.	1534+100n 1535+100n	4334+100n 4335+100n
Cd.28 Target position change value (new speed)	1000000	Set the new speed.	1536+100n 1537+100n	4336+100n 4337+100n
Cd.29 Target position change request flag	1	Set "1: Requests a change in the target position".	1538+100n	4338+100n

\*: Refer to Section 5.7 "List of control data" for details on the setting details.

(2) The following shows the time chart for target position change.

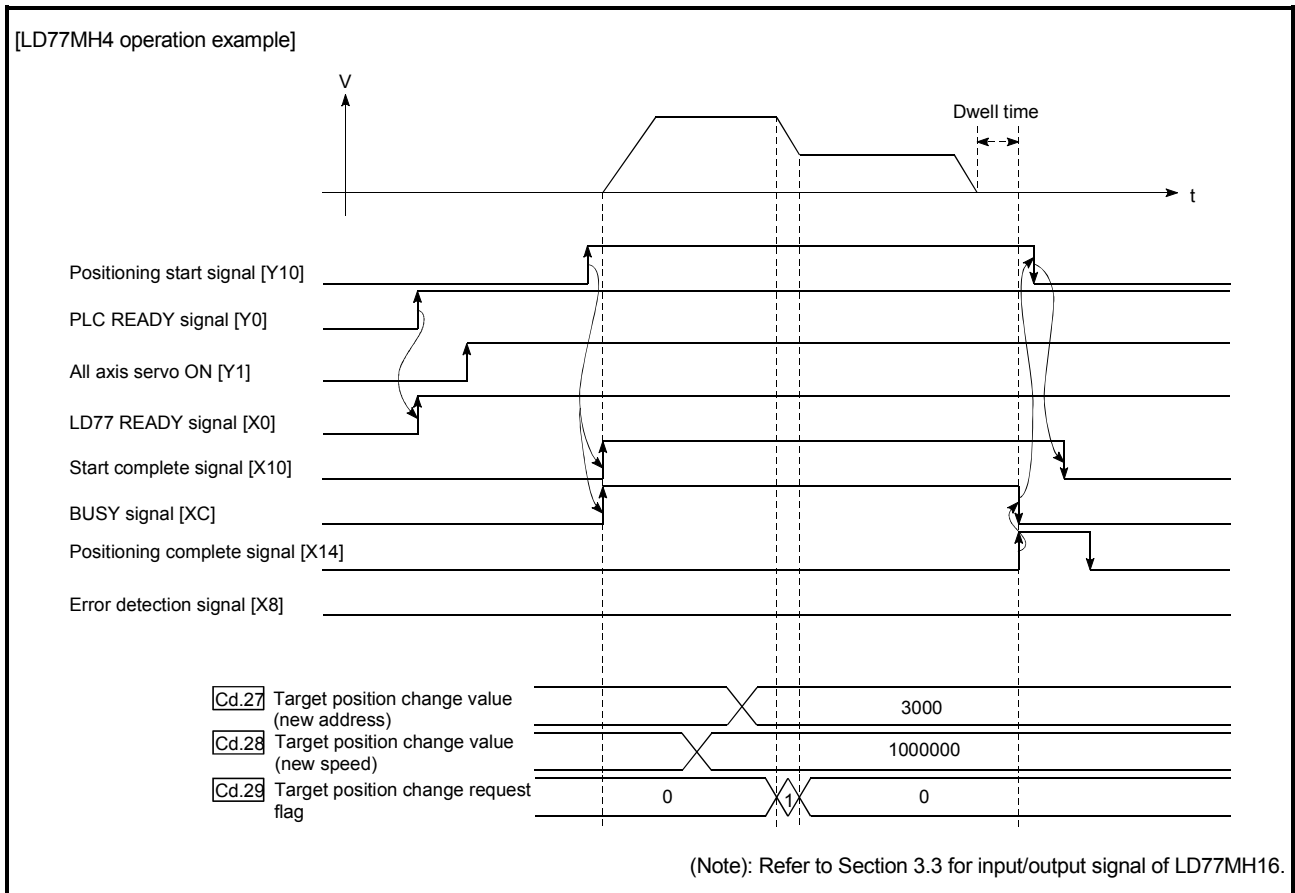
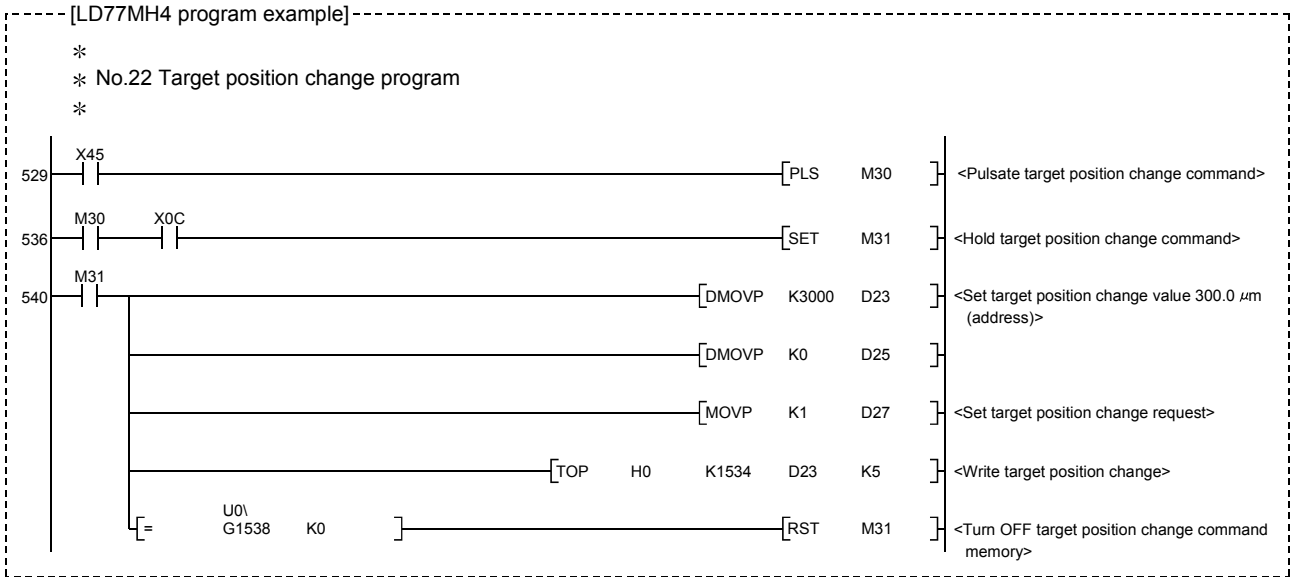

Fig. 13.34 Time chart for target position change from PLC CPU

(3) The following sequence program is added to the control program, and written to the PLC CPU.



### 13.6 Absolute position system

The LD77MH can construct an absolute position system by installing the absolute position system and connecting it through SSCNET III.

The following describes precautions when constructing the absolute position system.

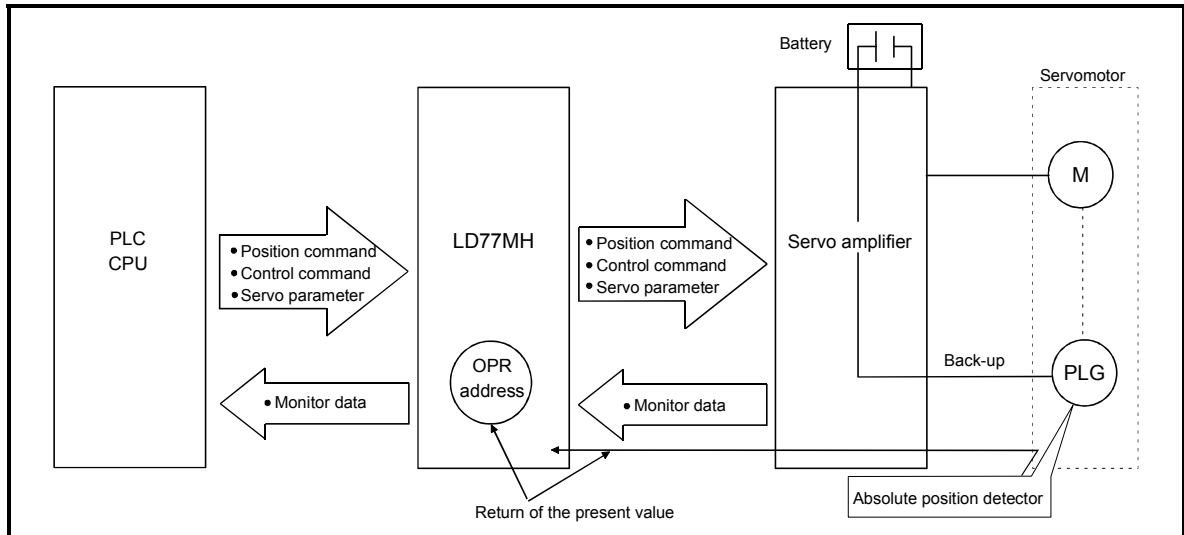

Fig. 13.35 Configuration of absolute position system

#### [1] Setting for absolute positions

When constructing an absolute position system, use a servomotor with absolute position detector.

It is also necessary to install a battery for retaining the location of the OPR in the servo amplifier. When an absolute position detector is installed, the "[Pr.103 Absolute position detection system]" is selected "1: Valid" in the amplifier setting for the servo parameters (basic setting).

	Buffer memory address	
	LD77MH4	LD77MH16
[Pr.103] Absolute position detection system	30103+200n	28403+100n

[2] OPR

The absolute position system can establish the OP position, using "Data set method", "Near-point dog method", "Count method" and "Scale origin signal detection method" OPR method.

In the "Data set method" OPR method, the location to which the location of the OP position is moved by manual operation (JOG operation/manual pulse generator operation) is treated as the OP position.

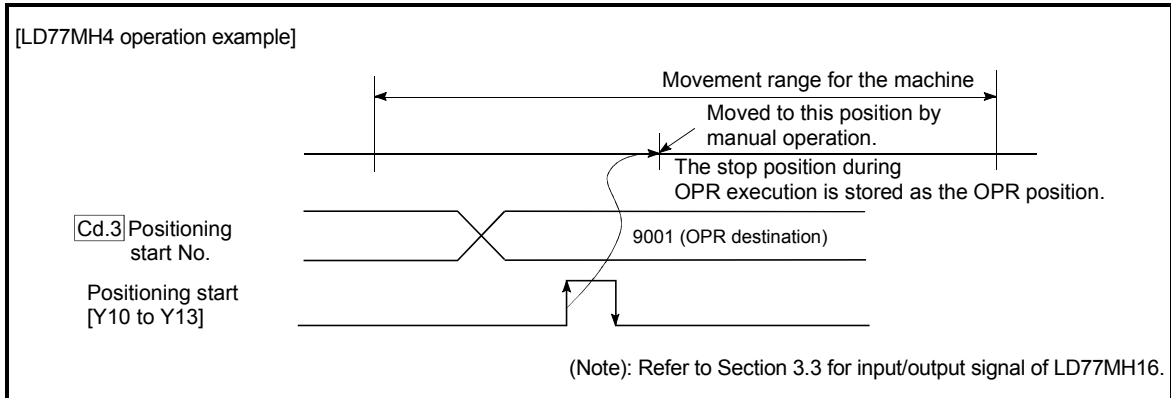

Fig. 13.36 Operation of the OPR execution

## 13.7 Other functions

Other functions include the "step function", "skip function", "M code output function", "teaching function", "command in-position function", "acceleration/deceleration processing function", "pre-reading start function", "deceleration start flag function", "stop command processing for deceleration stop function", "follow up processing function", "speed control 10 × multiplier setting for degree axis function" and "operation setting for incompleteness of OPR function". Each function is executed by parameter setting or sequence program creation and writing.

### 13.7.1 Step function

The "step function" is used to confirm each operation of the positioning control one by one.

It is used in debugging work for major positioning control, etc.

A positioning operation in which a "step function" is used is called a "step operation". In step operations, the timing for stopping the control can be set. (This is called the "step mode".) Control stopped by a step operation can be continued by setting "step continue" (to continue the control) in the "step start information".

The details shown below explain about the "step function".

- [1] Relation between the step function and various controls
- [2] Step mode
- [3] Step start information
- [4] Using the step operation
- [5] Control details
- [6] Precautions during control
- [7] Step function settings

#### [1] Relation between the step function and various controls

The following table shows the relation between the "step function" and various controls.

Control type		Step function	Step applicability
OPR control	Machine OPR control	×	Step operation not possible
	Fast OPR control	×	
Major positioning control	Position control	1-axis linear control	○
		2 to 4-axes linear interpolation control	○
		1-axis fixed-feed control	○
		2 to 4- axes fixed-feed control (interpolation)	○
		2-axis circular interpolation control	○
	1 to 4- axes Speed control	×	Step operation not possible
	Other control	Speed-position switching control	○
Position-speed switching control		○	
Manual control	Current value changing	○	Step operation not possible
	JUMP instruction, NOP instruction, LOOP to LEND	×	
Expansion control	JOG operation, Inching operation	×	Step operation not possible
	Manual pulse generator operation	×	
Expansion control	Speed-torque control	×	

○ : Set when required. × : Setting not possible

[2] Step mode

In step operations, the timing for stopping the control can be set. This is called the "step mode". (The "step mode" is set in the control data " [Cd.34] Step mode".)

The following shows the two types of "step mode" functions.

(1) Deceleration unit step

The operation stops at positioning data requiring automatic deceleration. (A normal operation will be carried out until the positioning data requiring automatic deceleration is found. Once found, that positioning data will be executed, and the operation will then automatically decelerate and stop.)

(2) Data No. unit step

The operation automatically decelerates and stops for each positioning data. (Even in continuous path control, an automatic deceleration and stop will be forcibly carried out.)

[3] Step start information

Control stopped by a step operation can be continued by setting "step continue" (to continue the control) in the "step start information". (The "step start information" is set in the control data " [Cd.36] Step start information".)

The following table shows the results of starts using the "step start information" during step operation.

Stop status in the step operation	[Md.26] Axis operation status	[Cd.36] Step start information	Step start results
1 step of positioning stopped normally	Step standby	1: Step continue	The next positioning data is executed.

The warnings "Step not possible (warning code: 511)" will occur if the " [Md.26] Axis operation status" is as shown below or the step valid flag is OFF when step start information is set.

[Md.26] Axis operation status	Step start results
Standby	Step not continued by warning
Stopped	
Interpolation	
JOG operation	
Manual pulse generator operation	
Analyzing	
Special start standby	
OPR	
Position control	
Speed control	
Speed control in speed-position switching control	
Position control in speed-position switching control	
Speed control in position-speed switching control	
Position control in position-speed switching control	
Control mode switch	
Speed control	
Torque control	

[4] Using the step operation

The following shows the procedure for checking positioning data using the step operation.

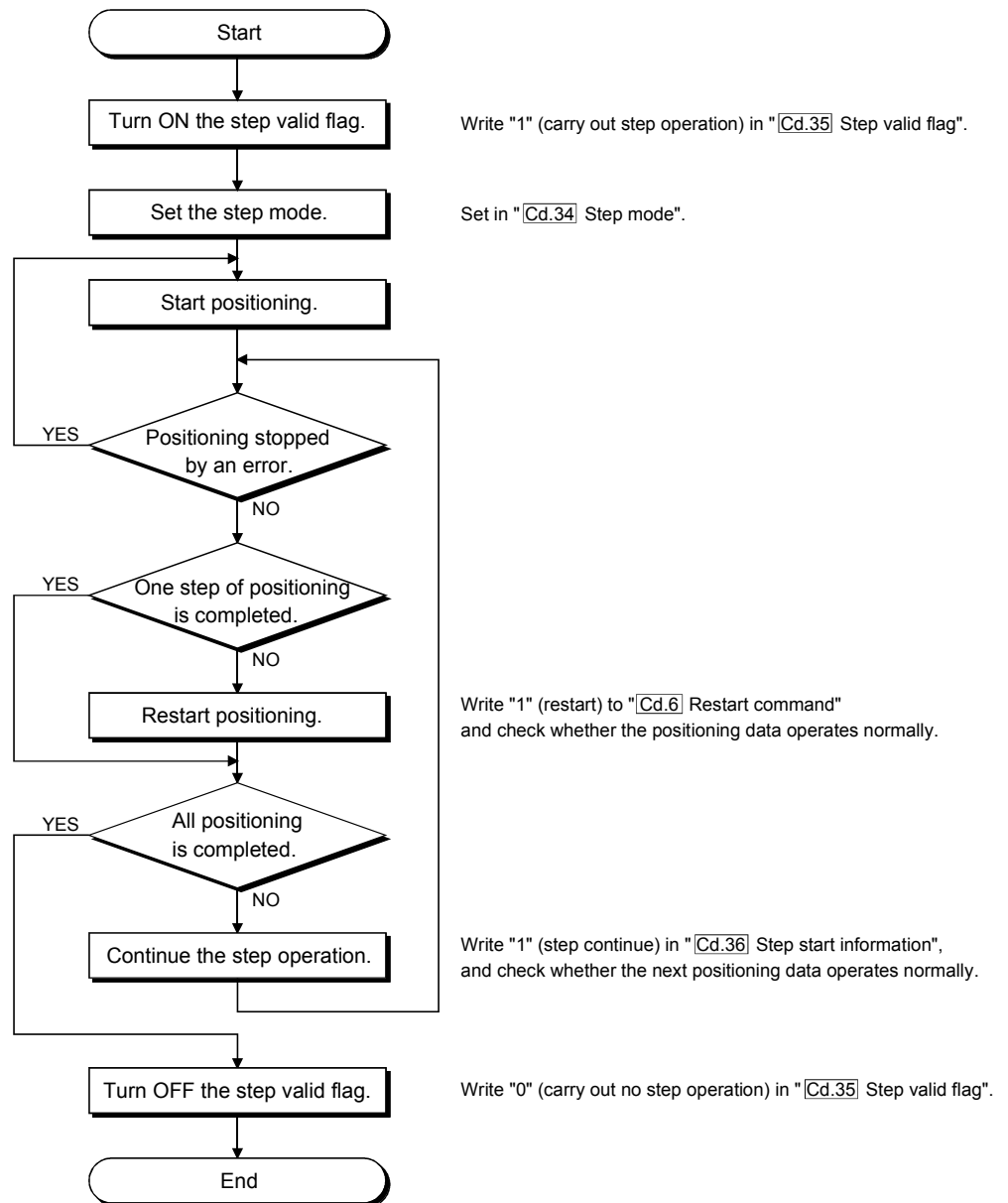



[5] Control details

(1) The following drawing shows a step operation during a "deceleration unit step".

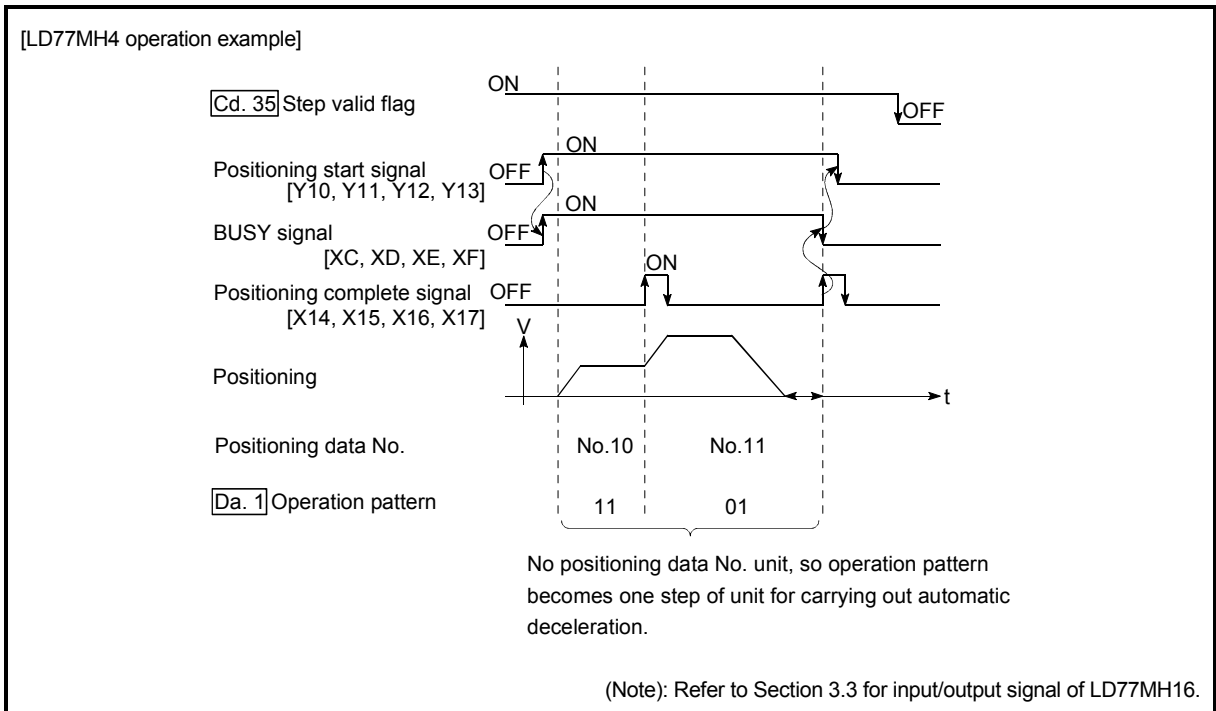

Fig. 13.37 Operation during step execution by deceleration unit step

(2) The following drawing shows a step operation during a "data No. unit step".

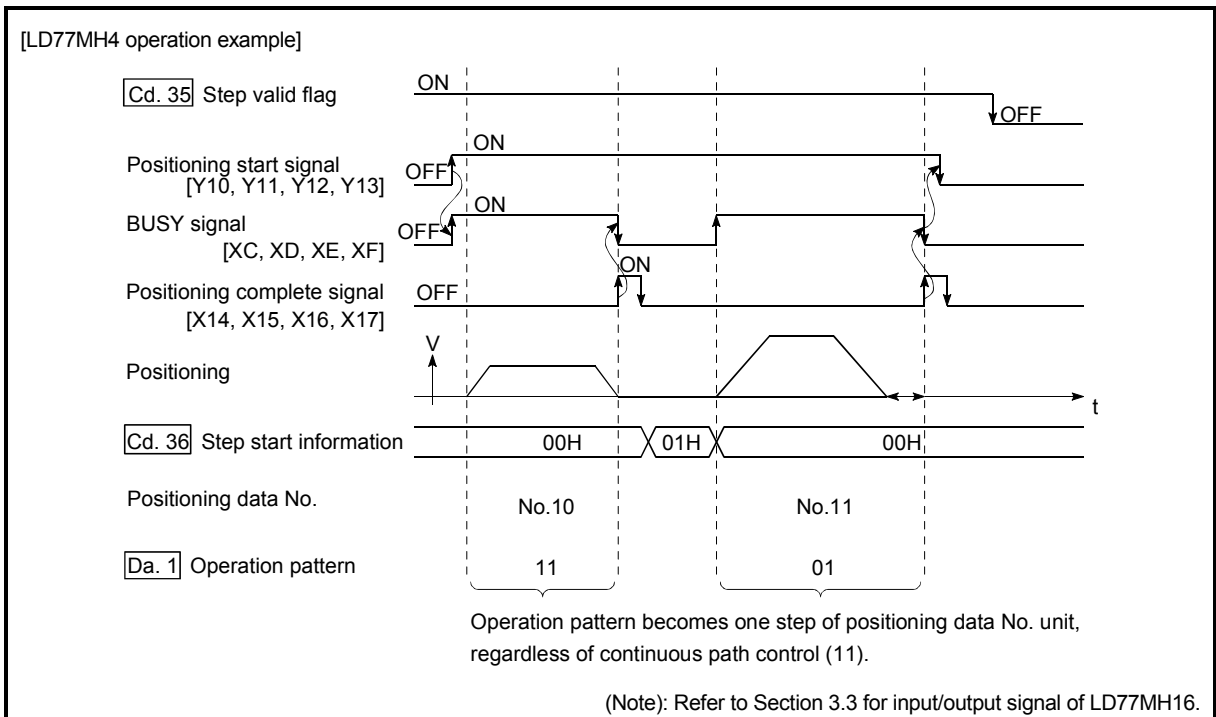

Fig. 13.38 Operation during step execution positioning data No. unit step

**[6] Precautions during control**

- (1) When step operation is carried out using interpolation control positioning data, the step function settings are carried out for the reference axis.
- (2) When the step valid flag is ON, the step operation will start from the beginning if the positioning start signal is turned ON while " [Md.26] Axis operation status" is "step standby". (The step operation will be carried out from the positioning data set in " [Cd.3] Positioning start No.".)

**[7] Step function settings**

To use the "step function", write the data shown in the following table to the LD77MH using the sequence program. Refer to section [4] "Using the step operation" for the timing of the settings.

The set details are validated when written to the LD77MH.

Setting item		Setting value	Setting details	Buffer memory address	
				LD77MH4	LD77MH16
[Cd.34]	Step mode	→	Set "0: Deceleration unit step" or "1: Data No. unit step".	1544+100n	4344+100n
[Cd.35]	Step valid flag	1	Set "1: Carry out step operation".	1545+100n	4345+100n
[Cd.36]	Step start information	→	Set "1: Step continue", depending on the stop status.	1546+100n	4346+100n

\*: Refer to Section 5.7 "List of control data" for details on the setting details.

## 13.7.2 Skip function

The "skip function" is used to stop (deceleration stop) the control of the positioning data being executed at the time of the skip signal input, and execute the next positioning data.

A skip is executed by a skip command ( [Cd.37](#) Skip command) or external command signal.

The "skip function" can be used during control in which positioning data is used.

The details shown below explain about the "skip function".

[1] Control details

[2] Precautions during control

[3] Setting the skip function from the PLC CPU

[4] Setting the skip function using an external command signal

### [1] Control details

The following drawing shows the skip function operation.

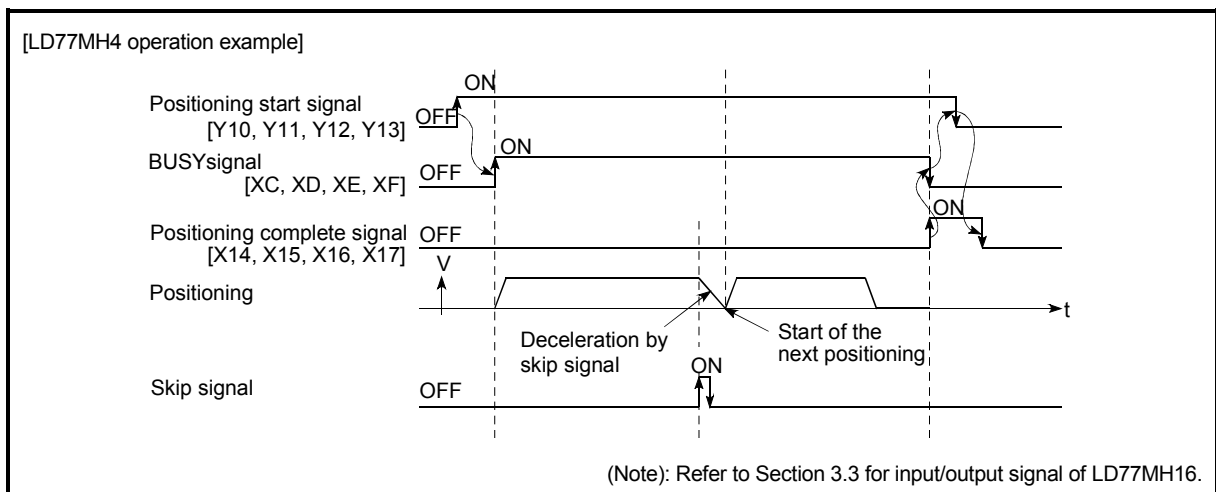

Fig. 13.39 Operation when a skip signal is input during positioning control

### [2] Precautions during control

- (1) If the skip signal is turned ON at the last of an operation, a deceleration stop will occur and the operation will be terminated.
- (2) When a control is skipped (when the skip signal is turned ON during a control), the positioning complete signals will not turn ON.
- (3) When the skip signal is turned ON during the dwell time, the remaining dwell time will be ignored, and the next positioning data will be executed.
- (4) When a control is skipped during interpolation control, the reference axis skip signal is turned ON. When the reference axis skip signal is turned ON, a deceleration stop will be carried out for every axis, and the next reference axis positioning data will be executed.
- (5) The M code ON signals will not turn ON when the M output is set to the AFTER mode (when "1: AFTER mode" is set in " [Pr.18](#) M code ON signal output timing").

(In this case, the M code will not be stored in " [Md.25](#) Valid M code".)

- (6) The skip cannot be carried out by the speed control and position-speed switching control.
- (7) If the skip signal is turned ON with the M code signal turned ON, the transition to the next data is not carried out until the M code signal is turned OFF.

[3] Setting the skip function from the PLC CPU

The following shows the settings and sequence program example for skipping the control being executed in axis 1 with a command from the PLC CPU.

- (1) Set the following data.  
(The setting is carried out using the sequence program shown below in section (2)).

Setting item	Setting value	Setting details	Buffer memory address	
			LD77MH4	LD77MH16
<span style="border: 1px solid black; padding: 2px;">Cd.37</span> Skip command	1	Set "1: Skip request".	1547+100n	4347+100n

\*: Refer to Section 5.7 "List of control data" for details on the setting details.

- (2) Add the following sequence program to the control program, and write it to the PLC CPU.
  - 1) When the "skip command" is input, the value "1" (skip request) set in "Cd.37 Skip command" is written to the LD77MH buffer memory.

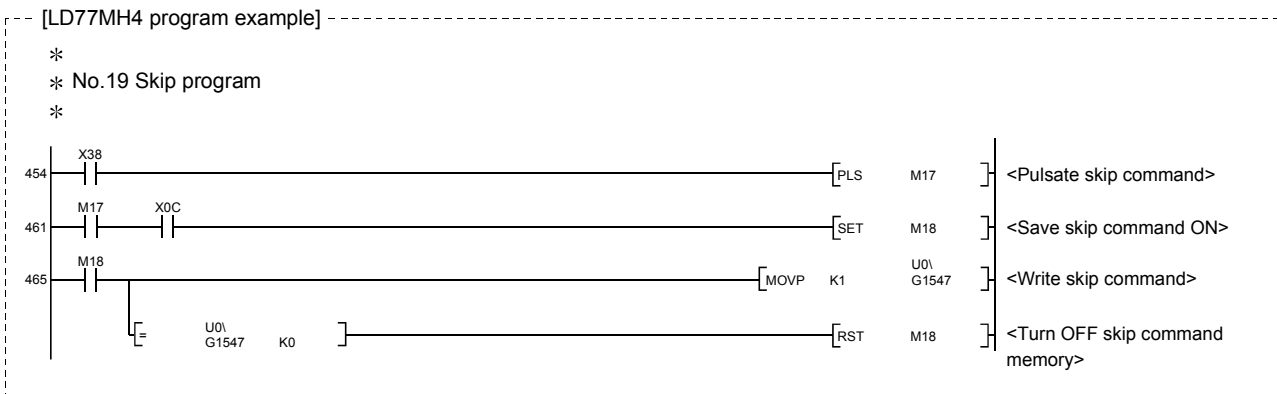

[4] Setting the skip function using an external command signal

The skip function can also be executed using an "external command signal".  
 The following shows the settings and sequence program example for skipping the control being executed in axis 1 using an "external command signal".

(1) Set the following data to execute the skip function using an external command signal.

(The setting is carried out using the sequence program shown below in section (2)).

Setting item	Setting value	Setting details	Buffer memory address	
			LD77MH4	LD77MH16
Pr.42	External command function selection	3	Set "3: Skip request".	
Cd.8	External command valid	1	1505+100n	4305+100n

\*: Refer to Section 5.2 "List of parameter" or Section 5.7 "List of control data" for details on the setting details.

(2) Add the following sequence program to the control program, and write it to the PLC CPU.

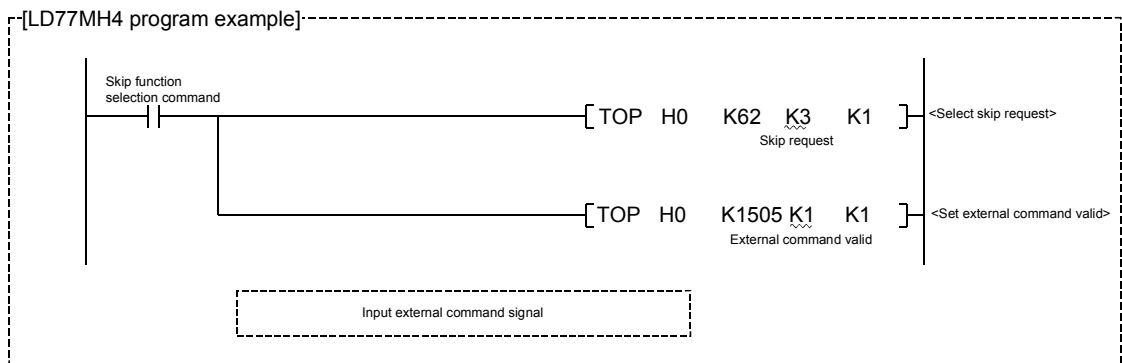

### 13.7.3 M code output function

The "M code output function" is used to command sub work (clamping, drill rotation, tool replacement, etc.) related to the positioning data being executed.

When the M code ON signal is turned ON during positioning execution, a No. called the M code is stored in "Md.25 Valid M code". These "Md.25 Valid M code" are read from the PLC CPU, and used to command auxiliary work. M codes can be set for each positioning data. (Set in setting item "Da.10 M code" of the positioning data.)

The timing for outputting (storing) the M codes can also be set in the "M code output function".

Signal	LD77MH4	LD77MH16
M code ON signal	X4, X5, X6, X7	M code ON ([Md.31] Status: b12)

The details shown below explain about the "M code output function".

- [1] M code ON signal output timing
- [2] M code OFF request
- [3] Precautions during control
- [4] Setting the M code output function
- [5] Reading M codes

#### [1] M code ON signal output timing

The timing for outputting (storing) the M codes can be set in the "M code output function". (The M code is stored in "Md.25 Valid M code" when the M code ON signal is turned ON.)

The following shows the two types of timing for outputting M codes: the "WITH mode" and the "AFTER mode".

##### (1) WITH mode

The M code ON signal is turned ON at the positioning start, and the M code is stored in "Md.25 Valid M code".

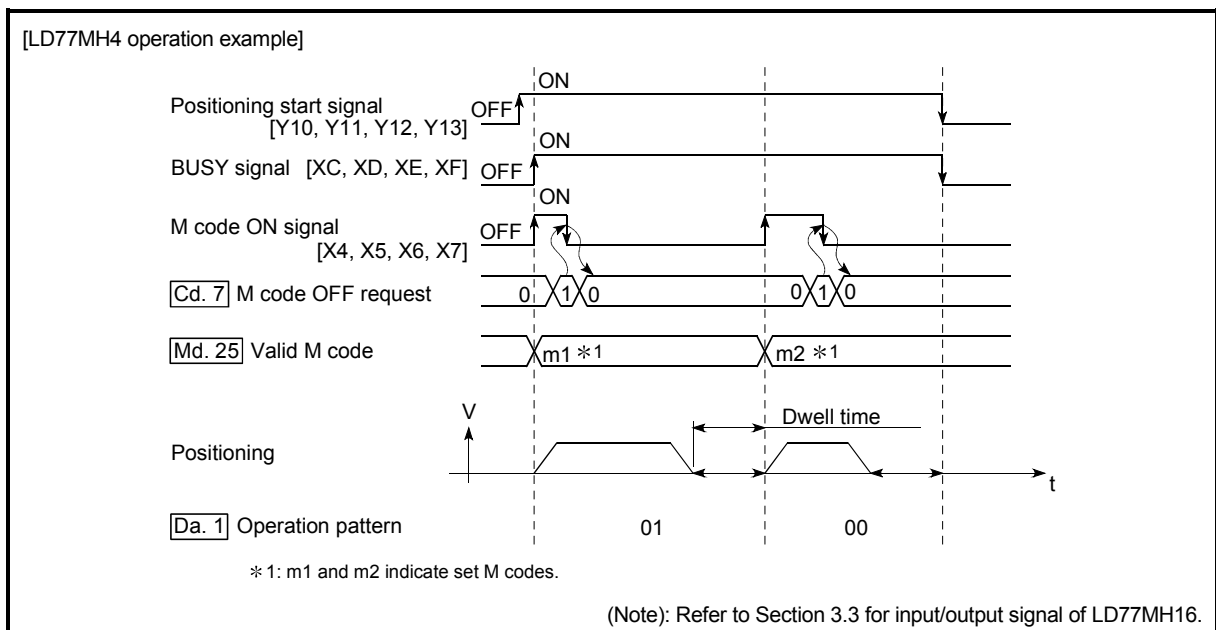

Fig. 13.40 M code ON/OFF timing (WITH mode)

(2) AFTER mode

The M code ON signal is turned ON at the positioning completion, and the M code is stored in "Md.25 Valid M code".

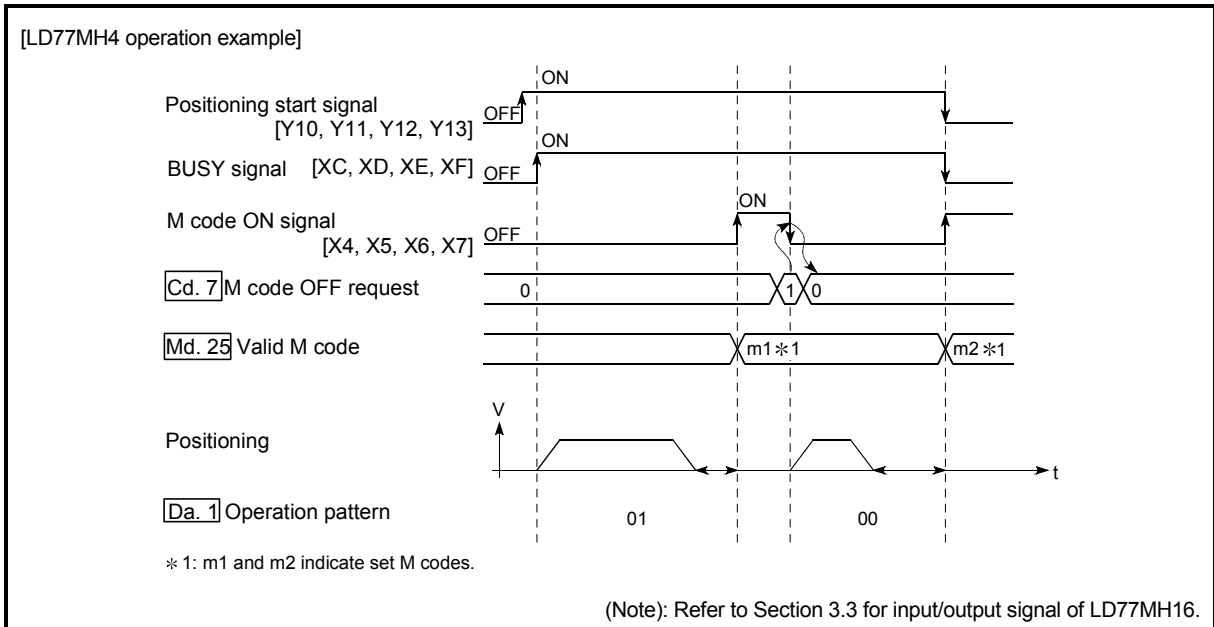

Fig. 13.41 M code ON/OFF timing (AFTER mode)

[2] M code OFF request

When the M code ON signal is ON, it must be turned OFF by the sequence program.

To turn OFF the M code ON signal, set "1" (turn OFF the M code signal) in "Cd.7 M code OFF request".

Setting item	Setting value	Setting details	Buffer memory address	
			LD77MH4	LD77MH16
Cd.7 M code OFF request	1	Set "1": Turn OFF the M code ON signal".	1504+100n	4304+100n

\*: Refer to Section 5.7 "List of control data" for details on the setting details.

The next positioning data will be processed as follows if the M code ON signal is not turned OFF. (The processing differs according to the Da.1 Operation pattern.)

Da.1 Operation pattern	Processing
00 Independent positioning control (Positioning control)	The next positioning data will not be executed until the M code ON signal is turned OFF.
01 Continuous positioning control	
11 Continuous path control	The next positioning data will be executed. If the M code is set to the next positioning data, a warning "M code ON signal ON start" (warning code: 503) will occur.

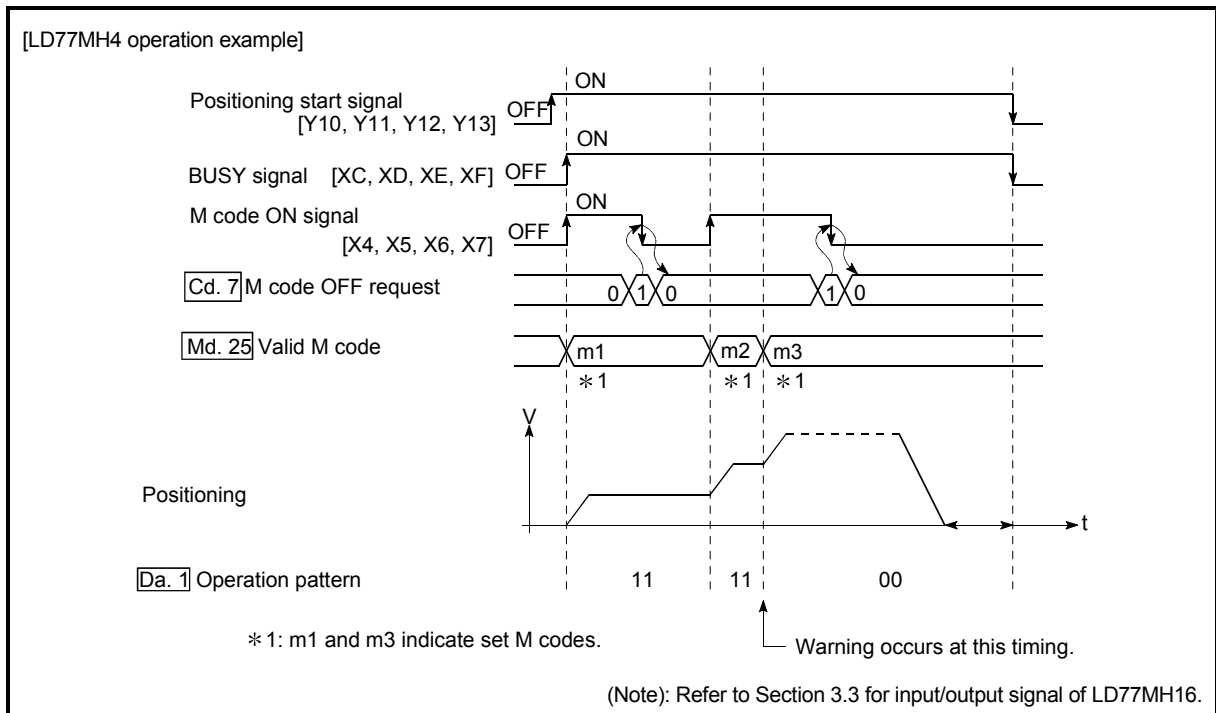

Fig. 13.42 Warning due to an M code ON signal during continuous path control

**POINT**

If the M code output function is not required, set a "0" in setting item " [Da.10] M code" of the positioning data.

**[3] Precautions during control**

- (1) During interpolation control, the reference axis M code ON signal is turned ON.
- (2) The M code ON signal will not turn ON if "0" is set in " [Da.10] M code". (The M code will not be output, and the previously output value will be held in " [Md.25] Valid M code".)
- (3) If the M code ON signal is ON at the positioning start, an error "M code signal ON at positioning start (error code: 536)" will occur, and the positioning will not start.
- (4) If the PLC READY signal [Y0] is turned OFF, the M code ON signal will turn OFF and "0" will be stored in " [Md.25] Valid M code".
- (5) If the positioning operation time is short during continuous path control, there will not be enough time to turn OFF the M code ON signal, and a warning "M code signal ON (error code: 503)" may occur. In this case, set a "0" in the " [Da.10] M code" of that section's positioning data.
- (6) In the AFTER mode during speed control, the M code is not output and the M code ON signal does not turn ON.
- (7) If current value changing where "9003" has been set to " [Cd.3] Positioning start No." is performed, the M code output function is made invalid.



[4] Setting the M code output function

The following shows the settings to use the "M code output function".

- (1) Set the M code No. in the positioning data " [Da.10] M code".
- (2) Set the timing to output the M code ON signal.

Set the required value in the following parameter, and write it to the LD77MH. The set details are validated at the rising edge (OFF → ON) of the PLC READY signal [Y0].

Setting item	Setting value	Setting details	Buffer memory address	
			LD77MH4	LD77MH16
[Pr.18] M code ON signal output timing	→	Set the timing to output the M code ON signal. 0: WITH mode 1: AFTER mode	27+150n	

\*: Refer to Section 5.2 "List of parameters" for setting details.

[5] Reading M codes

"M codes" are stored in the following buffer memory when the M code ON signal turns ON.

Monitor item	Monitor value	Storage details	Buffer memory address	
			LD77MH4	LD77MH16
[Md.25] Valid M code	→	The M code No. ( [Da.10] M code) set in the positioning data is stored.	808+100n	2408+100n

\*: Refer to Section 5.6 "List of monitor data" for information on the storage details.

The following shows a sequence program example for reading the " [Md.25] Valid M code" to the PLC CPU data register (D110). (The read value is used to command the sub work.)

Read M codes not as "rising edge commands", but as "ON execution commands".

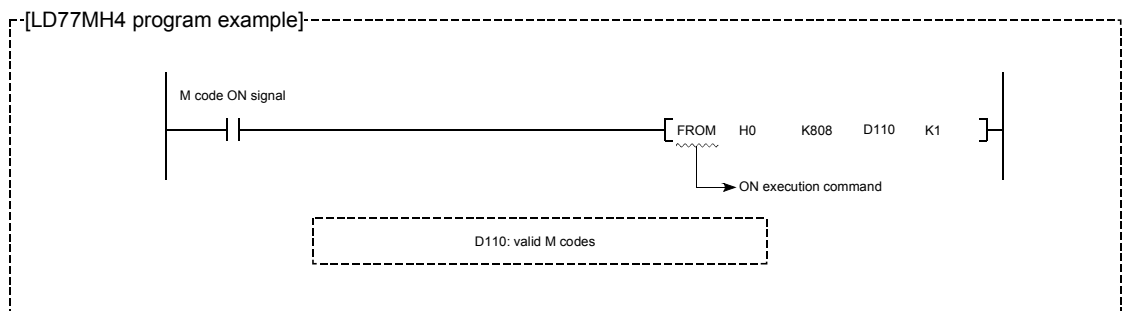

### 13.7.4 Teaching function

The "teaching function" is used to set addresses aligned using the manual control (JOG operation, inching operation manual pulse generator operation) in the positioning data addresses ("Da.6 Positioning address/movement amount", "Da.7 Arc address").

The details shown below explain about the "teaching function".

- [1] Control details
- [2] Precautions during control
- [3] Data used in teaching
- [4] Teaching procedure
- [5] Teaching program example

#### [1] Control details

##### (1) Teaching timing

Teaching is executed using the sequence program when the BUSY signal is OFF. (During manual control, teaching can be carried out as long as the axis is not BUSY, even when an error or warning has occurred.)

Signal	LD77MH4	LD77MH16
BUSY signal	XC to XF	X10 to X1F

##### (2) Addresses for which teaching is possible

The addresses for which teaching is possible are "current feed values" (Md.20 Current feed value) having the OP as a reference. The settings of the "movement amount" used in incremental system positioning cannot be used. In the teaching function, these "current feed values" are set in the "Da.6 Positioning address/movement amount" or "Da.7 Arc address".

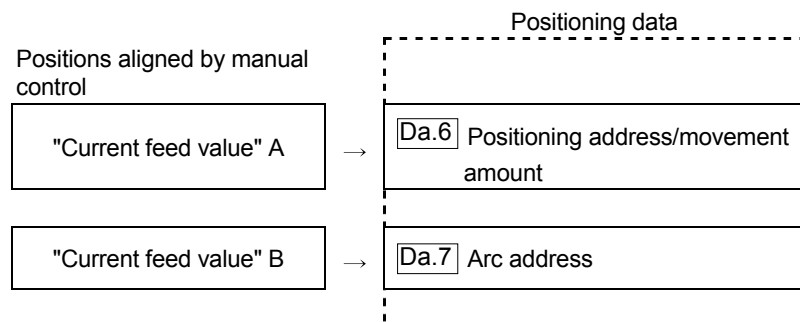

##### (3) Dedicated instructions "ZP.TEACH 1, ZP.TEACH 2, ZP.TEACH 3, ZP.TEACH 4"

When the dedicated instructions "ZP.TEACH 1, ZP.TEACH 2, ZP.TEACH 3, ZP.TEACH 4" are used to execute the teaching function, the programming becomes easier. Refer to Chapter 15 "Dedicated Instructions" for details.

## [2] Precautions during control

- (1) Before teaching, a "machine OPR" must be carried out to establish the OP. (When a current value changing, etc., is carried out, " [Md.20] Current feed value" may not show absolute addresses having the OP as a reference.)
- (2) Teaching cannot be carried out for positions to which movement cannot be executed by manual control (positions to which the workpiece cannot physically move). (During center point designation circular interpolation control, etc., teaching of " [Da.7] Arc address" cannot be carried out if the center point of the arc is not within the moveable range of the workpiece.)
- (3) Writing to the flash ROM can be executed up to 100,000 times. If writing to the flash ROM exceeds 100,000 times, the writing may become impossible (assured value is up to 100,000 times). If an error (error code: 805) occurs when writing to the flash ROM has been completed, check whether or not the program is created so as to write continuously to the flash ROM.

## [3] Data used in teaching

The following control data is used in teaching.

Setting item	Setting value	Setting details	Buffer memory address	
			LD77MH4	LD77MH16
[Cd.1] Flash ROM write request	1	Write the set details to the flash ROM (backup the changed data).	1900	5900
[Cd.38] Teaching data selection	→	Sets to which "current feed value" is written. 0: Written to " [Da.6] Positioning address/ movement amount". 1: Written to " [Da.7] Arc address".	1548+100n	4348+100n
[Cd.39] Teaching positioning data No.	→	Designates the data to be taught. (Teaching is carried out when the setting value is 1 to 600.) When teaching has been completed, this data is zero cleared.	1549+100n	4349+100n

\*: Refer to Section 5.7 "List of control data" for details on the setting details.

[4] Teaching procedure

The following shows the procedure for a teaching operation.

(1) When teaching to the "[Da.6] Positioning address/movement amount"

(Teaching example on LD77MH4 [axis 1])

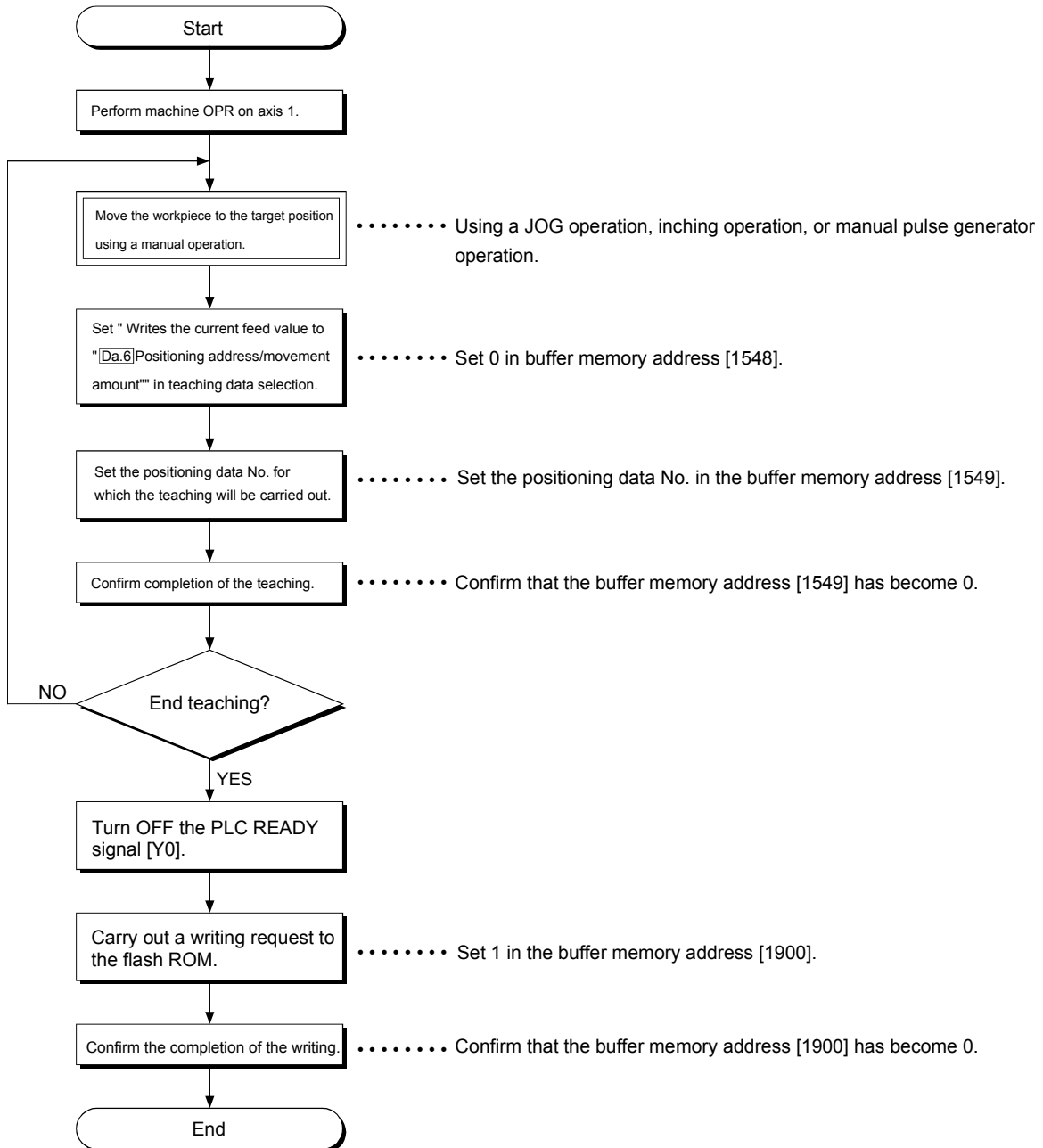

- (2) When teaching to the "[Da.7] Arc address", then teaching to the "[Da.6] Positioning address/movement amount"  
 (Teaching example for 2-axis circular interpolation control with sub point designation on LD77MH4 [axis 1] and [axis 2])

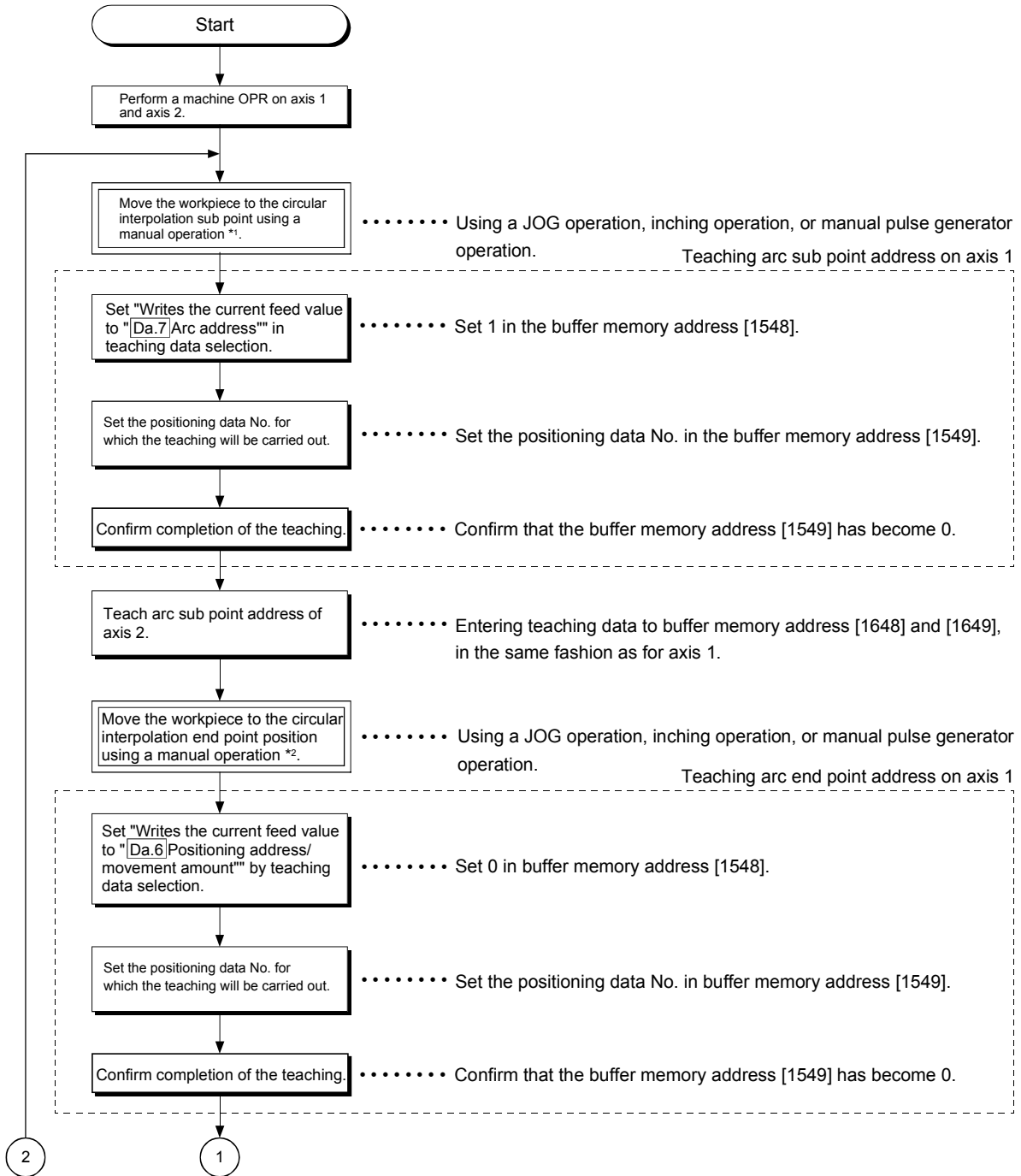

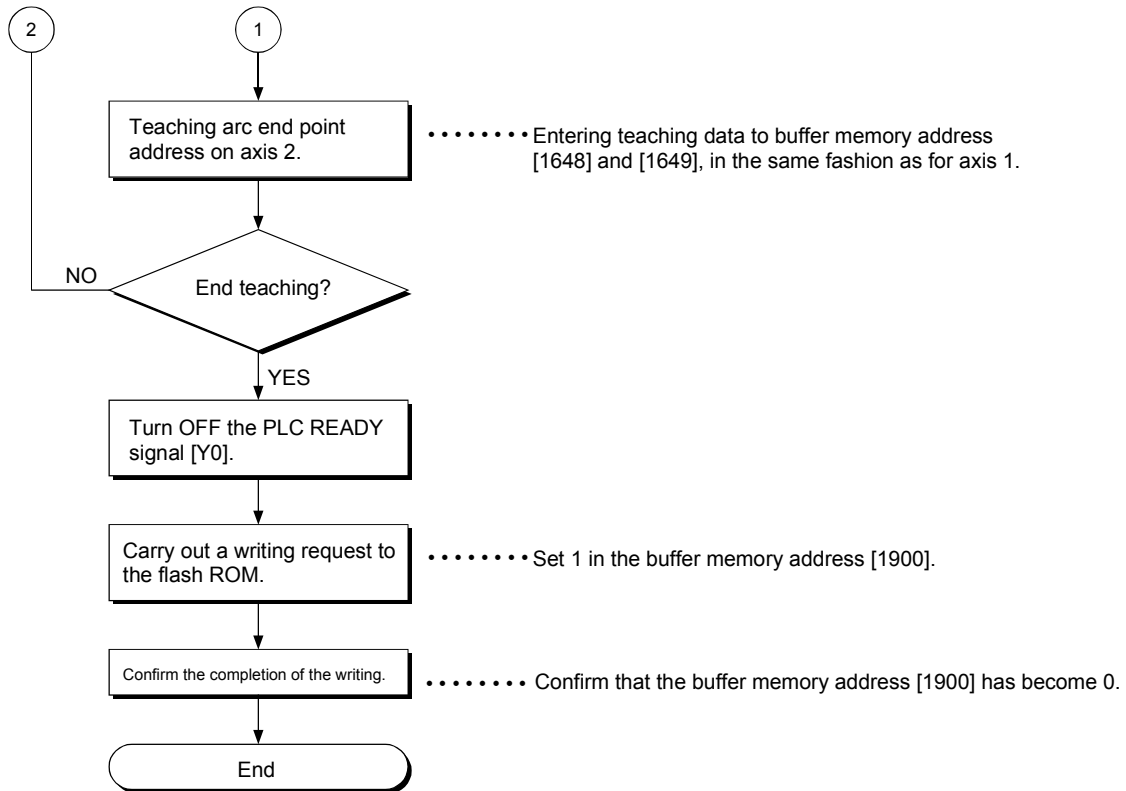

[Motion path]

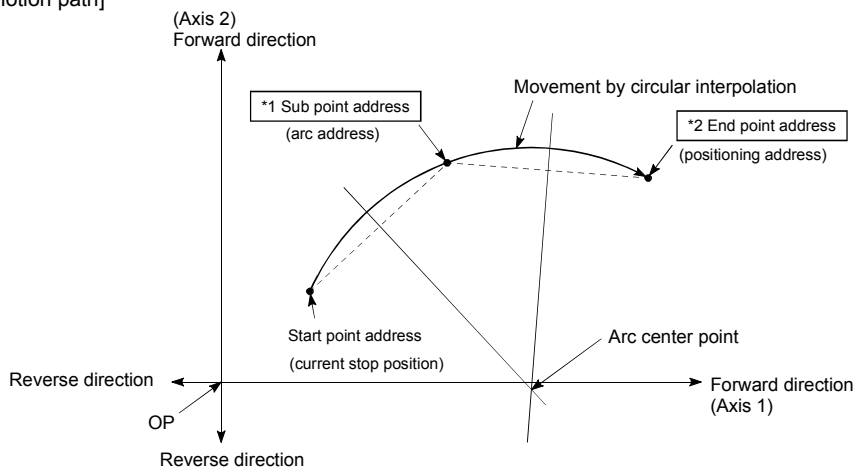

[5] Teaching program example

The following shows a sequence program example for setting (writing) the positioning data obtained with the teaching function to the LD77MH.

(1) Setting conditions

- When setting the current feed value as the positioning address, write it when the BUSY signal is OFF.

(2) Program example

- The following example shows a program to carry out the teaching of axis 1 by the dedicated instruction " ZP.TEACH 1".
  - 1) Move the workpiece to the target position using a JOG operation (or an inching operation, a manual pulse generator operation).

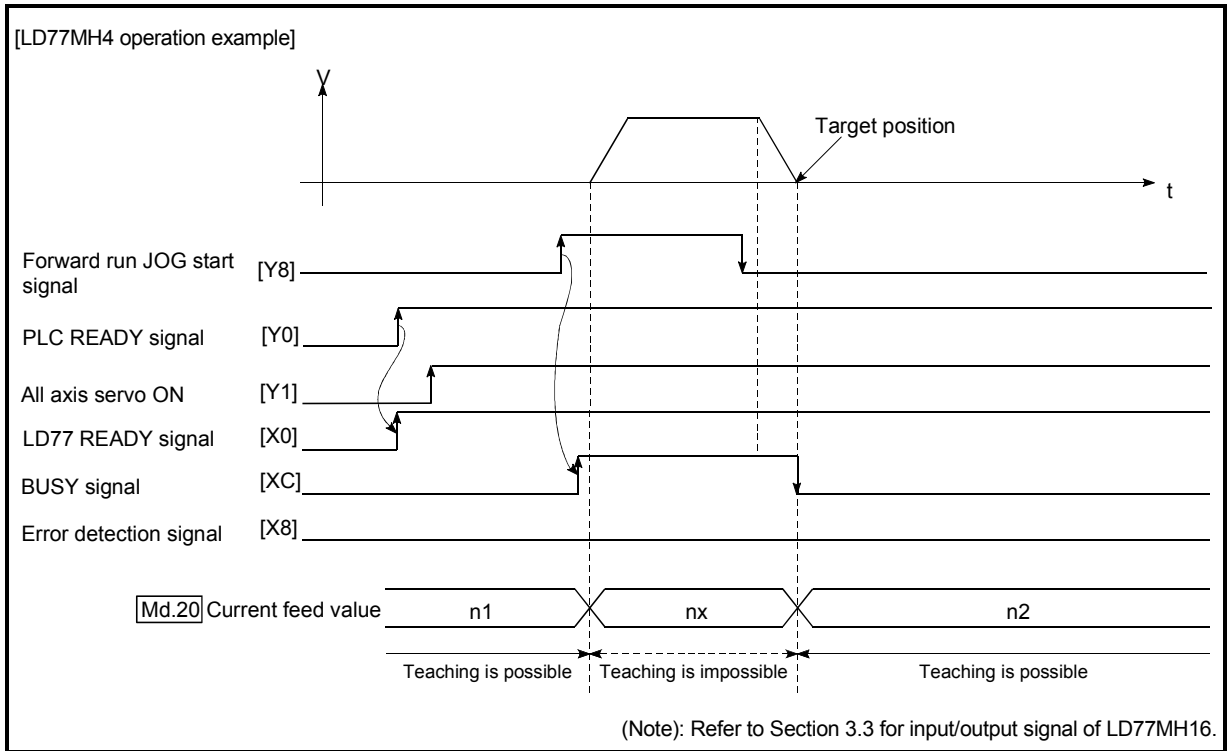

2) Carry out the teaching operation with the following program.

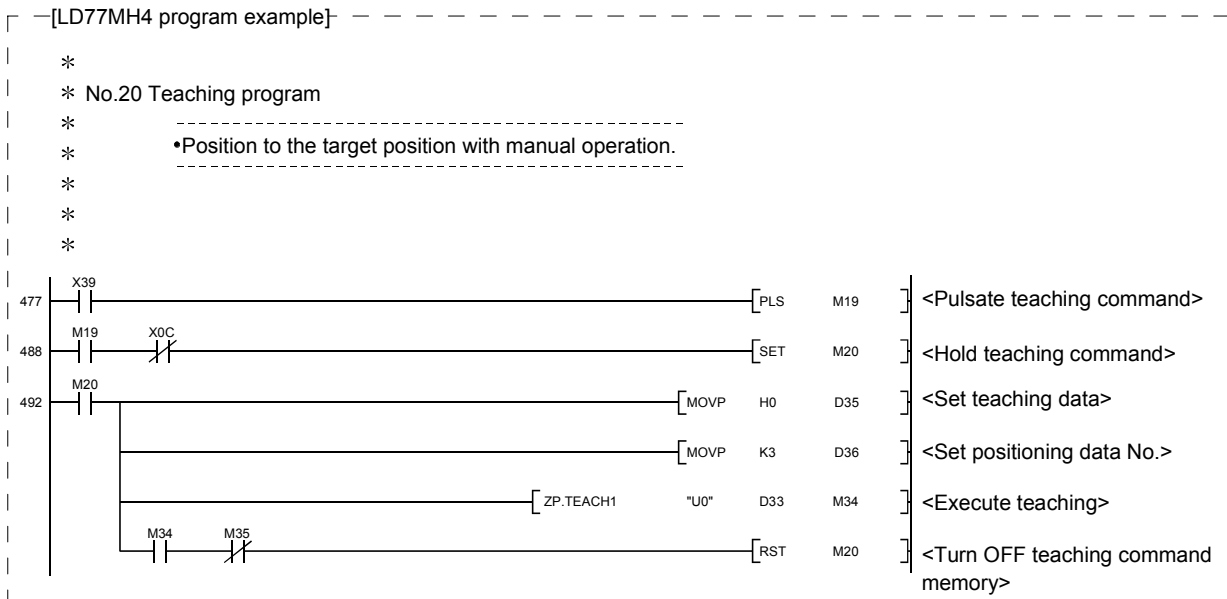

**POINT**

- (1) Confirm the teaching function and teaching procedure before setting the positioning data.
- (2) The positioning addresses that are written are absolute address (ABS) values.
- (3) If the positioning operation is correctly completed with the written positioning data, it is recommended that the positioning data be registered in the LD77MH flash ROM.

### 13.7.5 Command in-position function

The "command in-position function" checks the remaining distance to the stop position during the automatic deceleration of positioning control, and sets "1". This flag is called the "command in-position flag". The command in-position flag is used as a front-loading signal indicating beforehand the completion of the position control.

The details shown below explain about the "command in-position function".

[1] Control details

[2] Precautions during control

[3] Setting the command in-position function

[4] Confirming the command in-position flag

#### [1] Control details

The following shows control details of the command in-position function.

- (1) When the remaining distance to the stop position during the automatic deceleration of positioning control becomes equal to or less than the value set in "Pr.16 Command in-position width", "1" is stored in the command in-position flag (Md.31 Status: b2).

(Command in-position width check)

Remaining distance  $\leq$  "Pr.16 Command in-position width" setting value

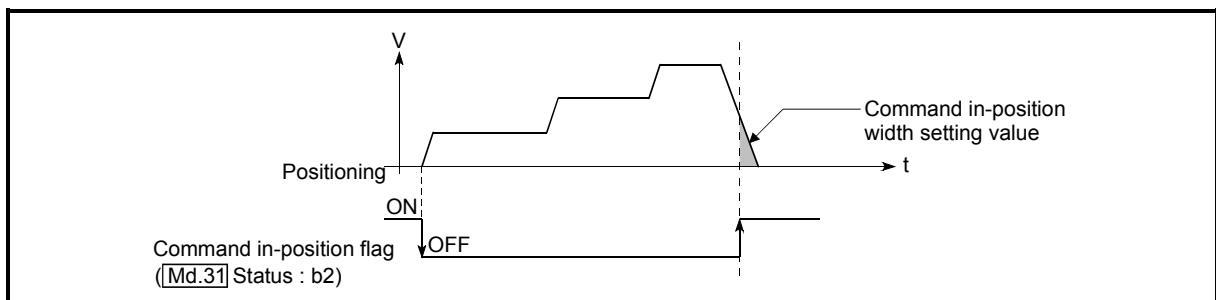

Fig. 13.43 Command in-position operation

- (2) A command in-position width check is carried out every operation cycle.



## [2] Precautions during control

(1) A command in-position width check will not be carried out in the following cases.

- During speed control.
- During speed control in speed-position switching control.
- During speed control in position-speed switching control.
- During speed control mode
- During torque control mode

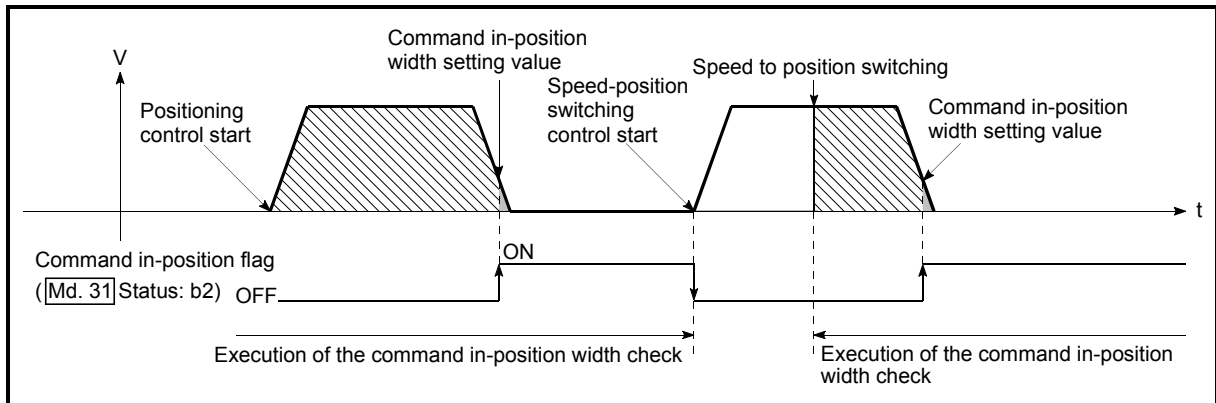

Fig. 13.44 Command in-position width check

(2) The command in-position flag will be turned OFF in the following cases.

("0" will be stored in "Md.31 Status: b2".)

- At the positioning control start
- At the speed control start
- At the speed-position switching control, position-speed switching control start
- At the OPR control start
- At the JOG operation start
- At the inching operation start
- When the manual pulse generator operation is enabled.

(3) The "Pr.16 Command in-position width" and command in-position flag (Md.31 Status: b2) of the reference axis are used during interpolation control.

When the "Pr.20 Interpolation speed designation method" is "Composite speed", the command in-position width check is carried out in the remaining distance on the composite axis (line/arc connecting the start point address and end point address).

**[3] Setting the command in-position function**

To use the "command in-position function", set the required value in the parameter shown in the following table, and write it to the LD77MH.

The set details are validated at the rising edge (OFF → ON) of the PLC READY signal [Y0].

Setting item	Setting value	Setting details	Factory-set initial value
Pr.16	→	Turn ON the command in-position flag, and set the remaining distance to the stop position of the position control.	100

\*: Refer to Section 5.2 "List of parameters" for setting details.

**[4] Confirming the command in-position flag**

The "command in-position flag" is stored in the following buffer memory.

Monitor item	Monitor value	Storage details	Buffer memory address	
			LD77MH4	LD77MH16
Md.31	→	The command in-position flag is stored in the "b2" position.	817+100n	2417+100n

\*: Refer to Section 5.6 "List of monitor data" for information on the storage details.

**REMARK**

- Parameters are set for each axis.
- It is recommended that the parameters be set whenever possible with GX Works2. Execution by sequence program uses many sequence programs and devices. The execution becomes complicated, and the scan times will increase.

### 13.7.6 Acceleration/deceleration processing function

The "acceleration/deceleration processing function" adjusts the acceleration/deceleration of each control to the acceleration/deceleration curve suitable for device.

Setting the acceleration/deceleration time changes the slope of the acceleration/deceleration curve.

The following two methods can be selected for the acceleration/deceleration curve:

- Trapezoidal acceleration/deceleration
- S-curve acceleration/deceleration

Refer to Section 12.1 "Speed-torque control" for acceleration/deceleration processing of speed-torque control.

The details shown below explain about the "acceleration/deceleration processing function".

[1] "Acceleration/deceleration time 0 to 3" control details and setting

[2] "Acceleration/deceleration method setting" control details and setting

#### [1] "Acceleration/deceleration time 0 to 3" control details and setting

In the LD77MH, four types each of acceleration time and deceleration time can be set. By using separate acceleration/deceleration times, control can be carried out with different acceleration/deceleration times for positioning control, JOG operation, OPR, etc.

Set the required values for the acceleration/deceleration time in the parameters shown in the following table, and write them to the LD77MH.

The set details are validated when written to the LD77MH.

Setting item	Setting value	Setting details	Factory-set initial value
Pr.9	Acceleration time 0	→	1000
Pr.25	Acceleration time 1	→	Set the acceleration time at a value within the range of 1 to 8388608 ms.
Pr.26	Acceleration time 2	→	
Pr.27	Acceleration time 3	→	
Pr.10	Deceleration time 0	→	
Pr.28	Deceleration time 1	→	Set the deceleration time at a value within the range of 1 to 8388608 ms.
Pr.29	Deceleration time 2	→	
Pr.30	Deceleration time 3	→	

\*: Refer to Section 5.2 "List of parameters" for setting details.

[2] "Acceleration/deceleration method setting" control details and setting

In the "acceleration/deceleration method setting", the acceleration/deceleration processing method is selected and set. The set acceleration/deceleration processing is applied to all acceleration/deceleration. (except for inching operation, manual pulse generator operation and speed-torque control.)

The two types of "acceleration/deceleration processing method" are shown below.

(1) Trapezoidal acceleration/deceleration processing method

This is a method in which linear acceleration/deceleration is carried out based on the acceleration time, deceleration time, and speed limit value set by the user.

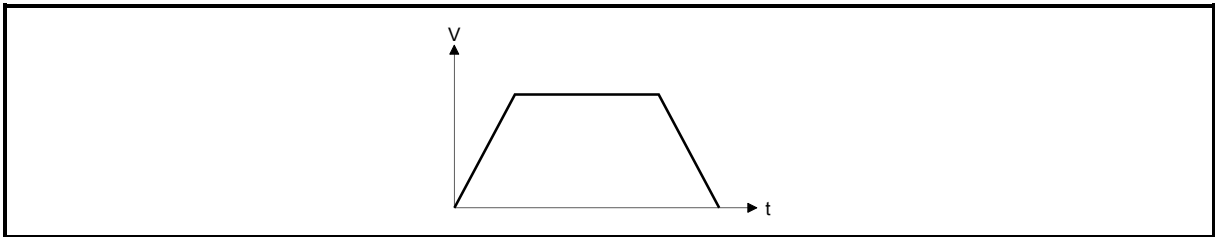

Fig. 13.45 Trapezoidal acceleration/deceleration processing method

(2) S-curve acceleration/deceleration processing method

In this method, the motor burden is reduced during starting and stopping. This is a method in which acceleration/deceleration is carried out gradually, based on the acceleration time, deceleration time, speed limit value, and "Pr.35 S-curve ratio" (1 to 100%) set by the user.

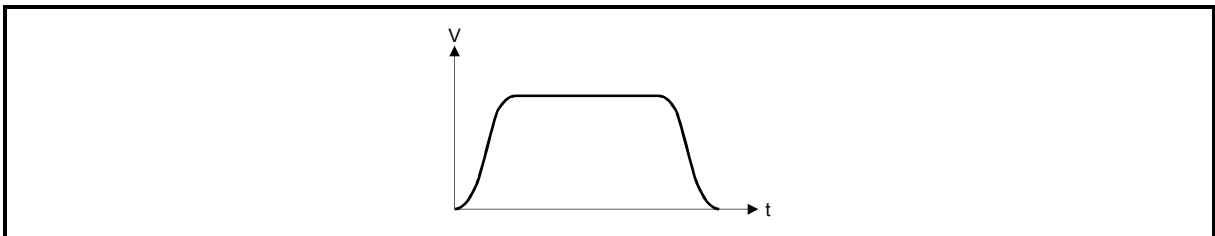

Fig. 13.46 S-curve acceleration/deceleration processing method

When a speed change request or override request is given during S-curve acceleration/ deceleration processing, S-curve acceleration/deceleration processing begins at a speed change request or override request start.

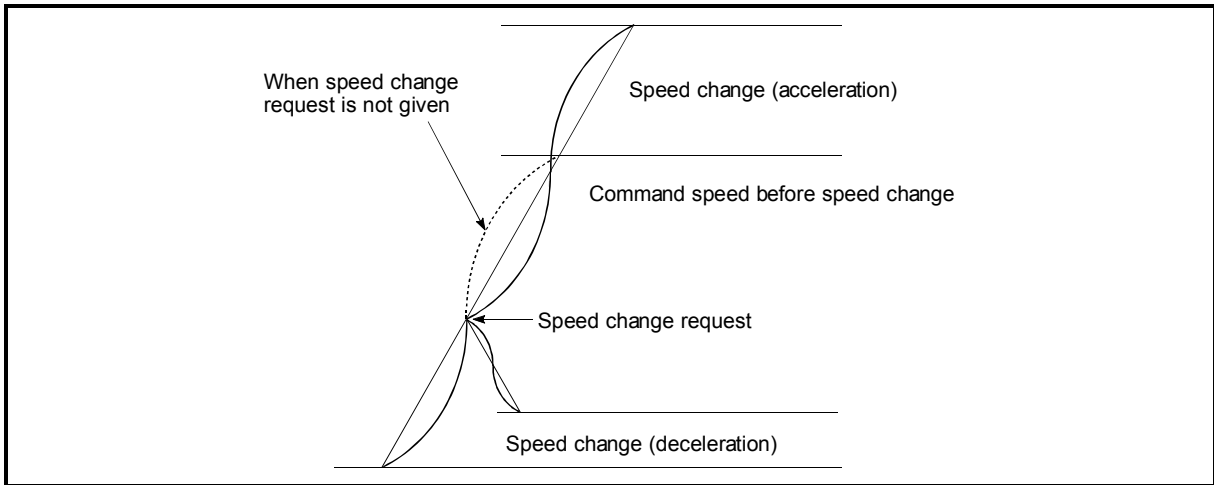

Fig. 13.47 Speed change during S-curve acceleration/deceleration processing

Set the required values for the "acceleration/deceleration method setting" in the parameters shown in the following table, and write them to the LD77MH.

The set details are validated when written to the LD77MH.

Setting item	Setting value	Setting details	Factory-set initial value
Pr.34 Acceleration/ deceleration process selection	→	Set the acceleration/deceleration method. 0: Trapezoidal acceleration/deceleration processing 1: S-curve acceleration/deceleration processing	0
Pr.35 S-curve ratio	→	Set the acceleration/deceleration curve when "1" is set in " Pr.34 Acceleration/deceleration process selection".	100

\*: Refer to Section 5.2 "List of parameters" for setting details.

**REMARK**

- Parameters are set for each axis.
- It is recommended that the parameters be set whenever possible with GX Works2. Execution by sequence program uses many sequence programs and devices. The execution becomes complicated, and the scan times will increase.

### 13.7.7 Pre-reading start function

The "pre-reading start function" does not start servo while the execution prohibition flag is ON if a positioning start request is given with the execution prohibition flag ON, and starts servo within operation cycle after OFF of the execution prohibition flag is detected. The positioning start request is given when the axis is in a standby status, and the execution prohibition flag is turned OFF at the axis operating timing.

The "pre-reading start function" will be explained below.

- [1] Controls
- [2] Precautions during control
- [3] Program examples

#### [1] Controls

The pre-reading start function is performed by turning ON the positioning start signal with the execution prohibition flag ON, or by executing the dedicated instruction (ZP.PSTRT1, ZP.PSTRT2, ZP.PSTRT3, ZP.PSTRT4). However, if positioning is started with the execution prohibition flag ON, the positioning data is analyzed but servo start is not provided. While the execution prohibition flag is ON, "Md.26 Axis operation status" remains unchanged from "5: Analyzing". The servo starts within operation cycle after the execution prohibition flag has turned OFF, and "Md.26 Axis operation status" changes to the status (e.g. position control, speed control) that matches the control system. (Refer to Fig.13.48)

Signal	LD77MH4	LD77MH16
Execution prohibition flag	Y14, Y15, Y16, Y17	<a href="#">Cd.183</a> Execution prohibition flag

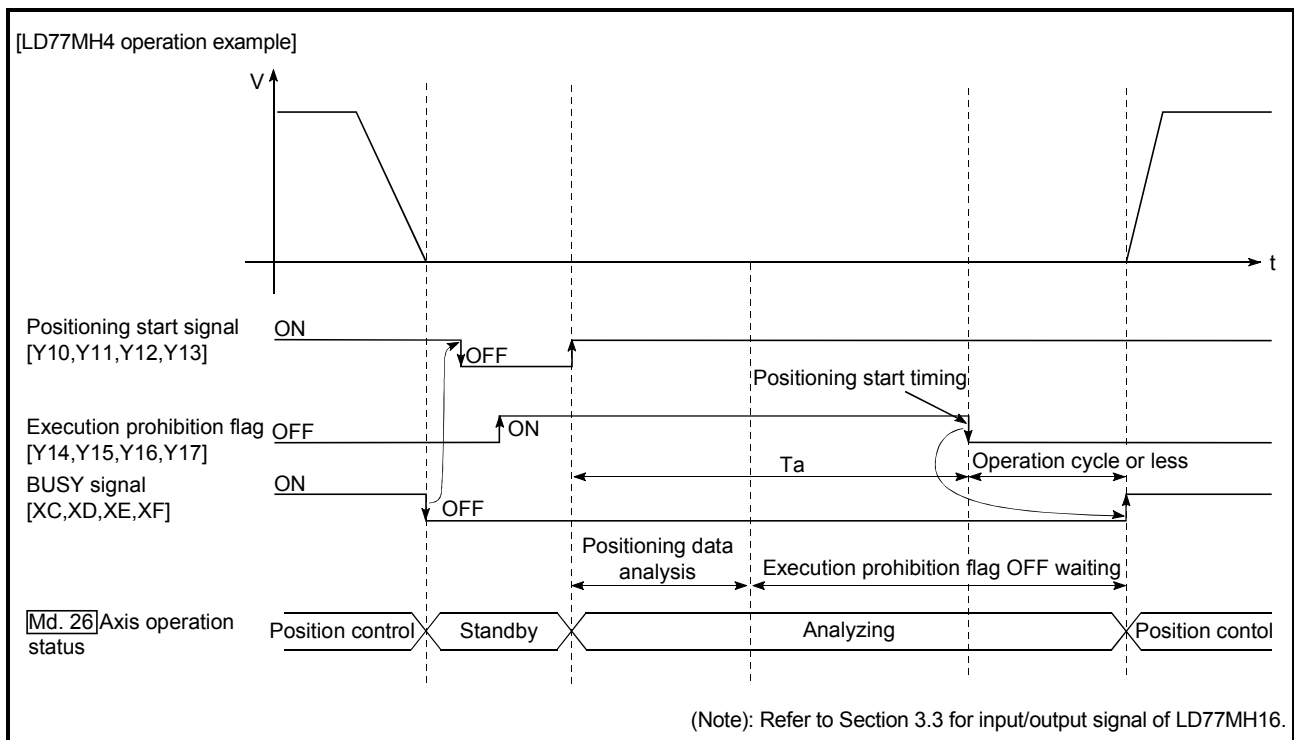

Fig. 13.48 Operations of pre-reading start function

[2] Precautions during control

- (1) The time required to analyze the positioning data is up to 0.88ms (LD77MH4)/ 3.55ms(LD77MH16).
- (2) After positioning data analysis, the system is put in an execution prohibition flag OFF waiting status. Any change made to the positioning data in the execution prohibition flag OFF waiting status is not reflected on the positioning data. Change the positioning data before turning ON the positioning start signal.
- (3) The pre-reading start function is invalid if the execution prohibition flag is turned OFF between when the positioning start signal has turned ON and when positioning data analysis is completed ( $T_a < \text{start time}$ ,  $T_a$ : Refer to Fig. 13.48).
- (4) The data No. which can be executed positioning start using "[Cd.3]Positioning start No." with the pre-reading start function are No. 1 to 600 only. Performing the pre-reading start function at the setting of No. 7000 to 7004 or 9001 to 9004 will result in an outside start No. range error (Error code: 543).
- (5) Always turn ON the execution prohibition flag at the same time or before turning ON the positioning start signal. Pre-reading may not be started if the execution prohibition flag is turned ON during  $T_a$  after the positioning start signal is turned ON. The pre-reading start function is invalid if the execution prohibition flag is turned ON after positioning start with the execution prohibition flag OFF. (It is made valid at the next positioning start.)

[3] Program examples

[LD77MH4 program example]

- \*
- \* Pre-reading start program (when positioning start signal Y10 is used)
- \*

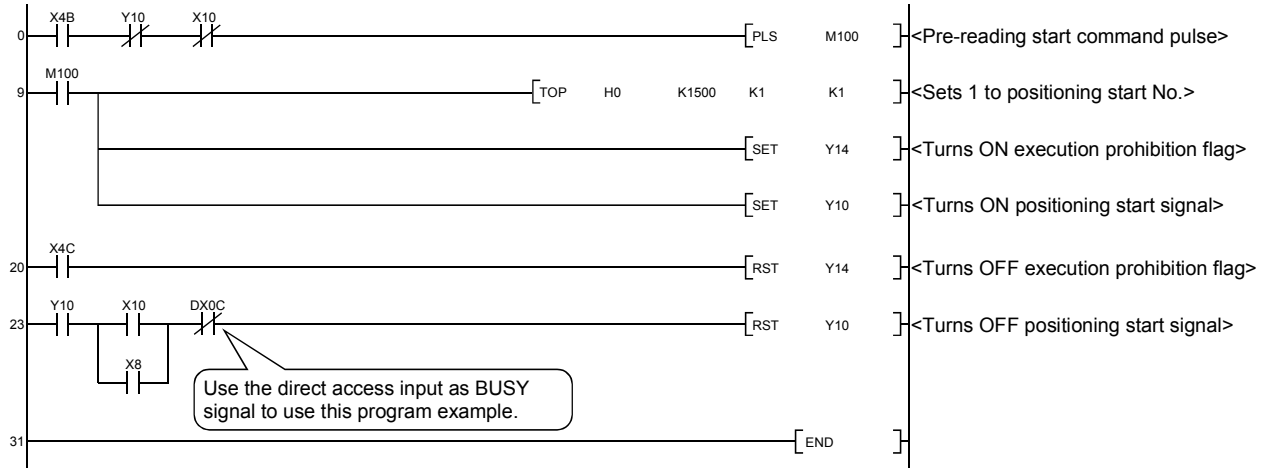

- \*
- \* Pre-reading start program (when dedicated instruction ZP.PSTRT1 is used)
- \*

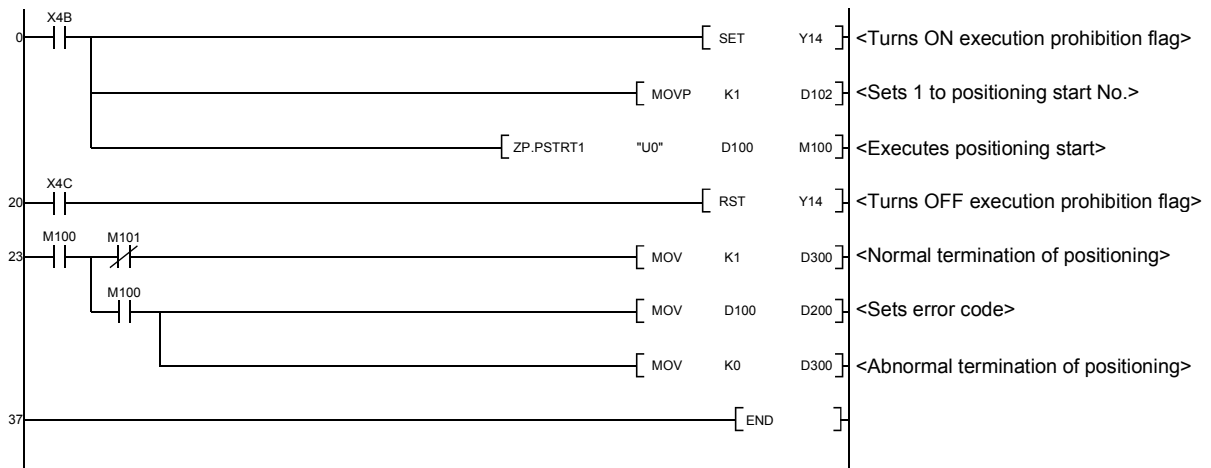



### 13.7.8 Deceleration start flag function

The "deceleration start flag function" turns ON the flag when the constant speed status or acceleration status switches to the deceleration status during position control whose operation pattern is "Positioning complete". This function can be used as a signal to start the operation to be performed by other equipment at each end of position control or to perform preparatory operation, etc. for the next position control.

For the "deceleration start flag function", the following will be explained.

- [1] Control details
- [2] Precautions during control
- [3] Deceleration start flag function setting method
- [4] Checking of deceleration start flag

#### [1] Control details

When deceleration for a stop is started in the position control whose operation pattern is "Positioning complete", "1" is stored into "Md.48 Deceleration start flag". When the next operation start is made or the manual pulse generator operation enable status is gained, "0" is stored. (Refer to Fig. 13.49.)

(1) Start made with positioning data No. specified

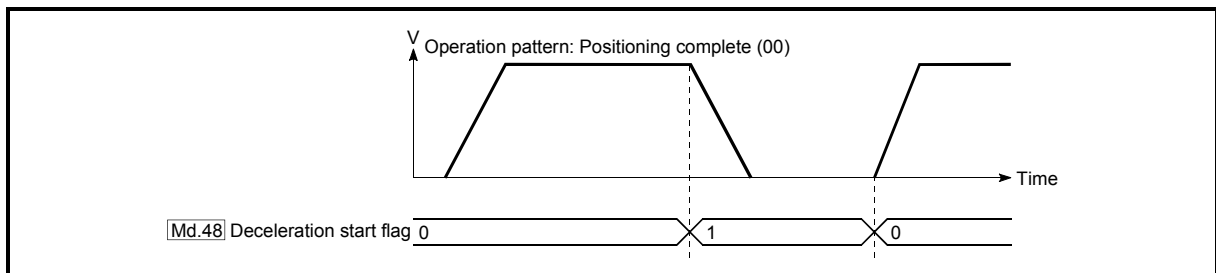

Fig. 13.49 Operation of deceleration start flag

(2) Block start

At a block start, this function is valid for only the position control whose operation pattern is "Positioning complete" at the point whose shape has been set to "End". (Refer to Fig. 13.50.)

The following table indicates the operation of the deceleration start flag in the case of the following block start data and positioning data.

Block start data	Da.11 Shape	Da.12 Start data No.	Da.13 Special start instruction
1st point	1: Continue	1	0: Block start
2nd point	1: Continue	3	0: Block start
3rd point	0: End	4	0: Block start
•			
•			

Positioning Data No.	Da.1 Operation pattern
1	01: Continuous positioning control
2	00: Positioning complete
3	00: Positioning complete
4	11: Continuous path control
5	00: Positioning complete
•	
•	

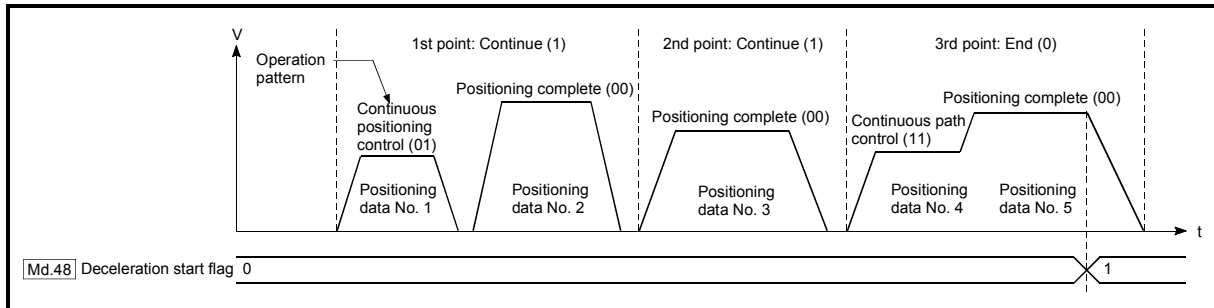
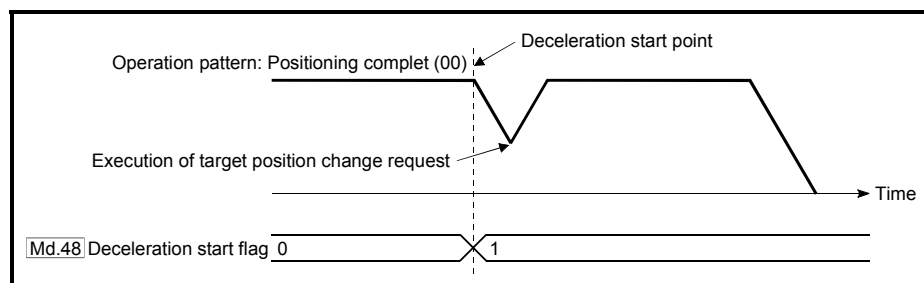

Fig. 13.50 Operation of deceleration start flag at block start

[2] Precautions during control

- (1) The deceleration start flag function is valid for the control system of "1-axis linear control", "2-axis linear interpolation control", "3-axis linear interpolation control", "4-axis linear interpolation control", "speed-position switching control" or "position-speed switching control". (In the case of linear interpolation control, the function is valid for only the reference axis.) Refer to Section 3.2.5 "Combination of LD77MH main functions and sub functions".
- (2) The deceleration start flag does not turn ON when the operation pattern is "continuous positioning control" or "continuous path control".
- (3) The deceleration start flag function is invalid for an OPR, JOG operation, inching operation, manual pulse generator operation, speed-torque control and deceleration made with a stop signal.
- (4) The deceleration start flag does not turn ON when a speed change or override is used to make deceleration.
- (5) If a target position change is made while the deceleration start flag is ON, the deceleration start flag remains ON.



- (6) When the movement direction is reversed by a target position change, the deceleration start flag turns ON.

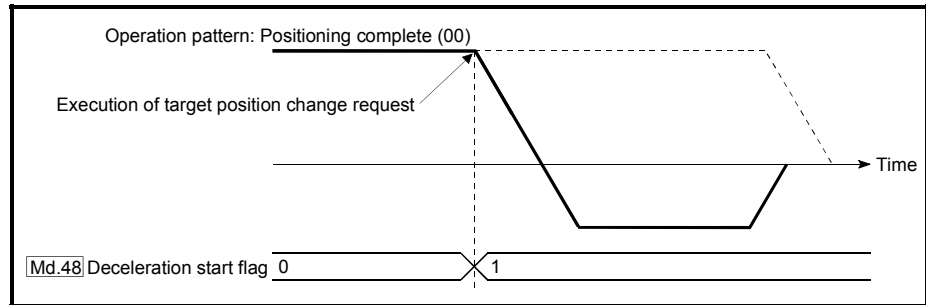

- (7) During position control of position-speed switching control, the deceleration start flag is turned ON by automatic deceleration. The deceleration start flag remains ON if position control is switched to speed control by the position-speed switching signal after the deceleration start flag has turned ON.
- (8) If the condition start of a block start is not made since the condition is not satisfied, the deceleration start flag turns ON when the shape is "End".
- (9) When an interrupt request during continuous operation is issued, the deceleration start flag turns ON at a start of deceleration in the positioning data being executed.

### [3] Deceleration start flag function setting method

To use the "deceleration start flag function", set "1" to the following control data using a sequence program.

The set data is made valid on the rising edge (OFF to ON) of the PLC READY signal [Y0].

Setting item	Setting value	Setting details	Buffer memory address	
			LD77MH4	LD77MH16
Cd.41 Deceleration start flag valid	→	Set whether the deceleration start flag function is made valid or invalid. 0: Deceleration start flag invalid 1: Deceleration start flag valid	1905	5905

\*: Refer to Section 5.7 "List of control data" for details on the setting details.

### [4] Checking of deceleration start flag

The "deceleration start flag" is stored into the following buffer memory addresses.

Monitor item	Monitor value	Storage details	Buffer memory address	
			LD77MH4	LD77MH16
Md.48 Deceleration start flag	→	0: Status other than below 1: Status from deceleration start to next operation start or manual pulse generator operation enable	899+100n	2499+100n

\*: Refer to Section 5.6 "List of monitor data" for information on the storage details.

### 13.7.9 Stop command processing for deceleration stop function

The "stop command processing for deceleration stop function" is provided to set the deceleration curve if a stop cause occurs during deceleration stop processing (including automatic deceleration).

This function is valid for both trapezoidal and S-curve acceleration/deceleration processing methods.

(For the stop cause, refer to Section 1.2.3 "Outline of stopping".)

The "stop command processing for deceleration stop function" performs the following two operations:

- (1) **Deceleration curve re-processing**  
Re-processes a deceleration curve starting from the speed at stop cause occurrence to stop, according to the preset deceleration time.
- (2) **Deceleration curve continuation**  
Continues the current deceleration curve after a stop cause has occurred.

This section explains the "stop command processing for deceleration stop function" as follows:

- [1] Control
- [2] Precautions for control
- [3] Setting method

#### [1] Control

The operation of "stop command processing for deceleration stop function" is explained below.

##### (1) Deceleration curve re-processing

A deceleration curve is re-processed starting from the speed at stop cause occurrence to stop, according to the preset deceleration time.

If a stop cause occurs during automatic deceleration of position control, the deceleration stop processing stops as soon as the target has reached the positioning address specified in the positioning data that is currently executed.

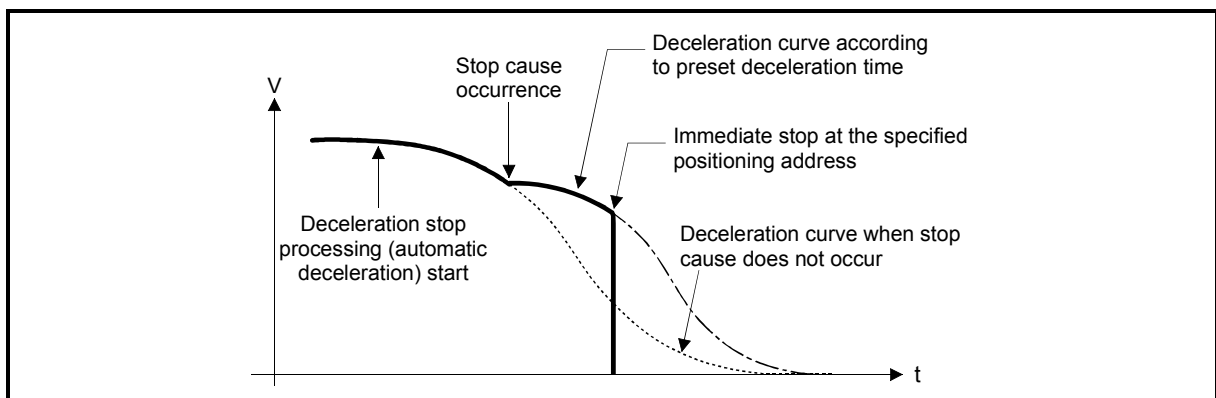

Fig. 13.51 Deceleration curve re-processing operation (for position control or S-curve acceleration/deceleration processing)

**(2) Deceleration curve continuation**

The current deceleration curve is continued after a stop cause has occurred.

If a stop cause occurs during automatic deceleration of position control, the deceleration stop processing may be complete before the target has reached the positioning address specified in the positioning data that is currently executed.

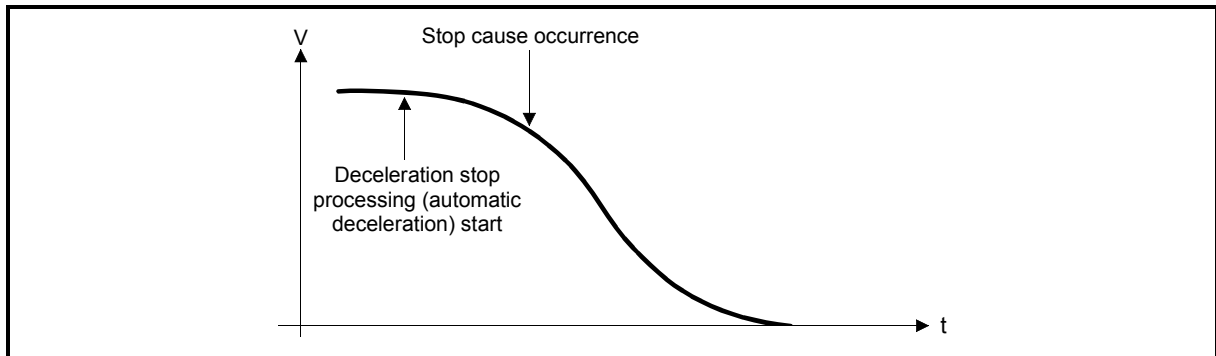

Fig. 13.52 Deceleration curve continuation operation (for position control or S-curve acceleration/deceleration processing)

**[2] Precautions for control**

- (1) In manual control (JOG operation, inching operation, manual pulse generator operation) and speed-torque control, the stop command processing for deceleration stop function is invalid.
- (2) The stop command processing for deceleration stop function is valid when "0: Normal deceleration stop" is set in "Pr.37 Stop group 1 sudden stop selection" to "Pr.39 Stop group 3 sudden stop selection" as the stopping method for stop cause occurrence.
- (3) The stop command processing for deceleration stop function is invalid when "1: Sudden stop" is set in "Pr.37 Stop group 1 sudden stop selection" to "Pr.39 Stop group 3 sudden stop selection". (A deceleration curve is re-processed, according to the "Pr.36 Sudden stop deceleration time" (starting from the speed at stop cause occurrence to a stop))

In the position control (including position control of speed/position changeover control or position/speed changeover control) mode, positioning may stop immediately depending on the stop cause occurrence timing and "Pr.36 Sudden stop deceleration time" setting.

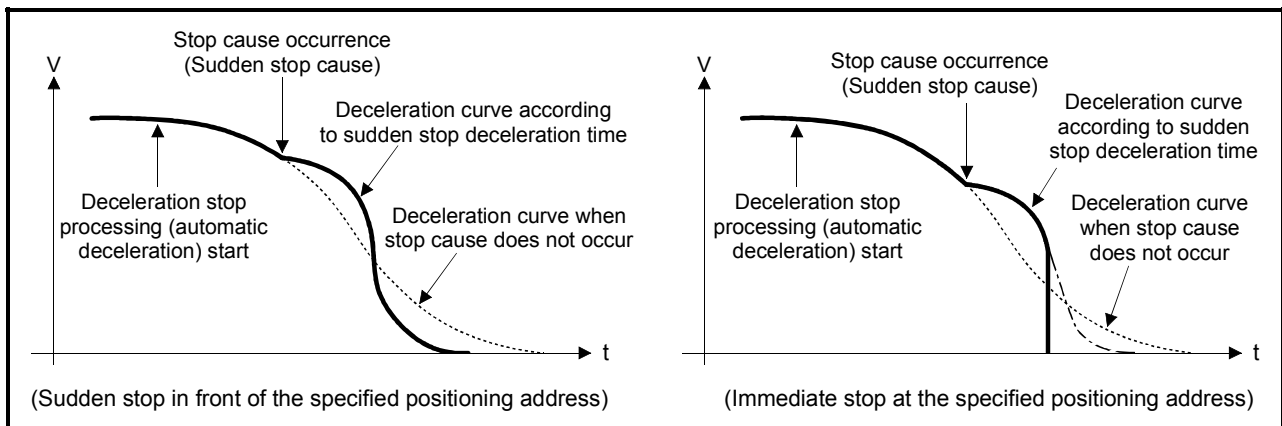

Fig. 13.53 Sudden stop operation (for position control or S-curve acceleration/deceleration processing)

## [3] Setting method

To use the "stop command processing for deceleration stop function", set the following control data in a sequence program.

The set data are made valid as soon as they are written to the buffer memory.

The PLC ready signal [Y0] is irrelevant.

Setting item	Setting value	Setting details	Buffer memory address	
			LD77MH4	LD77MH16
Cd.42	→	Set the stop command processing for deceleration stop function. 0: Deceleration curve re-processing 1: Deceleration curve continuation	1907	5907

\*: For details of the setting details, refer to Section 5.7 "List of control data".

### 13.7.10 Speed control 10 x multiplier setting for degree axis function

The "Speed control 10 x multiplier setting for degree axis function" is executed the positioning control by 10 x speed of the setting value in the command speed and the speed limit value when the setting unit is "degree".

This section explains the "speed control 10 multiplier specifying function for degree axis" as follows:

[1] Control details

[2] Setting method of "Speed control 10 x multiplier setting for degree axis function"

#### [1] Control details

When "Speed control 10 multiplier specifying function for degree axis" is valid, this function related to the command speed, monitor data, speed limit value, is shown below.

##### (1) Command speed

###### (a) Parameters

- "[Pr.7] Bias speed at start"
- "[Pr.46] OPR speed"
- "[Pr.47] Creep speed"
- "[Cd.14] New speed value"
- "[Cd.17] JOG speed"
- "[Cd.25] Position-speed switching control speed change register"
- "[Cd.28] Target position change value (new speed)"
- "[Cd.140] Command speed at speed control mode"
- "[Da.8] Command speed"

###### (b) Major positioning control

- 1) For "2 to 4 axis linear interpolation control" and "2 to 4 axis fixed-feed control", the positioning control is performed at decuple speed of command speed, when "[Pr.83] Speed control 10 x multiplier setting for degree axis" of reference axis is valid.
- 2) For "2 to 4 axis speed control", "[Pr.83] Speed control 10 x multiplier setting for degree axis" is evaluated whether it is valid for each axis. If valid, the positioning control will be performed at decuple speed of command speed.

(2) Monitor data

- "Md.22 Feedrate"
- "Md.27 Current speed"
- "Md.28 Axis feedrate"
- "Md.33 Target speed"
- "Md.122 Speed during command"

\*: For the above monitoring data, "Pr.83 Speed control 10 x multiplier setting for degree axis" is evaluated whether it is valid for each axis. If valid, unit conversion value is changed ( $\times 10^{-3} \rightarrow \times 10^{-2}$ ). The unit conversion table of monitor value is shown below.

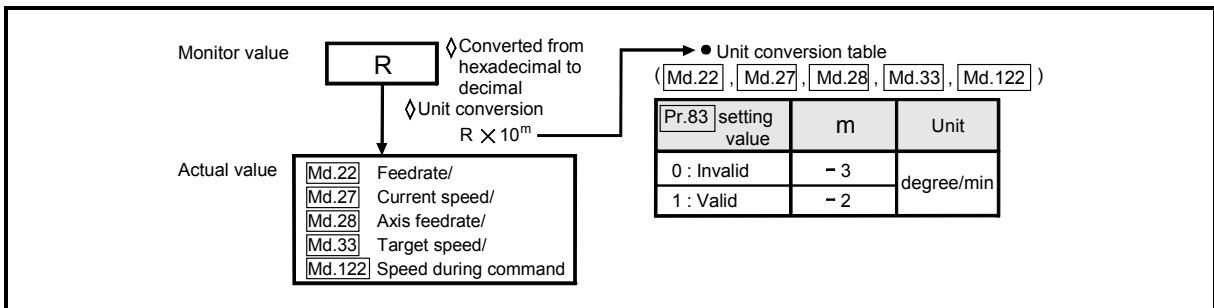

(3) Speed limit value

- "Pr.8 Speed limit value"
- "Pr.31 JOG speed limit value"
- "Cd.146 Speed limit value at torque control mode"

\*: For the speed limit value, "Pr.83 Speed control 10 x multiplier setting for degree axis" is evaluated whether it is valid for each axis. If valid, the positioning control will be performed at decuple speed of setting value (max. speed).

[2] Setting method of "Speed control 10 x multiplier setting for degree axis function"

Normally, the speed specification range is 0.001 to 2000000.000[degree/min], but it will be decupled and become 0.01 to 20000000.00[degree/min] by setting "Pr.83 Speed control 10 x multiplier setting for degree axis" to valid.

The use the "Pr.83 Speed control 10 x multiplier setting for degree axis function", set the parameters shown in the following table.

Setting item	Setting value	Setting details	Buffer memory address	
			LD77MH4	LD77MH16
Pr.83 Speed control 10 x multiplier setting for degree axis	→	Set the speed control 10 x multiplier setting for degree axis. 0: Invalid 1: Valid	63+150n	

\*: Refer to Section 5.2.4 "Detailed parameters 2" for details on the setting details.



## 13.7.11 Operation setting for incompleteness of OPR function

The "Operation setting for incompleteness of OPR function" is provided to select whether positioning control is operated or not, when OPR request flag is ON.

This section explains the "Operation setting for incompleteness of OPR function" as follows:

- [1] Control details
- [2] Precautions during control
- [3] Setting method of "Operation setting for incompleteness of OPR function"

## [1] Control details

When "Pr.55 Operation setting for incompleteness of OPR" is valid, this function related to the command speed, monitor data, speed limit value, is shown below.

Item	Pr.55 Operation setting for incompleteness of OPR	
	"0: Positioning control is not executed." and "OPR request flag ON"	"1: Positioning control is executed." and "OPR request flag ON"
<ul style="list-style-type: none"> <li>• Machine OPR</li> <li>• JOG operation</li> <li>• Inching operation</li> <li>• Manual pulse generator operation</li> <li>• Current value changing using current value changing start No. (No. 9003).</li> </ul>	○	○
The positioning control is impossible to start/restart in the following case. <ul style="list-style-type: none"> <li>• 1-axis linear control</li> <li>• 2/3/4-axis linear interpolation control</li> <li>• 1/2/3/4-axis fixed-feed control</li> <li>• 2-axis circular interpolation control with sub point designation</li> <li>• 2-axis circular interpolation control with center point designation</li> <li>• 1/2/3/4-axis speed control</li> <li>• Speed-position switching control (INC mode/ ABS mode)</li> <li>• Position-speed switching control</li> <li>• Current value changing using positioning data No. (No.1 to 600).</li> </ul>	×	○
Control mode switching	×	○

○ : Positioning start possible. (Execution possible)

× : Positioning start impossible. (Execution not possible)

## [2] Precautions during control

- (1) The "Operation starting at incompleteness of OPR" error (error code: 547) occurs if OPR request flag (Md.31 Status: b3) is executed the positioning control by turning on, when "0: Positioning control is not executed" is selected the operation setting for incompleteness of OPR setting, and positioning control will not be performed. At this time, operation with the manual control (JOG operation, inching operation, manual pulse generator operation) is available.

- (2) When OPR request flag ( **Md.31** Status: b3) is ON, starting Fast OPR will result in an "Home positioning return (OPR) request flag ON" error (error code: 207) despite the setting value of " **Pr.55** Operation setting for incompleteness of OPR", and Fast OPR will not be performed.

### [3] Setting method of "Operation setting for incompleteness of OPR"

The use the "Operation setting for incompleteness of OPR", set the following parameters using a sequence program.

Setting item		Setting value	Setting details	Buffer memory address	
				LD77MH4	LD77MH16
<b>Pr.55</b>	Operation setting for incompleteness of OPR	→	Set the operation setting for incompleteness of OPR. 0: Positioning control is not executed. 1: Positioning control is executed.	87+150n	

\*: Refer to Section 5.2.6 "OPR detailed parameters" for details on the setting details.

## 13.8 Servo ON/OFF

### 13.8.1 Servo ON/OFF

The servo amplifiers connected to the LD77MH is executed servo ON or OFF. By establishing the servo ON status with the servo ON command, servo motor operation is enabled.

The following two types of servo ON or OFF can be used.

- All axis servo ON [Y1]
- [Cd.100]Servo OFF command (Buffer memory addresses: 1551+100n[LD77MH4]/4351+100n[LD77MH16])

A list of the "All axis servo ON [Y1]" and "[Cd.100]Servo OFF command" is given below.

		[Cd.100]Servo OFF command	
		Setting value "0"	Setting value "1"
All axis servo ON: Y1	OFF	×	×
	ON	○	×

○: Servo ON (Servo operation enabled) , ×: Servo OFF (Servo operation disabled)

#### [1] Servo ON (Servo operation enabled)

The following shows the procedure for servo ON.

- (1) Make sure that the servo LED indicates "b□".  
(The initial value for "All axis servo ON [Y1]" is "OFF".)
- (2) Set "0" for "[Cd.100]Servo OFF command".
- (3) Turn ON "All axis servo ON [Y1]".

Now the servo amplifier turns ON the servo (servo operation enabled state).  
(The servo LED indicates "d□".)

#### [2] Servo OFF (Servo operation disabled)

The following shows the procedure for servo OFF.

- (1) Set "1" for "[Cd.100]Servo OFF command". (The servo LED indicates "c□".)  
(If the "[Cd.100]Servo OFF command" set "0" again, after the servo operation enabled.)
- (2) Turn OFF "All axis servo ON [Y1]".  
(The servo LED indicates "b□".)

**POINT**

- If the servomotor is rotated by external force during the servo OFF status, follow up processing is performed.
- Change between servo ON or OFF status while operation is stopped (position control mode).  
The servo OFF command of during positioning in position control mode, manual pulse control, OPR, speed control mode and torque control mode will be ignored.
- When the servo OFF is given to all axes, "All axis servo ON [Y1]" is applied even if all axis servo ON command is turned ON to OFF with "[Cd.100] Servo OFF command" set "0".
- When the delay time of "[Pr.165] Electromagnetic brake sequence output" is used, servo ON → OFF by "[Cd.100] Servo OFF command". (When all axis servo ON [Y1] is ON → OFF, servo OFF and turn off [Y1] after delay time passes.)

## 13.8.2 Follow up function

## (1) Follow up function

The follow up function monitors the number of motor rotations (actual present value) with the servo OFF and reflects the value in the present feed value.

Therefore, even if the servomotor rotates while the servo OFF, the servomotor will not just rotate for the quantify of droop pulses the next time the servo turns ON but positioning can be performed from the stop position.

## (2) Execution follow up

Follow up function is executed continually during the servo OFF status.

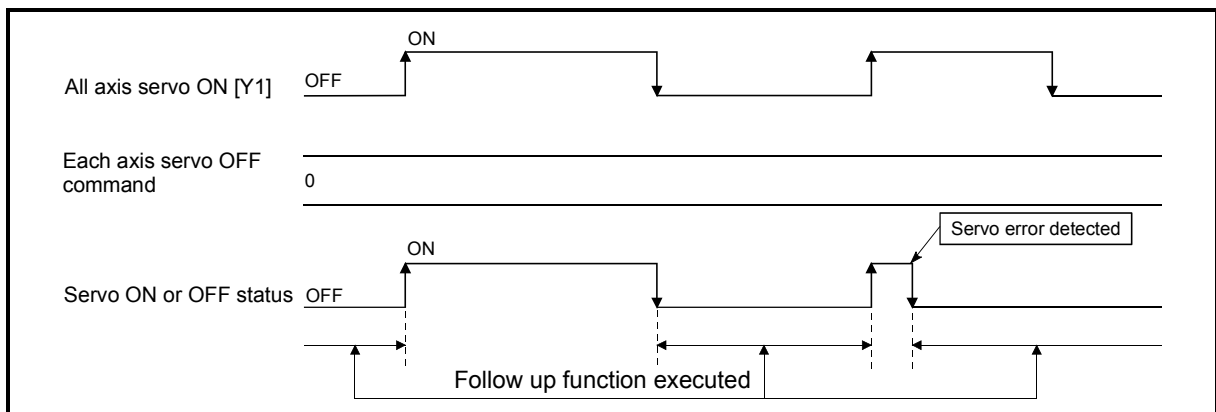

Fig. 13.54 Operation timings of follow up function

## POINT

- The follow-up function performs the process if the "LD77MH and the servo amplifier is turned ON" and "servo OFF" regardless of the presence of the absolute position system.

# Chapter 14 Common Functions

The details and usage of the "common functions" executed according to the user's requirements are explained in this chapter.

Common functions include functions required when using the LD77MH, such as parameter initialization and execution data backup. Read the setting and execution procedures for each common function indicated in this chapter thoroughly, and execute the appropriate function where required.

14.1	Outline of common functions.....	14- 2
14.2	Parameter initialization function .....	14- 3
14.3	Execution data backup function .....	14- 5
14.4	External signal selection function.....	14- 7
14.5	External I/O signal logic switching function.....	14- 8
14.6	History monitor function.....	14- 9
14.7	Amplifier-less operation function .....	14- 10
14.8	Virtual servo amplifier function .....	14- 15
14.9	Master-slave operation function .....	14- 18
14.10	Mark detection function .....	14- 23
14.11	Optional data monitor function .....	14- 33
14.12	Module error collection function .....	14- 36

## 14.1 Outline of common functions

"Common functions" are executed according to the user's requirements, regardless of the control system, etc. These common functions are executed by GX Works2 or sequence programs.

The following table shows the functions included in the "common functions".

Common function	Details	Means	
		Sequence program	GX Works2
Parameter initialization function	This function returns the parameter stored in the LD77MH buffer memory and flash ROM to the factory-set initial value.	○	○
Execution data backup function	This function writes the "execution data", currently being used for control, to the flash ROM.	○	○
External signal selection function	This function uses the upper/lower limit signal and the near-point dog signal with the external input signal of servo amplifier.	○	○
External I/O signal logic switching function	This function switches I/O signal logic according to the equipment connected to the LD77MH. For the system in which with b-contact, upper limit switch, and lower limit switch are not used, the parameter logic setting can be controlled without wiring if it is changed to a "positive logic".	○	○
History monitor function	This function monitors errors, warnings and start history of all axes.	—	○
Amplifier-less operation function	This function executes the positioning control of LD77MH without connecting to the servo amplifiers. It is used to debug the program at the start-up of the device or simulate the positioning operation.	○	—
Virtual servo amplifier function	This function executes the operation as the axis (virtual servo amplifier axis) that operates only command (instruction) virtually without servo amplifiers.	○	○
Master-slave operation function	This function uses the master-slave operation function of servo amplifier. The positioning control of master axis is executed with LD77MH, and the slave axis is controlled by data communication (driver communication) between servo amplifiers without LD77MH.	○	○
Mark detection function	This function is used to latch any data at the input timing of the mark detection signal (DI1 to DI4).	○	○
Optional data monitor function	This function is used to store the data selected by user up to 4 data per axis to buffer memory and monitor them.	○	○
Module error collection function	This function collects errors occurred in the LD77MH in the PLC CPU. Holding the error contents in the PLC CPU, this function enables to check the error history even after the PLC CPU in powered off or reset.	—	○

## 14.2 Parameter initialization function

The "parameter initialization function" is used to return the setting data set in the LD77MH buffer memory and flash ROM to their factory-set initial values.

The details shown below explain about the "parameter initialization function".

[1] Parameter initialization means

[2] Control details

[3] Precautions during control

[4] Parameter initialization method

[1] Parameter initialization means

- Initialization is executed with a sequence program.
- Initialization is executed by GX Works2.

Refer to the "Simple Motion Module Setting Tool Help" of GX Works2 for the execution method by GX Works2.

[2] Control details

The following table shows the setting data initialized by the "parameter initialization function".

(The data initialized are "buffer memory" and " flash ROM " setting data.)

Setting data
Basic parameters ( [Pr.1] to [Pr.10] )
Detailed parameters ( [Pr.11] to [Pr.42], [Pr.80] to [Pr.90], [Pr.95] )
OPR basic parameters ( [Pr.43] to [Pr.48] )
OPR detailed parameters ( [Pr.50] to [Pr.57] )
Expansion parameters ( [Pr.91] to [Pr.94], [Pr.96] )
Servo parameters ( [Pr.100] to [Pr.332] )
Positioning data (No.1 to 600)
Block start data (No.7000 to 7004)

[3] Precautions during control

- (1) Parameter initialization is only executed when the positioning control is not carried out (when the PLC READY signal [Y0] is OFF).  
A warning "In PLC READY (warning code: 111)" will occur if executed when the PLC READY signal [Y0] is ON.
- (2) A writing to the flash ROM is up to 100,000 times. If writing to the flash ROM exceeds 100,000 times, the writing may become impossible, and a flash ROM writing error (error code: 801) will occur.
- (3) A "PLC CPU reset" or "PLC CPU power restart" must be carried out after the parameters are initialized.
- (4) If an error occurs on the parameter set in the LD77MH when the PLC READY signal [Y0] is turned ON, the LD77 READY signal [X0] will not be turned ON and the control cannot be carried out.



**Important**

Parameter initialization takes about 10 seconds. (Up to 30 seconds are sometimes required.)

Do not turn the power ON/OFF or reset the PLC CPU, etc. during parameter initialization. If the power is turned OFF or the PLC CPU module is reset to forcibly end the process, the data backed up in the flash ROM will be lost.

**[4] Parameter initialization method**

(1) Parameter initialization is carried out using the dedicated instruction "ZP.PINIT".

(Refer to Chapter 15 "Dedicated Instructions" for details.)

(2) Parameter initialization can also be carried out by the writing of the data shown in the table below to the buffer memory using the TO command/intelligent function device.

The initialization of the parameter is executed at the time point the data is written to the LD77MH buffer memory.

Setting item	Setting value	Setting details	Buffer memory address	
			LD77MH4	LD77MH16
<b>Cd.2</b> Parameter initialization request	1	Set "1" (parameter initialization request).	1901	5901

\*: Refer to Section 5.7 "List of control data" for details on the setting details.

When the initialization is complete, "0" will be set in "**Cd.2** Parameter initialization request" by the LD77MH automatically.

### 14.3 Execution data backup function

When the LD77MH buffer memory data is rewritten from the PLC CPU, "the data backed up in the LD77MH flash ROM" may differ from "the data (buffer memory data) for which control is being executed".

In cases like these, the data being executed will be lost when the PLC power is turned OFF. (Refer to Chapter 7 "Memory Configuration and Data Process".)

In cases like these, the "execution data backup function" backs up the data being executed by writing it to the flash ROM. The data that was backed up is then written to the buffer memory when the power is turned ON next.

The details shown below explain about the "execution data backup function".

[1] Execution data backup (written to flash ROM) means

[2] Control details

[3] Precautions during control

[4] Execution data backup method

[1] Execution data backup (written to flash ROM) means

- The backup is executed with a sequence program.
- The backup is executed by GX Works2.

Refer to the "Simple Motion Module Setting Tool Help" of GX Works2 for execution data backup method by GX Works2.

[2] Control details

The following shows the data that can be written to the flash ROM using the "execution data backup function".

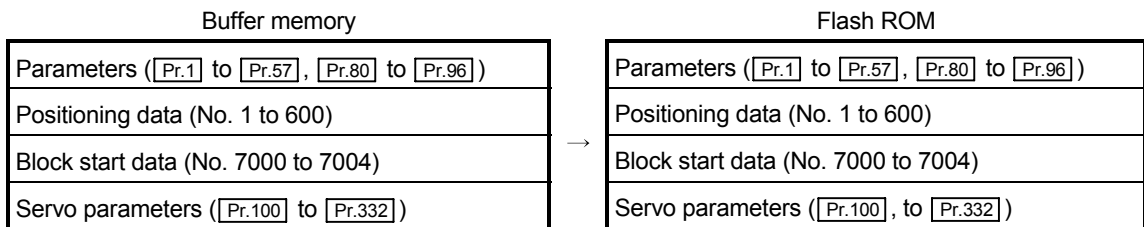

### [3] Precautions during control

- (1) Data can only be written to the flash ROM when the positioning control is not carried out (when the PLC READY signal [Y0] is OFF).

A warning "In PLC READY (warning code: 111)" will occur if executed when the PLC READY signal [Y0] is ON.

- (2) Writing to the flash ROM can be executed up to 100,000 times.  
If writing to the flash ROM exceeds 100,000 times, the writing may become impossible, and a "flash ROM writing error (error code: 801)" will occur.

- (3) After one power ON/PLC CPU reset operation, writing to the flash ROM using a sequence program is limited to up to 25 times.

If the 26th writing is executed, a "flash ROM write number error (error code: 805)" will occur. If this error occurs, carry out the error reset or power OFF→ON/PLC CPU reset operation again.

Refer to "[Md.19] Number of write accesses to flash ROM" of Section 5.1.9

"Types and roles of monitor data" for details.

#### Important

Do not turn the power ON/OFF, reset the PLC CPU, during writing to the flash ROM. If the power is turned OFF or the PLC CPU module is reset to forcibly end the process, the data backed up in the flash ROM will be lost.

### [4] Execution data backup method

- (1) Execution data backup (writing to the flash ROM) is carried out using the dedicated instruction "ZP.PFWRT". (Refer to Chapter 15 "Dedicated Instructions" for details.)

- (2) Refer to Section 7.2 "Data transmission process" for the data transmission processing at the backup of the execution data.

- (3) Execution data backup can also be carried out by the writing of the data shown in the table below to the LD77MH buffer memory using the TO command/intelligent function device.

The writing to the flash ROM is executed at the time point the data is written to the LD77MH buffer memory.

Setting item		Setting value	Setting details	Buffer memory address	
				LD77MH4	LD77MH16
[Cd.1]	Flash ROM write request	1	Set "1" (flash ROM write request).	1900	5900

\*: Refer to Section 5.7 "List of control data" for details on the setting details.

When the writing to the flash ROM is complete, "0" will be set in "[Cd.1] Flash ROM write request" by the LD77MH automatically.

## 14.4 External signal selection function

The "external signal selection function" is used to connect the upper/lower limit signal and near-point dog signal by the external input signal of servo amplifier (PIN No. CN3-2, CN3-12, CN3-19).

The details shown below explain about the "External signal selection function".

[1] Parameter setting details

[2] Precautions on parameter setting

### [1] Parameter setting details

The use the "External signal selection function", set the parameters shown in the following table.

Setting item	Setting value	Setting details	Buffer memory address	
			LD77MH4	LD77MH16
Pr.80	External input signal selection	1	Set the external signal selection. 1: External input signal of servo amplifier	
			32+150n	

n: Axis No.-1

The use the "External input signal of servo amplifier", set the Pin No. shown in the following table.

Setting details		
1: External input signal of servo amplifier		
	Pin No.	Signal name
Servo amplifier	CN3-19 (DI3)	DOG
	CN3-12 (DI2)	RLS
	CN3-2 (DI1)	FLS

※: Refer to the "Servo amplifier Instruction Manual" for details on the pin No. of servo amplifier.

### [2] Precautions on parameter setting

(1) Do not set except default value "1: External input signal of servo amplifier".

## 14.5 External I/O signal logic switching function

This function switches the signal logic according to the external equipment connected to the LD77MH or the external input signal (upper/lower limit switch, near-point dog) of the servo amplifier.

For the system in which b-contact, upper limit switch, and lower limit switch are not used, the parameter logic setting can be controlled without wiring if it is changed to a "positive logic".

When the upper limit switch, and lower limit switch are used, ensure to use them with b-contact.

The details shown below explain about the "External I/O signal logic switching function".

[1] Parameter setting details

[2] Precautions on parameter setting

### [1] Parameter setting details

To use the "External I/O signal logic switching function", set the parameters shown in the following table.

Setting item		Setting details		Factory-set initial value	Buffer memory address		
					LD77MH4	LD77MH16	
Pr.22	Input signal logic selection	• Selection of logic of signals input from external device to LD77MH		0		31+150n	
		b0	Lower limit				0: Negative logic, 1: Positive logic
		b1	Upper limit				
		b2	Not used				Set "0".
		b3	Not used				
		b4	External command/ switching signal * 1				0: Negative logic, 1: Positive logic
		b5	Not used				Set "0".
		b6	Near-point dog signal				0: Negative logic, 1: Positive logic
		b7	Not used				Set "0".
		b8	Manual pulse generator input				0: Negative logic, 1: Positive logic
		b9 to b15	Not used				Set "0".

n: Axis No.-1

\*1: Only the value specified against the axis 1 is valid for the logic selection of external command signal/switching signal (b4).

\*: Refer to Section 5.2 "List of parameters" for the information on detail settings.

### [2] Precautions on parameter setting

(1) The external I/O signal logic switching parameters are validated when the PLC READY signal [Y0] is turned OFF to ON. (The logic is negative right after power-on.)

(2) If each signal logic is set erroneously, the operation may not be carried out correctly.

Before setting, check the specifications of the equipment to be used.

## 14.6 History monitor function

This function monitors starting history, error history, and warning history stored in the buffer memory of LD77MH during operation.

### [1] Starting history

Sixteen starting history logs of operations such as positioning operation, JOG operation, and manual pulse generator operation can be monitored. When the number of logs exceeds 16, the latest log overwrites the oldest log so that the latest history 16 logs can be monitored all the time. This function allows users to check the operation sequence (whether the operations have been started in a predetermined sequence) at system start-up.

No.	Start information Restart flag	Start information Start origin	Start information Start axis	Start No. /Type	Starting time	Warning flag	Error flag	Error No.
1	OFF	PLC	Axis #1	JOG Operation	1/18/2011 4:15:24 PM	OFF	OFF	0
2	OFF	PLC	Axis #11	JOG Operation	1/18/2011 4:15:24 PM	OFF	OFF	0
3	OFF	PLC	Axis #3	Synchronous Control Operation	1/18/2011 4:15:35 PM	OFF	ON	108
4	OFF	PLC	Axis #5	Synchronous Control Operation	1/18/2011 4:15:35 PM	OFF	ON	108
5	OFF	PLC	Axis #7	Synchronous Control Operation	1/18/2011 4:15:35 PM	OFF	ON	108
6	OFF	PLC	Axis #2	Synchronous Control Operation	1/18/2011 4:15:35 PM	OFF	OFF	0
7	OFF	PLC	Axis #4	Synchronous Control Operation	1/18/2011 4:15:35 PM	OFF	OFF	0
8	OFF	PLC	Axis #6	Synchronous Control Operation	1/18/2011 4:15:35 PM	OFF	OFF	0
9	OFF	PLC	Axis #1	1	1/18/2011 4:15:37 PM	OFF	OFF	0
10	OFF	PLC	Axis #5	1	1/18/2011 4:15:37 PM	OFF	ON	108
11	OFF	PLC	Axis #9	1	1/18/2011 4:15:37 PM	OFF	OFF	0
12	OFF	PLC	Axis #16	1	1/18/2011 4:15:37 PM	OFF	OFF	0
13	OFF	GX Works2	Axis #1	JOG Operation	1/18/2011 4:18:50 PM	OFF	ON	108
14	OFF	GX Works2	Axis #1	JOG Operation	1/18/2011 4:20:03 PM	OFF	OFF	0

For the starting history check method, refer to the "Simple Motion Module Setting Tool Help" of GX Works2.

### [2] Error history, warning history

Sixteen error history logs and sixteen warning history logs can be monitored. When the number of logs exceeds 16, the latest log overwrites the oldest log so that the latest history 16 logs can be monitored all the time.

No.	Axis in which the error occurred	Axis error No.	Axis error occurrence time	Error details
1	Axis #3	108	1/18/2011 4:15:35 PM	Start not possible
2	Axis #5	108	1/18/2011 4:15:35 PM	Start not possible
3	Axis #7	108	1/18/2011 4:15:35 PM	Start not possible
4	Axis #5	108	1/18/2011 4:15:37 PM	Start not possible
5	Axis #1	101	1/18/2011 4:15:39 PM	PLC READY OFF during operation
6	Axis #9	101	1/18/2011 4:15:39 PM	PLC READY OFF during operation
7	Axis #16	101	1/18/2011 4:15:39 PM	PLC READY OFF during operation
8	Axis #2	101	1/18/2011 4:15:39 PM	PLC READY OFF during operation
9	Axis #4	101	1/18/2011 4:15:39 PM	PLC READY OFF during operation

No.	Axis in which the warning occurred	Axis warning No.	Axis warning occurrence time	Warning details
1	Axis #1	100	1/18/2011 5:03:08 PM	Start during operation
2	Axis #8	100	1/18/2011 5:03:31 PM	Start during operation
3	Axis #2	301	1/18/2011 5:07:01 PM	JOG speed limit value
4	Axis #16	100	1/18/2011 5:07:22 PM	Start during operation
5				
6				
7				
8				
9				

For the error and warning history check method, refer to the "Simple Motion Module Setting Tool Help" of GX Works2.

#### POINT

Set the clock of PLC CPU. Refer to the "GX Works2 Version1 Operating Manual (Common)" for setting method.

## 14.7 Amplifier-less operation function

The positioning control of LD77MH without servo amplifiers connection can be executed in the amplifier-less function. This function is used to debug of user program or simulate of positioning operation at the start.

The details shown below explain about the "Amplifier-less operation function".

- [1] Control details
- [2] Restrictions
- [3] Buffer memory list
- [4] Operation mode switching procedure

### [1] Control details

Switch the mode from the normal operation mode (with servo amplifier connection) to the amplifier-less operation mode (without servo amplifier connection) to use the amplifier-less operation function.

Operation for each axis without servo amplifier connection as the normal operation mode can be executed during amplifier-less operation mode. The start method of positioning control is also the same procedure of normal operation mode.

The normal operation (with servo amplifier connection) is possible by switching from the amplifier-less operation mode to the normal operation mode after amplifier-less operation.

The current value management (current feed value, machine feed value) at the switching the normal operation mode and amplifier-less operation mode is shown below.

"Pr.103] Absolute position detection system"	Current value management at the operation mode switching	
	Normal operation mode → Amplifier-less operation mode	Amplifier-less operation mode → Normal operation mode
"0: Invalid"	The current feed value and machine feed value are "0".	The current feed value and machine feed value are "0". (At the communication start to the servo amplifiers)
"1: Valid"	The amplifier-less operation mode starts with the address that the servo amplifier's power supply was finally turned OFF. However, the OP position is not established in the normal operation mode, the current feed value and machine feed value are "0".	The current feed value and machine feed value are restored according the actual position of servomotor. (At the communication start to the servo amplifiers) However, when the OP position is not established in the normal operation mode before switching to the amplifier-less operation mode, the current feed value and machine feed value are not restored. Execute the OPR. When the mode is switched to the normal operation mode after moving that exceeds the range "-2147483648(-2 <sup>31</sup> ) to 2147483647(2 <sup>31</sup> -1) [PLS]" from the actual position of servo motor during amplifier-less operation mode, the current feed value and machine feed value might be not restored correctly.

POINT
<p>(1) Switch of the normal operation mode and amplifier-less operation mode is executed by the batch of all axes. Switch of the operation mode for each axis cannot be executed.</p> <p>(2) Only axis that operated either the followings before switching to the amplifier-less operation mode becomes the connection status during amplifier-less operation.</p> <ul style="list-style-type: none"> <li>• "[Pr.100] Servo series" is set, and then the written to flash ROM is executed. (Turn the power supply ON or PLC CPU reset after written to flash ROM.)</li> <li>• "[Pr.100] Servo series" is set, and then the PLC ready signal is turned ON. (Servo amplifier connection is unnecessary.)</li> </ul> <p>(3) Suppose the following servo amplifier and servo motor are connected during amplifier-less operation mode.</p> <p style="padding-left: 20px;">Servo amplifier type : MR-J3-10B</p> <p style="padding-left: 20px;">Motor type : HF-KP053 (Resolution per servo motor rotation: 262144PLS)</p>

## [2] Restrictions

- (1) The following monitor data cannot be used during amplifier-less operation mode.

Storage item		Storage details	Buffer memory address	
			LD77MH4	LD77MH16
[Md.102]	Deviation counter value	Always "0" during amplifier-less operation mode.	852+100n 853+100n	2452+100n 2453+100n
[Md.106]	Servo amplifier software No.	Always "0" during amplifier-less operation mode.	864+100n to 869+100n	2464+100n to 2469+100n
[Md.107]	Parameter error No.	Always "0" during amplifier-less operation mode.	870+100n	2470+100n
[Md.108]	Servo status	As follows during amplifier-less operation mode.	876+100n	2476+100n
		<ul style="list-style-type: none"> <li>• Zero point pass (b0) : Always ON</li> <li>• Zero speed (b3) : Change depending on the command speed</li> <li>• Speed limit (b4) : Always OFF</li> <li>• PID control (b8) : Always OFF</li> </ul>		
		As follows during amplifier-less operation mode.	877+100n	2477+100n
		<ul style="list-style-type: none"> <li>• READY ON(b0), Servo ON(b1): Change depending on the all axis servo ON signal[Y1] and "[Cd.100] Servo OFF command".</li> <li>• Control mode (b2, b3) : Always OFF</li> <li>• Servo alarm(b7) : Always OFF</li> <li>• In-position(b12) : Always ON</li> <li>• Torque limit(b13) : Always OFF</li> <li>• Absolute position lost(b14) : Always OFF</li> <li>• Servo warning(b15) : Always OFF</li> </ul>		
[Md.109]	Regenerative load ratio/ Optional data monitor output 1	Always "0" during amplifier-less operation mode.	878+100n	2478+100n
[Md.110]	Effective load torque/ Optional data monitor output 2	Always "0" during amplifier-less operation mode.	879+100n	2479+100n
[Md.111]	Peak torque ratio/ Optional data monitor output 3	Always "0" during amplifier-less operation mode.	880+100n	2480+100n
[Md.112]	Optional data monitor output 4	Always "0" during amplifier-less operation mode.	/	2481+100n

n: Axis No.-1



- (2) The operation of following function differ from the normal operation mode during amplifier-less operation mode.

Function	Operation
External signal selection function	<p>When "1: External input signal of servo amplifier" is set in "[Pr.80] External input signal selection", the status of external signal at the amplifier-less operation mode start is shown below.</p> <ul style="list-style-type: none"> <li>• Upper/lower limit signal (FLS, RLS): ON</li> <li>• Near-point dog signal (DOG): OFF</li> </ul> <p>Change "[Md.30] External input signal" to change the signal status. (Refer to "Restrictions (3)" for details.)</p>

- (3) The operation of following monitor data differ from the normal operation mode during amplifier-less operation mode

Storage item		Storage details	Buffer memory address	
			LD77MH4	LD77MH16
[Md.30]	External input signal	When "1: External input signal of servo amplifier" is set in "[Pr.80] External input signal selection", the external input signal status can be operated by turning ON/OFF the "b0: Lower limit signal", "b1: Upper limit signal" or "b6: Near-point dog signal" during amplifier-less operation mode.	816+100n	2416+100n
[Md.104]	Motor current value	"0" is set at the amplifier-less operation mode start. The motor current value can be emulated by changing this monitor data in user side during amplifier-less operation mode.	856+100n	2456+100n

n: Axis No.-1

- (4) When the power supply is turned OFF → ON or PLC CPU is reset during amplifier-less operation mode, the mode is switched to the normal operation mode.
- (5) The operation of servo motor or the timing of operation cycle ,etc. at the amplifier-less operation is different from the case where the servo amplifiers are connected at the normal operation mode. Confirm the operation finally with a real machine.
- (6) The amplifier-less operation cannot be used in the test mode. Do not request to switch to the amplifier-less operation mode during test mode.
- (7) The amplifier-less operation cannot be used in the fully closed loop system, linear servo or direct drive motor.
- (8) Even if the PLC READY signal [Y0] is turned ON by changing "[Pr.100] Servo series" from "0: Servo series is not set" to other than "0", the setting does not become valid. (The axis connecting status remains disconnection.)

### [3] Buffer memory list

The buffer memory used in the amplifier-less operation function is shown below.

#### (1) System control data

Setting item		Setting value	Setting details	Buffer memory address	
				LD77MH4	LD77MH16
<b>Cd.137</b>	Amplifier-less operation mode switching request	→	Switch operation mode. ABCDh : Switch from the normal operation mode to the amplifier-less operation mode. 0000h : Switch from the amplifier-less operation mode to the normal operation mode	1926	5926

#### (2) System monitor data

Storage item		Monitor value	Storage details	Buffer memory address	
				LD77MH4	LD77MH16
<b>Md.51</b>	Amplifier-less operation mode status	→	Indicate the current operation mode. 0: Normal operation mode 1: Amplifier-less operation mode	1432	4232

### [4] Operation mode switching procedure

#### (1) Switch from the normal operation mode to the amplifier-less operation mode

- 1) Stop all operating axes, and then confirm that the BUSY signal for all axes turned OFF.
- 2) Turn OFF the PLC READY signal [Y0].
- 3) Confirm that the LD77 READY signal [X0] turned OFF.
- 4) Set "ABCDh" in "**Cd.137** Amplifier-less operation mode switching request".
- 5) Confirm that "1: Amplifier-less operation mode" was set in "**Md.51** Amplifier-less operation mode status".

#### (2) Switch from the amplifier-less operation mode to the normal operation mode

- 1) Stop all operating axes, and then confirm that the BUSY signal for all axes turned OFF.
- 2) Turn OFF the PLC READY signal [Y0].
- 3) Confirm that the LD77 READY signal [X0] turned OFF.
- 4) Set "0000h" in "**Cd.137** Amplifier-less operation mode switching request".
- 5) Confirm that "0: Normal operation mode" was set in "**Md.51** Amplifier-less operation mode status".

(3) Operation chart

The following drawing shows the operation for the switching of the normal operation mode and amplifier-less operation mode

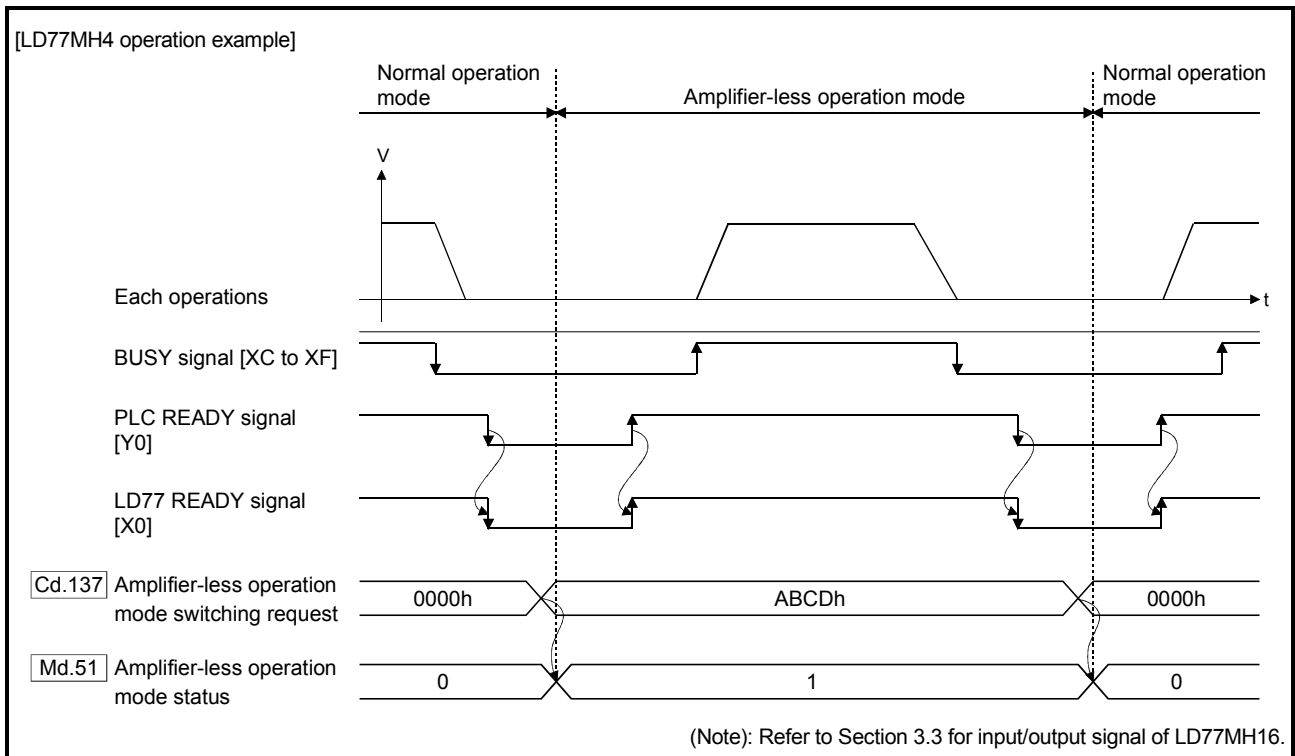

**POINT**

- (1) Switch the "normal operation mode" and "amplifier-less operation mode" after confirming the all input signals except synchronization flag [X1] OFF. When the switching of the normal operation mode and amplifier-less operation mode in the status of either of signals except synchronization flag [X1] ON, a "error when switching from normal operation mode to amplifier-less operation mode (error code: 808)" or "error when switching from amplifier-less operation mode to normal operation mode (error code: 809)" will occur, and the switching of operation mode will not execute.
- (2) When the operation mode is switched with the servo amplifiers connected, the communication to the servo amplifiers is shown below.
  - At switching from normal operation mode to amplifier-less operation mode: The communication for all axes during connection is disconnected. (The servo amplifier LED indicates "AA".)
  - At switching from amplifier-less operation mode to normal operation mode: The communication to the servo amplifiers during connection is started.
- (3) Even if the servo amplifiers are not connected, the switching of operation mode is possible.
- (4) The forced stop is invalid regardless of the setting in "[Pr.82] Forced stop valid/invalid selection" during the amplifier-less operation mode.
- (5) Only "0000h" and "ABCDh" are valid for the "[Cd.137] Amplifier-less operation mode switching request". The switching to amplifier-less operation mode can be accepted only when "[Cd.137] Amplifier-less operation mode switching request" is switched from "0000h" to "ABCDh". The switching to normal operation mode can be accepted only when "[Cd.137] Amplifier-less operation mode switching request" is switched from "ABCDh" to "0000h".

## 14.8 Virtual servo amplifier function

This function is used to operate as virtual servo amplifier axis that generates only command virtually by setting "4097" in servo parameter "[Pr.100] Servo series". The synchronous control with virtually input command is possible by using the virtual servo amplifier axis as servo input axis of synchronous control.

Also, it can be used as simulation operation for axes without servo amplifiers.

The details shown below explain about the " Virtual servo amplifier function".

[1] Control details

[2] Restrictions

### [1] Control details

- (1) When "4097" is set in "[Pr.100] Servo series" of flash ROM, it operates as virtual servo amplifier immediately after power supply ON.
- (2) When "0" is set in "[Pr.100] Servo series" of flash ROM, it operates as virtual servo amplifier by setting "4097" in "[Pr.100] Servo series" of buffer memory and by turning the PLC READY signal [Y0] OFF to ON after power supply ON.
- (3) The LED display status remains "Ab." and the servo amplifier is not recognized even if the actual servo amplifier is connected to axis set as virtual servo amplifier. The following servo amplifiers of actual servo series are recognized.
- (4) The current feed value and machine feed value of virtual servo amplifier are as follows.
  - (a) "0: Invalid" is set in "[Pr.103] Absolute position detection system".  
The both of current feed value and machine feed value are set to "0".
  - (b) "1: Valid" is set in "[Pr.103] Absolute position detection system".  
OP is established: Address at latest power supply OFF  
OP is not established: "0" (Feed current value and machine feed value)
- (5) When the virtual servo amplifier is set in the system setting of GX Works2, "0: Invalid" is set in "Absolute position detection system".  
Set "1: Valid" to the buffer memory to use as absolute position detection system.

#### POINT

Do not make to operate by switching between the actual servo amplifier and virtual servo amplifier. When except "0" is set in "[Pr.100] Servo series" of flash ROM, the operation is not changed even if the "[Pr.100] Servo series" of buffer memory is changed after power supply ON and then the PLC READY signal [Y0] is turned OFF to ON.

## [2] Restrictions

(1) The following monitor data of virtual servo amplifier differ from the actual servo amplifier.

Storage item		Storage details	Buffer memory address	
			LD77MH4	LD77MH16
<a href="#">Md.102</a>	Deviation counter value	Always "0".	852+100n 853+100n	2452+100n 2453+100n
<a href="#">Md.106</a>	Servo amplifier software No.	Always "0".	864+100n to 869+100n	2464+100n to 2469+100n
<a href="#">Md.107</a>	Parameter error No.	Always "0".	870+100n	2470+100n
<a href="#">Md.108</a>	Servo status	<ul style="list-style-type: none"> <li>• Zero point pass (b0) : Always ON</li> <li>• Zero speed (b3) : Change depending on the command speed</li> <li>• Speed limit (b4) : Always OFF</li> <li>• PID control (b8) : Always OFF</li> </ul>	876+100n	2476+100n
		<ul style="list-style-type: none"> <li>• READY ON (b0), Servo ON (b1) : Change depending on the all axis servo ON signal [Y1] and "<a href="#">Cd.100</a> Servo OFF command"</li> <li>• Control mode (b2, b3) : Always OFF</li> <li>• Servo alarm (b7) : Always OFF</li> <li>• In-position (b12) : Always ON</li> <li>• Torque limit (b13) : Always OFF</li> <li>• Absolute position lost (b14): Always OFF</li> <li>• Servo warning (b15) : Always OFF</li> </ul>	877+100n	2477+100n
<a href="#">Md.109</a>	Regenerative load ratio/Optional data monitor output 1	Always "0".	878+100n	2478+100n
<a href="#">Md.110</a>	Effective load torque/Optional data monitor output 2	Always "0".	879+100n	2479+100n
<a href="#">Md.111</a>	Peak torque ratio/Optional data monitor output 3	Always "0".	880+100n	2480+100n

n: Axis No.-1

(2) The operation for external signal selection function of virtual servo amplifier differ from the actual servo amplifier.

Function	Operation
External signal selection function	<p>The external signal status immediately after power supply ON is shown below.</p> <ul style="list-style-type: none"> <li>• Upper/lower limit signal (FLS, RLS): ON</li> <li>• Near-point dog signal (DOG): OFF</li> </ul> <p>Change the signal status in "<a href="#">Md.30</a> External input signal". (Refer to "Restrictions (3)" for details.)</p>

- (3) The following monitor data of virtual servo amplifier differ from the actual servo amplifiers. The writing operation is possible in the virtual servo amplifier.

Storage item		Storage details	Buffer memory address	
			LD77MH4	LD77MH16
<span style="border: 1px solid black; padding: 1px;">Md.30</span>	External input signal	<p>The external input signal status can be operated by turning ON/OFF the following signals.</p> <ul style="list-style-type: none"> <li>• b0: Lower limit signal</li> <li>• b1: Upper limit signal</li> <li>• b6: Near-point dog signal</li> </ul>	816+100n	2416+100n
<span style="border: 1px solid black; padding: 1px;">Md.104</span>	Motor current value	<p>"0" is set after immediately power supply ON.</p> <p>The motor current value can be emulated by changing this monitor data in user side.</p>	856+100n	2456+100n

n: Axis No.-1

## 14.9 Master-slave operation function

This function uses the "Master-slave operation function" of servo amplifier. The LD77MH controls positioning of master axis and the slave axis is controlled by data communication (driver communication) between servo amplifiers without LD77MH. This function is used for the case such as to operate the ball screw controlled by multiple axes via the belt.

The following shows the number of settable axes for the master axis and slave axis.

Model	Number of control axes	Combination of number of settable axes <sup>(Note-1)</sup>		Remark
		Master axis	Slave axis	
LD77MH4	4 axes	1 axis	1 axis to 3 axes	The axes other than the master axis and slave axis can be used as normal axis.
		2 axes	1 axis/1 master axis	
LD77MH16	16 axes	1 axis to 4 axes	—	

—: No restriction

(Note-1): When the slave axis is not allocated for the master axis, the operation is normal operation only of master axis.

The details shown below explain about the "master-slave operation function".

[1] Control details

[2] Precautions during control

[3] Servo parameter (Driver communication setting)

[1] Control details

Set the master axis and slave axis in the servo parameter.

Execute each control of LD77MH for the master axis. (However, be sure to execute the servo ON/OFF of slave axis and error reset at servo error occurrence in the slave axis.) The servo amplifier set as master axis receives command (positioning command, speed command, torque command) from the LD77MH, and send the control data to the servo amplifier set as slave axis by driver communication between servo amplifiers.

The servo amplifier set as the slave axis is controlled with the control data transmitted from master axis by driver communication between servo amplifiers.

Please consult your local Mitsubishi representative for details of driver communication and slave axis.

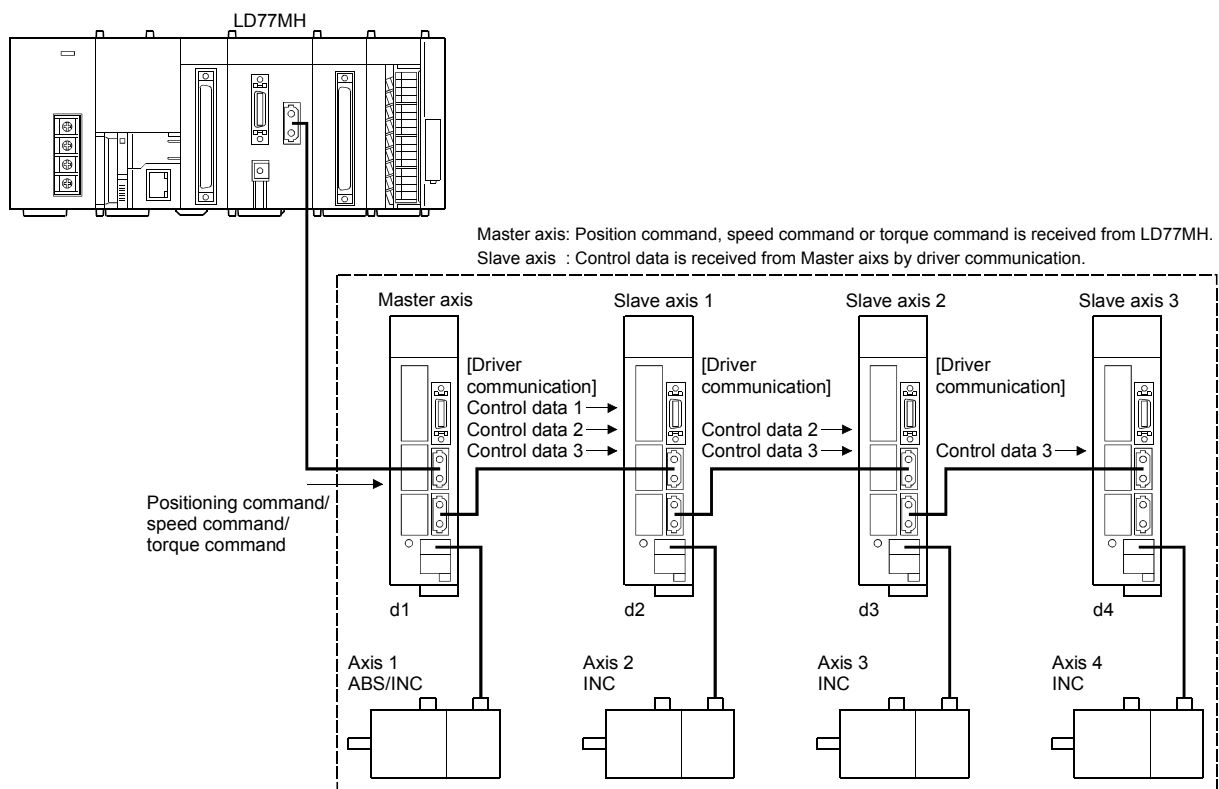

**POINT**

Connect the master axis to LD77MH before the slave axis.

[2] Precautions during control

**⚠ CAUTION**

- In the master-slave operation, the positioning control or JOG operation, etc. is not interrupted even if the servo error will occur in the slave axis. Be sure to stop the master axis by user program.



- (1) Servo amplifier
  - (a) Use the servo amplifiers of version compatible with the master-slave operation.
  - (b) When the master-slave operation is set, turn ON the system's power supply after all servo amplifier's power supply ON. It cannot be communicated with the servo amplifiers (including normal operation axis) turned ON after the system's power supply ON. ("1: Searching" is set in "[Md.52] Communication between amplifiers axes searching flag", and the servo amplifier's LED display remains "Ab".
  
- (2) OPR control, positioning control and manual control
  - (a) Do not start the slave axis. The command axis to servo amplifier becomes invalid if the slave axis is started.
  - (b) The OPR request flag ([Md.31] Status: b3) of slave axis is always ON. There is no influence for control of slave axis.
  - (c) There are some restrictions for data used as the positioning control of slave axis. The external input signals such as FLS or RLS, and the parameters such as software stroke limit are invalid. Refer to this section (5) or (6) for details.
  
- (3) Control change function
  - (a) Do not execute the following controls for slave axis. It becomes invalid to execute.
    - Speed change request
    - Override change
    - Target position change
    - Current value change
  - (b) When other than "0" is set to torque change value or torque output setting value of slave axis, the torque generated of slave axis (servo motor) is limited by setting value.
  
- (4) Absolute position system

Set "0: Invalid (Used in incremental system)" in "[Pr.103] Absolute position detection system" of servo parameter for slave axis. If "1: Valid (Used in absolute position detection system)" is set, the error "OPR data incorrect" (error code: 1201) will occur and the OPR of slave axis cannot be executed.
  
- (5) I/O signals of slave axis
  - (a) Input signal  
[LD77MH4]

Only the error detection signal [X8 to XB] is valid. And only the servo error detection is valid. (The control of slave axis is not influenced even if the error other than servo error has been occurred.)

  
[LD77MH16]

All signals cannot be used. The error detection signal is "[Md.31] Status: b13".

## (b) Output signal

All output signals of slave axis cannot be used.

## (6) Data used for positioning control of slave axis

- (a) Set only the following setting data in the slave axis. The other setting data are invalid.

Item		
Detailed parameters 1	[Pr.17]	Torque limit setting value
Servo parameters	[Pr.100]	Servo series
	[Pr.101] to [Pr.118], [Pr.332]	Basic setting parameters
	[Pr.119] to [Pr.163],	Gain/filter parameters
	[Pr.164] to [Pr.195],	Expansion setting parameters
	[Pr.196] to [Pr.227],	Input/output setting parameters
	[Pr.228] to [Pr.267],	Extension control parameters
	[Pr.268] to [Pr.299],	Special setting parameters
	[Pr.300] to [Pr.315],	Other setting parameters
	[Pr.316] to [Pr.331],	Option unit parameters

- (b) Only the following axis monitor data are valid in slave axis.

Item		Remark
[Md.23]	Axis error No.	Valid for only servo error detection.
[Md.35]	Torque limit stored value/forward torque limit stored value	—
[Md.108]	Servo status	The following bit is valid. • b0: Zero point pass (Execute OPR to the master axis.)
		The following bits are valid. • b0: READY ON • b1: Servo ON • b7: Servo alarm
[Md.120]	Reverse torque limit stored value	—

- (c) Only the following axis control data are valid in slave axis.

Item		Remark
[Cd.5]	Axis error reset	Only servo error detection
[Cd.22]	New torque value/forward new torque value	—
[Cd.100]	Servo OFF command	—
[Cd.101]	Torque output setting value	—
[Cd.112]	Torque change function switching request	—
[Cd.113]	Reverse new torque value	—

### [3] Servo parameter (Driver communication setting)

Set the driver communication setting to the following parameters for the axis to execute the master-slave operation.

(Please consult your local Mitsubishi representative for details.)

Setting item		Setting details	Buffer memory address		
			LD77MH4	LD77MH16	
Input/output setting	Pr.210 (PD15)	Driver communication setting	Set the master axis and slave axis.	30210+200n	Set with GX Works2
	Pr.211 (PD16)	Driver communication setting Master transmit data selection 1	Set the transmitted data at master axis setting.	30211+200n	
	Pr.212 (PD17)	Driver communication setting Master transmit data selection 2		30212+200n	
	Pr.213 (PD18)	Driver communication setting Master transmit data selection 3		30213+200n	
	Pr.214 (PD19)	Driver communication setting Master transmit data selection 4		30214+200n	
	Pr.215 (PD20)	Driver communication setting Master axis No. selection 1 for slave	Set the axis No. of master axis at slave axis setting.	30215+200n	
	Pr.216 (PD21)	Driver communication setting Master axis No. selection 2 for slave		30216+200n	
	Pr.217 (PD22)	Driver communication setting Master axis No. selection 3 for slave		30217+200n	
	Pr.218 (PD23)	Driver communication setting Master axis No. selection 4 for slave		30218+200n	

(Note-1): When the slave axis is not allocated for the master axis, the operation is normal operation only of master axis.

(Note-2): For LD77MH16, the above servo parameters are not allocated to the buffer memory. Write them to LD77MH16 with GX Works2.

POINT
<p>(1) The servo parameters are transmitted from LD77MH to servo amplifier after power supply ON or reset of PLC CPU. Execute flash ROM writing of LD77MH after writing the servo parameter to buffer memory, and then turn the power supply ON or reset of PLC CPU.</p> <p>(2) The driver communication setting (PD15 to PD23) of servo parameter becomes valid by turning the servo amplifier's power supply OFF to ON. Turn the servo amplifier's power supply OFF to ON after executing the above (1). And then, turn the system's power supply ON or reset of PLC CPU.</p>

14.10 Mark detection function **LD77MH16**

Any data can be latched at the input timing of the mark detection signal (DI1 to DI4). Also, only data within a specific range can be latched by specifying the data detection range.

The following three modes are available for execution of mark detection.

1) Continuous detection mode

The latched data is always stored to the first of mark detection data storage area at mark detection.

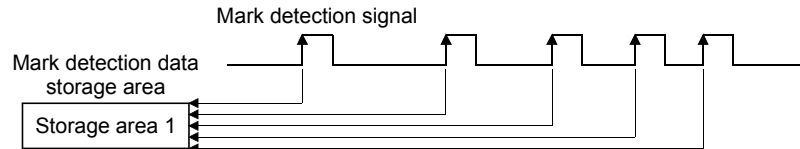

2) Specified number of detections mode

The latched data from a specified number of detections is stored.

The detected position for a specified number of detections can be collected when the mark detection signal is continuously input at high speed.

Example) Number of detections: 3

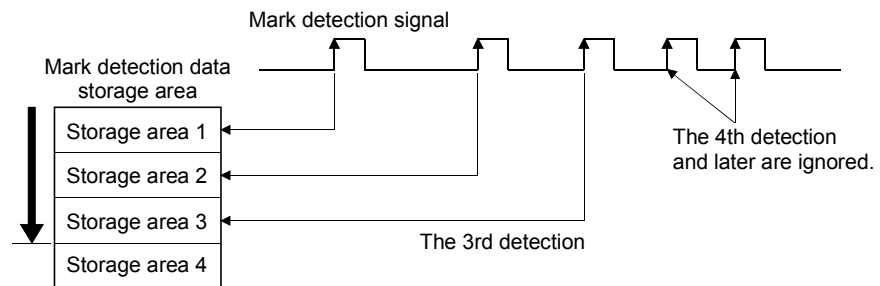

3) Ring buffer mode

The latched data is stored in a ring buffer for a specified number of detections. The latched data is always stored at mark detection.

Example) Number of detections: 4

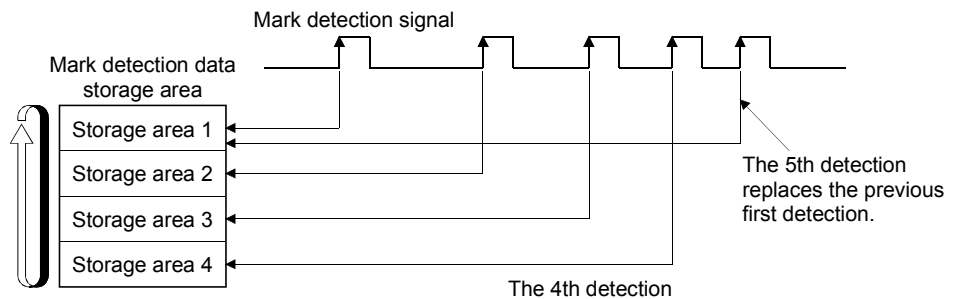

Item	Performance specifications
Number of mark detection settings	Up to 16
Input signal	Axis 1 to Axis 16 External input signal (DI1 to DI4)
Input signal detection direction	Selectable for leading edge or trailing edge in logic setting of external input signal
Input signal compensation time	Correctable within the range of -32768 to 32767 $\mu$ s
Detection accuracy	10 $\mu$ s
Latch data	11 types + Optional buffer memory data (2 word) (Current feed value, Machine feed value, Real current value, Servo input axis current value, Synchronous encoder axis current value, Synchronous encoder axis current value per cycle, Current value after composite main shaft gear, Current value per cycle after main shaft gear, Current value per cycle after auxiliary shaft gear, Cam axis current value per cycle, Cam axis current value per cycle (real position) )
Number of continuous latch data storage	Up to 32
Latched data range	Settable in the range of -2147483648 to 2147483647

The details shown below explain about the "Mark detection function".

- [1] Operation for mark detection function
- [2] How to use mark detection function
- [3] List of buffer memory
- [4] Precautions

[1] Operation for mark detection function

Operations done at mark detection are shown below.

- Calculations for the mark detection data are estimated at leading edge/trailing edge of the mark detection signal.

However, when the specified number of detections mode is set, the current number of mark detection counter is checked, and then it is judged whether to execute the mark detection.

- When a mark detection data range is set, it is first confirmed whether the mark detection data is within the range or not. Data outside the range are not detected.
- The mark detection data is stored in the mark detection data storage area according to the mark detection mode, and then the number of mark detection counter is updated.

(1) Continuous detection mode

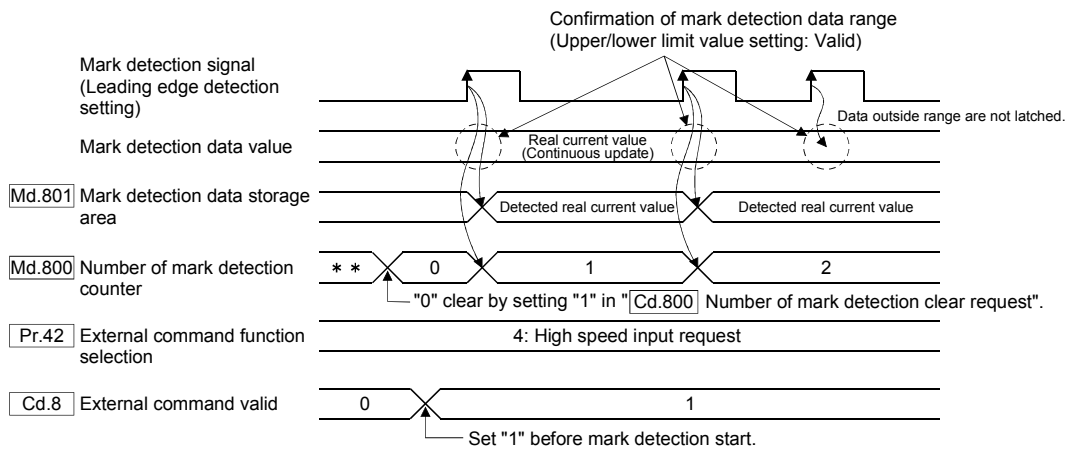

(2) Specified number of detection mode (Number of detections: 2)

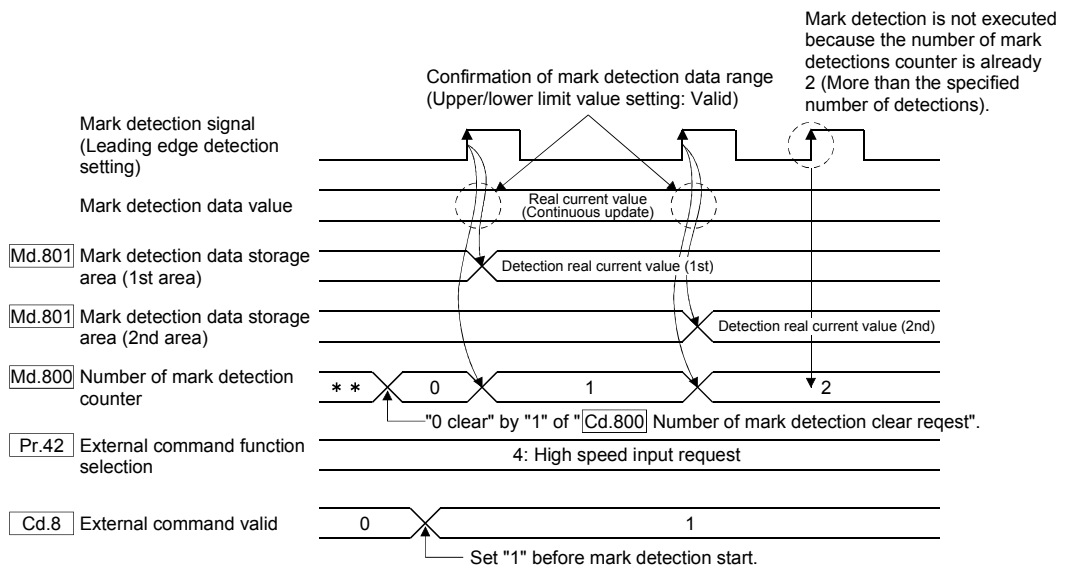

## [2] How to use mark detection function

The following shows an example for mark detection by the external command signal (DI3) of axis3.

The mark detection target is axis 4 real current value, and the all range is detected in continuous detection mode.

- (1) Allocate the input signal (DI3) to the external command signal of axis 3, and set the "high speed input request" for mark detection.

Storage item	Setting value	Storage details/storage value	Buffer memory address
Pr.95 External command signal selection	3	Set "3: DI3" to the external command signal of axis 3.	369 (69+150n)
Pr.42 External command function selection	4	Set "4: High speed input request" as the function used in the external command signal of axis 3.	362 (62+150n)

n: Axis No.-1

- (2) Set the following mark detection setting parameters. The optional mark detection setting No. can be set.

Storage item	Setting value	Storage details/storage value	Buffer memory address
Pr.800 Mark detection signal setting	3	Set "3: Axis 3" to the external input signal for mark detection.	54000+20k
Pr.801 Mark detection signal compensation time	0	Set "0: (No compensation)" to the compensation time such as delay of sensor.	54001+20k
Pr.802 Mark detection data type	2	Set "2: Real current value" to the target data for mark detection.	54002+20k
Pr.803 Mark detection data axis No.	4	Set "4: Axis 4" to the axis No. of target data for mark detection.	54003+20k
Pr.805 Latch data range upper limit value	0	Set "0" to the valid upper limit value for latch data at mark detection. (Mark detection for all range is executed by setting the same value as lower limit value.)	54006+20k 54007+20k
Pr.806 Latch data range lower limit value	0	Set "0" to the valid lower limit value for latch data at mark detection. (Mark detection for all range is executed by setting the same value as upper limit value.)	54008+20k 54009+20k
Pr.807 Mark detection mode setting	0	Set "0: Continuous detection mode" to the mark detection mode.	54010+20k

k: Mark detection setting No.-1

- (3) Turn the power supply OFF or reset of PLC CPU to validate the setting parameters.
- (4) The mark detection starts by setting "1: Validates an external command." in "[Cd.8] External command valid" of axis 3 with the sequence program. Refer to "[Md.800] Number of mark detection counter" or "[Md.801] Mark detection data storage area" of mark detection setting No. set in this section (2) for the number of mark detections and mark detection data.

## [3] List of buffer memory

The following shows the configuration of buffer memory for mark detection function.

Buffer memory address	Number of word	Item	Mark detection setting No.
54000 to 54019	20	Mark detection setting parameter [Pr.800] to [Pr.807]	Mark detection setting 1
54020 to 54039	20		Mark detection setting 2
54040 to 54059	20		Mark detection setting 3
to	to		to
54300 to 54319	20		Mark detection setting 16
54640 to 54649	10	Mark detection control data [Cd.800], [Cd.801]	Mark detection setting 1
54650 to 54659	10		Mark detection setting 2
54660 to 54669	10		Mark detection setting 3
to	to		to
54790 to 54799	10		Mark detection setting 16
54960 to 55039	80	Mark detection monitor data [Md.800], [Md.801]	Mark detection setting 1
55040 to 55119	80		Mark detection setting 2
55120 to 55199	80		Mark detection setting 3
to	to		to
56160 to 56239	80		Mark detection setting 16

- Guide to buffer memory address

In the buffer memory address, "k" in "54002+20k", etc. indicates a value corresponding to mark detection setting No. such as the following table.

Mark detection setting No.	k	Mark detection setting No.	k	Mark detection setting No.	k	Mark detection setting No.	k
1	0	5	4	9	8	13	12
2	1	6	5	10	9	14	13
3	2	7	6	11	10	15	14
4	3	8	7	12	11	16	15

(Note): Calculate as follows for the buffer memory address corresponding to each mark detection setting No.

(Example) For mark detection setting 16

$$54002+20k \text{ ([Pr.802] Mark detection data type)}=54002+20 \times 15=54302$$

$$54641+10k \text{ ([Cd.801] Mark detection invalid flag)}=54641+10 \times 15=54791$$



The following shows the buffer memory used in the mark detection function.

(1) Mark detection setting parameters

Setting item		Setting details/setting value	Default value	Buffer memory address	
				LD77MH4	LD77MH16
Pr.800	Mark detection signal setting	Set the external input signal (high speed input request) for mark detection. 0 : Invalid 1 to 16 : External command signal of axis 1 to axis 16  <u>Fetch cycle: Power supply ON</u>	0		54000+20k
Pr.801	Mark detection signal compensation time	Set the compensation time such as delay of sensor. Set a positive value to compensate for a delay. -32768 to 32767[μs]  <u>Fetch cycle: Power supply ON or PLC READY signal [Y0] OFF to ON</u>	0		54001+20k
Pr.802	Mark detection data type	Set the target data for mark detection. 0 to 12 : Data type -1 : Optional 2 word buffer memory  <u>Fetch cycle: Power supply ON</u>	0		54002+20k
Pr.803	Mark detection data axis No.	Set the axis No. of target data for mark detection. 1 to 16 : Axis 1 to Axis 16 801 to 804 : Synchronous encoder Axis 1 to 4  <u>Fetch cycle: Power supply ON</u>	0		54003+20k
Pr.804	Mark detection data buffer memory No.	Set the optional buffer memory No. Set this parameter as an even number. 0 to 65534: Optional buffer memory  <u>Fetch cycle: Power supply ON</u>	0		54004+20k 54005+20k
Pr.805	Latch data range upper limit value	Set the valid upper limit value for latch data at mark detection. -2147483648 to 2147483647  <u>Fetch cycle: Power supply ON or PLC READY signal [Y0] OFF to ON</u>	0		54006+20k 54007+20k
Pr.806	Latch data range lower limit value	Set the valid lower limit value for latch data at mark detection -2147483648 to 2147483647  <u>Fetch cycle: Power supply ON or PLC READY signal [Y0] OFF to ON</u>	0		54008+20k 54009+20k
Pr.807	Mark detection mode setting	Set the continuous detection mode or specified number of detection mode. 0 : Continuous detection mode 1 to 32 : Specified number of detection mode (Set the number of detections.) -1 to -32 : Ring buffer mode (Set the value that made the number of buffers into negative value.)  <u>Fetch cycle: Power supply ON or PLC READY signal [Y0] OFF to ON</u>	0		54010+20k

k: Mark detection setting No.-1

**Pr.800** Mark detection signal setting

Set the input signal for mark detection.

- 0 : Invalid
- 1 to 16 : External command signal [DI] of axis 1 to axis 16

Set "4: High speed input request" in "[Pr.42] External command function selection" and set "1: Validates an external command." in "[Cd.8] External command valid".

**Pr.801** Mark detection signal compensation time

Compensate the input timing of the mark detection signal.

Set this parameter to compensate such as delay of sensor input. (Set a positive value to compensate for a delay.)

**Pr.802** Mark detection data type

Set the data that latched at mark detection.

The target data is latched by setting "0 to 12". Set the axis No. in "[Pr.803] Mark detection data axis No.".

Optional 2 word buffer memory is latched by setting "-1". Set the buffer memory No. in "[Pr.804] Mark detection data buffer memory No.".

- 0 : Current feed value
- 1 : Machine feed value
- 2 : Real current value
- 3 : Servo input axis current value
- 6 : Synchronous encoder axis current value
- 7 : Synchronous encoder axis current value per cycle
- 8 : Current value after composite main shaft gear
- 9 : Current Value per cycle after main shaft gear
- 10 : Current value per cycle after auxiliary shaft gear
- 11 : Cam axis current value per cycle
- 12 : Cam axis current value per cycle (Real position)
- 1 : Optional 2 words buffer memory

**Pr.803** Mark detection data axis No.

Set the axis No. of data that latched at mark detection.

[Pr.802] Mark detection data type			[Pr.803] Mark detection data axis No.
Setting value	Data name	Unit	
0	Current feed value	10 <sup>-1</sup> [μm], 10 <sup>-5</sup> [inch], 10 <sup>-5</sup> [degree], [PLS]	1 to 16
1	Machine feed value		
2	Real current value		
3	Servo input axis current value		
6	Synchronous encoder axis current value	Synchronous encoder axis position unit	801 to 804
7	Synchronous encoder axis current value per cycle		
8	Current value after composite main shaft gear	Main input axis position unit	1 to 16
9	Current value per cycle after main shaft gear	Cam axis cycle unit	
10	Current value per cycle after auxiliary shaft gear		
11	Cam axis current value per cycle		
12	Cam axis current value per cycle (Real position) (Note)		

(Note): Cam axis current value per cycle that considered delay of the servo system.

**Pr.804** Mark detection data buffer memory No.

Set the No. of optional 2 words buffer memory that latched at mark detection.  
Set this No. as an even No.

**Pr.805** Latch data range upper limit value, **Pr.806** Latch data range lower limit value

Set the upper limit value and lower limit value of the latch data at mark detection. When the data at mark detection is within the range, they are stored in "**Md.801** Mark detection data storage area" (1 to 32) and the "**Md.800** Number of mark detection counter" is incremented by 1. The mark detection processing is not executed.

- Upper limit value > Lower limit value

The mark detection is executed when the mark detection data is "greater or equal to the lower limit value and less than the upper limit value".

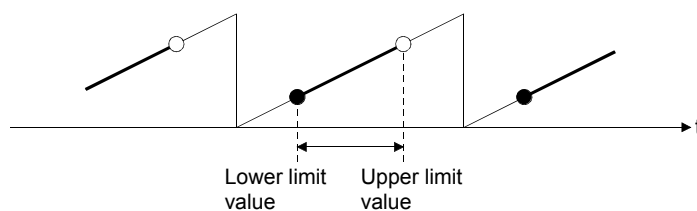

- Upper limit value < Lower limit value

The mark detection is executed when the mark detection data is "greater or equal to the lower limit value or less than the upper limit value".

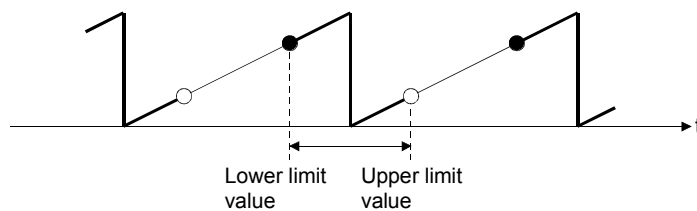

- Upper limit value = Lower limit value

The mark detection range is not checked. The mark detection is executed for all range.

**Pr.807** Mark detection mode setting

Set the data storage method of mark detection.

Mode	Setting value	Operation for mark detection	Mark detection data storage method
Continuous detection mode	0	Always	The data is updated in the mark detection data storage area 1.
Specified number of detection mode	1 to 32	Number of detections (If the number of mark detection counter is the number of detections or more, the mark detection is not executed.)	The data is stored to the mark detection data storage area "n". n = (1+ Number of mark detection counter)
Ring buffer mode	-1 to -32	Always (The mark detection data storage area 1 to 32 is used as a ring buffer for the number of detections.)	

## (2) Mark detection control data

Setting item		Setting details/setting value	Default value	Buffer memory address	
				LD77MH4	LD77MH16
<b>Cd.800</b>	Number of mark detection clear request	Set "1" to execute "0" clear of number of mark detections. "0" is automatically set after completion by "0" clear of number of mark detections. 1: 0 clear of number of mark detections <u>Fetch cycle: Operation cycle</u>	0		54640+10k
<b>Cd.801</b>	Mark detection invalid flag	Set this flag to invalidate mark detection temporarily. 1 : Mark detection: Invalid Others : Mark detection: Valid <u>Fetch cycle: Operation cycle</u>	0		54641+10k

k: Mark detection setting No.-1

**Cd.800** Number of mark detection clear request

Set "1" to execute "0" clear of "**Md.800** Number of mark detection counter". "0" is automatically set after completion by "0" clear of "**Md.800** Number of mark detection counter".

**Cd.801** Mark detection invalid flag

Set "1" to invalidate mark detection temporarily. The mark detection signal during invalidity is ignored.

## (3) Mark detection monitor data

Storage item		Storage details/storage value	Buffer memory address	
			LD77MH4	LD77MH16
<b>Md.800</b>	Number of mark detection counter	The number of mark detections is stored. "0" clear is executed at power supply ON. Continuous detection mode: 0 to 65535 (Ring counter) Specified number of detection mode: 0 to 32 Ring buffer mode: 0 to (number of buffers - 1)  <u>Refresh cycle: At mark detection</u>		54960+80k
<b>Md.801</b>	Mark detection data storage area 1 to Mark detection data storage area 32	The latch data at mark detection is stored. Data for up to 32 times are stored in the specified number of detection mode. Data are stored as a ring buffer for number of detections in the ring buffer mode. -2147483648 to 2147483647  <u>Refresh cycle: At mark detection</u>		54962+80k 54963+80k to 55024+80k 55025+80k

k: Mark detection setting No.-1

**Md.800** Number of mark detection counter

The counter value is incremented by 1 at mark detection. Preset "0" clear in "**Cd.800** Number of mark detection clear request" to execute the mark detection in specified number of detections mode or ring buffer mode.

**Md.801** Mark detection data storage area 1 to 32

The latch data at mark detection is stored. Data for up to 32 times can be stored in the specified number of detection mode or ring buffer mode.

**[4] Precautions**

When the data of "**Pr.802** Mark detection data type" or "**Pr.803** Mark detection data axis No." is selected incorrectly, the incorrect latch data is stored

14.11 Optional data monitor function **LD77MH16**

This function is used to store the data (refer to following table) up to four points per axis to the buffer memory and monitor them.

The details shown below explain about the "Optional data monitor function".

[1] Data that can be set

[2] List of buffer memory

## [1] Data that can be set

Data type	Unit
Effective load ratio	[%]
Regenerative load ratio	[%]
Peak load factor	[%]
Load inertia ratio	[×0.1]
Position loop gain 1	[rad/s]
Bus voltage	[V]
Servo motor rotation speed <sup>(Note-1)</sup>	[rpm]
Position feed back (Used point: 2 words)	[PLS]
Absolute position encoder single revolution position (Used point: 2 words)	[PLS]
Select synchronous position droop <sup>(Note-2)</sup> (Used point: 2 words)	[PLS]

(Note-1): The motor speed that took the average every 227[ms].

Use the servo amplifiers of version compatible with the monitor of motor speed.  
Always "0" if the monitor is executed for the servo amplifier which does not support this function.

(Note-2): The data set to "Droop pulse monitor setting for controller display" of "**Pr.237**"  
Fully closed loop selection 3" (PE10) is monitored.

[2] List of buffer memory

The buffer memory used in the optional data monitor function is shown below.

(1) Expansion parameter

Setting item		Setting details/setting value	Buffer memory address	
			LD77MH4	LD77MH16
[Pr.91]	Optional data monitor: Data type setting 1	Set the data type monitored in optional data monitor function every data type setting. 0 : No setting (Note-1)	/	100+150n
[Pr.92]	Optional data monitor: Data type setting 2	1 : Effective load ratio 2 : Regenerative load ratio 3 : Peak load factor		101+150n
[Pr.93]	Optional data monitor: Data type setting 3	4 : Load inertia ratio 5 : Position loop gain 1 6 : Bus voltage		102+150n
[Pr.94]	Optional data monitor: Data type setting 4	7 : Servo motor rotation speed 20 : Position feed back (Used point: 2 words) 21 : Absolute position encoder single revolution position (Used point: 2 words) 22 : Select synchronous position droop (Used point: 2 words) Others : No monitor ("0" is stored.)  (Note-1): The stored value of "[Md.109] Regenerative load ratio/Optional data monitor output 1" to "[Md.112] Optional data monitor output 4" is different every data type setting 1 to 4. (Refer to Section 5.6.2)		103+150n

n: Axis No.-1

<b>POINT</b>
<p>(1) The monitor address of optional data monitor is registered to servo amplifier with initialized communication after power supply ON or PLC CPU reset.</p> <p>(2) Set the data type of "used point: 2 words" in "[Pr.91] Optional data monitor: Data type setting 1" or "[Pr.93] Optional data monitor: Data type setting 3". If it is set in "[Pr.92] Optional data monitor: Data type setting 2" or "[Pr.94] Optional data monitor: Data type setting 4", the warning (warning code: 116) will occur with initialized communication to servo amplifier, and "0" is set in [Md.109] to [Md.112].</p> <p>(3) Set "0" in "[Pr.92] Optional data monitor: Data type setting 2" when the data type of "used point: 2 words" is set in "[Pr.91] Optional data monitor: Data type setting 1", and set "0" in "[Pr.94] Optional data monitor: Data type setting 4" when the data type of "used point: 2 words" is set in "[Pr.93] Optional data monitor: Data type setting 3". When other than "0" is set, the warning (warning code: 116) will occur with initialized communication to servo amplifier, and "0" is set in [Md.109] to [Md.112].</p> <p>(4) When the data type of "used point: 2 words" is set, the monitor data of low-order is "[Md.109] Regenerative load ratio/Optional data monitor output 1" or "[Md.111] Peak torque ratio/Optional data monitor output 3".</p>

## (2) Axis monitor data

Storage item		Storage details/storage value	Buffer memory address	
			LD77MH4	LD77MH16
<a href="#">Md.109</a>	Regenerative load ratio/Optional data monitor output 1	<ul style="list-style-type: none"> <li>The content set in "<a href="#">Pr.91</a> Optional data monitor: Data type setting 1" is stored at optional data monitor data type setting.</li> <li>The regenerative load ratio is stored when nothing is set.</li> </ul>		2478+100n
<a href="#">Md.110</a>	Effective load torque/Optional data monitor output 2	<ul style="list-style-type: none"> <li>The content set in "<a href="#">Pr.92</a> Optional data monitor: Data type setting 2" is stored at optional data monitor data type setting.</li> <li>The effective load ratio is stored when nothing is set.</li> </ul>		2479+100n
<a href="#">Md.111</a>	Peak torque ratio/Optional data monitor output 3	<ul style="list-style-type: none"> <li>The content set in "<a href="#">Pr.93</a> Optional data monitor: Data type setting 3" is stored at optional data monitor data type setting.</li> <li>The peak torque ratio is stored when nothing is set.</li> </ul>		2480+100n
<a href="#">Md.112</a>	Optional data monitor output 4	<ul style="list-style-type: none"> <li>The content set in "<a href="#">Pr.94</a> Optional data monitor: Data type setting 4" is stored at optional data monitor data type setting.</li> <li>"0" is stored when nothing is set.</li> </ul>		2481+100n

n: Axis No.-1

**POINT**

When the communication interrupted by the servo amplifier's power supply OFF or disconnection of communication cable with servo amplifiers during optional data monitor, "0" is stored in [Md.109](#) to [Md.112](#).



14.12 Module error collection function **LD77MH16**

This function collects errors occurred in the LD77MH in the PLC CPU. Those errors are stored in a memory (latch area) of the PLC CPU as module error logs. The stored error logs are retained even when the PLC CPU is powered off or reset.

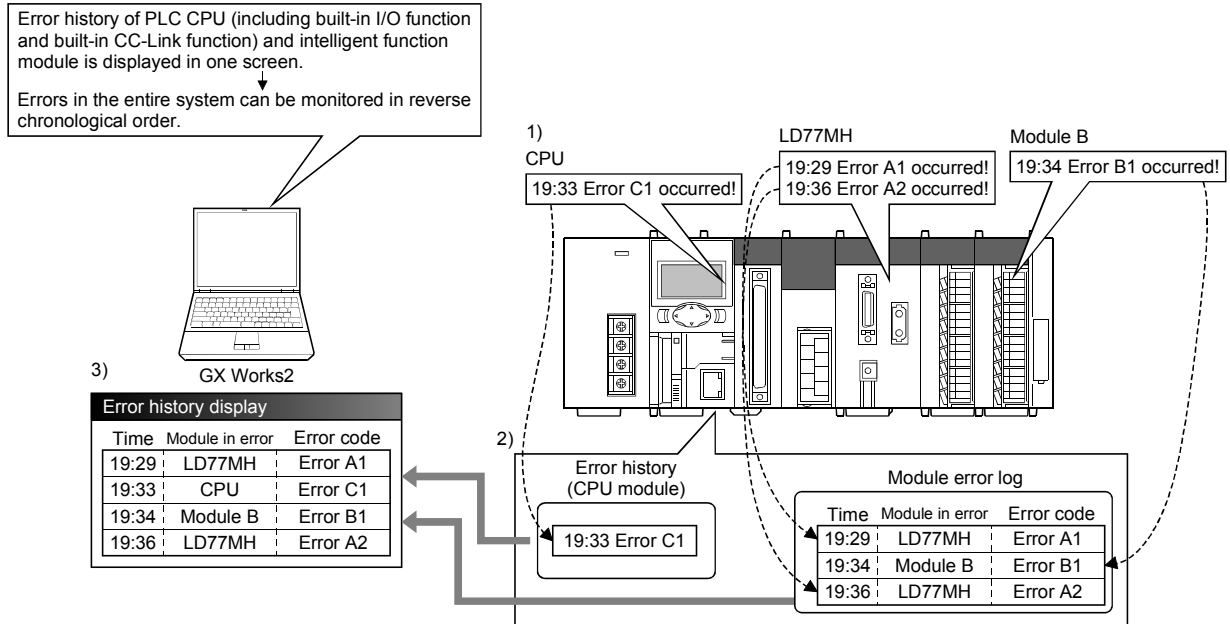

<Operation>

- 1) The error occurs in the PLC CPU or Intelligent function module.
- 2) The PLC CPU collects and stores the error in each intelligent function module as "Module error history".
- 3) The list of error in PLC CPU or each intelligent function module error is displayed with GX Works2.

[Example of screen display]

Error History List

Displayed Errors/Errors: 84/200      Error Code Notation:  DEC  HEX

No.	Error Code	Date and Time	Model Name	Start I/O
00200	0065	2011/01/18 16:59:26	LD77MH16	0010
00199	0065	2011/01/18 16:59:26	LD77MH16	0010
00198	0065	2011/01/18 16:59:26	LD77MH16	0010
00197	05DC	2011/01/18 16:58:55	L02CPU	----
00196	0065	2011/01/18 16:58:45	LD77MH16	0010
00195	0065	2011/01/18 16:58:35	LD77MH16	0010
00194	006C	2011/01/18 16:58:25	LD77MH16	0010
00193	006C	2011/01/18 16:58:24	LD77MH16	0010
00192	006C	2011/01/18 16:58:24	LD77MH16	0010
00191	006C	2011/01/18 16:58:24	LD77MH16	0010
00190	05DC	2011/01/18 16:18:50	L02CPU	----
00189	006C	2011/01/18 16:15:39	LD77MH16	0010
00188	006C	2011/01/18 16:15:39	LD77MH16	0010

For details on the module error collection function, refer to Section 16.1 "Checking errors using GX Works2".

# Chapter 15 Dedicated Instructions

The LD77MH dedicated instructions are explained in this chapter.

These instructions are used to facilitate the programming for the use of the functions of the intelligent function module.

Using the dedicated instructions, the programming can be carried out without being aware of the LD77MH buffer memory address and interlock signal.

15.1	List of dedicated instructions .....	15- 2
15.2	Interlock during dedicated instruction is executed .....	15- 2
15.3	ZP.PSTR1, ZP.PSTR2, ZP.PSTR3, ZP.PSTR4 .....	15- 3
15.4	ZP.TEACH1, ZP.TEACH2, ZP.TEACH3, ZP.TEACH4 .....	15- 7
15.5	ZP.PFWRT .....	15- 11
15.6	ZP.PINIT .....	15- 15

### 15.1 List of dedicated instructions

The dedicated instructions explained in this Chapter are listed in Table 15.1.

Table 15.1 List of dedicated instructions

Application	Dedicated instruction	Outline of functions	Reference
Positioning start	ZP.PSTRT1	This function starts the positioning control of the designated axis of the LD77MH.	Section 15.3
	ZP.PSTRT2		
	ZP.PSTRT3		
	ZP.PSTRT4		
Teaching	ZP.TEACH1	This function carries out teaching the designated axis of the LD77MH.	Section 15.4
	ZP.TEACH2		
	ZP.TEACH3		
	ZP.TEACH4		
Writing to flash ROM	ZP.PFWRT	This function writes the buffer memory parameters, positioning data and block start data to the flash ROM.	Section 15.5
Parameter initialization	ZP.PINIT	This function initializes the buffer memory and flash ROM setting data to the factory-set data (initial values).	Section 15.6

POINT
<p>The dedicated instructions of LD77MH16 can be used for only axis 1 to 4. They cannot be used for axis 5 to 16. If the ZP.PSTRT5 to ZP.PSTRT16 or ZP.TEACH5 to ZP.TEACH16 is executed, "Program code error" (error code: 4002) for PLC CPU and "PLC CPU error" (error code: 803) for LD77MH16 will occur and positioning cannot be started.</p> <p>Refer to "MELSEC-L CPU Module User's Manual (Hardware Design, Maintenance and Inspection) for error of PLC CPU".</p>

### 15.2 Interlock during dedicated instruction is executed

The positioning start instruction (ZP.PSTRT□) and teaching instruction (ZP.TEACH□) cannot be executed simultaneously in each axis. If they are executed at the same time, the second and later instructions are ignored by an internal interlock (no error will occur).

The timing of the positioning start instruction (ZP.PSTRT□) is as shown below.

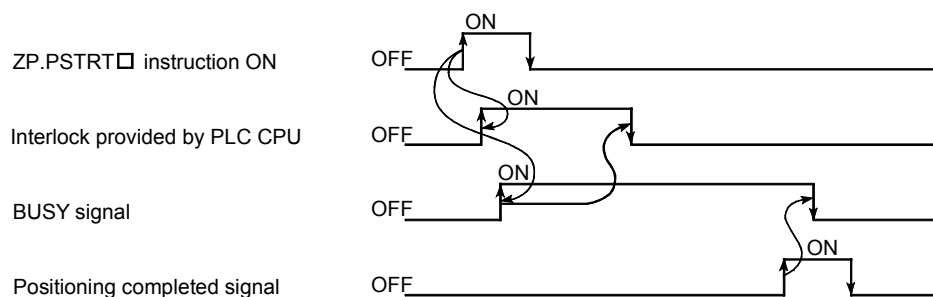

### 15.3 ZP.PSTR1, ZP.PSTR2, ZP.PSTR3, ZP.PSTR4

These dedicated instructions are used to start the positioning of the designated axis.

Setting data	Usable device								
	Internal device		File register	Link direct device J□□		Intelligent function module U□\G□	Index register Zn	Constant K, H	Others
	Bit	Word		Bit	Word				
(S)	–	○	–	–	–	–	–	–	
(D)	○	○	–	–	–	–	–	–	

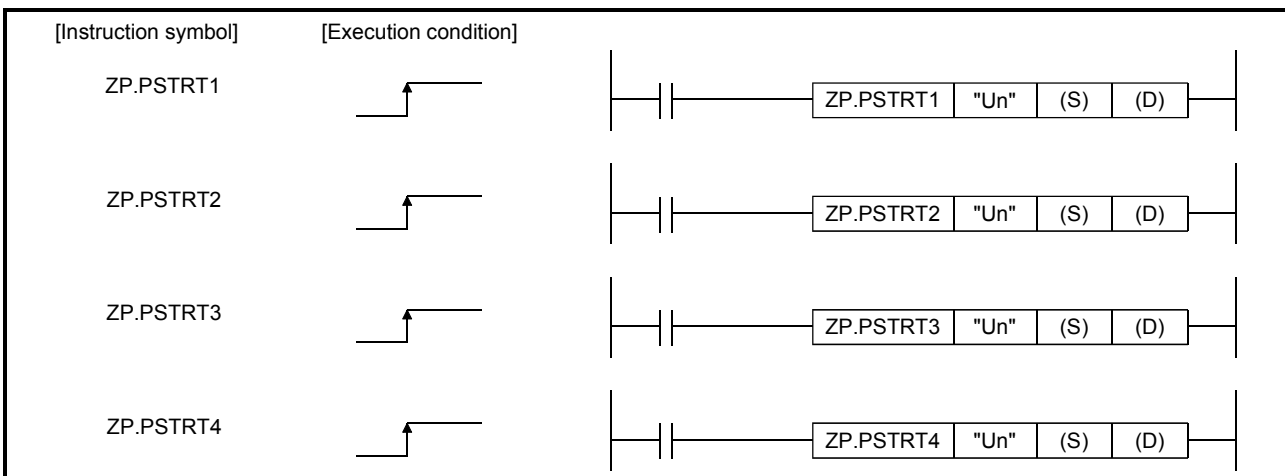

Note) When ZP.PSTR1, ZP.PSTR2, ZP.PSTR3, and ZP.PSTR4 are common to each other, they are designated as "ZP.PSTR□".

#### [Setting data]

Setting data	Setting details	Setting side (Note-1)	Data type
"Un"	LD77MH head I/O number (00 to FE: High-order two digits of I/O number expressed in three digits)	User	BIN 16 bits
(S)	Head number of a device in which control data is stored	–	Device name
(D)	Head number of a bit device which turns ON the operation by one scan at the time of completion of the instruction. If the instruction is completed abnormally, ((D) + 1) will also be turned ON.	System	Bit

Note) The file register of each of the local device and the program cannot be used as a device for setting data.

(Note-1): The data on the setting side is as follows.

- User : Data before the execution of dedicated instructions is stored by user.
- System: Data after the execution of dedicated instruction is stored by PLC CPU.

## [Control data]

Device	Item	Setting data	Setting range	Setting side (Note-1)
(S)+0	System area	–	–	–
(S)+1	Complete status	The state at the time of completion is stored. <ul style="list-style-type: none"> <li>• 0 : Normal completion</li> <li>• Other than 0: Abnormal completion (error code) (Note-2)</li> </ul>	–	System
(S)+2	Start No.	The following data Nos. to be started by the ZP.PSTRT□ instruction are designated. <ul style="list-style-type: none"> <li>• Positioning data No. : 1 to 600</li> <li>• Block start : 7000 to 7004</li> <li>• Machine OPR : 9001</li> <li>• Fast OPR : 9002</li> <li>• Current value changing : 9003</li> <li>• Multiple axes simultaneous start : 9004</li> </ul>	1 to 600 7000 to 7004 9001 to 9004	User

(Note-1): The data on the setting side is as follows.

- User : Data before the execution of dedicated instructions is stored by user.
- System: Data after the execution of dedicated instruction is stored by PLC CPU.

(Note-2): Refer to Section 16.5 for error codes at abnormal completion.

## [Functions]

- (1) The positioning start of the axes to be processed (See below) is carried out.
  - ZP.PSTRT1: Axis 1
  - ZP.PSTRT2: Axis 2
  - ZP.PSTRT3: Axis 3
  - ZP.PSTRT4: Axis 4
  
- (2) The block start, OPR start, current value changing, and multiple axes simultaneous start can be carried out by the setting of "start number" 7000 to 7004/9001 to 9004 in ((S)+2).
  
- (3) The ZP.PSTRT□ instruction completion can be confirmed using the complete devices ((D)+0) and ((D)+1).
  - (a) Complete device ((D)+0)  
This device is turned ON by the END processing of the scan for which ZP.PSTRT□ instruction is completed, and turned OFF by the next END processing.
  - (b) Complete state display device ((D)+1)  
This device is turned ON and OFF according to the state in which ZP.PSTRT□ instruction is completed.
    - When completed normally :Kept unchanged at OFF.
    - When completed abnormally: This device is turned ON by the END processing of the scan for which ZP.PSTRT□ instruction is completed, and turned OFF by the next END processing. (same ON/OFF operation as complete device).

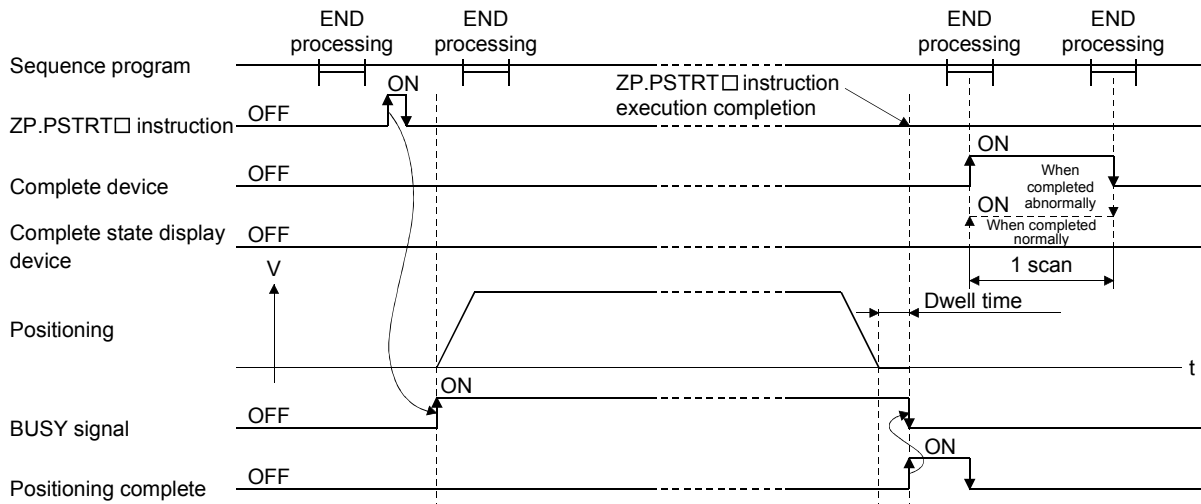

### [Errors]

- (1) When an ZP.PSTRT□ instruction is completed abnormally, the error complete signal ((D)+1) is turned ON, and the error code is stored in the complete status ((S)+1).  
Check and take a measure against the error referring to Section 16.5 "List of errors".

### [Precautions]

- (1) If the positioning is started by the ZP.PSTRT□ instruction, the start complete signals turn ON. However, since the ON time is short, the ON status may not be detected in the program.  
Confirm the operation during the positioning control using the ZP.PSTRT□ start instruction and BUSY signals.
- (2) If the stop instruction is input before completion of the positioning which has been started by the ZP.PSTRT□ instruction, the completion device (D) turns the 1-scan ON to complete execution of the ZP.PSTRT□ instruction.
- (3) The following dedicated instructions cannot be executed simultaneously for the same axis.  
(Can be executed simultaneously for different axes.)
  - Positioning start instructions (ZP.PSTRT1 to ZP.PSTRT4)
  - Teaching instructions (ZP.TEACH1 to ZP.TEACH4)
- (4) The ZP.PSTRT□ instruction can only be executed when the LD77 READY signal [X0] is turned ON.  
Even if the ZP.PSTRT□ instruction execution request is given when the LD77 READY signal [X0] is turned OFF, the ZP.PSTRT□ instruction will not be executed. (not processed.)  
Before executing the ZP.PSTRT□ instruction, turn ON the PLC READY signal [Y0], and turn ON the LD77 READY signal [X0].

- (5) If the ZP.PSTRT□ instruction is executed in the following cases, an error "Dedicated instruction error" (error code: 804) will occur and positioning cannot be started.
  - Any value other than 1 to 600, 7000 to 7004, and 9001 to 9004 is set to "Starting number" (device: (S)+2) of the control data.
- (6) When the multiple axes simultaneous start is executed by ZP.PSTRT□ instruction, the completion device (D) will turn ON when the positioning of the axes executed by ZP.PSTRT□ instructions (when the instructions is ZP.PSTRT1, the axis will be 1.) is completed.

[Program examples]

- The following program executes the positioning start of positioning data No. 1 when X100 turns ON in LD77MH4. Use D30 to D32 as the control data devices of positioning data No. 1, and M32 and M33 as the completion devices.

(1) Positioning start program

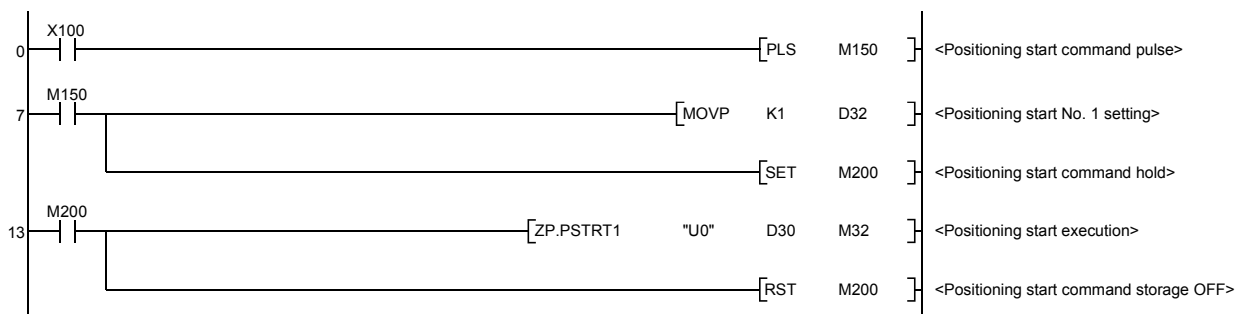

(2) Positioning start program (when dedicated instruction is not used)

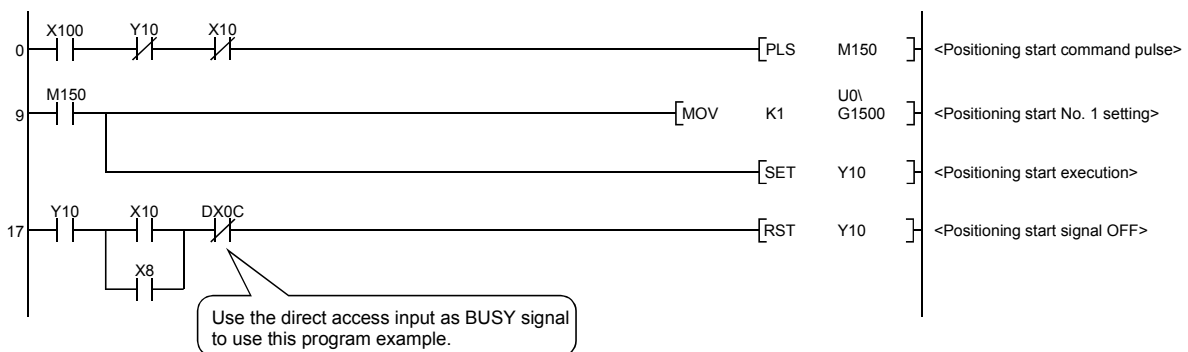

### 15.4 ZP.TEACH1, ZP.TEACH2, ZP.TEACH3, ZP.TEACH4

These dedicated instructions are used to teach the designated axis.

Setting data	Usable device								
	Internal device		File register	Link direct device J□\□		Intelligent function module U□\G□	Index register Zn	Constant K, H	Others
	Bit	Word		Bit	Word				
(S)	–	○	–	–	–	–	–	–	
(D)	○	○	–	–	–	–	–	–	

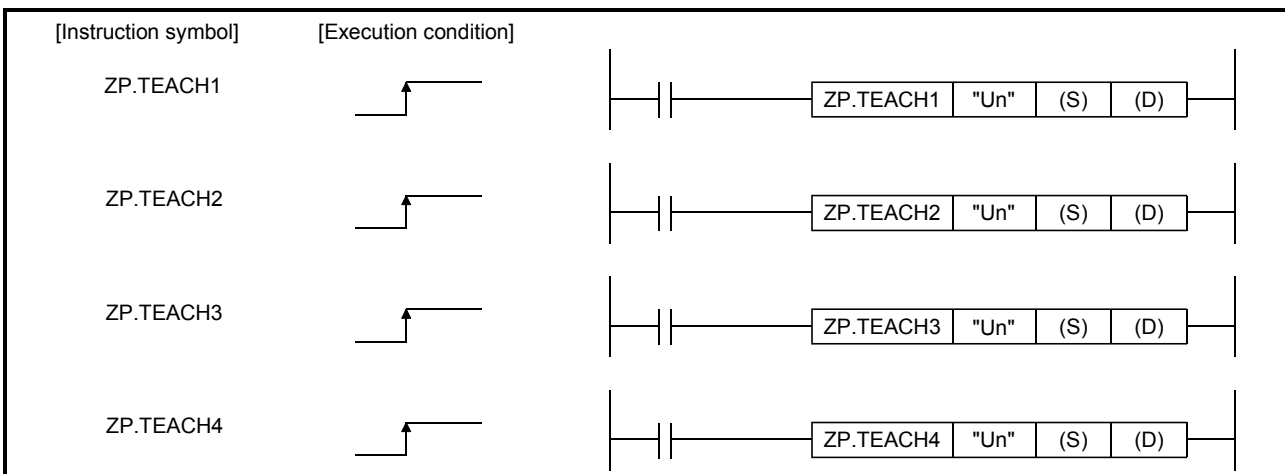

Note) When ZP.TEACH1, ZP.TEACH2, ZP.TEACH3, and ZP.TEACH4 are common to each other, they are designated as "ZP.TEACH□".

#### [Setting data]

Setting data	Setting details	Setting side (Note-1)	Data type
"Un"	LD77MH head I/O number (00 to FE: High-order two digits of I/O number expressed in three digits)	User	BIN 16 bits
(S)	Head number of a device in which control data is stored	–	Device name
(D)	Head number of a bit device which turns ON the operation by one scan at the time of completion of the instruction. If the instruction is completed abnormally, ((D) + 1) will also be turned ON.	System	Bit

Note) The file register of each of the local device and the program cannot be used as a device for setting data.

(Note-1): The data on the setting side is as follows.

- User : Data before the execution of dedicated instructions is stored by user.
- System: Data after the execution of dedicated instruction is stored by PLC CPU.



## [Control data]

Device	Item	Setting data	Setting range	Setting side (Note-1)
(S)+0	System area	–	–	–
(S)+1	Complete status	The state at the time of completion is stored. 0 : Normal completion Other than 0 : Abnormal completion (error code) (Note-2)	–	System
(S)+2	Teaching data selection	The address (positioning address/arc address) to which the current feed value is written is set. 0: Current feed value is written to positioning address. 1: Current feed value is written to arc address.	0, 1	User
(S)+3	Positioning data No.	The positioning data No. for which teaching is carried out is set.	1 to 600	User

(Note-1): The data on the setting side is as follows.

- User : Data before the execution of dedicated instructions is stored by user.
- System: Data after the execution of dedicated instruction is stored by PLC CPU.

(Note-2): Refer to Section 16.5 for error codes at abnormal completion.

## [Functions]

- (1) The "current feed value" of the axes to be set (See below) is set in the positioning address or arc address.  
The positioning data other than the positioning addresses and arc addresses are set by GX Works2 or using a sequence program.
  - ZP.TEACH1: Axis 1
  - ZP.TEACH2: Axis 2
  - ZP.TEACH3: Axis 3
  - ZP.TEACH4: Axis 4
- (2) Teaching can be carried out for the positioning data No. 1 to 600.
- (3) The movement of the machine to the address (position) set in the positioning address/arc address of the positioning data is carried out by the JOG operation, inching operation, or manual pulse generator operation.
- (4) The ZP.TEACH□ instruction completion can be confirmed using the complete devices ((D)+0) and ((D)+1).
  - (a) Complete device ((D)+0)  
This device is turned ON by the END processing of the scan for which ZP.TEACH□ instruction is completed, and turned OFF by the next END processing.
  - (b) Complete state display device ((D)+1)  
This device is turned ON and OFF according to the state in which ZP.TEACH□ instruction is completed.
    - When completed normally :Kept unchanged at OFF.
    - When completed abnormally: This device is turned ON by the END processing of the scan for which ZP.TEACH□ instruction is completed, and turned OFF by the next END processing. (same ON/OFF operation as complete device).

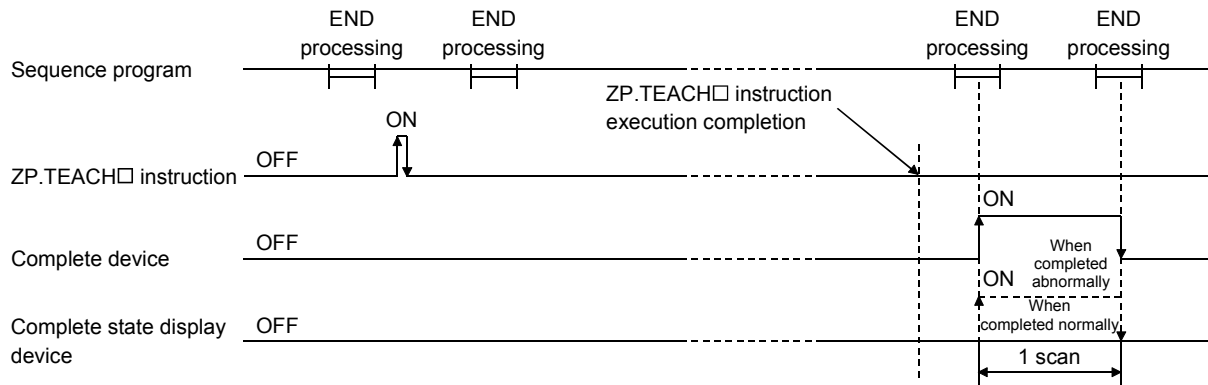

[Errors]

- (1) When a ZP.TEACH□ instruction is completed abnormally, the error complete signal ((D)+1) is turned ON, and the error code is stored in the complete status (S)+1.  
Check and take a measure against the error referring to Section 16.5 "List of errors".

[Precautions]

- (1) The following dedicated instructions cannot be executed simultaneously for the same axis.  
(Can be executed simultaneously for different axes.)
  - Positioning start instructions (ZP.PSTR1 to ZP.PSTR4)
  - Teaching instructions (ZP.TEACH1 to ZP.TEACH4)
- (2) The ZP.TEACH□ instruction can only be executed when the BUSY signal is turned OFF.  
When the BUSY signal is turned ON, the ZP.TEACH□ instruction will not be executed. (not processed.)  
Before executing the ZP.TEACH□ instruction, make sure that the BUSY signal for the axis to be processed is turned OFF.
- (3) If the ZP.TEACH□ instruction is executed in any of the following cases, an error "Dedicated instruction error" (error code: 804) will occur and teaching cannot be performed.
  - Any value other than 0 and 1 is set to "Teaching selection" (device: (S)+2) of the control data.
  - Any value other than 1 to 600 is set to "Positioning No." (device: (S)+3) of the control data.

[Program example]

Program to execute the teaching of the positioning data No. 3 of the axis 1 when X39 is turned ON in LD77MH4.

(1) Teaching program

Positioned manually to target position.

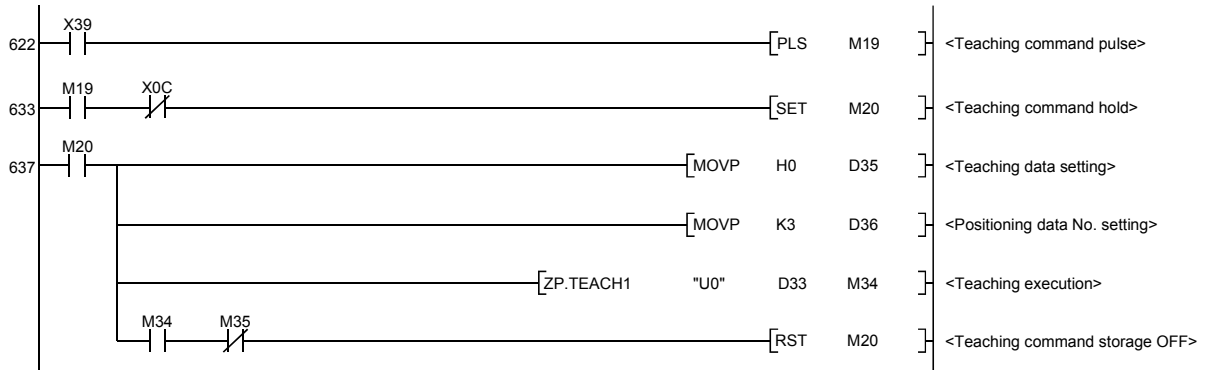

(2) Teaching program (when dedicated instruction is not used)

Positioned manually to target position.

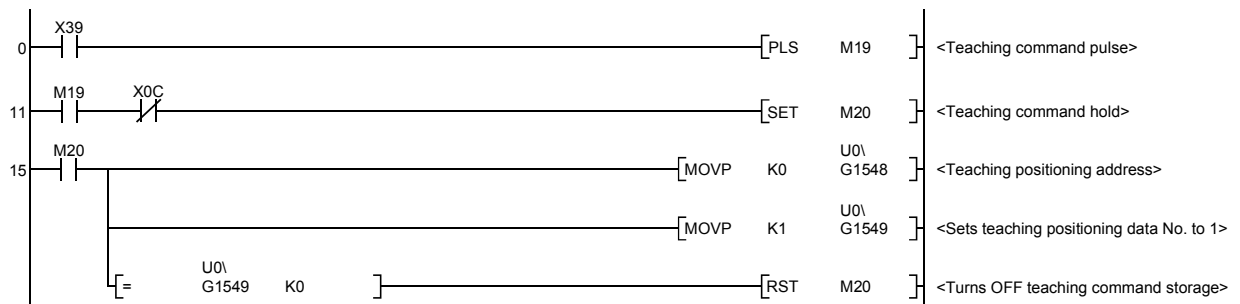

### 15.5 ZP.PFWRT

These dedicated instructions are used to write the LD77MH parameters, positioning data and block start data to the flash ROM.

Setting data	Usable device								
	Internal device		File register	Link direct device J□□		Intelligent function module U□\G□	Index register Zn	Constant K, H	Others
	Bit	Word		Bit	Word				
(S)	–	○	–	–	–	–	–	–	
(D)	○	○	–	–	–	–	–	–	

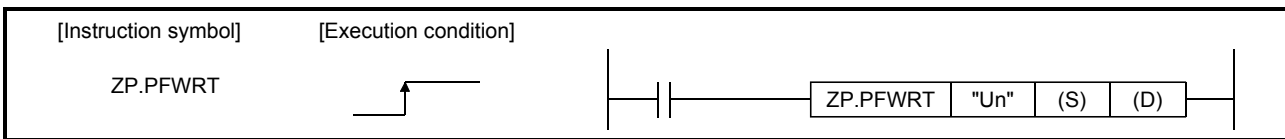

#### [Setting data]

Setting data	Setting details	Setting side (Note-1)	Data type
"Un"	LD77MH head I/O number (00 to FE: High-order two digits of I/O number expressed in three digits)	User	BIN 16 bits
(S)	Head number of a device in which control data is stored	–	Device name
(D)	Head number of a bit device which turns ON the operation by one scan at the time of completion of the instruction. If the instruction is completed abnormally, ((D) + 1) will also be turned ON.	System	Bit

(Note) The file register of each of the local device and the program cannot be used as a device for setting data.

(Note-1): The data on the setting side is as follows.

- User : Data before the execution of dedicated instructions is stored by user.
- System: Data after the execution of dedicated instruction is stored by PLC CPU.

#### [Control data]

Device	Item	Setting data	Setting Range	Setting side (Note-1)
(S)+0	System area	–	–	–
(S)+1	Complete status	The state at the time of completion is stored. 0 : Normal completion Other than 0 : Abnormal completion (error code) (Note-2)	–	System

(Note-1): The data on the setting side is as follows.

- User : Data before the execution of dedicated instructions is stored by user.
- System: Data after the execution of dedicated instruction is stored by PLC CPU.

(Note-2): Refer to Section 16.5 for error codes at abnormal completion.

[Functions]

(1) The ZP.PFWRT instruction completion can be confirmed using the complete devices ((D)+0) and ((D)+1).

(a) Complete device ((D)+0)

This device is turned ON by the END processing of the scan for which ZP.PFWRT instruction is completed, and turned OFF by the next END processing.

(b) Complete state display device ((D)+1)

This device is turned ON and OFF according to the state in which ZP.PFWRT instruction is completed.

- When completed normally : Kept unchanged at OFF.
- When completed abnormally : This device is turned ON by the END processing of the scan for which ZP.PFWRT instruction is completed, and turned OFF by the next END processing. (same ON/OFF operation as complete device).

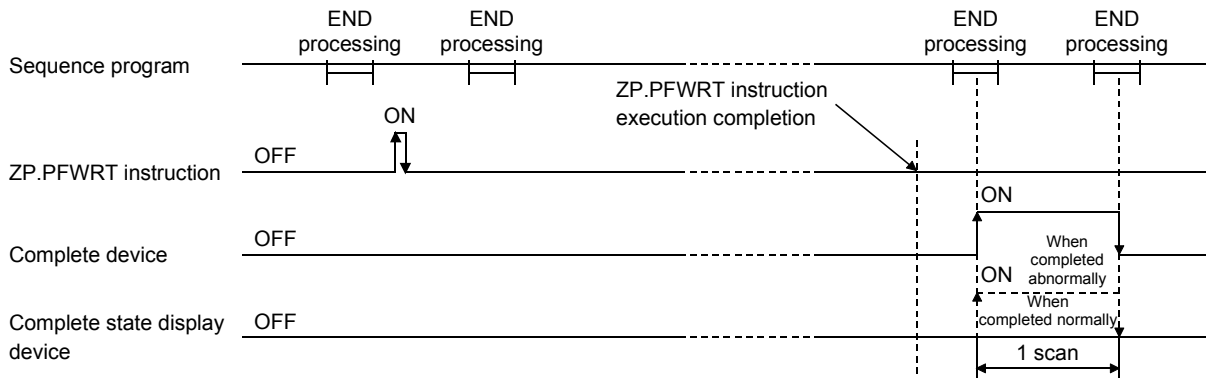

[Errors]

(1) When a dedicated instruction is completed abnormally, the error complete signal ((D)+1) is turned ON, and the error code is stored in the complete status ((S)+1). Check and take measures against the error referring to Section 16.5 "List of errors".

## [Precautions]

- (1) Do not turn ON the power and reset the PLC CPU while parameters, positioning data and block start data are written to the flash ROM using the ZP.PFWRT instruction.  
 A parameter error will occur or normal positioning start will become impossible because the parameters, positioning data and block start data are not written normally to the flash ROM.  
 If this occurs, restart the operation by the method shown below.
  - For GX Works2, write the parameters, positioning data and block start data again to the flash ROM.
  - For a sequence program, write the parameters, positioning data and block start data to the LD77MH after initializing the parameters (ZP.PINIT instruction execution and others).  
 Then execute the ZP.PFWRT instruction again.
  
- (2) A writing to the flash ROM is up to 100,000 times.  
 If writing to the flash ROM exceeds 100,000 times, the writing to the flash ROM will become impossible.
  
- (3) After the power ON and PLC CPU reset operation, writing to the flash ROM using a sequence program is limited to up to 25 times. (Not limited to up to 25 times when writing to the flash ROM is carried out by GX Works2.)  
 If the 26th or more writing is requested after the power ON/PLC CPU reset operation, a flash ROM exceed writing error (error code: 805) will occur, and the writing will be disabled. If a flash ROM write error occurs by one writing to the flash ROM, check and correct the flash ROM writing program. Then reset the error or turn ON the power and reset the PLC CPU again.
  
- (4) The ZP.PFWRT instruction can only be executed when the LD77 READY signal [X0] is turned OFF.  
 When the LD77 READY signal [X0] is turned ON, the ZP.PFWRT instruction cannot be executed.  
 Before executing the ZP.PFWRT instruction, turn OFF the PLC READY signal [Y0] and then turn OFF the LD77 READY signal [X0].
  
- (5) When the PLC READY signal [Y0] is turned ON, an error (error code: 1205) occurs, "Pr.114 Rotation direction selection" is changed by sequence program or the GX Works2 after the servo parameter is transmitted to servo amplifier (LED of the servo amplifier is indicated b□, C□, or d□).  
 When "Pr.114 Rotation direction selection" is changed, transmit the servo parameter to servo amplifier.

[Program example]

Program used to write the parameters and positioning data stored in the buffer memory to the flash ROM when X3D is turned ON in LD77MH4.

(1) Flash ROM write program

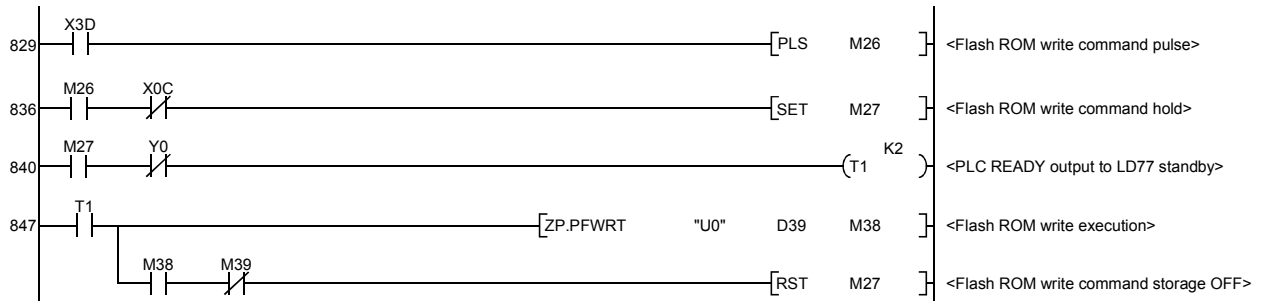

(2) Flash ROM write program (when dedicated instruction is not used)

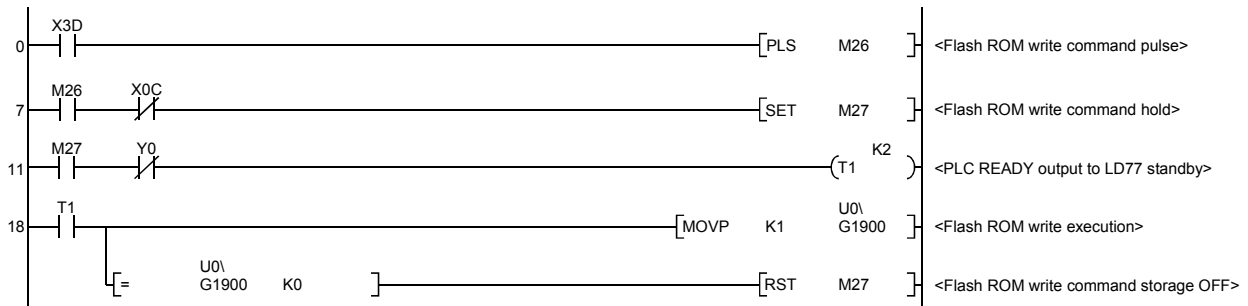

### 15.6 ZP.PINIT

This dedicated instruction is used to initialize the setting data of the LD77MH.

Setting data	Usable device								
	Internal device		File register	Link direct device J□□□		Intelligent function module U□\G□	Index register Zn	Constant K, H	Others
	Bit	Word		Bit	Word				
(S)	–	○	–	–	–	–	–	–	
(D)	○	○	–	–	–	–	–	–	

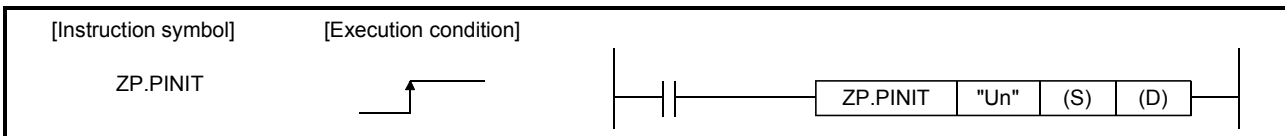

#### [Setting data]

Setting data	Setting details	Setting side (Note-1)	Data type
"Un"	LD77MH head I/O number (00 to FE: High-order two digits of I/O number expressed in three digits)	User	BIN 16 bits
(S)	Head number of a device in which control data is stored	–	Device name
(D)	Head number of a bit device which turns ON the operation by one scan at the time of completion of the instruction. If the instruction is completed abnormally, ((D) + 1) will also be turned ON.	System	Bit

Note) The file register of each of the local device and the program cannot be used as a device for setting data.

(Note-1): The data on the setting side is as follows.

- User : Data before the execution of dedicated instructions is stored by user.
- System: Data after the execution of dedicated instruction is stored by PLC CPU.

#### [Control data]

Device	Item	Setting data	Setting range	Setting side (Note-1)
(S)+0	System area	–	–	–
(S)+1	Complete status	The state at the time of completion is stored. 0 : Normal completion Other than 0: Abnormal completion (error code) (Note-2)	–	System

(Note-1): The data on the setting side is as follows.

- User : Data before the execution of dedicated instructions is stored by user.
- System: Data after the execution of dedicated instruction is stored by PLC CPU.

(Note-2): Refer to Section 16.5 for error codes at abnormal completion.



## [Functions]

- (1) This dedicated instruction is used to return the setting data set in the LD77MH buffer memory and flash ROM to their factory-set data (initial values). Refer to Section 14.2 for initialized setting data.
- (2) The ZP.PINIT instruction completion can be confirmed using the complete devices ((D)+0) and ((D)+1).
  - (a) Complete device ((D)+0)  
This device is turned ON by the END processing of the scan for which ZP.PINIT instruction is completed, and turned OFF by the next END processing.
  - (b) Complete state display device ((D)+1)  
This device is turned ON and OFF according to the state in which ZP.PINIT instruction is completed.
    - When completed normally : Kept unchanged at OFF.
    - When completed abnormally : This device is turned ON by the END processing of the scan for which ZP.PINIT instruction is completed, and turned OFF by the next END processing. (same ON/OFF operation as complete device).

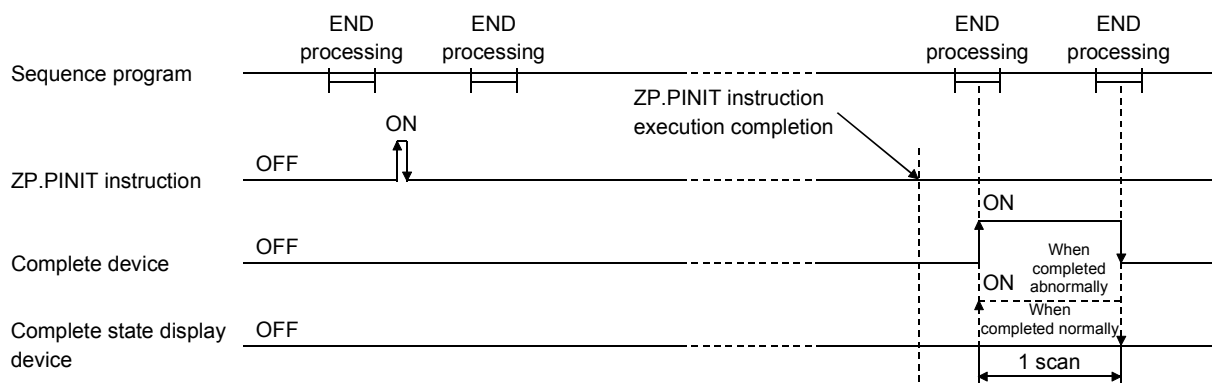

## [Errors]

- (1) When a dedicated instruction is completed abnormally, the error complete signal ((D)+1) is turned ON, and the error code is stored in the complete status ((S)+1). Check and take measures against the error referring to Section 16.5 "List of errors".

## [Precautions]

- (1) The ZP.PINIT instruction can only be executed when the LD77 READY signal [X0] is turned OFF.  
When the LD77 READY signal [X0] is turned ON, the ZP.PINIT instruction cannot be executed.  
Before executing the ZP.PINIT instruction, turn OFF the PLC READY signal [Y0] and then turn OFF the LD77 READY signal [X0].
- (2) A writing to the flash ROM is up to 100,000 times.  
If writing to the flash ROM exceeds 100,000 times, the writing to the flash ROM will become impossible.

(3) After the power ON and PLC CPU reset operation, writing to the flash ROM using a sequence program is limited to up to 25 times. (Not limited to up to 25 times when writing to the flash ROM is carried out by GX Works2.)

If the 26th or more writing is requested after the power ON/PLC CPU reset operation, a flash ROM exceed writing error (error code: 805) will occur, and the writing will be disabled. If a flash ROM write error occurs by one writing to the flash ROM, check and correct the flash ROM writing program. Then reset the error or turn ON the power and reset the PLC CPU again.

[Program example]

The following program initializes the parameters in buffer memory and flash ROM when X3C turns ON in LD77MH4.

(1) Parameter initialization program

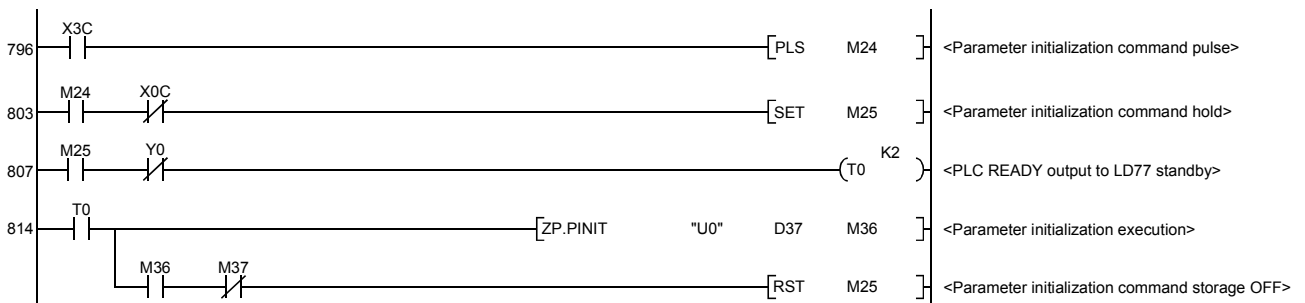

(2) Parameter initialization program (when dedicated instruction is not used)

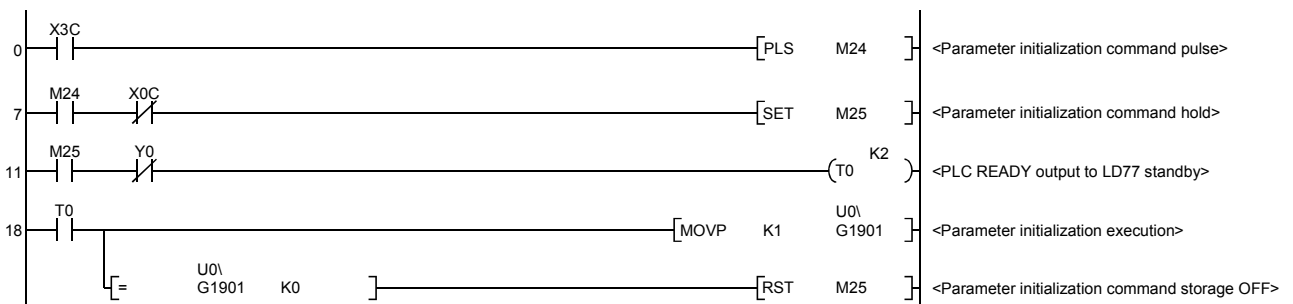



# Chapter 16 Troubleshooting

The "errors" and "warnings" detected by the LD77MH are explained in this chapter.

Errors can be confirmed with the LD77MH LED display and GX Works2.  
When an error or warning is detected, confirm the detection details and carry out the required measures.

16.1	Checking errors using GX Works2.....	16-	2
16.2	Checking errors using a display unit.....	16-	5
16.3	Troubleshooting.....	16-	6
16.4	Error and warning details.....	16-	9
16.5	List of errors.....	16-	14
	16.5.1 LD77MH detection error.....	16-	14
	16.5.2 Servo amplifier detection error.....	16-	44
16.6	List of warnings.....	16-	52
	16.6.1 LD77MH detection warning.....	16-	52
	16.6.2 Servo amplifier detection warning.....	16-	62

## 16.1 Checking errors using GX Works2

Error codes corresponding to the errors occurred in the LD77MH can be checked either on the following screen of GX Works2.

Select the screen according to the purpose and usage.

- "Module's Detailed Information" screen
- "Error History" screen **LD77MH16**

## (1) Checking errors on the "Module's Detailed Information" screen

Select [Diagnostics]→[System Monitor] on GX Works2.

Select " LD77MH " for "Main block" and click the [Detailed information] button.

The "Module's Detailed Information" screen for the LD77MH appears and error code, error details, and corrective actions can be checked.

The latest error code is displayed.

The error history is displayed.

Contents of the error code selected in the error history and solution for it is displayed.

**Module's Detailed Information**

Monitor Status: Monitoring

Module:

Model Name	LD77MH16
I/O Address	0010
Mount Position	Main block 0th slot
Product Information	I2102000000000-A
Production Number	---

Module Information:

Module Access	Possible
Status of External Power Supply	---
Fuse Blown Status	---
Status of I/O Address Verify	Agree
I/O Clear / Hold Setting	---
Noise Filter Setting	---
Input Type	---
Remote Password Setting Status	---

Error Information:

Latest Error Code: 108

Update Error History

Error Clear

Display Format:  HEX  DEC

Clear Error History

No.	Error Code
8	101
9	101
10	101
11	108

The error history is sequentially displayed from an old error. The latest error is displayed at the bottom line.

Error and Solution:

Contents: Start not possible  
\* Start is requested when start is not possible in the axis operation state.

Solution: Do not request the start when the axis operation state is other than 'standby', 'stop', and 'step standby'.

Stop Monitor Close

(2) Checking errors on the "Error History" screen. **LD77MH16**

On the "Error History" screen, the error logs of the LD77MH are displayed in a list together with the error logs of other modules. The logs can be output to a CSV format file. The error codes and the time of error occurrence can be checked even after the PLC CPU is powered off and then on or reset.

Select [Diagnostics] → [System Monitor] → [System Error History] button on GX Works2.

The screenshot shows the "Error History" window with the following data in the Error History List:

No.	Error Code	Date and Time	Model Name	Start I/O
00049	020C	2010/10/29 11:23:21	LD77MH16	0010
00050	0223	2010/10/29 11:37:51	LD77MH16	0010
00052	0223	2010/10/29 13:01:54	LD77MH16	0010
00053	0067	2010/10/29 13:57:33	LD77MH16	0010
00056	00CF	2010/10/29 15:24:56	LD77MH16	0010
00071	0067	2010/11/11 12:59:28	LD77MH16	0010
00074	0067	2010/11/11 15:16:42	LD77MH16	0010
00076	0069	2010/11/11 16:11:57	LD77MH16	0010
00077	006C	2010/11/11 16:12:06	LD77MH16	0010
00080	0069	2010/11/11 19:07:20	LD77MH16	0010
00087	0065	2010/11/18 16:20:43	LD77MH16	0010
00088	0065	2010/11/18 16:20:43	LD77MH16	0010
00089	0065	2010/11/18 16:20:43	LD77MH16	0010
00090	0065	2010/11/18 16:20:43	LD77MH16	0010
00091	0065	2010/11/18 16:20:43	LD77MH16	0010
00092	0065	2010/11/18 16:20:43	LD77MH16	0010
00114	0065	2010/12/21 19:22:05	LD77MH16	0010
00115	0065	2010/12/21 19:22:05	LD77MH16	0010
00116	0065	2010/12/21 19:22:05	LD77MH16	0010

The Error Details panel on the right shows the following information:

- Model Name: LD77MH16
- Start I/O: 0010
- Mount Position: Main block 0th slot
- Explanation: Control system setting error. \* The control system setting value is outside the setting range. \* The number of control axes differs from the
- Solution: \* Correct the control system, axis to be interpolated or parameter.

## (a) Error History List

Module error logs are displayed in a list.

(b) Error and Solution, Intelligent Module Information

• Error and Solution

Details of the selected in the "Error History List" and its corrective action are displayed.

• Intelligent Module Information

The LD77MH status when the error selected in the "Error History List" occurred is displayed.

Item	Description
Start axis	The axis No. requested to start is stored.
Positioning start No.	The start No. at positioning start is stored. <sup>(Note-1)</sup>
Axis in which the error occurred	The axis No. in which the error occurred is stored.
Axis error occurrence (Data No.)	The positioning data No. currently being executed in which the error occurred is stored. <sup>(Note-1), (Note-2)</sup>
Current feed value	The current feed value (at the time of error) of the error axis is stored.
State of the input signal [X0 to XF]	The status of input signals [X0 to XF] (at the time of error) is stored (in binary).
State of the input signal [X10 to X1F]	The status of input signals [X10 to X1F] (at the time of error) is stored (in binary).
State of the output signal [Y0 to YF]	The status of output signals [Y0 to YF] (at the time of error) is stored (in binary).
State of the output signal [Y10 to Y1F]	The status of output signals [Y10 to Y1F] (at the time of error) is stored (in binary).
<ul style="list-style-type: none"> <li>• Axis in which the error occurred (Upper limit signal)</li> <li>• Axis in which the error occurred (Lower limit signal)</li> <li>• Axis in which the error occurred (External command signal/switching signal)</li> <li>• Axis in which the error occurred (Near-point signal)</li> </ul>	The status of axis in which the error occurred external input signals (at the time of error) is stored.

(Note-1): "0" is stored at the servo error occurrence.

(Note-2): The current cam data No. is displayed for output axis of synchronous control.

(c) [Create CSV File] button

The module error logs are output to a CSV format file.

**POINT**

(1) If errors frequently occur in the LD77MH, "\*\*HST.LOSS\*\*" (instead of an actual error code) may be displayed in the Error Code column.  
(Display example)

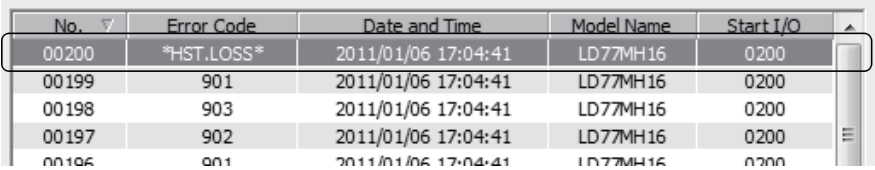

No.	Error Code	Date and Time	Model Name	Start I/O
00200	*HST.LOSS*	2011/01/06 17:04:41	LD77MH16	0200
00199	901	2011/01/06 17:04:41	LD77MH16	0200
00198	903	2011/01/06 17:04:41	LD77MH16	0200
00197	902	2011/01/06 17:04:41	LD77MH16	0200
00196	901	2011/01/06 17:04:41	LD77MH16	0200

If "\*\*HST.LOSS\*\*" is frequently displayed, set a larger value for the number of errors collected per scan in the PLC RAS tab of the PLC Parameter dialog box.  
For the setting, refer to the "MELSEC-L CPU Module User's Manual (Function Explanation, Program Fundamentals)".

(2) If the error occurred at the simultaneous start, the axis No. in which the error is detected is stored in the "Starting axis" in Error History.

## 16.2 Checking errors using a display unit

The buffer memory monitor/test function of a display unit allows users to check the errors in the LD77MH without using the software package.

For the operation methods of a display unit and display contents, refer to the "MELSEC-L CPU Module User's Manual (Function Explanation, Program Fundamentals)".



## 16.3 Troubleshooting

## (1) Troubleshooting using the LEDs

Check items and corrective actions for troubleshooting using the indicator LEDs of the LD77MH are described below.

(a) When the RUN LED turns off.

Check item	Action
Is the power supplied?	Check that the voltage supplied to the power supply module is within the rated range.
Is the power supply capacity sufficient?	Calculate the total current consumption of the connected modules (PLC CPU module, I/O modules, and intelligent function modules) and check that the power supply capacity is not insufficient.
Is the module connected correctly?	<ul style="list-style-type: none"> <li>• Check that the connector on the side of the module is properly inserted.</li> <li>• Check that the module joint levers are locked.</li> </ul>

If there is no problem on the above check items, a watchdog timer error may have occurred. Reset the PLC CPU and check that the RUN LED turns on.

If not, the possible cause is a hardware failure. Please consult your local Mitsubishi representative, explaining a detailed description of the problem.

(b) When the ERR.LED turns on

Check item	Action
Is there a system error?	An error may have occurred in the PLC CPU. Check the error code and take a corrective action.

(c) When the ERR. LED and axis LED flash

Check item	Action
Is there an axis error?	Check the error code and take the action described in Section 16.5.

(d) When all LEDs turn on

Reset the PLC CPU and check that the module is in the normal status. If all LEDs still turn on, the possible cause is a hardware failure. Please consult your local Mitsubishi representative, explaining a detailed description of the problem.

## (2) Troubleshooting when a motor does not rotate

Check items and corrective actions for troubleshooting when a motor does not rotate are described below.

POINT		
The following signals must be ON for the LD77MH to operate (excluding when the "positioning test function" of GX Works2 is used).		
<ul style="list-style-type: none"> <li>• LD77 READY signal [X0]</li> <li>• Servo READY signal</li> <li>• Upper limit signal and Lower limit signal</li> </ul>		
The ON status of signals can be checked by the following monitor data.		
<ul style="list-style-type: none"> <li>• Servo READY signal: "[Md.108] Servo status (high-order buffer memory address)" (b0, b1).</li> <li>• Upper limit signal and Lower limit signal: "[Md.30] External input signal" (b0, b1).</li> </ul>		
	Buffer memory address (high-order)	
	LD77MH4	LD77MH16
[Md.108] Servo status: b0, b1	877+100n	2477+100n

Check item	Action
Are all the LD77 READY signal [X0], servo READY signal, and upper/lower limit signals ON?	Review and correct the sequence program and wiring so that all the LD77 READY signal [X0], servo READY signal, and upper/lower limit signals turn ON.
Is there an error in the LD77MH? (ERR. LED is on or flashing)	Check the error code and take a corrective action.
Is the servo amplifier powered ON?	Power on the servo amplifier.
Is there an error in the servo amplifier?	Check the error code of the servo amplifier and take a corrective action.
Is the wiring between the LD77MH and servo amplifier correct?	Check the wiring between the LD77MH and servo amplifier, and correct it.
Is the wiring between the servo amplifier and motor correct?	Check the wiring between the servo amplifier and motor, and correct it.
Is the value in "[Md.20] Current feed value" changed after positioning control is performed?	Review the start program.
Is the cumulative command pulse of servo amplifier changed after positioning control is performed?	Refer to the "Servo amplifier Instruction Manual" and check that the function to suppress the motor rotation is not working.
Isn't the value in "[Md.26] Axis operation status" "1: stopped"?	Review the stop program.

If a motor does not rotate even after the above items are checked, the possible cause is a hardware failure.

Please consult your local Mitsubishi representative, explaining a detailed description of the problem.

(3) Troubleshooting when a motor does not rotate as intended.

Check items and corrective actions for troubleshooting when a motor does not rotate as intended are described below.

(a) When a motor rotates only in the opposite direction

Check item	Action
Is the value in "[Pr.114] Rotation direction selection" correct?	Check that the value in "[Pr.114] Rotation direction selection" match the settings of servo amplifier.

(b) When a motor does not rotate at the set speed

Check item	Action									
Does the value in "[Md.28] Axis feedrate" (Note) indicate the set speed?	<p>[When "[Md.28] Axis feedrate" indicates the set speed]</p> <ul style="list-style-type: none"> <li>• Check that the values in "[Pr.2] Number of pulses per rotation (AP)", "[Pr.3] Movement amount per rotation (AL)", and "[Pr.4] Unit magnification (AM)" meet the system.</li> <li>• When the servo amplifier has the electronic gear function, check that the settings meet the system.</li> </ul> <p>[When "[Md.28] Axis feedrate" does not indicate the set speed]</p> <ul style="list-style-type: none"> <li>• Check that the speed is not limited by the value in "[Pr.8] Speed limit value".</li> <li>• In the JOG operation, check that the speed is not limited by the value in "[Pr.31] JOG speed limit value".</li> <li>• In the JOG operation, check that Forward run JOG start signal and Reverse run JOG start signal do not repeatedly turn ON and OFF.</li> </ul> <table border="1"> <thead> <tr> <th>Signal</th> <th>LD77MH4</th> <th>LD77MH16</th> </tr> </thead> <tbody> <tr> <td>Forward run JOG start signal</td> <td>Y8, YA, YC, YE</td> <td>[Cd.181] Forward run JOG start</td> </tr> <tr> <td>Reverse run JOG start signal</td> <td>Y9, YB, YD, YF</td> <td>[Cd.182] Reverse run JOG start</td> </tr> </tbody> </table>	Signal	LD77MH4	LD77MH16	Forward run JOG start signal	Y8, YA, YC, YE	[Cd.181] Forward run JOG start	Reverse run JOG start signal	Y9, YB, YD, YF	[Cd.182] Reverse run JOG start
Signal	LD77MH4	LD77MH16								
Forward run JOG start signal	Y8, YA, YC, YE	[Cd.181] Forward run JOG start								
Reverse run JOG start signal	Y9, YB, YD, YF	[Cd.182] Reverse run JOG start								

(Note): Speed control mode: "[Md.122] Speed during command"

(c) When the set position is not reached

Check item	Action						
Does the value in "[Md.20] Current feed value" indicate the intended position when the motor stops?	<p>[When the position set in "[Md.20] Current feed value" is reached]</p> <ul style="list-style-type: none"> <li>• Check that the values in "[Pr.2] Number of pulses per rotation (AP)", "[Pr.3] Movement amount per rotation (AL)", and "[Pr.4] Unit magnification (AM)" meet the system.</li> <li>• When the servo amplifier has the electronic gear function, check that the settings meet the system.</li> </ul> <p>[When the position set in "[Md.20] Current feed value" is not reached]</p> <ul style="list-style-type: none"> <li>• Check that the motor is not stopped by Axis stop signals. If a motor is stopped by them, the value "1: stopped" is stored in "[Md.26] Axis operation status".</li> </ul> <table border="1"> <thead> <tr> <th>Signal</th> <th>LD77MH4</th> <th>LD77MH16</th> </tr> </thead> <tbody> <tr> <td>Axis stop signal</td> <td>Y4 to Y7</td> <td>[Cd.180] Axis stop</td> </tr> </tbody> </table>	Signal	LD77MH4	LD77MH16	Axis stop signal	Y4 to Y7	[Cd.180] Axis stop
Signal	LD77MH4	LD77MH16					
Axis stop signal	Y4 to Y7	[Cd.180] Axis stop					

## 16.4 Error and warning details

### [1] Errors

#### ■ Types of errors

Errors detected by the LD77MH include parameter setting range errors, errors at the operation start or during operation and errors detected by servo amplifier.

- (1) Errors detected by the LD77MH include parameter setting range errors  
 The parameters are checked when the power is turned ON and at the rising edge (OFF → ON) of the PLC READY signal [Y0]. An error will occur if there is a mistake in the parameter setting details at that time.  
 When this kind of error occurs, the LD77 READY [X0] signal does not turn ON.  
 To cancel this kind of error, set the correct value in the parameter for which the error occurred, and then turn ON the PLC READY signal [Y0].

POINT
Execute the re-setup of the parameter after you execute the initialization (refer to the Section 14.2) of the parameter when the error (error code: 900 to 999) occurs in many and LD77MH doesn't start.

- (2) Errors at the operation start or during operation (LD77MH detection errors)  
 These are errors that occur at the operation start or during operation when the positioning control, JOG operation, or inching operation is used. If an axis error occurs during interpolation operation, the error No. will be stored in both the reference axis and the interpolation axis.  
 Note that, in the following cases (a) and (b), the axis error No. will be stored only in the reference axis during analysis of the positioning data set in each point of the positioning start data table.
- (a) When the interpolation axis is BUSY.
  - (b) When the error occurred in positioning data or parameters unrelated to interpolation control.

If the error occurred at the simultaneous start of a positioning operation, the axis error storage details will differ depending on whether the error occurred before or after the simultaneous start.

- If the error occurred before the simultaneous start (illegal axis No., other axis BUSY, etc.), an "error before simultaneous start" will occur.
- If the error occurred after the simultaneous start (positioning data error, software stroke limit error, etc.), an error code corresponding to the axis in which the error occurred will be stored. Because a simultaneous start cannot be carried out due to this, a "simultaneous start not possible error" error code will be stored in all axes in which an error has not occurred.

The axis operation status will be displayed as "error occurring" for axes in which an error occurred.

If an error occurs during operation, any moving axes will deceleration stop, and their operation status will be displayed as "error occurring".

All axes will decelerate to a stop during interpolation operations, even if the error occurs in only one axis.

(3) Servo amplifier detection errors

These are errors that occur at the hardware error such as servo amplifier and servomotor or the servo parameter error.

Servo is turned off at the error occurrence, and axis stop. If you remove an error factor, reset the servo amplifier.

(4) Types of error codes

Error code	Classification of errors
001 to 009	Fatal errors
100 to 199	Common errors
200 to 299	OPR or absolute position restoration errors
300 to 399	JOG operation or inching operation errors
500 to 599	Positioning operation errors
600 to 699	Synchronous control input axis errors
700 to 799	Synchronous control output axis errors
800 to 899	I/F (Interface) errors
900 to 999	Parameter setting range errors
1201 to 1209	Encoder errors
2000 to 2099	Servo amplifier errors

■ Error storage

When an error occurs, the error detection signal turns ON, and the error code corresponding to the error details is stored in the following buffer memory address ( [Md.23] Axis error No.) for axis error No. storage. Note that there is a delay of up to operation cycle after the error detection signal turns ON until the error code is stored.

Axis No.	LD77MH4		LD77MH16	
	Error detection signal	Buffer memory address	Error detection signal	Buffer memory address
1	X8	806	[Md.31] Status: b13	2406
2	X9	906		2506
3	XA	1006		2606
4	XB	1106		2706
5	/			2806
to				to
16				3906

A new error code is stored in the buffer memory address ( [Md.23] Axis error No.) for axis error storage every time an error occurs.

**POINT**

When any of the following errors is detected, it is stored in the axis error No. of axis 1. (These errors are stored in the axis error No. of axis 1 for the system which not use the axis 1.)

Error code:001, 002, 107, 190, 800, 802, 805, 999

## [2] Warnings

### ■ Types of warnings

Warnings detected by the LD77MH include system warnings, axis warnings and warnings detected by servo amplifier.

#### (1) Warnings include system warnings.

The types of system warnings are shown below.

- System control data setting warnings  
An axis warning for axis 1 will occur.
- Positioning data setting warnings  
An axis warning for each axis will occur.  
Note that a warning will occur for the reference axis when an interpolation designation or axis setting warning occurs.

#### (2) Warnings include axis warnings.

- Axis warnings occur due to setting warnings from operations such as positioning operations, JOG operations or manual pulse generator operations.
- Axis warnings occur due to system warnings.  
The axis operation status does not change even if an axis warning occurs.

#### (3) Servo amplifier detection warnings

These are warning that occur at the hardware error such as servo amplifier and servomotor or the inapplicable servo parameters.

Error or normality operation can't be executed by warning when warning is left as it is though servo off isn't executed.

When the warning cause is removed, warning is automatically released in servo amplifier. However, the state of generating warning is continued in LD77MH.

Reset it if necessary.

#### (4) Types of warning codes

Warning code	Classification of warnings
100 to 199	Common warnings
300 to 399	JOG operation warnings
400 to 499	Manual pulse generator operation warnings
500 to 599	Positioning operation warnings
600 to 699	Synchronous control input axis warnings
700 to 799	Synchronous control output axis warnings
800 to 899	Cam data control warnings
900 to 999	System control data setting range check warnings
2090 to 2999	Servo amplifier warnings (The contents of a vary in the model of servo amplifier.)

### ■ Warning storage

- (1) When an axis warning occurs, the warning code corresponding to the warning details is stored in the following buffer memory ([Md.24] Axis warning No.) for axis warning No. storage.

Axis No.	Buffer memory address	
	LD77MH4	LD77MH16
1	807	2407
2	907	2507
3	1007	2607
4	1107	2707
5	/	2807
to		to
16		3907

- (2) When an axis warning occurs in a positioning operation, etc "axis warning detection ([Md.31] Status: b9)" turns ON of the following buffer memory for axis status storage turns ON.

Axis No.	Buffer memory address	
	LD77MH4	LD77MH16
1	817	2417
2	917	2517
3	1017	2617
4	1117	2717
5	/	2817
to		to
16		3917

### [3] Resetting errors and warnings

Remove the cause of error or warning following the actions described in Section 16.5 and 16.6, before cancel an error or warning state by resetting the error.

### ■ How to clear errors or warnings

An error or warning state is canceled after the following processing has been carried out by setting a "1" in the address of the buffer memory for axis error resetting ([Cd.5] Axis error reset).

- Axis error detection signal turned OFF
- "[Md.23] Axis error No." cleared
- "[Md.24] Axis warning No." cleared
- Changing of "[Md.26] Axis operation status" from "Error" to "Standby".
- "Axis warning detection ([Md.31] Status: b9)" turned OFF

**[4] Confirming the error and warning definitions**

The error and warning definitions can be confirmed with the error codes and warning codes. Confirming them requires GX Works2.

■ **Confirming the error definitions**

- System monitor of GX Works2 (Refer to Section 16.1.)
- Error history screen of GX Works2 (Simple Motion Module Setting Tool)  
(Refer to the Simple Motion Module Setting Tool Help.)

■ **Confirming the warning definitions**

- Warning history screen of GX Works2 (Simple Motion Module Setting Tool)  
(Refer to the Simple Motion Module Setting Tool Help.)



## 16.5 List of errors

The following table shows the error details and remedies to be taken when an error occurs.

## 16.5.1 LD77MH detection error

Classification of errors	Error code	Error name	Error	Operation status at error occurrence	
—	000	(Normal status)	—	—	
Fatal errors	001	Faults	Hardware is faulty.	The system stops.	
	002	Internal circuit fault			
Common errors	101	PLC READY OFF during operation	The PLC READY signal [Y0] is turned OFF during operation.	The system stops with the setting (deceleration stop/sudden stop) of the detailed parameter 2 Sudden stop selection (stop group 2). (Note that the deceleration stop only occurs during the manual pulse generator operation.)	
	102	Servo READY signal OFF during operation	The servo READY signal is turned OFF during operation.	The system stops immediately.	
	103	Test mode faults during operation	The personal computer cannot communicate with the CPU module.	The system stops with the setting (deceleration stop/sudden stop) of the detailed parameter 2 Sudden stop selection (stop group 2). (Note that the deceleration stop only occurs during the manual pulse generator operation.)	
	104	Hardware stroke limit (+)	The hardware stroke limit (upper limit signal FLS) is turned OFF during operation.	The system stops with the setting (deceleration stop/sudden stop) of the detailed parameter 2 Sudden stop selection (stop group 1). (Note that the deceleration stop only occurs during the manual pulse generator operation.)	
			Start is requested when the hardware stroke limit (upper limit signal FLS) is turned OFF.	The system does not start.	
	105	Hardware stroke limit (-)	The hardware stroke limit (lower limit signal RLS) is turned OFF during operation.	The system stops with the setting (deceleration stop/sudden stop) of the detailed parameter 2 Sudden stop selection (stop group 1). (Note that the deceleration stop only occurs during the manual pulse generator operation.)	
Start is requested when the hardware stroke limit (lower limit signal RLS) is turned OFF.			The system does not start.		
106	Stop signal ON at start	Start is requested when a stop signal is turned ON.	The system does not start.		

	Related buffer memory address		Set range (Setting with sequence program)	Remedy
	LD77MH4	LD77MH16		
	—	—	—	—
	—	—	—	Check that there is no influence from noise.
	—	—	—	Review the program which turns ON/OFF PLC READY signal [Y0].
	—	—	—	Check the servo amplifier power, wiring with the servo amplifier, and connection of connectors.
	—	—	—	Check that there is no error on the personal computer side I/F to which a cable is connected.
	—	—	—	After making an axis error reset (refer to [3] in Section 16.4), perform manual control operation (refer to Chapter 11) to move the axis to the other position in order that the upper limit signal (FLS) will not turn OFF.
	—	—	—	<ul style="list-style-type: none"> <li>• Check the wiring of upper limit signal FLS.</li> <li>• Check if the specification of the limit switch and the setting of the "[Pr.22] Input signal logic selection" match.</li> <li>• If hardware stroke limit (limit switch) is unnecessary system for installation, wire to always turn ON the upper limit signal (FLS) input of LD77MH.</li> </ul>
	—	—	—	After making an axis error reset (refer to [3] in Section 16.4), perform manual control operation (refer to Chapter 11) to move the axis to the other position in order that the lower limit signal (RLS) will not turn OFF.
	—	—	—	<ul style="list-style-type: none"> <li>• Check the wiring of lower limit signal RLS.</li> <li>• Check if the specification of the limit switch and the setting of the "[Pr.22] Input signal logic selection" match.</li> <li>• If hardware stroke limit (limit switch) is unnecessary system for installation, wire to always turn ON the lower limit signal (RLS) input of LD77MH.</li> </ul>
	—	—	—	After confirming the stop command status, then review the timing of start.

Classification of errors	Error code	Error name	Error	Operation status at error occurrence	
Common errors	107	READY OFF → ON during BUSY	The PLC READY signal is turned from OFF to ON when BUSY signal is turned ON.	The LD77 READY signal [X0] is not turned ON.	
	108	Start not possible	Start is requested when start is not possible in the axis operation state.	The system does not start positioning.	
	190	Operation cycle time over error	The calculation process time of the positioning etc. exceeds the operation cycle.	The operation continues.	
Home position return (OPR)	201	Start at OP	<ul style="list-style-type: none"> <li>When the OPR retry invalid is set, the near-point dog method machine OPR is started with the OPR complete flag turned ON.</li> <li>Scale origin signal detection method machine OPR is started with the OPR complete flag turned ON and the near-point dog signal turned ON.</li> </ul>	The machine OPR does not start.	
	203	Dog detection timing fault	The near-point dog signal is turned OFF during the deceleration from an OPR speed to a creep speed by the near-point dog method machine OPR.	The system stops with the setting (deceleration stop/sudden stop) of the detailed parameter 2 Sudden stop selection (stop group 3). (Note that the deceleration stop only occurs during the manual pulse generator operation.)	
	206	Count method movement amount fault	In the count method 1 and 2 machine OPR, a parameter "Setting for the movement amount after near-point dog ON" is smaller than a distance necessary for deceleration stop from an OPR speed.	At start : The system does not operate. During operation : The system stops with the setting (deceleration stop/sudden stop) of the detailed parameter 2 Sudden stop selection (stop group 3).	
	207	OPR request ON	The OPR request flag is turned ON when a fast -OPR is started (positioning start No. 9002).	The fast -OPR does not start.	
	209	OPR restart not possible	The restart command is turned ON after the machine OPR is stopped using a stop signal.	The restart is not carried out.	
	210	OPR zero point not passed	The zero point is not passed when the dog method, count method or scale origin signal detection method OPR is re-started, or data set method OPR is executed.	The OPR does not complete.	
	211	ZCT read error	The data is not loaded from the servo amplifier properly upon the OPR.		
	212	ABS reference point read error	The data is not loaded from the servo amplifier properly upon the OPR.		
	230	Encoder ABS data not established	OPR is started on the direct drive motor when the absolute position data of the encoder has not been established.	The OPR does not start.	

	Related buffer memory address		Set range (Setting with sequence program)	Remedy
	LD77MH4	LD77MH16		
	—	—	—	Turn ON the PLC READY signal [Y0] with the BUSY signals of all axes OFF.
	—	—	—	Do not request the start when the axis operation state is other than "standby", "stop", and "step standby".
		105	—	Review the content of the positioning or "[Pr.96] Operation cycle setting" longer than the current setting.
	78+150n		<OPR retry> 0, 1	<ul style="list-style-type: none"> <li>Validate the OPR retry function (set value: 1). (Refer to Section 13.2.1).</li> <li>Move the work piece from the current position (on OP) using the manual control operation (refer to Chapter 11), then carry out a machine OPR again.</li> </ul>
	74+150n 75+150n		<OPR speed> 1 to 50000000 [PLS/s] 1 to 2000000000 [ $\times 10^{-2}$ mm/min or others]	<ul style="list-style-type: none"> <li>Lower the OPR speed.</li> <li>Increase the dog signal input time. (Refer to Section 8.2.3)</li> </ul>
	80+150n 81+150n		<Movement amount setting after near-point dog ON> 0 to 2147483647	<ul style="list-style-type: none"> <li>Calculate the movement distance using a speed limit, OPR speed, and deceleration time, and set the movement amount after near-point dog ON so that the distance becomes a deceleration distance or longer.</li> </ul>
	74+150n 75+150n		<OPR speed> 1 to 50000000 [PLS/s] 1 to 2000000000 [ $\times 10^{-2}$ mm/min]	<ul style="list-style-type: none"> <li>Lower the OPR speed.</li> <li>Adjust the near-point dog position so that the movement amount after near-point dog ON becomes longer. (Refer to Section 8.2.4, 8.2.5)</li> </ul>
	1500+100n	4300+100n	<Positioning start No.> 1 to 600, 7000 to 7004, 9001 to 9004	Execute the machine OPR (positioning start No. 9001). (Refer to Section 8.2)
	1500+100n	4300+100n	<Positioning start No.> 1 to 600, 7000 to 7004, 9001 to 9004	Start the machine OPR (positioning start No. 9001) again. (Refer to Section 8.2)
	—	—	—	Turn the motor more than one revolution using JOG or positioning operation.
	—	—	—	<ul style="list-style-type: none"> <li>Execute OPR again.</li> <li>When the servo amplifier parameter "[Pr.180] Function selection C-4" (PC17) is changed to "1: Not need to pass motor Z-phase after the power supply is switched on", transfer the parameter from LD77MH to the servo amplifier and turn the power supply of the servo amplifier OFF. Then, turn it ON and execute OPR again.</li> </ul>
	—	—	—	Execute OPR again.
	—	—	—	Turn the power supplies of the system or servo amplifier from OFF to ON after passing the zero point of the motor by the JOG operation, etc.

Classification of errors	Error code	Error name	Error	Operation status at error occurrence														
Home position return (OPR)	231	Z-phase passing parameter invalid	Servo amplifier parameter "[Pr.180] Function selection C-4" (PC17) is not set to "0: Need to pass motor Z-phase after the power supply is switched on." in the machine OPR of scale origin signal detection method.	The OPR does not start.														
JOG operation or inching operation errors	300	Outside JOG speed range	At the time of JOG starting, the JOG speed comes out of a specified range.	The JOG operation is not carried out when the JOG speed is outside the setting range at the time of JOG start.														
	301	Inching movement amount error	<p>The inching movement amount dose not satisfy the setting conditions. (The setting value is large.)</p> <p>Setting condition:                      "Inching movement amount × (A) ≤ JOG speed limit value"</p> <p>Use the following values for (A).</p> <table border="1"> <thead> <tr> <th rowspan="2"></th> <th colspan="2">Operation cycle</th> </tr> <tr> <th>0.88</th> <th>1.77</th> </tr> </thead> <tbody> <tr> <td>When unit is set to PLS</td> <td>1125</td> <td>562.5</td> </tr> <tr> <td>When unit is set to degree and "[Pr.83] Speed control 10 x multiplier setting for degree axis" is valid</td> <td>67.5</td> <td>33.75</td> </tr> <tr> <td>When unit setting is other than the above</td> <td>675</td> <td>337.5</td> </tr> </tbody> </table>		Operation cycle		0.88	1.77	When unit is set to PLS	1125	562.5	When unit is set to degree and "[Pr.83] Speed control 10 x multiplier setting for degree axis" is valid	67.5	33.75	When unit setting is other than the above	675	337.5	The inching operation is not carried out when the inching movement amount exceeds a JOG speed limit at the time of inching start.
	Operation cycle																	
	0.88	1.77																
When unit is set to PLS	1125	562.5																
When unit is set to degree and "[Pr.83] Speed control 10 x multiplier setting for degree axis" is valid	67.5	33.75																
When unit setting is other than the above	675	337.5																
Positioning operation errors	500	Illegal condition data No.	The condition data No. is outside the setting range when a block using the condition data is started by a special starting (conditional start, wait start, simultaneous start, FOR (condition)). (1 ≤ Condition data No. ≤ 10)	The operation is terminated.														

	Related buffer memory address		Set range (Setting with sequence program)	Remedy
	LD77MH4	LD77MH16		
	30180+200n	28480+100n	—	Set "0: Need to pass motor Z-phase after the power supply is switched on." in the servo amplifier parameter "[Pr.180] Function selection C-4" (PC17).
	1518+100n 1519+100n	4318+100n 4319+100n	<JOG speed> 1 to 50000000 [PLS/s] 1 to 2000000000 [ $\times 10^{-2}$ mm/min or others]	Bring the JOG speed into the setting range. (Refer to Section 11.2)
	1517+100n	4317+100n	<Inching movement amount> 0 to 65535	Set a smaller inching movement amount so that the setting condition is satisfied. (Refer to Section 11.3)
	Refer to Section 5.4 "List of block start data"		<Condition data No.> 1 to 10	Review the condition data No. (Refer to Section 5.4 [Da.14])

Classification of errors	Error code	Error name	Error	Operation status at error occurrence		
Positioning operation errors	501	Error before simultaneous start <b>LD77MH4</b>	<When blocks are started simultaneously> • The partner axis for simultaneous start is BUSY.	At start : The system does not operate. During operation: The system stops immediately.		
			<When multiple axes are started and controlled simultaneously> • The partner axis for simultaneous start is BUSY. • The "Simultaneous starting axis start data No." of the start axis is 0 or is outside the setting range. • The "Simultaneous starting axis start data No." of those axes other than the start axis is outside the setting range.			
		Error before simultaneous start <b>LD77MH16</b>	<When blocks are started simultaneously> • The partner axis for simultaneous start is BUSY.			
			<When multiple axes are started and controlled simultaneously> • The same axis number is set to multiple simultaneous start axes. • The own axis number is set to a simultaneous start axis. • The number of simultaneous start axes is outside the setting range of 2 to 4. • The partner axis for simultaneous start is BUSY. • The "Simultaneous starting axis start data No." of the start axis and the partner axis for simultaneous start is 0 or is outside the setting range.			
	502	Illegal data No.	• The positioning data No. tried to be executed is outside the ranges of 1 to 600, 7000 to 7004, and 9001 to 9004. • The designation of a JUMP destination is executed currently. • The designation of a JUMP destination is outside the ranges of 1 to 600.		The positioning data is not executed.	
	503	No command speed	• At the start of positioning, a current speed (-1) is set for the command speed of the positioning data to be initially executed. • The current speed is set by speed control. • The current speed is set for speed-position or position-speed switching control.		The operation does not start at positioning start.	

Related buffer memory address		Set range (Setting with sequence program)	Remedy
LD77MH4	LD77MH16		
Refer to Section 5.5 "List of condition data"		<Condition operators> Axis designation: 10H, 20H, 30H, 40H, 50H, 60H, 70H, 80H, 90H, A0H, B0H, C0H, D0H, E0H	Normalize the condition operators. (Refer to Section 5.5 [Da.16])
1540+100n		Axis 1 start data No.	Simultaneous starting axis start data No.  0 to 600
1541+100n		Axis 2 start data No.	
1542+100n		Axis 3 start data No.	
1543+100n		Axis 4 start data No.	
	4339+100n	<Simultaneous starting axis> b12 to b15 : 2 to 4 b8 to b11 : 0h to Fh b4 to b7 : 0h to Fh b0 to b3 : 0h to Fh	Normalize the simultaneous start axis.
	4339+100n	<Simultaneous starting axis> b12 to b15 : 2 to 4 b8 to b11 : 0h to Fh b4 to b7 : 0h to Fh b0 to b3 : 0h to Fh	Normalize the simultaneous starting own axis start data No. and the simultaneous starting axis start data No.(1 to 3). (Refer to Section 10.5)
	4340+100n	<Simultaneous starting own axis start data No.> 1 to 600	
	4341+100n	Simultaneous starting axis start data No.1	
	4342+100n	Simultaneous starting axis start data No.2	
	4343+100n	Simultaneous starting axis start data No.3	
1500+100n	4300+100n	<Positioning start No.> 1 to 600, 7000 to 7004, 9001 to 9004	Normalize the positioning start No., positioning start data (in block start), and positioning data (in JUMP instruction).
		<JUMP destination> 1 to 600	
Refer to Section 5.3 "List of positioning data"		<Command speed> 1 to 50000000 [PLS/s] 1 to 2000000000 [ $\times 10^{-2}$ mm/min or others]	Normalize the positioning data.



Classification of errors	Error code	Error name	Error	Operation status at error occurrence	
Positioning operation errors	504	Outside linear movement amount range	<ul style="list-style-type: none"> <li>When the parameter "interpolation speed designation method" performs a linear interpolation in setting a "composite speed", the axis movement amount for each positioning data exceeds 1073741824(2<sup>30</sup>).</li> <li>The positioning address is -360.00000 or less or 360.00000 or more using INC instruction, where the control unit is set to "degree" and software stroke limit upper limit is not equal to the software stroke limit lower limit.</li> </ul>	<p>At start : The system does not operate.</p> <p>During operation: The system stops immediately.</p>	
	506	Large arc error deviation	When an arc is interpolated by the designation of the center point, a difference between a radius of start point-center point and a radius of end point-center point exceeds the parameter "Circular interpolation error allowable limit".	<p>At start : The circular interpolation control by center point designation is not executed.</p> <p>During operation: The system stops immediately.</p>	
	507	Software stroke limit+	<ul style="list-style-type: none"> <li>The positioning is executed at a position exceeding the upper limit of the software stroke limit.</li> <li>The positioning address and the new current value exceed the upper limit of the software stroke limit.</li> <li>In the circular interpolation with sub points designated, the sub point exceeds the upper limit of the software stroke limit.</li> <li>During the speed control mode/the torque control mode, the current feed value exceeded the upper limit of the software stroke limit.</li> </ul>	<p>At operation start: The system does not operate.</p> <p>In the analysis of new current value: Current value is not changed.</p> <p>During operation:</p> <ul style="list-style-type: none"> <li>The system stops immediately when the positioning address during position control (including position control in speed-position switching control or position-speed switching control) is switched to the data outside the software stroke limit range.</li> <li>The system makes a stop at the setting (normal deceleration stop only) of sudden stop selection (stop group 3) in the detailed parameter 2 when the current feed value or machine feed value during speed control (including speed control in speed-position switching control or position-speed switching control) or during manual control falls outside the software stroke limit range.</li> </ul>	
	508	Software stroke limit-	<ul style="list-style-type: none"> <li>The positioning is executed at a position exceeding the lower limit of the software stroke limit.</li> <li>The positioning address and the new current value exceed the lower limit of the software stroke limit.</li> <li>In the circular interpolation with sub points designated, the sub point exceeds the lower limit of the software stroke limit.</li> <li>During the speed control mode/the torque control mode, the current feed value exceeded the lower limit of the software stroke limit.</li> </ul>	<p>At speed control mode/torque control mode: The mode is switched to the position control mode and the system stops immediately when the current feed value falls outside the software stroke limit range.</p>	

Related buffer memory address		Set range (Setting with sequence program)	Remedy
LD77MH4	LD77MH16		
Refer to Section 5.3 "List of positioning data"		<Positioning address/movement amount> • ABS unit [mm] [inch] [PLS] -2147483648 to 2147483647 Unit [degree] 0 to 35999999 • INC (When software stroke limits are valid) Unit [mm], [inch] [PLS]: -2147483648 to 2147483647 Unit [degree]: -35999999 to 35999999 (When software stroke limits are invalid) -2147483648 to 2147483647 • Speed-position switching INC mode: 0 to 2147483647 ABS mode: 0 to 35999999 ((degree) only) • Position-speed switching 0 to 2147483647 <Arc address> -2147483648 to 2147483647	Review the positioning address.  • Correct the center point address (arc address) • Correct the end address (positioning address)
		60+150n 61+150n	<Circular interpolation error allowable limit> 0 to 1000000
New current value		<New current value> <Software stroke upper and lower limits> • [mm] [inch] [PLS] -2147483648 to 2147483647 • [degree] 0 to 35999999	At operation start : • Set the current feed value within the software stroke limit by the manual control operation. (Refer to Chapter 11) • Correct the positioning address. (At circular interpolation with sub points designated, also check the arc address.) New current value : Set the new current value within the software stroke limit. (Refer to Section 9.2.19) During operation : Correct the positioning address. (For the positioning and arc addresses, refer to <a href="#">Da.6</a> and <a href="#">Da.7</a> in Section 5.3) At speed control mode/torque control mode: Review the operation so that the current feed value does not exceed the software stroke limit.
1506+100n 1507+100n	4306+100n 4307+100n		
Software stroke limit upper limit			
18+150n 19+150n			
Software stroke limit lower limit			
20+150n 21+150n			

Classification of errors	Error code	Error name	Error	Operation status at error occurrence	
Positioning operation errors	514	Outside new current value range	The new current address is outside the ranges of 0 to 359.99999, where the control unit is set to "degree".	Current value is not changed.	
	515	New current value not possible	<ul style="list-style-type: none"> <li>The control system sets an operation pattern (continuous path control) using new current positioning data.</li> <li>The operation pattern sets a "new current value" in the control system using the data following the "continuous path control" positioning data.</li> </ul>		
	516	Continuous path control not possible	<ul style="list-style-type: none"> <li>The continuous path control is designated using a control system which is not allowed to use for continuous path control such as speed control, speed-position switching control, position-speed switching control, fixed-feed, and current value changing.</li> <li>The previous data such as those on speed control, speed-position switching control, position-speed switching control, fixed-feed, and current value changing shows a continuous path control.</li> <li>The continuous positioning control is designated for speed control or position-speed switching control.</li> </ul>	The system does not operate at start.	
	518	Outside operation pattern range	The operation pattern set value is 2.	At start : The system does not operate. During operation: The system stops with the setting (deceleration stop/sudden stop) of the detailed parameter 2 Sudden stop selection (stop group 3). (Note that the deceleration stop only occurs during the manual pulse generator operation.)	
	519	Interpolation while interpolation axis BUSY	Interpolation is started during the operation of the interpolation axis.		
	520	Unit group unmatched	The reference and interpolation axis units are different at the parameter "interpolation speed designation method" setting of "composite speed".		
	521	Illegal interpolation description command	In 2-axis interpolation, the axis to be interpolated is the self axis or an axis not present.		
	522	Command speed setting error	The command speed is outside the setting range. Linear interpolation, circular interpolation: Reference axis is outside the setting range. Speed control interpolation: Either of reference axis and interpolation axis is outside the speed range.		

	Related buffer memory address		Set range (Setting with sequence program)	Remedy
	LD77MH4	LD77MH16		
	1506+100n 1507+100n	4306+100n 4307+100n	<New current value> [degree] 0 to 35999999	Bring the new current value into the setting range. (Refer to Section 9.2.19)
	Refer to Section 5.3 "List of positioning data"		<Control system> 01H to 1EH, 80H to 84H • 03H, 0CH, 17H, 1CH: 1 to 4 axis fixed-feed control • 04H, 05H, 13H, 14H, 18H, 19H, 1DH, 1EH: 1 to 4 axis speed control • 81H: current value changing • Speed-position switching control: 06H, 07H • Position-speed switching control: 08H, 09H <Operation pattern> 00, 01, 11 • 01: Continuous positioning control • 11: Continuous path control	<ul style="list-style-type: none"> <li>Do not designate a current value changing using the positioning data following the continuous path control.</li> <li>Do not designate positioning data following continuous path control using a "current value changing". (Refer to Section 9.2.19)</li> </ul>
				<ul style="list-style-type: none"> <li>Do not designate a speed control, fixed-feed, speed-position switching control, position-speed switching control, and current value changing using the positioning data following the continuous path control data.</li> <li>Do not carry out the fixed-feed, speed control, speed-position switching control, position-speed switching control, and current value changing using the continuous path control operation pattern.</li> <li>Do not carry out the speed control and position-speed switching control using the continuous path control operation pattern. (Refer to Chapter 9)</li> </ul>
	Same as error codes 515 to 516			Correct the operation pattern. (Refer to Section 5.3 <a href="#">Da.1</a> )
	Same as error codes 515 to 516			Correct the control system. (Refer to Section 5.3 <a href="#">Da.2</a> )
	0+150n		<Unit setting> 0, 1, 2, 3	Correct the positioning data or change the parameter "Unit setting" of the axis to be interpolated. (Refer to Section 9.1.6)
	Same as error codes 515 to 516			<ul style="list-style-type: none"> <li>Correct the control system. (Refer to Section 5.3 <a href="#">Da.2</a>)</li> <li>Correct the axis to be interpolated. (Refer to Section 5.3 <a href="#">Da.5</a>, <a href="#">Da.20</a> to <a href="#">Da.22</a>)</li> </ul>
	Command speed storage addresses of positioning data No. 1 to 600		<Command speed> 1 to 50000000 [PLS/s] 1 to 200000000 [ $\times 10^{-2}$ mm/min or others]	Correct the command speed. (Refer to Section 5.3 <a href="#">Da.8</a> )

Classification of errors	Error code	Error name	Error	Operation status at error occurrence	
Positioning operation errors	523	Interpolation mode error	<ul style="list-style-type: none"> <li>For starting, a composite speed is designated in the reference axis parameter "Interpolation speed designation method" using the speed interpolation control or 4-axis linear interpolation control.</li> <li>For starting, a reference axis speed is designated in the reference axis parameter "Interpolation speed designation method" using the circular interpolation control.</li> </ul>	At start : The system does not operate. During operation : The system stops with the setting (deceleration stop/sudden stop) of the detailed parameter 2 Sudden stop selection (stop group 3). (Note that the deceleration stop only occurs during the manual pulse generator operation.)	
	524	Control system setting error	<ul style="list-style-type: none"> <li>The control system setting value is outside the setting range.</li> <li>The number of control axes or the axis to be interpolated differs from the previous data when continuous positioning control or continuous path control is to be exercised for continuously.</li> <li>The NOP instruction was set to the control system of positioning data No. 600.</li> </ul>		
	525	Sub point setting error	Either of the following applies in the circular interpolation with sub points designated. <ul style="list-style-type: none"> <li>Start point = sub point</li> <li>End point = sub point</li> <li>Start point, end point, and sub point are in line with each other.</li> <li>Sub point address and center point address are outside the range of -2147483648 to 2147483647.</li> </ul>	At start : The system does not operate. During operation : The system stops immediately.	
	526	End point setting error	<ul style="list-style-type: none"> <li>Start point is equal to end point in the circular interpolation with sub points designated.</li> <li>End point address is outside the range of -2147483648 to 2147483647 in the circular interpolation with auxiliary point designation and center point designation.</li> </ul>		
	527	Center point setting error	Circular interpolation with center point designation applicable to one of the followings. <ul style="list-style-type: none"> <li>Start point = Center point</li> <li>End point = Center point</li> <li>Center point address is outside the range of -2147483648 to 2147483647.</li> </ul>		

	Related buffer memory address		Set range (Setting with sequence program)	Remedy
	LD77MH4	LD77MH16		
	29+150n		<Interpolation speed designation method> 0: Composite speed 1: Reference axis speed	Set the "Interpolation speed designation method" correctly. (Refer to Section 9.1.6)
	Same as error codes 515 to 516			Correct the control system, axis to be interpolated or parameter. (Refer to Section 9.1.6, 9.2.20)
	Refer to Section 5.3 "List of positioning data"		<Positioning address/movement amount> • unit [mm] [PLS] [inch] –2147483648 to 2147483647 (Unit [degree]) cannot be set.	Correct the sub address (arc address). (Refer to Section 9.2.10)
			<Arc address> –2147483648 to 2147483647	Correct the end address (positioning address). (Refer to Section 9.2.10)
	Same as in error codes 525 to 526.			Correct the center point address (arc address). (Refer to Section 9.2.11)

Classification of errors	Error code	Error name	Error	Operation status at error occurrence	
Positioning operation errors	530	Outside address range	<ul style="list-style-type: none"> <li>In the speed-position switching control and the position-speed switching control, the setting value of a positioning address is negative.</li> <li>In ABS1, ABS2, ABS3 and ABS4, the setting value of a positioning address is outside the range of 0 to 359.99999 degrees.</li> </ul>	<p>At start : The system does not operate.</p> <p>During operation: The system stops immediately with the setting (deceleration stop/sudden stop) of the detailed parameter 2 sudden stop selection (stop group 3). (Note that the deceleration stop only occurs during the manual pulse generator operation.)</p>	
	532	Simultaneous start not possible	Among the axes to be started simultaneously, there is an axis on which an error other than this error occurs.		
	533	Condition data error	<ul style="list-style-type: none"> <li>The condition setting values are not set or outside the setting range.</li> <li>The condition operator setting values are not set or outside the setting range.</li> <li>The condition operator is a bit operator, and the parameter 1 is 32 or more.</li> <li>An unusable condition operator is set for the set condition.</li> <li>The conditional operator has been [parameter 1 is greater than to parameter 2] with 05H (P1 ≤ ** ≤ P2).</li> <li>The setting value of "address" is outside the setting range when the condition target is set to "Buffer memory (1-word/2-word)". (1-word: 0 to 32767, 2-word: 0 to 32766)</li> <li>The setting value of "simultaneous starting axis" is outside the setting range when the condition target is set to "positioning data No.". <b>LD77MH16</b></li> </ul>	The operation is terminated.	
	534	Special start instruction error	No applicable special start instruction is present.		
	535	Circular interpolation not possible	Circular interpolation is carried out on an axis in the unit of degree.		
	536	M code ON signal start	The positioning start is carried out when an M code ON signal is turned ON.		
	537	PLC READY OFF start	The positioning start is carried out when the PLC READY signal [Y0] is turned OFF.		
	538	READY OFF start	The positioning start is carried out when the LD77 READY signal [X0] is turned OFF.	The system does not operate at start.	
	543	Outside start No. range	<ul style="list-style-type: none"> <li>At the start of positioning, the setting value of the "positioning start No." of the axis control data is outside the ranges of 1 to 600, 7000 to 7004, and 9001 to 9004.</li> <li>At a Pre-reading start, the "positioning start No." setting of the axis control data is other than 1 to 600.</li> </ul>		

Related buffer memory address		Set range (Setting with sequence program)	Remedy
LD77MH4	LD77MH16		
Same as in error codes 504, 506.			Correct the positioning address. (Refer to Section 9.2.16, 9.2.17, 9.2.18)
Refer to Section 5.3 "List of positioning data" and Section 5.4 "List of block start data"		—	In the error history, check the axis where the error other than this error occurred, and remove the error factor. Correct the block start data and positioning data.
Refer to Section 5.4 "List of block start data"		—	Normalize the block start data.
		<Special start instruction> 00H to 06H	Correct the instruction code of the special start. (Refer to Section 5.4 [Da.13])
Refer to Section 5.3 "List of positioning data"		—	Correct the control system. (Refer to Section 5.3 [Da.2])
1504+100n	4304+100n	<M code OFF request> 1: M code ON signal is turned OFF	After turning OFF the M code ON signal, start the system. (Refer to Section 13.7.3)
—	—	—	Check the program which turns ON/OFF the PLC READY signal [Y0], and turn ON the PLC READY signal. Then start the system.
—	—	—	Check the LD77 READY ON signal, and then start the system. (Refer to Section 3.3.2)
1500+100n	4300+100n	<Positioning start No.> 1 to 600, 7000 to 7004, 9001 to 9004	Normalize the positioning start No. (Refer to Section 13.7.7)



Classification of errors	Error code	Error name	Error	Operation status at error occurrence	
Positioning operation errors	544	Outside radius range	The arc radius exceeds 536870912.	At start : The system does not operate. During operation: The system stops immediately.	
	545	Control system LOOP setting error	A "0" is set in the repeating times of the control system "LOOP".	The operation is terminated.	
	546	Illegal setting of ABS direction in unit of degree	The setting value of ABS direction in the unit of degree is as follows. • Set outside the setting range. • A figure other than "0" is set when the software stroke limit is valid.	At start : The system does not operate. During operation: The system decelerates to a stop. (Note that, in the continuous positioning control and continuous path control, the system continues operating with the setting set at the time of start even if the setting is changed during the operation.)	
	547	Start at OPR incomplete	• When executing operation setting at OPR incomplete, positioning was started at OPR request ON. • When executing operation setting at OPR incomplete, control mode switching was executed at OPR request ON.	At start : The system does not operate. At control mode switching: The mode does not change.	
I/F errors	800	Hold error	In the CPU module parameter "Output at error stop", the setting for LD77MH is "Hold".	At start : The system does not operate. During operation: The system stops with the setting (deceleration stop/sudden stop) of the detailed parameter 2 sudden stop selection (stop group 3). (Note that the deceleration stop only occurs during the manual pulse generator operation.)	
	801	Flash ROM write error	Data is not written to the flash ROM.		
	802	Flash ROM sum check error	While data is written to the flash ROM, the power is turned OFF.	At start: The system does not operate.	
	803	PLC CPU error	The CPU resulted in an error.	At start : The system does not operate. During operation: The system stops with the setting (deceleration stop/sudden stop) of the detailed parameter 2 sudden stop selection (stop group 2). (Note that the deceleration stop only occurs during the manual pulse generator operation.)	

Related buffer memory address		Set range (Setting with sequence program)	Remedy
LD77MH4	LD77MH16		
Refer to Section 5.3 "List of positioning data"		<Maximum radius> 536870912	Correct the positioning data. (Refer to Section 9.2.10, 9.2.11)
		<LOOP to LEND> 1 to 65535	Set 1 to 65535 in the repeating time of LOOP. (Refer to Section 9.2.22)
ABS setting direction in the unit of degree		0: Shortcut 1: Clockwise 2: Counterclockwise	<ul style="list-style-type: none"> <li>Set the ABS setting direction in the unit of degree within the setting range.</li> <li>Set "0" when the software stroke limits are valid. (Refer to Section 9.1.5)</li> </ul>
1550+100n	4350+100n		
Software stroke limit upper limit		<ul style="list-style-type: none"> <li>[mm] [inch] [PLS] -2147483648 to 2147483647</li> <li>[degree] 0 to 35999999</li> </ul>	<ul style="list-style-type: none"> <li>Invalidate the software stroke limit. (To invalidate, set the software stroke limit upper limit value to the software stroke limit lower limit value.) (Refer to Section 9.1.5)</li> </ul>
18+150n 19+150n			
Software stroke limit lower limit			
20+150n 21+150n			
Operation setting for incompleteness of OPR		<Operation setting for incompleteness of OPR> 0, 1	<ul style="list-style-type: none"> <li>Start after the OPR is executed.</li> <li>Switch the control mode after the OPR is executed.</li> <li>For systems which can operate the positioning control and speed-torque control though the OPR request is ON, set "1" to the setting value of the operation setting at OPR incomplete.</li> </ul>
87+150n			
—	—	—	Clear the setting of the CPU module parameter "Output at error stop".
—	—	—	The flash ROM is expected to be at the end of its writable life.
1901	5901	<Parameter initialization request> 1: Parameter initialization is requested	Return the parameter to that set at the time of delivery from the plant. (Refer to Section 14.2)
—	—	—	<ul style="list-style-type: none"> <li>Check the error code in CPU. (Refer to the "MELSEC-L CPU Module User's Manual (Hardware Design, Maintenance and Inspection)".)</li> </ul>

Classification of errors	Error code	Error name	Error	Operation status at error occurrence	
I/F errors	804	Dedicated instruction error	<ul style="list-style-type: none"> <li>The ZP.PSTRTO instruction is executed with the start No. set to other than 1 to 600, 7000 to 7004 and 9001 to 9004.</li> <li>The ZP.TEACHTO instruction is executed with the teaching data selection set to other than 0 and 1.</li> <li>The ZP.TEACHTO instruction is executed with the positioning data No. set to other than 1 to 600.</li> <li>The instruction of a non-existent axis is specified by the ZP.PSTRTO or ZP.TEACHTO instruction.</li> </ul>	The function for each instruction is not executed.	
	805	Flash ROM write number error	Data is written to the flash ROM continuously 25 times or more from the program.	At start: The system does not operate.	
	806	Dedicated instruction I/F error	Mismatching occurs between the CPU module and LD77MH.		
	808	Error when switching from normal operation mode to amplifier-less operation mode	Input signals other than synchronization flag [X1] are ON when switching from the normal operation mode to the amplifier-less operation mode.	The operation mode is not changed.	
	809	Error when switching from amplifier-less operation mode to normal operation mode	Input signals other than synchronization flag [X1] are ON when switching from the amplifier-less operation mode to the normal operation mode.		
Parameter setting range errors	900	Outside unit setting range	The set value of the basic parameter 1 "Unit setting" is outside the setting range.	The LD77 READY signal [X0] is not turned ON.	
	901	Outside pulse number per rotation range	The set value of the basic parameter 1 "Number of pulses per rotation" is outside the setting range.		
	902	Outside movement amount per rotation range	The set value of the basic parameter 1 "Movement amount per rotation" is outside the setting range.		
	903	Outside unit magnification range	<ul style="list-style-type: none"> <li>The set value of the basic parameter 1 "Unit magnification" is outside the setting range.</li> <li>"Movement amount per rotation (AL)" × "Unit magnification (AM)" exceeds 2147483648.</li> </ul>		
	906	Outside bias speed range	<ul style="list-style-type: none"> <li>The set value of the basic parameter 1 "Bias speed at start" is outside the setting range.</li> <li>The bias speed exceeds the speed limit.</li> </ul>		
	907	Outside electronic gear setting range	The set value of the electronic gear is outside the setting range.	The LD77 READY signal [X0] is not turned ON.	

Related buffer memory address		Set range (Setting with sequence program)	Remedy
LD77MH4	LD77MH16		
—	—	<p>&lt; ZP.PSTRTO start No.&gt; 1 to 600, 7000 to 7004, 9001 to 9004</p> <p>&lt; ZP.TEACHO teaching data selection&gt; 0: The current feed value is written to the positioning address. 1: The current feed value is written to the arc address.</p> <p>&lt; ZP.TEACHO positioning data No.&gt; 1 to 600</p>	<ul style="list-style-type: none"> <li>When executing the ZP.PSTRTO instruction, set the start No. within the setting range. (Refer to Section 15.3)</li> <li>When executing the ZP.TEACHO instruction, set the teaching data selection and positioning data No. within the setting range. (Refer to Section 15.4)</li> <li>Do not specify the instruction of a non-existent axis by the ZP.PSTRTO and ZP.TEACHO instructions. (Refer to Section 15.3 to Section 15.4)</li> </ul>
—	—	—	Review the program so that data is not written continuously to the flash ROM. (Using "Md.19" in Section 5.6.1, the number of flash ROM write times can be monitored.) (If this error has occurred in a proper using method, writing is enabled by resetting the error, switching power OFF, then ON, or resetting the CPU module.)
—	—	—	A trouble occurs. Repair.
—	—	—	Switch the operation mode after confirming that all input signals other than synchronization flag [X1] are OFF.
—	—	—	
0+150n		0, 1, 2, 3	With the setting brought into the setting range, turn the PLC READY signal [Y0] from OFF to ON.
2+150n 3+150n		1 to 200000000	
4+150n 5+150n		1 to 200000000	
1+150n		1,10,100,1000	<ul style="list-style-type: none"> <li>Set AL and AM values which make "Movement amount per rotation (AL)" × "Unit magnification (AM)" within 2147483647, and then turn the PLC READY signal [Y0] from OFF to ON.</li> <li>With the setting brought into the setting range, turn the PLC READY signal [Y0] from OFF to ON.</li> </ul>
6+150n 7+150n		0 [PLS/s] 0 [ $\times 10^{-2}$ mm/min or others]	<ul style="list-style-type: none"> <li>Set the bias speed to not more than the speed limit value.</li> <li>With the setting brought into the setting range, turn the PLC READY signal [Y0] from OFF to ON.</li> </ul>
Unit magnification		$0.001 \leq \text{Electronic gear} \leq 20000$  $\text{Electronic gear} = \frac{\text{Pr.2}}{\text{Pr.3} \times \text{Pr.4}}$	"Pr.2 Number of pulses per rotation (AP)", "Pr.3 Movement amount per rotation (AL)", "Pr.4 Unit magnification (AM)" Review these parameters . (Refer to Section 5.2.1)
1+150n			
Number of pulses per rotation			
2+150n 3+150n			
Movement amount per rotation			
4+150n 5+150n			

Classification of errors	Error code	Error name	Error	Operation status at error occurrence	
Parameter setting range errors	910	Outside speed limit value range	<ul style="list-style-type: none"> <li>The set value of the basic parameter 2 "Speed limit value" is outside the setting range.</li> <li>The speed limit value is smaller than the OPR speed.</li> </ul>	When the PLC READY signal [Y0] is turned from OFF to ON : LD77 READY signal [X0] is not turned ON. At start : The system does not operate.	
	911	Outside acceleration time 0 range	The set value of the basic parameter 2 "Acceleration time 0" is outside the setting range.		
	912	Outside deceleration time 0 range	The set value of the basic parameter 2 "Deceleration time 0" is outside the setting range.		
	920	Backlash compensation amount error	The calculation result of the following equation is smaller than 0 or larger than 65536. $0 \leq \frac{[Pr.11] \times [Pr.2]}{[Pr.3] \times [Pr.4]} \leq 65535$	The LD77 READY signal [X0] is not turned ON.	
	921	Software stroke limit upper limit	<ul style="list-style-type: none"> <li>In the unit of "degree", the set value of the detailed parameter 1 "Software stroke limit upper limit value" is outside the setting range.</li> <li>In a unit other than degree, the software stroke limit upper limit value is smaller than the software stroke limit lower limit value.</li> </ul>		
	922	Software stroke limit lower limit	<ul style="list-style-type: none"> <li>In the unit of "degree", the set value of the detailed parameter 1 "Software stroke limit lower limit value" is outside the setting range.</li> <li>In a unit other than degree, the software stroke limit upper limit value is smaller than the software stroke limit lower limit value.</li> </ul>		
	923	Software stroke limit selection	<ul style="list-style-type: none"> <li>The set value of the detailed parameter 1 "Software stroke limit selection" is outside the setting range.</li> <li>In the unit of "degree", "1: Apply software stroke limit on machine feed value" is set.</li> </ul>		
	924	Software stroke limit valid/invalid setting	The set value of the detailed parameter 1 "Software stroke limit valid/invalid setting" is outside the setting range.		
	925	Command in-position width	The set value of the detailed parameter 1 "Command in-position width" is outside the setting range.		
	926	Illegal torque limit setting value	The set value of the detailed parameter 1 "Torque limit setting value" is outside the setting range.		
927	M code ON timing error	The set value of the detailed parameter 1 "M code ON signal output timing" is outside the setting range.			
928	Speed switching mode error	The set value of the detailed parameter 1 "Speed switching mode" is outside the setting range.			

	Related buffer memory address		Set range (Setting with sequence program)	Remedy
	LD77MH4	LD77MH16		
	10+150n 11+150n		<Speed limit value> 1 to 50000000 [PLS/s] 1 to 2000000000 [ $\times 10^{-2}$ mm/min or others]	<ul style="list-style-type: none"> <li>Set a value which is not less than the OPR speed.</li> <li>With the setting brought into the setting range, turn the PLC READY signal [Y0] from OFF to ON.</li> </ul>
	12+150n 13+150n		1 to 8388608	With the setting brought into the setting range, turn the PLC READY signal [Y0] from OFF to ON.
	14+150n 15+150n		1 to 8388608	
	17+150n		$0 \leq \frac{\text{Pr.11} \times \text{Pr.2}}{\text{Pr.3} \times \text{Pr.4}} \leq 65535$	"Pr.2 Number of pulses per rotation (AP)", "Pr.3 Movement amount per rotation (AL)", "Pr.4 Unit magnification (AM)" "Pr.11 Backlash compensation amount" Review the items above. (Refer to Section 5.2.1 or Section 5.2.3)
	18+150n 19+150n		<ul style="list-style-type: none"> <li>[mm] [inch] [PLS] -2147483648 to 2147483647</li> <li>[degree] 0 to 35999999</li> </ul>	<ul style="list-style-type: none"> <li>Bring the setting into the setting range.</li> <li>In a unit other than degree, set so that the lower limit value is smaller than the upper limit value.</li> </ul>
	20+150n 21+150n		<ul style="list-style-type: none"> <li>[mm] [inch] [PLS] -2147483648 to 2147483647</li> <li>[degree] 0 to 35999999</li> </ul>	
	22+150n		0, 1	<ul style="list-style-type: none"> <li>Bring the setting into the setting range.</li> <li>In the unit of "degree", set "0: Apply software stroke limit on current feed value".</li> </ul>
	23+150n		0, 1	With the setting brought into the setting range, turn the PLC READY signal [Y0] from OFF to ON.
	24+150n 25+150n		1 to 2147483647	
	26+150n		1 to 1000	
	27+150n		0, 1	
	28+150n		0, 1	

Classification of errors	Error code	Error name	Error	Operation status at error occurrence	
Parameter setting range errors	929	Interpolation speed designation method error	The set value of the detailed parameter 1 "Interpolation speed designation method" is outside the setting range.	The LD77 READY signal [X0] is not turned ON.	
	930	Current value update request error	The set value of the detailed parameter 1 "Current feed value during speed control" is outside the setting range.		
	932	Manual pulse generator input mode error	The set value of the detailed parameter 1 "Manual pulse generator/Incremental synchronous encoder input selection" is outside the setting range.		
	935	Speed-position function selection error	The detailed parameter 1 "Speed-position function selection" is preset to 2 and the following three conditions are not satisfied: 1) Unit is "degree". 2) Software stroke limits are invalid. 3) Update current feed value.		
	936	External input signal selection error	The set value of the detailed parameter 1 "External input signal selection" is outside the setting range.		
	937	Forced stop valid/invalid setting error	The set value of the detailed parameter 1 "Forced stop valid/invalid setting" is outside the setting range.		
	950	Acceleration time 1 setting error	The set value of the detailed parameter 2 "Acceleration time 1" is outside the setting range.	When the PLC READY signal [Y0] is turned from OFF to ON: The LD77 READY signal [X0] is not turned ON. At start : The system does not operate. During operation : The system stops with the setting (deceleration stop/sudden stop) of the detailed parameter 2 sudden stop selection (stop group 3). (Note that the deceleration stop only occurs during the manual pulse generator operation.)	
	951	Acceleration time 2 setting error	The set value of the detailed parameter 2 "Acceleration time 2" is outside the setting range.		
	952	Acceleration time 3 setting error	The set value of the detailed parameter 2 "Acceleration time 3" is outside the setting range.		
	953	Deceleration time 1 setting error	The set value of the detailed parameter 2 "Deceleration time 1" is outside the setting range.		
	954	Deceleration time 2 setting error	The set value of the detailed parameter 2 "Deceleration time 2" is outside the setting range.		
	955	Deceleration time 3 setting error	The set value of the detailed parameter 2 "Deceleration time 3" is outside the setting range.		
	956	JOG speed limit value error	<ul style="list-style-type: none"> <li>The set value of the detailed parameter 2 "JOG speed limit value" is outside the setting range.</li> <li>The set value of the detailed parameter 2 "JOG speed limit value" exceeds the speed limit.</li> </ul>		
	957	JOG acceleration time selection setting error	The set value of the detailed parameter 2 "JOG operation acceleration time selection" is outside the setting range.		
958	JOG deceleration time selection setting error	The set value of the detailed parameter 2 "JOG operation deceleration time selection" is outside the setting range.			

	Related buffer memory address		Set range (Setting with PLC program)	Remedy	
	LD77MH4	LD77MH16			
	29+150n		0, 1	With the setting brought into the setting range, turn the PLC READY signal [Y0] from OFF to ON.	
	30+150n		0, 1, 2		
	33		0, 3 <b>LD77MH4</b>		
			0, 2, 3 <b>LD77MH16</b>		
	34+150n		0, 2	<ul style="list-style-type: none"> <li>Speed-position switching control (ABS mode) should satisfy the conditions 1) to 3) given on the left.</li> <li>When speed-position switching control (ABS mode) is not to be exercised, set 0 to speed-position function selection and turn the PLC READY signal [Y0] from OFF to ON.</li> </ul>	
	32+150n		0, 1	With the setting brought into the setting range, turn the PLC READY signal [Y0] from OFF to ON.	
	35		0, 1		
	36+150n 37+150n		1 to 8388608		
	38+150n 39+150n		1 to 8388608		
	40+150n 41+150n		1 to 8388608		
	42+150n 43+150n		1 to 8388608		
	44+150n 45+150n		1 to 8388608		
	46+150n 47+150n		1 to 8388608		
	48+150n 49+150n		<JOG speed limit value> 1 to 50000000 [PLS/s] 1 to 2000000000 [ $\times 10^{-2}$ mm/min or others]		<ul style="list-style-type: none"> <li>With the setting brought into the setting range, turn the PLC READY signal [Y0] from OFF to ON.</li> <li>Bring the setting into the speed limit value or below.</li> </ul>
	50+150n		0, 1, 2, 3		With the setting brought into the setting range, turn the PLC READY signal [Y0] from OFF to ON.
	51+150n		0, 1, 2, 3		



Classification of errors	Error code	Error name	Error	Operation status at error occurrence	
Parameter setting range errors	959	Acceleration/deceleration process selection setting error	The set value of the detailed parameter 2 "Acceleration/deceleration process selection" is outside the setting range.	When the PLC READY signal [Y0] is turned from OFF to ON: The LD77 READY signal [X0] is not turned ON. At start : The system does not operate. During operation : The system stops with the setting (deceleration stop/sudden stop) of the detailed parameter 2 sudden stop selection (stop group 3). (Note that the deceleration stop only occurs during the manual pulse generator operation.)	
	960	S-curve ratio setting error	The set value of the detailed parameter 2 "S-curve ratio" is outside the setting range.		
	961	Illegal sudden stop deceleration time	The set value of the detailed parameter 2 "Sudden stop deceleration time" is outside the setting range.		
	962	Stop group 1 sudden stop selection error	The set value of the detailed parameter 2 "Stop group 1 sudden stop selection" is outside the setting range.		
	963	Stop group 2 sudden stop selection error	The set value of the detailed parameter 2 "Stop group 2 sudden stop selection" is outside the setting range.		
	964	Stop group 3 sudden stop selection error	The set value of the detailed parameter 2 "Stop group 3 sudden stop selection" is outside the setting range.		
	966	Outside allowance circular interpolation error width	The set value of the detailed parameter 2 "Allowance circular interpolation error width" is outside the setting range.		
	967	External command function selection error	The set value of the detailed parameter 2 "External command function selection" is outside the setting range.		
	970	Restart allowable range error	The set value of the detailed parameter 2 "Restart allowable range when servo OFF to ON" is outside the setting range.	The LD77 READY signal [X0] is not turned ON.	
	971	Speed control 10 x multiplier setting for degree axis error	The set value of the detailed parameter 2 "Speed control 10 x multiplier setting for degree axis" is outside the setting range.		
	972	Number of master axis error	Number of axes set for the master axis in servo parameter "Driver communication setting (PD15)" exceed the setting range.		
	973	Master axis No. error	Servo parameters "Driver communication setting Master axis No. selection (1 to 4) for slave (PD20 to PD23)" are set the self axis.		
	974	Master axis setting error	Not setting the master axis in Servo parameters " Driver communication setting Master axis No. selection (1 to 4) for slave (PD20 to PD23) ".		
	975	Driver communication setting error	Setting the driver communication to servo amplifier which does not support the driver communication.	The communication between servo amplifiers of target axis is not executed. (The servo amplifier's LED display remains "Ab".)	
	976	Manual pulse generator/Incremental synchronous encoder input type selection error	The set value of the detailed parameter 2 "Manual pulse generator/Incremental synchronous encoder input type selection" is outside the setting range.	The LD77 READY signal [X0] is not turned ON.	
977	Operation setting for speed-torque control mode error	The set value of the detailed parameter 2 "Operation setting for speed-torque control mode" is outside the setting range.			

	Related buffer memory address		Set range (Setting with sequence program)	Remedy
	LD77MH4	LD77MH16		
	52+150n		0, 1	With the setting brought into the setting range, turn the PLC READY signal [Y0] from OFF to ON.
	53+150n		1 to 100	
	54+150n 55+150n		1 to 8388608	
	56+150n		0, 1	
	57+150n		0, 1	
	58+150n		0, 1	
	60+150n 61+150n		0 to 10000	
	62+150n		0, 1, 2, 3	
	64+150n 65+150n		0 to 327680	
	63+150n		0, 1	
	30210+200n	Set with GX Works2	—	Set the number of master axis not more than the number can be set in servo parameter "PD15". (Refer to Section 14.9)
	30215+200n 30216+200n 30217+200n 30218+200n	Set with GX Works2	—	Review the master axis No. of servo parameters "PD20 to PD23". (Refer to Section 14.9)
	—	—	—	Confirm the driver communication and the actually connected servo amplifier.
	67		0, 1	With the setting brought into the setting range, turn the PLC READY signal [Y0] from OFF to ON.
	68+150n		<Speed initial value selection (b8 to b11)> 0, 1 <Condition selection at mode switching (b12 to b15)> <b>LD77MH16</b> 0, 1	

Classification of errors	Error code	Error name	Error	Operation status at error occurrence	
Parameter setting range errors	978	External command signal selection error	The set value of the detailed parameter 2 "External command signal selection" is outside the setting range.	The LD77 READY signal [X0] is not turned ON.	
	979	ABS synchronous encoder unsupported error	"Servo series" of the axis which uses the ABS synchronous encoder is other than "3: MR-J3-□BS".		
	980	OPR method error	The set value of the OPR basic parameter "OPR method" is outside the setting range.		
	981	OPR direction error	The set value of the OPR basic parameter "OPR direction" is outside the setting range.		
	982	OP address setting error	The set value of the OPR basic parameter "OP address" is outside the setting range.		
	983	OPR speed error	<ul style="list-style-type: none"> <li>The set value of the OPR basic parameter "OPR speed" is outside the setting range.</li> <li>The set value of the OPR basic parameter "OPR speed" is smaller than the bias speed at start.</li> </ul>		
	984	Creep speed error	<ul style="list-style-type: none"> <li>The set value of the OPR basic parameter "Creep speed" is outside the setting range.</li> <li>The set value of the OPR basic parameter "Creep speed" is larger than the OPR speed.</li> <li>The set value of the OPR basic parameter "Creep speed" is smaller than the bias speed at start.</li> </ul>		
	985	OPR retry error	The set value of the OPR basic parameter "OPR retry" is outside the setting range.		
	991	Setting for the movement amount after near-point dog ON error	The set value of the OPR detailed parameter "Setting for the movement amount after near-point dog ON" is outside the setting range.		
	992	OPR acceleration time selection error	The set value of the OPR detailed parameter "OPR acceleration time selection" is outside the setting range.		
	993	OPR deceleration time selection error	The set value of the OPR detailed parameter "OPR deceleration time selection" is outside the setting range.		
	995	OPR torque limit value error	<ul style="list-style-type: none"> <li>The set value of the OPR detailed parameter "OPR torque limit value" is outside the setting range.</li> <li>The OPR detailed parameter "OPR torque limit value" has exceeded the detailed parameter 1 "Torque limit setting value".</li> </ul>		
997	Speed designation during OP shift error	The set value of the OPR detailed parameter "Speed designation during OP shift" is outside the setting range.			

	Related buffer memory address		Set range (Setting with sequence program)	Remedy
	LD77MH4	LD77MH16		
		69+150n	0, 1, 2, 3, 4	With the setting brought into the setting range, turn the PLC READY signal [Y0] from OFF to ON.
	30100+200n	28400+100n	3	
	70+150n		0, 1, 4, 5, 6	
	71+150n		0, 1	
	72+150n 73+150n		<ul style="list-style-type: none"> <li>• [mm] [inch] [PLS] -2147483648 to 2147483647</li> <li>• [degree] 0 to 35999999</li> </ul>	
	74+150n 75+150n		<p style="text-align: center;">&lt;OPR speed&gt;</p> <p style="text-align: center;">1 to 50000000 [PLS/s] 1 to 2000000000 [<math>\times 10^{-2}</math> mm/min or others]</p>	<ul style="list-style-type: none"> <li>• Bring the setting into the setting range.</li> <li>• Set the speed to the bias speed at start or higher. (Refer to Section 5.2.5)</li> </ul>
	76+150n 77+150n		<p style="text-align: center;">&lt;Creep speed&gt;</p> <p style="text-align: center;">1 to 50000000 [PLS/s] 1 to 2000000000 [<math>\times 10^{-2}</math> mm/min or others]</p>	<ul style="list-style-type: none"> <li>• Bring the setting into the setting range.</li> <li>• Set the speed to that below the OPR speed.</li> <li>• Set the value to the bias speed at start or higher. (Refer to Section 5.2.5)</li> </ul>
	78+150n		0, 1	With the setting brought into the setting range, turn the PLC READY signal [Y0] from OFF to ON.
	80+150n 81+150n		0 to 2147483647	
	82+150n		0, 1, 2, 3	
	83+150n		0, 1, 2, 3	
	86+150n		1 to 1000	
	88+150n		0, 1	

Classification of errors	Error code	Error name	Error	Operation status at error occurrence	
Parameter setting range errors	998	Operation setting for incompleteness of OPR error	The set value of the OPR detailed parameter "Operation setting for incompleteness of OPR" is outside the setting range.	The LD77 READY signal [X0] is not turned ON.	
	999	Operation cycle setting error	The set value of the expansion parameter "Operation cycle setting" is outside the setting range.		
Encoder errors	1201	OPR data incorrect	The backup data for absolute position restoration is illegal.	The operation continues.	
Absolute position	1205	SSCNTT communication error	Data received from servo amplifier is in error.	The operation continues.	

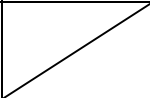
	Related buffer memory address		Set range (Setting with sequence program)	Remedy
	LD77MH4	LD77MH16		
	87+150n		0, 1	With the setting brought into the setting range, turn the PLC READY signal [Y0] from OFF to ON.
		105	0, 1	With the setting brought into the setting range, write to the flash ROM and switch the power on again or reset the PLC.
	—	—	—	Execute OPR.
	—	—	—	<ul style="list-style-type: none"> <li>• Check the SSCNETIII cable.</li> <li>• Check the servomotor and encoder cable.</li> <li>• Take measures against noise.</li> <li>• Check whether the rotation direction ( [Pr.114] Rotation direction selection ) is set "0 → 1" or "1 → 0" in the user program or the GX Works2. (Refer to Section 15.5)</li> </ul>

## 16.5.2 Servo amplifier detection error

The detection error list for servo amplifier is shown below.  
Refer to the "Servo amplifier Instruction Manual" for details.

Servo amplifier type	Instruction manual name
MR-J3-□B	SSCNETⅢ Compatible MR-J3-□B Servo amplifier Instruction Manual (SH-030051)
MR-J3W-□B	SSCNETⅢ interface 2-axis AC Servo Amplifier MR-J3W-□B Servo amplifier Instruction Manual (SH-030073)
MR-J3-□B-RJ004	SSCNETⅢ Compatible Linear Servo MR-J3-□B-RJ004 Instruction Manual (SH-030054)
MR-J3-□B-RJ006	SSCNETⅢ Compatible Fully Closed Loop Control MR-J3-□B-RJ006 Servo amplifier Instruction Manual (SH-030056)
MR-J3-□BS	SSCNETⅢ interface Drive Safety integrated MR-J3-□B Safety Servo amplifier Instruction Manual (SH-030084)

## (1) MR-J3-□B

Classification of errors	Error code	Servo amplifier LED display	Error name	Remarks
Servo amplifier errors	2010	10	Under voltage	
	2012	12	Memory error 1 (RAM)	
	2013	13	Clock error	
	2015	15	Memory error 2 (EEP-ROM)	
	2016	16	Encoder error 1 (At power on)	
	2017	17	Board error	
	2019	19	Memory error 3 (Flash-ROM)	
	2020	20	Encoder error 2 (Run time)	
	2021	21	Encoder error 3 (Run time)	
	2024	24	Main circuit error	
	2025	25	Absolute position erase	
	2030	30	Regenerative error	
	2031	31	Overspeed	
	2032	32	Overcurrent	
	2033	33	Overvoltage	
	2034	34	Receive error 1	
	2035	35	Command frequency error	
	2036	36	Receive error 2	
	2037	37	Parameter error	
	2045	45	Main circuit device over heated	
	2046	46	Servomotor overheate	
	2047	47	Cooling fan alarm	
	2050	50	Overload 1	
	2051	51	Overload 2	
2052	52	Error excessive		
2060	1A	Motor combination error		
2082	82	Master/slave operation error 1		
2088	888	Watchdog		
2907	1B	Converter alarm		
2921	3D	Driver communication parameter setting error		

(Note): The LED display is different when using the servo amplifiers with a large capacity.  
Refer to the "Servo amplifier Instruction Manual" for details.

## (2) MR-J3W-□B

Classification of errors	Error code	Servo amplifier LED display	Name	Details name	Remarks
Servo amplifier errors	2010	10.1	Undervoltage	Voltage drop in the control power	
		10.2		Voltage drop in the main circuit power	
	2011	11.1	Switch setting error	Rotary switch setting error	
		11.2		DIP switch setting error	
		11.3		Rotation/linear motor selection switch setting error	
				11.4	Rotation/linear motor selection switch setting error 2
	2012	12.1	Memory error 1 (RAM)	CPU built-in RAM error	
		12.2		CPU data RAM error	
		12.3		Custom IC RAM error	
	2013	13.1	Clock error	Clock error	
	2015	15.1	Memory error 2 (EEP-ROM)	EEP-ROM error at power on	
		15.2		EEP-ROM error during operation	
	2016	16.1	Encoder initial communication error 1	Encoder receive data error 1	
		16.2		Encoder receive data error 2	
		16.3		Encoder receive data error 3	
		16.5		Encoder transmission data error 1	
				16.6	Encoder transmission data error 2
		16.7		Encoder transmission data error 3	
	2017	17.1	Board error	AD converter error	
		17.2		Current feedback data error	
		17.3		Custom IC error	
		17.4		Amplifier detection signal error <sup>(Note)</sup>	
		17.5		Rotary switch error	
				17.6	DIPSW error
	2019	19.1	Memory error 3 (Flash ROM)	Flash-ROM error 1	
		19.2		Flash-ROM error 2	
	2020	20.1	Encoder normal communication error 1	Encoder receive data error 1	
		20.2		Encoder receive data error 2	
		20.3		Encoder receive data error 3	
		20.5		Encoder transmission data error 1	
20.6				Encoder transmission data error 2	
20.7		Encoder transmission data error 3			
2021	21.1	Encoder normal communication error 2	Encoder data error		
	21.2		Encoder data update error		
2024	24.1	Main circuit error	Ground fault detected at hardware detection circuit		
	24.2		Ground fault detected at software detection function		
2025	25.1	Absolute position erase	Absolute position data erase		

(Note): The details name is different when using the linear servo motors.  
Refer to the "Servo amplifier Instruction Manual" for details.



Classification of errors	Error code	Servo amplifier LED display	Name	Details name	Remarks
Servo amplifier errors	2027	27.1	Initial magnetic pole detection error	Magnetic pole detection abnormal termination	Linear servo motor use
		27.2		Magnetic pole detection time out error	
		27.3		Magnetic pole detection limit switch error	
		27.4		Magnetic pole detection estimated error	
		27.5		Magnetic pole detection position deviation error	
		27.6		Magnetic pole detection speed deviation error	
		27.7		Magnetic pole detection current error	
	2028	28.1	Linear encoder error 2	Linear encoder environment error	
	2030	30.1	Regenerative error	Regeneration heat error	
		30.2		Regenerative transistor error	
		30.4		Regenerative transistor feedback data error	
	2031	31.1	Overspeed	Abnormal motor rotation number <sup>(Note)</sup>	
	2032	32.1	Overcurrent	Overcurrent detected at hardware detection circuit (during operation).	
		32.2		Overcurrent detected at software detection function (during operation).	
		32.3		Overcurrent detected at hardware detection circuit (during a stop).	
		32.4		Overcurrent detected at software detection function (during a stop).	
	2033	33.1	Overvoltage	Main circuit voltage error	
	2034	34.1	SSCNET receive error 1	SSCNET receive data error	
		34.2		SSCNET communication connector connection error	
		34.3		Communication data error	
		34.4		Hardware error signal detection	
	2035	35.1	Command frequency error	Command frequency error	
	2036	36.1	SSCNET receive error 2	Continuous communication data error	
	2037	37.1	Parameter error	Parameter setting range error	
		37.2		Parameter combination error	
	2042	42.1	Linear servo control error	Linear servo control error on the positioning detection	Linear servo motor use
		42.2		Linear servo control error on the speed detection	
42.3		Linear servo control error on the thrust detection			
2045	45.1	Main circuit device overheat	Main circuit abnormal temperature		
	45.2		Board temperature error		
2046	46.1	Servo motor overheat	Abnormal temperature of servo motor <sup>(Note)</sup>		
2047	47.1	Cooling fan error	Cooling fan stop error		
	47.2		Decreased cooling fan speed error		

(Note): The details name is different when using the linear servo motors. Refer to the "Servo amplifier Instruction Manual" for details.

Classification of errors	Error code	Servo amplifier LED display	Name	Details name	Remarks
Servo amplifier errors	2050	50.1	Overload 1	Thermal overload error 1 during operation	
		50.2		Thermal overload error 2 during operation	
		50.3		Thermal overload error 4 during operation	
		50.4		Thermal overload error 1 during a stop	
		50.5		Thermal overload error 2 during a stop	
		50.6		Thermal overload error 4 during a stop	
	2051	51.1	Overload 2	Thermal overload error 3 during operation	
		51.2		Thermal overload error 3 during a stop	
	2052	52.3	Error excessive	Excess droop pulse existing between the model position and the actual servo motor position	
		52.4		Maximum deviation at 0 torque limit	
	2060	1A.1	Motor combination error	Motor combination error	
	2061	2A.1	Linear encoder error 1	Linear encoder side error 1	Linear servo motor use
		2A.2		Linear encoder side error 2	
		2A.3		Linear encoder side error 3	
		2A.4		Linear encoder side error 4	
		2A.5		Linear encoder side error 5	
		2A.6		Linear encoder side error 6	
2A.7		Linear encoder side error 7			
2A.8		Linear encoder side error 8			
2063	1E.1	Encoder initial communication error 2	Encoder failure		
2064	1F.1	Encoder initial communication error 3	Incompatible encoder		
2088	888	Watchdog	—		

(Note): The details name is different when using the linear servo motors.  
Refer to the "Servo amplifier Instruction Manual" for details.

## (3) MR-J3-□B-RJ004 (For linear servo)

Classification of errors	Error code	Servo amplifier LED display	Name	Remarks
Servo amplifier errors	2010	10	Undervoltage	
	2012	12	Memory error 1 (RAM)	
	2013	13	Clock error	
	2015	15	Memory error 2 (EEP-ROM)	
	2016	16	Encoder error 1 (At power on)	
	2017	17	Board error	
	2019	19	Memory error 3 (Flash ROM)	
	2020	20	Encoder error 2	
	2024	24	Main circuit error	
	2027	27	Initial magnetic pole detection error	
	2028	28	Linear encoder error 2	
	2030	30	Regenerative error	
	2031	31	Overspeed	
	2032	32	Overcurrent	
	2033	33	Overvoltage	
	2034	34	Receive error 1	
	2035	35	Command frequency alarm	
	2036	36	Receive error 2	
	2037	37	Parameter error	
	2042	42	Linear servo control error	
	2045	45	Main circuit device overheat	
	2046	46	Linear servo motor overheat	
	2047	47	Cooling fan alarm	
	2050	50	Overload 1	
	2051	51	Overload 2	
	2052	52	Error excessive	
2061	2A	Linear encoder error 1		
2088	888	Watchdog		

## (4) MR-J3-□B-RJ006 (For fully closed control)

Classification of errors	Error code	Servo amplifier LED display	Name	Remarks
Servo amplifier errors	2010	10	Undervoltage	
	2012	12	Memory error 1 (RAM)	
	2013	13	Clock error	
	2015	15	Memory error 2 (EEP-ROM)	
	2016	16	Encoder error 1 (At power on)	
	2017	17	Board error	
	2019	19	Memory error 3 (Flash ROM)	
	2020	20	Encoder error 2 (During runtime)	
	2021	21	Encoder error 3 (During runtime)	
	2024	24	Main circuit error	
	2028	28	Linear encoder error 2	
	2030	30	Regenerative error	
	2031	31	Overspeed	
	2032	32	Overcurrent	
	2033	33	Overvoltage	
	2034	34	Receive error 1	
	2035	35	Command frequency alarm	
	2036	36	Receive error 2	
	2037	37	Parameter error	
	2042	42	Fully closed control error detection	
	2045	45	Main circuit device overheat	
	2046	46	Servo motor overheat	
	2047	47	Cooling fan alarm	
	2050	50	Overload 1	
	2051	51	Overload 2	
	2052	52	Error excessive	
	2060	1A	Motor combination error	
	2061	2A	Linear encoder error 1	
2070	70	Load side encoder error 1		
2071	71	Load side encoder error 2		
2088	888	Watchdog		

## (5) MR-J3-□B-RJ080W (For direct drive motor)

Classification of errors	Error code	Servo amplifier LED display	Name	Remarks
Servo amplifier errors	2010	10	Undervoltage	
	2012	12	Memory error 1 (RAM)	
	2013	13	Clock error	
	2015	15	Memory error 2 (EEP-ROM)	
	2016	16	Encoder error 1	
	2017	17	Board error	
	2019	19	Memory error 3 (Flash ROM)	
	2020	20	Encoder error 2	
	2021	21	Encoder error 3	
	2024	24	Main circuit error	
	2025	25	Absolute position erase	
	2027	27	Initial magnetic pole detection error	
	2030	30	Regenerative error	
	2031	31	Overspeed	
	2032	32	Overcurrent	
	2033	33	Overvoltage	
	2034	34	Receive error 1	
	2035	35	Command frequency alarm	
	2036	36	Receive error 2	
	2037	37	Parameter error	
	2042	42	Servo control error	
	2045	45	Main circuit device overheat	
	2046	46	Direct drive motor overheat	
	2047	47	Cooling fan alarm	
	2050	50	Overload 1	
	2051	51	Overload 2	
2052	52	Error excessive		
2060	1A	Motor combination error		
2064	1F	Encoder combination error		
2088	888	Watchdog		
2913	2B	Encoder counter error		

## (6) MR-J3-□BS (For safety servo)

Classification of errors	Error code	Servo amplifier LED display	Name	Remarks
Servo amplifier errors	2010	10	Undervoltage	
	2012	12	Memory error 1 (RAM)	
	2013	13	Clock error	
	2015	15	Memory error 2 (EEP-ROM)	
	2016	16	Encoder error 1 (At power on)	
	2017	17	Board error	
	2019	19	Memory error 3 (Flash ROM)	
	2020	20	Encoder error 2 (during runtime)	
	2021	21	Encoder error 3 (during runtime)	
	2024	24	Main circuit error	
	2025	25	Absolute position erase	
	2028	28	Linear encoder error 2	
	2030	30	Regenerative error	
	2031	31	Overspeed	
	2032	32	Overcurrent	
	2033	33	Overvoltage	
	2034	34	Receive error 1	
	2035	35	Command frequency error	
	2036	36	Receive error 2	
	2037	37	Parameter error	
	2042	42	Fully closed control error detection	
	2045	45	Main circuit device overheat	
	2046	46	Servo motor overheat	
	2047	47	Cooling fan error	
	2050	50	Overload 1	
	2051	51	Overload 2	
	2052	52	Error excessive	
	2056	56	Forced stop error	
	2070	70	Load side encoder error 1	
	2071	71	Load side encoder error 2	
2060	1A	Motor combination error		
2061	2A	Linear encoder error 1		
2063	63	STO timing error		
2088	888	Watchdog		

## 16.6 List of warnings

The following table shows the warning details and remedies to be taken when a warning occurs.

## 16.6.1 LD77MH detection warning

Classification of warnings	Warning code	Warning name	Warning	Operation status at warning occurrence	
—	000	(Normal status)	—	—	
Common warnings	100	Start during operation	<ul style="list-style-type: none"> <li>The start request is issued while the axis is BUSY.</li> <li>Positioning was started during speed control mode/torque control mode.</li> </ul>	Position control mode: The operation continues. Speed control mode/torque control mode: The operation continues. (Positioning start is not executed.)	
	104	Restart not possible	The restart command is issued when the axis operation status is not "Stopped".	Continue the operation.	
	109	Teaching in BUSY	The teaching request is issued while the axis is BUSY.	The warning is issued for the axis designated at the time of the teaching request.	
	110	Less than minimum speed	The overridden speed becomes "0".	The system is controlled with the currently executing unit of 1.	
	111	In PLC READY	The request for writing to the flash ROM is issued when the PLC READY is turned ON.	The warning for axis 1 is issued.	
	112	Illegal override value	A value other than 1 to 300 is set for the override value.	<ul style="list-style-type: none"> <li>Controlled at a setting value of 0 : 100.</li> <li>Controlled at a setting value of 301 or over : 300.</li> </ul>	
	113	Outside new torque value range/outside forward new torque value range	A new torque value/forward new torque value is exceeded the torque limit setting value. (Note): When the individual setting is used for new torque value and reverse new torque value, it indicates outside forward new torque value.	The torque change is not carried out.	
	114	Below bias speed	The command speed is below the bias speed at start.	Operate by the bias speed at start.	
	115	Outside reverse new torque value range	A reverse new torque value is exceeded the torque limit setting value.	The torque change is not carried out.	

	Related buffer memory address		Set range (Setting with sequence program)	Remedy
	LD77MH4	LD77MH16		
	—	—	—	—
	—	—	—	<ul style="list-style-type: none"> <li>• Normalize the start request ON timing.</li> <li>• When in speed control mode/torque control mode, start positioning after switching to the position control mode.</li> </ul>
	1503+100n	4303+100n	<Restart command> 1: Restart	Normalize the start request ON timing. (Refer to Section 6.5.5) (Do not issue the restart command when the axis operation is not stopped.)
	1548+100n 1549+100n	4348+100n 4349+100n	<Teaching data selection> 0, 1 <Teaching positioning data No.> 1 to 600	Carry out the teaching request when the axis is not BUSY. (Refer to Section 13.7.4)
	1513+100n	4313+100n	<Positioning operation speed override> 1 to 300	Prevent the overridden speed from being reduced to 0. (Refer to Section 13.5.2)
	Same as warning code 109			Request to write when the PLC READY signal [Y0] is OFF.
	1513+100n	4313+100n	<Positioning operation speed override> 1 to 300	Set a value within the setting range.
	1525+100n	4325+100n	<New torque value/forward new torque value > 0 to [Torque limit setting value]	Set a new torque value or a forward new torque value less than the limit value.
	26+150n		<Torque limit setting value> 1 to 1000	
	Refer to Section 5.3 "List of positioning data" for command speed		<Command speed> 1 to 50000000 [PLS/s] 1 to 2000000000 [ $\times 10^{-2}$ mm/min or another]	Re-set the command speed/bias speed at start so that the command speed is equal to or larger than the bias speed at start.
	Bias speed at start		<Bias speed at start> 0 [PLS/s] 0 [ $\times 10^{-2}$ mm/min or another]	
	6+150n 7+150n			
	1564+100n	4364+100n	<Reverse new torque value> 0 to [Torque limit setting value]	Set a value which does not exceed the torque limit setting value as the reverse new torque value.
	26+150n		<Torque limit setting value> 1 to 1000	



Classification of warnings	Warning code	Warning name	Warning	Operation status at warning occurrence	
Common warnings	116	Optional data monitor data type setting error	In the optional data monitor, 2-word data is not set correctly.	Monitoring is not carried out. "0" is stored in <u>Md.109</u> to <u>Md.112</u> (Optional data monitor output 1 to 4).	
	120	Control mode switching during BUSY	Control mode switching was executed from the position control mode to the speed control mode/torque control mode while BUSY was turned ON.	The control mode is not switched. (Positioning during operation continues.)	
	121	Control mode switching during zero speed OFF	Control mode was changed when "Zero Speed" ( <u>Md.108</u> Servo status) was turned OFF.	The control mode is not switched. (Current operation continues.)	
	122	Outside control mode range	Control mode switching request was performed by specifying a value outside the range for " <u>Cd.139</u> Control mode setting".		
	123	Control mode switching	Control mode switching request was performed during the control mode switching.	Control mode switching request is not accepted.	
JOG operation warnings	300	Speed change during deceleration	The speed change request is issued during deceleration stop with JOG start signal OFF.	The speed change is not carried out.	
	301	JOG speed limit value	<ul style="list-style-type: none"> <li>The JOG speed <sup>(Note-1)</sup> is exceeded the speed limit value at start.</li> <li>The new speed value <sup>(Note-1)</sup> exceeds the JOG speed limit value when the speed is changed during operation.</li> </ul> (Note-1): This speed is a value in which override value is considered when override function is used. (" <u>Cd.13</u> Positioning operation speed override" is set other than 100[%].)	<ul style="list-style-type: none"> <li>When the speed exceeds the JOG speed limit, the JOG operation is carried out with the JOG speed limit value.</li> <li>While the speed is limited by the JOG speed limit value, the "<u>Md.39</u> In speed limit flag" is turned ON.</li> </ul>	
Manual pulse generator operation warnings	401	Outside manual pulse generator input magnification range	The manual pulse generator 1 pulse input magnification is set to 0, 10001 or more, or negative value.	<ul style="list-style-type: none"> <li>When input magnification is set at 10001 or more, or negative value: Re-set to 10000.</li> <li>When input magnification is set at 0: Re-set to 1.</li> </ul>	

Related buffer memory address		Set range (Setting with sequence program)	Remedy		
LD77MH4	LD77MH16				
Optional data monitor: Data type setting 1	100+150n	—	Set the 2-word data to "[Pr.91] Optional data monitor: Data type setting 1" or "[Pr.93] Optional data monitor: Data type setting 3" and 0 to "[Pr.92] Optional data monitor: Data type setting 2" or "[Pr.94] Optional data monitor: Data type setting 4".		
Optional data monitor: Data type setting 2	101+150n				
Optional data monitor: Data type setting 3	102+150n				
Optional data monitor: Data type setting 4	103+150n				
—	—			—	Switch the control mode after turning BUSY OFF.
—	—			—	Switch the control mode after turning "Zero Speed" ([Md.108] Servo status) ON.
1575+100n	4375+100n			<Control mode setting> 0, 10, 20	Switch the control mode after setting a value within the range for "[Cd.139] Control mode setting".
—	—	—	Carry out the control mode switching request after completing the control mode switching.		
JOG speed		<JOG speed> 1 to 50000000 [PLS/s] 1 to 2000000000 [ $\times 10^{-2}$ mm/min or another]	Do not carry out the JOG speed change during deceleration with the JOG start signal OFF.		
1518+100n 1519+100n	4318+100n 4319+100n				
New speed value		<New speed value> 0 to 50000000 [PLS/s] 0 to 2000000000 [ $\times 10^{-2}$ mm/min or another]	Bring the set value into the setting range.		
1514+100n 1515+100n	4314+100n 4315+100n				
JOG speed limit value		<JOG speed limit value> 1 to 50000000 [PLS/s] 1 to 2000000000 [ $\times 10^{-2}$ mm/min or another]			
48+150n 49+150n					
Positioning operation speed override		< Positioning operation speed override > 1 to 300 [%]			
1513+100n	4313+100n				
1522+100n 1523+100n	4322+100n 4323+100n	<Manual pulse generator 1 pulse input magnification> 1 to 1000	Set the manual pulse generator 1 pulse input magnification to within the setting range.		

Classification of warnings	Warning code	Warning name	Warning	Operation status at warning occurrence	
Positioning operation warnings	500	Deceleration/stop speed change	The speed change request is issued during deceleration stop.	The speed change is not carried out.	
	501	Speed limit value over	<ul style="list-style-type: none"> <li>• Setting speeds <sup>(Note-2)</sup> exceed the speed limit value when starting/restarting the positioning or when changing the speed at the positioning <sup>(Note-1)</sup>. (At the interpolation control, either of reference axes or interpolation axes exceed the speed limit value.)</li> <li>• "[Cd.140] Command speed at speed control mode" exceeds "[Pr.8] Speed limit value" during the speed control mode.</li> <li>• "[Cd.146] Speed limit value at torque control mode" exceeds "[Pr.8] Speed limit value" during the torque control mode.</li> </ul> <p>(Note-1): The speed change by position-speed switching control, target position change function, or override function is contained.</p> <p>(Note-2): This speed is a value in which override value is considered when override function is used. (" [Cd.13] Positioning operation speed override" is set other than 100[%].)</p>	<p>[Position control mode]</p> <ul style="list-style-type: none"> <li>• The speed is controlled with the speed limit value.</li> <li>• The "[Md.39] In speed limit flag" is turned ON.</li> </ul> <p>[Speed control mode/Torque control mode]</p> <ul style="list-style-type: none"> <li>• The speed is controlled with the speed limit value. (The "[Md.39] In speed limit flag" is not turned ON.)</li> </ul>	
	503	M code ON signal ON start	The M code ON signal is turned ON when the positioning data is executed.	Continue executing the positioning data.	
	505	No operation termination setting	In the positioning by block starting, the 50th point of the positioning start data is set to CONTINUE.	The operation is terminated.	
	506	FOR to NEXT nest construction	FOR to NEXT is nested.		
508	Speed-position switching (during acceleration) signal ON	The switching signal for speed-position switching control (INC mode) is turned ON during acceleration.	The operation is continued.		

Related buffer memory address		Set range (Setting with sequence program)	Remedy
LD77MH4	LD77MH16		
1516+100n	4316+100n	<Speed change request> 1: Speed change is requested	Do not carry out the speed change during deceleration with a stop command, during stoppage, or during automatic deceleration with position control.
OPR speed		<OPR speed> 1 to 50000000 [PLS/s] 1 to 2000000000 [ $\times 10^{-2}$ mm/min or another]	Review each speed so that setting speeds do not exceed the speed limit value.
74+150n 75+150n			
Command speed		<Command speed> 1 to 50000000 [PLS/s] 1 to 2000000000 [ $\times 10^{-2}$ mm/min or another]	
Refer to Section 5.3 "List of positioning data"			
New speed value		<New speed value> 0 to 50000000 [PLS/s] 0 to 2000000000 [ $\times 10^{-2}$ mm/min or another]	
1514+100n	4314+100n		
1515+100n	4315+100n		
Position-speed switching control speed change register		<Position-speed switching control speed change register> 0 to 50000000 [PLS/s] 0 to 2000000000 [ $\times 10^{-2}$ mm/min or another]	
1530+100n	4330+100n		
1531+100n	4331+100n		
Target position change value (New speed)		<Target position change value (New speed)> 0 to 50000000 [PLS/s] 0 to 2000000000 [ $\times 10^{-2}$ mm/min or another]	
1536+100n	4336+100n		
1537+100n	4337+100n		
Speed limit value		<JOG speed limit value> 1 to 50000000 [PLS/s] 1 to 2000000000 [ $\times 10^{-2}$ mm/min or another]	
10+150n 11+150n			
Positioning operation speed override		<Positioning operation speed override> 1 to 300[%]	
1513+100n	4313+100n		
Command speed at speed control mode		<Command speed at speed control mode> -50000000 to 50000000 [PLS/s] -2000000000 to 2000000000 [ $\times 10^{-2}$ mm/min or another]	
1576+100n	4376+100n		
1577+100n	4377+100n		
Speed limit value at torque control mode		<Speed limit value at torque control mode> 0 to 50000000 [PLS/s] 0 to 2000000000 [ $\times 10^{-2}$ mm/min or another]	
1584+100n	4384+100n		
1585+100n	4385+100n		
1504+100n	4304+100n	<M code OFF request> 1: M code ON signal is turned OFF	Normalize the ON and OFF timings of the "M code OFF request". (Refer to Section 13.7.3)
Refer to Section 5.3 "List of positioning data"		<Operation pattern> 00: Positioning end 01: Continuous positioning control 11: Continuous path control	Set the operation termination to the 50th point. (Refer to Chapter 10)
—	—	—	Make 1 nest construction for FOR to NEXT. (Refer to Section 10.3.8)
—	—	—	Do not turn ON the speed-position switching signal during acceleration. (Refer to Section 9.2.16)

Classification of warnings	Warning code	Warning name	Warning	Operation status at warning occurrence	
Positioning operation warnings	509	Insufficient remaining distance	<ul style="list-style-type: none"> <li>At a continuous operation interrupt request, the distance required deceleration stop is not long enough.</li> <li>At a speed change request, the remaining distance is shorter than the distance required for speed change.</li> </ul>	<ul style="list-style-type: none"> <li>When a command speed is changed: Change to a value as near a new speed value as possible.</li> <li>When a target position is changed: Adjust the speed to a value as near the command speed as possible, and then change to a target position.</li> </ul> (When the operation pattern is a continuous path control, ignore the operations stated above.)	
	511	Step not possible	Code 1 is set for the step start information when the step is outside standby.	The step will not start.	
	512	Illegal external command function	The detailed parameter 2 "External command function selection" setting range is exceeded.	Even if the external command signal is turned ON, the system will not perform anything.	
	513	Insufficient movement amount	The movement amount is not large enough for automatic deceleration.	The system stops immediately after it reaches the positioning address.	
	514	Outside command speed range	<ul style="list-style-type: none"> <li>The speed change value is outside the setting range when changing the speed during operation <sup>(Note-1)</sup></li> <li>"[Cd.140] Command speed at speed control mode" is outside the setting range during the speed control mode.</li> <li>"[Cd.146] Speed limit value at torque control mode" is outside the setting range during the torque control mode.</li> </ul> (Note-1): The speed change by position-speed switching control or target position change function is contained.	<ul style="list-style-type: none"> <li>The speed change value is controlled as the "maximum value within the setting range".</li> <li>The "[Md.39] In speed limit flag" is turned ON.</li> </ul>	
	516	Illegal teaching data No.	The positioning data No. is set outside the setting range.	Teaching is not carried out when the set value is 0 or 601 or more. (The set value is automatically reset to "0" by the LD77MH even when a "0" or "601" or more is set.)	
	517	Illegal teaching data selection	The teaching data selection set value is outside the setting range.	Teaching is not carried out.	

	Related buffer memory address		Set range (Setting with sequence program)	Remedy
	LD77MH4	LD77MH16		
	—	—	—	Give a request at the position where there is an enough remaining distance.
	1546+100n	4346+100n	<Step start information> 1: Step is continued 2: Re-start is carried out	Do not set a "1" to the step start information when the step is not in standby state. (Refer to Section 13.7.1)
	62+150n		<External command function selection> 0, 1, 2, 3	Set the detailed parameter 2 "External command function selection" to within the setting range.
	Refer to Section 5.3 "List of positioning data"		—	Set a decelerating address or a movement amount to the positioning data.
	New speed value		<New speed value> 0 to 50000000 [PLS/s] 0 to 2000000000 [ $\times 10^{-2}$ mm/min or another]	<ul style="list-style-type: none"> <li>• Set the speed change value to within the setting range.</li> <li>• Set "[Cd.140] Command speed at speed control mode" to within the setting range during the speed control mode.</li> <li>• Set "[Cd.146] Speed limit value at torque control mode" to within the setting range during the torque control mode.</li> </ul>
	1514+100n	4314+100n		
	1515+100n	4315+100n		
	Position-speed switching control speed change register		<Position-speed switching control speed change register> 0 to 50000000 [PLS/s] 0 to 2000000000 [ $\times 10^{-2}$ mm/min or another]	
	1530+100n	4330+100n		
	1531+100n	4331+100n		
	Target position change value (New speed)		<Target position change value (New speed)> 0 to 50000000 [PLS/s] 0 to 2000000000 [ $\times 10^{-2}$ mm/min or another]	
	1536+100n	4336+100n		
	1537+100n	4337+100n		
	Command speed at speed control mode		<Command speed at speed control mode> -50000000 to 50000000 [PLS/s] -2000000000 to 2000000000 [ $\times 10^{-2}$ mm/min or another]	
	1576+100n	4376+100n		
	1577+100n	4377+100n		
	Speed limit value at torque control mode		<Speed limit value at torque control mode> 0 to 50000000 [PLS/s] 0 to 2000000000 [ $\times 10^{-2}$ mm/min or another]	
	1584+100n	4384+100n		
	1585+100n	4385+100n		
	1549+100n	4349+100n	<Teaching positioning data No.> 1 to 600	Set the positioning data No. to within the setting range.
	1548+100n	4348+100n	<Teaching data selection> 0, 1	Set the teaching data selection set value to within the setting range.

Classification of warnings	Warning code	Warning name	Warning	Operation status at warning occurrence	
Positioning operation warnings	518	Target position change not possible	<ul style="list-style-type: none"> <li>• A target position change request was given for the control system other than ABS1 and INC1.</li> <li>• A target position change request is turned ON during continuous path control.</li> <li>• A new target position address is outside the software stroke limit range.</li> <li>• A target position change request was given during deceleration to a stop.</li> <li>• A target position change request was issued when speed change 0 flag (<b>[Md.31]</b> Status: b10) was ON.</li> </ul>	The target position change is not carried out.	
	520	Torque limit value over	A value exceeding " <b>[Pr.17]</b> Torque limit setting value" is set to " <b>[Cd.143]</b> Command torque at torque control mode" at torque control mode.	The torque is controlled with the torque limit setting value.	

	Related buffer memory address		Set range (Setting with sequence program)	Remedy
	LD77MH4	LD77MH16		
	1538+100n	4338+100n	<Target position change request flag> 1: Target position change request	<ul style="list-style-type: none"> <li>• Do not turn ON the target position change request in the following cases.               <ol style="list-style-type: none"> <li>1) An operating pattern "continuous path control" is used.</li> <li>2) A control system other than ABS1, and INC1 is used.</li> <li>3) During deceleration stop.</li> <li>4) When speed change 0 flag (<span style="border: 1px solid black; padding: 0 2px;">Md.31</span>Status: b10) is ON.</li> </ol> </li> <li>• When the target position change address is outside the software stroke limit range, correct the target position change address. (Refer to Section 13.5.5)</li> </ul>
	Command torque at torque control mode		<Command torque at torque control mode> -10000 to 10000 [ $\times 10^{-1}\%$ ]	Review the setting value so that the setting torque is not exceeded the torque limit setting value.
	1580+100n	4380+100n		
	Torque limit setting value		<Torque limit setting value> 1 to 1000[%]	
	26+150n			



## 16.6.2 Servo amplifier detection warning

The detection warning list for Servo amplifier is shown below.

Refer to the "Servo amplifier Instruction Manual" for details.

Servo amplifier type	Instruction manual name
MR-J3-□B	SSCNETⅢ Compatible MR-J3-□B Servo amplifier Instruction Manual (SH-030051)
MR-J3W-□B	SSCNETⅢ interface 2-axis AC Servo Amplifier MR-J3W-□B Servo amplifier Instruction Manual (SH-030073)
MR-J3-□B-RJ004	SSCNETⅢ Compatible Linear Servo MR-J3-□B-RJ004 Instruction Manual (SH-030054)
MR-J3-□B-RJ006	SSCNETⅢ Compatible Fully Closed Loop Control MR-J3-□B-RJ006 Servo amplifier Instruction Manual (SH-030056)
MR-J3-□BS	SSCNETⅢ interface Drive Safety integrated MR-J3-□B Safety Servo amplifier Instruction Manual (SH-030084)

## (1) MR-J3-□B

Classification of warnings	Warning code	Servo amplifier LED display	Warning name	Remarks
Servo amplifier warnings	2102	92	Open battery cable warning	
	2106	96	Home position setting warning	
	2116	9F	Battery warning	
	2140	E0	Excessive regenerative load warning	
	2141	E1	Over load warning1	
	2143	E3	Absolute position counter warning	
	2144	E4	Parameter warning	
	2146	E6	Servo forced stop warning	
	2147	E7	Controller forced stop warning	
	2148	E8	Cooling fan speed reduction warning	
	2149	E9	Main circuit of warning	
	2152	EC	Overload warning 2	
	2153	ED	Output watt excess warning	
2956	9C	Converter warning		

## (2) MR-J3W-□B

Classification of warnings	Warning code	Servo amplifier LED display	Name	Details name	Remarks
Servo amplifier warnings	2101	91.1	Main circuit device overheat warning	Main circuit device overheat warning	
		91.2		Board temperature warning	
	2102	92.1	Battery cable disconnection warning	Encoder battery disconnection warning signal detection	
	2106	96.1	Home position setting warning	INP error at home positioning	
		96.2		Command input error at home positioning	
	2116	9F.1	Battery warning	Low battery	
	2140	E0.1	Excessive regeneration warning	Excessive regeneration warning	
	2141	E1.1	Overload warning 1	Thermal overload warning 1 during operation	
		E1.2		Thermal overload warning 2 during operation	
		E1.3		Thermal overload warning 3 during operation	
		E1.4		Thermal overload warning 4 during operation	
		E1.5		Thermal overload warning 1 during a stop	
		E1.6		Thermal overload warning 2 during a stop	
		E1.7		Thermal overload warning 3 during a stop	
		E1.8		Thermal overload warning 4 during a stop	
	2142	E2.1	Linear servo motor overheat warning	Linear servo motor overheat warning	Linear servo motor use
	2143	E3.1	Absolute position counter warning	Multi-revolution counter movement amount excess warning	
		E3.2		Absolute positioning counter error	
	2144	E4.1	Parameter warning	Parameter setting range error warning	
	2146	E6.1	Servo forced stop warning	Forced stop warning	
	2147	E7.1	Controller forced stop warning	Controller forced stop warning	
2148	E8.1	Cooling fan speed reduction warning	Decreased cooling fan speed warning		
2149	E9.1	Main circuit off warning	Servo-on signal on at main circuit off		
	E9.2		Bus voltage drop during low speed operation <sup>(Note)</sup>		
2151	EB.1	The other axis fault warning	The other axis fault warning		
2152	EC.1	Overload warning 2	Overload warning 2		
2153	ED.1	Output watt excess warning	Output watt excess		

(Note): The details name is different when using the linear servo motors.  
Refer to the "Servo amplifier Instruction Manual" for details.

## (3) MR-J3-□B-RJ004 (For linear servo)

Classification of warnings	Warning code	Servo amplifier LED display	Name	Remarks
Servo amplifier warnings	2106	96	Home position setting error	
	2140	E0	Excessive regeneration warning	
	2141	E1	Overload warning 1	
	2142	E2	Linear servo motor overheat warning	
	2144	E4	Parameter warning	
	2146	E6	Servo forced stop warning	
	2147	E7	Controller emergency stop warning	
	2148	E8	Cooling fan speed reduction warning	
	2149	E9	Main circuit off warning	
	2152	EC	Overload warning 2	
2153	ED	Output watt excess warning		

## (4) MR-J3-□B-RJ006 (For fully closed control)

Classification of warnings	Warning code	Servo amplifier LED display	Name	Remarks
Servo amplifier warnings	2106	96	Home position setting error	
	2140	E0	Excessive regeneration warning	
	2141	E1	Overload warning 1	
	2144	E4	Parameter warning	
	2146	E6	Servo forced stop warning	
	2147	E7	Controller emergency stop warning	
	2148	E8	Cooling fan speed reduction warning	
	2149	E9	Main circuit off warning	
	2152	EC	Overload warning 2	
2153	ED	Output watt excess warning		

## (5) MR-J3-□B-RJ080W (For direct drive motor)

Classification of warnings	Warning code	Servo amplifier LED display	Name	Remarks
Servo amplifier warnings	2102	92	Battery cable disconnection warning	
	2106	96	Home position setting error	
	2116	9F	Battery warning	
	2140	E0	Excessive regeneration warning	
	2141	E1	Overload warning 1	
	2142	E2	Direct drive motor overheat	
	2143	E3	Absolute position counter warning	
	2144	E4	Parameter warning	
	2146	E6	Servo forced stop warning	
	2147	E7	Controller emergency stop warning	
	2148	E8	Cooling fan speed reduction warning	
	2149	E9	Main circuit off warning	
	2152	EC	Overload warning 2	
2153	ED	Output watt excess warning		

## (6) MR-J3-□BS (For safety servo)

Classification of warnings	Warning code	Servo amplifier LED display	Name	Remarks
Servo amplifier warnings	2095	95	STO warning	
	2102	92	Battery cable disconnection warning	
	2106	96	Home position setting warning	
	2116	9F	Battery warning	
	2140	E0	Excessive regeneration warning	
	2141	E1	Overload warning 1	
	2143	E3	Absolute position counter warning	
	2144	E4	Parameter warning	
	2146	E6	Servo forced stop warning	
	2147	E7	Controller forced stop warning	
	2148	E8	Cooling fan speed reduction warning	
	2149	E9	Main circuit off warning	
	2152	EC	Overload warning 2	
	2153	ED	Output watt excess warning	



# Appendices

Appendix 1 Positioning data (No.1 to 600) List of buffer memory addresses (LD77MH4).....	Appendix- 2
Appendix 2 Connection with servo amplifiers.....	Appendix- 26
Appendix 2.1 Connection of SSCNET III cables .....	Appendix- 26
Appendix 2.2 Wiring of SSCNET III cables .....	Appendix- 27
Appendix 3 Connection with external device.....	Appendix- 31
Appendix 3.1 Connector.....	Appendix- 31
Appendix 3.2 External input signal cable.....	Appendix- 34
Appendix 4 Comparisons with positioning modules.....	Appendix- 37
Appendix 4.1 Comparisons with LD75P/D model .....	Appendix- 37
Appendix 4.2 Differences with QD75MH models.....	Appendix- 38
Appendix 5 When using GX Works2 .....	Appendix- 45
Appendix 6 When using GX Developer or GX Configurator-QP .....	Appendix- 46
Appendix 6.1 Operation of GX Developer.....	Appendix- 46
Appendix 6.2 Operation of GX Configurator-QP .....	Appendix- 46
Appendix 7 Positioning control troubleshooting .....	Appendix- 47
Appendix 8 List of buffer memory addresses .....	Appendix- 53
Appendix 9 External dimension drawing .....	Appendix- 71

Appendix 1 Positioning data (No.1 to 600)  
List of buffer memory addresses (LD77MH4)

(1) For axis 1

Data No.	Positioning identifier	M code	Dwell time	Command speed		Positioning address		Arc data	
				Low-order	High-order	Low-order	High-order	Low-order	High-order
1	2000	2001	2002	2004	2005	2006	2007	2008	2009
2	2010	2011	2012	2014	2015	2016	2017	2018	2019
3	2020	2021	2022	2024	2025	2026	2027	2028	2029
4	2030	2031	2032	2034	2035	2036	2037	2038	2039
5	2040	2041	2042	2044	2045	2046	2047	2048	2049
6	2050	2051	2052	2054	2055	2056	2057	2058	2059
7	2060	2061	2062	2064	2065	2066	2067	2068	2069
8	2070	2071	2072	2074	2075	2076	2077	2078	2079
9	2080	2081	2082	2084	2085	2086	2087	2088	2089
10	2090	2091	2092	2094	2095	2096	2097	2098	2099
11	2100	2101	2102	2104	2105	2106	2107	2108	2109
12	2110	2111	2112	2114	2115	2116	2117	2118	2119
13	2120	2121	2122	2124	2125	2126	2127	2128	2129
14	2130	2131	2132	2134	2135	2136	2137	2138	2139
15	2140	2141	2142	2144	2145	2146	2147	2148	2149
16	2150	2151	2152	2154	2155	2156	2157	2158	2159
17	2160	2161	2162	2164	2165	2166	2167	2168	2169
18	2170	2171	2172	2174	2175	2176	2177	2178	2179
19	2180	2181	2182	2184	2185	2186	2187	2188	2189
20	2190	2191	2192	2194	2195	2196	2197	2198	2199
21	2200	2201	2202	2204	2205	2206	2207	2208	2209
22	2210	2211	2212	2214	2215	2216	2217	2218	2219
23	2220	2221	2222	2224	2225	2226	2227	2228	2229
24	2230	2231	2232	2234	2235	2236	2237	2238	2239
25	2240	2241	2242	2244	2245	2246	2247	2248	2249
26	2250	2251	2252	2254	2255	2256	2257	2258	2259
27	2260	2261	2262	2264	2265	2266	2267	2268	2269
28	2270	2271	2272	2274	2275	2276	2277	2278	2279
29	2280	2281	2282	2284	2285	2286	2287	2288	2289
30	2290	2291	2292	2294	2295	2296	2297	2298	2299
31	2300	2301	2302	2304	2305	2306	2307	2308	2309
32	2310	2311	2312	2314	2315	2316	2317	2318	2319
33	2320	2321	2322	2324	2325	2326	2327	2328	2329
34	2330	2331	2332	2334	2335	2336	2337	2338	2339
35	2340	2341	2342	2344	2345	2346	2347	2348	2349
36	2350	2351	2352	2354	2355	2356	2357	2358	2359
37	2360	2361	2362	2364	2365	2366	2367	2368	2369
38	2370	2371	2372	2374	2375	2376	2377	2378	2379
39	2380	2381	2382	2384	2385	2386	2387	2388	2389
40	2390	2391	2392	2394	2395	2396	2397	2398	2399
41	2400	2401	2402	2404	2405	2406	2407	2408	2409
42	2410	2411	2412	2414	2415	2416	2417	2418	2419
43	2420	2421	2422	2424	2425	2426	2427	2428	2429
44	2430	2431	2432	2434	2435	2436	2437	2438	2439
45	2440	2441	2442	2444	2445	2446	2447	2448	2449
46	2450	2451	2452	2454	2455	2456	2457	2458	2459
47	2460	2461	2462	2464	2465	2466	2467	2468	2469
48	2470	2471	2472	2474	2475	2476	2477	2478	2479
49	2480	2481	2482	2484	2485	2486	2487	2488	2489
50	2490	2491	2492	2494	2495	2496	2497	2498	2499

Data No.	Positioning identifier	M code	Dwell time	Command speed		Positioning address		Arc data	
				Low-order	High-order	Low-order	High-order	Low-order	High-order
51	2500	2501	2502	2504	2505	2506	2507	2508	2509
52	2510	2511	2512	2514	2515	2516	2517	2518	2519
53	2520	2521	2522	2524	2525	2526	2527	2528	2529
54	2530	2531	2532	2534	2535	2536	2537	2538	2539
55	2540	2541	2542	2544	2545	2546	2547	2548	2549
56	2550	2551	2552	2554	2555	2556	2557	2558	2559
57	2560	2561	2562	2564	2565	2566	2567	2568	2569
58	2570	2571	2572	2574	2575	2576	2577	2578	2579
59	2580	2581	2582	2584	2585	2586	2587	2588	2589
60	2590	2591	2592	2594	2595	2596	2597	2598	2599
61	2600	2601	2602	2604	2605	2606	2607	2608	2609
62	2610	2611	2612	2614	2615	2616	2617	2618	2619
63	2620	2621	2622	2624	2625	2626	2627	2628	2629
64	2630	2631	2632	2634	2635	2636	2637	2638	2639
65	2640	2641	2642	2644	2645	2646	2647	2648	2649
66	2650	2651	2652	2654	2655	2656	2657	2658	2659
67	2660	2661	2662	2664	2665	2666	2667	2668	2669
68	2670	2671	2672	2674	2675	2676	2677	2678	2679
69	2680	2681	2682	2684	2685	2686	2687	2688	2689
70	2690	2691	2692	2694	2695	2696	2697	2698	2699
71	2700	2701	2702	2704	2705	2706	2707	2708	2709
72	2710	2711	2712	2714	2715	2716	2717	2718	2719
73	2720	2721	2722	2724	2725	2726	2727	2728	2729
74	2730	2731	2732	2734	2735	2736	2737	2738	2739
75	2740	2741	2742	2744	2745	2746	2747	2748	2749
76	2750	2751	2752	2754	2755	2756	2757	2758	2759
77	2760	2761	2762	2764	2765	2766	2767	2768	2769
78	2770	2771	2772	2774	2775	2776	2777	2778	2779
79	2780	2781	2782	2784	2785	2786	2787	2788	2789
80	2790	2791	2792	2794	2795	2796	2797	2798	2799
81	2800	2801	2802	2804	2805	2806	2807	2808	2809
82	2810	2811	2812	2814	2815	2816	2817	2818	2819
83	2820	2821	2822	2824	2825	2826	2827	2828	2829
84	2830	2831	2832	2834	2835	2836	2837	2838	2839
85	2840	2841	2842	2844	2845	2846	2847	2848	2849
86	2850	2851	2852	2854	2855	2856	2857	2858	2859
87	2860	2861	2862	2864	2865	2866	2867	2868	2869
88	2870	2871	2872	2874	2875	2876	2877	2878	2879
89	2880	2881	2882	2884	2885	2886	2887	2888	2889
90	2890	2891	2892	2894	2895	2896	2897	2898	2899
91	2900	2901	2902	2904	2905	2906	2907	2908	2909
92	2910	2911	2912	2914	2915	2916	2917	2918	2919
93	2920	2921	2922	2924	2925	2926	2927	2928	2929
94	2930	2931	2932	2934	2935	2936	2937	2938	2939
95	2940	2941	2942	2944	2945	2946	2947	2948	2949
96	2950	2951	2952	2954	2955	2956	2957	2958	2959
97	2960	2961	2962	2964	2965	2966	2967	2968	2969
98	2970	2971	2972	2974	2975	2976	2977	2978	2979
99	2980	2981	2982	2984	2985	2986	2987	2988	2989
100	2990	2991	2992	2994	2995	2996	2997	2998	2999

(1) For axis 1

Data No.	Positioning identifier	M code	Dwell time	Command speed		Positioning address		Arc data	
				Low-order	High-order	Low-order	High-order	Low-order	High-order
101	3000	3001	3002	3004	3005	3006	3007	3008	3009
102	3010	3011	3012	3014	3015	3016	3017	3018	3019
103	3020	3021	3022	3024	3025	3026	3027	3028	3029
104	3030	3031	3032	3034	3035	3036	3037	3038	3039
105	3040	3041	3042	3044	3045	3046	3047	3048	3049
106	3050	3051	3052	3054	3055	3056	3057	3058	3059
107	3060	3061	3062	3064	3065	3066	3067	3068	3069
108	3070	3071	3072	3074	3075	3076	3077	3078	3079
109	3080	3081	3082	3084	3085	3086	3087	3088	3089
110	3090	3091	3092	3094	3095	3096	3097	3098	3099
111	3100	3101	3102	3104	3105	3106	3107	3108	3109
112	3110	3111	3112	3114	3115	3116	3117	3118	3119
113	3120	3121	3122	3124	3125	3126	3127	3128	3129
114	3130	3131	3132	3134	3135	3136	3137	3138	3139
115	3140	3141	3142	3144	3145	3146	3147	3148	3149
116	3150	3151	3152	3154	3155	3156	3157	3158	3159
117	3160	3161	3162	3164	3165	3166	3167	3168	3169
118	3170	3171	3172	3174	3175	3176	3177	3178	3179
119	3180	3181	3182	3184	3185	3186	3187	3188	3189
120	3190	3191	3192	3194	3195	3196	3197	3198	3199
121	3200	3201	3202	3204	3205	3206	3207	3208	3209
122	3210	3211	3212	3214	3215	3216	3217	3218	3219
123	3220	3221	3222	3224	3225	3226	3227	3228	3229
124	3230	3231	3232	3234	3235	3236	3237	3238	3239
125	3240	3241	3242	3244	3245	3246	3247	3248	3249
126	3250	3251	3252	3254	3255	3256	3257	3258	3259
127	3260	3261	3262	3264	3265	3266	3267	3268	3269
128	3270	3271	3272	3274	3275	3276	3277	3278	3279
129	3280	3281	3282	3284	3285	3286	3287	3288	3289
130	3290	3291	3292	3294	3295	3296	3297	3298	3299
131	3300	3301	3302	3304	3305	3306	3307	3308	3309
132	3310	3311	3312	3314	3315	3316	3317	3318	3319
133	3320	3321	3322	3324	3325	3326	3327	3328	3329
134	3330	3331	3332	3334	3335	3336	3337	3338	3339
135	3340	3341	3342	3344	3345	3346	3347	3348	3349
136	3350	3351	3352	3354	3355	3356	3357	3358	3359
137	3360	3361	3362	3364	3365	3366	3367	3368	3369
138	3370	3371	3372	3374	3375	3376	3377	3378	3379
139	3380	3381	3382	3384	3385	3386	3387	3388	3389
140	3390	3391	3392	3394	3395	3396	3397	3398	3399
141	3400	3401	3402	3404	3405	3406	3407	3408	3409
142	3410	3411	3412	3414	3415	3416	3417	3418	3419
143	3420	3421	3422	3424	3425	3426	3427	3428	3429
144	3430	3431	3432	3434	3435	3436	3437	3438	3439
145	3440	3441	3442	3444	3445	3446	3447	3448	3449
146	3450	3451	3452	3454	3455	3456	3457	3458	3459
147	3460	3461	3462	3464	3465	3466	3467	3468	3469
148	3470	3471	3472	3474	3475	3476	3477	3478	3479
149	3480	3481	3482	3484	3485	3486	3487	3488	3489
150	3490	3491	3492	3494	3495	3496	3497	3498	3499

Data No.	Positioning identifier	M code	Dwell time	Command speed		Positioning address		Arc data	
				Low-order	High-order	Low-order	High-order	Low-order	High-order
151	3500	3501	3502	3504	3505	3506	3507	3508	3509
152	3510	3511	3512	3514	3515	3516	3517	3518	3519
153	3520	3521	3522	3524	3525	3526	3527	3528	3529
154	3530	3531	3532	3534	3535	3536	3537	3538	3539
155	3540	3541	3542	3544	3545	3546	3547	3548	3549
156	3550	3551	3552	3554	3555	3556	3557	3558	3559
157	3560	3561	3562	3564	3565	3566	3567	3568	3569
158	3570	3571	3572	3574	3575	3576	3577	3578	3579
159	3580	3581	3582	3584	3585	3586	3587	3588	3589
160	3590	3591	3592	3594	3595	3596	3597	3598	3599
161	3600	3601	3602	3604	3605	3606	3607	3608	3609
162	3610	3611	3612	3614	3615	3616	3617	3618	3619
163	3620	3621	3622	3624	3625	3626	3627	3628	3629
164	3630	3631	3632	3634	3635	3636	3637	3638	3639
165	3640	3641	3642	3644	3645	3646	3647	3648	3649
166	3650	3651	3652	3654	3655	3656	3657	3658	3659
167	3660	3661	3662	3664	3665	3666	3667	3668	3669
168	3670	3671	3672	3674	3675	3676	3677	3678	3679
169	3680	3681	3682	3684	3685	3686	3687	3688	3689
170	3690	3691	3692	3694	3695	3696	3697	3698	3699
171	3700	3701	3702	3704	3705	3706	3707	3708	3709
172	3710	3711	3712	3714	3715	3716	3717	3718	3719
173	3720	3721	3722	3724	3725	3726	3727	3728	3729
174	3730	3731	3732	3734	3735	3736	3737	3738	3739
175	3740	3741	3742	3744	3745	3746	3747	3748	3749
176	3750	3751	3752	3754	3755	3756	3757	3758	3759
177	3760	3761	3762	3764	3765	3766	3767	3768	3769
178	3770	3771	3772	3774	3775	3776	3777	3778	3779
179	3780	3781	3782	3784	3785	3786	3787	3788	3789
180	3790	3791	3792	3794	3795	3796	3797	3798	3799
181	3800	3801	3802	3804	3805	3806	3807	3808	3809
182	3810	3811	3812	3814	3815	3816	3817	3818	3819
183	3820	3821	3822	3824	3825	3826	3827	3828	3829
184	3830	3831	3832	3834	3835	3836	3837	3838	3839
185	3840	3841	3842	3844	3845	3846	3847	3848	3849
186	3850	3851	3852	3854	3855	3856	3857	3858	3859
187	3860	3861	3862	3864	3865	3866	3867	3868	3869
188	3870	3871	3872	3874	3875	3876	3877	3878	3879
189	3880	3881	3882	3884	3885	3886	3887	3888	3889
190	3890	3891	3892	3894	3895	3896	3897	3898	3899
191	3900	3901	3902	3904	3905	3906	3907	3908	3909
192	3910	3911	3912	3914	3915	3916	3917	3918	3919
193	3920	3921	3922	3924	3925	3926	3927	3928	3929
194	3930	3931	3932	3934	3935	3936	3937	3938	3939
195	3940	3941	3942	3944	3945	3946	3947	3948	3949
196	3950	3951	3952	3954	3955	3956	3957	3958	3959
197	3960	3961	3962	3964	3965	3966	3967	3968	3969
198	3970	3971	3972	3974	3975	3976	3977	3978	3979
199	3980	3981	3982	3984	3985	3986	3987	3988	3989
200	3990	3991	3992	3994	3995	3996	3997	3998	3999



(1) For axis 1

Data No.	Positioning identifier	M code	Dwell time	Command speed		Positioning address		Arc data	
				Low-order	High-order	Low-order	High-order	Low-order	High-order
201	4000	4001	4002	4004	4005	4006	4007	4008	4009
202	4010	4011	4012	4014	4015	4016	4017	4018	4019
203	4020	4021	4022	4024	4025	4026	4027	4028	4029
204	4030	4031	4032	4034	4035	4036	4037	4038	4039
205	4040	4041	4042	4044	4045	4046	4047	4048	4049
206	4050	4051	4052	4054	4055	4056	4057	4058	4059
207	4060	4061	4062	4064	4065	4066	4067	4068	4069
208	4070	4071	4072	4074	4075	4076	4077	4078	4079
209	4080	4081	4082	4084	4085	4086	4087	4088	4089
210	4090	4091	4092	4094	4095	4096	4097	4098	4099
211	4100	4101	4102	4104	4105	4106	4107	4108	4109
212	4110	4111	4112	4114	4115	4116	4117	4118	4119
213	4120	4121	4122	4124	4125	4126	4127	4128	4129
214	4130	4131	4132	4134	4135	4136	4137	4138	4139
215	4140	4141	4142	4144	4145	4146	4147	4148	4149
216	4150	4151	4152	4154	4155	4156	4157	4158	4159
217	4160	4161	4162	4164	4165	4166	4167	4168	4169
218	4170	4171	4172	4174	4175	4176	4177	4178	4179
219	4180	4181	4182	4184	4185	4186	4187	4188	4189
220	4190	4191	4192	4194	4195	4196	4197	4198	4199
221	4200	4201	4202	4204	4205	4206	4207	4208	4209
222	4210	4211	4212	4214	4215	4216	4217	4218	4219
223	4220	4221	4222	4224	4225	4226	4227	4228	4229
224	4230	4231	4232	4234	4235	4236	4237	4238	4239
225	4240	4241	4242	4244	4245	4246	4247	4248	4249
226	4250	4251	4252	4254	4255	4256	4257	4258	4259
227	4260	4261	4262	4264	4265	4266	4267	4268	4269
228	4270	4271	4272	4274	4275	4276	4277	4278	4279
229	4280	4281	4282	4284	4285	4286	4287	4288	4289
230	4290	4291	4292	4294	4295	4296	4297	4298	4299
231	4300	4301	4302	4304	4305	4306	4307	4308	4309
232	4310	4311	4312	4314	4315	4316	4317	4318	4319
233	4320	4321	4322	4324	4325	4326	4327	4328	4329
234	4330	4331	4332	4334	4335	4336	4337	4338	4339
235	4340	4341	4342	4344	4345	4346	4347	4348	4349
236	4350	4351	4352	4354	4355	4356	4357	4358	4359
237	4360	4361	4362	4364	4365	4366	4367	4368	4369
238	4370	4371	4372	4374	4375	4376	4377	4378	4379
239	4380	4381	4382	4384	4385	4386	4387	4388	4389
240	4390	4391	4392	4394	4395	4396	4397	4398	4399
241	4400	4401	4402	4404	4405	4406	4407	4408	4409
242	4410	4411	4412	4414	4415	4416	4417	4418	4419
243	4420	4421	4422	4424	4425	4426	4427	4428	4429
244	4430	4431	4432	4434	4435	4436	4437	4438	4439
245	4440	4441	4442	4444	4445	4446	4447	4448	4449
246	4450	4451	4452	4454	4455	4456	4457	4458	4459
247	4460	4461	4462	4464	4465	4466	4467	4468	4469
248	4470	4471	4472	4474	4475	4476	4477	4478	4479
249	4480	4481	4482	4484	4485	4486	4487	4488	4489
250	4490	4491	4492	4494	4495	4496	4497	4498	4499

Data No.	Positioning identifier	M code	Dwell time	Command speed		Positioning address		Arc data	
				Low-order	High-order	Low-order	High-order	Low-order	High-order
251	4500	4501	4502	4504	4505	4506	4507	4508	4509
252	4510	4511	4512	4514	4515	4516	4517	4518	4519
253	4520	4521	4522	4524	4525	4526	4527	4528	4529
254	4530	4531	4532	4534	4535	4536	4537	4538	4539
255	4540	4541	4542	4544	4545	4546	4547	4548	4549
256	4550	4551	4552	4554	4555	4556	4557	4558	4559
257	4560	4561	4562	4564	4565	4566	4567	4568	4569
258	4570	4571	4572	4574	4575	4576	4577	4578	4579
259	4580	4581	4582	4584	4585	4586	4587	4588	4589
260	4590	4591	4592	4594	4595	4596	4597	4598	4599
261	4600	4601	4602	4604	4605	4606	4607	4608	4609
262	4610	4611	4612	4614	4615	4616	4617	4618	4619
263	4620	4621	4622	4624	4625	4626	4627	4628	4629
264	4630	4631	4632	4634	4635	4636	4637	4638	4639
265	4640	4641	4642	4644	4645	4646	4647	4648	4649
266	4650	4651	4652	4654	4655	4656	4657	4658	4659
267	4660	4661	4662	4664	4665	4666	4667	4668	4669
268	4670	4671	4672	4674	4675	4676	4677	4678	4679
269	4680	4681	4682	4684	4685	4686	4687	4688	4689
270	4690	4691	4692	4694	4695	4696	4697	4698	4699
271	4700	4701	4702	4704	4705	4706	4707	4708	4709
272	4710	4711	4712	4714	4715	4716	4717	4718	4719
273	4720	4721	4722	4724	4725	4726	4727	4728	4729
274	4730	4731	4732	4734	4735	4736	4737	4738	4739
275	4740	4741	4742	4744	4745	4746	4747	4748	4749
276	4750	4751	4752	4754	4755	4756	4757	4758	4759
277	4760	4761	4762	4764	4765	4766	4767	4768	4769
278	4770	4771	4772	4774	4775	4776	4777	4778	4779
279	4780	4781	4782	4784	4785	4786	4787	4788	4789
280	4790	4791	4792	4794	4795	4796	4797	4798	4799
281	4800	4801	4802	4804	4805	4806	4807	4808	4809
282	4810	4811	4812	4814	4815	4816	4817	4818	4819
283	4820	4821	4822	4824	4825	4826	4827	4828	4829
284	4830	4831	4832	4834	4835	4836	4837	4838	4839
285	4840	4841	4842	4844	4845	4846	4847	4848	4849
286	4850	4851	4852	4854	4855	4856	4857	4858	4859
287	4860	4861	4862	4864	4865	4866	4867	4868	4869
288	4870	4871	4872	4874	4875	4876	4877	4878	4879
289	4880	4881	4882	4884	4885	4886	4887	4888	4889
290	4890	4891	4892	4894	4895	4896	4897	4898	4899
291	4900	4901	4902	4904	4905	4906	4907	4908	4909
292	4910	4911	4912	4914	4915	4916	4917	4918	4919
293	4920	4921	4922	4924	4925	4926	4927	4928	4929
294	4930	4931	4932	4934	4935	4936	4937	4938	4939
295	4940	4941	4942	4944	4945	4946	4947	4948	4949
296	4950	4951	4952	4954	4955	4956	4957	4958	4959
297	4960	4961	4962	4964	4965	4966	4967	4968	4969
298	4970	4971	4972	4974	4975	4976	4977	4978	4979
299	4980	4981	4982	4984	4985	4986	4987	4988	4989
300	4990	4991	4992	4994	4995	4996	4997	4998	4999

(1) For axis 1

Data No.	Positioning identifier	M code	Dwell time	Command speed		Positioning address		Arc data	
				Low-order	High-order	Low-order	High-order	Low-order	High-order
301	5000	5001	5002	5004	5005	5006	5007	5008	5009
302	5010	5011	5012	5014	5015	5016	5017	5018	5019
303	5020	5021	5022	5024	5025	5026	5027	5028	5029
304	5030	5031	5032	5034	5035	5036	5037	5038	5039
305	5040	5041	5042	5044	5045	5046	5047	5048	5049
306	5050	5051	5052	5054	5055	5056	5057	5058	5059
307	5060	5061	5062	5064	5065	5066	5067	5068	5069
308	5070	5071	5072	5074	5075	5076	5077	5078	5079
309	5080	5081	5082	5084	5085	5086	5087	5088	5089
310	5090	5091	5092	5094	5095	5096	5097	5098	5099
311	5100	5101	5102	5104	5105	5106	5107	5108	5109
312	5110	5111	5112	5114	5115	5116	5117	5118	5119
313	5120	5121	5122	5124	5125	5126	5127	5128	5129
314	5130	5131	5132	5134	5135	5136	5137	5138	5139
315	5140	5141	5142	5144	5145	5146	5147	5148	5149
316	5150	5151	5152	5154	5155	5156	5157	5158	5159
317	5160	5161	5162	5164	5165	5166	5167	5168	5169
318	5170	5171	5172	5174	5175	5176	5177	5178	5179
319	5180	5181	5182	5184	5185	5186	5187	5188	5189
320	5190	5191	5192	5194	5195	5196	5197	5198	5199
321	5200	5201	5202	5204	5205	5206	5207	5208	5209
322	5210	5211	5212	5214	5215	5216	5217	5218	5219
323	5220	5221	5222	5224	5225	5226	5227	5228	5229
324	5230	5231	5232	5234	5235	5236	5237	5238	5239
325	5240	5241	5242	5244	5245	5246	5247	5248	5249
326	5250	5251	5252	5254	5255	5256	5257	5258	5259
327	5260	5261	5262	5264	5265	5266	5267	5268	5269
328	5270	5271	5272	5274	5275	5276	5277	5278	5279
329	5280	5281	5282	5284	5285	5286	5287	5288	5289
330	5290	5291	5292	5294	5295	5296	5297	5298	5299
331	5300	5301	5302	5304	5305	5306	5307	5308	5309
332	5310	5311	5312	5314	5315	5316	5317	5318	5319
333	5320	5321	5322	5324	5325	5326	5327	5328	5329
334	5330	5331	5332	5334	5335	5336	5337	5338	5339
335	5340	5341	5342	5344	5345	5346	5347	5348	5349
336	5350	5351	5352	5354	5355	5356	5357	5358	5359
337	5360	5361	5362	5364	5365	5366	5367	5368	5369
338	5370	5371	5372	5374	5375	5376	5377	5378	5379
339	5380	5381	5382	5384	5385	5386	5387	5388	5389
340	5390	5391	5392	5394	5395	5396	5397	5398	5399
341	5400	5401	5402	5404	5405	5406	5407	5408	5409
342	5410	5411	5412	5414	5415	5416	5417	5418	5419
343	5420	5421	5422	5424	5425	5426	5427	5428	5429
344	5430	5431	5432	5434	5435	5436	5437	5438	5439
345	5440	5441	5442	5444	5445	5446	5447	5448	5449
346	5450	5451	5452	5454	5455	5456	5457	5458	5459
347	5460	5461	5462	5464	5465	5466	5467	5468	5469
348	5470	5471	5472	5474	5475	5476	5477	5478	5479
349	5480	5481	5482	5484	5485	5486	5487	5488	5489
350	5490	5491	5492	5494	5495	5496	5497	5498	5499

Data No.	Positioning identifier	M code	Dwell time	Command speed		Positioning address		Arc data	
				Low-order	High-order	Low-order	High-order	Low-order	High-order
351	5500	5501	5502	5504	5505	5506	5507	5508	5509
352	5510	5511	5512	5514	5515	5516	5517	5518	5519
353	5520	5521	5522	5524	5525	5526	5527	5528	5529
354	5530	5531	5532	5534	5535	5536	5537	5538	5539
355	5540	5541	5542	5544	5545	5546	5547	5548	5549
356	5550	5551	5552	5554	5555	5556	5557	5558	5559
357	5560	5561	5562	5564	5565	5566	5567	5568	5569
358	5570	5571	5572	5574	5575	5576	5577	5578	5579
359	5580	5581	5582	5584	5585	5586	5587	5588	5589
360	5590	5591	5592	5594	5595	5596	5597	5598	5599
361	5600	5601	5602	5604	5605	5606	5607	5608	5609
362	5610	5611	5612	5614	5615	5616	5617	5618	5619
363	5620	5621	5622	5624	5625	5626	5627	5628	5629
364	5630	5631	5632	5634	5635	5636	5637	5638	5639
365	5640	5641	5642	5644	5645	5646	5647	5648	5649
366	5650	5651	5652	5654	5655	5656	5657	5658	5659
367	5660	5661	5662	5664	5665	5666	5667	5668	5669
368	5670	5671	5672	5674	5675	5676	5677	5678	5679
369	5680	5681	5682	5684	5685	5686	5687	5688	5689
370	5690	5691	5692	5694	5695	5696	5697	5698	5699
371	5700	5701	5702	5704	5705	5706	5707	5708	5709
372	5710	5711	5712	5714	5715	5716	5717	5718	5719
373	5720	5721	5722	5724	5725	5726	5727	5728	5729
374	5730	5731	5732	5734	5735	5736	5737	5738	5739
375	5740	5741	5742	5744	5745	5746	5747	5748	5749
376	5750	5751	5752	5754	5755	5756	5757	5758	5759
377	5760	5761	5762	5764	5765	5766	5767	5768	5769
378	5770	5771	5772	5774	5775	5776	5777	5778	5779
379	5780	5781	5782	5784	5785	5786	5787	5788	5789
380	5790	5791	5792	5794	5795	5796	5797	5798	5799
381	5800	5801	5802	5804	5805	5806	5807	5808	5809
382	5810	5811	5812	5814	5815	5816	5817	5818	5819
383	5820	5821	5822	5824	5825	5826	5827	5828	5829
384	5830	5831	5832	5834	5835	5836	5837	5838	5839
385	5840	5841	5842	5844	5845	5846	5847	5848	5849
386	5850	5851	5852	5854	5855	5856	5857	5858	5859
387	5860	5861	5862	5864	5865	5866	5867	5868	5869
388	5870	5871	5872	5874	5875	5876	5877	5878	5879
389	5880	5881	5882	5884	5885	5886	5887	5888	5889
390	5890	5891	5892	5894	5895	5896	5897	5898	5899
391	5900	5901	5902	5904	5905	5906	5907	5908	5909
392	5910	5911	5912	5914	5915	5916	5917	5918	5919
393	5920	5921	5922	5924	5925	5926	5927	5928	5929
394	5930	5931	5932	5934	5935	5936	5937	5938	5939
395	5940	5941	5942	5944	5945	5946	5947	5948	5949
396	5950	5951	5952	5954	5955	5956	5957	5958	5959
397	5960	5961	5962	5964	5965	5966	5967	5968	5969
398	5970	5971	5972	5974	5975	5976	5977	5978	5979
399	5980	5981	5982	5984	5985	5986	5987	5988	5989
400	5990	5991	5992	5994	5995	5996	5997	5998	5999

(1) For axis 1

Data No.	Positioning identifier	M code	Dwell time	Command speed		Positioning address		Arc data	
				Low-order	High-order	Low-order	High-order	Low-order	High-order
401	6000	6001	6002	6004	6005	6006	6007	6008	6009
402	6010	6011	6012	6014	6015	6016	6017	6018	6019
403	6020	6021	6022	6024	6025	6026	6027	6028	6029
404	6030	6031	6032	6034	6035	6036	6037	6038	6039
405	6040	6041	6042	6044	6045	6046	6047	6048	6049
406	6050	6051	6052	6054	6055	6056	6057	6058	6059
407	6060	6061	6062	6064	6065	6066	6067	6068	6069
408	6070	6071	6072	6074	6075	6076	6077	6078	6079
409	6080	6081	6082	6084	6085	6086	6087	6088	6089
410	6090	6091	6092	6094	6095	6096	6097	6098	6099
411	6100	6101	6102	6104	6105	6106	6107	6108	6109
412	6110	6111	6112	6114	6115	6116	6117	6118	6119
413	6120	6121	6122	6124	6125	6126	6127	6128	6129
414	6130	6131	6132	6134	6135	6136	6137	6138	6139
415	6140	6141	6142	6144	6145	6146	6147	6148	6149
416	6150	6151	6152	6154	6155	6156	6157	6158	6159
417	6160	6161	6162	6164	6165	6166	6167	6168	6169
418	6170	6171	6172	6174	6175	6176	6177	6178	6179
419	6180	6181	6182	6184	6185	6186	6187	6188	6189
420	6190	6191	6192	6194	6195	6196	6197	6198	6199
421	6200	6201	6202	6204	6205	6206	6207	6208	6209
422	6210	6211	6212	6214	6215	6216	6217	6218	6219
423	6220	6221	6222	6224	6225	6226	6227	6228	6229
424	6230	6231	6232	6234	6235	6236	6237	6238	6239
425	6240	6241	6242	6244	6245	6246	6247	6248	6249
426	6250	6251	6252	6254	6255	6256	6257	6258	6259
427	6260	6261	6262	6264	6265	6266	6267	6268	6269
428	6270	6271	6272	6274	6275	6276	6277	6278	6279
429	6280	6281	6282	6284	6285	6286	6287	6288	6289
430	6290	6291	6292	6294	6295	6296	6297	6298	6299
431	6300	6301	6302	6304	6305	6306	6307	6308	6309
432	6310	6311	6312	6314	6315	6316	6317	6318	6319
433	6320	6321	6322	6324	6325	6326	6327	6328	6329
434	6330	6331	6332	6334	6335	6336	6337	6338	6339
435	6340	6341	6342	6344	6345	6346	6347	6348	6349
436	6350	6351	6352	6354	6355	6356	6357	6358	6359
437	6360	6361	6362	6364	6365	6366	6367	6368	6369
438	6370	6371	6372	6374	6375	6376	6377	6378	6379
439	6380	6381	6382	6384	6385	6386	6387	6388	6389
440	6390	6391	6392	6394	6395	6396	6397	6398	6399
441	6400	6401	6402	6404	6405	6406	6407	6408	6409
442	6410	6411	6412	6414	6415	6416	6417	6418	6419
443	6420	6421	6422	6424	6425	6426	6427	6428	6429
444	6430	6431	6432	6434	6435	6436	6437	6438	6439
445	6440	6441	6442	6444	6445	6446	6447	6448	6449
446	6450	6451	6452	6454	6455	6456	6457	6458	6459
447	6460	6461	6462	6464	6465	6466	6467	6468	6469
448	6470	6471	6472	6474	6475	6476	6477	6478	6479
449	6480	6481	6482	6484	6485	6486	6487	6488	6489
450	6490	6491	6492	6494	6495	6496	6497	6498	6499

Data No.	Positioning identifier	M code	Dwell time	Command speed		Positioning address		Arc data	
				Low-order	High-order	Low-order	High-order	Low-order	High-order
451	6500	6501	6502	6504	6505	6506	6507	6508	6509
452	6510	6511	6512	6514	6515	6516	6517	6518	6519
453	6520	6521	6522	6524	6525	6526	6527	6528	6529
454	6530	6531	6532	6534	6535	6536	6537	6538	6539
455	6540	6541	6542	6544	6545	6546	6547	6548	6549
456	6550	6551	6552	6554	6555	6556	6557	6558	6559
457	6560	6561	6562	6564	6565	6566	6567	6568	6569
458	6570	6571	6572	6574	6575	6576	6577	6578	6579
459	6580	6581	6582	6584	6585	6586	6587	6588	6589
460	6590	6591	6592	6594	6595	6596	6597	6598	6599
461	6600	6601	6602	6604	6605	6606	6607	6608	6609
462	6610	6611	6612	6614	6615	6616	6617	6618	6619
463	6620	6621	6622	6624	6625	6626	6627	6628	6629
464	6630	6631	6632	6634	6635	6636	6637	6638	6639
465	6640	6641	6642	6644	6645	6646	6647	6648	6649
466	6650	6651	6652	6654	6655	6656	6657	6658	6659
467	6660	6661	6662	6664	6665	6666	6667	6668	6669
468	6670	6671	6672	6674	6675	6676	6677	6678	6679
469	6680	6681	6682	6684	6685	6686	6687	6688	6689
470	6690	6691	6692	6694	6695	6696	6697	6698	6699
471	6700	6701	6702	6704	6705	6706	6707	6708	6709
472	6710	6711	6712	6714	6715	6716	6717	6718	6719
473	6720	6721	6722	6724	6725	6726	6727	6728	6729
474	6730	6731	6732	6734	6735	6736	6737	6738	6739
475	6740	6741	6742	6744	6745	6746	6747	6748	6749
476	6750	6751	6752	6754	6755	6756	6757	6758	6759
477	6760	6761	6762	6764	6765	6766	6767	6768	6769
478	6770	6771	6772	6774	6775	6776	6777	6778	6779
479	6780	6781	6782	6784	6785	6786	6787	6788	6789
480	6790	6791	6792	6794	6795	6796	6797	6798	6799
481	6800	6801	6802	6804	6805	6806	6807	6808	6809
482	6810	6811	6812	6814	6815	6816	6817	6818	6819
483	6820	6821	6822	6824	6825	6826	6827	6828	6829
484	6830	6831	6832	6834	6835	6836	6837	6838	6839
485	6840	6841	6842	6844	6845	6846	6847	6848	6849
486	6850	6851	6852	6854	6855	6856	6857	6858	6859
487	6860	6861	6862	6864	6865	6866	6867	6868	6869
488	6870	6871	6872	6874	6875	6876	6877	6878	6879
489	6880	6881	6882	6884	6885	6886	6887	6888	6889
490	6890	6891	6892	6894	6895	6896	6897	6898	6899
491	6900	6901	6902	6904	6905	6906	6907	6908	6909
492	6910	6911	6912	6914	6915	6916	6917	6918	6919
493	6920	6921	6922	6924	6925	6926	6927	6928	6929
494	6930	6931	6932	6934	6935	6936	6937	6938	6939
495	6940	6941	6942	6944	6945	6946	6947	6948	6949
496	6950	6951	6952	6954	6955	6956	6957	6958	6959
497	6960	6961	6962	6964	6965	6966	6967	6968	6969
498	6970	6971	6972	6974	6975	6976	6977	6978	6979
499	6980	6981	6982	6984	6985	6986	6987	6988	6989
500	6990	6991	6992	6994	6995	6996	6997	6998	6999

(1) For axis 1

Data No.	Positioning identifier	M code	Dwell time	Command speed		Positioning address		Arc data	
				Low-order	High-order	Low-order	High-order	Low-order	High-order
501	7000	7001	7002	7004	7005	7006	7007	7008	7009
502	7010	7011	7012	7014	7015	7016	7017	7018	7019
503	7020	7021	7022	7024	7025	7026	7027	7028	7029
504	7030	7031	7032	7034	7035	7036	7037	7038	7039
505	7040	7041	7042	7044	7045	7046	7047	7048	7049
506	7050	7051	7052	7054	7055	7056	7057	7058	7059
507	7060	7061	7062	7064	7065	7066	7067	7068	7069
508	7070	7071	7072	7074	7075	7076	7077	7078	7079
509	7080	7081	7082	7084	7085	7086	7087	7088	7089
510	7090	7091	7092	7094	7095	7096	7097	7098	7099
511	7100	7101	7102	7104	7105	7106	7107	7108	7109
512	7110	7111	7112	7114	7115	7116	7117	7118	7119
513	7120	7121	7122	7124	7125	7126	7127	7128	7129
514	7130	7131	7132	7134	7135	7136	7137	7138	7139
515	7140	7141	7142	7144	7145	7146	7147	7148	7149
516	7150	7151	7152	7154	7155	7156	7157	7158	7159
517	7160	7161	7162	7164	7165	7166	7167	7168	7169
518	7170	7171	7172	7174	7175	7176	7177	7178	7179
519	7180	7181	7182	7184	7185	7186	7187	7188	7189
520	7190	7191	7192	7194	7195	7196	7197	7198	7199
521	7200	7201	7202	7204	7205	7206	7207	7208	7209
522	7210	7211	7212	7214	7215	7216	7217	7218	7219
523	7220	7221	7222	7224	7225	7226	7227	7228	7229
524	7230	7231	7232	7234	7235	7236	7237	7238	7239
525	7240	7241	7242	7244	7245	7246	7247	7248	7249
526	7250	7251	7252	7254	7255	7256	7257	7258	7259
527	7260	7261	7262	7264	7265	7266	7267	7268	7269
528	7270	7271	7272	7274	7275	7276	7277	7278	7279
529	7280	7281	7282	7284	7285	7286	7287	7288	7289
530	7290	7291	7292	7294	7295	7296	7297	7298	7299
531	7300	7301	7302	7304	7305	7306	7307	7308	7309
532	7310	7311	7312	7314	7315	7316	7317	7318	7319
533	7320	7321	7322	7324	7325	7326	7327	7328	7329
534	7330	7331	7332	7334	7335	7336	7337	7338	7339
535	7340	7341	7342	7344	7345	7346	7347	7348	7349
536	7350	7351	7352	7354	7355	7356	7357	7358	7359
537	7360	7361	7362	7364	7365	7366	7367	7368	7369
538	7370	7371	7372	7374	7375	7376	7377	7378	7379
539	7380	7381	7382	7384	7385	7386	7387	7388	7389
540	7390	7391	7392	7394	7395	7396	7397	7398	7399
541	7400	7401	7402	7404	7405	7406	7407	7408	7409
542	7410	7411	7412	7414	7415	7416	7417	7418	7419
543	7420	7421	7422	7424	7425	7426	7427	7428	7429
544	7430	7431	7432	7434	7435	7436	7437	7438	7439
545	7440	7441	7442	7444	7445	7446	7447	7448	7449
546	7450	7451	7452	7454	7455	7456	7457	7458	7459
547	7460	7461	7462	7464	7465	7466	7467	7468	7469
548	7470	7471	7472	7474	7475	7476	7477	7478	7479
549	7480	7481	7482	7484	7485	7486	7487	7488	7489
550	7490	7491	7492	7494	7495	7496	7497	7498	7499

Data No.	Positioning identifier	M code	Dwell time	Command speed		Positioning address		Arc data	
				Low-order	High-order	Low-order	High-order	Low-order	High-order
551	7500	7501	7502	7504	7505	7506	7507	7508	7509
552	7510	7511	7512	7514	7515	7516	7517	7518	7519
553	7520	7521	7522	7524	7525	7526	7527	7528	7529
554	7530	7531	7532	7534	7535	7536	7537	7538	7539
555	7540	7541	7542	7544	7545	7546	7547	7548	7549
556	7550	7551	7552	7554	7555	7556	7557	7558	7559
557	7560	7561	7562	7564	7565	7566	7567	7568	7569
558	7570	7571	7572	7574	7575	7576	7577	7578	7579
559	7580	7581	7582	7584	7585	7586	7587	7588	7589
560	7590	7591	7592	7594	7595	7596	7597	7598	7599
561	7600	7601	7602	7604	7605	7606	7607	7608	7609
562	7610	7611	7612	7614	7615	7616	7617	7618	7619
563	7620	7621	7622	7624	7625	7626	7627	7628	7629
564	7630	7631	7632	7634	7635	7636	7637	7638	7639
565	7640	7641	7642	7644	7645	7646	7647	7648	7649
566	7650	7651	7652	7654	7655	7656	7657	7658	7659
567	7660	7661	7662	7664	7665	7666	7667	7668	7669
568	7670	7671	7672	7674	7675	7676	7677	7678	7679
569	7680	7681	7682	7684	7685	7686	7687	7688	7689
570	7690	7691	7692	7694	7695	7696	7697	7698	7699
571	7700	7701	7702	7704	7705	7706	7707	7708	7709
572	7710	7711	7712	7714	7715	7716	7717	7718	7719
573	7720	7721	7722	7724	7725	7726	7727	7728	7729
574	7730	7731	7732	7734	7735	7736	7737	7738	7739
575	7740	7741	7742	7744	7745	7746	7747	7748	7749
576	7750	7751	7752	7754	7755	7756	7757	7758	7759
577	7760	7761	7762	7764	7765	7766	7767	7768	7769
578	7770	7771	7772	7774	7775	7776	7777	7778	7779
579	7780	7781	7782	7784	7785	7786	7787	7788	7789
580	7790	7791	7792	7794	7795	7796	7797	7798	7799
581	7800	7801	7802	7804	7805	7806	7807	7808	7809
582	7810	7811	7812	7814	7815	7816	7817	7818	7819
583	7820	7821	7822	7824	7825	7826	7827	7828	7829
584	7830	7831	7832	7834	7835	7836	7837	7838	7839
585	7840	7841	7842	7844	7845	7846	7847	7848	7849
586	7850	7851	7852	7854	7855	7856	7857	7858	7859
587	7860	7861	7862	7864	7865	7866	7867	7868	7869
588	7870	7871	7872	7874	7875	7876	7877	7878	7879
589	7880	7881	7882	7884	7885	7886	7887	7888	7889
590	7890	7891	7892	7894	7895	7896	7897	7898	7899
591	7900	7901	7902	7904	7905	7906	7907	7908	7909
592	7910	7911	7912	7914	7915	7916	7917	7918	7919
593	7920	7921	7922	7924	7925	7926	7927	7928	7929
594	7930	7931	7932	7934	7935	7936	7937	7938	7939
595	7940	7941	7942	7944	7945	7946	7947	7948	7949
596	7950	7951	7952	7954	7955	7956	7957	7958	7959
597	7960	7961	7962	7964	7965	7966	7967	7968	7969
598	7970	7971	7972	7974	7975	7976	7977	7978	7979
599	7980	7981	7982	7984	7985	7986	7987	7988	7989
600	7990	7991	7992	7994	7995	7996	7997	7998	7999

(2) For axis 2

Data No.	Positioning identifier	M code	Dwell time	Command speed		Positioning address		Arc data	
				Low-order	High-order	Low-order	High-order	Low-order	High-order
1	8000	8001	8002	8004	8005	8006	8007	8008	8009
2	8010	8011	8012	8014	8015	8016	8017	8018	8019
3	8020	8021	8022	8024	8025	8026	8027	8028	8029
4	8030	8031	8032	8034	8035	8036	8037	8038	8039
5	8040	8041	8042	8044	8045	8046	8047	8048	8049
6	8050	8051	8052	8054	8055	8056	8057	8058	8059
7	8060	8061	8062	8064	8065	8066	8067	8068	8069
8	8070	8071	8072	8074	8075	8076	8077	8078	8079
9	8080	8081	8082	8084	8085	8086	8087	8088	8089
10	8090	8091	8092	8094	8095	8096	8097	8098	8099
11	8100	8101	8102	8104	8105	8106	8107	8108	8109
12	8110	8111	8112	8114	8115	8116	8117	8118	8119
13	8120	8121	8122	8124	8125	8126	8127	8128	8129
14	8130	8131	8132	8134	8135	8136	8137	8138	8139
15	8140	8141	8142	8144	8145	8146	8147	8148	8149
16	8150	8151	8152	8154	8155	8156	8157	8158	8159
17	8160	8161	8162	8164	8165	8166	8167	8168	8169
18	8170	8171	8172	8174	8175	8176	8177	8178	8179
19	8180	8181	8182	8184	8185	8186	8187	8188	8189
20	8190	8191	8192	8194	8195	8196	8197	8198	8199
21	8200	8201	8202	8204	8205	8206	8207	8208	8209
22	8210	8211	8212	8214	8215	8216	8217	8218	8219
23	8220	8221	8222	8224	8225	8226	8227	8228	8229
24	8230	8231	8232	8234	8235	8236	8237	8238	8239
25	8240	8241	8242	8244	8245	8246	8247	8248	8249
26	8250	8251	8252	8254	8255	8256	8257	8258	8259
27	8260	8261	8262	8264	8265	8266	8267	8268	8269
28	8270	8271	8272	8274	8275	8276	8277	8278	8279
29	8280	8281	8282	8284	8285	8286	8287	8288	8289
30	8290	8291	8292	8294	8295	8296	8297	8298	8299
31	8300	8301	8302	8304	8305	8306	8307	8308	8309
32	8310	8311	8312	8314	8315	8316	8317	8318	8319
33	8320	8321	8322	8324	8325	8326	8327	8328	8329
34	8330	8331	8332	8334	8335	8336	8337	8338	8339
35	8340	8341	8342	8344	8345	8346	8347	8348	8349
36	8350	8351	8352	8354	8355	8356	8357	8358	8359
37	8360	8361	8362	8364	8365	8366	8367	8368	8369
38	8370	8371	8372	8374	8375	8376	8377	8378	8379
39	8380	8381	8382	8384	8385	8386	8387	8388	8389
40	8390	8391	8392	8394	8395	8396	8397	8398	8399
41	8400	8401	8402	8404	8405	8406	8407	8408	8409
42	8410	8411	8412	8414	8415	8416	8417	8418	8419
43	8420	8421	8422	8424	8425	8426	8427	8428	8429
44	8430	8431	8432	8434	8435	8436	8437	8438	8439
45	8440	8441	8442	8444	8445	8446	8447	8448	8449
46	8450	8451	8452	8454	8455	8456	8457	8458	8459
47	8460	8461	8462	8464	8465	8466	8467	8468	8469
48	8470	8471	8472	8474	8475	8476	8477	8478	8479
49	8480	8481	8482	8484	8485	8486	8487	8488	8489
50	8490	8491	8492	8494	8495	8496	8497	8498	8499

Data No.	Positioning identifier	M code	Dwell time	Command speed		Positioning address		Arc data	
				Low-order	High-order	Low-order	High-order	Low-order	High-order
51	8500	8501	8502	8504	8505	8506	8507	8508	8509
52	8510	8511	8512	8514	8515	8516	8517	8518	8519
53	8520	8521	8522	8524	8525	8526	8527	8528	8529
54	8530	8531	8532	8534	8535	8536	8537	8538	8539
55	8540	8541	8542	8544	8545	8546	8547	8548	8549
56	8550	8551	8552	8554	8555	8556	8557	8558	8559
57	8560	8561	8562	8564	8565	8566	8567	8568	8569
58	8570	8571	8572	8574	8575	8576	8577	8578	8579
59	8580	8581	8582	8584	8585	8586	8587	8588	8589
60	8590	8591	8592	8594	8595	8596	8597	8598	8599
61	8600	8601	8602	8604	8605	8606	8607	8608	8609
62	8610	8611	8612	8614	8615	8616	8617	8618	8619
63	8620	8621	8622	8624	8625	8626	8627	8628	8629
64	8630	8631	8632	8634	8635	8636	8637	8638	8639
65	8640	8641	8642	8644	8645	8646	8647	8648	8649
66	8650	8651	8652	8654	8655	8656	8657	8658	8659
67	8660	8661	8662	8664	8665	8666	8667	8668	8669
68	8670	8671	8672	8674	8675	8676	8677	8678	8679
69	8680	8681	8682	8684	8685	8686	8687	8688	8689
70	8690	8691	8692	8694	8695	8696	8697	8698	8699
71	8700	8701	8702	8704	8705	8706	8707	8708	8709
72	8710	8711	8712	8714	8715	8716	8717	8718	8719
73	8720	8721	8722	8724	8725	8726	8727	8728	8729
74	8730	8731	8732	8734	8735	8736	8737	8738	8739
75	8740	8741	8742	8744	8745	8746	8747	8748	8749
76	8750	8751	8752	8754	8755	8756	8757	8758	8759
77	8760	8761	8762	8764	8765	8766	8767	8768	8769
78	8770	8771	8772	8774	8775	8776	8777	8778	8779
79	8780	8781	8782	8784	8785	8786	8787	8788	8789
80	8790	8791	8792	8794	8795	8796	8797	8798	8799
81	8800	8801	8802	8804	8805	8806	8807	8808	8809
82	8810	8811	8812	8814	8815	8816	8817	8818	8819
83	8820	8821	8822	8824	8825	8826	8827	8828	8829
84	8830	8831	8832	8834	8835	8836	8837	8838	8839
85	8840	8841	8842	8844	8845	8846	8847	8848	8849
86	8850	8851	8852	8854	8855	8856	8857	8858	8859
87	8860	8861	8862	8864	8865	8866	8867	8868	8869
88	8870	8871	8872	8874	8875	8876	8877	8878	8879
89	8880	8881	8882	8884	8885	8886	8887	8888	8889
90	8890	8891	8892	8894	8895	8896	8897	8898	8899
91	8900	8901	8902	8904	8905	8906	8907	8908	8909
92	8910	8911	8912	8914	8915	8916	8917	8918	8919
93	8920	8921	8922	8924	8925	8926	8927	8928	8929
94	8930	8931	8932	8934	8935	8936	8937	8938	8939
95	8940	8941	8942	8944	8945	8946	8947	8948	8949
96	8950	8951	8952	8954	8955	8956	8957	8958	8959
97	8960	8961	8962	8964	8965	8966	8967	8968	8969
98	8970	8971	8972	8974	8975	8976	8977	8978	8979
99	8980	8981	8982	8984	8985	8986	8987	8988	8989
100	8990	8991	8992	8994	8995	8996	8997	8998	8999

(2) For axis 2

Data No.	Positioning identifier	M code	Dwell time	Command speed		Positioning address		Arc data	
				Low-order	High-order	Low-order	High-order	Low-order	High-order
101	9000	9001	9002	9004	9005	9006	9007	9008	9009
102	9010	9011	9012	9014	9015	9016	9017	9018	9019
103	9020	9021	9022	9024	9025	9026	9027	9028	9029
104	9030	9031	9032	9034	9035	9036	9037	9038	9039
105	9040	9041	9042	9044	9045	9046	9047	9048	9049
106	9050	9051	9052	9054	9055	9056	9057	9058	9059
107	9060	9061	9062	9064	9065	9066	9067	9068	9069
108	9070	9071	9072	9074	9075	9076	9077	9078	9079
109	9080	9081	9082	9084	9085	9086	9087	9088	9089
110	9090	9091	9092	9094	9095	9096	9097	9098	9099
111	9100	9101	9102	9104	9105	9106	9107	9108	9109
112	9110	9111	9112	9114	9115	9116	9117	9118	9119
113	9120	9121	9122	9124	9125	9126	9127	9128	9129
114	9130	9131	9132	9134	9135	9136	9137	9138	9139
115	9140	9141	9142	9144	9145	9146	9147	9148	9149
116	9150	9151	9152	9154	9155	9156	9157	9158	9159
117	9160	9161	9162	9164	9165	9166	9167	9168	9169
118	9170	9171	9172	9174	9175	9176	9177	9178	9179
119	9180	9181	9182	9184	9185	9186	9187	9188	9189
120	9190	9191	9192	9194	9195	9196	9197	9198	9199
121	9200	9201	9202	9204	9205	9206	9207	9208	9209
122	9210	9211	9212	9214	9215	9216	9217	9218	9219
123	9220	9221	9222	9224	9225	9226	9227	9228	9229
124	9230	9231	9232	9234	9235	9236	9237	9238	9239
125	9240	9241	9242	9244	9245	9246	9247	9248	9249
126	9250	9251	9252	9254	9255	9256	9257	9258	9259
127	9260	9261	9262	9264	9265	9266	9267	9268	9269
128	9270	9271	9272	9274	9275	9276	9277	9278	9279
129	9280	9281	9282	9284	9285	9286	9287	9288	9289
130	9290	9291	9292	9294	9295	9296	9297	9298	9299
131	9300	9301	9302	9304	9305	9306	9307	9308	9309
132	9310	9311	9312	9314	9315	9316	9317	9318	9319
133	9320	9321	9322	9324	9325	9326	9327	9328	9329
134	9330	9331	9332	9334	9335	9336	9337	9338	9339
135	9340	9341	9342	9344	9345	9346	9347	9348	9349
136	9350	9351	9352	9354	9355	9356	9357	9358	9359
137	9360	9361	9362	9364	9365	9366	9367	9368	9369
138	9370	9371	9372	9374	9375	9376	9377	9378	9379
139	9380	9381	9382	9384	9385	9386	9387	9388	9389
140	9390	9391	9392	9394	9395	9396	9397	9398	9399
141	9400	9401	9402	9404	9405	9406	9407	9408	9409
142	9410	9411	9412	9414	9415	9416	9417	9418	9419
143	9420	9421	9422	9424	9425	9426	9427	9428	9429
144	9430	9431	9432	9434	9435	9436	9437	9438	9439
145	9440	9441	9442	9444	9445	9446	9447	9448	9449
146	9450	9451	9452	9454	9455	9456	9457	9458	9459
147	9460	9461	9462	9464	9465	9466	9467	9468	9469
148	9470	9471	9472	9474	9475	9476	9477	9478	9479
149	9480	9481	9482	9484	9485	9486	9487	9488	9489
150	9490	9491	9492	9494	9495	9496	9497	9498	9499

Data No.	Positioning identifier	M code	Dwell time	Command speed		Positioning address		Arc data	
				Low-order	High-order	Low-order	High-order	Low-order	High-order
151	9500	9501	9502	9504	9505	9506	9507	9508	9509
152	9510	9511	9512	9514	9515	9516	9517	9518	9519
153	9520	9521	9522	9524	9525	9526	9527	9528	9529
154	9530	9531	9532	9534	9535	9536	9537	9538	9539
155	9540	9541	9542	9544	9545	9546	9547	9548	9549
156	9550	9551	9552	9554	9555	9556	9557	9558	9559
157	9560	9561	9562	9564	9565	9566	9567	9568	9569
158	9570	9571	9572	9574	9575	9576	9577	9578	9579
159	9580	9581	9582	9584	9585	9586	9587	9588	9589
160	9590	9591	9592	9594	9595	9596	9597	9598	9599
161	9600	9601	9602	9604	9605	9606	9607	9608	9609
162	9610	9611	9612	9614	9615	9616	9617	9618	9619
163	9620	9621	9622	9624	9625	9626	9627	9628	9629
164	9630	9631	9632	9634	9635	9636	9637	9638	9639
165	9640	9641	9642	9644	9645	9646	9647	9648	9649
166	9650	9651	9652	9654	9655	9656	9657	9658	9659
167	9660	9661	9662	9664	9665	9666	9667	9668	9669
168	9670	9671	9672	9674	9675	9676	9677	9678	9679
169	9680	9681	9682	9684	9685	9686	9687	9688	9689
170	9690	9691	9692	9694	9695	9696	9697	9698	9699
171	9700	9701	9702	9704	9705	9706	9707	9708	9709
172	9710	9711	9712	9714	9715	9716	9717	9718	9719
173	9720	9721	9722	9724	9725	9726	9727	9728	9729
174	9730	9731	9732	9734	9735	9736	9737	9738	9739
175	9740	9741	9742	9744	9745	9746	9747	9748	9749
176	9750	9751	9752	9754	9755	9756	9757	9758	9759
177	9760	9761	9762	9764	9765	9766	9767	9768	9769
178	9770	9771	9772	9774	9775	9776	9777	9778	9779
179	9780	9781	9782	9784	9785	9786	9787	9788	9789
180	9790	9791	9792	9794	9795	9796	9797	9798	9799
181	9800	9801	9802	9804	9805	9806	9807	9808	9809
182	9810	9811	9812	9814	9815	9816	9817	9818	9819
183	9820	9821	9822	9824	9825	9826	9827	9828	9829
184	9830	9831	9832	9834	9835	9836	9837	9838	9839
185	9840	9841	9842	9844	9845	9846	9847	9848	9849
186	9850	9851	9852	9854	9855	9856	9857	9858	9859
187	9860	9861	9862	9864	9865	9866	9867	9868	9869
188	9870	9871	9872	9874	9875	9876	9877	9878	9879
189	9880	9881	9882	9884	9885	9886	9887	9888	9889
190	9890	9891	9892	9894	9895	9896	9897	9898	9899
191	9900	9901	9902	9904	9905	9906	9907	9908	9909
192	9910	9911	9912	9914	9915	9916	9917	9918	9919
193	9920	9921	9922	9924	9925	9926	9927	9928	9929
194	9930	9931	9932	9934	9935	9936	9937	9938	9939
195	9940	9941	9942	9944	9945	9946	9947	9948	9949
196	9950	9951	9952	9954	9955	9956	9957	9958	9959
197	9960	9961	9962	9964	9965	9966	9967	9968	9969
198	9970	9971	9972	9974	9975	9976	9977	9978	9979
199	9980	9981	9982	9984	9985	9986	9987	9988	9989
200	9990	9991	9992	9994	9995	9996	9997	9998	9999

(2) For axis 2

Data No.	Positioning identifier	M code	Dwell time	Command speed		Positioning address		Arc data	
				Low-order	High-order	Low-order	High-order	Low-order	High-order
201	10000	10001	10002	10004	10005	10006	10007	10008	10009
202	10010	10011	10012	10014	10015	10016	10017	10018	10019
203	10020	10021	10022	10024	10025	10026	10027	10028	10029
204	10030	10031	10032	10034	10035	10036	10037	10038	10039
205	10040	10041	10042	10044	10045	10046	10047	10048	10049
206	10050	10051	10052	10054	10055	10056	10057	10058	10059
207	10060	10061	10062	10064	10065	10066	10067	10068	10069
208	10070	10071	10072	10074	10075	10076	10077	10078	10079
209	10080	10081	10082	10084	10085	10086	10087	10088	10089
210	10090	10091	10092	10094	10095	10096	10097	10098	10099
211	10100	10101	10102	10104	10105	10106	10107	10108	10109
212	10110	10111	10112	10114	10115	10116	10117	10118	10119
213	10120	10121	10122	10124	10125	10126	10127	10128	10129
214	10130	10131	10132	10134	10135	10136	10137	10138	10139
215	10140	10141	10142	10144	10145	10146	10147	10148	10149
216	10150	10151	10152	10154	10155	10156	10157	10158	10159
217	10160	10161	10162	10164	10165	10166	10167	10168	10169
218	10170	10171	10172	10174	10175	10176	10177	10178	10179
219	10180	10181	10182	10184	10185	10186	10187	10188	10189
220	10190	10191	10192	10194	10195	10196	10197	10198	10199
221	10200	10201	10202	10204	10205	10206	10207	10208	10209
222	10210	10211	10212	10214	10215	10216	10217	10218	10219
223	10220	10221	10222	10224	10225	10226	10227	10228	10229
224	10230	10231	10232	10234	10235	10236	10237	10238	10239
225	10240	10241	10242	10244	10245	10246	10247	10248	10249
226	10250	10251	10252	10254	10255	10256	10257	10258	10259
227	10260	10261	10262	10264	10265	10266	10267	10268	10269
228	10270	10271	10272	10274	10275	10276	10277	10278	10279
229	10280	10281	10282	10284	10285	10286	10287	10288	10289
230	10290	10291	10292	10294	10295	10296	10297	10298	10299
231	10300	10301	10302	10304	10305	10306	10307	10308	10309
232	10310	10311	10312	10314	10315	10316	10317	10318	10319
233	10320	10321	10322	10324	10325	10326	10327	10328	10329
234	10330	10331	10332	10334	10335	10336	10337	10338	10339
235	10340	10341	10342	10344	10345	10346	10347	10348	10349
236	10350	10351	10352	10354	10355	10356	10357	10358	10359
237	10360	10361	10362	10364	10365	10366	10367	10368	10369
238	10370	10371	10372	10374	10375	10376	10377	10378	10379
239	10380	10381	10382	10384	10385	10386	10387	10388	10389
240	10390	10391	10392	10394	10395	10396	10397	10398	10399
241	10400	10401	10402	10404	10405	10406	10407	10408	10409
242	10410	10411	10412	10414	10415	10416	10417	10418	10419
243	10420	10421	10422	10424	10425	10426	10427	10428	10429
244	10430	10431	10432	10434	10435	10436	10437	10438	10439
245	10440	10441	10442	10444	10445	10446	10447	10448	10449
246	10450	10451	10452	10454	10455	10456	10457	10458	10459
247	10460	10461	10462	10464	10465	10466	10467	10468	10469
248	10470	10471	10472	10474	10475	10476	10477	10478	10479
249	10480	10481	10482	10484	10485	10486	10487	10488	10489
250	10490	10491	10492	10494	10495	10496	10497	10498	10499

Data No.	Positioning identifier	M code	Dwell time	Command speed		Positioning address		Arc data	
				Low-order	High-order	Low-order	High-order	Low-order	High-order
251	10500	10501	10502	10504	10505	10506	10507	10508	10509
252	10510	10511	10512	10514	10515	10516	10517	10518	10519
253	10520	10521	10522	10524	10525	10526	10527	10528	10529
254	10530	10531	10532	10534	10535	10536	10537	10538	10539
255	10540	10541	10542	10544	10545	10546	10547	10548	10549
256	10550	10551	10552	10554	10555	10556	10557	10558	10559
257	10560	10561	10562	10564	10565	10566	10567	10568	10569
258	10570	10571	10572	10574	10575	10576	10577	10578	10579
259	10580	10581	10582	10584	10585	10586	10587	10588	10589
260	10590	10591	10592	10594	10595	10596	10597	10598	10599
261	10600	10601	10602	10604	10605	10606	10607	10608	10609
262	10610	10611	10612	10614	10615	10616	10617	10618	10619
263	10620	10621	10622	10624	10625	10626	10627	10628	10629
264	10630	10631	10632	10634	10635	10636	10637	10638	10639
265	10640	10641	10642	10644	10645	10646	10647	10648	10649
266	10650	10651	10652	10654	10655	10656	10657	10658	10659
267	10660	10661	10662	10664	10665	10666	10667	10668	10669
268	10670	10671	10672	10674	10675	10676	10677	10678	10679
269	10680	10681	10682	10684	10685	10686	10687	10688	10689
270	10690	10691	10692	10694	10695	10696	10697	10698	10699
271	10700	10701	10702	10704	10705	10706	10707	10708	10709
272	10710	10711	10712	10714	10715	10716	10717	10718	10719
273	10720	10721	10722	10724	10725	10726	10727	10728	10729
274	10730	10731	10732	10734	10735	10736	10737	10738	10739
275	10740	10741	10742	10744	10745	10746	10747	10748	10749
276	10750	10751	10752	10754	10755	10756	10757	10758	10759
277	10760	10761	10762	10764	10765	10766	10767	10768	10769
278	10770	10771	10772	10774	10775	10776	10777	10778	10779
279	10780	10781	10782	10784	10785	10786	10787	10788	10789
280	10790	10791	10792	10794	10795	10796	10797	10798	10799
281	10800	10801	10802	10804	10805	10806	10807	10808	10809
282	10810	10811	10812	10814	10815	10816	10817	10818	10819
283	10820	10821	10822	10824	10825	10826	10827	10828	10829
284	10830	10831	10832	10834	10835	10836	10837	10838	10839
285	10840	10841	10842	10844	10845	10846	10847	10848	10849
286	10850	10851	10852	10854	10855	10856	10857	10858	10859
287	10860	10861	10862	10864	10865	10866	10867	10868	10869
288	10870	10871	10872	10874	10875	10876	10877	10878	10879
289	10880	10881	10882	10884	10885	10886	10887	10888	10889
290	10890	10891	10892	10894	10895	10896	10897	10898	10899
291	10900	10901	10902	10904	10905	10906	10907	10908	10909
292	10910	10911	10912	10914	10915	10916	10917	10918	10919
293	10920	10921	10922	10924	10925	10926	10927	10928	10929
294	10930	10931	10932	10934	10935	10936	10937	10938	10939
295	10940	10941	10942	10944	10945	10946	10947	10948	10949
296	10950	10951	10952	10954	10955	10956	10957	10958	10959
297	10960	10961	10962	10964	10965	10966	10967	10968	10969
298	10970	10971	10972	10974	10975	10976	10977	10978	10979
299	10980	10981	10982	10984	10985	10986	10987	10988	10989
300	10990	10991	10992	10994	10995	10996	10997	10998	10999

(2) For axis 2

Data No.	Positioning identifier	M code	Dwell time	Command speed		Positioning address		Arc data	
				Low-order	High-order	Low-order	High-order	Low-order	High-order
301	11000	11001	11002	11004	11005	11006	11007	11008	11009
302	11010	11011	11012	11014	11015	11016	11017	11018	11019
303	11020	11021	11022	11024	11025	11026	11027	11028	11029
304	11030	11031	11032	11034	11035	11036	11037	11038	11039
305	11040	11041	11042	11044	11045	11046	11047	11048	11049
306	11050	11051	11052	11054	11055	11056	11057	11058	11059
307	11060	11061	11062	11064	11065	11066	11067	11068	11069
308	11070	11071	11072	11074	11075	11076	11077	11078	11079
309	11080	11081	11082	11084	11085	11086	11087	11088	11089
310	11090	11091	11092	11094	11095	11096	11097	11098	11099
311	11100	11101	11102	11104	11105	11106	11107	11108	11109
312	11110	11111	11112	11114	11115	11116	11117	11118	11119
313	11120	11121	11122	11124	11125	11126	11127	11128	11129
314	11130	11131	11132	11134	11135	11136	11137	11138	11139
315	11140	11141	11142	11144	11145	11146	11147	11148	11149
316	11150	11151	11152	11154	11155	11156	11157	11158	11159
317	11160	11161	11162	11164	11165	11166	11167	11168	11169
318	11170	11171	11172	11174	11175	11176	11177	11178	11179
319	11180	11181	11182	11184	11185	11186	11187	11188	11189
320	11190	11191	11192	11194	11195	11196	11197	11198	11199
321	11200	11201	11202	11204	11205	11206	11207	11208	11209
322	11210	11211	11212	11214	11215	11216	11217	11218	11219
323	11220	11221	11222	11224	11225	11226	11227	11228	11229
324	11230	11231	11232	11234	11235	11236	11237	11238	11239
325	11240	11241	11242	11244	11245	11246	11247	11248	11249
326	11250	11251	11252	11254	11255	11256	11257	11258	11259
327	11260	11261	11262	11264	11265	11266	11267	11268	11269
328	11270	11271	11272	11274	11275	11276	11277	11278	11279
329	11280	11281	11282	11284	11285	11286	11287	11288	11289
330	11290	11291	11292	11294	11295	11296	11297	11298	11299
331	11300	11301	11302	11304	11305	11306	11307	11308	11309
332	11310	11311	11312	11314	11315	11316	11317	11318	11319
333	11320	11321	11322	11324	11325	11326	11327	11328	11329
334	11330	11331	11332	11334	11335	11336	11337	11338	11339
335	11340	11341	11342	11344	11345	11346	11347	11348	11349
336	11350	11351	11352	11354	11355	11356	11357	11358	11359
337	11360	11361	11362	11364	11365	11366	11367	11368	11369
338	11370	11371	11372	11374	11375	11376	11377	11378	11379
339	11380	11381	11382	11384	11385	11386	11387	11388	11389
340	11390	11391	11392	11394	11395	11396	11397	11398	11399
341	11400	11401	11402	11404	11405	11406	11407	11408	11409
342	11410	11411	11412	11414	11415	11416	11417	11418	11419
343	11420	11421	11422	11424	11425	11426	11427	11428	11429
344	11430	11431	11432	11434	11435	11436	11437	11438	11439
345	11440	11441	11442	11444	11445	11446	11447	11448	11449
346	11450	11451	11452	11454	11455	11456	11457	11458	11459
347	11460	11461	11462	11464	11465	11466	11467	11468	11469
348	11470	11471	11472	11474	11475	11476	11477	11478	11479
349	11480	11481	11482	11484	11485	11486	11487	11488	11489
350	11490	11491	11492	11494	11495	11496	11497	11498	11499

Data No.	Positioning identifier	M code	Dwell time	Command speed		Positioning address		Arc data	
				Low-order	High-order	Low-order	High-order	Low-order	High-order
351	11500	11501	11502	11504	11505	11506	11507	11508	11509
352	11510	11511	11512	11514	11515	11516	11517	11518	11519
353	11520	11521	11522	11524	11525	11526	11527	11528	11529
354	11530	11531	11532	11534	11535	11536	11537	11538	11539
355	11540	11541	11542	11544	11545	11546	11547	11548	11549
356	11550	11551	11552	11554	11555	11556	11557	11558	11559
357	11560	11561	11562	11564	11565	11566	11567	11568	11569
358	11570	11571	11572	11574	11575	11576	11577	11578	11579
359	11580	11581	11582	11584	11585	11586	11587	11588	11589
360	11590	11591	11592	11594	11595	11596	11597	11598	11599
361	11600	11601	11602	11604	11605	11606	11607	11608	11609
362	11610	11611	11612	11614	11615	11616	11617	11618	11619
363	11620	11621	11622	11624	11625	11626	11627	11628	11629
364	11630	11631	11632	11634	11635	11636	11637	11638	11639
365	11640	11641	11642	11644	11645	11646	11647	11648	11649
366	11650	11651	11652	11654	11655	11656	11657	11658	11659
367	11660	11661	11662	11664	11665	11666	11667	11668	11669
368	11670	11671	11672	11674	11675	11676	11677	11678	11679
369	11680	11681	11682	11684	11685	11686	11687	11688	11689
370	11690	11691	11692	11694	11695	11696	11697	11698	11699
371	11700	11701	11702	11704	11705	11706	11707	11708	11709
372	11710	11711	11712	11714	11715	11716	11717	11718	11719
373	11720	11721	11722	11724	11725	11726	11727	11728	11729
374	11730	11731	11732	11734	11735	11736	11737	11738	11739
375	11740	11741	11742	11744	11745	11746	11747	11748	11749
376	11750	11751	11752	11754	11755	11756	11757	11758	11759
377	11760	11761	11762	11764	11765	11766	11767	11768	11769
378	11770	11771	11772	11774	11775	11776	11777	11778	11779
379	11780	11781	11782	11784	11785	11786	11787	11788	11789
380	11790	11791	11792	11794	11795	11796	11797	11798	11799
381	11800	11801	11802	11804	11805	11806	11807	11808	11809
382	11810	11811	11812	11814	11815	11816	11817	11818	11819
383	11820	11821	11822	11824	11825	11826	11827	11828	11829
384	11830	11831	11832	11834	11835	11836	11837	11838	11839
385	11840	11841	11842	11844	11845	11846	11847	11848	11849
386	11850	11851	11852	11854	11855	11856	11857	11858	11859
387	11860	11861	11862	11864	11865	11866	11867	11868	11869
388	11870	11871	11872	11874	11875	11876	11877	11878	11879
389	11880	11881	11882	11884	11885	11886	11887	11888	11889
390	11890	11891	11892	11894	11895	11896	11897	11898	11899
391	11900	11901	11902	11904	11905	11906	11907	11908	11909
392	11910	11911	11912	11914	11915	11916	11917	11918	11919
393	11920	11921	11922	11924	11925	11926	11927	11928	11929
394	11930	11931	11932	11934	11935	11936	11937	11938	11939
395	11940	11941	11942	11944	11945	11946	11947	11948	11949
396	11950	11951	11952	11954	11955	11956	11957	11958	11959
397	11960	11961	11962	11964	11965	11966	11967	11968	11969
398	11970	11971	11972	11974	11975	11976	11977	11978	11979
399	11980	11981	11982	11984	11985	11986	11987	11988	11989
400	11990	11991	11992	11994	11995	11996	11997	11998	11999



(2) For axis 2

Data No.	Positioning identifier	M code	Dwell time	Command speed		Positioning address		Arc data	
				Low-order	High-order	Low-order	High-order	Low-order	High-order
401	12000	12001	12002	12004	12005	12006	12007	12008	12009
402	12010	12011	12012	12014	12015	12016	12017	12018	12019
403	12020	12021	12022	12024	12025	12026	12027	12028	12029
404	12030	12031	12032	12034	12035	12036	12037	12038	12039
405	12040	12041	12042	12044	12045	12046	12047	12048	12049
406	12050	12051	12052	12054	12055	12056	12057	12058	12059
407	12060	12061	12062	12064	12065	12066	12067	12068	12069
408	12070	12071	12072	12074	12075	12076	12077	12078	12079
409	12080	12081	12082	12084	12085	12086	12087	12088	12089
410	12090	12091	12092	12094	12095	12096	12097	12098	12099
411	12100	12101	12102	12104	12105	12106	12107	12108	12109
412	12110	12111	12112	12114	12115	12116	12117	12118	12119
413	12120	12121	12122	12124	12125	12126	12127	12128	12129
414	12130	12131	12132	12134	12135	12136	12137	12138	12139
415	12140	12141	12142	12144	12145	12146	12147	12148	12149
416	12150	12151	12152	12154	12155	12156	12157	12158	12159
417	12160	12161	12162	12164	12165	12166	12167	12168	12169
418	12170	12171	12172	12174	12175	12176	12177	12178	12179
419	12180	12181	12182	12184	12185	12186	12187	12188	12189
420	12190	12191	12192	12194	12195	12196	12197	12198	12199
421	12200	12201	12202	12204	12205	12206	12207	12208	12209
422	12210	12211	12212	12214	12215	12216	12217	12218	12219
423	12220	12221	12222	12224	12225	12226	12227	12228	12229
424	12230	12231	12232	12234	12235	12236	12237	12238	12239
425	12240	12241	12242	12244	12245	12246	12247	12248	12249
426	12250	12251	12252	12254	12255	12256	12257	12258	12259
427	12260	12261	12262	12264	12265	12266	12267	12268	12269
428	12270	12271	12272	12274	12275	12276	12277	12278	12279
429	12280	12281	12282	12284	12285	12286	12287	12288	12289
430	12290	12291	12292	12294	12295	12296	12297	12298	12299
431	12300	12301	12302	12304	12305	12306	12307	12308	12309
432	12310	12311	12312	12314	12315	12316	12317	12318	12319
433	12320	12321	12322	12324	12325	12326	12327	12328	12329
434	12330	12331	12332	12334	12335	12336	12337	12338	12339
435	12340	12341	12342	12344	12345	12346	12347	12348	12349
436	12350	12351	12352	12354	12355	12356	12357	12358	12359
437	12360	12361	12362	12364	12365	12366	12367	12368	12369
438	12370	12371	12372	12374	12375	12376	12377	12378	12379
439	12380	12381	12382	12384	12385	12386	12387	12388	12389
440	12390	12391	12392	12394	12395	12396	12397	12398	12399
441	12400	12401	12402	12404	12405	12406	12407	12408	12409
442	12410	12411	12412	12414	12415	12416	12417	12418	12419
443	12420	12421	12422	12424	12425	12426	12427	12428	12429
444	12430	12431	12432	12434	12435	12436	12437	12438	12439
445	12440	12441	12442	12444	12445	12446	12447	12448	12449
446	12450	12451	12452	12454	12455	12456	12457	12458	12459
447	12460	12461	12462	12464	12465	12466	12467	12468	12469
448	12470	12471	12472	12474	12475	12476	12477	12478	12479
449	12480	12481	12482	12484	12485	12486	12487	12488	12489
450	12490	12491	12492	12494	12495	12496	12497	12498	12499

Data No.	Positioning identifier	M code	Dwell time	Command speed		Positioning address		Arc data	
				Low-order	High-order	Low-order	High-order	Low-order	High-order
451	12500	12501	12502	12504	12505	12506	12507	12508	12509
452	12510	12511	12512	12514	12515	12516	12517	12518	12519
453	12520	12521	12522	12524	12525	12526	12527	12528	12529
454	12530	12531	12532	12534	12535	12536	12537	12538	12539
455	12540	12541	12542	12544	12545	12546	12547	12548	12549
456	12550	12551	12552	12554	12555	12556	12557	12558	12559
457	12560	12561	12562	12564	12565	12566	12567	12568	12569
458	12570	12571	12572	12574	12575	12576	12577	12578	12579
459	12580	12581	12582	12584	12585	12586	12587	12588	12589
460	12590	12591	12592	12594	12595	12596	12597	12598	12599
461	12600	12601	12602	12604	12605	12606	12607	12608	12609
462	12610	12611	12612	12614	12615	12616	12617	12618	12619
463	12620	12621	12622	12624	12625	12626	12627	12628	12629
464	12630	12631	12632	12634	12635	12636	12637	12638	12639
465	12640	12641	12642	12644	12645	12646	12647	12648	12649
466	12650	12651	12652	12654	12655	12656	12657	12658	12659
467	12660	12661	12662	12664	12665	12666	12667	12668	12669
468	12670	12671	12672	12674	12675	12676	12677	12678	12679
469	12680	12681	12682	12684	12685	12686	12687	12688	12689
470	12690	12691	12692	12694	12695	12696	12697	12698	12699
471	12700	12701	12702	12704	12705	12706	12707	12708	12709
472	12710	12711	12712	12714	12715	12716	12717	12718	12719
473	12720	12721	12722	12724	12725	12726	12727	12728	12729
474	12730	12731	12732	12734	12735	12736	12737	12738	12739
475	12740	12741	12742	12744	12745	12746	12747	12748	12749
476	12750	12751	12752	12754	12755	12756	12757	12758	12759
477	12760	12761	12762	12764	12765	12766	12767	12768	12769
478	12770	12771	12772	12774	12775	12776	12777	12778	12779
479	12780	12781	12782	12784	12785	12786	12787	12788	12789
480	12790	12791	12792	12794	12795	12796	12797	12798	12799
481	12800	12801	12802	12804	12805	12806	12807	12808	12809
482	12810	12811	12812	12814	12815	12816	12817	12818	12819
483	12820	12821	12822	12824	12825	12826	12827	12828	12829
484	12830	12831	12832	12834	12835	12836	12837	12838	12839
485	12840	12841	12842	12844	12845	12846	12847	12848	12849
486	12850	12851	12852	12854	12855	12856	12857	12858	12859
487	12860	12861	12862	12864	12865	12866	12867	12868	12869
488	12870	12871	12872	12874	12875	12876	12877	12878	12879
489	12880	12881	12882	12884	12885	12886	12887	12888	12889
490	12890	12891	12892	12894	12895	12896	12897	12898	12899
491	12900	12901	12902	12904	12905	12906	12907	12908	12909
492	12910	12911	12912	12914	12915	12916	12917	12918	12919
493	12920	12921	12922	12924	12925	12926	12927	12928	12929
494	12930	12931	12932	12934	12935	12936	12937	12938	12939
495	12940	12941	12942	12944	12945	12946	12947	12948	12949
496	12950	12951	12952	12954	12955	12956	12957	12958	12959
497	12960	12961	12962	12964	12965	12966	12967	12968	12969
498	12970	12971	12972	12974	12975	12976	12977	12978	12979
499	12980	12981	12982	12984	12985	12986	12987	12988	12989
500	12990	12991	12992	12994	12995	12996	12997	12998	12999

(2) For axis 2

Data No.	Positioning identifier	M code	Dwell time	Command speed		Positioning address		Arc data	
				Low-order	High-order	Low-order	High-order	Low-order	High-order
501	13000	13001	13002	13004	13005	13006	13007	13008	13009
502	13010	13011	13012	13014	13015	13016	13017	13018	13019
503	13020	13021	13022	13024	13025	13026	13027	13028	13029
504	13030	13031	13032	13034	13035	13036	13037	13038	13039
505	13040	13041	13042	13044	13045	13046	13047	13048	13049
506	13050	13051	13052	13054	13055	13056	13057	13058	13059
507	13060	13061	13062	13064	13065	13066	13067	13068	13069
508	13070	13071	13072	13074	13075	13076	13077	13078	13079
509	13080	13081	13082	13084	13085	13086	13087	13088	13089
510	13090	13091	13092	13094	13095	13096	13097	13098	13099
511	13100	13101	13102	13104	13105	13106	13107	13108	13109
512	13110	13111	13112	13114	13115	13116	13117	13118	13119
513	13120	13121	13122	13124	13125	13126	13127	13128	13129
514	13130	13131	13132	13134	13135	13136	13137	13138	13139
515	13140	13141	13142	13144	13145	13146	13147	13148	13149
516	13150	13151	13152	13154	13155	13156	13157	13158	13159
517	13160	13161	13162	13164	13165	13166	13167	13168	13169
518	13170	13171	13172	13174	13175	13176	13177	13178	13179
519	13180	13181	13182	13184	13185	13186	13187	13188	13189
520	13190	13191	13192	13194	13195	13196	13197	13198	13199
521	13200	13201	13202	13204	13205	13206	13207	13208	13209
522	13210	13211	13212	13214	13215	13216	13217	13218	13219
523	13220	13221	13222	13224	13225	13226	13227	13228	13229
524	13230	13231	13232	13234	13235	13236	13237	13238	13239
525	13240	13241	13242	13244	13245	13246	13247	13248	13249
526	13250	13251	13252	13254	13255	13256	13257	13258	13259
527	13260	13261	13262	13264	13265	13266	13267	13268	13269
528	13270	13271	13272	13274	13275	13276	13277	13278	13279
529	13280	13281	13282	13284	13285	13286	13287	13288	13289
530	13290	13291	13292	13294	13295	13296	13297	13298	13299
531	13300	13301	13302	13304	13305	13306	13307	13308	13309
532	13310	13311	13312	13314	13315	13316	13317	13318	13319
533	13320	13321	13322	13324	13325	13326	13327	13328	13329
534	13330	13331	13332	13334	13335	13336	13337	13338	13339
535	13340	13341	13342	13344	13345	13346	13347	13348	13349
536	13350	13351	13352	13354	13355	13356	13357	13358	13359
537	13360	13361	13362	13364	13365	13366	13367	13368	13369
538	13370	13371	13372	13374	13375	13376	13377	13378	13379
539	13380	13381	13382	13384	13385	13386	13387	13388	13389
540	13390	13391	13392	13394	13395	13396	13397	13398	13399
541	13400	13401	13402	13404	13405	13406	13407	13408	13409
542	13410	13411	13412	13414	13415	13416	13417	13418	13419
543	13420	13421	13422	13424	13425	13426	13427	13428	13429
544	13430	13431	13432	13434	13435	13436	13437	13438	13439
545	13440	13441	13442	13444	13445	13446	13447	13448	13449
546	13450	13451	13452	13454	13455	13456	13457	13458	13459
547	13460	13461	13462	13464	13465	13466	13467	13468	13469
548	13470	13471	13472	13474	13475	13476	13477	13478	13479
549	13480	13481	13482	13484	13485	13486	13487	13488	13489
550	13490	13491	13492	13494	13495	13496	13497	13498	13499

Data No.	Positioning identifier	M code	Dwell time	Command speed		Positioning address		Arc data	
				Low-order	High-order	Low-order	High-order	Low-order	High-order
551	13500	13501	13502	13504	13505	13506	13507	13508	13509
552	13510	13511	13512	13514	13515	13516	13517	13518	13519
553	13520	13521	13522	13524	13525	13526	13527	13528	13529
554	13530	13531	13532	13534	13535	13536	13537	13538	13539
555	13540	13541	13542	13544	13545	13546	13547	13548	13549
556	13550	13551	13552	13554	13555	13556	13557	13558	13559
557	13560	13561	13562	13564	13565	13566	13567	13568	13569
558	13570	13571	13572	13574	13575	13576	13577	13578	13579
559	13580	13581	13582	13584	13585	13586	13587	13588	13589
560	13590	13591	13592	13594	13595	13596	13597	13598	13599
561	13600	13601	13602	13604	13605	13606	13607	13608	13609
562	13610	13611	13612	13614	13615	13616	13617	13618	13619
563	13620	13621	13622	13624	13625	13626	13627	13628	13629
564	13630	13631	13632	13634	13635	13636	13637	13638	13639
565	13640	13641	13642	13644	13645	13646	13647	13648	13649
566	13650	13651	13652	13654	13655	13656	13657	13658	13659
567	13660	13661	13662	13664	13665	13666	13667	13668	13669
568	13670	13671	13672	13674	13675	13676	13677	13678	13679
569	13680	13681	13682	13684	13685	13686	13687	13688	13689
570	13690	13691	13692	13694	13695	13696	13697	13698	13699
571	13700	13701	13702	13704	13705	13706	13707	13708	13709
572	13710	13711	13712	13714	13715	13716	13717	13718	13719
573	13720	13721	13722	13724	13725	13726	13727	13728	13729
574	13730	13731	13732	13734	13735	13736	13737	13738	13739
575	13740	13741	13742	13744	13745	13746	13747	13748	13749
576	13750	13751	13752	13754	13755	13756	13757	13758	13759
577	13760	13761	13762	13764	13765	13766	13767	13768	13769
578	13770	13771	13772	13774	13775	13776	13777	13778	13779
579	13780	13781	13782	13784	13785	13786	13787	13788	13789
580	13790	13791	13792	13794	13795	13796	13797	13798	13799
581	13800	13801	13802	13804	13805	13806	13807	13808	13809
582	13810	13811	13812	13814	13815	13816	13817	13818	13819
583	13820	13821	13822	13824	13825	13826	13827	13828	13829
584	13830	13831	13832	13834	13835	13836	13837	13838	13839
585	13840	13841	13842	13844	13845	13846	13847	13848	13849
586	13850	13851	13852	13854	13855	13856	13857	13858	13859
587	13860	13861	13862	13864	13865	13866	13867	13868	13869
588	13870	13871	13872	13874	13875	13876	13877	13878	13879
589	13880	13881	13882	13884	13885	13886	13887	13888	13889
590	13890	13891	13892	13894	13895	13896	13897	13898	13899
591	13900	13901	13902	13904	13905	13906	13907	13908	13909
592	13910	13911	13912	13914	13915	13916	13917	13918	13919
593	13920	13921	13922	13924	13925	13926	13927	13928	13929
594	13930	13931	13932	13934	13935	13936	13937	13938	13939
595	13940	13941	13942	13944	13945	13946	13947	13948	13949
596	13950	13951	13952	13954	13955	13956	13957	13958	13959
597	13960	13961	13962	13964	13965	13966	13967	13968	13969
598	13970	13971	13972	13974	13975	13976	13977	13978	13979
599	13980	13981	13982	13984	13985	13986	13987	13988	13989
600	13990	13991	13992	13994	13995	13996	13997	13998	13999

(3) For axis 3

Data No.	Positioning identifier	M code	Dwell time	Command speed		Positioning address		Arc data	
				Low-order	High-order	Low-order	High-order	Low-order	High-order
1	14000	14001	14002	14004	14005	14006	14007	14008	14009
2	14010	14011	14012	14014	14015	14016	14017	14018	14019
3	14020	14021	14022	14024	14025	14026	14027	14028	14029
4	14030	14031	14032	14034	14035	14036	14037	14038	14039
5	14040	14041	14042	14044	14045	14046	14047	14048	14049
6	14050	14051	14052	14054	14055	14056	14057	14058	14059
7	14060	14061	14062	14064	14065	14066	14067	14068	14069
8	14070	14071	14072	14074	14075	14076	14077	14078	14079
9	14080	14081	14082	14084	14085	14086	14087	14088	14089
10	14090	14091	14092	14094	14095	14096	14097	14098	14099
11	14100	14101	14102	14104	14105	14106	14107	14108	14109
12	14110	14111	14112	14114	14115	14116	14117	14118	14119
13	14120	14121	14122	14124	14125	14126	14127	14128	14129
14	14130	14131	14132	14134	14135	14136	14137	14138	14139
15	14140	14141	14142	14144	14145	14146	14147	14148	14149
16	14150	14151	14152	14154	14155	14156	14157	14158	14159
17	14160	14161	14162	14164	14165	14166	14167	14168	14169
18	14170	14171	14172	14174	14175	14176	14177	14178	14179
19	14180	14181	14182	14184	14185	14186	14187	14188	14189
20	14190	14191	14192	14194	14195	14196	14197	14198	14199
21	14200	14201	14202	14204	14205	14206	14207	14208	14209
22	14210	14211	14212	14214	14215	14216	14217	14218	14219
23	14220	14221	14222	14224	14225	14226	14227	14228	14229
24	14230	14231	14232	14234	14235	14236	14237	14238	14239
25	14240	14241	14242	14244	14245	14246	14247	14248	14249
26	14250	14251	14252	14254	14255	14256	14257	14258	14259
27	14260	14261	14262	14264	14265	14266	14267	14268	14269
28	14270	14271	14272	14274	14275	14276	14277	14278	14279
29	14280	14281	14282	14284	14285	14286	14287	14288	14289
30	14290	14291	14292	14294	14295	14296	14297	14298	14299
31	14300	14301	14302	14304	14305	14306	14307	14308	14309
32	14310	14311	14312	14314	14315	14316	14317	14318	14319
33	14320	14321	14322	14324	14325	14326	14327	14328	14329
34	14330	14331	14332	14334	14335	14336	14337	14338	14339
35	14340	14341	14342	14344	14345	14346	14347	14348	14349
36	14350	14351	14352	14354	14355	14356	14357	14358	14359
37	14360	14361	14362	14364	14365	14366	14367	14368	14369
38	14370	14371	14372	14374	14375	14376	14377	14378	14379
39	14380	14381	14382	14384	14385	14386	14387	14388	14389
40	14390	14391	14392	14394	14395	14396	14397	14398	14399
41	14400	14401	14402	14404	14405	14406	14407	14408	14409
42	14410	14411	14412	14414	14415	14416	14417	14418	14419
43	14420	14421	14422	14424	14425	14426	14427	14428	14429
44	14430	14431	14432	14434	14435	14436	14437	14438	14439
45	14440	14441	14442	14444	14445	14446	14447	14448	14449
46	14450	14451	14452	14454	14455	14456	14457	14458	14459
47	14460	14461	14462	14464	14465	14466	14467	14468	14469
48	14470	14471	14472	14474	14475	14476	14477	14478	14479
49	14480	14481	14482	14484	14485	14486	14487	14488	14489
50	14490	14491	14492	14494	14495	14496	14497	14498	14499

Data No.	Positioning identifier	M code	Dwell time	Command speed		Positioning address		Arc data	
				Low-order	High-order	Low-order	High-order	Low-order	High-order
51	14500	14501	14502	14504	14505	14506	14507	14508	14509
52	14510	14511	14512	14514	14515	14516	14517	14518	14519
53	14520	14521	14522	14524	14525	14526	14527	14528	14529
54	14530	14531	14532	14534	14535	14536	14537	14538	14539
55	14540	14541	14542	14544	14545	14546	14547	14548	14549
56	14550	14551	14552	14554	14555	14556	14557	14558	14559
57	14560	14561	14562	14564	14565	14566	14567	14568	14569
58	14570	14571	14572	14574	14575	14576	14577	14578	14579
59	14580	14581	14582	14584	14585	14586	14587	14588	14589
60	14590	14591	14592	14594	14595	14596	14597	14598	14599
61	14600	14601	14602	14604	14605	14606	14607	14608	14609
62	14610	14611	14612	14614	14615	14616	14617	14618	14619
63	14620	14621	14622	14624	14625	14626	14627	14628	14629
64	14630	14631	14632	14634	14635	14636	14637	14638	14639
65	14640	14641	14642	14644	14645	14646	14647	14648	14649
66	14650	14651	14652	14654	14655	14656	14657	14658	14659
67	14660	14661	14662	14664	14665	14666	14667	14668	14669
68	14670	14671	14672	14674	14675	14676	14677	14678	14679
69	14680	14681	14682	14684	14685	14686	14687	14688	14689
70	14690	14691	14692	14694	14695	14696	14697	14698	14699
71	14700	14701	14702	14704	14705	14706	14707	14708	14709
72	14710	14711	14712	14714	14715	14716	14717	14718	14719
73	14720	14721	14722	14724	14725	14726	14727	14728	14729
74	14730	14731	14732	14734	14735	14736	14737	14738	14739
75	14740	14741	14742	14744	14745	14746	14747	14748	14749
76	14750	14751	14752	14754	14755	14756	14757	14758	14759
77	14760	14761	14762	14764	14765	14766	14767	14768	14769
78	14770	14771	14772	14774	14775	14776	14777	14778	14779
79	14780	14781	14782	14784	14785	14786	14787	14788	14789
80	14790	14791	14792	14794	14795	14796	14797	14798	14799
81	14800	14801	14802	14804	14805	14806	14807	14808	14809
82	14810	14811	14812	14814	14815	14816	14817	14818	14819
83	14820	14821	14822	14824	14825	14826	14827	14828	14829
84	14830	14831	14832	14834	14835	14836	14837	14838	14839
85	14840	14841	14842	14844	14845	14846	14847	14848	14849
86	14850	14851	14852	14854	14855	14856	14857	14858	14859
87	14860	14861	14862	14864	14865	14866	14867	14868	14869
88	14870	14871	14872	14874	14875	14876	14877	14878	14879
89	14880	14881	14882	14884	14885	14886	14887	14888	14889
90	14890	14891	14892	14894	14895	14896	14897	14898	14899
91	14900	14901	14902	14904	14905	14906	14907	14908	14909
92	14910	14911	14912	14914	14915	14916	14917	14918	14919
93	14920	14921	14922	14924	14925	14926	14927	14928	14929
94	14930	14931	14932	14934	14935	14936	14937	14938	14939
95	14940	14941	14942	14944	14945	14946	14947	14948	14949
96	14950	14951	14952	14954	14955	14956	14957	14958	14959
97	14960	14961	14962	14964	14965	14966	14967	14968	14969
98	14970	14971	14972	14974	14975	14976	14977	14978	14979
99	14980	14981	14982	14984	14985	14986	14987	14988	14989
100	14990	14991	14992	14994	14995	14996	14997	14998	14999

(3) For axis 3

Data No.	Positioning identifier	M code	Dwell time	Command speed		Positioning address		Arc data	
				Low-order	High-order	Low-order	High-order	Low-order	High-order
101	15000	15001	15002	15004	15005	15006	15007	15008	15009
102	15010	15011	15012	15014	15015	15016	15017	15018	15019
103	15020	15021	15022	15024	15025	15026	15027	15028	15029
104	15030	15031	15032	15034	15035	15036	15037	15038	15039
105	15040	15041	15042	15044	15045	15046	15047	15048	15049
106	15050	15051	15052	15054	15055	15056	15057	15058	15059
107	15060	15061	15062	15064	15065	15066	15067	15068	15069
108	15070	15071	15072	15074	15075	15076	15077	15078	15079
109	15080	15081	15082	15084	15085	15086	15087	15088	15089
110	15090	15091	15092	15094	15095	15096	15097	15098	15099
111	15100	15101	15102	15104	15105	15106	15107	15108	15109
112	15110	15111	15112	15114	15115	15116	15117	15118	15119
113	15120	15121	15122	15124	15125	15126	15127	15128	15129
114	15130	15131	15132	15134	15135	15136	15137	15138	15139
115	15140	15141	15142	15144	15145	15146	15147	15148	15149
116	15150	15151	15152	15154	15155	15156	15157	15158	15159
117	15160	15161	15162	15164	15165	15166	15167	15168	15169
118	15170	15171	15172	15174	15175	15176	15177	15178	15179
119	15180	15181	15182	15184	15185	15186	15187	15188	15189
120	15190	15191	15192	15194	15195	15196	15197	15198	15199
121	15200	15201	15202	15204	15205	15206	15207	15208	15209
122	15210	15211	15212	15214	15215	15216	15217	15218	15219
123	15220	15221	15222	15224	15225	15226	15227	15228	15229
124	15230	15231	15232	15234	15235	15236	15237	15238	15239
125	15240	15241	15242	15244	15245	15246	15247	15248	15249
126	15250	15251	15252	15254	15255	15256	15257	15258	15259
127	15260	15261	15262	15264	15265	15266	15267	15268	15269
128	15270	15271	15272	15274	15275	15276	15277	15278	15279
129	15280	15281	15282	15284	15285	15286	15287	15288	15289
130	15290	15291	15292	15294	15295	15296	15297	15298	15299
131	15300	15301	15302	15304	15305	15306	15307	15308	15309
132	15310	15311	15312	15314	15315	15316	15317	15318	15319
133	15320	15321	15322	15324	15325	15326	15327	15328	15329
134	15330	15331	15332	15334	15335	15336	15337	15338	15339
135	15340	15341	15342	15344	15345	15346	15347	15348	15349
136	15350	15351	15352	15354	15355	15356	15357	15358	15359
137	15360	15361	15362	15364	15365	15366	15367	15368	15369
138	15370	15371	15372	15374	15375	15376	15377	15378	15379
139	15380	15381	15382	15384	15385	15386	15387	15388	15389
140	15390	15391	15392	15394	15395	15396	15397	15398	15399
141	15400	15401	15402	15404	15405	15406	15407	15408	15409
142	15410	15411	15412	15414	15415	15416	15417	15418	15419
143	15420	15421	15422	15424	15425	15426	15427	15428	15429
144	15430	15431	15432	15434	15435	15436	15437	15438	15439
145	15440	15441	15442	15444	15445	15446	15447	15448	15449
146	15450	15451	15452	15454	15455	15456	15457	15458	15459
147	15460	15461	15462	15464	15465	15466	15467	15468	15469
148	15470	15471	15472	15474	15475	15476	15477	15478	15479
149	15480	15481	15482	15484	15485	15486	15487	15488	15489
150	15490	15491	15492	15494	15495	15496	15497	15498	15499

Data No.	Positioning identifier	M code	Dwell time	Command speed		Positioning address		Arc data	
				Low-order	High-order	Low-order	High-order	Low-order	High-order
151	15500	15501	15502	15504	15505	15506	15507	15508	15509
152	15510	15511	15512	15514	15515	15516	15517	15518	15519
153	15520	15521	15522	15524	15525	15526	15527	15528	15529
154	15530	15531	15532	15534	15535	15536	15537	15538	15539
155	15540	15541	15542	15544	15545	15546	15547	15548	15549
156	15550	15551	15552	15554	15555	15556	15557	15558	15559
157	15560	15561	15562	15564	15565	15566	15567	15568	15569
158	15570	15571	15572	15574	15575	15576	15577	15578	15579
159	15580	15581	15582	15584	15585	15586	15587	15588	15589
160	15590	15591	15592	15594	15595	15596	15597	15598	15599
161	15600	15601	15602	15604	15605	15606	15607	15608	15609
162	15610	15611	15612	15614	15615	15616	15617	15618	15619
163	15620	15621	15622	15624	15625	15626	15627	15628	15629
164	15630	15631	15632	15634	15635	15636	15637	15638	15639
165	15640	15641	15642	15644	15645	15646	15647	15648	15649
166	15650	15651	15652	15654	15655	15656	15657	15658	15659
167	15660	15661	15662	15664	15665	15666	15667	15668	15669
168	15670	15671	15672	15674	15675	15676	15677	15678	15679
169	15680	15681	15682	15684	15685	15686	15687	15688	15689
170	15690	15691	15692	15694	15695	15696	15697	15698	15699
171	15700	15701	15702	15704	15705	15706	15707	15708	15709
172	15710	15711	15712	15714	15715	15716	15717	15718	15719
173	15720	15721	15722	15724	15725	15726	15727	15728	15729
174	15730	15731	15732	15734	15735	15736	15737	15738	15739
175	15740	15741	15742	15744	15745	15746	15747	15748	15749
176	15750	15751	15752	15754	15755	15756	15757	15758	15759
177	15760	15761	15762	15764	15765	15766	15767	15768	15769
178	15770	15771	15772	15774	15775	15776	15777	15778	15779
179	15780	15781	15782	15784	15785	15786	15787	15788	15789
180	15790	15791	15792	15794	15795	15796	15797	15798	15799
181	15800	15801	15802	15804	15805	15806	15807	15808	15809
182	15810	15811	15812	15814	15815	15816	15817	15818	15819
183	15820	15821	15822	15824	15825	15826	15827	15828	15829
184	15830	15831	15832	15834	15835	15836	15837	15838	15839
185	15840	15841	15842	15844	15845	15846	15847	15848	15849
186	15850	15851	15852	15854	15855	15856	15857	15858	15859
187	15860	15861	15862	15864	15865	15866	15867	15868	15869
188	15870	15871	15872	15874	15875	15876	15877	15878	15879
189	15880	15881	15882	15884	15885	15886	15887	15888	15889
190	15890	15891	15892	15894	15895	15896	15897	15898	15899
191	15900	15901	15902	15904	15905	15906	15907	15908	15909
192	15910	15911	15912	15914	15915	15916	15917	15918	15919
193	15920	15921	15922	15924	15925	15926	15927	15928	15929
194	15930	15931	15932	15934	15935	15936	15937	15938	15939
195	15940	15941	15942	15944	15945	15946	15947	15948	15949
196	15950	15951	15952	15954	15955	15956	15957	15958	15959
197	15960	15961	15962	15964	15965	15966	15967	15968	15969
198	15970	15971	15972	15974	15975	15976	15977	15978	15979
199	15980	15981	15982	15984	15985	15986	15987	15988	15989
200	15990	15991	15992	15994	15995	15996	15997	15998	15999

(3) For axis 3

Data No.	Positioning identifier	M code	Dwell time	Command speed		Positioning address		Arc data	
				Low-order	High-order	Low-order	High-order	Low-order	High-order
201	16000	16001	16002	16004	16005	16006	16007	16008	16009
202	16010	16011	16012	16014	16015	16016	16017	16018	16019
203	16020	16021	16022	16024	16025	16026	16027	16028	16029
204	16030	16031	16032	16034	16035	16036	16037	16038	16039
205	16040	16041	16042	16044	16045	16046	16047	16048	16049
206	16050	16051	16052	16054	16055	16056	16057	16058	16059
207	16060	16061	16062	16064	16065	16066	16067	16068	16069
208	16070	16071	16072	16074	16075	16076	16077	16078	16079
209	16080	16081	16082	16084	16085	16086	16087	16088	16089
210	16090	16091	16092	16094	16095	16096	16097	16098	16099
211	16100	16101	16102	16104	16105	16106	16107	16108	16109
212	16110	16111	16112	16114	16115	16116	16117	16118	16119
213	16120	16121	16122	16124	16125	16126	16127	16128	16129
214	16130	16131	16132	16134	16135	16136	16137	16138	16139
215	16140	16141	16142	16144	16145	16146	16147	16148	16149
216	16150	16151	16152	16154	16155	16156	16157	16158	16159
217	16160	16161	16162	16164	16165	16166	16167	16168	16169
218	16170	16171	16172	16174	16175	16176	16177	16178	16179
219	16180	16181	16182	16184	16185	16186	16187	16188	16189
220	16190	16191	16192	16194	16195	16196	16197	16198	16199
221	16200	16201	16202	16204	16205	16206	16207	16208	16209
222	16210	16211	16212	16214	16215	16216	16217	16218	16219
223	16220	16221	16222	16224	16225	16226	16227	16228	16229
224	16230	16231	16232	16234	16235	16236	16237	16238	16239
225	16240	16241	16242	16244	16245	16246	16247	16248	16249
226	16250	16251	16252	16254	16255	16256	16257	16258	16259
227	16260	16261	16262	16264	16265	16266	16267	16268	16269
228	16270	16271	16272	16274	16275	16276	16277	16278	16279
229	16280	16281	16282	16284	16285	16286	16287	16288	16289
230	16290	16291	16292	16294	16295	16296	16297	16298	16299
231	16300	16301	16302	16304	16305	16306	16307	16308	16309
232	16310	16311	16312	16314	16315	16316	16317	16318	16319
233	16320	16321	16322	16324	16325	16326	16327	16328	16329
234	16330	16331	16332	16334	16335	16336	16337	16338	16339
235	16340	16341	16342	16344	16345	16346	16347	16348	16349
236	16350	16351	16352	16354	16355	16356	16357	16358	16359
237	16360	16361	16362	16364	16365	16366	16367	16368	16369
238	16370	16371	16372	16374	16375	16376	16377	16378	16379
239	16380	16381	16382	16384	16385	16386	16387	16388	16389
240	16390	16391	16392	16394	16395	16396	16397	16398	16399
241	16400	16401	16402	16404	16405	16406	16407	16408	16409
242	16410	16411	16412	16414	16415	16416	16417	16418	16419
243	16420	16421	16422	16424	16425	16426	16427	16428	16429
244	16430	16431	16432	16434	16435	16436	16437	16438	16439
245	16440	16441	16442	16444	16445	16446	16447	16448	16449
246	16450	16451	16452	16454	16455	16456	16457	16458	16459
247	16460	16461	16462	16464	16465	16466	16467	16468	16469
248	16470	16471	16472	16474	16475	16476	16477	16478	16479
249	16480	16481	16482	16484	16485	16486	16487	16488	16489
250	16490	16491	16492	16494	16495	16496	16497	16498	16499

Data No.	Positioning identifier	M code	Dwell time	Command speed		Positioning address		Arc data	
				Low-order	High-order	Low-order	High-order	Low-order	High-order
251	16500	16501	16502	16504	16505	16506	16507	16508	16509
252	16510	16511	16512	16514	16515	16516	16517	16518	16519
253	16520	16521	16522	16524	16525	16526	16527	16528	16529
254	16530	16531	16532	16534	16535	16536	16537	16538	16539
255	16540	16541	16542	16544	16545	16546	16547	16548	16549
256	16550	16551	16552	16554	16555	16556	16557	16558	16559
257	16560	16561	16562	16564	16565	16566	16567	16568	16569
258	16570	16571	16572	16574	16575	16576	16577	16578	16579
259	16580	16581	16582	16584	16585	16586	16587	16588	16589
260	16590	16591	16592	16594	16595	16596	16597	16598	16599
261	16600	16601	16602	16604	16605	16606	16607	16608	16609
262	16610	16611	16612	16614	16615	16616	16617	16618	16619
263	16620	16621	16622	16624	16625	16626	16627	16628	16629
264	16630	16631	16632	16634	16635	16636	16637	16638	16639
265	16640	16641	16642	16644	16645	16646	16647	16648	16649
266	16650	16651	16652	16654	16655	16656	16657	16658	16659
267	16660	16661	16662	16664	16665	16666	16667	16668	16669
268	16670	16671	16672	16674	16675	16676	16677	16678	16679
269	16680	16681	16682	16684	16685	16686	16687	16688	16689
270	16690	16691	16692	16694	16695	16696	16697	16698	16699
271	16700	16701	16702	16704	16705	16706	16707	16708	16709
272	16710	16711	16712	16714	16715	16716	16717	16718	16719
273	16720	16721	16722	16724	16725	16726	16727	16728	16729
274	16730	16731	16732	16734	16735	16736	16737	16738	16739
275	16740	16741	16742	16744	16745	16746	16747	16748	16749
276	16750	16751	16752	16754	16755	16756	16757	16758	16759
277	16760	16761	16762	16764	16765	16766	16767	16768	16769
278	16770	16771	16772	16774	16775	16776	16777	16778	16779
279	16780	16781	16782	16784	16785	16786	16787	16788	16789
280	16790	16791	16792	16794	16795	16796	16797	16798	16799
281	16800	16801	16802	16804	16805	16806	16807	16808	16809
282	16810	16811	16812	16814	16815	16816	16817	16818	16819
283	16820	16821	16822	16824	16825	16826	16827	16828	16829
284	16830	16831	16832	16834	16835	16836	16837	16838	16839
285	16840	16841	16842	16844	16845	16846	16847	16848	16849
286	16850	16851	16852	16854	16855	16856	16857	16858	16859
287	16860	16861	16862	16864	16865	16866	16867	16868	16869
288	16870	16871	16872	16874	16875	16876	16877	16878	16879
289	16880	16881	16882	16884	16885	16886	16887	16888	16889
290	16890	16891	16892	16894	16895	16896	16897	16898	16899
291	16900	16901	16902	16904	16905	16906	16907	16908	16909
292	16910	16911	16912	16914	16915	16916	16917	16918	16919
293	16920	16921	16922	16924	16925	16926	16927	16928	16929
294	16930	16931	16932	16934	16935	16936	16937	16938	16939
295	16940	16941	16942	16944	16945	16946	16947	16948	16949
296	16950	16951	16952	16954	16955	16956	16957	16958	16959
297	16960	16961	16962	16964	16965	16966	16967	16968	16969
298	16970	16971	16972	16974	16975	16976	16977	16978	16979
299	16980	16981	16982	16984	16985	16986	16987	16988	16989
300	16990	16991	16992	16994	16995	16996	16997	16998	16999

(3) For axis 3

Data No.	Positioning identifier	M code	Dwell time	Command speed		Positioning address		Arc data	
				Low-order	High-order	Low-order	High-order	Low-order	High-order
301	17000	17001	17002	17004	17005	17006	17007	17008	17009
302	17010	17011	17012	17014	17015	17016	17017	17018	17019
303	17020	17021	17022	17024	17025	17026	17027	17028	17029
304	17030	17031	17032	17034	17035	17036	17037	17038	17039
305	17040	17041	17042	17044	17045	17046	17047	17048	17049
306	17050	17051	17052	17054	17055	17056	17057	17058	17059
307	17060	17061	17062	17064	17065	17066	17067	17068	17069
308	17070	17071	17072	17074	17075	17076	17077	17078	17079
309	17080	17081	17082	17084	17085	17086	17087	17088	17089
310	17090	17091	17092	17094	17095	17096	17097	17098	17099
311	17100	17101	17102	17104	17105	17106	17107	17108	17109
312	17110	17111	17112	17114	17115	17116	17117	17118	17119
313	17120	17121	17122	17124	17125	17126	17127	17128	17129
314	17130	17131	17132	17134	17135	17136	17137	17138	17139
315	17140	17141	17142	17144	17145	17146	17147	17148	17149
316	17150	17151	17152	17154	17155	17156	17157	17158	17159
317	17160	17161	17162	17164	17165	17166	17167	17168	17169
318	17170	17171	17172	17174	17175	17176	17177	17178	17179
319	17180	17181	17182	17184	17185	17186	17187	17188	17189
320	17190	17191	17192	17194	17195	17196	17197	17198	17199
321	17200	17201	17202	17204	17205	17206	17207	17208	17209
322	17210	17211	17212	17214	17215	17216	17217	17218	17219
323	17220	17221	17222	17224	17225	17226	17227	17228	17229
324	17230	17231	17232	17234	17235	17236	17237	17238	17239
325	17240	17241	17242	17244	17245	17246	17247	17248	17249
326	17250	17251	17252	17254	17255	17256	17257	17258	17259
327	17260	17261	17262	17264	17265	17266	17267	17268	17269
328	17270	17271	17272	17274	17275	17276	17277	17278	17279
329	17280	17281	17282	17284	17285	17286	17287	17288	17289
330	17290	17291	17292	17294	17295	17296	17297	17298	17299
331	17300	17301	17302	17304	17305	17306	17307	17308	17309
332	17310	17311	17312	17314	17315	17316	17317	17318	17319
333	17320	17321	17322	17324	17325	17326	17327	17328	17329
334	17330	17331	17332	17334	17335	17336	17337	17338	17339
335	17340	17341	17342	17344	17345	17346	17347	17348	17349
336	17350	17351	17352	17354	17355	17356	17357	17358	17359
337	17360	17361	17362	17364	17365	17366	17367	17368	17369
338	17370	17371	17372	17374	17375	17376	17377	17378	17379
339	17380	17381	17382	17384	17385	17386	17387	17388	17389
340	17390	17391	17392	17394	17395	17396	17397	17398	17399
341	17400	17401	17402	17404	17405	17406	17407	17408	17409
342	17410	17411	17412	17414	17415	17416	17417	17418	17419
343	17420	17421	17422	17424	17425	17426	17427	17428	17429
344	17430	17431	17432	17434	17435	17436	17437	17438	17439
345	17440	17441	17442	17444	17445	17446	17447	17448	17449
346	17450	17451	17452	17454	17455	17456	17457	17458	17459
347	17460	17461	17462	17464	17465	17466	17467	17468	17469
348	17470	17471	17472	17474	17475	17476	17477	17478	17479
349	17480	17481	17482	17484	17485	17486	17487	17488	17489
350	17490	17491	17492	17494	17495	17496	17497	17498	17499

Data No.	Positioning identifier	M code	Dwell time	Command speed		Positioning address		Arc data	
				Low-order	High-order	Low-order	High-order	Low-order	High-order
351	17500	17501	17502	17504	17505	17506	17507	17508	17509
352	17510	17511	17512	17514	17515	17516	17517	17518	17519
353	17520	17521	17522	17524	17525	17526	17527	17528	17529
354	17530	17531	17532	17534	17535	17536	17537	17538	17539
355	17540	17541	17542	17544	17545	17546	17547	17548	17549
356	17550	17551	17552	17554	17555	17556	17557	17558	17559
357	17560	17561	17562	17564	17565	17566	17567	17568	17569
358	17570	17571	17572	17574	17575	17576	17577	17578	17579
359	17580	17581	17582	17584	17585	17586	17587	17588	17589
360	17590	17591	17592	17594	17595	17596	17597	17598	17599
361	17600	17601	17602	17604	17605	17606	17607	17608	17609
362	17610	17611	17612	17614	17615	17616	17617	17618	17619
363	17620	17621	17622	17624	17625	17626	17627	17628	17629
364	17630	17631	17632	17634	17635	17636	17637	17638	17639
365	17640	17641	17642	17644	17645	17646	17647	17648	17649
366	17650	17651	17652	17654	17655	17656	17657	17658	17659
367	17660	17661	17662	17664	17665	17666	17667	17668	17669
368	17670	17671	17672	17674	17675	17676	17677	17678	17679
369	17680	17681	17682	17684	17685	17686	17687	17688	17689
370	17690	17691	17692	17694	17695	17696	17697	17698	17699
371	17700	17701	17702	17704	17705	17706	17707	17708	17709
372	17710	17711	17712	17714	17715	17716	17717	17718	17719
373	17720	17721	17722	17724	17725	17726	17727	17728	17729
374	17730	17731	17732	17734	17735	17736	17737	17738	17739
375	17740	17741	17742	17744	17745	17746	17747	17748	17749
376	17750	17751	17752	17754	17755	17756	17757	17758	17759
377	17760	17761	17762	17764	17765	17766	17767	17768	17769
378	17770	17771	17772	17774	17775	17776	17777	17778	17779
379	17780	17781	17782	17784	17785	17786	17787	17788	17789
380	17790	17791	17792	17794	17795	17796	17797	17798	17799
381	17800	17801	17802	17804	17805	17806	17807	17808	17809
382	17810	17811	17812	17814	17815	17816	17817	17818	17819
383	17820	17821	17822	17824	17825	17826	17827	17828	17829
384	17830	17831	17832	17834	17835	17836	17837	17838	17839
385	17840	17841	17842	17844	17845	17846	17847	17848	17849
386	17850	17851	17852	17854	17855	17856	17857	17858	17859
387	17860	17861	17862	17864	17865	17866	17867	17868	17869
388	17870	17871	17872	17874	17875	17876	17877	17878	17879
389	17880	17881	17882	17884	17885	17886	17887	17888	17889
390	17890	17891	17892	17894	17895	17896	17897	17898	17899
391	17900	17901	17902	17904	17905	17906	17907	17908	17909
392	17910	17911	17912	17914	17915	17916	17917	17918	17919
393	17920	17921	17922	17924	17925	17926	17927	17928	17929
394	17930	17931	17932	17934	17935	17936	17937	17938	17939
395	17940	17941	17942	17944	17945	17946	17947	17948	17949
396	17950	17951	17952	17954	17955	17956	17957	17958	17959
397	17960	17961	17962	17964	17965	17966	17967	17968	17969
398	17970	17971	17972	17974	17975	17976	17977	17978	17979
399	17980	17981	17982	17984	17985	17986	17987	17988	17989
400	17990	17991	17992	17994	17995	17996	17997	17998	17999

(3) For axis 3

Data No.	Positioning identifier	M code	Dwell time	Command speed		Positioning address		Arc data	
				Low-order	High-order	Low-order	High-order	Low-order	High-order
401	18000	18001	18002	18004	18005	18006	18007	18008	18009
402	18010	18011	18012	18014	18015	18016	18017	18018	18019
403	18020	18021	18022	18024	18025	18026	18027	18028	18029
404	18030	18031	18032	18034	18035	18036	18037	18038	18039
405	18040	18041	18042	18044	18045	18046	18047	18048	18049
406	18050	18051	18052	18054	18055	18056	18057	18058	18059
407	18060	18061	18062	18064	18065	18066	18067	18068	18069
408	18070	18071	18072	18074	18075	18076	18077	18078	18079
409	18080	18081	18082	18084	18085	18086	18087	18088	18089
410	18090	18091	18092	18094	18095	18096	18097	18098	18099
411	18100	18101	18102	18104	18105	18106	18107	18108	18109
412	18110	18111	18112	18114	18115	18116	18117	18118	18119
413	18120	18121	18122	18124	18125	18126	18127	18128	18129
414	18130	18131	18132	18134	18135	18136	18137	18138	18139
415	18140	18141	18142	18144	18145	18146	18147	18148	18149
416	18150	18151	18152	18154	18155	18156	18157	18158	18159
417	18160	18161	18162	18164	18165	18166	18167	18168	18169
418	18170	18171	18172	18174	18175	18176	18177	18178	18179
419	18180	18181	18182	18184	18185	18186	18187	18188	18189
420	18190	18191	18192	18194	18195	18196	18197	18198	18199
421	18200	18201	18202	18204	18205	18206	18207	18208	18209
422	18210	18211	18212	18214	18215	18216	18217	18218	18219
423	18220	18221	18222	18224	18225	18226	18227	18228	18229
424	18230	18231	18232	18234	18235	18236	18237	18238	18239
425	18240	18241	18242	18244	18245	18246	18247	18248	18249
426	18250	18251	18252	18254	18255	18256	18257	18258	18259
427	18260	18261	18262	18264	18265	18266	18267	18268	18269
428	18270	18271	18272	18274	18275	18276	18277	18278	18279
429	18280	18281	18282	18284	18285	18286	18287	18288	18289
430	18290	18291	18292	18294	18295	18296	18297	18298	18299
431	18300	18301	18302	18304	18305	18306	18307	18308	18309
432	18310	18311	18312	18314	18315	18316	18317	18318	18319
433	18320	18321	18322	18324	18325	18326	18327	18328	18329
434	18330	18331	18332	18334	18335	18336	18337	18338	18339
435	18340	18341	18342	18344	18345	18346	18347	18348	18349
436	18350	18351	18352	18354	18355	18356	18357	18358	18359
437	18360	18361	18362	18364	18365	18366	18367	18368	18369
438	18370	18371	18372	18374	18375	18376	18377	18378	18379
439	18380	18381	18382	18384	18385	18386	18387	18388	18389
440	18390	18391	18392	18394	18395	18396	18397	18398	18399
441	18400	18401	18402	18404	18405	18406	18407	18408	18409
442	18410	18411	18412	18414	18415	18416	18417	18418	18419
443	18420	18421	18422	18424	18425	18426	18427	18428	18429
444	18430	18431	18432	18434	18435	18436	18437	18438	18439
445	18440	18441	18442	18444	18445	18446	18447	18448	18449
446	18450	18451	18452	18454	18455	18456	18457	18458	18459
447	18460	18461	18462	18464	18465	18466	18467	18468	18469
448	18470	18471	18472	18474	18475	18476	18477	18478	18479
449	18480	18481	18482	18484	18485	18486	18487	18488	18489
450	18490	18491	18492	18494	18495	18496	18497	18498	18499

Data No.	Positioning identifier	M code	Dwell time	Command speed		Positioning address		Arc data	
				Low-order	High-order	Low-order	High-order	Low-order	High-order
451	18500	18501	18502	18504	18505	18506	18507	18508	18509
452	18510	18511	18512	18514	18515	18516	18517	18518	18519
453	18520	18521	18522	18524	18525	18526	18527	18528	18529
454	18530	18531	18532	18534	18535	18536	18537	18538	18539
455	18540	18541	18542	18544	18545	18546	18547	18548	18549
456	18550	18551	18552	18554	18555	18556	18557	18558	18559
457	18560	18561	18562	18564	18565	18566	18567	18568	18569
458	18570	18571	18572	18574	18575	18576	18577	18578	18579
459	18580	18581	18582	18584	18585	18586	18587	18588	18589
460	18590	18591	18592	18594	18595	18596	18597	18598	18599
461	18600	18601	18602	18604	18605	18606	18607	18608	18609
462	18610	18611	18612	18614	18615	18616	18617	18618	18619
463	18620	18621	18622	18624	18625	18626	18627	18628	18629
464	18630	18631	18632	18634	18635	18636	18637	18638	18639
465	18640	18641	18642	18644	18645	18646	18647	18648	18649
466	18650	18651	18652	18654	18655	18656	18657	18658	18659
467	18660	18661	18662	18664	18665	18666	18667	18668	18669
468	18670	18671	18672	18674	18675	18676	18677	18678	18679
469	18680	18681	18682	18684	18685	18686	18687	18688	18689
470	18690	18691	18692	18694	18695	18696	18697	18698	18699
471	18700	18701	18702	18704	18705	18706	18707	18708	18709
472	18710	18711	18712	18714	18715	18716	18717	18718	18719
473	18720	18721	18722	18724	18725	18726	18727	18728	18729
474	18730	18731	18732	18734	18735	18736	18737	18738	18739
475	18740	18741	18742	18744	18745	18746	18747	18748	18749
476	18750	18751	18752	18754	18755	18756	18757	18758	18759
477	18760	18761	18762	18764	18765	18766	18767	18768	18769
478	18770	18771	18772	18774	18775	18776	18777	18778	18779
479	18780	18781	18782	18784	18785	18786	18787	18788	18789
480	18790	18791	18792	18794	18795	18796	18797	18798	18799
481	18800	18801	18802	18804	18805	18806	18807	18808	18809
482	18810	18811	18812	18814	18815	18816	18817	18818	18819
483	18820	18821	18822	18824	18825	18826	18827	18828	18829
484	18830	18831	18832	18834	18835	18836	18837	18838	18839
485	18840	18841	18842	18844	18845	18846	18847	18848	18849
486	18850	18851	18852	18854	18855	18856	18857	18858	18859
487	18860	18861	18862	18864	18865	18866	18867	18868	18869
488	18870	18871	18872	18874	18875	18876	18877	18878	18879
489	18880	18881	18882	18884	18885	18886	18887	18888	18889
490	18890	18891	18892	18894	18895	18896	18897	18898	18899
491	18900	18901	18902	18904	18905	18906	18907	18908	18909
492	18910	18911	18912	18914	18915	18916	18917	18918	18919
493	18920	18921	18922	18924	18925	18926	18927	18928	18929
494	18930	18931	18932	18934	18935	18936	18937	18938	18939
495	18940	18941	18942	18944	18945	18946	18947	18948	18949
496	18950	18951	18952	18954	18955	18956	18957	18958	18959
497	18960	18961	18962	18964	18965	18966	18967	18968	18969
498	18970	18971	18972	18974	18975	18976	18977	18978	18979
499	18980	18981	18982	18984	18985	18986	18987	18988	18989
500	18990	18991	18992	18994	18995	18996	18997	18998	18999

(3) For axis 3

Data No.	Positioning identifier	M code	Dwell time	Command speed		Positioning address		Arc data	
				Low-order	High-order	Low-order	High-order	Low-order	High-order
501	19000	19001	19002	19004	19005	19006	19007	19008	19009
502	19010	19011	19012	19014	19015	19016	19017	19018	19019
503	19020	19021	19022	19024	19025	19026	19027	19028	19029
504	19030	19031	19032	19034	19035	19036	19037	19038	19039
505	19040	19041	19042	19044	19045	19046	19047	19048	19049
506	19050	19051	19052	19054	19055	19056	19057	19058	19059
507	19060	19061	19062	19064	19065	19066	19067	19068	19069
508	19070	19071	19072	19074	19075	19076	19077	19078	19079
509	19080	19081	19082	19084	19085	19086	19087	19088	19089
510	19090	19091	19092	19094	19095	19096	19097	19098	19099
511	19100	19101	19102	19104	19105	19106	19107	19108	19109
512	19110	19111	19112	19114	19115	19116	19117	19118	19119
513	19120	19121	19122	19124	19125	19126	19127	19128	19129
514	19130	19131	19132	19134	19135	19136	19137	19138	19139
515	19140	19141	19142	19144	19145	19146	19147	19148	19149
516	19150	19151	19152	19154	19155	19156	19157	19158	19159
517	19160	19161	19162	19164	19165	19166	19167	19168	19169
518	19170	19171	19172	19174	19175	19176	19177	19178	19179
519	19180	19181	19182	19184	19185	19186	19187	19188	19189
520	19190	19191	19192	19194	19195	19196	19197	19198	19199
521	19200	19201	19202	19204	19205	19206	19207	19208	19209
522	19210	19211	19212	19214	19215	19216	19217	19218	19219
523	19220	19221	19222	19224	19225	19226	19227	19228	19229
524	19230	19231	19232	19234	19235	19236	19237	19238	19239
525	19240	19241	19242	19244	19245	19246	19247	19248	19249
526	19250	19251	19252	19254	19255	19256	19257	19258	19259
527	19260	19261	19262	19264	19265	19266	19267	19268	19269
528	19270	19271	19272	19274	19275	19276	19277	19278	19279
529	19280	19281	19282	19284	19285	19286	19287	19288	19289
530	19290	19291	19292	19294	19295	19296	19297	19298	19299
531	19300	19301	19302	19304	19305	19306	19307	19308	19309
532	19310	19311	19312	19314	19315	19316	19317	19318	19319
533	19320	19321	19322	19324	19325	19326	19327	19328	19329
534	19330	19331	19332	19334	19335	19336	19337	19338	19339
535	19340	19341	19342	19344	19345	19346	19347	19348	19349
536	19350	19351	19352	19354	19355	19356	19357	19358	19359
537	19360	19361	19362	19364	19365	19366	19367	19368	19369
538	19370	19371	19372	19374	19375	19376	19377	19378	19379
539	19380	19381	19382	19384	19385	19386	19387	19388	19389
540	19390	19391	19392	19394	19395	19396	19397	19398	19399
541	19400	19401	19402	19404	19405	19406	19407	19408	19409
542	19410	19411	19412	19414	19415	19416	19417	19418	19419
543	19420	19421	19422	19424	19425	19426	19427	19428	19429
544	19430	19431	19432	19434	19435	19436	19437	19438	19439
545	19440	19441	19442	19444	19445	19446	19447	19448	19449
546	19450	19451	19452	19454	19455	19456	19457	19458	19459
547	19460	19461	19462	19464	19465	19466	19467	19468	19469
548	19470	19471	19472	19474	19475	19476	19477	19478	19479
549	19480	19481	19482	19484	19485	19486	19487	19488	19489
550	19490	19491	19492	19494	19495	19496	19497	19498	19499

Data No.	Positioning identifier	M code	Dwell time	Command speed		Positioning address		Arc data	
				Low-order	High-order	Low-order	High-order	Low-order	High-order
551	19500	19501	19502	19504	19505	19506	19507	19508	19509
552	19510	19511	19512	19514	19515	19516	19517	19518	19519
553	19520	19521	19522	19524	19525	19526	19527	19528	19529
554	19530	19531	19532	19534	19535	19536	19537	19538	19539
555	19540	19541	19542	19544	19545	19546	19547	19548	19549
556	19550	19551	19552	19554	19555	19556	19557	19558	19559
557	19560	19561	19562	19564	19565	19566	19567	19568	19569
558	19570	19571	19572	19574	19575	19576	19577	19578	19579
559	19580	19581	19582	19584	19585	19586	19587	19588	19589
560	19590	19591	19592	19594	19595	19596	19597	19598	19599
561	19600	19601	19602	19604	19605	19606	19607	19608	19609
562	19610	19611	19612	19614	19615	19616	19617	19618	19619
563	19620	19621	19622	19624	19625	19626	19627	19628	19629
564	19630	19631	19632	19634	19635	19636	19637	19638	19639
565	19640	19641	19642	19644	19645	19646	19647	19648	19649
566	19650	19651	19652	19654	19655	19656	19657	19658	19659
567	19660	19661	19662	19664	19665	19666	19667	19668	19669
568	19670	19671	19672	19674	19675	19676	19677	19678	19679
569	19680	19681	19682	19684	19685	19686	19687	19688	19689
570	19690	19691	19692	19694	19695	19696	19697	19698	19699
571	19700	19701	19702	19704	19705	19706	19707	19708	19709
572	19710	19711	19712	19714	19715	19716	19717	19718	19719
573	19720	19721	19722	19724	19725	19726	19727	19728	19729
574	19730	19731	19732	19734	19735	19736	19737	19738	19739
575	19740	19741	19742	19744	19745	19746	19747	19748	19749
576	19750	19751	19752	19754	19755	19756	19757	19758	19759
577	19760	19761	19762	19764	19765	19766	19767	19768	19769
578	19770	19771	19772	19774	19775	19776	19777	19778	19779
579	19780	19781	19782	19784	19785	19786	19787	19788	19789
580	19790	19791	19792	19794	19795	19796	19797	19798	19799
581	19800	19801	19802	19804	19805	19806	19807	19808	19809
582	19810	19811	19812	19814	19815	19816	19817	19818	19819
583	19820	19821	19822	19824	19825	19826	19827	19828	19829
584	19830	19831	19832	19834	19835	19836	19837	19838	19839
585	19840	19841	19842	19844	19845	19846	19847	19848	19849
586	19850	19851	19852	19854	19855	19856	19857	19858	19859
587	19860	19861	19862	19864	19865	19866	19867	19868	19869
588	19870	19871	19872	19874	19875	19876	19877	19878	19879
589	19880	19881	19882	19884	19885	19886	19887	19888	19889
590	19890	19891	19892	19894	19895	19896	19897	19898	19899
591	19900	19901	19902	19904	19905	19906	19907	19908	19909
592	19910	19911	19912	19914	19915	19916	19917	19918	19919
593	19920	19921	19922	19924	19925	19926	19927	19928	19929
594	19930	19931	19932	19934	19935	19936	19937	19938	19939
595	19940	19941	19942	19944	19945	19946	19947	19948	19949
596	19950	19951	19952	19954	19955	19956	19957	19958	19959
597	19960	19961	19962	19964	19965	19966	19967	19968	19969
598	19970	19971	19972	19974	19975	19976	19977	19978	19979
599	19980	19981	19982	19984	19985	19986	19987	19988	19989
600	19990	19991	19992	19994	19995	19996	19997	19998	19999



(4) For axis 4

Data No.	Positioning identifier	M code	Dwell time	Command speed		Positioning address		Arc data	
				Low-order	High-order	Low-order	High-order	Low-order	High-order
1	20000	20001	20002	20004	20005	20006	20007	20008	20009
2	20010	20011	20012	20014	20015	20016	20017	20018	20019
3	20020	20021	20022	20024	20025	20026	20027	20028	20029
4	20030	20031	20032	20034	20035	20036	20037	20038	20039
5	20040	20041	20042	20044	20045	20046	20047	20048	20049
6	20050	20051	20052	20054	20055	20056	20057	20058	20059
7	20060	20061	20062	20064	20065	20066	20067	20068	20069
8	20070	20071	20072	20074	20075	20076	20077	20078	20079
9	20080	20081	20082	20084	20085	20086	20087	20088	20089
10	20090	20091	20092	20094	20095	20096	20097	20098	20099
11	20100	20101	20102	20104	20105	20106	20107	20108	20109
12	20110	20111	20112	20114	20115	20116	20117	20118	20119
13	20120	20121	20122	20124	20125	20126	20127	20128	20129
14	20130	20131	20132	20134	20135	20136	20137	20138	20139
15	20140	20141	20142	20144	20145	20146	20147	20148	20149
16	20150	20151	20152	20154	20155	20156	20157	20158	20159
17	20160	20161	20162	20164	20165	20166	20167	20168	20169
18	20170	20171	20172	20174	20175	20176	20177	20178	20179
19	20180	20181	20182	20184	20185	20186	20187	20188	20189
20	20190	20191	20192	20194	20195	20196	20197	20198	20199
21	20200	20201	20202	20204	20205	20206	20207	20208	20209
22	20210	20211	20212	20214	20215	20216	20217	20218	20219
23	20220	20221	20222	20224	20225	20226	20227	20228	20229
24	20230	20231	20232	20234	20235	20236	20237	20238	20239
25	20240	20241	20242	20244	20245	20246	20247	20248	20249
26	20250	20251	20252	20254	20255	20256	20257	20258	20259
27	20260	20261	20262	20264	20265	20266	20267	20268	20269
28	20270	20271	20272	20274	20275	20276	20277	20278	20279
29	20280	20281	20282	20284	20285	20286	20287	20288	20289
30	20290	20291	20292	20294	20295	20296	20297	20298	20299
31	20300	20301	20302	20304	20305	20306	20307	20308	20309
32	20310	20311	20312	20314	20315	20316	20317	20318	20319
33	20320	20321	20322	20324	20325	20326	20327	20328	20329
34	20330	20331	20332	20334	20335	20336	20337	20338	20339
35	20340	20341	20342	20344	20345	20346	20347	20348	20349
36	20350	20351	20352	20354	20355	20356	20357	20358	20359
37	20360	20361	20362	20364	20365	20366	20367	20368	20369
38	20370	20371	20372	20374	20375	20376	20377	20378	20379
39	20380	20381	20382	20384	20385	20386	20387	20388	20389
40	20390	20391	20392	20394	20395	20396	20397	20398	20399
41	20400	20401	20402	20404	20405	20406	20407	20408	20409
42	20410	20411	20412	20414	20415	20416	20417	20418	20419
43	20420	20421	20422	20424	20425	20426	20427	20428	20429
44	20430	20431	20432	20434	20435	20436	20437	20438	20439
45	20440	20441	20442	20444	20445	20446	20447	20448	20449
46	20450	20451	20452	20454	20455	20456	20457	20458	20459
47	20460	20461	20462	20464	20465	20466	20467	20468	20469
48	20470	20471	20472	20474	20475	20476	20477	20478	20479
49	20480	20481	20482	20484	20485	20486	20487	20488	20489
50	20490	20491	20492	20494	20495	20496	20497	20498	20499

Data No.	Positioning identifier	M code	Dwell time	Command speed		Positioning address		Arc data	
				Low-order	High-order	Low-order	High-order	Low-order	High-order
51	20500	20501	20502	20504	20505	20506	20507	20508	20509
52	20510	20511	20512	20514	20515	20516	20517	20518	20519
53	20520	20521	20522	20524	20525	20526	20527	20528	20529
54	20530	20531	20532	20534	20535	20536	20537	20538	20539
55	20540	20541	20542	20544	20545	20546	20547	20548	20549
56	20550	20551	20552	20554	20555	20556	20557	20558	20559
57	20560	20561	20562	20564	20565	20566	20567	20568	20569
58	20570	20571	20572	20574	20575	20576	20577	20578	20579
59	20580	20581	20582	20584	20585	20586	20587	20588	20589
60	20590	20591	20592	20594	20595	20596	20597	20598	20599
61	20600	20601	20602	20604	20605	20606	20607	20608	20609
62	20610	20611	20612	20614	20615	20616	20617	20618	20619
63	20620	20621	20622	20624	20625	20626	20627	20628	20629
64	20630	20631	20632	20634	20635	20636	20637	20638	20639
65	20640	20641	20642	20644	20645	20646	20647	20648	20649
66	20650	20651	20652	20654	20655	20656	20657	20658	20659
67	20660	20661	20662	20664	20665	20666	20667	20668	20669
68	20670	20671	20672	20674	20675	20676	20677	20678	20679
69	20680	20681	20682	20684	20685	20686	20687	20688	20689
70	20690	20691	20692	20694	20695	20696	20697	20698	20699
71	20700	20701	20702	20704	20705	20706	20707	20708	20709
72	20710	20711	20712	20714	20715	20716	20717	20718	20719
73	20720	20721	20722	20724	20725	20726	20727	20728	20729
74	20730	20731	20732	20734	20735	20736	20737	20738	20739
75	20740	20741	20742	20744	20745	20746	20747	20748	20749
76	20750	20751	20752	20754	20755	20756	20757	20758	20759
77	20760	20761	20762	20764	20765	20766	20767	20768	20769
78	20770	20771	20772	20774	20775	20776	20777	20778	20779
79	20780	20781	20782	20784	20785	20786	20787	20788	20789
80	20790	20791	20792	20794	20795	20796	20797	20798	20799
81	20800	20801	20802	20804	20805	20806	20807	20808	20809
82	20810	20811	20812	20814	20815	20816	20817	20818	20819
83	20820	20821	20822	20824	20825	20826	20827	20828	20829
84	20830	20831	20832	20834	20835	20836	20837	20838	20839
85	20840	20841	20842	20844	20845	20846	20847	20848	20849
86	20850	20851	20852	20854	20855	20856	20857	20858	20859
87	20860	20861	20862	20864	20865	20866	20867	20868	20869
88	20870	20871	20872	20874	20875	20876	20877	20878	20879
89	20880	20881	20882	20884	20885	20886	20887	20888	20889
90	20890	20891	20892	20894	20895	20896	20897	20898	20899
91	20900	20901	20902	20904	20905	20906	20907	20908	20909
92	20910	20911	20912	20914	20915	20916	20917	20918	20919
93	20920	20921	20922	20924	20925	20926	20927	20928	20929
94	20930	20931	20932	20934	20935	20936	20937	20938	20939
95	20940	20941	20942	20944	20945	20946	20947	20948	20949
96	20950	20951	20952	20954	20955	20956	20957	20958	20959
97	20960	20961	20962	20964	20965	20966	20967	20968	20969
98	20970	20971	20972	20974	20975	20976	20977	20978	20979
99	20980	20981	20982	20984	20985	20986	20987	20988	20989
100	20990	20991	20992	20994	20995	20996	20997	20998	20999

(4) For axis 4

Data No.	Positioning identifier	M code	Dwell time	Command speed		Positioning address		Arc data	
				Low-order	High-order	Low-order	High-order	Low-order	High-order
101	21000	21001	21002	21004	21005	21006	21007	21008	21009
102	21010	21011	21012	21014	21015	21016	21017	21018	21019
103	21020	21021	21022	21024	21025	21026	21027	21028	21029
104	21030	21031	21032	21034	21035	21036	21037	21038	21039
105	21040	21041	21042	21044	21045	21046	21047	21048	21049
106	21050	21051	21052	21054	21055	21056	21057	21058	21059
107	21060	21061	21062	21064	21065	21066	21067	21068	21069
108	21070	21071	21072	21074	21075	21076	21077	21078	21079
109	21080	21081	21082	21084	21085	21086	21087	21088	21089
110	21090	21091	21092	21094	21095	21096	21097	21098	21099
111	21100	21101	21102	21104	21105	21106	21107	21108	21109
112	21110	21111	21112	21114	21115	21116	21117	21118	21119
113	21120	21121	21122	21124	21125	21126	21127	21128	21129
114	21130	21131	21132	21134	21135	21136	21137	21138	21139
115	21140	21141	21142	21144	21145	21146	21147	21148	21149
116	21150	21151	21152	21154	21155	21156	21157	21158	21159
117	21160	21161	21162	21164	21165	21166	21167	21168	21169
118	21170	21171	21172	21174	21175	21176	21177	21178	21179
119	21180	21181	21182	21184	21185	21186	21187	21188	21189
120	21190	21191	21192	21194	21195	21196	21197	21198	21199
121	21200	21201	21202	21204	21205	21206	21207	21208	21209
122	21210	21211	21212	21214	21215	21216	21217	21218	21219
123	21220	21221	21222	21224	21225	21226	21227	21228	21229
124	21230	21231	21232	21234	21235	21236	21237	21238	21239
125	21240	21241	21242	21244	21245	21246	21247	21248	21249
126	21250	21251	21252	21254	21255	21256	21257	21258	21259
127	21260	21261	21262	21264	21265	21266	21267	21268	21269
128	21270	21271	21272	21274	21275	21276	21277	21278	21279
129	21280	21281	21282	21284	21285	21286	21287	21288	21289
130	21290	21291	21292	21294	21295	21296	21297	21298	21299
131	21300	21301	21302	21304	21305	21306	21307	21308	21309
132	21310	21311	21312	21314	21315	21316	21317	21318	21319
133	21320	21321	21322	21324	21325	21326	21327	21328	21329
134	21330	21331	21332	21334	21335	21336	21337	21338	21339
135	21340	21341	21342	21344	21345	21346	21347	21348	21349
136	21350	21351	21352	21354	21355	21356	21357	21358	21359
137	21360	21361	21362	21364	21365	21366	21367	21368	21369
138	21370	21371	21372	21374	21375	21376	21377	21378	21379
139	21380	21381	21382	21384	21385	21386	21387	21388	21389
140	21390	21391	21392	21394	21395	21396	21397	21398	21399
141	21400	21401	21402	21404	21405	21406	21407	21408	21409
142	21410	21411	21412	21414	21415	21416	21417	21418	21419
143	21420	21421	21422	21424	21425	21426	21427	21428	21429
144	21430	21431	21432	21434	21435	21436	21437	21438	21439
145	21440	21441	21442	21444	21445	21446	21447	21448	21449
146	21450	21451	21452	21454	21455	21456	21457	21458	21459
147	21460	21461	21462	21464	21465	21466	21467	21468	21469
148	21470	21471	21472	21474	21475	21476	21477	21478	21479
149	21480	21481	21482	21484	21485	21486	21487	21488	21489
150	21490	21491	21492	21494	21495	21496	21497	21498	21499

Data No.	Positioning identifier	M code	Dwell time	Command speed		Positioning address		Arc data	
				Low-order	High-order	Low-order	High-order	Low-order	High-order
151	21500	21501	21502	21504	21505	21506	21507	21508	21509
152	21510	21511	21512	21514	21515	21516	21517	21518	21519
153	21520	21521	21522	21524	21525	21526	21527	21528	21529
154	21530	21531	21532	21534	21535	21536	21537	21538	21539
155	21540	21541	21542	21544	21545	21546	21547	21548	21549
156	21550	21551	21552	21554	21555	21556	21557	21558	21559
157	21560	21561	21562	21564	21565	21566	21567	21568	21569
158	21570	21571	21572	21574	21575	21576	21577	21578	21579
159	21580	21581	21582	21584	21585	21586	21587	21588	21589
160	21590	21591	21592	21594	21595	21596	21597	21598	21599
161	21600	21601	21602	21604	21605	21606	21607	21608	21609
162	21610	21611	21612	21614	21615	21616	21617	21618	21619
163	21620	21621	21622	21624	21625	21626	21627	21628	21629
164	21630	21631	21632	21634	21635	21636	21637	21638	21639
165	21640	21641	21642	21644	21645	21646	21647	21648	21649
166	21650	21651	21652	21654	21655	21656	21657	21658	21659
167	21660	21661	21662	21664	21665	21666	21667	21668	21669
168	21670	21671	21672	21674	21675	21676	21677	21678	21679
169	21680	21681	21682	21684	21685	21686	21687	21688	21689
170	21690	21691	21692	21694	21695	21696	21697	21698	21699
171	21700	21701	21702	21704	21705	21706	21707	21708	21709
172	21710	21711	21712	21714	21715	21716	21717	21718	21719
173	21720	21721	21722	21724	21725	21726	21727	21728	21729
174	21730	21731	21732	21734	21735	21736	21737	21738	21739
175	21740	21741	21742	21744	21745	21746	21747	21748	21749
176	21750	21751	21752	21754	21755	21756	21757	21758	21759
177	21760	21761	21762	21764	21765	21766	21767	21768	21769
178	21770	21771	21772	21774	21775	21776	21777	21778	21779
179	21780	21781	21782	21784	21785	21786	21787	21788	21789
180	21790	21791	21792	21794	21795	21796	21797	21798	21799
181	21800	21801	21802	21804	21805	21806	21807	21808	21809
182	21810	21811	21812	21814	21815	21816	21817	21818	21819
183	21820	21821	21822	21824	21825	21826	21827	21828	21829
184	21830	21831	21832	21834	21835	21836	21837	21838	21839
185	21840	21841	21842	21844	21845	21846	21847	21848	21849
186	21850	21851	21852	21854	21855	21856	21857	21858	21859
187	21860	21861	21862	21864	21865	21866	21867	21868	21869
188	21870	21871	21872	21874	21875	21876	21877	21878	21879
189	21880	21881	21882	21884	21885	21886	21887	21888	21889
190	21890	21891	21892	21894	21895	21896	21897	21898	21899
191	21900	21901	21902	21904	21905	21906	21907	21908	21909
192	21910	21911	21912	21914	21915	21916	21917	21918	21919
193	21920	21921	21922	21924	21925	21926	21927	21928	21929
194	21930	21931	21932	21934	21935	21936	21937	21938	21939
195	21940	21941	21942	21944	21945	21946	21947	21948	21949
196	21950	21951	21952	21954	21955	21956	21957	21958	21959
197	21960	21961	21962	21964	21965	21966	21967	21968	21969
198	21970	21971	21972	21974	21975	21976	21977	21978	21979
199	21980	21981	21982	21984	21985	21986	21987	21988	21989
200	21990	21991	21992	21994	21995	21996	21997	21998	21999

(4) For axis 4

Data No.	Positioning identifier	M code	Dwell time	Command speed		Positioning address		Arc data	
				Low-order	High-order	Low-order	High-order	Low-order	High-order
201	22000	22001	22002	22004	22005	22006	22007	22008	22009
202	22010	22011	22012	22014	22015	22016	22017	22018	22019
203	22020	22021	22022	22024	22025	22026	22027	22028	22029
204	22030	22031	22032	22034	22035	22036	22037	22038	22039
205	22040	22041	22042	22044	22045	22046	22047	22048	22049
206	22050	22051	22052	22054	22055	22056	22057	22058	22059
207	22060	22061	22062	22064	22065	22066	22067	22068	22069
208	22070	22071	22072	22074	22075	22076	22077	22078	22079
209	22080	22081	22082	22084	22085	22086	22087	22088	22089
210	22090	22091	22092	22094	22095	22096	22097	22098	22099
211	22100	22101	22102	22104	22105	22106	22107	22108	22109
212	22110	22111	22112	22114	22115	22116	22117	22118	22119
213	22120	22121	22122	22124	22125	22126	22127	22128	22129
214	22130	22131	22132	22134	22135	22136	22137	22138	22139
215	22140	22141	22142	22144	22145	22146	22147	22148	22149
216	22150	22151	22152	22154	22155	22156	22157	22158	22159
217	22160	22161	22162	22164	22165	22166	22167	22168	22169
218	22170	22171	22172	22174	22175	22176	22177	22178	22179
219	22180	22181	22182	22184	22185	22186	22187	22188	22189
220	22190	22191	22192	22194	22195	22196	22197	22198	22199
221	22200	22201	22202	22204	22205	22206	22207	22208	22209
222	22210	22211	22212	22214	22215	22216	22217	22218	22219
223	22220	22221	22222	22224	22225	22226	22227	22228	22229
224	22230	22231	22232	22234	22235	22236	22237	22238	22239
225	22240	22241	22242	22244	22245	22246	22247	22248	22249
226	22250	22251	22252	22254	22255	22256	22257	22258	22259
227	22260	22261	22262	22264	22265	22266	22267	22268	22269
228	22270	22271	22272	22274	22275	22276	22277	22278	22279
229	22280	22281	22282	22284	22285	22286	22287	22288	22289
230	22290	22291	22292	22294	22295	22296	22297	22298	22299
231	22300	22301	22302	22304	22305	22306	22307	22308	22309
232	22310	22311	22312	22314	22315	22316	22317	22318	22319
233	22320	22321	22322	22324	22325	22326	22327	22328	22329
234	22330	22331	22332	22334	22335	22336	22337	22338	22339
235	22340	22341	22342	22344	22345	22346	22347	22348	22349
236	22350	22351	22352	22354	22355	22356	22357	22358	22359
237	22360	22361	22362	22364	22365	22366	22367	22368	22369
238	22370	22371	22372	22374	22375	22376	22377	22378	22379
239	22380	22381	22382	22384	22385	22386	22387	22388	22389
240	22390	22391	22392	22394	22395	22396	22397	22398	22399
241	22400	22401	22402	22404	22405	22406	22407	22408	22409
242	22410	22411	22412	22414	22415	22416	22417	22418	22419
243	22420	22421	22422	22424	22425	22426	22427	22428	22429
244	22430	22431	22432	22434	22435	22436	22437	22438	22439
245	22440	22441	22442	22444	22445	22446	22447	22448	22449
246	22450	22451	22452	22454	22455	22456	22457	22458	22459
247	22460	22461	22462	22464	22465	22466	22467	22468	22469
248	22470	22471	22472	22474	22475	22476	22477	22478	22479
249	22480	22481	22482	22484	22485	22486	22487	22488	22489
250	22490	22491	22492	22494	22495	22496	22497	22498	22499

Data No.	Positioning identifier	M code	Dwell time	Command speed		Positioning address		Arc data	
				Low-order	High-order	Low-order	High-order	Low-order	High-order
251	22500	22501	22502	22504	22505	22506	22507	22508	22509
252	22510	22511	22512	22514	22515	22516	22517	22518	22519
253	22520	22521	22522	22524	22525	22526	22527	22528	22529
254	22530	22531	22532	22534	22535	22536	22537	22538	22539
255	22540	22541	22542	22544	22545	22546	22547	22548	22549
256	22550	22551	22552	22554	22555	22556	22557	22558	22559
257	22560	22561	22562	22564	22565	22566	22567	22568	22569
258	22570	22571	22572	22574	22575	22576	22577	22578	22579
259	22580	22581	22582	22584	22585	22586	22587	22588	22589
260	22590	22591	22592	22594	22595	22596	22597	22598	22599
261	22600	22601	22602	22604	22605	22606	22607	22608	22609
262	22610	22611	22612	22614	22615	22616	22617	22618	22619
263	22620	22621	22622	22624	22625	22626	22627	22628	22629
264	22630	22631	22632	22634	22635	22636	22637	22638	22639
265	22640	22641	22642	22644	22645	22646	22647	22648	22649
266	22650	22651	22652	22654	22655	22656	22657	22658	22659
267	22660	22661	22662	22664	22665	22666	22667	22668	22669
268	22670	22671	22672	22674	22675	22676	22677	22678	22679
269	22680	22681	22682	22684	22685	22686	22687	22688	22689
270	22690	22691	22692	22694	22695	22696	22697	22698	22699
271	22700	22701	22702	22704	22705	22706	22707	22708	22709
272	22710	22711	22712	22714	22715	22716	22717	22718	22719
273	22720	22721	22722	22724	22725	22726	22727	22728	22729
274	22730	22731	22732	22734	22735	22736	22737	22738	22739
275	22740	22741	22742	22744	22745	22746	22747	22748	22749
276	22750	22751	22752	22754	22755	22756	22757	22758	22759
277	22760	22761	22762	22764	22765	22766	22767	22768	22769
278	22770	22771	22772	22774	22775	22776	22777	22778	22779
279	22780	22781	22782	22784	22785	22786	22787	22788	22789
280	22790	22791	22792	22794	22795	22796	22797	22798	22799
281	22800	22801	22802	22804	22805	22806	22807	22808	22809
282	22810	22811	22812	22814	22815	22816	22817	22818	22819
283	22820	22821	22822	22824	22825	22826	22827	22828	22829
284	22830	22831	22832	22834	22835	22836	22837	22838	22839
285	22840	22841	22842	22844	22845	22846	22847	22848	22849
286	22850	22851	22852	22854	22855	22856	22857	22858	22859
287	22860	22861	22862	22864	22865	22866	22867	22868	22869
288	22870	22871	22872	22874	22875	22876	22877	22878	22879
289	22880	22881	22882	22884	22885	22886	22887	22888	22889
290	22890	22891	22892	22894	22895	22896	22897	22898	22899
291	22900	22901	22902	22904	22905	22906	22907	22908	22909
292	22910	22911	22912	22914	22915	22916	22917	22918	22919
293	22920	22921	22922	22924	22925	22926	22927	22928	22929
294	22930	22931	22932	22934	22935	22936	22937	22938	22939
295	22940	22941	22942	22944	22945	22946	22947	22948	22949
296	22950	22951	22952	22954	22955	22956	22957	22958	22959
297	22960	22961	22962	22964	22965	22966	22967	22968	22969
298	22970	22971	22972	22974	22975	22976	22977	22978	22979
299	22980	22981	22982	22984	22985	22986	22987	22988	22989
300	22990	22991	22992	22994	22995	22996	22997	22998	22999

(4) For axis 4

Data No.	Positioning identifier	M code	Dwell time	Command speed		Positioning address		Arc data	
				Low-order	High-order	Low-order	High-order	Low-order	High-order
301	23000	23001	23002	23004	23005	23006	23007	23008	23009
302	23010	23011	23012	23014	23015	23016	23017	23018	23019
303	23020	23021	23022	23024	23025	23026	23027	23028	23029
304	23030	23031	23032	23034	23035	23036	23037	23038	23039
305	23040	23041	23042	23044	23045	23046	23047	23048	23049
306	23050	23051	23052	23054	23055	23056	23057	23058	23059
307	23060	23061	23062	23064	23065	23066	23067	23068	23069
308	23070	23071	23072	23074	23075	23076	23077	23078	23079
309	23080	23081	23082	23084	23085	23086	23087	23088	23089
310	23090	23091	23092	23094	23095	23096	23097	23098	23099
311	23100	23101	23102	23104	23105	23106	23107	23108	23109
312	23110	23111	23112	23114	23115	23116	23117	23118	23119
313	23120	23121	23122	23124	23125	23126	23127	23128	23129
314	23130	23131	23132	23134	23135	23136	23137	23138	23139
315	23140	23141	23142	23144	23145	23146	23147	23148	23149
316	23150	23151	23152	23154	23155	23156	23157	23158	23159
317	23160	23161	23162	23164	23165	23166	23167	23168	23169
318	23170	23171	23172	23174	23175	23176	23177	23178	23179
319	23180	23181	23182	23184	23185	23186	23187	23188	23189
320	23190	23191	23192	23194	23195	23196	23197	23198	23199
321	23200	23201	23202	23204	23205	23206	23207	23208	23209
322	23210	23211	23212	23214	23215	23216	23217	23218	23219
323	23220	23221	23222	23224	23225	23226	23227	23228	23229
324	23230	23231	23232	23234	23235	23236	23237	23238	23239
325	23240	23241	23242	23244	23245	23246	23247	23248	23249
326	23250	23251	23252	23254	23255	23256	23257	23258	23259
327	23260	23261	23262	23264	23265	23266	23267	23268	23269
328	23270	23271	23272	23274	23275	23276	23277	23278	23279
329	23280	23281	23282	23284	23285	23286	23287	23288	23289
330	23290	23291	23292	23294	23295	23296	23297	23298	23299
331	23300	23301	23302	23304	23305	23306	23307	23308	23309
332	23310	23311	23312	23314	23315	23316	23317	23318	23319
333	23320	23321	23322	23324	23325	23326	23327	23328	23329
334	23330	23331	23332	23334	23335	23336	23337	23338	23339
335	23340	23341	23342	23344	23345	23346	23347	23348	23349
336	23350	23351	23352	23354	23355	23356	23357	23358	23359
337	23360	23361	23362	23364	23365	23366	23367	23368	23369
338	23370	23371	23372	23374	23375	23376	23377	23378	23379
339	23380	23381	23382	23384	23385	23386	23387	23388	23389
340	23390	23391	23392	23394	23395	23396	23397	23398	23399
341	23400	23401	23402	23404	23405	23406	23407	23408	23409
342	23410	23411	23412	23414	23415	23416	23417	23418	23419
343	23420	23421	23422	23424	23425	23426	23427	23428	23429
344	23430	23431	23432	23434	23435	23436	23437	23438	23439
345	23440	23441	23442	23444	23445	23446	23447	23448	23449
346	23450	23451	23452	23454	23455	23456	23457	23458	23459
347	23460	23461	23462	23464	23465	23466	23467	23468	23469
348	23470	23471	23472	23474	23475	23476	23477	23478	23479
349	23480	23481	23482	23484	23485	23486	23487	23488	23489
350	23490	23491	23492	23494	23495	23496	23497	23498	23499

Data No.	Positioning identifier	M code	Dwell time	Command speed		Positioning address		Arc data	
				Low-order	High-order	Low-order	High-order	Low-order	High-order
351	23500	23501	23502	23504	23505	23506	23507	23508	23509
352	23510	23511	23512	23514	23515	23516	23517	23518	23519
353	23520	23521	23522	23524	23525	23526	23527	23528	23529
354	23530	23531	23532	23534	23535	23536	23537	23538	23539
355	23540	23541	23542	23544	23545	23546	23547	23548	23549
356	23550	23551	23552	23554	23555	23556	23557	23558	23559
357	23560	23561	23562	23564	23565	23566	23567	23568	23569
358	23570	23571	23572	23574	23575	23576	23577	23578	23579
359	23580	23581	23582	23584	23585	23586	23587	23588	23589
360	23590	23591	23592	23594	23595	23596	23597	23598	23599
361	23600	23601	23602	23604	23605	23606	23607	23608	23609
362	23610	23611	23612	23614	23615	23616	23617	23618	23619
363	23620	23621	23622	23624	23625	23626	23627	23628	23629
364	23630	23631	23632	23634	23635	23636	23637	23638	23639
365	23640	23641	23642	23644	23645	23646	23647	23648	23649
366	23650	23651	23652	23654	23655	23656	23657	23658	23659
367	23660	23661	23662	23664	23665	23666	23667	23668	23669
368	23670	23671	23672	23674	23675	23676	23677	23678	23679
369	23680	23681	23682	23684	23685	23686	23687	23688	23689
370	23690	23691	23692	23694	23695	23696	23697	23698	23699
371	23700	23701	23702	23704	23705	23706	23707	23708	23709
372	23710	23711	23712	23714	23715	23716	23717	23718	23719
373	23720	23721	23722	23724	23725	23726	23727	23728	23729
374	23730	23731	23732	23734	23735	23736	23737	23738	23739
375	23740	23741	23742	23744	23745	23746	23747	23748	23749
376	23750	23751	23752	23754	23755	23756	23757	23758	23759
377	23760	23761	23762	23764	23765	23766	23767	23768	23769
378	23770	23771	23772	23774	23775	23776	23777	23778	23779
379	23780	23781	23782	23784	23785	23786	23787	23788	23789
380	23790	23791	23792	23794	23795	23796	23797	23798	23799
381	23800	23801	23802	23804	23805	23806	23807	23808	23809
382	23810	23811	23812	23814	23815	23816	23817	23818	23819
383	23820	23821	23822	23824	23825	23826	23827	23828	23829
384	23830	23831	23832	23834	23835	23836	23837	23838	23839
385	23840	23841	23842	23844	23845	23846	23847	23848	23849
386	23850	23851	23852	23854	23855	23856	23857	23858	23859
387	23860	23861	23862	23864	23865	23866	23867	23868	23869
388	23870	23871	23872	23874	23875	23876	23877	23878	23879
389	23880	23881	23882	23884	23885	23886	23887	23888	23889
390	23890	23891	23892	23894	23895	23896	23897	23898	23899
391	23900	23901	23902	23904	23905	23906	23907	23908	23909
392	23910	23911	23912	23914	23915	23916	23917	23918	23919
393	23920	23921	23922	23924	23925	23926	23927	23928	23929
394	23930	23931	23932	23934	23935	23936	23937	23938	23939
395	23940	23941	23942	23944	23945	23946	23947	23948	23949
396	23950	23951	23952	23954	23955	23956	23957	23958	23959
397	23960	23961	23962	23964	23965	23966	23967	23968	23969
398	23970	23971	23972	23974	23975	23976	23977	23978	23979
399	23980	23981	23982	23984	23985	23986	23987	23988	23989
400	23990	23991	23992	23994	23995	23996	23997	23998	23999

(4) For axis 4

Data No.	Positioning identifier	M code	Dwell time	Command speed		Positioning address		Arc data	
				Low-order	High-order	Low-order	High-order	Low-order	High-order
401	24000	24001	24002	24004	24005	24006	24007	24008	24009
402	24010	24011	24012	24014	24015	24016	24017	24018	24019
403	24020	24021	24022	24024	24025	24026	24027	24028	24029
404	24030	24031	24032	24034	24035	24036	24037	24038	24039
405	24040	24041	24042	24044	24045	24046	24047	24048	24049
406	24050	24051	24052	24054	24055	24056	24057	24058	24059
407	24060	24061	24062	24064	24065	24066	24067	24068	24069
408	24070	24071	24072	24074	24075	24076	24077	24078	24079
409	24080	24081	24082	24084	24085	24086	24087	24088	24089
410	24090	24091	24092	24094	24095	24096	24097	24098	24099
411	24100	24101	24102	24104	24105	24106	24107	24108	24109
412	24110	24111	24112	24114	24115	24116	24117	24118	24119
413	24120	24121	24122	24124	24125	24126	24127	24128	24129
414	24130	24131	24132	24134	24135	24136	24137	24138	24139
415	24140	24141	24142	24144	24145	24146	24147	24148	24149
416	24150	24151	24152	24154	24155	24156	24157	24158	24159
417	24160	24161	24162	24164	24165	24166	24167	24168	24169
418	24170	24171	24172	24174	24175	24176	24177	24178	24179
419	24180	24181	24182	24184	24185	24186	24187	24188	24189
420	24190	24191	24192	24194	24195	24196	24197	24198	24199
421	24200	24201	24202	24204	24205	24206	24207	24208	24209
422	24210	24211	24212	24214	24215	24216	24217	24218	24219
423	24220	24221	24222	24224	24225	24226	24227	24228	24229
424	24230	24231	24232	24234	24235	24236	24237	24238	24239
425	24240	24241	24242	24244	24245	24246	24247	24248	24249
426	24250	24251	24252	24254	24255	24256	24257	24258	24259
427	24260	24261	24262	24264	24265	24266	24267	24268	24269
428	24270	24271	24272	24274	24275	24276	24277	24278	24279
429	24280	24281	24282	24284	24285	24286	24287	24288	24289
430	24290	24291	24292	24294	24295	24296	24297	24298	24299
431	24300	24301	24302	24304	24305	24306	24307	24308	24309
432	24310	24311	24312	24314	24315	24316	24317	24318	24319
433	24320	24321	24322	24324	24325	24326	24327	24328	24329
434	24330	24331	24332	24334	24335	24336	24337	24338	24339
435	24340	24341	24342	24344	24345	24346	24347	24348	24349
436	24350	24351	24352	24354	24355	24356	24357	24358	24359
437	24360	24361	24362	24364	24365	24366	24367	24368	24369
438	24370	24371	24372	24374	24375	24376	24377	24378	24379
439	24380	24381	24382	24384	24385	24386	24387	24388	24389
440	24390	24391	24392	24394	24395	24396	24397	24398	24399
441	24400	24401	24402	24404	24405	24406	24407	24408	24409
442	24410	24411	24412	24414	24415	24416	24417	24418	24419
443	24420	24421	24422	24424	24425	24426	24427	24428	24429
444	24430	24431	24432	24434	24435	24436	24437	24438	24439
445	24440	24441	24442	24444	24445	24446	24447	24448	24449
446	24450	24451	24452	24454	24455	24456	24457	24458	24459
447	24460	24461	24462	24464	24465	24466	24467	24468	24469
448	24470	24471	24472	24474	24475	24476	24477	24478	24479
449	24480	24481	24482	24484	24485	24486	24487	24488	24489
450	24490	24491	24492	24494	24495	24496	24497	24498	24499

Data No.	Positioning identifier	M code	Dwell time	Command speed		Positioning address		Arc data	
				Low-order	High-order	Low-order	High-order	Low-order	High-order
451	24500	24501	24502	24504	24505	24506	24507	24508	24509
452	24510	24511	24512	24514	24515	24516	24517	24518	24519
453	24520	24521	24522	24524	24525	24526	24527	24528	24529
454	24530	24531	24532	24534	24535	24536	24537	24538	24539
455	24540	24541	24542	24544	24545	24546	24547	24548	24549
456	24550	24551	24552	24554	24555	24556	24557	24558	24559
457	24560	24561	24562	24564	24565	24566	24567	24568	24569
458	24570	24571	24572	24574	24575	24576	24577	24578	24579
459	24580	24581	24582	24584	24585	24586	24587	24588	24589
460	24590	24591	24592	24594	24595	24596	24597	24598	24599
461	24600	24601	24602	24604	24605	24606	24607	24608	24609
462	24610	24611	24612	24614	24615	24616	24617	24618	24619
463	24620	24621	24622	24624	24625	24626	24627	24628	24629
464	24630	24631	24632	24634	24635	24636	24637	24638	24639
465	24640	24641	24642	24644	24645	24646	24647	24648	24649
466	24650	24651	24652	24654	24655	24656	24657	24658	24659
467	24660	24661	24662	24664	24665	24666	24667	24668	24669
468	24670	24671	24672	24674	24675	24676	24677	24678	24679
469	24680	24681	24682	24684	24685	24686	24687	24688	24689
470	24690	24691	24692	24694	24695	24696	24697	24698	24699
471	24700	24701	24702	24704	24705	24706	24707	24708	24709
472	24710	24711	24712	24714	24715	24716	24717	24718	24719
473	24720	24721	24722	24724	24725	24726	24727	24728	24729
474	24730	24731	24732	24734	24735	24736	24737	24738	24739
475	24740	24741	24742	24744	24745	24746	24747	24748	24749
476	24750	24751	24752	24754	24755	24756	24757	24758	24759
477	24760	24761	24762	24764	24765	24766	24767	24768	24769
478	24770	24771	24772	24774	24775	24776	24777	24778	24779
479	24780	24781	24782	24784	24785	24786	24787	24788	24789
480	24790	24791	24792	24794	24795	24796	24797	24798	24799
481	24800	24801	24802	24804	24805	24806	24807	24808	24809
482	24810	24811	24812	24814	24815	24816	24817	24818	24819
483	24820	24821	24822	24824	24825	24826	24827	24828	24829
484	24830	24831	24832	24834	24835	24836	24837	24838	24839
485	24840	24841	24842	24844	24845	24846	24847	24848	24849
486	24850	24851	24852	24854	24855	24856	24857	24858	24859
487	24860	24861	24862	24864	24865	24866	24867	24868	24869
488	24870	24871	24872	24874	24875	24876	24877	24878	24879
489	24880	24881	24882	24884	24885	24886	24887	24888	24889
490	24890	24891	24892	24894	24895	24896	24897	24898	24899
491	24900	24901	24902	24904	24905	24906	24907	24908	24909
492	24910	24911	24912	24914	24915	24916	24917	24918	24919
493	24920	24921	24922	24924	24925	24926	24927	24928	24929
494	24930	24931	24932	24934	24935	24936	24937	24938	24939
495	24940	24941	24942	24944	24945	24946	24947	24948	24949
496	24950	24951	24952	24954	24955	24956	24957	24958	24959
497	24960	24961	24962	24964	24965	24966	24967	24968	24969
498	24970	24971	24972	24974	24975	24976	24977	24978	24979
499	24980	24981	24982	24984	24985	24986	24987	24988	24989
500	24990	24991	24992	24994	24995	24996	24997	24998	24999

(4) For axis 4

Data No.	Positioning identifier	M code	Dwell time	Command speed		Positioning address		Arc data	
				Low-order	High-order	Low-order	High-order	Low-order	High-order
501	25000	25001	25002	25004	25005	25006	25007	25008	25009
502	25010	25011	25012	25014	25015	25016	25017	25018	25019
503	25020	25021	25022	25024	25025	25026	25027	25028	25029
504	25030	25031	25032	25034	25035	25036	25037	25038	25039
505	25040	25041	25042	25044	25045	25046	25047	25048	25049
506	25050	25051	25052	25054	25055	25056	25057	25058	25059
507	25060	25061	25062	25064	25065	25066	25067	25068	25069
508	25070	25071	25072	25074	25075	25076	25077	25078	25079
509	25080	25081	25082	25084	25085	25086	25087	25088	25089
510	25090	25091	25092	25094	25095	25096	25097	25098	25099
511	25100	25101	25102	25104	25105	25106	25107	25108	25109
512	25110	25111	25112	25114	25115	25116	25117	25118	25119
513	25120	25121	25122	25124	25125	25126	25127	25128	25129
514	25130	25131	25132	25134	25135	25136	25137	25138	25139
515	25140	25141	25142	25144	25145	25146	25147	25148	25149
516	25150	25151	25152	25154	25155	25156	25157	25158	25159
517	25160	25161	25162	25164	25165	25166	25167	25168	25169
518	25170	25171	25172	25174	25175	25176	25177	25178	25179
519	25180	25181	25182	25184	25185	25186	25187	25188	25189
520	25190	25191	25192	25194	25195	25196	25197	25198	25199
521	25200	25201	25202	25204	25205	25206	25207	25208	25209
522	25210	25211	25212	25214	25215	25216	25217	25218	25219
523	25220	25221	25222	25224	25225	25226	25227	25228	25229
524	25230	25231	25232	25234	25235	25236	25237	25238	25239
525	25240	25241	25242	25244	25245	25246	25247	25248	25249
526	25250	25251	25252	25254	25255	25256	25257	25258	25259
527	25260	25261	25262	25264	25265	25266	25267	25268	25269
528	25270	25271	25272	25274	25275	25276	25277	25278	25279
529	25280	25281	25282	25284	25285	25286	25287	25288	25289
530	25290	25291	25292	25294	25295	25296	25297	25298	25299
531	25300	25301	25302	25304	25305	25306	25307	25308	25309
532	25310	25311	25312	25314	25315	25316	25317	25318	25319
533	25320	25321	25322	25324	25325	25326	25327	25328	25329
534	25330	25331	25332	25334	25335	25336	25337	25338	25339
535	25340	25341	25342	25344	25345	25346	25347	25348	25349
536	25350	25351	25352	25354	25355	25356	25357	25358	25359
537	25360	25361	25362	25364	25365	25366	25367	25368	25369
538	25370	25371	25372	25374	25375	25376	25377	25378	25379
539	25380	25381	25382	25384	25385	25386	25387	25388	25389
540	25390	25391	25392	25394	25395	25396	25397	25398	25399
541	25400	25401	25402	25404	25405	25406	25407	25408	25409
542	25410	25411	25412	25414	25415	25416	25417	25418	25419
543	25420	25421	25422	25424	25425	25426	25427	25428	25429
544	25430	25431	25432	25434	25435	25436	25437	25438	25439
545	25440	25441	25442	25444	25445	25446	25447	25448	25449
546	25450	25451	25452	25454	25455	25456	25457	25458	25459
547	25460	25461	25462	25464	25465	25466	25467	25468	25469
548	25470	25471	25472	25474	25475	25476	25477	25478	25479
549	25480	25481	25482	25484	25485	25486	25487	25488	25489
550	25490	25491	25492	25494	25495	25496	25497	25498	25499

Data No.	Positioning identifier	M code	Dwell time	Command speed		Positioning address		Arc data	
				Low-order	High-order	Low-order	High-order	Low-order	High-order
551	25500	25501	25502	25504	25505	25506	25507	25508	25509
552	25510	25511	25512	25514	25515	25516	25517	25518	25519
553	25520	25521	25522	25524	25525	25526	25527	25528	25529
554	25530	25531	25532	25534	25535	25536	25537	25538	25539
555	25540	25541	25542	25544	25545	25546	25547	25548	25549
556	25550	25551	25552	25554	25555	25556	25557	25558	25559
557	25560	25561	25562	25564	25565	25566	25567	25568	25569
558	25570	25571	25572	25574	25575	25576	25577	25578	25579
559	25580	25581	25582	25584	25585	25586	25587	25588	25589
560	25590	25591	25592	25594	25595	25596	25597	25598	25599
561	25600	25601	25602	25604	25605	25606	25607	25608	25609
562	25610	25611	25612	25614	25615	25616	25617	25618	25619
563	25620	25621	25622	25624	25625	25626	25627	25628	25629
564	25630	25631	25632	25634	25635	25636	25637	25638	25639
565	25640	25641	25642	25644	25645	25646	25647	25648	25649
566	25650	25651	25652	25654	25655	25656	25657	25658	25659
567	25660	25661	25662	25664	25665	25666	25667	25668	25669
568	25670	25671	25672	25674	25675	25676	25677	25678	25679
569	25680	25681	25682	25684	25685	25686	25687	25688	25689
570	25690	25691	25692	25694	25695	25696	25697	25698	25699
571	25700	25701	25702	25704	25705	25706	25707	25708	25709
572	25710	25711	25712	25714	25715	25716	25717	25718	25719
573	25720	25721	25722	25724	25725	25726	25727	25728	25729
574	25730	25731	25732	25734	25735	25736	25737	25738	25739
575	25740	25741	25742	25744	25745	25746	25747	25748	25749
576	25750	25751	25752	25754	25755	25756	25757	25758	25759
577	25760	25761	25762	25764	25765	25766	25767	25768	25769
578	25770	25771	25772	25774	25775	25776	25777	25778	25779
579	25780	25781	25782	25784	25785	25786	25787	25788	25789
580	25790	25791	25792	25794	25795	25796	25797	25798	25799
581	25800	25801	25802	25804	25805	25806	25807	25808	25809
582	25810	25811	25812	25814	25815	25816	25817	25818	25819
583	25820	25821	25822	25824	25825	25826	25827	25828	25829
584	25830	25831	25832	25834	25835	25836	25837	25838	25839
585	25840	25841	25842	25844	25845	25846	25847	25848	25849
586	25850	25851	25852	25854	25855	25856	25857	25858	25859
587	25860	25861	25862	25864	25865	25866	25867	25868	25869
588	25870	25871	25872	25874	25875	25876	25877	25878	25879
589	25880	25881	25882	25884	25885	25886	25887	25888	25889
590	25890	25891	25892	25894	25895	25896	25897	25898	25899
591	25900	25901	25902	25904	25905	25906	25907	25908	25909
592	25910	25911	25912	25914	25915	25916	25917	25918	25919
593	25920	25921	25922	25924	25925	25926	25927	25928	25929
594	25930	25931	25932	25934	25935	25936	25937	25938	25939
595	25940	25941	25942	25944	25945	25946	25947	25948	25949
596	25950	25951	25952	25954	25955	25956	25957	25958	25959
597	25960	25961	25962	25964	25965	25966	25967	25968	25969
598	25970	25971	25972	25974	25975	25976	25977	25978	25979
599	25980	25981	25982	25984	25985	25986	25987	25988	25989
600	25990	25991	25992	25994	25995	25996	25997	25998	25999

## Appendix 2 Connection with servo amplifiers

### Appendix 2.1 Connection of SSCNET III cables

Between the LD77MH and servo amplifiers or servo amplifier and servo amplifier connected by SSCNET III cable.

When absolute position detection control is executed, installed battery (MR-J3BAT) to servo amplifier.

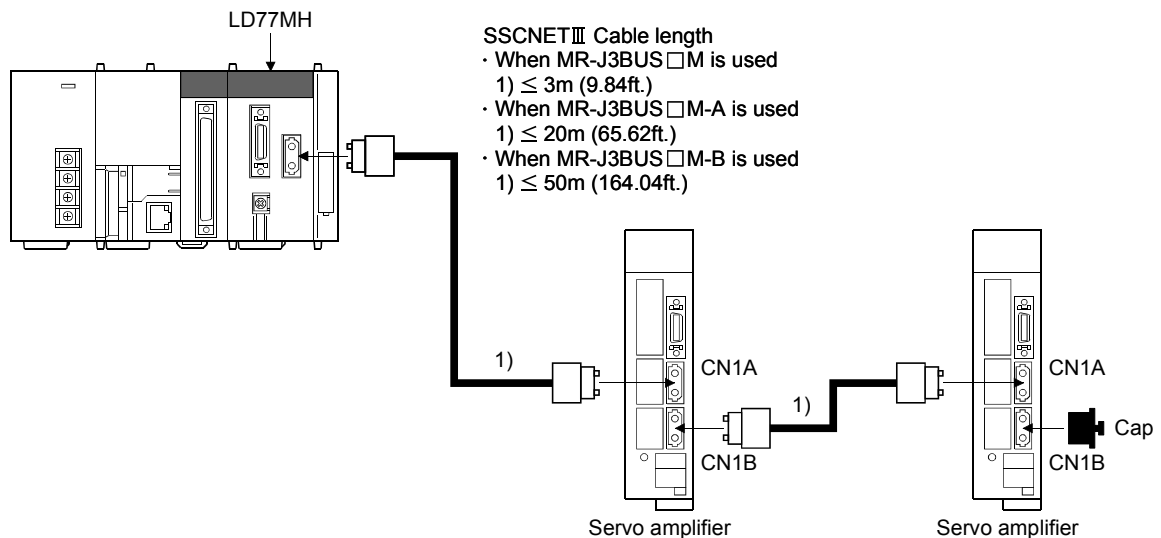

(Note): It cannot communicate with that the connection of CN1A and CN1B is mistaken.

## ⚠ CAUTION

- Be sure to connect SSCNET III cable with the above connector. If the connection is mistaken, between the LD77MH and servo amplifier cannot be communicated.
- SSCNET III connector to connect the SSCNET III cable is put a cap to protect light device inside connector from dust. For this reason, do not remove a cap until just before connecting SSCNET III cable. Then, when removing SSCNET III cable, make sure to put a cap.
- Keep the cap and the tube for protecting light cord end of SSCNET III cable in a plastic bag with a zipper of SSCNET III cable to prevent them from becoming dirty.
- Do not remove the SSCNET III cable while turning on the power supply of LD77MH and servo amplifier. Do not see directly the light generated from SSCNET III connector of LD77MH or servo amplifier and the end of SSCNET III cable. When the light gets into eye, may feel something is wrong for eye. (The light source of SSCNET III cable complies with class1 defined in JISC6802 or IEC60825-1.)
- When exchanging the LD77MH or servo amplifier, make sure to put a cap on SSCNET III connector. When asking repair of LD77MH or servo amplifier for some troubles, make also sure to put a cap on SSCNET III connector. When the connector is not put a cap, the light device may be damaged at the transit. In this case, exchange and repair of light device is required.

Appendix 2.2 Wiring of SSCNET III cables

Generally use the SSCNET III cables available as our products.

(1) Model explanation

Numeral in the column of cable length on the table is a symbol put in the "□" part of cable model. Cables of which symbol exists are available.

Table 2.1 SSCNET III cable list

Cable model	Cable length [m(ft.)]											Flex life	Application/ remark
	0.15 (0.49)	0.3 (0.98)	0.5 (1.64)	1 (3.28)	3 (9.84)	5 (16.40)	10 (32.81)	20 (65.62)	30 (98.43)	40 (131.23)	50 (164.04)		
MR-J3BUS□M	015	03	05	1	3	/	/	/	/	/	/	Standard	Standard cord for inside panel
MR-J3BUS□M-A	/	/	/	/	/	5	10	20	/	/	/	Standard	Standard cable for outside panel
MR-J3BUS□M-B (Note-1)	/	/	/	/	/	/	/	/	30	40	50	Long flex	Long distance cable

(Note-1) : For the cable of less than 30[m](98.43[ft.]), contact your nearest Mitsubishi sales representative.

(2) Specification

Table 2.2 SSCNET III cable list

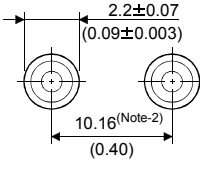
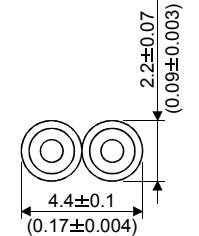
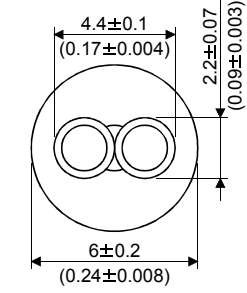
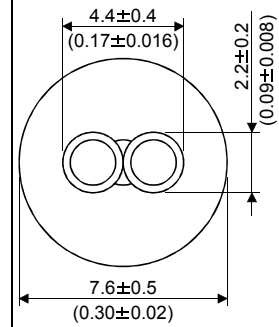
		Description			
SSCNET III cable model		MR-J3BUS□M		MR-J3BUS□M-A	MR-J3BUS□M-B
SSCNET III cable length [m(ft.)]		0.15 (0.49)	0.3 to 3 (0.98 to 9.84)	5 to 20 (16.40 to 65.62)	30 to 50 (98.43 to 164.04)
Optical cable (Cord)	Minimum bend radius [mm(inch)]	25(0.98)		Enforced covering cord: 50 (1.97) Cord: 25 (0.98)	Enforced covering cord: 50 (1.97) Cord: 30(1.18)
	Tension strength [N]	70	140	420 (Enforced covering cord)	980 (Enforced covering cord)
	Temperature range for use [°C(°F)] (Note-1)	-40 to 80 (-40 to 176)			-20 to 70 (-4 to 158)
	Ambient	Indoors (no direct sunlight), No solvent or oil			
	External appearance [mm(inch)]				

(Note-1): This temperature range for use is the value for optical cable (cord) only.

(Note-2): Dimension of connector fiber insert location. The distance of two cords is changed by how to bend it.



## CAUTION

- Please use the processing method and the processing treatment device that exists in the connector when you fix the cord part of the SSCNET III cable to the connector.
- It must not cut squarely when you cut the cord part of the SSCNET III cable, the cutting edge side must not be made smooth, and garbage etc. must not adhere.
- The damage etc. must not adhere to the optical cord part when you peel off the film of the cable of the SSCNET III cable.
- If the end face of cord tip for the SSCNET III cable is dirty, optical transmission is interrupted and it may cause malfunctions. If it becomes dirty, wipe with a bonded textile, etc. Do not use solvent such as alcohol.
- Do not add impossible power to the connector of the SSCNET III cable.
- When incinerating the SSCNET III cable (optical fiber), hydrogen fluoride gas or hydrogen chloride gas which is corrosive and harmful may be generated. For disposal of the SSCNET III cable (optical fiber), request for specialized industrial waste disposal services who has incineration facility for disposing hydrogen fluoride gas or hydrogen chloride gas.

(a) MR-J3BUS□M  
1) Model explanation

Type: MR-J3BUS□M - \*

Symbol	Cable type
None	Standard cord for inside panel
A	Standard cable for outside panel
B	Long distance cable

Symbol	Cable length [m(ft.)]
015	0.15(0.49)
03	0.3(0.98)
05	0.5(1.64)
1	1(3.28)
3	3(9.84)
5	5(16.40)
10	10(32.81)
20	20(65.62)
30	30(98.43)
40	40(131.23)
50	50(164.04)

2) Exterior dimensions

• MR-J3BUS015M

[Unit : mm(inch)]

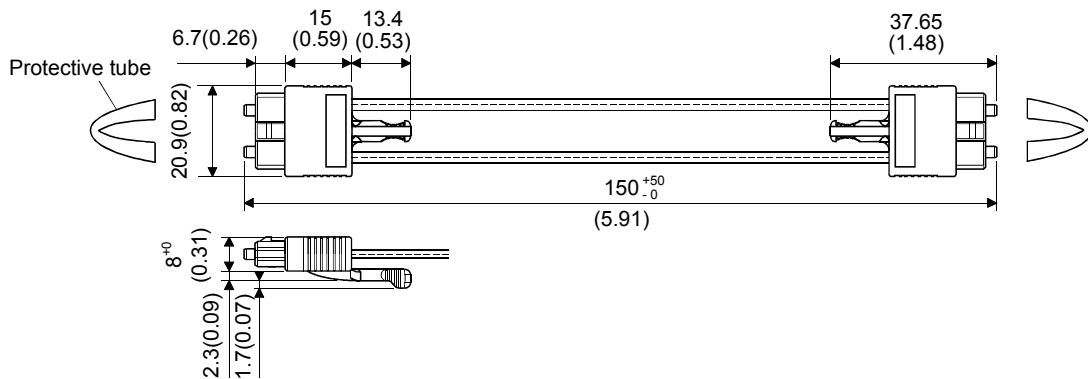

• MR-J3BUS03M to MR-J3BUS3M

Refer to the table of this section (1) for cable length (L).

[Unit : mm(inch)]

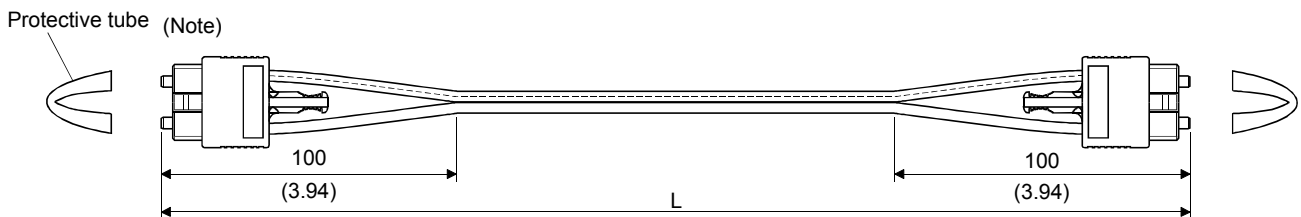

(Note): Dimension of connector part is the same as that of MR-J3BUS015M.

- MR-J3BUS5M-A to MR-J3BUS20M-A
- MR-J3BUS30M-B to MR-J3BUS50M-B

Refer to the table of this section (1) for cable length (L).

SSCNET III Cable	Variation [mm(inch)]	
	A	B
MR-J3BUS5M-A to MR-J3BUS20M-A	100(3.94)	30(1.18)
MR-J3BUS30M-B to MR-J3BUS50M-B	150(5.91)	50(1.97)

[Unit : mm(inch)]

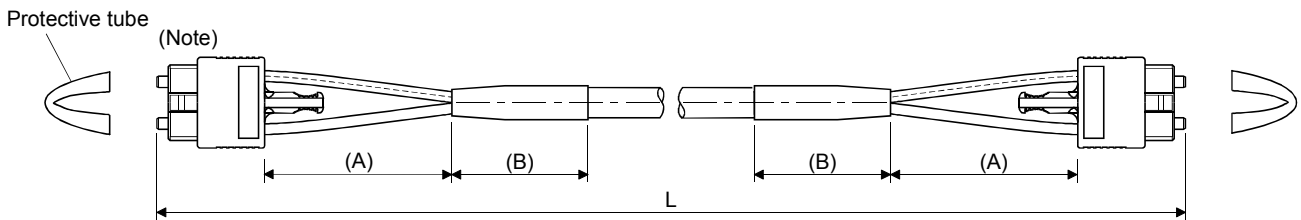

(Note): Dimension of connector part is the same as that of MR-J3BUS015M.

**POINT**

Keep the cap and the tube for protecting light cord end of SSCNET III cable in a plastic bag with a zipper of SSCNET III cable to prevent them from becoming dirty.

(b) SSCNET III cable connector

[Unit : mm(inch)]

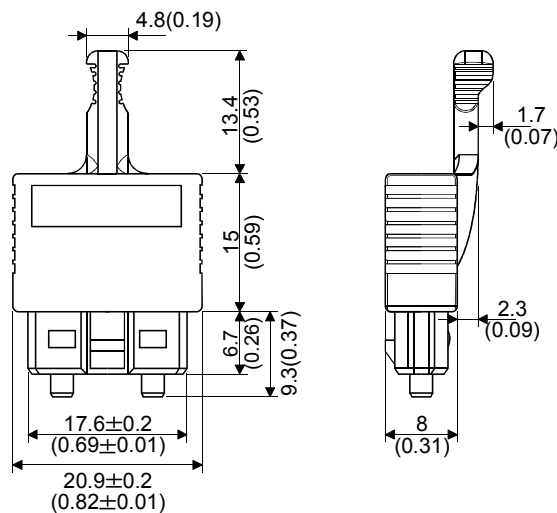

## Appendix 3 Connection with external device

### Appendix 3.1 Connector

Mounted onto an external input signal connector of the LD77MH and used for wiring an external device. The "external device connector" includes the following 3 types.

#### (1) Connector type

Type		Type	
		Connector	Connector case
Soldering type (LD77MHIOCON)	Quick release metal latch type	10126-3000PE	10326-52F0-008
Soldering type <sup>(Note)</sup>	Threaded type	10126-3000PE	10326-52A0-008
Pressure-displacement type (Note)	Quick release metal latch type	10126-6000EL	10326-3210-000

(Note): These connectors are not options. Please purchase them by customer.

#### (2) Specifications of the connector

Part name	Specification	
Applicable connector	Soldering type (Quick release metal latch type/ Threaded type)	Pressure-displacement type (Quick release metal latch type)
Applicable wire size	AWG24 to AWG30 (0.2 to 0.05mm <sup>2</sup> )	AWG28 (Stranded, 0.08mm <sup>2</sup> )

(Note): The external device connector has been prepared. Please purchase them by customer.

#### Specialized tool

- MDR assembly press for pressure-displacement type
  - Model name: 10960 (Hand press)
  - : 10962 (Fixture unit)
  - : 10963 (Fixture block)
  - : 10964-1 (Cable clamp (black) 14 - 50 position)
- Contact for the specialized tool: Sumitomo 3M

(3) External dimension drawing

(a) Soldering type (Quick release metal latch type) (LD77MHIOCON)

[Unit: mm(inch)]

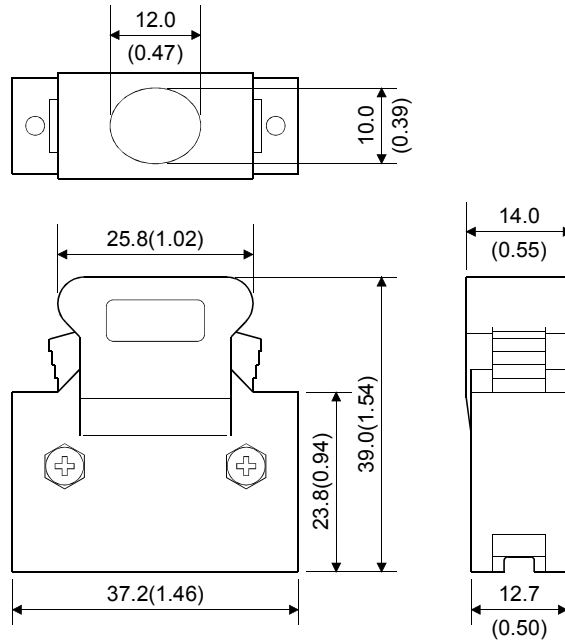

(b) Soldering type (Threaded type)

[Unit: mm(inch)]

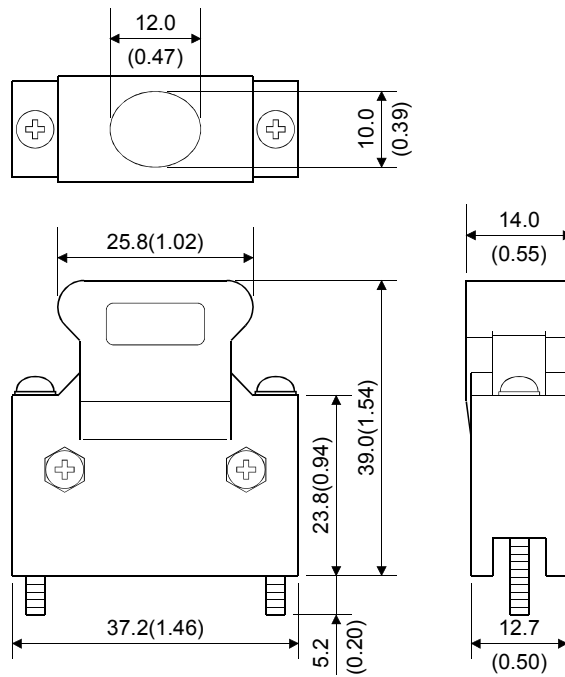

(c) Pressure-displacement type (Quick release metal latch type)

[Unit: mm(inch)]

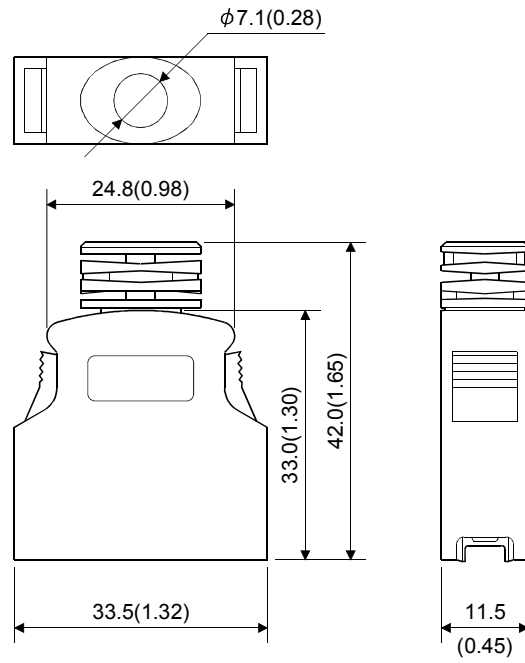

### Appendix 3.2 External input signal cable

There are no our option in the external input signal cable. The external input signal cable fabricate on the customer side.

#### (1) Connection diagram

Make the cable as shown in the following connection diagram.

##### (a) Differential-output type

Make the cable within 30m(98.43ft.).

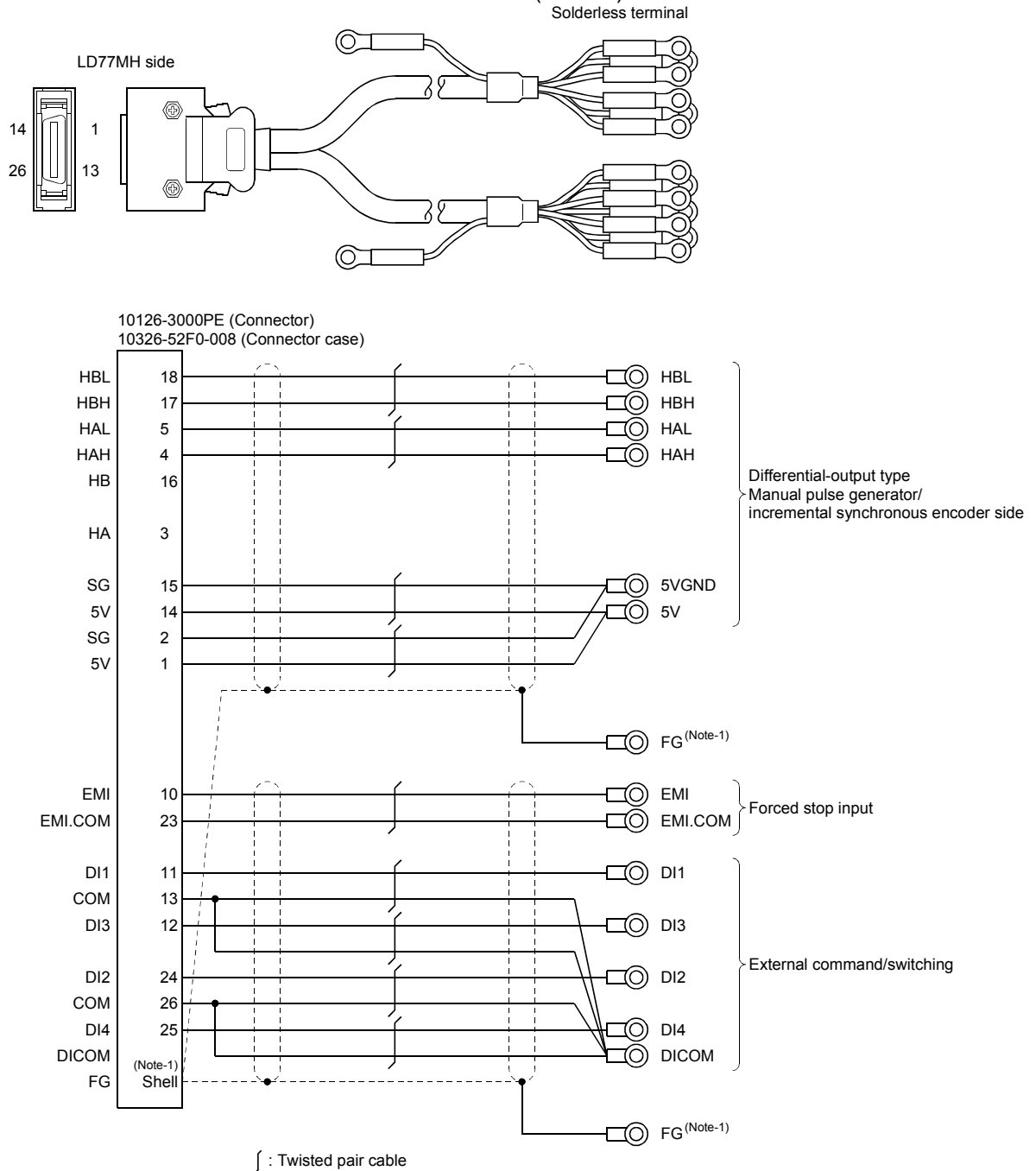

(Note-1): Ground FG terminal on the used equipment side. Also, connect it to the shell of connector side.

(b) Voltage-output/Open-collector type

Make the cable within 10m(32.81ft.).

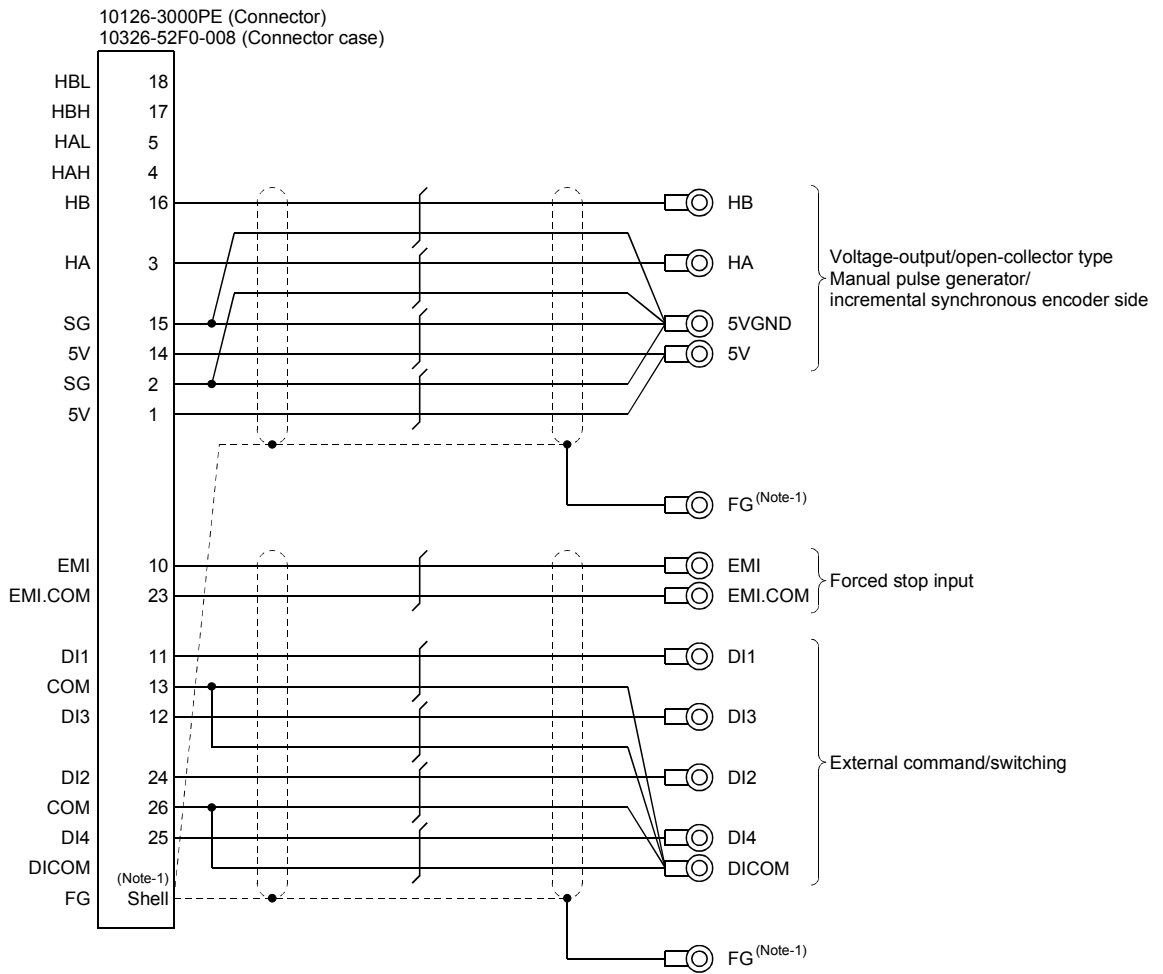
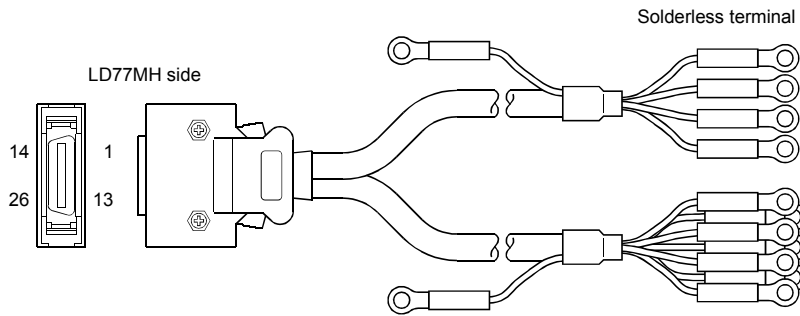



- 1) The following table indicates the external input signal cables used with motion controller and the manual pulse generator. Make selection according to your operating conditions.

Table 3.1 Table of wire specifications

Wire model	Core size [mm <sup>2</sup> ]	Number of cores	Characteristics of one core			Finish OD [mm] <sup>(Note-2)</sup>
			Structure [Number of wires/mm]	Conductor resistance [ $\Omega$ /km]	Insulating sheath OD d[mm] <sup>(Note-1)</sup>	
20276FACBL 7/0.18mm×4P	AWG25(0.16mm <sup>2</sup> )	8(4 pairs)	7/0.18TA	115	1.0	6.8
20276FACBL 7/0.18mm×5P	AWG25(0.16mm <sup>2</sup> )	10(5 pairs)	7/0.18TA	115	1.0	7.3

(Note-1): d is as shown below.

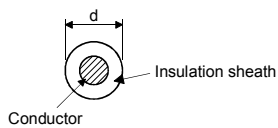

(Note-2): Standard OD. Max. OD is about 10% larger.

## ⚠ CAUTION

- When fabricating the cable, do not make incorrect connection. Wrong connection will cause runaway or explosion.

Appendix 4 Comparisons with positioning modules

Appendix 4.1 Comparisons with LD75P/D model

Model		LD77MH4	LD77MH16	LD75P4/LD75D4
Item				
Number of control axes		4	16	4
Number of positioning data items		600/axis		
Interpolation functions	2-axis linear interpolation		○	
	3-axis linear interpolation		○	
	4-axis linear interpolation		○	
	2-axis circular interpolation		○	
Positioning systems	Position control		○	
	Speed control		○	
	Speed-position switching control		○ (INC/ABS mode)	
	Position-speed switching control		○	
Machine OPR function (OPR method)		○ (5 types) (Near-point dog method, Count method 1) 2), Data set method and scale origin signal detection method)		○ (6 types) (Near-point dog method, Stopper method 1) to 3) and Count method 1) 2))
JOG operation			○	
Inching operation			○	
Manual pulse generator function			○	
Speed-torque control		○		×
Synchronous control		○		×
Acceleration/deceleration processing	Trapezoidal acceleration/deceleration		○	
	S-curve acceleration/deceleration		○	
Acceleration/deceleration time		Acceleration time and deceleration time setting possible (4 patterns each)		
Compensation		Electronic gears, backlash compensation		
Error display		Error LED		
History data (Start, error, warning)		Provided (3 types, 16 items/axis)		
Data storage destination		Flash ROM (battery-less backup)		
Connected to servo amplifier		SSCNET III compatible servo amplifier (Upper/lower limit signal, Near-point dog signal)		Open collector output system compatible drive unit/differential driver output system compatible drive unit (Pulse signal, servo ON signal, Servo READY signal and Zero point signal)
ABS function		Absolute position system by parameter setting		Absolute position restoration function
Follow up function		○		×
Electronic gears ratio		Denominator/numerator (32 bit)		Denominator/numerator (16 bit)
Absolute positioning system (degree) with unlimited length feed can be configured grantee.		Provided		None
External wiring connection system		26-pin connector		40-pin connector
Number of input/output points		32		
Number of module occupied slots		2		

○ : Possible, × : Not possible

Appendix 4.2 Differences with QD75MH models

When the sequence program used in the Q series system is used to the L series, refer to the "MELSEC-L CPU Module User's Manual (Function Explanation, Program Fundamentals)".

(1) Differences of performance specifications

Model		LD77MH4	LD77MH16 <sup>(Note-1)</sup>	QD75MH4
Item				
Number of control axes		4	16	4
Operation cycle [ms]		0.88	0.88/1.77	1.77
Control system	Speed-torque control	○ <sup>(Note-2)</sup>		×
Synchronous control		○ <sup>(Note-2)</sup>		×
Starting time (1-axis linear)		0.88ms (Trapezoidal acceleration/deceleration, S-curve acceleration/deceleration)	1.77ms (Trapezoidal acceleration/deceleration, S-curve acceleration/deceleration)	Trapezoidal acceleration/deceleration: 3.5ms S-curve acceleration/deceleration: 4.0ms
Compatible servo amplifier		MR-J3-□B/MR-J3W-□B/MR-J3-□B-RJ006/ MR-J3-□BS/MR-J3-□B-RJ004/ MR-J3-□B-RJ080W <sup>(Note-2)</sup>		MR-J3-□B/MR-J3W-□B/MR-J3-□B-RJ006/ MR-J3-□BS/MR-J3-□B-RJ004/ MR-J3-□B-RJ080W <sup>(Note-3)</sup>
Controlled servo parameter group		PA, PB, PC, PD, PE, PS, PF <sup>(Note-2)</sup> , Po <sup>(Note-2)</sup>		PA, PB, PC, PD, PE, PS
Monitor data refresh cycle [ms]		Operation cycle		1.77
				Other than the following Machine feed value, Feedrate, Axis feedrate, External input signal, Forced stop input
Manual pulse generator	Signal input form	Set "differential-output type" or "voltage-output/open-collector type" by parameter ([Pr.89]). <sup>(Note-2)</sup>		Automatic recognition of "differential-output type" or "voltage-output/open-collector type" by hardware
	1 pulse input magnification	1 to 10000		1 to 1000 <sup>(Note-3)</sup>
Machine OPR function (OPR method)		5 types (Near-point dog method, Count method 1) 2), Data set method, Scale origin signal detection method <sup>(Note-2)</sup> )		4 types (Near-point dog method, Count method 1) 2), Data set method)
External signal selection function		External input signal of servo amplifier (FLS, RLS, DOG)		External input signal of QD75MH (FLS, RLS, DOG, STOP, CHG) or servo amplifier (FLS, RLS, DOG)
Torque change function		Forward/reverse same setting and individual setting		Forward/reverse same setting only <sup>(Note-3)</sup>
Amplifier-less operation function		○		× <sup>(Note-3)</sup>
Virtual servo amplifier function <b>LD77MH16</b>		×	○	×
Master-slave operation function		○ <sup>(Note-2)</sup>		×
Mark detection function <b>LD77MH16</b>		×	○	×
Optional data monitor function <b>LD77MH16</b>		×	○	×
Module error collection function <b>LD77MH16</b>		×	○	×
History data (Start, Error, Warning)		Information display of "Year" <sup>(Note-2)</sup> , Month <sup>(Note-2)</sup> , Day <sup>(Note-2)</sup> , Hour, Minute, Second"		Information display of "Hour, Minute, Second"

Differences of performance specifications (Continued)

Model		LD77MH4	LD77MH16 <sup>(Note-1)</sup>	QD75MH4
Item				
Connection connector		LD77MHIOCON: Soldering type		A6CON1, A6CON4: Soldering type, Optional A6CON2: Crimp contact type, Optional A6CON3: Pressure-displacement type, Optional
Applicable wire size		LD77MHIOCON: AWG24 to AWG30 (0.2 to 0.05mm <sup>2</sup> )		A6CON1, A6CON4: AWG22 (0.3mm <sup>2</sup> ) A6CON2: AWG24 (0.2mm <sup>2</sup> ) A6CON3: AWG28 (Stranded, 0.08mm <sup>2</sup> ) AWG30 (Solid, 0.05mm <sup>2</sup> )
5VDC internal current consumption [A]		0.55	0.70	0.60
Number of module occupied slots		2		1
Outline dimensions [mm(inch)]		90.0(3.54) (H)×45.0(1.77) (W)×95.0(3.74) (D)		98.0(3.86) (H)×27.4(1.08) (W)×90.0(3.54) (D)
Mass [kg]		0.22		0.16
External command signal	Switching signal	DI signal (External start or speed-position switching can be selected by parameter.)		CHG signal (External start or speed-position switching can be selected by parameter.)

○ : Possible, × : Not possible

(Note-1): LD77MH16 cannot be used with GX Configurator-QP.

(Note-2): Use GX Works2 to use this setting in LD77MH4. (Not supported with GX Configurator-QP.)

(Note-3): These functions are equal to the LD77MH's specification in the following version of QD75MH.

Rating plate: 11072000000000-B or more, Product information: 11052000000000-B or more

(2) Differences of function

(a) Added functions

Functions	Remarks
Scale origin signal detection method OPR	Refer to Section 8.2.7
Speed-torque control	Refer to Section 12.1
Virtual servo amplifier function <b>LD77MH16</b>	Refer to Section 14.8
Master-slave operation function	Refer to Section 14.9
Mark detection function <b>LD77MH16</b>	Refer to Section 14.10
Optional data monitor function <b>LD77MH16</b>	Refer to Section 14.11
Module error collection function <b>LD77MH16</b>	Refer to Section 14.12

(b) Changed functions

Function	Description	Specification		
		LD77MH4	LD77MH16	QD75MH4
[Pr.22] Input signal logic selection	Range of setting value	b0: Lower limit b1: Upper limit b4: External command/switching signal b6: Near-point dog signal b8: Manual pulse generator input		b0: Lower limit b1: Upper limit b3: Stop signal b4: External command/switching signal b6: Near-point dog signal b8: Manual pulse generator input
[Pr.24] Manual pulse generator /Incremental synchronous encoder input selection	Name	Manual pulse generator/Incremental synchronous encoder input selection		Manual pulse generator input selection
	Range of setting value	0: A-phase/B-phase multiplied by 4 2: A-phase/B-phase multiplied by 1 <b>LD77MH16</b> 3: PLS/SIGN		0: A-phase/B-phase multiplied by 4 1: A-phase/B-phase multiplied by 2 2: A-phase/B-phase multiplied by 1 3: PLS/SIGN
[Pr.42] External command function selection	Range of setting value	0: External positioning start 1: External speed change request 2: Speed-position, position-speed switching request 3: Skip request 4: High speed input request <b>LD77MH16</b>		0: External positioning start 1: External speed change request 2: Speed-position, position-speed switching request 3: Skip request
[Pr.43] OPR method	Range of setting value	0 : Near-point dog method 4 : Count method 1) 5 : Count method 2) 6 : Data set method 7: Scale origin signal detection method		0 : Near-point dog method 4 : Count method 1) 5 : Count method 2) 6 : Data set method
[Pr.89] Manual pulse generator /Incremental synchronous encoder input type selection	New parameter	0: Differential-output type 1: Voltage-output/Open-collector type		No setting (Automatic recognition by hardware)
[Pr.80] External input signal selection	Range of setting value	1: External input signal of servo amplifier		0: External input signal of QD75MH 1: External input signal of servo amplifier
[Pr.95] External command signal selection <b>LD77MH16</b>	New parameter	No parameter setting	0: Not used 1: DI1 2: DI2 3: DI3 4: DI4	No parameter setting
[Pr.96] Operation cycle setting <b>LD77MH16</b>	New parameter	No parameter setting	0: 0.88ms 1: 1.77ms	No parameter setting
Starting history	Information display of starting time	Starting time is displayed by "Year : Month : Day : Hour : Minute : Second". [Md.54] Start Year: month [Md.5] Start Day: hour [Md.6] Start Minute: second		Starting time is displayed by "Hour, Minute, Second". [Md.5] Start Hour [Md.6] Start Minute: second
Axis error occurrence time	Information display of axis error occurrence time	Occurrence time of axis error is displayed by "Year, Month, Day, Hour, Minute, Second". [Md.55] Axis error occurrence (Year: month) [Md.11] Axis error occurrence (Day: hour) [Md.12] Axis error occurrence (Minute: second)		Occurrence time of axis error is displayed by "Hour, Minute, Second". [Md.11] Axis error occurrence (Hour) [Md.12] Axis error occurrence (Minute: second)

Changed functions (Continued)

Function	Description	Specification		
		LD77MH4	LD77MH16	QD75MH4
Axis warning occurrence time	Information display of axis warning occurrence time	Occurrence time of axis warning is displayed by "Year, Month, Day, Hour, Minute, Second". [Md.56] Axis warning occurrence (Year: month) [Md.16] Axis warning occurrence (Day: hour) [Md.17] Axis warning occurrence (Minute: second)		Occurrence time of axis warning is displayed by "Hour, Minute, Second". [Md.16] Axis warning occurrence (Hour) [Md.17] Axis warning occurrence (Minute: second)
[Md.26] Axis operation status	Range of monitor value	-2: Step standby -1: Error 0: Standby 1: Stopped 2: Interpolation 3: JOG operation 4: Manual pulse generator operation 5: Analyzing 6: Special start standby 7: OPR 8: Position control 9: Speed control 10: Speed control in speed-position switching control 11: Position control in speed-position switching control 12: Position control in position-speed switching control 13: Speed control in position-speed switching control 20: Servo amplifier has not been connected/servo amplifier power OFF 21: Servo OFF 30: Control mode switch 31: Speed control 32: Torque control		-2: Step standby -1: Error 0: Standby 1: Stopped 2: Interpolation 3: JOG operation 4: Manual pulse generator operation 5: Analyzing 6: Special start standby 7: OPR 8: Position control 9: Speed control 10: Speed control in speed-position switching control 11: Position control in speed-position switching control 12: Position control in position-speed switching control 13: Speed control in position-speed switching control 20: Servo amplifier has not been connected/servo amplifier power OFF 21: Servo OFF
[Md.30] External input signal	Range of monitor value	b0: Lower limit signal b1: Upper limit signal b2: Not used b3: Not used b4: External command signal/switching signal b5: Not used b6: Near-point dog signal b7: Not used b8: Not used		b0: Lower limit signal b1: Upper limit signal b2: Not used b3: Stop signal b4: External command signal/switching signal b5: Not used b6: Near-point dog signal b7: Not used b8: Not used

Changed functions (Continued)

Function	Description	Specification		
		LD77MH4	LD77MH16	QD75MH4
<b>[Md.31]</b> Status	Range of monitor value	b0: In speed control flag b1: Speed-position switching latch flag b2: Command in-position flag b3: OPR request flag b4: OPR complete flag b5: Position-speed switching latch flag b9: Axis warning detection b10: Speed change 0 flag b12: M code ON <b>[LD77MH16]</b> b13: Error detection <b>[LD77MH16]</b> b14: Start complete <b>[LD77MH16]</b> b15: Positioning complete <b>[LD77MH16]</b>	b0: In speed control flag b1: Speed-position switching latch flag b2: Command in-position flag b3: OPR request flag b4: OPR complete flag b5: Position-speed switching latch flag b9: Axis warning detection b10: Speed change 0 flag	
<b>[Md.47]</b> Positioning data being executed	Storage item	Positioning identifier ([Da.1] to [Da.4], [Da.5] <b>[LD77MH4]</b> ) Positioning address ([Da.6]) Arc address ([Da.7]) Command speed ([Da.8]) Dwell time ([Da.9]) M code ([Da.10]) Axis to be interpolated ([Da.20] to [Da.22]) <b>[LD77MH16]</b>	Positioning identifier ([Da.1] to [Da.5]) Positioning address ([Da.6]) Arc address ([Da.7]) Command speed ([Da.8]) Dwell time ([Da.9]) M code ([Da.10])	
<b>[Md.107]</b> Parameter error No.	Range of monitor value	1 to 18 : PA01 to PA18 19 to 63 : PB01 to PB45 64 to 95 : PC01 to PC32 96 to 127 : PD01 to PD32 128 to 167 : PE01 to PE40 168 to 183 : PF01 to PF16 184 to 199 : Po01 to Po16 200 to 231 : PS01 to PS32 232 : PA19	1 to 18 : PA01 to PA18 19 to 63 : PB01 to PB45 64 to 95 : PC01 to PC32 96 to 127 : PD01 to PD32	
<b>[Md.108]</b> Servo status	Range of monitor value	Low-order buffer memory b0: Zero point pass b3: Zero speed b4: Speed limit b8: PID control	Low-order buffer memory b0: Zero point pass b3: Zero speed	
		High-order buffer memory b0: READY ON b1: Servo ON b2, b3: Control mode b7: Servo alarm b12: In-position b13: Torque limit b14: Absolute position lost b15: Servo warning	High-order buffer memory b0: READY ON b1: Servo ON b7: Servo alarm b12: In-position b13: Torque limit b14: Absolute position lost b15: Servo warning	
<b>[Md.109]</b> Regenerative load ratio/Optional data monitor output 1	Name	Regenerative load ratio/Optional data monitor output 1	Regenerative load ratio	
<b>[Md.110]</b> Effective load torque/Optional data monitor output 2		Effective load torque/Optional data monitor output 2	Effective load torque	

Changed functions (Continued)

Function	Description	Specification		
		LD77MH4	LD77MH16	QD75MH4
<a href="#">Md.111</a> Peak torque ratio/ Optional data monitor output 3	Name	Peak torque ratio/Optional data monitor output 3		Peak torque ratio
<a href="#">Md.112</a> Optional data monitor output 4 <a href="#">LD77MH16</a>	New monitor data	No monitor data	Content set in " <a href="#">Pr.94</a> Optional data monitor: Data type setting 4" is displayed.	No monitor data
<a href="#">Md.113</a> Semi/Fully closed loop status	Buffer memory address	Axis 1: 887 Axis 2: 987 Axis 3: 1087 Axis 4: 1187	Axis 1: 2487 Axis 2: 2587 Axis 3: 2687 Axis 4: 2787 to Axis 16: 3987	Axis 1: 881 Axis 2: 981 Axis 3: 1081 Axis 4: 1181
<a href="#">Md.132</a> Operation cycle setting <a href="#">LD77MH16</a>	New monitor data	No monitor data	0: 0.88ms 1: 1.77ms	No monitor data
<a href="#">Md.133</a> Operation cycle over flag <a href="#">LD77MH16</a>		No monitor data	0: OFF 1: ON (Operation cycle over occurred.)	No monitor data
<a href="#">Md.134</a> Operation time		Operation time [μs]		No monitor data
<a href="#">Md.135</a> Maximum operation time		Maximum operation time [μs]		No monitor data
<a href="#">Cd.43</a> Simultaneous starting axis <a href="#">LD77MH16</a>	New control data	No control data	Number of simultaneous starting axes 2 to 4: 2 axes to 4 axes Simultaneous starting axis No. 0 to F: Axis 1 to Axis 16	No control data
<a href="#">Cd.30</a> Simultaneous starting own axis start data No.	Name	<a href="#">Cd.30</a> Simultaneous starting axis start data No. (axis 1 start data No.)	<a href="#">Cd.30</a> Simultaneous starting own axis start data No.	<a href="#">Cd.30</a> Simultaneous starting axis start data No. (axis 1 start data No.)
<a href="#">Cd.31</a> Simultaneous starting axis start data No.1		<a href="#">Cd.31</a> Simultaneous starting axis start data No. (axis 2 start data No.)	<a href="#">Cd.31</a> Simultaneous starting axis start data No.1	<a href="#">Cd.31</a> Simultaneous starting axis start data No. (axis 2 start data No.)
<a href="#">Cd.32</a> Simultaneous starting axis start data No.2		<a href="#">Cd.32</a> Simultaneous starting axis start data No. (axis 3 start data No.)	<a href="#">Cd.32</a> Simultaneous starting axis start data No.2	<a href="#">Cd.32</a> Simultaneous starting axis start data No. (axis 3 start data No.)
<a href="#">Cd.33</a> Simultaneous starting axis start data No.2		<a href="#">Cd.33</a> Simultaneous starting axis start data No. (axis 4 start data No.)	<a href="#">Cd.33</a> Simultaneous starting axis start data No.3	<a href="#">Cd.33</a> Simultaneous starting axis start data No. (axis 4 start data No.)
Axis stop	Input/output signal	Y4 to Y7	<a href="#">Cd.180</a> Axis stop	Y4 to Y7
Forward run JOG start		Y8, YA, YC, YE	<a href="#">Cd.181</a> Forward run JOG start	Y8, YA, YC, YE
Reverse run JOG start		Y9, YB, YD, YF	<a href="#">Cd.182</a> Reverse run JOG start	Y9, YB, YD, YF
Execution prohibition flag		Y14 to Y17	<a href="#">Cd.183</a> Execution prohibition flag	Y14 to Y17
Axis to be interpolated	Item of buffer memory	<a href="#">Da.5</a> Axis to be interpolated	<a href="#">Da.20</a> Axis to be interpolated No.1 <a href="#">Da.21</a> Axis to be interpolated No.2 <a href="#">Da.22</a> Axis to be interpolated No.3	<a href="#">Da.5</a> Axis to be interpolated



Changed functions (Continued)

Function	Description	Specification		
		LD77MH4	LD77MH16	QD75MH4
Da.16 Condition operator	Range of setting value	01: **=P1 02: **≠P1 03: **≤P1 04: **≥P1 05: P1≤**≤P2 06: **≤P1,P2≤** 07: DEV=ON 08: DEV=OFF 10: Axis 1 selected 20: Axis 2 selected 30: Axis 1 and 2 selected 40: Axis 3 selected 50: Axis 1 and 3 selected 60: Axis 2 and 3 selected 70: Axis 1, 2 and 3 selected 80: Axis 4 selected 90: Axis 1 and 4 selected A0: Axis 2 and 4 selected B0: Axis 1, 2 and 4 selected C0: Axis 3 and 4 selected D0: Axis 1, 3 and 4 selected E0: Axis 2, 3 and 4 selected	LD77MH4 01: **=P1 02: **≠P1 03: **≤P1 04: **≥P1 05: P1≤**≤P2 06: **≤P1,P2≤** 07: DEV=ON 08: DEV=OFF 10: Axis 1 selected 20: Axis 2 selected 30: Axis 1 and 2 selected 40: Axis 3 selected 50: Axis 1 and 3 selected 60: Axis 2 and 3 selected 70: Axis 1, 2 and 3 selected 80: Axis 4 selected 90: Axis 1 and 4 selected A0: Axis 2 and 4 selected B0: Axis 1, 2 and 4 selected C0: Axis 3 and 4 selected D0: Axis 1, 3 and 4 selected E0: Axis 2, 3 and 4 selected	01: **=P1 02: **≠P1 03: **≤P1 04: **≥P1 05: P1≤**≤P2 06: **≤P1,P2≤** 07: DEV=ON 08: DEV=OFF 10: Axis 1 selected 20: Axis 2 selected 30: Axis 1 and 2 selected 40: Axis 3 selected 50: Axis 1 and 3 selected 60: Axis 2 and 3 selected 70: Axis 1, 2 and 3 selected 80: Axis 4 selected 90: Axis 1 and 4 selected A0: Axis 2 and 4 selected B0: Axis 1, 2 and 4 selected C0: Axis 3 and 4 selected D0: Axis 1, 3 and 4 selected E0: Axis 2, 3 and 4 selected
Da.18 Parameter 1	Range of setting value	Set by "Da.16 Condition operator" and "Da.23 Number of simultaneously starting axes". LD77MH16		Set by "Da.16 Condition operator".
Da.19 Parameter 2	Range of setting value	Set by "Da.16 Condition operator" and "Da.23 Number of simultaneously starting axes". LD77MH16		Set by "Da.16 Condition operator".
Da.23 Number of simultaneously starting axes LD77MH16	New positioning data	No positioning data	2: 2 axes 3: 3 axes 4: 4 axes	No positioning data
Da.24 Simultaneously starting axis No.1 Da.25 Simultaneously starting axis No.2 Da.26 Simultaneously starting axis No.3 LD77MH16	New positioning data	No positioning data	0: Axis 1 selected 1: Axis 2 selected 2: Axis 3 selected 3: Axis 4 selected 4: Axis 5 selected 5: Axis 6 selected 6: Axis 7 selected 7: Axis 8 selected 8: Axis 9 selected 9: Axis 10 selected A: Axis 11 selected B: Axis 12 selected C: Axis 13 selected D: Axis 14 selected E: Axis 15 selected F: Axis 16 selected	No positioning data

## Appendix 5 When using GX Works2

Use the "Simple Motion Module Setting Tool" for LD77MH various setting.

The following shows the procedure for positioning operation when GX Works2 is used.

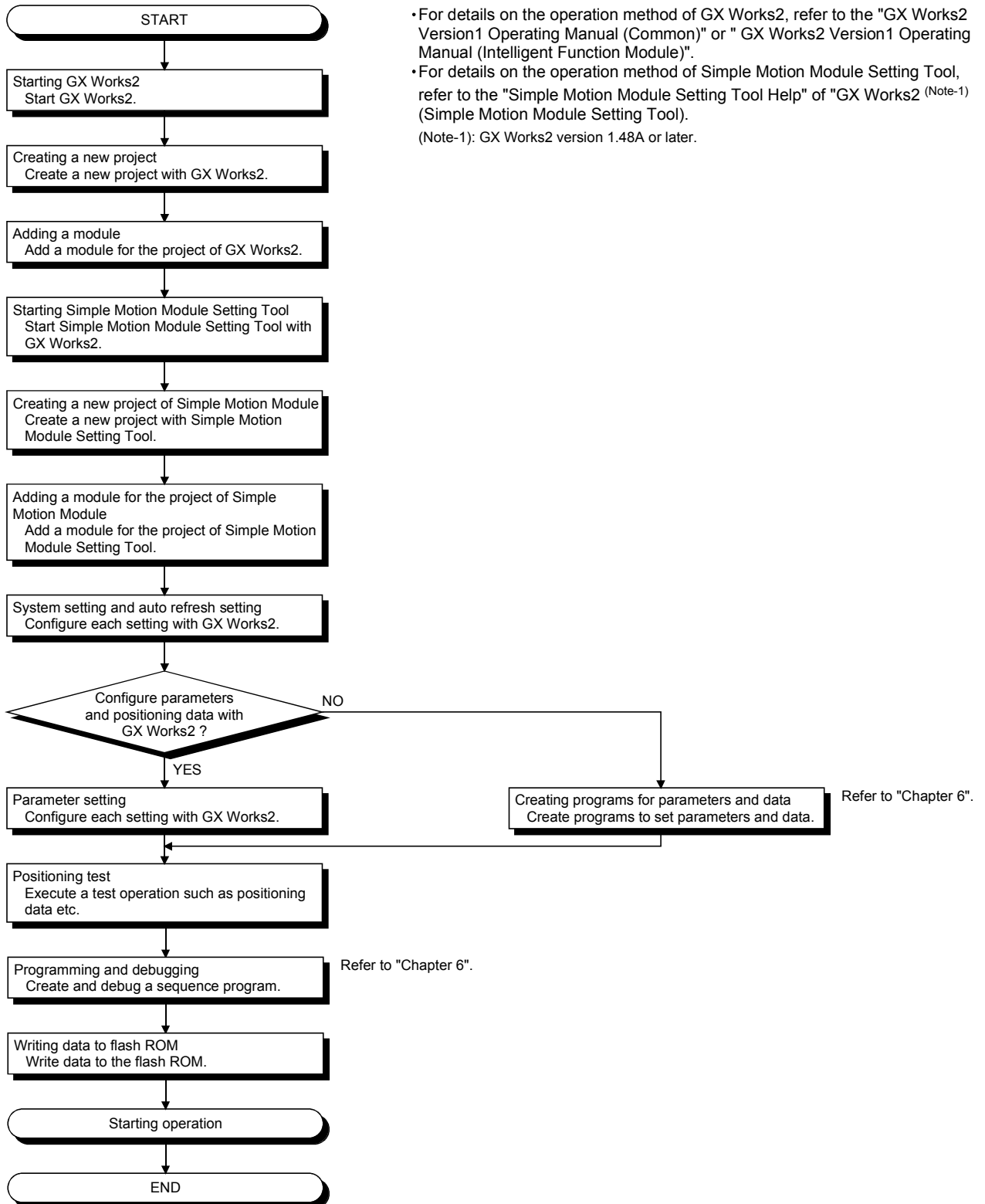

## Appendix 6 When using GX Developer or GX Configurator-QP

This section describes the operation method when GX Developer or GX Configurator-QP is used.

Refer to "MELSEC-L CPU Module User's Manual (Hardware Design, Maintenance and Inspection)" for applicable programming tool's versions.

### REMARK

LD77MH16 cannot be supported with GX Developer and GX Configurator-QP. Use GX Works2 to use LD77MH16.

## Appendix 6.1 Operation of GX Developer

With GX Developer, set the type of the module to be connected and the I/O signal range in the I/O assignment tab of the PLC parameter dialog box.

### ■ I/O assignment tab

#### (1) Operating procedure

##### 1. Open the "L Parameter setting" dialog box.

Parameter → [PLC parameter] → [I/O assignment]

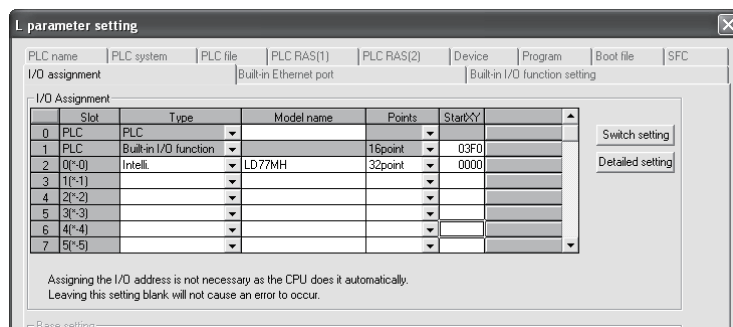

##### 2. Configure settings.

Set the following items.

Item	Contents
Type	Select "Intelli".
Model	Enter the module model name.
Points	Select "32point".
Start XY	Enter the start I/O number for the positioning module.

## Appendix 6.2 Operation of GX Configurator-QP

Refer to "GX Configurator-QP Version 2 Operating Manual" for the functions and operation method of GX Configurator-QP.

Appendix 7 Positioning control troubleshooting

Trouble type	Questions/Trouble	Remedy	No.
Parameter	Display reads "FFFFH" when a parameter is read with GX Works2.	The PLC CPU power was turned OFF or the PLC CPU was reset, etc., during flash ROM writing, which deleted the data in the flash ROM. Initialize the parameters, and reset the required parameters. (Refer to Section 14.2 "Parameter initialization function" for details.)	1
	How can the parameters be returned to their initial values?	Set the " [Cd.2] Parameter initialization request" to "1". (Refer to Section 14.2 "Parameter initialization function" for details.)	2
	A parameter error occurred although the parameter was set correctly by GX Works2.	The parameter may have been overwritten in the sequence program. Review the sequence program.	3
Hardware stroke limit	The machine overruns if operating at high speeds when the hardware stroke limit range is exceeded.	In the LD77MH, deceleration stops are executed after the machine exceeds hardware stroke limit range. Because of this, more time is required for the deceleration stop as the speed increases, and the overrun becomes larger. (The deceleration time becomes shorter at lower speeds, so the overrun becomes smaller.)	4
	When the machine exceeded the hardware stroke limit range, positioning toward inside the range was started, but the machine did not start.	Use a "JOG operation", " Inching operation" or "Manual pulse generator operation" to return the machine to inside the hardware stroke limit range. (When the hardware stroke limit range is exceeded, positioning will not start toward inside the range even when so commanded. Once the range is exceeded, a return to inside the range can only be executed using a "JOG operation", "Inching operation" or "Manual pulse generator operation".)	5
Degree	Exactly one rotation is required, but the setting range for a "degree" unit setting is "0 to 359.999...". Won't the rotation deviate by "0.00...1"?	Designate "360.000" in the INC control. The motor will make exactly one rotation.	6
Movement amount per pulse	If the "movement amount per pulse" is calculated as written in the manual, settings smaller than the basic parameter setting range cannot be carried out.	Set "movement amount per pulse" in the LD77MH using the three parameter values of [Pr.2] to [Pr.4] . Try setting the values following the explanations for each parameter.	7
Override	Will an override setting value written before starting be valid?	It will be valid.	8
	During path control, will the override still be valid after the point is passed?	It will still be valid.	9
	How can the override be canceled?	Set the " [Cd.13] Positioning operation speed override" to "100".	10

Trouble type	Questions/Trouble	Remedy	No.
Acceleration/ deceleration time	How can the deceleration stop time during stopping be shortened using the hardware stroke limit?	Set "1: Sudden stop" in the " [Pr.37] Stop group 1 sudden stop selection", and reduce the setting value of " [Pr.36] Sudden stop deceleration time".	11
	The motor does not operate at "60000ms" although the acceleration/deceleration time is set to "60000ms".	The value set for the acceleration/deceleration time is the time required for the machine to accelerate from speed "0" to the value set in " [Pr.8] Speed limit value". Because of that, the acceleration/deceleration time will also be shorter than "60000ms" if the command speed value is smaller than the " [Pr.8] Speed limit value". (Refer to the explanation for [Pr.9] and [Pr.10] for details.)	12
	Can each acceleration/ deceleration time be individually set to trapezoidal or S- curve acceleration/deceleration?	The trapezoidal and S-curve acceleration/deceleration processing is a common setting for all acceleration/deceleration times, so individual setting is not possible. (Refer to Section 13.7.6 "Acceleration/deceleration processing function".)	13
	The machine starts and stops suddenly when carrying out JOG operations and positioning operations.	Review the parameter settings for acceleration/ deceleration time, speed limit value, JOG speed limit value, JOG acceleration/deceleration time, etc.	14
Positional deviation	The physical position deviates from the commanded position, although the positioning is complete (and the monitored current position is correct).	If the deviation counter value is not "0", the servo side is still moving. Increase the torque.	15
Electronic gear	A setting of "1[μm] = 1[PLS]" is required in the following system. <ul style="list-style-type: none"> <li>Ball screw pitch = 10[mm]</li> <li>Number of feedback pulses = 262144[PLS]</li> </ul>	In this case, the following values will result. <ul style="list-style-type: none"> <li>Number of pulses per rotation = 262144</li> <li>Movement amount per rotation = 10000</li> <li>Unit magnification = 10</li> </ul> Therefore, the "Movement amount per pulse" will become "0.0381μm". This value is fixed by the machine system, so it cannot be changed. Thus, the setting "1[μm] = 1[PLS]" cannot be achieved.	16
Error compensation	The machine only moves to "10081230", although positioning with a command value of "10081234" carried out. How can the error be compensated? The following values are currently set. <ul style="list-style-type: none"> <li>" [Pr.2] Number of pulses per rotation (AP)" = 262144[PLS]</li> <li>" [Pr.3] Movement amount per rotation (AL)" = 8000[μm]</li> </ul>	Reset [Pr.3] and [Pr.2] in the following order. <ol style="list-style-type: none"> <li>Calculate "<math>\frac{262144}{8000} \times \frac{10081234}{10081230}</math>".</li> <li>Obtain the reduced value.</li> <li>Set the numerator in " [Pr.3] Movement amount per rotation (AL)", and the denominator in " [Pr.2] Number of pulses per rotation (AP)".</li> </ol>	17

Trouble type	Questions/Trouble	Remedy	No.
OPR	When carrying out a count-method machine OPR, the message "Leave Sufficient Distance From The OP Position To The Near-Point Dog OFF." appears. Is there a problem if the distance is short?	The near-point dog must be set to turn OFF at a position after the OP is passed. (When the OPR is started on the near-point dog ON in a count-method machine OPR, the machine enters a normal machine OPR operation after returning to the near-point dog OFF region.) (If the near-point dog is turned OFF before the OP, and the machine OPR is started between the near-point dog OFF position and the OP, the machine will mistakenly interpret that its current position is before the near-point dog ON position, and it will pass over the OP and continue moving.)	18
	In the near-point dog method machine OPR, the stop positions are not uniform.	Carry out the following measures. 1) Separate the near-point dog signal and zero signal detection positions. 2) Lower the values in " [Pr.46] OPR speed" and " [Pr.47] Creep speed". 3) Confirm whether the zero signal and near-point dog signal turn ON normally. 4) Check that there is no play (backlash) in the machine system.	19
	Can the machine OPR be carried out with the OPR retry function when it is started with the near-point dog ON and the upper/lower limit OFF?	A "Hardware stroke limit error" will occur and the operation will not be carried out. (The machine will interpret any position where the near-point dog is ON as being within the working range, and that the upper/lower limit is ON.)	20
	Are ABS and INC positioning possible without carrying out an OPR?	They are possible. In this case, the position where the power is turned ON is handled as the current feed value "0".	21
	After an OPR, the OPR request flag sometimes turns ON for no apparent reason.	The OPR request flag turns ON in the following cases. 1) When not using an absolute position system <ul style="list-style-type: none"> <li>• System power supply on or reset</li> <li>• Servo amplifier power supply on</li> <li>• Machine OPR start</li> </ul> 2) When using an absolute position system <ul style="list-style-type: none"> <li>• When not executing a machine OPR once after system start</li> <li>• Machine OPR start</li> <li>• Erase of an absolute data in LD77MH according to causes, such as battery error (error [1201] occurrence)</li> <li>• Error [2025] (absolute position erase) occurrence ([Md.108] Servo status b14 ON)</li> <li>• Warning [2143] (absolute position counter warning) occurrence ([Md.108] Servo status b14 ON)</li> <li>• When the "[Pr.114] Rotation direction selection" of servo parameter is changed,</li> </ul> <p>If no problem is found when the above are checked, then it is possible that the communication is being interrupted by "a fault in the bus cable", "noise influence", etc.</p>	22

Trouble type	Questions/Trouble	Remedy	No.
Start	The positioning start signal [Y10] is kept ON until the BUSY signal is OFF, but is there any problem with turning it OFF before the BUSY signal turns OFF?	After the BUSY signal turns ON, there is no problem with turning [Y10] OFF before the BUSY signal turns OFF. (The LD77MH detects the rising edge (OFF → ON) of the positioning start signal [Y10].)	23
	The operation will not start even when the start signal is turned ON.	Check the " [Md.26] Axis operation status" and " [Md.23] Axis error No.".	24
Stop	How many milliseconds should the axis stop signal <sup>(Note)</sup> be turned ON for? (Note): LD77MH4: Axis stop signal [Y4] LD77MH16: "[Cd.180] Axis stop"	The signal should be turned ON at 4ms or more. (If possible, set the signal so it does not turn ON only momentarily, but instead stays ON until the BUSY signal turns OFF. This will keep the stop signal from skipping.)	25
	How can a sudden stop be selected?	Set "1: Sudden stop" in the parameter from [Pr.37] to [Pr.39] corresponding to the stop group, and reduce the setting value of " [Pr.36] Sudden stop deceleration time".	26
	"Normal deceleration stop" was selected in " [Pr.39] Stop group 3 sudden stop selection", and Y stop was turned ON. If the " [Pr.39] "setting is changed to "sudden stop" during a deceleration stop, and the Y stop signal turns from OFF to ON, will the operation change to a sudden stop from that point?	The operation will not change. Even if the same stop factor is input again during the deceleration stop, it will be ignored. The same deceleration stop process used when the stop signal was first input will be continued. (This also applies for [Pr.37] and [Pr.38] .)	27
Circular interpolation	ABS system circular interpolation operates normally, but a vertically oblong circle results when INC system circular interpolation is carried out.	The address designation may be incorrect. When carrying out INC system circular interpolation, designate the relative addresses from the starting point of both the center point and end point.	28
Speed-position switching control	Can the speed be changed during speed control and position control by speed-position switching control?	No. The speed for the speed control and position control cannot be set differently.	29
JOG operation	Even if the JOG start signal is turned ON, the response until it turns ON is sometimes slow.	Either of the following is possible. 1) The sequence program may be incorrect. Check by creating a test program in which the JOG start signal is turned ON only. 2) If the machine is hitting something when the torque setting is low, it may be trying to move by JOG operation in the opposite direction. In this case, the machine will start moving only after the internal droop pulses have been reached 0 in the counter, even if the JOG start signal has been turned ON. This makes it seem that the response is slow.	30
	The operation is not carried out at the set JOG speed, although the speed limit value has not been reached.	Either of the following is possible. 1) The JOG start signal may be chattering. Monitor the JOG start signal to confirm whether it is chattering. (When using the "BUSY signal" in the JOG operation start circuit, check the position of the BUSY signal.) 2) The " [Pr.31] JOG speed limit value" may not be appropriate. Review the setting value and carry out the JOG operation again.	31

Trouble type	Questions/Trouble	Remedy	No.
JOG operation	When a JOG operation is attempted, an error results and the machine does not move.	The " [Pr.31] JOG speed limit value" may be larger than the " [Pr.8] Speed limit value". Review the parameters and carry out the JOG operation again.	32
	Why does the positioning complete signal turns ON during the JOG operation?	If a value other than "0" is set for " [Cd.16] Inching movement amount", the inching operation is carried out and the positioning complete signal turns ON. Confirm that the " [Cd.16] Inching movement amount" is set to "0".	33
Manual pulse generator operation	Is it possible to count the pulses when the B phase is set to "1", and only A phase pulses are input?	Possible. Set the " [Pr.24] Manual pulse generator input selection" to "3: PLS/ SIGN mode". It is possible to count the pulses when only A phase pulses are input.	34
	Can a manual pulse generator other than the Mitsubishi MR-HDP01 be used?	Other manual pulse generators can be used if they conform to Section 3.4 "Specifications of interfaces with external devices." The product warranty by the combination of LD77MH and manual pulse generator other than the MR-HDP01 is not possible.	35
	Can one manual pulse generator be operated connected to several LD77MH modules?	This is possible if the system conforms to the electrical specifications. The product warranty by the combination of several LD77MH and one manual pulse generator is not possible.	36
Current value changing	The BUSY signal is not canceled by the current value changing. How can it be canceled?	The BUSY signal may not be detected if the scan time is long. Use a complete signal to check whether the current value changing has been executed.	37
LD77 READY signal	The LD77 READY signal does not turn ON even when the PLC READY signal [Y0] is turned ON.	"A parameter error" has occurred. Confirm the error No. in the error history, and correct the parameter.	38
M code ON signal	Is there any problem with setting an M code ON signal OFF request in the next scan after the M code ON signal ON?	The LD77MH checks the M code ON signal OFF request every operation cycle, so there is a possibility that the M code ON signal OFF may be delayed by a maximum operation cycle after the M code ON signal ON, even if an M code ON signal OFF request is set.	39
Module	Error 537 (PLC READY signal OFF at positioning start) occurs after the LD77MH is replaced. (The sequence program is the same.)	The internal parameters of the LD77MH may be different. Check if the LD77 READY signal [X0] turns ON when the PLC READY signal [Y0] turns ON. When the PLC READY signal is ON but the LD77 READY signal is OFF, the parameter error has occurred. Check the error code and modify the parameter with the error.	40
Motor	The motor only rotates in one direction.	The parameter settings on the LD77MH side may not match those on the servo side. Check the parameter settings.	41



Trouble type	Questions/Trouble	Remedy	No.
Error/warning	Error 920 (backlash compensation amount error) occurs even when the backlash compensation value is set to "1".	$0 \leq \frac{\text{Backlash compensation value}}{\text{Movement amount per pulse}} \leq 65535$ Setting is not possible if the above equation is not satisfied.	42
	When a JOG operation is attempted, errors such as error 104 (hardware stroke limit+) or error 105 (hardware stroke limit -) occur and the machine does not move.	The hardware stroke limit wiring has probably not been carried out. Refer to Section 13.4.4 "Hardware stroke limit function" for details, and wire accordingly.	43
	Error 997 (Speed selection at OP shift error) appears when the PLC READY signal [Y0] turns from OFF to ON.	A value besides "0" or "1" may be set in the "Pr.56" Speed designation during OP shift". Review the set sequence program, and reset the correct parameters.	44
	When the start signal was turned ON immediately after the stop signal ON, warning 100 (start during operation) was detected, and the start was ignored.	The LD77MH starts the deceleration stop process when the stop signal ON is detected. Thus, the machine interprets that "positioning is still being executed" immediately after the stop signal ON. Even if the start signal is turned ON at that time, the start request will be ignored and warning 100 will occur.	45
	Does warning 500 (deceleration and stop speed change) occur only during "stop deceleration" and "automatically deceleration"? Is there any problem if the operation is continued in that state without resetting the error?	The warning occurs only at those times mentioned at the left. Because this is a warning, there is no problem if the operation can be continued without resetting the error. (When the speed is changed using the override, the new value will not be reflected on the data being executed, but will be reflected from the next start.)	46
Positioning completion signal	When the position control is carried out, the positioning completion signal is not turned ON.	The positioning may have not been completed properly by the occurrence of the stop factor. Check the axis monitor "Md.26" Axis operation state" after BUSY signal OFF. Stopped : The stop signal is turned ON during positioning. Check the condition of the stop signal (Y stop or external stop) ON. During error occurrence : An error occurred during positioning. Check the cause of error occurrence from "Md.23" Axis error No.".	47
		The setting value for detailed parameter 2 "Positioning completion signal output time" is 0 or shorter than scan time. Set the properly detectable time using the sequence program.	48

Appendix 8 List of buffer memory addresses

The following shows the relation between the buffer memory addresses and the various items.

(Note): Do not use the buffer memory address that not been described here for a "Maker setting".

Buffer memory address		Compatibility of setting value	Item	Memory area	
LD77MH4	LD77MH16			Basic parameters 1	Positioning parameters
0+150n		○	Pr.1 Unit setting		
1+150n		○	Pr.4 Unit magnification (AM)		
2+150n 3+150n		○	Pr.2 Number of pulses per rotation (AP)		
4+150n 5+150n		○	Pr.3 Movement amount per rotation (AL)		
6+150n 7+150n		○	Pr.7 Bias speed at start		
10+150n 11+150n		○	Pr.8 Speed limit value	Basic parameters 2	
12+150n 13+150n		○	Pr.9 Acceleration time 0		
14+150n 15+150n		○	Pr.10 Deceleration time 0		
17+150n		○	Pr.11 Backlash compensation amount	Detailed parameters 1	
18+150n 19+150n		○	Pr.12 Software stroke limit upper limit value		
20+150n 21+150n		○	Pr.13 Software stroke limit lower limit value		
22+150n		○	Pr.14 Software stroke limit selection		
23+150n		○	Pr.15 Software stroke limit valid/invalid setting		
24+150n 25+150n		○	Pr.16 Command in-position width		
26+150n		○	Pr.17 Torque limit setting value		
27+150n		○	Pr.18 M code ON signal output timing		
28+150n		○	Pr.19 Speed switching mode		
29+150n		○	Pr.20 Interpolation speed designation method		
30+150n		○	Pr.21 Current feed value during speed control		
31+150n		○	Pr.22 Input signal logic selection		
32+150n		○	Pr.80 External input signal selection		
33		△	Pr.24 Manual pulse generator/Incremental synchronous encoder input selection		
34+150n		○	Pr.81 Speed-position function selection		
35		○	Pr.82 Forced stop valid/invalid selection		

n: Axis No.-1

○: Compatible △: Partly compatible ×: Not compatible

Buffer memory address		Compatibility of setting value	Item	Memory area	
LD77MH4	LD77MH16				
36+150n	37+150n	○	Pr.25 Acceleration time 1	Detailed parameters 2	Positioning parameters
38+150n	39+150n	○	Pr.26 Acceleration time 2		
40+150n	41+150n	○	Pr.27 Acceleration time 3		
42+150n	43+150n	○	Pr.28 Deceleration time 1		
44+150n	45+150n	○	Pr.29 Deceleration time 2		
46+150n	47+150n	○	Pr.30 Deceleration time 3		
48+150n	49+150n	○	Pr.31 JOG speed limit value		
50+150n		○	Pr.32 JOG operation acceleration time selection		
51+150n		○	Pr.33 JOG operation deceleration time selection		
52+150n		○	Pr.34 Acceleration/deceleration process selection		
53+150n		○	Pr.35 S-curve ratio		
54+150n	55+150n	○	Pr.36 Sudden stop deceleration time		
56+150n		○	Pr.37 Stop group 1 sudden stop selection		
57+150n		○	Pr.38 Stop group 2 sudden stop selection		
58+150n		○	Pr.39 Stop group 3 sudden stop selection		
59+150n		○	Pr.40 Positioning complete signal output time		
60+150n	61+150n	○	Pr.41 Allowable circular interpolation error width		
62+150n		△	Pr.42 External command function selection		
63+150n		○	Pr.83 Speed control 10 x multiplier setting for degree axis		
64+150n	65+150n	○	Pr.84 Restart allowable range when servo OFF to ON		
67		○	Pr.89 Manual pulse generator/incremental synchronous encoder input type selection		
68+150n		△	Pr.90 Operation setting for speed torque control mode		
	69+150n	×	Pr.95 External command signal selection		
70+150n		○	Pr.43 OPR method	OPR basic parameters	OPR parameters
71+150n		○	Pr.44 OPR direction		
72+150n	73+150n	○	Pr.45 OP address		
74+150n	75+150n	○	Pr.46 OPR speed		
76+150n	77+150n	○	Pr.47 Creep speed		
78+150n		○	Pr.48 OPR retry		

n: Axis No.-1

○: Compatible △: Partly compatible ×: Not compatible

Buffer memory address		Compatibility of setting value	Item	Memory area	
LD77MH4	LD77MH16				
80+150n	81+150n	○	[Pr.50] Setting for the movement amount after near-point dog ON	OPR detailed parameters	OPR parameters
82+150n		○	[Pr.51] OPR acceleration time selection		
83+150n		○	[Pr.52] OPR deceleration time selection		
84+150n	85+150n	○	[Pr.53] OP shift amount		
86+150n		○	[Pr.54] OPR torque limit value		
87+150n		○	[Pr.55] Operation setting for incompleteness of OPR		
88+150n		○	[Pr.56] Speed designation during OP shift		
89+150n		○	[Pr.57] Dwell time during OPR retry		
	100+150n	×	[Pr.91] Optional data monitor: Data type setting 1	Expansion parameter	
	101+150n	×	[Pr.92] Optional data monitor: Data type setting 2		
	102+150n	×	[Pr.93] Optional data monitor: Data type setting 3		
	103+150n	×	[Pr.94] Optional data monitor: Data type setting 4		
	105	×	[Pr.96] Operation cycle setting		

n: Axis No.-1

○: Compatible    △: Partly compatible    ×: Not compatible

Buffer memory address		Compatibility of setting value	Item	Memory area	
LD77MH4	LD77MH16				
1200	4000	○	[Md.1] In test mode flag	System monitor data Monitor data	
1206 1207	4006 4007	○	[Md.130] OS version		
1208	4008	○	[Md.134] Operation time		
1209	4009	○	[Md.135] Maximum operation time		
1211	4011	○	[Md.131] Digital oscilloscope executing		
1212+5p	4012+5p	○	[Md.3] Start information		Start history
1213+5p	4013+5p	○	[Md.4] Start No.		
1440+p	4240+p	○	[Md.54] Start Year: month		
1214+5p	4014+5p	○	[Md.5] Start Day: hour		
1215+5p	4015+5p	○	[Md.6] Start Minute: second		
1216+5p	4016+5p	○	[Md.7] Error judgment		
1292	4092	○	[Md.8] Start history pointer		Error history
1293+4p	4093+4p	○	[Md.9] Axis in which the error occurred		
1294+4p	4094+4p	○	[Md.10] Axis error No.		
1456+p	4256+p	○	[Md.55] Axis error occurrence (Year: month)		
1295+4p	4095+4p	○	[Md.11] Axis error occurrence (Day: hour)		
1296+4p	4096+4p	○	[Md.12] Axis error occurrence (Minute: second)		
1357	4157	○	[Md.13] Error history pointer		Warning history
1358+4p	4158+4p	○	[Md.14] Axis in which the warning occurred		
1359+4p	4159+4p	○	[Md.15] Axis warning No.		
1472+p	4272+p	○	[Md.56] Axis warning occurrence (Year: month)		
1360+4p	4160+4p	○	[Md.16] Axis warning occurrence (Day: hour)		
1361+4p	4161+4p	○	[Md.17] Axis warning occurrence (Minute: second)		
1422	4222	○	[Md.18] Warning history pointer		System monitor data Monitor data
1424 1425	4224 4225	○	[Md.19] Number of write accesses to flash ROM		
1431	4231	○	[Md.50] Forced stop input		
1432	4232	○	[Md.51] Amplifier-less operation mode status		
1434	4234	○	[Md.52] Communication between amplifiers axes searching flag		
	4238	×	[Md.132] Operation cycle setting		
	4239	×	[Md.133] Operation cycle over flag		

○: Compatible    △: Partly compatible    ×: Not compatible

• Guide to buffer memory address

In the buffer memory address, "p" in "4012+5p", etc. indicates a pointer No.

Calculate as follows for the buffer memory address corresponding to each pointer No.

(Example) For pointer No. 15

$$4012+5p \text{ ([Md.3] Start information)} = 4012 + 5 \times 15 = 4087$$

$$4093+4p \text{ ([Md.9] Axis in which the error occurred)} = 4093 + 4 \times 15 = 4153$$

Buffer memory address		Compatibility of setting value	Item	Memory area	
LD77MH4	LD77MH16			Axis monitor data	Monitor data
800+100n 801+100n	2400+100n 2401+100n	○	Md.20 Current feed value		
802+100n 803+100n	2402+100n 2403+100n	○	Md.21 Machine feed value		
804+100n 805+100n	2404+100n 2405+100n	○	Md.22 Feedrate		
806+100n	2406+100n	○	Md.23 Axis error No.		
807+100n	2407+100n	○	Md.24 Axis warning No.		
808+100n	2408+100n	○	Md.25 Valid M code		
809+100n	2409+100n	○	Md.26 Axis operation status		
810+100n 811+100n	2410+100n 2411+100n	○	Md.27 Current speed		
812+100n 813+100n	2412+100n 2413+100n	○	Md.28 Axis feedrate		
814+100n 815+100n	2414+100n 2415+100n	○	Md.29 Speed-position switching control positioning amount		
816+100n	2416+100n	○	Md.30 External input signal		
817+100n	2417+100n	△	Md.31 Status		
818+100n 819+100n	2418+100n 2419+100n	○	Md.32 Target value		
820+100n 821+100n	2420+100n 2421+100n	○	Md.33 Target speed		
824+100n 825+100n	2424+100n 2425+100n	○	Md.34 Movement amount after near-point dog ON		
826+100n	2426+100n	○	Md.35 Torque limit stored value/forward torque limit stored value		
827+100n	2427+100n	○	Md.36 Special start data instruction code setting value		
828+100n	2428+100n	○	Md.37 Special start data instruction parameter setting value		
829+100n	2429+100n	○	Md.38 Start positioning data No. setting value.		
830+100n	2430+100n	○	Md.39 In speed limit flag		
831+100n	2431+100n	○	Md.40 In speed change processing flag		
832+100n	2432+100n	○	Md.41 Special start repetition counter		
833+100n	2433+100n	○	Md.42 Control system repetition counter		
834+100n	2434+100n	○	Md.43 Start data pointer being executed		
835+100n	2435+100n	○	Md.44 Positioning data No. being executed		
836+100n	2436+100n	○	Md.45 Block No. being executed		
837+100n	2437+100n	○	Md.46 Last executed positioning data No.		

n: Axis No.-1

○: Compatible △: Partly compatible ×: Not compatible

Buffer memory address		Compatibility of setting value	Item	Memory area	
LD77MH4	LD77MH16			Axis monitor data	Monitor data
838+100n	2438+100n	△	Md.47 Positioning data being executed		
839+100n	2439+100n	○		M code	
840+100n	2440+100n	○		Dwell time	
	2441+100n	×		Axis to be interpolated	
842+100n	2442+100n	○		Command speed	
843+100n	2443+100n			Positioning address	
844+100n	2444+100n	○		Arc address	
845+100n	2445+100n				
846+100n	2446+100n	○			
847+100n	2447+100n				
848+100n	2448+100n	○	Md.100 OPR re-travel value		
849+100n	2449+100n				
850+100n	2450+100n	○	Md.101 Real current value		
851+100n	2451+100n				
852+100n	2452+100n	○	Md.102 Deviation counter value		
853+100n	2453+100n				
854+100n	2454+100n	○	Md.103 Motor rotation speed		
855+100n	2455+100n				
856+100n	2456+100n	○	Md.104 Motor current value		
864+100n	2464+100n	○	Md.106 Servo amplifier software No.		
865+100n	2465+100n				
866+100n	2466+100n				
867+100n	2467+100n				
868+100n	2468+100n				
869+100n	2469+100n				
870+100n	2470+100n	○	Md.107 Parameter error No.		
876+100n	2476+100n	○	Md.108 Servo status		
877+100n	2477+100n				
878+100n	2478+100n	△	Md.109 Regenerative load ratio/Optional data monitor output 1		
879+100n	2479+100n	△	Md.110 Effective load torque/Optional data monitor output 2		
880+100n	2480+100n	△	Md.111 Peak torque ratio/Optional data monitor output 3		
	2481+100n	×	Md.112 Optional data monitor output 4		
887+100n	2487+100n	○	Md.113 Semi/Fully closed loop status		
888+100n	2488+100n	○	Md.114 Servo alarm		
890+100n	2490+100n	○	Md.116 Encoder option information		
891+100n	2491+100n	○	Md.120 Reverse torque limit stored value		
892+100n	2492+100n	○	Md.122 Speed during command		
893+100n	2493+100n				
894+100n	2494+100n	○	Md.123 Torque during command		
899+100n	2499+100n	○	Md.48 Deceleration start flag		

n: Axis No.-1

○: Compatible △: Partly compatible ×: Not compatible

Buffer memory address		Compatibility of setting value	Item	Memory area	
LD77MH4	LD77MH16				
1500+100n	4300+100n	○	Cd.3 Positioning start No.	Axis control data	Control data
1501+100n	4301+100n	○	Cd.4 Positioning starting point No.		
1502+100n	4302+100n	○	Cd.5 Axis error reset		
1503+100n	4303+100n	○	Cd.6 Restart command		
1504+100n	4304+100n	○	Cd.7 M code OFF request		
1505+100n	4305+100n	○	Cd.8 External command valid		
1506+100n 1507+100n	4306+100n 4307+100n	○	Cd.9 New current value		
1508+100n 1509+100n	4308+100n 4309+100n	○	Cd.10 New acceleration time value		
1510+100n 1511+100n	4310+100n 4311+100n	○	Cd.11 New deceleration time value		
1512+100n	4312+100n	○	Cd.12 Acceleration/deceleration time change during speed change, enable/disable selection		
1513+100n	4313+100n	○	Cd.13 Positioning operation speed override		
1514+100n 1515+100n	4314+100n 4315+100n	○	Cd.14 New speed value		
1516+100n	4316+100n	○	Cd.15 Speed change request		
1517+100n	4317+100n	○	Cd.16 Inching movement amount		
1518+100n 1519+100n	4318+100n 4319+100n	○	Cd.17 JOG speed		
1520+100n	4320+100n	○	Cd.18 Interrupt request during continuous operation		
1521+100n	4321+100n	○	Cd.19 OPR request flag OFF request		
1522+100n 1523+100n	4322+100n 4323+100n	○	Cd.20 Manual pulse generator 1 pulse input magnification		
1524+100n	4324+100n	○	Cd.21 Manual pulse generator enable flag		
1525+100n	4325+100n	○	Cd.22 New torque value/forward new torque value		
1526+100n 1527+100n	4326+100n 4327+100n	○	Cd.23 Speed-position switching control movement amount change register		
1528+100n	4328+100n	○	Cd.24 Speed-position switching enable flag		
1530+100n 1531+100n	4330+100n 4331+100n	○	Cd.25 Position-speed switching control speed change register		
1532+100n	4332+100n	○	Cd.26 Position-speed switching enable flag		
1534+100n 1535+100n	4334+100n 4335+100n	○	Cd.27 Target position change value (New address)		
1536+100n 1537+100n	4336+100n 4337+100n	○	Cd.28 Target position change value (New speed)		
1538+100n	4338+100n	○	Cd.29 Target position change request flag		
	4339+100n	×	Cd.43 Simultaneous starting axis		
1540+100n		×	Cd.30 Simultaneous starting axis start data No. (axis 1 start data No.)		
	4340+100n		Cd.30 Simultaneous starting own axis start data No.		

n: Axis No.-1

○: Compatible    △: Partly compatible    ×: Not compatible



Buffer memory address		Compatibility of setting value	Item	Memory area	
LD77MH4	LD77MH16			Axis control data	Control data
1541+100n		×	Cd.31 Simultaneous starting axis start data No. (axis 2 start data No.)		
	4341+100n		Cd.31 Simultaneous starting axis start data No.1		
1542+100n		×	Cd.32 Simultaneous starting axis start data No. (axis 3 start data No.)		
	4342+100n		Cd.32 Simultaneous starting axis start data No.2		
1543+100n		×	Cd.33 Simultaneous starting axis start data No. (axis 4 start data No.)		
	4343+100n		Cd.33 Simultaneous starting axis start data No.3		
1544+100n	4344+100n	○	Cd.34 Step mode		
1545+100n	4345+100n	○	Cd.35 Step valid flag		
1546+100n	4346+100n	○	Cd.36 Step start information		
1547+100n	4347+100n	○	Cd.37 Skip command		
1548+100n	4348+100n	○	Cd.38 Teaching data selection		
1549+100n	4349+100n	○	Cd.39 Teaching positioning data No.		
1550+100n	4350+100n	○	Cd.40 ABS direction in degrees		
1551+100n	4351+100n	○	Cd.100 Servo OFF command		
1552+100n	4352+100n	○	Cd.101 Torque output setting value		
1554+100n	4354+100n	○	Cd.130 Parameter write request		
1555+100n	4355+100n	○	Cd.131 Parameter No-		
1556+100n	4356+100n	○	Cd.132 Change data		
1558+100n	4358+100n	○	Cd.133 Semi/Fully closed loop switching request		
1559+100n	4359+100n	○	Cd.108 Gain changing command		
1563+100n	4363+100n	○	Cd.112 Torque change function switching request		
1564+100n	4364+100n	○	Cd.113 Reverse new torque value		
1565+100n	4365+100n	○	Cd.136 PI-PID switching request		
1574+100n	4374+100n	○	Cd.138 Control mode switching request		
1575+100n	4375+100n	○	Cd.139 Control mode setting		
1576+100n	4376+100n	○	Cd.140 Command speed at speed control mode		
1577+100n	4377+100n				
1578+100n	4378+100n	○	Cd.141 Acceleration time at speed control mode		
1579+100n	4379+100n	○	Cd.142 Deceleration time at speed control mode		
1580+100n	4380+100n	○	Cd.143 Command torque at torque control mode		
1581+100n	4381+100n	○	Cd.144 Torque time constant at torque control mode (Forward direction)		
1582+100n	4382+100n	○	Cd.145 Torque time constant at torque control mode (Reverse direction)		
1584+100n	4384+100n	○	Cd.146 Speed limit value at torque control mode		
1585+100n	4385+100n				

n: Axis No.-1

○: Compatible △: Partly compatible ×: Not compatible

Buffer memory address		Compatibility of setting value	Item	Memory area					
LD77MH4	LD77MH16								
1900	5900	○	[Cd.1] Flash ROM write request	System control data	Control data				
1901	5901	○	[Cd.2] Parameter initialization request						
1905	5905	○	[Cd.41] Deceleration start flag valid						
1907	5907	○	[Cd.42] Stop command processing for deceleration stop selection						
1926	5926	○	[Cd.137] Amplifier-less operation mode switching request						
	30100+10n	×	[Cd.180] Axis stop	Expansion axis control data	Control data				
	30101+10n	×	[Cd.181] Forward run JOG start						
	30102+10n	×	[Cd.182] Reverse run JOG start						
	30103+10n	×	[Cd.183] Execution prohibition flag						
2000+6000n	6000+1000n	○	[Da.1] Operation pattern	No.1	Positioning data				
		○	[Da.2] Control system						
		○	[Da.3] Acceleration time No.						
		○	[Da.4] Deceleration time No.						
	×	[Da.5] Axis to be interpolated	Positioning identifier						
2001+6000n	6001+1000n	○	[Da.10] M code/condition data No. /Number of LOOP to LEND repetitions	No.1	Positioning data				
2002+6000n	6002+1000n	○	[Da.9] Dwell time/JUMP destination positioning data No.						
	6003+1000n	×	[Da.20] Axis to be interpolated No.1			Axis to be interpolated			
			[Da.21] Axis to be interpolated No.2						
			[Da.22] Axis to be interpolated No.3						
2004+6000n	6004+1000n	○	[Da.8] Command speed	No.1	Positioning data				
2005+6000n	6005+1000n								
2006+6000n	6006+1000n	○	[Da.6] Positioning address/movement amount			No.1	Positioning data		
2007+6000n	6007+1000n								
2008+6000n	6008+1000n	○	[Da.7] Arc address					No.1	Positioning data
2009+6000n	6009+1000n								
2010+6000n to 2019+6000n	6010+1000n to 6019+1000n	△	No.2	No.1	Positioning data				
2020+6000n to 2029+6000n	6020+1000n to 6029+1000n	△	No.3						
to	to	to	to						
2990+6000n to 2999+6000n	6990+1000n to 6999+1000n	△	No.100						
3000+6000n to 3009+6000n	Set with GX Works2	△	No.101						
to		to	to						
7990+6000n to 7999+6000n		△	No.600						

n: Axis No.-1

○: Compatible △: Partly compatible ×: Not compatible

Buffer memory address				Compatibility of setting value	Item	Memory area		
LD77MH4		LD77MH16				1st point	Block start data	Starting block 0
26000+1000n	/	22000+400n	/	○	Da.11 Shape Da.12 Start data No.			
/	26050+1000n	/	22050+400n	○	Da.13 Special start instruction Da.14 Parameter			
26001+1000n	26051+1000n	22001+400n	22051+400n	○	2nd point	Block start data		
26002+1000n	26052+1000n	22002+400n	22052+400n	○	3rd point			
to		to		to	to			
26049+1000n	26099+1000n	22049+400n	22099+400n	○	50th point			
26100+1000n		22100+400n		○	Da.15 Condition target			
				△	Da.16 Condition operator	No.1	Condition data	
		22101+400n		×	Da.23 Number of simultaneously starting axes			
					Da.24 Simultaneously starting axis No.1			
					Da.25 Simultaneously starting axis No.2			
					Da.26 Simultaneously starting axis No.3			
26102+1000n 26103+1000n		22102+400n 22103+400n		○	Da.17 Address			
26104+1000n 26105+1000n		22104+400n 22105+400n		△	Da.18 Parameter 1			
26106+1000n 26107+1000n		22106+400n 22107+400n		△	Da.19 Parameter 2			
26110+1000n to 26119+1000n		22110+400n to 22119+400n		△	No.2			
26120+1000n to 26129+1000n		22120+400n to 22129+400n		△	No.3			
to		to		to	to			
26190+1000n to 26199+1000n		22190+400n to 22199+400n		△	No.10			
26200+1000n to 26299+1000n		22200+400n to 22299+400n		○	Block start data	Starting block 1		
26300+1000n to 26399+1000n		22300+400n to 22399+400n		△	Condition data			
26400+1000n to 26499+1000n	Set with GX Works2			○	Block start data	Starting block 2		
26500+1000n to 26599+1000n				△	Condition data			

n: Axis No.-1

○: Compatible △: Partly compatible ×: Not compatible

Buffer memory address		Compatibility of setting value	Item	Memory area	
LD77MH4	LD77MH16				
26600+1000n to 26699+1000n	Set with GX Works2	○	Block start data	Starting block 3	Positioning data
26700+1000n to 26799+1000n		△	Condition data		
26800+1000n to 26899+1000n		○	Block start data	Starting block 4	
26900+1000n to 26999+1000n		△	Condition data		
30000	to	○	Condition judgement target data of the condition data	PLC CPU memo area	Positioning data
to					
30099					

n: Axis No.-1

○: Compatible    △: Partly compatible    ×: Not compatible

Buffer memory address		Compatibility of setting value	Item	Servo amplifier parameter No.	Memory area
LD77MH4	LD77MH16				
30100+200n	28400+100n	○	Pr.100	—	Basic setting parameters
30101+200n	28401+100n	○	Pr.101	PA01	
30102+200n	28402+100n	○	Pr.102	PA02	
30103+200n	28403+100n	○	Pr.103	PA03	
30104+200n	28404+100n	○	Pr.104	PA04	
30105+200n	28405+100n	○	Pr.105	PA05	
30106+200n	28406+100n	○	Pr.106	PA06	
30107+200n	28407+100n	○	Pr.107	PA07	
30108+200n	28408+100n	○	Pr.108	PA08	
30109+200n	28409+100n	○	Pr.109	PA09	
30110+200n	28410+100n	○	Pr.110	PA10	
30111+200n	28411+100n	○	Pr.111	PA11	
30112+200n	28412+100n	○	Pr.112	PA12	
30113+200n	28413+100n	○	Pr.113	PA13	
30114+200n	28414+100n	○	Pr.114	PA14	
30115+200n	28415+100n	○	Pr.115	PA15	
30116+200n	28416+100n	○	Pr.116	PA16	
30117+200n	28417+100n	○	Pr.117	PA17	
30118+200n	28418+100n	○	Pr.118	PA18	
30932+50n	Set with GX Works2	○	Pr.332	PA19	Servo parameters
30119+200n	28419+100n	○	Pr.119	PB01	
30120+200n	28420+100n	○	Pr.120	PB02	
30121+200n	28421+100n	○	Pr.121	PB03	
30122+200n	28422+100n	○	Pr.122	PB04	
30123+200n	28423+100n	○	Pr.123	PB05	
30124+200n	28424+100n	○	Pr.124	PB06	
30125+200n	28425+100n	○	Pr.125	PB07	
30126+200n	28426+100n	○	Pr.126	PB08	
30127+200n	28427+100n	○	Pr.127	PB09	
30128+200n	28428+100n	○	Pr.128	PB10	
30129+200n	28429+100n	○	Pr.129	PB11	
30130+200n	28430+100n	○	Pr.130	PB12	
30131+200n	28431+100n	○	Pr.131	PB13	
30132+200n	28432+100n	○	Pr.132	PB14	
30133+200n	28433+100n	○	Pr.133	PB15	
30134+200n	28434+100n	○	Pr.134	PB16	
30135+200n	28435+100n	○	Pr.135	PB17	
30136+200n	28436+100n	○	Pr.136	PB18	
30137+200n	28437+100n	○	Pr.137	PB19	
30138+200n	28438+100n	○	Pr.138	PB20	
30139+200n	28439+100n	○	Pr.139	PB21	
30140+200n	28440+100n	○	Pr.140	PB22	
30141+200n	28441+100n	○	Pr.141	PB23	

n: Axis No.-1

○: Compatible    △: Partly compatible    ×: Not compatible

Buffer memory address		Compatibility of setting value	Item	Servo amplifier parameter No.	Memory area
LD77MH4	LD77MH16				
30142+200n	28442+100n	○	Pr.142	PB24	Gain/filter parameters
30143+200n	28443+100n	○	Pr.143	PB25	
30144+200n	28444+100n	○	Pr.144	PB26	
30145+200n	28445+100n	○	Pr.145	PB27	
30146+200n	28446+100n	○	Pr.146	PB28	
30147+200n	28447+100n	○	Pr.147	PB29	
30148+200n	28448+100n	○	Pr.148	PB30	
30149+200n	28449+100n	○	Pr.149	PB31	
30150+200n	28450+100n	○	Pr.150	PB32	
30151+200n	28451+100n	○	Pr.151	PB33	
30152+200n	28452+100n	○	Pr.152	PB34	
30153+200n	28453+100n	○	Pr.153	PB35	
30154+200n	28454+100n	○	Pr.154	PB36	
30155+200n	28455+100n	○	Pr.155	PB37	
30156+200n	28456+100n	○	Pr.156	PB38	
30157+200n	28457+100n	○	Pr.157	PB39	
30158+200n	28458+100n	○	Pr.158	PB40	
30159+200n	28459+100n	○	Pr.159	PB41	
30160+200n	28460+100n	○	Pr.160	PB42	
30161+200n	28461+100n	○	Pr.161	PB43	
30162+200n	28462+100n	○	Pr.162	PB44	
30163+200n	28463+100n	○	Pr.163	PB45	
30164+200n	28464+100n	○	Pr.164	PC01	Expansion setting parameters
30165+200n	28465+100n	○	Pr.165	PC02	
30166+200n	28466+100n	○	Pr.166	PC03	
30167+200n	28467+100n	○	Pr.167	PC04	
30168+200n	28468+100n	○	Pr.168	PC05	
30169+200n	28469+100n	○	Pr.169	PC06	
30170+200n	28470+100n	○	Pr.170	PC07	
30171+200n	28471+100n	○	Pr.171	PC08	
30172+200n	28472+100n	○	Pr.172	PC09	
30173+200n	28473+100n	○	Pr.173	PC10	
30174+200n	28474+100n	○	Pr.174	PC11	
30175+200n	28475+100n	○	Pr.175	PC12	
30176+200n	28476+100n	○	Pr.176	PC13	
30177+200n	28477+100n	○	Pr.177	PC14	
30178+200n	28478+100n	○	Pr.178	PC15	
30179+200n	28479+100n	○	Pr.179	PC16	
30180+200n	28480+100n	○	Pr.180	PC17	
30181+200n	28481+100n	○	Pr.181	PC18	
30182+200n	28482+100n	○	Pr.182	PC19	
30183+200n	28483+100n	○	Pr.183	PC20	
30184+200n	28484+100n	○	Pr.184	PC21	
30185+200n	28485+100n	○	Pr.185	PC22	

n: Axis No.-1

○: Compatible    △: Partly compatible    ×: Not compatible

Buffer memory address		Compatibility of setting value	Item	Servo amplifier parameter No.	Memory area	
LD77MH4	LD77MH16				Expansion setting parameters	Servo parameters
30186+200n	28486+100n	○	Pr.186	PC23		
30187+200n	28487+100n	○	Pr.187	PC24		
30188+200n	28488+100n	○	Pr.188	PC25		
30189+200n	28489+100n	○	Pr.189	PC 26		
30190+200n	28490+100n	○	Pr.190	PC 27		
30191+200n	28491+100n	○	Pr.191	PC28		
30192+200n	28492+100n	○	Pr.192	PC29		
30193+200n	28493+100n	○	Pr.193	PC30		
30194+200n	28494+100n	○	Pr.194	PC31		
30195+200n	28495+100n	○	Pr.195	PC32		
30196+200n	Set with GX Works2	○	Pr.196	PD01	Input/output setting parameters	
30197+200n		○	Pr.197	PD02		
30198+200n		○	Pr.198	PD03		
30199+200n		○	Pr.199	PD04		
30200+200n		○	Pr.200	PD05		
30201+200n		○	Pr.201	PD06		
30202+200n		○	Pr.202	PD07		
30203+200n		○	Pr.203	PD08		
30204+200n		○	Pr.204	PD09		
30205+200n		○	Pr.205	PD10		
30206+200n		○	Pr.206	PD11		
30207+200n		○	Pr.207	PD12		
30208+200n		○	Pr.208	PD13		
30209+200n		○	Pr.209	PD14		
30210+200n		○	Pr.210	PD15		
30211+200n		○	Pr.211	PD16		
30212+200n		○	Pr.212	PD17		
30213+200n		○	Pr.213	PD18		
30214+200n		○	Pr.214	PD19		
30215+200n		○	Pr.215	PD20		
30216+200n		○	Pr.216	PD21		
30217+200n		○	Pr.217	PD22		
30218+200n		○	Pr.218	PD23		
30219+200n		○	Pr.219	PD24		
30220+200n		○	Pr.220	PD25		
30221+200n		○	Pr.221	PD26		
30222+200n		○	Pr.222	PD27		
30223+200n	○	Pr.223	PD28			
30224+200n	○	Pr.224	PD29			
30225+200n	○	Pr.225	PD30			
30226+200n	○	Pr.226	PD31			
30227+200n	○	Pr.227	PD32			

n: Axis No.-1

○: Compatible    △: Partly compatible    ×: Not compatible

Buffer memory address		Compatibility of setting value	Item	Servo amplifier parameter No.	Memory area	
LD77MH4	LD77MH16				Extension control parameters	Servo parameters
30228+200n	Set with GX Works2	○	Pr.228	PE01		
30229+200n		○	Pr.229	PE02		
30230+200n		○	Pr.230	PE03		
30231+200n		○	Pr.231	PE04		
30232+200n		○	Pr.232	PE05		
30233+200n		○	Pr.233	PE06		
30234+200n		○	Pr.234	PE07		
30235+200n		○	Pr.235	PE08		
30236+200n		○	Pr.236	PE09		
30237+200n		○	Pr.237	PE10		
30238+200n		○	Pr.238	PE11		
30239+200n		○	Pr.239	PE12		
30240+200n		○	Pr.240	PE13		
30241+200n		○	Pr.241	PE14		
30242+200n		○	Pr.242	PE15		
30243+200n		○	Pr.243	PE16		
30244+200n		○	Pr.244	PE17		
30245+200n		○	Pr.245	PE18		
30246+200n		○	Pr.246	PE19		
30247+200n		○	Pr.247	PE20		
30248+200n		○	Pr.248	PE21		
30249+200n		○	Pr.249	PE22		
30250+200n		○	Pr.250	PE23		
30251+200n		○	Pr.251	PE24		
30252+200n		○	Pr.252	PE25		
30253+200n		○	Pr.253	PE26		
30254+200n		○	Pr.254	PE27		
30255+200n		○	Pr.255	PE28		
30256+200n		○	Pr.256	PE29		
30257+200n		○	Pr.257	PE30		
30258+200n		○	Pr.258	PE31		
30259+200n		○	Pr.259	PE32		
30260+200n		○	Pr.260	PE33		
30261+200n		○	Pr.261	PE34		
30262+200n		○	Pr.262	PE35		
30263+200n		○	Pr.263	PE36		
30264+200n		○	Pr.264	PE37		
30265+200n		○	Pr.265	PE38		
30266+200n		○	Pr.266	PE39		
30267+200n		○	Pr.267	PE40		

n: Axis No.-1

○: Compatible    △: Partly compatible    ×: Not compatible



Buffer memory address		Compatibility of setting value	Item	Servo amplifier parameter No.	Memory area	
LD77MH4	LD77MH16				Special setting parameters	Servo parameters
30268+200n	Set with GX Works2	○	Pr.268	PS01		
30269+200n		○	Pr.269	PS02		
30270+200n		○	Pr.270	PS03		
30271+200n		○	Pr.271	PS04		
30272+200n		○	Pr.272	PS05		
30273+200n		○	Pr.273	PS06		
30274+200n		○	Pr.274	PS07		
30275+200n		○	Pr.275	PS08		
30276+200n		○	Pr.276	PS09		
30277+200n		○	Pr.277	PS10		
30278+200n		○	Pr.278	PS11		
30279+200n		○	Pr.279	PS12		
30280+200n		○	Pr.280	PS13		
30281+200n		○	Pr.281	PS14		
30282+200n		○	Pr.282	PS15		
30283+200n		○	Pr.283	PS16		
30284+200n		○	Pr.284	PS17		
30285+200n		○	Pr.285	PS18		
30286+200n		○	Pr.286	PS19		
30287+200n		○	Pr.287	PS20		
30288+200n		○	Pr.288	PS21		
30289+200n		○	Pr.289	PS22		
30290+200n		○	Pr.290	PS23		
30291+200n		○	Pr.291	PS24		
30292+200n		○	Pr.292	PS25		
30293+200n		○	Pr.293	PS26		
30294+200n		○	Pr.294	PS27		
30295+200n		○	Pr.295	PS28		
30296+200n		○	Pr.296	PS29		
30297+200n		○	Pr.297	PS30		
30298+200n		○	Pr.298	PS31		
30299+200n		○	Pr.299	PS32		

n: Axis No.-1

○: Compatible    △: Partly compatible    ✕: Not compatible

Buffer memory address		Compatibility of setting value	Item	Servo amplifier parameter No.	Memory area	
LD77MH4	LD77MH16				Other setting parameters	Option unit parameters
30900+50n	Set with GX Works2	○	Pr.300	PF01		
30901+50n		○	Pr.301	PF02		
30902+50n		○	Pr.302	PF03		
30903+50n		○	Pr.303	PF04		
30904+50n		○	Pr.304	PF05		
30905+50n		○	Pr.305	PF06		
30906+50n		○	Pr.306	PF07		
30907+50n		○	Pr.307	PF08		
30908+50n		○	Pr.308	PF09		
30909+50n		○	Pr.309	PF10		
30910+50n		○	Pr.310	PF11		
30911+50n		○	Pr.311	PF12		
30912+50n		○	Pr.312	PF13		
30913+50n		○	Pr.313	PF14		
30914+50n		○	Pr.314	PF15		
30915+50n		○	Pr.315	PF16		
30916+50n		○	Pr.316	Po01	Option unit parameters	
30917+50n		○	Pr.317	Po02		
30918+50n		○	Pr.318	Po03		
30919+50n		○	Pr.319	Po04		
30920+50n		○	Pr.320	Po05		
30921+50n		○	Pr.321	Po06		
30922+50n		○	Pr.322	Po07		
30923+50n		○	Pr.323	Po08		
30924+50n		○	Pr.324	Po09		
30925+50n		○	Pr.325	Po10		
30926+50n		○	Pr.326	Po11		
30927+50n		○	Pr.327	Po12		
30928+50n		○	Pr.328	Po13		
30929+50n		○	Pr.329	Po14		
30930+50n		○	Pr.330	Po15		
30931+50n		○	Pr.331	Po16		

n: Axis No.-1

○: Compatible    △: Partly compatible    ×: Not compatible

The following shows the relation between the buffer memory addresses for mark detection function and the various items.

(Note): Do not use the buffer memory address that not been described here for a "Maker setting".

Buffer memory address		Compatibility of setting value	Item		Memory area	
LD77MH4	LD77MH16					
—	54000+20k	×	Pr.800	Mark detection signal setting	Mark detection setting parameters	
—	54001+20k	×	Pr.801	Mark detection signal compensation time		
—	54002+20k	×	Pr.802	Mark detection data type		
—	54003+20k	×	Pr.803	Mark detection data axis No.		
—	54004+20k 54005+20k	×	Pr.804	Mark detection data buffer memory No.		
—	54006+20k 54007+20k	×	Pr.805	Latch data range upper limit value		
—	54008+20k 54009+20k	×	Pr.806	Latch data range lower limit value		
—	54010+20k	×	Pr.807	Mark detection mode setting		
—	54640+10k	×	Cd.800	Number of mark detection clear request	Mark detection control data	
—	54641+10k	×	Cd.801	Mark detection invalid flag		
—	54960+80k	×	Md.800	Number of mark detection counter	Mark detection monitor data	
—	54962+80k 54963+80k	×	Md.801	Mark detection data storage area		1
	54964+80k 54965+80k					2
	54966+80k 54967+80k					3
	to					to
	55024+80k 55025+80k					32

k: Mark detection setting No.-1

○: Compatible    △: Partly compatible    ×: Not compatible

Appendix 9 External dimension drawing

[1] LD77MH4

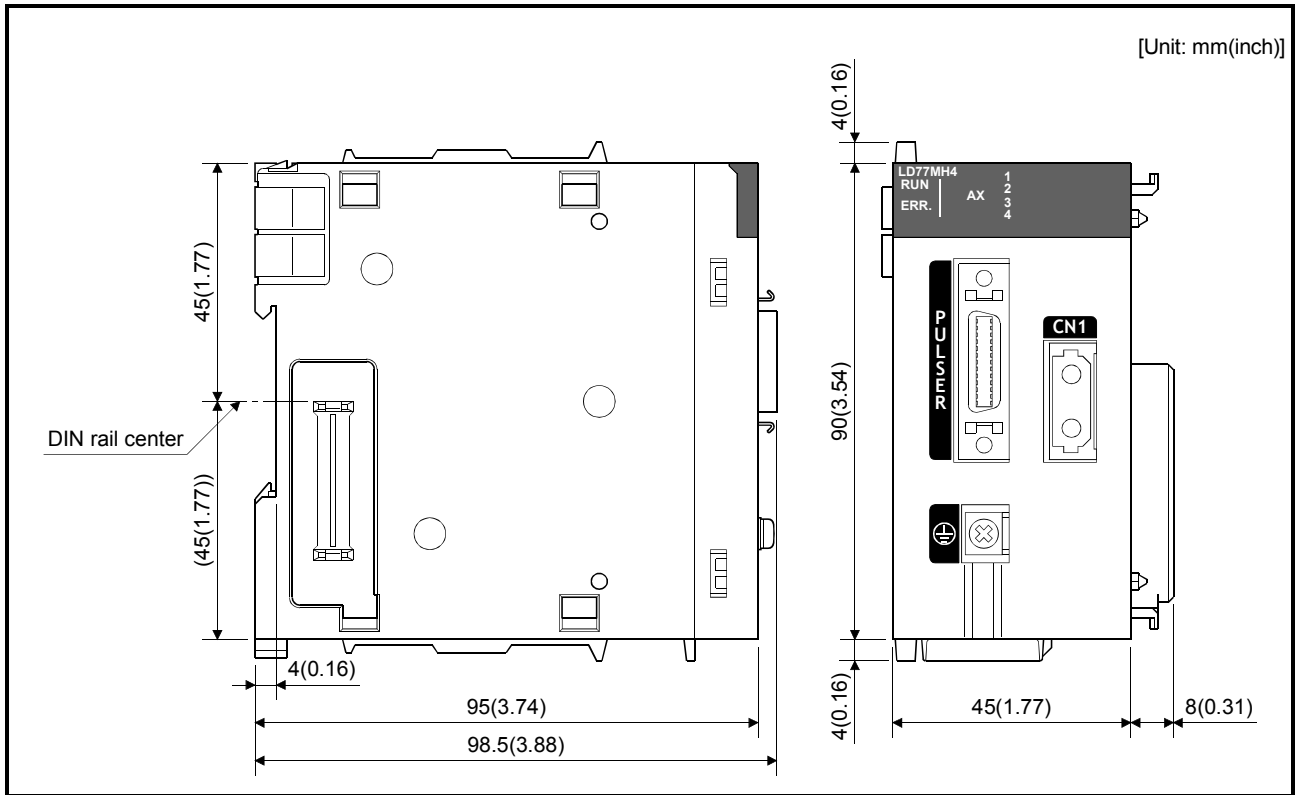

[2] LD77MH16

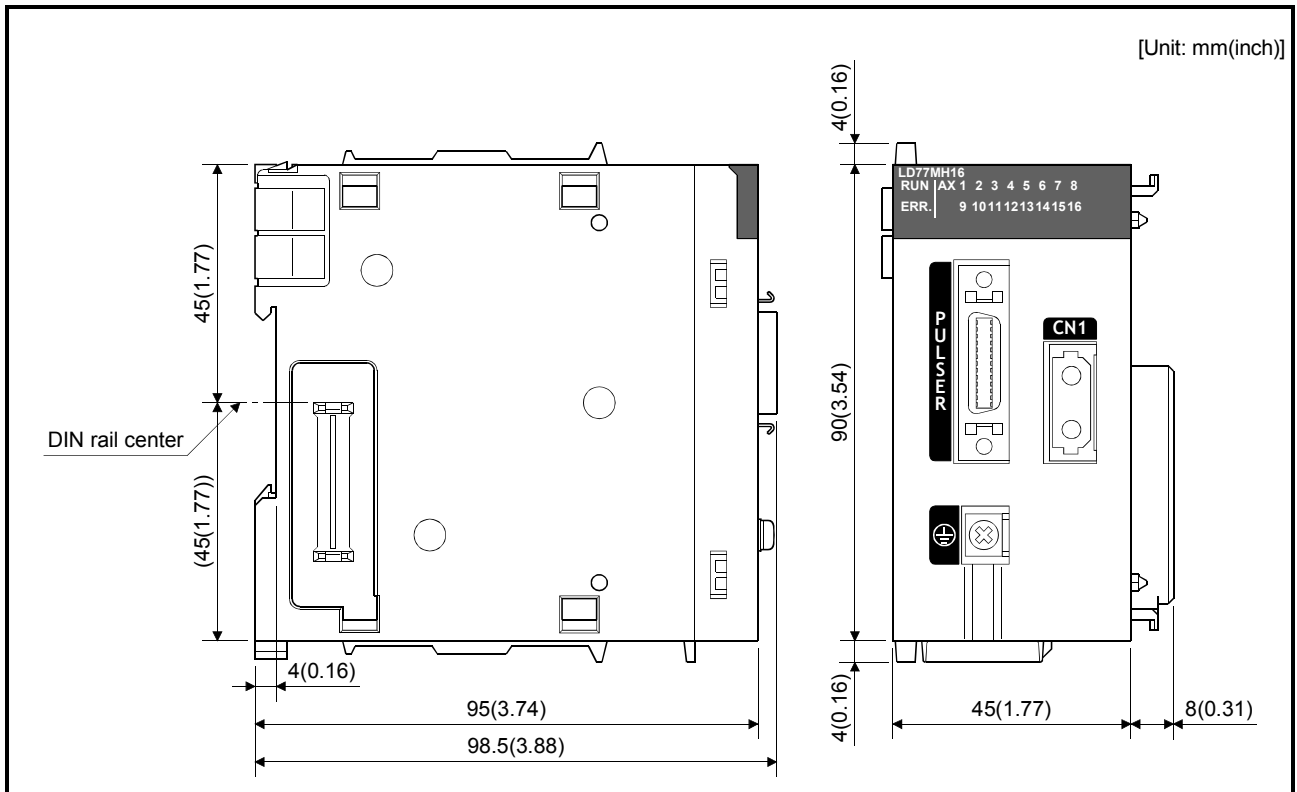



# WARRANTY

Please confirm the following product warranty details before using this product.

## 1. Gratis Warranty Term and Gratis Warranty Range

If any faults or defects (hereinafter "Failure") found to be the responsibility of Mitsubishi occurs during use of the product within the gratis warranty term, the product shall be repaired at no cost via the sales representative or Mitsubishi Service Company.

However, if repairs are required onsite at domestic or overseas location, expenses to send an engineer will be solely at the customer's discretion. Mitsubishi shall not be held responsible for any re-commissioning, maintenance, or testing on-site that involves replacement of the failed module.

### [Gratis Warranty Term]

The gratis warranty term of the product shall be for one year after the date of purchase or delivery to a designated place.

Note that after manufacture and shipment from Mitsubishi, the maximum distribution period shall be six (6) months, and the longest gratis warranty term after manufacturing shall be eighteen (18) months. The gratis warranty term of repair parts shall not exceed the gratis warranty term before repairs.

### [Gratis Warranty Range]

- (1) The range shall be limited to normal use within the usage state, usage methods and usage environment, etc., which follow the conditions and precautions, etc., given in the instruction manual, user's manual and caution labels on the product.
- (2) Even within the gratis warranty term, repairs shall be charged for in the following cases.
  1. Failure occurring from inappropriate storage or handling, carelessness or negligence by the user. Failure caused by the user's hardware or software design.
  2. Failure caused by unapproved modifications, etc., to the product by the user.
  3. When the Mitsubishi product is assembled into a user's device, Failure that could have been avoided if functions or structures, judged as necessary in the legal safety measures the user's device is subject to or as necessary by industry standards, had been provided.
  4. Failure that could have been avoided if consumable parts (battery, backlight, fuse, etc.) designated in the instruction manual have been correctly serviced or replaced.
  5. Failure caused by external irresistible forces such as fires or abnormal voltages, and Failure caused by force majeure such as earthquakes, lightning, wind and water damage.
  6. Failure caused by reasons unpredictable by scientific technology standards at time of shipment from Mitsubishi.
  7. Any other failure found to not be the responsibility of Mitsubishi or that admitted not to be so by the user.

## 2. Onerous repair term after discontinuation of production

- (1) Mitsubishi shall accept onerous product repairs for seven (7) years after production of the product is discontinued. Discontinuation of production shall be notified with Mitsubishi Technical Bulletins, etc.
- (2) Product supply (including repair parts) is not available after production is discontinued.

## 3. Overseas service

Overseas, repairs shall be accepted by Mitsubishi's local overseas FA Center. Note that the repair conditions at each FA Center may differ.

## 4. Exclusion of loss in opportunity and secondary loss from warranty liability

Regardless of the gratis warranty term, Mitsubishi shall not be liable for compensation to damages caused by any cause found not to be the responsibility of Mitsubishi, loss in opportunity, lost profits incurred to the user by Failures of Mitsubishi products, special damages and secondary damages whether foreseeable or not, compensation for damages to products other than Mitsubishi products, replacement by the user, maintenance of on-site equipment, start-up test run and other tasks.

## 5. Changes in product specifications

The specifications given in the catalogs, manuals or technical documents are subject to change without prior notice.

Microsoft, Windows, Windows NT, and Windows Vista are registered trademarks of Microsoft Corporation in the United States and other countries.

Pentium is a trademark of Intel Corporation in the United States and other countries.

Ethernet is a trademark of Xerox Corporation.

All other company names and product names used in this manual are trademarks or registered trademarks of their respective companies.

# MELSEC-L LD77MH Simple Motion Module User's Manual

## Positioning Control

MODEL	LD77MH-U-S-E
MODEL CODE	1XB942
IB(NA)-0300172-B(1112)MEE	

 **MITSUBISHI ELECTRIC CORPORATION**

HEAD OFFICE : TOKYO BUILDING, 2-7-3 MARUNOUCHI, CHIYODA-KU, TOKYO 100-8310, JAPAN  
NAGOYA WORKS : 1-14, YADA-MINAMI 5-CHOME, HIGASHI-KU, NAGOYA, JAPAN

When exported from Japan, this manual does not require application to the  
Ministry of Economy, Trade and Industry for service transaction permission.

Specifications subject to change without notice.