



Mitsubishi Electric AC Servo System

MITSUBISHI ELECTRIC SERVO SYSTEM
MELSERVO-J5

Rotary Servo Motor
User's Manual
(For MR-J5)



-HK-KT_
-HK-MT_
-HK-ST_
-HK-RT_

SAFETY INSTRUCTIONS

Please read the instructions carefully before using the equipment.

To use the equipment correctly, do not attempt to install, operate, maintain, or inspect the equipment until you have read through this manual, installation guide, and appended documents carefully. Do not use the equipment until you have a full knowledge of the equipment, safety information and instructions.





In this manual, the safety instruction levels are classified into "WARNING" and "CAUTION".

 WARNING	Indicates that incorrect handling may cause hazardous conditions, resulting in death or severe injury.
 CAUTION	Indicates that incorrect handling may cause hazardous conditions, resulting in medium or slight injury.

Note that the CAUTION level may lead to a serious consequence depending on conditions.

Please follow the instructions of both levels because they are important to personnel safety.

Forbidden actions and required actions are indicated by the following diagrammatic symbols.

	Indicates a forbidden action. For example, "No Fire" is indicated by  .
	Indicates a required action. For example, grounding is indicated by  .

In this manual, precautions for hazards that can lead to property damage, instructions for other functions, and other information are shown separately in the "Point" area.

After reading this manual, keep it accessible to the operator.

[Installation/wiring]

WARNING

- To prevent an electric shock, turn off the power and wait for 15 minutes or more (20 minutes or more for converter units/drive units) before starting wiring and/or inspection.
 - To prevent an electric shock, ground the rotary servo motor securely.
 - To prevent an electric shock, any person who is involved in wiring should be fully competent to do the work.
 - To prevent an electric shock, do not attempt to wire the rotary servo motor until it has been mounted.
 - To prevent an electric shock, do not touch the conductive parts.
-

[Installation/wiring]

CAUTION

- To prevent injury, do not touch the rotor of the rotary servo motor during operation.
 - To prevent injury, transport the products correctly according to their mass.
 - To prevent injury when handling the rotary servo motor, do not touch sharp edges such as the sharp edges of the rotary servo motor and the shaft keyway with bare hands.
-

[Maintenance]

WARNING

- To prevent an electric shock, any person who is involved in inspection should be fully competent to do the work.
-

ABOUT THE MANUAL

Point

e-Manuals are Mitsubishi Electric FA electronic book manuals that can be browsed with a dedicated tool.

e-Manuals enable the following:

- Searching for desired information in multiple manuals at the same time (manual cross searching)
- Jumping from a link in a manual to another manual for reference
- Browsing for hardware specifications by scrolling over the components shown in product illustrations
- Bookmarking frequently referenced information
- Copying sample programs to engineering tools

If using the servo for the first time, prepare and use the following related manuals to ensure that the servo is used safely. For the related manuals, refer to the User's Manual (Introduction).

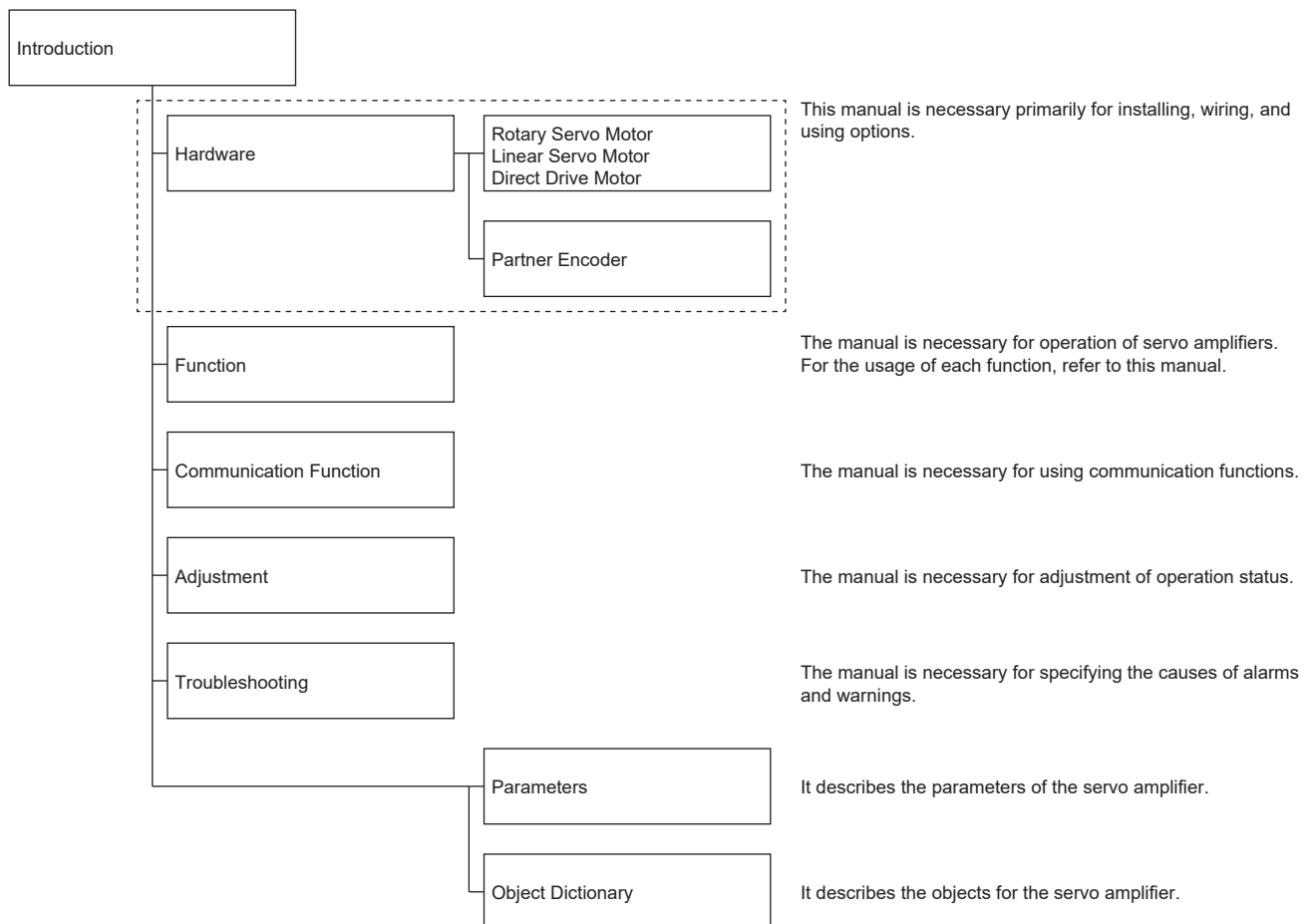

When reading this manual to use a drive unit, substitute "drive unit" for "servo amplifier".

Global standards and regulations

Compliance with the indicated global standards and regulations is current as of the release date of this manual. Some standards and regulations may have been modified or withdrawn.

CABLES USED FOR WIRING

Cables mentioned in this manual are selected based on an ambient temperature of 40 °C.

U.S. CUSTOMARY UNITS

U.S. customary units are not shown in this manual. Convert the values if necessary according to the following table.

Quantity	SI (metric) unit	U.S. customary unit
Mass	1 [kg]	2.2046 [lb]
Length	1 [mm]	0.03937 [inch]
Torque	1 [N•m]	141.6 [oz•inch]
Moment of inertia	1 [$\times 10^{-4}$ kg•m ²]	5.4675 [oz•inch ²]
Load (thrust load/axial load)	1 [N]	0.2248 [lbf]
Temperature	N [$^{\circ}$ C] \times 9/5 + 32	N [$^{\circ}$ F]

CONTENTS

SAFETY INSTRUCTIONS	1
ABOUT THE MANUAL	3
CABLES USED FOR WIRING	3
U.S. CUSTOMARY UNITS	4
CHAPTER 1 INTRODUCTION	10
1.1 Rating plate	10
1.2 Environment	12
1.3 Parts identification	13
1.4 Electromagnetic brake	14
1.5 Rotary servo motor shaft shapes	16
1.6 Servo motors with functional safety	18
1.7 Instructions on storage	18
1.8 Instructions on maintenance	18
1.9 Instructions on protection	18
CHAPTER 2 INSTALLATION	19
2.1 Mounting direction	20
2.2 Load mounting/dismounting precautions	21
2.3 Permissible load for the shaft	22
2.4 Protection from oil and water	22
2.5 Cable	23
2.6 Rotary servo motors with an oil seal	23
2.7 Inspection items	24
Periodic inspection	24
2.8 Parts with a service life	24
2.9 Machine accuracy	25
2.10 Instructions on swing rotation	25
2.11 Mounting rotary servo motors	26
CHAPTER 3 CONNECTORS USED FOR ROTARY SERVO MOTOR WIRING	27
3.1 Selection of connectors	27
3.2 Wiring connectors (connector configuration A)	29
3.3 Wiring connectors (connector configurations B/C/D/E)	30
CHAPTER 4 CONNECTING THE SERVO AMPLIFIER AND ROTARY SERVO MOTOR	34
4.1 Precautions for wiring	35
4.2 Wiring	36
HK-KT series/HK-MT series/HK-RT (1.0 kW - 2.0 kW) series	36
HK-ST series/HK-RT (3.5 kW - 7.0 kW) series	51
4.3 Selection example of wires	56
CHAPTER 5 WIRING OPTION	59
5.1 Cables/connector sets	59
Combinations of cables/connector sets	60
Cable and connector list	61

5.2	Motor cables/connector sets	68
	MR-AEPB2CBL_M-_ /MR-AEP2CBL_M-_	68
	MR-AEPB2J10CBL03M-_L/MR-AEP2J10CBL03M-_L	72
	MR-AEPB2J20CBL03M-_L/MR-AEP2J20CBL03M-_L	75
	MR-AEPB1CBL_M-_ /MR-AEP1CBL_M-_	78
5.3	Encoder cable	81
	MR-AEKCBL_M-_	81
	MR-AENSCBL_M-_	84
	MR-J3ENSCBL_M-_	87
5.4	Wires for option cables	90
	Precautions for option cables	90
	MR-AEPB2CBL_M-_L/MR-AEPB2CBL_M-_H	91
	MR-AEP2CBL_M-_L/MR-AEP2CBL_M-_H	92
	MR-AEPB2J20CBL03M-_L/MR-AEPB2J10CBL03M-_L	93
	MR-AEP2J20CBL03M-_L/MR-AEP2J10CBL03M-_L	94
	MR-AEPB1CBL_M-_L/MR-AEP1CBL_M-_L	95
	MR-AEPB1CBL_M-_H/MR-AEP1CBL_M-_H	96
	MR-AENSCBL_M-L/MR-AENSCBL_M-H	97
	MR-AEKCBL_M-L/MR-AEKCBL_M-H	98
	MR-J3ENSCBL_M-L/MR-J3ENSCBL_M-H	99
5.5	Shielding CN2, CN2A, CN2B, and CN2C connectors	100
5.6	Cable flex life	101
CHAPTER 6 HK-KT SERIES		102
6.1	Model designation	103
6.2	Standard specifications	104
	Standard specifications list	104
	Torque characteristics	111
	Permissible load for the output shaft	118
6.3	The graph of overload protection characteristics of rotary servo motor	120
6.4	Characteristics of electromagnetic brake	120
6.5	Derating	121
	Restrictions on the flange size	122
	Restrictions on the ambient temperature	123
	Restrictions on the altitude	123
6.6	Rotary servo motors with special shafts	124
	D-cut shaft	124
	L-cut shaft	125
	Keyed shaft (with double round-ended key)	125
	Keyed shaft (without key)	126
6.7	Geared servo motor	127
	For general industrial machine (G1)	127
	For high precision applications (G5/G7)	130
6.8	Mounting/removing connectors	134
	Mounting connectors	134
	Removing connectors	136
6.9	Dimensions	137
	Without gear reducer	137
	With gear reducer for general industrial machine	141
	With flange-output type gear reducer for high precision applications, flange mounting	142

With shaft-output type gear reducer for high precision applications, flange mounting	144
Cable direction: Load side/opposite direction of the load side	146
Cable direction: Vertical	147

CHAPTER 7 HK-MT SERIES 148

7.1 Model designation	148
7.2 Standard specifications	149
Standard specifications list	149
Torque characteristics	152
Permissible load for the output shaft	155
7.3 Characteristics of electromagnetic brake	157
7.4 Derating	158
Restrictions on the flange size	159
Restrictions on the ambient temperature	160
Restrictions on the altitude	160
7.5 Rotary servo motors with special shafts	161
D-cut shaft	161
L-cut shaft	161
Keyed shaft (with double round-ended key)	162
Keyed shaft (without key)	162
7.6 Mounting connectors	163
7.7 Dimensions	163

CHAPTER 8 HK-ST SERIES 165

8.1 Model designation	166
8.2 Standard specifications	167
Standard specifications list	167
Torque characteristics	175
Permissible load for the output shaft	181
8.3 The graph of overload protection characteristics of rotary servo motor	182
8.4 Characteristics of electromagnetic brake	182
8.5 Derating	183
Restrictions on the flange size	183
Restrictions on the ambient temperature	184
Restrictions on the altitude	184
8.6 Rotary servo motors with special shafts	185
Keyed shaft (with double round-ended key)	185
Keyed shaft (without key)	186
8.7 Geared servo motor	187
For general industrial machine (G1/G1H)	187
For high precision applications (G5/G7)	194
8.8 Mounting connectors	198
One-touch lock fitting	198
Screw fitting	199
8.9 Dimensions	200
Without gear reducer	201
With gear reducer for general industrial machine	204
With gear reducer for general industrial machine (foot-mounting)	209
With flange-output type gear reducer for high precision applications, flange mounting	214
With shaft-output type gear reducer for high precision applications, flange mounting	217

CHAPTER 9	HK-RT SERIES	220
9.1	Model designation	220
9.2	Standard specifications	221
	Standard specifications list	221
	Torque characteristics	225
	Permissible load for the output shaft	227
9.3	Characteristics of electromagnetic brake	228
9.4	Derating	229
	Restrictions on the flange size	229
	Restrictions on the ambient temperature	230
	Restrictions on the altitude	230
9.5	Rotary servo motors with special shafts	231
	Keyed shaft (with double round-ended key)	231
	Keyed shaft (without key)	232
9.6	Mounting connectors	232
9.7	Dimensions	233
	Cable direction: Load side/opposite direction of the load side	238
	Cable direction: Vertical	239
CHAPTER 10	COMPLIANCE WITH EACH REGION	240
10.1	Compliance with CE/UKCA marking	240
	CE/UKCA marking	240
	For compliance	240
10.2	Compliance with UL/CSA standard	241
	Flange size	241
	Selection example of wires	242
CHAPTER 11	APPENDIX	244
11.1	Rotary servo motor ID codes	244
11.2	Selection example of rotary servo motor power cable	246
11.3	Connector dimensions	247
	MT50W-8D/2D4ES-CVLD(7.5)	248
	MT50W-8D/2D4ES-CVL(11.9)	248
	MT50W-8D/2D4ES-CVSD(7.5)	249
	MT50W-8D/2D4ES-CVS(11.9)	249
	CMV1-SP10S-M_/CMV1-SP2S-__	250
	CMV1-AP10S-M_/CMV1-AP2S-__	250
	CMV1S-SP10S-M_/CMV1S-SP2S-__	250
	CMV1S-AP10S-M_/CMV1S-AP2S-__	251
	JL10-6A_- _SE-EB	251
	JL10-8A_- _SE-EB	252
	JL04V-6A_- _SE-EB-R	252
	JL04V-8A_- _SE-EBH-R	253
	JL04- _CK(_)- _R	253
11.4	Fabricating the encoder cable	254
11.5	Gear reducer model designation	255
	HK-KT_ G1	255
	HK-KT_ G5/G7	255
	HK-ST_ G1/G1H	256
	HK-ST_ G5/G7	256

REVISIONS	257
WARRANTY	259
TRADEMARKS	260

1 INTRODUCTION

1.1 Rating plate

Products proven to comply with the standards set by a given Certification Body are marked with the appropriate certification marks. The marks vary for each Certification Body.

The date of manufacture of the rotary servo motor is indicated in the serial number on the rating plate.

For the date of manufacture, the last two digits of the year and the month in numerical format [1 to 9, X (10), Y (11), and Z (12)] are displayed.

For April 2019, the serial number would be "SER. _____ 194".

The following shows an example of the rating plate for explanation of each item.

HK-KT series/HK-MT series/HK-RT (1.0 kW - 2.0 kW) series

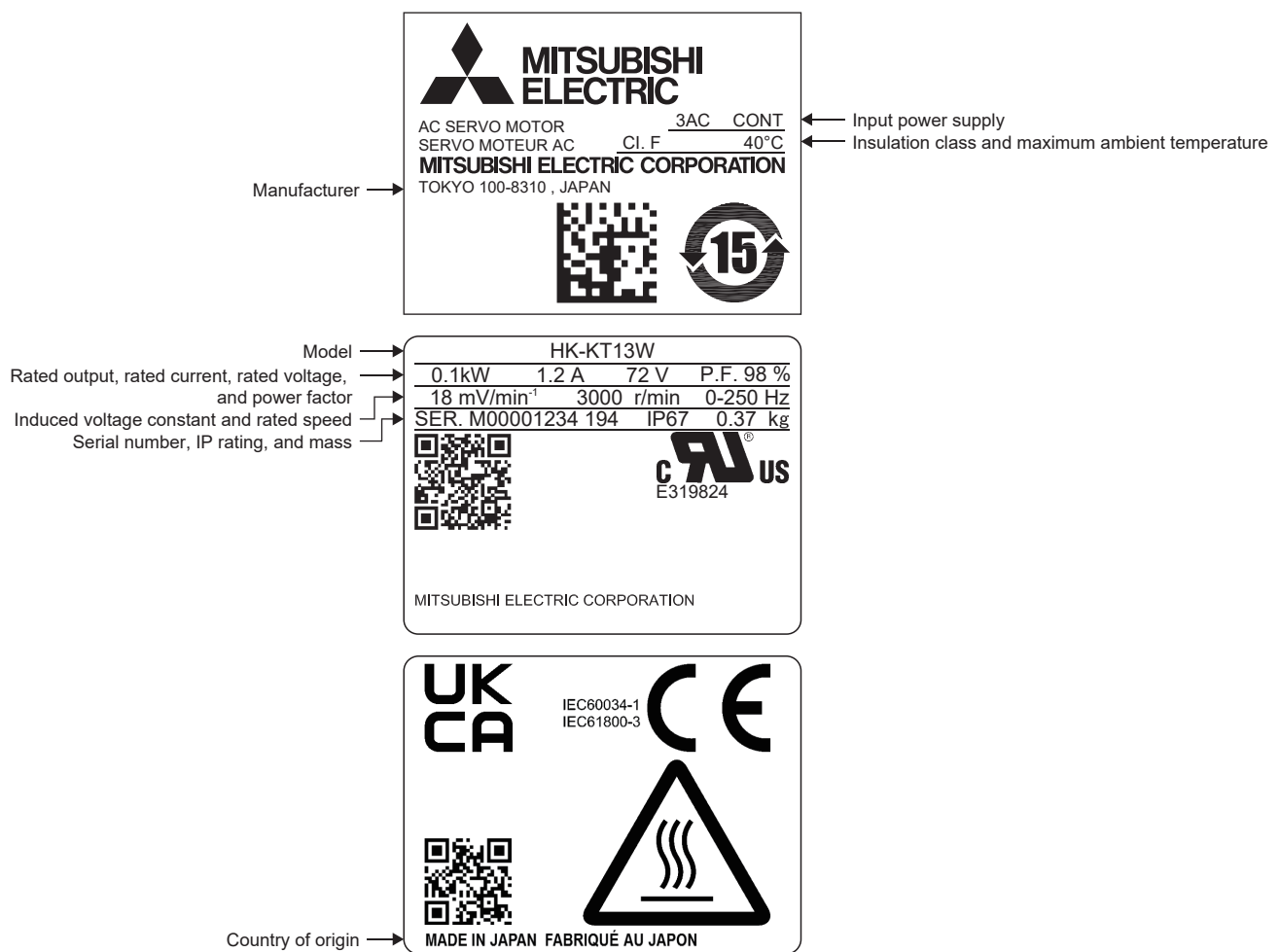











HK-ST series/HK-RT (3.5 kW - 7.0 kW) series

The rating plate indicates the characteristic values for when the torque has been increased by changing the servo amplifier. For the characteristics in combination with each servo amplifier, refer to "Servo amplifier/motor combinations" in the following manuals.

📖 MR-J5 User's Manual (Hardware)

📖 MR-J5D User's Manual (Hardware)

		MITSUBISHI ELECTRIC	AC SERVO MOTOR SERVO MOTEUR AC
		HK-ST102W	
Model →		3AC 102V 7.0A 1kW	
Input power, rated voltage, rated current, and rated output →		5.2 kg Cl.F	CONT
Mass and insulation class →		1500r/min 0-125Hz	
Rated speed →		58 mV/min⁻¹ 40°C	
Induced voltage constant and maximum ambient temperature →		P.F. 98% IP67	
Power factor and IP rating →		SER.M00001234 194	
Serial number →		MADE IN JAPAN IEC60034-1	
Country of origin →		FABRIQUÉ AU JAPON IEC61800-3	
		MITSUBISHI ELECTRIC CORPORATION	
Manufacturer →		TOKYO 100-8310, JAPAN	

			
			
			
		SPECIFICATION MODEL E.E.68 I HK-ST102W	

1.2 Environment

Conditions	Operation	Storage
Ambient temperature	0 °C to 60 °C (non-freezing) ^{*2}	-15 °C to 70 °C (non-freezing)
Ambient humidity	10 %RH to 90 %RH (non-condensing)	10 %RH to 90 %RH (non-condensing)
Ambience ^{*1}	Indoors (no direct sunlight); no corrosive gas, inflammable gas, oil mist, dust, nor high magnetic field	
Altitude	2000 m or less ^{*3}	
External magnetic field	10 mT or less	
Vibration resistance	Refer to the following. ☞ Page 104 Standard specifications ☞ Page 149 Standard specifications ☞ Page 167 Standard specifications ☞ Page 221 Standard specifications	

*1 Do not use in an environment where there is exposure to oil mist, oil, and water.

*2 Refer to the following for restrictions on the ambient temperature.

☞ Page 121 Derating

☞ Page 158 Derating

☞ Page 183 Derating

☞ Page 229 Derating

*3 Refer to the following for restrictions on using this product at an altitude exceeding 1000 m and up to 2000 m.

☞ Page 121 Derating

☞ Page 158 Derating

☞ Page 183 Derating

☞ Page 229 Derating

1.3 Parts identification

HK-KT series/HK-MT series/HK-RT (1.0 kW - 2.0 kW) series

■ Without an electromagnetic brake

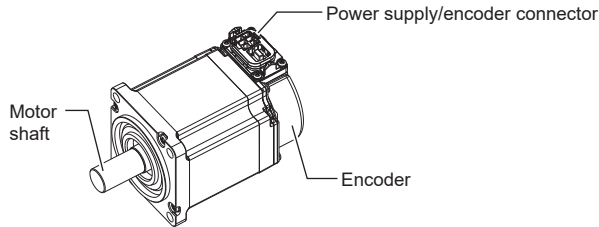

■ With an electromagnetic brake

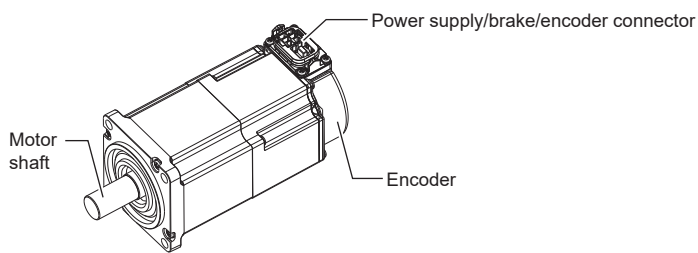

HK-ST series/HK-RT (3.5 kW - 7.0 kW) series

■ Without an electromagnetic brake

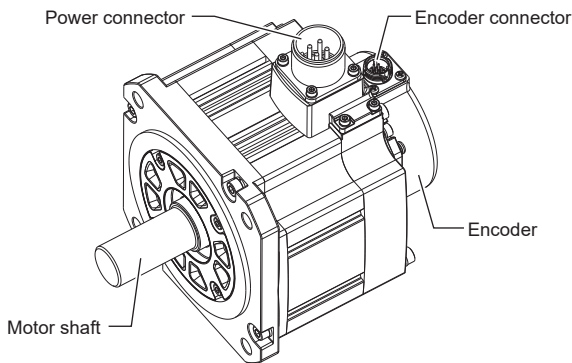

■ With an electromagnetic brake

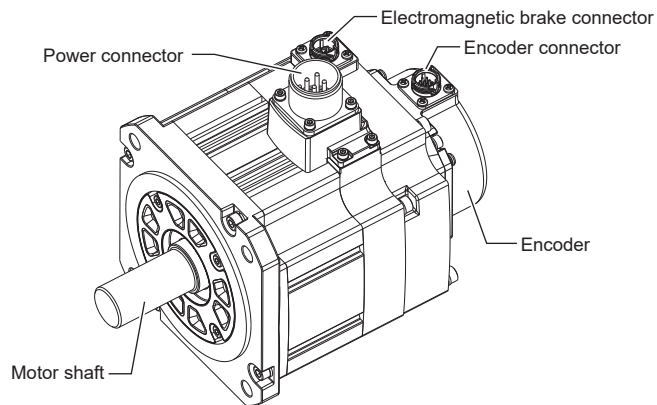

1.4 Electromagnetic brake

The rotary servo motor with an electromagnetic brake can be used to prevent a drop in vertical lift applications or to ensure double safety at an emergency stop, for example. When operating the rotary servo motor, supply power to the electromagnetic brake to release the brake. Switching power off enables the electromagnetic brake.

Precautions

- The electromagnetic brake on the rotary servo motor is designed to hold the motor shaft and should not be used for ordinary braking.
- Incorrect wiring, service life, or the mechanical structure (e.g. where a ball screw and the rotary servo motor are coupled via a timing belt) may cause the electromagnetic brake to be unable to hold the motor shaft. To ensure safety, install a stopper on the machine side.
- If it is assumed that a power failure or product malfunction may result in a hazardous situation, use a rotary servo motor with an electromagnetic brake or provide an external brake system for holding purpose to prevent such hazard.
- Configure an electromagnetic brake circuit that interlocks with the external emergency stop switch.

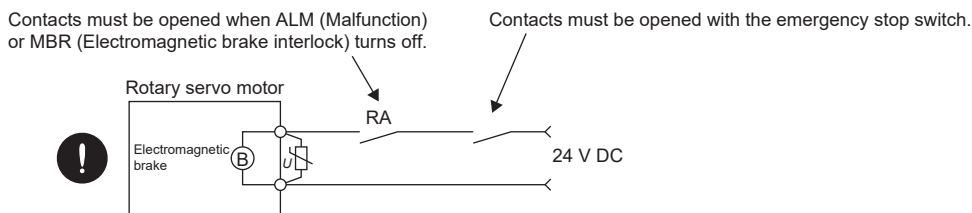

- The electromagnetic brake is provided to prevent a drop at a power failure or servo alarm occurrence during vertical drive or to hold a shaft at a stop. Do not use it for normal braking (including braking at servo-lock).
- The electromagnetic brake has a release delay time. Ensure enough time between releasing the electromagnetic brake and starting the rotary servo motor. Check the release delay time with an actual machine.
- For details of the circuit configuration, refer to "Servo motor with an electromagnetic brake" in the following manuals.

MR-J5 User's Manual (Hardware)

MR-J5D User's Manual (Hardware)

- For details of the timing chart, refer to "Electromagnetic brake interlock function" in the following manual.

MR-J5 User's Manual (Function)

- When the electromagnetic brake is released, the temperature of the rotary servo motor may increase regardless of driving.
- The service life of the brake may be shortened under sudden acceleration/deceleration conditions.

Electromagnetic brake power supply

Prepare the following power supply for use with the electromagnetic brake only. The electromagnetic brake terminals (B1 and B2) have no polarity.

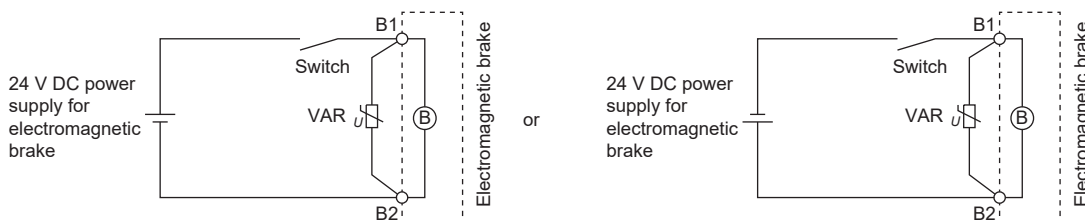

A surge absorber (VAR) must be installed between B1 and B2. For a selection example of surge absorbers, refer to the "Characteristics of electromagnetic brake" section in the chapter of the applicable rotary servo motor series.

When a diode is used as a surge absorber, the electromagnetic braking time becomes longer.

Sound generation

The brake lining may rattle during a low-speed operation; however, it poses no functional problem.

The noise may be reduced or eliminated by the machine resonance suppression filter set with the parameters of the servo amplifier. For details, refer to "Machine resonance suppression filter" in the following manual.

📖MR-J5 User's Manual (Adjustment)

Selection of surge absorbers for electromagnetic brake circuit

The following shows an example of how to select a varistor as a surge absorber.

■ Selection conditions

Item	Conditions
Electromagnetic brake specification	R [Ω]: Resistance L [H]: Inductance Vb [V]: Power supply voltage
Desired suppression voltage	Vs [V] or less
Durable surge application time	N times

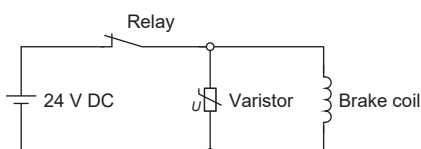

■ Tentative selection and verification of surge absorber

- Maximum permissible circuit voltage of varistor

Tentatively select a varistor whose maximum permissible voltage is larger than Vb [V].

- Brake current (Ib)

$$I_b = \frac{V_b}{R} \text{ [A]}$$

- Energy (E) generated by brake coil

$$E = \frac{L \times I_b^2}{2} \text{ [J]}$$

- Varistor limit voltage (Vi)

From the energy (E) generated in the brake coil and the varistor characteristic diagram, calculate the varistor limit voltage (Vi) when the brake current (Ib) flows into the tentatively selected varistor during opening of the circuit.

Vi is favorable when the varistor limit voltage (Vi) [V] is smaller than the desired suppressed voltage (Vs) [V].

If Vi is not smaller than Vs, reselect a varistor or improve the withstand voltage of devices.

- Surge current width (τ)

Given that the varistor absorbs all energies, the surge current width (τ) is as follows.

$$\tau = \frac{E}{V_i \times I_b} \text{ [S]}$$

- Examining surge life of varistor

From the varistor characteristic diagram, find the guaranteed current value (Ip) in which the number of the surge application life is N at the surge current width (τ). Calculate the guaranteed current value (Ip) ratio (Ip/Ib) to brake current (Ib).

If a sufficient margin is ensured for Ip/Ib, the number of the surge application life N [time] can be considered as favorable.

Other precautions

A leakage magnetic flux occurs at the shaft end of the servo motor with an electromagnetic brake. Note that chips, screws, and other debris are attracted.

1.5 Rotary servo motor shaft shapes

Do not use shafts other than the straight shaft for frequent start/stop applications. Use a friction coupling or the like when coupling the shaft with a machine.

There are six shaft shape types for the rotary servo motor: straight shaft, D-cut shaft, L-cut shaft, keyed shaft (with double round-ended key), keyed shaft (without key), and keyed shaft (with single pointed key).

The keyed shaft (with single pointed key) supports only geared servo motors for high precision applications.

Straight shaft

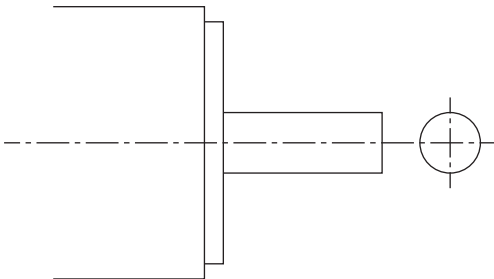

D-cut shaft

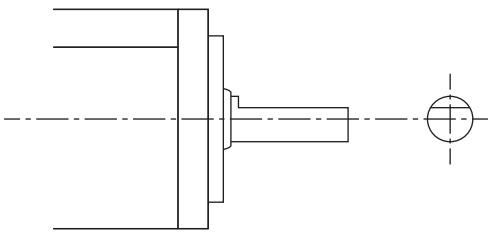

L-cut shaft

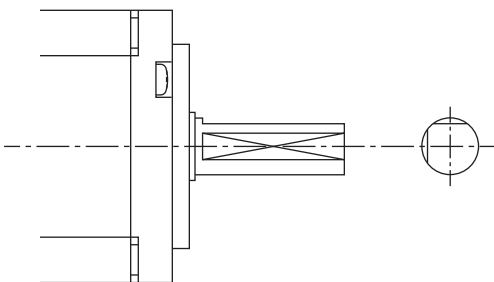

Keyed shaft (with double round-ended key)

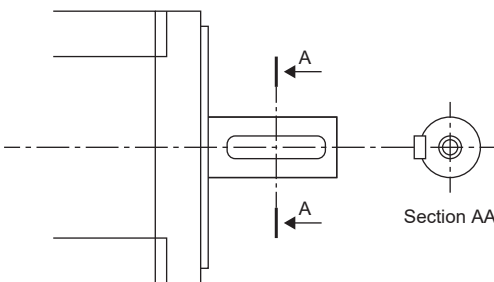

Keyed shaft (without key)

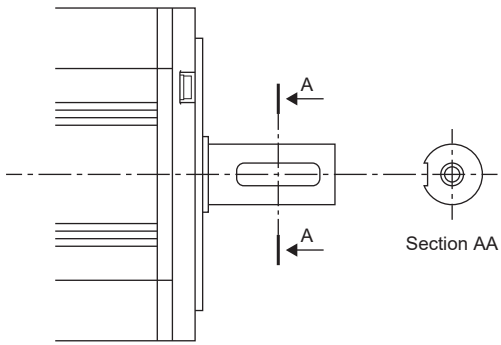

Keyed shaft (with single pointed key)

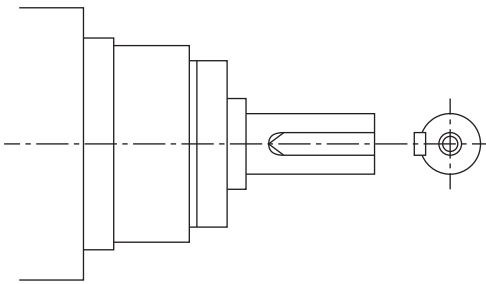

1.6 Servo motors with functional safety

The HK-KT series, HK-MT series, HK-ST series, and HK-RT series support servo motors with functional safety. The specifications and dimensions of servo motors with functional safety are not changed.

For the available safety-sub functions and the achievable safety levels, refer to "Functional safety" in the User's Manual (Introduction).

1.7 Instructions on storage

Precautions

Note the following when storing the rotary servo motor for an extended period of time (guideline: three or more months).

- Always store the servo motor indoors in a clean and dry place.
- When storing in a dusty and humid area, take measures such as covering the whole product.
- If the insulation resistance of the magnet wire decreases, reconsider how the equipment is being stored.
- Although the servo motor has been given rust prevention treatment with paint and preventive oil before shipment, rust may still appear depending on the storage period and conditions. If the servo motor is to be stored for longer than six months, apply rust prevention oil again, especially to the machined surfaces of the shaft and other parts.
- Before using the product after an extended storage, hand-turn the rotary servo motor output shaft and check to ensure that there is no abnormality. For the rotary servo motor with an electromagnetic brake, check it after releasing the electromagnetic brake with the brake power supply.
- When the product has been stored for an extended period of time, contact your local sales office.

1.8 Instructions on maintenance

Precautions

- To prevent the scuffed surface, do not scratch the coated surface with hard objects nor clean the coated surface with an organic solvent.
- For repair and parts replacement, contact your local sales office.

1.9 Instructions on protection

Precautions

- Provide adequate protection to prevent an unexpected restart after an instantaneous power failure.

2 INSTALLATION

Precautions

- Install the rotary servo motor on incombustible material. Installing them either directly on or near combustibles may lead to smoke or a fire.
- Provide adequate protection so as to prevent conductive matter (such as screws and metal fragments) and combustible matter (such as oil) from entering the rotary servo motor.
- The temperature of the rotary servo motor may exceed 100 °C depending on the operating method. Take safety measures such as providing covers.
- The eyebolts of the rotary servo motor are only for transportation of the rotary servo motor. Do not use them to transport the rotary servo motor when it is mounted on a machine.
- Be sure to install the geared servo motor in the specified direction. Not doing so will cause oil leakage which may lead to a fire and malfunction.
- Do not overtighten the eyebolts of the rotary servo motor. To prevent damage to the tap, avoid tightening too hard.
- Do not stack in excess of the specified number of product packages.
- Do not carry the rotary servo motor by the cables, connectors, or encoder. Doing so may cause the rotary servo motor to drop.
- When installing the rotary servo motor, follow the user's manual and install the motor in a place that can support its weight.
- Do not install or operate any rotary servo motor that is missing parts or is damaged.
- Securely fix the rotary servo motor to a machine. If attached insecurely, the motor may come off during operation.
- To prevent a connection failure, malfunction, or similar problem, do not strike the connector.
- Be sure to measure the vibration level with the rotary servo motor mounted on the machine. A great vibration may cause early damage to a bearing, encoder, brake, and gear reducer. The great vibration may also cause the poor connector connection or bolt looseness.
- For the gain adjustment at the equipment startup, check the torque waveform and the speed waveform with a measurement device to check that no vibration occurs. If the vibration occurs due to high gain, the vibration may cause early damage to the rotary servo motor.
- Use the product within the specified environment. For the environment, refer to the specifications of the rotary servo motor series.
- To prevent an encoder malfunction from occurring, do not apply shocks, e.g. hit with a hammer, when coupling the shaft end of the rotary servo motor.
- To prevent the shaft from being broken, do not subject the shaft of the rotary servo motor to more than the permissible load.
- To prevent the shaft from being broken and bearing from being worn out, do not use a rigid coupling when coupling a load to the rotary servo motor.
- To prevent vibration during rotary servo motor operation and to prevent damage to the bearings and encoder, the balance level of the load needs to be as even as possible.
- To prevent a malfunction, do not use the rotary servo motor where the shaft-through portion may be subject to pressure (e.g. compressed air).
- Take safety measures such as providing covers to avoid accidentally touching the rotor of rotary servo motor during operation.
- Do not get on the equipment or put a heavy load on it.
- Do not drop or strike the rotary servo motor.
- To prevent a fire or injury from occurring in case of an earthquake or other natural disasters, securely install, mount, and wire the rotary servo motor in accordance with the user's manual.
- To prevent an electric shock or a fire, do not disassemble, repair, or modify the product. Disassembled, repaired, and/or modified products are not covered under warranty.
- The equipment must be installed in the specified direction.
- Do not use the product in environments where it is exposed to strong magnetic fields, electric fields, or radiation. Doing so may cause operation failure or malfunction.

2.1 Mounting direction

The mounting direction of the rotary servo motor is shown in the following table.

Rotary servo motor series	Mounting direction
HK-KT HK-MT HK-ST HK-RT	Any direction

It is recommended to set the connector section downward if the rotary servo motor is mounted horizontally. Examine the cable clamping method, and give a gentle slack to the connection cable, to prevent excessive load from being applied to the connector and cable connection part.

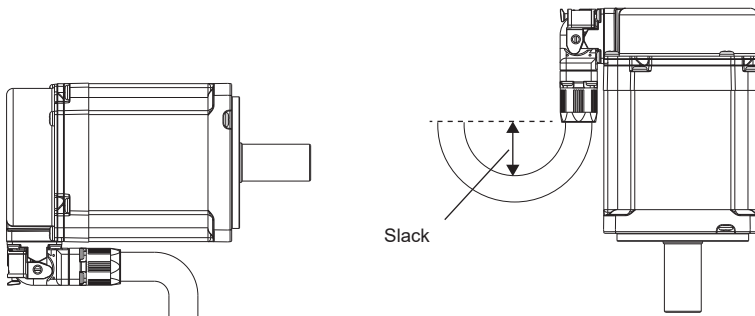

Rotary servo motor with an electromagnetic brake

The rotary servo motor with an electromagnetic brake can also be mounted in the same directions as the one without an electromagnetic brake. When the servo motor with an electromagnetic brake is mounted with the shaft end upward, the brake plate may generate sliding sound but it is not a fault.

Geared servo motor

The installing direction of the geared servo motor varies depending on the type of the gear reducer. Be sure to install the geared servo motor in the specified direction. For details, refer to the chapter of the applicable rotary servo motor series.

2.2 Load mounting/dismounting precautions

- When mounting a pulley to the rotary servo motor with a keyed shaft, use the screw hole in the shaft end. To fit the pulley, first insert a double-end bolt into the screw hole of the shaft, put a washer against the end face of the coupling, and insert and tighten a nut to force the pulley in.

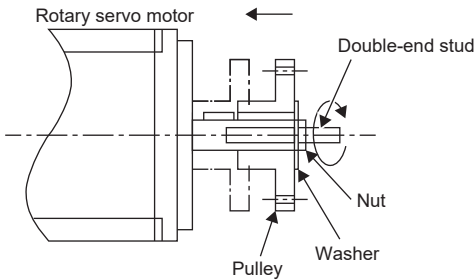

- For shafts without a keyway, use a friction coupling or the like for coupling the rotary servo motor with a load.
- When removing the pulley, use a pulley remover to protect the shaft from excessive load and impact.
- To ensure safety, fit a protective cover or the like on the rotary area, such as the pulley, mounted to the shaft.
- When a threaded shaft end part is needed to mount a pulley on the shaft, please contact your local sales office.
- The direction of the encoder on the rotary servo motor cannot be changed.
- When mounting the rotary servo motor, use spring washers or similar parts and fully tighten the bolts so that they do not become loose due to vibration.
- The part A of the shaft has a grinding clearance shaped as shown in the detailed figure of the part A, and the part B of the shaft has the center hole shaped as shown in the detailed figure of the part B. As these dimensions vary widely depending on the products and cannot be guaranteed, do not use the dimensions for positioning pulleys or washers. In addition, approximately C0.4 of the shaft edge is trimmed off (the dimensions may vary depending on the products).

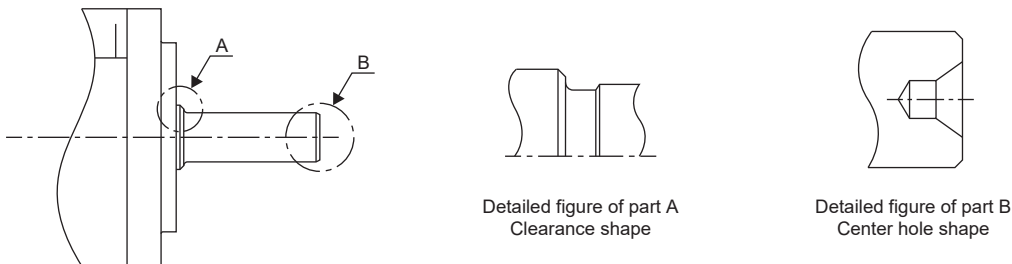

Precautions

- To prevent a malfunction on the encoder, the shaft end must not be hammered during assembling.

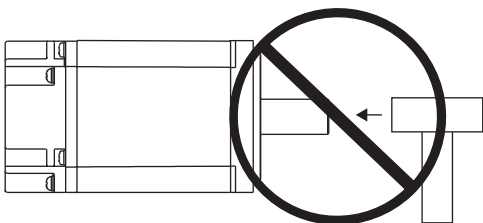

- Do not process the shaft to avoid damage to the encoder and bearing.

2.3 Permissible load for the shaft

For the permissible load for the shaft specific to the rotary servo motor, refer to the chapter of the applicable rotary servo motor series.

- Use a flexible coupling and adjust the misalignment of the shaft to less than the permissible radial load.
- When using a pulley, sprocket, or timing belt, keep the radial load within the permissible value.
- Exceeding the permissible load can cause deterioration of the bearing and damage to the shaft.
- The load indicated in this section is a static load in a single direction and does not include eccentric loads. To prevent the rotary servo motor being damaged, make eccentric loads as small as possible.

Precautions

Do not use a rigid coupling as it may apply excessive bending load to the shaft of the rotary servo motor, leading the shaft to break and the bearing to wear out.

2.4 Protection from oil and water

Provide adequate protection to prevent foreign matter, such as oil from entering the rotary servo motor shaft. When installing the rotary servo motor, consider the items in this section.

- Do not use the rotary servo motor with its cable soaked in oil or water.

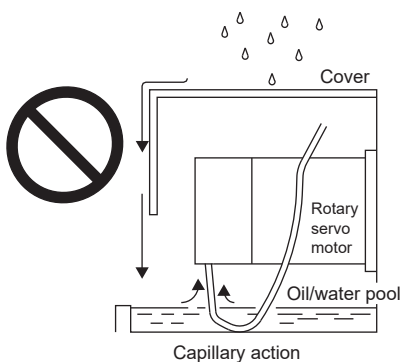

- When the servo motor is to be installed with the shaft end upward, provide measures so that it is not exposed to oil and water entering from the machine side, gear box, etc.

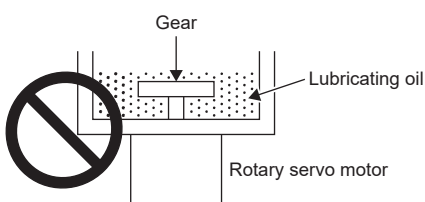

- If oil such as cutting oil splashes on the servo motor, the sealant, packing, cable, and other parts may be affected depending on the oil type.
- In the environment where the rotary servo motor is exposed to oil mist, oil, or water, the rotary servo motor of the standard specifications may not be usable. Please contact your local sales office.

2.5 Cable

The power supply and encoder cables routed from the rotary servo motor should be fixed to the rotary servo motor to keep them unmovable. Otherwise, the cable may be disconnected. In addition, do not modify the connectors, terminals, and other areas at the ends of the cables.

Precautions

The cables should not be damaged, stressed, loaded, or pinched.

2.6 Rotary servo motors with an oil seal

For rotary servo motors with an oil seal, the oil seal prevents the entry of oil into the rotary servo motor. Make sure to install it in accordance with this section.

Even if the oil seal on the rotary servo motor makes noises during operation, it does not indicate a problem with the functions.

Pressure and oil level

Install the rotary servo motor horizontally, and set the oil level in the gear box to be always lower than the oil seal lip. If the oil level is higher than the oil seal lip, the oil enters the rotary servo motor and may cause a malfunction. For the height above oil level, refer to the chapter of the applicable rotary servo motor series.

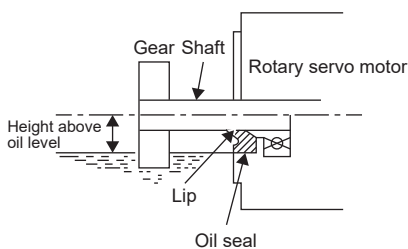

High pressure against the oil seal causes abrasion, which shortens the service life of the product. Keep constant internal pressure by equipping a ventilator to the gear box.

Temperature

If the oil seal lip reaches a high temperature, the service life of the oil seal will be shortened. The maximum applicable temperature of material of the oil lip is 100 °C, and the temperature of the oil lip increases by 10 °C to 15 °C at maximum rotation. Keep high-temperature oil away from the oil lip.

2.7 Inspection items

- To prevent a malfunction, do not perform an insulation resistance test (megger test) on the rotary servo motor.
- Customers must not disassemble and/or repair the equipment.

Periodic inspection

Perform the following inspections.

- Check the bearings, brake section, and the like for unusual noise.
- Check the cables and the like for scratches or cracks. Inspect them periodically according to operating conditions especially when the cables are movable.
- Check the rotary servo motor shaft and coupling for misalignment.
- Check the power connector and encoder connector tightening screws for looseness.

2.8 Parts with a service life

The service life of the following parts is listed below. If any fault is found in a part, replace it immediately because its service life varies depending on the operating methods and environment. For parts replacement, please contact your local sales office.

Part name	Recommended service life
Bearings	20000 hours to 30000 hours
Encoder	20000 hours to 30000 hours
Oil seal	5000 hours
Gear reducer	10000 hours to 20000 hours

Bearings

When the motor is run at rated speed and at rated load, bearings should be changed every 20000 to 30000 hours as a guideline. As this differs depending on the operating conditions, the bearings must also be changed if unusual noise or vibration occurs during inspection.

Oil seal

Oil seals must be changed in 5000 hours of operation at rated speed as a guideline. This differs depending on the operating conditions. The oil seals must also be changed if oil leakage a similar problem is found during inspection. Even if the oil seal on the rotary servo motor makes noises during operation, it does not indicate a problem with the functions.

2.9 Machine accuracy

The following table shows the machine accuracy of the output shaft and mounting parts of the rotary servo motor.

Accuracy [mm]	Measuring position	Flange size		
		□90 or less	□130	□176
Runout of flange surface to output shaft	a)	0.05	0.06	0.08
Runout of fitting OD of flange surface	b)	0.04	0.04	0.06
Runout of output shaft end	c)	0.02	0.02	0.03

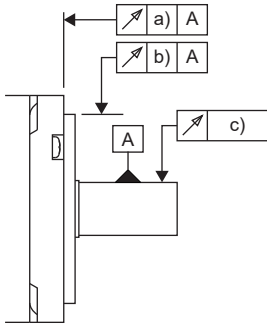

2.10 Instructions on swing rotation

If the rotary servo motor performs a swing rotation (moves continuously in both the positive and negative direction) within a small angle, rotate the rotary servo motor by equal to or more than the smallest swing angle in the following, at least once a day to keep the bearings lubricated.

Flange size	Minimum oscillation angle
□40, □60	140°
□80, □90, □130	120°
□176	110°

2.11 Mounting rotary servo motors

Be sure to use the rotary servo motor within the specified environment, and mount the rotary servo motor on a machine having the equivalent heat dissipation effect as the following aluminum flange.

The temperature rise value of the rotary servo motor changes depending on its mounting environment, operating conditions, and other factors. Make sure that alarms do not occur on the actual machine before operation.

Flange size [mm]	Rotary servo motor			
	HK-KT	HK-MT	HK-ST	HK-RT
250 × 250 × 6	053W 13W 1M3W 13UW 23W	053(V)W 13(V)W 1M3(V)W 23(V)W	—	—
250 × 250 × 12	43(4)W	43(V)W	—	—
300 × 300 × 12	63(4)W 23UW 43UW 63(4)UW 7M3(4)W 103(4)W 7M3UW 103(4)UW	63(V)W 7M3(V)W 103(V)W	52(4)W 102(4)W 172(4)W 202(4)AW 302(4)W	103(4)W 153(4)W 203(4)W
300 × 300 × 20	153(4)W 203(4)W 202(4)W	—	202(4)W 352(4)W	—
550 × 550 × 30	—	—	7M2UW 172UW 353(4)W 503(4)W	353(4)W 503(4)W 703(4)W
650 × 650 × 35	—	—	502(4)W 702(4)W	—

3 CONNECTORS USED FOR ROTARY SERVO MOTOR WIRING

Precautions

- The indicated IP rating is the connector's protection against ingress of dust and water when the connector is connected to a rotary servo motor. If the IP rating of the connector and rotary servo motor varies, the overall IP rating depends on the lowest IP rating of all components.
- If the mating part of the connector has a flaw or an excessive load (including a temporary load at installation or other situations) is applied to the connector and cable clamp, the performance of the connector IP rating may not be satisfied.
- The fitting warranty is applied only to the option cables and the connectors manufactured by the manufacturers introduced in this manual.

3.1 Selection of connectors

Use the connector configuration products given in the table as the connectors for connection with the rotary servo motor. Refer to the following for the compatible connector configuration products.

☞ Page 29 Wiring connectors (connector configuration A)

☞ Page 30 Wiring connectors (connector configurations B/C/D/E)

HK-KT series/HK-MT series/HK-RT (1.0 kW - 2.0 kW) series

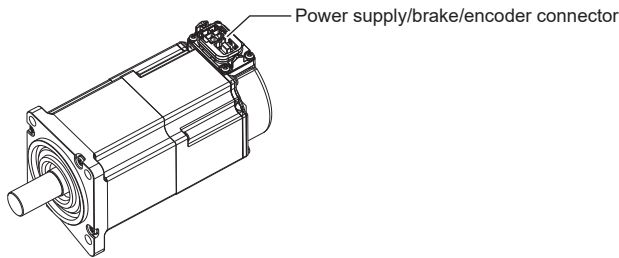

Rotary servo motor	Wiring connector		
	For encoder	For electromagnetic brake	For power supply
HK-KT_	Connector configuration A		
HK-MT_			
HK-RT103(4)W			
HK-RT153(4)W HK-RT203(4)W			

HK-ST series/HK-RT (3.5 kW - 7.0 kW) series

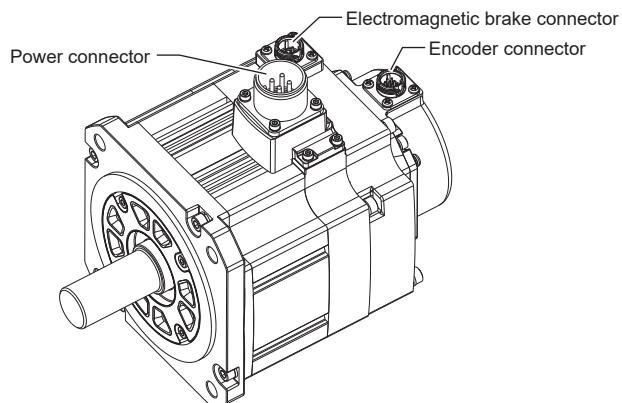

Rotary servo motor	Wiring connector		
	For encoder	For electromagnetic brake	For power supply
HK-ST52(4)W HK-ST102(4)W HK-ST172(4)W HK-ST202(4)AW HK-ST302(4)W HK-ST353(4)W HK-ST503(4)W	Connector configuration B *2	Connector configuration C *2	Connector configuration D **2
HK-ST7M2UW HK-ST172UW HK-ST202(4)W HK-ST352(4)W HK-ST502(4)W HK-ST702(4)W			Connector configuration E
HK-RT353(4)W HK-RT503(4)W HK-RT703(4)W			

*1 To make the HK-ST503W comply with the UL/CSA standard, the connector configuration D cannot be used. Refer to the following for details.

☞ Page 243 HK-ST series

*2 Connectors used for the geared servo motor HK-ST152(4)_ are the same as those for the HK-ST172(4)W.

3.2 Wiring connectors (connector configuration A)

Load-side lead/opposite to load-side lead

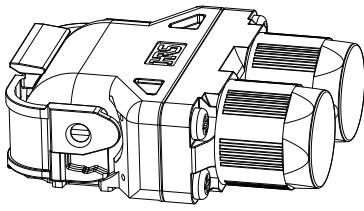

Two cable type

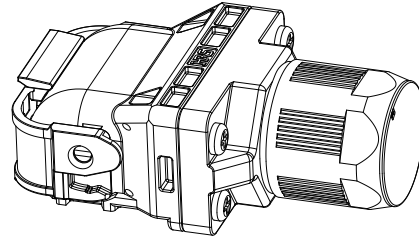

One cable type

Connector configuration	Feature	Plug (Hirose Electric)			Applicable cable OD	Rotary servo motor-side connector *1
		Type	Connector	Contact		
A	IP67	Dual cable	MT50W-8D/2D4ES-CVLD(7.5)	(1) For power supply Contact model: MT50E-1820SCFA Applicable wire size: AWG 20 to 18 Crimping tool: HT802/MT50E-1820S (2) For electromagnetic brake/encoder Contact model: MT50D-2224SCFA Applicable wire size: AWG 24 to 22 Crimping tool: HT802/MT50D-2224S	$\phi 7.5 \pm 0.3$	MT50W-8D/ 2D3E-PE-FL
		Single cable	MT50W-8D/2D4ES-CVL(11.9)		$\phi 11.9 \pm 0.3$	

*1 The connector to be mated.

Vertical lead

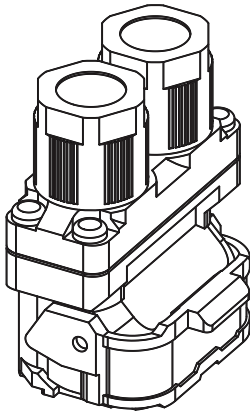

Two cable type

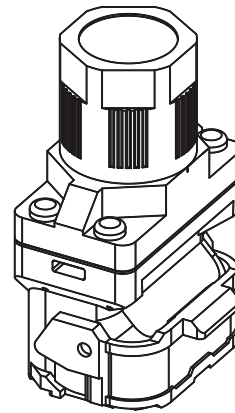

One cable type

Connector configuration	Feature	Plug (Hirose Electric)			Applicable cable OD	Rotary servo motor-side connector *1
		Type	Connector	Contact		
A	IP67	Dual cable	MT50W-8D/2D4ES-CVSD(7.5)	(1) For power supply Contact model: MT50E-1820SCFA Applicable wire size: AWG 20 to 18 Crimping tool: HT802/MT50E-1820S (2) For electromagnetic brake/encoder Contact model: MT50D-2224SCFA Applicable wire size: AWG 24 to 22 Crimping tool: HT802/MT50D-2224S	$\phi 7.5 \pm 0.3$	MT50W-8D/ 2D3E-PE-FL
		Single cable	MT50W-8D/2D4ES-CVS(11.9)		$\phi 11.9 \pm 0.3$	

*1 The connector to be mated.

3.3 Wiring connectors (connector configurations B/C/D/E)

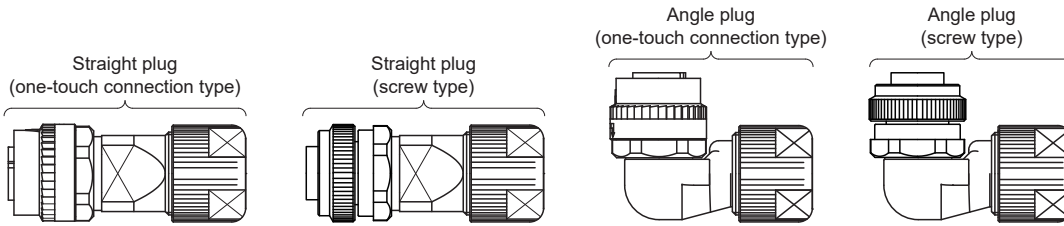

Connector configuration	Feature	Plug (DDK)					Rotary servo motor encoder connector *1	
		Type	Plug	Socket contact	Contact shape	Cable OD [mm] (reference)		
B	IP67	Straight	CMV1-SP10S-M1 (One-touch connection type) CMV1S-SP10S-M1 (Screw type)	CMV1-#22ASC-S1-100	Solder type Applicable wire size: AWG 20 or less	5.5 to 7.5	CMV1-R10P	
				CMV1-#22ASC-C1-100	Crimping type Applicable wire size: AWG 24 to 20 The crimping tool (357J-53162T) is required.			
				CMV1-#22ASC-C2-100	Crimping type Applicable wire size: AWG 28 to 24 The crimping tool (357J-53163T) is required.			
			CMV1-SP10S-M2 (One-touch connection type) CMV1S-SP10S-M2 (Screw type)	CMV1-#22ASC-S1-100	Solder type Applicable wire size: AWG 20 or less			7.0 to 9.0
				CMV1-#22ASC-C1-100	Crimping type Applicable wire size: AWG 24 to 20 The crimping tool (357J-53162T) is required.			
				CMV1-#22ASC-C2-100	Crimping type Applicable wire size: AWG 28 to 24 The crimping tool (357J-53163T) is required.			
		Angle	CMV1-AP10S-M1 (One-touch connection type) CMV1S-AP10S-M1 (Screw type)	CMV1-#22ASC-S1-100	Solder type Applicable wire size: AWG 20 or less	5.5 to 7.5		
				CMV1-#22ASC-C1-100	Crimping type Applicable wire size: AWG 24 to 20 The crimping tool (357J-53162T) is required.			
				CMV1-#22ASC-C2-100	Crimping type Applicable wire size: AWG 28 to 24 The crimping tool (357J-53163T) is required.			
			CMV1-AP10S-M2 (One-touch connection type) CMV1S-AP10S-M2 (Screw type)	CMV1-#22ASC-S1-100	Solder type Applicable wire size: AWG 20 or less			7.0 to 9.0
				CMV1-#22ASC-C1-100	Crimping type Applicable wire size: AWG 24 to 20 The crimping tool (357J-53162T) is required.			
				CMV1-#22ASC-C2-100	Crimping type Applicable wire size: AWG 28 to 24 The crimping tool (357J-53163T) is required.			

*1 The connector to be mated.

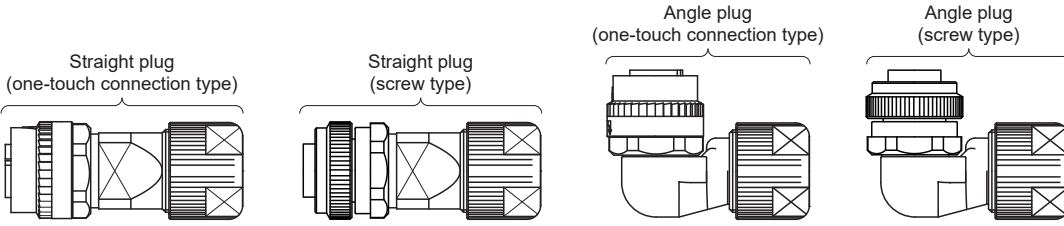

Connector configuration	Feature	Plug (DDK)					Rotary servo motor electromagnetic brake connector *1
		Type	Plug	Socket contact	Contact shape	Cable OD [mm] (reference)	
C	IP67	Straight	CMV1-SP2S-S (One-touch connection type) CMV1S-SP2S-S (Screw type)	CMV1-#22BSC-S2-100	Solder type Applicable wire size: AWG 16 or less	4.0 to 6.0	CMV1-R2P
				CMV1-#22BSC-C3-100	Crimping type Applicable wire size: AWG 20 to 16 The crimping tool (357J-53164T) is required.		
			CMV1-SP2S-M1 (One-touch connection type) CMV1S-SP2S-M1 (Screw type)	CMV1-#22BSC-S2-100	Solder type Applicable wire size: AWG 16 or less	5.5 to 7.5	
				CMV1-#22BSC-C3-100	Crimping type Applicable wire size: AWG 20 to 16 The crimping tool (357J-53164T) is required.		
			CMV1-SP2S-M2 (One-touch connection type) CMV1S-SP2S-M2 (Screw type)	CMV1-#22BSC-S2-100	Solder type Applicable wire size: AWG 16 or less	7.0 to 9.0	
				CMV1-#22BSC-C3-100	Crimping type Applicable wire size: AWG 20 to 16 The crimping tool (357J-53164T) is required.		
		CMV1-SP2S-L (One-touch connection type) CMV1S-SP2S-L (Screw type)	CMV1-#22BSC-S2-100	Solder type Applicable wire size: AWG 16 or less	9.0 to 11.6		
			CMV1-#22BSC-C3-100	Crimping type Applicable wire size: AWG 20 to 16 The crimping tool (357J-53164T) is required.			
		Angle	CMV1-AP2S-S (One-touch connection type) CMV1S-AP2S-S (Screw type)	CMV1-#22BSC-S2-100	Solder type Applicable wire size: AWG 16 or less	4.0 to 6.0	
				CMV1-#22BSC-C3-100	Crimping type Applicable wire size: AWG 20 to 16 The crimping tool (357J-53164T) is required.		
			CMV1-AP2S-M1 (One-touch connection type) CMV1S-AP2S-M1 (Screw type)	CMV1-#22BSC-S2-100	Solder type Applicable wire size: AWG 16 or less	5.5 to 7.5	
				CMV1-#22BSC-C3-100	Crimping type Applicable wire size: AWG 20 to 16 The crimping tool (357J-53164T) is required.		
			CMV1-AP2S-M2 (One-touch connection type) CMV1S-AP2S-M2 (Screw type)	CMV1-#22BSC-S2-100	Solder type Applicable wire size: AWG 16 or less	7.0 to 9.0	
				CMV1-#22BSC-C3-100	Crimping type Applicable wire size: AWG 20 to 16 The crimping tool (357J-53164T) is required.		
CMV1-AP2S-L (One-touch connection type) CMV1S-AP2S-L (Screw type)	CMV1-#22BSC-S2-100	Solder type Applicable wire size: AWG 16 or less	9.0 to 11.6				
	CMV1-#22BSC-C3-100	Crimping type Applicable wire size: AWG 20 to 16 The crimping tool (357J-53164T) is required.					

*1 The connector to be mated.

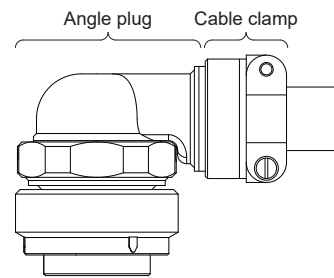
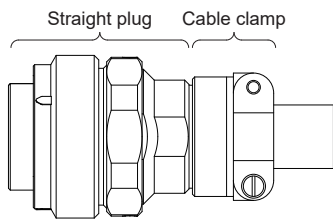

Connector configuration	Feature	Plug (JAE)		Cable clamp (JAE)		Rotary servo motor-side connector *2
		Type	Connector	Model *1	Cable OD [mm] (reference)	
D	IP67 EN compliant	One-touch connection type Straight	JL10-6A18-10SE-EB Applicable wire size: 3.5 mm ² (AWG 12) or less	JL04-18CK(10)-_-R	8 to 11	JL10-2E18-10PCE
				JL04-18CK(13)-_-R	11 to 14.1	
		One-touch connection type Angle	JL10-8A18-10SE-EB Applicable wire size: 3.5 mm ² (AWG 12) or less	JL04-18CK(10)-_-R	8 to 11	
				JL04-18CK(13)-_-R	11 to 14.1	
		Screw type Straight	JL04V-6A18-10SE-EB-R Applicable wire size: 3.5 mm ² (AWG 12) or less	JL04-18CK(10)-_-R	8 to 11	
				JL04-18CK(13)-_-R	11 to 14.1	
		Screw type Angle	JL04V-8A18-10SE-EBH-R Applicable wire size: 3.5 mm ² (AWG 12) or less	JL04-18CK(10)-_-R	8 to 11	
				JL04-18CK(13)-_-R	11 to 14.1	

*1 " _ " in the model names are replaced with the following symbols which designate the materials of the rubber bushing for the cable clamps:

Blank: nitrile rubber

CR: chloroprene rubber

EPDM: terpolymer rubber of ethylene, propylene, and dimethylene

*2 The connector to be mated.

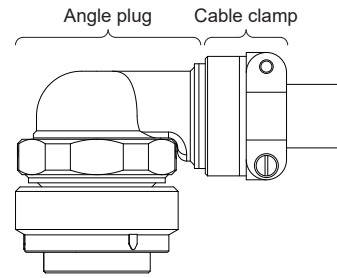
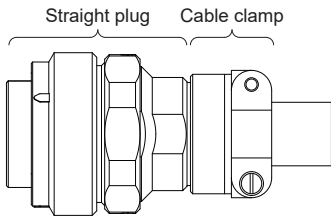

Connector configuration	Feature	Plug (JAE)		Cable clamp (JAE)		Rotary servo motor-side connector *2
		Type	Connector	Model *1	Cable OD [mm] (reference)	
E	IP67 EN compliant	One-touch connection type Straight	JL10-6A22-22SE-EB	JL04-2022CK(12)-_-R	9.5 to 13	JL10-2E22-22PCE
			Applicable wire size: 8 mm ² (AWG 8) or less	JL04-2022CK(14)-_-R	12.9 to 16	
		One-touch connection type Angle	JL10-8A22-22SE-EB	JL04-2022CK(12)-_-R	9.5 to 13	
			Applicable wire size: 8 mm ² (AWG 8) or less	JL04-2022CK(14)-_-R	12.9 to 16	
		Screw type Straight	JL04V-6A22-22SE-EB-R	JL04-2022CK(12)-_-R	9.5 to 13	
			Applicable wire size: 8 mm ² (AWG 8) or less	JL04-2022CK(14)-_-R	12.9 to 16	
		Screw type Angle	JL04V-8A22-22SE-EBH-R	JL04-2022CK(12)-_-R	9.5 to 13	
			Applicable wire size: 8 mm ² (AWG 8) or less	JL04-2022CK(14)-_-R	12.9 to 16	

*1 " _ " in the model names are replaced with the following symbols which designate the materials of the rubber bushing for the cable clamps:

Blank: nitrile rubber

CR: chloroprene rubber

EPDM: terpolymer rubber of ethylene, propylene, and dimethylene

*2 The connector to be mated.

4 CONNECTING THE SERVO AMPLIFIER AND ROTARY SERVO MOTOR

Precautions

- Insulate the conductive parts of the terminals.
- To prevent unexpected operation of the rotary servo motor, wire the equipment correctly and securely.
- Make sure to connect the cables and connectors by using the fixing screws and the locking mechanism. Failing to do so may cause the cables and connectors to disconnect during operation.
- To prevent abnormal operation and malfunction, connect the servo amplifier power outputs (U/V/W) to the rotary servo motor power inputs (U/V/W) directly. Do not connect a magnetic contactor or the like between the servo amplifier power output and the rotary servo motor power input.

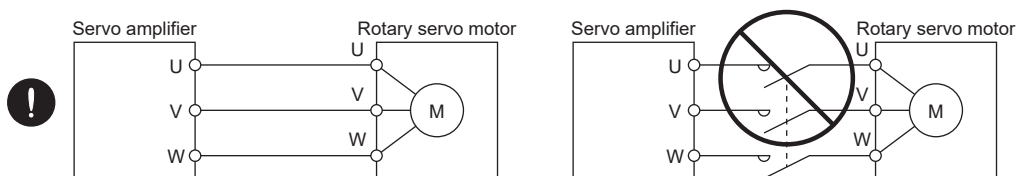

- To prevent a malfunction, do not connect the AC power supply directly to the rotary servo motor.
- When the wires are not properly secured to the terminal block, the wires or terminal block may generate heat because of the poor contact. Be sure to secure the wires with the specified torque.
- Use the rotary servo motor with the specified servo amplifier.
- Do not modify the equipment.
- To prevent malfunction, eliminate static electricity before wiring, switch operation, or similar operations.
- To prevent failure and malfunction, only the power/signal specified in the user's manual should be connected to each terminal.
- We recommend using HIV wires to connect the servo amplifier to the rotary servo motor. Therefore, the recommended wire sizes may be different from those of the wires used for previous generation rotary servo motors.

4.1 Precautions for wiring

To ground the servo motor, connect the grounding lead wire to the servo amplifier, then connect the wire from the servo amplifier to the ground via the protective earth (PE) terminal of the cabinet. Do not connect the wire directly to the protective earth (PE) terminal of the cabinet.

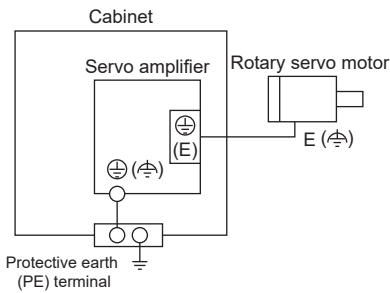

Precautions

- Do not install a power capacitor, surge killer, or radio noise filter (optional FR-BIF(-H)) on the servo amplifier output side.
- To avoid a malfunction, connect the wires to the correct phase terminals (U/V/W) of the servo amplifier and the rotary servo motor.
- Do not use the 24 V DC interface power supply for the electromagnetic brake. To prevent malfunction, use the power supply designed exclusively for the electromagnetic brake.
- For encoder cable selection, refer to the following.

📖 Page 59 WIRING OPTION

- For the selection of a surge absorber for the electromagnetic brake, refer to the chapter of the applicable rotary servo motor series.

4.2 Wiring

To wire to the servo amplifier, use connectors packed with the servo amplifier or optional connectors.

For connectors of the MR-J5-_/MR-J5W_-_, refer to "Wiring CNP1, CNP2, and CNP3" in the following manual.

📖MR-J5 User's Manual (Hardware)

For connectors of the MR-J5D_-_, refer to "Wiring CNP3" in the following manual.

📖MR-J5D User's Manual (Hardware)

HK-KT series/HK-MT series/HK-RT (1.0 kW - 2.0 kW) series

Servo amplifier	Cable type	Cable length	Electromagnetic brake cable	IP rating with extension cable	Connection diagram	
1-axis	Dual cable	10 m or less	○	—	Connection diagram 1	
			×	—	Connection diagram 2	
		Longer than 10 m	○	IP20	Connection diagram 3	
			×	IP65	Connection diagram 4	
	Single cable	10 m or less	○	IP20	Connection diagram 5	
			×	IP65	Connection diagram 6	
		Longer than 10 m	○	IP20	Connection diagram 7	
			×	IP65	Connection diagram 8	
Multi axis	Dual cable	10 m or less	○	—	Connection diagram 9	
			×	—	Connection diagram 10	
		Longer than 10 m	○	IP20	Connection diagram 11	
			×	IP65	Connection diagram 12	
		Single cable	10 m or less	○	IP20	Connection diagram 13
				×	IP65	Connection diagram 14
	Longer than 10 m		○	—	Connection diagram 15	
			×	—	Connection diagram 16	

Connection diagram 1

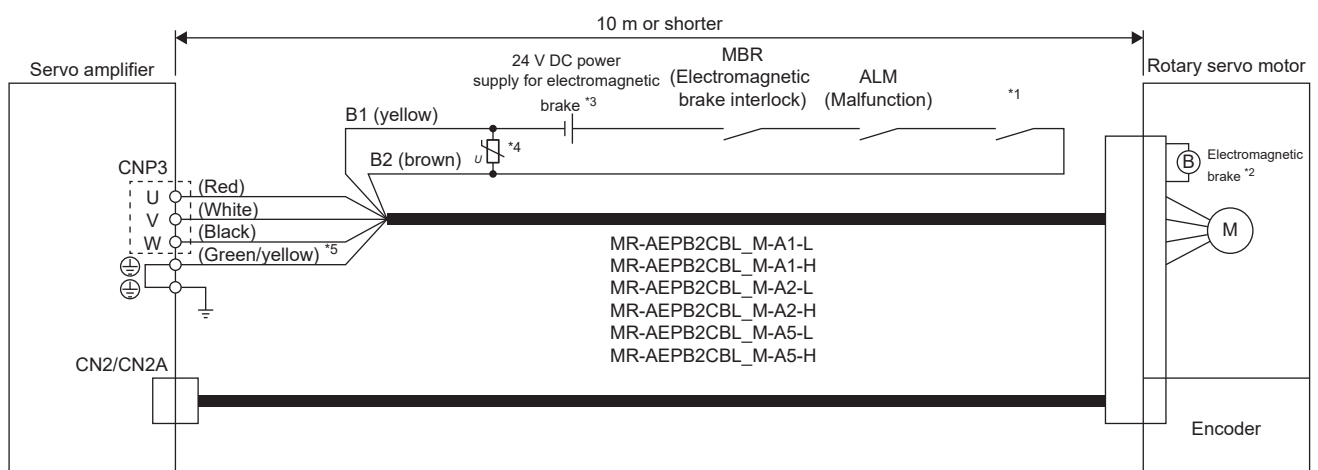

*1 Configure a circuit which interlocks with an emergency stop switch to shut off.

*2 The electromagnetic brake terminals (B1 and B2) have no polarity.

*3 Do not use the 24 V DC interface power supply for the electromagnetic brake.

*4 Connect a surge absorber as close to the rotary servo motor as possible.

*5 For the MR-J5D1-_, connect the wire to "E" of CNP3.

Connection diagram 2

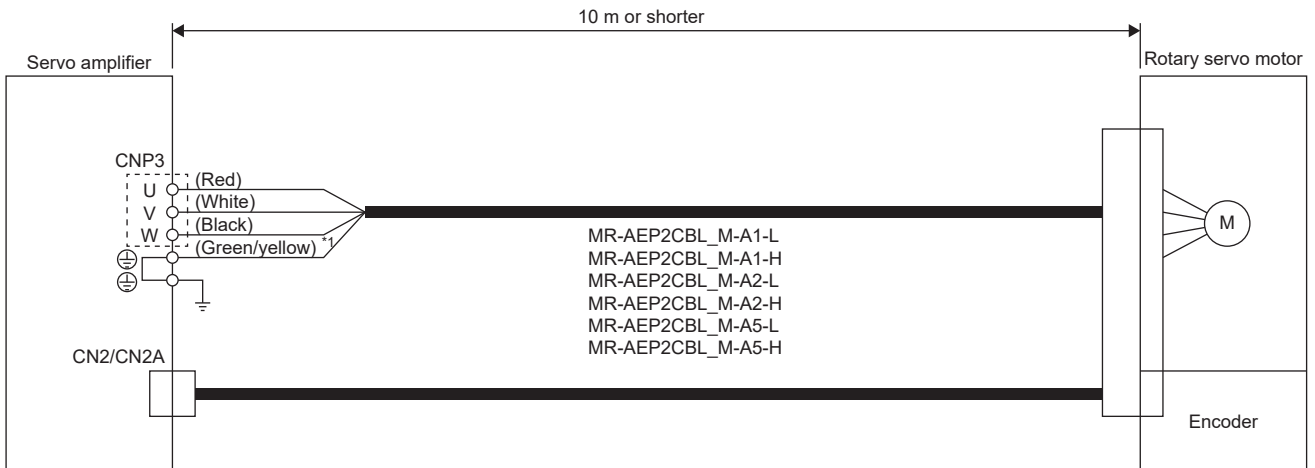

*1 For the MR-J5D1-_, connect the wire to "E" of CNP3.

Connection diagram 3

Fabricate an extension cable as shown below.

Refer to the following for the wires used for the extension cable.

☞ Page 56 Selection example of wires

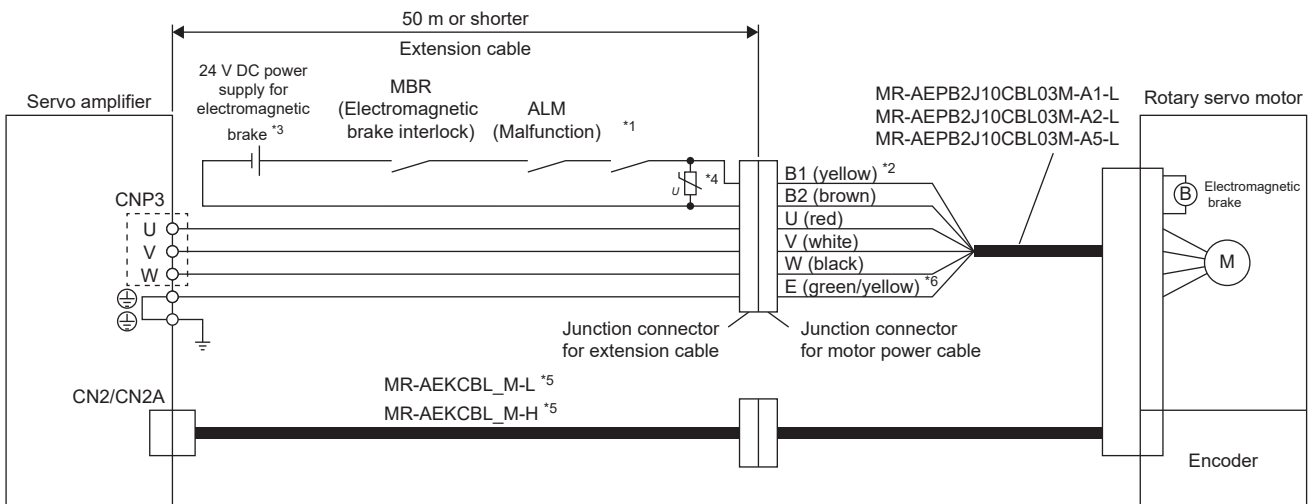

*1 Configure a circuit which interlocks with an emergency stop switch to shut off.

*2 The electromagnetic brake terminals (B1 and B2) have no polarity.

*3 Do not use the 24 V DC interface power supply for the electromagnetic brake.

*4 Connect a surge absorber as close to the rotary servo motor as possible.

*5 For MR-AEKCBL_M-_, refer to the following.

☞ Page 81 MR-AEKCBL_M-_

*6 For the MR-J5D1-_, connect the wire to "E" of CNP3.

Connection diagram 4

Fabricate an extension cable as shown below.

Refer to the following for the wires used for the extension cable.

☞ Page 56 Selection example of wires

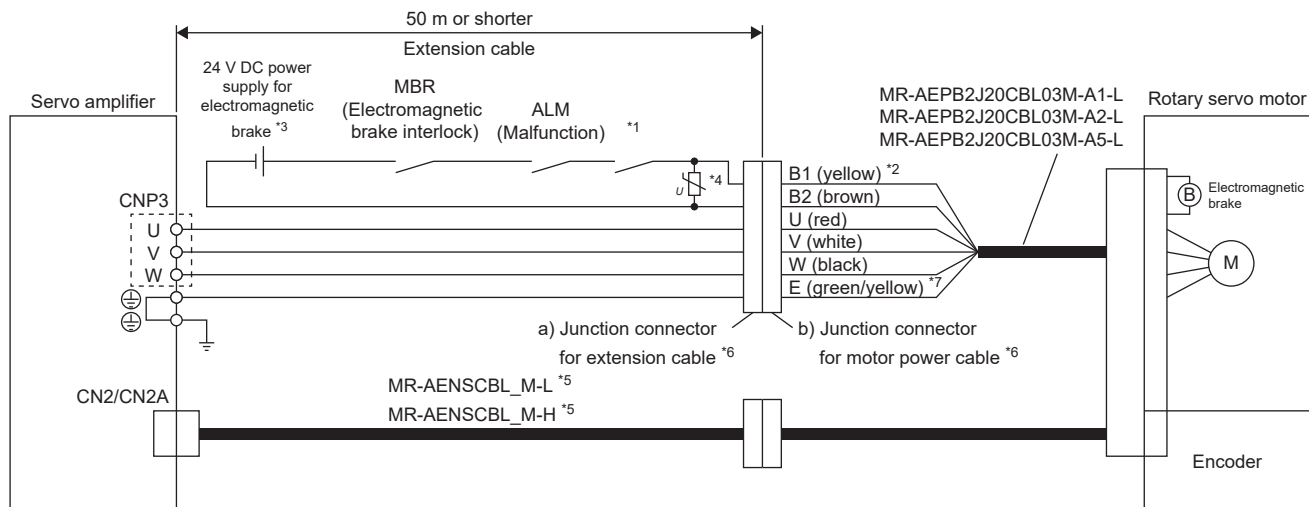

*1 Configure a circuit which interlocks with an emergency stop switch to shut off.

*2 The electromagnetic brake terminals (B1 and B2) have no polarity.

*3 Do not use the 24 V DC interface power supply for the electromagnetic brake.

*4 Connect a surge absorber as close to the rotary servo motor as possible.

*5 For MR-AENSCBL_M-_, refer to the following.

☞ Page 84 MR-AENSCBL_M-_

*6 Use of the following connectors is recommended:

Junction connector	Description	IP rating
a) Junction connector for extension cable	Connector: CE05-6A22-23SD-D-BSS Cord clamp: CE3057-12A-2-D (DDK Ltd.) The number varies depending on the cable OD.	IP67
b) Junction connector for motor power cable	Connector: D/MS3101A22-23P(D263) Backshell: CE02-22BS-S-D Cord clamp: CE3057-12A-3-D (DDK Ltd.) The number varies depending on the cable OD.	IP67

*7 For the MR-J5D1-_, connect the wire to "E" of CNP3.

Connection diagram 5

Fabricate an extension cable as shown below.

Refer to the following for the wires used for the extension cable.

☞ Page 56 Selection example of wires

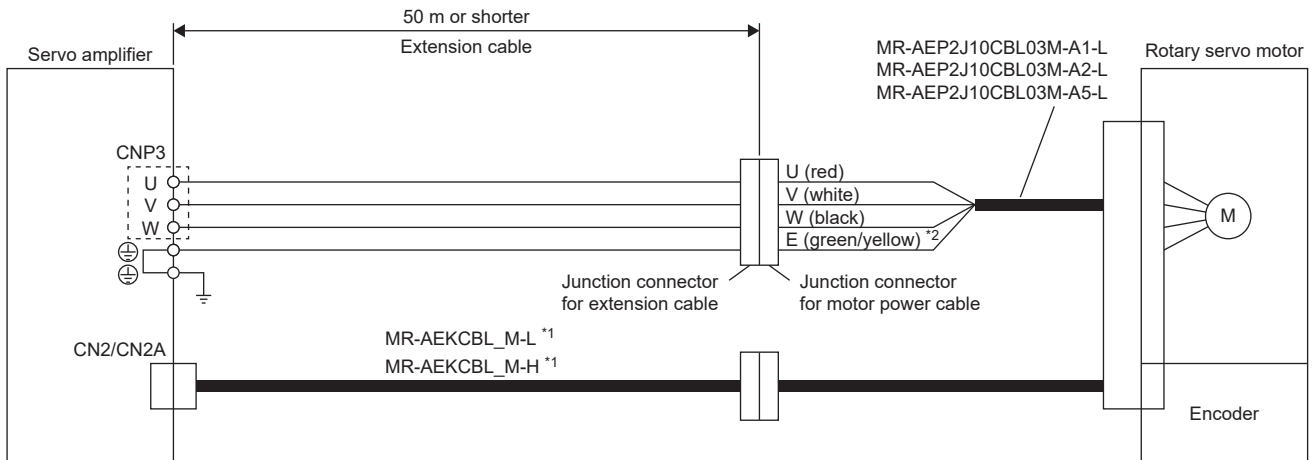

*1 For MR-AEKCBL_M_, refer to the following.

☞ Page 81 MR-AEKCBL_M_

*2 For the MR-J5D1_, connect the wire to "E" of CNP3.

Connection diagram 6

Fabricate an extension cable as shown below.

Refer to the following for the wires used for the extension cable.

☞ Page 56 Selection example of wires

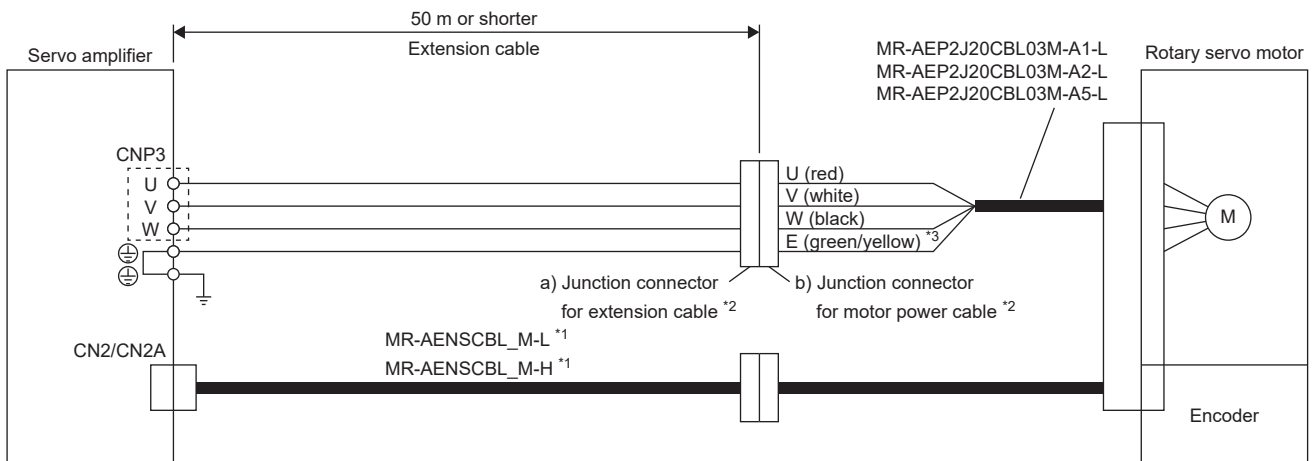

*1 For MR-AENSCBL_M_, refer to the following.

☞ Page 84 MR-AENSCBL_M_

*2 Use of the following connectors is recommended:

Junction connector	Description	IP rating
a) Junction connector for extension cable	Connector: CE05-6A18-10SD-D-BSS Cord clamp: CE3057-10A-2-D (DDK Ltd.) The number varies depending on the cable OD.	IP67
b) Junction connector for motor power cable	Connector: D/MS3101A18-10P(D263) Backshell: CE02-18BS-S-D Cord clamp: CE3057-10A-3-D (DDK Ltd.) The number varies depending on the cable OD.	IP67

*3 For the MR-J5D1_, connect the wire to "E" of CNP3.

Connection diagram 7

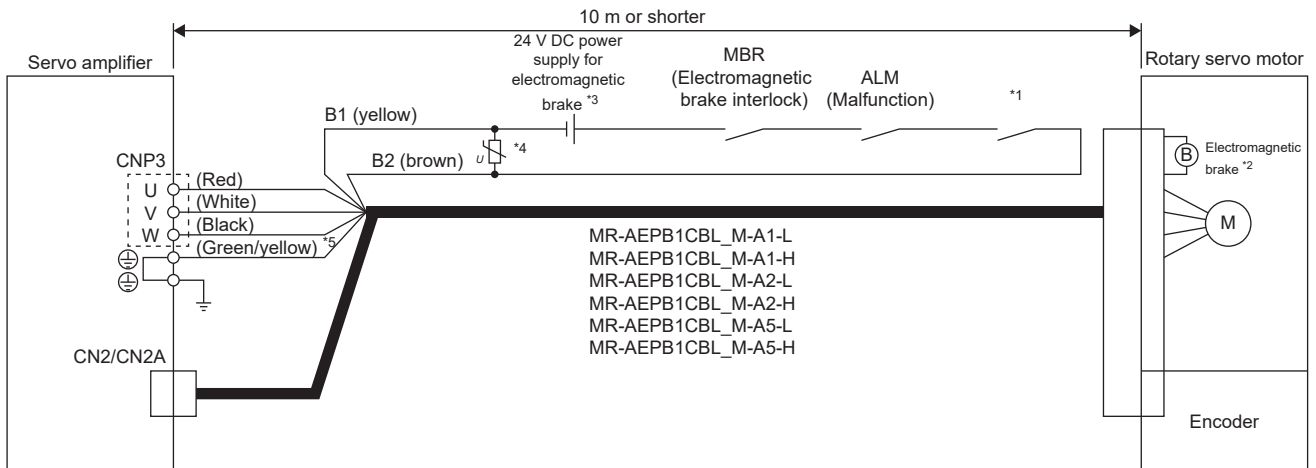

- *1 Configure a circuit which interlocks with an emergency stop switch to shut off.
- *2 The electromagnetic brake terminals (B1 and B2) have no polarity.
- *3 Do not use the 24 V DC interface power supply for the electromagnetic brake.
- *4 Connect a surge absorber as close to the rotary servo motor as possible.
- *5 For the MR-J5D1-_, connect the wire to "E" of CNP3.

Connection diagram 8

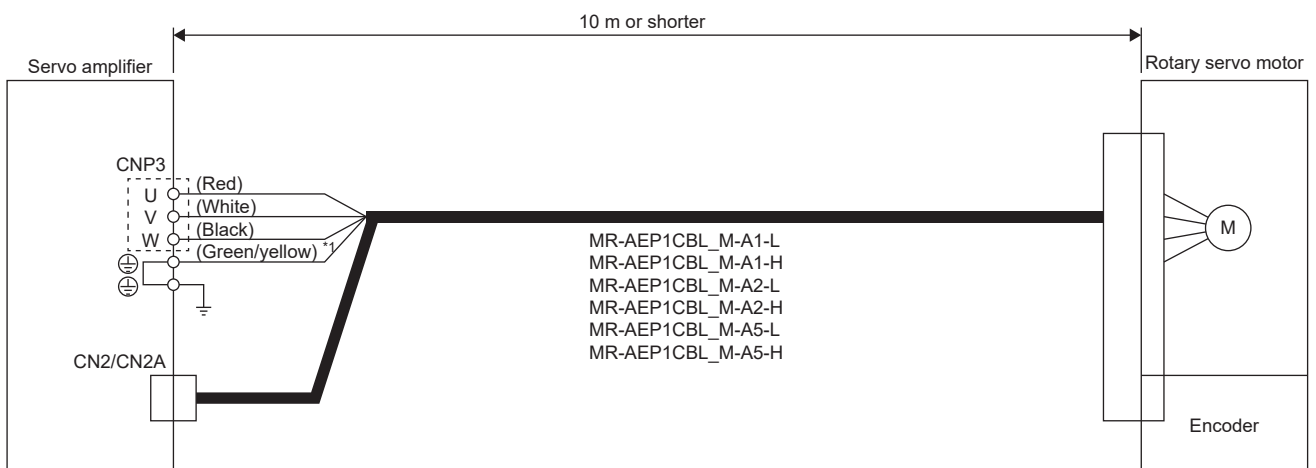

- *1 For the MR-J5D1-_, connect the wire to "E" of CNP3.

Connection diagram 9

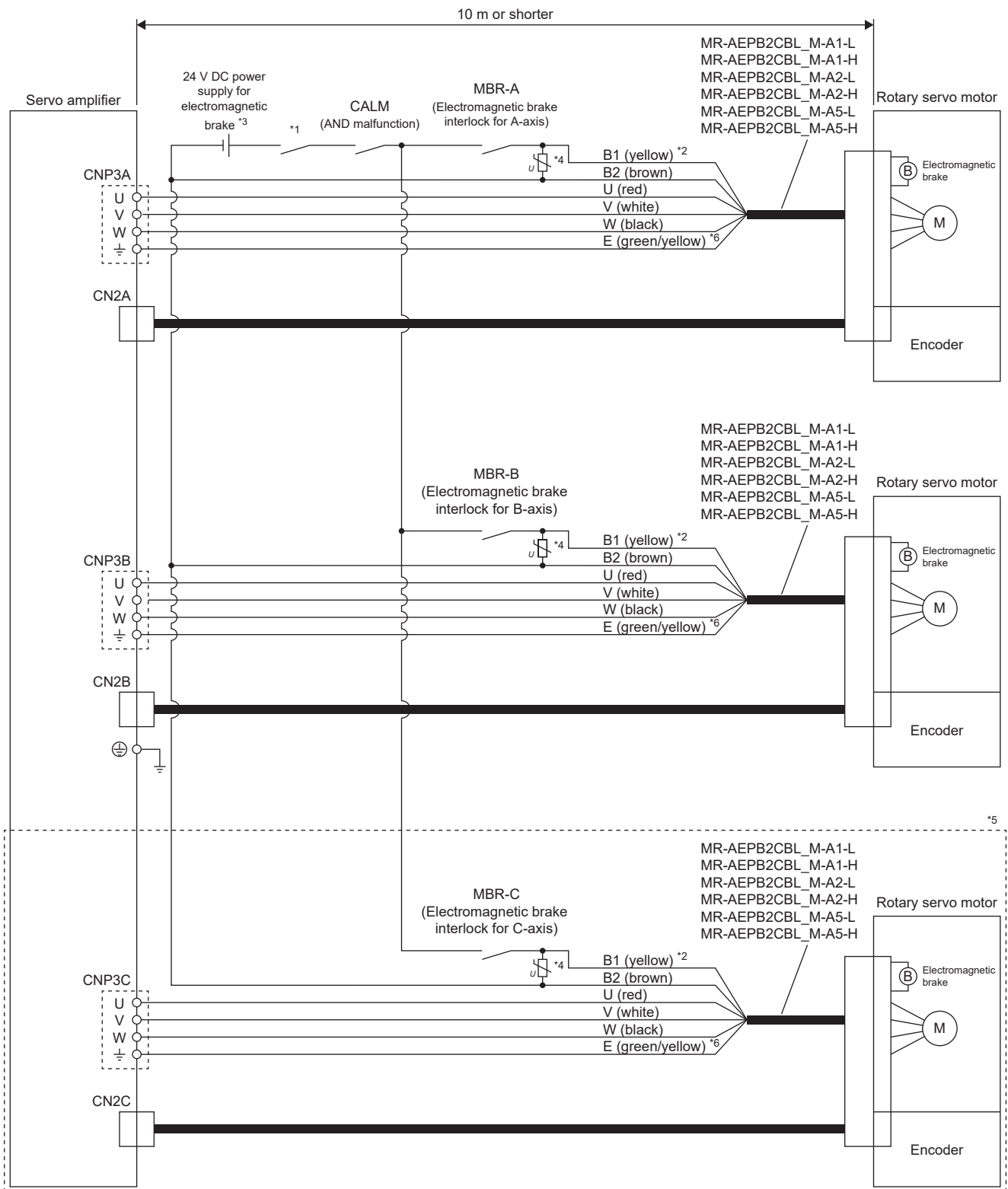

*1 Configure a circuit which interlocks with an emergency stop switch to shut off.

*2 The electromagnetic brake terminals (B1 and B2) have no polarity.

*3 Do not use the 24 V DC interface power supply for the electromagnetic brake.

*4 Connect a surge absorber as close to the rotary servo motor as possible.

*5 This connection is for the MR-J5W3- and MR-J5D3-.

*6 For the MR-J5D1-, connect the wire to "E" of CNP3.

Connection diagram 10

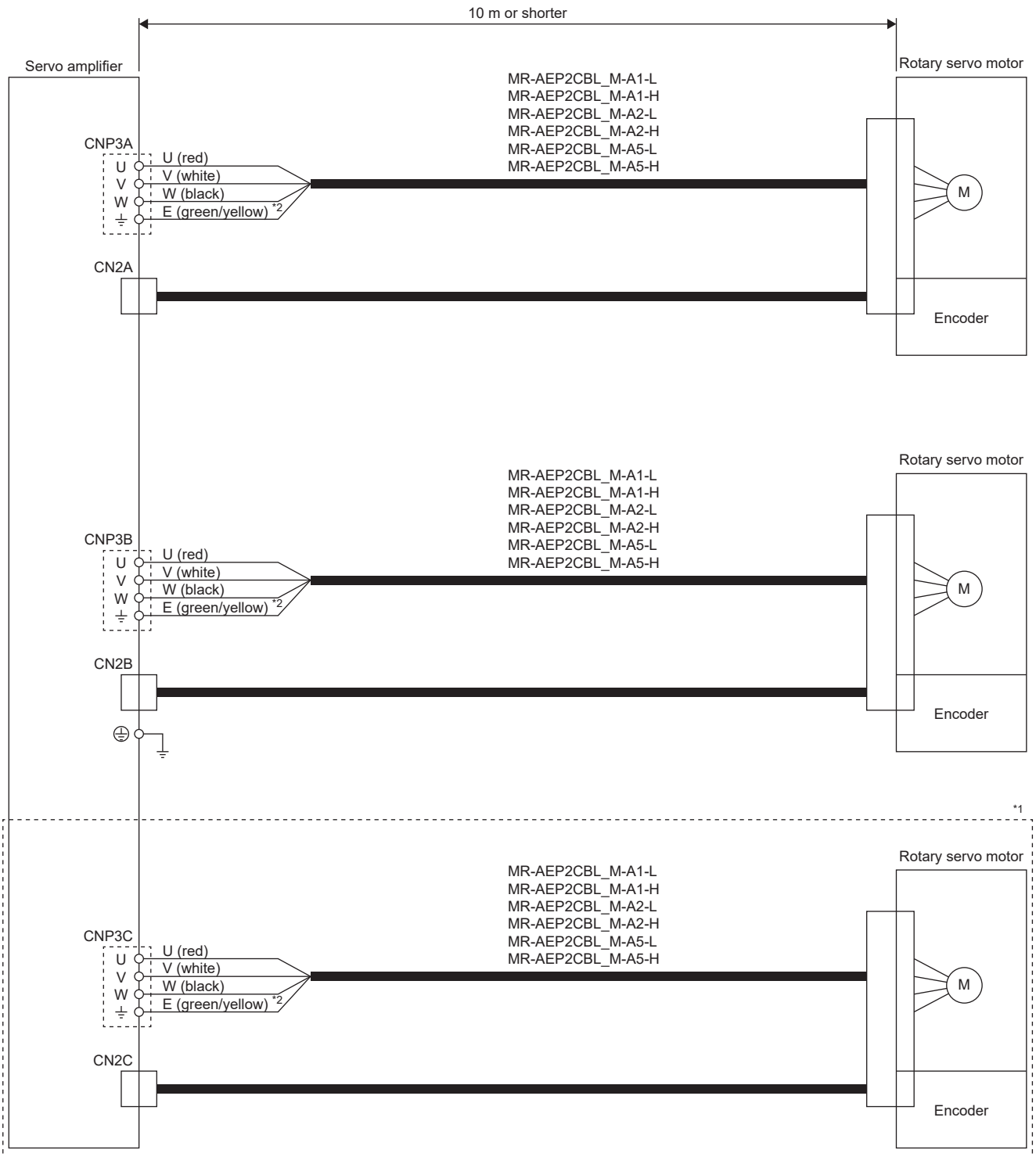

*1 This connection is for the MR-J5W3- and MR-J5D3-.

*2 For the MR-J5D1-, connect the wire to "E" of CNP3.

Connection diagram 11

Fabricate an extension cable as shown below.

Refer to the following for the wires used for the extension cable.

☞ Page 56 Selection example of wires

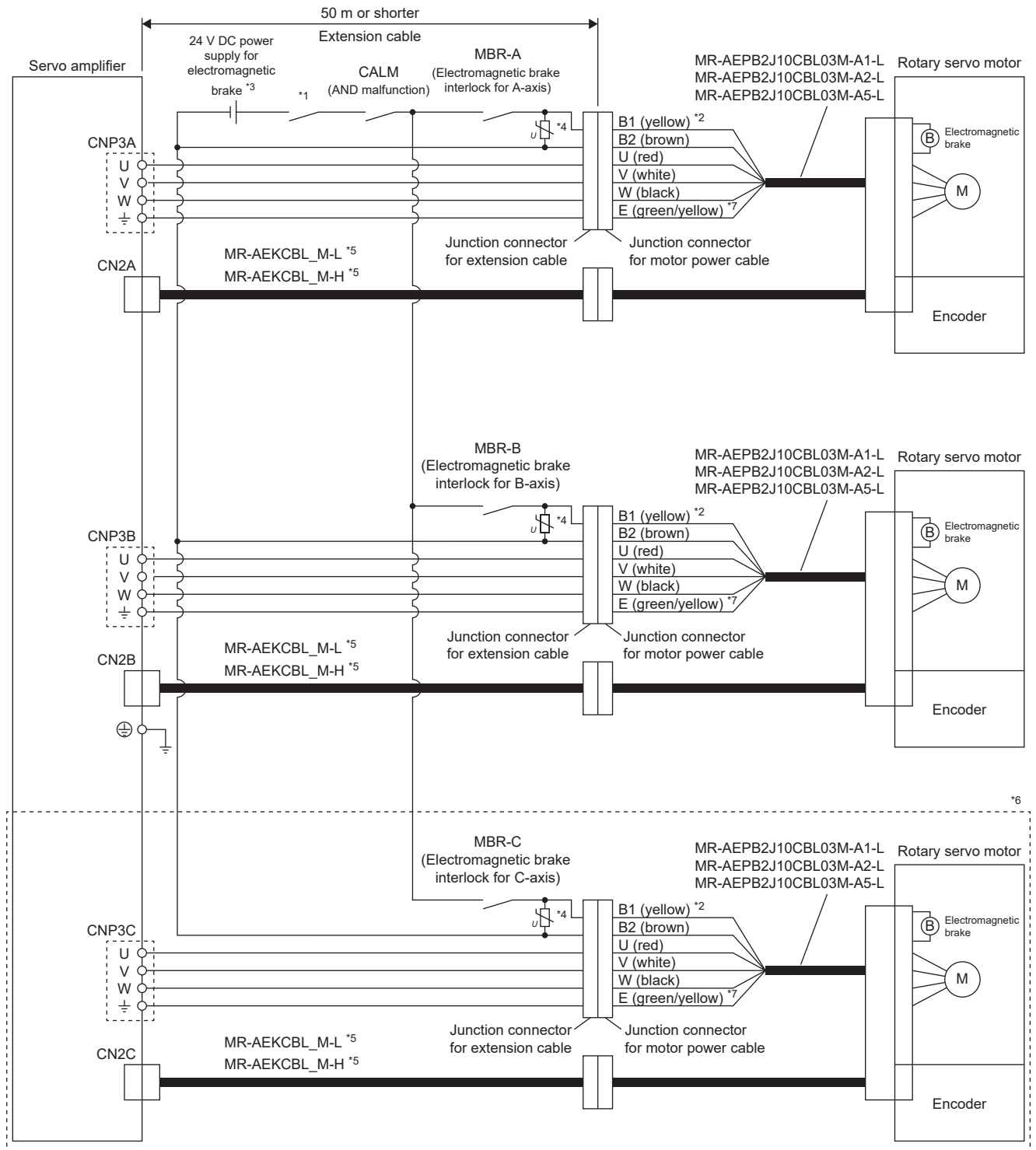

*1 Configure a circuit which interlocks with an emergency stop switch to shut off.

*2 The electromagnetic brake terminals (B1 and B2) have no polarity.

*3 Do not use the 24 V DC interface power supply for the electromagnetic brake.

*4 Connect a surge absorber as close to the rotary servo motor as possible.

*5 For MR-AEKCBL_M-_, refer to the following.

☞ Page 81 MR-AEKCBL_M-_

*6 This connection is for the MR-J5W3-_ and MR-J5D3-_.

*7 For the MR-J5D1-_, connect the wire to "E" of CNP3.

Connection diagram 12

Fabricate an extension cable as shown below.

Refer to the following for the wires used for the extension cable.

☞ Page 56 Selection example of wires

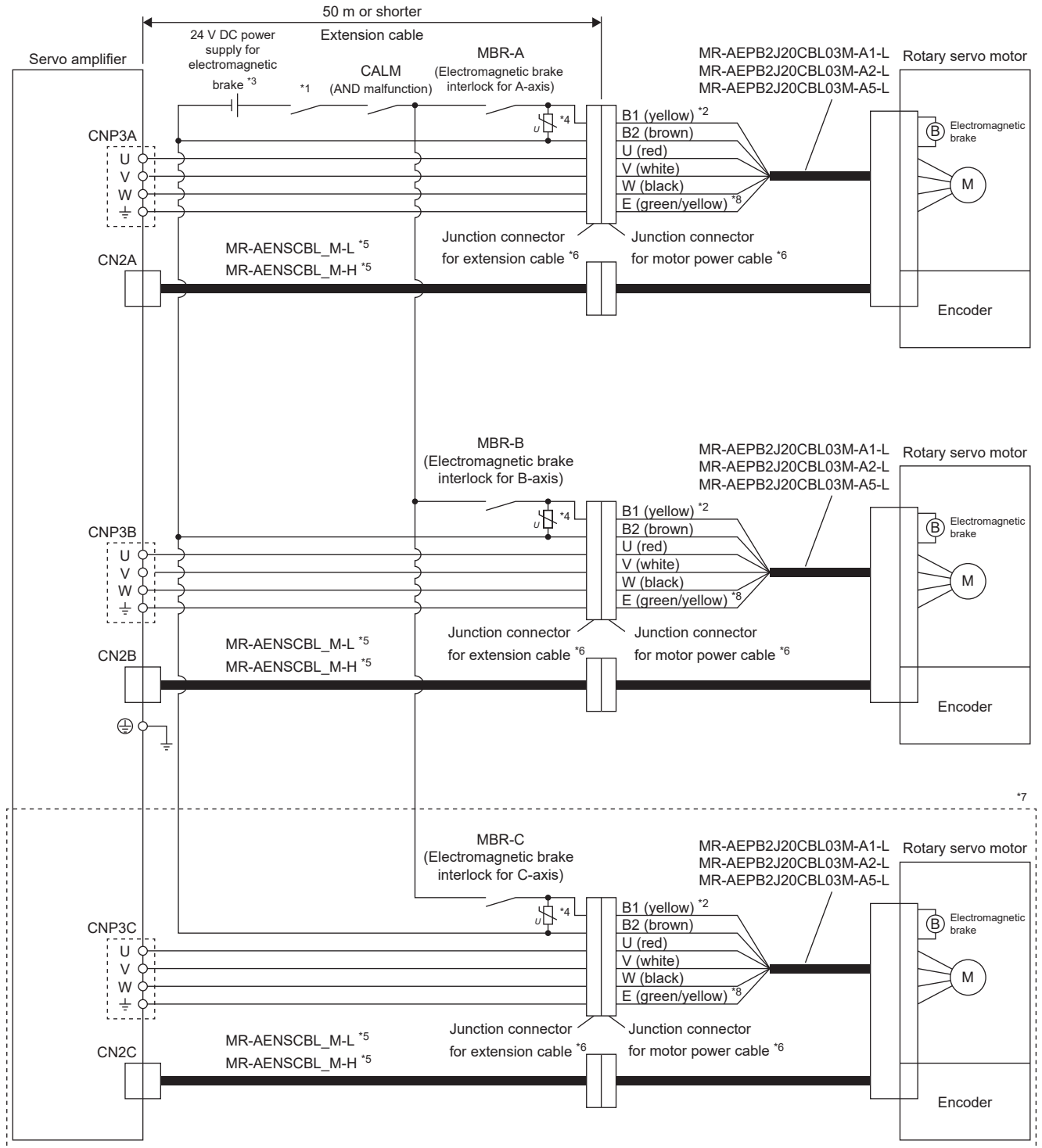

- *1 Configure a circuit which interlocks with an emergency stop switch to shut off.
- *2 The electromagnetic brake terminals (B1 and B2) have no polarity.
- *3 Do not use the 24 V DC interface power supply for the electromagnetic brake.
- *4 Connect a surge absorber as close to the rotary servo motor as possible.
- *5 For MR-AENSCBL_M-_, refer to the following.
 Page 84 MR-AENSCBL_M-_
- *6 Use of the following connectors is recommended:

Junction connector	Description	IP rating
a) Junction connector for extension cable	Connector: CE05-6A22-23SD-D-BSS Cord clamp: CE3057-12A-2-D (DDK Ltd.) _____ The number varies depending on the cable OD.	IP67
b) Junction connector for motor power cable	Connector: D/MS3101A22-23P(D263) Backshell: CE02-22BS-S-D Cord clamp: CE3057-12A-3-D (DDK Ltd.) _____ The number varies depending on the cable OD.	IP67

- *7 This connection is for the MR-J5W3-_ and MR-J5D3-_.
- *8 For the MR-J5D1-_, connect the wire to "E" of CNP3.

Connection diagram 13

Fabricate an extension cable as shown below.

Refer to the following for the wires used for the extension cable.

☞ Page 56 Selection example of wires

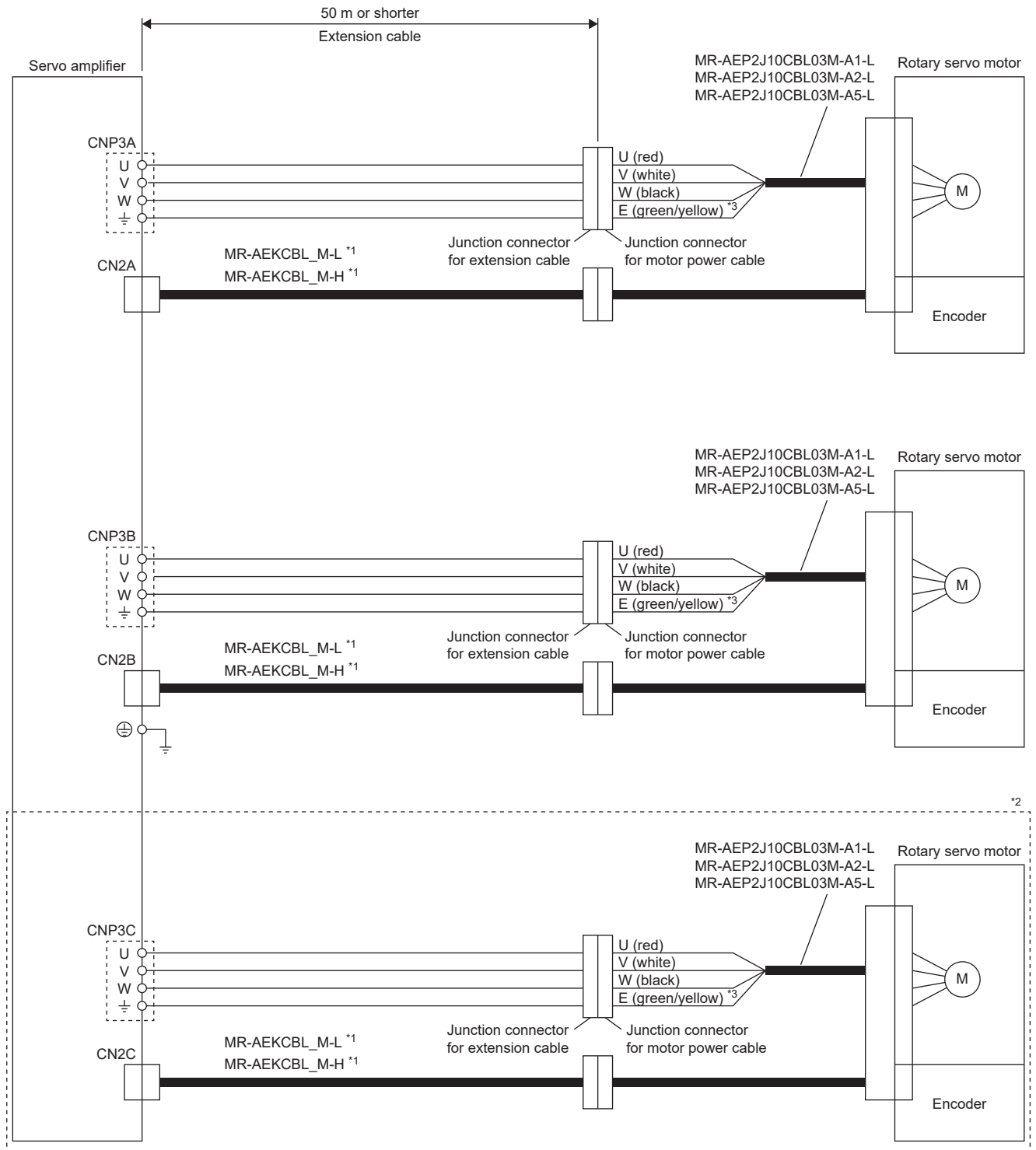

*1 For MR-AEKCBL_M-_, refer to the following.

☞ Page 81 MR-AEKCBL_M-_

*2 This connection is for the MR-J5W3-_ and MR-J5D3-_.

*3 For the MR-J5D1-_, connect the wire to "E" of CNP3.

Connection diagram 14

Fabricate an extension cable as shown below.

Refer to the following for the wires used for the extension cable.

☞ Page 56 Selection example of wires

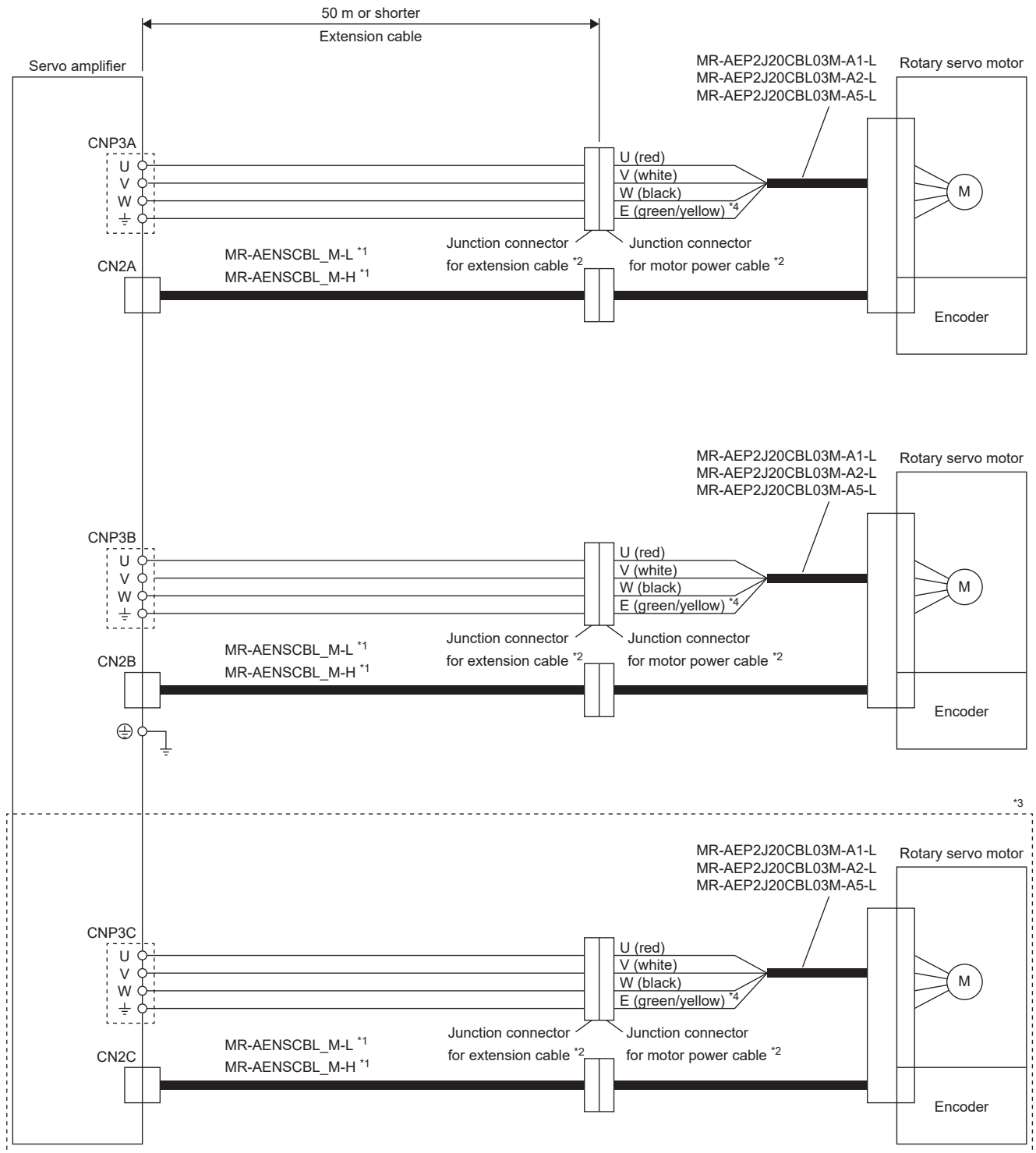

*1 For MR-AENSCBL_M-_, refer to the following.

☞ Page 84 MR-AENSCBL_M-_

*2 Use of the following connectors is recommended:

Junction connector	Description	IP rating
a) Junction connector for extension cable	Connector: CE05-6A18-10SD-D-BSS Cord clamp: CE3057-10A-2-D (DDK Ltd.) \perp The number varies depending on the cable OD.	IP67
b) Junction connector for motor power cable	Connector: D/MS3101A18-10P(D263) Backshell: CE02-18BS-S-D Cord clamp: CE3057-10A-3-D (DDK Ltd.) \perp The number varies depending on the cable OD.	IP67

*3 This connection is for the MR-J5W3-_ and MR-J5D3-_.

*4 For the MR-J5D1-_, connect the wire to "E" of CNP3.

Connection diagram 15

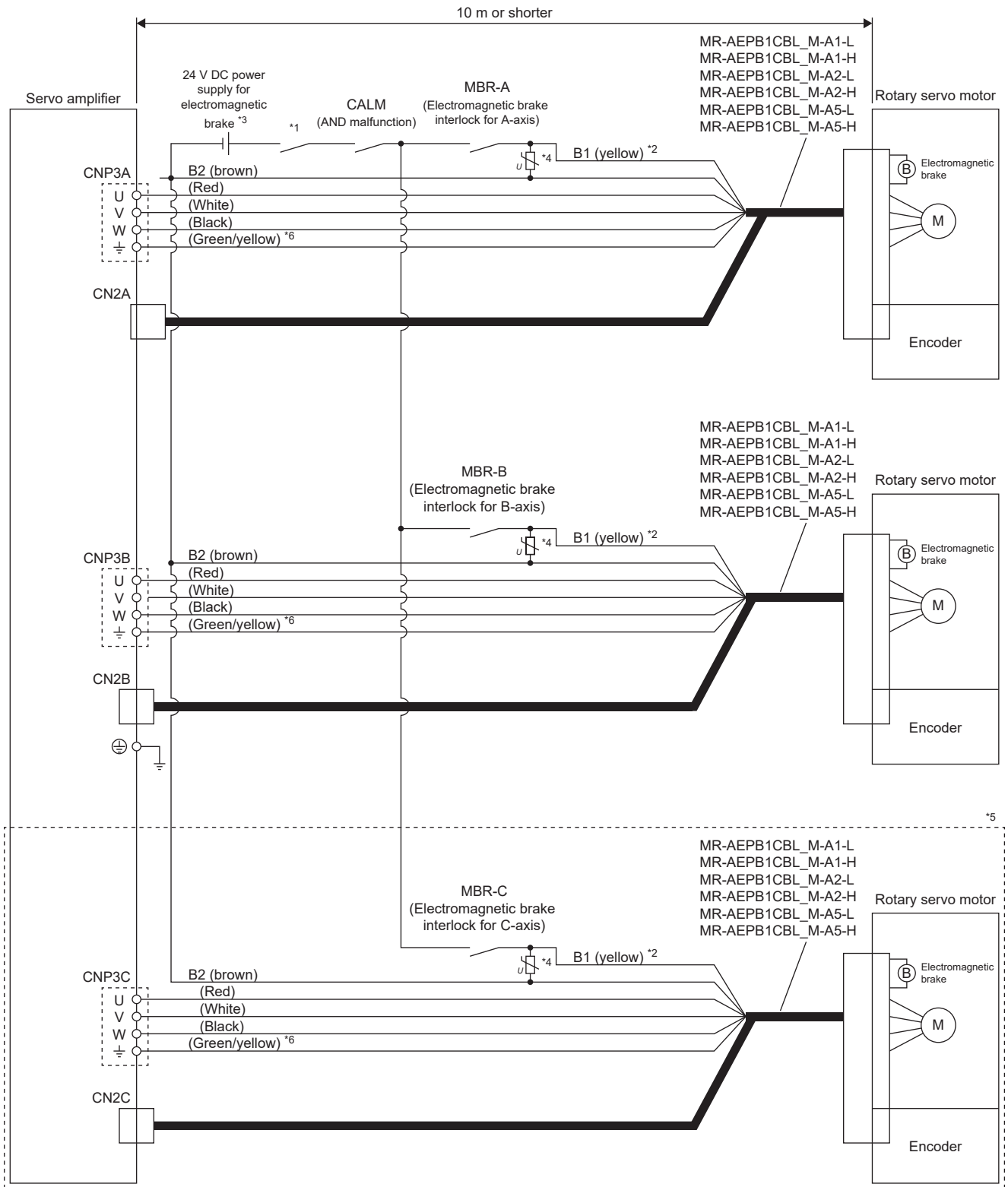

*1 Configure a circuit which interlocks with an emergency stop switch to shut off.

*2 The electromagnetic brake terminals (B1 and B2) have no polarity.

*3 Do not use the 24 V DC interface power supply for the electromagnetic brake.

*4 Connect a surge absorber as close to the rotary servo motor as possible.

*5 This connection is for the MR-J5W3- and MR-J5D3-.

*6 For the MR-J5D1-, connect the wire to "E" of CNP3.

Connection diagram 16

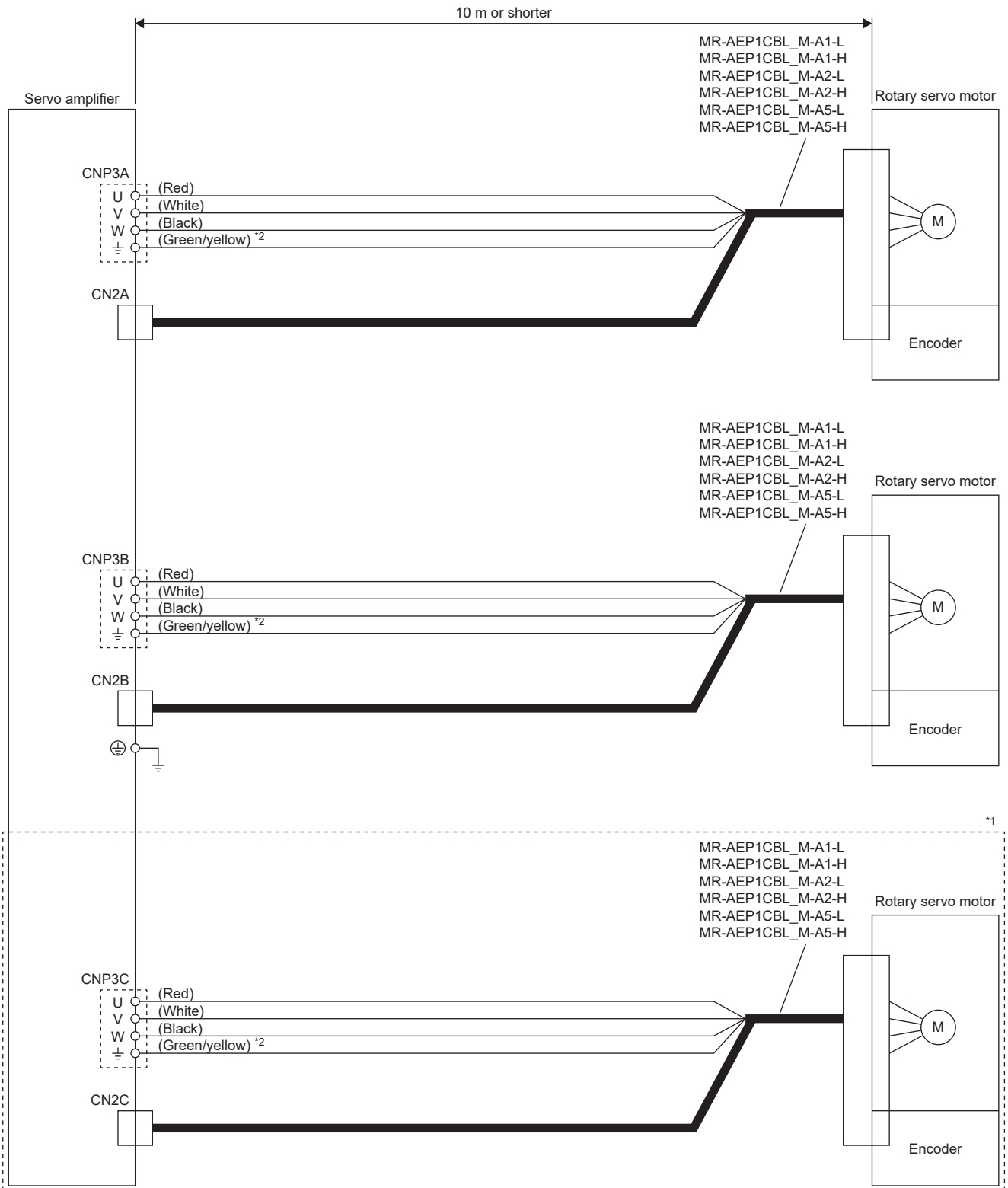

^{*1} This connection is for the MR-J5W3- and MR-J5D3-.

^{*2} For the MR-J5D1-, connect the wire to "E" of CNP3.

HK-ST series/HK-RT (3.5 kW - 7.0 kW) series

Refer to the following for the wires used for wiring.

☞ Page 56 Selection example of wires

Wiring diagram

■Connecting with a 1-axis servo amplifier

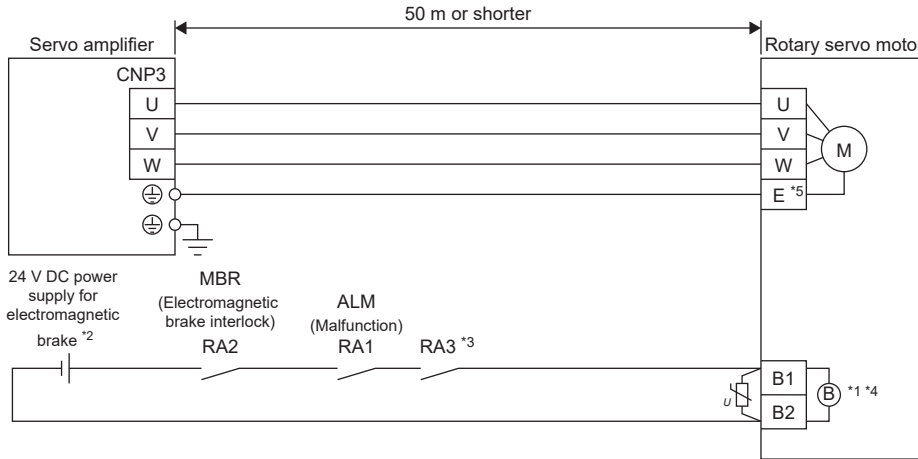

*1 The electromagnetic brake terminals (B1 and B2) have no polarity.

*2 Do not use the 24 V DC interface power supply for the electromagnetic brake.

*3 Configure a circuit which interlocks with an emergency stop switch to shut off.

*4 Some rotary servo motors do not have an electromagnetic brake. Refer to the chapter of the applicable rotary servo motor series.

*5 For the MR-J5D1-_, connect the wire to "E" of CNP3.

■Connecting with a multi-axis servo amplifier

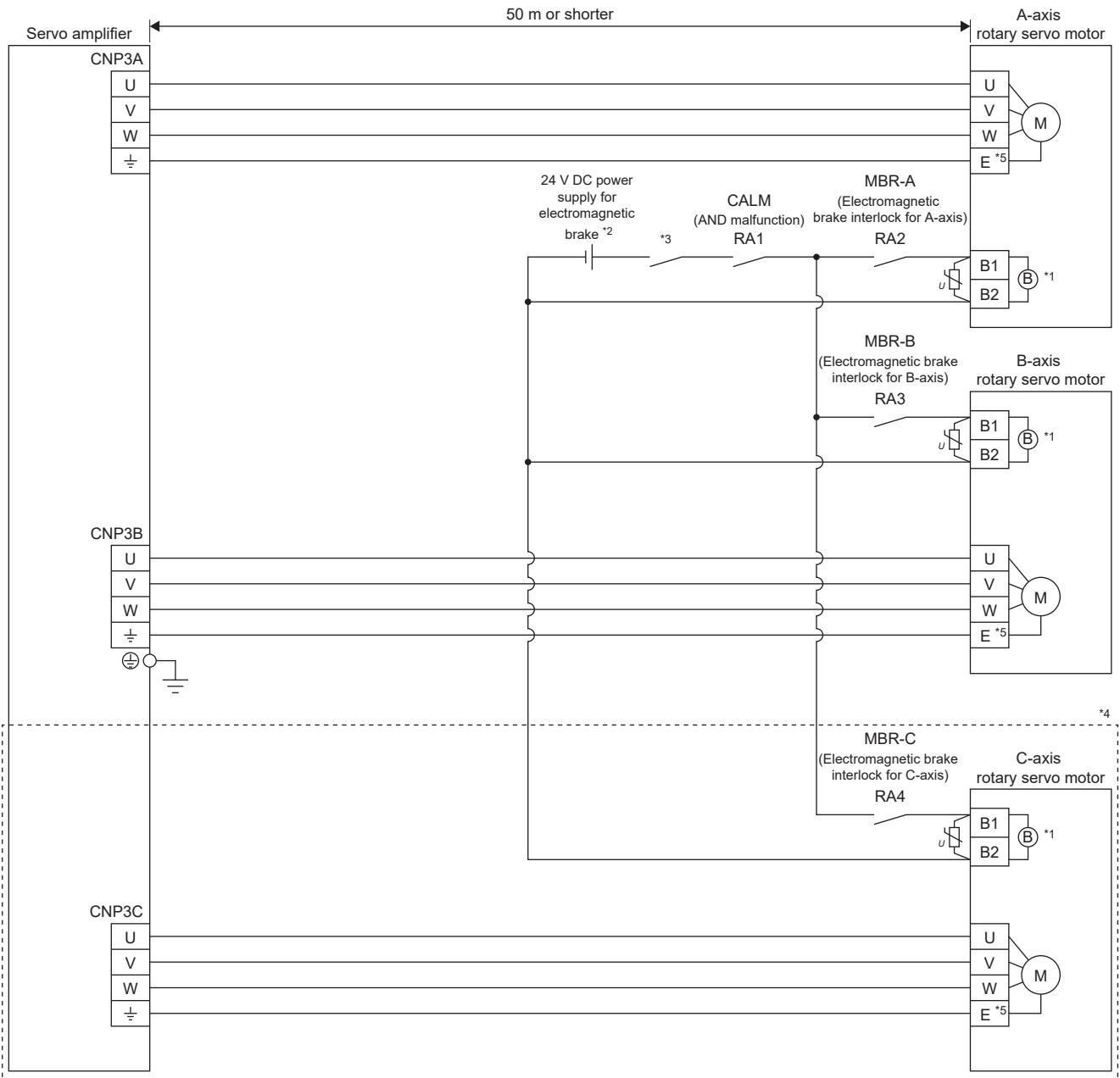

*1 The electromagnetic brake terminals (B1 and B2) have no polarity.

*2 Do not use the 24 V DC interface power supply for the electromagnetic brake.

*3 Configure a circuit which interlocks with an emergency stop switch to shut off.

*4 This connection is for the MR-J5W3- and MR-J5D3-.

*5 For the MR-J5D1- , connect the wire to "E" of CNP3.

Rotary servo motor terminal section

The rotary servo motor terminal section is shown in the following table.

Refer to the following for the details of the connectors.

☞ Page 54 Details of the rotary servo motor connectors

The connector fitting the rotary servo motor is prepared as options.

Refer to the following for details of the options.

☞ Page 59 WIRING OPTION

For types other than those prepared as options, refer to the following.

☞ Page 27 CONNECTORS USED FOR ROTARY SERVO MOTOR WIRING

■HK-ST series/HK-RT (3.5 kW - 7.0 kW) series

Rotary servo motor	Rotary servo motor terminal section		
	Encoder	Power supply	Electromagnetic brake
HK-ST52(4)W HK-ST102(4)W HK-ST172(4)W HK-ST202(4)AW HK-ST302(4)W HK-ST353(4)W HK-ST503(4)W	Connector A *1	Connector B *1	Connector D *1
HK-ST7M2UW HK-ST172UW HK-ST202(4)W HK-ST352(4)W HK-ST502(4)W HK-ST702(4)W		Connector C	
HK-RT353(4)W HK-RT503(4)W HK-RT703(4)W			

*1 Connectors used for the geared servo motor HK-ST152(4)_ are the same as those for the HK-ST172(4)W.

Details of the rotary servo motor connectors

The following figures show the encoder connector, power connector, and electromagnetic brake connector which are viewed from the connection side.

■Connector A

Encoder connector

CMV1-R10P

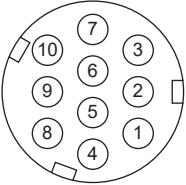

Terminal No.	Signal
1	MR
2	MRR
3	—
4	—
5	LG
6	—
7	—
8	P5
9	—
10	SHD

■Connector B

Power connector

JL10-2E18-10PCE

(MS3102A18-10P)

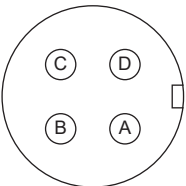

Terminal No.	Signal
A	U
B	V
C	W
D	E

■Connector C

Power connector
JL10-2E22-22PCE
(MS3102A22-22P)

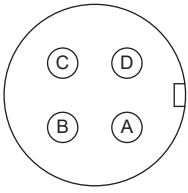

Terminal No.	Signal
A	U
B	V
C	W
D	E

4

■Connector D

Electromagnetic brake connector
CMV1-R2P

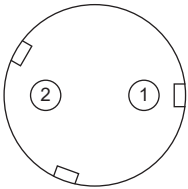

Terminal No.	Signal
1	B1 *1
2	B2 *1

*1 Supply electromagnetic brake power (24 V DC). There is no polarity.

4.3 Selection example of wires

When cables are fabricated by the customer, wires should be selected in accordance with the application.

Point

Wires indicated in this section are separated wires. When using a cable for power line (U/V/W) between the servo amplifier and rotary servo motor, use a 600 V grade EP rubber insulated chloroprene sheath cab-tire cable (2PNCT). For cable selection, refer to the following.

☞ Page 246 Selection example of rotary servo motor power cable

To comply with the UL/CSA standard, refer to the following.

☞ Page 241 Compliance with UL/CSA standard

To comply with other standards, use wires that comply with each standard.

Selection requirements for the wire size are as follows.

- Construction requirements: Single wire set in midair
- Wiring length: 30 m or less

The following shows the wires used for wiring. Use the wires given in this section or equivalent wires.

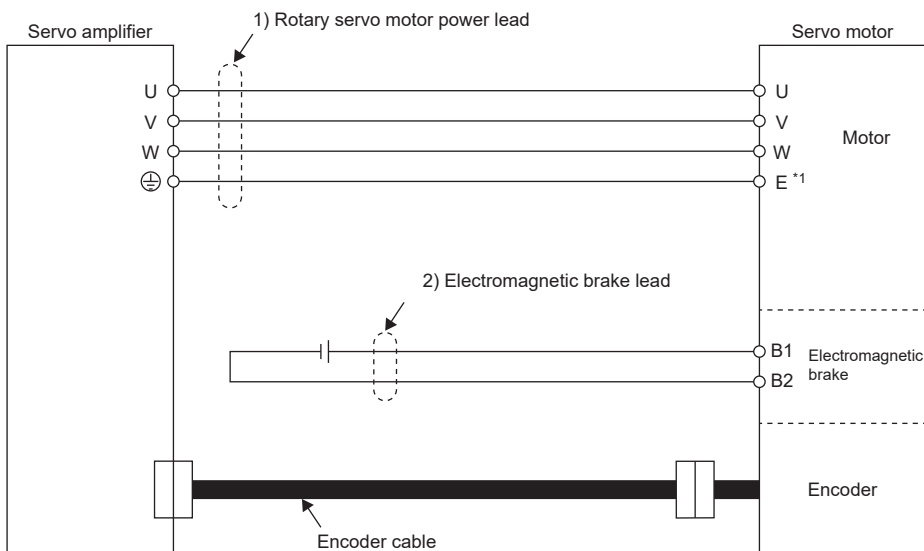

*1 For the MR-J5D1-_, connect the wire to "E" of CNP3.

Selection examples for the 600 V Grade heat-resistant polyvinyl chloride insulated wire (HIV wire) are indicated below. Even when the maximum torque is increased, the applicable wire sizes are the same.

HK-KT series

Rotary servo motor	Wire [mm ²]	
	1) U/V/W/E	2) B1/B2
HK-KT053W	0.75 (AWG 18) *1 *2	0.2 (AWG 24) *2 *4
HK-KT13W		
HK-KT1M3W		
HK-KT13UW		
HK-KT23W		
HK-KT43W		
HK-KT63W		
HK-KT23UW		
HK-KT43UW		
HK-KT7M3W		
HK-KT103W		
HK-KT63UW		
HK-KT7M3UW		
HK-KT103UW		
HK-KT153W		
HK-KT203W	0.75 (AWG 18) *1 *3	0.2 (AWG 24) *2 *4
HK-KT202W	0.75 (AWG 18) *1 *2	
HK-KT434W		
HK-KT634W		
HK-KT7M34W		
HK-KT1034W		
HK-KT634UW		
HK-KT1034UW		
HK-KT1534W		
HK-KT2034W		
HK-KT2024W		

*1 For the motor power connector wiring, use fluorine resin wire of 0.75 mm² (AWG 18).

*2 This applies when the wire length is 10 m or less. When fabricating an extension cable, use 1.25 mm² (AWG 16).

*3 This applies when the wire length is 10 m or less. When fabricating an extension cable, use 2.0 mm² (AWG 14).

*4 For wiring of the electromagnetic brake, use fluorine resin wire of 0.2 mm² (AWG 24).

HK-MT series

Rotary servo motor	Wire [mm ²]	
	1) U/V/W/E	2) B1/B2
HK-MT053(V)W	0.75 (AWG 18) *1 *2	0.2 (AWG 24) *2 *3
HK-MT13(V)W		
HK-MT1M3(V)W		
HK-MT23(V)W		
HK-MT43(V)W		
HK-MT63(V)W		
HK-MT7M3(V)W		
HK-MT103(V)W		

*1 For the motor power connector wiring, use fluorine resin wire of 0.75 mm² (AWG 18).

*2 This applies when the wire length is 10 m or less. When fabricating an extension cable, use 1.25 mm² (AWG 16).

*3 For wiring of the electromagnetic brake, use fluorine resin wire of 0.2 mm² (AWG 24).

HK-ST series

Rotary servo motor	Wire [mm ²]	
	1) U/V/W/E	2) B1/B2
HK-ST52W	1.25 (AWG 16)	1.25 (AWG 16)
HK-ST102W	1.25 (AWG 16)	
HK-ST172W	2 (AWG 14) *1	
HK-ST202AW	2 (AWG 14)	
HK-ST302W	2 (AWG 14)	
HK-ST353W	3.5 (AWG 12)	
HK-ST503W	3.5 (AWG 12)	
HK-ST7M2UW	1.25 (AWG 16)	
HK-ST172UW	1.25 (AWG 16)	
HK-ST202W	2 (AWG 14)	
HK-ST352W	3.5 (AWG 12)	
HK-ST502W	8 (AWG 8)	
HK-ST702W	8 (AWG 8)	
HK-ST524W	1.25 (AWG 16)	
HK-ST1024W	1.25 (AWG 16)	
HK-ST1724W	1.25 (AWG 16) *1	
HK-ST2024AW	1.25 (AWG 16)	
HK-ST3024W	1.25 (AWG 16)	
HK-ST3534W	2 (AWG 14)	
HK-ST5034W	2 (AWG 14)	
HK-ST2024W	1.25 (AWG 16)	
HK-ST3524W	2 (AWG 14)	
HK-ST5024W	3.5 (AWG 12)	
HK-ST7024W	3.5 (AWG 12)	

*1 Wires used for the geared servo motor HK-ST152_ are the same as those for the HK-ST172W.

Wires used for the geared servo motor HK-ST1524_ are the same as those for the HK-ST1724W.

HK-RT series

Rotary servo motor	Wire [mm ²]	
	1) U/V/W/E	2) B1/B2
HK-RT103W	0.75 (AWG 18) *1*2	0.2 (AWG 24) *2*4
HK-RT153W	0.75 (AWG 18) *1*3	
HK-RT203W		
HK-RT353W	3.5 (AWG 12)	1.25 (AWG 16)
HK-RT503W	5.5 (AWG 10)	
HK-RT703W	5.5 (AWG 10)	
HK-RT1034W	0.75 (AWG 18) *1*2	0.2 (AWG 24) *2*4
HK-RT1534W		
HK-RT2034W		
HK-RT3534W	1.25 (AWG 16)	1.25 (AWG 16)
HK-RT5034W	2 (AWG 14)	
HK-RT7034W	2 (AWG 14)	

*1 For the motor power connector wiring, use fluorine resin wire of 0.75 mm² (AWG 18).

*2 This applies when the wire length is 10 m or less. When fabricating an extension cable, use 1.25 mm² (AWG 16).

*3 This applies when the wire length is 10 m or less. When fabricating an extension cable, use 2 mm² (AWG 14).

*4 For wiring of the electromagnetic brake, use fluorine resin wire of 0.2 mm² (AWG 24).

5 WIRING OPTION

When cables are fabricated by the customer, wires should be selected in accordance with the application.

Precautions

- Use specified options. Otherwise, it may cause a malfunction or fire.
- MR-J3SCNS(A) and MR-ENCNS2(A) connector sets are packed with a plug and contacts. As using contacts for other plugs may damage the connector, use the enclosed contacts.
- Correctly wire options and peripheral equipment, etc. in the correct combination.
- We recommend using HIV wires to wire the rotary servo motors, options, and peripheral equipment. Therefore, the recommended wire sizes may be different from those of the wires used for previous generation rotary servo motors.
- The fitting warranty is applied only to the option cables and the connectors manufactured by the manufacturers introduced in this chapter.

5.1 Cables/connector sets

Point

The indicated IP rating is the cable and connector's protection against ingress of dust and water when the cable and connector are connected to a rotary servo motor. If the IP rating of the cable, connector, and rotary servo motor varies, the overall IP rating depends on the lowest IP rating of all components.

Please purchase the cable and connector options indicated in this section for the rotary servo motor. When fabricating an encoder cable, refer to the following.

 Page 254 Fabricating the encoder cable

Combinations of cables/connector sets

HK-KT series/HK-MT series/HK-RT (1.0 kW - 2.0 kW) series

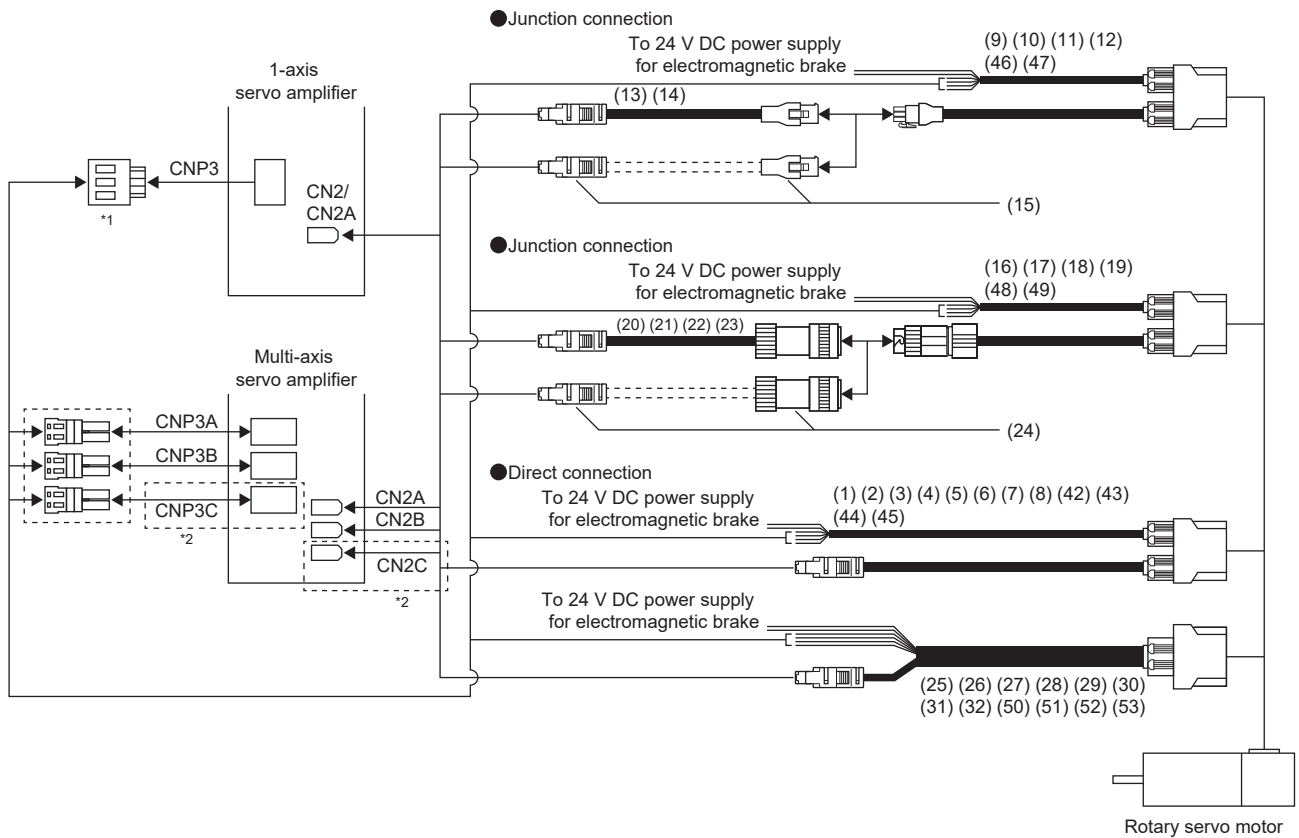

*1 Connectors for 3.5 kW or less.

*2 This connection is for the MR-J5W3- and MR-J5D3-.

HK-ST series/HK-RT (3.5 kW - 7.0 kW) series

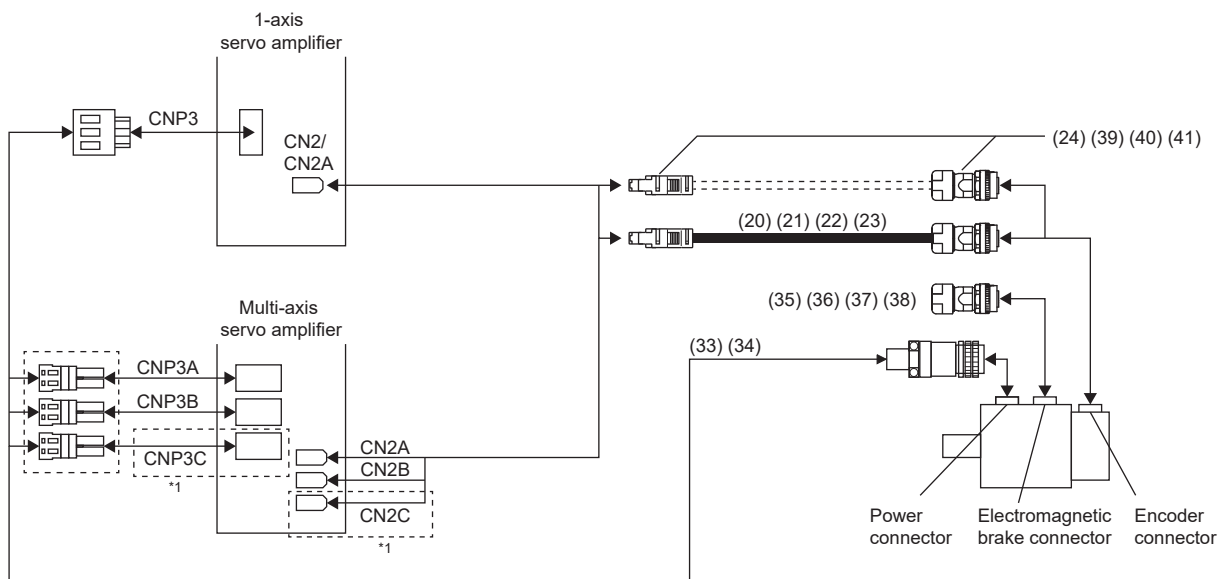









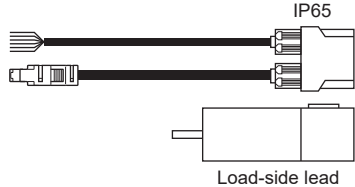

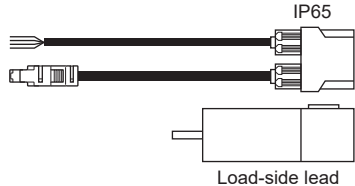

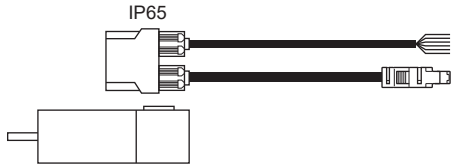

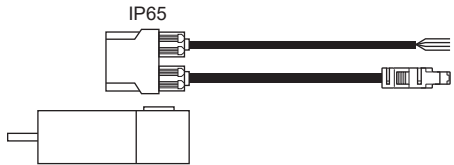



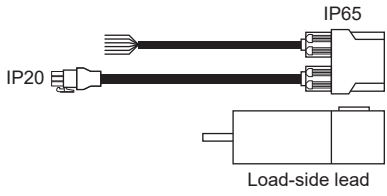

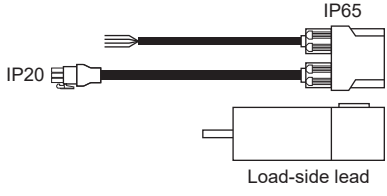
*1 This connection is for the MR-J5W3- and MR-J5D3-.

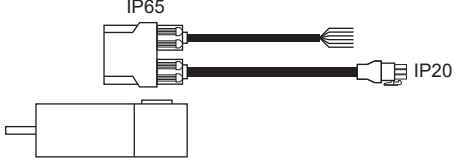

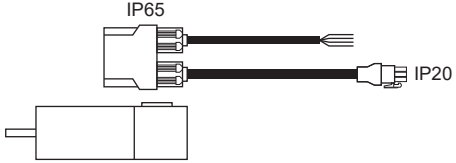
Cable and connector list







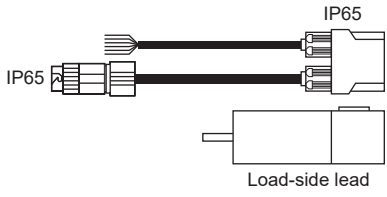
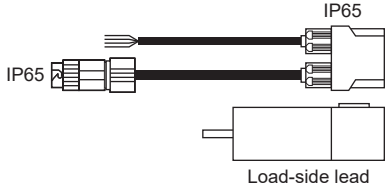
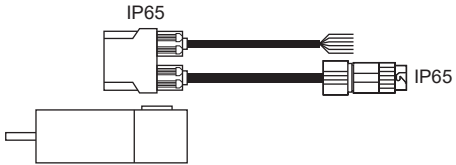
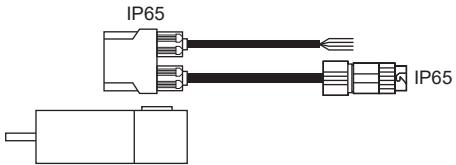









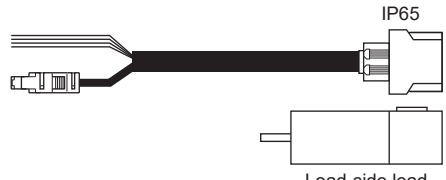

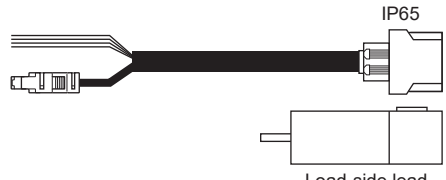

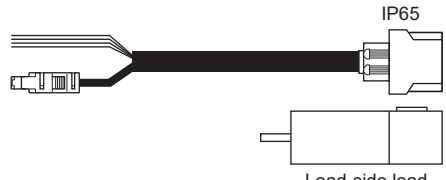

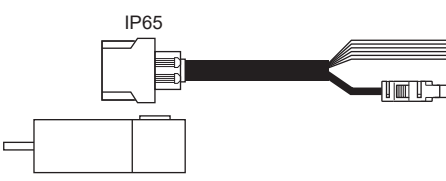

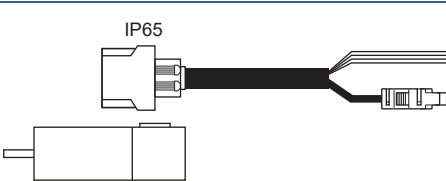

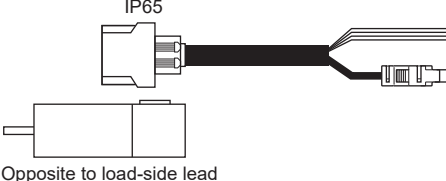

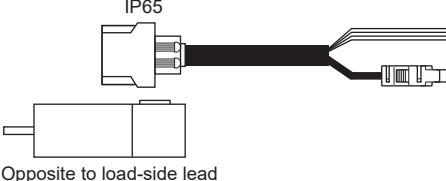









HK-ST7M2UW_ and HK-ST172UW_ will be available in the future.







No.	Product name	Application	Flex type	Cable length	Model	Description/IP rating/Cable direction
(1)	Motor cables (Dual cable type/ direct connection type) *1 Motor side: IP65	For the HK-KT series/HK-MT series/HK- RT103(4)W/HK- RT153(4)W/HK- RT203(4)W	Standard (for fixed parts)	2 m	MR-AEPB2CBL2M-A1-L	 <p>IP65</p> <p>Load-side lead</p>
				5 m	MR-AEPB2CBL5M-A1-L	
				10 m	MR-AEPB2CBL10M-A1-L	
(2)		With electromagnetic brake cable	High flex life (for moving parts)	2 m	MR-AEPB2CBL2M-A1-H	<p>Refer to the following for details.  Page 68 MR-AEPB2CBL_M-_-_/MR- AEP2CBL_M-_-_</p>
				5 m	MR-AEPB2CBL5M-A1-H	
				10 m	MR-AEPB2CBL10M-A1-H	
(3)		For the HK-KT series/HK-MT series/HK- RT103(4)W/HK- RT153(4)W/HK- RT203(4)W	Standard (for fixed parts)	2 m	MR-AEP2CBL2M-A1-L	 <p>IP65</p> <p>Load-side lead</p>
				5 m	MR-AEP2CBL5M-A1-L	
				10 m	MR-AEP2CBL10M-A1-L	
(4)		Without electromagnetic brake cable	High flex life (for moving parts)	2 m	MR-AEP2CBL2M-A1-H	<p>Refer to the following for details.  Page 68 MR-AEPB2CBL_M-_-_/MR- AEP2CBL_M-_-_</p>
				5 m	MR-AEP2CBL5M-A1-H	
				10 m	MR-AEP2CBL10M-A1-H	
(5)		For the HK-KT series/HK-MT series/HK- RT103(4)W/HK- RT153(4)W/HK- RT203(4)W	Standard (for fixed parts)	2 m	MR-AEPB2CBL2M-A2-L	 <p>IP65</p> <p>Opposite to load-side lead</p>
				5 m	MR-AEPB2CBL5M-A2-L	
				10 m	MR-AEPB2CBL10M-A2-L	
(6)		With electromagnetic brake cable	High flex life (for moving parts)	2 m	MR-AEPB2CBL2M-A2-H	<p>Refer to the following for details.  Page 68 MR-AEPB2CBL_M-_-_/MR- AEP2CBL_M-_-_</p>
				5 m	MR-AEPB2CBL5M-A2-H	
				10 m	MR-AEPB2CBL10M-A2-H	
(7)		For the HK-KT series/HK-MT series/HK- RT103(4)W/HK- RT153(4)W/HK- RT203(4)W	Standard (for fixed parts)	2 m	MR-AEP2CBL2M-A2-L	 <p>IP65</p> <p>Opposite to load-side lead</p>
				5 m	MR-AEP2CBL5M-A2-L	
				10 m	MR-AEP2CBL10M-A2-L	
(8)		Without electromagnetic brake cable	High flex life (for moving parts)	2 m	MR-AEP2CBL2M-A2-H	<p>Refer to the following for details.  Page 68 MR-AEPB2CBL_M-_-_/MR- AEP2CBL_M-_-_</p>
				5 m	MR-AEP2CBL5M-A2-H	
				10 m	MR-AEP2CBL10M-A2-H	



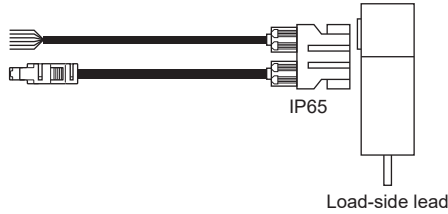

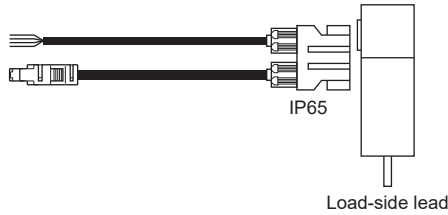

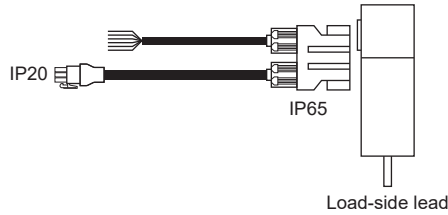
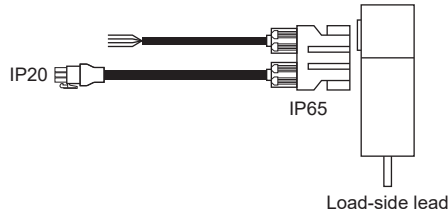

No.	Product name	Application	Flex type	Cable length	Model	Description/IP rating/Cable direction
(9)	Motor cables (Dual cable type/ junction connection type) Motor side: IP65 Junction side: IP20	For the HK-KT series/HK-MT series/HK- RT103(4)W/HK- RT153(4)W/HK- RT203(4)W With electromagnetic brake cable	Standard (for fixed parts)	0.3 m	MR-AEPB2J10CBL03M- A1-L	 <p>Refer to the following for details.  Page 72 MR-AEPB2J10CBL03M-_-L/MR-AEP2J10CBL03M-_-L</p>
(10)		For the HK-KT series/HK-MT series/HK- RT103(4)W/HK- RT153(4)W/HK- RT203(4)W Without electromagnetic brake cable	Standard (for fixed parts)	0.3 m	MR-AEP2J10CBL03M-A1- L	 <p>Refer to the following for details.  Page 72 MR-AEPB2J10CBL03M-_-L/MR-AEP2J10CBL03M-_-L</p>
(11)		For the HK-KT series/HK-MT series/HK- RT103(4)W/HK- RT153(4)W/HK- RT203(4)W With electromagnetic brake cable	Standard (for fixed parts)	0.3 m	MR-AEPB2J10CBL03M- A2-L	 <p>Refer to the following for details.  Page 72 MR-AEPB2J10CBL03M-_-L/MR-AEP2J10CBL03M-_-L</p>
(12)		For the HK-KT series/HK-MT series/HK- RT103(4)W/HK- RT153(4)W/HK- RT203(4)W Without electromagnetic brake cable	Standard (for fixed parts)	0.3 m	MR-AEP2J10CBL03M-A2- L	 <p>Refer to the following for details.  Page 72 MR-AEPB2J10CBL03M-_-L/MR-AEP2J10CBL03M-_-L</p>
(13)	Encoder cable Junction side: IP20	For the HK-KT series/HK-MT series/HK- RT103(4)W/HK- RT153(4)W/HK- RT203(4)W	Standard (for fixed parts)	20 m	MR-AEKCBL20M-L	 <p>Refer to the following for details.  Page 81 MR-AEKCBL_M-_-</p>
(14)			High flex life (for moving parts)	20 m	MR-AEKCBL20M-H	
				30 m	MR-AEKCBL30M-H	
				40 m	MR-AEKCBL40M-H	
				50 m	MR-AEKCBL50M-H	
(15)	Encoder connector set Junction side: IP20	For the HK-KT series/HK-MT series/HK- RT103(4)W/HK- RT153(4)W/HK- RT203(4)W	—	—	MR-ECNM	 <p>Refer to the following for details.  Page 81 MR-AEKCBL_M-_-</p>

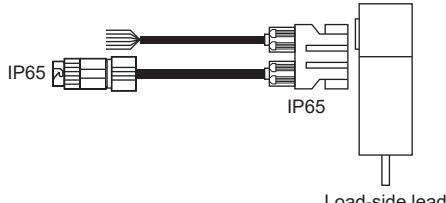
No.	Product name	Application	Flex type	Cable length	Model	Description/IP rating/Cable direction
(16)	Motor cables (Dual cable type/ junction connection type) Motor side: IP65 Junction side: IP65	For the HK-KT series/HK-MT series/HK- RT103(4)W/HK- RT153(4)W/HK- RT203(4)W With electromagnetic brake cable	Standard (for fixed parts)	0.3 m	MR-AEPB2J20CBL03M- A1-L	 <p>Refer to the following for details. Page 75 MR-AEPB2J20CBL03M-_-L/MR-AEP2J20CBL03M-_-L</p>
(17)		For the HK-KT series/HK-MT series/HK- RT103(4)W/HK- RT153(4)W/HK- RT203(4)W Without electromagnetic brake cable	Standard (for fixed parts)	0.3 m	MR-AEP2J20CBL03M-A1- L	 <p>Refer to the following for details. Page 75 MR-AEPB2J20CBL03M-_-L/MR-AEP2J20CBL03M-_-L</p>
(18)		For the HK-KT series/HK-MT series/HK- RT103(4)W/HK- RT153(4)W/HK- RT203(4)W With electromagnetic brake cable	Standard (for fixed parts)	0.3 m	MR-AEPB2J20CBL03M- A2-L	 <p>Opposite to load-side lead Refer to the following for details. Page 75 MR-AEPB2J20CBL03M-_-L/MR-AEP2J20CBL03M-_-L</p>
(19)		For the HK-KT series/HK-MT series/HK- RT103(4)W/HK- RT153(4)W/HK- RT203(4)W Without electromagnetic brake cable	Standard (for fixed parts)	0.3 m	MR-AEP2J20CBL03M-A2- L	 <p>Opposite to load-side lead Refer to the following for details. Page 75 MR-AEPB2J20CBL03M-_-L/MR-AEP2J20CBL03M-_-L</p>
(20)	Encoder cable Junction side: IP67	For the HK-KT series For the HK-MT series For the HK-ST series For the HK-RT series	Standard (for fixed parts)	2 m	MR-J3ENSCBL2M-L	 <p>Refer to the following for details. Page 84 MR-AENSCBL_M-_- Page 87 MR-J3ENSCBL_M-_-</p>
				5 m	MR-J3ENSCBL5M-L	
(21)				10 m	MR-J3ENSCBL10M-L	
				20 m	MR-AENSCBL20M-L	
			30 m	MR-AENSCBL30M-L		
(22)			High flex life (for moving parts)	2 m	MR-J3ENSCBL2M-H	
				5 m	MR-J3ENSCBL5M-H	
				10 m	MR-J3ENSCBL10M-H	
(23)	20 m	MR-AENSCBL20M-H				
	30 m	MR-AENSCBL30M-H				
	40 m	MR-AENSCBL40M-H				
	50 m	MR-AENSCBL50M-H				

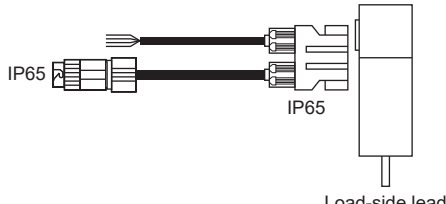
No.	Product name	Application	Flex type	Cable length	Model	Description/IP rating/Cable direction
(24)	Encoder connector set (One-touch connection type) Junction side: IP67	For the HK-KT series For the HK-MT series For the HK-ST series For the HK-RT series	—	—	MR-J3SCNS *2	  <p>Refer to the following for details.  Page 84 MR-AENSCBL_M_-  Page 87 MR-J3ENSCBL_M_-</p>
(25)	Motor cables (Single cable type/direct connection type) Motor side: IP65	For the HK-KT series/HK-MT series/HK-RT103(4)W/HK-RT153(4)W/HK-RT203(4)W With electromagnetic brake cable	Standard (for fixed parts)	2 m	MR-AEPB1CBL2M-A1-L	 <p>Refer to the following for details.  Page 78 MR-AEPB1CBL_M-_- /MR-AEP1CBL_M-_-</p>
5 m				MR-AEPB1CBL5M-A1-L		
10 m				MR-AEPB1CBL10M-A1-L		
(26)	Motor cables (Single cable type/direct connection type) Motor side: IP65	For the HK-KT series/HK-MT series/HK-RT103(4)W/HK-RT153(4)W/HK-RT203(4)W Without electromagnetic brake cable	High flex life (for moving parts)	2 m	MR-AEPB1CBL2M-A1-H	 <p>Refer to the following for details.  Page 78 MR-AEPB1CBL_M-_- /MR-AEP1CBL_M-_-</p>
5 m				MR-AEPB1CBL5M-A1-H		
10 m				MR-AEPB1CBL10M-A1-H		
(27)	Motor cables (Single cable type/direct connection type) Motor side: IP65	For the HK-KT series/HK-MT series/HK-RT103(4)W/HK-RT153(4)W/HK-RT203(4)W Without electromagnetic brake cable	Standard (for fixed parts)	2 m	MR-AEP1CBL2M-A1-L	 <p>Refer to the following for details.  Page 78 MR-AEPB1CBL_M-_- /MR-AEP1CBL_M-_-</p>
5 m				MR-AEP1CBL5M-A1-L		
10 m				MR-AEP1CBL10M-A1-L		
(28)	Motor cables (Single cable type/direct connection type) Motor side: IP65	For the HK-KT series/HK-MT series/HK-RT103(4)W/HK-RT153(4)W/HK-RT203(4)W Without electromagnetic brake cable	High flex life (for moving parts)	2 m	MR-AEP1CBL2M-A1-H	 <p>Refer to the following for details.  Page 78 MR-AEPB1CBL_M-_- /MR-AEP1CBL_M-_-</p>
5 m				MR-AEP1CBL5M-A1-H		
10 m				MR-AEP1CBL10M-A1-H		
(29)	Motor cables (Single cable type/direct connection type) Motor side: IP65	For the HK-KT series/HK-MT series/HK-RT103(4)W/HK-RT153(4)W/HK-RT203(4)W With electromagnetic brake cable	Standard (for fixed parts)	2 m	MR-AEPB1CBL2M-A2-L	 <p>Refer to the following for details.  Page 78 MR-AEPB1CBL_M-_- /MR-AEP1CBL_M-_-</p>
5 m				MR-AEPB1CBL5M-A2-L		
10 m				MR-AEPB1CBL10M-A2-L		
(30)	Motor cables (Single cable type/direct connection type) Motor side: IP65	For the HK-KT series/HK-MT series/HK-RT103(4)W/HK-RT153(4)W/HK-RT203(4)W With electromagnetic brake cable	High flex life (for moving parts)	2 m	MR-AEPB1CBL2M-A2-H	 <p>Refer to the following for details.  Page 78 MR-AEPB1CBL_M-_- /MR-AEP1CBL_M-_-</p>
5 m				MR-AEPB1CBL5M-A2-H		
10 m				MR-AEPB1CBL10M-A2-H		
(31)	Motor cables (Single cable type/direct connection type) Motor side: IP65	For the HK-KT series/HK-MT series/HK-RT103(4)W/HK-RT153(4)W/HK-RT203(4)W Without electromagnetic brake cable	Standard (for fixed parts)	2 m	MR-AEP1CBL2M-A2-L	 <p>Refer to the following for details.  Page 78 MR-AEPB1CBL_M-_- /MR-AEP1CBL_M-_-</p>
5 m				MR-AEP1CBL5M-A2-L		
10 m				MR-AEP1CBL10M-A2-L		
(32)	Motor cables (Single cable type/direct connection type) Motor side: IP65	For the HK-KT series/HK-MT series/HK-RT103(4)W/HK-RT153(4)W/HK-RT203(4)W Without electromagnetic brake cable	High flex life (for moving parts)	2 m	MR-AEP1CBL2M-A2-H	 <p>Refer to the following for details.  Page 78 MR-AEPB1CBL_M-_- /MR-AEP1CBL_M-_-</p>
5 m				MR-AEP1CBL5M-A2-H		
10 m				MR-AEP1CBL10M-A2-H		
(33)	Power connector set (One-touch connection type)	HK-ST52(4)W/ HK-ST102(4)W/ HK-ST172(4)W/ HK-ST202(4)AW/ HK-ST302(4)W/ HK-ST353(4)W/ HK-ST503(4)W *3*4	—	—	MR-APWCNS4	 <p>Plug: JL10-6A18-10SE-EB Cable clamp: JL04-18CK(13)-_R (JAE) Applicable cable Applicable wire size: 3.5 mm² (AWG 12) or less Cable OD: 11 mm to 14.1 mm</p>

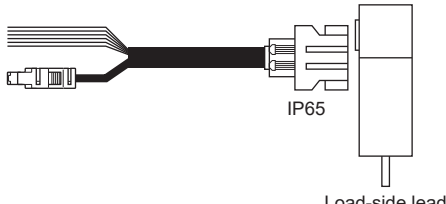
No.	Product name	Application	Flex type	Cable length	Model	Description/IP rating/Cable direction
(34)	Power connector set (One-touch connection type)	HK-ST7M2UW/ HK-ST172UW/ HK-ST202(4)W/ HK-ST352(4)W/ HK-ST502(4)W/ HK-ST702(4)W/ HK-RT353(4)W/ HK-RT503(4)W/ HK-RT703(4)W	—	—	MR-APWCNS5	 IP67 Plug: JL10-6A22-22SE-EB Cable clamp: JL04-2022CK(14)-_R (JAE) Applicable cable Applicable wire size: 8 mm ² (AWG 8) or less Cable OD: 12.9 mm to 16 mm
(35)	Electromagnetic brake connector set	For the HK-ST series/HK-RT353(4)W/HK-RT503(4)W/HK-RT703(4)W	—	—	MR-BKCNS1 *2	 IP67 Straight plug: CMV1-SP2S-L Socket contact: CMV1-#22BSC-S2-100 (DDK)
(36)	Electromagnetic brake connector set	For the HK-ST series/HK-RT353(4)W/HK-RT503(4)W/HK-RT703(4)W	—	—	MR-BKCNS1A *2	 IP67 Angle plug: CMV1-AP2S-L Socket contact: CMV1-#22BSC-S2-100 (DDK)
(37)	Electromagnetic brake connector set	For the HK-ST series/HK-RT353(4)W/HK-RT503(4)W/HK-RT703(4)W	—	—	MR-BKCNS2	 IP67 Straight plug: CMV1S-SP2S-L Socket contact: CMV1-#22BSC-S2-100 (DDK)
(38)	Electromagnetic brake connector set	For the HK-ST series/HK-RT353(4)W/HK-RT503(4)W/HK-RT703(4)W	—	—	MR-BKCNS2A	 IP67 Angle plug: CMV1S-AP2S-L Socket contact: CMV1-#22BSC-S2-100 (DDK)
(39)	Encoder connector set (Screw type) Junction side: IP67	For the HK-ST series/HK-RT353(4)W/HK-RT503(4)W/HK-RT703(4)W	—	—	MR-ENCNS2	  IP67 Refer to the following for details.  Page 84 MR-AENSCBL_M_  Page 87 MR-J3ENSCBL_M_-
(40)	Encoder connector set (One-touch connection type) Junction side: IP67	For the HK-ST series/HK-RT353(4)W/HK-RT503(4)W/HK-RT703(4)W	—	—	MR-J3SCNSA *2	  IP67 Refer to the following for details.  Page 84 MR-AENSCBL_M_  Page 87 MR-J3ENSCBL_M_-
(41)	Encoder connector set (Screw type) Junction side: IP67	For the HK-ST series/HK-RT353(4)W/HK-RT503(4)W/HK-RT703(4)W	—	—	MR-ENCNS2A	  IP67 Refer to the following for details.  Page 84 MR-AENSCBL_M_  Page 87 MR-J3ENSCBL_M_-

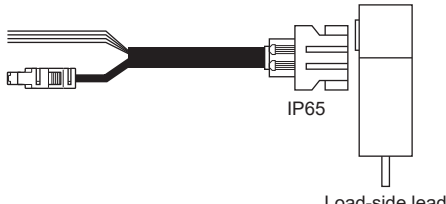
No.	Product name	Application	Flex type	Cable length	Model	Description/IP rating/Cable direction
(42)	Motor cables (Dual cable type/ direct connection type) *1 Motor side: IP65	For the HK-KT series/HK-MT series/HK- RT103(4)W/HK- RT153(4)W/HK- RT203(4)W	Standard (for fixed parts)	2 m	MR-AEPB2CBL2M-A5-L	 <p>IP65</p> <p>Load-side lead</p>
				5 m	MR-AEPB2CBL5M-A5-L	
				10 m	MR-AEPB2CBL10M-A5-L	
(43)		With electromagnetic brake cable	High flex life (for moving parts)	2 m	MR-AEPB2CBL2M-A5-H	<p>Refer to the following for details.  Page 68 MR-AEPB2CBL_M-_-_/MR-AEP2CBL_M-_-_</p>
				5 m	MR-AEPB2CBL5M-A5-H	
				10 m	MR-AEPB2CBL10M-A5-H	
(44)		For the HK-KT series/HK-MT series/HK- RT103(4)W/HK- RT153(4)W/HK- RT203(4)W	Standard (for fixed parts)	2 m	MR-AEP2CBL2M-A5-L	 <p>IP65</p> <p>Load-side lead</p>
				5 m	MR-AEP2CBL5M-A5-L	
				10 m	MR-AEP2CBL10M-A5-L	
(45)		Without electromagnetic brake cable	High flex life (for moving parts)	2 m	MR-AEP2CBL2M-A5-H	<p>Refer to the following for details.  Page 68 MR-AEPB2CBL_M-_-_/MR-AEP2CBL_M-_-_</p>
				5 m	MR-AEP2CBL5M-A5-H	
				10 m	MR-AEP2CBL10M-A5-H	
(46)	Motor cables (Dual cable type/ junction connection type) Motor side: IP65 Junction side: IP20	For the HK-KT series/HK-MT series/HK- RT103(4)W/HK- RT153(4)W/HK- RT203(4)W With electromagnetic brake cable	Standard (for fixed parts)	0.3 m	MR-AEPB2J10CBL03M- A5-L	 <p>IP20</p> <p>IP65</p> <p>Load-side lead</p>
(47)		For the HK-KT series/HK-MT series/HK- RT103(4)W/HK- RT153(4)W/HK- RT203(4)W Without electromagnetic brake cable	Standard (for fixed parts)	0.3 m	MR-AEP2J10CBL03M-A5- L	 <p>IP20</p> <p>IP65</p> <p>Load-side lead</p> <p>Refer to the following for details.  Page 72 MR-AEPB2J10CBL03M-_-L/MR-AEP2J10CBL03M-_-L</p>

No.	Product name	Application	Flex type	Cable length	Model	Description/IP rating/Cable direction
(48)	Motor cables (Dual cable type/ junction connection type) Motor side: IP65 Junction side: IP65	For the HK-KT series/HK-MT series/HK- RT103(4)W/HK- RT153(4)W/HK- RT203(4)W With electromagnetic brake cable	Standard (for fixed parts)	0.3 m	MR-AEPB2J20CBL03M- A5-L	 <p>Refer to the following for details.  Page 75 MR-AEPB2J20CBL03M-_-L/MR- AEP2J20CBL03M-_-L</p>
(49)		For the HK-KT series/HK-MT series/HK- RT103(4)W/HK- RT153(4)W/HK- RT203(4)W Without electromagnetic brake cable	Standard (for fixed parts)	0.3 m	MR-AEP2J20CBL03M-A5- L	 <p>Refer to the following for details.  Page 75 MR-AEPB2J20CBL03M-_-L/MR- AEP2J20CBL03M-_-L</p>
(50)	Motor cables (Single cable type/direct connection type) Motor side: IP65	For the HK-KT series/HK-MT series/HK- RT103(4)W/HK- RT153(4)W/HK- RT203(4)W With electromagnetic brake cable	Standard (for fixed parts)	2 m	MR-AEP1CBL2M-A5-L	 <p>Refer to the following for details.  Page 78 MR-AEP1CBL_M-_-/_MR- AEP1CBL_M-_-_</p>
5 m				MR-AEP1CBL5M-A5-L		
10 m				MR-AEP1CBL10M-A5-L		
(51)			High flex life (for moving parts)	2 m	MR-AEP1CBL2M-A5-H	
5 m				MR-AEP1CBL5M-A5-H		
10 m				MR-AEP1CBL10M-A5-H		
(52)	For the HK-KT series/HK-MT series/HK- RT103(4)W/HK- RT153(4)W/HK- RT203(4)W Without electromagnetic brake cable	Standard (for fixed parts)	2 m	MR-AEP1CBL2M-A5-L	 <p>Refer to the following for details.  Page 78 MR-AEP1CBL_M-_-/_MR- AEP1CBL_M-_-_</p>	
5 m			MR-AEP1CBL5M-A5-L			
10 m			MR-AEP1CBL10M-A5-L			
(53)		High flex life (for moving parts)	2 m	MR-AEP1CBL2M-A5-H		
5 m			MR-AEP1CBL5M-A5-H			
10 m			MR-AEP1CBL10M-A5-H			

*1 When IP67 cables are needed, contact your local sales office.

*2 The cable and the connector set may contain different connectors but still usable.

*3 To make the HK-ST503W comply with the UL/CSA standard, the MR-APWCNS4 cannot be used. Refer to the following for details.
 Page 243 HK-ST series

*4 Connectors used for the geared servo motor HK-ST152(4)_ are the same as those for the HK-ST172(4)W.

5.2 Motor cables/connector sets

MR-AEPB2CBL_M-_-_/MR-AEP2CBL_M-_-_

Model

The following describes what each block of a model name indicates. Not all combinations of the symbols are available.

MR - AEPB2CBL2M - A1 - L

Flex type

Symbol	Flex type
L	Standard (for fixed parts)
H	High flex life (for moving parts)

Outlet direction

Symbol	Outlet direction
A1	Load-side lead
A2	Opposite to load-side lead
A5	Vertical lead

Cable length

Symbol	Cable length [m]
2	2
5	5
10	10

Electromagnetic brake cable

Symbol	Electromagnetic brake cable
x	x
B	o

Connecting the servo amplifier and rotary servo motor

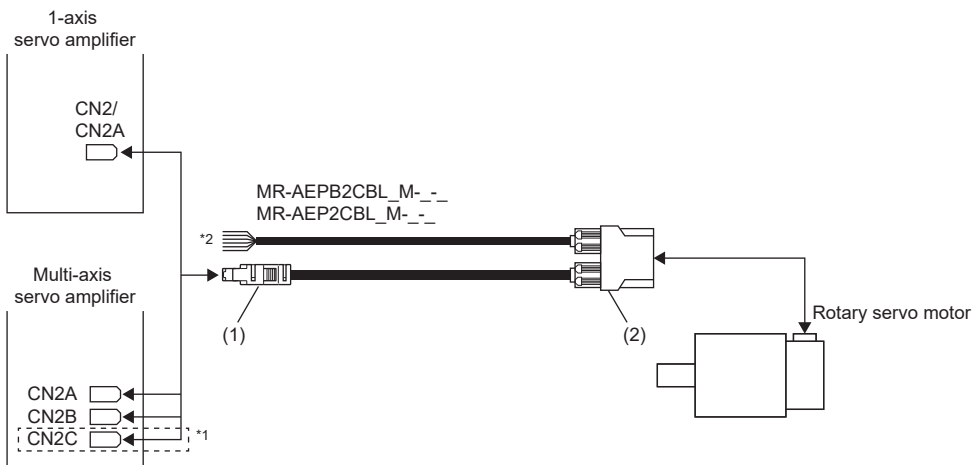

*1 This connection is for the MR-J5W3- and MR-J5D3-.

*2 Refer to the following for connection of the power connector.

☞ Page 36 Wiring

CN2, CN2A, CN2B, and CN2C side connector (1)

The following shows the view from the wiring side. Do not connect anything to the pins that are marked with a diagonal line. Securely connect the external conductor of the shielded cable to the ground plate and fix it to the connector shell.

☞ Page 100 Shielding CN2, CN2A, CN2B, and CN2C connectors

Receptacle: 36210-0100PL

Shell kit: 36310-3200-008

(3M or equivalent)

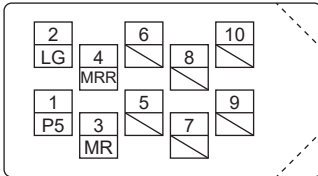

Connector set: 54599-1016

(Molex)

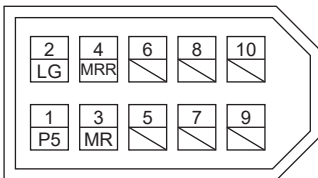

Motor-side connector (2)

■ Load-side lead/opposite to load-side lead

The following shows the view from the wiring side. Do not connect anything to the pins that are marked with a diagonal line.

Connector set: MT50W-8D/2D4ES-CVLD(7.5)

Contact (for motor power supply): MT50E-1820SCFA

Contact (for encoder and electromagnetic brake): MT50D-2224SCFA

(Hirose Electric)

- Load-side lead

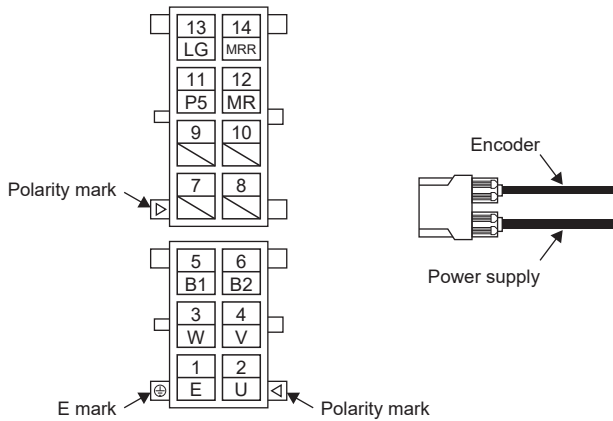

- Opposite to load-side lead

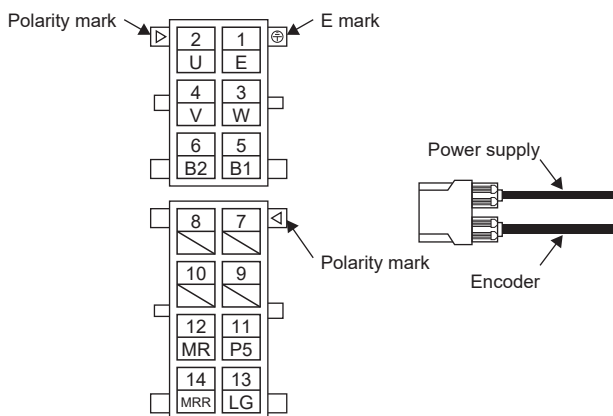

Vertical lead

The following shows the view from the wiring side. Do not connect anything to the pins that are marked with a diagonal line.

Connector set: MT50W-8D/2D4ES-CVSD(7.5)

Contact (for motor power supply): MT50E-1820SCFA

Contact (for encoder and electromagnetic brake): MT50D-2224SCFA

(Hirose Electric)

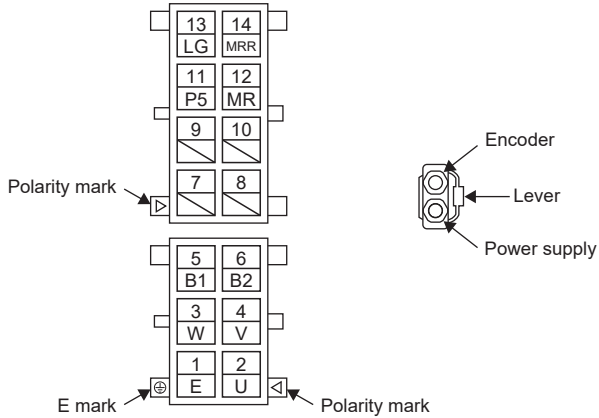

Cable internal wiring diagram

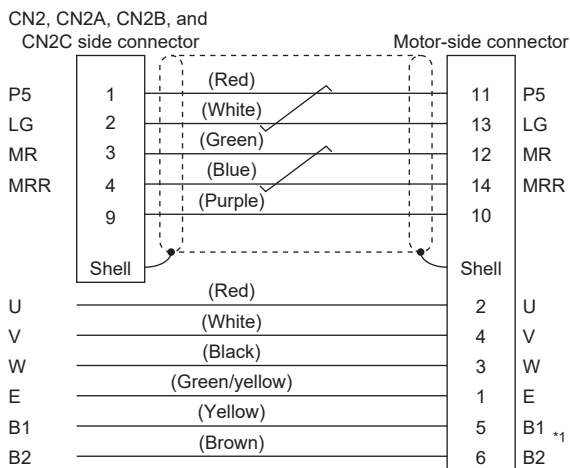

*1 B1 and B2 are the wiring for electromagnetic brake. Wire when MR-AEPB2CBL_M-_- is used. If MR-AEP2CBL_M-_- is used, B1 and B2 do not need to be wired as MR-AEP2CBL_M-_- does not have B1 and B2.

MR-AEPB2J10CBL03M-_-L/MR-AEP2J10CBL03M-_-L

The servo amplifier and the rotary servo motor cannot be connected by these cables alone. The servo amplifier-side encoder cable (MR-AEKCBL_M_-) is required.

Model

The following describes what each block of a model name indicates. Not all combinations of the symbols are available.

MR - A E P B 2 J 1 0 C B L 0 3 M - A 1 - L

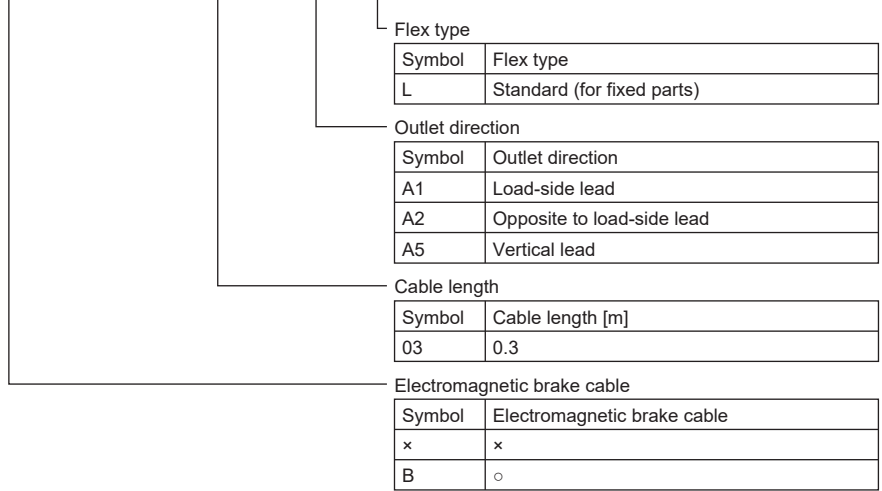

Connecting the servo amplifier and rotary servo motor

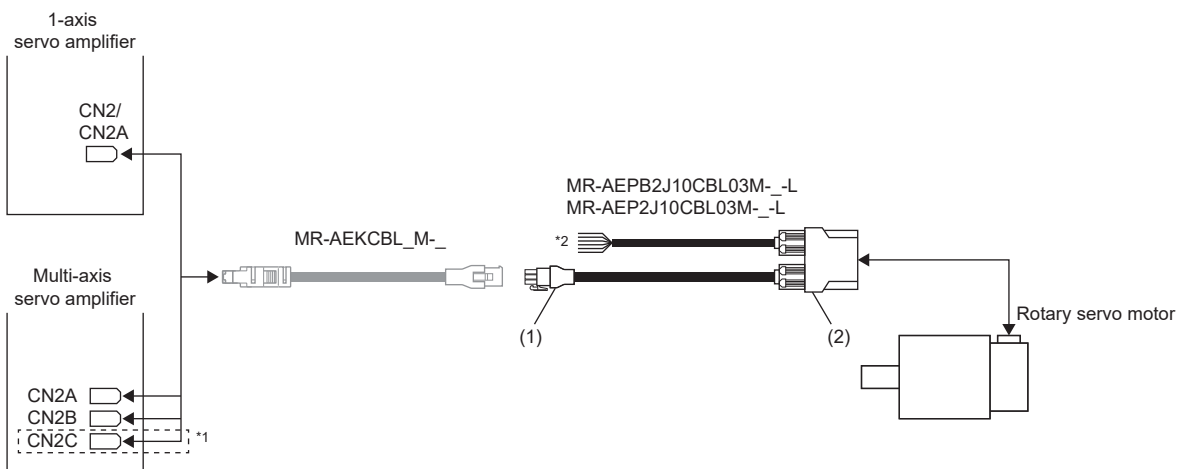

- *1 This connection is for the MR-J5W3-_- and MR-J5D3-_-.
- *2 Refer to the following for connection of the power connector.
 Page 36 Wiring

Junction connector (1)

The following shows the view from the wiring side.

Housing: 1-172169-9

Contact: 170361-4

Cable clamp: 316454-1

Crimping tool: 91529-1

(TE Connectivity)

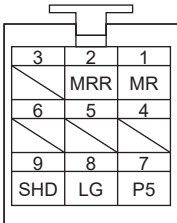

Motor-side connector (2)

■ Load-side lead/opposite to load-side lead

The following shows the view from the wiring side. Do not connect anything to the pins that are marked with a diagonal line.

Connector set: MT50W-8D/2D4ES-CVLD(7.5)

Contact (for motor power supply): MT50E-1820SCFA

Contact (for encoder and electromagnetic brake): MT50D-2224SCFA

(Hirose Electric)

- Load-side lead

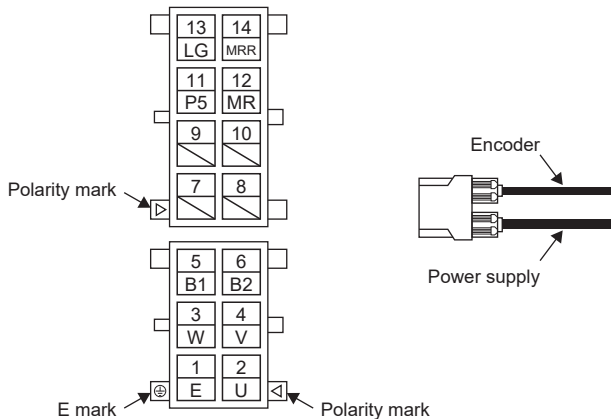

- Opposite to load-side lead

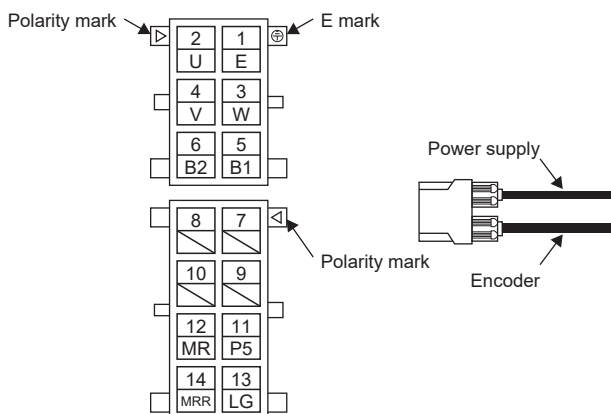

Vertical lead

The following shows the view from the wiring side. Do not connect anything to the pins that are marked with a diagonal line.

Connector set: MT50W-8D/2D4ES-CVSD(7.5)

Contact (for motor power supply): MT50E-1820SCFA

Contact (for encoder and electromagnetic brake): MT50D-2224SCFA

(Hirose Electric)

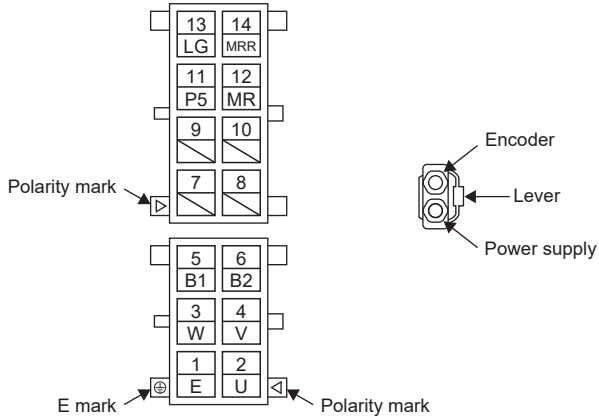

Cable internal wiring diagram

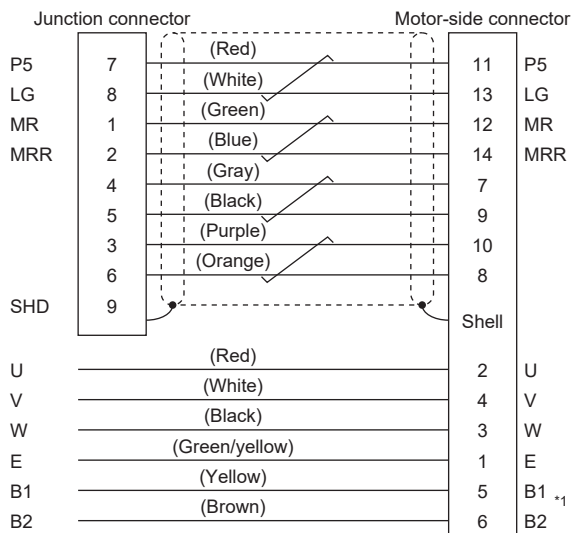

*1 B1 and B2 are the wiring for electromagnetic brake. Wire when MR-AEPB2J10CBL03M-_-L is used. If MR-AEP2J10CBL03M-_-L is used, B1 and B2 do not need to be wired as MR-AEP2J10CBL03M-_-L does not have B1 and B2.

MR-AEPB2J20CBL03M-_-L/MR-AEP2J20CBL03M-_-L

The servo amplifier and the rotary servo motor cannot be connected by these cables alone. The servo amplifier-side encoder cables (MR-AENSCBL_M-_ and MR-J3ENSCBL_M-_) are required.

Model

The following describes what each block of a model name indicates. Not all combinations of the symbols are available.

MR - A E P B 2 J 2 0 C B L 0 3 M - A 1 - L

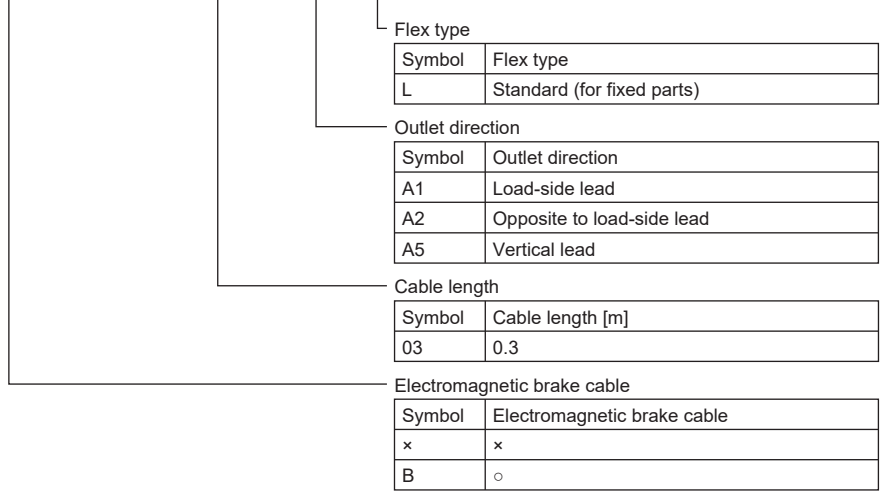

Connecting the servo amplifier and rotary servo motor

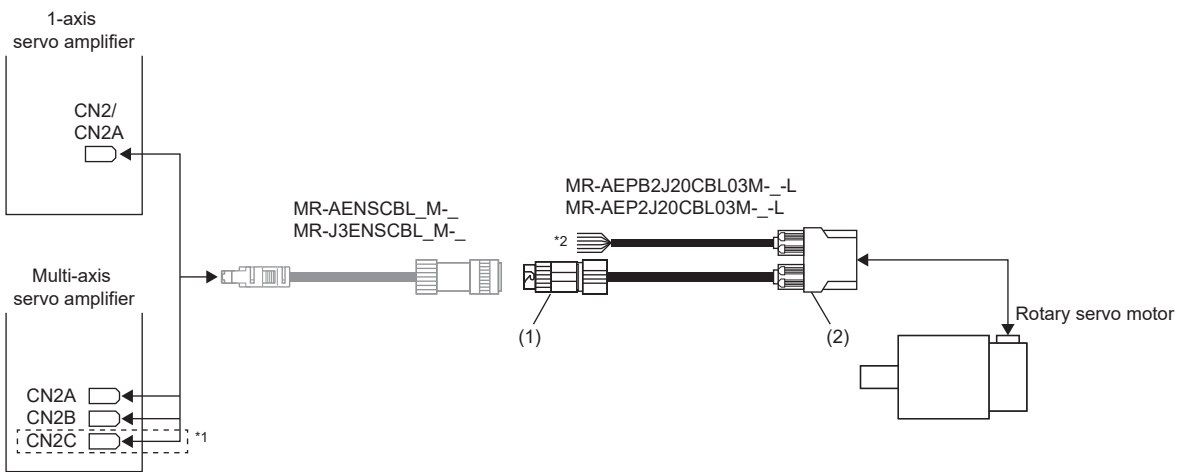

*1 This connection is for the MR-J5W3-_ and MR-J5D3-_.
 *2 Refer to the following for connection of the power connector.
 Page 36 Wiring

Junction connector (1)

The following shows the view from the wiring side.

Receptacle: CMV1-CR10P-M2

(DDK)

Applicable wire size: AWG 20 or lower

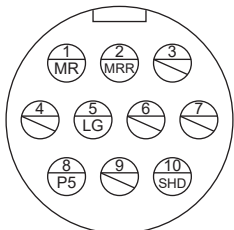

Motor-side connector (2)

■ Load-side lead/opposite to load-side lead

The following shows the view from the wiring side. Do not connect anything to the pins that are marked with a diagonal line.

Connector set: MT50W-8D/2D4ES-CVLD(7.5)

Contact (for motor power supply): MT50E-1820SCFA

Contact (for encoder and electromagnetic brake): MT50D-2224SCFA

(Hirose Electric)

- Load-side lead

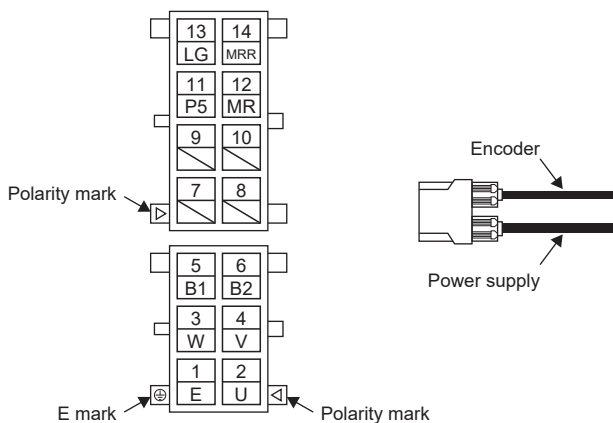

- Opposite to load-side lead

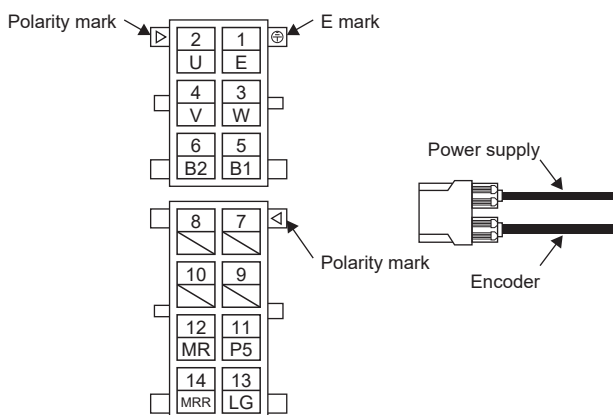

Vertical lead

The following shows the view from the wiring side. Do not connect anything to the pins that are marked with a diagonal line.

Connector set: MT50W-8D/2D4ES-CVSD(7.5)

Contact (for motor power supply): MT50E-1820SCFA

Contact (for encoder and electromagnetic brake): MT50D-2224SCFA

(Hirose Electric)

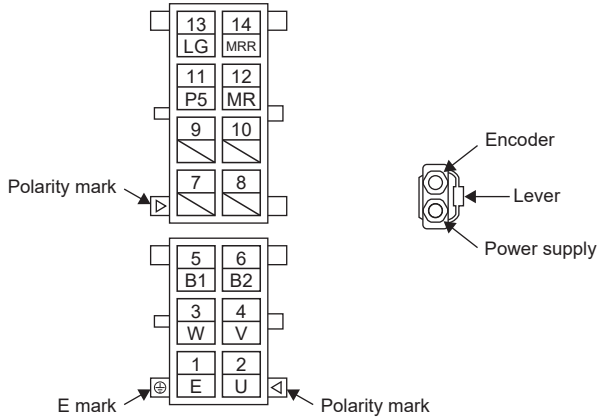

Cable internal wiring diagram

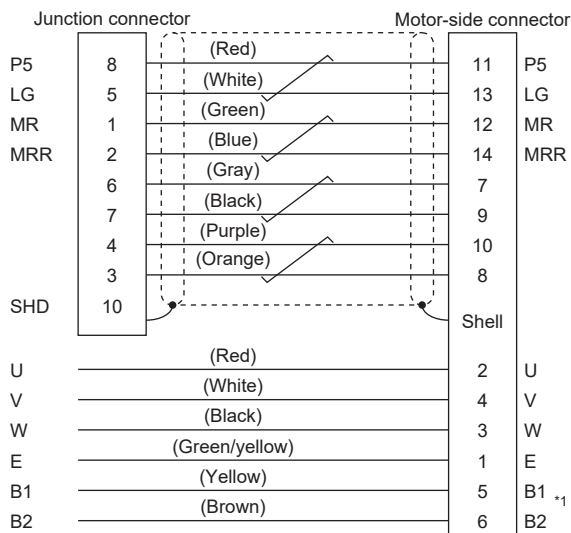

*1 B1 and B2 are the wiring for electromagnetic brake. Wire when MR-AEPB2J20CBL03M-_-L is used. If MR-AEP2J20CBL03M-_-L is used, B1 and B2 do not need to be wired as MR-AEP2J20CBL03M-_-L does not have B1 and B2.

MR-AEPB1CBL_M-_-/_MR-AEP1CBL_M-_-_

Model

The following describes what each block of a model name indicates. Not all combinations of the symbols are available.

MR - AEPB1CBL2M - A1 - L

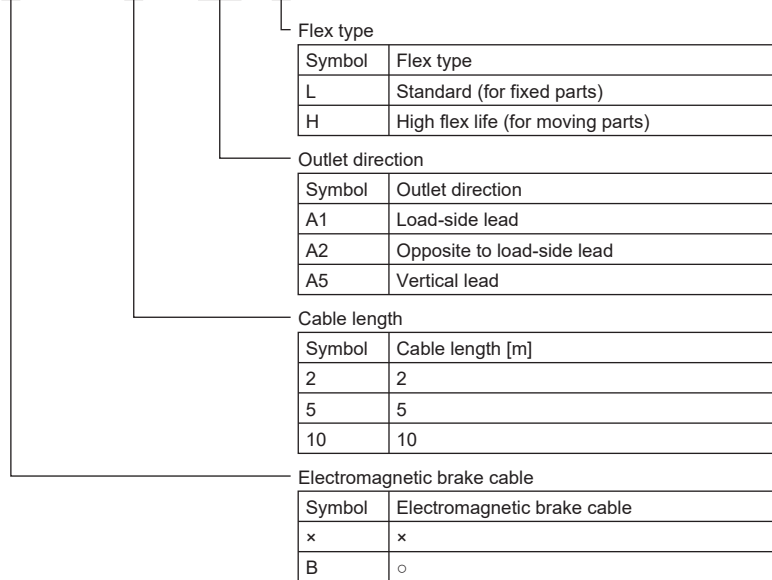

Connecting the servo amplifier and rotary servo motor

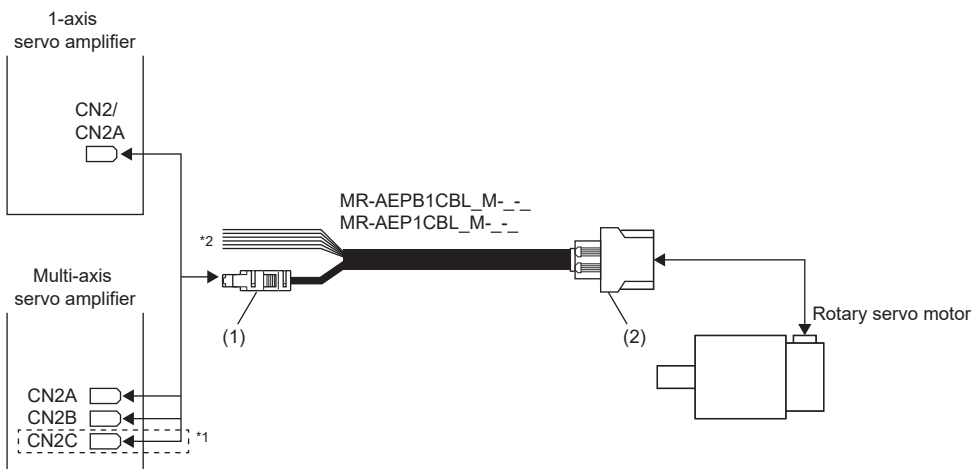

*1 This connection is for the MR-J5W3- and MR-J5D3-.

*2 Refer to the following for connection of the power connector.

☞ Page 36 Wiring

CN2, CN2A, CN2B, and CN2C side connector (1)

The following shows the view from the wiring side. Do not connect anything to the pins that are marked with a diagonal line. Securely connect the external conductor of the shielded cable to the ground plate and fix it to the connector shell.

☞ Page 100 Shielding CN2, CN2A, CN2B, and CN2C connectors

Receptacle: 36210-0100PL

Shell kit: 36310-3200-008

(3M or equivalent)

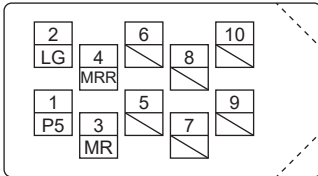

Connector set: 54599-1016

(Molex)

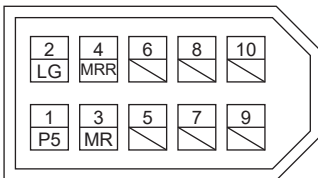

Motor-side connector (2)

■ Load-side lead/opposite to load-side lead

The following shows the view from the wiring side. Do not connect anything to the pins that are marked with a diagonal line.

Connector set: MT50W-8D/2D4ES-CVL(11.9)

Contact (for motor power supply): MT50E-1820SCFA

Contact (for encoder and electromagnetic brake): MT50D-2224SCFA

(Hirose Electric)

- Load-side lead

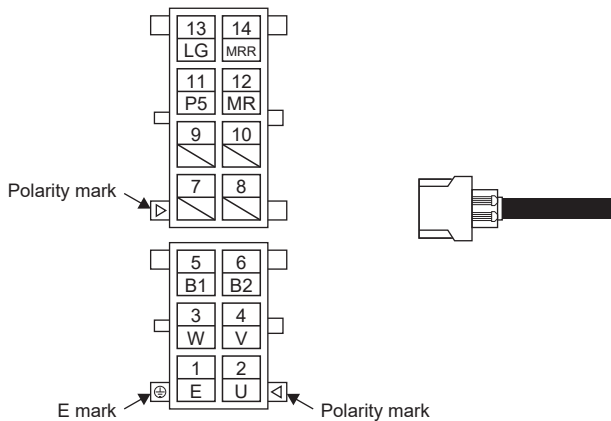

- Opposite to load-side lead

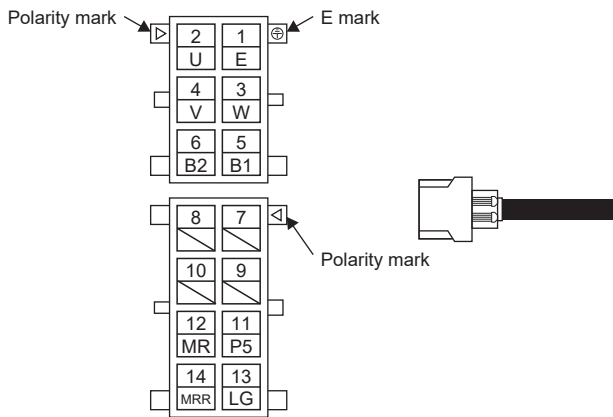

■ Vertical lead

The following shows the view from the wiring side. Do not connect anything to the pins that are marked with a diagonal line.

Connector set: MT50W-8D/2D4ES-CVSD(7.5)

Contact (for motor power supply): MT50E-1820SCFA

Contact (for encoder and electromagnetic brake): MT50D-2224SCFA

(Hirose Electric)

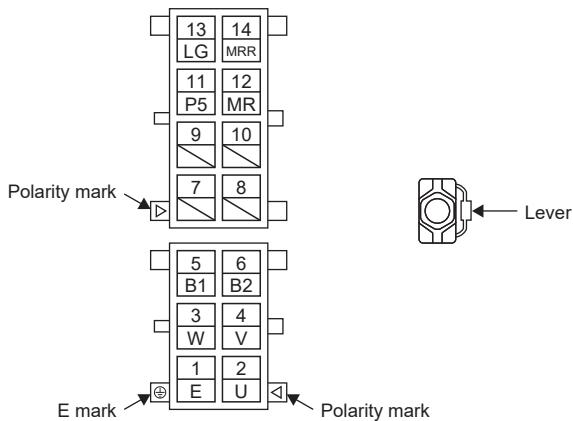

Cable internal wiring diagram

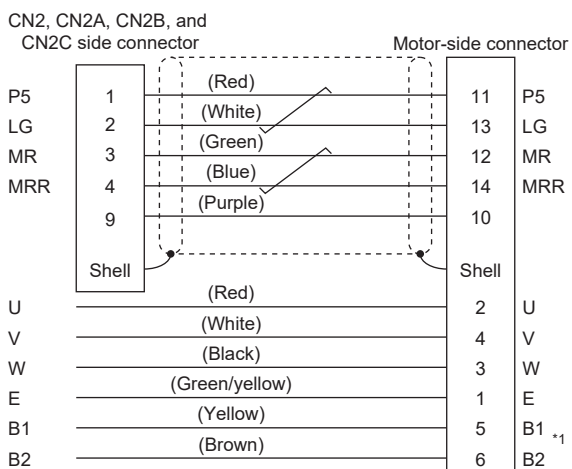

*1 B1 and B2 are the wiring for electromagnetic brake. Wire when MR-AEPB1CBL_M-_- is used. If MR-AEP1CBL_M-_- is used, B1 and B2 do not need to be wired as MR-AEP1CBL_M-_- does not have B1 and B2.

5.3 Encoder cable

MR-AEKCBL_M-__

The servo amplifier and the rotary servo motor cannot be connected by these cables alone. The motor cables for rotary servo motors (MR-AEPB2J10CBL03M-_-L/MR-AEP2J10CBL03M-_-L) are required.

Model

The following describes what each block of a model name indicates. Not all combinations of the symbols are available.

MR - AEKCBL 20M - L

Flex type	
Symbol	Flex type
L	Standard (for fixed parts)
H	High flex life (for moving parts)

Cable length	
Symbol	Cable length [m]
20	20
30	30
40	40
50	50

Connecting the servo amplifier and rotary servo motor

This connection is for when electromagnetic brake cable is included.

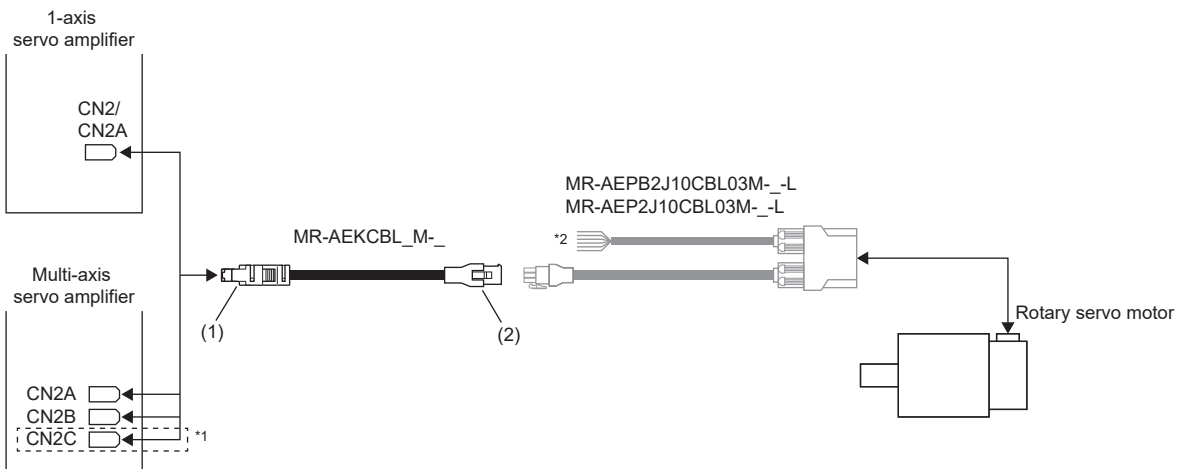

*1 This connection is for the MR-J5W3-__ and MR-J5D3-__.
 *2 Refer to the following for connection of the power connector.
 Page 36 Wiring

CN2, CN2A, CN2B, and CN2C side connector (1)

The following shows the view from the wiring side. Do not connect anything to the pins that are marked with a diagonal line. Securely connect the external conductor of the shielded cable to the ground plate and fix it to the connector shell.

☞ Page 100 Shielding CN2, CN2A, CN2B, and CN2C connectors

Receptacle: 36210-0100PL

Shell kit: 36310-3200-008

(3M or equivalent)

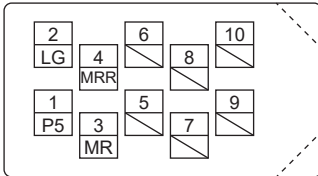

Connector set: 54599-1016

(Molex)

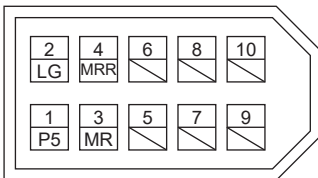

Junction connector (2)

The following shows the view from the wiring side.

Housing: 1-172161-9

Connector pin: 170359-1

Crimping tool: 91529-1

(TE Connectivity or equivalent)

Cable clamp: MTI-0002

(Toa Electric Industrial)

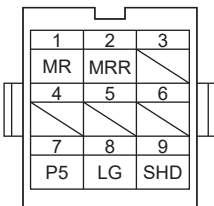

Internal wiring diagram

The cable colors in the connection diagram apply to the following cables:

HRZDEV-SLAB-C18448(20276), RMDCV-SLAB-C18451(20276) manufactured by Dyden Corporation

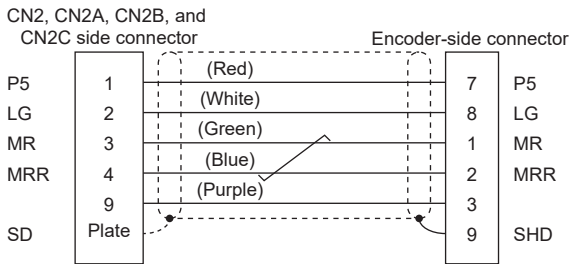



When fabricating an encoder cable

Prepare the following parts, and fabricate the cable in accordance with the following.

☞ Page 83 Internal wiring diagram

Refer to the following for the specifications of the cable to use.

☞ Page 90 Wires for option cables

Parts (Connector set)	Description	
	CN2, CN2A, CN2B, and CN2C side connector	Junction connector
MR-ECNM	 Receptacle: 36210-0100PL Shell kit: 36310-3200-008 (3M) or Connector set: 54599-1019 (Molex)	 Housing: 1-172161-9 Connector pin: 170359-1 (TE Connectivity or equivalent) Cable clamp: MTI-0002 (Toa Electric Industrial)

MR-AENSCBL_M-₋

Model

The following describes what each block of a model name indicates. Not all combinations of the symbols are available.

MR - A E N S C B L 2 0 M - L

Flex type

Symbol	Flex type
L	Standard (for fixed parts)
H	High flex life (for moving parts)

Cable length

Symbol	Cable length [m]
20	20
30	30
40	40
50	50

Connecting the servo amplifier and rotary servo motor

■HK-KT series/HK-MT series/HK-RT (1.0 kW - 2.0 kW) series

This connection is for when electromagnetic brake cable is included.

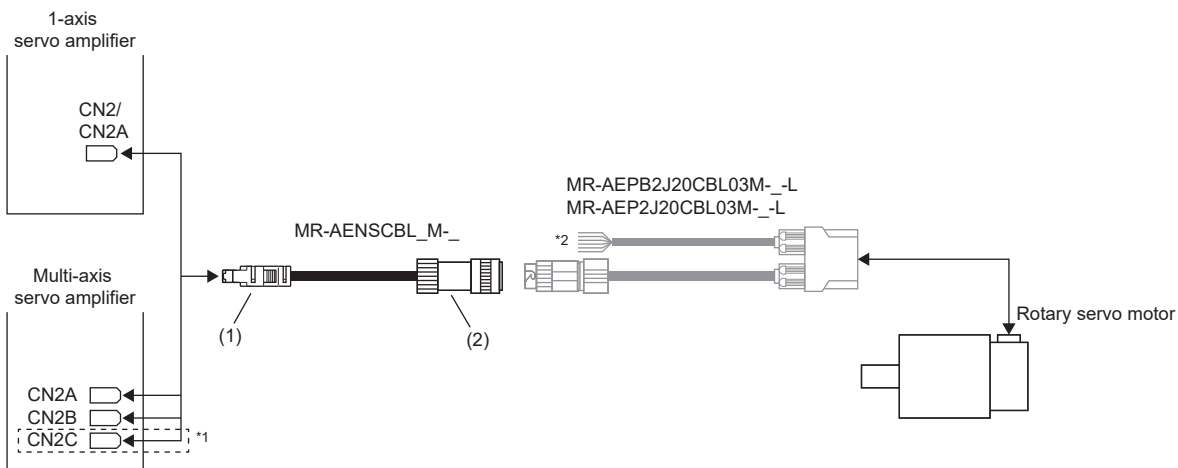

*1 This connection is for the MR-J5W3- and MR-J5D3-.

*2 Refer to the following for connection of the power connector.

☞ Page 36 Wiring

■HK-ST series/HK-RT (3.5 kW - 7.0 kW) series

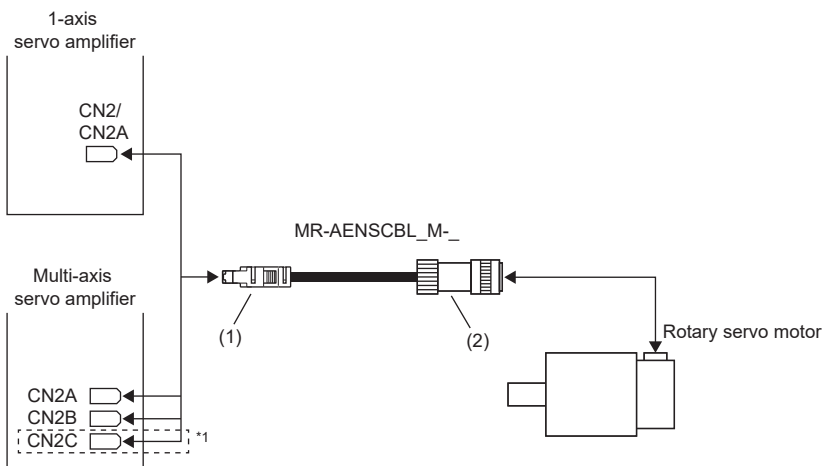

*1 This connection is for the MR-J5W3- and MR-J5D3-.

CN2, CN2A, CN2B, and CN2C side connector (1)

The following shows the view from the wiring side. Do not connect anything to the pins that are marked with a diagonal line. Securely connect the external conductor of the shielded cable to the ground plate and fix it to the connector shell.

☞ Page 100 Shielding CN2, CN2A, CN2B, and CN2C connectors

Receptacle: 36210-0100PL

Shell kit: 36310-3200-008

(3M or equivalent)

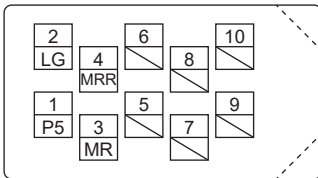

Connector set: 54599-1016

(Molex)

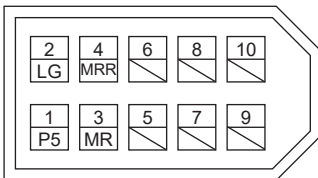

Junction connector (2)

Plug (DDK)	
Straight plug	Socket contact
CMV1-SP10S-M2	CMV1-#22ASC-S1-100 Applicable wire size: AWG 20 or lower

The following shows the view from the wiring side.

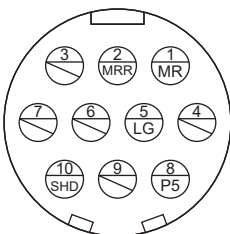

Cable internal wiring diagram

The cable colors in the connection diagram apply to the following cables:

HRZDEV-SLAB-C18448(20276), RMDCV-SLAB-C18451(20276) manufactured by Dyden Corporation

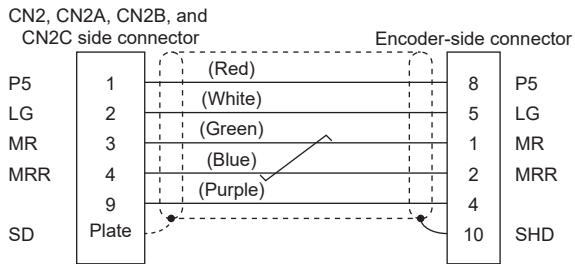





When fabricating an encoder cable

Prepare the following parts, and fabricate the cable in accordance with the following diagram.

☞ Page 86 Cable internal wiring diagram

Refer to the following for the specifications of the cable to use.

☞ Page 90 Wires for option cables

Parts (Connector set)	Description	
	Servo amplifier-side connector	Encoder-side connector (DDK)
MR-J3SCNS (One-touch connection type) *1	 Receptacle: 36210-0100PL Shell kit: 36310-3200-008 (3M) or Connector set: 54599-1019 (Molex)	 Straight plug: CMV1-SP10S-M2 Socket contact: CMV1-#22ASC-S1-100 Applicable wire size: AWG 20 or lower
MR-ENCNS2 (Screw type) *1	(Same as above)	 Straight plug: CMV1S-SP10S-M2 Socket contact: CMV1-#22ASC-S1-100 Applicable wire size: AWG 20 or lower
MR-J3SCNSA (One-touch connection type) *1	(Same as above)	 Angle plug: CMV1-AP10S-M2 Socket contact: CMV1-#22ASC-S1-100 Applicable wire size: AWG 20 or lower
MR-ENCNS2A (Screw type) *1	(Same as above)	 Angle plug: CMV1S-AP10S-M2 Socket contact: CMV1-#22ASC-S1-100 Applicable wire size: AWG 20 or lower

*1 Cable clamps and bushings for cables with an outer diameter of 5.5 mm to 7.5 mm and 7.0 mm to 9.0 mm are included.

MR-J3ENSCBL_M-

Model

The following describes what each block of a model name indicates. Not all combinations of the symbols are available.

MR - J 3 E N S C B L 2 M - L

Flex type

Symbol	Flex type
L	Standard (for fixed parts)
H	High flex life (for moving parts)

Cable length

Symbol	Cable length [m]
2	2
5	5
10	10

Connecting the servo amplifier and rotary servo motor

■HK-KT series/HK-MT series/HK-RT (1.0 kW - 2.0 kW) series

This connection is for when electromagnetic brake cable is included.

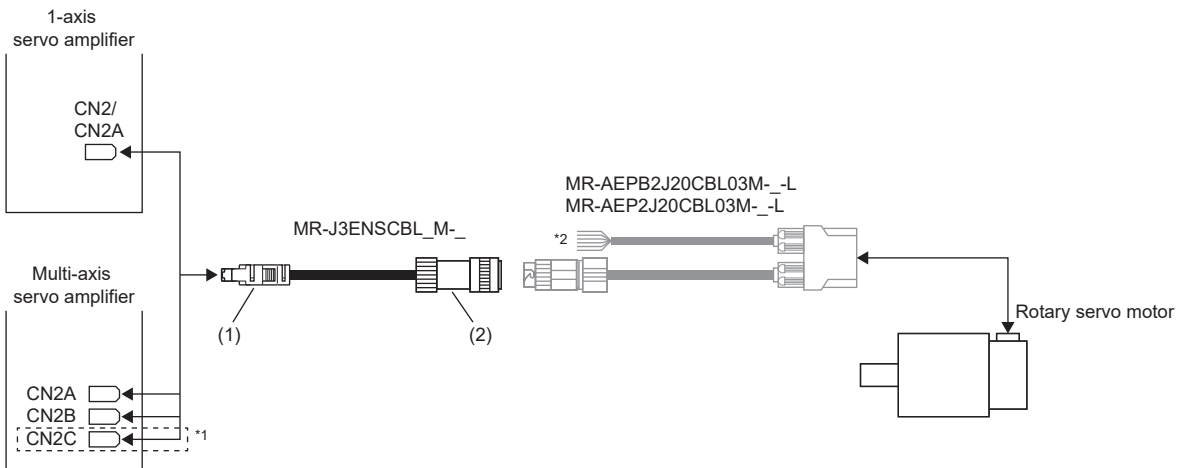

*1 This connection is for the MR-J5W3- and MR-J5D3-.

*2 Refer to the following for connection of the power connector.

☞ Page 36 Wiring

■HK-ST series/HK-RT (3.5 kW - 7.0 kW) series

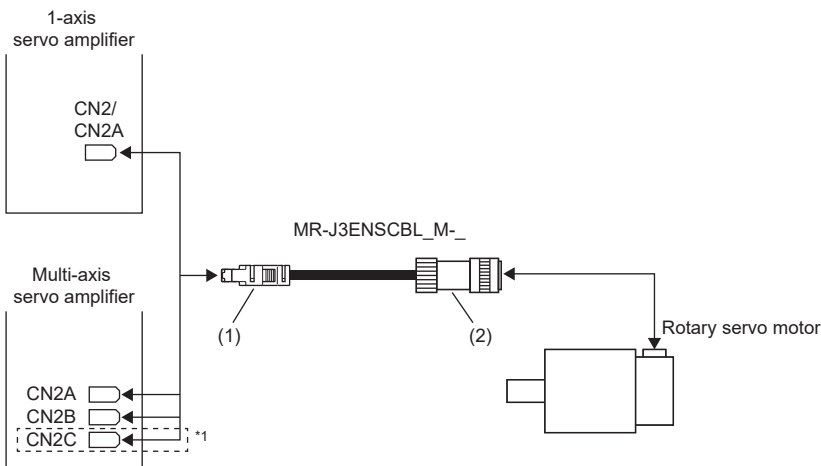

*1 This connection is for the MR-J5W3- and MR-J5D3-.

CN2, CN2A, CN2B, and CN2C side connector (1)

The following shows the view from the wiring side. Do not connect anything to the pins that are marked with a diagonal line. Securely connect the external conductor of the shielded cable to the ground plate and fix it to the connector shell.

☞ Page 100 Shielding CN2, CN2A, CN2B, and CN2C connectors

Receptacle: 36210-0100PL

Shell kit: 36310-3200-008

(3M or equivalent)

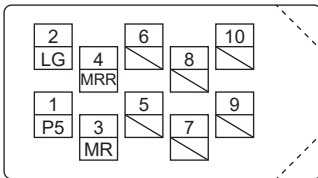

Connector set: 54599-1019

(Molex)

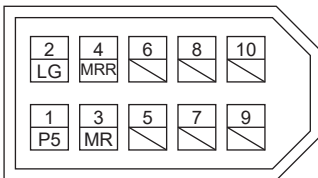

Junction connector (2)

Plug (DDK)	
Straight plug	Socket contact
CMV1-SP10S-M1	CMV1-#22ASC-C1-100 Applicable wire size: AWG 24 to 20 Crimping tool: 357J-53162T

The following shows the view from the wiring side.

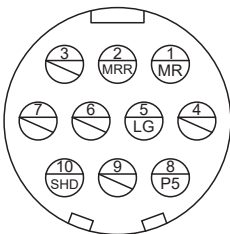

Cable internal wiring diagram

- MR-J3ENSCBL2M-L
- MR-J3ENSCBL5M-L
- MR-J3ENSCBL10M-L
- MR-J3ENSCBL2M-H
- MR-J3ENSCBL5M-H
- MR-J3ENSCBL10M-H

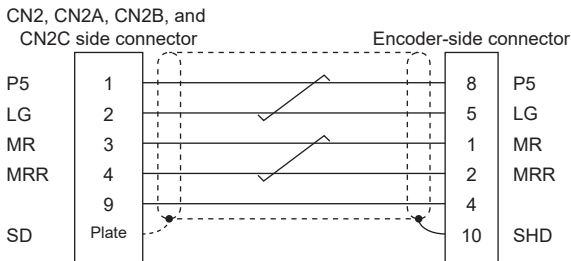





When fabricating an encoder cable

Prepare the following parts, and fabricate the cable in accordance with the following diagram.

☞ Page 89 Cable internal wiring diagram

Refer to the following for the specifications of the cable to use.

☞ Page 90 Wires for option cables

Parts (Connector set)	Description	
	Servo amplifier-side connector	Encoder-side connector (DDK)
MR-J3SCNS (One-touch connection type) *1	 Receptacle: 36210-0100PL Shell kit: 36310-3200-008 (3M) or Connector set: 54599-1019 (Molex)	 Straight plug: CMV1-SP10S-M2 Socket contact: CMV1-#22ASC-S1-100 Applicable wire size: AWG 20 or lower
MR-ENCNS2 (Screw type) *1		 Straight plug: CMV1S-SP10S-M2 Socket contact: CMV1-#22ASC-S1-100 Applicable wire size: AWG 20 or lower
MR-J3SCNSA (One-touch connection type) *1		 Angle plug: CMV1-AP10S-M2 Socket contact: CMV1-#22ASC-S1-100 Applicable wire size: AWG 20 or lower
MR-ENCNS2A (Screw type) *1		 Angle plug: CMV1S-AP10S-M2 Socket contact: CMV1-#22ASC-S1-100 Applicable wire size: AWG 20 or lower

*1 Cable clamps and bushings for cables with an outer diameter of 5.5 mm to 7.5 mm and 7.0 mm to 9.0 mm are included.

5.4 Wires for option cables

Precautions for option cables

When wiring the cables, leave the minimum bending radius or more to prevent stress from being applied to the cables. Refer to the following for the cable flex life.

 Page 101 Cable flex life

If special length shielded cables or shielded power cables are required, use the HK-KT/HK-MT/HK-RT (1.0 kW - 2.0 kW) motor cables manufactured by Mitsubishi Electric System & Service Co., Ltd. that meet the following specifications.

- UL 758 (AWM) (For encoder: UL style 20276 For power supply/brake: UL style 2586)
- Flame retardant UL 1581 VW-1

For the detailed specifications, contact your local sales office.

MR-AEPB2CBL_M-_-L/MR-AEPB2CBL_M-_-H

Item		Cable length [m]	Flex type	Applicable standard	
				For wiring between devices UL 758 (AWM)	Flame retardant UL 1581
MR-AEPB2CBL_M-_-L	For encoder	2 to 10	Standard (for fixed parts)	UL style 20276	VW-1
	For power supply/brake			UL style 2586	VW-1
MR-AEPB2CBL_M-_-H	For encoder	2 to 10	High flex life (for moving parts)	UL style 20276	VW-1
	For power supply/brake			UL style 2586	VW-1

Item		Physical characteristics			
		Conductor construction	Braided shielding material	Sheath material	Color
MR-AEPB2CBL_M-_-L	For encoder	AWG 22 × 3 pairs	Tinned annealed copper wire	Flame-retardant and oil-resistant PVC	Black
	For power supply/brake	AWG 18 × 4 cores AWG 24 × 2 cores	—	Flame-retardant and oil-resistant PVC	Black
MR-AEPB2CBL_M-_-H	For encoder	AWG 22 × 3 pairs	Tinned annealed copper wire	Flame-retardant and oil-resistant PVC	Black
	For power supply/brake	AWG 18 × 4 cores AWG 24 × 2 cores	—	Flame-retardant and oil-resistant PVC	Black

Item		Wire specifications				
		Conductor OD [mm]	Cable OD ^{*1} [mm]	Minimum bending radius [mm] (recommended value)	Insulation resistance (at 20 °C) [MΩ/km]	Withstand voltage [Vac/min]
MR-AEPB2CBL_M-_-L	For encoder	0.76 (AWG 22)	7.5	4 times the cable OD	10 or more	500
	For power supply/brake	1.21 (AWG 18) 0.6 (AWG 24)	7.5	4 times the cable OD	100 or more	2000
MR-AEPB2CBL_M-_-H	For encoder	0.77 (AWG 22)	7.5	4 times the cable OD	100 or more	500
	For power supply/brake	1.36 (AWG 18) 0.61 (AWG 24)	7.5	4 times the cable OD	100 or more	2000

Item		Wire specifications			Recommended product	
		Rated temperature [°C]	Conductor resistance (at 20 °C) [Ω/km]	Rated voltage [V]	Model	Manufacturer
MR-AEPB2CBL_M-_-L	For encoder	80	55.0 or less	30	HRZVV-SB-C18465 (20276)	Dyden
	For power supply/brake	105	21.8 or less 92.2 or less	600	HRZFEV-C18213 (2586)	
MR-AEPB2CBL_M-_-H	For encoder	80	55.0 or less	30	RMFEV-SB-C18466 (20276)	
	For power supply/brake	105	25.6 or less 97.6 or less	600	RMFEV-C18211 (2586)	

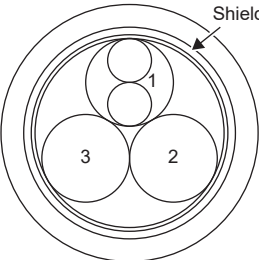
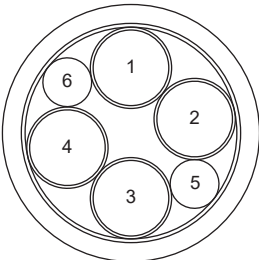
HRZVV-SB-C18465(20276)/RMFEV-SB-C18466(20276)		HRZFEV-C18213(2586)/RMFEV-C18211(2586)	
Reference diagram 	AWG 22 1: Red and white 2: Green and blue 3: Purple and orange	Reference diagram 	Power supply (AWG 18) 1: Black 2: White 3: Red 4: Green/yellow Electromagnetic brake (AWG 24) 5: Brown 6: Yellow

MR-AEP2CBL_M-_-L/MR-AEP2CBL_M-_-H

Item		Cable length [m]	Flex type	Applicable standard	
				For wiring between devices UL 758 (AWM)	Flame retardant UL 1581
MR-AEP2CBL_M-_-L	For encoder	2 to 10	Standard (for fixed parts)	UL style 20276	VW-1
	For power supply			UL style 2586	VW-1
MR-AEP2CBL_M-_-H	For encoder	2 to 10	High flex life (for moving parts)	UL style 20276	VW-1
	For power supply			UL style 2586	VW-1

Item		Physical characteristics			
		Conductor construction	Braided shielding material	Sheath material	Color
MR-AEP2CBL_M-_-L	For encoder	AWG 22 × 3 pairs	Tinned annealed copper wire	Flame-retardant and oil-resistant PVC	Black
	For power supply	AWG 18 × 4 cores	—	Flame-retardant and oil-resistant PVC	Black
MR-AEP2CBL_M-_-H	For encoder	AWG 22 × 3 pairs	Tinned annealed copper wire	Flame-retardant and oil-resistant PVC	Black
	For power supply	AWG 18 × 4 cores	—	Flame-retardant and oil-resistant PVC	Black

Item		Wire specifications				
		Conductor OD [mm]	Cable OD *1 [mm]	Minimum bending radius [mm] (recommended value)	Insulation resistance (at 20 °C) [MΩ/km]	Withstand voltage [Vac/min]
MR-AEP2CBL_M-_-L	For encoder	0.76 (AWG 22)	7.5	4 times the cable OD	10 or more	500
	For power supply	1.21 (AWG 18)	7.5	4 times the cable OD	100 or more	2000
MR-AEP2CBL_M-_-H	For encoder	0.77 (AWG 22)	7.5	4 times the cable OD	100 or more	500
	For power supply	1.36 (AWG 18)	7.5	4 times the cable OD	100 or more	2000

Item		Wire specifications			Recommended product	
		Rated temperature [°C]	Conductor resistance (at 20 °C) [Ω/km]	Rated voltage [V]	Model	Manufacturer
MR-AEP2CBL_M-_-L	For encoder	80	55.0 or less	30	HRZVV-SB-C18465 (20276)	Dyden
	For power supply	105	21.8 or less	600	HRZFEV-C18355 (2586)	
MR-AEP2CBL_M-_-H	For encoder	80	55.0 or less	30	RMFEV-SB-C18466 (20276)	
	For power supply	105	25.6 or less	600	RMFEV-C18353 (2586)	

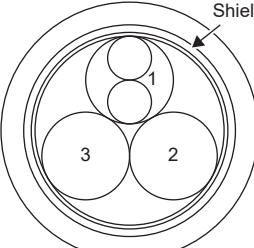
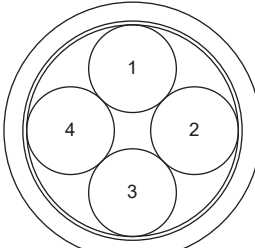
HRZVV-SB-C18465(20276)/RMFEV-SB-C18466(20276)		HRZFEV-C18355(2586)/RMFEV-C18353(2586)	
Reference diagram 	AWG 22 1: Red and white 2: Green and blue 3: Purple and orange	Reference diagram 	AWG 18 1: Black 2: White 3: Red 4: Green/yellow

MR-AEPB2J20CBL03M-_-L/MR-AEPB2J10CBL03M-_-L

Item	Cable length [m]	Flex type	Applicable standard		
			For wiring between devices UL 758 (AWM)	Flame retardant UL 1581	
MR-AEPB2J20CBL03M-_-L	For encoder	0.3	Standard (for fixed parts)	UL style 20276	VW-1
	For power supply/brake			UL style 2586	VW-1
MR-AEPB2J10CBL03M-_-L	For encoder	0.3	Standard (for fixed parts)	UL style 20276	VW-1
	For power supply/brake			UL style 2586	VW-1

Item	Physical characteristics				
	Conductor construction	Braided shielding material	Sheath material	Color	
MR-AEPB2J20CBL03M-_-L	For encoder	AWG 24 × 4 pairs	Tinned annealed copper wire	Flame-retardant and oil-resistant PVC	Black
	For power supply/brake	AWG 18 × 4 cores AWG 24 × 2 cores	—	Flame-retardant and oil-resistant PVC	Black
MR-AEPB2J10CBL03M-_-L	For encoder	AWG 24 × 4 pairs	Tinned annealed copper wire	Flame-retardant and oil-resistant PVC	Black
	For power supply/brake	AWG 18 × 4 cores AWG 24 × 2 cores	—	Flame-retardant and oil-resistant PVC	Black

Item	Wire specifications					
	Conductor OD [mm]	Cable OD *1 [mm]	Minimum bending radius [mm] (recommended value)	Insulation resistance (at 20 °C) [MΩ/km]	Withstand voltage [Vac/min]	
MR-AEPB2J20CBL03M-_-L	For encoder	0.6 (AWG 24)	7.5	4 times the cable OD	10 or more	500
	For power supply/brake	1.21 (AWG 18) 0.6 (AWG 24)	7.5	4 times the cable OD	100 or more	2000
MR-AEPB2J10CBL03M-_-L	For encoder	0.6 (AWG 24)	7.5	4 times the cable OD	10 or more	500
	For power supply/brake	1.21 (AWG 18) 0.6 (AWG 24)	7.5	4 times the cable OD	100 or more	2000

Item	Wire specifications			Recommended product		
	Rated temperature [°C]	Conductor resistance (at 20 °C) [Ω/km]	Rated voltage [V]	Model	Manufacturer	
MR-AEPB2J20CBL03M-_-L	For encoder	80	92.2 or less	30	HRZVV-SB-C18467 (20276)	Dyden
	For power supply/brake	105	21.8 or less 92.2 or less	600	HRZFEV-C18213 (2586)	
MR-AEPB2J10CBL03M-_-L	For encoder	80	92.2 or less	30	HRZVV-SB-C18467 (20276)	Dyden
	For power supply/brake	105	21.8 or less 92.2 or less	600	HRZFEV-C18213 (2586)	

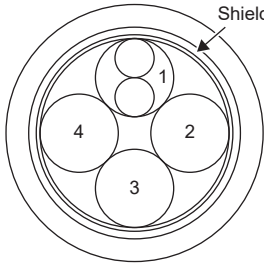
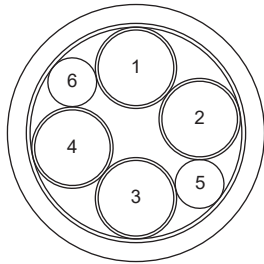
HRZVV-SB-C18467(20276)		HRZFEV-C18213(2586)	
Reference diagram 	AWG 24 1: Red and white 2: Green and blue 3: Purple and orange 4: Gray and black	Reference diagram 	Power supply (AWG 18) 1: Black 2: White 3: Red 4: Green/yellow Electromagnetic brake (AWG 24) 5: Brown 6: Yellow

MR-AEP2J20CBL03M-_-L/MR-AEP2J10CBL03M-_-L

Item		Cable length [m]	Flex type	Applicable standard	
				For wiring between devices UL 758 (AWM)	Flame retardant UL 1581
MR-AEP2J20CBL03M-_-L	For encoder	0.3	Standard (for fixed parts)	UL style 20276	VW-1
	For power supply			UL style 2586	VW-1
MR-AEP2J10CBL03M-_-L	For encoder	0.3	Standard (for fixed parts)	UL style 20276	VW-1
	For power supply			UL style 2586	VW-1

Item		Physical characteristics			
		Conductor construction	Braided shielding material	Sheath material	Color
MR-AEP2J20CBL03M-_-L	For encoder	AWG 24 × 4 pairs	Tinned annealed copper wire	Flame-retardant and oil-resistant PVC	Black
	For power supply	AWG 18 × 4 cores	—	Flame-retardant and oil-resistant PVC	Black
MR-AEP2J10CBL03M-_-L	For encoder	AWG 24 × 4 pairs	Tinned annealed copper wire	Flame-retardant and oil-resistant PVC	Black
	For power supply	AWG 18 × 4 cores	—	Flame-retardant and oil-resistant PVC	Black

Item		Wire specifications				
		Conductor OD [mm]	Cable OD *1 [mm]	Minimum bending radius [mm] (recommended value)	Insulation resistance (at 20 °C) [MΩ/km]	Withstand voltage [Vac/min]
MR-AEP2J20CBL03M-_-L	For encoder	0.6 (AWG 24)	7.5	4 times the cable OD	10 or more	500
	For power supply	1.21 (AWG 18)	7.5	4 times the cable OD	100 or more	2000
MR-AEP2J10CBL03M-_-L	For encoder	0.6 (AWG 24)	7.5	4 times the cable OD	10 or more	500
	For power supply	1.21 (AWG 18)	7.5	4 times the cable OD	100 or more	2000

Item		Wire specifications			Recommended product	
		Rated temperature [°C]	Conductor resistance (at 20 °C) [Ω/km]	Rated voltage [V]	Model	Manufacturer
MR-AEP2J20CBL03M-_-L	For encoder	80	92.2 or less	30	HRZVV-SB-C18467 (20276)	Dyden
	For power supply	105	21.8 or less	600	HRZFEV-C18355 (2586)	
MR-AEP2J10CBL03M-_-L	For encoder	80	92.2 or less	30	HRZVV-SB-C18467 (20276)	Dyden
	For power supply	105	21.8 or less	600	HRZFEV-C18355 (2586)	

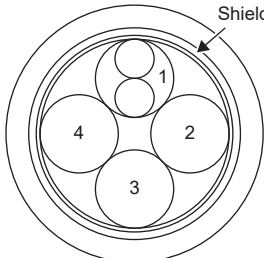
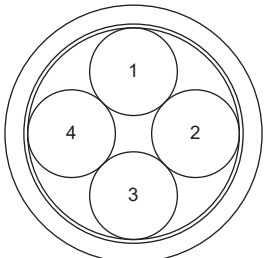
HRZVV-SB-C18467(20276)		HRZFEV-C18355(2586)	
Reference diagram 	AWG 24 1: Red and white 2: Green and blue 3: Purple and orange 4: Gray and black	Reference diagram 	AWG 18 1: Black 2: White 3: Red 4: Green/yellow

MR-AEPB1CBL_M-_-L/MR-AEP1CBL_M-_-L

Item		Cable length [m]	Flex type	Applicable standard	
				For wiring between devices UL 758 (AWM)	Flame retardant UL 1581
MR-AEPB1CBL_M-_-L	For encoder/power supply/brake	2 to 10	Standard (for fixed parts)	UL style 2586	VW-1
MR-AEP1CBL_M-_-L	For encoder/power supply	2 to 10	Standard (for fixed parts)	UL style 2586	VW-1

Item		Physical characteristics			
		Conductor construction	Braided shielding material	Sheath material	Color
MR-AEPB1CBL_M-_-L	For encoder/power supply/brake	AWG 18 × 4 cores AWG 24 × 2 cores AWG 22 × 3 pairs	Tinned annealed copper wire (encoder cables only)	Flame-retardant and oil-resistant PVC	Black
MR-AEP1CBL_M-_-L	For encoder/power supply	AWG 18 × 4 cores AWG 22 × 3 pairs	Tinned annealed copper wire (encoder cables only)	Flame-retardant and oil-resistant PVC	Black

Item		Wire specifications				
		Conductor OD [mm]	Cable OD *1 [mm]	Minimum bending radius [mm] (recommended value)	Insulation resistance (at 20 °C) [MΩ/km]	Withstand voltage [Vac/min]
MR-AEPB1CBL_M-_-L	For encoder/power supply/brake	1.21 (AWG 18) 0.6 (AWG 24) 0.76 (AWG 22)	11.9	4 times the cable OD	100 or more	2000
MR-AEP1CBL_M-_-L	For encoder/power supply	1.21 (AWG 18) 0.76 (AWG 22)	11.9	4 times the cable OD	100 or more	2000

Item		Wire specifications			Recommended product	
		Rated temperature [°C]	Conductor resistance (at 20 °C) [Ω/km]	Rated voltage [V]	Model	Manufacturer
MR-AEPB1CBL_M-_-L	For encoder/power supply/brake	105	21.8 or less 92.2 or less 55.0 or less	600	HRZFEV-ESB-C18737 (2586)	Dyden
MR-AEP1CBL_M-_-L	For encoder/power supply	105	21.8 or less 55.0 or less	600	HRZFEV-ESB-C18785 (2586)	

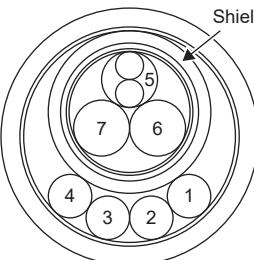
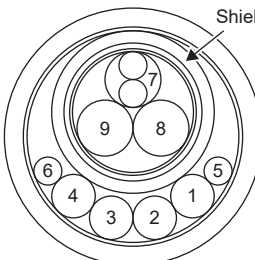
HRZFEV-ESB-C18785(2586)		HRZFEV-ESB-C18737(2586)	
Reference diagram	Power supply (AWG 18) 1: Black 2: White 3: Red 4: Green/yellow Encoder (AWG 22) 5: Red and white 6: Green and blue 7: Purple and orange	Reference diagram	Power supply (AWG 18) 1: Black 2: White 3: Red 4: Green/yellow Electromagnetic brake (AWG 24) 5: Brown 6: Yellow Encoder (AWG 22) 7: Red and white 8: Green and blue 9: Purple and orange
			

MR-AEPB1CBL_M-_-H/MR-AEP1CBL_M-_-H

Item		Cable length [m]	Flex type	Applicable standard	
				For wiring between devices UL 758 (AWM)	Flame retardant UL 1581
MR-AEPB1CBL_M-_-H	For encoder/power supply/brake	2 to 10	High flex life (for moving parts)	UL style 2586	VW-1
MR-AEP1CBL_M-_-H	For encoder/power supply	2 to 10	High flex life (for moving parts)	UL style 2586	VW-1

Item		Physical characteristics			
		Conductor construction	Braided shielding material	Sheath material	Color
MR-AEPB1CBL_M-_-H	For encoder/power supply/brake	AWG 18 × 4 cores AWG 24 × 2 cores AWG 22 × 3 pairs	Tinned annealed copper wire (encoder cables only)	Flame-retardant and oil-resistant PVC	Black
MR-AEP1CBL_M-_-H	For encoder/power supply	AWG 18 × 4 cores AWG 22 × 3 pairs	Tinned annealed copper wire (encoder cables only)	Flame-retardant and oil-resistant PVC	Black

Item		Wire specifications				
		Conductor OD [mm]	Cable OD *1 [mm]	Minimum bending radius [mm] (recommended value)	Insulation resistance (at 20 °C) [MΩ/km]	Withstand voltage [Vac/min]
MR-AEPB1CBL_M-_-H	For encoder/power supply/brake	1.36 (AWG 18) 0.61 (AWG 24) 0.77 (AWG 22)	11.9	4 times the cable OD	100 or more	2000
MR-AEP1CBL_M-_-H	For encoder/power supply	1.36 (AWG 18) 0.77 (AWG 22)	11.9	4 times the cable OD	100 or more	2000

Item		Wire specifications			Recommended product	
		Rated temperature [°C]	Conductor resistance (at 20 °C) [Ω/km]	Rated voltage [V]	Model	Manufacturer
MR-AEPB1CBL_M-_-H	For encoder/power supply/brake	105	25.6 or less 97.6 or less 55.0 or less	600	RMFEV-ESB-C18222 (2586)	Dyden
MR-AEP1CBL_M-_-H	For encoder/power supply	105	25.6 or less 55.0 or less	600	RMFEV-ESB-C18786 (2586)	

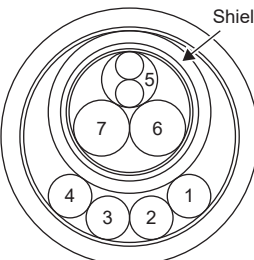
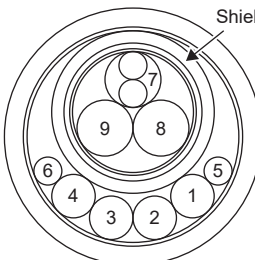
RMFEV-ESB-C18786(2586)		RMFEV-ESB-C18222(2586)	
Reference diagram	Power supply (AWG 18) 1: Black 2: White 3: Red 4: Green/yellow Encoder (AWG 22) 5: Red and white 6: Green and blue 7: Purple and orange	Reference diagram	Power supply (AWG 18) 1: Black 2: White 3: Red 4: Green/yellow Electromagnetic brake (AWG 24) 5: Brown 6: Yellow Encoder (AWG 22) 7: Red and white 8: Green and blue 9: Purple and orange
			

MR-AENSCBL_M-L/MR-AENSCBL_M-H

Item		Cable length [m]	Flex type	Applicable standard	
				For wiring between devices UL 758 (AWM)	Flame retardant UL 1581
MR-AENSCBL_M-L	For encoder	20, 30	Standard (for fixed parts)	UL style 20276	VW-1
MR-AENSCBL_M-H	For encoder	20 to 50	High flex life (for moving parts)	UL style 20276	VW-1

Item		Physical characteristics			
		Conductor construction	Braided shielding material	Sheath material	Color
MR-AENSCBL_M-L	For encoder	AWG 15 × 2 cores AWG 22 × 2 pairs AWG 24 × 1 pair	Tinned annealed copper wire	Flame-retardant and oil-resistant PVC	Black
MR-AENSCBL_M-H	For encoder	AWG 15 × 2 cores AWG 23 × 2 pairs AWG 24 × 1 pair	Tinned annealed copper wire	Flame-retardant and oil-resistant PVC	Black

Item		Wire specifications				
		Conductor OD [mm]	Cable OD *1 [mm]	Minimum bending radius [mm] (recommended value)	Insulation resistance (at 20 °C) [MΩ/km]	Withstand voltage [Vac/min]
MR-AENSCBL_M-L	For encoder	1.83 (AWG 15) 0.78 (AWG 22) 0.6 (AWG 24)	8.6	4 times the cable OD	100 or more	500
MR-AENSCBL_M-H	For encoder	2.0 (AWG 15) 0.72 (AWG 23) 0.61 (AWG 24)	8.7	4 times the cable OD	100 or more	500

Item		Wire specifications			Recommended product	
		Rated temperature [°C]	Conductor resistance (at 20 °C) [Ω/km]	Rated voltage [V]	Model	Manufacturer
MR-AENSCBL_M-L	For encoder	80	10.5 or less 55.5 or less 93.9 or less	30	HRZDEV-SLAB-C18448 (20276)	Dyden
MR-AENSCBL_M-H	For encoder	80	11.0 or less 72.9 or less 99.4 or less	30	RMDCV-SLAB-C18451 (20276)	

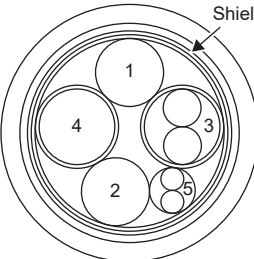
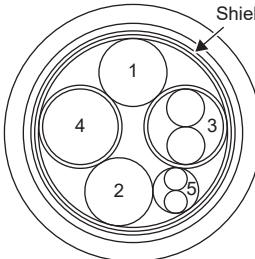
HRZDEV-SLAB-C18448(20276)		RMDCV-SLAB-C18451(20276)	
Reference diagram 	AWG 15 1: Red 2: White AWG 22 3: Green and blue 4: Gray and black AWG 24 5: Purple and orange	Reference diagram 	AWG 15 1: Red 2: White AWG 23 3: Green and blue 4: Gray and black AWG 24 5: Purple and orange

MR-AEKCBL_M-L/MR-AEKCBL_M-H

Item		Cable length [m]	Flex type	Applicable standard	
				For wiring between devices UL 758 (AWM)	Flame retardant UL 1581
MR-AEKCBL_M-L	For encoder	20, 30	Standard (for fixed parts)	UL style 20276	VW-1
MR-AEKCBL_M-H	For encoder	20 to 50	High flex life (for moving parts)	UL style 20276	VW-1

Item		Physical characteristics			
		Conductor construction	Braided shielding material	Sheath material	Color
MR-AEKCBL_M-L	For encoder	AWG 15 × 2 cores AWG 22 × 2 pairs AWG 24 × 1 pair	Tinned annealed copper wire	Flame-retardant and oil-resistant PVC	Black
MR-AEKCBL_M-H	For encoder	AWG 15 × 2 cores AWG 23 × 2 pairs AWG 24 × 1 pair	Tinned annealed copper wire	Flame-retardant and oil-resistant PVC	Black

Item		Wire specifications				
		Conductor OD [mm]	Cable OD *1 [mm]	Minimum bending radius [mm] (recommended value)	Insulation resistance (at 20 °C) [MΩ/km]	Withstand voltage [Vac/min]
MR-AEKCBL_M-L	For encoder	1.83 (AWG 15) 0.78 (AWG 22) 0.6 (AWG 24)	8.6	4 times the cable OD	100 or more	500
MR-AEKCBL_M-H	For encoder	2.0 (AWG 15) 0.72 (AWG 23) 0.61 (AWG 24)	8.7	4 times the cable OD	100 or more	500

Item		Wire specifications			Recommended product	
		Rated temperature [°C]	Conductor resistance (at 20 °C) [Ω/km]	Rated voltage [V]	Model	Manufacturer
MR-AEKCBL_M-L	For encoder	80	10.5 or less 55.5 or less 93.9 or less	30	HRZDEV-SLAB-C18448 (20276)	Dyden
MR-AEKCBL_M-H	For encoder	80	11.0 or less 72.9 or less 99.4 or less	30	RMDCV-SLAB-C18451 (20276)	

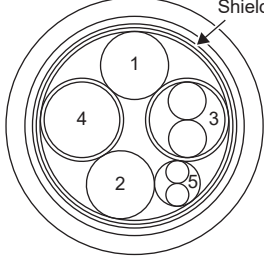
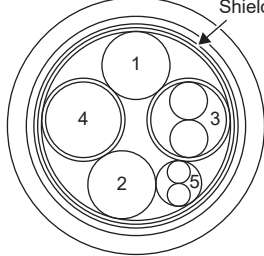
HRZDEV-SLAB-C18448(20276)		RMDCV-SLAB-C18451(20276)	
Reference diagram 	AWG 15 1: Red 2: White AWG 22 3: Green and blue 4: Gray and black AWG 24 5: Purple and orange	Reference diagram 	AWG 15 1: Red 2: White AWG 23 3: Green and blue 4: Gray and black AWG 24 5: Purple and orange

MR-J3ENSCBL_M-L/MR-J3ENSCBL_M-H

Item		Cable length [m]	Flex type	Applicable standard	
				For wiring between devices UL 758 (AWM)	Flame retardant UL 1581
MR-J3ENSCBL_M-L	For encoder	2 to 10	Standard (for fixed parts)	—	—
MR-J3ENSCBL_M-H	For encoder	2 to 10	High flex life (for moving parts)	—	—

Item		Physical characteristics			
		Conductor construction	Braided shielding material	Sheath material	Color
MR-J3ENSCBL_M-L	For encoder	AWG 22 × 3 pairs	Tinned annealed copper wire	Lead-free heat resistant PVC	Black
MR-J3ENSCBL_M-H	For encoder	AWG 22 × 3 pairs	Tinned annealed copper wire	Lead-free heat resistant PVC	Black

Item		Wire specifications				
		Conductor OD [mm]	Cable OD *1 [mm]	Minimum bending radius [mm] (recommended value)	Insulation resistance (at 20 °C) [MΩ/km]	Withstand voltage [Vac/min]
MR-J3ENSCBL_M-L	For encoder	0.78 (AWG 22)	7.2	8 times the cable OD	10 or more	500
MR-J3ENSCBL_M-H	For encoder	0.77 (AWG 22)	7.2	8 times the cable OD	10 or more	500

Item		Wire specifications			Recommended product	
		Rated temperature [°C]	Conductor resistance (at 20 °C) [Ω/km]	Rated voltage [V]	Model	Manufacturer
MR-J3ENSCBL_M-L	For encoder	80	53.0 or less	30	VSVP 7/0.26 (AWG#22 or equivalent)-3P KB-1655	Bando Densen
MR-J3ENSCBL_M-H	For encoder	80	56.0 or less	30	TPE•SVP 70/0.08 (AWG#22 or equivalent)-3P KB-2237	

VSVP 7/0.26 (AWG#22 or equivalent)-3P KB-1655
TPE•SVP 70/0.08 (AWG#22 or equivalent)-3P KB-2237

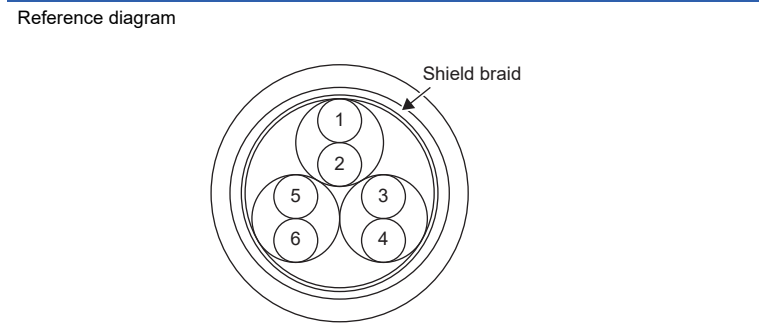

- AWG 22
 1: Black
 2: White
 3: Red
 4: Green
 5: Yellow
 6: Brown

*1 Standard OD. The maximum OD is about 10 % greater.

5.5 Shielding CN2, CN2A, CN2B, and CN2C connectors

When wiring the CN2, CN2A, CN2B, and CN2C side connectors, securely connect the external conductor of the shielded cable to the ground plate and fix it to the connector shell.

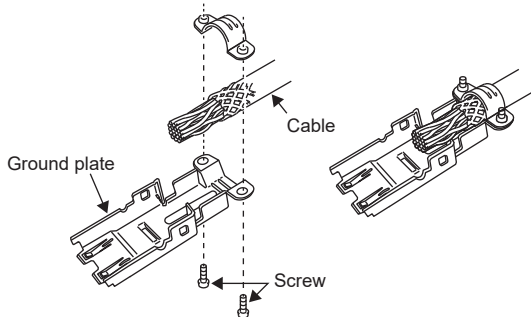

5.6 Cable flex life

The flex life of the cables is shown below. This graph shows calculated values and not guaranteed values. The cable flex life factors in conductor and insulation breakage. The values are calculated from fully disconnected cables and do not take into account wear from electrical characteristics, sheath abrasion, or insulation deterioration. Allow for a deviation in these values.

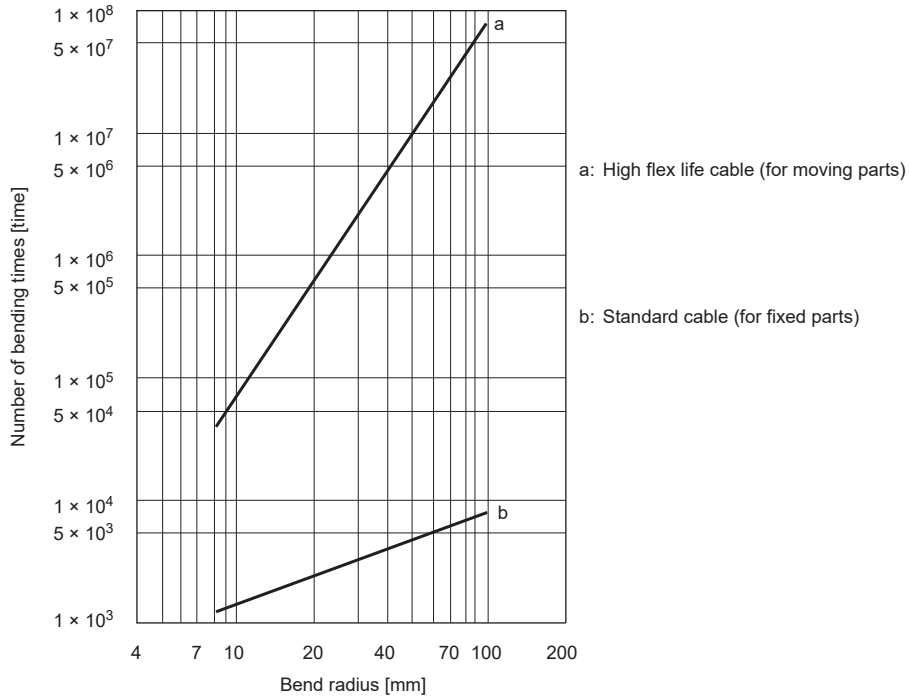

6 HK-KT SERIES

This chapter provides information on the rotary servo motor specifications and characteristics. The indicated values and those without tolerance are representative values. When using the HK-KT series rotary servo motor, read chapters 1 to 5 and SAFETY INSTRUCTIONS at the beginning of this manual in addition to this chapter.

For the combinations of servo amplifiers and rotary servo motors, restrictions on the firmware version of the servo amplifier, and restrictions by the date of manufacture of the rotary servo motor, refer to "Servo amplifier/motor combinations" in the following manuals.

 MR-J5 User's Manual (Hardware)

 MR-J5D User's Manual (Hardware)

6.1 Model designation

The following describes what each block of a model name indicates. Not all combinations of the symbols are available.

HK - KT 4 3 4 WB

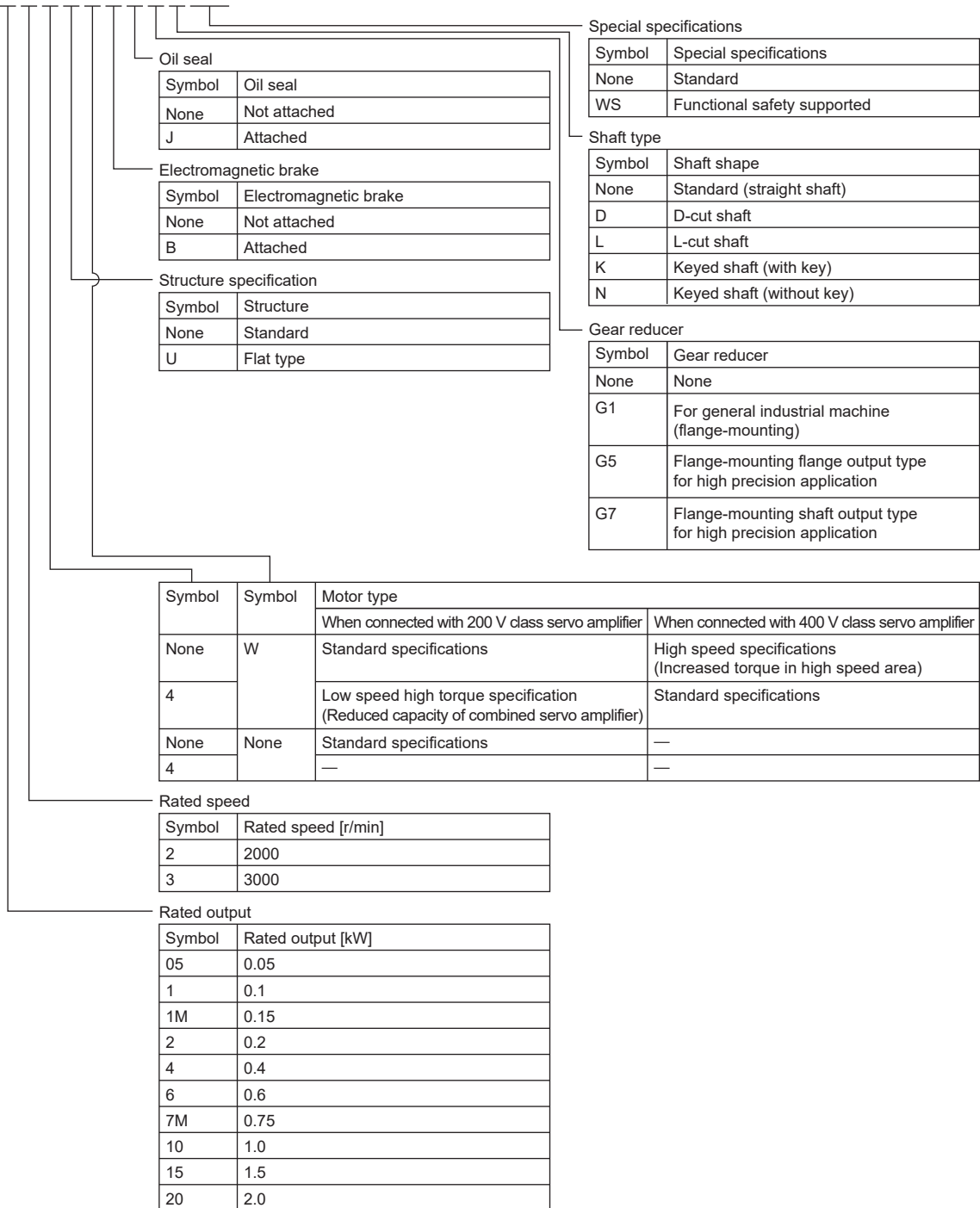

6.2 Standard specifications

Standard specifications list

When connected with 200 V servo amplifier

Series		HK-KT_ (Low inertia/small capacity)						
Flange size		□40			□60			
Rotary servo motor model		053W	13W	1M3W	13UW	23W	43W	63W
Power supply capacity		Refer to "Power supply capacity and generated loss" in the following manual. □□MR-J5 User's Manual (Hardware)						
Power supply voltage [V]		200 V AC (3-phase 200 V AC to 240 V AC)						
Continuous running duty ^{*1}	Rated output [kW]	0.05	0.1	0.15	0.1	0.2	0.4	0.6
	Rated torque [N·m]	0.16 ^{*14}	0.32	0.48	0.32	0.64	1.3	1.9
Maximum torque ^{*8} [N·m]		0.56 (0.72)	1.1 (1.4)	1.7 (2.1)	1.1 (1.4)	2.2 (2.9)	4.5 (5.7)	6.7 (8.6)
Rated speed ^{*1} [r/min]		3000						
Maximum speed ^{*1} [r/min]		6700						
Power rate at continuous rated torque [kW/s]	Without an electromagnetic brake	6.4	14.8	23.3	8.4	19.4	39.5	61.0
	With an electromagnetic brake	5.8	14.0	22.4	6.6	16.0	36.7	58.0
Rated current [A]		1.3	1.2	1.2	1.1	1.4	2.6	4.5
Maximum current ^{*8} [A]		4.6 (6.2)	4.6 (6.0)	4.5 (6.0)	4.6 (6.0)	5.4 (7.1)	9.8 (14)	19 (25)
Moment of inertia J [$\times 10^{-4}$ kg·m ²]	Without an electromagnetic brake	0.0394	0.0686	0.0977	0.121	0.209	0.410	0.598
	With an electromagnetic brake	0.0434	0.0725	0.102	0.153	0.254	0.442	0.629
Recommended load to motor inertia ratio ^{*2}		20 times or less ^{*11}		20 times or less	10 times or less ^{*11}	23 times or less ^{*10}	23 times or less	25 times or less
Speed/position detector		26-bit encoder common to batteryless absolute position and incremental systems (resolution per rotary servo motor revolution: 67108864 pulses/rev)						
Type		Permanent magnet synchronous motor						
Oil seal		× ^{*7}						
Electromagnetic brake		× ^{*15}						
Thermistor		×						
Insulation class		155 (F)						
Structure		Totally enclosed, natural cooling (IP rating: IP67) ^{*3*9*13}						
Vibration resistance ^{*4} [m/s ²]		X: 49, Y: 49						
Vibration rank ^{*5}		V10						
Permissible load for the shaft ^{*6*12}	L [mm]	25				30		
	Radial [N]	88				245		
	Thrust [N]	59				98		
Mass ^{*12} [kg]	Without an electromagnetic brake	0.27	0.37	0.47	0.57	0.77	1.2	1.5
	With an electromagnetic brake	0.53	0.63	0.73	0.79	1.2	1.6	1.9

Series		HK-KT_ (Low inertia/small capacity)										
Flange size		□80				□90						
Rotary servo motor model		23UW	43UW	7M3W	103W	63UW	7M3U W	103UW	153W	203W	202W	
Power supply capacity		Refer to "Power supply capacity and generated loss" in the following manual. □□MR-J5 User's Manual (Hardware)										
Power supply voltage [V]		200 V AC (3-phase 200 V AC to 240 V AC)										
Continuous running duty ^{*1*8}	Rated output [kW]	0.2	0.4	0.75	1.0	0.6	0.75	1.0	1.5	2.0	2.0	
	Rated torque [N•m]	0.64	1.3	2.4	3.2	1.9 (2.4)	2.4	3.2	4.8	6.4	9.5	
Maximum torque ^{*8} [N•m]		1.9 (2.5)	4.5 (5.7)	8.4 (10.7)	11.1 (14.3)	6.3 (10.3)	8.4 (10.7)	11.1 (14.3)	16.7 (21.5)	19.1 (25.5)	28.6 (38.2)	
Rated speed ^{*1*8} [r/min]		3000				3000 (2400)	3000				2000	
Maximum speed ^{*8} [r/min]		6700			6500	6000 (6700)	6700	6000	6700	6000	3000	
Power rate at continuous rated torque ^{*8} [kW/s]	Without an electromagnetic brake	9.7	22.3	41.6	60.3	17.3 (27.0)	27.0	37.0	52.0	71.7	111	
	With an electromagnetic brake	7.3	18.8	37.7	56.0	14.9 (23.3)	23.3	32.9	48.3	67.7	107	
Rated current ^{*8} [A]		1.5	2.1	4.7	5.0	3.2 (4.0)	4.0	4.9	8.7	11	9.0	
Maximum current ^{*8} [A]		5.9 (9.0)	9.2 (13)	20 (26)	21 (28)	12 (20)	16 (22)	21 (27)	34 (46)	34 (48)	30 (41)	
Moment of inertia J [$\times 10^{-4}$ kg•m ²]	Without an electromagnetic brake	0.419	0.726	1.37	1.68	2.11	2.11	2.74	4.38	5.65	8.18	
	With an electromagnetic brake	0.557	0.864	1.51	1.81	2.45	2.45	3.08	4.72	5.99	8.53	
Recommended load to motor inertia ratio ^{*2}		10 times or less		16 times or less	17 times or less	10 times or less		15 times or less				
Speed/position detector		26-bit encoder common to batteryless absolute position and incremental systems (resolution per rotary servo motor revolution: 67108864 pulses/rev)										
Type		Permanent magnet synchronous motor										
Oil seal		× ^{*7}										
Electromagnetic brake		× ^{*15}										
Thermistor		×										
Insulation class		155 (F)										
Structure		Totally enclosed, natural cooling (IP rating: IP67) ^{*3*9*13}										
Vibration resistance ^{*4} [m/s ²]		X: 49, Y: 49				X: 24.5, Y: 49			X: 24.5, Y: 24.5			
Vibration rank ^{*5}		V10										
Permissible load for the shaft ^{*6*12}	L [mm]	30		40								
	Radial [N]	245		392								
	Thrust [N]	98		147								
Mass ^{*12} [kg]	Without an electromagnetic brake	1.2	1.5	2.2	2.4	2.3	2.3	2.7	3.6	4.4	5.9	
	With an electromagnetic brake	1.6	1.9	2.9	3.1	2.9	2.9	3.3	4.7	5.5	7.0	

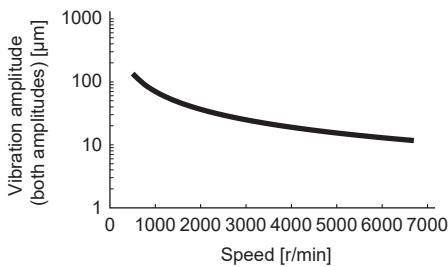
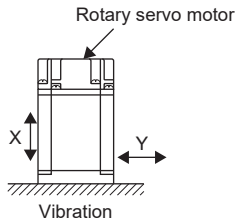

Series		HK-KT_4_ (Low inertia/small capacity)						
Flange size		□60		□80		□90		
Rotary servo motor model		434W	634W	7M34W	1034W	1534W	2034W	2024W
Power supply capacity		Refer to "Power supply capacity and generated loss" in the following manual. □□MR-J5 User's Manual (Hardware)						
Power supply voltage [V]		200 V AC (3-phase 200 V AC to 240 V AC)						
Continuous running duty *1	Rated output [kW]	0.2	0.3	0.375	0.5	0.75	1.0	1.0
	Rated torque [N·m]	1.3	1.9	2.4	3.2	4.8	6.4	9.5
Maximum torque *8 [N·m]		4.5 (5.7)	6.7 (8.6)	8.4 (10.7)	11.1 (14.3)	19.1 (21.5)	22.3 (25.5)	38.2
Rated speed *1 [r/min]		1500						1000
Maximum speed *1 [r/min]		3500			3000			1500
Power rate at continuous rated torque [kW/s]	Without an electromagnetic brake	39.5	61.0	41.6	60.3	52.0	71.7	111
	With an electromagnetic brake	36.7	58.0	37.7	56.0	48.3	67.7	107
Rated current [A]		1.3	2.3	2.4	2.5	4.4	5.3	4.5
Maximum current *8 [A]		4.9 (6.6)	9.1 (13)	9.7 (13)	11 (14)	20 (23)	21 (24)	21
Moment of inertia J [$\times 10^{-4}$ kg·m ²]	Without an electromagnetic brake	0.410	0.598	1.37	1.68	4.38	5.65	8.18
	With an electromagnetic brake	0.442	0.629	1.51	1.81	4.72	5.99	8.53
Recommended load to motor inertia ratio *2		25 times or less		17 times or less		15 times or less		
Speed/position detector		26-bit encoder common to batteryless absolute position and incremental systems (resolution per rotary servo motor revolution: 67108864 pulses/rev)						
Type		Permanent magnet synchronous motor						
Oil seal		× *7						
Electromagnetic brake		× *15						
Thermistor		×						
Insulation class		155 (F)						
Structure		Totally enclosed, natural cooling (IP rating: IP67) *3*9						
Vibration resistance *4 [m/s ²]		X: 49, Y: 49				X: 24.5, Y: 24.5		
Vibration rank *5		V10						
Permissible load for the shaft *6	L [mm]	30		40				
	Radial [N]	245		392				
	Thrust [N]	98		147				
Mass [kg]	Without an electromagnetic brake	1.2	1.5	2.2	2.4	3.6	4.4	5.9
	With an electromagnetic brake	1.6	1.9	2.9	3.1	4.7	5.5	7.0

- *1 When the power supply voltage drops, the continuous running duty and the speed cannot be guaranteed.
- *2 If the load to motor inertia ratio exceeds the indicated value, contact your local sales office.
- *3 The shaft-through portion is excluded. IP classifies the degree of protection provided against the intrusion of solid objects and water in electrical enclosures.
- *4 The vibration directions are shown in the following figure. The value is the one at the part that indicates the maximum value (normally the opposite to load-side bracket). When the rotary servo motor stops, fretting is likely to occur at the bearing. Therefore, suppress the vibration to about half of the permissible value. However, the description above is not applied to a geared servo motor is used.

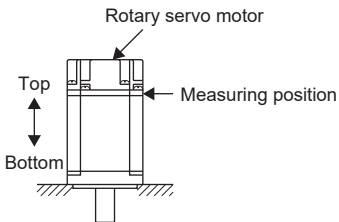

- *5 V10 indicates that the amplitude of a rotary servo motor as a single unit is 10 μm or less. The following figure shows the rotary servo motor mounting position for measurement and the measuring position.



- *6 Refer to the following for permissible load for the shaft.
 Page 118 Permissible load for the output shaft
- *7 Servo motors with an oil seal are also compatible.
- *8 The values in () are for when the torque is increased.
- *9 When IP67 cables are needed, contact your local sales office.
- *10 If the speed is 6000 r/min or less, the recommended load to motor inertia ratio will be 28 times or less.
- *11 This is a recommended load to motor inertia ratio that is applicable when the servo motor is operated at the rated speed in combination with the servo amplifier with a capacity of 0.1 kW. When the servo motor is to be operated at a speed exceeding the rated speed, check whether a regenerative option is required by using Drive System Capacity Selection Software Motorizer. The servo motor can be combined with servo amplifiers with larger capacity.
- *12 Refer to the following for geared servo motors.
 Page 127 Geared servo motor
- *13 When a geared servo motor is used, the IP rating for the gear reducer area is equivalent to IP44.
- *14 For the HK-KT053W_J_ (with an oil seal), use it at a derating rate of 80 %.
- *15 Servo motors with an electromagnetic brake are also compatible.

When connected with 400 V servo amplifier

Series		HK-KT_ (Low inertia/small capacity)		
Flange size		□40		
Rotary servo motor model		053W	13W	1M3W
Power supply capacity		Refer to "Power supply capacity and generated loss" in the following manuals. MR-J5 User's Manual (Hardware) MR-J5D User's Manual (Hardware)		
Power supply voltage [V]		400 V AC (3-phase 380 V AC to 480 V AC)		
Continuous running duty ^{*1}	Rated output [kW]	0.05	0.1	0.15
	Rated torque [N•m]	0.16 ^{*12}	0.32	0.48
Maximum torque ^{*8} [N•m]		0.56 (0.72)	1.1 (1.4)	1.7 (2.1)
Rated speed ^{*1} [r/min]		3000		
Maximum speed ^{*1} [r/min]		6700		
Power rate at continuous rated torque [kW/s]	Without an electromagnetic brake	6.4	14.8	23.3
	With an electromagnetic brake	5.8	14.0	22.4
Rated current [A]		1.3	1.2	1.2
Maximum current ^{*8} [A]		4.6 (6.2)	4.6 (6.0)	4.5 (6.0)
Moment of inertia J [$\times 10^{-4}$ kg•m ²]	Without an electromagnetic brake	0.0394	0.0686	0.0977
	With an electromagnetic brake	0.0434	0.0725	0.102
Recommended load to motor inertia ratio ^{*2}	MR-J5	20 times or less		
	MR-J5D	20 times or less		
Speed/position detector		26-bit encoder common to batteryless absolute position and incremental systems (resolution per rotary servo motor revolution: 67108864 pulses/rev)		
Type		Permanent magnet synchronous motor		
Oil seal		x ^{*7}		
Electromagnetic brake		x ^{*13}		
Thermistor		x		
Insulation class		155 (F)		
Structure		Totally enclosed, natural cooling (IP rating: IP67) ^{*3*9}		
Vibration resistance ^{*4} [m/s ²]		X: 49, Y: 49		
Vibration rank ^{*5}		V10		
Permissible load for the shaft ^{*6}	L [mm]	25		
	Radial [N]	88		
	Thrust [N]	59		
Mass [kg]	Without an electromagnetic brake	0.27	0.37	0.47
	With an electromagnetic brake	0.53	0.63	0.73

Series		HK-KT_4_ (Low inertia/small capacity)									
Flange size		□60			□80			□90			
Rotary servo motor model		434W	634W	7M34W	1034W	634UW	1034UW	1534W	2034W	2024W	
Power supply capacity		Refer to "Power supply capacity and generated loss" in the following manuals. <input type="checkbox"/> MR-J5 User's Manual (Hardware) <input type="checkbox"/> MR-J5D User's Manual (Hardware)									
Power supply voltage [V]		400 V AC (3-phase 380 V AC to 480 V AC)									
Continuous running duty ^{*1*}	Rated output [kW]	0.4	0.6	0.75	1.0	0.6	1.0	1.5	2.0	2.0	
	Rated torque [N·m]	1.3	1.9	2.4	3.2	1.9 (2.4)	3.2	4.8	6.4	9.5	
Maximum torque ^{*8} [N·m]		4.5 (5.7)	6.7 (8.6)	8.4 (10.7)	11.1 (14.3)	6.3 (10.3)	11.1 (14.3)	16.7 (21.5)	19.1 (25.5)	28.6 (38.2)	
Rated speed ^{*1} [r/min]		3000			3000 (2400)		3000			2000	
Maximum speed ^{*1} [r/min]		6700			6500	6000 (6700)	6000	6700	6000	3000	
Power rate at continuous rated torque ^{*8} [kW/s]	Without an electromagnetic brake	39.5	61.0	41.6	60.3	17.3 (27.0)	37.0	52.0	71.7	111	
	With an electromagnetic brake	36.7	58.0	37.7	56.0	14.9 (23.3)	32.9	48.3	67.7	107	
Rated current ^{*8} [A]		1.3	2.3	2.4	2.5	1.6 (2.0)	2.5	4.4	5.3	4.5	
Maximum current ^{*8} [A]		4.9 (6.6)	9.1 (13)	9.7 (13)	11 (14)	5.6 (9.7)	9.7 (14)	17 (23)	17 (24)	15 (21)	
Moment of inertia J [$\times 10^{-4}$ kg·m ²]	Without an electromagnetic brake	0.410	0.598	1.37	1.68	2.11	2.74	4.38	5.65	8.18	
	With an electromagnetic brake	0.442	0.629	1.51	1.81	2.45	3.08	4.72	5.99	8.53	
Recommended load to motor inertia ratio ^{*2}	MR-J5	23 times or less	20 times or less ^{*10}	9 times or less ^{*11}	7 times or less ^{*10}	10 times or less		11 times or less ^{*10}	10 times or less ^{*10}	15 times or less	
	MR-J5D	23 times or less	30 times or less	20 times or less	30 times or less	10 times or less		10 times or less	9 times or less	15 times or less	
Speed/position detector		26-bit encoder common to batteryless absolute position and incremental systems (resolution per rotary servo motor revolution: 67108864 pulses/rev)									
Type		Permanent magnet synchronous motor									
Oil seal		x ^{*7}									
Electromagnetic brake		x ^{*13}									
Thermistor		x									
Insulation class		155 (F)									
Structure		Totally enclosed, natural cooling (IP rating: IP67) ^{*3*9}									
Vibration resistance ^{*4} [m/s ²]		X: 49, Y: 49				X: 24.5, Y: 49					
Vibration rank ^{*5}		V10									
Permissible load for the shaft ^{*6}	L [mm]	30			40						
	Radial [N]	245			392						
	Thrust [N]	98			147						
Mass [kg]	Without an electromagnetic brake	1.2	1.5	2.2	2.4	2.3	2.7	3.6	4.4	5.9	
	With an electromagnetic brake	1.6	1.9	2.9	3.1	2.9	3.3	4.7	5.5	7.0	

- *1 When the power supply voltage drops, the continuous running duty and the speed cannot be guaranteed.
- *2 If the load to motor inertia ratio exceeds the indicated value, contact your local sales office.
- *3 The shaft-through portion is excluded. IP classifies the degree of protection provided against the intrusion of solid objects and water in electrical enclosures.
- *4 The vibration directions are shown in the following figure. The value is the one at the part that indicates the maximum value (normally the opposite to load-side bracket). When the rotary servo motor stops, fretting is likely to occur at the bearing. Therefore, suppress the vibration to about half of the permissible value.

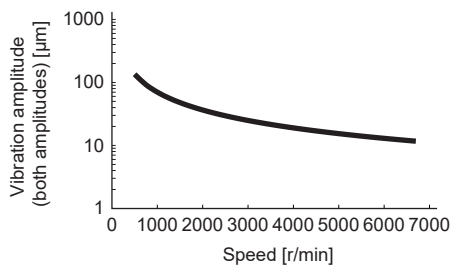
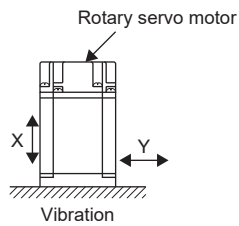

- *5 V10 indicates that the amplitude of a rotary servo motor as a single unit is 10 μm or less. The following figure shows the rotary servo motor mounting position for measurement and the measuring position.

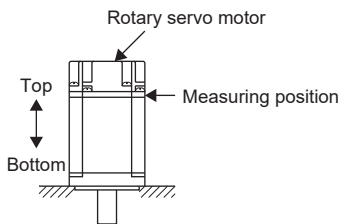

- *6 Refer to the following for permissible load for the shaft.
 - ☞ Page 118 Permissible load for the output shaft
- *7 Servo motors with an oil seal are also compatible.
- *8 The values in () are for when the torque is increased.
- *9 When IP67 cables are needed, contact your local sales office.
- *10 If the speed is 3000 r/min or less, the recommended load to motor inertia ratio will be 30 times or less.
- *11 If the speed is 3000 r/min or less, the recommended load to motor inertia ratio will be 20 times or less.
- *12 For the HK-KT053W_J_ (with an oil seal), use it at a derating rate of 80 %.
- *13 Servo motors with an electromagnetic brake are also compatible.

Torque characteristics

- For machines where unbalanced torque occurs, such as a vertical axis system, the unbalanced torque should be kept at 70 % or lower of the rated torque.

When connected with 200 V servo amplifier

If using 1-phase power supply in combination with the servo motor of 750 W or higher and the MR-J5-100_ or the MR-J5-200_, operate the product at 75 % or less of the effective load ratio.

When the power supply voltage drops, the torque decreases. --- : A rough indication of the possible continuous running range for 3-phase 170 V AC

— : 3-phase 200 V AC
 --- : 1-phase 200 V AC

■HK-KT_W

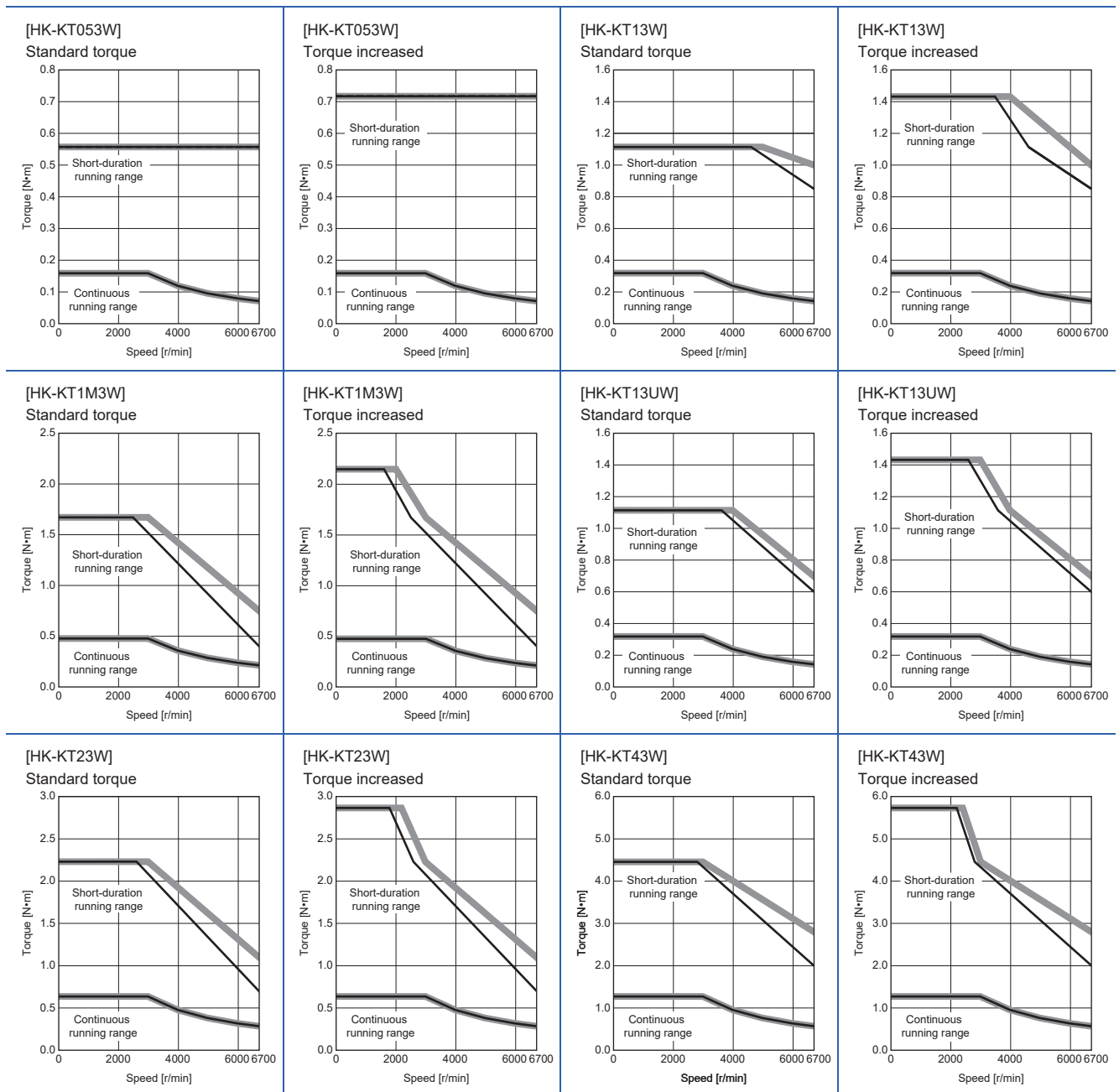

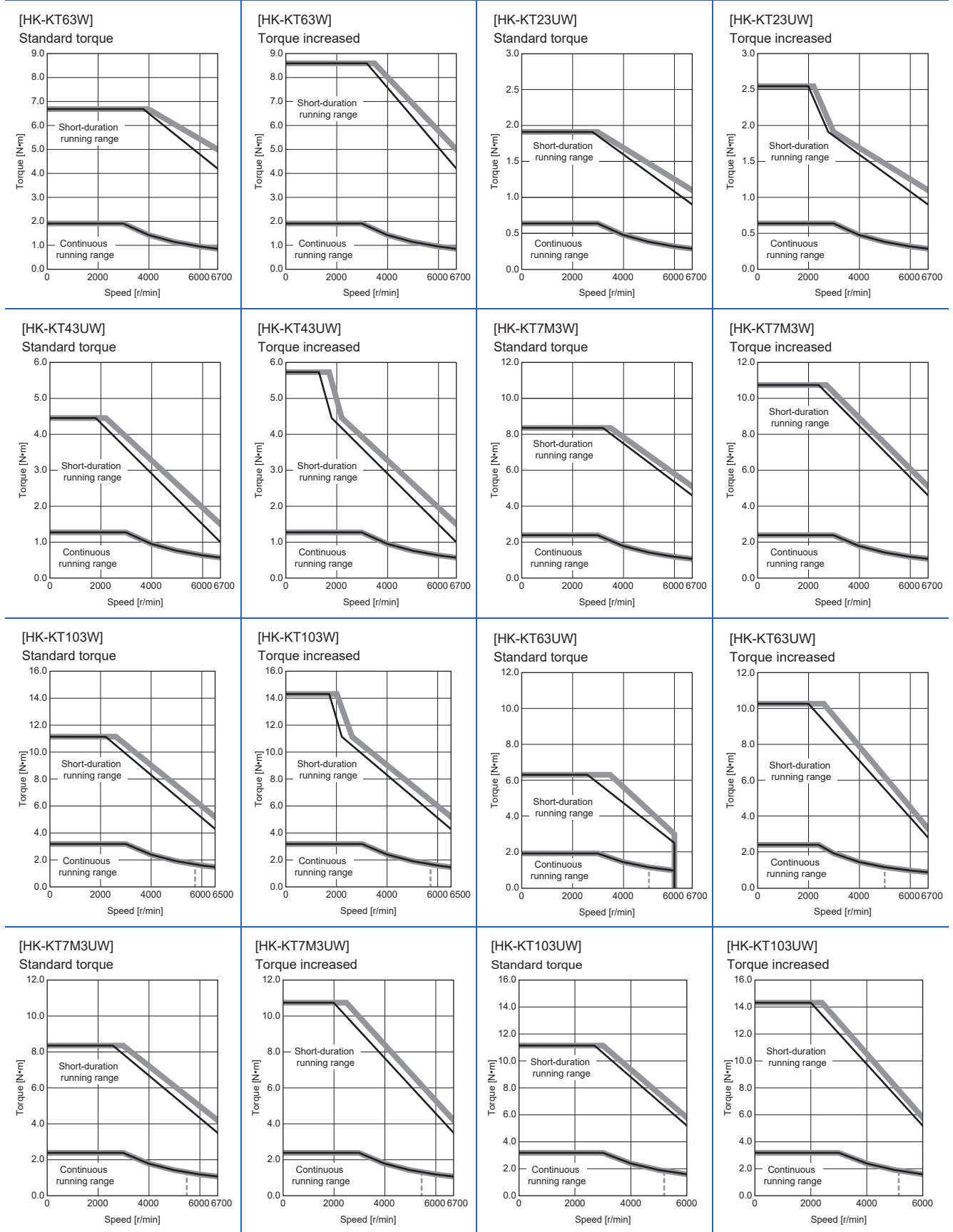

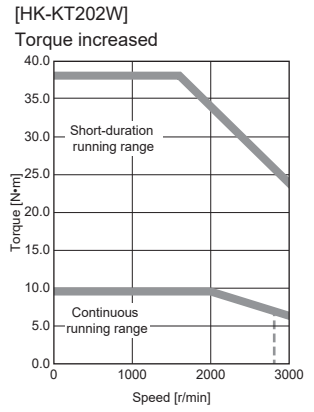
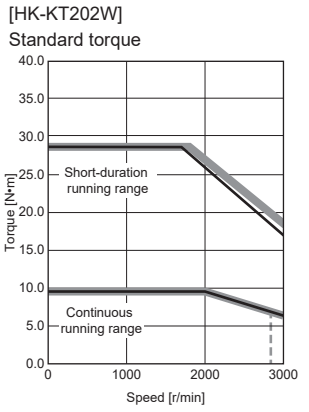
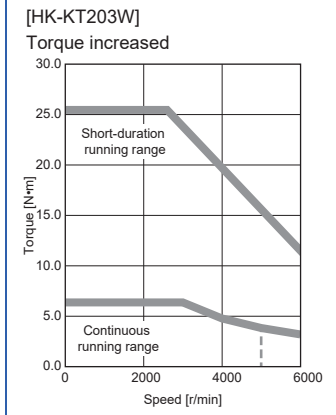
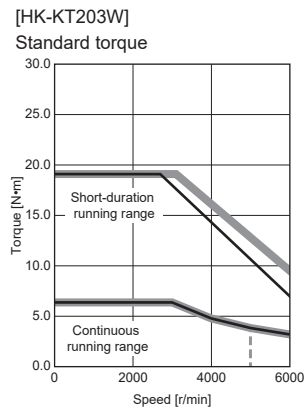
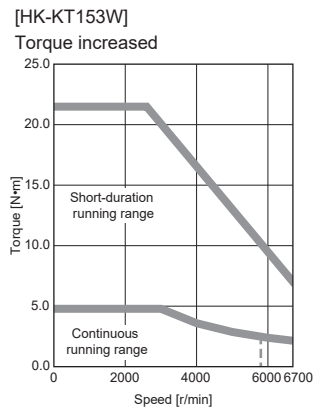
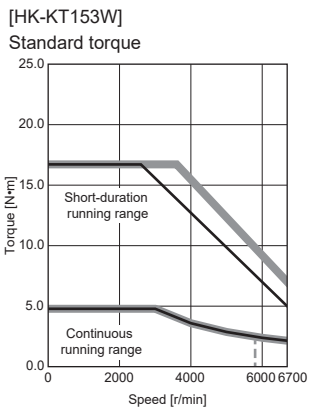

■HK-KT_4_W

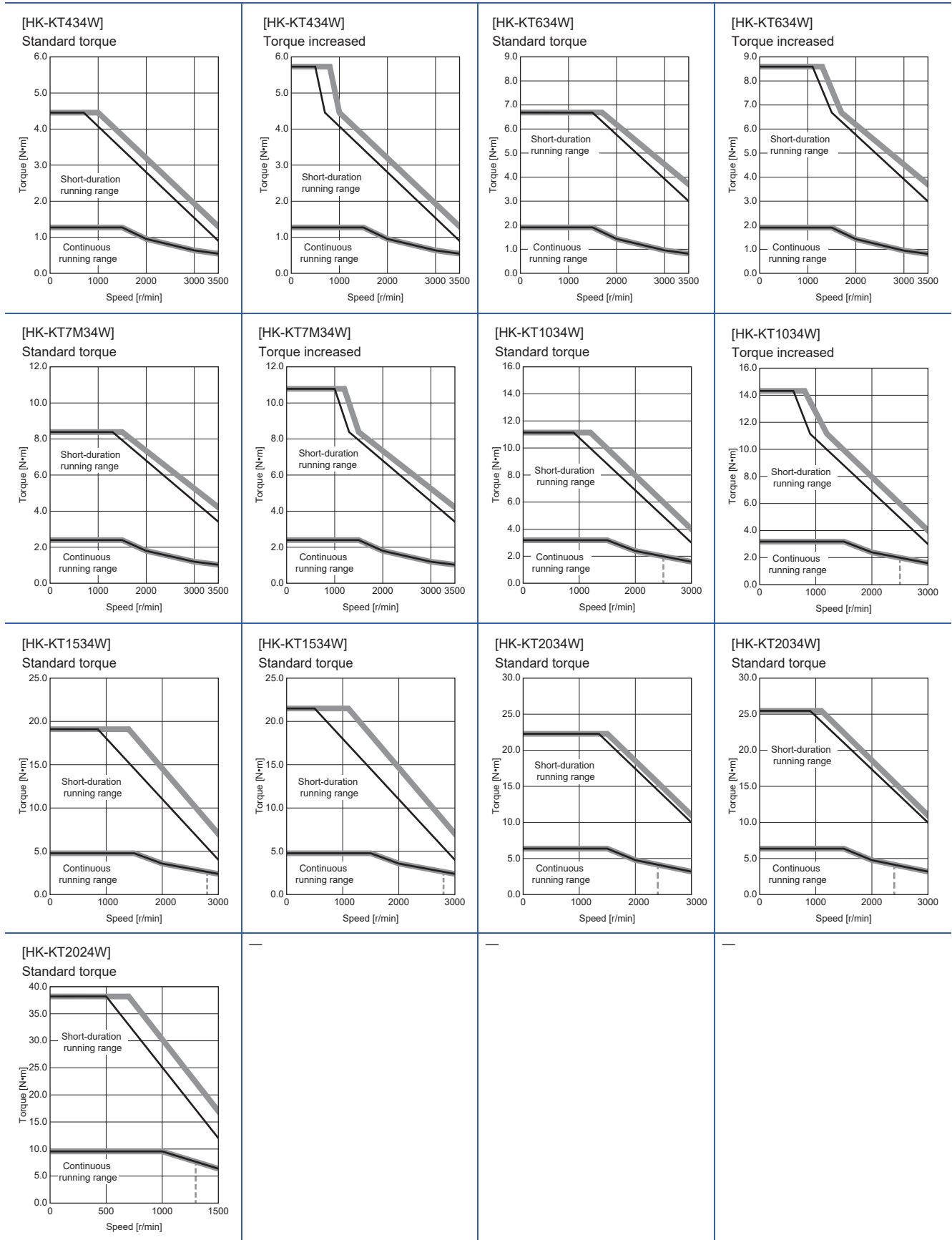

When connected with 400 V servo amplifier

When the power supply voltage drops, the torque decreases. ---- : A rough indication of the possible continuous running range for 3-phase 323 V AC

- : 3-phase 400 V AC
- : 3-phase 380 V AC

■HK-KT_W

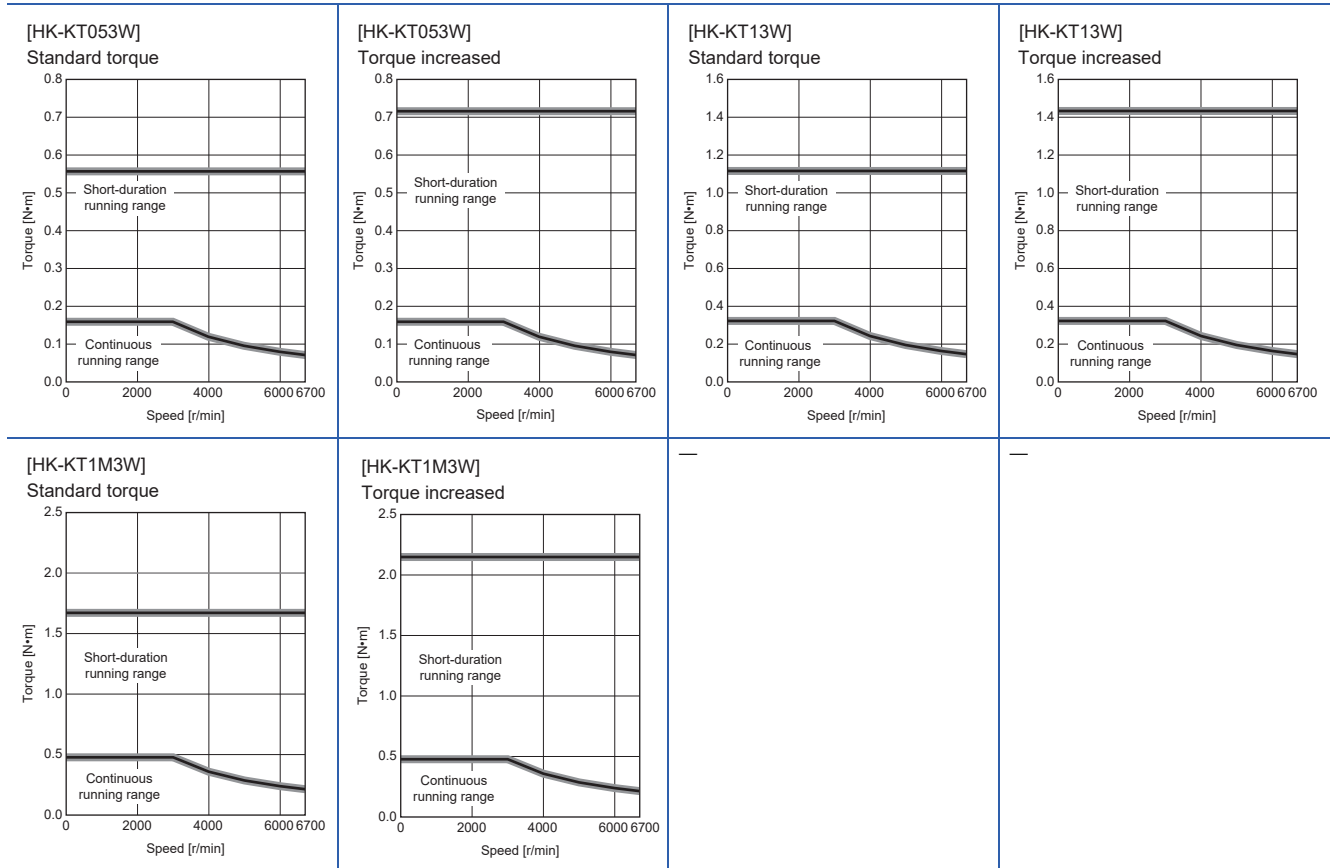

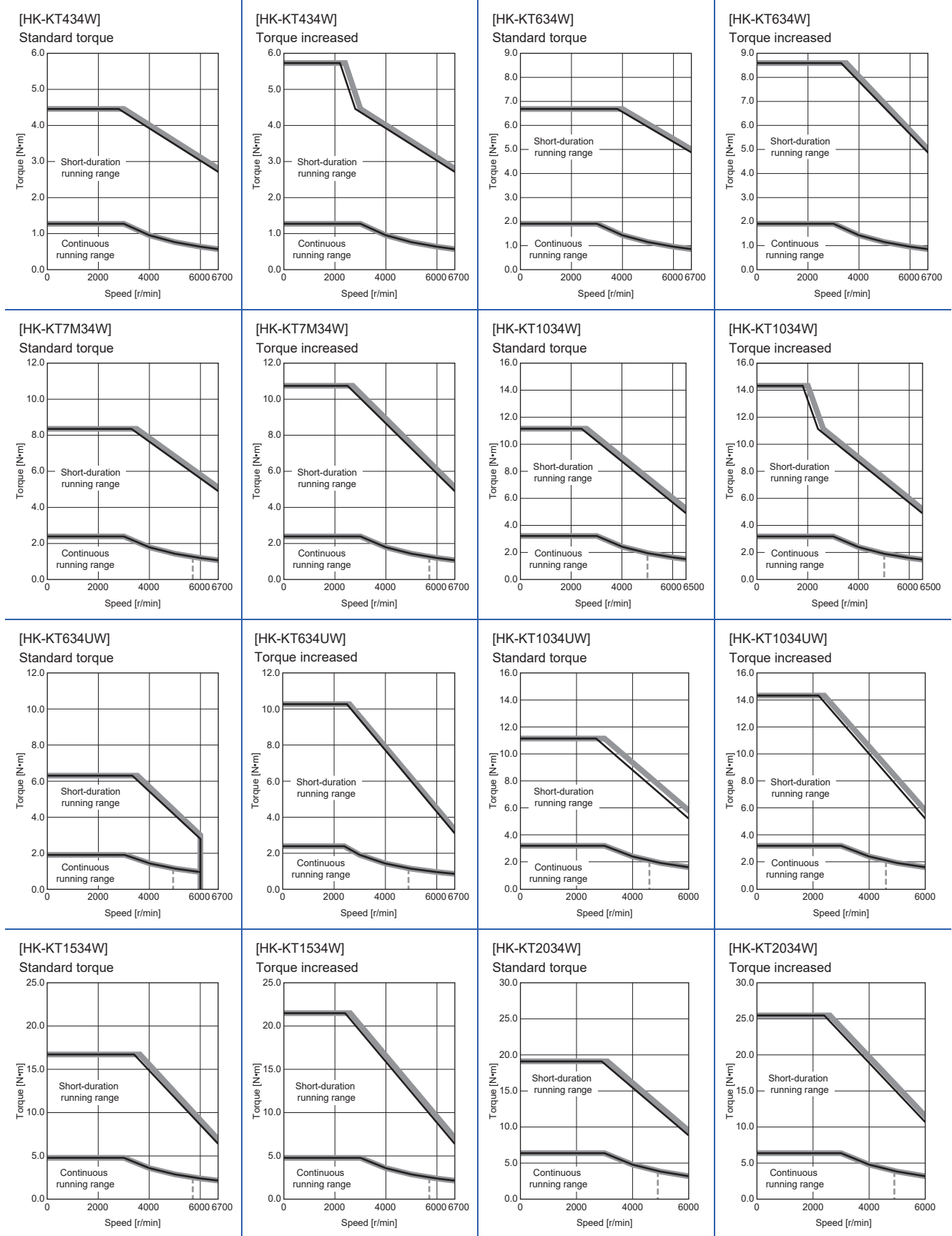

[HK-KT2024W]
Standard torque

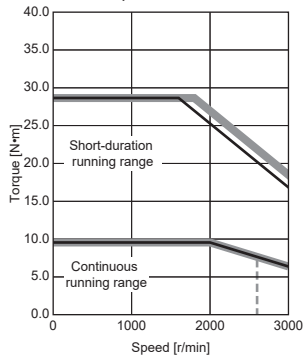

[HK-KT2024W]
Torque increased

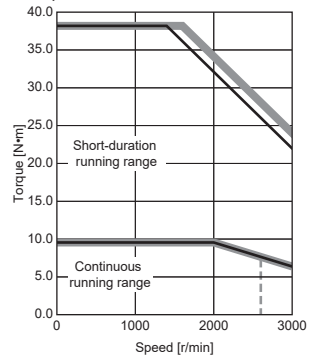

Permissible load for the output shaft

The permissible load for the shaft is shown in the following. Do not subject the shaft to loads greater than the permissible value. The value assumes that the load is applied independently.

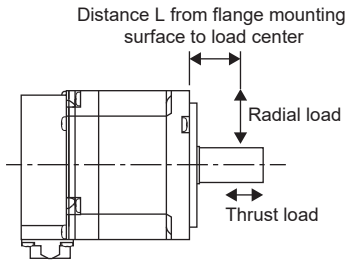

In case where the load position changes, calculate the permissible radial load from the distance measured from the flange mounting surface to the center of the load, and make the load equal to or less than the permissible radial load, referring to the graph shown in the following.

Model	Radial load		Thrust load	The graph of the relation between the load and the load position
	Load position L [mm]	Load [N]	Load [N]	
HK-KT053W HK-KT13W HK-KT1M3W HK-KT13UW	25	88	59	
HK-KT23W HK-KT43(4)W HK-KT63(4)W HK-KT23UW HK-KT43UW	30	245	98	

Model	Radial load		Thrust load	The graph of the relation between the load and the load position												
	Load position L [mm]	Load [N]	Load [N]													
HK-KT7M3(4)W HK-KT103(4)W HK-KT63(4)UW HK-KT7M3UW HK-KT103(4)UW	40	392	147	<table border="1"> <caption>Data for Graph 1</caption> <thead> <tr> <th>Distance L from flange surface [mm]</th> <th>Permissible load [N]</th> </tr> </thead> <tbody> <tr><td>0</td><td>570</td></tr> <tr><td>10</td><td>520</td></tr> <tr><td>20</td><td>470</td></tr> <tr><td>30</td><td>430</td></tr> <tr><td>40</td><td>390</td></tr> </tbody> </table>	Distance L from flange surface [mm]	Permissible load [N]	0	570	10	520	20	470	30	430	40	390
Distance L from flange surface [mm]	Permissible load [N]															
0	570															
10	520															
20	470															
30	430															
40	390															
HK-KT153(4)W HK-KT203(4)W HK-KT202(4)W	40	392	147	<table border="1"> <caption>Data for Graph 2</caption> <thead> <tr> <th>Distance L from flange surface [mm]</th> <th>Permissible load [N]</th> </tr> </thead> <tbody> <tr><td>0</td><td>485</td></tr> <tr><td>10</td><td>460</td></tr> <tr><td>20</td><td>440</td></tr> <tr><td>30</td><td>420</td></tr> <tr><td>40</td><td>390</td></tr> </tbody> </table>	Distance L from flange surface [mm]	Permissible load [N]	0	485	10	460	20	440	30	420	40	390
Distance L from flange surface [mm]	Permissible load [N]															
0	485															
10	460															
20	440															
30	420															
40	390															

6.3 The graph of overload protection characteristics of rotary servo motor

Overload protection of rotary servo motors has been enhanced for MR-J5 servo amplifiers with firmware version A7 or later. Refer to "Overload protection characteristics" in the following manual.

📖 MR-J5 User's Manual (Hardware)

6.4 Characteristics of electromagnetic brake

Point

Before operating the servo motor, confirm that the electromagnetic brake operates properly. The operation time of the electromagnetic brake varies depending on the power supply circuit being used. Check the operation delay time with an actual machine.

The characteristics of the electromagnetic brake provided for the rotary servo motor with an electromagnetic brake are shown below.

Item		HK-KT053WB HK-KT13WB HK-KT1M3WB HK-KT13UWB	HK-KT23WB HK-KT43(4)WB HK-KT63(4)WB	HK-KT23UWB HK-KT43UWB	HK-KT7M3(4)WB HK-KT103(4)WB	HK-KT63(4)UWB HK-KT7M3UWB HK-KT103(4)UWB	HK-KT153(4)WB HK-KT203(4)WB HK-KT202(4)WB
Type ^{*1}		Spring actuated type safety brake					
Rated voltage ^{*4}		24 V DC (-10 % to 0 %)					
Power consumption at 20 °C [W]		6.4	7.9	8.2	10	9.0	13.8
Coil resistance ^{*5} [Ω]		91	73	70	57	64	42
Inductance ^{*5} [H]		0.14	0.20	0.19	0.16	0.23	0.15
Brake static friction torque ^{*7} [N•m]		0.48 or more	1.9 or more	1.3 or more	3.2 or more	3.2 or more	9.5 or more
Release delay time ^{*2} [s]		0.03	0.03	0.03	0.04	0.03	0.09
Braking delay time [s]	DC off ^{*2}	0.01	0.02	0.02	0.02	0.03	0.03
Permissible braking work [J]	Per braking	5.6	22	22	64	66	64
	Per hour	56	220	220	640	660	640
Brake looseness at servo motor shaft ^{*5} [degree]		2.5	1.2	0.9	0.9	0.9	0.9
Brake life ^{*3}	Number of braking times [times]	20000	20000	20000	20000	20000	5000
	Work per braking [J]	5.6	22	22	64	33	64
Selection example of surge absorbers to be used ^{*6}	For the suppressed voltage 125 V	TND20V-680KB (Manufactured by NIPPON CHEMI-CON CORPORATION)					
	For the suppressed voltage 350 V	TND10V-221KB (Manufactured by NIPPON CHEMI-CON CORPORATION)					

*1 This type does not have a manual release mechanism. Use a 24 V DC power supply to release the brake electrically.

*2 The value for initial on gap at 20 °C.

*3 Brake lining wear due to braking will increase the brake gap, but the gap is not adjustable. Therefore, the brake life indicates the number of times the brake can be applied before gap adjustment becomes necessary.

*4 Prepare a power supply exclusively for the electromagnetic brake.

*5 The values are design values. These are not the guaranteed values.

*6 Select the electromagnetic brake control relay properly, in consideration of the characteristics of the electromagnetic brake and surge absorber. When a diode is used as a surge absorber, the electromagnetic braking time becomes longer.

*7 The value of the brake static friction torque is the lower limit in the initial state at 20 °C.

6.5 Derating

The derating condition is the reference value at the rated speed. As the temperature rise value of the rotary servo motor changes depending on the operation conditions such as speed, confirm that [AL. 0E2 Servo motor overheat warning] or [AL. 046 Servo motor overheat] does not occur on the actual machine before use.

If [AL. 0E2 Servo motor overheat warning] or [AL. 046 Servo motor overheat] occurs, consider the following measures:

- Lower the effective load ratio of the rotary servo motor.
- Review the heat dissipation conditions.

To use this product under conditions with multiple derating, calculate the multiplication of each derating rate, and use at the calculated derating rate or lower.

For machines where unbalanced torque occurs, such as a vertical axis system, the unbalanced torque should be kept at 70 % or lower of the rated torque. When applying the derating rate in the conditions above, calculate the multiplication of the derating rate of 70 % in the unbalanced torque and the derating rate of each condition, and use this product at the calculated derating rate or lower.

Restrictions on the flange size

When mounting the rotary servo motor on a machine smaller than the specified aluminum flanges listed in section 2.11, derate the servo motor in accordance with the following conditions:

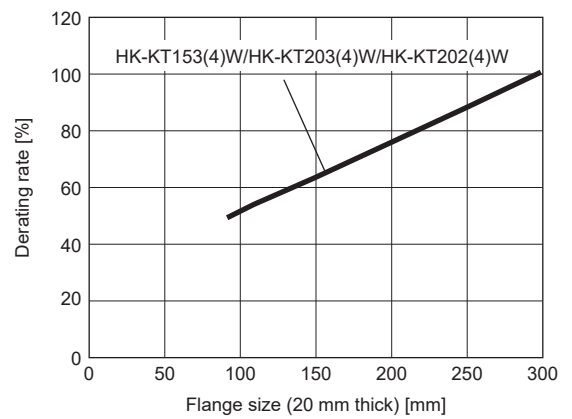
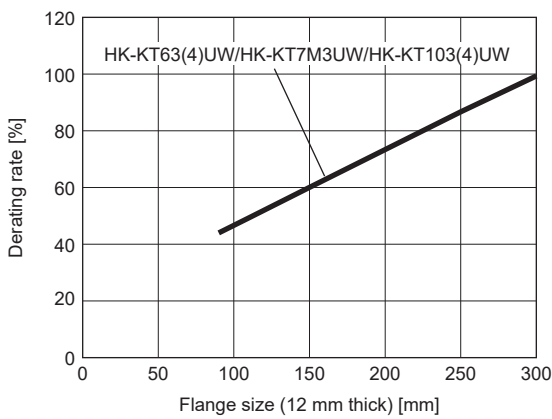
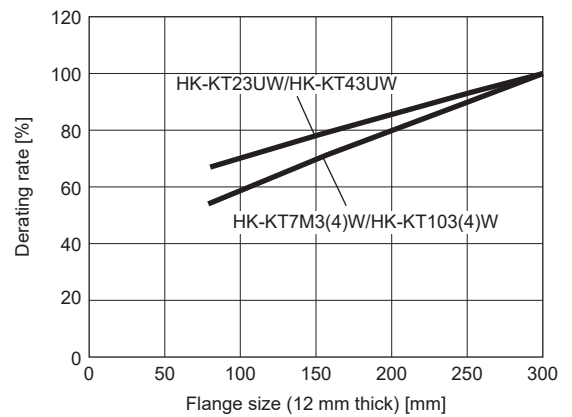
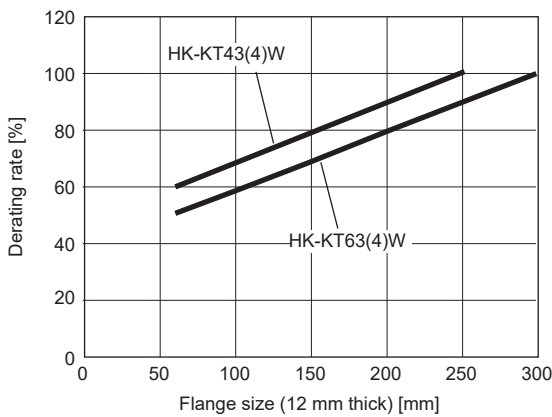
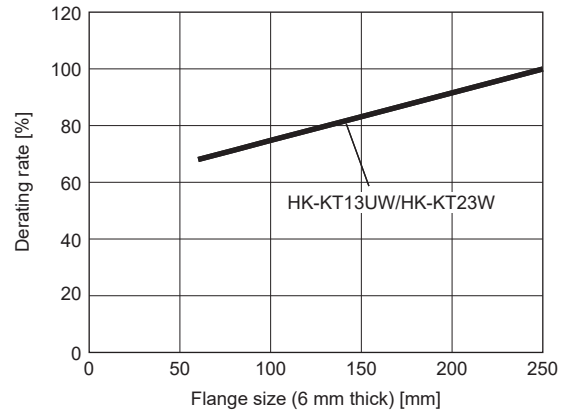
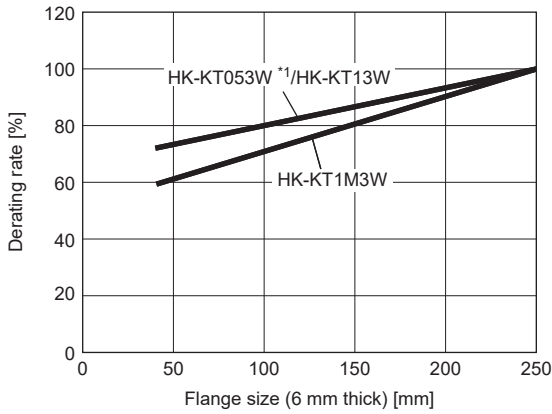

*1 For the HK-KT053W_J_ (with an oil seal), use it at a derating rate of 80 %. When applying the derating in the conditions above, calculate the multiplication of the derating rate of 80 % with an oil seal and the derating rate of each condition, and use the servo motor at the calculated derating rate or lower.

Restrictions on the ambient temperature

When using this product in an environment with a high ambient temperature, derate the product in accordance with the following conditions:

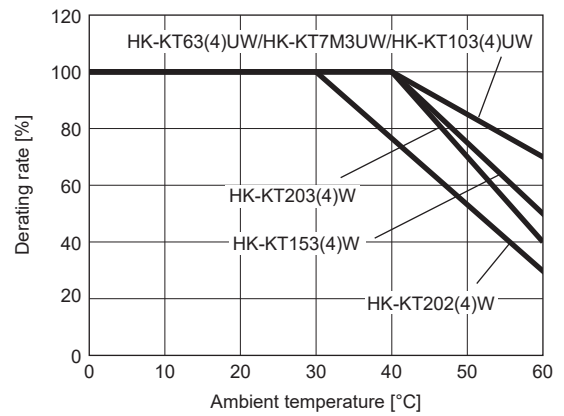
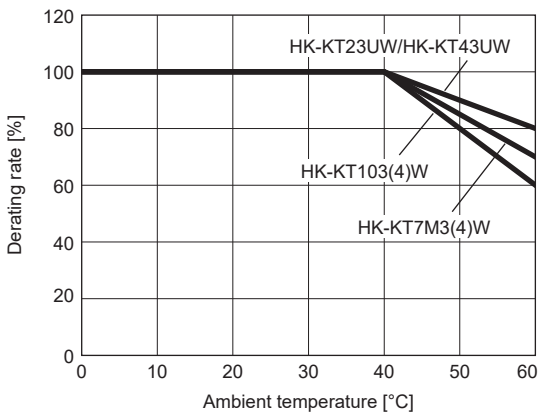
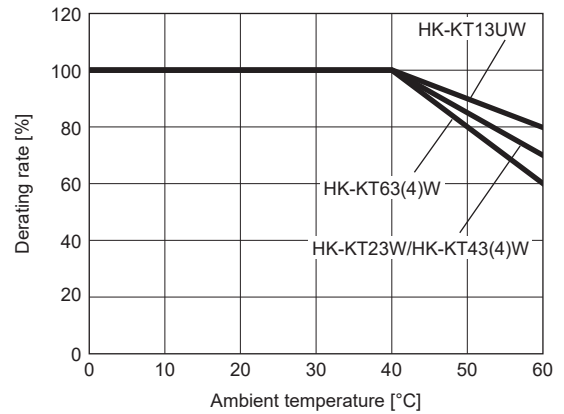
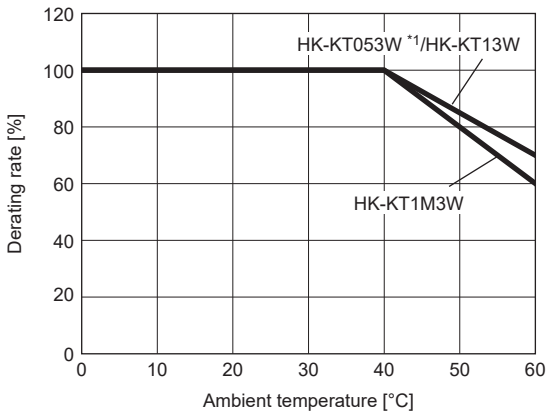

*1 For the HK-KT053W_J_ (with an oil seal), use it at a derating rate of 80 %. When applying the derating in the conditions above, calculate the multiplication of the derating rate of 80 % with an oil seal and the derating rate of each condition, and use the servo motor at the calculated derating rate or lower.

Restrictions on the altitude

To use this product at an altitude between 1000 m and 2000 m, derate the product in accordance with the following conditions:

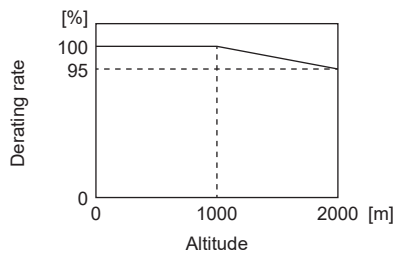

6.6 Rotary servo motors with special shafts

For rotary servo motors, there are four types of shafts: D-cut shaft, L-cut shaft, keyed shaft (with double round-ended key), and keyed shaft (without key).

To prevent an accident such as motor shaft fracture, do not use a servo motor with a D-cut shaft, L-cut shaft, or keyed shaft for frequent start/stop applications.

For geared servo motors with special shafts, refer to the following.

☞ Page 133 Servo motor with special shaft

Rotary servo motor	Shaft shape			
	D-cut shaft	L-cut shaft	Keyed shaft	
			With double round-ended key	Without key
HK-KT053W HK-KT13W HK-KT1M3W HK-KT13UW	D	L	K	N
HK-KT23W HK-KT43(4)W HK-KT63(4)W HK-KT23UW HK-KT43UW HK-KT7M3(4)W HK-KT103(4)W HK-KT63(4)UW HK-KT7M3UW HK-KT103(4)UW HK-KT153(4)W HK-KT203(4)W HK-KT202(4)W	—	—	K	N

D-cut shaft

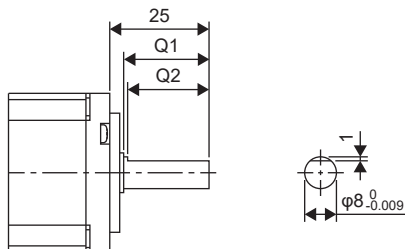

[Unit: mm]

Rotary servo motor	Variable dimensions	
	Q1	Q2
HK-KT053WD HK-KT13WD HK-KT1M3WD	21.5	20.5
HK-KT13UWD	21	20

L-cut shaft

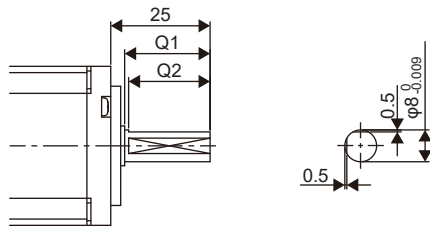

Rotary servo motor	Variable dimensions	
	Q1	Q2
HK-KT053WL HK-KT13WL HK-KT1M3WL	21.5	20.5
HK-KT13UWL	21	20

Keyed shaft (with double round-ended key)

6

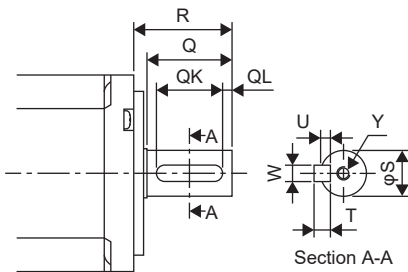

[Unit: mm]

Rotary servo motor	Variable dimensions								
	S	R	Q	W	QK	QL	U	T	Y
HK-KT053WK HK-KT13WK HK-KT1M3WK	8 ⁰ _{-0.009}	25	21.5	3	14	5	1.8	3	M3 Screw hole depth 8
HK-KT13UWK			21						
HK-KT23WK HK-KT43(4)WK HK-KT63(4)WK HK-KT23UWK HK-KT43UWK	14 ⁰ _{-0.011}	30	26	5	20	3	3	5	M4 Screw hole depth 15
HK-KT7M3(4)WK HK-KT103(4)WK HK-KT63(4)UWK HK-KT7M3UWK HK-KT103(4)UWK HK-KT153(4)WK HK-KT203(4)WK HK-KT202(4)WK	19 ⁰ _{-0.013}	40	36	6	25	5	3.5	6	M5 Screw hole depth 20

Keyed shaft (without key)

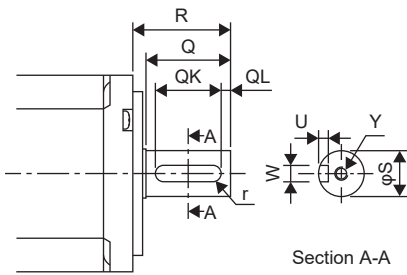

[Unit: mm]

Rotary servo motor	Variable dimensions								
	S	R	Q	W	QK	QL	U	r	Y
HK-KT053WN HK-KT13WN HK-KT1M3WN	8 ⁰ _{-0.009}	25	21.5	3 ^{-0.004} _{-0.029}	14	5	1.8 ^{+0.1} ₀	1.5	M3 Screw hole depth 8
HK-KT13UWN			21						
HK-KT23WN HK-KT43(4)WN HK-KT63(4)WN HK-KT23UWN HK-KT43UWN	14 ⁰ _{-0.011}	30	26	5 ⁰ _{-0.03}	20	3	3 ^{+0.1} ₀	2.5	M4 Screw hole depth 15
HK-KT7M3(4)WN HK-KT103(4)WN HK-KT63(4)UWN HK-KT7M3UWN HK-KT103(4)UWN HK-KT153(4)WN HK-KT203(4)WN HK-KT202(4)WN	19 ⁰ _{-0.013}	40	36	6 ⁰ _{-0.03}	25	5	3.5 ^{+0.1} ₀	3	M5 Screw hole depth 20

6.7 Geared servo motor

Point

When using an oil-lubricated geared servo motor, remove the oil when transporting and mounting the servo motor. If the geared servo motor is tipped over while filled with oil, oil leakage may occur.

Do not attach a gear reducer removed from a geared servo motor to a rotary servo motor that originally does not have a gear reducer. If the geared servo motor being used requires repair, contact your local sales office.

The geared servo motors are for general industrial machine and for high precision applications. Some geared rotary servo motors also have an electromagnetic brake.

For general industrial machine (G1)

Common specifications

Item	Description
Mounting method	Flange-mounting
Mounting direction	Any direction
Lubrication method	Grease lubrication (lubricant filled from the factory)
Output shaft rotation direction	The same direction as the rotary servo motor
Backlash ^{*3}	60 arc minutes or less on the gear reducer output shaft
Permissible load to motor inertia ratio (converted into equivalent value on rotary servo motor shaft) ^{*1}	For 50 W/100 W/750 W: 5 times or less For 200 W/400 W: 7 times or less
Maximum torque ^{*4} (For rotary servo motor shaft)	3 times the rated torque for the rotary servo motor
Maximum speed (For rotary servo motor shaft)	4500 r/min
IP rating (gear reducer area)	Equivalent to IP44
Gear reducer efficiency ^{*2}	40 % to 85 %

*1 If the permissible load to motor inertia ratio exceeds the indicated values, contact your local sales office.

*2 The gear reducer efficiency varies depending on the reduction ratio. The gear reducer efficiency also varies depending on the operating conditions such as output torque, speed, and temperature. The values in the table are the representative values at the rated torque, rated speed, and the room temperature, and are not guaranteed values.

*3 The unit of backlash is calculated as follows: 1 arc minute = 0.0167 °

*4 The maximum torque of the geared servo motor does not increase even if in combination with a servo amplifier with a larger capacity.

Exclusive specifications

Rotary servo motor	Reduction ratio	Actual reduction ratio	Moment of inertia ^{*1} [× 10 ⁻⁴ kg·m ²]		Permissible load ^{*2*3}		Mass [kg]	
			Without an electromagnetic brake	With an electromagnetic brake	Permissible radial load [N]	Permissible thrust load [N]	Without an electromagnetic brake	With an electromagnetic brake
HK-KT053G1	1/5	9/44	0.0764	0.0804	150	200	1.4	1.6
	1/12	49/576	0.0984	0.1024	240	320	1.8	2.0
	1/20	25/484	0.0804	0.0844	370	450	1.8	2.0
HK-KT13G1	1/5	9/44	0.106	0.110	150	200	1.5	1.7
	1/12	49/576	0.128	0.132	240	320	1.9	2.1
	1/20	25/484	0.110	0.114	370	450	1.9	2.1
HK-KT23G1	1/5	19/96	0.363	0.408	330	350	3.2	3.6
	1/12	961/11664	0.494	0.539	710	720	3.8	4.2
	1/20	513/9984	0.375	0.420	780	780	3.8	4.2
HK-KT43G1	1/5	19/96	0.564	0.596	330	350	3.5	3.9
	1/12	961/11664	0.695	0.727	710	720	4.1	4.5
	1/20	7/135	0.687	0.719	760	760	5.2	5.6
HK-KT7M3G1	1/5	1/5	1.79	1.93	430	430	5.4	6.1
	1/12	7/87	1.85	1.99	620	620	6.5	7.2
	1/20	625/12544	2.52	2.66	970	960	9.4	11

*1 The moment inertia value is converted into the equivalent value on the servo motor shaft of the servo motor combined with the gear reducer (and an electromagnetic brake).

*2 Do not subject the shaft to loads greater than the indicated value. Each value in the table indicates the load to be applied independently.

*3 The permissible radial loads in the table are the values at the center of the gear reducer output shaft. Refer to the following for the shaft length.

☞ Page 137 Dimensions

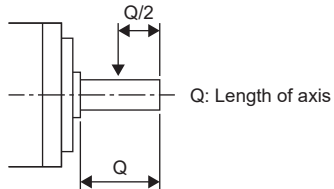

Servo motor with special shaft

The rotary servo motors for general industrial machine (G1) have a keyed shaft (with double round-ended key).

Model	Reduction ratio (actual reduction ratio)	Variable dimensions						
		S	Q	W	QK	U	T	Y
HK-KT053G1K	1/5 (9/44)	16 ⁰ _{-0.011}	25	5	20	3	5	M4X8
	1/12 (49/576)							
	1/20 (25/484)							
HK-KT13G1K	1/5 (9/44)	16 ⁰ _{-0.011}	25	5	20	3	5	M4X8
	1/12 (49/576)							
	1/20 (25/484)							
HK-KT23G1K	1/5 (19/96)	25 ⁰ _{-0.013}	35	8	30	4	7	M6X12
	1/12 (961/11664)							
	1/20 (513/9984)							
HK-KT43G1K	1/5 (19/96)	25 ⁰ _{-0.013}	35	8	30	4	7	M6X12
	1/12 (961/11664)							
	1/20 (7/135)							
HK-KT7M3G1K	1/5 (1/5)	32 ⁰ _{-0.016}	50	10	40	5	8	M8X16
	1/12 (7/87)							
	1/20 (625/12544)	40 ⁰ _{-0.016}	60	12	50			M10X20

6

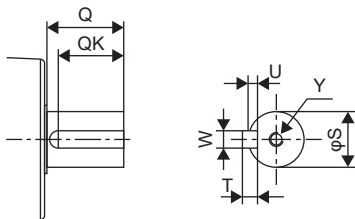

[Unit: mm]

For high precision applications (G5/G7)

Common specifications

Item	Description
Mounting method	Flange-mounting
Mounting direction	Any direction
Lubrication method	Grease lubrication (lubricant filled from the factory)
Output shaft rotation direction	The same direction as the rotary servo motor
Backlash ^{*3}	3 arc minutes or less on the gear reducer output shaft
Permissible load to motor inertia ratio (converted into equivalent value on rotary servo motor shaft) ^{*1}	For 50 W/100 W/750 W: 10 times or less For 200 W/400 W: 14 times or less
Maximum torque ^{*4} (For rotary servo motor shaft)	3 times the rated torque for the rotary servo motor
Maximum speed (For rotary servo motor shaft)	6000 r/min
IP rating (gear reducer area)	Equivalent to IP44
Gear reducer efficiency ^{*2}	For 50 W (gear reducer model 14A): 1/5, 12 %; 1/11 to 1/45, 22 % to 34 % For 50 W (gear reducer model 11B)/100 W/200 W/400 W/750 W: 48 % to 84 %

*1 If the permissible load to motor inertia ratio exceeds the indicated values, contact your local sales office.

*2 The gear reducer efficiency varies depending on the reduction ratio. The gear reducer efficiency also varies depending on the operating conditions such as output torque, speed, and temperature. The values in the table are the representative values at the rated torque, rated speed, and the room temperature, and are not guaranteed values.

*3 The unit of backlash is calculated as follows: 1 arc minute = 0.0167 °

*4 The maximum torque of the geared servo motor does not increase even if in combination with a servo amplifier with a larger capacity.

Exclusive specifications

■ With flange-output type gear reducer for high precision applications, flange mounting: G5

Rotary servo motor	Reduction ratio	Gear reducer model	Moment of inertia ^{*1} [× 10 ⁻⁴ kg·m ²]		Permissible load ^{*2*3}			Mass [kg]		
			Without an electromagnetic brake	With an electromagnetic brake	Radial load point L [mm]	Permissible radial load [N]	Permissible thrust load [N]	Without an electromagnetic brake	With an electromagnetic brake	
HK-KT053G5	1/5 (□40 ^{*4})	11B	0.0429	0.0469	17	93	431	0.48	0.66	
	1/5 (□60 ^{*4})	14A	0.1074	0.1114	23	177	706	1.1	1.3	
	1/9	11B	0.0419	0.0459	17	111	514	0.49	0.67	
	1/11	14A	0.0994	0.1034	23	224	895	1.2	1.4	
	1/21		0.0904	0.0944	23	272	1087	1.2	1.4	
	1/33		0.0844	0.0884	23	311	1244	1.2	1.4	
	1/45		0.0844	0.0884	23	342	1366	1.2	1.4	
HK-KT13G5	1/5 (□40 ^{*4})	11B	0.0721	0.076	17	93	431	0.58	0.76	
	1/5 (□60 ^{*4})	14A	0.137	0.141	23	177	706	1.2	1.4	
			1/11	0.129	0.133	23	224	895	1.3	1.5
			1/21	0.120	0.124	23	272	1087	1.3	1.5
	1/33	20A	0.131	0.135	32	733	2581	2.5	2.7	
	1/45		0.130	0.134	32	804	2833	2.5	2.7	
HK-KT23G5	1/5	14A	0.410	0.455	23	177	706	1.7	2.1	
	1/11		0.412	0.457	23	224	895	1.8	2.2	
	1/21	20A	0.707	0.752	32	640	2254	3.3	3.7	
	1/33		0.661	0.706	32	733	2581	3.3	3.7	
	1/45		0.660	0.705	32	804	2833	3.3	3.7	
HK-KT43G5	1/5	14A	0.611	0.643	23	177	706	2.1	2.5	
	1/11	20A	0.986	1.02	32	527	1856	3.7	4.1	
	1/21		0.908	0.940	32	640	2254	3.7	4.1	
	1/33	32A	0.960	0.992	57	1252	4992	5.8	6.2	
	1/45		0.954	0.986	57	1374	5478	5.8	6.2	
HK-KT7M3G5	1/5	20A	2.02	2.16	32	416	1465	4.2	4.9	
	1/11	32A	1.93	2.07	32	527	1856	4.5	5.2	
	1/21		2.12	2.26	57	1094	4359	6.6	7.3	
	1/33		1.90	2.04	57	1252	4992	6.6	7.3	
	1/45		1.90	2.04	57	1374	5478	6.6	7.3	

*1 The moment inertia value is converted into the equivalent value on the servo motor shaft of the servo motor combined with the gear reducer (and an electromagnetic brake).

*2 Do not subject the shaft to loads greater than the indicated value. Each value in the table indicates the load to be applied independently.

*3 The radial load points of high-precision gear reducers are as follows.

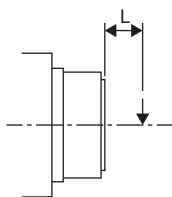

L: Distance between gear reducer end face and load center

*4 The value in () indicates the flange dimensions.

■With shaft-output type gear reducer for high precision applications, flange mounting: G7

Rotary servo motor	Reduction ratio	Gear reducer model	Moment of inertia ^{*1} [× 10 ⁻⁴ kg·m ²]		Permissible load ^{*2*3}		Mass [kg]		
			Without an electromagnetic brake	With an electromagnetic brake	Permissible radial load [N]	Permissible thrust load [N]	Without an electromagnetic brake	With an electromagnetic brake	
HK-KT053G7	1/5 (□40 ^{*4})	11B	0.0456	0.0496	93	431	0.51	0.69	
	1/5 (□60 ^{*4})	14A	0.113	0.117	177	706	1.1	1.3	
	1/9	11B	0.0436	0.0476	111	514	0.51	0.69	
	1/11	14A	0.100	0.104	224	895	1.2	1.4	
	1/21		0.0904	0.0944	272	1087	1.2	1.4	
	1/33		0.0844	0.0884	311	1244	1.2	1.4	
	1/45		0.0844	0.0884	342	1366	1.2	1.4	
HK-KT13G7	1/5 (□40 ^{*4})	11B	0.0748	0.0787	93	431	0.61	0.79	
	1/5 (□60 ^{*4})	14A	0.143	0.147	177	706	1.2	1.4	
			1/11	0.130	0.134	224	895	1.3	1.5
			1/21	0.120	0.124	272	1087	1.3	1.5
	1/33	20A	0.132	0.136	733	2581	2.8	3.0	
			1/45	0.130	0.134	804	2833	2.8	3.0
HK-KT23G7	1/5	14A	0.416	0.461	177	706	1.7	2.2	
			1/11	0.412	0.457	224	895	1.8	2.3
	1/21	20A	0.709	0.754	640	2254	3.7	4.1	
			1/33	0.662	0.707	733	2581	3.7	4.1
			1/45	0.660	0.705	804	2833	3.7	4.1
HK-KT43G7	1/5	14A	0.617	0.649	177	706	2.2	2.6	
		20A	1/11	0.994	1.03	527	1856	4.1	4.5
	1/21		0.910	0.942	640	2254	4.1	4.5	
	1/33		32A	0.966	0.998	1252	4992	7.2	7.6
		1/45		0.957	0.989	1374	5478	7.2	7.6
HK-KT7M3G7	1/5	20A	2.06	2.20	416	1465	4.6	5.3	
			1/11	1.94	2.08	527	1856	4.9	5.6
	1/21	32A	2.14	2.28	1094	4359	8.0	8.7	
			1/33	1.91	2.05	1252	4992	8.0	8.7
			1/45	1.90	2.04	1374	5478	8.0	8.7

*1 The moment inertia value is converted into the equivalent value on the servo motor shaft of the servo motor combined with the gear reducer (and an electromagnetic brake).

*2 Do not subject the shaft to loads greater than the indicated value. Each value in the table indicates the load to be applied independently.

*3 The radial load points of high-precision gear reducers are as follows. Refer to the following for the shaft length.

☞ Page 137 Dimensions

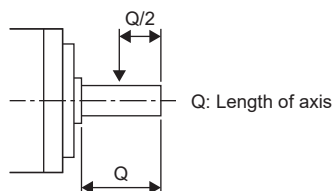

*4 The value in () indicates the flange dimensions.

Servo motor with special shaft

The flange-mounting shaft output type rotary servo motors for high precision application (G7) have a keyed shaft (with single pointed key).

[Unit: mm]

Rotary servo motor	Gear reducer model	Q	ϕS	W	T	QK	U	Y
HK-KT_G7K	11B	20	10h7	4	4	15	2.5	M3 screw hole depth 6
	14A	28	16h7	5	5	25	3	M4 screw hole depth 8
	20A	42	25h7	8	7	36	4	M6 screw hole depth 12
	32A	82	40h7	12	8	70	5	M10 screw hole depth 20

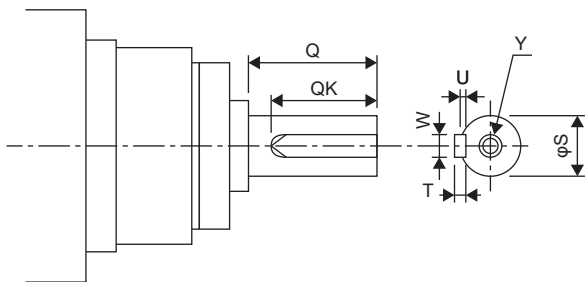

6.8 Mounting/removing connectors

Mount the connectors in the procedure shown below. If the connector is not fixed securely, it may come off or may not produce a splash-proof effect during operation. The receptacle connector has a splash-proof seal (O-ring). When mounting, use care to prevent the seal from dropping and being pinched.

Mounting connectors

1. Insertion

The insertion direction of the plug connector varies depending on the cable direction which is the load side, opposite to load side, and vertical. Check the insertion direction of the plug connector and the mating part before inserting the plug connector. Insert the plug connector (cable side) into the receptacle connector (motor side). The plug connector will stop in the midway of the insertion hole if inserted in an incorrect direction. Continuing to insert the plug connector forcefully even after the stop may damage the plug connector and the receptacle connector.

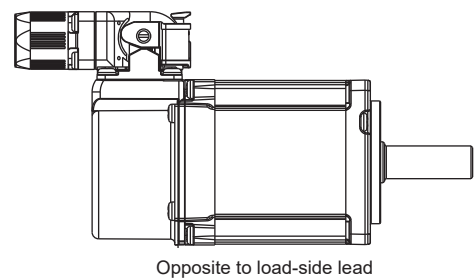
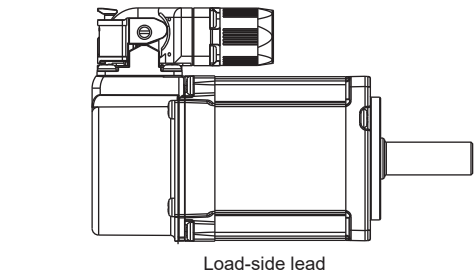
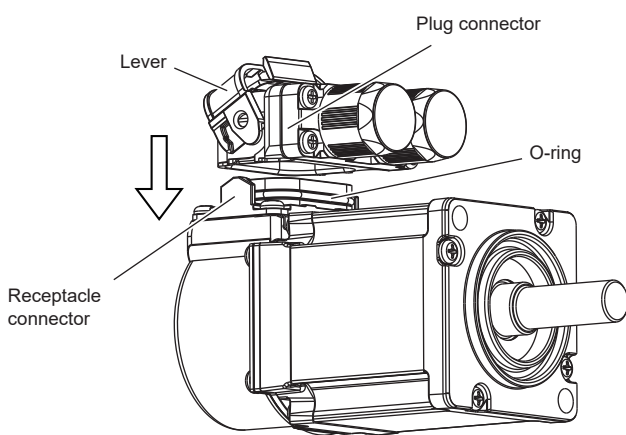

The following shows the view from the connected side.

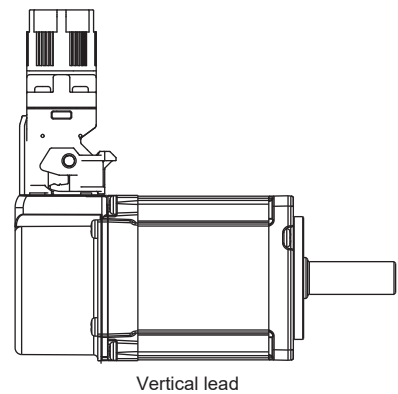
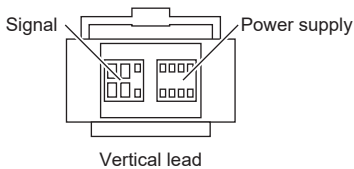
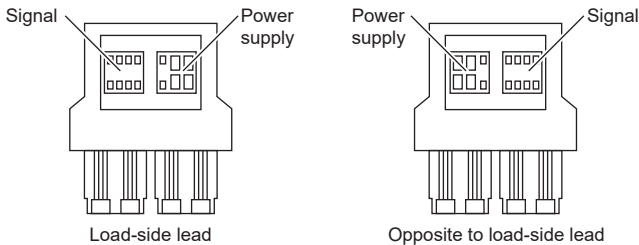

2. Starting to lock

Pull the lever. Pulling the lever firmly inserts the plug into the receptacle connector. If the plug is pushed forcefully without pulling the lever, the components may damage. If the plug is inserted diagonally or twisted hard while being inserted, the plug may be deformed or come off or the O-ring may be deformed, which may prevent the splash-proof effect. Insert the plug connector as straight as possible.

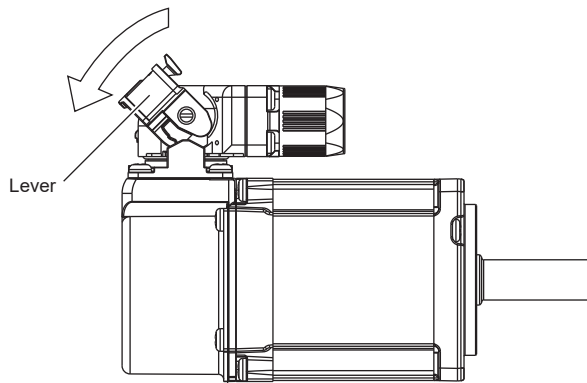

3. Finishing locking

Pull the lever properly until it clicks. It can be felt to the touch when the plug connector is properly locked. After pulling the lever, pull the plug connector lightly to check that the connector is firmly connected.

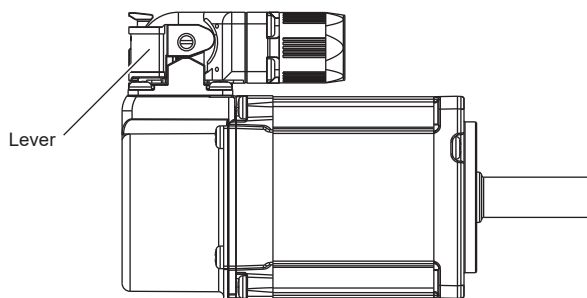

Removing connectors

Remove the connectors in the procedure shown below.

Unlocking jigs can also be used to unlock the plug connector. For the unlocking jigs, contact Hirose Electric co., Ltd. (Unlocking jig model: MT50W/RE-MD)

Unlocking/removal

■When unlocking jigs are not used

Unlock the connector by pushing the lever diagonally upward with your fingers.

After pushing the lever up, hold the plug connector and remove it from the receptacle connector.

To push the lever up, allow space around the plug connector.

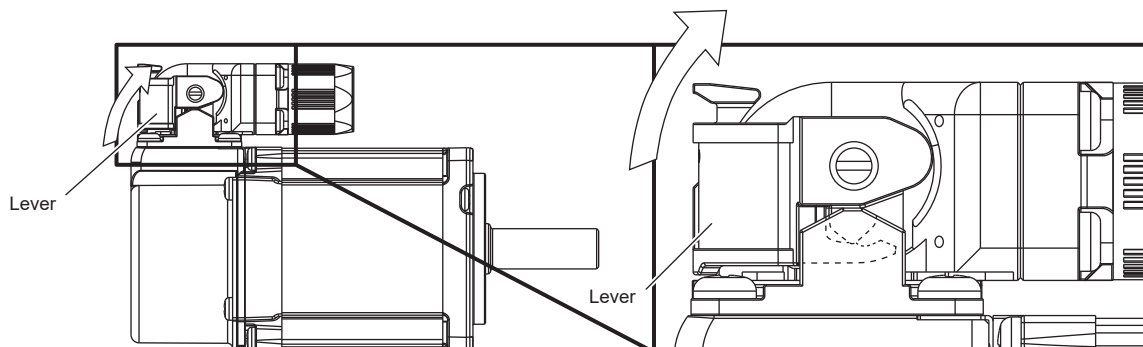

■When unlocking jigs are used

Hook the unlocking jig to the lever and lift them, and unlock the connector.

After unlocking the connector, hold the plug connector and remove it from the receptacle connector.

To lift the unlocking jig hooked on the lever, allow space around the plug connector.

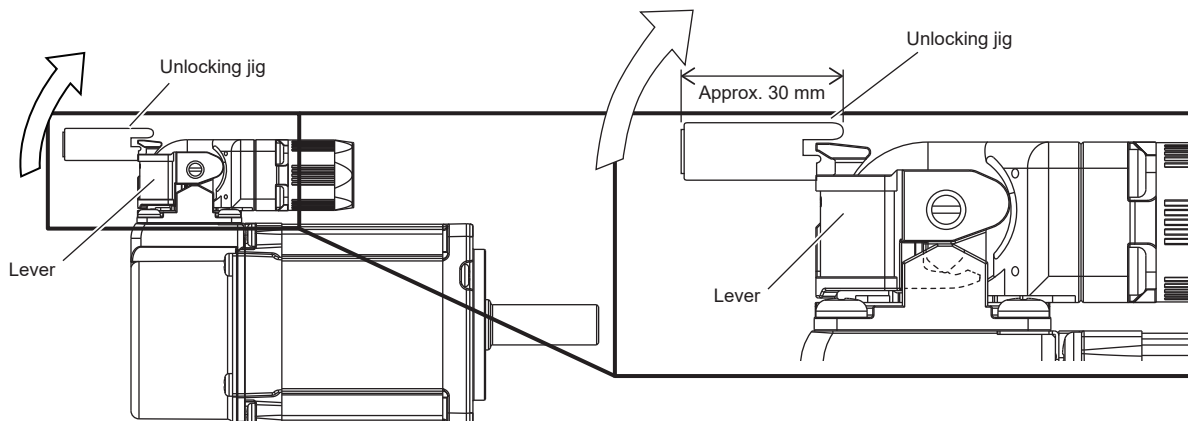

6.9 Dimensions

- When running the cables to the load side, take care to avoid interference with the machine.
- The dimensions are for when cables (dual cable type) are run to the load-side. When running the cables vertically or to the opposite direction of the load-side, and for the dimensions for single cable type cables, refer to the following.
 - ☞ Page 146 Cable direction: Load side/opposite direction of the load side
 - ☞ Page 147 Cable direction: Vertical
- Not all parts are created the exact same size or assembled in precisely the same manner. Therefore, the actual dimensions of rotary servo motors may be a maximum of approximately 3 mm larger than those in the drawings. In addition, the described dimensions and dimensional tolerances are the values at 20 °C. Since the values of the dimensions may vary depending on the ambient temperature, allow some margin when designing the machine side.
- The dimensions are the same, regardless of whether the servo motor has an oil seal or not.
- Use a friction coupling for coupling the servo motor with a load.

Without gear reducer

HK-KT053W(B)/HK-KT13W(B)/HK-KT1M3W(B)

Model	Variable dimensions *1	
	L	KL
HK-KT053W(B)	55.5 (90.5)	42.8 (77.8)
HK-KT13W(B)	68 (103)	55.3 (90.3)
HK-KT1M3W(B)	80.5 (115.5)	67.8 (102.8)

*1 The values in () of the dimensions are for the servo motors with an electromagnetic brake.

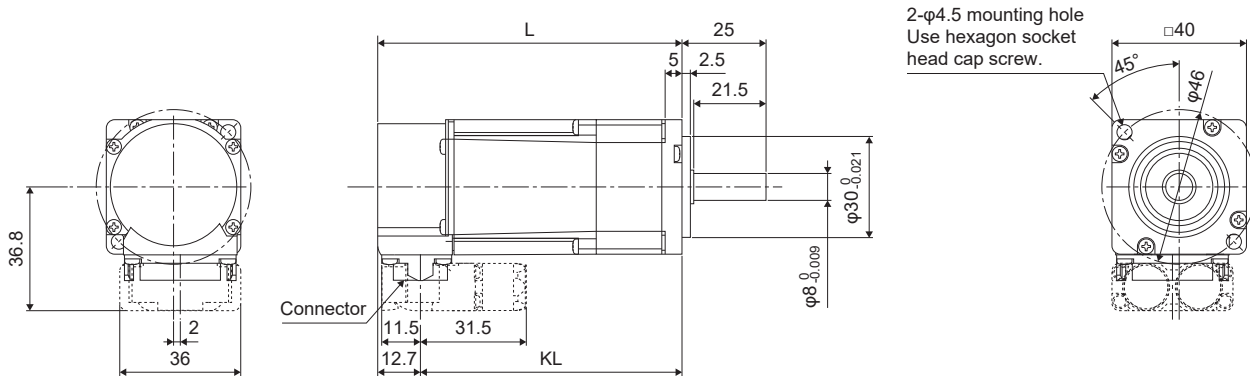

[Unit: mm]

HK-KT13UW(B)

Model	Variable dimensions *1	
	L	KL
HK-KT13UW(B)	58.5 (82)	46.8 (70.3)

*1 The values in () of the dimensions are for the servo motors with an electromagnetic brake.

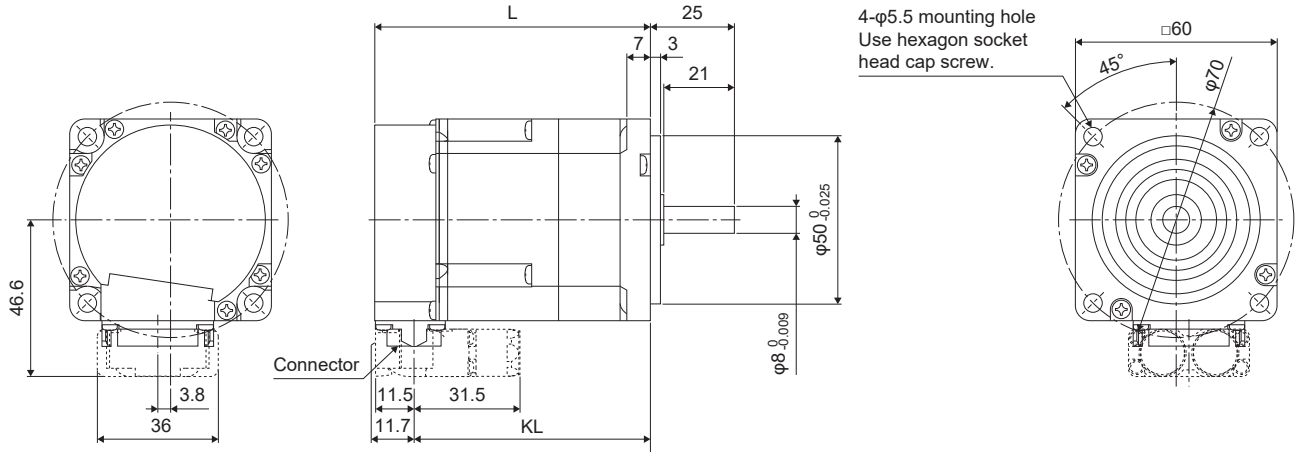

[Unit: mm]

HK-KT23W(B)/HK-KT43W(B)/HK-KT63W(B)/HK-KT434W(B)/HK-KT634W(B)

Model	Variable dimensions *1	
	L	KL
HK-KT23W(B)	67.5 (102.1)	55.8 (90.4)
HK-KT43W(B) HK-KT434W(B)	85.5 (120.1)	73.8 (108.4)
HK-KT63W(B) HK-KT634W(B)	103.5 (138.1)	91.8 (126.4)

*1 The values in () of the dimensions are for the servo motors with an electromagnetic brake.

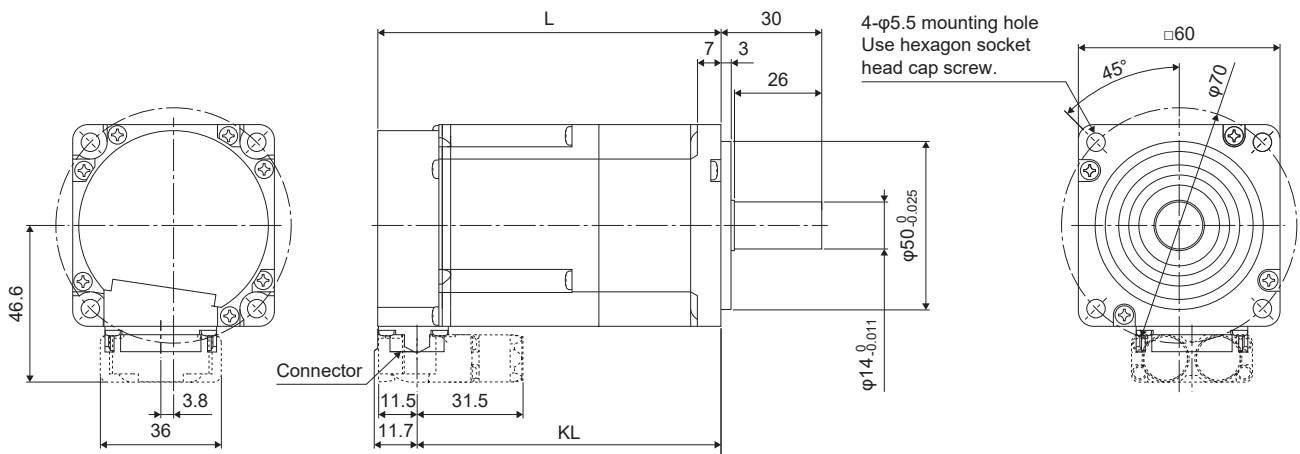

[Unit: mm]

HK-KT23UW(B)/HK-KT43UW(B)

Model	Variable dimensions *1	
	L	KL
HK-KT23UW(B)	65.5 (87.5)	53.8 (75.8)
HK-KT43UW(B)	74.5 (96.5)	62.8 (84.8)

*1 The values in () of the dimensions are for the servo motors with an electromagnetic brake.

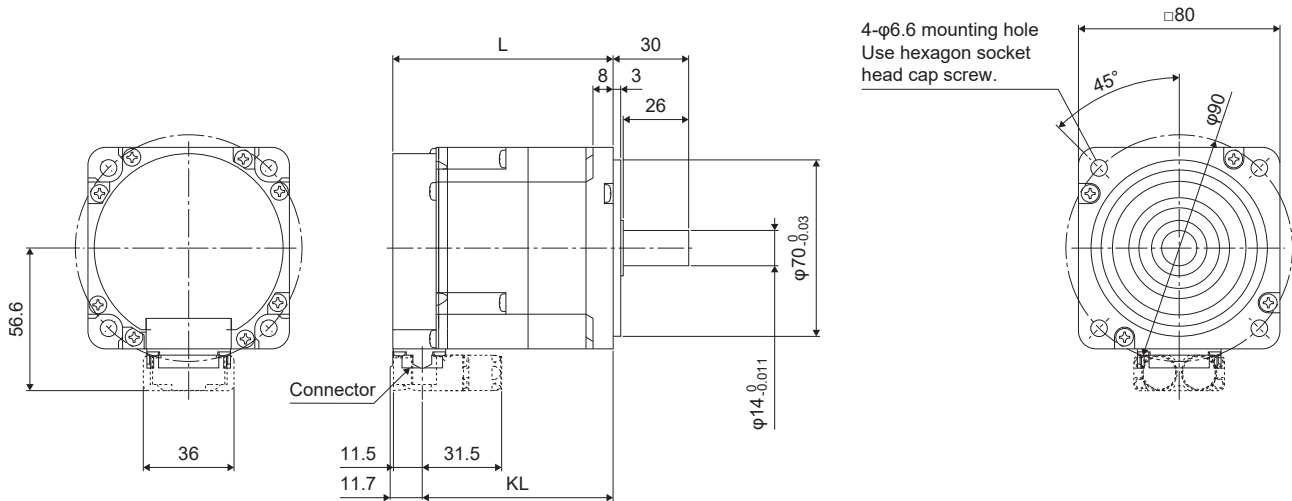

[Unit: mm]

HK-KT7M3W(B)/HK-KT103W(B)/HK-KT7M34W(B)/HK-KT1034W(B)

Model	Variable dimensions *1	
	L	KL
HK-KT7M3W(B)	92.5 (128)	80.8 (116.3)
HK-KT7M34W(B)		
HK-KT103W(B)	101.5 (137)	89.8 (125.3)
HK-KT1034W(B)		

*1 The values in () of the dimensions are for the servo motors with an electromagnetic brake.

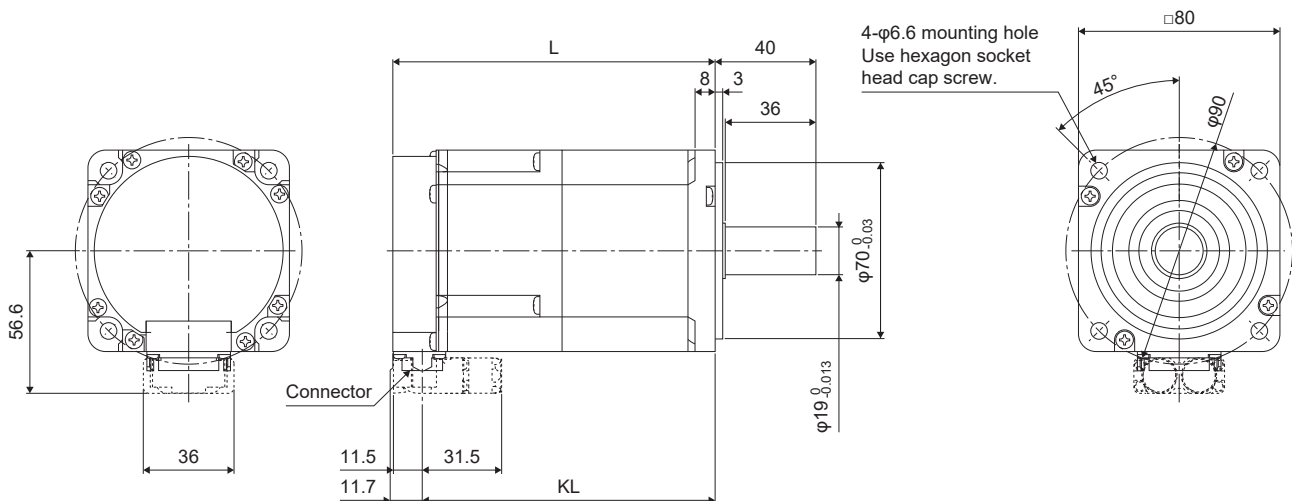

[Unit: mm]

HK-KT63UW(B)/HK-KT7M3UW(B)/HK-KT103UW(B)/HK-KT153W(B)/HK-KT203W(B)/HK-KT202W(B)/HK-KT634UW(B)/HK-KT1034UW(B)/HK-KT1534W(B)/HK-KT2034W(B)/HK-KT2024W(B)

Model	Variable dimensions *1	
	L	KL
HK-KT63UW(B) HK-KT634UW(B) HK-KT7M3UW(B)	83.5 (111)	71.8 (99.3)
HK-KT103UW(B) HK-KT1034UW(B)	92.5 (120)	80.8 (108.3)
HK-KT153W(B) HK-KT1534W(B)	118.9 (158.3)	107.2 (146.6)
HK-KT203W(B) HK-KT2034W(B)	136.9 (176.3)	125.2 (164.6)
HK-KT202W(B) HK-KT2024W(B)	172.9 (212.3)	161.2 (200.6)

*1 The values in () of the dimensions are for the servo motors with an electromagnetic brake.

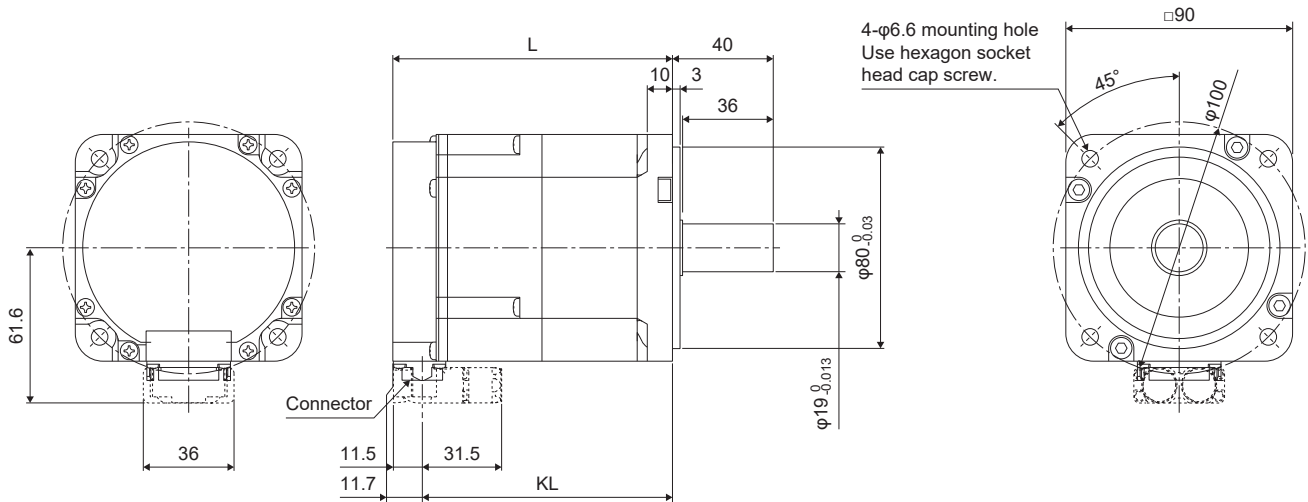

[Unit: mm]

With gear reducer for general industrial machine

HK-KT053(B)G1/HK-KT13(B)G1/HK-KT23(B)G1/HK-KT43(B)G1/HK-KT7M3(B)G1

Model	Reduction ratio (actual reduction ratio)	Variable dimensions *1														
		L	LA	LC	LD	LE	S	LH	LK	KL	LG	Q	LR	M	KA	LT
HK-KT053(B)G1	1/5 (9/44)	99.2 (134.2)	75	60 _{-0.03} ⁰	65	50	16 _{-0.011} ⁰	6.5	8	86.5 (121.5)	34.5	25	60.5	7	36.8	12.7
	1/12 (49/576)	118 (153)								105.3 (140.3)						
	1/20 (25/484)															
HK-KT13(B)G1	1/5 (9/44)	111.7 (146.7)	75	60 _{-0.03} ⁰	65	50	16 _{-0.011} ⁰	6.5	8	99 (134)	34.5	25	60.5	7	36.8	12.7
	1/12 (49/576)	130.5 (165.5)								117.8 (152.8)						
	1/20 (25/484)															
HK-KT23(B)G1	1/5 (19/96)	120.7 (155.3)	100	82 _{-0.035} ⁰	90	75	25 _{-0.013} ⁰	8	10	109 (143.6)	38	35	74	9	46.6	11.7
	1/12 (961/11664)	140.5 (175.1)								128.8 (163.4)						
	1/20 (513/9984)															
HK-KT43(B)G1	1/5 (19/96)	138.7 (173.3)	100	82 _{-0.035} ⁰	90	75	25 _{-0.013} ⁰	8	10	127 (161.6)	38	35	74	9	46.6	11.7
	1/12 (961/11664)	158.5 (193.1)								146.8 (181.4)						
	1/20 (7/135)	162.5 (197.1)								150.8 (185.4)						
HK-KT7M3(B)G1	1/5 (1/5)	157.5 (193)	115	95 _{-0.035} ⁰	100	83	32 _{-0.016} ⁰	9.5	9.5	145.8 (181.3)	39	50	90	5	56.6	11.7
	1/12 (7/87)	179.5 (215)								167.8 (203.3)						
	1/20 (625/12544)	192.5 (228)								180.8 (216.3)						

*1 The values in () of the dimensions are for the servo motors with an electromagnetic brake.

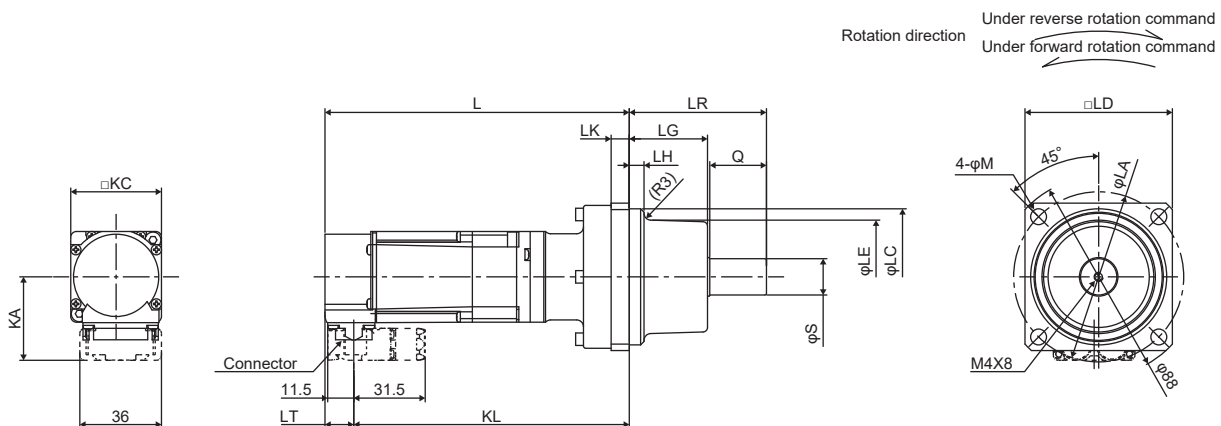

[Unit: mm]

With flange-output type gear reducer for high precision applications, flange mounting

HK-KT053(B)G5/HK-KT13(B)G5

Model	Reduction ratio	Variable dimensions *1																			
		L	LA	LB	LC	LD	LE	LF	LG	LH	LK	LM	KL	T	N	P	R	M	KA	LT	
HK-KT053(B)G5	1/5 (□40)	95 (130)	46	18	40 ₀ ^{-0.025}	40	24	5 ₀ ^{+0.012}	15 _{-0.20} ^{+0.25}	2.5	5	34.5	82.3 (117.3)	3	3	M4	6	3.4	36.8	12.7	
	1/5 (□60)	119.5 (154.5)	70	30	56 ₀ ^{-0.03}	60	40	14 ₀ ^{+0.018}	21 _{-0.5} ^{+0.4}	3	8	56	106.8 (141.8)	5	6		7	5.5			
	1/9	95 (130)	46	18	40 ₀ ^{-0.025}	40	24	5 ₀ ^{+0.012}	15 _{-0.20} ^{+0.25}	2.5	5	34.5	82.3 (117.3)	3	3		6	3.4			
	1/11	119.5 (154.5)	70	30	56 ₀ ^{-0.03}	60	40	14 ₀ ^{+0.018}	21 _{-0.5} ^{+0.4}	3	8	56	106.8 (141.8)	5	6		7	5.5			
	1/21																				
	1/33																				
	1/45																				
HK-KT13(B)G5	1/5 (□40)	107.5 (142.5)	46	18	40 ₀ ^{-0.025}	40	24	5 ₀ ^{+0.012}	15 _{-0.20} ^{+0.25}	2.5	5	34.5	94.8 (129.8)	3	3		6	3.4			
	1/5 (□60)	132 (167)	70	30	56 ₀ ^{-0.03}	60	40	14 ₀ ^{+0.018}	21 _{-0.5} ^{+0.4}	3	8	56	119.3 (154.3)	5	6		7	5.5			
	1/11	134.5 (169.5)	105	45	85 ₀ ^{-0.035}	90	59	24 ₀ ^{+0.021}	27 _{-0.5} ^{+0.4}	8	10	56.5	121.8 (156.8)			M6	10	9			
	1/21																				
	1/33																				
	1/45																				

*1 The values in () of the dimensions are for the servo motors with an electromagnetic brake.

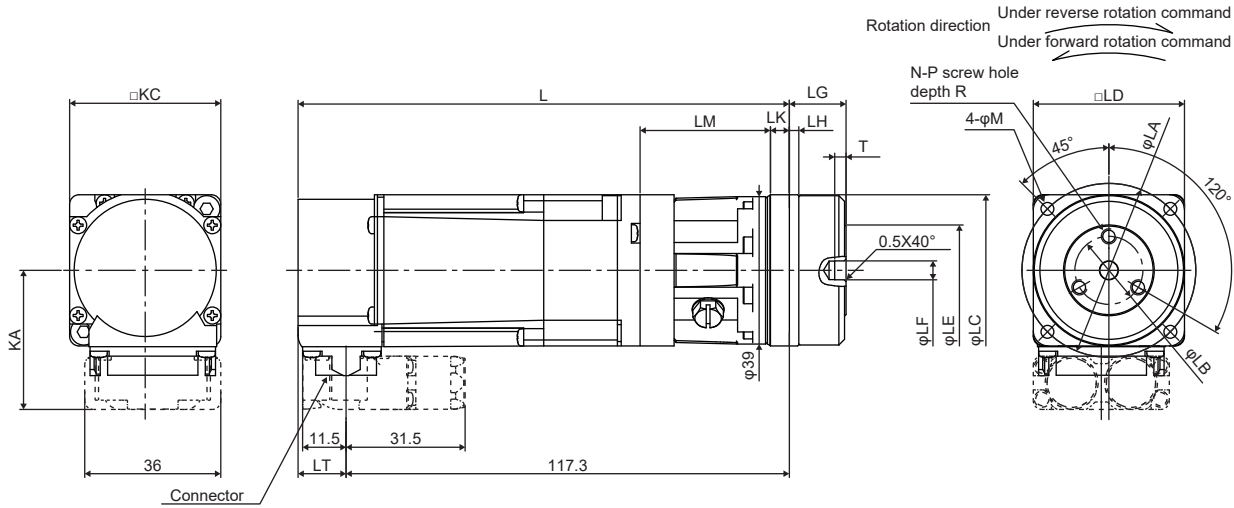

[Unit: mm]

HK-KT23(B)G5/HK-KT43(B)G5/HK-KT7M3(B)G5

Model	Reduction ratio	Variable dimensions *1														T	N	P	R	M	KA	LT
		L	LA	LB	LC	LD	LE	LF	LG	LH	LK	LM	KL									
HK-KT23(B)G5	1/5	131.5 (166.1)	70	30	56 _{-0.03} ⁰	60	40	14 ₀ ^{+0.018}	21 _{-0.5} ^{+0.4}	3	8	56	119.8 (154.4)	5	6	M4	7	5.5	46.6	11.7		
	1/11																					
	1/21	138.5 (173.1)	105	45	85 _{-0.035} ⁰	90	59	24 ₀ ^{+0.021}	27 _{-0.5} ^{+0.4}	8	10	61	126.8 (161.4)									
	1/33																					
	1/45																					
HK-KT43(B)G5	1/5	149.5 (184.1)	70	30	56 _{-0.03} ⁰	60	40	14 ₀ ^{+0.018}	21 _{-0.5} ^{+0.4}	3	8	56	137.8 (172.4)	5	6	M4	7	5.5	46.6	11.7		
	1/11	156.5 (191.1)	105	45	85 _{-0.035} ⁰	90	59	24 ₀ ^{+0.021}	27 _{-0.5} ^{+0.4}	8	10	61	144.8 (179.4)									
	1/21																					
	1/33	168.5 (203.1)	135	60	115 _{-0.035} ⁰	120	84	32 ₀ ^{+0.025}	35 _{-0.5} ^{+0.4}	13	13	70	156.8 (191.4)									
	1/45																					
HK-KT7M3(B)G5	1/5	170.5 (206)	105	45	85 _{-0.035} ⁰	90	59	24 ₀ ^{+0.021}	27 _{-0.5} ^{+0.4}	8	10	68	158.8 (194.3)	5	6	M6	10	9	56.6	11.7		
	1/11																					
	1/21	180.5 (216)	135	60	115 _{-0.035} ⁰	120	84	32 ₀ ^{+0.025}	35 _{-0.5} ^{+0.4}	13	13	75	168.8 (204.3)									
	1/33																					
	1/45																					

*1 The values in () of the dimensions are for the servo motors with an electromagnetic brake.

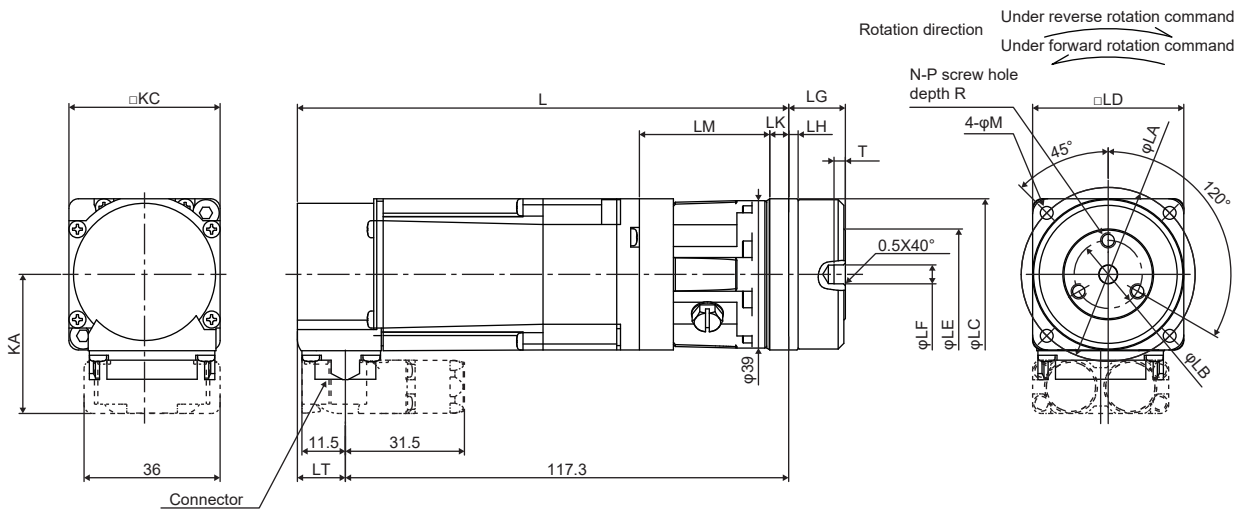

[Unit: mm]

With shaft-output type gear reducer for high precision applications, flange mounting

HK-KT053(B)G7/HK-KT13(B)G7

Model	Reduction ratio	Variable dimensions *1															
		L	LA	LC	LD	LE	S	LG	LH	Q	LR	LK	LM	KL	M	KA	LT
HK-KT053(B)G7	1/5 (□40)	95 (130)	46	40 _{0 -0.025}	40	29	10 _{0 -0.015}	15	2.5	20	42	5	34.5	82.3 (117.3)	3.4	36.8	12.7
	1/5 (□60)	119.5 (154.5)	70	56 _{0 -0.03}	60	40	16 _{0 -0.018}	21	3	28	58	8	56	106.8 (141.8)	5.5		
	1/9	95 (130)	46	40 _{0 -0.025}	40	29	10 _{0 -0.015}	15	2.5	20	42	5	34.5	82.3 (117.3)	3.4		
	1/11	119.5 (154.5)	70	56 _{0 -0.03}	60	40	16 _{0 -0.018}	21	3	28	58	8	56	106.8 (141.8)	5.5		
	1/21																
	1/33																
	1/45																
HK-KT13(B)G7	1/5 (□40)	107.5 (142.5)	46	40 _{0 -0.025}	40	29	10 _{0 -0.015}	15	2.5	20	42	5	34.5	94.8 (129.8)	3.4	36.8	12.7
	1/5 (□60)	132 (167)	70	56 _{0 -0.03}	60	40	16 _{0 -0.018}	21	3	28	58	8	56	119.3 (154.3)	5.5		
	1/11	134.5 (169.5)	105	85 _{0 -0.035}	90	59	25 _{0 -0.021}	27	8	42	80	10	56.5	121.8 (156.8)	9		
	1/21																
	1/33																
	1/45																

*1 The values in () of the dimensions are for the servo motors with an electromagnetic brake.

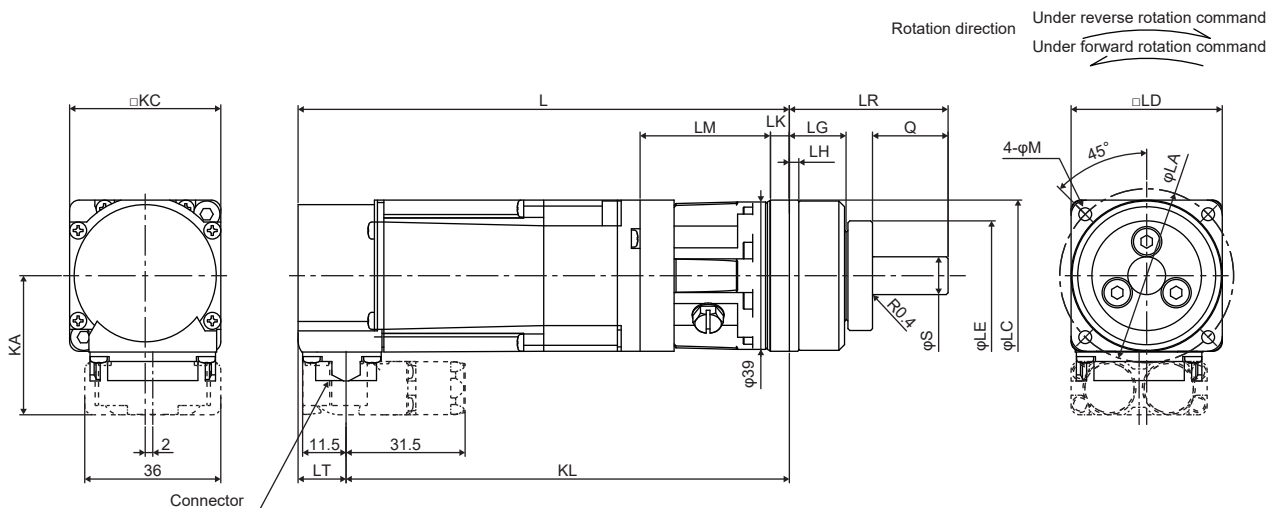

[Unit: mm]

HK-KT43(B)G7/HK-KT7M3(B)G7

Model	Reduction ratio	Variable dimensions *1															
		L	LA	LC	LD	LE	S	LG	LH	Q	LR	LK	LM	KL	M	KA	LT
HK-KT23(B)G7	1/5	131.5 (166.1)	70	56 _{-0.03} ⁰	60	40	16 _{-0.018} ⁰	21	3	28	58	8	56	119.8 (154.4)	5.5	46.6	11.7
	1/11																
	1/21	138.5 (173.1)	105	85 _{-0.035} ⁰	90	59	25 _{-0.021} ⁰	27	8	42	80	10	61	126.8 (161.4)	9		
	1/33																
	1/45																
HK-KT43(B)G7	1/5	149.5 (184.1)	70	56 _{-0.03} ⁰	60	40	16 _{-0.018} ⁰	21	3	28	58	8	56	137.8 (172.4)	5.5	46.6	11.7
	1/11	156.5 (191.1)	105	85 _{-0.035} ⁰	90	59	25 _{-0.021} ⁰	27	8	42	80	10	61	144.8 (179.4)	9		
	1/21																
	1/33	168.5 (203.1)	135	115 _{-0.035} ⁰	120	84	40 _{-0.025} ⁰	35	13	82	133	13	70	156.8 (191.4)	11		
	1/45																
HK-KT7M3(B)G7	1/5	170.5 (206)	105	85 _{-0.035} ⁰	90	59	25 _{-0.021} ⁰	27	8	42	80	10	68	158.8 (194.3)	9	56.6	11.7
	1/11																
	1/21	180.5 (216)	135	115 _{-0.035} ⁰	120	84	40 _{-0.025} ⁰	35	13	82	133	13	75	168.8 (204.3)	11		
	1/33																
	1/45																

*1 The values in () of the dimensions are for the servo motors with an electromagnetic brake.

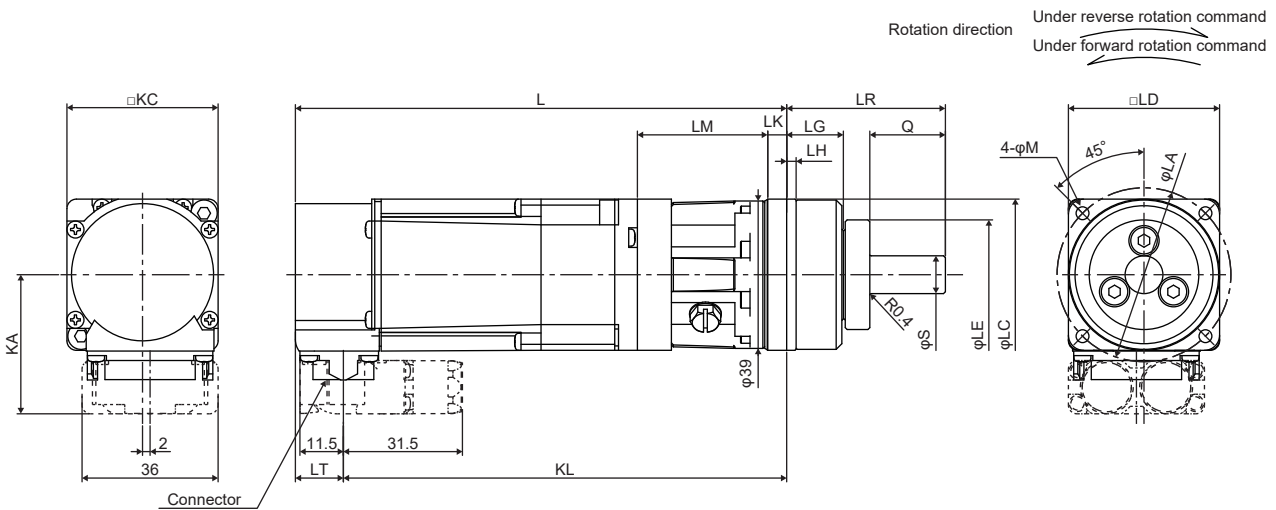

[Unit: mm]

Cable direction: Load side/opposite direction of the load side

Model	Variable dimensions							
	Dual cable				Single cable			
	A	B	C	D	A	B	C	D
HK-KT053W HK-KT13W HK-KT1M3W	36.8	36	12.7	31.5	39.6	32	12.7	40
HK-KT13UW HK-KT23W HK-KT43(4)W HK-KT63(4)W	46.6		11.7		49.4		11.7	
HK-KT23UW HK-KT43UW HK-KT7M3(4)W HK-KT103(4)W	56.6		59.4					
HK-KT63(4)UW HK-KT7M3UW HK-KT103(4)UW HK-KT153(4)W HK-KT203(4)W HK-KT202(4)W	61.6		64.4					

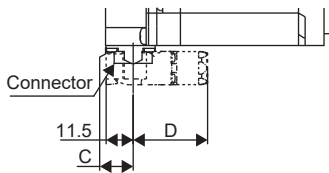
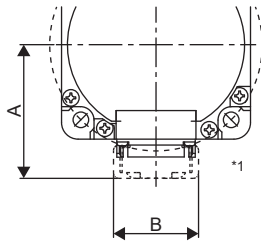

Cable direction: Load side *1

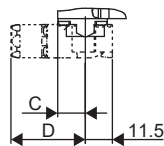

Cable direction: Opposite direction of the load side *1

[Unit: mm]

*1 The figures are for dual cable type motor cables.

Cable direction: Vertical

Model	Variable dimensions					
	Dual cable			Single cable		
	A	B	C	A	B	C
HK-KT053W HK-KT13W HK-KT1M3W	63.4	36	12.7	71.9	32	12.7
HK-KT13UW HK-KT23W HK-KT43(4)W HK-KT63(4)W	73.2		11.7			
HK-KT23UW HK-KT43UW HK-KT7M3(4)W HK-KT103(4)W	83.2			91.7		
HK-KT63(4)UW HK-KT7M3UW HK-KT103(4)UW HK-KT153(4)W HK-KT203(4)W HK-KT202(4)W	88.2			96.7		

6

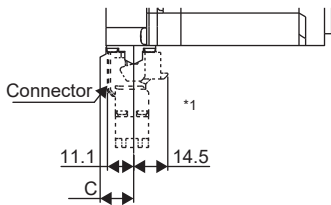
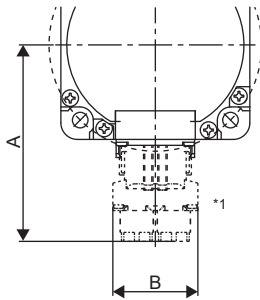

[Unit: mm]

*1 The figures are for dual cable type motor cables.

7 HK-MT SERIES

This chapter provides information on the rotary servo motor specifications and characteristics. The indicated values and those without tolerance are representative values. When using the HK-MT series rotary servo motor, read chapters 1 to 5 and SAFETY INSTRUCTIONS at the beginning of this manual in addition to this chapter.

For the combinations of servo amplifiers and rotary servo motors, restrictions on the firmware version of the servo amplifier, and restrictions by the date of manufacture of the rotary servo motor, refer to "Servo amplifier/motor combinations" in the following manuals.

MR-J5 User's Manual (Hardware)

MR-J5D User's Manual (Hardware)

7.1 Model designation

The following describes what each block of a model name indicates. Not all combinations of the symbols are available.

HK - MT 4 3 VWB

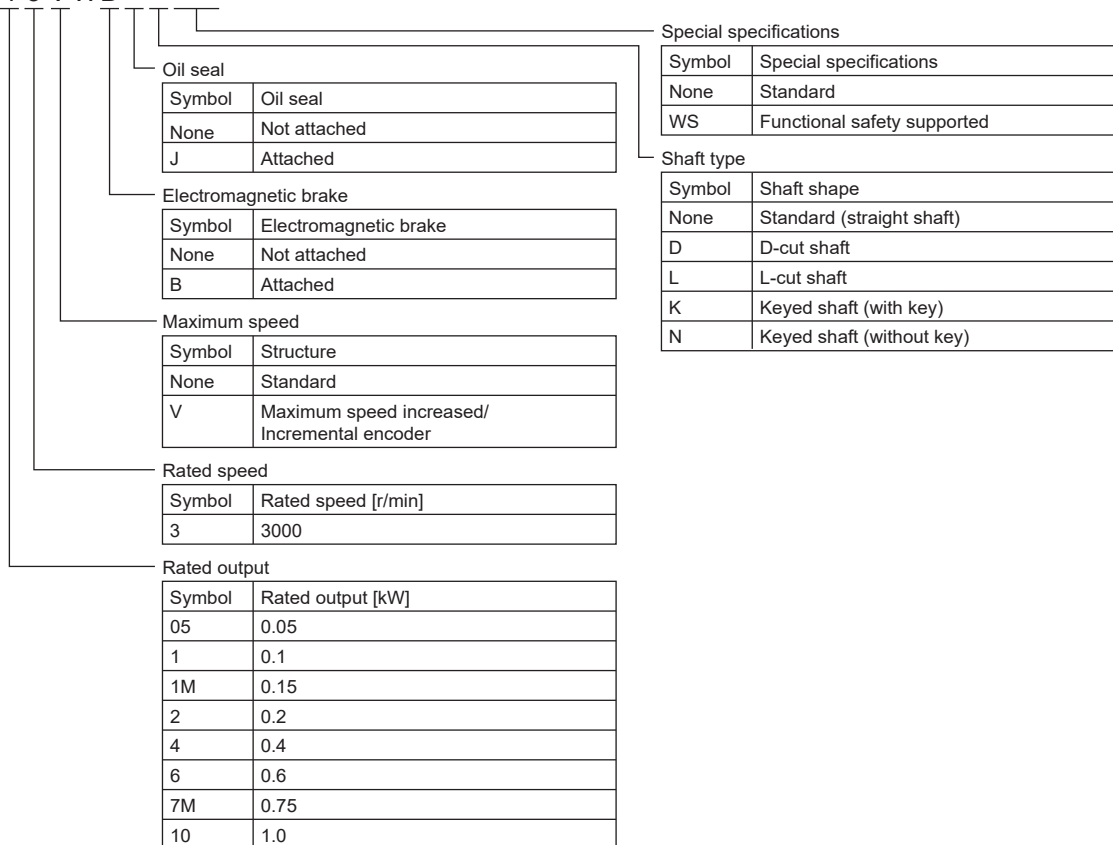

7.2 Standard specifications

Standard specifications list

When connected with 200 V servo amplifier									
Series		HK-MT_ (Ultra-low inertia/small capacity)							
Flange size		□40			□60			□80	
Rotary servo motor model		053W	13W	1M3W	23W	43W	63W	7M3W	103W
Power supply capacity		Refer to "Power supply capacity and generated loss" in the following manual. □□MR-J5 User's Manual (Hardware)							
Power supply voltage [V]		200 V AC (3-phase 200 V AC to 240 V AC)							
Continuous running duty ^{*1}	Rated output [kW]	0.05	0.1	0.15	0.2	0.4	0.6	0.75	1.0
	Rated torque [N·m]	0.16 ^{*10}	0.32	0.48	0.64	1.3	1.9	2.4	3.2
Maximum torque ^{*8} [N·m]		0.48 (0.64)	0.95 (1.3)	1.4 (1.9)	1.9 (2.3)	3.8 (4.5)	5.7 (7.1)	7.2 (8.8)	9.5 (12.4)
Rated speed ^{*1} [r/min]		3000							
Maximum speed ^{*1} [r/min]		6700							
Power rate at continuous rated torque [kW/s]	Without an electromagnetic brake	12.5	31.7	52.2	41.5	101.3	155.9	104.6	142.5
	With an electromagnetic brake	10.4	28.1	47.8	31.2	84.4	137.2	83.4	119.3
Rated current [A]		1.2	1.2	1.2	1.6	2.5	5.3	5.8	5.4
Maximum current ^{*8} [A]		4.3 (6.3)	4.6 (5.9)	4.6 (6.5)	6.3 (9.8)	9.7 (13)	21 (28)	21 (31)	20 (31)
Moment of inertia J [$\times 10^{-4}$ kg·m ²]	Without an electromagnetic brake	0.0203	0.0320	0.0437	0.0976	0.160	0.234	0.545	0.711
	With an electromagnetic brake	0.0243	0.0360	0.0477	0.130	0.192	0.266	0.683	0.849
Recommended load to motor inertia ratio ^{*2}		35 times or less ^{*1}			35 times or less				
Speed/position detector		26-bit encoder common to batteryless absolute position and incremental systems (resolution per rotary servo motor revolution: 67108864 pulses/rev)							
Type		Permanent magnet synchronous motor							
Oil seal		× ^{*7}							
Electromagnetic brake		× ^{*11}							
Thermistor		×							
Insulation class		155 (F)							
Structure		Totally enclosed, natural cooling (IP rating: IP67) ^{*3*9}							
Vibration resistance ^{*4} [m/s ²]		X: 49, Y: 49							
Vibration rank ^{*5}		V10							
Permissible load for the shaft ^{*6}	L [mm]	25			30			40	
	Radial [N]	88			245			392	
	Thrust [N]	59			98			147	
Mass [kg]	Without an electromagnetic brake	0.31	0.43	0.54	0.92	1.4	1.8	2.8	3.3
	With an electromagnetic brake	0.59	0.74	0.82	1.4	1.8	2.2	3.5	3.9

Series		HK-MT_V_ (Ultra-low inertia/small capacity)							
Flange size		□40			□60			□80	
Rotary servo motor model		053VW	13VW	1M3VW	23VW	43VW	63VW	7M3VW	103VW
Power supply capacity		Refer to "Power supply capacity and generated loss" in the following manual. □□IMR-J5 User's Manual (Hardware)							
Power supply voltage [V]		200 V AC (3-phase 200 V AC to 240 V AC)							
Continuous running duty ^{*1}	Rated output [kW]	0.05	0.1	0.15	0.2	0.4	0.6	0.75	1.0
	Rated torque [N·m]	0.16 ^{*10}	0.32	0.48	0.64	1.3	1.9	2.4	3.2
Maximum torque ^{*8} [N·m]		0.48 (0.64)	0.95 (1.3)	1.4 (1.9)	1.9 (2.3)	3.8 (4.5)	5.7 (7.1)	7.2 (8.8)	9.5 (11.5)
Rated speed ^{*1} [r/min]		3000							
Maximum speed ^{*1} [r/min]		10000							
Power rate at continuous rated torque [kW/s]	Without an electromagnetic brake	12.5	31.7	52.2	41.5	101.3	155.9	104.6	142.5
	With an electromagnetic brake	10.4	28.1	47.8	31.2	84.4	137.2	83.4	119.3
Rated current [A]		1.2	1.2	1.2	1.6	3.0	5.3	5.8	8.1
Maximum current ^{*8} [A]		4.3 (6.3)	4.6 (5.9)	4.6 (6.5)	6.3 (9.8)	12 (15)	21 (28)	21 (31)	30 (37)
Moment of inertia J [$\times 10^{-4}$ kg·m ²]	Without an electromagnetic brake	0.0203	0.0320	0.0437	0.0976	0.160	0.234	0.545	0.711
	With an electromagnetic brake	0.0243	0.0360	0.0477	0.130	0.192	0.266	0.683	0.849
Recommended load to motor inertia ratio ^{*2}		24 times or less ^{*1}		24 times or less			30 times or less		
Speed/position detector		Incremental 26-bit encoder (resolution per rotary servo motor revolution: 67108864 pulses/rev)							
Type		Permanent magnet synchronous motor							
Oil seal		× ^{*7}							
Electromagnetic brake		× ^{*11}							
Thermistor		×							
Insulation class		155 (F)							
Structure		Totally enclosed, natural cooling (IP rating: IP67) ^{*3*9}							
Vibration resistance ^{*4} [m/s ²]		X: 49, Y: 49							
Vibration rank ^{*5}		V10							
Permissible load for the shaft ^{*6}	L [mm]	25			30			40	
	Radial [N]	88			245			392	
	Thrust [N]	59			98			147	
Mass [kg]	Without an electromagnetic brake	0.31	0.43	0.54	0.92	1.4	1.8	2.8	3.3
	With an electromagnetic brake	0.59	0.74	0.82	1.4	1.8	2.2	3.5	3.9

- *1 When the power supply voltage drops, the continuous running duty and the speed cannot be guaranteed.
- *2 If the load to motor inertia ratio exceeds the indicated value, contact your local sales office.
- *3 The shaft-through portion is excluded. IP classifies the degree of protection provided against the intrusion of solid objects and water in electrical enclosures.
- *4 The vibration directions are shown in the following figure. The value is the one at the part that indicates the maximum value (normally the opposite to load-side bracket). When the rotary servo motor stops, fretting is likely to occur at the bearing. Therefore, suppress the vibration to about half of the permissible value. However, the description above is not applied to a geared servo motor is used.

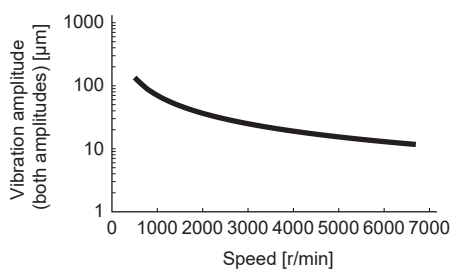
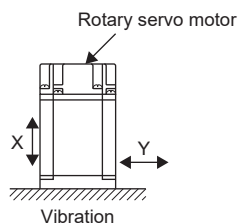

- *5 V10 indicates that the amplitude of a rotary servo motor as a single unit is 10 μm or less. The following figure shows the rotary servo motor mounting position for measurement and the measuring position.

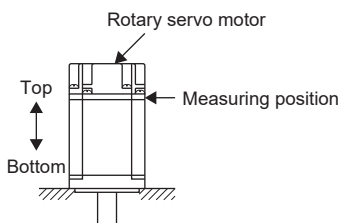

- *6 Refer to the following for permissible load for the shaft.
 Page 155 Permissible load for the output shaft
- *7 Servo motors with an oil seal are also compatible.
- *8 The values in () are for when the torque is increased.
- *9 When IP67 cables are needed, contact your local sales office.
- *10 For the HK-MT053W_J_ (with an oil seal), use it at a derating rate of 80 %.
- *11 Servo motors with an electromagnetic brake are also compatible.

Torque characteristics

- For machines where unbalanced torque occurs, such as a vertical axis system, the unbalanced torque should be kept at 70 % or lower of the rated torque.

When connected with 200 V servo amplifier

If using 1-phase power supply in combination with the servo motor of 750 W or higher and the MR-J5-100_ or the MR-J5-200_, operate the product at 75 % or less of the effective load ratio.

When the power supply voltage drops, the torque decreases. --- : A rough indication of the possible continuous running range for 3-phase 170 V AC

— : 3-phase 200 V AC
 --- : 1-phase 200 V AC

■HK-MT_W

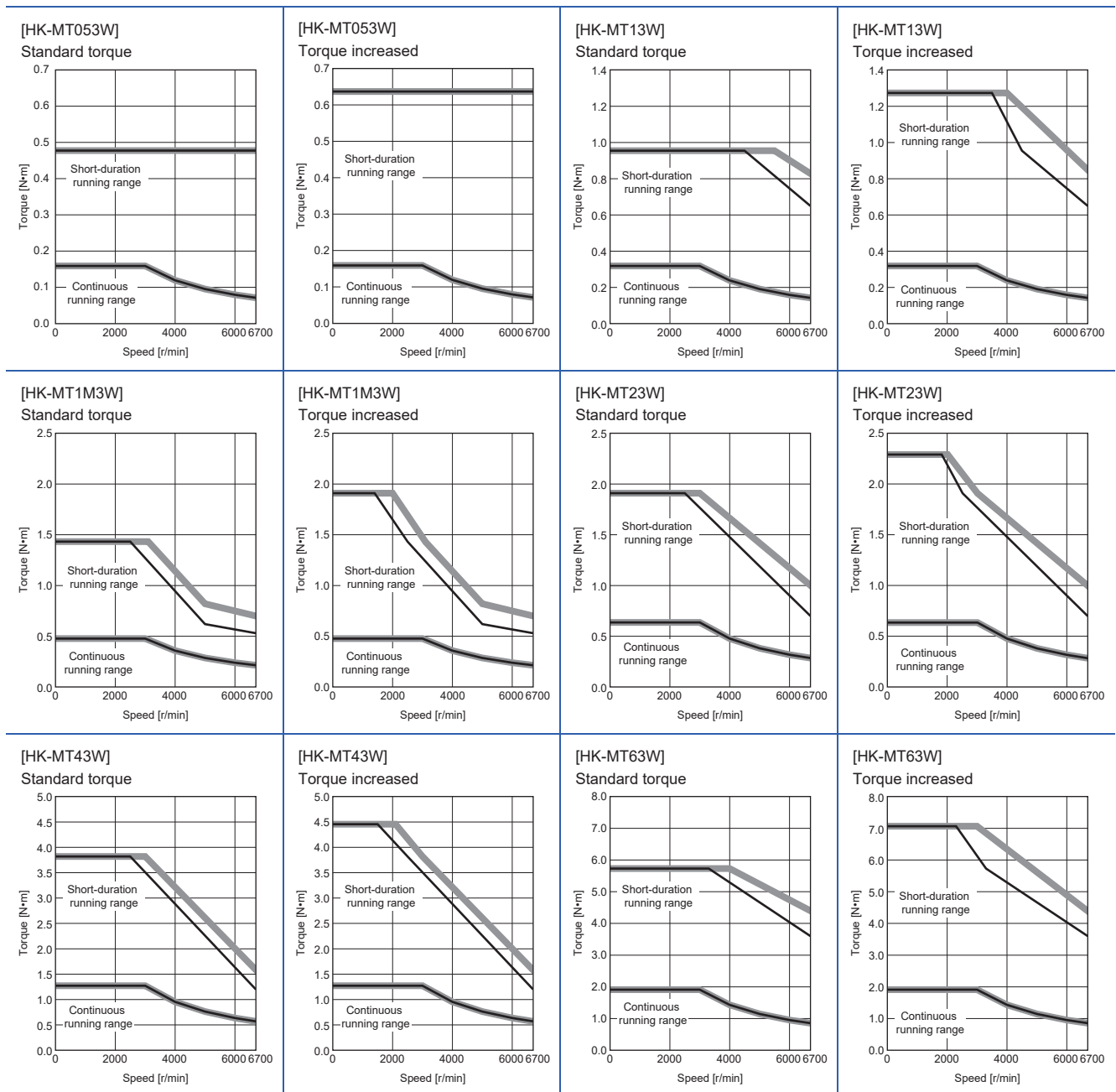

[HK-MT7M3W]
Standard torque

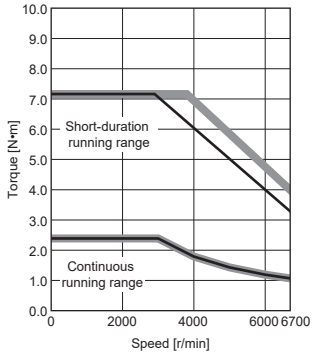

[HK-MT7M3W]
Torque increased

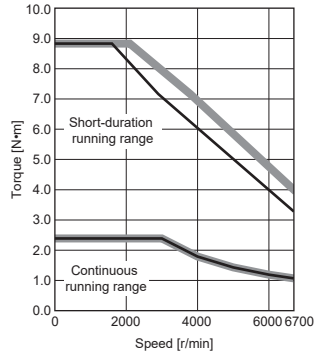

[HK-MT103W]
Standard torque

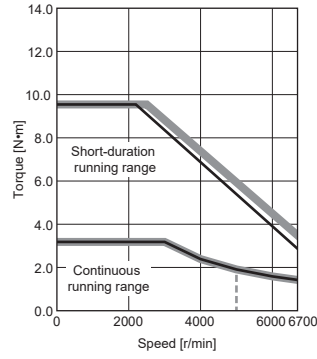

[HK-MT103W]
Torque increased

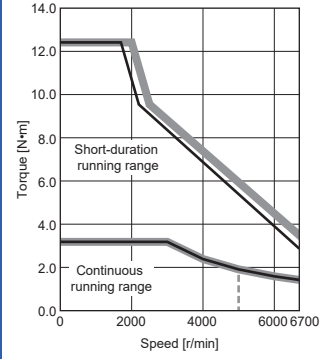

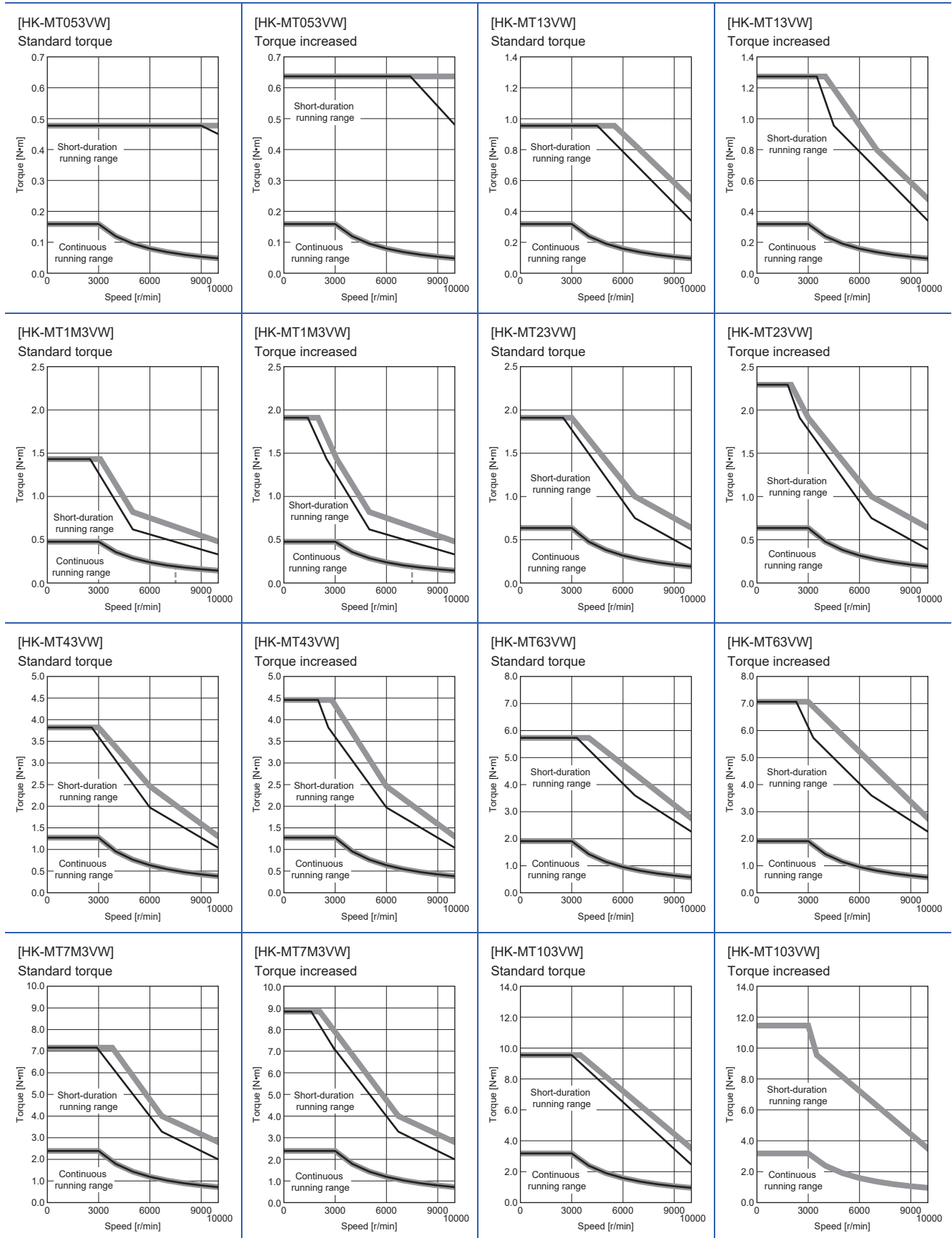

Permissible load for the output shaft

The permissible load for the shaft is shown in the following. Do not subject the shaft to loads greater than the permissible value. The value assumes that the load is applied independently.

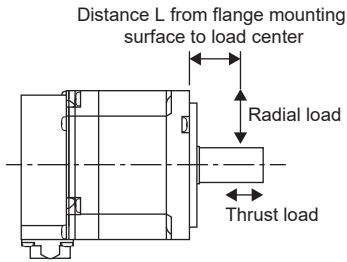

In case where the load position changes, calculate the permissible radial load from the distance measured from the flange mounting surface to the center of the load, and make the load equal to or less than the permissible radial load, referring to the graph shown in the following.

Model	Radial load		Thrust load	The graph of the relation between the load and the load position
	Load position L [mm]	Load [N]	Load [N]	
HK-MT053(V)W HK-MT13(V)W HK-MT1M3(V)W	25	88	59	
HK-MT23(V)W HK-MT43(V)W HK-MT63(V)W	30	245	98	

Model	Radial load		Thrust load	The graph of the relation between the load and the load position												
	Load position L [mm]	Load [N]	Load [N]													
HK-MT7M3(V)W HK-MT103(V)W	40	392	147	<table border="1"> <caption>Data points for the graph</caption> <thead> <tr> <th>Distance L from flange surface [mm]</th> <th>Permissible load [N]</th> </tr> </thead> <tbody> <tr><td>5</td><td>570</td></tr> <tr><td>10</td><td>530</td></tr> <tr><td>20</td><td>475</td></tr> <tr><td>30</td><td>430</td></tr> <tr><td>40</td><td>392</td></tr> </tbody> </table>	Distance L from flange surface [mm]	Permissible load [N]	5	570	10	530	20	475	30	430	40	392
Distance L from flange surface [mm]	Permissible load [N]															
5	570															
10	530															
20	475															
30	430															
40	392															

7.3 Characteristics of electromagnetic brake

Point

Before operating the servo motor, confirm that the electromagnetic brake operates properly.

The operation time of the electromagnetic brake varies depending on the power supply circuit being used.

Check the operation delay time with an actual machine.

The characteristics of the electromagnetic brake provided for the rotary servo motor with an electromagnetic brake are shown below.

Item		HK-MT053(V)WB HK-MT13(V)WB HK-MT1M3(V)WB	HK-MT23(V)WB HK-MT43(V)WB HK-MT63(V)WB	HK-KT7M3(V)WB HK-KT103(V)WB
Type *1		Spring actuated type safety brake		
Rated voltage *4		24 V DC (-10 % to 0 %)		
Power consumption at 20 °C [W]		6.4	7.9	10
Coil resistance *6 [Ω]		91	73	57
Inductance *6 [H]		0.14	0.20	0.16
Brake static friction torque *7 [N·m]		0.48 or more	1.9 or more	3.2 or more
Release delay time *2 [s]		0.03	0.03	0.04
Braking delay time [s]	DC off *2	0.01	0.02	0.02
Permissible braking work [J]	Per braking	5.6	22	64
	Per hour	56	220	640
Brake looseness at servo motor shaft *5 [degree]		2.5	1.2	0.9
Brake life *3	Number of braking times [times]	20000	20000	20000
	Work per braking [J]	5.6	22	64
Selection example of surge absorbers to be used *6	For the suppressed voltage 125 V	TND20V-680KB (Manufactured by NIPPON CHEMI-CON CORPORATION)		
	For the suppressed voltage 350 V	TND10V-221KB (Manufactured by NIPPON CHEMI-CON CORPORATION)		

*1 This type does not have a manual release mechanism. Use a 24 V DC power supply to release the brake electrically.

*2 The value for initial on gap at 20 °C.

*3 Brake lining wear due to braking will increase the brake gap, but the gap is not adjustable. Therefore, the brake life indicates the number of times the brake can be applied before gap adjustment becomes necessary.

*4 Prepare a power supply exclusively for the electromagnetic brake.

*5 The values are design values. These are not the guaranteed values.

*6 Select the electromagnetic brake control relay properly, in consideration of the characteristics of the electromagnetic brake and surge absorber. When a diode is used as a surge absorber, the electromagnetic braking time becomes longer.

*7 The value of the brake static friction torque is the lower limit in the initial state at 20 °C.

7.4 Derating

The derating condition is the reference value at the rated speed. As the temperature rise value of the rotary servo motor changes depending on the operation conditions such as speed, confirm that [AL. 0E2 Servo motor overheat warning] or [AL. 046 Servo motor overheat] does not occur on the actual machine before use.

If [AL. 0E2 Servo motor overheat warning] or [AL. 046 Servo motor overheat] occurs, consider the following measures:

- Lower the effective load ratio of the rotary servo motor.
- Review the heat dissipation conditions.

To use this product under conditions with multiple derating, calculate the multiplication of each derating rate, and use at the calculated derating rate or lower.

For machines where unbalanced torque occurs, such as a vertical axis system, the unbalanced torque should be kept at 70 % or lower of the rated torque. When applying the derating rate in the conditions above, calculate the multiplication of the derating rate of 70 % in the unbalanced torque and the derating rate of each condition, and use this product at the calculated derating rate or lower.

Restrictions on the flange size

When mounting the rotary servo motor on a machine smaller than the specified aluminum flanges listed in section 2.11, derate the servo motor in accordance with the following conditions:

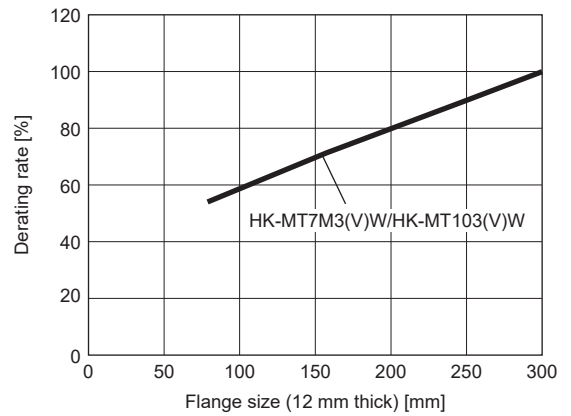
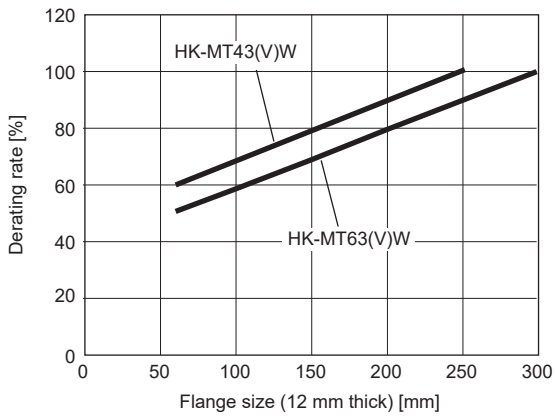
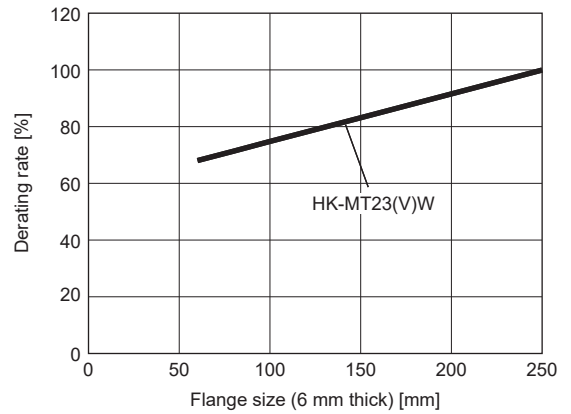
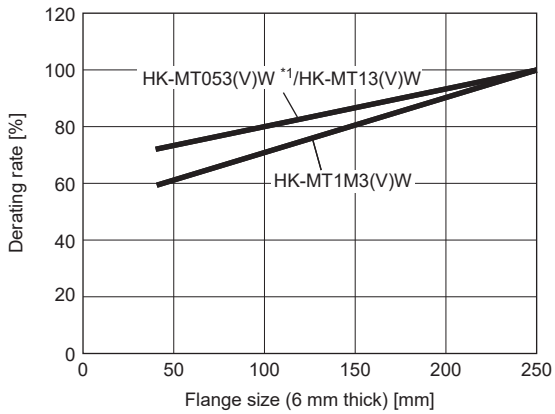

*1 For the HK-MT053W_J_ (with an oil seal), use it at a derating rate of 80 %. When applying the derating in the conditions above, calculate the multiplication of the derating rate of 80 % with an oil seal and the derating rate of each condition, and use the servo motor at the calculated derating rate or lower.

Restrictions on the ambient temperature

When using this product in an environment with a high ambient temperature, derate the product in accordance with the following conditions:

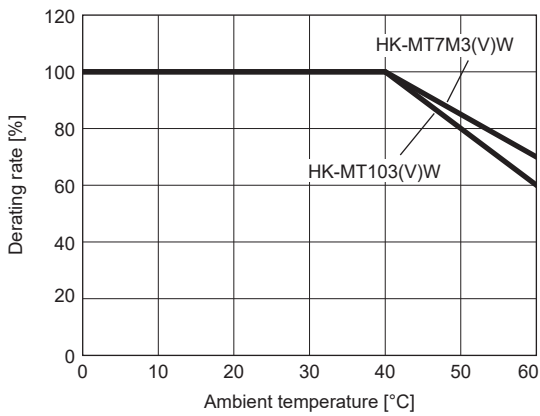
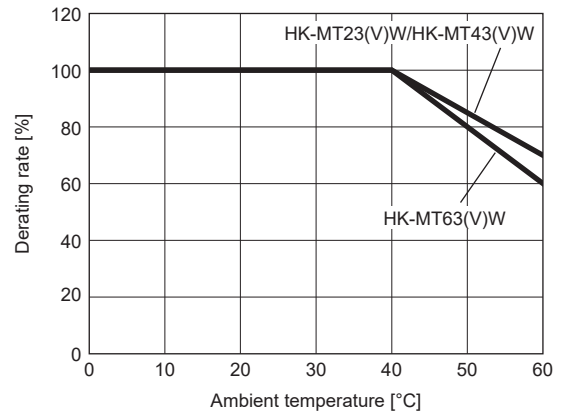
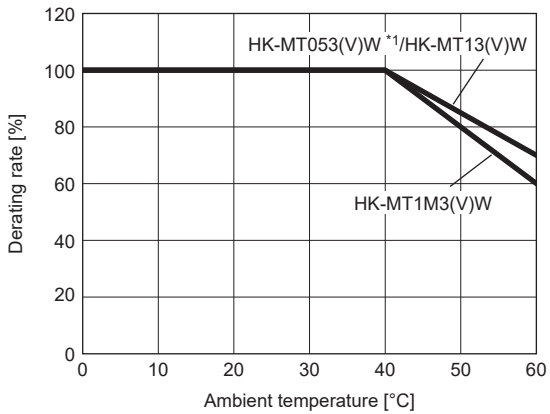

*1 For the HK-MT053W_J_ (with an oil seal), use it at a derating rate of 80 %. When applying the derating in the conditions above, calculate the multiplication of the derating rate of 80 % with an oil seal and the derating rate of each condition, and use the servo motor at the calculated derating rate or lower.

Restrictions on the altitude

To use this product at an altitude between 1000 m and 2000 m, derate the product in accordance with the following conditions:

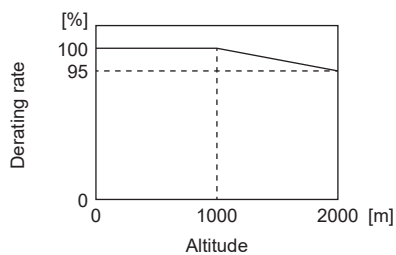

7.5 Rotary servo motors with special shafts

For rotary servo motors, there are four types of shafts: D-cut shaft, L-cut shaft, keyed shaft (with double round-ended key), and keyed shaft (without key).

To prevent an accident such as motor shaft fracture, do not use a servo motor with a D-cut shaft, L-cut shaft, or keyed shaft for frequent start/stop applications.

For geared servo motors with special shafts, refer to the following.

☞ Page 161 Rotary servo motors with special shafts

Rotary servo motor	Shaft shape			
	D-cut shaft	L-cut shaft	Keyed shaft	
			With double round-ended key	Without key
HK-MT053(V)W HK-MT13(V)W HK-MT1M3(V)W	D	L	K	N
HK-MT23(V)W HK-MT43(V)W HK-MT63(V)W HK-MT7M3(V)W HK-MT103(V)W	—	—	K	N

D-cut shaft

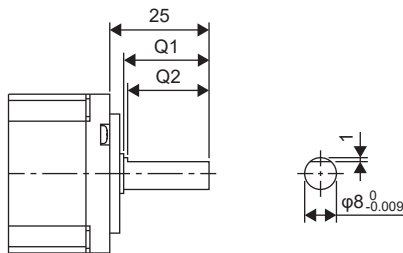

[Unit: mm]

Rotary servo motor	Variable dimensions	
	Q1	Q2
HK-MT053(V)WD HK-MT13(V)WD HK-MT1M3(V)WD	21.5	20.5

L-cut shaft

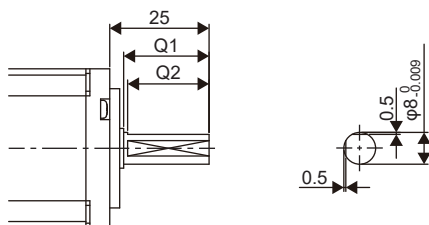

Rotary servo motor	Variable dimensions	
	Q1	Q2
HK-MT053(V)WL HK-MT13(V)WL HK-MT1M3(V)WL	21.5	20.5

Keyed shaft (with double round-ended key)

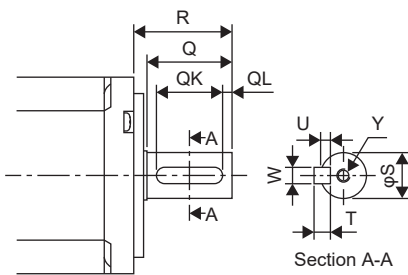

[Unit: mm]

Rotary servo motor	Variable dimensions								
	S	R	Q	W	QK	QL	U	T	Y
HK-MT053(V)WK HK-MT13(V)WK HK-MT1M3(V)WK	$8_{-0.009}^0$	25	21.5	3	14	5	1.8	3	M3 Screw hole depth 8
HK-MT23(V)WK HK-MT43(V)WK HK-MT63(V)WK	$14_{-0.011}^0$	30	26	5	20	3	3	5	M4 Screw hole depth 15
HK-MT7M3(V)WK HK-MT103(V)WK	$19_{-0.013}^0$	40	36	6	25	5	3.5	6	M5 Screw hole depth 20

Keyed shaft (without key)

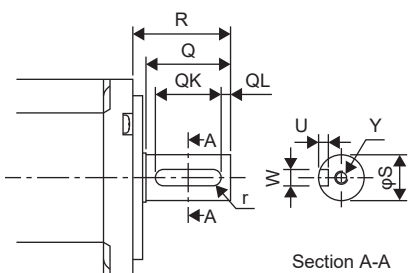

[Unit: mm]

Rotary servo motor	Variable dimensions								
	S	R	Q	W	QK	QL	U	r	Y
HK-MT053(V)WN HK-MT13(V)WN HK-MT1M3(V)WN	$8_{-0.009}^0$	25	21.5	$3_{-0.029}^{-0.004}$	14	5	$1.8_{0}^{+0.1}$	1.5	M3 Screw hole depth 8
HK-MT23(V)WN HK-MT43(V)WN HK-MT63(V)WN	$14_{-0.011}^0$	30	26	$5_{-0.03}^0$	20	3	$3_{0}^{+0.1}$	2.5	M4 Screw hole depth 15
HK-MT7M3(V)WN HK-MT103(V)WN	$19_{-0.013}^0$	40	36	$6_{-0.03}^0$	25	5	$3.5_{0}^{+0.1}$	3	M5 Screw hole depth 20

7.6 Mounting connectors

Refer to the following page for information on mounting connectors.

☞ Page 134 Mounting/removing connectors

7.7 Dimensions

- When running the cables to the load side, take care to avoid interference with the machine.
- The dimensions are for when cables (dual cable type) are run to the load-side. When running the cables vertically or to the opposite direction of the load-side, and for the dimensions for single cable type cables, refer to the following.

☞ Page 146 Cable direction: Load side/opposite direction of the load side

☞ Page 147 Cable direction: Vertical

- Not all parts are created the exact same size or assembled in precisely the same manner. Therefore, the actual dimensions of rotary servo motors may be a maximum of approximately 3 mm larger than those in the drawings. In addition, the described dimensions and dimensional tolerances are the values at 20 °C. Since the values of the dimensions may vary depending on the ambient temperature, allow some margin when designing the machine side.
- The dimensions are the same, regardless of whether the servo motor has an oil seal or not.
- Use a friction coupling for coupling the servo motor with a load.

HK-MT053(V)W(B)/HK-MT13(V)W(B)/HK-MT1M3(V)W(B)

Model	Variable dimensions *1	
	L	KL
HK-MT053(V)W(B)	61.3 (96.3)	48.6 (83.6)
HK-MT13(V)W(B)	74.8 (109.8)	62.1 (97.1)
HK-MT1M3(V)W(B)	88.3 (123.3)	75.6 (110.6)

*1 The values in () of the dimensions are for the servo motors with an electromagnetic brake.

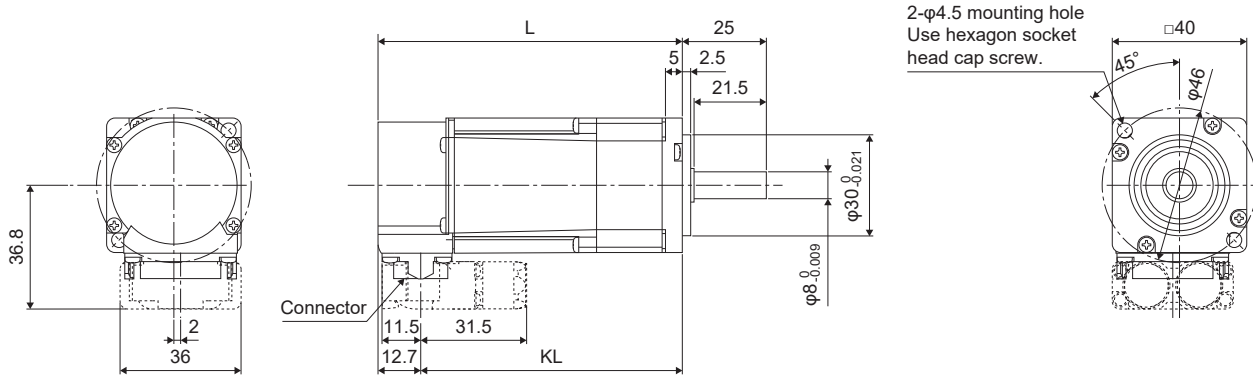

[Unit: mm]

HK-MT23(V)W(B)/HK-MT43(V)W(B)/HK-MT63(V)W(B)

Model	Variable dimensions *1	
	L	KL
HK-MT23(V)W(B)	76.6 (111.2)	64.9 (99.5)
HK-MT43(V)W(B)	96.1 (130.7)	84.4 (119)
HK-MT63(V)W(B)	118.6 (153.2)	106.9 (141.5)

*1 The values in () of the dimensions are for the servo motors with an electromagnetic brake.

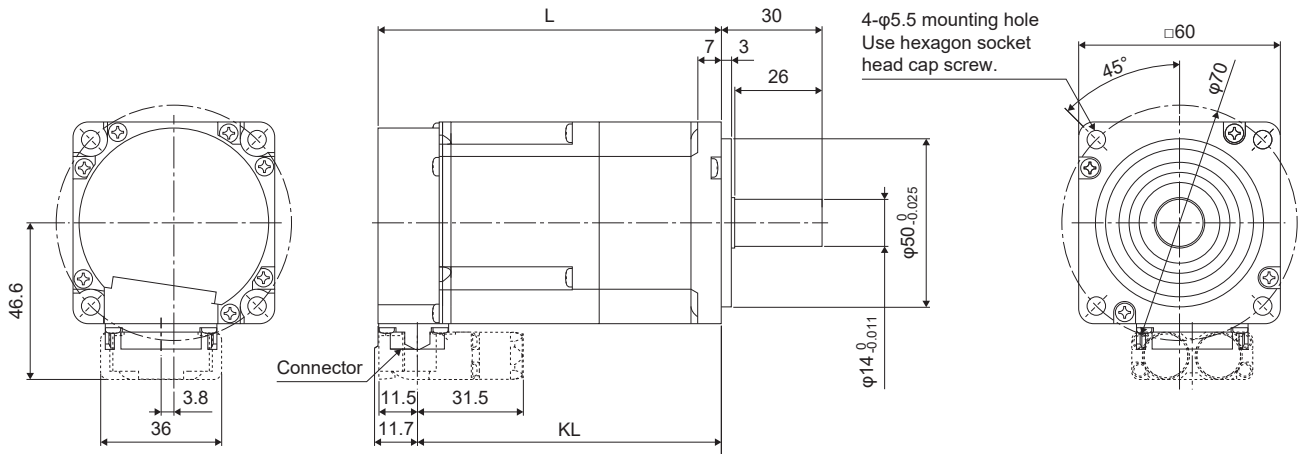

[Unit: mm]

HK-MT7M3(V)W(B)/HK-MT103(V)W(B)

Model	Variable dimensions *1	
	L	KL
HK-MT7M3W(B) HK-MT7M3VW(B)	110 (145.5)	98.3 (133.8)
HK-MT103W(B) HK-MT103VW(B)	129.5 (165)	117.8 (153.3)

*1 The values in () of the dimensions are for the servo motors with an electromagnetic brake.

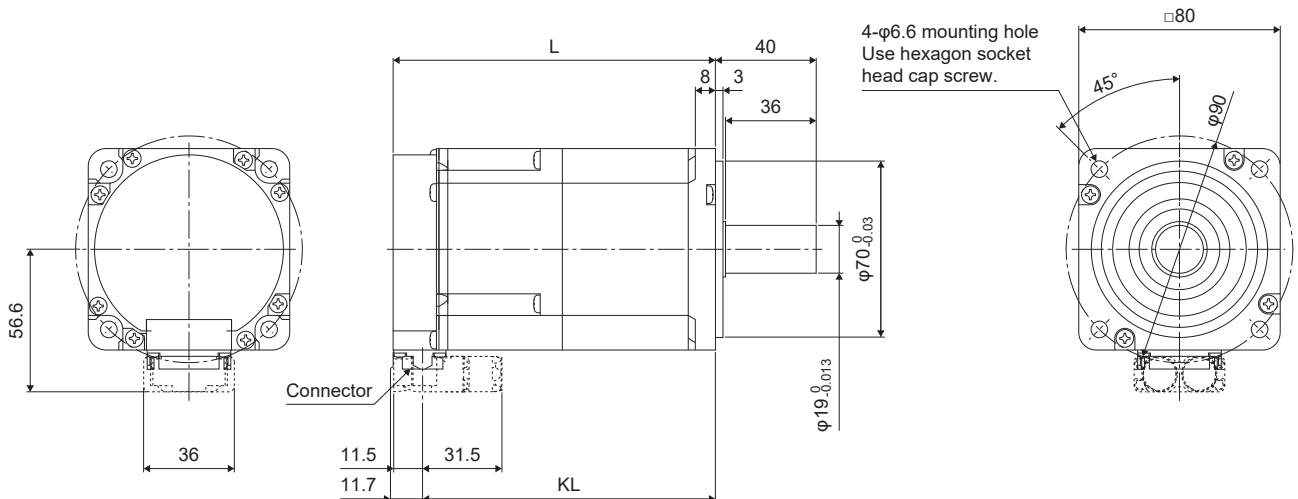

[Unit: mm]

8 HK-ST SERIES

This chapter provides information on the rotary servo motor specifications and characteristics. The indicated values and those without tolerance are representative values. When using the HK-ST series rotary servo motor, read chapters 1 to 5 and SAFETY INSTRUCTIONS at the beginning of this manual in addition to this chapter.

For the combinations of servo amplifiers and rotary servo motors, restrictions on the firmware version of the servo amplifier, and restrictions by the date of manufacture of the rotary servo motor, refer to "Servo amplifier/motor combinations" in the following manuals.

 MR-J5 User's Manual (Hardware)

 MR-J5D User's Manual (Hardware)

8.1 Model designation

The following describes what each block of a model name indicates. Not all combinations of the symbols are available.

HK - ST 2 0 2 4 AWB

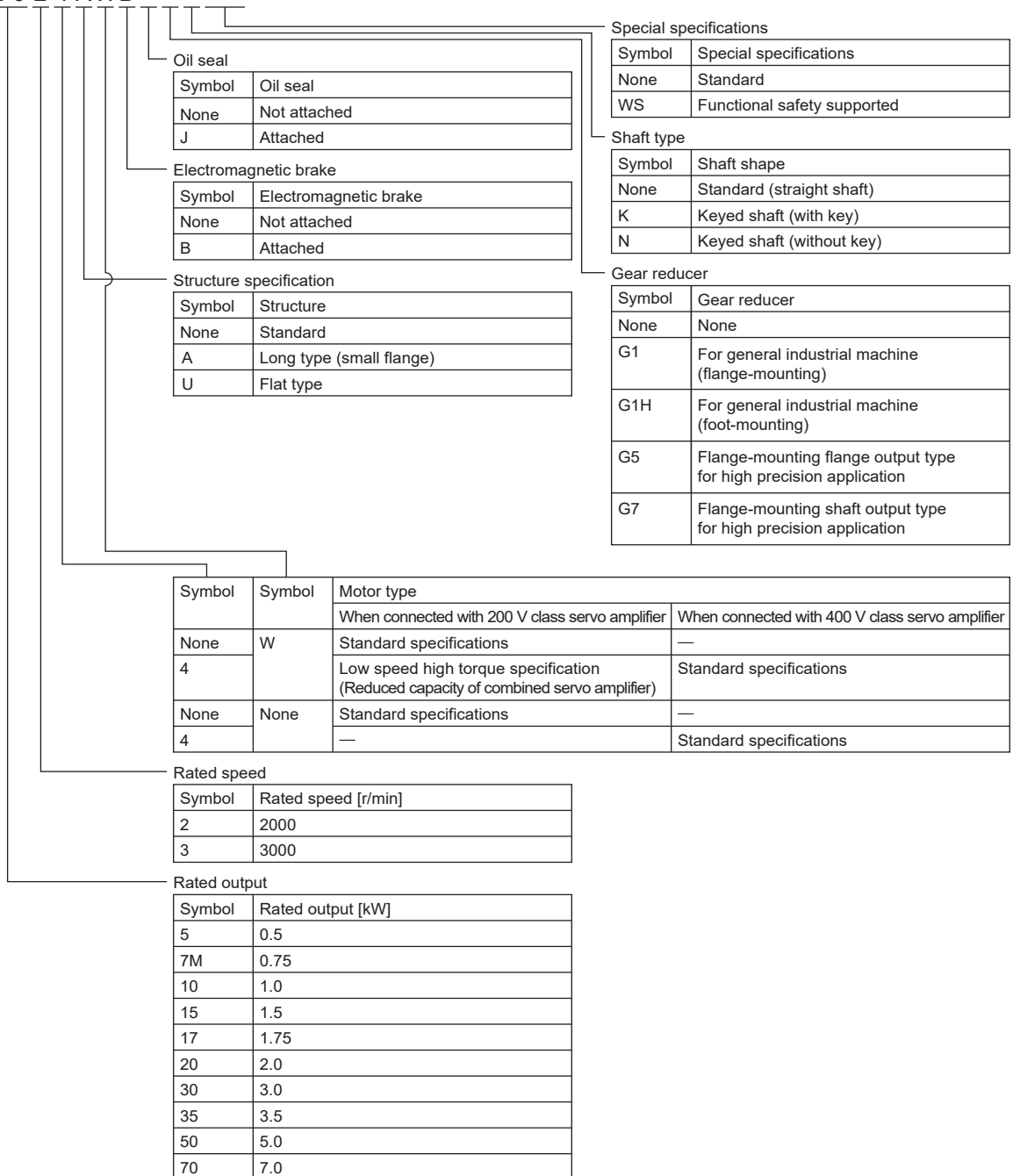

8.2 Standard specifications

Standard specifications list

When connected with 200 V servo amplifier

Series		HK-ST_ (Medium inertia/medium capacity)						
Flange size		□130						
Rotary servo motor model		52W	102W	172W	202AW	302W	353W	503W
Power supply capacity		Refer to "Power supply capacity and generated loss" in the following manual. □MR-J5 User's Manual (Hardware)						
Power supply voltage [V]		200 V AC (3-phase 200 V AC to 240 V AC)						
Continuous running duty ^{*1*8}	Rated output [kW]	0.5	1.0	1.75	2.0	3.0	2.6 (3.5)	5.0
	Rated torque [N·m]	2.4 (3.2)	4.8 (6.4)	8.4	9.5 (11.6)	14.3	8.3 (11.1)	15.9
Maximum torque ^{*8} [N·m]		7.2 (12.7)	14.3 (19.1)	25.1	28.6 (34.7)	43.0 (50.1)	24.8 (44.6)	47.8 (63.7)
Rated speed ^{*1*8} [r/min]		2000 (1500)	2000 (1500)	2000	2000 (1650)	2000	3000	3000
Maximum speed ^{*1} [r/min]		4000				2500	6700	6000
Power rate at continuous rated torque ^{*8} [kW/s]	Without an electromagnetic brake	9.7 (17.2)	26.3 (46.8)	61.2	53.9 (79.2)	91.5	40.5 (73.4)	91.5
	With an electromagnetic brake	7.0 (12.4)	20.9 (37.2)	51.1	47.8 (70.3)	83.6	35.9 (65.0)	84.7
Rated current ^{*8} [A]		3.0 (4.0)	5.3 (7.0)	9.3	11 (13)	11	14 (19)	23
Maximum current ^{*8} [A]		11 (19)	18 (24)	32	34 (42)	34 (40)	43 (83)	73 (100)
Moment of inertia J [$\times 10^{-4}$ kg·m ²]	Without an electromagnetic brake	5.90	8.65	11.4	16.9	22.4	16.9	27.7
	With an electromagnetic brake	8.15	10.9	13.7	19.1	24.5	19.1	29.9
Recommended load to motor inertia ratio ^{*2}		15 times or less ^{*9}	23 times or less	24 times or less			10 times or less	
Speed/position detector		26-bit encoder common to batteryless absolute position and incremental systems (resolution per rotary servo motor revolution: 67108864 pulses/rev)						
Type		Permanent magnet synchronous motor						
Oil seal		× ^{*7}						
Electromagnetic brake		× ^{*15}						
Thermistor		×						
Insulation class		155 (F)						
Structure		Totally enclosed, natural cooling (IP rating: IP67) ^{*3*14}						
Vibration resistance ^{*4} [m/s ²]		X: 24.5, Y: 49						
Vibration rank ^{*5}		V10						
Permissible load for the shaft ^{*6*13}	L [mm]	55						
	Radial [N]	980						
	Thrust [N]	490						
Mass ^{*13} [kg]	Without an electromagnetic brake	5.0	6.0	7.1	9.1	11	9.1	13
	With an electromagnetic brake	6.8	7.8	8.8	11	13	11	15

Series		HK-ST_ (Medium inertia/medium capacity)					
Flange size		□176					
Rotary servo motor model		7M2UW	172UW	202W	352W	502W	702W
Power supply capacity		Refer to "Power supply capacity and generated loss" in the following manual.  MR-J5 User's Manual (Hardware)					
Power supply voltage [V]		200 V AC (3-phase 200 V AC to 240 V AC)					
Continuous running duty ^{*18}	Rated output [kW]	0.75	1.75	2.0	3.5	5.0	7.0
	Rated torque [N•m]	3.6	8.4	9.5 (12.7)	16.7 (20.3)	23.9 (28.9)	33.4
Maximum torque ^{*8} [N•m]		10.7 (12.5)	25.1 (29.2)	28.6 (38.2)	50.1 (60.8)	71.6 (86.8)	100
Rated speed ^{*18} [r/min]		2000		2000 (1500)	2000 (1650)	2000 (1650)	2000
Maximum speed ^{*1} [r/min]		3000		4000	3500	4000	3000
Power rate at continuous rated torque ^{*8} [kW/s]	Without an electromagnetic brake	12.2	36.6	25.1 (44.6)	52.1 (76.5)	80.4 (118)	106
	With an electromagnetic brake	10.4	33.4	22.0 (39.2)	47.7 (70.0)	75.2 (110)	101
Rated current ^{*8} [A]		4.6	9.0	10 (14)	16 (19)	27 (32)	28
Maximum current ^{*8} [A]		18 (24)	34 (40)	32 (45)	52 (66)	90 (110)	102
Moment of inertia J [$\times 10^{-4}$ kg•m ²]	Without an electromagnetic brake	10.5	19.1	36.4	53.6	70.8	105
	With an electromagnetic brake	12.3	20.9	41.4	58.6	75.8	110
Recommended load to motor inertia ratio ^{*2}		19 times or less		15 times or less ^{*10}	12 times or less ^{*11}	10 times or less ^{*12}	8 times or less ^{*12}
Speed/position detector		26-bit encoder common to batteryless absolute position and incremental systems (resolution per rotary servo motor revolution: 67108864 pulses/rev)					
Type		Permanent magnet synchronous motor					
Oil seal		x ^{*7}					
Electromagnetic brake		x ^{*15}					
Thermistor		x					
Insulation class		155 (F)					
Structure		Totally enclosed, natural cooling (IP rating: IP67) ^{*3*14}					
Vibration resistance ^{*4} [m/s ²]		X: 24.5, Y: 24.5		X: 24.5, Y: 49		X: 24.5, Y: 29.4	
Vibration rank ^{*5}		V10					
Permissible load for the shaft ^{*6*13}	L [mm]	55		79			
	Radial [N]	980		2058			
	Thrust [N]	490		980			
Mass ^{*13} [kg]	Without an electromagnetic brake	7.5	9.2	13	16	20	27
	With an electromagnetic brake	9.5	11	18	21	25	31

Series		HK-ST_4_ (Medium inertia/medium capacity)				
Flange size		□130				
Rotary servo motor model		524W	1024W	1724W	2024AW	3024W
Power supply capacity		Refer to "Power supply capacity and generated loss" in the following manual. □MR-J5 User's Manual (Hardware)				
Power supply voltage [V]		200 V AC (3-phase 200 V AC to 240 V AC)				
Continuous running duty ^{*1}	Rated output [kW]	0.3	0.6	0.85	1.0	1.5
	Rated torque [N•m]	2.9	5.7	8.1	9.5	14.3
Maximum torque ^{*8} [N•m]		11.5	17.2 (20.1)	24.4	33.4	43.0
Rated speed ^{*1} [r/min]		1000				
Maximum speed ^{*1} [r/min]		2000				1200
Power rate at continuous rated torque [kW/s]	Without an electromagnetic brake	13.9	37.9	57.8	53.9	91.5
	With an electromagnetic brake	10.1	30.1	48.3	47.8	83.6
Rated current [A]		1.8	3.2	4.5	5.2	5.1
Maximum current [A]		8.3	11 (13)	17	20	17
Moment of inertia J [$\times 10^{-4}$ kg•m ²]	Without an electromagnetic brake	5.90	8.65	11.4	16.9	22.4
	With an electromagnetic brake	8.15	10.9	13.7	19.1	24.5
Recommended load to motor inertia ratio ^{*2}		15 times or less	24 times or less		20 times or less	24 times or less
Speed/position detector		26-bit encoder common to batteryless absolute position and incremental systems (resolution per rotary servo motor revolution: 67108864 pulses/rev)				
Type		Permanent magnet synchronous motor				
Oil seal		x ^{*7}				
Electromagnetic brake		x ^{*15}				
Thermistor		x				
Insulation class		155 (F)				
Structure		Totally enclosed, natural cooling (IP rating: IP67) ^{*3*14}				
Vibration resistance ^{*4} [m/s ²]		X: 24.5, Y: 49				
Vibration rank ^{*5}		V10				
Permissible load for the shaft ^{*6*13}	L [mm]	55				
	Radial [N]	980				
	Thrust [N]	490				
Mass ^{*13} [kg]	Without an electromagnetic brake	5.0	6.0	7.1	9.1	11
	With an electromagnetic brake	6.8	7.8	8.8	11	13

Series		HK-ST_4_ (Medium inertia/medium capacity)			
Flange size		□176			
Rotary servo motor model		2024W	3524W	5024W	7024W
Power supply capacity		Refer to "Power supply capacity and generated loss" in the following manual. ☐MR-J5 User's Manual (Hardware)			
Power supply voltage [V]		200 V AC (3-phase 200 V AC to 240 V AC)			
Continuous running duty *1	Rated output [kW]	1.2	2.0	3.0	4.2
	Rated torque [N·m]	11.5	19.1	28.6	40.1
Maximum torque *8 [N·m]		40.1	57.3 (66.8)	85.9	120
Rated speed *1 [r/min]		1000			
Maximum speed *1 [r/min]		2000	1500	2000	1500
Power rate at continuous rated torque [kW/s]	Without an electromagnetic brake	36.1	68.0	116	153
	With an electromagnetic brake	31.7	62.3	108	146
Rated current [A]		6.0	9.0	16	17
Maximum current *8 [A]		24	32 (37)	52	60
Moment of inertia J [$\times 10^{-4}$ kg·m ²]	Without an electromagnetic brake	36.4	53.6	70.8	105
	With an electromagnetic brake	41.4	58.6	75.8	110
Recommended load to motor inertia ratio *2		23 times or less			
Speed/position detector		26-bit encoder common to batteryless absolute position and incremental systems (resolution per rotary servo motor revolution: 67108864 pulses/rev)			
Type		Permanent magnet synchronous motor			
Oil seal		× *7			
Electromagnetic brake		× *15			
Thermistor		×			
Insulation class		155 (F)			
Structure		Totally enclosed, natural cooling (IP rating: IP67) *3*14			
Vibration resistance *4 [m/s ²]		X: 24.5, Y: 49		X: 24.5, Y: 29.4	
Vibration rank *5		V10			
Permissible load for the shaft *6*13	L [mm]	79			
	Radial [N]	2058			
	Thrust [N]	980			
Mass *13 [kg]	Without an electromagnetic brake	13	16	20	27
	With an electromagnetic brake	18	21	25	31

- *1 When the power supply voltage drops, the continuous running duty and the speed cannot be guaranteed.
- *2 If the load to motor inertia ratio exceeds the indicated value, contact your local sales office.
- *3 The shaft-through portion is excluded. IP classifies the degree of protection provided against the intrusion of solid objects and water in electrical enclosures.
- *4 The vibration directions are shown in the following figure. The value is the one at the part that indicates the maximum value (normally the opposite to load-side bracket). When the rotary servo motor stops, fretting is likely to occur at the bearing. Therefore, suppress the vibration to about half of the permissible value.

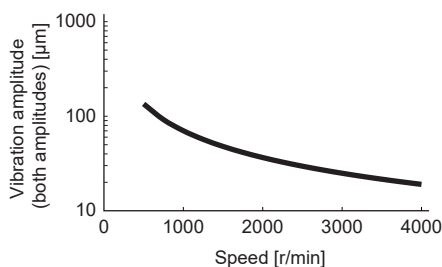
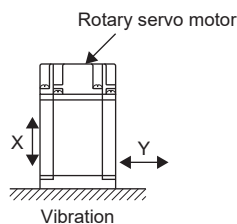

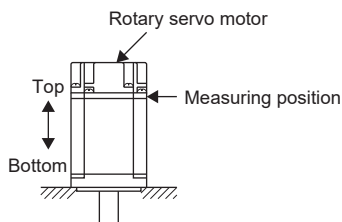

- *5 V10 indicates that the amplitude of a rotary servo motor as a single unit is 10 µm or less. The following figure shows the rotary servo motor mounting position for measurement and the measuring position.



- *6 Refer to the following for permissible load for the shaft.
 - ☞ Page 181 Permissible load for the output shaft
- *7 Servo motors with an oil seal are also compatible.
- *8 The values in () are for when the torque is increased.
- *9 If the speed is 3000 r/min or less, the recommended load to motor inertia ratio will be 19 times or less.
- *10 If the speed is 3000 r/min or less, the recommended load to motor inertia ratio will be 20 times or less.
- *11 If the speed is 3000 r/min or less, the recommended load to motor inertia ratio will be 22 times or less.
- *12 If the speed is 2000 r/min or less, the recommended load to motor inertia ratio will be 22 times or less.
- *13 Refer to the following for geared servo motors.
 - ☞ Page 187 Geared servo motor
- *14 When a geared servo motor is used, the IP rating for the gear reducer area is equivalent to IP44.
- *15 Servo motors with an electromagnetic brake are also compatible.

When connected with 400 V servo amplifier

Series		HK-ST_4_ (Medium inertia/medium capacity)						
Flange size		□130						
Rotary servo motor model		524W	1024W	1724W	2024AW	3024W	3534W	5034W
Power supply capacity		Refer to "Power supply capacity and generated loss" in the following manuals. □ MR-J5 User's Manual (Hardware) □ MR-J5D User's Manual (Hardware)						
Power supply voltage [V]		400 V AC (3-phase 380 V AC to 480 V AC)						
Continuous running duty ^{*1*8}	Rated output [kW]	0.5	1.0	1.75	2.0	3.0	2.6 (3.5)	5.0
	Rated torque [N·m]	2.4 (3.2)	4.8 (6.4)	8.4	9.5 (11.6)	14.3	8.3 (11.1)	15.9
Maximum torque ^{*8} [N·m]		7.2 (12.7)	14.3 (19.1)	25.1	28.6 (34.7)	43.0 (50.1)	24.8 (44.6)	47.8 (63.7)
Rated speed ^{*1*8} [r/min]		2000 (1500)	2000 (1500)	2000	2000 (1650)	2000	3000	3000
Maximum speed ^{*1} [r/min]		4000				2500	6700	6000
Power rate at continuous rated torque ^{*8} [kW/s]	Without an electromagnetic brake	9.7 (17.2)	26.3 (46.8)	61.2	53.9 (79.2)	91.5	40.5 (73.4)	91.5
	With an electromagnetic brake	7.0 (12.4)	20.9 (37.2)	51.1	47.8 (70.3)	83.6	35.9 (65.0)	84.7
Rated current ^{*8} [A]		1.5 (2.0)	2.7 (3.5)	4.7	5.2 (6.3)	5.1	6.9 (9.2)	12
Maximum current ^{*8} [A]		5.1 (9.3)	8.8 (12)	16	17 (21)	17 (20)	22 (42)	37 (52)
Moment of inertia J [$\times 10^{-4}$ kg·m ²]	Without an electromagnetic brake	5.90	8.65	11.4	16.9	22.4	16.9	27.7
	With an electromagnetic brake	8.15	10.9	13.7	19.1	24.5	19.1	29.9
Recommended load to motor inertia ratio ^{*2}	MR-J5	4 times or less ^{*11}	4 times or less ^{*14}	4 times or less ^{*15}	8 times or less ^{*15}	24 times or less	10 times or less	—
	MR-J5D	19 times or less	16 times or less	11 times or less	7 times or less ^{*15}	24 times or less	3 times or less ^{*20}	2 times or less ^{*21}
Speed/position detector		26-bit encoder common to batteryless absolute position and incremental systems (resolution per rotary servo motor revolution: 67108864 pulses/rev)						
Type		Permanent magnet synchronous motor						
Oil seal		× ^{*7}						
Electromagnetic brake		× ^{*22}						
Thermistor		×						
Insulation class		155 (F)						
Structure		Totally enclosed, natural cooling (IP rating: IP67) ^{*3*10}						
Vibration resistance ^{*4} [m/s ²]		X: 24.5, Y: 49						
Vibration rank ^{*5}		V10						
Permissible load for the shaft ^{*6*9}	L [mm]	55						
	Radial [N]	980						
	Thrust [N]	490						
Mass ^{*9} [kg]	Without an electromagnetic brake	5.0	6.0	7.1	9.1	11	9.1	13
	With an electromagnetic brake	6.8	7.8	8.8	11	13	11	15

Series		HK-ST_4_ (Medium inertia/medium capacity)			
Flange size		□176			
Rotary servo motor model		2024W	3524W	5024W	7024W
Power supply capacity		Refer to "Power supply capacity and generated loss" in the following manuals.  MR-J5 User's Manual (Hardware)  MR-J5D User's Manual (Hardware)			
Power supply voltage [V]		400 V AC (3-phase 380 V AC to 480 V AC)			
Continuous running duty ^{*18}	Rated output [kW]	2.0	3.5	5.0	7.0
	Rated torque [N·m]	9.5 (12.7)	16.7 (20.3)	23.9 (28.9)	33.4
Maximum torque ^{*8} [N·m]		28.6 (38.2)	50.1 (60.8)	71.6 (86.8)	100
Rated speed ^{*18} [r/min]		2000 (1500)	2000 (1650)	2000 (1650)	2000
Maximum speed ^{*1} [r/min]		4000	3500	4000	3000
Power rate at continuous rated torque ^{*8} [kW/s]	Without an electromagnetic brake	25.1 (44.6)	52.1 (76.5)	80.4 (118)	106
	With an electromagnetic brake	22.0 (39.2)	47.7 (70.0)	75.2 (110)	101
Rated current ^{*8} [A]		5.0 (6.7)	7.9 (9.5)	14 (16)	14
Maximum current ^{*8} [A]		16 (23)	26 (33)	45 (55)	59
Moment of inertia J [$\times 10^{-4}$ kg·m ²]	Without an electromagnetic brake	36.4	53.6	70.8	105
	With an electromagnetic brake	41.4	58.6	75.8	110
Recommended load to motor inertia ratio ^{*2}	MR-J5	4 times or less ^{*12}	5 times or less ^{*13}	—	—
	MR-J5D	2 times or less ^{*16}	4 times or less ^{*17}	2 times or less ^{*18}	2 times or less ^{*19}
Speed/position detector		26-bit encoder common to batteryless absolute position and incremental systems (resolution per rotary servo motor revolution: 67108864 pulses/rev)			
Type		Permanent magnet synchronous motor			
Oil seal		× ^{*7}			
Electromagnetic brake		× ^{*22}			
Thermistor		×			
Insulation class		155 (F)			
Structure		Totally enclosed, natural cooling (IP rating: IP67) ^{*3*10}			
Vibration resistance ^{*4} [m/s ²]		X: 24.5, Y: 49		X: 24.5, Y: 29.4	
Vibration rank ^{*5}		V10			
Permissible load for the shaft ^{*6*9}	L [mm]	79			
	Radial [N]	2058			
	Thrust [N]	980			
Mass ^{*9} [kg]	Without an electromagnetic brake	13	16	20	27
	With an electromagnetic brake	18	21	25	31

- *1 When the power supply voltage drops, the continuous running duty and the speed cannot be guaranteed.
- *2 If the load to motor inertia ratio exceeds the indicated value, contact your local sales office.
- *3 The shaft-through portion is excluded. IP classifies the degree of protection provided against the intrusion of solid objects and water in electrical enclosures.
- *4 The vibration directions are shown in the following figure. The value is the one at the part that indicates the maximum value (normally the opposite to load-side bracket). When the rotary servo motor stops, fretting is likely to occur at the bearing. Therefore, suppress the vibration to about half of the permissible value.

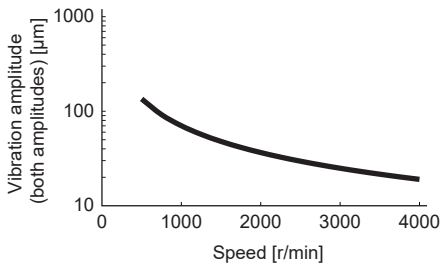
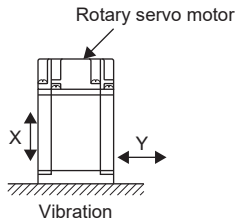

- *5 V10 indicates that the amplitude of a rotary servo motor as a single unit is 10 μm or less. The following figure shows the rotary servo motor mounting position for measurement and the measuring position.

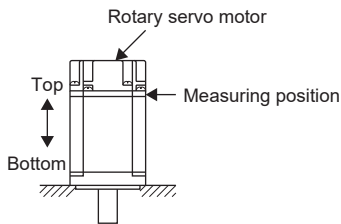

- *6 Refer to the following for permissible load for the shaft.
 - ☞ Page 181 Permissible load for the output shaft
- *7 Servo motors with an oil seal are also compatible.
- *8 The values in () are for when the torque is increased.
- *9 Refer to the following for geared servo motors.
 - ☞ Page 187 Geared servo motor
- *10 When a geared servo motor is used, the IP rating for the gear reducer area is equivalent to IP44.
- *11 If the speed is 2000 r/min or less, the recommended load to motor inertia ratio will be 19 times or less.
- *12 If the speed is 2000 r/min or less, the recommended load to motor inertia ratio will be 20 times or less.
- *13 If the speed is 2000 r/min or less, the recommended load to motor inertia ratio will be 22 times or less.
- *14 If the speed is 2000 r/min or less, the recommended load to motor inertia ratio will be 23 times or less.
- *15 If the speed is 2000 r/min or less, the recommended load to motor inertia ratio will be 24 times or less.
- *16 If the speed is 2000 r/min or less, the recommended load to motor inertia ratio will be 12 times or less.
- *17 If the speed is 2000 r/min or less, the recommended load to motor inertia ratio will be 14 times or less.
- *18 If the speed is 2000 r/min or less, the recommended load to motor inertia ratio will be 10 times or less.
- *19 If the speed is 2000 r/min or less, the recommended load to motor inertia ratio will be 7 times or less.
- *20 If the speed is 3000 r/min or less, the recommended load to motor inertia ratio will be 20 times or less.
- *21 If the speed is 3000 r/min or less, the recommended load to motor inertia ratio will be 12 times or less.
- *22 Servo motors with an electromagnetic brake are also compatible.

Torque characteristics

- For machines where unbalanced torque occurs, such as a vertical axis system, the unbalanced torque should be kept at 75 % or lower of the rated torque.

When connected with 200 V servo amplifier

If using 1-phase power supply in combination with the servo motor of 750 W or higher and the MR-J5-100_ or the MR-J5-200_, operate the product at 75 % or less of the effective load ratio.

When the power supply voltage drops, the torque decreases. --- : A rough indication of the possible continuous running range for 3-phase 170 V AC

— : 3-phase 200 V AC
 --- : 1-phase 200 V AC

■HK-ST_W

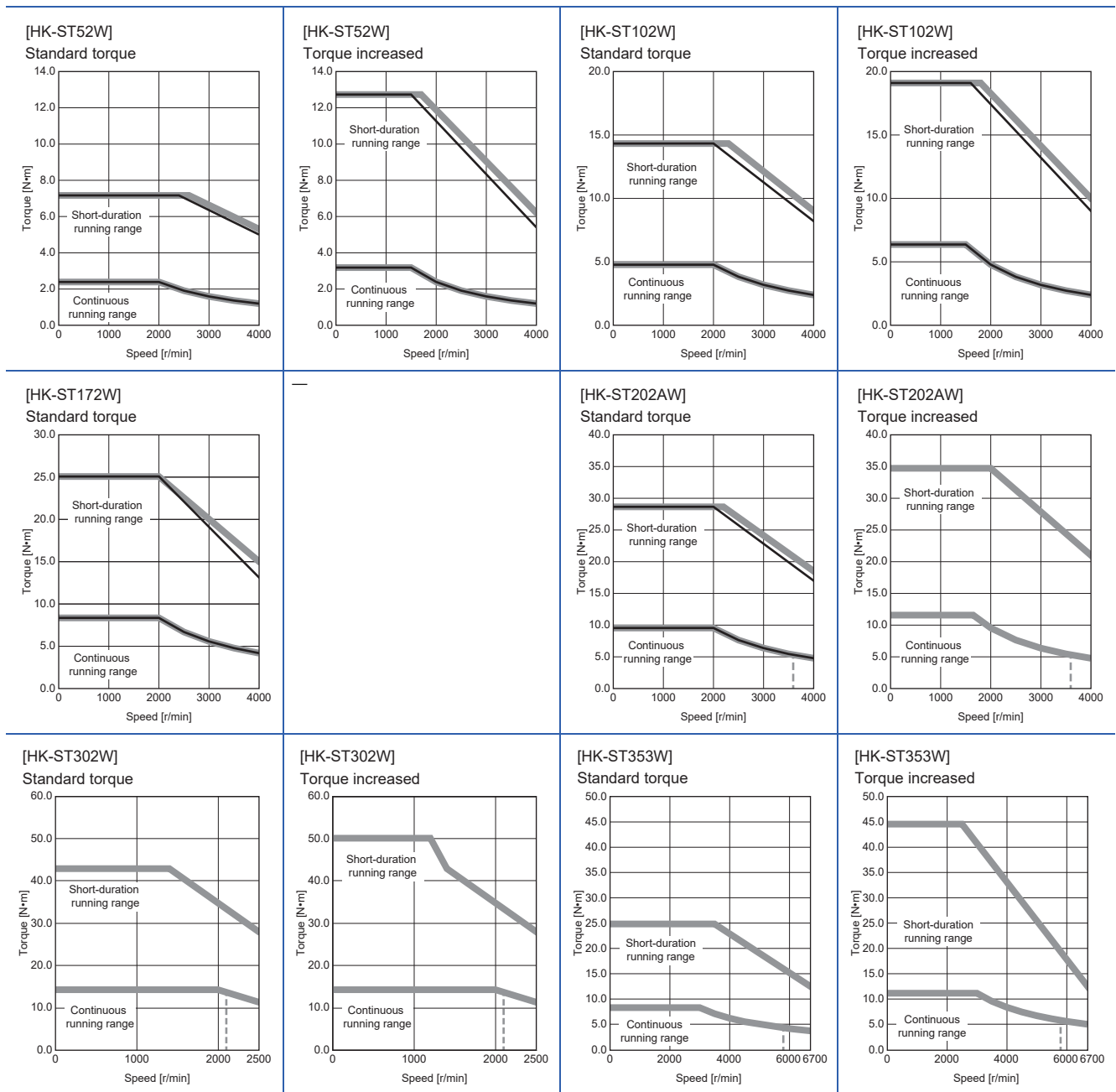

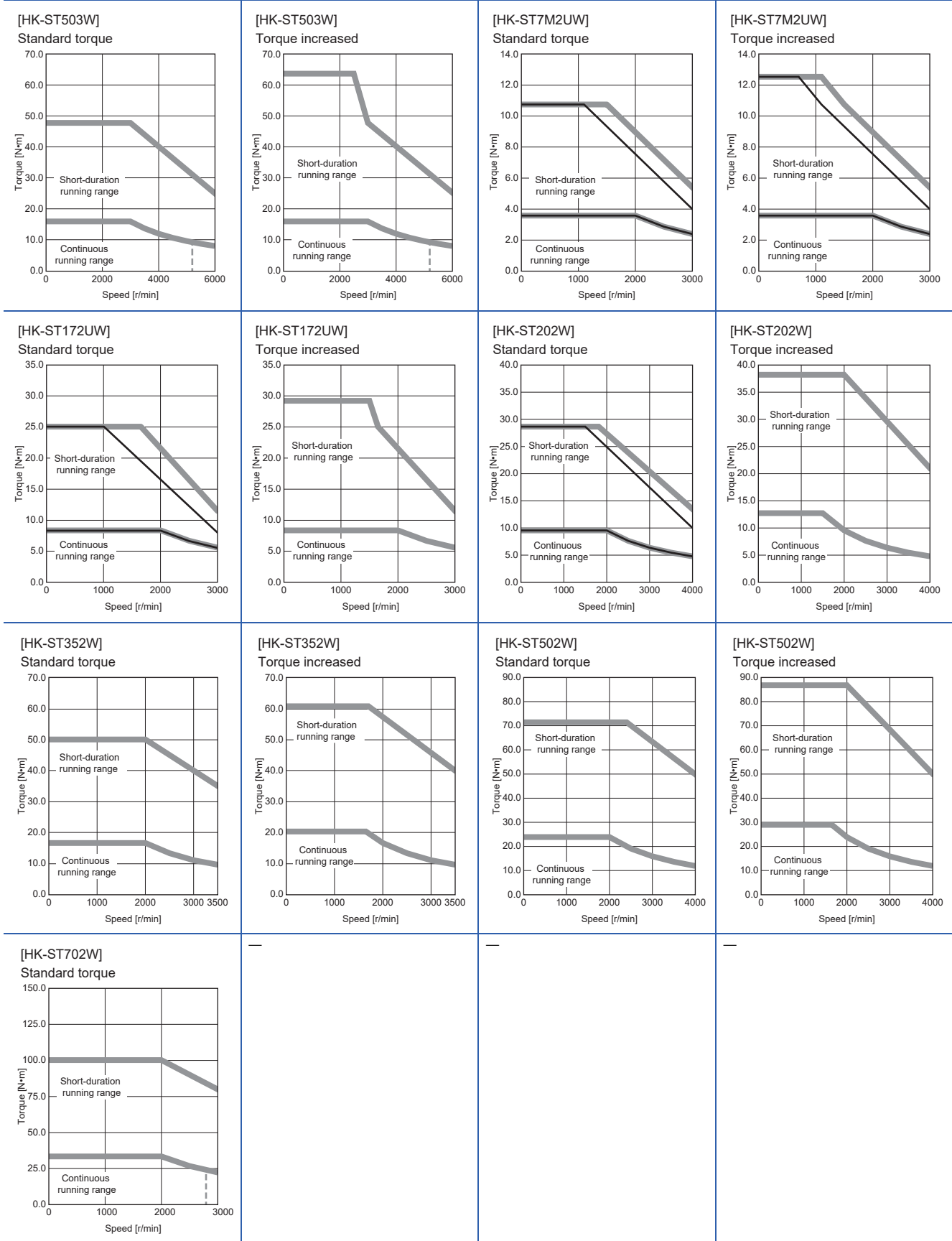

■HK-ST_4_W

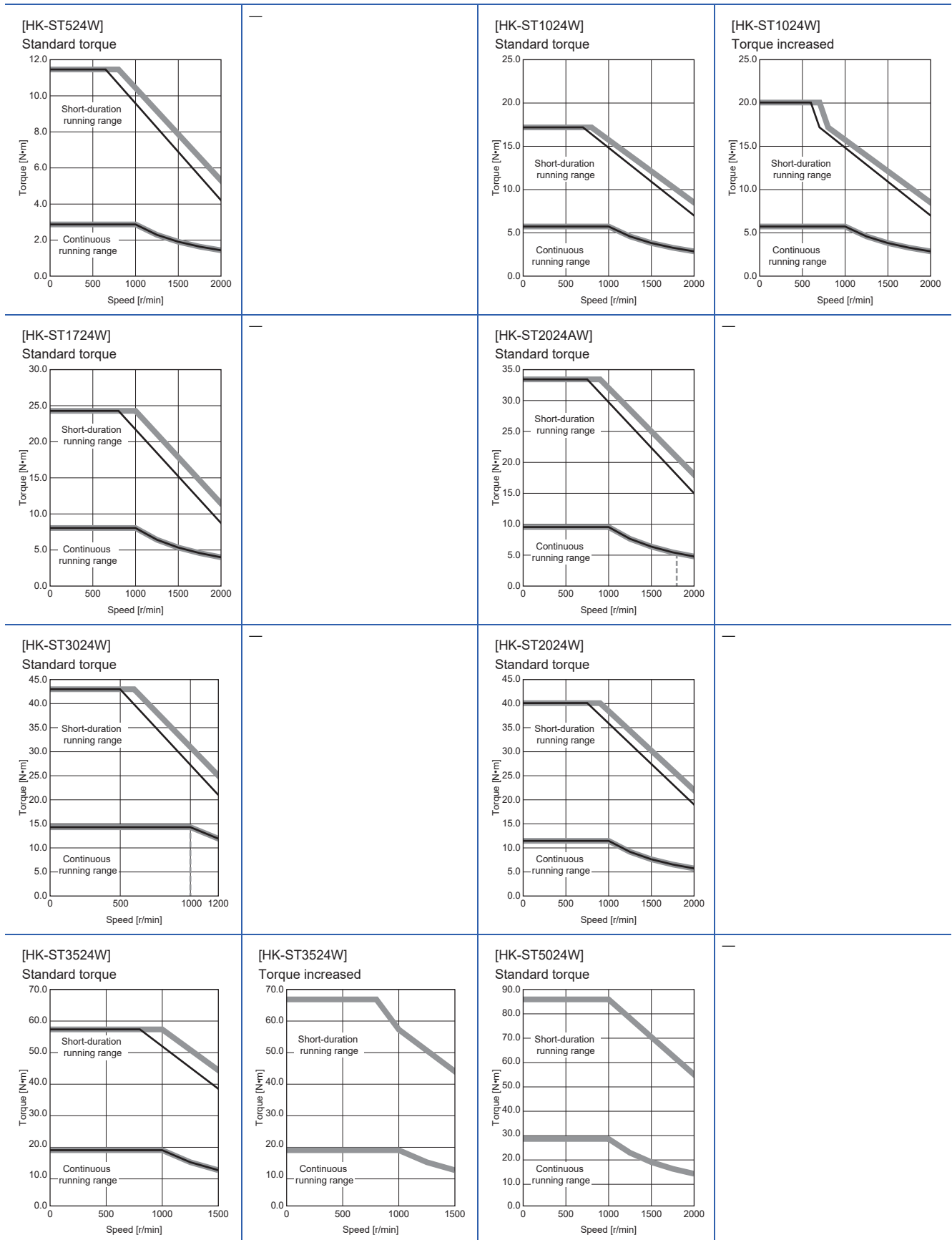

[HK-ST7024W]
Standard torque

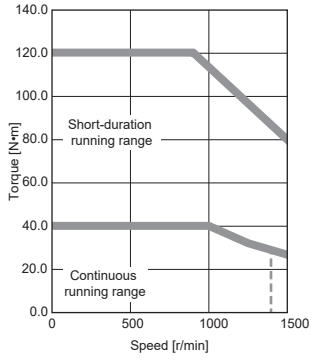

When connected with 400 V servo amplifier

When the power supply voltage drops, the torque decreases. ---- : A rough indication of the possible continuous running range for 3-phase 323 V AC

- : 3-phase 400 V AC
- : 3-phase 380 V AC

■HK-ST_4_W

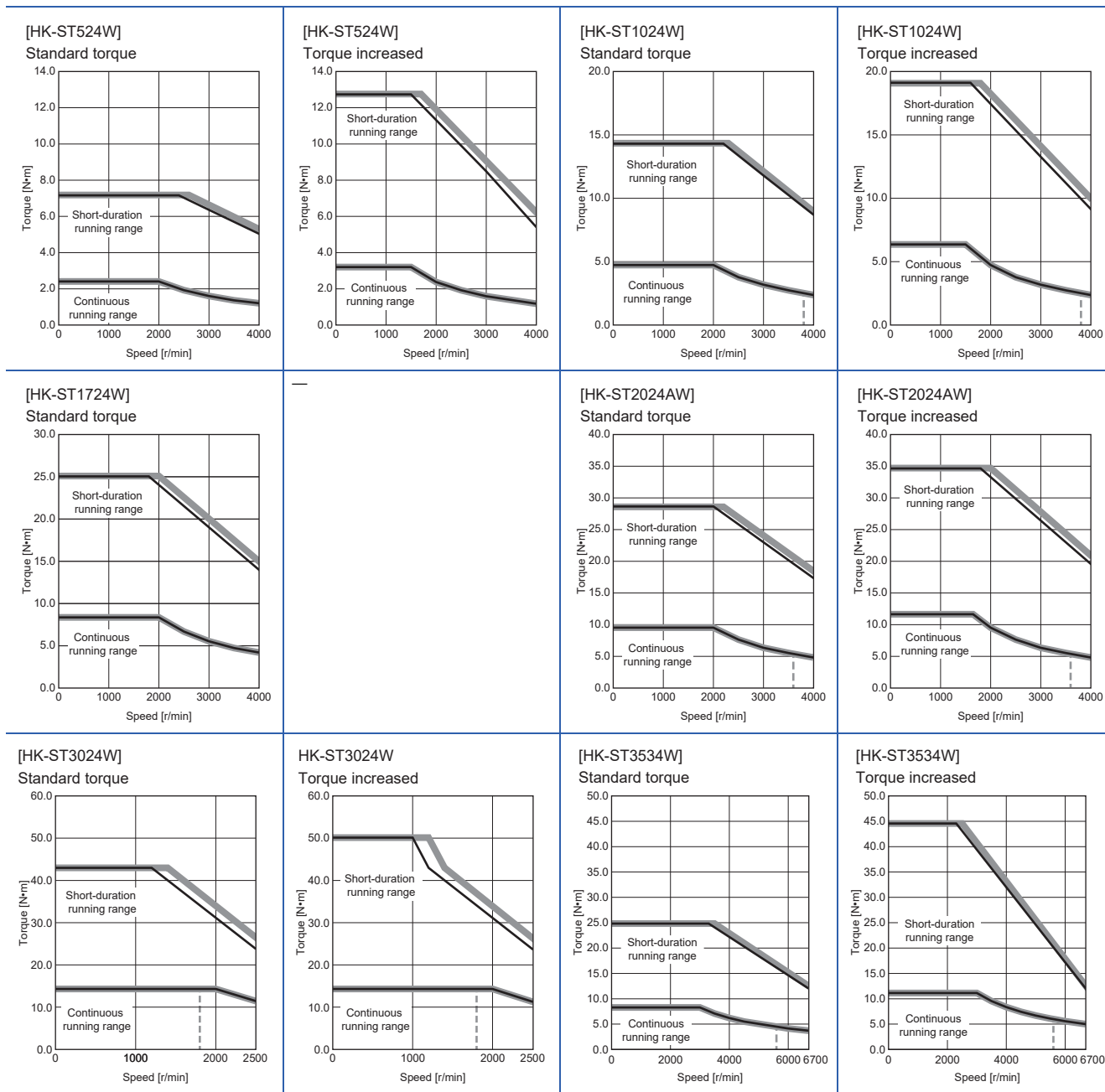

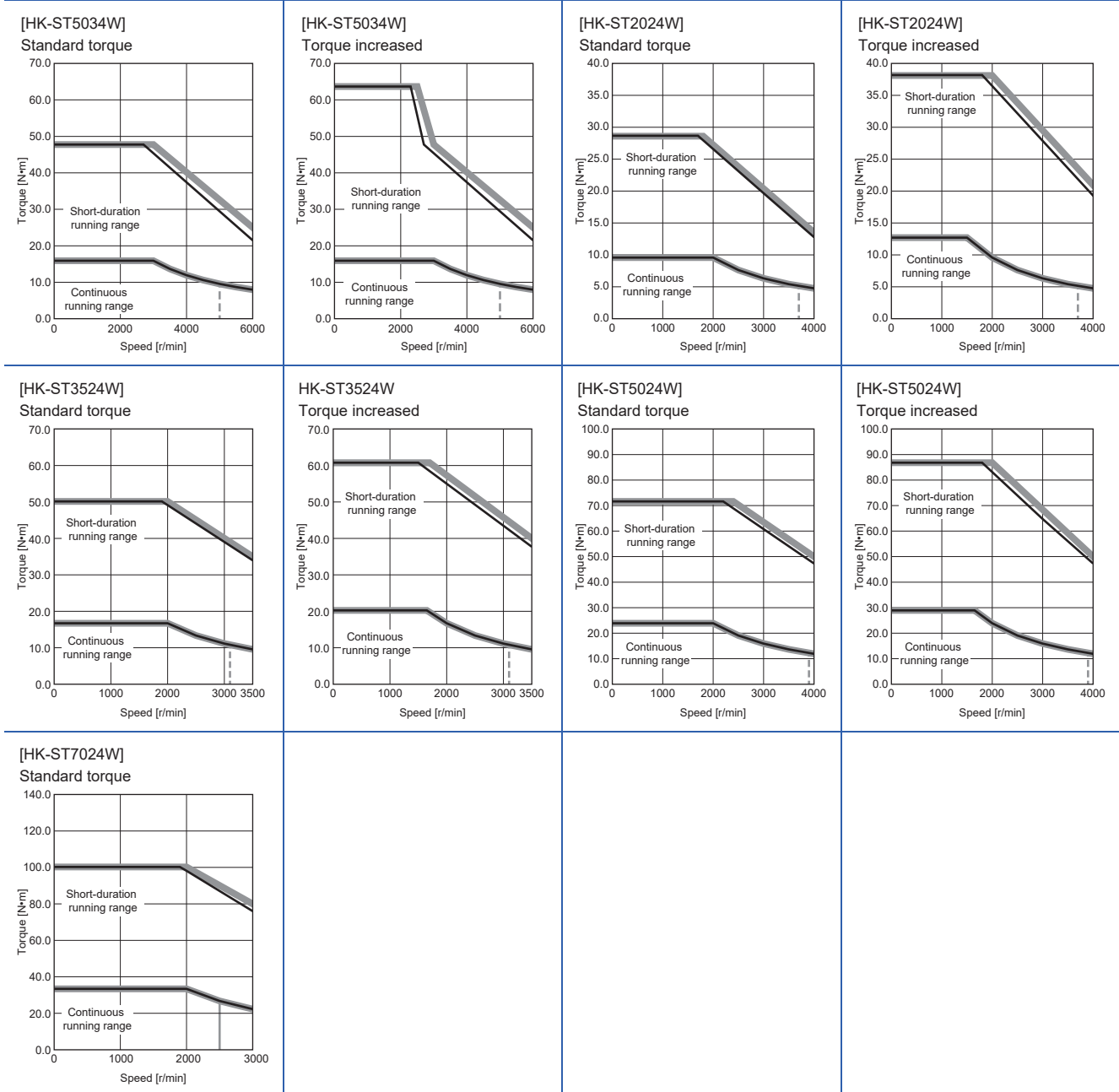

Permissible load for the output shaft

The permissible load for the shaft is shown in the following. Do not subject the shaft to loads greater than the permissible value. The value assumes that the load is applied independently.

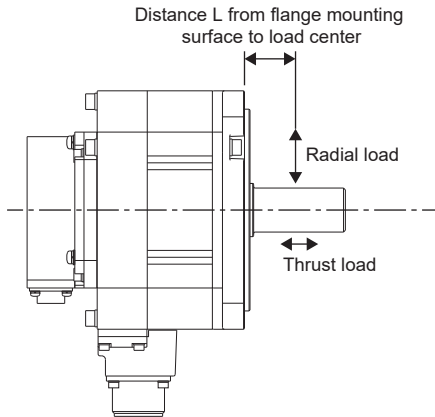

In case where the load position changes, calculate the permissible radial load from the distance measured from the flange mounting surface to the center of the load, and make the load equal to or less than the permissible radial load, referring to the graph shown in the following.

Model	Radial load		Thrust load	The graph of the relation between the load and the load position
	Load position L [mm]	Load [N]	Load [N]	
HK-ST52(4)W HK-ST102(4)W HK-ST172(4)W HK-ST202(4)AW HK-ST302(4)W HK-ST353(4)W HK-ST503(4)W HK-ST7M2UW HK-ST172UW	55	980	490	
HK-ST202(4)W HK-ST352(4)W HK-ST502(4)W HK-ST702(4)W	79	2058	980	

8.3 The graph of overload protection characteristics of rotary servo motor

Overload protection of rotary servo motors has been enhanced for MR-J5 servo amplifiers with firmware version A7 or later. Refer to "Overload protection characteristics" in the following manual.

📖 MR-J5 User's Manual (Hardware)

8.4 Characteristics of electromagnetic brake

Point

Before operating the servo motor, confirm that the electromagnetic brake operates properly. The operation time of the electromagnetic brake varies depending on the power supply circuit being used. Check the operation delay time with an actual machine.

The characteristics of the electromagnetic brake provided for the rotary servo motor with an electromagnetic brake are shown below.

Item		HK-ST52(4)WB HK-ST102(4)WB HK-ST172(4)WB	HK-ST202(4)AWB HK-ST302(4)WB	HK-ST7M2UW HK-ST172UW	HK-ST202(4)WB HK-ST352(4)WB HK-ST502(4)WB HK-ST702(4)WB
Type *1		Spring actuated type safety brake			
Rated voltage *4		24 V DC (-10 % to 0 %)			
Power consumption at 20 °C [W]		20	23	20	34
Coil resistance *5 [Ω]		29	25	29	17
Inductance *5 [H]		0.05	0.25	0.9	0.06
Brake static friction torque *7 [N·m]		8.5 or more	16 or more	8.5 or more	44 or more
Release delay time *2 [s]		0.04	0.12	0.04	0.1
Braking delay time [s]	DC off *2	0.03	0.03	0.03	0.03
Permissible braking work	Per braking [J]	400	400	400	4500
	Per hour [J]	4000	4000	4000	45000
Brake looseness at servo motor shaft *5 [degree]		0.2 to 0.6	0.01 to 0.6	0.6 or less	0.2 to 0.6
Brake life *3	Number of braking times [times]	20000	5000	20000	20000
	Work per braking [J]	200	400	200	1000
Selection example of surge absorbers to be used *6	For the suppressed voltage 125 V	TND20V-680KB (Manufactured by NIPPON CHEMI-CON CORPORATION)			
	For the suppressed voltage 350 V	TND10V-221KB (Manufactured by NIPPON CHEMI-CON CORPORATION)			

*1 This type does not have a manual release mechanism. Use a 24 V DC power supply to release the brake electrically.

*2 The value for initial on gap at 20 °C.

*3 Brake lining wear due to braking will increase the brake gap, but the gap is not adjustable. Therefore, the brake life indicates the number of times the brake can be applied before gap adjustment becomes necessary.

*4 Prepare a power supply exclusively for the electromagnetic brake.

*5 The values are design values. These are not the guaranteed values.

*6 Select the electromagnetic brake control relay properly, in consideration of the characteristics of the electromagnetic brake and surge absorber. When a diode is used as a surge absorber, the electromagnetic braking time becomes longer.

*7 The value of the brake static friction torque is the lower limit in the initial state at 20 °C.

8.5 Derating

The derating condition is the reference value at the rated speed. As the temperature rise value of the rotary servo motor changes depending on the operation conditions such as speed, confirm that [AL. 0E2 Servo motor overheat warning] or [AL. 046 Servo motor overheat] does not occur on the actual machine before use.

If [AL. 0E2 Servo motor overheat warning] or [AL. 046 Servo motor overheat] occurs, consider the following measures:

- Lower the effective load ratio of the rotary servo motor.
- Review the heat dissipation conditions.

To use this product under conditions with multiple derating, calculate the multiplication of each derating rate, and use at the calculated derating rate or lower. For machines where unbalanced torque occurs, such as a vertical axis system, the unbalanced torque should be kept at 70 % or lower of the rated torque. When applying the derating rate in the conditions above, calculate the multiplication of the derating rate of 70 % in the unbalanced torque and the derating rate of each condition, and use this product at the calculated derating rate or lower.

Restrictions on the flange size

When mounting the rotary servo motor on a machine smaller than the specified aluminum flanges listed in section 2.11, derate the servo motor in accordance with the following conditions:

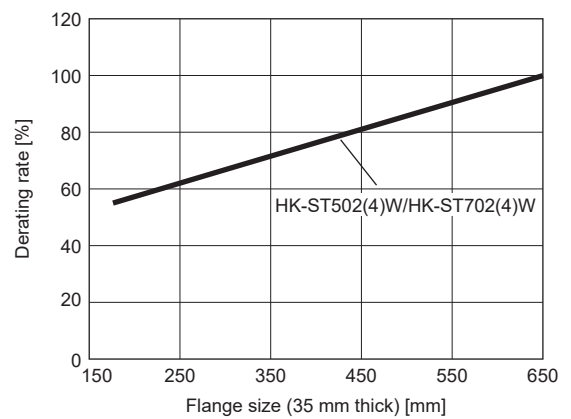
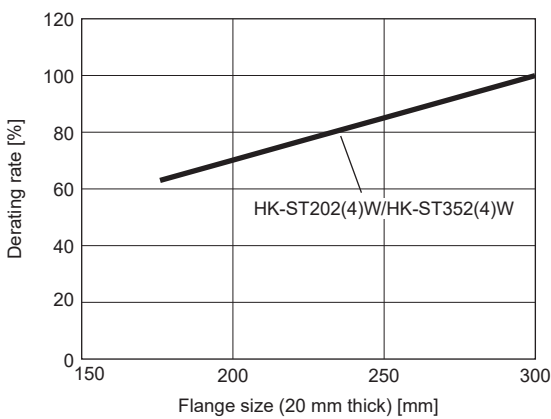
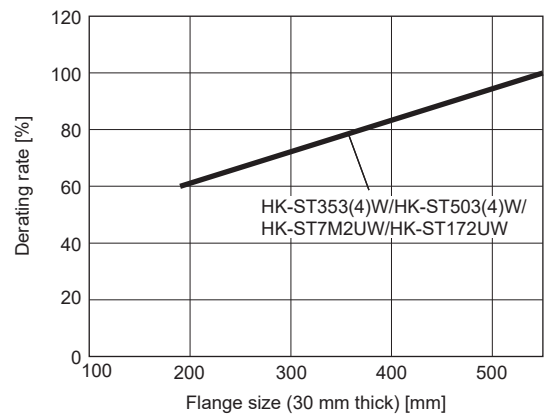
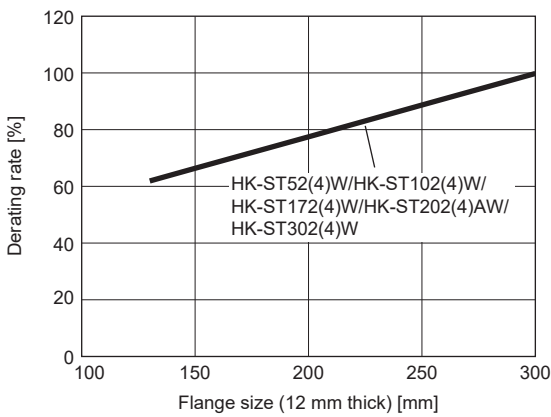

Restrictions on the ambient temperature

When using this product in an environment with a high ambient temperature, derate the product in accordance with the following conditions:

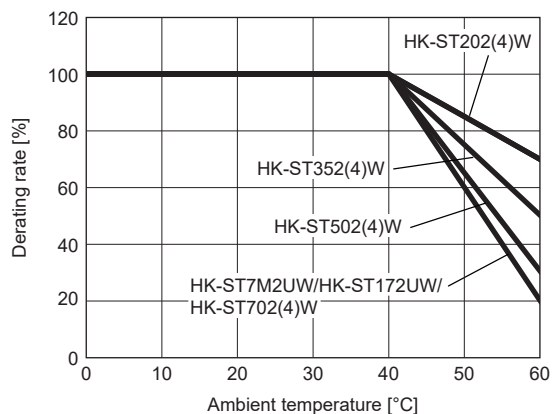
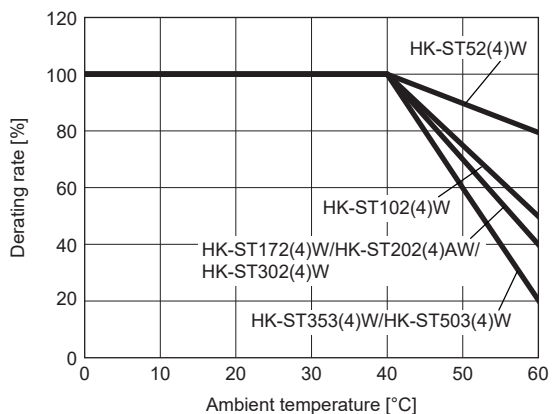

Restrictions on the altitude

To use this product at an altitude between 1000 m and 2000 m, derate the product in accordance with the following conditions:

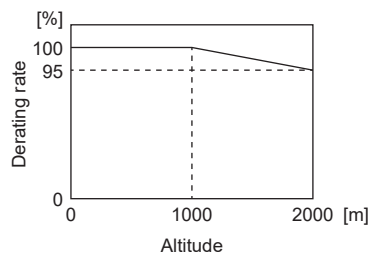

8.6 Rotary servo motors with special shafts

For rotary servo motors, there are two types of shafts: keyed shaft (with double round-ended key) and keyed shaft (without key).

Rotary servo motor	Shaft shape	
	Keyed shaft	
	With double round-ended key	Without key
HK-ST52(4)W HK-ST102(4)W HK-ST172(4)W HK-ST202(4)AW HK-ST302(4)W HK-ST353(4)W HK-ST503(4)W HK-ST7M2UW HK-ST172UW	K	N
HK-ST202(4)W HK-ST352(4)W HK-ST502(4)W HK-ST702(4)W	K	N

Keyed shaft (with double round-ended key)

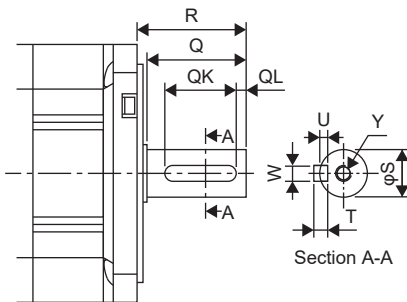

[Unit: mm]

Rotary servo motor	Variable dimensions								
	S	R	Q	W	QK	QL	U	T	Y
HK-ST52(4)WK HK-ST102(4)WK HK-ST172(4)WK HK-ST202(4)AWK HK-ST302(4)WK HK-ST353(4)WK HK-ST503(4)WK HK-ST7M2UWK HK-ST172UWK	24 ⁰ _{-0.013}	55	50	8	36	5	4	7	M8 Screw hole depth 20
HK-ST202(4)WK HK-ST352(4)WK HK-ST502(4)WK HK-ST702(4)WK	35 ^{+0.010} ₀	79	75	10	55	5	5	8	M8 Screw hole depth 20

Keyed shaft (without key)

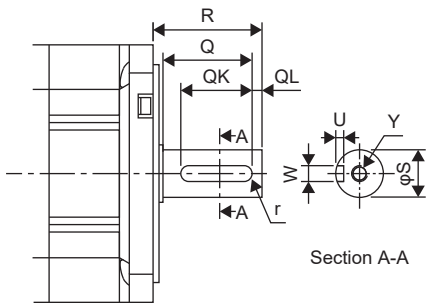

[Unit: mm]

Rotary servo motor	Variable dimensions								
	S	R	Q	W	QK	QL	U	r	Y
HK-ST52(4)WN HK-ST102(4)WN HK-ST172(4)WN HK-ST202(4)AWN HK-ST302(4)WN HK-ST353(4)WN HK-ST503(4)WN HK-ST7M2UWN HK-ST172UWN	24 $^0_{-0.013}$	55	50	8 $^0_{-0.036}$	36	5	4 $^{+0.2}_0$	4	M8 Screw hole depth 20
HK-ST202(4)WN HK-ST352(4)WN HK-ST502(4)WN HK-ST702(4)WN	35 $^{+0.010}_0$	79	75	10 $^0_{-0.036}$	55	5	5 $^{+0.2}_0$	5	M8 Screw hole depth 20

8.7 Geared servo motor

Precautions

Mount the geared rotary servo motor in the specified mounting direction.
Not doing so will cause oil leakage which may lead to a fire and malfunction.

Point

For handling, recommended grease/lubricating oil, positions of oil ports, maintenance, and inspection of the gear reducer, refer to the instruction manual "Cyclo[®] 6000" of Sumitomo Heavy Industries, Ltd. included with the product and to the manufacturer's website.

When using an oil-lubricated geared servo motor, remove the oil when transporting and mounting the servo motor. If the geared servo motor is tipped over while filled with oil, oil leakage may occur.

Do not attach a gear reducer removed from a geared servo motor to a servo motor which originally does not have a gear reducer. If the geared servo motor being used requires repair, contact your local sales office.

The geared rotary servo motors are for general industrial machine and for high precision applications.
Some geared rotary servo motors also have an electromagnetic brake.

For general industrial machine (G1/G1H)

Common specifications

Item	Description
Mounting method	☞ Page 188 Mounting method and mounting direction
Mounting direction	☞ Page 188 Mounting method and mounting direction
Lubrication method	☞ Page 188 Lubrication method
Recommended lubricants *1	☞ Page 188 Recommended lubricants
Output shaft rotation direction	Opposite direction of rotary servo motor output shaft
Backlash *5	40 arc minutes to 2 ° on the gear reducer output shaft *4
Permissible load to motor inertia ratio (converted into equivalent value on servo motor shaft) *2	4 times or less
Maximum torque *7 (For rotary servo motor shaft)	3 times the rated torque for the rotary servo motor *6
Maximum speed (For servo motor shaft)	☞ Page 189 Maximum speed
IP rating (gear reducer area)	Equivalent to IP44
Gear reducer efficiency *3	85 % to 94 %

*1 For grease-lubricated geared servo motors, grease is filled from the factory.

*2 If the permissible load to motor inertia ratio exceeds the indicated values, contact your local sales office.

*3 The gear reducer efficiency varies depending on the reduction ratio. The gear reducer efficiency also varies depending on the operating conditions such as output torque, speed, and temperature. The values in the table are the representative values at the rated torque, rated speed, and the room temperature, and are not guaranteed values.

*4 This is a design value and not a guaranteed value.

*5 The unit of backlash is calculated as follows: 1 arc minute = 0.0167 °

*6 The torque characteristics of the HK-ST152(4) is the specifications calculated by derating the HK-ST172(4)W with the output ratio (rated torque: 7.2 N·m). The moment of inertia and characteristics of electromagnetic brake are the same as those of the HK-ST172(4)W.

*7 The torque of the geared servo motor does not increase even if in combination with a servo amplifier with a larger capacity.

■ Mounting method and mounting direction

Gear reducer model	CNHM	CNVM	CHHM	CHVM	CVHM	CVVM	CWHM	CWVM
Mounting method	Foot-mounting	Flange-mounting	Foot-mounting	Flange-mounting	Foot-mounting	Flange-mounting	Foot-mounting	Flange-mounting
Mounting direction	Shaft any direction		Shaft horizontal		Shaft downward		Shaft upward	

■ Lubrication method

The oil-lubrication method cannot be used for applications where the rotary servo motor moves. Specify grease lubrication in such applications.

For grease lubrication, the grease is filled from the factory. For oil lubrication, the oil is to be filled by the customers.

Gear reducer frame No.	Gear reducer model							
	CNHM (Foot-mounting)	CNVM (Flange-mounting)	CHHM (Foot-mounting)	CHVM (Flange-mounting)	CVHM (Foot-mounting)	CVVM (Flange-mounting)	CWHM (Foot-mounting)	CWVM (Flange-mounting)
6100	Grease	Grease	—	—	—	—	—	—
6120	Grease	Grease	—	—	—	—	—	—
6130/6135	—	—	Oil *1	Oil *1	Oil *1	Oil *1	Grease	Grease
6160/6165 (other than 1/6) *2	—	—	Oil *1	Oil *1	Oil *1	Oil *1	Grease	Grease
6165 (1/6) *2	—	—	Oil	Oil	Oil	Oil	—	—
6170/6175	—	—	Oil	Oil	Oil	Oil	—	—
6180/6185	—	—	Oil	Oil	Oil	Oil	—	—
6195	—	—	Oil	Oil	Oil	Oil	—	—

*1 The grease lubrication method is also available on special purpose products.

*2 The value in () is the reduction ratio.

■ Recommended lubricants



For handling, recommended grease/lubricating oil, positions of oil ports, maintenance, and inspection of the gear reducer, refer to the instruction manual "Cyclo® 6000" of Sumitomo Heavy Industries, Ltd. included with the product and to the manufacturer's website.

As the oil-lubricated models are shipped without lubricating oil, prepare the oil and be sure to fill it up to the upper red line of the oil gauge before operation. The Cyclo Drives Speed Reducer may have a small amount of lubricating oil structurally remaining from the shipment test, but the remaining oil does not need to be removed when the oil is supplied.

• Lubricating oil amount

Gear reducer frame No.	Oil amount [L]	
	Horizontal type	Vertical type
6130/6135	0.7	1.1
6160/6165	1.4	1.0
6170/6175	1.9	1.9
6180/6185	2.5	2.0
6195	4.0	2.7

■ Lubrication change period

- Grease

Gear reducer frame No. 6100, 6120: Maintenance-free

Other than the gear reducer frame No. 6100, 6120: Refer to the instruction manual "Cyclo[®] 6000" of Sumitomo Heavy Industries, Ltd. included with the product and to the manufacturer's website.

- Lubricating oil

Number of replacement times	Operating hours per day	
	Less than 10 hours	10 to 24 hours
First time	500 hours	
Second time or later	6 months	2500 hours

■ Maximum speed

Servo motor	Reduction ratio						
	1/6	1/11	1/17	1/29	1/35	1/43	1/59
HK-ST52(4)G1(H)	3000 [r/min]						
HK-ST102(4)G1(H)	3000 [r/min]					2000 [r/min]	
HK-ST152(4)G1(H)	3000 [r/min]			2000 [r/min]			
HK-ST202(4)G1(H)	3000 [r/min]			2000 [r/min]			
HK-ST352(4)G1(H)	2000 [r/min]						
HK-ST502(4)G1(H)	2000 [r/min]						
HK-ST702(4)G1(H)	2000 [r/min]						

Exclusive specifications

■With gear reducer for general industrial machine (flange-mounting): G1

Rotary servo motor	Reduction ratio	Gear reducer frame No.	Moment of inertia ^{*1} [× 10 ⁻⁴ kg·m ²]		Permissible load ^{*2*3}		Mass [kg]	
			Without an electromagnetic brake	With an electromagnetic brake	Permissible radial load [N]	Permissible thrust load [N]	Without an electromagnetic brake	With an electromagnetic brake
HK-ST52(4)G1	1/6	6100	6.72	8.97	2058	1470	17	19
	1/11		6.29	8.54	2391	1470	17	19
	1/17		6.17	8.42	2832	1470	17	19
	1/29		6.11	8.36	3273	1470	17	19
	1/35	6120	6.90	9.15	5253	2940	27	29
	1/43		6.86	9.11	5253	2940	27	29
	1/59		6.82	9.07	5880	2940	27	29
HK-ST102(4)G1	1/6	6120	11.9	14.1	2842	2352	29	31
	1/11		10.4	12.6	3273	2764	29	31
	1/17		9.95	12.2	3646	2940	29	31
	1/29		9.65	11.9	4410	2940	29	31
	1/35		9.65	11.9	5253	2940	29	31
	1/43	6130	10.9	13.1	6047	3920	48	50
	1/59	6160	16.2	18.4	9741	6860	80	82
HK-ST152(4)G1	1/6	6120	14.6	16.9	2842	2352	30	32
	1/11		13.1	15.4	3273	2764	30	32
	1/17		12.7	15.0	3646	2940	30	32
	1/29	6130	13.8	16.1	5135	3920	49	51
	1/35		13.7	16.0	6047	3920	49	51
	1/43	6160	19.0	21.3	8555	6860	81	83
	1/59		18.9	21.2	9741	6860	81	83
HK-ST202(4)G1	1/6	6120	39.6	44.6	2842	2352	37	42
	1/11		38.0	43.0	3273	2764	37	42
	1/17		37.7	42.7	3646	2940	37	42
	1/29	6165	44.4	49.4	7291	6860	88	93
	1/35		44.1	49.1	8555	6860	88	93
	1/43		43.9	48.9	8555	6860	88	93
	1/59		43.8	48.8	9741	6860	88	93
HK-ST352(4)G1	1/6	6135	62.1	67.1	3332	3920	59	63
	1/11		57.8	62.8	3871	3920	59	63
	1/17		56.5	61.5	4420	3920	59	63
	1/29	6165	61.6	66.6	7291	6860	91	96
	1/35		61.3	66.3	8555	6860	91	96
	1/43	6175	80.0	85.0	11662	9800	135	140
	1/59		79.0	84.0	13132	9800	135	140
HK-ST502(4)G1	1/6	6165	97.1	102	5448	5000	94	99
	1/11		85.1	90.1	5488	6292	94	99
	1/17		81.1	86.1	6468	6860	94	99
	1/29	6180	112	117	13426	13720	165	170
	1/35		111	116	16072	13720	165	170
	1/43		110	115	16072	13720	165	170
	1/59		6185	109	114	16072	13720	165

Rotary servo motor	Reduction ratio	Gear reducer frame No.	Moment of inertia ^{*1} [$\times 10^{-4} \text{ kg}\cdot\text{m}^2$]		Permissible load ^{*2*3}		Mass [kg]	
			Without an electromagnetic brake	With an electromagnetic brake	Permissible radial load [N]	Permissible thrust load [N]	Without an electromagnetic brake	With an electromagnetic brake
HK-ST702(4)G1	1/6	6165	131	136	7526	5000	100	105
	1/11	6170	144	149	7526	8085	145	150
	1/17		136	141	8683	9673	145	150
	1/29	6180	146	151	13426	13720	170	175
	1/35		146	151	16072	13720	170	175
	1/43	6195	221	226	22540	19600	240	245
	1/59		220	225	22540	19600	240	245

*1 The moment inertia value is converted into the equivalent value on the servo motor shaft of the servo motor combined with the gear reducer (and an electromagnetic brake).

*2 The permissible radial loads in the table are the values at the center of the gear reducer output shaft. Refer to the following for the shaft length.

 Page 200 Dimensions

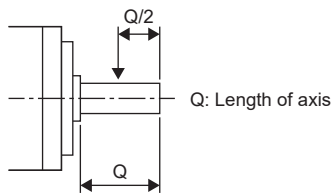

*3 Do not subject the shaft to loads greater than the indicated value. Each value in the table indicates the load to be applied independently.

■With gear reducer for general industrial machine (foot-mounting): G1H

Rotary servo motor	Reduction ratio	Gear reducer frame No.	Moment of inertia *1 [× 10 ⁻⁴ kg·m ²]		Permissible load *2*3		Mass [kg]	
			Without an electromagnetic brake	With an electromagnetic brake	Permissible radial load [N]	Permissible thrust load [N]	Without an electromagnetic brake	With an electromagnetic brake
HK-ST52(4)G1H	1/6	6100	6.72	8.97	2058	1470	20	22
	1/11		6.29	8.54	2391	1470	20	22
	1/17		6.17	8.42	2832	1470	20	22
	1/29		6.11	8.36	3273	1470	20	22
	1/35	6120	6.90	9.15	5253	2940	28	30
	1/43		6.86	9.11	5253	2940	28	30
	1/59		6.82	9.07	5880	2940	28	30
HK-ST102(4)G1H	1/6	6120	11.9	14.1	2842	2352	30	32
	1/11		10.4	12.6	3273	2764	30	32
	1/17		9.95	12.2	3646	2940	30	32
	1/29		9.65	11.9	4410	2940	30	32
	1/35		9.65	11.9	5253	2940	30	32
	1/43		6130	10.9	13.1	6047	3920	49
	1/59	6160	16.2	18.4	9741	6860	85	87
HK-ST152(4)G1H	1/6	6120	14.6	16.9	2842	2352	31	33
	1/11		13.1	15.4	3273	2764	31	33
	1/17		12.7	15.0	3646	2940	31	33
	1/29	6130	13.8	16.1	5135	3920	50	52
	1/35		13.7	16.0	6047	3920	50	52
	1/43	6160	19.0	21.3	8555	6860	86	88
	1/59		18.9	21.2	9741	6860	86	88
HK-ST202(4)G1H	1/6	6120	39.6	44.6	2842	2352	38	43
	1/11		38.0	43.0	3273	2764	38	43
	1/17		37.7	42.7	3646	2940	38	43
	1/29	6165	44.4	49.4	7291	6860	93	98
	1/35		44.1	49.1	8555	6860	93	98
	1/43	6175	43.9	48.9	8555	6860	93	98
	1/59		43.8	48.8	9741	6860	93	98
HK-ST352(4)G1H	1/6	6135	62.1	67.1	3332	3920	60	64
	1/11		57.8	62.8	3871	3920	60	64
	1/17		56.5	61.5	4420	3920	60	64
	1/29	6165	61.6	66.6	7291	6860	96	105
	1/35		61.3	66.3	8555	6860	96	105
	1/43	6175	80.0	85.0	11662	9800	140	145
	1/59		79.0	84.0	13132	9800	140	145
HK-ST502(4)G1H	1/6	6165	97.1	102	5448	5000	99	105
	1/11		85.1	90.1	5488	6292	99	105
	1/17		81.1	86.1	6468	6860	99	105
	1/29	6180	112	117	13426	13720	180	185
	1/35		111	116	16072	13720	180	185
	1/43	6185	110	115	16072	13720	180	185
	1/59		109	114	16072	13720	180	185

Rotary servo motor	Reduction ratio	Gear reducer frame No.	Moment of inertia ^{*1} [× 10 ⁻⁴ kg·m ²]		Permissible load ^{*2*3}		Mass [kg]	
			Without an electromagnetic brake	With an electromagnetic brake	Permissible radial load [N]	Permissible thrust load [N]	Without an electromagnetic brake	With an electromagnetic brake
HK-ST702(4)G1H	1/6	6165	131	136	7526	5000	105	110
	1/11	6170	144	149	7526	8085	145	150
	1/17		136	141	8683	9673	145	150
	1/29	6180	146	151	13426	13720	185	190
	1/35		146	151	16072	13720	185	190
	1/43	6195	221	226	22540	19600	255	260
	1/59		220	225	22540	19600	255	260

*1 The moment inertia value is converted into the equivalent value on the servo motor shaft of the servo motor combined with the gear reducer (and an electromagnetic brake).

*2 The permissible radial loads in the table are the values at the center of the gear reducer output shaft. Refer to the following for the shaft length.

 Page 200 Dimensions

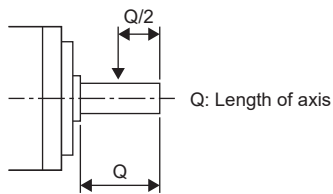

*3 Do not subject the shaft to loads greater than the indicated value. Each value in the table indicates the load to be applied independently.

For high precision applications (G5/G7)

Specifications

Item	Description
Mounting method	Flange-mounting
Mounting direction	Any direction
Lubrication method	Grease lubrication (lubricant filled from the factory)
Output shaft rotation direction	The same direction as the rotary servo motor
Backlash ^{*3}	3 arc minutes or less on the gear reducer output shaft
Permissible load to motor inertia ratio (converted into equivalent value on servo motor shaft) ^{*1}	10 times or less
Maximum torque ^{*5} (For rotary servo motor shaft)	3 times the rated torque for the rotary servo motor ^{*4}
Maximum speed (For servo motor shaft)	3000 r/min
IP rating (gear reducer area)	Equivalent to IP44
Gear reducer efficiency ^{*2}	77 % to 92 %

*1 If the permissible load to motor inertia ratio exceeds the indicated values, contact your local sales office.

*2 The gear reducer efficiency varies depending on the reduction ratio. The gear reducer efficiency also varies depending on the operating conditions such as output torque, speed, and temperature. The values in the table are the representative values at the rated torque, rated speed, and the room temperature, and are not guaranteed values.

*3 The unit of backlash is calculated as follows: 1 arc minute = 0.0167 °

*4 The torque characteristics of the HK-ST152(4) is the specifications calculated by derating the HK-ST172(4)W with the output ratio (rated torque: 7.2 N·m) . The moment of inertia and characteristics of electromagnetic brake are the same as those of the HK-ST172(4)W.

*5 The torque of the geared servo motor does not increase even if in combination with a servo amplifier with a larger capacity.

Permissible load for the rotary servo motor shaft

■ With flange-output type gear reducer for high precision applications, flange mounting: G5

Rotary servo motor	Reduction ratio	Gear reducer model	Moment of inertia ^{*1} [$\times 10^{-4}$ kg·m ²]		Radial load point L [mm]	Permissible load ^{*2*3}		Mass [kg]						
			Without an electromagnetic brake	With an electromagnetic brake		Permissible radial load [N]	Permissible thrust load [N]	Without an electromagnetic brake	With an electromagnetic brake					
HK-ST52(4)G5	1/5	20A	6.55	8.80	32	416	1465	7.1	8.8					
	1/11		6.46	8.71						32	527	1856	7.5	9.2
	1/21	32A	8.80	11.1	57	1094	4359	11	13					
	1/33		8.60	10.9						57	1252	4992	11	13
	1/45		8.60	10.9						57	1374	5478	11	13
HK-ST102(4)G5	1/5	20A	9.30	11.6	32	416	1465	8.0	9.7					
	1/11	32A	12.0	14.2	57	901	3590	12	14					
	1/21		11.6	13.8						57	1094	4359	12	14
	1/33	50A	13.4	15.6	62	2929	10130	22	23					
	1/45		13.3	15.5						62	3215	11117	22	23
HK-ST152(4)G5	1/5	20A	12.1	14.4	32	416	1465	9.0	11					
	1/11	32A	14.7	17.0	57	901	3590	13	15					
	1/21	50A	17.1	19.4	62	2558	8845	23	24					
	1/33		16.1	18.4						62	2929	10130	23	24
	1/45		16.0	18.3						62	3215	11117	23	24
HK-ST202(4)G5	1/5	32A	41.0	46.0	57	711	2834	20	25					
	1/11		40.8	45.8						57	901	3590	20	25
	1/21	50A	42.8	47.8	62	2558	8845	30	35					
	1/33		41.8	46.8						62	2929	10130	30	35
	1/45		41.8	46.8						62	3215	11117	30	35
HK-ST352(4)G5	1/5	32A	58.2	63.2	57	711	2834	23	28					
	1/11	50A	61.7	66.7	62	2107	7285	33	38					
	1/21		60.0	65.0						62	2558	8845	33	38
HK-ST502(4)G5	1/5	50A	80.9	85.9	62	1663	5751	34	39					
	1/11		78.9	83.9						62	2107	7285	36	41
HK-ST702(4)G5	1/5	50A	115	120	62	1663	5751	40	45					

*1 The moment inertia value is converted into the equivalent value on the servo motor shaft of the servo motor combined with the gear reducer (and an electromagnetic brake).

*2 The radial load points of high-precision gear reducers are as follows.

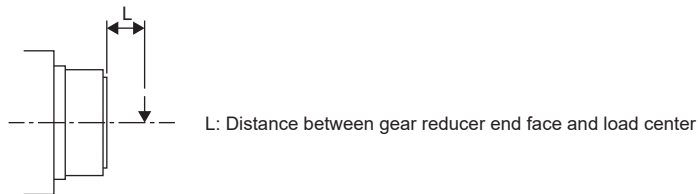

*3 Do not subject the shaft to loads greater than the indicated value. Each value in the table indicates the load to be applied independently.

■With shaft-output type gear reducer for high precision applications, flange mounting: G7

Rotary servo motor	Reduction ratio	Gear reducer model	Moment of inertia ^{*1} [× 10 ⁻⁴ kg·m ²]		Permissible load ^{*2*3}		Mass [kg]	
			Without an electromagnetic brake	With an electromagnetic brake	Permissible radial load [N]	Permissible thrust load [N]	Without an electromagnetic brake	With an electromagnetic brake
HK-ST52(4)G7	1/5	20A	6.59	8.84	416	1465	7.5	9.2
	1/11		6.46	8.71	527	1856	7.7	9.4
	1/21	32A	8.8	11.1	1094	4359	13	14
	1/33		8.6	10.9	1252	4992	13	14
	1/45		8.6	10.9	1374	5478	13	14
HK-ST102(4)G7	1/5	20A	9.34	11.6	416	1465	8.4	11
	1/11	32A	12.1	14.3	901	3590	14	15
	1/21		11.6	13.8	1094	4359	14	15
	1/33	50A	13.4	15.6	2929	10130	25	26
	1/45		13.4	15.6	3215	11117	25	26
HK-ST152(4)G7	1/5	20A	12.1	14.4	416	1465	9.4	11
	1/11	32A	14.8	17.1	901	3590	15	16
	1/21	50A	17.1	19.4	2558	8845	26	27
	1/33		16.1	18.4	2929	10130	26	27
	1/45		16.1	18.4	3215	11117	26	27
HK-ST202(4)G7	1/5	32A	41.3	46.3	711	2834	21	26
	1/11		40.9	45.9	901	3590	22	27
	1/21	50A	42.9	47.9	2558	8845	33	38
	1/33		41.8	46.8	2929	10130	33	38
	1/45		41.8	46.8	3215	11117	33	38
HK-ST352(4)G7	1/5	32A	58.5	63.5	711	2834	24	29
	1/11	50A	62.0	67.0	2107	7285	36	41
	1/21		60.1	65.1	2558	8845	36	41
HK-ST502(4)G7	1/5	50A	82.3	87.3	1663	5751	37	42
	1/11		79.2	84.2	2107	7285	39	44
HK-ST702(4)G7	1/5	50A	116.5	121.5	1663	5751	43	48

*1 The moment inertia value is converted into the equivalent value on the servo motor shaft of the servo motor combined with the gear reducer (and an electromagnetic brake).

*2 The radial load points of high-precision gear reducers are as follows. Refer to the following for the shaft length.

☞ Page 200 Dimensions

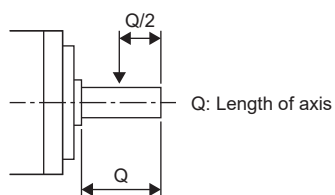

*3 Do not subject the shaft to loads greater than the indicated value. Each value in the table indicates the load to be applied independently.

Servo motor with special shaft

The flange-mounting shaft output type servo motors for high precision application (G7) have a keyed shaft (with single pointed key).

[Unit: mm]

Rotary servo motor	Gear reducer model	Q	ϕS	W	T	QK	U	Y
HK-ST_G7K	20A	42	25h7	8	7	36	4	M6 screw hole depth 12
	32A	82	40h7	12	8	70	5	M10 screw hole depth 20
	50A	82	50h7	14	9	70	5.5	

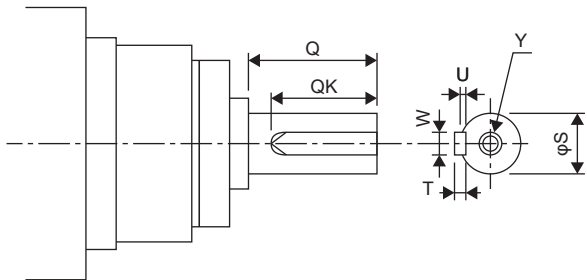

8.8 Mounting connectors

Both the one-touch lock fitting type and the screw fitting type can be used for the power connector. Mount the power connector as shown in the following procedure.

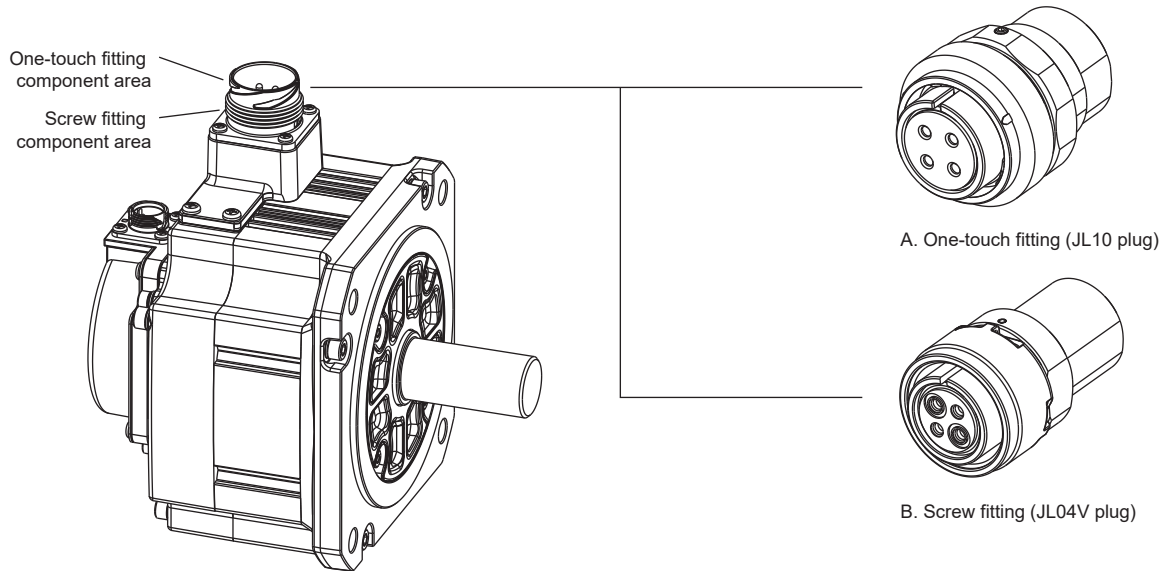

One-touch lock fitting

1. Align the main key of the receptacle connector (motor side) with its groove on the plug connector (cable side), and insert the plug into the receptacle.

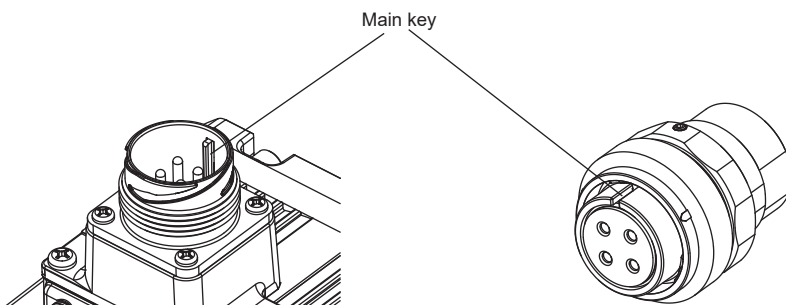

2. While pushing the plug lightly, rotate the coupling nut clockwise until it clicks.
3. Pull the plug lightly to check that the plug does not come off.

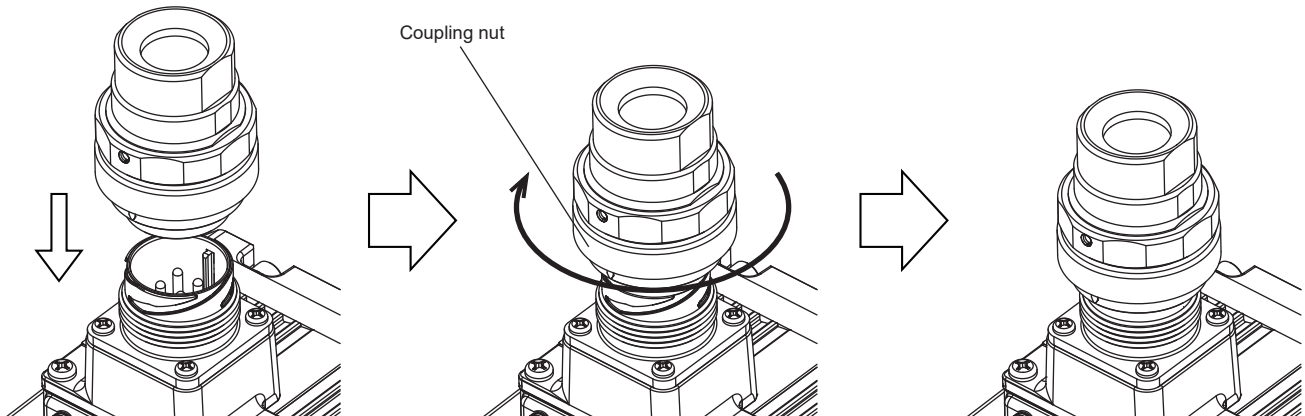

Screw fitting

1. Align the main key of the receptacle connector (motor side) with its groove on the plug connector (cable side), and insert the plug into the receptacle.

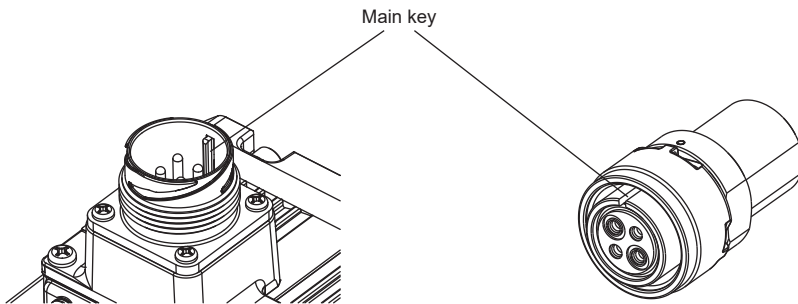

2. Push in the plug straight until the coupling nut engages with the thread of the receptacle.
3. Tighten the coupling nut with a recommended tightening torque of 4.0 to 4.5 N•m.

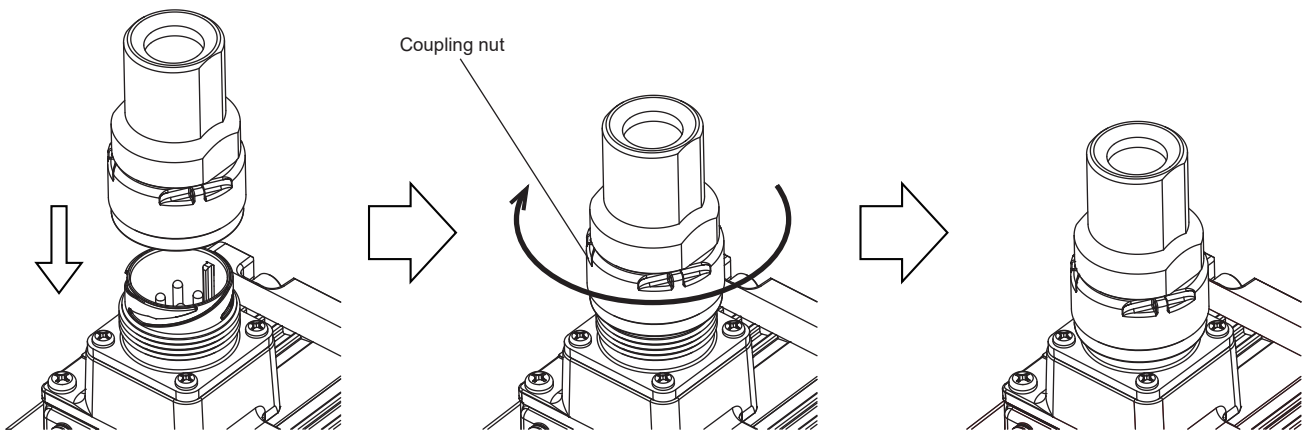

8.9 Dimensions

- Not all parts are created the exact same size or assembled in precisely the same manner. Therefore, the actual dimensions of rotary servo motors may be a maximum of approximately 3 mm larger than those in the drawings. In addition, the described dimensions and dimensional tolerances are the values at 20 °C. Since the values of the dimensions may vary depending on the ambient temperature, allow some margin when designing the machine side.
- The dimensions are the same, regardless of whether the servo motor has an oil seal or not.
- Use a friction coupling for coupling the servo motor with a load.
- The standard shaft type of the geared servo motors for general industrial machine and for general industrial machine (foot-mounting) is keyed shaft (with key).

Without gear reducer

HK-ST52W(B)/HK-ST102W(B)/HK-ST172W(B)/HK-ST202AW(B)/HK-ST302W(B)/HK-ST353W(B)/HK-ST503W(B)/HK-ST524W(B)/HK-ST1024W(B)/HK-ST1724W(B)/HK-ST2024AW(B)/HK-ST3024W(B)/HK-ST3534W(B)

Model	Variable dimensions *1	
	L	KL
HK-ST52W(B) HK-ST524W(B)	115.5 (150)	59.8
HK-ST102W(B) HK-ST1024W(B)	126.5 (161)	70.8
HK-ST172W(B) HK-ST1724W(B)	137.5 (172)	81.8
HK-ST202AW(B) HK-ST2024AW(B)	159.5 (194)	103.8
HK-ST302W(B) HK-ST3024W(B)	181.5 (216)	125.8
HK-ST353W(B) HK-ST3534W(B)	159.5 (194)	103.8
HK-ST503W(B) HK-ST5034W(B)	203.5 (238)	147.8

*1 The values in () of the dimensions are for the servo motors with an electromagnetic brake.

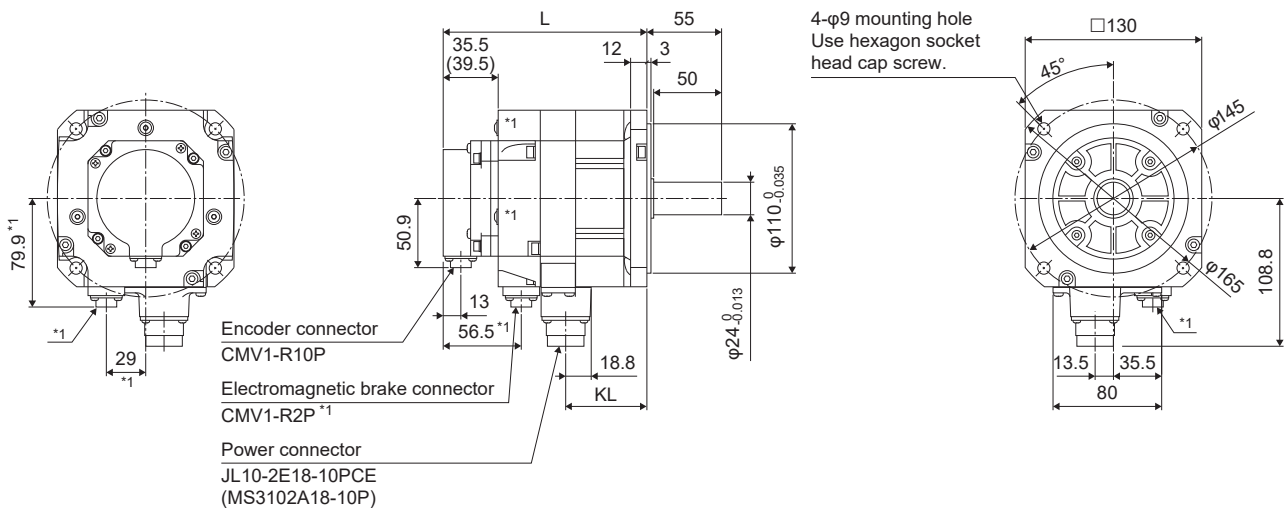

[Unit: mm]

*1 For servo motors with an electromagnetic brake.

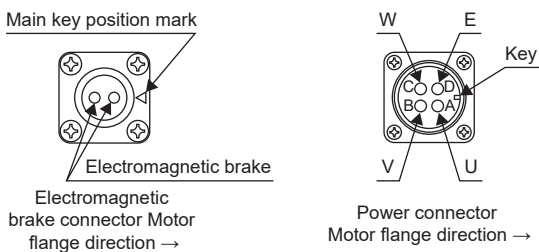

HK-ST7M2UW(B)/HK-ST172UW(B)

Model	Variable dimensions *1	
	L	KL
HK-ST7M2UW(B)	108.5 (142)	50.7
HK-ST172UW(B)	118.5 (152)	60.7

*1 The values in () of the dimensions are for the servo motors with an electromagnetic brake.

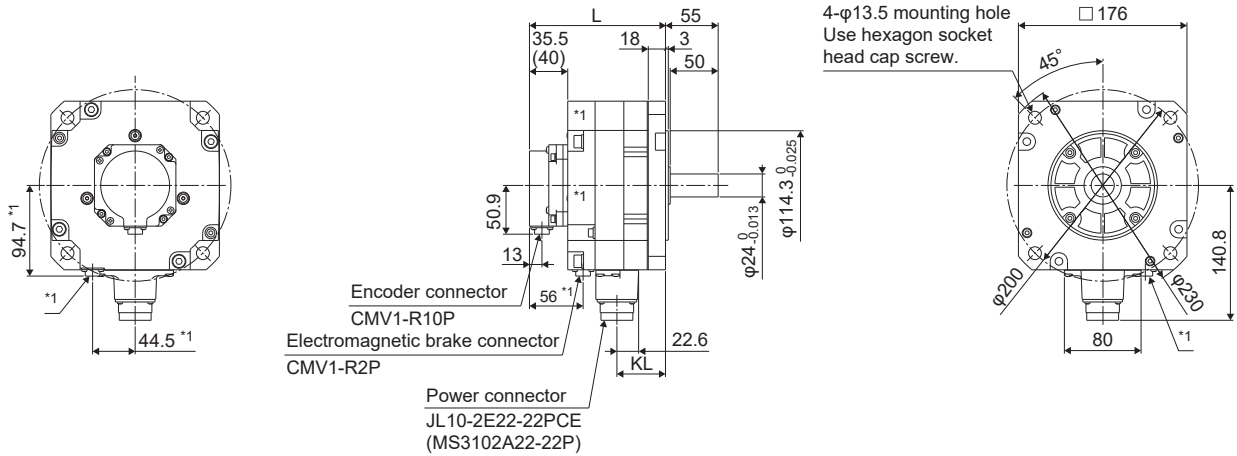

[Unit: mm]

*1 For servo motors with an electromagnetic brake.

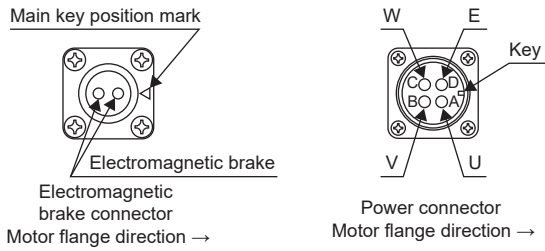

HK-ST202W(B)/HK-ST352W(B)/HK-ST502W(B)/HK-ST702W(B)/HK-ST2024W(B)/HK-ST3524W(B)/HK-ST5024W(B)/HK-ST7024W(B)

Model	Variable dimensions *1	
	L	KL
HK-ST202W(B) HK-ST2024W(B)	138.5 (188)	80.7
HK-ST352W(B) HK-ST3524W(B)	158.5 (208)	100.7
HK-ST502W(B) HK-ST5024W(B)	178.5 (228)	120.7
HK-ST702W(B) HK-ST7024W(B)	218.5 (268)	160.7

*1 The values in () of the dimensions are for the servo motors with an electromagnetic brake.

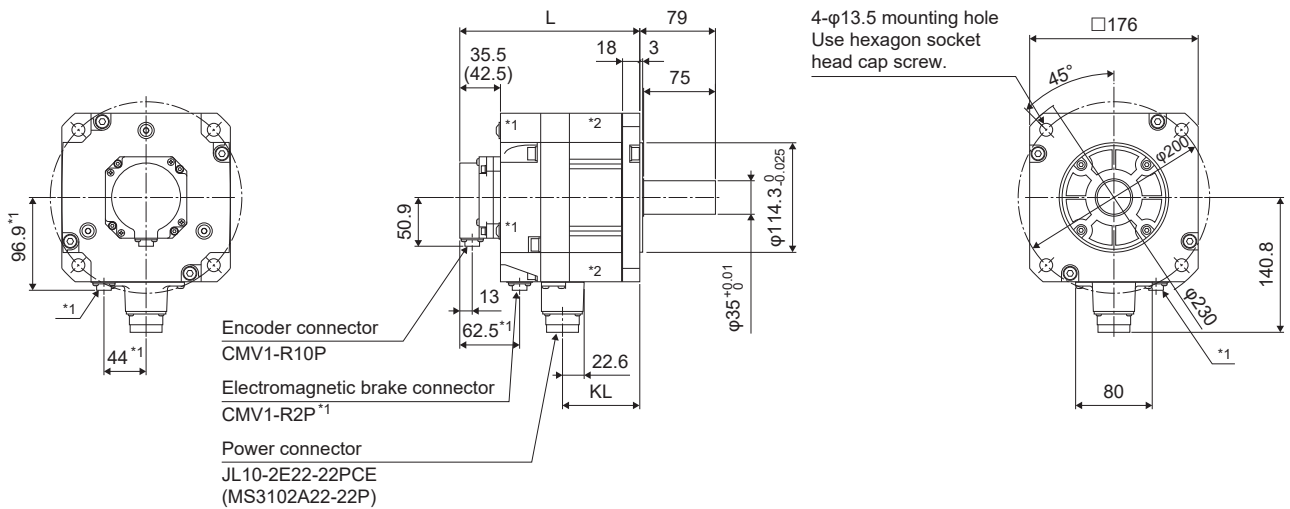

[Unit: mm]

*1 For servo motors with an electromagnetic brake.

*2 The HK-ST352W(B), HK-ST3524W(B), HK-ST502W(B), HK-ST5024W(B), HK-ST702W(B), and HK-ST7024W(B) have screw holes for eyebolts (M8).

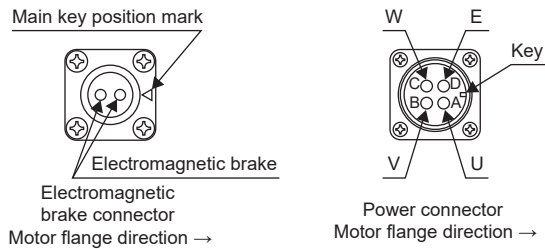

With gear reducer for general industrial machine

The dimensions are schematic. The oil cap, shape, and mounting screws may differ from the actual product.

HK-ST52(4)(B)G1/HK-ST102(4)(B)G1

Model	Reduction ratio	Variable dimensions *1													
		L	LA	LC	LD	LG	LK	LR	IE	KL	KA	LP	LT	LW	LS
HK-ST52(4)(B)G1	1/6	272.5 (307)	134	110 ^{-0.036} _{-0.090}	160	9	150	48	119	55.7 (90.2)	18.8	(56.5)	35.5 (39.5)	13.5	(29)
	1/11														
	1/17														
	1/29														
	1/35	265 (299.5)	180	140 ^{-0.043} _{-0.106}	210	13	204	69	132	55.7 (90.2)	18.8	(56.5)	35.5 (39.5)	13.5	(29)
	1/43														
1/59															
HK-ST102(4)(B)G1	1/6	276 (310.5)	180	140 ^{-0.043} _{-0.106}	210	13	204	69	132	55.7 (90.2)	18.8	(56.5)	35.5 (39.5)	13.5	(29)
	1/11														
	1/17														
	1/29														
	1/35	321.5 (356)	230	200 ^{-0.050} _{-0.122}	260	15	230	76	145	55.7 (90.2)	18.8	(56.5)	35.5 (39.5)	13.5	(29)
	1/43														
1/59	379 (413.5)														

Model	Reduction ratio	Variable dimensions *1														
		KE	Z	K	E	H	KB	KD	KC	Q	QK	S	T	U	W	Y
HK-ST52(4)(B)G1	1/6	80	4-φ11	45	3	108	108.8	(79.9)	130	35	32	28 ⁰ _{-0.013}	7	4	8	M8X20
	1/11															
	1/17															
	1/29															
	1/35	80	6-φ11	30	4	117	108.8	(79.9)	130	55	50	38 ⁰ _{-0.016}	8	5	10	M8X20
	1/43															
1/59																
HK-ST102(4)(B)G1	1/6	80	6-φ11	30	4	117	108.8	(79.9)	130	55	50	38 ⁰ _{-0.016}	8	5	10	M8X20
	1/11															
	1/17															
	1/29															
	1/35	80	6-φ11	60	4	164	108.8	(79.9)	130	70	56	50 ⁰ _{-0.016}	9	5.5	14	M10X18
	1/43															
1/59	80															

*1 The values in () of the dimensions are for the servo motors with an electromagnetic brake.

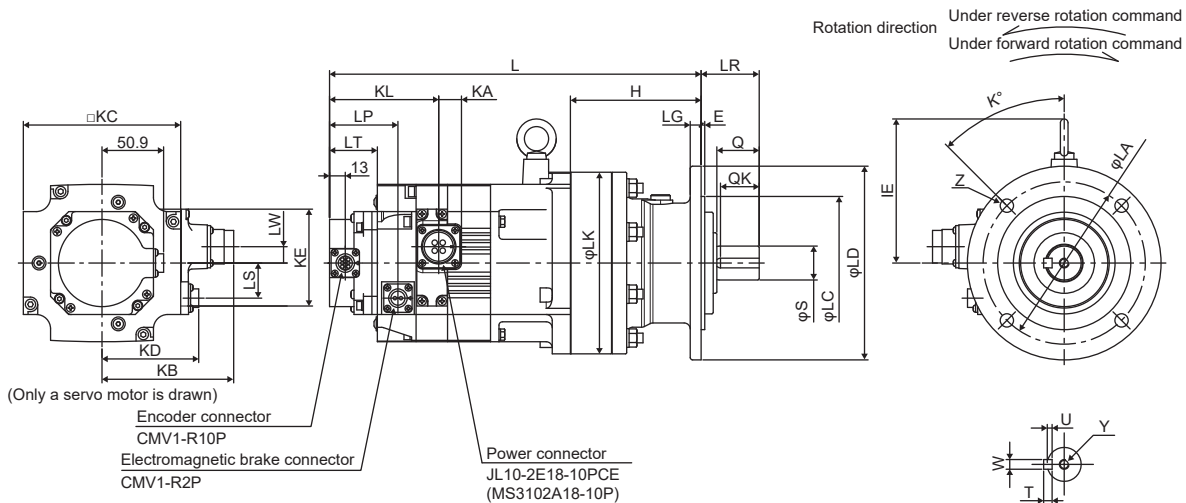

[Unit: mm]

HK-ST152(4)(B)G1/HK-ST202(4)(B)G1

Model	Reduction ratio	Variable dimensions *1													
		L	LA	LC	LD	LG	LK	LR	IE	KL	KA	LP	LT	LW	LS
HK-ST152(4)(B)G1	1/6	287 (321.5)	180	140 ^{-0.043} _{-0.106}	210	13	204	69	132	55.7 (90.2)	18.8	(56.5)	35.5 (39.5)	13.5	(29)
	1/11														
	1/17														
	1/29	332.5 (367)	230	200 ^{-0.050} _{-0.122}	260	15	230	76	145	55.7 (90.2)	18.8	(56.5)	35.5 (39.5)	13.5	(29)
	1/35														
	1/43														
1/59	390 (424.5)	310	270 ^{-0.056} _{-0.137}	340	20	300	89	192	55.7 (90.2)	18.8	(56.5)	35.5 (39.5)	13.5	(29)	
HK-ST202(4)(B)G1	1/6	306 (355.5)	180	140 ^{-0.043} _{-0.106}	210	13	204	69	142	57.8 (107.3)	22.6	(62.5)	35.5 (42.5)	0	(44)
	1/11														
	1/17														
	1/29	403 (452.5)	310	270 ^{-0.056} _{-0.137}	340	20	300	89	181	57.8 (107.3)	22.6	(62.5)	35.5 (42.5)	0	(44)
	1/35														
	1/43														
1/59															

Model	Reduction ratio	Variable dimensions *1														
		KE	Z	K	E	H	KB	KD	KC	Q	QK	S	T	U	W	Y
HK-ST152(4)(B)G1	1/6	80	6-φ11	30	4	117	108.8	(79.9)	130	55	50	38 ⁰ _{-0.016}	8	5	10	M8X20
	1/11															
	1/17															
	1/29	80	6-φ11	60	4	164	108.8	(79.9)	130	70	56	50 ⁰ _{-0.016}	9	5.5	14	M10X18
	1/35															
	1/43															
1/59	80	6-φ11	60	4	219	108.8	(79.9)	130	90	80	60 ⁰ _{-0.019}	11	7	18		
HK-ST202(4)(B)G1	1/6	80	6-φ11	30	4	117	140.8	(96.9)	176	55	50	38 ⁰ _{-0.016}	8	5	10	M8X20
	1/11															
	1/17															
	1/29	80	6-φ11	60	4	219	140.8	(96.9)	176	90	80	60 ⁰ _{-0.019}	11	7	18	M10X18
	1/35															
	1/43															
1/59																

*1 The values in () of the dimensions are for the servo motors with an electromagnetic brake.

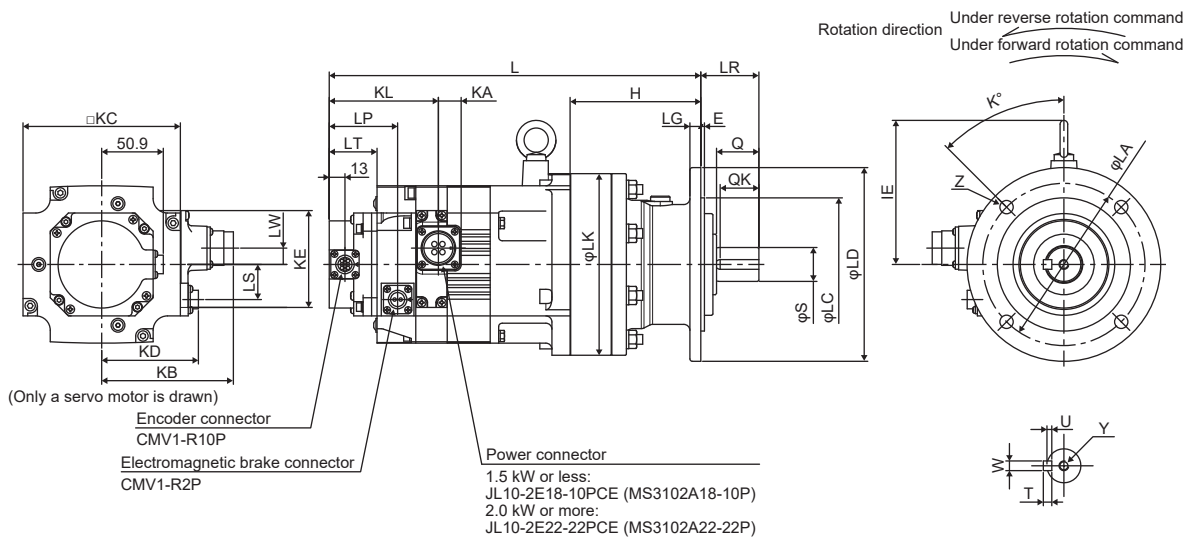

[Unit: mm]

HK-ST352(4)(B)G1/HK-ST502(4)(B)G1

Model	Reduction ratio	Variable dimensions *1													
		L	LA	LC	LD	LG	LK	LR	IE	KL	KA	LP	LT	LW	LS
HK-ST352(4)(B)G1	1/6	368.5 (418)	230	200 ^{-0.043} _{-0.106}	260	15	230	76	145	57.8 (107.3)	22.6	(62.5)	35.5 (42.5)	0	(44)
	1/11														
	1/17														
	1/29	423 (472.5)	310	270 ^{-0.056} _{-0.137}	340	20	300	89	181	57.8 (107.3)	22.6	(62.5)	35.5 (42.5)	0	(44)
	1/35														
	1/43	462.5 (512)	360	316 ^{-0.062} _{-0.151}	400	22	340	94	181	57.8 (107.3)	22.6	(62.5)	35.5 (42.5)	0	(44)
1/59															
HK-ST502(4)(B)G1	1/6	443 (492.5)	310	270 ^{-0.056} _{-0.137}	340	20	300	89	181	57.8 (107.3)	22.6	(62.5)	35.5 (42.5)	0	(44)
	1/11														
	1/17														
	1/29	506.5 (556)	390	345 ^{-0.062} _{-0.151}	430	22	370	110	176	57.8 (107.3)	22.6	(62.5)	35.5 (42.5)	0	(44)
	1/35														
	1/43														
1/59															

Model	Reduction ratio	Variable dimensions *1														
		KE	Z	K	E	H	KB	KD	KC	Q	QK	S	T	U	W	Y
HK-ST352(4)(B)G1	1/6	80	6-φ11	60	4	164	140.8	(96.9)	176	70	56	50 ⁰ _{-0.016}	9	5.5	14	M10X18
	1/11															
	1/17															
	1/29	80	6-φ11	60	4	219	140.8	(96.9)	176	90	80	60 ⁰ _{-0.019}	11	7	18	
	1/35															
	1/43	80	8-φ14	22.5	5	258	140.8	(96.9)	176	90	80	70 ⁰ _{-0.019}	12	7.5	20	M12X24
1/59																
HK-ST502(4)(B)G1	1/6	80	6-φ11	60	4	219	140.8	(96.9)	176	90	80	60 ⁰ _{-0.019}	11	7	18	M10X18
	1/11															
	1/17															
	1/29	80	8-φ18	22.5	5	279	140.8	(96.9)	176	110	100	80 ⁰ _{-0.019}	14	9	22	M12X24
	1/35															
	1/43															
1/59																

*1 The values in () of the dimensions are for the servo motors with an electromagnetic brake.

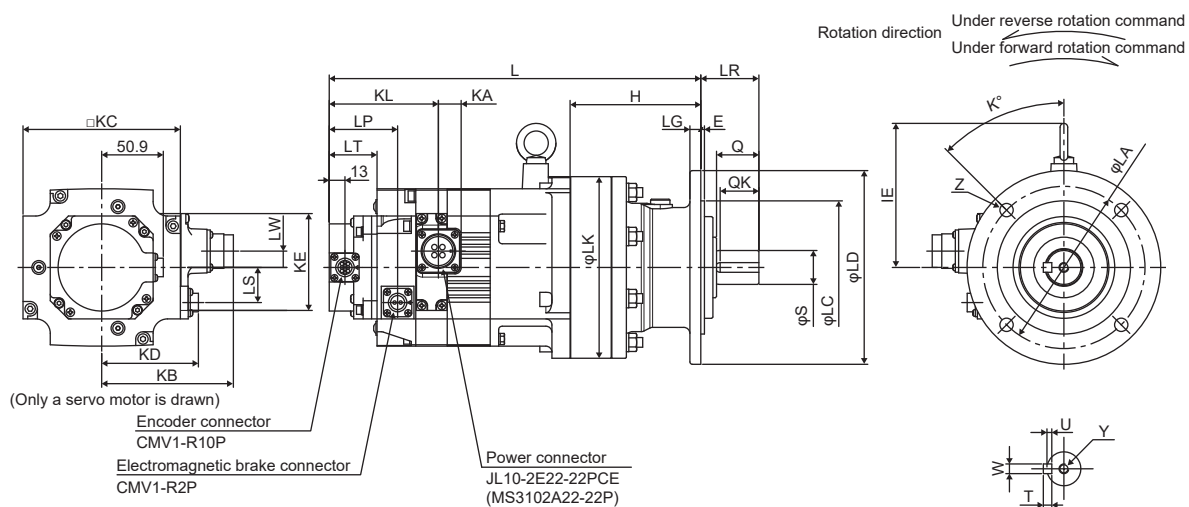

[Unit: mm]

HK-ST702(4)(B)G1

Model	Reduction ratio	Variable dimensions *1													
		L	LA	LC	LD	LG	LK	LR	IE	KL	KA	LP	LT	LW	LS
HK-ST702(4)(B)G1	1/6	483 (532.5)	310	270 ^{-0.056} _{-0.137}	340	20	300	89	181	57.8 (107.3)	22.6	(62.5)	35.5 (42.5)	0	(44)
	1/11	522.5 (572)	360	316 ^{-0.062} _{-0.151}	400	22	340	94	181	57.8 (107.3)	22.6	(62.5)	35.5 (42.5)	0	(44)
	1/17														
	1/29	546.5 (596)	390	345 ^{-0.062} _{-0.151}	430	22	370	110	176	57.8 (107.3)	22.6	(62.5)	35.5 (42.5)	0	(44)
	1/35														
	1/43	602.5 (652)	450	400 ^{-0.062} _{-0.151}	490	30	430	145	210	57.8 (107.3)	22.6	(62.5)	35.5 (42.5)	0	(44)
	1/59														

Model	Reduction ratio	Variable dimensions *1														
		KE	Z	K	E	H	KB	KD	KC	Q	QK	S	T	U	W	Y
HK-ST702(4)(B)G1	1/6	80	6-φ11	60	4	219	140.8	(96.9)	176	90	80	60 ⁰ _{-0.019}	11	7	18	M10X18
	1/11	80	8-φ14	22.5	5	258	140.8	(96.9)	176	90	80	70 ⁰ _{-0.019}	12	7.5	20	M12X24
	1/17															
	1/29	80	8-φ18	22.5	5	279	140.8	(96.9)	176	110	100	80 ⁰ _{-0.019}	14	9	22	M12X24
	1/35															
	1/43	80	12-φ18	15	6	320	140.8	(96.9)	176	135	125	95 ⁰ _{-0.022}	14	9	25	M20X34
	1/59															

*1 The values in () of the dimensions are for the servo motors with an electromagnetic brake.

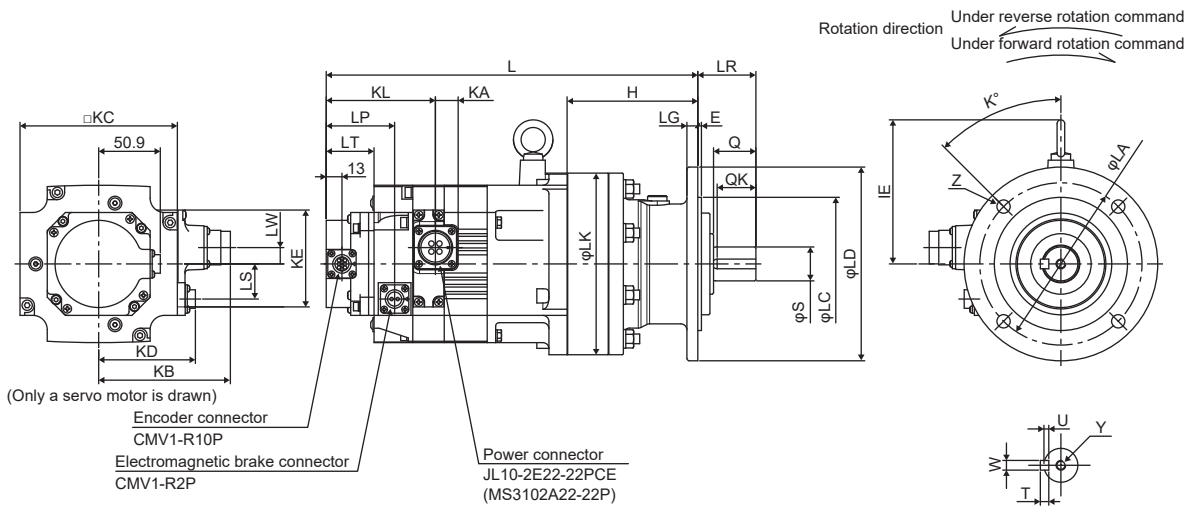

[Unit: mm]

With gear reducer for general industrial machine (foot-mounting)

The dimensions are schematic. The oil cap, shape, and mounting screws may differ from the actual product.

HK-ST52(4)(B)G1H

Model	Reduction ratio	Variable dimensions *1													
		L	LA	LB	LK	LS	LT	LP	LW	H	KL	KA	KB	KD	KC
HK-ST52(4)(B)G1H	1/6	320.5 (355)	100	219	150	(29)	35.5 (39.5)	(56.5)	13.5	121	55.7 (90.2)	18.8	108.8	(79.9)	130
	1/11														
	1/17														
	1/29														
	1/35	334 (368.5)	120	252	204	(29)	35.5 (39.5)	(56.5)	13.5	131	55.7 (90.2)	18.8	108.8	(79.9)	130
	1/43														
	1/59														

Model	Reduction ratio	Variable dimensions *1																
		KE	Z	FA	FB	FC	FD	FE	FF	FG	FH	Q	QK	S	T	U	W	Y
HK-ST52(4)(B)G1H	1/6	80	11	90	135	60	15	12	40	150	180	35	32	28 ⁰ _{-0.013}	7	4	8	M8X20
	1/11																	
	1/17																	
	1/29																	
	1/35	80	14	115	155	82	20	15	55	190	230	55	50	38 ⁰ _{-0.016}	8	5	10	
	1/43																	
	1/59																	

*1 The values in () of the dimensions are for the servo motors with an electromagnetic brake.

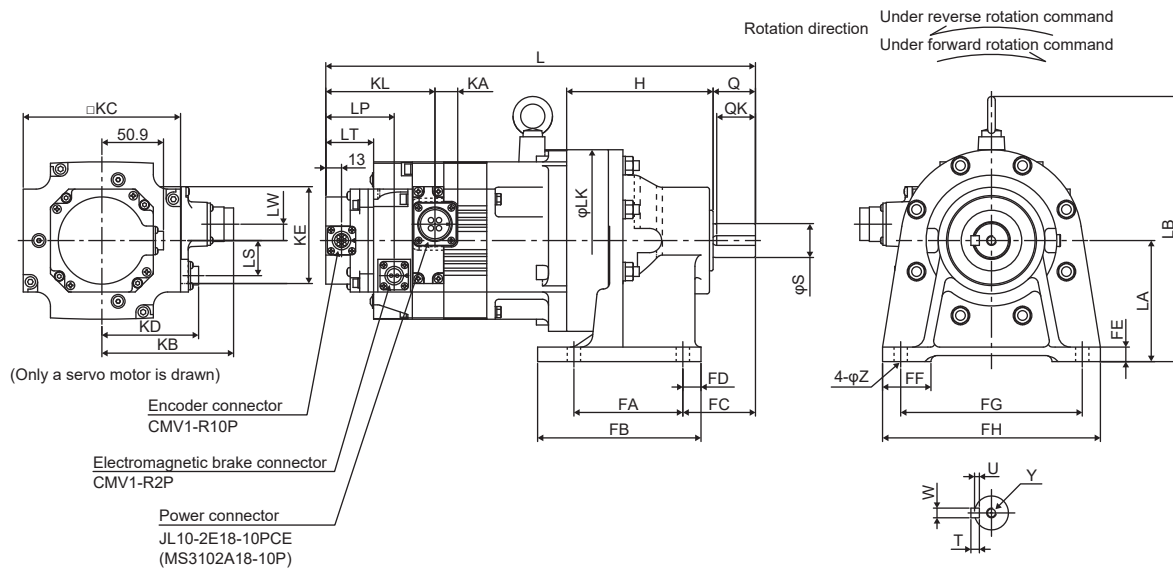

[Unit: mm]

HK-ST102(4)(B)G1H

Model	Reduction ratio	Variable dimensions *1													
		L	LA	LB	LK	LS	LT	LP	LW	H	KL	KA	KB	KD	KC
HK-ST102(4)(B)G1H	1/6	345 (379.5)	120	252	204	(29)	35.5 (39.5)	(56.5)	13.5	131	55.7 (90.2)	18.8	108.8	(79.9)	130
	1/11														
	1/17														
	1/29														
	1/35														
	1/43	397.5 (432)	150	295	230	(29)	35.5 (39.5)	(56.5)	13.5	170	55.7 (90.2)	18.8	108.8	(79.9)	130
1/59	468 (502.5)	160	352	300	(29)	35.5 (39.5)	(56.5)	13.5	218	55.7 (90.2)	18.8	108.8	(79.9)	130	

Model	Reduction ratio	Variable dimensions *1																
		KE	Z	FA	FB	FC	FD	FE	FF	FG	FH	Q	QK	S	T	U	W	Y
HK-ST102(4)(B)G1H	1/6	80	14	115	155	82	20	15	55	190	230	55	50	$38_{-0.016}^0$	8	5	10	M8X20
	1/11																	
	1/17																	
	1/29																	
	1/35																	
	1/43	80	18	145	195	100	25	22	65	290	330	70	56	$50_{-0.016}^0$	9	5.5	14	M10X18
1/59	80	18	150	238	139	44	25	75	370	410	90	80	$60_{-0.019}^0$	11	7	18		

*1 The values in () of the dimensions are for the servo motors with an electromagnetic brake.

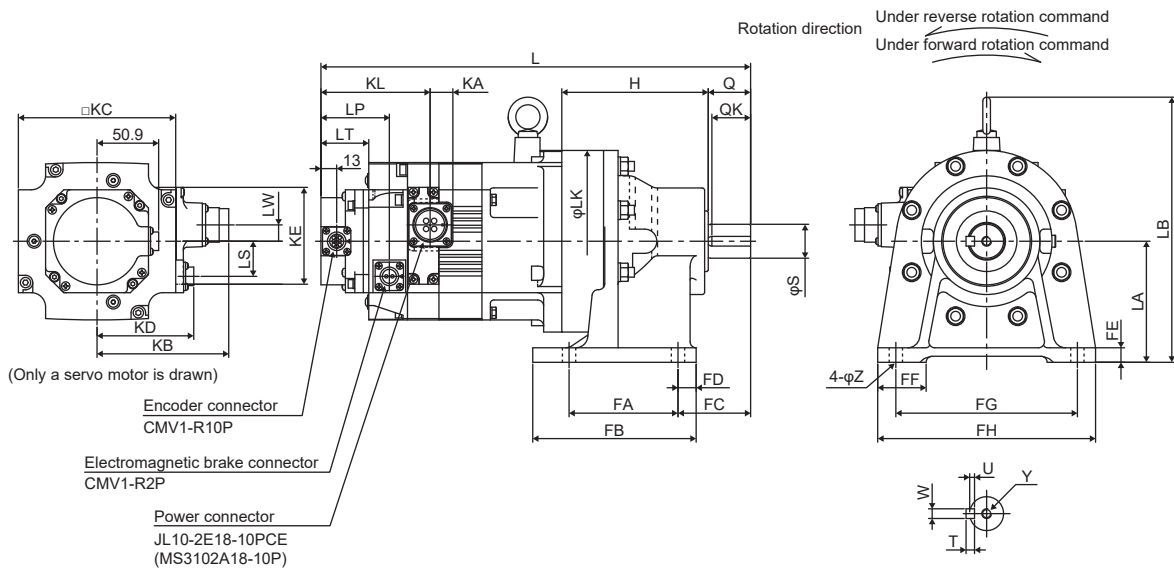

[Unit: mm]

HK-ST152(4)(B)G1H/HK-ST202(4)(B)G1H

Model	Reduction ratio	Variable dimensions *1													
		L	LA	LB	LK	LS	LT	LP	LW	H	KL	KA	KB	KD	KC
HK-ST152(4)(B)G1H	1/6	356 (390.5)	120	252	204	(29)	35.5 (39.5)	(56.5)	13.5	131	55.7 (90.2)	18.8	108.8	(79.9)	130
	1/11														
	1/17														
	1/29	408.5 (443)	150	295	230	(29)	35.5 (39.5)	(56.5)	13.5	170	55.7 (90.2)	18.8	108.8	(79.9)	130
	1/35														
	1/43	479 (513.5)	160	352	300	(29)	35.5 (39.5)	(56.5)	13.5	218	55.7 (90.2)	18.8	108.8	(79.9)	130
HK-ST202(4)(B)G1H	1/6	375 (424.5)	120	262	204	(44)	35.5 (42.5)	(62.5)	0	131	57.8 (107.3)	22.6	140.8	(96.9)	176
	1/11														
	1/17														
	1/29	492 (541.5)	160	341	300	(44)	35.5 (42.5)	(62.5)	0	218	57.8 (107.3)	22.6	140.8	(96.9)	176
	1/35														
	1/43														

Model	Reduction ratio	Variable dimensions *1																
		KE	Z	FA	FB	FC	FD	FE	FF	FG	FH	Q	QK	S	T	U	W	Y
HK-ST152(4)(B)G1H	1/6	80	14	115	155	82	20	15	55	190	230	55	50	38 ⁰ _{0.016}	8	5	10	M8X20
	1/11																	
	1/17																	
	1/29	80	18	145	195	100	25	22	65	290	330	70	56	50 ⁰ _{0.016}	9	5.5	14	M10X18
	1/35																	
	1/43	80	18	150	238	139	44	25	75	370	410	90	80	60 ⁰ _{0.019}	11	7	18	
HK-ST202(4)(B)G1H	1/6	80	14	115	155	82	20	15	55	190	230	55	50	38 ⁰ _{0.016}	8	5	10	M8X20
	1/11																	
	1/17																	
	1/29	80	18	150	238	139	44	25	75	370	410	90	80	60 ⁰ _{0.019}	11	7	18	M10X18
	1/35																	
	1/43																	

*1 The values in () of the dimensions are for the servo motors with an electromagnetic brake.

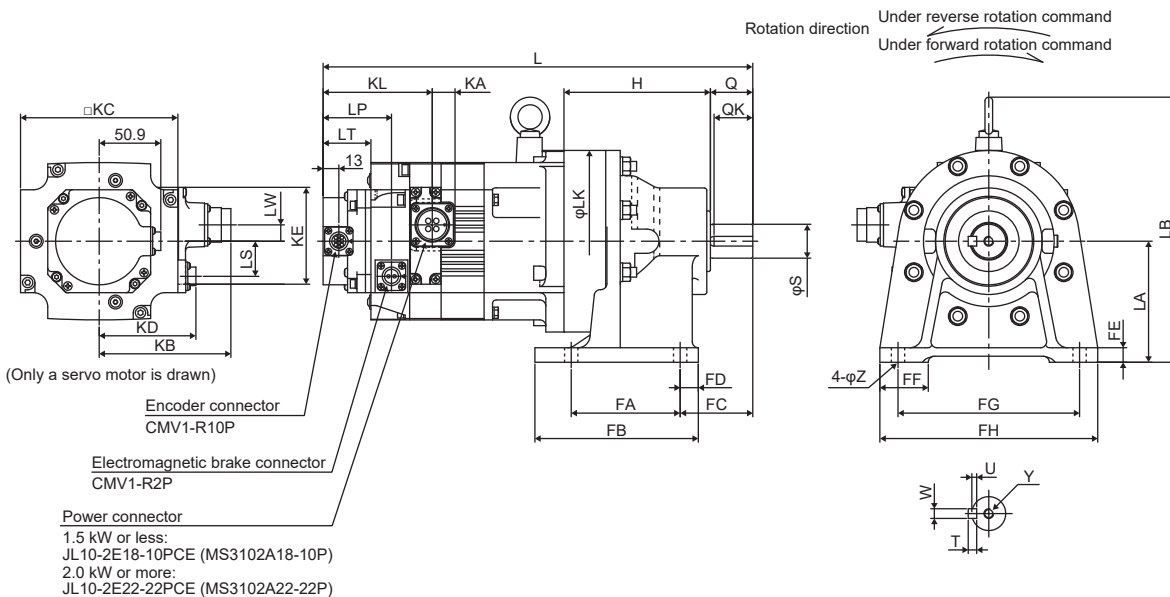

[Unit: mm]

HK-ST352(4)(B)G1H/HK-ST502(4)(B)G1H

Model	Reduction ratio	Variable dimensions *1													
		L	LA	LB	LK	LS	LT	LP	LW	H	KL	KA	KB	KD	KC
HK-ST352(4)(B)G1H	1/6	444.5 (494)	150	295	230	(44)	35.5 (42.5)	(62.5)	0	170	57.8 (107.3)	22.6	140.8	(96.9)	176
	1/11														
	1/17														
	1/29	512 (561.5)	160	341	300	(44)	35.5 (42.5)	(62.5)	0	218	57.8 (107.3)	22.6	140.8	(96.9)	176
	1/35														
	1/43	556.5 (606)	200	381	340	(44)	35.5 (42.5)	(62.5)	0	262	57.8 (107.3)	22.6	140.8	(96.9)	176
HK-ST502(4)(B)G1H	1/6	532 (581.5)	160	341	300	(44)	35.5 (42.5)	(62.5)	0	218	57.8 (107.3)	22.6	140.8	(96.9)	176
	1/11														
	1/17														
	1/29	616.5 (666)	220	405	370	(44)	35.5 (42.5)	(62.5)	0	279	57.8 (107.3)	22.6	140.8	(96.9)	176
	1/35														
	1/43														

Model	Reduction ratio	Variable dimensions *1																	
		KE	Z	FA	FB	FC	FD	FE	FF	FG	FH	Q	QK	S	T	U	W	Y	
HK-ST352(4)(B)G1H	1/6	80	18	145	195	100	25	22	65	290	330	70	56	50 ⁰ _{0.016}	9	5.5	14	M10X18	
	1/11																		
	1/17																		
	1/29	80	18	150	238	139	44	25	75	370	410	90	80	60 ⁰ _{0.019}	11	7	18		
	1/35																		
	1/43	80	22	275	335	125	30	30	80	380	430	90	80	70 ⁰ _{0.019}	12	7.5	20	M12X24	
HK-ST502(4)(B)G1H	1/6	80	18	150	238	139	44	25	75	370	410	90	80	60 ⁰ _{0.019}	11	7	18	M10X18	
	1/11																		
	1/17																		
	1/29	80	22	320	380	145	30	30	85	420	470	110	100	80 ⁰ _{0.019}	14	9	22	M12X24	
	1/35																		
	1/43																		

*1 The values in () of the dimensions are for the servo motors with an electromagnetic brake.

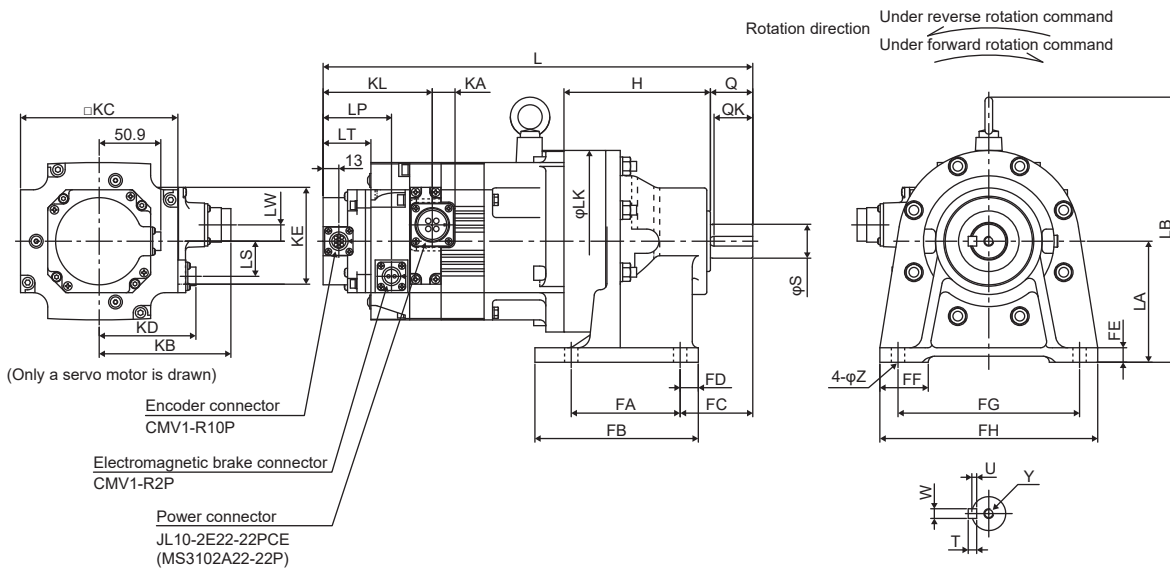

[Unit: mm]

HK-ST702(4)(B)G1H

Model	Reduction ratio	Variable dimensions *1													
		L	LA	LB	LK	LS	LT	LP	LW	H	KL	KA	KB	KD	KC
HK-ST702(4)(B)G1H	1/6	572 (621.5)	160	341	300	(44)	35.5 (42.5)	(62.5)	0	218	57.8 (107.3)	22.6	140.8	(96.9)	176
	1/11	616.5 (666)	200	381	340	(44)	35.5 (42.5)	(62.5)	0	262	57.8 (107.3)	22.6	140.8	(96.9)	176
	1/17														
	1/29	656.5 (706)	220	405	370	(44)	35.5 (42.5)	(62.5)	0	279	57.8 (107.3)	22.6	140.8	(96.9)	176
	1/35														
	1/43	747.5 (797)	250	465	430	(44)	35.5 (42.5)	(62.5)	0	330	57.8 (107.3)	22.6	140.8	(96.9)	176
1/59															

Model	Reduction ratio	Variable dimensions *1																
		KE	Z	FA	FB	FC	FD	FE	FF	FG	FH	Q	QK	S	T	U	W	Y
HK-ST702(4)(B)G1H	1/6	80	18	150	238	139	44	25	75	370	410	90	80	60 ⁰ _{-0.019}	11	7	18	M10X18
	1/11	80	22	275	335	125	30	30	80	380	430	90	80	70 ⁰ _{-0.019}	12	7.5	20	M12X24
	1/17																	
	1/29	80	22	320	380	145	30	30	85	420	470	110	100	80 ⁰ _{-0.019}	14	9	22	M12X24
	1/35																	
	1/43	80	26	380	440	170	30	35	90	480	530	135	125	95 ⁰ _{-0.022}	14	9	25	M20X34
1/59																		

*1 The values in () of the dimensions are for the servo motors with an electromagnetic brake.

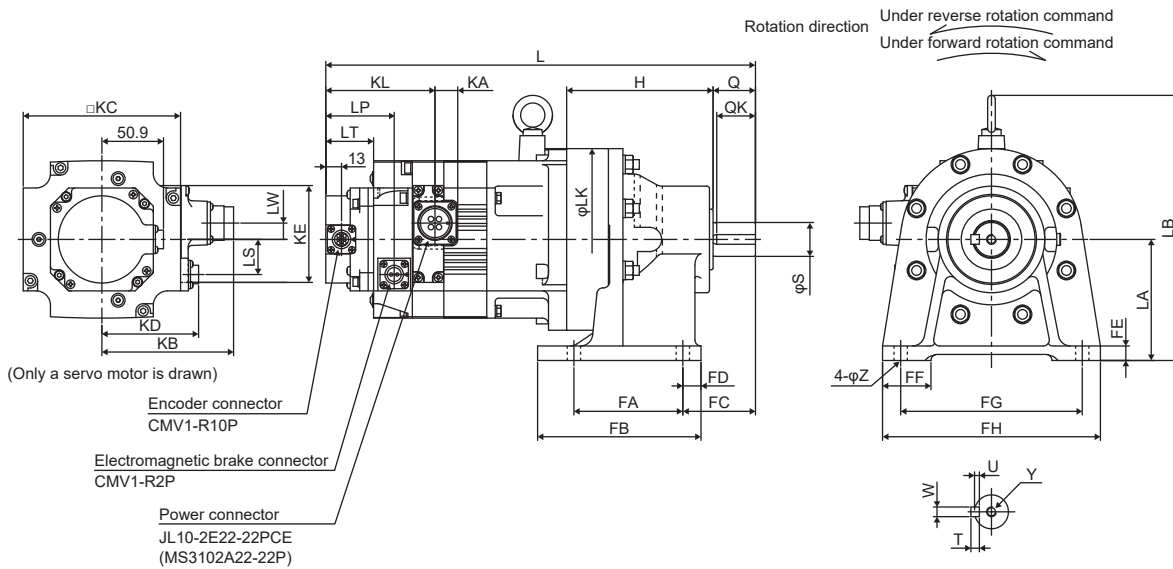

[Unit: mm]

With flange-output type gear reducer for high precision applications, flange mounting

HK-ST52(4)(B)G5/HK-ST102(4)(B)G5

Model	Reduction ratio	Variable dimensions ^{*1}											
		L	LA	LB	LC	LD	LE	LF	LG	LH	LK	LM	LT
HK-ST52(4)(B)G5	1/5	210.5 (245)	105	45	$85_{-0.035}^0$	90	59	$24_{0}^{+0.021}$	$27_{-0.5}^{+0.4}$	8	10	85	35.5 (39.5)
	1/11												
	1/21	222.5 (257)	135	60	$115_{-0.035}^0$	120	84	$32_{0}^{+0.025}$	$35_{-0.5}^{+0.4}$	13	13	94	35.5 (39.5)
	1/33												
	1/45												
HK-ST102(4)(B)G5	1/5	221.5 (256)	105	45	$85_{-0.035}^0$	90	59	$24_{0}^{+0.021}$	$27_{-0.5}^{+0.4}$	8	10	85	35.5 (39.5)
	1/11	233.5 (268)	135	60	$115_{-0.035}^0$	120	84	$32_{0}^{+0.025}$	$35_{-0.5}^{+0.4}$	13	13	94	35.5 (39.5)
	1/21												
	1/33	249.5 (284)	190	100	$165_{-0.063}^0$	170	122	$47_{0}^{+0.025}$	$53_{-0.8}^{+0.5}$	13	16	107	35.5 (39.5)
	1/45												

Model	Reduction ratio	Variable dimensions ^{*1}													
		KL	LP	LW	LS	T	N	P	R	M	KB	KD	KC	KE	Front view
HK-ST52(4)(B)G5	1/5	154.8	(56.5)	13.5	(35.5)	5	6	M6	10	9	108.8	(79.9)	130	80	A
	1/11														
	1/21	166.8	(56.5)	13.5	(35.5)	5	6	M8	12	11	108.8	(79.9)	130	80	A
	1/33														
	1/45														
HK-ST102(4)(B)G5	1/5	165.8	(56.5)	13.5	(35.5)	5	6	M6	10	9	108.8	(79.9)	130	80	A
	1/11	177.8	(56.5)	13.5	(35.5)	5	6	M8	12	11	108.8	(79.9)	130	80	A
	1/21														
	1/33	193.8	(56.5)	13.5	(35.5)	7	14	M8	12	14	108.8	(79.9)	130	80	B
	1/45														

*1 The values in () of the dimensions are for the servo motors with an electromagnetic brake.

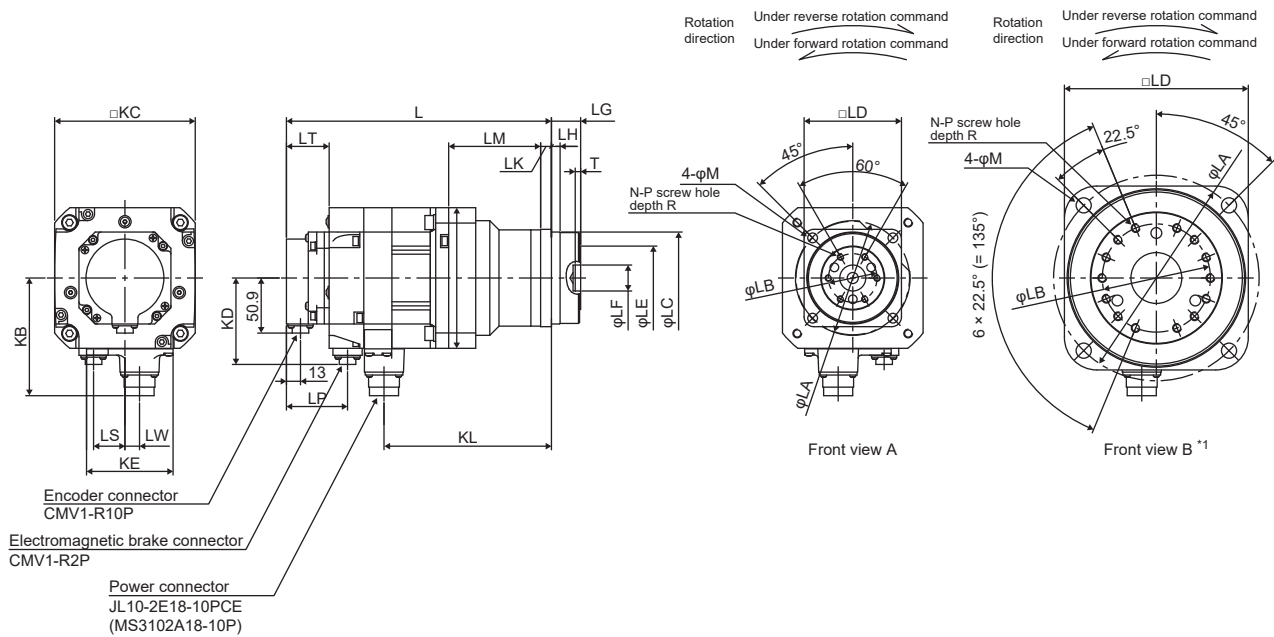

[Unit: mm]

*1 For the front view B, the screw positions are not placed equally in pitch around the circumference.

HK-ST152(4)(B)G5/HK-ST202(4)(B)G5

Model	Reduction ratio	Variable dimensions *1											
		L	LA	LB	LC	LD	LE	LF	LG	LH	LK	LM	LT
HK-ST152(4)(B)G5	1/5	232.5 (267)	105	45	85 $^{0}_{-0.035}$	90	59	24 $^{+0.021}_{0}$	27 $^{+0.4}_{-0.5}$	8	10	85	35.5 (39.5)
	1/11	244.5 (279)	135	60	115 $^{0}_{-0.035}$	120	84	32 $^{+0.025}_{0}$	35 $^{+0.4}_{-0.5}$	13	13	94	35.5 (39.5)
	1/21	260.5 (295)	190	100	165 $^{0}_{-0.063}$	170	122	47 $^{+0.025}_{0}$	53 $^{+0.5}_{-0.8}$	13	16	107	35.5 (39.5)
	1/33												
	1/45												
HK-ST202(4)(B)G5	1/5	267.5 (317)	135	60	115 $^{0}_{-0.035}$	120	84	32 $^{+0.025}_{0}$	35 $^{+0.4}_{-0.5}$	13	13	116	35.5 (42.5)
	1/11	287.5 (337)	190	100	165 $^{0}_{-0.063}$	170	122	47 $^{+0.025}_{0}$	53 $^{+0.5}_{-0.8}$	13	16	133	35.5 (42.5)
	1/21												
	1/33												
	1/45												

Model	Reduction ratio	Variable dimensions *1													
		KL	LP	LW	LS	T	N	P	R	M	KB	KD	KC	KE	Front view
HK-ST152(4)(B)G5	1/5	176.8	(56.5)	13.5	(35.5)	5	6	M6	10	9	108.8	(79.9)	130	80	A
	1/11	188.8	(56.5)	13.5	(35.5)	5	6	M8	12	11	108.8	(79.9)	130	80	A
	1/21	204.8	(56.5)	13.5	(35.5)	7	14	M8	12	14	108.8	(79.9)	130	80	B
	1/33														
	1/45														
HK-ST202(4)(B)G5	1/5	209.7	(62.5)	0	(40)	5	6	M8	12	11	140.8	(96.9)	176	80	A
	1/11	229.7	(62.5)	0	(40)	7	14	M8	12	14	140.8	(96.9)	176	80	B
	1/21														
	1/33														
	1/45														

*1 The values in () of the dimensions are for the servo motors with an electromagnetic brake.

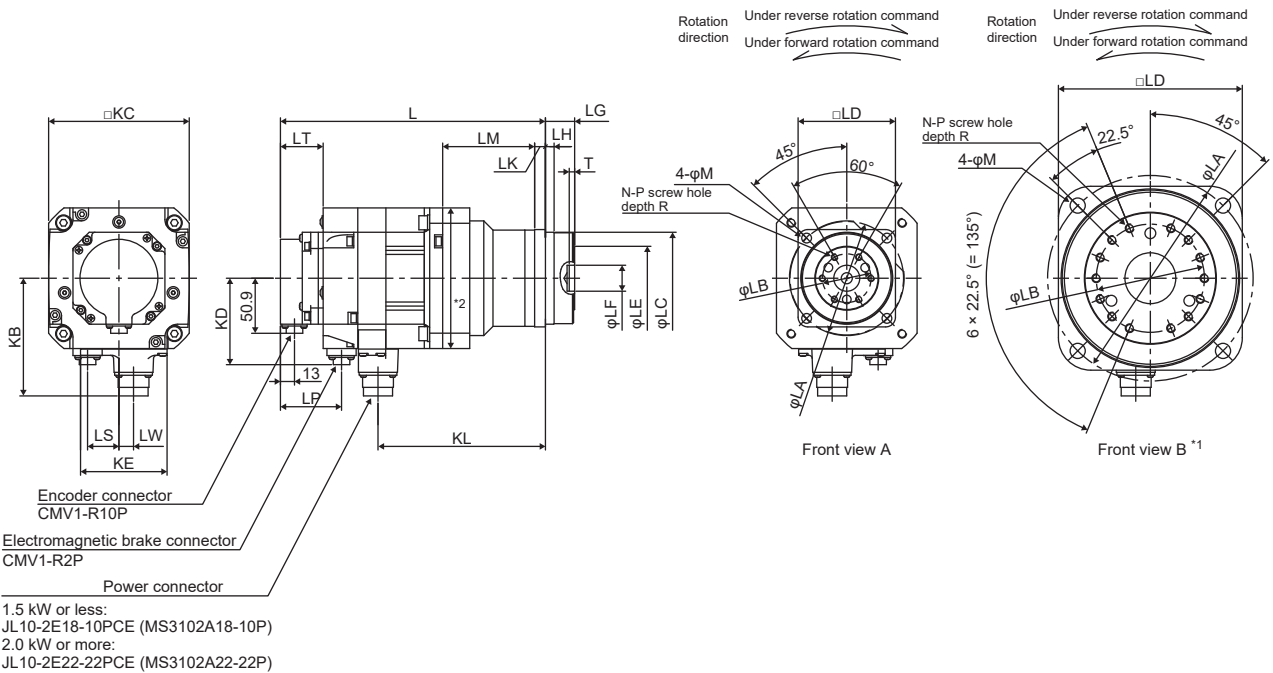

[Unit: mm]

*1 For the front view B, the screw positions are not placed equally in pitch around the circumference.

*2 For the HK-ST202(4)(B)G7, this range has an area with 180 mm × 180 mm at maximum dimensions.

HK-ST352(4)(B)G5/HK-ST502(4)(B)G5/HK-ST702(4)(B)G5

Model	Reduction ratio	Variable dimensions *1											
		L	LA	LB	LC	LD	LE	LF	LG	LH	LK	LM	LT
HK-ST352(4)(B)G5	1/5	287.5 (337)	135	60	115 $^{0}_{-0.035}$	120	84	32 $^{+0.025}_{0}$	35 $^{+0.4}_{-0.5}$	13	13	116	35.5 (42.5)
	1/11	307.5 (357)	190	100	165 $^{0}_{-0.063}$	170	122	47 $^{+0.025}_{0}$	53 $^{+0.5}_{-0.8}$	13	16	133	35.5 (42.5)
	1/21												
HK-ST502(4)(B)G5	1/5	327.5 (377)	190	100	165 $^{0}_{-0.063}$	170	122	47 $^{+0.025}_{0}$	53 $^{+0.5}_{-0.8}$	13	16	133	35.5 (42.5)
	1/11												
HK-ST702(4)(B)G5	1/5	367.5 (417)	190	100	165 $^{0}_{-0.063}$	170	122	47 $^{+0.025}_{0}$	53 $^{+0.5}_{-0.8}$	13	16	133	35.5 (42.5)

Model	Reduction ratio	Variable dimensions *1													
		KL	LP	LW	LS	T	N	P	R	M	KB	KD	KC	KE	Front view
HK-ST352(4)(B)G5	1/5	229.7	(62.5)	0	(40)	5	6	M8	12	11	140.8	(96.9)	176	80	A
	1/11	249.7	(62.5)	0	(40)	7	14	M8	12	14	140.8	(96.9)	176	80	B
	1/21														
HK-ST502(4)(B)G5	1/5	269.7	(62.5)	0	(40)	7	14	M8	12	14	140.8	(96.9)	176	80	B
	1/11														
HK-ST702(4)(B)G5	1/5	309.7	(62.5)	0	(40)	7	14	M8	12	14	140.8	(96.9)	176	80	B

*1 The values in () of the dimensions are for the servo motors with an electromagnetic brake.

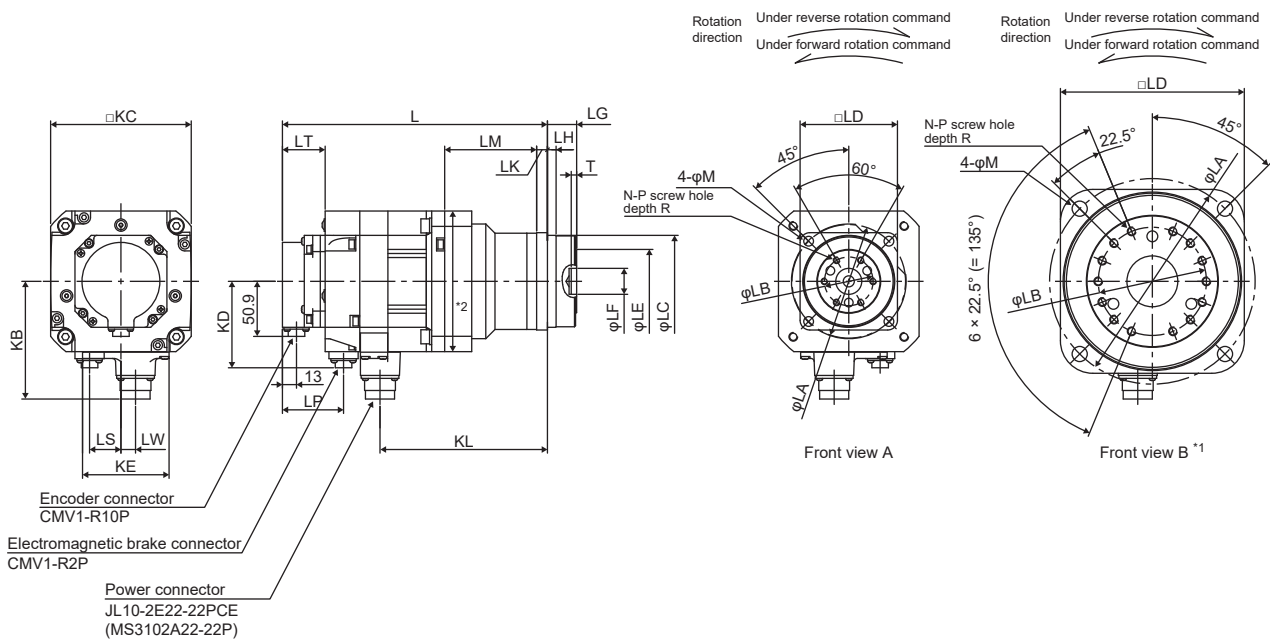

[Unit: mm]

*1 For the front view B, the screw positions are not placed equally in pitch around the circumference.

*2 This range has an area with 180 mm × 180 mm at maximum dimensions.

With shaft-output type gear reducer for high precision applications, flange mounting

HK-ST52(4)(B)G7/HK-ST102(4)(B)G7

Model	Reduction ratio	Variable dimensions *1										
		L	LA	LC	LD	LE	S	LG	LH	Q	LR	LK
HK-ST52(4)(B)G7	1/5	210.5 (245)	105	85 _{-0.035} ⁰	90	59	25 _{-0.021} ⁰	27	8	42	80	10
	1/11											
	1/21	222.5 (257)	135	115 _{-0.035} ⁰	120	84	40 _{-0.025} ⁰	35	13	82	133	13
	1/33											
	1/45											
HK-ST102(4)(B)G7	1/5	221.5 (256)	105	85 _{-0.035} ⁰	90	59	25 _{-0.021} ⁰	27	8	42	80	10
	1/11											
	1/21	233.5 (268)	135	115 _{-0.035} ⁰	120	84	40 _{-0.025} ⁰	35	13	82	133	13
	1/33											
	1/45											
1/33	249.5 (284)	190	165 _{-0.063} ⁰	170	122	50 _{-0.025} ⁰	53	13	82	156	16	
1/45												

Model	Reduction ratio	Variable dimensions *1										
		LM	LT	KL	LP	LW	LS	M	KB	KD	KC	KE
HK-ST52(4)(B)G7	1/5	85	35.5 (39.5)	154.8	(56.5)	13.5	(35.5)	9	108.8	(79.9)	130	80
	1/11											
	1/21	94	35.5 (39.5)	166.8	(56.5)	13.5	(35.5)	11	108.8	(79.9)	130	80
	1/33											
	1/45											
HK-ST102(4)(B)G7	1/5	85	35.5 (39.5)	165.8	(56.5)	13.5	(35.5)	9	108.8	(79.9)	130	80
	1/11											
	1/21	94	35.5 (39.5)	177.8	(56.5)	13.5	(35.5)	11	108.8	(79.9)	130	80
	1/33											
	1/45											
1/33	107	35.5 (39.5)	193.8	(56.5)	13.5	(35.5)	14	108.8	(79.9)	130	80	
1/45												

*1 The values in () of the dimensions are for the servo motors with an electromagnetic brake.

Rotation direction $\overleftarrow{\hspace{1cm}}$ Under reverse rotation command
 $\overrightarrow{\hspace{1cm}}$ Under forward rotation command

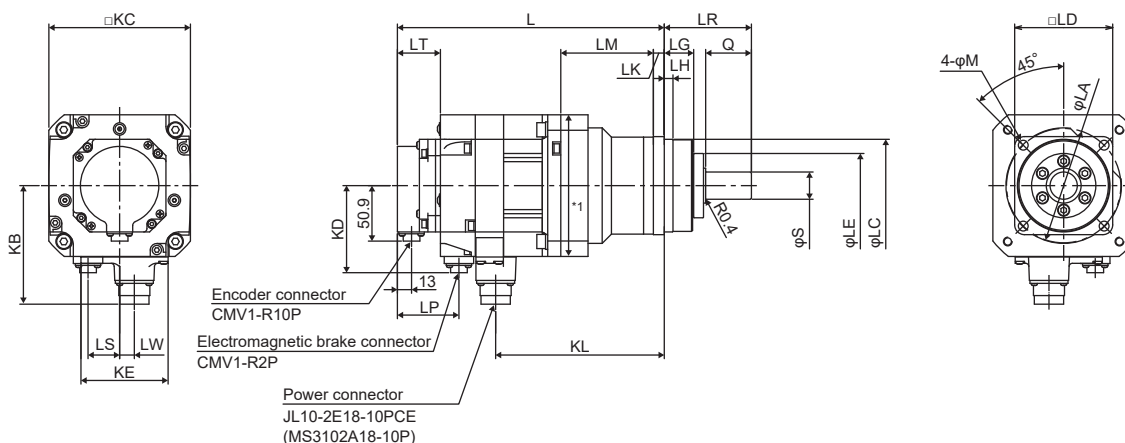

[Unit: mm]

HK-ST152(4)(B)G7/HK-ST202(4)(B)G7

Model	Reduction ratio	Variable dimensions *1										
		L	LA	LC	LD	LE	S	LG	LH	Q	LR	LK
HK-ST152(4)(B)G7	1/5	232.5 (267)	105	85 _{-0.035} ⁰	90	59	25 _{-0.021} ⁰	27	8	42	80	10
	1/11	244.5 (279)	135	115 _{-0.035} ⁰	120	84	40 _{-0.025} ⁰	35	13	82	133	13
	1/21	260.5 (295)	190	165 _{-0.063} ⁰	170	122	50 _{-0.025} ⁰	53	13	82	156	16
	1/33											
	1/45											
HK-ST202(4)(B)G7	1/5	267.5 (317)	135	115 _{-0.035} ⁰	120	84	40 _{-0.025} ⁰	35	13	82	133	13
	1/11	287.5 (337)	190	165 _{-0.063} ⁰	170	122	50 _{-0.025} ⁰	53	13	82	156	16
	1/21											
	1/33											
	1/45											

Model	Reduction ratio	Variable dimensions *1										
		LM	LT	KL	LP	LW	LS	M	KB	KD	KC	KE
HK-ST152(4)(B)G7	1/5	85	35.5 (39.5)	176.8	(56.5)	13.5	(35.5)	9	108.8	(79.9)	130	80
	1/11	94	35.5 (39.5)	188.8	(56.5)	13.5	(35.5)	11	108.8	(79.9)	130	80
	1/21	107	35.5 (39.5)	204.8	(56.5)	13.5	(35.5)	14	108.8	(79.9)	130	80
	1/33											
	1/45											
HK-ST202(4)(B)G7	1/5	116	35.5 (42.5)	209.7	(62.5)	0	(44)	11	140.8	(96.9)	176	80
	1/11											
	1/21	133	35.5 (42.5)	229.7	(62.5)	0	(44)	14	140.8	(96.9)	176	80
	1/33											
	1/45											

*1 The values in () of the dimensions are for the servo motors with an electromagnetic brake.

Rotation direction
 Under reverse rotation command
 Under forward rotation command

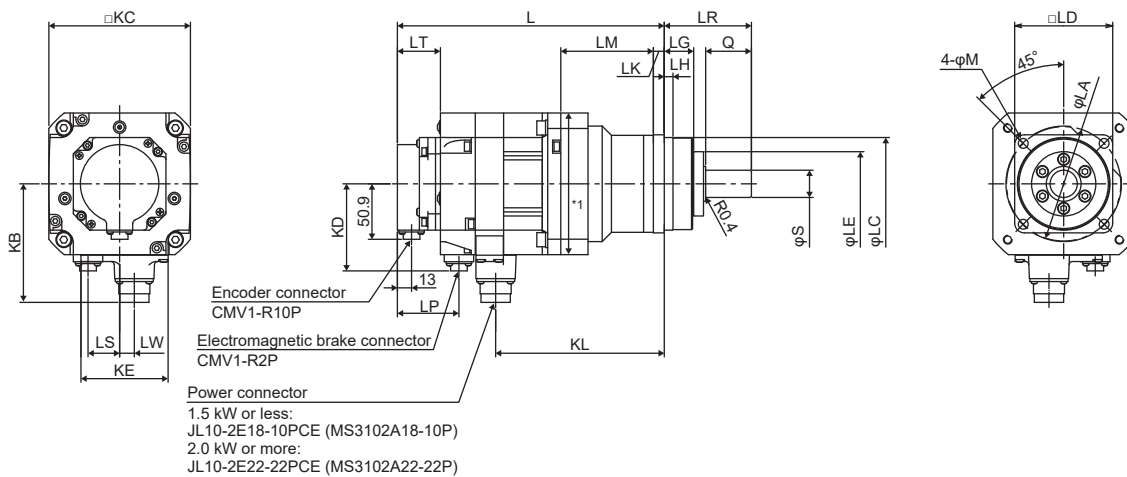

[Unit: mm]

*1 For the HK-ST202(4)(B)G7, this range has an area with 180 mm × 180 mm at maximum dimensions.

HK-ST352(4)(B)G7/HK-ST502(4)(B)G7/HK-ST702(4)(B)G7

Model	Reduction ratio	Variable dimensions *1										
		L	LA	LC	LD	LE	S	LG	LH	Q	LR	LK
HK-ST352(4)(B)G7	1/5	287.5 (337)	135	115 _{0.035}	120	84	40 _{0.025}	35	13	82	133	13
	1/11	307.5 (357)	190	165 _{0.063}	170	122	50 _{0.025}	53	13	82	156	16
	1/21											
HK-ST502(4)(B)G7	1/5	327.5 (377)	190	165 _{0.063}	170	122	50 _{0.025}	53	13	82	156	16
	1/11											
HK-ST702(4)(B)G7	1/5	367.5 (417)	190	165 _{0.063}	170	122	50 _{0.025}	53	13	82	156	16

Model	Reduction ratio	Variable dimensions *1										
		LM	LT	KL	LP	LW	LS	M	KB	KD	KC	KE
HK-ST352(4)(B)G7	1/5	116	35.5 (42.5)	229.7	(62.5)	0	(44)	11	140.8	(96.9)	176	80
	1/11	133	35.5 (42.5)	249.7	(62.5)	0	(44)	14	140.8	(96.9)	176	80
	1/21											
HK-ST502(4)(B)G7	1/5	133	35.5 (42.5)	269.7	(62.5)	0	(44)	14	140.8	(96.9)	176	80
	1/11											
HK-ST702(4)(B)G7	1/5	133	35.5 (42.5)	309.7	(62.5)	0	(44)	14	140.8	(96.9)	176	80

*1 The values in () of the dimensions are for the servo motors with an electromagnetic brake.

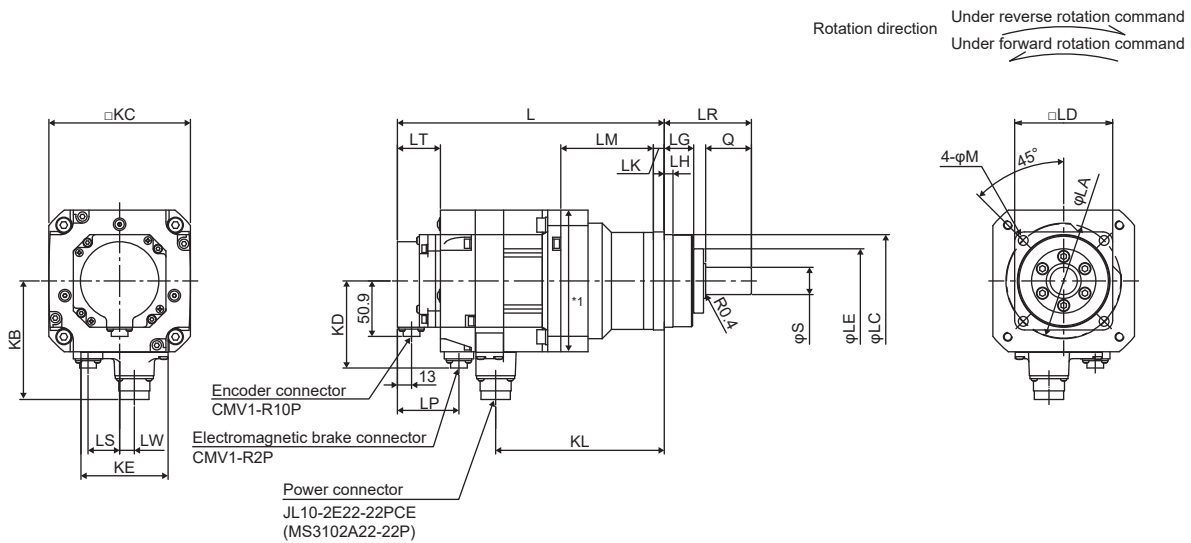

[Unit: mm]

*1 This range has an area with 180 mm × 180 mm at maximum dimensions.

9 HK-RT SERIES

This chapter provides information on the rotary servo motor specifications and characteristics. The indicated values and those without tolerance are representative values. When using the HK-RT series rotary servo motor, read chapters 1 to 5 and SAFETY INSTRUCTIONS at the beginning of this manual in addition to this chapter.

For the combinations of servo amplifiers and rotary servo motors, restrictions on the firmware version of the servo amplifier, and restrictions by the date of manufacture of the rotary servo motor, refer to "Servo amplifier/motor combinations" in the following manuals.

MR-J5 User's Manual (Hardware)

MR-J5D User's Manual (Hardware)

9.1 Model designation

The following describes what each block of a model name indicates. Not all combinations of the symbols are available.

HK - RT 1 0 3 4WB

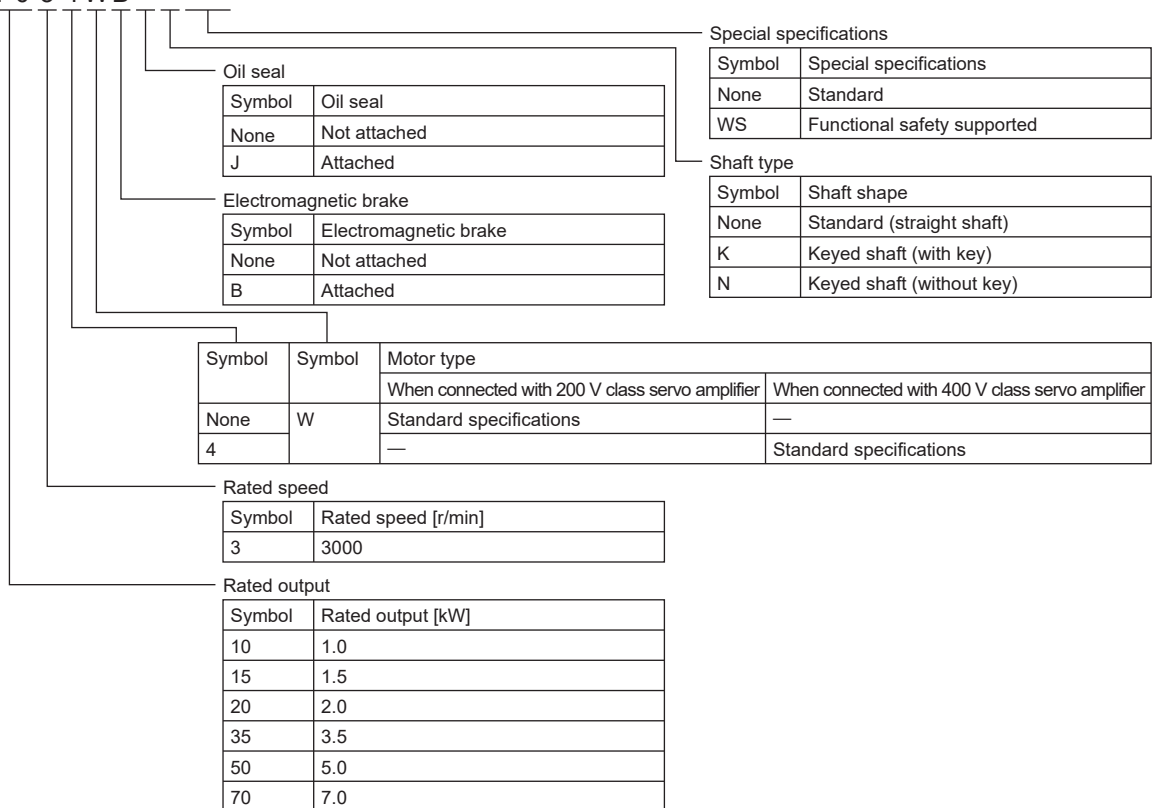

9.2 Standard specifications

Standard specifications list

When connected with 200 V servo amplifier

Series		HK-RT_ (Ultra-low inertia/medium capacity)					
Flange size		□90			□130		
Rotary servo motor model		103W	153W	203W	353W	503W	703W
Power supply capacity		Refer to "Power supply capacity and generated loss" in the following manual. □MR-J5 User's Manual (Hardware)					
Power supply voltage [V]		200 V AC (3-phase 200 V AC to 240 V AC)					
Continuous running duty *1	Rated output [kW]	1.0	1.5	2.0	3.5	5.0	7.0
	Rated torque [N·m]	3.2	4.8	6.4	11.1	15.9	22.3
Maximum torque *8 [N·m]		8.0 (9.5)	11.9 (12.9)	15.9/19.1	27.9/33.4	47.7/55.7	66.8
Rated speed *1 [r/min]		3000					
Maximum speed *1 [r/min]		6700			6000		5000
Power rate at continuous rated torque [kW/s]	Without an electromagnetic brake	141	251	317	280	403	655
	With an electromagnetic brake	95.6	182	249	189	301	512
Rated current [A]		5.2	11	9.5	16	25	28
Maximum current *8 [A]		17 (21)	34 (42)	30/37	51/62	90/110	102
Moment of inertia J [$\times 10^{-4}$ kg·m ²]	Without an electromagnetic brake	0.721	0.909	1.28	4.44	6.29	7.58
	With an electromagnetic brake	1.06	1.25	1.63	6.57	8.41	9.70
Recommended load to motor inertia ratio *2		11 times or less			10 times or less		
Speed/position detector		26-bit encoder common to batteryless absolute position and incremental systems (resolution per rotary servo motor revolution: 67108864 pulses/rev)					
Type		Permanent magnet synchronous motor					
Oil seal		× *7					
Electromagnetic brake		× *10					
Thermistor		×					
Insulation class		155 (F)					
Structure		Totally enclosed, natural cooling (IP rating: IP67) *3*9			Totally enclosed, natural cooling (IP rating: IP67) *3		
Vibration resistance *4 [m/s ²]		X: 24.5, Y: 49			X: 24.5, Y: 24.5		
Vibration rank *5		V10					
Permissible load for the shaft *6	L [mm]	40			55		
	Radial [N]	686			980		
	Thrust [N]	196			490		
Mass [kg]	Without an electromagnetic brake	3.6	4.4	5.9	13	17	20
	With an electromagnetic brake	4.7	5.5	7.0	15	19	23

- *1 When the power supply voltage drops, the continuous running duty and the speed cannot be guaranteed.
- *2 If the load to motor inertia ratio exceeds the indicated value, contact your local sales office.
- *3 The shaft-through portion is excluded. IP classifies the degree of protection provided against the intrusion of solid objects and water in electrical enclosures.
- *4 The vibration directions are shown in the following figure. The value is the one at the part that indicates the maximum value (normally the opposite to load-side bracket). When the rotary servo motor stops, fretting is likely to occur at the bearing. Therefore, suppress the vibration to about half of the permissible value.

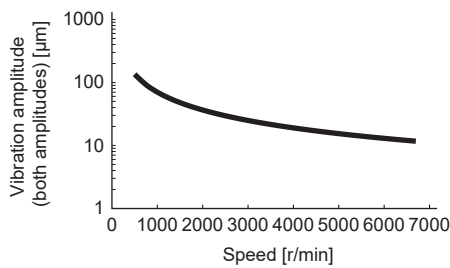
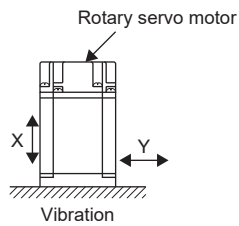

- *5 V10 indicates that the amplitude of a rotary servo motor as a single unit is 10 μm or less. The following figure shows the rotary servo motor mounting position for measurement and the measuring position.

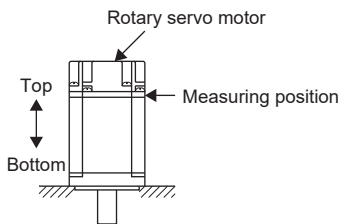

- *6 Refer to the following for permissible load for the shaft.
 Page 227 Permissible load for the output shaft
- *7 Servo motors with an oil seal are also compatible.
- *8 The values in () are for when the torque is increased.
- *9 When IP67 cables are needed, contact your local sales office.
- *10 Servo motors with an electromagnetic brake are also compatible.

When connected with 400 V servo amplifier

Series		HK-RT_4_ (Ultra-low inertia/medium capacity)					
Flange size		□90			□130		
Rotary servo motor model		1034W	1534W	2034W	3534W	5034W	7034W
Power supply capacity		Refer to "Power supply capacity and generated loss" in the following manuals. □ MR-J5 User's Manual (Hardware) □ MR-J5D User's Manual (Hardware)					
Power supply voltage [V]		400 V AC (3-phase 380 V AC to 480 V AC)					
Continuous running duty *1	Rated output [kW]	1.0	1.5	2.0	3.5	5.0	7.0
	Rated torque [N·m]	3.2	4.8	6.4	11.1	15.9	22.3
Maximum torque *8 [N·m]		8.0 (9.5)	11.9 (12.9)	15.9/19.1	27.9/33.4	47.7/55.7	66.8
Rated speed *1 [r/min]		3000					
Maximum speed *1 [r/min]		6700			6000		5000
Power rate at continuous rated torque [kW/s]	Without an electromagnetic brake	141	251	317	280	403	655
	With an electromagnetic brake	95.6	182	249	189	301	512
Rated current [A]		2.6	5.3	4.7	7.8	13	14
Maximum current *8 [A]		8.5 (11)	18 (20)	15 (19)	26 (31)	45 (55)	51
Moment of inertia J [$\times 10^{-4}$ kg·m ²]	Without an electromagnetic brake	0.721	0.909	1.28	4.44	6.29	7.58
	With an electromagnetic brake	1.06	1.25	1.63	6.57	8.41	9.70
Recommended load to motor inertia ratio *2	MR-J5	11 times or less			10 times or less	—	—
	MR-J5D	11 times or less			10 times or less		
Type		Permanent magnet synchronous motor					
Speed/position detector		26-bit encoder common to batteryless absolute position and incremental systems (resolution per servo motor revolution: 67108864 pulses/rev)					
Oil seal		× *7					
Electromagnetic brake		× *10					
Thermistor		×					
Insulation class		155 (F)					
Structure		Totally enclosed, natural cooling (IP rating: IP67) *3*9			Totally enclosed, natural cooling (IP rating: IP67) *3		
Vibration resistance *4 [m/s ²]		X: 24.5, Y: 49			X: 24.5, Y: 24.5		
Vibration rank *5		V10					
Permissible load for the shaft *6	L [mm]	40			55		
	Radial [N]	686			980		
	Thrust [N]	196			490		
Mass [kg]	Without an electromagnetic brake	3.6	4.4	5.9	13	17	20
	With an electromagnetic brake	4.7	5.5	7.0	15	19	23

- *1 When the power supply voltage drops, the continuous running duty and the speed cannot be guaranteed.
- *2 If the load to motor inertia ratio exceeds the indicated value, contact your local sales office.
- *3 The shaft-through portion is excluded. IP classifies the degree of protection provided against the intrusion of solid objects and water in electrical enclosures.
- *4 The vibration directions are shown in the following figure. The value is the one at the part that indicates the maximum value (normally the opposite to load-side bracket). When the rotary servo motor stops, fretting is likely to occur at the bearing. Therefore, suppress the vibration to about half of the permissible value.

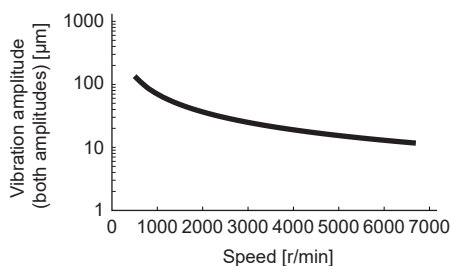
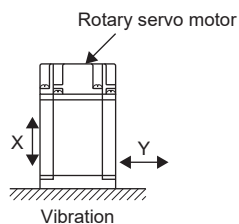

- *5 V10 indicates that the amplitude of a rotary servo motor as a single unit is 10 μm or less. The following figure shows the rotary servo motor mounting position for measurement and the measuring position.

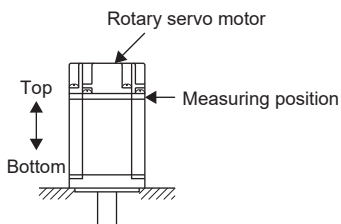

- *6 Refer to the following for permissible load for the shaft.
 Page 227 Permissible load for the output shaft
- *7 Servo motors with an oil seal are also compatible.
- *8 The values in () are for when the torque is increased.
- *9 When IP67 cables are needed, contact your local sales office.
- *10 Servo motors with an electromagnetic brake are also compatible.

Torque characteristics

- For machines where unbalanced torque occurs, such as a vertical axis system, the unbalanced torque should be kept at 70 % or lower of the rated torque.

When connected with 200 V servo amplifier

If using 1-phase power supply in combination with the servo motor of 750 W or higher and the MR-J5-100_ or the MR-J5-200_, operate the product at 75 % or less of the effective load ratio.

- When the power supply voltage drops, the torque decreases. --- : A rough indication of the possible continuous running range for 3-phase 170 V AC

— : 3-phase 200 V AC
 --- : 1-phase 200 V AC

■HK-RT_W

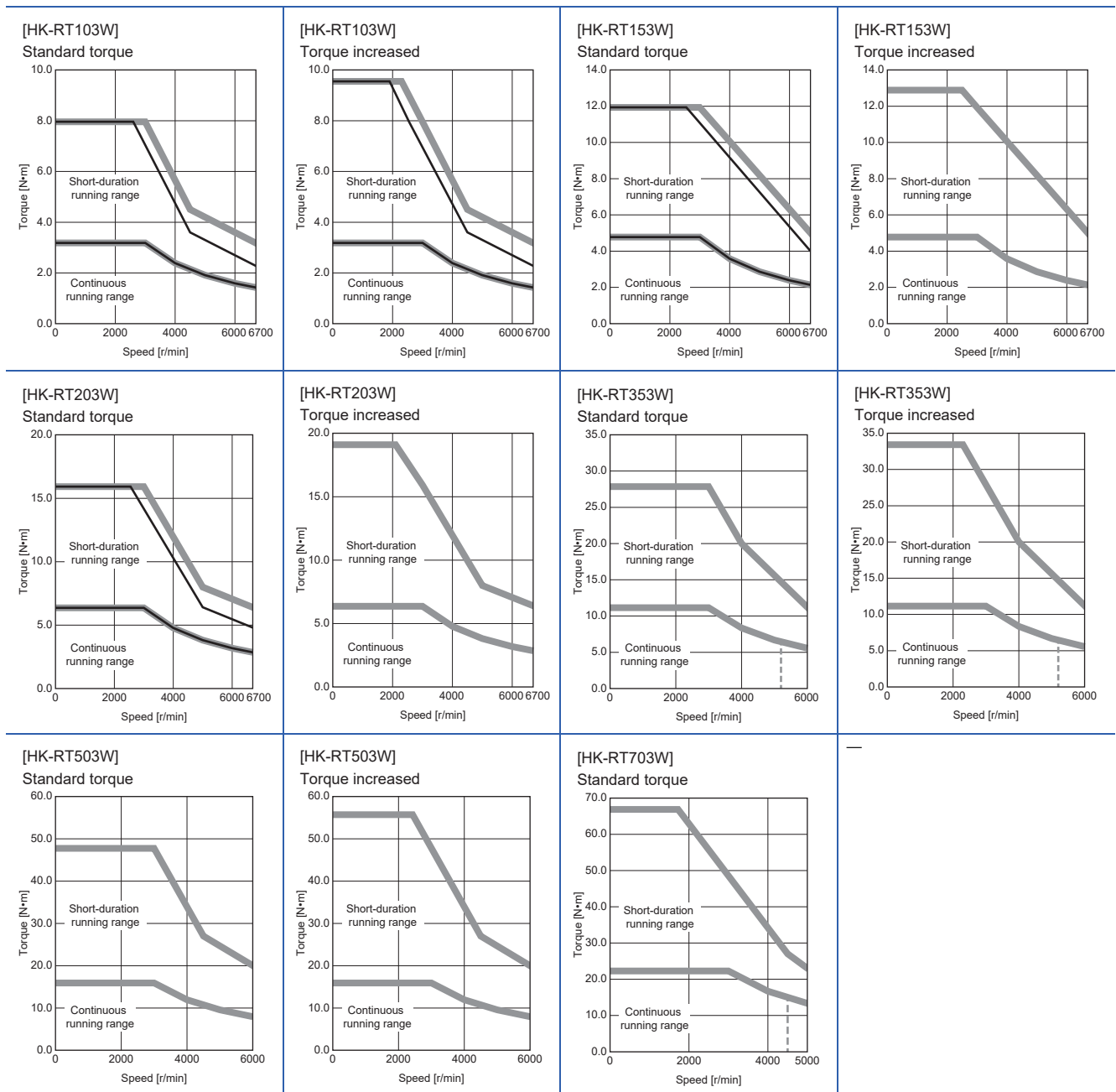

When connected with 400 V servo amplifier

- When the power supply voltage drops, the torque decreases. ---- : A rough indication of the possible continuous running range for 3-phase 323 V AC

— : 3-phase 400 V AC
 ---- : 3-phase 380 V AC

■HK-RT_4_W

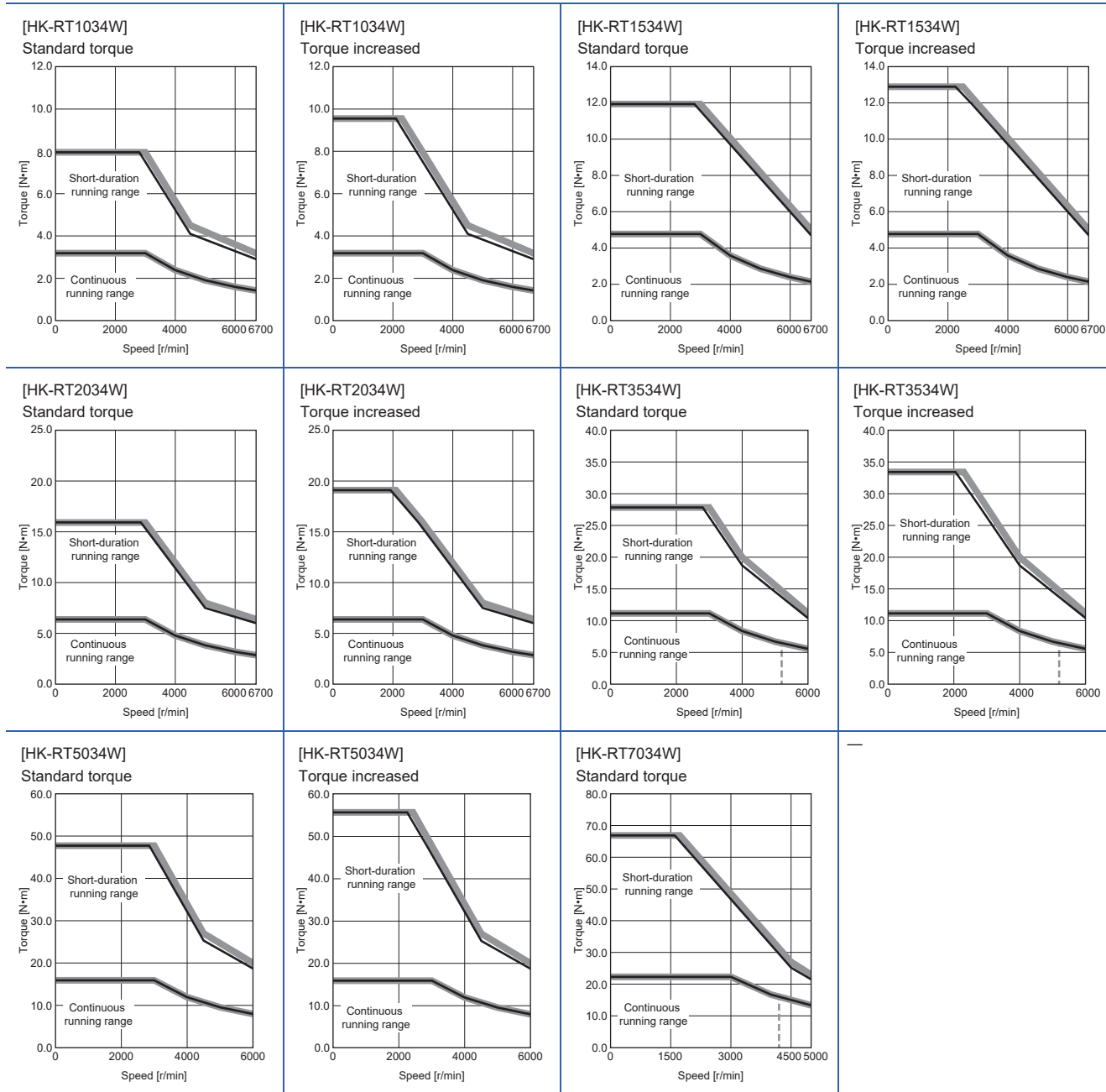

Permissible load for the output shaft

The permissible load for the shaft is shown in the following. Do not subject the shaft to loads greater than the permissible value. The value assumes that the load is applied independently.

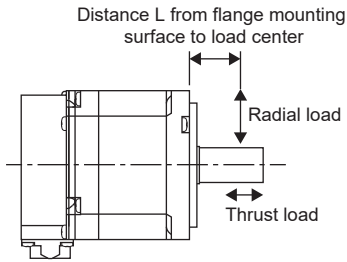

In case where the load position changes, calculate the permissible radial load from the distance measured from the flange mounting surface to the center of the load, and make the load equal to or less than the permissible radial load, referring to the graph shown in the following.

Model	Radial load		Thrust load	The graph of the relation between the load and the load position
	Load position L [mm]	Load [N]	Load [N]	
HK-RT103(4)W HK-RT153(4)W HK-RT203(4)W	40	686	196	
HK-RT353(4)W HK-RT503(4)W HK-RT703(4)W	55	980	490	

9.3 Characteristics of electromagnetic brake

Point

Before operating the servo motor, confirm that the electromagnetic brake operates properly.

The operation time of the electromagnetic brake varies depending on the power supply circuit being used.

Check the operation delay time with an actual machine.

The characteristics of the electromagnetic brake provided for the rotary servo motor with an electromagnetic brake are shown below.

Item	HK-RT103(4)WB HK-RT153(4)WB HK-RT203(4)WB	HK-RT353(4)WB HK-RT503(4)WB HK-RT702(4)WB
Type *1	Spring actuated type safety brake	
Rated voltage *4		
Power consumption at 20 °C [W]	13.8	23
Coil resistance *5 [Ω]	42	25
Inductance *5 [H]	0.15	0.25
Brake static friction torque *7 [N·m]	9.5 or more	16 or more
Release delay time *2 [s]	0.09	0.12
Braking delay time [s]	DC off *2	0.03
Permissible braking work	Per braking [J]	64
	Per hour [J]	640
Brake looseness at servo motor shaft *5 [degree]	0.9	0.01 to 0.6
Brake life *3	Number of braking times [times]	5000
	Work per braking [J]	64
Selection example of surge absorbers to be used *6	For the suppressed voltage 125 V	TND20V-680KB (Manufactured by NIPPON CHEMI-CON CORPORATION)
	For the suppressed voltage 350 V	TND10V-221KB (Manufactured by NIPPON CHEMI-CON CORPORATION)

*1 This type does not have a manual release mechanism. Use a 24 V DC power supply to release the brake electrically.

*2 The value for initial on gap at 20 °C.

*3 Brake lining wear due to braking will increase the brake gap, but the gap is not adjustable. Therefore, the brake life indicates the number of times the brake can be applied before gap adjustment becomes necessary.

*4 Prepare a power supply exclusively for the electromagnetic brake.

*5 The values are design values. These are not the guaranteed values.

*6 Select the electromagnetic brake control relay properly, in consideration of the characteristics of the electromagnetic brake and surge absorber. When a diode is used as a surge absorber, the electromagnetic braking time becomes longer.

*7 The value of the brake static friction torque is the lower limit in the initial state at 20 °C.

9.4 Derating

The derating condition is the reference value at the rated speed. As the temperature rise value of the rotary servo motor changes depending on the operation conditions such as speed, confirm that [AL. 0E2 Servo motor overheat warning] or [AL. 046 Servo motor overheat] does not occur on the actual machine before use.

If [AL. 0E2 Servo motor overheat warning] or [AL. 046 Servo motor overheat] occurs, consider the following measures:

- Lower the effective load ratio of the rotary servo motor.
- Review the heat dissipation conditions.

To use this product under conditions with multiple derating, calculate the multiplication of each derating rate, and use at the calculated derating rate or lower. For machines where unbalanced torque occurs, such as a vertical axis system, the unbalanced torque should be kept at 70 % or lower of the rated torque. When applying the derating rate in the conditions above, calculate the multiplication of the derating rate of 70 % in the unbalanced torque and the derating rate of each condition, and use this product at the calculated derating rate or lower.

Restrictions on the flange size

When mounting the rotary servo motor on a machine smaller than the specified aluminum flanges listed in section 2.11, derate the servo motor in accordance with the following conditions:

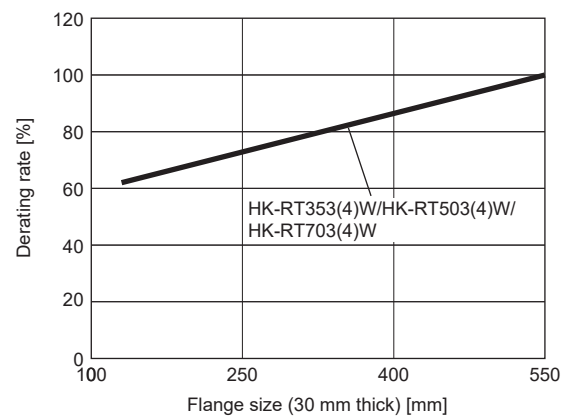
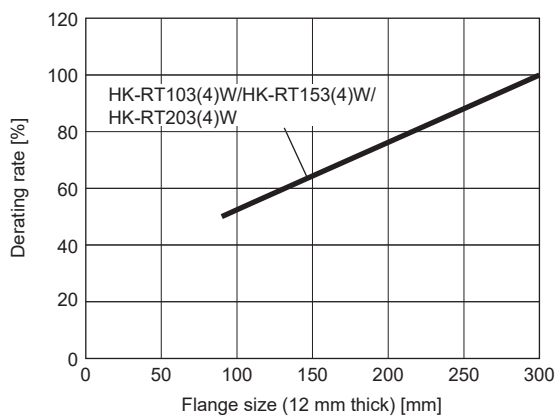

Restrictions on the ambient temperature

When using this product in an environment with a high ambient temperature, derate the product in accordance with the following conditions:

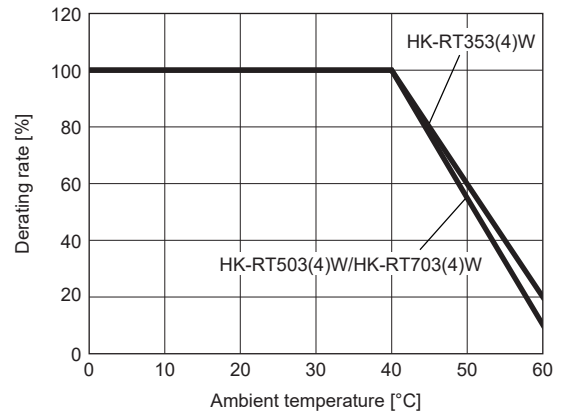
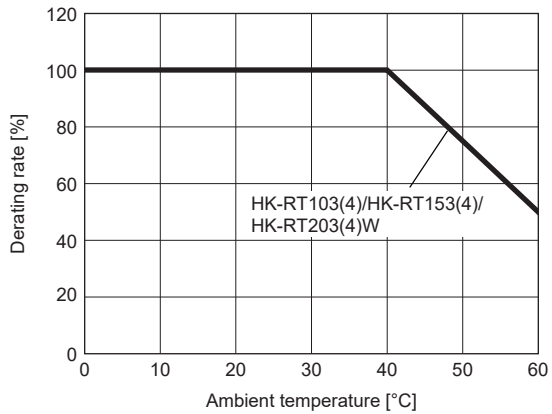

Restrictions on the altitude

To use this product at an altitude between 1000 m and 2000 m, derate the product in accordance with the following conditions:

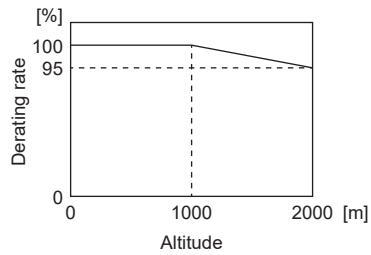

9.5 Rotary servo motors with special shafts

For rotary servo motors, there are two types of shafts: keyed shaft (with double round-ended key) and keyed shaft (without key).

To prevent an accident such as motor shaft fracture, do not use a servo motor with a keyed shaft for frequent start/stop applications.

Rotary servo motor	Shaft shape	
	Keyed shaft	
	With double round-ended key	Without key
HK-RT103(4)W HK-RT153(4)W HK-RT203(4)W HK-RT353(4)W HK-RT503(4)W HK-RT703(4)W	K	N

Keyed shaft (with double round-ended key)

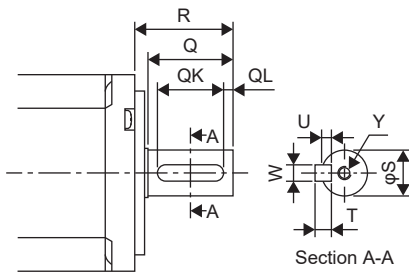

[Unit: mm]

Rotary servo motor	Variable dimensions								
	S	R	Q	W	QK	QL	U	T	Y
HK-RT103(4)WK HK-RT153(4)WK HK-RT203(4)WK	19 ⁰ _{-0.013}	40	36	6	25	5	3.5	6	M5 Screw hole depth 20
HK-RT353(4)WK HK-RT503(4)WK HK-RT703(4)WK	24 ⁰ _{-0.013}	55	50	8	36	5	4	7	M8 Screw hole depth 20

Keyed shaft (without key)

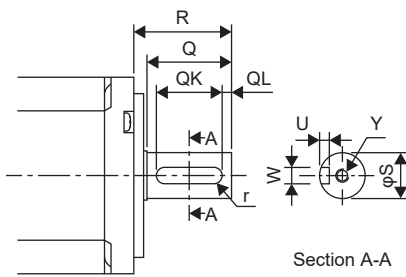

[Unit: mm]

Rotary servo motor	Variable dimensions								
	S	R	Q	W	QK	QL	U	r	Y
HK-RT103(4)WN HK-RT153(4)WN HK-RT203(4)WN	24 $^{0}_{-0.013}$	55	50	8 $^{0}_{-0.036}$	36	5	4 $^{+0.2}_{0}$	4	M8 Screw hole depth 20
HK-RT353(4)WN HK-RT503(4)WN HK-RT703(4)WN	35 $^{+0.010}_{0}$	79	75	10 $^{0}_{-0.036}$	55	5	5 $^{+0.2}_{0}$	5	M8 Screw hole depth 20

9.6 Mounting connectors

HK-RT103(4)W/HK-RT153(4)W/HK-RT203(4)W

Refer to the following page for information on mounting connectors.

☞ Page 134 Mounting/removing connectors

HK-RT353(4)W/HK-RT503(4)W/HK-RT703(4)W

Refer to the following page for information on mounting connectors.

☞ Page 198 Mounting connectors

9.7 Dimensions

- When running the cables to the load side, take care to avoid interference with the machine.
- Not all parts are created the exact same size or assembled in precisely the same manner. Therefore, the actual dimensions of rotary servo motors may be a maximum of approximately 3 mm larger than those in the drawings. In addition, the described dimensions and dimensional tolerances are the values at 20 °C. Since the values of the dimensions may vary depending on the ambient temperature, allow some margin when designing the machine side.
- The dimensions are the same, regardless of whether the servo motor has an oil seal or not.
- Use a friction coupling for coupling the servo motor with a load.

HK-RT103W(B)/HK-RT1034W(B)/HK-RT153W(B)/HK-RT1534W(B)/HK-RT203W(B)/HK-RT2034(B)W

The dimensions are for when cables (dual cable type) are run to the load-side. When running the cables vertically or to the opposite direction of the load-side, and for the dimensions for single cable type cables, refer to the following.

☞ Page 238 Cable direction: Load side/opposite direction of the load side

☞ Page 239 Cable direction: Vertical

Model	Variable dimensions *1	
	L	KL
HK-RT103W(B) HK-RT1034W(B)	118.9 (158.3)	107.2 (146.6)
HK-RT153W(B) HK-RT1534W(B)	136.9 (176.3)	125.2 (164.6)
HK-RT203W(B) HK-RT2034W(B)	172.9 (212.3)	161.2 (200.6)

*1 The values in () of the dimensions are for the servo motors with an electromagnetic brake.

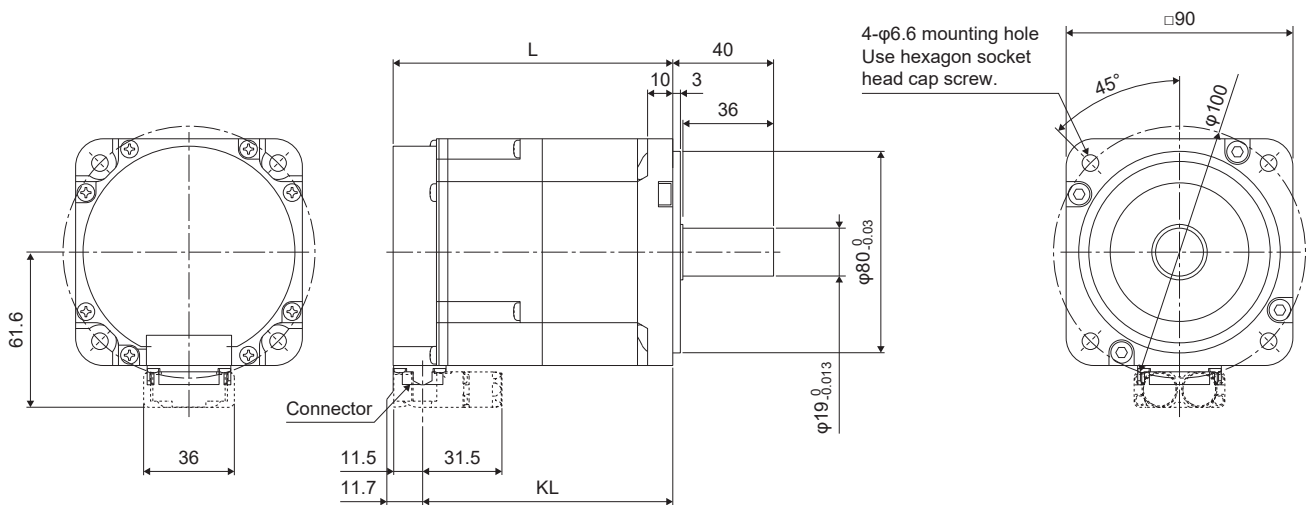

[Unit: mm]

HK-RT353W/HK-RT3534W

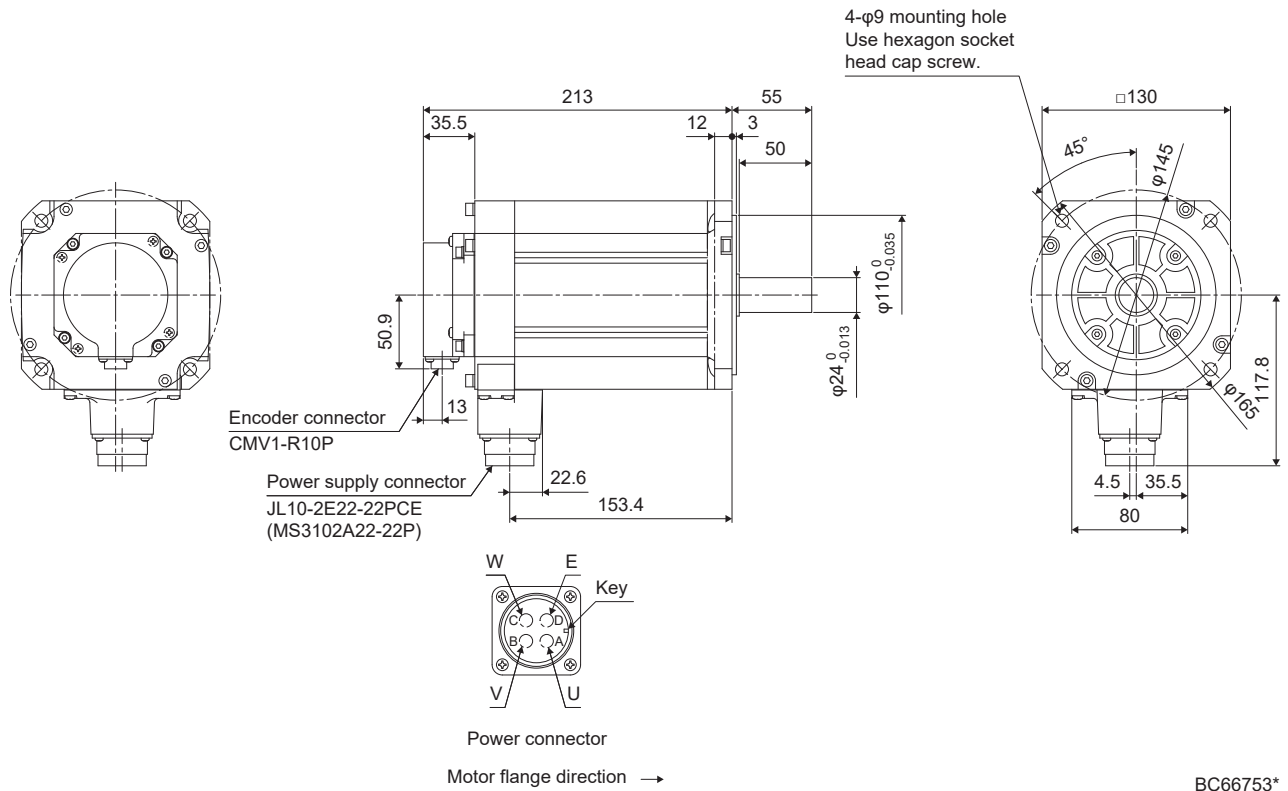

[Unit: mm]

HK-RT353WB/HK-RT3534WB

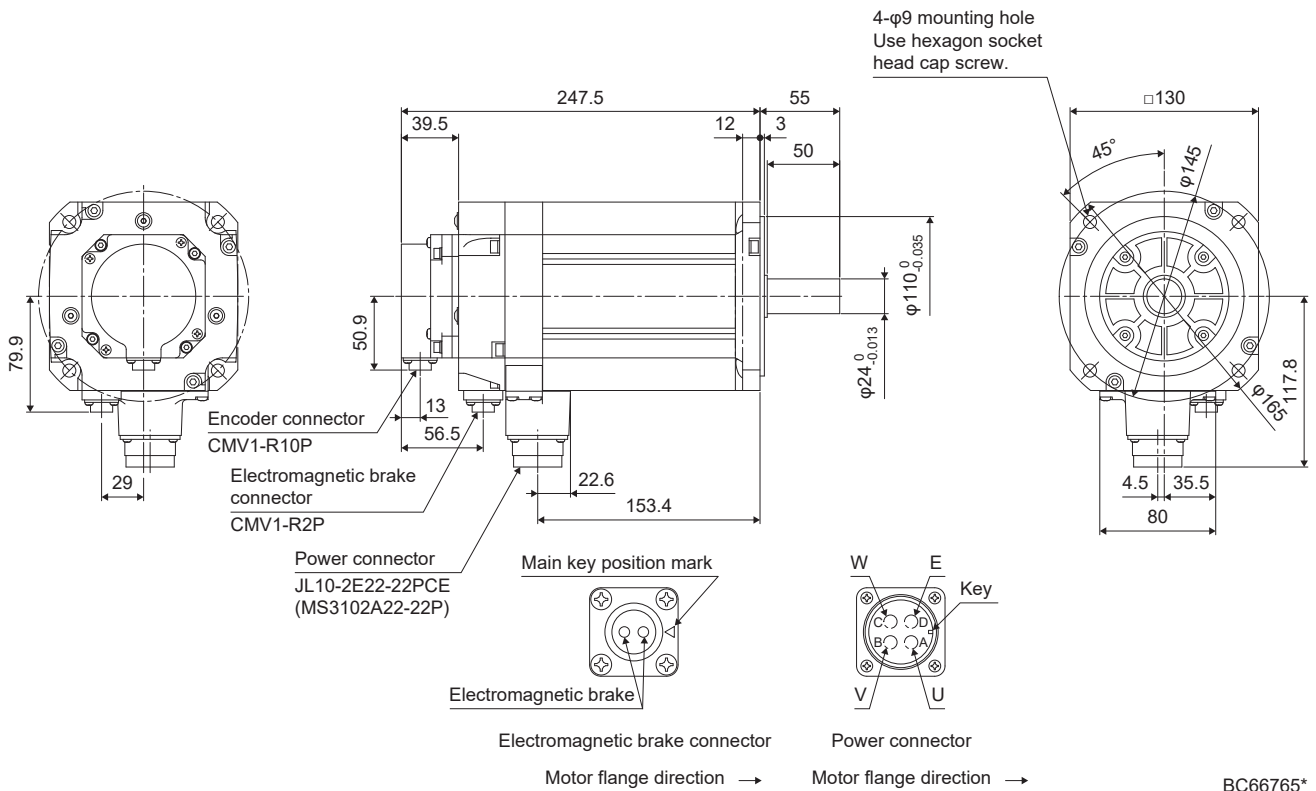

[Unit: mm]

HK-RT503W/HK-RT5034W

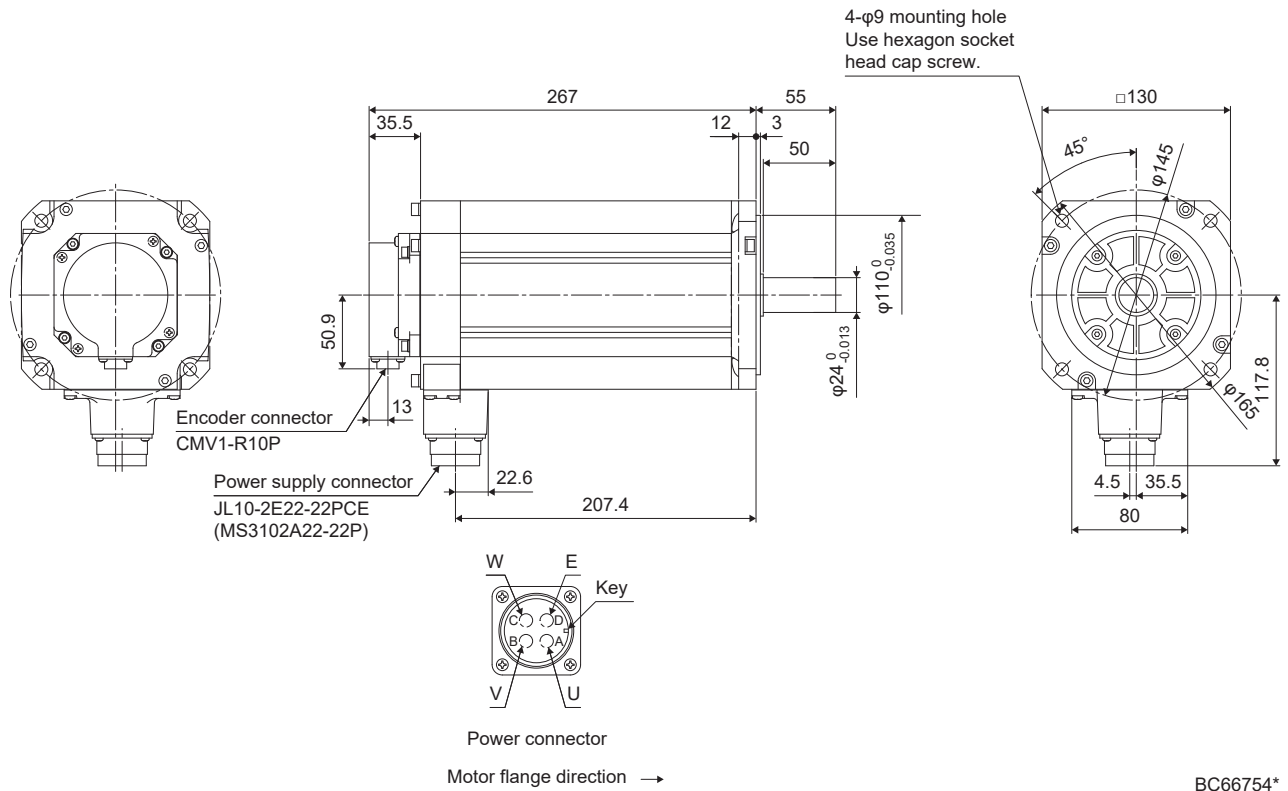

[Unit: mm]

HK-RT503WB/HK-RT5034WB

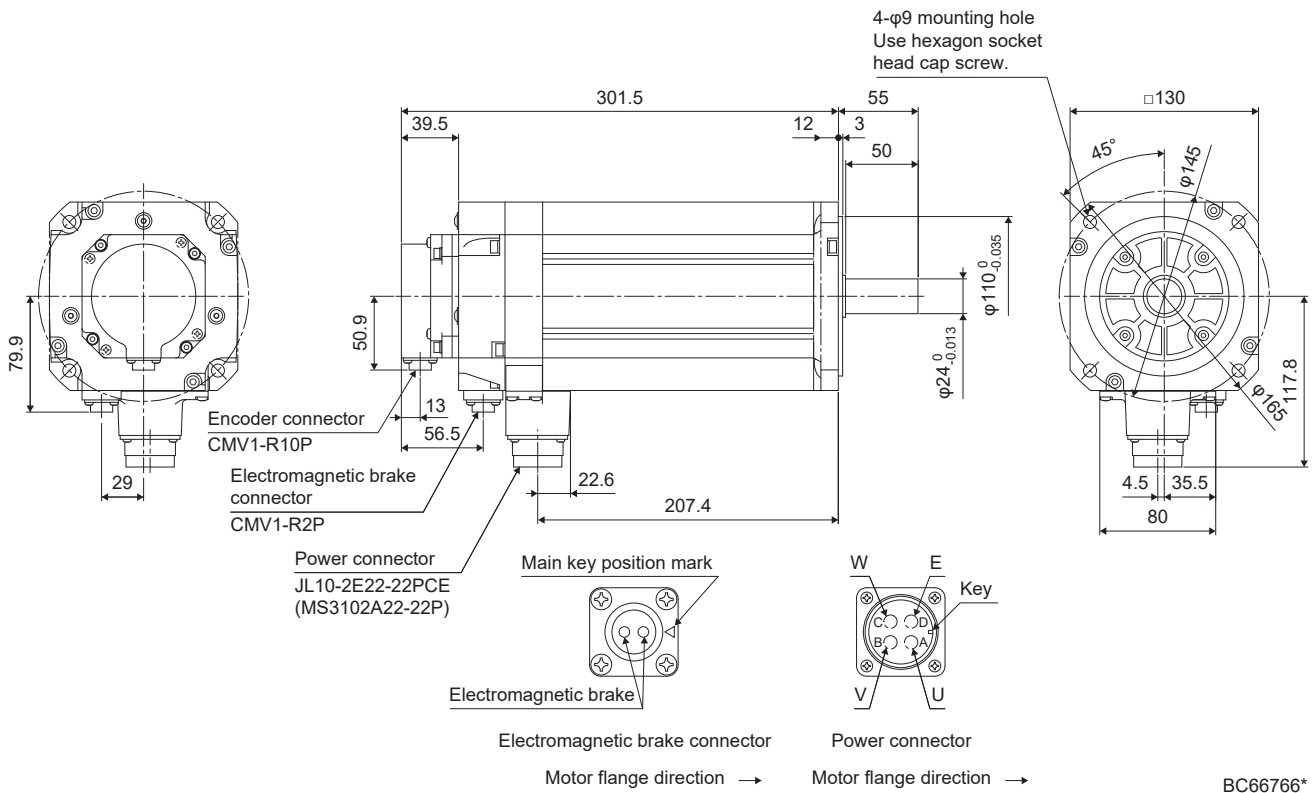

[Unit: mm]

HK-RT703W/HK-RT7034W

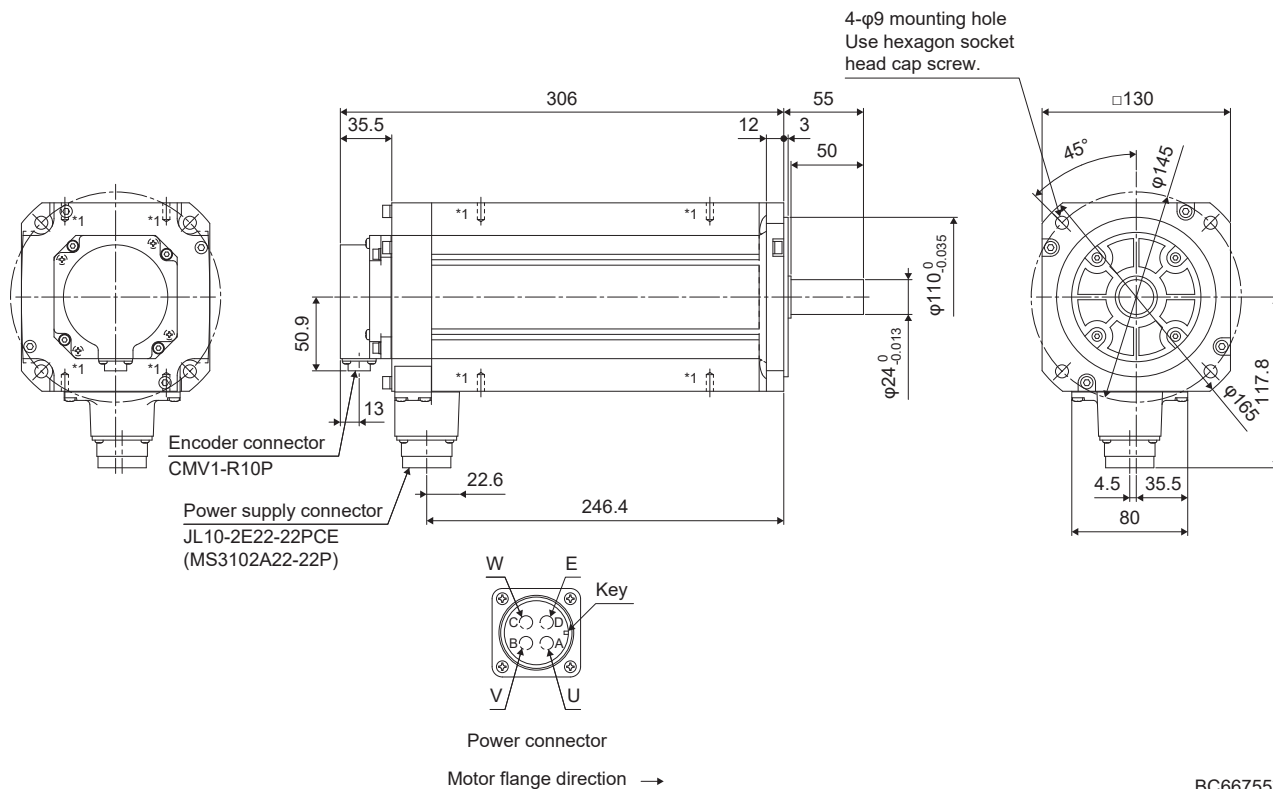

[Unit: mm]

*1 The HK-RT703W has screw holes for eyebolts (M6 screw hole depth 10.5). If using eyebolts, secure them to the servo motor with washers φ14 or more.

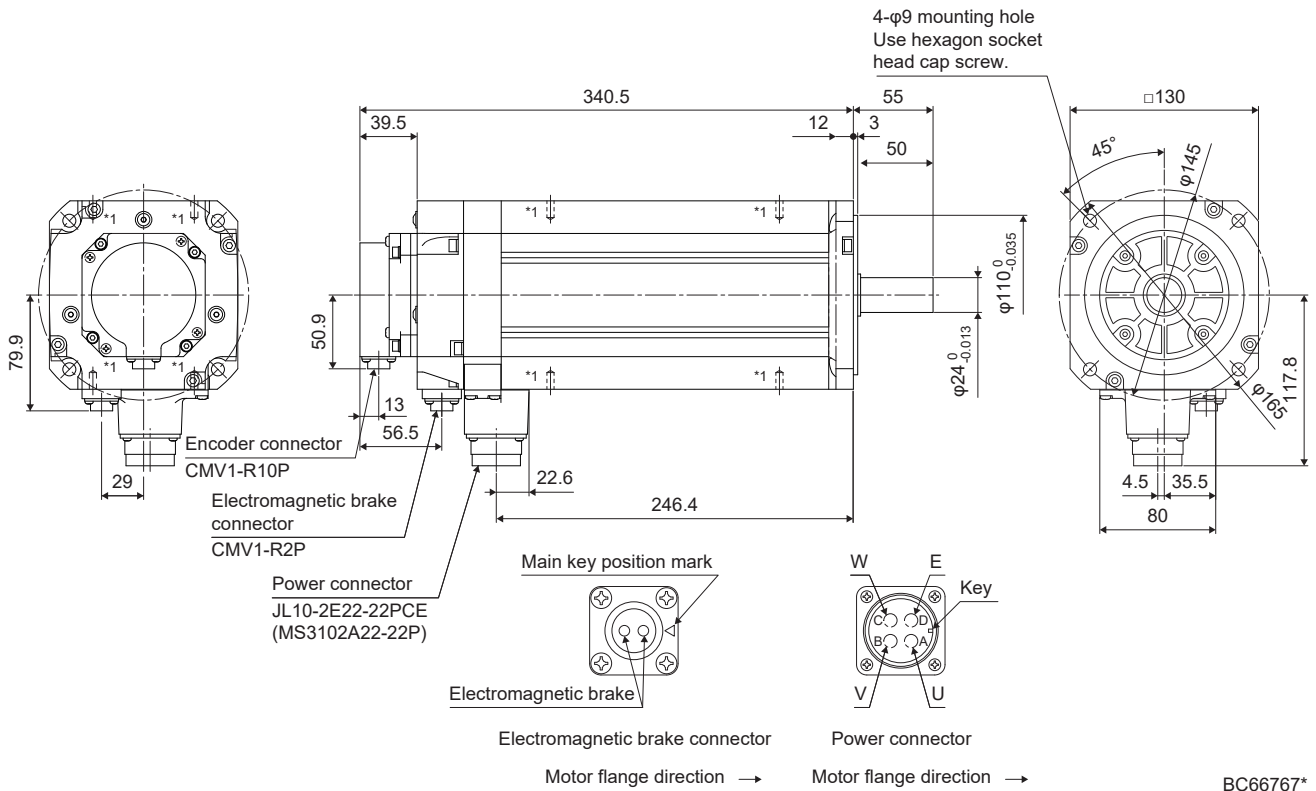

[Unit: mm]

*1 The HK-RT703WB has screw holes for eyebolts (M6 screw hole depth 10.5). If using eyebolts, secure them to the servo motor with washers φ14 or more.

Cable direction: Load side/opposite direction of the load side

Model	Variable dimensions							
	Dual cable				Single cable			
	A	B	C	D	A	B	C	D
HK-RT103(4)W HK-RT153(4)W HK-RT203(4)W	61.6	36	11.7	31.5	64.4	32	11.7	40

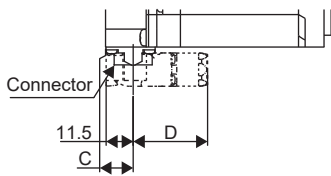
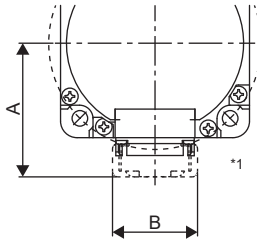

Cable direction: Load side *1

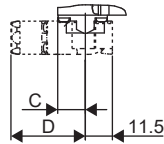

Cable direction: Opposite direction of the load side *1

[Unit: mm]

*1 The figures are for dual cable type motor cables.

Cable direction: Vertical

Model	Variable dimensions					
	Dual cable			Single cable		
	A	B	C	A	B	C
HK-RT103(4)W HK-RT153(4)W HK-RT203(4)W	88.2	36	11.7	96.7	32	11.7

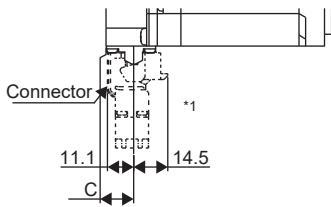
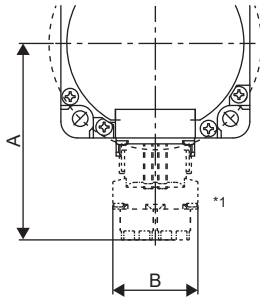

[Unit: mm]

*1 The figures are for dual cable type motor cables.

10 COMPLIANCE WITH EACH REGION

10.1 Compliance with CE/UKCA marking

CE/UKCA marking

The CE/UKCA marking is mandatory and must be affixed to specific products placed on the European Union area and the United Kingdom. When a product conforms to the requirements by category as defined in the EU directive, UK rules, etc., the CE/UKCA marking must be affixed to the product. The CE/UKCA marking also applies to the machines and equipment that are for sale with the servo motors in the European Union area and the United Kingdom. Each manual is available in different languages. For details, refer to our website or contact our local sales office.

EMC directive

The EMC directive also applies to the rotary servo motor as a single unit. Therefore, the rotary servo motor is designed to comply with the EMC directive. The EMC directive also applies to machines and equipment incorporating rotary servo motors. The HK-KT series, HK-MT series, HK-ST series, and HK-RT series comply with EN 61800-3 Category 3. These series are not intended to be used on a low-voltage public network which supplies domestic premises. When used on such network, radio frequency interference may occur. The installer must provide a guide for installation and use, including the recommended mitigation devices.

Low voltage directive

The low voltage directive also applies to the rotary servo motor as a single unit. The rotary servo motor is designed to comply with the low voltage directive.

Machinery directive

The rotary servo motor as a single unit falls under Article 1 2. (k), and therefore is not subject to the Machinery directive. However, the Machinery directive does apply to machines and equipment incorporating rotary servo motors. Please check if the machines and equipment as a whole are in compliance.

For compliance

Be sure to perform an appearance inspection of every unit before installation. In addition, perform a final performance inspection on the entire machine, and keep the inspection record.

Wiring

Use EN compliant products for wiring the power supply of the rotary servo motor. Products that comply with EN are available as options. Refer to the following for details of the options.

☞ Page 59 WIRING OPTION

Performing EMC tests

The EMC test of machines and devices that incorporate servo amplifiers and rotary servo motors must meet electromagnetic compatibility (immunity/emission) standards and satisfy the environment and electrical equipment specifications to be used. For EMC directive compliance methods relating to servo amplifiers and rotary servo motors, refer to "EMC Installation Guidelines".

10.2 Compliance with UL/CSA standard

Use a rotary servo motor that complies with the UL/CSA standard. For the latest information of compliance, contact your local sales office. Unless otherwise specified, the handling, performance, specifications, etc., of the UL/CSA compliant products are the same as those of the standard models.

Flange size

The rotary servo motor complies with the UL/CSA standard when it is mounted on the flanges made of aluminum whose sizes are indicated in the following table. The rated torque of the rotary servo motor under the UL/CSA standard indicates the continuous permissible torque value that can be generated when the motor is mounted on the flange specified in this table, and used in an environment with a specified ambient temperature (0 ° C to 40 ° C). Therefore, to comply with the UL/CSA standard, mount the rotary servo motor on a machine with a heat radiating effect equivalent to that of this flange.

Insulation class 155 (F)

Flange size [mm]	Rotary servo motor			
	HK-KT	HK-MT	HK-ST	HK-RT
250 × 250 × 6	053W 13W 1M3W 13UW 23W	053(V)W 13(V)W 1M3(V)W 23(V)W	—	—
250 × 250 × 12	43(4)W	43(V)W	—	—
300 × 300 × 12	63(4)W 23UW 43UW 7M3(4)W 103(4)W 63(4)UW 7M3UW 103(4)UW	63(V)W 7M3(V)W 103(V)W	52(4)W 102(4)W 172(4)W 202(4)AW 302(4)W	103(4)W 153(4)W 203(4)W
300 × 300 × 20	153(4)W 203(4)W 202(4)W	—	202(4)W 352(4)W	—
550 × 550 × 30	—	—	7M2UW 172UW 353(4)W 503(4)W	353(4)W 503(4)W 703(4)W
650 × 650 × 35	—	—	502(4)W 702(4)W	—

Selection example of wires

When cables are fabricated by the customer, wires should be selected in accordance with the application.

To comply with the UL/CSA standard, use UL-approved copper wires rated at 75 °C for wiring. The following table shows wires [AWG] rated at 75 °C.

HK-KT series

Rotary servo motor	Wire [AWG]	
	U/V/W/⊕	B1/B2
HK-KT053W	14 *1	16 *1
HK-KT13W		
HK-KT1M3W		
HK-KT13UW		
HK-KT23W		
HK-KT43W		
HK-KT63W		
HK-KT23UW		
HK-KT43UW		
HK-KT7M3W		
HK-KT103W		
HK-KT63UW		
HK-KT7M3UW		
HK-KT103UW		
HK-KT153W		
HK-KT203W		
HK-KT202W		
HK-KT434W		
HK-KT634W		
HK-KT7M34W		
HK-KT1034W		
HK-KT634UW		
HK-KT1034UW		
HK-KT1534W		
HK-KT2034W		
HK-KT2024W		

*1 This is used for fabricating extension cables. Use options when wiring the servo motor.

HK-MT series

Rotary servo motor	Wire [AWG]	
	U/V/W/⊕	B1/B2
HK-MT053(V)W	14 *1	16 *1
HK-MT13(V)W		
HK-MT1M3(V)W		
HK-MT23(V)W		
HK-MT43(V)W		
HK-MT63(V)W		
HK-MT7M3(V)W		
HK-MT103(V)W		

*1 This is used for fabricating extension cables. Use options when wiring the servo motor.

HK-ST series

Rotary servo motor	Wire [AWG]	
	U/V/W/⊕	B1/B2
HK-ST52W	14 *2	16
HK-ST102W		
HK-ST172W		
HK-ST202AW		
HK-ST302W		
HK-ST353W	12	
HK-ST503W	10 *1	
HK-ST202W	14	
HK-ST7M2UW		
HK-ST172UW		
HK-ST352W	12	
HK-ST502W	8	
HK-ST702W	8	
HK-ST524W	14 *2	
HK-ST1024W		
HK-ST1724W		
HK-ST2024AW		
HK-ST3024W		
HK-ST3534W		
HK-ST5034W		
HK-ST2024W		
HK-ST3524W		
HK-ST5024W		12
HK-ST7024W		

*1 To make the HK-ST503W comply with the UL/CSA standard, fabricate an extension cable using the cable manufactured by Mitsubishi Electric System & Service Co., Ltd. (SC-PWC403C_M-SBLL or SC-PWC403C_M-SBLH). For the SC-PWC403C_M-SBLL and SC-PWC403C_M-SBLH, contact your local sales office.

*2 Wires used for the geared servo motor HK-ST152_ are the same as those for the HK-ST172W.
Wires used for the geared servo motor HK-ST1524_ are the same as those for the HK-ST1724W.

HK-RT series

Rotary servo motor	Wire [AWG]	
	U/V/W/⊕	B1/B2
HK-RT103W	14 *1	16 *1
HK-RT153W		
HK-RT203W		
HK-RT353W	12	16
HK-RT503W	10	
HK-RT703W		
HK-RT1034W	14 *1	16 *1
HK-RT1534W		
HK-RT2034W		
HK-RT3534W	14	16
HK-RT5034W		
HK-RT7034W		

*1 This is used for fabricating extension cables. Use options when wiring the servo motor.

11 APPENDIX

11.1 Rotary servo motor ID codes

Rotary servo motor series ID	Rotary servo motor type ID	Rotary servo motor encoder ID	Rotary servo motor
0311	0053	F001	HK-KT053W
	FF13		HK-KT13W
	0153		HK-KT1M3W
	FF23		HK-KT23W
	FF43		HK-KT43W
	FF63		HK-KT63W
	0753		HK-KT7M3W
	F103		HK-KT103W
	F153		HK-KT153W
	F203		HK-KT203W
	F202		HK-KT202W
	0312		FF13
FF23		HK-KT23UW	
FF43		HK-KT43UW	
FF63		HK-KT63UW	
0753		HK-KT7M3UW	
F103		HK-KT103UW	
0313	FF43	F001	HK-KT434W
	FF63		HK-KT634W
	0753		HK-KT7M34W
	F103		HK-KT1034W
	F153		HK-KT1534W
	F203		HK-KT2034W
	F202		HK-KT2024W
0317	FF63	F001	HK-KT634UW
	F103		HK-KT1034UW
0301	0053	F005	HK-MT053W
	FF13		HK-MT13W
	0153		HK-MT1M3W
	FF23		HK-MT23W
	FF43		HK-MT43W
	FF63		HK-MT63W
	0753		HK-MT7M3W
	F103		HK-MT103W
0302	0053	F005	HK-MT053VW
	FF13		HK-MT13VW
	0153		HK-MT1M3VW
	FF23		HK-MT23VW
	FF43		HK-MT43VW
	FF63		HK-MT63VW
	0753		HK-MT7M3VW
	F103		HK-MT103VW

Rotary servo motor series ID	Rotary servo motor type ID	Rotary servo motor encoder ID	Rotary servo motor	
0321	FF52	F001	HK-ST52W	
	F102		HK-ST102W	
	F152		HK-ST152	
	F172		HK-ST172W	
	F302		HK-ST302W	
	F353		HK-ST353W	
	F503		HK-ST503W	
	F202		HK-ST202W	
	F352		HK-ST352W	
	F502		HK-ST502W	
	F702		HK-ST702W	
	0322		F202	HK-ST202AW
	0323		FF52	HK-ST524W
F102		HK-ST1024W		
F152		HK-ST1524		
F172		HK-ST1724W		
F302		HK-ST3024W		
F353		HK-ST3534W		
F503		HK-ST5034W		
F202		HK-ST2024W		
F352		HK-ST3524W		
F502		HK-ST5024W		
F702		HK-ST7024W		
0324	F202	HK-ST2024AW		
0328	0752	HK-ST7M2UW		
	F172	HK-ST172UW		
0341	F103	HK-RT103W		
	F153	HK-RT153W		
	F203	HK-RT203W		
	F353	HK-RT353W		
	F503	HK-RT503W		
	F703	HK-RT703W		
0342	F103	HK-RT1034W		
	F153	HK-RT1534W		
	F203	HK-RT2034W		
	F353	HK-RT3534W		
	F503	HK-RT5034W		
	F703	HK-RT7034W		

11.2 Selection example of rotary servo motor power cable

When cables are fabricated by the customer, wires should be selected in accordance with the application.

Point

Selection requirements for the wire size are as follows.

Wiring length: 30 m or less

As some cables do not fit in the optional or recommended cable clamp, select cable clamps applicable to the cable diameters.

Selection example when using the 600 V grade EP rubber insulated chloroprene sheath cab-tire cable (2PNCT) for rotary servo motor power (U/V/W) is indicated below.

Rotary servo motor	Wire size [mm ²]
HK-ST52W	1.25
HK-ST102W	1.25
HK-ST172W	2 *1
HK-ST202AW	2
HK-ST302W	2
HK-ST353W	3.5
HK-ST503W	3.5
HK-ST7M2UW	1.25
HK-ST172UW	1.25
HK-ST202W	2
HK-ST352W	3.5
HK-ST502W	8
HK-ST702W	8
HK-ST524W	1.25
HK-ST1024W	1.25
HK-ST1724W	1.25 *1
HK-ST2024AW	1.25
HK-ST3024W	1.25
HK-ST3534W	2
HK-ST5034W	2
HK-ST2024W	1.25
HK-ST3524W	2
HK-ST5024W	3.5
HK-ST7024W	3.5
HK-RT353W	3.5
HK-RT503W	5.5
HK-RT703W	5.5
HK-RT3534W	1.25
HK-RT5034W	2
HK-RT7034W	2

*1 Wires used for the geared servo motor HK-ST152_ are the same as those for the HK-ST172W.

Wires used for the geared servo motor HK-ST1524_ are the same as those for the HK-ST1724W.

11.3 Connector dimensions

The connector dimensions for wiring the rotary servo motor are shown below.

Rotary servo motor series		Type	Model	Manufacturer	Dimensions	
HK-KT series/HK-MT series/HK-RT (1.0 kW - 2.0 kW) series		Horizontal lead, dual cable	MT50W-8D/2D4ES-CVLD(7.5)	Hirose Electric	☞ Page 248 MT50W-8D/2D4ES-CVLD(7.5)	
		Horizontal lead, single cable	MT50W-8D/2D4ES-CVL(11.9)		☞ Page 248 MT50W-8D/2D4ES-CVL(11.9)	
		Vertical lead, dual cable	MT50W-8D/2D4ES-CVSD(7.5)		☞ Page 249 MT50W-8D/2D4ES-CVSD(7.5)	
		Vertical lead, single cable	MT50W-8D/2D4ES-CVS(11.9)		☞ Page 249 MT50W-8D/2D4ES-CVS(11.9)	
HK-ST series/ HK-RT (3.5 kW - 7.0 kW) series	For electromagnetic brake/encoder	One-touch connection, straight	CMV1-SP10S-M_/CMV1-SP2S-__	DDK	☞ Page 250 CMV1-SP10S-M_/CMV1-SP2S-__	
		One-touch connection, angle	CMV1-AP10S-M_/CMV1-AP2S-__		☞ Page 250 CMV1-AP10S-M_/CMV1-AP2S-__	
		Screw type, straight	CMV1S-SP10S-M_/CMV1S-SP2S-__		☞ Page 250 CMV1S-SP10S-M_/CMV1S-SP2S-__	
		Screw type, angle	CMV1S-AP10S-M_/CMV1S-AP2S-__		☞ Page 251 CMV1S-AP10S-M_/CMV1S-AP2S-__	
	For power supply	Plug connector	One-touch connection, straight	JL10-6A_-_SE-EB	JAE	☞ Page 251 JL10-6A_-_SE-EB
			One-touch connection, angle	JL10-8A_-_SE-EB		☞ Page 252 JL10-8A_-_SE-EB
			Screw type, straight	JL04V-6A_-_SE-EB-R		☞ Page 252 JL04V-6A_-_SE-EB-R
			Screw type, angle	JL04V-8A_-_SE-EBH-R		☞ Page 253 JL04V-8A_-_SE-EBH-R
	Cable clamp	—	JL04-_CK(_)-_R		☞ Page 253 JL04-_CK(_)-_R	

MT50W-8D/2D4ES-CVLD(7.5)

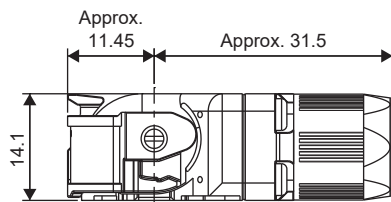
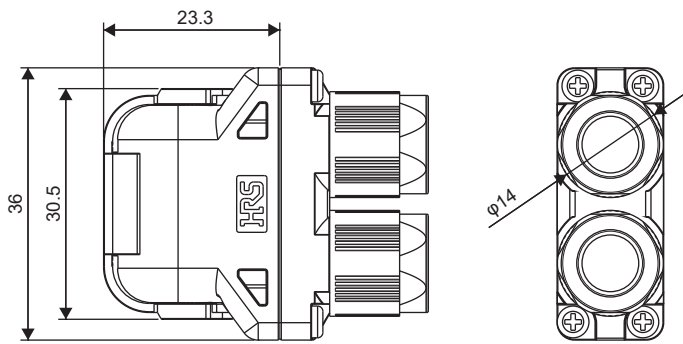

[Unit: mm]

MT50W-8D/2D4ES-CVL(11.9)

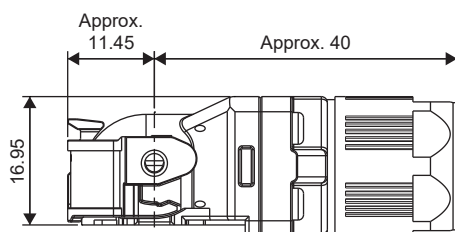
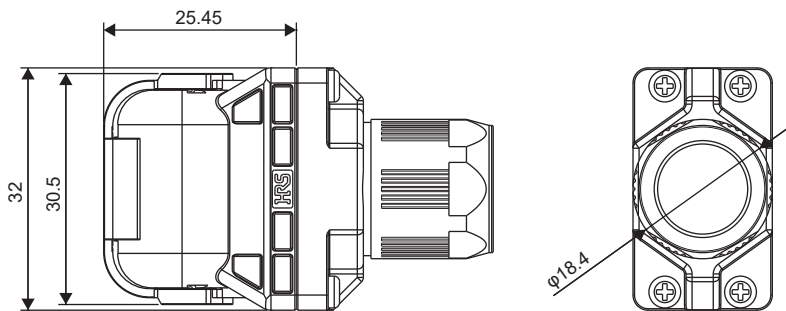

[Unit: mm]

MT50W-8D/2D4ES-CVSD(7.5)

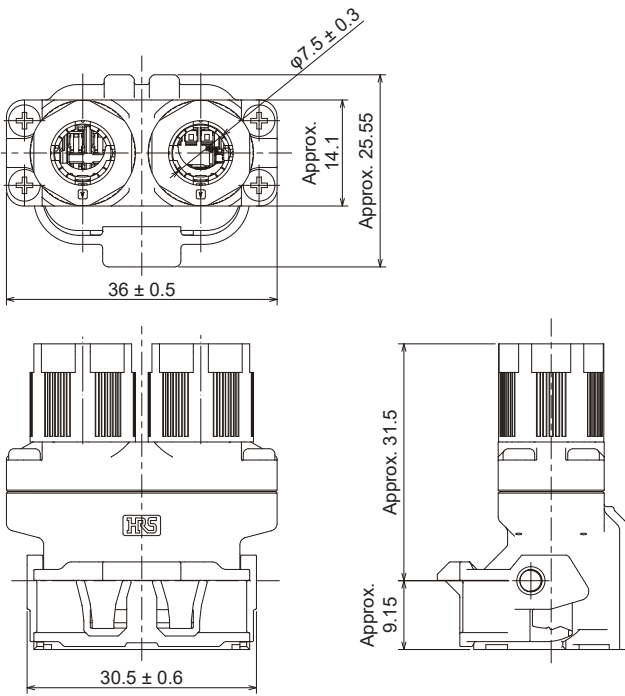

[Unit: mm]

MT50W-8D/2D4ES-CVS(11.9)

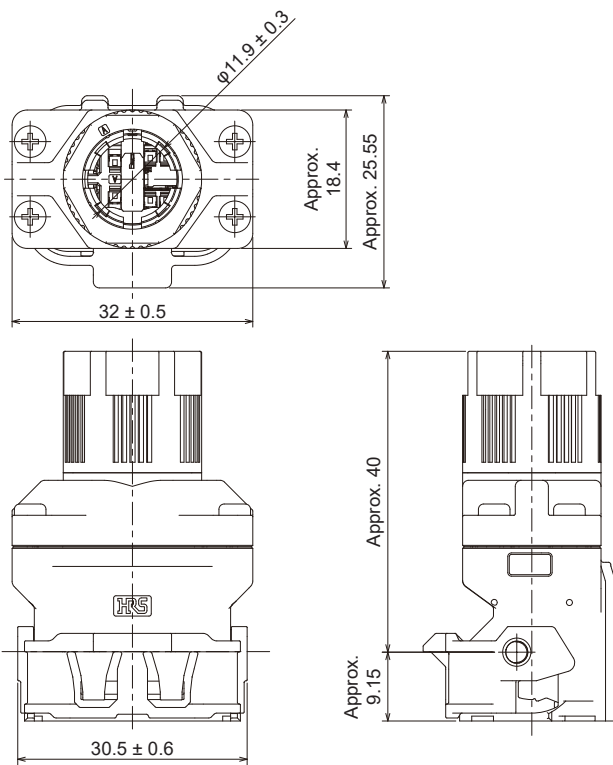

[Unit: mm]

CMV1-SP10S-M_/CMV1-SP2S-_ ---

Refer to the following for details of the crimping tool.

 Page 30 Wiring connectors (connector configurations B/C/D/E)

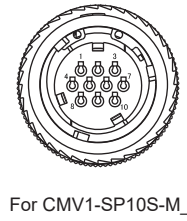
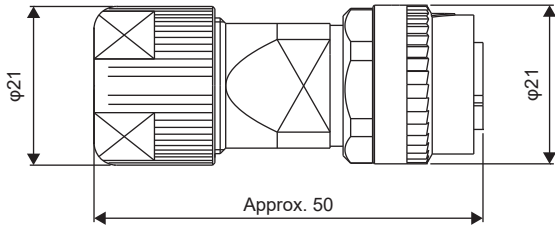

For CMV1-SP10S-M_

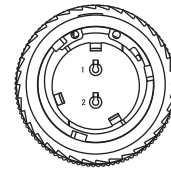

For CMV1-SP2S-_

[Unit: mm]

CMV1-AP10S-M_/CMV1-AP2S-_ ---

Refer to the following for details of the crimping tool.

 Page 30 Wiring connectors (connector configurations B/C/D/E)

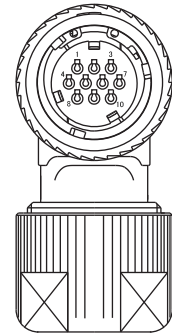
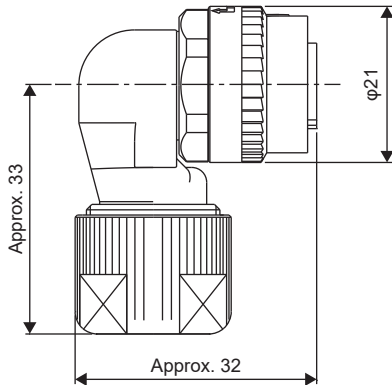

For CMV1-AP10S-M_

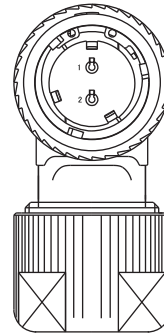

For CMV1-AP2S-_

[Unit: mm]

CMV1S-SP10S-M_/CMV1S-SP2S-_ ---

Refer to the following for details of the crimping tool.

 Page 30 Wiring connectors (connector configurations B/C/D/E)

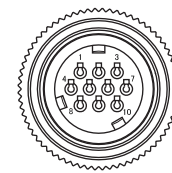
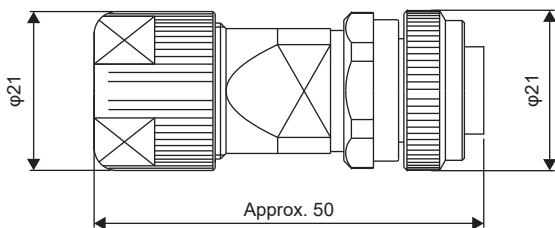

For CMV1S-SP10S-M_

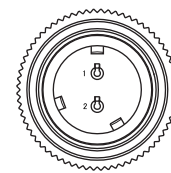

For CMV1S-SP2S-_

[Unit: mm]

CMV1S-AP10S-M_/CMV1S-AP2S-__

Refer to the following for details of the crimping tool.

 Page 30 Wiring connectors (connector configurations B/C/D/E)

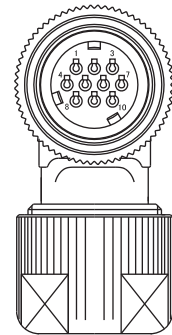
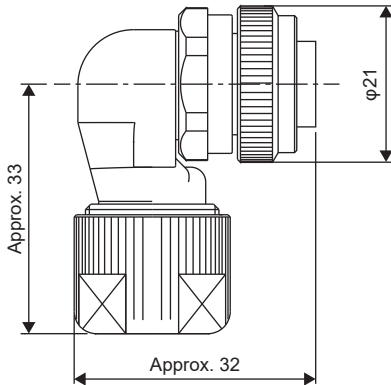

For CMV1S-AP10S-M_

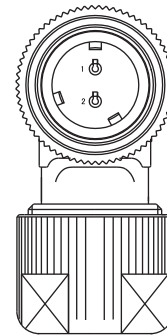

For CMV1S-AP2S-__

[Unit: mm]

JL10-6A_-SE-EB

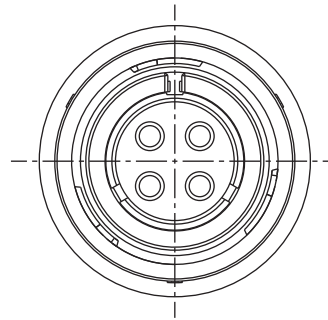
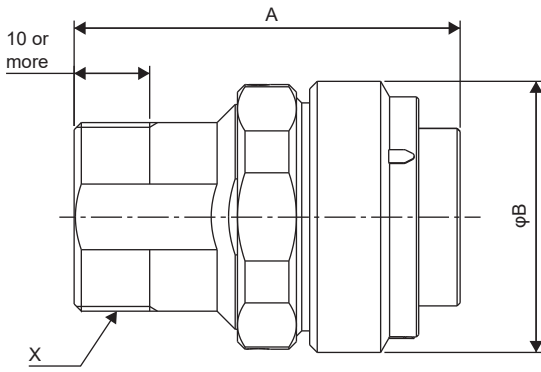

[Unit: mm]

Model	A	B	X
JL10-6A18-10SE-EB	51.05	35.85	1-20UNEF-2A
JL10-6A22-22SE-EB	58.65	42.2	1 3/16-18UNEF-2A

JL10-8A_-_SE-EB

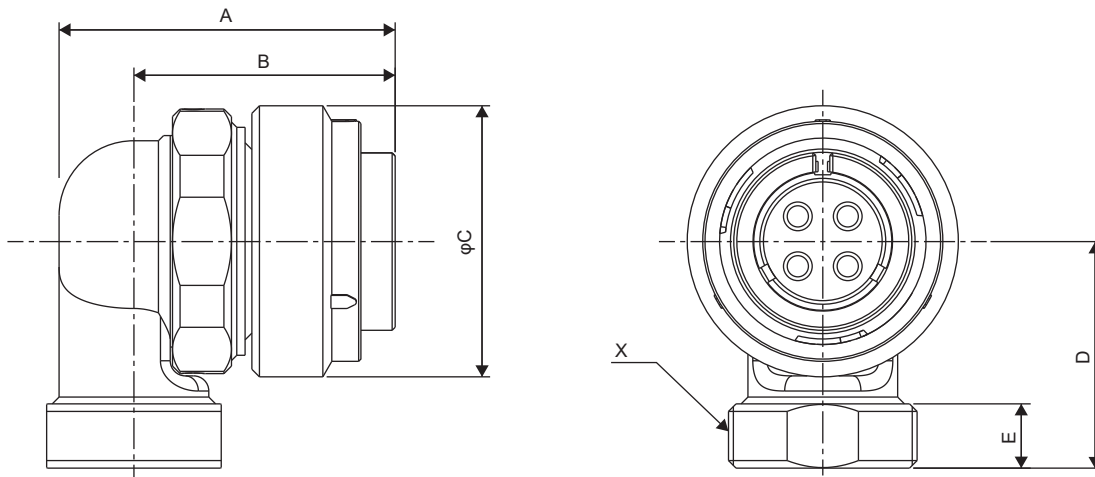

[Unit: mm]

Model	A	B	C	D	E	X
JL10-8A18-10SE-EB	44.45	34.55	35.85	30	8.5	1-20UNEF-2A
JL10-8A22-22SE-EB	51.85	40.65	42.2	37.4	10	1 3/16-18UNEF-2A

JL04V-6A_-_SE-EB-R

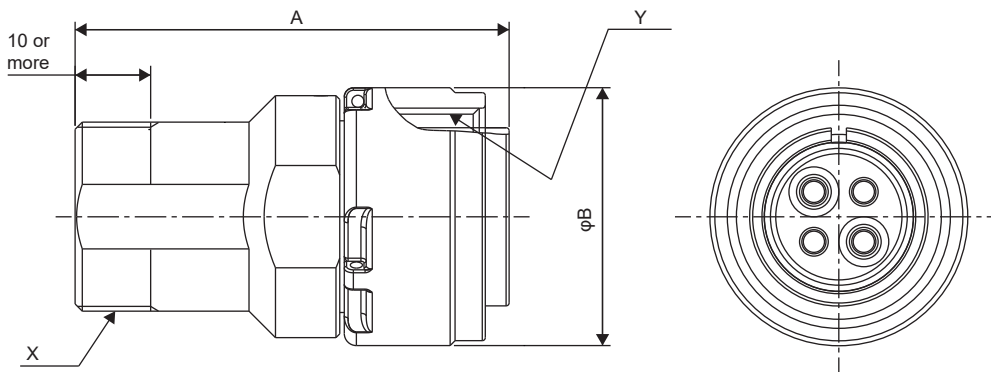

[Unit: mm]

Model	A	B	X	Y
JL04V-6A18-10SE-EB-R	57.4	34.1	1-20UNEF-2A	1 1/8-18UNEF-2B
JL04V-6A22-22SE-EB-R	67.63	40.5	1 3/16-18UNEF-2A	1 3/8-18UNEF-2B

JL04V-8A_-_SE-EBH-R

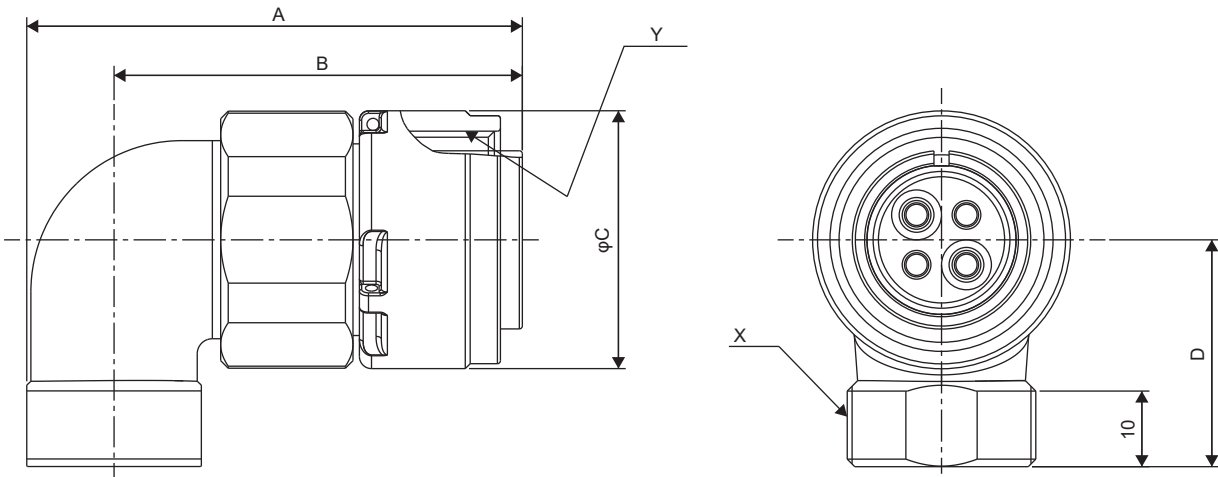

[Unit: mm]

Model	A	B	C	D	X	Y
JL04V-8A18-10SE-EBH-R	65.6	54	34.1	30	1-20UNEF-2A	1 1/8-18UNEF-2B
JL04V-8A22-22SE-EBH-R	73	59	40.5	32	1 3/16-18UNEF-2A	1 3/8-18UNEF-2B

JL04-_CK(_)-_-R

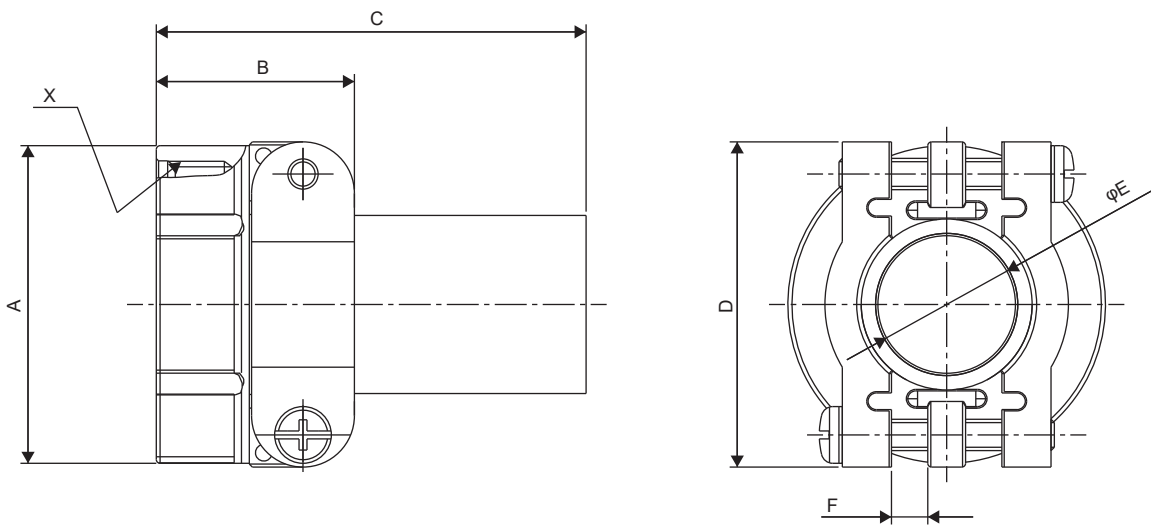

[Unit: mm]

Model	Shell size	A	B	C	D	E	F	X	Cable OD (reference)
JL04-18CK(10)-_-R	18	30.2	24.1	53.8	31.8	11	3.2	1-20UNEF-2B	φ8 to 11
14.1						φ11 to 14.1			
JL04-2022CK(12)-_-R	22	34.9	24.3	53.8	37.3	13	4	1 3/16-18UNEF-2B	φ9.5 to 13
JL04-2022CK(14)-_-R						16			φ12.9 to 16

11.4 Fabricating the encoder cable

Point

It is recommended to use options indicated in the following section for the encoder cable.

☞ Page 59 WIRING OPTION

When fabricating an encoder cable, use the recommended products described in the following chapters.

☞ Page 27 CONNECTORS USED FOR ROTARY SERVO MOTOR WIRING

☞ Page 34 CONNECTING THE SERVO AMPLIFIER AND ROTARY SERVO MOTOR

☞ Page 59 WIRING OPTION

When fabricating encoder cables, note the descriptions in this section, in order to ensure the reliability of communication. Fabricate cables with the following procedure.

1. Selection of connectors

- Check the cable clamp size.

☞ Page 27 CONNECTORS USED FOR ROTARY SERVO MOTOR WIRING

☞ Page 34 CONNECTING THE SERVO AMPLIFIER AND ROTARY SERVO MOTOR

- Obtain the specification, wiring guide for the connector, and other documents from the manufacturer.
- Purchase assembly jigs and similar parts as necessary.

2. Selection of cables

- Select a recommended wire described in chapter 5. For the MR-J3ENSCBL_M-_ (10 m or less), a recommended wire or equivalent wires can be used.
- Select a shielded cable.
- Select a cable with a diameter that can be clamped with the connector cable clamp.
- Select a cable whose length, diameter, and flex type are appropriate.

3. Assembly of the cable

- Check the wiring guide of the connector manufacturer, then connect the connector properly.
- Check internal wiring described in chapter 5 to connect it properly.
- Perform a shielding process on the encoder cable properly.
- Do not connect anything to unused pins.
- When wiring the CN2, CN2A, CN2B, and CN2C side connectors, connect the external conductor of the shielded cable to the ground plate and fix it to the connector shell.
- When wiring the connector on the rotary servo motor-side, connect the external conductor of the shielded cable to the SHD terminal.
- Check if the pin arrangement is correct.
- Connect the twisted pair cable using the correct combination.
- Check if the number of pairs of P5/LG wiring connected in parallel is correct.
- Fix the cable to the connector with a proper clamping torque.

4. Inspection

- After assembly, perform conduction, insulation, and other inspections to check if the connection is correct.
- Check the surface for scratches and contamination.
- Check the connector pins for distortions, bending, dents, and other problems.
- Check the connector pins for foreign matter adhesion, contamination, and discoloration.

5. Complete

11.5 Gear reducer model designation

Check the rating plate of the gear reducer for the gear reducer model.

HK-KT_G1

Gear reducer model designation

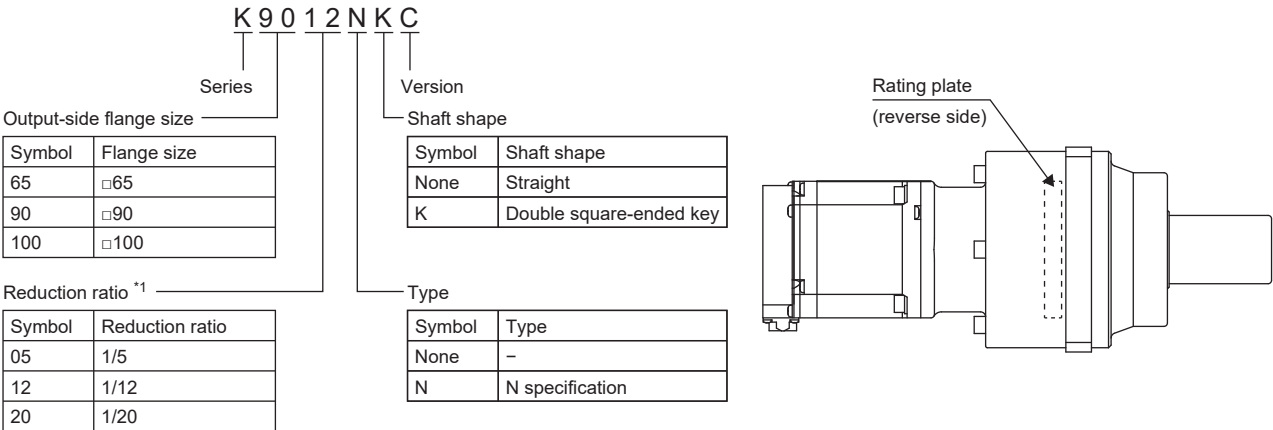

*1 The reduction ratio is different from the actual reduction ratio. Refer to the following for the actual reduction ratio.

☞ Page 128 Exclusive specifications

HK-KT_G5/G7

Gear reducer model designation

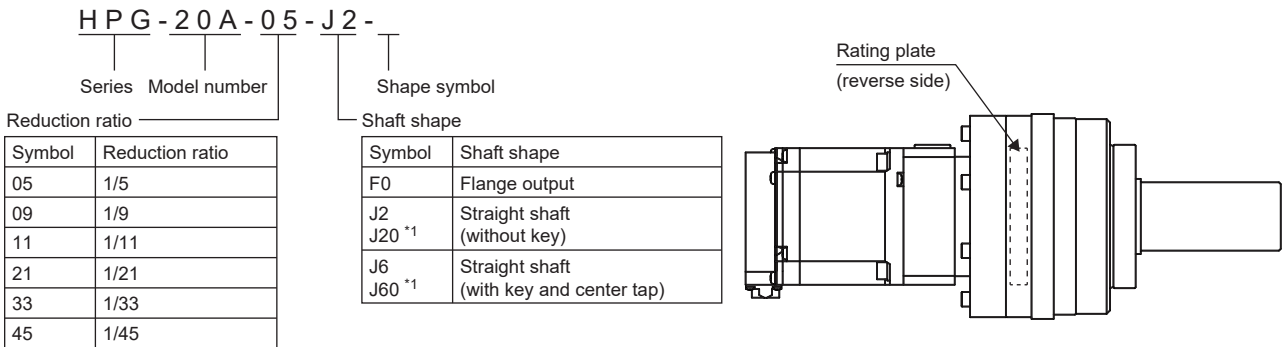

*1 Only for the gear reducer model 11B

HK-ST_G1/G1H

Gear reducer model designation

For the reduction ratio, check the item "RATIO" on the gear reducer rating plate. For details of the items indicated on the gear reducer rating plate, refer to "Cyclo® 6000" of Sumitomo Heavy Industries, Ltd.

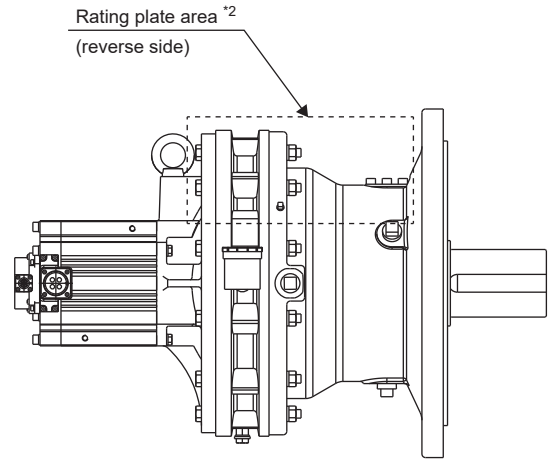
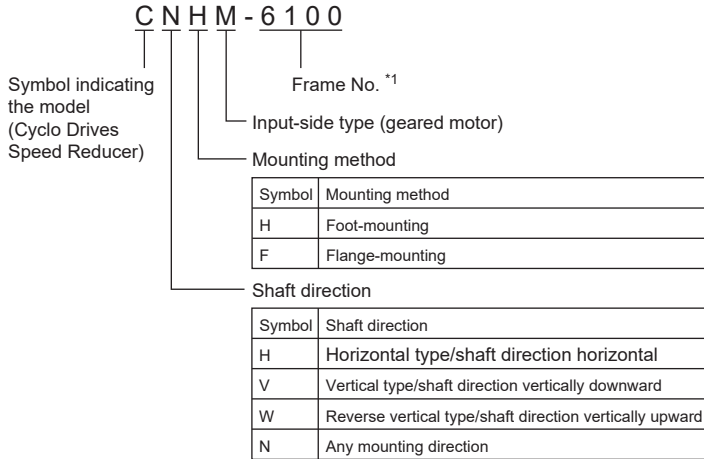

*1 Refer to the following for the frame No.

Page 190 Exclusive specifications

*2 The area where the gear reducer rating plate is attached to varies depending on the model.

HK-ST_G5/G7

Gear reducer model designation

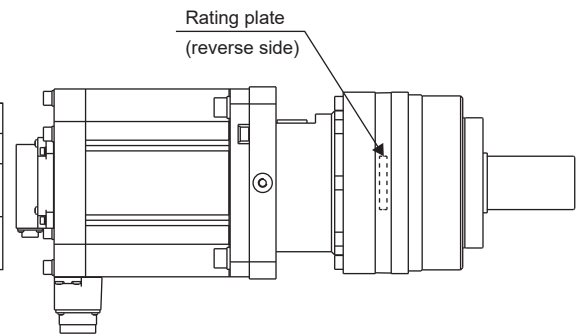
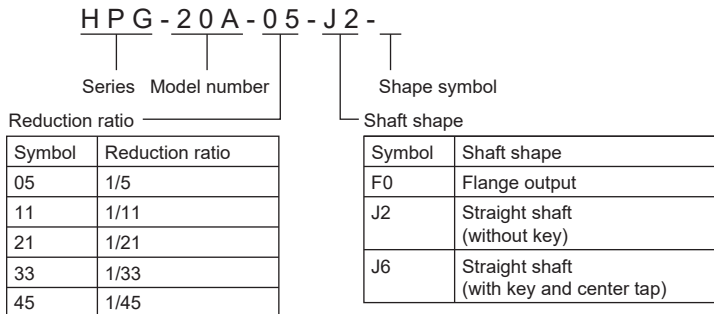

REVISIONS

*The manual number is given on the bottom left of the back cover.

Revision date	*Manual number	Description
July 2019	SH(NA)-030314ENG-A	First edition
February 2020	SH(NA)-030314ENG-B	<ul style="list-style-type: none"> ■The graphs of overload protection characteristics are deleted. ■Edited Section 6.2, Section 7.2
July 2020	SH(NA)-030314ENG-C	<ul style="list-style-type: none"> ■The following motors are added: HK-ST152, HK-ST502W, HK-ST702W ■The following cables are added: MR-AEPB2CBL2M-A5-_, MR-AEPB2CBL5M-A5-_, MR-AEPB2CBL10M-A5-_, MR-AEP2CBL2M-A5-_, MR-AEP2CBL5M-A5-_, MR-AEP2CBL10M-A5-_, MR-AEPB2J10CBL03MA5-_, MR-AEP2J10CBL03MA5-_, MR-AEPB2J20CBL03MA5-_, MR-AEP2J20CBL03MA5-_, MR-AEPB1CBL2M-A5-_, MR-AEPB1CBL5M-A5-_, MR-AEPB1CBL10M-A5-_, MR-AEP1CBL2M-A5-_, MR-AEP1CBL5M-A5-_, MR-AEP1CBL10M-A5-_ ■Geared servo motors are added. ■Items of functional safety are added. ■Combinations with servo amplifiers and motors are deleted. ■Edited Section 2.8, Section 2.11, Section 3.1, Section 3.2, Section 4.2, Section 4.3, Section 5.1, Section 5.2, Section 5.4, Section 6.1, Section 6.8, Section 6.9, Section 7.1, Section 7.4, Section 7.5, Section 7.6, Section 7.9, Section 8.2, Section 9.1, Section 9.2, Section 9.4 ■Added Section 5.5, Section 6.7, Section 7.7 ■Deleted Section 6.3, Section 7.3
November 2020	SH(NA)-030314ENG-D	<ul style="list-style-type: none"> ■HK-RT series servo motors are added. ■Instances where a 400 V class servo amplifier is connected are added. ■Edited Section 1.2, Section 1.3, Section 1.4, Section 1.7, Section 2.1, Section 2.11, Chapter 3, Section 3.1, Chapter 4, Section 4.2, Section 4.3, Section 5.1, Section 5.5, Section 6.1, Section 6.7, Section 7.1, Section 7.6, Chapter 9, Section 9.2, Chapter 10, Section 10.1, Section 10.2, Section 10.3 ■Added: Chapter 8
March 2021	SH(NA)-030314ENG-E	<ul style="list-style-type: none"> ■The torque characteristics of HK-ST series servo motors are added. ■Description of when connected with 400 V servo amplifier for HK-ST_4_ is added. ■Edited Section 4.2, Section 6.2, Section 6.7, Chapter 7, Section 7.2, Section 7.7, Section 7.8, Section 8.2 ■Added Section 6.1, Section 7.1, Section 8.1 ■Deleted Section 1.1
June 2021	SH(NA)-030314ENG-F	<ul style="list-style-type: none"> ■HK-MT series servo motors are added. ■Instances where an MR-J5D-_G servo amplifier is connected are added. ■The mass of the following servo motors are changed. HK-KT, HK-ST ■Edited Section 1.1, Section 1.2, Section 1.3, Section 1.6, Section 2.1, Section 2.11, Chapter 3, Section 3.1, Chapter 4, Section 4.2, Section 4.3, Section 5.1, Section 5.2, Section 5.3, Section 6.1, Section 6.2, Section 6.3, Section 6.4, Section 6.5, Section 6.6, Section 6.9, Section 8.2, Section 8.5, Section 8.6, Section 8.9, Chapter 9, Section 9.2, Section 10.2, Section 11.1, Section 11.2, Section 11.3 ■Added Chapter 7

Revision date	*Manual number	Description
August 2022	SH(NA)-030314ENG-G	<ul style="list-style-type: none"> ■Complied with UKCA ■The description that the HK-MT series servo motors will be available in the near future is deleted. ■Information on special specifications is added to the model designation for the HK-MT series servo motors. ■The following servo motors are added: HK-ST7M2UW, HK-ST172UW ■Edited Section 1.1, Chapter 3, Section 6.2, Section 7.1, Section 7.2, Section 7.5, Section 7.7, Section 8.2, Section 8.7, Section 8.8, Section 8.9, Section 9.2, Section 9.7, Section 10.1, Section 11.1, Section 11.3
January 2023	SH(NA)-030314ENG-H	<ul style="list-style-type: none"> ■The unlocking jig is added. ■Edited Chapter 3, Section 4.3, Section 5.1, Section 6.7, Section 6.8, Section 8.7, Section 11.1, Section 11.2
July 2023	SH(NA)-030314ENG-J	<ul style="list-style-type: none"> ■Release information of the HK-ST_UW servo motor is deleted. ■Edited: Section 1.2, Section 2.11, Section 3.1, Section 4.2, Section 4.3, Section 6.7, Chapter 8, Section 8.2, Section 8.7, Section 8.9, Section 10.2, Chapter 11

This manual confers no industrial property rights or any rights of any other kind, nor does it confer any patent licenses. Mitsubishi Electric Corporation cannot be held responsible for any problems involving industrial property rights which may occur as a result of using the contents noted in this manual.

© 2019 MITSUBISHI ELECTRIC CORPORATION

WARRANTY

Warranty

1. Warranty period and coverage

We will repair any failure or defect hereinafter referred to as "failure" in our FA equipment hereinafter referred to as the "Product" arisen during warranty period at no charge due to causes for which we are responsible through the distributor from which you purchased the Product or our service provider. However, we will charge the actual cost of dispatching our engineer for an on-site repair work on request by customer in Japan or overseas countries. We are not responsible for any on-site readjustment and/or trial run that may be required after a defective unit are repaired or replaced.

[Term]

For terms of warranty, please contact your original place of purchase.

[Limitations]

- (1) You are requested to conduct an initial failure diagnosis by yourself, as a general rule.

It can also be carried out by us or our service company upon your request and the actual cost will be charged. However, it will not be charged if we are responsible for the cause of the failure.

- (2) This limited warranty applies only when the condition, method, environment, etc. of use are in compliance with the terms and conditions and instructions that are set forth in the instruction manual and user manual for the Product and the caution label affixed to the Product.
- (3) Even during the term of warranty, the repair cost will be charged on you in the following cases;
1. a failure caused by your improper storing or handling, carelessness or negligence, etc., and a failure caused by your hardware or software problem
 2. a failure caused by any alteration, etc. to the Product made on your side without our approval
 3. a failure which may be regarded as avoidable, if your equipment in which the Product is incorporated is equipped with a safety device required by applicable laws and has any function or structure considered to be indispensable according to a common sense in the industry
 4. a failure which may be regarded as avoidable if consumable parts designated in the instruction manual, etc. are duly maintained and replaced
 5. any replacement of consumable parts (battery, fan, smoothing capacitor, etc.)
 6. a failure caused by external factors such as inevitable accidents, including without limitation fire and abnormal fluctuation of voltage, and acts of God, including without limitation earthquake, lightning and natural disasters
 7. a failure generated by an unforeseeable cause with a scientific technology that was not available at the time of the shipment of the Product from our company
 8. any other failures which we are not responsible for or which you acknowledge we are not responsible for

2. Term of warranty after the stop of production

- (1) We may accept the repair at charge for another seven (7) years after the production of the product is discontinued. The announcement of the stop of production for each model can be seen in our Sales and Service, etc.
- (2) Please note that the Product (including its spare parts) cannot be ordered after its stop of production.

3. Service in overseas countries

Our regional FA Center in overseas countries will accept the repair work of the Product. However, the terms and conditions of the repair work may differ depending on each FA Center. Please ask your local FA center for details.

4. Exclusion of loss in opportunity and secondary loss from warranty liability

Regardless of the gratis warranty term, Mitsubishi shall not be liable for compensation to:

- (1) Damages caused by any cause found not to be the responsibility of Mitsubishi.
- (2) Loss in opportunity, lost profits incurred to the user by Failures of Mitsubishi products.
- (3) Special damages and secondary damages whether foreseeable or not, compensation for accidents, and compensation for damages to products other than Mitsubishi products.
- (4) Replacement by the user, maintenance of on-site equipment, start-up test run and other tasks.

5. Change of Product specifications

Specifications listed in our catalogs, manuals or technical documents may be changed without notice.

6. Application and use of the Product

- (1) For the use of our AC Servo, its applications should be those that may not result in a serious damage even if any failure or malfunction occurs in AC Servo, and a backup or fail-safe function should operate on an external system to AC Servo when any failure or malfunction occurs.
- (2) Our AC Servo is designed and manufactured as a general purpose product for use at general industries. Therefore, applications substantially influential on the public interest for such as atomic power plants and other power plants of electric power companies, and also which require a special quality assurance system, including applications for railway companies and government or public offices are not recommended, and we assume no responsibility for any failure caused by these applications when used.
- In addition, applications which may be substantially influential to human lives or properties for such as airlines, medical treatments, railway service, incineration and fuel systems, man-operated material handling equipment, entertainment machines, safety machines, etc. are not recommended, and we assume no responsibility for any failure caused by these applications when used. We will review the acceptability of the abovementioned applications, if you agree not to require a specific quality for a specific application. Please contact us for consultation.
- (3) Mitsubishi Electric shall have no responsibility or liability for any problems involving programmable controller trouble and system trouble caused by DoS attacks, unauthorized access, computer viruses, and other cyberattacks.

TRADEMARKS

MELSERVO is a trademark or registered trademark of Mitsubishi Electric Corporation in Japan and/or other countries. All other product names and company names are trademarks or registered trademarks of their respective companies.

SH(NA)-030314ENG-J(2307)MEE

MODEL:

MODEL CODE:

MITSUBISHI ELECTRIC CORPORATION

HEAD OFFICE: TOKYO BLDG., 2-7-3, MARUNOUCHI, CHIYODA-KU, TOKYO 100-8310, JAPAN
NAGOYA WORKS: 1-14, YADA-MINAMI 5-CHOME, HIGASHI-KU, NAGOYA 461-8670, JAPAN

When exported from Japan, this manual does not require application to the
Ministry of Economy, Trade and Industry for service transaction permission.

Specifications subject to change without notice.

Compliance with the indicated global standards and regulations is current as of the release date of this manual.