



## GT2506HS-VTBD

### GT25 Handy GOT General Description

<b>GRAPHIC OPERATION TERMINAL</b> <b>GOT2000</b>	Manual Number	JY997D72901H
	Date	Dec. 2022

This manual describes the part names, dimensions, mounting, and specifications of the product. Before use, read this manual and manuals of relevant products fully to acquire proficiency in handling and operating the product. Make sure to learn all the product information, safety information, and precautions.

And, store this manual in a safe place so that you can take it out and read it whenever necessary. Always forward it to the end user.

Registration  
Ethernet is a trademark of Xerox Corporation in the United States. VNC is a registered trademark of RealVNC Ltd. in the United States and other countries. MODBUS is a trademark of Schneider Electric SA. The company name and the product name to be described in this manual are the registered trademarks or trademarks of each company.

Effective Dec. 2022  
Specifications are subject to change without notice.  
© 2017 MITSUBISHI ELECTRIC CORPORATION

#### Safety Precaution (Read these precautions before using.)

Before using this product, please read this manual and the relevant manuals introduced in this manual carefully and pay full attention to safety to handle the product correctly.

The precautions given in this manual are concerned with this product. In this manual, the safety precautions are ranked as "WARNING" and "CAUTION".

**WARNING** Indicates that incorrect handling may cause hazardous conditions, resulting in death or severe injury.

**CAUTION** Indicates that incorrect handling may cause hazardous conditions, resulting in medium or slight personal injury or physical damage.

Depending on circumstances, procedures indicated by "CAUTION" may also be linked to serious results. In any case, it is important to follow the directions for usage.

<b>DESIGN PRECAUTIONS</b>	<b>WARNING</b>
<ul style="list-style-type: none"> <li>Some failures of the GOT or cable may keep the outputs on or off. Some failures of a touch panel may cause malfunction of the input objects such as a touch switch. An external monitoring circuit should be provided to check for output signals which may lead to a serious accident. Not doing so can cause an accident due to false output or malfunction.</li> <li>Do not use the GOT as the warning device that may cause a serious accident. An independent and redundant hardware or mechanical interlock is required to configure the device that displays and outputs serious warning. Not doing so can cause an accident due to false output or malfunction.</li> <li>The GOT backlight failure disables the operation on the touch switch(s). When the GOT backlight has a failure, the POWER LED blinks (orange/blue) and the display section dims. In such a case, the input by the touch switch(s) is disabled.</li> <li>The display section of the GOT is an analog-resistive type touch panel. Simultaneous pressing of two or more areas on the display section may activate the switch between those areas. Do not press two or more areas simultaneously on the display section. Doing so may cause an accident due to incorrect output or malfunction.</li> <li>When programs or parameters of the controller (such as a PLC) that is monitored by the GOT are changed, be sure to shut off the power of the GOT promptly and power on the GOT again. Not doing so can cause an accident due to false output or malfunction.</li> </ul>	

<b>DESIGN PRECAUTIONS</b>	<b>WARNING</b>
<ul style="list-style-type: none"> <li>If a communication fault (including cable disconnection) occurs during monitoring on the GOT, communication between the GOT and PLC CPU is suspended and the GOT becomes inoperative. A system where the GOT is used should be configured to perform any significant operation to the system by using the switches of a device other than the GOT on the assumption that a GOT communication fault will occur. Not doing so can cause an accident due to false output or malfunction.</li> <li>To maintain the security (confidentiality, integrity, and availability) of the GOT and the system against unauthorized access, DoS<sup>*1</sup> attacks, computer viruses, and other cyberattacks from unreliable networks and devices via network, take appropriate measures such as firewalls, virtual private networks (VPNs), and antivirus solutions. Mitsubishi Electric shall have no responsibility or liability for any problems involving GOT trouble and system trouble by unauthorized access, DoS attacks, computer viruses, and other cyberattacks. <sup>*1</sup> DoS: A denial-of-service (DoS) attack disrupts services by overloading systems or exploiting vulnerabilities, resulting in a denial-of-service (DoS) state.</li> </ul>	

<b>DESIGN PRECAUTIONS</b>	<b>CAUTION</b>
<ul style="list-style-type: none"> <li>Do not bundle the control and communication cables with main-circuit, power or other wiring. Run the above cables separately from such wiring and keep them a minimum of 100 mm apart. Not doing so noise can cause a malfunction.</li> <li>Do not press the GOT display section with a pointed material as a pen or driver. Doing so can result in a damage or failure of the display section.</li> <li>Turn on the controllers and the network devices to be ready for communication before they communicate with the GOT. Failure to do so can cause a communication error on the GOT.</li> <li>When the GOT is subject to shock or vibration, or some colors appear on the screen of the GOT, the screen of the GOT might flicker.</li> <li>When the GOT is connected to the Ethernet network, the available IP address is restricted according to the system configuration.</li> <li>When the GOT is connected to the Ethernet network, the available IP address is restricted according to the system configuration. When a GOT2000 series model and a GOT1000 series model are on an Ethernet network, do not set the IP address 192.168.0.18 for the GOTs and the controllers on this network. Doing so can cause IP address duplication at the GOT startup, adversely affecting the communication of the device with the IP address 192.168.0.18. The operation at the IP address duplication depends on the devices and the system.</li> </ul>	

<b>MOUNTING PRECAUTIONS</b>	<b>WARNING</b>
<ul style="list-style-type: none"> <li>Be sure to shut off all phases of the external power supply used by the system before mounting or removing the GOT main unit to/from the panel. Not doing so can cause the unit to fail or malfunction.</li> <li>Always turn off the power ON/OFF switch on the connector conversion box (GT16H-CNB-42S) before connecting or disconnecting the GOT to it. Connecting or disconnecting the GOT with the power being turned on may result in damage to the unit or malfunctions.</li> </ul>	

<b>MOUNTING PRECAUTIONS</b>	<b>CAUTION</b>
<ul style="list-style-type: none"> <li>Use the GOT in the environment that satisfies the general specifications described in this manual. Not doing so can cause an electric shock, fire, malfunction or product damage or deterioration.</li> <li>Remove the protective film of the GOT. When the user continues using the GOT with the protective film, the film may not be removed.</li> <li>Operate and store the GOT in environments without direct sunlight, high temperature, dust, humidity, and vibrations.</li> <li>Do not use the GOT in an environment with oil or chemicals. Doing so may cause failure or malfunction due to the oil or chemical entering into the GOT.</li> </ul>	

<b>WIRING PRECAUTIONS</b>	<b>WARNING</b>
<ul style="list-style-type: none"> <li>Make sure to attach the back cover to the Handy GOT before turning on the power and starting operation after the installation or wiring work. Otherwise, electrical shock may be caused.</li> <li>Be sure to shut off all phases of the external power supply used by the system before wiring. Failure to do so may result in an electric shock, product damage or malfunctions.</li> <li>Use a DC power supply for this product. The power supply in the specified range must be applied for the power supply, the operation switch, and the emergency stop switch. If they are connected to the power supply of the different specification, it may cause a fire or failure.</li> </ul>	

<b>WIRING PRECAUTIONS</b>	<b>CAUTION</b>
<ul style="list-style-type: none"> <li>Connect connection cables securely to the specified connectors while the power is turned OFF. Imperfect connection may cause malfunction or failure.</li> <li>Please make sure to ground FG terminal of the GOT power supply section by applying 100 Ω or less which is used exclusively for the GOT. Not doing so may cause an electric shock or malfunction.</li> <li>Exercise care to avoid foreign matter such as chips and wire cutoffs entering the GOT. Not doing so can cause a fire, failure or malfunction.</li> </ul>	

<b>WIRING PRECAUTIONS</b>	<b>CAUTION</b>
<ul style="list-style-type: none"> <li>Plug the communication cable into the GOT interface or the connector of the connected unit, and tighten the mounting screws and the terminal screws in the specified torque range. Undertightening can cause a short circuit or malfunction. Overtightening can cause a short circuit or malfunction due to the damage of the screws or unit.</li> </ul>	

<b>TEST OPERATION PRECAUTIONS</b>	<b>WARNING</b>
<ul style="list-style-type: none"> <li>Before performing the test operations of the user creation monitor screen (such as turning ON or OFF bit device, changing the word device current value, changing the settings or current values of the timer or counter, and changing the buffer memory current value), read through the manual carefully and make yourself familiar with the operation method. During test operation, never change the data of the devices which are used to perform significant operation for the system. False output or malfunction can cause an accident.</li> </ul>	

<b>STARTUP/MAINTENANCE PRECAUTIONS</b>	<b>WARNING</b>
<ul style="list-style-type: none"> <li>When power is on, do not touch the terminals. Doing so can cause an electric shock or malfunction.</li> <li>Connect the battery correctly. Do not discharge, disassemble, heat, short, solder or throw the battery into the fire. Incorrect handling may cause the battery to generate heat, burst or take fire, resulting in injuries or fires.</li> <li>Before starting cleaning or terminal screw retightening, always switch off the power externally in all phases. Not doing so can cause the unit to fail or malfunction. Undertightening can cause a short circuit or malfunction. Overtightening can cause a short circuit or malfunction due to the damage of the screws or unit.</li> </ul>	

<b>STARTUP/MAINTENANCE PRECAUTIONS</b>	<b>CAUTION</b>
<ul style="list-style-type: none"> <li>Do not disassemble or modify the unit. Doing so can cause a failure, malfunction, injury or fire.</li> <li>Do not touch the conductive and electronic parts of the unit directly. Doing so can cause a unit malfunction or failure.</li> <li>Do not drop or give an impact to the battery mounted to the unit. Dispose of the battery without using when it is dropped or given an impact, because it may be damaged.</li> <li>The cables connected to the unit must be run in ducts or clamped. Not doing so can cause the unit or cable to be damaged due to the dangling, motion or accidental pulling of the cables or can cause a malfunction due to a cable connection fault.</li> <li>When unplugging the cable connected to the unit, do not hold and pull from the cable portion. Doing so can cause the unit or cable to be damaged or can cause a malfunction due to a cable connection fault.</li> <li>Do not drop the module or subject it to strong shock. A module damage may result.</li> <li>Before touching the unit, always touch grounded metals, etc. to discharge static electricity from human body, etc. Not doing so can cause the unit to fail or malfunction.</li> <li>Replace battery with GT15-BAT by Mitsubishi electric Co. only. Use of another battery may present a risk of fire or explosion.</li> <li>Dispose of used battery promptly. Keep away from children. Do not disassemble and do not dispose of in fire.</li> </ul>	

<b>TOUCH PANEL PRECAUTIONS</b>	<b>CAUTION</b>
<ul style="list-style-type: none"> <li>For the analog-resistive film type touch panels, normally the adjustment is not required. However, the difference between a touched position and the object position may occur as the period of use elapses. When any difference between a touched position and the object position occurs, execute the touch panel calibration.</li> <li>When any difference between a touched position and the object position occurs, other object may be activated. This may cause an unexpected operation due to incorrect output or malfunction.</li> </ul>	

<b>PRECAUTIONS WHEN THE DATA STORAGE IS IN USE</b>	<b>WARNING</b>
<ul style="list-style-type: none"> <li>If the SD card mounted on drive A of the GOT is removed while the GOT is accessed, processing for the GOT might be interrupted about for 20 seconds. The GOT cannot be operated during this period. The functions that run in the background including a screen updating, alarm, logging, scripts, and others are also interrupted. Since this interruption makes an impact to the system operation, it might cause failure. After inhibiting access to the SD card on the GOT utility screen, check that the SD card access LED is off and remove the SD card.</li> </ul>	

<b>PRECAUTIONS WHEN THE DATA STORAGE IS IN USE</b>	<b>CAUTION</b>
<ul style="list-style-type: none"> <li>If the data storage mounted on the GOT is removed while the GOT is accessed, the data storage and files are damaged. To remove the data storage from the GOT, check that the access to the data storage in SD card access LED, the system signal, and others is not performed.</li> <li>Turning off the GOT while it accesses the SD card results in damage to the SD card and files.</li> <li>When removing the SD card from the GOT, make sure to support the SD card by hand as it may pop out. Failure to do so may cause the SD card to drop from the GOT, resulting in a failure or break.</li> <li>When installing a USB memory to the GOT, make sure to install the USB memory to the USB interface firmly. Failure to do so may cause a malfunction due to poor contact.</li> <li>Before removing the USB device from the GOT, follow the procedure for removal on the utility screen of the GOT. After the successful completion dialog is displayed, remove the USB device by hand carefully. Failure to do so may cause the USB device to drop from the GOT, resulting in a failure or break.</li> </ul>	

<b>PRECAUTIONS FOR REMOTE CONTROL</b>	<b>WARNING</b>
<ul style="list-style-type: none"> <li>Remote control is available through a network by using GOT functions, including the SoftGOT-GOT link function, the remote personal computer operation function, the VNC server function, and the GOT Mobile function. If these functions are used to perform remote control of control equipment, the field operator may not notice the remote control, possibly leading to an accident. In addition, a communication delay or interruption may occur depending on the network environment, and remote control of control equipment cannot be performed normally in some cases. Before using the above functions to perform remote control, fully grasp the circumstances of the field site and ensure safety.</li> </ul>	

<b>PRECAUTIONS FOR EXCLUSIVE AUTHORIZATION CONTROL</b>	<b>WARNING</b>
<ul style="list-style-type: none"> <li>Make sure to fully understand the GOT network interaction function before using this function to control the authorization among pieces of equipment to prevent simultaneous operations. The exclusive authorization control of the GOT network interaction function can be enabled or disabled for each screen. (For all screens, the exclusive authorization control is disabled by default.) Properly determine the screens for which the exclusive authorization control is required, and set the control by screen. A screen for which the exclusive authorization control is disabled can be operated simultaneously from pieces of equipment. Make sure to determine the operation period for each operator, fully grasp the circumstances of the field site, and ensure safety to perform operations.</li> </ul>	

<b>DISPOSAL PRECAUTIONS</b>	<b>CAUTION</b>
<ul style="list-style-type: none"> <li>When disposing of this product, treat it as industrial waste.</li> <li>When disposing of batteries, separate them from other wastes according to the local regulations. (Refer to the GOT2000 Series User's Manual for details of the battery directive in the EU member states.)</li> </ul>	

**TRANSPORTATION PRECAUTIONS** **CAUTION**

- When transporting lithium batteries, make sure to treat them based on the transport regulations. (Refer to the GOT2000 Series User's Manual (Hardware) for details of the regulated models.)
- Make sure to transport the GOT main unit and/or relevant unit(s) in the manner they will not be exposed to the impact exceeding the impact resistance described in the general specifications of this manual, as they are precision devices. Failure to do so may cause the unit to fail. Check if the unit operates correctly after transportation.
- When fumigants that contain halogen materials such as fluorine, chlorine, bromine, and iodine are used for disinfecting and protecting wooden packaging from insects, they cause malfunction when entering our products. Please take necessary precautions to ensure that remaining materials from fumigant do not enter our products, or treat packaging with methods other than fumigation (heat method). Additionally, disinfect and protect wood from insects before packing products.
- Before transporting the GOT, turn the GOT power on and check that the battery voltage status is normal on the Time setting & display screen (Utilities screen). In addition, confirm that the adequate battery life remains on the rating plate. Transporting the GOT with the low battery voltage or the battery the reached battery life may destabilize the backup data unstable during transportation.
- When transporting lithium batteries, make sure to treat them based on the transport regulations. (Refer to the GOT2000 Series User Manual (Hardware) for details of the regulated models.)

**Certification of UL, cUL standards**

UL, cUL Standards are recognized in use by the following combination.

- GT2506HS-VTBD
- GT16H-CNB-42S (Hardware version D or later)
- External cable (GT16H-C30-42P, GT16H-C60-42P, GT16H-C100-42P)
- GT16H-CNB-37S
- External cable (GT16H-C30-37PE, GT16H-C60-37PE, GT16H-C100-37PE)

**General notes on power supply**

This equipment must be supplied by a UL Listed or Recognized 24 V dc rated power supply and UL Listed or Recognized fuse rated not higher than 4A, or a UL Listed Class 2 power supply.

**Compliance with EC directive (CE Marking)**

This note does not guarantee that an entire mechanical module produced in accordance with the contents of this note will comply with the following standards. Compliance to EMC directive for the entire mechanical module should be checked by the user/manufacturer. For more details please contact the local Mitsubishi Electric sales site.

**Notification of CE marking**

The following products have shown compliance through direct testing (to the identified standards) and design analysis (forming a technical construction file) to the European Directive for Electromagnetic Compatibility (2014/30/EU) when used as directed by the appropriate documentation.

- This product is designed for use in industrial applications
  - Type: Graphic operation terminal
  - Models: GOT2000 series

Standard	Remark
EN61131-2: 2007 Programmable controllers - Equipment, requirements and tests	EMI Compliance with all relevant aspects of the standard. (Radiated Emissions)
	EMS Compliance with all relevant aspects of the standard. (ESD, RF electromagnetic field, EFTB, Surge, RF conducted disturbances and Power frequency magnetic field)

For more details please contact your local Mitsubishi Electric sales site.

For details of CE marking, refer to the following.

→GOT2000 Series User's Manual (Hardware)

**Compliant with the UKCA marking**

Requirements for compliance with the UKCA marking are the same with the EC Directives (CE marking).

**Notes for compliance to EMC regulation**

1) General notes on the control panel

Make sure to combine the GT25 Handy GOT with the Connector Conversion Box to comply with the EMC directive. The Connector Conversion Box is an open type device (device installed to another device) and must be installed in a conductive control panel.

2) General notes on the use of communication cables

Any device which utilizes a data communication function is susceptible to the wider effects of local EMC noise. Therefore, when installing any communication cables care should always be taken with the routing and location of those cables.

- External cable (GT16H-C30-42P, GT16H-C60-42P, GT16H-C100-42P)
- Direct connection cable

Existing Cables	User Made Cables
GT01-C30R4-8P GT11H-C30R2-8P	The cable need to be independently tested by the user to demonstrate EMC compatibility.

- Ethernet connection cable  
Shielded twisted pair cable (STP)

3) General notes on power supply

The Connector Conversion Box requires an additional ferrite filter to be attached to the 24V DC power supply cables. The filter should be attached in a similar manner as shown in the figure opposite, i.e. the power cables are wrapped around the filter. However, as with all EMC situations the more correctly applied precautions the better the systems Electro-magnetic Compatibility. The ferrite recommended is a TDK ZCAT3035-1330 or similar. The ferrite should be placed as near to the 24V DC terminals of the Connector Conversion Box as possible (which should be within 75mm of the GOT terminal).

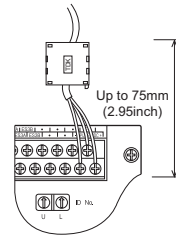

**Detailed Manual**

Manual name	Manual number (Model code)
GOT2000 Series User's Manual (Hardware)	SH-081194ENG (1D7MJ5)
GOT2000 Series User's Manual (Utility)	SH-081195ENG (1D7MJ6)

For detailed manuals, refer to the PDF manuals stored in the DVD-ROM for the drawing software used.

**Relevant Manuals**

For relevant manuals, refer to the Help or the PDF manuals stored in the DVD-ROM for the drawing software used.

The latest manuals are also available from MITSUBISHI ELECTRIC FA Global Website ([www.mitsubishielectric.com/fa](http://www.mitsubishielectric.com/fa)).

**Bundled Items**

Product Name	Model Name	Specifications
GOT	GT2506HS-VTBD	[640 × 480 dots], TFT color (65536 colors), built-in battery

Bundled item	Quantity
Operation switch name character sheets 1) OHP sheet 2) Reference dimension sheet (switch name change sheet mount)	1) One sheet 2) One sheet
Selector switch keys	2
GT25 Handy GOT General Description (This manual)	1

**1. Part Name**

**1.1 Front Panel**

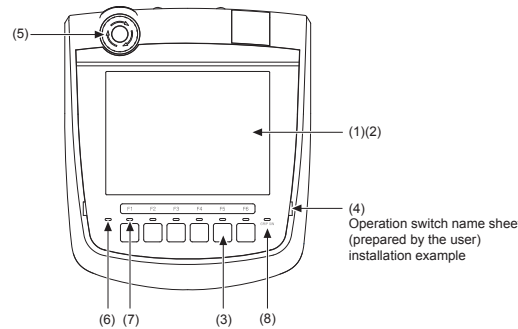

No	Name	Specifications
(1)	Display section	Displays the utility screen and the user creation screen.
(2)	Touch panel	For touch switch operation on the utility screen and the user creation screen.
(3)	Operation switch (6 switches)	Switch for external direct wiring (independent contact)
(4)	Operation switch name sheet installation place	Place (concave shape) where the operation switch name sheet (Insert into the space from a transverse direction) is installed.

No	Name	Specifications
(5)	Emergency stop switch	Switch for external direct wiring (independent contact)
(6)	POWER LED	Lit in blue: Power is correctly supplied. Lit in orange: Screen saving and backlight not lit. Blinks in orange/blue: Blown back light bulb. Not lit: Power is not supplied.
(7)	Display LED for operation switch (6 LEDs)	Display LED for operation switch (green) (lighting control from display section)
(8)	Display LED for grip switch	Display LED for grip switch (green) (lighting control from display section)

**1.2 Back Panel**

Environmental protection back cover closed

Environmental protection back cover opened

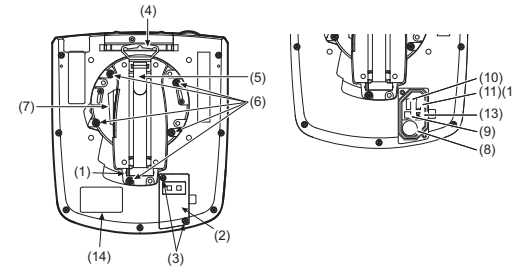

No	Name	Specifications												
(1)	External interface connector	For external connection cable connection (for PLC, switch and power supply external wiring) (connector: square 42 pins, male)												
(2)	Environmental protection back cover	Opened and closed when the PLC communication type is changed (RS-422/485 ↔ RS-232, before shipping: RS-422/485), or the battery is replaced.												
(3)	Environmental protection back cover screw	For opening and closing the environmental protection back cover (drop prevention screw)												
(4)	Hook for hanging on walls	Hook when the Handy GOT is used hanging on walls.												
(5)	Hand strap	Used to hold the Handy GOT in hand by putting a hand under the strap. Length adjustable.												
(6)	Grip angle changing screw	Used when changing the angle of the grip. (5, M4 screw) The angle of the grip can be set either to the standard angle (as before shipping) or 15 degrees to the right.												
(7)	Grip switch	Switch for external direct wiring (independent contact)												
(8)	Battery	For storing clock data, maintenance timing notification and system log data												
(9)	Connector for battery connection	For battery connection												
(10)	RS-232 connector	Connector for PLC communication using RS-232												
(11)	RS-422/485 connector	Connector for PLC communication using RS-422/485												
(12)	Cable connector for PLC communication	Interface cable connector for PLC communication Connector for either (10) or (11) and for selection of the PLC communication type. (Connected to RS-422/485 before shipping.)												
(13)	Terminating resistor setting switch	For switching the RS-422/485 communication interface terminating resistor (Set to Disable before shipping) Terminating resistor setting switch enlarged view <div style="display: flex; align-items: center;"> <div style="margin-right: 10px;"> <p>ON side</p> <p>OFF side</p> </div> <table border="1" style="margin-left: 10px;"> <thead> <tr> <th>Terminating resistor</th> <th colspan="2">Switch No.</th> </tr> <tr> <td></td> <th>1</th> <th>2</th> </tr> </thead> <tbody> <tr> <td>Enable</td> <td>ON</td> <td>ON</td> </tr> <tr> <td>Disable</td> <td>OFF</td> <td>OFF</td> </tr> </tbody> </table> <p style="margin-left: 10px;">Set to "Disable" before shipping</p> </div>	Terminating resistor	Switch No.			1	2	Enable	ON	ON	Disable	OFF	OFF
Terminating resistor	Switch No.													
	1	2												
Enable	ON	ON												
Disable	OFF	OFF												
(14)	Rating plate	-												

**1.3 Top Face (Interface)**

■Interface environmental protection cover closed

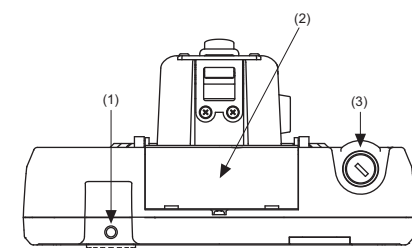

■Interface environmental protection cover opened

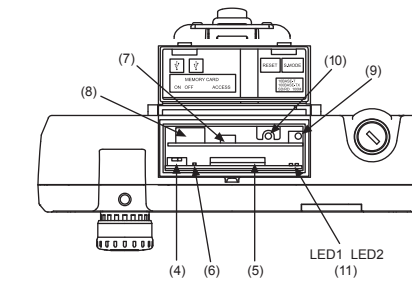

No	Name	Specifications
(1)	Emergency stop switch guard cover installing hole	Threaded hole for mounting the GT16H-60ESCOV type emergency stop switch (option) (M3)
(2)	Interface environmental protection cover	Opened and closed when using the USB port, S.MODE switch and reset switch, as well as when inserting the SD card.
(3)	Keylock switch (2-position switch)	Switch for external direct wiring (independent contact)
(4)	SD card access switch	Prohibits accessing the SD card before removing the card from the Handy GOT. (OFF before shipping.)
(5)	SD card interface	Connector for mounting the SD card (compact flash card) to the Handy GOT
(6)	SD card access LED	With a switching function for accepting and stopping the access to the SD card When the cover is opened: Access is prohibited When the cover is closed: Access is allowed
(7)	USB interface (Device)	For PC connection (connector type: Mini-B)
(8)	USB interface (Host)	For data transfer, data storage (connector type: TYPE-A)
(9)	S.MODE switch (OS install switch)	Switch used for OS installation at GOT startup.
(10)	Reset switch	Switch for resetting the hardware
(11)	Ethernet communication status LED	LED1: Turns on during data transfer/reception, LED2: Turns on during 100Mbps transmission.

## 2. Specifications

### 2.1 General Specifications

Item	Specifications					
	GT2506HS-VTBD					
Operating ambient temperature	0 °C to 40 °C					
Storage ambient temperature	-20 °C to 60 °C					
Operating ambient humidity	10% RH to 90% RH, non-condensing					
Storage ambient humidity	10% RH to 90% RH, non-condensing					
Vibration resistance	Compliant with JIS B 3502 and IEC 61131-2	Under intermittent vibration	Frequency	Acceleration	Half-amplitude	10 times in each X, Y, or Z direction
			5 to 8.4Hz	--	3.5mm	
		8.4 to 150Hz	9.8m/s <sup>2</sup>	--		
		Under continuous vibration	Frequency	Acceleration	Half-amplitude	
5 to 8.4Hz	--	1.75mm				
8.4 to 150Hz	4.9m/s <sup>2</sup>	--				
Shock resistance	Compliant with JIS B 3502 and IEC 61131-2 (147 m/s <sup>2</sup> (15G), 3 times in each X, Y, or Z direction)					
Operating atmosphere	No greasy fumes, corrosive gas, flammable gas, excessive conductive dust, and direct sunlight (as well as at storage)					
Operating altitude <sup>*1</sup>	2000 m or less					
Overvoltage category <sup>*2</sup>	II or less					
Pollution degree <sup>*3</sup>	2 or less					
Cooling method	Self-cooling					
Grounding	Grounding with a ground resistance of 100 Ω or less by using a ground cable that has a cross-sectional area of 2 mm <sup>2</sup> or more. If impossible, connect the ground cable to the control panel.					
Type rating	UL Type 1					

\*1 Do not use or store the GOT under a pressure higher than the atmospheric pressure at altitude 0 m. Doing so may cause a malfunction.

\*2 This indicates the section of the power supply to which the equipment is assumed to be connected between the public electrical power distribution network and the machinery within the premises.  
Category II applies to equipment that is supplied with power from fixed facilities.  
The withstand surge voltage for the equipment with the rated voltage up to 300 V is 2500 V.

\*3 This indicates the occurrence rate of conductive material in an environment where a device is used.  
Pollution degree 2 indicates an environment where only non-conductive pollution occurs normally and a temporary conductivity caused by condensation shall be expected depending on the conditions.

### 2.2 Performance Specifications

Item	Specifications	
	GT2506HS-VTBD	
Display section <sup>*1,2</sup>	Model	TFT color LCD
	Screen size	6.5"
	Resolution	VGA: 640 × 480 dots
	Display size	132.5(5.22) (W) × 99.4(3.91) (H) mm(inch)
	Number of displayed characters	16-dot standard font: 40 characters × 30 lines (two-byte characters) 12-dot standard font: 53 characters × 40 lines (two-byte characters)
	Display color	65536 colors
	Brightness adjustment	32 levels
	Backlight	LED (Not replaceable)
	Backlight life <sup>*4</sup>	Approximately 40000 hours (Operating ambient temperature: 25°C, display intensity: 50%)
Touch panel <sup>*3</sup>	Type	Analog resistive film
	Key size	Minimum 2 × 2 dots <sup>*7</sup> (per key)
	The number of simultaneous press	Not available <sup>*5</sup> (Only 1 point can be touched.)
	Life	1 million touches or more (Operating force: 0.98 N or less)
Buzzer output	Single tone (tone and tone length adjustable)	
Protective structure	IP65F <sup>*6,8</sup> (Valid when the external cable is connected. except for the relay connector side of the external cable.)	
External dimensions	201(7.91) (W) × 230(9.06) (H) × 97(3.82) (D) mm(inch) (Excluding projections such as the emergency stop switch)	
Weight	1.2(2.6) kg(lb) (GT25 Handy main unit only)	

Item	Specifications	
	GT2506HS-VTBD	
Compatible software package	GT Works3 Version1.170C or later	
Switch	Operation switch	6 switches (6 contacts/common) N/O contact, Maximum rating 10 mA/24V DC, Life: 1000000 times
	Grip switch	1 switch (single wiring) (IDEC HE3B-M2PB) Enable switch (deadman switch) 3-position system of OFF ←→ ON ←→ OFF 2 N/O contacts Maximum rating 1 A/24V DC (resistance load), Maximum rating 0.3 A/24V DC (induction load), Life: 100000 times
	Emergency stop switch	1 switch (single wiring) (IDEC XA1E-BV303R) 3 N/C contacts Maximum rating 1 A/24V DC (resistance load), Maximum rating 0.3 A/24V DC (induction load), Life: 100000 times
	Selector switch with key	1 switch (single wiring) (IDEC AS6M-2KT1PB) 2-notch type (Manual stop at each position/A key can be inserted and removed on only the left side./On the right side, a key cannot be removed./Two keys are provided.) 2-position, Maximum rating 1 A/24V DC (resistance load), Maximum rating 0.3 A/24V DC (induction load), Life: 100000 times
LED	POWER LED	2 colors (blue and orange)
User memory	User memory capacity	Memory for storage (ROM): 32 MB Memory for operation (RAM): 80 MB
	Life (number of write times)	100000 times
Battery	GT15-BAT lithium battery	
Built-in interface	Life	Approx. 5 years (Ambient temperature: 25 °C)
	RS-232 <sup>*9</sup>	1 channel Transmission speed: 115200, 57600, 38400, 19200, 9600, 4800 bps Connector shape: Square 42 pins (Male)
	RS-422/485 <sup>*9</sup>	1 channel Transmission speed: 115200, 57600, 38400, 19200, 9600, 4800 bps Connector shape: Square 42 pins (Male)
	Ethernet	1 channel Data transfer method: 100BASE-TX, 10BASE-T Connector shape: Square 42 pins (Male)
	USB (Host)	1 channel (Top face)
		Maximum transfer rate: High-Speed 480 Mbps Connector shape: USB-A
	USB (Device)	1 channel (Top face)
		Maximum transfer rate: High-Speed 480 Mbps Connector shape: USB Mini-B
	SD card	1 channel, SDHC compliant (maximum 32 GB)

\*1 As a characteristic of liquid crystal display panels, bright dots (always lit) and dark dots (never lit) may appear on the panel. Since liquid crystal display panels comprise a great number of display elements, the appearance of bright and dark dots cannot be reduced to zero. Individual differences in liquid crystal display panels may cause differences in color, uneven brightness and flickering. Note that these phenomena are characteristics of liquid crystal display panels and it does not mean the products are defective or damaged.

\*2 Flickering may occur due to vibration, shock, or the display colors.

\*3 When a stylus is used, the touch panel has a life of 100 thousand touches.  
The stylus must satisfy the following specifications.  
• Material: Polyacetal resin  
• Tip radius: 0.8 mm or more

\*4 To prevent the display section from burning in and lengthen the backlight life, enable the screen save function and turn off the backlight.

\*5 If you touch two points or more simultaneously on the touch panel, a switch in an unintended location may operate. Do not touch two points or more simultaneously on the touch panel.

\*6 Note that the structure does not guarantee protection in all users' environments.  
The protection is not applied when the interface environment protection cover or environment protection back cover is removed.  
The GOT may not be used in an environment where the GOT is exposed to oil or chemicals for a long time, or where oil mist fills the air.

\*7 The minimum size of a key that can be arranged.  
To ensure safe use of the product, the following settings are recommended.  
• Key size: 16 × 16 dots or larger  
• Distance between keys: 16 dots or more

\*8 The suffix "F" of IP65F is a symbol that indicates protection rate against oil.  
It is described in the Appendix of JIS C 0920 of the Japanese Industrial Standards.

\*9 Select either RS-422/485 or RS232 when used.  
The channel is set to RS-422/485 before shipping.

### 2.3 Power Supply Specifications

Item	Specifications
	GT2506HS-VTBD
Input power supply voltage	24V DC (+10% -15%)
Power consumption	11.6W or less
	At backlight off
Inrush current	30A or less (2ms, ambient temperature: 25°C, under the maximum load)
Permissible instantaneous power failure time	5ms or less
Noise immunity	Noise voltage: 1000Vp-p, noise width: 1μs, measured by a noise simulator with noise frequency ranging from 30Hz to 100Hz.
Dielectric withstand voltage	500V DC for 1 minute across power supply terminals and earth
Insulation resistance	500V DC across power supply terminals and earth, 10 MΩ or more by an insulation resistance tester

### 2.4 External Dimensions

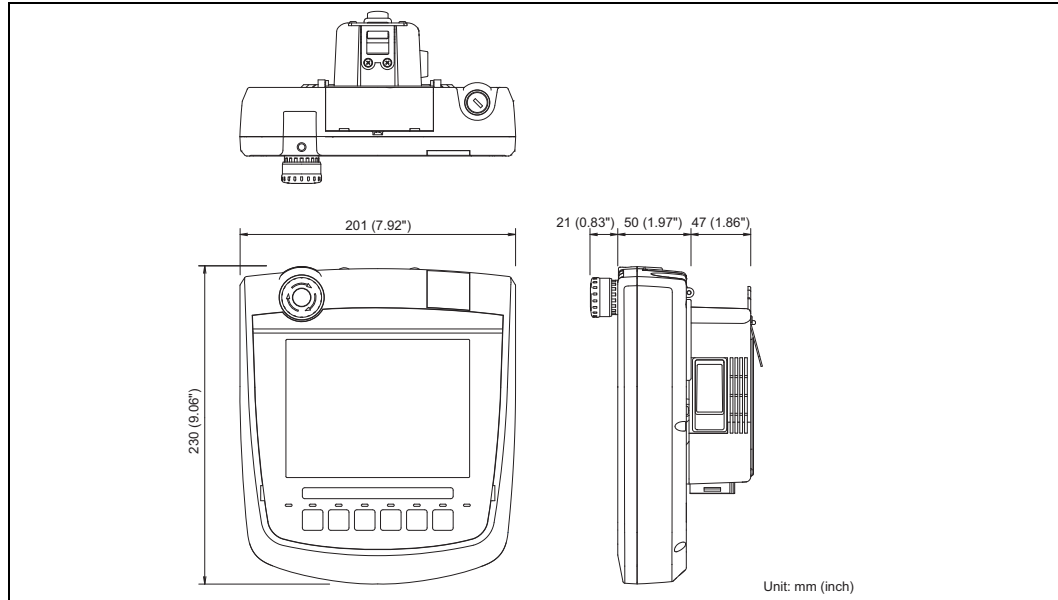

### 3. Maintenance and Inspection

The GOT does not include consumable components that will cause the shorten life. However, The battery, LCD, and backlight have their life spans respectively. It is recommended to replace the battery periodically. (For the replacement of the liquid crystal screen, please consult your nearest sales office or FA Center.)

#### 3.1 Daily Inspection

##### Daily inspection items

No.	Inspection Item	Inspection Method	Criterion	Action	
1	Connection status	Loose connectors	Visual check	Not loose	Replace external cable.
		Dirt on protection sheet	Visual check	Not outstanding	Replace with new one
2	Usage status	Foreign material attachment	Visual check	No foreign matter sticking	Remove clean

#### 3.2 Periodic Inspection

##### Yearly or half-yearly inspection items

The following inspection should also be performed when equipment has been moved or modified or the wiring changed.

No.	Inspection Item	Inspection Method	Criterion	Action	
1	Surrounding environment	Ambient temperature	Make measurement with thermometer or hygrometer	0 to 40°C	For use in control panel, temperature inside control panel is ambient temperature
		Ambient humidity	Measure	10 to 90%RH	
		Atmosphere	Measure corrosive gas	No corrosive gas	
2	Power supply voltage check	24V DC Measure voltage across terminals.	20.4 to 26.4V DC	Change supply power	
3	Mounting status	Dirt, foreign matter	Visual check	No dirt, foreign matter sticking	Remove, clean
4	Connection status	Loose connectors	Visual check	Not loose	Replace external cable.
5	Battery	Check the system alarm (error code: 500) report on the Alarm Information screen	(Preventive maintenance)	Replace with new battery when the current battery has reached the specified life span, even if battery voltage is not displayed.	

### 3.3 Battery Replacement

The battery retains RAM data, clock data, and system status log data. Screen data is stored in the flash memory and data is retained even if the battery is dead.

- Battery model name  
Handy GOT is shipped with the following battery.  
Use it at replacement.

Product name	Model name
Battery	GT15-BAT

- Battery replacement procedure

- After keeping the GOT turned ON more than 10 minutes, turn OFF the GOT. After turning OFF the GOT, perform the procedure 2) to 7) within 5 minutes.
- Loosen the environmental protection back cover screws at two points on GOT rear face to remove the cover.

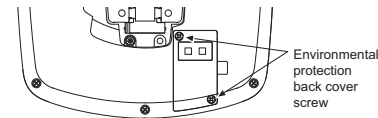

- Remove the old battery from the holder and disconnect the connector.
- Insert the connector of the new battery.
- Install the battery to the GOT.

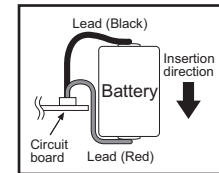
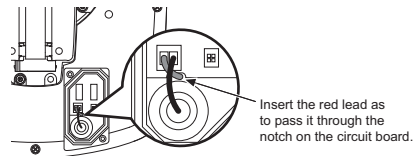
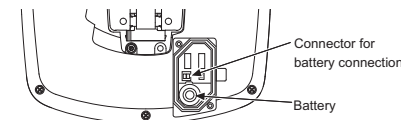

- Attach the environmental protection back cover and tighten the screws.  
Tightening torque: 0.36 to 0.48 N·m
- Turn the GOT power on.
- Check if the battery condition is normal with the utility.

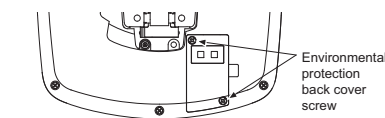

- Battery life  
Approximate battery life:  
5 years (ambient temperature: 25°C)  
Battery replacement: In 4 to 5 years

Approximate life is 5 years, but life may be shorter depending on the ambient temperature, therefore, note that the battery must be replaced in 4 to 5 years. Make sure to purchase a new battery as needed as it self-discharges.

Battery status can be confirmed on a GOT utility screen. For information on how to check the battery voltage status and set the battery alarm display, refer to the GOT2000 Series User's Manual (Utility).

### 4. Precautions

#### 4.1 Cautions on Using Emergency Stop Switch

- When using the emergency stop switch in the handy GOT, judge the validity to use the emergency stop switch in accordance with the risk assessment in your system.
- When using the parallel circuit (which disables the emergency stop status while the handy GOT is removed), the system may not conform to the safety standards. Check the safety standards required in the system, and then judge the validity to use the emergency stop switch.

「电器电子产品有害物质限制使用标识要求」的表示方式



Note: This symbol mark is for China only.

含有有害6物质的名称, 含有量, 含有部品  
本产品中所含有的有害6物质的名称, 含有量, 含有部品如下表所示。

部件名称	有害物质					
	铅 (Pb)	汞 (Hg)	镉 (Cd)	六价铬 (Cr (VI))	多溴联苯 (PBB)	多溴二苯醚 (PBDE)
显示器	○	○	○	○	○	○
GOT	○	○	○	○	○	○
外壳	○	○	○	○	○	○
印刷基板	×	○	○	○	○	○
电缆	×	○	○	○	○	○

本表格依据SJ/T 11364的规定编制。

○: 表示该有害物质在该部件所有均质材料中的含量均在GB/T 26572规定的限量要求以下。  
×: 表示该有害物质至少在该部件的某一均质材料中的含量超出GB/T 26572规定的限量要求。

Referenced Standard: GB/T15969.2  
(Requirement of Chinese standardized law)

This manual confers no industrial property rights or any rights of any other kind, nor does it confer any patent licenses. Mitsubishi Electric Corporation cannot be held responsible for any problems involving industrial property rights which may occur as a result of using the contents noted in this manual.

#### Warranty

Exclusion of loss in opportunity and secondary loss from warranty liability  
Regardless of the gratis warranty term, Mitsubishi Electric shall not be liable for compensation to:  
(1) Damages caused by any cause found not to be the responsibility of Mitsubishi Electric.  
(2) Loss in opportunity, lost profits incurred to the user by Failures of Mitsubishi Electric products.  
(3) Special damages and secondary damages whether foreseeable or not, compensation for accidents, and compensation for damages to products other than Mitsubishi Electric products.  
(4) Replacement by the user, maintenance of on-site equipment, start-up test run and other tasks.

#### ⚠ For safe use

- This product has been manufactured as a general-purpose part for general industries, and has not been designed or manufactured to be incorporated in a device or system used in purposes related to human life.
- Before using the product for special purposes such as nuclear power, electric power, aerospace, medicine or passenger movement vehicles, consult with Mitsubishi Electric.
- This product has been manufactured under strict quality control. However when installing the product where major accidents or losses could occur if the product fails, install appropriate backup or failsafe functions in the system.

MITSUBISHI ELECTRIC CORPORATION

HEAD OFFICE : TOKYO BUILDING, 2-7-3 MARUNOUCHI, CHIYODA-KU, TOKYO 100-8310, JAPAN





GT2506HS-VTBD

GT25 Handy GOT General Description

Manual Number	JY997D72901H
Date	Dec. 2022

This manual describes the part names, dimensions, mounting, and specifications of the product. Before use, read this manual and manuals of relevant products fully to acquire proficiency in handling and operating the product. Make sure to learn all the product information, safety information, and precautions. And, store this manual in a safe place so that you can take it out and read it whenever necessary. Always forward it to the end user.

Registration  
Ethernet is a trademark of Xerox Corporation in the United States. VNC is a registered trademark of RealVNC Ltd. in the United States and other countries. MODBUS is a trademark of Schneider Electric SA. The company name and the product name to be described in this manual are the registered trademarks or trademarks of each company.

Effective Dec. 2022  
Specifications are subject to change without notice.  
© 2017 MITSUBISHI ELECTRIC CORPORATION

**Safety Precaution** (Read these precautions before using.)

Before using this product, please read this manual and the relevant manuals introduced in this manual carefully and pay full attention to safety to handle the product correctly. The precautions given in this manual are concerned with this product. In this manual, the safety precautions are ranked as "WARNING" and "CAUTION".

**WARNING** Indicates that incorrect handling may cause hazardous conditions, resulting in death or severe injury.

**CAUTION** Indicates that incorrect handling may cause hazardous conditions, resulting in medium or slight personal injury or physical damage.

Depending on circumstances, procedures indicated by "CAUTION" may also be linked to serious results. In any case, it is important to follow the directions for usage.

**DESIGN PRECAUTIONS** **WARNING**

- Some failures of the GOT or cable may keep the outputs on or off. Some failures of a touch panel may cause malfunction of the input objects such as a touch switch. An external monitoring circuit should be provided to check for output signals which may lead to a serious accident. Not doing so can cause an accident due to false output or malfunction.
- Do not use the GOT as the warning device that may cause a serious accident. An independent and redundant hardware or mechanical interlock is required to configure the device that displays and outputs serious warning. Not doing so can cause an accident due to false output or malfunction.
- The GOT backlight failure disables the operation on the touch switch(s). When the GOT backlight has a failure, the POWER LED blinks (orange/blue) and the display section dims. In such a case, the input by the touch switch(s) is disabled.
- The display section of the GOT is an analog-resistive type touch panel. Simultaneous pressing of two or more areas on the display section may activate the switch between those areas. Do not press two or more areas simultaneously on the display section. Doing so may cause an accident due to incorrect output or malfunction.
- When programs or parameters of the controller (such as a PLC) that is monitored by the GOT are changed, be sure to shut off the power of the GOT promptly and power on the GOT again. Not doing so can cause an accident due to false output or malfunction.

**DESIGN PRECAUTIONS** **WARNING**

- If a communication fault (including cable disconnection) occurs during monitoring on the GOT, communication between the GOT and PLC CPU is suspended and the GOT becomes inoperative. A system where the GOT is used should be configured to perform any significant operation to the system by using the switches of a device other than the GOT on the assumption that a GOT communication fault will occur. Not doing so can cause an accident due to false output or malfunction.
- To maintain the security (confidentiality, integrity, and availability) of the GOT and the system against unauthorized access, DoS<sup>1</sup> attacks, computer viruses, and other cyberattacks from unreliable networks and devices via network, take appropriate measures such as firewalls, virtual private networks (VPNs), and antivirus solutions. Mitsubishi Electric shall have no responsibility or liability for any problems involving GOT trouble and system trouble by unauthorized access, DoS attacks, computer viruses, and other cyberattacks. <sup>1</sup> DoS: A denial-of-service (DoS) attack disrupts services by overloading systems or exploiting vulnerabilities, resulting in a denial-of-service (DoS) state.

**DESIGN PRECAUTIONS** **CAUTION**

- Do not bundle the control and communication cables with main-circuit, power or other wiring. Run the above cables separately from such wiring and keep them a minimum of 100 mm apart. Not doing so noise can cause a malfunction.
- Do not press the GOT display section with a pointed material as a pen or driver. Doing so can result in a damage or failure of the display section.
- Turn on the controllers and the network devices to be ready for communication before they communicate with the GOT. Failure to do so can cause a communication error on the GOT.
- When the GOT is subject to shock or vibration, or some colors appear on the screen of the GOT, the screen of the GOT might flicker.
- When the GOT is connected to the Ethernet network, the available IP address is restricted according to the system configuration.
- When the GOT is connected to the Ethernet network, the available IP address is restricted according to the system configuration. When a GOT2000 series model and a GOT1000 series model are on an Ethernet network, do not set the IP address duplication at the GOT startup, adversely affecting the communication of the device with the IP address 192.168.0.18. The operation at the IP address duplication depends on the devices and the system.

**MOUNTING PRECAUTIONS** **WARNING**

- Be sure to shut off all phases of the external power supply used by the system before mounting or removing the GOT main unit to/from the panel. Not doing so can cause the unit to fail or malfunction.
- Always turn off the power ON/OFF switch on the connector conversion box (GT16H-CNB-42S) before connecting or disconnecting the GOT to it. Connecting or disconnecting the GOT with the power being turned on may result in damage to the unit or malfunctions.

**MOUNTING PRECAUTIONS** **CAUTION**

- Use the GOT in the environment that satisfies the general specifications described in this manual. Not doing so can cause an electric shock, fire, malfunction or product damage or deterioration.
- Remove the protective film of the GOT. When the user continues using the GOT with the protective film, the film may not be removed.
- Operate and store the GOT in environments without direct sunlight, high temperature, dust, humidity, and vibrations.
- Do not use the GOT in an environment with oil or chemicals. Doing so may cause failure or malfunction due to the oil or chemical entering into the GOT.

**WIRING PRECAUTIONS** **WARNING**

- Make sure to attach the back cover to the Handy GOT before turning on the power and starting operation after the installation or wiring work. Otherwise, electrical shock may be caused.
- Be sure to shut off all phases of the external power supply used by the system before wiring. Failure to do so may result in an electric shock, product damage or malfunctions.
- Use a DC power supply for this product. The power supply in the specified range must be applied for the power supply, the operation switch, and the emergency stop switch. If they are connected to the power supply of the different specification, it may cause a fire or failure.

**WIRING PRECAUTIONS** **CAUTION**

- Connect connection cables securely to the specified connectors while the power is turned OFF. Imperfect connection may cause malfunction or failure.
- Please make sure to ground FG terminal of the GOT power supply section by applying 100 Ω or less which is used exclusively for the GOT. Not doing so may cause an electric shock or malfunction.
- Exercise care to avoid foreign matter such as chips and wire offcuts entering the GOT. Not doing so can cause a fire, failure or malfunction.

**WIRING PRECAUTIONS** **CAUTION**

- Plug the communication cable into the GOT interface or the connector of the connected unit, and tighten the mounting screws and the terminal screws in the specified torque range. Undertightening can cause a short circuit or malfunction. Overtightening can cause a short circuit or malfunction due to the damage of the screws or unit.

**TEST OPERATION PRECAUTIONS** **WARNING**

- Before performing the test operations of the user creation monitor screen (such as turning ON or OFF bit device, changing the word device current value, changing the settings or current values of the timer or counter, and changing the buffer memory current value), read through the manual carefully and make yourself familiar with the operation method. During test operation, never change the data of the devices which are used to perform significant operation for the system. False output or malfunction can cause an accident.

**STARTUP/MAINTENANCE PRECAUTIONS** **WARNING**

- When power is on, do not touch the terminals. Doing so can cause an electric shock or malfunction.
- Connect the battery correctly. Do not discharge, disassemble, heat, short, solder or throw the battery into the fire. Incorrect handling may cause the battery to generate heat, burst or take fire, resulting in injuries or fires.
- Before starting cleaning or terminal screw retightening, always switch off the power externally in all phases. Not doing so can cause the unit to fail or malfunction. Undertightening can cause a short circuit or malfunction. Overtightening can cause a short circuit or malfunction due to the damage of the screws or unit.

**STARTUP/MAINTENANCE PRECAUTIONS** **CAUTION**

- Do not disassemble or modify the unit. Doing so can cause a failure, malfunction, injury or fire.
- Do not touch the conductive and electronic parts of the unit directly. Doing so can cause a unit malfunction or failure.
- Do not drop or give an impact to the battery mounted to the unit. Dispose of the battery without using when it is dropped or given an impact, because it may be damaged.
- The cables connected to the unit must be run in ducts or clamped. Not doing so can cause the unit or cable to be damaged due to the dangling, motion or accidental pulling of the cables or can cause a malfunction due to a cable connection fault.
- When unplugging the cable connected to the unit, do not hold and pull from the cable portion. Doing so can cause the unit or cable to be damaged or can cause a malfunction due to a cable connection fault.
- Do not drop the module or subject it to strong shock. A module damage may result.
- Before touching the unit, always touch grounded metals, etc. to discharge static electricity from human body, etc. Not doing so can cause the unit to fail or malfunction.
- Replace battery with GT15-BAT by Mitsubishi electric Co. only. Use of another battery may present a risk of fire or explosion.
- Dispose of used battery promptly. Keep away from children. Do not disassemble and do not dispose of in fire.

**TOUCH PANEL PRECAUTIONS** **CAUTION**

- For the analog-resistive film type touch panels, normally the adjustment is not required. However, the difference between a touched position and the object position may occur as the period of use elapses. When any difference between a touched position and the object position occurs, execute the touch panel calibration.
- When any difference between a touched position and the object position occurs, other object may be activated. This may cause an unexpected operation due to incorrect output or malfunction.

**PRECAUTIONS WHEN THE DATA STORAGE IS IN USE** **WARNING**

- If the SD card mounted on drive A of the GOT is removed while the GOT is accessed, processing for the GOT might be interrupted about for 20 seconds. The GOT cannot be operated during this period. The functions that run in the background including a screen updating, alarm, logging, scripts, and others are also interrupted. Since this interruption makes an impact to the system operation, it might cause failure. After inhibiting access to the SD card on the GOT utility screen, check that the SD card access LED is off and remove the SD card.

**PRECAUTIONS WHEN THE DATA STORAGE IS IN USE** **CAUTION**

- If the data storage mounted on the GOT is removed while the GOT is accessed, the data storage and files are damaged. To remove the data storage from the GOT, check that the access to the data storage in SD card access LED, the system signal, and others is not performed.
- Turning off the GOT while it accesses the SD card results in damage to the SD card and files.
- When removing the SD card from the GOT, make sure to support the SD card by hand as it may pop out. Failure to do so may cause the SD card to drop from the GOT, resulting in a failure or break.
- When installing a USB memory to the GOT, make sure to install the USB memory to the USB interface firmly. Failure to do so may cause a malfunction due to poor contact.
- Before removing the USB device from the GOT, follow the procedure for removal on the utility screen of the GOT. After the successful completion dialog is displayed, remove the USB device by hand carefully. Failure to do so may cause the USB device to drop from the GOT, resulting in a failure or break.

**PRECAUTIONS FOR REMOTE CONTROL** **WARNING**

- Remote control is available through a network by using GOT functions, including the SoftGOT-GOT link function, the remote personal computer operation function, the VNC server function, and the GOT Mobile function. If these functions are used to perform remote control of control equipment, the field operator may not notice the remote control, possibly leading to an accident. In addition, a communication delay or interruption may occur depending on the network environment, and remote control of control equipment cannot be performed normally in some cases. Before using the above functions to perform remote control, fully grasp the circumstances of the field site and ensure safety.

**PRECAUTIONS FOR EXCLUSIVE AUTHORIZATION CONTROL** **WARNING**

- Make sure to fully understand the GOT network interaction function before using this function to control the authorization among pieces of equipment to prevent simultaneous operations. The exclusive authorization control of the GOT network interaction function can be enabled or disabled for each screen. (For all screens, the exclusive authorization control is disabled by default.) Properly determine the screens for which the exclusive authorization control is required, and set the control by screen. A screen for which the exclusive authorization control is disabled can be operated simultaneously from pieces of equipment. Make sure to determine the operation period for each operator, fully grasp the circumstances of the field site, and ensure safety to perform operations.

**DISPOSAL PRECAUTIONS** **CAUTION**

- When disposing of this product, treat it as industrial waste. When disposing of batteries, separate them from other wastes according to the local regulations. (Refer to the GOT2000 Series User's Manual for details of the battery directive in the EU member states.)

**TRANSPORTATION PRECAUTIONS** **CAUTION**

- When transporting lithium batteries, make sure to treat them based on the transport regulations. (Refer to the GOT2000 Series User's Manual (Hardware) for details of the regulated models.)
- Make sure to transport the GOT main unit and/or relevant unit(s) in the manner they will not be exposed to the impact exceeding the impact resistance described in the general specifications of this manual, as they are precision devices. Failure to do so may cause the unit to fail. Check if the unit operates correctly after transportation.
- When fumigants that contain halogen materials such as fluorine, chlorine, bromine, and iodine are used for disinfecting and protecting wooden packaging from insects, they cause malfunction when entering our products. Please take necessary precautions to ensure that remaining materials from fumigation do not enter our products, or treat packaging with methods other than fumigation (heat method). Additionally, disinfect and protect wood from insects before packing products.
- Before transporting the GOT, turn the GOT power on and check that the battery voltage status is normal on the Time setting & display screen (utilities screen). In addition, confirm that the adequate battery life remains on the rating plate. Transporting the GOT with the low battery voltage or the battery life reached battery life may destabilize the backup data unstable during transportation.
- When transporting lithium batteries, make sure to treat them based on the transport regulations. (Refer to the GOT2000 Series User's Manual (Hardware) for details of the regulated models.)

**Certification of UL, cUL standards**

- UL, cUL Standards are recognized in use by the following combination.
  - GT2506HS-VTBD
  - GT16H-CNB-42S (Hardware version D or later)
  - External cable (GT16H-C30-42P, GT16H-C60-42P, GT16H-C100-42P)
  - GT16H-CNB-37S
  - External cable (GT16H-C30-37PE, GT16H-C60-37PE, GT16H-C100-37PE)

**General notes on power supply**

This equipment must be supplied by a UL Listed or Recognized 24 V dc rated power supply and UL Listed or Recognized fuse rated not higher than 4A, or a UL Listed Class 2 power supply.

**Compliance with EC directive (CE Marking)**

This note does not guarantee that an entire mechanical module produced in accordance with the contents of this note will comply with the following standards. Compliance to EMC directive for the entire mechanical module should be checked by the user/manufacturer. For more details please contact the local Mitsubishi Electric sales site.

**Notification of CE marking**

The following products have shown compliance through direct testing (to the identified standards) and design analysis (forming a technical construction file) to the European Directive for Electromagnetic Compatibility (2014/30/EU) when used as directed by the appropriate documentation.

- This product is designed for use in industrial applications
  - Type: Graphic operation terminal
  - Models: GOT2000 series

Standard	EMI	Remark
EN61131-2: 2007 Programmable controllers - Equipment, requirements and tests	EMI	Compliance with all relevant aspects of the standard. (Radiated Emissions)
	EMS	Compliance with all relevant aspects of the standard. (ESD, RF electromagnetic field, EFTB, Surge, RF conducted disturbances and Power frequency magnetic field)

For more details please contact your local Mitsubishi Electric sales site. For details of CE marking, refer to the following. →GOT2000 Series User's Manual (Hardware)

**Compliant with the UKCA marking**

Requirements for compliance with the UKCA marking are the same with the EC Directives (CE marking).

**Notes for compliance to EMC regulation**

- General notes on the control panel  
Make sure to combine the GT25 Handy GOT with the Connector Conversion Box to comply with the EMC directive. The Connector Conversion Box is an open type device (device installed to another device) and must be installed in a conductive control panel.
- General notes on the use of communication cables  
Any device which utilizes a data communication function is susceptible to the wider effects of local EMC noise. Therefore, when installing any communication cables care should always be taken with the routing and location of those cables.
  - External cable (GT16H-C30-42P, GT16H-C60-42P, GT16H-C100-42P)
  - Direct connection cable

Existing Cables	User Made Cables
GT01-C30R4-8P GT11H-C30R2-6P	The cable need to be independently tested by the user to demonstrate EMC compatibility.

- Ethernet connection cable  
Shielded twisted pair cable (STP)
- General notes on power supply  
The Connector Conversion Box requires an additional ferrite filter to be attached to the 24V DC power supply cables. The filter should be attached in a similar manner as shown in the figure opposite, i.e. the power cables are wrapped around the filter. However, as with all EMC situations the more correctly applied precautions the better the systems Electromagnetic Compatibility. The ferrite recommended is a TDK ZCAT3035-1330 or similar. The ferrite should be placed as near to the 24V DC terminals of the Connector Conversion Box as possible (which should be within 75mm of the GOT terminal).

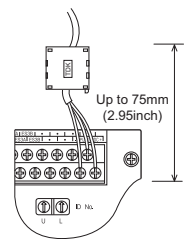

**Detailed Manual**

Manual name	Manual number (Model code)
GOT2000 Series User's Manual (Hardware)	SH-081194ENG (1D7MJ5)
GOT2000 Series User's Manual (Utility)	SH-081195ENG (1D7MJ6)

For detailed manuals, refer to the PDF manuals stored in the DVD-ROM for the drawing software used.

**Relevant Manuals**

For relevant manuals, refer to the Help or the PDF manuals stored in the DVD-ROM for the drawing software used. The latest manuals are also available from MITSUBISHI ELECTRIC FA Global Website ([www.mitsubishielectric.com/fal](http://www.mitsubishielectric.com/fal)).

**Bundled Items**

Product Name	Model Name	Specifications
GOT	GT2506HS-VTBD	[640 × 480 dots], TFT color (65536 colors), built-in battery

Bundled item	Quantity
Operation switch name character sheets	
1) OHP sheet	1) One sheet
2) Reference dimension sheet (switch name change sheet mount)	2) One sheet
Selector switch keys	2
GT25 Handy GOT General Description (This manual)	1

**1. Part Name**

**1.1 Front Panel**

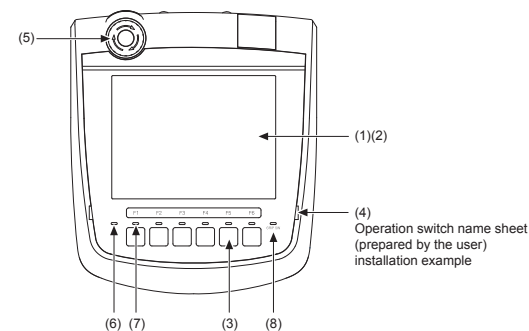

No	Name	Specifications
(1)	Display section	Displays the utility screen and the user creation screen.
(2)	Touch panel	For touch switch operation on the utility screen and the user creation screen.
(3)	Operation switch (6 switches)	Switch for external direct wiring (independent contact)
(4)	Operation switch name sheet installation place	Place (concave shape) where the operation switch name sheet (insert into the space from a transverse direction) is installed.

No	Name	Specifications
(5)	Emergency stop switch	Switch for external direct wiring (independent contact)
(6)	POWER LED	Lit in blue: Power is correctly supplied. Lit in orange: Screen saving and backlight not lit. Blinks in orange/blue: Blown back light bulb. Not lit: Power is not supplied.
(7)	Display LED for operation switch (6 LEDs)	Display LED for operation switch (green) (lighting control from display section)
(8)	Display LED for grip switch	Display LED for grip switch (green) (lighting control from display section)

**1.2 Back Panel**

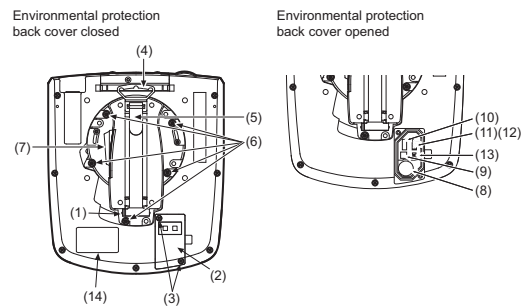

No	Name	Specifications
(1)	External interface connector	For external connection cable connection (for PLC, switch and power supply external wiring) (connector: square 42 pins, male)
(2)	Environmental protection back cover	Opened and closed when the PLC communication type is changed (RS-422/485 ↔ RS-232, before shipping: RS-422/485), or the battery is replaced.
(3)	Environmental protection back cover screw	For opening and closing the environmental protection back cover (drop prevention screw)
(4)	Hook for hanging on walls	Hook when the Handy GOT is used hanging on walls.
(5)	Hand strap	Used to hold the Handy GOT in hand by putting a hand under the strap. Length adjustable.
(6)	Grip angle changing screw	Used when changing the angle of the grip. The angle of the grip can be set either to the standard angle (as before shipping) or 15 degrees to the right.
(7)	Grip switch	Switch for external direct wiring (independent contact)
(8)	Battery	For storing clock data, maintenance timing notification and system log data
(9)	Connector for battery connection	For battery connection
(10)	RS-232 connector	Connector for PLC communication using RS-232
(11)	RS-422/485 connector	Connector for PLC communication using RS-422/485
(12)	Cable connector for PLC communication	Interface cable connector for PLC communication Connector for either (10) or (11) and for selection of the PLC communication type. (Connected to RS-422/485 before shipping.)
(13)	Terminating resistor setting switch	For switching the RS-422/485 communication interface terminating resistor (Set to Disable before shipping) Terminating resistor setting switch enabled view ON side OFF side Set to "Disable" before shipping
(14)	Rating plate	-

**1.3 Top Face (Interface)**

■Interface environmental protection cover closed

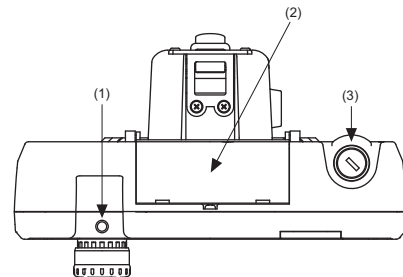

■Interface environmental protection cover opened

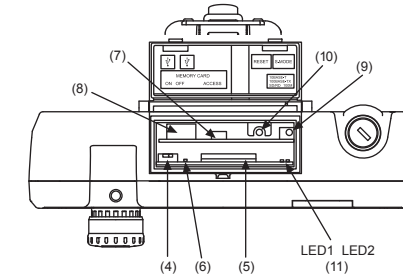

No	Name	Specifications
(1)	Emergency stop switch guard cover installing hole	Threaded hole for mounting the GT16H-60ESCOV type emergency stop switch guard (option) (M3)
(2)	Interface environmental protection cover	Opened and closed when using the USB port, S.MODE switch and reset switch, as well as when inserting the SD card.
(3)	Keylock switch (2-position switch)	Switch for external direct wiring (independent contact)
(4)	SD card access switch	Prohibits accessing the SD card before removing the card from the Handy GOT. (Off before shipping.)
(5)	SD card interface	Connector for mounting the SD card (compact flash card) to the Handy GOT
(6)	SD card access LED	With a switching function for accepting and stopping the access to the SD card When the cover is opened: Access is prohibited When the cover is closed: Access is allowed
(7)	USB interface (Device)	For PC connection (connector type: Mini-B)
(8)	USB interface (Host)	For data transfer, data storage (connector type: TYPE-A)
(9)	S.MODE switch (OS install switch)	Switch used for OS installation at GOT startup.
(10)	Reset switch	Switch for resetting the hardware
(11)	Ethernet communication status LED	LED1: Turns on during data transfer/reception. LED2: Turns on during 100Mbps transmission.

## 2. Specifications

### 2.1 General Specifications

Item	Specifications	
Operating ambient temperature	0 °C to 40 °C	
Storage ambient temperature	-20 °C to 60 °C	
Operating ambient humidity	10% RH to 90% RH, non-condensing	
Storage ambient humidity	10% RH to 90% RH, non-condensing	
Vibration resistance	Compliant with JIS B 3502 and IEC 61131-2	
	Under intermittent vibration	Frequency: 5 to 8.4Hz, Acceleration: --, Half-amplitude: 3.5mm
	Under continuous vibration	Frequency: 5 to 8.4Hz, Acceleration: --, Half-amplitude: 1.75mm
		8.4 to 150Hz, Acceleration: 9.8m/s <sup>2</sup> , Half-amplitude: --
Shock resistance	Compliant with JIS B 3502 and IEC 61131-2 (147 m/s <sup>2</sup> (15G), 3 times in each X, Y, or Z direction)	
Operating atmosphere	No greasy fumes, corrosive gas, flammable gas, excessive conductive dust, and direct sunlight (as well as at storage)	
Operating altitude <sup>*1</sup>	2000 m or less	
Overvoltage category <sup>2</sup>	II or less	
Pollution degree <sup>3</sup>	2 or less	
Cooling method	Self-cooling	
Grounding	Grounding with a ground resistance of 100 Ω or less by using a ground cable that has a cross-sectional area of 2 mm <sup>2</sup> or more. If impossible, connect the ground cable to the control panel.	
Type rating	UL Type 1	

\*1 Do not use or store the GOT under a pressure higher than the atmospheric pressure at altitude 0 m. Doing so may cause a malfunction.

\*2 This indicates the section of the power supply to which the equipment is assumed to be connected between the public electrical power distribution network and the machinery within the premises. Category II applies to equipment that is supplied with power from fixed facilities. The withstand surge voltage for the equipment with the rated voltage up to 300 V is 2500 V.

\*3 This indicates the occurrence rate of conductive material in an environment where a device is used. Pollution degree 2 indicates an environment where only non-conductive pollution occurs normally and a temporary conductivity caused by condensation shall be expected depending on the conditions.

### 2.2 Performance Specifications

Item	Specifications	
	GT2506HS-VTBD	
Display section <sup>*1,2</sup>	Model	TFT color LCD
	Screen size	6.5"
	Resolution	VGA: 640 × 480 dots
	Display size	132.5(5.22) (W) × 99.4(3.91) (H) mm(inch)
	Number of displayed characters	16-dot standard font: 40 characters × 30 lines (two-byte characters) 12-dot standard font: 53 characters × 40 lines (two-byte characters)
	Display color	65536 colors
	Brightness adjustment	32 levels
	Backlight	LED (Not replaceable)
	Backlight life <sup>4</sup>	Approximately 40000 hours (Operating ambient temperature: 25°C, display intensity: 50%)
	Touch panel <sup>3</sup>	Type
Key size		Minimum 2 × 2 dots <sup>7</sup> (per key)
The number of simultaneous press		Not available <sup>5</sup> (Only 1 point can be touched.)
Life		1 million touches or more (Operating force: 0.98 N or less)
Buzzer output	Single tone (tone and tone length adjustable)	
Protective structure	IP65F <sup>6,8</sup> (Valid when the external cable is connected, except for the relay connector side of the external cable.)	
External dimensions	201(7.91) (W) × 230(9.06) (H) × 97(3.82) (D) mm(inch) (Excluding projections such as the emergency stop switch)	
Weight	1.2(2.6) kg(lb) (GT25 Handy main unit only)	

### 2.3 Power Supply Specifications

Item	Specifications
	GT2506HS-VTBD
Input power supply voltage	24V DC (+10% -15%)
Power consumption	11.6W or less
At backlight off	8.2W
Inrush current	30A or less (2ms, ambient temperature: 25°C, under the maximum load)
Permissible instantaneous power failure time	5ms or less
Noise immunity	Noise voltage: 1000Vp-p, noise width: 1μs, measured by a noise simulator with noise frequency ranging from 30Hz to 100Hz.
Dielectric withstand voltage	500V DC for 1 minute across power supply terminals and earth
Insulation resistance	500V DC across power supply terminals and earth, 10 MΩ or more by an insulation resistance tester

### 2.4 External Dimensions

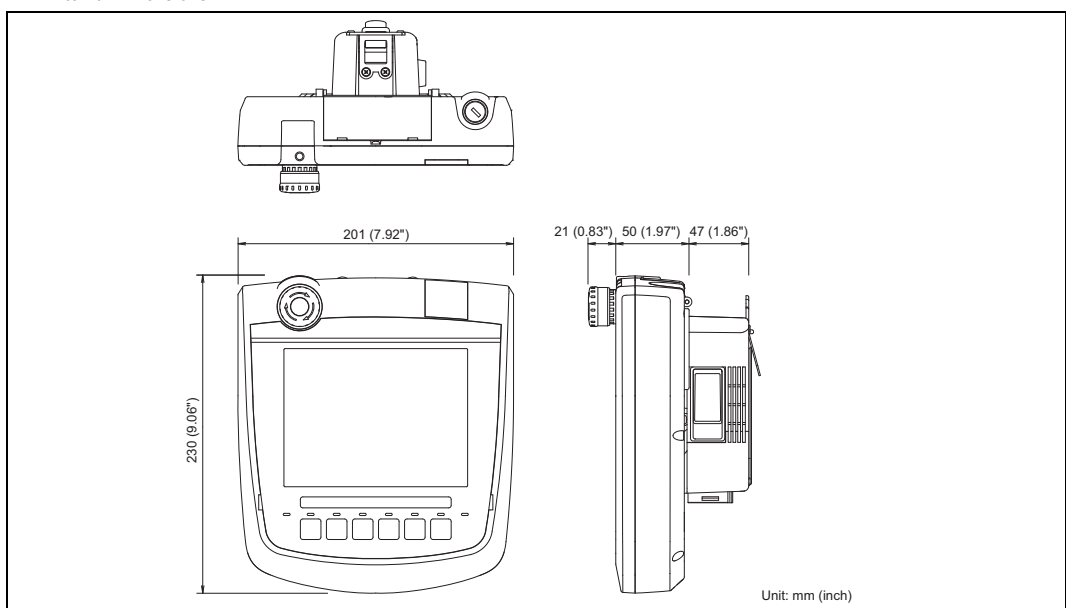

### 3. Maintenance and Inspection

The GOT does not include consumable components that will cause the shorten life. However, the battery, LCD, and backlight have their life spans respectively. It is recommended to replace the battery periodically. (For the replacement of the liquid crystal screen, please consult your nearest sales office or FA Center.)

#### 3.1 Daily Inspection

##### Daily inspection items

No.	Inspection Item	Inspection Method	Criterion	Action	
1	Connection status	Loose connectors	Visual check	Not loose	Replace external cable.
		Dirt on protection sheet	Visual check	Not outstanding	Replace with new one
2	Usage status	Foreign material attachment	Visual check	No foreign matter sticking	Remove clean

#### 3.2 Periodic Inspection

**Yearly or half-yearly inspection items**  
The following inspection should also be performed when equipment has been moved or modified or the wiring changed.

No.	Inspection Item	Inspection Method	Criterion	Action	
1	Surrounding environment	Ambient temperature	Make measurement with thermometer or hygrometer	0 to 40°C	For use in control panel, temperature inside control panel is ambient temperature
		Ambient humidity	Measure corrosive gas	10 to 90%RH	
		Atmosphere	Measure corrosive gas	No corrosive gas	
2	Power supply voltage check	24V DC Measure voltage across terminals.	20.4 to 26.4V DC	Change supply power	
3	Mounting status	Dirt, foreign matter	Visual check	No dirt, foreign matter sticking	Remove, clean
4	Connection status	Loose connectors	Visual check	Not loose	Replace external cable.
5	Battery	Check the system alarm (error code: 500) report on the Alarm Information screen	(Preventive maintenance)	Replace with new battery when the current battery has reached the specified life span, even if battery voltage is not displayed.	

Item	Specifications	
	GT2506HS-VTBD	
Compatible software package	GT Works3 Version1.170C or later	
Switch	Operation switch	6 switches (6 contacts/common) N/O contact, Maximum rating 10 mA/24V DC, Life: 1000000 times
	Grip switch	1 switch (single wiring) (IDEC HE3B-M2PB) Enable switch (deadman switch) 3-position system of OFF ← ON → OFF 2 N/O contacts Maximum rating 1 A/24V DC (resistance load), Maximum rating 0.3 A/24V DC (induction load), Life: 100000 times
	Emergency stop switch	1 switch (single wiring) (IDEC XA1E-BV303R) 3 N/C contacts Maximum rating 1 A/24V DC (resistance load), Maximum rating 0.3 A/24V DC (induction load), Life: 100000 times
	Selector switch with key	1 switch (single wiring) (IDEC AS6M-2KT1PB) 2-notch type (Manual stop at each position/A key can be inserted and removed on only the left side./On the right side, a key cannot be removed./Two keys are provided.) 2-position, Maximum rating 1 A/24V DC (resistance load), Maximum rating 0.3 A/24V DC (induction load), Life: 100000 times
LED	POWER LED	2 colors (blue and orange)
User memory	User memory capacity	Memory for storage (ROM): 32 MB Memory for operation (RAM): 80 MB
	Life (number of write times)	100000 times
Battery	GT15-BAT lithium battery	
	Life	Approx. 5 years (Ambient temperature: 25 °C)
Built-in interface	RS-232 <sup>9</sup>	1 channel Transmission speed: 115200, 57600, 38400, 19200, 9600, 4800 bps Connector shape: Square 42 pins (Male)
	RS-422/485 <sup>9</sup>	1 channel Transmission speed: 115200, 57600, 38400, 19200, 9600, 4800 bps Connector shape: Square 42 pins (Male)
	Ethernet	1 channel Data transfer method: 100BASE-TX, 10BASE-T Connector shape: Square 42 pins (Male)
	USB (Host)	1 channel (Top face)
		Maximum transfer rate: High-Speed 480 Mbps Connector shape: USB-A
	USB (Device)	1 channel (Top face)
		Maximum transfer rate: High-Speed 480 Mbps Connector shape: USB Mini-B
SD card	1 channel, SDHC compliant (maximum 32 GB)	

\*1 As a characteristic of liquid crystal display panels, bright dots (always lit) and dark dots (never lit) may appear on the panel. Since liquid crystal display panels comprise a great number of display elements, the appearance of bright and dark dots cannot be reduced to zero. Individual differences in liquid crystal display panels may cause differences in color, uneven brightness and flickering. Note that these phenomena are characteristics of liquid crystal display panels and it does not mean the products are defective or damaged.

\*2 Flickering may occur due to vibration, shock, or the display colors.

\*3 When a stylus is used, the touch panel has a life of 100 thousand touches.

The stylus must satisfy the following specifications.

• Material: Polyacetal resin

• Tip radius: 0.8 mm or more

\*4 To prevent the display section from burning in and lengthen the backlight life, enable the screen save function and turn off the backlight.

\*5 If you touch two points or more simultaneously on the touch panel, a switch in an unintended location may operate. Do not touch two points or more simultaneously on the touch panel.

\*6 Note that the structure does not guarantee protection in all users' environments. The protection is not applied when the interface environment protection cover or environment protection back cover is removed. The GOT may not be used in an environment where the GOT is exposed to oil or chemicals for a long time, or where oil mist fills the air.

\*7 The minimum size of a key that can be arranged. To ensure safe use of the product, the following settings are recommended.

• Key size: 16 × 16 dots or larger

• Distance between keys: 16 dots or more

\*8 The suffix "F" of IP65F is a symbol that indicates protection rate against oil. It is described in the Appendix of JIS C 0920 of the Japanese Industrial Standards.

\*9 Select either RS-422/485 or RS232 when used. The channel is set to RS-422/485 before shipping.

### 3.3 Battery Replacement

The battery retains RAM data, clock data, and system status log data. Screen data is stored in the flash memory and data is retained even if the battery is dead.

- Battery model name  
Handy GOT is shipped with the following battery.  
Use it at replacement.

Product name	Model name
Battery	GT15-BAT

#### Battery replacement procedure

- 1) After keeping the GOT turned ON more than 10 minutes, turn OFF the GOT. After turning OFF the GOT, perform the procedure 2) to 7) within 5 minutes.
- 2) Loosen the environmental protection back cover screws at two points on GOT rear face to remove the cover.

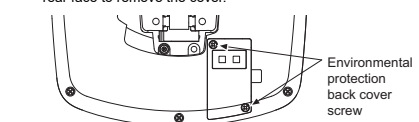

- 3) Remove the old battery from the holder and disconnect the connector.
- 4) Insert the connector of the new battery.
- 5) Install the battery to the GOT.

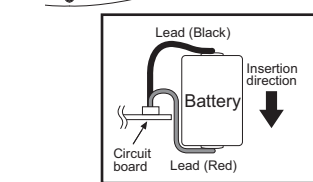
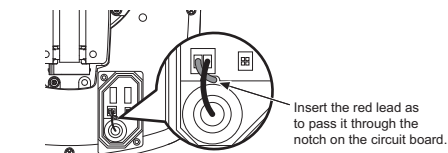
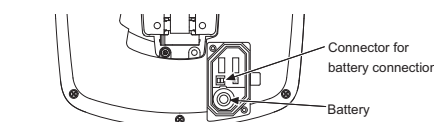

- 6) Attach the environmental protection back cover and tighten the screws. Tightening torque: 0.36 to 0.48 N·m
- 7) Turn the GOT power on.
- 8) Check if the battery condition is normal with the utility.

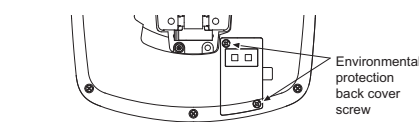

- Battery life  
Approximate battery life:  
5 years (ambient temperature: 25°C)  
Battery replacement: In 4 to 5 years

Approximate life is 5 years, but life may be shorter depending on the ambient temperature, therefore, note that the battery must be replaced in 4 to 5 years. Make sure to purchase a new battery as needed as it self-discharges.

Battery status can be confirmed on a GOT utility screen. For information on how to check the battery voltage status and set the battery alarm display, refer to the GOT2000 Series User's Manual (Utility).

### 4. Precautions

#### 4.1 Cautions on Using Emergency Stop Switch

- 1) When using the emergency stop switch in the handy GOT, judge the validity to use the emergency stop switch in accordance with the risk assessment in your system.
- 2) When using the parallel circuit (which disables the emergency stop status while the handy GOT is removed), the system may not conform to the safety standards. Check the safety standards required in the system, and then judge the validity to use the emergency stop switch.

「电器电子产品有害物质限制使用标识要求」的表示方式



Note: This symbol mark is for China only.

含有有害6物质的名称, 含有量, 含有部品  
本产品中所含有的有害6物质的名称, 含有量, 含有部品如下表所示。

部件名称	产品中有害物质的名称及含量					
	铅 (Pb)	汞 (Hg)	镉 (Cd)	六价铬 (Cr(VI))	多溴联苯 (PBB)	多溴二苯醚 (PBDE)
显示器	○	○	○	○	○	○
GOT	○	○	○	○	○	○
外壳	○	○	○	○	○	○
印刷基板	×	○	○	○	○	○
电缆	×	○	○	○	○	○

本表格依据SJ/T 11364的规定编制。

○: 表示该有害物质在该部件所有均质材料中的含量均在GB/T 26572规定的限量要求以下。  
×: 表示该有害物质至少在该部件的某一均质材料中的含量超出GB/T 26572规定的限量要求。

Referenced Standard: GB/T15969.2  
(Requirement of Chinese standardized law)

This manual confers no industrial property rights or any rights of any other kind, nor does it confer any patent licenses. Mitsubishi Electric Corporation cannot be held responsible for any problems involving industrial property rights which may occur as a result of using the contents noted in this manual.

**Warranty**  
Exclusion of loss in opportunity and secondary loss from warranty liability. Regardless of the gratis warranty term, Mitsubishi Electric shall not be liable for compensation to:

- (1) Damages caused by any cause found not to be the responsibility of Mitsubishi Electric.
- (2) Loss in opportunity, lost profits incurred by the user by Failures of Mitsubishi Electric products.
- (3) Special damages and secondary damages whether foreseeable or not, compensation for accidents, and compensation for damages to products other than Mitsubishi Electric products.
- (4) Replacement by the user, maintenance of on-site equipment, start-up test run and other tasks.

**⚠ For safe use**

- This product has been manufactured as a general-purpose part for general industries, and has not been designed or manufactured to be incorporated in a device or system used in purposes related to human life.
- Before using the product for special purposes such as nuclear power, electric power, aerospace, medicine or passenger movement vehicles, consult with Mitsubishi Electric.
- This product has been manufactured under strict quality control. However when installing the product where major accidents or losses could occur if the product fails, install appropriate backup or failsafe functions in the system.