



INVERTER

A800

PARALLEL OPERATION FUNCTION MANUAL

FR-A842-09620(400K) to 12120(500K)-P

Parallel Operation Function

This Function Manual explains the functions for a parallel operation. For the functions not found in this Function Manual, refer to the Instruction Manual (Detailed) of the FR-A800 inverter.
In addition to this Function Manual, please read the Instruction Manual (Detailed) of the FR-A800 inverter carefully. Do not use this product until you have a full knowledge of the equipment, safety information and instructions.

Please forward this Function Manual to the end user.

A800-P

CONTENTS

1	INTRODUCTION	4
1.1	FR-A802-P overview	4
2	PARALLEL OPERATION FUNCTION	5
2.1	Parallel operation selection	5
2.2	Parallel operation communication check time (Pr.652)	7
2.3	Parallel operation ready (Y227) signal	7
2.4	Vector control of multi-wound motor	7
2.5	Setting procedure for V/F control, Advanced magnetic flux vector control, and Real sensorless vector control	9
2.6	Emergency drive	12
3	SUPPLEMENTARY EXPLANATION TO THE FR-A800 INSTRUCTION MANUAL (DETAILED)	21
3.1	Torque current command limit (torque limit)	21
3.2	Torque current command limit (torque command)	22
4	PLUG-IN OPTIONS	24
4.1	Motor thermistor interface (FR-A8AZ) supported	24
4.2	PPO TYPE SUPPORT SPECIFICATION	25
5	PARAMETER	27
5.1	Parameter list	27
5.2	Input signal list	41
5.3	Output signal list	43
5.4	List of monitor items	45
6	PROTECTIVE FUNCTIONS	48
6.1	Causes and corrective actions	48

7 SPECIFICATIONS **50**

7.1	Common specifications	50
-----	-----------------------	----

8 APPENDIX **52**

8.1	Differences in the functions from the standard inverter	52
-----	---	----

8.2	Compatible options	53
-----	--------------------	----

1 INTRODUCTION

1.1 FR-A802-P overview

The FR-A802-P inverter is a parallel operation specification model. This function allows one motor having a large capacity to be driven by operating two or three inverters and converter units for parallel operation connected in parallel to the motor.

◆ Abbreviations

Abbreviation / generic name	Description
DU	Operation panel (FR-DU08)
Operation panel	Operation panel (FR-DU08) and LCD operation panel (FR-LU08)
Parameter unit	Parameter unit (FR-PU07)
PU	Operation panel and parameter unit
Inverter	Mitsubishi Electric FR-A802-P inverter (separated converter type for parallel operation)
Converter unit	FR-CC2-P converter unit (for parallel operation)
Vector control compatible option	FR-A8AP/FR-A8AL (plug-in option), FR-A8TP (control terminal option)
Pr.	Parameter number (number assigned to function)
PU operation	Operation using the PU (operation panel / parameter unit)
External operation	Operation using the control circuit signals
Combined operation	Combined operation using the PU (operation panel / parameter unit) and External operation

2 PARALLEL OPERATION FUNCTION

2.1 Parallel operation selection

The master/slave inverters to be operated in parallel can be set.

Pr.	Name	Initial value	Setting range	Applied motor	Description	
					Master/slave station	Number of slave stations
1001 E390	Parallel operation selection	100	1	Single wound motor	Slave station 1	—
			2		Slave station 2	—
			100 (initial value)		Master station	0
			200	1		
			300	2		
			10200	Multi-wound motor	Master station	1
			10201		Slave station 1	—

◆ Parallel operation selection (Pr.1001)

- When two inverters are operated in parallel, set **Pr.1001 Parallel operation selection** as follows.
 - When a single wound motor is driven
Master: **Pr.1001** = "200"
Slave: **Pr.1001** = "1 or 2" (The operation is enabled regardless of the number set for the slave.)
 - When a multi-wound motor is driven
Master: **Pr.1001** = "10200"
Slave: **Pr.1001** = "10201"
- To operate two inverters in parallel, set "200" in **Pr.1001 Parallel operation selection** of the master, and "1 or 2" in **Pr.1001** in the slave. (The operation is enabled regardless of the number set for the slave.)
- To operate three inverters in parallel, set "300" in **Pr.1001** of the master, "1" in **Pr.1001** of slave 1, and "2" in **Pr.1001** of slave 2.
- For operating one inverter (when the parallel operation is not performed) in case of an emergency, set "100 (initial value)" in **Pr.1001**.

NOTE

- The setting of **Pr.1001** will be applied after next power ON or inverter reset.
- When an inverter is specified as a slave station, either of the following indicators appears on the first monitor screen. (refer to [page 49](#))
SLV.1 (parallel operation slave 1): When a single wound motor or multi-wound motor is driven by the slave 1 inverter (**Pr.1001** = "1" or "10201").
SLV.2 (parallel operation slave 2): When a single wound motor is driven by the slave 2 inverter (**Pr.1001** = "2").
- While the slave stations are operated, [FWD] indicator on the operation panel is on regardless of forward rotation/reverse rotation.

CAUTION

- Be sure to set **Pr.1001** correctly. Operation with incorrect settings may damage the inverters.

◆ Setting procedure (for driving a single wound motor by two inverters in parallel)

- Install wiring between the RS-485 terminals on the master inverter and on the slave inverter. (For the details, refer to the Instruction Manual (Hardware) of the inverter.)
- Set "1 or 2" in **Pr.1001** of the slave inverter, and then reset the inverter.
- Set "200" in **Pr.1001** of the master inverter, and then reset the inverter.
- The communication starts between the master and the slave.

◆ Setting procedure (for driving a single wound motor by three inverters in parallel)

- 1** Install wiring between the RS-485 terminals on the master inverter and on the slave inverter.
(For the details, refer to the Instruction Manual (Hardware) of the inverter.)
- 2** Set "1" in Pr.1001 of the slave 1 inverter, and then reset the inverter.
- 3** Set "2" in Pr.1001 of the slave 2 inverter, and then reset the inverter.
- 4** Set "300" in Pr.1001 of the master inverter, and then reset the inverter.
- 5** The communication starts between the master and the slave.

NOTE

- For operating three inverters in parallel, it is not important which order steps 2 and 3 are performed in.

◆ Setting procedure (for driving a multi-wound motor by two inverters in parallel)

- 1** Install wiring between the RS-485 terminals on the master inverter and on the slave inverter.
(For the details, refer to the Instruction Manual (Hardware) of the inverter.)
- 2** Set "10201" in Pr.1001 of the slave inverter, and then reset the inverter.
- 3** Set "10200" in Pr.1001 of the master inverter, and then reset the inverter.
- 4** The communication starts between the master and the slave.

◆ Precautions for parameter setting during the parallel operation

- Set up the slave inverter first before the master inverter by the **Pr.1001** setting and the inverter reset. Otherwise, an error may occur in communication between the converter units.
- Before the parallel operation, set the same values between the master and the slave in **Pr.30, Pr.57, Pr.249, and Pr.261**. If the settings are not correct, the parallel operation will not be performed correctly.

◆ Resetting the inverter during the parallel operation

- When the RES signal of the master remains ON, the master keeps attempting to perform the inverter reset. However, the slave performs the inverter reset only once and does not keep attempting to perform the reset.
- For the inverter reset, reset the master inverter. The slave inverter will be reset simultaneously.

2.2 Parallel operation communication check time (Pr.652)

Pr.	Name	Initial value	Setting range	Description
652 N092	Parallel operation communication check time	1 s	0	Parallel operation communication disabled
			0.1 to 120 s	Set the interval of the communication check (signal loss detection) time. If a no-communication state persists for the permissible time or longer, the inverter will trip.
			9999	No communication check (signal loss detection)

- If the communication between the master and the slave is lost for a certain period, the inverter assumes it is in disconnection state and activates the protective function (E.SER) to shut off the output.
- If the communication for the time set in **Pr.652** is lost while the inverter is stopped, the signal loss detection is assumed and the protective function (E.SER) is activated.
- When the **Pr.652** setting is any of 0.1 to 120 s, the signal loss detection is made.
- When the **Pr.652** setting is "9999", the signal loss detection is not made.
- When the **Pr.652** setting is "0", the parallel operation communication is not possible.

2.3 Parallel operation ready (Y227) signal

- After the wiring of the RS-485 terminals and the setting of **Pr.1001** on all inverters are completed, communication between the inverters starts automatically and the inverters are prepared for the parallel operation. When the inverters are ready, the Parallel operation ready (Y227) signal turns ON.
- For the Y227 signal, set "227 (positive logic) or 327 (negative logic)" in any of **Pr.190 to Pr.196 (Output terminal function selection)** to assign the function to the output terminal.

NOTE

- Changing the terminal assignment using **Pr.190 to Pr.196 (Output terminal function selection)** may affect the other functions. Set parameters after confirming the function of each terminal.

2.4 Vector control of multi-wound motor

When a multi-wound motor is driven, Real sensorless vector control and Vector control are available. When the parallel operation is performed for a multi-wound motor under Real sensorless vector control or Vector control, sending a current command from the master station to the slave station via RS-485 communication and controlling the current in each station prevent a current reduction.

- To perform the parallel operation for a multi-wound motor under Real sensorless vector control or Vector control, set the motor constant parameters in both the master station and the slave station as shown in the following table. The setting values are basically the same for the master station and the slave station.

Pr.	Name	Setting*1
71	Applied motor	Set the same value for the master station and the slave stations according to the motor used and the motor constant setting increment.
82	Motor excitation current	(Value of the equivalent circuit for one winding) × 2 (number of windings)
90	Motor constant (R1)	(Value of the equivalent circuit for one winding) / 2 (number of windings)
91	Motor constant (R2)	(Value of the equivalent circuit for one winding) / 2 (number of windings)
92	Motor constant (L1)	(Value of the equivalent circuit for one winding) / 2 (number of windings)
93	Motor constant (L2)	(Value of the equivalent circuit for one winding) / 2 (number of windings)
94	Motor constant (X)	Value of the equivalent circuit for one winding
859	Torque current	(Value of the equivalent circuit for one winding) × 2 (number of windings)

*1 Motor constant of the equivalent circuit when connecting a multi-wound motor with the single wound motor connection diagram.

- When different motors are set as the first motor and the second motor and the operation is switched between them, the first motor must be driven under Real sensorless vector control or Vector control, and the second motor must be driven under V/F control or Advanced magnetic flux vector control.

◆ Parameter list

- When a multi-wound motor is driven under Real sensorless vector control or Vector control, setting the following parameters is enabled for the slave station. For the parameter details, refer to the FR-A800 Instruction Manual (Detailed).

Pr.	Name	Master station*1	Slave station*1
71	Applied motor	△	△
82	Motor excitation current	○	□
90	Motor constant (R1)	○	□
91	Motor constant (R2)	○	□
92	Motor constant (L1)	○	□
93	Motor constant (L2)	○	□
94	Motor constant (X)	○	□
827	Torque detection filter 1	○	□
859	Torque current	○	□

*1 ○: All setting values are valid.

△: Some setting values are invalid.

□: Parameter setting is valid when the parallel operation is performed for a multi-wound motor under Real sensorless vector control or Vector control.

NOTE

- When performing Vector control of multi-wound motor, always set the motor constant parameters in both the master station and the slave station. Otherwise, increase in the output current, significant difference between the command setting and the actual rotation speed, or other problems may occur.

2.5 Setting procedure for V/F control, Advanced magnetic flux vector control, and Real sensorless vector control

Configure settings under each control method as described in the applicable procedure.

◆ Setting procedure for V/F control

1 Wire the RS-485 terminals of the inverters.

(Refer to the FR-A802-P Instruction Manual (Hardware).)

2 Set Pr.1001 Parallel operation selection in each inverter as shown in the following table.

Winding type		Station	Pr.1001 setting
Single wound motor	Two units in parallel	Master station	200
		Slave station	1 or 2
	Three units in parallel	Master station	300
		Slave station 1	1
Multi-wound motor	Slave station 2	2	
	Master station	10200	
	Slave station	10201	

3 Set the motor to be used for the master station (Pr.71).

(Refer to the FR-A800 Instruction Manual (Detailed).)

Set "0" (standard motor) or "1" (constant-torque motor) in **Pr.71 Applied motor**

4 Set the overheat protection of the motor in the master station (Pr.9).

(Refer to the FR-A800 Instruction Manual (Detailed).)

5 Set the operation command in the master station.

Select the start command and speed command.

Check the **Pr.79** setting (refer to [page 27](#)) and the availability of signals (refer to [page 41](#)). For details, refer to the FR-A800 Instruction Manual (Detailed).

6 Set the stall prevention operation level in the master station (Pr.22).

(Refer to the FR-A800 Instruction Manual (Detailed).)

7 Perform offline auto tuning in the master station (Pr.96).

(Refer to the FR-A800 Instruction Manual (Detailed).)

When **Pr.96** = "11", tuning is performed without the motor rotating.

8 Test operation

NOTE

Configure the following settings in the master station as required. For the parameters, refer to [page 27](#). For more details, refer to the FR-A800 Instruction Manual (Detailed).

- Selecting online auto tuning (**Pr.95**)
- Easy gain tuning (**Pr.819, Pr.880**)
- Adjusting the speed control gain manually (**Pr.820, Pr.821**)

◆ Setting procedure for Advanced magnetic flux vector control

1 Wire the RS-485 terminals of the inverters.

(Refer to the FR-A802-P Instruction Manual (Hardware).)

2 Set Pr.1001 Parallel operation selection in each inverter as shown in the following table.

Winding type		Station	Pr.1001 setting
Single wound motor	Two units in parallel	Master station	200
		Slave station	1 or 2
	Three units in parallel	Master station	300
		Slave station 1	1
		Slave station 2	2
Multi-wound motor	Master station	10200	
	Slave station	10201	

3 Set the motor to be used for the master station (Pr.71).

(Refer to the FR-A800 Instruction Manual (Detailed).)

Set "0" (standard motor) or "1" (constant-torque motor) in **Pr.71 Applied motor**

4 Set the overheat protection of the motor in the master station (Pr.9).

(Refer to the FR-A800 Instruction Manual (Detailed).)

5 Set the motor capacity and number of motor poles in the master station (Pr.80, Pr.81).

(Refer to the FR-A800 Instruction Manual (Detailed).)

V/F control is performed when the setting is "9999" (initial value).

6 Set the rated motor voltage and the rated motor frequency in the master station (Pr.83, Pr.84).

(Refer to the FR-A800 Instruction Manual (Detailed).)

7 Set the operation command in the master station.

Select the start command and speed command.

Check the **Pr.79** setting (refer to [page 27](#)) and the availability of signals (refer to [page 41](#)). For details, refer to the FR-A800 Instruction Manual (Detailed).

8 Set the stall prevention operation level in the master station (Pr.22).

(Refer to the FR-A800 Instruction Manual (Detailed).)

9 Perform offline auto tuning in the master station (Pr.96).

(Refer to the FR-A800 Instruction Manual (Detailed).)

When **Pr.96** = "1", tuning is performed without the motor rotating.

10 Test operation



Configure the following settings in the master station as required. For the parameters, refer to [page 27](#). For more details, refer to the FR-A800 Instruction Manual (Detailed).

- Selecting online auto tuning (**Pr.95**)
- Easy gain tuning (**Pr.819, Pr.880**)
- Adjusting the speed control gain manually (**Pr.820, Pr.821**)

◆ Setting procedure for Real sensorless vector control

1 Wire the RS-485 terminals of the inverters.

(Refer to the FR-A802-P Instruction Manual (Hardware).)

2 Set Pr.1001 Parallel operation selection in each inverter as shown in the following table.

Winding type		Station	Pr.1001 setting
Single wound motor	Two units in parallel	Master station	200
		Slave station	1 or 2
	Three units in parallel	Master station	300
		Slave station 1	1
Multi-wound motor	Slave station 2	2	
	Master station	10200	
	Slave station	10201	

3 Set the motor to be used for the master station (Pr.71).

(Refer to the FR-A800 Instruction Manual (Detailed).)

Set "0" (standard motor) or "1" (constant-torque motor) in **Pr.71 Applied motor**

4 Set the overheat protection of the motor in the master station (Pr.9).

(Refer to the FR-A800 Instruction Manual (Detailed).)

5 Set the motor capacity and number of motor poles in the master station (Pr.80, Pr.81).

(Refer to the FR-A800 Instruction Manual (Detailed).)

V/F control is performed when the setting is "9999" (initial value).

6 Set the rated motor voltage and the rated motor frequency in the master station (Pr.83, Pr.84).

(Refer to the FR-A800 Instruction Manual (Detailed).)

7 Select the control method for the master station (Pr.800).

(Refer to the FR-A800 Instruction Manual (Detailed).)

Select **Pr.800** = "10" (speed control) or "12" (speed/torque switchover) to enable speed control.

8 Set the operation command in the master station.

Select the start command and speed command.

Check the **Pr.79** setting (refer to [page 27](#)) and the availability of signals (refer to [page 41](#)). For details, refer to the FR-A800 Instruction Manual (Detailed).

9 Set the torque limit level in the master station (Pr.22).

(Refer to the FR-A800 Instruction Manual (Detailed).)

10 Perform offline auto tuning in the master station (Pr.96).

(Refer to the FR-A800 Instruction Manual (Detailed).)

When **Pr.96** = "1", tuning is performed without the motor rotating.

11 For a multi-wound motor, set the motor constant in the slave stations (not required for a single wound motor) (Pr.71, Pr.82, Pr.90, Pr.91, Pr.92, Pr.93, Pr.94, Pr.859).

When a multi-wound motor is used under Real sensorless vector control, set the motor constant of the slave stations using the tuning result of the master station. For details on the motor constant setting, refer to the description of Vector control of multi-wound motor (on [page 7](#)).

12 Test operation



Configure the following settings in the master station as required. For the parameters, refer to [page 27](#). For more details, refer to the FR-A800 Instruction Manual (Detailed).

- Selecting online auto tuning (**Pr.95**)
- Easy gain tuning (**Pr.819, Pr.880**)
- Adjusting the speed control gain manually (**Pr.820, Pr.821**)

2.6 Emergency drive



This function is used in case of emergency such as a fire to forcibly continue inverter operation to drive a motor without activating protective functions even if the inverter detects a fault. Using this function may cause damage of the motor or the inverter because driving the motor is given the highest priority. Use this function for emergency operation only. When the inverter is damaged by a fault, the motor operation can be continued by switching to the commercial power supply operation. The emergency drive function is available only when the function is set in the master inverter. To enable the emergency drive function, the function must be set in both the master inverter and the master converter unit (FR-CC2-P).

The emergency drive function is unavailable when any of the following conditions is satisfied.

- A value other than "10, 110, and 20" is set in Pr.800 or a value other than "10, 110, 20, and 9999" is set in Pr.451.
- The FR-A8NF or FR-A8NS is used.
- The brake sequence function is set.

Pr.	Name	Initial value		Setting range	Description
		FM	CA		
67 H301*1	Number of retries at fault occurrence	0		0 to 10, 101 to 110	Select whether to output the Fault (ALM) signal during the retry operation while the emergency drive operation is performed. 0 to 10: The ALM signal is not output during retry. 101 to 110: The ALM signal is output during retry.
69 H303*1	Retry count display erase	0		0	Setting "0" clears the retry success counter ("retry success" means that the inverter successfully restarts).
523 H320*1	Emergency drive mode selection	9999		100, 111, 112, 121, 122, 123, 124, 200, 211, 212, 221, 222, 223, 224, 300, 311, 312, 321, 322, 323, 324, 400, 411, 412, 421, 422, 423, 424	Select the operation mode of the emergency drive.
				9999	Emergency drive disabled.
524 H321*1*2	Emergency drive running speed	9999		0 to 590 Hz*3	Set the running frequency in the fixed frequency mode of the emergency drive (when the fixed frequency mode is selected in Pr.523)
				0% to 100%*3	Set the PID set point in the PID control mode of the emergency drive (when the PID control mode is selected in Pr.523)
				9999*3	Emergency drive disabled.
515 H322*1	Emergency drive dedicated retry count	1		1 to 200	Set the retry count during emergency drive operation.
				9999	Without retry count excess (no restriction on the number of retries).
1013 H323*1	Emergency drive running speed after retry reset	60 Hz	50 Hz	0 to 590 Hz	Set the frequency for operation after a retry when any of E.CPU, E.1 to E.3, and E.5 to E.7 occurs during emergency drive operation.
514 H324*1	Emergency drive dedicated waiting time	9999		0.1 to 600 s	Set the retry waiting time during emergency drive operation.
				9999	Waiting time: 1 s
136 A001*1	MC switchover interlock time	1 s		0 to 100 s	Set the operation interlock time for MC2 and MC3.
139 A004*1	Automatic switchover frequency from inverter to bypass operation	9999		0 to 60 Hz	Set the frequency at which the inverter-driven operation is switched over to the commercial power supply operation when the condition for the electronic bypass is established during emergency drive operation.
				9999	Electronic bypass during emergency drive is disabled.

Pr.	Name	Initial value		Setting range	Description
		FM	CA		
57 A702 ^{*4}	Restart coasting time	9999		0	Coasting time differs according to the inverter capacity. (Refer to the Instruction Manual (Detailed) of the FR-A800 inverter.)
				0.1 to 30 s	Set the waiting time for the inverter to perform a restart after restoring power due to an instantaneous power failure.
				9999	No restart

*1 The function is available only when the parameter is set in the master inverter. Settings in the slave does not enable the function.

*2 Set **Pr.524** after setting **Pr.523**.

*3 When **Pr.523** = "100, 200, 300, or 400", the emergency drive is activated regardless of the **Pr.524** setting.

*4 When setting **Pr.57**, set the same setting value in the master and the slave.

◆ Connection diagram

The following diagram shows a connection example for emergency drive operation (in the commercial mode).

- Example for driving a single wound motor by two inverters in parallel.

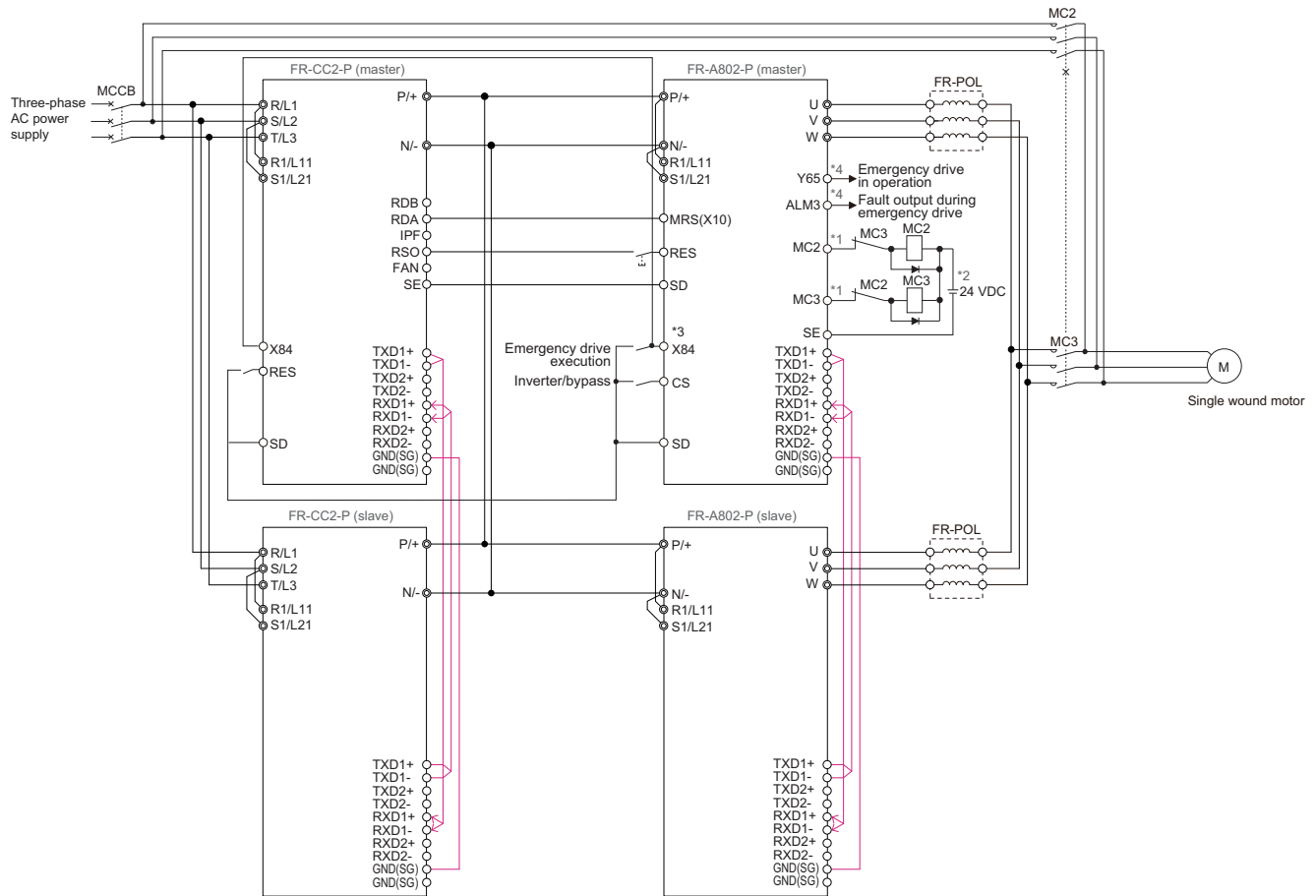

- *1 Be careful of the rated specifications of the output terminals. The applied terminals differ by the settings of Pr.190 to Pr.196 (Output terminal function selection).

Output terminal	Rated specification
Open collector output of inverter (RUN, SU, IPF, OL, FU)	Permissible load: 24 VDC 0.1 A
Inverter relay output (A1-C1, B1-C1, A2-C2, B2-C2) Relay output option (FR-A8AR)	Contact capacity: 230 VAC 0.3 A 30 VDC 0.3 A

- *2 When connecting a DC power supply, insert a protective diode. When connecting an AC power supply, use relay output terminals of the inverter or contact output terminals of the relay output option (FR-A8AR).
- *3 The applied terminals differ by the settings of Pr.180 to Pr.189 (Input terminal function selection)
- *4 The applied terminals differ by the settings of Pr.190 to Pr.196 and Pr.320 to Pr.322 (Output terminal function selection).

NOTE

- Be sure to provide a mechanical interlock for MC2 and MC3.
- Parameter settings for the emergency drive function are enabled in the master inverter only. Settings in the slave does not enable the function.
- Settings in the master converter unit (FR-CC2-P) is also required to enable the emergency drive function.

◆ Emergency drive execution sequence

- When the X84 signal is ON for 3 seconds, the emergency drive is activated.
 - The Y65 signal turns ON during emergency drive operation.
 - "ED" appears on the operation panel during emergency drive operation.
 - The ALM3 signal turns ON when a fault occurs during emergency drive operation.
- The following diagram shows the operation of the emergency drive function (in the retry / output shutoff mode or in the fixed frequency mode (**Pr.523** = "211")).

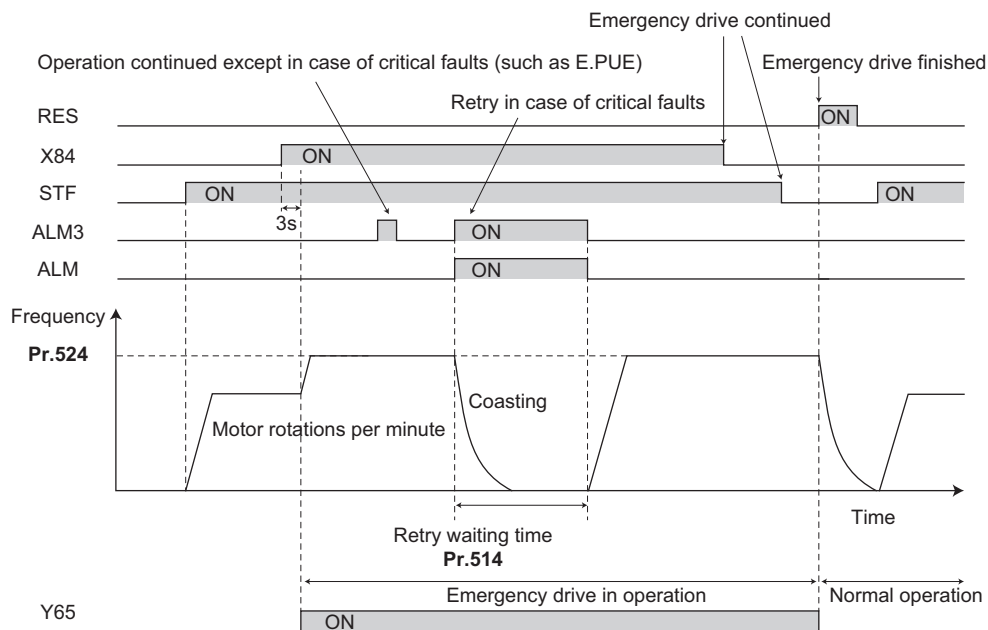

- The following diagram shows the operation of switching over to the commercial power supply operation during emergency drive operation by turning ON the CS signal (in the commercial mode or in the fixed frequency mode (**Pr.523** = "411")).

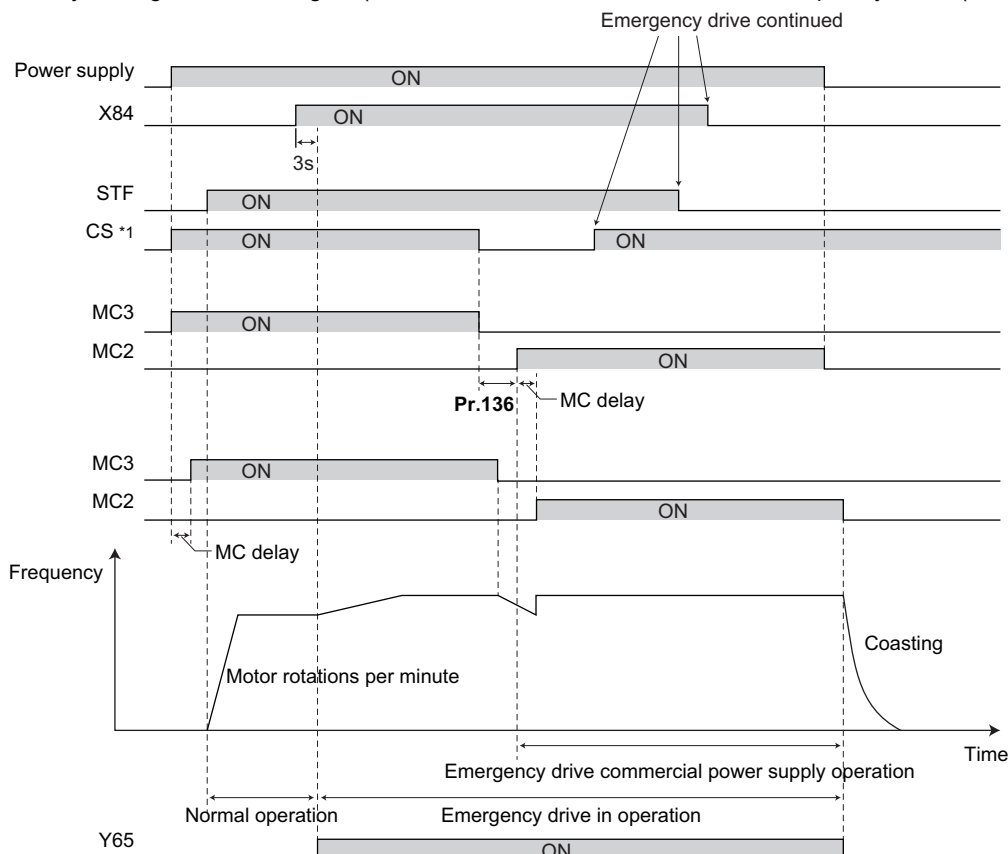

*1 Input the CS signal via an external terminal.

◆ Emergency drive operation selection (Pr.523, Pr.524)

- Use **Pr.523 Emergency drive mode selection** to select the emergency drive operation. Set a value in the hundreds place to select the operation when a valid protective function is activated (critical fault) during emergency drive. Set values in the ones and tens places to select the operation method.

Pr.523 setting	Emergency drive operation mode		Description
1□□	Output shutoff mode		Output shutoff at a critical fault occurrence.
2□□	Retry / output shutoff mode		Retry operation at a critical fault occurrence. (Output shutoff at the occurrence of a fault for which retry is not permitted.) The output is shut off when a critical fault for which retry is not permitted occurs, or the retry count is exceeded.
3□□	Retry / commercial mode		Retry operation at a critical fault occurrence. (Electronic bypass at the occurrence of a critical fault for which retry is not permitted.) The operation is switched over to the commercial power supply operation when a critical fault for which retry is not permitted occurs, or the retry count is exceeded. While Pr.515 = "9999", the operation is switched over to the commercial power supply operation when the retry count reaches 200.
4□□	Commercial mode		The operation is switched over to the commercial power supply operation when a critical fault occurs.
□□0	Normal operation		The operation is performed with the same set frequency and by the same starting command as those in the normal operation. Use this mode to avoid output shutoff due to a fault.
□□11	Fixed frequency mode	Forward rotation	The operation is forcibly performed with the frequency set in Pr.524 . Even when the motor is stopped, the operation is started by the emergency drive operation.
□□12		Reverse rotation	
□□21	PID control mode	Forward rotation	The operation is performed under PID control using the Pr.524 setting as a set point. The measured values are input in the method set in Pr.128 .
□□22		Reverse rotation	
□□23		Forward rotation (Second PID measured value input)	The operation is performed under PID control using the Pr.524 setting as a set point. The measured values are input in the method set in Pr.753 .
□□24		Reverse rotation (Second PID measured value input)	
9999	Emergency drive disabled.		

NOTE

- When the emergency drive is activated in the fixed frequency mode or in the PID control mode, the operation is automatically switched from the PU operation mode or External/PU combined operation mode to the External operation mode.

◆ Retry operation during emergency drive (Pr.515, Pr.514)

- Set the retry operation during emergency drive operation. Use **Pr.515 Emergency drive dedicated retry count** to set the retry count, and use **Pr.514 Emergency drive dedicated waiting time** to set the retry waiting time.
- The ALM signal output conditions depend on the **Pr.67 Number of retries at fault occurrence** setting.
- For the protective functions (critical faults) for which a retry is performed during emergency drive operation, refer to [page 18](#).

NOTE

- The inverter output is shut off when the Inverter operation enable signals in the converter unit (FR-CC2-P) are in not ready state (the RDA signal is OFF and the RDB signal is ON) during emergency drive.

◆ Electronic bypass during emergency drive (Pr.136, Pr.139, Pr.57)

- For selecting the commercial mode (Pr.523 = "3□□, 4□□"), setting is required as follows.
Set **Pr.136 MC switchover interlock time** and **Pr.139 Automatic switchover frequency from inverter to bypass operation** and assign MC2 and MC3 signals to output terminals.
When the CS signal is assigned to an input terminal, set **Pr.57 Restart coasting time** ≠ "9999" and input the CS signal through the terminal. (In the initial setting, the CS signal is assigned to the terminal CS.)
- During emergency drive operation, the operation is switched over to the commercial power supply operation when any of the following conditions is satisfied.
CS signal turns OFF.
A critical fault for which retry is not permitted occurs while **Pr.523**="3□□".
A critical fault occurs while **Pr.523** = "4□□".
- While the motor is driven by the inverter during emergency drive operation, if a condition for electronic bypass is satisfied, the output frequency is accelerated/decelerated to the **Pr.139** setting. When the frequency reaches the set frequency, the operation is switched over to the commercial power supply operation. (The operation is immediately switched over to the commercial power supply operation during output shutoff due to a critical fault occurrence.)
- If the parameter for electronic bypass is not set while the commercial mode is set (**Pr.523** = "3□□, 4□□"), the operation is not switched over to the commercial power supply operation even when a condition for switchover is satisfied, and the output is shut off.
- To assign the MC2 and MC3 signals to output terminals, use any two of **Pr.190 to Pr.196 (Output terminal function selection)** and set "18 (positive logic)" for the MC2 signal and set "19 (positive logic)" for the MC3 signal.
- Operation of magnetic contactor (MC2, MC3)

Magnetic contactor	Installation location	Operation	
		During commercial power supply operation	During inverter operation
MC2	Between power supply and motor	Shorted	Open
MC3	Between inverter output side and motor	Open	Shorted

- The input signals are as shown below.

Signal	Function	Operation	MC operation*3	
			MC2	MC3
CS	Inverter/bypass	ON: Inverter operation*1	×	○
		OFF: Emergency drive commercial power supply operation	○	×
X84	Emergency drive operation	ON: Emergency drive operation	—	—
		OFF: Normal operation*2	×	○
RES	Operation status reset	ON: Reset	×	No change
		OFF: Normal operation	—	—

*1 If the signal is turned ON after switchover to the emergency drive commercial power supply operation, the operation will not be returned to the inverter-driven operation.

*2 If the signal is turned OFF during the emergency drive operation, the operation will not be returned to normal.

*3 MC operation is as shown below.

Notation	MC operation
○	ON
×	OFF
—	During inverter operation: MC2-OFF, MC3-ON During commercial power supply operation: MC2-ON, MC3-OFF
No change	The operation status before changing the signal state to ON or OFF is held.

NOTE

- During electronic bypass operation while the electronic bypass sequence is enabled (Pr.135 = "1"), the emergency drive function is not available.

◆PID control during emergency drive operation

- During emergency drive operation in the PID control mode, the operation is performed under PID control using the **Pr.524** setting as a set point. Input the measured values in the method set in **Pr.128** or **Pr.753**.
- When the PID control mode is selected for emergency drive, the PID action during emergency drive operation is as follows depending on the PID control setting.

Item	PID control action		
	Set point / measured value input setting	Deviation input setting	Without PID control setting
Measured value input selection (Pr.128, Pr.753)	Held	Terminal 4 input	Terminal 4 input
Forward action / reverse action selection (Pr.128, Pr.753)	Held	Held	Reverse action
Proportional band (Pr.129, Pr.756)	Held	Held	100% (initial value)
Integral time (Pr.130, Pr.757)	Held	Held	1 s (initial setting)
Differential time (Pr.134, Pr.758)	Held	Held	Not used (initial setting)
Applied to the frequency / calculation only (Pr.128, Pr.753)	Applied to the frequency	Applied to the frequency	Applied to the frequency
Dancer control	Disabled	Disabled	Disabled
Other PID-related settings	Held	Held	Held

- While the "retry" (**Pr.523** = "22[], 32[]") is selected in the PID control mode, if a retry occurs at an occurrence of E.CPU, E.1 to E.3, or E.5 to E.7 during emergency drive operation, the operation is performed not under PID control but with the fixed frequency.

Use **Pr.1013 Emergency drive running speed after retry reset** to set the fixed frequency.



- For details on the PID control, refer to the FR-A800 Instruction Manual (Detailed).

◆Operation of protective functions during emergency drive

- Operation of protective functions during emergency drive is as follows.

Protective function	Operation during emergency drive
E.OC1	Retry
E.OC2	Retry
E.OC3	Retry
E.OCT	Retry
E.OV1	Retry
E.OV2	Retry
E.OV3	Retry
E.OVT	Retry
E.THT	Retry
E.THM	Retry
E.FIN	Retry
E.OLT	Retry
E.SOT	Retry
E.BE	Retry*1
E.GF	Retry
E.LF	The function is disabled.
E.OHT	Retry
E.PTC	Retry
E.OPT	The function is disabled.
E.OP1	The function is disabled.

Protective function	Operation during emergency drive
E.OP2	The function is disabled.
E.OP3	The function is disabled.
E.16	The function is disabled.
E.17	The function is disabled.
E.18	The function is disabled.
E.19	The function is disabled.
E.20	The function is disabled.
E.PA1	Retry / output shutoff*2
E.PA2	Retry / output shutoff*2
E.PE	Output shutoff
E.PUE	The function is disabled.
E.RET	Output shutoff
E.PE2	Output shutoff
E.CPU	Retry
E.CTE	The function is disabled.
E.P24	The function is disabled.
E.CDO	Retry
E.SER	Retry*4
E.AIE	The function is disabled.
E.USB	The function is disabled.

Protective function	Operation during emergency drive
E.SAF	Retry*1
E.PBT	Retry*1
E.OS	The function is disabled.
E.OSD	The function is disabled.
E.ECT	The function is disabled.
E.OD	The function is disabled.
E.ECA	The function is disabled.
E.MB1 to E.MB7	The function is disabled.
E.EP	The function is disabled.
E.LCI	The function is disabled.
E.PCH	The function is disabled.
E.PID	The function is disabled.
E.1	Retry*3
E.2	Retry*3
E.3	Retry*3
E.5	Retry*3
E.6	Retry*1*3
E.7	Retry*1*3
E.11	The function is disabled.
E.13	Output shutoff

*1 While the switchover to the commercial power supply operation during emergency drive operation is enabled, when the same protective function is activated twice consecutively, the retry is attempted up to twice.
 *2 The output is shut off when one of the faults to shut off the output shown in the table occurs in a slave.
 *3 In normal operation (**Pr.523** = "200 or 300"), the start signal is turned OFF at the same time the retry function resets the protective function. Input the start signal again to resume the operation.
 *4 The output is shut off when the protection function is activated in the slave inverter.

- The fault output during emergency drive operation is as follows.

Signal	Pr.190 to Pr.196 setting		Description
	Positive logic	Negative logic	
ALM	99	199	Turns ON at the occurrence of a fault that causes the above-mentioned "retry" or "output shutoff" during emergency drive operation. Use Pr.67 Number of retries at fault occurrence to select whether to output the Fault (ALM) signal during the retry operation. In the initial setting, "0" is set (the ALM signal is not output during retry).
ALM3	66	166	Output when a fault occurs during emergency drive operation. During emergency drive operation, if a fault that does not activate any protective function occurs, the signal turns ON for 3 seconds and then turns OFF.

◆ Input signal operation

- During emergency drive operation in the fixed frequency mode or in the PID control mode, input signals unrelated to the emergency drive become invalid with some exceptions.
- The following table shows functions of the signals that do not become invalid during emergency drive operation in the fixed frequency mode or in the PID control mode.

Input signal status	Fixed frequency mode	PID control mode
Valid	OH, X10, TRG, TRC, X51, RES	OH, X10, TRG, TRC, X51, RES
Held	RT, X9, X17, X18, SQ, X84	RT, X9, X16, X17, X18, SQ, X64, X65, X66, X67, X79, X84
Always-ON	—	X14, X77, X78, X80

- The X84 signal input is valid either through the external terminal or via network regardless of the **Pr.338** and **Pr.339** settings (Selection of control source in Network operation mode).
- Except for the following signals, input signals to the slave during emergency drive operation are fixed to OFF. CS, OH, X14, X16, TRG, TRC, SQ, X51, RES, X64, X65, X66, X72, X73, X79, X80

◆ Emergency drive status monitor

- Set "68" in **Pr.52, Pr.774 to Pr.776, Pr.992** to monitor the status of the emergency drive on the operation panel.
- Description of the status monitor

Operation panel indication	Description	
	Emergency drive setting	Emergency drive operating status
0	Emergency drive function setting is not available.	—
1	Electronic bypass during emergency drive operation is disabled.	During normal operation
2		Operating properly
3		A certain alarm is occurring.*2
4		Emergency drive in operation
5		A critical fault is occurring. The continuous operation is not allowed due to output shutoff.
11	Electronic bypass during emergency drive operation is enabled.	During normal operation
12		Operating properly
13		A certain alarm is occurring.*2
14		Emergency drive in operation
15		A critical fault is occurring. The continuous operation is not allowed due to output shutoff.
2 ₊ ⁺¹		Electronic bypass is started during emergency drive (during acceleration/deceleration to the switchover frequency).
3 ₊ ⁺¹		During electronic bypass during emergency drive (waiting during the interlock time).
4 ₊ ⁺¹		During commercial power supply operation during emergency drive

*1 The first digit remains the same as the previous numerical value (fault condition).

*2 "A certain alarm" means a protective function disabled during emergency drive shown in the tables on [page 18](#).

Emergency drive

NOTE

- When the "retry" (Pr.523 = "2000, 3000") is selected, it is recommended to use the automatic restart after instantaneous power failure function at the same time.
- Parameter setting is not available during emergency drive operation.
- To return to the normal operation during emergency drive operation, do the following.
(The operation will not be returned to normal only by turning OFF the X84 signal.)
Reset the inverter, or turn OFF and ON the power supply.
Clear a fault by turning ON the X51 signal while the sequence function is enabled (when the protective function is activated).
- When the emergency drive operation in the fixed frequency mode or PID control mode is switched to normal by clearing a fault by turning ON the X51 signal while the sequence function is enabled, the "Emergency drive in operation" status is retained.
For example, when the PU/External combined operation mode is selected, the operation is fixed at External operation mode during emergency drive operation. To return the operation to the one performed before emergency drive operation, Pr.79 must be set again or an inverter reset is required.
- The operation is switched over to the commercial power supply operation in case of the following during emergency drive operation while the commercial mode or the retry / commercial mode is selected.
- 24 V external power supply operation, power failure status or operation with the power supplied through R1/S1, undervoltage

CAUTION

- When the emergency drive function is enabled, the operation is continued or the retry operation (automatic reset and restart) is repeated even if a fault occurs, which may damage or burn the inverter, the converter unit, or the motor. Before restarting the normal operation after the operation using this function, make sure that the inverter, the converter unit, and the motor have no fault. Any damage of the inverter, the converter unit, or the motor caused by using the emergency drive function is not covered by the warranty even within the guarantee period.

◆ Automatic parameter setting (Pr.999)

A parameter related to the emergency drive function is added to the list of the parameters which are changed automatically when Pr.999 Automatic parameter setting = "20 or 21" shown in the FR-A800 Instruction Manual (Detailed). Refer to the following table.

Pr.	Name	Initial value		Pr.999 = "21"	Pr.999 = "20"
		FM type	CA type		
3	Base frequency	60Hz	50Hz	60Hz	50Hz
4	Multi-speed setting (high speed)	60Hz	50Hz	60Hz	50Hz
20	Acceleration/deceleration reference frequency	60Hz	50Hz	60Hz	50Hz
37	Speed display	0		0	
55	Frequency monitoring reference	60Hz	50Hz	60Hz	50Hz
66	Stall prevention operation reduction starting frequency	60Hz	50Hz	60Hz	50Hz
116	Third output frequency detection	60Hz	50Hz	60Hz	50Hz
125 (903)	Terminal 2 frequency setting gain frequency	60Hz	50Hz	60Hz	50Hz
126 (905)	Terminal 4 frequency setting gain frequency	60Hz	50Hz	60Hz	50Hz
263	Subtraction starting frequency	60Hz	50Hz	60Hz	50Hz
266	Power failure deceleration time switchover frequency	60Hz	50Hz	60Hz	50Hz
386	Frequency for maximum input pulse	60Hz	50Hz	60Hz	50Hz
505	Speed setting reference	60Hz	50Hz	60Hz	50Hz
808	Forward rotation speed limit/ speed limit	60Hz	50Hz	60Hz	50Hz
C14 (918)	Terminal 1 gain frequency (speed)	60Hz	50Hz	60Hz	50Hz
1013	Emergency drive running speed after retry reset	60Hz	50Hz	60Hz	50Hz

3 SUPPLEMENTARY EXPLANATION TO THE FR-A800 INSTRUCTION MANUAL (DETAILED)

Refer to descriptions in this chapter for relevant sections in the FR-A800 Instruction Manual (Detailed) on the CD-ROM enclosed with the product.

3.1 Torque current command limit (torque limit)

FR-A800 Instruction Manual (Detailed): 5.3.4 Setting the torque limit level

The following is the descriptions for "Changing the torque characteristic of the constant-power range (Pr.803)".

Pr.	Name	Initial value	Setting range	Description	
801 H704	Output limit level	9999	0 to 400%	Set the torque current limit level.	
			9999	The torque limit setting value is used for limiting the torque current level.	
803 G210	Constant output range torque characteristic selection	0	0	The torque rises in the low-speed range.	The motor power output is limited to be constant in the constant power range.
			1	The torque is kept constant in the low-speed range.	The torque is limited to be constant in the constant power range.
			2	The torque is kept constant in the low-speed range. (The torque current is limited.)	The torque is limited to be constant in the constant power range unless the output limit of the torque current is reached. (The torque current is limited.)
			10	The torque is kept constant in the low-speed range.	The motor power output is limited to be constant in the constant power range.
			11	The torque rises in the low-speed range.	The torque is limited to be constant in the constant power range.

◆ Changing the torque characteristic in the constant power output range (Pr.803)

- Under Real sensorless vector control or Vector control, the torque characteristic can be changed between in the low-speed range and in the constant power range.
- Use **Pr.85 Excitation current break point** to change the low-speed range, and use **Pr.86 Excitation current low speed scaling factor** to change the torque in the low-speed range. When **Pr.85** = "9999 (initial value)", a predetermined frequency is used, and when **Pr.86** = "9999 (initial value)", a predetermined scaling factor is used. (Refer to the description of the excitation current low-speed scaling factor in the Instruction Manual (Detailed).)

Pr.803 setting	Torque characteristic in low-speed range	Torque characteristic in constant power range	
		Torque characteristic	Output limit
0 (initial value)	The torque changes according to the scaling factor set in Pr.86.*1	Constant motor output	—
1	Constant torque	Constant torque	Without
2	Constant torque	Constant torque	With
10	Constant torque	Constant motor output	—
11	The torque changes according to the scaling factor set in Pr.86.*1	Constant torque	Without

*1 This is applicable only under Real sensorless vector control. The upper limit of the torque at 0 Hz is determined by multiplying the torque limit in the constant-torque range by the scaling factor set in **Pr.86**.

Torque current command limit (torque command)

- To avoid overload or overcurrent of the inverter or motor, use **Pr.801 Output limit level** to limit the torque current.

Pr.801 setting	Description
0 to 400%	Set the torque current limit level.
9999	The torque limit setting value (Pr.22, Pr.812 to Pr.817, etc.) is used for limiting the torque current.

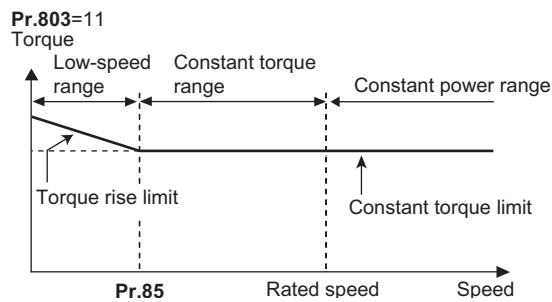
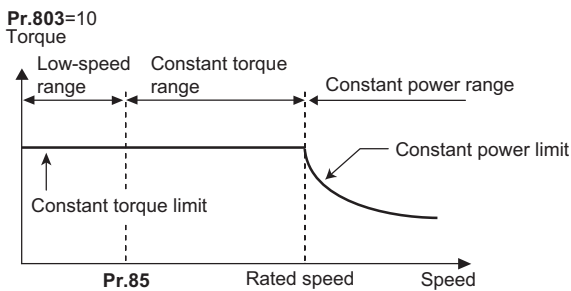
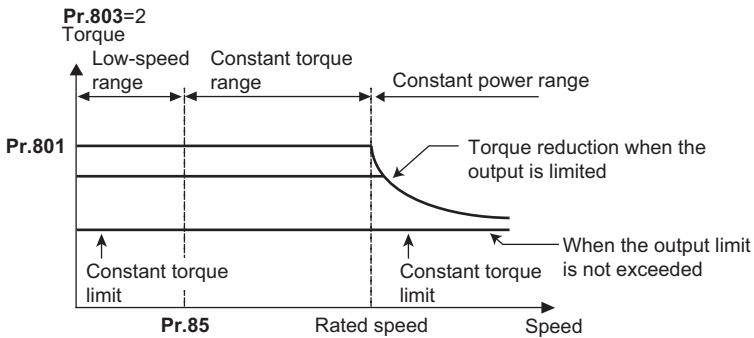
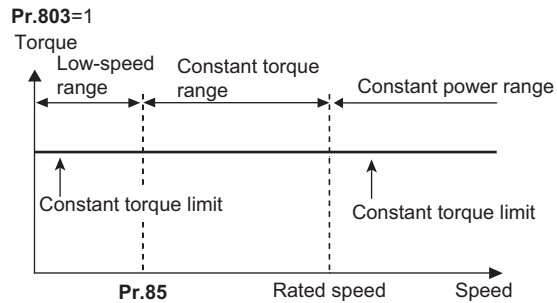
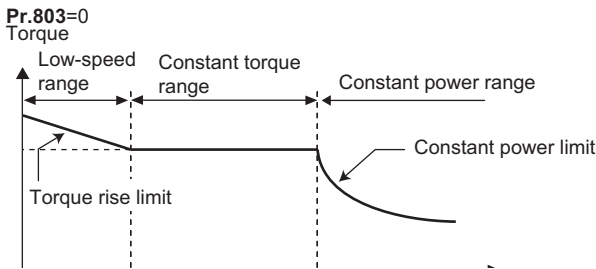

NOTE

- When the torque limit setting value (**Pr.22, Pr.812 to Pr.817, etc.**) is less than the value set in **Pr.801**, the **Pr.801** setting is used for limiting the torque current.

3.2 Torque current command limit (torque command)

FR-A800 Instruction Manual (Detailed): 5.4.4 Torque command

The following is the descriptions for "Changing the torque characteristic of the constant-power range (**Pr.803**)".

Pr.	Name	Initial value	Setting range	Description
801 H704	Output limit level	9999	0 to 400%	Set the torque current limit level.
			9999	The torque limit setting value is used for limiting the torque current level.
803 G210	Constant output range torque characteristic selection	0	0, 10	Constant motor output command
			1, 11	Constant torque command
			2	The torque is constant unless the output limit of the torque current is reached. (The torque current is limited.)
				Set the torque in the constant power range.

◆ Changing the torque characteristic in the constant power output range (Pr.803)

- Due to the characteristics of motors, the torque is reduced when the speed exceeds the rated speed. To keep the torque constant at the speed more than the rated speed, set "1 or 11" in **Pr.803 Constant output range torque characteristic selection**.
- During torque control, the torque is kept constant in the low-speed range regardless of the **Pr.803** setting. However, When "2" is set in **Pr.803** under Real sensorless vector control, the torque may not be kept constant in the low-speed range.

Pr.803 setting	Torque characteristic in constant power range	
	Torque characteristic	Output limit
0 (initial value), 10	Constant motor output	—
1, 11	Constant torque	Without
2	Constant torque	With

- To avoid overload or overcurrent of the inverter or motor, use **Pr.801 Output limit level** to limit the torque current in the constant power range.

Pr.801 setting	Description
0 to 400%	Set the torque current limit level.
9999	The torque limit setting value (Pr.22, Pr.812 to Pr.817, etc.) is used for limiting the torque current.

Pr.803 = 0, 1, 10, 11

Torque

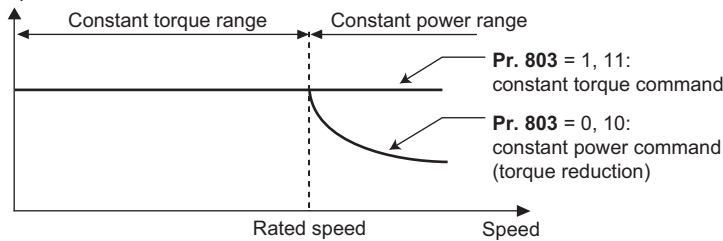

Pr.803 = 2

Torque

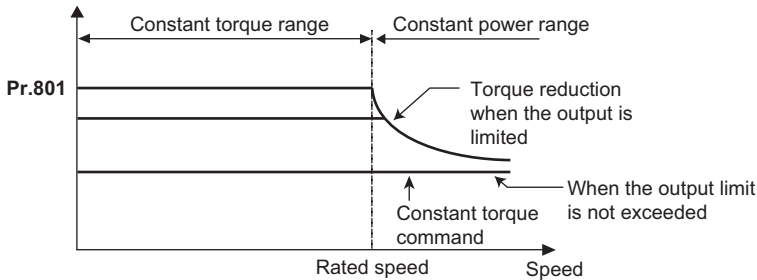

4 PLUG-IN OPTIONS

4.1 Motor thermistor interface (FR-A8AZ) supported

When using the vector inverter motor equipped with a thermistor (SF-V5RU □□□□□ T/A), the inverter can receive feedback (detected temperature) from the motor-side thermistor. The feedback is used to reduce the fluctuation of output torque. The detected motor temperature can be output as an output signal (Y55 signal) or be displayed on the monitor.

For more details, refer to the FR-A8AZ Instruction Manual.

- The availability of the related parameters for the master and the slave is as follows

Pr.	Pr. group	Name	Master	Slave
326	G062	Motor temperature feedback reference	<input type="radio"/>	<input type="radio"/>
407	T620	Motor temperature detection filter	<input type="radio"/>	<input type="radio"/>
408	H023	Motor thermistor selection	<input type="radio"/>	<input type="radio"/>
750	M061	Motor temperature detection level	<input type="radio"/>	<input type="radio"/>
751	M046	Reference motor temperature	<input type="radio"/>	<input type="radio"/>
C29(925)	H041	Motor temperature detection calibration (analog input)	<input type="radio"/>	<input type="radio"/>

- The availability of the Y55 signal for the master and the slave is as follows

Setting		Signal name	Function	Master	Slave
Positive logic	Negative logic				
55	155	Y55	Motor temperature detection	<input type="radio"/>	<input type="radio"/>

- The availability of the motor temperature monitor for the master and the slave is as follows.

Pr.52, Pr.54, Pr.158, Pr.774 to Pr.776, Pr.992, and Pr.1027 to Pr.1034 are available to set the monitor item.

Parameter setting for monitor item	Monitor item	Master	Slave
46	Motor temperature	<input type="radio"/>	<input type="radio"/>

4.2 PPO TYPE SUPPORT SPECIFICATION

The setting value "11" for **Pr.1110 PROFIBUS format selection** is available.

The format can be selected from among PRO types when the plug-in option FR-A8NP is used.

◆ PROFIBUS profiles

- The option unit operates as a "slave of the PROFIBUS DP master" or a "controller equivalent to PROFIBUS DP master class 1 on an RS-485 network".
- The PROFIBUS profile (data buffer) can be selected from among six different types, "PPO type1" to "PPO type5", and "A5NP". (For the module type "A5NP" profile, refer to the FR-A8NP Instruction Manual.)
- Module type is changed with the slave module setting. For details, refer to the instruction manual of the Network Master Configuration Software. The configuration of PPO type is as follows.

◆ Setting the PROFIBUS format (Pr.1110)

- For the FR-A800 series, set the PROFIBUS format in the **Pr.1110 PROFIBUS format selection**.
- Set **Pr.1110** = "1" to extend the PPO type 2 and PPO type 5 PROFIBUS profile formats. Then, commands and monitor items can be assigned to Word 8 to Word 10 in PPO type 2, and Word 8 to Word 14 in PPO type 5. (The format is not extended for PPO type 1, PPO type 3, and PPO type 4.)
- Set **Pr.1110** = "11" to prioritize commands (HSW, STW, ECW and REF1 to 7) in extended format. (Communication processing time (the time in which the inverter is busy with the request) does not change.)

Pr.	Name	Initial value	Setting range	Function
1110 N290	PROFIBUS format selection	0	0	Standard format
			1, 11 *1	Extended format

*1 For **Pr.1110** = "11", the function is enabled by combining the FR-A842-P or FR-A872-P inverter (manufactured in November 2020 or later) with the FR-A8NP plug-in option (manufactured in March 2018 or later).

◆ SERIAL number check

- The FR-A8NP, for which the setting value "11" for **Pr.1110 PROFIBUS format selection** is available, can be used for the inverter models listed below with the following SERIAL number or later. Check the SERIAL number indicated on the inverter rating plate or package. For the location of the rating plate, refer to the Instruction Manual (Hardware) of the inverter.
- Rating plate example

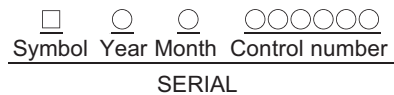
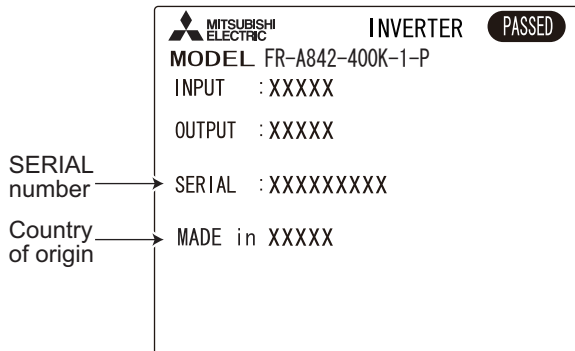

The SERIAL consists of one symbol, two characters indicating the production year and month, and six characters indicating the control number.

The last digit of the production year is indicated as the Year, and the Month is indicated by 1 to 9, X (October), Y (November), or Z (December).

- Inverters supporting the **Pr.1110 PROFIBUS format selection** setting value "11"

Model	Country of origin indication	SERIAL number
FR-A842-09620(400K) to 12120(500K)-P	MADE in Japan	□ 0 Y ○ ○ ○ ○ ○ ○
FR-A872-05690(450K) to 07150(560K)-P	MADE in China	□ 0 Z ○ ○ ○ ○ ○ ○

NOTE

- As shown in the following table, the availability of communication methods and function depends on a SERIAL number combination of the applied inverter and FR-A8NP. Check the circuit board of the FR-A8NP for its SERIAL number.
- Availability of communication methods
For the inverter manufactured in Japan

SERIAL number of the FR-A8NP	SERIAL number of the FR-A800 series inverter (FR-A842-P/FR-A872-P)	
	<input type="checkbox"/> 0 X ○○○○○○ or earlier	<input type="checkbox"/> 0 Y ○○○○○○ or later
<input type="checkbox"/> 82○○○ or earlier	Pr.1110 = "0, 1" valid.	Pr.1110 = "0, 1" valid. Setting Pr.1110 = "11" is the same as setting Pr.1110 = "1".
<input type="checkbox"/> 83○○○ or later		Pr.1110 = "0, 1 or 11" valid.

For the inverter manufactured in China

SERIAL number of the FR-A8NP	SERIAL number of the FR-A800 series inverter (FR-A842-P/FR-A872-P)	
	<input type="checkbox"/> 0 Y ○○○○○○ or earlier	<input type="checkbox"/> 0 Z ○○○○○○ or later
<input type="checkbox"/> 82○○○ or earlier	Pr.1110 = "0, 1" valid.	Pr.1110 = "0, 1" valid. Setting Pr.1110 = "11" is the same as setting Pr.1110 = "1".
<input type="checkbox"/> 83○○○ or later		Pr.1110 = "0, 1 or 11" valid.

- SERIAL number example of the FR-A8NP

□	8	3	○○○
Symbol	Year	Month	Control number

The SERIAL consists of one symbol, two characters indicating the production year and month, and three characters indicating the control number.
 The last digit of the production year is indicated as the Year, and the Month is indicated by 1 to 9, X (October), Y (November), or Z (December).

5 PARAMETER

5.1 Parameter list

The following is the list of parameters of the FR-A802-P (including the availability for the master and the slave).

○ indicates that all the settings are valid. △ indicates that some settings are invalid. × indicates that all the settings are invalid.

□ indicates that setting is valid under certain conditions.

The parameter marked with any of the following is available when the corresponding option is installed.

[AP]FR-A8AP, [TP]FR-A8TP, [AR]FR-A8AR, [AX]FR-A8AX, [AY]FR-A8AY, [AZ]FR-A8AZ, [NC]FR-A8NC, [NCE]FR-A8NCE,

[ND]FR-A8ND, [AL]FR-A8AL, [NP]FR-A8NP, [NS]FR-A8NS, [NF]FR-A8NF

Pr.	Name	Master	Slave	Refer to page
0	Torque boost	○	×	*1
1	Maximum frequency	○	×	*1
2	Minimum frequency	○	×	*1
3	Base frequency	○	×	*1
4	Multi-speed setting (high speed)	○	×	*1
5	Multi-speed setting (middle speed)	○	×	*1
6	Multi-speed setting (low speed)	○	×	*1
7	Acceleration time	○	×	*1
8	Deceleration time	○	×	*1
9	Electronic thermal O/L relay	○	×	*1
10	DC injection brake operation frequency	○	×	*1
11	DC injection brake operation time	○	×	*1
12	DC injection brake operation voltage	○	×	*1
13	Starting frequency	○	×	*1
14	Load pattern selection	○	×	*1
15	Jog frequency	○	×	*1
16	Jog acceleration/ deceleration time	○	×	*1
17	MRS input selection	○	○	*1
18	High speed maximum frequency	△	×	52
19	Base frequency voltage	○	×	*1
20	Acceleration/ deceleration reference frequency	○	×	*1
21	Acceleration/ deceleration time increments	○	×	*1
22	Stall prevention operation level (Torque limit level)	○	×	*1
23	Stall prevention operation level compensation factor at double speed	○	×	*1
24	Multi-speed setting (speed 4)	○	×	*1
25	Multi-speed setting (speed 5)	○	×	*1
26	Multi-speed setting (speed 6)	○	×	*1
27	Multi-speed setting (speed 7)	○	×	*1
28	Multi-speed input compensation selection	○	×	*1
29	Acceleration/ deceleration pattern selection	○	×	*1
30	Regenerative function selection	○	○	*1
31	Frequency jump 1A	○	×	*1
32	Frequency jump 1B	○	×	*1
33	Frequency jump 2A	○	×	*1
34	Frequency jump 2B	○	×	*1
35	Frequency jump 3A	○	×	*1
36	Frequency jump 3B	○	×	*1
37	Speed display	○	○	*1
41	Up-to-frequency sensitivity	○	×	*1
42	Output frequency detection	○	×	*1
43	Output frequency detection for reverse rotation	○	×	*1
44	Second acceleration/ deceleration time	○	×	*1
45	Second deceleration time	○	×	*1
46	Second torque boost	○	×	*1
47	Second V/F (base frequency)	○	×	*1
48	Second stall prevention operation level	○	×	*1
49	Second stall prevention operation frequency	○	×	*1
50	Second output frequency detection	○	×	*1
51	Second electronic thermal O/L relay	○	×	*1
52	Operation panel main monitor selection	○	△	45
54	FM/CA terminal function selection	○	△	45
55	Frequency monitoring reference	○	○	*1
56	Current monitoring reference	○	○	52
57	Restart coasting time	○	○	*1
58	Restart cushion time	○	×	*1

Parameter list

Pr.	Name	Master	Slave	Refer to page
59	Remote function selection	○	×	*1
60	Energy saving control selection	△	×	52
61	Reference current	○	×	52
62	Reference value at acceleration	○	×	*1
63	Reference value at deceleration	○	×	*1
64	Starting frequency for elevator mode	○	×	*1
65	Parameter for manufacturer setting. Do not set.			
66	Stall prevention operation reduction starting frequency	○	×	*1
67	Number of retries at fault occurrence	○	×	*3
68	Parameter for manufacturer setting. Do not set.			
69	Retry count display erase	○	×	*1
71	Applied motor	△	×	52
72	Parameter for manufacturer setting. Do not set.			
73	Analog input selection	○	○	*1
74	Input filter time constant	○	×	*1
75	Reset selection/ disconnected PU detection/PU stop selection	○	△	52
76	Fault code output selection	○	○	*1
77	Parameter write selection	○	○	*1
78	Reverse rotation prevention selection	○	×	*1
79	Operation mode selection	○	○	*1
80	Motor capacity	○	×	*1
81	Number of motor poles	○	×	*1
82	Motor excitation current	○	□*4	*1
83	Rated motor voltage	○	×	*1
84	Rated motor frequency	○	×	*1
85	Excitation current refraction point	○	×	*1
86	Excitation current low speed multiplying factor	○	×	*1
89	Speed control gain (Advanced magnetic flux vector)	○	×	*1
90	Motor constant (R1)	○	□*4	*1
91	Motor constant (R2)	○	□*4	*1
92	Motor constant (L1)	○	□*4	*1
93	Motor constant (L2)	○	□*4	*1
94	Motor constant (X)	○	□*4	*1
95	Online auto tuning selection	○	×	*1
96	Auto tuning setting/status	△	×	52
100	V/F1 (first frequency)	○	×	*1
101	V/F1 (first frequency voltage)	○	×	*1
102	V/F2 (second frequency)	○	×	*1
103	V/F2 (second frequency voltage)	○	×	*1
104	V/F3 (third frequency)	○	×	*1

Pr.	Name	Master	Slave	Refer to page
105	V/F3 (third frequency voltage)	○	×	*1
106	V/F4 (fourth frequency)	○	×	*1
107	V/F4 (fourth frequency voltage)	○	×	*1
108	V/F5 (fifth frequency)	○	×	*1
109	V/F5 (fifth frequency voltage)	○	×	*1
110	Third acceleration/ deceleration time	○	×	*1
111	Third deceleration time	○	×	*1
112	Third torque boost	○	×	*1
113	Third V/F (base frequency)	○	×	*1
114	Third stall prevention operation level	○	×	*1
115	Third stall prevention operation frequency	○	×	*1
116	Third output frequency detection	○	×	*1
117	PU communication station number	○	○	*1
118	PU communication speed	○	○	*1
119	PU communication stop bit length / data length	○	○	*1
120	PU communication parity check	○	○	*1
121	Number of PU communication retries	○	○	*1
122	PU communication check time interval	○	○	*1
123	PU communication waiting time setting	○	○	*1
124	PU communication CR/ LF selection	○	○	*1
125	Terminal 2 frequency setting gain frequency	○	×	*1
126	Terminal 4 frequency setting gain frequency	○	×	*1
127	PID control automatic switchover frequency	○	×	*1
128	PID action selection	○	△	52
129	PID proportional band	○	○	*1
130	PID integral time	○	○	*1
131	PID upper limit	○	○	*1
132	PID lower limit	○	○	*1
133	PID action set point	○	○	*1
134	PID differential time	○	○	*1
135	Electronic bypass sequence selection	○	×	*1
136	MC switchover interlock time	○	×	*1
137	Start waiting time	○	×	*1
138	Bypass selection at a fault	○	×	52
139	Automatic switchover frequency from inverter to bypass operation	○	×	*1
140	Backlash acceleration stopping frequency	○	×	*1
141	Backlash acceleration stopping time	○	×	*1

Pr.	Name	Master	Slave	Refer to page	Pr.	Name	Master	Slave	Refer to page
142	Backlash deceleration stopping frequency	○	×	*1	179	STR terminal function selection	○	△	41
143	Backlash deceleration stopping time	○	×	*1	180	RL terminal function selection	○	△	41
144	Speed setting switchover	○	○	*1	181	RM terminal function selection	○	△	41
145	PU display language selection	○	○	*1	182	RH terminal function selection	○	△	41
147	Acceleration/ deceleration time switching frequency	○	×	*1	183	RT terminal function selection	○	△	41
148	Stall prevention level at 0 V input	○	×	*1	184	AU terminal function selection	○	△	41
149	Stall prevention level at 10 V input	○	×	*1	185	JOG terminal function selection	○	△	41
150	Output current detection level	○	×	52	186	CS terminal function selection	○	△	41
151	Output current detection signal delay time	○	×	*1	187	MRS terminal function selection	○	△	41
152	Zero current detection level	○	×	52	188	STOP terminal function selection	○	△	41
153	Zero current detection time	○	×	*1	189	RES terminal function selection	○	△	41
154	Voltage reduction selection during stall prevention operation	○	×	*1	190	RUN terminal function selection	○	△	43
155	RT signal function validity condition selection	○	×	*1	191	SU terminal function selection	○	△	43
156	Stall prevention operation selection	○	×	52	192	IPF terminal function selection	○	△	43
157	OL signal output timer	○	×	*1	193	OL terminal function selection	○	△	43
158	AM terminal function selection	○	△	45	194	FU terminal function selection	○	△	43
159	Automatic switchover frequency range from bypass to inverter operation	○	×	*1	195	ABC1 terminal function selection	○	△	43
160	User group read selection	○	○	*1	196	ABC2 terminal function selection	○	△	43
161	Frequency setting/key lock operation selection	○	△	52	232	Multi-speed setting (speed 8)	○	×	*1
162	Automatic restart after instantaneous power failure selection	△	×	52	233	Multi-speed setting (speed 9)	○	×	*1
163	First cushion time for restart	○	×	*1	234	Multi-speed setting (speed 10)	○	×	*1
164	First cushion voltage for restart	○	×	*1	235	Multi-speed setting (speed 11)	○	×	*1
165	Stall prevention operation level for restart	○	×	*1	236	Multi-speed setting (speed 12)	○	×	*1
166	Output current detection signal retention time	○	×	*1	237	Multi-speed setting (speed 13)	○	×	*1
167	Output current detection operation selection	○	×	*1	238	Multi-speed setting (speed 14)	○	×	*1
168	Parameter for manufacturer setting. Do not set.				239	Multi-speed setting (speed 15)	○	×	*1
169					240	Soft-PWM operation selection	○	×	*1
170	Watt-hour meter clear	○	×	*1	241	Analog input display unit switchover	○	○	*1
171	Operation hour meter clear	○	○	*1	242	Terminal 1 added compensation amount (terminal 2)	○	○	*1
172	User group registered display/batch clear	○	○	*1	243	Terminal 1 added compensation amount (terminal 4)	○	○	*1
173	User group registration	○	○	*1	244	Cooling fan operation selection	○	○	*1
174	User group clear	○	○	*1	245	Rated slip	○	×	52
178	STF terminal function selection	○	△	41					

Parameter list

Pr.	Name	Master	Slave	Refer to page
246	Slip compensation time constant	○	×	52
247	Constant-power range slip compensation selection	○	×	52
248	Self power management selection	○	×	52
249	Earth (ground) fault detection at start	○	○	*1
250	Stop selection	○	×	*1
251	Output phase loss protection selection	○	○	*1
252	Override bias	○	×	*1
253	Override gain	○	×	*1
254	Main circuit power OFF waiting time	○	×	*1
255	Life alarm status display	○	○	*1
257	Control circuit capacitor life display	○	○	*1
260	Parameter for manufacturer setting. Do not set.			
261	Power failure stop selection	○	○	*1
262	Subtracted frequency at deceleration start	○	×	*1
263	Subtraction starting frequency	○	×	*1
264	Power-failure deceleration time 1	○	×	*1
265	Power-failure deceleration time 2	○	×	*1
266	Power failure deceleration time switchover frequency	○	×	*1
267	Terminal 4 input selection	○	○	*1
268	Monitor decimal digits selection	○	○	*1
269	Parameter for manufacturer setting. Do not set.			
270	Stop-on contact/load torque high-speed frequency control selection	○	×	*1
271	High-speed setting maximum current	○	×	52
272	Middle-speed setting minimum current	○	×	52
273	Current averaging range	○	×	*1
274	Current averaging filter time constant	○	×	*1
275	Stop-on contact excitation current low-speed multiplying factor	○	×	*1
276	Parameter for manufacturer setting. Do not set.			
278	Brake opening frequency	○	×	*1
279	Brake opening current	○	×	*1
280	Brake opening current detection time	○	×	*1
281	Brake operation time at start	○	×	*1
282	Brake operation frequency	○	×	*1
283	Brake operation time at stop	○	×	*1

Pr.	Name	Master	Slave	Refer to page
284	Deceleration detection function selection	○	×	*1
285	Overspeed detection frequency (Speed deviation excess detection frequency)	○	×	*1
286	Droop gain	○	×	*1
287	Droop filter time constant	○	×	*1
288	Droop function activation selection	○	×	*1
289	Inverter output terminal filter	○	○	*1
290	Monitor negative output selection	○	○	*1
291	Pulse train I/O selection	○	○	*1
292	Automatic acceleration/ deceleration	○	×	*1
293	Acceleration/ deceleration separate selection	○	×	*1
294	UV avoidance voltage gain	○	×	*1
295	Frequency change increment amount setting	○	○	*1
296	Password lock level	○	○	*1
297	Password lock/unlock	○	○	*1
298	Frequency search gain	○	×	*1
299	Rotation direction detection selection at restarting	○	×	*1
300	BCD input bias [AX]	○	×	*2
301	BCD input gain [AX]	○	×	*2
302	BIN input bias [AX]	○	×	*2
303	BIN input gain [AX]	○	×	*2
304	Digital input and analog input compensation enable/disable selection [AX]	○	×	*1
305	Read timing operation selection [AX]	○	×	*1
306	Analog output signal selection [AY]	○	△	45
307	Setting for zero analog output [AY]	○	○	*1
308	Setting for maximum analog output [AY]	○	○	*1
309	Analog output signal voltage/current switchover [AY]	○	○	*1
310	Analog meter voltage output selection [AY]	○	△	45
311	Setting for zero analog meter voltage output [AY]	○	○	*1
312	Setting for maximum analog meter voltage output [AY]	○	○	*1
313	DO0 output selection [AY] [NC] [NCE]	○	△	43

Pr.	Name	Master	Slave	Refer to page	Pr.	Name	Master	Slave	Refer to page
314	DO1 output selection [AY] [NC] [NCE]	○	△	43	355	DC injection brake start position [AP] [AL] [TP]	○	×	*2
315	DO2 output selection [AY] [NC] [NCE]	○	△	43	356	Internal stop position command [AP] [AL] [TP]	○	×	*2
316	DO3 output selection [AY]	○	△	43	357	Orientation in-position zone [AP] [AL] [TP]	○	×	*2
317	DO4 output selection [AY]	○	△	43	358	Servo torque selection [AP] [AL] [TP]	○	×	*2
318	DO5 output selection [AY]	○	△	43	359	Encoder rotation direction [AP] [AL]	○	×	*2
319	DO6 output selection [AY]	○	△	43	360	16-bit data selection [AP] [AL] [TP]	○	×	*2
320	RA1 output selection [AR]	○	△	43	361	Position shift [AP] [AL] [TP]	○	×	*2
321	RA2 output selection [AR]	○	△	43	362	Orientation position loop gain [AP] [AL] [TP]	○	×	*2
322	RA3 output selection [AR]	○	△	43	363	Completion signal output delay time [AP] [AL] [TP]	○	×	*2
323	AM0 0V adjustment [AY]	○	○	*2	364	Encoder stop check time [AP] [AL] [TP]	○	×	*2
324	AM1 0mA adjustment [AY]	○	○	*2	365	Orientation limit [AP] [AL] [TP]	○	×	*2
326	Motor temperature feedback reference [AZ]	□*6	×	*2	366	Recheck time [AP] [AL] [TP]	○	×	*2
329	Digital input unit selection [AX]	○	×	*2	367	Speed feedback range [AP] [AL] [TP]	○	×	*2
331	Parameter for manufacturer setting. Do not set.				368	Feedback gain [AP] [AL] [TP]	○	×	*2
332					369	Number of encoder pulses [AP] [AL]	○	×	*2
333					374	Overspeed detection level	○	×	*1
334					376	Encoder signal loss detection enable/disable selection [AP] [AL]	○	×	*2
335					379	SSCNET III/(H) rotation direction selection [NS]	○	×	*2
336					380	Acceleration S-pattern 1	○	×	*1
337					381	Deceleration S-pattern 1	○	×	*1
338	Communication operation command source	○	×	*1	382	Acceleration S-pattern 2	○	×	*1
339	Communication speed command source	○	×	*1	383	Deceleration S-pattern 2	○	×	*1
340	Communication startup mode selection	○	○	*1	384	Input pulse division scaling factor	○	×	*1
341	Parameter for manufacturer setting. Do not set.				385	Frequency for zero input pulse	○	×	*1
342	Communication EEPROM write selection	○	○	*1	386	Frequency for maximum input pulse	○	×	*1
343	Parameter for manufacturer setting. Do not set.				393	Orientation selection [AP] [AL] [TP]	○	×	*2
345	DeviceNet address [ND]	○	○	*2	394	Number of machine side gear teeth [AP] [AL] [TP]	○	×	*2
346	DeviceNet/ControlNet baud rate [ND]	○	○	*2	395	Number of motor side gear teeth [AP] [AL] [TP]	○	×	*2
349	Communication reset selection [NC] [NCE] [ND] [NP] [NS] [NF]	○	○	*2	396	Orientation speed gain (P term) [AP] [AL] [TP]	○	×	*2
350	Stop position command selection [AP] [AL] [TP]	○	×	*2					
351	Orientation speed [AP] [AL] [TP]	○	×	*2					
352	Creep speed [AP] [AL] [TP]	○	×	*2					
353	Creep switchover position [AP] [AL] [TP]	○	×	*2					
354	Position loop switchover position [AP] [AL] [TP]	○	×	*2					

Parameter list

Pr.	Name	Master	Slave	Refer to page
397	Orientation speed integral time [AP] [AL] [TP]	○	×	*2
398	Orientation speed gain (D term) [AP] [AL] [TP]	○	×	*2
399	Orientation deceleration ratio [AP] [AL] [TP]	○	×	*2
406	High resolution analog input selection [AZ]	○	×	*2
407	Motor temperature detection filter [AZ]	□*6	□*6	*2
408	Motor thermistor selection [AZ]	□*6	□*6	*2
413	Encoder pulse division ratio [AL]	○	×	*2
414	PLC function operation selection	○	○	*1
415	Inverter operation lock mode setting	○	×	*1
416	Pre-scale function selection	○	○	*1
417	Pre-scale setting value	○	○	*1
418	Extension output terminal filter [AY] [AR]	○	○	*2
419	Position command source selection	○	×	*1
420	Command pulse scaling factor numerator (electronic gear numerator)	○	×	*1
421	Command pulse multiplication denominator (electronic gear denominator)	○	×	*1
422	Position control gain	○	×	*1
423	Position feed forward gain	○	×	*1
424	Position command acceleration/ deceleration time constant	○	×	*1
425	Position feed forward command filter	○	×	*1
426	In-position width	○	×	*1
427	Excessive level error	○	×	*1
428	Command pulse selection	○	×	*1
429	Clear signal selection	○	×	*1
430	Pulse monitor selection	○	×	*1
432	Pulse train torque command bias [AL]	○	×	*2
433	Pulse train torque command gain [AL]	○	×	*2
434	Network number (CC-Link IE) [NCE]	○	○	*2
435	Station number (CC-Link IE) [NCE]	○	○	*2
446	Model position control gain	○	×	*1
447	Digital torque command bias [AX]	○	×	*2

Pr.	Name	Master	Slave	Refer to page
448	Digital torque command gain [AX]	○	×	*2
449	SSCNET III(/H) input filter setting [NS]	○	×	*2
450	Second applied motor	○	×	52
451	Second motor control method selection	△	×	52
453	Second motor capacity	○	×	*1
454	Number of second motor poles	○	×	*1
455	Second motor excitation current	○	×	*1
456	Rated second motor voltage	○	×	*1
457	Rated second motor frequency	○	×	*1
458	Second motor constant (R1)	○	×	*1
459	Second motor constant (R2)	○	×	*1
460	Second motor constant (L1)	○	×	*1
461	Second motor constant (L2)	○	×	*1
462	Second motor constant (X)	○	×	*1
463	Second motor auto tuning setting/status	○	×	*1
464	Digital position control sudden stop deceleration time	○	×	*1
465	First target position lower 4 digits	○	×	*1
466	First target position upper 4 digits	○	×	*1
467	Second target position lower 4 digits	○	×	*1
468	Second target position upper 4 digits	○	×	*1
469	Third target position lower 4 digits	○	×	*1
470	Third target position upper 4 digits	○	×	*1
471	Fourth target position lower 4 digits	○	×	*1
472	Fourth target position upper 4 digits	○	×	*1
473	Fifth target position lower 4 digits	○	×	*1
474	Fifth target position upper 4 digits	○	×	*1
475	Sixth target position lower 4 digits	○	×	*1
476	Sixth target position upper 4 digits	○	×	*1
477	Seventh target position lower 4 digits	○	×	*1
478	Seventh target position upper 4 digits	○	×	*1
479	Eighth target position lower 4 digits	○	×	*1
480	Eighth target position upper 4 digits	○	×	*1

Pr.	Name	Master	Slave	Refer to page	Pr.	Name	Master	Slave	Refer to page
481	Ninth target position lower 4 digits	○	×	*1	523	Emergency drive mode selection	○	×	12
482	Ninth target position upper 4 digits	○	×	*1	524	Emergency drive running speed	○	×	12
483	Tenth target position lower 4 digits	○	×	*1	539 Parameter for manufacturer setting. Do not set.				
484	Tenth target position upper 4 digits	○	×	*1	541	Frequency command sign selection [NC] [NCE] [NP]	○	×	*2
485	Eleventh target position lower 4 digits	○	×	*1	542	Communication station number (CC-Link) [NC]	○	○	*2
486	Eleventh target position upper 4 digits	○	×	*1	543	Baud rate selection (CC-Link) [NC]	○	○	*2
487	Twelfth target position lower 4 digits	○	×	*1	544	CC-Link extended setting [NC]	○	○	*2
488	Twelfth target position upper 4 digits	○	×	*1	547	USB communication station number	○	○	*1
489	Thirteenth target position lower 4 digits	○	×	*1	548	USB communication check time interval	○	○	*1
490	Thirteenth target position upper 4 digits	○	×	*1	549 Parameter for manufacturer setting. Do not set.				
491	Fourteenth target position lower 4 digits	○	×	*1	550				
492	Fourteenth target position upper 4 digits	○	×	*1	551	PU mode operation command source selection	△	×	52
493	Fifteenth target position lower 4 digits	○	×	*1	552	Frequency jump range	○	×	*1
494	Fifteenth target position upper 4 digits	○	×	*1	553	PID deviation limit	○	○	*1
495	Remote output selection	○	○	*1	554	PID signal operation selection	○	○	*1
496	Remote output data 1	○	○	*1	555	Current average time	○	×	*1
497	Remote output data 2	○	○	*1	556	Data output mask time	○	×	*1
498	PLC function flash memory clear	○	○	*1	557	Current average value monitor signal output reference current	○	×	*1
499	SSCNET III(H) operation selection [NS]	○	×	*2	560	Second frequency search gain	○	×	*1
500	Communication error execution waiting time [NC] [NCE] [ND] [NP] [NS] [NF]	○	○	*2	561	PTC thermistor protection level	○	○	*1
501	Communication error occurrence count display [NC] [NCE] [ND] [NP] [NS] [NF]	○	○	*2	563	Energization time carrying-over times	○	○	*1
502	Stop mode selection at communication error	△	×	52	564	Operating time carrying-over times	○	○	*1
503	Maintenance timer 1	○	○	*1	565	Second motor excitation current break point	○	×	*1
504	Maintenance timer 1 warning output set time	○	○	*1	566	Second motor excitation current low-speed scaling factor	○	×	*1
505	Speed setting reference	○	○	*1	569	Second motor speed control gain	○	×	*1
514	Emergency drive dedicated retry waiting time	○	×	12	570	Multiple rating setting	△	△	52
515	Emergency drive dedicated retry count	○	×	12	571	Holding time at a start	○	×	*1
516	S-pattern time at a start of acceleration	○	×	*1	573	4 mA input check selection	○	×	*1
517	S-pattern time at a completion of acceleration	○	×	*1	574	Second motor online auto tuning	○	×	*1
518	S-pattern time at a start of deceleration	○	×	*1	575	Output interruption detection time	○	×	*1
519	S-pattern time at a completion of deceleration	○	×	*1	576	Output interruption detection level	○	×	*1
522	Output stop frequency	○	×	*1	577	Output interruption cancel level	○	×	*1
					592	Traverse function selection	○	×	*1
					593	Maximum amplitude amount	○	×	*1

Parameter list

Pr.	Name	Master	Slave	Refer to page
594	Amplitude compensation amount during deceleration	○	×	*1
595	Amplitude compensation amount during acceleration	○	×	*1
596	Amplitude acceleration time	○	×	*1
597	Amplitude deceleration time	○	×	*1
598	Undervoltage level	○	○	*1
599	X10 terminal input selection	○	×	*1
600	First free thermal reduction frequency 1	○	×	*1
601	First free thermal reduction ratio 1	○	×	*1
602	First free thermal reduction frequency 2	○	×	*1
603	First free thermal reduction ratio 2	○	×	*1
604	First free thermal reduction frequency 3	○	×	*1
606	Power failure stop external signal input selection	○	×	*1
607	Motor permissible load level	○	×	*1
608	Second motor permissible load level	○	×	*1
609	PID set point/deviation input selection	○	○	*1
610	PID measured value input selection	○	○	*1
611	Acceleration time at a restart	○	×	*1
617	Reverse rotation excitation current low-speed scaling factor	○	×	*1
635	Cumulative pulse clear signal selection AP AL TP	○	×	*2
636	Cumulative pulse division scaling factor AP AL TP	○	×	*2
637	Control terminal option-Cumulative pulse division scaling factor AP AL TP	○	×	*2
638	Cumulative pulse storage AP AL TP	○	×	*2
639	Brake opening current selection	○	×	*1
640	Brake operation frequency selection	○	×	*1
641	Second brake sequence operation selection	○	×	*1
642	Second brake opening frequency	○	×	*1
643	Second brake opening current	○	×	*1
644	Second brake opening current detection time	○	×	*1

Pr.	Name	Master	Slave	Refer to page
645	Second brake operation time at start	○	×	*1
646	Second brake operation frequency	○	×	*1
647	Second brake operation time at stop	○	×	*1
648	Second deceleration detection function selection	○	×	*1
650	Second brake opening current selection	○	×	*1
651	Second brake operation frequency selection	○	×	*1
652	Parallel operation communication check time	○	○	7
653	Speed smoothing control	○	×	*1
654	Speed smoothing cutoff frequency	○	×	*1
655	Analog remote output selection	○	○	*1
656	Analog remote output 1	○	○	*1
657	Analog remote output 2	○	○	*1
658	Analog remote output 3	○	○	*1
659	Analog remote output 4	○	○	*1
660	Increased magnetic excitation deceleration operation selection	○	×	*1
661	Magnetic excitation increase rate	○	×	*1
662	Increased magnetic excitation current level	○	×	*1
663	Control circuit temperature signal output level	○	○	*1
665	Regeneration avoidance frequency gain	○	×	*1
668	Power failure stop frequency gain	○	×	*1
673	Parameter for manufacturer setting. Do not set.			
674	Parameter for manufacturer setting. Do not set.			
679	Second droop gain	○	×	*1
680	Second droop filter time constant	○	×	*1
681	Second droop function activation selection	○	×	*1
682	Second droop break point gain	○	×	*1
683	Second droop break point torque	○	×	*1
684	Tuning data unit switchover	○	○	*1
686	Maintenance timer 2	○	○	*1
687	Maintenance timer 2 warning output set time	○	○	*1
688	Maintenance timer 3	○	○	*1
689	Maintenance timer 3 warning output set time	○	○	*1
690	Deceleration check time	○	×	*1
692	Second free thermal reduction frequency 1	○	×	*1
693	Second free thermal reduction ratio 1	○	×	*1

Pr.	Name	Master	Slave	Refer to page
694	Second free thermal reduction frequency 2	○	×	*1
695	Second free thermal reduction ratio 2	○	×	*1
696	Second free thermal reduction frequency 3	○	×	*1
699	Input terminal filter	○	○	*1
702	Parameter for manufacturer setting. Do not set.			
706	Parameter for manufacturer setting. Do not set.			
707	Motor inertia (integer)	○	×	*1
711	Parameter for manufacturer setting. Do not set.			
712	Parameter for manufacturer setting. Do not set.			
717	Parameter for manufacturer setting. Do not set.			
721	Parameter for manufacturer setting. Do not set.			
724	Motor inertia (exponent)	○	×	*1
725	Parameter for manufacturer setting. Do not set.			
738	Parameter for manufacturer setting. Do not set.			
739	Parameter for manufacturer setting. Do not set.			
740	Parameter for manufacturer setting. Do not set.			
741	Parameter for manufacturer setting. Do not set.			
742	Parameter for manufacturer setting. Do not set.			
743	Parameter for manufacturer setting. Do not set.			
744	Second motor inertia (integer)	○	×	*1
745	Second motor inertia (exponent)	○	×	*1
746	Parameter for manufacturer setting. Do not set.			
747	Parameter for manufacturer setting. Do not set.			
750	Motor temperature detection level [AZ]	□*6	□*6	*2
751	Reference motor temperature [AZ]	□*6	□*6	*2
753	Second PID action selection	○	△	52
754	Second PID control automatic switchover frequency	○	×	*1
755	Second PID action set point	○	○	*1
756	Second PID proportional band	○	○	*1
757	Second PID integral time	○	○	*1
758	Second PID differential time	○	○	*1
759	PID unit selection	○	○	*1
760	Pre-charge fault selection	○	×	*1
761	Pre-charge ending level	○	×	*1
762	Pre-charge ending time	○	×	*1
763	Pre-charge upper detection level	○	×	*1
764	Pre-charge time limit	○	×	*1
765	Second pre-charge fault selection	○	×	*1
766	Second pre-charge ending level	○	×	*1
767	Second pre-charge ending time	○	×	*1
768	Second pre-charge upper detection level	○	×	*1
769	Second pre-charge time limit	○	×	*1
774	Operation panel monitor selection 1	○	×	45
775	Operation panel monitor selection 2	○	△	45
776	Operation panel monitor selection 3	○	△	45
777	4 mA input fault operation frequency	○	×	*1
778	4 mA input check filter	○	×	*1
779	Operation frequency during communication error	△	×	52
788	Parameter for manufacturer setting. Do not set.			
791	Parameter for manufacturer setting. Do not set.			
792	Parameter for manufacturer setting. Do not set.			
799	Pulse increment setting for output power	○	×	*1
800	Control method selection	△	×	52
802	Pre-excitation selection	○	×	*1
803	Constant power range torque characteristic selection	○	×	*1
804	Torque command source selection	○	×	*1
805	Torque command value (RAM)	○	×	*1
806	Torque command value (RAM, EEPROM)	○	×	*1
807	Speed limit selection	○	×	*1
808	Forward rotation speed limit/speed limit	○	×	*1
809	Reverse rotation speed limit/reverse-side speed limit	○	×	*1
810	Torque limit input method selection	○	×	*1
811	Set resolution switchover	○	○	*1
812	Torque limit level (regeneration)	○	×	*1
813	Torque limit level (3rd quadrant)	○	×	*1
814	Torque limit level (4th quadrant)	○	×	*1
815	Torque limit level 2	○	×	*1
816	Torque limit level during acceleration	○	×	*1
817	Torque limit level during deceleration	○	×	*1
818	Easy gain tuning response level setting	○	×	*1
819	Easy gain tuning selection	○	×	*1
820	Speed control P gain 1	○	×	*1
821	Speed control integral time 1	○	×	*1
822	Speed setting filter 1	○	×	*1
823	Speed detection filter 1 [AP] [AL] [TP]	○	×	*2
824	Torque control P gain 1 (current loop proportional gain)	○	×	*1

Parameter list

Pr.	Name	Master	Slave	Refer to page
825	Torque control integral time 1 (current loop integral time)	○	×	*1
826	Torque setting filter 1	○	×	*1
827	Torque detection filter 1	○	□*5	*1
828	Model speed control gain	○	×	*1
829	Number of machine end encoder pulses [AL]	○	×	*2
830	Speed control P gain 2	○	×	*1
831	Speed control integral time 2	○	×	*1
832	Speed setting filter 2	○	×	*1
833	Speed detection filter 2 [AP] [AL] [TP]	○	×	*1
834	Torque control P gain 2	○	×	*1
835	Torque control integral time 2	○	×	*1
836	Torque setting filter 2	○	×	*1
837	Torque detection filter 2	○	×	*1
838	DA1 terminal function selection [AZ]	○	△	45
839	DA1 output filter [AZ]	○	○	*2
840	Torque bias selection	□	×	*1
841	Torque bias 1	○	×	*1
842	Torque bias 2	○	×	*1
843	Torque bias 3	○	×	*1
844	Torque bias filter	○	×	*1
845	Torque bias operation time	○	×	*1
846	Torque bias balance compensation	○	×	*1
847	Fall-time torque bias terminal 1 bias	○	×	*1
848	Fall-time torque bias terminal 1 gain	○	×	*1
849	Analog input offset adjustment	○	×	*1
850	Brake operation selection	○	×	*1
851	Control terminal option-Number of encoder pulses [TP]	○	×	*2
852	Control terminal option-Encoder rotation direction [TP]	○	×	*2
853	Speed deviation time [AP] [AL] [TP]	○	×	*2
854	Excitation ratio	○	×	*1
855	Control terminal option-Signal loss detection enable/disable selection [TP]	○	×	*2
857	DA1-0V adjustment [AZ]	○	○	*2
858	Terminal 4 function assignment	○	○	*1
859	Torque current	○	□*4	*1
860	Second motor torque current	○	×	*1
862	Encoder option selection [AP] [AL] [TP]	○	×	*2

Pr.	Name	Master	Slave	Refer to page
863	Control terminal option-Encoder pulse division ratio [TP]	○	×	*2
864	Torque detection	○	×	*1
865	Low speed detection	○	×	*1
866	Torque monitoring reference	○	×	*1
867	AM output filter	○	○	*1
868	Terminal 1 function assignment	○	○	*1
869	Current output filter	○	○	*1
870	Speed detection hysteresis	○	×	*1
873	Speed limit [AP] [AL] [TP]	○	×	*2
874	OLT level setting	○	×	*1
875	Fault definition	○	×	*1
876	Thermal protector input [TP]	○	○	*2
877	Speed feed forward control/model adaptive speed control selection	○	×	*1
878	Speed feed forward filter	○	×	*1
879	Speed feed forward torque limit	○	×	*1
880	Load inertia ratio	○	×	*1
881	Speed feed forward gain	○	×	*1
882	Regeneration avoidance operation selection	○	×	*1
883	Regeneration avoidance operation level	○	×	*1
884	Regeneration avoidance at deceleration detection sensitivity	○	×	*1
885	Regeneration avoidance compensation frequency limit value	○	×	*1
886	Regeneration avoidance voltage gain	○	×	*1
888	Free parameter 1	○	○	*1
889	Free parameter 2	○	○	*1
891	Cumulative power monitor digit shifted times	○	○	*1
892	Load factor	○	×	*1
893	Energy saving monitor reference (motor capacity)	○	×	*1
894	Control selection during commercial power-supply operation	○	×	*1
895	Power saving rate reference value	○	×	*1
896	Power unit cost	○	×	*1
897	Power saving monitor average time	○	×	*1
898	Power saving cumulative monitor clear	○	×	*1
899	Operation time rate (estimated value)	○	×	*1
C0 (900)	FM/CA terminal calibration	○	○	*1

Pr.	Name	Master	Slave	Refer to page	Pr.	Name	Master	Slave	Refer to page
C1 (901)	AM terminal calibration	○	○	*1	C10 (931)	Current output gain signal	○	○	*1
C2 (902)	Terminal 2 frequency setting bias frequency	○	×	*1	C11 (931)	Current output gain current	○	○	*1
C3 (902)	Terminal 2 frequency setting bias	○	○	*1	C38 (932)	Terminal 4 bias command (torque/magnetic flux)	○	×	*1
125 (903)	Terminal 2 frequency setting gain frequency	○	×	*1	C39 (932)	Terminal 4 bias (torque/magnetic flux)	○	×	*1
C4 (903)	Terminal 2 frequency setting gain	○	○	*1	C40 (933)	Terminal 4 gain command (torque/magnetic flux)	○	×	*1
C5 (904)	Terminal 4 frequency setting bias frequency	○	×	*1	C41 (933)	Terminal 4 gain (torque/magnetic flux)	○	×	*1
C6 (904)	Terminal 4 frequency setting bias	○	○	*1	C42 (934)	PID display bias coefficient	○	○	*1
126 (905)	Terminal 4 frequency setting gain frequency	○	×	*1	C43 (934)	PID display bias analog value	○	○	*1
C7 (905)	Terminal 4 frequency setting gain	○	○	*1	C44 (935)	PID display gain coefficient	○	○	*1
C12 (917)	Terminal 1 bias frequency (speed)	○	×	*1	C45 (935)	PID display gain analog value	○	○	*1
C13 (917)	Terminal 1 bias (speed)	○	×	*1	977	Input voltage mode selection	○	×	*1
C14 (918)	Terminal 1 gain frequency (speed)	○	×	*1	989	Parameter copy alarm release	○	○	*1
C15 (918)	Terminal 1 gain (speed)	○	×	*1	990	PU buzzer control	○	○	*1
C16 (919)	Terminal 1 bias command (torque/magnetic flux)	○	×	*1	991	PU contrast adjustment	○	○	*1
C17 (919)	Terminal 1 bias (torque/magnetic flux)	○	×	*1	992	Operation panel setting dial push monitor selection	○	△	45
C18 (920)	Terminal 1 gain command (torque/magnetic flux)	○	×	*1	994	Droop break point gain	○	×	*1
C19 (920)	Terminal 1 gain (torque/magnetic flux)	○	×	*1	995	Droop break point torque	○	×	*1
C29 (925)	Motor temperature detection calibration (analog input) [AZ]	□*6	□*6	*2	997	Fault initiation	○	○	*1
C30 (926)	Terminal 6 bias frequency (speed) [AZ]	○	×	*2	998	Parameter for manufacturer setting. Do not set.			
C31 (926)	Terminal 6 bias (speed) [AZ]	○	×	*2	999	Automatic parameter setting	○	○	*1
C32 (927)	Terminal 6 gain frequency (speed) [AZ]	○	×	*2	1000	Direct setting selection	○	○	*1
C33 (927)	Terminal 6 gain (speed) [AZ]	○	×	*2	1001	Parallel operation selection	○	○	5
C34 (928)	Terminal 6 bias command (torque) [AZ]	○	×	*2	1002	Parameter for manufacturer setting. Do not set.			
C35 (928)	Terminal 6 bias (torque) [AZ]	○	×	*2	1003	Notch filter frequency	○	×	*1
C36 (929)	Terminal 6 gain command (torque) [AZ]	○	×	*2	1004	Notch filter depth	○	×	*1
C37 (929)	Terminal 6 gain (torque) [AZ]	○	×	*2	1005	Notch filter width	○	×	*1
C8 (930)	Current output bias signal	○	○	*1	1006	Clock (year)	○	○	*1
C9 (930)	Current output bias current	○	○	*1	1007	Clock (month, day)	○	○	*1
					1008	Clock (hour, minute)	○	○	*1
					1013	Emergency drive running speed after retry reset	○	×	12
					1015	Integral stop selection at limited frequency	○	○	*1
					1016	PTC thermistor protection detection time	○	○	*1
					1018	Monitor with sign selection	○	○	*1
					1019	Analog meter voltage minus output selection [AY]	○	○	*2
					1020	Trace operation selection	○	○	*1

Parameter list

Pr.	Name	Master	Slave	Refer to page	Pr.	Name	Master	Slave	Refer to page
1021	Trace mode selection	<input type="radio"/>	<input type="radio"/>	*1	1103	Deceleration time at emergency stop	<input type="radio"/>	<input checked="" type="radio"/>	*1
1022	Sampling cycle	<input type="radio"/>	<input type="radio"/>	*1	1106	Torque monitor filter	<input type="radio"/>	<input checked="" type="radio"/>	*1
1023	Number of analog channels	<input type="radio"/>	<input type="radio"/>	*1	1107	Running speed monitor filter	<input type="radio"/>	<input checked="" type="radio"/>	*1
1024	Sampling auto start	<input type="radio"/>	<input type="radio"/>	*1	1108	Excitation current monitor filter	<input type="radio"/>	<input type="radio"/>	*1
1025	Trigger mode selection	<input type="radio"/>	<input type="radio"/>	*1	1109	PROFIBUS communication command source selection <input type="checkbox"/> NP	<input type="radio"/>	<input checked="" type="radio"/>	*2
1026	Number of sampling before trigger	<input type="radio"/>	<input type="radio"/>	*1	1110	PROFIBUS format selection <input type="checkbox"/> NP	<input type="radio"/>	<input type="radio"/>	*2
1027	Analog source selection (1ch)	<input type="radio"/>	<input type="radio"/>	45	1113	Speed limit method selection	<input type="radio"/>	<input checked="" type="radio"/>	*1
1028	Analog source selection (2ch)	<input type="radio"/>	<input type="radio"/>	45	1114	Torque command reverse selection	<input type="radio"/>	<input checked="" type="radio"/>	*1
1029	Analog source selection (3ch)	<input type="radio"/>	<input type="radio"/>	45	1115	Speed control integral term clear time	<input type="radio"/>	<input checked="" type="radio"/>	*1
1030	Analog source selection (4ch)	<input type="radio"/>	<input type="radio"/>	45	1116	Constant output range speed control P gain compensation	<input type="radio"/>	<input checked="" type="radio"/>	*1
1031	Analog source selection (5ch)	<input type="radio"/>	<input type="radio"/>	45	1117	Speed control P gain 1 (per-unit system)	<input type="radio"/>	<input checked="" type="radio"/>	*1
1032	Analog source selection (6ch)	<input type="radio"/>	<input type="radio"/>	45	1118	Speed control P gain 2 (per-unit system)	<input type="radio"/>	<input checked="" type="radio"/>	*1
1033	Analog source selection (7ch)	<input type="radio"/>	<input type="radio"/>	45	1119	Model speed control gain (per-unit system)	<input type="radio"/>	<input checked="" type="radio"/>	*1
1034	Analog source selection (8ch)	<input type="radio"/>	<input type="radio"/>	45	1121	Per-unit speed control reference frequency	<input type="radio"/>	<input checked="" type="radio"/>	*1
1035	Analog trigger channel	<input type="radio"/>	<input type="radio"/>	*1	1134	PID upper limit manipulated value	<input type="radio"/>	<input checked="" type="radio"/>	*1
1036	Analog trigger operation selection	<input type="radio"/>	<input type="radio"/>	*1	1135	PID lower limit manipulated value	<input type="radio"/>	<input checked="" type="radio"/>	*1
1037	Analog trigger level	<input type="radio"/>	<input type="radio"/>	*1	1136	Second PID display bias coefficient	<input type="radio"/>	<input type="radio"/>	*1
1038	Digital source selection (1ch)	<input type="radio"/>	<input type="radio"/>	*1	1137	Second PID display bias analog value	<input type="radio"/>	<input type="radio"/>	*1
1039	Digital source selection (2ch)	<input type="radio"/>	<input type="radio"/>	*1	1138	Second PID display gain coefficient	<input type="radio"/>	<input type="radio"/>	*1
1040	Digital source selection (3ch)	<input type="radio"/>	<input type="radio"/>	*1	1139	Second PID display gain analog value	<input type="radio"/>	<input type="radio"/>	*1
1041	Digital source selection (4ch)	<input type="radio"/>	<input type="radio"/>	*1	1140	Second PID set point/deviation input selection	<input type="radio"/>	<input type="radio"/>	*1
1042	Digital source selection (5ch)	<input type="radio"/>	<input type="radio"/>	*1	1141	Second PID measured value input selection	<input type="radio"/>	<input type="radio"/>	*1
1043	Digital source selection (6ch)	<input type="radio"/>	<input type="radio"/>	*1	1142	Second PID unit selection	<input type="radio"/>	<input type="radio"/>	*1
1044	Digital source selection (7ch)	<input type="radio"/>	<input type="radio"/>	*1	1143	Second PID upper limit	<input type="radio"/>	<input type="radio"/>	*1
1045	Digital source selection (8ch)	<input type="radio"/>	<input type="radio"/>	*1	1144	Second PID lower limit	<input type="radio"/>	<input type="radio"/>	*1
1046	Digital trigger channel	<input type="radio"/>	<input type="radio"/>	*1	1145	Second PID deviation limit	<input type="radio"/>	<input type="radio"/>	*1
1047	Digital trigger operation selection	<input type="radio"/>	<input type="radio"/>	*1	1146	Second PID signal operation selection	<input type="radio"/>	<input type="radio"/>	*1
1048	Display-off waiting time	<input type="radio"/>	<input type="radio"/>	*1	1147	Second output interruption detection time	<input type="radio"/>	<input checked="" type="radio"/>	*1
1049	USB host reset	<input type="radio"/>	<input type="radio"/>	*1	1148	Second output interruption detection level	<input type="radio"/>	<input checked="" type="radio"/>	*1
1072	DC brake judgment time for vibration control operation	<input type="radio"/>	<input checked="" type="radio"/>	*1	1149	Second output interruption cancel level	<input type="radio"/>	<input checked="" type="radio"/>	*1
1073	Vibration control operation selection	<input type="radio"/>	<input checked="" type="radio"/>	*1	1150	User parameters 1	<input type="radio"/>	<input type="radio"/>	*1
1074	Vibration suppression frequency	<input type="radio"/>	<input checked="" type="radio"/>	*1					
1075	Vibration suppression depth	<input type="radio"/>	<input checked="" type="radio"/>	*1					
1076	Vibration suppression width	<input type="radio"/>	<input checked="" type="radio"/>	*1					
1077	Rope length	<input type="radio"/>	<input checked="" type="radio"/>	*1					
1078	Trolley weight	<input type="radio"/>	<input checked="" type="radio"/>	*1					
1079	Load weight	<input type="radio"/>	<input checked="" type="radio"/>	*1					

Pr.	Name	Master	Slave	Refer to page
1151	User parameters 2	○	○	*1
1152	User parameters 3	○	○	*1
1153	User parameters 4	○	○	*1
1154	User parameters 5	○	○	*1
1155	User parameters 6	○	○	*1
1156	User parameters 7	○	○	*1
1157	User parameters 8	○	○	*1
1158	User parameters 9	○	○	*1
1159	User parameters 10	○	○	*1
1160	User parameters 11	○	○	*1
1161	User parameters 12	○	○	*1
1162	User parameters 13	○	○	*1
1163	User parameters 14	○	○	*1
1164	User parameters 15	○	○	*1
1165	User parameters 16	○	○	*1
1166	User parameters 17	○	○	*1
1167	User parameters 18	○	○	*1
1168	User parameters 19	○	○	*1
1169	User parameters 20	○	○	*1
1170	User parameters 21	○	○	*1
1171	User parameters 22	○	○	*1
1172	User parameters 23	○	○	*1
1173	User parameters 24	○	○	*1
1174	User parameters 25	○	○	*1
1175	User parameters 26	○	○	*1
1176	User parameters 27	○	○	*1
1177	User parameters 28	○	○	*1
1178	User parameters 29	○	○	*1
1179	User parameters 30	○	○	*1
1180	User parameters 31	○	○	*1
1181	User parameters 32	○	○	*1
1182	User parameters 33	○	○	*1
1183	User parameters 34	○	○	*1
1184	User parameters 35	○	○	*1
1185	User parameters 36	○	○	*1
1186	User parameters 37	○	○	*1
1187	User parameters 38	○	○	*1
1188	User parameters 39	○	○	*1
1189	User parameters 40	○	○	*1
1190	User parameters 41	○	○	*1
1191	User parameters 42	○	○	*1
1192	User parameters 43	○	○	*1
1193	User parameters 44	○	○	*1
1194	User parameters 45	○	○	*1
1195	User parameters 46	○	○	*1
1196	User parameters 47	○	○	*1
1197	User parameters 48	○	○	*1
1198	User parameters 49	○	○	*1
1199	User parameters 50	○	○	*1
1220	Target position/speed selection	○	×	*1
1221	Start command edge detection selection	○	×	*1
1222	First positioning acceleration time	○	×	*1
1223	First positioning deceleration time	○	×	*1
1224	First positioning dwell time	○	×	*1
1225	First positioning sub-function	○	×	*1

Pr.	Name	Master	Slave	Refer to page
1226	Second positioning acceleration time	○	×	*1
1227	Second positioning deceleration time	○	×	*1
1228	Second positioning dwell time	○	×	*1
1229	Second positioning sub-function	○	×	*1
1230	Third positioning acceleration time	○	×	*1
1231	Third positioning deceleration time	○	×	*1
1232	Third positioning dwell time	○	×	*1
1233	Third positioning sub-function	○	×	*1
1234	Fourth positioning acceleration time	○	×	*1
1235	Fourth positioning deceleration time	○	×	*1
1236	Fourth positioning dwell time	○	×	*1
1237	Fourth positioning sub-function	○	×	*1
1238	Fifth positioning acceleration time	○	×	*1
1239	Fifth positioning deceleration time	○	×	*1
1240	Fifth positioning dwell time	○	×	*1
1241	Fifth positioning sub-function	○	×	*1
1242	Sixth positioning acceleration time	○	×	*1
1243	Sixth positioning deceleration time	○	×	*1
1244	Sixth positioning dwell time	○	×	*1
1245	Sixth positioning sub-function	○	×	*1
1246	Seventh positioning acceleration time	○	×	*1
1247	Seventh positioning deceleration time	○	×	*1
1248	Seventh positioning dwell time	○	×	*1
1249	Seventh positioning sub-function	○	×	*1
1250	Eighth positioning acceleration time	○	×	*1
1251	Eighth positioning deceleration time	○	×	*1
1252	Eighth positioning dwell time	○	×	*1
1253	Eighth positioning sub-function	○	×	*1
1254	Ninth positioning acceleration time	○	×	*1
1255	Ninth positioning deceleration time	○	×	*1
1256	Ninth positioning dwell time	○	×	*1
1257	Ninth positioning sub-function	○	×	*1

Parameter list

Pr.	Name	Master	Slave	Refer to page	Pr.	Name	Master	Slave	Refer to page
1258	Tenth positioning acceleration time	○	×	*1	1289	Home position return stopper torque	○	×	*1
1259	Tenth positioning deceleration time	○	×	*1	1290	Home position return stopper waiting time	○	×	*1
1260	Tenth positioning dwell time	○	×	*1	1292	Position control terminal input selection	○	×	*1
1261	Tenth positioning sub-function	○	×	*1	1293	Roll feeding mode selection	○	×	*1
1262	Eleventh positioning acceleration time	○	×	*1	1294	Position detection lower 4 digits	○	×	*1
1263	Eleventh positioning deceleration time	○	×	*1	1295	Position detection upper 4 digits	○	×	*1
1264	Eleventh positioning dwell time	○	×	*1	1296	Position detection selection	○	×	*1
1265	Eleventh positioning sub-function	○	×	*1	1297	Position detection hysteresis width	○	×	*1
1266	Twelfth positioning acceleration time	○	×	*1	1298	Second position control gain	○	×	*1
1267	Twelfth positioning deceleration time	○	×	*1	1299	Second pre-excitation selection	○	×	*1
1268	Twelfth positioning dwell time	○	×	*1	1387	Power monitoring reference	○	○	47
1269	Twelfth positioning sub-function	○	×	*1	1410	Starting times lower 4 digits	○	×	*1
1270	Thirteenth positioning acceleration time	○	×	*1	1411	Starting times upper 4 digits	○	×	*1
1271	Thirteenth positioning deceleration time	○	×	*1	1412	Parameter for manufacturer setting. Do not set.			
1272	Thirteenth positioning dwell time	○	×	*1	1413				
1273	Thirteenth positioning sub-function	○	×	*1	1499				
1274	Fourteenth positioning acceleration time	○	×	*1					
1275	Fourteenth positioning deceleration time	○	×	*1					
1276	Fourteenth positioning dwell time	○	×	*1					
1277	Fourteenth positioning sub-function	○	×	*1					
1278	Fifteenth positioning acceleration time	○	×	*1					
1279	Fifteenth positioning deceleration time	○	×	*1					
1280	Fifteenth positioning dwell time	○	×	*1					
1281	Fifteenth positioning sub-function	○	×	*1					
1282	Home position return method selection	○	×	*1					
1283	Home position return speed	○	×	*1					
1284	Home position return creep speed	○	×	*1					
1285	Home position shift amount lower 4 digits	○	×	*1					
1286	Home position shift amount upper 4 digits	○	×	*1					
1287	Travel distance after proximity dog ON lower 4 digits	○	×	*1					
1288	Travel distance after proximity dog ON upper 4 digits	○	×	*1					

- *1 For details, refer to the Instruction Manual (Detailed) of the FR-A800 inverter.
- *2 For details, refer to the Instruction Manual of the plug-in option.
- *3 The parameter details differ from the A800 standard model. Refer to [page 16](#).
- *4 Parameter setting is valid when a multi-wound motor is driven.
- *5 Parameter setting is valid when a multi-wound motor is driven under Real sensorless vector control or Vector control.
- *6 Parameter setting is valid when the FR-A8AZ is installed and a motor with thermistor equivalent to the Vector control dedicated motor with thermistor (SF-V5RU □□□□□ T/A) is driven.

5.2 Input signal list

The following is the list of input signals of the FR-A802-P (including the availability for the master and the slave during the parallel operation).

○ indicates that the signal is valid. × indicates that the signal is invalid.

Use **Pr.178 to Pr.189 (Input terminal function selection)** to set the functions assigned to the input terminals.

For the details of the input signals, refer to the Instruction Manual (Detailed) of the FR-A800 inverter.

Setting	Signal name	Function	Master	Slave
0	RL	Low-speed operation command	○	×
1	RM	Middle-speed operation command	○	×
2	RH	High-speed operation command	○	×
3	RT	Second function selection	○	×
4	AU	Terminal 4 input selection	○	○
5	JOG	Jog operation selection	○	×
6*1	CS	Selection of automatic restart after instantaneous power failure / flying start, or Electronic bypass function	○	○
7	OH	External thermal relay input	○	○
8	REX	15-speed selection (Combination with multi-speeds of RL, RM, and RH)	○	×
9	X9	Third function selection	○	×
10	X10	Inverter run enable (FR-CC2 connection)	○	×
11	X11	FR-CC2 connection, instantaneous power failure detection	○	○
12	X12	PU operation external interlock	○	○
13	X13	External DC injection brake operation start	○	×
14	X14	PID control valid	○	○
15	BRI	Brake opening completion	○	×
16	X16	PU/External operation switchover (External operation with X16-ON)	○	○
17	X17	Load pattern selection forward/reverse rotation boost (For constant-torque with X17-ON)	○	×
18	X18	V/F switchover (V/F control with X18-ON)	○	×
19	X19	Load torque high-speed frequency	○	×
20	X20	S-pattern acceleration/deceleration C switchover	○	×
22	X22	Orientation command	○	×
23	LX	Pre-excitation/servo ON	○	×
24	MRS	Output stop	○	○
25	STP (STOP)	Start self-holding selection	○	×
26	MC	Control mode switchover	○	×
27	TL	Torque limit selection	○	×
28	X28	Start-time tuning start external input	○	×
37	X37	Traverse function selection	○	×
42	X42	Torque bias selection 1	○	×
43	X43	Torque bias selection 2	○	×
44	X44	P/PI control switchover (P control with X44-ON)	○	×
45	BRI2	Second brake sequence open completion	○	×
46	TRG	Trace trigger input	○	○
47	TRC	Trace sampling start/end	○	○
48	X48	Power failure stop external	○	×
50	SQ	Sequence start	○	○
51	X51	Fault clear	○	○
52	X52	Cumulative pulse monitor clear	○	×
53	X53	Cumulative pulse monitor clear (control terminal option)	○	×
57	JOGF	JOG forward rotation command	○	×
58	JOGR	JOG reverse rotation command	○	×
59	CLRN	NET position pulse clear	○	×
60	STF	Forward rotation command (Assignable to the STF terminal (Pr.178) only)	○	×
61	STR	Reverse rotation command (Assignable to the STR terminal (Pr.179) only)	○	×
62	RES	Inverter reset	○	○

Input signal list

Setting	Signal name	Function	Master	Slave
64	X64	PID forward/reverse action switchover	○	○
65	X65	PU/NET operation switchover (PU operation with X65-ON)	○	○
66	X66	External/NET operation switchover (NET operation with X66-ON)	○	○
67	X67	Command source switchover (Command by Pr.338 , Pr.339 enabled with X67-ON)	○	×
68	NP	Simple position pulse train sign	○	×
69	CLR	Simple position droop pulse clear	○	×
72	X72	PID integral value reset	○	○
73	X73	Second PID P control switchover	○	○
74	X74	Magnetic flux decay output shutoff	○	×
76	X76	Proximity dog	○	×
77	X77	Pre-charge end command	○	×
78	X78	Second pre-charge end command	○	×
79	X79	Second PID forward/reverse action switchover	○	○
80	X80	Second PID control valid terminal	○	○
84	X84	Emergency drive operation	○	×
85	X85	SSCNET III(/H) communication disabled	○	×
87	X87	Sudden stop	○	×
88	LSP	Upper stroke limit	○	×
89	LSN	Lower stroke limit	○	×
92	X92	Emergency stop	○	×
93	X93	Torque limit selection	○	×
94	X94	Control signal input for main circuit power supply MC	○	×
95	X95	Converter unit fault input	○	×
96	X96	Converter unit fault (E.OHT, E.CPU) input	○	×
9999	—	(No function)	○	○

*1 To enable the automatic restart after instantaneous power failure function, the settings for **Pr.57** and terminal CS must be the same between the master and the slave.

5.3 Output signal list

The following is the list of output signals of the FR-A802-P (including the availability for the master and the slave during the parallel operation).

○ indicates that the signal is valid. × indicates that the signal is invalid. □ indicates that the signal is valid under certain conditions.

Use **Pr.190 to Pr.196 (Output terminal function selection)** to set the functions assigned to the output terminals.

For the details of the output signals, refer to the Instruction Manual (Detailed) of the FR-A800 inverter.

Setting		Signal name	Function	Master	Slave
Positive logic	Negative logic				
0	100	RUN	Inverter running	○	○*1
1	101	SU	Up to frequency	○	×
3	103	OL	Overload warning	○	×
4	104	FU	Output frequency detection	○	×
5	105	FU2	Second output frequency detection	○	×
6	106	FU3	Third output frequency detection	○	×
8	108	THP	Electronic thermal O/L relay pre-alarm	○	○
10	110	PU	PU operation mode	○	○
11	111	RY	Inverter operation ready	○*2	○*2
12	112	Y12	Output current detection	○	×
13	113	Y13	Zero current detection	○	×
14	114	FDN	PID lower limit	○	○
15	115	FUP	PID upper limit	○	○
16	116	RL	PID forward/reverse rotation output	○	×
17	—	MC1	Electronic bypass MC1	○	×
18	—	MC2	Electronic bypass MC2	○	×
19	—	MC3	Electronic bypass MC3	○	×
20	120	BOF	Brake opening request	○	×
22	122	BOF2	Second brake opening request	○	×
25	125	FAN	Fan fault output	○	○
26	126	FIN	Heat sink overheat pre-alarm	○	○
27	127	ORA	Orientation complete	○	×
28	128	ORM	Orientation fault	○	×
30	130	Y30	Forward rotation output	○	×
31	131	Y31	Reverse rotation output	○	×
32	132	Y32	Regenerative status output	○	×
33	133	RY2	Operation ready 2	○	×
34	134	LS	Low speed detection	○	×
35	135	TU	Torque detection	○	×
36	136	Y36	In-position	○	×
38	138	MEND	Travel completed	○	×
39	139	Y39	Start time tuning completion	○	×
40	140	Y40	Trace status	○	○
41	141	FB	Speed detection	○	×
42	142	FB2	Second speed detection	○	×
43	143	FB3	Third speed detection	○	×
44	144	RUN2	Inverter running 2	○	×
45	145	RUN3	Inverter running and start command is ON	○	×
46	146	Y46	During deceleration at occurrence of power failure	○	×
47	147	PID	During PID control activated	○	○
48	148	Y48	PID deviation limit	○	○
49	149	Y49	During pre-charge operation	○	×
50	150	Y50	During second pre-charge operation	○	×
51	151	Y51	Pre-charge time over	○	×
52	152	Y52	Second pre-charge time over	○	×
53	153	Y53	Pre-charge level over	○	×

Output signal list

Setting		Signal name	Function	Master	Slave	
Positive logic	Negative logic					
54	154	Y54	Second pre-charge level over	○	×	
55	155	Y55	Motor temperature detection	□*4	□*4	
56	156	ZA	Home position return failure	○	×	
57	157	Signal for manufacturer check. Do not set.				
60	160	FP	Position detection level	○	×	
61	161	PBSY	During position command operation	○	×	
63	163	ZP	Home position return completed	○	×	
64	164	Y64	During retry	○	×	
65	165	Y65	Emergency drive in operation	○	○	
66	166	ALM3	Fault output during emergency drive	○	○	
67	167	Y67	Power failed	○	○	
68	168	EV	24 V external power supply operation	○	○	
70	170	SLEEP	PID output interruption	○	×	
79	179	Y79	Pulse train output of output power	○	×	
80	180	SAFE	Safety monitor output	○	○	
84	184	RDY	Position control preparation ready	○	×	
86	186	Y86	Control circuit capacitor life (For Pr.313 to Pr.322)	○	○	
88	188	Y88	Cooling fan life (For Pr.313 to Pr.322)	○	○	
90	190	Y90	Life alarm	○	○	
91	191	Y91	Fault output 3 (power-OFF signal)	○	○	
92	192	Y92	Energy saving average value updated timing	○	×	
93	193	Y93	Current average monitor	○	×	
94	194	ALM2	Fault output 2	○	○	
95	195	Y95	Maintenance timer	○	○	
96	196	REM	Remote output	○	○	
97	197	ER	Alarm output 2	○	○	
98	198	LF	Alarm	○	○	
99	199	ALM	Fault	○	○*3	
200	300	FDN2	Second PID lower limit	○	○	
201	301	FUP2	Second PID upper limit	○	○	
202	302	RL2	Second PID forward/reverse rotation output	○	×	
203	303	PID2	Second During PID control activated	○	○	
204	304	SLEEP2	During second PID output shutoff	○	×	
205	305	Y205	Second PID deviation limit	○	○	
206	306	Y206	Cooling fan operation command	○	○	
207	307	Y207	Control circuit temperature	○	○	
208	308	PS	PU stopped	○	○	
227	327	Y227	Parallel operation ready (refer to page 7)	○	○	
9999		—	(No function)	○	○	

*1 In the slave, the signal is OFF during operation and ON during stop.

*2 The signal is OFF when **Pr.1001 Parallel operation selection** ≠ "100" and the Y227 signal is OFF. When the signal is OFF in the slave, it is also OFF in the master.

*3 The signal is output during emergency drive operation, and a fault output is provided during the retry operation regardless of **Pr.67** setting.

*4 Parameter setting is valid when the FR-A8AZ is installed and a motor with thermistor equivalent to the Vector control dedicated motor with thermistor (SF-V5RU □□□□□ T/A) is driven.

5.4 List of monitor items

The following is the list of monitor items of the FR-A802-P (including the availability for the master and the slave during the parallel operation).

○ indicates that the monitor item is valid in the same way as the FR-A802. Δ indicates that the monitor item is valid in the different way from the FR-A802. × indicates that the monitor item is invalid ("0" is displayed). □ indicates that the monitor item is valid under certain conditions.

Pr.52, Pr.54, Pr.158, Pr.774 to Pr.776, Pr.992, and Pr.1027 to Pr.1034 are available to set the monitor item.

For the details of each parameter and each monitor item, refer to the FR-A800 Instruction Manual (Detailed).

Parameter setting for monitor item	Monitor item*1	Master	Slave
1	Output frequency/speed*2	○	×
2	Output current	Δ*3	○
3	Output voltage	○	×
—	Fault display	○	○
5	Frequency setting value/speed setting*2	○	×
6	Running speed	○	×
7	Motor torque	○	×
8	Converter output voltage	○	○
10	Electronic thermal O/L relay load factor	○	○
11	Output current peak value	Δ*4	○
12	Converter output voltage peak value	○	○
13	Input power*5	Δ*6	×
14	Output power*5	Δ*7	×
17	Load meter	○	×
18	Motor excitation current	○	×
19	Position pulse	○	×
20	Cumulative energization time	○	○
21	Reference voltage output	○	○
22	Orientation status	○	×
23	Actual operation time	○	○
24	Motor load factor	Δ*8	○
25	Cumulative power	Δ*9	×
26	Position command	○	×
27	Position command (upper digits)	○	×
28	Current position	○	×
29	Current position (upper digits)	○	×
30	Droop pulse	○	×
31	Droop pulse (upper digits)	○	×
32	Torque command	Δ	×
33	Torque current command	○	×
34	Motor output	○	×
35	Feedback pulse	○	×
36	Torque monitor (power driving/regenerative driving polarity switching)	○	×
38	Trace status	○	○
39	SSCNET III(/H) communication status	○	×
40	PLC function user monitor 1	○	○
41	PLC function user monitor 2	○	○
42	PLC function user monitor 3	○	○
43	For manufacturer check. Do not set.		
44	Station number (PU)	○	○
45	Station number (CC-Link)	○	○
46	Motor temperature	□*12	□*12
50	Energy saving effect*10	○	×
51	Cumulative energy saving	○	×
52	PID set point	○	○
53	PID measured value	○	○
54	PID deviation	○	○
55	Input terminal status	○	○
	Output terminal status	○	○
56	Option input terminal status	○	○
57	Option output terminal status	○	○

List of monitor items

Parameter setting for monitor item	Monitor item ^{*1}	Master	Slave
—	Option input terminal status 1 (for communication)	○	○
—	Option input terminal status 2 (for communication)	○	○
—	Option output terminal status (for communication)	○	○
61	Motor thermal load factor	○	×
62	Inverter thermal load factor	○	○
64	PTC thermistor resistance	○	○
67	PID measured value 2	○	○
68	Emergency drive status	○	×
71	Cumulative pulse	○	×
72	Cumulative pulse overflow times	○	×
73	Cumulative pulse (control terminal option)	○	×
74	Cumulative pulse overflow times (control terminal option)	○	×
—	32-bit cumulative power (lower 16 bits)	△*9	×
—	32-bit cumulative power (upper 16 bits)	△*9	×
—	32-bit cumulative power (lower 16 bits)	△*9	×
—	32-bit cumulative power (upper 16 bits)	△*9	×
87	Remote output value 1	○	○
88	Remote output value 2	○	○
89	Remote output value 3	○	○
90	Remote output value 4	○	○
91	PID manipulated variable	○	○
92	Second PID set point	○	○
93	Second PID measured value	○	○
94	Second PID deviation	○	○
95	Second PID measured value 2	○	○
96	Second PID manipulated variable	○	○
97	Dancer main speed setting	○	×
98	Control circuit temperature	○	○
201	*Output frequency	○	×
202	*U Phase Output Current	△*11	○
203	*V Phase Output Current	△*11	○
204	*W Phase Output Current	△*11	○
205	*Converter Output Voltage	○	○
206	*Output Current (all three phases)	△*11	○
207	*Excitation Current (A)	△*11	×
208	*Torque Current (A)	△*11	×
209	Terminal 2	○	○
210	Terminal 4	○	○
211	Terminal 1	○	○
212	*Excitation Current (%)	○	×
213	*Torque Current (%)	○	×
222	Position command	○	×
223	Position command (upper digits)	○	×
224	Current position	○	×
225	Current position (upper digits)	○	×
226	Droop pulse	○	×
227	Droop pulse (upper digits)	○	×
230	*Output Frequency (signed)	○	×
231	*Motor Speed (signed)	○	×
232	*Speed Command (signed)	○	×
235	*Torque Command	○	×
236	*Motor Torque	○	×
237	*Excitation Current Command	○	×
238	*Torque Current Command	○	×

1 "" shows a monitored item with a high-speed sampling cycle.

*2 The speed is not displayed on a monitoring device connected to terminal FM/CA or AM.

*3 The total output current from the master and slaves is displayed.

*4 The total of the output current peak value of the master and slaves is displayed.

*5 The full scale output via terminal FM/CA or AM for monitoring is twice as large as the total rated power of the master and slaves.

*6 The total input power to the master and slaves is displayed.

*7 The total output power from the master and slaves is displayed.

*8 Monitored value = Monitored output current / (Inverter rated current × Number of the inverters in parallel) × 100%

*9 The total cumulative power value of the master and slaves is displayed.

*10 The full scale output via terminal FM/CA or AM for monitoring is the total capacity of the master and slaves.

*11 The value is displayed in 1 A increments.

*12 Parameter setting is valid when the FR-A8AZ is installed and a motor with thermistor equivalent to the Vector control dedicated motor with thermistor (SF-V5RU □□□□□ T/A) is driven.

◆ Power monitoring reference

Pr.1387 can be used to set the full-scale value when the monitor values of the following items are output through terminal FM, CA, or AM.

Pr.	Pr. group	Name	Setting range	Minimum setting increments	Initial value	Master	Slave
1387	M047	Power monitoring reference	0 to 3000 kW	0.1 kW	Inverter rated capacity	○	○

Monitor	Full-scale value
Input power	Pr.1387×2
Output power	
Energy saving effect	Pr.1387

6 PROTECTIVE FUNCTIONS

6.1 Causes and corrective actions

◆ Fault

When a protective function is activated, the inverter output is shut off and a fault signal is output.

Operation panel indication	E.OCT	<i>E. OCT</i>	FR-LU08 indication	E.OCT
Name	Overcurrent trip (Data code: 19 (H13))*1			
Description	The output from a slave inverter in parallel operation is shut off if the input current exceeds the specified level.			
Check point	<ul style="list-style-type: none"> • Check for sudden load change. • Check for a short-circuit in the output circuit. • Check that the wiring is performed correctly. • Check that any power supply failure did not occur. 			
Corrective action	<ul style="list-style-type: none"> • Keep the load stable. • Check the wiring to make sure that output short circuit does not occur. • Check the wiring. • Check the power supply. 			
Operation panel indication	E.OVT	<i>E. OVT</i>	FR-LU08 indication	E.OVT
Name	Overvoltage trip (Data code: 35 (H23))*1			
Description	If the DC voltage at the main circuit in a slave inverter in parallel operation reaches or exceeds the specified value, the protective circuit is activated to stop the inverter output. The circuit may also be activated by a surge voltage produced in the power supply system.			
Check point	<ul style="list-style-type: none"> • Check for sudden load change and excessive regeneration. • Check that any power supply failure did not occur. 			
Corrective action	<ul style="list-style-type: none"> • Keep the load stable. • Check the power supply. 			
Operation panel indication	E.PA1	<i>E. PA1</i>	FR-LU08 indication	E.PA1
Name	Parallel operation slave 1 fault (Data code: 169 (HA9))*1			
Description	Appears on the master inverter when a fault occurs in the slave 1 inverter during the parallel operation. Appears on the master inverter even when the RS-485 terminals are incorrectly connected.			
Check point	<ul style="list-style-type: none"> • Check if any protective function is activated in the slave 1. • Check the RS-485 terminal wiring. 			
Corrective action	<ul style="list-style-type: none"> • Remove the fault in the slave 1. • Perform correct wiring of the RS-485 terminals. 			
Operation panel indication	E.PA2	<i>E. PA2</i>	FR-LU08 indication	E.PA2
Name	Parallel operation slave 2 fault (Data code: 170 (HAA))*1			
Description	Appears on the master inverter when a fault occurs in the slave 2 inverter during the parallel operation. Appears on the master inverter even when the RS-485 terminals are incorrectly connected.			
Check point	<ul style="list-style-type: none"> • Check if any protective function is activated in the slave 2. • Check the RS-485 terminal wiring. 			
Corrective action	<ul style="list-style-type: none"> • Remove the fault in the slave 2. • Perform correct wiring of the RS-485 terminals. 			

Operation panel indication	E.SER	E. SER	FR-LU08 indication	Communication fault
Name	Communication fault (inverter) (Data code: 198 (HC6))*1			
Description	A faulty wiring of the RS-485 terminals stops the inverter output. The inverter output is shut off if communication has been cut off for the time set in Pr.652 Parallel operation communication check time while the inverter is stopped.			
Check point	<ul style="list-style-type: none"> • Check the RS-485 terminal wiring. • Check that the time set in Pr.652 is appropriate. • Check for excessive noise around the inverter. 			
Corrective action	<ul style="list-style-type: none"> • Perform correct wiring of the RS-485 terminals. • Set the time set in Pr.652 longer. • Take measures against noises if there are devices producing excess electrical noises around the inverter. If the situation does not improve after taking the above measure, contact your sales representative.			

*1 The data code is used for checking the fault via communication or for setting **Pr.997 Fault initiation**. (Refer to the Instruction Manual (Detailed) of the FR-A800 inverter.)

◆Warning

Output is not shut off when a protective function is activated.

Operation panel indication	ED	Ed	FR-LU08 indication	ED
Name	Emergency drive in operation			
Description	Appears during emergency drive operation.			
Check point	• Emergency drive operation is performed by turning ON the X84 signal.			
Corrective action	• The display is cleared when the emergency drive operation ends. (Refer to page 12.)			

◆Others

The faults history and the operation status of the inverter are displayed. It is not a fault indication.

Operation panel indication	E.0	E. 0	FR-LU08 indication	No Alarm
Name	No fault history			
Description	Appears when no fault records are stored. (Appears when the fault history is cleared after the protective function has been activated.)			

Operation panel indication	SLV.1	SLV.1		
Name	Parallel operation slave 1			
Description	Appears on the first monitor screen of the slave 1 inverter (Pr.1001 Parallel operation selection = "1 or 10201").			

Operation panel indication	SLV.2	SLV.2		
Name	Parallel operation slave 2			
Description	Appears on the first monitor screen of the slave 2 inverter (Pr.1001 Parallel operation selection = "2").			

7 SPECIFICATIONS

7.1 Common specifications

Control specifications	Control method		Soft-PWM control, PWM control (selectable among V/F control, Advanced magnetic flux vector control, Real sensorless vector control), and vector control*1
	Output frequency range		0.2 to 120 Hz
	Frequency setting resolution	Analog input	0.015 Hz/60 Hz (terminal 2, 4: 0 to 10 V/12 bits) 0.03 Hz/60 Hz (0 to 5 V/11 bits or 0 to 20 mA/approx. 11 bits for terminals 2 and 4, 0 to ±10 V/12 bits for terminal 1) 0.06 Hz/60 Hz (0 to ±5 V/11 bits for terminal 1)
		Digital input	0.01 Hz
	Frequency accuracy	Analog input	Within ±0.2% of the max. output frequency (25°C ±10°C)
		Digital input	Within 0.01% of the set output frequency
	Voltage/frequency characteristics		Base frequency can be set from 0 to 120 Hz. Constant-torque/variable-torque pattern or adjustable 5 points V/F can be selected.
	Starting torque		LD rating: 150% 0.3 Hz, ND rating: 200%*2 0.3 Hz (under Real sensorless vector control or vector control*1)
	Torque boost		Manual torque boost
	Acceleration/deceleration time setting		0 to 3600 s (acceleration and deceleration can be set individually), linear or S-pattern acceleration/deceleration mode, backlash countermeasures acceleration/deceleration can be selected.
	DC injection brake (induction motor)		Operation frequency (0 to 120 Hz), operation time (0 to 10 s), operation voltage (0 to 30%) variable
Stall prevention operation level		Activation range of stall prevention operation (LD rating: 0 to 150%, ND rating: 0 to 220%). Whether to use the stall prevention or not can be selected. (V/F control, Advanced magnetic flux vector control)	
Torque limit level		Torque limit value can be set (0 to 400% variable). (Real sensorless vector control, vector control*1)	
Operation specifications	Frequency setting signal	Analog input	Terminals 2 and 4: 0 to 10 V, 0 to 5 V, 4 to 20 mA (0 to 20 mA) are available. Terminal 1: -10 to +10 V, -5 to 5 V are available.
		Digital input	Input using the setting dial of the operation panel or parameter unit Four-digit BCD or 16-bit binary (when used with option FR-A8AX)
	Start signal		Forward and reverse rotation or start signal automatic self-holding input (3-wire input) can be selected.
	Input signals (twelve terminals)		Low-speed operation command, Middle-speed operation command, High-speed operation command, Second function selection, Terminal 4 input selection, Jog operation selection, Selection of automatic restart after instantaneous power failure, flying start, Output stop, Start self-holding selection, Forward rotation command, Reverse rotation command, Inverter reset The input signal can be changed using Pr.178 to Pr.189 (Input terminal function selection) .
	Pulse train input		100k pulses/s
	Operational functions		Maximum and minimum frequency settings, multi-speed operation, acceleration/deceleration pattern, thermal protection, DC injection brake, starting frequency, JOG operation, output stop (MRS), stall prevention, regeneration avoidance, increased magnetic excitation deceleration, frequency jump, rotation display, automatic restart after instantaneous power failure, electronic bypass sequence, remote setting, automatic acceleration/deceleration, forward/reverse rotation prevention, operation mode selection, slip compensation, droop control, load torque high-speed frequency control, speed smoothing control, traverse, applied motor selection, gain tuning, RS-485 communication, PID control, PID pre-charge function, easy dancer control, cooling fan operation selection, stop selection (deceleration stop/coasting), stop-on-contact control, PLC function, life diagnosis, maintenance timer, current average monitor, multiple rating, orientation control*1, speed control, torque control, position control, pre-excitation, torque limit, test run, 24 V power supply input for control circuit, safety stop function, vibration control, Emergency drive
	Open collector output (five terminals)		Inverter running, Up to frequency, Overload warning, Output frequency detection, Fault
	Relay output (two terminals)		The output signal can be changed using Pr.190 to Pr.196 (Output terminal function selection) . Fault codes of the inverter can be output (4 bits) from the open collector.
	Pulse train output		50k pulses/s
	Indication	For meter	Pulse train output (FM type)
Current output (CA type)			Max. 20 mADC: one terminal (output current) The monitor item can be changed using Pr.54 FM/CA terminal function selection .
Voltage output			Max. 10 VDC: one terminal (output voltage) The monitor item can be changed using Pr.158 AM terminal function selection .
Operation panel (FR-DU08)		Operating status	Output frequency, output current, output voltage, frequency setting value The monitor item can be changed using Pr.52 Operation panel main monitor selection .
	Fault record	Fault record is displayed when a fault occurs. Past 8 fault records and the conditions immediately before the fault (output voltage/current/frequency/cumulative energization time/year/month/date/time) are saved.	

Protective/ warning function	Protective function	Overcurrent trip during acceleration, Overcurrent trip during constant speed, Overcurrent trip during deceleration or stop, Overcurrent trip, Regenerative overvoltage trip during acceleration, Regenerative overvoltage trip during constant speed, Regenerative overvoltage trip during deceleration or stop, Overvoltage trip, Inverter overload trip (electronic thermal relay function), Motor overload trip (electronic thermal relay function), Heat sink overheat, Stall prevention stop, Output side earth (ground) fault overcurrent, Output phase loss, External thermal relay operation*5, PTC thermistor operation*5, Option fault, Communication option fault, Parameter storage device fault, PU disconnection*5, Parameter storage device fault, CPU fault, Operation panel power supply short circuit / RS-485 terminals power supply short circuit, 24 VDC power fault, Abnormal output current detection*5, Communication fault (inverter), Analog input fault, USB communication fault, Safety circuit fault, Overspeed occurrence*5, Speed deviation excess detection*1*5, Signal loss detection*1*5, Excessive position fault*1*5, Brake sequence fault*5, 4 mA input fault*5, Pre-charge fault*5, PID signal fault*5, Opposite rotation deceleration fault*5, Internal circuit fault, Retry count excess, Parallel operation slave 1 fault, Parallel operation slave 2 fault
	Warning function	Fan alarm, Stall prevention (overcurrent), Stall prevention (overvoltage), Electronic thermal relay function pre-alarm, PU stop, Speed limit indication (output during speed limit)*5, Parameter copy, Safety stop, Maintenance timer 1 to 3*5, USB host error, Home position return setting error*1*5, Home position return uncompleted*1*5, Operation panel lock*5, Password locked*5, Parameter write error, Copy operation error, 24 V external power supply operation, Continuous operation during communication fault*5, Emergency drive in operation*5
Environment	Surrounding air temperature	-10°C to +50°C (non-freezing)
	Surrounding air humidity	95% RH or less (non-condensing) (With circuit board coating (conforming to IEC60721-3-3 3C2/3S2)) 90% RH or less (non-condensing) (Without circuit board coating)
	Storage temperature*3	-20°C to +65°C
	Atmosphere	Indoors (without corrosive gas, flammable gas, oil mist, dust and dirt, etc.)
	Altitude/vibration	2500 m or lower*4, 2.9 m/s ² or less at 10 to 55 Hz (directions of X, Y, Z axes)

- *1 Available only when a vector control compatible option is mounted.
- *2 In the initial setting, it is limited to 150% by the torque limit level.
- *3 Temperature applicable for a short time, e.g. in transit.
- *4 For the installation at an altitude above 1000 m, consider a 3% reduction in the rated current per 500 m increase in altitude.
- *5 This protective function is not available in the initial status.

8 APPENDIX

8.1 Differences in the functions from the standard inverter

The following functions of the FR-A800 standard inverter are changed in the FR-A802-P.

Function name	Description
FWD and REV keys on the operation panel	The FWD and REV keys on the operation panel of the slave are disabled.
Mitsubishi inverter protocol communication	Since RS-485 terminals are used for RS-485 communication between the master and slave inverters, communication using the Mitsubishi inverter protocol through the RS-485 terminals is not available.
MODBUS RTU protocol communication	The MODBUS RTU protocol communication is not available.
High speed maximum frequency (Pr.18)	The upper limit of the output frequency is 120 Hz. Even if a value higher than 120 Hz is set as a high speed maximum frequency, the setting is fixed to 120 Hz.
Current monitoring reference (Pr.56)	The initial value of Pr.56 varies according to the setting in Pr.1001 Parallel operation selection as follows. <ul style="list-style-type: none"> Inverter rated current × Number of the inverters × 0.8 when Pr.1001 = "200 or 300" Inverter rated current × 0.8 when Pr.1001 = "1 or 2"
Optimum excitation control (Pr.60)	The Optimum excitation control mode (Pr.60 = "9") is not available.
Reference current (Pr.61)	It is determined by the following formula: Inverter rated current × Number of the inverters × 0.8, when Pr.61 = "9999 (initial value)"
Applied motor (Pr.71 (Pr.450))	The electronic thermal relay characteristic when Pr.71 (Pr.450) = "8090, 8093, 8094, 9090, 9093, or 9094" is the same as that of the standard motor.
Carrier frequency (Pr.72)	The carrier frequency is fixed at 2 kHz. It cannot be changed using parameters.
PU stop selection (Pr.75)	The setting for PU stop selection (Pr.75) in the slave inverter is invalid. (The setting of Pr.75 in the master inverter is applied to the slave inverter.) <ul style="list-style-type: none"> When the STOP/RESET key on PU of the slave inverter is pressed while Pr.75 of the master inverter = "14 to 17 or 114 to 117", the motor decelerates to stop regardless of the inverter's operation mode and the warning "PS" (PU stop) indication appears on the slave inverter. The "PS" can be reset on the master inverter. When Pr.75 of the master inverter = "0 to 3, 100 to 103", the motor does not stop by pressing the STOP/RESET key on the PU of the slave inverter even if the inverters are in the PU operation mode.
Auto tuning setting/status (Pr.96)	Tuning is not available although "101" (offline tuning with motor rotation) is set in Pr.96 .
PID action selection (Pr.128 (Pr.753))	When Pr.128 (Pr.753) of the slave inverter ≠ "2000, 2001, 2010, or 2011", the PID action selection function of the slave inverter is invalid.
Bypass selection at a fault (Pr.138)	Setting "1" in Pr.138 of the master inverter enables automatic switchover to commercial power supply operation when a protective function (E.OHT or E.CPU) is activated in the slave inverter. Install a thermal relay to the master inverter to protect the motor from overheating.
Output current detection level (Pr.150), Zero current detection level (Pr.152)	The result of the following formula corresponds to "100" (100%) of Pr.150 (Output current detection level) and Pr.152 (Zero current detection level) in the master inverter: Inverter rated current × Number of the inverters × 0.8.
Fast-response current limit (Pr.156)	This function is not available.
Frequency setting / key lock operation selection (Pr.161)	Regardless of the Pr.161 setting of the slave inverter, the setting dial frequency setting mode and setting dial potentiometer mode are disabled on the slave inverter. (The function to lock the operation panel keys is available.)
Automatic restart after instantaneous power failure selection (Pr.162)	Even when a value other than "3 or 13" is set in Pr.162 , a frequency search (reduced impact restart) is performed.
Slip compensation (Pr.245 to Pr.247)	To use the slip compensation function, set the motor capacity in Pr.80 (Pr.453) of the master in advance.
Self power management selection (Pr.248)	When "2" is set in Pr.248 of the master inverter, the MC1 signal turns OFF when the circuit failure protective function or E.PA1/E.PA2 (Parallel operation slave 1 fault / Parallel operation slave 2 fault) is activated.
High-speed setting maximum current (Pr.271), Middle-speed setting minimum current (Pr.272)	During operation with the X19 signal ON, when the average current of the current averaging range becomes equal to or less than the result of the following formula 1: Inverter rated current × Number of the inverters × 0.8 × Pr.271 setting (%), the maximum frequency is automatically defined as the setting of Pr.4 Multi-speed setting (high speed) . During operation with the X19 signal ON, when the average current of the current averaging range becomes equal to or more than the result of the following formula 2: Inverter rated current × Number of the inverters × 0.8 × Pr.272 setting (%), the maximum frequency is automatically defined as the setting of Pr.5 Multi-speed setting (middle speed) . When the average current is more than the result of the formula 1 and less than the result of the formula 2, linear compensation is performed.

Function name	Description
Stop mode selection at communication error (Pr.502), Operation frequency during communication error (Pr.779)	The settings of Pr.502 and Pr.779 does not affect communication between the inverters via the RS-485 terminals. (The setting affects only communication via the communication option.)
PU mode operation command source selection (Pr.551)	The command source is the PU connector when Pr.551 = "1" and the inverters are in the PU operation mode. When a USB memory device is connected to the USB connector, the command source is the USB connector.
Multiple rating setting (Pr.570)	The SLD and HD ratings are not supported. When "0 or 3" is set in Pr.570, the ND rating is applied.
Control method selection (Pr.800 (Pr.451))	The PM sensorless vector control is not available. When Pr.800 (Pr.451) = "13, 14, 113, or 114", Real sensorless vector control is applied.
Fast-response operation (Pr.800 (Pr.451))	Even if the fast-response operation is selected in Pr.800 (Pr.451), the normal-response operation is applied.
Torque control P gain (Pr.824, Pr.834)	The 100% current loop proportional gain is equivalent to 800 rad/s during Real sensorless vector control, and to 1120 rad/s during Vector control.

NOTE

- Functions not mentioned above are the same as those of the FR-A800 standard inverter. (The functions added in and after July 2016 are not supported.)

8.2 Compatible options

◆ Plug-in option

Availability of the plug-in options for the master and the slave inverters during the parallel operation is as follows.

○ indicates that the option is available, Δ indicates that the option is available but some functions are unavailable, and × indicates that the option is not available.

Name	Model	Master	Slave
Vector control	FR-A8AP	○	×
Vector control / encoder pulse dividing output	FR-A8AL	○	×
16-bit digital input	FR-A8AX	○	Δ*1
Digital output / additional analog output	FR-A8AY	○	Δ*2, *3
Relay output	FR-A8AR	○	Δ*2
Bipolar analog output / high-resolution analog input	FR-A8AZ	Δ	Δ*3, *4
CC-Link communication	FR-A8NC	○	Δ*5
CC-Link IE Field Network communication	FR-A8NCE	○	Δ*5
DeviceNet communication	FR-A8ND	○	Δ*5
PROFIBUS-DP communication	FR-A8NP	○	Δ*5
FL remote communication	FR-A8NF	○	Δ*5
SSCNET III(H) communication	FR-A8NS	○	×
EtherNet/IP	A8NEIP_2P*6	○	Δ*5
PROFINET	A8NPRT_2P*6	○	Δ*5
EtherCAT	A8NECT_2P*6	○	Δ*5
PROFIBUS-DP V1	A8NDPV1*6	○	Δ*5

*1 The speed command and torque command are not executed.

*2 Some of the output signals (refer to [page 43](#)) are not available.

*3 Some of the monitor items (refer to [page 45](#)) are not available.

*4 The high-resolution analog input function is not available.

*5 Only the monitoring function is available.

*6 The option is available for inverters with the following SERIAL number or later.

Made in Japan: February 2022 or later

Made in China: March 2022 or later

For checking the SERIAL number, refer to [page 25](#).

◆ Control terminal option

Availability of the control terminal option for the master and the slave inverters during the parallel operation is as follows.

○ indicates that the option is available, and × indicates that the option is not available.

Name	Model	Master	Slave
Vector control terminal block	FR-A8TP	○	×
Screw terminal block	FR-A8TR	○	○

MEMO

REVISIONS

*The manual number is given on the bottom left of the back cover.

Revision Date	*Manual number	Revision
Nov. 2016	IB(NA)-0600654ENG-A	First edition
Jul. 2018	IB(NA)-0600654ENG-B	Added <ul style="list-style-type: none"> • Safety stop function
Jan. 2022	IB(NA)-0600654ENG-C	Added <ul style="list-style-type: none"> • Compatibility with multi-wound motors Setting values "10200 and 10201" for Pr.1001 • Vector control of multi-wound motor • Supplementary explanation to the FR-A800 Instruction Manual (Detailed) • Emergency drive • Compatibility with plug-in options A8NEIP_2P, A8NPRT_2P, A8NECT_2P, A8NDPV1

mitsubishi electric corporation
HEAD OFFICE: TOKYO BUILDING 2-7-3, MARUNOUCHI, CHIYODA-KU, TOKYO 100-8310, JAPAN