



9300-RADES

Remote Access Dial-In Ethernet Modem

Technical Reference Manual
Publication GMSC10-UM004A-EN-E, March 2007

Contacting Rockwell Automation	Technical Support Contact Information found at: http://support.rockwellautomation.com/contactinformation/
Web Support	Remote Access Website: http://support.rockwellautomation.com/modem/modem_Main.asp Rockwell Automation Knowledgebase: http://support.rockwellautomation.com/knowledgebase/ Submit Online Support Request: http://support.rockwellautomation.com/supportrequests/ Access My Support: http://support.rockwellautomation.com/mysupport.asp Download Latest Rockwell Software product updates: http://support.rockwellautomation.com/webupdates/ Download Firmware Updates: http://support.rockwellautomation.com/controlflash/ Manuals Online: http://www.ab.com/manuals/
On-Site Support	Emergency Service in the US call (all hours): 1-800-800-0522 Emergency Service outside the US (all hours): Contact your local sales office. * Learn more about emergency/scheduled callout at: http://support.rockwellautomation.com/SupportPrograms/default.asp
Copyright Notice	

*for sales office nearest you visit <http://rockwellautomation.com> and click on the locations link.

Important Disclaimers

Because of the variety of uses for the products described in this publication, those responsible for the application and use of this control equipment must satisfy themselves that all necessary steps have been taken to assure that each application and use meets all performance and safety requirements, including any applicable laws, regulations, codes and standards.

The illustrations, charts, sample programs and layout examples shown in this guide are intended solely for purposes of example. Since there are many variables and requirements associated with any particular installation, Rockwell Automation does not assume liability (to include intellectual property liability) for actual use based upon the examples shown in this publication.

Reproduction of the contents of this copyrighted publication, in whole or in part, without written permission of Rockwell Automation is prohibited.

Contents

Preface

[About the documentation](#) 6

Chapter 1: Basic Configuration 8

[Accessing the home page](#) 9

[9300-RADES home page](#) 9

[Set IP address](#) 12

[Set security](#) 13

[Miscellaneous](#) 13

Chapter 2: Network Services Setup 15

[RIP Configuration](#) 16

[NAT Configuration](#) 17

[Router Advertisements](#) 19

[IGMP Configuration](#) 19

[DHCP Configuration](#) 19

Chapter 3: Dial In 21

[Dial In user Configuration](#) 21

[Access Settings](#) 22

[Calling Direction](#) 22

[Authentication Type](#) 22

[IP address Supplier](#) 24

[Compression](#) 24

[Routing on PPP](#) 24

Chapter 4: Dial Out 26

[ISP Profile Configuration](#) 26

[Sample App: Enet MSG between two SLC5/05](#) 27

Chapter 5: Modem Setup 31

[Dialing /Answering](#) 31

[Line Speed/Control](#) 33

[V42/MNP Protocols](#) 33

[Other S Registers](#) 34

Chapter 6: Diagnostics 35

[Display Routing Table](#) 35

[Display Switch Counters](#) 36

[IGMP Report](#) 38

[MAC Address Report](#) 38

[Report Line Parameters](#) 38

[Alarm Setup](#) 39

Dial to ISP	39
Hang Up Connection	39
Controller Restart	39
Chapter 7: Switch Management	40
Port Configuration	40
Mirror Configuration	41
VLAN Setup	42
QoS Setup	43
Appendix A	
Upgrading 9300-RADES Firmware	
Complete flash procedure for the 9300-RADES	45
Appendix B	
Username and Password Rules	
Characters that cannot be used, length, and recommendations	47
Appendix C	
Country Codes	
Country Codes settings for phone line characteristics	48
Appendix D	
Factory Reset	
Setting the modem to factory default	49

About the Documentation

This documentation will cover the management interface of the 9300-RADES. We will move in order of the menu (see below).

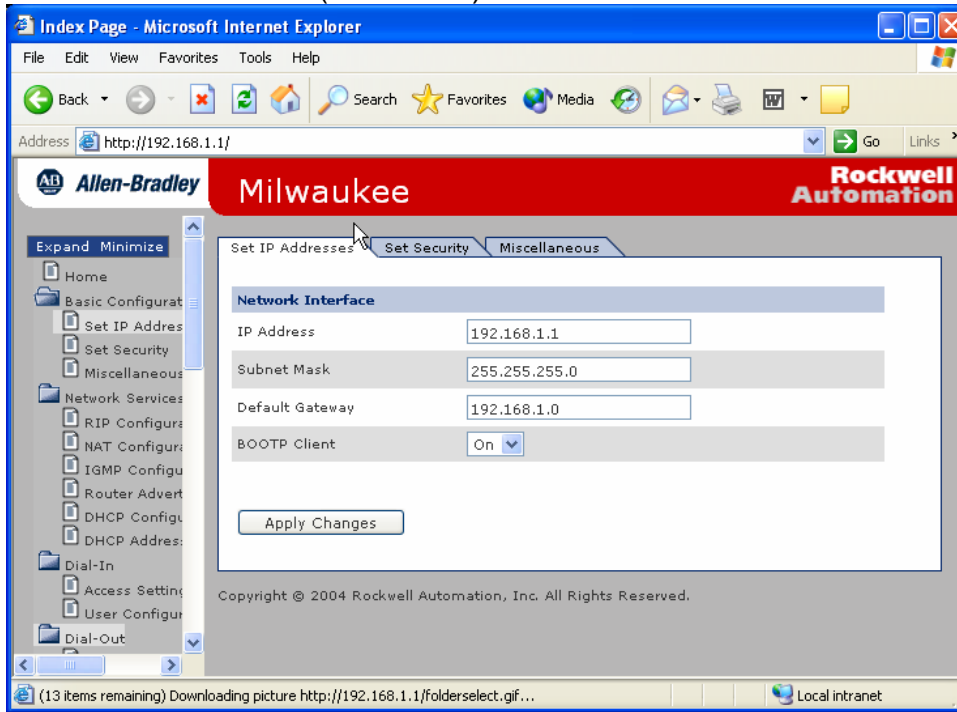

Chapter 1 covers all items under the “Basic Configuration” option and provides information about the management interface. Chapter 2 covers all items found under “Network Services Setup” and so on. The “Quick Start Guide”, which is embedded in the 9300-RADES, will cover the Windows setup and basic use of the product. Therefore, we will not cover those topics with this document. The Quick Start Guide can be found under resources, on the Home page of the product. The Quick Start Guide can also be downloaded from:

http://support.rockwellautomation.com/Ethernet_Modem/emodem_downloads.asp

The 9300-RADES Website is located at:

http://support.rockwellautomation.com/Ethernet_modem/emodem_main.asp

It contains:

- Sample applications
- AutoCAD Drawings
- Latest firmware
- Documentation
- Brochure
- Specification (environmental, and compliance info)
- Ordering information
- Demo line information (try out the product by dialing into our sample network)

IMPORTANT

This manual assumes that the user is familiar with all procedures in the Quick Start guide. If you have not already done so, please read through the Quick Start Guide before referencing this publication.

A word about terminology:

This device has two different types of connections. An Ethernet connection is a connection to the switch board of the device with Ethernet cable or over the Ethernet network. The modem connection is the remote connection established with Windows Dial-Up Networking. Please keep this in mind when reading this document to avoid confusion.

The following Documents can be found at www.ietf.org. The Internet Engineering Task Force produces the following documents:

RFC: (Request for Comments) public documents on many networking topics and protocols.

STD: Internet Standards Documents

BCP: Best Current Practices Documents

FYI: Informational Documents

These documents will be occasionally referenced throughout this manual.

1 Basic Configuration

This Chapter covers:

- Management interface information
- The Home page

All items under the “Basic Configuration” menu option

- Setting the IP address
- Setting the security
- Miscellaneous
- Setup

Accessing the management interface

Before the management interface can be accessed, a connection (Ethernet or Modem) must be established with the 9300-RADES. (see the Quickstart guide for further instruction)

Once the connection (Ethernet or Modem) is established, open your web browser.

1. Type <http://XXX.XXX.XXX.XXX> into the address bar and hit Enter.
Replace the X's with your 9300-RADES IP address.
2. Username is left Empty and the password is ZYPCOM

If the Web Browser won't open:

1. verify the IP address of the 9300-RADES (192.168.1.1 by default)
2. verify your connection setup (see Quick Start for further guidance)
3. verify that the 9300-RADES has power
4. verify that the is cable connected (do you see a green or yellow LED lit on the Ethernet port.
5. verify that a proxy server is not preventing you from accessing the 9300-RADES

9300-RADES Home Page



Name:

Possible values are: user programmable

Default value is: Milwaukee, WI

Identifies the unit (see Basic Configuration, Miscellaneous for instructions on changing the unit's name)

WAN Port Status:

Possible values: ON-LINE, IDLE, NEGOTIATING, AUTHENTICATING, ANSWERING
The WAN (Wide Area Network) Port is the modem connection. If the Modem is online the Status will be ON-LINE. While the modem is off-line the Status will be IDLE.

WAN IP address:

The connection IP address is configured by the Dial-in client (Windows connection). Instructions on setting up your Windows connection can be found in the "Quick Start Guide". When a connection is established, the 9300-RADES reads the IP address assigned by the client and reports it here. Will read N/A when no modem connection is established

Speed:

Possible values are: N/A, 1200-56000 bps

Default Value: modem will try 56000 V90 first

This shows the speed of our dial-up connection. 33600 is the maximum speed attainable between two analog modems. The modem will check the integrity of the phone line to calculate which speed it can maintain reliably. Connections to ISP's can be made at speeds up to 56,000 bps.

Calling Direction:

Possible values are: Disabled, Dial-in only, Dial-out only, both

Default Value is: Dial-in only

This value is changed under Dial-In>Calling Direction

In addition to dialing into the modem to browse your devices, the modem can also dial out to another modem. For example, a computer connected to the 9300-RADES can dial into an ISP provider (ex. AOL) to browse the internet. (see chapter 4 for more details on this feature)

Port Forwarding:

Possible Values are: ON, OFF

Default Value is: OFF

Used only when Dialing out is enabled. It tells the user that NAT (Network Address Translation) is enabled. We will discuss NAT further in Chapter 2 of this publication.

Calling Line ID:

This will read N/A when connected, unless the phone line has caller ID enabled and the user has not dialed in anonymously. The value will always be N/A when no one is connected. Displays the phone number of the caller that is dialed into the 9300-RADES

TX packets:

The number of packets transmitted over the phone line. Will be N/A when no one is using the modem

RX packets:

The number of packets received over the phone line. Will be N/A when the modem is not being used

Errors:

The number of packets received with errors. The checksum of the packet does not match the checksum computed upon receipt of the packet.

Connect Time:

The timer starts when a connection is established to the modem. Will read N/A if no connection is established.

Product Type:

The part number of the device, should always be 9300-RADES

Serial Number:

Unique to every unit ex. 3A1138111

Firmware Revision:

Check our website to make sure you are up to date.

<http://support.rockwellautomation.com/modem>

The Web-Browser Interface

We have recently added web browser capability to this product. This allows the user to manage the modem through a web browser interface opened with Internet Explorer. All

modems can be upgraded to include this feature, for instructions on upgrading the modem see Appendix A.

How to tell if you currently have the web browser interface:

Establish a telnet connection with the modem and check the firmware revision. If the web browser capability is in your modem the firmware revision number will be followed by a web browser revision number. For example:

Firmware revision: 0.88 (This does not have the web browser capability you will have to upgrade the modem to get it)

Firmware revision: 0.88w040822 (This does have the web browser capability and no upgrade is needed to use it)

To connect to the modem using telnet:

1. Establish an Ethernet or Modem connection with the 9300-RADES
2. Click on Start then Run
3. Type telnet xxx.xxx.xxx.xxx replace x's with the 9300-RADES IP address and click OK.
4. The password is ZYPCOM

The 9300-RADES can be configured using the web browser or telnet. Both interfaces offer the same capability.

The Switch Port Section:

Switch Port:

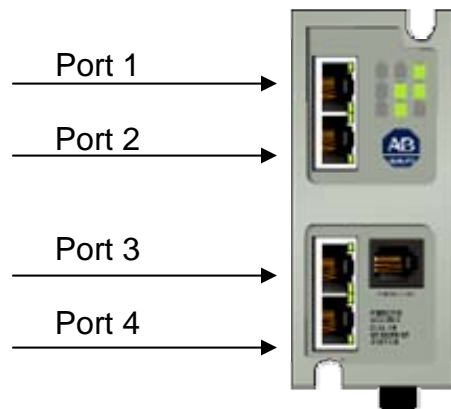

Link:

Possible Values: ON, OFF

On if a device is connected to the port and has power

Speed:

Possible Values: 10 (green LED), 100 (orange LED)

Duplex:

Possible Values: Full, Half

The Resources section:

Provides Links to our website and this manual (you will have to be connected to the Internet for these links to function). The Quick Start Guide Link is also found in this section, but does not require an Internet connection because it is embedded in the product.

Set IP address

Changing your IP address will probably be necessary to install the 9300-RADES into your Ethernet network. Follow the following steps to change the IP address.

1. Find an available IP address on your subnet
2. Establish a connection with the 9300-RADES (pg. 8)
3. Click on the “Basic Configuration” Folder
4. Click “Set IP address”
5. Your screen should appear as follows:

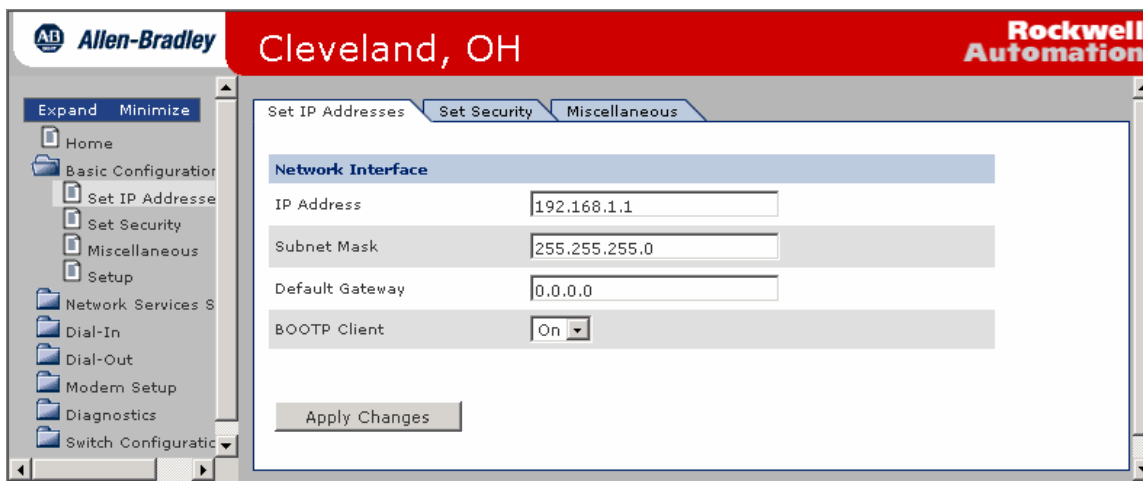

6. Enter your new IP address
7. If needed, change the subnet mask and Gateway
8. Click “Apply Changes”
9. Once IP and subnet are changed, power MUST be cycled to load the new address

THE MODEM WILL NOT LOAD THE NEW IP, AND SUBNET ADDRESS UNTIL POWER IS CYCLED

Power can be cycled remotely through the management interface by:

1. Click “Diagnostics” folder
2. Click “Controller Restart” (Note: This restarts the modem only, this will not restart the PLC and all communications will be interrupted)

Setting IP address with Bootp:

The modem comes with Bootp client on by default. To assign an address simply put the RADES on a network with a Bootp Server, and cycle power to the 9300-RADES. It will attempt to get an IP address several times from the server, before timing out and sticking with 192.168.1.1

Set Security

We recommend changing the Administrator password before the unit is placed in service. We will discuss changing the Client Authentication passwords in a future section, in this section we are discussing the password for the management interface (HTTP session) and the ftp interface (used to upgrade the firmware). Change your Administrative username and password as follows:

1. Click "Basic Configuration" Folder
2. Click "Set Security"
3. Change the username and password (see appendix B for recommendations)
4. Cycle power to the unit to load the new username and password

The Administrative password applies to Telnet, FTP, and the Web Browser Interface. THIS IS NOT THE DIAL IN PASSWORD. The Dial In password is set up under Dial IN (See Chapter 3).

THE MODEM WILL NOT LOAD THE NEW SETTINGS UNTIL POWER IS CYCLED

Note:

This does not change your password for the modem connection (Window's Dial-Up networking). This username and password are used to establish an FTP, HTTP or Telnet session only.

Another option under the set security menu allows the user to disable telnet security. This is not recommended; turning off this feature would allow any user, over the Ethernet or modem connection, to make changes to the configuration of the 9300-RADES.

Miscellaneous

Box Name:

This setting allows you to give your 9300-RADES a name that describes its location or connected devices. This feature is useful when multiple 9300-RADES are installed. It reports this name on the Home Page

To change this setting:

1. Click “Basic Configuration” Folder
2. Click “Miscellaneous”
3. Type the new name in the Text Box and click “Apply Changes”
4. The new name will not be shown on the Home page until you hit the Refresh button on the browser

User Inactivity

This setting allows you to change the length of time the management interface will remain open while inactive. Choose anywhere from 0-99 minutes.

Selecting a value of 0 = feature disabled, the interface will remain open until it is closed.

Default Value: 3 Minutes

Status Refresh

This setting controls the refresh rate of the management interface. Choose anywhere from 0-99 seconds.

Value of 0 = Feature Disabled, will not refresh

Default Value: 5 seconds

The web browser interface also has the ability to enter contact info and a contact email address. This info will appear on the home page of the 9300-RADES

2 Network Services Setup

This Chapter covers:

- RIP Definition and Configuration
- NAT Definition and Configuration
- IGMP Definition and Configuration
- Router Advertisements
- DHCP Definition and Configuration

Definitions

UDP: Defined by RFC 1122, section 4.1: The User Datagram Protocol offers only a minimal transport service. UDP is used by applications that do not require the level of service of TCP or that wish to use communications services (e.g., multicast or broadcast delivery) not available from TCP. An application program running over UDP must deal directly with end-to-end communication problems that a connection-oriented protocol would have handled -- e.g., retransmission for reliable delivery, packetization and reassembly, flow control, congestion avoidance, etc., when these are required.

TCP: Transmission Control Protocol, TCP enables two hosts to establish a connection and exchange streams of data. TCP guarantees delivery of data and also guarantees that packets will be delivered in the same order in which they were sent.

Router – a.k.a (Gateway), forwards packets, not on the local subnet, to its destination network or another router.

Routing information protocol - Distributes routing information to the routers within an autonomous system. Most common of the IGP (interior gateway protocols), bases its routing decisions on the number of hops that it will take to get to the target IP-addressed network. This protocol prevents the user from having to manually update the routing table. Defined by STD 34, RFC 1058 and updated by RFC 1388

DNS- (Domain Name Server) Translates domain names into IP addresses, for example www.example.com may translate to 192.168.100.100

DHCP- (Dynamic Host Configuration Protocol) Commonly used on office networks, Scarce IP address space is efficiently used because IP addresses are "leased" to clients for a limited time. This lease concept facilitates the recycling of addresses, which is the heart of DHCP.

Bootp- (Bootstrap Protocol) Commonly used with AB Ethernet products, defined by RFC 951, BOOTP protocol is used by a client machine to locate its IP address and network mask.

Domain- A group of computers and devices on a network that are controlled as a unit with common rules and procedures

NAT- A Network Address Translator (NAT) is an IP router defined in RFC 1631 that can translate IP addresses and TCP/UDP port numbers of packets as they are being forwarded.

PAT- (Port Address Translation) translates private hosts to a public address.

RIP Definition and Configuration

RIP Definition

Router – a.k.a (Gateway), forwards packets, not on the local subnet, to its destination network or another router.

Routing information protocol - Distributes routing information to the routers within an autonomous system. Most common of the IGPs (interior gateway protocols), bases its routing decisions on the number of hops that it will take to get to the target IP-addressed network. This protocol prevents the user from having to manually update the routing table. Defined by STD 34, RFC 1058 and updated by RFC 1388

RIP Configuration

For most applications, these settings should not be modified from default. For routing diagnostics see Chapter 6

RIP Direction

Default: Talk and Listen – sends updated routing table to other routers and receives routing updates from other routers.

Other options: Talk Only – sends updates only, Listen Only – receives updates only, None – Does not send or receive updates.

Applies to the Ethernet connections of the 9300-RADES

RIP Version

Default: RIP2: follows the updated standard defined by STD 34, RFC 1388

Other options: RIP1: follows the original standard defined by STD 34, RFC 1058

Applies to the Ethernet connections of the 9300-RADES

RIP PPP direction

Default: None

Other Options: Talk and Listen, Talk only, Listen only, None

Applies to the modem connection of the 9300-RADES

RIP PPP Version

Default: RIP2

Other Options: RIP1

Applies to the modem connection of the 9300-RADES

NAT Definition and Configuration

NAT Definition

A Network Address Translator (NAT) is an IP router defined in RFC 1631 that can translate IP addresses and TCP/UDP port numbers of packets as they are being forwarded. Consider a small business network with multiple computers connecting to the Internet. A small business would normally have to obtain an Internet Service Provider (ISP)–allocated public IP address for each computer on their network. With NAT, however, the small business can use private addressing (as described in RFC 1597) and have the NAT map its private addresses to a single or to multiple public IP addresses as allocated by its ISP.

For example, if a small business is using the 10.0.0.0 private network for its intranet and has been granted the public IP address of 198.200.200.1 by its ISP, NAT maps (using static or dynamic mappings) all private IP addresses being used on network 10.0.0.0 to the public IP address of 198.200.200.1.

When a private user on the small business intranet connects to an Internet resource, the user's IP stack creates an IP packet with the following values set in the IP and TCP or UDP headers (**bold text indicates the fields changed by the 9300-RADES**):

- Destination IP Address: Internet resource IP address
- Source IP Address: **Private IP address**
- Destination Port: Internet resource TCP or UDP port
- Source Port: **Source application TCP or UDP port**

The source host or another router forwards this IP packet to the NAT, which translates the addresses of the outgoing packet as follows (**bold text indicates the fields changed by the 9300-RADES**):

- Destination IP Address: Internet resource IP address
- Source IP Address: **ISP-allocated public address**
- Destination Port: Internet resource TCP or UDP port
- Source Port: **Remapped source application TCP or UDP port**

When trying to reach a host on a private network (behind a NAT router) NAT is used to forward to the private host. NAT will translate the packet and forward to the appropriate host on the intranet. Translation occurs as follows (**bold text indicates fields changed by the 9300-RADES**):

- Destination IP Address: **ISP-allocated public address**

- Source IP Address: Internet resource IP address
- Destination Port: **Remapped source application TCP or UDP port**
- Source Port: Internet resource TCP or UDP port

NAT maps and translates the addresses and forwards the packet to the intranet client, it contains the following addressing information (**bold text indicates the fields changed by the 9300-RADES**):

- Destination IP Address: **Private IP address**
- Source IP Address: Internet resource IP address
- Destination Port: **Source application TCP or UDP port**
- Source Port: Internet resource TCP or UDP port

For outgoing packets, the source IP address and TCP/UDP port numbers are mapped to a public source IP address and a possibly changed TCP/UDP port number. For incoming packets, the destination IP address and TCP/UDP port numbers are mapped to the private IP address and original TCP/UDP port number.

Advantages of NAT

NAT provides security because private addresses are never available to the public. All that can be seen on the web is the public IP address assigned by the ISP provider.

NAT eliminates the need for multiple public IP addresses. There are a limited number of IP addresses and with the number of people on the internet, not everyone can have their own. NAT allows all computers connected to a router to use the same public address, thus conserving addresses.

NAT Configuration

NAT is configured dynamically in our product. To view the configuration, select NETWORK SERVICES SETUP>NAT CONFIGURATION, you will see the NAT table displayed. NAT configuration can be manually edited, however this is not encouraged and can disrupt communications. When editing manually, the user is required to enter the port number for translation referred to as PAT (port address translation). The table below shows that the server (computer) at address 192.168.1.7 handles all requests coming onto the private network over the telnet port (port 23).

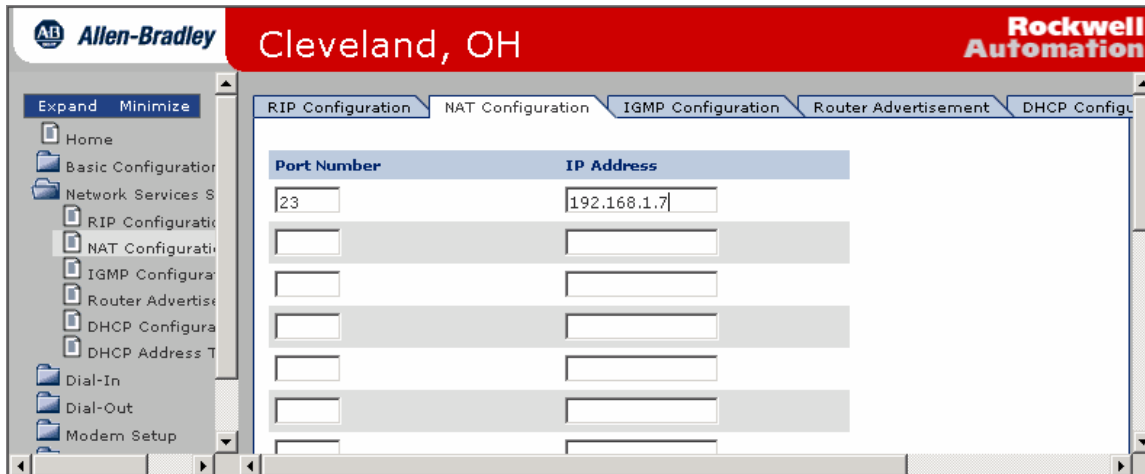

Router Advertisements

Default Value: Off

The 9300-RADES has routing capability; if this capability is needed advertisements may need to be turned on. Selecting on allows the 9300-RADES to advertise its presence, various link parameters, and various Internet parameters. Routers advertise either periodically, or in response to a router solicitation message. Router advertisements contain prefixes that are used for on-link determination or address configuration, a suggested hop limit value, and so on. This setting will not be used for most applications of the 9300-RADES.

IGMP Definition and Configuration

IGMP Definition

The 9300-RADES includes a feature called IGMP snooping. IGMP snooping will sort multicasting devices into groups. This will limit the multicast packets received by hosts that do not need the info, thus making the network more efficient and deterministic.

IGMP Configuration

IGMP is configured by enabling it and setting the version and query period. The 9300-RADES supports version 1 and version 2 IGMP, determine which one your devices are using and make the appropriate selection. The Query period determines how often your network is queried for Group information, the hosts on your network will respond with their group information. To see your multicast groups, the IGMP report can be found under "Diagnostics".

DHCP Definition and Configuration

The 9300-RADES functions as a DHCP/BOOTP server. This is not to be confused with BOOTP/DHCP client which allows the 9300-RADES to receive and address from a DHCP/BOOTP server.

DHCP Definition

BOOTP (Bootstrap protocol)

Commonly used with AB Ethernet products, defined by RFC 951, BOOTP protocol is used by a client machine to locate its IP address and network mask. Bootp ties the IP address to the MAC hardware address; therefore Bootp will always assign the same address to the same Hardware.

DHCP (Dynamic Host Configuration Protocol)

Commonly used on office networks, Scarce IP address space is efficiently used because IP addresses are "leased" to clients for a limited time. This lease concept facilitates the recycling of addresses, which is the heart of DHCP.

DHCP/BOOTP Configuration

It is important to keep this feature shut off if this device is on a larger IT controlled network. Company networks already have DHCP servers in place to service the computers on the network with IP addresses. This device may conflict with the existing DHCP servers on the network and prevent them from handing out addresses.

The 9300-RADES has the ability to serve IP addresses to 32 nodes. We set up the 9300-RADES as follows:

1. Establish a Connection with the 9300-RADES (pg. 8)
2. Select NETWORK SERVICES SETUP>DHCP CONFIGURATION
3. Enable DHCP Server by setting to "ON" (Will be off by default)
4. Select your subnet and gateway addresses for the network
5. Select the primary and secondary DNS servers. (9300-RADES has DNS capability therefore its address can be listed under the primary address if you do not have another DNS server already established on the network)
6. The domain name should be filled out if the 9300-RADES resides on a domain
7. Next we assign a pool of address for the 9300-RADES to pick from.
8. Dynamic bootp should be enabled to answer bootp requests
9. Lease time only comes into play with DHCP requests, therefore will usually be irrelevant. Bootp will set this value to 49710 days because it will always want the same address
10. Cycle power for the changes to take effect

Most applications with PLCs will not require the DNS, Domain name, and lease time fields to be changed. If this does not apply to your network, leave these fields at their default value.

3 Dial-In Configuration

This Chapter covers:

- Dial-in access settings
- Dial-in user configuration

Dial-in user configuration

The 9300-RADES supports up to 10 different user accounts. The default account of: ppp_user, ZYPCOM, should be changed for security reasons. See Appendix B for password and username rules.

Adding an account:

To add an account, follow these steps:

1. access the management interface
2. click on Dial in from the Home page
3. click on User Configuration
4. Select an empty user Account and click on it.

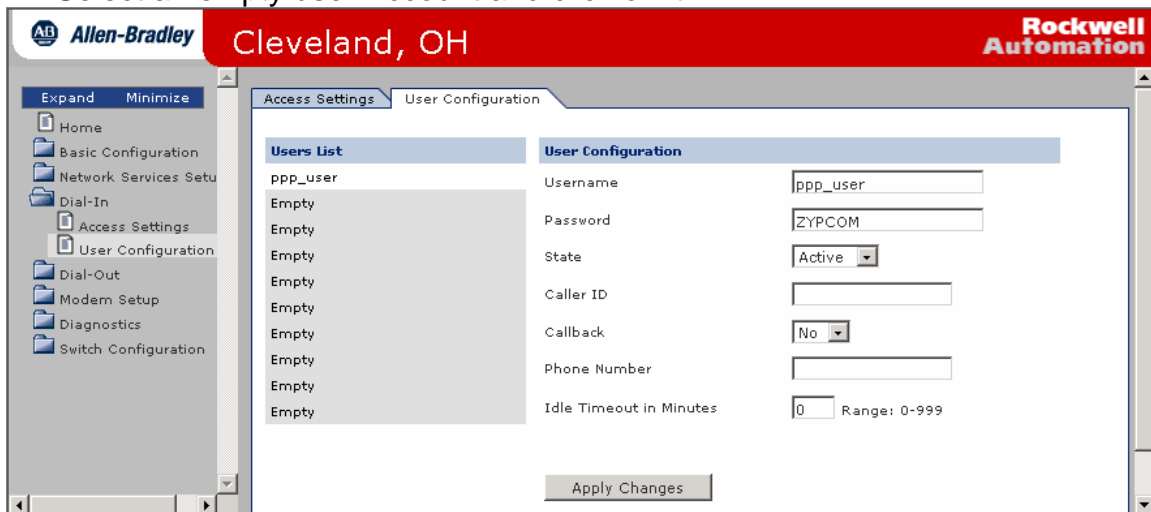

5. Enter the user account information

username: username for the account

state: Unused or active (Must be changed to active for account to work)

password: password for the account

caller ID: Caller ID must also be enabled under Access Settings

callback: Callback will call back the user at a pre-determined number to allow access.

Phone number: This is the number called when callback is activated, if this field is left blank, the user will be prompted for the phone

number when attempting to dial in.

Idle Timeout in Minutes: The connection will automatically disconnect if there is no activity for this amount of time. A value of 0 will leave the connection open until disconnected by the user

6. Once the information is entered, click Apply Changes
7. IMPORTANT: The new account will not be active until the 9300-RADES is restarted
8. Select Diagnostics>Controller Restart to restart remotely

Deleting an account:

1. Access the management interface
2. Click Dial In from the Main Menu
3. Click User configuration
4. Select the account you wish to delete
5. Change the State from Active to Unused

Deleting all user accounts:

1. Carefully remove the plastic clip from the back of the unit.
2. Inside of the slot on the right, you will see a yellow button.
3. Hold in the button with a small screwdriver for 3 seconds.
4. While continuing to hold the button, cycle power to the unit.
5. Continue to hold the button until the LEDs begin to move in a circular pattern
6. The modem is now reset back to default.

Access Settings

Calling Direction

Default Value: Dial-In only

Possible Values: Disabled, Dial-in only, Dial-out only, Both Directions

This modem also has routing capability. When the 9300-RADES receives an off network TCP/IP packet, it has the ability to route it to another location over the phone line. To use this capability Dial-out will have to be enabled here.

Authentication Type/ PAP, CHAP

Default Value: CHAP/PAP

Possible Values: None, CHAP/PAP, CHAP only, PAP only

PAP only:

Password authentication protocol authenticates username and password. The client (Windows Dial Up Networking) sends the server (9300-RADES) a username and password when connecting.

CHAP only:

CHAP Challenge Handshake Authentication Protocol can be used for establishing the PPP link. Using CHAP implements extra security on the negotiation of the username and password. CHAP uses MD5 (Message Digest 5) to hash the password to a unique packet (that cannot be undone) often called a “secret”. Upon negotiation, the client (Dial in User w/CHAP turned on) sends the “secret” to the server (9300-RADES) to prove that we (the client) know the password, without having to send it across the wire.

Setting up your Dial UP connection to use CHAP authentication:

1. Click START/SETTINGS/NETWORK AND DIAL-UP CONNECTIONS
2. Click MAKE NEW CONNECTION
3. Follow the directions and click FINISH to create your connection’s icon.
4. Right-Click on the connection that was just created.
5. Enter your username and password and click PROPERTIES
6. Click on the Security TAB.
7. Select the ADVANCED radio button and click SETTINGS

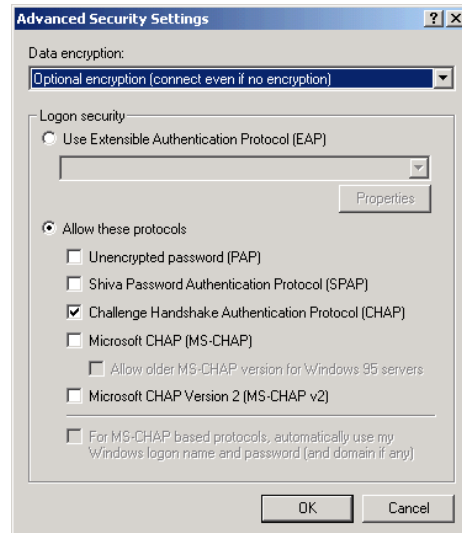
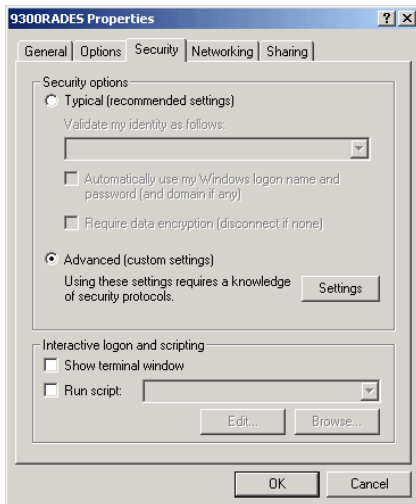

8. Select the ALLOW THESE PROTOCOLS radio button and check CHAP and click OK

9. Click on the NETWORKING tab and follow the directions from the quick start guide to finish the configuration.

The connection now has the additional security offered by CHAP authentication

None:

No Authentication used, NOT RECOMMENDED

CHAP/PAP:

The 9300-RADES will first attempt to authenticate with CHAP, if authentication fails, it will attempt to authenticate with PAP.

Remote IP address Supplier

Another part of the negotiation process is the negotiation of WAN IP address. The WAN IP address is used by Windows to route TCP/IP packets over the Dial-UP connection. This address is assigned by the Client (Windows Dial-Up Networking). See the Quick Start Guide for further instruction.

Changing IP address Supplier:

The IP address supplier can be changed to the RADES modem. This would simplify the configuration of Windows Dial-up networking. To make this change:

1. Connect to the Management interface
2. Click Dial-In and Select Access Settings
3. Change Remote IP Address Supplier to Z90e router
4. You will now have the option to set the PPP remote IP
5. Select an available IP address on the network for the PPP remote IP
6. Once this is done, your dial up connection's TCP/IP properties will need to be changed to "obtain an IP address automatically"

Compression

Default: Both

Possible Choices: Both, Frame, Header Only, Off

This refers to PPP protocol compression.

Routing on PPP

Default: Unnumbered Link

Possible Values: Unnumbered Link, Full Route

Unnumbered Link:

A simple way to route packets over the PPP link. When it is selected the 9300-RADES will automatically consume its IP address and its IP address plus 1 to route Ethernet packets successfully over the phone line. For Example, a default unit will use 192.168.1.1 and 192.168.1.2 when a modem connection is active.

Full Route:

When Full Route is selected the user has the capability of selecting the IP and IP mask used to route. The 9300-RADES will not automatically use the RADES IP plus 1 as done with unnumbered link, it will use the available address entered by the user in the PPP Local IP address and MASK fields.

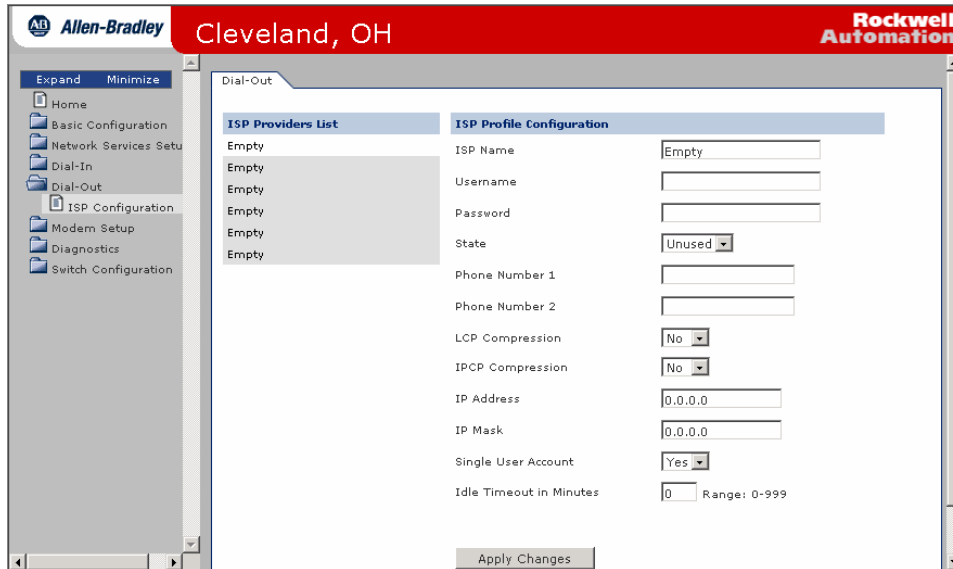

4 Dial-Out Configuration

This Chapter covers:

- ISP profile Configuration
- Sending an ENET MSG over a Dial-Up connection

This Chapter only applies if using the routing feature of the 9300-RADES. By Default this feature is disabled.

ISP Profile Configuration

The routing feature allows TCP/IP packets to be routed to another network. For the modem to do this, it has to dial that network and log in.

ISP name: Name associated with that Dial-UP account. Ex. AOL, or MSN

State: Active or Unused

Phone1 Number: Tries this number first when attempting the connection

Phone2 Number: Alternate number. Will try if the first number fails

Username: username for the remote account

Password: password for the remote account

LCP Compression: Link Control Protocol, Compression

IPCP Compression: Internet Protocol, Control Protocol

IP address and Mask: Must be an available address on the remote Network. **IMPORTANT-** If using an ISP provider Like AOL your IP and Mask will be assigned by the remote server, therefore, these fields should be blank.

Single User Account: Single or Multiple user account

Idle Timeout: When the account is inactive for this amount of time, the connection will terminate. Value of zero turns off this feature

Sending an ENET MSG over a Dial-Up connection

The 9300-RADES has routing capability. When it receives an Ethernet packet that does not belong on its local network, it routes it to another via the phone line. This example, uses:

2- 9300-RADES Modems

2- SLC 5/05 Processors on 2 remote networks

On the local End:
9300-RADES Modem 192.168.1.1/255.255.255.0
(enable Dial Out capability and enter Dial Out Profile)

Configuration of SLC:

1747-L552 SLC 5/05 192.168.1.8/255.255.255.0, gateway 192.168.1.1 (RADES IP address), Sending a MSG to a 1747-l552 at 100.100.101.16/255.255.255.0 through another Ethernet Modem at 100.100.101.17.

Configuration of local 9300-RADES:



Default calling direction is Dial In only. This must be changed to both. (select Dial-In>Calling Direction>Both Directions)

Power must be cycled on the modem for the changes to take effect

Create a Dial Out account that will connect to the remote 9300-RADES at 100.100.101.17.

Click Dial Out from the Home Page.

*** Note that the current firmware supports only one Dial-Out account**

ISP Providers List	ISP Profile Configuration	
CLX	ISP Name	<input type="text" value="CLX"/>
Empty	Username	<input type="text" value="ppp_user"/>
Empty	Password	<input type="text" value="ZYPCOM"/>
Empty	State	<input type="text" value="Active"/>
Empty	Phone Number 1	<input type="text" value="5554444"/>
	Phone Number 2	<input type="text"/>
	LCP Compression	<input type="text" value="No"/>
	IPCP Compression	<input type="text" value="No"/>
	IP Address	<input type="text" value="192.168.1.7"/>
	IP Mask	<input type="text" value="255.255.255.0"/>
	Single User Account	<input type="text" value="Yes"/>
	Idle Timeout in Minutes	<input type="text" value="1"/> Range: 0-999
<input type="button" value="Apply Changes"/>		

1. Enter a name for the account (Should be descriptive)
2. Change the state to active
3. Enter the phone number of the remote 9300-RADES
4. LCP and IPCP compression should be left at NO
5. Your connection will need an IP address and MASK on the remote network.
*this step doesn't always apply. When connecting with an ISP provider (like AOL) the remote server usually assigns this address. When this is the case, leave these fields blank.
6. Make sure Single User Account is set to YES (the connection will not work if this is set to NO)
7. Click Apply Changes and Cycle Power to the unit to activate the account. Your 9300-RADES is now ready to call. Now your processor needs to be configured.

LOCAL SLC Channel and MSG configuration:

The local processor needs to be on the same network as the local modem. In the example the local SLC is @ 192.168.1.8/255.255.255.0. The gateway address **MUST** be the address of the local 9300-RADES (in the example 192.168.1.1). We must also increase the channel msg timeout and reply timeout to 45 seconds. The channel timeout must also be changed from 30 minutes to 1 minute to allow the modem to hang up once the msg is sent (see below)

Protocol Control

Bootp Enable

Msg Connection Timeout (x 1mS): 45000

Msg Reply Timeout (x 1mS): 45000

Inactivity Timeout (x Min): 1

Contact: _____

Location: _____

The MSG configuration for this example looks like this:

MSG - N7:0 : (51 Elements)

General

This Controller

Communication Command : 500CPU Read

Data Table Address: N9:0

Size in Elements: 1

Channel: 1

Target Device

Message Timeout : 91

Data Table Address: S:42

Ethernet (IP) Address: 100.100.101.16

Local / Remote : Local MultiHop: No

Control Bits

Ignore if timed out (TO): 0

To be retried (NR): 0

Awaiting Execution (EW): 0

Continuous Run (CO): 0

Error (ER): 0

Message done (DN): 1

Message Transmitting (ST): 0

Message Enabled (EN): 0

Waiting for Queue Space : 0

Error

Error Code(Hex): 0

Error Description

note that local is selected.

Remote RADES configuration:

The remote RADES must be set up to authenticate the phone call from the local RADES. Click Dial-In>User Configuration, Select an unused Dial-In Profile, fill in the appropriate username and password, make sure to change the state to active. (in this example username: mark and password: password to match the Dial-Out profile of the local modem) The IP address will need to be changed to 100.100.101.17 for this example.

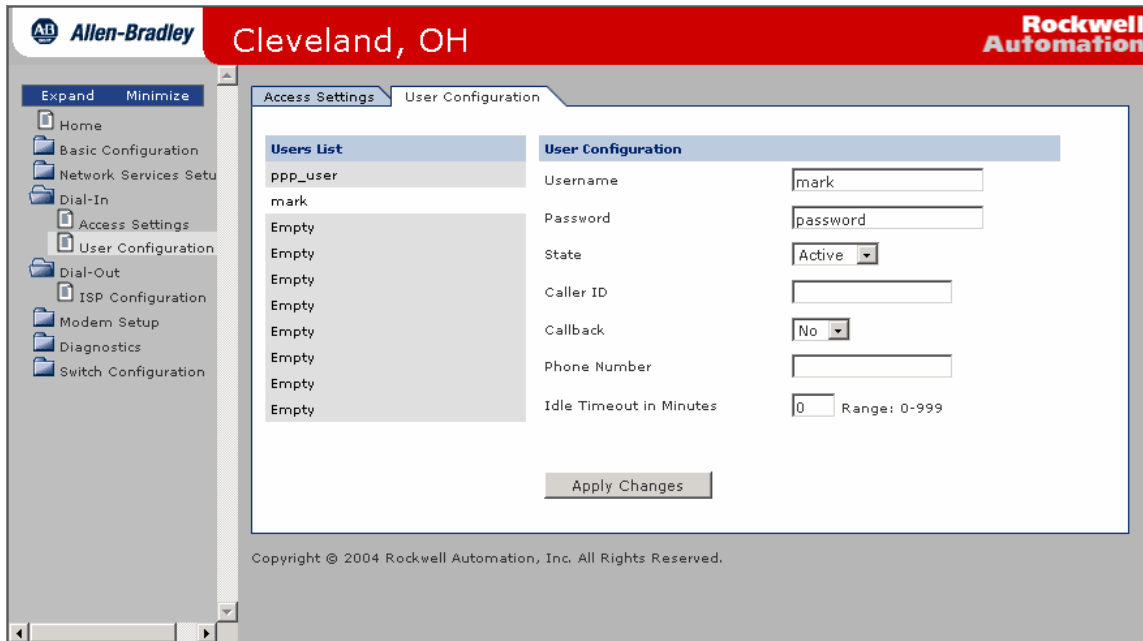

Remote SLC Configuration:

The remote SLC's channel configuration of this example will require an IP address of: 100.100.101.16/255.255.255.0/100.100.101.17

What Happens:

When the MSG instruction is fired, the packet for 100.100.101.16 is sent to the gateway because 100.100.101.16 is not on the same network with 192.168.1.8 (address of the local SLC). Once the 9300-RADES (192.168.1.1) receives the packet it dials the Dial Out account and sends the packet to the remote 9300-RADES (100.100.101.17), which forwards it to the remote SLC (100.100.101.16) which responds back through the same channel. Once the connection is not active for 1 minute it is terminated by the local 9300-RADES. (The Idle timeout must be set to 30 seconds and the channel timeout to 1 minute for this to happen. By default, the 9300-RADES is set to hang up after 4 minutes of inactivity)

5

Modem Setup

This Chapter covers:

- Dialing/Answering
- Line Speed/Control
- V42/MNP Protocols
- Other S-Registers

Dialing and Answering



Auto-answer

Default: 2, (modem answers in 2 rings)

Controls the S0 register of the modem, number of rings the modem needs to see before the answer sequence begins

Dial-tone Delay

Default: 2, (2 seconds)

Controls the S6 register of the modem, Determines how long the modem will wait after going off hook before dialing

CXR wait time

Default: 60, (60 seconds)

Controls the S7 register of the modem, Controls the length of negotiation time allowed when the modem is establishing a connection, Should be at least 60 seconds for international calls

Comma delay

Default: 2, (2 seconds)

Controls the S8 register of the modem, Determines the length of a pause when a (,) is inserted into the dial string.

Carrier detect

Default: 6, (.6 seconds)

Controls the S9 register of the modem, the modem must see the carrier signal for this length of time before the signal is considered valid

Touch tone

Default: 95, (.095 seconds) phone company standard

Controls the S11 register of the modem, controls the length of time that the tones are transmitted by the modem when dialing an outgoing call.

Dial-tone detect

Default: Yes, X4, Detects busy tone, dial tone, and connect xxxx messages

This is used to configure the modem to ignore Dial tone. Changing the value to No tells the modem to ignore Dial tone.

Redial attempts

Default: 0

Controls the S41 register of the modem, number of times the modem will attempt to redial a telephone number when the connection is not made. Used in conjunction with the S53 register

Redial interval

Default: 1 (1 minute)

Controls the S53 register of the modem, interval between retries

Line Speed/Control

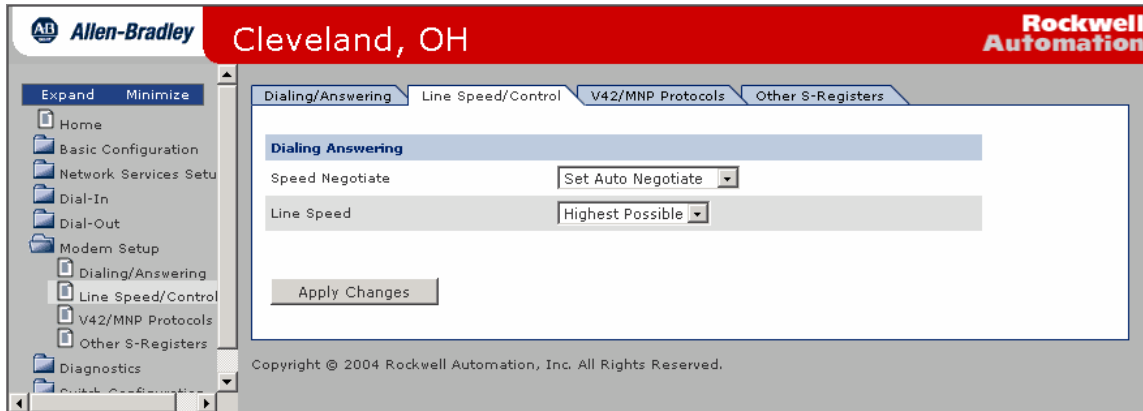

Speed Negotiate

Default: 1 (modem determines maximum line rate)
Works in conjunction with line speed

Line Speed

Default: 0 (auto-negotiate line speed)
Controls the S37 register of the modem
Transmits data over the phone line at this rate.

V42/MNP Protocols

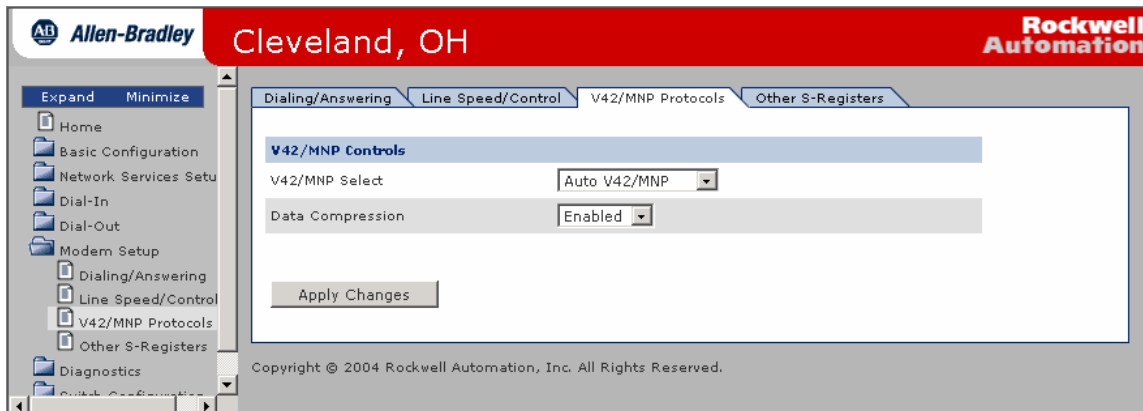

V42/MNP select

Default: 7 (auto-detects data mode)

Data Compression

Default: 1 (Data compression enabled)
Allows a 4:1 compression ratio

Other S- Registers

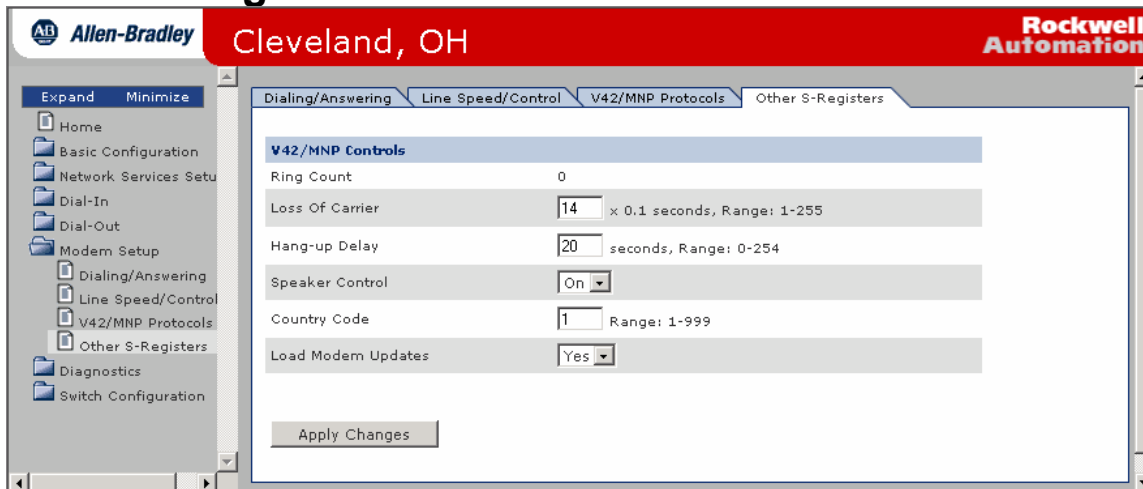

Ring Count

Non-writeable register

Counts the number of rings the modem sees on an incoming call. When S1 matches S0 (Auto-answer register) the modem answers the call.

Loss of Carrier

Default: 14 (tenths of a second or 1.4 seconds)

Should be set to at least 50 for cellular connections

Amount of time the modem must wait after losing carrier from the remote modem before disconnecting.

Hang-up Delay

Default: 20 seconds

Delay allows the modem to empty its receive buffers after receiving the hang up command

Speaker control

Default: On

Controls Modem Speaker

Country Codes

Default: 1 (USA phone settings)

Controls S98 register, See appendix C for more settings

Load Modem Updates

Default: On

When powering up, the modem will apply enhancements to the DSP chip. Delays power up sequence

6

Diagnostics

This Chapter covers:

- Displaying routing table
- Displaying switch counters
- IGMP report
- MAC address report
- Phone line Diagnostics
- Dial ISP testing
- Hang Up ISP testing
- Controller Restart
- Alarm Setup

Displaying Routing Table

PPP Connection Example

The PPP connection with Microsoft Windows Dial Up networking, gives RSLinx the illusion that the CLX is on the same Ethernet network. Windows handles routing its traffic through the PPP tunnel to the remote network on the other end of the phone line.

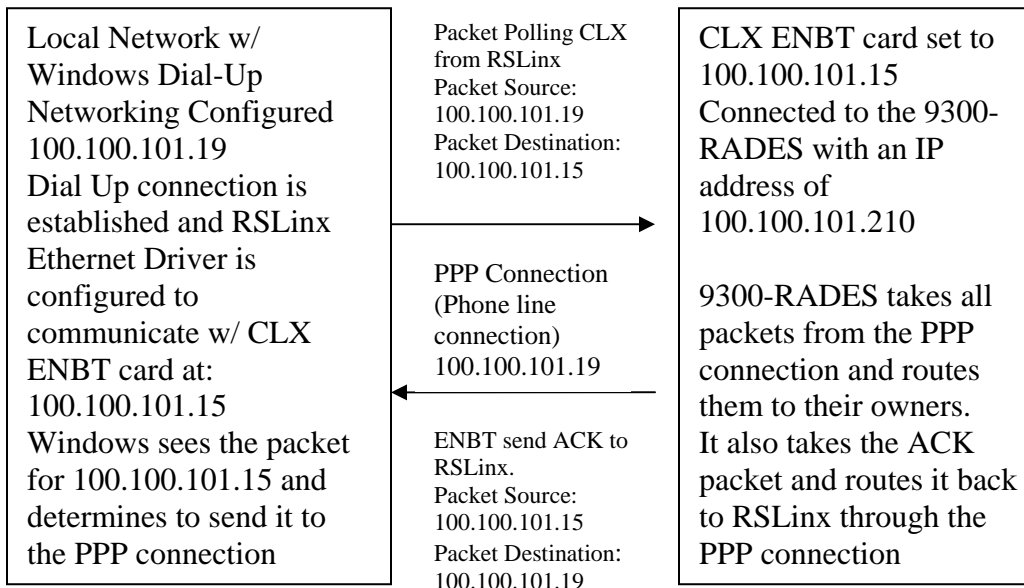

Routing table from the example application above

Dest	Mask	IF	NextHop	Cost	Type	Owner	Age
100.100.101.19	255.255.255.255	3(ppp0)	0.0.0.0	0	direct		static
100.100.101.0	255.255.255.0	2(eth0)	0.0.0.0	0	direct	local	153
127.0.0.0	255.0.0.0	1(lo)	0.0.0.0	0	direct	local	153

Some routers require manual entry of the routing table. This is not the case with the 9300-RADES. The 9300-RADES uses RIP protocol to dynamically create the routing table and send the routing information to other hosts on the network.

The first line of 100.100.101.19/255.255.255.255 tells the modem to send only packets w/ destination address of 100.100.101.19 to the PPP connection.

The second line of 100.100.101.0/255.255.255.0 tells the 9300-RADES to send all packets for 100.100.101 network to the switch board to be routed.

The third line deals with the universal IP loop-back

Displaying Switch Counters

This option will give you various counts from the switch. All counters are displayed in Hex.

Octet = 8 bits

TX counters

Tx Octet Count

Total of transmitted good octets from the selected port

Tx Drop Pkts Count

Packet is not acknowledged by the receiving host

Tx BroadcastPkts Count

Number of good packets sent w/ destination of everyone. Receivers are unspecified

Tx MulticastPkts Count

Packets sent to members of multicast group. One terminal to many hosts

Tx UnicastPkts Count

In contrast with multicast, consist of one terminal transmitting to one host

Tx Collisions Count

Two terminals transmit packets at the same time causing them to collide

Tx SingleCollision Count

Packet collides with one other terminal's transmitted packet

Tx MultipleCollision Count

Packet collides with more than one terminals' transmitted packets

Tx DeferredTransmit Count

Number of packets delayed because the network is busy (Higher the number the less deterministic your network)

Tx LateCollision Count

Collision is detected later than the 512 bits into the packet transmission

Tx ExcessiveCollision Count

Packets not transmitted because the packet experienced 16 failed attempts

Tx FrameInDisc Count

Network Device is not acting in compliance with a flow control request

Tx PausePkts Count

Pause frames sent by this port

RX counters**Rx Octets**

Total good octets received on selected port

Rx Undersize Pkts

Good packets that are under 64 octets long

Rx Pause Pkts

Pause packets received by this port

Pkts64 Octets

Data packets = 512 bits

Pkts65to127 Octets

Data packets = 520-1016 bits

Pkts128to255 Octet

Data packets = 1024-2040 bits

Pkts256to511 Octet

Data packets = 2048-4088 bits

Pkts512to1023 Octet

Data packets = 4096-8184 bits

Pkts1024to1522 Octet

Data packets = 8192-12176 bits

RxOversize Pkts

Packets over 12176 bits or 1523-1536 Octets

RxJabbers Pkts

Packets longer than 1522 Octets, and have an error

RxAlignment Errors

Packets between 64 and 1522 octets, and have an error

RxFCS Errors

Packets received (between 64-1522 octets) with FCS (frame check sequence) not matching

RXGoodPkts

Octets received with no errors

RxDrop Pkts

Packets dropped due to lack of resources (bandwidth, input buffer)

RxUnicast Pkts

Unicast packet received (only 1 receiving host)

RxMulticast Pkts

Multicast packets received (many receiving hosts)

RxBroadcast Pkts

Received by all hosts on the network

RxSACHanges

Number of times the Source address of a good packet has changed value. A count greater than 1 indicates a repeater based network

RxFragments

Packets received less than 64 octets

RxExcessSizeDisc

Packets received greater than 1536 octets and discarded due to excessive length.

RxSymbolError

Invalid data symbol detected

IGMP Report

IGMP protocol adds a group number to a transmitted packet. Only hosts in that IGMP group will receive the packet. IGMP protocol prevents a multicast packet from behaving like a broadcast (transmitted to all network hosts). The switch assumes the task of forming a table of IGMP groups and hosts belonging to those groups. The table can be displayed by selecting Diagnostics>IGMP report

MAC Address Report

All Ethernet equipment has a MAC address (hardware address). These can be displayed by selecting Diagnostics>MAC address report. A pool of MAC addresses are assigned to each Ethernet product manufacturer. For example, Allen Bradley Ethernet equipment MAC addresses usually begin with 00:00:BC.

Phone line Diagnostics

These values can be helpful when troubleshooting possible phone line issues.

The screenshot shows the Rockwell Automation software interface for a RADES DEMO. The navigation tree on the left includes 'Diagnostics' with sub-items: 'Display Routing Table', 'IGMP Report', 'MAC Address Report', 'Report Line Parameters', 'Alarm Setup', 'Dial to ISP', 'Hang Up Connection', 'Controller Restart', 'Switch Counters - S', 'Switch Counters - A', and 'Switch Configuration'. The main window displays the 'Line Parameters Report' with the following data:

Modem Connection Status	
Receive Line Rate	33600
Transmit Line Rate	33600
Negotiated Protocol	V42bis

Line Parameters	
RX Level	-25.6 dB
TX Level	-10 dB
SNR	40.6 dB

Copyright © 2004 Rockwell Automation, Inc. All Rights Reserved.

Receive Line Rate:

Modem above is receiving data at 33600 bps

Transmit Line Rate:

Modem is transmitting data at 33600 bps

Negotiated Protocol:

Both modems are using this protocol to send and receive data

RX Level:

Calculate dB loss on the phone line by subtracting from -10dB. In the example above, the line has 15.6 dB loss, problems will begin at about 40-45 dB loss.

TX Level:

FCC standards dictate transmit level to be -10 dB for permissive connections

SNR:

Signal to noise ratio, used by the modems to calculate the most reliable phone line rate. This number decreases with the reliability of the phone line.

Alarm Setup

Alarm setup is used to see the bandwidth on each port; the bar will turn red when the bandwidth is out of range.

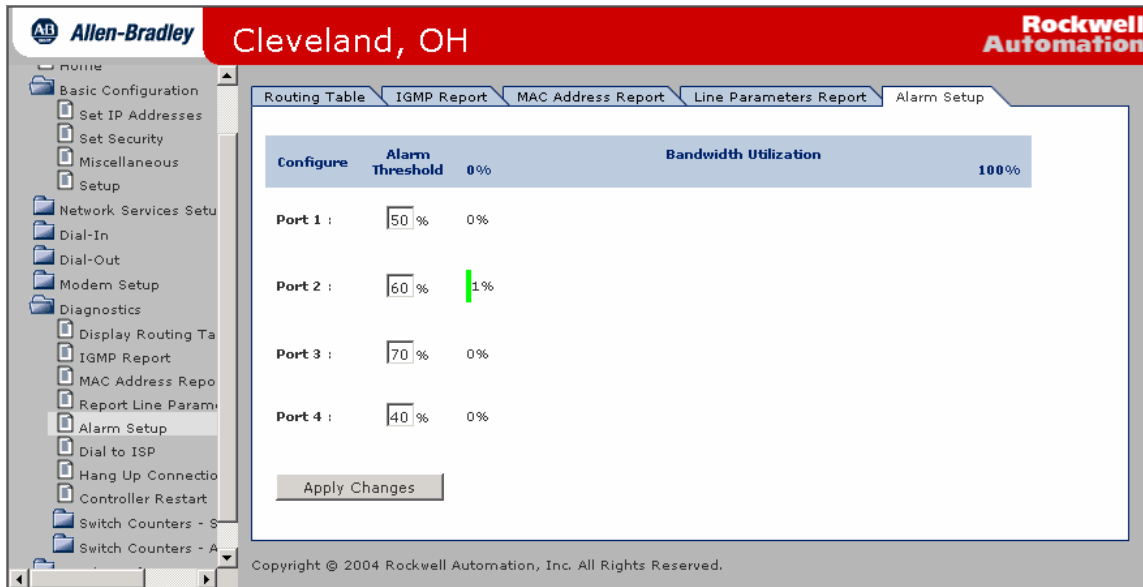

Dial ISP Testing

If a Dial Out account is enabled, selecting this option will force an outgoing connection to be made.

Hang Up Connection

To force the modem to hang up its connection

Controller Restart

This selection will restart the modem. It is useful when making configuration changes over the phone line. The modem must always be restarted for any changes to take effect.

7

Switch Management

This Chapter covers:

- Port Configuration
- Mirror Configuration
- VLAN setup
- QoS setup
- Display Counters

Port Configuration

This device auto-negotiates most of its settings to ease the configuration process. However, these settings can be manually set by using this menu option.

TX/RX

Default: Both

Choices: None, TX, RX, Both

Controls communications on the selected port

Negotiation

Default: Auto

Choices: None, Auto

Turn off auto-negotiation here

Rate

Auto-negotiates 10 or 100 based on connected device. Must be manually selected if the negotiation parameter is changed to none

Duplex mode

Auto-negotiates half or full based on connected device. Must be manually selected if the negotiation parameter is changed to none

Flow Control

Default: On

Prevents port buffers from over filling

Port Mirroring

Default: Disabled

Allows traffic on one port, to be copied and sent (mirrored) to another port to allow an Ethernet sniffer to capture it.

Quality of Service

Default: Disabled

When enabled, the switch can prioritize packet delivery to a certain port or MAC address.

IGMP snooping

Default: Disabled

When enabled, it sorts Multicast packets into their groups and delivers them to the appropriate group.

Mirror Configuration

In this section we configure the rules or filters for our port mirroring.

Filters can be configured to only capture packets from certain devices (MAC addresses). We can also filter to capture packet with a certain destination address.

Setting Up Ports:

Default: None

Choices: IN, OUT, BOTH, NONE

In: mirror incoming traffic, Out: mirror outgoing traffic,

Both: Capture both directions, Capt: capture mirrored traffic

The above selections are port based.

Setting Up Filter:

Two filters need to be configured, the Input (Ingress Mirror Filter) and the Output (Egress Mirror Filter)

Default: All Transmitted

Choices: All Transmitted, All Transmitted frames with Destination Address equal to the MAC address field, All Received frames with Source Address equal to the MAC address field

Setting Up Divider:

The Divider allows further filtering

Example: Port 4 is set up to CAPT, Port 3's incoming frames

The Input Filter is set to capture traffic with Source Address 00:00:BC:03:4E:08

Input Divider is set to 2, to capture **every other** frame **coming to port 3** with **Source address of 00:00:BC:03:4E:08**, this MAC address belongs to IP address 100.100.101.2.

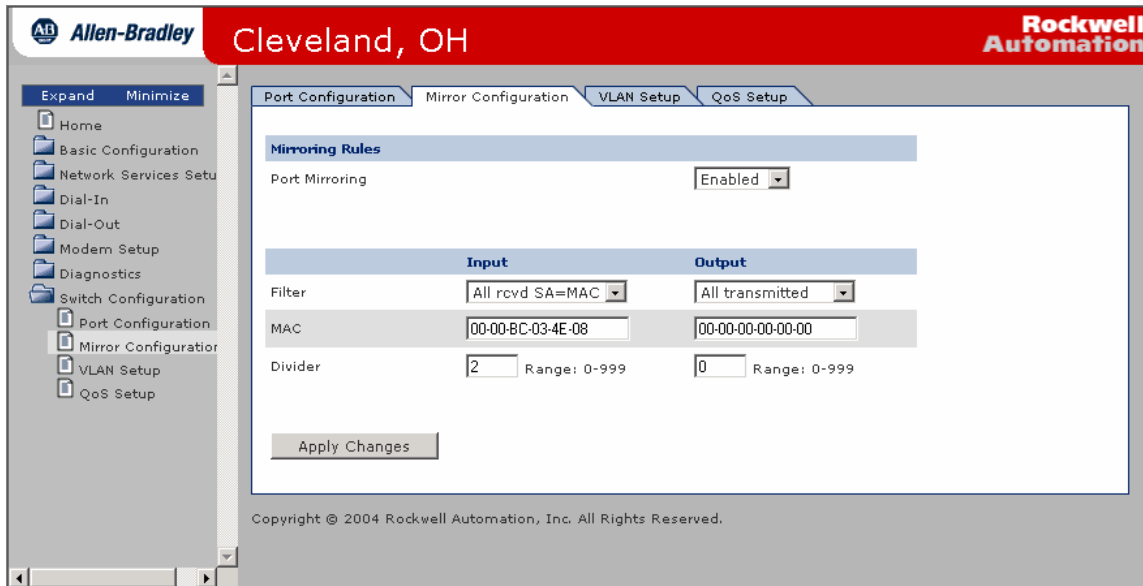

No.	Status	Source Address	Dest Address	Summary	Len (B)	Rel. Time	Delta Time	Abs. Time
1	M	[100.100.101.2]	[100.100.101.10]	TCP: D=4409 S=44818 ACK=2639891430 SEQ=1	122	0:00:00.000	0:000.000	...
2		[100.100.101.2]	[100.100.101.10]	TCP: D=4409 S=44818 ACK=2639891494 SEQ=1	122	0:00:00.305	0:305.559	...
3		[100.100.101.2]	[100.100.101.10]	TCP: D=4409 S=44818 ACK=2639891558 SEQ=1	122	0:00:00.499	0:193.517	...
4		[100.100.101.2]	[100.100.101.10]	TCP: D=4409 S=44818 ACK=2639891622 SEQ=1	122	0:00:00.704	0:205.430	...
5		[100.100.101.2]	[100.100.101.10]	TCP: D=4409 S=44818 ACK=2639891686 SEQ=1	122	0:00:00.899	0:194.853	...
6		[100.100.101.2]	[100.100.101.10]	TCP: D=4409 S=44818 ACK=2639891750 SEQ=1	122	0:00:01.094	0:195.143	...
7		[100.100.101.2]	[100.100.101.10]	TCP: D=4409 S=44818 ACK=2639891814 SEQ=1	122	0:00:01.300	0:205.802	...
8		[100.100.101.2]	[100.100.101.10]	TCP: D=4409 S=44818 ACK=2639891878 SEQ=1	122	0:00:01.495	0:194.873	...
9		[100.100.101.2]	[100.100.101.10]	TCP: D=4409 S=44818 ACK=2639891942 SEQ=1	122	0:00:01.701	0:205.837	...
10		[100.100.101.2]	[100.100.101.10]	TCP: D=4409 S=44818 ACK=2639892006 SEQ=1	122	0:00:01.896	0:194.996	...
11		[100.100.101.2]	[100.100.101.10]	TCP: D=4409 S=44818 ACK=2639892070 SEQ=1	122	0:00:02.102	0:206.520	...
12		[100.100.101.2]	[100.100.101.10]	TCP: D=4409 S=44818 ACK=2639892134 SEQ=1	122	0:00:02.297	0:195.180	...
13		[100.100.101.2]	[100.100.101.10]	TCP: D=4409 S=44818 ACK=2639892198 SEQ=1	122	0:00:02.503	0:205.824	...
14		[100.100.101.2]	[100.100.101.10]	TCP: D=4409 S=44818 ACK=2639892262 SEQ=1	122	0:00:02.698	0:195.140	...
15		[100.100.101.2]	[100.100.101.10]	TCP: D=4409 S=44818 ACK=2639892326 SEQ=1	122	0:00:02.796	0:097.456	...
16		[100.100.101.2]	[100.100.101.10]	TCP: D=4409 S=44818 ACK=2639892454 WIN=3066	66	0:00:03.190	0:394.841	...
17		[100.100.101.2]	[100.100.101.10]	TCP: D=4409 S=44818 ACK=2639892454 SEQ=1	122	0:00:03.196	0:005.461	...
18		[100.100.101.2]	[100.100.101.10]	TCP: D=4409 S=44818 ACK=2639892518 SEQ=1	122	0:00:03.598	0:402.072	...
19		[100.100.101.2]	[100.100.101.10]	TCP: D=4409 S=44818 ACK=2639892582 SEQ=1	122	0:00:03.901	0:302.859	...
20		[100.100.101.2]	[100.100.101.10]	TCP: D=4409 S=44818 ACK=2639892646 SEQ=1	122	0:00:04.096	0:195.093	...
21		[100.100.101.2]	[100.100.101.10]	TCP: D=4409 S=44818 ACK=2639892710 SEQ=1	122	0:00:04.302	0:205.647	...
22		[100.100.101.2]	[100.100.101.10]	TCP: D=4409 S=44818 ACK=2639892774 SEQ=1	122	0:00:04.497	0:195.063	...
23		[100.100.101.2]	[100.100.101.10]	TCP: D=4409 S=44818 ACK=2639892838 SEQ=1	122	0:00:04.703	0:206.173	...

Important Note: Port Mirroring and IGMP snooping are mutually exclusive. When Port Mirroring is enabled IGMP snooping is disabled. Port mirroring is a diagnostic tool; this feature should be disabled while running production.

VLAN setup

Used when network bandwidth becomes critical.

VLAN can be used to eliminate traffic caused by Multicast and Broadcast Ethernet traffic. With this feature, we can partition the switches' ports into different private domains.

For each received packet the switch resolves the destination address and determines the appropriate port. The VLAN configuration is then checked to see if the destination address is configured to receive traffic from the source port.

Example:

Flex IO is connected to port 2 on the RADES, the IO is communicating with a ControlLogix on port 3. **We only want the ControlLogix on port 3** to receive traffic from the Flex IO on port 2. VLAN can be used to prevent other devices on the network from receiving packets from the Flex IO.

Our VLAN configuration would look as follows:

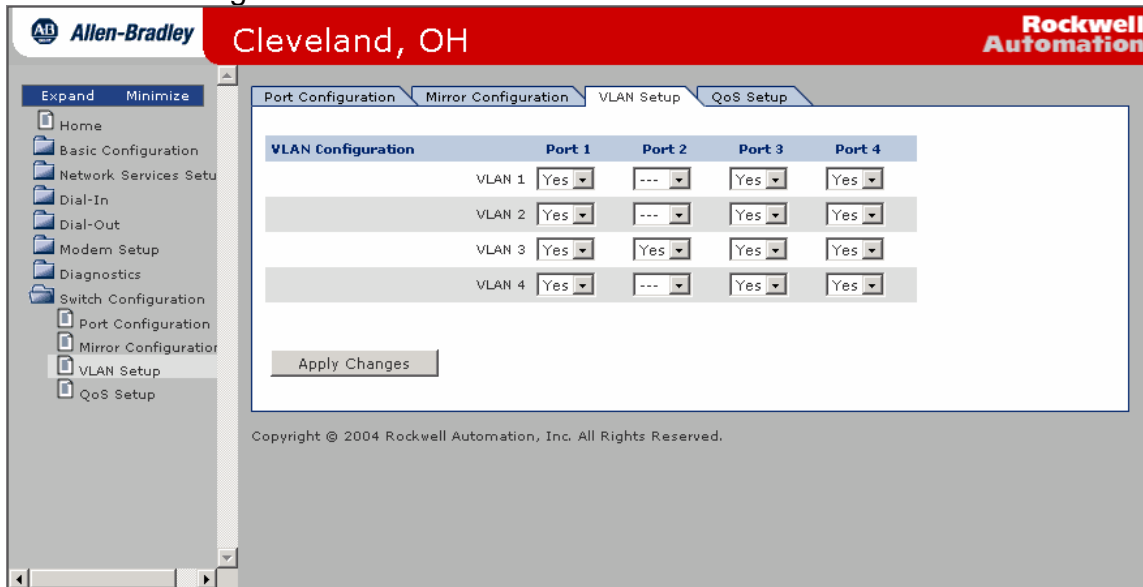

The Ingress Port (Source Port) 2 Will only Transmit to Egress Port (Destination Port) 3

QoS setup

QoS (Quality of service) allows the classification of Ethernet traffic into “high” and “low” priority queues. High priority packets will be forwarded to their destination address before a low priority packet. Packets can be classified as high or low by: MAC address, 802.1p priority tag, and or port ID.

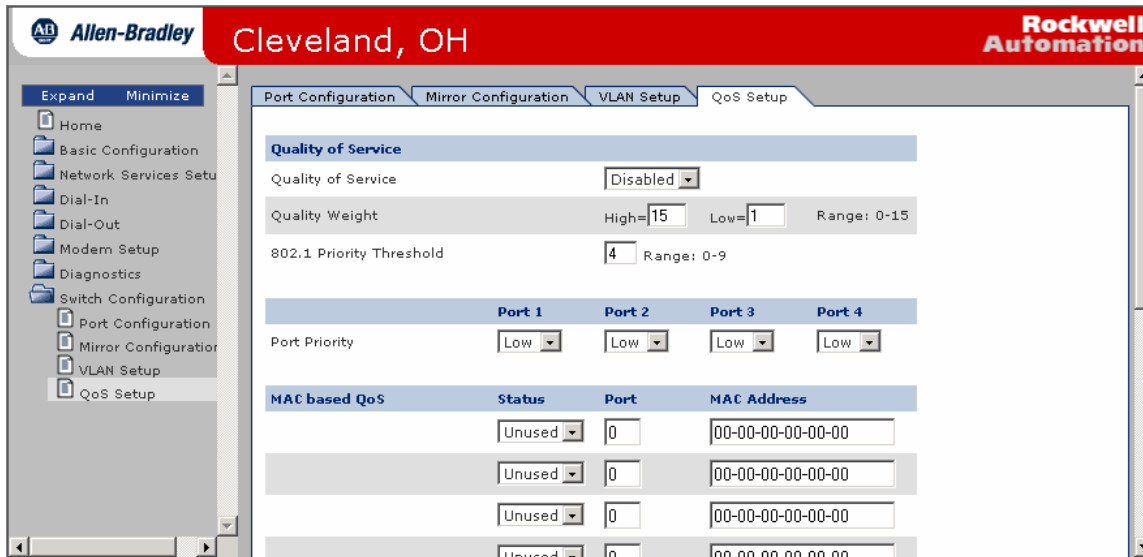

Port based priority

When changed to Yes, the incoming traffic for that port is considered High Priority.

High/Low Quality weight

Establishes algorithm for switching between High and low priority Queues. The default value of 15/1 will send 15 blocks of High priority traffic then send 1 block of low priority traffic.

MAC based priority

Incoming packets are cross referenced with the MAC based QoS list, and put into the high priority queue if the destination address is on the list.

802.1P priority

Each incoming packet is examined for a valid 802.1p priority tag. If present, the packet will be put in the high priority queue if the priority tag exceeds the QoS Priority Threshold.

A Upgrading 9300-RADES Firmware

WARNING:

The modem will cycle power automatically at the end of the flash procedure. Any switching activity will be temporarily interrupted.

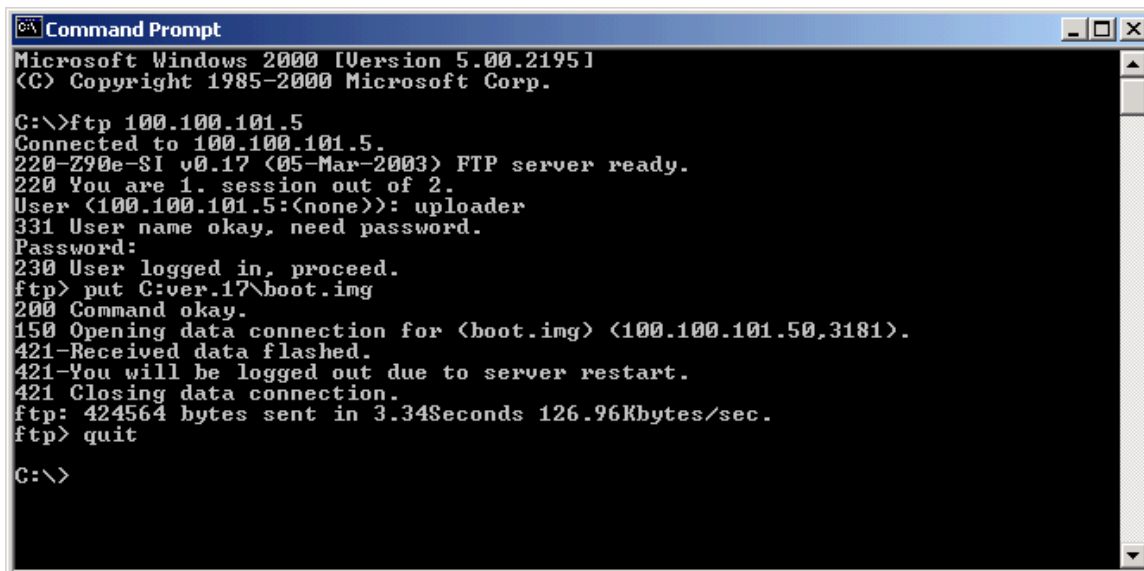

```
Microsoft Windows [Version 5.00.2195]
(C) Copyright 1985-2000 Microsoft Corp.

C:\>ftp 100.100.101.5
Connected to 100.100.101.5.
220-Z90e-SI v0.17 (05-Mar-2003) FTP server ready.
220 You are 1. session out of 2.
User (100.100.101.5:(none)): uploader
331 User name okay, need password.
Password:
230 User logged in, proceed.
ftp> put C:\ver.17\boot.img
200 Command okay.
150 Opening data connection for (boot.img) (100.100.101.50,3181).
421-Received data flashed.
421-You will be logged out due to server restart.
421 Closing data connection.
ftp: 424564 bytes sent in 3.34Seconds 126.96Kbytes/sec.
ftp> quit

C:\>
```

1. Open a Command window.
2. Type FTP then the IP address of the modem. Default is 192.168.1.1. The address we are using in the example picture is 100.100.101.5.
3. Once an FTP connection has been established you will have to enter a username and password. The default values are:

Username is: uploader (lowercase)

Password is: ZYPCOM (uppercase)
4. Now we have an FTP prompt (ftp>) and we can issue standard FTP commands. We will use the PUT command to send our firmware file to the modem. Type: put (File Path)\(File Name). Omit the parenthesis. In the example picture we have put the file named "boot.img" into a folder named

"ver.17" which resides in the root of the C: drive.

The flash code must be on the hard drive. It will not work from a floppy

5. The modem will flash itself and the connection will automatically close. Use the "quit" command to exit ftp mode and then close the command window.
6. Wait about 60 seconds, then re-establish you ftp connection, then run the put command for the webdata.img and qsdata.img files. Power will not cycle when these files are done loading. These files upgrade the web server file and the embedded Quick Start file.

Flashing the unit does not overwrite your IP address or password.

C

Country Codes

Table 22. Country Code Setting

COUNTRY	CODE	COUNTRY	CODE
Algeria	213	Mexico	52
Argentina	54	Morocco	212
Australia	61	Netherlands	31
Austria	43	New_Zealand	64
Bahrain	973	Norway	47
Belgium	32	Oman	968
Bolivia	591	Panama	507
Brazil	55	Peru	51
Chile	56	Philippines	63
China	86	Poland	48
Colombia	57	Portugal	351
Costa_Rica	506	Puerto_Rico	999
Cyprus	357	Qatar	974
Czechoslovakia	42	Reset†	911
Denmark	45	Russia	7
Ecuador	593	Saudi_Arabia	966
Egypt	20	Singapore	65
Finland	358	Slovakia	428
France	33	Slovenia	386
Germany	49	South_Africa	27
Greece	30	Spain	34
Guatemala	502	Sweden	46
Hong_Kong	852	Switzerland	41
Hungary	36	Syria	963
India	91	Taiwan	886
Indonesia	62	Thailand	66
Ireland	353	Trinidad	888
Israel	972	Turkey	90
Italy	39	Tunisia	216
Japan	81	UAE	971
Jordan	962	UK	44
Korea	82	Uruguay	598
Kuwait	965	USA/Canada	1
Lebanon	961	Venezuela	58
Malaysia	60	Yemen	967

D Factory Reset

Factory Reset

Factory Reset is accomplished with a small button located on the back of the unit. To access it you will need to carefully remove the plastic Din rail clip by gently lifting the tab in the center with a screwdriver and sliding the clip upward.

We have two levels of reset:

What you will need:

1. a small screwdriver
2. the AC adaptor included with the 9300-RADES

Resetting IP address only:

To reset the IP address only:

1. With power applied, Push the reset button with a small screwdriver
2. Hold button in until the LEDs light in a circular pattern
3. Cycle power to complete the IP reset

Your IP address will default to 192.168.1.1

Changing all settings back to default:

To reset all settings to factory default:

1. Remove power
2. Push the reset button with a small screwdriver.
3. Apply power using the AC adapter while continuing to hold the reset button
4. Hold the button in until the LEDs light in a circular pattern
5. Cycle power to complete the reset