

# POINT I/O EtherNet/IP Adapter Module



Catalog Number 1734-AENT  
User Manual



# Important User Information

Solid state equipment has operational characteristics differing from those of electromechanical equipment. Safety Guidelines for the Application, Installation and Maintenance of Solid State Controls (publication [SGI-1.1](http://literature.rockwellautomation.com) available from your local Rockwell Automation sales office or online at <http://literature.rockwellautomation.com>) describes some important differences between solid state equipment and hard-wired electromechanical devices. Because of this difference, and also because of the wide variety of uses for solid state equipment, all persons responsible for applying this equipment must satisfy themselves that each intended application of this equipment is acceptable.





In no event will Rockwell Automation, Inc. be responsible or liable for indirect or consequential damages resulting from the use or application of this equipment.

The examples and diagrams in this manual are included solely for illustrative purposes. Because of the many variables and requirements associated with any particular installation, Rockwell Automation, Inc. cannot assume responsibility or liability for actual use based on the examples and diagrams.

No patent liability is assumed by Rockwell Automation, Inc. with respect to use of information, circuits, equipment, or software described in this manual.

Reproduction of the contents of this manual, in whole or in part, without written permission of Rockwell Automation, Inc., is prohibited.

Throughout this manual, when necessary, we use notes to make you aware of safety considerations.

<b>WARNING</b> 	Identifies information about practices or circumstances that can cause an explosion in a hazardous environment, which may lead to personal injury or death, property damage, or economic loss.
<b>IMPORTANT</b>	Identifies information that is critical for successful application and understanding of the product.
<b>ATTENTION</b> 	Identifies information about practices or circumstances that can lead to: personal injury or death, property damage, or economic loss. Attentions help you identify a hazard, avoid a hazard, and recognize the consequence.
<b>SHOCK HAZARD</b> 	Labels may be on or inside the equipment, such as a drive or motor, to alert people that dangerous voltage may be present.
<b>BURN HAZARD</b> 	Labels may be on or inside the equipment, such as a drive or motor, to alert people that surfaces may reach dangerous temperatures.

Allen-Bradley, Rockwell Automation, POINT I/O, RSLinx, RSLogix 5000 and TechConnect are trademarks of Rockwell Automation, Inc.

Trademarks not belonging to Rockwell Automation are property of their respective companies.

## What This Preface Contains

This preface describes how to use this manual. See the table for a list of where to find specific information within this chapter.

Topic	Page
Who Should Use This Manual	iii
Common Techniques Used in This Manual	iii
How to Use This Manual	iv
About the Example Applications	iv
System Components	v
Where to Find More Information	vi
Terminology	vii

## Who Should Use This Manual

This manual is intended for control engineers and technicians who are installing, configuring, and maintaining an EtherNet/IP control system that communicates with POINT I/O modules through a 1734-AENT adapter. We assume you have a good understanding of Ethernet networks and the TCP/IP protocol.

---

### ATTENTION



You must use series C POINT I/O modules with the 1734-AENT adapter. Series A or B POINT I/O modules will not work with this adapter.

---

## Common Techniques Used in This Manual

We use the following conventions throughout this manual:

- Numbered lists provide sequential steps.
- Bulleted lists provide information, not procedural steps.

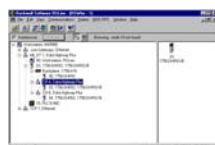

The screen captures shown in this manual are pictures of the software's actual screens.

### TIP

This symbol identifies helpful tips.

## How to Use This Manual

This manual contains an overview of the 1734-AENT adapter. It describes how to install and configure the adapter and provides examples showing how to use the adapter to communicate with POINT I/O modules over an EtherNet/IP network.

## About the Example Applications

This manual presents two example applications that demonstrate the procedures for configuring and communicating with POINT I/O modules using the 1734-AENT adapter. We intend the example applications as building blocks to help you get your own system up and running. We recommend that you set up and run the example applications and use them as guides.

Here is the type of system you'll be setting up.

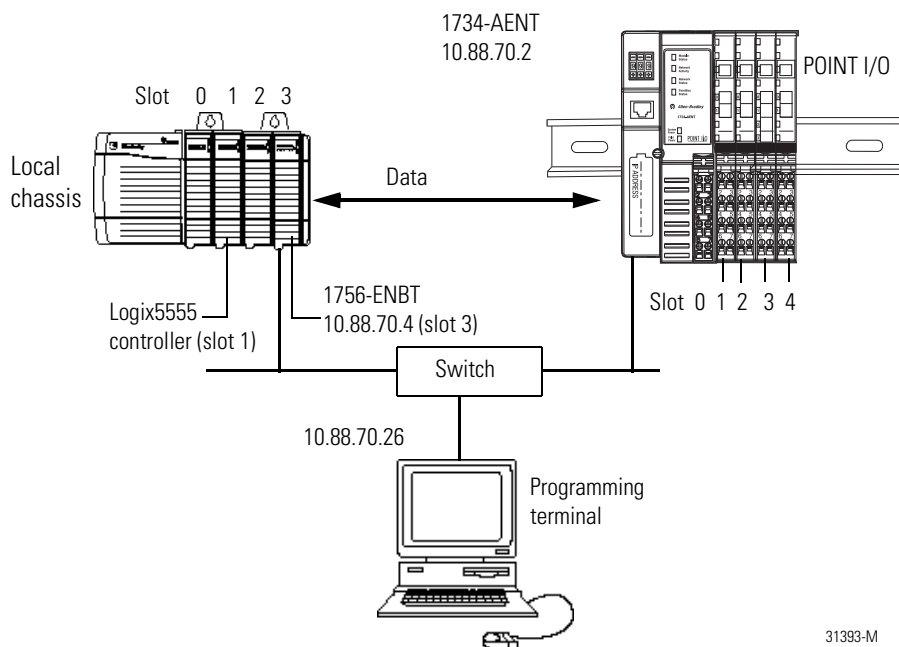

31393-M

## System Components

We used the following components for the example applications. You need the same or similar components to set up your own control system using POINT I/O modules on an EtherNet/IP network.

Quantity	Product Name	Catalog Number
<b>Hardware</b>		
1	POINT I/O EtherNet/IP adapter	1734-AENT
1	POINT I/O 24V DC sink output module	1734-0V4E/C
1	POINT I/O relay output module	1734-0W2/C
1	DIN rail	199-DR1 or equivalent
1	ControlLogix chassis	1756-A4 (or 1756-A7, 1756-A13, 1756-A17)
1	ControlLogix power supply	1756-PA72 (or 1756-PB72)
1	Logix5555 controller	1756-L55
1	ControlLogix EtherNet/IP bridge module	1756-ENBT
1	Personal computer that supports RSLogix 5000 software	Any appropriate model running Windows NT 4.0, Service Pack 6A or higher
1	Ethernet switch	Refer to manufacturer's specifications
1	24V DC power supply	1734-EP24DC
Associated media and connectors as needed		
<b>Software</b>		
1	RSLinx communications software, version 2.31.00 or later	9355-WAB, 9355-WABOEM, 9355-WABC
1	RSLogix 5000 programming software, version 11.11 or later	9324-RLD300ENE

## Where to Find More Information

Refer to the following Rockwell publications as needed for additional help when setting up and using your EtherNet/IP network.

For Information About	See This Publication	Publication Number
Using EtherNet/IP for industrial control	EtherNet/IP Performance and Application Guide	<a href="#">ENET-AP001</a>
Ethernet communication interface modules	Ethernet Communication Interface Module Installation Instructions	<a href="#">1756-IN053</a>
	Ethernet Communication Interface Module User Manual	<a href="#">1756-UM051</a>
ControlLogix chassis	ControlLogix Chassis Installation Instructions	<a href="#">1756-IN080</a> (series B)
ControlLogix power supplies	ControlLogix Power Supplies Installation Instructions	<a href="#">1756-IN613</a> (PA72/PB72)
Logix5555 programmable controllers	Logix5555 Controller User Manual	<a href="#">1756-UM523</a>
SoftLogix5800 controller	SoftLogix5800 User Manual	<a href="#">1789-UM002</a> (L10, L30, L60)
ControlLogix EtherNet/IP bridge module with firmware revision 2.3 or later	ControlLogix EtherNet/IP Bridge Module Installation Instructions	<a href="#">1756-IN019</a>
RSLogix 5000 programming software	Getting Results with RSLogix 5000, version 3.2.1 or later	<a href="#">9399-RLD300GR</a>
1734-AENT adapter	POINT I/O EtherNet/IP Adapter Installation Instructions	<a href="#">1734-IN590</a>
POINT I/O digital and analog modules and PointBLOCK I/O modules	POINT I/O Digital and Analog Modules and PointBLOCK I/O Modules User Manual	<a href="#">1734-UM001</a>
POINT I/O interface modules	POINT I/O RS-232 ASCII Module User Manual	<a href="#">1734-UM009</a>
	POINT I/O RS-232 ASCII Module Installation Instructions	<a href="#">1734-IN588</a>
POINT I/O expansion power supply	POINT I/O 24V DC Expansion Power Supply Installation Instructions	<a href="#">1734-IN058</a>
POINT I/O field potential distributor	POINT I/O Field Potential Distributor Installation Instructions	<a href="#">1734-IN059</a>
POINT I/O input modules	POINT I/O 120V AC Input Module Installation Instructions	<a href="#">1734-IN010</a>
	POINT I/O Input Module Installation Instructions	<a href="#">1734-IN051</a>
POINT I/O encoders/counter modules	POINT I/O Encoders/Counter Module User Manual	<a href="#">1734-UM006</a>
	POINT I/O Encoders/Counter Module Installation Instructions	<a href="#">1734-IN005</a>
POINT I/O 22V AC input module	POINT I/O 220V AC Input Module Installation Instructions	<a href="#">1734-IN008</a>
POINT I/O RTD and isolated thermocouple input module	POINT I/O RTD and Isolated Thermocouple Input Module Installation Instructions	<a href="#">1734-IN011</a>
POINT I/O thermocouple and RTD input module	Thermocouple and RTD Input Module User Manual	<a href="#">1734-UM004</a>
POINT I/O IV2 and IV4 input module	POINT I/O Input Module Installation Instructions	<a href="#">1734-IN052</a>
POINT I/O 120/220V AC output module	POINT I/O 120/220V AC Output Module Installation Instructions	<a href="#">1734-IN009</a>
POINT I/O protected output module	POINT I/O Protected Output Module Installation Instructions	<a href="#">1734-IN056</a>
	POINT I/O Protected Output Module Installation Instructions (OB2EP)	<a href="#">1734-IN586</a>
POINT I/O voltage output analog module	POINT I/O 2 Voltage Output Analog Module Installation Instructions	<a href="#">1734-IN002</a>
POINT I/O protected sink output module	POINT I/O Protected Sink Output Module Installation Instructions	<a href="#">1734-IN585</a>

For Information About	See This Publication	Publication Number
POINT I/O 2 relay output module	POINT I/O 2 Relay Output Module Installation Instructions (OX2)	<a href="#">1734-IN587</a>
	POINT I/O 2 Relay Output Module Installation Instructions (OW2)	<a href="#">1734-IN055</a>
POINT I/O synchronous serial interface absolute encoder module	POINT I/O Synchronous Serial Interface Absolute Encoder Module Installation Instructions	<a href="#">1734-UM007</a>
POINT I/O cold junction compensation wiring base assembly	POINT I/O Cold Junction Compensation Wiring Base Assembly Installation Instructions	<a href="#">1734-IN583</a>
POINT I/O wiring base assembly	POINT I/O Wiring Base Assembly Installation Instructions	<a href="#">1734-IN013</a>
Very high-speed counter module	POINT I/O Very High-speed Counter Module Installation Instructions	<a href="#">1734-IN003</a>
	Very High-speed Counter Module User Manual	<a href="#">1734-UM003</a>
RSLinx	RSLinx Enterprise Getting Results Guide	<a href="#">LNXENT-GR001</a>

**TIP**

Many of these publications are available online from:  
<http://literature.rockwellautomation.com/>

**TIP**

Rockwell Software products contain extensive tutorials and help screens. We recommend that you use the tutorials and help screens to learn about these products.

For more information about Rockwell Software products, visit the Rockwell Software internet site:  
<http://www.software.rockwell.com>

## Terminology

Refer to the table for the meaning of common terms.

Term	Definition
BootP	BootP (Bootstrap Protocol) is a low-level protocol that provides configurations to other nodes on a TCP/IP network. BootP configuration files let you automatically assign IP addresses to an Ethernet module. You can also obtain subnet masks and gateway addresses from BootP.
Bridge	A node between two similar communication subnets where protocol translation is minimal.
CIP	Control and information protocol, the EtherNet/IP application layer uses the producer/consumer networking model. In this model one producer broadcasts (multicasts) the data once to all the consumers. All consumers see the data simultaneously and may choose whether to consume (receive) the data or not. Delivery time is consistent, no matter how many consumers there are.
Connection	The communication mechanism from the controller to another module in the control system, usually used to exchange I/O data.
Consumer	A destination device in the CIP networking model. See CIP.

<b>Term</b>	<b>Definition</b>
CSMA/CD	Carrier sense multiple access/collision detection is the access method used in Ethernet. When a device wants to gain access to the network, it checks to see if the network is quiet (senses the carrier). If it is not, it waits a random amount of time before retrying. If the network is quiet and two devices access the line at exactly the same time, their signals collide. When the collision is detected, they both back off and each waits a random amount of time before retrying.
Determinism	The ability to predict when information will be delivered. Important in time-critical applications.
DHCP	<p>The dynamic host configuration protocol is an Internet protocol, similar to BootP, for automating the configuration of computers that use TCP/IP. DHCP can be used to automatically assign IP addresses, to deliver IP stack configuration parameters, such as the subnet mask and default router, and to provide other configuration information, such as the addresses for printer, time, and news servers.</p> <p>The 1734-AENT factory default is DHCP enabled. When you apply power, the module sends a message containing its hardware address to any DHCP server on the network. The server(s) replies by sending a message with an appropriate IP address for the adapter. The adapter responds by acknowledging to a server that it will use the offered IP address.</p>
DNS	The domain name system is a hierarchical, distributed method of organizing the name space of the Internet. The DNS administratively groups hosts into a hierarchy of authority that allows addressing and other information to be widely distributed and maintained. A big advantage to the DNS is that using it eliminates dependence on a centrally-maintained file that maps host names to addresses.
Ethernet	A physical layer standard using carrier sense multiple access with collision detection (CSMA/CD) methods.
EtherNet/IP	Ethernet industrial protocol applies a common application layer (CIP) over Ethernet by encapsulating messages in TCP/UDP/IP.
Ethernet network	A local area network designed for the high-speed exchange of information between computers and related devices.
Explicit messaging	Non-time critical messaging used for device configuration and data collection, such as downloading programs or peer-to-peer messaging between two PLC units.
Full duplex	A mode of communication that allows a device to send and receive information at the same time, effectively doubling the bandwidth.
Fully qualified domain name	A fully qualified domain name (FQDN) is a domain name that includes all higher level domains relevant to the entity named. If you think of the DNS as a tree-structure with each node having its own label, a fully qualified domain name for a specific node would be its label followed by the labels of all the other nodes between it and the root of the tree. For example, for a host, a FQDN would include the string that identifies the particular host, plus all domains of which the host is a part, up to and including the top-level domain (the root domain is always null). For example, PARIS.NISC.SRI.COM is a fully qualified domain name for the host at 192.33.33.109.
Gateway	A module or set of modules that allows communications between nodes on dissimilar networks.



<b>Term</b>	<b>Definition</b>
Hardware address	Each Ethernet device has a unique hardware address (sometimes called a MAC address) that is 48 bits. The address appears as six digits separated by colons (such as, xx:xx:xx:xx:xx:xx). Each digit has a value between 0 and 255 (0x00 to 0xFF). This address is assigned in the hardware and cannot be changed. The hardware address is required to identify the device if you are using a BOOTP utility.
Host name	<p>The host name is the unique name for a computer within its domain. It's always the first element of a full name, and, with its domain and top-level domain suffix, creates the unique name of that computer on the Internet. For example, let's say a trading website is www.trading.com. The host name is www, which is not unique on the web, but is unique within the trading domain.</p> <p>The host name can also refer to the fully qualified domain name (FQDN), or in this example, www.trading.com. Both naming methods seem to be used interchangeably in various documents. For the purposes of this document, the host name will refer to the FQDN, or as in this example, www.trading.com.</p>
Hub	A central connecting device that joins devices together in a star configuration. Hubs are generally not suitable for use in I/O control systems, since they are time-critical applications that cannot tolerate lost packets.
Implicit messaging	Real-time messaging of I/O data.
IP	Internet protocol that provides the routing mechanism for messages. All messages contain not only the address of the destination station, but the address of a destination network, which allows messages to be sent to multiple networks within an organization or around the world.
IP address	A 32-bit identification number for each node on an Internet Protocol network. These addresses are represented as four sets of 8-bit numbers (numbers from 0 to 255), with decimals between them. Each node on the network must have a unique IP address.
Latency	The time between initiating a request for data and the beginning of the actual data transfer.
Multicast	In the CIP producer/consumer model, one producer multicasts (broadcasts) the data once to all the consumers.
Producer	The source of information in the CIP networking model. See CIP.
Rack-optimized	A physical and logical collection of application modules.
Subnet mask	An extension of the IP address that allows a site to use a single net ID for multiple networks.
Switch	A network device that cross connects devices or network segments. A switch provides each sender/receiver the full network bandwidth (2x in full duplex mode), reduces collisions, and increases determinism.
TCP	The transport control protocol is a more reliable but slower transport protocol than UDP. It is used for explicit (not time critical) messaging in EtherNet/IP.

<b>Term</b>	<b>Definition</b>
TCP/IP	The transmission control protocol/internet protocol is a transport-layer protocol (TCP) and a network-layer protocol (IP) commonly used for communication within networks and across internetworks.
Transaction	An exchange of request and data and response and data.
UDP	The user datagram protocol (UDP) is a transport protocol that provides a very simple but fast capability to send datagrams between two devices. It is used for I/O (implicit) messaging in EtherNet/IP.

	Important User Information . . . . .	ii
<b>Preface</b>	What This Preface Contains . . . . .	iii
	Who Should Use This Manual. . . . .	iii
	Common Techniques Used in This Manual . . . . .	iii
	How To Use This Manual . . . . .	iv
	About the Example Applications . . . . .	iv
	System Components . . . . .	v
	Where to Find More Information . . . . .	vi
	Terminology . . . . .	vii
<b>Summary of Changes</b>	New and Revised Information . . . . .	xv
	Change Bars . . . . .	xv
	<b>Chapter 1</b>	
<b>About the Adapter</b>	What This Chapter Contains . . . . .	1
	Important Adapter Considerations . . . . .	1
	Set the Chassis Size . . . . .	1
	Adapter Replacement . . . . .	2
	Empty Slots and RIUP Situations. . . . .	2
	Cycle Power To a System For the First Time . . . . .	4
	Adapter Features . . . . .	4
	Hardware/Software Compatibility . . . . .	5
	What the Adapter Does . . . . .	5
	Use of the Common Industrial Protocol (CIP) . . . . .	5
	Understand the Producer/Consumer Model . . . . .	6
	Specify the Requested Packet Interval (RPI) . . . . .	6
	Support of Rack-optimized and Direct Connections . . . . .	7
	Mix Rack-optimized and Direct Connections . . . . .	7
	Before You Begin. . . . .	8
	Determine Compatibility. . . . .	8
	Understand Messaging. . . . .	8
	Establish I/O Connections. . . . .	8
	Configure Autobaud . . . . .	8
	<b>Chapter 2</b>	
<b>Install the Adapter</b>	What This Chapter Contains . . . . .	9
	Identify Adapter Components . . . . .	9
	Mount the Adapter on a DIN Rail Before Installing Modules . . . . .	10
	Mount (or Replace) the Adapter to an Existing System. . . . .	11
	Wire Your Adapter. . . . .	12
	Mounting Dimensions . . . . .	13
	<b>Chapter 3</b>	
<b>Configure the Adapter for Your EtherNet/IP Network</b>	What This Chapter Contains . . . . .	15
	IP Address . . . . .	17
	Gateway Address . . . . .	17
	Subnet Mask. . . . .	18
	Set the Network Address. . . . .	19
	Use the Rockwell BootP/DHCP Utility. . . . .	20
	Save the Relation List . . . . .	22
	Use DHCP Software to Configure Your Adapter . . . . .	23

<b>Configure the Adapter for Direct Connection in RSLogix 5000 Software</b>	<b>Chapter 4</b>	What This Chapter Contains . . . . .	25
		Set Up the Hardware . . . . .	25
		Create the Example Application . . . . .	26
		Configure the I/O . . . . .	27
		Add the Local EtherNet/IP Bridge to the I/O Configuration. . . . .	28
		Add the POINT I/O Adapter to the I/O Configuration. . . . .	30
		Add the POINT I/O Modules to the I/O Configuration . . . . .	33
		Edit the Controller Tags . . . . .	38
		Create the Ladder Program . . . . .	39
		Download the Program to the Controller. . . . .	39
		Verify the Module Chassis Size . . . . .	41
		Configure the Adapter with Fixed IP Address. . . . .	43
		Recover From an Overloaded Adapter. . . . .	44
<b>Configure the Adapter for Direct Connection and Rack Optimization in RSLogix 5000 Software</b>	<b>Chapter 5</b>	What This Chapter Contains . . . . .	45
		Create the Example Application . . . . .	47
		Configure the I/O Modules . . . . .	48
		Add the Local EtherNet/IP Bridge to the I/O Configuration. . . . .	48
		Add the POINT I/O Adapter to the I/O Configuration. . . . .	50
		Add the POINT I/O Module and Configure for Direction Connection. . . . .	53
		Add the POINT I/O Module and Configure For Rack Optimization. . . . .	55
		Download the Program to the Controller. . . . .	58
		Verify the Module Chassis Size . . . . .	59
		Access Module Data. . . . .	62
<b>LED Status Indicators</b>	<b>Chapter 6</b>	What This Chapter Contains . . . . .	63
		Interpret the Status Indicators . . . . .	63
<b>Adapter Web Pages</b>	<b>Appendix A</b>	What This Appendix Contains . . . . .	67
		Work with the Home Page . . . . .	67
		Work with the Diagnostics Pages . . . . .	69
		Use the Diagnostic Overview Page. . . . .	70
		Use the Network Settings Page. . . . .	71
		Use the Ethernet Statistics Page . . . . .	72
		Use the I/O Connections Page. . . . .	74
		Use the Diagnostic Messaging Page . . . . .	75
		Work with the Configuration Pages . . . . .	76
		Use the Identity Page. . . . .	77
		Use the Network Configuration Page. . . . .	78
		Use the Services Page . . . . .	80
		Work with the Browse Chassis Page. . . . .	80
	<b>Appendix B</b>		

<b>Configure the RSLinx Ethernet Communication Driver</b>	What This Appendix Contains . . . . .	87
	Install the RSLinx Software . . . . .	87
	Configure the AB_ETH/IP Driver . . . . .	88
	<b>Appendix C</b>	
<b>1734 POINT I/O Module/RSLogix 5000 Controller Tag Reference</b>	What This Appendix Contains . . . . .	91
	1734 POINT I/O Catalog Numbers . . . . .	91
	Valid Number Ranges for RSLogix 5000 Data Types . . . . .	92
	Digital 2 POINT Input . . . . .	93
	Digital 2 POINT Output – With Over Load and Open Load Diagnostic Status . . . . .	96
	Digital 2 POINT Output – With Over Load Diagnostic Status . . . . .	97
	Digital 4 POINT Output – With Over Load and Open Load Diagnostic Status . . . . .	98
	Digital 4 POINT Output – With Over Load Diagnostic Status . . . . .	99
	Analog 2 Channel Output . . . . .	109
	<b>Appendix D</b>	
<b>Quick Start</b>	What This Appendix Contains . . . . .	131
	Necessary Prerequisites . . . . .	131
	Configure the Adapter . . . . .	132
	Enter Adapter Properties . . . . .	133
	Add Another Module Under the Adapter . . . . .	134
	Configure 1734 POINT I/O Modules . . . . .	135
	Configure an Ethernet Driver in RSLinx Software . . . . .	138
	Launch RSLinx Software . . . . .	138
<b>Index</b>		

**Notes:**

This publication contains new and revised information not in the last release.

### New and Revised Information

See the table for a summary of the major changes in this manual.

Chapter	Revised to include
Appendix B - Configure the RSLinx Ethernet Communication Driver	Removal of Ethernet device installation instructions

### Change Bars

Change bars (as shown with this paragraph) show the areas in this manual that are different from previous editions and indicate the addition of new or revised information.

**Notes:**



## About the Adapter

### What This Chapter Contains

This chapter provides an overview of the 1734-AENT POINT I/O EtherNet/IP adapter, its primary features, and how to use it. You need to understand the concepts discussed in this chapter to configure your adapter and use it in an EtherNet/IP control system. See the table for a list of where to find specific information in this chapter.

Topic	Page
Important Adapter Considerations	1
Set the Chassis Size	1
Adapter Replacement	2
Empty Slots and RIUP Situations	2
Cycle Power To a System For the First Time	4
Adapter Features	4
Hardware/Software Compatibility	5
What the Adapter Does	5
Use of the Common Industrial Protocol (CIP)	5
Understand the Producer/Consumer Model	6
Specify the Requested Packet Interval (RPI)	6
Support of Rack-optimized and Direct Connections	7
Mix Rack-optimized and Direct Connections	7

#### ATTENTION



You must use series C POINT I/O modules with the 1734-AENT adapter. Series A or B POINT I/O modules will not work with this adapter.

### Important Adapter Considerations

Before you begin using your adapter, note the following important considerations.

#### Set the Chassis Size

The 1734-AENT POINT I/O adapter for EtherNet/IP requires configuration of its chassis size before you can make any I/O connections.

The default setting for the chassis size is 1 slot, which represents the adapter by itself.

Set the chassis size as the sum of the slot of the adapter plus the slots of each I/O module in the adapter backplane. For example, the adapter plus 4 I/O modules uses a chassis size of 5. The adapter stores this chassis size setting in non-volatile storage.

When the adapter's non-volatile chassis size does not match the actual number of modules present on its backplane, the adapter does not make any I/O connections and an error occurs, as shown in the Module Properties dialog.

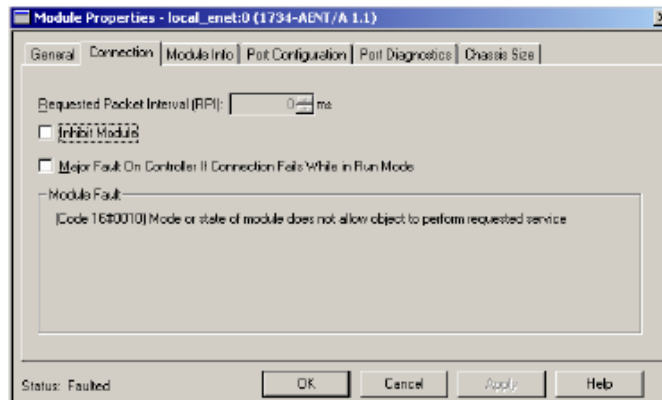

## Adapter Replacement

It is important to note that during a connection request from the controller, the chassis size setting for a 1734-AENT adapter is not communicated to the adapter. You must always set this chassis size using a separate operation. This includes situations when you are replacing an adapter. The adapter does not make any I/O connections until it is configured with the appropriate chassis size.

## Empty Slots and RIUP Situations

The POINT I/O system does not have the ability to detect an empty terminal base. Because of this, there are numerous situations in which you can potentially configure a system that is unusable or one that exercises unintended control.

In an attempt to address these situations, you must observe the following rules for POINT I/O system construction and the removal and reinsertion of modules:

- A correct POINT I/O system does not have any empty terminal bases.
- After you cycle power, the adapter does not run any I/O until the number of modules comprising the chassis equals the stored chassis size.
  - Because the adapter cannot detect empty terminal bases, it cannot assume any safe operation until there is a match between the number of modules indicating their presence in the chassis and what the adapter has saved in non-volatile memory.
  - Actual module identification (such as, electronic keying) is done when connection establishment requests are received from the controller or controllers.
- A module removed under power does not disrupt operation of the other I/O modules.
  - When you remove a module, the adapter determines what changed.
  - Whenever you remove a module with an active connection from the POINT I/O system, the adapter indicates this by flashing the POINTBus Status LED red and reports a minor recoverable fault.
- If more than one contiguous module is removed under power, connections to all modules in the contiguous missing module set are disallowed until all modules are replaced. Because the adapter cannot detect an empty base, it does not know the physical positioning of the modules until all the missing modules are replaced.
- If a module separating two sets of contiguous missing modules is removed, the two sets merge into a single set. All the modules must be replaced before connections are permitted to any module in the set.
- If modules of different types are removed and returned to the wrong locations, attempts to connect to these modules fail during verification of the electronic ID (providing that keying has not been disabled).
- If modules of the same type are removed and returned to the wrong locations, they accept connections from the controller or controllers and reconfigure with the correct data once they pass their electronic keying check.
- These removal and return conditions apply whether the system is under power or not. If the system is under power, the situation arises immediately. If the system is not under power, the situation arises in the next power cycle.

## Cycle Power To a System for the First Time

When you cycle power to the POINT I/O for the first time, the adapter must assign addresses to every module in the backplane. POINT I/O modules all ship configured at the same address.

When you first apply power, we expect that all but one module on the backplane exhibits a solid red Module Status LED.

One by one the adapter resets these modules and addresses them appropriately. The amount of time that this operation takes is proportional to the size of your POINT I/O system.

## Adapter Features

The 1734-AENT adapter has the following features:

- EtherNet/IP messages encapsulated within standard TCP/UDP/IP protocol
- Common application layer with ControlNet and DeviceNet networks
- Interfacing via Category 5 rated twisted pair cable
- Half/full duplex 10 Mbit or 100 Mbit operation
- DIN rail mounting
- Communication to and from other POINT I/O modules on the same DIN rail
- Communication supported by RSLinx software
- IP address assigned via standard BootP or DHCP tools
- I/O configuration via RSLogix 5000 software
- No network scheduling required
- No routing tables required
- Support of connections from multiple controllers simultaneously

## Hardware/Software Compatibility

The 1734-AENT adapter and the applications described in this manual are compatible with the following firmware revisions and software releases. Contact Rockwell Automation if you need software or firmware upgrades to use this equipment.

Product	Firmware Revision/ Software Release
1734-AENT adapter	1.xx or later
1756-ENBT module	2.3 or later
Logix 5555 controller	11 or later
RSLogix 5000 software	11.11 or later
RSLinx software	2.3.1 or later

## What the Adapter Does

The 1734-AENT adapter performs the following primary tasks:

- Control of real-time I/O data (also known as implicit messaging) – the 1734-AENT adapter serves as a bridge between POINT I/O modules and the network

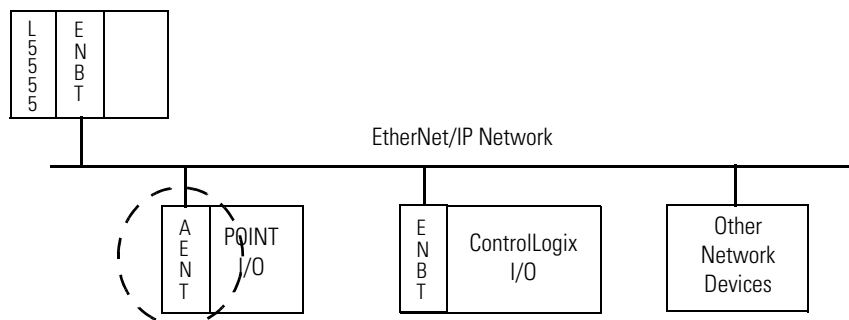

- Support of messaging data for configuration and programming information (also known as explicit messaging)

## Use of the Common Industrial Protocol (CIP)

The 1734-AENT adapter uses the Common Industrial Protocol (CIP). CIP is the application layer protocol specified for EtherNet/IP, the Ethernet Industrial Protocol, as well as for ControlNet and DeviceNet networks. It is a message-based protocol that implements a relative path to send a message from the producing device in a system to the consuming devices.

The producing device contains the path information that steers the message along the proper route to reach its consumers. Since the producing device holds this information, other devices along the path simply **pass** this information; they do not need to **store** it.

This has the following significant benefits:

- You do not need to configure routing tables in the bridging modules, which greatly simplifies maintenance and module replacement.

- You maintain full control over the route taken by each message, which enables you to select alternative paths for the same end device.

## Understand the Producer/Consumer Model

The CIP producer/consumer networking model replaces the old source/destination (master/slave) model. The producer/consumer model reduces network traffic and increases speed of transmission. In traditional I/O systems, controllers poll input modules to obtain their input status. In the CIP system, input modules are not polled by a controller. Instead, they produce (multicast) their data either upon a change of state (COS) or periodically.

The frequency of update depends upon the options chosen during configuration and where on the network the input module resides. The input module, therefore, is a producer of input data, and the controller is a consumer of the data.

The controller can also produce data for other controllers to consume. The produced and consumed data is accessible by multiple controllers and other devices over the EtherNet/IP network. This data exchange conforms to the producer/consumer model.

## Specify the Requested Packet Interval (RPI)

The RPI is the update rate specified for a particular piece of data on the network. The RPI can be specified for the adapter and include all of the I/O modules communicating through it (using a rack-optimized connection) or specified for a particular module (using direct connection).

When you add a module or an adapter to the I/O configuration of a controller, you must enter the RPI as a parameter. This value specifies how often to produce the data for that device. For example, if you specify an RPI of 50 ms, it means that every 50 ms the device should send its data to the controller or the controller should send its data to the device.

Use RPIs only for devices that exchange data. For example, a ControlLogix EtherNet/IP bridge module in the same chassis as the controller does not require an RPI, because it is not a data-producing member of the system. Its use is only as a bridge to remote racks.

---

## Support of Rack-optimized and Direct Connections

The 1734-AENT adapter supports both direct and rack-optimized connections. A direct connection is a real-time data transfer link between the controller and whatever module occupies the slot that the configuration data references. Direct connection messaging occurs at a cyclic rate specified by the RPI during configuration. A rack-optimized connection is a grouping of data from more than one I/O module into a single block of data sent over a single connection at the same data rate.

Rack-optimized connections reduce the total number of connections needed to transfer data when using many I/O modules in a system. The following example illustrates the benefit of rack-optimized connections.

Assume you set up a system that contains 8 digital I/O modules interfaced to a 1734-AENT adapter. If you use direct connections to transfer data to each of these I/O modules, you need 8 connections to transfer all of the data, one to each of the 8 I/O modules. If you use a rack-optimized connection to transfer the data, you only need a single connection – the connection to the 1734-AENT adapter.

---

### IMPORTANT

Although rack-optimized connections offer an efficient way to use resources, there are a few limitations on their use.

- You can use only rack-optimized connections to send data to and from digital I/O modules. Analog or speciality I/O requires direct connections.
- All data is sent at the same time as the RPI rate of the 1734-AENT adapter.

---

See the EtherNet/IP Performance and Application Guide, publication number [ENET-AP001](#), for more information on connections.

## Mix Rack-optimized and Direct Connections

You can mix communication formats for different I/O modules communicating through the same adapter. I/O modules set up to use rack optimization communicate at the rate of the RPI configured for the 1734-AENT adapter. I/O modules configured for direct communication communicate at their own set RPIs and ignore the 1734-AENT adapter's RPI.

## Before You Begin

To effectively use your adapter, note the following considerations.

### Determine Compatibility

If using the adapter with a 1756-ENBT module or 1788-ENBT module, use the following required firmware revisions for these bridge modules:

- 1756-ENBT firmware revision 2.3 or later
- 1788-ENBT firmware revision 1.33 or later

If you use the BootP Utility to assign IP addresses to the adapter, use revision 2.3.2 or later.

### Understand Messaging

Class 3 (Explicit Message) requests through the 1734-AENT adapter to a specific POINT I/O module may not always receive a response from the I/O modules. In the case where the I/O module does not reply to the request, the adapter responds with an error code indicating a timeout.

### Establish I/O Connections

When you apply power to a POINT I/O system and establish I/O connections, the outputs transition to the idle state, applying idle state data before going to RUN mode. This occurs even when the controller making the connection is already in RUN mode.

### Configure Autobaud

The adapter cannot reconfigure an I/O module that you previously configured to operate at a fixed communication rate. When you reuse a POINT I/O module from another POINT I/O system, configure the module to autobaud before using it with the adapter.



## Install the Adapter

### What This Chapter Contains

This chapter describes how to physically install the adapter on the DIN rail and connect it to the EtherNet/IP network. The following table lists where to find specific information.

Topic	Page
Identify Adapter Components	9
Mount the Adapter on a DIN Rail Before Installing Modules	10
Mount or Replace the Adapter to an Existing System	11
Wire Your Adapter	12
Mounting Dimensions	13

#### ATTENTION



You must use series C POINT I/O modules with the 1734-AENT adapter. Series A or B POINT I/O modules will not work with this adapter.

### Identify Adapter Components

Use the figure to identify the external features of the adapter.

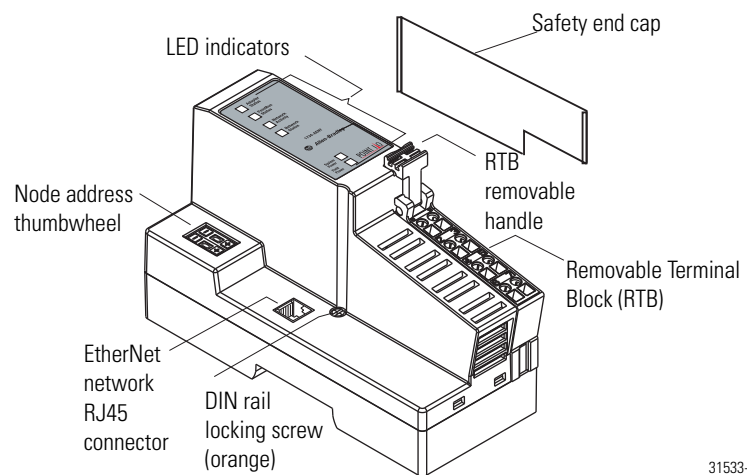

31533-M

## Mount the Adapter on a DIN Rail Before Installing Modules

Use the following procedure to mount the adapter on a new system before you install any I/O modules.

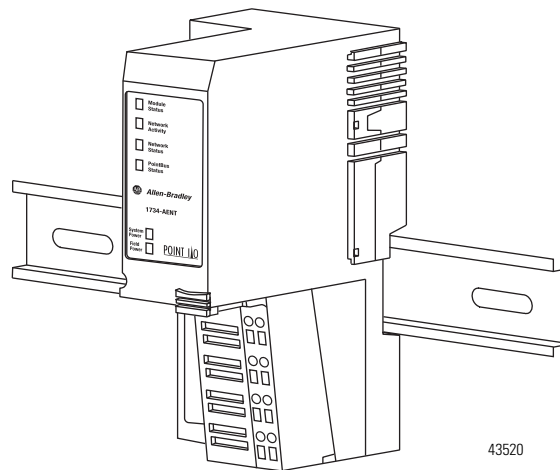

1. Position the adapter vertically above the DIN rail.
2. Press down firmly to install the adapter on the DIN rail, noting that the locking mechanism locks the adapter to the DIN rail.
3. Set the network address thumbwheel switches to the desired value. For more information, see Set the Network Address on page 19.

### WARNING



If you connect or disconnect the Ethernet cable with power applied to this module or any device on the network, an electrical arc can occur. This could cause an explosion in hazardous location installations.

Be sure that power is removed or the area is nonhazardous before proceeding.

4. Slide the safety end cap up to remove it.

This exposes the backplane and power interconnections.

### ATTENTION



Do not discard the adapter's end cap. Use this end cap to cover the exposed interconnections on the last mounting base on the DIN rail. Failure to do so could result in equipment damage or injury from electric shock.

## Mount or Replace the Adapter to an Existing System

Follow these steps to mount or replace an adapter.

1. Remove the existing adapter (if there is one) from the DIN rail as follows:
  - a. Pull up on the RTB removal handle to remove the terminal block.
  - b. Disconnect the Ethernet connector from the adapter.
  - c. Remove the adjacent module from its base.
  - d. Use a small-bladed screwdriver to rotate the DIN-RAIL locking screw to a vertical position.

This releases the locking mechanism.

- e. Lift straight up to remove.

2. For the replacement adapter, slide the safety end cap up to remove.

This exposes the backplane and power connections.

3. Position the replacement adapter vertically above the DIN rail.

4. Make certain the DIN rail lock is in the horizontal position.

5. Slide the adapter down, allowing the interlocking side pieces to engage the adjacent module.

6. Press firmly to seat the adapter on the DIN rail.

The adapter locking mechanism snaps into place.

7. Replace the adjacent module in its base.

8. Reconnect the Ethernet cable to the adapter.

9. Set the network address thumbwheel switches to the value used on the replaced module. For more information, see [Set the Network Address](#) on page 19.

10. Insert the end of the terminal block (RTB) opposite the handle into the base unit.

This end has a curved section that engages with the wiring base.

11. Rotate the terminal block into the wiring base until it locks itself into place.

## Wire Your Adapter

Refer to the illustration to wire the adapter.

**WARNING**



If you connect or disconnect wiring while the field-side power is on, an electrical arc can occur. This could cause an explosion in hazardous location installations.

Be sure that power is removed or the area is nonhazardous before proceeding.

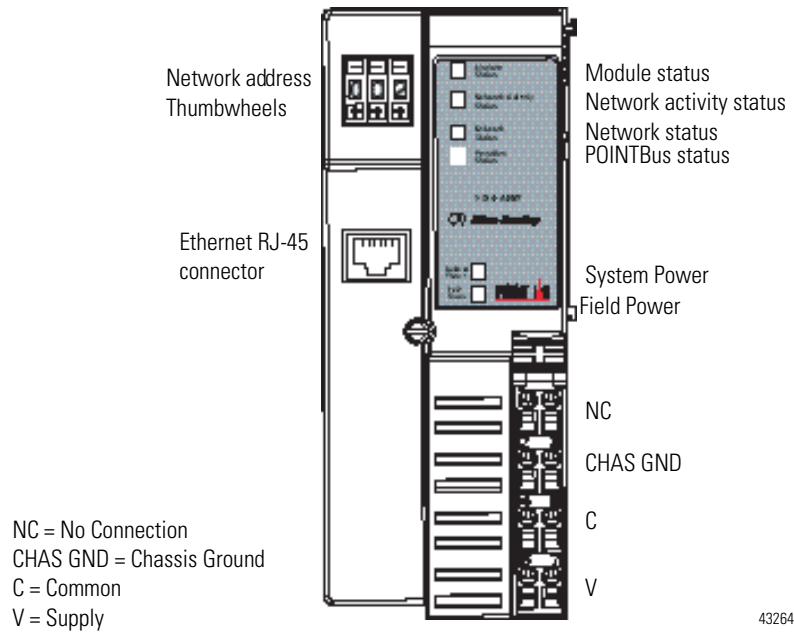

NC = No Connection  
 CHAS GND = Chassis Ground  
 C = Common  
 V = Supply

12/24V DC

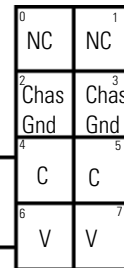

This DC supply will be connected to the internal power bus.



**ATTENTION**



Do not connect 120/240V AC power to this supply.

# Mounting Dimensions

Refer to the figure for mounting dimensions.

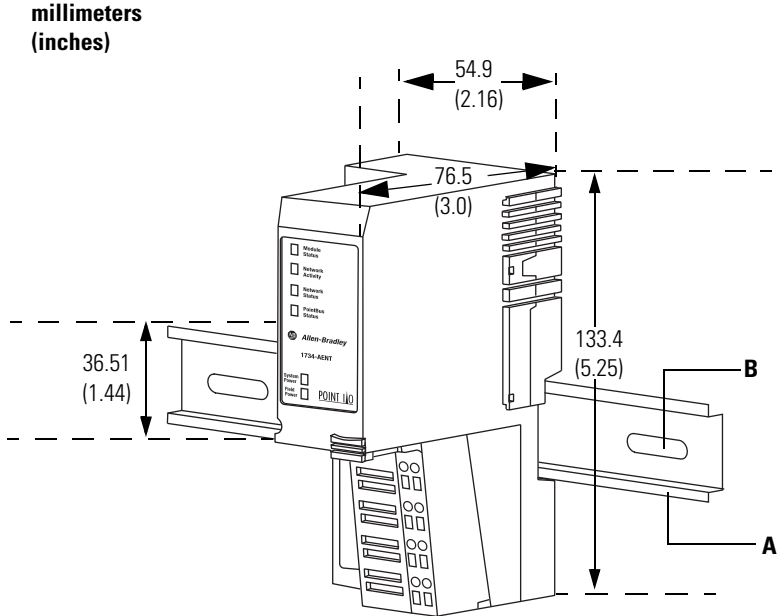

43520

- A = DIN rail
- B = Secure DIN rail approximately every 200 mm (7.8 in.)

**1734-AENT**  
76.2H x 54.9W x 133.4D  
(3.0H x 2.16W x 5.25D)

**Notes:**

## Configure the Adapter for Your EtherNet/IP Network

### What This Chapter Contains

Before using your adapter in an EtherNet/IP network, configure it with an IP address, subnet mask, and optional Gateway address. This chapter describes these configuration requirements and the procedures for providing them. Here are ways you can do this:

- Use the Rockwell BootP utility, version 2.3 or later, that ships with RSLogix 5000 or RSLinx software.  
You can also use this utility to reconfigure a device with an IP address you must change.
- Use a third party DHCP server.
- Use the Network Address thumbwheel switch.
- Have your network administrator configure the adapter via the network server.

See the table for a list of where to find information in this chapter.

Topic	Page
Configuration Requirements	16
IP Address	17
Gateway Address	17
Subnet Mask	18
Set the Network Address	19
Use the Rockwell BootP/DHCP Utility	20
Save the Relation List	22
Use DHCP Software to Configure Your Adapter	23

#### ATTENTION



You must use series C POINT I/O modules with the 1734-AENT adapter. Series A or B POINT I/O modules will not work with this adapter.

## Configuration Requirements

Before you can use your adapter, you must configure its IP address, its subnet mask, and, optionally, gateway address. You can use the Rockwell BootP utility, version 2.3 or later, to perform the configuration. You can also use a DHCP server or the network address switches to configure these parameters.

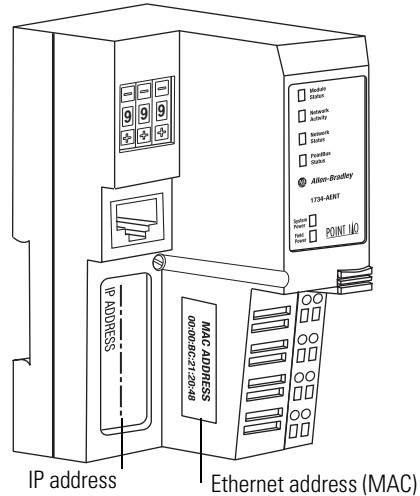

43519

### IMPORTANT

If you set the thumbwheels on the adapter to the value 888 and then power cycle the module, the following will occur.

- The DHCP Enabled function is enabled (set to True).
- The Ethernet link is negotiated automatically (the Auto Negotiate function will be set to True).
- The web server is enabled (the Disabled Web Server function is disabled).
- The password for this page resets to the factory default (the word password is the factory default password).

Note the value of the switches before you enter the 888 value, because you return the adapter to those values once this process is complete.

### IMPORTANT

If using the BootP/DHCP utility, you need to know the Ethernet hardware address of your adapter. Rockwell Automation assigns each 1734-AENT adapter a unique 48-bit hardware address at the factory. The address is printed on a label on the side of your 1734-AENT adapter as shown in the figure. It consists of six hexadecimal digits separated by colons. This address is fixed by the hardware and cannot be changed.

If you change or replace the 1734-AENT adapter, you must enter the new Ethernet hardware address of the adapter when you configure the new adapter.



## IP Address

The IP address identifies each node on the IP network (or system of connected networks). Each TCP/IP node on a network (including the 1734-AENT adapter) must have a unique IP address.

The IP address is 32 bits long and has a net ID part and Host ID part. Networks are classified A, B, C, (or other). The class of the network determines how an IP address is formatted.

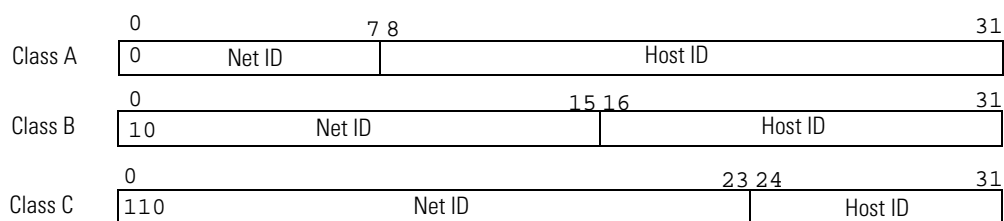

You can distinguish the class of the IP address from the first integer in its dotted-decimal IP address as follows:

Range of first integer	Class	Range of first integer	Class
0 ... 127	A	192 ... 223	C
128 ... 191	B	224 ... 255	other

Each node on the same physical network must have an IP address of the same class and must have the same net ID. Each node on the same network must have a different Host ID thus giving it a unique IP address.

IP addresses are written as four decimal integers (0...255) separated by periods where each integer gives the value of one byte of the IP address.

### EXAMPLE

For example, the 32-bit IP address:

10000000 00000001 00000000 00000001 is written as  
128.1.0.1

## Gateway Address

This section applies to multi-network systems. If you have a single network system, refer to the next section.

The Gateway Address is the default address of a network. It provides a single domain name and point of entry to the site. Gateways connect individual physical networks into a system of networks.

When a node needs to communicate with a node on another network, a gateway transfers the data between the two networks. The figure shows gateway G connecting Network 1 with Network 2.

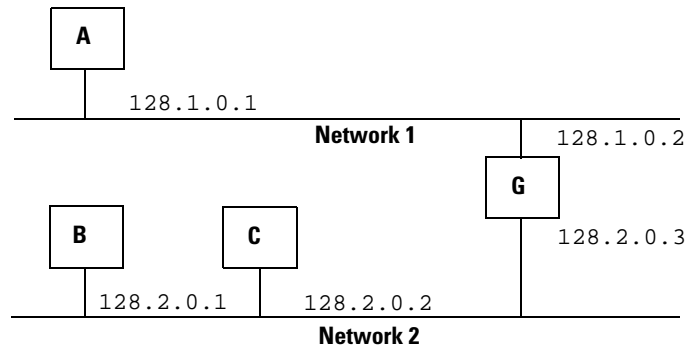

When host B with IP address 128.2.0.1 communicates with host C, it knows from C's IP address that C is on the same network. In an Ethernet environment, B can then resolve C's IP address into a hardware address (MAC address) and communicate with C directly.

When host B communicates with host A, it knows from A's IP address that A is on another network (the net IDs are different). In order to send data to A, B must have the IP address of the gateway connecting the two networks. In this example, the gateway's IP address on Network 2 is 128.2.0.3.

The gateway has two IP addresses (128.1.0.2 and 128.2.0.3). The first must be used by hosts on Network 1 and the second must be used by hosts on Network 2. To be usable, a host's gateway must be addressed using a net ID matching its own.

## Subnet Mask

The subnet mask is used for splitting IP networks into a series of subgroups, or subnets. The mask is a binary pattern that is matched up with the IP address to turn part of the Host ID address field into a field for subnets.

### EXAMPLE

Take Network 2 (a Class B network) in the previous example and add another physical network. Selecting the following subnet mask would add two additional net ID bits, allowing for four physical networks:

11111111 11111111 **11**000000 00000000 = 255.255.192.0

These two bits of the Host ID are used to extend the net ID.

Two bits of the Class B host ID are used to extend the net ID. Each unique combination of bits in the part of the Host ID where subnet mask bits are 1 specifies a different physical network.

The new configuration is:

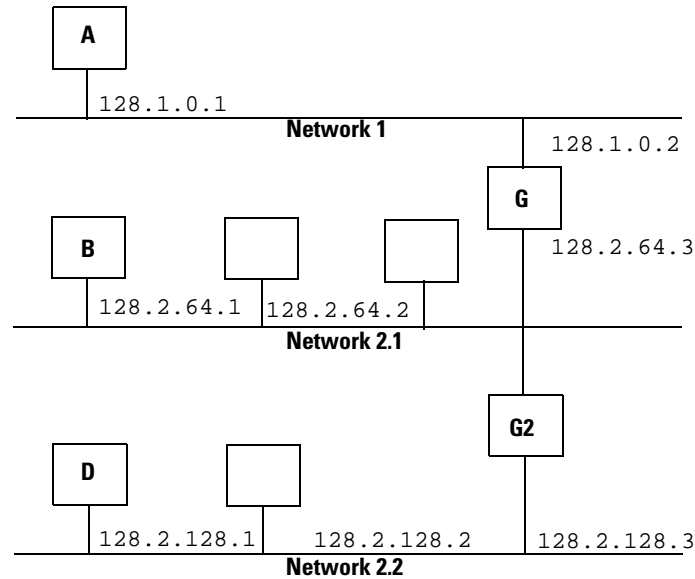

A second network with Hosts D and E was added. Gateway G2 connects Network 2.1 with Network 2.2.

Hosts D and E will use Gateway G2 to communicate with hosts not on Network 2.2.

Hosts B and C will use Gateway G to communicate with hosts not on Network 2.1.

When B is communicating with D, G (the configured Gateway for B) will route the data from B to D through G2.

## Set the Network Address

The adapter ships with the thumbwheel switches set to 999 and DHCP enabled. You can set the network Internet Protocol (IP) address in these ways:

- Use the thumbwheel switches located on the module.
- Use a Dynamic Host Configuration Protocol (DHCP) server, such as Rockwell Automation BootP/DHCP.
- Retrieve the IP address from nonvolatile memory.

Network address  
thumbwheel  
Press either the + or -  
buttons to change the  
number.

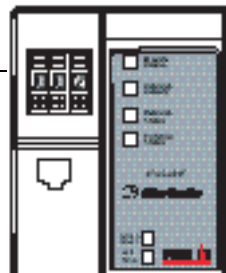

43248

The adapter reads the thumbwheel switches only when you cycle power to determine if the switches are set to a valid number. Press either the + or - buttons to change the number.

Valid settings range from 001 to 254. When the switches are set to a valid number, the adapter's IP address will be 192.168.1.xxx (where xxx represents the number set on the switches). The adapter's subnet mask will be 255.255.255.0 and the gateway address is set to 0.0.0.0. The adapter will not have a host name assigned, or use any Domain Name System when using the thumbwheel settings.

If the switches are set to an invalid number (such as 000 or a value greater than 254), the adapter checks to see if DHCP is enabled. If DHCP is enabled, the adapter requests an address from a DHCP server. The DHCP server will also assign other Transport Control Protocol (TCP) parameters.

If DHCP is not enabled, the adapter will use the IP address (along with other TCP configurable parameters) stored in nonvolatile memory. The factory default switch setting is 999, and DHCP is enabled.

## Use the Rockwell BootP/DHCP Utility

The Rockwell Automation BootP/DHCP utility is a stand alone program that incorporates the functionality of standard BootP software with a user friendly graphical interface. It is located in the Utils directory on the RSLogix 5000 software installation CD. The 1734-AENT adapter must have DHCP enabled (factory default and the network address switches set to an illegal value) to use the utility.

To configure your adapter using the BootP utility, perform the following steps:

1. Run the BootP software.

In the BOOTP Request History panel you see the hardware addresses of devices issuing BootP requests.

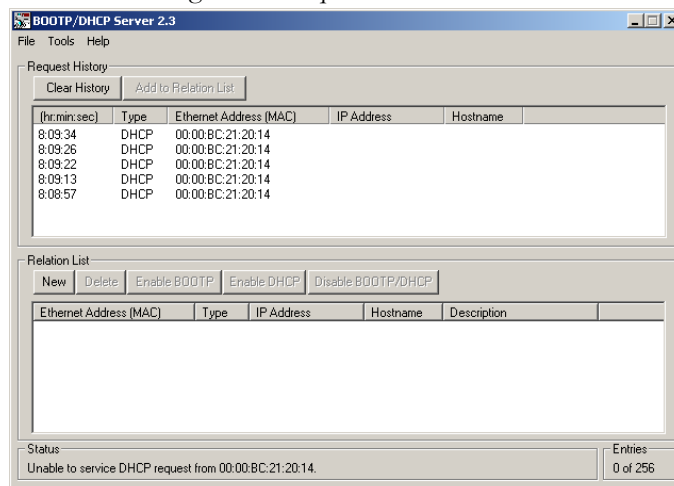

2. Double-click the hardware address of the device you want to configure.

You see the New Entry dialog with the device's Ethernet Address (MAC).

3. Enter the IP Address you want to assign to the device, and click OK.

The device is added to the Relation List, displaying the Ethernet Address (MAC) and corresponding IP Address, Hostname, and Description (if applicable).

[hr:min:sec]	Type	Ethernet Address (MAC)	IP Address	Hostname
12:47:24	DHCP	00:00:BC:21:20:14	10.88.70.2	
12:47:24	DHCP	00:00:BC:21:20:14		

Ethernet Address (MAC)	Type	IP Address	Hostname	Description
00:00:BC:21:20:14	DHCP	10.88.70.2		

When the address displays in the IP Address column in the Request History section, it signifies that the IP address assignment has been made.

4. To assign this configuration to the device, highlight the device in the Relation List panel, and click the Disable BOOTP/DHCP button.

When power is cycled to the device, it uses the configuration you assigned and not issue a DHCP request.

5. To enable DHCP for a device with DHCP disabled, highlight the device in the Relation List, and click the Enable DHCP button.

You must have an entry for the device in the Relation List panel to re-enable DHCP.

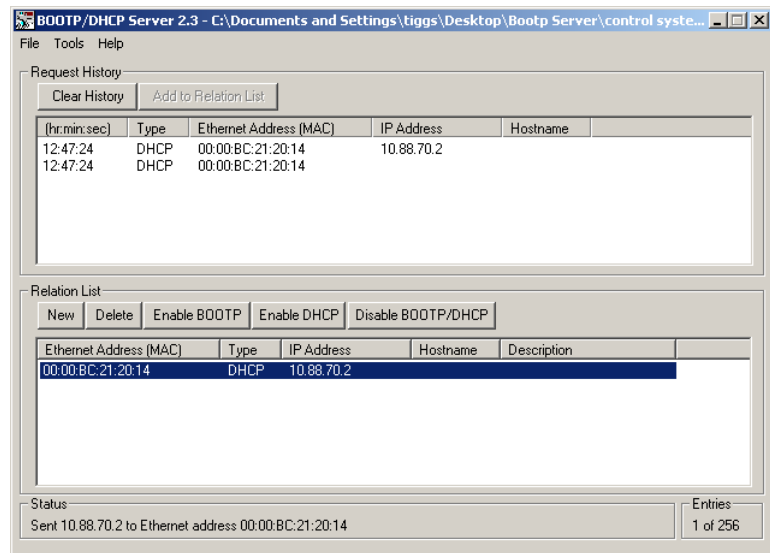

## Save the Relation List

You can save the Relation List to use later. To save the Relation List perform the following steps:

1. Select Save As... from the File menu.

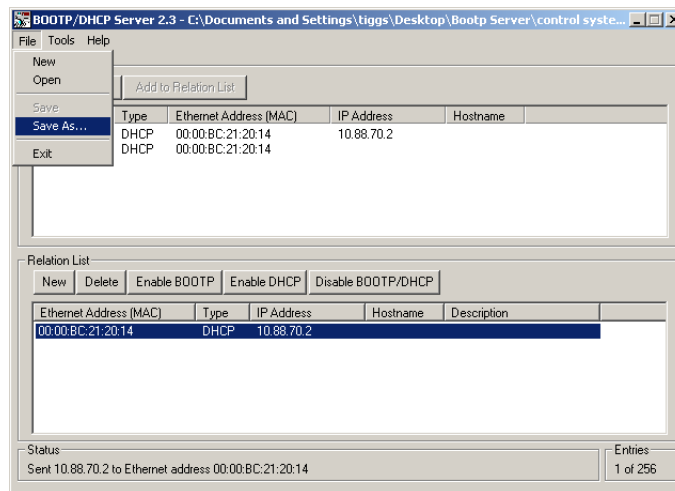

The Save As dialog appears.

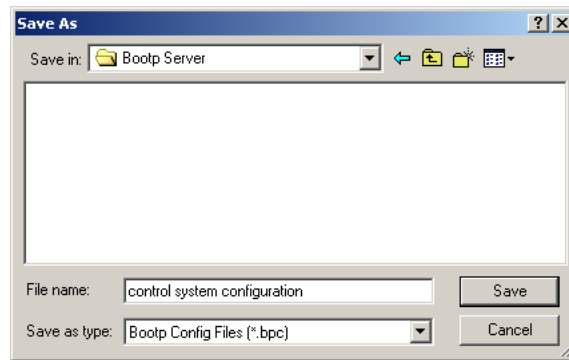

2. Select the folder you want to save to.
3. Enter a file name for the Relation List (for example, control system configuration), and click Save.

You can leave the Save as type at the default setting:  
Bootp Config Files (\*.bpc).

You can then open the file containing the Relation List at a later session.

## Use DHCP Software to Configure Your Adapter

DHCP (Dynamic Host Configuration Protocol) software automatically assigns IP addresses to client stations logging onto a TCP/IP network.

DHCP is based on BootP and maintains some backward compatibility. The main difference is that BootP was designed for manual configuration, while DHCP allows for dynamic allocation of network addresses and configurations to newly attached devices.

Be cautious about using DHCP software to configure your adapter. A DHCP server typically assigns a finite lease time to the offered IP address.

When 50% of the leased time has expired, the 1734-AENT adapter attempts to renew its IP address with the DHCP server.

The possibility exists that the adapter will be assigned a different IP address, which would cause the adapter to cease communicating with the ControlLogix controller.

To configure the adapter with a fixed IP address, see [Configure the Adapter with Fixed IP Address](#) on page 43.

---

**ATTENTION**



To avoid unintended control, the 1734-AENT adapter must be assigned a fixed IP address. The IP address of this adapter should not be dynamically provided. If a DHCP server is used, it must be configured to assign a fixed IP address for your adapter.

Failure to observe this precaution may result in unintended machine motion or loss of process control.

---



## Configure the Adapter for Direct Connection in RSLogix 5000 Software

**What This Chapter Contains** In this example, a ControlLogix controller communicates with POINT I/O modules via the 1734-AENT adapter using a direct connection.

The adapter makes a direct connection to each of the modules referenced by the data. The modules presented in this chapter use RSLogix 5000 software, version 11.

Topic	Page
Set Up the Hardware	25
Create the Example Application	26
Configure the I/O	27
Add the Local EtherNet/IP Bridge to the I/O Configuration	28
Add the POINT I/O Adapter to the I/O Configuration	30
Add the POINT I/O Modules to the I/O Configuration	33
Add the Relay Output Module	33
Add the Digital Output Module	36
Edit the Controller Tags	38
Create the Ladder Program	39
Download the Program to the Controller	39
Verify the Module Chassis Size	41
Configure the Adapter with Fixed IP Address	38
Recover From an Overloaded Adapter	44

### ATTENTION



You must use series C POINT I/O modules with the 1734-AENT adapter. Series A or B POINT I/O modules will not work with this adapter.

### Set Up the Hardware

In this example, a ControlLogix chassis contains the Logix5555 processor in slot 1 and a 1756-ENBT bridge module in slot 3.

We mounted the 1734-AENT adapter on a DIN rail in slot 0, with a 1734-OW2/C relay output module in slot 1, a 1734-OV4E/C sink output module in slot 2, and a power supply (not shown).

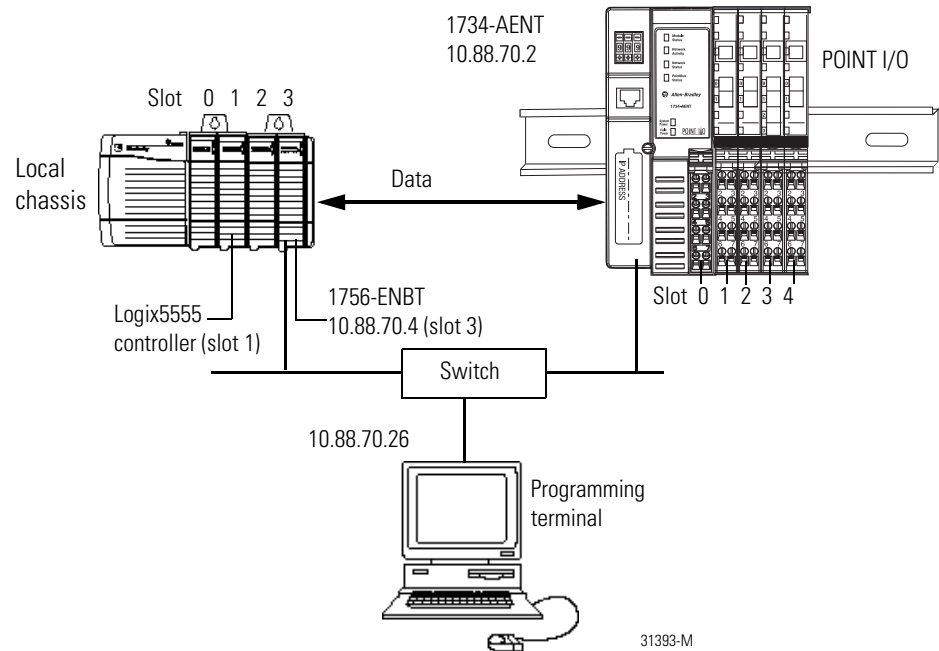

To work along with this example, set up your system as shown in the figure.

- In the example application, we assume that the Logix5555 controller and 1756-ENBT module (firmware revision 2.3, or later) are in the slots shown in the figure.
- Verify the IP addresses for your programming terminal, 1756-ENBT module, and 1734-AENT adapter.
- Verify the position (slot) of the I/O modules on the DIN rail.
- Verify that you connected all wiring and cabling properly.
- Be sure you configured your communication driver (for example, AB\_ETH/IP-1) in RSLinx software, as described in Appendix A Configure the RSLinx Ethernet Communication Driver on page 87 of this manual.

## Create the Example Application

Perform the following steps to create the example application:

1. Start RSLogix 5000 Enterprise Series software to open the RSLogix 5000 Main dialog.

- From the File menu, select New.

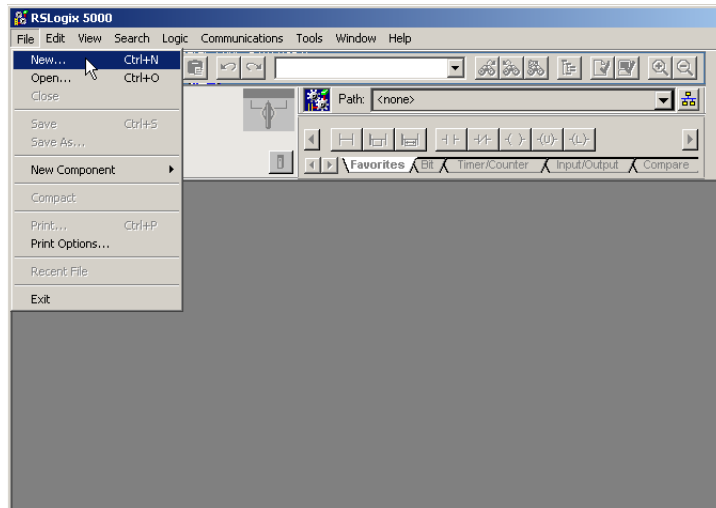

The New Controller dialog opens.

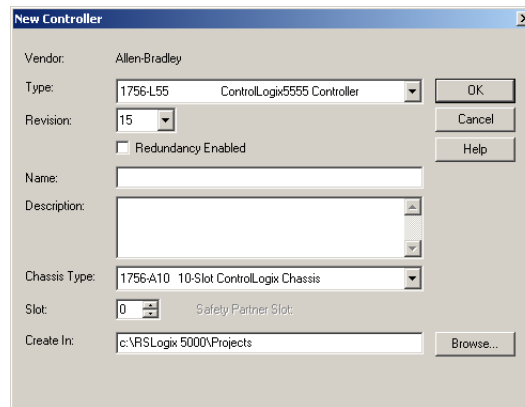

- Enter an appropriate Name for the Controller, for example, POINT\_IO\_Controller.
- Select the correct Version, Chassis Type, and Slot number of the Logix5555 controller, and the folder where you want to save the RSLogix 5000 file (Create In). The Description is optional.

RSLogix 5000 software version 11 or later lets you choose to enable redundancy. This example does not use redundancy. To use redundancy in your system, check the Redundancy Enabled checkbox so that a checkmark appears.

- Click OK.

## Configure the I/O

You now add the POINT I/O modules to the controller I/O configuration performing these procedures.

- Add the local 1756-ENBT module to the I/O configuration.
- Add the 1734-AENT adapter as a child of the 1756-ENBT module.
- Add the I/O modules as children of the 1734-AENT adapter.

**IMPORTANT**

Click the Help buttons on the configuration dialogs shown in this section if you need assistance in selecting and setting the parameters.

## Add the Local EtherNet/IP Bridge to the I/O Configuration

1. Select the I/O Configuration folder in the project dialog, and click the right mouse button.

A dialog opens.



2. Click New Module.



The Select Module dialog opens.

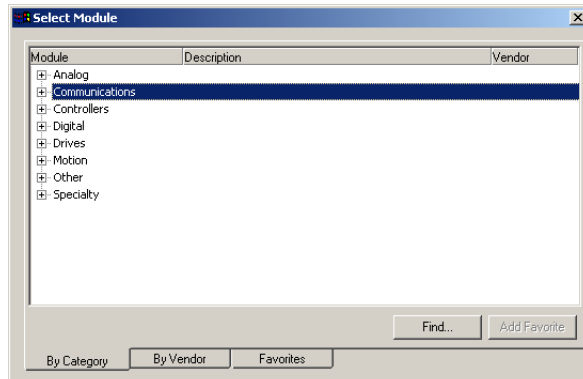

- Expand Communications to see the list of Communications modules.

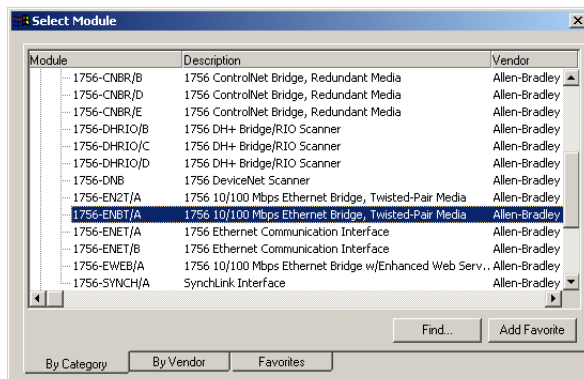

- Select the 1756-ENBT EtherNet/IP Bridge, and click OK.

The Select Major Revision dialog opens.

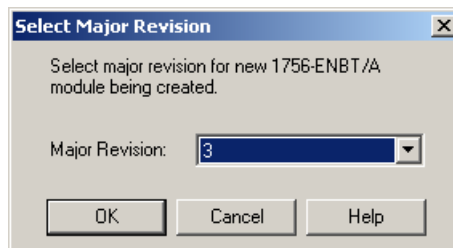

- Select the number for Major Revision, and click OK.

The New Module dialog opens.

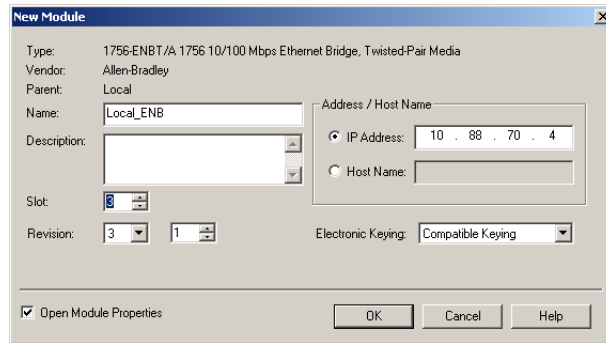

6. Enter values for Name, IP Address, Slot, Electronic Keying, and Revision, noting that we used the following values:

Name	Local_ENB
IP Address	10.88.70.4
Slot	3
Electronic Keying	Compatible Keying
Revision	3.1

7. Click OK to accept the configuration.

The Module Properties dialog opens.

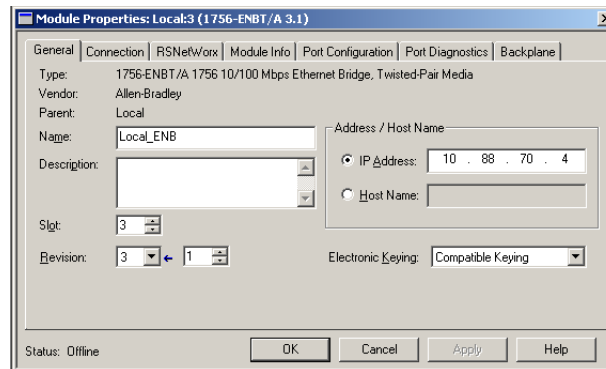

## Add the POINT I/O Adapter to the I/O Configuration

Next, you must add the 1734-AENT adapter as a child of the local 1756-ENBT module.

1. In the Project dialog, right-click the local 1756-ENBT module under the I/O Configuration folder, and select New Module from the dialog.

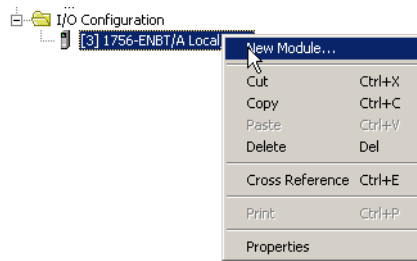

The Select Module dialog opens.

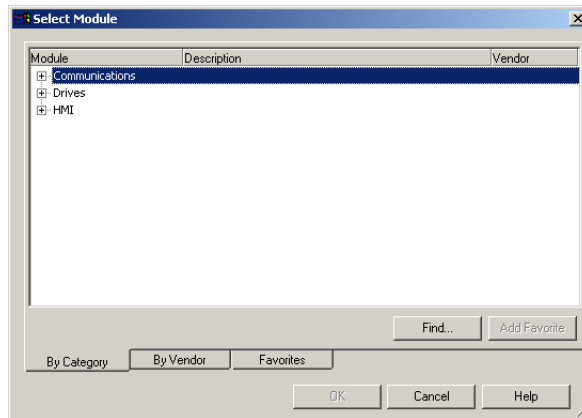

2. Expand Communications to see the list of Communications modules.

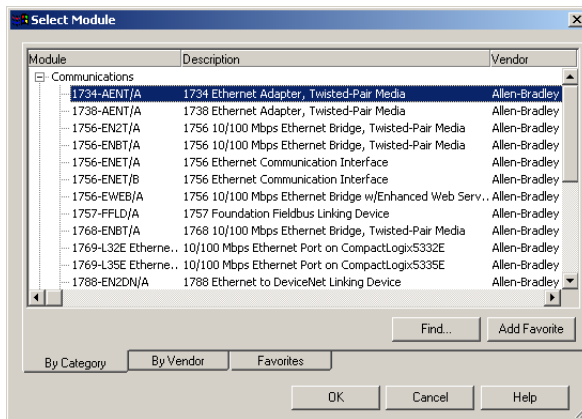

3. Select the 1734-AENT/A Ethernet adapter from the list, and click OK, noting that we used these values.

Name	POINT_IO_Adapter
IP Address	10.88.70.2
Comm Format	None
Chassis Size	3
Electronic Keying	Compatible Keying
Revision	1.1

The **Slot** field appears grey because the slot is automatically 0 for the 1734-AENT adapter.

### IMPORTANT

The chassis size equals 1 for the adapter plus the number of POINT I/O modules installed (physically present on the POINT I/O backplane).

The New Module dialog opens.

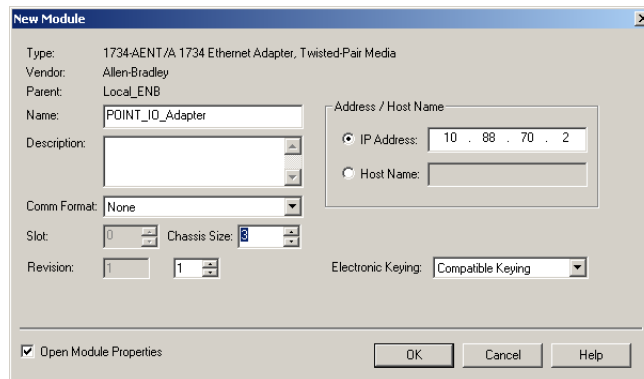

Comm Format choices are the following.

- **None** – the adapter makes a direct connection to each of the modules referenced by the data.
  - **Rack optimization** – digital I/O data is collected into a rack image. This does not include analog or specialty I/O modules.
  - **Listen only - rack optimization** – read or verify data only, but does not control the modules. When you have multiple controllers, one controller is used to control and the other controllers are used to monitor.
4. Choose None as Comm Format, because we are making a direct connection, and click OK.

Because you entered None as the Comm Format, the requested packet interval (RPI) is disabled.



The 1734-AENT adapter appears in the Ethernet folder.

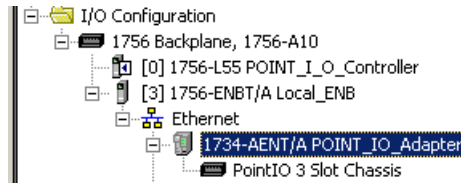

## Add the POINT I/O Modules to the I/O Configuration

You now add POINT I/O modules to the I/O Configuration List under the 1734-AENT adapter.

In this example, you add a 1734-OW2 relay output and a 1734-OV4E sink output module with standard configurations. Use these steps as a guide when configuring different I/O modules for your system.

**TIP**

This example application uses the I/O modules default configurations. For more information, see the POINT I/O Selection Guide, publication [1734-SG001](#).

### Add the Relay Output Module

1. Right-click the remote 1734-AENT adapter under the I/O Configuration folder and select New Module.

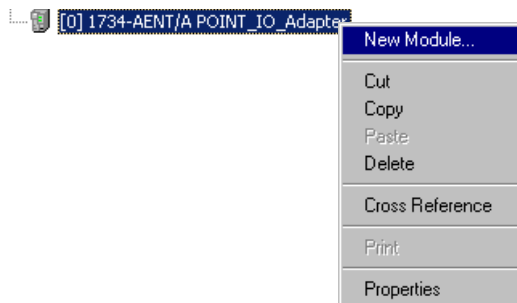

The Select Module dialog opens.

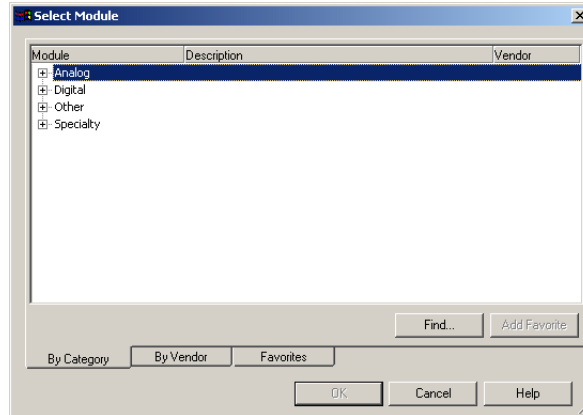

2. Expand Digital to see the list of Digital modules.

3. Select the 1734-OW2 relay output module from the list, and click OK.

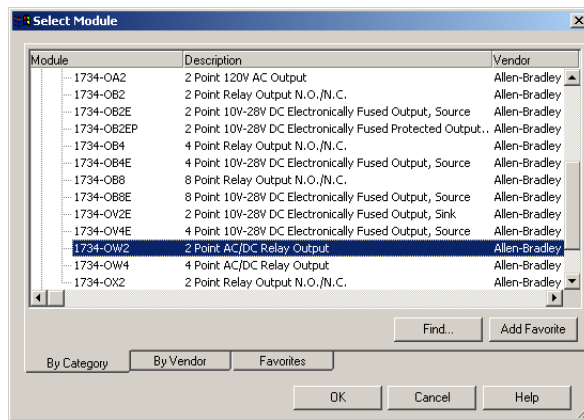

The New Module dialog opens.

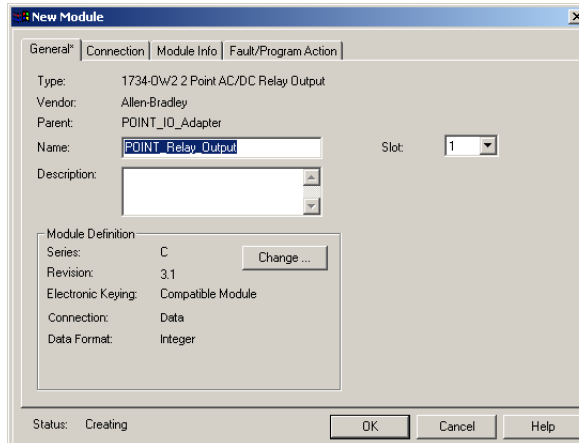

4. Enter values for Name and Slot, noting that we used the following values.

Name	POINT_Relay_Output
Slot	1

5. Choose Connection.

The RPI is selectable since it is a direct connection.

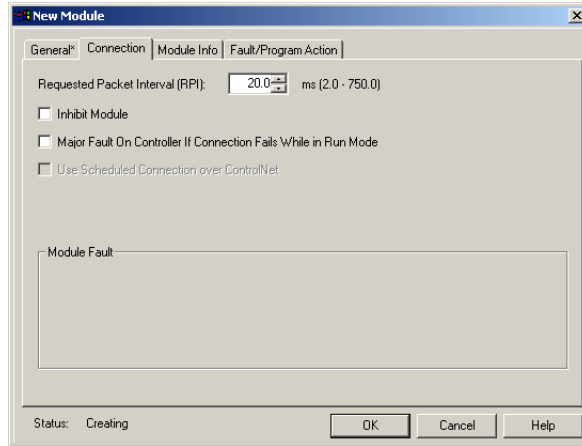

6. Enter 50 for requested packet interval (RPI) to set how often you exchange data with the 1734-AENT adapter.

**IMPORTANT**

To avoid overloading the 1734-AENT adapter, we recommend that RPI be no less than 10 ms for rack connections and 50 ms for direct connections.

7. Click OK to save the configuration.

The relay output module appears under Ethernet.

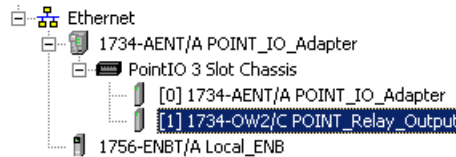

### Add the Digital Output Module

1. Right-click the 1734-AENT adapter, and select New Module.

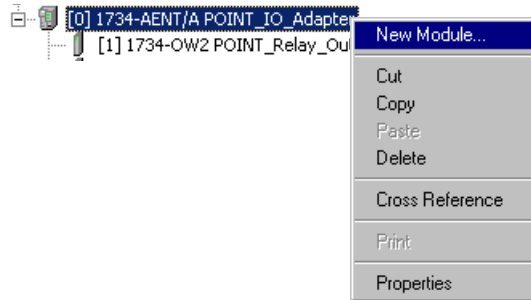

The Select Module dialog opens.

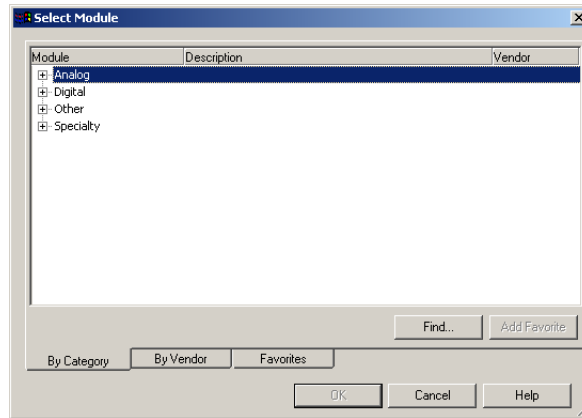

2. Expand Digital to see the list of Digital modules..

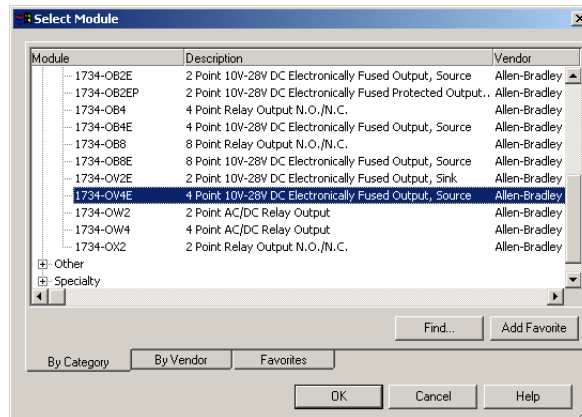

3. Select the 1734-OV4E digital output module from the list.
4. Click OK.

The New Module dialog opens.

- Enter values for Name and Slot, noting we used the following.

Name	POINT_Digital_Output
Slot	2

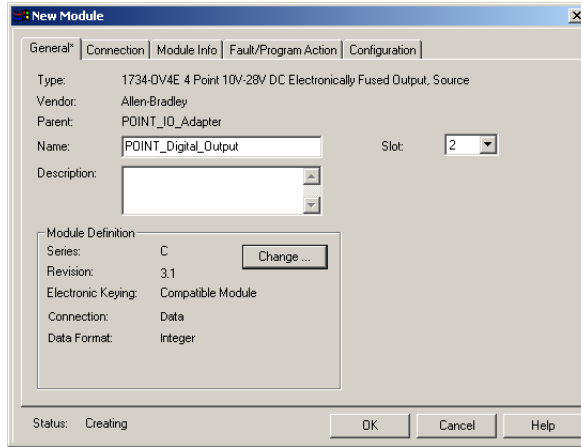

- On the Connection tab, enter 10 ms as the RPI for the 1734-OV4E module.

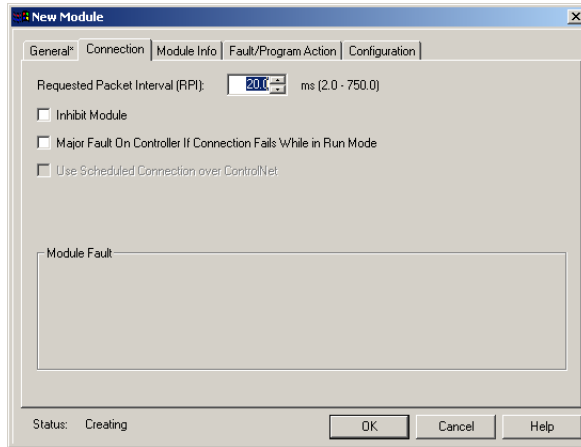

- Click OK.

The I/O Configuration in the Project dialog should look similar to the following.

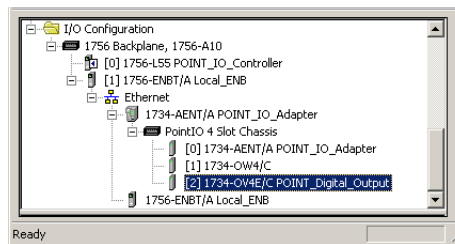

## Edit the Controller Tags

When you add modules to the I/O configuration the system creates tags for those modules to use in the application program.

For the example application you need to add one more controller tags.

1. Double-click the Controller Tags folder in the project dialog.

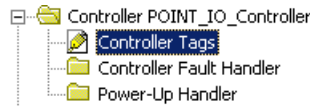

The Controller Tags dialog opens. You see the tags created for the 1734-AENT adapter and digital I/O modules.

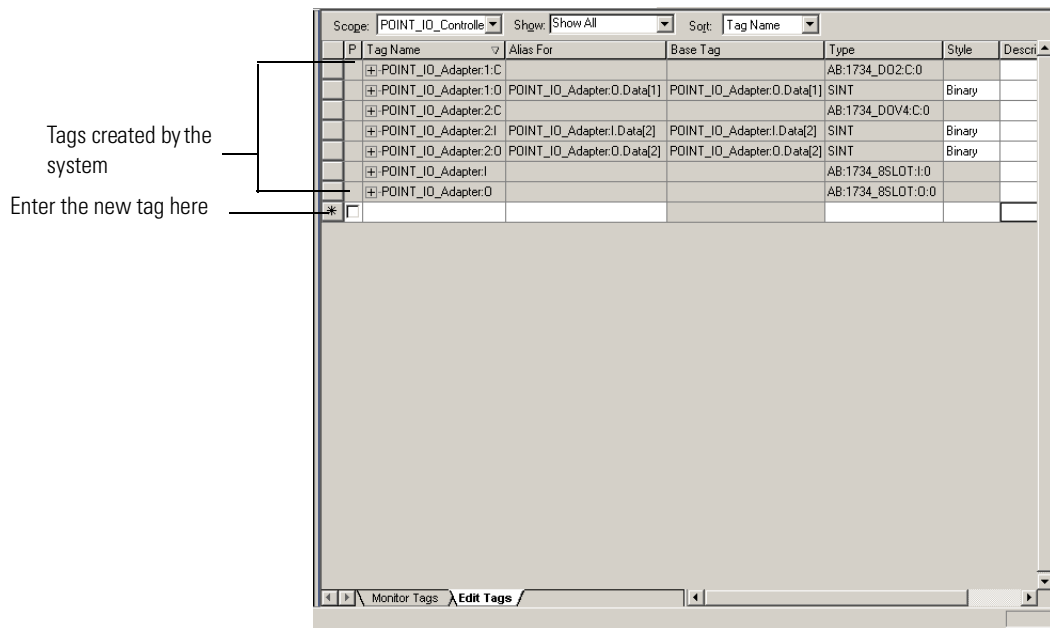

2. Click the Edit Tags tab at the bottom of the Controller Tags dialog.

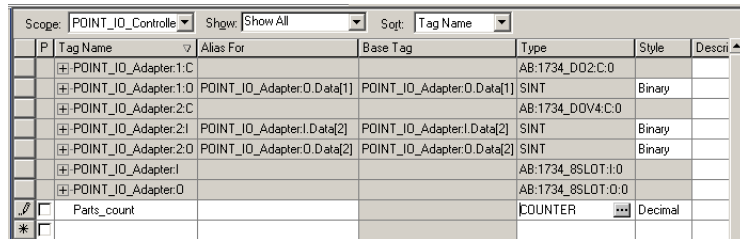

3. Create the following tag:

Tag	Type
Parts_Count	Counter

4. Close the Controller Tags dialog.

## Create the Ladder Program

Next create the example ladder program to test the I/O.

1. Double-click Main Routine under the Main Program folder.

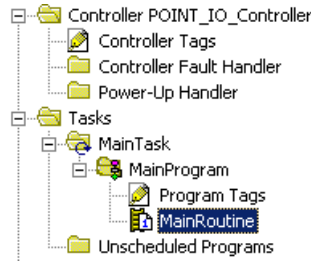

2. Enter the following ladder program using the tags previously created.

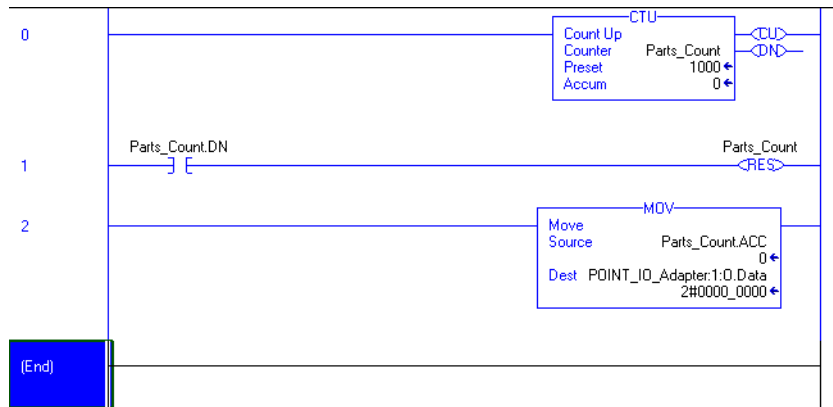

3. Save the program.

## Download the Program to the Controller

Follow this procedure to download the program you just saved to the ControlLogix controller.

1. From the main menu, choose Communications>Who-Active.

The Who Active dialog opens.

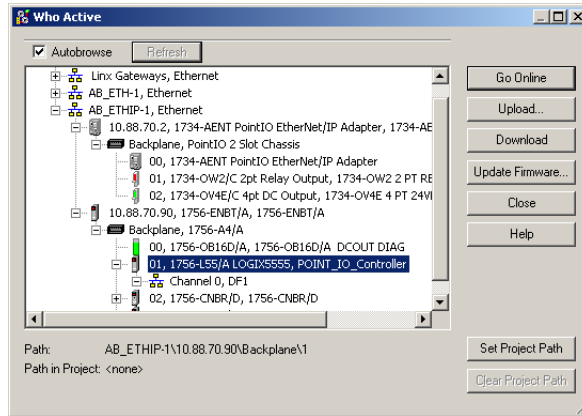

2. Navigate to select the slot where the controller is located in the chassis.
3. Choose Set Project Path.
4. Choose Download.

The Download dialog opens with a reminder of the following:

- The controller is in Remote Run mode.
- The mode changes to Remote Program prior to download.

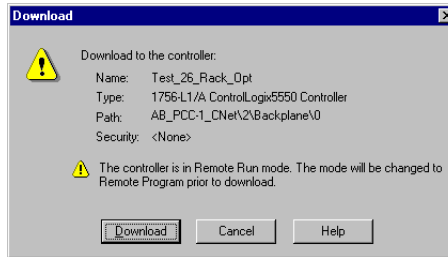



- From the Download dialog, choose Download to see the RSLogix 5000 software dialog.

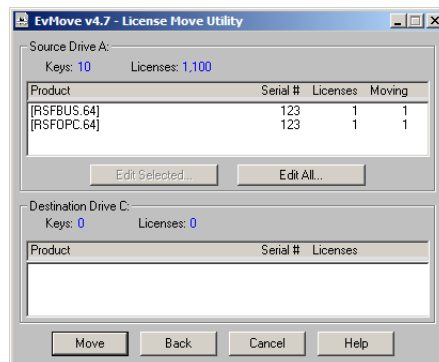

- Notice that the 1756-ENBT Bridge is now online.

If yellow triangles are present, see the following section.

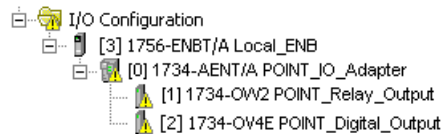

## Verify the Module Chassis Size

You have now built the I/O tree in RSLogix 5000 software, and the RSLogix 5000 software used the chassis size from the 1734-AENT General tab.

Now you need to download this new chassis size value into the 1734-AENT adapter hardware. This procedure synchronizes the chassis size value from the RSLogix 5000 software into the 1734-AENT adapter hardware.

- Verify that RSLogix 5000 is online.
- Right-click the 1734-AENT adapter under I/O Configuration in the Project dialog.
- Select Properties.
- Click the Connection tab.

You see the Module Fault error code.

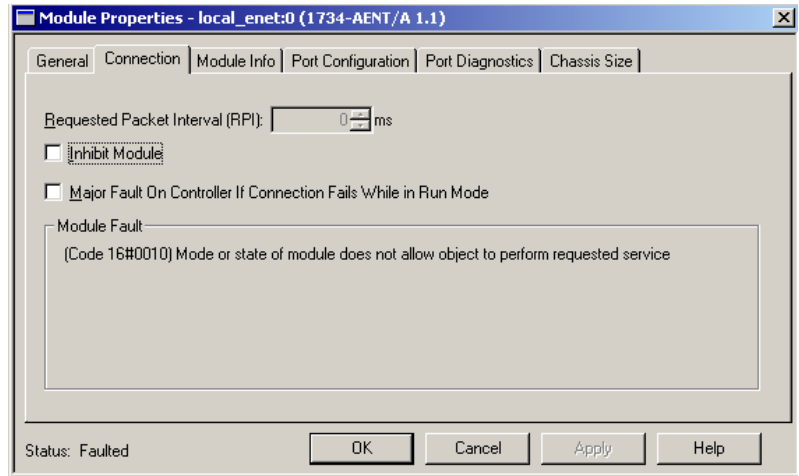

5. Click the Chassis Size tab.
6. Click Set Chassis Size in Module.

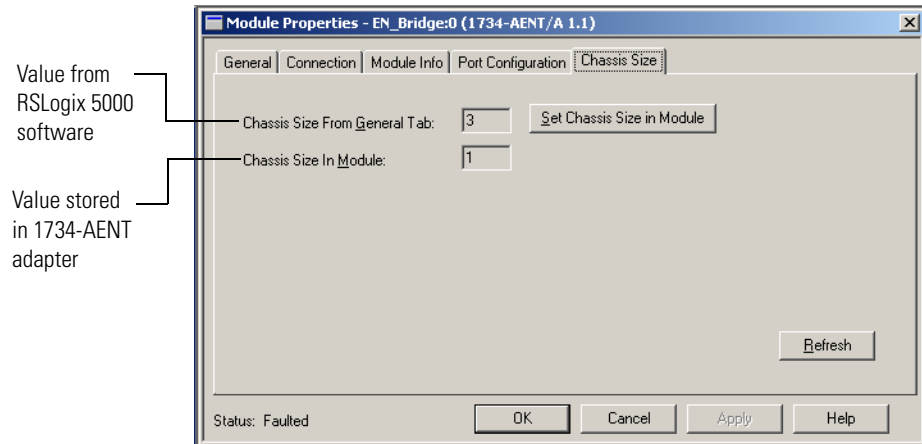

7. Read and acknowledge the warning dialog.

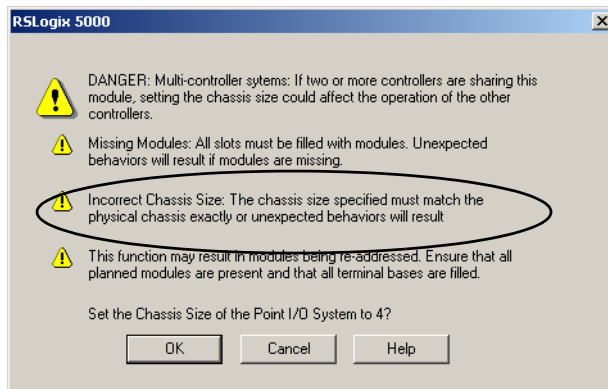

8. Click OK to continue.

Notice the chassis size in the module is modified to 3.

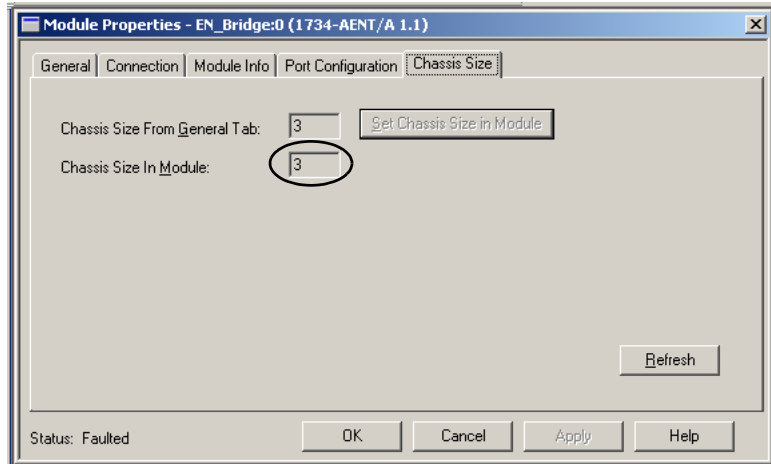

9. Click OK.

At this point, your POINTBus status LED should be solid green. All the yellow triangles in your I/O configuration should be gone.

## Configure the Adapter with Fixed IP Address

To configure the 1734-AENT adapter with a fixed IP address to prevent the adapter from ceasing to communicate with the ControllLogix controller:

1. Click the Port Configuration tab in the 1734-AENT adapter properties dialog.
2. Uncheck the Enable DHCP box.

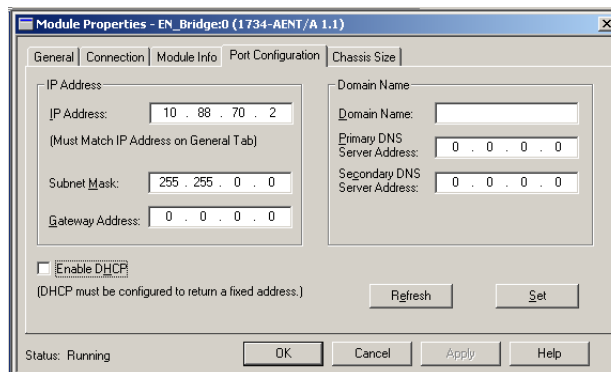

3. Click the Set button.

4. Read and acknowledge the warning.

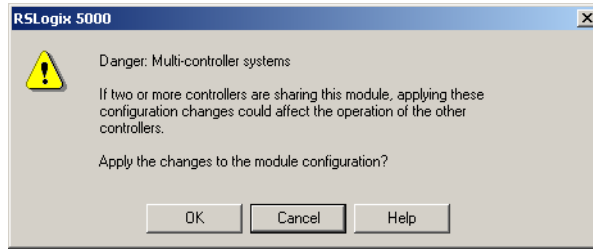

5. Click OK.
6. Click the Refresh button to verify the changes.

## Recover From an Overloaded Adapter

Each POINT I/O connection established with the 1734-AENT adapter consumes a portion of the microprocessor's bandwidth. The amount of bandwidth used by a connection depends on a number of variables, including the requested packet interval (RPI), the number of POINT I/O modules involved in the connection, and the rate of change of the I/O.

The 1734-AENT adapter continuously monitors this bandwidth and rejects requests for new connections when there is insufficient bandwidth available to support the new connection.

The condition where the 1734-AENT adapter cannot support the connection due to a limit of the microprocessor's bandwidth is shown in the following dialog.

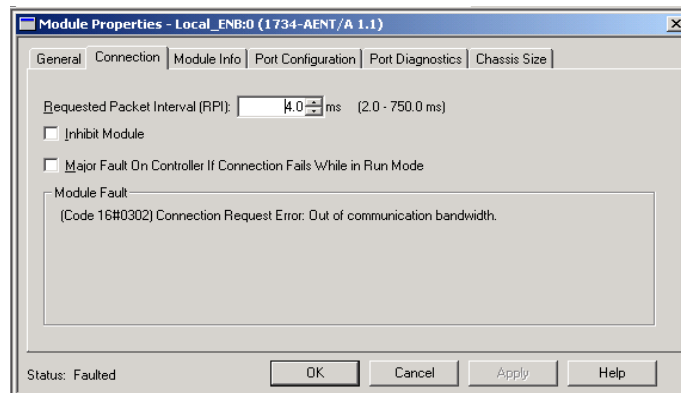

If you encounter this condition, the only action you can take is to alter the existing connections to reduce the amount of microprocessor bandwidth consumed. The most likely fixes for this condition include the following.

- Increase the RPI.
- Decrease the number of connections.

## Configure the Adapter for Direct Connection and Rack Optimization in RSLogix 5000 Software

### What This Chapter Contains

This chapter guides you through the steps required to configure your POINT I/O Ethernet adapter for both direct connection and rack optimization using RSLogix 5000 software.

You can mix communication formats for different I/O modules communicating through the same adapter. I/O modules set up to use rack optimization communicate at the rate of the RPI configured for the 1734-AENT adapter.

I/O modules configured for direct communication communicate at their own set RPI and ignore the 1734-AENT adapter RPI. The modules presented in this chapter have a configuration using RSLogix 5000 software, version 15. The chapter contains the following main sections:

Topic	Page
Set Up the Hardware	46
Create the Example Application	47
Configure the I/O Modules	48
Add the Local EtherNet/IP Bridge to the I/O Configuration	48
Add the POINT I/O Adapter to the I/O Configuration	50
Add the POINT I/O Module and Configure for Direction Connection	53
Add the POINT I/O Module and Configure For Rack Optimization	55
Download the Program to the Controller	58
Verify the Module Chassis Size	59
Access Module Data	62

#### ATTENTION



You must use series C POINT I/O modules with the 1734-AENT adapter. Series A or B POINT I/O modules will not work with this adapter.

## Set Up the Hardware

In this example, a ControlLogix chassis contains the Logix 5555 controller in slot 1 and a 1756-ENBT bridge module in slot 3. We mounted the 1734-AENT adapter on a DIN rail in slot 0, with a 1734-OW2/C relay output module in slot 1, a 1734-OV4E/C sink output module in slot 2, and a power supply (not shown).

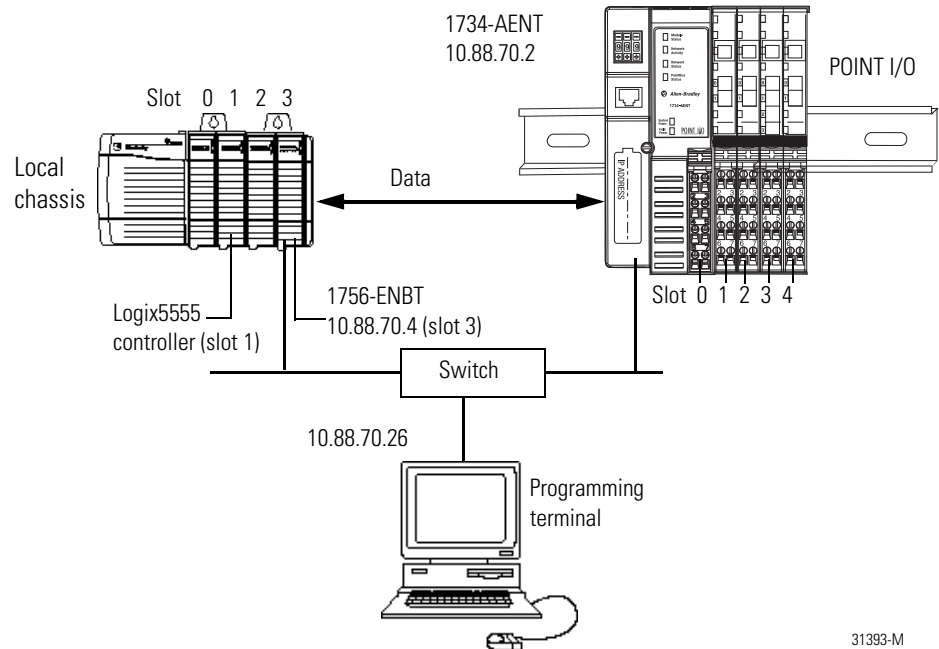

31393-M

To work along with this example, set up your system as shown in the figure.

- Note that in the example application, the Logix5555 controller and 1756-ENBT module (firmware revision 2.3 or later) we assume are in the slots shown in the figure.
- Verify the IP addresses for your programming terminal, 1756-ENBT module, and 1734-AENT adapter.
- Verify the position (slot) of the I/O modules on the DIN rail.
- Verify that you properly connected all wiring and cabling.
- Be sure you configured your communication driver (such as AB-ETHIP-1) in RSLinx software as described in Appendix A Configure the RSLinx Ethernet Communication Driver on page 87 of this manual.

## Create the Example Application

Perform the following steps to create the example application:

1. Start the RSLogix 5000 Enterprise Series software.

You see the RSLogix 5000 main dialog.

2. From the File menu, select New.

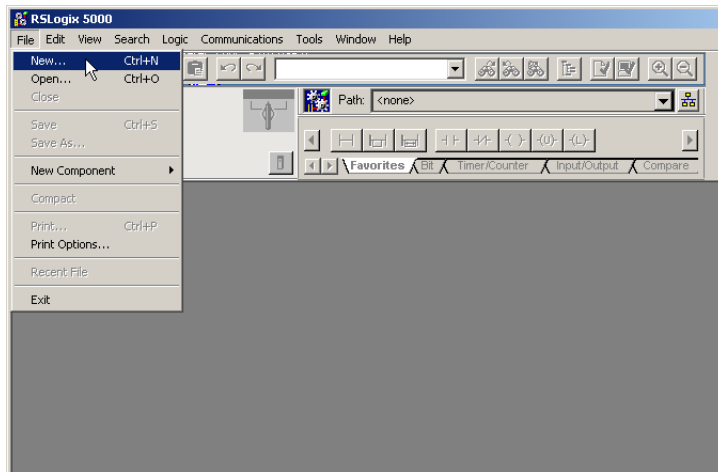

The New Controller dialog opens.

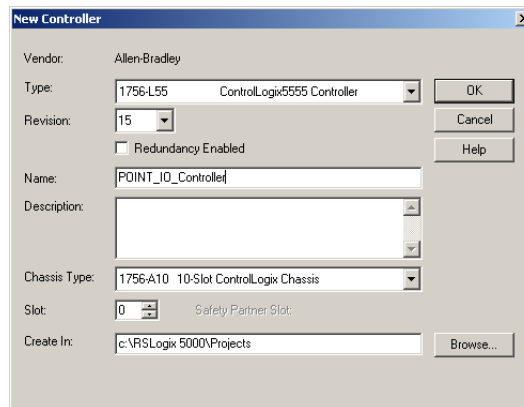

3. Enter an appropriate Name for the Controller, for example, POINT\_IO\_Controller.
4. Specify the following.
  - Revision
  - Chassis Type
  - Slot number
  - Description (optional)
5. Complete the Create In entry by selecting the folder where you want to save the RSLogix 5000 file.

6. To use redundancy in your system, check the Redundancy Enabled checkbox so that a checkmark appears.

RSLogix 5000 software, version 11 and later, includes enable redundancy. This example does not use redundancy.

7. Click OK.

## Configure the I/O Modules

You now add the POINT I/O modules to the controller I/O configuration. To do this, first add the local 1756-ENBT module to the I/O configuration. Next, add the 1734-AENT adapter as a child of the 1756-ENBT module. Then add the I/O modules as children of the 1734-AENT adapter.

### IMPORTANT

Click the Help buttons on the configuration dialog shown in this section if you need assistance in selecting and setting the parameters.

## Add the Local EtherNet/IP Bridge to the I/O Configuration

1. Select the I/O Configuration folder in the project dialog, and click the right mouse button.

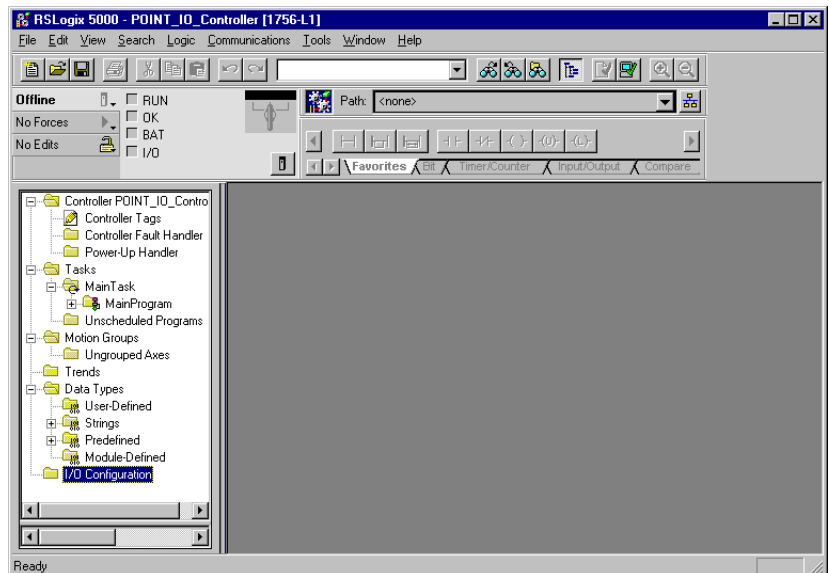

A dialog opens.



2. Click New Module.

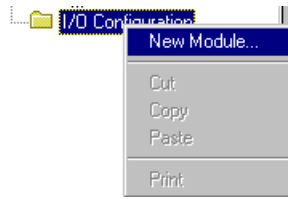

The Select Module dialog opens.

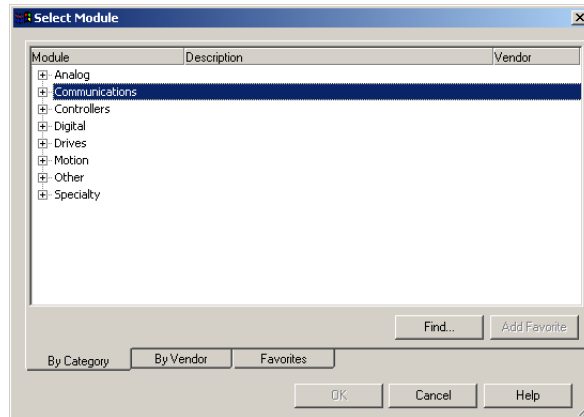

3. Expand Communications to see the list of Communications modules.

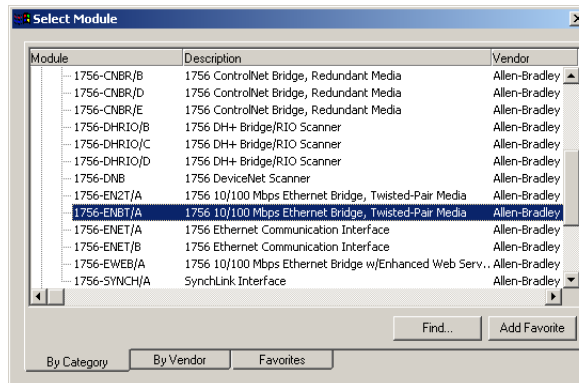

4. Select the 1756-ENBT EtherNet/IP Bridge, and click OK.

The Select Major Revision dialog opens.

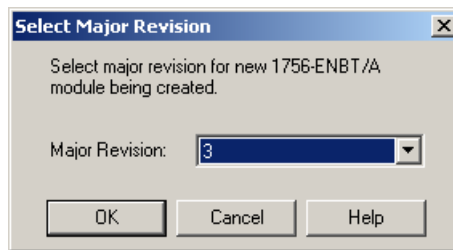

5. Select the value for Major Revision, and click OK.

The Module Properties dialog opens.

- Enter values for Name, IP Address, Slot, Electronic Keying, and Revision, noting we used the following values:

Name	Local_ENB
IP Address	10.88.70.4
Slot	3
Electronic Keying	Compatible Module
Revision	1.1

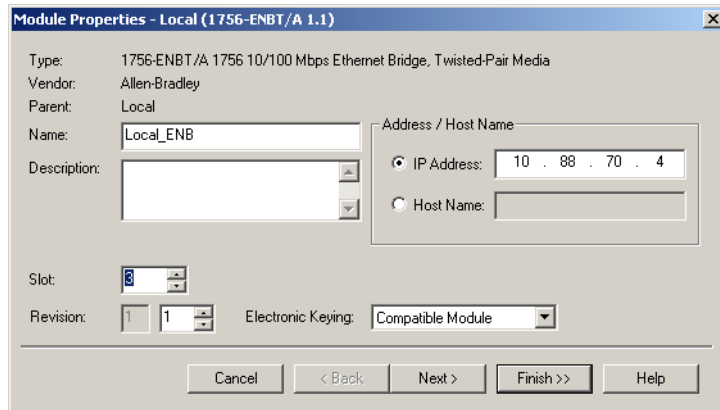

- Click Finish to accept the configuration.

## Add the POINT I/O Adapter to the I/O Configuration

Next, you must add the 1734-AENT adapter as a child of the local 1756-ENBT module.

- In the Project dialog, right-click the local 1756-ENBT module under the I/O Configuration folder, and select New Module from the dialog.

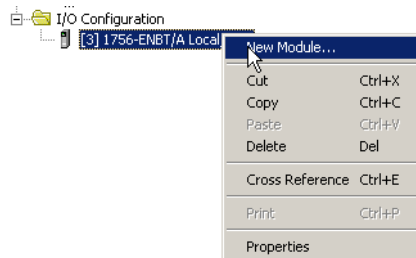

The Select Module dialog opens.

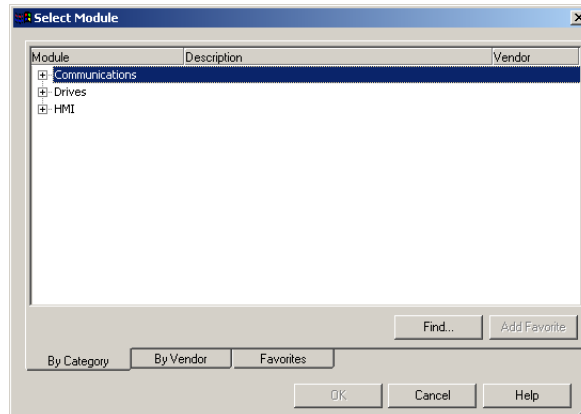

2. Expand Communications to see the list of Communications modules.

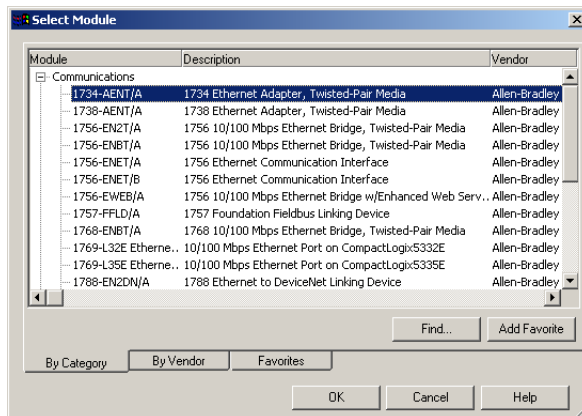

3. Select the 1734-AENT/A Ethernet adapter from the list, and click OK.

The New Module dialog opens.

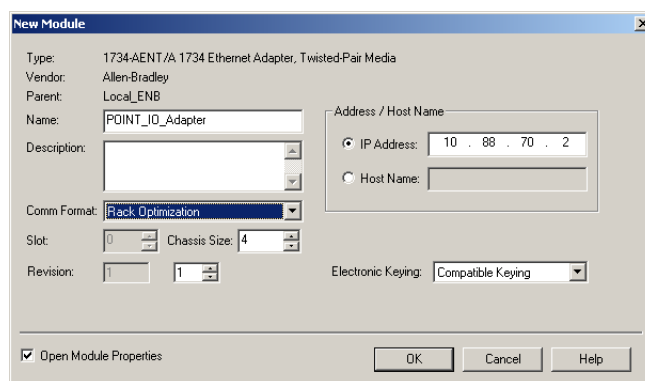

4. Enter values for Name, IP Address, Comm Format, Chassis Size, Electronic Keying, and Revision, noting we used the following values.

Name	POINT_IO_Adapter
IP Address	10.88.70.2
Comm Format	Rack Optimization
Chassis Size	4
Electronic Keying	Compatible Keying
Revision	1.1

The Slot field appears grey because the slot is automatically 0 for the 1734-AENT adapter.

**IMPORTANT**

The chassis size equals 1 for the adapter plus the number of POINT I/O modules installed (physically present on the POINT I/O backplane).

Comm Format choices include:

- **None** – the adapter makes a direct connection to each of the modules referenced by the data.
  - **Rack optimization** – digital I/O data is collected into a rack image. This does not include analog or specialty I/O modules.
  - **Listen only - rack optimization** – read or verify data only, but does not control the modules. When you have multiple controllers, one controller is used to control and the other controllers are used to monitor.
5. Choose Rack Optimization as Comm Format, because we are making a mixed connection that includes both a direct connection and rack-optimized connection.
6. Click OK.

The Module Properties dialog opens.

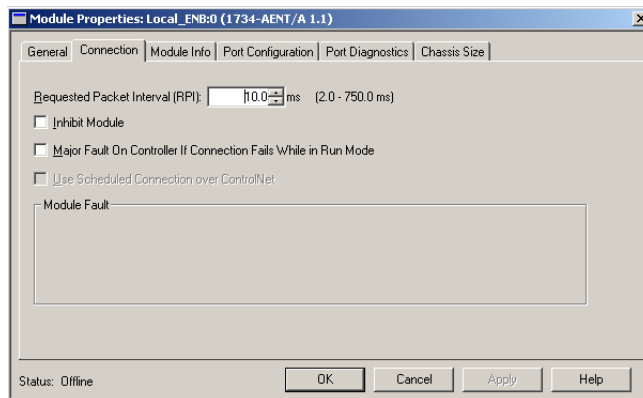

7. Verify that the requested packet interval (RPI) is appropriate for your system.

You use this value for the rack-optimized connection to the I/O modules.

**IMPORTANT**

To avoid overloading the 1734-AENT adapter, we recommend that you set RPI no less than 10 ms for rack connections and 50 ms for direct connections.

8. Click OK.

The 1734-AENT adapter appears in the Ethernet folder.



## Add the POINT I/O Module and Configure for Direction Connection

1. Highlight the 1734-AENT adapter under the I/O Configuration folder, and select New Module.

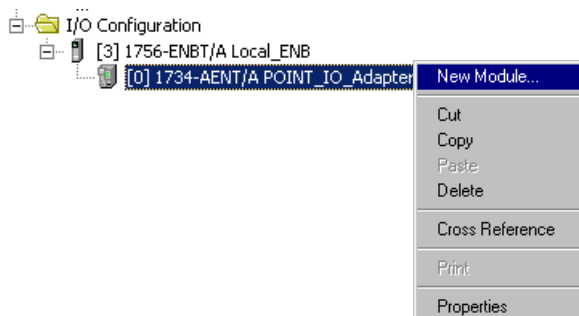

The Select Module dialog opens.

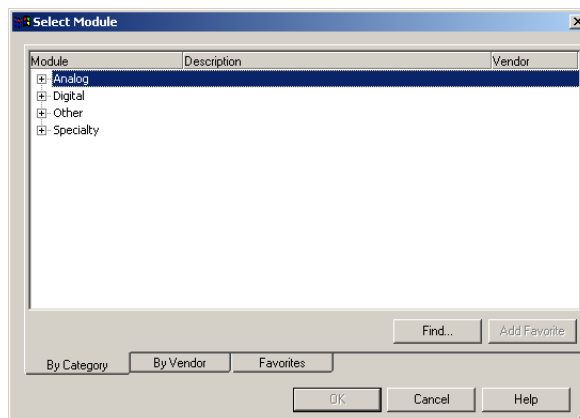

2. Expand Digital to see the list of digital modules.
3. Select the 1734-OW2 relay output module from the list, and click OK.

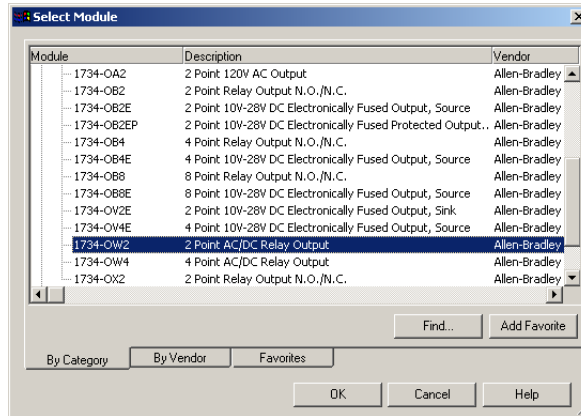

The New Module dialog opens.

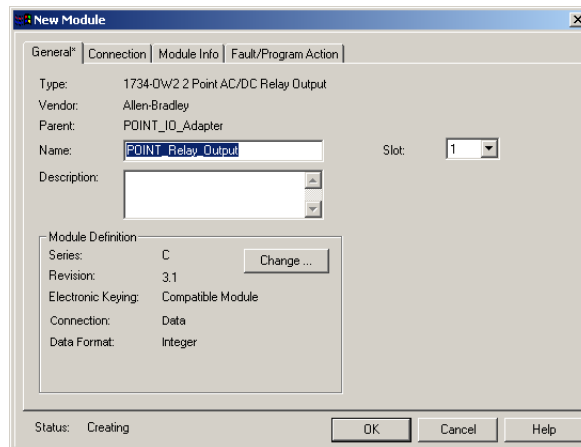

4. Enter values for Name and Slot. Note that we used the following values.

Name	POINT_Relay_Output
Slot	1

5. Choose Connection.

The RPI is selectable, since it is a direct connection.

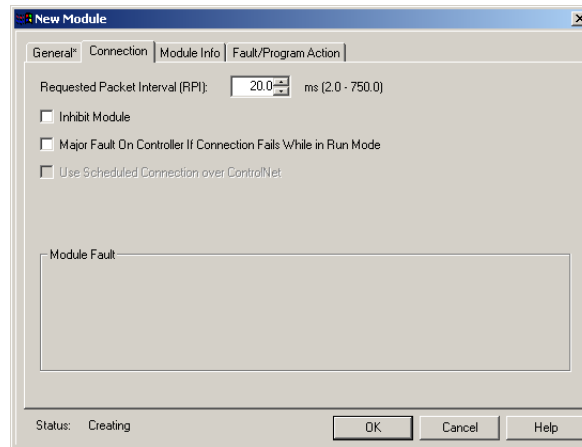

6. Verify that the requested packet interval (RPI) is appropriate for your system (10 ms for this example). You use this value for the rack-optimized connection to the I/O modules.

---

**IMPORTANT**

To avoid overloading the 1734-AENT adapter, we recommend that the RPI be no less than 10 ms for rack connections and 50 ms for direct connections.

---

7. Click OK to accept the configuration.

The 1734-AENT adapter appears indented under the local 1734-ENBT in the I/O Configuration folder.



## Add the POINT I/O Module and Configure For Rack Optimization

1. Right-click the 1734-AENT adapter under the I/O Configuration folder, and select New Module.

---

**IMPORTANT**

If you exceed the 1734-AENT chassis size, trying to add more modules than you configured, the New Module selection appears dim and is disabled. Increase the 1734-AENT chassis size to add more POINT I/O modules.

---

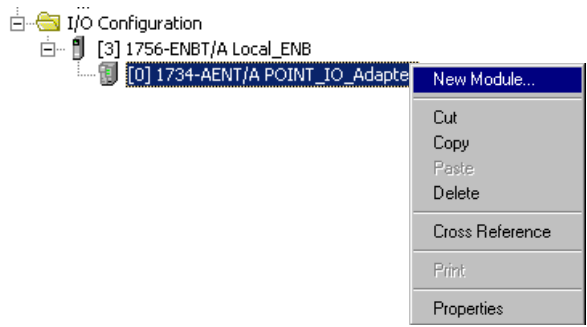

The Select Module dialog opens.

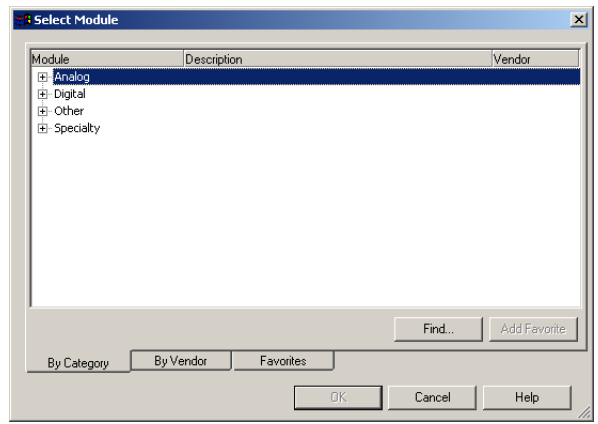

2. Expand Digital to see the list of digital modules available.

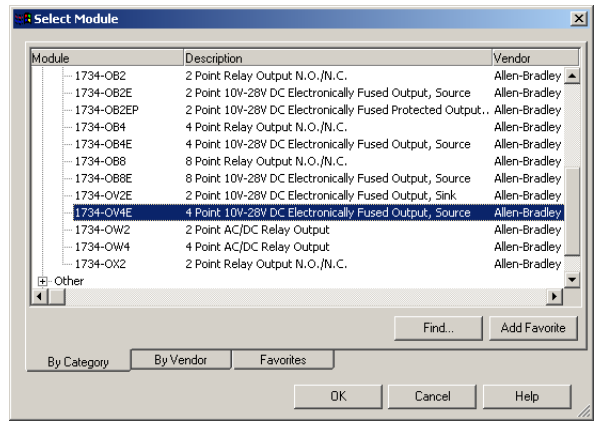

3. Choose the 1734-OV4E/C module, and click OK.



The New Module dialog opens.

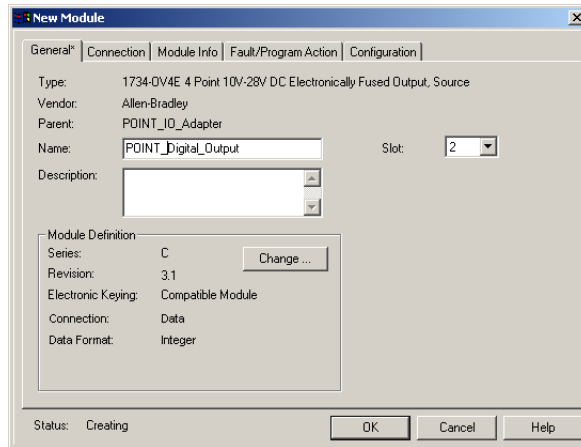

4. From the New Module dialog, complete the following.

- Enter a value for Name.
- Enter a value for Slot.
- Click Change.

The Module Definition dialog opens.

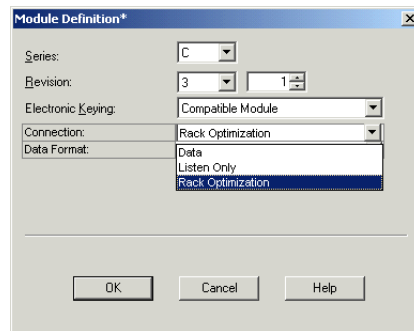

5. From the Connection tab, select Rack Optimization.

6. Click OK.

The New Module dialog opens.

7. From the New Module dialog, click the Connection tab.

The New Module Connection tab dialog opens.

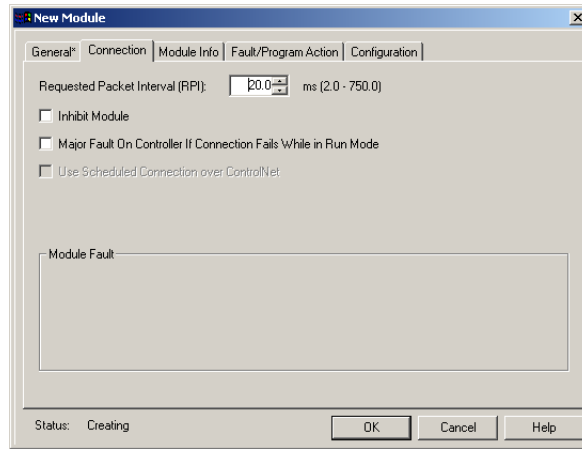

8. On the Connection tab, enter 50 for the requested packet interval (RPI).
9. Keep the following unchecked:
  - Inhibit Module
  - Major Fault on Controller If Connection fails While in Run Mode
10. Click OK.
11. Choose File → Save and enter the name and location of the RSLogix 5000 file.

## Download the Program to the Controller

Follow this procedure to download the program we just saved to the ControlLogix controller.

1. From the main menu, choose Communications → Who-Active.
2. From the Who Active dialog, navigate to select the slot where the controller is located in the chassis.

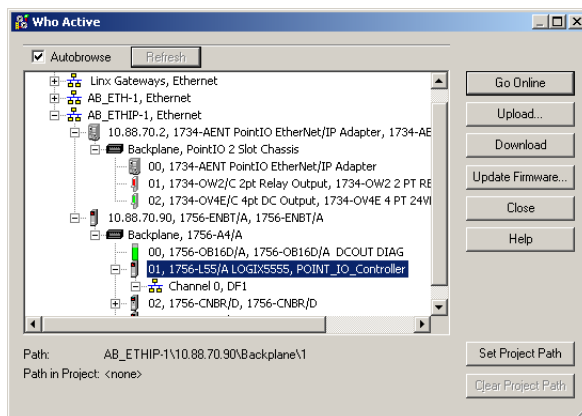

3. Choose Set Project Path.

4. Choose Download.

You see the Download dialog.

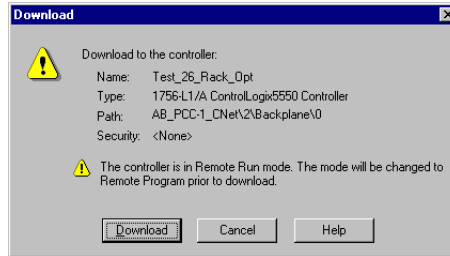

5. From the Download dialog, click Download.

You see this RSLogix 5000 dialog.

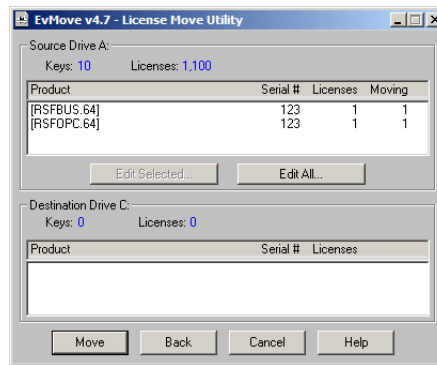

6. Notice that the 1756-ENBT Bridge is now online.

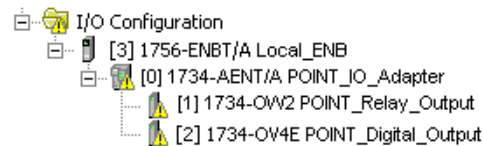

If yellow triangles are present, see the following section.

## Verify the Module Chassis Size

You have now built the I/O tree in RSLogix 5000, and the RSLogix 5000 software used the chassis size from the 1734-AENT General tab. Now you need to download this new chassis size value into the 1734-AENT adapter hardware. This procedure synchronizes the chassis size value from the RSLogix 5000 software into the 1734-AENT hardware. You must be online to perform this procedure.

1. Verify that RSLogix 5000 software is online.
2. Right-click the 1734-AENT adapter under I/O Configuration in the Project dialog.

3. Select Properties.
4. Click the Connection tab.

You see the Module Fault error code.

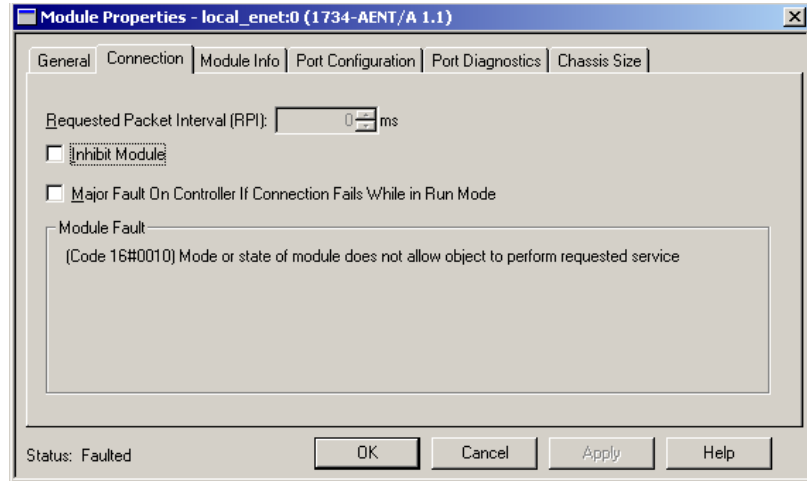

5. Click the Chassis Size tab.
6. Click Set Chassis Size in Module.

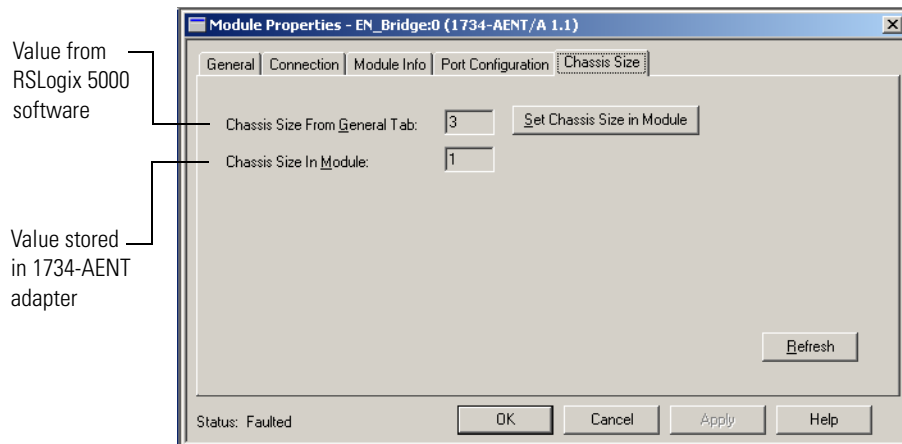

7. Read and acknowledge the warning dialog.

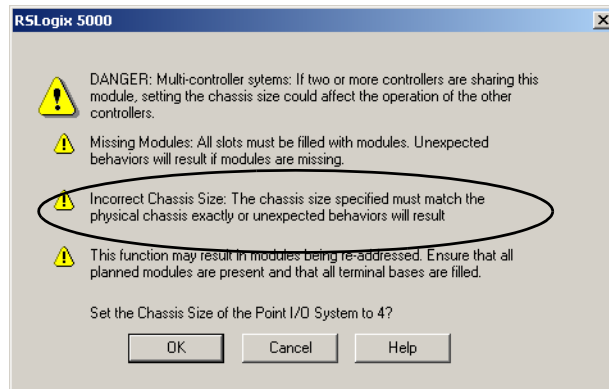

8. Click OK to continue.

9. Notice the chassis size in the module is modified to 3.

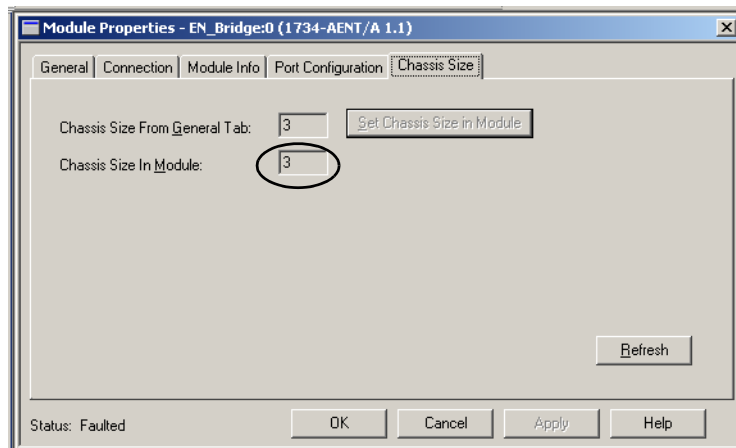

10. Click OK.

At this point, your POINTBus status LED should be solid green. All the yellow triangles in your I/O configuration tree should be gone.

11. Click OK to close the dialog.

12. Click File → Save to save the project.

## Access Module Data

Use the following information to use the 1734 POINT I/O Ethernet adapter data in the ladder logic program.

- POINT\_IO\_Adapter = the name you gave to your Ethernet adapter
- # = slot number of POINT I/O module
- C = configuration, I = input, O = output

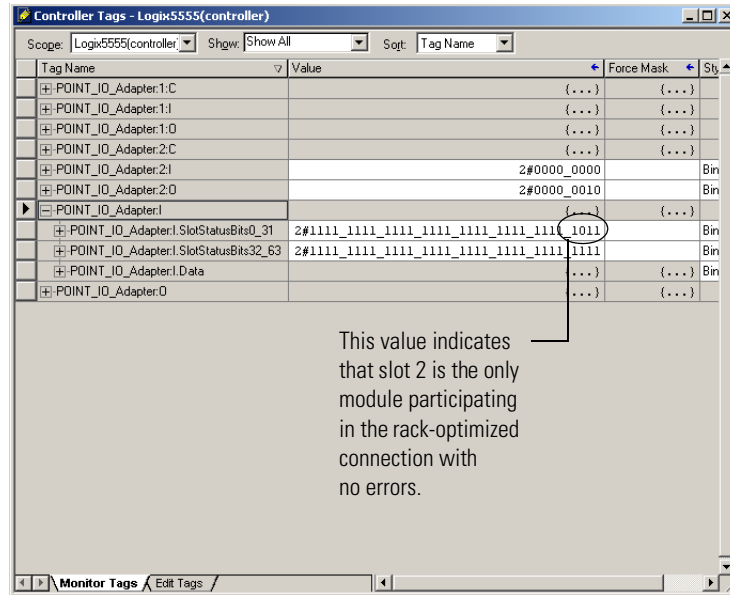

Use the controller tags in your ladder program to read input data or write output data.

- For RSLogix 5000 programming instructions, refer to RSLogix 5000 Getting Results, publication [9399-RLD300GR](#).
- For ControlLogix controller information, refer to ControlLogix System User Manual, publication [1756-UM001](#).
- Slot Status Bits: The Slot Status bits display the connection status for each of the POINT I/O modules that use a rack-optimized connection.
  - Bit 0 is reserved for the adapter and always reports a value of 1.
  - Each of the other bits (1...63) correspond to a POINT I/O module that you install in the POINT I/O backplane.
  - In this example, we configured the 1734-AENT adapter for both rack-optimized and direct connections. The slot status bits indicate that we installed the module in slot 2 with it operating correctly:
    - 0=module participating with no errors and
    - 1=module not participating or connection error (typically, module removed/missing).

## LED Status Indicators

**What This Chapter Contains** Read this chapter for information about LED status indicators.

### Interpret the Status Indicators

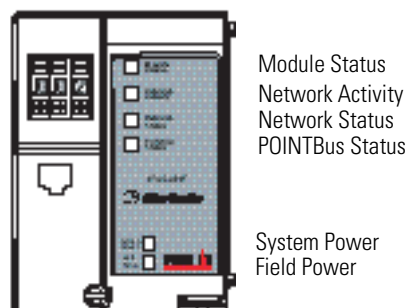

43248aent

#### ATTENTION



You must use series C POINT I/O modules with the 1734-AENT adapter. Series A or B POINT I/O modules will not work with this adapter.

Indication	Probable Cause	Recommended Action
<b>Module Status</b>		
Off	No power applied to device	Apply power to the device.
Flashing red/green	LED cycle power test (module self-test) present.	None
Solid green	Device is operating normally.	None
Flashing red	Recoverable fault has occurred: Firmware (NVS) update present. Address switches changed.	Complete firmware update. Verify address switches.
Solid red	Unrecoverable fault has occurred: Self-test failure present (checksum failure, or RAMtest failure at cycle power). Firmware fatal error present.	Replace adapter.

Indication	Probable Cause	Recommended Action
<b>Network Activity</b>		
Off	No link established.	Verify network cabling, and correct, as needed.
Flashing green/Off	Transmit or receive activity present.	None
Steady green	Link established.	None
<b>Network Status</b>		
Off	Device not initialized. The module does not have an IP address.	Apply power to device, verify IP address, and correct, as needed.
Flashing green	No CIP connections present. Device has an IP address, but no CIP connections are established.	None
Solid green	CIP connections present. Device online and has an IP address, and CIP connections are established.	None
Flashing red	One or more CIP connections has timed-out.	Check for I/O module failure and controller operation, and correct, as needed.
Solid red	Duplicate IP address detected.	Verify IP address setting and correct, as needed.
Flashing red/green	The module is performing a self-test (only occurs during cycle power test).	None
<b>POINTBus Status</b>		
Off	Device not powered – check module status indicator.	Apply power to device.
Flashing red/green	LED cycle power test present.	None
Flashing red	Recoverable fault occurred: <ul style="list-style-type: none"> <li>• At cycle power the number of expected modules does not equal the number of modules present</li> <li>• A module is missing</li> <li>• Node fault (I/O connection timeout) occurred.</li> </ul>	<ul style="list-style-type: none"> <li>• Configure chassis size.</li> <li>• Check for missing module and reinstall as needed.</li> <li>• Check for I/O module failure and correct as needed.</li> </ul>
Solid red	Unrecoverable fault occurred – the adapter is bus off.	<ol style="list-style-type: none"> <li>1. Cycle power to device.</li> <li>2. If condition persists, replace device.</li> </ol>
Flashing green	Firmware (NVS) update in progress.	None
Solid green	Adapter online with connections established (normal operation, Run mode).	None



---

<b>System Power</b>		
Off	Not active; field power is off or DC-DC converter problem present.	1. Verify power is on, and apply power if needed. 2. Verify backplane power not exceeded, and correct. 3. Replace 1734-AENT module.
Green	System power is on; DC-DC converter is active (5V).	None
<b>Field Power</b>		
Off	Not active; field power is off.	Apply field power.
Green	Power is on; 24V is present.	None

**Notes:**

## Adapter Web Pages

### What This Appendix Contains

Read this appendix for information about the adapter Web page diagnostics that offer extensive internal and network diagnostics.

Topic	Page
Work with the Home Page	67
Work with the Diagnostics Pages	69
Work with the Configuration Pages	76
Work with the Browse Chassis Page	80

### Work with the Home Page

Use the adapter diagnostics Home page to access other adapter diagnostics Web pages and see the following information.

- Host Name
- Module Description
- Module Location
- IP Address
- Ethernet Address (MAC)
- DHCP Enabled
- Product Revision
- Serial Number
- Status
- Auto Negotiate
- Media Speed
- Half or Full Duplex

To display and work with the adapter diagnostics Home page, follow these procedures.

---

**IMPORTANT**

Make sure that your PC Internet LAN setting and your TCP/IP settings are configured to access the subnet on which your adapter communicates.

---

**ATTENTION**



You must use Series C POINT I/O modules with the 1734-AENT adapter. Series A or B POINT I/O modules will not work with this adapter.

1. From a browser such as Netscape or Microsoft Internet Explorer, enter the adapter IP address to see the Home page.

Enter the adapter IP address to see the Home page.

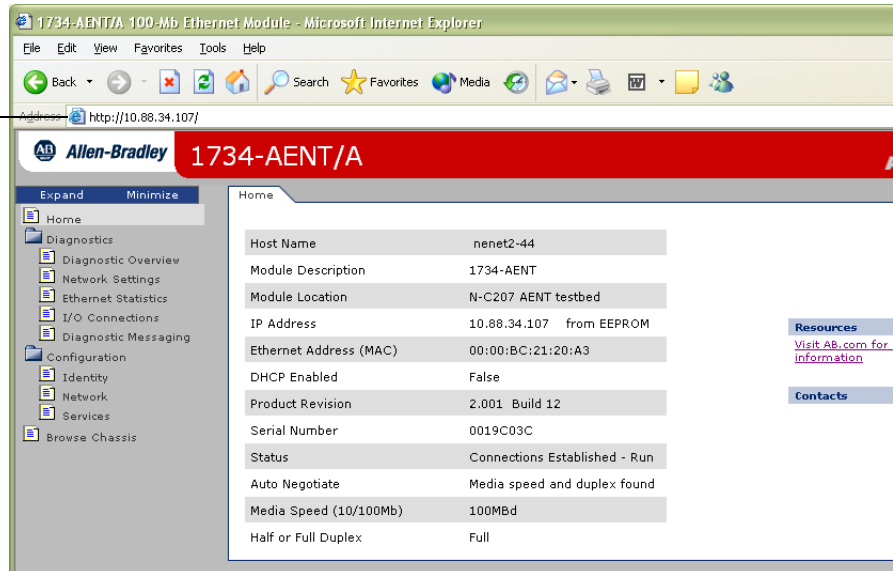

2. From the Home page, click Expand to expand options, as in the figure, or Minimize to see Diagnostics, Configuration, and Browse Chassis options without the expansion.

Click Expand to expand options.

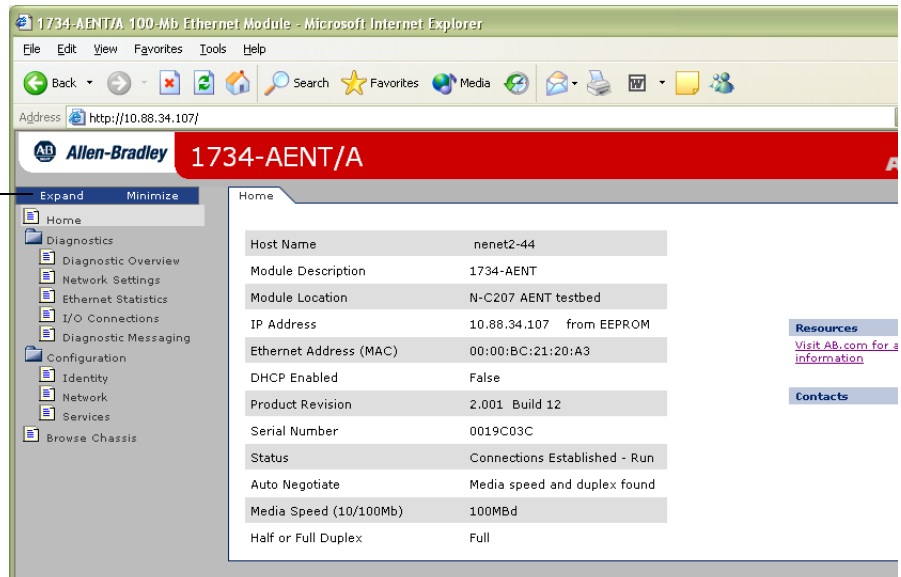

3. From the Home page, complete one of these, as desired.
  - Click one of these to go to <http://www.ab.com/>.
    - Allen-Bradley logo at the top of the page
    - Visit [ab.com](http://www.ab.com/) for additional information statement under Resources
  - Click Rockwell Automation at the top right to go to <http://www.rockwellautomation.com/>.
  - Click these to see additional diagnostics Web pages.
    - Diagnostics – Diagnostic overview, Network Settings, Ethernet Statistics, I/O Connections, Diagnostic messaging
    - Configuration - Identity, Network, Services
    - Browse chassis

## Work with the Diagnostics Pages

To work with the Diagnostics options, follow these procedures.

1. From the Home page, click Diagnostics or Expand to see the following diagnostics options from the panel at the left.
  - Diagnostic overview
  - Network settings
  - Ethernet statistics
  - I/O connections
  - Diagnostic messaging
2. From from the top of the page, as shown in the figure, if desired, type a refresh rate, noting that the default is 15 seconds.
3. From the panel at the left or tabs at the top of the page, as shown in the figure, click one of the diagnostics options to see the corresponding page.

Click tabs to see the corresponding page.

Click from this panel to see the corresponding page.

## Use the Diagnostic Overview Page

To use the Diagnostic Overview page to view general diagnostics information, follow this procedure.

1. From the Web page, click the Diagnostic Overview tab at the top of the page or panel on the left.

The Diagnostic Overview tab opens.

The screenshot shows the Diagnostic Overview page for the 1734-AENT/A module. The page is displayed in a Microsoft Internet Explorer browser window. The browser's address bar shows the URL http://10.88.92.96/. The page header includes the Allen-Bradley logo and the product name 1734-AENT/A. The main content area is divided into several sections:

- Ethernet Link**: Media Speed (10/100Mb) is 100MBd, Half or Full Duplex is Full, and Autonegotiate Status is Media speed and duplex found.
- Module Settings**: Chassis Size is 5 and Switches is 999.
- System Resource Utilization**: CPU Utilization is 0.0% (1.2% [pk]) and Module Uptime is 0 days, 17h:41m:53s.
- CIP Connection Statics**: Current CIP Msg Connections is 0, CIP Msg Connection Limit is 32, Max Msg Connections Observed is 0, Current CIP I/O Connections is 0, CIP I/O Connection Limit is 20, Max I/O Connections Observed is 0, and Conn Opens is 0.

2. From the Diagnostic Overview tab, view the following.

- Ethernet Link Status
  - Media Speed
  - Half or Full Duplex
  - Autonegotiate Status
- System Resource Utilization
  - CPU Utilization
  - Module Uptime
- CIP Connection Statics
  - Current CIP MSG Connections
  - CIP MSG Connection Limit
  - Max Msg Connections Observed
  - Current CIP I/O Connections
  - CIP I/O Connection Limit
  - Max I/O Connections Observed
  - Conn Opens

- Open Errors
- Conn Closes
- Close Errors
- Conn Timeout
- Status
- Module Settings
  - Chassis Size
  - Switches

## Use the Network Settings Page

To use the Network Settings page to view network related information, follow this procedure.

1. From the Web page, click the Network Settings tab at the top of the page or panel on the left.

The Network Settings tab opens.

Network Interface	
Ethernet Address (MAC)	00:00:BC:21:92:13
IP Address	10.88.92.96
Subnet Mask	255.255.252.0
Default Gateway	10.88.92.1
Primary Name Server	
Secondary Name Server	
Default Domain Name	
Host Name	
Name Resolution	DNS Disabled
Ethernet Interface Configuration	
Obtain Network Configuration	Static
Ethernet Link	
Media Speed (10/100Mb)	100Mb
Half or Full Duplex	Full
Autonegotiate Status	Media speed and duplex found

2. From the Network Settings page, view the following.

- Network Interface
  - Ethernet Address (MAC)
  - IP Address
  - Subnet Mask
  - Default Gateway
  - Primary Name Server
  - Secondary Name Server
  - Default Domain Name
  - Host Name
  - Name Resolution
- Ethernet Interface Configuration
  - How the Network Configuration was obtained - Static or Dynamic
- Ethernet Link
  - Media Speed
  - Half or Full Duplex
  - Autonegotiate Status

## **Use the Ethernet Statistics Page**

To use the Ethernet Statistics page to view information about the Ethernet link and interface and media counters, use this procedure.

1. From the Web page, click the Ethernet Statistics tab at the top of the page or panel on the left.



The Ethernet Statistics tab opens.

The screenshot shows the Allen-Bradley 1734-AENT/A web interface. The 'Ethernet Statistics' tab is active. The page displays the following data:

Ethernet Link		Media Counters	
Media Speed (10/100Mb)	100MBd	Alignment Errors	0
Half or Full Duplex	Full	FCS Errors	0
Autonegotiate Status	Media speed and duplex found	Single Collisions	0
<b>Interface Counters</b>		Multiple Collisions	0
In Octets	8273283	SQE Test Errors	0
In Ucast Packets	28574	Deferred Transmissions	0
In NUcast Packets	7451	Late Collisions	0
In Discards	0	Excessive Collisions	0
In Errors	0	MAC Transmit Errors	2415
In Unknown Protos	36087	Carrier Sense Errors	0
Out Octets	2817464	Frame Too Long	0
Out Ucast Packets	26050	MAC Receive Errors	0
Out NUcast Packets	165		
Out Discards	0		
Out Errors	0		

2. From the Ethernet Statistics tab, view the following:

- Ethernet Link
  - Media Speed, Half or Full Duplex, Autonegotiate Status
- Interface Counters
  - In Octets, In UCast Packets, In NUcast Packets, In Discards, In Errors, In Unknown Protos, Out Octets, Out Ucast Packets, Out NUcast Packets, Out Discards, Out Errors
- Media Counters
  - Alignment Errors
  - FCS Errors
  - Single Collisions
  - Multiple Collisions
  - SQE Test Errors
  - Deferred Transmissions
  - Late Collisions
  - Excessive Collisions
  - MAC Transmit Errors
  - Carrier Sense Errors
  - Frame Too Long
  - Mac Receive Errors

## Use the I/O Connections Page

To use the I/O Connections page to view CIP I/O (Class 1) connection information, follow this procedure.

1. From the Web page, click the I/O Connections tab at the top of the page or panel on the left.

The I/O Connections tab opens.

The top value in this column representing Lost shows the number of packets from the source missing.

The value for Slot shows the slot number of the I/O module this connection is controlling.

Conn #/Uptime	Rcv/Xmt	Conn. ID	Source	Dest	Multicast Addr.	RPI	Lost/Slot	Size
1	Rcv	0x44C00101	10.88.92.100 (O)	10.88.92.96		10	0	17
00h:26m:09s	Xmt	0x44C00115	10.88.92.96 (T)	10.88.92.100	239.192.13.0	10	0	13
3	Rcv	0x44C00303	10.88.92.100 (O)	10.88.92.96		50	0	0
00h:26m:07s	Xmt	0x44C00317	10.88.92.96 (T)	10.88.92.100	239.192.13.2	50	2	10
4	Rcv	0x44C00404	10.88.92.100 (O)	10.88.92.96		50	0	8
00h:26m:07s	Xmt	0x44C00418	10.88.92.96 (T)	10.88.92.100	239.192.13.3	50	3	6
5	Rcv	0x44C00202	10.88.92.100 (O)	10.88.92.96		10	0	0
00h:26m:07s	Xmt	0x44C00216	10.88.92.96 (T)	10.88.92.100	239.192.13.1	10	4	5

2. From the I/O Connections page, view the following:

- Connection Number
- Uptime
- Receive and Transmit (Rcv/Xmt)
- Connection ID
- Source IP Address with an indication of the following
  - (O) for originator
  - (I) for target
- Destination IP Address
- Multicast Address
- Requested Packet Interval (RPI)
- Lost/Slot that shows the number of lost packets and the slot number for the connection, with a slot value of 0 indicating that this is a rack-optimized connection
- Size of data in bytes

## Use the Diagnostic Messaging Page

To use the Diagnostic Messaging page to execute explicit, unconnected message services, use this procedure.

1. From the Web page, click the Diagnostic Messaging tab at the top of the page or panel on the left.

The Diagnostic Messaging tab opens.

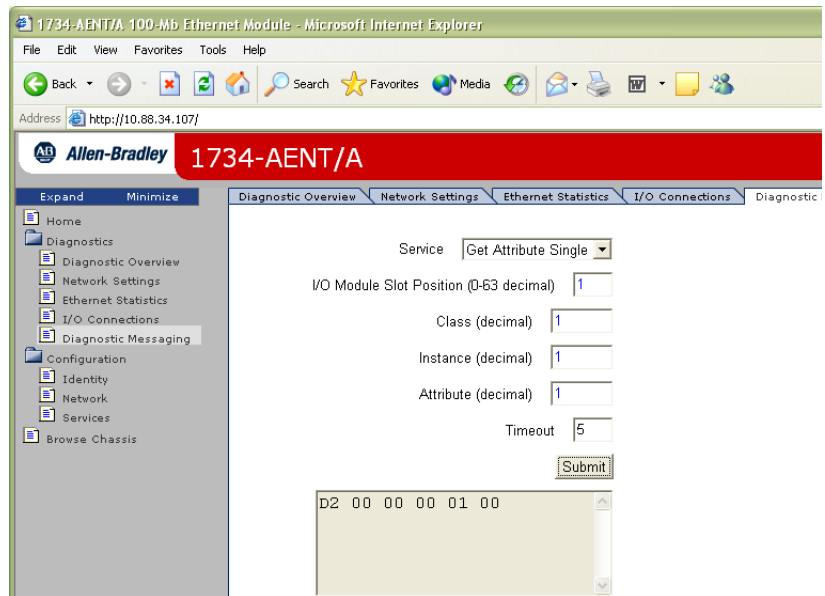

2. From the Diagnostic Messaging tab, enter the following:
  - Service – choose either Get Attribute Single or Get Attributes All
  - I/O Module Slot Position (0...63 decimal)
  - Class (decimal)
  - Instance (decimal)
  - Attribute (decimal)
  - Timeout

- From the Diagnostic Messaging tab, click Submit to see values similar to that in the figure.

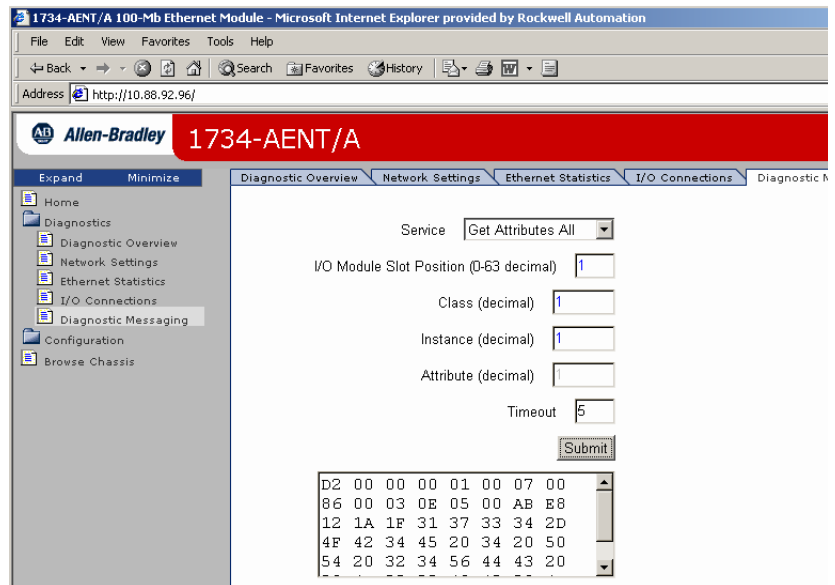

## Work with the Configuration Pages

To work with the Configuration pages, follow these procedures, noting that values on these pages are stored in and retrieved from non-volatile memory.

### IMPORTANT

The values on these pages are in non-volatile memory. Changes to these parameters do not take effect until you reset or cycle power to the 1734-AENT adapter.

### IMPORTANT

If you set the thumbwheels on the 1734-AENT adapter to the value 888 and then power cycle the module, the following occurs:

- The DHCP Enabled function is enabled (set to True).
- The Ethernet link is negotiated automatically. The Auto Negotiate function is set to True.
- The Web server is enabled. The Disabled Web Server function is disabled.
- The password for this page resets to the factory default. The word password is the factory default password.

Note the value of the switches before you enter the 888 value because you return the adapter to those values once this process is complete.

- From the Home page, click Configuration or Expand to see the Configuration options, if needed.

2. From the Configuration page, click one of these.
  - Identity
  - Network
  - Services

The Enter Network Password dialog opens.

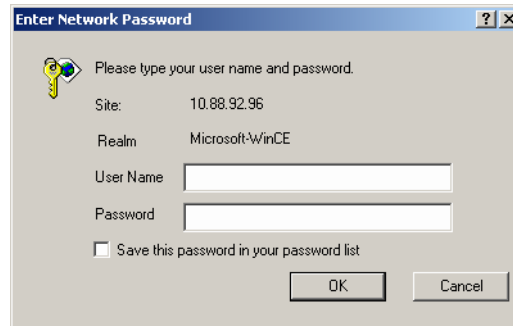

3. From the user name and password dialog, enter values, noting the following.
  - The values for user name and password are case sensitive.
  - The default user name is admin.
  - The default password is password.
4. From the user name and password dialog, click OK to log in, noting that after you log in you can go to any of the Configuration pages without logging in again.
5. Refer to the section of this manual that describes which of these you clicked: Identity, Network, Services.

## Use the Identity Page

To use the Identify page to make entries for the host name, module description, module location, and chassis size, use this procedure.

1. From the Web page, click Identity from the tab at the top of the page or panel on the left.

You see the Identity page.

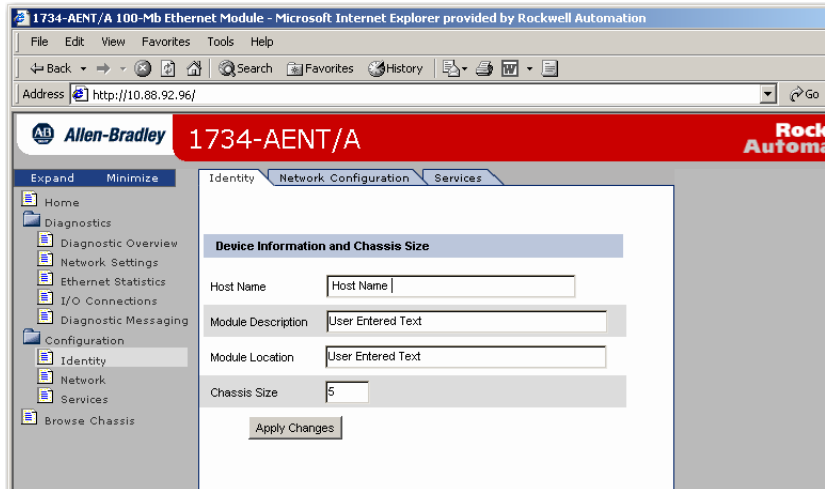

2. From the Identity tab, complete entries for the following, noting that the description and location help you identify where modules are in the facility.
  - Host Name – the name a Domain Name Server uses to resolve this adapter’s IP address
  - Module Description
  - Module Location
  - Chassis Size – the value that shows the number of POINT I/O modules plus the adapter. This value must match the number of I/O modules plus one for the adapter before any I/O connections are allowed.
3. Click Apply Changes to save the modified values.

## Use the Network Configuration Page

To use the Network Configuration page to make entries for enabling or disabling DHCP and setting TCP/IP parameters and Ethernet link operation, follow this procedure.

1. From the Web page, click the Network tab at the top of the page or panel on the left.

You see the Network Configuration page.

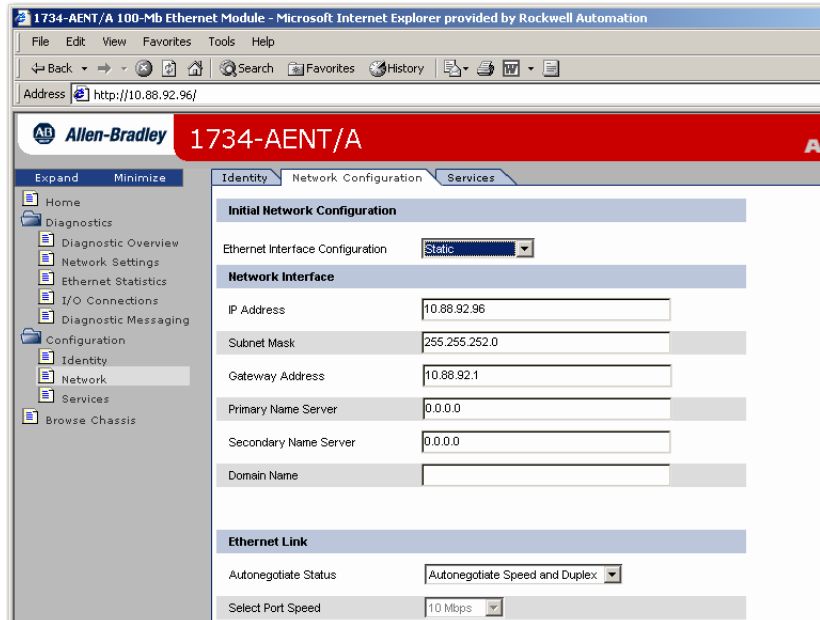

2. From the Network Configuration tab, complete these entries, noting that values for Network Interface are disabled when DHCP is Dynamic DHCP and port speed and duplex mode are disabled when Autonegotiate Speed and Duplex is selected.
  - For Initial Network Configuration
    - Ethernet Interface Configuration
      - Static
      - Dynamic DHCP
  - For Network Interface, select from these choices.
    - IP Address
    - Subnet Mask
    - Gateway Address
    - Primary Name Server
    - Secondary Name Server
    - Domain Name
  - For Ethernet Link, select from these choices.
    - Autonegotiate Status
      - Autonegotiate Speed and Duplex
      - Force Speed and Duplex
    - Select Port Speed – 10 megabits, 100 megabits
    - Select Duplex Mode – Half Duplex, Full Duplex
3. Click Apply Changes to save the modified values.

## Use the Services Page

To use the Services page to change the password for the Configuration web page or disable the Web server, complete these procedures.

1. From the Web page, click the Services tab at the top of the page or panel on the left.

The Services tab opens.

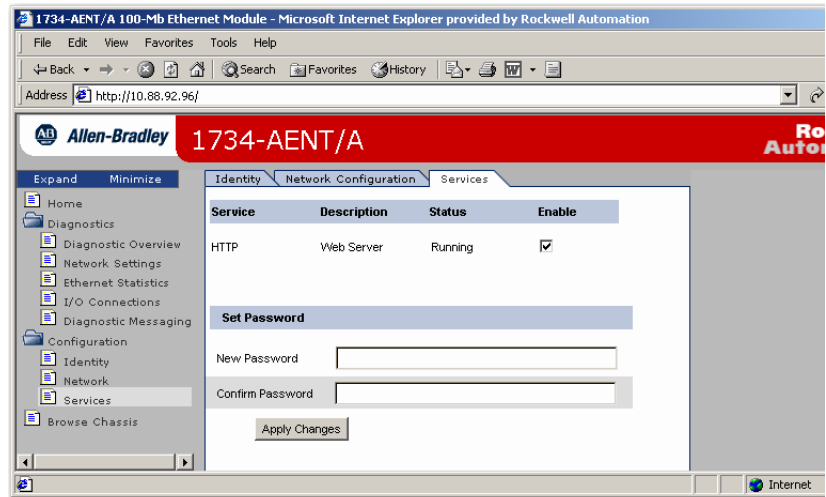

2. From the Services tab, make these entries:
  - Click in the Enable box to change whether the Web server runs after the module is reset.
  - Change the password by typing the new value for New Password and Confirm Password, noting the following.
    - The entry is case sensitive.
    - The default value is the word password.
3. Click Apply Changes.

## Work with the Browse Chassis Page

Use the Browse Chassis page for the following.

- See what modules are present on the system.
- Run a query from slot 1 to slot 63.
- Display the modules found based on the query.
- Provide an easy way to see what modules the adapter is recognizing on your system.



To work with the Browse Chassis page, follow these procedures.

1. From the Home page, click Browse Chassis.

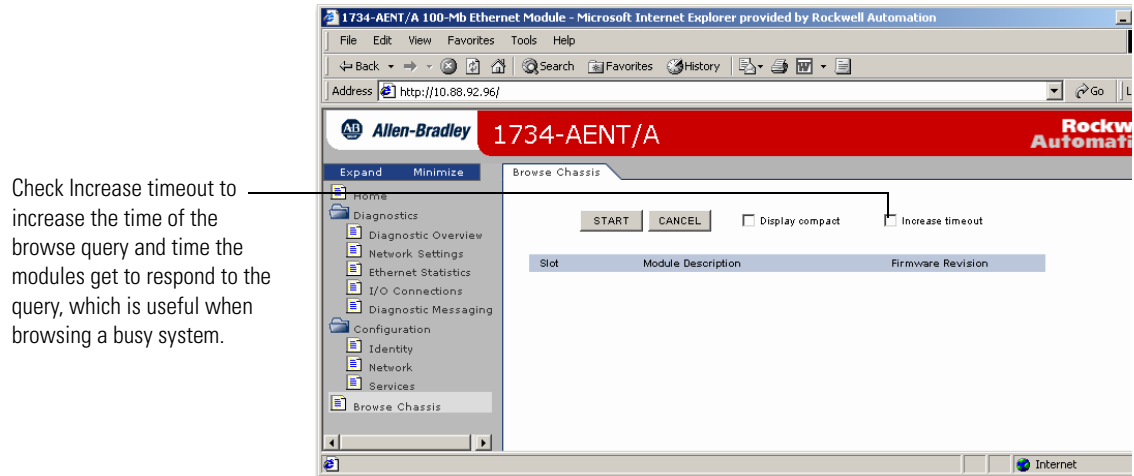

2. From the Browse Chassis page, leave the Display compact check box unchecked, if desired, unless you want to decrease the font size, making it easier to read the full page after the query.
3. Check the Increase timeout check box so a check mark appears, if desired.

This increases the time of the browse query and time the modules get to respond to the query. This function is useful when you are browsing a busy system.

4. Click Start to run the query, noting that you see a page such as the one in the the figure, which shows that module hyperlinks are disabled while browsing before the query completes or is cancelled.

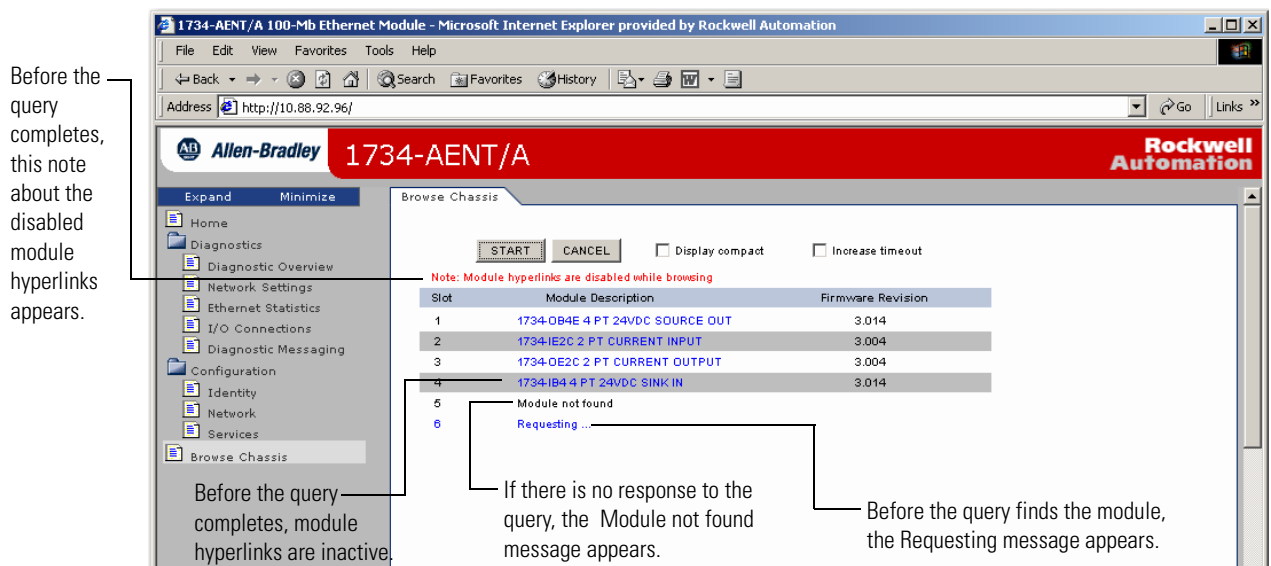

After completion of a query, here is how a typical Browse Chassis page looks with the module hyperlinks active and the Display compact check box unchecked.

Click a module hyperlink to view information about the module.

Slot	Module Description	Firmware Revision
1	<a href="#">1734-OB4E 4 PT 24VDC SOURCE OUT</a>	3.014
2	<a href="#">1734-IE2C 2 PT CURRENT INPUT</a>	3.004
3	<a href="#">1734-OE2C 2 PT CURRENT OUTPUT</a>	3.004
4	<a href="#">1734-IB4 4 PT 24VDC SINK IN</a>	3.014
5	Module not found	
6	Module not found	
7	Module not found	
8	Module not found	
9	Module not found	
10	Module not found	
11	Module not found	
12	Module not found	
13	Module not found	
14	Module not found	

Here is how a typical Browse Chassis page looks with the Display compact check box checked.

Click a module hyperlink to view information about the module.

Slot	Module Description	Firmware Revision
1	<a href="#">1734-OB4E 4 PT 24VDC SOURCE OUT</a>	3.014
2	<a href="#">1734-IE2C 2 PT CURRENT INPUT</a>	3.004
3	<a href="#">1734-OE2C 2 PT CURRENT OUTPUT</a>	3.004
4	<a href="#">1734-IB4 4 PT 24VDC SINK IN</a>	3.014
5	Module not found	
6	Module not found	
7	Module not found	
8	Module not found	
9	Module not found	
10	Module not found	
11	Module not found	
12	Module not found	
13	Module not found	
14	Module not found	
15	Module not found	
16	Module not found	
17	Module not found	
18	Module not found	
19	Module not found	
20	Module not found	
21	Module not found	
22	Module not found	

- From the Browse Chassis page, to view information about a particular module, click the Module Description hyperlink.

The Module Information page displays the following about the module:

- Product Name
- Vendor
- Product Type
- Product Code

- Module Revision
- Serial Number
- Status

The screenshot shows a Microsoft Internet Explorer browser window displaying the '1734 Module Information' page. The browser's address bar shows the URL 'http://10.88.92.96/ModuleInfo.html?Slot=4'. The page header features the Allen-Bradley logo and the model number '1734-AENT/A'. The main content area is titled 'Module Information' and contains a table of details for 'Slot 4'. Below the table, there are four input status indicators, each labeled 'Input X = Off' with a corresponding square checkbox.

Module Information: Slot 4	
Product Name	1734-IB4 4 PT 24VDC SINK IN
Vendor	1
Product Type	7
Product Code	130
Module Revision	3.00e
Serial Number	1A130ECF
Status	0005

Input 0 = Off

Input 1 = Off

Input 2 = Off

Input 3 = Off

**Notes:**

## Configure the RSLinx Ethernet Communication Driver

### What This Appendix Contains

To communicate with your 1734-AENT adapter over your network you must configure the RSLinx EtherNet/IP driver (AB\_ETH/IP). You need one of these drivers to download the example application programs in this manual.

See the table for a list of the contents of this appendix and where to find specific information:

Topic	Page
Install the RSLinx Software	87
Configure the AB_ETH/IP Driver	88

**ATTENTION**

You must use series C POINT I/O modules with the 1734-AENT adapter. Series A or B POINT I/O modules will not work with this adapter.

### Install the RSLinx Software

Use this procedure to install RSLinx software on your computer.

1. Insert the CD in the CD-ROM drive.

Note that the CD-ROM supports Windows Autorun. Once inserted into the CD-ROM drive, if you have Autorun configured, the installation automatically starts at the first setup screen.

If Autorun is not configured for your CD-ROM drive, go to step 2.

2. From the Start menu, choose Run.  
The Run dialog appears.
3. Type d:/setup (if it doesn't appear automatically), where d: is your CD-ROM driver letter.
4. Click OK.  
You see the progress bar, followed by the welcome screen.

## Configure the AB\_ETH/IP Driver

To configure the AB\_ETH/IP Ethernet communication driver, perform the following steps.

1. Start RSLinx software.
2. From the Communications menu, select Configure Drivers.

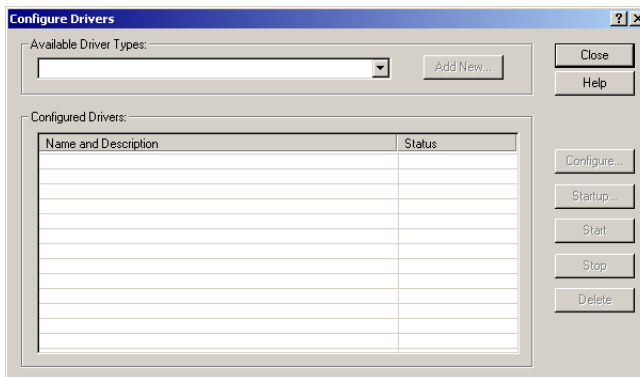

3. Click the arrow to the right of the Available Driver Types box. The Available Driver Types list appears.
4. Select EtherNet/IP Devices and click Add/New.

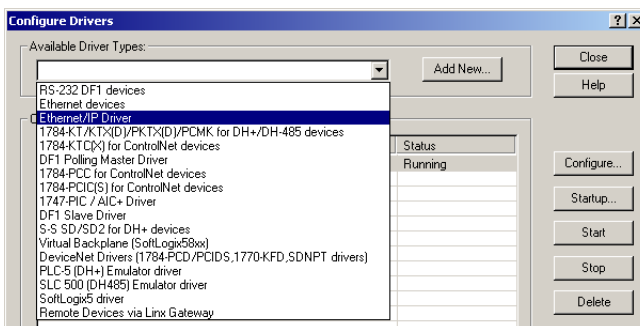

The Configure driver dialog opens.

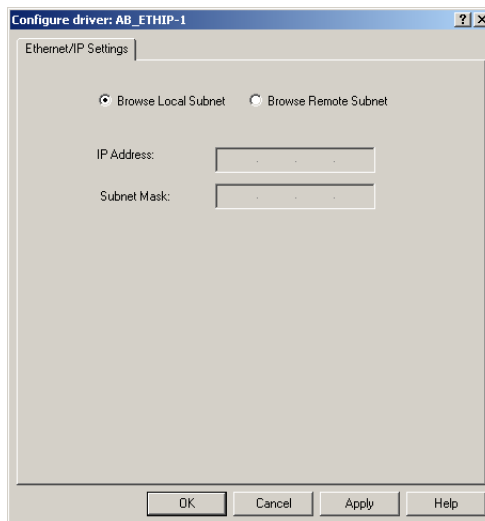

5. Make sure the Browse Local Subnet button is selected.

RSLinx software browses your local subnet and automatically reads the IP address.

6. Click OK.

The AB\_ETH/IP driver is now configured and appears in the configured drivers window.

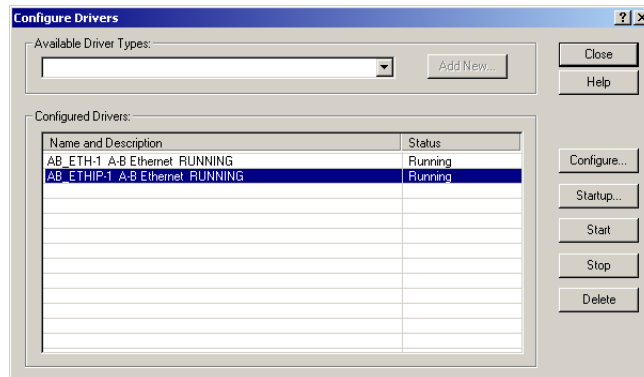

7. Close RSLinx software.

## Notes:



## POINT I/O Module and RSLogix 5000 Software Controller Tag Reference

### What This Appendix Contains

Read this appendix for information about tag references.

**ATTENTION**

You must use series C POINT I/O modules with the 1734-AENT adapter. Series A or B POINT I/O modules will not work with this adapter.

### 1734 POINT I/O Catalog Numbers

1734 POINT I/O Catalog Number	RSLogix 5000 Module Description
<b>Digital Modules</b>	
1734-IA2/C	2 POINT 120V AC Input
1734-IB2/C	2 POINT 10...28V DC Input, Sink
1734-IB4/C	4 POINT 10...28V DC Input, Sink
1734-IM2/C	2 POINT 240V AC Input
1734-IV2/C	2 POINT 10...28V DC Input, Source
1734-IV4/C	4 POINT 10...28V DC Input, Source
1734-OA2/C	2 POINT 120V AC Output
1734-OB2E/C	2 POINT 10...28V DC Electronically Fused Output, Source
1734-OB2EP/C	2 POINT 10...28V DC Electronically Fused Protected Output, Source
1734-OB4E/C	4 POINT 10...28V DC Electronically Fused Output, Source
1734-OV2E/C	2 POINT 10...28V DC Electronically Fused Output, Sink
1734-OV4E/C	4 POINT 10...28V DC Electronically Fused Output, Sink
1734-OW2/C	2 POINT AC/DC Relay Output
1734-OX2/C	2 POINT Relay Output N.O./N.C.
<b>Analog Modules</b>	
1734-IE2C/C	2 Channel Analog Current Input
1734-IE2V/C	2 Channel Analog Voltage Input
1734-IR2/C	2 Channel RTD Input
1734-IT2I/C	2 Channel Thermocouple Input, Isolated
1734-OE2C/C	2 Channel Analog Current Output
1734-OE2V/C	2 Channel Analog Voltage Output

1734 POINT I/O Catalog Number	RSLogix5000 Module Description
<b>Specialty I/O</b>	
1734-232ASC/C	1 Channel ASCII Interface Module
1734-IJ/C	1 Channel 5V DC Encoder/Counter
1734-IK/C	1 Channel 15...24V DC Encoder/Counter
1734-SSI/C	1 Channel Synchronous Serial Interface
1734-VHSC24/C	1 Channel 15...24V DC Very High-speed Counter
1734-VHSC5/C	1 Channel 5V DC Very High-speed Counter

Note that all POINT I/O modules must be **series C** or above for RSLogix 5000 software, version 11, compatibility.

The 1734-232ASC/A (series A) is presently the only exception to the **series C** requirement. With RSLogix 5000 software, version 11, use it as a generic 1734 module. With RSLogix 5000 software, version 12 or later, it is directly supported.

## Valid Number Ranges for RSLogix 5000 Data Types

Type	Number	Range
BIT	1 Bit	0 or 1
SINT	8 Bit	-128...127
INT	16 Bit	-32,768...32,767
DINT	32 Bit	-2,147,483,648...2,147,483,647

Accepted parameter values are dependent on POINT I/O module type and tag type.

## Digital 2 POINT Input

### 1734-IA2

2 POINT 120V AC Input

### 1734-IB2

2 POINT 10...28V DC Input, Sink

### 1734-IM2

2 POINT 240V AC Input

### 1734-IV2

2 POINT 10...28V DC Input, Source

Configuration Data	Data Type	Default Value	Valid Data Values
Filter Off On Time - POINT 0	INT	1,000	-32,768...32,767 $\mu\text{s}$ <sup>(1)</sup> (0...65,535)
Filter On Off Time - POINT 0	INT	1,000	-32,768...32,767 $\mu\text{s}$ <sup>(1)</sup> (0...65,535)
Filter Off On Time - POINT 1	INT	1,000	-32,768...32,767 $\mu\text{s}$ <sup>(1)</sup> (0...65,535)
Filter On Off Time - POINT 1	INT	1,000	-32,768...32,767 $\mu\text{s}$ <sup>(1)</sup> (0...65,535)

Input Data	Data Type	Default Value	Valid Data Values
Input Data - POINT 0, 1	SINT, BIT	0	<b>0=Off</b> 1=On

Output Data	Data Type	Default Value	Valid Data Values
<b>None</b>			

<sup>(1)</sup> POINT I/O Modules support the Unsigned Integer data type UINT (0...65,535 range).  
RSLogix 5000 software supports the signed Integer data type INT (-32,768 ...+32,767 range).  
To enter Filter values from +32,768...+65,535  $\mu\text{s}$ , use this conversion formula:  
Desired Filter Value (in  $\mu\text{s}$ ) - 65536 = Entered Filter Value (in  $\mu\text{s}$ ).  
As an example, for a 40 ms filter time, 40000 - 65536 = -25536

## Digital 4 POINT Input

### 1734-IB4

4 POINT 10...28V DC Input, Sink

### 1734-IV4

4 POINT 10...28V DC Input, Source

Configuration Data	Data Type	Default Value	Valid Data Values
Filter Off On Time - POINT 0	INT	1,000	-32,768...32,767 $\mu$ s <sup>(1)</sup> (0...65,535)
Filter On Off Time - POINT 0	INT	1,000	-32,768...32,767 $\mu$ s <sup>(1)</sup> (0...65,535)
Filter Off On Time - POINT 1	INT	1,000	-32,768...32,767 $\mu$ s <sup>(1)</sup> (0...65,535)
Filter On Off Time - POINT 1	INT	1,000	-32,768...32,767 $\mu$ s <sup>(1)</sup> (0...65,535)
Filter Off On Time - POINT 2	INT	1,000	-32,768...32,767 $\mu$ s <sup>(1)</sup> (0...65,535)
Filter On Off Time - POINT 2	INT	1,000	-32,768...32,767 $\mu$ s <sup>(1)</sup> (0...65,535)
Filter Off On Time - POINT 3	INT	1,000	-32,768...32,767 $\mu$ s <sup>(1)</sup> (0...65,535)
Filter On Off Time - POINT 3	INT	1,000	-32,768...32,767 $\mu$ s <sup>(1)</sup> (0...65,535)

Input Data	Data Type	Default Value	Valid Data Values
Input Data - POINT 0, 1, 2, 3	SINT, BIT	0	<b>0=Off</b> 1=On

Output Data	Data Type	Default Value	Valid Data Values
<b>None</b>			

<sup>(1)</sup> POINT I/O Modules support the Unsigned Integer data type UINT (0...65,535 range).  
RSLogix 5000 software supports the signed Integer data type INT (-32,768...+32,767 range).  
To enter Filter values from +32,768...+65,535  $\mu$ s, use this conversion formula:  
Desired Filter Value (in  $\mu$ s) - 65536 = Entered Filter Value (in  $\mu$ s).  
As an example, for a 40 ms filter time, 40000 - 65536 = -25536

## Digital 2 POINT Output – Without Diagnostic Status

**1734-0A2**  
2 POINT 120V AC Output

**1734-0W2**  
2 POINT AC/DC Relay Output

**1734-0X2**  
2 POINT Relay Output N.O./N.C.

Configuration Data	Data Type	Default Value	Valid Data Values
Fault Mode - POINT 0, 1	SINT, BIT	0	<b>0=Fault Value</b> 1=Hold Last State
Fault Value - POINT 0, 1	SINT, BIT	0	<b>0=Off</b> 1=On
Program Mode - POINT 0, 1	SINT, BIT	0	<b>0=Program Value</b> 1=Hold Last State
Program Value - POINT 0, 1	SINT, BIT	0	<b>0=Off</b> 1=On

Input Data	Data Type	Default Value	Valid Data Values
None			

Output Data	Data Type	Default Value	Valid Data Values
Output Data - POINT 0, 1	SINT, BIT	0	<b>0=Off</b> 1=On

## Digital 2 POINT Output – With Over Load and Open Load Diagnostic Status

### 1734-OB2E

2 POINT 10...28V DC Electronically Fused Output, Source

### 1734-OB2EP

2 POINT 10...28V DC Electronically Fused Protected Output, Source

Configuration Data	Data Type	Default Value	Valid Data Values
Fault Mode - POINT 0, 1	SINT, BIT	0	<b>0=Fault Value</b> 1=Hold Last State
Fault Value - POINT 0, 1	SINT, BIT	0	<b>0=Off</b> 1=On
Program Mode - POINT 0, 1	SINT, BIT	0	<b>0=Program Value</b> 1=Hold Last State
Program Value - POINT 0, 1	SINT, BIT	0	<b>0=Off</b> 1=On
No Load Enable - POINT 0, 1 (Wire Off Diagnostic)	SINT, BIT	1	0=Disabled <b>1=Enabled</b>
Auto Restart Enable - POINT 0, 1 (Over Load Behavior)	SINT, BIT	0	<b>0=Latch Off</b> 1=Auto Retry
Fault Latch Enable - POINT 0, 1 (Open Load or Over Load)	SINT, BIT	0	<b>0=No Latching</b> 1=Alarms Latch

Input Data	Data Type	Default Value	Valid Data Values
Status Data - POINT 0, 1 (Open Load or Over Load)	SINT, BIT	0	<b>0=Off</b> 1=On (Load Fault)

Output Data	Data Type	Default Value	Valid Data Values
Output Data - POINT 0, 1	SINT, BIT	0	<b>0=Off</b> 1=On

## Digital 2 POINT Output – With Over Load Diagnostic Status

### 1734-0V2E

2 POINT 10...28V DC Electronically Fused Output, Sink

Configuration Data	Data Type	Default Value	Valid Data Values
Fault Mode - POINT 0, 1	SINT, BIT	0	<b>0=Fault Value</b> 1=Hold Last State
Fault Value - POINT 0, 1	SINT, BIT	0	<b>0=Off</b> 1=On
Program Mode - POINT 0, 1	SINT, BIT	0	<b>0=Program Value</b> 1=Hold Last State
Program Value - POINT 0, 1	SINT, BIT	0	<b>0=Off</b> 1=On
Auto Restart Enable - POINT 0, 1 (Over Load Behavior)	SINT, BIT	0	<b>0=Latch Off</b> 1=Auto Retry
Fault Latch Enable - POINT 0, 1 (Over Load)	SINT, BIT	0	<b>0=No Latching</b> 1=Alarms Latch

Input Data	Data Type	Default Value	Valid Data Values
Status Data - POINT 0, 1 (Over Load)	SINT, BIT	0	<b>0=Off</b> 1=On (Load Fault)

Output Data	Data Type	Default Value	Valid Data Values
Output Data - POINT 0, 1	SINT, BIT	0	<b>0=Off</b> 1=On

## Digital 4 POINT Output – With Over Load and Open Load Diagnostic Status

### 1734-OB4E

4 POINT 10...28V DC Electronically Fused Output, Source

Configuration Data	Data Type	Default Value	Valid Data Values
Fault Mode - POINT 0, 1, 2, 3	SINT, BIT	0	<b>0=Fault Value</b> 1=Hold Last State
Fault Value - POINT 0, 1, 2, 3	SINT, BIT	0	<b>0=Off</b> 1=On
Program Mode - POINT 0, 1, 2, 3	SINT, BIT	0	<b>0=Program Value</b> 1=Hold Last State
Program Value - POINT 0, 1, 2, 3	SINT, BIT	0	<b>0=Off</b> 1=On
No Load Enable - POINT 0, 1, 2, 3 (Wire Off Diagnostic)	SINT, BIT	1	0=Disabled <b>1=Enabled</b>
Auto Restart Enable - POINT 0, 1, 2, 3 (Over Load Behavior)	SINT, BIT	0	<b>0=Latch Off</b> 1=Auto Retry
Fault Latch Enable - POINT 0, 1, 2, 3 (Open Load or Over Load)	SINT, BIT	0	<b>0=No Latching</b> 1=Alarms Latch

Input Data	Data Type	Default Value	Valid Data Values
Status Data - POINT 0, 1, 2, 3 (Open Load or Over Load)	SINT, BIT	0	<b>0=Off</b> 1=On (Load Fault)

Output Data	Data Type	Default Value	Valid Data Values
Output Data - POINT 0, 1, 2, 3	SINT, BIT	0	<b>0=Off</b> 1=On



## Digital 4 POINT Output – With Over Load Diagnostic Status

### 1734-0V4E

4 POINT 10...28V DC Electronically Fused Output, Sink

Configuration Data	Data Type	Default Value	Valid Data Values
Fault Mode - POINT 0, 1, 2, 3	SINT, BIT	0	<b>0=Fault Value</b> 1=Hold Last State
Fault Value - POINT 0, 1, 2, 3	SINT, BIT	0	<b>0=Off</b> 1=On
Program Mode - POINT 0, 1, 2, 3	SINT, BIT	0	<b>0=Program Value</b> 1=Hold Last State
Program Value - POINT 0, 1, 2, 3	SINT, BIT	0	<b>0=Off</b> 1=On
Auto Restart Enable - POINT 0, 1, 2, 3 (Over Load Behavior)	SINT, BIT	0	<b>0=Latch Off</b> 1=Auto Retry
Fault Latch Enable - POINT 0, 1, 2, 3 (Over Load)	SINT, BIT	0	<b>0=No Latching</b> 1=Alarms Latch
Input Data	Data Type	Default Value	Valid Data Values
Status Data - POINT 0, 1, 2, 3 (Over Load)	SINT, BIT	0	<b>0=Off</b> 1=On (Load Fault)
Output Data	Data Type	Default Value	Valid Data Values
Output Data - POINT 0, 1, 2, 3	SINT, BIT	0	<b>0=Off</b> 1=On

## Analog 2 Channel Input

### 1734-IE2C

2 Channel Analog Current Input

Configuration Data	Data Type	Default Value	Valid Data Values
Low Engineering Channel 0	INT	3,277	-32,768...32,767
High Engineering Channel 0	INT	16,383	-32,768...32,767
Digital Filter Channel 0	INT	0	0...10,000 ms
Low Alarm Limit Channel 0	INT	3,113	-32,768...32,767
High Alarm Limit Channel 0	INT	16,547	-32,768...32,767
Low Low Alarm Limit Channel 0	INT	2,867	-32,768...32,767
High High Alarm Limit Channel 0	INT	16,793	-32,768...32,767
Range Type Channel 0	SINT	3	<b>3=4...20 mA</b> 8=0...20 mA
Limit Alarm Latch Channel 0	SINT	0	<b>0=No Latching</b> 1=Alarms Latch
Alarm Disable Channel 0	SINT	0	<b>0=Alarms Enabled</b> 1=Alarms Disabled
Low Engineering Channel 1	INT	3,277	-32,768...32,767
High Engineering Channel 1	INT	16,383	-32,768...32,767
Digital Filter Channel 1	INT	0	0...10,000 ms
Low Alarm Limit Channel 1	INT	3,113	-32,768...32,767
High Alarm Limit Channel 1	INT	16,547	-32,768...32,767
Low Low Alarm Limit Channel 1	INT	2,867	-32,768...32,767
High High Alarm Limit Channel 1	INT	16,793	-32,768...32,767
Range Type Channel 1	SINT	3	<b>3=4-20 mA</b> 8=0-20 mA
Limit Alarm Latch Channel 1	SINT	0	<b>0=No Latching</b> 1=Alarms Latch
Alarm Disable Channel 1	SINT	0	<b>0=Alarms Enabled</b> 1=Alarms Disabled
Notch Filter <b>(Channel 0 &amp; 1)</b>	SINT	2	1=50 Hz <b>2=60 Hz</b> 4=250 Hz 6=500 Hz
Real-time Sample <b>(Channel 0 &amp; 1)</b>	INT	100	0...10,000 ms

**1734-IE2C**  
2 Channel Analog Current Input

<b>Input Data</b>	<b>Data Type</b>	<b>Default Value</b>	<b>Valid Data Values</b>
Data Channel 0	INT	0	-32,768...32,767
Data Channel 1	INT	0	-32,768...32,767
Status Byte Channel 0	SINT	0	Bit 0 Fault Bit 1 Calibration Bit 2 LowAlarm Bit 3 HighAlarm Bit 4 LowLowAlarm Bit 5 HighHighAlarm Bit 6 Underrange Bit 7 Overrange
Status Byte Channel 1	SINT	0	Bit 0 Fault Bit 1 Calibration Bit 2 LowAlarm Bit 3 HighAlarm Bit 4 LowLowAlarm Bit 5 HighHighAlarm Bit 6 Underrange Bit 7 Overrange

<b>Output Data</b>	<b>Data Type</b>	<b>Default Value</b>	<b>Valid Data Values</b>
None			

**1734-IE2V**

2 Channel Analog Voltage Input

<b>Configuration Data</b>	<b>Data Type</b>	<b>Default Value</b>	<b>Valid Data Values</b>
Low Engineering Channel 0	INT	0	-32,768...32,767
High Engineering Channel 0	INT	10,000	-32,768...32,767
Digital Filter Channel 0	INT	0	0...10,000 ms
Low Alarm Limit Channel 0	INT	500	-32,768...32,767
High Alarm Limit Channel 0	INT	9,500	-32,768...32,767
Low Low Alarm Limit Channel 0	INT	200	-32,768...32,767
High High Alarm Limit Channel 0	INT	9,800	-32,768...32,767
Range Type Channel 0	SINT	2	0=-10...+10V 2=0...10V
Limit Alarm Latch Channel 0	SINT	0	<b>0=No Latching</b> 1=Alarms Latch
Alarm Disable Channel 0	SINT	0	<b>0=Alarms Enabled</b> 1=Alarms Disabled
Low Engineering Channel 1	INT	0	-32,768...32,767
High Engineering Channel 1	INT	10,000	-32,768...32,767
Digital Filter Channel 1	INT	0	0...10,000 ms
Low Alarm Limit Channel 1	INT	500	-32,768...32,767
High Alarm Limit Channel 1	INT	9,500	-32,768...32,767
Low Low Alarm Limit Channel 1	INT	200	-32,768...32,767
High High Alarm Limit Channel 1	INT	9,800	-32,768...32,767
Range Type Channel 1	SINT	2	0=-10...+10V <b>2=0...10V</b>
Limit Alarm Latch Channel 1	SINT	0	<b>0=No Latching</b> 1=Alarms Latch
Alarm Disable Channel 1	SINT	0	<b>0=Alarms Enabled</b> 1=Alarms Disabled
Notch Filter <b>(Channel 0 &amp; 1)</b>	SINT	2	1=50 Hz <b>2=60 Hz</b> 4=250 Hz 6=500 Hz
Real-time Sample <b>(Channel 0 &amp; 1)</b>	INT	100	0...10,000 ms

**1734-IE2V**  
2 Channel Analog Voltage Input

<b>Input Data</b>	<b>Data Type</b>	<b>Default Value</b>	<b>Valid Data Values</b>
Data Channel 0	INT	0	-32,768...32,767
Data Channel 1	INT	0	-32,768...32,767
Status Byte Channel 0	SINT	0	Bit 0 Fault Bit 1 Calibration Bit 2 LowAlarm Bit 3 HighAlarm Bit 4 LowLowAlarm Bit 5 HighHighAlarm Bit 6 Underrange Bit 7 Overrange
Status Byte Channel 1	SINT	0	Bit 0 Fault Bit 1 Calibration Bit 2 LowAlarm Bit 3 HighAlarm Bit 4 LowLowAlarm Bit 5 HighHighAlarm Bit 6 Underrange Bit 7 Overrange

<b>Output Data</b>	<b>Data Type</b>	<b>Default Value</b>	<b>Valid Data Values</b>
None			

**1734-IR2**

2 Channel RTD Input

<b>Configuration Data</b>	<b>Data Type</b>	<b>Default Value</b>	<b>Valid Data Values</b>
Low Engineering Channel 0	INT	1,000	-32,768...32,767
High Engineering Channel 0	INT	5,000	-32,768...32,767
Digital Filter Channel 0	INT	0	0...10,000 ms
Low Alarm Limit Channel 0	INT	-32,768	-32,768...32,767
High Alarm Limit Channel 0	INT	32,767	-32,768...32,767
Low Low Alarm Limit Channel 0	INT	-32,768	-32,768...32,767
High High Alarm Limit Channel 0	INT	32,767	-32,768...32,767
Limit Alarm Latch Channel 0	SINT	0	<b>0=No Latching</b> 1=Alarms Latch
Alarm Disable Channel 0	SINT	0	<b>0=Alarms Enabled</b> 1=Alarms Disabled
Sensor Type Channel 0	SINT	1	0=0hms <b>1=100 Ω Pt α 385</b> 2=200 Ω Pt α 385 5=100 Ω JPt α 3916 6=200 Ω JPt α 3916 9=10 Ω Cu α 427 10=120 Ω Ni α 672 11=100 Ω Ni α 618 12=120 Ω Ni α 618
Temperature Mode Channel 0	SINT	1	0=Custom Scale <b>1=°C</b> 2=°F 3=°K 4=°R
Low Engineering Channel 1	INT	1,000	-32,768...32,767
High Engineering Channel 1	INT	5,000	-32,768...32,767
Digital Filter Channel 1	INT	0	0...10,000 ms
Low Alarm Limit Channel 1	INT	-32,768	-32,768...32,767
High Alarm Limit Channel 1	INT	32,767	-32,768...32,767
Low Low Alarm Limit Channel 1	INT	-32,768	-32,768...32,767
High High Alarm Limit Channel 1	INT	32,767	-32,768...32,767
Limit Alarm Latch Channel 1	SINT	0	<b>0=No Latching</b> 1=Alarms Latch
Alarm Disable Channel 1	SINT	0	<b>0=Alarms Enabled</b> 1=Alarms Disabled

**1734-IR2**

2 Channel RTD Input

<b>Configuration Data</b>	<b>Data Type</b>	<b>Default Value</b>	<b>Valid Data Values</b>
Sensor Type Channel 1	SINT	1	0=0hms <b>1=100 Ω Pt α 385</b> 2=200 Ω Pt α 385 5=100 Ω JPt α 3916 6=200 Ω JPt α 3916 9=10 Ω Cu α 427 10=120 Ω Ni α 672 11=100 Ω Ni α 618 12=120 Ω Ni α 618
Temperature Mode Channel 1	SINT	1	0=Custom Scale <b>1=°C</b> 2=°F 3=°K 4=°R
Notch Filter <b>(Channel 0 &amp; 1)</b>	SINT	1	0=50 Hz <b>1=60 Hz</b> 2=100 Hz 3=120 Hz 4=200 Hz 5=240 Hz 6=300 Hz 7=400 Hz 8=480 Hz

<b>Input Data</b>	<b>Data Type</b>	<b>Default Value</b>	<b>Valid Data Values</b>
Data Channel 0	INT	0	-32,768...32,767
Data Channel 1	INT	0	-32,768...32,767
Status Byte Channel 0	SINT	0	Bit 0 Fault Bit 1 Calibration Bit 2 LowAlarm Bit 3 HighAlarm Bit 4 LowLowAlarm Bit 5 HighHighAlarm Bit 6 Underrange Bit 7 Overrange
Status Byte Channel 1	SINT	0	Bit 0 Fault Bit 1 Calibration Bit 2 LowAlarm Bit 3 HighAlarm Bit 4 LowLowAlarm Bit 5 HighHighAlarm Bit 6 Underrange Bit 7 Overrange
<b>Output Data</b>	<b>Data Type</b>	<b>Default Value</b>	<b>Valid Data Values</b>
None			

**1734-IT2**

2 Channel Thermocouple Input, Isol.

<b>Configuration Data</b>	<b>Data Type</b>	<b>Default Value</b>	<b>Valid Data Values</b>
Cold Junction Notch Filter	SINT	1	0=50 Hz <b>1=60 Hz</b>
Cold Junction Mode	SINT	1	0=None <b>1=Channel 0</b> 2=Channel 1 3=Average Both
Low Engineering Channel 0	INT	0	-32,768...32,767
High Engineering Channel 0	INT	7,000	-32,768...32,767
Alarm Disable Channel 0	SINT	0	<b>0=Alarms Enabled</b> 1=Alarms Disabled
Limit Alarm Latch Channel 0	SINT	0	<b>0=No Latching</b> 1=Alarms Latch
Notch Filter Channel 0	SINT	1	0=50 Hz <b>1=60 Hz</b> 2=100 Hz 3=120 Hz 4=200 Hz 5=240 Hz 6=300 Hz 7=400 Hz 8=480 Hz
Sensor Type Channel 0	SINT	5	0=mV 1=B 2=C 3=E 4=J <b>5=K</b> 6=N 7=R 8=S 9=T
Digital Filter Channel 0	INT	0	0... 10,000 ms
Low Alarm Limit Channel 0	INT	-32,768	-32,768...32,767
High Alarm Limit Channel 0	INT	32,767	-32,768...32,767
Low Low Alarm Limit Channel 0	INT	-32,768	-32,768...32,767
High High Alarm Limit Channel 0	INT	32,767	-32,768...32,767



**1734-IT2**

2 Channel Thermocouple Input, Isol.

<b>Configuration Data</b>	<b>Data Type</b>	<b>Default Value</b>	<b>Valid Data Values</b>
Temperature Mode Channel 0	SINT	1	0=mV/Custom Scale <b>1=°C</b> 2=°F 3=°K 4=°R
Cold Junction Enable Channel 0	SINT	1	0=Disabled <b>1=Enabled</b>
Cold Junction Offset Channel 0	INT	0	0...7,000 (0.00...70.00)
Low Engineering Channel 1	INT	0	-32,768...32,767
High Engineering Channel 1	INT	7,000	-32,768...32,767
Alarm Disable Channel 1	SINT	0	<b>0=Alarms Enabled</b> 1=Alarms Disabled
Limit Alarm Latch Channel 1	SINT	0	<b>0=No Latching</b> 1=Alarms Latch
Notch Filter Channel 1	SINT	1	0=50 Hz <b>1=60 Hz</b> 2=100 Hz 3=120 Hz 4=200 Hz 5=240 Hz 6=300 Hz 7=400 Hz 8=480 Hz
Sensor Type Channel 1	SINT	5	0=mV 1=B 2=C 3=E 4=J <b>5=K</b> 6=N 7=R 8=S 9=T
Digital Filter Channel 1	INT	0	0...10,000 ms
Low Alarm Limit Channel 1	INT	-32,768	-32,768...32,767
High Alarm Limit Channel 1	INT	32,767	-32,768...32,767
Low Low Alarm Limit Channel 1	INT	-32,768	-32,768...32,767
High High Alarm Limit Channel 1	INT	32,767	-32,768...32,767

**1734-IT2**

2 Channel Thermocouple Input, Isol.

<b>Configuration Data</b>	<b>Data Type</b>	<b>Default Value</b>	<b>Valid Data Values</b>
Temperature Mode Channel 1	SINT	1	0=mV/Custom Scale 1=°C 2=°F 3=°K 4=°R
Cold Junction Enable Channel 1	SINT	1	0=Disabled  <b>1=Enabled</b>
Cold Junction Offset Channel 1	INT	0	0...7,000 (0.00...70.00)

<b>Input Data</b>	<b>Data Type</b>	<b>Default Value</b>	<b>Valid Data Values</b>
Data Channel 0	INT	0	-32,768...32,767
Data Channel 1	INT	0	-32,768...32,767
Status Byte Channel 0	SINT	0	Bit 0 Fault Bit 1 Calibration Bit 2 LowAlarm Bit 3 HighAlarm Bit 4 LowLowAlarm Bit 5 HighHighAlarm Bit 6 Underrange Bit 7 Overage
Status Byte Channel 1	SINT	0	Bit 0 Fault Bit 1 Calibration Bit 2 LowAlarm Bit 3 HighAlarm Bit 4 LowLowAlarm Bit 5 HighHighAlarm Bit 6 Underrange Bit 7 Overage
Cold Junction Data	INT	0	-32,768...32,767

<b>Output Data</b>	<b>Data Type</b>	<b>Default Value</b>	<b>Valid Data Values</b>
None			

## Analog 2 Channel Output

### 1734-0E2C

2 Channel Analog Current Output

Configuration Data	Data Type	Default Value	Valid Data Values
Fault Value Channel 0	INT	0	-32,768...32,767
Program Value Channel 0	INT	0	-32,768...32,767
Low Engineering Channel 0	INT	1,638	-32,768...32,767
High Engineering Channel 0	INT	8,191	-32,768...32,767
Low Limit Channel 0	INT	-32,768	-32,768...32,767
High Limit Channel 0	INT	32,767	-32,768...32,767
Range Type Channel 0	SINT	0	<b>0=4...20 mA</b> 2=0...20 mA
Fault Mode Channel 0	SINT	1	0=Hold Last State <b>1=Go to Low Clamp</b> 2=Go to High Clamp 3=Go to Fault Value
Idle Mode Channel 0	SINT	1	0=Hold Last State <b>1=Go to Low Clamp</b> 2=Go to High Clamp 3=Go to Fault Value
Limit Alarm Latch Channel 0	SINT	0	<b>0=No Latching</b> 1=Alarms Latch
Alarm Disable Channel 0	SINT	0	<b>0=Alarms Enabled</b> 1=Alarms Disabled
Fault Value Channel 1	INT	0	-32,768...32,767
Program Value Channel 1	INT	0	-32,768...32,767
Low Engineering Channel 1	INT	1,638	-32,768...32,767
High Engineering Channel 1	INT	8,191	-32,768...32,767
Low Limit Channel 1	INT	-32,768	-32,768...32,767
High Limit Channel 1	INT	32,767	-32,768...32,767
Range Type Channel 1	SINT	0	<b>0=4...20 mA</b> 2=0...20 mA
Fault Mode Channel 1	SINT	1	0=Hold Last State <b>1=Go to Low Clamp</b> 2=Go to High Clamp 3=Go to Fault Value

**1734-0E2C**

2 Channel Analog Current Output

<b>Configuration Data</b>	<b>Data Type</b>	<b>Default Value</b>	<b>Valid Data Values</b>
Idle Mode Channel 1	SINT	1	0=Hold Last State <b>1=Go to Low Clamp</b> 2=Go to High Clamp 3=Go to Fault Value
Limit Alarm Latch Channel 1	SINT	0	<b>0=No Latching</b> 1=Alarms Latch
Alarm Disable Channel 1	SINT	0	<b>0=Alarms Enabled</b> 1=Alarms Disabled

<b>Input Data</b>	<b>Data Type</b>	<b>Default Value</b>	<b>Valid Data Values</b>
Status Byte Channel 0	SINT	0	Bit 0 Fault Bit 1 Calibration Bit 2 LowAlarm Bit 3 HighAlarm
Status Byte Channel 1	SINT	0	Bit 0 Fault Bit 1 Calibration Bit 2 LowAlarm Bit 3 HighAlarm

<b>Output Data</b>	<b>Data Type</b>	<b>Default Value</b>	<b>Valid Data Values</b>
Data Channel 0	INT	0	-32,768...32,767
Data Channel 1	INT	0	-32,768...32,767

**1734-OE2V**

## 2 Channel Analog Voltage Output

<b>Configuration Data</b>	<b>Data Type</b>	<b>Default Value</b>	<b>Valid Data Values</b>
Fault Value Channel 0	INT	0	-32,768...32,767
Program Value Channel 0	INT	0	-32,768...32,767
Low Engineering Channel 0	INT	0	-32,768...32,767
High Engineering Channel 0	INT	10,000	-32,768...32,767
Low Limit Channel 0	INT	-32,768	-32,768...32,767
High Limit Channel 0	INT	32,767	-32,768...32,767
Range Type Channel 0	SINT	1	<b>1=0...10V</b> 3=-10...+10V
Fault Mode Channel 0	SINT	1	0=Hold Last State <b>1=Go to Low Clamp</b> 2=Go to High Clamp 3=Go to Fault Value
Idle Mode Channel 0	SINT	1	0=Hold Last State <b>1=Go to Low Clamp</b> 2=Go to High Clamp 3=Go to Fault Value
Limit Alarm Latch Channel 0	SINT	0	<b>0=No Latching</b> 1=Alarms Latch
Alarm Disable Channel 0	SINT	0	<b>0=Alarms Enabled</b> 1=Alarms Disabled
Fault Value Channel 1	INT	0	-32,768...32,767
Program Value Channel 1	INT	0	-32,768...32,767
Low Engineering Channel 1	INT	0	-32,768...32,767
High Engineering Channel 1	INT	10,000	-32,768...32,767
Low Limit Channel 1	INT	-32,768	-32,768...32,767
High Limit Channel 1	INT	32,767	-32,768...32,767
Range Type Channel 1	SINT	1	<b>1=0...10V</b> 3=-10...+10V
Fault Mode Channel 1	SINT	1	0=Hold Last State <b>1=Go to Low Clamp</b> 2=Go to High Clamp 3=Go to Fault Value
Idle Mode Channel 1	SINT	1	0=Hold Last State <b>1=Go to Low Clamp</b> 2=Go to High Clamp 3=Go to Fault Value

**1734-0E2V**

2 Channel Analog Voltage Output

<b>Configuration Data</b>	<b>Data Type</b>	<b>Default Value</b>	<b>Valid Data Values</b>
Limit Alarm Latch Channel 1	SINT	0	<b>0=No Latching</b> 1=Alarms Latch
Alarm Disable Channel 1	SINT	0	<b>0=Alarms Enabled</b> 1=Alarms Disabled

<b>Input Data</b>	<b>Data Type</b>	<b>Default Value</b>	<b>Valid Data Values</b>
Status Byte Channel 0	SINT	0	Bit 0 Fault Bit 1 Calibration Bit 2 LowAlarm Bit 3 HighAlarm
Status Byte Channel 1	SINT	0	Bit 0 Fault Bit 1 Calibration Bit 2 LowAlarm Bit 3 HighAlarm

<b>Output Data</b>	<b>Data Type</b>	<b>Default Value</b>	<b>Valid Data Values</b>
Data Channel 0	INT	0	-32,768...32,767
Data Channel 1	INT	0	-32,768...32,767

## Specialty I/O

### 1734-VHSC24

1 Channel 15...24V DC Very High-speed Counter

### 1734-VHSC5

1 Channel 5V DC Very High-speed Counter

Configuration Data	Data Type	Default Value	Valid Data Values
Counter Config	SINT	0	
Config_0	BIT 0		<b>0000=0=Counter</b> 0001=1=Encoder X1 0010=2=Encoder X2 0011=3=PWM 0100=4=Encoder X4 0101=5=Period/Rate 0110=6=Continuous/Rate 0111=7=Rate Measurement 1000=8=Pulse Generator
Config_1	BIT 1		
Config_2	BIT 2		
Config_3	BIT 3		
Mode_4	BIT 4		<b>000=Store Count Disable</b> 001=Store/Continue 010=Store/Wait/Resume 011=Store,Reset/Wait/Start 100=Store,Reset/Start
Mode_5	BIT 5		
Mode_6	BIT 6		
Z Input	BIT 7		<b>0=Z Input Not Inverted</b> 1=Z Input Is Inverted
Filter	SINT	120	
Filter_0	BIT 0	(0x78H)	0000=No Filter 0001=50 kHz 0010=5 kHz 0100=500 Hz <b>1000=50 Hz</b>
Filter_1	BIT 1		
Filter_2	BIT 2		
Filter_3	BIT 3		
FilterA	BIT 4		0=Input A/B/Z Not Filtered <b>1=Input A/B/Z Is Filtered</b>
FilterB	BIT 5		
FilterZ	BIT 6		
Decimal Position	SINT	0	Counter Config 0, 1, 2, 3, 4: -128...+127 (0...255) Counter Config 5, 6, & 7: -4...+2
Time Base (in 10 ms intervals)	INT	0	Counter Config 3 & 7 only: 0...3000 ms (10 ms...3 sec)
Gate Interval (Product of Time Base x Gate Interval must be ≤3000 ms)	SINT	0	Counter Config 3 & 7 only: -128...+127 (0...200)

**1734-VHSC24**

1 Channel 15...24V DC Very High-speed Counter

**1734-VHSC5**

1 Channel 5V DC Very High-speed Counter

Configuration Data	Data Type	Default Value	Valid Data Values
Scalar	SINT	0	Counter Config 5, 6, 8 only: -128...+127 (0...255) Single Bit only: 0, 1, 2, 4, 8, 16, 32, 64, -128
Output Ties 0 Out 0 Window 1 Out 0 Window 2 Out 0 Window 3 Out 0 Window 4	SINT BIT 0 BIT 1 BIT 2 BIT 3	0	<b>0=Output 0 Not Tied</b> 1=Output 0 Tied to Window Counter Config 3 (PWM): Output 0 Window 1 PWM In
Output Ties 1 Out 1 Window 1 Out 1 Window 2 Out 1 Window 3 Out 1 Window 4	SINT BIT 0 BIT 1 BIT 2 BIT 3	0	<b>0=Output 1 Not Tied</b> 1=Output 1 Tied to Window Counter Config 3 (PWM): Output 1 Window 1 PWM In
Rollover	DINT	16,777,215	1...16,777,216
Preset (< Rollover)	DINT	0	0...16,777,215
On Value 1 Off Value 1 On Value 2 Off Value 2 On Value 3 Off Value 3 On Value 4 Off Value 4	DINT DINT DINT DINT DINT DINT DINT DINT	0 0 0 0 0 0 0 0	Counter Config 3, 5, 6, 7: 0...16,777,215 Counter Config 0, 1, 2, 4: 0 to Rollover Value
SS PWM Value (<0 or >9500 =Hold Last State)	INT	0	<b>0</b> ...9500 (0.00...95.00%)
SS Counter Control  SS Counter Reset  SS Counter Preset  SS Value Reset (Stored / Accum. Count)	SINT  BIT 0  BIT 1  BIT 2	0	<b>0=Count Unchanged</b> 1=Count Cleared  <b>0=Count Unchanged</b> 1=Count Set to Preset  <b>0=Count Unchanged</b> 1=Count Cleared



**1734-VHSC24**

1 Channel 15...24V DC Very High-speed Counter

**1734-VHSC5**

1 Channel 5V DC Very High-speed Counter

Configuration Data	Data Type	Default Value	Valid Data Values
SS Output Control	SINT	0	
SS Out 0 Force	BIT 0		<b>0=Output Off</b> 1=Output Forced On
SS Out 0 En	BIT 1		<b>0=Output Disabled</b> 1=Output Enabled
SS Out 0 Electronic Fuse	BIT 2		<b>0=Auto Retry</b> 1=Latch Off
SS Out 0 Diagnostic Speed	BIT 3		<b>0 ≤ 8 ms Response</b> 1=50 ms Response
SS Out 1 Force	BIT 4		<b>0=Output Off</b> 1=Output Forced On
SS Out 1 En	BIT 5		<b>0=Output Disabled</b> 1=Output Enabled
SS Out 1 Electronic Fuse	BIT 6		<b>0=Auto Retry</b> 1=Latch Off
SS Out 1 Diagnostic Speed	BIT 7		<b>0 ≤ 8 ms Response</b> 1=50 ms Response

To enter values from +128...+255, use these conversion formulas:

Desired Decimal Position Value - 256 = Entered Decimal Position Value.

As an example, for a divisor of 200, 200 - 256 = -56

Desired Gate Interval Value - 256 = Entered Gate Interval Value.

As an example, for a Gate Interval of 200, 200 - 256 = -56

Desired Scalar Value - 256 = Entered Scalar Value.

As an example, for a Scalar of 128, 128 - 256 = -128

**1734-VHSC24**

1 Channel 15...24V DC Very High-speed Counter

**1734-VHSC5**

1 Channel 5V DC Very High-speed Counter

Input Data	Data Type	Default Value	Valid Data Values
Present Data	DINT	0	0...16,777,215
Stored Data	DINT	0	-2,147,483,648...2,147,483,647  (0...4,294,967,295)
Status	INT	0	
Zero Frequency Detected	BIT 1		<b>0=No Fault</b> 1=Fault Detected
Stored Data Count_2	BIT 2		Cycles through <b>0, 1, 2, 3, 0</b> , Increments after update
Stored Data Count_3	BIT 3		
A Input Status	BIT 4		<b>0=Input A/B/Z is Off</b> 1=Input A/B/Z is On
B Input Status	BIT 5		
Z Input Status	BIT 6		
Output Status_8 (Output 0)	BIT 8		<b>0=Output is Off</b> 1=Output is On
Output Status_9 (Output 1)	BIT 9		
Output Fault_10 (Output 0)	BIT 10		<b>0=No Fault</b> 1=Open or Over Load
Output Fault_11 (Output 1)	BIT 11		
Not Ready	BIT 13		<b>0=Module Ready</b> 1=Module Initializing
EEPROM Fault	BIT 14		<b>0=No Fault</b> 1=EEPROM data bad
Program Fault (incomplete / incorrect / conflict)	BIT 15		<b>0=No Fault</b> 1=Bad Configuration (Refer to Program Fault on page 117)

### Stored Data

To interpret values from -2,147,483,648 to -1, use this conversion formula:

Stored Data Tag Value + 4,294,967,296 = Actual Stored Data Tag Value.

As an example, for a read value of -1,794,967,296:

$-1,794,967,296 + 4,294,967,296 = 2,500,000,000$  actual value

### Program Fault

Programming Fault Error bit – If an incomplete, incorrect, or conflicting set of configuration parameters is sent to the module, the Program Fault bit will be asserted and an error code will be placed in the Programming Error Code word (assembly 6816). The module will **not** enter a normal operational state. Bit definitions (decimal) for the error codes are:

- 10 An invalid assembly was chosen for poll consumption (0, 105, or 106 are valid).
- 9 The decimal point position is outside of the acceptable range.
- 8 Counter 0 window ON & OFF values are equal and **not** zero; or Counter 0 window ON & OFF value is greater than Rollover.
- 7 A tie has been connected to an unprogrammed window.
- 6 A configuration was selected that requires the scalar and none was programmed; or Multiple scalars were selected.
- 5 The preset is out of range (Rollover).
- 4 A rollover of zero was programmed through PWM was not selected; or  
A rollover was programmed and PWM was selected OR Rollover is out of range (>0x01000000).
- 3 A configuration requiring a time base was selected and no gate interval was set; or  
Gate interval is out of range (>200); or  
Product of time base and gate interval is greater than 3 seconds.
- 2 A time base was entered that is not a multiple of 10; or  
Time base is out of range (>3000, or 3 seconds).
- 1 ZF/BF/AF were selected and no filter was programmed; or  
Multiple filters were selected.
- 0 A reserved configuration/mode was programmed.

**1734-VHSC24**

1 Channel 15...24V DC Very High-speed Counter

**1734-VHSC5**

1 Channel 5V DC Very High-speed Counter

Output Data	Data Type	Default Value	Valid Data Values
PWM Value	INT	0	0...9500 (0.00...95.00%)
Counter Control	SINT	0	
Counter Reset	BIT 0	0	<b>0=Count Unchanged</b> 1=Count Cleared
Counter Preset	BIT 1	0	<b>0=Count Unchanged</b> 1=Count Set to Preset
Value Reset (Stored / Accumulated Count)	BIT 2	0	<b>0=Count Unchanged</b> 1=Count Cleared
Output Control	SINT	0	
Output 0 Force	BIT 0	0	<b>0=Output Off</b> 1=Output Forced On
Output 0 Enable	BIT 1	0	<b>0=Output Disabled</b> 1=Output Enabled
Output 0 Electronic Fuse	BIT 2	0	<b>0=Auto Retry</b> 1=Latch Off
Output 0 Diagnostic Speed	BIT 3	0	<b>0 ≤ 8 ms Response</b> 1=50 ms Response
Output 1 Force	BIT 4	0	<b>0=Output Off</b> 1=Output Forced On
Output 1 Enable	BIT 5	0	<b>0=Output Disabled</b> 1=Output Enabled
Output 1 Electronic Fuse	BIT 6	0	<b>0=Auto Retry</b> 1=Latch Off
Output 1 Diagnostic Speed	BIT 7	0	<b>0 ≤ 8 ms Response</b> 1=50 ms Response

**1734-IJ**  
1 Channel 5V DC Encoder / Counter

**1734-IK**  
1 Channel 15...24V DC Encoder / Counter

Configuration Data	Data Type	Default Value	Valid Data Values
Counter Config Config_0 Config_1 Config_2 Config_3  Mode_4 Mode_5 Mode_6  Z Input	SINT BIT 0 BIT 1 BIT 2 BIT 3  BIT 4 BIT 5 BIT 6  BIT 7	0	<b>0000=0=Counter</b> 0001=1=Encoder X1 0010=2=Encoder X2 0100=4=Encoder X4 0101=5=Period/Rate 0111=7=Rate Measurement  <b>000=Store Count Disable</b> 001=Store/Continue 010=Store/Wait/Resume 011=Store,Reset/Wait/Start 100=Store,Reset/Start  <b>0=Z Input Not Inverted</b> 1=Z Input Is Inverted
Filter Filter_0 Filter_1 Filter_2 Filter_3  FilterA FilterB FilterZ	SINT BIT 0 BIT 1 BIT 2 BIT 3  BIT 4 BIT 5 BIT 6	120 (0x78H)	0000=No Filter 0001=50 kHz 0010=5 kHz 0100=500 Hz <b>1000=50 Hz</b>  0=Input A/B/Z Not Filtered <b>1=Input A/B/Z Is Filtered</b>
Decimal Position	SINT	0	Counter Config 0, 1, 2, 4: -128...+127 (0...255) Counter Config 5 & 7: -4...+2
Time Base (in 10 ms intervals)	INT	0	Counter Config 7 only: 0...3000 ms (10 ms...3 s)
Gate Interval (Product of Time Base x Gate Interval must be ≤3000 ms)	SINT	0	Counter Config 7 only: -128...+127 (0...200)
Scalar	SINT	0	Counter Config 5 only: -128...+127 (0...255) 0, 1, 2, 4, 8, 16, 32, 64, -128
Rollover	DINT	16,777,215	1...16,777,216
Preset (< Rollover)	DINT	0	0...16,777,215

**1734-IJ**

1 Channel 5V DC Encoder / Counter

**1734-IK**

1 Channel 15...24V DC Encoder / Counter

Configuration Data	Data Type	Default Value	Valid Data Values
SS Counter Control SS Counter Reset	SINT BIT 0	0	<b>0=Count Unchanged</b> 1=Count Cleared
SS Counter Preset	BIT 1		<b>0=Count Unchanged</b> 1=Count Set to Preset
SS Value Reset	BIT 2		<b>0=Count Unchanged</b> 1=Count Cleared

To enter values from +128...+255, use these conversion formulas:

*Decimal Position*

Desired Decimal Position Value - 256 = Entered Decimal Position Value.

As an example, for a divisor of 200,  $200 - 256 = -56$

*Gate Interval*

Desired Gate Interval Value - 256 = Entered Gate Interval Value.

As an example, for a Gate Interval of 200,  $200 - 256 = -56$

*Scalar*

Desired Scalar Value - 256 = Entered Scalar Value.

As an example, for a Scalar of 128,  $128 - 256 = -128$

**1734-IJ**

1 Channel 5V DC Encoder / Counter

**1734-IK**

1 Channel 15...24V DC Encoder / Counter

Input Data	Data Type	Default Value	Valid Data Values
Present Data	DINT	0	0...16,777,215
Stored Data	DINT	0	-2,147,483,648... 2,147,483,647 (0...4,294,967,295)
Status Zero Frequency Detected	INT BIT 1	0	<b>0=No Fault</b> 1=Fault Detected
Stored Data Count_2	BIT 2		Cycles through <b>0, 1, 2, 3, 0,</b>
Stored Data Count_3	BIT 3		Increments after update
A Input Status B Input Status Z Input Status	BIT 4 BIT 5 BIT 6		<b>0=Input A/B/Z is Off</b> 1=Input A/B/Z is On
Not Ready	BIT 13		<b>0=Module Ready</b> 1=Module Initializing
EEPROM Fault	BIT 14		<b>0=No Fault</b> 1=EEPROM data bad
Program Fault (incomplete / incorrect / conflict)	BIT 15		<b>0=No Fault</b> 1=Bad Configuration (See <b>Program Fault Note</b> )

*Stored Data*

To interpret values from -2,147,483,648... -1, use this conversion formula:

Stored Data Tag Value + 4,294,967,296 = Actual Stored Data Tag Value.  
As an example, for a read value of -1,794,967,296: -1,794,967,296 +  
4,294,967,296 = 2,500,000,000 actual value

*Program Fault Note*

Programming Fault Error bit – If an incomplete, incorrect, or conflicting set of configuration parameters is sent to the module, the Program Fault bit is asserted and an error code placed in the Programming Error Code word (assembly 6816). The module will **not** enter a normal operational state. Bit definitions (decimal) for the error codes are:

- 10 An invalid assembly was chosen for poll consumption (0, 105, or 106 are valid).
- 9 The decimal point position is outside of the acceptable range.
- 8 Counter 0 window ON & OFF values are equal and **not** zero; or Counter 0 window ON & OFF value is greater than the Rollover.
- 7 A tie has been connected to an unprogrammed window.
- 6 A configuration was selected that requires the scalar and none was programmed; or Multiple scalars were selected.
- 5 The preset is out of range (Rollover).
- 4 A rollover of zero was programmed through PWM was not selected; or A rollover was programmed and PWM was selected; or Rollover is out of range (>0x01000000).
- 3 A configuration requiring a time base was selected and no gate interval was set; or Gate interval is out of range (>200); or Product of time base and gate interval is greater than 3 seconds.
- 2 A time base was entered that is not a multiple of 10; or Time base is out of range (>3000, or 3 seconds).
- 1 ZF/BF/AF were selected and no filter was programmed; or Multiple filters were selected.
- 0 A reserved configuration/mode was programmed.

**1734-IJ**  
1 Channel 5V DC Encoder / Counter

**1734-IK**  
1 Channel 15...24V DC Encoder / Counter

Output Data	Data Type	Default Value	Valid Data Values
Counter Control	SINT	0	
Counter Reset	BIT 0	0	<b>0=Count Unchanged</b> 1=Count Cleared
Counter Preset	BIT 1	0	<b>0=Count Unchanged</b> 1=Count Set to Preset
Value Reset (Stored / Accumulated Count)	BIT 2	0	<b>0=Count Unchanged</b> 1=Count Cleared



**1734-SSI**

## 1 Channel Synchronous Serial Interface

<b>Configuration Data</b>	<b>Data Type</b>	<b>Default Value</b>	<b>Valid Data Values</b>
Run	SINT	1	0=Module Not Running <b>1=Module Is Running</b>
Gray Binary	SINT	1	0=Binary Code <b>1=Gray Code</b>
Word Length	SINT	13	2...31
Data Speed	SINT	5	<b>5=125 Kbps</b> 6=250 Kbps 7=500 Kbps 8=1 MB 9=2 MB
G2B Convert (Gray to Binary)	SINT	0	<b>0=No Convert</b> 1=Convert
Standardization (Divide / Shift using Trailing)	SINT	0	<b>0=No Standardization</b> 1=Apply Standardization
SSI Word Delay Time	INT	64	-32,768...32,767 $\mu$ s (16...65,535)
Trailing (No. of Trailing Bits)	SINT	0	<b>0</b> ...16
Input Latch Control InputLatch_0 InputLatch_1	SINT BIT 0 BIT 1	0	<b>00=Off</b> 01= Falling Edge of Input 10=Rising Edge of Input 11=Both Edges of Input
Sensor Resolution (Positions per Rev. or Stroke)	INT	1	-32,768...32,767 counts (1...65,535)
Sensor Cycle (Total Revolutions or Strokes)	INT	1	-32,768...32,767 counts (1...65,535)
Compare 0 Value	DINT	0	-2,147,483,648... 2,147,483,647 (0...4,294,967,295)
Compare 1 Value	DINT	0	-2,147,483,648... 2,147,483,647 (0...4,294,967,295)
Compare 0 Control Compare0_0 Compare0_1	SINT BIT 0 BIT 1	0	<b>00=Off</b> 01=Up Direction 10=Down Direction 11=Both Directions
Compare 1 Control; Compare1_0 Compare1_1	SINT BIT 0 BIT 1	0	<b>00=Off</b> 01=Up Direction 10=Down Direction 11=Both Directions

### *SSI Word Delay Time*

To enter Delay values from +32,768...+65,535  $\mu$ s, use this conversion formula:

Desired Delay Value (in  $\mu$ s) - 65536 = Entered Delay Value (in  $\mu$ s).  
As an example, for a 40 ms delay time, 40000 - 65536 = -25536

### *Sensor Resolution*

To enter Resolution values from +32,768...+65,535  $\mu$ s, use this conversion formula:

Desired Resolution Value - 65536 = Entered Resolution Value.  
As an example, for a 40,000 count sensor, 40000 - 65536 = -25536

### *Sensor Cycle*

To enter Cycle values from +32,768...+65,535, use this conversion formula:

Desired Cycle Value - 65536 = Entered Cycle Value.  
As an example, for 50,000 sensor cycle rotations, 50000 - 65536 = -15536

### *Compare 0,1 Value*

To enter Compare values from +2,147,483,647...+4,294,967,295, use this conversion formula:

Desired Compare Value - 4,294,967,296 = Entered Compare Value.  
As an example, for a 3,000,000,000 compare value,  
3,000,000,000 - 4,294,967,296 = -1,294,967,296

**1734-SSI**

## 1 Channel Synchronous Serial Interface

<b>Input Data</b>	<b>Data Type</b>	<b>Default Value</b>	<b>Valid Data Values</b>
Present Data	DINT	0	-2,147,483,648...2,147,483,647 (0...4,294,967,295)
Latched Data	DINT	0	-2,147,483,648...2,147,483,647 (0...4,294,967,295)
Status Input Status	INT BIT 0	0	<b>0=Input is Off</b> 1=Input is On
Run	BIT 1		<b>0=Module is not Running</b> 1=Module is Running
Decreasing Count	BIT 2		<b>0=Count not Decreasing</b> 1=Count is Decreasing
Increasing Count	BIT 3		<b>0=Count not Increasing</b> 1=Count is Increasing
Compare0 Reached Compare1 Reached	BIT 4 BIT 5		<b>0=Compare not Reached</b> 1=Compare was Reached
Compare0 Status Compare1 Status	BIT 6 BIT 7		<b>0=Compare Off</b> 1=Compare On
Power Fault	BIT 8		<b>0=No 24Vdc Power Fault</b> 1=24Vdc Power Fault
Configuration Fault	BIT 9		<b>0=No FPGA Config Fault</b> 1=FPGA Config data bad
Communication Fault	BIT 10		<b>0=No FPGA Comm Fault</b> 1=FPGA Comm Fault
Input Data Fault	BIT 11		<b>0=No Input Data Fault</b> 1=Input Power Fault (short)
Data Latched	BIT 12		<b>0=Input Data Not Latched</b> 1=Input Data Latched

*Present / Latched Data*

To interpret values from -2,147,483,648...-1, use this conversion formula:

Stored Data Tag Value + 4,294,967,296 = Actual Stored Data Tag Value.

As an example, for a read value of -1,794,967,296:

$-1,794,967,296 + 4,294,967,296 = 2,500,000,000$  actual value

**1734-SSI**

1 Channel Synchronous Serial Interface

<b>Output Data</b>	<b>Data Type</b>	<b>Default Value</b>	<b>Valid Data Values</b>
Control	SINT	0	
Latch Acknowledge	BIT 0	0	<b>0=Latch Not Cleared</b> 1=Latch Cleared
Compare 0 Acknowledge	BIT 1	0	<b>0=Compare0 Not Reset</b> 1=Compare0 Reset
Compare 1 Acknowledge	BIT 2	0	<b>0=Compare1 Not Reset</b> 1=Compare1 Reset
Compare 0 Select	BIT 3	0	<b>0=Compare0 Not Selected</b> 1=Compare0 Selected
Compare 1 Select	BIT 4	0	<b>0=Compare1 Not Selected</b> 1=Compare1 Selected

**1734-232ASC**

1 Channel ASCII Interface Module

<b>Configuration Data</b>	<b>Data Type</b>	<b>Default Value</b>	<b>Valid Data Values</b>
Serial Character Format (ASCII Format: Data Bits / Parity / Stop)	SINT	0	<b>0=7N2</b> 1=7E1 2=7O1 3=8N1 4=8N2 5=8E1 6=8O1 7=7E2 8=7O2
Serial Comm Speed (Communication Rate of the Serial Port)	SINT	0	<b>0=9600 Kbps</b> 1=1200 Kbps 2=2400 Kbps 3=4800 Kbps 4=19.2 KBps 5=38.4 KBps
Max Receive Characters	SINT	20	-128...+127 (0...128)
Receive Start Delimiter Mode	SINT	0	<b>0=No Start Delimiter</b> 1=Exclude Start Delimiter 2=Include Start Delimiter
Receive Start Delimiter Character	SINT	58 (0x3A)	Any Valid ASCII Character (Default is Colon [:])
Receive Record End Mode	SINT	2	0=No End Delimiter 1=Exclude End Delimiter <b>2=Include End Delimiter</b>
Receive End Delimiter	SINT	13 (0x0d)	Any Valid ASCII Character (Default is Carr. Return)
Receive String Data Type	SINT	1	0=Array <b>1=Short String</b> 2=String
Pad Mode	SINT	1	0=Pad Mode Disabled <b>1=Pad Mode Enabled</b>
Pad Character	SINT	0 (0x00)	Any Valid ASCII Character (Default is NULL)
Receive Swap Mode	SINT	0	<b>0=Disabled</b> 1=16-bit Swap Enabled 2=24-bit Swap Enabled 3=32-bit Swap Enabled
DeviceNet Handshake Mode	SINT	1	0=Master/Slave handshake <b>1=Produce Immediate</b>
Max Transmit Characters	SINT	20	-128...+127 (0...128)

**1734-232ASC**

1 Channel ASCII Interface Module

<b>Configuration Data</b>	<b>Data Type</b>	<b>Default Value</b>	<b>Valid Data Values</b>
Transmit End Delimiter Mode	SINT	2	0=No End Delimiter 1=Exclude End Delimiter 2=Include End Delimiter
Transmit End Delimiter Character	SINT	13 (0x0d)	Any Valid ASCII Character (Default is Carr. Return)
Consume String Data Type	SINT	1	0=Array <b>1=Short String</b> 2=String
Transmit Swap Mode	SINT	0	<b>0=Disabled</b> 1=16-bit Swap Enabled 2=24-bit Swap Enabled 3=32-bit Swap Enabled
DeviceNet Record Header Mode	SINT	0	<b>0=Transmit Handshake</b> 1=Transmit Immediate

*Transmit Data / Receive Data / Delimiter / Pad Character*

Note that 7 data bits allows ASCII Character data values of 0...127, which RSLogix 5000 software does support in the signed Short Integer data type SINT (-128...+127 range).

Note that 8 data bits allows ASCII Character data values of 0 to 255. To enter values from +128...+255, use this conversion formula:

Desired Decimal Value - 256 = Entered Decimal Value.

As an example, for an ASCII Character value of 128,

128 - 256 = -128

**1734-232ASC**

1 Channel ASCII Interface Module

<b>Input Data</b>	<b>Data Type</b>	<b>Default Value</b>	<b>Valid Data Values</b>
Receive Record Number	SINT	0	-128...+127 (0...255)
Status TX FIFO Overflow	SINT BIT 0	0	<b>0=No Error</b> 1=TX FIFO Overflow Error
RX FIFO Overflow	BIT 1		<b>0=No Error</b> 1=RX FIFO Overflow Error
RX Parity Error	BIT 2		<b>0=No Error</b> 1=RX Parity Overflow Error
Handshake Error	BIT 6		<b>0=No Error</b> 1=Handshake Error
New Data Flag	BIT 7		<b>0=No New Data</b> 1=New Data Present
Length_Lo	SINT	20	-128...+127 (0...128)
Length_Hi	SINT	0	0 or 1
Data[128]	SINT	0	Received ASCII Message

<b>Output Data</b>	<b>Data Type</b>	<b>Default Value</b>	<b>Valid Data Values</b>
Transmit Record Number	SINT	0	-128...+127 (0...255)
Receive Record Number	SINT	0	-128...+127 (0...255)
Status TX FIFO Overflow	SINT BIT 0	0	<b>0=No Error</b> 1=TX FIFO Overflow Error
RX FIFO Overflow	BIT 1		<b>0=No Error</b> 1=RX FIFO Overflow Error
RX Parity Error	BIT 2		<b>0=No Error</b> 1=RX Parity Overflow Error
Handshake Error	BIT 6		<b>0=No Error</b> 1=Handshake Error
New Data Flag	BIT 7		<b>0=No New Data</b> 1=New Data Present
Length_Lo	SINT	20	-128...+127 (0...128)
Length_Hi	SINT	0	0 or 1
Data[128]	SINT	0	Transmitted ASCII Message

*Transmit Record Number / Receive Record Number / Length\_Lo*

Note that 7 data bits allows Transmit / Receive record Number of Length\_Lo values of 0...127, which RSLogix 5000 software does support in the signed Short Integer data type SINT (-128...+127 range).

Note that 8 data bits allows Transmit / Receive record Number of Length\_Lo values of 0...255.

To enter values from +128...+255, use this conversion formula:

Desired Decimal Value - 256 = Entered Decimal Value.

As an example, for a Transmit / Receive record Number of Length\_Lo value of 128,  $128 - 256 = -128$



## Quick Start

### What This Appendix Contains

In this quick start, you learn how to use the 1734-AENT adapter with a ControlLogix controller for EtherNet/IP systems.

---

**IMPORTANT**

This quick start contains a simple set of steps and reminders that will help you avoid errors when you are configuring your POINT I/O system for an EtherNet/IP network.

---

**ATTENTION**

You must use series C POINT I/O modules with the 1734-AENT adapter. Series A or B POINT I/O modules will not work with this adapter.

---

### Necessary Prerequisites

Before you begin this quick start, make sure the following conditions are in place.

- The ControlLogix controller and RSLogix software version must be version 11 or later.
- The 1756-ENBT module must be revision 2.3 or later.
- The 1734 POINT I/O modules must be series C (except for the 1734-232ASC modules, which can be series A).
- The recommended RPIs are being used: Digital = 10 ms or higher, Analog and Specialty = 50 ms or higher.
- The 1734-AENT POINT I/O adapter is a child to a local 1756-ENBT module.

## Configure the Adapter

In the 1734-AENT Module Properties dialog, perform the following steps.

1. Complete the Name field.
2. Enter the following address into the IP Address field: 192.168.1.42

You are setting the last digit, because the first three digits are set for you as set by the push wheel switches on the adapter. The push wheel switches should be set to 042.

3. From the Comm Format menu, choose None if you do not want a rack-optimized connection, or choose Rack Optimization if you want a rack-optimized connection.
4. For the Electronic Keying field, select Compatible Module.
5. Enter the Chassis Size.

Regarding chassis size, the POINT I/O adapter itself takes up a count in the chassis. The default chassis size for the POINT I/O is 1, which covers the adapter only and allows for no I/O. To configure your POINTBus modules, set the chassis size to the physical amount of your I/O modules plus one for the adapter; otherwise, you get an error. For example, if you have six modules in the chassis, you must set chassis to  $6+1=7$ .

6. Enter the Slot.

For the adapter itself, the slot number is always 0 and cannot be modified.

7. Click Finish.

Your I/O Configuration tree now looks similar to the following:

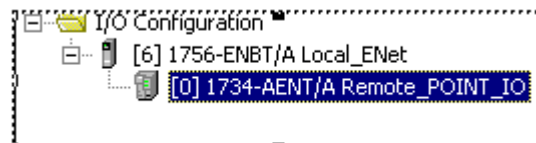

## Enter Adapter Properties

Use this procedure to enter adapter properties.

1. Right-click the 1734-AENT adapter and select Properties. The Module Properties dialog appears.

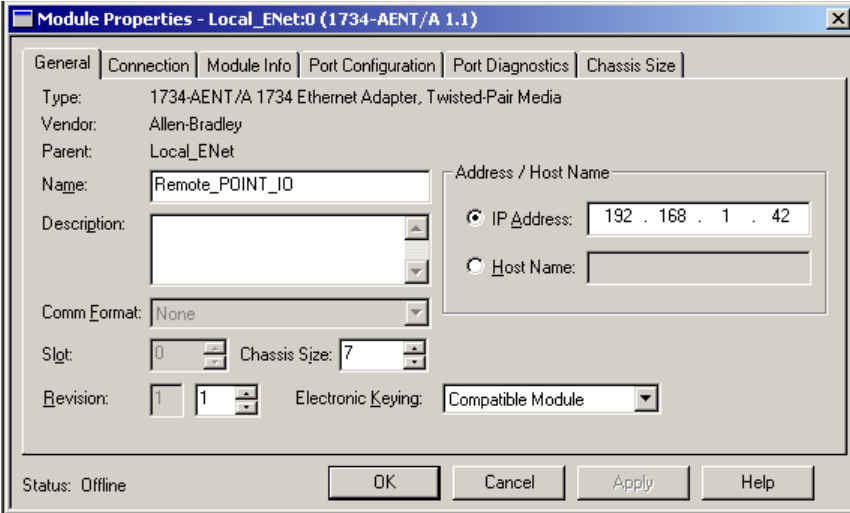

2. Click the Chassis Size tab.

Notice that the data under this tab is dimmed while offline. Use the Chassis Size tab to send the module size from the General tab to the module itself once you are online. Otherwise, you get an error. We explore this later. For now, click OK to close this dialog:

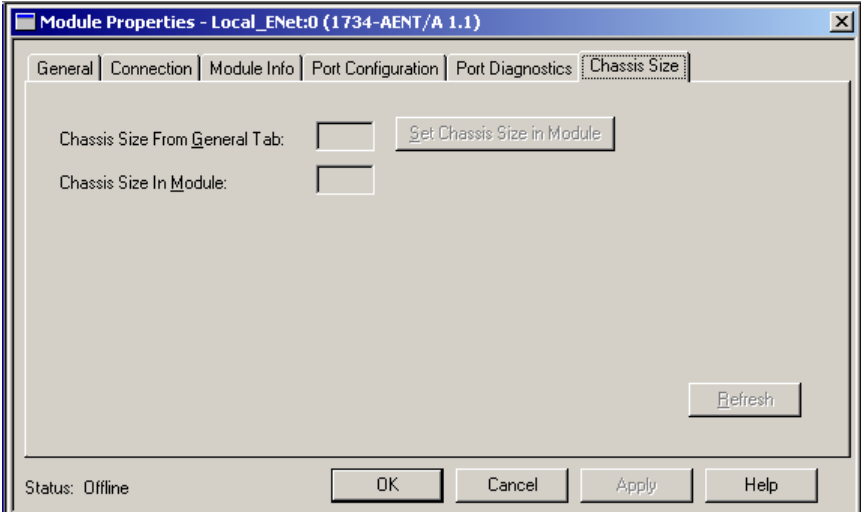

3. Right-click the POINT I/O adapter under I/O Configuration to add a new module.
4. Select the module from the list and click OK.

5. In the Module Properties dialog, enter the following information.
  - a. Name
  - b. Slot
  - c. Comm Format
  - d. Electronic Keying, choose Compatible Module to verify the major revision C, because only series C modules support EtherNet/IP.
  - e. Click Next on the bottom of the dialog.
  - f. Set the RPI to 10 ms for digital and 50 ms for analog or specialty.
6. Click Finish.

### **Add Another Module Under the Adapter**

Use this procedure to add another module under the adapter.

1. Right-click the POINT I/O adapter under I/O configuration to add a new module.

Your second module is in slot 2.

2. Select the module from the Module Type list, and click OK.
3. In the Module Properties dialog, enter the following information:
  - a. Name
  - b. Slot
  - c. Comm Format
  - d. Electronic Keying, choose Compatible Module.
  - e. Click Next.
  - f. Set the RPI to 10 ms for digital and 50 ms for analog or specialty.
4. Click Finish.

Continue to add modules to the adapter in this fashion until you have added all of the POINT I/O modules connected to the 1734-AENT adapter to the I/O Configuration tree.

## Configure 1734 POINT I/O Modules

For RSLogix 5000 software version 13 and earlier, configure your POINT I/O modules via the Controller Tags database, using the following steps. For RSLogix 5000 software, versions 15 or later, the preferred method for module configuration is to use the Module Properties dialog for each POINT I/O module, as described in the individual user manual for the module.

1. Double-click the Controller Tags in the project dialog.

Look at the bottom of the screen to make sure you are in the Monitor Tags tab.

We are going to assume there is an analog input module 1734-IE2V, which resides in slot 6. We configure Channel 0 of this module to operate over the range -10...+10V DC.

Tag Name	Value	Force Mask	Style	Type	Description
remote_POINT_IO:6:C	(...)	(...)		AB1734_IE2C0	
remote_POINT_IO:6:C.Ch0LowEngineering	0		Decimal	INT	
remote_POINT_IO:6:C.Ch0HighEngineering	10000		Decimal	INT	
remote_POINT_IO:6:C.Ch0DigitalFilter	0		Decimal	INT	
remote_POINT_IO:6:C.Ch0AlarmLimit	900		Decimal	INT	
remote_POINT_IO:6:C.Ch0HAlarmLimit	9500		Decimal	INT	
remote_POINT_IO:6:C.Ch0LAlarmLimit	200		Decimal	INT	
remote_POINT_IO:6:C.Ch0HAlarmLimit	9800		Decimal	INT	
remote_POINT_IO:6:C.Ch0RangeType	2		Decimal	SINT	
remote_POINT_IO:6:C.Ch0LimitAlarmLatch	0		Decimal	SINT	
remote_POINT_IO:6:C.Ch0AlarmDisable	0		Decimal	SINT	
remote_POINT_IO:6:C.Ch1LowEngineering	0		Decimal	INT	
remote_POINT_IO:6:C.Ch1HighEngineering	10000		Decimal	INT	
remote_POINT_IO:6:C.Ch1DigitalFilter	0		Decimal	INT	
remote_POINT_IO:6:C.Ch1AlarmLimit	500		Decimal	INT	
remote_POINT_IO:6:C.Ch1HAlarmLimit	9500		Decimal	INT	
remote_POINT_IO:6:C.Ch1LAlarmLimit	200		Decimal	INT	
remote_POINT_IO:6:C.Ch1HAlarmLimit	9800		Decimal	INT	
remote_POINT_IO:6:C.Ch1RangeType	2		Decimal	SINT	
remote_POINT_IO:6:C.Ch1LimitAlarmLatch	0		Decimal	SINT	
remote_POINT_IO:6:C.Ch1AlarmDisable	0		Decimal	SINT	
remote_POINT_IO:6:C.NoiseFilter	2		Decimal	SINT	
remote_POINT_IO:6:C.RealTimeSample	100		Decimal	INT	
remote_POINT_IO:6:I	(...)	(...)		AB1734_IE2I0	

2. Click the configuration tag remote\_POINT\_IO:3:C.

From here you can set the module configuration and alarms.

In this configuration dialog, you enter the values that would correspond to the desired range. The range type default value for a 1734-IE2V module is 2, which is equal to 0...10V DC.

3. Click the configuration tag for the module in slot 4, remote\_POINT\_IO:3:Ch0RangeType.
4. Check the value in the tag remote\_POINT\_IO:3:C.Ch0RangeType.

It is set to 2, which is the default value. There are two settings that this module supports:

- 2 = 0...10V DC
- 0 = -10...+10V DC

Tag Name	Value	Force Mark	Style	Type	Description
remote_POINT_ID6C	{...}	{...}		AB1734JE2C0	
remote_POINT_ID6CChLowEngineering	0		Decimal	INT	
remote_POINT_ID6CChHighEngineering	30000		Decimal	INT	
remote_POINT_ID6CChDigitalFilter	0		Decimal	INT	
remote_POINT_ID6CChLAlarmLimit	500		Decimal	INT	
remote_POINT_ID6CChHAlarmLimit	9500		Decimal	INT	
remote_POINT_ID6CChLLAlarmLimit	200		Decimal	INT	
remote_POINT_ID6CChHAlarmLimit	9000		Decimal	INT	
remote_POINT_ID6CChRangeType	0		Decimal	SINT	
remote_POINT_ID6CChLineAlarmLatch	0		Decimal	SINT	
remote_POINT_ID6CChAlarmDisable	0		Decimal	SINT	
remote_POINT_ID6CChLowEngineering	0		Decimal	INT	
remote_POINT_ID6CChHighEngineering	30000		Decimal	INT	
remote_POINT_ID6CChDigitalFilter	0		Decimal	INT	
remote_POINT_ID6CChLAlarmLimit	500		Decimal	INT	
remote_POINT_ID6CChHAlarmLimit	9500		Decimal	INT	
remote_POINT_ID6CChLLAlarmLimit	200		Decimal	INT	
remote_POINT_ID6CChHAlarmLimit	9000		Decimal	INT	
remote_POINT_ID6CChRangeType	2		Decimal	SINT	
remote_POINT_ID6CChLineAlarmLatch	0		Decimal	SINT	
remote_POINT_ID6CChAlarmDisable	0		Decimal	SINT	
remote_POINT_ID6CChNotchFilter	2		Decimal	SINT	
remote_POINT_ID6CChRedTimeSample	100		Decimal	INT	
remote_POINT_ID6I	{...}	{...}		AB1734JE210	

- Click the value 2 and change it to 0, which changes the voltage range to -10...+10V DC for channel 0.

Note the following:

- The controller sends the configuration data only when connection is being established.
  - Should you need to modify any of the tag values once you change the tag, you need to access the updated information and download it into the module. These are the ways to download the updated configuration information into the module.
- Ideally, you enter the correct code number in the Range Type field at the same time that you add the I/O to the I/O Configuration tree. You then download later.

- If you downloaded the offline configuration into the module and then realize that you must modify any of the module's configuration parameters, then the preferred way to make these changes online is to go to the Module Connection tab and inhibit the module, apply the changes, and then uninhibit the module. Doing this breaks the connection, causing the configuration information to be downloaded right after the connection is made.

**IMPORTANT**

Switching the controller from Program to Run mode does not change the module connection status and does not re-send module configuration data.

We highly recommend that you use the inhibit/uninhibit process and avoid power cycling.

6. Right-click the 1734-AENT adapter and select Properties.
7. Click the Connection tab.

You see the following message:

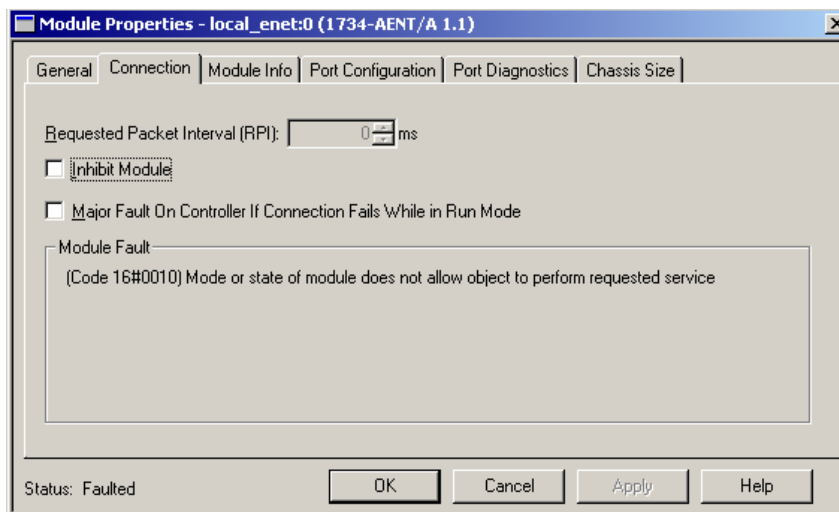

The module is faulted because, even though you set up the adapters POINT I/O chassis size to the actual number of the modules plus the adapter, the adapter still remembers the size of 1 (the factory default value) until you reset this size manually. This option is available only online.

8. Click the Chassis Size tab.
9. Click the Set Chassis Size in Module button and set the chassis size in the adapter.

Remember to inhibit and uninhibit the module for this to take effect.

Now you can put your controller in Run mode, and the connection should be successful.

**IMPORTANT**

The information found in the Controller Tag Reference section of this user manual is also available in the RSLogix 5000 online help file. Use the Help file search function under the 1734 catalog number that you are configuring and select the **Module Defined Data Types** option. You see all of the configurable parameters and associated values.

## Configure an Ethernet Driver in RSLinx Software

To configure an Ethernet driver in RSLinx software, launch RSLinx software.

### Launch RSLinx Software

Launching the RSLinx software enables you to configure the driver you use to communicate with the ControlLogix controller.



1. Double-click the RSLinx icon on the Desktop to launch RSLinx software.
2. Click the RSWho icon .



The Rockwell Software RSLinx Gateway - [RSWho - 1] screen appears.

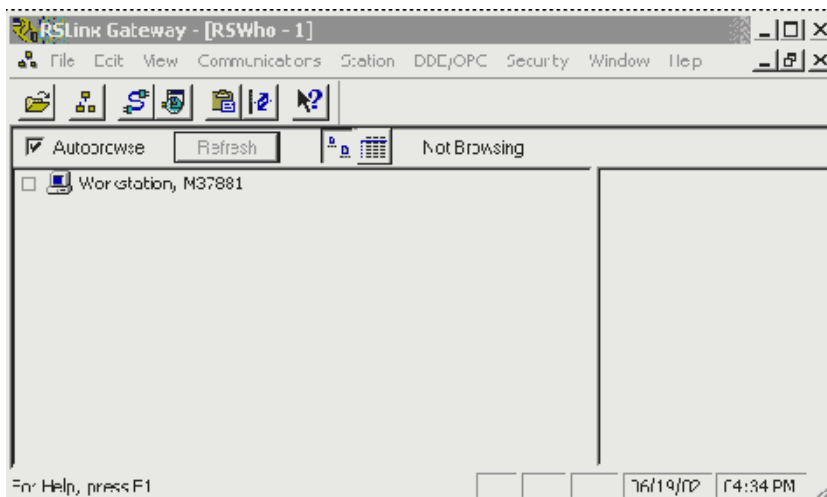

#### TIP

The RSWho screen is actually RSLinx's network browser interface, which lets you view all of your active network connections.

The left pane of this display is the Tree Control, which shows networks and devices in a hierarchical view. When a network or device is collapsed, as indicated by the + sign, you can click the + sign or double-click the network or device icon to expand the view and begin browsing. When a network or device is expanded, as indicated by the - sign, you can click the - sign or double-click the network or device icon to collapse the view. The right pane of the RSWho display is the List Control, which is a graphical representation of all of the devices present on the network.

#### TIP

If there is a communication status error with a device (for example, when a recognized device is inadvertently unplugged), that device appears with a red X, indicating that RSWho previously recognized it, but now it cannot. You can choose to remove the device from the RSWho display, or you can choose to correct the communication error.

## Add the AB\_ETHIP-1 (EtherNet/IP) Driver

1. From the Communications menu, choose Configure Drivers.

The Configure Drivers dialog appears.

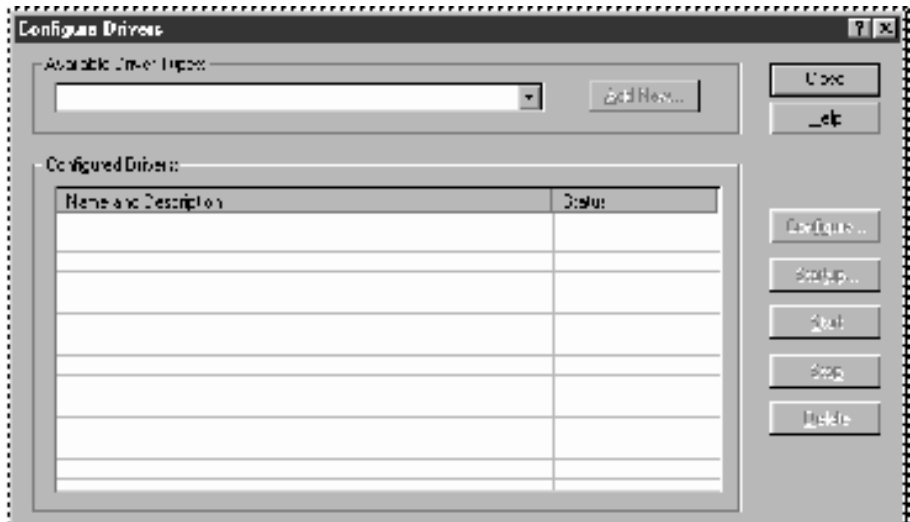

2. From the Available Driver Types pull-down menu, choose EtherNet/IP Driver.
3. Click the Add New button.
4. Click OK to accept the default name (AB\_ETHIP-1).  
Be sure that the radio button for Browse Local Subnet is enabled.
5. Click OK.
6. Verify that the driver you just configured is running, and click the Close button to exit the Configure Drivers dialog.
7. Click the X in the upper right corner of the RSWho dialog to stop RSWho.
8. Click the minimize icon  in the upper right corner of the RSLinx dialog to minimize RSLinx software.

**Numerics****1734-POINT I/O catalog numbers** 89**A****AB-ETHIP driver** 85  
**access module data** 62  
**adapter**

- features 4
- replacing on system 11
- wiring 12

**auto negotiate** 16  
**autobaud** 8**B****bandwidth, insufficient** 44  
**BootP/DHCP utility** 20  
**browse chassis page** 80**C****catalog numbers** 89  
**chassis size** 1  
**CIP Common Industrial Protocol** 5  
**Common Industrial Protocol (CIP)** 5  
**compatibility**

- hardware and software 5

**configuration** 16  
**configure adapter**

- for direct connection and rack
  - optimization in RSLogix 5000
  - software 45, 25

**configure I/O modules** 27, 48  
**controller tag reference**

- analog 2 channel input 98, 107
- digital 2 POINT input 91
  - with over load 95, 94, 93
  - 92
  - with over load 97, 96
- specialty I/O 111

**D****data types**

- RSLogix 5000
  - valid number ranges 90

**DHCP (Dynamic Host Configuration Protocol)** 23  
**DHCP enabled function** 16  
**DHCP software** 23  
**direct connection** 7**disabled web server function** 16**E****edit controller tags** 38  
**empty slots** 2  
**empty terminal bases** 3  
**example applications** v**F****firmware revisions** 5, 8  
**fixed IP address** 43**G****gateway address** 17**H****hardware** 25, 46**I****installing the 1734-AENT adapter**

- mount adapter to existing system 11, 10
- replacing adapter 11
- set the network address 11
- wiring 12

**IP address** 17, 43**L****ladder program** 39  
**LED status indicators** 63**M****master/slave model** 6  
**mix rack optimized and direct connections** 7  
**mount adapter to existing system** 11  
**mounting dimensions** 13  
**mounting modules on DIN rail before modules installed** 10**N****network address** 11, 19**O****overloaded adapter** 44

**P**

- power up system for the first time** 4
- producer/consumer model**
  - understanding 6
- program fault note** 115, 120
- publications**
  - related vi

**Q**

- quick start** 129

**R**

- rack optimized connection** 7
- recover from an overloaded adapter** 44
- reinsertion of modules** 2
- relation list** 22
- removal of modules** 2
- replace adapter on system** 11
- replacement of adapter** 2
- requested packet interval (RPI)** 6
- RIUP remove and replace under power** 2
- Rockwell BootP/DHCP utility** 20
- RPI requested packet interval** 6
- RSLinx Ethernet communication driver**
  - 85
- RSLinx software**
  - install 85
- RSLogix 5000 data types**
  - valid number ranges 90

**S**

- set chassis size** 1
- set the network address** 11
- software releases** 5
- subnet mask** 18

**T**

- terminology** vii
- third party DHCP server** 15
- thumbwheel** 19
- troubleshooting** 63

**U**

- upgrades**
  - hardware and firmware 5
- utils directory** 20

**V**

- verify module chassis size** 41, 59

**W**

- web page diagnostics** 67
  - Browse Chassis page 80
  - Configuration page 76
  - Diagnostics page 69
  - Home page 67
- what the adapter does** 5
- wiring the adapter** 12



## Rockwell Automation Support

Rockwell Automation provides technical information on the Web to assist you in using its products.

At <http://www.rockwellautomation.com/support/>, you can find technical manuals, a knowledge base of FAQs, technical and application notes, sample code and links to software service packs, and a MySupport feature that you can customize to make the best use of these tools.

For an additional level of technical phone support for installation, configuration, and troubleshooting, we offer TechConnect support programs. For more information, contact your local distributor or Rockwell Automation representative, or visit <http://www.rockwellautomation.com/support/>.

## Installation Assistance

If you experience a problem within the first 24 hours of installation, review the information that is contained in this manual. You can contact Customer Support for initial help in getting your product up and running.

United States or Canada	1.440.646.3434
Outside United States or Canada	Use the <a href="#">Worldwide Locator</a> at <a href="http://www.rockwellautomation.com/support/americas/phone_en.html">http://www.rockwellautomation.com/support/americas/phone_en.html</a> , or contact your local Rockwell Automation representative.

## New Product Satisfaction Return

Rockwell Automation tests all of its products to ensure that they are fully operational when shipped from the manufacturing facility. However, if your product is not functioning and needs to be returned, follow these procedures.

United States	Contact your distributor. You must provide a Customer Support case number (call the phone number above to obtain one) to your distributor to complete the return process.
Outside United States	Please contact your local Rockwell Automation representative for the return procedure.

## Documentation Feedback

Your comments will help us serve your documentation needs better. If you have any suggestions on how to improve this document, complete this form, publication [RA-DU002](#), available at <http://www.rockwellautomation.com/literature/>.

Rockwell Otomasyon Ticaret A.Ş., Kar Plaza İş Merkezi E Blok Kat:6 34752 İçerenköy, İstanbul, Tel: +90 (216) 5698400

**[www.rockwellautomation.com](http://www.rockwellautomation.com)**

---

### Power, Control and Information Solutions Headquarters

Americas: Rockwell Automation, 1201 South Second Street, Milwaukee, WI 53204-2496 USA, Tel: (1) 414.382.2000, Fax: (1) 414.382.4444

Europe/Middle East/Africa: Rockwell Automation NV, Pegasus Park, De Kleetlaan 12a, 1831 Diegem, Belgium, Tel: (32) 2 663 0600, Fax: (32) 2 663 0640

Asia Pacific: Rockwell Automation, Level 14, Core F, Cyberport 3, 100 Cyberport Road, Hong Kong, Tel: (852) 2887 4788, Fax: (852) 2508 1846

Publication 1734-UM011D-EN-P - May 2011

Supersedes Publication 1734-UM011C-EN-P - January 2006

Copyright © 2011 Rockwell Automation, Inc. All rights reserved. Printed in the U.S.A.