

SELECTION GUIDE

# Essential Components

Get the right components, at the right price, right when you need them.

Smart Devices

Power

Motor Control & Protection

Logic Control

Operator Interface

Connectivity

Safety

Sensors



**Allen-Bradley**

by ROCKWELL AUTOMATION





# Choose Innovation and Excellence

## Rely on Award-Winning Products

Order and install with confidence. Don't just take our word for it. Year after year, Allen-Bradley industrial component products are ranked best in category by your peers. Our winners include:



### Reader's Choice awards:

- PLC Programming
- SCADA
- Human-machine interface
- Panel displays
- Operator interface terminals
- Electric motor drives
- Input/output systems
- Data acquisition systems
- Remote terminal units



### Control Engineering's 35th Annual Engineers' Choice Awards

#### Winner:

- Software

#### Honorable Mention:

- I/O & Networking - I/O Modules

## Innovation Awards

*"Our PEOPLE are the foundation of all we do, and creating an environment where everyone can do their best work is fundamental to our success."*

- Blake Moret,  
President and  
Chief Executive Officer



## World's Most Ethical Companies List

For the sixteenth time, the Ethisphere Institute has named Rockwell Automation as one of the "World's Most Ethical (WME) Companies," a recognition that honors organizations that continue to raise the bar on ethical leadership and corporate behavior.



The Ethisphere Institute is an independent center of research promoting best practices in corporate ethics and governance. World's Most Ethical Company honorees understand the correlation between ethics, reputation and daily interactions.

# Rockwell Automation Services

Minimizing Risk. Maximizing Productivity.



## Workforce support & training

- Remediate
- Enable
- Supplement
- Optimize



## People & asset safety

- Hazardous energy control
- Machine safety



## Asset & plant optimization

- Inventory services
- Asset modernization
- Asset performance

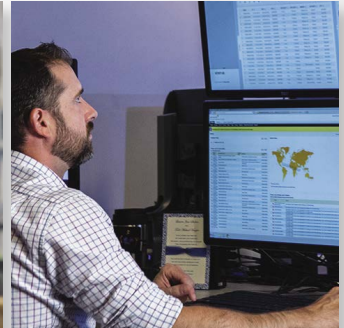

## Information infrastructure & security

- Infrastructure development and management
- Asset performance

## Product & application lifecycle support

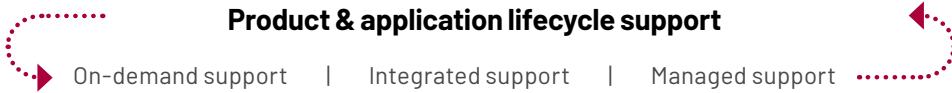

For more information about how we can help you solve your unique business challenges, contact your local authorized Rockwell Automation sales office or Allen-Bradley distributor, or visit: [rok.auto/services](http://rok.auto/services)

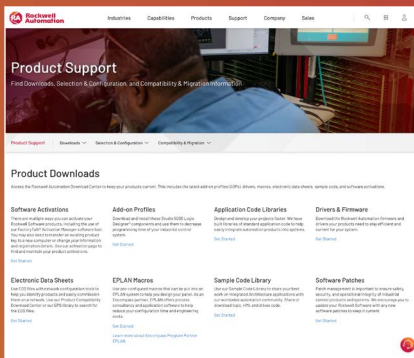

## Support

Visit the Rockwell Automation support website for more information on all our offerings.

[rok.auto/support](http://rok.auto/support)



# Online Resources

Rockwell Automation offers a wide range of online tools to assist you in selecting and configuring your application.



## Literature Library

Browse Literature Library for technical and commercial publications in multiple languages.

- Application Guides
- User Manuals
- Brochures
- White Papers
- Instruction Sheets

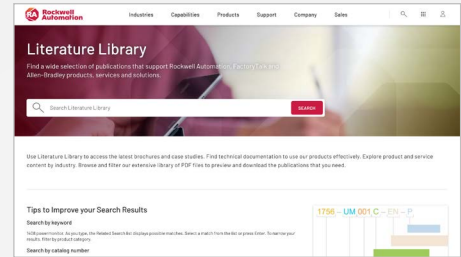

[rok.auto/library](http://rok.auto/library)

## Select, Design and Configure

Browse our diverse collection of tools designed to help you choose the right products, and plan and configure a system to support your business needs.

- Accelerator Toolkits
- System Configuration
- Product Drawings
- Product Certifications
- Product Selection

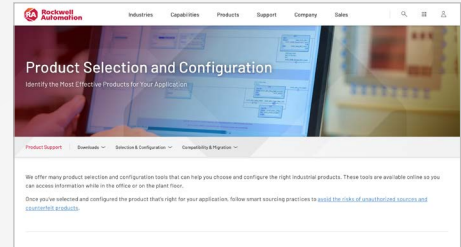

[rok.auto/selection](http://rok.auto/selection)

## Drivers, Software and Downloads

Get access to all the latest resources to support your application.

- Drivers
- Software Downloads
- Firmware Updates
- Software Activations and Transfers
- Network Resources

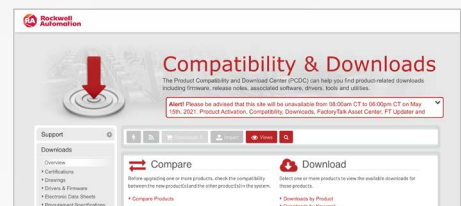

[rok.auto/downloads](http://rok.auto/downloads)



## ROK Talk Podcasts

Stay up to date with the latest in Allen-Bradley® products.

[rok.auto/roktalk-safety-sensing-industrial-components](http://rok.auto/roktalk-safety-sensing-industrial-components)

[rok.auto/roktalk-drives](http://rok.auto/roktalk-drives)



## Looking for More?

This catalog highlights only our most essential components. For a complete product selection, visit our online product directory at

[rok.auto/directory](http://rok.auto/directory)



# ESSENTIAL COMPONENTS – TABLE OF CONTENTS

✦ Denotes new product information

## **Smart Devices** **0-6**

---

Smart Devices .....	0-6
Smart Sensing and Industrial Control.....	0-8
Smart Safety .....	0-10

## **Power** **1-1**

---

Circuit Breakers .....	✦ 1-2
Disconnect Switches.....	1-16
Control & Load Switches .....	1-24
Control Circuit & Load Protection .....	✦ 1-28
Power Supplies.....	✦ 1-40
Power Quality & Energy Management .....	1-48
Surge & Filter .....	1-52
Additional Logic Products .....	1-56

## **Motor Control** **2-1**

---

Contactors .....	✦ 2-2
Starters.....	2-16
Motor Protection .....	✦ 2-30
Smart Motor Control .....	2-36
Drives.....	2-46
Additional Power Products .....	✦ 2-52

## **Logic Control** **3-1**

---

Relays & Timers.....	✦ 3-2
Programmable Controllers.....	3-20
Signal Interface .....	3-24

## **Operator Interface** **4-1**

---

Push Buttons.....	4-2
Signaling .....	✦ 4-24
Graphic Terminals.....	4-36
Additional Operator Interface Products .....	4-38

## **Connectivity** **5-1**

---

Terminal Blocks.....	✦ 5-2
Wiring Systems .....	5-34
Connection Systems.....	5-36
Safety Connection Systems .....	5-46
Network Media .....	5-50
Additional Connectivity Products.....	5-58

## **Safety** **6-1**

---

GuardLink.....	6-2
Presence Sensing Safety Devices .....	✦ 6-6
Interlock Switches.....	✦ 6-20
Access Control .....	6-40
Safety Relays.....	6-42
Emergency Stop Devices .....	6-48
Safety Limit Switches.....	6-50
Additional Safety Products .....	✦ 6-52

## **Sensors** **7-1**

---

Photoelectric Sensors .....	✦ 7-2
Proximity Sensors .....	✦ 7-50
Ultrasonic Sensors .....	✦ 7-80
Limit Switches .....	7-84
Encoders.....	✦ 7-96
Condition Sensing .....	✦ 7-104
RFID .....	✦ 7-114
Additional Sensor Products .....	7-122

# SMART DEVICES



<b>Smart Devices</b>	
Smart Devices.....	0-6
<b>Smart Sensing and Industrial Control</b>	
Smart Sensing and Industrial Control.....	0-8
<b>Smart Safety</b>	
Smart Safety .....	0-10



# Smart Devices

## Make your machines and equipment smarter

Smart Devices are the core of modern automation, which expand what's possible and is a catalyst that makes you more productive and more connected.

Allen-Bradley Smart Devices deliver information and insights that enable predictive maintenance, speed troubleshooting, reduce downtime – and maximize ROI. Scalable Smart Devices lay the foundation for smarter machines, smart connected systems and knowledge-driven operations.

**Real-time data**  
Current, voltage, kWh, running time, temperature, safety

**Information**  
CONTEXTUALIZATION  
Production output, warnings/alarms, energy usage, downtime causals

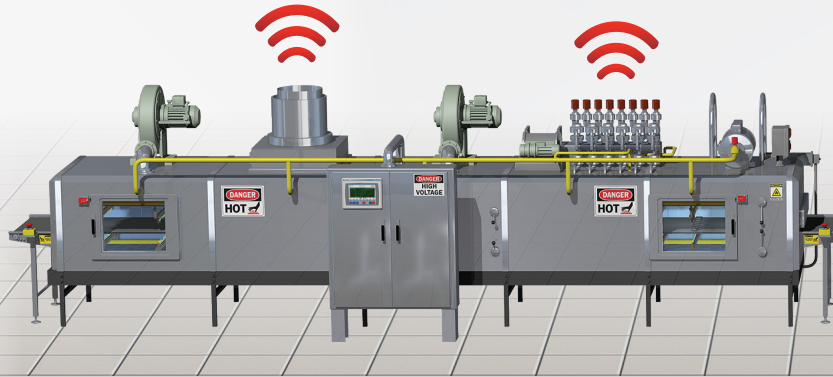

Our Smart Devices include:

**Variable Frequency Drives**



**Servo Drives**



**Motor Starters**



**Condition Monitoring**





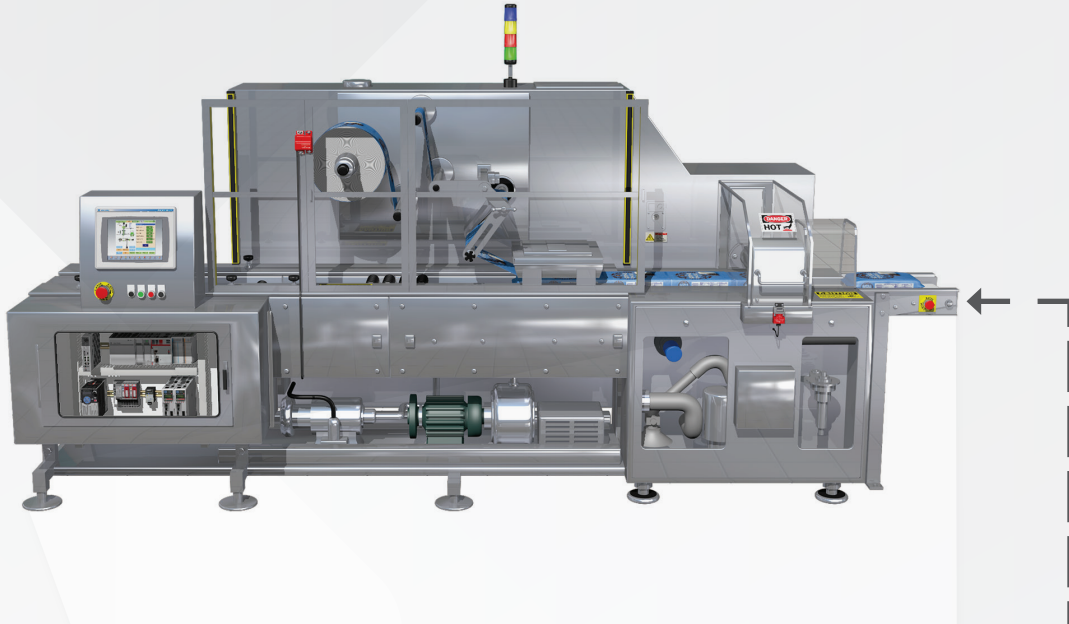

**Knowledge**  
ANALYTICS  
Mean time to repair,  
predictive maintenance, OEE

**Optimize**  
ACTION  
More efficient process workflows,  
continuous improvement



**Power Monitoring**

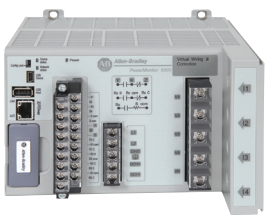

**Motor Protection**



**Sensors**



**Safety**

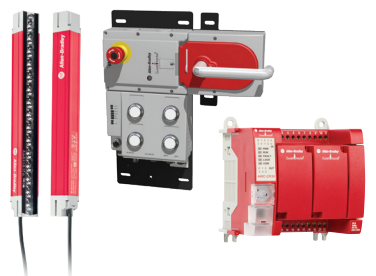

# Smart Sensing and Industrial Control

## Our Integrated Smart Sensing and Industrial Control Solution

When it comes to linking end point devices on the plant floor to The Connected Enterprise, Rockwell Automation offers a wide range of smart sensing and industrial control products that deliver information, advanced functionality and flexibility while increasing efficiency machine- and plant-wide. These Allen-Bradley® sensors and industrial control products use IO-Link technology for visibility of field devices through your Integrated Architecture.

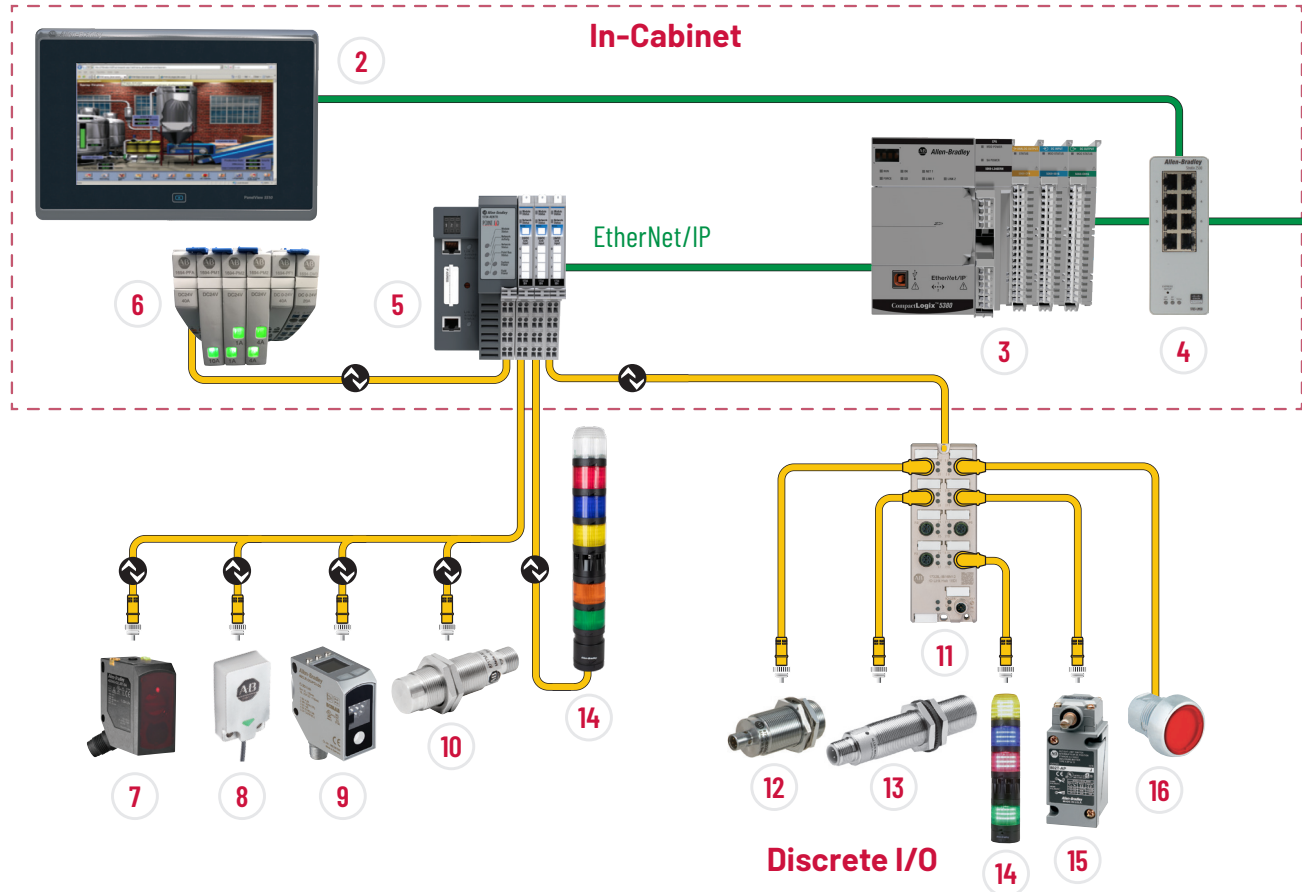

Item Number	Description
2	PanelView™ 5510
3	CompactLogix™ 5380
4	Stratix Switch
5	1734-4IOL Point I/O IO-Link Master
6	1694 Electronic Circuit Protector
7	45DMS Distance Measurement Sensor
8	871FM Mini Flat Pack Proximity Sensor
9	46CLR ColorSight™ True Color Sensor

Item Number	Description
10	871TM Tubular Stainless Steel Sensor
11	ArmorBlock IO-Link Hub
12	872C WorldProx™ Tubular General Purpose Inductive Proximity Sensor
13	871C Tubular Extended Temperature Sensor
14	856T Control Tower™ Stack Lights
15	802T Oiltight Limit Switch
16	800F 22 mm Round Operator

### Smart Sensing & Industrial Control



0-8...0-9

GuardLink



0-10...0-11

CIP Safety



0-12...0-13

## What is IO-Link?

IO-Link is a worldwide open-standard peer-to-peer serial communication protocol (IEC 61131-9) that allows sensors and actuators to easily integrate into The Connected Enterprise. Through IO-Link you can access all sensor configuration parameters, process data and diagnostics. So you can go beyond detecting products on your machine – now you can MONITOR your machine’s health as it runs. Plus, IO-Link simplifies setup and commissioning while offering enhanced flexibility for current – and future – processes.

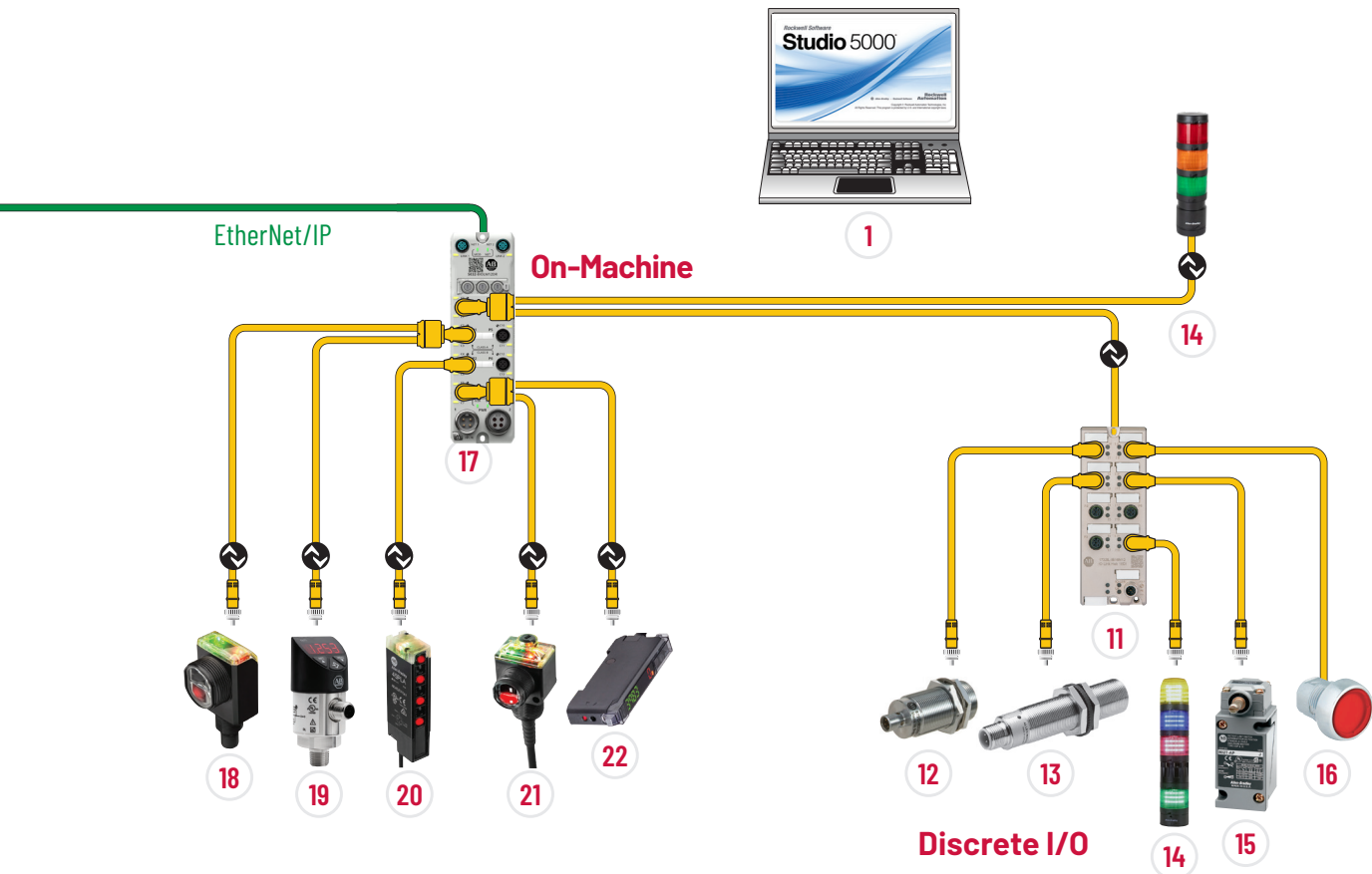

Item Number	Description
1	Studio 5000®
11	ArmorBlock IO-Link Hub
12	872C WorldProx™ Tubular General Purpose Inductive Proximity Sensor
13	871C Tubular Extended Temperature Sensor
14	856T Control Tower™ Stack Lights
15	802T Oiltight Limit Switch

Item Number	Description
16	800F 22 mm Round Operator
17	1732-E810LM12R ArmorBlock IO-Link Master
18	42AF RightSight™ M30 Sensor
19	836P Solid-State Pressure Sensor
20	45PLA Polarized Light Array Photoelectric Sensor
21	42EF RightSight™ Sensor
22	46DFA DIN Rail Fiber Optic Amplifier

 Look for this symbol for IO-Link enabled Smart Devices

For more information on our Smart Device products, please visit:  
[rok.auto/smart-devices](http://rok.auto/smart-devices)





# Smart Safety

## Smart Safety Technology

Rockwell Automation smart safety products enhance safety while providing connectivity through The Connected Enterprise. Allen-Bradley Guardmaster® smart safety devices featuring EtherNet/IP connectivity or GuardLink® enabling technology deliver information, diagnostics, advanced functionality and flexibility, while enhancing safety and increasing efficiency machine- and plant-wide.

### THE CONNECTED ENTERPRISE/INDUSTRY 4.0

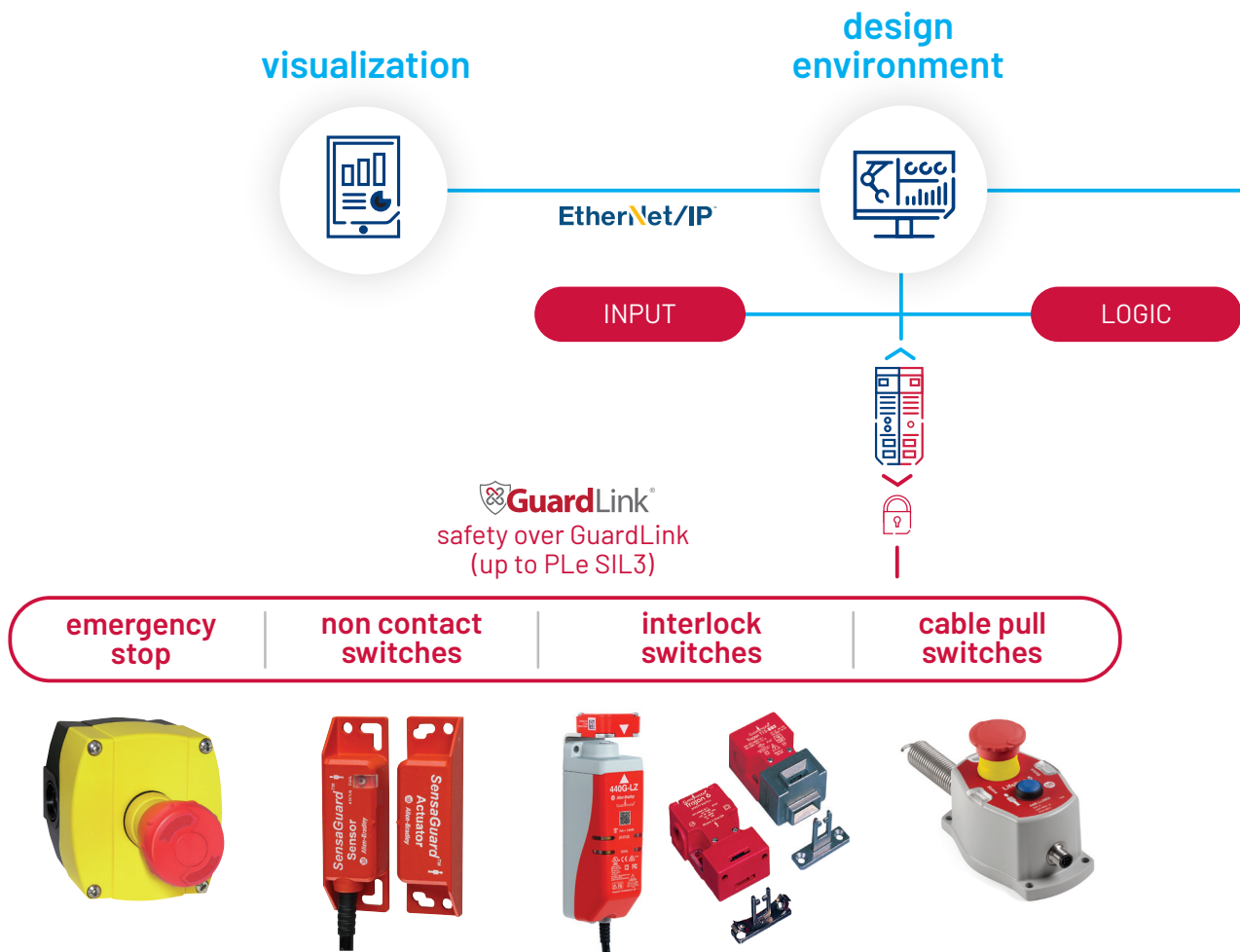

**Cable reduction of up to 38%**

Smart Sensing & Industrial Control

EtherNet/IP



0-8...0-9

GuardLink



0-10...0-11

CIP Safety

EtherNet/IP



0-12...0-13

Smart safety solutions provide detailed diagnostic data to your design environment, visualization system, information software and GuardLogix® Programmable Automation Controller - enabling Smart Machines for Smart Manufacturing and helping to increase productivity and minimize downtime while reducing total cost of ownership.

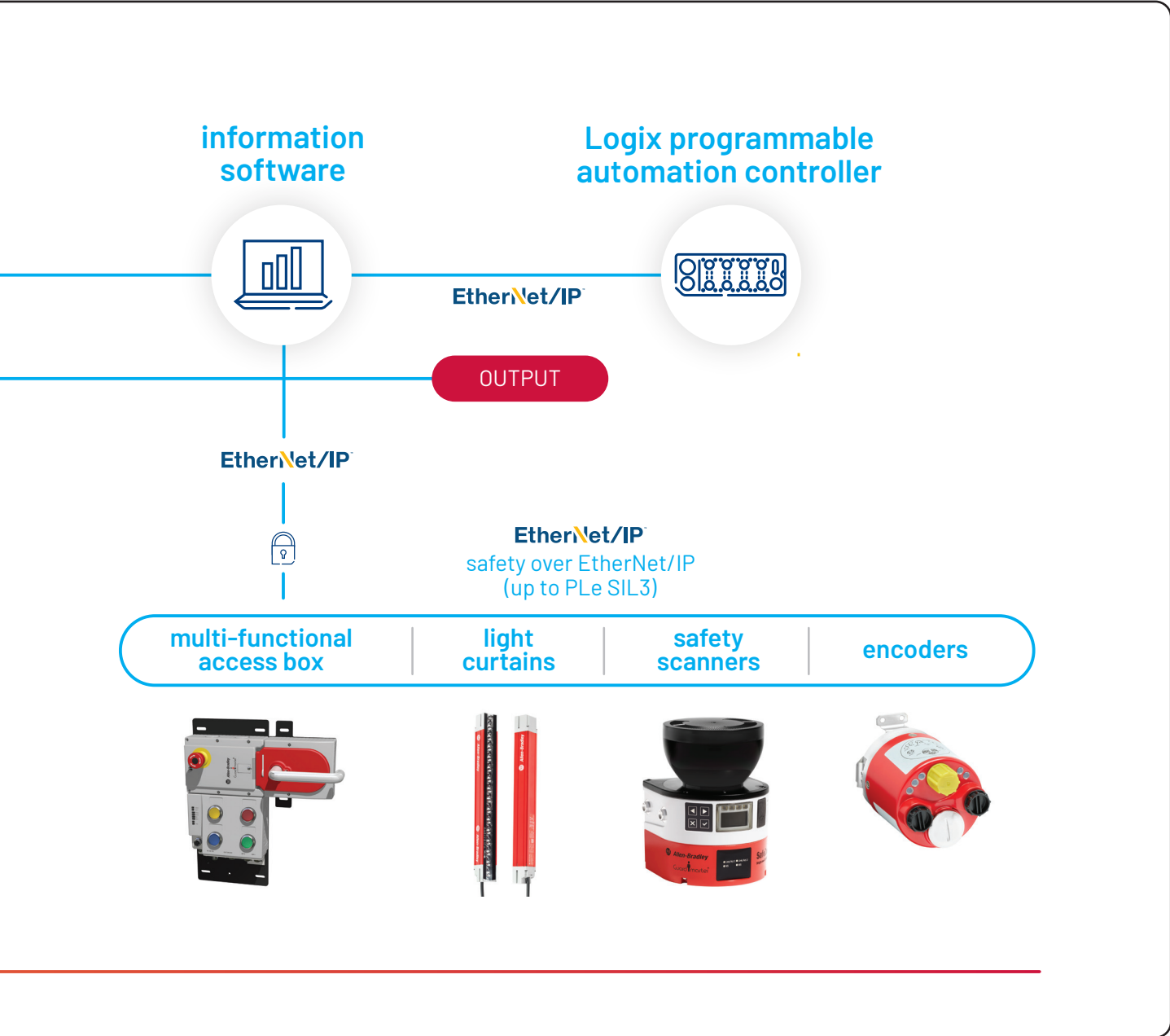

# Smart Safety

Smart safety solutions provide detailed diagnostic data to your design environment, visualization system, information software, and GuardLogix® Programmable Automation Controller — enabling Smart Machines for Smart Manufacturing and helping to increase productivity and minimize downtime while reducing the total cost of ownership.

## 440G-MZ Guard Locking Interlock Switch

Guard Locking switches lock/unlock signals can be provided, giving the devices current state and specific location within the system. Individual indications of the guard doors state including guard open, guard closed, guard locked or guard unlocked can also be provided.

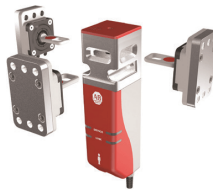

## 450L Light Curtains

450L Light curtains can be connected simply to GuardLink® via a GuardLink enabled tap. Access to the light curtains status along with the location can be communicated.



## Lifeline 5

Connect a Lifeline™ 5 Cable Pull Switch to get the location of the device and rope tension status to avoid nuisance trips from occurring when operated.

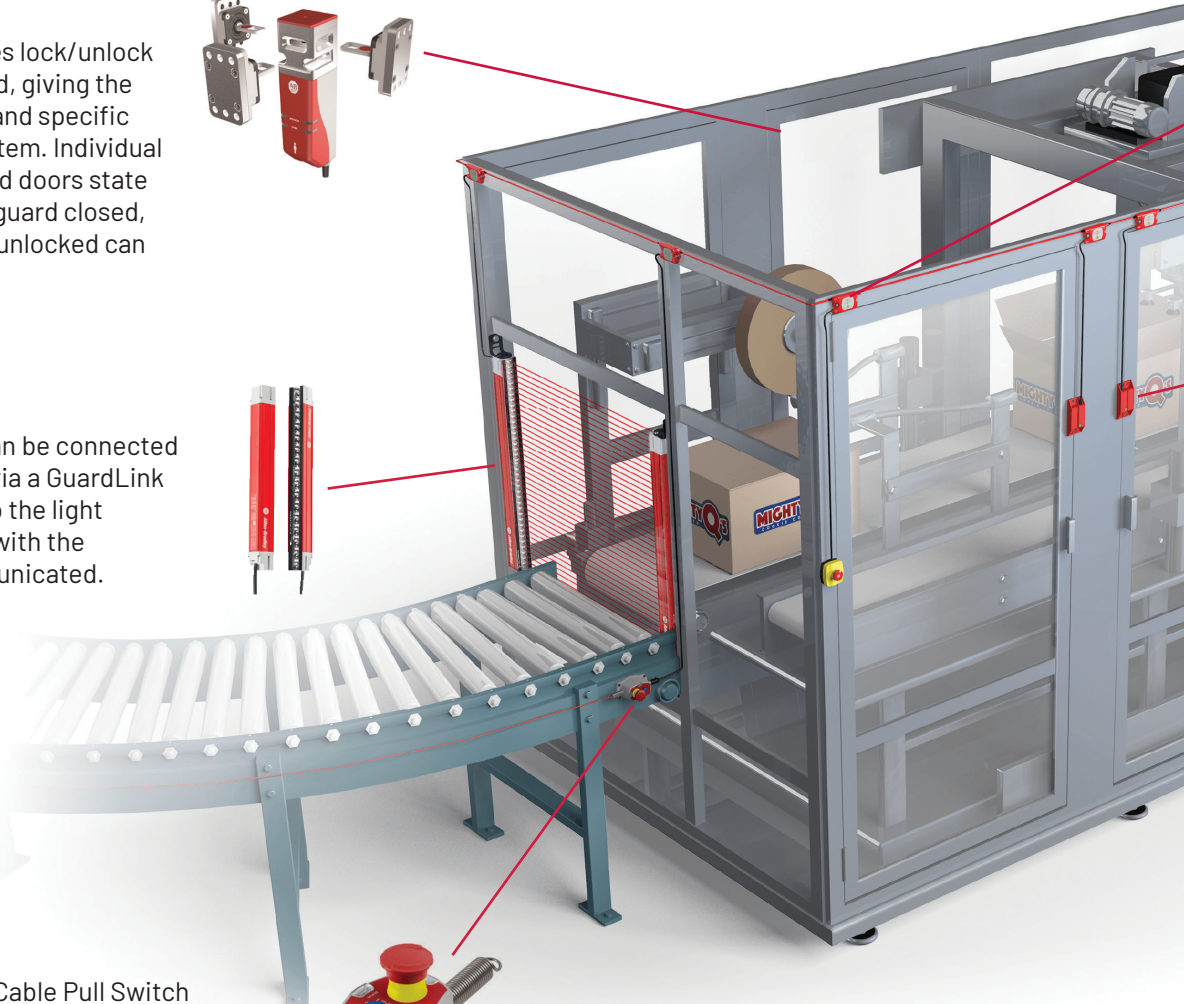

Smart Sensing & Industrial Control

EtherNet/IP



0-8...0-9

GuardLink



0-10...0-11

CIP Safety

EtherNet/IP



0-12...0-13



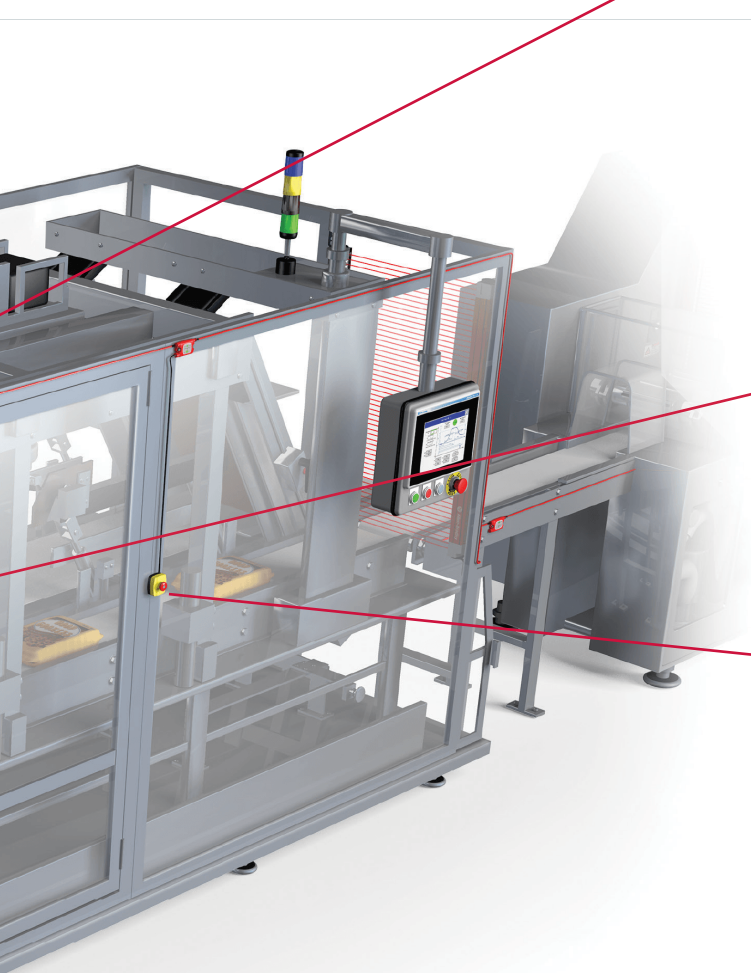

### GuardLink-Enabled Tap Indication

#### LED Input

- Green** = Connected input device healthy
- Flashing Green** = Connected input device healthy but fault on system
- Red** = Trip on connected input device
- Flashing Red** = Connected input device has not performed correctly

#### LED Link

- Green** = Operational
- Red** = Tripped
- Flashing Red** = Faulty tap



### SensaGuard™ Non-contact Guard Interlock Switch

Connect Non-contact Interlock Switches to a GuardLink-enabled tap and receive data on the location of the switch and any fault conditions through GuardLink when the guard door is opened or closed.



### 800F Emergency Stop Push Button

Connect Emergency Stop Push Buttons to a GuardLink-enabled tap quickly and simply via an M12 connector. Get information on its location when the device is operated.



### 432ES GuardLink EtherNet/IP On-Machine™ Interface

The 432ES GuardLink EtherNet/IP Interface monitors three independent channels of GuardLink-enabled devices and communicates the status of those devices to a safety-rated controller over a CIP Safety EtherNet/IP network.



### GSR DG - Dual GuardLink Safety Relay

The GSR DG - Dual GuardLink Safety Relay can monitor two GuardLink channels and communicate status information for each safety input device via the EtherNet/IP Network Interface.



# Smart Manufacturing Delivers Measurable Results

## Improve safety, increase quality and optimize plant performance

Thanks to constant evolution of technology, resulting in free flowing/open connectivity coupled to modern automation solutions, smart manufacturing has morphed from an abstract concept into a technological reality – and is now, arguably, an engineering necessity!

Modern market forces demand levels of flexibility, agility and overall operational equipment effectiveness (OEE) that only smart solutions can deliver. Are you keeping pace?

Many contemporary business outcomes – like reducing downtime – are based around knowledge-driven operations and smart, flexible manufacturing. But what is smart?

How do you get smart? Are you already smart? And what will being smart deliver?

Smart Devices provide the foundation for a digital transformation, Smart Machines provide unsurpassed level of intelligence to drive productivity and Smart Systems enable knowledge-driven operations.

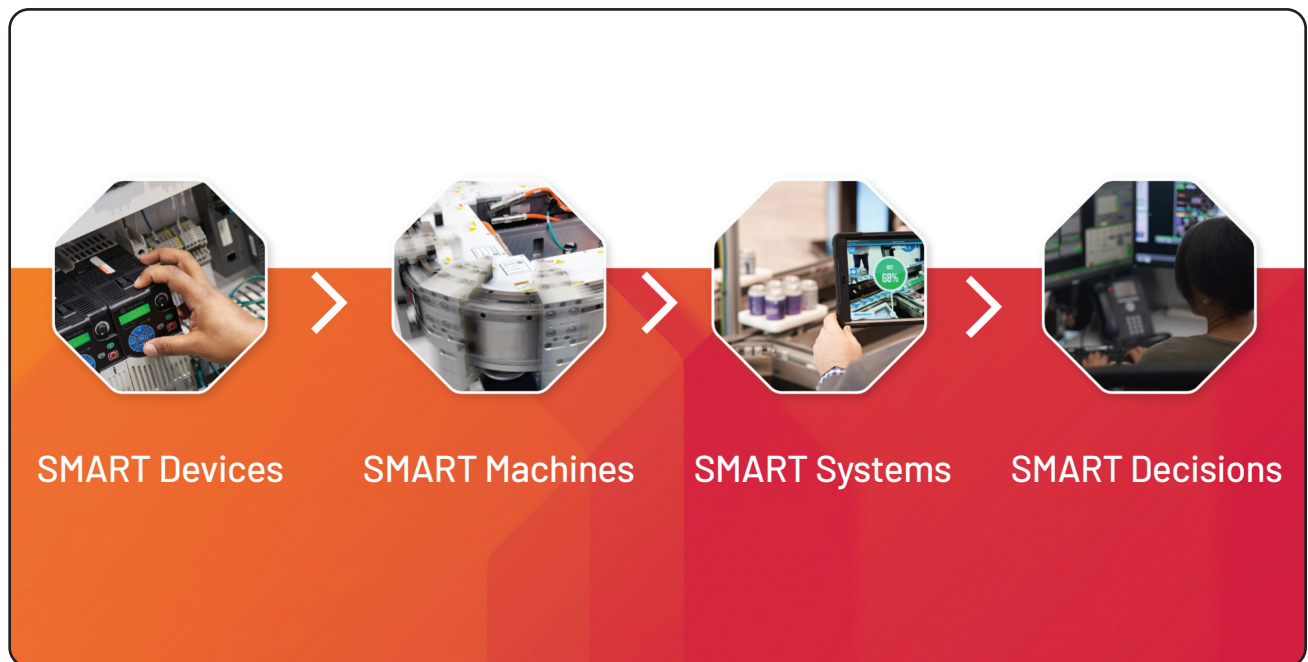

## Circuit Breakers

- Motor Circuit Protectors.....1-2
- Motor Protection Circuit Breakers .....1-2
- Molded Case Circuit Breakers .....1-2

## Disconnect Switches

- Rotary Disconnect Switches.....1-16
- Visible Blade Disconnect Switches .....1-20

## Control & Load Switches

- Control & Load Switches .....1-24
- Load Switches .....1-26

## Control Circuit & Load Protection

- Miniature Circuit Breakers.....1-28
- Regional Circuit Breakers.....1-32
- Residual Current Devices.....1-34
- Fuse Holders .....1-36
- Modular Electronic Circuit Protection.....1-38

## Power Supplies

- Switched Mode.....1-40
- Switched Mode Modules .....1-41
- Uninterruptible Power Supplies .....1-46

## Power Quality & Energy Management

- PowerMonitor 500 .....1-48
- PowerMonitor 1000.....1-48
- PowerMonitor 5000 .....1-48

## Surge & Filter

- DIN Rail AC Power Surge Protector .....1-52
- Filter Protective Devices .....1-54

## Additional Power Products.....1-56

# Circuit Breakers

## Applying Circuit Protection

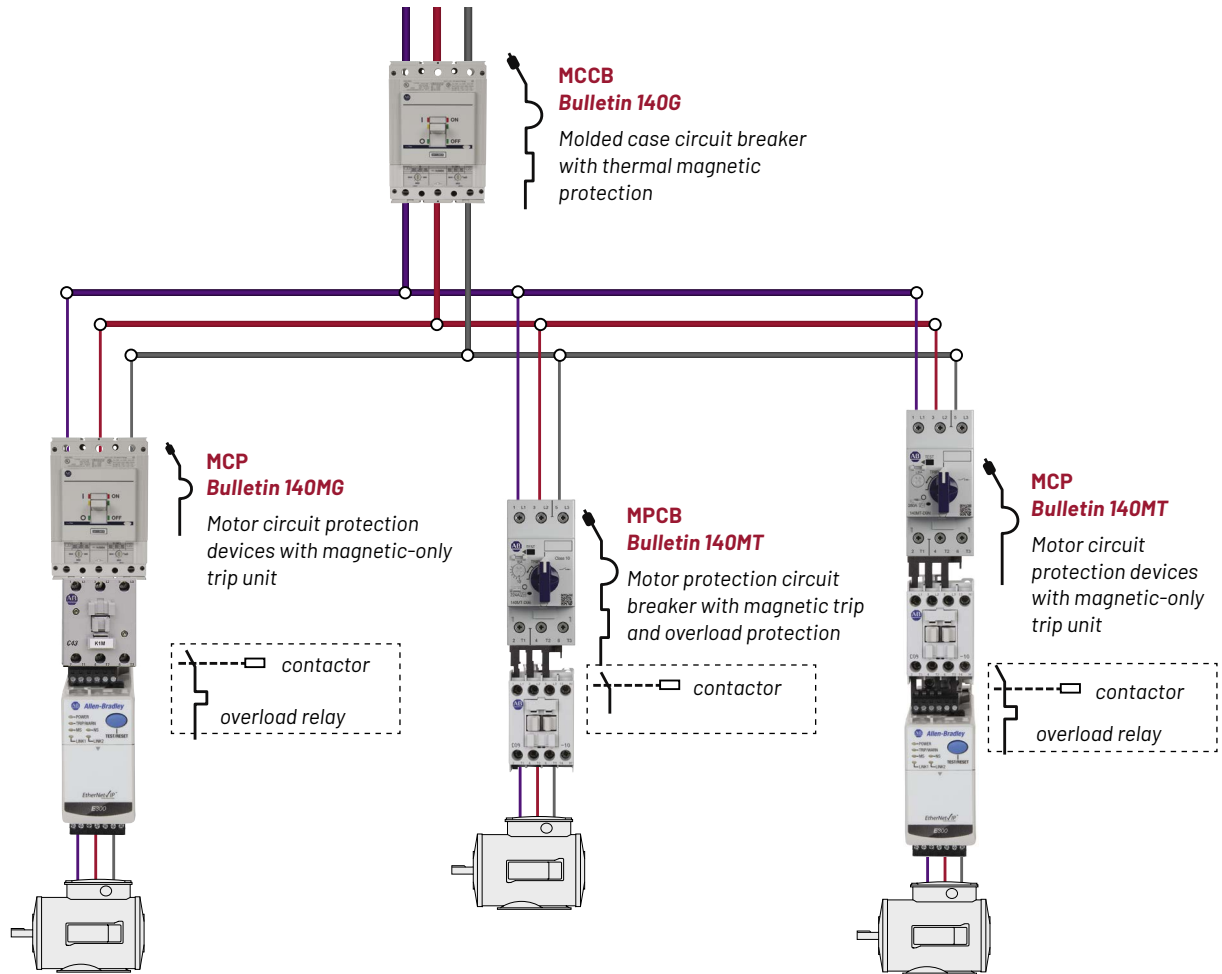

**Molded Case Circuit Breakers (MCCBs)** are designed to protect an electrical circuit from damage caused by overload or short circuit. Their basic function is to detect a fault condition and interrupt current flow. You can reset an MCCB (either manually or automatically) to resume normal operation.

**Motor Circuit Protectors (MCPs)** are designed to provide short-circuit (magnetic) protection and disconnect for a motor circuit. They are designed to be used with a contactor (to start/stop the motor) and an overload relay (to protect against overcurrent).

**Motor Protection Circuit Breakers (MPCBs)** are designed to provide short circuit (magnetic) protection, a disconnect for motor circuit, and overload protection for the motor, all in one device.

### Circuit Breakers



1-2...1-15

### Disconnect Switches



1-16...1-23

### Control & Load Switches



1-24...1-27

### Control Circuit & Load Protection



1-28...1-39

### Power Supplies



1-40...1-47

### Power Quality & Energy Management



1-48...1-51

### Surge & Filter



1-52...1-55





## Product Selection

### 140MP, 140MT, 140MG (Various Frames)



Bulletin No.	140MP-A	140MT-C	140MT-D	140MG	140MG
Frame Size	-	C-Frame	D-Frame	H-Frame	J-Frame
Dimensions (mm)	45 x 90 x 85.5	45 x 96 x 84	45 x 96 x 94	130 (5.19) x 90 (3.54) x 82.5 (3.25)	160 (6.23) x 105 (4.13) x 82.5 (3.25)
Current Range (A)	0.1...32	0.1...32	0.4...40	25, 60, 100 adj. from 0.4...1 x I <sub>n</sub>	40, 60, 100, 150 adj. from 0.4...1 x I <sub>n</sub>
SCCR @ 480V (kA)	18-30	30-65	30-50-65	65	65
SCCR @ 400V (kA)	15-50-100	15-65-100	50-65-100	65	65
Short Circuit Protection	●	●	●	●	●
Overload Protection	●	●	●	●	●
Overload Trip Class	10A	10	10	3E, 5E, 10E, 20E	3E, 5E, 10E, 20E
Phase Loss Sensitivity	●	●	●	●	●
Short Circuit Indication	-	●	●	●	●
Lockable knob	Optional	Optional	Standard	Toggle	Toggle
Compatible at output of VFD	-	-	●	-	-
MCP Version, High Inrush version	-	-	●	-	-

### UL 60947-4-1 Application Ratings

Motor Disconnect Rated	●	●	●	●	●
Group Motor Rated	●	●	●	-	-
Tap Conductor Protection	-	●	●	●	●
Man/Self Protected (Type E)	-	●	●	-	-
UL Type F Ratings	-	100-C, 100-E, 100-K	100-C, 100-E, 100-K	-	-

### Standards Compliance and Certifications

cULus Listed (3)	●	●	●	●	●
IEC/EN 60947-2	●	●	●	●	●
IEC/EN 60947-4-1	●	●	●	●	●
CE	●	●	●	●	●
ATEX	-	●	●	-	-
IECEX	-	●	●	-	-
EAC	●	●	●	●	●
CCC	●	●	●	●	●
KC	●	-	-	-	-
CB Scheme	●	●	●	-	-



# Circuit Breakers



## Product Selection

### 140MT Motor Circuit Protectors

POWER

Rated Operational Current ( $I_n$ ) [A]	Motor Current Adjustment Range [A]	Nominal Magnetic Trip Current [A]	Max Short-circuit Current [kA]		Max. 3-phase Hp Ratings <sup>1</sup>				Max. kW, 3-Phase - AC-3 <sup>1</sup>				Cat. No.
			400V ( $I_{cu}$ )	480V (group motor)	200V	230V	460V	575V	230V	400/415V	500V	690V	
D-Frame, Fixed Magnetic (14 x $I_n$ )													
0.16	—	2.2	100	65	—	—	—	—	—	0.02	0.06	0.06	140MT-D9N-A16
0.25	—	3.5	100	65	—	—	—	—	—	0.04	0.09	0.09	140MT-D9N-A25
0.4	—	5.6	100	65	—	—	—	—	0.06	0.09	0.12	0.18	140MT-D9N-A40
0.63	—	8.8	100	65	—	—	—	—	0.09	0.18	0.18	0.25	140MT-D9N-A63
1	—	14	100	65	—	—	0.5	0.5	0.18	0.25	0.37	0.55	140MT-D9N-B10
1.6	—	22	100	65	0.25	0.33	0.75	0.75	0.25	0.55	0.75	1.1	140MT-D9N-B16
2.5	—	35	100	65	0.5	0.5	1	1.5	0.37	0.75	1.1	1.8	140MT-D9N-B25
4	—	56	100	65	0.75	0.75	2	3	0.75	1.5	2.2	3	140MT-D9N-B40
6.3	—	88	100	65	1	1.5	3	5	1.5	2.2	3	4	140MT-D9N-B63
10	—	140	100	65	2	3	5	7.5	2.2	4	6.3	7.5	140MT-D9N-C10
16	—	224	100	65	3	5	10	10	4	7.5	10	13	140MT-D9N-C16
20	—	280	100	65	5	5	10	15	5.5	10	11	17	140MT-D9N-C20
25	—	350	65	50	7.5	7.5	15	20	5.5	11	15	22	140MT-D9N-C25
29	—	406	50	50	7.5	10	20	25	7.5	13	18.5	25	140MT-D9N-C29
32	—	448	50	50	7.5	10	20	30	7.5	15	20	25	140MT-D9N-C32
36	—	432	50	30	10	10	25	30	—	18.5	20	25	140MT-D9N-C36 <sup>2</sup>
40	—	480	50	30	10	10	30	30	11	20	24	30	140MT-D9N-C40 <sup>2</sup>
F-Frame, Fixed Magnetic (13 x $I_n$ )													
25	—	325	100	65	7.5	10	20	25	6.3	11	15	22	140M-F8N-C25
32	—	416	65	65	7.5	10	25	30	7.5	15	20	30	140M-F8N-C32
45	—	585	65	65	10	15	30	40	13	22	30	40	140M-F8N-C45

<sup>1</sup> Horsepower/kW ratings shown are for reference. The final selection of the MCP depends on the actual motor full load current.

<sup>2</sup> Suitable for continuous operation at 90% current rating at 480V only if used in a minimum enclosure size of 250 x 175 x 150 mm (10 x 7 x 6 in).

See technical data for de-rating for Trip class 20 and 30 applications.

### Circuit Breakers



1-2...1-15

### Disconnect Switches



1-16...1-23

### Control & Load Switches



1-24...1-27

### Control Circuit & Load Protection



1-28...1-39

### Power Supplies



1-40...1-47

### Power Quality & Energy Management



1-48...1-51

### Surge & Filter



1-52...1-55



## Product Selection

### 140MP Motor Protective Switching Devices

Rated Operational Current ( $I_e$ ) [A]	Motor Current Adjustment Range [A]	Nominal Magnetic Trip Current [A]	Max Short-circuit Current [kA]		Max. 3-phase Hp Ratings <sup>1</sup>				Max. kW, 3-Phase - AC-3 <sup>1</sup>				Cat. No.
			400V ( $I_{cu}$ )	480V (group motor)	200V	230V	460V	575V	230V	400/415V	500V	690V	
0.16	0.10...0.16	2	100	30	—	—	—	—	—	0.02	0.06	0.06	140MP-A3E-A16
0.25	0.16...0.25	3.1	100	30	—	—	—	—	—	0.04	0.09	0.09	140MP-A3E-A25
0.4	0.25...0.40	5	100	30	—	—	—	0.25	0.06	0.09	0.12	0.18	140MP-A3E-A40
0.63	0.40...0.63	7.9	100	30	—	—	0.25	0.33	0.09	0.18	0.18	0.25	140MP-A3E-A63
1	0.63...1.0	12.5	100	30	—	—	0.5	0.75	0.18	0.25	0.37	0.55	140MP-A3E-B10
1.6	1.0...1.6	20	100	30	0.25	0.33	1	1	0.25	0.55	0.75	1.1	140MP-A3E-B16
2.5	1.6...2.5	31.3	75	30	0.5	0.75	1.5	2	0.37	0.75	1.1	1.8	140MP-A3E-B25
4	2.5...4.0	50	75	18	1	1	3	3	0.75	1.5	2.2	3	140MP-A3E-B40
6.3	4.0...6.3	78.8	50	18	1.5	2	5	5	1.5	2.2	3	4	140MP-A3E-B63
10	6.3...10	150	50	18	3	3	7.5	10	2.2	4	6.3	7.5	140MP-A3E-C10
12	8.0...12	180	50	18	3	3	7.5	10	3	5.5	6.3	7.5	140MP-A3E-C12
16	10...16	240	15	18	5	5	10	15	4	7.5	10	13	140MP-A3E-C16
20	16...20	300	15	18	5	7.5	15	20	5.5	10	11	17	140MP-A3E-C20
25	20...25	375	15	18	7.5	7.5	20	20	5.5	11	15	22	140MP-A3E-C25
32	25...32	480	15	18	7.5	10	25	30	7.5	15	20	25	140MP-A3E-C32

### 140MT Motor Protective Switching Devices

Rated Operational Current ( $I_e$ ) [A]	Motor Current Adjustment Range [A]	Nominal Magnetic Trip Current [A]	Max Short-circuit Current [kA]		Max. 3-phase Hp Ratings <sup>1</sup>				Max. kW, 3-Phase - AC-3 <sup>1</sup>				Cat. No.
			400V ( $I_{cu}$ )	480V (group motor)	200V	230V	460V	575V	230V	400/415V	500V	690V	
C-Frame, Adjustable Thermal/Fixed Magnetic (14 x $I_n$ )													
0.16	0.10...0.16	2.2	100	65	—	—	—	—	—	0.02	0.06	0.06	140MT-C3E-A16
0.25	0.16...0.25	3.5	100	65	—	—	—	—	—	0.04	0.09	0.09	140MT-C3E-A25
0.4	0.25...0.40	5.6	100	65	—	—	—	—	0.06	0.09	0.12	0.18	140MT-C3E-A40
0.63	0.40...0.63	8.8	100	65	—	—	—	—	0.09	0.18	0.18	0.25	140MT-C3E-A63
1	0.63...1.0	14	100	65	—	—	0.5	0.5	0.18	0.25	0.37	0.55	140MT-C3E-B10
1.6	1.0...1.6	22	100	65	0.25	0.33	0.75	0.75	0.25	0.55	0.75	1.1	140MT-C3E-B16
2.5	1.6...2.5	35	100	65	0.5	0.5	1	1.5	0.37	0.75	1.1	1.8	140MT-C3E-B25
4	2.5...4.0	56	100	65	0.75	0.75	2	3	0.75	1.5	2.2	3	140MT-C3E-B40
6.3	4.0...6.3	88	100	65	1	1.5	3	5	1.5	2.2	3	4	140MT-C3E-B63
10	6.3...10	140	100	65	2	3	5	7.5	2.2	4	6.3	7.5	140MT-C3E-C10
16	10...16	224	65	30	3	5	10	10	4	7.5	10	13	140MT-C3E-C16
20	14.5...20	280	50	30	5	5	10	15	5.5	10	11	17	140MT-C3E-C20
25	18...25	350	15	30	7.5	7.5	15	20	5.5	11	15	22	140MT-C3E-C25
29	23...29	406	15	30	7.5	10	20	25	7.5	13	18.5	25	140MT-C3E-C29
32	26.5...32	448	15	30	7.5	10	20	30	7.5	15	20	25	140MT-C3E-C32

<sup>1</sup> Horsepower/kW ratings shown are for reference. The final selection of the MPCB/MPSD depends on the actual motor full load current.

For more information on our complete family of circuit protection products, please visit:  
[rok.auto/circuit-load-protection](http://rok.auto/circuit-load-protection)



# Circuit Breakers



## Product Selection

### 140MT Motor Protection Circuit Breaker for Multiple Motor Installation with Drives

Rated Operational Current ( $I_r$ ) [A]	Motor Current Adjustment Range [A]	Nominal Magnetic Trip Current [A]	Max Short-circuit Current [kA]		Max. 3-phase Hp Ratings <sup>1</sup>				Max. kW, 3-Phase - AC-3 <sup>1</sup>				Cat. No.
			400V ( $I_{cu}$ )	480V (group motor)	200V	230V	460V	575V	230V	400/415V	500V	690V	
D-Frame, Fixed Magnetic (application at output of VFD multi-motor)													
1.6	1.0...1.6	88	100	65	—	—	0.75	—	0.25	0.55	0.75	—	140MT-D9V-B16
2.5	1.6...2.5	88	100	65	0.5	0.5	1	—	0.37	0.75	1.1	—	140MT-D9V-B25
4	2.5...4.0	88	100	65	0.75	0.75	2	—	0.75	1.5	2.2	—	140MT-D9V-B40
6.3	4.0...6.3	88	100	65	1	1.5	3	—	1.5	2.2	3	—	140MT-D9V-B63
10	6.3...10	140	100	65	2	3	5	—	2.2	4	6.3	—	140MT-D9V-C10
16	10...16	224	100	65	3	5	10	—	4	7.5	10	—	140MT-D9V-C16
20	14.5...20	280	100	65	5	5	10	—	5.5	10	11	—	140MT-D9V-C20
25	18...25	350	65	50	7.5	7.5	15	—	5.5	11	15	—	140MT-D9V-C25
29	23...29	406	50	50	7.5	10	20	—	7.5	13	18.5	—	140MT-D9V-C29
32	26.5...32	448	50	50	7.5	10	20	—	7.5	15	20	—	140MT-D9V-C32
36	30...36	432	50	30	10	10	25	—	—	18.5	20	—	140MT-D9V-C36 <sup>2</sup>
40	34...40	480	50	30	10	10	30	—	11	20	24	—	140MT-D9V-C40 <sup>2</sup>

<sup>1</sup> Horsepower/kW ratings shown in the tables above are for reference. The final selection of the manual starter depends on the actual motor full load current.  
<sup>2</sup> Suitable for continuous operation at 90% current rating at 480V only if used in a minimum enclosure size of 250 x 175 x 150 mm (10 x 7 x 6 in).

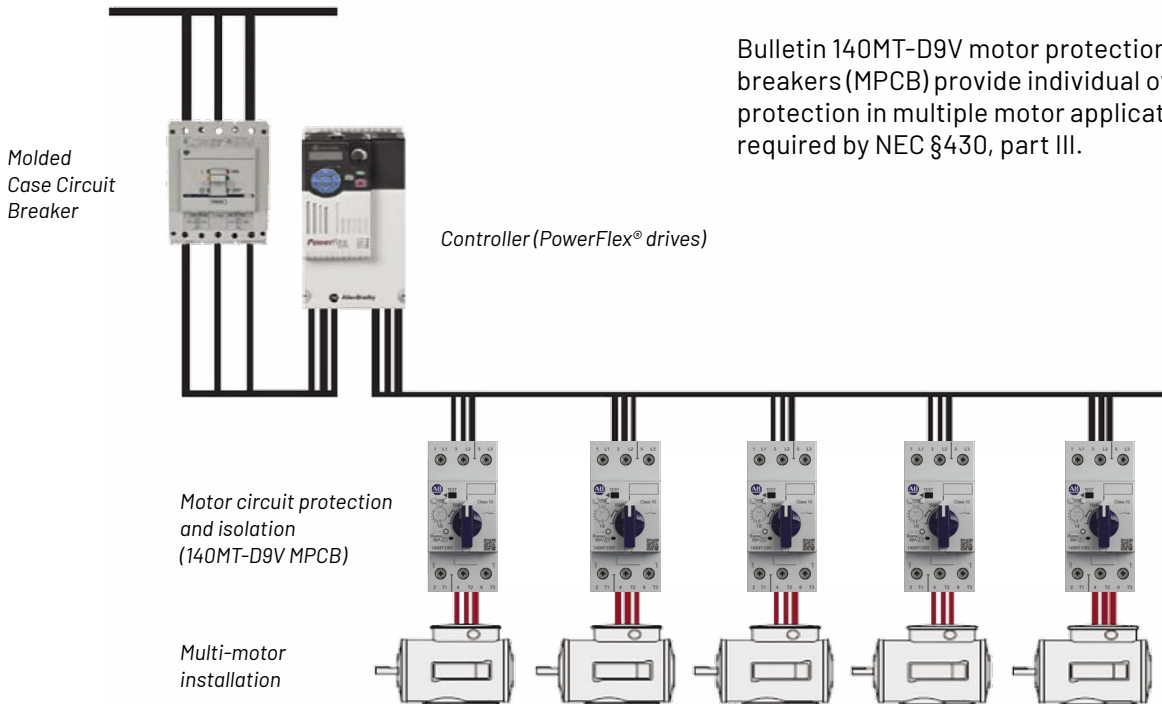

Bulletin 140MT-D9V motor protection circuit breakers (MPCB) provide individual overload protection in multiple motor applications as required by NEC §430, part III.

## Circuit Breakers



1-2...1-15

## Disconnect Switches



1-16...1-23

## Control & Load Switches



1-24...1-27

## Control Circuit & Load Protection



1-28...1-39

## Power Supplies



1-40...1-47

## Power Quality & Energy Management



1-48...1-51

## Surge & Filter



1-52...1-55





## Product Selection

### 140MG Motor Circuit Protectors

Rated Operational Current ( $I_e$ ) [A]	Magnetic Trip Current [A]	Ultimate Interrupting Current [kA]	Max. 3-phase Hp Ratings 1		Max. kW, 3-Phase - AC-3 1		Cat. No.
	CAM Setting Range	415V / $I_{cu}$	230V	460V	230V	400/415V	
G-Frame							
3	12...33	5	0.5	1.5	0.6	0.75	140MG-G8P-B30
7	28...77	5	2	3	1.1	2.2	140MG-G8P-B70
H-Frame							
30	90...330	70	10	20	5.5	11	140MG-H8P-C30
50	150...550	70	15	30	11	22	140MG-H8P-C50
J-Frame							
100	600...1200	50	30	75	22	37	140MG-J8P-D10
110	660...1320	50	40	75	22	45	140MG-J8P-D11
175	875...1750	70	60	125	37	55	140MG-J8P-D17
200	1000...2000	70	75	150	45	75	140MG-J8P-D20

<sup>1</sup> Horsepower/kW ratings shown in the tables above are for reference. The final selection of the MCP depends on the actual motor full load current.



### 140MG Motor Protection Circuit Breakers

3-phase kW Ratings (50 Hz)	3-phase Hp Ratings (60 Hz)		Max. Short-Circuit Current [kA]		L		U	I	Cat. No.
	400/415V	460V	575V	480V	600V	Motor Current Adjustment Range $I_1$ [A]	Trip Class	50% of $I_1$	
H-Frame									
11	15	20	65	25	10...25	3E, 5E, 10E, 20E (approx. 2...20 s)	ON or OFF	Adjustable from 6...13 x $I_n$	140MG-H8E-C25
32	40	50	65	25	24...60				140MG-H8E-C60
55	75	100	65	25	40...100				140MG-H8E-D10
J-Frame									
22	30	40	65	25	16...40	3E, 5E, 10E, 20E (approx. 2...20 s)	ON or OFF	Adjustable from 6...13 x $I_n$	140MG-J8E-C40
32	40	50	65	25	24...60				140MG-J8E-C60
55	75	100	65	25	40...100				140MG-J8E-D10
80	100	150	65	25	60...150				140MG-J8E-D15



# Circuit Breakers

## Accessories

### 140MT Motor Circuit Protectors and 140MT Motor Protection Circuit Breakers

#### Auxiliary Contacts

Description	Auxiliary Contacts		For Use With	Cat. No.
	N.O.	N.C.		
Front-mounted	1	0	140MT-C, D	140MT-C-AFA10
	1	1		140MT-C-AFA11
	2	0		140MT-C-AFA20
Right Side-mounted	2	0	140MT-C, D	140MT-C-ASA20
	0	2		140MT-C-ASA02
	1	1		140MT-C-ASAT1

#### Voltage Trip Units

Description	Trip Rating	For Use With	Cat. No.
Shunt trip	110V, 50 Hz / 120V, 60 Hz	140MT-C, D	140MT-C-SND
	230V, 50 Hz		140MT-C-SNF
	240...260V, 60 Hz		140MT-C-SNA
	24V DC		140MT-C-SNZJ
Undervoltage trip	110V, 50 Hz / 120V, 60 Hz	140MT-C, D	140MT-C-UXD
	230V, 50 Hz		140MT-C-UXF
	240...260V, 60 Hz		140MT-C-UXA
	480V, 60 Hz / 415V, 50 Hz		140MT-C-UXB

#### Handles

Description		For Use With	Cat. No.
Lockable Knob	Black	140MT-C, D	140MT-C-KN
Lockable Knob	Red/Yellow		140MT-C-KRY

#### Feeder Terminals and Compact Busbars

Description	For Use With	Cat. No.	
Feeder Block for Compact Busbar • Supply of compact busbars • Increases terminal capacity	140MT-C, -D	140MT-C-WBE	
Feeder Terminal for Compact Busbar • Meets UL Type E spacing requirements	140MT-C, -D 140M-F	140MT-C-WTEN 140M-F-WTE	
Three-phase Compact Busbar for 32 A Motor Protection Circuit Breakers - 64 A Max. Continuous Current • 45 mm spacing • Front-mounted auxiliary contact	2 connections	140MT-C, -D	140MT-C-W452
	3 connections		140MT-C-W453
	4 connections		140MT-C-W454
	5 connections		1140MT-C-W455
Three-phase Compact Busbar for 32 A Motor Protection Circuit Breakers - 64 A Max. Continuous Current • 54 mm spacing • Side-mounted auxiliary contact	2 connections	140MT-C, -D	1140MT-C-W542
	3 connections		140MT-C-W543
	4 connections		140MT-C-W544
	5 connections		140MT-C-W545
Three-phase Compact Busbar for 45 A Motor Protection Circuit Breakers - 115 A Max. Continuous Current • 54 mm spacing • Front-mounted auxiliary contact	2 connections	140M-F	140M-F-W542
	3 connections		140M-F-W543
	4 connections		140M-F-W544
	4 connections		140M-F-W544
Three-phase Compact Busbar for 45 A Motor Protection Circuit Breakers - 115 A Max. Continuous Current • 63 mm spacing • Side-mounted auxiliary contact	2 connections	140M-F	140M-F-W632
	3 connections		140M-F-W633
	4 connections		140M-F-W634

### 140MG Motor Circuit Protectors and 140MG Motor Protection Circuit Breakers

#### Operating Mechanisms

Description	For Use With	Shaft Length	Cat. No.
Rotary, variable depth operator kits	140MG-G, I Frames	12 in (30.48 mm)	140G-G-RVM12B
		21 in (53.34 mm)	140G-G-RVM21B
	140MG-H, J Frames	12 in (30.48 mm)	140G-H-RVM12B
		21 in (53.34 mm)	140G-H-RVM21B

Description	For Use With	Cable Length	Cat. No.
Flex cable operator kits	140MG-G Frame	3 ft (9.1 m)	140G-G-FCXB03
		4 ft (1.3 m)	140G-G-FCXB04
		6 ft (1.9 m)	140G-G-FCXB06
	140MG-H, Frame	3 ft (9.1 m)	140G-H-FCXB03
		4 ft (1.3 m)	140G-H-FCXB04
		6 ft (1.9 m)	140G-H-FCXB06

#### Voltage Trip Units

Description	Trip Rating	For Use With	Cat. No.
Shunt trip	110...127V AC/ 110...125V DC	140MG-H, J	140G-G-SND
			220...240V AC/ 220...250V DC
	24...30V AC/DC		
	Undervoltage trip		110...127V AC/ 110...125V DC
220...240V AC/ 220...250V DC		140G-G-UVA	
		24...30V AC/DC	140G-G-UVJ

#### Circuit Breakers



1-2...1-15

#### Disconnect Switches



1-16...1-23

#### Control & Load Switches



1-24...1-27

#### Control Circuit & Load Protection



1-28...1-39

#### Power Supplies



1-40...1-47

#### Power Quality & Energy Management



1-48...1-51

#### Surge & Filter



1-52...1-55



# Product Selection

## 140G Assembled Molded Case Circuit Breakers G Frame, Thermal-Magnetic, Fixed



Rated Current $I_n$ [A]	Thermal Trip [A] $I_t = I_n$	Magnetic Trip [A] $I_m$	Interrupting Code G2 <sup>2</sup>		Interrupting Code G3 <sup>2</sup>		Interrupting Code G6 <sup>2</sup>	
			Cat. No.		Cat. No.		Cat. No.	
			3 Poles	4 Poles	3 Poles	4 Poles	3 Poles	4 Poles
15	15	500	140G-G2C3-C15	140G-G2C4-C15	140G-G3C3-C15	140G-G3C4-C15	140G-G6C3-C15	140G-G6C4-C15
16	16	500	140G-G2C3-C16	140G-G2C4-C16	140G-G3C3-C16	140G-G3C4-C16	140G-G6C3-C16	140G-G6C4-C16
20	20	500	140G-G2C3-C20	140G-G2C4-C20	140G-G3C3-C20	140G-G3C4-C20	140G-G6C3-C20	140G-G6C4-C20
25	25	500	140G-G2C3-C25	140G-G2C4-C25	140G-G3C3-C25	140G-G3C4-C25	140G-G6C3-C25	140G-G6C4-C25
30	30	500	140G-G2C3-C30	140G-G2C4-C30	140G-G3C3-C30	140G-G3C4-C30	140G-G6C3-C30	140G-G6C4-C30
32	32	500	140G-G2C3-C32	140G-G2C4-C32	140G-G3C3-C32	140G-G3C4-C32	140G-G6C3-C32	140G-G6C4-C32
35	35	500	140G-G2C3-C35	140G-G2C4-C35	140G-G3C3-C35	140G-G3C4-C35	140G-G6C3-C35	140G-G6C4-C35
40	40	500	140G-G2C3-C40	140G-G2C4-C40	140G-G3C3-C40	140G-G3C4-C40	140G-G6C3-C40	140G-G6C4-C40
45	45	500	140G-G2C3-C45	140G-G2C4-C45	140G-G3C3-C45	140G-G3C4-C45	140G-G6C3-C45	140G-G6C4-C45
50	50	500	140G-G2C3-C50	140G-G2C4-C50	140G-G3C3-C50	140G-G3C4-C50	140G-G6C3-C50	140G-G6C4-C50
60	60	600	140G-G2C3-C60	140G-G2C4-C60	140G-G3C3-C60	140G-G3C4-C60	140G-G6C3-C60	140G-G6C4-C60
63	63	600	140G-G2C3-C63	140G-G2C4-C63	140G-G3C3-C63	140G-G3C4-C63	140G-G6C3-C63	140G-G6C4-C63
70	70	700	140G-G2C3-C70	140G-G2C4-C70	140G-G3C3-C70	140G-G3C4-C70	140G-G6C3-C70	140G-G6C4-C70
80	80	800	140G-G2C3-C80	140G-G2C4-C80	140G-G3C3-C80	140G-G3C4-C80	140G-G6C3-C80	140G-G6C4-C80
90	90	900	140G-G2C3-C90	140G-G2C4-C90	140G-G3C3-C90	140G-G3C4-C90	140G-G6C3-C90	140G-G6C4-C90
100	100	1000	140G-G2C3-D10	140G-G2C4-D10	140G-G3C3-D10	140G-G3C4-D10	140G-G6C3-D10	140G-G6C4-D10
110	110	1100	140G-G2C3-D11	140G-G2C4-D11	140G-G3C3-D11	140G-G3C4-D11	140G-G6C3-D11	140G-G6C4-D11
125	125	1250	140G-G2C3-D12	140G-G2C4-D12	140G-G3C3-D12	140G-G3C4-D12	140G-G6C3-D12	140G-G6C4-D12
160 <sup>3</sup>	112...160	1600	140G-G2E3-D16	140G-G2E4-D16	140G-G3E3-D16	140G-G3E4-D16	140G-G6E3-D16	140G-G6E4-D16

## H Frame, Thermal-Magnetic, Fixed and Adjustable

Rated Current $I_n$ [A]	Thermal Trip [A] $I_t = I_n$	Magnetic Trip [A] $I_m$	Interrupting Code H2 <sup>2</sup>		Interrupting Code H3 <sup>2</sup>		Interrupting Code H6 <sup>2</sup>	
			Cat. No.		Cat. No.		Cat. No.	
			3 Poles	4 Poles	3 Poles	4 Poles	3 Poles	4 Poles
15	15	400	140G-H2C3-C15	140G-H2C4-C15	140G-H3C3-C15	140G-H3C4-C15	140G-H6C3-C15	140G-H6C4-C15
16	16	400	140G-H2C3-C16	140G-H2C4-C16	140G-H3C3-C16	140G-H3C4-C16	140G-H6C3-C16	140G-H6C4-C16
20	20	400	140G-H2C3-C20	140G-H2C4-C20	140G-H3C3-C20	140G-H3C4-C20	140G-H6C3-C20	140G-H6C4-C20
25	25	400	140G-H2C3-C25	140G-H2C4-C25	140G-H3C3-C25	140G-H3C4-C25	140G-H6C3-C25	140G-H6C4-C25
30	30	400	140G-H2C3-C30	140G-H2C4-C30	140G-H3C3-C30	140G-H3C4-C30	140G-H6C3-C30	140G-H6C4-C30
32	32	400	140G-H2C3-C32	140G-H2C4-C32	140G-H3C3-C32	140G-H3C4-C32	140G-H6C3-C32	140G-H6C4-C32
35	35	400	140G-H2C3-C35	140G-H2C4-C35	140G-H3C3-C35	140G-H3C4-C35	140G-H6C3-C35	140G-H6C4-C35
40	40	400	140G-H2C3-C40	140G-H2C4-C40	140G-H3C3-C40	140G-H3C4-C40	140G-H6C3-C40	140G-H6C4-C40
45	45	500	140G-H2C3-C45	140G-H2C4-C45	140G-H3C3-C45	140G-H3C4-C45	140G-H6C3-C45	140G-H6C4-C45
50	50	500	140G-H2C3-C50	140G-H2C4-C50	140G-H3C3-C50	140G-H3C4-C50	140G-H6C3-C50	140G-H6C4-C50
60	60	600	140G-H2C3-C60	140G-H2C4-C60	140G-H3C3-C60	140G-H3C4-C60	140G-H6C3-C60	140G-H6C4-C60
63	63	600	140G-H2C3-C63	140G-H2C4-C63	140G-H3C3-C63	140G-H3C4-C63	140G-H6C3-C63	140G-H6C4-C63
70	70	700	140G-H2C3-C70	140G-H2C4-C70	140G-H3C3-C70	140G-H3C4-C70	140G-H6C3-C70	140G-H6C4-C70
80	56...80	400...800	140G-H2F3-C80	140G-H2F4-C80	140G-H3F3-C80	140G-H3F4-C80	140G-H6F3-C80	140G-H6F4-C80
90	63...90	450...900	140G-H2F3-C90	140G-H2F4-C90	140G-H3F3-C90	140G-H3F4-C90	140G-H6F3-C90	140G-H6F4-C90
100	70...100	500...1000	140G-H2F3-D10	140G-H2F4-D10	140G-H3F3-D10	140G-H3F4-D10	140G-H6F3-D10	140G-H6F4-D10
110	77...110	550...1100	140G-H2F3-D11	140G-H2F4-D11	140G-H3F3-D11	140G-H3F4-D11	140G-H6F3-D11	140G-H6F4-D11
125	87...125	625...1250	140G-H2F3-D12	140G-H2F4-D12	140G-H3F3-D12	140G-H3F4-D12	140G-H6F3-D12	140G-H6F4-D12
160 <sup>3</sup>	112...160	800...1600	140G-H2F3-D16	140G-H2F4-D16	140G-H3F3-D16	140G-H3F4-D16	140G-H6F3-D16	140G-H6F4-D16

<sup>2</sup> See page 1-12 for the interrupting rating/breaking capacity specifications.

<sup>3</sup> IEC only.

**Note:** End Cap terminals provided as standard.

POWER



# Circuit Breakers

## Product Selection

### 140G Assembled Molded Case Circuit Breakers I Frame, Thermal-Magnetic, Fixed

Rated Current $I_n$ [A]	Thermal Trip [A] $I_r = I_n$	Magnetic Trip [A] $I_m$	Interrupting Code I2 <sup>2</sup>		Interrupting Code I3 <sup>2</sup>	
			Cat. No.		Cat. No.	
			3 Poles	4 Poles	3 Poles	4 Poles
90	90	900	140G-I2C3-C90	140G-I2C4-C90	140G-I3C3-C90	140G-I3C4-C90
100	100	1000	140G-I2C3-D10	140G-I2C4-D10	140G-I3C3-D10	140G-I3C4-D10
125	125	1250	140G-I2C3-D12	140G-I2C4-D12	140G-I3C3-D12	140G-I3C4-D12
150	150	1500	140G-I2C3-D15	140G-I2C4-D15	140G-I3C3-D15	140G-I3C4-D15
175	175	1750	140G-I2C3-D17	140G-I2C4-D17	140G-I3C3-D17	140G-I3C4-D17
200	200	2000	140G-I2C3-D20	140G-I2C4-D20	140G-I3C3-D20	140G-I3C4-D20
225	225	2250	140G-I2C3-D22	140G-I2C4-D22	140G-I3C3-D22	140G-I3C4-D22

### J Frame, Thermal-Magnetic, Adjustable

Rated Current $I_n$ [A]	Thermal Trip [A] $I_r = I_n$	Magnetic Trip [A] $I_m$	Interrupting Code J2 <sup>2</sup>		Interrupting Code J3 <sup>2</sup>		Interrupting Code J6 <sup>2</sup>	
			Cat. No.		Cat. No.		Cat. No.	
			3 Poles	4 Poles	3 Poles	4 Poles	3 Poles	4 Poles
80	56...80	400...800	140G-J2F3-C80	140G-J2F4-C80	140G-J3F3-C80	140G-J3F4-C80	140G-J6F3-C80	140G-J6F4-C80
90	63...90	450...900	140G-J2F3-C90	140G-J2F4-C90	140G-J3F3-C90	140G-J3F4-C90	140G-J6F3-C90	140G-J6F4-C90
100	70...100	500...1000	140G-J2F3-D10	140G-J2F4-D10	140G-J3F3-D10	140G-J3F4-D10	140G-J6F3-D10	140G-J6F4-D10
110	77...110	550...1100	140G-J2F3-D11	140G-J2F4-D11	140G-J3F3-D11	140G-J3F4-D11	140G-J6F3-D11	140G-J6F4-D11
125	87...125	625...1250	140G-J2F3-D12	140G-J2F4-D12	140G-J3F3-D12	140G-J3F4-D12	140G-J6F3-D12	140G-J6F4-D12
150	105...160	750...1500	140G-J2F3-D15	140G-J2F4-D15	140G-J3F3-D15	140G-J3F4-D15	140G-J6F3-D15	140G-J6F4-D15
160	112...150	800...1600	140G-J2F3-D16	140G-J2F4-D16	140G-J3F3-D16	140G-J3F4-D16	140G-J6F3-D16	140G-J6F4-D16
175	122.5...175	875...1750	140G-J2F3-D17	140G-J2F4-D17	140G-J3F3-D17	140G-J3F4-D17	140G-J6F3-D17	140G-J6F4-D17
200	140...200	1000...2000	140G-J2F3-D20	140G-J2F4-D20	140G-J3F3-D20	140G-J3F4-D20	140G-J6F3-D20	140G-J6F4-D20
225	157.5...225	1125...2250	140G-J2F3-D22	140G-J2F4-D22	140G-J3F3-D22	140G-J3F4-D22	140G-J6F3-D22	140G-J6F4-D22
250	175...250	1250...2500	140G-J2F3-D25	140G-J2F4-D25	140G-J3F3-D25	140G-J3F4-D25	140G-J6F3-D25	140G-J6F4-D25

### K Frame, Thermal-Magnetic, Adjustable

Rated Current $I_n$ [A]	Thermal Trip [A] $I_r = I_n$	Magnetic Trip [A] $I_m$	Interrupting Code K3 <sup>2</sup>		Interrupting Code K6 <sup>2</sup>		Interrupting Code K0 <sup>2</sup>	
			Cat. No.		Cat. No.		Cat. No.	
			3 Poles	4 Poles	3 Poles	4 Poles	3 Poles	4 Poles
300	210...300	1500...3000	140G-K3F3-D30	140G-K3F4-D30	140G-K6F3-D30	140G-K6F4-D30	140G-K0F3-D30	140G-K0F4-D30
400	280...400	2000...4000	140G-K3F3-D40	140G-K3F4-D40	140G-K6F3-D40	140G-K6F4-D40	140G-K0F3-D40	140G-K0F4-D40

### M Frame, Thermal-Magnetic, Adjustable

Rated Current $I_n$ [A]	Thermal Trip [A] $I_r = I_n$	Magnetic Trip [A] $I_m$	Interrupting Code M5 <sup>2</sup>		Interrupting Code M6 <sup>2</sup>		Interrupting Code M0 <sup>2</sup>	
			Cat. No.		Cat. No.		Cat. No.	
			3 Poles	4 Poles	3 Poles	4 Poles	3 Poles	4 Poles
600	420...600	3000...6000	140G-M5F3-D60	140G-M5F4-D60	140G-M6F3-D60	140G-M6F4-D60	140G-M0F3-D60	140G-M0F4-D60
630 <sup>3</sup>	441...630	3150...6300	140G-M5F3-D63	140G-M5F4-D63	140G-M6F3-D63	140G-M6F4-D63	140G-M0F3-D63	140G-M0F4-D63
800	560...800	4000...8000	140G-M5F3-D80	140G-M5F4-D80	140G-M6F3-D80	140G-M6F4-D80	140G-M0F3-D80	140G-M0F4-D80

<sup>2</sup> See page 1-12 for the interrupting rating/breaking capacity specifications.

<sup>3</sup> IEC only.

**Note:** End Cap terminals provided as standard.

#### Circuit Breakers



1-2...1-15

#### Disconnect Switches



1-16...1-23

#### Control & Load Switches



1-24...1-27

#### Control Circuit & Load Protection



1-28...1-39

#### Power Supplies



1-40...1-47

#### Power Quality & Energy Management



1-48...1-51

#### Surge & Filter



1-52...1-55





## Product Selection

### 140G Assembled Current-limiting Molded Case Circuit Breakers H Frame, Thermal-Magnetic, Fixed and Adjustable

Rated Current $I_n$ [A]	Thermal Trip [A] $I_t$	Magnetic Trip [A] $I_m$	Interrupting Code HC6	Interrupting Code HCO
			Cat. No.	Cat. No.
15	15	400	140G-HC6C3-C15	140G-HCOC3-C15
20	20	400	140G-HC6C3-C20	140G-HCOC3-C20
30	30	400	140G-HC6C3-C30	140G-HCOC3-C30
40	40	400	140G-HC6C3-C40	140G-HCOC3-C40
50	50	500	140G-HC6C3-C50	140G-HCOC3-C50
60	60	600	140G-HC6C3-C60	140G-HCOC3-C60
70	70	700	140G-HC6C3-C70	140G-HCOC3-C70
80	56...80	400...800	140G-HC6F3-C80	140G-HCOF3-C80
90	63...90	450...900	140G-HC6F3-C90	140G-HCOF3-C90
100	70...100	500...1000	140G-HC6F3-D10	140G-HCOF3-D10
125	87...125	625...1250	140G-HC6F3-D12	140G-HCOF3-D12
160 <sup>3</sup>	112...160	800...1600	140G-HC6F3-D16	140G-HCOF3-D16

<sup>3</sup> IEC only.

### J Frame, Thermal-Magnetic, Fixed and Adjustable

Rated Current $I_n$ [A]	Thermal Trip [A] $I_t$	Magnetic Trip [A] $I_m$	Interrupting Code JC6	Interrupting Code JCO
			Cat. No.	Cat. No.
25	25	400	140G-JC6C3-C25	140G-JCOC3-C25
30	30	400	140G-JC6C3-C30	140G-JCOC3-C30
40	40	400	140G-JC6C3-C40	140G-JCOC3-C40
50	50	500	140G-JC6C3-C50	140G-JCOC3-C50
60	60	600	140G-JC6C3-C60	140G-JCOC3-C60
70	70	700	140G-JC6C3-C70	140G-JCOC3-C70
80	56...80	400...800	140G-JC6F3-C80	140G-JCOF3-C80
90	63...90	450...900	140G-JC6F3-C90	140G-JCOF3-C90
100	70...100	500...1000	140G-JC6F3-D10	140G-JCOF3-D10
125	87.5...125	625...1250	140G-JC6F3-D12	140G-JCOF3-D12
150	105...150	750...1500	140G-JC6F3-D15	140G-JCOF3-D15
160	112...160	800...1600	140G-JC6F3-D16	140G-JCOF3-D16
175	122.5...175	875...1750	140G-JC6F3-D17	140G-JCOF3-D17
200	140...200	1000...2000	140G-JC6F3-D20	140G-JCOF3-D20
225	157.5...225	1125...2250	140G-JC6F3-D22	140G-JCOF3-D22
250	175...250	1250...2500	140G-JC6F3-D25	140G-JCOF3-D25

### K Frame, Thermal-Magnetic, Fixed and Adjustable

Rated Current $I_n$ [A]	Thermal Trip [A] $I_t$	Magnetic Trip [A] $I_m$	Interrupting Code HC6	Interrupting Code HCO
			Cat. No.	Cat. No.
15	15	400	140G-HC6C3-C15	140G-HCOC3-C15
20	20	400	140G-HC6C3-C20	140G-HCOC3-C20

Current-limiting MCCBs are rated to open in less than half of a cycle under fault conditions which limits the let-through energy, providing enhanced protection for downstream components.



# Circuit Breakers

## Product Selection

### Interrupting Rating/Breaking Capacity – Thermal-Magnetic Circuit Breakers

Interrupting Rating (50/60 Hz), UL 489/CSA C22.2-5, No. 5-02 [kA]			Breaking Capacity (50/60 Hz), IEC 60947-2 $I_{cu}$ [kA] / $I_{cs}$ %								Interrupting Code	Frame
240V	480V	600Y/ 347V	220V		415V		440V		690V			
			$I_{cu}$ [kA]	$I_{cs}$ [% $I_{cu}$ ]	$I_{cu}$ [kA]	$I_{cs}$ [% $I_{cu}$ ]	$I_{cu}$ [kA]	$I_{cs}$ [% $I_{cu}$ ]	$I_{cu}$ [kA]	$I_{cs}$ [% $I_{cu}$ ]		
50	25	10	65	75	36	100	36	50	6	75	G2	G
65	35	14	85	75	50	100	50	50	8	50	G3	
100	65	25	100	75	70	50	65	50	10	50	G6	
65	25	14	65	100	36	100	36	100	10	100	H2	H
100	35	18	85	100	50	100	50	100	12	100	H3	
150	65	25	100	100	70	100	65	100	15	100	H6, HC6	
200	100	35	150	100	120	100	100	100	18	100	H0, HCO	
200	150	42	200	100	150	100	150	100	20	75	H15	
50	25	10	50	75	36	75	25	75	5	50	I2	I
65	35	10	85	50	50	50	40	50	6	50	I3	
100	35	18	85	100	50	100	50	100	12	100	J3	J
150	65	25	100	100	70	100	65	100	15	100	J6	
200	100	35	150	100	120	100	100	100	20	100	J0	
100	35	25	85	100	50	100	40	100	25	100	K3	K
150	65	35	100	100	70	100	65	100	40	100	K6	
200	100	65	200	100	120	100	100	100	70	100	K0	
100	50	25	85	100	50	100	22	75	22	75	M5	M
200	65	35	100	100	70	100	25	75	25	75	M6	
200	100	42	200	100	100	100	30	75	30	75	M0	

POWER

#### Circuit Breakers



1-2...1-15

#### Disconnect Switches



1-16...1-23

#### Control & Load Switches



1-24...1-27

#### Control Circuit & Load Protection



1-28...1-39

#### Power Supplies



1-40...1-47

#### Power Quality & Energy Management



1-48...1-51

#### Surge & Filter



1-52...1-55



## Accessories

### 140G Assembled Molded Case Circuit Breakers Terminal Lugs

Description	Frame Size	Cat. No. (Pkg. Qty. 3)	Cat. No. (Pkg. Qty. 4)
Cu wire, MCCB only (1) 14...1/0 AWG or 2.5...70 mm <sup>2</sup>	G	140G-G-TLC13	140G-G-TLC14
Cu wire, MCP only (1) 14...1/0 AWG or 1.5...70 mm <sup>2</sup>		140G-G-TLC13A	-
Multiple cable - Cu wire (6) 14...2 AWG or 2.5...35 mm <sup>2</sup>		140G-G-MTL63	140G-G-MTL64
Cu wire only (1) 14...1/0 AWG or 2.5...95 mm <sup>2</sup>	H	140G-G-TLC13	140G-G-TLC14
Multiple cable - Cu wire (6) 14...2 AWG or 2.5...35 mm <sup>2</sup>		140G-G-MTL63	140G-G-MTL64
Al or Cu wire (1) 14...1/0 AWG or 2.5...50 mm <sup>2</sup>	I	140G-I-TLA13	140G-I-TLA14
Al or Cu wire (1) 4...300 MCM or 25...150 mm <sup>2</sup>		140G-I-TLA1A3	140G-I-TLA1A4
Cu wire only (1) 10...250 MCM or 6...185 mm <sup>2</sup>		140G-I-TLC13	140G-I-TLC14
Multiple cable - Cu wire (6) 12...2 AWG or 2.5...35 mm <sup>2</sup>		140G-I-MTL63	140G-I-MTL64
Al or Cu wire (1) 14...1/0 AWG or 2.5...50 mm <sup>2</sup>	J	140G-J-TLA13	140G-J-TLA14
Al or Cu wire (1) 4...300 MCM or 25...150 mm <sup>2</sup>		140G-J-TLA1A3	140G-J-TLA1A4
Cu wire only (1) 10...250 MCM or 6...185 mm <sup>2</sup>		140G-J-TLC13	140G-J-TLC14
Multiple cable - Cu wire (6) 12...2 AWG or 2.5...35 mm <sup>2</sup>		140G-J-MTL63	140G-J-MTL64
Cu wire only (1) 250...350 MCM or 120...185 mm <sup>2</sup>		140G-J-TLC1A3	140G-J-TLC1A4
Al or Cu wire (1) 250...500 MCM or 120...240 mm <sup>2</sup>	K	140G-K-TLA13	140G-K-TLA14
Al or Cu wire (2) 2/0...250 MCM or 95...120 mm <sup>2</sup>		140G-K-TLA23	140G-K-TLA24
Multiple cable - Cu wire (6) 6...1/0 AWG or 16...50 mm <sup>2</sup>		140G-K-MTL63	140G-K-MTL64
Al or Cu wire (2) 250...500 MCM or 120...240 mm <sup>2</sup>	M	140G-M-TLA23	140G-M-TLA24
Al or Cu wire (3) 2/0...400 MCM or 7...185 mm <sup>2</sup>		140G-M-TLA13	140G-M-TLA14

Frame Size	Height	3-Pole Cat. No. (Pkg. Qty. 2)	4-Pole Cat. No. (Pkg. Qty. 2)
G	2 in. (50 mm)	140G-G-TC3H	140G-G-TC4H
H	2 in. (50 mm)	140G-H-TC3H	140G-H-TC4H
I	2.36 in. (60 mm)	140G-I-TC3H	140G-I-TC4H
J	2.36 in. (60 mm)	140G-J-TC3H	140G-J-TC4H
K	2.36 in. (60 mm)	140G-K-TC3H	140G-K-TC4H
M	2.36 in. (60 mm)	140G-M-TC3H	140G-M-TC4H



#### Global Short Circuit Current Ratings Selection Tool

Try out the Global SCCR Selection Tool, providing coordinated high fault branch circuit solutions for motor starters, soft starters and component drives.

[rok.auto/sccr](http://rok.auto/sccr)



# Circuit Breakers

## Accessories

### 140G Assembled Molded Case Circuit Breakers Operating Mechanisms

POWER

Description	Frame Size	Handle Color	Shaft Length	Cat. No.
Rotary variable depth operator kits	G, I	Black	12 in (305 mm)	140G-G-RVM12B
		Red/Yellow		140G-G-RVM12R
		Black	21 in (533 mm)	140G-G-RVM21B
		Red/Yellow		140G-G-RVM21R
	H, J	Black	12 in (305 mm)	140G-H-RVM12B
		Red/Yellow		140G-H-RVM12R
		Black	21 in (533 mm)	140G-H-RVM21B
		Red/Yellow		140G-H-RVM21R
	K	Black	12 in (305 mm)	140G-K-RVM12B
		Red/Yellow		140G-K-RVM12R
		Black	22 in (559 mm)	140G-K-RVM21B
		Red/Yellow		140G-K-RVM21R
	M	Black	12 in (305 mm)	140G-M-RVM12B
		Red/Yellow		140G-M-RVM12R
		Black	22 in (559 mm)	140G-M-RVM21B
		Red/Yellow		140G-M-RVM21R

Description	Frame Size	Handle Type	Cable Length	Cat. No.
Flex cable operator kits	G	Non-metallic Handle, Type 1/3/12/4/4X	3 ft (.91 m)	140G-G-FCXB03
			4 ft (1.3 m)	140G-G-FCXB04
			6 ft (1.9 m)	140G-G-FCXB06
			10 ft (3.0 m)	140G-G-FCXB10
		Stainless Steel Handle, Type 4/4X	3 ft (.91 m)	140G-G-FCSB03
			4 ft (1.3 m)	140G-G-FCSB04
			6 ft (1.9 m)	140G-G-FCSB06
			10 ft (3.0 m)	140G-G-FCSB10
	H	Non-metallic Handle, Type 1/3/12/4/4X	3 ft (.91 m)	140G-H-FCXB03
			4 ft (1.3 m)	140G-H-FCXB04
			6 ft (1.9 m)	140G-H-FCXB06
			10 ft (3.0 m)	140G-H-FCXB10
		Stainless Steel Handle, Type 4/4X	3 ft (.91 m)	140G-H-FCSB03
			4 ft (1.3 m)	140G-H-FCSB04
			6 ft (1.9 m)	140G-H-FCSB06
			10 ft (3.0 m)	140G-H-FCSB10
I	Non-metallic Handle, Type 1/3/12/4/4X	3 ft (.91 m)	140G-I-FMXB03	
		6 ft (1.9 m)	140G-I-FMXB06	

#### Circuit Breakers



1-2...1-15

#### Disconnect Switches



1-16...1-23

#### Control & Load Switches



1-24...1-27

#### Control Circuit & Load Protection



1-28...1-39

#### Power Supplies



1-40...1-47

#### Power Quality & Energy Management



1-48...1-51

#### Surge & Filter



1-52...1-55





## Accessories

### 140G Assembled Molded Case Circuit Breakers Operating Mechanisms

Description	Frame Size	Handle Type	Cable Length	Cat. No.
Flex cable operator kits	J	Non-metallic Handle, Type 1/3/12/4/4X	3 ft (.91 m)	140G-J-FCXB03
			4 ft (1.3 m)	140G-J-FCXB04
			6 ft (1.9 m)	140G-J-FCXB06
			10 ft (3.0 m)	140G-J-FCXB10
		Stainless Steel Handle, Type 4/4X	3 ft (.91 m)	140G-J-FCSB03
			4 ft (1.3 m)	140G-J-FCSB04
			6 ft (1.9 m)	140G-J-FCSB06
			10 ft (3.0 m)	140G-J-FCSB10
	K	Non-metallic Handle, Type 1/3/12/4/4X	3 ft (.91 m)	140G-K-FCXB03
			4 ft (1.3 m)	140G-K-FCXB04
			6 ft (1.9 m)	140G-K-FCXB06
			10 ft (3.0 m)	140G-K-FCXB10
		Stainless Steel Handle, Type 4/4X	3 ft (.91 m)	140G-K-FCSB03
			4 ft (1.3 m)	140G-K-FCSB04
			6 ft (1.9 m)	140G-K-FCSB06
			10 ft (3.0 m)	140G-K-FCSB10

### Auxiliary Contacts

Description	Designation	For Use With	Cat. No.
(1) Auxiliary contact, 250V	AX2	140G-G, H, I, J	140G-G-EA1A
(1) Auxiliary, (1) alarm contact, 250V	AX2/AL1		140G-G-EA1R1A
(1) Auxiliary contact, 24V	1		140G-G-EA1J
(1) Auxiliary, (1) alarm contact, 24V	2		140G-G-EA1R1J
(1) Auxiliary, (1) alarm contact, 250V	AX2/AL1	K, M	140G-K-EA1R1A
(1) Auxiliary, (1) alarm contact, 24V			140G-K-EA1R1J

### Shunt Trips

Description	Frame Size	Cat. No.
24...30V AC/DC	G, H, I, J	140G-G-SNJ
48...60V AC/DC		140G-G-SNKY
110...127V AC/110...125V DC		140G-G-SND
220...240V AC/220...250V DC		140G-G-SNA
24...30V AC/DC	K, M	140G-G-SNJ
48...60V AC/DC		140G-G-SNKY
110...127V AC/110...125V DC		140G-G-SND
220...240V AC/220...250V DC		140G-G-SNA

### Undervoltage Release

Description	Frame Size	Cat. No.
24...30V AC/DC	G, H, I, J	140G-G-UVJ
48V AC/DC		140G-G-UVKY
60V AC/DC		140G-G-UVY
110...127V AC/110...125V DC		140G-G-UVD
220...240V AC/220...250V DC		140G-G-UVA
380...440V AC		140G-G-UVB
480...525V AC		140G-G-UVC
24...30V AC/DC		K, M
48V AC/DC	140G-K-UKY	
60V AC/DC	140G-K-UVY	
110...127V AC/110...125V DC	140G-K-UVD	
220...240V AC/220...250V DC	140G-K-UVA	
380...440V AC	140G-K-UVB	



#### Product Selection Tools

Available online or for download, our tools help you access info while in the office or on the go.

[rok.auto/selection](http://rok.auto/selection)



# Disconnect Switches



## Rotary Disconnect Switch, Fused 194R

- Up to 1250 A for IEC, and 800 A for UL
- Touch-safe, compact design
- Padlocking available
- Double-break switching for full fuse line and load side isolation when switch is OFF
- Side operation

## Rotary Disconnect Switch, Non-fused 194R

- Up to 1250 A for IEC, and 1200 A for UL
- Compact footprint for both UL and IEC switch bodies
- Suitable for severe utilization categories (AC-22 & AC-23)



## Rotary Disconnect Switch, Enclosed 194R

- Lock-out/tag-out functionality
- Use as at-motor isolation
- Enclosure options:
  - Stainless Steel, NEMA 4/4X (194R-C)
  - Painted Metal, NEMA 3/4/12 (194R-F)
  - Thermoplastic, NEMA 4/4X (194R-K)

\* For enclosed disconnect switches, please visit <https://rok.auto/directory>.



Circuit Breakers



1-2...1-15

**Disconnect Switches**



**1-16...1-23**

Control & Load Switches



1-24...1-27

Control Circuit & Load Protection



1-28...1-39

Power Supplies



1-40...1-47

Power Quality & Energy Management



1-48...1-51

Surge & Filter



1-52...1-55



## Product Selection

### 194R Rotary Disconnect Switches, UL/CSA

Rated Current [A]	Maximum Hp Ratings, 3-Phase (60 Hz)				Fused		Non-Fused
	240V	480V	600V		Fuse Type	Cat. No. <sup>1</sup>	Cat. No. <sup>3</sup>
			Fused	Non-Fused			
30	7.5	15	20	20	30 A Class J, HRCI-J	194R-J30-1753 <sup>2</sup>	194R-N30-1753
60	15	30	50	40	60 A Class J, HRCI-J	194R-J60-1753 <sup>2</sup>	194R-N60-1753
100	30	60	75	100	100 A Class J, HRCI-J	194R-J100-1753	194R-NU100-1753
200	60	125	150	200	200 A Class J, HRCI-J	194R-J200-1753	194R-NU200-1753
400	125	250	350	350	400 A Class J, HRCI-J	194R-J400-1753	194R-NU400-1753
600	200	500	500	350	600 A Class J, HRCI-J	194R-J600-1753	194R-NU600-1753
800	200	500	500	500	800 A Class L, HRCI-L	194R-L800-1753	194R-NU800-1753
1200	200	500	—	500	—	—	194R-NU1200-1753

<sup>1</sup> Time delay fuses may be required to utilize the disconnect switch at its maximum horsepower rating.

<sup>2</sup> Blown fuse indicator available by adding **S** to the end of the catalog number.

<sup>3</sup> Non-fused disconnect switches must use separately installed fuses for upstream short circuit protection.

### 194R Rotary Disconnect Switches, IEC

Load Rating [A]	Maximum kW Ratings				Fused		Non-Fused
	200/220/230V	380/400/415V	660/690V		Fuse Type	Cat. No.	Cat. No. <sup>3</sup>
			Fused	Non-Fused			
32	9	18.5	30	—	NH000	194R-D32-1753	—
63	18.5	30	55	—	NH000	194R-D63-1753	—
125	—	63	90	55	NH00	194R-D125-1753	194R-NE125-1753
160	—	80	110	55	NH00	194R-D160-1753	194R-NE160-1753
250	—	132	220	90	NH1	194R-D250-1753	194R-NE250-1753
400	—	220	220	150	NH2	194R-D400-1753	194R-NE400-1753
630	—	355	295	150	NH3	194R-D630-1753	194R-NE630-1753
800	—	450	400	185	NH3	194R-D800-1753	194R-NE800-1753
1250	—	560	400	415	NH4a	194R-D1250-1753	194R-NE1250-1753

<sup>3</sup> Non-fused disconnect switches must use separately installed fuses for upstream short circuit protection.



Padlockable handle, test mode (30...60 A)



Padlockable handle (100...400 A)



Padlockable handle, standard (30...60 A)

## Operating Handles

Range	Handle Operating Shaft <sup>4</sup>		Padlockable Handle	
	Cat. No. 12 in (304.8 mm)	Cat. No. 21 in (533.4 mm)	Cat. No. Black	Cat. No. Red/Yellow
up to 60 A	194R-S1	194R-S2	194R-PB	194R-PY
up to 60 A	194R-S1	194R-S2	194R-PBT	194R-PYT
100...400 A	194R-R7	194R-R8	194R-HM4	194R-HM4E
600...1250 A	194R-R9	194R-R10	194R-HM4-L	194R-HM4E-L

<sup>4</sup> For additional lengths, please visit <https://rok.auto/directory>.



# Disconnect Switches

POWER

## Rotary Disconnect Switch, Non-fused Bulletin 194U

- Touch-safe, compact design
- UL 30...125 A – IEC 40...160 A
- Can be used as main panel disconnect switch (UL98), or as at-motor disconnect switch (UR)
- NFPA79 compliant handle for robust lock-out/tag-out
- Multiple configuration options



## Configuration and Accessories

### Body Styles

3- and 4-pole versions are available in both front and base mount.



Base mount style

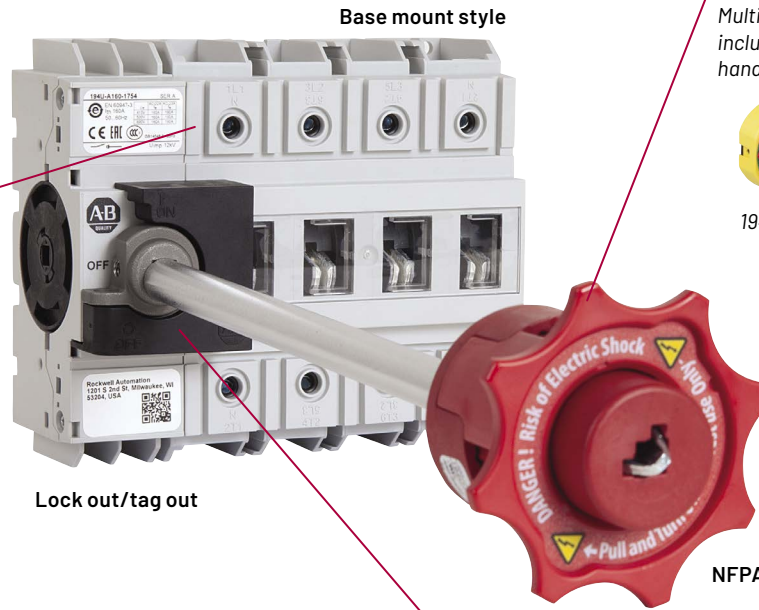

### Handle Options

Multiple handle options are available including the NFPA79-compliant handle for robust lock-out/tag-out.



194E handles 194R handles



194L handles

NFPA79-compliant handle

### Accessories

Additional accessories are available to meet your application needs.



Ground and 4<sup>th</sup> pole terminals



Terminal shrouds



Auxiliary contacts

## Disconnect Switches

Circuit Breakers



1-2...1-15



1-16...1-23

Control & Load Switches

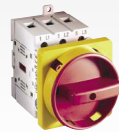

1-24...1-27

Control Circuit & Load Protection



1-28...1-39

Power Supplies



1-40...1-47

Power Quality & Energy Management



1-48...1-51

Surge & Filter



1-52...1-55





## Product Selection

### 194U Rotary Disconnect Switches

Base Mount	3 pole	194U-A30-1753	194U-A60-1753	194U-A100-1753	194U-A160-1753	
	4 pole	194U-A30-1753 + 194U-A100-FP	194U-A60-1753 + 194U-A100-FP	194U-A100-1753 + 194U-A100-FP	194U-A160-1754	
Front Mount	3 pole	194U-E30-1753	194U-E60-1753	194U-E100-1753	194U-E160-1753	
	4 pole	194U-E30-1753 + 194U-E100-FP	194U-E60-1753 + 194U-E100-FP	194U-E100-1753 + 194U-E100-FP	194U-E160-1754	
<b>Standard Compliance</b>		cULus, EAC, IEC	cULus, EAC, IEC	cULus, EAC, IEC, CCC	cULus, EAC, IEC, CCC	
<b>UL compliance</b>		UL98	UL98	UL98	UL98	UR
<b>Ampere Rating</b>	[A]	30	60	100	100	125
<b>Max Hp/FLA, 3-phase AC</b>						
<b>240V</b>	[Hp/A]	10/28	20/54	30/80	40/104	40/104
<b>480V</b>	[Hp/A]	20/27	40/52	50/65	75/96	75/96
<b>600V</b>	[Hp/A]	30/32	30/32	30/32	100/99	100/99
<b>Short Circuit Rating</b>						
<b>J Fuse</b>	[kA]	200	200	200	100	100
<b>T Fuse</b>	[kA]	200	200	200	100	100
<b>Fuse Size</b>	[A]	100/60	100/60	100/100	200	200
<b>Rated Oper. Current AC-23 A 400...415V</b>	[A]	40	63	90	160	
<b>Rated Oper. Power AC-23 A 400...415V</b>	[kW]	15	18.5	45	75	

## Handles and Accessories

Description	For Use with	Color / Type	Catalog Number
Padlockable Handle 3R, 3 12, 4, 4X Protection	Bul. 194U disconnect switches up to 60 A	Black	194R-PB
		Red/Yellow	194R-PY
	Bul 194U base mounted switches, 30...125 A	Black	194E-SB
		Red/Yellow	194E-SY
Type N handle, 0-I, OFF-ON 67 x 67 mm	Front and base mount switches 30...100 A	Red/Yellow	194L-HE6N-175
Switch handle	Front mounted switches up to 160 A	Black	194U-FB
		Red/Yellow	194U-FY
NFPA 79 internal operating handle with 12 in. (30.5 cm) shaft	Bul 194U base mounted switches, 30...125 A	—	194U-N1
Extension kit for N handle	Base mounted 30...100 A	9.25 in. (23.5 cm)	194U-G3393
Shaft for S-type handle	Base mounted 30...125 A	12 in. (30.5 cm)	194U-S1
Front mount handle adapter	Front mounted switches	—	194U-DMA
Auxiliary Contact	All 194 U switches	NC	194U-NC
		Auxiliary Contact	194U-NO
		NO/NC	194U-NONC
Terminal shroud	30...100 A switches	1 pole (Qty. 1)	194U-C1
		3 pole (Qty. 1)	194U-C3
	125 (160) A switches	1 pole (Qty. 1)	194U-160-C1
		3 pole (Qty. 1)	194U-160-C3



# Disconnect Switches

## Visible Blade Disconnect Switch 1494U Universal Mechanism

- 30...100 A, 3-pole, 600V AC/DC ratings
- Universal mechanism allows for rod or cable operation
- Fusible or non-fusible versions
- Lockable handle
- Visible blade construction for safety



### Visible Blade Construction

- Reliable visible blade indication
- Blades visible – switch is de-energized
- Blades hidden – switch is energized

### Lug Connectors

- Included aluminum lugs accept copper or aluminum wire

### Fuse Blocks

- Common base across 30/60/100 A
  - Integrated Phase Barriers
  - J and R fuse clips are available for the fusible styles

### Universal Mechanism

- Provides flexibility of installation for either rod- or cable-operated applications

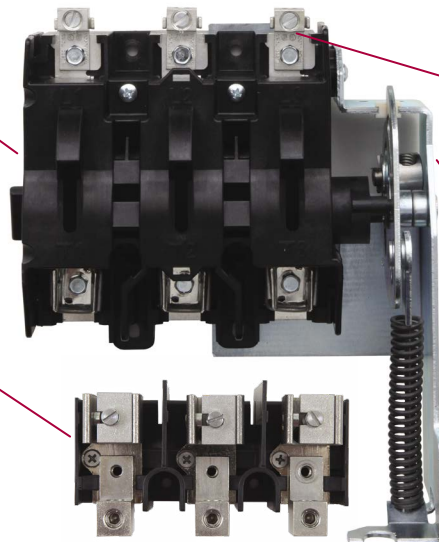

1494U Rod-operated System



1494U Cable-operated System

## Lug Connectors

Disconnect Switch Size [A]	Description	Wire Size	Cat. No.
30...60	Aluminum, 1 port	(1) #14...2 AWG, copper-aluminum (2) #14...10 AWG, copper (2) #12...10 AWG, aluminum	1494U-LA36
100	Aluminum, 1 port	(2) #12...4 AWG, copper-aluminum (1) #14...1/0 AWG, copper (1) #12...1/0 AWG, aluminum	1494U-LA100
30...100	Aluminum, 6 port	(1) #14...4 AWG, copper (1) #12...4 AWG, aluminum (2) #10 AWG, copper-aluminum	1494U-LM31

Circuit Breakers



1-2...1-15

Disconnect Switches



1-16...1-23

Control & Load Switches



1-24...1-27

Control Circuit & Load Protection



1-28...1-39

Power Supplies



1-40...1-47

Power Quality & Energy Management



1-48...1-51

Surge & Filter



1-52...1-55



## Product Selection

### 1494U Disconnect Switches <sup>1</sup>

Continuous Current Rating [A] 600V AC, 600V DC	Maximum Hp - UL and CSA Applications					1-Phase, AC 3-Phase, 50 Hz		DC <sup>2</sup>	Maximum kW - IEC Applications (Category AC 23)			Switch with Right-Hand Mechanism Cat. No.
	3-Phase, 60 Hz					3-Phase, 50 Hz						
	115V	200...208V	230V	460V	575V	115V	230V	600V	220...240V	380...440V	500...600V	
30	3	7.5	7.5	15	20	2	3	15	5.5	11	15	1494U-D30
60	7.5	15	15	30	50	3	10	30	11	22	37	1494U-D60
100	-	25	30	60	75	-	-	50	22	45	55	1494U-D100

<sup>1</sup> Aluminum lug/line kits are provided with each disconnect switch.

<sup>2</sup> Ratings based on using two poles in series to break one line of the DC supply voltage and the remaining pole breaking the second DC supply line.

### Connecting Rods

Disconnect Switch Size [A]	Enclosure Working Depth [in. (mm)] <sup>3</sup>		Cat. No.
	Minimum	Maximum	
30, 60, 100, 200	6-3/4 (172)	19 (483)	1494U-R1

<sup>3</sup> Enclosure working depth is measured from the top of the flange to the disconnect switch mounting surface. Dimensions are approximate.

**NOTE:** For enclosure depths greater than 19 in. but less than 23 in., select catalog number 1494V-RA4.

### Operating Handles

Handle Type	Description	Mounting	Disconnect Switch Size [A]	Cat. No.
Type 1, 3R, 4, 4X, 12	Nonmetallic	Right or Left Flange	30, 60, 100	1494U-HP1
Type 1, 3R, 4, 12	Painted Metal			1494U-HM1
Type 4, 4X	Stainless Steel			1494U-HS1

### Cable Mechanism

Disconnect Switch Size [A]	Cable Length [ft (m)]	Right-hand Cable Mechanism Cat. No.
30, 60, 100	3 (0.91)	1494U-C313
	4 (1.22)	1494U-C314
	5 (1.52)	1494U-C315
	6 (1.83)	1494U-C316

### Fuse Clip Kits

Fuse Class	Fuse Clip Rating [A]		Cat. No.
	250V	600V	
H/J	30	-	1494U-FC302J
	60	30	1494U-FC30J
	-	60	1494U-FC60J
	100	100	1494U-FC100J
R	30	-	1494U-FC302R
	60	30	1494U-FC30R
	-	60	1494U-FC60R
	100	100	1494U-FC100R

### Trailer Fuse Block Kits

Disconnect Switch Size [A]	Cat. No.
30	1494U-F30
60	1494U-F60
100	1494U-F100



#### Product Selection Tools

Available online or for download, our tools help you access info while in the office or on the go.

[rok.auto/selection](http://rok.auto/selection)



# Disconnect Switches

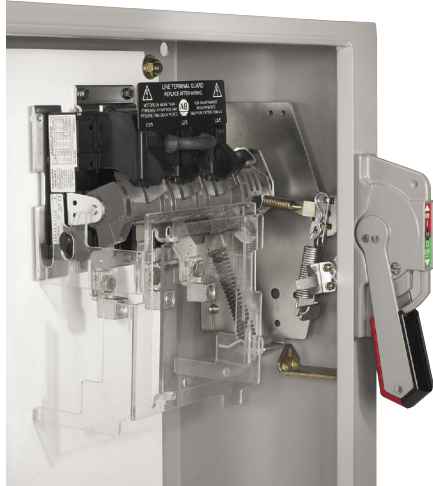

## Visible Blade Disconnect Switches 1494V Variable Depth

- 200...600 A, 3-pole, 600V AC ratings
- Rod-operated, flange-mounted handle
- Fusible or non-fusible versions
- Lockable handle
- Visible blade construction for safety

## Visible Blade Disconnect Switches 1494C Cable Operated

- 200...600 A, 3-pole, 600V AC ratings
- Cable operation allows flexible mounting within the panel
- Fusible or non-fusible versions
- Lockable handle
- Visible blade construction for safety



## Application Spotlight

Bulletin 1494 disconnect switches are a time-proven, robust design with visible blade construction that is the product of choice in automotive manufacturing applications.

Circuit Breakers



1-2...1-15

**Disconnect Switches**



**1-16...1-23**

Control & Load Switches



1-24...1-27

Control Circuit & Load Protection



1-28...1-39

Power Supplies



1-40...1-47

Power Quality & Energy Management



1-48...1-51

Surge & Filter



1-52...1-55



## Product Selection

### 1494V Visible Blade Disconnect Switch Components

Continuous Current Rating [A] 600V AC, 250V DC	NEMA, UL, CSA Maximum Rating Hp		IEC Utilization Category AC-23 Maximum Rating kW		Rod Operated	
	3-Phase, 60 Hz		3-Phase, 50 Hz		Switch with Right-Hand Mechanism	Switch with Left-Hand Mechanism
	200...208V	460V	220...240V	380...440V	Cat. No.	Cat. No.
200	50...60	125	48	90	1494V-DS200	1494V-DSX200
400	75	250	90	185	1494V-DS400	1494V-DSX400
600	150	400	150	295	1494V-DS600 <sup>1</sup>	

### 1494C Visible Blade Disconnect Switch Components

Continuous Current Rating [A] 600V AC, 250V DC	NEMA, UL, CSA Maximum Rating Hp		IEC Utilization Category AC-23 Maximum Rating kW		Cable Operated	
	3-Phase, 60 Hz		3-Phase, 50 Hz		Switch with Right-Hand Mechanism	Switch with Left-Hand Mechanism
	200...208V	460V	220...240V	380...440V	Cat. No.	Cat. No.
200	50...60	125	48	90	1494F-D200	1494F-DX200
400	75	250	90	185	1494F-D400	1494F-DX400
600	150	400	150	295	1494V-DS600 <sup>1</sup>	

<sup>1</sup> Switch can be converted in the field for left-hand operation.

### Cable Mechanisms for 1494C Disconnect Switch

Disconnect Switch Size [A]	Cable Length [ft]	Right-Hand Cable Mechanisms	Left-Hand Cable Mechanisms
		Cat. No.	Cat. No.
200	4	1494C-CM5	1494C-CMX5
	5	1494C-CM6	1494C-CMX6
	6	1494C-CM7	1494C-CMX7
	10	1494C-CM8	1494C-CMX8
400	4	1494C-CM9	1494C-CMX9
	5	1494C-CM10	1494C-CMX10
	6	1494C-CM11	1494C-CMX11
	10	1494C-CM12	1494C-CMX12
600	4	1494C-CM13	1494C-CMX13
	5	1494C-CM14	1494C-CMX14
	6	1494C-CM15	1494C-CMX15
	10	1494C-CM16	1494C-CMX16

### Trailer Fuse Block Kits for 1494V & 1494C

Disconnect Switch Size [A]	Cat. No.
200	1494V-FS200
400	1494V-FS400
600	1494V-FS600

### Fuse Clip Kits for 1494V & 1494C

Fuse Class	Fuse Clip Rating [A]		Cat. No. <sup>4</sup>
	250V	600V	
J	200	200	1401-N45
	400	400	1401-N46
	600	600	<sup>5</sup>

<sup>4</sup> Includes six clips and mounting hardware.

<sup>5</sup> Fuse clips not required: fuse bolts directly to terminal.

### Operating Handles for 1494V & 1494C

Handle Type <sup>6</sup>	Description	Disconnect Switch Size [A]	Cat. No.
Type 1, 3R, 4, 4X, 12	Nonmetallic	200	1494F-P1
Type 1, 3R, 4, 12	Painted Metal	200	1494F-M1
		400, 600	1494F-M2
Type 4, 4X	Stainless Steel	200	1494F-S1
		400, 600	1494F-S2

<sup>6</sup> Right or left flange mounting available.

### Connecting Rods for 1494V Disconnect Switches

Disconnect Switch Size [A]	Enclosure Depth [in. (mm)] <sup>2</sup>		Cat. No.
	Minimum	Maximum	
200	6-3/4 (172)	9-1/8 (232)	1494V-RA3
	6-3/4 (172)	21-5/8 (549)	1494V-RA4
400, 600	9-1/2 (241)	10 (254)	1494V-RB3 <sup>3</sup>
	9-1/2 (241)	23 (584)	1494V-RB4 <sup>3</sup>

<sup>2</sup> Enclosure depth is measured from the top of the flange to the disconnect switch mounting surface.

<sup>3</sup> Kit includes two connecting rods.





# Control & Load Switches

POWER

## Control & Load Switches 194L

- Available in ON-OFF, changeover, star-delta (Wye-delta), reversing, ammeter, voltmeter and step switch configurations
- Front door, Base/DIN Rail mounting configurations
- 1...6-pole versions
- Enclosed products available up to 25 A
- Padlockable handles available (up to 3 padlocks)



### Switch Body

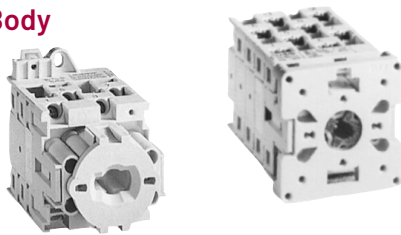

### Shaft



### Handle



N Style



G Style



I Style



A Style

Bulletin 194L Control & Load Switches are designed for use as manual motor controllers and at motor disconnects.

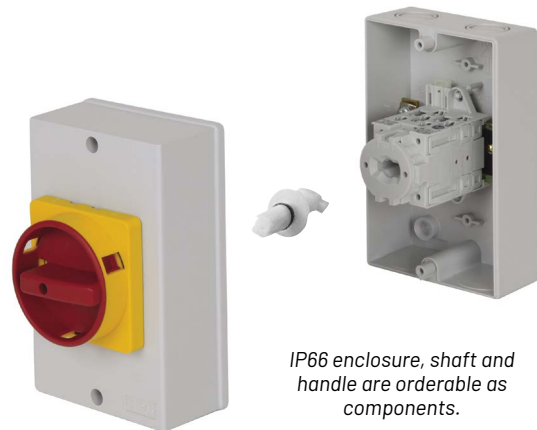

IP66 enclosure, shaft and handle are orderable as components.

### Handles

(Includes OFF-ON legend plate and control knob)

Type (for front or base mounting)	With Legend Plate 0-1, 48 x 48 mm	With Legend Plate 0-1, 67 x 67 mm
	Cat. No.	Cat. No.
A - Standard switch	194L-HE4A-175	194L-HE6A-175
G - Disconnect switch	194L-HE4G-175	194L-HE6G-175
I - Emergency stop	194L-HE4I-175	194L-HE6I-175
N - Disconnect switch/Emergency stop	194L-HE4N-175	194L-HE6N-175

1-24

Circuit  
Breakers



1-2...1-15

Disconnect  
Switches



1-16...1-23

Control & Load  
Switches



1-24...1-27

Control Circuit &  
Load Protection



1-28...1-39

Power  
Supplies



1-40...1-47

Power Quality  
& Energy  
Management



1-48...1-51

Surge &  
Filter



1-52...1-55



## Product Selection

### 194L Switch Bodies, ON-OFF

Function	/ AC-21A [A]	Poles	Front/Door Mounting	Base/DIN Rail Mounting
			Cat. No. <sup>1</sup>	Cat. No. <sup>1</sup>
	12	1	194L-E12-1751	194L-A12-1751
		2	194L-E12-1752	194L-A12-1752
		3	194L-E12-1753	194L-A12-1753
	16	1	194L-E16-1751	194L-A16-1751
		2	194L-E16-1752	194L-A16-1752
		3	194L-E16-1753	194L-A16-1753
	20	1	194L-E20-1751	194L-A20-1751
		2	194L-E20-1752	194L-A20-1752
		3	194L-E20-1753	194L-A20-1753
	25	1	194L-E25-1751	194L-A25-1751
		2	194L-E25-1752	194L-A25-1752
		3	194L-E25-1753	194L-A25-1753

<sup>1</sup> To change number of poles, change final number to **1, 2, 3** or **4**.

### 194L Switch Bodies, Changeover Switches

Function	/ AC-21A [A]	Poles	Front/Door Mounting
			Cat. No.
	12	3	194L-E12-3503
		4	194L-E12-3504
16	16	3	194L-E16-3503
		4	194L-E16-3504
20	20	3	194L-E20-3503
		4	194L-E20-3504
25	25	3	194L-E25-3503
		4	194L-E25-3504

### 194L Switch Bodies, Changeover Switches 2

Function	/ AC-21A [A]	Poles	Front/Door Mounting
			Cat. No.
	12	3	194L-E12-2503
	16		194L-E16-2503
	20		194L-E20-2504
	25		194L-E25-2503

<sup>2</sup> With both 0-1 and OFF/ON inscriptions.

### Enclosed Control & Load Switches

For Use With	Number of Contacts	IP66 Enclosure, ABS Material	Required Shaft for ABS	IP66 Enclosure, Noryl Material	Required Shaft for Noryl
		Cat. No.	Cat. No.	Cat. No.	Cat. No.
194L-A12/16	1...2	194L-G3572	194L-G3195	194L-G3576	194L-G3195
	3...4	194L-G3572	194L-G2830	194L-G3576	194L-G2830
	5...6	194L-G3573	194L-G3195	194L-G3577	194L-G3195
194L-A20/25	1...2	194L-G3572	194L-G3194	194L-G3576	194L-G3194
	3...4	194L-G3572	194L-G2830	194L-G3576	194L-G2830
	5...6	194L-G3573	194L-G3194	194L-G3577	194L-G3194

For more information on our complete family of control and load switch products, please visit:  
[rok.auto/control-load-switches](http://rok.auto/control-load-switches)



# Control & Load Switches

POWER

## Load Switches 194E

- Base/DIN Rail, or front/door mounting configurations
- Available in OFF-ON and changeover configurations
- 3- and 6-pole switches
- Enclosed products available up to 100 A
- Padlockable handles available (up to 3 padlocks)

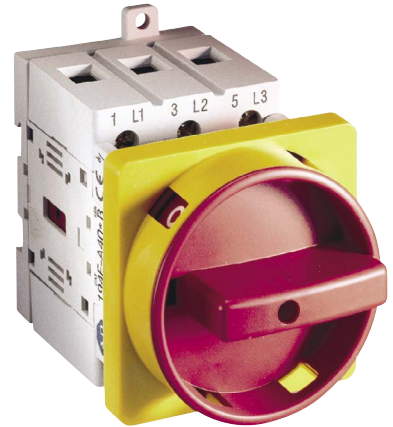

Bulletin 194E load switches are suitable as motor disconnect or other load switch applications.

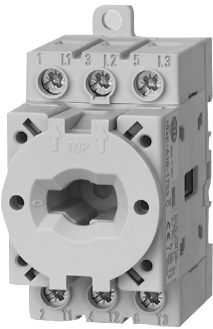

**Handle Options**  
Available as front mounting/  
DIN Rail mounting

194E  
16...100 A



N Style



G Style



I Style



A Style

**Enclosed Load Switches**  
Base/DIN Rail Mounting Only



Stainless steel



Non-metallic



Thermoplastic

Circuit Breakers



1-2...1-15

Disconnect Switches



1-16...1-23

**Control & Load Switches**



**1-24...1-27**

Control Circuit & Load Protection



1-28...1-39

Power Supplies



1-40...1-47

Power Quality & Energy Management



1-48...1-51

Surge & Filter



1-52...1-55



## Product Selection

### OFF-ON 3-Pole Switch (includes operating shaft)

Function	I AC-21A [A]	Front/Door Mounting	Base/DIN Rail Mounting
		Cat. No.	Cat. No.
	16	194E-E16-1753	194E-A16-1753
	25	194E-E25-1753	194E-A25-1753
	32	194E-E32-1753	194E-A32-1753
	40	194E-E40-1753	194E-A40-1753
	63	194E-E63-1753	194E-A63-1753
	80	194E-E80-1753	194E-A80-1753
	100	194E-E100-1753	194E-A100-1753

### OFF-ON 6-Pole Switch (includes operating shaft)

Function	I AC-21A [A]	Front/Door Mounting	Base/DIN Rail Mounting
		Cat. No.	Cat. No.
	16	194E-E16-1756	194E-A16-1756
	25	194E-E25-1756	194E-A25-1756
	32	194E-E32-1756	194E-A32-1756
	40	194E-E40-1756	194E-A40-1756
	63	194E-E63-1756	194E-A63-1756
	80	194E-E80-1756	194E-A80-1756
	100	194E-E100-1756	194E-A100-1756

### Enclosed Load Switches, 3-Pole

Description	Rated Operational Current [A]	Cat. No.
Enclosed Switches	16	194E-◆A16 <sup>1</sup>
	25	194E-◆A20 <sup>1</sup>
	32	194E-◆A32 <sup>1</sup>
	40	194E-◆A40 <sup>1</sup>
	63	194E-◆A63 <sup>1</sup>
	80	194E-◆A80 <sup>1</sup>
	100	194E-◆A00 <sup>1</sup>
Thermoplastic enclosure, IP66	16	194E-Y16-1753-4N <sup>2</sup>
	25	194E-Y25-1753-6N <sup>2</sup>
	32	194E-Y32-1753-6N <sup>2</sup>
	40	194E-Y40-1753-6N <sup>2</sup>

<sup>1</sup> Catalog number shown is for black handle. To order a red/yellow handle, add an **E** to the end of the catalog number.

<sup>2</sup> Catalog number shown is for red/yellow handle.

◆ The catalog number as listed is incomplete. Select an enclosure types code from the table below.

#### ◆ Enclosure Type

Code	Description
C, D	Stainless steel enclosure, IP66, UL Type 4/4X, Hinged
K	Non-metallic enclosure, IP66, UL Type 4/4X
A	Painted steel, IP54, Type 1, Hinged
F, G	Painted steel, IP66, Type 3/4/12, Hinged

### Handles (Includes OFF-ON legend plate and control knob)

Type (for front or base mounting)	Up to 16 A	25...100A
	Cat. No.	Cat. No.
A Standard switch	194L-HE4A-175	194E-HE6A-175
G Disconnect switch	194E-HE4G-175	194E-HE6G-175
I Emergency Stop	194L-HE4I-175	194E-HE6I-175
N Disconnect switch/Emergency stop	194E-HE4N-175	194E-HE6N-175

### Accessories

Auxiliary Contacts	Cat. No.	For Use With
1 N.O. + 1 N.C.	194E-A-P11	194E-A16...100
	194E-E-P11	194E-E16...100
1 N.O. + 1 N.C.L.B.	194E-A-PL11	194E-A16...100
	194E-E-PL11	194E-E16...100
2 N.O. + 2 N.C.	194E-A-P22	194E-A16...100
	194E-E-P22	194E-E16...100
1 N.O.E.B.	194E-A16-PD10	194E-A16
	194E-A-PD10	194E-A25...100
	194E-E16-PD10	194E-E16
	194E-E-PD10	194E-E25...100
Additional Pole, 1 N.O.	Neutral Terminal	For Use With
194E-A16-NP	194E-A16-TN	194E-A16
194E-A25-NP	194E-A32-TN	194E-A25
194E-A32-NP	194E-A32-TN	194E-A32
194E-A40-NP	194E-A63-TN	194E-A40
194E-A63-NP	194E-A63-TN	194E-A63
194E-A80-NP	194E-A100-TN	194E-A80
194E-A100-NP	194E-A100-TN	194E-A100
194E-E16-NP	194E-E16-TN	194E-E16
194E-E25-NP	194E-E32-TN	194E-E25
194E-E32-NP	194E-E32-TN	194E-E32
194E-E40-NP	194E-E63-TN	194E-E40
194E-E63-NP	194E-E63-TN	194E-E63
194E-E80-NP	194E-E100-TN	194E-E80
194E-E100-NP	194E-E100-TN	194E-E100



# Control Circuit & Load Protection

POWER

## Miniature Circuit Breakers 1489

- UL/CSA Listed for branch circuit protection
- Current limiting
- Fast breaking times
- Reversible line and load connections
- Attachments available for Lockout/tagout
- Trip curves: C and D

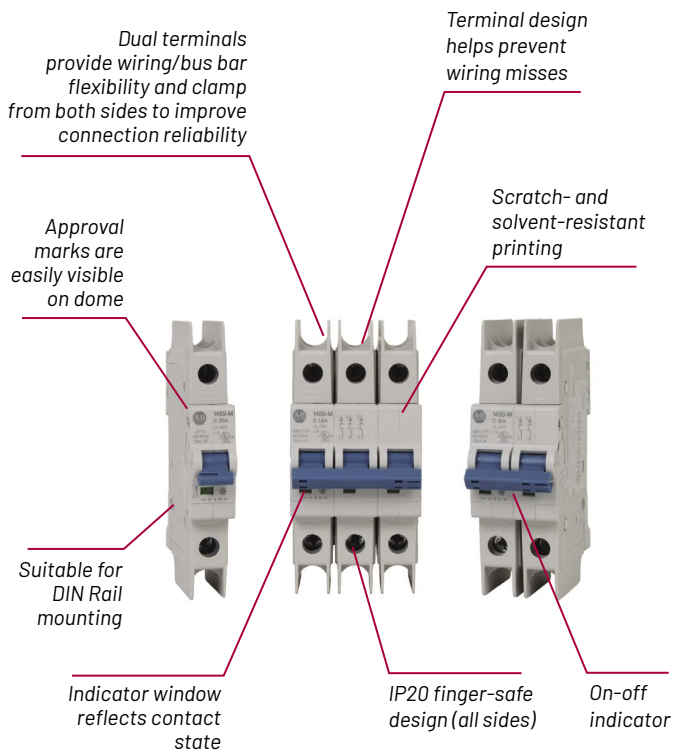

1489-M thermal-magnetic circuit breakers are approved for branch circuit protection in the United States and Canada, and are certified as miniature circuit breakers for IEC applications.

These branch protectors are compatible with many accessories to meet diverse application needs, including UL 508 Listed bus bars for convenience in panel assembly, auxiliary contacts, signal contacts and shunt trips for versatility, and lockout attachments for safety during maintenance.



### Control Circuit & Load Protection

1-28

Circuit Breakers



1-2...1-15

Disconnect Switches



1-16...1-23

Control & Load Switches

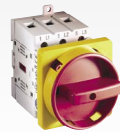

1-24...1-27



1-28...1-39

Power Supplies



1-40...1-47

Power Quality & Energy Management



1-48...1-51

Surge & Filter



1-52...1-55





## Product Selection

### Miniature Circuit Breakers

Continuous Current Rating ( $I_n$ ) [A]	Trip Curve C <sup>1</sup> - Inductive, 5...10 $I_n$		
	1-Pole	2-Pole	3-Pole
	Cat. No.	Cat. No.	Cat. No.
0.5	1489-M1C005	1489-M2C005	1489-M3C005
1	1489-M1C010	1489-M2C010	1489-M3C010
1.6	1489-M1C016	1489-M2C016	1489-M3C016
2	1489-M1C020	1489-M2C020	1489-M3C020
3	1489-M1C030	1489-M2C030	1489-M3C030
4	1489-M1C040	1489-M2C040	1489-M3C040
5	1489-M1C050	1489-M2C050	1489-M3C050
6	1489-M1C060	1489-M2C060	1489-M3C060
7	1489-M1C070	1489-M2C070	1489-M3C070
8	1489-M1C080	1489-M2C080	1489-M3C080
10	1489-M1C100	1489-M2C100	1489-M3C100
13	1489-M1C130	1489-M2C130	1489-M3C130
15	1489-M1C150	1489-M2C150	1489-M3C150
16	1489-M1C160	1489-M2C160	1489-M3C160
20	1489-M1C200	1489-M2C200	1489-M3C200
25	1489-M1C250	1489-M2C250	1489-M3C250
30	1489-M1C300	1489-M2C300	1489-M3C300
32	1489-M1C320	1489-M2C320	1489-M3C320
35	1489-M1C350	1489-M2C350	1489-M3C350

<sup>1</sup> The catalog number listed represents Trip Curve C: Inductive. To order Trip Curve D (highly inductive), replace the **C** in the catalog number with **D**. Example: Catalog number 1489-M1C005 becomes Catalog number 1489-M1D005.

## Specifications

<b>Standards Compliance</b>	UL 489, CSA C22.2 No. 235, EN 60947-2, GB 14048.2
<b>Certifications</b>	UL Listed, File No. E197878, CSA, CCC, EAC, UKCA and VDE certified, CE Marked, RoHS Compliant
<b>Rated Voltage</b>	UL/CSA: Max. 480Y/277V AC IEC: Ue 230/400V AC
<b>Interrupting Capacity</b>	UL/CSA: 10 kA IEC: 15 kA

## Accessories

Description	Contacts	Cat. No.
Shunt trip 110...415V AC/110...250V DC	—	1489-AMST1
Shunt trip 12...60V AC/DC	—	1489-AMST2
Signal contact	1 N.O./N.C. (1 C.O.)	1489-AMRS3
Auxiliary contact	1 N.O./N.C. (1 C.O.)	1489-AMRA3

## Bus Bars

Description	No. of Pins	No. of Circuit Breakers	Cat. No. <sup>2,3,4</sup>
1-phase	6	6	1489-AMCL106
	12	12	1489-AMCL112
	18	18	1489-AMCL118
2-phase	6	3	1489-AMCL206
	12	6	1489-AMCL212
	18	9	1489-AMCL218
3-phase	6	2	1489-AMCL306
	12	4	1489-AMCL312
	18	6	1489-AMCL318

### Bus Bar Accessories

Description	Cat. No.
Terminal power feed, 35 mm <sup>2</sup> • occupy one terminal or phase on the breaker	1489-AMCLT35
Dedicated power feed, 50 mm <sup>2</sup> • attach and mount to the bus bar pin instead of the 1489-M terminal • add more height to the bus bar installation	1489-AMCLT50D
Protective shroud (for unused pins)	1489-AMCLPS

<sup>2</sup> Package quantity of 10

<sup>3</sup> cULus, UL 508, EN 60947-1, CE Marked

<sup>4</sup> Maximum of three bus bars allowed



# Control Circuit & Load Protection

POWER

## Miniature Circuit Breakers 1492-SPM

- Supplemental protection for North America
- Current limiting
- Fast breaking times
- Installation of up to six accessories per circuit breaker
- Reversible line and load connections
- Trip curves: B, C, and D

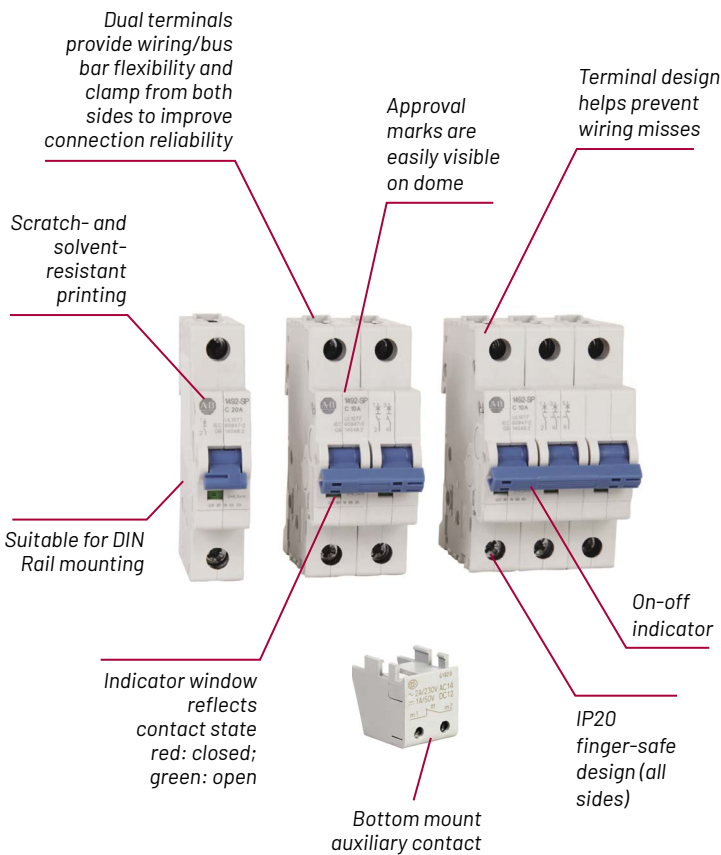

1492-SPM is a thermal-magnetic miniature circuit breaker as defined by IEC Standards. These devices are also rated as supplementary protectors, in North America, providing overcurrent protection for equipment where branch circuit protection is already provided, or is not required.

These supplementary protectors are offered as a broad portfolio of pole variants, current ratings, and trip curves to match the appropriate level of protection for your application. They may be used with bus bars for convenience in panel assembly, a wide range of left-, right- and space saving bottom-mount accessories, and lock out attachments for safety during maintenance.



### Control Circuit & Load Protection

1-30

Circuit Breakers



1-2...1-15

Disconnect Switches



1-16...1-23

Control & Load Switches

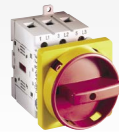

1-24...1-27



1-28...1-39

Power Supplies



1-40...1-47

Power Quality & Energy Management



1-48...1-51

Surge & Filter



1-52...1-55



## Product Selection

### Miniature Circuit Breakers/Supplemental Protectors

Continuous Current Rating ( $I_n$ ) [A]	Trip Curve C - Inductive, 5...10 $I_n^1$		
	1-Pole <sup>2</sup>	2-Pole	3-Pole <sup>2</sup>
	Cat. No.	Cat. No.	Cat. No.
0.5	1492-SPM1C005	1492-SPM2C005	1492-SPM3C005
1	1492-SPM1C010	1492-SPM2C010	1492-SPM3C010
2	1492-SPM1C020	1492-SPM2C020	1492-SPM3C020
3	1492-SPM1C030	1492-SPM2C030	1492-SPM3C030
4	1492-SPM1C040	1492-SPM2C040	1492-SPM3C040
5	1492-SPM1C050	1492-SPM2C050	1492-SPM3C050
6	1492-SPM1C060	1492-SPM2C060	1492-SPM3C060
7	1492-SPM1C070	1492-SPM2C070	1492-SPM3C070
8	1492-SPM1C080	1492-SPM2C080	1492-SPM3C080
10	1492-SPM1C100	1492-SPM2C100	1492-SPM3C100
13	1492-SPM1C130	1492-SPM2C130	1492-SPM3C130
15	1492-SPM1C150	1492-SPM2C150	1492-SPM3C150
16	1492-SPM1C160	1492-SPM2C160	1492-SPM3C160
20	1492-SPM1C200	1492-SPM2C200	1492-SPM3C200
25	1492-SPM1C250	1492-SPM2C250	1492-SPM3C250
30	1492-SPM1C300	1492-SPM2C300	1492-SPM3C300
32	1492-SPM1C320	1492-SPM2C320	1492-SPM3C320
40	1492-SPM1C400	1492-SPM2C400	1492-SPM3C400
50	1492-SPM1C500	1492-SPM2C500	1492-SPM3C500
63	1492-SPM1C630	1492-SPM2C630	1492-SPM3C630

<sup>1</sup> The catalog number listed represents Trip Curve C: Inductive. To order Trip Curve B (slightly inductive) replace the **C** in the catalog number with **B**. Example catalog number 1492-SPM1C005 becomes catalog number 1492-SPM1B005.

To order Trip Curve D (highly inductive) replace the **C** in the catalog number with **D**.

<sup>2</sup> For 1+N and 3+N versions: add the suffix **-N** to the catalog number.

## Specifications

<b>Standards Compliance</b>	UL 1077, CSA C22.2 No. 235, EN 60947-2, GB 14048.2
<b>Certifications</b>	UL Recognized - File No. E65138 <sup>4</sup> , EAC Certified, CSA Certified - File No. 259391 <sup>4</sup> , CE Marked, CCC Certified, VDE Certified, RoHS Compliant, UKCA, KCC <sup>4</sup>
<b>Rated Voltage</b>	UL/CSA: Max. 480Y/277V AC, IEC: Ue 230/400V AC
<b>Interrupting Capacity</b>	UL/CSA: 5...10 kA, IEC: 15 kA

<sup>4</sup> 1+N and 3+N devices are not UL recognized, CSA or KCC certified.

## Accessories

Mounting Position	Description	Contacts	Cat. No.
Right mount	Shunt trip 110...415V AC/ 110...250V DC	—	189-AST1
	Shunt trip 12...60V AC/DC	—	189-AST2
	Auxiliary/signal contact	1 N.O./N.C. (1 C.O.)	189-ASCR3
		1 N.O./N.C. (1 C.O.)	189-AR3
	Auxiliary contact	1 N.O. + 1 N.C.	189-ART1
		2 N.C.	189-AR02
2 N.O.		189-AR20	
Bottom mount	Auxiliary contact	1 N.C.	189-AB01
		1 N.O.	189-AB10

## Bus Bars

Description	Without Aux. Contact		With Aux. Contact	
	80 A	100 A	80 A	100 A
	Cat. No. <sup>3</sup>	Cat. No. <sup>3</sup>	Cat. No. <sup>3</sup>	Cat. No. <sup>3</sup>
1-phase	1492-A1B8	1492-A1B1	1492-A1B8H	1492-A1B1H
2-phase	1492-A2B8	1492-A2B1	1492-A2B8H	1492-A2B1H
3-phase	1492-A3B8	1492-A3B1	1492-A3B8H	1492-A3B1H

### Bus Bar Accessories

Description	Cat. No.
Terminal power feed, 35 mm <sup>2</sup> - straight lug • offset lug, low profile • occupy one terminal or phase on the breaker • for 1-phase bus bar	1492-AAT1S
Terminal power feed, 35 mm <sup>2</sup> - offset lug low profile • straight lug • occupy one terminal or phase on the breaker • for 2- and 3-phase bus bars	1492-AAT1LP
Dedicated power feed, 50 mm <sup>2</sup> • attach and mount to the bus bar pin instead of the 1492-SP terminal • add more height to the bus bar installation	1492-AAT2
End cover, for 1-phase bus bars	1492-A1E
End cover, for 2-, 3-phase bus bars	1492-AME
Protective cover (for unused pins)	1492-AAP

<sup>3</sup> Catalog numbers listed are for 1 meter bus bars.



# Control Circuit & Load Protection

POWER

## Regional Circuit Breakers 188-J

- Available only in China and Europe
- 0.5...63 A; 1(+N), 2, 3(+N), 4-pole
- Fast breaking times
- Current limiting
- Reversible line and load connections
- Trip curves: B, C and D

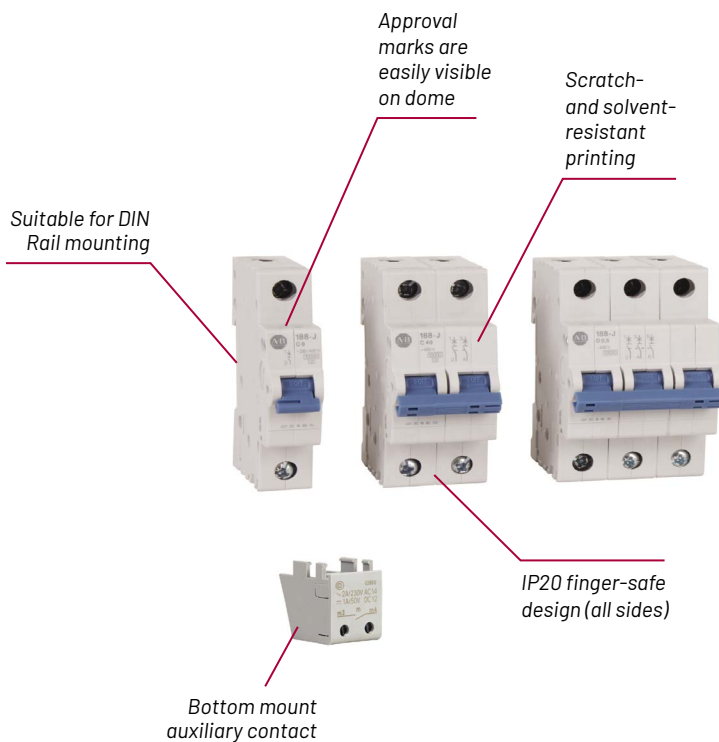

188-J circuit breakers are for application at the equipment level. These products have regional certifications only and are available in China and Europe.



### Control Circuit & Load Protection

1-32

Circuit Breakers



1-2...1-15

Disconnect Switches



1-16...1-23

Control & Load Switches



1-24...1-27



1-28...1-39

Power Supplies



1-40...1-47

Power Quality & Energy Management



1-48...1-51

Surge & Filter



1-52...1-55



## Product Selection

### Regional Circuit Breakers

Continuous Current Rating ( $I_n$ ) [A]	Trip Curve C - Inductive, 5...10 $I_n$ <sup>1,2</sup>			
	1-Pole <sup>3</sup>	2-Pole	3-Pole <sup>3</sup>	4-Pole
	Cat. No.	Cat. No.	Cat. No.	Cat. No.
0.5	188-J1C005	188-J2C005	188-J3C005	188-J4C005
1	188-J1C010	188-J2C010	188-J3C010	188-J4C010
2	188-J1C020	188-J2C020	188-J3C020	188-J4C020
3	188-J1C030	188-J2C030	188-J3C030	188-J4C030
4	188-J1C040	188-J2C040	188-J3C040	188-J4C040
6	188-J1C060	188-J2C060	188-J3C060	188-J4C060
8	188-J1C080	188-J2C080	188-J3C080	188-J4C080
10	188-J1C100	188-J2C100	188-J3C100	188-J4C100
13	188-J1C130	188-J2C130	188-J3C130	188-J4C130
16	188-J1C160	188-J2C160	188-J3C160	188-J4C160
20	188-J1C200	188-J2C200	188-J3C200	188-J4C200
25	188-J1C250	188-Ja2C250	188-J3C250	188-J4C250
32	188-J1C320	188-J2C320	188-J3C320	188-J4C320
40	188-J1C400	188-J2C400	188-J3C400	188-J4C400
50	188-J1C500	188-J2C500	188-J3C500	188-J4C500
63	188-J1C630	188-J2C630	188-J3C630	188-J4C630

<sup>1</sup> The catalog number listed represents Trip Curve C: Inductive. To order Trip Curve B (slightly inductive) replace the **C** in the catalog number with **B**. To order Trip Curve D (highly inductive) replace the **C** in the catalog number with **D**.

<sup>2</sup> Trip Curve B is not available in current ratings 0.5...4 A.

<sup>3</sup> For 1+N and 3+N versions: add the suffix -N to the catalog number.

## Specifications

<b>Standards Compliance</b>	EN 60898-1, GB 10963
<b>Certifications</b>	CE Marked, CCC Certified, VDE Certified, EAC Certified, UKCA Certified
<b>Rated Voltage</b>	IEC: $U_g$ 230/400V AC
<b>Interrupting Capacity</b>	IEC: 10 kA

## Accessories

Mounting Position	Description	Contacts	Cat. No.
Right mount	Shunt trip 110...415V AC/ 110...250V DC	—	189-AST1
	Shunt trip 12...60V AC/DC	—	189-AST2
	Auxiliary/signal contact	1 N.O./N.C. (1 C.O.)	189-ASCR3
		1 N.O./N.C. (1 C.O.)	189-AR3
	Auxiliary contact	1 N.O. + 1 N.C.	189-ART1
		2 N.C.	189-ARO2
2 N.O.		189-AR20	
Bottom mount	Auxiliary contact	1 N.C.	189-AB01
		1 N.O.	189-AB10

## Bus Bars

Description	Pkg. Qty.	Without Aux. Contact		With Aux. Contact	
		No. of Pins	Cat. No.	No. of Pins	Cat. No.
1-phase	1	60	189-CL1	38	189-CL1H
	20	12	189-CL112	9	189-CL1H09
	20	6	189-CL106	6	189-CL1H06
	20	2	189-CL102	2	189-CL1H02
2-phase	1	58	189-CL2	44	189-CL2H
	10	12	189-CL212	10	189-CL2H10
	10	6	189-CL206	6	189-CL2H06
	10	4	189-CL204	4	189-CL2H04
3-phase	1	60	189-CL3	48	189-CL3H
	10	12	189-CL312	12	189-CL3H12
	10	6	189-CL306	6	189-CL3H06
4-phase	1	56	189-CL4	48	189-CL4H

Description	Pkg. Qty.	No. of Pins	Cat. No.
2-phase MCB to RCD	10	4	189-CL204
4-phase MCB to RCD	10	8	189-CL408

Bus Bar Accessories			
Terminal power feed, 25 mm <sup>2</sup>	10	—	189-CLT25
Terminal power feed, 50 mm <sup>2</sup>	10	—	189-CLT50
Dedicated power feed, 50mm <sup>2</sup>	10	—	189-CLT50D
End cover, for 1-phase bus bars	10	—	189-CL1EC
End cover, for 2- and 3-phase bus bars	10	—	189-CL3EC
End cover, for 4-phase bus bars	10	—	189-CL4EC
Protective cover (for unused pins)	10	—	189-CLPS





# Control Circuit & Load Protection

POWER

## Residual Current Devices 1492-RCDA

- 25...80 A residual current devices
- 30 mA sensitivity devices for personnel protection
- Reversible line and load connections
- Suitable for protection against AC and pulsating DC (rectified AC) earth leakage current
- Dual terminals allow a more secure connection of two wires, or both a wire and bus bar



By detecting small leakage currents and disconnecting all ungrounded connectors quickly, residual current devices (RCDs) can prevent injury to exposed personnel and damage to equipment.

*Dual terminals provide wiring/bus bar flexibility and clamp from both sides to improve connection reliability*

*Approval marks are easily visible on dome*

*Terminal design helps prevent wiring misses*

*Test push button to verify device functionality*

*Indicator window reflects contact state: red = closed, green = open*

*Suitable for DIN Rail mounting*

*Accepts right-mounted auxiliary and signal contacts*

*Scratch- and solvent-resistant printing*

*IP20 finger-safe design (all sides)*

### Accessories

**Aux/Signal Contact**      **Bus Bar**

1-34

Circuit Breakers



1-2...1-15

Disconnect Switches



1-16...1-23

Control & Load Switches



1-24...1-27

### Control Circuit & Load Protection



1-28...1-39

Power Supplies



1-40...1-47

Power Quality & Energy Management



1-48...1-51

Surge & Filter



1-52...1-55

## Product Selection

Sensitivity (mA)	Rated Current (A)	2-Pole (1-Pole + Neutral)		4-Pole (3-Pole + Neutral)		
		$U_t$ min = 110V	$U_t$ min = 170V	$U_t$ min = 110V	$U_t$ min = 110V (With Delay)	$U_t$ min = 170V
30	25	1492-RCDA2A25-US	1492-RCDA2A25	1492-RCDA4A25-US	—	1492-RCDA4A25
	40	1492-RCDA2A40-US	1492-RCDA2A40	1492-RCDA4A40-US	—	1492-RCDA4A40
	63	—	—	1492-RCDA4A63-US	—	1492-RCDA4A63
	80	—	—	—	—	1492-RCDA4A80
100	25	1492-RCDA2B25	—	1492-RCDA4B25	—	—
	40	1492-RCDA2B40	—	1492-RCDA4B40	1492-RCDA4B40S	—
	63	—	—	1492-RCDA4B63	1492-RCDA4B63S	—
300	25	1492-RCDA2C25	—	1492-RCDA4C25	—	—
	40	1492-RCDA2C40	—	1492-RCDA4C40	1492-RCDA4C40S	—
	63	—	—	1492-RCDA4C63	1492-RCDA4C63S	—
	80	—	—	1492-RCDA4C80	—	—
500	25	—	—	1492-RCDA4D25	—	—
	40	—	—	1492-RCDA4D40	—	—
	63	—	—	1492-RCDA4D63	—	—
	80	—	—	1492-RCDA4D80	—	—
Diagram						

## Accessories

### Contact Blocks

Description <sup>1,2,3</sup>	Contacts	Cat. No.
Auxiliary/signal contact	1 N.O./N.C. (1 C.O.)	189-ASCR3

- A maximum of one C.O. type signal contact and one C.O. type auxiliary contact OR two C.O. type auxiliary contacts may be installed per 1492-RCD.
- A maximum of one 189-AR11, -AR02, or AR20 auxiliary contact may be installed per 1492-RCD. They may not be combined with C.O. type contacts.
- A maximum of three accessories of any type may be installed per 1492-RCD. The signal contact must be mounted closest to the RCD, then the auxiliary contact(s). For allowed combinations and installation instructions, please contact your local Rockwell Automation sales office or Allen-Bradley distributor.

### Bus Bars

Description	Pins	Pkg. Qty.	Cat. No. <sup>4</sup>
2-Phase MCB to RCD	4	10	189-CL204
4-Phase MCB to RCD	8	10	189-CL208

<sup>4</sup> These devices are CE marked, but not certified to any UL, CSA, or other standard.

## Specifications

<b>Standards Compliance</b>	UL 1053, ANSI/NFPA 70, EN 61008, CSA C22.2 No. 144, GB 16916
<b>Certifications</b>	cURus Recognized, File No. E53935, CE Marked, CCC Certified, VDE Certified, RoHS Compliant, EAC Certified, UKCA certified
<b>Rated Voltage</b>	UL/CSA: Max. 480Y/277V AC IEC: Ue 230/400V AC
<b>Interrupting Capacity</b>	Rated conditional short-circuit 10 kA (SCPD - fuse gG 100 A) Rated residual breaking capacity 1 kA



# Control Circuit & Load Protection

POWER

## Fuse Holders 1492-FB

- For Class CC, J and 10x38 mm fuses
- Compact size
- Handle isolates the fuse from top-wired power when installing or removing fuse
- Terminals are shipped in open position
- Optional blown fuse indicator



Optional blown fuse indicators for easy circuit troubleshooting

Terminal power feed

Busbar

Suitable for DIN Rail mounting

Label holder

IP20 finger-safe design (front)

The 1492-FB fuse holder family is designed for use in many OEM applications, such as power supplies, equipment protection, primary and secondary control transformers, solenoids, lighting and heater loads, and drives.

1492-FB fuse holders provide a safe and convenient means for installation of Class CC, J and 10 x 38 mm fuses. To support correct fuse type installation, the Class CC fuse holder is designed to reject a 10 x 38 mm fuse. The Class J fuse holder will reject all fuses other than a Class J fuse.

All fuse holders are UL Listed and CSA Certified for branch circuit protection. They are excellent for wire protection, small motor loads, and group protection of small motor loads. The 10 x 38 mm fuse holder is also CE marked for use with 10 x 38 mm IEC fuses.

### Control Circuit & Load Protection

Circuit Breakers



1-2...1-15

Disconnect Switches



1-16...1-23

Control & Load Switches



1-24...1-27



1-28...1-39

Power Supplies



1-40...1-47

Power Quality & Energy Management



1-48...1-51

Surge & Filter



1-52...1-55



## Product Selection

### Fuse Holders

Description		10 x 38 mm Fuse	Class CC Fuse	Class J Fuse	
		30 A	30 A <sup>1</sup>	30 A	60 A
1-Pole	Fuse block	1492-FB1M30	1492-FB1C30	1492-FB1J30	1492-FB1J60
	Fuse block with indication, 110...600V <sup>2</sup>	1492-FB1M30-L	1492-FB1C30-L	1492-FB1J30-L	1492-FB1J60-L
	Fuse block with indication, 12...72V	1492-FB1M30-D1	1492-FB1C30-D1	-	-
	Pieces per carton	12	12	6	6
2-Pole	Fuse block	1492-FB2M30	1492-FB2C30	1492-FB2J30	1492-FB2J60
	Fuse block with indication, 110...600V <sup>2</sup>	1492-FB2M30-L	1492-FB2C30-L	1492-FB2J30-L	1492-FB2J60-L
	Pieces per carton	6	6	3	3
3-Pole	Fuse block	1492-FB3M30	1492-FB3C30	1492-FB3J30	1492-FB3J60
	Fuse block with indication, 110...600V <sup>2</sup>	1492-FB3M30-L	1492-FB3C30-L	1492-FB3J30-L	1492-FB3J60-L
	Pieces per carton	4	4	2	2

<sup>1</sup> All major fuse brands and current ranges have been evaluated for this fuse holder. Due to the heat they generate, the following fuses must be derated: Mersen ATQR 1.25 I = 0.42 A max., Mersen ATQR 1.40 I = 0.47 A max.

<sup>2</sup> 690V when used in IEC applications.

### Bus Bars

Description	Devices Per Meter	80 A	100 A
		Cat. No.	Cat. No.
1-phase	57	1492-A1B8	1492-A1B1
2-phase	29	1492-A2B8	1492-A2B1
3-phase	19	1492-A3B8	1492-A3B1

#### Bus Bar Accessories<sup>1</sup>

Description		Pkg.	Cat. No. <sup>2</sup>
Terminal Power Feed, 35 mm <sup>2</sup>	for 1-phase bus bar	10	1492-AAT1LP
	for 2- or 3-phase bus bar	10	1492-AAT1
Dedicated Power Feed, 50 mm <sup>2</sup>	—	10	1492-AAT2
End Cover	for 1-phase bus bar	10	1492-A1E
	for 2- or 3-phase bus bar	10	1492-AME
Protective Shroud for unused pins		10	1492-AAP

<sup>1</sup> All major fuse brands and current ranges have been evaluated for this fuse holder. Due to the heat they generate, the following fuses must be derated: Mersen ATQR 1.25 I = 0.42 A max., Mersen ATQR 1.40 I = 0.47 A max.

<sup>2</sup> 690V when used in IEC applications.

### Specifications

<b>Certifications</b>	UL Listed, File No. E34648, CSA Certified, CE Marked ROHS Compliant, UKCA Marked CCC (10 x 38 mm and Class C only)
<b>Standards Compliance</b>	UL 512, CSA 22.2 No. 39, EN 60269-2

### Accessories

Description	Size	Pkg. Qty.	Cat. No.
Fuse holder Identification Slide-in Markers • Blank marker squares slip into molded slot • 100 markers/card	5 mm x 5 mm	5 cards	1492-MC5X5
	6 mm x 5 mm		1492-MC6X5
ClearMultiprint™ Markers	5 mm x 5 mm	1 roll (1220/roll)	1492-MTCP5X5
	6 mm x 5 mm	1 roll (1020/roll)	1492-MTCP6X5
ClearMultiprint roller • For use with ClearMultiprint marking system	—	1	1492-PROLLTBPC



# Control Circuit & Load Protection

POWER

## Modular Electronic Circuit Protection 1694

- Clear status indication by means of multicolor LED and auxiliary contact (located in power feed)
- Selective load protection by means of electronic trip curve
- No tools required at commissioning
- Width per channel only 12.5 mm (1-channel) or 6.25 mm (2-channel)



**Protection models** are fed from power module and attached by attaching with built-in levers

**Optional AUX contact** for signaling any of the attached modules has tripped

**Input feed** from power supply, up to 40 A

**Push-in Terminals** for time-saving wiring



Bulletin 1694 Electronic Circuit Protection (ECP) Modules protect the secondary circuit of 24V DC switched mode power supplies. The modular system can handle multiple channels or 40 A of total current consumption. Designed for 24V DC circuits, 1694 Electronic Circuit Protectors provide comprehensive protection against short circuit and overcurrent conditions while allowing for inrush current.

### 1694 Electronic Circuit Protectors

<b>Voltage</b>	24V DC (18...30V DC)
<b>Output Current</b>	1...10 A (1-channel) 1 A/1 A...6 A/6 A (2-channel) 1...4 A NEC Class 2
<b>Standards Compliance</b>	UL 2367, File No. E350272 UL 1310 NEC Class 2 cULus508, File No. E56639
<b>Certifications</b>	CE Marked RoHS Compliant China RoHS Morocco EMC WEEE RCM Australia UKCA United Kingdom

1-38

Circuit Breakers



1-2...1-15

Disconnect Switches



1-16...1-23

Control & Load Switches



1-24...1-27

**Control Circuit & Load Protection**



1-28...1-39

Power Supplies



1-40...1-47

Power Quality & Energy Management



1-48...1-51

Surge & Filter



1-52...1-55





## Product Selection

### Power Feed Modules

Mounting Position	Supply Voltage	Max Current	Aux Contact	Pkg. Qty.	Cat. No.
Left	24V DC	40 A	No	1	1694-PF1244
	24V DC	40 A	Yes	1	1694-PFA1244
	0V Ground	40 A	No	1	1694-PF1G4
	24V DC	40 A	No	1	1694-PFD1244
Middle	24V DC	40 A Line Separated	No	1	1694-PF2L4S
Middle or Right	24V DC	40 A Line Connected	No	1	1694-PF3L4C
	0V Ground	40 A	No	1	1694-PF3G4

### Protection Modules

Number of Channels	Fixed or Adjustable Current	Current	Pkg. Qty.	Cat. No.
1	Fixed	1 A	4	1694-PM11 <sup>1</sup>
		2 A	4	1694-PM12 <sup>1</sup>
		3 A	4	1694-PM13 <sup>1</sup>
		4 A	4	1694-PM14 <sup>1</sup>
		6 A	4	1694-PM16
		8 A	4	1694-PM18
		10 A	4	1694-PM10
2		1 A	4	1694-PM211 <sup>1</sup>
		2 A	4	1694-PM222 <sup>1</sup>
		3 A	4	1694-PM233 <sup>1</sup>
		4 A	4	1694-PM244 <sup>1</sup>
		6 A	4	1694-PM266
1		8 A	4	1694-PMD18
		10 A	4	1694-PMD10
2	1 A	4	1694-PMD211 <sup>1</sup>	
	2 A	4	1694-PMD222 <sup>1</sup>	
	3 A	4	1694-PMD233 <sup>1</sup>	
	4 A	4	1694-PMD244 <sup>1</sup>	
	6 A	4	1694-PMD266	
	Adjustable <sup>2</sup>	1...10 A	4	1694-PMD2A10

<sup>1</sup> For Class 2 power supply, add **-CL2** to the end of the catalog number (for example 1694-PM11-CL2)<sup>2</sup> Can be used Standard and/or IO-Link devices

IO-Link enabled.

### Distribution Modules (can be used Standard and/or IO-Link devices)

Description	Pkg. Qty.	Cat. No.
10 Terminals, 1 x LINE, 9 x LOAD, $I_{max}$ 20 A	1	1694-DM1L2
10 Terminals, 2 x LINE, 4 x LOAD, $I_{max}$ 20 A	1	1694-DM2L2
10 Terminals, Ground, $I_{max}$ 20 A	1	1694-DM3G2



# Power Supplies

## Power Supplies 1606

- Intelligent circuit design with long-life electrolytic capacitors
- Allows 20% continuous (XLE/XLD family) or 50% temporary (XLS family) additional power reserve without reducing output voltage, while minimizing ripple and noise
- Redundancy modules or power supplies with built-in redundancy provide a means for managing multiple power supplies for back-up power
- Compact size saves valuable panel space



### Allen-Bradley efficiency = smaller enclosures

These thermal images show the difference an efficient power supply can make in a panel. All three power supplies are using the same transformer, but the Allen-Bradley power supply has the whole package running cooler due to its more efficient design.

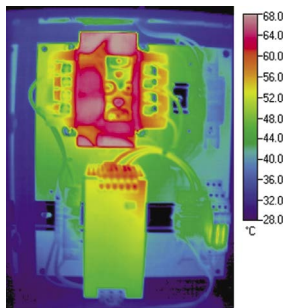

Allen-Bradley 1606-XLS – 10 A, 24V DC – 93% Efficiency

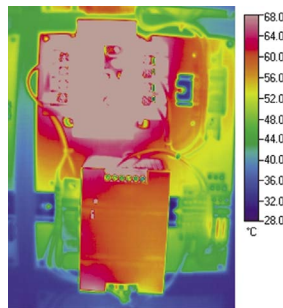

Competitor A – 10 A, 24V DC – 91% Efficiency

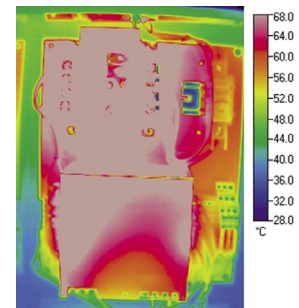

Competitor B – 10 A, 24V DC – 84% Efficiency

## Selection Criteria

Power Supply Family	Basic 1606-XLB	Essential 1606- XLE	DC-DC Converter 1606-XLD	Compact 1606-XLP	Performance 1606-XLS
Input Voltage	Single-phase	Single-/multi-phase	DC Voltage	Single-/multi-phase	Single-/multi-phase
Watt Range	36...480 W	80...960 W	92...240 W	15...100 W	80... 960 W
Output Voltages	24...28V DC	12, 24, 48V DC	24, 48V DC	5, 12, 15, 24, 48V DC	12, 24, 30, 36, 48V DC
Terminations	Screw, push-in	Screw, cam lock spring, plug, push-in	Cam lock spring, screw	Cam lock spring, screw	Cam lock spring, plug, screw
Auto Select Input	●	●	—	●	●
Power Boost	—	120%	120%	—	150%/5 s
DC OK Relay Output	●	●	●	●	●
DC OK LED Indicator	●	●	●	●	●
Conformal Coat for Harsh Environments	—	●	—	—	●
Hazardous Location Approvals	—	●	●	●	●

Circuit Breakers



1-2...1-15

Disconnect Switches



1-16...1-23

Control & Load Switches



1-24...1-27

Control Circuit & Load Protection



1-28...1-39

Power Supplies



1-40...1-47

Power Quality & Energy Management



1-48...1-51

Surge & Filter



1-52...1-55



## Product Selection – 1606-XLB

### Basic Power Supplies - Single-phase

Input Voltage	Output Voltage [V DC]	Output Power [W]	Output Current [A]	Steady-state Input Current [V AC]		Cat. No.
				@ 120V AC	@ 230V AC	
AC 100...240V	24...28	36	1.5	0.63	0.38	1606-XLB36EH
AC 100...240V	12...15	60	5	1.0	0.6	1606-XLB60BH
AC 100...240V	24...28	60	2.5	1.0	0.6	1606-XLB60EH
AC 100...240V		60	2.5	1.0	0.6	1606-XLB60E
AC 100...240V		90	3.75	1.45	0.95	1606-XLB90EH
AC 100...240V				1.45	0.95	1606-XLB90E
AC 100...240V				1.45	0.95	1606-XLB90EQ
AC 100...120/200...240V		120	5	1.72	1.05	1606-XLB120E
AC 100...240V		240	10	2.17	1.18	1606-XLB240E
AC 100...240V		480	20	4.3	2.3	1606-XLB480E



## Product Selection – 1606-XLD

### Basic Power Supplies - Single-phase

Input Voltage	Output Voltage [V DC]	Output Power [W]	Output Current [A]	Steady-state Input Current [V DC]		Cat. No.
				@ 24V DC	@ 48V DC	
24	24	92	3.8	4.25	–	1606-XLDC92D
24	24	240	10	10.5	–	1606-XLDD240E
48	24	120	5	–	2.75	1606-XLDF120E
48	48	240	5	–	5.3	1606-XLDF240F



# Power Supplies



## Product Selection - 1606-XLE

### Essential Power Supplies

POWER

Phase	Input Voltage	Output Voltage [V DC]	Output Power [W]	Output Current [A]	Steady-state Input Current [V AC/V AC]		Cat. No.
					120	230	
1	100...240V AC	24...28	80	3.3	1.24	0.68	1606-XLE80E
			120	5	1.09	0.6	1606-XLE120E
			120	5	1.09	0.6	1606-XLE120EC <sup>1</sup>
	100...120V AC		120	5	1.94	-	1606-XLE120EN
	200...240V AC		120	5	2.2	-	1606-XLE120EE
	100...240V AC		240	10	2.15	1.13	1606-XLE240E
	100...120V AC		240	10	3.84	-	1606-XLE240EN
	200...240V AC		240	10	2.2	-	1606-XLE240EE
	100...120/200...240V AC	48...52	240	5	0.7	0.6	1606-XLE240F
2	380...480V AC	12...15	96	8	0.64/0.56 A @ 3 x 400/480V AC		1606-XLE96B-2
3		48...56	240	5	0.7/0.6 A @ 3 x 400/480V AC		1606-XLE240F-3
2		24...28	120	5	0.75/0.68 A @ 3 x 400/480V AC		1606-XLE120E-2
3			240	10	0.7/0.6 A @ 3 x 400/480V AC		1606-XLE240E-3
		24V	960	40	1.4 A @ 3 x 480V AC		1606-XLE960DX-3N
1	100...240V AC	48...56	260	5.4	2.32	1.20	1606-XLE260F
		24...28	240	10	2.15	1.13	1606-XLE240EC
		24V	240	10	2.17	1.14	1606-XLE240ERL
			240	10	2.17	1.14	1606-XLE240ERZ
			240	10	2.17	1.14	1606-XLE240ECRZ
			240	10	2.17	1.14	1606-XLE240EDRZ
		24...28	240	10	2.15	1.13	1606-XLE240EL
			240	10	2.15	1.13	1606-XLE240EH
		24V	240	10	2.17	1.14	1606-XLE240EDRZ
			120	5	1.09	0.6	1606-XLE120EL
		24...28	120	5	1.09	0.6	1606-XLE120EH
			120	5	1.09	0.6	1606-XLE120ED
		48...56	120	2.5	1.09	0.6	1606-XLE120F
			24V	480	20	4.28	2.25
		480		20	4.28	2.25	1606-XLE480ERZ
		480		20	4.28	2.25	1606-XLE480ECRZ
		24...28	480	20	4.26	2.23	1606-XLE480EL
			480	20	4.26	2.23	1606-XLE480EH
			480	20	4.26	2.23	1606-XLE480EM
		24V	480	20	4.28	2.25	1606-XLE480EDRZ
	110...300V DC	48...56	480	10	4.68/1.69 A @ 110/300 V DC		1606-XLE480FP-D

<sup>1</sup> The **C** suffix in the catalog number indicates that the product has conformal coating. Please see technical data for additional catalog numbers available.

Circuit Breakers



1-2...1-15

Disconnect Switches



1-16...1-23

Control & Load Switches



1-24...1-27

Control Circuit & Load Protection



1-28...1-39

Power Supplies



1-40...1-47

Power Quality & Energy Management



1-48...1-51

Surge & Filter



1-52...1-55



**Allen-Bradley**

by ROCKWELL AUTOMATION

## Product Selection – 1606-XLP Compact Power Supplies

Phase	Input Voltage	Output Voltage [V DC]	Output Power [W]	Output Current [A]	Steady-state Input Current [V AC]		Cat. No.
					120	230	
1	100...240V AC, 110-300V DC	5...5.5	15 <sup>1</sup>	3	0.28	0.17	1606-XLP15A
		12...15	15 <sup>1</sup>	1.3	0.28	0.17	1606-XLP15B
		24...28	15 <sup>1</sup>	0.63	0.28	0.17	1606-XLP15E
		5...5.5	25 <sup>1</sup>	5	0.60	0.35	1606-XLP25A
		10...12	30 <sup>1</sup>	3	0.60	0.25	1606-XLP30B
		24...28	30 <sup>1</sup>	1.3	0.60	0.35	1606-XLP30E
		24...28	30 <sup>1</sup>	1.3	0.54	0.30	1606-XLP30EQ
		±12/15	36 <sup>1</sup>	2.8	0.65	0.40	1606-XLP36C
		12...15	50 <sup>1</sup>	4.2	1.00	0.60	1606-XLP50B
		24...28	50 <sup>1</sup>	2.1	0.77	0.44	1606-XLP50E
		24...28	50 <sup>1</sup>	2.1	1.00	0.60	1606-XLP50EZ
		48...56	50 <sup>1</sup>	1.05	1.00	0.60	1606-XLP50F
	100...240V AC, 110...300V DC	12...15	60 <sup>1</sup>	4.5	0.91	0.54	1606-XLP60BQ
			60 <sup>1</sup>	4.5	0.97	0.61	1606-XLP60BQT
		24...28	60 <sup>1</sup>	2.5	0.98	0.58	1606-XLP60EQ
			60 <sup>1</sup>	2.5	1.05	0.66	1606-XLP60EQT
	100...120/220...240V AC, 220...375V DC	12...15	72 <sup>1</sup>	3	1.60	0.80	1606-XLP72E
			90 <sup>1</sup>	7.5	1.90	0.90	1606-XLP90B
	100...200/200...240V AC, 220...375V DC	24...28	95 <sup>1</sup>	4.0	1.63	0.95	1606-XLP95E
			100 <sup>1</sup>	4.2	2.10	1.00	1606-XLP100E
		48...56	100	2.1	2.10	1.00	1606-XLP100F
2	380...480V AC	24...28	90 <sup>1</sup>	3.75	0.42 A @ 400V AC 0.36 A @ 480V AC		1606-XLP90E-2
			100	4.2	0.46 A @ 400V AC 0.40 A @ 480V AC		1606-XLP100E-2

<sup>1</sup> NEC CLASS 2 Rated

POWER

For more information on our complete family of power supply products, please visit:  
[rok.auto/power-supplies](http://rok.auto/power-supplies)





# Power Supplies

## Product Selection - 1606-XLS

### Performance Power Supplies



POWER

Phase	Input Voltage	Output Voltage [V DC]	Output Power [W]	Output Current [A]	Steady-state Input Current		Cat. No.
					120 [V AC / V DC]	230 [V AC / V DC]	
1	100...240V AC, 110...300V DC	24...48	80	3.4	1.42	0.82	1606-XLS80E
			120	5	1.10	0.62	1606-XLS120E 1606-XLS120EA
		12...15	180	15	1.65	0.93	1606-XLS180B
		24...48	240	10	2.22	1.22	1606-XLS240E
	1606-XLS240EA <sup>1</sup>						
	1606-XLS240EC <sup>1</sup>						
	100...240V AC 110...300V DC	24...28	240	10	2.22	1.22	1606-XLS240E-D
			48...56	240	5	2.22	1.22
	100...240V AC, 110...150V DC	48...56	240	5	2.22	1.22	1606-XLS240F
			28...32	240	8	2.22	1.22
		24...48	480	20	4.56	2.48	1606-XLS480E
							1606-XLS480EA <sup>1</sup> 1606-XLS480EC <sup>1</sup>
	600V DC				0.85A @ 600V DC	1606-XLS480E-D	
	200...240V AC	24...48	480	20	-	4.45	1606-XLS480EE
	100...240V AC, 110...150V DC	48...55	480	10	4.56	2.48	1606-XLS480F
		36...42	480	13.3	4.56	2.48	1606-XLS480G
	200...240V AC, 220...300V DC	24...28	960	34.3	-	4.6	1606-XLS960EE
		48...54	960	20	-	4.6	1606-XLS960FE
100...240V AC	24...28	960	40	8.6	4.5	1606-XLS960E	
100...240V AC	48...54	960	20	8.6	4.5	1606-XLS960F	
100...240V AC 110...300V DC	24...28	240	10	2.22	1.22	1606-XLS240E-D	
100...240V AC 110...300V DC	48...56	240	5	2.22	1.22	1606-XLS240F-D	
3	380...480V AC	24...28	480	20	0.79/0.65A @ 3 x 400/480V AC		1606-XLS480E-3 1606-XLS480E-3C <sup>1</sup>
				10	0.79/0.65A @ 3 x 400/480V AC		1606-XLS480F-3
	380...480V AC	48...55	960	13.3	0.79/0.65A @ 3 x 400/480V AC		1606-XLS480G-3
				24...28	1.65/1.35A @ 3 x 400/480V AC		1606-XLS960E-3
				48...54	1.65/1.35A @ 3 x 400/480V AC		1606-XLS960F-3
				20	1.65/1.35A @ 3 x 400/480V AC		1606-XLS960F-3

<sup>1</sup> The **C** suffix in the catalog number indicates that the product has conformal coating. The **A** suffix in the catalog number indicates that the product carries the ATEX rating.

Circuit Breakers



1-2...1-15

Disconnect Switches



1-16...1-23

Control & Load Switches



1-24...1-27

Control Circuit & Load Protection



1-28...1-39

Power Supplies



1-40...1-47

Power Quality & Energy Management



1-48...1-51

Surge & Filter



1-52...1-55



## Redundancy Modules 1606

- Provide back-up power if the primary power supply fails
- For all switched mode power supply lines
- Status indication for each switched mode power supply



## Buffer Modules 1606

- Buffer load currents during typical mains faults, switching events or load peaks
- Prevent application interruption due to short voltage dips, drops or inrush spikes
- 10+ years of life expectancy based on recommended usage

## DC UPS Modules

- Back-up power for bridge dips, sags or loss of power
- Extensive diagnostic and monitoring functions to aide in troubleshooting
- When power supply provides sufficient voltage, module charges the battery
- Capacitor and battery-based models available



## ArmorPower On-Machine Power Supplies 1607-XT

- IP67 and NEC Class 2 ratings
- Vacuum encapsulation technology
- Quick connectors
- Smooth surface, suitable for washdown



# Power Supplies

POWER

## Uninterruptible Power Supplies 1609-B, 1609-D

- Integrated remote on/off and dry I/O contacts
- USB communications
- Available EtherNet/IP communications (1609-D only)
- Remote on/off enables UPS to deactivate when servicing electrical panel
- Logix integration with add on profiles (1609-D only)



## Fast Recovery from Power Failures

The 1609 Uninterruptible Power Supply (UPS) is uniquely designed for the industrial market to provide back-up AC power to the control cabinet. The 1609 UPS will bridge dips, sags, or brief losses of power. If necessary, the 1609 UPS provides enough time to facilitate a safe shut-down of your industrial PC, PLC, data logging HMI, or any other critical device in the control scheme.

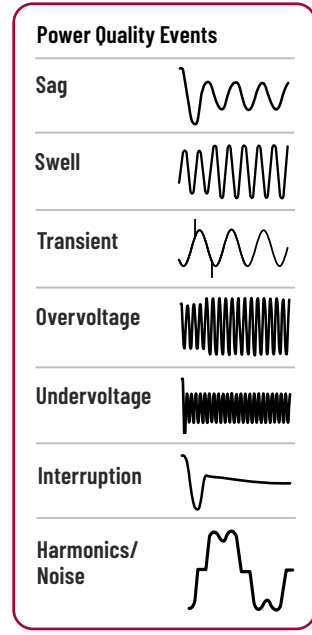
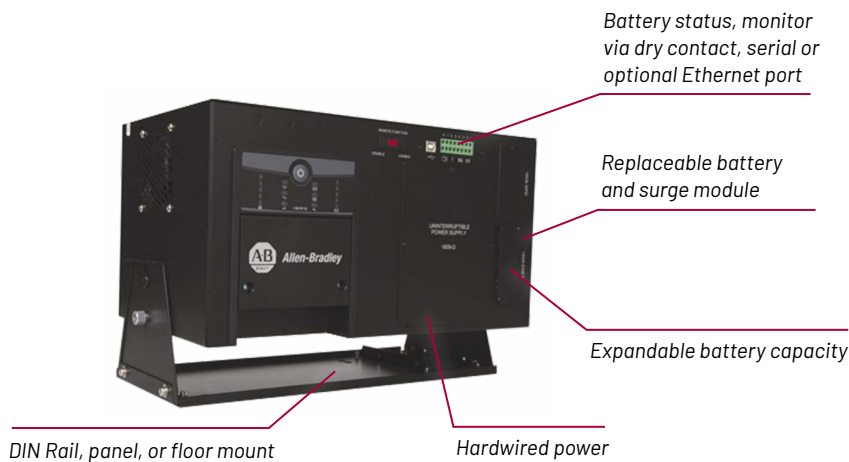

Product	Panel Mount	Integrated Dry I/O Contacts	Remote On/Off	Replaceable Surge Protection	EtherNet/IP	USB	Auto Voltage Regulation	Expandable Battery
1609-B	•	•	•	•		•		
1609-D	•	•	•	•	•	•	•	•

<p>Circuit Breakers</p> <p>1-2...1-15</p>	<p>Disconnect Switches</p> <p>1-16...1-23</p>	<p>Control &amp; Load Switches</p> <p>1-24...1-27</p>	<p>Control Circuit &amp; Load Protection</p> <p>1-28...1-39</p>	<p><b>Power Supplies</b></p> <p><b>1-40...1-47</b></p>	<p>Power Quality &amp; Energy Management</p> <p>1-48...1-51</p>	<p>Surge &amp; Filter</p> <p>1-52...1-55</p>
-------------------------------------------	-----------------------------------------------	-------------------------------------------------------	-----------------------------------------------------------------	--------------------------------------------------------	-----------------------------------------------------------------	----------------------------------------------



# Product Selection Uninterruptible Power Supplies

Product Family	Input/ Output Voltage [V]	Output Power [VA]	Cat. No.
1609-B Basic <sup>1</sup>	120	600	1609-B600N
		1000	1609-B1000N
	230	600	1609-B600
		1000	1609-B1000E
1609-D Deluxe <sup>2</sup> (full featured)	120	600	1609-D600N
		1000	1609-D1000N
		1500	1609-D1500N
	230	600	1609-D600E
		1000	1609-D1000E
		1500	1609-D1500E

<sup>1</sup> 1609-B UPS requires two 12V batteries that can be ordered separately from the Accessories table below.

<sup>2</sup> 1609-D UPS requires two 12V batteries that can be ordered separately from the Accessories table below.

## Specifications

### Input

		VA	1609-B	1609-D	
Capacity		600	600VA (390 W)	600VA (390 W)	
		1000	1000VA (390 W)	1000VA (650 W)	
		1500	N/A	1500VA (980 W)	
Voltage Range 120V AC/230V AC		90...145V/184...264			
Current	1609-B	Input Voltage	600VA	1000VA	1500VA
		120V	5.4 A	8.9 A	N/A
	230V	2.8 A	4.7 A	N/A	
	1609-D	120V	5.5 A	8.8 A	13 A
		230V	3.3 A	4.7 A	7.1A
	Capacity Frequency		50/60 Hz ± 3 Hz		
PFC		None (load power factor is reflected in the input line)			

### Output

	VA	1609-B	1609-D
Capacity	600	600VA (390 W)	600VA (390 W)
	1000	1000VA (390 W)	1000VA (650 W)
	1500	N/A	1500VA (980 W)

## Accessories

Description	Cat. No.
Standard replacement battery (0...40 °C) 32...104 °F	1609-SBAT
High-temperature replacement battery (0...50 °C) 32...122 °F	1609-HBAT
External battery pack	1609-EXBAT
Surge protection module	1609-SPD
Replacement mounting bracket	1609-BRK



### Product Selection Tools

Available online or for download, our tools help you access info while in the office or on the go.

[rok.auto/selection](http://rok.auto/selection)



# Power Quality & Energy Management

POWER

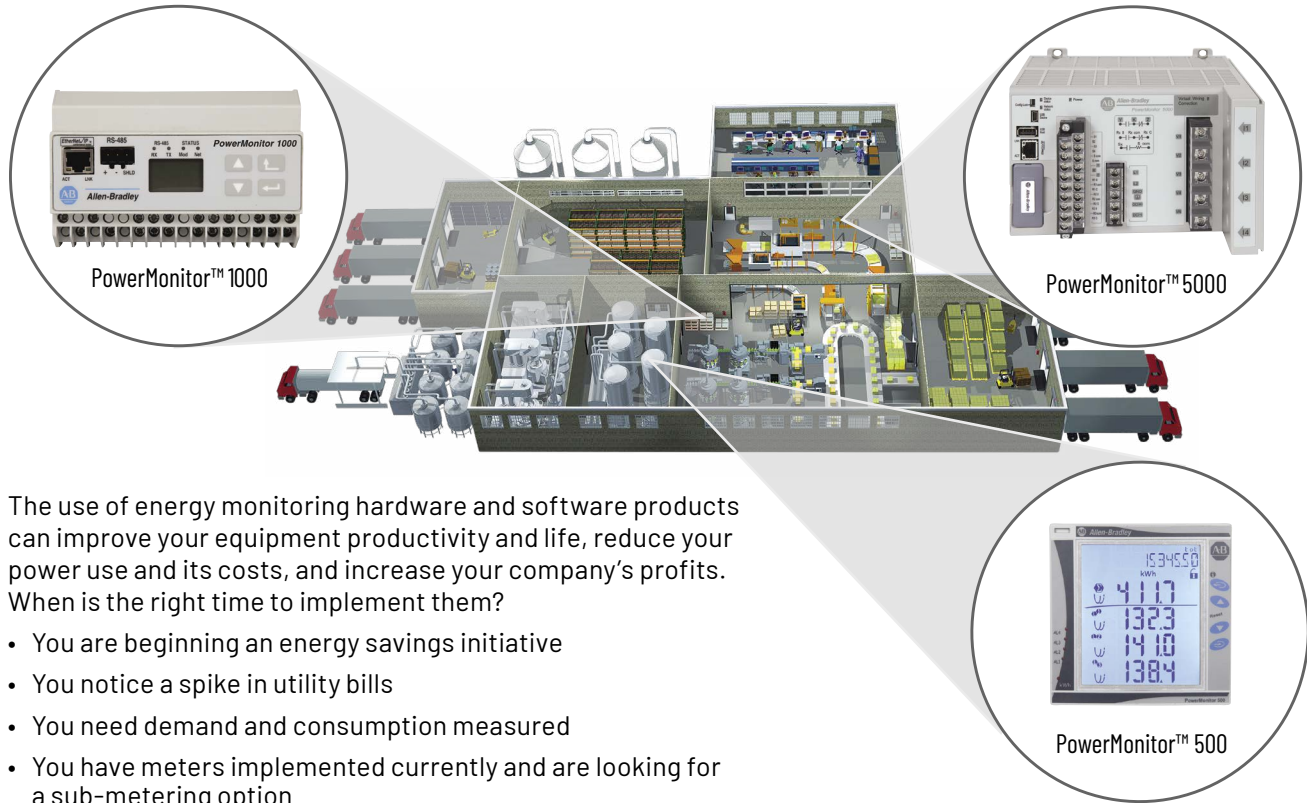

The use of energy monitoring hardware and software products can improve your equipment productivity and life, reduce your power use and its costs, and increase your company's profits. When is the right time to implement them?

- You are beginning an energy savings initiative
- You notice a spike in utility bills
- You need demand and consumption measured
- You have meters implemented currently and are looking for a sub-metering option
- You want to monitor individual processes and subprocesses

## Product Family Comparison

Features	PowerMonitor 500	PowerMonitor 1000 <sup>1</sup>	PowerMonitor 5000
Energy (Consumption) (kWh)	●	●	●
Demand (kW)	●	●	●
Power factor	●	●	●
Internal logs	—	●	●
Power quality aspects (sag/swell detection, harmonics, and transients)	—	—	●
Waveform capture	—	—	●
Door-mounted display	●	Optional	Optional
Ethernet/IP Network Communication	●	●	●
Configurable by using webpage	—	●	●
Configurable setpoints/alarms	●	—	●
<b>Accuracy levels (per standard EN62053-22)</b>			
Class 1, 1% energy accuracy	●	●	—
Class 0.2, 0.2% energy accuracy	—	—	●

<sup>1</sup> The PowerMonitor 1000 unit has an LCD display option and can be used with any Rockwell Automation operator interface.

<p>Circuit Breakers</p>  <p>1-2...1-15</p>	<p>Disconnect Switches</p>  <p>1-16...1-23</p>	<p>Control &amp; Load Switches</p>  <p>1-24...1-27</p>	<p>Control Circuit &amp; Load Protection</p>  <p>1-28...1-39</p>	<p>Power Supplies</p>  <p>1-40...1-47</p>	<p><b>Power Quality &amp; Energy Management</b></p>  <p><b>1-48...1-51</b></p>	<p>Surge &amp; Filter</p>  <p>1-52...1-55</p>
-------------------------------------------------------------------------------------------------------------------------------	-----------------------------------------------------------------------------------------------------------------------------------	-------------------------------------------------------------------------------------------------------------------------------------------	-----------------------------------------------------------------------------------------------------------------------------------------------------	-------------------------------------------------------------------------------------------------------------------------------	---------------------------------------------------------------------------------------------------------------------------------------------------------------------	------------------------------------------------------------------------------------------------------------------------------------



## Product Selection

### PowerMonitor 500<sup>1</sup>



Type	Description	Cat. No.
PowerMonitor 500 V1	Serial power meter	1420-V1-485
	Serial power meter, analog output	1420-V1A-485
	Serial power meter, pulse (digital) output	1420-V1P-485
	EtherNet/IP power meter	1420-V1-ENT
	EtherNet/IP power meter, analog output	1420-V1A-ENT
	EtherNet/IP power meter, pulse (digital) output	1420-V1P-ENT
PowerMonitor 500 V2	Serial power meter	1420-V2-485
	Serial power meter, analog output	1420-V2A-485
	Serial power meter, pulse (digital) output	1420-V2P-485
	EtherNet/IP power meter	1420-V2-ENT
	EtherNet/IP power meter, analog output	1420-V2A-ENT
	EtherNet/IP power meter, pulse (digital) output	1420-V2P-ENT

<sup>1</sup> V1 model: 120V AC LN, 208V AC LL  
V2 model: 400V AC LN, 600V AC LL



### PowerMonitor 1000

Type	Description	Cat. No.
PowerMonitor 1000 BC3	Basic consumption meter w/serial	1408-BC3A-485
	Basic consumption meter w/Ethernet	1408-BC3A-ENT
PowerMonitor 1000 TS3	Consumption + Volt/Current w/serial	1408-TS3A-485
	Consumption + Volt/Current w/Ethernet	1408-TS3A-ENT
PowerMonitor 1000 EM3	Energy management meter w/serial	1408-EM3A-485
	Energy management meter w/Ethernet	1408-EM3A-ENT

### PowerMonitor 1000 Models

Meter Data	BC3	TS3	EM3
PowerMonitor	●	●	●
Power Factor	●	●	●
Energy Consumption	●	●	●
Voltage, Current	—	●	●
Demand	—	—	●

### PowerMonitor 5000



Type	Description	Cat. No.
PowerMonitor 5000 M5	Basic Power Quality w/Ethernet	1426-M5E
	Ethernet and optional ControlNet	1426-M5E-CNT
	Ethernet and optional DeviceNet	1426-M5E-DNT
PowerMonitor 5000 M6	Power Quality w/Ethernet	1426-M6E
	Ethernet and optional ControlNet	1426-M6E-CNT
	Ethernet and optional DeviceNet	1426-M6E-DNT
PowerMonitor 5000 M8	Advanced Power Quality w/Ethernet	1426-M8E
	Ethernet and optional ControlNet	1426-M8E-CNT
	Ethernet and optional DeviceNet	1426-M8E-DNT

### PowerMonitor 5000 Power Quality Meter

Power Quality	1426-M5E	1426-M6E	1426-M8E
Unbalance (V,I)	●	●	●
Crest Factor, K-Factor (waveform distortion factors)	●	●	●
Voltage Sag and Swell	●	●	●
Total Harmonic Distortion (THD)	●	●	●
Waveform Capture	—	●	●
Interruption	—	●	●
Power Frequency Variations	—	●	●
DC Offset	—	●	●
Individual Harmonics (DC-63rd)	—	●	●
Individual Harmonics (DC-127th)	—	—	●
Interharmonics	—	—	●
Transient	—	—	●
Voltage Fluctuations (Flicker)	—	—	●



# Power Quality & Energy Management

POWER

## Power Monitor Accessories

### PowerMonitor Wiring Accessory Kit Bulletin 1400

- Safely and correctly wire the power monitor
- Includes shorting block for CTs, fuses and fuse holders for voltage inputs and for control power



### Current Transformers Bulletin 1411

- Solid core and split core options
- Rectangular or round-shape CTs suitable for a variety of conductor sizes
- 5A output compatible with PowerMonitor 500, 1000, and 5000

### PowerMonitor Display Module 1426-DM

- Factory-installed applications to view data from 1, 2, or 3 PowerMonitor units
- 4 in. Touchscreen Display
- Minimal setup for communication is required



1-50

Circuit Breakers



1-2...1-15

Disconnect Switches



1-16...1-23

Control & Load Switches



1-24...1-27

Control Circuit & Load Protection



1-28...1-39

Power Supplies



1-40...1-47

**Power Quality & Energy Management**

Surge & Filter



**1-48...1-51**



1-52...1-55



## Specifications

### PowerMonitor 500

Parameter	Accuracy in % of Reading at 25 °C 50/60 Hz Unity Power Factor	Nominal/Range
Voltage sense inputs: V1	±0.5%	Line-neutral rms: 120 V nominal, 40...144V Line-line rms: 208 V nominal, 70...250V
Voltage sense inputs: V2		Line-neutral rms: 400 V nominal, 160...480V Line-line rms: 600 V nominal, 277...830V
Current	±0.5%	5A nominal, 0.01...6 A rms
Real Energy	Class 2 according to EN62053-21, ANSI C12.1 Class B according to EN50470-3	—
Reactive Energy	Class 2 according to EN62053-23, ANSI C12.1	—

### PowerMonitor 5000

Parameter	Accuracy in % of Reading at 25 °C 50/60 Hz Unity Power Factor	Nominal/Range
Voltage sense inputs: V1, V2, V3, VN	±0.1%	Line-neutral rms: 398V nominal, 15...660V Line-line rms: 690V nominal, 26...1144V
Current sense input: I1, I2, I3, I4	±0.1%	5A nominal, 0.05...15.6 A rms
Power functions: kW, kVA, kVAR	ANSI C12.20 -2010 Class 0.2 EN 62053-22 -2003 Class 0.2 accuracy	—
Demand functions: kW, kVA, kVAR		
Energy functions: kWh, kVAh, kVARh		

### PowerMonitor 1000

Parameter	Accuracy in % of Reading at 25 °C 50/60 Hz Unity Power Factor	Nominal/Range
Voltage sense inputs: V1, V2, V3	±0.5%	Line-neutral rms: 347V nominal, 15...399V Line-line rms: 600V nominal, 26...691V
Current sense	±0.5%	5 A rms
Power functions: kW, kVA, kVAR Demand functions: kW, kVA, kVAR Energy functions: kWh, kVAh, kVARh	EN62053-21:2003 Accuracy Requirement Class 1	—



# Surge & Filter

POWER

## DIN Rail AC Power Surge Protector 4983-DS

- Compact modular design
- Visual fault indicator linked to internal thermal disconnect
- A controlled end-life occurrence will trigger SPD replacement indicator
- Equipped standard with safety remote signaling AC network connection



### Application Information

Brief voltage spikes and surges can be caused by a wide range of factors originating from both within and outside of a production facility. Whatever their source, these transients can damage electronic equipment, requiring expensive replacement and production delays.

Bulletin 4983-DS surge protectors use metal oxide varistor (MOV) technology. Unlike most MOV-based surge protection, these devices are larger, replaceable and designed for DIN Rail mounting in an electrical environment.

The MOV technology is a high-impedance component (high-resistance device). When a surge occurs, the MOV changes to a low-impedance (resistance) device and diverts the surge away from the load and directs it to ground. MOVs have high energy capability and consistent clamping performance.

Because MOV-based surge protectors are sacrificial – they break down every time they divert surges away from a load – 4983-DS protectors can be replaced after an event. Many electronic components have some form of built-in protection and are not user replaceable.

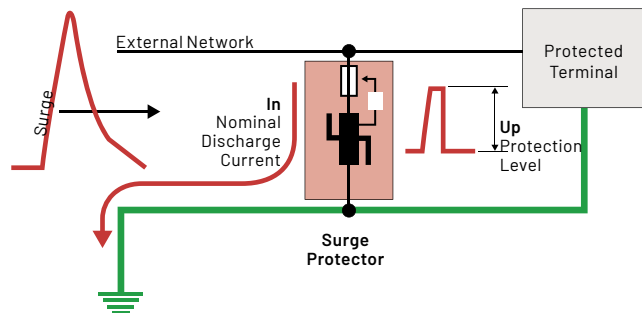

1-52

Circuit Breakers



1-2...1-15

Disconnect Switches



1-16...1-23

Control & Load Switches



1-24...1-27

Control Circuit & Load Protection



1-28...1-39

Power Supplies



1-40...1-47

Power Quality & Energy Management



1-48...1-51

Surge & Filter



1-52...1-55





### Product Selection

AC Network	Connection Mode	No. of Poles	Max. Continuous Operating Voltage (MCOV) (U <sub>c</sub> ) [V AC]	Max. Discharge Current 8/20 ms (I <sub>max</sub> ) [kA]	Protection Level (Up) [kV]	UL 1449 Voltage Protection Rating (VPR) [V]	Cat. No. Base and Module			
120	L/G or N/G	1	150	40	0.9	700	4983-DS120-401			
	L/G, N/G	2					4983-DS120-402			
120/208Y	L1/G, L2/G, L3/G	3					4983-DS120-403			
	L1/G, L2/G, L3/G, N/G	4					4983-DS120-404			
230/400	L/G or N/G	1					275	1.25	1000	4983-DS230-401
	L/G, N/G	2								4983-DS230-402
	L1/G, L2/G, N/G	3	4983-DS230-403							
277	L/G or N/G	1	420		1.8	1500	4983-DS277-401			
	L1/G, L2/G, L3/G	3					4983-DS277-403			
L1/G, L2/G, L3/G, N/G		4					4983-DS277-404			
	480D	L1/G, L2/G, L3/G					3	550	1.8	1800
230/400	L/G, N/G	2					275	1.25	1000	4983-DS230-401G
	L1/G, L2/G, L3/G, N/G	4		1000					4983-DS230-403G	
120	L/G or N/G	1	150	80	0.9	700	4983-DS120-801			
	L/G, N/G	2					4983-DS120-802			
	L1/G, L2/G, L3/G	3					4983-DS120-803			
230/400	L/G or N/G	1					275	1.25	1000	4983-DS230-801
	L/G, N/G	2								4983-DS230-802
	L1/G, L2/G, N/G	3								4983-DS230-803
277	L/G or N/G	1	420		1.8	1500	4983-DS277-801			
	L1/G, L2/G, L3/G	3					4983-DS277-803			
L1/G, L2/G, L3/G, N/G		4					4983-DS277-804			
	480D	L1/G, L2/G, L3/G					4	680	2500	4983-DS277-804
600D	L1/G, L2/G, L3/G	4					690	4983-DS600-804		

POWER

### Specifications

Connection/mounting type	Parallel/DIN Rail mount
Certifications	cURus, CSA, CE Marked
Conductor material	Cu, solid, or stranded
Conductor range	#10...4 AWG (4...28 mm <sup>2</sup> )
Strip length	0.4 in. (10 mm)
Tightening torque	2.0...2.5 N•m (17.8...22.1 lb•in.)
No. of conductors/terminal	1
Operating temperature	-40...+80 °C

**Product Certifications**

Global certifications available online:  
[rok.auto/certifications](http://rok.auto/certifications)



For more information on our complete family of circuit and load protection products, please visit: [rok.auto/circuit-load-protection](http://rok.auto/circuit-load-protection)



# Surge & Filter

## Filter Protective Devices 4983-PF

- Filter for low-level transients and high-frequency noise
- UL 1283, CSA, CE
- Features Islatrol® filter technology
- LED power indication
- Panel (flange) mount



4983-PF

## 4983-DC

- UL 1449 Third Edition, UL 1283, CE
- Small combination (filter and SPD) package size
- Features Islatrol filter technology
- LED power indication
- Form C contact for remote status indication



4983-DC

Bulletin 4983-PF and 4983-DC filter protective devices address low-level voltage transients and high-frequency noise disturbances that, over time, cause premature aging. The long-term effects of noise are just as damaging as high voltage transients. The 4983-PF and 4983-DC devices feature Islatrol filter technology. Islatrol filter technology continually tracks and monitors the input signal to provide clean and reliable AC power for critical equipment.

Bulletin 4983-PF and 4983-DC filters are connected in series. Protection is best when the devices are installed directly in front of the load requiring protection. Typical applications include any microprocessor-based products such as PLCs, motion control systems, and computers exposed to harsh environments.



Circuit  
Breakers



1-2...1-15

Disconnect  
Switches



1-16...1-23

Control &  
Load Switches



1-24...1-27

Control Circuit &  
Load Protection



1-28...1-39

Power  
Supplies



1-40...1-47

Power Quality  
& Energy  
Management



1-48...1-51

Surge &  
Filter



1-52...1-55



## Product Selection

Operating Voltage [V AC]	Max. Continuous Operating Voltage [V AC]	Line Frequency [Hz]	Ampacity [A]	Cat. No.	Cat. No.
120	150	47...63	2.5	4983-PF120-02	—
			3	—	4983-DC120-03
			5	4983-PF120-05	4983-DC120-05
			10	—	4983-DC120-10
			15	4983-PF120-15	—
			20	—	4983-DC120-20
			30	4983-PF120-30	—
240	275		2.5	4983-PF240-02	—
	320		3	—	4983-DC240-03
	275		5	4983-PF240-05	—
	320		5	—	4983-DC240-05
	320		10	—	4983-DC240-10
	275		15	4983-PF240-15	—
	320		20	—	4983-DC240-20
	275	30	4983-PF240-30	—	

## Specifications

	4983-PF	4983-DC
<b>Connection/Mounting Type</b>	Series/panel (flange) mount	Series/DIN Rail mount
<b>Enclosure</b>	Grey, high-impact plastic	Metal
<b>Modes of Protection</b>	Line - Neutral	
	Line - Line	
	Line - PE	
	Neutral - PE	
<b>Certifications</b>	UR Recognized component, CE Marked	UR Recognized, CSA, CE Marked
<b>Typical Cat. A Ringwave Rating</b>	< 10V peak	< 60V peak
<b>Typical Cat. B Ringwave Rating</b>	< 50V peak	< 100V peak
<b>Response Time</b>	Normal mode: < 0.5 ns	
	Common mode: < 5 ns	
<b>Operating Temperature</b>	-40...+60 °C derate linearly to 60% @ +70 °C	
<b>Fusing</b>	Appropriate external fusing is required	
<b>Frequency Response (Forward - Reverse) 100 kHz...50 MHz</b>	Normal mode - 90 dB min.	Normal mode (100 kHz...50 MHz) - 90 dB min.
	Common mode - 60 dB min.	Common mode (5...50 MHz) - 60 dB min.
	3 kHz cut-off frequency	50 kHz cut-off frequency



# Additional Power Products



## Control Circuit Transformers 1497

- Designed to reduce supply voltages to control circuits, providing greater safety to operators
- P2X finger-safe terminal covers and fuse covers
- 1497 global control transformers 63...2000 VA (50, 60 and 50/60 Hz)
- 1497A machine tool transformers 50...3000 VA (50/60 Hz)
- 1497B control power transformers 50...3000 VA (60 Hz)
- 1497D general purpose transformers 0.050...25.0 kVA (60 and 50/60 Hz)

## i-Sense/i-Grid Intelligent Network 1608S

The i-Sense® voltage event monitor is ideal for analyzing the feed into your facility with limited investment. Voltage quality data is viewed on the i-Grid® cloud-based application, which means that there is no software to install or maintain. Instant event e-mail and text notifications will keep power quality data at your fingertips.



## DySC Voltage Sag Correctors 1608

DySC® voltage sag correctors protect against voltage sags and momentary outages that account for a significant amount of manufacturing downtime and damaged equipment.

- Single- and three-phase portfolio
- Up to five seconds of ride-through
- 1608N Mini DySC (0.25...14 kVA)
- 1608P Pro DySC (10...165 kVA)
- 1608M Mega DySC (333...2000 kVA)

Circuit Breakers



1-2...1-15

Disconnect Switches



1-16...1-23

Control & Load Switches



1-24...1-27

Control Circuit & Load Protection



1-28...1-39

Power Supplies



1-40...1-47

Power Quality & Energy Management



1-48...1-51

Surge & Filter



1-52...1-55







# MOTOR CONTROL & PROTECTION

## TABLE OF CONTENTS

### Contactors

IEC Contactors .....	2-2
Safety Contactors .....	2-9
Definite Purpose Contactors .....	2-14

### Starters

Manual Motor Starters .....	2-16
Open Starters, IEC.....	2-18
Enclosed Starters, IEC .....	2-20
Combination Starters, IEC .....	2-22
Open Starters, NEMA.....	2-24
Combination Starters, NEMA .....	2-28

### Motor Protection

Bimetallic Overload Relays.....	2-30
Electronic Overload Relays .....	2-32

### Smart Motor Control

Solid-State Contactors.....	2-36
Starting Torque Controller .....	2-38
SMC Smart Motor Controllers .....	2-40

### Drives

PowerFlex Drives.....	2-46
-----------------------	------

### Additional Motor Control & Protection Products .....

2-52

# Contactors

## Miniature IEC Contactors 100-K/104-K

- Designed for commercial and light industrial applications
- 5...12 A
- Compact size with smaller panel depth and height requirements
- Full-voltage non-reversing and reversing contactors
- Same dimensions for AC and DC



Miniature IEC contactors can be used on the CrossBoard® bus bar mounting system as shown below.<sup>1</sup>

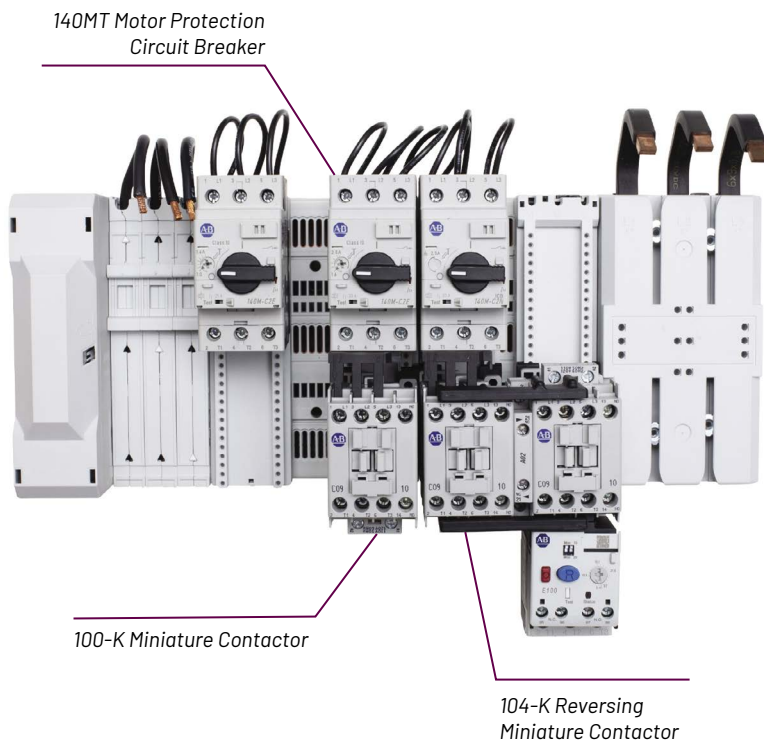

### Accessories<sup>2</sup>

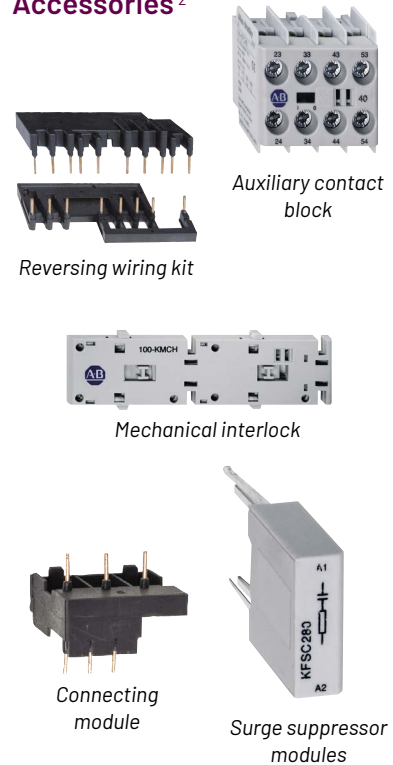

<sup>1</sup> Additional details on the 141 Mounting Systems can be found on page 2-52.

<sup>2</sup> Additional details on accessories can be found on page 1-31.

### Contactors



2-2...2-15

### Starters



2-16...2-29

### Motor Protection



2-30...2-35

### Smart Motor Control



2-36...2-45

### Drives



2-46...2-51

## Product Selection

### AC- and DC-Control Miniature Contactors <sup>1</sup>

Rated Operational Current [A]		Ratings for Switching AC Motors			Power Poles		Aux. Contacts		Direct-on-Line	
		3-Phase kW	3-Phase Hp						Screw Terminal	Spring Clamp
AC-3	AC-1	400/415V	200/230V	460/575V	N.O.	N.C.	N.O.	N.C.	Cat. No.	Cat. No.
3-pole										
5	20	2.2	1-1/2	3	3	0	1	0	100-K05⊗10	100-KR05⊗10
							0	1	100-K05⊗01	100-KR05⊗01
9	20	4	2	5			1	0	100-K09⊗10	100-KR09⊗10
							0	1	100-K09⊗01	100-KR09⊗01
12	20	5.5	3	7-1/2			1	0	100-K12⊗10	-
							0	1	100-K12⊗01	-
4-pole										
5	20	2.2	1-1/2	3	4	0	0	0	100-K05⊗400	-
					2	2	0	0	100-K05⊗200	-
9	20	4	2	5	4	0	0	0	100-K09⊗400	-
					2	2	0	0	100-K09⊗200	-
12	20	5.5	3	7-1/2	4	0	0	0	100-K12⊗400	-
					2	2	0	0	100-K12⊗200	-

⊗ The catalog number as listed is incomplete. Select a coil voltage code from the table below.

<sup>1</sup> Additional details on accessories can be found on pages 2-6 and 2-7.

#### ⊗ Coil Voltage Codes for AC and DC Control

AC Control	
Code	Description
KJ	24V, 50/60 Hz
D	110V, 50 Hz/120V, 60 Hz
KF	230V, 50/60 Hz
KA	240V, 50/60 Hz

DC Control	
Code	Description
DJ	24V, Integrated diode
ZJ	24V, Standard

For more coil voltage codes, please visit <https://rok.auto/directory>.



#### Product Certifications

Global certifications available online:

[rok.auto/certifications](https://rok.auto/certifications)



# Contactors

MOTOR CONTROL

## IEC Contactors 100-C/104-C

- 9...97 A
- Environmentally friendly materials
- Low-consumption AC or DC coils
- Common accessories for all contactor sizes



## Flexible Starter Configurations

### Three-component Starter

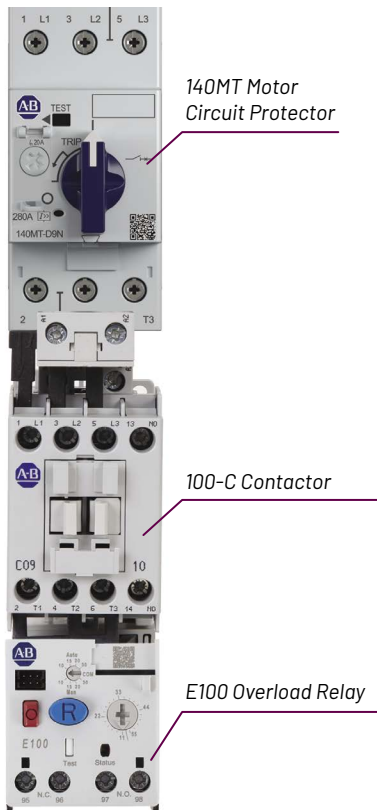

### Two-component Starter



### Short Circuit Protection Provided Separately



Multiple mounting methods available:

- Panel mount
- DIN Rail
- Bus bar



### Contactors



2-2...2-15

### Starters



2-16...2-29

### Motor Protection



2-30...2-35

### Smart Motor Control



2-36...2-45

### Drives



2-46...2-51

## Product Selection

### AC- and DC-Operated Contactors <sup>3</sup>

Rated Operational Current [A]		Ratings for Switching AC Motors – AC-2, AC-3			Direct-on-Line			Reversing		
		3-Phase kW	3-Phase Hp		Auxiliary Contacts <sup>1,2</sup>		Cat. No.	Auxiliary Contacts installed per contactor		Cat. No.
AC-3	AC-1	400/415V	200/230V	460/575V	N.O.	N.C.		N.O.	N.C.	
3-pole, Screw Terminals										
9	32	4	5	7-1/2	1	0	100-C09⊗10	1	1	104-C09⊗22
12	32	5.5	7-1/2	10	1	0	100-C12⊗10	1	1	104-C12⊗22
16	32	7.5	10	15	1	0	100-C16⊗10	1	1	104-C16⊗22
23	32	11	15	15	1	0	100-C23⊗10	1	1	104-C23⊗22
30	65	15	20	25	0	0	100-C30⊗00	1	1	104-C30⊗22
37	65	18.5/20	25	30	0	0	100-C37⊗00	1	1	104-C37⊗22
43	85	22	30	30	0	0	100-C43⊗00	1	1	104-C43⊗22
55	85	30	40	40	0	0	100-C55⊗00	1	1	104-C55⊗22
60	100	32	40	50	0	0	100-C60⊗00	1	1	104-C60⊗22
72	100	40	50	60	0	0	100-C72⊗00	1	1	104-C72⊗22
85	100	45	60	60	0	0	100-C85⊗00	1	1	104-C85⊗22
97	130	55	75	75	0	0	100-C97⊗00	1	1	104-C97⊗22

⊗ The catalog number as listed is incomplete. Select a coil voltage code from the table below.

<sup>1</sup> To add a N.O. auxiliary contact, change the catalog number from 100C-C30⊗00 to 100C-C30⊗10.

<sup>2</sup> To add a N.C. auxiliary contact, change the catalog number from 100C-C30⊗00 to 100C-C30⊗01.

<sup>3</sup> Additional details on accessories can be found on pages 2-6 and 2-7.

#### ⊗ Coil Voltage Codes for AC and DC Control

AC Control		DC Control with Integrated Surge Suppression	
Code	Description	Code	Description
KJ	24V, 50/60 Hz	DJ	24V (60...97 A only)
D	110V, 50 Hz/120V, 60 Hz	EJ	24V, Electronic (9...55 A only)
KF	230V, 50/60 Hz	ED	110V, Electronic (9...55 A only)
G	400-415V, 50 Hz		
L	200-220V 50 Hz / 208-240V 60 Hz		

For more coil voltage codes, please visit [rok.auto/directory](http://rok.auto/directory).



#### Global Short Circuit Current Ratings Selection Tool

Try out the Global SCCR Selection Tool, providing coordinated high fault branch circuit solutions for motor starters, soft starters and component drives.

[rok.auto/sccr](http://rok.auto/sccr)





# Contactors

## Accessories

### 100-K Miniature Contactors

Description	Auxiliary Contacts		Spring Clamp Cat. No.	Screw Terminals Cat. No.
	N.O.	N.C.		
Front-mounted auxiliary contacts	0	2	100-KRFC02	100-KFC02
	1	1	100-KRFC11	100-KFC11
	2	0	100-KRFC20	100-KFC20
	2	2	100-KRFC22	100-KFC22
	3	1	100-KRFC31	100-KFC31
	4	0	100-KRFC40	100-KFC40

Description	Cat. No.	
RC suppressor	24...48V AC	100-KFSC50
	110...280V AC	100-KFSC280
	380...480V AC	100-KFSC480
MOV surge suppressor	12...55V AC, 12...77V DC	100-KFSV55
	56...136V AC, 78...180V DC	100-KFSV136
	137...277V AC, 181...250V DC	100-KFSV277
Diode surge suppressor	12...250V DC	100-KFSD250
Mechanical interlock	100-KMCH	
Power wiring kit- for reversing and star/delta combinations	100-KPR	
ECO connecting module for electrical and mechanical connection to a 140M-T motor protection circuit breaker - 12 A	140M-T-PEK12	



### Sales Offices and Distributors

Our network of sales offices and distributors offers exceptional knowledge and service to help you design, implement and support your automation investment.

[rok.auto/buy](http://rok.auto/buy)

Auxiliary Options are available. These can be found in ProposalWorks™ or in the IEC Contactor Technical Documentation.

### Contactors



2-2...2-15

### Starters



2-16...2-29

### Motor Protection



2-30...2-35

### Smart Motor Control



2-36...2-45

### Drives



2-46...2-51



## Accessories

### 100-C Contactors with Screw Terminals

Description	Auxiliary Contacts		Screw Terminals Cat. No.
	N.O.	N.C.	
Front-mounted auxiliary contacts	0	2	100-FA02
	1	1	100-FA11
	2	0	100-FA20
	2	2	100-FA22
	3	1	100-FA31
	4	0	100-FA40
Side-mounted auxiliary contacts	0	1	100-SB01
	1	0	100-SB10
	0	1	100-SB11
	2	0	100-SB20

Surge Suppressors		Cat. No.
RC Module	24...48V AC, 50/60 Hz	100-FSC48
	110...280V AC, 50/60 Hz	100-FSC280
	380...480V AC, 50/60 Hz	100-FSC480
MOV Surge Suppressor	12...55V AC, 12...77V DC	100-FSV55
	56...136V AC, 78...180V DC	100-FSV136
	137...277V AC, 181...250V DC	100-FSV277

Mechanical Interlock	For Use With	Cat. No.
Mechanical only, without aux contacts	100-C (except 100-C40...C90)	100-MCA00
Mechanical/electrical, with 2 N.C. aux contacts		100-MCA02

Timing Modules	For Use With	Cat. No.
<b>Pneumatic Timing Modules:</b> Contacts switch after the delay time; main control relay contacts continue to operate without delay	On-Delay 0.3...30 s Range	100-C w/ AC Coils or DC Electronic Coils
	On-Delay 2...180 s Range	
<b>Electronic Timing Modules:</b> Delay of the contactor or control relay solenoid; contactor or control relay is energized at the end of the delay time	On-Delay 0.1...3 s Range	100-C w/ 110...240V, 50/60 Hz or 110...250V conventional DC coils
	On-Delay 1...30 s Range	
	On-Delay 10...180 s Range	
	On-Delay 0.1...3 s Range	100-C w/ 24...48V conventional DC coils
	On-Delay 1...30 s Range	

Reversing Power Wiring Kit	For Use With	Cat. No.
For reversing connection with a solid-state or thermal overload relay	100-C09...C23	105-PW23
	100-C30...C37	105-PW37
	100-C43...C55	105-PW55
	100-C60...C97	105-PW85



# Contactors

MOTOR CONTROL

## IEC Contactors 100-E/104-E

- 9...2650 A
- Compact size for smaller panel space requirements
- Wide range of electronic coils for reduced energy consumption
- Environmentally friendly
- Built-in surge suppression



The Bulletin 100-E/104-E contactor family offers a wide range of AC/DC electronic coils for reduced energy consumption and a compact design.

**140MG-J Circuit Breaker**

**100-PCE Connection Bars**

**100-E IEC Contactor**

**Optional 24V DC PLC Interface**

- Separate hold-in auxiliary contact not required
- Optional on 100-E116...E370 contactors
- Standard on all 100-E400...E2650 contactors
- 200...220V 50 Hz / 208...240V 60 Hz

**Optional built-in terminal lugs**

- Finger-safe protection
- Allows for 2 wires per pole
- For contactors up to 146 A

### ⊗ Coil Voltage Codes for AC and DC Control

AC/DC Control	
Electronic Standard Coils, 100-E09...E370	
Code	Description
KJ	24...60V 50/60 Hz, DC
KD	100...250V 50/60 Hz, DC
KN	250...500V 50/60 Hz, DC
Electronic Coils with PLC Interface, 100-E116...E370	
Code	Description
ED	100...250V 50/60 Hz, DC
EN	250...500V 50/60 Hz, DC
Electronic Coils with PLC Interface, 100-E400...E750, E1260	
Code	Description
EJ	24...60V DC <sup>1</sup>
ED	100...250V 50/60 Hz, DC
EN	250...500V 50/60 Hz, DC
Electronic Coils with PLC Interface, 100-E860, E1060, E2050, E2650	
Code	Description
ED	100...250V 50/60 Hz, DC

<sup>1</sup> Also available for 100-E09...E38

#### Contactors



2-2...2-15

#### Starters



2-16...2-29

#### Motor Protection



2-30...2-35

#### Smart Motor Control



2-36...2-45

#### Drives



2-46...2-51



## Safety Contactors 100S-C/104S-C, 100S-E

- 9...750 A
- SUVA third party certification
- AC and DC operating coils
- Mechanically linked/mirror contact performance

MOTOR CONTROL

**Safety contactors** provide mechanically linked, or mirror, contact performance, which is required in feedback circuits monitoring energy isolating switchgear used in hazardous motion loads.

Red contact housing for easy identification

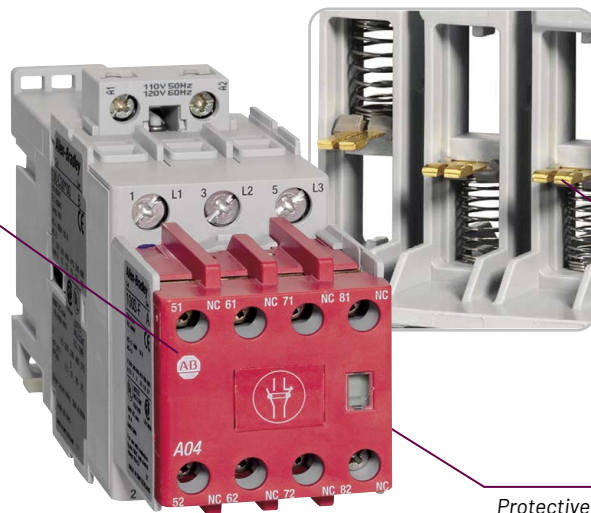

Gold plated, bifurcated contacts for improved signal reliability

Protective cover prevents manual operation

**100S-C Safety Contactor**

### Certifications (100S-C)

- CE Marked
- cULus Listed (File No. E3125; Guide NLDX, NLDX7)
- CCC

### Certifications (100S-E)

- CE Marked
- cULus Listed (File No. E41850; Guide NLDX, NLDX7)
- SUVA Certified
- CCC



# Contactors

## Product Selection

### 100-E/104-E Contactors – 3-Pole AC- and DC-operated Direct-on-line Contactors

Rated Operational Current I <sub>e</sub> [A]		Ratings for switching AC motors - AC-2, AC-3											Auxiliary Contacts		Cat No.
60 °C	40 °C	kW (50 Hz)							Hp (60 Hz)				N.O.	N.C.	
AC-3 (400V)	AC-1 (690V)	220-240V	380-400V	415V	440V	500V	690V	1000V	200V	230V	460V	575V			
9	25	2.2	4	4	4	5.5	5.5	–	2	2	5	7.5	1	0	
													0	1	100-E09⊗01
12	28	3	5.5	5.5	5.5	7.5	7.5	–	3	3	7.5	10	1	0	100-E12⊗10
													0	1	100-E12⊗01
16	30	4	7.5	9	9	9	9	–	5	5	10	15	1	0	100-E16⊗10
													0	1	100-E16⊗01
26	45	6.5	11	11	15	15	15	–	7.5	7.5	15	20	0	0	100-E26⊗00
32	50	9	15	15	18.5	18.5	18.5	–	10	10	20	25	0	0	100-E30⊗00
38	50	11	18.5	18.5	22	22	22	–	10	10	25	30	0	0	100-E38⊗00
40	70	11	18.5	22	22	22	22	–	10	15	30	40	0	0	100-E40⊗00
52	100	15	22	30	30	30	30	–	15	20	40	50	0	0	100-E52⊗00
65	105	18.5	30	37	37	37	37	–	20	25	50	60	0	0	100-E65⊗00
80	125	22	37	45	45	45	45	35	25	30	60	75	0	0	100-E80⊗00
96	130	25	45	55	55	55	55	40	30	30	60	75	0	0	100-E96⊗00

Rated Operational Current [A]		Ratings for Switching AC Motors - AC-2, AC-3			Direct-on-Line Contactors			Reversing Contactors		
AC-3 400V	AC-1 690V	3-Phase kW (50 Hz)		3-Phase Hp (60 Hz)	Auxiliary Contacts		Cat. No.	Auxiliary Contacts installed per contactor		Cat. No.
		400V	460V		575V	N.O.		N.C.	N.O.	
116	160	55	75	100	1	1	100-E116⊗11 <sup>1</sup>	2	2	104-E116⊗22 <sup>1</sup>
146	225	75	100	125	1	1	100-E146⊗11 <sup>1</sup>	2	2	104-E146⊗22 <sup>1</sup>
190	275	90	125	150	1	1	100-E190⊗11	2	2	104-E190⊗22
205	350	110	150	200	1	1	100-E205⊗11	2	2	104-E205⊗22
265	400	132	200	250	1	1	100-E265⊗11	2	2	104-E265⊗22
305	500	160	250	300	1	1	100-E305⊗11	2	2	104-E305⊗22
370	600	200	300	350	1	1	100-E370⊗11	2	2	104-E370⊗22
400	600	200	350	400	1	1	100-E400⊗11	2	2	104-E400⊗22
460	700	250	400	500	1	1	100-E460⊗11	2	2	104-E460⊗22
580	800	315	500	600	1	1	100-E580⊗11	2	2	104-E580⊗22
750	1050	400	600	700	1	1	100-E750⊗11	2	2	104-E750⊗22
860	1350	475	800	1000	1	1	100-E860⊗11	-	-	-
1060	1650	560	900	1150	1	1	100-E1060⊗11	-	-	-
-	1260	-	-	-	1	1	100-E1260⊗11	-	-	-
-	2050	-	-	-	1	1	100-E2050⊗11	-	-	-
-	2650	-	-	-	1	1	100-E2650⊗11	-	-	-

⊗ The catalog number as listed is incomplete. Select a coil voltage code from page 2-8.

<sup>1</sup> To order with built-in terminal lugs, add the letter "L" to the end of the catalog number (e.g., 100-E116⊗11L).

#### Contactors



2-2...2-15

#### Starters



2-16...2-29

#### Motor Protection



2-30...2-35

#### Smart Motor Control



2-36...2-45

#### Drives



2-46...2-51





## Product Selection

### 100-E/104-E Contactors – 3-Pole AC- and DC-operated Reversing Contactors

Rated Operational Current $I_n$ [A]		Ratings for switching AC motors - AC-2, AC-3											Auxiliary Contacts		Cat No.
60 °C	40 °C	kW (50 Hz)							Hp (60 Hz)				N.O.	N.C.	
AC-3 (400V)	AC-1 (690V)	220-240V	380-400V	415V	440V	500V	690V	1000V	200V	230V	460V	575V			
9	25	2.2	4	4	4	5.5	5.5	–	2	2	5	7.5	0	1	
													1	1 <sup>1</sup>	104-E09⊗22 <sup>2</sup>
12	28	3	5.5	5.5	5.5	7.5	7.5	–	3	3	7.5	10	0	1	104-E12⊗02
													1	1 <sup>1</sup>	104-E12⊗22 <sup>2</sup>
16	30	4	7.5	9	9	9	9	–	5	5	10	15	0	1	104-E16⊗02
													1	1 <sup>1</sup>	104-E16⊗22 <sup>2</sup>
26	45	6.5	11	11	15	15	15	–	7.5	7.5	15	20	0	1 <sup>1</sup>	104-E26⊗02 <sup>2</sup>
													1	1	104-E26⊗22
32	50	9	15	15	18.5	18.5	18.5	–	10	10	20	25	0	1 <sup>1</sup>	104-E30⊗02 <sup>2</sup>
													1	1	104-E30⊗22
38	50	11	18.5	18.5	18.5	22	22	–	10	10	25	30	0	1 <sup>1</sup>	104-E38⊗02 <sup>2</sup>
													1	1	104-E38⊗22
40	70	11	18.5	22	22	22	22	–	10	15	30	40	1	1	104-E40⊗22
52	100	15	22	30	30	30	30	–	15	20	40	50	1	1	104-E52⊗22
65	105	18.5	30	37	37	37	37	–	20	25	50	60	1	1	104-E65⊗22
80	125	22	37	45	45	45	45	35	25	30	60	75	1	1	104-E80⊗22
96	130	25	45	55	55	55	55	40	30	30	60	75	1	1	104-E96⊗22

<sup>1</sup> The N.C. auxiliary contact is supplied as part of the mechanical/electrical interlock.

<sup>2</sup> For AC control voltages only.

### 100S-C Safety Contactors

Rated Operational Current [A]		Ratings for switching AC motors			Auxiliary Contacts		No. of Poles	Cat. No. <sup>1</sup>
AC-3	AC-1	3-Phase kW (50 Hz)	3-Phase Hp (60 Hz)		N.O.	N.C.		
		400/415V	460V	575V				
9	32	4	5	7 1/2	1	4	3	100S-C09⊗14BC
12	32	5.5	7-1/2	10	1	4	3	100S-C12⊗14BC
16	32	7.5	10	15	1	4	3	100S-C16⊗14BC
23	32	11	15	15	1	4	3	100S-C23⊗14BC
30	65	15	20	25	1	4	3	100S-C30⊗14BC
37	65	18.5/20	25	30	1	4	3	100S-C37⊗14BC
43	85	22	30	30	1	4	3	100S-C43⊗14BC
55	85	30	40	40	1	4	3	100S-C55⊗14BC
60	100	32	40	50	1	4	3	100S-C60⊗14BC
72	100	40	50	60	1	4	3	100S-C72⊗14BC
85	100	45	60	60	1	4	3	100S-C85⊗14BC
97	130	55	75	75	1	4	3	100S-C97⊗14BC

⊗ The catalog number as listed is incomplete. Select a coil voltage code from page 2-12.

<sup>1</sup> For additional contact configurations, please visit our online product directory. BC = bifurcated and C = standard.

MOTOR CONTROL



# Contactors

## Product Selection

### 100S-E Safety Contactors – 3-Pole AC- and DC-operated Safety Contactors

Rated Operational Current I <sub>e</sub> [A]		Ratings for switching AC motors - AC-2, AC-3											Auxiliary Contacts			Direct-on-line Contactor
60 °C	40 °C	kW (50 Hz)							Hp (60 Hz)				N.O.	N.C.	N.C. <sup>1</sup>	Cat No.
AC-3 (400V)	AC-1 (690V)	220-240V	380-400V	415V	440V	500V	690V	1000V	200V	230V	460V	575V				
9	25	2.2	4	4	4	5.5	5.5	—	2	2	5	7.5	1	0	4	100S-E09⊗14C
12	28	3	5.5	5.5	5.5	7.5	7.5	—	3	3	7.5	10	1	0	4	100S-E12⊗14C
16	30	4	7.5	9	9	9	9	—	5	5	10	15	1	0	4	100S-E16⊗14C
26	45	6.5	11	11	15	15	15	—	7.5	7.5	15	20	2	0	2	100S-E26⊗22C
32	50	9	15	15	18.5	18.5	18.5	—	10	10	20	25	2	0	2	100S-E30⊗22C
38	50	11	18.5	18.5	22	22	22	—	10	10	25	30	2	0	2	100S-E38⊗22C
40	70	11	18.5	22	22	22	22	—	10	15	30	40	2	0	2	100S-E40⊗22C
52	100	15	22	30	30	30	30	—	15	20	40	50	2	0	2	100S-E52⊗22C
65	105	18.5	30	37	37	37	37	—	20	25	50	60	2	0	2	100S-E65⊗22C
80	125	22	37	45	45	45	45	35	25	30	60	75	2	0	2	100S-E80⊗22C
96	130	25	45	55	55	55	55	40	30	30	60	75	2	0	2	100S-E96⊗22C

⊗ The catalog number as listed is incomplete. Select a coil voltage code from the table below.

<sup>1</sup> The N.C. contact meets IEC 60947-4-1 Annex F requirements for mirror contact performance.

Rated Operational Current [A]		Ratings for switching AC motors			Auxiliary Contacts			No. of Poles	Cat. No.
AC-3	AC-1	3-Phase kW (50 Hz)	3-Phase Hp (60 Hz)		N.O.	N.C.	N.C. <sup>3</sup>		
400V	690V	400V	460V	575V					
116	160	55	75	100	1	1	1	3	100S-E116⊗12C <sup>2</sup>
146	225	75	100	125	1	1	1	3	100S-E146⊗12C <sup>2</sup>
190	275	90	125	150	1	1	1	3	100S-E190⊗12C
205	350	110	150	200	1	1	1	3	100S-E205⊗12C
265	400	132	200	250	1	1	1	3	100S-E265⊗12C
305	500	160	250	300	1	1	1	3	100S-E305⊗12C
370	600	200	300	350	1	1	1	3	100S-E370⊗12C
400	600	200	350	400	1	1	1	3	100S-E400⊗12C
460	700	250	400	500	1	1	1	3	100S-E460⊗12C
580	800	315	500	600	1	1	1	3	100S-E580⊗12C
750	1050	400	600	700	1	1	1	3	100S-E750⊗12C

⊗ The catalog number as listed is incomplete. Select a coil voltage code from the table below.

<sup>2</sup> To order with built-in terminal lugs, add the letter "L" to the end of the catalog number (e.g. 100-E116⊗11L).

<sup>3</sup> The N.C. contact meets IEC 60947-4-1 Annex F requirements for mirror contact performance.

#### ⊗ Coil Voltage Codes for AC and DC Control

AC Control, 100S-C	
Code	Description
KJ	24V, 50/60 Hz
D	110V, 50 Hz / 120V, 60 Hz
KF	230V, 50/60 Hz

DC Control, 100S-C	
Code	Description
EJ	24V, Electronic coils (9...55 A only)
DJ	24V, Integrated diode (60...97 A only)

AC/DC Control, 100S-E	
Code	Description
Electronic Standard Coils, 100S-E09...E370	
KJ	24...60V 50/60 Hz, DC
KD	100...250V 50/60 Hz, DC
KN	250...500V 50/60 Hz, DC
Electronic Coils with PLC Interface, 100S-E116...E370	
ED	100...250V 50/60 Hz, DC
EN	250...500V 50/60 Hz, DC

AC/DC Control, 100S-E	
Code	Description
Electronic Coils with PLC Interface, 100S-E400...E750, E1260	
EJ	24...60V DC <sup>1</sup>
ED	100...250V 50/60 Hz, DC
EN	250...500V 50/60 Hz, DC
Electronic Coils with PLC Interface, 100S-E860, E1060, E2050, E2650	
ED	100...250V 50/60 Hz, DC
L	200...220V 50 Hz / 208...240V 60 Hz

#### Contactors



2-2...2-15

#### Starters



2-16...2-29

#### Motor Protection



2-30...2-35

#### Smart Motor Control



2-36...2-45

#### Drives



2-46...2-51



## Accessories

### Auxiliary Contact Blocks with Standard Auxiliary Contacts

Description	N.O.	N.C.	For Use With	Cat. No.
Auxiliary Contact Blocks for Front Mounting <ul style="list-style-type: none"> <li>1-pole</li> <li>Quick and easy mounting without tools</li> <li>Screw connection terminals</li> <li>Switching down to 12V, 3m A</li> <li>Mirror contact performance to the main contactor poles</li> <li>L=Late break N.C./early make N.O.</li> </ul>	1	0	100-E09... 100-E96	100-EFA10
	0	1		100-EFA01
Auxiliary Contact Blocks for Side Mounting <ul style="list-style-type: none"> <li>2-pole</li> <li>Two-way numbering for right or left mounting on the contactor</li> <li>With or without sequence terminal designations</li> <li>Quick and easy mounting without tools</li> <li>Screw connecting terminals</li> <li>Switching down to 12V, 3m A</li> <li>Mirror contact performance to the main contactor poles</li> </ul>	1	1	100-E26... 100-E96	100-ESB11

### Mechanical Interlocks

Description		For Use With	Cat. No.
Mechanical Interlock <ul style="list-style-type: none"> <li>For interlocking of two contactors</li> <li>Two fixing clips included</li> </ul>	Mechanical only, without auxiliary contacts	100-E09... 100-E38 (3 pole), 100-E09⊗400... 100-E38⊗400	100-EMCA00A
		100-EMCA00B	
Mechanical and Electrical Interlock <ul style="list-style-type: none"> <li>For interlocking of two contactors</li> <li>Two fixing clips, a mechanical interlock and an electrical interlock block with A2 – A2 connection included</li> <li>Front-face connection of the electrical interlock block connects the 2 built-in N.C. interlocking contacts with the two coils</li> </ul>	Mechanical/ electrical interlock	100-E40... 100-E96 (3 pole), 100-E40⊗400... 100-E80⊗400	100-EMCA02

### Side Mounted Auxiliary Contacts

Description	For Use With	Mtg. Position	N.O.	N.C.	Cat. No.
Standard contacts <ul style="list-style-type: none"> <li>Left or right side mtg.</li> <li>Min switching 24V, 50 mA</li> </ul>	100-E116...E370	Inside	1	1	100-ES1-11
		Outside	1	1	100-ES2-11
	100-E400...E2650	Inside	1	1	100-ES3-11
		Outside	1	1	100-ES4-11
Standard contacts <ul style="list-style-type: none"> <li>Left or right side mtg.</li> <li>Min switching 3V, 1 mA</li> </ul>	100-E116...E370	Inside	1	-	100-ES1-B10
		Inside	-	1	100-ES1-B01
	100-E400...E2650	Inside	1	-	100-ES3-B10
		Inside	-	1	100-ES3-B01

### Terminal Lugs

Description	For Use With	Cat. No.
Terminal Lug Kit (set of two)	100-E116...E146	100-ECL146
	100-E190...E205	100-ETL205
Terminal Lugs (set of three)	100-E265...E370	100-ETL370
		100-ETL370B <sup>2</sup>
	100-E400...E460	100-ETL580
	100-E580...E1250	100-ETL750
	100-E860	100-ETL860
	100-ETL1060	
	100-E1060	100-ETL1060B <sup>3</sup>

<sup>2</sup> Accepts 2 conductors.<sup>3</sup> Accepts 6 conductors.

### Mechanical Interlock

Description	For Use With	Cat. No.
For interlocking two contactors	100-E116...E370	100-EM1-00
	100-E400...E2650	100-EM2-00



# Contactors

MOTOR CONTROL

## Definite-Purpose Contactors 400DP

- 1...4-pole options, 25...120 A resistive loads
- Feed-through wiring
- Double-break contacts
- Snap-on auxiliary contacts
- Rated for inductive lighting and resistive loads

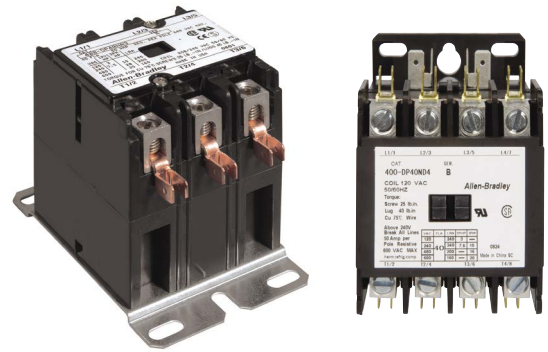

### Stationary Terminal

One-piece terminal design with integral dual 0.250 in. quick connects. Meets NEMA Standard for spacing without insulated terminals.

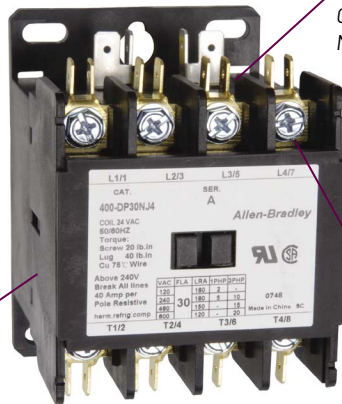

### Base Assembly

High arc-resistant polyester holds stationary terminals, positions actuator, and magnet/coil assembly.

### Exclusive Terminal Screw

Hex, Slotted, Phillips, screw, #10-32 SEMs. Box lugs standard on 40 A FLA models and larger.

## Applications

- Air conditioners
- Compressors
- Welding equipment
- Business machines
- Power supplies
- Refrigeration equipment
- Resistive heating
- Food service equipment



## Contactors



2-2...2-15

## Starters



2-16...2-29

## Motor Protection



2-30...2-35

## Smart Motor Control



2-36...2-45

## Drives



2-46...2-51



# Product Selection

## 400 Definite-Purpose Contactors

Full Load Amps [A]	No. of Poles	Max. Continuous Ampere Rating [A]		Line Voltage [V]	Locked Rotor Current [A]	Resistive Current Rating [A]	Control Voltage [V]	Max. [Hp]		Cat. No.
		Tungsten Lamp Loads <sup>1</sup>	Ballast Lighting Load					1-Phase	3-Phase	
20/25	2	25	240/277	150	35	120	2	-	400-DP25N⊗2	
			480	125	35	240	3	-		
			600	100			3	-		
	3	25	240/277	150	35	110/120	2	5	400-DP25N⊗3	
			480	125	35	240/277	5	10		
			600	100	35	480	-	15		
30	2	30	240/277	150	40	120	2	-	400-DP30N⊗2	
			480	125	40	240	3	-		
			600	100			3	-		
	3	30	240/277	180	40	110/120	2	5	400-DP30N⊗3	
			480	150	40	240/277	5	10		
			600	150	40	480	-	15		
40	2	40	240/277	240	50	120	-	-	400-DP40N⊗2	
			480	200	50	240	-	-		
			600	120	50	240	-	-		
40	3	-	240/277 480 600	240 200 120	50 50 50	110/120	-	-	400-DP40N⊗3	
						200/208	-	-		
						240/277	-	-		
						480	-	-		
						600	-	-		

<sup>1</sup> Max. 480V line, 277V load.

⊗ The catalog number as listed is incomplete. Select coil voltage code from the table.

### ⊕ Factory-installed Modifications

Description	Suffix Code
Auxiliary contact - 1 N.O./1 N.C. with QC for 3-pole - 20/25 and 30 A only	-AB5
Auxiliary contact - SPDT with QC for 3-pole - 20/25 and 30 A only	-A5
Auxiliary contact - 2 SPDT with QC for 3-pole - 20/25 and 30 A only	-AA5

### ⊗ AC Coil Voltage Codes

Code	Description
J	24V
D	120V
A	208/240V
F	277V
B	480V

## Accessories

Description	Cat. No.
Arc covers for 20/25 and 30 A - 2-pole	400-C2
Mechanical interlock kit	20/25...40 A, 3-pole 400-MK1
DIN Rail adapter	20/25...40 A, 1-...4-pole 400-DRA
Auxiliary contact	1 N.O./1 N.C. w/QCs 400-AB1
	SPDT w/QCs 400-A1
	2-SPDT w/QCs 400-B2



### Sales Offices and Distributors

Our network of sales offices and distributors offers exceptional knowledge and service to help you design, implement and support your automation investment.

[rok.auto/buy](http://rok.auto/buy)





# Starters

## Low Voltage Manual Motor Starters 600, 609, 609U, 609TU

- Undervoltage protection
- Manual operation with overload protection
- Ideal for low Hp applications, up to 10 Hp three phase



Manual motor starters are specifically designed for full-voltage motor starting applications where remote push button control is not necessary. They are ideally suited for starting and protecting smaller motors frequently used for fans and blowers.

### 600 Manual Starting Switches

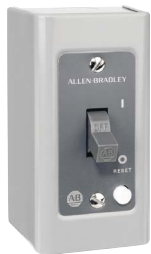

- Single phase
- Starting and overload protection of small AC/DC motors up to 1 Hp

### 609 Manual Starting Switches



- Single and three phase
- Contact position indicator
- Locking feature
- Reversing and 2-speed
- Wide range of enclosures, including hazardous location



### 609U & 609TU Manual Starting Switches

- Undervoltage protection
- Single and three phase
- Contact position indicator
- Locking feature
- Wide range of enclosures
- Push button or toggle switch

**Stay tuned** for the next version of this selection guide to discover the future of motor starting with the M100 Electronic Motor Starter:

[rok.auto/m100-electronic-motor-starter](http://rok.auto/m100-electronic-motor-starter)

#### Contactors



2-2...2-15

#### Starters



2-16...2-29

#### Motor Protection



2-30...2-35

#### Smart Motor Control



2-36...2-45

#### Drives



2-46...2-51



## Product Selection

### 600 Manual Motor Starters

Type	No. of Poles	Open Type Without Enclosure Includes Legend Plate	Type 1 General Purpose Enclosure Surface Mount	Type 1 General Purpose Enclosure Flush Mount Includes Flush Plate Only
<b>Switch Only</b>				
Toggle	1	600-TOX4	600-TAX4	600-TQX4
	2	600-TOX5	600-TAX5	600-TQX5
Key	2	600-TOX49	600-TAX49	600-TQX49
Lever	1	600-TOX149	600-TAX149	-
<b>Switch with Neon Pilot Light (115 or 230V)</b>				
Toggle	1	600-TOX216	600-TAX216	600-TQX216
	2	600-TOX109	600-TAX109	600-TQX109
Key	2	600-TOX110	600-TAX110	600-TQX110
<b>Switch and Hand-Off-Auto Selector Switch (for use on AC only)</b>				
Toggle	2	-	600-TAX9	600-TQX9
<b>Switch with Neon Pilot Light and Hand-Off-Auto Selector Switch (115 or 230V, AC only)</b>				
Toggle	2	-	600-TAX142	600-TQX142
Key	2	-	600-TAX145	-

### 609 Manual Motor Starters

Type	Phase	Size	Max. Hp Rating				Open Type without Enclosure	Type 1 General Purpose Enclosure Surface Mount
			Motor Voltage, 60 Hz					
			115V	200V	230V	460...575V	Cat. No.	Cat. No.
Push Button	1	0	1	-	2	-	609-AOX	609-AAX
		1	2	-	3	-	609-BOX	609-BAX
		1P	3	-	5	-	609-XOX	609-XAX
	3	0	-	3	3	5	609-AOW	609-AAW
		1	-	7-1/2	7-1/2	10	609-BOW	609-BAW
Toggle Lever	1	0	1	-	2	-	609T-AOX	609T-AAX
		1	2	-	3	-	609T-BOX	609T-BAX
		1P	3	-	5	-	609T-XOX	609T-XAX
	3	0	-	3	3	5	609T-AOW	609T-AAW
		1	-	7-1/2	7-1/2	10	609T-BOW	609T-BAW

**Heater Elements** - All single-phase starters require one heater element and three-phase starters require three heater elements.

Product selection for 609U & 609TU is available at [rok.auto/lv-starters](http://rok.auto/lv-starters)



# Starters

## IEC Eco Starters 190E/191E

- 5...38 A
- Type 1 and 2 coordination
- AC or DC coils available
- Shares common accessories with 100-C/100-K contactors and 140M motor protection circuit breakers



The 190E/191E motor controllers can be used in a variety of applications. These starters can be used in a group motor application or as a stand-alone product without any additional short-circuit protection in the motor branch circuits. Rated Type F combination motor controllers (UL/CSA).

### Options for Field Assembly

190/191-E starters can be field assembled. Select the following:

- 100-K/104-K miniature contactor, 100-C/104-C contactor, or 100-E/104-E contactor
- 140MT motor protection circuit breaker (page 1-3)
- Eco connecting module

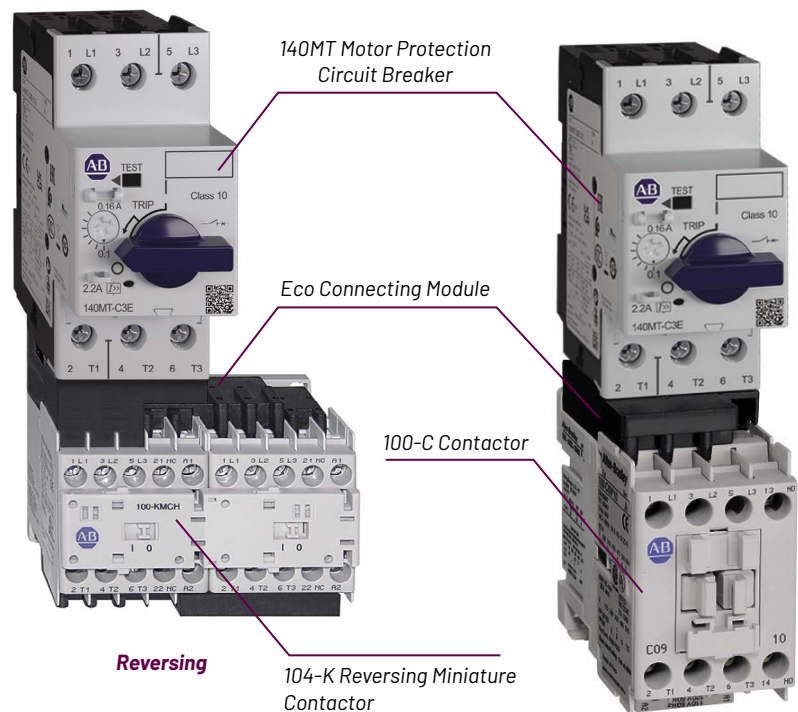

Direct-on-Line

### Contactors



2-2...2-15

### Starters



2-16...2-29

### Motor Protection



2-30...2-35

### Smart Motor Control



2-36...2-45

### Drives



2-46...2-51

## Product Selection

### IEC Eco Starters with AC and DC-Operated Contactors

Motor Current Adjustment Range [A]	3-Phase kW (50 Hz)	3-Phase Hp (60 Hz)	Max. Short-Circuit Current Type 1 Coordination [kA]	With 100-K IEC Miniature Contactors		With 100-C IEC Contactors	
				Direct-on-Line Cat. No.	Reversing Cat. No.	Direct-on-Line Cat. No.	Reversing Cat. No.
0.10...0.16	0.02	-	65	190E-KMN⊗2-CA16X	191E-KMN⊗1-CA16X	190E-AN⊗2-CA16X	191E-AN⊗3-CA16X
0.16...0.25	0.06	-	65	190E-KMN⊗2-CA25X	191E-KMN⊗1-CA25X	190E-AN⊗2-CA25X	191E-AN⊗3-CA25X
0.25...0.40	0.09	-	65	190E-KMN⊗2-CA40X	191E-KMN⊗1-CA40X	190E-AN⊗2-CA40X	191E-AN⊗3-CA40X
0.40...0.63	0.12...0.18	-	65	190E-KMN⊗2-CA63X	191E-KMN⊗1-CA63X	190E-AN⊗2-CA63X	191E-AN⊗3-CA63X
0.63...1.00	0.25	0.5	65	190E-KMN⊗2-CB10X	191E-KMN⊗1-CB10X	190E-AN⊗2-CB10X	191E-AN⊗3-CB10X
1.00...1.60	0.37...0.55	0.5...1	65	190E-KMN⊗2-CB16X	191E-KMN⊗1-CB16X	190E-AN⊗2-CB16X	191E-AN⊗3-CB16X
1.60...2.50	0.75	0.75...1.5	65	190E-KMN⊗2-CB25X	191E-KMN⊗1-CB25X	190E-AN⊗2-CB25X	191E-AN⊗3-CB25X
2.50...4.00	1.1...1.5	1.5...3	65	190E-KMN⊗2-CB40X	191E-KMN⊗1-CB40X	190E-AN⊗2-CB40X	191E-AN⊗3-CB40X
4.00...6.30	2.2	3...5	65	190E-KMN⊗2-CB63X	191E-KMN⊗1-CB63X	190E-AN⊗2-CB63X	191E-AN⊗3-CB63X
6.30...10.0	3.0...4.0	5...7.5	65	190E-KPN⊗2-CC10X	191E-KPN⊗1-CC10X	190E-BN⊗2-CC10X	191E-BN⊗3-CC10X
10.0...11.0	5.5	7.5	30	190E-KPN⊗2-CC16X	191E-KPN⊗1-CC16X	-	-
10.0...12.0	4.0...5.5	7.5	30	-	-	190E-BN⊗2-CC16X	191E-BN⊗3-CC16X
10.0...16.0	5.5...6.3	7.5...10.0	30	-	-	190E-CN⊗2-CC16X	191E-CN⊗3-CC16X

⊗ The catalog number as listed is incomplete. Select a coil voltage code from the table below.

## Accessories

Description	For Use With	Cat. No.
ECO Connecting Modules - 25 A	140MT-C to 100-C09...C23	140M-C-PEC23

### ⊗ Coil Voltage Codes for AC and DC Control

AC Control		24V DC Control	
Code	Description	Code	Description
KJ	24V, 50/60 Hz	ZJ	Standard (190E/191E-K)
D	110V, 50 Hz/120V, 60 Hz	DJ	Integrated diode (190E/191E-K)
KF	230V, 50/60 Hz	EJ	Electronic with integrated diode (190E/191E-A...D)



### Product Selection Tools

Available online or for download, our tools help you access info while in the office or on the go.

[rok.auto/selection](http://rok.auto/selection)



For more information on our complete family of IEC starter products, please visit:  
[rok.auto/lv-starters](http://rok.auto/lv-starters)

# Starters

## Enclosed Starters, IEC 109-C/105-C

- Reversing and non-reversing
- Electronic motor protection
- Non-combination, disconnecting means to be provided separately
- Factory modifications available



## Compact Installation

Plastic enclosures provide a compact, cost-effective solution to help reduce machine space and expand product flexibility.

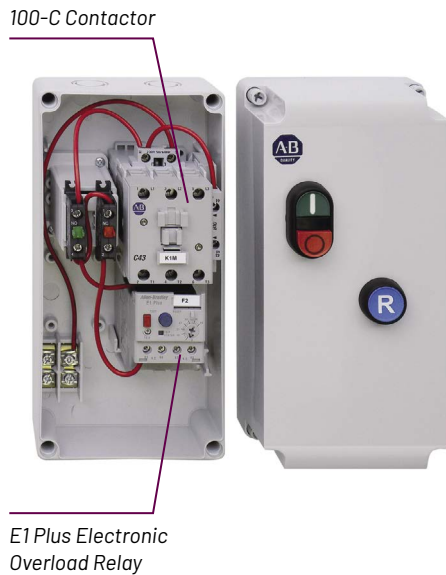

## Wiring Made Easy

Metal enclosures now feature component wiring color-coded by function. The wiring sleeve cover corresponds to a colored label on the terminal block, reducing wiring errors and allowing quicker installation times.

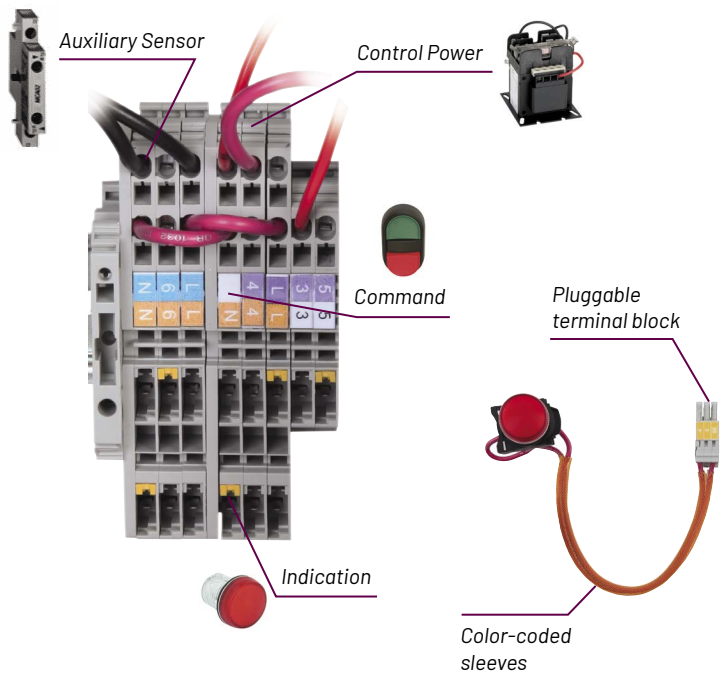

### Contactors



2-2...2-15

### Starters



2-16...2-29

### Motor Protection



2-30...2-35

### Smart Motor Control



2-36...2-45

### Drives



2-46...2-51



# Product Selection

## IEC Enclosed Starters, Plastic

Type		Direct-on-Line Starter <sup>2</sup> 109-C	Reversing 105-C
Ratings AC-3	E1 Plus <sup>1</sup> Overload Relay	IP66, Type 4/4X/12, Molded Plastic	IP66, Type 4/4X/12, Molded Plastic
Amps	Motor Current Setting Range		With FORWARD/OFF/REVERSE Multifunction Push Button (3 Functions) and Reset
[A]	[A]	Cat. No.	Cat. No.
9	1.0...5.0	109-C09K⊗E1C-⊕	105-C09L⊗E1C-1M-7
9	3.2...16.0	109-C09K⊗E1D-⊕	105-C09L⊗E1D-1M-7
12	3.2...16.0	109-C12K⊗E1D-⊕	105-C12L⊗E1D-1M-7
16	3.2...16.0	109-C16K⊗E1D-⊕	105-C16L⊗E1D-1M-7
23	5.4...27.0	109-C23K⊗E1E-⊕	105-C23L⊗E1E-1M-7
30	9.0...45.0	109-C30L⊗E1F-1M-7 <sup>3</sup>	-
37	9.0...45.0	109-C37L⊗E1F-1M-7 <sup>3</sup>	-
43	9.0...45.0	109-C43L⊗E1F-1M-7 <sup>3</sup>	-

<sup>1</sup> For eutectic alloy overload relay, please visit [rok.auto/directory](http://rok.auto/directory).

<sup>2</sup> For other enclosure types, please visit [rok.auto/directory](http://rok.auto/directory).

<sup>3</sup> With START/STOP Multifunction Push Button (2 Functions) and Reset.

⊗ The catalog number as listed is incomplete. Select a coil voltage code from the table to the right.

⊕ The catalog number as listed is incomplete. Replace with start and stop (1) or reset (7).

### ⊗ Coil Voltage Codes for AC and DC Control

AC Control	
Code	Description
KJ	24V, 50/60 Hz
D	110V, 50 Hz/120V, 60 Hz
KF	230V, 50/60 Hz

DC Control with Integrated Surge Suppression	
Code	Description
DJ	24V (60...97 A only)
EJ	24V, Electronic (9...55 A only)
ED	110V, Electronic (9...55 A only)

## IEC Enclosed Starters, Metal <sup>4</sup>

Amps	Max. Hp Rating				Cat. No.	
	3-Phase				Type 1 (IP42)	
	200V AC	230V AC	460V AC	575V AC	Non-reversing	Reversing
9	2	2	5	7 1/2	109-C09AD-OLR	105-C09AD-OLR
12	3	3	7 1/2	10	109-C12AD-OLR	105-C12AD-OLR
16	5	5	10	15	109-C16AD-OLR	105-C16AD-OLR
23	5	7 1/2	15	15	109-C23AD-OLR	105-C23AD-OLR
30	7 1/2	10	20	25	109-C30AD-OLR	105-C30AD-OLR
37	10	10	25	30	109-C37AD-OLR	105-C37AD-OLR

<sup>4</sup> All starters come standard with a 120V AC coil.

## Electronic Overload Relays

IEC Contactor	Overload Relay FLA Range [A]	Three-phase Cat. No.
109-C09...109-C23	0.1...0.5	193-EEAB
	0.2...1.0	193-EEBB
	1.0...5.0	193-EECB
	5.4...27	193-EEEB
109-C30...109-C55	5.4...27	193-EEED
	9...45	193-EEFD
	11...55	193-EEQD
External reset adapter – required		193-ERA

## Snap-together Accessory Kits

Kit Description	Cat. No.
Push Button, Start-Stop	198-SSPB <sup>5</sup>
Selector Switch, Plastic, HOA/FOR	198-3SS
Push Button, For-Rev-Stop	198-FRSPB <sup>6</sup>
Pilot Light, 24...120V AC/DC, Red LED	198-RUPL
Pilot Light, 24...120V AC/DC, Green LED	198-GUPL
Pilot Light, 24...120V AC/DC, White LED	198-WUPL
N.O./N.C. Auxiliary contact kit	198-SA11 <sup>5</sup>
208/120V AC transformer kit	1497-HD50 <sup>7</sup>
240/120V AC transformer kit	1497-AD50 <sup>7</sup>
480/120V AC transformer kit	1497-BD50 <sup>7</sup>
600/120V AC transformer kit	1497-CD50 <sup>7</sup>

<sup>5</sup> Can only be used with non-reversing starters and contactors.

<sup>6</sup> Can only be used with reversing starters.

<sup>7</sup> Transformer kits are pre-engineered with fuses and fuse covers.

MOTOR CONTROL





# Starters

## Combination Starters, IEC 112/113

- Fusible and non-fusible disconnect switches (112) or circuit breaker (113) options
- Non-reversing and reversing
- IP42 (Type 1) and IP66 (Type 3/4/12) enclosures
- Padlockable handle for up to three padlocks



These full-voltage combination starters are designed to provide the disconnecting means, short-circuit protection (with suitable fuses), and control and overload protection for three-phase squirrel-cage motors. All starters include a normally open auxiliary contact as standard.

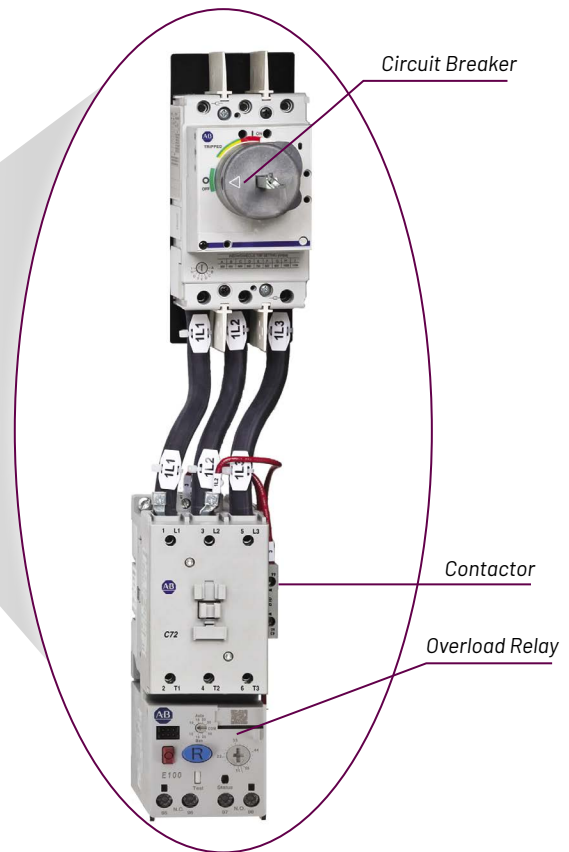

### Enclosures

- IP42 (Type 1) general purpose sheet metal (hinged cover)
- IP66 (Type 3/4/12) watertight, dusttight sheet metal (hinged cover)

### Contactors



2-2...2-15

### Starters



2-16...2-29

### Motor Protection



2-30...2-35

### Smart Motor Control



2-36...2-45

### Drives



2-46...2-51



# Product Selection

## IEC Combination Starters, Non-Reversing

Ratings (AC-3, AC-4)			IP42 (Type 1) General Purpose Sheet Metal Enclosure (Hinged Cover)			IP66 (Type 3/4/12) Watertight, Dusttight Sheet Metal Enclosure (Hinged Cover)		
Max. I <sub>e</sub> [A]	Hp		Fusible Disconnect Type <sup>1</sup>		Circuit Breaker Type	Fusible Disconnect Type <sup>1</sup>		Circuit Breaker Type
	230V	460V	Fuse Clip Rating/ UL Class	Cat. No.	Cat. No.	Fuse Clip Rating/ UL Class	Cat. No.	Cat. No.
9	2	5	30 A/Class J	112-C09A⊗⊕	-	30 A/Class J	112-C09F⊗⊕	-
12	3	7.5	30 A/Class J	112-C12A⊗⊕	-	30 A/Class J	112-C12F⊗⊕	-
23	7.5	15	30 A/Class J	112-C23A⊗⊕	-	30 A/Class J	112-C23F⊗⊕	-
30	10	20	60 A/Class J	112-C30A⊗⊕	113-C30A⊗⊕-□	60 A/Class J	112-C30F⊗⊕	113-C30F⊗⊕-□
43	15	30	60 A/Class J	112-C43A⊗⊕	113-C43A⊗⊕-□	60 A/Class J	112-C43F⊗⊕	113-C43F⊗⊕-□
60	20	40	100 A/Class J	112-C60A⊗⊕	113-C60A⊗⊕-□	100 A/Class J	112-C60F⊗⊕	113-C60F⊗⊕-□
72	25	50	100 A/Class J	112-C72A⊗⊕	113-C72A⊗⊕-□	100 A/Class J	112-C72F⊗⊕	113-C72F⊗⊕-□

⊗ The catalog number as listed is incomplete. Select a coil voltage code, circuit breaker code, and overload relay code from the tables below.

<sup>1</sup> Non-fusible versions also available.

### □ Circuit Breaker Code

Code	Max. Hp	Code	Max. Hp	Code	Max. Hp	Code	Max. Hp
33	0.5	39	5	43	20	50	100
35	1	40	7.5	44	25	51	125
36	1.5	41	10	45	30	52	150
38	3	42	15	48	60	54	200

### ⊕ Overload Relay Code

Full Load Current Range [A]	3-Phase Overload Relay Code
0.1...0.5	E1A
0.2...1.0	E1B
1.0...5.0	E1C
3.2...16	E1D
5.4...27	E1E
9.0...45	E1F
18...90	E1G

### ⊗ Coil Voltage Codes for AC and DC Control

AC Control		DC Control with Integrated Surge Suppression	
Code	Description	Code	Description
KJ	24V, 50/60 Hz	DJ	24V (60...97 A only)
D	110V, 50 Hz/120V, 60 Hz	EJ	24V, Electronic (9...55 A only)
KF	230V, 50/60 Hz	ED	110V, Electronic (9...55 A only)
KA	240V, 50/60 Hz		

### Modifications

Description	Suffix Code
START-STOP push button	1
Hand-Off-Auto selector switch	3
Red pilot light	4R

MOTOR CONTROL



# Starters

## Space-Saving NEMA Full Voltage Starters 300

- NEMA sizes 0...8
- Energy-saving, universal coil design covers a wide-range of AC and DC control voltages (sizes 4...8)
- Solid-state overload relay (direct mount through size 4)
- Panel or DIN Rail mounts available
- Safety versions available (sizes 4...8)



Approximate size of traditional NEMA contactor 7 x 13.39 in., 178 x 340 mm (W x L)

The Allen-Bradley® Bulletin 300 NEMA Contactors and motor starters provide a space-saving and cost-effective alternative for applications that require NEMA-rated motor control. Based on our Bulletin 100 IEC Contactor design, these NEMA-rated products are compatible with a wide range of accessories and solid-state overload relays.



Compatible with full range of Bulletin 100-C/100-E accessories for wide selection

Compact design saves panel space

Bulletin 300 Size 5  
5.51 x 8.86 in., 140 x 225 mm (W x L)  
actual size 30% smaller than traditional NEMA versions

Energy-saving, wide range AC/DC current coils (sizes 4...8)

### Contactors



2-2...2-15

### Starters



2-16...2-29

### Motor Protection



2-30...2-35

### Smart Motor Control



2-36...2-45



### Drives



2-46...2-51

## Product Selection

### 3-Pole AC/DC Operated Contactors and Starters

NEMA Size	Continuous Current Rating [A]	Switching of 3-phase Motors – AC-2, AC-3				Auxiliary Contacts Each Contactor		Bulletin 300 Direct On-line Contactor	Bulletin 305 Reversing Starter	Bulletin 309 Starter	Safety Contactor
		Hp (60 Hz)				N.O.	N.C.				
		200 V	230 V	460 V	575 V						
0	18	3	3	5	5	1	–	300-A0⊗930	305-A0⊗-⊕	309-A0⊗-⊕	•
1	27	7.5	7.5	10	10	1	–	300-B0⊗930	305-B0⊗-⊕	309-B0⊗-⊕	•
2	45	10	15	25	25	1	–	300-C0⊗930	305-C0⊗-⊕	309-C0⊗-⊕	•
3	90	25	30	50	50	1	–	300-D0⊗930	305-D0⊗-⊕	309-D0⊗-⊕	•
4	135	40	50	100	100	1	1	300-E0⊗9311 <sup>1</sup>	305-E0⊗-⊕	309-E0⊗-⊕	300S-E0⊗9312C <sup>1</sup>
5	270	75	100	200	200	1	1	300-F0⊗9311	–	–	300S-F0⊗9312C
6	540	150	200	400	400	1	1	300-G0⊗9311	–	–	300S-G0⊗9312C
7	810	250	300	600	600	1	1	300-H0⊗9311	–	–	300S-H0⊗9312C
8	1215	–	450	900	900	1	1	300-J0⊗9311	–	–	300S-J0⊗9312C

⊗ The catalog number as listed is incomplete. Select a control voltage code from the tables below.

⊕ The catalog number as listed is incomplete. Select a overload relay code from the table below.

Example: **Cat. No. 305-A0D-⊕** becomes **Cat. No. 305-A0D-EEC**.

<sup>1</sup> To order with built-in terminal lugs, add the letter "L" to the end of the catalog number (for example, **300-E0⊗9311-L**).

#### ⊗ Coil Voltage Codes and Terminal Position (NEMA Sizes 0...3)

	[V]	24	110	120	220	240	277	440	480	550	600
NEMA Size 0...3	AC, 50 Hz	K <sup>2</sup>	D	P <sup>2</sup>	A	T <sup>2</sup>	–	B	–	C	–
	AC, 60 Hz	J <sup>2</sup>	–	D	–	A	T <sup>2</sup>	–	B	–	C
	AC, 50/60 Hz	KJ	–	–	–	KA <sup>2</sup>	–	–	–	–	–
NEMA Size 0...2	DC	EJ	–	–	–	–	–	–	–	–	–
NEMA Size 3	DC	DJ <sup>2</sup>	–	–	–	–	–	–	–	–	–

<sup>2</sup> Bulletin 300 contactors only

<sup>3</sup> 24...60V DC only.

#### ⊗ Coil Voltage Codes (NEMA sizes 4...8)

Electronic Coils with PLC Interface	[V]	24...60	48...130	100...250	250...500
NEMA Size 4...5	AC/DC	J	Y	D	B
NEMA Size 4...5	AC/DC with PLC Input	–	–	ED	EN
NEMA Size 6...7		EJ <sup>3</sup>	EY	ED	EN
NEMA Size 8		–	–	ED	–

#### ⊕ E100 Electronic Overload Relay (Bulletin 305, 309, NEMA Sizes 0...4)

NEMA Size	Adjustment Range [A]	Overload Relay Code
0	1.0...5	EEC
0...1	5.4...27	EEE
2	9...45	EEF
3	18...90	EEG
4	30...150	A2M



# Starters

## NEMA Full-Voltage Starters 509 Heavy Duty Industrial 309 Space- and Energy-saving

- NEMA sizes 00...5
- Available as a modular kit for faster delivery
- Includes a 120V AC coil and one N.O. auxiliary contact as standard
- Solid-state overload relays: Class 10, 15, 20, and 30
- Snap-together wiring available on lift-off enclosures
- Enclosure rating: Type 1, 3R/12, 4/4X stainless steel, and 7 & 9



The 509 NEMA Starters are designed for full-voltage starting of polyphase squirrel-cage motors. These starters are available for constant horsepower, constant torque or variable torque, three-phase motors.

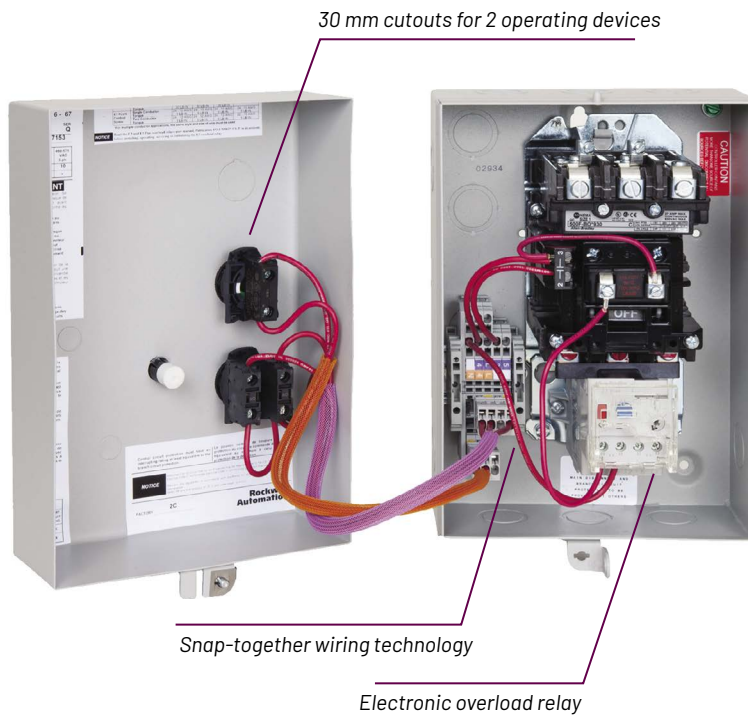

**509 Enclosed Starter**

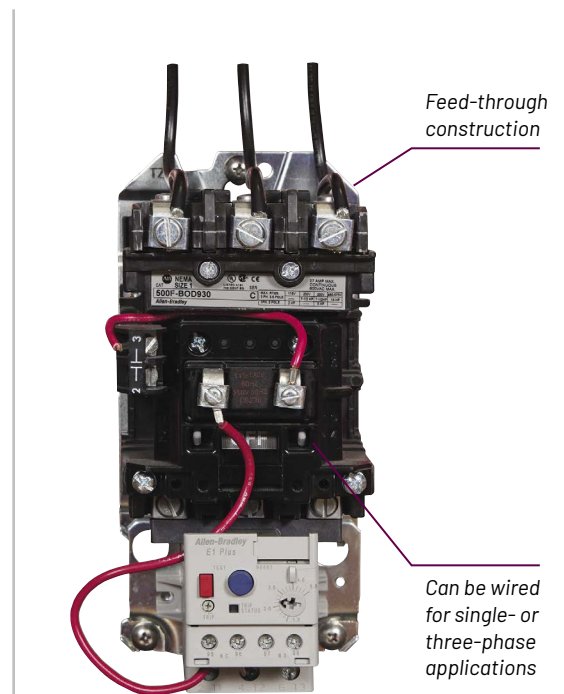

**509 Open Starter**

### Contactors



2-2...2-15

### Starters



2-16...2-29

### Motor Protection



2-30...2-35

### Smart Motor Control



2-36...2-45

### Drives



2-46...2-51



## Product Selection

### NEMA Reversing and Non-reversing Starters and Contactors<sup>1</sup>

NEMA Size	Max. Hp Rating				Catalog Number				
	3-Phase				Type 1				
	200V	230V	460V	575V	Non-reversing	Reversing	Non-reversing space saving	Reversing space saving	Contactors only <sup>1</sup>
00	1 1/2	1 1/2	2	2	509-TAD-XXX	505-TAD-XXX	-	-	500-TAD930
0	3	3	5	5	509-AAD-XXX	-	309-AAD-XXX	305-AAD-XXX	500-AAD930
1	7 1/2	7 1/2	10	10	509-BAD-XXX	-	309-BAD-XXX	305-BAD-XXX	500-BAD930
2	10	15	25	25	509-CAD-XXX	-	309-CAD-XXX	-	500-CAD930

<sup>1</sup> All starters and contactors come standard with a 120V AC coil.

### NEMA Sizes 0...3 by Components

#### Base Contactor with 120V Coil

Open Type Without Enclosure		
NEMA Size	Continuous Ampere Rating [A]	Cat. No.
0	18	500F-AOD930
1	27	500F-BOD930
2	45	500F-COD930
3	90	500F-DOD930

#### Coils<sup>4</sup>

Description	NEMA Size		
	0...1	2	3
	Cat. No.	Cat. No.	Cat. No.
24V DC	599-B24DC	599-C24DC	599-D24DC
110V 50 Hz, 120V 60 Hz	599-CB236	599-CC236	599-CD236
220V 50 Hz, 240V 60 Hz	599-CB254	599-CC254	599-CD254
440V 50 Hz, 480V 60 Hz	599-CB273	599-CC273	599-CD273

<sup>4</sup> For 309 replacement coils and overloads, visit [rok.auto/directory](http://rok.auto/directory).

#### Command and Indication Devices

Kit Description	Cat. No.
Push Button, Start-Stop	198-SSPB <sup>2</sup>
Selector Switch, Plastic, HOA/FOR	198-3SS
Pilot Light, 24...120V AC/DC, Red LED	198-RUPL
Pilot Light, 24...120V AC/DC, Green LED	198-GUPL
208/120V AC transformer kit	1497-HD50 <sup>3</sup>
240/120V AC transformer kit	1497-AD50 <sup>3</sup>
480/120V AC transformer kit	1497-BD50 <sup>3</sup>
600/120V AC transformer kit	1497-CD50 <sup>3</sup>

<sup>2</sup> Can only be used with non-reversing starters and contactors.

<sup>3</sup> Transformer kits are pre-engineered with fuses and fuse covers.

#### Solid-State Overload Relays<sup>5</sup>

NEMA Size	Current Range [A]	Cat. No.
0, 1	1.0...5.0	592-1EFCC
0...2	5.4...27	592-1EFEC
3	11...55	592-1EFFD
3	20...110	592-1EFGD

<sup>5</sup> For Eutectic Alloy Overload Relays, please visit [rok.auto/directory](http://rok.auto/directory).





# Starters

## Combination Starters, NEMA 312, 512 / 313, 513

- 312, 512 with fusible and non-fusible disconnect switches  
313, 513 with circuit breakers
- Starter sizes 0...7
- Patented snap-together wiring<sup>1</sup>
- Overload relays: eutectic or solid-state
- Reversing and non-reversing available
- NEMA Type 1, 4/12/3R, 4/4X, 3R/7-9
- UL Listed and CSA certified

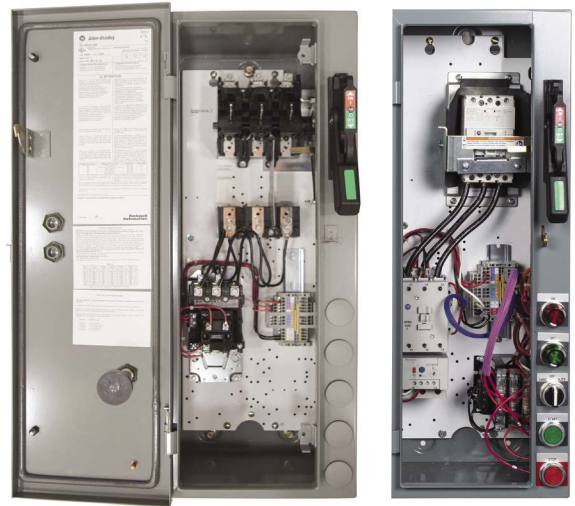

Our robust NEMA combination starters, now with patented snap-together wiring, have a versatile design and flexible configurations, allowing various command and indication options, enclosure sizes and environmental type ratings.

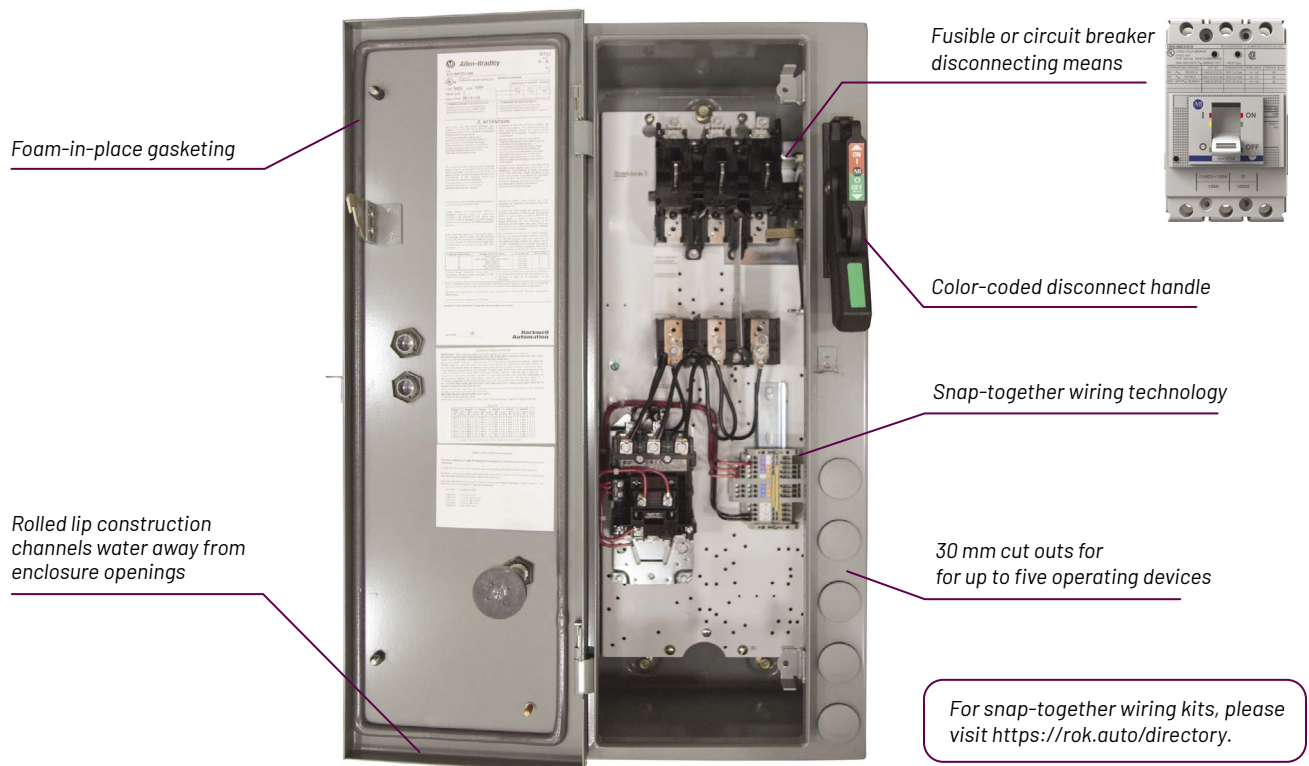

<sup>1</sup> Snap-together wiring is not available for NEMA size 6 reversing starters and higher, or for NEMA Type 7/9.

### Contactors



2-2...2-15

### Starters



2-16...2-29

### Motor Protection



2-30...2-35

### Smart Motor Control



2-36...2-45

### Drives



2-46...2-51



### Product Selection

#### 312, 512 NEMA Non-Reversing Combination Starters in Type 3R/4/12 Rainproof, Dustproof Enclosures

Size	Cont. Ampere Rating [A]	Max. Hp Rating <sup>2</sup>		Fuse Clip Rating [A] <sup>1</sup>	312-*	512-*
		Motor Voltage, 60 Hz			Cat. No.	Cat. No.
		230V	460...575V			
1	27	7-1/2	10	30	312-BF⊗-R03	512-BF⊗-R24R
2	45	15	25	60	312-CF⊗-R06	512-CF⊗-R25R
3	90	30	50	100	312-DF⊗-R10	512-DF⊗-R26R
4	135	50	100	200	312-EF⊗-R20	512-EF⊗-R27R
		50	100	400	312-EF⊗-J40	512-EF⊗-R28J
5	270	75	200	400	312-FF⊗-R40	512-FF⊗-R28R
6	540	200	400	600 <sup>3</sup>	312-GF⊗-R60	512-GF⊗-R29R

#### 313, 513 NEMA Non-Reversing Combination Starters

Size	Cont. Ampere Rating [A]	Max. Hp Rating <sup>2</sup>			313-*	513-*
		Motor Voltage, 60 Hz			Cat. No.	Cat. No.
		230V	460V	575V		
1	27	1/2...1	0...1	0...1	313-BF⊗-C15	513-BF⊗-C35
		1-1/2...3	1-1/2...3	1-1/2...3	313-BF⊗-C15	513-BF⊗-C38
		5...7-1/2	5...7-1/2	5...7-1/2	313-BF⊗-C30	513-BF⊗-C40
2	45	10	-	-	313-CF⊗-C30	513-CF⊗-C41
		15	15	15	313-CF⊗-C30	513-CF⊗-C42
		-	20...25	20...25	313-CF⊗-C50	513-CF⊗-C44
3	90	30	-	30	313-DF⊗-C50	513-DF⊗-C45
		-	30...50	40...50	313-DF⊗-D10	513-DF⊗-C47
4	135	-	-	60	313-EF⊗-D10	513-EF⊗-C48
		-	60...75	-	313-EF⊗-D12	513-EF⊗-C49
		-	100	75...100	313-EF⊗-D15	513-EF⊗-C50
5	270	100	-	-	313-FF⊗-D30	513-FF⊗-C50
		-	-	125	313-FF⊗-D30	513-FF⊗-C51
		-	125...150	-	313-FF⊗-D40	513-FF⊗-C52
6	540	150	-	-	313-GF⊗-D60	513-GF⊗-C52T
		200	-	-	313-GF⊗-D60	513-GF⊗-C54T
		-	250	250	313-GF⊗-D60	513-GF⊗-C56T

⊗ The catalog number as listed is incomplete. Select coil voltage and overload relay codes from the tables. Use product configuration tool for additional options and accessories.

<sup>1</sup> Fuses not included. Select per NEC.

<sup>2</sup> Full load current must not exceed continuous ampere rating.

<sup>3</sup> For 230V and 460V Hp ratings, limit the maximum fuse sizing to 125% of motor full load current.

#### ⊗ AC Coil Voltage Codes

Common or Transformer Control	
Code	Line Voltage
H	208V, 60 Hz
A	240V, 60 Hz
B	480V, 60 Hz
C	600V, 60 Hz

120V Separate Control (No Transformer)	
Code	Description
HD	208V / 120V, 60 Hz
AD	240V / 120V, 60 Hz
BD	480V / 120V, 60 Hz
CD	600V / 120V, 60 Hz

#### ⊗ Overload Relay Code

NEMA Size	FLC Adjustment Range [A]	Overload Relay Code
0, 1	0.2...1.0	A2C
	1.0...5.0	A2E
	3.2...16	A2F
1	5.4...27	A2G
	9...45	A2J
2	5.4...27	A2G
	11...55	A2J
3	11...55	A2J
	20...100	A2L
4	30...150	A2M
5	60...300	A2N
6	120...600	A2R



# Motor Protection

MOTOR CONTROL

## Bimetallic Overload Relays 193-K/193-T1

- Most basic motor protection device
- Overload protection Trip Class 10
- Phase loss sensitivity
- Rated for DC and variable frequency drive applications up to 400 Hz
- 1 N.O. and 1 N.C. auxiliary contacts



Bimetallic Thermal Overload Relays are motor protectors for IEC applications.

- 193-K bimetallic overload relays are for use with 100-K and 104-K miniature reversing contactors.
- 193-T1 bimetallic overload relays are for use with 100-C and 104-C Reversing Contactors.

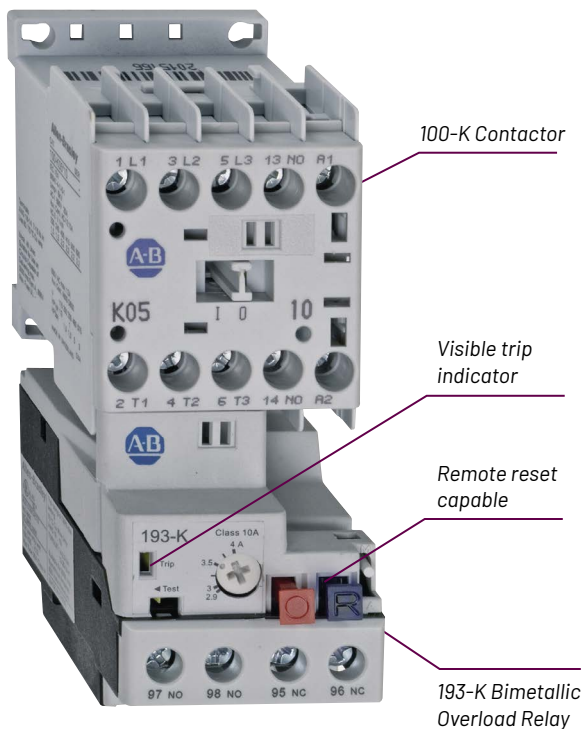

## Applications

- Conveyors
- Fans
- Pumps
- VFD-controlled motors



### Remote Reset Solenoid

For remote reset of 193-K and 193-T1 overload relays

2-30

Contactors



2-2...2-15

Starters



2-16...2-29

**Motor Protection**



**2-30...2-35**

Smart Motor Control



2-36...2-45

Drives



2-46...2-51

## Product Selection

### Bimetallic Overload Relays

Mounts to Contactor	Adjustment Range [A]	Cat. No.
100-C09...100-C23	0.90...1.3	193-T1AB13
	1.8...2.5	193-T1AB25
	2.9...4.0	193-T1AB40
	4.5...6.3	193-T1AB60
	5.5...7.5	193-T1AB75
	7.2...10	193-T1AC10
	9.0...12.5	193-T1AC12
	11.3...16	193-T1AC16
	21...25	193-T1AC25
100-C30...100-C37	15...20	193-T1BC20
	21...25	193-T1BC25
	29...36	193-T1BC36
	33...38	193-T1BC38
100-C43...100-C55	17...25	193-T1CC25
	35...47	193-T1CC47
	45...60	193-T1CC60
100-C60...100-C97	35...47	193-T1DC47
	45...60	193-T1DC60 <sup>1</sup>
	58...75	193-T1DC75 <sup>1</sup>
	72...90	193-T1DC90 <sup>1</sup>
	77...97	193-T1DC97 <sup>1</sup>

<sup>1</sup> Panel mount version available.

Mounts to Contactor	Adjustment Range [A]	Cat. No.
100-K05...K12	0.16...0.25	193-KA25
	0.25...0.40	193-KA40
	0.35...0.50	193-KA50
	0.45...0.63	193-KA63
	0.55...0.80	193-KA80
	0.75...1.0	193-KB10
	0.9...1.3	193-KB13
	1.1...1.6	193-KB16
	1.4...2.0	193-KB20
	1.8...2.5	193-KB25
	2.3...3.2	193-KB32
	2.9...4.0	193-KB40
100-K09...K12	3.5...4.8	193-KB48
	4.5...6.3	193-KB63
	5.5...7.5	193-KB75
100-K12	7.2...10.0	193-KC10
	9.0...12.5	193-KC12



#### Product Selection Tools

Available online or for download, our tools help you access info while in the office or on the go.

[rok.auto/selection](http://rok.auto/selection)

## Accessories

Description		For Use With	Cat. No.
DIN Rail/Panel Mounting Adapter	For separate mounting of overload relays. Snaps on to 35 mm top hat rail	193-T1AA, 193-T1AB, 193-T1AC, 193-T1BC	193-T1APM
Screw Adapter	For screw fixing of the 193-T1APM panel adapter. (2 required per adapter)	193-T1APM	140M-C-N45
Remote Reset Solenoid	24V AC, 50/60 Hz	193-K, 193-T1	193-T1RKJ
	110/120V AC, 50/60 Hz		193-T1RD
	220/240V AC, 50/60 Hz		193-T1RKF
	24V DC		193-T1RZJ
	48V DC		193-T1RZY
	115V DC		193-T1RZD

For more information on our complete family of circuit protection products, please visit:  
[rok.auto/circuit-load-protection](http://rok.auto/circuit-load-protection)



# Motor Protection

MOTOR CONTROL

## Electronic Overload Relays E100

- Up to four adjustable trip classes: 10, 15, 20 or 30
- 5:1 wide current adjustment range to cover a variety of motor applications
- Pass-thru options available, minimizing number of power terminal connections
- 48% footprint reduction using pass-thru solution
- Accurate and repeatable settings to help minimize commissioning time
- Built-in thermal memory and phase loss detection helps protect your motor investment



The E100 Electronic Overload Relay is the next generation basic-tier electronic overload relay. It has enhanced features to better safeguard your motor protection investments, including increased accuracy and repeatability, a self-powered design with lower heat dissipation, and an aggressive component certification strategy.

### Optional Accessories

- Ground fault/jam
- Remote reset and/or indication
- Anti-tamper shields
- DIN Rail/panel mounting
- External CT configurations

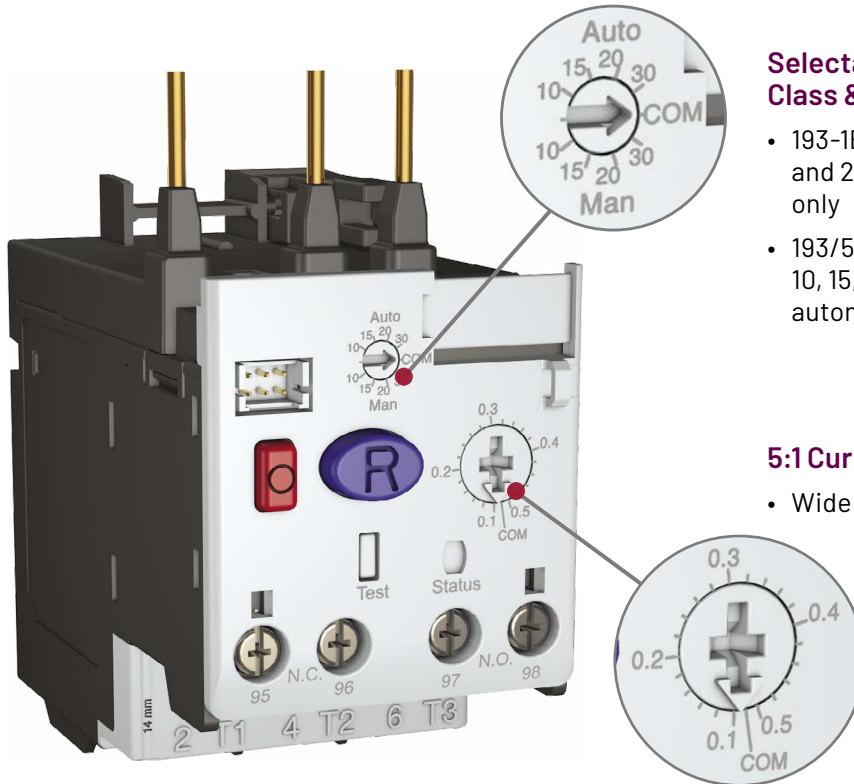

E100-EE shown

### Selectable Trip Class & Reset Mode

- 193-1EE: Trip Class 10 and 20, manual reset only
- 193/592-1EF: Trip Class 10, 15, 20, 30, manual or automatic reset

### 5:1 Current Range

- Wide FLA range

#### Contactors



2-2...2-15

#### Starters



2-16...2-29

#### Motor Protection



2-30...2-35

#### Smart Motor Control



2-36...2-45

#### Drives



2-46...2-51





## Product Selection

Current Range [A]	Mounting Style	Basic/Advanced	Cat. No.
0.1...5	IEC Direct Mount (100-C09...C23)	Basic	193-1EEAB
0.2...1.0	IEC Direct Mount (100-C09...C23)	Basic	193-1EEBB
1...5	IEC Direct Mount (100-C09...C23)	Basic	193-1EECB
3.2...16	IEC Direct Mount (100-C09...C23)	Basic	193-1EEDB
5.4...27	IEC Direct Mount (100-C09...C23)	Basic	193-1EEEB
5.4...27	IEC Direct Mount (100-C030...C55)	Basic	193-1EEED
11...55	IEC Direct Mount (100-C030...C55)	Basic	193-1EEFD
20...100	IEC Direct Mount (100-C060...C97)	Basic	193-1EEGE
0.1...0.5	IEC Direct Mount (100-E09...E16)	Basic	193-1EEAF
0.2...1.0	IEC Direct Mount (100-E09...E16)	Basic	193-1EEBF
1.0...5.0	IEC Direct Mount (100-E09...E16)	Basic	193-1EECF
3.2...16	IEC Direct Mount (100-E09...E16)	Basic	193-1EEDF
5.4...27	IEC Direct Mount (100-E09...E16)	Basic	193-1EEEF
1.0...5.0	IEC Direct Mount (100-E26...E38)	Basic	193-1EECG
5.4...27	IEC Direct Mount (100-E26...E38)	Basic	193-1EEEG
11...55	IEC Direct Mount (100-E26...E38)	Basic	193-1EEFG
13.2...66	IEC Direct Mount (100-E40...E65)	Basic	193-1EEQH
20...100	IEC Direct Mount (100-E80...E96)	Basic	193-1EEGJ
0.1...0.5	IEC Direct Mount (100-C09...C23)	Advanced	193-1EFAB
0.2...1.0	IEC Direct Mount (100-C09...C23)	Advanced	193-1EFBB
1...5	IEC Direct Mount (100-C09...C23)	Advanced	193-1EFCB
3.2...6	IEC Direct Mount (100-C09...C23)	Advanced	193-1EFDB
5.4...27	IEC Direct Mount (100-C09...C23)	Advanced	193-1EFEB
5.4...27	IEC Direct Mount (100-C030...C55)	Advanced	193-1EFED
11...55	IEC Direct Mount (100-C030...C55)	Advanced	193-1EFFD
20...100	IEC Direct Mount (100-C060...C97)	Advanced	193-1EFGE
0.1...0.5	IEC Direct Mount (100-E09...E16)	Advanced	193-1EFAF
0.2...1.0	IEC Direct Mount (100-E09...E16)	Advanced	193-1EFBF
1.0...5.0	IEC Direct Mount (100-E09...E16)	Advanced	193-1EFCF
3.2...16	IEC Direct Mount (100-E09...E16)	Advanced	193-1EFDF
5.4...27	IEC Direct Mount (100-E09...E16)	Advanced	193-1EFEF
1.0...5.0	IEC Direct Mount (100-E26...E38)	Advanced	193-1EFCG
5.4...27	IEC Direct Mount (100-E26...E38)	Advanced	193-1EFEG
11...55	IEC Direct Mount (100-E26...E38)	Advanced	193-1EFFG
13.2...66	IEC Direct Mount (100-E40...E65)	Advanced	193-1EFQH
20...00	IEC Direct Mount (100-E80...E96)	Advanced	193-1EFGJ
0.1...0.5	NEMA Direct Mount (Size 00)	Advanced	592-1EFAT
0.2...1.0	NEMA Direct Mount (Size 00)	Advanced	592-1EFBT
1...5	NEMA Direct Mount (Size 00)	Advanced	592-1EFCT
3.2...16	NEMA Direct Mount (Size 00)	Advanced	592-1EFDT
0.2...1.0	NEMA Direct Mount (Size 0...2)	Advanced	592-1EFBC
1...5	NEMA Direct Mount (Size 0...2)	Advanced	592-1EFCC

Current Range [A]	Mounting Style	Basic/Advanced	Cat. No.
3.2...16	NEMA Direct Mount (Size 0...2)	Advanced	592-1EFDC
5.4...27	NEMA Direct Mount (Size 0...2)	Advanced	592-1EFEC
11...55	NEMA Direct Mount (Size 0...2)	Advanced	592-1EFFC
20...100	NEMA Direct Mount (Size 3)	Advanced	592-1EFGD
30...150	External CT Configurations	Advanced	193-1EFHZ
40...200	External CT Configurations	Advanced	193-1EFJZ
60...300	External CT Configurations	Advanced	193-1EFKZ
100...500	External CT Configurations	Advanced	193-1EFLZ
120...600	External CT Configurations	Advanced	193-1EFMZ
160...800	External CT Configurations	Advanced	193-1EFNZ
80...400	External CT Configurations	Advanced	193-1EFWZ
1...5	Pass - Thru	Basic	193-1EECP
3.2...16	Pass - Thru	Basic	193-1EEDP
5.4 - 27	Pass - Thru	Basic	193-1EEEP
11...55	Pass - Thru	Basic	193-1EEFP
20...100	Pass - Thru	Basic	193-1EEGP
1...5	Pass - Thru	Advanced	193-1EFCP
3.2...16	Pass - Thru	Advanced	193-1EFDP
5.4...27	Pass - Thru	Advanced	193-1EFEP
11...55	Pass - Thru	Advanced	193-1EFFP
20...100	Pass - Thru	Advanced	193-1EFGP

## Accessories

Accessory	Cat. No.
Base Unit Anti-Tamper Shield	193-1BC8
Universal Protection Module	193-1EGJ
Protection Accessory Anti-Tamper Shield	193-1EMC
240V AC Remote Reset Solenoid	193-1EMRA
120V AC Remote Reset Solenoid	193-1EMRD
24V DC Remote Reset Solenoid	193-1EMRZ
DIN Rail/Panel Adapter Frame B	193-1EPB
DIN Rail/Panel Adapter Frame D	193-1EPD
DIN Rail/Panel Adapter Frame E	193-1EPE
External Reset Adapter	193-1ERA
ERID Adapter	193-1ERR
Remote indication Display with Reset	193-ERID
Remote Indication Display - No Reset	193-1ERIDN
Accessory Panel/DIN Mounting Kit	193-1EIKIT1
Accessory Install Kit & Spare Terminal Blocks	193-1EIKIT2





# Motor Protection

## Electronic Overload Relays E300/E200

- Modular design for application customization
- Sensing, control, and communication modules
- Diagnostic information to monitor motor performance
- Logix integration with add-on profiles, add-on instructions, and pre-configured operator faceplate objects
- Dual-port EtherNet/IP, DeviceNet, and non-networked communication options
- Simplified wiring between E300™/E200™ Electronic Overload Relay and 100-C contactor



The E300/E200 Electronic Overload Relays provide a flexible design and advanced intelligence. Real-time motor diagnostic information proactively indicates when a motor is having a problem, allowing you to efficiently troubleshoot.

### Mounting Options

Multiple mounting options let you install the E300/E200 Electronic Overload Relays into your existing system.

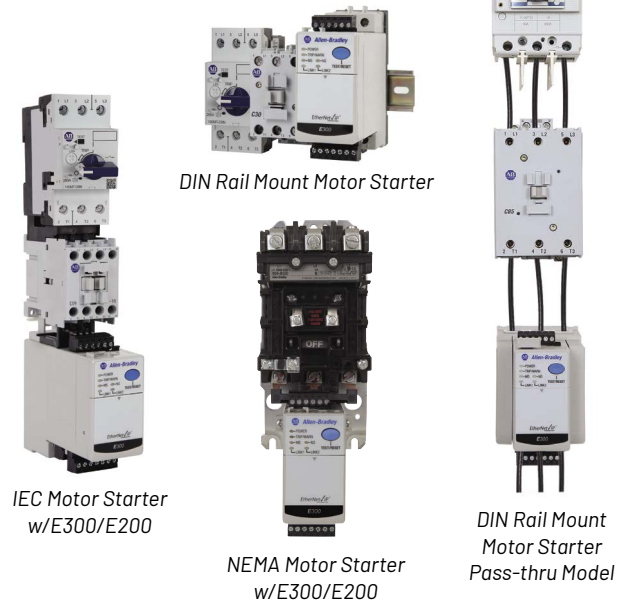

### Modular Design

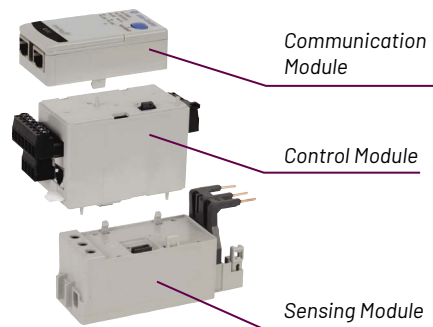

### DeviceLogix

- Faster local I/O processing
- Helps improve control system performance
- Increase system reliability
- Increase system/machine modularity

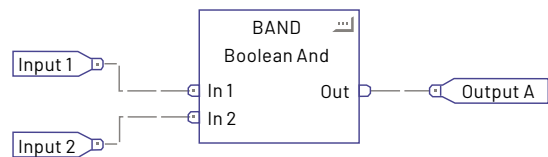

#### Contactors



2-2...2-15

#### Starters



2-16...2-29

#### Motor Protection



2-30...2-35

#### Smart Motor Control



2-36...2-45

#### Drives



2-46...2-51



## Product Selection

### Sensing Modules

Mounting Options	Current Range [A]	For Use With	Cat. No.
IEC Contactors	0.5...30	100-C09...C23	193-ESM-⊗-30A-C23
		100-C30...C55	193-ESM-⊗-30A-C55
	6...60	100-C30...C55	193-ESM-⊗-60A-C55
	10...100	100-C60...100-C97	193-ESM-⊗-100A-C97
	20...200	100-E116...100-E146	193-ESM-⊗-200A-E146
100-E190...100-E205		193-ESM-⊗-200A-E205	
DIN Rail / Panel Mount Power Terminals	0.5...30	All contactors and external current transformers	193-ESM-⊗-30A-T
	6...60	All contactors	193-ESM-⊗-60A-T
	10...100		193-ESM-⊗-100A-T
DIN Rail / Panel Mount Power Terminals, Directly replaces 193-ECPM_	0.5...30	All contactors and external current transformers	193-ESM-⊗-30A-E3T
	6...60	All contactors	193-ESM-⊗-60A-E3T
	10...100		193-ESM-⊗-100A-E3T
DIN Rail / Panel Mount Pass-thru	0.5...30	All contactors and external current transformers	193-ESM-⊗-30A-P
	6...60	All contactors	193-ESM-⊗-60A-P
	10...100		193-ESM-⊗-100A-P
NEMA Contactors	0.5...30	NEMA Size 0...2	592-ESM-⊗-30A-S2
	6...60		592-ESM-⊗-60A-S2
	10...100	NEMA Size 3	592-ESM-⊗-100A-S3

⊗ The catalog number as listed is incomplete. Use an **I** (Current), **IG** (Current/Ground Fault) or **VIG** (Voltage/Current/Ground Fault) to complete the catalog number.

### Control Modules

Description	No. of Inputs/Outputs	Rated Control Voltage [V]	Cat. No.
I/O Module	6 in/3 out	24V DC	193-EI0-63-24D
	2 in/2 out		193-EI0-22-24D
	4 in/3 out	110...120V AC, 50/60 Hz	193-EI0-43-120
	2 in/2 out		193-EI0-22-120
	4 in/3 out	220...240V AC, 50/60 Hz	193-EI0-43-240
	2 in/2 out		193-EI0-22-240
I/O and Protection Module. Thermistor (PTC) and External Ground Fault Current <sup>1</sup>	4 in/2 out	24V DC	193-EIOGP-42-24D
	2 in/2 out	110...120V AC, 50/60 Hz	193-EIOGP-22-120
	2 in/2 out	220...240V AC, 50/60 Hz	193-EIOGP-22-240

<sup>1</sup> Requires core balanced ground fault sensor, refer to chart on 2-45.

### Communication Modules

Description	Cat. No.
EtherNet/IP	193-ECM-ETR
DeviceNet	193-ECM-DNT
Parameter Configuration Module (E200)	193-ECM-PCM

### Expansion Modules

Description	No. of Inputs/Outputs	Rated Control Voltage [V]	Cat. No.
Digital Expansion Module, 24V DC	4 in/2 out	24V DC	193-EXP-DIO-42-24D
Digital Expansion Module, 120V AC	4 in/2 out	110...120V AC, 50/60 Hz	193-EXP-DIO-42-120
Digital Expansion Module, 240V AC	4 in/2 out	220...240V AC, 50/60 Hz	193-EXP-DIO-42-240
Analog Expansion Module: mA, V, RTD, and Resistance	3 universal in/1 out	-	193-EXP-AIO-31 <sup>2</sup>
Expansion Power Supply		24V DC	193-EXP-PS-DC
		110...240V AC, 50/60 Hz	193-EXP-PS-AC
Starter Control Station with 3-Meter Cable	-	-	193-EOS-SCS
Starter Diagnostic Station with 3-Meter Cable	-	-	193-EOS-SDS <sup>2</sup>

<sup>2</sup> Module requires control module firmware v3.xxx or higher for Series A. No firmware version restrictions for Series B control modules.

For more information on our complete family of circuit protection products, please visit:  
[rok.auto/circuit-load-protection](http://rok.auto/circuit-load-protection)



# Smart Motor Control

MOTOR CONTROL

## Solid-state Contactors 156-C

- Ideal for high duty cycle applications
- Operational current rating 20...85 A
- 1-, 2-, or 3-phase capable
- AC and DC control options
- Zero-cross switching to help reduce EMC emissions



The next generation 156-C solid-state contactors from Allen-Bradley are flexible in configuration and design, these devices can be panel or DIN Rail mounted complete with the integrated heatsink and do not require additional components or assembly. Microprocessor and PLC compatible, the solid-state contactors can be used in applications that range from heaters to small motors and valves.

Panel or DIN Rail mounting for flexible installation

Compact modular design with heatsink

### Optimized to help reduce electrical costs and needs

- Low electrical and acoustical noise
- Low input power
- Operational current up to 85 A (AC-1), 65 A (AC-3)
- Line voltage ratings up to 600V
- UL/cUL Listed as a motor controller
- IEC AC-51/AC-53 resistive/inductive rated



LED Status Indicators

2- or 3-phase capable in 3-pole configuration (1-pole option available)

2-36

Contactors



2-2...2-15

Starters



2-16...2-29

Motor Protection



2-30...2-35

Smart Motor Control



2-36...2-45

Drives



2-46...2-51



## Product Selection

### Single-Phase Power Contactors

Current Rating [A]	Control Voltage	Rated Power @ 40 °C (104 °F)						Operational voltage < 240V AC	Operational Voltage < 600V AC
			115V	230V	400V	480V	600V		
20	20...275V AC 24...190V DC	Hp	1/3	1	2	3	3	156-C1P20NAB	156-C1P20NCB
	5...32V DC	kW	0.18	0.37	0.75	1.1	1.5	156-C1P20NAD	156-C1P20NCD
25	20...275V AC 24...190V DC	Hp	1/3	1	2	3	3	156-C1P25NAB	156-C1P25NCB
	5...32V DC	kW	0.18	0.37	0.75	1.1	1.5	156-C1P25NAD	156-C1P25NCD
43	20...275V AC 24...190V DC	Hp	1-1/2	3	5	7-1/2	10	—	156-C1P43NCB
	5...32V DC	kW	0.6	1.5	2.2	3.7	4.0	—	156-C1P43NCD
65	20...275V AC 24...190V DC	Hp	2	5	7-1/2	10	15	—	156-C1P65NCB
	5...32V DC	kW	0.75	1.5	4.0	4.0	5.5	—	156-C1P65NCD
85	20...275V AC 24...190V DC	Hp	2	5	7-1/2	10	15	—	156-C1P85NCB
	5...32V DC	kW	0.75	1.5	4.0	4.0	5.5	—	156-C1P85NCD

### Dual-Phase Power Contactors

Current Rating [A]	Control Voltage	Rated Power @ 40 °C (104 °F)						Operational voltage < 240V AC	Operational Voltage < 600V AC
			115V	230V	400V	480V	600V		
25	20...275V AC 24...190V DC	Hp	1-1/2	3	5	7-1/2	10	—	156-C2P25NCB
	5...32V DC	kW	1.1	3.0	5.5	5.5	9.0	—	156-C2P25NCD
40	20...275V AC 24...190V DC	Hp	3	5	10	10	15	—	156-C2P40NCB
	5...32V DC	kW	1.5	4.0	7.5	9.0	11.0	—	156-C2P40NCD
75	20...275V AC 24...190V DC	Hp	5	10	15	20	25	—	156-C2P75NCBA
	5...32V DC	kW	3.0	7.5	11.0	15.0	22.0	—	156-C2P75NCDA

### Three-Phase Power Contactors

Current Rating [A]	Control Voltage	Rated Power @ 40 °C (104 °F)						Operational voltage < 240V AC	Operational Voltage < 600V AC
			115V	230V	400V	480V	600V		
20	20...275V AC 24...190V DC	Hp	1	3	5	7-1/2	10	156-C3P20NAB	156-C3P20NCB
	5...32V DC	kW	0.8	2.2	4.0	5.5	7.5	156-C3P20NAD	156-C3P20NCD
25	20...275V AC 24...190V DC	Hp	2	3	7-1/2	10	10	—	156-C3P25NCB
	5...32V DC	kW	1.1	2.2	4.0	5.5	7.5	—	156-C3P25NCD
30	20...275V AC 24...190V DC	Hp	2	5	10	10	15	—	156-C3P30NCB
	5...32V DC	kW	1.5	3.0	5.5	7.5	11.0	—	156-C3P30NCD
40	20...275V AC 24...190V DC	Hp	2	5	10	10	15	—	156-C3P40NCBA
	5...32V DC	kW	1.4	4.0	7.5	9.0	11.0	—	156-C3P40NCDD
65	20...275V AC 24...190V DC	Hp	3	10	15	20	25	—	156-C3P65NCBA
	5...32V DC	kW	3.0	5.5	11.0	15.0	20.0	—	156-C3P65NCDA



# Smart Motor Control

## Starting Torque Controllers 154

- Ideal for reducing electrical and mechanical system shock
- Operational current rating 12...25 A
- 1- or 3-phase capable with 1 or 2 controlling phases
- AC and DC control options
- Adjustable torque setting and ramp time duration



The Allen-Bradley Starting Torque Controller is designed for low-horsepower single- and three-phase squirrel cage-induction motors. It is designed to help reduce system shock (electrical and mechanical) typically seen in systems that use direct-on-line starting. This provides a smoother start and helps decrease downtime due to shock- and vibration-related problems. Typical applications include fans, material handling, pumps, palletizers, car washes and reduced voltage start single-phase applications.

Compact modular design with heat sink

Panel or DIN Rail mounting for flexible installation

### Optimized to help reduce downtime due to shock and vibration problems

- 10...80% initial torque value
- 0.5...5 s ramp time
- Operational current up to 25 A
- Line voltage ratings up to 600V
- UL/cUL Listed as a motor controller
- IEC AC-53 inductive ratings



1- or 3-phase capable

### Contactors



2-2...2-15

### Starters



2-16...2-29

### Motor Protection



2-30...2-35

### Smart Motor Control



2-36...2-45

### Drives



2-46...2-51



## Product Selection

### Single-Phase with Single Control Phase Starting Torque Controllers

Current Rating [A]	Rated Power @ 40 °C (104 °F)			Control Voltage	
		115V	230V	24V AC/DC	100...240V AC
12	Hp	0.5	2	154-SP1C12NAR	154-SP1C12NAD
	kW	0.55	1.1		
16	Hp	0.5	2	154-SP1C16NAR	154-SP1C16NAD
	kW	0.75	1.5		
25	Hp	1	3	154-SP1C25NAR	154-SP1C25NAD
	kW	1.5	3		

### Three-Phase with Single Control Phase Starting Torque Controllers

Current Rating [A]	Rated Power @ 40 °C (104 °F)					Control Voltage	
		220V	400V	460V	575V	24V AC/DC	100...240V AC
12	Hp	3	5	7.5	10	154-TP1C12NCR	154-TP1C12NCD
	kW	3	5.5	6.3	6.3		
16	Hp	5	7.5	10	10	154-TP1C16NCR	154-TP1C16NCD
	kW	4	7.5	7.5	7.5		
25	Hp	7.5	10	15	20	154-TP1C25NCR	154-TP1C25NCD
	kW	6.3	11	13	15		

### Three-Phase with Two Control Phases Starting Torque Controllers

Current Rating [A]	Rated Power @ 40 °C (104 °F)					Control Voltage	
		220V	400V	460V	575V	24V AC/DC	100...240V AC
12	Hp	3	5	7.5	10	154-TP2C12NCR	154-TP2C12NCD
	kW	3	5.5	6.3	6.3		
16	Hp	5	7.5	10	10	154-TP2C16NCR	154-TP2C16NCD
	kW	4	7.5	7.5	7.5		
25	Hp	7.5	10	15	20	154-TP2C25NCR	154-TP2C25NCD
	kW	6.3	11	13	15		





# Smart Motor Control

MOTOR CONTROL

## Smart Motor Controller 150 SMC™-3

- Solid-state soft-start motor controller with internal bypass
- Current ratings of 1...480 A
- Compact footprint
- Five start/stop modes
- Built-in machine overload protection
- 3-phase monitoring



**Internal Bypass**  
The bypass automatically closes when the motor reaches its nominal speed, minimizing heat generation.

- Reduced enclosure size
- Reduced total cost

**Easy and Secure Setup**  
DIP switches allow setting of the START/STOP profile, built-in overload, connection type, trip class, and auxiliary contact characteristics.

- Process optimization
- Setup efficiency

**Hold to Test/ Push to Reset Button**  
Used to simulate fault conditions or reset the unit.

- Reduces downtime
- Assists during setup

**Ultra-Compact Size**  
1...37 A units are only 45 mm wide.

- Reduced panel space
- Higher-density installations

**Simplified Motor FLA Setup**  
Rotary switch allows quick and easy setup of motor FLA.

- Setup efficiency
- Protects motor assets

**LED Display**  
Status information provided including RUN, Fault type and OFF.

- Instant status display
- Assists during troubleshooting

45 mm

2-40

Contactors



2-2...2-15

Starters



2-16...2-29

Motor Protection



2-30...2-35

Smart Motor Control



2-36...2-45

Drives



2-46...2-51



## Product Selection

### Line-Connected Controllers

Rated Voltage [V AC]	Current Rating [A]	Starting Duty		Open Type		IP65 (Type 4/12) Enclosed Non-combination Controllers
		kW	Hp, 60 Hz	100...240V AC, 50/60 Hz Control	24V AC/DC Control	
		350%	350%	Cat. No.	Cat. No.	
380/400/ 415/460	1...3	1.1	0.5...1.5	150-C3NBD	150-C3NBR	150-C3FBD
	3...9	4	1.5...5	150-C9NBD	150-C9NBR	150-C9FBD
	5.3...16	7.5	5...10	150-C16NBD	150-C16NBR	150-C16FBD
	6.3...19	7.5	5...10	150-C19NBD	150-C19NBR	150-C19FBD
	9.2...25	11	7.5...15	150-C25NBD	150-C25NBR	150-C25FBD
	10...30	15	7.5...20	150-C30NBD	150-C30NBR	150-C30FBD
	12.3...37	18.5	10...25	150-C37NBD	150-C37NBR	150-C37NBD
	14.3...43	22	10...30	150-C43NBD	150-C43NBR	150-C43FBD
	20...60	30	15...40	150-C60NBD	150-C60NBR	150-C60FBD
	28.3...85	45	25...60	150-C85NBD	150-C85NBR	150-C85FBD
	27...108	55	50...75	150-C108NBD	150-C108NBR <sup>1</sup>	150-C108FBD
	34...135	75	60...100	150-C135NBD	150-C135NBR <sup>1</sup>	150-C135FBD
	67...201	95...110	75...150	150-C201NBD	150-C201NBR <sup>1</sup>	150-C201FBD
	84...251	95...132	100...200	150-C251NBD	150-C251NBR <sup>1</sup>	150-C251FBD
	106...317	95...160	125...250	150-C317NBD	150-C317NBR <sup>1</sup>	150-C317FBD
	120...361	110...200	250...300	150-C361NBD	150-C361NBR <sup>1</sup>	150-C361FBD
160...480	160...250	300...400	150-C480NBD	150-C480NBR <sup>1</sup>	150-C480FBD	

<sup>1</sup> Separate 120V or 240V single phase power supply is required for fan operation.

## Accessories

### Protective Modules

Description	For Use With	Cat. No.
480V Protective Module	150-C3...37NB	150-C84
	150-C43...85NB (line and/or load)	150-C84P
	150-C108...480NB (line and/or load)	150-F84L

### Replacement Fan

Description	For Use With	Cat. No.
Field installable replacement fan	150-C3...37	150-CF64
	150-C43...85	150-CF147
	150-C108, 150-C135	41391-801-03
	150-C201, 150-C251	41391-801-01
	150-C317...C480	41391-801-02

### Terminal Lug Kits (108...480 A)

Current Rating [A] <sup>2</sup>	Wire Size	Total No. of Line Controller Terminal Lugs		Pkg. Qty.	Cat. No.	Terminal Covers
		Per Line Side	Per Load Side			Cat. No.
108...135 <sup>3</sup>	#6...250 MCM AWG	3	3	3	199-LF1	150-TC1
201...251 <sup>3</sup>	16...120 mm <sup>2</sup>	6	6		199-LG1	150-TC2
317...480 <sup>3</sup>	#4...500 MCM AWG 25...240 mm <sup>2</sup>	6	6			150-TC3

<sup>2</sup> 5...85 A units have box lugs standard. No additional lugs are required.

<sup>3</sup> When a multi-conductor lug is required, refer to the Instruction Sheet for appropriate lug catalog number.

### Auxiliary Contact Blocks

Description	N.O.	N.C.	Connection Diagram	Cat. No.
Side mount with sequence terminal designations • 1- and 2-pole • Quick and easy mounting without tools • One block per device only	1	0		150-CA10
	2	0		150-CA20
	0	1		150-CA01
	1	1		150-CA11 (Form C)



# Smart Motor Control

MOTOR CONTROL

## Smart Motor Controller 150 SMC™ Flex

- Solid-state soft-start motor controller with internal bypass
- Current ratings of 1...1250 A
- Modular for installation and maintenance
- Built-in LCD and keypad
- Nine start/stop modes and up to three slow-speed modes
- Full metering and diagnostics



**Integral Bypass**  
The bypass automatically closes when the motor reaches its nominal speed, minimizing heat generation.

- Reduced enclosure size
- Reduced total cost

**Feed-through Wiring**

**Power Pole**

**Communications**  
Optional communication modules allow the SMC Flex to be connected to multiple networks.

- Common DPI modules reduce inventory
  - EtherNet/IP, DeviceNet, ControlNet and other networks available

**Advanced Monitoring and Diagnostics**  
Built-in current and voltage protection provide enhanced power monitoring and diagnostic capabilities.

- No additional monitoring equipment required
- PTC input
- Ground fault detection

**Simplified Application Setup**  
Built-in multilingual, backlit LCD display for programming and monitoring.

- Setup efficiency
- Process optimization

Contactors



2-2...2-15

Starters



2-16...2-29

Motor Protection



2-30...2-35

Smart Motor Control



2-36...2-45

Drives



2-46...2-51



## Product Selection

### Line-Connected Controllers

Rated Voltage [V AC]	Motor Current [A]	kW	Hp, 60 Hz	Open Type		IP65 (Type 4/12) Enclosed Non-combination Controllers <sup>3,4</sup>
				100...240V AC, 50/60 Hz Control <sup>1</sup>	24V AC/DC Control <sup>2</sup>	
				Cat. No.	Cat. No.	
400/415/460	1...5	2.2	3	150-F5NBD	150-F5NBR	150-F5FBD
	5...25	11	15	150-F25NBD	150-F25NBR	150-F25FBD
	8.6...43	22	30	150-F43NBD	150-F43NBR	150-F43FBD
	12...60	30	40	150-F60NBD	150-F60NBR	150-F60FBD
	17...85	45	60	150-F85NBD	150-F85NBR	150-F85FBD
	27...108	55	75	150-F108NBD	150-F108NBR	150F-D10JCD
	34...135	75	100	150-F135NBD	150-F135NBR	150F-D13JCD
	67...201	110	150	150-F201NBD	150-F201NBR	150F-D20JCD
	84...251	132	200	150-F251NBD	150-F251NBR	150F-D25JCD
	106...317	160	250	150-F317NBD	150-F317NBR	150F-D31JCD
	120...361	200	300	150-F361NBD	150-F361NBR	150F-D36JCD
	160...480	250	400	150-F480NBD	150-F480NBR	150F-D48JCD
	208...625	355	500	150-F625NBE	-	150F-D62JCD
	260...780	450	600	150-F780NBE	-	150F-D78JCD
323...970	560	800	150-F970NBE	-	-	
416...1250	710	1000	150-F1250NBE	-	-	

<sup>1</sup> 625...1250 A devices listed are only available for 110/120V control. For 230/240V control, change the **E** in the catalog number to an **A**.  
Example: Catalog number 150-F625NBE becomes 150-F625NBA.

<sup>2</sup> Separate 120V or 240V single-phase power supply is required for fan operation.

<sup>3</sup> Line and load termination are provided as standard.

<sup>4</sup> These controllers require a separate 100...240V, 50/60 Hz single-phase control source. To add a control circuit transformer to the enclosure, add the appropriate option code to the catalog number.

## Accessories

### Terminal Lug Kits (108...1250 A)

Current Rating [A] <sup>5</sup>	Wire Size	Total No. of Line Controller Terminal Lugs		Cat. No.	Terminal Covers
		Per Line Side	Per Load Side		Cat. No.
108...135 <sup>6</sup>	#6...250 MCM AWG 16...120 mm <sup>2</sup>	3	3	199-LF1	150-TC1
201...251 <sup>6</sup>		6	6		150-TC2
317...480 <sup>6</sup>	#4...500 MCM AWG 25...240 mm <sup>2</sup>	6	6	199-LG1	150-TC3
625...780	2/0...500 MCM AWG	6	6	100-DL630	
970	4/0...500 MCM AWG	3	3	100-DL860	
1250 <sup>7</sup>	2/0...500 MCM AWG	3	3	100-DL630	
	4/0...500 MCM AWG	3	3	100-DL860	

<sup>5</sup> 5...85 A units have box lugs standard. No additional lugs are required.

<sup>6</sup> When a multi-conductor lug is required, see the SMC Flex user manual for recommended lugs.

<sup>7</sup> The 1250 A device requires (1) catalog number 100-DL630 and (1) catalog number 100-DL860 per connection.

## Protective Modules

Current Rating [A]	Description	Cat. No.
5...85	480V Protective Module	150-F84
108...1250		150-F84L
5...85	600V Protective Module	150-F86
108...1250		150-F86L
5...480 <sup>8</sup>	Core Balance Current Transformer	825-CBCT

<sup>8</sup> For the 625...1250 A devices, please see user manual.

## Communication Modules

Network	Cat. No.
EtherNet/IP	20-COMM-E
Dual-port EtherNet/IP	20-COMM-ER
DeviceNet	20-COMM-D
ControlNet (Coax)	20-COMM-C
PROFIBUS DP	20-COMM-P



# Smart Motor Control

MOTOR CONTROL

## Smart Motor Controller 150 SMC™-50

- Internal Bypass Power Structure
  - Ideal for standard applications
  - Current ratings of 108...480 A
- Solid-state Power Structure
  - Ideal for harsh environments
  - Ideal for more aggressive duty-cycle applications
  - Current ratings of 90...520 A
  - Normal and heavy-duty ratings
- 17 Start/stop modes and 3 slow-speed modes
- DeviceLogix programming for embedded user logic



The scalable design of the SMC-50 satisfies a wide variety of control needs. Advanced monitoring, superior communications capabilities and Energy Saver mode help increase efficiency and reduce downtime. The Internal Bypass power structure automatically closes when the motor reaches its nominal speed, minimizing heat generation. It offers reduced enclosure size and cost. The solid-state power structure offers higher operations per hour, scalable thermal ratings and higher SCCR ratings.



<b>Simplified, Scalable Application Setup</b>	Optional parameter configuration module, human interface module, or PC-based software for programming and monitoring simplifies setup.	<ul style="list-style-type: none"> <li>• Setup efficiency</li> <li>• Process optimization</li> </ul>	✓	✓
<b>Hardware Expansion Ports</b>	Three hardware expansion ports accept optional digital and analog I/O expansion modules as well as a protection module (PTC, Ground Fault, Current Feedback).	<ul style="list-style-type: none"> <li>• Process scalability and optimization</li> <li>• Application flexibility (simple to complex)</li> </ul>	✓	✓
<b>Common Control Module</b>	All features/functions are included in standard control module including linear acceleration/deceleration, torque control, pump control, Smart Motor Braking (SMB), and Energy Saver mode.	<ul style="list-style-type: none"> <li>• Reduced inventory</li> <li>• Increased efficiency</li> </ul>	✓	✓
<b>Hold to Test/ Push to Reset Button</b>	Used to quickly test for fault conditions or reset the unit.	<ul style="list-style-type: none"> <li>• Reduces downtime</li> <li>• Assist during setup</li> </ul>	✓	✓
<b>LED Display</b>	Multi-colored LED provides both diagnostics and controller status information.	<ul style="list-style-type: none"> <li>• Instant status display</li> <li>• Assists during troubleshooting</li> </ul>	✓	✓
<b>Communications</b>	Optional communication modules allow the SMC-50 to be connected to multiple networks.	<ul style="list-style-type: none"> <li>• Common DPI modules reduce inventory</li> <li>• EtherNet/IP, DeviceNet, ControlNet and other networks available</li> </ul>	✓	✓

### SMC-50 Virtual Demonstration

For more information please visit: [rok.auto/SMC50](http://rok.auto/SMC50)

Contactors



2-2...2-15

Starters



2-16...2-29

Motor Protection



2-30...2-35

Smart Motor Control



2-36...2-45

Drives



2-46...2-51



# Product Selection

## Line-Connected Controllers

Rated Voltage [V AC]	Motor Current [A]	kW	Hp, 60 Hz	Open Type		IP65 (Type 4/12) Enclosed Non-combination Controllers
				100...240V AC, 50/60 Hz	24V DC	
				Cat. No.	Cat. No.	Cat. No. <sup>1,2</sup>
<b>Internal Bypass</b>						
400/415 kW 460 Hp	27...108	55	75	150-S108NBD	150-S108NBR	150S-D10JDC
	34...135	75	100	150-S135NBD	150-S135NBR	150S-D13JDC
	67...201	110	150	150-S201NBD	150-S201NBR	150S-D20JDC
	84...251	132	200	150-S251NBD	150-S251NBR	150S-D25JDC
	106...317	160	250	150-S317NBD	150-S317NBR	150S-D31JDC
	120...361	200	300	150-S361NBD	150-S361NBR	150S-D36JDC
	160...480	250	400	150-S480NBD	150-S480NBR	150S-D48JDC
<b>Solid-State</b>						
400/415 kW 460 Hp	30...90	17	25...60	150-SB1NBD	150-S1NBR	150S-C90JCD-3B-BP <sup>3</sup>
	37...110	20	30...75	150-SB2NBD	150-SB2NBR	150S-D11JCD-3B-BP <sup>3</sup>
	47...140	30	40...100	150-SB3NBD	150-SB3NBR	150S-D14JCD-3B-BP <sup>3</sup>
	60...180	37	50...150	150-SB4NBD	150-SB4NBR	150S-D18JCD-3B-BP <sup>3</sup>
	70...210	40	60...150	150-SC1NBD	150-SC1NBR	150S-D21JCD-3B-BP <sup>3</sup>
	87...260	50	75...200	150-SC2NBD	150-SC2NBR	150S-D26JCD-3B-BP <sup>3</sup>
	107...320	63	100...250	150-SC3NBD	150-SC3NBR	150S-D32JCD-3B-BP <sup>3</sup>
	120...361	75	100...300	150-SD1NBD	150-SD1NBR	150S-D36JCD-3B-BP <sup>3</sup>
	140...420	80	125...300	150-SD2NBD	150-SD2NBR	150S-D42JCD-3B-BP <sup>3</sup>
	174...520	100	150...450	150-SD3NBD	150-SD3NBR	150S-D52JCD-3B-BP <sup>3</sup>

- <sup>1</sup> Line and load termination are provided as standard.
- <sup>2</sup> These controllers require a separate 100...240V, 50/60 Hz single-phase control source. To add a control circuit transformer to the enclosure, add the appropriate option code to the catalog number.
- <sup>3</sup> Requires a bypass contactor. Add **-BP** or **-NB** to the end of the catalog number to denote an IEC or NEMA bypass contactor, respectively. Example: For an IEC bypass contactor, catalog number 150-SB1NBD becomes catalog number 150-SB1NBD-**BP**.

## Accessories

### Option Modules

Description	Cat. No.
PTC, ground fault & current feedback	150-SM2
Analog I/O: 2 Inputs, 2 outputs	150-SM3
Digital I/O : 4 100...240V AC inputs, 3 relay outputs	150-SM4
Basic parameter configuration	150-SM6
Core Balance Ground Fault Sensor <sup>4</sup>	825-CBCT

<sup>4</sup> Used with a Cat. No. 150-SM2.

### Communication Modules <sup>5</sup>

Network	Cat. No.
EtherNet/IP	20-COMM-E
Dual-port EtherNet/IP	20-COMM-ER
DeviceNet	20-COMM-D
ControlNet (Coax)	20-COMM-C
PROFIBUS DP	20-COMM-P

<sup>5</sup> Additional modules are available.

### Bypass Kit (Solid State Only)

Description	Cat. No.
C-Frame Bypass Kit (210...320 A)	150-SCBK
D-Frame Bypass Kit (361...520 A)	150-SDBK

### Protective Modules

AC Line Voltage (VAC)	Cat. No.
200...480	150-F84L
200...600	150-F86L

### Line-Connected Controllers Terminal Lug Kits

Current Rating [A]	Wire Size	Total No. of Line Controller Terminal Lugs		Pkg. Qty.	Cat. No.	Terminal Covers
		Per Line Side	Per Load Side			Cat. No.
<b>Internal Bypass</b>						
108...135 <sup>6</sup>	#6...250 MCM AWG	3	3	3	199-LF1	150-TC1
201...251 <sup>6</sup>	16...120 mm <sup>2</sup>	6	6	3		150-TC2
317...480 <sup>6</sup>	#4...500 MCM AWG	6	6	3	199-LG1	150-TC3
<b>Solid-State</b>						
90...180	#6...250 MCM AWG, 16...120 mm <sup>2</sup>	3	3	3	199-LF1 <sup>7</sup>	150-STCB
210...320	#6...250 MCM AWG, 16...120 mm <sup>2</sup>	6 <sup>8</sup>	6	3	199-LF1	-
361...520	#4...500 MCM AWG, 25...240 mm <sup>2</sup>	6 <sup>8</sup>	6	3	199-LG1	-

<sup>6</sup> When a multi-conductor lug is required, see the SMC Flex user manual for recommended lugs.

<sup>7</sup> For SMC-50 Solid-State with External Bypass see SMC Technical Data Document for recommended lugs.

<sup>8</sup> Six additional line side terminal lugs needed for bypass kit.

MOTOR CONTROL





# Drives

## MOTOR CONTROL

### AC Drives 22F PowerFlex® 4M

- Power ratings of 0.2...11 kW / 0.25...15 Hp at 120V, 240V, and 480V to meet a wide range of applications
- Volts per Hertz and slip compensation to meet application demands
- Flexible, time-saving installation using DIN Rail mounting with A and B frame drives
- Feed-through wiring for simple retrofitting into applications requiring variable speed motor control
- Side-by-side mounting in ambient temperatures up to 40 °C (104 °F), saving valuable panel space



Providing powerful motor speed control in a compact, space saving design, the Allen-Bradley® PowerFlex 4M AC drive is the smallest and most cost-effective member of the PowerFlex family of drives.

Integral human interface module (HIM) with a 4-digit display for simple configuration

Drives operate up to 50 °C (122 °F) with minimal spacing

5 digital inputs (24V DC, 2 programmable)  
1 analog input (unipolar voltage or current)  
1 relay (form C)

Supports a wide range of communication option cards, including EtherNet/IP and DeviceNet

An integral RS485/DSI port supports low-cost multi-drive networking

Feed-through wiring for simple retrofitting

A compact footprint requires a 120 mm (4.7 in.) air-flow gap at the top and bottom of the drive, helping save space inside a panel

#### Contactors



2-2...2-15

#### Starters



2-16...2-29

#### Motor Protection



2-30...2-35

#### Smart Motor Control



2-36...2-45

#### Drives



2-46...2-51



## Product Selection

### Single-Phase, 50/60 Hz, No Brake, IP20, NEMA/UL Type Open

Drive Ratings		100...120V AC			200...240V AC			Cat. No. with EMC Filter
kW	Hp	Output Current [A]	Frame Size	Cat. No.	Output Current [A]	Frame Size	Cat. No.	
0.2	0.25	1.6	A	22F-V1P6N103	1.6	A	22F-A1P6N103	22F-A1P6N113
0.4	0.5	2.5	A	22F-V2P5N103	2.5	A	22F-A2P5N103	22F-A2P5N113
0.75	1	4.5	B	22F-V4P5N103	4.2	A	22F-A4P2N103	22F-A4P2N113
1.1	1.5	6	B	22F-V6P0N103	-	-	-	-
1.5	2	-	-	-	8	B	22F-A8P0N103	22F-A8P0N113
2.2	3	-	-	-	11	B	22F-A011N103	22F-A011N113

### Three-Phase, 50/60 Hz, No Brake, IP20, NEMA/UL Type Open

Drive Ratings		200...240V AC			380...480V AC			Cat. No. with EMC Filter
kW	Hp	Output Current [A]	Frame Size	Cat. No.	Output Current [A]	Frame Size	Cat. No.	
0.2	0.25	1.6	A	22F-B1P6N103	-	-	-	-
0.4	0.5	2.5	A	22F-B2P5N103	1.5	A	22F-D1P5N103	22F-D1P5N113
0.75	1	4.2	A	22F-B4P2N103	2.5	A	22F-D2P5N103	22F-D2P5N113
1.5	2	8	A	22F-B8P0N103	4.2	A	22F-D4P2N103	22F-B8P0N103
2.2	3	12	B	22F-B012N103	6	B	22F-D6P0N103	22F-D6P0N113
3.7	5	17.5	B	22F-B017N103	8.7	B	22F-D8P7N103	22F-D8P7N113
5.5	7.5	25	C	22F-B025N104	13	C	22F-D013N104	22F-D013N114
7.5	10	33	C	22F-B033N104	18	C	22F-D018N104	22F-D018N114
11	15	-	-	-	24	C	22F-D024N104	22F-D024N114

## Specifications

<b>Power Ratings</b>	100...120V: 0.2...1.1 kW / 0.25...1.5 Hp 200...240V: 0.2...7.5 kW / 0.25...10 Hp	380...480V: 0.4...11 kW / 0.5...15 Hp	
<b>Motor Control</b>	Volts per Hertz	Slip compensation	-
<b>Application</b>	Open loop speed regulation	-	-
<b>Control I/O</b>	5 digital inputs (24V DC, 2 programmable)	1 analog input (unipolar voltage or current)	1 relay (form C)
<b>Communications</b>	Integral RS485 with Modbus RTU/DSI	Optional: DeviceNet, Bluetooth, EtherNet/IP, PROFIBUS DP, ControlNet, BACnet (Optional networks for use only with external DSI communications kit)	
<b>Control Features</b>	Flying start V/F ratio	Bus regulator Auto Restart	4 preset speeds Multi-drive connectivity (requires communication option card)



# Drives

MOTOR CONTROL

## AC Drives 25A PowerFlex® 523

- Power ratings of 0.2...22 kW / 0.25...30 Hp in global voltage classes from 100...600V to meet a wide range of applications
- Modular design features a removable control module that allows simultaneous wiring installation and software configuration to help increase productivity
- AppView® application parameter groups and CustomView™ configuration help speed machine commissioning
- Volts per Hertz and sensorless vector control provide flexible motor control options



Allen-Bradley PowerFlex 523 AC drives are designed to help reduce installation and configuration time while offering the control you need for your application. These drives offer convenient programming features and installation flexibility in a cost-effective solution.

Supports a wide range of communication option cards, including dual port EtherNet/IP™ and DeviceNet

An integral RS485/DSI port supports low-cost multi-drive networking

A compact footprint requires a 50 mm (1.96 in.) mounting clearance for air flow at the top and bottom of the drive, helping save space inside a panel

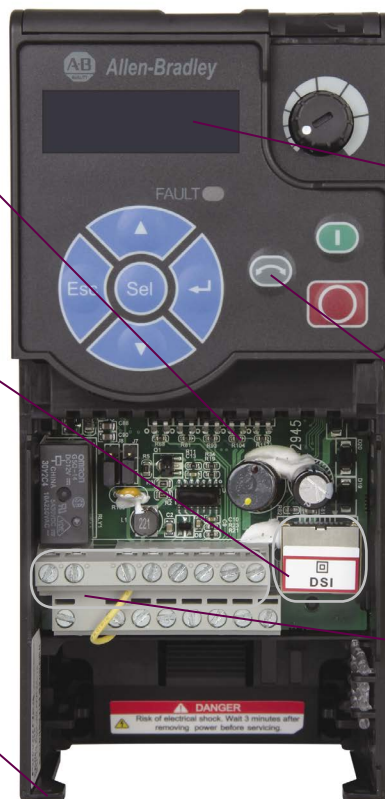

An integral LCD human interface module (HIM) eases configuration with multi-language support and QuickView™ scrolling text to help explain parameters and codes

Drives operate in ambient temperatures from -20...+50 °C (-4...+122 °F). With current derating and a control module fan kit, up to 70 °C (158 °F)

5 digital inputs (24V DC, 4 programmable)  
1 analog input (unipolar voltage or current)  
1 relay (form C)

Explore the PowerFlex 523 AC drive in our virtual brochure:  
[rok.auto/PowerFlex520](http://rok.auto/PowerFlex520)

### Contactors



2-2...2-15

### Starters



2-16...2-29

### Motor Protection



2-30...2-35

### Smart Motor Control



2-36...2-45

### Drives



2-46...2-51



## Product Selection

### Single-Phase

Drive Ratings, Normal & Heavy Duty		100...120V AC, 50/60 Hz			200...240V AC, 50/60 Hz			
kW	Hp	Output Current [A]	Frame Size	Cat. No.	Output Current [A]	Frame Size	Cat. No.	Cat. No. with EMC Filter
0.2	0.25	1.6	A	25A-V1P6N104	1.6	A	25A-A1P6N104	25A-A1P6N114
0.4	0.5	2.5	A	25A-V2P5N104	2.5	A	25A-A2P5N104	25A-A2P5N114
0.75	1	4.8	B	25A-V4P8N104	4.8	A	25A-A4P8N104	25A-A4P8N114
1.1	1.5	6	B	25A-V6PON104	-	-	-	-
1.5	2	-	-	-	8	B	25A-A8PON104	25A-A8PON114
2.2	3	-	-	-	11	B	25A-A011N104	25A-A011N114

### Three-Phase

Drive Ratings				200...240V AC, 50/60 Hz			380...480V AC, 50/60 Hz				525...600V AC, 50/60 Hz		
Normal Duty		Heavy Duty		Output Current [A]	Frame Size	Cat. No.	Output Current [A]	Frame Size	Cat. No.	Cat. No. with EMC Filter	Output Current [A]	Frame Size	Cat. No.
kW	Hp	kW	Hp										
0.2	0.25	0.2	0.25	1.6	A	25A-B1P6N104	-	-	-	-	-	-	-
0.4	0.5	0.4	0.5	2.5	A	25A-B2P5N104	1.4	A	25A-D1P4N104	25A-D1P4N114	0.9	A	25A-E0P9N104
0.75	1	0.75	1	4.8	A	25A-B5PON104	2.3	A	25A-D2P3N104	25A-D2P3N114	1.7	A	25A-E1P7N104
1.5	2	1.5	2	8	A	25A-B8PON104	4	A	25A-D4PON104	25A-D4PON114	3	A	25A-E3PON104
2.2	3	2.2	3	11	A	25A-B011N104	6	A	25A-D6PON104	25A-D6PON114	4.2	A	25A-E4P2N104
4	5	4	5	17.5	B	25A-B017N104	10.5	B	25A-D010N104	25A-D010N114	6.6	B	25A-E6P6N104
5.5	7.5	5.5	7.5	24	C	25A-B024N104	13	C	25A-D013N104	25A-D013N114	9.9	C	25A-E9P9N104
7.5	10	7.5	10	32.3	D	25A-B032N104	17	C	25A-D017N104	25A-D017N114	12	C	25A-E012N104
11	15	11	15	48.3	E	25A-B048N104	24	D	25A-D024N104	25A-D024N114	19	D	25A-E019N104
15	20	11	15	62.1	E	25A-B062N104	30	D	25A-D030N104	25A-D030N114	22	D	25A-E022N104
18.5	25	15	20	-	-	-	37	E	-	25A-D037N114	27	E	25A-E027N104
22	30	18.5	25	-	-	-	43	E	-	25A-D043N114	32	E	25A-E032N104

## Specifications

<b>Power Ratings</b>	100...120V: 0.2...1.1 kW / 0.25...1.5 Hp 380...480V: 0.4...22 kW / 0.5...30 Hp	200...240V: 0.2...15 kW / 0.25...20 Hp 525...600V: 0.4...22 kW / 0.5...30 Hp
<b>Motor Control</b>	Volts per Hertz	Sensorless vector control Sensorless vector control with Economizer
<b>Application</b>	Open loop speed regulation	-
<b>Control I/O</b>	5 digital inputs (24V DC, 4 programmable)	1 relay (form c) 1 analog input (unipolar voltage or current)
<b>Communications</b>	Integral RS485 with Modbus RTU/DSI PROFIBUS® DP option card	DeviceNet option card Dual port EtherNet/IP option card
<b>Control Features</b>	Flying start W/F ratio Bus regulator Process PID	Common DC bus Fiber application specific features PTC input compatible 1/2 DC bus operation 8 datalinks (4 in and 4 out, requires comm. option card) Multi-drive connectivity (requires comm. option card) 8 preset speeds

For more information on our complete family of compact drives, please visit:  
[rok.auto/compact-drives](http://rok.auto/compact-drives)



# Drives

MOTOR CONTROL

## AC Drives 25B PowerFlex® 525

- Power ratings of 0.4...22 kW / 0.5...30 Hp in global voltage classes from 100...600V to meet a wide range of applications
- Standard built-in single port for EtherNet/IP and Safe Torque Off
- AppView application parameter groups and CustomView configuration help speed machine commissioning



Allen-Bradley PowerFlex 525 AC drives are designed to support fast and easy installation and configuration and provide a variety of motor control and flexible mounting options. Available with standard built in EtherNet/IP communications and safe torque-off.

An embedded port for EtherNet/IP supports seamless integration into the Logix environment and EtherNet/IP networks

- 7 digital inputs (24V DC, 6 programmable)
- 2 analog inputs (1 bipolar voltage, 1 current)
- 2 digital outputs
- 1 analog output (1 unipolar voltage or current)
- 2 relays (1 form A relay & 1 form B relay; 24V DC, 120V AC, 240V AC)

Embedded Safe Torque Off can help to protect personnel

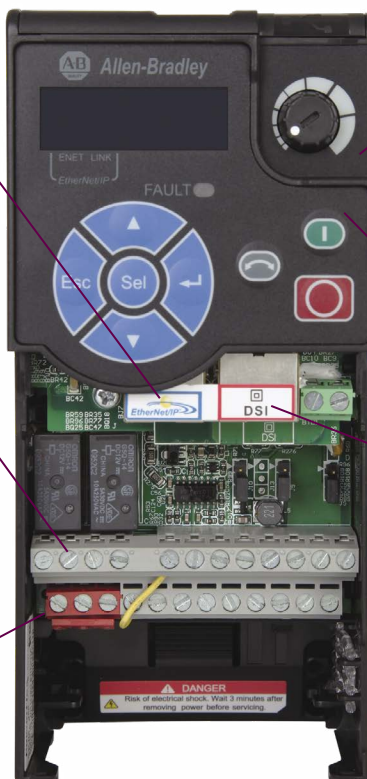

Modular design features a removable control module that allows simultaneous wiring installation and software configuration to help increase productivity

Volts per Hertz, sensorless vector control, closed loop velocity vector control and permanent magnet motor control to meet a wide range of applications<sup>1</sup>

A built in DSI port supports multi-drive networking, connecting up to five PowerFlex AC drives on one node

2-50

Contactors



2-2...2-15

Starters



2-16...2-29

Motor Protection



2-30...2-35

Smart Motor Control



2-36...2-45

Drives



2-46...2-51

## Product Selection

### Single-Phase

Drive Ratings, Normal & Heavy Duty		100...120V AC, 50/60 Hz			200...240V AC, 50/60 Hz			
kW	Hp	Output Current [A]	Frame Size	Cat. No.	Output Current [A]	Frame Size	Cat. No.	Cat. No. with EMC Filter
0.4	0.5	2.5	A	25B-V2P5N104	2.5	A	25B-A2P5N104	25B-A2P5N114
0.75	1	4.8	B	25B-V4P8N104	4.8	A	25B-A4P8N104	25B-A4P8N114
1.1	1.5	6	B	25B-V6P0N104	-	-	-	-
1.5	2	-	-	-	8	B	25B-A8P0N104	25B-A8P0N114
2.2	3	-	-	-	11	B	25B-A011N104	25B-A011N114

### Three-Phase

Drive Ratings				200...240V AC, 50/60 Hz			380...480V AC, 50/60 Hz				525...600V AC, 50/60 Hz		
Normal Duty		Heavy Duty		Output Current [A]	Frame Size	Cat. No.	Output Current [A]	Frame Size	Cat. No.	Cat. No. with EMC Filter	Output Current [A]	Frame Size	Cat. No.
kW	Hp	kW	Hp										
0.4	0.5	0.4	0.5	2.5	A	25B-B2P5N104	1.4	A	25B-D1P4N104	25B-D1P4N114	0.9	A	25B-E0P9N104
0.75	1	0.75	1	4.8	A	25B-B5P0N104	2.3	A	25B-D2P3N104	25B-D2P3N114	1.7	A	25B-E1P7N104
1.5	2	1.5	2	8	A	25B-B8P0N104	4	A	25B-D4P0N104	25B-D4P0N114	3	A	25B-E3P0N104
2.2	3	2.2	3	11	A	25B-B011N104	6	A	25B-D6P0N104	25B-D6P0N114	4.2	A	25B-E4P2N104
4	5	4	5	17.5	B	25B-B017N104	10.5	B	25B-D010N104	25B-D010N114	6.6	B	25B-E6P6N104
5.5	7.5	5.5	7.5	24	C	25B-B024N104	13	C	25B-D013N104	25B-D013N114	9.9	C	25B-E9P9N104
7.5	10	7.5	10	32.3	D	25B-B032N104	17	C	25B-D017N104	25B-D017N114	12	C	25B-E012N104
11	15	11	15	48.3	E	25B-B048N104	24	D	25B-D024N104	25B-D024N114	19	D	25B-E019N104
15	20	11	15	62.1	E	25B-B062N104	30	D	25B-D030N104	25B-D030N114	22	D	25B-E022N104
18.5	25	15	20	-	-	-	37	E	-	25B-D037N114	27	E	25B-E027N104
22	30	18.5	25	-	-	-	43	E	-	25B-D043N114	32	E	25B-E032N104

## Specifications

<b>Power Ratings</b>	100...120V: 0.2...1.1 kW / 0.25...1.5 Hp 380...480V: 0.4...22 kW / 0.5...30 Hp	200...240V: 0.2...15 kW / 0.25...20 Hp 525...600V: 0.4...22 kW / 0.5...30 Hp	
<b>Motor Control</b>	Volts per Hertz	Sensorless vector control	Sensorless vector control with Economizer
<b>Application</b>	Open loop speed regulation	-	-
<b>Control I/O</b>	5 digital inputs (24V DC, 4 programmable)	1 relay (form c)	1 analog input (unipolar voltage or current)
<b>Communications</b>	Integral RS485 with Modbus RTU/DSI PROFIBUS® DP option card	DeviceNet option card	Dual port EtherNet/IP option card
<b>Control Features</b>	Flying start, Fiber application specific features, 8 datalinks (4 in and 4 out), V/F ratio, Common DC bus, Position control, Bus regulator, 1/2 DC bus operation, StepLogic Function (Relay & Timers), Process PID, Regulation with encoder feedback or analog input, 16 preset speeds, PTC input compatible, Multi-drive connectivity (requires communication option card)		

For more information on our complete family of compact drives, please visit:  
[rok.auto/compact-drives](http://rok.auto/compact-drives)





# Additional Motor Control & Protection Products

## CrossBoard® System

The CrossBoard System provides flexibility in motor control and protection devices. The out-of-the-box system is provided as one complete base unit, a bus structure with touch-safe plastic housing, that can be directly assembled and fitted with components after unpacking. Components simply snap onto the CrossBoard without tools, meaning the connection is automatic. Available in two widths (225 and 405 mm), the base units can be combined by adding a supply module to bridge the base units.



Available in two widths

- Space saving and clear, clean design
- High degree of safety with IEC 61439 and UL 508 standard ratings, including IP20 touch-safe protection
- Out-of-the-box system that saves substantial time on installation and maintenance
- System components plug in easily without tools
- Up to 100 A UL (125 A IEC)

## A True Plug and Play Power Distribution System

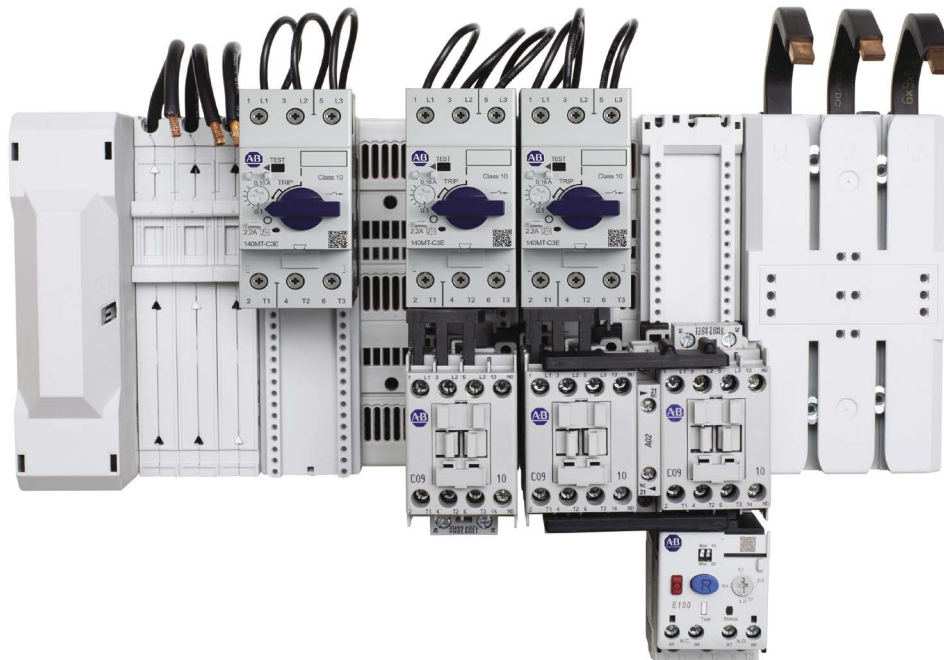

### Three mounting options:

#### Standard DIN

- 225 mm - up to 2 kg
- 405 mm - up to 2 kg

#### Deep Profile DIN

- 225 mm - up to 2 kg
- 405 mm - up to 2 kg

#### Panel Mounted

- Recommended

Contactors



2-2...2-15

Starters



2-16...2-29

Motor Protection



2-30...2-35

Smart Motor Control



2-36...2-45

Drives



2-46...2-51

## ArmorStart® Distributed Motor Controllers

- Offers EtherNet/IP™ or DeviceNet™ communication capabilities and Embedded Switch Technology
- Offers local disconnecting means, embedded field I/O, and local logic that uses DeviceLogix® software
- Offers LED status and diagnostic indication
- Includes a hardened wash-down rating with the ability to mount the device near the motor or machine, which provides shorter cable runs
- Allows the ability to choose factory-installed options for specific applications
- Is suitable for group installations with high short circuit current rating
- Available for use with round quick connect power media or fixed pipe and wire



Learn more about the On-Machine Solution from the Armor Start virtual demo:  
[rok.auto/VBR-Armorstart](http://rok.auto/VBR-Armorstart)

## MachineAlert™ Dedicated Function Motor Protection Relays 809S/813S/814S/817S

- Programmable latching or inhibit at set level
- Adjustable time delay settings
- Three-phase devices are powered by the measuring circuit
- LED indication for relay, alarm, and power supply
- Global application with CE and UL approvals
- For product selection, visit <https://rok.auto/directory>.



# Additional Motor Control & Protection Products



## Molded Case Circuit Breakers

The Bulletin 140UT-D Molded Case Circuit Breaker (MCCB) is a UL489 and IEC 60947-2 compliant circuit breaker for global applications. The current-limiting circuit breaker provides fixed short-circuit and overcurrent protection and offers high interrupting ratings for 2- and 3-pole devices. These circuit breakers are suitable for back feeding at 240V and 480Y/277V.

- UL 489 and IEC 60947-2 ratings up to 40 A
- Reduce panel footprint with compact design
- Lower heat load with improved thermal performance
- SCCR tested with 100-E, 100-C and 100-K contactors and connecting modules
- Back feeding capability

## NEMA Vacuum Contactors

1102C/1104C NEMA vacuum contactors provide motor control system reliability in harsh, dirty environments.

- 1500V AC maximum
- Current ratings: 200, 400 and 600 A
- Visual ON/OFF indicator
- Line and load terminals up front for ease of wiring
- Snap-on side mount auxiliary contacts



## Lighting Contactors

The 500LG compact, modular-designed lighting contactors deliver simplicity and versatility in product configuration, to meet a wide range of applications including full-bus and split-bus lighting panelboards.

- Contacts switch ballast (fluorescent or HID), tungsten, and general use loads
- Available in 30 A rating, with up to 12 field-convertible poles (maximum of 8 N.C.)
- Finger- and back-of-hand-safe power terminals
- Electronically and mechanically held versions

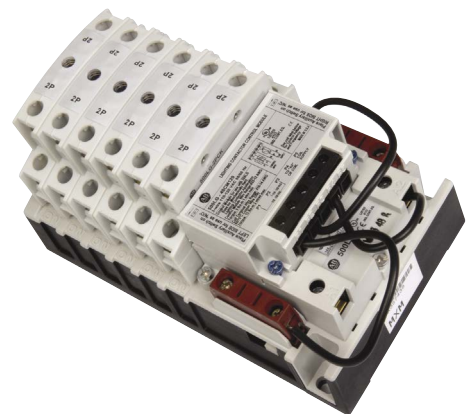

Contactors



2-2...2-15

Starters



2-16...2-29

Motor Protection



2-30...2-35

Smart Motor Control



2-36...2-45

Drives



2-46...2-51



## Enclosed At-motor Disconnecting Means

Suitable as at-motor disconnecting means (UL508), available in metal enclosures.

- 140M Motor Protection Circuit Breakers (MPCB)
- 194R Rotary Disconnect Switches

## IEC Enclosures for Low Voltage Starters

198E starter enclosures are designed for a multitude of IEC starter configurations. They are available in metal or plastic, and are suitable for either indoor or outdoor environments. The enclosures are rated UL Type 1, 3, 4, 4X, 12, 12K (IP42 to IP66).

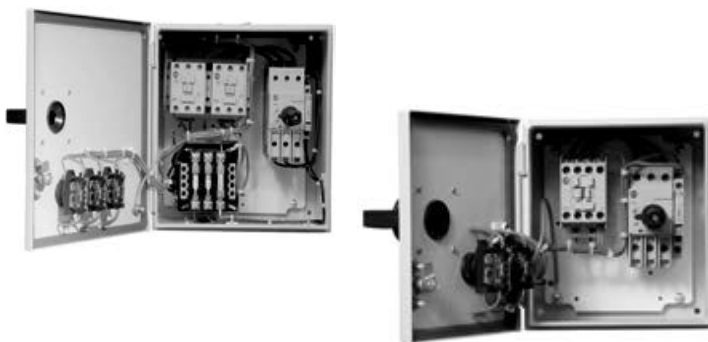

## Combination Starter, IEC 103H/107H

- Type E and Type F combination motor controllers (UL/CSA)
- 0.1...45 A
- 100-C / 104-C Contactor
- Factory-installed options available





# Additional Motor Control & Protection Products

## Enclosed Soft Starters 150, 152, 153

- 90...520 A
- Snap-together wiring technology
- Floor standing Type 1, 12, 3R (IP54) enclosures
- Up to 100 kA Interrupting Capacity



## Pump Control Panels

Solutions for a wide variety of pumping applications. Designed for standalone usage, the water-tight NEMA Type 3R enclosure can be placed either indoors or outdoors. With pole mounting brackets on the enclosure, the panel can be installed in remote locations.

- NEMA starters: durable direct-on-line (DOL), up to 200 Hp
- Smart Motor Controllers: five start/stop modes, built-in overload protection, up to 300 Hp
- PowerFlex variable frequency drives up to 250 Hp

## Hazardous Locations Solutions

- Copper-free cast aluminum alloy
- Compact designs for inside and outside applications
- Flexible configuration options
- Gasket inside cover to guard against moisture and corrosive elements



### Certifications and Ratings

- UL Listed/CSA certified
- UL classified enclosures
- Class I Division 1 & 2, Groups C, D
- 65 kA short circuit rating
- Class II Division 1 & 2, Groups E, F & G
- 10,000 A short circuit rating
- NEMA Type 3R, 7-9 rated



Contactors



2-2...2-15

Starters



2-16...2-29

Motor Protection



2-30...2-35

Smart Motor Control



2-36...2-45

Drives

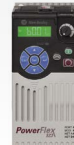

2-46...2-51



**Allen-Bradley**

by ROCKWELL AUTOMATION

## Modified Industrial Controls

Instead of waiting weeks to get industrial control products with customer requested options, our availability strategy allows our products to be configured as close to the customer as possible.

Configure products such as:

- Enclosed starters
- Stack lights
- Wiring assemblies



## Modified Industrial Control Panels

We will turn your high-volume custom panels into a repeatable solution with panels tailored to your specifications so you get exactly what you need, when you need it.

Customizable Panels Include:

- Programmable controllers
- Starters
- Distributed I/O
- Servo drives
- Push buttons and pilot lights
- Partner products and other third-party devices



For more information on Modified Industrial Controls, please visit:  
[rok.auto/modified-icp](http://rok.auto/modified-icp)



For more information on our complete family of motor control products, please visit:  
[rok.auto/motor-control](http://rok.auto/motor-control)







## Relays & Timers

Economy Timing Relays.....	3-2
High Performance Timing Relays .....	3-2
Tube Base Relays .....	3-4
Miniature Ice Cube Relays.....	3-6
Slim Line Relays .....	3-8
Terminal Block Relays.....	3-10
Dial Timing Relay .....	3-12
NEMA Heavy-Duty Relays.....	3-14
Industrial Control Relays.....	3-16
Safety Control Relays .....	3-18

## Programmable Controllers

Micro Controllers.....	3-20
Connected Components Workbench Software.....	3-21

## Signal Interface

Signal Conditioners .....	3-24
Intrinsic Safety Modules .....	3-26

# Relays & Timers

LOGIC CONTROL

## Economy Timing Relays 700-FE

- Adjustable functions and timing
- Socket-free DIN Rail mount
- Coil surge protection

## High Performance Timing Relays 700-FS

- Additional adjustable functions and timing
- Coil surge protection
- Hazardous location version available



700-FE Economy Timing Relays are a very narrow 17.5 mm wide. They have a timing range of 0.05 s...100 hr. The multi-function version helps reduce your spare parts inventory and standardize your design.

700-FS DIN Rail High Performance Timing Relays have a 22.5 mm space-saving design and a timing range of 0.05 s...300 hr. The multi-function timing helps you reduce stock and standardize your design.

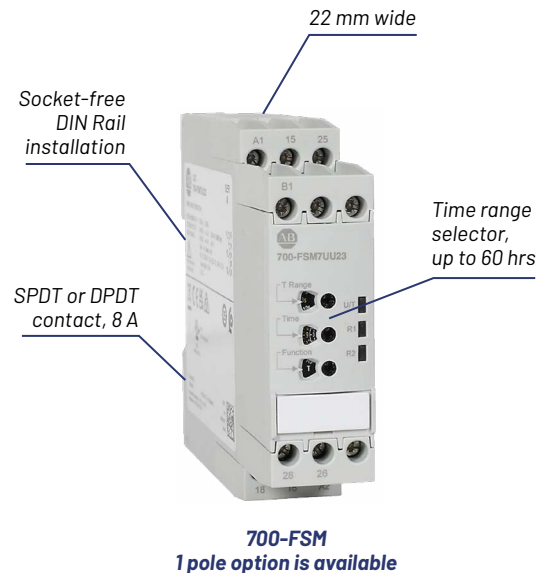
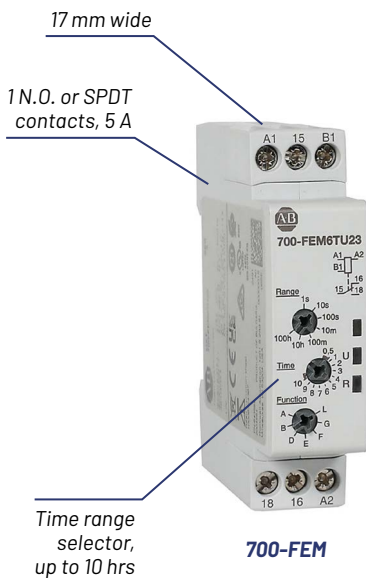

### Relays & Timers



3-2...3-19

### Programmable Controllers



3-20...3-23

### Signal Interface



3-24...3-27



## Product Selection

### Economy and High Performance Timing Relays

#### Multi-Function

This device offers you the flexibility of selecting one of 7 single timing functions.

Operating Mode	Contact Output	Timing Range <sup>1</sup>	Input Voltage	Cat. No.
ON-delay, OFF-delay, One Shot, Flasher (repeat cycle starting with pulse), Fleeting OFF-Delay, Pulse Former, Flasher (Repeat Cycle starting with pause).	SPDT (1 C/O)	0.05 s...100 hr (7 settings)	24...48V DC 24...240V AC 50/60 Hz	700-FEM6TU23
	DPDT (2 C/O)		12...240V AC/DC	700-FEM6TZ12

<sup>1</sup> Time ranges: 0.05...1 s, 0.5...10 s, 5...100 s, 0.5...10 min, 5...100 min, 0.5...10 h, 5...100 h

#### Single-Function

This device offers you one specific timing function.

Operating Mode	Contact Output	Timing Range <sup>1</sup>	Input Voltage	Cat. No.
ON-delay	SPDT (1 C/O)	0.05 s...100 hr (7 settings)	24V...48V DC 24...240V AC 50/60 Hz	700-FEA6TU23
OFF-delay	SPDT (1 C/O)	0.05 s...100 hr (7 settings)	24V...48V DC 24...240V AC 50/60 Hz	700-FEB6TU23
One Shot	SPDT (1 C/O)	0.05 s...100 hr (7 settings)	24V...48V DC 24...240V AC 50/60 Hz	700-FED6TU23
Flasher (repeat cycle starting with pulse)	SPDT (1 C/O)	0.05 s...100 hr (7 settings)	24V...48V DC 24...240V AC 50/60 Hz	700-FEF6TU23

<sup>1</sup> Time ranges: 0.05...1 s, 0.5...10 s, 5...100 s, 0.5...10 min, 5...100 min, 0.5...10 h, 5...100 h

#### Special Function

Operating Mode	Contact Output	Timing Range <sup>1</sup>	Input Voltage	Cat. No.
Star-Delta	2 N.O. with 1 Common	0.15 s...10 min (4 settings)	24V...48V DC 24...240V AC 50/60 Hz	700-FEY6QU23

<sup>1</sup> Time ranges: 0.05...1 s, 0.5...10 s, 5...100 s, 0.5...10 min

## Accessories

### 700-FE

Description	Pkg. Qty	Cat. No.
Panel mounting adapter - For surface mounting according to drilling plan EN 50002	5	199-FSA





# Relays & Timers

LOGIC CONTROL

## Tube Base Relays 700-HA

- 10 A contact rating
- DPDT or 3PDT
- Pin-style (8- or 11-pin)
- ON/OFF flag indicator
- LED, push-to-test with manual override options
- Optional bifurcated gold-plated contacts available for low energy switching



Tube-style bases are popular in general-purpose relay applications and meet a wide range of needs with 2-pole (8-pin) and 3-pole (11-pin) options. Socket bases are available in North American (open) and IEC (guarded) styles.

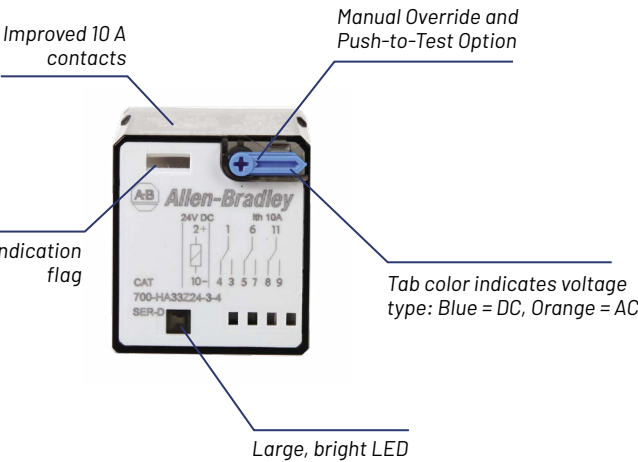

### Ideal Applications

- Switching currents or voltage too high for PLC outputs to handle
- Interfacing two or more system voltages - for example, 24V to 120V

### Relays & Timers



3-2...3-19

### Programmable Controllers



3-20...3-23

### Signal Interface



3-24...3-27



## Product Selection

### Tube Base Relays

Description	Contact Rating	Coil Voltage	Cat. No. <sup>1, 2, 3, 4</sup>	
			2-pole (DPDT) 8-pin, 2 Form C	3-pole (3PDT) 11-pin, 3 Form C
General purpose relay single AgNi contact	10 A B300	12V AC	700-HA32A12	700-HA33A12
		24V AC	700-HA32A24	700-HA33A24
		120V AC	700-HA32A1	700-HA33A1
		230V AC	700-HA32A03	700-HA33A03
		240V AC	700-HA32A2	700-HA33A2
		12V DC	700-HA32Z12	700-HA33Z12
		24V DC	700-HA32Z24	700-HA33Z24
		110V DC	700-HA32Z1	700-HA33Z1
		125V DC	700-HA32Z01	700-HA33Z01

<sup>1</sup> LED Option: Add suffix **-4** to the selected 700-HA Relay Catalog number; for the 240V AC units, add **-4L**.

<sup>2</sup> Push-to-test, Manual Override, and LED Option: Add suffix **-3-4** to the selected 700-HA Relay Catalog number; for the 240V AC units, add **-3-4L**.

<sup>3</sup> Push-to-test and Manual Override option: Add suffix **-3** to the selected 700-HA relay.

<sup>4</sup> For Gold-plated bifurcated contacts, please visit <https://rok.auto/directory>.

**700-HN100****700-HN205**

## Accessories

Description	Pkg. Qty.	Cat. No.	
Screw terminal tube base socket - guarded terminal style	2-pole (DPDT) 8-pin	10	700-HN100
	3-pole (3PDT) 11-pin	10	700-HN101
Screw terminal tube base socket open style construction	2-pole (DPDT) 8-pin	10	700-HN125
	3-pole (3PDT) 11-pin	10	700-HN126
Screw terminal tube base socket For use with or without timing/surge suppression module - guarded terminal style	2-pole (DPDT) 8-pin	10	700-HN204
	3-pole (3PDT) 11-pin	10	700-HN205
Diode with LED surge suppressor <sup>5</sup>	10	700-ADL1R	
Diode surge suppressor <sup>5</sup>	10	700-ADR	
RC surge suppressor <sup>5</sup>	10	700-AR2	
Timing module <sup>5</sup>	1	700-AT3	
Varistor with LED surge suppressor <sup>5</sup>	10	700-AV3R	
Multi-function multi-range time module <sup>5, 6</sup>	1	700-HT3	

<sup>5</sup> Suppressors and timer modules easily plug into sockets (catalog numbers 700-HN204 and 700-HN205). For use with 700-HA relays.

<sup>6</sup> Catalog number 700-HT3 is wired with signal "S" connected to "A1". See wiring diagram marked on the timer module.





# Relays & Timers

## Miniature Ice Cube Relays 700-HC

- 7 or 10 A contact ratings
- DPDT or 4PDT
- Blade-style
- ON/OFF flag indicator
- LED, push-to-test with manual override options
- Optional bifurcated gold-plated contacts available for low energy switching



700-HC Miniature Square Base Relays are 2-pole or 4-pole plug-in relays for your low-energy switching applications. The same sockets can be used for DPDT or 4PDT versions, which improves flexibility and reduces inventory.

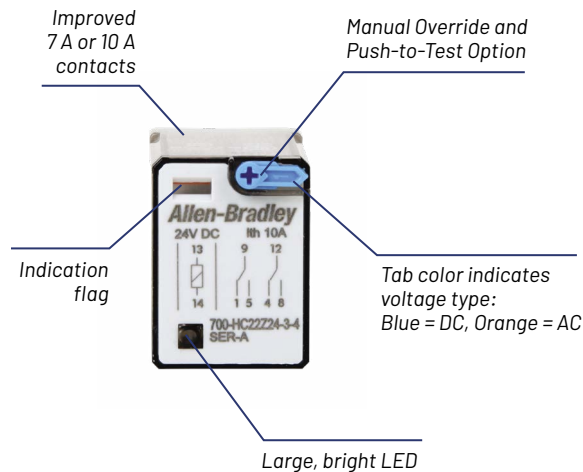

### Ideal Applications

- Provides longer life for PLC, saving money and increasing efficiency
- Switching currents or voltages too high for PLC outputs to handle
- Interfacing two or more system voltages – for example, 24V to 120V
- Multiplies PLC outputs by using relays to turn many devices on and off simultaneously
- Provides isolation from solid-state output leakage current

### Relays & Timers



3-2...3-19

### Programmable Controllers



3-20...3-23

### Signal Interface



3-24...3-27



## Product Selection

### Miniature Ice Cube Relays

Description	Contact Rating	Coil Voltage	Pkg. Qty.	Cat. No. <sup>1,2,3,4</sup>
DPDT 2-pole 2 form C contacts: 10 A = AgNi contacts	10 A C300 R300 Low energy rating; (10V, 10 mA)	24V DC	1	700-HC22Z24
		120V AC		700-HC22A1
4PDT 4-pole 4 form C contacts: 7 A = AgNi contacts	7 A C300 R300 Low energy rating; (10V, 10 mA)	24V AC	1	700-HC24A24
		120V AC		700-HC24A1
		240V AC		700-HC24A2
		12V DC		700-HC24Z12
		24V DC		700-HC24Z24
		48V DC		700-HC24Z48

<sup>1</sup> LED option: Add suffix **-4** to the selected 700-HC relay catalog number; for the 240V AC units, add **-4L**.

<sup>2</sup> Push-to-test and LED option: Add suffix **-3-4** to the selected 700-HC relay catalog number; for the 240V AC units, add **-3-4L**.

<sup>3</sup> Push-to-test and Manual Override option: Add suffix **-3** to the selected 700-HC relay.

<sup>4</sup> For Gold-plated bifurcated contacts, please visit <https://rok.auto/directory>.

**700-HN103****700-HN104**

## Accessories

Description	Pkg. Qty.	Cat. No.
Screw terminal socket – guarded terminal style	10	700-HN103
Screw terminal socket for use with or without timing/surge suppression module – guarded terminal style	10	700-HN104
Screw terminal base socket – Open-style construction	10	700-HN128
Diode with LED surge suppressor <sup>5</sup>	10	700-ADL1R
Diode surge suppressor <sup>5</sup>	10	700-ADR
RC surge suppressor <sup>5</sup>	10	700-AR2
Timing module <sup>5</sup>	1	700-AT3
Varistor with LED surge suppressor <sup>5</sup>	10	700-AV3R
Multi-function multi-range time module <sup>5,6</sup>	1	700-HT3

<sup>5</sup> Suppressors and Time Modules easily plug into socket (catalog number 700-HN104). For use with 700-HC relays.

<sup>6</sup> Catalog number 700-HT3 is wired with signal "S" connected to "A1." See wiring diagram marked on the timer module.



# Relays & Timers

## Slim Line Relays 700-HK

- 8 A (2-pole) or 16 A (1-pole) contact ratings
- DPDT or SPDT
- Blade-style
- ON/OFF flag indicator
- LED, push-to-test and manual override options
- Standard or gold-plated AgNi contacts
- Maximum duty version available
- Screw or push-in socket terminals

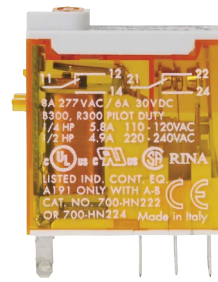

The 700-HK relays are designed for a variety of high-density isolation and interposing applications. Installation is easy and cost effective through the use of the 8-way jumper wiring system that requires only one wire connection to a coil, common or contact power distribution terminal. Optional gold contacts switch low-energy loads reliably as low as 5V, 10 mA, 50 mW.

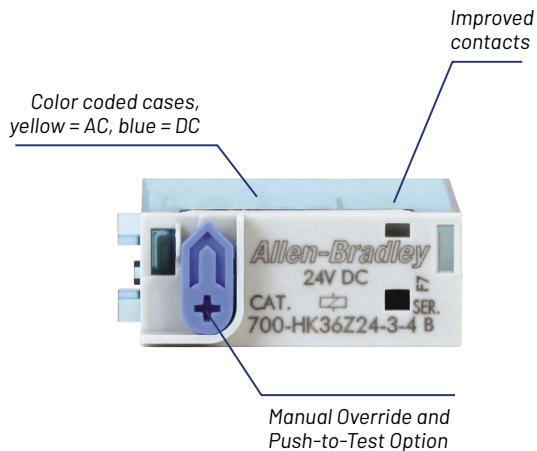
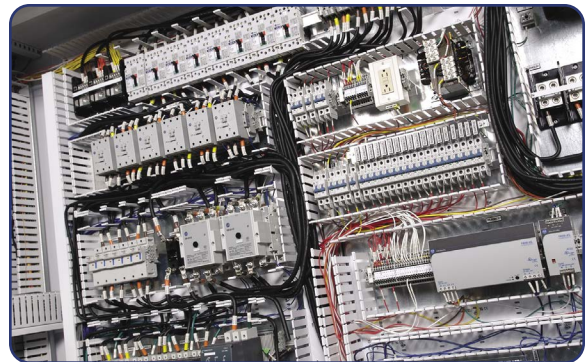

### Ideal Applications

- Provides longer life for PLC, saving money and increasing efficiency
- Switching currents or voltages too high for PLC outputs to handle
- Interfacing two or more system voltages – for example, 24V to 120V
- Multiplies PLC outputs by using relays to turn two devices on and off simultaneously
- Provides isolation from solid-state output leakage current

### Relays & Timers



3-2...3-19

### Programmable Controllers



3-20...3-23

### Signal Interface



3-24...3-27



# Product Selection

## Slim Line Relay

Description	Contact Rating	Coil Voltage	Pkg. Qty.	Cat. No. <sup>1, 2, 3</sup>
SPDT 1-pole 1 form C AgNi contacts	16 A	24V AC	1	700-HK36A24
		120V AC		700-HK36A1
		240V AC		700-HK36A2
		12V DC		700-HK36Z12
		24V DC		700-HK36Z24
		110V DC		700-HK36Z1
DPDT 2-pole 2 form C AgNi contacts	8 A	24V AC	1	700-HK32A24
		120V AC		700-HK32A1
		240V AC		700-HK32A2
		12V DC		700-HK32Z12
		24V DC		700-HK32Z24
		110V DC		700-HK32Z1

<sup>1</sup> LED option: Add suffix **-4** to the selected 700-HK relay catalog number; for the 240V AC units, add **-4L**.  
<sup>2</sup> Push-to-test and LED option: Add suffix **-3-4** to the selected 700-HK relay catalog number; for 240V AC units, add suffix **-3-4L**.  
<sup>3</sup> For AgNi contact with gold plating: Replace **3** with **X** in catalog number. For example, catalog number 700-HK36A1 becomes catalog number 700-HKX6A1.

## Accessories

Description	Pkg. Qty.	Cat. No.
Screw terminal socket - guarded terminal style, accepts forked lug conductors. <sup>5</sup>	10	1-pole, 5-blade, 10 A 700-HN121
		2-pole, 8-blade, 5 A 700-HN122
Push-in terminal socket <sup>5</sup>	10	1-pole, 5-blade 700-HN223
Screw terminal socket for use with or without timing/surge suppression module - guarded terminal style <sup>4, 5</sup>	10	1-pole, 5-blade, 16 A 700-HN221
		2-pole, 8-blade, 8 A 700-HN222
Push-in terminal socket <sup>5</sup>	10	2-pole, 8-blade 700-HN224
8-way jumper (can be cut to length)	1	Red 700-HN180R
	1	Grey 700-HN180G
	1	Blue 700-HN180B

<sup>4</sup> Suppressors and time modules easily plug into socket (catalog number 700-HN221). For use with 700-HK relays.  
<sup>5</sup> Socket includes retainer clip.



700-HN221



700-HN223



700-HN222



700-HN224



### Sales Offices and Distributors

Our network of sales offices and distributors offers exceptional knowledge and service to help you design, implement and support your automation investment.

<https://rok.auto/buy>



For more information on our complete family of general-purpose relay products, please visit: [rok.auto/general-purpose-relays](https://rok.auto/general-purpose-relays)

# Relays & Timers

LOGIC CONTROL

## Terminal Block Relays 700-HL / 700-HL Next Gen

- Terminal Block style (1-pole: 6.2 mm wide)
- 6 A (1-pole) or 10 A (2-pole) contact rating
- Screw or spring-clamp terminal (700-HL) & screw or push-in terminals (700-HL Next Gen)
- Silver or gold contacts
- LED, reverse polarity and surge protection
- Replaceable relay modules
- Wide range voltage input (700-HL Next Gen)

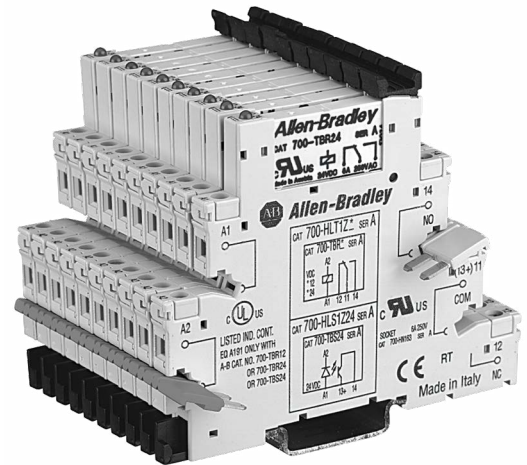

700-HL Terminal Block Relays work in a variety of high-density isolation and interposing applications. The thin per-pole interface (6.2 mm wide) and quick connections help reduce installation costs. Optional leakage current suppression circuit design addresses nuisance coil turn-on or contact non-drop-out concerns for TRIAC controller outputs. The spring-clamp terminal base option is ideal for applications that are subject to vibration.

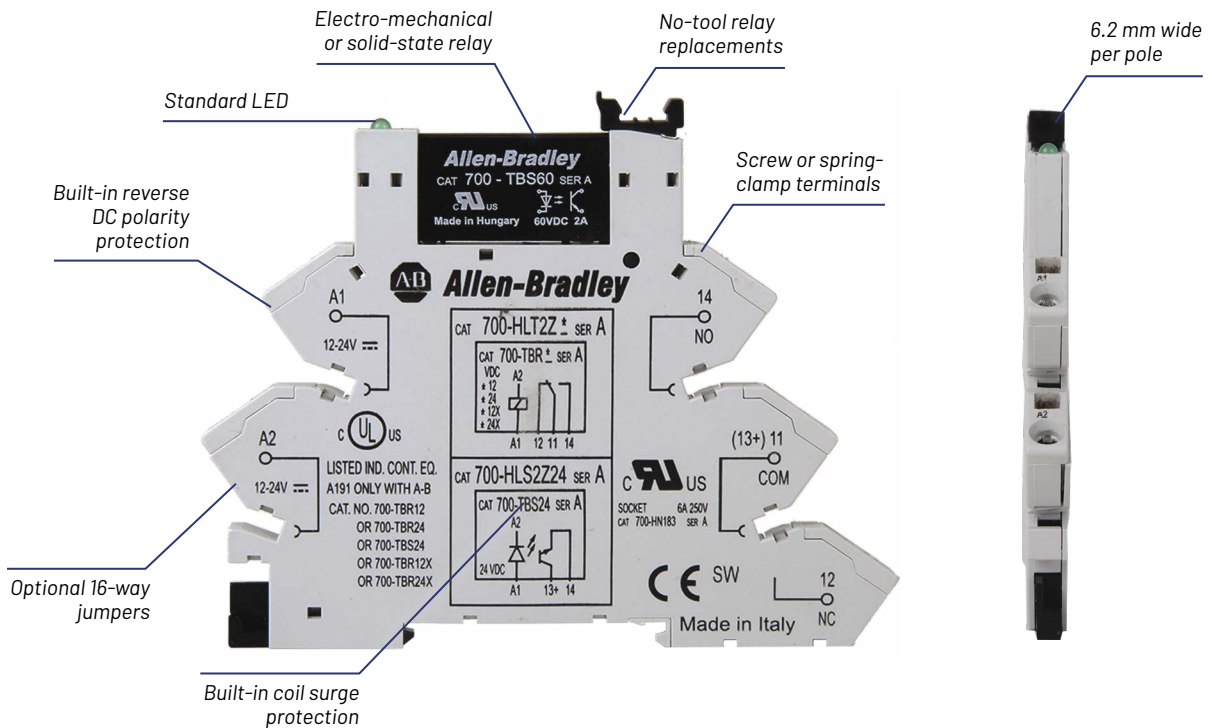

### Relays & Timers



3-2...3-19

### Programmable Controllers



3-20...3-23

### Signal Interface



3-24...3-27





## Product Selection

### Terminal Block Relay – 1-pole

Assembled Devices Input Voltage	Output Type	Pkg. Qty.	Screw Terminals	Spring-Clamp Terminals	Solid-State			
					Screw Terminals (DC Output)	Spring Clamp Terminals (DC Output)	Screw Terminals (AC Output)	
					Cat. No. <sup>1</sup>			
24V DC	SPDT (1 C/O); $I_{th} = 6$ A	10	700-HLT1Z24 <sup>3</sup>	700-HLT2Z24	700-HLS1Z24 <sup>3</sup>	700-HLS2Z24	700-HLS1Z24	
24V AC/DC			700-HLT1U24	700-HLT2U24	–	–	–	
110/125V AC/DC			700-HLT1U1 <sup>3</sup>	700-HLT2U1	700-HLS1U1 <sup>3</sup>	700-HLS2U1	700-HLS1U1	
220...240V AC/DC			700-HLT1U2 <sup>3</sup>	700-HLT2U2	700-HLS1U2 <sup>3</sup>	700-HLS2U2	700-HLS1U2	
Built-in LCSC (leakage current suppression circuit) <sup>2,3</sup>			120V AC and 125V DC	700-HLT1L1 <sup>3</sup>	–	700-HLS1L1 <sup>3</sup>	–	700-HLS1L1
			240V AC	700-HLT1L2 <sup>3</sup>	–	700-HLS1L2 <sup>3</sup>	–	700-HLS1L2

### Terminal Block Relay - 1 and 2 Pole Screw and Push-in

Input Voltage	Pkg. Qty.	Cat No. (Screw Terminals)	Cat No. (Push-in Terminals)	Cat No. (Screw Terminals) (DC Output)	Cat No. (Push-in Terminals) (DC Output)	Cat No. (Screw Terminals) (AC Output)	Cat No. (Push-in Terminals) (AC Output)
12V AC/DC	10	700-HLTN1U12	700-HLTN2U12	–	–	–	–
24V AC/DC	10	700-HLTN1U24	700-HLTN2U24	700-HLSN1U24	700-HLSN2U24	700-HLSN1U24	700-HLSN2U24
24...240V AC/DC <sup>4</sup>	10	700-HLTN1U18	700-HLTN2U18	700-HLSN1U18	700-HLSN2U18	700-HLSN1U18	700-HLSN2U18

### Terminal Block Relay – 2-pole

Assembled Devices Input Voltage	Output Type	Pkg. Qty.	Screw Terminals	Spring-Clamp Terminals
			Cat. No. <sup>1</sup>	
12V DC	DPDT (2 C/O); $I_{th} = 10$ A	10	700-HLT1Z212	700-HLT2Z212
24V DC			700-HLT1Z224	700-HLT2Z224
24V AC/DC			700-HLT1U24	700-HLT2U24
110/125V AC/DC			700-HLT1U1	700-HLT2U1
220...240V AC/DC			700-HLT1U2	700-HLT2U2

<sup>1</sup> For gold-plated contacts, add the letter **X** at the end of the catalog number. For example: if catalog number 700-TBR24 is required with gold plating, it becomes catalog number 700-TBR24X. Gold-plated contacts are not available in the two-pole 12 and 48V DC relays.

<sup>2</sup> Leakage current suppression up to 2.2 mA off state current.

<sup>3</sup> Electromechanical relay to solid-state relay interchangeability is possible.

<sup>4</sup> Leak current suppression up to 2.2 mA off state current.

Hazardous location versions available.





# Relays & Timers

## Dial Timing Relay 700-HR

- Timing range from 0.05 s...300 hr
- 5 A contact ratings or transistor outputs
- Socket- or panel-mount
- Single- or multi-function
- Multi-voltage inputs
- Up to 8 timing functions



700-HR Dial Timing Relays are plug-in, socket-mounted timing relays. They are easy to set, and can be panel- or DIN Rail-mounted.

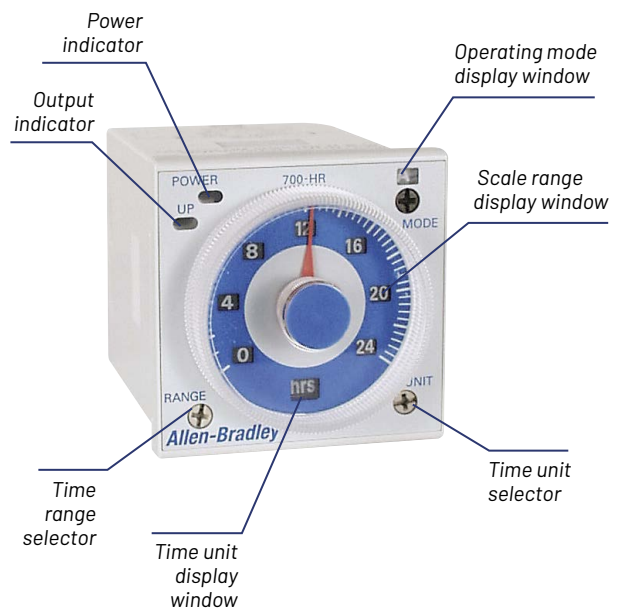

### Relays & Timers



3-2...3-19

### Programmable Controllers



3-20...3-23

### Signal Interface



3-24...3-27



# Product Selection

## Dial Timing Relay

Timing Mode	No. of Pins	Input Voltage	Contact Output	Cat. No. <sup>1</sup>
ON-delay (A), OFF-delay (D) One Shot (E), Repeat cycle OFF-Start (B), Repeat cycle ON-start (B2), Signal ON/OFF-delay (C), Delayed One Shot (J), Signal ON/OFF - delay (G)	11	24...48V AC 12...48V DC	DPDT	700-HR52TU24
		100...240V AC 100...125V DC		700-HR52TA17 <sup>2</sup>
ON-delay (A), One Shot (E), Repeat cycle OFF-start (B), Repeat cycle ON-start (B2), Delayed One Shot (J)	8	24...48V AC 12...48V DC	SPDT timed + instantaneous contact	700-HRS42TU24
		24...48V AC/DC		700-HRP42TU24
		100...240V AC 100...125V DC		DPDT 700-HRS42TA17
ON-delay (A)	8	24...48V AC/DC	SPDT timed + instantaneous contact	700-HRC12TU24
		24...48V AC 12...48V DC	DPDT	700-HRM12TU24 700-HRM12TA17
		100...240V AC	SPDT timed + instantaneous contact	700-HRC12TA17
Repeat cycle OFF-start (B)	8	12...48V DC/24...48V AC	DPDT	700-HRF72DU26
		100...125V DC/100...240V AC		700-HRF72DU27
Repeat cycle ON-start (B2)	8	100...125V DC/100...240V AC	DPDT	700-HRF82DU27

<sup>1</sup> Star-Delta model also available.

<sup>2</sup> Compatible with connections to 3-wire sensors.



700-HN100

## Accessories

Description		Pkg. Qty.	Cat. No.
Screw terminal socket - guarded terminal style	8-pin	10	700-HN100
	11-pin		700-HN101
Frame adapter - For flush or door mounting		1	700-HN130
Protective cover		1	700-HN132

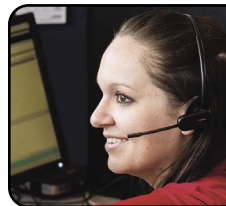

### Need Help?

The Rockwell Automation Support Center is your 24/7 support for the answers you need now.

<https://rok.auto/support>



# Relays & Timers

LOGIC

## NEMA Heavy-Duty Relays 700-P

- NEMA and IEC ratings
- 600V maximum AC/DC
- Broad current switching options (10 A, 20 A, 35 A)
- For machine tool and other heavy-duty applications

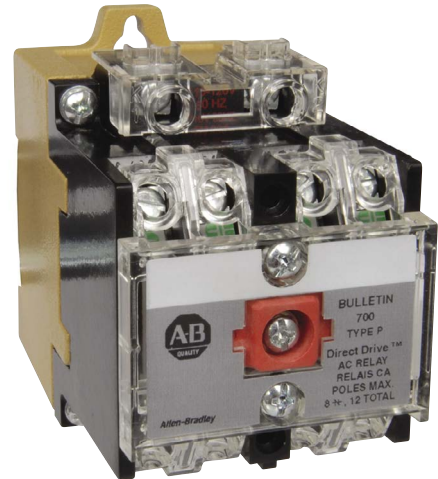

Heavy-Duty Relays have four types of contact cartridges to meet your specific switching requirements. Time delay, latching attachments, overlapping, and logic reed contacts can be combined into one relay to yield a custom-tailored application solution.

*Integral DIN Rail  
adapter on AC relays*

*Finger-safe  
protection standard*

*Convertible "swing  
around" cartridges  
(N.O. to N.C.)*

*Specified wire sizes  
are easily installed  
with the protective  
covers attached*

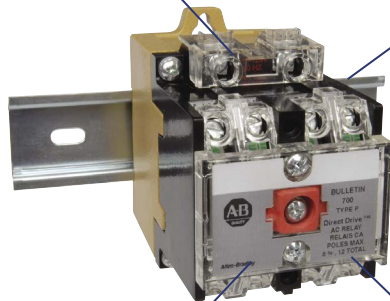

### Relays & Timers



3-2...3-19

### Programmable Controllers



3-20...3-23

### Signal Interface



3-24...3-27



## Product Selection

**NEMA Heavy-Duty Modular Relay =  
Base Blank Relay + Contact Cartridge Kit + Adder Decks (optional) + Operating Coil**

### Base Relays (up to 4 poles)

Description	Coil	Cat. No.
Base blank relay	AC	110/120V AC 700-P◆00A1
	DC	24V DC 700DC-P◆00Z24

◆ Change symbol to **0,2,4** for number of poles required. 2 and 4 pole models include standard contact cartridge.

### Individual Cartridge Selection

Description	Cat. No.
Standard contact cartridge - 10A	700-CP1
Master cartridge - 20A	700-CPM

### Contact Cartridge Kits

Description	Package Contents	Cat. No.
Master cartridge relay kit	(4) Master contact cartridges 20 A rating	700-PMCKIT
Heavy-duty contact relay kit	Master cartridge kit, plus: (4) jumper terminals (to make two 35 A power pole contacts)	700-PHDKIT



Standard contact cartridge  
700-CP1



Master contact cartridge  
700-CPM

### Adder Decks

Device Description	Additional Contact Cartridge Kits Required	Cat. No.
8 pole device	1 additional kit	700-PB00
12 pole device	2 additional kits	700-PB00 (Qty. 1) 700-PC00 (Qty. 1)

### AC Operating Coils

Coil Volts	60 Hz Cat. No.	50 Hz Cat. No.
24	PA013	PA407
110 <sup>1</sup>	—	PA236
115...120 <sup>1</sup>	PA236	—
110...115 <sup>2</sup>	—	PA322
120	PA322	—

<sup>1</sup> This coil is optimized for 115...120V, 60 Hz applications and will operate satisfactorily at 110V, 50 Hz.

<sup>2</sup> This coil is optimized for 110...115V, 50 Hz applications and will operate satisfactorily at 120V, 60 Hz.



#### Product Selection Tools

Available online or for download, our tools help you access info while in the office or on the go.

<https://rok.auto/selection>



# Relays & Timers

LOGIC

## Industrial Control Relays 700-K Mini

- Bifurcated contacts for low-level signals
- Optional integrated coil protection diode

## 700-CF / 700-EF

- Mechanically linked contact performance
- Gold-plated, bifurcated version for low level switching (700-CF)
- Master control relay version rated 15 A (AC-15 (700-CF)
- Electronic coils (700-EF)
- Wide control voltage range (700-EF)
- Add on auxiliary control blocks (front or side mount)



700-K, 700-CF and 700-EF IEC control relays are compact industrial relays capable of switching low-energy signals and providing features required for demanding industrial applications – mechanically linked contacts, timing options, long contact life – in an IEC design. These relays share accessories with the equivalent 100 IEC contactors.

### Wide range of accessories to meet your application requirements

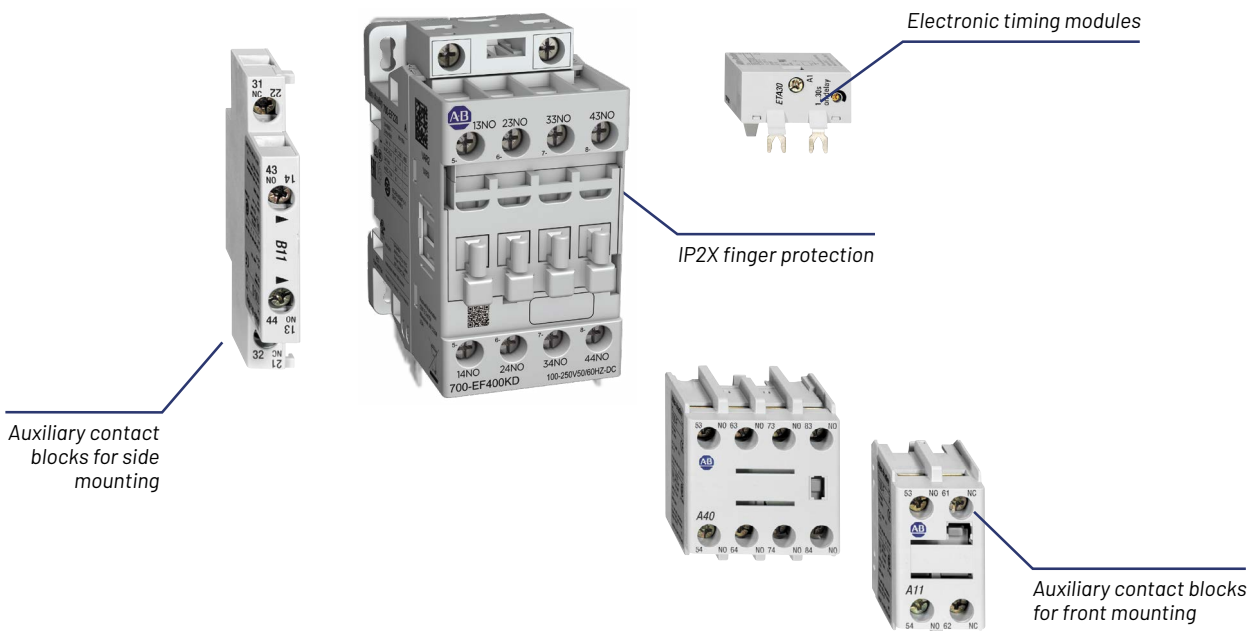

### Relays & Timers



3-2...3-19

### Programmable Controllers



3-20...3-23

### Signal Interface



3-24...3-27





## Product Selection

### Control Relays

AC-12 $I_{th}$ [A]		AC-15 $I_g$ [A]		No. of Contacts		Screw Terminals
40 °C	60 °C	240V	400V	N.O.	N.C.	Cat. No.
20	20	10	6	2	2	700-CF220⊗
				3	1	700-CF310⊗
				4	0	700-CF400⊗

⊗ The catalog number as listed is incomplete. Select a coil voltage code from the table below.

### Control Relays

AC-12 $I_{th}$ [A]	AC-15 $I_g$ [A]			No. of Contacts		Screw Terminals
</ 40 °C	24V	120V	240V	N.O.	N.C.	Cat. No.
16	6	6	4	2	2	700-EF220-⊗
				3	1	700-EF310-⊗
				4	0	700-EF400-⊗

⊗ The catalog number as listed is incomplete. Select a coil voltage code from the table below.

### Miniature Control Relays

AC-12 $I_{th}$ [A]		AC-15 $I_g$ [A]							No. of Contacts		Screw Terminals	Spring Clamp Terminals
40 °C	60 °C	24/48V	120V	240V	400V	500V	600V	690V	N.O.	N.C.	Cat. No.	Cat. No.
10	6	3	2	1	0.6	4	0	700-K40E-⊗	700-KR40E-⊗			
						3	1	700-K31Z-⊗	700-KR31Z-⊗			
						2	2	700-K22Z-⊗	700-KR22Z-⊗			
						1+1L <sup>1</sup>	1+1L <sup>1</sup>	700-KL22Z-⊗	700-KRL22Z-⊗			

<sup>1</sup> Late Break N.C. / Early Make N.O.

⊗ The catalog number as listed is incomplete. Select a coil voltage code from the table above.

#### ⊗ Coil Voltage Codes for AC and DC Control 700-CF / 700-K

AC Control		DC Control	
Code	Description	Code	Description
KJ	24V, 50/60 Hz	EJ	24V electronic (700-CF only)
D	110V, 50 Hz/120V, 60 Hz	ZJ	24V *
KF	230V, 50 Hz	DJ	24V with integrated diode *
K	240V, 60 Hz *		

\* 700-K only

#### ⊗ Coil Voltage Codes for 700-EF

AC / DC Control 700-EF	
Code	Description
KJ	24...60V AC
	20...60V DC
KY	48...130V AC/DC
KD	100...250V AC/DC
KN	250...500V AC/DC





# Relays & Timers

LOGIC

## Safety Control Relays 700-HPS, 700S-EF, 700S-P/-PK

- Designed for use in safety circuits
- NEMA, IEC and general purpose styles
- Mechanically linked contacts



Allen-Bradley® relays designed for use in safety circuits are available in NEMA, IEC and general purpose styles. All feature mechanically linked contacts to comply with applicable IEC standards and are marked accordingly.

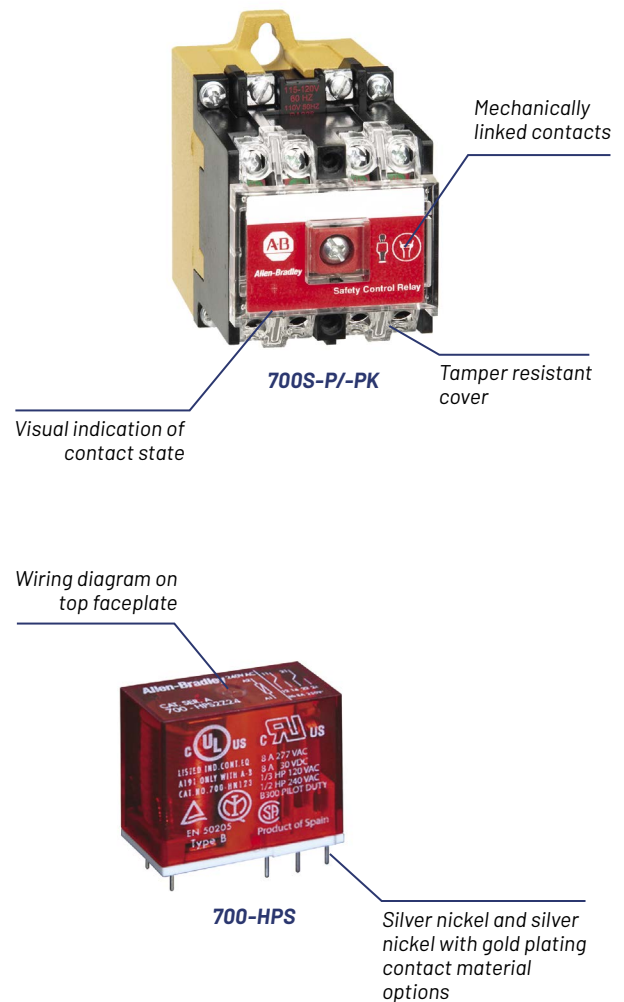
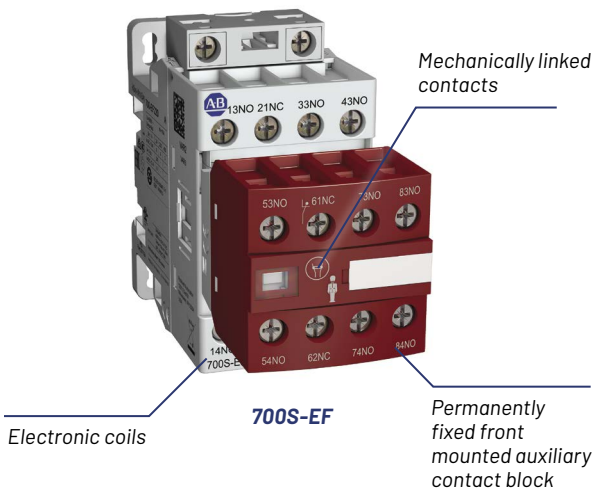

### Relays & Timers



3-2...3-19

### Programmable Controllers



3-20...3-23

### Signal Interface



3-24...3-27



# Product Selection

## IEC Safety Control Relays <sup>1</sup>

No. of Contacts		Standard Contacts
N.O.	N.C.	Cat. No.
4	4	700S-EF440⊗IC
5	3	700S-EF530⊗IC
6	2	700S-EF620⊗IC

<sup>1</sup> For contact ratings, see 700-EF on page 3-17.

⊗ The catalog number as listed is incomplete. Select a coil voltage code from the table at right.

## NEMA Safety Control Relays – Standard, 10 A

No. of Contacts		AC Coils	24V DC Coil
N.O.	N.C.	Cat. No.	Cat. No.
3	1	700S-P310⊗	700S-DCP310DZ24
2	2	700S-P220⊗	700S-DCP220DZ24
7	1	700S-P710⊗	700S-DCP710DZ24
6	2	700S-P620⊗	700S-DCP620DZ24
5	3	700S-P530⊗	700S-DCP530DZ24
4	4	700S-P440⊗	700S-DCP440DZ24
3	5	700S-P350⊗	700S-DCP350DZ24
10	2	700S-P1020⊗	700S-DCP1020DZ24

⊗ The catalog number as listed is incomplete. Select a coil voltage code from the table at right.

## NEMA Safety Control Relays – Master, 20 A

No. of Contacts		120V AC Coil	24V DC Coil
N.O.	N.C.	Cat. No.	Cat. No.
7	1	700S-PK710A1	700S-DCPK710Z24
6	2	700S-PK620A1	700S-DCPK620Z24
5	3	700S-PK530A1	700S-DCPK530Z24
4	4	700S-PK440A1	700S-DCPK440Z24
3	5	700S-PK350A1	700S-DCPK350Z24
10	2	700S-PK1020A1	700S-DCPK1020Z24
3	1	700S-PK310A1	700S-DCPK310Z24

### ⊗ Coil Voltage Codes for AC and DC Control

Code	Description	Code	Description
<b>IEC Safety Control Relays Standard AC/DC</b>		<b>IEC Safety Control Relays Low Consumption</b>	
KJ	24...60V AC 20...60V DC	EQ	12...20V DC
KY	48...130V AC/DC	QJ	24V DC Faster drop out
KD	100...250V AC/DC	EJ	24...60V AC 20...60V DC
KN	250...500V AC/DC		
<b>NEMA Safety Control Relays</b>		<b>NEMA Safety Control Relays</b>	
A24	24V, 60 Hz	Z24	24V DC
B11	110V, 50Hz		
A1	120V, 60 Hz		

## General Purpose Safety Control Relays

Description	Coil Voltage	AgNi + Au Gold Plated Contacts	AgNi Contacts
		Cat. No.	Cat. No.
8 A Relay	6V DC	700-HPSXZ06	700-HPS2Z06
	12V DC	700-HPSXZ12	700-HPS2Z12
	24V DC	700-HPSXZ24	700-HPS2Z24
	48V DC	700-HPSXZ48	700-HPS2Z48
	60V DC	700-HPSXZ60	700-HPS2Z60
	110V DC	700-HPSXZ1	700-HPS2Z1
	125V DC	700-HPSXZ01	700-HPS2Z01
Socket	—	700-HN123	



### Safety

Our innovative safety products and solutions improve the functional operation of your machinery while helping to increase personnel safety, efficiency and productivity.

<https://rok.auto/safety-products>



# Programmable Controllers

LOGIC CONTROL

## Micro Controllers Micro800™ Family, Bulletin 2080

- Wide range of micro controllers (built-in I/O from 10...48 pts)
- Use Connected Components Workbench™ software to program your Micro800 controllers
- Micro800 Expansion I/O and plug-in modules to customize your controller
- Supports a wide variety of communication protocols to suit specific application needs: EtherNet/IP™, DeviceNet®, Modbus TCP, Modbus RTU, ASCII, and Open socket capabilities



Micro800 Control Systems are easy to install and maintain. One software package applies to the entire family. Right-size your controllers for your standalone machines. Invest in the functionality you need, and use Expansion I/O and plug-in modules for a system tailored to your specific application.



### Micro810® Controllers Smart Relay Micro PLC

- Offers 12-point controllers
- Includes 8 A outputs, which replace the need for external relays
- Supports program download through USB programming port (adapter required)
- Allows you to configure and operate smart relay function blocks without a PC (LCD required)

\* Product selection starts on page 3-22.



### Micro820® Controllers Remote Automation Micro PLC

- Offers 20-point controllers
- Provides embedded 0...10V non-isolated 4-channel analog input and 1-channel analog output for speed control of an AC drive
- Communicates via EtherNet/IP and serial
- Supports program download through USB with an optional 3.5 in. remote LCD
- Supports up to two Micro800 plug-in modules

\* Product selection starts on page 3-22.

Relays & Timers



3-2...3-19

Programmable Controllers



3-20...3-23

Signal Interface



3-24...3-27



## Connected Components Workbench™ Software

- Single software to program your controllers, configure your drives, servo drives and safety relays, and design your human machine interface (HMI) screens
- Easy to Configure – Single software for the Micro Control System reduces machine development time and cost
- Easy to Program – Simplify programming with sample code, user-defined function blocks (UDFB) and user-defined data types (UDDT)
- Easy to Visualize – Reference Micro800 and CompactLogix™ controller variables when creating HMI tags

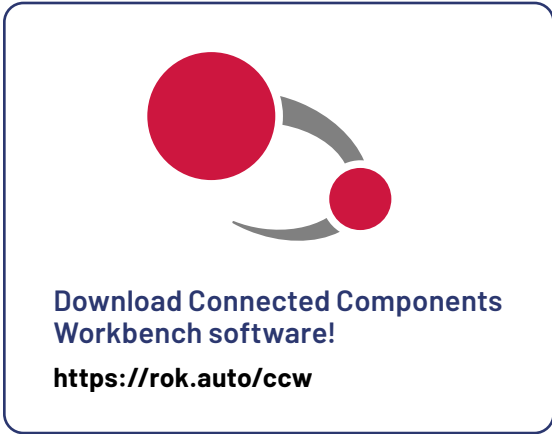

**Download Connected Components Workbench software!**  
<https://rok.auto/ccw>

**LOGIC CONTROL**



Micro870 Controller with Expansion I/O Modules

### Micro850® and Micro870® Controllers Scalable Micro PLCs with Ethernet

- Provides embedded communications via non-isolated serial port (for RS-232 and RS-485 communications) and Ethernet port
- Provides embedded motion capabilities: Micro850 – up to three axes with 100 kHz PTO; Micro870 – up to two axes with 100 kHz PTO
- Provides ease of integration over EtherNet/IP™ to Kinetix® 5100 and PowerFlex® 520 series drives using Class 1 implicit messaging with pre-defined tags and generic profile for all other EtherNet/IP™ devices. Up to 8 nodes supported.

#### Micro850 Controllers

- Supports up to five Micro800 plug-in modules and up to four Micro800 expansion I/O modules
- Offers 24-point and 48-point controllers

#### Micro870 Controllers

- Twice the memory capacity of Micro850 controller that supports up to 20,000 program steps and up to 128 KB user data
- Supports up to three plug-in modules, up to eight Expansion I/O modules and up to 304 I/O points
- Offers 24-point controllers

\* Product selection starts on page 3-22.



# Programmable Controllers

## Product Selection

### Micro810® Controllers, 12 Point



Line Power	Inputs	Outputs	Cat. No.
24V DC	(8) 12/24V DC <sup>1</sup>	(4) relay	2080-LC10-12QWB
120/240V AC	(8) 120/240V AC	(4) relay	2080-LC10-12AWA
24V DC	(8) 12/24V DC <sup>1</sup>	(4) 24V source DC	2080-LC10-12QBB
12V DC	(8) 12V DC <sup>1</sup>	(4) relay	2080-LC10-12DWD
Accessories			
Description			Cat. No.
USB adapter plug			2080-USBADAPTER
1.5 in. LCD display and keypad			2080-LCD
120/240V AC to 24V DC power supply for Micro810, Micro820 and Micro830 10/16pt			2080-PSAC-12W

<sup>1</sup> Four configurable as analog.

### Micro820® Controllers, 20 Point



Line Power	Inputs	Outputs	Cat. No.
24V DC	(12) 24V DC	(7) 24V DC source	2080-LC20-20QBB(K) <sup>1</sup>
	(12) 24V DC	(7) relay	2080-LC20-20QWB
	(8) 120V AC (4) 24V DC	(7) relay	2080-LC20-20AWB
	(12) 24V DC	(7) 24V DC source	2080-LC20-20QBRR
	(12) 24V DC	(7) relay	2080-LC20-20QWBR
	(8) 120V AC (4) 24V DC	(7) relay	2080-LC20-20AWBR
Accessories			
Description			Cat. No.
Micro800™ 3.5 inch remote LCD display module			2080-REMLCD
microSD™ card 2 GB			2080-SD-2GB
120/240V AC to 24V DC power supply Micro810, Micro820 and Micro830 10/16pt			2080-PSAC-12W

<sup>1</sup> Catalog numbers with the suffix 'K' are conformal coated and their specifications are the same as non-conformal coated catalogs.

### Micro850® Controllers, 24...48 Points



Line Power	Inputs	Outputs	Cat. No.
24V DC	(14) 120V AC	(10) relay	2080-L50E-24AWB
	(14) 24V DC	(10) 24V DC source	2080-L50E-24QBB
	(14) 24V DC	(10) 24V DC sink	2080-L50E-24QVB
	(14) 24V DC	(10) relay	2080-L50E-24QWB
	(28) 120V AC	(20) relay	2080-L50E-48AWB
	(28) 24V DC	(20) 24V DC source	2080-L50E-48QBB
	(28) 24V DC	(20) 24V DC sink	2080-L50E-48QVB
	(28) 24V DC	(20) relay	2080-L50E-48QWB(K) <sup>1</sup>
Accessories			
Description			Cat. No.
120/240V AC to 24V DC power supply for Micro800			2080-PS120-240VAC

<sup>1</sup> Catalog numbers with the suffix 'K' are conformal coated and their specifications are the same as non-conformal coated catalogs.

Relays & Timers



3-2...3-19

Programmable Controllers



3-20...3-23

Signal Interface



3-24...3-27





# Product Selection

## Micro870® Controllers, 24 Point



Line Power	Inputs	Outputs	Cat. No.
24V DC	(14) 120V AC	(10) relay	2080-L70E-24AWB
	(14) 24V DC	(10) 24V DC source	2080-L70E-24QB(K) <sup>1</sup>
	(14) 24V DC	(10) 24V DC source	2080-L70E-24QBBN2
	(14) 24V DC	(10) relay	2080-L70E-24QWB(K) <sup>1</sup>
	(14) 24V DC	(10) relay	2080-L70E-24QWBN(K) <sup>1, 2</sup>

<sup>1</sup> Catalog numbers with the suffix 'K' are conformal coated and their specifications are the same as non-conformal coated catalogs.

<sup>2</sup> Catalog numbers with the suffix 'N' indicate support for DNP3 protocol.



## Expansion I/O Modules

Description	Cat. No.
8-point, 120V AC input	2085-IA8
8-point, 240V AC input	2085-IM8
8-point, 120/240V AC triac output	2085-OA8
16-point, 12/24V DC sink/source input	2085-IQ16
32-point, 12/24V DC sink/source input	2085-IQ32T
16-point, 12/24V DC sink transistor output	2085-OV16
16-point, 12/24V DC source transistor output	2085-OB16
8-point, AC/DC relay output	2085-OW8
16-point, AC/DC relay output	2085-OW16
4-channel, 14-bit isolated voltage/current input	2085-IF4
8-channel, 14-bit isolated voltage/current input	2085-IF8
4-channel, 12-bit isolated voltage/current output	2085-OF4
4-channel, 16-bit RTD and TC isolated input	2085-IRT4
2085 bus terminator	2085-ECR
Expansion power supply module	2085-EP24VDC

## Plug-in Modules<sup>1</sup>



Description	Cat. No.
4-channel V/I analog input unipolar 0...20 mA, 0...10V, 12bits (non-isolated)	2080-IF4
2-channel V/I analog input unipolar 0...20 mA, 0...10V, 12bits (non-isolated)	2080-IF2(K) <sup>2</sup>
2-channel V/I analog output unipolar 0...20 mA, 0...10V, 12 bits	2080-OF2
RS232/485 isolated serial port	2080-SERIALISOL(K) <sup>2</sup>
6-channel trim pot analog input	2080-TRIMPOT6
Project, data log, recipe backup and high accuracy RTC 1	2080-MEMBAK-RTC 2080-MEMBAK-RTC2
2-channel RTD (non-isolated)	2080-RTD2
2-channel thermocouple (non-isolated)	2080-TC2
4-point, 12/24V DC sink/source input	2080-IQ4
4-point relay output, individually isolated, 2 A	2080-OW4I
8-point combo, 12/24V DC, sink/source input, 12/24V DC sink output	2080-IQ4OV4
8-point combo, 12/24V DC sink/source input 12/24V DC source output	2080-IQ4OB4
4-point, 24V DC source output	2080-OB4
4-point, 24V DC sink output	2080-OV4
High speed counter, 250 kHz	2080-MOT-HSC
20-node DeviceNet® scanner	2080-DNET20

<sup>1</sup> All plug-in modules are for use with the Micro820, Micro830, Micro850, and Micro870 controllers, except catalog numbers 2080-MEMBAK-RTC and 2080-MEMBAK-RTC2. 2080-MEMBAK-RTC is for use with Micro830 controllers. 2080-MEMBAK-RTC2 is for use with Micro830, Micro850 and Micro870 controllers.

<sup>2</sup> Catalog numbers with the suffix 'K' are conformal coated and their specifications are the same as non-conformal coated catalogs.





# Signal Interface

LOGIC CONTROL

## Signal Conditioners 931 N/S

- Helps protect your expensive control system from transients and noise
- Eliminates ground loop/noise-induced errors in process measurements through high levels of galvanic isolation
- Cost effective signal conversion to solve a signal mismatch between field device and I/O
- Eliminates signal degradation of critical process measurement during transmission



Signal Conditioners are designed for use with I/O systems to provide reduced installation and maintenance costs in process applications. A wide range of products are available for use wherever temperature, pressure, speed, weight, level, and flow are measured and controlled as part of a continuous or batch production process.

A variety of product types are offered to meet your application needs, including:

### 931N - Nano Series

- Space-saving 6 mm housing
- Easy onboard configuration
- Angled terminals for ease of wiring
- Power rail option reduces supply wiring



### 931S - Smart Series

- Compact housings 12.5, 17.5, and 22.5 mm wide
- Angled terminals for ease of wiring
- Removable terminals
- Interactive display



## Accessories

	Description	DIN Size	Length	Catalog Number
	Kit Contains: • 1 bus circuit layer insert • 1 support section • 1 cover • 1 end left plate • 1 end right plate	35 x 7.5 mm	250 mm	931A-CS
			500 mm	931A-FS
		35 x 15 mm	250 mm	931A-CL
			500 mm	931A-FL

## Configuration Cable

Description	Part
USB Cable	931A-CB*

\* Assists in the configuration of devices with DTM files.

Relays & Timers



3-2...3-19

Programmable Controllers



3-20...3-23

Signal Interface



3-24...3-27



## Product Selection

### 931N - Nano Series

Input	Output					
	0...23 mA	0/4...20 mA; 0/1/2...5/10 V (Configurable)	4...20 mA; 20...4 mA	± 10 mA, ± 20 mA	Channel	Power
0...23 mA	931N -C121				1	24V DC
	931N -C122				Splitter	24V DC
	931N -C141				1	Input Loop
	931N -C144				2	Input Loop
	931N -C161				1	Output Loop
	931N -C164				2	Output Loop
0/4...20 mA; 0/1/2...5/10V (Configurable)		931N -A221			1	24V DC
		931N -A222			Splitter	24V DC
± 10/± 20 mA, ±10 V (Configurable)		931N -X221			1	24V DC
		931N -X422		931N -X422	Splitter	24V DC
Thermocouple J, K		931N -T221			1	24V DC
PT100			931N -R161		1	Output Loop
			931N -R221		1	24V DC
Thermocouple J, K; PT100			931N -N161		1	Output Loop
Universal (All Thermocouples, PT RTDs, Potentiometer, Resistance, Current, Voltage)		931N -U221			1	24V DC

### 931S - Smart Series

Input	Output									
	0...22 mA, 0...11 V (Config small measurement ranges, 4mA/2V)	0/4...20 mA; 0/1/2...5/10 V (Configurable)	0/4...20 mA with HART	0/2...10 V	0/4...20 mA, ± 20 mA, 0/1/2...5/10 V, ± 5/10 V	Relay	Relay; 0/4...20 mA, ± 20 mA, 0/1/2...5/10 V, ± 5/10 V	0/4...20 mA, Transistor	Channels	Power
0...22 mA, 0...11 V (Config small meas. ranges, 4mA/2V)	931S-A481								1	12...60V DC
Load Cell/Bridge ± 10 mV, ± 20 mV, ± 30 mV, ± 50 mV		931S-B481							1	10...60V DC
0/4...20 mA with HART			931S-C121						1	24V DC
			931S-C122					Splitter		
			931S-C124					2		
0/4...20 mA				931S-C221					1	24V DC
0...1/5/10 A AC or DC					931S-L521				1	24V DC
0...40/50/60 A AC or DC						931S-M321			1	24V DC
0...5/10 A AC or DC							931S-M5211		Splitter	24V DC
0...20/25/30 A AC or DC							931S-M5213		Splitter	24V DC
0...40/50/60 A AC or DC							931S-M5216		Splitter	24V DC
PT100, PTC						931S-N392			Splitter	20...264V AC/DC
± 0.1mA...±100 mA, ±20 mV...±300 V					931S-P491				1	24...240V AC/DC
0...660V DC, 0...440V AC		931S-V291							1	24...240V AC/DC
200...480V AC (3Ph)						931S-V342			Splitter	Input Loop Powered
110/240/400V AC/DC						931S-V392			Splitter	24...240V AC/DC
Universal (All Thermocouples, PT/RTDs, Potentiometer, Resistance, Current, Voltage)						931S-U382			Splitter	9...60 V DC
						931S-U392				90...264 V AC
								931S-U561		Output Loop Powered



# Signal Interface

LOGIC CONTROL

## Intrinsic Safety Modules 937 Z/T/C

- For analog and digital signals in hazardous locations
- Simple maintenance with integrated diagnostics and quick change of modules during ongoing operation
- Comprehensive standards compliance, including up to SIL3 compliance for easy and reliable planning and documentation
- Horizontal or vertical mounting with no reduction in operational ratings
- Power Rail for drastically reduced wiring, collective error messaging, efficient troubleshooting and installation



Bulletin 937 Intrinsic Safety Modules connect intrinsically safe rated equipment – such as transmitters, solenoids, proximity sensors and encapsulated assemblies – with control systems.

### Product Range Overview

- From simple switch amplifiers to highly functional signal converters
- Modules available with galvanic isolation
- Low heat dissipation thanks to low power consumption
- Broad supply voltage range including AC, DC and universal power supply (AC/DC)

### Easy Configuration

- DIP switches or Pushbuttons with LCD display
  - FDT Interface between devices and control system

### Power Rail System

- Allows simple snap-in of modules
- Power supply and monitoring of lead breakages/short circuit on gold-plates rails
- Reduces wiring
- Vertical and horizontal mounting
- Simplifies future expansions

### Compact Size

- 12.5 mm housing allowed for 2 channel densities

### Removable Terminals

- Rapid connection
- Up to 2.5mm/14 AWG wiring
  - Keyed terminals eliminate misconnection



### Power Feed Module

- Link power supply to the Power Rail
- Group fusing
- Redundancy options
- Alarming for lead breakage, short circuit, and power failure
- Reduces I/O overhead
- Front switch for mode of operation

### Relays & Timers



3-2...3-19

### Programmable Controllers



3-20...3-23

### Signal Interface



3-24...3-27



## Product Selection

### Isolated/Converter Barriers

Module Type	Signal Type	Device Power	Channels	Signal Splitter	Width	Cat. No.
Switch amplifier	Digital input, Transistor output	24V DC	1-channel	Yes	12.5 mm	937TH-DISTS-DC1
			2-channel	No		937TH-DISAT-DC2
			1-channel	Yes		937TH-DISRS-DC1
			2-channel	No		937TH-DISAR-DC2
	Digital input, Relay output	115V AC	1-channel	Yes	20 mm	937TS-DISRS-KD1
			2-channel	No		937TS-DISAR-KD2
		230V AC	1-channel	Yes		937TS-DISRS-KF1
			2-channel	No		937TS-DISAR-KF2
Solenoid driver	Digital output	Input loop powered	1-channel	No	12.5 mm	937TH-DOSND-IP1
SMART transmitter supply	Analog input	24V DC	1-channel	No	12.5 mm	937TH-AITXP-DC1
			1-channel	Yes	12.5 mm	937TH-AITXS-DC1
			2-channel	No	20 mm	937TS-AITXP-DC2
Temperature repeater	Analog input	24V DC	1-channel	No	12.5 mm	937TH-AIRRP-DC1
SMART current driver	Analog output			No	12.5 mm	937TH-AOSCD-DC1
Universal temp converter	Analog input			20 mm	937CS-AITMP-DC1 <sup>1</sup>	
Transmitter supply converter	Analog input	20-90V DC/48-253 V AC	1-channel	-	40 mm	937CU-AITXF-DC1
HART loop converter	Analog input					937CU-AIHLP-DC1
Strain gauge converter	Analog input					937CU-AISTR-DC1
Frequency converter	Digital input					937CU-DIFRQ-DC1
	Digital input					937CU-DIFRQ-BC1

<sup>1</sup> Configured via Field Device Tool (FDT) software such as Rockwell Software FactoryTalk AssetCentre or PACTware.

### Zener Barriers

Signal Type	Max Resistance	Other Functionality	Channels	Width	Cat. No.
Positive polarity DC	646 Ohm	-	2-channel	12.5 mm	937ZH-DPAN-2
	327 Ohm	-	1-channel		937ZH-DPBN-1
	36 + 0.9V Ohm	Diode return	2-channel		937ZH-DPCD-2
	327 Ohm	-	2-channel		937ZH-DPBN-2
	250 Ohm	Diode return, high power	2-channel		937ZH-DPDP-2

### Accessories

Power rail feed module	Power feed module for power rail system	Width: 20 mm	937A-PSFD
Power rail 0.8 meter	Power rail with cover and 2 end caps	Length: 0.8 M	937A-PR08
Power rail 2 meter	Power rail with cover and 2 end caps	Length: 2 M	937A-PR20
Power rail end caps	Power rail end caps	-	937A-PREC
USB interface cable	USB interface programming cable	-	937A-USBA
Cold junction compensation connector	Cold junction compensation for 937CS-AITMP-DC1 (thermocouples)	-	937A-TCJC







# OPERATOR INTERFACE

## Push Buttons

22 mm Push Buttons, Pilot Lights, and Selector Switches .....	4-2
22 mm Emergency Stop Operators .....	4-8
22 mm Monolithic Push Buttons, Pilot Lights, and Selector Switches.....	4-10
30 mm Push Buttons, Pilot Lights, Selector Switches, and Push-Pulls .....	4-12
30 mm Emergency Stop Operators .....	4-18
Piezoelectric Push Buttons .....	4-20
16 mm Push Buttons, Pilot Lights, Selector Switches, and E-Stops .....	4-22

## Signaling\*

Panel Mount Alarms.....	4-24
Control Tower Stack Lights .....	4-26
Wall Mount Signal Lights.....	4-30
Industrial Horns.....	4-32
Industrial Beacons .....	4-34

## Graphic Terminals

PanelView 800 Graphic Terminals.....	4-36
--------------------------------------	------

## Additional Operator Interface Products ..... 4-38

**\*IMPORTANT** These products are intended for use in industrial signaling applications only.



# Push Buttons

## 22 mm Push Buttons, Pilot Lights, and Selector Switches 800F

- 800FP plastic operators
  - IP65/66/69k, Type 4/4X/13
  - Engineering grade thermoplastics
  - Chemical-resistant for harsh environments
- 800FM metal operators
  - IP65/66, Type 4/13
  - Die-cast metal construction
  - Chrome-plated



### 800F Push Buttons

- Momentary or alternate action
- Illuminated or non-illuminated
- Flush or extended
- 2-color legend caps
- Multi-operators

### 800F Pilot Lights

- LED and incandescent
- Multiple voltages
- 24V, 120V, 240V
- 6 color options

### 800F Selector Switches

- 2-, 3-, and 4-position
- Illuminated or non-illuminated
- Maintained or spring return
- Key selector switches



#### Dependable Sealing

- IP66 and Type 4/13
- Superior ingress protection
- Diaphragm seals

#### Selection Switches feature Positive Detent

- No hang-up between positions
- Constant energy solution
- Vibration insensitive



#### Rotating Latch Collar

- Easier installation
- One-hand removal
- Plastic or metal



### Push Buttons



4-2...4-23

### Signaling



4-24...4-35

### Graphic Terminals



4-36...4-37

## Product Selection

800F – Momentary and Maintained Push Button Operators – Flush, Extended, Guarded, Alternate Action, Non-Illuminated, Illuminated



Type	Button Color	Text Color	Legend Text	Flush	Extended	Guarded	Alternate Action
				Cat. No.	Cat. No.	Cat. No.	Cat. No.
Non-Illuminated	● Orange	–	–	800F⊗-F0	800F⊗-E0	800F⊗-G0	800F⊗-FA0
	○ White	–	–	800F⊗-F1	800F⊗-E1	800F⊗-G1	800F⊗-FA1
	● Black	–	–	800F⊗-F2	800F⊗-E2	800F⊗-G2	800F⊗-FA2
	● Black	White	→	800F⊗-F208	800F⊗-E208	800F⊗-G208	–
	● Green	–	–	800F⊗-F3	800F⊗-E3	800F⊗-G3	800F⊗-FA3
	● Green	White	START	800F⊗-F301	–	800F⊗-G301	–
	● Green	White		800F⊗-F306	–	800F⊗-G306	–
	● Red	–	–	800F⊗-F4	800F⊗-E4	800F⊗-G4	800F⊗-FA4
	● Red	White	STOP	800F⊗-F402	800F⊗-E402	800F⊗-G402	–
	● Red	White	○	800F⊗-F405	800F⊗-E405	800F⊗-G405	–
	● Yellow	–	–	800F⊗-F5	800F⊗-E5	800F⊗-G5	800F⊗-FA5
	● Blue	–	–	800F⊗-F6	800F⊗-E6	800F⊗-G6	800F⊗-FA6
	● Blue	White	R	800F⊗-F611	800F⊗-E611	800F⊗-G611	–
	● Grey	–	–	800F⊗-F8	–	–	–
		No Cap	–	–	800F⊗-F9	800F⊗-E9	800F⊗-G9
Illuminated	● Amber	–	–	800F⊗-LF0	800F⊗-LE0	800F⊗-LG0	800F⊗-LFA0
	● Green	–	–	800F⊗-LF3	800F⊗-LE3	800F⊗-LG3	800F⊗-LFA3
	● Red	–	–	800F⊗-LF4	800F⊗-LE4	800F⊗-LG4	800F⊗-LFA4
	● Yellow	–	–	800F⊗-LF5	800F⊗-LE5	800F⊗-LG5	800F⊗-LFA5
	● Blue	–	–	800F⊗-LF6	800F⊗-LE6	800F⊗-LG6	800F⊗-LFA6
	○ Clear	–	–	800F⊗-LF7	800F⊗-LE7	800F⊗-LG7	800F⊗-LFA7
		No Cap	–	–	800F⊗-LF9	800F⊗-LE9	800F⊗-LG9

⊗ To complete the catalog number, replace the ⊗ with one of the following letters: **P** – Plastic operator, or **M** – Metal operator.

## Pilot Light Operators

Color	Plastic	Metal
	Cat. No.	Cat. No.
● Amber	800FP-P0	800FM-P0
● Green	800FP-P3	800FM-P3
● Red	800FP-P4	800FM-P4
● Yellow	800FP-P5	800FM-P5
● Blue	800FP-P6	800FM-P6
○ Clear	800FP-P7	800FM-P7
	800FP-P9	800FM-P9



## Specifications

Material	Plastic	Glass-filled Polyamide
	Metal	Chromated Zinc
Degree of Protection	Plastic	IP65/66/69K (Type 3/3R/4/4X/12/13)
	Metal	IP65/66 (Type 3/3R/4/12/13)
Operational Temperature Range		-25...+70 C (-13...+158 °F)
Certifications		UR/UL, CSA, CCC, CE
Standards Compliance		NEMA ICS-5; UL 508; EN ISO 13850; EN60947-1; EN 60947-5-1; EN 60947-5-5

For more information on our complete family of 22 mm push button products, please visit:  
[rok.auto/22mm-push-buttons](http://rok.auto/22mm-push-buttons)



# Push Buttons

## Product Selection

Selector Switch Operators –  
Non-illuminated, Illuminated, Key-operated



Type	Knob Color	# of Positions	Knob Type or Keyed	Plastic	Metal
				Cat. No.	Cat. No.
Non-Illuminated	● Black	2	Standard	800FP-S⊗2	800FM-S⊗2
	● Black	2	Knob Lever	800FP-H⊗2	800FM-H⊗2
	● Black	3	Standard	800FP-S⊗3	800FM-S⊗3
	● Black	3	Knob Lever	800FP-H⊗3	800FM-H⊗3
	● Black	4	Standard	800FP-SM4	800FM-SM4
	● Black	4	Knob Lever	800FP-HM4	800FM-HM4
	● Black	2	Keyed	800FP-K⊗2◆	800FM-K⊗2◆
	● Black	3	Keyed	800FP-K⊗3☒	800FM-K⊗3☒
Illuminated	● Amber	2	Standard	800FP-LS⊗20	800FM-LS⊗20
	● Green	2	Standard	800FP-LS⊗23	800FM-LS⊗23
	● Red	2	Standard	800FP-LS⊗24	800FM-LS⊗24
	● Yellow	2	Standard	800FP-LS⊗25	800FM-LS⊗25
	● Blue	2	Standard	800FP-LS⊗26	800FM-LS⊗26
	○ Clear	2	Standard	800FP-LS⊗27	800FM-LS⊗27
	○ Clear	2	Knob Lever	800FP-LH⊗27	800FM-LH⊗27
	● Amber	3	Standard	800FP-LS⊗30	800FM-LS⊗30
	● Green	3	Standard	800FP-LS⊗33	800FM-LS⊗33
	● Red	3	Standard	800FP-LS⊗34	800FM-LS⊗34
	● Yellow	3	Standard	800FP-LS⊗35	800FM-LS⊗35
	● Blue	3	Standard	800FP-LS⊗36	800FM-LS⊗36
	○ Clear	3	Standard	800FP-LS⊗37	800FM-LS⊗37
	○ Clear	3	Knob Lever	800FP-LH⊗37	800FM-LH⊗37

- ⊗ - add **M**- Maintained, **R**-spring return from **Right**, **L**-spring return from **Left**.
- ⊗ - add **M**- Maintained, **R**-spring return from **Right**, **L**-spring return from **Left**, **B**-spring return from **Both**.
- ◆ - add **1**-key removal in Left, **2**-key removal in Right, **3**-key removal in All.
- ☒ - add **1**-key removal in Left, **2**-key removal in Right, **3**-key removal in All, **4**-key removal in center, **5**-key removal in Left and Center, **7**-key removal in Center and Right.

### Push Buttons



4-2...4-23

### Signaling



4-24...4-35

### Graphic Terminals



4-36...4-37

## Product Selection



### 2-Position Push-Pull Operators

Color	Non-Illuminated			Illuminated			
	40 mm Cap	90 mm Half Dome	30 mm Cap	40 mm Cap	60 mm Cap	90 mm Half Dome	
	Cat. No.	Cat. No.	Cat. No.	Cat. No.	Cat. No.	Cat. No.	
● Black	800F⊗-MP42	800F⊗-MP92	—	—	—	—	
● Green	800F⊗-MP43	—	800F⊗-LMP33	800F⊗-LMP43	800F⊗-LMP63	—	
● Red	800F⊗-MP44	800F⊗-MP94	800F⊗-LMP34	800F⊗-LMP44	800F⊗-LMP64	800F⊗-LMP94	
● Yellow	800F⊗-MP45	800F⊗-MP95	800F⊗-LMP35	800F⊗-LMP45	800F⊗-LMP65	800F⊗-LMP95	
● Blue	800F⊗-MP46	—	800F⊗-LMP36	800F⊗-LMP46	800F⊗-LMP66	—	

⊗ - To complete the catalog number, replace the ⊗ with one of the following letters: **P** - Plastic operator, or **M** - Metal operator.



### Momentary Mushroom Operators

Color	Non-Illuminated			Illuminated
	40 mm Cap	60 mm Cap	90 mm Cap	40 mm Cap
	Cat. No.	Cat. No.	Cat. No.	Cat. No.
● Black	800F⊕-MM42	800F⊕-MM62	800F⊕-MM92	—
● Green	800F⊕-MM43	800F⊕-MM63	—	800F⊕-LMM43
● Red	800F⊕-MM44	800F⊕-MM64	800F⊕-MM94	800F⊕-LMM44
● Yellow	800F⊕-MM45	800F⊕-MM65	800F⊕-MM95	800F⊕-LMM45
● Blue	800F⊕-MM46	800F⊕-MM66	—	800F⊕-LMM46
○ Clear	—	—	—	800F⊕-LMM47

⊕ - To complete the catalog number, replace the ⊕ with one of the following letters: **P** - Plastic operator, or **M** - Metal operator.



### 3-Position Push-Pull Operator

Type	Color	Function	Cat. No.	Function	Cat. No.
Non-Illuminated	● Black	Out - Momentary Center - Maintained In-Momentary	800FM-MM42E3	Out - Momentary Center - Maintained In-Maintained	800FM-MP42E3
	● Green		800FM-MM43E3		800FM-MP43E3
	● Red		800FM-MM44E3		800FM-MP44E3
Illuminated	● Amber		800FM-LMM40E3		800FM-LMP40E3
	● Green		800FM-LMM43E3		800FM-LMP43E3
	● Red		800FM-LMM44E3		800FM-LMP44E3
	● Blue		800FM-LMM46E3		800FM-LMP46E3
	○ Clear		800FM-LMM47E3		800FM-LMP47E3

For more information on our complete family of 22 mm push button products, please visit:  
[rok.auto/22mm-push-buttons](http://rok.auto/22mm-push-buttons)



# Push Buttons

## Product Selection

Multi-Function Operators –  
2-Function, 3-Function, Non-Illuminated, Illuminated



Top Cap			Bottom Cap				Non-Illuminated		Illuminated	
Color	Type	Graphic	Color	Type	Graphic	2-Function	3-Function	2-Function		
						Cat. No.	Cat. No.	Cat. No.		
●	Green	Flush		●	Red	Extended	○	800F☉-U2EFFE	800F☉-U3EFFE4	800F☉-LU2EFFE
●	Green	Flush	–	●	Red	Extended	–	800F☉-U2E4F3	800F☉-U3E4F34	800F☉-LU2E4F3
●	Green	Flush	–	●	Green	Flush	–	800F☉-U2F3F3	800F☉-U3F3F34	800F☉-LU2F3F3
○	White	Flush		●	Black	Extended	○	800F☉-U2EHFG	800F☉-U3EHFG4	800F☉-LU2EHFG
○	White	Flush	–	●	Black	Flush	–	800F☉-U2F2F1	800F☉-U3F2F14	800F☉-LU2F2F1
●	Black	Flush	–	●	Black	Flush	–	800F☉-U2F2F2	800F☉-U3F2F24	800F☉-LU2F2F2
○	White	Flush	–	○	White	Flush	–	800F☉-U2F1F1	800F☉-U3F1F14	800F☉-LU2F1F1

☉ - To complete the catalog number, replace the ☉ with one of the following letters: **P** - Plastic operator, or **M** - Metal operator.

## Potentiometer – Single Turn



Resistive Element	Cat. No
None	800FP-POT
150 Ω	800FP-POT1
500 Ω	800FP-POT2
1000 Ω	800FP-POT3
2500 Ω	800FP-POT4
5000 Ω	800FP-POT5
10000 Ω	800FP-POT6

## Toggle Switch Operators – Mechanical and/or Electrical Reset



Positions	Function	Cat. No.
—	Maintained	800FM-JM2
	Momentary	800FM-JR2
+	Maintained	800FM-JM4
	Momentary	800FM-JR4

## Selector Push Button



Positions	Cap Color	Cat. No.
2	● Black	800F☒-SJ22
	● Green	800F☒-SJ23
3	● Black	800F☒-SJ32
	● Green	800F☒-SJ33

## Reset Operators – Mechanical and/or Electrical Reset



Button Color	Text Color	Legend Text	Flush	
			Plastic	Metal
			Cat. No.	Cat. No.
● Blue	White	R	800FP-R611	800FM-R611
● Blue	–	–	800FP-R6	800FM-R6

☒ To complete the catalog number, replace the ☒ with one of the following letters: **P** - Plastic operator, or **M** - Metal operator.

### Push Buttons



4-2...4-23

### Signaling



4-24...4-35

### Graphic Terminals



4-36...4-37



## Product Selection



### Mounting Latches

Material	Cat. No.
Plastic	800F-ALP
Metal	800F-ALM



### Contact Blocks

Contact Type - Screw Termination	Cat. No.
N.O. - Normally Open	800F-X10
N.C. - Normally Closed	800F-X01
N.C. - Self-Monitoring	800F-X01S
N.O. Low Voltage - add voltage	800F-X10V
N.C. Low Voltage - add voltage	800F-X01V
Dual circuit - 2 N.O.	800F-X20D
Dual circuit - 2 N.C.	800F-X02D
Dual circuit - 1 N.O./1 N.C.	800F-X11D
N.O.E.M. - Early Make	800F-X10E
N.O.L.M. - Late Make	800F-X10N
N.C.E.B. - Early Break	800F-X01B
N.C.L.B - Late Break	800F-X01L



### LED Power Modules

Color	Volts	Cat. No.
● Green	24V AC/DC	800F-N3G
● Red		800F-N3R
○ White		800F-N3W
● Green	120V AC	800F-N5G
● Red		800F-N5R
○ White		800F-N5W
● Green	240V AC	800F-N7G
● Red		800F-N7R
○ White		800F-N7W

### Legend Plates

Type	Available Colors	Text / Symbol	Cat. No.
30 x 40 mm 2-piece Snap-in Plate and Frame	○ White	Blank	800F-11☒E100
	● Black	START	800F-11☒E208
	● Red	STOP	800F-11☒E212
	● Aluminum	- ○	800F-11☒U232
30 x 50 mm 2-piece Snap-in Plate and Frame	○ White	Blank	800F-12◆E100
	● Black	HAND-OFF-AUTO	800F-12◆E128
	● Aluminum	ON-OFF	800F-12◆E165
30 x 40 mm 1-piece	○ White	-	800F-34☒E100
	● Black		
30 x 50 mm 1-piece	● Red	-	800F-35☒E100
	● Aluminum		

☒ To complete the catalog number, replace the ☒ with one of the following letters for the desired color: **W** = White, **B** = Black, **A** = Aluminum or **R** = Red.

◆ To complete the catalog number, replace the ◆ with one of the following letters for the desired color: **W** = White, **B** = Black, **A** = Aluminum.



### Enclosures

Holes	Grey Plastic	Yellow Plastic	Metal
1	800F-1P☒	800F-1Y☒ 800F-1Y☒D <sup>1</sup>	800F-1M☒
2	800F-2P☒	-	800F-2M☒
3	800F-3P☒	-	800F-3M☒
4	800F-4P☒	-	-
5	-	-	800F-5M☒
6	800F-6P☒	-	-

☒ To complete the catalog number, replace the ☒ with one of the following letters for through holes: **M** = metric knock out, **P** = PG knock out.

<sup>1</sup> Dual circuit contact blocks allowed.





# Push Buttons

## 22 mm Emergency Stop Operators 800F/800FD

- Trigger action
- 30, 40, 60, and 90 mm operating heads
- Complies with EN ISO 13850 and EN 60947-5-5
- Self-monitoring contact blocks for increased safety
- Global certifications
- Select plastic operators IP69K Rated



Rockwell Automation safety products and solutions improve the functional operation of your machinery while helping to increase personnel safety, efficiency and productivity. 800F 22 mm E-stops offer a wide variety of devices to meet individual customer application requirements.

### Self-Monitoring Contact Blocks (SMCB)



- Opens controlled circuit in unlikely event contact block is separated from operator
- Monitors proper installation between:
  - Operator and latch
  - Latch and SMCB

### 800F Enclosed E-stops for SensaGuard, GuardLink or Series Wiring

The pre-wired 800F E-stop push button stations allow for quick installation with the 5- and 8-pin SensaGuard™ and GuardLink family of non-contact safety switches. The 5-pin stations can also be wired in series with each other for easy conveyor or long run installation.



- 24V AC/DC
- Pre-tested and factory sealed for time savings on wiring and set-up
- Illuminated when activated for ease and speed of identification
- Maintains SensaGuard PLe, Cat 4, SIL 3 rating
- Flexibility for use in non-SensaGuard and GuardLink applications

To learn more about GuardLink technology and its benefits, see page 5-2



For additional emergency stop devices, see page 5-48



### Push Buttons



4-2...4-23

### Signaling



4-24...4-35

### Graphic Terminals



4-36...4-37



## Product Selection

E-Stop Twist-To-Release, Push-Pull Operators – Non-Illuminated, Illuminated, Keyed



Color	Size [mm]	Twist-to-Release			
		Non-Illuminated		Illuminated	
		Plastic	Metal	Plastic	Metal
		Cat. No.	Cat. No.	Cat. No.	Cat. No.
Red	30	800FP-MT34	800FM-MT34	–	–
	40	800FP-MT44	800FM-MT44	800FP-LMT44	800FM-LMT44
	60	800FP-MT64	800FM-MT64	800FP-LMT64	800FM-LMT64
	40 Keyed	800FP-MK44	800FM-MK44	–	–

Color	Size [mm]	Push-Pull			
		Non-Illuminated		Illuminated	
		Plastic	Metal	Plastic	Metal
		Cat. No.	Cat. No.	Cat. No.	Cat. No.
Red	30	–	–	800FP-LMP34	800FM-LMP34
	40	800FP-MP44	800FM-MP44	800FP-LMP44	800FM-LMP44
	60	–	–	800FP-LMP64	800FM-LMP64
	90	800FP-MP94	800FM-MP94	800FP-LMP94	800FM-LMP94

Assembled E-Stop Stations – Unwired, Series Wiring, SensaGuard and GuardLink



Description	Contact Type	Pins	SensaGuard/ GuardLink	Series Wiring	Cat. No.
Unwired	1 N.C.	–	–	–	800F-1YM1
Unwired	1 N.C./1 N.O.	–	–	–	800F-1YM2
Unwired	2 N.C.	–	–	–	800F-1YM3
End Station	2 N.C./1 N.O. 24V DC Illuminated	5	–	●	800F-1YMD51
T-Port Station		5	●	●	800F-1YMD52
Safety Distribution Block		8	●	–	800F-1YMD81

Monolithic Twist-to-Release/Push-Pull



Color	Size [mm]	Pkg. Qty.	Contact Type	Plastic Cat. No.
Red	40	1	1 N.C.	800FD-MT44X01
			2 N.C.	800FD-MT44X02

## Accessories

### Contact Blocks

Contact Type	Cat. No.
N.O.	800F-X10
N.C.	800F-X01
Self-monitoring	800F-X01S

### Mounting Latches

Description	Cat. No.
Metal	800F-ALM
Plastic	800F-ALP



### Legend Plate

Description	Cat. No.
EMERGENCY STOP - 60 mm round (30.5 mm mounting hole)	800F-15YE112
EMERGENCY STOP - 60 mm round <sup>1</sup> (22.5 mm mounting hole)	800F-15YSE112
EMERGENCY STOP - 90 mm round <sup>1</sup> (22.5 mm mounting hole)	800F-16YE112
Blank Legend Plate	800F-15Y, 800F-15YS & 800F-16Y

<sup>1</sup> Not for use with base-mounted contact blocks.

For more information on our complete family of 22 mm push button products, please visit: [rok.auto/22mm-push-buttons](http://rok.auto/22mm-push-buttons)



# Push Buttons

## 22 mm Monolithic Push Buttons, Pilot Lights, and Selector Switches 800FD

- Single-piece construction with integrated contact block
- Cost-effective design
- Low back-of-panel profile (45.7 mm)
- IP66, Type 3/3R/4/4X/12/13



800FD monolithic push buttons feature a self-contained design that combines the contact block and operator for ease of ordering, stocking, and installation.



**Push Button Operator**



**Pilot Light Device**

### Products

- Non-illuminated
  - Momentary push button
  - 2-position push-pull/twist-to-release E-stop
  - 2-position selector switch
  - 3-position selector switch
- Illuminated
  - Pilot light, LED
  - Pilot light, incandescent

### Pilot Light Devices

		LED		
		24V AC/DC	120V AC	240V AC
Color		Cat. No.	Cat. No.	Cat. No.
● Amber		800FD-P0N3	800FD-P0N5	800FD-P0N7
● Green		800FD-P3N3	800FD-P3N5	800FD-P3N7
● Red		800FD-P4N3	800FD-P4N5	800FD-P4N7
● Yellow		800FD-P5N3	800FD-P5N5	800FD-P5N7
● Blue		800FD-P6N3	800FD-P6N5	800FD-P6N7
○ Clear		800FD-P7N3	800FD-P7N5	800FD-P7N7

#### Push Buttons



4-2...4-23

#### Signaling



4-24...4-35

#### Graphic Terminals



4-36...4-37

## Product Selection

### Momentary Push Button Operators – Flush, Extended, Non-illuminated



Type	Button Color	Text Color	Legend Text	Contact Block Configuration				
				1 N.O.	1 N.C.	1 N.O. & 1 N.C.	2 N.O.	
				Cat. No.	Cat. No.	Cat. No.	Cat. No.	
Flush	○	White	–	–	800FD-F1X10	800FD-F1X01	800FD-F1X11	800FD-F1X20
	●	Black	–	–	800FD-F2X10	800FD-F2X01	800FD-F2X11	800FD-F2X20
	●	Black	White	→	800FD-F208X10	800FD-F208X01	800FD-F208X11	800FD-F208X20
	●	Green	–	–	800FD-F3X10	800FD-F3X01	800FD-F3X11	800FD-F3X20
	●	Green	White	START	800FD-F301X10	800FD-F301X01	800FD-F301X11	800FD-F301X20
	●	Green	White		800FD-F306X10	800FD-F306X01	800FD-F306X11	800FD-F306X20
	●	Red	–	–	800FD-F4X10	800FD-F4X01	800FD-F4X11	800FD-F4X20
	●	Yellow	–	–	800FD-F5X10	800FD-F5X01	800FD-F5X11	800FD-F5X20
	●	Blue	–	–	800FD-F6X10	800FD-F6X01	800FD-F6X11	800FD-F6X20
Extended	○	White	–	–	800FD-E1X10	800FD-E1X01	800FD-E1X11	800FD-E1X20
	●	Black	–	–	800FD-E2X10	800FD-E2X01	800FD-E2X11	800FD-E2X20
	●	Black	White	→	800FD-E208X10	800FD-E208X01	800FD-E208X11	800FD-E208X20
	●	Green	–	–	800FD-E3X10	800FD-E3X01	800FD-E3X11	800FD-E3X20
	●	Red	–	–	800FD-E4X10	800FD-E4X01	800FD-E4X11	800FD-E4X20
	●	Red	White	STOP	800FD-E402X10	800FD-E402X01	800FD-E402X11	800FD-E402X20
	●	Red	White	○	800FD-E405X10	800FD-E405X01	800FD-E405X11	800FD-E405X20
	●	Yellow	–	–	800FD-E5X10	800FD-E5X01	800FD-E5X11	800FD-E5X20
	●	Blue	–	–	800FD-E6X10	800FD-E6X01	800FD-E6X11	800FD-E6X20
	●	Blue	White	R	800FD-E611X10	800FD-E611X01	800FD-E611X11	800FD-E611X20

### Selector Switches – Non-illuminated

# of Positions	Contact Block Type	Contact Block Location	Contact Type	Target Table			Cat. No.
2	1 N.C.	Left	N.C.	X	–	0	800FD-S⊗2X01
		Right	–	–	–	–	
2	1 N.O.	Left	–	–	–	–	800FD-S⊗2X10
		Right	N.O.	0	–	X	
2	1 N.O. & 1 N.C.	Left	N.C.	X	–	0	800FD-S⊗2X11
		Right	N.O.	0	–	X	
2	2 N.C.	Left	N.C.	X	–	0	800FD-S⊗2X02
		Right	N.C.	X	–	0	
2	2 N.O.	Left	N.O.	0	–	X	800FD-S⊗2X20
		Right	N.O.	0	–	X	
3	1 N.O. & 1 N.C.	Left	N.C.	0	X	X	800FD-S⊗3X11
		Right	N.O.	0	0	X	
3	2 N.C.	Left	N.C.	0	X	X	800FD-S⊗3X02
		Right	N.C.	X	X	0	
3	2 N.O.	Left	N.O.	X	0	0	800FD-S⊗3X20
		Right	N.O.	0	0	X	

⊗ - add **M**- Maintained, **R**-spring return from **Right**, **L**-spring return from **Left**

⊗ - add **M**- Maintained, **R**-spring return from **Right**, **L**-spring return from **Left**, **B**-spring return from **Both**



# Push Buttons

## 30 mm Push Buttons, Pilot Lights, Selector Switches, and Push-Pulls 800T/H

- Heavy industrial stations and operators
- Type 4/13 watertight/oiltight (800T)
- Type 4/4X/13 watertight/corrosion-resistant/oiltight (800H)
- Universal LED for long life, simplified product selection and reduced energy usage
- Class I, Div. 2 solutions available



## Imitated, But Never Duplicated

800T and 800H push button product lines are in a class by themselves. They are designed and constructed to perform in the most demanding industrial environments. Bold yet functional, rugged yet attractive, Allen-Bradley® push buttons represent the world's most innovative and unique offering.

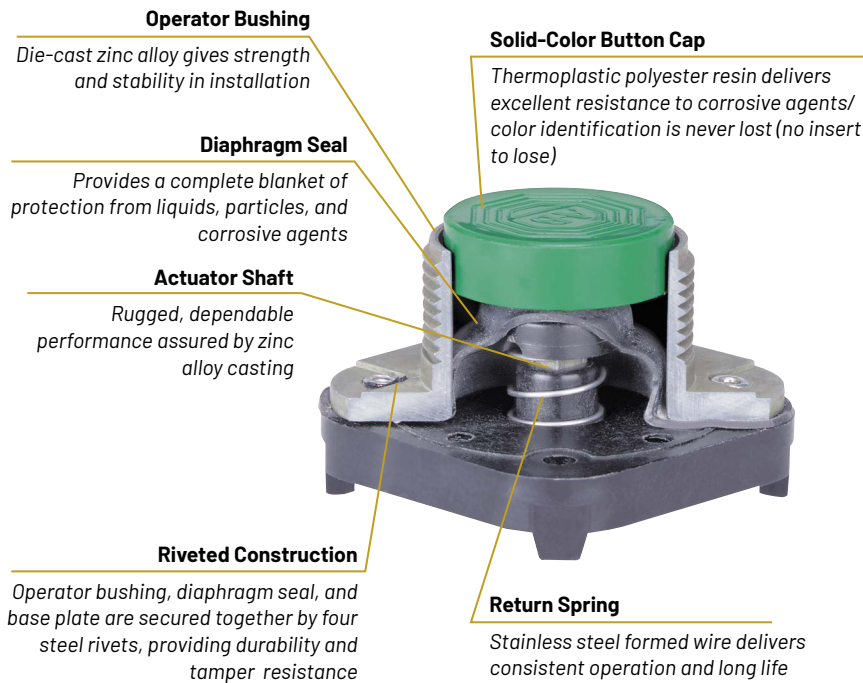

### Explosion-Protected Contact Block

- Class I Div. 2 certified
- Ideal for high shock and vibration applications
- 1 N.O., 1 N.C., A600-rated
- Positive opening N.C. contact



### Push Buttons



4-2...4-23

### Signaling



4-24...4-35

### Graphic Terminals



4-36...4-37



## Product Selection

### Momentary Contact Push Button Units – Non-Illuminated



Contact Type	Button Color	Type 4/13		Type 4/4X/13	
		Flush Head	Extended Head	Booted <sup>1</sup>	Bootless Flush Head
		Cat. No.	Cat. No.	Cat. No.	Cat. No.
No Contact	● Green	800T-A1	800T-B1	800H-R1	800H-AR1
	● Black	800T-A2	800T-B2	800H-R2	800H-AR2
	● Red	800T-A6	800T-B6	800H-R6	800H-AR6
1 N.O.	● Green	800T-A1D1	800T-B1D1	800H-R1D1	800H-AR1D1
	● Black	800T-A2D1	800T-B2D1	800H-R2D1	800H-AR2D1
	● Red	800T-A6D1	800T-B6D1	800H-R6D1	800H-AR6D1
1 N.C.	● Green	800T-A1D2	800T-B1D2	800H-R1D2	800H-AR1D2
	● Black	800T-A2D2	800T-B2D2	800H-R2D2	800H-AR2D2
	● Red	800T-A6D2	800T-B6D2	800H-R6D2	800H-AR6D2
1 N.O. – 1 N.C.	● Green	800T-A1A	800T-B1A	800H-R1A	800H-AR1A
	● Black	800T-A2A	800T-B2A	800H-R2A	800H-AR2A
	● Red	800T-A6A	800T-B6A	800H-R6A	800H-AR6A

<sup>1</sup> Underlying operators are extended head. Boot material is chlorosulfonated polyethylene.

### Momentary Contact Push Button Units – Illuminated, LED



Type	Voltage	Color	Type 4/13		Type 4/4X/13	
			Extended Head without Guard <sup>2</sup>	Extended Head with Guard <sup>2</sup>	Extended Head without Guard <sup>2</sup>	Extended Head with Guard <sup>2</sup>
			Cat. No.	Cat. No.	Cat. No.	Cat. No.
Universal	12...130V AC/DC	● Red	800T-QBH2R	800T-QAH2R	800H-QRBH2R	800H-QRAH2R
		● Green	800T-QBH2G	800T-QAH2G	800H-QRBH2G	800H-QRAH2G
		● Amber	800T-QBH2A	800T-QAH2A	800H-QRBH2A	800H-QRAH2A

<sup>2</sup> Includes as standard one catalog number 800T-XA (1 N.O. – 1 N.C.) contact block.

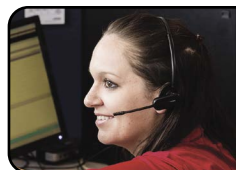

#### Need Help?

The Rockwell Automation Support Center is your 24/7 support for the answers you need now.  
[rok.auto/support](http://rok.auto/support)

For more information on our complete family of 30 mm push button products, please visit:  
[rok.auto/30mm-push-buttons](http://rok.auto/30mm-push-buttons)





# Push Buttons

## Product Selection



### Selector Switch Units – 2-Position, Non-Illuminated

Contact Type	Operator Position		M = Maintained S = Spring Return	Type 4/13		Type 4/4X/13	Type 4/13 Cylinder Lock		
				Standard Knob	Knob Lever	Standard Knob	Key Removal (Left) <sup>2</sup>	Key Removal (Right) <sup>2</sup>	Key Removal (Both) <sup>2</sup>
				Cat. No.	Cat. No.	Cat. No.	Cat. No.	Cat. No.	Cat. No.
No contacts	–	–	M M	800T-H2	800T-H17	800H-HR2	800T-H31	800T-H32	800T-H33
			S→M	800T-H4	800T-H18	800H-HR4	–	–	–
			M←S	800T-H5	800T-H19	800H-HR5	800T-H48	–	–
1 N.O.	0	X	M M	800T-H2D1	800T-H17D1	800H-HR2D1	800T-H31D1	800T-H32D1	800T-H33D1
			S→M <sup>1</sup>	800T-H4D1	800T-H18D1	800H-HR4D1	–	800T-H42D1	–
			M←S	800T-H5D1	800T-H19D1	800H-HR5D1	800T-H48D1	–	–
1 N.O. 1 N.C.	0 X	X 0	M M	800T-H2A	800T-H17A	800H-HR2A	800T-H31A	800T-H32A	800T-H33A
			S→M <sup>1</sup>	800T-H4A	800T-H18A	800H-HR4A	–	800T-H42A	–
			M←S	800T-H5A	800T-H19A	800H-HR5A	800T-H48A	–	–

<sup>1</sup> Target tables are reversed from those shown.

<sup>2</sup> Keys removable from maintained positions only.



### Selector Switch Units – 3-Position, Non-Illuminated

Contact Type	Operator Position			M = Maintained S = Spring Return	Type 4/13		Type 4/4X/13	Type 4/13 Cylinder Lock		
					Standard Knob	Knob Lever	Standard Knob	Key Removal (Left) <sup>2</sup>	Key Removal (Right) <sup>2</sup>	Key Removal (All) <sup>2</sup>
					Cat. No.	Cat. No.	Cat. No.	Cat. No.	Cat. No.	Cat. No.
No contacts	–	–	–	M M M	800T-J2	800T-J17	800H-JR2	800T-J41	800T-J42	800T-J44
				S→M M	800T-J4	800T-J18	800H-JR4	–	800T-J50	–
				M M←S	800T-J5	800T-J19	800H-JR5	800T-J69	800T-J38	–
				S→M←S	800T-J91	800T-J20	800H-JR91	–	800T-J631	–
1 N.O. 1 N.C.	0 X	0 0	X 0	M M M	800T-J2A	800T-J17A	800H-JR2A	800T-J41A	800T-J42A	800T-J44A
				S→M M	800T-J4A	800T-J18A	800H-JR4A	–	800T-J50A	–
				M M←S	800T-J5A	800T-J19A	800H-JR5A	800T-J69A	800T-J38A	–
				S→M←S	800T-J91A	800T-J20A	800H-JR91A	–	800T-J631A	–

<sup>1</sup> Target tables are reversed from those shown.

<sup>2</sup> Keys removable from maintained positions only.

#### Push Buttons



4-2...4-23

#### Signaling



4-24...4-35

#### Graphic Terminals



4-36...4-37



## Product Selection

### Pilot Light Units - LED





Contact Type	Volts	Color	Type 4/13		Type 4/4X/13	
			Pilot Light	Push-to-Test <sup>1</sup>	Pilot Light	Push-to-Test <sup>1</sup>
			Cat. No.	Cat. No.	Cat. No.	Cat. No.
Universal	12...130V AC/DC	● Red	800T-QH2R	800T-QTH2R	800H-QRH2R	800H-QRTH2R
		● Green	800T-QH2G	800T-QTH2G	800H-QRH2G	800H-QRTH2G
		● Amber	800T-QH2A	800T-QTH2A	800H-QRH2A	800H-QRTH2A

<sup>1</sup> Includes one standard catalog number 800T-XA (1 N.O. - 1 N.C.) contact block.





### 2-Position Push-Pull and Push-Pull/Twist Release Units - Non-Illuminated

Contact Type	Operator Position		Type 4/13		Type 4/4X/13
			Push-Pull	Push-Pull/ Twist Release	Push-Pull/ Twist Release
	Out	In	Cat. No.	Cat. No.	Cat. No.
N.C.L.B	X	0	800T-FX6D4	800T-FXT6D4	800H-FRXT6D4
N.O. N.C.L.B	0 X	X 0	800T-FX6A1	800T-FXT6A1	800H-FRXT6A1
N.C.L.B N.C.L.B	X X	0 0	800T-FX6A5	800T-FXT6A5	800H-FRXT6A5
S.M.C.B.	X	0	800TC-FX6D4S	800TC-FXT6D4S	800HC-FRXT6D4S
N.O. S.M.C.B.	0 X	X 0	800TC-FX6A1S	800TC-FXT6A1S	800HC-FRXT6A1S
S.M.C.B S.M.C.B	X X	0 0	800TC-FX6A5S	800TC-FXT6A5S	800HC-FRXT6A5S



### 2-Position Push-Pull and Push-Pull/Twist Release Units - Illuminated, LED

Contact Type	Volts	Contacts	Operator Position		Type 4/13		Type 4/4X/13
					Push-Pull	Push-Pull/ Twist Release	Push-Pull/ Twist Release
			Out	In	Cat. No.	Cat. No.	Cat. No.
Universal	12...130V AC/DC	N.O. N.C.L.B	0 X	X 0	800T-FXQH2RA1	800T-FXTQH2RA1	800H-FRXTQH2RA1



# Push Buttons

## Product Selection



### Enclosures

	Die Cast <sup>1,2</sup> (Type 4/13)	Stainless Steel <sup>1</sup> (Type 4/4X/13)	Glass-Filled Polyester (Type 4/4X/13)	Fiberglass <sup>3</sup> (Type 4/4X/13)	Thermoplastic Polyester <sup>4</sup> (Type 4/4X)
Operator Openings	Cat. No.	Cat. No.	Cat. No.	Cat. No.	Cat. No.
1	800T-1TZ	800H-1HZ4	800H-1HZ4R	800H-1HZ4Y	800H-1HZ4C
2	800T-2TZ	800H-2HZ4	800H-2HZ4R	800H-2HZ4Y	800H-2HZ4C
3	800T-3TZ	800H-3HZ4	800H-3HZ4R	800H-3HZ4Y	800H-3HZ4C
4	800T-4TZ	800H-4HZ4	800H-4HZ4R	—	800H-4HZ4C
6	800T-6TZ	800H-6HZ4	800H-6HZ4R	—	—

<sup>1</sup> Bottom conduit entry. Grounding screw provided.

<sup>2</sup> Enclosure depth will accommodate one shallow and one mini-contact block stacked.

<sup>3</sup> Extra deep - accommodates two levels of explosion-protected contact blocks.

<sup>4</sup> No conduit openings provided.



### Contact Blocks

Contact Type	Shallow Block <sup>5</sup>	Mini Block <sup>5</sup>	PenTUFF (Low Voltage) Block <sup>5</sup>	Explosion-Protected Block <sup>6</sup>	Self-Monitoring Contact Block	Max Duty Block
	Cat. No.	Cat. No.	Cat. No.	Cat. No.	Cat. No.	Cat. No.
1 N.O.	800T-XD1	800T-XD5	800T-XD1V	—	—	800T-XD1M
1 N.C.	800T-XD2	800T-XD6	800T-XD2V	—	—	800T-XD2M
1 N.O.E.M.	800T-XD3	—	800T-XD3V	—	—	—
1 N.C.L.B.	800T-XD4	—	800T-XD4V	—	—	800T-XD4M
1 N.O. - 1 N.C.	800T-XA	—	800T-XAV	800TC-XAF	—	—
2 N.O.	800T-XA2	—	—	—	—	—
2 N.C.	800T-XA4	—	—	—	—	—
1 N.C.L.B. - 1 N.O.	800T-XA1	—	—	—	—	—
1 N.C.L.B. - 1 N.C.	800T-XA7	—	—	—	—	—
1 N.C.L.B. (wired in series with 1 N.O. monitoring contact)	—	—	—	—	800TC-XD4S	—

<sup>5</sup> Contact blocks with normally closed contacts meet direct drive positive opening standard requirements when properly fused to IEC 269-1 and 269-2. Shallow/mini contacts: 10 A gI or N type cartridge fuse. PenTUFF contacts: 6 A gI or N type cartridge fuse.

<sup>6</sup> 800T operators using explosion protected, sealed switch or logic reed contact blocks and installed in a suitable enclosure are UL Listed as suitable for use in Class I, Division 2 hazardous locations.

#### Push Buttons



4-2...4-23

#### Signaling



4-24...4-35

#### Graphic Terminals



4-36...4-37



## Product Selection

### Blank and Custom Legend Plates – Aluminum, Type 4/13 (800T)

Legend Plate Color	Standard	Jumbo
	Cat. No.	Cat. No.
Grey	800T-X559	800T-X559J
Red	800T-X621	800T-X621J
Yellow	800T-X679	800T-X679J
Grey (with custom text)	800T-X559E	800T-X559JE
Red (with custom text)	800T-X621E	800T-X621JE
Yellow (with custom text)	80T-X679E	80T-X679JE

### Standard Legends

Marking	Aluminum, Type 4/13	Grey Plastic, Type 4/4X	Marking	Aluminum, Type 4/13	Grey Plastic, Type 4/4X	Marking	Aluminum, Type 4/13	Grey Plastic, Type 4/4X
	Cat. No.	Cat. No.		Cat. No.	Cat. No.		Cat. No.	Cat. No.
AUTO-MAN-OFF	800T-X625	800H-W059	JOG	800T-X517	800H-W110	RUN	800T-X540	800H-W123
AUTO-OFF-HAND	800T-X501	800H-W154	JOG FORWARD	800T-X518	800H-W111	RUN-JOG	800T-X541	800H-W032
CLOSE	800T-X502	800H-W101	JOG REVERSE	800T-X519	800H-W112	SAFE-RUN	800T-X542	800H-W033
DOWN	800T-X503	800H-W102	JOG RUN	800T-X520	800H-W135	SLOW	800T-X544	800H-W125
EMERG. STOP (Red) <sup>1</sup>	800T-X504	800H-W372	JOG-STOP-RUN	800T-X521	800H-W057	SLOW-FAST	800T-X545	800H-W136
EMERG. STOP (Yellow)	800T-X504Y	–	LOW	800T-X524	800H-W113	SLOW-OFF-FAST	800T-X546	800H-W157
EMERGENCY STOP (Red) <sup>1</sup>	800T-X648	800H-W373	OFF	800T-X527	800H-W116	SPEED <sup>2</sup>	800T-X608	800H-W081
FAST	800T-X505	800H-W104	OFF-ON	800T-X529	800H-W133	START	800T-X547	800H-W126
FOR.-OFF-REV.	800T-X507	800H-W152	ON	800T-X530	800H-W117	START-JOG	800T-X548	800H-W138
FOR.-REV.	800T-X506	800H-W132	ON-OFF	800T-X622	–	START-STOP	800T-X549	800H-W137
FORWARD	800T-X508	800H-W105	OPEN	800T-X531	800H-W118	STOP (Red)	800T-X550	800H-W371
HAND-AUTO	800T-X510	800H-W131	OPEN-CLOSE	800T-X532	800H-W134	STOP-START	800T-X551	800H-W038
HAND-OFF-AUTO	800T-X511	800H-W151	OPEN-OFF-CLOSE	800T-X533	800H-W153	TEST	800T-X554	800H-W128
HIGH	800T-X512	800H-W107	POWER ON	800T-X639	800H-W001	UP	800T-X556	800H-W009
HIGH-LOW	800T-X513	800H-W030	RESET	800T-X538	800H-W121	UP-DOWN	800T-X557	800H-W039
HIGH-OFF-LOW	800T-X514	800H-W058	REVERSE	800T-X539	800H-W122	UP-OFF-DOWN	800T-X558	800H-W160



<sup>1</sup> These legend plates do not comply with E-Stop standards that specify a yellow background, such as IEC 60947-5-5 and NFPA 79.

<sup>2</sup> Potentiometer type with graduated markings.

For more information on our complete family of 30 mm push button products, please visit:  
[rok.auto/30mm-push-buttons](http://rok.auto/30mm-push-buttons)



# Push Buttons

## 30 mm Emergency Stop Operators 800T/H

- Trigger action
- Certified UL Category NISD and NNTD Emergency Stop Devices
- Complies with EN ISO 13850 and EN 60947-5-5
- Tamper-resistant front-of-panel mounting
- Non-removable mushroom cap
- Non-teasible with standard normally closed (N.C.) contacts



## State-of-the-art, Tamper-resistant Design

Trigger action functionality provided in the 800T/H trigger action E-stop delivers operators that meet global requirements and are ideal for installation in heavy duty applications. The twist release design conforms to functional safety guidelines where intentional action is required to reset the E-stop device.

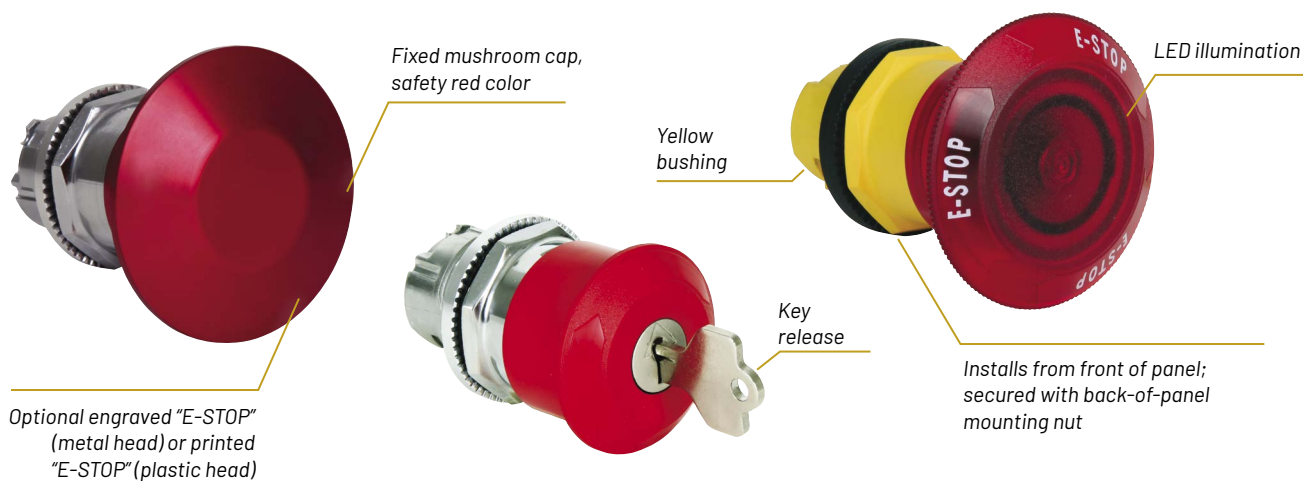

## Self-Monitoring Contact Block



- Opens controlled circuit in the unlikely event the contact block becomes separated from the operator
- 10 A max., A600 rated
- Bifurcated spanner with pure fine silver contacts
- Color-coded yellow for easy identification
- IP2X finger-safe protection standard

### Push Buttons



4-2...4-23

### Signaling



4-24...4-35

### Graphic Terminals



4-36...4-37



## Product Selection

### 2-Position Red Trigger Action Twist-to-Release – Non-Illuminated



Contact Type	Operator Position		Type 4/13			Type 4/4X/13
			45 mm Plastic	63 mm Metal	Key Release	45 mm Plastic
	Out	In	Cat. No. <sup>1,2,3</sup>	Cat. No. <sup>1,4</sup>	Cat. No. <sup>1</sup>	Cat. No. <sup>1,2,3</sup>
No contacts	–	–	800T-TFXT6	800T-TFXLT6	800T-TFXK6	800H-TFRXT6
1 N.C.	X	0	800T-TFXT6D2	800T-TFXLT6D2	800T-TFXK6D2	800H-TFRXT6D2
1 N.O. - 1 N.C.	0 X	X 0	800T-TFXT6A	800T-TFXLT6A	800T-TFXK6A	800H-TFRXT6A
1 S.M.C.B. <sup>5</sup>	X	0	800TC-TFXT6D4S	800TC-TFXLT6D4S	800TC-TFXK6D4S	800HC-TFRXT6D4S
2 N.C.	X X	0 0	800T-TFXT6A4	800T-TFXLT6A4	800T-TFXK6A4	800H-TFRXT6A4
2 S.M.C.B.	X X	0 0	800TC-TFXT6A5S	800TC-TFXLT6A5S	800TC-TFXK6A5S	800HC-TFRXT6A5S

- <sup>1</sup> For finger-safe contact block terminals, add a **C** to the catalog number Example: Catalog number 800**TC**-TFXT6 or 800**HC**-TFRXT6.
- <sup>2</sup> To order a device with a jumbo (60 mm) plastic head add the letter **J** after X. Example: Catalog number 800T-TFX**J**T6A or 800H-TFRX**J**T6A.
- <sup>3</sup> To order a jumbo head device with "E-STOP" printed on the cap add the letters **JE** after X. Example: Catalog number 800T-TFX**JE**T6 or 800H-TFRX**JE**T6.
- <sup>4</sup> To order a device with "E-STOP" engraved on the cap add the letter **E** after L. Example: Catalog number 800TC-TFX**LE**T6D4S.
- <sup>5</sup> Self-monitoring contact block.



### 2-Position Red Trigger Action Twist-to-Release – Illuminated

Type	Voltage	Contact Type	Operator Position		Type 4/13			Type 4/4X/13
					45 mm	60 mm	45 mm	60 mm
			Out	In	Cat. No. <sup>6</sup>	Cat. No. <sup>6,7</sup>	Cat. No. <sup>6</sup>	Cat. No. <sup>6,7</sup>
Operator only <sup>8</sup>		No contacts			800T-TFXTS00R	800T-TFXJTS00R	800H-TFRXTS00R	800H-TFRXJTS00R
Universal	12...130V AC/DC	N.O. - N.C.	0 X	X 0	800T-TFXTQH2RA	800T-TFXJQH2RA	800H-TFRXQH2RA	800H-TFRXJQH2RA

- <sup>6</sup> For finger-safe contact block terminals, add a **C** to the catalog number Example: Catalog number 800**TC**-TFXTS00R or 800**HC**-TFRXTS00R.
- <sup>7</sup> To order a device with "E-STOP" printed on the cap add the letter **E** after J. Example: Catalog number 800T-TFX**JE**TQH2RA or 800H-TFRX**JE**TQH2RA.
- <sup>8</sup> Operator-only supplied without power module, lamp, or contact blocks.



**Safety**  
Our innovative safety products and solutions improve the functional operation of your machinery while helping to increase personnel safety, efficiency and productivity.  
[rok.auto/safety-products](http://rok.auto/safety-products)





# Push Buttons

## Piezoelectric Push Buttons 800K

- IP69K rating
- 22.5 mm and 30.5 mm
- 316 stainless-steel
- Smooth, crevice-free surface
- Custom engraving (text and symbols) available



The 800K Piezoelectric push buttons represent an innovative rethinking of push button technology and its industrial applications. The potted piezoelectric circuit detects pressure on the surface of the button to provide a momentary actuation signal with no moving parts. These push buttons are ideal for food, beverage and other industries where high-pressure, caustic washdowns can challenge even the most robust push buttons.

### Smooth, Crevice-free Surface

- Easier to clean
- Minimizes areas on the button in which contaminants can potentially be lodged

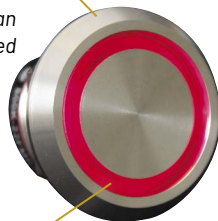

### Illumination

Red, green, white, blue or yellow

### 316 Stainless-steel

Corrosion resistant to caustic wash-down solutions



### Potted Circuit

- Helps prevent fluids from corroding operator components
- Provides an additional barrier of protection

### No Moving Parts

By using piezoelectric technology, moving seals and crevices can be eliminated from the push button

### Mounting Ring

Nickel-plated Brass



### Anti-rotation Washer

316 Stainless Steel

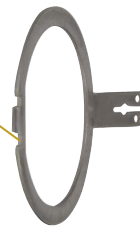

### Push Buttons



3-2...3-23

### Signaling



3-24...3-35

### Graphic Terminals



3-36...3-37



## Product Selection



### Momentary Push Button Operators – Screw Termination, 24VDC

Hole Size		Color	Contact Type	Engraving	Cat. No.	
22.5 mm		Non-Illuminated	N.O.	Blank	800K-22FMN24X10	
	●	Green	N.O.		800K-22FMG24X10	
	●	Red	N.C.		800K-22FMR24X01	
	○	White	N.O.		800K-22FMW24X10	
	●	Blue	N.O.		800K-22FMB24X10	
	●	Yellow	N.O.		800K-22FMY24X10	
		Non-Illuminated	N.O.		Custom Text or Symbol	800K-22FMN24X10⊗
	●	Green	N.O.	800K-22FMG24X10⊗		
	●	Red	N.C.	800K-22FMR24X01⊗		
	○	White	N.O.	800K-22FMW24X10⊗		
	●	Blue	N.O.	800K-22FMB24X10⊗		
	●	Yellow	N.O.	800K-22FMY24X10⊗		
	30.5 mm		Non-Illuminated	N.O.		Blank
		●	Green	N.O.	800K-30FMG24X10	
●		Red	N.C.	800K-30FMR24X01		
○		White	N.O.	800K-30FMW24X10		
●		Blue	N.O.	800K-30FMB24X10		
●		Yellow	N.O.	800K-30FMY24X10		
		Non-Illuminated	N.O.	Custom Text or Symbol	800K-30FMN24X10⊗	
●		Green	N.O.		800K-30FMG24X10⊗	
●		Red	N.C.		800K-30FMR24X01⊗	
○		White	N.O.		800K-30FMW24X10⊗	
●		Blue	N.O.		800K-30FMB24X10⊗	
●		Yellow	N.O.		800K-30FMY24X10⊗	

⊗ - Add custom text Font Code **E100G** (12 pt), **E100H** (16 pt), **E100J** (20 pt) or custom symbol code **U100**.

⊕ - Add custom text codes **E100H** (16 pt), **E100J** (20 pt) or custom symbol code **U100**.

### Custom Text Lines / Character Chart

Font Code	No. of Lines	Characters per Line			
		22.5 mm		30.5 mm	
		Non-Illuminated	Illuminated	Non-Illuminated	Illuminated
E100G (12 pt)	1	8	6	-	-
	2	8/8	5...6/5...6	-	-
	3	7/8/7	4/6/4	-	-
E100H (16 pt)	1	6...7	5	9	6...7
	2	6/6	4/4	8/8	6/6
	3	4/6/4	-	7/9/7	4/6/4
E100J (20 pt)	1	5	1...4	7	5
	2	5/5	-	6...7/6...7	5/5
	3	-	-	6/7/6	-



# Push Buttons

## 16 mm Push Buttons, Pilot Lights, Selector Switches, and E-Stops 800B

- Ergonomic design
- Designed to global standards
- IP66 and Type 4/13
- Excellent for panels with limited space
- Illuminated and non-illuminated
- Trigger action E-stop



800B 16 mm push buttons can meet your light industrial and instrumentation application needs with their highly configurable and flexible design. These operators are excellent for applications with limited panel space or a small footprint. They are made of corrosion-proof plastic to ensure long push button life.

### Ease of Installation

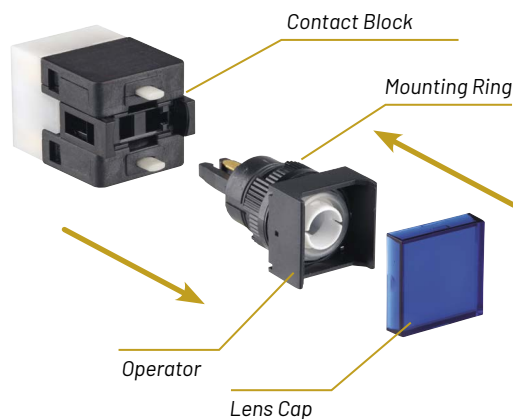

### Push Buttons & Pilot Lights

- Momentary or maintained options
- Bright, bold, consistent operators (green, red, yellow, blue, white)
- Contoured button surface for comfort
- Diaphragm seals

### Selector Switches

- 2- or 3-position
- V seal - High pressure sealing
- Gold-plated snap action contacts

### E-stop

- Anti-tease feature
- Trigger-action design
- K seal - Dual wiping action

#### Push Buttons



3-2...3-23

#### Signaling



3-24...3-35

#### Graphic Terminals



3-36...3-37

## Product Selection



### Push Button & Pilot Light Operators

Operator Type	Round	Square	Rectangle	Large Square
	Cat. No.	Cat. No.	Cat. No.	Cat. No.
Momentary, push button/pilot light	800B-EPA	800B-EPB	800B-EPC	800B-EPD
Maintained, push button	800B-EAA	800B-EAB	800B-EAC	800B-EAD

**Note:** All operators are sold without a lens cap and diffuser.

### Lens Cap with Diffuser



Lens Color	Round	Square	Rectangle	Large Square
	Cat. No.	Cat. No.	Cat. No.	Cat. No.
Green	800B-ALA3	800B-ALB3	800B-ALC3	800B-ALD3
Red	800B-ALA4	800B-ALB4	800B-ALC4	800B-ALD4
Yellow	800B-ALA5	800B-ALB5	800B-ALC5	800B-ALD5
Blue	800B-ALA6	800B-ALB6	800B-ALC6	800B-ALD6
White	800B-ALA7	800B-ALB7	800B-ALC7	800B-ALD7

### Selector Switch Operators



Operator Type	Maintained	Return from Right	Keyed, Maintained	Keyed, Return from Right
	Cat. No.	Cat. No.	Cat. No.	Cat. No.
2-position	800B-SM2A	800B-SR2A	800B-KM2A	800B-KR2A

Operator Type	Maintained	Return from Both	Keyed, Maintained	Keyed, Return from Both
	Cat. No.	Cat. No.	Cat. No.	Cat. No.
3-position	800B-SM3A	800B-SB3A	800B-KM3A	800B-KB3A

### Emergency Stop Operator

Operator Type	Cat. No.
Emergency stop operator	800B-MT



### Illumination



Description	Lamp Color	Lamp Voltage	Cat. No.
LED bulb <sup>1</sup>	Green	12...24V AC/DC	800B-N3G
		120V AC	800B-N5G
	Red	12...24V AC/DC	800B-N3R
		120V AC	800B-N5R
	White	12...24V AC/DC	800B-N3W
		120V AC	800B-N5W
Incandescent bulb <sup>2</sup>	Clear	6V AC/DC	800B-N1C
		12V AC/DC	800B-N2C
		24V AC/DC	800B-N3C

<sup>1</sup> Not available in 6V AC/DC.

<sup>2</sup> Not available in 120V AC.

### Contact Block/Latch Module



Description	Cat. No.
<b>Push Button/Selector Switch</b>	
1 N.O./1 N.C. snap action	800B-PS11
2 N.O./2 N.C. snap action	800B-PS22
<b>Pilot Light</b>	
Placeholder block	800B-PL
<b>Emergency Stop/Push Button/Selector Switch</b>	
1 N.C. slow make/break	800B-PT01
2 N.C. slow make/break	800B-PT02
1 N.O./1 N.C. slow make/break	800B-PT11



### Sales Offices and Distributors

Our network of sales offices and distributors offers exceptional knowledge and service to help you design, implement and support your automation investment.

[rok.auto/buy](http://rok.auto/buy)



# Signaling

## Panel Mount Alarms 855P

- Visual, audible, or combined indication
- Completely enclosed front, suitable for harsh washdown environments
- Ingress protection rating UL Type 4/4X/13, IP65
- Rear-securing and finger-safe terminals
- Mount in a standard 22.5 mm hole or 30.5 mm hole with adapter



855P panel mount alarms allow local indication of the status of a machine or equipment while enhancing space efficiency with devices ready to be installed in a control panel. These devices include features that preserve the control panel integrity and reduce installation time. Alarm options include sounders, status indicator beacons, xenon strobes, and sounders with status indicator combination, as well as dual-circuit alarms.

### Bulletin 855PB LED Beacon

Mounting ring to secure device to the rear of the panel



### 855P Sounders

Removable plug-in terminal block  
Keyed to avoid wiring mistakes



### 855PC Combined Sounder w/ LED beacon

Completely enclosed front tamper/vandal resistant suitable for wash down environments



### Bulletin 855PS Xenon Strobe Beacon

Voltage color coding for easy identification of the circuit



### 2-Color Half-Lens (with barrier)

Signal up to two different conditions on a machine with only one device



Push Buttons



4-2...4-23

Signaling



4-24...4-35

Graphic Terminals

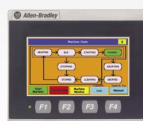

4-36...4-37



## Product Selection

### 855P Panel Mount Sounders

Voltage	Size [mm]	Cat. No.
12...24V AC/DC	30 (72 dB)	855P-B30SE22
	30 (80 dB)	855P-B30SH22
	45	855P-B30ME22
120V AC	65	855P-B30LE22
	30 (72 dB)	855P-B10SE22
	30 (80 dB)	855P-B10SH22
120V AC	45	855P-B10ME22
	65	855P-B10LE22

### Accessories

Description	Cat. No.
22.5...30.5 mm hole adapter kit	855P-AHA1

### Specifications

<b>Housing Material</b>	<b>Base</b>	Polycarbonate (black)
	<b>Lens</b>	Polycarbonate (red, amber, yellow, green, blue, and clear)
<b>Environmental Ratings</b>	UL Type 4/4X/13, IP65	
<b>Operation Temperature Range</b>	-25...+60 °C (-13...+140 °F)	
<b>Mounting</b>	Central mounting for bore holes 22 mm or 30.5 mm with hole adapter kit (Cat. No. 855P-AHA1)	
<b>Certifications</b>	cULus Listed, CE Marked	

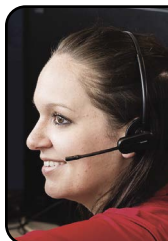

#### Need Help?

The Rockwell Automation Support Center is your 24/7 support for the answers you need now.

[rok.auto/support](http://rok.auto/support)

### 855PS Panel Mount Strobes and 855PB Selectable Steady or Flashing LED Beacons

Voltage	Diameter [mm]	Lens Color	Panel Mount Strobe	Selectable Steady/Flashing LED Beacon
			Cat. No.	Cat. No.
24V AC/DC	30	Green	855PS-B24SE322	855PB-B24SE322
		Red	855PS-B24SE422	855PB-B24SE422
	45	Green	855PS-B30ME322	855PB-B24ME322
		Red	855PS-B30ME422	855PB-B24ME422
	65	Green	855PS-B30LE322	855PB-B24LE322
		Red	855PS-B30LE422	855PB-B24LE422
120V AC	30	Green	855PS-B10SE322	855PB-B10SE322
		Red	855PS-B10SE422	855PB-B10SE422
	45	Green	855PS-B10ME322	855PB-B10ME322
		Red	855PS-B10ME422	855PB-B10ME422
	65	Green	855PS-B10LE322	855PB-B10LE322
		Red	855PS-B10LE422	855PB-B10LE422

### 855PC Combined Sounders with LED Beacon and 855PD Dual-Circuit Alarms

Function	Voltage	Diameter [mm]	Color(s)	Combined Sounder with LED Beacon	Dual Circuit Alarm
				Cat. No.	Cat. No.
Sounder with LED	24V AC/DC	45	Green	855PC-B24ME322	855PD-B24MEC1322
			Red	855PC-B24ME422	855PD-B24MEC1422
		65	Green	855PC-B24LE322	855PD-B24LEC1322
			Red	855PC-B24LE422	855PD-B24LEC1422
	120V AC	45	Green	855PC-B10ME322	855PD-B10MEC1322
			Red	855PC-B10ME422	855PD-B10MEC1422
Half-lens, steady LED beacon <sup>1</sup>	24V AC/DC	30	Red & Green	-	855PD-B24SEH4322
		45		-	855PD-B24MEH4322
		65		-	855PD-B24LEH4322
	120V AC	45	Red & Green	-	855PD-B10MEH4322
				65	-

<sup>1</sup> Full lens style with 2 LED beacons also available.





# Signaling

## Control Tower™ Stack Lights 854J (40 mm) & 854K (60 mm)

- Suitable for indoor and outdoor use
- IP66 rated housing
- Expandable to five levels per stack or up to ten modules in a single arrangement via the double-sided base option
- Piezoelectric sound modules maintain the ingress rating when mounted in the stack



The Control Tower stack lights are designed to communicate status of different conditions alerting you to critical equipment and systems needs on plant floor. Available in a wide variety of light and sound functions, sizes, colors, voltages and mounting options, our stack lights help monitor some of your most challenging control panel and On-Machine applications.

**Lens Colors Options**

		
3 = Green	4 = Red	5 = Amber
		
6 = Blue	7 = Clear	8 = Yellow



Five circuits maximum in one stack



854K (60 mm)

**Piezo Sound Module**

**Light Modules**

- LED or incandescent
- Multiple color options

Terminal Block mounted on top of the base for easy wiring

**Mounting Options**

- Pole
- Quick release
- Surface
- Tube
- Vertical
- Double-sided base
- Half-inch NPT base
- Surface mount with M12-5 pin connector



854J (40 mm)

Tool-free lens assembly

Up to ten circuits maximum on double sided base

Push Buttons



4-2...4-23

Signaling



4-24...4-35

Graphic Terminals



4-36...4-37



## Product Selection

### Pre-configured Devices

Voltage	Mounting Base	Level 1		Level 2		Level 3		Piezo Sound Module	40 mm	60 mm
		LED Module	Color	LED Module	Color	LED Module	Color		Cat. No.	Cat. No.
24V AC/DC	10 cm pole mount	Steady	Red	-	-	-	-	-	854JC-P10B24Y4	854KC-P10B24Y4
	10 cm pole mount	-	-	-	-	-	-	Yes	854JC-P10B24P1	854KC-P10B24P1
	10 cm pole mount	Steady	Blue	Steady	Green	Steady	Red	-	854JC-P10B24Y6Y3Y4	854KC-P10B24Y6Y3Y4
	1/2 in. NPT thread	Steady	Green	Steady	Red	Steady	Amber	-	854JC-NPTB24Y3Y4Y5	854KC-NPTB24Y3Y4Y5

## Accessories

Description	For use with 854J	For use with 854K
	Cat. No.	Cat. No.
10 cm plastic base extension, black	854J-ABBE	854K-ABBE
Plastic vertical bracket for pole foot, black	854J-ABPB	854J-ABPB
O-rings for lenses	854J-ALSG <sup>1</sup>	854K-ALSG <sup>1</sup>
O-rings for bases	854J-ABSG <sup>1</sup>	854K-ALSG
Gasket for SH surface mount bases	854J-ASG2 <sup>1</sup>	854K-ASG2 <sup>1</sup>
Upper base with terminal block, black	854J-ABUB	854K-ABUB
Cap, black	854J-ABCAP	854K-ABCAP
Conduit mount adapter for threaded tube base (1/2 in. NPT to M20x1.5)	854J-ACMK	854J-ACMK
L-bracket for threaded tube base (vertical mount kit)	854J-ABVM	854J-ABVM
Direct mount kit for threaded tube base	854J-ARDM	854J-ARDM

<sup>1</sup> Order quantity of 1 to receive package of 5.

## Specifications

Housing Material	Modules (lenses, caps, bases)	Polycarbonate
	Seals and gaskets	Nitrile rubber
	Pole and base	Powder coated aluminum pole with polycarbonate base
	Mounting screw washers	Polypropylene
Environmental Ratings		UL Type 4/4X/13, IP66
Operating Temperature Range		-25...+60 °C (-13...+140 °F)
Mounting		Surface mount base, vertical base, aluminum pole base, dual sided base, quick release base, threaded tube, or NPT conduit mounting for indoor and outdoor use
Flash Frequency		Flashing Modules: 1.5 Hz (Time On/Time Off = 1:1) Strobe Modules: 2 Hz (flash duration 1/50,000 second)
Sound Module dB Rating		Max. 80 dB (non-adjustable) at 1m from sound module for 854J or Max. 90 dB (adjustable) at 1m from sound module for 854K
Certifications		cULus Listed, CE Marked, RoHS Compliant



Configure the Control Tower Stack Lights to meet your application needs through Product Selection:

[rok.auto/854-stack-lights](http://rok.auto/854-stack-lights)



### Looking for More?

This catalog highlights only our most essential components; for a complete product selection, visit us at: [rok.auto/directory](http://rok.auto/directory)



# Signaling

OPERATOR INTERFACE

## Control Tower™ Stack Lights 856T

- Up to 7 modules in a single stack
- Outstanding brightness with low power consumption
- Light modules with multi-function capabilities available in seven colors
- Choice of piezoelectric, transducer and recordable sound modules to complement visual indication
- Beacon shaped light modules available for low profile signaling applications
- IO-Link connectivity allows for real-time insight into the status of your control system



### Component Selection

**4** Select Top Sounder, Beacon or Cap



**3** Select Light Modules or In-Line Sounders



**2** Select Power or IO-link Module\*



**1** Select the Base Mounting Adaptor



\* Not compatible with M12 5- or 8-pin connector bases.

Push Buttons



4-2...4-23

Signaling



4-24...4-35

Graphic Terminals



4-36...4-37



## Product Selection

### 856T – Bases / Power Modules 1 2

Base Style	Base Adaptor <sup>1</sup>	Power Module 24V AC/DC up to 7 circuits	Power Module 120/240V AC up to 3 circuits	Power Module 120/240V AC up to 7 circuits	IO-Link Module
	Cat. No.	Cat. No. <sup>5</sup>	Cat. No. <sup>5</sup>	Cat. No. <sup>5</sup>	Cat. No.
Surface Mounting 1/2 NPT	856T-BMASN	856T-B24C	856T-BAC3C	856T-BAC7C	856T-B24LC
Surface Mounting 1/2 NPT w/pre-installed screws	856T-BMASH	856T-B24C	856T-BAC3C	856T-BAC7C	856T-B24LC
Vertical Mount	856T-BMAVM	856T-B24C	856T-BAC3C	856T-BAC7C	856T-B24LC
Tube Mount	856T-BMAT <sup>3</sup>	856T-B24C	856T-BAC3C	856T-BAC7C	856T-B24LC
Pole Mount	856T-BMAP <sup>4</sup>	856T-B24C	856T-BAC3C	856T-BAC7C	856T-B24LC
M12 5-pin connector <sup>2</sup>	856T-B24QD5C	-	-	-	-
M12 8-pin connector <sup>2</sup>	856T-B24QD8C	-	-	-	-
Quick Release Base-10 cm <sup>2</sup>	856T-B24Q10C	-	-	-	-
Quick Release Base-25 cm <sup>2</sup>	856T-B24Q25C	-	-	-	-

<sup>1</sup> A complete mounting base requires a Base Adaptor and one of the Power Modules listed in the table. (e.g., 856T-BMASN+856T-B24C for a 24V DC surface mounting base).

<sup>2</sup> These are factory pre-assembled bases for 24V AC/DC only. They do not require power module selection. These bases are not compatible with the IO-Link module.

<sup>3</sup> Available tube mount lengths are 10 and 25 cm choose one length to complete Base adaptor cat. Number. (856T-BMAT10 or 856T-BMAT25)

<sup>4</sup> Available pole mount lengths are 10, 25, 40 and 60 cm. Select one length to complete Base adaptor cat. Number. 856T-BMAP10 or 856T-BMAP40)

<sup>5</sup> All factory pre-assembled bases and power modules include a cap. IO-Link module does not include a cap.

### 856T – Light Modules 3

Function	Colors available <sup>6</sup>	Cat. No.
LED Steady	G,R,A,B,W,Y,M	856T-BT <sup>7</sup>
LED Multi function		856T-BB <sup>7</sup>
LED Rotating	G,R,A,B,W,Y	856T-BR <sup>7</sup>
7 color RGB LED Module	Can produce up to 7 colors	856T-BMC
LED Steady/Flashing - Beacon shape	G,R,A,B,W,Y	856T-BGB <sup>7</sup>
LED Strobe - Beacon shape	R,A,B	856T-BSB <sup>7</sup>
LED Rotating - Beacon shape	R,A	856T-BRB <sup>7</sup>
7 color RGB LED Module - Beacon shape	Can produce up to 7 colors	856T-BMB

<sup>6</sup> Denotes color where G=Green, R=Red, A=Amber, B=Blue, W=White, Y=Yellow, M=Magenta.

<sup>7</sup> Catalog number is not complete. Please select a color designator: 3=Green, 4=Red, 5=Amber, 6=Blue, 7=White, 8=Yellow, 9= Magenta to complete catalog (e.g. 856T-BT4 is a LED steady Red).

### 856T – Accessories

Description	Cat. No.
Black cap	856T-ABCAP <sup>1</sup>
O-ring for light modules, power modules and base adaptors	856T-ARNG
Gasket for surface mount base adaptor	856T-ASFG
Gasket for vertical mount base adaptor	856T-AVFG
Lens diffuser kit	856T-ADK
Screws for pole connection boxes	856T-AJBS
Vertical mounting bracket for pole, M12 and surface mount bases	855T-AVM

<sup>1</sup> Cap included with all power modules

### 856T – Sound Modules 4

Function	Tones / Circuits	Sound Output	Cat. No.
Piezo Sounder - Top mount	8 tones - single circuit	105 dB at 1 m	856T-BP1
Piezo Sounder - In Line	8 tones - single circuit	102 dB at 1 m	856T-BPL1
Transducer Sounder <sup>8</sup>	16 tables / 7 tones per table - 3 circuits	105 dB at 1 m	856T-BTR3
Recordable Sounder	up to 7 customer pre-recorded messages	90 dB at 1 m (voice) 95 dB at 1 m (tone)	856T-BH3

<sup>8</sup> Three-circuit sounders may work with fewer than three circuits. They can produce three tones / messages with two circuits available or one tone / message with one circuit available.

## Specifications

<b>Materials</b>	Bases, Cap, Sound module housing, Lens, Pole foot, Diffuser	Polycarbonate
	Threaded Tube/Pole bases	Aluminum with clear powdercoat
	Gaskets and O-rings	Nitrile rubber
	Mounting screw washers	Polypropylene
<b>Light Modules and Sounders Environmental Ratings</b>	UL Type 4/4X/13, IP 66/67	
<b>Operating Temperature Range</b>	-30...+70 °C (-22...+158 °F)	
<b>Mounting Options</b>	Surface mount base, vertical base, aluminum pole base, M12 connector base, Quick release base, threaded tube base, 1/2 in. NPT conduit mount	
<b>Flashing Frequency Multi-function Module</b>	Flashing mode 2 Hz Single Strobe mode (1.4 Hz) Double Flash Strobe mode (1.4 Hz)	
<b>Sound Module dB Rating</b>	Piezo Top sounder (105 dB) In-line Piezo sounder (102 dB) Transducer sounder (105 dB)	
<b>Certifications</b>	cULus Listed, CE Marked, KCC, RCM, RoHS compliant	



# Signaling

## Wall Mount Signal Lights 855W

- Up to six different conditions can be indicated (five visual and one audible) in the same device
- Wall mount does not add extra height to machine or equipment
- Units can be mounted vertically or horizontally
- IP65 ingress protection rating for indoor/outdoor and harsh environment use



855W wall mount signal lights are designed to communicate the status of different conditions in the machine or critical equipment in a compact size housing. Our signal lights are available in configurations from two- to five-light indicators with optional sound in the same unit.

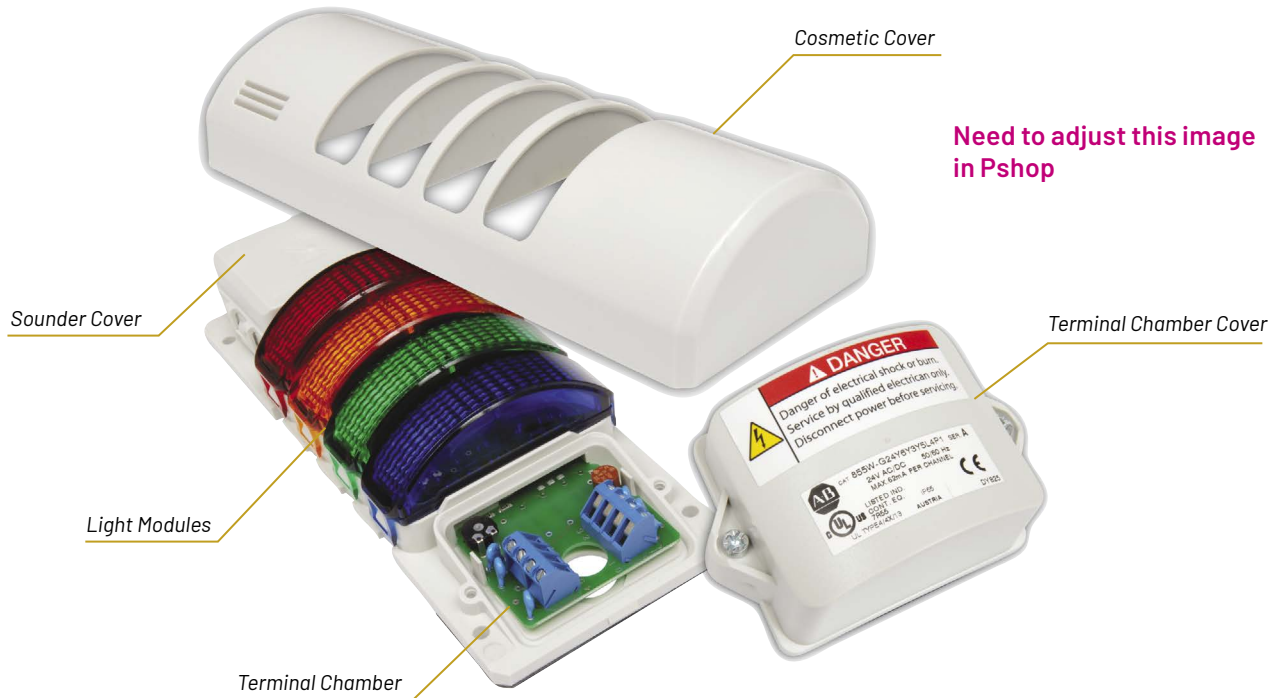

4-30

Push Buttons



4-2...4-23

Signaling



4-24...4-35

Graphic Terminals



4-36...4-37

## Product Selection

Voltage	Level 1		Level 2		Level 3		Level 4		Level 5		Grey Cover	Chrome Cover
	LED Module	Color	LED Module	Color	LED Module	Color	LED Module	Color	LED Module	Color	Cat. No. <sup>1</sup>	Cat. No. <sup>1</sup>
24V AC/DC	Steady	Green	Steady	Red	–	–	–	–	–	–	855W-G24Y3Y4	855W-C24Y3Y4
	Steady	Clear	Steady	Green	–	–	–	–	–	–	855W-G24Y7Y3	855W-C24Y7Y3
	Steady	Green	Flashing	Red	–	–	–	–	–	–	855W-G24Y3L4	855W-C24Y3L4
	Steady	Green	Steady	Amber	Steady	Red	–	–	–	–	855W-G24Y3Y5Y4	855W-C24Y3Y5Y4
	Steady	Red	Steady	Amber	Steady	Green	–	–	–	–	855W-G24Y4Y5Y3	855W-C24Y4Y5Y3
	Steady	Green	Flashing	Yellow	Flashing	Red	–	–	–	–	855W-G24Y3L8L4	855W-C24Y3L8L4
	Steady	Green	Steady	Red	Flashing	Amber	–	–	–	–	855W-G24Y3Y4L5	855W-C24Y3Y4L5
	Steady	Amber	Steady	Blue	Steady	Green	Steady	Red	–	–	855W-G24Y5Y6Y3Y4	855W-C24Y5Y6Y3Y4
	Steady	Clear	Steady	Green	Steady	Amber	Steady	Red	–	–	855W-G24Y7Y3Y5Y4	855W-C24Y7Y3Y5Y4
	Steady	Red	Steady	Amber	Steady	Blue	Steady	Green	Steady	Clear	855W-G24Y4Y5Y6Y3Y7	855W-C24Y4Y5Y6Y3Y7
	Flashing	Blue	Flashing	Amber	Flashing	Red	Flashing	Green	Flashing	Yellow	855W-G24L6L5L4L3L8	855W-C24L6L5L4L3L8
Flashing	Clear	Steady	Red	Steady	Blue	Steady	Amber	Steady	Yellow	855W-G24L7Y4Y6Y5Y8	855W-C24L7Y4Y6Y5Y8	
120V AC	Steady	Green	Steady	Red	–	–	–	–	–	–	855W-G10Y3Y4	855W-C10Y3Y4
	Steady	Green	Flashing	Red	–	–	–	–	–	–	855W-G10Y3L4	855W-C10Y3L4
	Flashing	Red	Steady	Yellow	–	–	–	–	–	–	855W-G10L4Y8	855W-C10L4Y8
	Flashing	Blue	Flashing	Clear	–	–	–	–	–	–	855W-G10L6L7	855W-C10L6L7
	Steady	Green	Steady	Amber	Steady	Red	–	–	–	–	855W-G10Y3Y5Y4	855W-C10Y3Y5Y4
	Flashing	Red	Flashing	Amber	Flashing	Blue	Flashing	Yellow	–	–	855W-G10L4L5L6L8	855W-C10L4L5L6L8
	Steady	Blue	Steady	Green	Steady	Amber	Steady	Red	–	–	855W-G10Y6Y3Y5Y4	855W-C10Y6Y3Y5Y4
	Steady	Clear	Steady	Blue	Steady	Green	Steady	Amber	Steady	Red	855W-G10Y7Y6Y3Y5Y4	855W-C10Y7Y6Y3Y5Y4

<sup>1</sup> For a signal light with piezo sound module add **PI** to the end of the catalog number For example, Catalog number 855W-G24Y3Y4 becomes Catalog number 855W-G24Y3Y4**PI**.

## Specifications

<b>Housing Material</b>	<b>Base</b>	Polycarbonate	<b>Operation Temperature Range</b>	-25...+50 °C (-13...+122 °F)	
	<b>Lens</b>	Polycarbonate		<b>Mounting</b>	Surface mounting. Can be mounted in any orientation.
	<b>Rubber Seals and Gaskets</b>	NBR 70			<b>Flashing LED Frequency</b>
<b>Environmental Ratings</b>			<b>Piezo Sounder dB Rating</b>	90 dBA (potentiometer adjustable down to 70 dB) determined at a distance of 1 m from sound module	

For more information on our complete family of visual signaling device products, please visit:  
[rok.auto/visual-signaling](http://rok.auto/visual-signaling)





# Signaling

## Industrial Horns 855H/855HM

- Multi-tone, multi-stage (circuits), and voice playback capabilities
- Visualization option for enhanced industrial applications
- Surface and wall mount styles
- Multi-horn synchronization for most models
- Plastic and metal housings are heat and shock resistant, corrosion-free, suitable for harsh environments and outdoor applications



855H audible devices include general purpose, high-performance, and recordable electronic horns that provide multi-stage, multi-tone voice messaging and volume control capabilities. The high-performance and recordable horns are available as stand-alone devices or with beacons attached.

### General Purpose



#### Mounting Options

- Surface mount
- Semi-flush mount

#### Sound Options

- 108...113 dB tones
- Three tones

#### Environmental Ratings

- Semi-flush mount:  
UL Type 3R/13, IP54
- Surface mount:  
UL Type 4/4X/13/3R,  
IP66

### High Performance

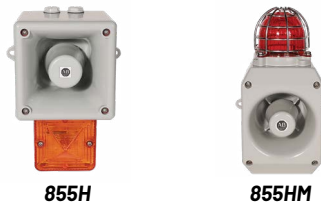

#### Mounting Options

- Surface mount

#### Illumination Options

- 855H - Xenon tube (strobe, 5 J)
- 855HM - LED

#### Sound Options

- 855H - 100...126 dB outputs
- 855HM - 119 dB output
- Up to 64 tones and 4 circuits

#### Environmental Ratings

- 855H - Frame C and E: UL Type 3R, 4/4X, 13, IP66
- 855H - Frame A, B, and D: UL Type 13/3R, IP66
- 855HM - UL Type 4/4X/13/3R, IP66

### Recordable



#### Mounting Options

- Surface mount
- Adjustable bracket (flare style)

#### Illumination Options

LED beacon (red or amber)

#### Sound Options

- 101...111 dB voice
- 110...126 dB tone
- Up to 45 tones

#### Environmental Ratings

- Frame C and E:  
UL Type 3R, 4/4X, 13, IP66
- Flare:  
UL Type 3R, 4/4X, 13, IP66/IP67

Push Buttons



4-2...4-23

Signaling



4-24...4-35

Graphic Terminals

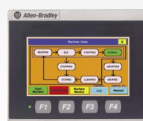

4-36...4-37



## Product Selection 855H General Purpose Horns

Mounting Type	Function	Supply Voltage	Cat. No.
Surface base with conduit entrance	Standard (1 stage)	24V AC/DC	855H-SG24GPA
		120V AC	855H-SG10GPA
		240V AC	855H-SG20GPA
	Enhanced (2 stages)	10...30V DC	855H-SG30GPE
40...260V AC/DC		855H-SG45GPE	
Semi-flush wall plate	Standard (1 stage)	24V AC/DC	855H-FG24GPA
		120V AC	855H-FG10GPA
		240V AC	855H-FG20GPA

## 855H High Performance Horns and Combination Units with Optional Attached Beacon

Sound Output	Supply Voltage	Horn Only	Horn with Beacon
		Cat. No.	Cat. No. <sup>1,2</sup>
100 dB max. at 1 m, 2 circuit DC, 1 circuit AC, 10 selectable tones <b>Frame A</b>	24V DC	855H-BD30AD	855H-BCD24ADR4
	115V AC, 50/60 Hz	855H-BA10AD	855H-BCA10ADR4
	230V AC, 50/60 Hz	855H-BA20AD	855H-BCA20ADR4
110 dB max. at 1 m, 4 circuit AC or DC, 64 selectable tones <b>Frame B</b> Negative and positive switching for DC version	24V DC	855H-BD30BD	855H-BCD24BDR4
	115V AC, 50/60 Hz	855H-BA45BD	855H-BCA10BDR4
	230V AC, 50/60 Hz	855H-BA45BD	855H-BCA20BDR4
113 dB max. at 1 m, 4 circuit AC or DC, 64 selectable tones <b>Frame C</b> Negative and positive switching for DC version	24V DC	855H-BD30CD	855H-BCD24CDR4
	115V AC, 50/60 Hz	855H-A45CD	855H-BCA10CDR4
	230V AC, 50/60 Hz	855H-A45DC	855H-BCA20CDR4
119 dB max. at 1 m, 3 circuit AC or DC, 45 selectable tones <b>Frame D</b>	24V DC	855H-BD30DD	855H-BCD24DDR4
	115V AC, 50/60 Hz	855H-BA10DD	855H-BCA10DDR4
	230V AC, 50/60 Hz	855H-BA20DD	855H-BCA20DDR4
124 dB max. at 1 m, 4 circuit AC or DC, 64 selectable tones <b>Frame E</b> Negative and positive switching for DC version	24V DC	855H-BD30ED	855H-BCD24EDR4
	115V AC, 50/60 Hz	855H-BA45ED	855H-BCA10EDR4
	230V AC, 50/60 Hz	855H-BA45ED	855H-BCA20EDR4

<sup>1</sup> Frames B,C,D and E are available as standard with red or amber beacons. Catalog numbers listed are for a red beacon. To select an amber beacon, replace the **4** (red) at the end of the catalog number with a **5** (amber). Example: 855H-BCD24BDR**5**. Other lens colors are available as field replaceable accessories.

<sup>2</sup> Frame A can be ordered with different color beacons by replacing the **4** (red) at the end of the catalog number by a **3** (Green), **5** (Amber), **6** (Blue), **7** (Clear) or **8** (Yellow). For example: 855H-BCA10ADR**7**.

## 855H Recordable Horns with Optional Attached Beacon

Description	Supply Voltage	Horn Only	Horn with Beacon
		Cat. No.	Cat. No. <sup>1</sup>
101 dB(A) voice, 110 dB(A) tone at 1 m, 45 selectable tones, 4 stages, Frame C	10...30V DC	855H-R30C	855H-RC30C4
	90...260V AC, 50/60 Hz	855H-R45C	855H-RC45C4
111 dB(A) voice, 126 dB(A) tone at 1 m, 45 selectable tones, 4 stages, Frame E	14...30V DC	855H-R30E	855H-RC30E4
	90...260V AC, 50/60 Hz	855H-R45E	855H-RC45E4
111 dB(A) voice, 126 dB(A) tone at 1 m, 45 selectable tones, 4 stages, Flare style	14...30V DC	855H-R30F	—
	90...260V AC, 50/60 Hz	855H-R45F	—

<sup>1</sup> Standard beacon colors are red and amber. Catalog number listed is for a red beacon. For an amber beacon, replace the **4** (red) with a **5** (amber). Example 855H-RC30C**5**. Other lens colors are available as accessories to be installed in the field.

## 855HM High Performance Horn, Metal

Description	Supply Voltage	Horn Only	Horn with Beacon
		Cat. No.	Cat. No. <sup>1</sup>
119 dB max. at 1 m, 3 circuit AC or DC, 45 selectable tones	12...30V DC	855HM-GMD30D	855HM-CGMD30DL4
	115V AC, 50/60 Hz	855HM-GMA10D	855HM-CGMA10DL4
	230V AC, 50/60 Hz	855HM-GMA20D	855HM-CGMA20DL4

<sup>1</sup> Standard beacon colors are red and amber. Catalog number listed is for a red beacon. For an amber beacon, replace the **4** (red) with a **5** (amber). Example: 855HM-CGMD30DL**5**. Other lens colors are available as accessories to be installed in the field.



### Product Selection Tools

Available online or for download, our tools help you access info while in the office or on the go.

[rok.auto/selection](http://rok.auto/selection)



# Signaling

## Industrial Beacons 855B, 855R

- Round beacons with two diameter sizes
- Illumination options: LED and xenon tube
- 110 mm beacons available in six colors green, red, amber, blue, clear, yellow and multicolor. 90 mm beacons available in six colors green, red, amber, blue, clear and yellow
- 855BS, 855R
  - Surface, NPT conduit, or tube mounting options
  - 855BS UL Type 4/4X/13, IP65
  - 855R UL type 4/4X/13, IP66/67
- 855BS-GMS
  - Surface mount only
  - UL Type 3R, IP66
  - 855R UL type 4/4X/13, IP66/67



855BS and 855R industrial beacons offer flexibility in size, mounting, voltages, colors, and illumination options to fit your application needs. The 110 mm size offers two form factors: high and compact lens, multifunction capabilities (steady, flashing strobe and rotating) and steady multicolor versions are also available. The 90 mm size offers also LED steady, flashing, strobe and three-color functionality.



**855R-BS24HMF4**  
High lens multifunction beacon with low-profile surface mount base

- Steady, Flashing, Strobe, Rotating and Pulse



**855R-BN24MF3**  
High lens steady beacon with surface or 1/2" NPT base

- Steady



**855R-BS24HMF7**  
High lens multicolor beacon with low profile base

- Can produce 7 colors (green, red, blue, white, yellow, turquoise, magenta)



**855BS - 90 mm**  
Illumination Options

- LED (steady/flashing/strobe/3-color)



**855B-GMS - Square**  
Illumination Options

- Xenon tube (strobe)



**855R-BS10CML**  
Compact lens multifunction beacon with low profile base

- Steady, flashing, strobe, pulse



**855R-BN20CMF3**  
Compact lens multicolor beacon with 1/2" NPT base

- Can produce 7 colors (green, red, blue, white, yellow, turquoise, magenta)



**855R-BSA24**  
855R audible base

- 32 tones
- 3 stages (circuits)

Push Buttons



4-2...4-23

Signaling



4-24...4-35

Graphic Terminals



4-36...4-37



## Product Selection

### 855BS 90 mm LED Round Beacons

	Steady/Flashing	Strobe	Multi-Color (green/red/amber)
Surface mount <sup>1</sup>	855BS-S◆SL□	855BS-S■BL□	855BS-S●ML345□
0.5 in. NPT mount	855BS-N◆SL□	855BS-N■BL□	855BS-N●ML345□
25 mm tube mount	855BS-T◆SL□	855BS-T■BL□	855BS-T●ML345□

<sup>1</sup> Surface mount base must be installed with rough wall plate (Catalog number 855BS-AWP) for UL Type 4/4X/13 rating, otherwise UL Type 1 only.

- ◆ Voltage Code: **35** = 24/48V AC/DC, **45** = 120/240V AC/DC
- Voltage Code: **35** = 24/48V AC/DC, **10** = 120V AC, **20** = 240V AC
- Voltage Code: **24** = 24V AC/DC, **10** = 120V AC, **20** = 240V AC
- Add lens color option code from table at right.

#### Lens Colors Options

  
**3 = Green**

  
**4 = Red**

  
**5 = Amber**

  
**6 = Blue**

  
**7 = Clear**

  
**8 = Yellow**

### 90 mm Round LED Beacons

	Steady/flashing	Strobe	Multicolor (green/amber/red)
Surface mount	855BS-S◆SL□	855BS-S■BL□	855BS-S●ML345
Half-inch NPT mount	855BS-N◆SL□	855BS-N■BL□	855BS-N●ML345
25 MM Tube mount	855BS-T◆SL□	855BS-T■BL□	855BS-T●ML345

- ◆ Voltage Code: **35** = 24V AC/DC, **45** = 120/240V AC/DC
- Voltage Code: **35** = 24V AC/DC, **10** = 120V AC, **20** = 240V AC
- Voltage Code: **24** = 24V AC/DC, **10** = 120V AC, **20** = 240V AC
- Add lens color option code from table at right.

### 110 mm Round LED Beacons (Assembled)

	Beacon Output	Standard Brightness		High BRIGHTNESS	
		Surface Low profile Base	Surface Mount- 1/2 in. NPT	Surface Low profile Base	Surface Mount- 1/2 in. NPT
Function	Steady	855R-BS◆TL□	855R-BN◆T□L	—	—
	Multi-function <sup>1</sup>	855R-BS●MF□	855R-BN●MF□	855R-BS●HMF□	855R-BN●HMF□
	Multicolor <sup>3</sup>	855R-BS●ML	855R-BN●ML	—	—
	Compact Multifunction <sup>2</sup>	855R-BS●CMF□	855R-BN●CMF□	—	—
	Compact Multicolor <sup>3</sup>	855R-BS●CML	855R-BN●CML	—	—

- ◆ Voltage Code: **24** = 24V AC/DC, **45** = 120/240V AC
- Voltage Code: **24** = 24V AC/DC, **10** = 120V AC, **20** = 240V AC
- Add lens color option code from table at right.

- <sup>1</sup> Produces up to 15 light effects (Steady, Flashing, Strobe, Rotating, Pulse)
- <sup>2</sup> Produces up to 6 different light effects (Steady, Flashing, Strobe Multi-burst and Double Pulse Fading)
- <sup>3</sup> Produces up to 7 different colors: green, red, blue, white, yellow, turquoise and magenta. Clear lens for ML and white translucent lens for CML.

### 855B Mini Square Beacon

Supply Voltage	Cat. No.
24V AC/DC	855B-GMS24R□
115V AC, 50/60 Hz	855B-GMS10R□

□ Add lens color option code from table above



# Graphic Terminals

OPERATOR INTERFACE

## PanelView™ 800 Graphic Terminals 2711R

- High-resolution display (65K colors) with LED backlight, supporting simple graphic animation
- Communicate with MicroLogix™, Micro800™, CompactLogix™ 5370, and CompactLogix™ 5380 controllers and other devices using serial (RS-232, RS422/485), Modbus RTU/TCP, EtherNet/IP, DNP3, and DF1
- Review alarm status, history and time/date of equipment events even after power cycle
- Languages supported: French, German, Italian, Portuguese, Spanish and Simplified Chinese



The PanelView 800 graphic terminal features a high-speed processor, high-resolution display with LED backlight and internal memory; helping to improve productivity and maintenance, while enjoying the convenience and efficiencies of single-source buying.

### Landscape and Portrait Modes



Serial or Ethernet Network

Optimized for use with Micro800 and MicroLogix controllers.

## Connected Components Workbench Software

Connected Components Workbench™ software is a single software environment supporting...

- E200™ electronic overload relays
- Guardmaster® 440C-CR30 software configure safety relay
- Guardmaster speed monitory safety relays
- GuardShield™ 450L safety light curtains
- Kinetix® servo drives
- Micro800 controllers
- PanelView 800 graphic terminals
- PowerFlex® drives
- SMC™ soft starters

...in your standalone machines.



4-36

Push Buttons



4-2...4-23

Signaling



4-24...4-35

Graphic Terminals



4-36...4-37





Download the Connected Components Workbench Software!

[rok.auto/ccw](http://rok.auto/ccw)



## Product Selection

### PanelView 800 Specifications

Feature	4-inch	7-inch	10-inch
			
<b>Catalog Number</b>	<b>2711R-T4T</b>	<b>2711R-T7T</b>	<b>2711R-T10T</b>
<b>Resolution</b>	480 x 272 WQVGA	800 x 480 WVGA	800 x 600 SVGA
<b>Display type</b>	TFT touch screen, wide LCD		
<b>Display hour</b>	40,000 hours		
<b>Colors</b>	65K colors		
<b>Backlight</b>	LED		
<b>Operator input</b>	Resistive touch and tactile function keys	Resistive touch	
<b>Power supply</b>	24V DC		
<b>Processor, CPU speed</b>	800 MHz		
<b>Internal storage</b>	256 MB		
<b>RAM</b>	256 MB DDR		
<b>Operation system</b>	Microsoft Windows CE 6.0		
<b>Real-time clock with battery</b>	Yes		
<b>Operating temperature</b>	0...50 °C		
<b>RS232/RS422/485 (isolated)</b>	Separate RS232 and RS422/RS485 connectors		
<b>Ethernet 10/100 Mbps</b>	1		
<b>USB host (USB 2.0)</b>	Yes		
<b>microSD™ slot</b>	Yes		
<b>Product dimension (mm) (height x width x depth)</b>	116 x 138 x 43	144 x 197 x 54	225 x 287 x 55
<b>Panel cutout (mm) (height x width)</b>	99 x 119	125 x 179	206 x 269
<b>Weight</b>	0.35 kg (0.76 lb)	0.68 kg (1.48 lb)	1.57 kg (3.41 lb)
<b>Front bezel protection</b>	IP65, NEMA 4X, 12, 13		
<b>Certifications</b>	cULus listed; Class I Div 2, Groups A,B,C,D, T4A, CE, RCM, KC, RoHS		
<b>Software</b>	Connected Components Workbench software release 8.00 or later		
<b>Additional functionality</b>	Supports 50 recipes. Supports Virtual Network Computing (VNC) server connection.		

## Accessories

Catalog Number	-	<b>2711R-APK7</b>	<b>2711R-APK10</b>
Accessories	-	7 in. Adapter plate kit	10 in. Adapter plate kit

For more information on our complete family of PanelView 800 Component products, please visit:  
[rok.auto/PanelView800](http://rok.auto/PanelView800)





# Additional Operator Interface Products



## Hazardous Location Products

- 800G/H/R Push Buttons
- 855XH/XB/XC/XM Horns and Beacons
- Steady or flashing (incandescent or LED) and strobe (Xenon) light modules
- Available in six colors: green, red, amber, blue, white, yellow (magenta also available for steady LED modules)
- Black or grey housing

## Control Tower™ Stack Lights 855E (50 mm)

- UL Type 4/4X/13, IP65
- Stacking configurations 1...5 modules high
- Continuous or pulsing piezo sound modules
- Steady or flashing (incandescent or LED) and strobe (Xenon) light modules
- Available in six colors: green, red, amber, blue, white, yellow (magenta also available for steady LED modules)
- Black or grey housing



## Compact Control Tower Stack Lights 855D (30 mm)

- UL Type 4/4X/13, IP65
- Steady and flashing LED light modules
- Continuous or pulsing piezo sound modules
- Multiple mounting options
- Factory pre-assembled and pre-wired



## Panel Light Bars 855L

- Low voltage potential in panel
- Low heat output
- Low weight due to absence of heavy ballast
- Ideal for environments with high shock and vibration



Push Buttons



4-2...4-23

Signaling



4-24...4-35

Graphic Terminals



4-36...4-37

**Terminal Blocks**

Terminal Blocks.....	5-2
Push-in Terminal Blocks.....	5-4
Control Power Distribution Blocks.....	5-8
Sensor/Signal Blocks.....	5-12
Screw Clamp Terminal Blocks.....	5-14
Spring Clamp Terminal Blocks.....	5-21
Terminal Block Marking Systems.....	5-30
Power Distribution Blocks.....	5-32

**Wiring Systems**

Wiring Systems.....	5-34
---------------------	------

**Connection Systems**

Non-network Connectivity Solutions.....	5-36
DC Micro Cordsets & Patchcords.....	5-38
AC Micro Cordsets & Patchcords.....	5-39
Mini Cordsets.....	5-40
Pico Cordsets & Patchcords.....	5-41
DC Micro & Pico Distribution Boxes.....	5-42
Terminal Chambers & IDC Connectors.....	5-43
Receptacles.....	5-44
Mini & Pico Receptacles.....	5-45

**Safety Connection Systems**

Safety Connectivity.....	5-46
Safety Distribution Boxes.....	5-48
Safety Wired T-Port & Shorting Plug.....	5-49

**Network Media**

Industrial Ethernet Connectivity.....	5-50
Ethernet Media Cable Spools.....	5-52
Ethernet M12 D Code Cordsets & Patchcords.....	5-53
Ethernet RJ45 Cordsets & Patchcords.....	5-54
Ethernet Accessories.....	5-55
Gigabit Ethernet Connectivity.....	5-56

**Additional Connectivity Products.....** 5-58

# Terminal Blocks

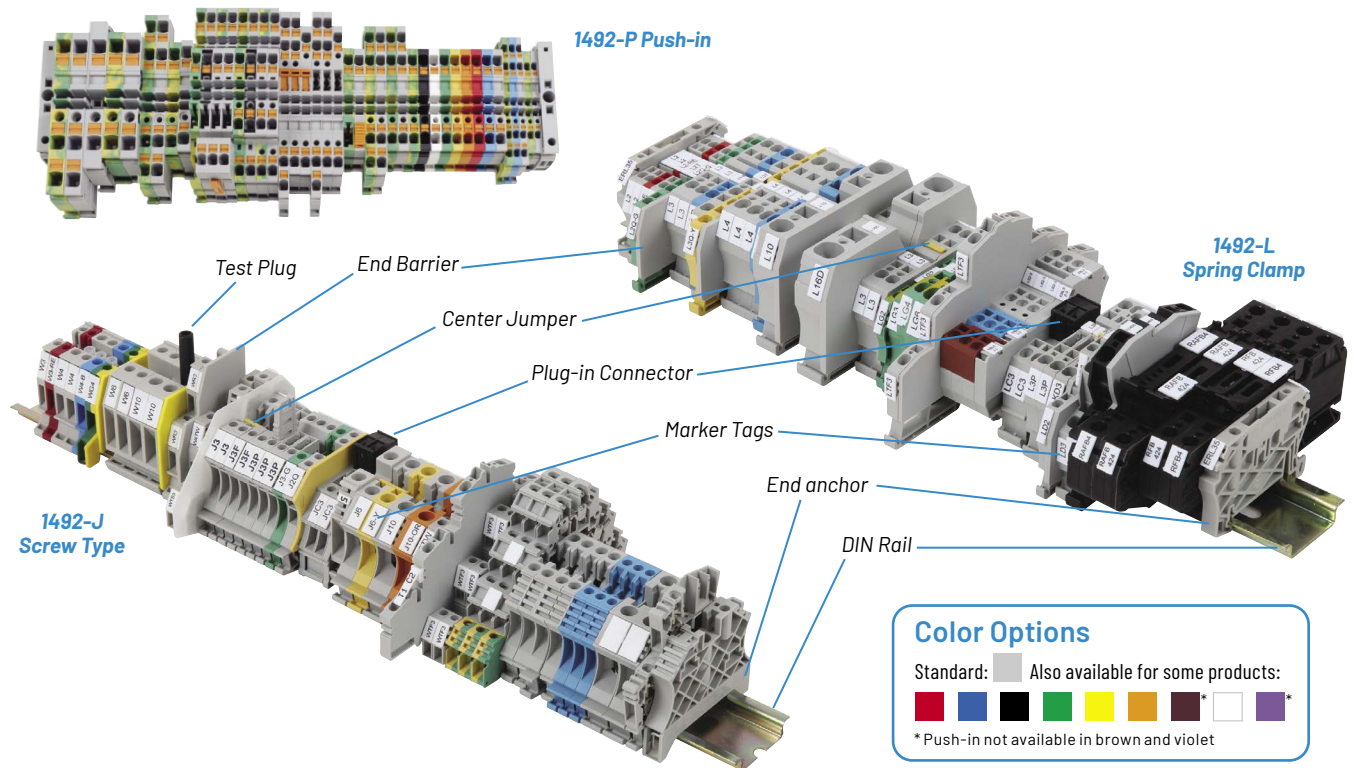

Leading the industry in efficiency and productivity, our family of IEC terminal blocks includes a broad range of DIN Rail mountable products. With push-in, screw and spring clamp connections available, they are designed for safety, installation ease, and ruggedness.

## Push-in, Screw Type and Spring Clamp Terminal Blocks are Available in the Following Styles:

### Standard Feed-through Terminal Blocks

- Designed for single-circuit feed-through applications

### Multi-circuit Feed-through Terminal Blocks

- Designed for high-density wiring applications

### Sensor Terminal Blocks

- Provide all connections needed for two-, three-, and four-wire applications in one terminal block

### Grounding Terminal Blocks

- Provides easy to identify grounding bus that is mounted on the DIN Rail

### Plug-in Style Terminal Blocks

- Allow for insertion of fixed components into control circuits (resistor, diodes, surge suppression circuit and shunt bars)

### Fuse Blocks

- Provide better overcurrent protection in hinged-arm design

### Control Power Distribution

- Available in Push-in Terminal Blocks

**Stay tuned for the next version of this selection guide for the future of the connected enterprise with EtherNet/IP™ In-cabinet Solutions!**

### Terminal Blocks



5-2...5-33

### Wiring Systems



5-34...5-35

### Connection Systems



5-36...5-45

### Safety Connection Systems



5-46...5-49

### Network Media



5-50...5-57

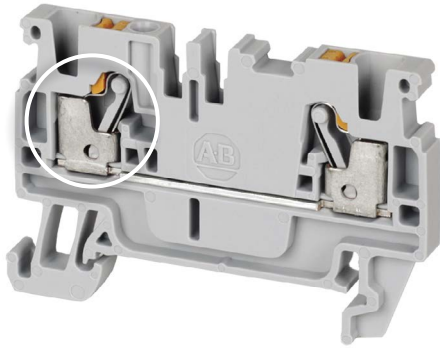

### Push-in Terminal Blocks 1492-P

- When using an automated ferrule machine, installation time can be up to 65% faster than a screw clamp
- One-hand, one-second installation
- No torque values are needed to install or double check

### Screw Clamp Terminal Blocks 1492-J

- All screw clamps have self-locking feature for unmatched connection reliability
- UL tested and approved for multiple wire terminations per connection terminal
- Use strong clamping materials to form gas-tight connection

\* Product selection begins on page 5-14.

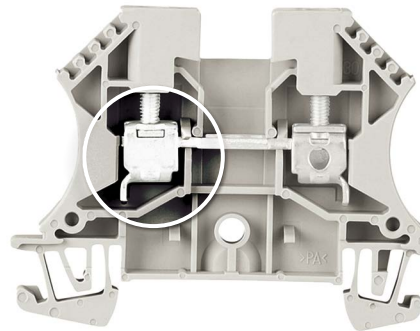

### Spring Clamp Terminal Blocks 1492-L

- Help reduce wiring connection time by up to 30...50%
  - Excellent reliability performance in high-vibration environments
- Easy top-wire installation

\* Product selection begins on page 5-21.

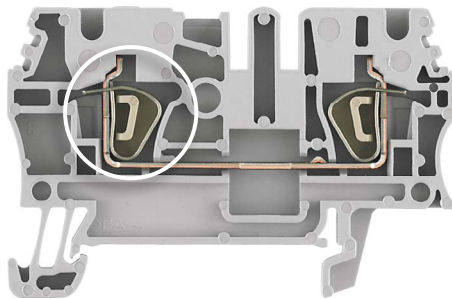

#### Available Accessories<sup>1</sup>

- Marker cards
- Partition Plates
- DIN Rail
- End Anchor
- Jumpers

<sup>1</sup> DIN Rail and End Anchors can be found on page 5-29. For accessory options, please visit [rok.auto/directory](http://rok.auto/directory)

#### All IEC Terminal Blocks are:

- IP2x finger-safe
- DIN Rail mount
- High fault short-circuit current rating (SCCR) with fuses and circuit breakers
- Meet IEC, UL, CSA and ATEX standards





# Terminal Blocks

## Product Selection

### Standard Feed-through Terminal Blocks, Push-in (2.5...6 mm<sup>2</sup> mm wire size)

Dimensions are not intended to be used for manufacturing purposes.

Note: Height for dimension is measured from top of rail to top of terminal block.

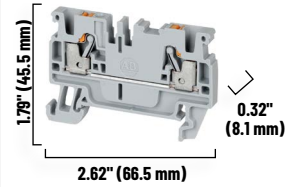
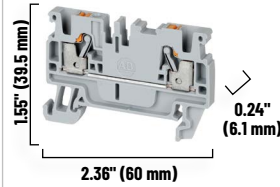
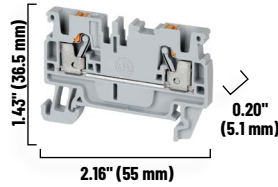

Standards	1492-P3			1492-P4			1492-P6		
	UR/CSA	IEC	ATEX	UR/CSA	IEC	ATEX	UR/CSA	IEC	ATEX
Voltage rating [V AC/DC]	600	800	550	600	800	550	600	800	550
Maximum current [A]	20	24	21	30	32	30	38	41	36
Wire range (Rated cross section)	#28...12 AWG	2.5 mm <sup>2</sup>	2.5 mm <sup>2</sup>	#26...10 AWG	4 mm <sup>2</sup>	4 mm <sup>2</sup>	#22...8 AWG	6 mm <sup>2</sup>	6 mm <sup>2</sup>
Terminal block	Cat. No.	Pkg. Qty.		Cat. No.	Pkg. Qty.		Cat. No.	Pkg. Qty.	
Grey	1492-P3	100		1492-P4	100		1492-P6	50	
Color	1492-P3-⊗			1492-P4-⊗			1492-P6-⊗		

### Standard Feed-through Terminal Blocks, Push-in (10...16 mm<sup>2</sup> wire size)

Dimensions are not intended to be used for manufacturing purposes.

Note: Height for dimension is measured from top of rail to top of terminal block.

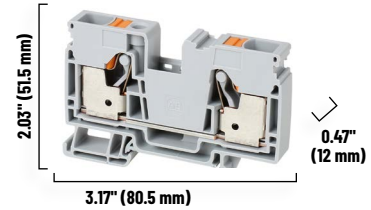
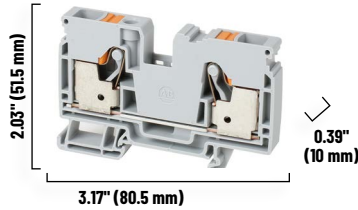

Standards	1492-P10			1492-P16		
	UR/CSA	IEC	ATEX	UR/CSA	IEC	ATEX
Voltage rating [V AC/DC]	600	1000	550	600	1000	550
Maximum current [A]	55	57	52	62	76	64
Wire range (Rated cross section)	#20...6 AWG	10 mm <sup>2</sup>	10 mm <sup>2</sup>	#18...6 AWG	16 mm <sup>2</sup>	16 mm <sup>2</sup>
Terminal block	Cat. No.	Pkg. Qty.		Cat. No.	Pkg. Qty.	
Grey	1492-P10	25		1492-P16	20	
Color	1492-P10-⊗			1492-P16-⊗		

⊗ For colored terminal blocks, replace the ⊗ in the catalog number with the following: **RE** = Red, **B** = Blue, **BL** = Black, **G** = Green, **Y** = Yellow, **OR** = Orange, **W** = White, to the end of the catalog number.

#### Terminal Blocks



5-2...5-33

#### Wiring Systems



5-34...5-35

#### Connection Systems



5-36...5-45

#### Safety Connection Systems



5-46...5-49

#### Network Media



5-50...5-57



## Product Selection

### Multi-circuit Two-Level Feed-through Terminal Blocks, Push-in (2.5 mm<sup>2</sup> wire size)

Dimensions are not intended to be used for manufacturing purposes.

Note: Height for dimension is measured from top of rail to top of terminal block.

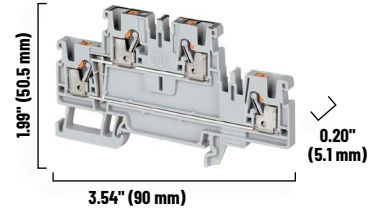
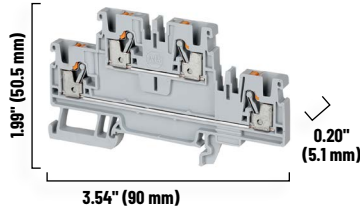

	1492-PD3			1492-PD3C		
<b>Standards</b>	UR/CSA	IEC	ATEX	UR/CSA	IEC	ATEX
<b>Voltage rating [V AC/DC]</b>	600	800	550	600	800	550
<b>Maximum current [A]</b>	20	24	21	20	24	21
<b>Wire range (Rated cross section)</b>	#28...12 AWG	2.5 mm <sup>2</sup>	2.5 mm <sup>2</sup>	#28...12 AWG	2.5 mm <sup>2</sup>	2.5 mm <sup>2</sup>
<b>Terminal block</b>	<b>Cat. No.</b>	<b>Pkg. Qty.</b>		<b>Cat. No.</b>	<b>Pkg. Qty.</b>	
<b>Grey</b>	1492-PD3	50		1492-PD3C	50	
<b>Color</b>	1492-PD3-⊗			1492-PD3C-⊗		

### Multi-circuit Two-Level Feed-through Terminal Blocks, Push-in (4 mm<sup>2</sup> wire size)

Dimensions are not intended to be used for manufacturing purposes.

Note: Height for dimension is measured from top of rail to top of terminal block.

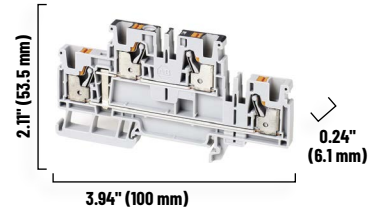
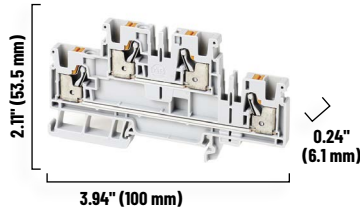

	1492-PD4			1492-PD4C		
<b>Standards</b>	UR/CSA	IEC	ATEX	UR/CSA	IEC	ATEX
<b>Voltage rating [V AC/DC]</b>	600	800	550	600	800	550
<b>Maximum current [A]</b>	30	32	25	30	32	25
<b>Wire range (Rated cross section)</b>	#26...10 AWG	4 mm <sup>2</sup>	4 mm <sup>2</sup>	#26...10 AWG	4 mm <sup>2</sup>	4 mm <sup>2</sup>
<b>Terminal block</b>	<b>Cat. No.</b>	<b>Pkg. Qty.</b>		<b>Cat. No.</b>	<b>Pkg. Qty.</b>	
<b>Grey</b>	1492-PD4	50		1492-PD4C	50	
<b>Color</b>	1492-PD4-⊗			1492-PD4C-B		

⊗ For colored terminal blocks, replace the ⊗ in the catalog number with the following: **RE** = Red, **B**= Blue, **BL** = Black, **G**= Green, **Y**= Yellow, **OR**= Orange, **W**=White, to the end of the catalog number.

For more information on our complete family of push-in terminal block products, please visit: [rok.auto/push-in-terminal-blocks](http://rok.auto/push-in-terminal-blocks)





# Terminal Blocks

## Product Selection

### Multi-circuit Three-Level Feed-through Terminal Blocks, Push-in (2.5 mm<sup>2</sup> wire size)

Dimensions are not intended to be used for manufacturing purposes.

Note: Height for dimension is measured from top of rail to top of terminal block.

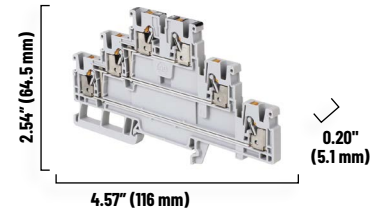
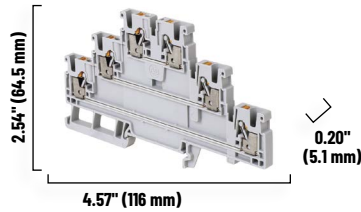

	1492-PT3			1492-PT3C		
<b>Standards</b>	UR/CSA	IEC	ATEX	UR/CSA	IEC	ATEX
<b>Voltage rating [V AC/DC]</b>	600	800	550	600	800	550
<b>Maximum current [A]</b>	20	24	21	20	24	21
<b>Wire range (Rated cross section)</b>	#28...12 AWG	2.5 mm <sup>2</sup>	2.5 mm <sup>2</sup>	#28...12 AWG	2.5 mm <sup>2</sup>	2.5 mm <sup>2</sup>
<b>Terminal block</b>	<b>Cat. No.</b>	<b>Pkg. Qty.</b>		<b>Cat. No.</b>	<b>Pkg. Qty.</b>	
	Grey	1492-PT3	50	1492-PT3C	50	
	Color	1492-PT3-B		1492-PT3C-B		

### Grounding Terminal Blocks, Push-in (2.5...6 mm<sup>2</sup> wire size)

Dimensions are not intended to be used for manufacturing purposes.

Note: Height for dimension is measured from top of rail to top of terminal block.

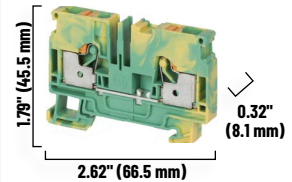
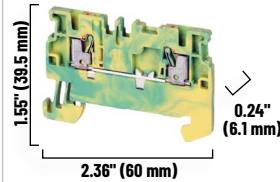
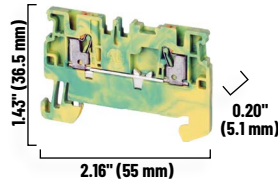

	1492-PG3			1492-PG4			1492-PG6		
<b>Standards</b>	UR/CSA	IEC	ATEX	UR/CSA	IEC	ATEX	UR/CSA	IEC	ATEX
<b>Voltage rating [V AC/DC]</b>	600	800	550	600	800	550	600	800	550
<b>Wire range (Rated cross section)</b>	#28...12 AWG	2.5 mm <sup>2</sup>	2.5 mm <sup>2</sup>	#26...10 AWG	4 mm <sup>2</sup>	4 mm <sup>2</sup>	#22...8 AWG	6 mm <sup>2</sup>	6 mm <sup>2</sup>
<b>Wire strip length</b>	0.4 in. (10 mm)			0.47 in. (12 mm)			0.47 in. (12 mm)		
<b>Density</b>	59 pcs/ft (196 pcs/m)			49 pcs/ft (163 pcs/m)			37 pcs/ft (123 pcs/m)		
<b>Housing temperature range</b>	-76...266°F (-60...130 °C)			-76...266°F (-60...130 °C)			-76...266°F (-60...130 °C)		
<b>Terminal block</b>	<b>Cat. No.</b>	<b>Pkg. Qty.</b>		<b>Cat. No.</b>	<b>Pkg. Qty.</b>		<b>Cat. No.</b>	<b>Pkg. Qty.</b>	
	Green/Yellow	1492-PG3	50	1492-PG4	50	1492-PG6	50	50	

⊗ For colored terminal blocks, replace the ⊗ in the catalog number with the following: **RE** = Red, **B** = Blue, **BL** = Black, **G** = Green, **Y** = Yellow, **OR** = Orange, **W** = White, to the end of the catalog number.

#### Terminal Blocks



5-2...5-33

#### Wiring Systems



5-34...5-35

#### Connection Systems



5-36...5-45

#### Safety Connection Systems



5-46...5-49

#### Network Media



5-50...5-57



## Product Selection

### Grounding Terminal Blocks, Push-in (10...16 mm<sup>2</sup> wire size)

Dimensions are not intended to be used for manufacturing purposes.

Note: Height for dimension is measured from top of rail to top of terminal block.

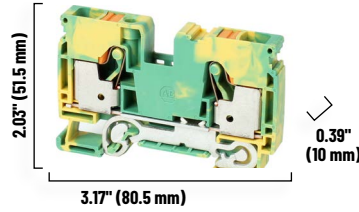

#### 1492-PG10

<b>Standards</b>	UR/CSA	IEC	ATEX
<b>Voltage rating [V AC/DC]</b>	600	1000	550
<b>Wire range (Rated cross section)</b>	#20...6 AWG	10 mm <sup>2</sup>	10 mm <sup>2</sup>
<b>Wire Strip Length</b>	0.71 in (18 mm)		
<b>Density</b>	30 pcs/ft (100 pcs/m)		
<b>Housing Temperature Range</b>	-76...+266°F (-60...+130 °C)		
<b>Terminal block</b>	<b>Cat. No.</b>	<b>Pkg. Qty.</b>	
<b>Green/Yellow</b>	1492-PG10	25	

Dimensions are not intended to be used for manufacturing purposes.

Note: Height for dimension is measured from top of rail to top of terminal block.

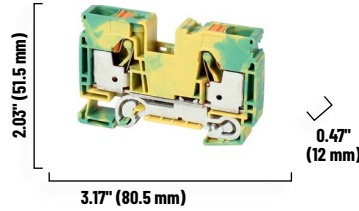

#### 1492-PG16

<b>Standards</b>	UR/CSA	IEC	ATEX
<b>Voltage rating [V AC/DC]</b>	600	1000	550
<b>Wire range (Rated cross section)</b>	#18...6 AWG	16 mm <sup>2</sup>	16 mm <sup>2</sup>
<b>Wire Strip Length</b>	0.71 in (18 mm)		
<b>Density</b>	25 pcs/ft (83 pcs/m)		
<b>Housing Temperature Range</b>	-76...+266°F (-60...+130 °C)		
<b>Terminal block</b>	<b>Cat. No.</b>	<b>Pkg. Qty.</b>	
<b>Green/Yellow</b>	1492-PG16	20	

⊗ For colored terminal blocks, replace the ⊗ in the catalog number with the following: **RE** = Red, **B** = Blue, **BL** = Black, **G** = Green, **Y** = Yellow, **OR** = Orange, **W** = White, to the end of the catalog number.



# Terminal Blocks

## Control Power Distribution Blocks

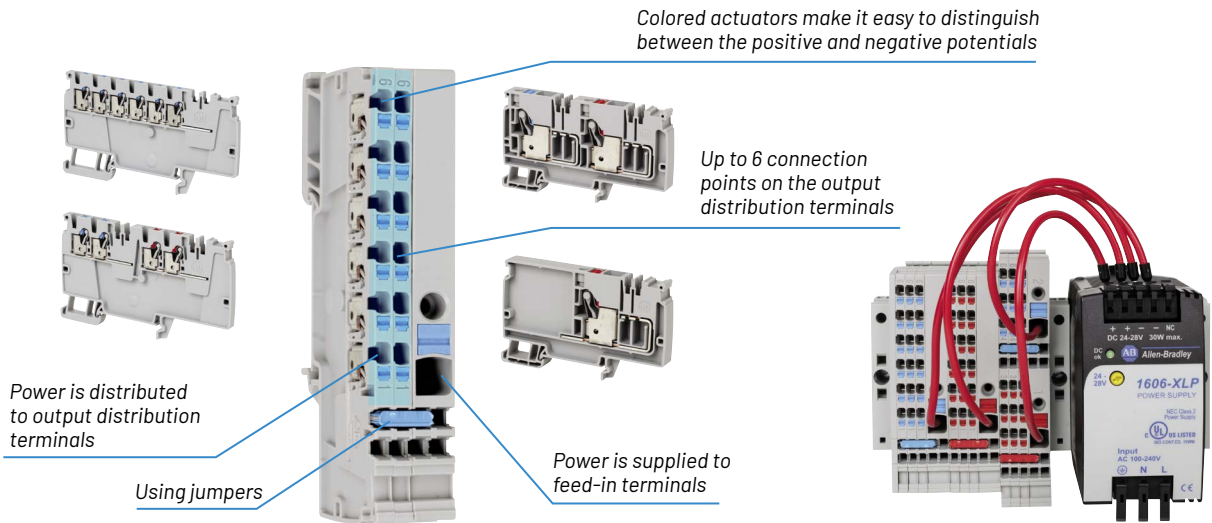

Control Power Distribution			
Color	Catalog Number		Wire Range (Rated cross section)
	Start (Feed-in)	End (Output)	
Standard	1492-P6PD2S-1B <sup>1</sup>	-	22-8 AWG (6.0 mm <sup>2</sup> )
Standard	1492-P6PD2S-1RE <sup>1</sup>	-	
with Grounding <sup>3</sup>	1492-PG6PD2S <sup>1</sup>	-	
Standard	-	1492-P6PD2E-6B <sup>1</sup>	26-14 AWG (1.5mm <sup>2</sup> )
Standard	-	1492-P6PD2E-6RE <sup>1</sup>	
Standard	1492-P6PD2S-1B1RE <sup>2</sup>	-	22-8 AWG (6.0 mm <sup>2</sup> )
with Grounding <sup>3</sup>	1492-P6PD2S-1RE1G <sup>2</sup>	-	
Standard	-	1492-P6PD2E-3B3RE <sup>2</sup>	26-14 AWG (1.5mm <sup>2</sup> )
Ferrules	For specific information on which Panduit ferrules to use with individual Bulletin 1492-P Push-in Terminal Blocks, consult Appendix sections in Publication 1492-TD017.		

Control Power Distribution			
Color	Catalog Number		Wire Range (Rated cross section)
	Start (Feed-in)	End (Output)	
Standard	1492-P10PD3S-1B <sup>1</sup>	-	22-6 AWG (10.0 mm <sup>2</sup> )
Standard	1492-P10PD3S-1RE <sup>1</sup>	-	
with Grounding <sup>3</sup>	1492-PG10PD3S <sup>1</sup>	-	
Standard	-	1492-P10PD3E-5B <sup>1</sup>	28-12 AWG (2.5mm <sup>2</sup> )
Standard	-	1492-P10PD3E-5RE <sup>1</sup>	
Standard	1492-P10PD3S-1B1RE <sup>2</sup>	-	22-6 AWG (10.0 mm <sup>2</sup> )
with Grounding <sup>3</sup>	1492-P10PD3S-1RE1G <sup>2</sup>	-	
Standard	-	1492-P10PD3E-2B2RE <sup>2</sup>	28-12 AWG (2.5mm <sup>2</sup> )
Ferrules	For specific information on which Panduit ferrules to use with individual Bulletin 1492-P Push-in Terminal Blocks, consult Appendix sections in Publication 1492-TD017.		

<sup>1</sup> Shape/Size Configuration #1: (+/-) on separate terminal blocks.

<sup>2</sup> Shape/Size Configuration #2: (+/-) integrated into a single terminal block.

<sup>3</sup> Not grounded to the DIN Rail. This is a functional earth ground that allows you ground the minus potential of the power supply to 0 V.

### Terminal Blocks



5-2...5-33

### Wiring Systems



5-34...5-35

### Connection Systems



5-36...5-45

### Safety Connection Systems



5-46...5-49

### Network Media



5-50...5-57



# Control Power Distribution Blocks

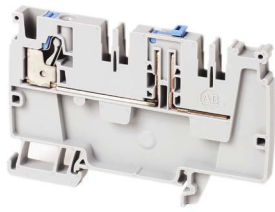

1492-P10PD4E-KD

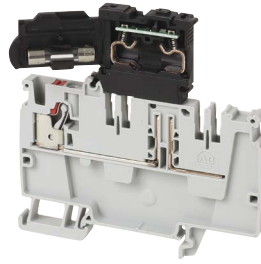

1492-P10PD4E-FB\*

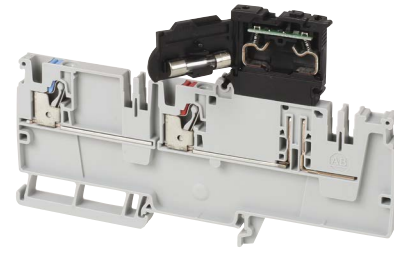

1492-P10PD4E-1B1FB\*

Block Type	Catalog Number		Wire Range (Rated Cross Section)
	Start (Feed-in)	End (Output)	
Standard	1492-P10PD4S-1B <sup>1</sup>		20-6 AWG (10.0 mm <sup>2</sup> )
Standard	1492-P10PD4S-1RE <sup>1</sup>		20-6 AWG (10.0 mm <sup>2</sup> )
with Grounding <sup>3</sup>	1492-PG10PD4S <sup>1</sup>		20-6 AWG (10.0 mm <sup>2</sup> )
Standard		1492-P10PD4E-1B <sup>1</sup>	26-10 AWG (4.0 mm <sup>2</sup> )
Standard		1492-P10PD4E-1RE <sup>1</sup>	26-10 AWG (4.0 mm <sup>2</sup> )
Standard		1492-P10PD4E-KD <sup>1,4</sup>	26-10 AWG (4.0 mm <sup>2</sup> )
Standard		1492-P10PD4E-FB <sup>1,5</sup>	26-10 AWG (4.0 mm <sup>2</sup> )
Standard		1492-P10PD4E-FB24 <sup>1,6</sup>	26-10 AWG (4.0 mm <sup>2</sup> )
Standard		1492-P10PD4E-FB48 <sup>1,6</sup>	26-10 AWG (4.0 mm <sup>2</sup> )
Standard		1492-P10PD4E-FB120 <sup>1,6</sup>	26-10 AWG (4.0 mm <sup>2</sup> )
Standard		1492-P10PD4E-FB250 <sup>1,6</sup>	26-10 AWG (4.0 mm <sup>2</sup> )
Standard	1492-P10PD4S-1B1RE <sup>2</sup>		20-6 AWG (10.0 mm <sup>2</sup> )
with Grounding <sup>3</sup>	1492-P10PD4S-1RE1G <sup>2</sup>		20-6 AWG (10.0 mm <sup>2</sup> )
Standard		1492-P10PD4E-1B1FB <sup>2,5</sup>	26-10 AWG (4.0 mm <sup>2</sup> )
Standard		1492-P10PD4E-1B1FB24 <sup>2,6</sup>	26-10 AWG (4.0 mm <sup>2</sup> )
Standard		1492-P10PD4E-1B1FB48 <sup>2,6</sup>	26-10 AWG (4.0 mm <sup>2</sup> )
Standard		1492-P10PD4E-1B1FB120 <sup>2,6</sup>	26-10 AWG (4.0 mm <sup>2</sup> )
Standard		1492-P10PD4E-1B1FB250 <sup>2,6</sup>	26-10 AWG (4.0 mm <sup>2</sup> )

<sup>1</sup> Shape/Size Configuration #1: (+/-) on separate terminal blocks

<sup>2</sup> Shape/Size Configuration #2: (+/-) integrated into a single terminal block

<sup>3</sup> Not grounded to the Din Rail. This is a functional earth ground that allows you ground the minus potential of the power supply to 0 V.

<sup>4</sup> Includes knife disconnect/isolation

<sup>5</sup> Includes non indicating fuse holder

<sup>6</sup> Includes LED indicating fuse holder

\* Available in non-indicating and LED indicating. LED indicating is available in 24, 48, 120 and 250V AC/DC.



# Terminal Blocks

## Product Selection

### Isolation & Plug-in Terminal Blocks, Push-in

Dimensions are not intended to be used for manufacturing purposes.

Note: Height for dimension is measured from top of rail to top of terminal block.

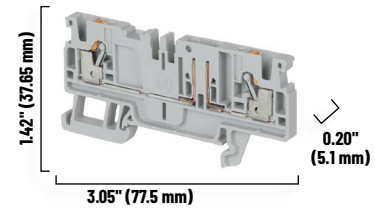
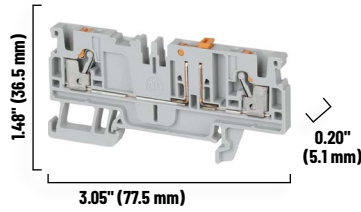

		1492-PKD3			1492-P3P	
<b>Standards</b>		UR/CSA	IEC	ATEX	UR/CSA	IEC
<b>Voltage rating [V AC/DC]</b>		300	500	400	300	500
<b>Maximum current [A]</b>		20	20	20	20	20
<b>Wire range (Rated cross section)</b>		#28...12 AWG	2.5 mm <sup>2</sup>	2.5 mm <sup>2</sup>	#28...12 AWG	2.5 mm <sup>2</sup>
<b>Terminal block</b>						
<b>Gray</b>		1492-PKD3	50		1492-P3P	50
<b>Blue</b>		1492-PKD3-B			-	-
<b>Accessories</b>		<b>Cat. No.</b>	<b>Pkg. Qty.</b>	<b>Cat. No.</b>	<b>Pkg. Qty.</b>	
<b>End Barrier</b>		1492-EBP3Q	50	1492-EBP3Q	20	
<b>Plug-in center jumper</b>	<b>10-pole</b>	1492-CJP3-10	20	1492-CJP3-10	20	
	<b>2-pole</b>	1492-CJP3-2	60	1492-CJP3-2	60	
<b>Disconnect plug</b>		-	-	1492-DPL	50	
<b>Component plug</b>		-	-	1492-CPL	50	
<b>Without blown fuse indicator</b>		-	-	1492-FPK2	20	
<b>10...36V blown fuse indicator</b>		-	-	1492-FPK224	20	
<b>35...75V blown fuse indicator</b>		-	-	1492-FPK248	20	
<b>60...150V blown fuse indicator</b>		-	-	1492-FPK2120	20	
<b>140...250V blown fuse indicator</b>		-	-	1492-FPK2250	20	
<b>Test Plugs</b>	Start Test Plug	1492-PTPS	50	1492-PTPS	50	
	Test Plug	1492-P3TPE		1492-P3TPE		
<b>Marking Systems</b>	ClearPlot Basic Marker Cards	1492-MR5X8 (120/card)	5 cards	1492-MR5X8 (120/card)	5 cards	
	ClearMultiprint Markers	1492-MT5X8 (800/roll)	1 roll	1492-MT5X8 (800/roll)	1 roll	
<b>Ferrules</b>	For specific information on which Panduit ferrules to use with individual Bulletin 1492-P Push-in Terminal Blocks, consult Appendix sections in Publication 1492-TD017.					

⊗ For colored terminal blocks, replace the ⊗ in the catalog number with the following: **RE** = Red, **B** = Blue, **BL** = Black, **G** = Green, **Y** = Yellow, **OR** = Orange, **W** = White, to the end of the catalog number.

<sup>1</sup> Available in orange as standard, to order other colors add the appropriate suffix to the catalog number listed: Blue =B, Red = RE. Example for a red 2-pole center jumper, the catalog number will be 1492-CJP3-2-RE.

#### Terminal Blocks



5-2...5-33



5-34...5-35



5-36...5-45



5-46...5-49



5-50...5-57



# Product Selection

## Fuse Blocks, Push-in

Dimensions are not intended to be used for manufacturing purposes.

Note: Height for dimension is measured from top of rail to top of terminal block.

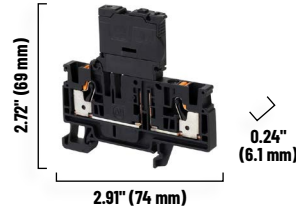

		1492-PG10		
<b>Standards</b>		UR/CSA	IEC	ATEX
<b>Voltage rating [V AC/DC]</b>	<b>1492-PFB4</b>	300	250	250
	<b>1492-PFB424</b>		10...36	
	<b>1492-PFB448</b>		30...70	
	<b>1492-PFB4120</b>		60...150	
	<b>1492-PFB4250</b>		100...250	
<b>Maximum current [A]</b>		10	6.3	6.3
<b>Wire range (Rated cross section)</b>		#26...10 AWG	4 mm <sup>2</sup>	4 mm <sup>2</sup>
<b>Wire Strip Length</b>		0.47 in. (12 mm)		
<b>Density</b>		49 pcs/ft (163 pcs/m)		
<b>Housing Temperature Range</b>		-76...266°F (-60...130 °C)		
<b>Fuse Size</b>		5 x 20 mm		
<b>Terminal block</b>	<b>Color</b>	<b>Includes LED for Blown Fuse Indication</b>	<b>Cat. No.</b>	<b>Pkg. Qty.</b>
	Black	No	1492-PFB4	50
		Yes	1492-PFB424	
			1492-PFB448	
			1492-PFB4120	
		1492-PFB4250		
<b>Accessories</b>		<b>Cat. No.</b>	<b>Pkg. Qty.</b>	
<b>End Barrier</b>		1492-EBP4T	20	
<b>Center Jumpers <sup>1</sup></b>	2-pole	Orange	1492-CJP4-2	60
<b>Test Plugs</b>		Start Test Plug	1492-PTPS	50
		Test Plug	1492-P4TPE	50
<b>Marking Systems</b>		ClearMark Advanced and ClearPlot Basic Marker Cards	1492-MR6X8 (120/card)	5 cards
		ClearMultiprint Markers	1492-MT6X8 (600/roll)	1 roll
<b>Ferrules</b>		For specific information on which Panduit ferrules to use with individual Bulletin 1492-P Push-in Terminal Blocks, consult Appendix sections in Publication 1492-TD017.		

<sup>1</sup> Available in orange as standard, to order other colors add the appropriate suffix to the catalog number listed: Blue =B, Red = RE. Example for a red 2-pole center jumper, the catalog number will be 1492-CJP3-2-RE. Multiple pole sizes available.

For more information on our complete family of push-in terminal block products, please visit: [rok.auto/push-in-terminal-blocks](http://rok.auto/push-in-terminal-blocks)





# Terminal Blocks

## Sensor/Signal Blocks

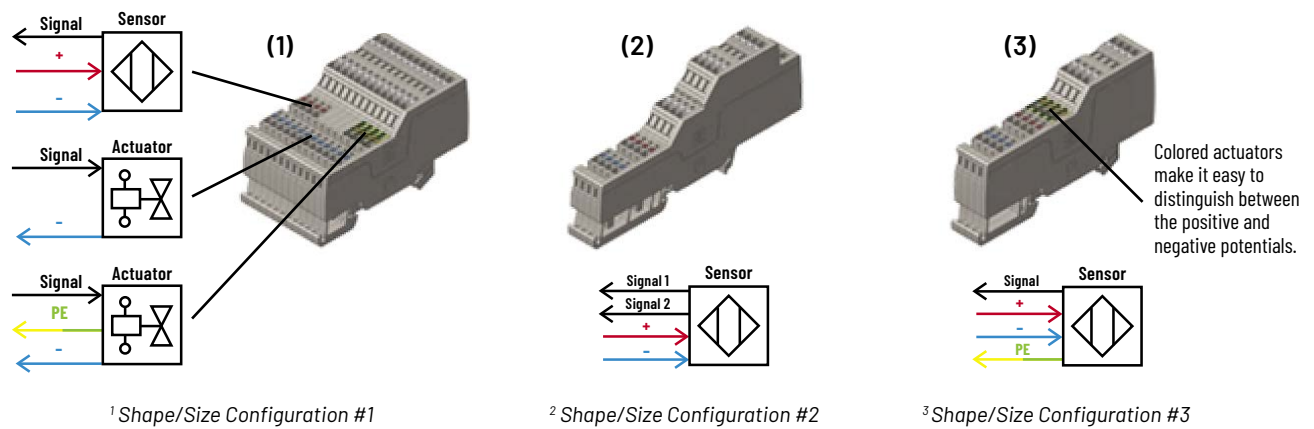

Sensor/Signal				
Color	Catalog Number			Wire Range (Rated cross section)
	2 Circuit	3 Circuit	4 Circuit	
Standard	1492-PS2-2 <sup>1</sup>	1492-PS2-3 <sup>1</sup>	1492-PS2-4 <sup>2</sup>	26-14 AWG (1.5mm <sup>2</sup> )
with Grounding	-	1492-PSG2-3 <sup>1</sup>	1492-PSG2-4 <sup>3</sup>	26-14 AWG (1.5mm <sup>2</sup> )
Ferrules	For specific information on which Panduit ferrules to use with individual Bulletin 1492-P Push-in Terminal Blocks, consult Appendix sections in Publication 1492-TD017.			

### Terminal Blocks



5-2...5-33

Wiring Systems



5-34...5-35

Connection Systems



5-36...5-45

Safety Connection Systems



5-46...5-49

Network Media



5-50...5-57



## Accessories

			1492-P3		1492-P4		1492-P6	
Accessories			Cat. No.	Pkg. Qty.	Cat. No.	Pkg. Qty.	Cat. No.	Pkg. Qty.
<b>End Barrier</b>			1492-EBP3	50	1492-EBP4	50	1492-EBP6	50
<b>Center Jumpers</b> <sup>1</sup>	2-pole	Orange	1492-CJP3-2	60	1492-CJP4-2	60	1492-CJP6-2	60
<b>Test Plugs</b>	Start Test Plug		1492-PTPS	50	1492-PTPS	50	1492-PTPS	50
	Test Plug		1492-P3TPE		1492-P4TPE		1492-P6TPE	
<b>Marking Systems</b>	ClearPlot Basic Marker Cards		1492-MR5X8 (120/card)	5 cards	1492-MR6X8 (120/card)	5 cards	1492-MR8X10 (120/card)	5 cards
	ClearMultiprint Markers		1492-MT5X8 (800/roll)	1 roll	1492-MT6X8 (600/roll)	1 roll	1492-MT8X8 (500/roll)	1 roll
<b>Ferrules</b>			For specific information on which Panduit ferrules to use with individual Bulletin 1492-P Push-in Terminal Blocks, consult Appendix sections in Publication 1492-TD017.					

			1492-P10		1492-P16	
Accessories			Cat. No.	Pkg. Qty.	Cat. No.	Pkg. Qty.
<b>End Barrier</b>			1492-EBP10/16	20	1492-EBP10/16	20
<b>Center Jumpers</b> <sup>1</sup>	2-pole	Orange	1492-CJP10-2	25	1492-CJP16-2	25
<b>Test Plugs</b>	Start Test Plug		1492-PTPS	50	1492-PTPS	50
	Test Plug		1492-P10TPE	50	1492-P10TPE	
<b>Marking Systems</b>	ClearMark Advanced and ClearPlot Basic Marker Cards <sup>2</sup>		1492-MR5X8 (120/card)	5 cards	1492-MR6X8 (120/card)	5 cards
	ClearMultiprint Markers		1492-MT10X8 (370/roll)	1 roll	1492-MT12X8 (320/roll)	1 roll
<b>Ferrules</b>			For specific information on which Panduit ferrules to use with individual Bulletin 1492-P Push-in Terminal Blocks, consult Appendix sections in Publication 1492-TD017.			

			1492-PD3		1492-PD4		1492-PT3	
Accessories			Cat. No.	Pkg. Qty.	Cat. No.	Pkg. Qty.	Cat. No.	Pkg. Qty.
<b>End Barrier</b>			1492-EBPD3	20	1492-EBPD4	20	1492-EBPT3	20
<b>Center Jumpers</b> <sup>1</sup>	2-pole	Orange	1492-CJP3-2	60	1492-CJP4-2	60	1492-CJP3-2	60
<b>Test Plugs</b>	Start Test Plug		1492-PTPS	50	1492-PTPS	50	1492-PTPS	50
	Test Plug		1492-P3TPE		1492-P4TPE		1492-P3TPE	
<b>Marking Systems</b>	ClearPlot Basic Marker Cards		1492-MR5X8 (120/card)	5 cards	1492-MR6X8 (120/card)	5 cards	1492-MR5X8 (120/card)	5 cards
	ClearMultiprint Markers		1492-MT5X8 (800/roll)	1 roll	1492-MT6X8 (600/roll)	1 roll	1492-MT5X8 (800/roll)	1 roll
<b>Ferrules</b>			For specific information on which Panduit ferrules to use with individual Bulletin 1492-P Push-in Terminal Blocks, consult Appendix sections in Publication 1492-TD017.					

<sup>1</sup> Available in orange as standard, to order other colors add the appropriate suffix to the catalog number listed: Blue =B, Red =RE. Example for a red 2-pole center jumper, the catalog number will be 1492-CJP3-2-RE. Multiple pole sizes available.

<sup>2</sup> Two marker card markers per terminal block are required.

For more information on our complete family of push-in terminal block products, please visit:  
[rok.auto/push-in-terminal-blocks](http://rok.auto/push-in-terminal-blocks)



# Terminal Blocks

## Product Selection

### Standard Feed-through Terminal Blocks, Screw Type

Dimensions are not intended to be used for manufacturing purposes.

Note: Height for dimension is measured from top of rail to top of terminal block.

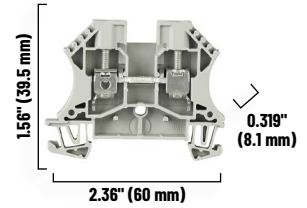
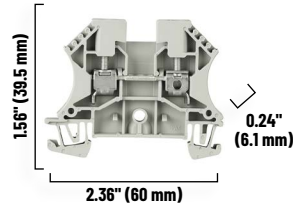
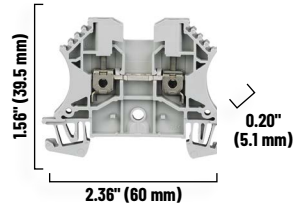

	1492-J3				1492-J4				1492-J6			
Standards	UR	CSA	IEC	ATEX	UR	CSA	IEC	ATEX	UR	CSA	IEC	ATEX
Voltage rating [V AC/DC]	600		800	550	600		800	690	600		800	550
Maximum current [A]	25	20	24	21	35	25	32	28	50		41	36
Wire range (Rated cross section)	#28... 12 AWG	#26... 12 AWG	2.5 mm <sup>2</sup>	2.5 mm <sup>2</sup> (#20... 14 AWG)	#22... 10 AWG	#26... 10 AWG	4 mm <sup>2</sup>	4 mm <sup>2</sup> (#20... 12 AWG)	#22... 8 AWG		6 mm <sup>2</sup>	6 mm <sup>2</sup> (#20... 10 AWG)
Terminal block	Cat. No.		Pkg. Qty.		Cat. No.		Pkg. Qty.		Cat. No.		Pkg. Qty.	
Grey	1492-J3		100		1492-J4		100		1492-J6		100	
Color	1492-J3-⊗		100		1492-J4-⊗		100		1492-J6-⊗		100	
Accessories	Cat. No.		Pkg. Qty.		Cat. No.		Pkg. Qty.		Cat. No.		Pkg. Qty.	
End barrier	1492-EBJ3		50		1492-EBJ4		50		1492-EBJ6		50	
Screw center jumper 2-pole	1492-CJJ5-2		50		1492-CJJ6-2		50		1492-CJJ8-2		50	
Plug-in center jumper 2-pole	1492-CJLJ5-2		60		1492-CJLJ6-2		60		-		-	
Partition plates	1492-EBJ16		20		1492-EBJ16		20		1492-EBJ16		20	
Snap-in marker cards	1492-MR5X12		5 cards (120/card)		1492-MR6X12		5 cards (120/card)		1492-MR8X12		5 cards (84/card)	
Snap-in marker tags for ClearMultiPrint	1492-MT5X12		800		1492-MT6X12		600		1492-MT8X12		500	

⊗ For colored terminal blocks, replace the ⊗ in the catalog number with the following: **RE** = Red, **B** = Blue, **BL** = Black, **G** = Green, **Y** = Yellow, **OR** = Orange, **BR** = Brown, **W** = White, to the end of the catalog number. Multiple pole sizes available.

#### Terminal Blocks



5-2...5-33

#### Wiring Systems



5-34...5-35

#### Connection Systems



5-36...5-45

#### Safety Connection Systems



5-46...5-49

#### Network Media



5-50...5-57



# Product Selection

## Standard Feed-through Terminal Blocks, Screw Type

Dimensions are not intended to be used for manufacturing purposes.

Note: Height for dimension is measured from top of rail to top of terminal block.

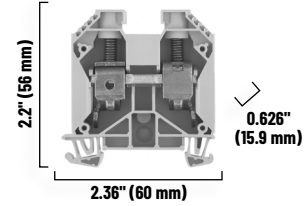
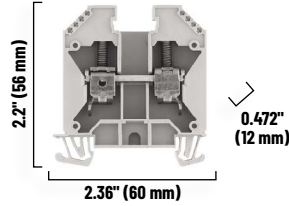
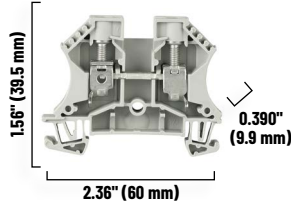

	1492-J10				1492-J16				1492-J35			
Standards	UR	CSA	IEC	ATEX	UR	CSA	IEC	ATEX	UR	CSA	IEC	ATEX
Voltage rating [V AC/DC]	600		1000	550	600		1000	690	1000	600	1000	690
Maximum current [A]	65	50	57	50	85	76	66		150	120	125	109
Wire range (rated cross section)	#18... 6 AWG		10 mm <sup>2</sup>	10 mm <sup>2</sup> (#16... 8 AWG)	#18... 4 AWG		16 mm <sup>2</sup>	16 mm <sup>2</sup> (#16... 6 AWG)	12... 1/0 AWG	12... 2 AWG	35 mm <sup>2</sup>	35 mm <sup>2</sup> (#14... 2 AWG)
Terminal block	Cat. No.		Pkg. Qty.		Cat. No.		Pkg. Qty.		Cat. No.		Pkg. Qty.	
Grey	1492-J10		50		1492-J16		50		1492-J35		40	
Color	1492-J10-⊗		50		1492-J16-⊗		50		-		-	
Accessories	Cat. No.		Pkg. Qty.		Cat. No.		Pkg. Qty.		Cat. No.		Pkg. Qty.	
End barrier	1492-EBJ3		50		1492-EBJ16		20		1492-EBJ16		20	
Screw center jumper 2-pole	1492-CJJ10-2		50		1492-CJJ12-2		20		1492-CJJ16-2		20	
Partition plates	1492-EBJ16		20		1492-PPJD3		20		1492-PPJD3		20	
Snap-in marker cards	1492-M7X12		5 cards (108/card)		1492-M7X12		5 cards (108/card)		1492-M7X12		5 cards (108/card)	
Snap-in marker tags for ClearMultiPrint	1492-MT5X12		800		1492-MT6X12		600		1492-MT8X12		500	

⊗ For colored terminal blocks, replace the ⊗ in the catalog number with the following: **RE** = Red, **B** = Blue, **BL** = Black, **G** = Green, **Y** = Yellow, **OR** = Orange, **BR** = Brown, **W** = White, to the end of the catalog number. Multiple pole sizes available.

CONNECTIVITY



# Terminal Blocks

## Product Selection

### Multi-circuit Feed-through Terminal Blocks, Screw Type

Dimensions are not intended to be used for manufacturing purposes.

Note: Height for dimension is measured from top of rail to top of terminal block.

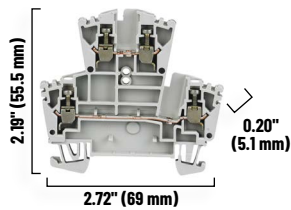

1492-JD3

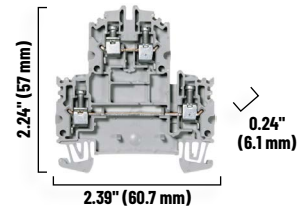

1492-JD4

Two-level, Feed-through terminal block

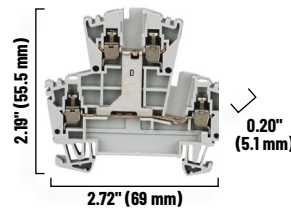

1492-JD3C

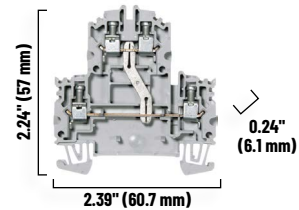

1492-JD4C

Two-level, Feed-through terminal block with commoning bar

Standards	UR	CSA	IEC	ATEX	UR	CSA	IEC	ATEX
Voltage rating [V AC/DC]	600	300	400	275	600	300	800	550
Maximum current [A]	20	10	24	21	35	30	32	28
Wire range (rated cross section)	#22... 12 AWG	#26... 12 AWG	2.5 mm <sup>2</sup>	2.5 mm <sup>2</sup> (#20... 14 AWG)	#26...10 AWG		0.5...4 mm <sup>2</sup>	4 mm <sup>2</sup> (#20... 12 AWG)
Terminal block	Cat. No.		Pkg. Qty.		Cat. No.		Pkg. Qty.	
Grey	1492-JD3		100		1492-JD4		100	
Color	1492-JD3-⊗		100		1492-JD4-⊗		100	
Grey w/commoning bar	1492-JD3C		100		1492-JD4C		100	
Accessories	Cat. No.		Pkg. Qty.		Cat. No.		Pkg. Qty.	
End barrier	1492-EBJD3		20		1492-EBJD4		20	
Center jumper - 2-pole	1492-CJJ5-2		50		1492-CJLJ6-2		60	
Partition plates	1492-PPJD3		20		1492-PPJD3		20	
Snap-in marker cards	1492-MR5X8		5 cards (120/card)		1492-MR6X8		5 cards (120/card)	
Snap-in marker cards	1492-M5X5		5 cards (200/card)		1492-M6X5		5 cards (200/card)	
Snap-in marker tags for ClearMultiprint	1492-MT5X8		800		1492-MT6X8		600	

⊗ For colored terminal blocks, replace the ⊗ in the catalog number with the following: **RE** = Red, **B** = Blue, **BL** = Black, **G** = Green, **Y** = Yellow, **OR** = Orange, **BR** = Brown, **W** = White, to the end of the catalog number. Multiple pole sizes available.

#### Terminal Blocks



5-2...5-33

#### Wiring Systems



5-34...5-35

#### Connection Systems



5-36...5-45

#### Safety Connection Systems



5-46...5-49

#### Network Media



5-50...5-57



## Product Selection

### Grounding Terminal Blocks, Screw Type

Dimensions are not intended to be used for manufacturing purposes

Note: Height for dimension is measured from top of rail to top of terminal block.

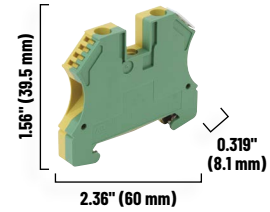
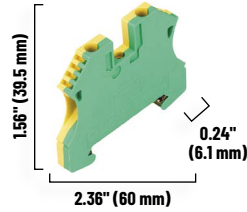
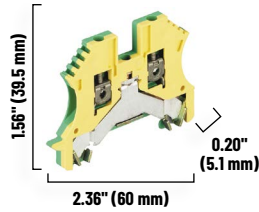

		1492-JG3				1492-JG4				1492-JG6			
Standards		UR	CSA	IEC	ATEX	UR	CSA	IEC	ATEX	UR	CSA	IEC	ATEX
Wire range (Rated cross section)		#22...12 AWG		2.5 mm <sup>2</sup>	2.5 mm <sup>2</sup> (#20...14 AWG)	#22...10 AWG		4 mm <sup>2</sup>	4 mm <sup>2</sup> (#20...12 AWG)	#22...8 AWG		6 mm <sup>2</sup>	6 mm <sup>2</sup> (#20...10 AWG)
Terminal block	Type	Cat. No.		Pkg. Qty.	Cat. No.		Pkg. Qty.	Cat. No.		Pkg. Qty.			
	Green/Yellow	1492-JG3		100	1492-JG4		100	1492-JG6		50			
End barrier	Yellow	1492-EBJ3-Y		50	Not required		-	Not required		-			
Snap-in markers		1492-MR5X12 (120/card)		5	1492-MR6X12 (120/card)		5	1492-MR8X12 (84/card)		5			
Snap-in marker tags for ClearMultiPrint		1492-MT5X12		800	1492-MT6X12		600	1492-MT8X12		500			

Dimensions are not intended to be used for manufacturing purposes

Note: Height for dimension is measured from top of rail to top of terminal block.

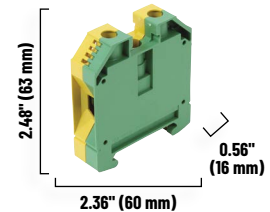
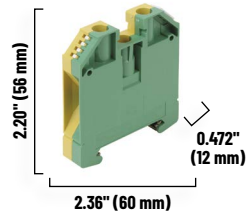
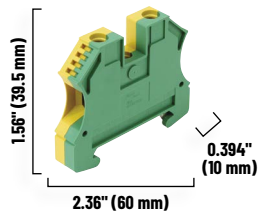

		1492-JG10				1492-JG16				1492-JG35			
Standards		UR	CSA	IEC	ATEX	UR	CSA	IEC	ATEX	UR	CSA	IEC	ATEX
Wire range (Rated cross section)		#16...6 AWG		10 mm <sup>2</sup>	10 mm <sup>2</sup> (#16...8 AWG)	#14...4 AWG		16 mm <sup>2</sup>	16 mm <sup>2</sup> (#16...6 AWG)	#12...1 AWG	#12...2 AWG	35 mm <sup>2</sup>	35 mm <sup>2</sup> (#14...2 AWG)
Terminal block	Type	Cat. No.		Pkg. Qty.	Cat. No.		Pkg. Qty.	Cat. No.		Pkg. Qty.			
	Green/Yellow	1492-JG10		50	1492-JG16		50	1492-JG35		25			
End barrier	Not required		-	Not required		-	Not required		-				
Snap-in markers		1492-MR8X12		5 cards (84/card)	1492-MR8X12		5 cards (84/card)	1492-MR8X12		5 cards (84/card)			
Snap-in marker tags for ClearMultiPrint		1492-MT8X12		500	1492-MT8X12		500	1492-MT8X12		500			

For more information on our complete family of terminal block products, please visit: [rok.auto/terminal-blocks](http://rok.auto/terminal-blocks)





# Terminal Blocks

## Product Selection

### Plug-in Style Terminal Blocks, Screw Type

Dimensions are not intended to be used for manufacturing purposes

Note: Height for dimension is measured from top of rail to top of terminal block.

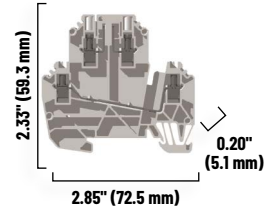
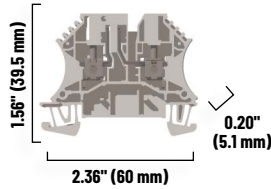

		1492-J3P			1492-JD3P		
<b>Standards</b>		UL	CSA	IEC	UL	CSA	IEC
<b>Voltage rating [V AC/DC]</b>		600	300	500	300		500
<b>Maximum current [A]</b>		20	10	24	20		24
<b>Wire range (Rated cross section)</b>		#30...12 AWG		2.5 mm <sup>2</sup>	#24...12 AWG	#30...12 AWG	2.5 mm <sup>2</sup>
Terminal Block	Type	Cat. No.		Pkg. Qty.	Cat. No.		Pkg. Qty.
	Grey	1492-J3P		100	1492-J3DP		50
	Red	1492-J3P-RE		100	-		-
<b>End barrier</b>		1492-EBJ3		50	1492-EBJD3P		20
<b>Center jumpers</b>	10-pole	1492-CJLJ5-10		20	1492-CJJ5-10		20
	2-pole	1492-CJLJ5-2		60	1492-CJJ5-2		50
<b>Disconnect plug</b>		1492-DPL		50	1492-DPL		50
<b>Component plug</b>		1492-CPL		50	1492-CPL		50
<b>Without blown fuse indicator</b>		1492-FPK2		20	1492-FPK2		20
<b>10...36V blown fuse indicator</b>		1492-FPK224		20	1492-FPK224		20
<b>35...75V blown fuse indicator</b>		1492-FPK248		20	1492-FPK248		20
<b>60...150V blown fuse indicator</b>		1492-FPK2120		20	1492-FPK2120		20
<b>140...250V blown fuse indicator</b>		1492-FPK2250		20	1492-FPK2250		20
<b>Snap-in marker cards</b>		1492-MR5X12		5 cards (120/card)	1492-M5X5		5 cards (200/card)
<b>Snap-in marker cards</b>		1492-M5X5		5 cards (200/card)	1492-MS5X10		5 cards (144/card)
<b>Snap-in marker tags for ClearMultiPrint</b>		1492-MT5X12		800	1492-MT5X5		800

#### Terminal Blocks



5-2...5-33

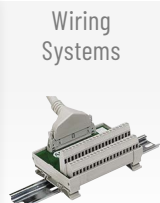

5-34...5-35

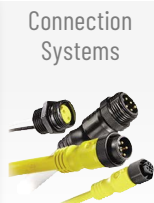

5-36...5-45



5-46...5-49

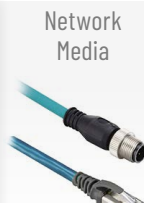

5-50...5-57



## Product Selection

### Fuse Blocks, Screw Type

Dimensions are not intended to be used for manufacturing purposes

Note: Height for dimension is measured from top of rail to top of terminal block.

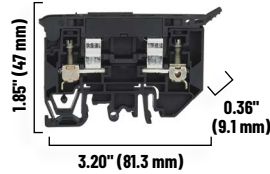

		1492-H...		1492-WFB4...		1492-JD3FB/-JDG3FB	
<b>Specifications</b>		Single-circuit fusible terminal block with or without fuse indication (1/4" x 1-1/4" Fuse)		Single-circuit fuse block with or without fuse indication (5 x 20 mm Fuse)		2-Level fuse block with or without ground connection (5 x 20 mm Fuse)	
<b>Standards</b>		UR	CSA	IEC	UR	CSA	IEC
<b>Voltage rating</b>	H6/WFB4/JD3FB/JDG3FB	300V AC/DC		500V AC/DC	300V AC/DC		500V AC/DC
	H5/WFB424/JD3FB24/JDG3FB24	10...57V AC/DC			10...57V AC/DC		10...36V AC/DC
	JD3FB48/JDG3FB48	-			-		30...70V AC/DC
	JD3FB120/JDG3FB120	-			-		60...150V AC/DC
	H4/WFB4250/JD3FB250/JDG3FB250	100...300V AC			85...264V AC		100...250V AC/DC
<b>Maximum current [A]</b>		15			15	15 *	-
<b>Fuse circuit</b>		-			-		10 A
<b>Feed-through circuit</b>		-			-		20 A
<b>Wire range (rated cross section)</b>		#30...12 AWG		0.5...4 mm <sup>2</sup>	#30...12 AWG		0.5...4 mm <sup>2</sup>
<b>Terminal block</b>		<b>Cat. No.</b>	<b>Pkg. Qty.</b>	<b>Cat. No.</b>	<b>Pkg. Qty.</b>	<b>Cat. No.</b>	<b>Pkg. Qty.</b>
<b>Black (non-indicating)</b>		1492-H6	25	1492-WFB4	50	-	-
<b>Grey (non-indicating) 2-level without ground</b>		-	-	-	-	1492-JD3FB	50
<b>Grey (non-indicating) 2-level with Ground</b>		-	-	-	-	1492-JDG3FB	50
<b>Black with blown fuse indication (10...57V AC/DC)</b>		1492-H5	25	1492-WFB424	50	-	-
<b>Black with blown fuse indication (100...300V AC/DC)</b>		1492-H4	25	1492-WFB4250	50	-	-
<b>Accessories</b>		<b>Cat. No.</b>	<b>Pkg. Qty.</b>	<b>Cat. No.</b>	<b>Pkg. Qty.</b>	<b>Cat. No.</b>	<b>Pkg. Qty.</b>
<b>End barrier</b>		1492-N37	50	Not required	-	1492-EBJD3FB	20
<b>Marker card for base block</b>		1492-MS8X12	5 (56/card)	1492-MS8X12	5 (56/card)	1492-M6X5	5 (200/card)
		1492-MS8X9	5 (56/card)	1492-MS8X9	5 (56/card)	-	-
<b>Marker card for handle</b>		1492-MS8X12	5 (56/card)	1492-MS8X9	5 (56/card)	1492-M7X12	5 (108/card)

\* IEC standards for 5 x 20 mm fuses do not include rating above 6.3 A.



# Terminal Blocks

## Product Selection

### Sensor Terminal Blocks, Screw Type

Dimensions are not intended to be used for manufacturing purposes.

Note: Height for dimension is measured from top of rail to top of terminal block.

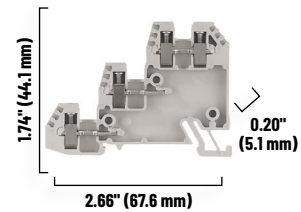
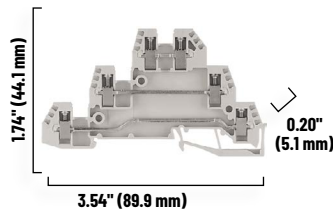

		1492-WTF3			1492-WTS3		
<b>Standards</b>		UL	CSA	IEC	UL	CSA	IEC
<b>Voltage rating [V AC/DC]</b>		300		250	300		250
<b>Maximum current [A]</b>		10		24	10		24
<b>Wire range (rated cross section)</b>		#26...14 AWG		0.5...2.5 mm <sup>2</sup>	#26...14 AWG		0.5...2.5 mm <sup>2</sup>
<b>Terminal block</b>	<b>Type</b>	<b>Cat. No.</b>		<b>Pkg. Qty.</b>	<b>Cat. No.</b>		<b>Pkg. Qty.</b>
	Grey	1492-WTF3		50	1492-WTS3		50
	Blue	-		-	1492-WTS3-B		50
	Grey for PNP devices	1492-WTF3LP		50	1492-WTS3LP		50
	Grey for NPN devices	1492-WTF3LN		50	1492-WTS3LN		50
<b>End barrier</b>		1492-EBTF3		50	1492-EBTS3		50
<b>Center jumpers</b>	50-pole	1492-CJT5-50		5	1492-CJT5-50		5
	10-pole	1492-CJT5-10		10	1492-CJT5-10		10
	3-pole	1492-CJT5-3		10	1492-CJT5-3		10
	2-pole	1492-CJT5-2		10	1492-CJT5-2		10
<b>Partition plate</b>		1492-PPTS3		50	1492-PPTS3		50
<b>Snap-in marker cards</b>		1492-MS5X9		5 cards (80/card)	1492-MS5X9		5 cards (80/card)

### Terminal Blocks



5-2...5-33

### Wiring Systems



5-34...5-35

### Connection Systems



5-36...5-45

### Safety Connection Systems



5-46...5-49

### Network Media



5-50...5-57



# Product Selection

## Standard Feed-through Terminal Blocks, Spring Clamp

CONNECTIVITY

Dimensions are not intended to be used for manufacturing purposes

Note: Height for dimension is measured from top of rail to top of terminal block.

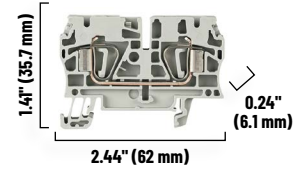
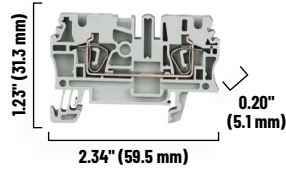
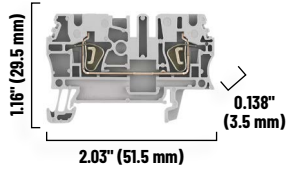

	1492-L2				1492-L3				1492-L4			
Standards	UR	CSA	IEC	ATEX	UR	CSA	IEC	ATEX	UR	CSA	IEC	ATEX
Voltage rating [V AC/DC]	300		500	550	600		800	550	600		800	550
Maximum current [A]	15	20	17.5	15	25	27	24	21	33	35	32	28
Wire range (rated cross section)	#26...14 AWG		1.5 mm <sup>2</sup>	1.5 mm <sup>2</sup> (#20...16 AWG)	#26...12 AWG	#26...12 AWG	2.5 mm <sup>2</sup>	2.5 mm <sup>2</sup> (#20...12 AWG)	#26...10 AWG		4 mm <sup>2</sup>	4 mm <sup>2</sup> (#20...10 AWG)
Terminal block	Cat. No.		Pkg. Qty.		Cat. No.		Pkg. Qty.		Cat. No.		Pkg. Qty.	
Grey	1492-L2		50		1492-L3 †		100		1492-L4 †		50	
Color	1492-L2-⊗		50		1492-L3-⊗		100		1492-L4-⊗		50	
Accessories <sup>1</sup>	Cat. No.		Pkg. Qty.		Cat. No.		Pkg. Qty.		Cat. No.		Pkg. Qty.	
End barrier (Grey)	1492-EBL2		50		1492-EBL3 †		50		1492-EBL4 †		50	
Plug-in center jumper 2-pole	1492-CJL4-2		60		1492-CJK5-2		60		1492-CJK6-2		60	
Marker card (edge marking)	1492-M3X5		5 cards (120/card)		1492-M5X10		5 cards (144/card)		1492-M6X10		5 cards (120/card)	
Marker card (center marking)	1492-M3X12		5 cards (200/card)		1492-MR5X8		5 cards (200/card)		1492-M6X5		5 cards (200/card)	
Snap-in marker tags for ClearMultiPrint	1492-MT3X12		1000		1492-MT5X8		800		1492-MT6X8		600	

⊗ For colored terminal blocks, replace the ⊗ in the catalog number with the following: **RE** = Red, **B** = Blue, **BL** = Black, **G** = Green, **Y** = Yellow, **OR** = Orange, **BR** = Brown, **W** = White, to the end of the catalog number.

† For blocks with 1-in and 2-out, add a **T** after the L3 or L4. For blocks with 2-in and 2-out a **Q** after the L3 or L4. Example: catalog number 1492-L3T, 1492-L4Q, 1492-L3T-RE, 1492-L4Q-BL.

\* You must also add a **T** or **Q** to the end barrier part number when using 3 or 4 connection terminal blocks.

Example: The end barrier for Bulletin 1492-L3T is catalog number 1492-EBL3T. For the Bulletin 1492-L2Q, the end barrier is catalog number 1492-EBL2Q.

<sup>1</sup> Multiple pole sizes available.



# Terminal Blocks

## Product Selection

### Standard Feed-through Terminal Blocks, Spring Clamp

Dimensions are not intended to be used for manufacturing purposes

Note: Height for dimension is measured from top of rail to top of terminal block.

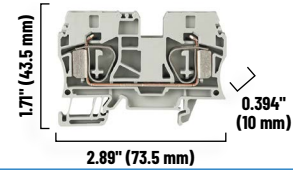
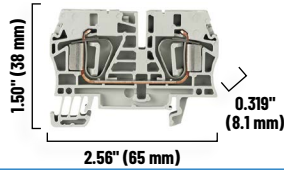

	1492-L6				1492-L10			
<b>Standards</b>	UR	CSA	IEC	ATEX	UR	CSA	IEC	ATEX
<b>Voltage rating [V AC/DC]</b>	600		800	550	600		800	550
<b>Maximum current [A]</b>	50		41	36	60	55	57	50
<b>Wire range (rated cross section)</b>	#22...8 AWG	#20...8 AWG	6 mm <sup>2</sup>	6 mm <sup>2</sup> (#20...8 AWG)	#16...6 AWG		10 mm <sup>2</sup>	10 mm <sup>2</sup> (#16...8 AWG)
<b>Terminal block</b>	<b>Cat. No.</b>		<b>Pkg. Qty.</b>		<b>Cat. No.</b>		<b>Pkg. Qty.</b>	
<b>Grey</b>	1492-L6 <sup>†</sup>		50		1492-L10		25	
<b>Color</b>	1492-L6-⊗		50		1492-L10-⊗		25	
<b>Accessories</b>	<b>Cat. No.</b>		<b>Pkg. Qty.</b>		<b>Cat. No.</b>		<b>Pkg. Qty.</b>	
<b>End barrier (grey)</b>	1492-EBL6 <sup>*</sup>		50		1492-EBL10		50	
<b>Plug-in center jumper 2-pole</b>	1492-CJL8-2		60		1492-CJL10-2		60	
<b>Marking systems: marker card (corner marking)</b>	1492-MR8X12		5 cards (84/card)		1492-MR8X12		5 cards (84/card)	
<b>Marker card (center marking)</b>	1492-M8X5		5 cards (160/card)		1492-M8X5		5 cards (160/card)	
<b>Snap-in marker tags for ClearMultiPrint</b>	1492-MT8X12		500		1492-MT8X12		500	

Dimensions are not intended to be used for manufacturing purposes

Note: Height for dimension is measured from top of rail to top of terminal block.

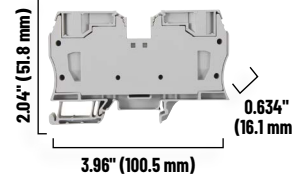
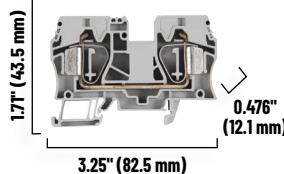

	1492-L16				1492-L35			
<b>Standards</b>	UR	CSA	IEC	ATEX	UR	CSA	IEC	ATEX
<b>Voltage rating [V AC/DC]</b>	600		800	550	600		800	690
<b>Maximum current [A]</b>	65		76	66	120		125	109
<b>Wire range (rated cross section)</b>	#14...4 AWG		16 mm <sup>2</sup>	16 mm <sup>2</sup> (#16...6 AWG)	#12...2 AWG		35 mm <sup>2</sup>	35 mm <sup>2</sup> (#14...2 AWG)
<b>Terminal block</b>	<b>Cat. No.</b>		<b>Pkg. Qty.</b>		<b>Cat. No.</b>		<b>Pkg. Qty.</b>	
<b>Grey</b>	1492-L16		25		1492-L35		10	
<b>Color</b>	1492-L16-⊗		25		1492-L35-⊗		25	
<b>Accessories</b>	<b>Cat. No.</b>		<b>Pkg. Qty.</b>		<b>Cat. No.</b>		<b>Pkg. Qty.</b>	
<b>End barrier (grey)</b>	1492-EBL16		20		Not required		-	
<b>Plug-in center jumper 2-pole</b>								
<b>Marker card (edge marking)</b>	1492-MR8X12		5 cards (84/card)		1492-MR8X12		5 cards (84/card)	
<b>Marker card (center marking)</b>	1492-M8X5		5 cards (160/card)		1492-M8X5		5 cards (160/card)	
<b>Snap-in marker tags for ClearMultiPrint</b>	1492-MT8X12		500		1492-MT8X12		500	

⊗ For colored terminal blocks, replace the ⊗ in the catalog number with the following: **RE** = Red, **B** = Blue, **BL** = Black, **G** = Green, **Y** = Yellow, **OR** = Orange, **BR** = Brown, **W** = White, to the end of the catalog number.

<sup>†</sup> For blocks with 1-in and 2-out, add a T after the L6. Example: catalog number 1492-L6T, 1492-L6T-BR.

\* You must add a T to the end barrier catalog number when selecting the end barrier for catalog number 1492-L6T. Example: catalog number 1492-EBL6T.

#### Terminal Blocks



5-2...5-33

#### Wiring Systems



5-34...5-35

#### Connection Systems



5-36...5-45

#### Safety Connection Systems



5-46...5-49

#### Network Media



5-50...5-57



# Product Selection

## Multi-circuit Feed-through Terminal Blocks, Spring Clamp

Dimensions are not intended to be used for manufacturing purposes

Note: Height for dimension is measured from top of rail to top of terminal block.

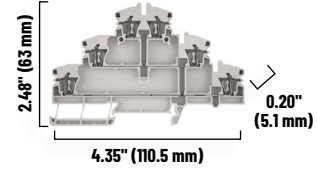
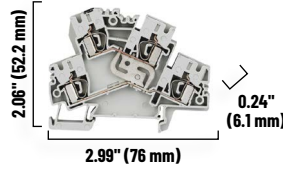
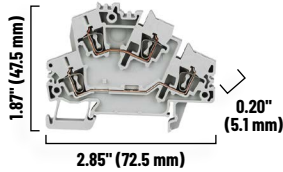

	1492-LD3				1492-LD4				1492-LTF3			
<b>Specifications</b>	Two-circuit feed-through terminal block (LD3)				Two-circuit feed-through terminal block (LD4)				Three-circuit feed-through terminal block with optional cross-connection links to common multiple levels			
	Two-circuit feed-through terminal block with commoning bar (LD3C)				Two-circuit feed-through terminal block with commoning bar (LD4C)							
<b>Standards</b>	UR	CSA	IEC	ATEX	UR	CSA	IEC	ATEX	UR	CSA	IEC	ATEX
<b>Voltage rating [V AC/DC]</b>	600		800	550	600		800		300		500	
<b>Maximum current [A]</b>	20	25	24	20	25	30	32		15		20	
<b>Wire range (rated cross section)</b>	#30...12 AWG		2.5 mm <sup>2</sup>	0.5...2.5 mm <sup>2</sup> (#20...14 AWG)	#26...10 AWG		4 mm <sup>2</sup>		#26...12 AWG		0.5...2.5 mm <sup>2</sup>	
<b>Terminal block</b>	<b>Cat. No.</b>		<b>Pkg. Qty.</b>		<b>Cat. No.</b>		<b>Pkg. Qty.</b>		<b>Cat. No.</b>		<b>Pkg. Qty.</b>	
<b>Two-circuit feed-through</b>	<b>Grey</b>	1492-LD3	25		1492-LD4	20		-		-		
	<b>Color</b>	1492-LD3-⊗	25		1492-LD4-⊗	20		-		-		
<b>Two-circuit block with commoning bar</b>	<b>Grey</b>	1492-LD3C	25		1492-LD4C	20		-		-		
<b>Three-circuit feed-through block with commoning link</b>	-		-		-		-		1492-LTF3	25		
<b>Accessories</b>	<b>Cat. No.</b>		<b>Pkg. Qty.</b>		<b>Cat. No.</b>		<b>Pkg. Qty.</b>		<b>Cat. No.</b>		<b>Pkg. Qty.</b>	
<b>End barrier (grey)</b>	1492-EBLD3		20		1492-EBLD4		20		1492-EBLTF3		20	
<b>Plug-in center jumper 10-pole</b>	1492-CJK5-10		20		1492-CJK6-10		20		1492-CJK5-10		20	
<b>Plug-in center jumper 2-pole</b>	1492-CJK5-2		60		1492-CJK6-2		60		1492-CJK5-2		60	
<b>Vertical cross connector</b>	-		-		-		-		1492-CJL5D		20	
<b>Marker card</b>	1492-M5X10		5 cards (144/card)		1492-M6X10		5 cards (120/card)		1492-M5X5		5 cards (200/card)	
<b>Snap-in marker tags for ClearMultiPrint</b>	1492-MT5X8		800		1492-MT6X8		600		1492-MT5X5		800	

⊗ For colored terminal blocks, replace the ⊗ in the catalog number with the following: **RE** = Red, **B** = Blue, **BL** = Black, **G** = Green, **Y** = Yellow, **OR** = Orange, **BR** = Brown, **W** = White, to the end of the catalog number.

CONNECTIVITY





# Terminal Blocks

## Product Selection

### Sensor Terminal Blocks, Spring Clamp

Dimensions are not intended to be used for manufacturing purposes

Note: Height for dimension is measured from top of rail to top of terminal block.

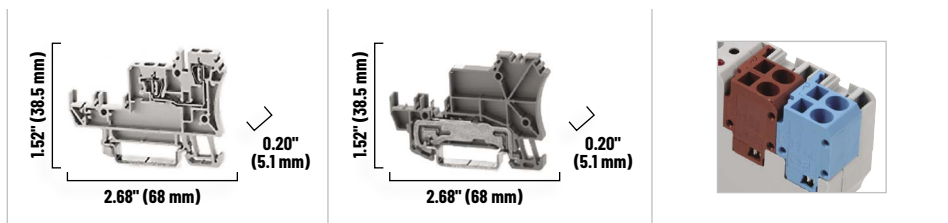

		1492-LS2-3/-LS2-4		1492-LSG2-3/-LSG2-4		1492-LS2-B/-LS2-BR/-LSG2	
Standards		UR	CSA	IEC	UR	CSA	IEC
Voltage rating [V AC/DC]		300		250		300	
Maximum current [A]		10		17.5		10	
Wire range (rated cross section)		#26...14 AWG		1.5 mm <sup>2</sup>		#26...14 AWG	
Wire range (rated cross section)				0.5... 1.5 mm <sup>2</sup>			
Terminal block	Color	Cat. No.	Pkg. Qty.	Cat. No.	Pkg. Qty.	Cat. No.	Pkg. Qty.
3-Conductor	Grey	1492-LS2-3	50	-	-	-	-
	Green	-	-	1492-LSG2-3	20	-	-
3-Conductor led indication	Grey	1492-LS2-3L	50	-	-	-	-
4-Conductor	Grey	1492-LS2-4	50	-	-	-	-
	Green	-	-	1492-LSG2-4	20	-	-
4-Conductor led indication	Grey	1492-LS2-4L	50	-	-	-	-
Self-linking plug-in connection blocks	Blue	-	-	-	-	1492-LS2-B	100
	Brown	-	-	-	-	1492-LS2-BR	100
	Green	-	-	-	-	1492-LSG2	100
Accessories		Cat. No.	Pkg. Qty.	Cat. No.	Pkg. Qty.	Cat. No.	Pkg. Qty.
End barrier	3-Conductor	1492-EBLS2-3	50	1492-EBLS2-3	50	Not required	-
	4-Conductor	1492-EBLS2-4	50	1492-EBLS2-4	50	Not required	-
Plug-in center jumper (50-pole)		1492-CJK5-50	10	-	-	-	-
Plug-in center jumper (10-pole)		1492-CJK5-10	20	-	-	-	-
Plug-in center jumper (2-pole)		1492-CJK5-2	60	-	-	-	-
Marker card		1492-MS5X5	5 (200/card)	1492-MS5X5	5 (200/card)	-	-
Snap-in marker tags for ClearMultiprint		1492-MT5X8	800	1492-MT5X8	800	-	-

### Terminal Blocks



5-2...5-33



5-34...5-35



5-36...5-45



5-46...5-49



5-50...5-57



# Product Selection

## Grounding Terminal Blocks, Spring Clamp

Dimensions are not intended to be used for manufacturing purposes

Note: Height for dimension is measured from top of rail to top of terminal block.

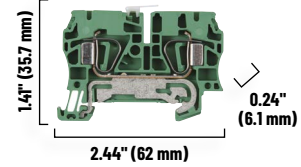
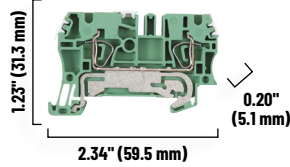
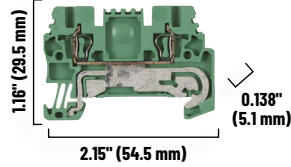

	1492-LG2				1492-LG3				1492-LG4			
Standards	UR	CSA	IEC	ATEX	UR	CSA	IEC	ATEX	UR	CSA	IEC	ATEX
Wire range (rated cross section)	#26...14 AWG		0.5... 1.5 mm <sup>2</sup>	0.5... 1.5 mm <sup>2</sup> (#20... 16 AWG)	#30...12 AWG	#26...12 AWG	2.5 mm <sup>2</sup>	2.5 mm <sup>2</sup> (#20... 12 AWG)	#26...10 AWG		4 mm <sup>2</sup>	4 mm <sup>2</sup> (#20... 10 AWG)
Maximum current	Grounding				Grounding				Grounding			
Terminal block	Cat. No.	Pkg. Qty.		Cat. No.	Pkg. Qty.		Cat. No.	Pkg. Qty.		Cat. No.	Pkg. Qty.	
Green/Yellow	1492-LG2	50		1492-LG3 †	50		1492-LG4 †	50		1492-LG4 †	50	
Accessories	Cat. No.	Pkg. Qty.		Cat. No.	Pkg. Qty.		Cat. No.	Pkg. Qty.		Cat. No.	Pkg. Qty.	
End barrier (yellow)	1492-EBL2-Y	50		1492-EBL3-Y <sup>ø</sup>	50		1492-EBL4-Y <sup>ø</sup>	50		1492-EBL4-Y <sup>ø</sup>	50	
Marker card (edge marking)	1492-M3X12	5 cards (120/card)		1492-M5X10	5 cards (144/card)		1492-M6X10	5 cards (120/card)		1492-M6X10	5 cards (120/card)	
Marker card (center marking)	1492-M3X5	5 cards (100/card)		1492-MR5X8	5 cards (120/card)		1492-MR6X8	5 cards (120/card)		1492-MR6X8	5 cards (120/card)	
Snap-in marker tags for ClearMultiprint	1492-MT3X8	1000		1492-MT5X8	800		1492-MT6X8	600		1492-MT6X8	600	

† For blocks with 1-in and 2-out, add a **T** after the LG3 or LG4. For blocks with 2-in and 2-out, add a **Q** after the LG3 or LG4. Example: catalog number 1492-LG3**T**, 1492-LG4**Q**.

ø You must also add a **T** or **Q** to the end barrier part number when using 3 or 4 connection terminal blocks. Example: The end barrier for Bulletin 1492-LG3**T** is catalog number 1492-EBL3**T**-Y. For the Bulletin 1492-LG2**Q**, the end barrier is catalog number 1492-EBL2**Q**-Y.

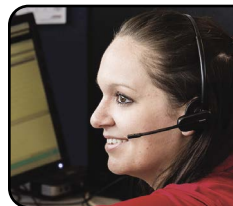

### Need Help?

The Rockwell Automation Support Center is your 24/7 support for the answers you need now.

[rok.auto/support](http://rok.auto/support)



# Terminal Blocks

## Product Selection

### Grounding Terminal Blocks, Spring Clamp

Dimensions are not intended to be used for manufacturing purposes

Note: Height for dimension is measured from top of rail to top of terminal block.

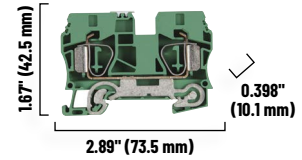
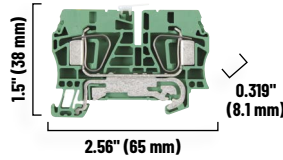

	1492-LG6				1492-LG10			
<b>Standards</b>	UR	CSA	IEC	ATEX	UR	CSA	IEC	ATEX
<b>Voltage rating [V AC/DC]</b>	-				-			
<b>Maximum current</b>	Grounding				Grounding			
<b>Wire range (rated cross section)</b>	#22...8 AWG	#20...8 AWG	6 mm <sup>2</sup>	6 mm <sup>2</sup> (#20...8 AWG)	#16...6 AWG	10 mm <sup>2</sup>	10 mm <sup>2</sup> (#16...8 AWG)	
<b>Terminal block</b>	<b>Cat. No.</b>		<b>Pkg. Qty.</b>		<b>Cat. No.</b>		<b>Pkg. Qty.</b>	
<b>Green/Yellow</b>	1492-LG6 †		50		1492-LG10		25	
<b>Accessories</b>	<b>Cat. No.</b>		<b>Pkg. Qty.</b>		<b>Cat. No.</b>		<b>Pkg. Qty.</b>	
<b>End barrier (yellow)</b>	1492-EBL6-Y †		50		1492-EBL10-Y		20	
<b>Marker card (edge marking)</b>	1492-MR8X12		5 cards (84/card)		1492-MR8X12		5 cards (84/card)	
<b>Marker card (center marking)</b>	1492-M8X5		5 cards (160/card)		1492-M8X5		5 cards (160/card)	
<b>Snap-in marker tags for ClearMultiprint</b>	1492-MT8X12		500		1492-MT8X12		500	

Dimensions are not intended to be used for manufacturing purposes

Note: Height for dimension is measured from top of rail to top of terminal block.

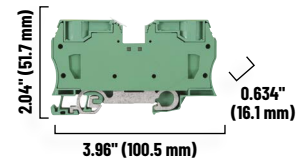
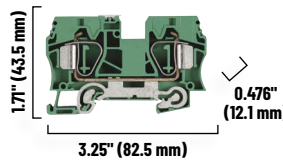

	1492-LG16				1492-LG35			
<b>Standards</b>	UR	CSA	IEC	ATEX	UR	CSA	IEC	ATEX
<b>Voltage rating [V AC/DC]</b>	-				-			
<b>Maximum current</b>	Grounding				Grounding			
<b>Wire range (rated cross section)</b>	#14...6 AWG	#14...4 AWG	16 mm <sup>2</sup>	16 mm <sup>2</sup> (#16...6 AWG)	#12...2 AWG	35 mm <sup>2</sup>	35 mm <sup>2</sup> (#14...2 AWG)	
<b>Terminal block</b>	<b>Cat. No.</b>		<b>Pkg. Qty.</b>		<b>Cat. No.</b>		<b>Pkg. Qty.</b>	
<b>Green/Yellow</b>	1492-LG16 †		25		1492-LG35		10	
<b>Accessories</b>	<b>Cat. No.</b>		<b>Pkg. Qty.</b>		<b>Cat. No.</b>		<b>Pkg. Qty.</b>	
<b>End barrier (yellow)</b>	1492-EBL16-Y		20		Not required		-	
<b>Marker card (edge marking)</b>	1492-MR8X12		5 cards (84/card)		1492-MR8X12		5 cards (84/card)	
<b>Marker card (center marking)</b>	1492-M8X5		5 cards (160/card)		1492-M8X5		5 cards (160/card)	
<b>Snap-in marker tags for ClearMultiprint</b>	1492-MT8X12		500		1492-MT8X12		500	

† For blocks with 1-in and 2-out, add a T after the LG6. Example: catalog number 1492-LG6T.

⊘ You must also add a T to the end barrier catalog number when selecting the end barrier for catalog number 1492-LG6T. Example: catalog number 1492-EBL6T-Y.

#### Terminal Blocks



5-2...5-33

#### Wiring Systems



5-34...5-35

#### Connection Systems



5-36...5-45

#### Safety Connection Systems



5-46...5-49

#### Network Media



5-50...5-57



## Product Selection

### Isolation & Plug-in Terminal Blocks, Spring Clamp

Dimensions are not intended to be used for manufacturing purposes

Note: Height for dimension is measured from top of rail to top of terminal block.

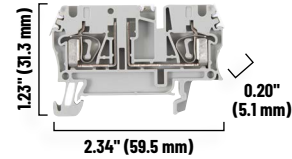
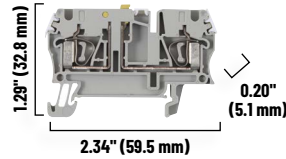

	1492-LKD3				1492-L3P			
Standards	UR	CSA	IEC	ATEX	UR	CSA	IEC	ATEX
Voltage rating [V AC/DC]	600		500		600		500	
Maximum current [A]	20		24		20		24	
Wire range (rated cross section)	#30...12 AWG		2.5 mm <sup>2</sup>		#30...12 AWG		4 mm <sup>2</sup>	
Terminal block								
<b>Grey</b>	1492-LKD3		25		1492-L3P		25	
Accessories	<b>Cat. No.</b>		<b>Pkg. Qty.</b>		<b>Cat. No.</b>		<b>Pkg. Qty.</b>	
End barrier (grey)	1492-EBL3		50		1492-EBL3		50	
Plug-in center jumper (10-pole)	1492-CJK5-10		20		1492-CJK5-10		20	
Plug-in center jumper (2-pole)	1492-CJK5-2		60		1492-CJK5-2		60	
Fuse plug non-indicating	-		-		1492-FPK2		20	
10...36V LED	-		-		1492-FPK224		20	
35...70V LED	-		-		1492-FPK248		20	
60...150V LED	-		-		1492-FPK2120		20	
140...250V LED	-		-		1492-FPK2250		20	
Disconnect plug	-		-		1492-DPL		50	
Component plug	-		-		1492-CPL		50	
Snap-in marker cards	1492-MR5X8		5 cards (120/card)		1492-MR5X8		5 cards (120/card)	
Snap-in marker tags for ClearMultiPrint	1492-MT5X8		800		1492-MT5X8		800	



# Terminal Blocks

## Product Selection

### Fuse Blocks, Spring Clamp

Dimensions are not intended to be used for manufacturing purposes.

Note: Height for dimension is measured from top of rail to top of terminal block.

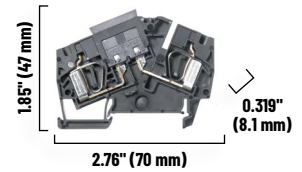
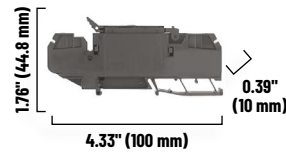
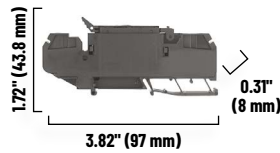

		1492-RFB4...		1492-RAFB4...		1492-LAFB6...	
<b>Specifications</b>		Single-circuit fuse terminal block with or without fuse indication (5...20 mm Fuse)		Single-circuit fuse terminal block with or without fuse indication (1/4 x 1-1/4" Fuse)		Automotive style fuse block	
<b>Standards</b>		UR	CSA	IEC	UR	CSA	IEC
<b>Voltage rating</b>	RFB4/RAFB4/LAFB6	300V AC/DC		500V AC/DC		300V AC/DC	
	RFB424/RAFB424/LAFB624	10...57V AC/DC		10...57V AC/DC		10...36V AC/DC	
	RFB4250/RAFB4250	85...264V AC		85...264V AC		-	
<b>Leakage current</b>	RFB424/RAFB424/LAFB624	2 mA @ 24V		2 mA @ 24V		2 mA @ 24V	
	RFB4250/RAFB4250	1 mA @ 264V		1 mA @ 264V		-	
<b>Maximum current [A]</b>		15 *		15		30	25
<b>Wire range (rated cross section)</b>		#22...12 AWG	0.5...4 mm <sup>2</sup>	#22...12 AWG	0.5...4 mm <sup>2</sup>	#22...12 AWG	#22...10 AWG
<b>Terminal block</b>							
<b>Black (non-indicating)</b>		1492-RFB4	25	1492-RAFB4	25	1492-LAFB6	25
<b>Black with blown fuse indication (10...57V AC/DC)</b>		1492-RFB424	25	1492-RAFB424	25	1492-LAFB624	25
<b>Black with blown fuse indication (85...264V AC/DC)</b>		1492-RFB4250	25	1492-RAFB4250	25	-	-
<b>Accessories</b>		<b>Cat. No.</b>	<b>Pkg. Qty.</b>	<b>Cat. No.</b>	<b>Pkg. Qty.</b>	<b>Cat. No.</b>	<b>Pkg. Qty.</b>
<b>Plug-in center jumper (10-pole)</b>		1492-CJR8-10	10	-	-	1492-CJL8-32 (32-pole)	10
<b>Plug-in center jumper (2-pole)</b>		1492-CJR8-2	20	1492-CJRA10-2	10	1492-CJL8-2	60
<b>Center jumper link</b>		1492-CJRL6	60	1492-CJRL5	10	-	-
<b>Marker card for base block</b>		1492-MS8X12	5 (56/card)	1492-MS8X12	5 (56/card)	1492-M5X8	5 (144/card)
<b>Marker card for handle</b>		1492-MS6X9	5 (80/card)	1492-MS6X9	5 (80/card)	-	-

\* IEC standards for 5 x 20 mm fuses do not include ratings above 6.3 A.

### Terminal Blocks



5-2...5-33



5-34...5-35



5-36...5-45



5-46...5-49







5-50...5-57



## Accessories

### End Anchors and End Retainers

	Dimensions (W x L x H)	Tightening Torque	Markers	Used With	Color	Pkg. Qty.	Cat. No
	0.31 x 2.20 x 1.85 in. (8 x 56 x 47 mm)	4.4 lb•in (0.5 N•m)	1492-GM5X30 1492-M7X12 1492-M8X5	199-DR1, 199-DR2, 1492-DR4, 1492-DR5, 1492-DR6, 1492-DR7, 1492-DR8, 1492-DR9	Grey	100	1492-EAJ35
	0.48 x 2.20 x 2.48 in. (12.2 x 56 x 63 mm)	7.0 lb•in (0.8 N•m)	1492- M7X12 1492- M5X5	199-DR1, 199-DR2, 1492-DR4, 1492-DR5, 1492-DR6, 1492-DR7, 1492-DR8, 1492-DR9	Grey	50	1492-EAHJ35
	0.24 x 2.19 x 1.63 in. (6 x 55.6 x 41.5 mm)	-	1492-GM5X30 1492- M5X10 1492- M5X5	199-DR1, 199-DR2, 1492-DR4, 1492-DR5, 1492-DR6, 1492-DR7, 1492-DR8, 1492-DR9	Grey	20	1492-ERL35
	0.31 x 2.28 x 1.42 in. (8 x 58 x 36 mm)	5.3 lb-in (0.6 N-m)	1492-GM5X30 1492-MT8X8	199-DR1, 199-DR2, 1492-DR4, 1492-DR5, 1492-DR6, 1492-DR7, 1492-DR8, 1492-DR9	Grey	50	1492-EAP35

### DIN Mounting Rails

	Description	Pkg. Qty.	Cat. No
	Symmetrical rail 35 x 7.5 mm 3.28 ft (1 m) long Zinc-plated Chromated steel EN60715 Din#3	10	199-DR1
	Symmetrical rail 35 x 7.5 mm 6.56 ft (2 m) long Zinc-Plated Chromated steel EN60715 Din#3	20	199-DR2
	Raised symmetrical rail 35 x 7.5 mm 2.26 in. (57.4 mm) high 3.28 ft (1 m) long Copper-free Aluminum Din#3	2	1492-DR6
	Angled symmetrical rail 35 x 7.5 mm 2.80 in. (71.0 mm) high 3.28 ft (1 m) long Angled 30° Zinc-plated Chromated steel Din#3	2	1492-DR7

For accessory options, please visit  
[rok.auto/directory](http://rok.auto/directory)





# Terminal Blocks

## Terminal Block Marking Systems 1492

- Choose from two marking system technologies
- ClearMultiprint™ for cost sensitive applications using spool format marker tags
- ClearPlot™ for high quality applications using card format marker tags

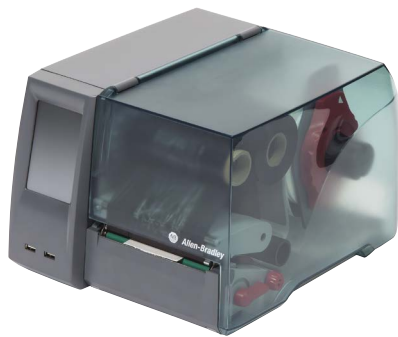
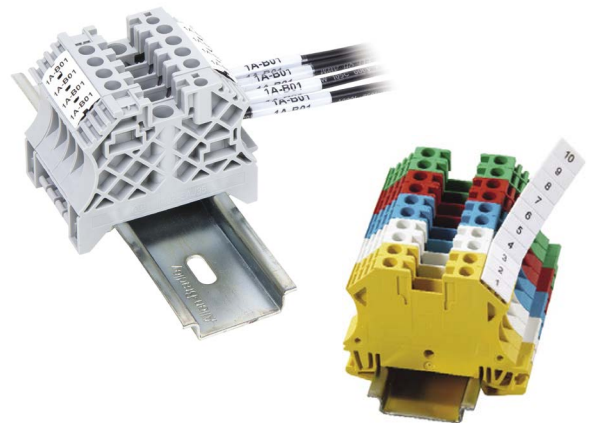

### ClearMultiprint™ Marking System

The ClearMultiprint marking system provides high-quality spool media printing in an easy-to-use format for all users.

- Thermal transfer technology eliminates ink dry out issues
- Less than a minute to print and set a full row of marker cards
- Provides high contrast on white marker tags and wire labels
- Wide range of print media: terminal block tags, wire and cable labeling, heat shrink, and adhesive device markers

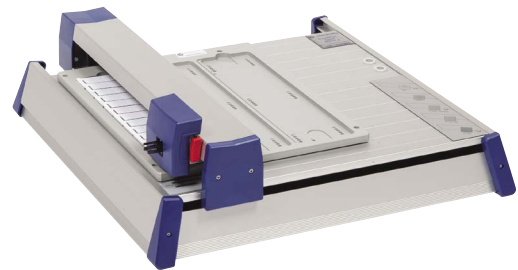

### ClearPlot™ Marking System

The ClearPlot marking system provides high-quality printing for low to medium volume users on terminal block marker cards.

- Plot partial marker cards
- Load up to three marker cards at a time (mix and match)
- Character customization
- Extensive marker card library offers optimal flexibility

### ClearTools™ Software

Free ClearTools software makes it easy to create everything from basic numbering and sequences to images. You can import from a variety of file formats or use the included library of symbols.

#### Terminal Blocks



5-2...5-33



5-34...5-35



5-36...5-45



5-46...5-49



5-50...5-57



# Product Selection

## Marking Systems

Marking System	Cat. No
ClearMultiPrint™	1492-PRINTCMP
ClearPlot™ Basic	1492-PL0TBSC



## Marker Tags for ClearMultiPrint

Catalog	Used With	Markers Per Roll	Size
1492-MT3X5	1492-L	1000	3mm x 5mm
1492-MT5X5	1492-J,L	800	5mm x 5mm
1492-MT6X5	1492-J,L	600	6mm x 5mm
1492-MT8X5	1492-J,L	500	8mm x 5mm
1492-MT3X12	1492-L	1000	3mm x 12mm
1492-MT5X12	1492-J,L	800	5mm x 12mm
1492-MT6X12	1492-J,L and 1738 ArmorPoint	600	6mm x 12mm
1492-MT8X12	1492-J,L	500	8mm x 12mm
1492-MT3X8	1492	1000	3mm x 8mm
1492-MT5X8	1492-J,L	800	5mm x 8mm
1492-MT6X8	1492-J,L	600	6mm x 8mm
1492-MT8X8	1492	500	8mm x 8mm
1492-GM8X30	1492-EAJ35, 1492-ERL35	50	8mm x 30mm
1492-MGT6X30	1492-GM8X30, 1492-MWCTC8X30	100	6mm x 30mm
1492-MT5X12-BP	1492-J,L	5500	5mm x 12mm
1492-MT6X12-BP	1492-J,L and 1738 ArmorPoint	4500	6mm x 12mm

## Accessories for ClearMultiPrint

Description	Cat. No
Marker Tag Ribbon	1492-PRIBTB
Wire Label & Adhesive Marker Ribbon	1492-PRIBLAB
Heat Shrink Ribbon	1492-PRIBHS
Terminal Block Marker Tag Roller	1492-PROLLTB 1492-PROLLTBW5/6/8X9 1492-PROLLTBW5/6/8X12 1492-PROLLTBCPC 1492-PROLLTBCW
Flat Media Roller	1492-PROLLLAB
External Roll Holder	1492-PEXTRH <sup>1</sup>

<sup>1</sup> 1492-PEXTRH is only needed for the 1492-MT5X12-BP and the 1492-MT6X12-BP big packs.

CONNECTIVITY

## Selection for additional media types can be found in Product Selection\*



Heat shrink



Wire labels



Adhesive device markers



Marker tags

\* Marker tags are also available that are compatible with Allen-Bradley 1492-W as well as Phoenix and Wago Terminal blocks. Reference publication 1492-TD016.



# Terminal Blocks

## Power Distribution Blocks 1492-PDE

- IP20 Finger-safe protection
- Power distribution through 510 A
- DIN Rail and panel mountable
- High fault SSCR up to 100 kA



Finger-safe power distribution terminal blocks are designed to prevent accidental contact with live connectors – without the use of additional barriers or shields. These panel mount devices have a compact footprint, and are available with either aluminum or copper terminals. Captive termination screws ensure that parts never get lost and the rugged thermoplastic housing will resist physical damage.

These single-pole devices are available with DIN or panel mount options and can easily be assembled together to create multi-pole solutions.

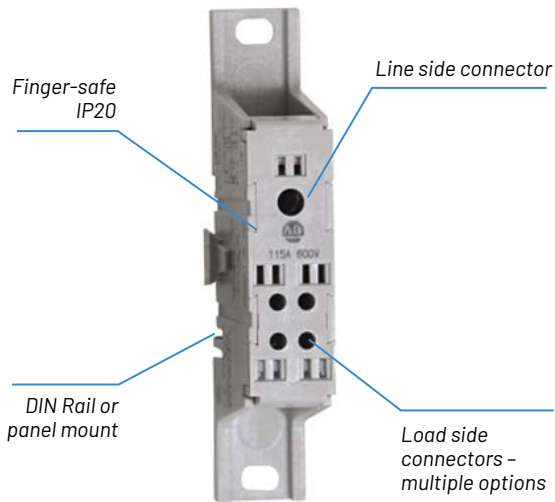

### Terminal Blocks



5-2...5-33

### Wiring Systems



5-34...5-35

### Connection Systems



5-36...5-45

### Safety Connection Systems



5-46...5-49

### Network Media



5-50...5-57



## Product Selection

### Power Distribution Blocks

Amps (Cu Wire) 75° C	No. of Poles	Line			Load			Flexible Copper Wire *	Cat. No.	
		Connector Diagram	Wire Range [kcmil / AWG (mm <sup>2</sup> )]	Openings per Pole	Connector Diagram	Wire Range [kcmil / AWG (mm <sup>2</sup> )]	Openings per Pole			
115			#2...#14 (35...2.5)	1		#2...#14 (35...2.5) †	1	Yes	1492-PDME1111 <sup>Ⓑ</sup>	
						#10...#14 (6...2.5) <sup>Ⓑ</sup>	4	Yes	1492-PDME1141 <sup>Ⓑ</sup>	
200	1-pole		2/0...#14 (70...2.5)	1		2/0...#14 (70...2.5)	1	Yes	1492-PDE1112 <sup>Ⓑ</sup>	
						#2...#14 (35...2.5) †	4	Yes	1492-PDE1142 <sup>Ⓑ</sup>	
			250 ... #6 (120...16)	2		250...#6 (120...16)	2	2	Yes (line side)	1492-PDE1225
									1492-PDE1C255 <sup>Δ</sup>	
335			(1) 400...#6 (185...16)  (1) 2/0...#14 (70...2.5)	1		#2...#14 (35...2.5) †	8	Yes (line side)	1492-PDE1183	
									1492-PDE1C183 <sup>Δ</sup>	

† Wire openings rated for #2-14 AWG are multiple wire rated: (2) #6 CU Str, (2) #8 CU Str, (2-4) #10 CU Str, (2 to 4) #12 CU Str, and (2 to 4) #14 CU Str.

⊘ Wire openings rated for #2/0 -14 AWG are multiple wire rated: (2) #4 CU Str, (2) #6 CU Str, (2) #8 CU Str, (2) #10 CU Str, (2) #12 CU Str.

\* Flexible copper wire connections approved for flexible wire, stranding Classes G, H, I, K and DLO wire without the need for additional crimp connectors.

Δ The **C** in the catalog number designates copper terminals. The catalog numbers without the **C**, have aluminum connectors.

Ⓑ UL 1953 Listed E 313475 Guide OPQS.

## Standards Compliance and Certifications

<b>Standards Compliance</b>	UL 1059, UL 1953, CSA C22.2 No. 158, EN/IEC 60947-1, -7-1
<b>Certifications</b>	CE Marked, CSA Certified (File No. 72582, Class 6228-01), UL Component Recognized (File No. E40735, Guide No. XCFR2), UL Listed (File No. E313475, Guide No. OPQS), RoHS
<b>Flammability Ratings</b>	94V-0

For more information on our complete family of terminal block products, please visit:  
[rok.auto/terminal-blocks](http://rok.auto/terminal-blocks)



# Wiring Systems

CONNECTIVITY

## Wiring Systems 1492

- Interface modules (IFM) connect through pre-wired cables to digital and analog I/O
- Simplified design reduces bill of materials – one IFM module and cable replaces multiple terminal blocks, wires and terminations
- Design flexibility – feed-through, LED indication, fusing, and interposing relay IFMs are available to meet application variables



## Value Add of Wiring Systems

You can achieve up to 75% savings on your control wiring time and reduce wiring errors when using a Bulletin 1492 Wiring System compared with wiring to traditional terminal blocks.

### 1492 Wiring Systems

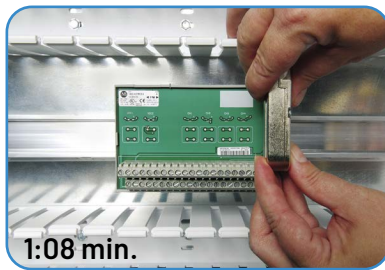

1:08 min.

Replace multiple terminal blocks, wires and terminations with single IFM and cable.

### Conventional Wiring

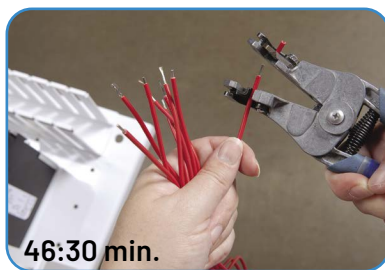

46:30 min.

### Cables:

- Pre-wired
- IFM Ready
- I/O Ready

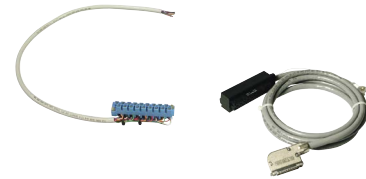

### Interface Modules (IFM):

#### Digital

- Straight Feed-through
- LED indicating
- Fused
- Relay

#### Analog

- Straight Feed-through
- Fused
- Specialty

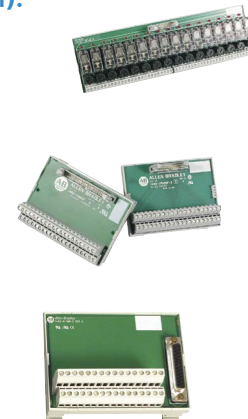

Terminal Blocks



5-2...5-33

Wiring Systems



5-34...5-35

Connection Systems



5-36...5-45

Safety Connection Systems



5-46...5-49

Network Media



5-50...5-57





Wiring systems replace the point-to-point wiring between a PLC I/O module and individual terminal blocks – providing quicker, more accurate connections between control and factory devices.

**ControlLogix® Controllers**  
1756



**CompactLogix™ Controllers**  
1769



**MicroLogix™ 1200 Controllers (40 Embedded I/O)**  
1762

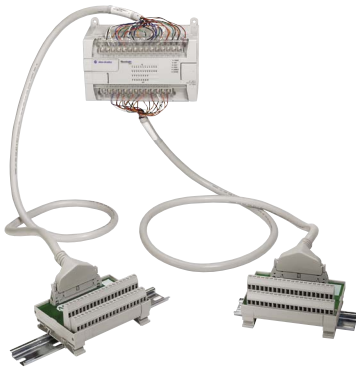

**MicroLogix™ 1500 Controllers**  
1764



**Flex™ I/O (with Flex D-Shell Base Modules)**  
1794



**CompactLogix™ L1/L2 (Embedded I/O)**  
5370





# Connection Systems

## Non-network Connectivity Solutions

Allen-Bradley® passive connectivity components make up a complete plug & play solution that simplifies and consolidates wiring, while providing secure connections for proximity sensors, limit switches, photoelectric sensors, and other field devices.

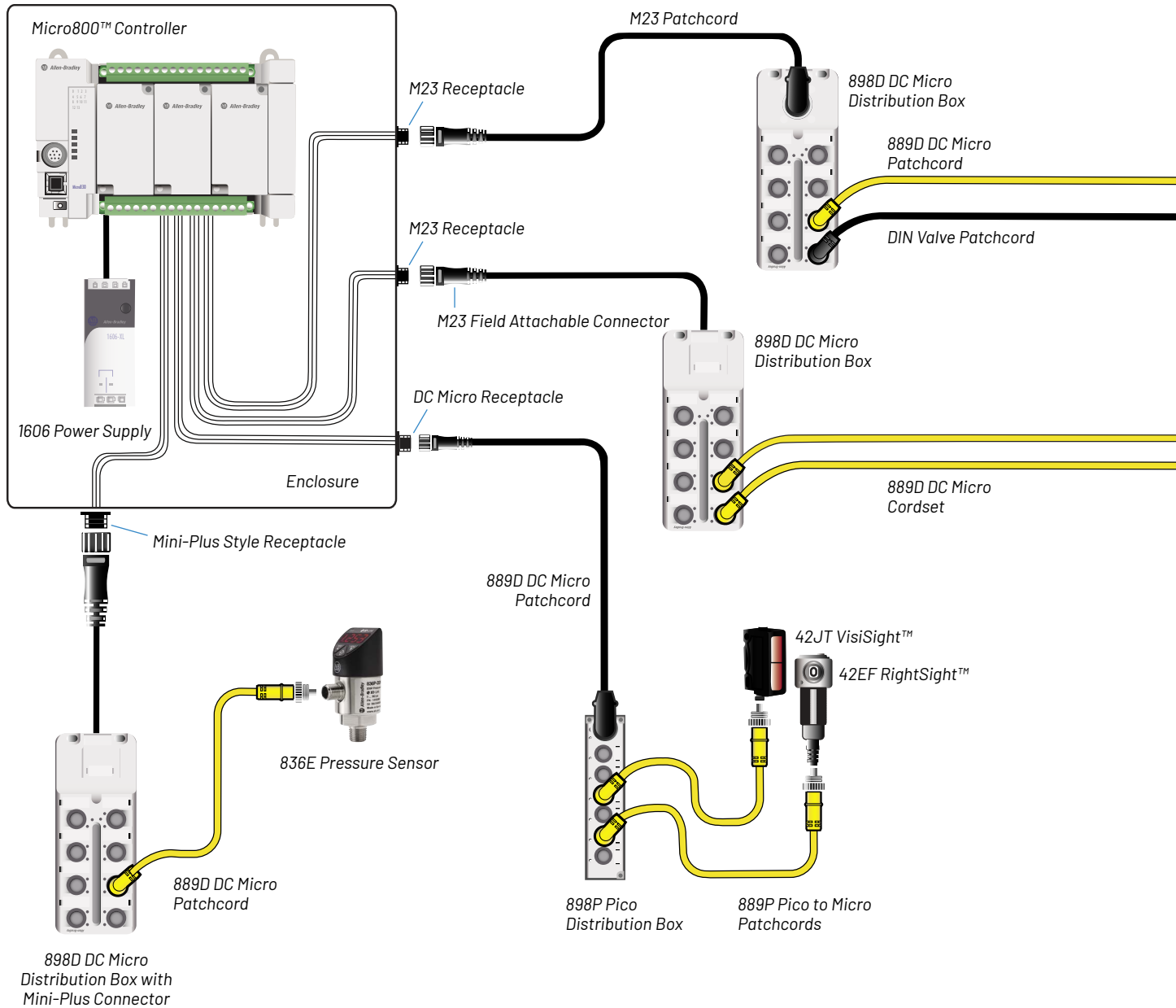

898D DC Micro Distribution Box with Mini-Plus Connector

Terminal Blocks



5-2...5-33

Wiring Systems



5-34...5-35

Connection Systems



5-36...5-45

Safety Connection Systems



5-46...5-49

Network Media



5-50...5-57



### Application

Non-network Connectivity is ideal for compact machines, cost-sensitive applications or those where minimal diagnostics are required.

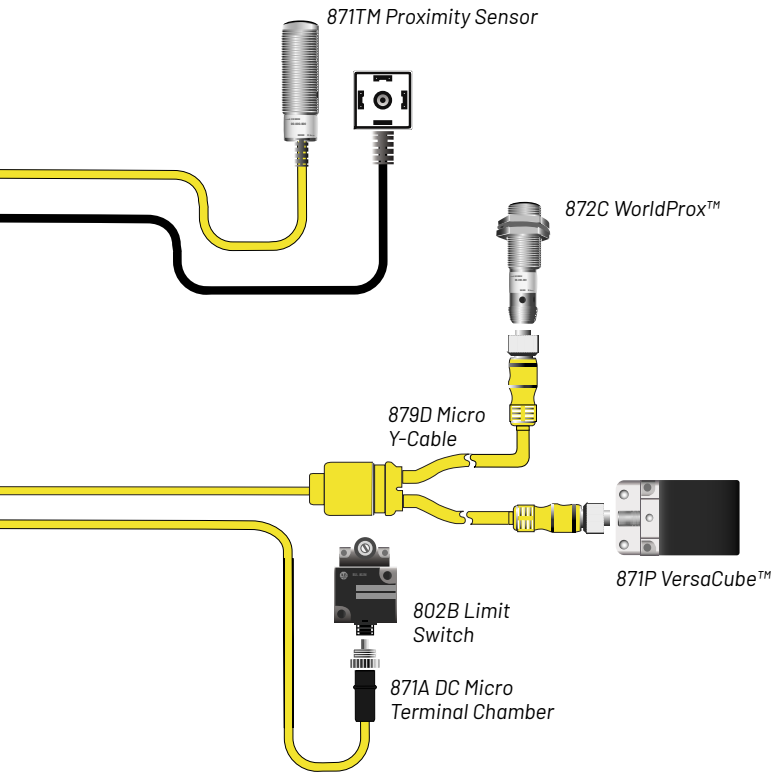

#### ProposalWorks Proposal Builder

We offer many standard and custom connectivity products not shown in this catalog. Our free ProposalWorks software is the easiest way to select or configure a solution from our wide range of connectivity products.

[rok.auto/configure](http://rok.auto/configure)

#### A complete connectivity solution, including:

- Cordsets (connector at one end, leads on the other)
- Patchcords (connectors at each end)
- Field-attachable connectors
- Panel-mount receptacles
- Distribution boxes
- V- and Y-cables
- Splitters and tees
- Raw cable spools

#### Connectivity Styles

- DC micro (M12)
- AC micro (1/2 in.)
- Mini (7/8 in.)
- M23
- Pico
- Mini Plus
- EAC micro
- DIN Valve

#### Various cable jacket materials, colors, and flex ratings for a wide range of applications and environments:

- PVC – General purpose applications  
- Yellow, black, grey, red, or blue
- TPE – Bending and flexing applications, temperature extremes  
- Yellow and black
- PUR – Bending and flexing applications, chemical environments, water submersion  
- Yellow and black
- ToughWeld™ (CPE) – Welding applications, chemical environments
- ToughLink™ (TPE) – UV and water resistant, chemical environments
- High Flex TPE and PUR – rated to 5 million, 9 million, and 10 million flex cycles



# Connection Systems

CONNECTIVITY

## DC Micro Cordsets & Patchcords 889D

- 4-, 5-, and 8-pin connectors
- Straight or right angle versions
- 22 or 24 AWG cable
- Oil-resistant yellow, black or red PVC jacket



## Product Selection

### Cordsets

Female (Sensor End) Connector Style	Cable			Cat. No. <sup>1,3</sup>
	Wire Color		Assembly Rating	
4-pin straight	1 Brown 2 White	3 Blue 4 Black	22 AWG 250V, 4 A	1...30m (3.3...98.4 ft)
4-pin straight				889D-F4AC-2
4-pin right angle				889D-R4AC-2
5-pin straight	1 Brown 2 White	3 Blue 4 Black 5 Grey	24 AWG, 30V AC/36V DC, 1.5 A	2 (6.56)
8-pin straight	1 White 2 Brown 3 Green 4 Yellow	5 Grey 6 Pink 7 Blue 8 Red		889D-F8AB-2 <sup>2</sup>

\* Quick Connect version

### Patchcords

Female (Sensor End) Connector Style	Male (I/O End) Connector Style	Cable		Cat. No. <sup>1</sup>
		Assembly Rating	Length [ m (ft) ]	
4-pin straight	4-pin straight	22 AWG 250V, 4 A	2 (6.56)	889D-F4ACDM-2
	4-pin right angle			889D-F4ACDE-2
4-pin right angle	4-pin straight			889D-R4ACDM-2
	4-pin right angle			889D-R4ACDE-2
5-pin straight	5-pin straight			889D-F5ACDM-2
8-pin straight	8-pin straight			889D-F8ABDM-2 <sup>2</sup>

<sup>1</sup> Replace the **2** after the dash with **1, 5, or 10** for additional lengths in meters.

<sup>2</sup> The 8-pin cordset is for Safety devices. To order with a red PVC jacket, replace the **A** in the catalog number with an **N**. For example, 889D-F8**N**B-2 or 889D-F8**N**BDM-2.

<sup>3</sup> To order with black PVC jacket, replace the **A** in the catalog number with a **B**. For example, 889D-F4**B**C-2.

5-38

Terminal  
Blocks



5-2...5-33

Wiring  
Systems



5-34...5-35

Connection  
Systems



5-36...5-45

Safety  
Connection  
Systems



5-46...5-49

Network  
Media



5-50...5-57



### AC Micro Cordsets & Patchcords 889R

- 3-, 4-, 5- and 6-pin connectors
- Straight or right angle female connector
- Standard 18 or 22 AWG braided cable
- Oil-resistant yellow PVC jacket

## Product Selection

### Cordsets

Female Connector Style	Cable			Cat. No. <sup>1</sup>	
	Wire Color	Wire Rating	Length [m (ft)]		
3-pin straight	1 Green (GND) 2 Red/Black Tr.	3 Red/White Tr.	Braided 22 AWG 250V, 4 A	2 (6.5)	889R-F3ECA-2
3-pin straight	1 Green (GND) 2 Red/Black Tr.	3 Red/White Tr.	18 AWG 250V 4 A		889R-F3AEA-2
4-pin straight	1 Red/Black Tr. 2 Red/White Tr.	3 Red 4 Green (GND)			889R-F4AEA-2
3-pin right angle	1 Green (GND) 2 Red/Black Tr.	3 Red/White Tr.	18 AWG 250V 4 A		889R-R3AEA-2
4-pin right angle	1 Red/Black Tr. 2 Red/White Tr.	3 Red 4 Green (GND)			889R-R4AEA-2
5-pin straight	1 Red/White Tr. 2 Red 3 Green	4 Red/Yellow Tr. 5 Red/Black Tr.	Braided 22 AWG 250V 4 A		889R-F5AEA-2
6-pin straight	1 Red/White Tr. 2 Red 3 Green	4 Red/Yellow Tr. 5 Red/Black Tr. 6 Red/Blue Tr.			889R-F6ECA-2

### Patchcords

Female (Sensor End) Connector Style	Male (I/O End) Connector Style	Cable		Cat. No.
		Assembly Rating	Length [m (ft)]	
3-pin straight	3-pin straight	18 AWG, 250V, 4 A	2 (6.5)	889R-F3AERM-2

<sup>1</sup> Replace the 2 after the dash with 1, 5, or 10 for additional lengths in meters.



# Connection Systems

CONNECTIVITY

## Mini Cordsets 889N

- 3-, 4-, and 5-pin connectors
- Straight or right angle versions
- Heavy duty ST00W 16 AWG cable
- Oil-resistant yellow PVC jacket



## Product Selection

### Cordsets

Female Connector Style	Wire Rating	Length [m (ft)]	Cat. No. <sup>1</sup>	
			IEC	US
3-pin straight	16 AWG, 600V, 13 A	1.8 (6)	-	889N-F3AFC-6F
4-pin straight	16 AWG, 600V, 10 A	1.8 (6)	889N-F4AF-6F	889N-F4AFC-6F
5-pin straight	16 AWG, 600V, 8 A	1.8 (6)	889N-F5AF-6F	889N-F5AFC-6F
3-pin right angle	16 AWG, 600V, 13 A	1.8 (6)	-	889N-R3AFC-6F
4-pin right angle	16 AWG, 600V, 10 A	1.8 (6)	889N-R4AF-6F	889N-R4AFC-6F
5-pin right angle	16 AWG, 600V, 8 A	1.8 (6)	889N-R5AF-6F	889N-R5AFC-6F

<sup>1</sup> Replace the **6F** after the dash with **12F** or **20F** for additional lengths in feet.

### Color Code

	3-pin	4-pin	5-pin
US	1 Green 2 Black 3 White	1 Black 2 White 3 Red 4 Green	1 White 2 Red 3 Green 4 Orange 5 Black
IEC	-	1 Black 2 Blue 3 Brown 4 White	1 Black 2 Blue 3 Orange 4 Brown 5 White

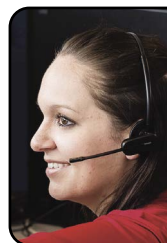

### Need Help?

The Rockwell Automation Support Center is your 24/7 support for the answers you need now.

[rok.auto/support](http://rok.auto/support)

5-40

Terminal Blocks



5-2...5-33

Wiring Systems



5-34...5-35

Connection Systems



5-36...5-45

Safety Connection Systems



5-46...5-49

Network Media



5-50...5-57



## Pico Cordsets & Patchcords 889P

- 3- or 4-pin connectors
- Straight or right angle female
- Standard 24 AWG cable
- Oil-resistant yellow PVC jacket

CONNECTIVITY

## Product Selection

### Cordsets

Female (Sensor End) Connector Style	Cable			Cat. No. <sup>1</sup>
	Wire Color	Wire Rating	Length [m (ft)]	
3-pin straight	1 Brown 3 Blue 4 Black	24 AWG 60V AC/75V DC 4 A	2 (6.5)	889P-F3AB-2
3-pin right angle			2 (6.5)	889P-R3AB-2
4-pin straight	1 Brown 2 White 3 Blue 4 Black		2 (6.5)	889P-F4AB-2

<sup>1</sup> Replace the **2** after the dash with **5** or **10** for additional lengths in meters.

### Patchcords

Female (Sensor End) Connector Style	Male Connector (I/O End) Connector Style	Cable		Cat. No. <sup>2</sup>
		Wire Rating	Length [m (ft)]	
3-pin straight	3-pin straight	24 AWG 60V AC/75V DC 4 A	1 (3.3)	889P-F3ABPM-1

<sup>2</sup> Replace the **1** after the dash with **2**, **5**, or **10** for additional lengths in meters.





# Connection Systems

CONNECTIVITY

## DC Micro & Pico Distribution Boxes 898D & 898P

- 4-pin DC micro or 3-pin pico connectors
- Top mount inputs
- 4- or 8-port parallel wired
- PNP wired LED versions
- Single input per port
- Prewired master cable
- Rugged grey Pocan® body



## Product Selection

Style	No. of Connections	Illuminated	Operating Voltage/ Supply Current	Cable Length [m (ft)]	Cat. No.
DC Micro	4	PNP LED	10...30V DC 2 A max./port 10 A max. total	5 (16.4)	898D-P54PT-B5
				10 (32.8)	898D-P54PT-B10
	8			5 (16.4)	898D-P58PT-B5
				10 (32.8)	898D-P58PT-B10
Pico	4		10...30V DC 2 A max./port 6 A max. total	5 (16.4)	898P-P34PT-B5
	8				898P-P38PT-B5



### Sales Offices and Distributors

Our network of sales offices and distributors offers exceptional knowledge and service to help you design, implement and support your automation investment.

[rok.auto/buy](http://rok.auto/buy)

Terminal  
Blocks



5-2...5-33

Wiring  
Systems



5-34...5-35

Connection  
Systems



5-36...5-45

Safety  
Connection  
Systems



5-46...5-49

Network  
Media



5-50...5-57



## Terminal Chambers & IDC Connectors 871A, 889D, 889P

- 4-pin micro or 3-pin pico connector
- Male and female versions
- Supports cable O.D. 4...8 mm

### Product Selection

#### Screw Terminal

Description	Type	Connector Style	Jacket Cable Diameter [mm (in.)]	Wire Rating	Cat. No.
DC Micro	Female	4-pin straight	4.0...6.0 (0.16...0.24)	250V, 4 A	871A-TS4-D
			6.0...8.0 (0.24...0.32)		871A-TS4-D1
	Male		4.0...6.0 (0.16...0.24)		871A-TS4-DM
			6.0...8.0 (0.24...0.32)		871A-TS4-DM1

#### IDC Connector

Description	Type	Connector Style	Jacket Cable Diameter [mm (in.)]	Wire Rating	Cat. No.
DC Micro	Female	4-pin straight	4.0...5.1 (0.16...0.20)	32V, 4 A	889D-F4DC-H
	Male				889D-M4DC-H
Pico	Female	3-pin straight	4.0...5.1 (0.16...0.20)	32V, 3 A	889P-F3DC-H
	Male				889P-M3DC-H



# Connection Systems

CONNECTIVITY

## DC Micro & AC Micro Receptacles 888D & 888R

- Male and female versions
- 1/2 inch NPT threads
- 22 AWG conductors
- Rugged anodized aluminum body



## Product Selection

### DC Micro Style

Connector Style	Wire Color	Wire Rating	Length [m (ft)]	Panel Mount Thread Size	Cat. No.
4-pin female	1 Brown 2 White 3 Blue 4 Black	22 AWG 250V 4 A	0.3 (1)	1/2 in.-14 NPT	888D-F4AC1-0M3
4-pin male					888D-M4AC1-0M3
5-pin female	1 Brown 2 White 3 Blue 4 Black 5 Grey				888D-F5AC1-0M3
5-pin female					888D-M5AC1-0M3

### AC Micro Style

Connector Style	Wire Color	Wire Rating	Length [m (ft)]	Panel Mount Thread Size	Cat. No.
3-pin female	1 Green (GND) 2 Red/Black Tr. 3 Red/White Tr.	22 AWG 250V 4 A	0.3 (1)	1/2 in.-14 NPT	888R-F3AC1-1F
3-pin male					888R-M3AC1-1F
4-pin female	1 Red/Black Tr. 2 Red/White Tr. 3 Red 4 Green (GND)	22 AWG 300V 3 A			888R-F4AC1-1F
4-pin male					888R-M4AC1-1F

Terminal  
Blocks



5-2...5-33

Wiring  
Systems



5-34...5-35

Connection  
Systems



5-36...5-45

Safety  
Connection  
Systems



5-46...5-49

Network  
Media



5-50...5-57



## Mini & Pico Receptacles 888N & 888P

- Male and female versions
- Heavy-duty 16 AWG conductors (mini)
- 24 AWG conductors (pico)
- Black epoxy-coated aluminum body (mini)
- Rugged nickel-plated brass body (pico)

CONNECTIVITY

### Product Selection

#### Mini Style (US Color Code)

Connector Style	Wire Color	Wire Rating	Length [m (ft)]	Panel Mount Thread Size	Cat. No.
3-pin female	1 Green 2 Black 3 White	16 AWG 600V 13 A	0.3 (1)	1/2 in.-14 NPT	888N-F3AF1-1F
3-pin male					888N-M3AF1-1F
4-pin female	1 Black 2 White 3 Red 4 Green	16 AWG 600V 10 A			888N-F4AF1-1F
4-pin male					888N-M4AF1-1F
5-pin female	1 White 2 Red 3 Green 4 Orange 5 Black	16 AWG 600V 8 A			888N-F5AF1-1F
5-pin male					888N-M5AF1-1F

#### Pico Style

Connector Style	Wire Color	Wire Rating	Length [m (ft)]	Panel Mount Thread Size	Cat. No.
3-pin female	1 Brown 3 Blue 4 Black	24 AWG 60V AC/75V DC 4 A	0.3 (1)	M8 x 0.5	888P-F3AB4-0M3
3-pin male					888P-M3AB4-0M3
4-pin female	1 Brown 2 White 3 Blue 4 Black				888P-F4AB4-0M3
4-pin male					888P-M4AB4-0M3

For more information on our complete family of connection device products, please visit:  
[rok.auto/connection-devices](http://rok.auto/connection-devices)



# Safety Connection Systems

## Safety Connectivity

Allen-Bradley safety connection systems offer a complete wiring solution dedicated to machine safety.

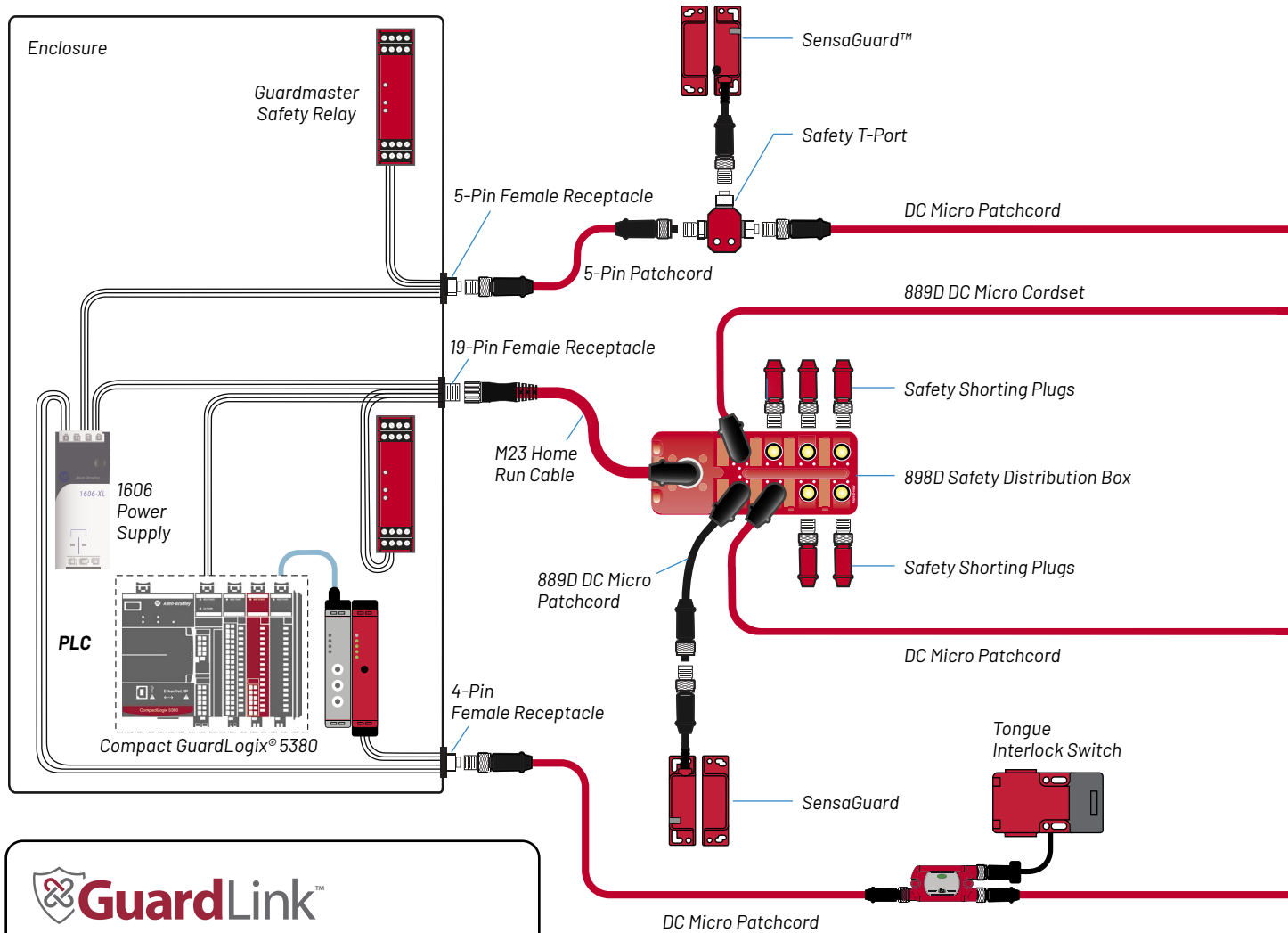

GuardLink is a safety-based communications protocol that links safety to The Connected Enterprise. Allen-Bradley® Guardmaster® smart safety devices featuring GuardLink technology deliver information, advanced functionality and flexibility, while enhancing safety and increasing efficiency machine- and plant-wide.

[rok.auto/guardlink](http://rok.auto/guardlink)

### Application

Safety Connectivity is suited for compact machines with a limited number of safety components using safety relays for monitoring.

\* Product selection for red patchcords can be found on page 5-41.

Terminal Blocks



5-2...5-33

Wiring Systems



5-34...5-35

Connection Systems



5-36...5-45

### Safety Connection Systems



5-46...5-49

Network Media



5-50...5-57

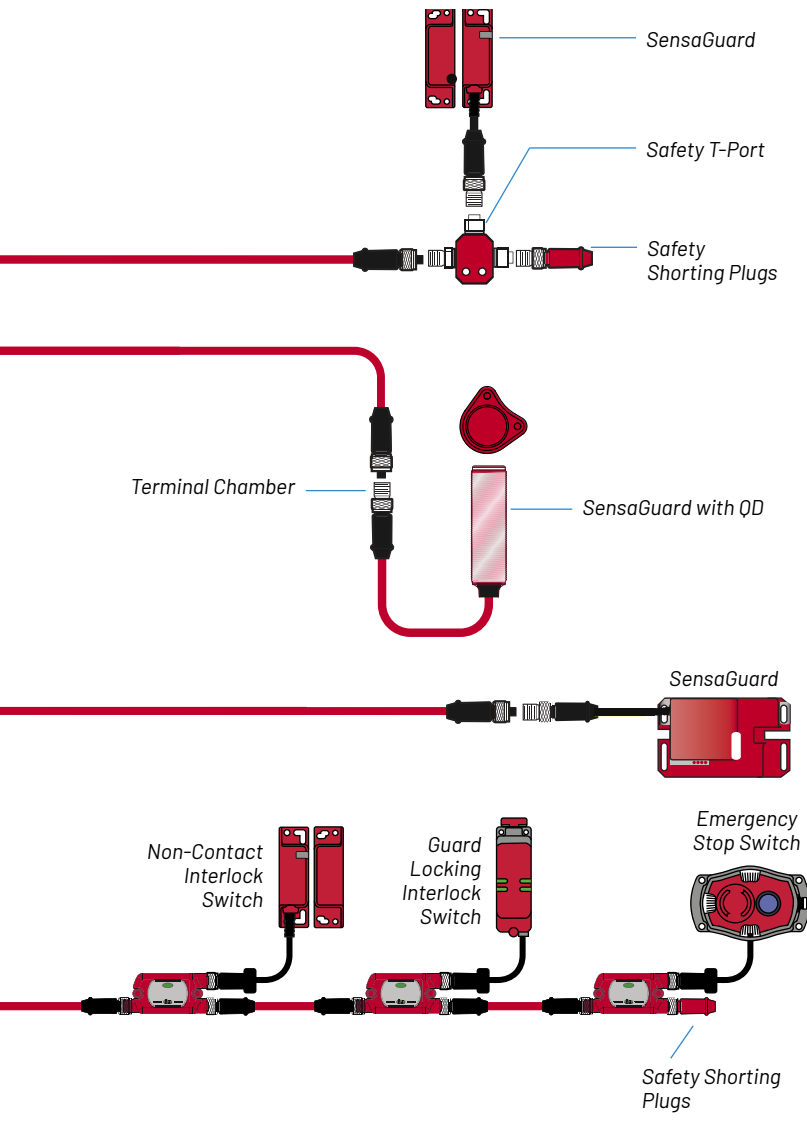

Allen-Bradley Guardmaster safety connection systems are complete quick-disconnect wiring solutions dedicated to machine safety.

### Components

- Safety-wired GuardLink Enabled Taps
- Safety-wired distribution boxes
- Safety-wired shorting plugs
- Patchcords
- Receptacles

### Connector Options

- DC Micro (M12)
- M23

### Flexible and reliable connections for safety

- Interlock switches
- Safety limit switches
- Cable pull switches
- Guard locking switches
- SensaGuard
- E-Stops
- Safety relays
- Safety mats switches

### Not Suitable For

- Pressure-sensitive safety edges

### Notes

- Designed to simplify the installation of safety devices
- Reduced installation costs, simplified expansion and troubleshooting, increased modularity
- Single- or dual-channel options with or without enunciation
- Enunciation systems allow direct feedback on individual systems in the system and provide an auxiliary contact as input for tower lights, audible alarms, PLC input cards, etc.
- Shorting plugs must be installed in all unused distribution box ports for the system to operate





# Safety Connection Systems

CONNECTIVITY

## Safety Distribution Boxes 898D & 898R

- Prewired for compatibility with safety dual-channel and three-channel switches
- For use in Cat 2, 3, or 4 systems per EN 954-1 and up to SIL3 per EN 13849-1
- Enunciation models identify open contacts via LEDs on box and discrete wire in home-run connection



## Product Selection – Safety Wired Distribution Box

### Dual-Channel

Safety Switch Configuration	Enunciation	Connection Type	No. of Ports	Home Run Connection	Cat. No.
2 N.C.	No	4-pin DC micro	4	DC micro pigtail, 200 mm (7.87 in.)	898D-44LT-DM4
			8		898D-48LT-DM4
1 N.C. & 1 N.O. for Enunciation	Yes	4-pin DC micro	8	Cable, 5 m (16.4 ft)	898D-P48JT-A5
				Cable, 10 m (32.8 ft)	898D-P48JT-A10
2 N.C. & 1 N.O. for Enunciation	Yes	6-pin AC micro	8	Cable, 5 m (16.4 ft)	898R-P68MT-A5
				Cable, 10 m (32.8 ft)	898R-P68MT-A10
2 OSSD <sup>1</sup>	Yes	8-pin DC micro	4	M23, 19-pin	898D-P84RT-M19
			8		898D-P88RT-M19

<sup>1</sup> SensaGuard compatible.



### Product Selection Tools

Available online or for download, our tools help you access info while in the office or on the go.  
[rok.auto/selection](http://rok.auto/selection)

\* Product selection for red patchcords can be found on page 5-41.

Terminal  
Blocks



5-2...5-33

Wiring  
Systems



5-34...5-35

Connection  
Systems



5-36...5-45

Safety  
Connection  
Systems



5-46...5-49

Network  
Media



5-50...5-57



## Safety Wired T-Port & Shorting Plug 898D & 898R

### Safety Wired T-Port

- T-Port/splitter designed for use with dual-channel safety devices with four-pin DC micro connector
- For use in Cat 2 or 3 systems per EN 954-1
- SensaGuard™ units may be wired in series maintaining a Cat 4/SIL3 rating

### Safety Wired Shorting Plug

- Shorting plug designed for use with safety-wired distribution boxes
- Ratcheting coupling nut on four-pin models for vibration resistance

CONNECTIVITY

## Product Selection – Safety Wired T-Port

### DC Micro Style (Dual-Channel, No Enunciation)

Configuration	Female QD (2 Ports)	Male QD (1 Port)	Cat. No.
2 N.C.	4-pin DC micro	4-pin DC micro	898D-43LY-D4
1 N.O. & 1 N.C.			898D-43KY-D4
For use with SensaGuard switches only		8-pin DC micro	898D-438Y-D8

## Product Selection – Safety Wired Shorting Plug

### DC & AC Micro Style

Safety Switch Configuration	Male QD	Coupling Nut Material	Cat. No.
2 N.C.	4-pin DC micro	Epoxy-coated zinc	898D-41LU-DM
1 N.O. & 1 N.C.			898D-41KU-DM
2 N.C. & 1 N.O.	6-pin DC micro	Nickel-plated brass	898R-61MU-RM
For use with SensaGuard compatible T-Ports only	4-pin DC micro		898D-418U-DM
2 OSSD	8-pin DC micro		898D-81RU-DM
2 OSSD with 24V DC connected to Aux. input			898D-81RU-DM2

\* Product selection for red patchcords can be found on page 5-41.



# Network Media

## Industrial Ethernet Connectivity

We offer a complete portfolio of industrial-grade Ethernet physical media specifically designed for use in harsh environments.

### Application

Ethernet Network Connectivity is ideal for highly distributed machines that require extensive diagnostics at the PLC.

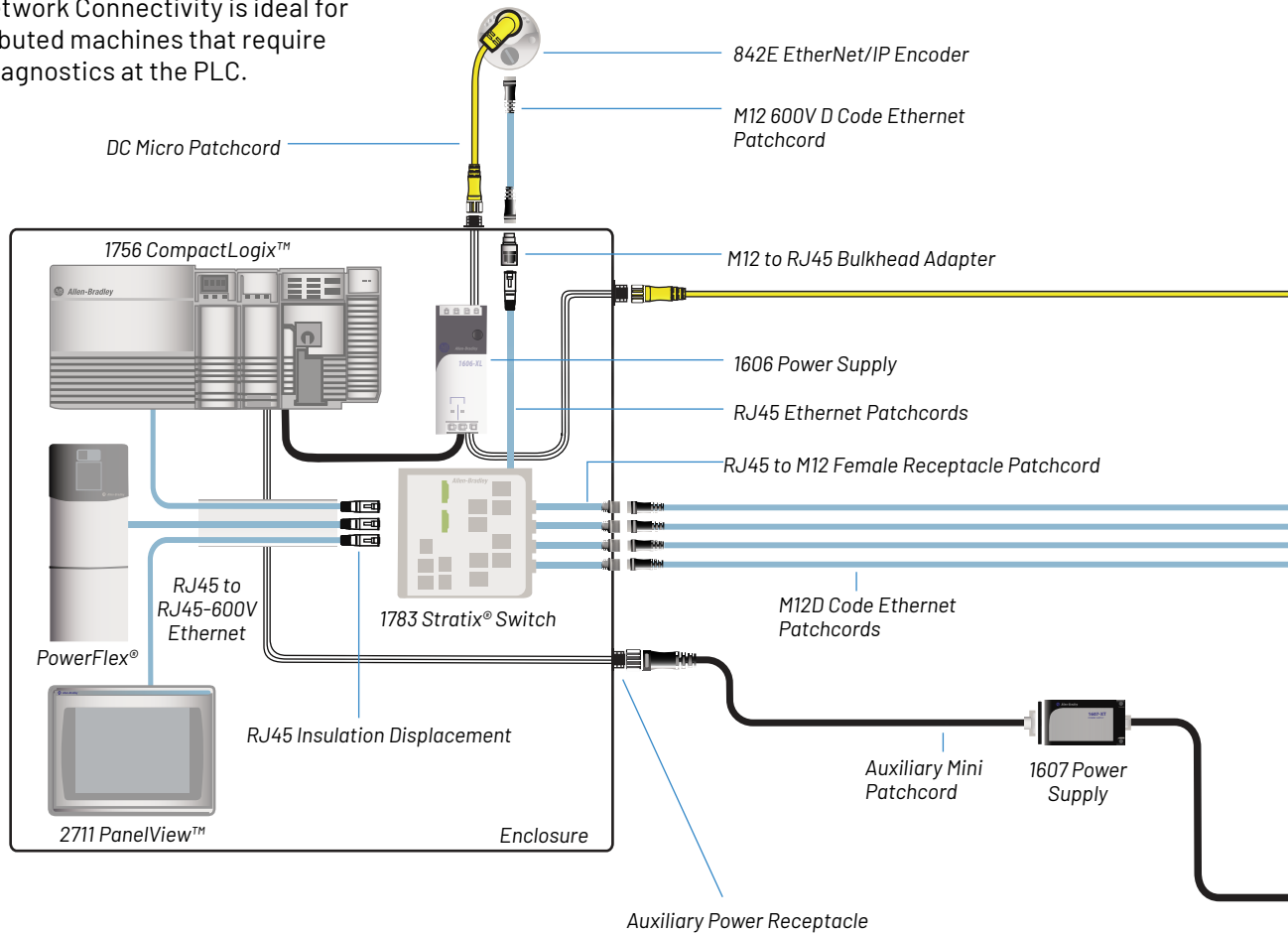

### Sales Offices and Distributors

Our network of sales offices and distributors offers exceptional knowledge and service to help you design, implement and support your automation investment.

[rok.auto/buy](http://rok.auto/buy)

Terminal  
Blocks



5-2...5-33

Wiring  
Systems



5-34...5-35

Connection  
Systems



5-36...5-45

Safety  
Connection  
Systems



5-46...5-49

### Network Media



5-50...5-57



Allen-Bradley® Ethernet media components combine specially-designed cable with rugged connector construction to preserve network integrity and performance.

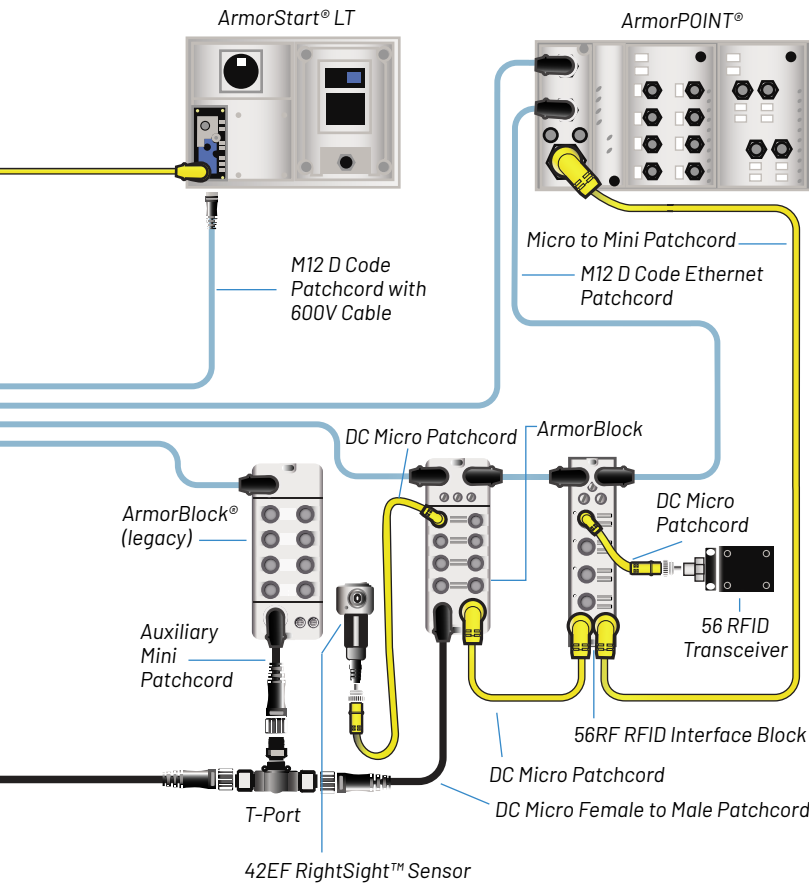

### Components

- Cordsets and patchcords
- Receptacles/outlets
- Bulkhead adapters
- Raw cable spools
- Field-attachable connectors

### Connector Options

- RJ45 (IP20)
- M12 D-Coded (IP67)

### Two- or four-pair shielded and unshielded cable options in multiple cable jackets:

- Two-pair for 10/100 BaseT and On-Machine applications
- Four-pair for backbone and uplink ports or any areas requiring data rates greater than 100 BaseT Interlock switches
- PVC Cable – General purpose applications
- PUR Cable – High flex, Halogen-free
- TPE Cable – High flex applications
- Plenum Cable – Air handling applications
- 600V PVC – Use in cable trays with up to 600V rated cables

### Notes

- Allen-Bradley Ethernet media is designed to OSHA EtherNet/IP™ standards for enhanced performance in industrial applications
- The 600V rated cable has a 600V AWM rating as well as PLTC (Power Limited Tray Cable) – NEC Type PLTC Listed, which is approved for cable tray use in Class 1, Division 2, hazardous areas and nonhazardous areas, cable trays, raceways, conduit and supported by messenger wires
- Transition from inside the cabinet to on-machine can be accomplished with an RJ45-to-M12 bulkhead adapter or an RJ45-to-M12 female panel mount patchcord. Both solutions provide a sealed solution mounted on to the cabinet and enables as easy transition from IP20 to IP67
- High flex cables rated to 10 million flexing cables



# Network Media

## Ethernet Media Cable Spools 1585

- Four- and eight-conductor styles
- 24 AWG conductors, Cat 5e
- Twisted pairs maintain signal balance through cable to provide high noise immunity without need for shield
- Designed to ODVA EtherNet/IP™ specifications and ISO IEC 24702, IEC 61918
- Suitable in noise environments M3 I3 C3 E3
- Robotic cables are flex rated, rated to 10 million cycles

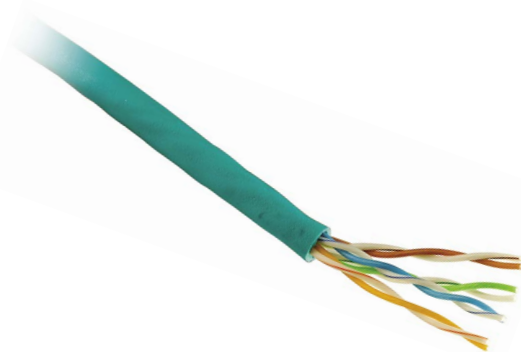

## Product Selection

### Cable Spools

Cable Type	No. of Conductors	Nominal Outer Diameter	Jacket Color	Color Code	Cable Rating	Cat. No. <sup>1</sup>
Unshielded riser PVC	8 (four pair)	5.84 mm (0.23 in.)	Teal	White/Orange, Orange, White/Green, Blue, White/Blue, Green, White/Brown, Brown	UL CMR; cUL CMG; Standard TIA 568-B	1585-C8PB-S100
Unshielded robotic TPE	4 (two pair)	5.6 mm (0.22 in.)	Teal	White/Orange, White/Green, Orange, Green	Weld splatter, sunlight, and oil resistant; UL CM, CMX; cUL CM; Standard TIA 568-B, high flex rated	1585-C4TB-S100
	8 (four pair)	5.84 mm (0.23 in.)	Teal	White/Orange, Orange, White/Green, Blue, White/Blue, Green, White/Brown, Brown	Weld splatter, sunlight and oil resistant; UL CM, CMX; cUL CM; Standard TIA 568-B, high flex rated	1585-C8TB-S100
Foil and braided shield robotic PUR	8 (four pair)	6.2 ± 12 mm (0.244 in.)	Teal	-	C(ETL)US TYPE CMX; TIA 568-B, Flex rated, Halogen-Free	1585-C8UB-S100
Foil and braided shield robotic PUR	4 (two pair)	-	Teal	-	C(ETL)US TYPE CMX; TIA 568-B, Flex rated, Halogen-Free	1585-C4UB-S100
Foil shield 600V PVC	8 (four pair)	8.13 ± 0.38 mm (0.32 in.)	Teal	-	(UL) CMX, CMR; c(UL) CMG; (UL) PLTC or AWM 257080 °C 600V; TIA-568-B	1585-C8HB-S100

<sup>1</sup> Replace **S100** with **S300** (300 m) or **S600** (600 m) for additional cable lengths.

Terminal Blocks



5-2...5-33

Wiring Systems



5-34...5-35

Connection Systems



5-36...5-45

Safety Connection Systems



5-46...5-49

Network Media



5-50...5-57



## Ethernet M12 D Code Cordsets & Patchcords 1585D

- Industrial-grade overmolded IP67 cable
- Flex-rated to 10 million cycles
- Single-ended cordsets can be custom terminated with one of several field-attachable connectors
  - Designed to ODVA EtherNet/IP specifications and ISO IEC 24702, IEC 61918
  - Twisted pairs provide high noise immunity
    - Suitable for noise environments M3 I3 C3 E3
    - Cat 5e



### Product Selection

#### M12 D Code Cordsets

Cable Style	First End Connector	Second End Connector	Cat. No. <sup>1</sup>
TPE, high flex, unshielded	Male M12 D-code, straight	Flying leads	1585D-M4TB-2
PUR, foil and braided shield, high flex, halogen free			1585D-M4UB-2
PVC, 600V rated, foil shield			1585D-M4HB-2

#### M12 D Code Patchcords

Cable Style	First End Connector	Second End Connector	Cat. No. <sup>1</sup>
TPE, high flex, unshielded	Male M12 D-code, straight	Male M12 D-code, straight	1585D-M4TBDM-2
	Male M12 D-code, right angle	Male M12 D-code, right angle	1585D-E4TBDE-2
	Male M12 D-code, straight	Male M12 D-code, right angle	1585D-M4TBDE-2
	Male M12 D-code, straight	Female M12 D-code, straight	1585D-M4TBDF-2
PUR, foil and braided shield, high flex, halogen free	Male M12 D-code, straight	Male M12 D-code, straight	1585D-M4UBDM-2
	Male M12 D-code, right angle	Male M12 D-code, right angle	1585D-E4UBDE-2
	Male M12 D-code, straight	Male M12 D-code, right angle	1585D-M4UBDE-2
	Male M12 D-code, straight	Female M12 D-code, straight	1585D-M4UBDF-2
PVC, 600V rated, foil shield	Male M12 D-code, straight	Male M12 D-code, straight	1585D-M4HBDM-2
	Male M12 D-code, right angle	Male M12 D-code, right angle	1585D-E4HBDE-2
	Male M12 D-code, straight	Male M12 D-code, right angle	1585D-M4HBDE-2
	Male M12 D-code, straight	Female M12 D-code, straight	1585D-M4HBDF-2
TPE, high flex, unshielded	Male M12 D-code, straight	RJ45, straight	1585D-M4TBJM-2
PUR, foil and braided shield, high flex, halogen free			1585D-M4UBJM-2
PVC, 600V rated, foil shield			1585D-M4HBJM-2

<sup>1</sup> Replace **2** (2 m) with **1** (1 m), **5** (5 m), or **10** (10 m) for additional standard cable lengths. Other standard and build-to-order lengths are available. Contact your local Rockwell Automation sales office or Allen-Bradley distributor for details.





# Network Media

CONNECTIVITY

## Ethernet RJ45 Cordsets & Patchcords 1585J

- PVC riser and flex-rated TPE and PUR cables for various applications
- Rugged strain relief and hitch mechanism to maintain network integrity
- Suitable environments M3 I3 C3 E3
- Unshielded, #24 AWG
- Flex rated to 10 million cycles
- Cat 5e

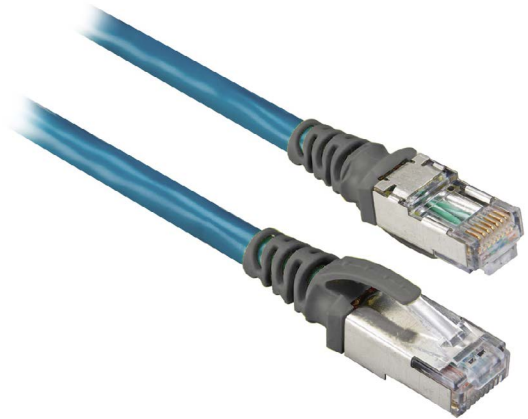

## Product Selection

### RJ45 Cordsets

No. of Conductors	Jacket Material	Shielding	Cat. No. <sup>1</sup>
4	Teal high-flex TPE	Unshielded twisted pair	1585J-M4TB-2
8	Teal high-flex TPE		1585J-M8TB-2
8	Teal riser PVC		1585J-M8PB-2
8	Teal riser PVC	Foil and braided shield	1585J-M8CB-2
4	Teal high-flex PUR		1585J-M4UB-2
8	Teal high-flex PUR		1585J-M8UB-2
8	Teal 600V PVC	Foil shield	1585J-M8HB-2

### RJ45 Patchcords

No. of Conductors	Jacket Material	Cable Type	Cable Rating	Cat. No. <sup>1</sup>
4	Teal high-flex, TPE	Unshielded twisted pair	Weld splatter, sun light and oil resistant; UL CMG, CMX; cUL CMG; Standard TIA 568-B, flex rated	1585J-M4TBJM-2
8	Teal high-flex, TPE			1585J-M8TBJM-2
	Teal riser, PVC		UL CMR; cUL CMG; Standard TIA 568-B	1585J-M8PBJM-2
4	Teal high-flex, PUR	Braid over foil shield	C(ETL)US TYPE CMX; TIA 568-B, flex-rated, halogen-free	1585J-M4UBJM-2
	Teal riser, PVC		UL CMR; CUR CMG, TIA B	1585J-M8CBJM-2
8	Teal high-flex, PUR		C(ETL)US TYPE CMX; TIA 568-B, flex-rated, halogen-free	1585J-M8UBJM-2
	Teal 600V, PVC	Foil shield	(UL) CMX, CMR; c(UL) CMG; (UL) PLTC or AWM 2570 80 °C 600V; TIA-568-B	1585J-M8HBJM-2

<sup>1</sup> Replace **2** (2 m) with **1** (1 m), **5** (5 m), or **10** (10 m) for additional standard cable lengths. Other standard and build-to-order lengths are available. Contact your local Rockwell Automation sales office or Allen-Bradley distributor for details.

Terminal Blocks



5-2...5-33

Wiring Systems



5-34...5-35

Connection Systems



5-36...5-45

Safety Connection Systems



5-46...5-49

Network Media



5-50...5-57



## Ethernet Accessories 1585D, 1585A, & 1585J

- Field-installable accessories for easy cabling modification
- For use with raw cable or single-ended cordsets
- M12 and RJ45 styles
- M12 to RJ45 adapter for bulkhead installation

CONNECTIVITY

### Product Selection

#### M12 Insulation Displacement Connector

No. of Pins	Connector Material	Cable Diameter [mm (in.)]	Wire Size	Assembly Rating	Connector Style	Cat. No.
4	Polyamide small body unshielded	4.0...5.1 (0.16...0.20)	#26...22 AWG	32V, 4 A	Straight male	1585D-M4DC-H
	Zinc die-cast large body shielded	5.5...7.2 (0.22...0.28)	#24...22 AWG		Straight female	1585D-F4DC-SH
					Straight male	1585D-M4DC-SH

#### Field Attachable RJ45 Connectors

Description	Material	Insulation Material	Contact Material	Channel Bandwidth	Cat. No.
RJ45 insulation displacement connector (IDC)	Diecast zinc	Plastic	Gold-plated copper alloy	Cat 6	1585J-M8CC-H

#### 4-pin, M12 Receptacle & M12 to RJ45 Adapter

Description	Mounting	Assembly Rating	Cat. No.
Female M12 receptacle to RJ45 female adapter right angle	PG 9 panel mount threads	32V, 4 A	1585A-DD4JD



# Network Media

CONNECTIVITY

## Gigabit Ethernet Connectivity 1585D/1585J

- Ethernet speeds of 1 Gigabit per second
- 360 degree shield for optimal signal performance without system noise interference
- Cat 6, UL Listed. Conforms to ISO IEC 11801, ANSI/TIA-1005, TIA-568-C.2.
- Flex-rated TPE cables for various applications.
- M12 feature X-code key alignment and are IP67 and M3 I3 C3 E3 rated
- RJ45 features ideal 1p20 industrial applications and M1 I1 C2 E2

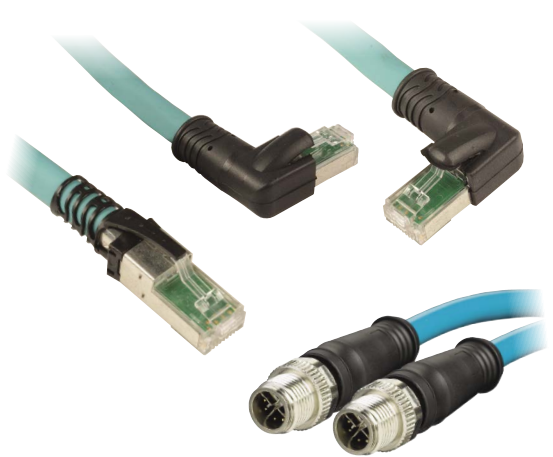

## Innovative Connectivity for Demanding High-speed Data Transfer in Industrial Applications

Our Ethernet media connects with Stratix™ Ethernet switches, programmable controllers, PanelView™ graphic terminals and drives.

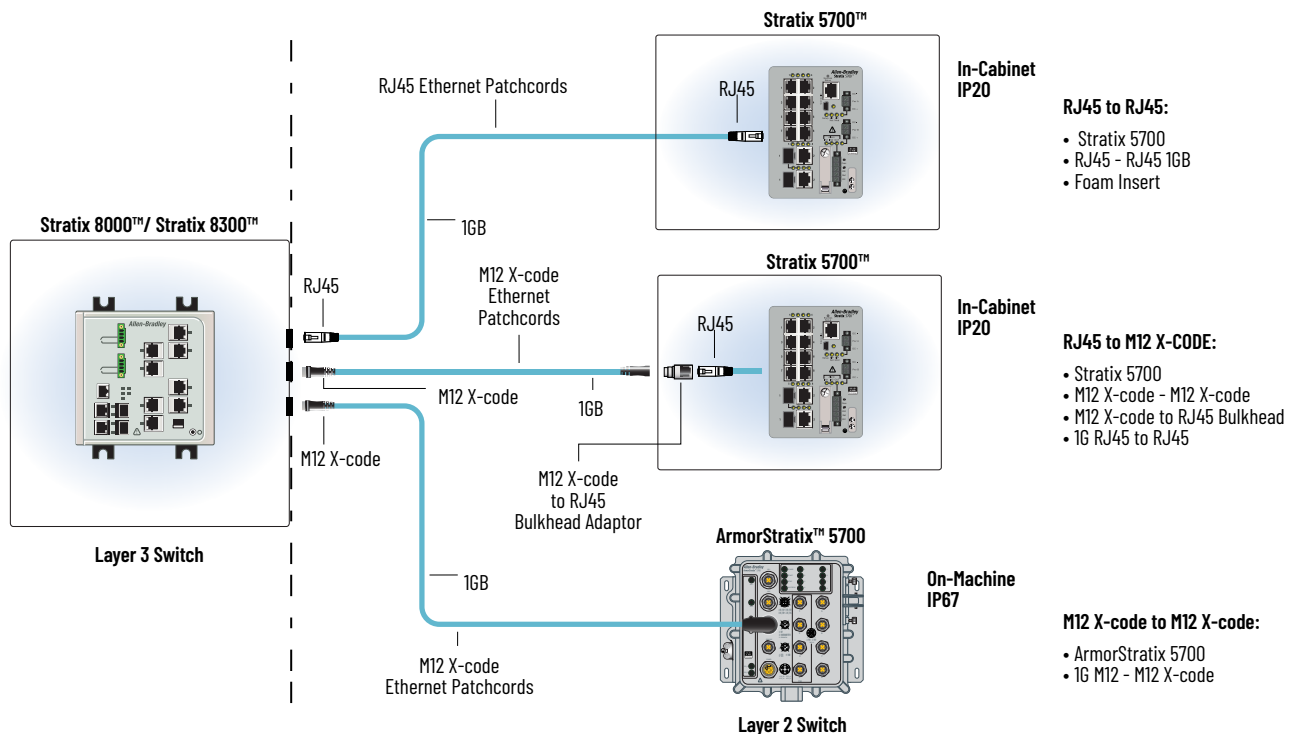

Terminal Blocks



5-2...5-33

Wiring Systems



5-34...5-35

Connection Systems



5-36...5-45

Safety Connection Systems



5-46...5-49

Network Media



5-50...5-57



## Product Selection

### RJ45 Gigabit Cordset

Shielding	Connector Style	Cable Type	Cable Length	Cat. No. <sup>1</sup>
Foil and braided shield	Straight male	8-conductor, teal high-flex TPE, 600V	2 m (6.56 ft)	1585J-M8TG-2
Foil and braided shield	Right angle male	8-conductor, teal high-flex TPE, 600V	2 m (6.56 ft)	1585J-E8TG-2

### RJ45 Gigabit Patchcords

Shielding	Connector Style	Cable Type	Cable Length	Cat. No. <sup>1</sup>
Foil and braided shield	RJ45 straight male	8-conductor (4 pair), teal high-flex TPE, 600V	2 m (6.56 ft)	1585J-M8TGJM-2
Foil and braided shield	RJ45 straight male to right angle male	8-conductor (4 pair), teal high-flex TPE, 600V	2 m (6.56 ft)	1585J-M8TGJE-2
Foil and braided shield	RJ45 right angle male to right angle male	8-conductor (4 pair), teal high-flex TPE, 600V	2 m (6.56 ft)	1585J-E8TGJE-2

<sup>1</sup> Replace **2** (6.56 ft) with **5** (16.4 ft) or **10** m (32.8 ft) for additional standard cable lengths.

### M12 X-code to M12 X-code Patchcords

Shielding	Connector Style	Cable Type	Cable Length	Cat. No. <sup>1</sup>
Foil and braided shield	Straight male	Shielded teal PUR, 4 twisted pairs, 26 AWG, Industrial Cat 6, UL Listed, sun light and oil resistant	1 m (3.28 ft)	1585D-M8UGDM-1

### M12 X-code to RJ45 Patchcord

Shielding	Connector Style	Cable Type	Cable Length	Cat. No. <sup>2</sup>
Foil and braided shield	Straight male	Shielded teal PUR, 4 twisted pairs, 26 AWG, Industrial Cat 6, UL Listed, sun light and oil resistant	1 m (3.28 ft)	1585D-M8UGJM-1

<sup>2</sup> Replace **1** with **2** m (6.56 ft), **3** m (9.84 ft), **4** m (13.1 ft), **5** m (16.4 ft), **10** m (32.8 ft), **15** m (49.5 ft), **20** m (65.6 ft), **30** m (98.42 ft), or **40** m (131.23 ft) for additional standard cable lengths.

## Accessories

Description	Cat. No.
Female M12 X-code receptacle to RJ45 female adaptor right angle	1585A-DD8JD



# Additional Connectivity Products



## DeviceNet Media

Used as the backbone for your DeviceNet network, our media includes multiple trunk and drop cable solutions to best suit your topology.

- Choose from traditional round media or time-saving KwikLink™ flat media
- Options for IP20 and IP67 applications
- Available in bulk spools or pre-molded cordsets or patchcords
- DeviceNet media tools help simplify your network installation and diagnostics

## NEMA and Process Terminal Blocks 1492, 1492JP

The 1492 family of NEMA terminal blocks offer easy wiring with standard size screwdrivers, easy visual verification of proper wire position and easy marking.

1492-JP process terminal blocks are designed specifically for process marshalling applications to save 45% panel space and improve the performance of signal routing and distribution.

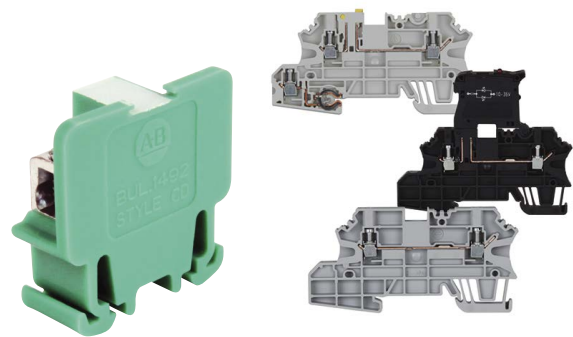

Terminal  
Blocks



5-2...5-33

Wiring  
Systems



5-34...5-35

Connection  
Systems



5-36...5-45

Safety  
Connection  
Systems



5-46...5-49

Network  
Media



5-50...5-57

**GuardLink Technology** ..... 6-2

**Presence Sensing Safety Devices**

Safety Light Curtains

- GuardShield 450LB Point of Operation Control Type 4 ..... 6-6
- GuardShield 450LE Point of Operation Control Type 4 ..... 6-8
- GuardShield 440L Point of Operation Control Type 4 ..... 6-10
- Micro 400 Point of Operation Control Type 4 ..... 6-12
- GuardShield Perimeter Access Control Type 4 & Safe 4 /Micro 400 ..... 6-14
- SafeZone Safety Laser Scanners ..... 6-16
- Safety Mat System ..... 6-18

**Interlock Switches**

- SensaGuard Non-Contact Switches ..... 6-20
- Magnetically Coded Non-Contact Switches ..... 6-22
- Tongue Interlock Switches ..... 6-24
- Electromagnetic Switches ..... 6-28
- 440G-LZ Guard Locking Switches ..... 6-30
- 440G-MZ Guard Locking Switches ..... 6-32
- TLS-Z GD2 Guard Locking Switches ..... 6-34
- TLS-GD2 Guard Locking Switches ..... 6-36
- Trapped Key Switches ..... 6-38

**Access Control**

- Guardmaster Multifunctional Access Box ..... 6-40

**Safety Relays**

- Software-Configurable Relay ..... 6-42
- Guardmaster Safety Relays (GSR Family) ..... 6-44
- Single and Specialty Function Safety Relays (MSR Family) ..... 6-46

**Emergency Stop Devices**

- Lifeline Cable Pull Switches ..... 6-48

**Safety Limit Switches**

- 22 mm Metal and Plastic, 30 mm Metal and 16 mm Plastic ..... 6-50

**Additional Safety Products** ..... 6-52



# GuardLink Technology

## GuardLink® Technology

GuardLink is a safety-based communications protocol that links safety to The Connected Enterprise. Allen-Bradley® Guardmaster® smart safety devices featuring GuardLink technology deliver information, advanced functionality and flexibility, while enhancing safety and increasing efficiency machine- and plant-wide. GuardLink enabled devices offer advanced features and diagnostics that can only be accessed through a GuardLink connection tap.



**GuardLink provides access to diagnostic data when the safety function occurs**

- No configuration is required, with wiring achieved through the use of standard cables with M12 connectors
- A maximum of 32 safety input devices can be connected in series
- GuardLink enabled taps allow standard safety input devices with either electromechanical or solid state safety outputs to be connected to a GuardLink system
- Passive taps allow safety input devices with built-in GuardLink technology to be connected to a GuardLink system
- Remote lock/unlock and fault reset of safety input devices can be achieved
- Certified for applications up to and including PLe Cat 4 (ISO 13849-1) and SIL CL3 (IEC 62061)

## Why Choose GuardLink?

Series connection of safety input devices is common practice in safety control systems. However when the system trips, fault finding is difficult due to the lack of diagnostic information. Providing diagnostics historically meant connecting auxiliary contacts from each safety input device to the PLC increasing costs due to the need for additional input cards, and increased installation time to hard wire each auxiliary contact to the allocated input. GuardLink provides both safety information and diagnostics through the same cable, with the diagnostics available via EtherNet/IP, reducing the amount of wiring required for the safety system, and the cost and time to install the solution.

## Two Solutions Available

### In cabinet, independent, single-zone solution

The Dual GuardLink, DG, safety monitoring relay is the host of the GuardLink safety system. It controls the safety function for one zone.

### On-Machine™, integrated, multi-zone solution

The 432ES is a GuardLink to EtherNet/IP interface. The 432ES passes GuardLink information from three independent channels to a safety controller via CIP Safety on EtherNet/IP.

Presence Sensing Devices



6-4...6-19

Interlock Switches



6-20...6-39

Access Control



6-40...6-41

Safety Relays



6-42...6-47

Emergency Stop Devices



6-48...6-49

Safety Limit Switches



6-50...6-51

## In Cabinet DG Solution

- Dual channel relay monitors up to two circuits:
  - one or two GuardLink circuits, one or two safety input devices, or one of each
- Local controls to configure the safety function
- Configurable multipurpose terminals
- Voltage-free relay outputs to switch higher loads
- Support of Single Wire Safety (SWS) to cascade multiple safety relays
- Monitors up to 32 devices on each of the GuardLink inputs (total up to 64 devices)
- Timing potentiometer for Stop Category 1
- Supports unconditional plus conditional guard locking safety rated up to SIL2, PLd.
- Connectivity to network interface via optical link
- Add-on profile for Studio 5000® Logix Designer software provides access to relay and GuardLink device data

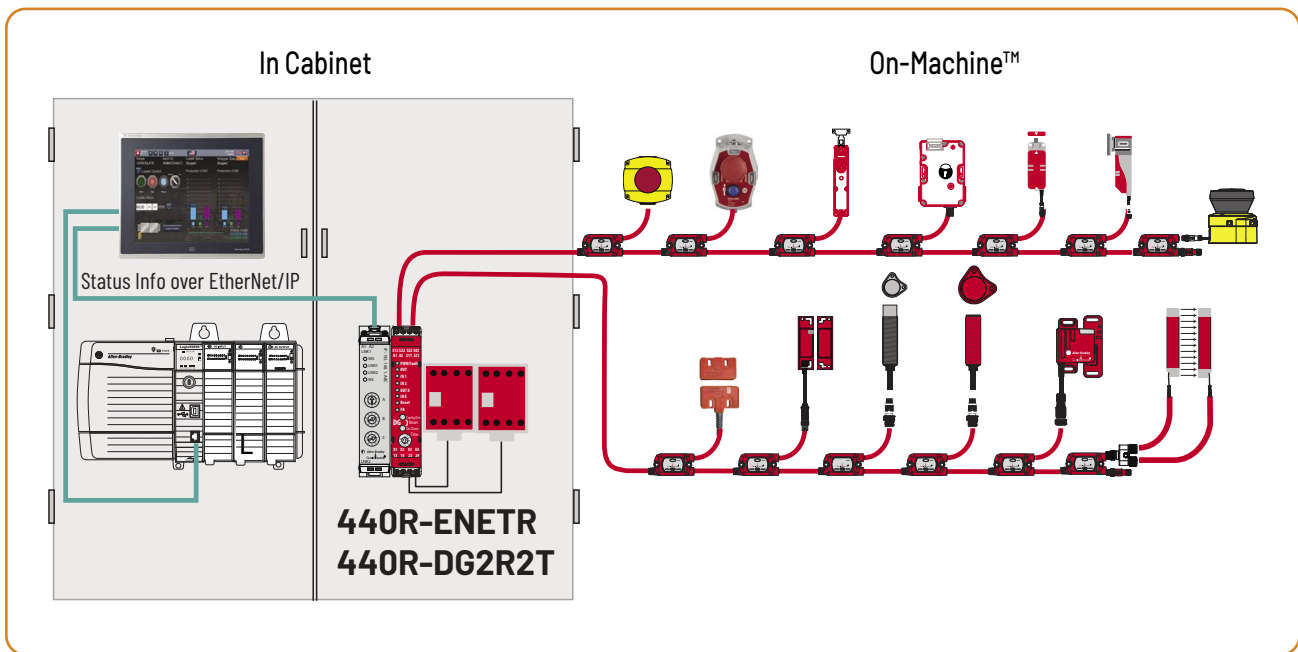

# GuardLink Technology

## On-Machine 432ES Solution

- On-Machine mounting meeting ingress protections IP66, IP67, and IP69K (high pressure and high temperature)
- Is an Intelligent interface between the safety controller and the safety devices
- CIP Safety, CIP Security and CIP Sync rated on EtherNet/IP
- M12 QD connectors for quick and easy installation
- Dual IP connectors supporting linear and DLR networks
- Daisy-chained power supply connectors with independent module and output power connections
- Three independent GuardLink channels:
  - one or two GuardLink circuits, one or two safety input devices, or one of each
- Automatic diagnostic reporting when used with PanelView 5500
- Timestamping - transitions from operating to safe state are timestamped; facilitating productivity
- Visibility of the host 432ES as well as every GuardLink enabled device in the Logix Designer Controller Organizer
- Supports unconditional guard locking

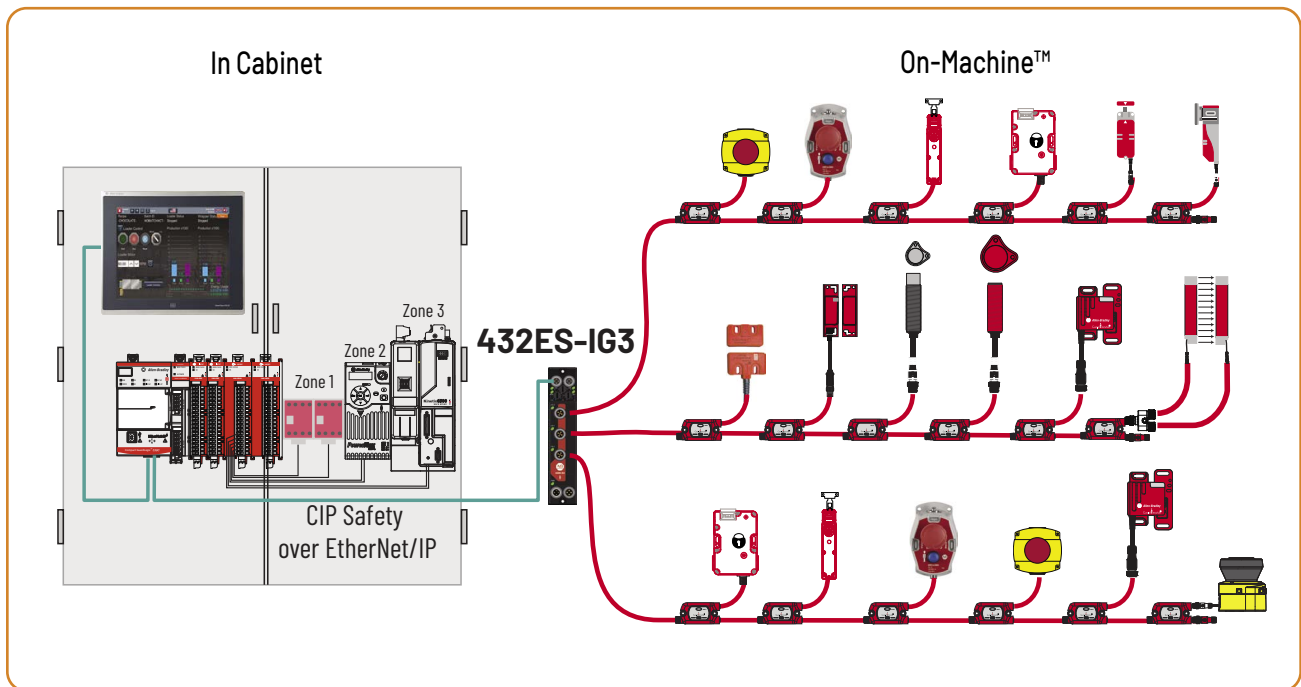

Presence Sensing Devices



6-4...6-19

Interlock Switches



6-20...6-39

Access Control



6-40...6-41

Safety Relays



6-42...6-47

Emergency Stop Devices



6-48...6-49

Safety Limit Switches



6-50...6-51



## GuardLink Taps

- Compact 40 mm wide housing fits on standard aluminum profiles
- TÜV Approved PLe, SIL 3, Cat 4 Rated
- IP65/IP67/IP69K environmental rating
- Three types of taps
  - GuardLink Enabled - connects to typical safety devices
  - Passive - connects to GuardLink enabled devices
  - Passive Power - adds power into very long systems
- Cable Distances, max
  - 30m to first tap
  - 30m between remaining taps when guard locking is used, or
  - 100m between remaining taps when guard locking is not used.
  - 10m from tap to safety device

## Product Selection

	Description	Catalog Number
EtherNet/IP	432ES GuardLink EtherNet/IP Interface	432ES-IG3
	GSR Ethernet Gateway	440R-ENETR
Safety Relay, Ethernet Gateway and cable to the first GuardLink enabled tap	Guardmaster Safety Relay Dual GuardLink Master	440R-DG2R2T
	Replace * in order number with 2, 5, 10, 15, 20 or 30 for required cable length in meters	889D-F4NE-*
GuardLink enabled taps and cables to connect between the taps	5-pin GuardLink Enabled Tap for use with 5-pin Electronic Safety Input devices	440S-SF5D
	8-pin GuardLink Enabled Tap for use with 8-pin Electronic Safety Input devices, power-to-release	440S-SF8D
	8-pin GuardLink Enabled Tap for use with 8-pin Electronic Safety Input devices, power-to-lock	440S-SLF8D
	5-pin GuardLink Enabled Tap for use with 5-pin Electromechanical Safety devices	440S-MF5D
	8-pin GuardLink Enabled Tap for use with 8-pin Electromechanical Safety devices, power-to-release	440S-MF8D
	8-pin GuardLink Enabled Tap for use with 8-pin Electromechanical Safety devices, power-to-lock	440S-MLF8D
	5-pin Passive Tap for use with 5-pin GuardLink Enabled Safety devices	440S-PF5D
	5-pin Passive Power Tap for additional power and for use with 5-pin GuardLink Enabled Safety devices	440S-PF5D4
Connection cables from the GuardLink enabled taps to the input devices	Replace *** in order number with OM3, OM6, 1, 2, 5 or 10 for cable length in meters (OM3=300 mm, OM6=600 mm)	889D-F5NCDM-***
	Replace *** in order number with OM3, OM6, 1, 2, 5 or 10 for cable length in meters (OM3=300 mm, OM6=600 mm)	889D-F8NBDM-***
Accessories	Terminator for last GuardLink Enabled Tap	898D-418U-DM2
	8-pin Shorting Plug for 440S-SF8D, 440S-SLF8D, 440S-MF8D and 440S-MLF8D	898D-81RU-DM
	5-pin Shorting Plug for 440S-SF5D	898D-418U-DM
	5-pin Shorting Plug for 440S-PF5D and 440S-PF5D4	898D-41KU-DM2
	GuardLink Enabled Tap Mounting Bracket - Qty. 1	440S-GLTAPBRK1
GuardLink Enabled Tap Mounting Bracket - Qty. 5	440S-GLTAPBRK5	

For more information on our complete family of presence sensing safety device products, please visit: [rok.auto/safety-products](http://rok.auto/safety-products)



# Presence Sensing Safety Devices

SAFETY

## GuardShield POC Type 4 Safety Light Curtain 450L-B

- Point of Operation Control (POC) for finger or hand protection
- Innovative plug-in modules (purchased separately) for application flexibility and reduced inventory costs
- Protection heights 150...1950 mm (5.9...76.7 in.) in increments of 150 mm (0.5 ft)
- Compact design 30 mm x 30 mm (1.18 in. x 1.18 in.)
- TÜV certified PLe, Type 4 IEC 61496-1/-2, SILCL3 per EN ISO 13849-1, IEC 62061



## CIP Safety Over Ethernet/IP™ Safety Light Curtain

The GuardShield™ 450L-B Safety Light Curtain system features a patented technology which allows each transceiver to be used as a transmitter or receiver via an innovative plug-in module. The functionality of a pair of 450L-B safety light curtains is determined by inserting a plug-in module into the bottom of each transceiver. This advanced technology greatly reduces stock and provides a flexible, cost-effective safety solution. Plus, connection over EtherNet/IP makes the light curtain a smart safety device that enhances safety and delivers diagnostics while providing connectivity through The Connected Enterprise®.

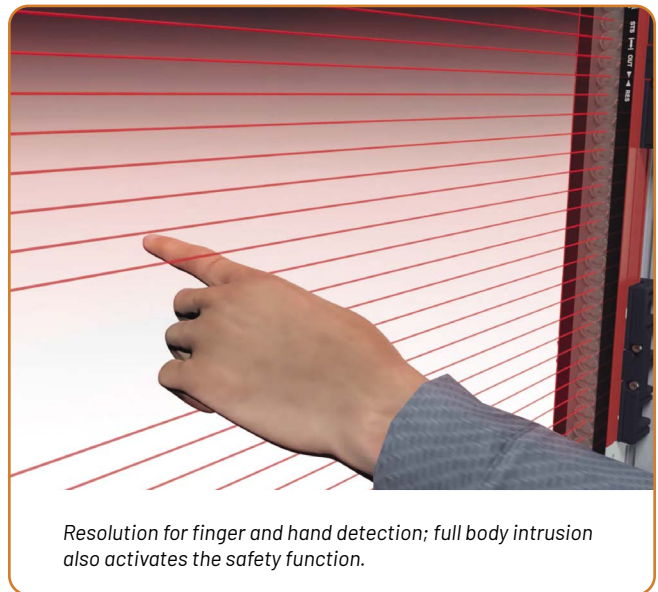
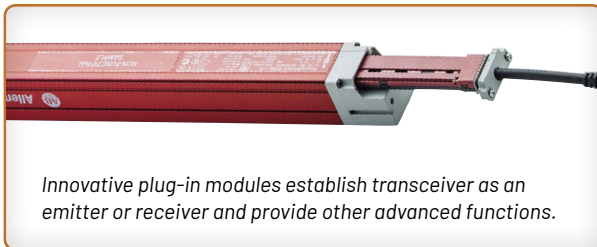

### Presence Sensing Devices



6-4...6-19

Interlock Switches



6-20...6-39

Access Control



6-40...6-41

Safety Relays



6-42...6-47

Emergency Stop Devices



6-48...6-49

Safety Limit Switches



6-50...6-51



## Product Selection

### Light Curtain System: Order two identical transceivers/catalog numbers

Description	Catalog Number <sup>1</sup>
Transceiver with finger resolution. 14 mm (0.55 in.) resolution. Top and bottom mounting kit included <sup>2</sup>	450L-B4FNxxxxYD
Transceiver with hand resolution. 30 mm (1.18 in.) resolution. Top and bottom mounting kit included <sup>2</sup>	450L-B4HNxxxxYD

<sup>1</sup> **xxxx** = 0150 ... 1950 mm (0.5 ... 6.4 ft) in increments of 150 mm (0.5 ft).

For example: "450L-B4FN**0900**YD" indicates an order for 900 mm finger detection light curtain system.

<sup>2</sup> Optional side mounting bracket kit is available below.

**Plug-in Modules: Order one transmitter and one receiver plug-in with the desired functionality for one system – or – Order two universal plug-ins for one system. Each universal plug-in can be used as a transmitter or a receiver.**

Description	Catalog Number
Transmitter plug-in, M12 5-pin	450L-APT-PW-5
Receiver plug-in, M12 5-pin, On/Off	450L-APR-ON-5
Transmitter plug-in, M12 8-pin <sup>3</sup>	450L-APT-PW-8
Receiver plug-in, M12 8-pin, reset mode, EDM, scanning range	450L-APR-ED-8
Universal plug-in, M12 8-pin, reset mode, EDM, scanning range <sup>4</sup>	450L-APU-UN-8
Receiver plug-in, M12 8-pin CIP Safety over EtherNet/IP <sup>5</sup>	450L-APR-EN-8

<sup>3</sup> The 8-pin transmitter plug-in option allows two 8-pin cordsets to be used in one system.

<sup>4</sup> Order two universal plug-ins for one system. Each universal plug-in can be used as a transmitter or a receiver.

<sup>5</sup> 450L-ENETR Network Interface Module is also required.

## Specifications

<b>Standards</b>	Type 4 (IEC 61496), PLe Cat 4 (ISO 13849-1), SIL CL3 (IEC 62061)
<b>Certifications</b>	UL Listed, TUV Certified, KC and CE Marked for all applicable directives
<b>Power Supply</b>	24V DC ±15%
<b>Safety Output</b>	2 OSSDs (max. 0.5 A)
<b>Enclosure Rating</b>	IP65
<b>Cross Section</b>	30 x 30 mm (1.19 x 1.19 in.)
<b>Scanning Range</b>	Resolution 14 mm (0.56 in.): 0.5...4 m (1.64...13.12 ft) Resolution 30 mm (1.19 in.): 0.9...7.0 m (2.95...22.97 ft)

## Accessories

Description	Catalog Number
M12 5-pin cable <sup>1</sup>	889D-F5BC-⊗
M12 8-pin cable <sup>1</sup>	889D-F8AB-⊗
Optical interface tool (required if using Connected Components Workbench software for diagnostic information)	450L-AD-0ID
Weld shield kit 2	450L-AW-xxxx
Laser alignment tool	440L-ALAT
Mounting bracket for laser alignment tool	450L-ALAT-C
Side mounting bracket kit	450L-AM-SM
Muting Distribution Block	450L-AMOD-AMUT-8
Muting Station	800F-MUT-2-MS
Muting Status Lamp	450L-AMUT-IL

⊗ The catalog number as listed is incomplete. Replace the ⊗ with **2** (6.6 ft), **5** (16.4 ft), **10** (32.8 ft), **15** (49.2 ft), **20** (65.6 ft), or **30** (98.4 ft) for available lengths in meters.

<sup>1</sup> Required Accessory

<sup>2</sup> **xxxx** = 0150 ... 1950 mm (0.5 ... 6.4 ft) in increments of 150 mm (0.5 ft).





# Presence Sensing Safety Devices

SAFETY

## GuardShield POC Type 4 Safety Light Curtain 450L-E

- Point of Operation Control (POC) for finger or hand protection
- Innovative plug-in modules (purchased separately) enables functionality for muting, blanking and cascading
- Protection heights 150...1950 mm (5.9...76.7 in.) in increments of 150 mm (0.5 ft)
- Integrated laser alignment system helps provide quick and more reliable installation
- TÜV certified PLe, Type 4 IEC 61496-1/-2, SILCL3 per EN ISO 13849-1, IEC 62061



## An Enhanced Light Curtain with Advanced Functions and EtherNet/IP™ Connectivity

The GuardShield™ 450L-E Safety Light Curtain system is the enhanced version of the GuardShield 450L-B Safety Light Curtain system. It offers a larger operating range and each stick has a integrated laser alignment feature which allows a quick and more reliable installation. Functionalities like blanking, muting or cascading can be integrated. This advanced modular technology greatly reduces stock and helps provide a flexible, cost-effective safety solution. Plus, connection over EtherNet/IP makes the light curtain a smart safety device that enhances safety and delivers diagnostics while providing connectivity through The Connected Enterprise®.

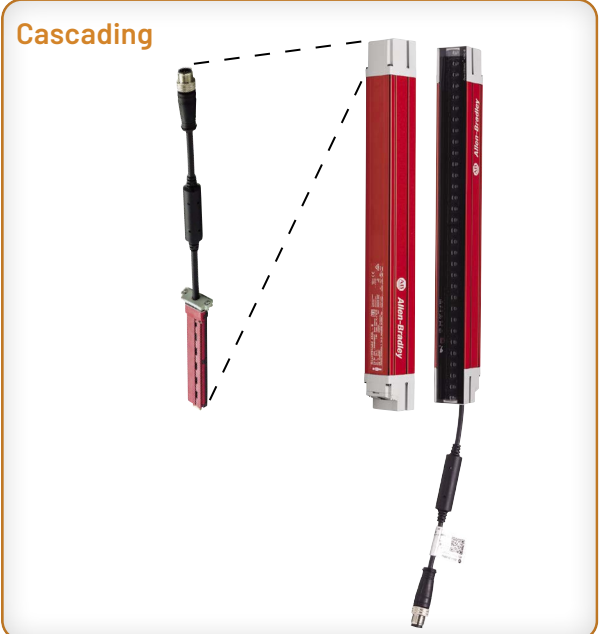

### Presence Sensing Devices



6-4...6-19

### Interlock Switches



6-20...6-39

### Access Control



6-40...6-41

### Safety Relays



6-42...6-47

### Emergency Stop Devices



6-48...6-49

### Safety Limit Switches



6-50...6-51



## Product Selection

### Light Curtain System: Order two identical transceivers/catalog numbers

Description	Catalog Number <sup>1</sup>
Transceiver with finger resolution. 14 mm (0.55 in.) resolution. Top and bottom mounting kit included <sup>2</sup>	450L-E4FLxxxxYD
Transceiver with hand resolution. 30 mm (1.18 in.) resolution. Top and bottom mounting kit included <sup>2</sup>	450L-E4HLxxxxYD

<sup>1</sup> **xxxx** = 0150 ... 1950 mm (0.5 ... 6.4 ft) in increments of 150 mm (0.5 ft).  
For example: "450L-E4FL**0900**YD" indicates an order for 900 mm finger detection light curtain transceiver stick.

<sup>2</sup> Optional side mounting bracket kit is available below.

### Plug-in Modules: Order one transmitter and one receiver plug-in with the desired functionality for one system – **or** – Order two universal plug-ins for one system. Each universal plug-in can be used as a transmitter or a receiver.

Description	Catalog Number
Transmitter plug-in, M12 5-pin	450L-APT-PW-5
Receiver plug-in, M12 5-pin, On/Off	450L-APR-ON-5
Transmitter plug-in, M12 8-pin <sup>3</sup>	450L-APT-PW-8
Receiver plug-in, M12 8-pin, reset mode, EDM, scanning range	450L-APR-ED-8
Receiver plug-in, M12 5-pin, blanking	450L-APR-BL-5
Receiver plug-in, M12 8-pin, muting, blanking, reset mode, EDM, scanning range	450L-APR-MU-8
Cascading plug-in, M12 8-pin, serial connection of light curtain sticks	450L-APC-IO-8
Universal plug-in, M12 8-pin, reset mode, EDM, scanning range <sup>4</sup>	450L-APU-UN-8
Receiver plug-in, M12 8-pin CIP Safety over EtherNet/IP™ <sup>5</sup>	450L-APR-EN-8

<sup>3</sup> The 8-pin transmitter plug-in option allows two 8-pin cordsets to be used in one system.

<sup>4</sup> Order two universal plug-ins for one system. Each universal plug-in can be used as a transmitter or a receiver.

<sup>5</sup> 450L-ENETR Network Interface Module is also required.

## Specifications

<b>Standards</b>	Type 4 (IEC 61496), PLe Cat 4 (ISO 13849-1), SIL CL3 (IEC 62061)
<b>Certifications</b>	UL Listed, TUV Certified, KC and CE Marked for all applicable directives
<b>Power Supply</b>	24V DC ±15%
<b>Safety Output</b>	2 OSSDs (max. 0.5 A)
<b>Enclosure Rating</b>	IP65
<b>Cross Section</b>	30 x 30 mm (1.19 x 1.19 in.)
<b>Scanning Range</b>	Resolution 14 mm (0.56 in.): 0.5...9 m (1.64...29.53 ft) Resolution 30 mm (1.19 in.): 0.9...16.2 m (2.95...53.15 ft)

## Accessories

Description	Catalog Number
M12 5-pin cable <sup>1</sup>	889D-F5BC-⊗
M12 8-pin cable <sup>1</sup>	889D-F8AB-⊗
Optical interface tool (required if using Connected Components Workbench software for diagnostic information)	450L-AD-0ID
Weld shield kit <sup>2</sup>	450L-AW-xxxx
Laser alignment tool	440L-ALAT
Mounting bracket for laser alignment tool 440L-ALAT	450L-ALAT-C
Side mounting bracket kit	450L-AM-SM
Termination plug, M12 8-pin for cascading plug-in	898D-8ICU-DM
Muting Distribution Block	450L-AMOD-AMUT-8
Muting Station	800F-MUT-2-MS
Muting Status Lamp	450L-AMUT-IL

⊗ The catalog number as listed is incomplete. Replace the ⊗ with **2** (6.6 ft), **5** (16.4 ft), **10** (32.8 ft), **15** (49.2 ft), **20** (65.6 ft), or **30** (98.4 ft) for available lengths in meters.

<sup>1</sup> Required Accessory

<sup>2</sup> **xxxx** = 0150 ... 1950 mm (0.5 ... 6.4 ft) in increments of 150 mm (0.5 ft).



# Presence Sensing Safety Devices

SAFETY

## GuardShield POC Type 4 Safety Light Curtain 440L

- Point of Operation Control (POC) for finger or hand protection
- Heavy-duty IP65 housing
- Wide operating range 0.3...16 m (0.98...52.49 ft)
- Dip switch selectable functions: blanking (including teach-in), beam coding, EDM (External Device Monitoring), and start mode
- Available options: cascading, integrated laser alignment, ArmorBlock® Guard I/O™ connectivity

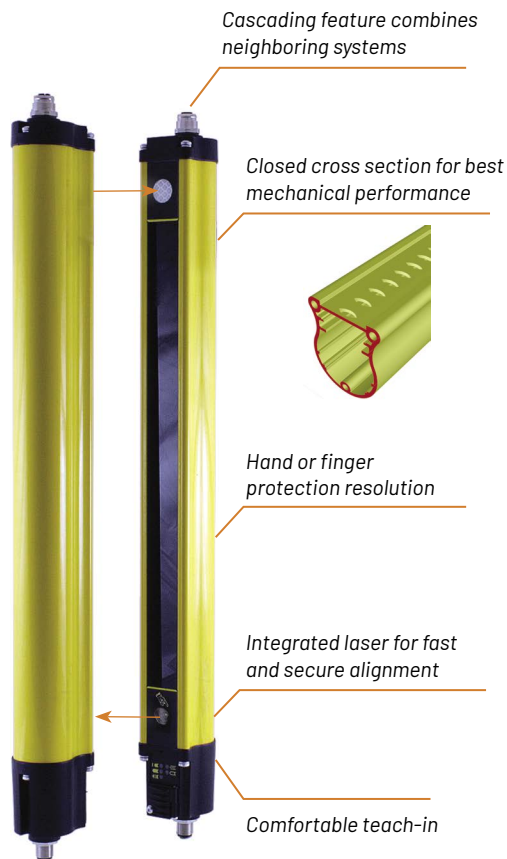

## A Robust Solution for Finger and Hand Detection

GuardShield™ safety light curtains offer an extraordinary robustness against high-mechanical impacts. The unique profile design is a perfect solution for heavy duty applications. An integrated laser feature allows for easy set up and a comfortable control of the alignment. With these features this product helps to provide the highest reliability.



### Presence Sensing Devices



6-4...6-19

Interlock Switches



6-20...6-39

Access Control



6-40...6-41

Safety Relays



6-42...6-47

Emergency Stop Devices



6-48...6-49

Safety Limit Switches



6-50...6-51



## Product Selection

### GuardShield POC Type 4

Description	Cat. No.	
	Finger Resolution (14 mm)	Hand Resolution (30 mm)
GuardShield Type 4	440L-P4JxxxxYD <sup>1</sup>	440L-P4KxxxxYD <sup>1</sup>
GuardShield Type 4 with laser	440L-P4JLxxxxYD <sup>2</sup>	440L-P4KLxxxxYD <sup>2</sup>
GuardShield Type 4 cascading	440L-C4JxxxxYD <sup>3</sup>	440L-C4KxxxxYD <sup>3</sup>
GuardShield Type 4 cascading with laser	440L-C4JLxxxxYD <sup>2</sup>	440L-C4KLxxxxYD <sup>2</sup>
GuardShield Type 4 Teach-in	440L-S4JxxxxYR	440L-S4KxxxxYR
GuardShield Type 4 Armor with laser	440L-P4JLxxxxYA <sup>2</sup>	440L-P4KLxxxxYA <sup>2</sup>

<sup>1</sup> Models are available in protective heights from 160...1760 mm (6.3...69.3 in.) in 160 mm increments. To order, replace the **xxxx** in the catalog number with the protective height in mm. For example, to order 160 mm height, replace the **xxxx** with **0160** (440L-P4K**0160**YD), or for 1760 mm height, replace **xxxx** with **1760** (440L-P4K**1760**YD).

<sup>2</sup> Models are available in protective heights from 320...1600 mm (12.6...63 in.) in 160 mm (6.3 in.) increments.

<sup>3</sup> Models are available in protective heights from 320...1760 mm (6.3...69.3in).

## Specifications

Standards	Type 4 (IEC 61496), PLc Cat 4 (ISO 13849-1), SIL CL3 (IEC 62061)
Certifications	UL Listed, TÜV Certified, and CE Marked for all applicable directives
Power Supply	24V DC ±20%
Safety Output	2 OSSDs (max. 0.5 A)
Enclosure Rating	IP65
Cross Section	40 x 50 mm (1.57 x 1.96 in.)
Scanning Range	Finger: 0.3...7 m (0.98...22.9 ft) Hand: 0.3...16 m (0.98...52 ft)

## Required Cordsets & Accessories

Description	Cat. No.
4-pin straight transmitter cable	889D-F4AC-2 <sup>4</sup>
8-pin straight receiver cable	889D-F8AB-2 <sup>4</sup>
Vertical shock mounting kit	440L-AF6120
Horizontal shock mount kit	440L-AF6121
Weld Shield	440L-AGWSxxxx <sup>1</sup>
IP67 washdown enclosure kit (limited offering) <sup>7</sup>	440L-AGSTxxxx <sup>1,6</sup>
Mirror 75 mm (2.95 in.)	440L-AM075yyyy <sup>5</sup>
Mirror 125 mm (4.92 in.)	440L-AM125yyyy <sup>5</sup>
Muting box	445L-AMUTBOX1

<sup>1</sup> Models are available in protective heights from 160...1760 mm (6.3...69.3 in.) in 160 mm increments. To order, replace the **xxxx** in the catalog number with the protective height in mm. For example, to order 160 mm height, replace the **xxxx** with **0160** (440L-P4K**0160**YD), or for 1760 mm height, replace **xxxx** with **1760** (440L-P4K**1760**YD).

<sup>4</sup> Replace the **2** with **5, 10, 15, 20,** or **30** for available lengths in meters.

<sup>5</sup> **yyyy** = mirror length in mm

<sup>6</sup> 440L-AGSTxxxx is only available for the standard i.e. non-laser model in the following sizes: 320, 480, 640, 800, 960.

<sup>7</sup> Washdown enclosure kits are not compatible with 440L models with integrated laser alignment.

**Note:** For additional information, see Safety Connection Systems (page 4-50).

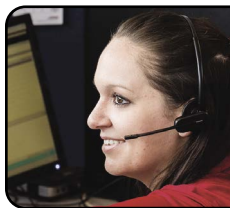

### Need Help?

The Rockwell Automation Support Center is your 24/7 support for the answers you need now.

[rok.auto/support](http://rok.auto/support)



# Presence Sensing Safety Devices

SAFETY

## Micro 400 POC Type 4 Safety Light Curtain 445L

- Point of Operation Control (POC) for finger or hand protection
- Slim housing
- Economical three-box system
- Requires MSR41 or MSR42 controller
- IP54 enclosure rating
- No dead zone
- TÜV Certified

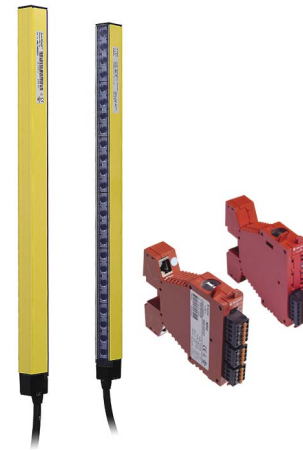

## A Slim-profile Solution for Point of Operation Control

Micro 400 are Type 4 safety light curtains with an extremely small profile of 15 x 20 mm (0.59 x 0.78 in.) and are available with both finger and hand resolution. They are designed to be built *into* the machine and not on the machine. This product must be used in combination with an MSR41 or MSR42 controller. The MSR42 controller is multi-functional and allows for additional functions like blanking, override, and muting.

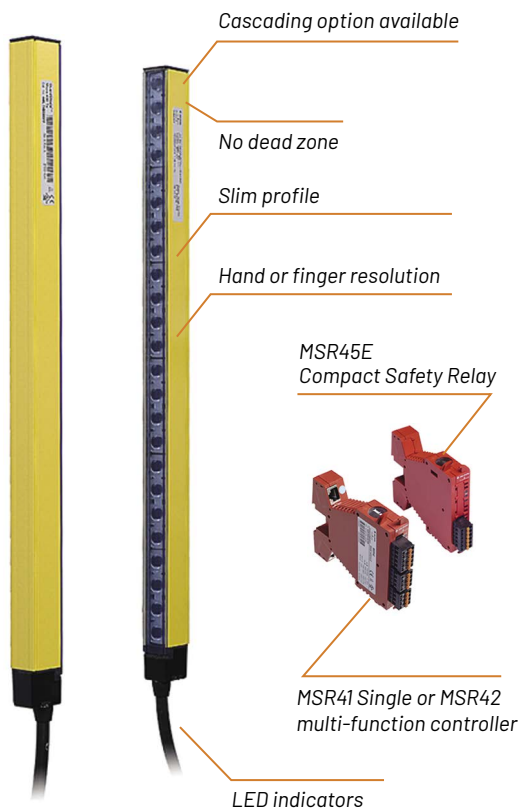

## Typical Application



### Presence Sensing Devices



6-4...6-19

Interlock Switches



6-20...6-39

Access Control



6-40...6-41

Safety Relays



6-42...6-47

Emergency Stop Devices



6-48...6-49

Safety Limit Switches



6-50...6-51



## Product Selection

### Micro 400 POC Type 4

Description	Cat. No. <sup>1</sup>	
	Finger Resolution (14 mm)	Hand Resolution (30 mm)
Micro 400	445L-P4CxxxxFP	445L-P4ExxxxFP
Micro 400 cascaded	445L-C4CxxxxFP <sup>2</sup>	445L-C4ExxxxFP <sup>2</sup>
Micro 400 IP69K	445L-P4CxxxxKP <sup>2</sup>	—

<sup>1</sup> Models are available in protective heights from 50...1200 mm (2.0...47.2 in.) in 50 mm increments. To order, replace the **xxxx** in the catalog number with the protective height in mm. For example, to order 600 mm height, replace the **xxxx** with **0600** (445L-P4C**0600**FP), or for 1200 mm height, replace **xxxx** with **1200** (445L-P4C**1200**FP).

<sup>2</sup> Not all protective heights.

## Specifications

<b>Standards</b>	Type 4 (IEC 61496-1, -2), PLe Cat 4 (ISO 13849-1), SIL CL3 (IEC 62061)
<b>Certifications</b>	UL Listed, TÜV Certified, and CE Marked for all applicable directives
<b>Enclosure Rating</b>	IP54
<b>Cross Section</b>	15 x 20 mm (0.59 x 0.79 in.)
<b>Scanning Range</b>	Finger: 0...5 m (0...16.4 ft) Hand: 0...5 m (0...16.4 ft)
<b>Power Supply</b>	24V DC ±20%
<b>Safety Output</b>	2 OSSDs (max. 0.4 A each)

## Required Cordsets & Accessories

Description	Cat. No.
Transmitter/receiver connection cable	445L-AC8RJ1 <sup>3</sup>
Transmitter/receiver patchcord cable	445L-AC8PC1 <sup>4</sup>
Flat mount kit	445L-AF6145
Adjustable flat mounting kit	445L-AF6149
MSR41 controller	440R-P22IAGS
MSR42 controller	440R-P226AGS-NNR
MSR45E relay (2 N.O.)	440R-P4NANS
Ribbon cable for one MSR45E	440R-ACABL1
Muting box	445L-AMUTBOX1

<sup>3</sup> Replace the **1** with **2**, **3**, **5**, or **8** for other available meter lengths.

<sup>4</sup> Replace the **1** with **3** or **5** for other available meter lengths.



### Product Selection Tools

Available online or for download,  
our tools help you access info  
while in the office or on the go.

[rok.auto/selection](http://rok.auto/selection)





# Presence Sensing Safety Devices

SAFETY

## GuardShield PAC Type 4 Safety Light Curtain 440L & 450L

- Perimeter Access Control (PAC) for whole body detection around machines
- Two-, three-, and four-beam solution
- Integrated laser alignment tool
- Long operating range
- cULus Listed and TÜV Certified

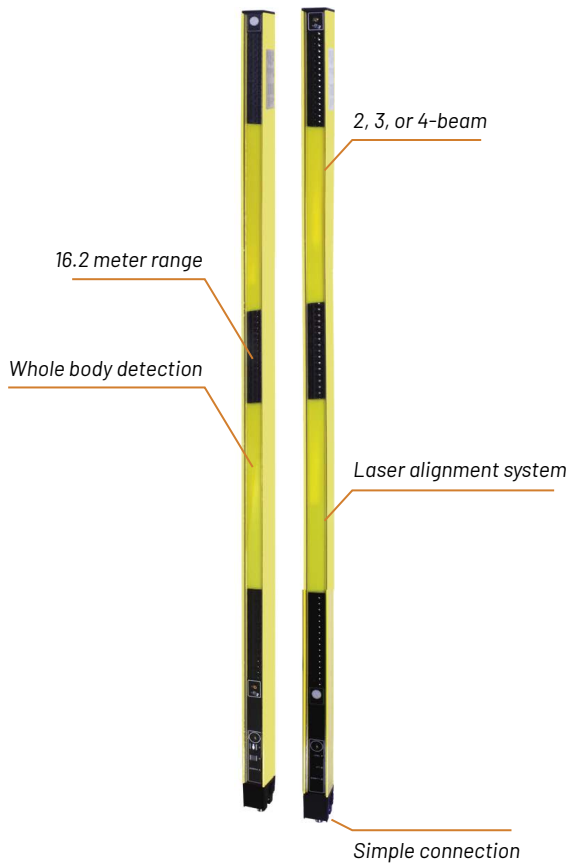
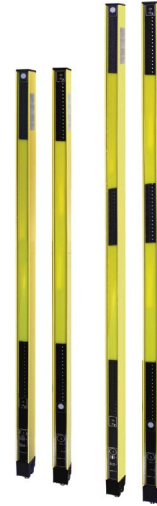

## Whole-body Detection for Machine Perimeter Safeguarding

Based on the individual safety light curtain platforms and perimeter access control (PAC), these safety light curtains are used for whole-body detection. They are typically positioned around an area or in front of a machine process entry or exit area. Multi-sided access control is attained through the use of corner mirrors. The integrated laser alignment tool makes the set up with mirrors most efficient.

## Typical Application

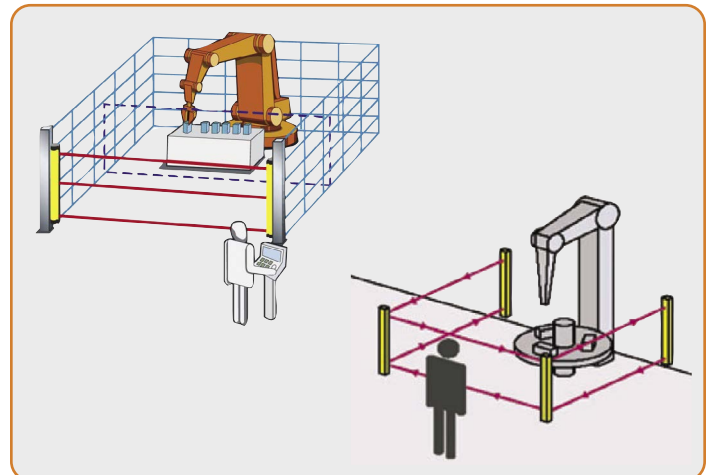

### Presence Sensing Devices



6-4...6-19

Interlock Switches



6-20...6-39

Access Control



6-40...6-41

Safety Relays



6-42...6-47

Emergency Stop Devices



6-48...6-49

Safety Limit Switches



6-50...6-51



## Product Selection

### GuardShield PAC Type 4 & Safe 4/Micro 400

	Description	Cat. No.		
		2-Beam	3-Beam	4-Beam
GuardShield Type 4	PAC	440L-P4A2500YD	440L-P4A3400YD	—
	PAC with Laser	440L-P4AL2500YD	440L-P4AL3400YD	—
	PAC ArmorBlock® with Laser	440L-P4AL3400YA	440L-P4AL3400YA	—
450L PAC	PAC with Laser	450L-E4A2L0600YD	450L-E4A3L0900YD	450L-E4A4L1050YD

## Specifications

	440L PAC	450L PAC
Profile Cross Section	40 x 50 (1.57 x 1.97 in.)	30 x 30 (1.18 x 1.18 in.)
Working Range	0.3...16 m (0.98...52.5 ft)	0.0...6.2 m (2.95...53.15)
Enclosure Type Rating	IP65	IP65
Integrated Laser Alignment	Optional	Standard
5-pin ArmorBlock	Optional	Standard
Integrated Controller	Yes	Yes
Beam Coding	Yes	Yes
EDM	Yes	Yes
Configuration	DIP switch	DIP switch
Safety	Type 4 (IEC 61496-1, -2); PLe Cat 4 (ISO 13849-1); SIL CL3 (IEC 62061)	
Aux. Output (Non-safety)	1 PNP, 0.5 A max.	Up to 3 (plug-in & configuration dependent), 0.2 A max.
Operating Temperature [C (F)]	-10...+55° (14...131°)	-10...+55° (14...131°)

## Required Cordsets & Accessories

### GuardShield Type 4 440L

Description	Cat. No.
4-pin straight transmitter cable	889D-F4AC-2 <sup>2</sup>
8-pin straight receiver cable	889D-F8AB-2 <sup>2</sup>
Vertical shock mounting kit	440L-AF6120
Horizontal shock mount kit	440L-AF6121
Weld Shield	440L-AGWSxxxx <sup>1</sup>
IP67 washdown enclosure kit (limited offering) <sup>5</sup>	440L-AGSTxxxx <sup>1</sup>

### GuardShield Type 4 PAC 450L

Description	Catalog Number
M12 5-pin cable <sup>1</sup>	889D-F5BC-⊗
M12 8-pin cable <sup>1</sup>	889D-F8AB-⊗
Optical interface tool (required if using Connected Components Workbench software for diagnostic information)	450L-AD-01D
Weld shield kit <sup>2</sup>	450L-AW-xxxx
Laser alignment tool	440L-ALAT
Mounting bracket for laser alignment tool 440L-ALAT	450L-ALAT-C
Side mounting bracket kit	450L-AM-SM
Termination plug, M12 8-pin for cascading plug-in	898D-81CU-DM
Muting Distribution Block	450L-AMOD-AMUT-8
Muting Station	800F-MUT-2-MS
Muting Status Lamp	450L-AMUT-IL

⊗ The catalog number as listed is incomplete. Replace the ⊗ with **2** (6.6 ft), **5** (16.4 ft), **10** (32.8 ft), **15** (49.2 ft), **20** (65.6 ft), or **30** (98.4 ft) for available lengths in meters.

<sup>1</sup> Required Accessory

<sup>2</sup> **xxxx** = 0150 ... 1950 mm (0.5 ... 6.4 ft) in increments of 150 mm (0.5 ft).



# Presence Sensing Safety Devices

SAFETY

## SafeZone Safety Laser Scanners 442L

- Singlezone, Multizone, Mini and EtherNet/IP versions
- Selectable resolutions of 30...200 mm
- Horizontal or vertical mounting
- Stationary or mobile applications
- SafeZone 3 AOP for integration to safety logix system
- Rugged IP65 housings
- Scanning angles of 190°, 270° and 275°
- Seven-segment diagnostic display, rotatable by 180°
- EtherNet/IP version has colored text display



EtherNet/IP



## SafeZone 3

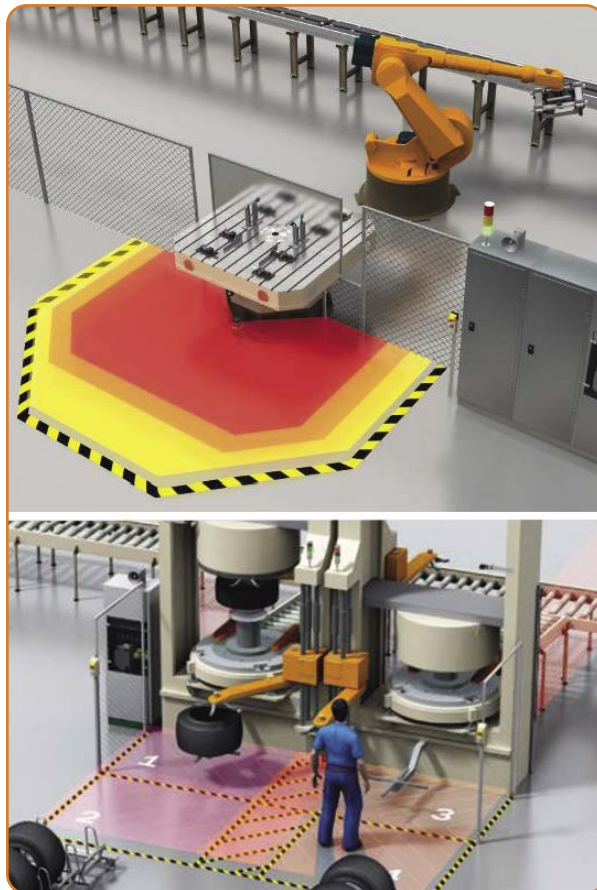

## A Flexible, Easy-to-Use Machine Safeguarding Solution

SafeZone™ safety laser scanners are Type 3 optoelectronic devices that use reflection of emitted infrared light to detect a person or object within a user-defined area. The Class 1 (eye safe) infrared laser scans a 190° to 275° angular area to create a two-dimensional detection field. Light reflected off an object or person in the field is processed by the SafeZone, which sends a stop signal to the machine or to the safety controller.

SafeZone Multizone has up to four configurable, switchable field sets (Safety and Warning). Two field sets can be simultaneously monitored.

SafeZone 3 has up to eight configurable fields, four safety and four warning. Up to four fields can be simultaneously monitored.

## SafeZone 3

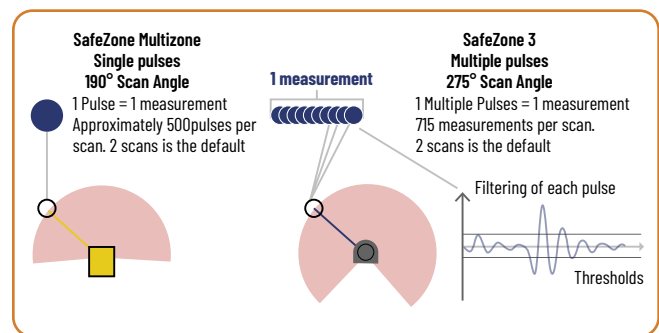

## Presence Sensing Devices



6-4...6-19

Interlock Switches



6-20...6-39

Access Control



6-40...6-41

Safety Relays



6-42...6-47

Emergency Stop Devices



6-48...6-49

Safety Limit Switches



6-50...6-51



## Product Selection

### SafeZone Safety Laser Scanners

Model	Application Specific Resolutions	Safety Outputs	Auxiliary Outputs	Angular Scanning Range	Safety Field Range	Cat. No.
SafeZone Mini: 2M&3M	30, 40, 50, 70, 150* mm	2 OSSDs	Two Configurable	270°	2 m, 3 m	42L-SFZNMN 442L-SFZNMN3
SafeZone Singlezone	30, 40, 50, 70, 150 mm	2 OSSDs	One	190°	4 m	442L-SFZNSZ
SafeZone Multizone	30, 40, 50, 70, 150 mm	2 OSSDs	One	190°	5 m	442L-SFZNMZ
SafeZone 3	30, 40, 50, 70, 150, 200 mm	4 Safety Bits	N/A	275°	5.5 m	442L-SZNMZCP

<sup>1</sup> SafeZone Mini 3M only.

### Required Parts for Singlezone, Multizone, SafeZone 3

Model	Description	Catalog Number
SafeZone Singlezone and Multizone	Prewired memory module, 10 or 20 m cable length	442L-CSFZNMZ-10 or 442L-CSFZNMZ-20
SafeZone 3	Memory Module	442L-SZNCPMOD

### Required Cable & Cordsets

Description	Cat. No.
Mini Scanner Cable: 8 pin M12 qd cordset, 2.5, 10, 20 m	442L-ACABL2 442L-ACABL10 442L-ACABL20
Singlezone, Multizone and Mini programming cable 2 m, 10 m	442L-ACUSB-2 442L-ACUSB-10
SafeZone 3 Power Cable -F is Straight, -R is Right angle	889D-F4AC-x <sup>2</sup> 889D-R4AC-x <sup>2</sup>
SafeZone 3 EtherNet Cables M12 to Flying leads M12 to M12 M12 to M12 Cat. 5 M12 to RJ45	1585D-M4UB-x <sup>2</sup> 1585D-M4UBDM-x <sup>2</sup> 1585D-M4UBDE-x <sup>2</sup> 1585D-M4UBJM-x <sup>2</sup>

<sup>2</sup> x is 2, 5 or 10 m standard lengths.

### Mounting Brackets

#### Singlezone or Multizone

Description	Cat. No.
Mounting kit 1: bracket for direct mounting at the rear of the scanner	442L-AMBSFZNMZ1
Mounting kit 2: mounts to bracket 1 only, horizontal adjustment.	442L-AMBSFZNMZ2
Mounting kit 3: mounts to bracket 1 and bracket 2 only, wall or floor mount	442L-AMBSFZNMZ3

#### SafeZone Mini

Description	Cat. No.
Mounting kit 1: mounts to scanner body	442L-AMBSZMN1
Mounting kit 2: mounts to scanner body with protection for optic window	442L-AMBSZMN2
Mounting kit 3: mounts to either mounting bracket 1 or bracket 2	442L-AMBSZMN3
Mounting kit 4: mounts to either mounting bracket 1 and 3 or bracket 2 and 3	442L-AMBSZMN4

#### SafeZone 3

Description	Cat. No.
Mounting kit 1: mounts to housing	442L-AMBSZCP1
Mounting kit 2: mounts to housing with protection for optic window	442L-AMBSZCP2
Mounting kit 3: mounts to bracket 1 or 2. Used when the system plug is installed on the bottom side of the safety laser scanner.	442L-AMBSZCP3
Mounting kit 4: mounts to bracket 1 or 2. Used when the system plug is installed on the rear side of the safety laser scanner.	442L-AMBSZCP4



# Presence Sensing Safety Devices

SAFETY

## Safety Mat System 440F

- Pressure-sensitive protective device per EN ISO 13856-1 for machine safeguarding
- Hardened steel plate construction
- No dead spots
- Four-wire system to detect opens and shorts
- Withstands 4500 psi static pressure
- IP67 rated
- PLd per ISO 13849-1 when used with a suitable safety control

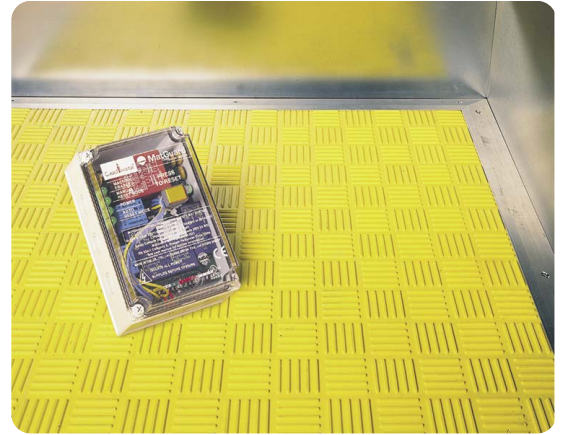

## Anatomy of a Safety Mat System

When integrated to a suitable safety mat controller, it detects a presence on the mat, a short circuit, or an open circuit. Under each of these conditions, the safety control issues a stop command. Multiple mats can be combined into one safety mat system with the use of joining trim.

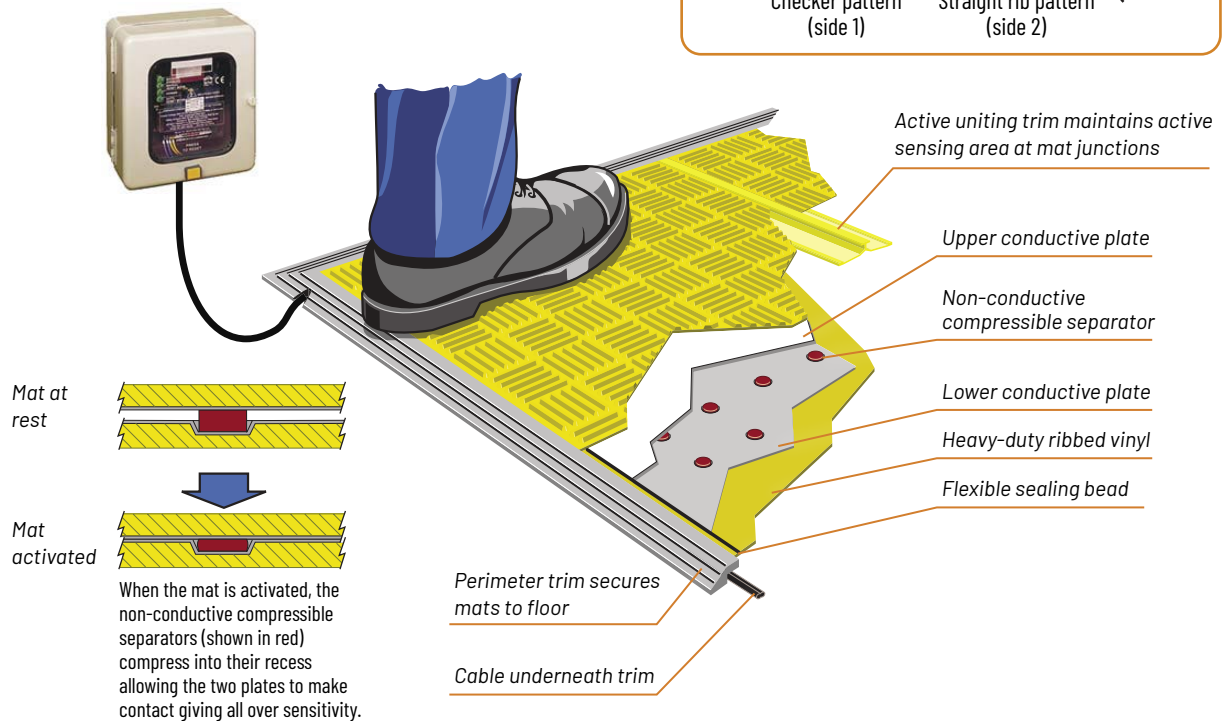
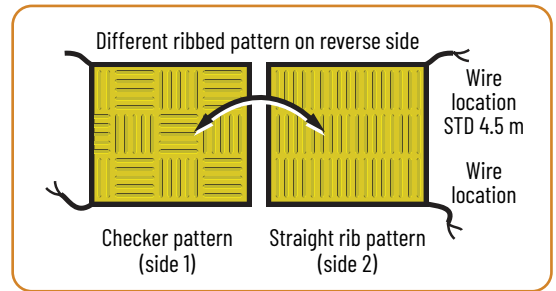

### Presence Sensing Devices



6-4...6-19



6-20...6-39

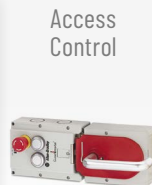

6-40...6-41



6-42...6-47



6-48...6-49



6-50...6-51





## Product Selection

### Safety Mats

Mat Size [mm (in.)]	Cat. No.	
	Standard Perimeter Trim Kit	Safety Mat
500 x 500 (19.7 x 19.7)	440F-T1010	440F-M1010BYNN
500 x 1500 (19.7 x 59.1)	440F-T1030	440F-M1030BYNN
750 x 1500 (29.5 x 59.1)	440F-T1530	440F-M1530BYNN
1000 x 1000 (39.4 x 39.4)	440F-T2020	440F-M2020BYNN
1000 x 1250 (39.4 x 49.2)	440F-T2025	440F-M2025BYNN
1000 x 1500 (39.4 x 59.1)	440F-T2030	440F-M2030BYNN
1000 x 1800 (39.4 x 70.9)	440F-T2036	440F-M2036BYNN

### Mat Control

Description	Cat. No.
MSR safety relay	440R-C23139
GSR SI (single input) safety relay	440R-S12R2
Multi-mat control (up to 8 sensor mats)	440F-C28014
440C-CR30 configurable safety relay	440C-CR30-22BBB

### Specifications

<b>Standards</b>	ISO 13856-1, ISO 13849-1
<b>Safety Classification</b>	Mat(s), connection cabling, and suitable mat safety control can achieve: SIL CL 2 per IEC 62061, PLd per ISO 13849-1
<b>Functional Safety Data</b>	Visit <a href="https://rok.auto/safety-sr001">https://rok.auto/safety-sr001</a>
<b>Certifications</b>	cULus Listed, TÜV Certified, and CE Marked for all applicable directives <a href="https://rok.auto/certifications">https://rok.auto/certifications</a>
<b>Power Supply</b>	24V DC, -20% +10%, provided by the control unit
<b>Mechanical Life</b>	1,000,000 operations

### Required Cordsets & Accessories

Description	Cat. No.	
Connection	4-Pin	5-Pin
Cordset	889D-F4AC-2 <sup>1</sup>	889D-F5AC-2 <sup>1</sup>
Patchcord	889D-F4ACDM-1 <sup>2</sup>	889D-F5ACDM-1 <sup>2</sup>
Distribution Box	898D-4 <sup>3</sup> LT-DM4	—
Shorting Plug	898D-41LU-DM	—
T-Port	898D-43LY-D4	—
Trim		Cat. No.
2 m perimeter trim with square end (up to 3 cables through channel)		440F-T3210
External corner perimeter trim for use with 440F-T3210 (up to 3 cables through channel)		440F-T3012
Internal corner perimeter trim for use with 440F-T3210 (up to 3 cables through channel)		440F-T3013
2 m, 2 part perimeter trim with square end (up to 8 cables through channel)		440F-T3211
External corner trim for use with 440F-T3211 (up to 8 cables through channel)		440F-T3014
Internal corner trim for use with 440F-T3211 (up to 8 cables through channel)		440F-T3015

**Note:** All perimeter trim features aluminum construction.

<sup>1</sup> Replace the **2** with **5** or **10** for available lengths in meters.

<sup>2</sup> Replace the **1** with **0M3**, **5**, or **10** for other available lengths in meters.

<sup>3</sup> Replace with **4** or **8** for number of ports available.

<sup>4</sup> Other 440F-C280xx controllers available with different voltages, connector types for Mats and Power. Please see technical data for additional catalog numbers.

**Note:** For additional information, see Safety Connection Systems (page 4-50).



### 440F Safedge™

- Conductive rubber technology
- Various profiles and cushion factors
- Up to 50 m lengths
- Aluminum, plastic, or zinc-coated steel mounting rails

For more information on our complete family of presence sensing safety device products, please visit: [rok.auto/safety-products](http://rok.auto/safety-products)





# Interlock Switches

SAFETY

## SensaGuard Non-Contact Switches 440N

- PLe Cat 4 per ISO 13849-1 (safety performance is maintained when connected in series)
- Type 4 interlocking device per ISO 14119 with low or high coded RFID actuators
- Standard, magnetic hold, and integrated latch versions
- IP69K washdown rating



## Non-contact Machine Safeguarding with RFID Technology

Featuring RFID technology for coding, inductive technology for sensing and combining a large sensing range with optimal operation and a generous tolerance to misalignment, SensaGuard™ switches offer a cost-effective solution that is ideally suited to a wide range of safety applications and is intended for use with all types of guard doors.

### Rectangular Flat Pack Version

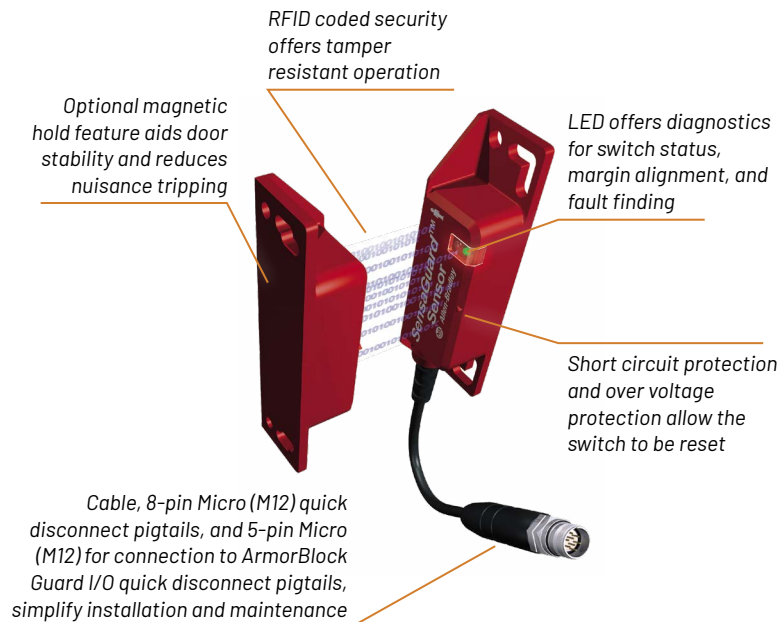

### Integrated Latch Version



Presence Sensing Devices



6-4...6-19

Interlock Switches



6-20...6-39

Access Control



6-40...6-41

Safety Relays



6-42...6-47

Emergency Stop Devices



6-48...6-49

Safety Limit Switches



6-50...6-51



# Product Selection

## SensaGuard Non-Contact Switches

Type	Assured Sensing Distance	Margin Indication	Magnetic Hold	Actuator Code Type	Cat. No.		
					Cable		Connector
					3 m	10 m	6 inch Pigtail, 8-pin Micro (M12) <sup>1</sup>
18 mm plastic barrel/18 mm actuator	On: 15 mm (0.59 in.)	—	—	Standard	440N-Z2IS16A	440N-Z2IS16B	440N-Z2IS16H
	Off: 25 mm (0.98 in.)			Unique	440N-Z2IU16A	440N-Z2IU16B	440N-Z2IU16H
18 mm plastic barrel/30 mm actuator	On: 25 mm (0.98 in.)	—	—	Standard	440N-Z2IS26A	440N-Z2IS26B	440N-Z2IS26H
	Off: 35 mm (1.38 in.)			Unique	440N-Z2IU26A	440N-Z2IU26B	440N-Z2IU26H
18 mm stainless steel barrel/18 mm actuator	On: 10 mm (0.39 in.)	—	—	Standard	440N-Z2IS17A	440N-Z2IS17B	440N-Z2IS17H
	Off: 20 mm (0.79 in.)			Unique	440N-Z2IU17A	440N-Z2IU17B	440N-Z2IU17H
Plastic rectangular/ rectangular actuator	On: 15 mm (0.59 in.)	—	—	Standard	440N-Z2ISS2A	440N-Z2ISS2B	440N-Z2ISS2H
				Unique	440N-Z2IUS2A	440N-Z2IUS2B	440N-Z2IUS2H
	Off: 25 mm (0.98 in.)	Yes	—	Standard	440N-Z2ISS2AN	440N-Z2ISS2BN	440N-Z2ISS2HN
				Unique	440N-Z2IUS2AN	440N-Z2IUS2BN	440N-Z2IUS2HN
		Yes	Yes (9 N)	Standard	440N-Z2ISS2AN9	440N-Z2ISS2BN9	440N-Z2ISS2HN9
				Unique	440N-Z2IUS2AN9	440N-Z2IUS2BN9	440N-Z2IUS2HN9
Plastic housing with integrated latch	On: Contact/latched	—	Adjustable 20...60 N	Standard	440N-Z2ISS3PA	440N-Z2ISS3PB	440N-Z2ISS3PH
	Off: 32 mm (1.26 in.)			Unique	440N-Z2ISU3PA	440N-Z2ISU3PB	440N-Z2ISU3PH

<sup>1</sup> For 5-pin Micro (M12) connector for connection to ArmorBlock Guard I/O, replace the H in the catalog letter with J.

## Specifications

<b>Standards</b>	ISO 14119, IEC 60947-5-3, IEC 61508, EN ISO 13849-1
<b>Safety Classification</b>	Type 4 Interlocking Device per ISO 14119 (Unique/ High and Standard/ Low Coding), PLe Cat 4 per ISO 13849-1
<b>Functional Safety Data</b>	Visit <a href="https://rok.auto/safety-sr001">https://rok.auto/safety-sr001</a>
<b>Certifications</b>	cULus Listed (UL 508), TÜV Certified, and CE Marked for all applicable directives <a href="https://rok.auto/certifications">https://rok.auto/certifications</a>

## Required Cordsets & Accessories

Description	Cat. No.
Cordset	889D-F8AB- <sup>2</sup>
Patchcord	889D-F8ABDM- <sup>3</sup>
Safety wired T-port	898D-438Y-D8
Safety wired shorting plug	898D-418U-DM

<sup>2</sup> Replace symbol with **2**, **5**, or **10** for standard cable lengths in meters.

<sup>3</sup> Replace symbol with **1**, **2**, **3**, **5**, or **10** for standard lengths in meters.

**Note:** For 5-pin Micro (M12) connector use 889D-F5ACDM-2.

**Note:** For additional information, see Safety Connection Systems (page 4-50).

SAFETY



# Interlock Switches

SAFETY

## Magnetically Coded Non-Contact Switches 440N

- Non-contact actuation
- Magnetic coded sensing
- Small size
- Molded-in mounting brackets
- High tolerance to misalignment
- Type 4 interlocking device per ISO 14119 with low coded actuators

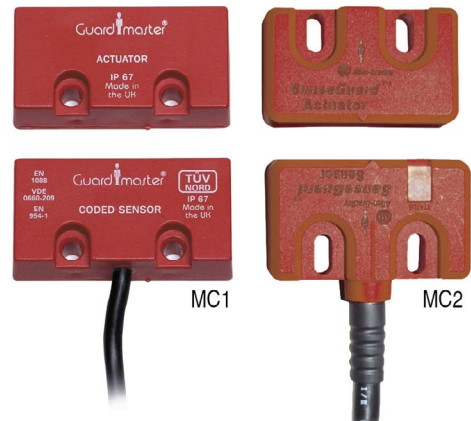

## Small Size, High Integrity

With the increasing speed and complexity of applications, a simple magnetic switch may be insufficient to meet the increased risks. The Magnetically Coded MC1 and MC2 non-contact switches incorporate several magnetically sensitive elements, which must be triggered in a particular sequence to operate correctly. The sensor with its molded-in brackets and diminutive size, is extremely versatile and simple to install.

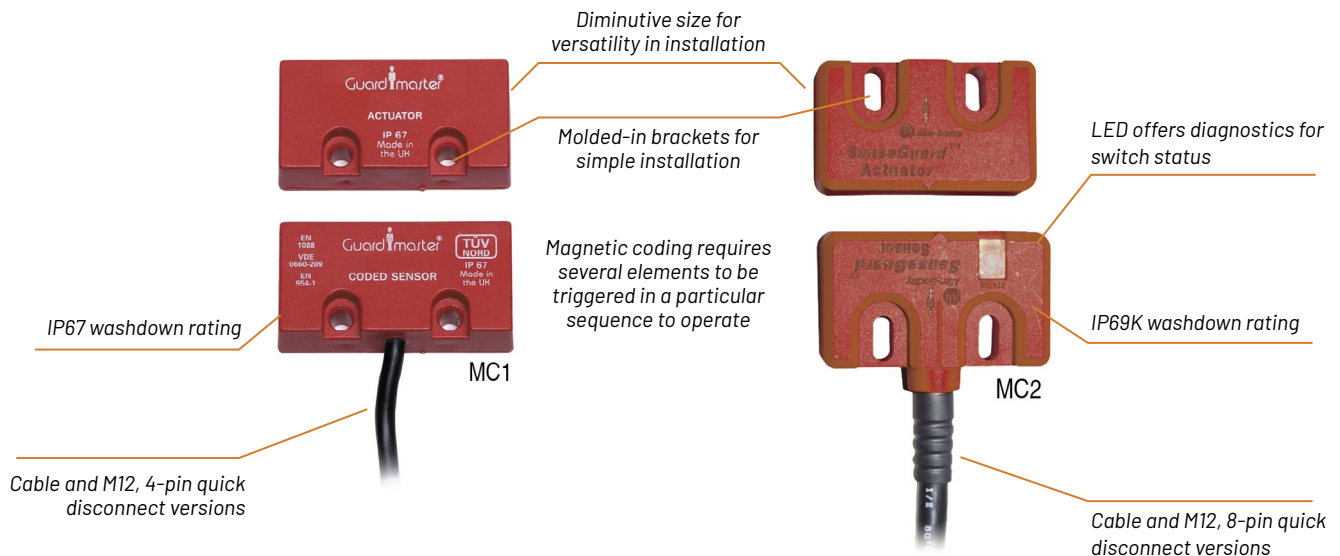

6-22

Presence Sensing Devices



6-4...6-19

**Interlock Switches**



**6-20...6-39**

Access Control



6-40...6-41

Safety Relays



6-42...6-47

Emergency Stop Devices



6-48...6-49

Safety Limit Switches



6-50...6-51



## Product Selection

### Magnetically Coded Non-Contact Switches

Type	Operating Voltage/ Input Current	Safety Outputs	Auxiliary Outputs	Status Indicator	Connection	Cat. No.
MC1	—	2 N.C. REEDS	—	No	4-pin micro (M12)	440N-Z2NRS1C
					3 m cable	440N-Z2NRS1A
					10 m cable	440N-Z2NRS1B
MC2	24V DC, +10%/15%/ 50 mA max.	2 N.C. Solid- State Relays	1 x PNP, 0.2 A max.; Status: OFF (0V DC)	Yes	8-pin micro (M12)	440N-Z21W1PH
					3 m cable	440N-Z21W1PA
					10 m cable	440N-Z21W1PB

## Specifications

<b>Standards</b>	ISO 14119, IEC 60947-5-3, ISO 13849-1 when used with approved safety control
<b>Safety Classification</b>	Type 4 Interlocking Device with low coding per ISO 14119
<b>Functional Safety Data</b>	Visit <a href="https://rok.auto/safety-sr001">https://rok.auto/safety-sr001</a>
<b>Certifications</b>	CULus Listed, TÜV Certified, and CE Marked for all applicable directives <a href="https://rok.auto/certifications">https://rok.auto/certifications</a>

## Required Cordsets & Accessories

Description	Cat. No.	
Cordset	889D-F4AC- <sup>1</sup>	889D-F8AB- <sup>1</sup>
Patchcord	889D-F4ACDM- <sup>2</sup>	889D-F8ABDM- <sup>2</sup>
Distribution box	898D-4 <sup>3</sup> LT-DM4	—
Shorting plug	898D-41LU-DM	—
T-port	898D-43LY-D4	—

<sup>1</sup> Replace symbol with **2**, **5**, or **10** for standard cable lengths in meters.

<sup>2</sup> Replace symbol with **1**, **2**, **3**, **5**, or **10** for standard lengths in meters.

<sup>3</sup> Replace with **4** or **8** for number of ports available.

**Note:** For additional information, see Safety Connection Systems (page 4-50).



### Sales Offices and Distributors

Our network of sales offices and distributors offers exceptional knowledge and service to help you design, implement and support your automation investment.

[rok.auto/buy](https://rok.auto/buy)



# Interlock Switches



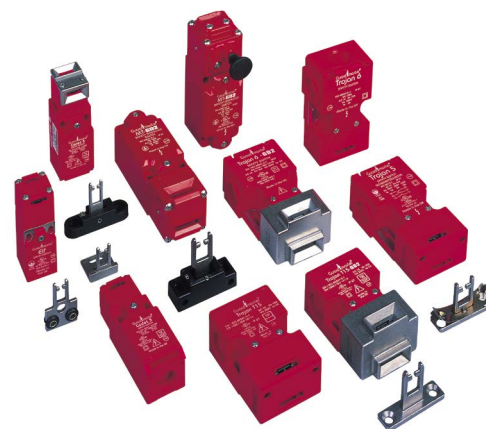

SAFETY

## Tongue Interlock Switches 440K

- A full range of guard interlocking switches
- Holding forces up to 40 N
- Multiple actuator options
- Conduit or quick disconnect models
- Optional GD2 heavy duty stainless steel style heads for increased robustness
- Type 2 interlocking devices per ISO 14119 with low coded tongue-shaped actuators



## A Complete Range of Guard Interlocking Solutions

	Trojan™ T15	Trojan T5 & T6 <sup>1</sup>	Elf™	Cadet™	MT-GD2
Description					
Dimensions [H x W x D]	75 x 31 x 52 mm (2.95 x 1.22 x 2.05 in.)	95 x 32 x 52 mm (3.74 x 1.26 x 2.05 in.)	75 x 25 x 29 mm (2.95 x 0.98 x 1.14 in.)	90.5 x 31 x 30.4 mm (3.56 x 1.22 x 1.2 in.)	116.5 x 38 x 40 mm (4.59 x 1.5 x 1.57 in.)
Break Contact Force	30 N	T5: 12 N typical, max. 30 N T6: 20 N	6 N	15 N	12, 32, 40 N
Safety/Aux. Contacts	2 N.C. 1 N.C./1 N.O.	T5: 2 N.C./1 N.O. T6: 3 N.C./1 N.O. T6: 2 N.C./2 N.O.	2 N.C. 1 N.C./1 N.O.	3 N.C. 2 N.C./1 N.O.	3 N.C./1 N.O. 2 N.C./2 N.O.
Material	Plastic w/plastic or metal head (GD2)	Plastic w/plastic or metal head (GD2)	Plastic w/optional metal alignment guide	Plastic w/optional metal alignment guide	Metal
Actuator Options	Standard & fully flexible	Standard, semi-flexible, & fully flexible	Flat, 90°, & semi-flexible	Flat, 90°, & semi-flexible	Standard, fully flexible, & extended flat

<sup>1</sup> Four-contact models are available (Trojan 6).

Presence Sensing Devices



6-4...6-19

Interlock Switches



6-20...6-39

Access Control



6-40...6-41

Safety Relays



6-42...6-47

Emergency Stop Devices



6-48...6-49

Safety Limit Switches



6-50...6-51

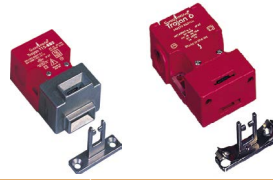

## Product Selection

### Trojan T15 & Trojan 5 Standard Plastic Switches

Type	Contact		Contact Action <sup>2</sup>	Actuator Type	Cat. No.		
	Safety	Auxiliary			M20 Conduit		Connector Micro (M12) <sup>3</sup>
					M20	1/2 in. NPT Adaptor	
Trojan T15 standard	2 N.C.	—	—	Standard	440K-T11303	440K-T11267	440K-T11307
				Fully flexible	440K-T11395	440K-T11273	440K-T11384
	1 N.C.	1 N.O.	BBM	Standard	440K-T11305	440K-T11268	440K-T11386
				Fully flexible	440K-T11396	440K-T11276	440K-T11387
Trojan T15 GD2 (metal head)	2 N.C.	—	—	GD2 Standard	440K-T11463	440K-T11288	440K-T11389
				Fully flexible	440K-T11397	440K-T11287	440K-T11390
	1 N.C.	1 N.O.	BBM	GD2 Standard	440K-T11398	440K-T11284	440K-T11392
				Fully flexible	440K-T11399	440K-T11283	440K-T11393
Trojan 5 standard	2 N.C.	1 N.O.	BBM	Standard	440K-T11090	440K-T11202	440K-T11205
				Semi-flexible	440K-T11110	440K-T11203	440K-T11206
				Fully flexible	440K-T11467	440K-T11204	440K-T11207
Trojan 5 GD2 (metal head)			BBM	GD2 standard	440K-T11336	440K-T11211	440K-T11366
				Semi-flexible	440K-T11337	440K-T11212	440K-T11367
				Fully flexible	440K-T11338	440K-T11213	440K-T11368
Trojan 5 30 N			BBM	Standard	440K-T11333	440K-T91024	440K-T11492

<sup>2</sup> Make Before Break (MBB) contact versions are also available.

<sup>3</sup> Trojan T15 uses a 4-pin connector and Trojan 5 uses a 6-pin connector.

## Specifications

<b>Standards</b>	ISO 14119, IEC 60947-5-1
<b>Safety Classification</b>	Type 2 Interlocking Device per ISO 14119
<b>Functional Safety Data</b>	Visit <a href="https://rok.auto/safety-sr001">https://rok.auto/safety-sr001</a>
<b>Certifications</b>	cULus Listed, TÜV Certified, and CE Marked for all applicable directives <a href="https://rok.auto/certifications">https://rok.auto/certifications</a>
<b>Outputs</b>	
<b>Thermal Current/<sub>I<sub>th</sub></sub></b>	10 A
<b>Switching Current @ Voltage</b>	3 mA @ 18V DC, min.
<b>Operating Characteristics</b>	
<b>Operating Radius</b>	175 mm (6.89 in.) [60 mm (2.36 in.) with flexible actuator, min.]
<b>Mechanical Life</b>	1,000,000 operations

## Required Cordsets & Accessories

Description	Cat. No.
GD2 standard actuator	440G-A27011
T5 standard actuator	440K-A11095
GD2 flat actuator	440K-A11112
T15 standard actuator	440K-A11238
Fully flexible actuator	440K-A27010
4-pin micro (M12) QD cordset	889D-F4AC- <sup>4</sup>
4-pin micro (M12) QD patchcord	889D-F4ACDM- <sup>5</sup>
6-pin micro (M12) QD cordset	889R-F6ECA- <sup>4</sup>
6-pin micro (M12) QD patchcord	889R-F6ECRM- <sup>5</sup>

<sup>4</sup> Use **2, 5, or 10** for standard cable lengths in meters.

<sup>5</sup> Use **1, 2, 3, 5, or 10** for standard cable lengths in meters.

**Note:** For additional information, see Safety Connection Systems (page 4-50).





# Interlock Switches



## Product Selection

### Elf Miniature Plastic Switches

Contact			Actuator Type	Cat. No.		
				M16 Conduit		Connector
Safety	Auxiliary	Action		M16	1/2 in. NPT Adaptor	4-pin Micro (M12)
1 N.C.	1 N.O.	BBM	90°	440K-E33040	440K-E33030	440K-E33025
			Semi-flexible	440K-E33034	440K-E33031	440K-E33075
2 N.C.	-	-	90°	440K-E33041	440K-E33045	440K-E33024
			Semi-flexible	-	440K-E33046	440K-E33078

### Cadet 3 Compact Plastic Switches

Contact			Actuator Type	Cat. No.		
				M16 Conduit		Connector
Safety	Auxiliary	Action		M16	1/2 in. NPT Adaptor	6-pin Micro (M12)
3 N.C.	-	-	90°	440K-C21097	440K-C21057	440K-C21091
			Semi-flexible	-	440K-C21062	440K-C21092
2 N.C.	1 N.O.	BBM	90°	440K-C21061	440K-C21058	440K-C21067
			Semi-flexible	-	440K-C21074	440K-C21088

## Specifications

<b>Standards</b>	ISO 14119
<b>Safety Classification</b>	Type 2 Interlocking Device per ISO 14119
<b>Functional Safety Data</b>	Visit <a href="http://literature.rockwellautomation.com/idc/groups/literature/documents/sr/safety-sr001_en-e.pdf">http://literature.rockwellautomation.com/idc/groups/literature/documents/sr/safety-sr001_en-e.pdf</a>
<b>Certifications</b>	cULus Listed, TÜV Certified, and CE Marked for all applicable directives <a href="https://rok.auto/certifications">https://rok.auto/certifications</a>
<b>Outputs</b>	
<b>Thermal Current/<sub>I<sub>th</sub></sub></b>	5 A (10 A if A600)
<b>Switching Current @ Voltage</b>	3 mA @ 18V DC, min.
<b>Operating Characteristics</b>	
<b>Operating Radius</b>	150 mm (5.90 in.) [60 mm (2.36 in.) with semi-flexible actuator, min.]
<b>Mechanical Life</b>	1,000,000 operations

## Required Cordsets & Accessories

Description	Cat. No.
4-pin micro (M12) QD cordset	889D-F4AC-1
6-pin micro (M12) QD cordset	889R-F6ECA-1
4-pin micro (M12) QD patchcord	889D-F4ACDM-2
6-pin micro (M12) QD patchcord	889R-F6ECRM-2
Flat actuator <sup>3</sup>	440K-A21014
90° actuator <sup>3</sup>	440K-A21006
Metal alignment guide with semi-flexible actuator	440K-A21030

<sup>1</sup> Use **2**, **5**, or **10** for standard cable lengths in meters.

<sup>2</sup> Use **1**, **2**, **3**, **5**, or **10** for standard cable lengths in meters.

<sup>3</sup> Not to be used with metal alignment guide.

**Note:** For additional information, see Safety Connection Systems (page 4-50).

Presence Sensing Devices



6-4...6-19

### Interlock Switches



6-20...6-39

Access Control



6-40...6-41

Safety Relays



6-42...6-47

Emergency Stop Devices



6-48...6-49

Safety Limit Switches



6-50...6-51



## Product Selection

### MT-GD2 Metal Body Switches

Type	Contact		Contact Action <sup>1</sup>	Actuator Type	Cat. No.		
	Safety	Auxiliary			M20 Conduit		Connector
					M20	1/2 in. NPT Adaptor	12-pin (M23)
MT-GD2	3 N.C.	1 N.O.	BBM	GD2 standard	440K-MT55074	440K-MT55022	440K-MT55095
				Fully flexible	440K-MT55075	440K-MT55029	440K-MT55096
	2 N.C.	2 N.O.		GD2 standard	440K-MT55076	440K-MT55026	440K-MT55098
				Fully flexible	440K-MT55077	440K-MT55087	440K-MT55099
MT-GD2 latch release	3 N.C.	1 N.O.		GD2 standard	440K-MT55078	440K-MT55041	440K-MT55070
				Fully flexible	440K-MT55079	440K-MT55045	440K-MT55103
	2 N.C.	2 N.O.		GD2 standard	440K-MT55080	440K-MT55050	440K-MT55104
				Fully flexible	440K-MT55081	440K-MT55051	440K-MT55052

<sup>1</sup> Make Before Break (MBB) and snap acting contact versions are also available.

## Specifications

<b>Standards</b>	ISO 14119, ISO 13849-1, IEC 60947-5-1
<b>Safety Classification</b>	Type 2 interlocking device per ISO 14119
<b>Functional Safety Data</b>	Visit <a href="https://rok.auto/safety-sr001">https://rok.auto/safety-sr001</a>
<b>Certifications</b>	cULus Listed, TÜV Certified, and CE Marked for all applicable directives <a href="https://rok.auto/certifications">https://rok.auto/certifications</a>
<b>Outputs</b>	
<b>Thermal Current/<sub>th</sub></b>	10 A
<b>Switching Current @ Voltage</b>	3 mA @ 18V DC, min.
<b>Operating Characteristics</b>	
<b>Break Contact Force</b>	12 N (1.35 lbf), min.
<b>Operating Radius</b>	150 mm (5.90 in.) [60 mm (2.36 in.) with GD2 kit, min.]
<b>Mechanical Life</b>	1,000,000 operations

## Required Cordsets & Accessories

Description	Cat. No.
12-pin (M23) QD cordset	889M-FX9AE- <sup>2</sup>
GD2 standard actuator	440G-A27011
GD2 flat actuator	440K-A1112
Fully flexible actuator	440K-A27010

<sup>2</sup> Use **2**, **5**, or **10** for standard cable lengths in meters.

**Note:** For additional information, see Safety Connection Systems (page 4-50).

## Additional Safety Switches

- 440G-MT Guard Locking Solenoid Switches
- 440H Hinge Interlock Switches
- 440J Enabling Switches



# Interlock Switches

SAFETY

## Electromagnetic Switches 440G-EZ

- PLe Cat 4, SIL CL3 for door position monitoring
- Type 4 interlocking device with a Power to Lock (PTL) electromagnetic locking function for process protection per ISO 14119
- Solid state OSSD outputs
- High tolerance to door offset within 5 mm (0.2 in.) in all directions
- IP69K enclosure rating
- Status indicators for switch and lock status
- Sensor can be surface mounted or flush mounted

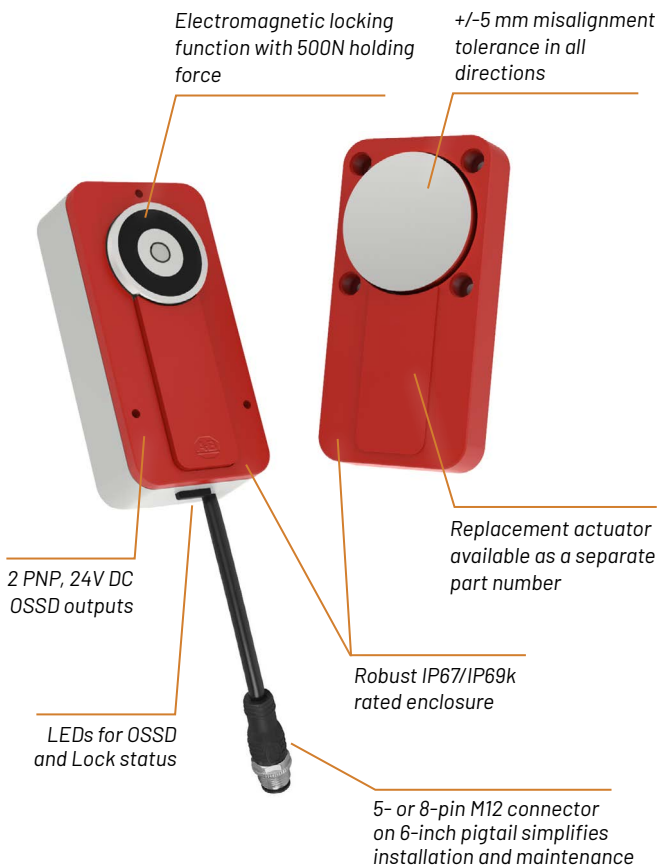

## Protection for Personnel and Process

Guardmaster® safety switches help protect personnel, processes and equipment by providing physical interlocking of guard doors, allowing access to potentially hazardous areas only when the area is safe.

The 440G-EZ electromagnetic interlocking safety switch is designed to protect a working process from unplanned downtime to improve productivity and increase efficiency while providing personnel safety.

The 440G-EZ electromagnetic safety switch combines a PTL electromagnetic locking function featuring a 500N holding force and  $\pm 5$  mm misalignment tolerance. Intended for use on all types of guard doors, 440G-EZ electromagnetic safety switches are TÜV-certified up to Cat 4, SIL3, PLe – the highest level of safety for guard position monitoring – and can be connected in series with other Cat 4, SIL 3 or PLe rated safety devices.

Presence Sensing Devices



6-4...6-19

Interlock Switches



6-20...6-39

Access Control



6-40...6-41

Safety Relays



6-42...6-47

Emergency Stop Devices



6-48...6-49

Safety Limit Switches



6-50...6-51



## Product Selection

### 440G-EZ Electromagnetic Switches

Description	Cat. No. <sup>1</sup>
5-pin Micro QD version (for point-to-point wiring)	440G-EZS21STL05J
8-pin Micro QD version (for series wiring)	440G-EZS21STL05H
Replacement actuator	440G-EMAS

<sup>1</sup> Product is supplied with safety switch, actuator, 4 screw hole caps and installation instructions.

## Specifications

<b>Standards</b>	IEC 60947-5-3, IEC 60947-5-1, IEC 61508, EN ISO 13849-1, IEC 62061, ISO 14119, UL 508
<b>Safety Classification</b>	Type 4 Interlocking Device per ISO 14119 with a power to lock (PTL) electromagnetic locking function for process protection PLe Cat 4 per ISO 13849-1 and SIL CL3 per IEC 61508 and IEC 62061
<b>Functional Safety</b>	PFHd 1.5 x 10 <sup>-8</sup> (EN ISO 13849). Mission time/PTI: 20 years
<b>Certifications</b>	CE marked for all applicable EU directives, c-UL-us (UL 508), TÜV, C-Tick
<b>Input Voltage</b>	24V DC
<b>Holding Force</b>	500 N
<b>Retaining force</b>	25 N
<b>Safety Outputs</b>	2 x PNP, 100 mA max., Status: ON (+24V DC)
<b>Auxiliary Outputs</b>	0.2 A, 25 mA max., (resistive load)
<b>Enclosure Type Rating</b>	IP67, IP69K

## Required Accessories

Description	Cat. No.
8-pin micro (M12) QD cordset	889D-F8AB <sup>2</sup>
8-pin micro (M12) QD patchcord	889D-F8ABDM <sup>1</sup>
5-pin micro (M12) QD cordset	889D-F5AC <sup>2</sup>
5-pin micro (M12) QD patchcord	889D-F5ACDM <sup>1</sup>
Standard Actuator	440G-EMAS

<sup>1</sup> (2 m), 5 (5 m), or 10 (10 m) for standard cable lengths.

<sup>2</sup> (1 m), 2 (2 m), 3 (3 m), 5 (5 m), or 10 (10 m) for standard cable lengths.



# Interlock Switches

SAFETY

## Guard Locking Switches 440G-LZ

- PLe Cat 4, SIL CL3 – the highest level of safety for guard position and lock monitoring
- Solid-state OSSD outputs
- RFID unique (high) or standard (low) coded actuators
- High holding force for partial body access applications
- Power-to-release and power-to-lock versions
- IP69K and hygienic design
- Type 4 interlocking device with guard locking per ISO 14119 with low or high coded RFID actuators
- Auxiliary output versions: lock status or guard proximity

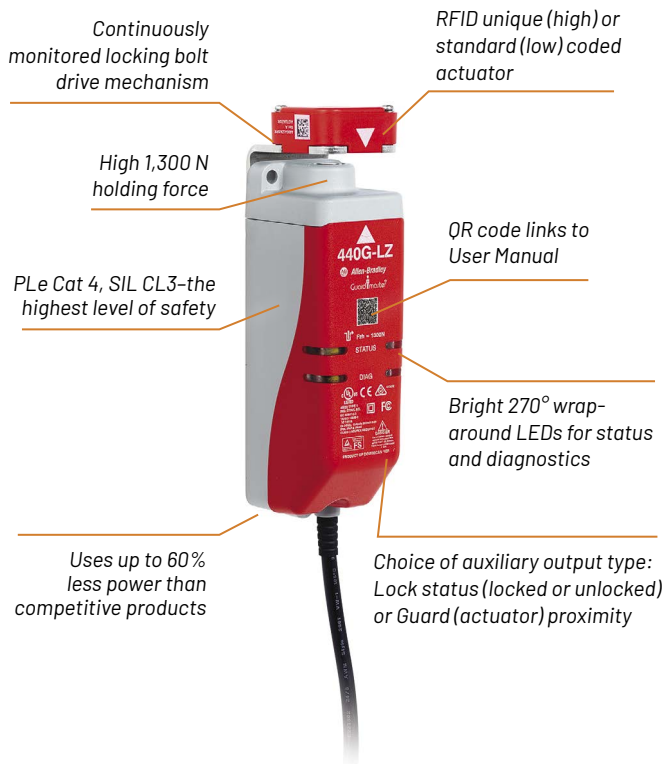

## The Highest Level of Safety

The Guardmaster® 440G-LZ is a guard locking switch designed for partial body access guards. Combining microprocessor technology with an RFID coded actuator, the 440G-LZ features a locking bolt drive mechanism that will only lock when the correct actuator is detected. The locking bolt is continuously monitored for correct insertion within the actuator. This extra functionality allows the 440G-LZ to be certified PLe Cat 4, SIL CL3 – the highest level of safety for guard position and lock monitoring – and it can be connected directly or in series with other PLe Cat 4 or SIL CL3 rated safety devices.



Presence Sensing Devices



6-4...6-19

Interlock Switches



6-20...6-39

Access Control



6-40...6-41

Safety Relays



6-42...6-47

Emergency Stop Devices



6-48...6-49

Safety Limit Switches



6-50...6-51



## Product Selection

### 440G-LZ Guard Locking Switches

Locking Type	Actuator Type	Cat. No. <sup>1</sup>			
		Connector Type			
		3 m Lead	10 m Lead	6-in. Pigtail with M12 5-pin QD	6-in. Pigtail with M12 8-pin QD
Power-to-release	Standard (low level to EN/ISO 14119:2013)	440G-LZS2IS⊗RA	440G-LZS2IS⊗RB	440G-LZS2ISJRJ	440G-LZS2IS⊗RH
	Unique (high level to EN/ISO 14119:2013)	440G-LZS2IU⊗RA	440G-LZS2IU⊗RB	440G-LZS2IUJRJ	440G-LZS2IU⊗RH
Power-to-lock	Standard (low level to EN/ISO 14119:2013)	440G-LZS2IS⊗LA	440G-LZS2IS⊗LB	440G-LZS2ISJLJ	440G-LZS2IS⊗LH
	Unique (high level to EN/ISO 14119:2013)	440G-LZS2IU⊗LA	440G-LZS2IU⊗LB	440G-LZS2IUJLJ	440G-LZS2IU⊗LH

<sup>1</sup> To select auxiliary output type, replace ⊗ in front of last two letters in catalog number with **P** for lock status or **T** for guard proximity. Example: 440G-TZS2IU<sup>TRH</sup>.

## Specifications

Standards	ISO 14119, IEC 60947-5-3, ISO 13849-1, IEC 62061
Safety Classification	Type 4 Interlocking Device with Guard Locking per ISO 14119 with low (standard) and high (unique) coding per ISO 14119 PLe Cat 4 per ISO 13849-1 and SIL CL3 per IEC 62061
Functional Safety	Visit <a href="https://rok.auto/safety-sr001">https://rok.auto/safety-sr001</a>
Certifications	cULus Listed, TÜV Certified, and CE Marked for all applicable directives <a href="https://rok.auto/certifications">https://rok.auto/certifications</a>
Power Supply	24V DC +10%/-15% Class 2 SELV
Holding Force Fzh (ISO 14119:2013)	1,300 N
Safety Outputs	2 x PNP, 0.2 A max., Status: ON (+24V DC)
Auxiliary Outputs	1 x PNP, 0.2 A max., Status: OFF (0V DC)
Enclosure Type Rating	NEMA 3, 4X, 12, 13, IP66, IP67, IP69K

## Required Cordset & Accessories

Description	Cat. No.
8-pin micro (M12) QD cordset	889D-F8AB- <sup>2</sup>
Standard power-to-release actuator	440G-LZASPR
Unique power-to-release actuator	440G-LZAUPR
Standard power-to-lock actuator	440G-LZASPL
Unique power-to-lock actuator	440G-LZAUPL
Actuator mounting bracket	440G-LZAM1
Switch body mounting bracket	440G-LZAM2

<sup>2</sup> Use **2**, **5**, or **10** for standard cable lengths in meters.

**Note:** For additional information, see Safety Connection Systems (page 4-50).



**Connected Components**  
Simpler, faster, cost-effective machine building.  
[rok.auto/ccw](http://rok.auto/ccw)





# Interlock Switches

SAFETY

## Guard Locking Switches 440G-MZ

- SIL 3, PLe, Cat 4 – the highest level of safety for guard position monitoring and guard locking
- Can operate as a standalone device (5-pin OSSD connection) or in a GuardLink system
- RFID unique (high) or standard (low) coded actuators
- High holding force optimized for full-sized guard doors, which allow whole body access to a safeguarded area
- IP65, IP66, IP67, IP69k rated



## Guard Locking for Whole Body Access

440G-MZ Guard locking switches help protect personnel and are suitable for use with many types of guard doors, including full-sized guard doors, which allow whole body access to the safeguarded area, where a high holding force and a wide tolerance to guard misalignment are commonly required.

The 440G-MZ has embedded GuardLink® technology making it a smart device that provides the benefits of enunciation and product-specific diagnostics. It reduces wiring, simplifies installation and enables premier integration via an Ethernet/IP communications adapter and safety logic device when connected in a GuardLink system using a passive tap.

Switch can operate as a standalone device (OSSD mode) or in a GuardLink system (GuardLink mode)

2500 N holding force suitable for full-size guard doors

RFID actuator (unique coded or standard)

Flexible and 360° rotatable actuator facilitates +/- 5 mm misalignment tolerance and mounting flexibility

Three directions of approach for mounting flexibility

Two bright 270° wrap-around LEDs – for DEVICE and LINK status

Ingress rating: IP65, IP66, IP67, IP69k



Escape Release Model

6-32

Presence Sensing Devices



6-4...6-19

Interlock Switches



6-20...6-39

Access Control



6-40...6-41

Safety Relays



6-42...6-47

Emergency Stop Devices



6-48...6-49

Safety Limit Switches



6-50...6-51



## Product Selection

### 440G-MZ Guard Locking Switches

Model Type	Actuator Type	Solenoid Voltage	Connection Type	Holding Force <sup>2</sup>	Escape Release	Cat No. <sup>3</sup>
Power to release	2 x PNP (0.2 mA max.), No Aux	24V DC <sup>1</sup>	6-in. pigtail with M12 5-pin QD	2500 N	No	440G-MZS20SNRJ
					Yes	440G-MZS20SNRJE
Power to release	2 x PNP (0.2 mA max.), No Aux	24V DC <sup>1</sup>	6-in. pigtail with M12 5-pin QD	2500 N	No	440G-MZS20UNRJ
					Yes	440G-MZS20SNRJE
Power to lock	2 x PNP (0.2 mA max.), No Aux	24V DC <sup>1</sup>	6-in. pigtail with M12 5-pin QD	2500 N	No	440G-MZS20SNLJ
					Yes	440G-MZS20SNRJE
Power to lock	2 x PNP (0.2 mA max.), No Aux	24V DC <sup>1</sup>	6-in. pigtail with M12 5-pin QD	2500 N	No	440G-MZS20UNLJ
					Yes	440G-MZS20SNRJE

<sup>1</sup> Use power supply Ue 24V DC +10% / -15% Class 2 PELV.

<sup>2</sup> Fzh as per ISO 14119.

<sup>3</sup> For Escape Release models add "E" to end of catalog number.

## Specifications

<b>Standards</b>	ISO 14119, IEC 60947-5-3, ISO 13849-1, IEC 62061
<b>Safety Classification</b>	Type 4 Interlocking Device with Guard Locking per ISO 14119 with low (standard) and high (unique) coding per ISO 14119 PLe Cat 4 per ISO 13849-1 and SIL cl3 per IEC 62061
<b>Functional Safety</b>	Proof test interval = 20 years; • OSSD mode PFHd = 3.17E-09 / PFD = 3.67E-04 • GuardLink® mode PFHd = 2.93E-09 / PFD = 3.59E-04
<b>Certifications</b>	cULus Listed, TÜV Certified, and CE Marked for all applicable directives <a href="https://rok.auto/certifications">https://rok.auto/certifications</a>
<b>Power Supply</b>	24V DC +10%/-15% Class 2 PELV
<b>Holding Force Fzh (ISO 14119)</b>	2500 N
<b>Safety Outputs</b>	2 x PNP, 0.2 A max., Status: ON (+24V DC)
<b>Enclosure Type Rating</b>	IP65, IP66, IP67, IP69, IP69K

## Required Cordset

Description	Cat. No.
5-pin micro (M12) QD cordset	889D-F5AC- <sup>4</sup>

<sup>4</sup> Use **2**, **5**, or **10** for standard cable lengths in meters.

**Note:** For additional information, see Safety Connection Systems (page 4-50).

## Accessories

Model Type	Cat. No.	
Actuator mounting bracket	L-shaped	440G-MZAM1
	Z-shaped	440G-MZAM2
Switch mounting bracket	440G-MZAM3	
Padlock accessory	440G-MZAL	
Auxiliary Release Tool	440G-MZAT	
Replacement Screw	440G-MZRSC	
Replacement Button	440G-MZRBU	



# Interlock Switches

SAFETY

## TLS-Z GD2 Guard Locking Switches 440G

- Type 4 Interlocking Devices with guard locking
- Meets PLe, Cat 4 per ISO 13849-1, the highest level of safety
- RFID high level coded actuator
- Solid-state series connectable OSSD outputs
- High holding force (Fzh)
- Power-to-release and power-to-lock versions
- Auxiliary output versions: lock status or guard proximity

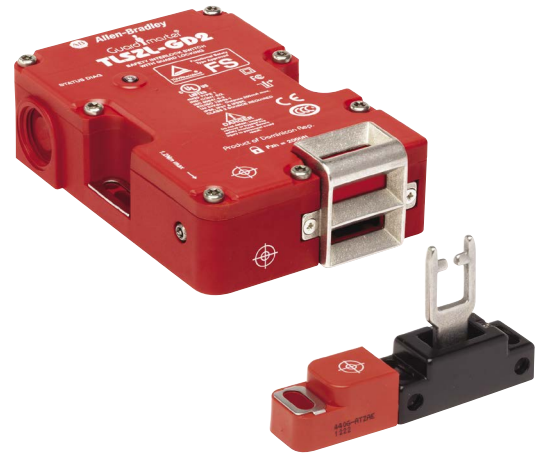

## Guard Locking Plus RFID Technology for Whole Body Access

The TLS-Z GD2 Guard Locking Switch is an interlock switch that has a uniquely coded RFID door sensor with inductive door position sensing technology. This switch can detect if an actuator key breaks or becomes separated from its door mounted position. Built with the same solid-state technology as the SensaGuard, this switch supports the highest level of safety – Performance Level “e”, Cat 4 per ISO 13849-1 for the guard position and lock monitoring.

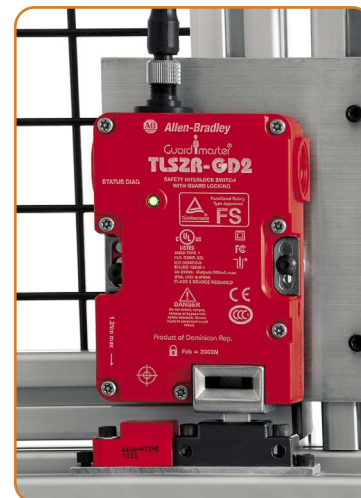
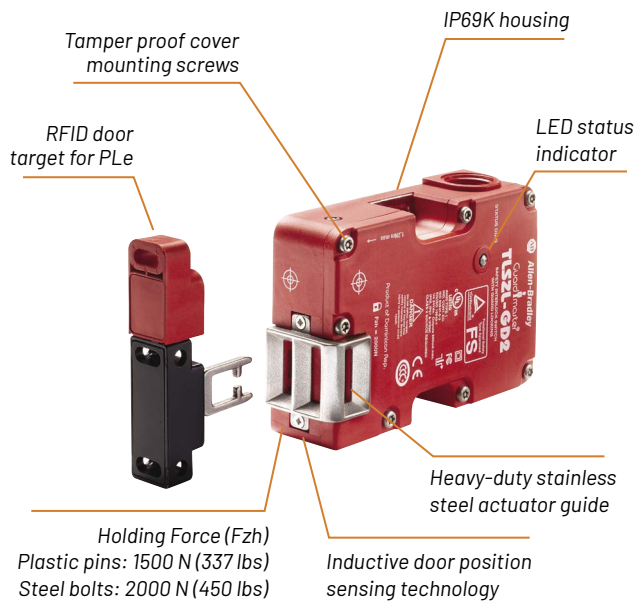

Presence Sensing Devices



6-4...6-19

Interlock Switches



6-20...6-39

Access Control



6-40...6-41

Safety Relays



6-42...6-47

Emergency Stop Devices



6-48...6-49

Safety Limit Switches



6-50...6-51



## Product Selection

### TLS-Z GD2 Guard Locking Switches

Type	Outputs		Voltage	Connector	Cat. No. <sup>1</sup>
	Safety (OSSD)	Auxiliary			
Power-to-release	2 x PNP, 0.2 A max., Status: ON (+24V DC)	1 x PNP, 0.2 A max., Status: OFF (0V DC)	24V DC	8-pin micro (M12)	440G-TZS2IU⊗RH
Power-to-lock					440G-TZS2IU⊗LH

<sup>1</sup> To select auxiliary output type, replace ⊗ in front of last two letters in catalog number with **P** for lock status or **T** for guard proximity. Example: 440G-TZS2IU**T**RH.

## Specifications

<b>Standards</b>	ISO 14119, IEC 60947-5-3, ISO 13849-1
<b>Safety Classification</b>	Type 4 Interlocking Device with Guard Locking per ISO 14119 with high (unique) coding per ISO 14119 PLc Cat 4 per ISO 13849-1
<b>Functional Safety</b>	Visit <a href="https://rok.auto/safety-sr001">https://rok.auto/safety-sr001</a>
<b>Certifications</b>	cULus Listed, TÜV Certified, and CE Marked for all applicable directives <a href="https://rok.auto/certifications">https://rok.auto/certifications</a>
<b>Power Supply</b>	24V DC +10%/-15% Class 2
<b>Holding Force Fzh (ISO 14119)</b>	Plastic pins: 1500 N (337 lbs) Steel bolts: 2000 N (450 lbs)
<b>Safety Outputs</b>	2 x PNP, 0.2 A max., Status: ON (+24V DC)
<b>Auxiliary Outputs</b>	1 x PNP, 0.2 A max., Status: OFF (0V DC)
<b>Enclosure Type Rating</b>	NEMA 3, 4X, 12, 13, IP66, IP67, IP69K

## Required Cordset & Accessories

Description	Cat. No.
8-pin micro (M12) QD cordset	889D-F8AB- <sup>1</sup>
Spare RFID door target	440G-ATZA
Fully flexible actuator	440G-A27143
Cover for TLS-1 with external override key	440G-A27371
Cover for TLS-1 with override key attached	440G-A27373
Emergency override key	440G-A36026
Flexible release – 1 m (3.28 ft) cable	440G-A27356
Flexible release – 3 m (9.84 ft) cable	440G-A27357
Dust cover	440K-A17183

<sup>1</sup> Use **2**, **5**, or **10** for standard cable lengths in meters.

**Note:** For additional information, see Safety Connection Systems (page 4-50).



# Interlock Switches

SAFETY

## TLS-GD2 Guard Locking Switches 440G

- Type 2 Interlocking Devices with guard locking and low coded (tongue-shaped) actuators per ISO 14119
- Plastic enclosure with stainless steel actuator guide
- High holding force (Fzh)
- Power-to-release and power-to-lock versions
- Four actuator entry points
- Escape release versions
- Quick disconnect versions
- Large range of accessories

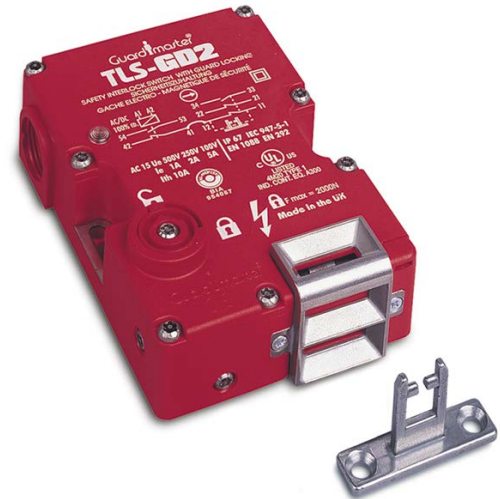

## For Demanding Whole Body Access Applications

The TLS-GD2 is for demanding whole body access guard locking applications where “zero volt” connectivity is needed. A stainless steel actuator guide is fitted to protect the unit from actuator damage due to poor guard alignment or guard wear. The TLS-GD2 is available in two versions: TLS-3 GD2 is power-to-release while the TLS-2 is power-to-lock. Each product has five sets of contacts of various forms. Four actuator entry points are possible; two manual release points. Optional key release and escape release versions are available. An ingress rating of IP69K makes TLS-GD2 suitable for washdown applications.

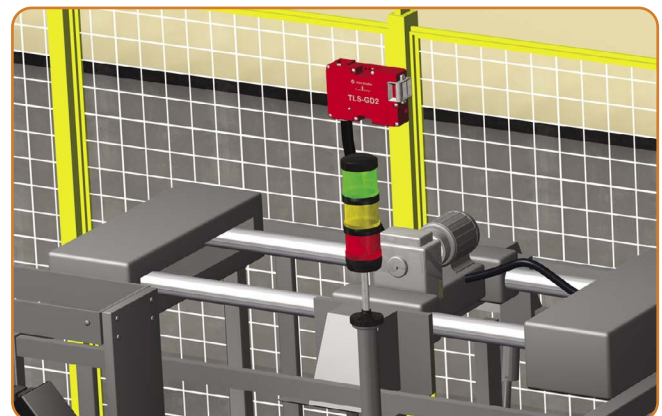
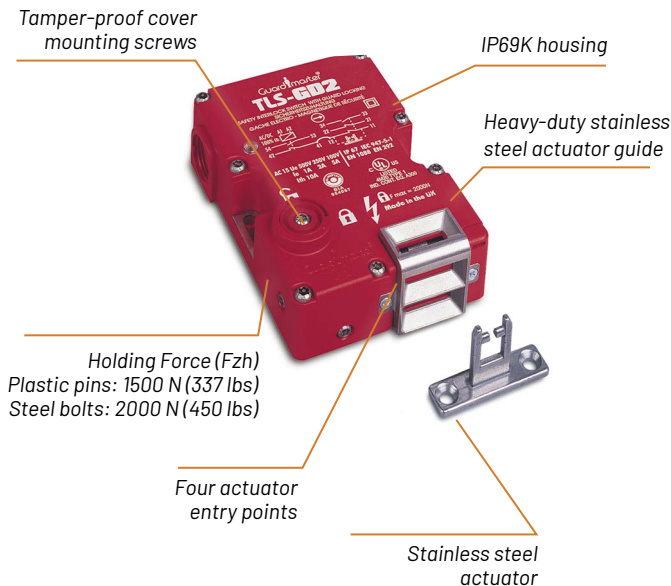

Presence Sensing Devices



6-4...6-19

Interlock Switches



6-20...6-39

Access Control



6-40...6-41

Safety Relays



6-42...6-47

Emergency Stop Devices



6-48...6-49

Safety Limit Switches



6-50...6-51





## Product Selection

### TLS-GD2 Guard Locking Switches

Type	Contacts		Solenoid		Actuator Type	Cat. No.			
						Conduit		Connector	
	Safety	Auxiliary	Contacts	Voltage		M20	1/2 in. NPT Adaptor	12-pin M23	8-pin Micro (M12) <sup>1</sup>
TLS-1 GD2 power-to-release	2 N.C.	1 N.O.	1 N.C. & 1 N.O.	24V AC/DC	—	440G-T27121	—	440G-T27233	440G-T2NBBPH-1R
					GD2 Standard	440G-T27251	440G-T27169	440G-T27234	—
					Fully flex	440G-T27252	440G-T27171	440G-T27235	—
TLS-2 GD2 power-to-lock	2 N.C.	1 N.O.	1 N.C. & 1 N.O.	24V AC/DC	—	440G-T27127	—	440G-T27239	440G-T2NBBPH-1L
					GD2 standard	440G-T27255	440G-T27175	440G-T27240	—
					Fully flex	440G-T27256	440G-T27177	440G-T27241	—
TLS-3 GD2 power-to-release	2 N.C.	1 N.O.	2 N.C.	24V AC/DC	—	440G-T27134	—	440G-T27245	440G-T2NBBPH-2R
					GD2 standard	440G-T27259	440G-T27181	440G-T27246	—
					Fully flex	440G-T27260	440G-T27183	440G-T27247	—
TLS-3 GD2 power-to-release with escape release	2 N.C.	1 N.O.	2 N.C.	24V AC/DC	—	440G-T21BNPM-2B	440G-T21BNPT-2B	440G-T21BNPL-2B	440G-T2NBNPH-2B
					GD2 standard	440G-T21BGPM-2B	440G-T21BGPT-2B	440G-T21BGPL-2B	—

<sup>1</sup> With an 8-pin micro connector, not all contacts are connected.

## Specifications

<b>Standards</b>	ISO 14119, IEC 60947-5-1
<b>Safety Classification</b>	Type 2 Interlocking Device with Guard Locking and low coding (tongue) per ISO 14119
<b>Functional Safety Data</b>	Visit <a href="https://rok.auto/safety-sr001">https://rok.auto/safety-sr001</a>
<b>Certifications</b>	cULus Listed, TÜV Certified, and CE Marked for all applicable directives <a href="https://rok.auto/certifications">https://rok.auto/certifications</a>
<b>Outputs</b>	
<b>Thermal Current /<sub>I<sub>th</sub></sub></b>	10 A
<b>Switching Current @ Voltage</b>	3 mA @ 18V DC
<b>Operating Characteristics</b>	
<b>Break Contact Force</b>	20 N (4.5 lbf), min.
<b>Operating Radius</b>	160 mm (6.3 in.) [80 mm (3.15 in.) with flexible actuator], min.
<b>Mechanical Life</b>	1,000,000 operations

## Required Cordsets & Accessories

Description	Cat. No.
8-pin micro (M12) QD cordset	889D-F8AB- <sup>2</sup>
12-pin M23 QD cordset	889M-F12AH- <sup>2</sup>
8-pin micro (M12) QD patchcord	889D-F8ABDM- <sup>3</sup>
12-pin M23 QD patchcord	889M-F12AHMU- <sup>4</sup>
GD2 standard actuator	440G-A27011
Fully flexible actuator	440G-A27143
Cover for TLS-3 external override key	440G-A27372
Cover for TLS-3 with override key attached	440G-A27374
Flexible release-1 m (3.28 ft) cable	440G-A27356
Flexible release-3 m (9.84 ft) cable	440G-A27357
Sliding bolt actuator	440K-AMDS
Mounting plates	440K-AMDSMPB

<sup>2</sup> Use **2, 5, or 10** for standard cable lengths in meters.

<sup>3</sup> Use **1, 2, 3, 5, or 10** for standard cable lengths in meters.

<sup>4</sup> Use **0M3, 0M6, 1, 2, or 3** for standard cable lengths in meters.

**Note:** For additional information, see Safety Connection Systems (page 4-50).

For more information on our complete family of interlock switch products, please visit:  
[rok.auto/safety-products](http://rok.auto/safety-products)





# Interlock Switches

SAFETY

## Trapped Key Switches 440T

- Interlocking for pre-determined sequence of events
- All stainless interlocking and coded parts
- Weather cap as standard
- Standard red color-coded key and ID tags
- A complete range of isolators, gate (guard) interlocks, key exchange units and specialty devices
- Meets the requirements of ISO 14119
- PLd, Cat 3 per ISO 13849



## Trapped Key Interlocks – Why Use Them?

Based upon the premise that a key cannot be in two places at once, trapped key interlock systems can be configured to provide that a predetermined sequence of events takes place or that hazards have been reduced before operators can become exposed to them.

A trapped key interlock system is mechanical and is therefore widely used in applications including those where the location of plant, environment, or explosive atmospheres make the use of electrical interlock systems unsuitable or expensive to install. In addition, unique coding can be provided, leading to a greater degree of security and tamper-resistance.

In order to derive the full benefits from a trapped key interlocking system its components must be totally practical, easily maintainable, and readily available. The unique key and code barrel of Prosafe® gives the ability for even complicated interlocking systems and spare parts to be ordered from our worldwide network of distributors fast – which is a first for trapped key interlocks.

### Isolators



Designed to isolate the machine's power and ensure the power remains off while the key is being used in another part of the interlocking system.

### Exchange Units



Used in an interlocking sequence to link other devices.

### Interlocks

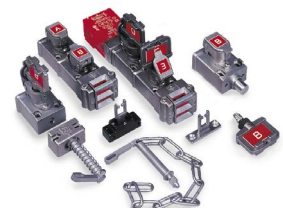

Ideal for interlocking guard doors, cams and valves.

To see our complete Prosafe solution (from access and chain switches to miniature valve switches, switchgear adaptors and more): Go to <https://rok.auto/safety-products>

Presence Sensing Devices



6-4...6-19

Interlock Switches



6-20...6-39

Access Control



6-40...6-41

Safety Relays



6-42...6-47

Emergency Stop Devices



6-48...6-49

Safety Limit Switches



6-50...6-51



# Design Suggestions for an Interlocking System

## Plant and Machinery Interlocking

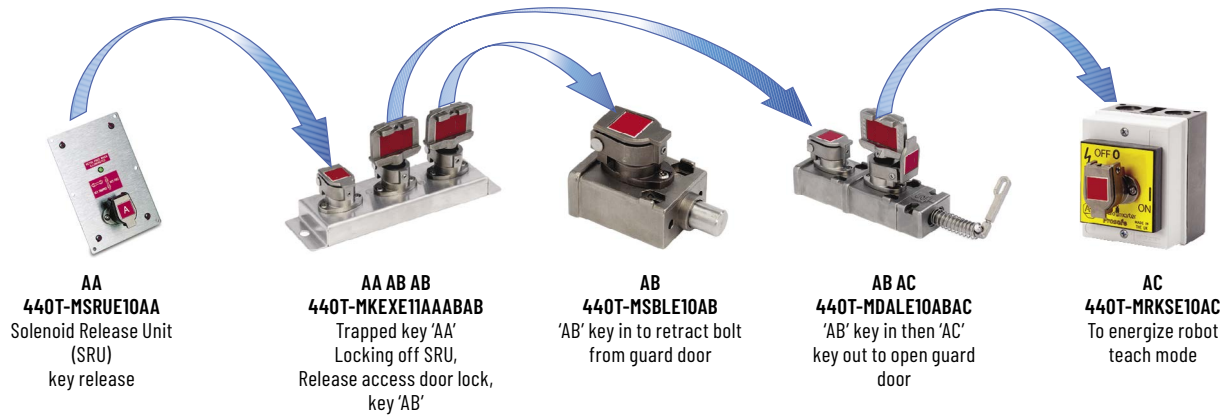

### Sequence of Operation

The Solenoid Release Unit (SRU) is used for electrical isolation of machinery to improve safe access. It consists of a rotary power switch and a solenoid. The trapped key can be removed once an external signal is given to its internal solenoid locking mechanism. An indicator light on the solenoid release unit indicates when the trapped key "AA" key can be removed. Insert the "AA" key into the Key Exchange Unit (KEX) and turn it 90°.

- Turn one of the "AB" keys 90° and remove it from the KEX. This traps the "AA" key in the KEX and prevents the restarting of the machine.
- Insert the "AB" key into the Single-key Bolt Lock (SBL) and turn it 90° to gain partial body access to the machine.

- Turn the second "AB" key 90° and remove it from the KEX. Removal of this key also traps the "AA" key in the KEX and prevents the restarting of the machine.
- Insert the "AB" key into the Dual-key Access Lock (DAL) and turn it 90°.
- Turn the "AC" key 90° and remove the "AC" key. Rotate the access handle to allow full body entry into the hazard zone.
- Take the "AC" key into the hazard zone, insert it into the rotary key switch (RKSE) and turn it 90° to send a signal to the machine control system, to allow the machine to operate in a slow or teach mode.

Reverse the process to return the machine to full operational mode.

### Specifications

<b>Standards</b>	ISO 14119, DGVV GS-ET-31, ISO 13849
<b>Safety Classification</b>	Meets the requirements of ISO 14119 PLd, Category 3 per ISO 13849
<b>Functional Safety</b>	Visit <a href="https://rok.auto/safety-sr001">https://rok.auto/safety-sr001</a>
<b>Certifications</b>	cULus Listed, TÜV Certified, and CE Marked for all applicable directives <a href="https://rok.auto/certifications">https://rok.auto/certifications</a>

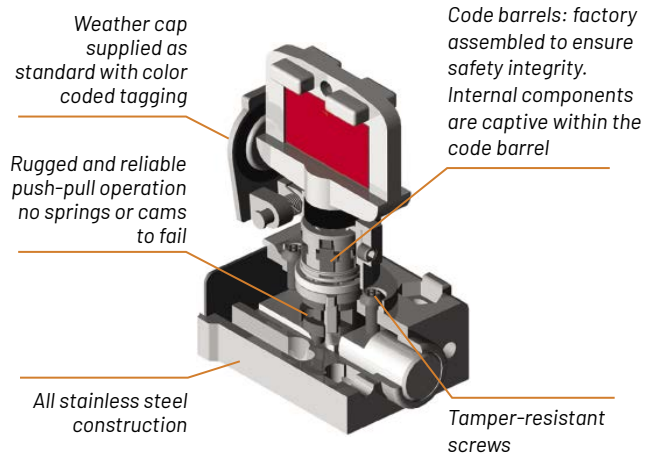

SAFETY



# Access Control

SAFETY

## Multifunctional Access Box 442G

- High holding force (Fzh) 2000 N per ISO 14119
- Power-to-Release or Power-to-Lock modules
- Diagnostic outputs for door position, bolt position, and lock status are available to the control system
- Standard models can be operated as a standalone device or in series with other devices, maintaining a PLe Cat 4 safety rating to ISO 13849-1
- Ethernet models enable easy integration in a networked automation control system using Studio 5000 Logix Designer



The Guardmaster® 442G Multifunctional Access Box, is an integrated access control and guard locking device which provides a complete safeguarding solution for full body access applications.

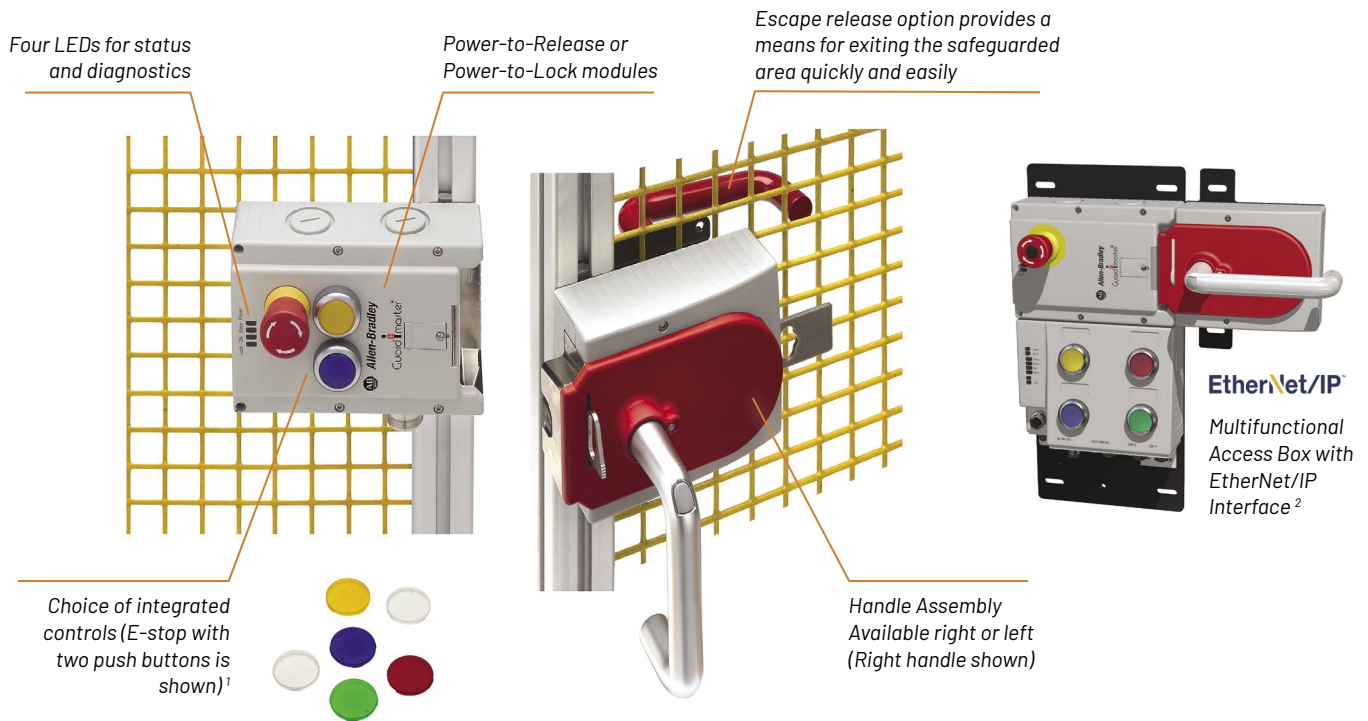

<sup>1</sup> Units with push buttons are supplied with a kit of colored caps, including one each of blue, green, red and yellow, and two white.  
<sup>2</sup> Shown with required mounting plate.

6-40

Presence Sensing Devices



6-4...6-19

Interlock Switches



6-20...6-39

Access Control



6-40...6-41

Safety Relays



6-42...6-47

Emergency Stop Devices



6-48...6-49

Safety Limit Switches





6-50...6-51



## Product Selection

### Step 1: Select Handle Assembly

Description		Cat. No.
Right handle		442G-MABH-R
Left handle		442G-MABH-L
Handle assembly mounting plate <sup>1</sup>		442G-MABAMP

<sup>1</sup> Handle assembly mounting plate is required for Ethernet versions, optional for standard.

### Step 2: Lock Module (Standard or Ethernet)

Standard Lock Module		
Lock Type	Connector	Catalog Number
Power-to-release	M23 (19-pin)	442G-MABR-U⊗M-◆
	M20 cable entry	442G-MABR-UT-◆
Power-to-lock	M23 (19-pin)	442G-MABL-U⊗M-◆
	M20 cable entry	442G-MABL-UT-◆
Ethernet Lock Module		
Lock Type	Description	Catalog Number
Power-to-release	Two push buttons <sup>2</sup>	442G-MABRB-U⊗-P49
Power-to-lock		442G-MABLB-U⊗-P49
Power-to-release	E-stop, two push buttons <sup>2</sup>	442G-MABRB-U⊗-EOP49
Power-to-lock		442G-MABLB-U⊗-EOP49
Power-to-release	E-stop, four push buttons, enabling switch connector <sup>2</sup>	442G-MABRB-U⊗-EOJP4679 <sup>3</sup>
Power-to-lock		442G-MABLB-U⊗-EOJP4679 <sup>3</sup>

<sup>2</sup> Covers with push buttons are supplied with a colored lens kit, including one each of blue, green, red and yellow, and two white.

<sup>3</sup> Ethernet models come standard with two 4-pin (M12) power connectors. They are also available with two 4-pin 7/8" mini-style power connectors (add -N4 suffix to catalog number).

⊗ Replace ⊗ with **R** for use with right handle or **L** for use with left handle.







◆ Replace the ◆ with the code for the selected cover controls.

Example: 442G-MABR-UT-**C01**

## Specifications

<b>Standards</b>	ISO 14119, IEC 60947-5-3, ISO 13849-1 EStop: ISO 13850, IEC 60947-5-1, IEC 60947-5-5
<b>Safety Classification of Interlocking Device Functions</b>	Type 4 Interlocking Device with Guard Locking with high (unique) coding per ISO 14119 PLe Cat 4 per ISO 13849-1
<b>Functional Safety</b>	Visit <a href="https://rok.auto/safety-sr001">https://rok.auto/safety-sr001</a>
<b>Certifications</b>	cULus Listed, TUV Certified, and CE Marked for all applicable directives <a href="https://rok.auto/certifications">https://rok.auto/certifications</a>
<b>Power Supply</b>	Class 2 PELV 24V DC +10/-15% required
<b>Holding Force Fzh (ISO 14119)</b>	2000 N (450 lbs)
<b>Safety Outputs</b>	Standard versions: 2 x PNP, 0.2 A max., Status: ON (+24V DC); Ethernet versions: CIP Safety
<b>Enclosure Type Rating</b>	IP65

## Cover Controls

Description		Cat. No.
Blank cover		C00
One illuminated push button <sup>2</sup>		C01
Two illuminated push buttons <sup>2</sup>		C02
E-stop with two illuminated push buttons <sup>2</sup>		C03
E-stop with three illuminated push buttons <sup>2</sup>		C04
E-stop only		C05

<sup>2</sup> Covers with push buttons are supplied with a colored lens kit, including one each of blue, green, red and yellow, and two white.

**Note:** If you selected right handle assembly and want a power-to-release lock module with a (19-pin) M23 connector and two illuminated push buttons, you would order 442G-MABR-URM-C02.

## Accessories

Description	Cat. No.
Escape release assembly w/standard actuation shaft (115 mm)	442G-MABE1
Escape release mounting plate	442G-MABAMPE
Escape release shaft (250 mm)	442G-MABASHFT
Lock module mounting plate	442G-MABAMPL
19-pin M23 2 m cordset <sup>4</sup>	889M-F19RM-2

<sup>4</sup> For additional cordset lengths, please visit <https://rok.auto/directory>





# Safety Relays

SAFETY

## Software-Configurable Relay 440C

- Monitoring and Configuration from Studio 5000 Logix Designer® or Connected Components Workbench software
- PLe Cat 4 per EN ISO 13849-1 & SIL CL3 per IEC 62061
- Predefined function blocks
- AND, OR, NAND, NOR, XOR Logic functions
- 22-point embedded safety I/O
- Expandable via two Micro800® Plug-in I/O Modules
- Expandable with EtherNet/IP™ plug-in
- Embedded communication via USB programming port and non-isolated RS-232 serial port
- Two single-wire safety input/output points

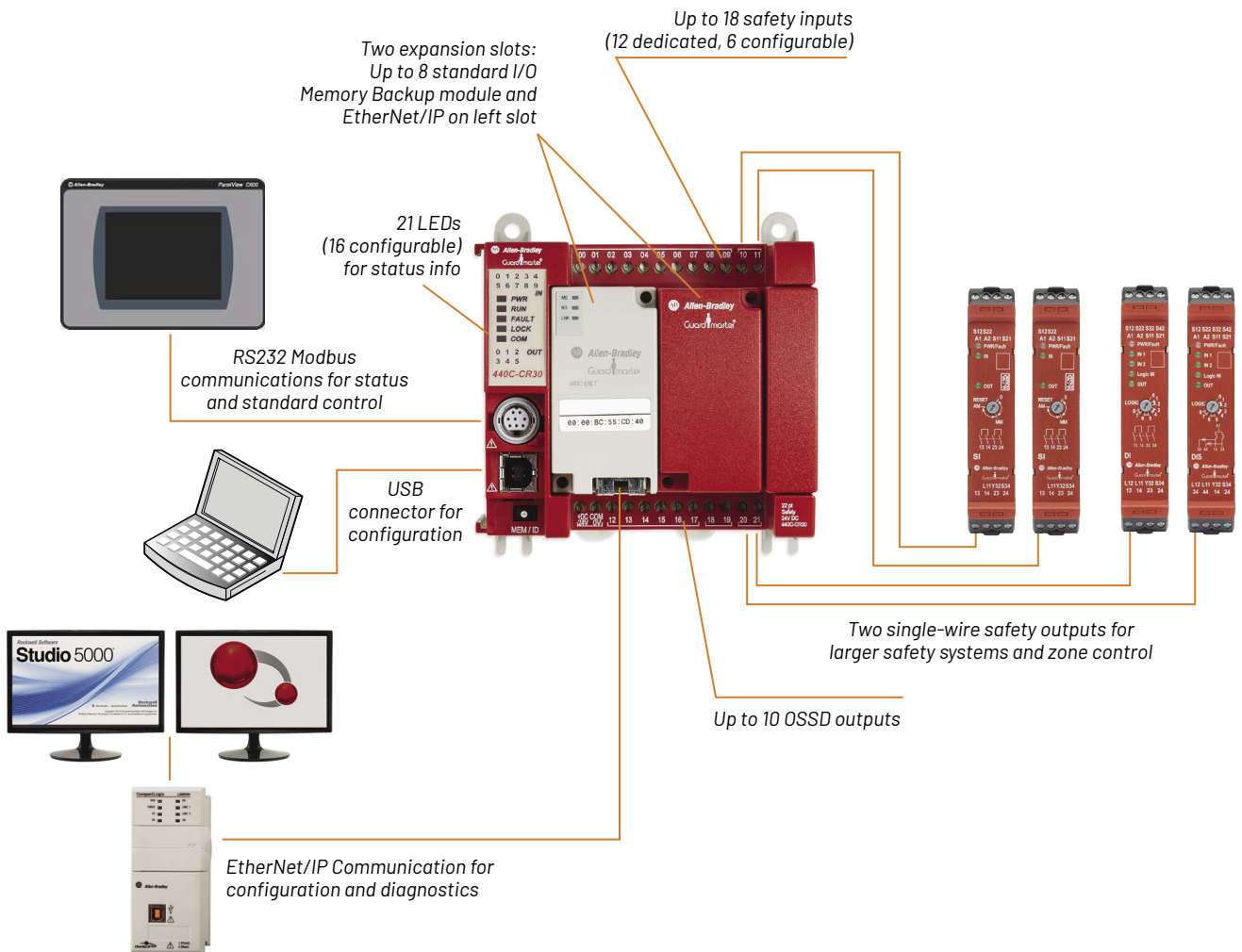
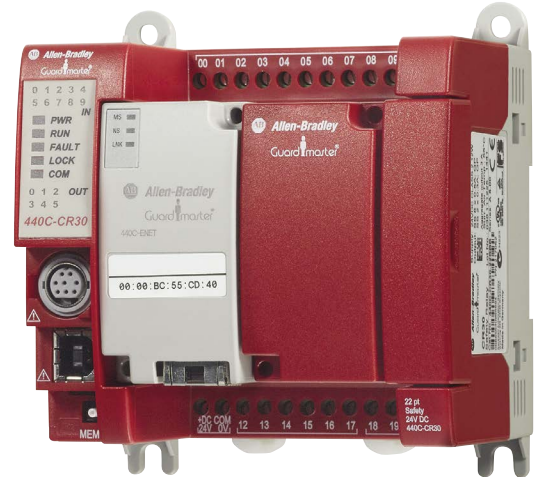

Presence Sensing Devices



6-4...6-19

Interlock Switches



6-20...6-39

Access Control



6-40...6-41

**Safety Relays**



**6-42...6-47**

Emergency Stop Devices



6-48...6-49

Safety Limit Switches



6-50...6-51



## Product Selection

### Software Configurable Relay

Relay Type	No. of Inputs	Type of Inputs	No. of Outputs	Cat No.
Software Configurable	Up to 18	1 N.C., 2 N.C., 3 N.C., 10 SSD, 20 SSD, 30 SSD, Mat, 2-hand control	Up to 10	440C-CR30-22BBB

### Configuration with Connected Components Workbench

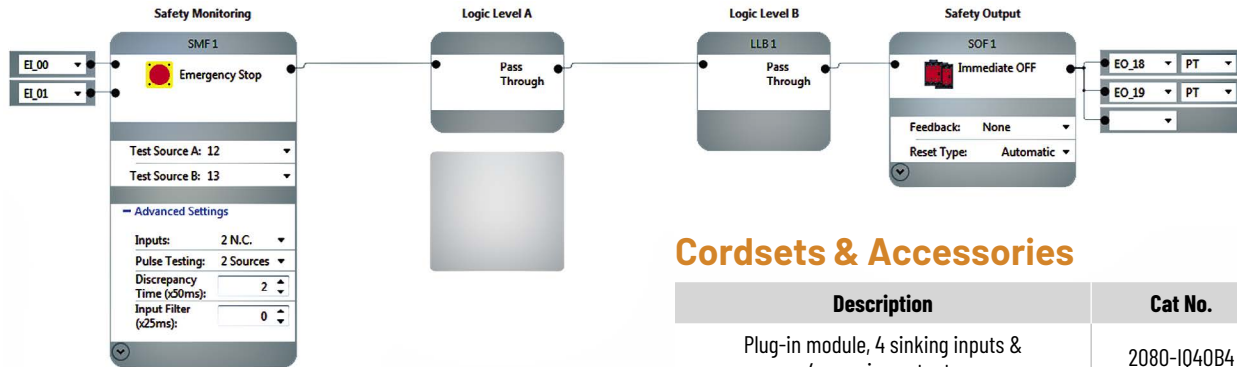

### Specifications

<b>Safety Rating</b>	Up to SIL CL3 Cat 4 per IEC 61508 and PLe per ISO 13849-1
<b>Number of I/O</b>	22 (plus 16 additional on plug-in modules)
<b>Operating Temperature [C (F)]</b>	-5...+55 ° (23...131 °)
<b>Operating Voltage</b>	20.4...26.4V DC UL Class 1, Div 2, PELV/SELV
<b>Power Consumption</b>	5.28 W
<b>Output Current</b>	0.5 A continuous, 1 A surge per point
<b>Response Times</b>	Safety inputs <45 ms Safety mats < 70 ms Single-wire safety output <60 ms
<b>Dimensions</b>	90 x 100 x 80 mm (3.54 x 3.94 x 3.15 in.)

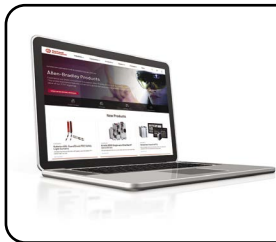

#### Looking for More?

This catalog highlights only our most essential components; for a complete product selection, visit us at: [rok.auto/directory](http://rok.auto/directory)

### Cordsets & Accessories

Description	Cat No.
Plug-in module, 4 sinking inputs & 4 sourcing outputs	2080-IQ40B4
Power supply, 120/240V AC	2080-PS120-240VAC
4-pt digital input, 12/24V DC, sink/source, IEC3	2080-IQ4
4-pt digital output, 12/24V DC, source	2080-OB4
4-pt relay output, individually isolated, 2 A	2080-OW4I
Memory backup and restore plug-in module	2080-MEMBAK-RTC
EtherNet/IP plug-in module	440C-ENET
Communication Cables	
8-pin mini DIN to 8-pin mini DIN 0.5 m (1.5 ft)	1761-CBL-AM00
8-pin mini DIN to 8-pin mini DIN 2 m (6.5 ft) cable	1761-CBL-HM02
8-pin mini DIN to 9-pin D shell 0.5 m (1.5 ft) cable	1761-CBL-AP00
8-pin mini DIN to 9-pin D shell 2 m (6.5 ft) cable	1761-CBL-PM02
Straight male RJ45 to straight male RJ45 ethernet patchcord, 8-conductor (4 pair), Cat 5e, TPE, 2m length	1585J-M8TBJM-2
Right angle male RJ45 to straight male RJ45 ethernet patchcord, 8-conductor (4 pair), Cat 5e, TPE, 2m length	1585J-M8TBJM-2
Left angle male RJ45 to straight male RJ45 ethernet patchcord, 8-conductor (4 pair), Cat 5e, TPE, 2m length	1585J-M8TBJM-2





# Safety Relays

SAFETY

## Guardmaster Safety Relays (GSR Family) 440R

- A broad range of safety functions
- Simple logic, reset, and timing configurations
- Single-wire safety relay connection
- Universal inputs
- Compact 22.5 mm housings
- Optional EtherNet/IP network interface



## Guardmaster Safety Relays

Guardmaster® Safety Relays include units capable of monitoring a broad range of safety devices in a variety of applications. These units can achieve most of the functions safety systems require, helping simplify purchasing and parts management. The family is designed to meet new functional safety standards, such as EN ISO 13849-1 or IEC/EN 62061 and offers key functions to simply installations and system complexity.

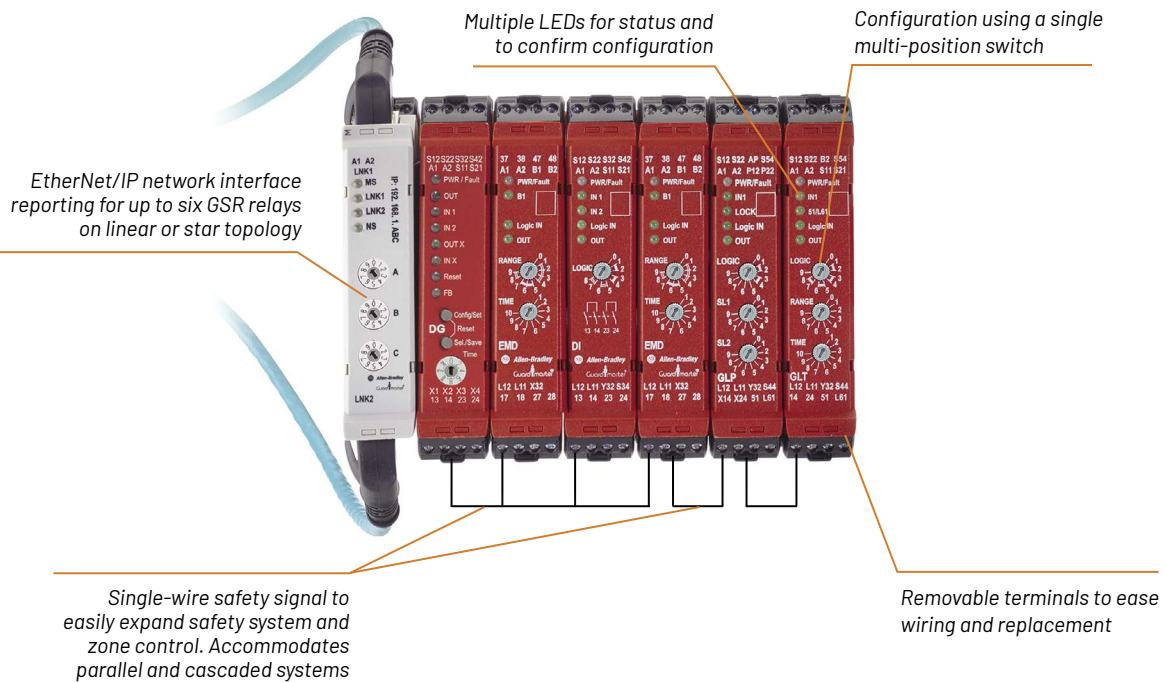

Presence Sensing Devices



6-4...6-19

Interlock Switches



6-20...6-39

Access Control



6-40...6-41

Safety Relays



6-42...6-47

Emergency Stop Devices



6-48...6-49

Safety Limit Switches



6-50...6-51



## Product Selection

### Guardmaster Safety Relays

Relay Type	No. of Inputs	Inputs	Immediate Safety Outputs	Delayed Safety Outputs	Time Delay	Immediate Auxiliary Outputs	Power Supply	Cat No.
Dual GuardLink (DG)	2 dual-channel and 1 SWS	1 N.C., 2 N.C., OSSD, GuardLink	SWS	2 N.O.	0 ms...30 s	up to 1 S.S.	24V DC	440R-DG2R2T
Dual Input (DI)		1 N.C., 2 N.C., OSSD, safety mat	2 N.O.	-	-	1 S.S.		440R-D22R2
Dual Input Solid-State Output (DIS)			2 S.S.					440R-D22S2
Single Input (SI)	1 dual-channel	1 N.C., 2 N.C., OSSD, safety mat	2 N.O.	-	-	1 S.S.	24V DC	440R-S12R2
Compatible Input (CI)		-	3 N.O.					440R-S13R2
Guard Locking Proximity (GLP)	1 dual channel, 2 PNP and 1 SWS	2 N.C., OSSD	2 S.S.	-	-	1 S.S.	24V DC	440R-GL2S2P
Guard Locking with Time Delay (GLT)	1 dual-channel and 1 SWS	2 N.C. or OSSD	2 S.S.	2 S.S.	100 ms...30 min	1 S.S.	24V DC	440R-GL2S2T
Expansion Module (EM)	1 single-wire safety	-	4 N.O.	-	-	1 S.S.	24V DC	440R-EM4R2
Expansion Module Time Delayed (EMD)			DI/SI: 2 N.O. CI: 3 N.O. DIS: 2 PNP (14, 24); 2 decoupled (34, 44) EM: 4 N.O. EMD: 4 N.O. delayed DIS/GLP: 2 PNP safety, 2 PNP lock	4 N.O.	100 ms...300 s on or off delay 100 ms...20 s jog			440R-EM4R2D
			Ethernet Module					

## Specifications

<b>Standards</b>	IEC 60204-1, ISO 13849-1, IEC 61508
<b>Safety Classification</b>	DI/DIS/CI/SI/EM/EMD/GLT: Suitable up to PLe and Cat 4 per ISO 13849-1, SIL CL3 per IEC 61508/IEC 62061:2006 depending on architecture and application characteristics GLP: Suitable up to PLd and Cat 3 per ISO 13849-1, SIL cl2 per IEC 61508:2010/IEC 62061 depending on architecture and application characteristics
<b>Certifications</b>	cULus Listed, TÜV Certified, China RoHs, CCCs, SMark and CE Marked for all applicable directives
<b>Enclosure Type Rating/ Terminal Protection</b>	IP40 (NEMA 1)/IP20
<b>Operating Temperature [C (F)]</b>	-5...+55 ° (23...131 °)
<b>Mounting</b>	35 mm DIN Rail
<b>Conductor Size, Max.</b>	0.2...4 mm <sup>2</sup> (24...12 AWG)

## Required Cordsets & Accessories

Description	Cat No.
Straight male RJ45 to straight male RJ45 ethernet patchcord, 8-conductor (4 pair), Cat 5e, TPE, 2 m length <sup>1</sup>	1585J-M8TBJM-2
Right angle male RJ45 to straight male RJ45 ethernet patchcord, 8-conductor (4 pair), Cat 5e, TPE, 2 m length <sup>2</sup>	1585J-E8TBJM-2
Left angle male RJ45 to straight male RJ45 ethernet patchcord, 8-conductor (4 pair), Cat 5e, TPE, 2 m length <sup>3</sup>	1585J-L8TBJM-2
GSR Replacement Screw Terminal kit, 4 pcs	440R-ATP4
GSR Replacement Spring Clamp Terminal kit, 4 pcs	440R-ATSC4

<sup>1</sup> All Ethernet media cables are available in 0.1 m increments up to 80 m.

<sup>2</sup> Recommended for RJ45 connection located at the top of the Guardmaster EtherNet/IP network interface.

<sup>3</sup> Recommended for RJ45 connection located at the bottom of the Guardmaster EtherNet/IP network interface.



For more information on our complete family of safety relay products, please visit:  
[rok.auto/safety-products](http://rok.auto/safety-products)

# Safety Relays

SAFETY

## Single and Specialty Function Safety Relays (MSR Family) 440R

- Single function and specialty relays
- Broad range of input types
- Multiple output configurations
- Electromechanical or solid-state
- Compact housings
- Fixed or removable terminals
- Safe speed control (MSR57)
- Back EMF Monitor (MSR55)



## A Full Line of Single and Specialty Function Relays

Guardmaster® single function and specialty safety relays support a wide variety of input devices and output configurations. Ideal for relatively small safety applications and single zone control, these relays are compact packages with removable terminals. They are also available in electromechanical versions, or solid-state models for applications involving high cycle rates. Applications include safe speed control (MSR57), Back EMF monitor (MSR55) and safety control circuits involving light curtains, laser scanners, safety mats, interlock switches, guard locking interlocks, two-hand controls, safety edges, enabling devices, and E-stop push buttons.

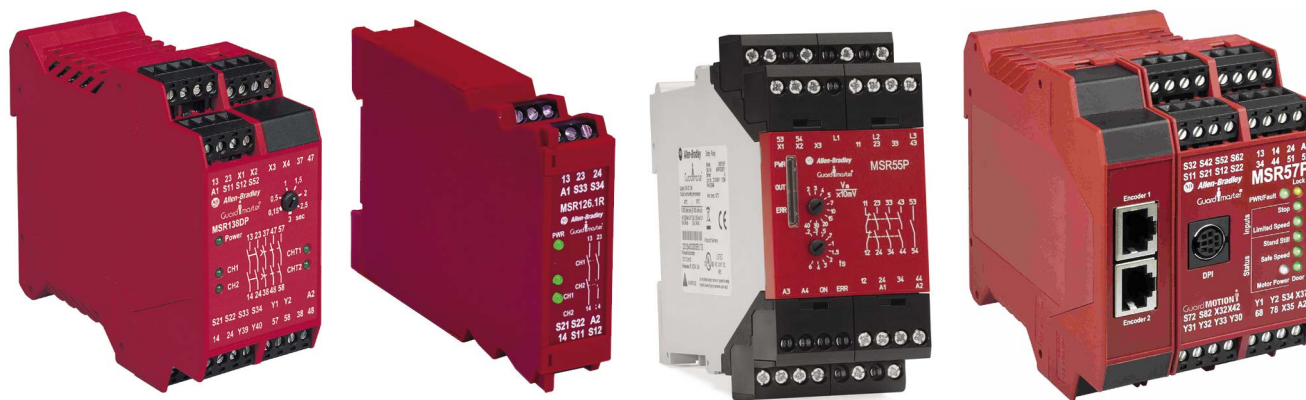

Interface directly and monitor safety control relays, valves, contactors, drives, and motion systems.

The MSR57 is ideal for small- to medium-sized safety related control systems dedicated to specific applications.

Presence Sensing Devices



6-4...6-19

Interlock Switches



6-20...6-39

Access Control



6-40...6-41

Safety Relays



6-42...6-47

Emergency Stop Devices



6-48...6-49

Safety Limit Switches



6-50...6-51



## Product Selection

### Single and Specialty Function Safety Relays

Model	Safety Inputs	Safety Inputs		Safety Outputs		Current <sup>1</sup> @ 24V DC	Delay Time	Terminals	Reset	Power	Cat No.							
		Immed.	Delayed	Immed.	Delayed													
MSR126	1 N.C., light curtain	2 N.O.	-	-	-	6 A	-	Removable	Auto./man.	24V AC/DC	440R-N23117							
MSR126.1	2 N.C.							Fixed	Mon. man.		440R-N23123							
MSR127	1 N.C., 2 N.C., light curtain	3 N.O.	-	1 N.C.	-	5 A	-	Removable	Auto./man.	24V AC/DC	440R-N23114							
								Spring			440R-N23132							
								Fixed			440R-N23132S							
								Fixed			440R-N23126							
								Removable	Mon. man.	115V DC	440R-N23131							
								Fixed	Mon. man.	24V AC/DC	440R-N23135							
MSR132 (expansion)	1 N.C., 2 N.C.	4 N.O.	-	2 N.C.	-	3 A	-	Removable	Automatic	24V AC/DC	440R-N23129							
								Fixed			440R-E23097							
MSR138	1 N.C., 2 N.C. light curtain	2 N.O.	3 N.O.	-	-	6 A	0.15...3 s 0.5...10 s 1.5...30 s	Removable	Auto./mon. man.	24V AC/DC	440R-M23143							
MSR138.1											2 N.O.	1 N.C.	440R-M23147					
													440R-M23151					
			440R-M23084															
MSR57 Speed Monitoring			5 x 1 N.C., 2 N.C., light curtain 1 N.O. & 1 N.C.	6 N.O.	-						4 N.O.	-	-	-	Removable	Automatic/ monitored manual	24V DC	440R-M23088
																		440R-M23092
	440R-S845AER-NNL																	
MSR125 Two-Hand Control	1 N.C. & 1 N.O.	2 N.O.	-	-	-	-	-	Removable	Auto./man.	24V AC/DC	440R-D23171							
MSR55P BACK EMF Monitor	2 Redundant monitored channels	-	-	-	3 N.O. 1 N.C.	4 A	0.2...6 s	Removable	Auto./man.	24V DC	440R-S35011							
											440R-S35014							
											115V AC	440R-S35012						
											440R-S35015							
											230V AC	440R-S35013						
440R-S35016																		

<sup>1</sup> DC-13 inductive load current switching at maximum of 6 ops/min. MSR127 440R-N23132 has AC-15 inductive load current switching of 5 A @ 250V AC.

## Specifications

<b>Standards</b>	EN ISO 13849-1, IEC/EN 60204-1, IEC 60947-5-1, ANSI B11.19, AS 4024.1
<b>Safety Classification</b>	Cat 4 per ISO 13849-1, SIL CL3 per IEC 62061, PLe per ISO 13849-1
<b>Certifications</b>	cULus Listed, c-Tick, and CE Marked for all applicable directives
<b>Enclosure Type Rating/Terminal Protection</b>	IP40, IP20, DIN 0470
<b>Operating Temperature [C (F)]</b>	-5...+55 ° (23...131 °)
<b>Mounting</b>	35 mm DIN Rail
<b>Conductor Size, Max.</b>	0.2...4 mm <sup>2</sup> (24...12 AWG)

For more information on our complete family of safety relay products, please visit:  
[rok.auto/safety-products](http://rok.auto/safety-products)





# Emergency Stop Devices

SAFETY

## Lifeline Cable Pull Switches 440E

- Up to 125 m cable span
- Universal mounting and operation
- Lid mounted emergency stop button
- Switch latches when cable is pulled or cable is slack
- Cable status indicator on switch lid
- Lifeline Rope Tensioner System (LRTS) speeds installation



The patented Lifeline™ 5 Cable Pull Switch is a microprocessor-based solution that brings advanced features and diagnostics that help enhance safety while improving productivity. The Lifeline 5 offers features and functions that simplify setup and allow for more efficient maintenance and troubleshooting, making it the most advanced switch on the market today.

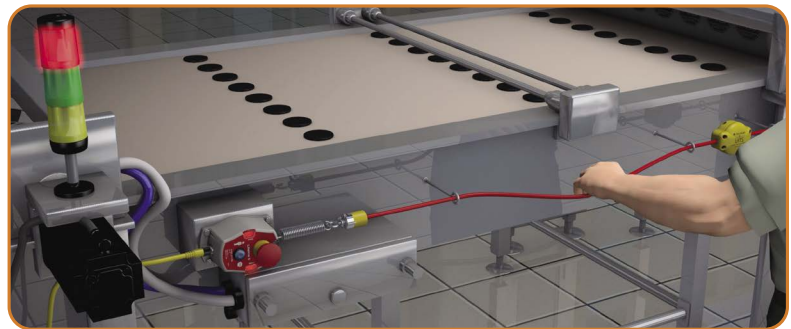

The Lifeline Rope Tensioner System (LRTS) is a unique cable (rope) tensioning system which enables quicker installation of cable actuated systems.

## Selection Guide

The patented Lifeline 5 cable pull switch rounds out the family offering that already includes the Lifeline 3 and Lifeline 4.

	Lifeline 5	Stainless Steel Lifeline 4	Lifeline 4	Lifeline 3
<b>Material</b>	Stainless Steel or Die Cast Aluminum	Stainless Steel 316	Painted Aluminum alloy	Painted Zinc alloy
<b>Reset</b>	Yes	Yes	Yes	Yes
<b>E-Stop</b>	Yes	Yes	Yes	No
<b>Cable Span</b>	100 m (328 ft)	75 m (246 ft)	75 m (246 ft) 125 m (410 ft) extended model	30 m (98 ft)

## Emergency Stop Devices

Presence Sensing Devices



6-4...6-19

Interlock Switches



6-20...6-39

Access Control



6-40...6-41

Safety Relays



6-42...6-47



6-48...6-49

Safety Limit Switches



6-50...6-51



## Product Selection

### Lifeline Cable Pull Switches

Model	Cable Span	Safety Outputs	Auxiliary Outputs	Cat. No.			
				M20	1/2 in. NPT	5-pin Micro (M12) <sup>2</sup>	8-pin Micro (M12) <sup>3</sup>
Lifeline 5	≤100 m	2 OSSDs	1 Aux	—	—	440E-LL5N5	—
		2 OSSD Outputs w/ 2 OSSD Inputs	1 Aux, 1 Tension	—	—	—	440E-LL5N8
Lifeline 5 with e-stop		2 OSSDs	1 Aux	—	—	440E-LL55E5	—
		2 OSSD Outputs w/ 2 OSSD Inputs	1 Aux, 1 Tension	—	—	—	440E-LL55E8
Lifeline 5 stainless steel <sup>1</sup>		2 OSSDs	1 Aux	—	—	440E-LL55S5	—
		2 OSSD Outputs w/ 2 OSSD Inputs	1 Aux, 1 Tension	—	—	—	440E-LL55S8
Lifeline 4	≤75 m	2 N.C.	2 N.O.	440E-L13137	440E-L13133	440E-L2NNYS	440E-L2IBNYH
		3 N.C.	1 N.O.	440E-L13042	440E-L13043	—	—
	75...125 m	2 N.C.	2 N.O.	440E-L13153	440E-L13155	—	440E-L21BTYH
		3 N.C.	1 N.O.	440E-L13150	440E-L13152	—	—
Lifeline 4 stainless steel <sup>1</sup>	≤75 m	2 N.C.	2 N.O.	440E-L22BNSMNH	440E-L22BNSR	—	—
Lifeline 3	≤30 m	2 N.C.	2 N.O.	440E-D13118	440E-D13120	440E-D2NNYS	440E-D2IBNYH
		3 N.C.	1 N.O.	440E-D13112	440E-D13114	—	—

<sup>1</sup> A dedicated stainless steel installation kit must be used with the stainless steel Lifeline instead of the LRTS.

<sup>2</sup> For standard 5-pin connection, recommended cordset is 889D-F5AC-2; for connection to ArmorBlock Guard I/O, recommended cordset is 889D-F4ACDM-2.

<sup>3</sup> For 8-pin connection, recommended cordset is 889D-F8AB-2.

## Specifications

<b>Standards</b>	All Lifeline models: IEC 60947-5-5, ISO 13850, IEC 60947-5-1 Emergency stop device in accordance with ISO 13850 Lifeline 5 only: Ple, Cat 4 according to EN ISO 13849-1 SIL CL3 per IEC 62061 and IEC 61508
<b>Functional Safety</b>	Visit <a href="https://rok.auto/safety-sr001">https://rok.auto/safety-sr001</a>
<b>Certifications</b>	cULus Listed, TÜV Certified, and CE Marked for all applicable directives <a href="https://rok.auto/certifications">https://rok.auto/certifications</a>
<b>Environmental</b>	
<b>Enclosure Type Rating</b>	IP66 (Lifeline 4, Lifeline 5), IP67 (Lifeline 3), IP69K (Lifeline 4 Stainless, Lifeline 5 Stainless)
<b>Operating Temperature [C (F)]</b>	-25...+80° (-13...176°) Lifeline 3, 4 -20...+75° C (-4...167° F) Lifeline 5

## Installation Kits<sup>4</sup>

Description	Length	Cat. No.
LRTS installation kit	5 m (16.4)	440E-A13079
	10 m (32.8 ft)	440E-A13080
	20 m (65.6 ft)	440E-A13082
	30 m (98.4 ft)	440E-A13083
	50 m (164 ft)	440E-A13084
	75 m (246 ft)	440E-A13085
Stainless steel installation kit	5 m (16.4 ft)	440E-A13194
	10 m (32.8 ft)	440E-A13195
	15 m (49.2 ft)	440E-A13196
	20 m (65.6 ft)	440E-A13197
	30 m (98.4 ft)	440E-A12198
	50 m (164 ft)	440E-A13199
	75 m (246 ft)	440E-A13200

<sup>4</sup> 1 x length of cable (rope), 2 x grippers, 1 x tensioner and quantity of eyebolts.





# Safety Limit Switches

SAFETY

## 22 mm Metal and Plastic, 30 mm Metal, and 15 mm Plastic 440P

- Lever and plunger type actuator styles
- Direct opening contacts
- Type 1 interlocking device per ISO 14119
- Replaceable actuators



### 22 mm Metal and Plastic

Various actuator style options

Multiple contact orientation

Direct opening action to overcome contact weld conditions (safety)



22 mm IEC mounting configuration

Rugged die-cast metal alloy or plastic enclosure

Conduit, preleaded 2 meter or QD style

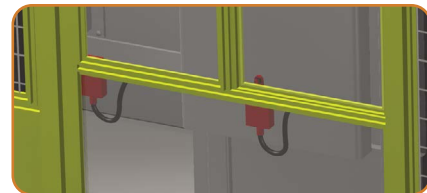

## A Full Line of IEC Safety Switches

The 440P limit switch family offers a full range of international-style solutions for both safety and standard sensing applications. Available in four different body styles – 30 mm metal, 22 mm metal and plastic, and 15 mm plastic – with a broad selection of operator types, circuit arrangements and connection options, the 440P is ideal for a wide variety of applications. These include material handling, packaging, elevators, escalators, scissor lifts, industrial trucks and tractors, cranes and hoists, overhead door as well as general safety guarding applications.

### 30 mm Metal

Various actuator style options

Multiple contact orientation

Direct opening action to overcome contact weld conditions (safety)



30 mm IEC mounting configuration

Rugged die-cast metal alloy enclosure

Conduit entry or QD style options



Rockwell Automation has a full range of limit switch levers. See page 6-90 for levers.

Presence Sensing Devices



6-4...6-19

Interlock Switches



6-20...6-39

Access Control



6-40...6-41

Safety Relays



6-42...6-47

Emergency Stop Devices



6-48...6-49

Safety Limit Switches



6-50...6-51



## Product Selection

### 22 mm Metal and Plastic, 30 mm Metal, and 15 mm Plastic

Description		Safety Contacts	Auxiliary Contacts	Contact Type	1/2 in. NPT Conduit	M20 Conduit	Quick Disconnect
30 mm metal	Metal roller plunger	1 N.C.	1 N.O.	Snap acting	440P-MRPS11E	440P-MRPS11B	440P-MRPS11N5
		2 N.C.	2 N.O.	BBM	440P-MRPB22E	440P-MRPB22B	440P-MRPB22M9
	Short lever, plastic roller	1 N.C.	1 N.O.	Snap acting	440P-MSLS11E	440P-MSLS11B	440P-MSLS11N5
		2 N.C.	2 N.O.	BBM	440P-MSLB22E	440P-MSLB22B	440P-MSLB22M9
	Short lever, metal roller	1 N.C.	1 N.O.	Snap acting	440P-MMHS11E	440P-MMHS11B	440P-MMHS11N5
		2 N.C.	2 N.O.	BBM	440P-MMHB22E	440P-MMHB22B	440P-MMHB22M9
Adjustable lever	1 N.C.	1 N.O.	Snap acting	440P-MALS11E	440P-MALS11B	440P-MALS11N5	
	2 N.C.	2 N.O.	BBM	440P-MALB22E	440P-MALB22B	440P-MALB22M9	
22 mm plastic	Plastic roller plunger	1 N.C.	1 N.O.	Snap acting	440P-CRPS11E	440P-CRPS11B	440P-CRPS11D4
		2 N.C.	1 N.O.	BBM	440P-CRPB12E	440P-CRPB12B	440P-CRPB12R6
	Adjustable lever	1 N.C.	1 N.O.	Snap acting	440P-CALS11E	440P-CALS11B	440P-CALS11D4
		2 N.C.	1 N.O.	BBM	440P-CALB12E	440P-CALB12B	440P-CALB12R6
	Short lever, plastic roller	1 N.C.	1 N.O.	Snap acting	440P-CSLS11E	440P-CSLS11B	440P-CSLS11D4
		2 N.C.	1 N.O.	BBM	440P-CSLB12E	440P-CSLB12B	440P-CSLB12R6

Description	Safety Contacts	Auxiliary Contacts	Contact Type	Cat. No.			
				2 m Bottom Cable	2 m Side Cable	Quick-Disconnect	
22 mm metal	Metal roller plunger	1 N.C.	1 N.O.	Snap acting	440P-ARPS11C	440P-ARPS11CS	440P-ARPS11D5
					Dome plunger	1 N.C.	1 N.O.

Description	Description	Safety Contacts	Auxiliary Contacts	Contact Type	Cat No.
15mm plastic	Roller plunger	1 N.C.	1 N.O.	Snap acting	440P-M18001
	Cross roller Plunger	1 N.C.	1 N.O.	Snap acting	440P-M18002

## Specifications

<b>Standards</b>	ISO 14119, IEC 60947-5-1
<b>Functional Safety</b>	Visit <a href="https://rok.auto/safety-sr001">https://rok.auto/safety-sr001</a>
<b>Certifications</b>	cULus Listed, TÜV Certified, and CE Marked for all applicable directives <a href="https://rok.auto/certifications">https://rok.auto/certifications</a>
<b>Outputs</b>	
<b>Thermal Current</b>	10 A
<b>Switching Current @ Voltage</b>	25 mA @ 5V DC, min.
<b>Operating Characteristics</b>	
<b>Actuation Frequency, Max.</b>	6000 operations per hr.
<b>Mechanical Life</b>	10 million operations

## Required Cordsets & Accessories

Description	Cat. No.
4-pin DC micro (M12), 2 m	889D-F4AC-2
6-pin AC micro (M12), 2 m	889R-F6ECA-2
5-pin mini, 2 m	889N-F5AE-6F
12-pin, 9-wire, 2 m	889M-FX9AE-2

**Note:** For additional information, see Safety Connection Systems (page 4-50).

For more information on our complete family of safety limit switch products, please visit:  
<https://rok.auto/safety-products>



# Additional Safety Products



## CIP Safety over EtherNet/IP™ Encoders 843ES

The 843ES CIP Safety over EtherNet/IP Encoders are designed for safety applications that require speed, direction, or position monitoring safety functions.

- Rated up to and including
  - SIL 3 according to IEC 61800-5-2, IEC 620261 and IEC 61508-1
  - PLe, Cat. 3, according to ISO 13849-1
- Dual Ethernet ports with embedded EtherNet/IP switch for linear networks and Device Level Ring topologies
- 15-bit safety resolution, 18-bit standard resolution, 12-bit multi-turn resolution

\* See Sensors pages 6-98 for more information

## Additional Safety Products

Our innovative safety products and solutions improve the functional operation of your machinery while helping to increase personnel safety, efficiency and productivity. We offer one the broadest safety portfolios in the industry to help you achieve both safety and productivity goals in process and discrete manufacturing applications.

- Safety Programmable Controllers
- Safety Input/Output (I/O) Modules
- Safety Motor Control
- Safety Drives and Motion Control

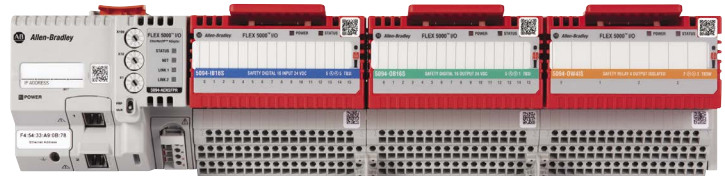

Presence  
Sensing Devices



6-4...6-19

Interlock  
Switches



6-20...6-39

Access  
Control



6-40...6-41

Safety  
Relays



6-42...6-47

Emergency  
Stop Devices



6-48...6-49

Safety Limit  
Switches



6-50...6-51

## Photoelectric Sensors

Sensor Selection .....	7-2	18 mm Stainless Steel	
Miniature .....	7-4	Cylindrical .....	7-28
VisiSight .....	7-6	Long-Range Background	
VisiSight Laser .....	7-8	Suppression .....	7-30
VisiSight M20A .....	7-10	Laser & Distance	
RightSight M30 .....	7-12	Measurement .....	7-32
RightSight S18 .....	7-14	ColorSight™ True Color .....	7-34
RightSight .....	7-16	Luminescence .....	7-36
RightSight LaserSight .....	7-18	Measuring and Discrete	
Series 9000 .....	7-20	Light Arrays .....	7-38
18 mm Plastic Cylindrical .....	7-22	Area and Bin Picking Arrays .....	7-40
18 mm Metal Cylindrical .....	7-24	Polarized Light Array .....	7-42
LaserSight 18 mm		Optical Fork .....	7-44
Metal Cylindrical .....	7-26	DIN Rail Fiber Optic Amplifier ..	7-46

## Proximity Sensors

Sensor Selection .....	7-50	Weld Field Immune .....	7-68
Miniature .....	7-52	Miniature Rectangular .....	7-70
WorldProx .....	7-54	VersaCube Equal Sensing .....	7-72
Stainless Steel -		VersaCube General Purpose ....	7-74
Weld Field Immune .....	7-60	Flat Pack .....	7-76
Food and Beverage .....	7-64	Capacitive .....	7-78
Weld Field Immune with			
Equal Sensing .....	7-66		

## Ultrasonic Sensors

18, 30 and 38.8 mm Plastic		18 mm Metal	
Discrete and Analog .....	7-80	General Purpose .....	7-82

## Limit Switches

Oiltight Plug-in .....	7-84	Operating Levers .....	7-92
Pre-wired, Factory Sealed .....	7-88	Compact, Precision and	
IEC 30 mm Metal .....	7-90	Small Precision .....	7-94

## Encoders

EtherNet/IP .....	7-96	CIP Safety with EtherNet/IP	
Sine Cosine/Serial .....	7-98	Encoder .....	7-100
		General Purpose and	
		Compact Incremental .....	7-102

## Condition Sensing

Integrated Condition		Solid-State	
Monitoring System .....	7-104	Temperature Switches .....	7-108
Solid-State Pressure Sensors .....	7-106	Solid-State Flow Switches .....	7-110
		Solid-State Level Switches .....	7-112

## Identification Devices

Code Reader .....	7-114
High Frequency .....	7-116
3D Sensing .....	7-120

## Additional Sensor Products .....

7-122



# Photoelectric Sensors

## Sensor Selection

Photoelectric Sensors operate by sensing a change in the amount of light that is either reflected or blocked by an object to be detected (target). The change of light could be the result of the presence or absence of the target or as the result in the change of the size, shape, reflectivity or color of a target.

These sensors can be used in applications to detect targets at distances over 300 m.

To successfully apply a photoelectric sensor the following requirements must be clearly understood:

### For Your Selection Keep in Mind...

**Margin:** defined as the measurement of the amount of light from the light source detected by the receiver, expressed as a multiple of the minimum amount of light level required to switch the sensor output. A margin of 2X is reached when the light level received is twice the minimum required to switch the output.

For minimizing maintenance the sensor should be operated at a margin greater than 2X. Detection in dirty environments (or of a low reflectivity target) requires sensors with higher margin.



**Light Operate Output (LO):** output is ON (energized) when the receiver can see sufficient light from the light source.

**Dark Operate Output (DO):** output is ON (energized) when the receiver cannot see light from the light source.

## Application Considerations

Target	Environmental	Electrical	Installation
Detection Range	Temperature	Supply Voltage	Mounting Space
Object	• High	• DC or AC	Cable Connections
• Shape	• Low	Output Type	• 2 m cable
• Size	Conditions	• PNP, NPN	• Micro M12 QD
• Opacity	• Wet or dry	• SPDT relay, MOSFET	• Pico M8 QD
• Reflectivity	• Clean or dirty	Response Time	Shock/Vibration
• Speed	• Humidity	Analog Outputs	Interference
	Chemical Substances	Communications	• Electrical Noise
	High-pressure Washdown		• Sunlight

## Standard Sensing Modes

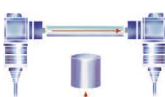
	Advantages	Precautions
<p><b>Diffuse</b></p> 	<ul style="list-style-type: none"> <li>• Ideal for short-range applications</li> <li>• No reflector required</li> <li>• Easy installation/alignment</li> </ul>	<ul style="list-style-type: none"> <li>• Sensing range depends on target's characteristics (color, reflectivity, etc.)</li> <li>• Highly reflective backgrounds may false trigger the sensor</li> <li>• Relatively short sensing distance</li> </ul>
<p><b>Retroreflective</b></p> 	<ul style="list-style-type: none"> <li>• Moderate sensing distances</li> <li>• Easy to align</li> <li>• Requires mounting and wiring of only one emitter/receiver unit</li> </ul>	<ul style="list-style-type: none"> <li>• Shorter sensing distances than transmitted beam</li> <li>• May detect reflections from shiny objects (see polarized retroreflective)</li> <li>• Reflector required</li> </ul>
<p><b>Transmitted Beam</b></p> 	<ul style="list-style-type: none"> <li>• High margin for contaminated environments</li> <li>• Longer sensing ranges than other technologies</li> <li>• Most reliable sensing mode for highly reflective objects</li> </ul>	<ul style="list-style-type: none"> <li>• Requires proper alignment</li> <li>• Not recommended for clear object sensing</li> <li>• Space required to mount and wire separate emitter and receiver</li> </ul>

### Photoelectric Sensors



7-2...7-49

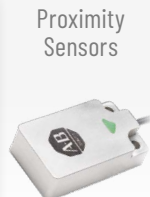

7-50...7-79



7-80...7-83



7-84...7-95



7-96...7-103











7-104...7-113



7-114...7-121



# General Purpose Solutions

		Sensing Range												
		100 mm	200 mm	400 mm	600 mm	800 mm	1 m	2 m	4 m	6 m	8 m	10 m	20 m	> 30 m
<b>42JA VisiSight</b> 	<ul style="list-style-type: none"> <li>IP67 enclosure</li> <li>360° visible LED status indicators</li> <li>Visible light source on all models</li> <li>Selectable light or dark operate adjustment knob</li> <li>Transmitted beam models available with infrared light source</li> <li>Input to disable light source on transmitted beam emitter</li> </ul>	<ul style="list-style-type: none"> <li>Diffuse (1 m)</li> <li>Background reflection (Adjusted - 350 mm)</li> <li>Adjustable Background Suppression (100 mm, 350 mm)</li> <li>Polarized Retroreflective (5 m)</li> <li>Transmitted Beam (10 m (red), 15 m (IR))</li> <li>Clear Object Detection (2.5 m)</li> </ul>												
<b>42JS VisiSight</b> 	<ul style="list-style-type: none"> <li>Industry standard small rectangular (20 mm L x 14 mm W x 33 mm H) enclosure</li> <li>Visible red LED on all models for ease of alignment</li> <li>Complementary LO and DO</li> <li>IP67 enclosure</li> </ul>	<ul style="list-style-type: none"> <li>Diffuse (250 mm, 800 mm)</li> <li>Background Suppression (55 mm, 130 mm)</li> <li>Polarized Retroreflective (3.5 m)</li> <li>Transmitted Beam (10 m)</li> </ul>												
<b>42JT VisiSight</b> 	<ul style="list-style-type: none"> <li>Industry standard small rectangular (20 mm L x 12 mm W x 34 mm H) enclosure</li> <li>Push button teach for easy set up</li> <li>Visible red LED or Laser (Class 1) on all models for ease of alignment</li> <li>Auto Detection continuously monitors and configures the output automatically to PNP or NPN</li> <li>LO or DO configurable on every model</li> <li>IP69K enclosure rating suitable for harsh duty environments</li> </ul>	<ul style="list-style-type: none"> <li>Diffuse (250 mm, 800 mm)</li> <li>Adjustable Background Suppression (120 mm, 200 mm, 400 mm)</li> <li>Polarized Retroreflective (6 m, 13 m)</li> <li>Transmitted Beam (13 m, 18 m)</li> <li>Clear Object Detection (2 m)</li> <li>Color Mark (12 mm)</li> </ul>												
<b>42AF RightSight M30</b> 	<ul style="list-style-type: none"> <li>Universal 30 mm nose and 18 mm base mounts</li> <li>360-degree visible status indicator LEDs</li> <li>Fully sealed IP67/IP69k housing to withstand high-pressure and high/low-temperature washdowns</li> <li>Dual auto PNP/NPN on DC only and Universal (AC/DC)</li> </ul>	<ul style="list-style-type: none"> <li>Background Suppression (400 mm, 600 mm, 800 mm, 1200 mm (1.2 m))</li> <li>Background reflection (800 mm)</li> <li>Polarized Retroreflective (10 m)</li> <li>Transmitted Beam (80 m)</li> </ul>												
<b>42EF RightSight</b> 	<ul style="list-style-type: none"> <li>Universal 18 mm base, nose and thru-hole mounting</li> <li>High-pressure washdown (IP69K and 1200 PSI) enclosure</li> <li>Fixed, teachable and adjustable sensitivity</li> <li>Dual (PNP and NPN) outputs or complementary (LO and DO) models</li> <li>DC and AC/DC solid state outputs</li> </ul>	<ul style="list-style-type: none"> <li>Diffuse (500 mm, 700 mm)</li> <li>Background Suppression (50 mm, 100 mm)</li> <li>Retroreflective (4.5 m)</li> <li>Polarized Retroreflective (3 m)</li> <li>Transmitted Beam (4 m, 8 m, 20 m)</li> <li>Fiber Optic (Max: Diffuse 275 mm, Transmitted beam 1.5 m)</li> <li>Sharp Cutoff Diffuse (130 mm)</li> </ul>												
<b>42CM</b> 	<ul style="list-style-type: none"> <li>Industry standard 18 mm enclosure</li> <li>Metal housing suitable for heavy duty environments</li> <li>Complementary LO and DO</li> <li>IP67 enclosure</li> </ul>	<ul style="list-style-type: none"> <li>Diffuse (100 mm, 400 mm)</li> <li>Background Suppression (50 mm, 100 mm)</li> <li>Retroreflective (4 m)</li> <li>Polarized Retroreflective (3 m)</li> <li>Transmitted Beam (20 m)</li> </ul>												
<b>42CA</b> 	<ul style="list-style-type: none"> <li>Industry standard 18 mm enclosure</li> <li>Plastic housing suitable for corrosive environments</li> <li>Complementary LO and DO</li> <li>Fast response time (0.5 ms) models</li> <li>IP67 enclosure</li> </ul>	<ul style="list-style-type: none"> <li>Diffuse (100 mm, 400 mm, 1 m)</li> <li>Background Suppression (50 mm, 100 mm)</li> <li>Retroreflective (4.8 m, 7.2 m)</li> <li>Polarized Retroreflective (3.8 m)</li> <li>Transmitted Beam (16 m)</li> </ul>												
<b>42KD</b> 	<ul style="list-style-type: none"> <li>Our smallest rectangular photoelectric sensor</li> <li>Ranges up to 3 m</li> <li>IP67 enclosure</li> <li>Auto PNP/NPN</li> <li>Push button teach</li> <li>Through-hole or dovetail clamp mounting</li> <li>Visible red</li> </ul>	<ul style="list-style-type: none"> <li>Fixed Background Suppression (15 mm, 30 mm, 50 mm)</li> <li>Adjustable Background Suppression (70 mm)</li> <li>Polarized Retroreflective (1.6 m)</li> </ul>												





# Photoelectric Sensors

SENSORS

## Miniature 42KD

- Our smallest rectangular photoelectric sensor
- Ranges up to 3 m (9.74 ft)
- IP67 enclosure rating
- Auto PNP/NPN
- Push button teach
- Through-hole or dovetail clamp mounting
- Visible red



## Our Smallest Photoelectric Sensor Package

The 42KD sensors, designed for applications with limited mounting space, offer the performance of much larger sensors in a compact housing. This family of LED and laser sensors is the most complete family of miniature sensors on the market. Additionally, these sensors offer easy commissioning via push button teach or through a control wire. The background suppression versions provide reliable object detection independent of the target size, shape, or color.

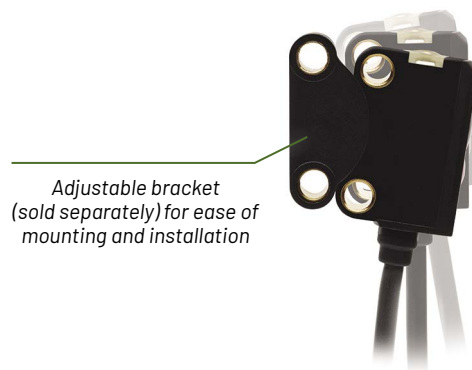
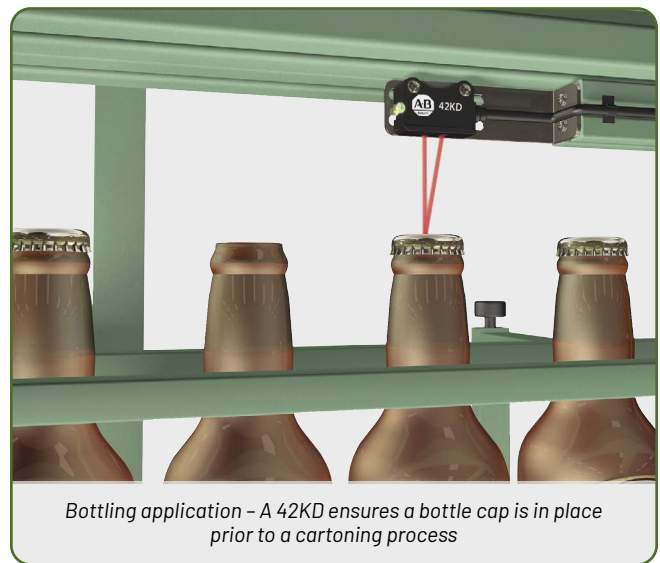

### Photoelectric Sensors



7-2...7-49

### Proximity Sensors



7-50...7-79

### Ultrasonic Sensors



7-80...7-83

### Limit Switches



7-84...7-95

### Encoders



7-96...7-103

### Condition Sensing



7-104...7-113

### Identification Devices



7-114...7-121



## Product Selection

### 42KD Miniature

Sensing Mode	Light Source	Sensing Distance	Sensitivity Adjustment	Output Configuration	Response Time	Cat. No. <sup>1</sup>
Polarized retroreflective	Visible red	0.1...1.6 m (0.33...5.25 ft)	Teach button	Teachable light or dark operate, auto PNP or NPN	0.5 ms	42KD-P2LAT1-Y4
Background suppression	Visible red	1...15 mm (0.04...0.59 in.)	None	Selectable light or dark operate by remote teach, auto PNP or NPN	0.5 ms	42KD-B2LAR1-Y4
		1...30 mm (0.04...0.59 in.)				42KD-B2LAR2-Y4
		1...50 mm (0.04...1.18 in.)				42KD-B2LAR3-Y4
		5...70 mm (0.2...2.75 in.)	Teach button	Teachable light or dark operate, auto PNP or NPN		42KD-B2LAT1-Y4

<sup>1</sup> The **-Y4** suffix describes a 4-pin Pico (M8) QD connector on a 150 mm (6 in.) pigtail.

## Specifications

<b>Certifications</b>	cULus Listed and CE Marked for all applicable directives
<b>Enclosure Type Rating</b>	IP67
<b>Operating Temperature [C (F)]</b>	-20...+50 ° (-4...+122 °)
<b>Operating Voltage</b>	10...30V DC, 30 mA
<b>Protection Type</b>	Reverse polarity, short circuit
<b>Output Current</b>	50 mA
<b>Housing Material</b>	PUR
<b>Lens Material</b>	PMMA
<b>Cover Material</b>	PMMA

## Required Cordsets and Accessories

Description	Cat. No.
DC Pico (M8) QD cordset, straight, 4-pin, 2 m (6.6 ft)	889P-F4AB-2
DC Pico (M8) QD cordset, right angle, 4-pin, 2 m (6.6 ft)	889P-R4AB-2
Reflector, Micro cube, 51 x 61 mm (2 x 2.5 in.)	92-118
42KD Swivel mounting bracket	42KD-BKT1

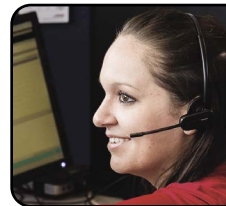

### Need Help?

The Rockwell Automation Support Center is your 24/7 support for the answers you need now.

[rok.auto/support](http://rok.auto/support)



# Photoelectric Sensors

SENSORS

## VisiSight 42JS and 42JT

- Industry standard 25.4 mm (1.0 in.) mounting
- Ranges up to 13 m (42.65 ft)
- IP69K and 1200 psi washdown rating (with ECOLAB) for 42JT
- Auto PNP/NPN (42JT only)
- Push button teach (42JT only)
- IO-Link enabled (42JT only)



## A Compact General-purpose Solution

The 42JS and 42JT VisiSight™ sensors offer a small rectangular package with visible light beam for ease of alignment and 25.4 mm industry standard mounting hole spacing.

The 42JS is a basic, cost-effective model ideal for general purpose applications. The 42JT is an advanced line that features push button teach and a unique “Auto PNP/NPN” output that simplifies installation and reduces the number of models to be stocked by 50%.

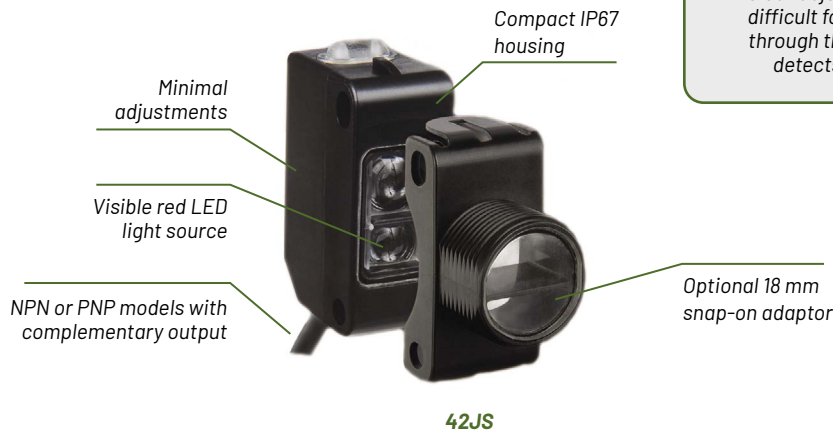
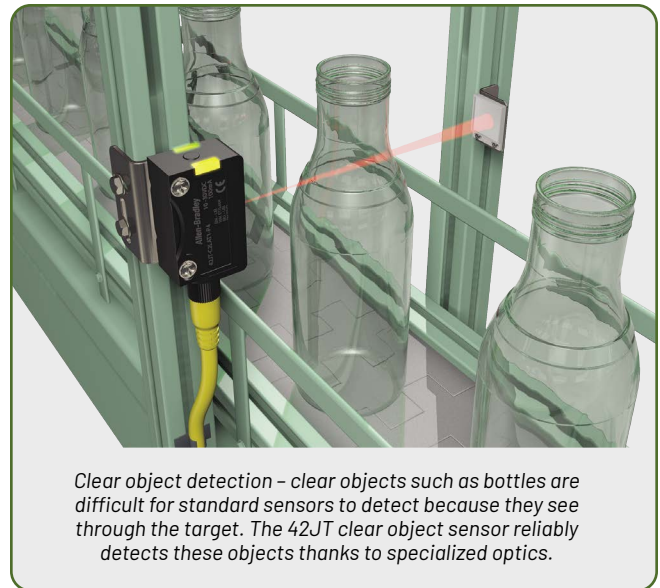

### Photoelectric Sensors



7-2...7-49

### Proximity Sensors



7-50...7-79

### Ultrasonic Sensors



7-80...7-83

### Limit Switches



7-84...7-95

### Encoders



7-96...7-103

### Condition Sensing



7-104...7-113

### Identification Devices



7-114...7-121



## Product Selection

### VisiSight

Sensing Mode	Sensing Distance	Sensitivity Adjustment	Light Source	Output Function	Cat. No. <sup>1</sup>
Polarized retroreflective	0.025...3.5 m (0.08...11.5 ft)	None	Visible red	Complementary L.O./D.O., PNP	42JS-P2MPB1-F4
		Adjustment knob			42JS-P2MPA2-F4
	0.1...6 m (0.33...19.7 ft)	Teach button		Teachable L.O./D.O., Auto PNP/NPN	42JT-P2LAT1-F4
Diffuse	3...250 mm (0.12...9.84 in.)	Adjustment knob	Visible red	Complementary L.O./D.O., PNP	42JS-D2MPA2-F4
		Teach button			42JS-D2MPA1-F4
	3...800 mm (0.12...31.5 in.)	Teach button		Teachable L.O./D.O., Auto PNP/NPN	42JT-D2LAT1-F4
Background suppression	2...130 mm (0.07...5.12 in.)	None	Visible red	Complementary L.O./D.O., PNP	42JS-B2MPB2-F4
					6...55 mm (0.24...2.17 in.)
	1...180 mm (0.04...7.1 in.)	Teach button		Teachable L.O./D.O., Auto PNP/NPN	42JT-B2LAT1-F4
					3...400 mm (0.12...15.75 in.)
Clear object detection	2 m (6.6 ft)	Teach button	Visible red	Teachable L.O./D.O., Auto PNP/NPN	42JT-C2LAT1-F4
Color mark	12 mm (0.47 in.) ±2.5 mm				White LED
Transmitted beam emitter	10 m (32.8 ft)	None	Infrared	NA	42JS-E1EZB1-F4
Transmitted beam receiver		Adjustment knob		Complementary L.O./D.O., PNP	42JS-R9MPA2-F4
Transmitted beam emitter	10 m (32.8 ft)	None	Visible red	NA	42JS-E2EZB1-F4
Transmitted beam receiver		Adjustment knob		Complementary L.O./D.O., PNP	42JS-R9MPA1-F4
Transmitted beam emitter	13 m (42.65 ft)	None	Visible red	NA	42JT-E2EZB1-F4
Transmitted beam receiver		Teach button		Teachable L.O./D.O., Auto PNP/NPN	42JT-R9LAT1-F4

<sup>1</sup> The -F4 suffix describes a 4-pin DC Micro (M12) QD connector on a 150 mm (6 in.) pigtail.

IO-Link enabled.

## Specifications

<b>Certifications</b>	cULus Listed and CE Marked for all applicable directives
<b>Enclosure Type Rating</b>	42JS: IP67; 42JT: IP67 and IP69K
<b>Operating Temperature [C (F)]</b>	-20...+60 ° (-4...+140 °)
<b>Operating Voltage</b>	10...30V DC (25 mA for 42JS, 30 mA for 42JT)
<b>Protection Type</b>	False pulse, reverse polarity, overload, short-circuit
<b>Load Current, Max.</b>	100 mA max.
<b>Housing Material</b>	ABS
<b>Lens Material</b>	PMMA
<b>Cover Material</b>	PMMA

## Required Cordsets and Accessories

Description	Cat. No.
DC Micro (M12) QD cordset, straight, 4-pin, 2 m (6.6 ft)	889D-F4AC-2
Mounting bracket, stainless steel, I-shaped for 42JT and 42JS	60-BJS-L1
Mounting bracket, stainless steel, I-shaped for 42JT and 42JS VisiSight	60-BJT-L2
Mounting bracket, plastic, swivel/tilt for 42JS and 42JT VisiSight	60-2619
Protective mounting bracket, stainless steel, u-shaped for 42JT and 42JS	60-BJT-U1
18 mm snap-on adaptor (42JS Only)	60-AJS-18
Reflector, corner cube, 76 mm (3 in.) diameter	92-124
Reflector, corner cube, 84 mm (3.3 in.) diameter	92-125
Reflector, Micro cube, 51 x 61 mm (2 x 2.5 in.) for laser and clear object models	92-118
Ethernet/IP Point I/O	1734-AENTR
Point I/O IO-Link Master Module	1734-4IOL
ArmorBlock IO-Link Master	1732E-8IOLM12R



# Photoelectric Sensors

SENSORS

## VisiSight Laser 42JT

- Class 1 eye safe visible laser for small object detection
- Industry standard 25.4 mm (1.0 in.) mounting
- Ranges up to 18 m (59.05 ft)
- IP69K (with ECOLAB)
- Auto PNP/NPN
- Push button teach



## Our Compact, Easy-to-use Laser-based Solution

Laser sensors are ideal for small object detection or in applications requiring a narrow field of view. In most cases, laser sensors offer better operating margin and/or longer sensing distances than their LED-based counterparts. The 42JT VisiSight™ family offers a wide range of sensing modes and a teach push button that simplifies sensitivity adjustment and offers light vs. dark operate output selection. The unique “Auto PNP/ NPN” output continuously monitors how the load is connected and automatically configures the output for proper operation and output LED to indicate correct output status. Not only do these features make the 42JT VisiSight easy to apply in challenging packaging and assembly applications, but they help optimize your supply chain by reducing the number of models to be stocked by 50%.



*Bottling inspection - When the single 42JT LaserSight mounted on the side of the conveyor senses the bottle carton, it triggers the three standard VisiSights above to check for missing bottles.*

### Photoelectric Sensors



7-2...7-49

### Proximity Sensors



7-50...7-79

### Ultrasonic Sensors



7-80...7-83

### Limit Switches



7-84...7-95

### Encoders



7-96...7-103

### Condition Sensing



7-104...7-113

### Identification Devices



7-114...7-121





## Product Selection

### 42JT VisiSight Laser

Sensing Mode	Sensing Distance	Sensitivity Adjustment	Light Source	Output Function	Cat. No. <sup>1</sup>
Background suppression	4...120 mm (0.16...4.72 in.)	Teach button	Class 1 laser	Teachable L.O./D.O., Auto PNP/ NPN	42JT-B8LAT1-F4
Diffuse	5...250 mm (0.20...9.84 in.)				42JT-D8LAT1-F4
Polarized retroreflective	0.1...13 m (0.33...42.7 ft)				42JT-P8LAT1-F4
Transmitted beam emitter	18 m (59.05 ft)	None		NA (emitter)	42JT-E8EZB1-F4
Transmitted beam receiver		Teach button		Teachable L.O./D.O., Auto PNP/ NPN	42JT-R8LAT1-F4

<sup>1</sup> The -F4 suffix describes a 4-pin DC Micro (M12) integral QD connector.

IO-Link enabled.



#### Sales Offices and Distributors

Our network of sales offices and distributors offers exceptional knowledge and service to help you design, implement and support your automation investment.

[rok.auto/buy](http://rok.auto/buy)

## Specifications

<b>Certifications</b>	cULus Listed and CE Marked for all applicable directives
<b>Enclosure Type Rating</b>	IP67 and IP69K
<b>Operating Temperature [C (F)]</b>	-20...+60 ° (-4...+140 °)
<b>Operating Voltage</b>	10...30V DC, 30mA
<b>Protection Type</b>	False pulse, reverse polarity, overload, short circuit
<b>Load Current</b>	100 mA max.
<b>Housing Material</b>	ABS
<b>Lens Material</b>	PMMA
<b>Cover Material</b>	PMMA

## Required Cordsets and Accessories

Description	Cat. No.
DC Micro (M12) QD cordset, straight, 4-pin, 2 m (6.6 ft)	889D-F4AC-2
Mounting bracket, stainless steel, L-shaped for 42JT and 42JS	60-BJS-L1
Mounting bracket, stainless steel, L-shaped for 42JT and 42JS	60-BJT-L2
Mounting bracket, plastic, swivel/tilt for 42JT	60-2619
Protective mounting bracket, stainless steel, U-shaped for 42JT and 42JS	60-BJT-U1
Reflector, Micro cube, 51 x 61 mm (2 x 2.5 in.)	92-118
Reflector, Micro cube, 20 x 32 mm (0.79 x 1.26 in.) with mounting tabs	92-134
Ethernet/IP Point I/O	1724-AENTR
Point I/O IO-Link Master Module	1734-4IOL
ArmorBlock IO-Link Master	1732E-8IOLM12R

For more information on our complete family of photoelectric products, please visit:  
[rok.auto/presence-sensing](http://rok.auto/presence-sensing)





# Photoelectric Sensors

SENSORS

## VisiSight M20A 42JA

- IP67 enclosure
- 360° visible LED status indicators
- Visible light source on all models
- Selectable light or dark operate adjustment knob
- Wide range of sensing modes
- Transmitted beam models available with infrared light source
- Input to disable light source on transmitted beam emitter



## An Economical and easy-to-apply global sensing solution

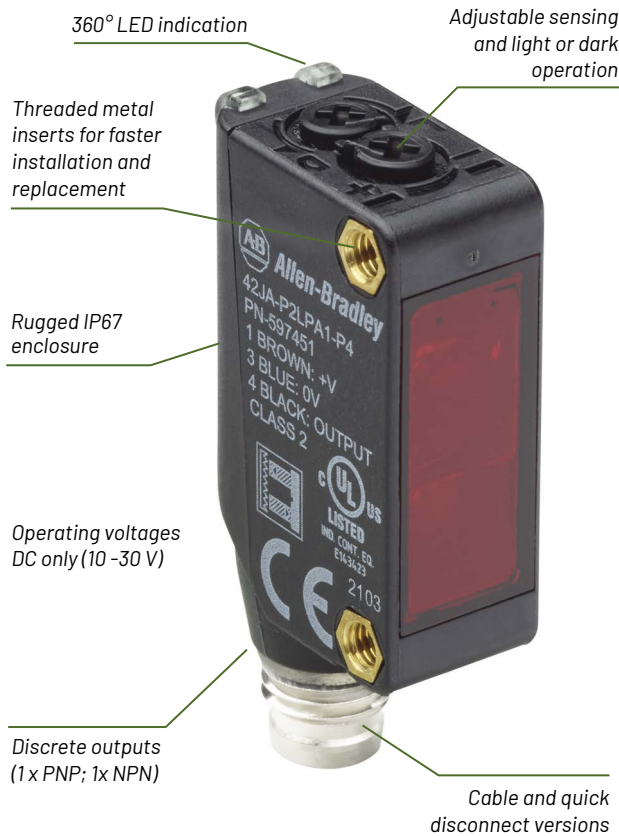

The VisiSight™ family of photoelectric sensors are ideal for material handling, packaging and assembly applications. The VisiSight also address the small form factor needs of many other industries including Life Sciences, Pharmaceutical, Food and Beverage and Home, Health and Beauty. VisiSight sensors offer a wide range of sensing modes, mounting options and unique features that make them optimal solutions for global use.



### Photoelectric Sensors



7-2...7-49

### Proximity Sensors



7-50...7-79

### Ultrasonic Sensors



7-80...7-83

### Limit Switches



7-84...7-95

### Encoders



7-96...7-103

### Condition Sensing



7-104...7-113

### Identification Devices



7-114...7-121



## Product Selection

### 42JA VisiSight M20A

Sensing Mode	Light Source	Sensing Distance	Sensitivity Adjustment	Output Function	Output Type	Cat. No. <sup>1</sup>
Polarized Retroreflective	Visible red	0.01 ... 5 m (0.3...16.4 ft) with 92-125 reflector	Adjustable knob	Selectable light or dark operate	NPN	42JA-P2LNA1-F4
					PNP	42JA-P2LAT1-F4
Clear Object Detection	Visible red	0.01 ... 2.5 m (0.3...8.2 ft) with 92-125 reflector	Adjustable knob	Selectable light or dark operate	NPN	42JA-C2LNA1-F4
					PNP	42JA-C2LAT1-F4
Diffuse	Visible red	3...1000 mm (0.1...39.4 in.)	Adjustable knob	Selectable light or dark operate	NPN	42JA-D2LNA1-F4
					PNP	42JA-D2LAT1-F4
Wide Angle Diffuse	Visible red	0...200 mm (0...7.9 in.)	Adjustable knob	Selectable light or dark operate	PNP	42JA-W2LPA1-F4
Background Suppression	Visible red	3...100 mm (0.1...3.9 in.)	Adjustable knob	Selectable light or dark operate	NPN	42JA-B2LNA1-F4
					PNP	42JA-B2LPA1-F4
		3...350 mm (0.1...13.8 in.)			NPN	42JA-B2LNA2-F4
					PNP	42JA-B2LPA2-F4
Background Reflection	Visible red	3...350 mm (0.1...13.8 in.)	Adjustable knob	Selectable light or dark operate	NPN	42JA-N2LNA2-F4
Transmitted Beam	Visible red	10 m (32.8 ft)	No Adjustable knob	Selectable light or dark operate	N/A	42JA-E2EZB1-F4
			Adjustable knob		NPN	42JA-R2LNA1-F4
			Adjustable knob		PNP	42JA-R2LPA1-F4
			Adjustable knob		N/A	42JA-E1EZB1-F4
	Infrared	15 m (49.2 ft)	No Adjustable knob		NPN	42JA-R1LNA1-F4
			Adjustable knob		PNP	42JA-R1LPA1-F4
			Adjustable knob			
			Adjustable knob			

<sup>1</sup> Connection options: The following suffixes describe the available connection options:

-F4: Describes a 4-pin DC micro (M12) quick-disconnect on a 300 mm (11.8 in.) length pigtail

-P4: Describes a 4-pin Pico (M8) quick-disconnect on a 300 mm (11.8 in.) length pigtail

-Y4: Describes a 4-pin Pico (M8) quick-disconnect on a 300 mm (11.8 in.) length pigtail

-A2: Describes a 2 m (6.6 ft) PVC cable

Additional connection options may be available. See <https://rok.auto/configuration> for available options by sensing mode.

## Specifications

<b>Certifications</b>	CE and cULus
<b>Enclosure Type Rating</b>	IP67
<b>Operating Temperature [C (F)]</b>	-30...+60 °C (-22...+140 °F)
<b>Operating Voltage</b>	10...30V DC
<b>Response Time</b>	Diffuse 0.5 ms Wide angle diffuse 0.5 ms Background suppression 1 ms Background reflection 1 ms Polarized retroreflective 0.5 ms Transmitted beam 2 ms Clear object detection 0.5 ms
<b>Load Current</b>	100 mA max.
<b>Housing Material</b>	Polycarbonate

## Required Cordsets and Accessories

Description	Cat. No.
DC Micro (M12) QD cordset, straight, 4-pin, 2 m (6.6 ft)	889D-F4AC-2
Mounting bracket, stainless steel, I-shaped for 42JT and 42JS	60-BJS-L1
Mounting bracket, stainless steel, I-shaped for 42JT and 42JS VisiSight	60-BJT-L2
Mounting bracket, plastic, swivel/tilt for 42JS and 42JT VisiSight	60-2619
Protective mounting bracket, stainless steel, u-shaped for 42JT and 42JS	60-BJT-U1
18 mm snap-on adaptor (42JS Only)	60-AJS-18
Reflector, corner cube, 76 mm (3 in.) diameter	92-124
Reflector, corner cube, 84 mm (3.3 in.) diameter	92-125
Reflector, Micro cube, 51 x 61 mm (2 x 2.5 in.) for laser and clear object models	92-118
Ethernet/IP Point I/O	1734-AENTR
Point I/O IO-Link Master Module	1734-4IOL
ArmorBlock IO-Link Master	1732E-8IOLM12R

For more information on our complete family of photoelectric products, please visit:  
[rok.auto/presence-sensing](https://rok.auto/presence-sensing)



# Photoelectric Sensors

SENSORS

## RightSight M30 42AF

- Universal 30 mm nose and 18 mm base mounts
- 360-degree highly visible status indicator LEDs
- Dual auto PNP/NPN
- 4 Available sensing modes:
  - Background suppression
  - Background reflection
  - Polarized retroreflective
  - Transmitted beam
- IP67, 1,200 psi and IP69k rated



## High-power, mid-size solution

The RightSight™ M30 addresses the challenges of a wide range of industries and applications. The rugged IP67/ IP69k housing is also fully sealed, allowing the RightSight M30 to withstand tough industrial environments, including those involving high-pressure and high-temperature washdowns.

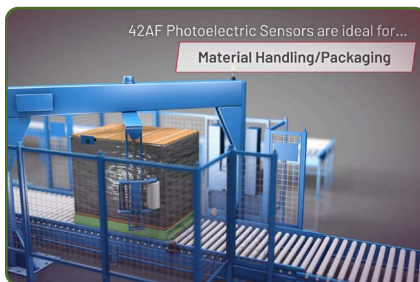

### Photoelectric Sensors



7-2...7-49

### Proximity Sensors



7-50...7-79

### Ultrasonic Sensors



7-80...7-83

### Limit Switches



7-84...7-95

### Encoders



7-96...7-103

### Condition Sensing



7-104...7-113

### Identification Devices



7-114...7-121

# Product Selection

## 42AF RightSight M30



**Allen-Bradley**

by ROCKWELL AUTOMATION

Sensing Mode	Operating Voltage	Light Source	Sensing Distance	Sensitivity Adjustment	Output Function	Output Type	Catalog Number
Background Suppression	10...30V DC	Infrared	Default setting: 10...400 mm (0...15.7 in.)	No physical adjustment. IO-Link teach: 4 m <sup>1</sup>	Light and dark operate	Dual auto PNP or NPN	42AF-B1MAB1-D4
			Default setting: 10...600 mm (0...23.6 in.)	No physical adjustment. IO-Link teach: 4 m <sup>1</sup>			42AF-B1MAB2-D4
			Default setting: 10...1.2 m (0...3.9 ft)	Push button teach: 3 m IO-Link teach: 4 m <sup>1</sup>			42AF-B1MAC1-D4
Background Reflection			0...800 mm (0...31.5 in.)	Push button teach: 3 m IO-Link teach: 4 m <sup>1</sup>			42AF-N1MAC1-D4
Polarized Retroreflective	10...30V DC	Visible red	0.025...10 m (0.03...33 ft) with 92-125 reflector	No adjustment (IO-Link adjustable)	Light and dark operate	Dual auto PNP or NPN	42AF-P2MAB1-D4
	20...250V DC 24...250V AC			No adjustment	Light operate	SPDT EM relay	42AF-P2RHB1-G4
					Dark operate		42AF-P2SHB1-G4
Transmitted Beam	10...30V DC	Infrared	0...80 m (0...262 ft)	No adjustment (IO-Link adjustable)	Transmitted beam emitter	N/A	42AF-P2CHB1-A2
	20...250V DC 24...250V AC						42AF-E1EZB1-D4
	10...30V DC			No adjustment	Light and dark operate	Dual auto PNP or NPN	42AF-R1MAB1-D4
	20...250V DC 24...250V AC				Light operate	SPDT EM relay	42AF-R1RHB1-G4
					Dark operate		42AF-R1SHB1-G4
		Light and dark operate		42AF-R1CHB1-A2			

IO-Link enabled.

Connection Options: The following suffixes describe the available connection options:

- D4: Describes an integral 4-pin DC micro (M12) quick-disconnect for DC models
- G4: Describes a 4-pin AC micro (M12) quick-disconnect on a 150 mm (6 in.) length pigtail on AC/DC models
- F4: Describes a 4-pin DC micro (M12) quick-disconnect on a 150 mm (6 in.) length pigtail on DC models
- A2: Describes a 2 m PVC cable
- M4: Describes a 4-pin mini quick-disconnect on a 150 mm (6 in.) length pigtail. Transmitted beam emitter only.
- M5: Describes a 5-pin mini quick-disconnect on a 150 mm (6 in.) length pigtail on AC/DC models. Polarized retroreflective and transmitted beam receivers only.

<sup>1</sup> Sensor response time can be changed up to 75 ms to achieve distance of up to 4 m. A higher distance between target and high reflectivity background may be needed when operating the sensors at distances greater than 2 m.

Additional connection options may be available. Refer to ProposalWorks for available options by sensing mode.

## Specifications

<b>Certifications</b>	CCC, cULus and CE marked for all applicable directives
<b>Enclosure Type Rating</b>	IP67, IP69K
<b>Operating Temperature [C (F)]</b>	-40...+70 °C (-40...158 °F) <sup>1</sup>
<b>Operating Voltage</b>	DC models: 10...30V DC, IO-Link: 18...30V AC/DC models: 20...250V DC 24...250V AC AC/DC: Reverse polarity
<b>Load Current</b>	DC: 100 mA max AC/DC SPDT: 10...30V DC: 3 A 31...125V DC: 200 mA 24...250V AC: 3 A
<b>Housing Material</b>	PBT
<b>Lens Material</b>	PMMA

<sup>1</sup> The sensing range for all sensing modes can be reduced up to 20% when operated between -40...-25 °C (-40...-13 °F).

## Mounting Accessories

Description	Cat. No.
DC micro cordset , 4-pin, 2 m (6.5 ft)	889D-F4AC-2
18 mm straight bracket	60-2656
18 mm right angle bracket	60-2657
30 mm stainless steel mounting bracket	60-2421
30 mm swivel/tilt bracket	60-2439
18 mm swivel/tilt bracket	60-2649
76 mm (3 in.) diameter reflector	92-39
47 mm (1.85 in.) diameter reflector	92-47
84 mm (3.3 in.) diameter reflector	92-125



For more information on our complete family of photoelectric products, please visit:  
[rok.auto/presence-sensing](http://rok.auto/presence-sensing)



# Photoelectric Sensors

SENSORS

## RightSight S18 42EA

- IP67 enclosure
- Industry standard 18 mm nose mount housing
- 360° visible LED status indicator
- Visible red light source
- Adjustable sensing range
- Multiple connection options
- Wide range of sensing modes



## An economical and easy-to-apply global sensing solution on (JA) or Excellent Detection Capabilities where Size and Shape Matter

The RightSight™ family of photoelectric sensors are ideal for material handling, packaging and assembly applications. The RightSight line also addresses the small form factor needs of many other industries including Life Sciences, Pharmaceutical, Food and Beverage and Home, Health and Beauty. The 42EA RightSight sensors offer a wide range of sensing modes, mounting options and unique features that make them optimal solutions for global use. including those involving high-pressure and high-temperature washdowns.

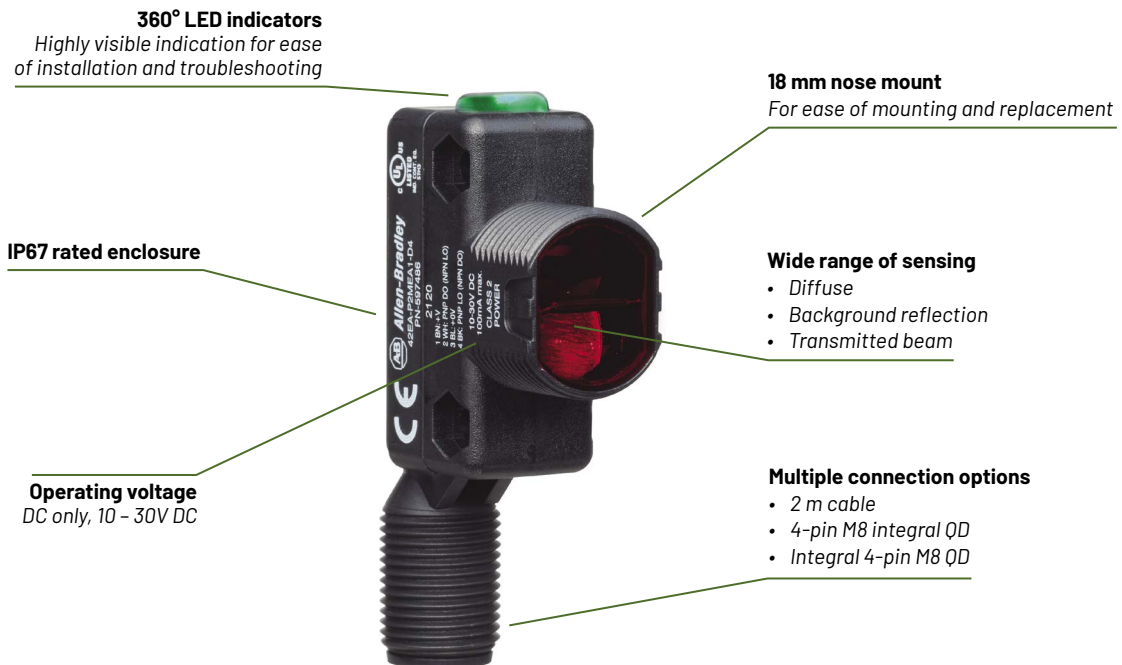

### Photoelectric Sensors



7-2...7-49

### Proximity Sensors



7-50...7-79

### Ultrasonic Sensors



7-80...7-83

### Limit Switches



7-84...7-95

### Encoders



7-96...7-103

### Condition Sensing



7-104...7-113

### Identification Devices



7-114...7-121



## Product Selection

### 42EA RightSight S18

Sensing Mode	Light Source	Sensing Distance	Sensitivity Adjustment	Output Function	Output Type	Cat. No. <sup>1</sup>
Polarized Retroreflective	Visible red	3.5 m (11.48 ft) with 92-125 reflector	Adjustable knob	Selectable light or dark operate	PNP and NPN	42EA-P2MEA1-D4
Diffuse	Infrared	10...450 mm (0.39...17.72 in.)	Adjustable knob	Selectable light or dark operate	PNP and NPN	42EA-D1MEA1-D4
Background Suppression	Visible red	10...50 mm (0.39...1.97 in.)	No adjustment knob	Selectable light or dark operate	PNP and NPN	42EA-B2MEB1-D4
		10...00 mm (0.39...3.94 in.)				42EA-B2MEB2-D4
Transmitted Beam	Visible red	10 m (32.81 ft)	No adjustment knob	Selectable light or dark operate	N/A	42EA-E1EZB1-D4
	Infrared		Adjustable knob		PNP and NPN	42EA-R1MEA1-D4

<sup>1</sup> Replace the x with the following connection option suffixes:

D4: An integral 4-pin DC micro (M12)

P4: An integral 4-pin Pico (M8) QD

A2: A 2 m (6.6 ft) PVC cable

RJ11: An RJ11 connector on a 2 m (6.6 ft) length cable (only available for 42EA-P2MEA1-RJ11)

Additional connection options may be available. See ProposalWorks™ for available options by sensing mode.

## Specifications

<b>Certifications</b>	cULus Listed and CE Marked for all applicable directives
<b>Operating voltage</b>	10...30V DC
<b>Diffuse, background suppression, and polarized retroreflective</b>	1 ms, max
<b>Transmitted beam</b>	3 ms, max
<b>Load current</b>	100 mA, max (resistive load)
<b>Housing material</b>	ABS
<b>Enclosure rating</b>	IP67
<b>Operating temperature</b>	-20...+55 °C (-4...+131 °F)

## Accessories

Description	Cat. No.
DC Micro QD Cordset, straight, 4-pin, 2 m (6.6 ft)	889D-F4AC-2
Pico QD Cordset, straight, 4-pin, 2 m (6.6 ft)	889P-F4AB-2
Mounting Bracket, swivel/tilt	60-2649
Reflector, 76 mm (3 in.) diameter	92-39
Reflector, 32 mm (1.25 in.) diameter	92-47





# Photoelectric Sensors

SENSORS

## RightSight 42EF

- Universal 18 mm mounting
- Ranges up to 20 m (65.6 ft)
- IP69K and 1200 psi washdown rating
- Non-adjustable, adjustable and teach models
- 360° visible LED indicators
- ECOLAB on cable models
- IO-Link enabled (select models)



### The Industry Standard for Durability and Performance

Many applications can be solved with a smaller sensor, but don't be fooled – this durable and rugged sensor has become the standard in many material handling applications. The polarized retroreflective has a maximum sensing range of 3 m (9.8 ft). It also requires much less space for mounting.



Material handling application – A retroreflective RightSight detecting packages on a conveyor line.

#### Photoelectric Sensors



7-2...7-49



7-50...7-79



7-80...7-83



7-84...7-95



7-96...7-103



7-104...7-113



7-114...7-121



## Product Selection

### 42EF RightSight

Sensing Mode	Operating Voltage	Light Source	Sensing Distance	Sensitivity Adjustment	Output Function	Cat. No. <sup>1</sup>
Retroreflective	10.8...30V DC	Visible red	25 mm...4.5 m (1 in...14.7 ft)	None	D.O., NPN & PNP	42EF-U2KBB-F4
	21.6...264V AC/DC				D.O., N-MOSFET	42EF-U2SCB-G4
Polarized retroreflective	10.8...30V DC		25 mm...3 m (1 in...9.8 ft)		L.O. & D.O., PNP	42EF-P2MPB-F4
	21.6...264V AC/DC				D.O., N-MOSFET	42EF-P2SCB-G4
Diffuse	10.8...30V DC	Infrared	3...500 mm (0.12...20 in.)	Single-turn knob	L.O. & D.O., PNP	42EF-D2MPAK-F4
	21.6...264V AC/DC		3...700 mm (0.12...27.6 in.)	Teach button	L.O., NPN & PNP	42EF-D1JBCK-F4
Sharp cutoff diffuse			10.8...30V DC	3...500 mm (0.12...20 in.)	Single-turn knob	L.O. & D.O., PNP
	21.6...264V AC/DC		L.O., N-MOSFET			42EF-S1RCA-G4
Background suppression	10.8...30V DC		3...50 mm (0.12...2 in.)	None	L.O. & D.O., PNP	42EF-B1MPBC-F4
			3...100 mm (0.12...3.9 in.)			42EF-B1MPBE-F4
	21.6...264V AC/DC		3...50 mm (0.12...2 in.)		L.O., N-MOSFET	42EF-B1RCBC-G4
			3...100 mm (0.12...3.9 in.)			42EF-B1RCBE-G4
Clear object detection	10.8...30V DC	Visible red	0.025...1 m (0.08...3.3 ft)	Single-turn knob	D.O., NPN & PNP	42EF-C2KBA-F4
	21.6...264V AC/DC				D.O., N-MOSFET	42EF-C2SCA-G4
Transmitted beam emitter	10.8...30V DC	Infrared	20 m (65.6 ft)	None	NA	42EF-E2EZB-F4
	21.6...264V AC/DC					42EF-E1EQZB-G4
Transmitted beam receiver	10.8...30V DC	Visible red			L.O. & D.O., PNP	42EF-R2MPB-F4
	21.6...264V AC/DC					D.O., N-MOSFET
Large aperture fiber optic	10.8...30V DC	Infrared	Depends on glass fiber optic cable selected on 6-44	Single-turn knob	L.O. & D.O., PNP	42EF-G1MPA-F4
	21.6...264V AC/DC				L.O. N-MOSFET	42EF-G1RCA-G4

<sup>1</sup> The **-F4** suffix describes a 4-pin DC Micro (M12) QD connector on a 150 mm (6 in.) pigtail. The **-G4** suffix describes a 4-pin AC Micro (M12) QD connector on a 150 mm pigtail.

IO-Link enabled.

## Specifications

<b>Certifications</b>	UL Listed, CSA Certified, and CE Marked for all applicable directives
<b>Enclosure Type Rating</b>	NEMA 4X, 6P, IP67 (IEC 529); 1200 psi (8270 kPa) washdown, IP69K
<b>Operating Temperature [C (F)]</b>	-25...+55 ° (-13...+131 °) ≥132V AC/DC -25...+70 ° (-13...+158 °) ≤132V AC/DC
<b>Protection Type</b>	False pulse, reverse polarity, overload, and short-circuit
<b>Output Current</b>	100 mA
<b>Response time</b>	DC models : 1 ms (4 ms for transmitted beam models); AC models: 8.3 ms (16.6 ms for transmitted beam)
<b>Housing Material</b>	Mindel®
<b>Lens Material</b>	Acrylic
<b>Cover Material</b>	Udel®

## Required Cordsets and Accessories

Description	Cat. No.
DC Micro (M12) QD cordset, straight, 4-pin, 2 m (6.6 ft)	889D-F4AC-2
AC Micro (M12) QD cordset, straight, 4-pin, 2 m (6.6 ft)	889R-F4AEA-2
Mounting bracket, plastic, swivel/tilt	60-2649
Reflector, round, 76 mm (3 in.) diameter	92-39
Reflector, round, 32 mm (1.25 in.) diameter	92-47
Ethernet/IP Point I/O	1724-AENTR
Point I/O IO-Link Master Module	1734-4IOL
ArmorBlock IO-Link Master	1732E-8IOLM12R

For more information on our complete family of photoelectric products, please visit:  
[rok.auto/presence-sensing](http://rok.auto/presence-sensing)



# Photoelectric Sensors

SENSORS

## RightSight LaserSight 42EF

- Class 1 eye safe visible laser for small object detection
- Universal 18 mm mounting
- Ranges up to 40 m (131.2 ft)
- IP69K rated enclosure for diffuse and transmitted beam
- IP54 for polarized retroreflective
- Non-adjustable, adjustable, and teach models
- 360° visible LED indicators



### Ideal for Small Object Detection

Laser sensors are ideal for small object detection or in applications requiring a narrow field of view. In most cases, laser sensors offer better operating margin and/or longer sensing distances than their LED-based counterparts.

The 42EF RightSight LaserSight uses eye-safe Class 1 visible laser light and features the same mounting options as other products in the RightSight product line. Class 1 lasers require no additional safety or protective training or equipment and are safe for general purpose use.



Roll detection - A 42EF RightSight LaserSight monitors a roll of film to indicate low film level.

### Photoelectric Sensors



7-2...7-49



Proximity Sensors

7-50...7-79



Ultrasonic Sensors

7-80...7-83



Limit Switches

7-84...7-95



Encoders

7-96...7-103



Condition Sensing

7-104...7-113



Identification Devices

7-114...7-121



## Product Selection

### 42EF RightSight LaserSight

Sensing Mode	Light Source	Sensing Distance	Sensitivity Adjustment	Output Function	Cat. No.
Polarized retroreflective	Class 1 laser	0.05...15 m (0.16...49.2 ft)	Teach button	D.O., NPN & PNP	42EF-P8KBC-F4
Diffuse	Class 1 laser	3...300 mm (0.1...11.8 in.)	Single-turn knob	L.O., NPN & PNP	42EF-D8JBA-F4
			Teach button		42EF-D8JBC-F4



**Connected Components**  
Simpler, faster, cost-effective machine building.  
[rok.auto/ccw](http://rok.auto/ccw)

## Specifications

<b>Certifications</b>	UL Listed, CSA Certified, and CE Marked for all applicable directives
<b>Enclosure Type Rating</b>	IP54 (polarized retroreflective only), All others: IP69K rated
<b>Operating Temperature [C (F)]</b>	-10...+40 ° (14...+104 °)
<b>Operating Voltage</b>	22...26V DC, 30 mA, max.
<b>Protection Type</b>	False pulse, reverse polarity, overload, short-circuit
<b>Output Current</b>	100 mA
<b>Response Time</b>	1 ms (4 ms for transmitted beam models)
<b>Housing Material</b>	Mindel <sup>®</sup>
<b>Lens Material</b>	Acrylic
<b>Cover Material</b>	Udel <sup>®</sup>

## Required Cordsets and Accessories

Description	Cat. No.
DC Micro (M12) QD cordset, straight, 4-pin, 2 m (6.6 ft)	889D-F4AC-2
Mounting bracket, plastic, swivel/tilt	60-2649
Microcube reflector	92-118



# Photoelectric Sensors

SENSORS

## Series 9000 42G

- Our longest range, full-featured offering – up to 61 m (200 ft)
- IP69K and ECOLAB
- ClearSight™ 9000 clear object detection models
- Series 9000 LaserSight™ models for small object detection
- Standard, timing, and teach models available
- Fiber optic capability



Series 9000



Series 9000 LaserSight

## Full-size and Full-featured

Series 9000™ general purpose sensors offer many features that help keep you up and running, even in harsh environments. With nearly 300 configurations to choose from – including multiple supply-voltage ranges, output options and connection choices – Series 9000 sensors provide the versatility needed to easily interface with programmable controllers and other electrical loads.

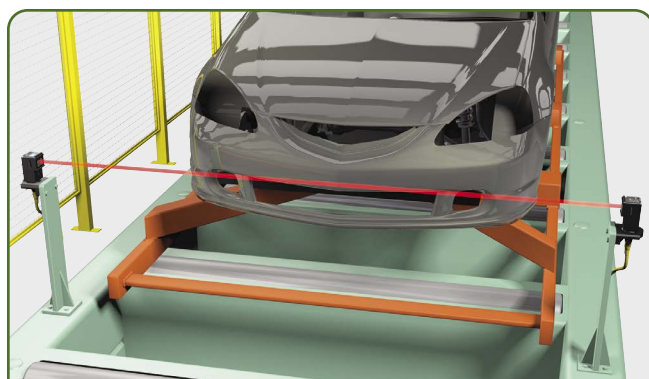

Body shop application – A LaserSight 9000 detecting precise position of a car body skid.

## Specifications

<b>Certifications</b>	UL Listed, CSA Approved, and CE Marked for all applicable directives
<b>Enclosure Type Rating</b>	IP69K, IP67 with 1200 psi; NEMA 3, 4X, 6P, 12, 13; ECOLAB rated
<b>Operating Temperature [C (F)]</b>	-34...+70 ° (-29...+158 °) -10...+50 ° (-14...+122 °) LaserSight model
<b>Operating Voltage</b>	10...30V DC, 40...264V AC/DC (see product selection table)
<b>Protection Type</b>	False pulse, reverse polarity, overload, short-circuit
<b>Load Current</b>	250 mA @ 30V DC (all models except 42GLP & 42GSP), 2 A @ 132V AC, 1 A @ 264 V AC (SPDT models)
<b>Housing Material</b>	Thermoplastic polyester resin
<b>Lens Material</b>	Acrylic
<b>Cover Material</b>	Neoprene

### Photoelectric Sensors



7-2...7-49

### Proximity Sensors



7-50...7-79

### Ultrasonic Sensors



7-80...7-83

### Limit Switches



7-84...7-95

### Encoders



7-96...7-103

### Condition Sensing



7-104...7-113

### Identification Devices



7-114...7-121





## Product Selection

### 42G Series 9000

Sensing Mode	Supply Voltage	Light Source	Sensing Distance	Output Function	Cat. No.
Polarized retroreflective	10...30V DC, 30 mA	Visible red	0.050 ... 4.9 m (0.16 ... 16 ft)	Selectable L.O. or D.O., NPN and PNP	42GRU-9200-QD
	70...264V AC/DC			Selectable L.O. or D.O., SPDT EM Relay	42GRU-9202-QD
	40...264V AC, 15 mA			Selectable L.O. or D.O., Solid-state isolated N.O.	42GRU-9203-QD
Diffuse	10...30V DC, 30 mA	Infrared	0.050...1.5 m (0.16...5 ft)	Selectable L.O. or D.O., NPN and PNP	42GLP-9000-QD
	70...264V DC 60...264V AC, 15 mA			Selectable L.O. or D.O., SPDT EM Relay	42GRP-9002-QD
	40...264V AC, 15 mA			Selectable L.O. or D.O., Solid-state isolated N.O.	42GRP-9003-QD
Clear object detection	10...30V DC, 30 mA	Visible red	0.050...1.2 m (0.16...4 ft)	Selectable L.O. or D.O., NPN and PNP	42GRC-9200-QD
	70...264V AC/DC			Selectable L.O. or D.O., SPDT EM Relay	42GRC-9202-QD
	45...264V AC, 15 mA			Selectable L.O. or D.O., Solid-state isolated N.O.	42GRC-9203-QD
Transmitted beam emitter	10...264V AC/DC, 15 mA	Infrared	0.025...61 m (0.83...200 ft)	NA	42GRL-9000-QD
Transmitted beam receiver	10...30V DC, 30 mA			Selectable L.O. or D.O., NPN and PNP	42GRR-9000-QD
	40...264V AC, 10 mA			Selectable L.O. or D.O., Solid-state isolated N.O.	42GRR-9003-QD
Large aperture fiber optic	10...30V DC, 30 mA	Infrared	Depends on fiber optic cable selected on 6-44	Selectable L.O. or D.O., NPN and PNP	42GRF-9000-QD
	70...264V AC/DC, 15 mA			Selectable L.O. or D.O., SPDT EM Relay	42GRF-9002-QD
	40...264V AC, 15 mA			Selectable L.O. or D.O., Solid-state isolated N.O.	42GRF-9003-QD

### 42G Series 9000 LaserSight

Sensing Mode	Sensing Distance	Operating Voltage	Light Source	Output Configuration	Cat. No. <sup>1</sup>
Polarized retroreflective	0.3 ... 40 m (1 ... 130 ft)	10...30V DC, 45 mA	Class 1 laser	Selectable L.O. or D.O., NPN and PNP	42GRU-92L0-QD
		110...132V AC, 70 mA		Selectable L.O. or D.O., SPDT EM Relay	42GRU-92L2-QD
Diffuse	800 mm (31.5 in.)	10...30V DC, 45 mA		Selectable L.O. or D.O., NPN and PNP	42GRP-92L0-QD
		110...132V AC, 70 mA		Selectable L.O. or D.O., SPDT EM Relay	42GRP-92L2-QD

<sup>1</sup> The **-QD** suffix describes a 4-pin DC Micro (M12) integral QD for DC models, a 5-pin mini QD for SPDT EM relay models.

## Required Cordsets and Accessories

Description	Cat. No.
DC Micro (M12) QD cordset, straight, 4-pin, 2 m (6.6 ft)	889D-F4AC-2
Mini QD cordset, 4-pin, 1.8 m (6 ft)	889N-F4AF-6F
Mounting bracket, plastic, swivel/tilt	60-2439
Mounting bracket, heavy duty impact	60-2702
Reflector, round, 76 mm (3 in.) diameter	92-39
Reflector, round, 32 mm (1.25 in.) diameter	92-47
Fiber optic cable lens extender	60-2738





# Photoelectric Sensors

SENSORS

## 18 mm Plastic Cylindrical 42CA

- 18 mm plastic cylindrical
- Ranges up to 16 m (52.5 ft)
- Extended range high-speed models
- IP67 rating
- Linear sensitivity adjustment
- Stability indication
- Dual LED indicators



## A Cost-effective General-purpose Solution

The 42CA 18 mm plastic cylindrical general-purpose sensors are ideal for light to medium duty industrial applications. Five possible sensing modes allow the 42CA to be used in a variety of complex applications. These sensors offer a highly linear sensitivity adjustment, stability indication and excellent noise immunity; making them easy to apply and maintain.

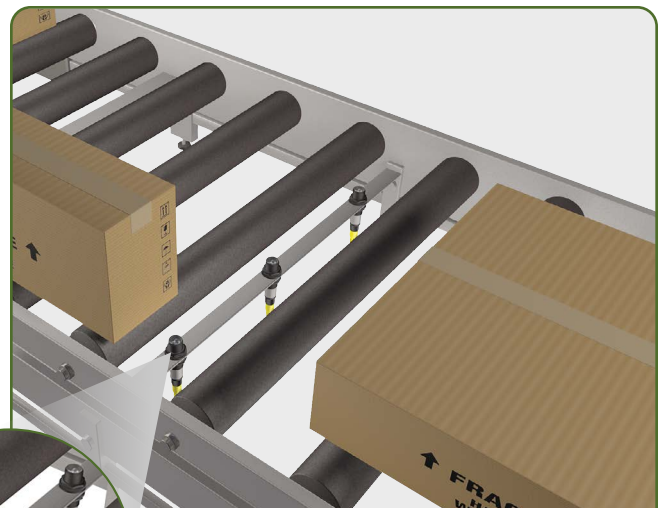
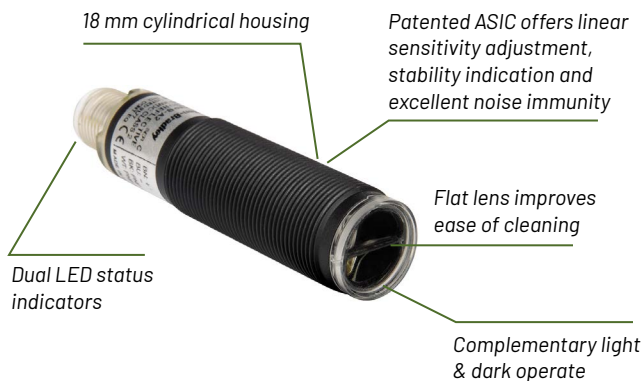

Material handling – Three 42CA sensors detecting boxes of varying sizes from below and in any position across the conveyor width.

### Photoelectric Sensors



7-2...7-49

### Proximity Sensors



7-50...7-79

### Ultrasonic Sensors



7-80...7-83

### Limit Switches



7-84...7-95

### Encoders



7-96...7-103

### Condition Sensing



7-104...7-113

### Identification Devices



7-114...7-121



## Product Selection

### 18 mm Plastic Cylindrical

Sensing Mode	Light Source	Sensing Distance	Sensitivity Adjustment	Output Configuration	Response Time	Cat. No. <sup>1</sup>
Retroreflective	Visible red	0.002...4.8 m (0.0 ...15.7 ft)	None	Complementary L.O. & D.O., PNP	1 ms	42CA-U2MPB-D4
		0.002...7.2 m (0.0 ...23.6 ft)	Single-turn potentiometer		0.5 ms	42CA-U2MPA-D4
Polarized retroreflective		0.002...3.8 m (0.0 ...12.5 ft)	None		1 ms	42CA-P2MPB-D4
Standard diffuse	Infrared	0...100 mm (0...3.9 in.)	Single-turn potentiometer		1 ms	42CA-D1MPAE-D4
		0...400 mm (0...15.7 in.)				42CA-D1MPAJ-D4
		0...1 m (0...3.28 ft)				42CA-D1MPAL-D4
Background suppression	Visible red	50 mm (2 in.)	None	Selectable L.O. or D.O., PNP	0.5 ms	42CA-B2LPBC-D4
		100 mm (3.9 in.)				42CA-B2LPBE-D4
Transmitted beam emitter	Infrared	0.003...16 m (0.01...52.5 ft)	Single-turn potentiometer	NA	NA	42CA-E1EZB1-D4
Transmitted beam receiver						Complementary L.O. & D.O., PNP

<sup>1</sup> The **-D4** suffix describes a 4-pin DC Micro (M12) QD connector.

## Specifications

<b>Certifications</b>	cULus Listed and CE Marked for all applicable directives
<b>Enclosure Type Rating</b>	IP67
<b>Operating Temperature [C (F)]</b>	-25...+70 ° (-13...+158 °)
<b>Operating Voltage</b>	10...30V DC, 30 mA
<b>Protection Type</b>	Reverse polarity, overload, short-circuit
<b>Load Current</b>	100 mA
<b>Housing Material</b>	PBT
<b>Lens Material</b>	PMMA

## Required Cordsets and Accessories

Description	Cat. No.
DC Micro QD cordset, straight, 4-pin, 2 m (6.6 ft)	889D-F4AC-2
DC Micro QD cordset, right angle, 4-pin, 2 m (6.6 ft)	889D-R4AC-2
Mounting bracket, snap-clamp	871A-SCBP18
Mounting bracket, right angle	60-2657
Mounting bracket, swivel/tilt	60-2649
Mounting bracket, straight	60-2656
Spare corner cube reflector (76 mm (3 in.) diameter with mounting hole)	92-39
Spare corner cube reflector (32 mm (1.3 in.) diameter with mounting hole)	92-47



# Photoelectric Sensors

SENSORS

## 18 mm Metal Cylindrical 42CM

- Heavy duty 18 mm metal housing
- Ranges up to 20 m (65.6 ft)
- IP67 rating
- Sensitivity adjustment (diffuse models only)



### General-purpose Sensing in a Rugged Metal Housing

The 42CM 18 mm Metal Cylindrical General-purpose Sensors are intended for heavy-duty industrial applications requiring an industry standard 18 mm cylindrical housing. Five possible modes of sensing allow the 42CM to be used in a variety of complex applications. Outputs are short-circuit protected to provide continuous operation even under unexpected conditions.

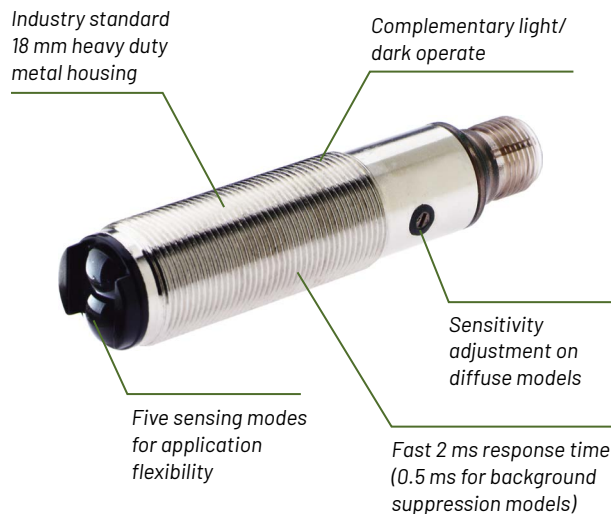

#### Photoelectric Sensors



7-2...7-49

#### Proximity Sensors



7-50...7-79

#### Ultrasonic Sensors



7-80...7-83

#### Limit Switches



7-84...7-95

#### Encoders



7-96...7-103

#### Condition Sensing



7-104...7-113

#### Identification Devices



7-114...7-121



## Product Selection

### 18 mm Metal Cylindrical

Sensing Mode	Light Source	Sensing Distance	Sensitivity Adjustment	Output Configuration	Response Time	Cat. No. <sup>1</sup>
Retroreflective	Infrared	0.003...4 m (0.0...13.2 ft)	None	Complementary L.O. & D.O., PNP	4 ms	42CM-U1MPB-D4
Polarized retroreflective	Visible red	0.003...3 m (0...9.9 ft)				42CM-P2MPB-D4
Standard diffuse		0...100 mm (0...3.9 in.)	2 ms		42CM-D2MPAE-D4	
		0...400 mm (0...15.7 in.)			42CM-D1MPAL-D4	
Background suppression		50 mm (2 in.)	Selectable L.O. or D.O., PNP	0.5 ms	42CM-B2LPBC-D4	
	100 mm (3.9 in.)	42CM-B2LPBE-D4				
Transmitted beam emitter	Infrared	3...20 m (0...65.6 ft)	None	NA	NA	42CM-E1EZB-D4
Transmitted beam receiver	Infrared or visible red		Complementary L.O. & D.O., PNP	2 ms	42CM-R1MPB-D4	

<sup>1</sup> The **-D4** suffix describes a 4-pin DC Micro (M12) QD connector.

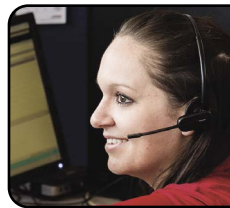

### Need Help?

The Rockwell Automation Support Center is your 24/7 support for the answers you need now.

[rok.auto/support](http://rok.auto/support)

## Specifications

<b>Certifications</b>	cULus Listed and CE Marked for all applicable directives
<b>Enclosure Type Rating</b>	IP67
<b>Operating Temperature [C (F)]</b>	-25...+70 ° (-13...+158 °)
<b>Operating Voltage</b>	10...30V DC, 30 mA
<b>Protection Type</b>	Reverse polarity, overload, short-circuit
<b>Load Current</b>	100 mA
<b>Housing Material</b>	Nickel-plated brass
<b>Lens Material</b>	PMMA/PC

## Required Cordsets and Accessories

Description	Cat. No.
DC Micro QD cordset, straight, 4-pin, 2 m (6.6 ft)	889D-F4AC-2
DC Micro QD cordset, right angle, 4-pin, 2 m (6.6 ft)	889D-R4AC-2
Mounting bracket, snap-clamp	871A-SCBP18
Mounting bracket, right angle	60-2657
Mounting bracket, swivel/tilt	60-2649
Mounting bracket, straight	60-2656
Spare corner cube reflector (76 mm (3 in.) diameter with mounting hole)	92-39
Spare corner cube reflector (32 mm (1.3 in.) diameter with mounting hole)	92-47

For more information on our complete family of photoelectric products, please visit:  
[rok.auto/presence-sensing](http://rok.auto/presence-sensing)



# Photoelectric Sensors

SENSORS

## LaserSight 18 mm Metal Cylindrical 42CM

- Class 1 eye safe visible laser for small object detection
- Heavy duty 18 mm metal housing
- Ranges up to 50 m (164 ft)
- Small 0.1 mm spot size
- IP67 rating



## Rugged, Laser-based Sensing

The 42CM 18 mm LaserSight photoelectric laser sensors combine an eye-safe Class 1 visible laser light source and an industry standard cylindrical housing. They are ideal for tough sensing applications that require a longer range, where the environment is dusty, dirty, or when the object to be sensed is small.

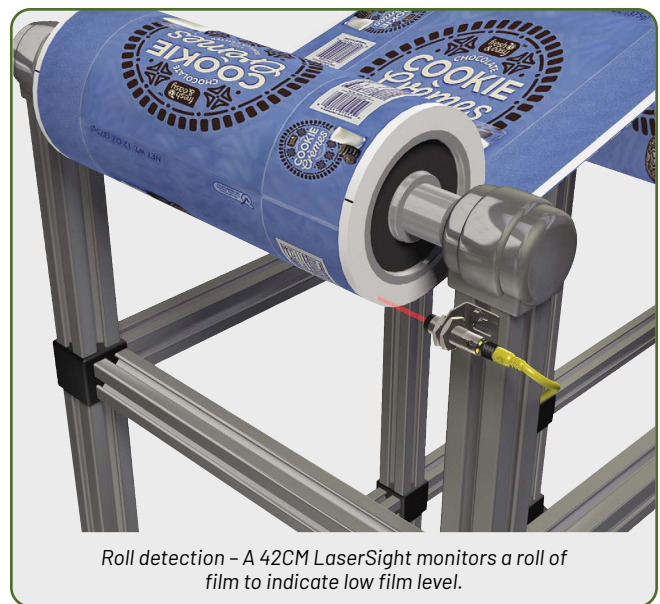

### Photoelectric Sensors



7-2...7-49

### Proximity Sensors



7-50...7-79

### Ultrasonic Sensors



7-80...7-83

### Limit Switches



7-84...7-95

### Encoders



7-96...7-103

### Condition Sensing



7-104...7-113

### Identification Devices



7-114...7-121





## Product Selection

### 42CM LaserSight 18 mm Metal Cylindrical

Sensing Mode	Light Source	Sensing Distance	Sensitivity Adjustment	Output Configuration	Response Time	Cat. No. <sup>1</sup>
Polarized retroreflective	Class 1 laser	0.003...30 m (0...78 ft)	None	Complementary L.O. and D.O., PNP	0.7 ms	42CM-P8MPB-D4
Diffuse		3...300 mm (0...11.8 in.)	Teach button			42CM-D8MPA-D4
Transmitted beam emitter		3...50 m (0...164 ft)	Potentiometer	NA	NA	42CM-E8EZB-D4
Transmitted beam receiver				Complementary L.O. and D.O., PNP	0.5 ms	42CM-R8MPB-D4

<sup>1</sup> The **-D4** suffix describes a 4-pin DC Micro (M12) QD connector.



#### Sales Offices and Distributors

Our network of sales offices and distributors offers exceptional knowledge and service to help you design, implement and support your automation investment.

[rok.auto/buy](http://rok.auto/buy)

## Specifications

<b>Certifications</b>	cULus Listed and CE Marked for all applicable directives
<b>Enclosure Type Rating</b>	IP67
<b>Operating Temperature [C (F)]</b>	-10...+55 ° (14...131 °)
<b>Operating Voltage</b>	10...30V DC, 25 mA
<b>Protection Type</b>	Reverse polarity, overload, short-circuit
<b>Load Current</b>	100 mA
<b>Housing Material</b>	Nickel-plated brass
<b>Lens Material</b>	Glass

## Required Cordsets and Accessories

Description	Cat. No.
DC Micro QD cordset, straight, 4-pin, 2 m (6.6 ft)	889D-F4AC-2
DC Micro QD cordset, right angle, 4-pin, 2 m (6.6 ft)	889D-R4AC-2
Mounting bracket, snap-clamp	871A-SCBP18
Mounting bracket, right angle	60-2657
Mounting bracket, swivel/tilt	60-2649
Mounting bracket, straight	60-2656
Rectangular reflector, 51 x 51 mm (2 x 2 in.)	92-118





# Photoelectric Sensors

SENSORS

## 18 mm Stainless Steel Cylindrical 42CS

- Stainless steel 18 mm cylindrical
- Smooth barrel design
- Ranges up to 20 m (65.6 ft)
- IP69K, ECOLAB, and Johnson Diversey rated
- Extended temperature operating range
- Ferromagnetic teach



## The Ideal Solution for Food and Beverage Applications

The 42CS stainless steel cylindrical sensors are ideal for food, beverage, and pharmaceutical applications. The smooth, clean design minimizes the collection and accumulation of undesired particles allowing for a fast and easy clean up. An innovative teach feature also simplifies setup – just place a ferromagnetic metal object on a section of the sensor housing to initiate the teach process.

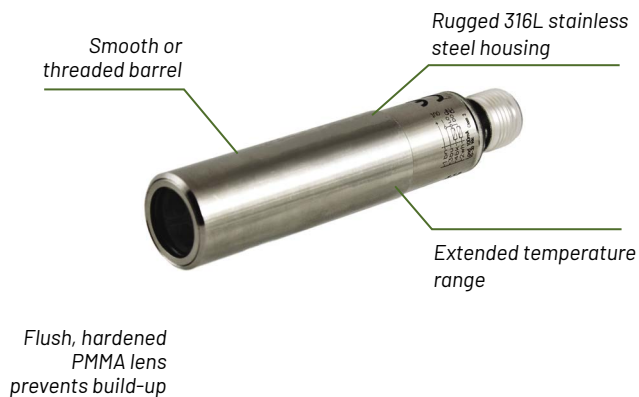

Optional block mounting bracket for smooth barrel housing (Cat. No. 60-BCS-18B)



Flap detection - When the single 42CS mounted on the side of the conveyor senses a food package, it triggers the two sensors above to check for open box flaps, ensuring all packages are sealed.

### Photoelectric Sensors



7-2...7-49

### Proximity Sensors



7-50...7-79

### Ultrasonic Sensors



7-80...7-83

### Limit Switches



7-84...7-95

### Encoders



7-96...7-103

### Condition Sensing



7-104...7-113

### Identification Devices



7-114...7-121



## Product Selection

### 18 mm Stainless Steel Cylindrical

Sensing Mode	Light Source	Sensing Distance	Sensitivity Adjustment	Output Configuration	Response Time	Cat. No. <sup>1</sup>
Polarized retroreflective	Visible red	4 m (13.1 ft)	None	Complementary L.O./D.O., PNP	1 ms	42CSS-P2MPB1-D4
Standard diffuse		Infrared	100 mm (3.9 in.)			Ferromagnetic teach
	400 mm (15.8 in.)		42CSS-D1MPA2-D4			
	800 mm (31.5 in.)		42CSS-D1MPA3-D4			
Background suppression	Visible red		60...100 mm (2.4...3.9 in.)		1.25 ms	
Clear object detection	Visible red	1 m (3.2 ft)	1 ms		42CSS-C2MPA1-D4	
Transmitted beam emitter		Infrared	0...20 m (0...65.6 ft)	None	NA	
Transmitted beam receiver	Complementary L.O./D.O., PNP			2 ms	42CSS-R9MPB1-D4	

<sup>1</sup> The prefix **42CSS** denotes smooth barrel. For threaded models, replace the **42CSS** with **42CST** (e.g., **42CST-P2MPB1-D4**). The **-D4** suffix describes a 4-pin DC Micro (M12) QD connector.



#### Product Selection Tools

Available online or for download, our tools help you access info while in the office or on the go.  
[rok.auto/selection](http://rok.auto/selection)

## Specifications

<b>Certifications</b>	cULus Listed and CE Marked for all applicable directives
<b>Enclosure Type Rating</b>	IP69K, ECOLAB, and Johnson Diversey rated
<b>Operating Temperature [C (F)]</b>	-25...+85 ° (-13...+185 °)
<b>Operating Voltage</b>	10...30V DC @ 35 mA max.
<b>Protection Type</b>	Reverse polarity, transient noise, short-circuit
<b>Load Current</b>	100 mA
<b>Housing Material</b>	316 stainless steel
<b>Lens Material</b>	PMMA

## Required Cordsets and Accessories

Description	Cat. No.
DC Micro QD cordset, straight, 4-pin, 2 m (6.6 ft)	889D-F4AC-2
DC Micro (M12) QD patchcord	889D-F4ACDM-2
Block mounting bracket for smooth barrel housing	60-BCS-18B
Straight mounting bracket for threaded models	60-2656
Right angle mounting bracket for threaded models	60-2657
Spare corner cube reflector (32 mm (1.26 in.) diameter with mounting hole)	92-47



# Photoelectric Sensors

## SENSORS

### Long-Range Background Suppression 42BT and 42BC

- Adjustable 1 m and 2 m range background suppression
- Slim flat pack housing design
- Infrared LED or red LED
- Selectable L.O. and D.O.
- Dual (PNP and NPN) outputs
- AC/DC relay output models (42BC)



### Sensing the Target While Ignoring the Background

Background suppression sensors are designed for applications requiring the sensor to see a target very close to a reflective background. Background suppression is particularly effective when the target and background have similar reflectivities or when dark targets are to be sensed against a lighter, more reflective background. These long range models offer high background suppression performance at sensing ranges up to 2 m (6.6 ft).

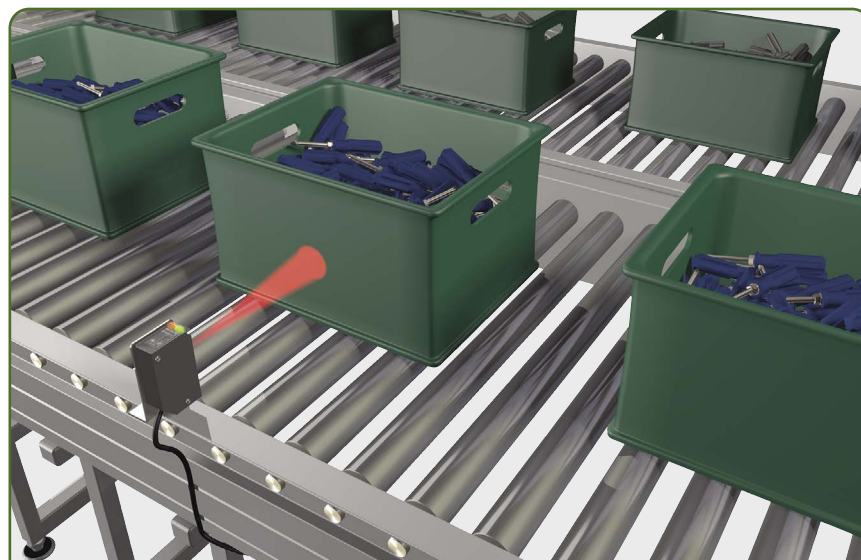

Side-by-side conveyors - A 42BT background suppression sensor detects bins on the near conveyor while ignoring bins on the second.

#### Photoelectric Sensors



7-2...7-49

#### Proximity Sensors



7-50...7-79

#### Ultrasonic Sensors



7-80...7-83

#### Limit Switches



7-84...7-95

#### Encoders



7-96...7-103

#### Condition Sensing



7-104...7-113

#### Identification Devices



7-114...7-121



## Product Selection

### Long-Range Background Suppression

Sensing Mode	Light Source	Sensing Distance [mm (in.)]	Sensitivity Adjustment	Output Configuration	Response Time	Cat. No.
Background suppression	Visible red	100...1000 (3.94...39.4)	5-turn potentiometer	Selectable L.O./D.O., NPN & PNP	2 ms	42BT-B2LBSL-F4
		100...2000 (3.94...78.7)				42BT-B1LBSN-F4
	Infrared	200...1000 (7.87...39.4)	Adjustment knob	Selectable L.O./D.O., SPST N.O Relay	20 ms	42BC-B1LBAL-T4
						42BC-B1CRAL-T4
		200...2000 (7.87...78.7)		Selectable L.O./D.O., NPN & PNP	30 ms	42BC-B1LBAN-T4
						42BC-B1CRAN-T4



**Connected Components**

Simpler, faster, cost-effective machine building.

[rok.auto/ccw](http://rok.auto/ccw)

## Specifications

Certifications	42BT	cULus Listed and CE certified for all applicable directives
	42BC	UL Listed and CSA certified
Enclosure Type Rating	42BT	IP66
	42BC	IP65
Operating Temperature [C (F)]	42BT	-25...+55 ° (-13...+131 °)
	42BC	
Operating Voltage	42BT	12...24V DC
	42BC	12...24V DC, 24...240V AC/DC
Protection Type	42BT	Short circuit
	42BC	Short circuit, reverse polarity, overload
Load Current	42BT	100 mA
	42BC	100 mA, 3A (AC/DC)
Housing Material	42BT	Polyarilate
	42BC	Polycarbonate and acrylic
Lens Material	42BT	Polyarilate
	42BC	

## Required Cordsets and Accessories

Description	Cat. No.
DC Micro QD cordset, straight, stainless steel, 4-pin, 2 m (6.6 ft)	889D-F4AC-2
DC Micro (M12) QD receptacle	888D-M4AC1-0M3
Vertical mounting bracket for 42BT	61-6738
Horizontal mounting bracket for 42BT	61-6739
Mounting bracket	60-2637
Replacement cover	60-2669
Mini QD receptacle	60-2668



# Photoelectric Sensors

SENSORS

## Laser Measurement 45LMS

- Long-range, high performance measurement
- One discrete and one analog (4...20 mA) output
- Push button setup of switch points or analog scaling

## PHOTOSWITCH® Distance Measurement 45DMS

- Averaging filter function stabilizes the signal to provide a more constant measurement
- Ability to change the 4-20 mA to 0-10V DC on the analog output models
- Accurate to  $\pm 20$  mm ( $\pm 1.18$  in.) linearity



## Compact and Flexible

The 45DMS and 45LMS are great solutions for long range detection/measurement in difficult applications. The 45DMS features a 3-in-1 sensing mode which can be easily interchanged - Distance Measurement, Background Suppression and Background Reflection. Available in three ranges, the 45LMS uses the Time of Flight principle and has a relatively small beam spot, even from a distance of 50 m (164 ft).



	45DMS	45LMS
Distance measurement range	0.06...5 m	0.2...8 m; 0.2...15 m
Light source	Class 1 Laser	
Outputs	1 x Auto PNP/NPN + Remote Teach, 1 x Auto PNP/NPN + 4...20 mA (0-10V via IO-Link)	1 x PNP + 4...20 mA
Linearity	(SYMBOL) $\pm 30$ mm	(SYMBOL) $\pm 25$ mm
Repeatability	1.2 mm (1 sigma)	Less than 5 mm
Resolution	1 mm IO-Link, 5 mm Analog	Less than 5 mm
Response time	2 ms	10 ms
Operating voltage	18...30V DC	10...30V DC
Enclosure size	50 x 50 x 23 mm	94 x 55 x 26 mm
Embedded IO-Link	included	
Enclosure rating	IP67 and IP69K	IP65

### Typical 45LMS applications:

- Distance measurement
- Verifying material position
- Stack level
- Roll diameter or thickness measurement
- Fixture positioning
- Error-proofing inspection
- Level monitoring
- Crane crash protection

### The 45DMS is ideal for space-limited applications:

- Food and beverage
- Material handling
- Packaging plants

### Photoelectric Sensors



7-2...7-49

### Proximity Sensors



7-50...7-79

### Ultrasonic Sensors



7-80...7-83

### Limit Switches



7-84...7-95

### Encoders



7-96...7-103

### Condition Sensing



7-104...7-113

### Identification Devices



7-114...7-121



## Product Selection

### Distance & Laser Measurement

Sensing Mode	Light Source	Sensing Distance	Sensitivity Adjustment Output Type	Spot Size	Cat. No.
Background suppression	Class 1 Laser	0.06...5 m (90% white) (2.36 in....16.40 ft) 0.06...3 m (6% black) (2.36 in....9.84 ft)	One Push Button Auto PNP or NPN	—	45DMS-B8LAT1-D4
Background reflection	Class 1 Laser	0.1...5 m (90% white) (3.94 in. to 16.40 ft) 0.1...3 m (6% black) (3.94 in. to 9.84 ft)	Two Push Buttons Auto PNP or NPN	—	45DMS-B8LGT1-D5
Diffuse	Class 1 laser	0.2...8 m (0.66...26.25 ft)	—	< 10 mm (0.39 in.) at 8 m (26 ft) and 20 °C (68 °F)	45LMS-D8LGC1-D4
	Class 1 laser	0.2...15 m (0.66...49.21 ft)	—	< 15 mm (0.59 in.) at 15 m (49 ft) and 20 °C (68 °F)	45LMS-D8LGC2-D4
Retroreflective	Class 1 laser	0.2...50 m (0.66...164.04 ft)	—	< 50 mm (2 in.) at 50 m (164 ft) and 20 °C (68 °F)	45LMS-U8LGC3-D4

IO-Link enabled.

## Specifications

	45DMS	45LMS
<b>Certifications</b>	cULus listed, and CE marked for all applicable directives	
<b>Enclosure Rating</b>	IP67 and IP69K	IP65
<b>Operating Temperature [C (F)]</b>	-40...+60 °C (-40...+140 °F)	-30...+50 ° (-22...+122 °)
<b>Operating Voltage</b>	18...30V DC	10...30V DC, (18...30V DC in IO-Link mode)
<b>Protection Type</b>	Short circuit, reverse polarity (for discrete output); Short circuit, overload protected (for analog output)	
<b>Load Current</b>	100 mA max.	
<b>Housing Material</b>	ABS	Plastic ABS
<b>Lens Material</b>	PMMA	Plastic pane

## Required Cordsets and Accessories

Description	Cat. No.
DC Micro (M12) straight QD cordset, 4-pin, 2 m (6.6 ft)	889D-F4AC-2
DC Micro (M12) right angle cordset, 4-pin, 2 m (6.6 ft)	889D-R4AC-2
Mounting bracket	45LMS-BKT1
Mounting bracket (L shape)	45LMS-BKT2
Weld slag cover	45LMS-BKT3
Stainless steel mounting bracket (L-shape)	60-BDMS-LS
Stainless steel precision mounting bracket	60-BDMS-PS
Bracket for Ø 12 mm mounting rod and 10x10 mm square profile	60-BDMS-RS
Protective stainless steel mounting bracket	60-BDMS-US
Point I/O IO-Link Master Module	1734-4IOL
ArmorBlock IO-Link Master	1732E-8IOLM12R





# Photoelectric Sensors

SENSORS

## ColorSight True Color 46CLR

- Three models to address your needs:
  - Glare suppression
  - Small spot size (for small object detection)
  - Long range
- Internally stores up to seven colors in color match mode and unlimited colors by using IO-Link when connected to CompactLogix™



## Advanced, High-Performance Color Sensing

The 46CLR was designed to perform the sensing operations commonly found in the automotive, food and beverage, pharmaceutical, and plastics, among other industries.

The 46CLR color sensing solution features patent-pending distance correction technology that confirms consistent color detection at ranges up to 65 mm. Additional features include internal storage of up to seven colors and nine adjustable tolerance levels for optimal application flexibility.

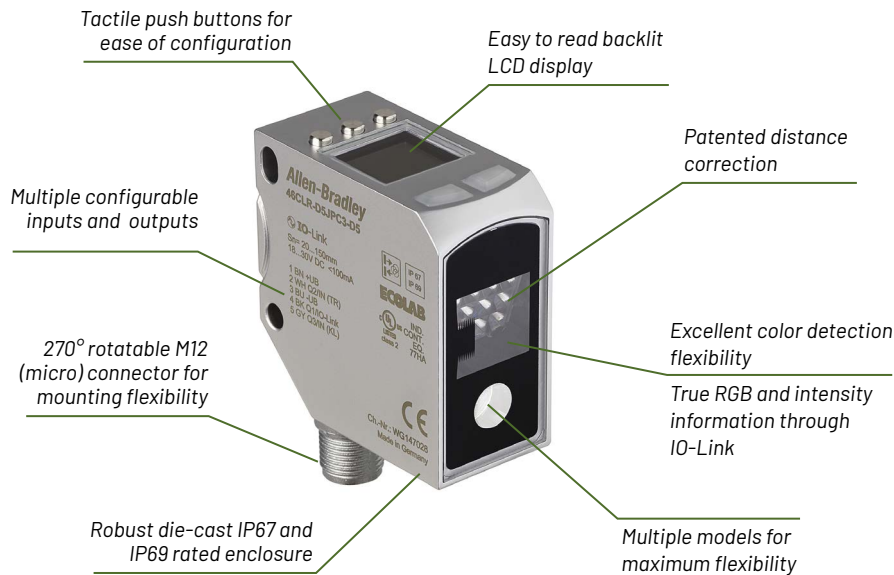

### Ideal for a variety of industries:

- automotive
- food and beverage
- pharmaceutical
- plastics

### Photoelectric Sensors



7-2...7-49

### Proximity Sensors



7-50...7-79

### Ultrasonic Sensors



7-80...7-83

### Limit Switches



7-84...7-95

### Encoders



7-96...7-103

### Condition Sensing



7-104...7-113

### Identification Devices



7-114...7-121



## Product Selection

### 46CLR ColorSight True Color

Model	Operating voltage	Light source	Sensing distance	Outputs	Inputs	Cat. No.
Glare Suppression	18...30V DC	White LED	18...32 mm	3 x PNP	Configurable Trigger and Push Button Lock	46CLR-D5LAC1-D5
Small Spot Size	18...30V DC	White LED	18...60 mm	3 x PNP	Configurable Trigger and Push Button Lock	46CLR-D5LAC2-D5
Long Range	18...30V DC	White LED	20...150 mm	3 x PNP	Configurable Trigger and Push Button Lock	46CLR-D5LAC3-D5

IO-Link enabled.

## Specifications

<b>Certifications</b>	cULus and CE marked for all applicable directives
<b>Enclosure Rating</b>	IP67 and IP69
<b>Operating Temperature [C (F)]</b>	-20...+55 °C (-4...+131°F)
<b>Operating Voltage</b>	18...30V DC
<b>Status Indicators</b>	LCD display with Green and Red LED backlights
<b>Adjustments</b>	3 push buttons
<b>Output Mode</b>	Programmable light or dark operate
<b>Output Type</b>	PNP or NPN programmable
<b>Response Time</b>	0.3...0.33 ms
<b>Enclosure Material</b>	Zinc die-cast, matt chrome

## Required Cordsets and Accessories

Description	Cat. No.
DC Micro (M12) straight QD cordset, 4-pin, 2 m (6.6 ft)	889D-F4AC-2
Mounting bracket	45CRM-BRK1-ADAPT
Point I/O IO-Link Master Module	1734-4IOL
ArmorBlock IO-Link Master	1732E-8IOLM12R
Mounting bracket (L-shaped)	60-BDMS-LS
Micro (M12) shielded QD cordset, 5-pin, 2 m (6.6 ft)	889D-F5EC-2



# Photoelectric Sensors

SENSORS

## Luminescence 45LUM

- Detects luminescent/fluorescent particles
- 5...50 mm (0.2...2 in.) sensing range
- Teach button setup
- External teach capability
- Rotatable M12 connector
- IP67 rating



## Detect What Is Invisible to the Human Eye

The 45LUM luminescence sensor provides a solution for detection of substances which are invisible to the human eye. This sensor detects luminophores or fluorescence, which are emitted from the object being detected. The sensor converts the UV light into a visible light, which is then received by the luminescence sensor. This sensor can detect particles such as glue, clear labels, oils, greases, paint, detergents, and chalks.



Label detection - A 45LUM checks bottles for missing labels.

### Photoelectric Sensors



7-2...7-49

### Proximity Sensors



7-50...7-79

### Ultrasonic Sensors



7-80...7-83

### Limit Switches



7-84...7-95

### Encoders



7-96...7-103

### Condition Sensing



7-104...7-113

### Identification Devices



7-114...7-121



## Product Selection

### 45LUM Luminescence

Sensing Mode	Light Source	Sensing Distance	Spot Size	Cat. No.
Diffuse	Ultraviolet LED	5...50 mm (0.2...2 in.)	3 mm (0.12 in.) at 18 mm (0.71 in.) distance	45LUM-D7JPT1-D5



#### Sales Offices and Distributors

Our network of sales offices and distributors offers exceptional knowledge and service to help you design, implement and support your automation investment.

[rok.auto/buy](http://rok.auto/buy)

## Specifications

<b>Certifications</b>	cULus Listed and CE Marked for all applicable directives
<b>Enclosure Type Rating</b>	IP67
<b>Operating Temperature [C (F)]</b>	-10...+55 ° (+14...+131 °)
<b>Operating Voltage</b>	12...28V DC
<b>Protection Type</b>	Class 2, short circuit and reverse polarity
<b>Supply Current</b>	≤ 40 mA (no load)
<b>Housing Material</b>	ABS
<b>Lens Material</b>	Glass

## Required Cordsets and Accessories

Description	Cat. No.
DC Micro (M12) straight QD cordset, 5-pin, 2 m (6.6 ft)	889D-F5AC-2
DC Micro (M12) straight QD cordset, 5-pin, 2 m (6.6 ft)	889D-R5AC-2
Mounting bracket	45BPD-BKT1
Protective mounting bracket	45BPD-BKT2



# Photoelectric Sensors

SENSORS

## Measuring and Discrete Light Arrays 45MLA and 45DLA

- Detect oddly shaped or non-uniform objects
- Detect targets with gaps or spaces
- Large sensing area
- Discrete (45DLA) and measurement (45MLA) models
- Slim housing profiles
- Sensing range:
  - 45MLA: 4 m
  - 45DLA: 1.5 m or 8 m, selectable via wiring



*Traditional photoelectric transmitted beam sensor - single sensing beam*



*Light array sensor - multiple sensing beams*

## Light Array Concept

Traditional photoelectric transmitted beam sensors detect in a single line from the emitter to the receiver. Light array sensors combine multiple emitter or receiver elements into a single housing to create a sensing field instead of a single sensing beam. Therefore, light arrays are capable of detecting targets over a wider area. This makes them ideal for detecting oddly shaped parts, products with gaps or spaces, or inconsistently positioned targets, at a fraction of the cost of using multiple sensor pairs.



*45DLA detects product with gaps or spaces.*

### Photoelectric Sensors



7-2...7-49

### Proximity Sensors



7-50...7-79

### Ultrasonic Sensors



7-80...7-83

### Limit Switches



7-84...7-95

### Encoders



7-96...7-103

### Condition Sensing



7-104...7-113

### Identification Devices



7-114...7-121



## Product Selection – Measuring and Discrete Light Arrays

### 45MLA Measuring Light Arrays

No. of Beams	Housing Height [mm (in.)]	Sensing Height <sup>1</sup> [mm (in.)]	Beam Spacing [mm (in.)]	Cat. No.
30	320 (12.6)	300 (11.8)	10 (0.39)	45MLA-AT0300P10
60	630 (24.4)	600 (23.6)	10 (0.39)	45MLA-AT0600P10
90	920 (36.2)	900 (35.4)	10 (0.39)	45MLA-AT0900P10
120	1220 (48)	1200 (47.2)	10 (0.39)	45MLA-AT1200P10
36	920 (36.2)	900 (35.4)	25 (0.98)	45MLA-AT0900P25
48	1220 (48)	1200 (47.2)	25 (0.98)	45MLA-AT1200P25

<sup>1</sup> Sensing heights up to 3 m and ATEX certification available upon request.

### 45MLA Controllers

Description	Cat. No.
45MLA controller - I/O	45MLA-CTRL
45MLA controller - RS-485	45MLA-CTRL-485
45MLA controller - analog	45MLA-CTRL-ALG
45MLA controller - basic	45MLA-CTRL-BSC
45MLA controller - CAN	45MLA-CTRL-CAN

### 45DLA Discrete Array

Housing Height [mm (in.)]	Sensing Height [mm (in.)]	Response Time	Sensing Distance [m (ft.)]	Resolution [mm (in.)]	Output	Cat. No.
266 (10.5)	118 (4.65)	25 ms	0.2...8 (0.7...26.2)	30 (1.2)	NPN/PNP	45DLA-1LEB1T-F4
354 (13.9)	206 (8.11)	45 ms	0.2...8 (0.7...26.2)	30 (1.2)	NPN/PNP	45DLA-1LEB2T-F4
530 (20.9)	382 (15.04)	85 ms	0.2...8 (0.7...26.2)	30 (1.2)	NPN/PNP	45DLA-1LEB4T-F4
706 (27.8)	558 (21.97)	125 ms	0.2...8 (0.7...26.2)	30 (1.2)	NPN/PNP	45DLA-1LEB6T-F4
882 (34.7)	734 (28.9)	165 ms	0.2...8 (0.7...26.2)	30 (1.2)	NPN/PNP	45DLA-1LEB8T-F4

## Specifications

<b>Certifications</b>	cULus Listed and CE Marked for all applicable directives
<b>Enclosure Type Rating</b>	45MLA and 45DLA: IP54
<b>Operating Temperature [C (F)]</b>	45MLA: 0...+55° (32...131°) 45DLA: -20...+65° (-4...+149°)
<b>Operating Voltage</b>	45MLA: 204...27.6V DC 45DLA: 14...30V DC
<b>Protection Type</b>	Short circuit, reverse polarity, overload
<b>Load Current</b>	100 mA
<b>Housing Material</b>	Aluminum
<b>Lens Material</b>	Polycarbonate

## Required Cordsets and Accessories

Description	Cat. No.
Flash mounting kit (two pieces/set)	445L-AF6145
Adjustable 180° bracket kit (two per kit) supplied with each pair. Two kits required per pair	445L-AF6143
180° adjustable flat bracket (two per kit). Two kits required per pair	445L-AF6149
Cable-light array to controller, 3 m patchcord, PVC jacket	445L-AC8RJ3
Cable-light array to controller, 5 m patchcord, M12 to RJ45	445L-AC8RJ5
Cable-light array to controller, 8 m patchcord, PVC jacket	445L-AC8RJ8
Cascadeable array extension patchcord, 1 m (3.28 ft) patchcord (optional)	445L-AC8PC1
Cascadeable array extension patchcord, 3 m (9.8 ft) patchcord (optional)	445L-AC8PC3
DC Micro QD cordset, straight, 4-pin, 2 m (6.5 ft)	889D-F4AC-2
DC Micro QD cordset, straight, 4-pin, 0.3 m (1 ft)	889D-F4AC-5





# Photoelectric Sensors

## SENSORS

### Area and Bin Picking Arrays 45AST and 45PVA

- Specialty light arrays
- Small parts detection (45AST)
- "Pick-to-light" bin picking verification (45PVA)
- Large detection area

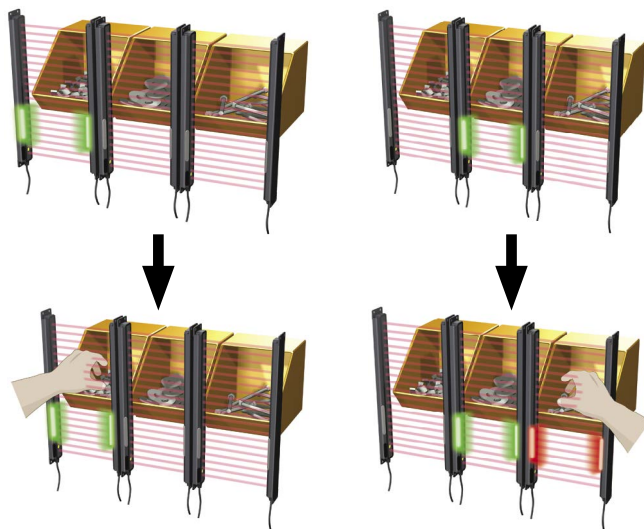

### 45PVA Parts Verification Array

The 45PVA parts verification array is a special purpose light array for bin picking applications. By mounting the sensors on parts bins and wiring them into a controller programmed with the necessary logic, a virtually error-free bin-picking process can be achieved.

- Bin picking sensors – "pick-to-light" with automatic feedback
- Green "job light" indicates proper bin
- Red "warning indicator" automatically indicates incorrect bin pick
- Reduce risk of missing components or incorrect assembly



*Part ejection/counting – A 45AST uses two-dimensional scanning technology to sense an object regardless of its orientation. This is ideal for the detection and counting of parts being ejected from a machine.*

### Photoelectric Sensors



7-2...7-49

### Proximity Sensors



7-50...7-79

### Ultrasonic Sensors



7-80...7-83

### Limit Switches



7-84...7-95

### Encoders



7-96...7-103

### Condition Sensing



7-104...7-113

### Identification Devices



7-114...7-121



## Product Selection

### 45AST Area and Bin Picking Arrays

Housing Height [mm (in.)]	Sensing Height [mm (in.)]	Response Time	Sensing Distance [m (ft.)]	Resolution [mm (in.)]	Output	Cat. No.
100 (3.9)	50 (2)	4 ms	0.5...2 (1.6...6.5)	15 (0.59)	PNP	45AST-1JPB1-F4
150 (5.9)	100 (3.9)	8 ms	0.15...0.8 (0.5...2.6)	11 (0.43)	PNP	45AST-1JPB2-F4
150 (5.9)	100 (3.9)	8 ms	0.5...2.5 (1.6...8.2)	13 (0.51)	PNP	45AST-1JPB3-F4
200 (7.9)	150 (5.9)	8 ms	0.15...0.8 (0.5...2.6)	17 (0.66)	PNP	45AST-1JPB4-F4

### 45PVA Parts Verification Arrays

Housing Height [mm (in.)]	Sensing Height [mm (in.)]	Response Time (ms)	Sensing Distance [m (ft.)]	Sensing Mode	Cat. No.
140 (5.5)	100 (3.9)	35 (L.O.), 25 (D.O.)	2 (6.5)	Transmitted beam pair	45PVA-1LEB1-F4
265 (10.4)	225 (8.9)	68 (L.O.), 42 (D.O.)	2 (6.5)	Transmitted beam pair	45PVA-1LEB2-F4
340 (13.4)	300 (11.8)	70 (L.O.), 42 (D.O.)	2 (6.5)	Transmitted beam pair	45PVA-1LEB3-F4
415 (16.3)	375 (14.7)	94 (L.O.), 58 (D.O.)	2 (6.5)	Transmitted beam pair	45PVA-1LEB4-F4
140 (5.5)	100 (3.9)	120	Retro: 2 (6.5); diffuse 0.4 (1.3)	Retroreflective/diffuse	45PVA-2LEA1-F4
265 (10.4)	225 (8.9)	120	Retro: 2 (6.5); diffuse 0.4 (1.3)	Retroreflective/diffuse	45PVA-2LEA2-F4

## Specifications

<b>Certifications</b>	cULus Listed and CE Marked for all applicable directives
<b>Enclosure Type Rating</b>	45AST: IP67 45PVA: NEMA 12, IP62
<b>Operating Temperature [C (F)]</b>	45AST: -5...+55 ° (23...131 °) 45PVA: 0...50 ° (32...122 °) for transmitted beam, -10...+50 ° (14...122 °)
<b>Operating Voltage</b>	45AST & 45PVA: 12...24V DC
<b>Protection Type</b>	45AST: Short circuit protection, reverse polarity, false pulse, overload; 45PVA: short circuit protection
<b>Load Current</b>	45AST: 100 mA, max. 45PVA: 50 mA, max.
<b>Housing Material</b>	Aluminum
<b>Lens Material</b>	45AST: Acrylic 45PVA: Polycarbonate

## Required Cordsets and Accessories

Description	Cat. No.
DC Micro QD cordset, straight, 4-pin, 2 m (6.5 ft)	889D-F4AC-2
DC Micro QD cordset, straight, 4-pin, 0.3 m (1 ft)	889D-F4AC-5
Mounting bracket used for parts verification array 45PVA	60-2773
Mounting bracket used for parts verification array 45PVA	60-2779
Mounting bracket used for parts verification array 45PVA	60-2772
Protective mounting bracket for 45PVA-1LEB1-F4	60-2775-1
Protective mounting bracket for 45PVA-1LEB2-F4	60-2776-1
Protective mounting bracket for 45PVA-1LEB3-F4	60-2777-1
Protective mounting bracket for 45PVA-1LEB4-F4	60-2778-1
Protective mounting bracket for 45PVA-2LEA1-F4	60-2785-1
Replacement reflective tape roll	92-100



# Photoelectric Sensors

SENSORS

## Polarized Light Array 45PLA

- 69 mm (2.7 in.) wide sensing area
- 6 mm (0.25 in.) smallest detectable object
- 4.5 m (14.76 ft) maximum sensing range
- Highly visible 360 degree indication LEDs
- IP67 rated



### Wide Area Sensing for Material Handling and Packaging Applications

The 45PLA Polarized Light Array is a compact retroreflective array designed to detect irregularly shaped objects in a wide range of industries and applications, notably in the material handling, packaging, food and beverage and lumber industries.

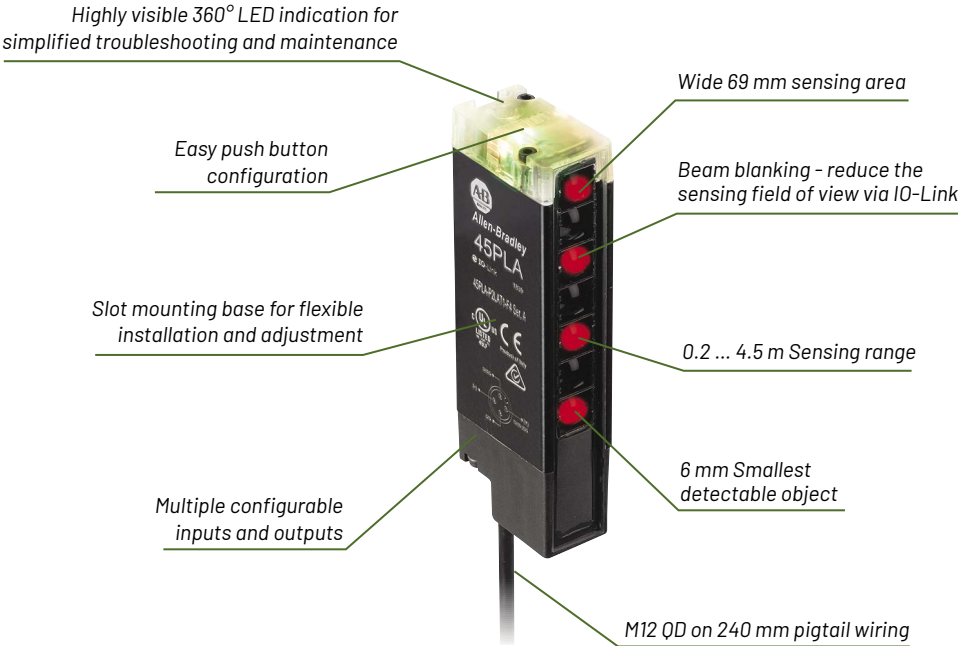

#### Photoelectric Sensors



7-2...7-49



Proximity Sensors  
7-50...7-79



Ultrasonic Sensors  
7-80...7-83



Limit Switches  
7-84...7-95



Encoders  
7-96...7-103



Condition Sensing  
7-104...7-113



Identification Devices  
7-114...7-121



## Product Selection

### 45PLA Polarized Light Array

Sensing Mode	Light Source	Sensing Distance	Smallest Detection Object	Output Type	Sensitivity Adjustment	Cat. No.
Polarized Retroreflective	Visible red LED	0.15 ... 4.5 m with 92-135 reflector (included)	6 mm	PNP and NPN	One push button	45PLA-P2LPT1-F4

IO-Link enabled.

## Specifications

<b>Certifications</b>	cULus Listed and CE marked for all applicable directives
<b>Enclosure Type Rating</b>	IP67
<b>Operating Temperature [C (F)]</b>	-10...+55 °C (14...131 °F)
<b>Operating Voltage</b>	12...30V DC
<b>Adjustments</b>	Push button
<b>Output mode</b>	Programmable light or dark operate
<b>Output type</b>	PNP or NPN programmable
<b>Response time</b>	2.5 ms
<b>Cycle time, min</b>	4 ms
<b>Process data bit length</b>	32 bits

## Required Cordsets and Accessories

Description	Cat. No.
DC Micro (M12) cordset, 4-pin, 5 m (16.40 ft)	889D-F4AC-5
Replacement mounting kit, with T-shaped insert with four M5 screws	60-BPLA-LS
Mounting bracket, kit of 4 vibration-damping supports	60-BPLA-4V
Replacement retroreflector, PMMA/ABS, 42.1 x 182 mm	92-135



# Photoelectric Sensors

SENSORS

## Optical Fork 45LSP

- Detects objects as small as 0.2 mm (0.008 in.)
- Highly visible status indication on both sides
- Through-hole, threaded hole, or dovetail mounting
- Gap size up to 120 mm (4.7 in.)
- Remote teach and teach button lock (4-pin models)
- No alignment required
- IP67 rated



## Alignment-free Small Part Detection

By eliminating the alignment and adjustment issues associated with other transmitted beam sensing solutions, optical fork sensors are the most easy-to-apply and cost-effective method for small part detection and counting in a wide range of industries.



The range of gap sizes and flexible mounting options make the 45LSP a viable solution for a broad range of applications. In addition to small object detection, these include, but are not limited to, edge detection, parts counting, gear tooth detection, and dimension verification.



Web alignment application - Two 45LSP fork sensors monitor horizontal film position on both sides of the roll. If the film drifts in either direction the sensor's light beam will be interrupted, causing the machine's dancer arm to correct the film position.

### Photoelectric Sensors



7-2...7-49

### Proximity Sensors



7-50...7-79

### Ultrasonic Sensors



7-80...7-83

### Limit Switches



7-84...7-95

### Encoders



7-96...7-103

### Condition Sensing



7-104...7-113

### Identification Devices



7-114...7-121



## Product Selection

### 45LSP Optical Fork

Sensing Mode	Light Source	Sensing Gap [mm (in.)]	Sensitivity Adjustment	Output Configuration	Response Time	Cat. No. <sup>1</sup>
Transmitted beam fork	Visible red	30 (1.2)	Teach button	Selectable L.O./D.O., PNP	250 µs	45LSP-2LPA1-P3
			Teach button + remote teach			45LSP-2LPA1-P4
		50 (2)	Push button			45LSP-2LPA2-P3
			Teach button + remote teach			45LSP-2LPA2-P4
		80 (3.2)	Push button			45LSP-2LPA3-P3
			Teach button + remote teach			45LSP-2LPA3-P4
		120 (4.7)	Push button			45LSP-2LPA4-P3
			Teach button + remote teach			45LSP-2LPA4-P4

<sup>1</sup> The **-P3** suffix describes a 3-pin Pico (M8) integral QD and the **-P4** suffix describes a 4-pin Pico (M8) integral QD.



**Connected Components**  
Simpler, faster, cost-effective machine building.  
[rok.auto/ccw](http://rok.auto/ccw)

## Specifications

<b>Certifications</b>	cULus Listed and CE marked for all applicable directives
<b>Enclosure Type Rating</b>	IP67
<b>Operating Temperature [C (F)]</b>	-20...+60 ° (-4...+140 °)
<b>Operating Voltage</b>	10...30V DC
<b>Protection Type</b>	Short circuit, reverse polarity
<b>Load Current</b>	100 mA, max.
<b>Housing Material</b>	Polycarbonate

## Required Cordsets and Accessories

Description	Cat. No.
DC Pico QD cordset, straight, 3-pin, 2 m (6.5 ft)	889P-F3AB-2
DC Pico QD cordset, straight, 4-pin, 2 m (6.5 ft)	889P-F4AB-2
Dovetail mounting bracket	44B-BKT

For more information on our complete family of photoelectric products, please visit:  
[rok.auto/presence-sensing](http://rok.auto/presence-sensing)





# Photoelectric Sensors

SENSORS

## DIN Rail Fiber Optic Amplifier 46DFA

- ECO display mode reduces power consumption by 25%
- Teachable LED intensity for reliable sensing of clear or transparent objects
- Fast, programmable response speeds
- Push button selectable PNP and NPN output using
- Two high-visibility displays
- Cross-talk protection
- Built-in totalizer



## Sensing for Space-critical Applications

Ideal for sensing small objects, fiber optic cables can be mounted in locations that would otherwise be inaccessible to photoelectric sensors. Other characteristics/advantages of fiber optic sensors include:

- Some glass fiber optic tips have the ability to withstand high temperatures [up to 482 °C (900 °F)]
- Withstand extreme shock and vibration
- Often have the fastest response times
- Immunity to electrical interference (EMI, RFI)



Small part detection - The 46DFA fiber optic ensures continuous flow of small parts exiting from a feeder bowl.

### Photoelectric Sensors



7-2...7-49



7-50...7-79



7-80...7-83



7-84...7-95



7-96...7-103



7-104...7-113



7-114...7-121



## Product Selection

### 46DFA DIN Rail Fiber Optic Amplifier

Optical Aperture	Light Source	Sensing Distance	Output Mode	Output Type	Response Time	Connection Type	Catalog Number
2.2 mm	Visible red LED	Depends on fiber optic cable	Programmable complementary light operate and dark operate	Programmable PNP or NPN (both outputs)	Programmable 50 µs, 500 µs, 4 ms, 32 ms (500 µs default)	2 m cable	46DFA-L2LBT1-A2
						4-pin M12 QD on 150 mm pigtail	46DFA-L2LBT1-F4

IO-Link enabled.

## Specifications

<b>Certifications</b>	cULus and CE marked for all applicable directives
<b>Status indicators</b>	Dual display, output and operation LEDs
<b>Adjustments</b>	Push buttons
<b>Sensing range</b>	Depends on fiber optic cable
<b>Light source</b>	Visible red LED 660 nm
<b>Operating voltage</b>	12...24V DC
<b>Sensor protection</b>	Reverse polarity and short circuit protection
<b>Output type</b>	Pin 4: PNP or NPN Pin 2: PNP or NPN
<b>Output mode</b>	Programmable light operate and dark operate
<b>Response time</b>	50 µs, 500 µs (Default), 4 ms, 32 ms
<b>Load current</b>	100 mA max
<b>Housing Material</b>	Polycarbonate
<b>Enclosure Rating</b>	IP40
<b>Operating Temperature</b>	1 to 5 adjacent sensors: -25...+55 °C (14...131 °F) 6 or more adjacent sensors: -25...+50 °C (14...122 °F)
<b>Connections</b>	2 m cable 4-pin M12 QD on 150 mm pigtail

## Required Cordsets and Accessories

Description	Catalog Number
4-pin DC Micro (M12) Cordset, 5 m length	889D-F4AC-5
Mounting bracket, DIN rail stop	60-BDFA-STP
Mounting bracket, 46DFA DIN rail single mount	60-BDFA-DIN

Go to [www.ab.com](http://www.ab.com) to see the full line of 46DFA DIN Rail Fiber Optic Amplifier sensors and accessories.



# Photoelectric Sensors

SENSORS

## Fiber Optic Cables

### Plastic

- Best used with visible light sources
- High flex applications
- Cost effective

### Glass

- Suitable for visible or infrared light source
- High temperature applications
- Chemically resistant



## Product Selection – Fiber Optic Cables

### Fiber Optic Cables for Use with These Large Aperture Sensors:

- Series 9000 42GxF-900x
- RightSight 42EF-G1xxA

Description	Sensing Tip Material	Fiber Bundle Diameter [mm (in.)]	Sheathing Material	Nominal Sensing Ref. [mm (in.)]	Cat No.
<b>Bifurcated Cables for Large Aperture Sensors [4.6 mm/0.187 in.]<sup>1</sup></b>					
Threaded 5/16 in. straight tip	Brass	-	PVC	120 (4.75)	43GR-TBB25ML
Threaded 5/16 in. straight tip	Brass	-	Stainless steel	120 (4.75)	43GR-TBB25SL
Right angle tip with 5/16 in. x 24 thread	Stainless steel	-	PVC	120 (4.75)	43GR-TMS25ML
Right angle tip with 5/16 in. x 24 thread	Brass/Stainless steel	-	Stainless steel	120 (4.75)	43GR-TMC25SL
Ferrule (smooth) right angle tip	Stainless steel	-	PVC	120 (4.75)	43GR-FIS25ML
Ferrule (smooth) right angle tip	Stainless steel	-	Stainless steel	120 (4.75)	43GR-FIS25SL
<b>Transmitted Beam Cables for Large Aperture Sensors [4.6 mm/0.187 in.]<sup>2</sup></b>					
Threaded 5/16 in. straight tip	Brass	-	PVC	508 (20)	43GT-TBB25ML
Threaded 5/16 in. straight tip	Brass	-	Stainless steel	508 (20)	43GT-TBB25SL
Threaded 5/16 in. with right angle tip	Brass	-	PVC	508 (20)	43GT-TQS25ML
Threaded 5/16 in. with right angle tip	Brass	-	Stainless steel	508 (20)	43GT-TQS25SL
Right angle tip with 5/16 in. x 24 thread	Stainless steel	-	PVC	508 (20)	43GT-TMS25ML
Right angle tip with 5/16 in. x 24 thread	Brass/Stainless steel	-	Stainless steel	508 (20)	43GT-TMC25SL
Ferrule (smooth) right angle tip	Stainless steel	-	PVC	508 (20)	43GT-FIS25ML
Ferrule (smooth) right angle tip	Stainless steel	-	Stainless steel	508 (20)	43GT-FIS25SSL

### Photoelectric Sensors



7-2...7-49

### Proximity Sensors



7-50...7-79

### Ultrasonic Sensors



7-80...7-83

### Limit Switches



7-84...7-95

### Encoders



7-96...7-103

### Condition Sensing



7-104...7-113

### Identification Devices



7-114...7-121



## Product Selection

### 1. Select Fiber

Approximate Dimensions [mm (in.)]	Bend Radius [mm (in.)]	Fiber Bundle Diameter [mm (in.)]	Sheathing Material	Catalog Number
<b>Threaded Transmitted Beam Cables for Small Aperture Sensors [2.2 mm (0.09 in.)]</b>				
	25 (1.0)	1 (0.04)	Polyethylene	43PT-NJS56FS
<b>Threaded Bifurcated Cables (Diffuse) for Small Aperture Sensors [2.2 mm (0.09 in.)]</b>				
	40 (1.6)	2 x 1.5 (0.06)	Polyethylene	43PR-NDS59FS

Note: Visit Proposal Works (<https://rok.auto/configure>) for complete fiber selection.

### 2. Select Amplifier

Optical Aperture	Light Source	Sensing Distance	Output Mode	Output Type	Response Time	Connection Type	Catalog Number
2.2 mm	Visible red LED	Depends on fiber optic cable	Programmable complementary light operate and dark operate	Programmable PNP or NPN (both outputs)	Programmable 50 μs, 500 μs, 4 ms, 32 ms (500 μs default)	2 m cable	46DFA-L2LBT1-A2
						4-pin M12 QD on 150 mm pigtail	46DFA-L2LBT1-F4





# Proximity Sensors

## Sensor Selection

Inductive proximity sensors provide non-contact detection of metal objects across relatively short distances (up to 2.5 inches or 65 mm). Sensor size, along with whether the sensor has shielded (flush-mountable) or unshielded (non flush-mountable) construction, dictates sensing range. Other factors/functions to consider include output and connection type, environmental protection rating, power requirements and proximity to electrical fields (i.e. weld field immunity).

Allen-Bradley® inductive proximity sensors set the standard for ruggedness, reliability and application flexibility. We offer one of the industry's widest sensor offerings serving the full spectrum of your needs, from light-duty packaging applications to the punishing environments on automotive welding equipment or the harsh washdowns in food processing plants. Below is a quick selection guide for our most popular products - to see our complete line of sensors, go to <https://rok.auto/sensors-switches>.

## Inductive Sensors

	Application	Housing Diameter/Dimensions (mm)	Sensing Range Shielded (mm)	Sensing Range Unshielded (mm)	Enclosure Ratings	2-wire DC	3-wire DC	4-wire DC	2-wire AC	2-wire AC/DC
 <p><b>872 WorldProx</b></p>	General Purpose	6.5	2 & 3	3	IP67	●	●	●	●	●
		8	2 & 3	3, 4, 6						
		12	3, 4, 6	4, 8, 10						
		18	5, 8, 12	8, 12, 20						
		30	10, 15, 22	15, 20, 40						
 <p><b>871TM</b></p>	Harsh Duty/Welding	8	3	6	All units IP67 & 1200 psi wash down rated (Selected units meet IP69K)	●	●		●	●
		12	2 & 6	4 & 10						
		18	5 & 10	8 & 20						
		30	10 & 20	15 & 40						
 <p><b>871TS</b></p>	Food & Beverage	12	4	4 & 8	IP67, IP68 & IP69K		●			
		18	8	8 & 12						

Photoelectric Sensors



7-2...7-49

**Proximity Sensors**



**7-50...7-79**

Ultrasonic Sensors



7-80...7-83

Limit Switches



7-84...7-95

Encoders



7-96...7-103

Condition Sensing



7-104...7-113

Identification Devices



7-114...7-121



## Inductive Sensors

	Application	Housing Diameter/ Dimensions (mm)	Sensing Range Shielded (mm)	Sensing Range Unshielded (mm)	Enclosure Ratings	2-wire DC	3-wire DC	4-wire DC	2-wire AC	2-wire AC/DC
<b>871Z</b> 	Welding	12	2	4	IP67					
		18	5	8		•			•	
		30	10	15						
<b>871ZT</b> 	Welding	12	3	8	IP67					
		18	5	12		•				
		30	10	20						
<b>871 VersaCube</b> 	Material Handling & Welding	40 x 40	20	40	All units IP67 & 1200 psi wash down rated (Selected units meet IP69K)			•		•
		40 x 40 WFI	15 & 20	25 & 40						
<b>871F Flat Pack</b> 	Material Handling & Welding	80 x 80	50	65	All units IP67 & 1200 psi wash down rated (Selected units meet IP69K)					
		80 x 80 WFI	40	50		•			•	
<b>871C Miniature Tubular</b> 	Automated Assembly & Robotics	3 smooth barrel	0.6 & 1	NA	IP67					
		4 smooth barrel	0.6 & 1	NA		•				
		4	0.8 & 1.5	NA						
		5	1 & 1.5	NA						
<b>871FM Miniature Rectangular</b> 	Automated Assembly, Robotics & Welding (Select Products)	5 x 5	0.8 & 1.5	NA	IP67					
		8 x 8	2	3		•				
		26 x 16 x 11	2	NA						
		20 x 32 x 8	NA	7	IP67 or IP69K			•		
		30 x 52 x 14	NA	10						

For more information on our complete family of inductive proximity products, please visit: [rok.auto/presence-sensing](http://rok.auto/presence-sensing)





# Proximity Sensors

SENSORS

## Miniature 871C

- Miniature housings for space-critical applications
- Extended sensing range
- Stainless steel housing
- Quick disconnect and cable options
- Fully integrated electronics



## Miniature Sensors for Industrial Automation

Our miniature inductive sensors were designed to meet the needs of today's compact machines. With limited space on these machines, mounting space for sensors is limited. Allen-Bradley 871C sensors were developed to meet this design requirement while providing superior performance, including longer sensing range. Longer sensing ranges allow our sensors to be mounted further away from the target reducing the risk of mechanical contact.

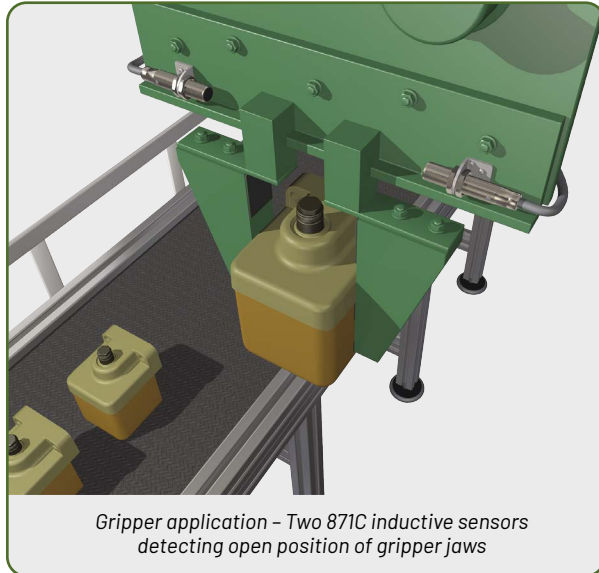

These small-barrel sensors are designed for space-critical applications where standard size sensors simply won't fit.



7-52

Photoelectric Sensors



7-2...7-49

Proximity Sensors



7-50...7-79

Ultrasonic Sensors



7-80...7-83

Limit Switches



7-84...7-95

Encoders



7-96...7-103

Condition Sensing



7-104...7-113

Identification Devices



7-114...7-121



## Product Selection

### 3-wire DC

Barrel Diameter	Nominal Sensing Distance [mm (in.)]	Shielded	Output Configuration	Switching Frequency [Hz]	Housing Length [mm (in.)]	Thread Length [mm (in.)]	Connection Type	Cat. No.
3 mm, smooth	1 (0.04)	Yes	N.O., PNP	3000	22 (0.87)	-	2 m cable	871C-MM1NP3-E2
4 mm, threaded							6 in. Pico QD pigtail	871C-MM1NP3-AP3
	4 mm, smooth					19 (0.74)	2 m cable	871C-M1NP4-E2
6 in. Pico QD pigtail							871C-M1NP4-AP3	
5 mm, threaded	1.5 (0.06)				25 (0.98)	-	2 m cable	871C-MM2NP4-E2
							38 (1.50)	Pico QD
5 mm, threaded					25 (0.98)	20 (0.79)	2 m cable	871C-M2NP5-E2
							38 (1.50)	23 (0.90)

IO-Link enabled.

## Specifications

<b>Certifications</b>	UL Listed and CE Marked for all applicable directives
<b>Enclosure Type Rating</b>	NEMA 1, 2, 3, 4, 12, 13; IP67 (cable only), IP65 (QD only) (IEC 529)
<b>Operating Temperature [C (F)]</b>	-25...+70 ° (-13...+158 °)
<b>Operating Voltage</b>	10...30V DC
<b>Protection Type</b>	False pulse, transient noise, reverse polarity, short circuit
<b>Load Current</b>	3 mm smooth and 4 mm threaded barrel: ≤100 mA 4 mm smooth and 5 mm threaded barrel: ≤200 mA
<b>Housing Material</b>	Stainless steel barrel, polyester face

## Required Cordsets and Accessories

Description	Cat. No.
DC Pico QD cordset, straight, 3-pin, 2 m (6.5 ft)	889P-F3AB-2
Clamp style bracket, 4 mm (0.16 in.)	871-BP4
Clamp style bracket, 5 mm (0.2 in.)	871-BP5
Point I/O IO-Link Master Module	1734-4IOL
ArmorBlock IO-Link Master	1732E-8IOLM12R



# Proximity Sensors

SENSORS

## WorldProx 872C

- General purpose
- Wide range of options
- Standard, extended and long range
- Extended range and long range models offer up to three times standard sensing range
- Multiple connection styles



## An Extended Range, General Purpose Solution

The most common cause of sensor failure is contact with the intended target. Sensors with longer range can be used to eliminate/limit contact with the target, thus reducing the cost associated with replacing damaged sensors (due to the cost of the sensor, maintenance time, and lost production).

Additionally, increased sensing range allows machine manufacturers to use smaller sensors and save space on the machine or to locate the sensors in previously inaccessible areas.

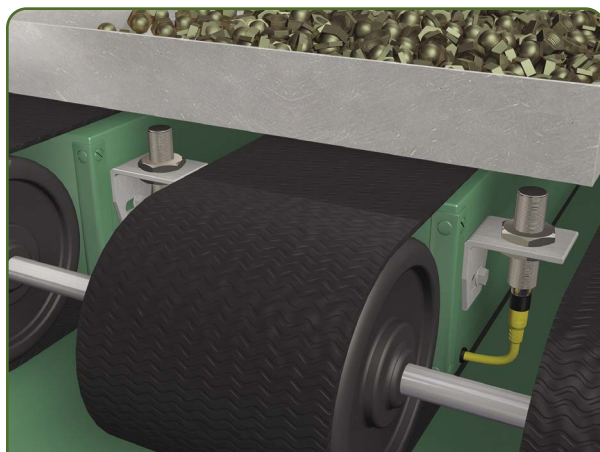

Conveyor application – Two 872C WorldProx sensors detecting presence of a part bin on a conveyor belt

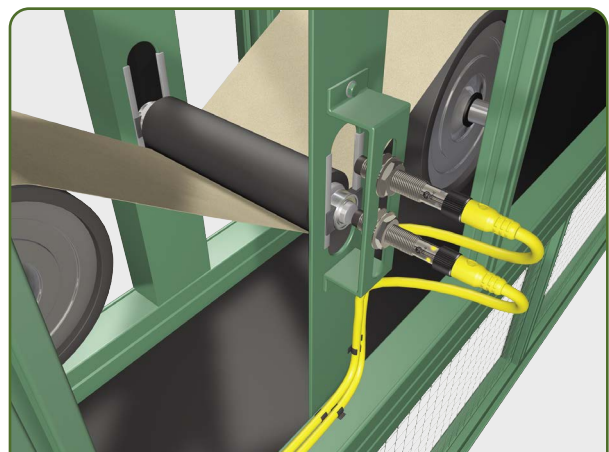

Paper tension – A pair of WorldProx sensors detecting the tension roller position for speed control

Photoelectric  
Sensors



7-2...7-49

Proximity  
Sensors



7-50...7-79

Ultrasonic  
Sensors



7-80...7-83

Limit  
Switches



7-84...7-95

Encoders



7-96...7-103

Condition  
Sensing



7-104...7-113

Identification  
Devices



7-114...7-121



## Product Selection

### 3-Wire DC Standard Barrel

Barrel Diameter	Nominal Sensing Distance [mm (in.)]	Shielded	Output Configuration	Switching Frequency [Hz]	Housing Length [mm (in.)]	Thread Length [mm (in.)]	Connection Type <sup>1</sup>	Cat. No.			
6.5 mm, smooth	3 (0.12)	Yes	N.O./PNP	1,000	66.0 (2.59)	–	Micro QD	872C-M3NP7-D4			
8 mm	2 (0.08)	Yes		2500	500	55 (2.17)		30 (1.18)	872C-D2NP8-D4 <sup>2,3</sup>		
	3 (0.12)	No				60 (3.62)			872C-D3NP8-D4 <sup>2,3</sup>		
	3 (0.12)	Yes				55 (2.17)			872C-M3NP8-D4 <sup>2,3</sup>		
	4 (0.16)	No				60 (3.62)			872C-N4NP8-D4 <sup>2,3</sup>		
	6 (0.23)	No				500			66.0 (2.59)	40.0 (1.57)	872C-N6NP8-D4
12 mm	4 (0.16)	No		2650	1650	74.5 (2.93)		50.5 (1.99)	872C-D4NP12-D4		
	4 (0.16)	Yes				64.5 (2.54)		48.5 (1.91)	872C-M4NP12-D4		
	8 (0.31)	No				74.5 (2.93)		50.5 (1.99)	872C-N8NP12-D4		
	6 (0.23)	Yes				800		60.0 (2.36)	40.0 (1.57)	872C-M6NP12-D4	
	10 (0.39)	No				400		60.0 (2.36)	47 (1.85)	872C-N10NP12-D4	
18 mm	5 (0.2)	Yes		1950	1350	66 (2.6)		872C-D5NP18-D4			
	8 (0.31)	No				76 (2.99)		872C-D8NP18-D4			
	8 (0.31)	Yes				66 (2.6)		872C-M8NP18-D4			
	12 (0.47)	No				1300		76 (2.99)		872C-N12NP18-D4	
	12 (0.47)	Yes				500		65.5 (2.58)	38.1 (1.50)	872C-M12NP18-D4	
30 mm	20 (0.79)	No		200	1100	63.5 (2.5)		32.0 (1.25)	872C-N20NP18-D4		
	10 (0.39)	Yes				1150		550	67.2 (2.65)	48.2 (1.90)	872C-D10NP30-D4
	15 (0.59)	No							76 (2.99)	39 (1.54)	872C-D15NP30-D4
	15 (0.59)	Yes							67.2 (2.65)	48.2 (1.90)	872C-M15NP30-D4
	25 (0.98)	No							400	76 (2.99)	39 (1.54)
22 (0.86)	Yes	200		73.5 (2.89)	52.0 (2.04)				872C-M22NP30-D4		
40 (1.57)	No	100		73.5 (2.89)	42.0 (1.65)	872C-N40NP30-D4					

<sup>1</sup> For additional connection types, please visit <https://rok.auto/directory>.<sup>2</sup> Operating Voltage: 5...30 VDC<sup>3</sup> Load Current: ≤ 100 mA

## Specifications

<b>Certifications</b>	cULus Listed and CE Marked for all applicable directives
<b>Enclosure Type Rating</b>	IP67 (IEC 529) M12, M18, & M30 standard and extended range models meet IP68
<b>Operating Temperature [C (F)]</b>	-25...+70 ° (-13...+158 °) M12, M18, & M30 standard and extended range models -40...+85° (-40...+185°)
<b>Operating Voltage</b>	10...30V DC
<b>Protection Type</b>	False pulse on power, transient noise, reverse polarity, short circuit, overload
<b>Load Current</b>	≤ 200 mA
<b>Housing Material</b>	Nickel-plated brass barrel, plastic face (PBT)

## Required Cordsets and Accessories

Description	Cat. No.
DC Micro (M12) QD cordset, straight, 4-pin, 2 m (6.5 ft)	889D-F4AC-2
Right angle mounting bracket	871A-BRN <sup>4</sup>
Snap clamp mounting bracket	871A-SCP <sup>5</sup>

<sup>4</sup> Add **8**, **12**, **18**, or **30** to the end of the catalog number for sensor barrel diameter in mm.<sup>5</sup> Add **12** or **18** to the end of the catalog number for sensor barrel diameter in mm.

# Proximity Sensors

## Product Selection

### 3-Wire DC Short Barrel

Barrel Diameter	Nominal Sensing Distance [mm (in.)]	Shielded	Output Configuration	Switching Frequency [Hz]	Housing Length [mm (in.)]	Thread Length [mm (in.)]	Connection Type <sup>1</sup>	Cat. No.
8 mm	2 (0.08)	Yes	N.O./PNP	2500	45.2 (1.78)	20.1 (0.79)	Micro QD	872C-DH2NP8-D4 <sup>2,3</sup>
	3 (0.12)	No			50 (1.97)			872C-DH3NP8-D4 <sup>2,3</sup>
	3 (0.12)	Yes			45.2 (1.78)			872C-MH3NP8-D4 <sup>2,3</sup>
	4 (0.16)	No			50 (1.97)			872C-NH4NP8-D4 <sup>2,3</sup>
12 mm	4 (0.16)	No		2650	54.5 (2.15)	30.5 (1.2)		872C-DH4NP12-D4
	4 (0.16)	Yes		2550	44.5 (1.75)	28.5 (1.12)		872C-MH4NP12-D4
	8 (0.32)	No		1650	54.5 (2.15)	30.5 (1.2)		872C-NH8NP12-D4
18 mm	5 (0.20)	Yes		1950	46 (1.81)	27 (1.06)		872C-DH5NP18-D4
	8 (0.31)	No		1650	56 (2.2)			872C-DH8NP18-D4
	8 (0.32)	Yes		1350	46 (1.81)			872C-MH8NP18-D4
	12 (0.47)	No		1300	56 (2.2)			872C-NH12NP18-D4
30 mm	15 (0.59)	No		1150	61 (2.4)	24 (0.94)		872C-DH15NP30-D4
	15 (0.59)	Yes	550	47.2 (1.86)	28.2 (1.11)	872C-MH15NP30-D4		
	25 (0.98)	No	400	61 (2.4)	24 (0.94)	872C-NH25NP30-D4		

<sup>1</sup> For additional connection types, please visit <https://rok.auto/directory>.

<sup>2</sup> Operating Voltage: 5...30 VDC

<sup>3</sup> Load Current: ≤ 100 mA

## Specifications

<b>Certifications</b>	cULus Listed and CE Marked for all applicable directives
<b>Enclosure Type Rating</b>	NEMA 1, 2, 3, 4, 6P, 12, 13, IP67 (IEC 529) M12, M18, & M30 standard and extended range models meet IP68
<b>Operating Temperature [C (F)]</b>	-25...+70 ° (-13...+158 °) M12, M18, & M30 standard and extended range models -40...+85° (-40...+185°)
<b>Operating Voltage</b>	10...30V DC
<b>Protection Type</b>	False pulse on power, transient noise, reverse polarity, short circuit, overload
<b>Load Current</b>	≤ 200 mA
<b>Housing Material</b>	Nickel-plated brass barrel, plastic face (PBT)

## Required Cordsets and Accessories

Description	Cat. No.
DC Micro QD cordset, straight, 4-pin, 2 m (6.5 ft)	889D-F4AC-2
Right angle mounting bracket	871A-BRN <sup>4</sup>
Snap clamp mounting bracket	871A-SCP <sup>5</sup>

<sup>4</sup> Add **8**, **12**, **18**, or **30** to the end of the catalog number for sensor barrel diameter in mm.

<sup>5</sup> Add **12** or **18** to the end of the catalog number for sensor barrel diameter in mm.

Photoelectric Sensors



7-2...7-49

**Proximity Sensors**



**7-50...7-79**

Ultrasonic Sensors



7-80...7-83

Limit Switches



7-84...7-95

Encoders



7-96...7-103

Condition Sensing



7-104...7-113

Identification Devices



7-114...7-121



## Product Selection

### 2-Wire DC

Barrel Diameter	Nominal Sensing Distance [mm (in.)]	Shielded	Output Configuration	Switching Frequency [Hz]	Housing Length [mm (in.)]	Thread Length [mm (in.)]	Connection Type <sup>1</sup>	Cat. No.
12 mm	3 (0.12)	Y	N.O.	2000	65.0 (2.56)	38.1 (1.50)	Micro QD	872C-D3NE12-D4
	4 (0.16)	N			72.4 (2.85)			872C-D4NE12-D4
18 mm	5 (0.20)	Y		1000	65.0 (2.56)			872C-D5NE18-D4
	8 (0.31)	N			76.5 (3.01)			872C-D8NE18-D4
30 mm	10 (0.39)	Y		500	65.0 (2.56)	46.7 (1.84)		872C-D10NE30-D4
	15 (0.59)	N			76.5 (3.01)			872C-D15NE30-D4

<sup>1</sup> For additional connection types, please visit <https://rok.auto/directory>.



#### Sales Offices and Distributors

Our network of sales offices and distributors offers exceptional knowledge and service to help you design, implement and support your automation investment.

[rok.auto/buy](https://rok.auto/buy)

## Specifications

<b>Certifications</b>	cULus Listed and CE Marked for all applicable directives
<b>Enclosure Type Rating</b>	NEMA 1, 2, 3, 4, 6P, 12, 13, IP67 (IEC 529)
<b>Operating Temperature [C (F)]</b>	-25...+70 ° (-13...+158 °)
<b>Operating Voltage</b>	10...30V DC
<b>Protection Type</b>	False pulse on power, transient noise, reverse polarity, overload
<b>Load Current</b>	≤100 mA
<b>Housing Material</b>	Nickel-plated brass barrel, plastic face (PBT)

## Required Cordsets and Accessories

Description	Cat. No.
DC Micro (M12) QD cordset, straight, 4-pin, 2 m (6.5 ft)	889D-F4AC-2
Right angle mounting bracket	871A-BRN <sup>2</sup>
Snap clamp mounting bracket	871A-SCPB <sup>3</sup>

<sup>2</sup> Add **8**, **12**, **18**, or **30** to the end of the catalog number for sensor barrel diameter in mm.

<sup>3</sup> Add **12** or **18** to the end of the catalog number for sensor barrel diameter in mm.





# Proximity Sensors

## Product Selection

### 2-Wire AC

Barrel Diameter	Nominal Sensing Distance [mm (in.)]	Shielded	Output Configuration	Switching Frequency (Hz)	Housing Length [mm (in.)]	Thread Length [mm (in.)]	Connection Type <sup>1</sup>	Cat. No.
12 mm	2 (0.08)	Y	N.O.	15	75.0 (2.95)	45.0 (1.77)	Micro QD	872C-A2N12-R3
	4 (0.16)			20				872C-F4N12-R3
	4 (0.16)	N		15		40.0 (1.57)		872C-A4N12-R3
	8 (0.31)			20				872C-G8N12-R3
18 mm	5 (0.20)	Y		15	80.0 (3.15)	60.0 (2.36)		872C-A5N18-R3
	8 (0.31)			20				872C-F8N18-R3
	10 (0.39)	N		15		52.0 (2.05)		872C-A10N18-R3
	12 (0.47)			20				872C-G12N18-R3
30 mm	10 (0.39)	Y	15	80.0 (3.15)	50.0 (1.96)	872C-A10N30-R3		
	15 (0.59)		20			872C-F15N30-R3		
	15 (0.59)	N	15		38.0 (1.50)	872C-A15N30-R3		
	30 (1.18)		20			872C-G30N30-R3		

<sup>1</sup> For additional connection types, please visit <https://rok.auto/directory>.

## Specifications

<b>Certifications</b>	cULus Listed and CE Marked for all applicable directives
<b>Enclosure Type Rating</b>	NEMA 1, 2, 3, 4, 6P, 12, 13, IP67 (IEC 529)
<b>Operating Temperature [C (F)]</b>	-25...+70 ° (-13...+158 °)
<b>Operating Voltage</b>	20...250V AC
<b>Protection Type</b>	False pulse on power, transient noise
<b>Load Current</b>	≤300 mA
<b>Housing Material</b>	Nickel-plated brass barrel, plastic face (PBT)

## Required Cordsets and Accessories

Description	Cat. No.
AC Micro (M12) QD cordset, straight, 3-pin, 2 m (6.5 ft)	889R-F3ECA-2
Right angle mounting bracket	871A-BRN <sup>2</sup>
Snap clamp mounting bracket	871A-SCPB <sup>3</sup>

<sup>2</sup> Add **12**, **18**, or **30** to the end of the catalog number for sensor barrel diameter in mm.

<sup>3</sup> Add **12** or **18** to the end of the catalog number for sensor barrel diameter in mm.

Photoelectric Sensors



7-2...7-49

**Proximity Sensors**



**7-50...7-79**

Ultrasonic Sensors



7-80...7-83

Limit Switches



7-84...7-95

Encoders



7-96...7-103

Condition Sensing



7-104...7-113

Identification Devices



7-114...7-121



## Product Selection

### 2-Wire AC/DC

Barrel Diameter	Nominal Sensing Distance [mm (in.)]	Shielded	Output Configuration	Switching Frequency (Hz)	Housing Length [mm (in.)]	Thread Length [mm (in.)]	Connection Type <sup>1</sup>	Cat. No.
12 mm	2 (0.08)	Y	N.O.	30	75.0 (2.95)	45.0 (1.77)	Micro QD	872C-J2N12-R3
	4 (0.16)	N				40.0 (1.57)		872C-K4N12-R3
18 mm	5 (0.20)	Y			80.0 (3.15)	60.0 (2.36)		872C-J5N18-R3
	8 (0.31)	N				52.0 (2.05)		872C-K8N18-R3
30 mm	10 (0.39)	Y			80.0 (3.15)	50.0 (1.96)		872C-J10N30-R3
	15 (0.59)	N				38.0 (1.50)		872C-K15N30-R3

<sup>1</sup> For additional connection types, please visit <https://rok.auto/directory>.



#### Product Selection Tools

Available online or for download, our tools help you access info while in the office or on the go.

[rok.auto/selection](https://rok.auto/selection)

## Specifications

<b>Certifications</b>	cULus Listed and CE Marked for all applicable directives
<b>Enclosure Type Rating</b>	NEMA 1, 2, 3, 4, 6P, 12, 13, IP67 (IEC 529)
<b>Operating Temperature [C (F)]</b>	-25...+70 ° (-13...+158 °)
<b>Operating Voltage</b>	20...250V AC/DC
<b>Protection Type</b>	False pulse on power, transient noise, short circuit, overload
<b>Load Current</b>	≤300 mA for 12 mm units, and ≤350 mA for 18 and 30 mm units
<b>Housing Material</b>	Nickel-plated brass barrel, plastic face (PBT)

## Required Cordsets and Accessories

Description	Cat. No.
AC Micro (M12) QD cordset, straight, 3-pin, 2 m (6.5 ft)	889R-F3ECA-2
Right angle mounting bracket	871A-BRN <sup>2</sup>
Snap clamp mounting bracket	871A-SCPB <sup>3</sup>

<sup>2</sup> Add **12**, **18**, or **30** to the end of the catalog number for sensor barrel diameter in mm.

<sup>3</sup> Add **12** or **18** to the end of the catalog number for sensor barrel diameter in mm.

For more information on our complete family of inductive proximity products, please visit:  
[rok.auto/presence-sensing](https://rok.auto/presence-sensing)



# Proximity Sensors

SENSORS

## Stainless Steel – Weld Field Immune 871TM

- Heavy duty stainless steel face and barrel
- IP69K and 1200 psi washdown rated
- Chemical and abrasion resistant
- Long range models offer equal sensing distance for all metals
- Long range weld field immune up to 40mT (select models)
- IO-Link enabled (select models)



## For Your Toughest Applications

The 871TM stainless steel sensors are ideal for harsh or extremely demanding environments. These sensors resist impact, abrasion and corrosion – to keep things moving where ordinary sensors grind to a halt. This line features full mechanical seals at all barrel openings and full epoxy encapsulation for optimal performance in the toughest environments.

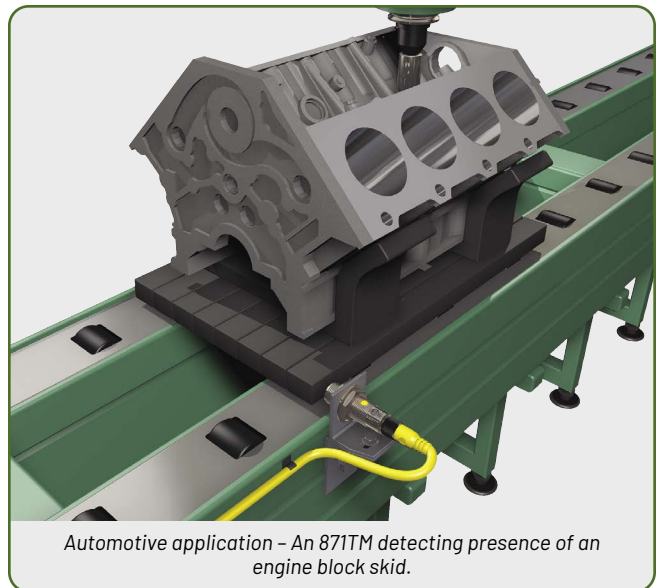
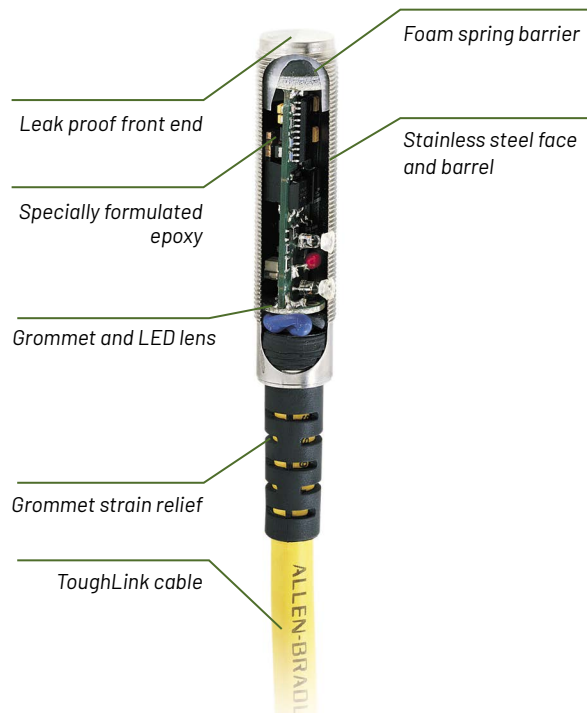

### Welding Applications

Select weld field immune models are ideal for welding environments and other applications where strong magnetic fields are present.

Photoelectric Sensors



7-2...7-49

Proximity Sensors



7-50...7-79

Ultrasonic Sensors



7-80...7-83

Limit Switches



7-84...7-95

Encoders



7-96...7-103

Condition Sensing



7-104...7-113

Identification Devices



7-114...7-121



## Product Selection

### 3-Wire DC (weld field immune select models)

Barrel Diameter	Nominal Sensing Distance [mm (in.)]	Shielded	Weld Field Immune	Output Configuration	Switching Frequency [Hz]	Housing Length [mm (in.)]	Thread Length [mm (in.)]	Connection Type	Cat. No.
8 mm	3 (0.12)	Yes	No	N.O./PNP	700	66 (2.59)	46 (1.81)	Micro QD	871TM-M3NP8-D4
	3 (0.12)	Yes	Yes		400	60 (2.36)	45 (1.77)	Pico QD	871TM-MW3NP8-P3
	6 (0.23)	No	No		700	66 (2.59)	42 (1.65)	Micro QD	871TM-N6NP8-D4
12 mm	2 (0.08)	Yes	No		75	61 (2.40)	26.4 (1.04)		871TM-DH2NP12-D4
	6 (0.23)		Yes		400	60 (2.36)	41 (1.61)		871TM-M6NP12-D4
12 mm	6 (0.23)	No	No		400	60 (2.36)	41 (1.61)		871TM-MW6NP12-D4
	4 (0.16)		No		70	61 (2.40)	28 (1.10)		871TM-DH4NP12-D4
	10 (0.39)		No		400	60 (2.36)	36 (1.42)		871TM-N10NP12-D4
18 mm	5 (0.20)	Yes	No		60	65 (2.55)	41.7 (1.64)	Micro QD	871TM-DH5NP18-D4
	10 (0.39)		Yes		200	63.5(2.5)	42.5 (1.67)		871TM-M10NP18-D4
	10 (0.39)		Yes		400	63.5(2.5)	42.5 (1.67)		871TM-MW10NP18-D4
	8 (0.31)	No	No		40	65 (2.55)	41.7 (1.64)		871TM-DH8NP18-D4
	20 (0.79)		No	200	63.5 (2.5)	35.5 (1.40)	871TM-N20NP18-D4		
30 mm	10 (0.39)	Yes	No	40	66.3 (2.61)	41.9 (1.65)	871TM-DH10NP30-D4		
	20 (0.79)			80	63.5 (2.5)	42.5 (1.67)	871TM-M20NP30-D4		
	15 (0.59)	No		30	66.3 (2.61)	39.4 (1.55)	871TM-DH15NP30-D4		
	40 (1.57)			80	63.5 (2.5)	35.5 (1.40)	871TM-N40NP30-D4		

IO-Link enabled.

## Specifications

<b>Certifications</b>	CE Marked for all applicable directives (standard range models also UL Listed and CSA Certified), long range also cULus Listed)
<b>Enclosure Type Rating</b>	NEMA 1, 2, 3, 3R, 4, 4X, 6, 6P, 12, 13; IP67 (IEC 529) all models; 1200 psi (8270 kPa) washdown; standard range Micro connector versions are also rated IP69K (IEC 529) except for 8 mm versions
<b>Operating Temperature [C (F)]</b>	Operating Temperature Range: 871TM-DH -25 to 70 °C (-13 to 158 °F) 871TM-M and 871TM-N -25 to 85 °C (-13 to 185 °F)
<b>Operating Voltage</b>	10...30V DC
<b>Protection Type</b>	False pulse, transient noise, reverse polarity, short-circuit (trigger at 340 mA typical), overload
<b>Load Current</b>	≤200 mA
<b>Leakage Current, Max.</b>	≤10 mA on standard range models, ≤0.1 mA on extended range models
<b>Housing Material</b>	Stainless steel face and barrel

## Required Cordsets and Accessories

Description	Cat. No.
DC Micro (M12) QD cordset, straight, 4-pin, 2 m (6.5 ft)	889D-F4AC-2
DC Pico QD cordset, straight, 3-pin, 2 m (6.5 ft)	889P-F3AB-2
Right angle mounting bracket	871A-BRN <sup>1</sup>
Snap clamp mounting bracket	871A-SCPB <sup>2</sup>
Point I/O IO-Link Master Module	1734-4IOL
ArmorBlock IO-Link Master	1732E-8IOLM12R

<sup>1</sup> Add **8**, **12**, **18**, or **30** to the end of the catalog number for sensor barrel diameter in mm.

<sup>2</sup> Add **12** or **18** to the end of the catalog number for sensor barrel diameter in mm.

For more information on our complete family of inductive proximity products, please visit:  
[rok.auto/presence-sensing](http://rok.auto/presence-sensing)



# Proximity Sensors

## Product Selection

### 2-Wire DC

Barrel Diameter	Nominal Sensing Distance [mm (in.)]	Shielded	Output Configuration	Switching Frequency (Hz)	Housing Length [mm (in.)]	Thread Length [mm (in.)]	Connection Type	Cat. No.
12 mm	2 (0.08)	Y	N.O.	75	61.0 (2.40)	26.4 (1.04)	Micro QD	871TM-DH2NE12-D4
	4 (0.16)	N				19.6 (0.77)		871TM-DH4NE12-D4
18 mm	5 (0.20)	Y		60	65.0 (2.56)	41.7 (1.64)		871TM-DH5NE18-D4
	8 (0.31)	N				871TM-DH8NE18-D4		
30 mm	10 (0.39)	Y		40	66.3 (2.61)	41.9 (1.65)		871TM-DH10NE30-D4
	15 (0.59)	N				39.4 (1.55)		871TM-DH15NE30-D4



**Looking for More?**  
 This catalog highlights only our most essential components; for a complete product selection, visit us at:  
<https://rok.auto/directory>

## Specifications







<b>Certifications</b>	UL Listed, CSA Certified, and CE Marked for all applicable directives
<b>Enclosure Type Rating</b>	NEMA 1, 2, 3, 3R, 4, 4X, 6, 6P, 12, 13; IP67 (IEC 529) all models; 1200 psi (8270 kPa) washdown; ToughLink™ and Micro connector versions are also rated IP69K (IEC 529)
<b>Operating Temperature [C (F)]</b>	-25...+70 ° (-13...+158 °)
<b>Operating Voltage</b>	10...30V DC
<b>Protection Type</b>	False pulse on power, transient noise, reverse polarity, short-circuit, overload
<b>Load Current</b>	≤ 25 mA
<b>Housing Material</b>	Stainless steel face and barrel

## Required Cordsets and Accessories

Description	Cat. No.
DC Micro (M12) QD cordset, straight, 4-pin, 2 m (6.5 ft)	889D-F4AC-2
Right angle mounting bracket	871A-BRN <sup>1</sup>
Snap clamp mounting bracket	871A-SCPB <sup>2</sup>

<sup>1</sup> Add **12**, **18**, or **30** to the end of the catalog number for sensor barrel diameter in mm.

<sup>2</sup> Add **12** or **18** to the end of the catalog number for sensor barrel diameter in mm.

<p>Photoelectric Sensors</p>  <p>7-2...7-49</p>	<p><b>Proximity Sensors</b></p>  <p><b>7-50...7-79</b></p>	<p>Ultrasonic Sensors</p>  <p>7-80...7-83</p>	<p>Limit Switches</p>  <p>7-84...7-95</p>	<p>Encoders</p>  <p>7-96...7-103</p>	<p>Condition Sensing</p>  <p>7-104...7-113</p>	<p>Identification Devices</p>  <p>7-114...7-121</p>
------------------------------------------------------------------------------------------------------------------------------------	-----------------------------------------------------------------------------------------------------------------------------------------------	----------------------------------------------------------------------------------------------------------------------------------	------------------------------------------------------------------------------------------------------------------------------	--------------------------------------------------------------------------------------------------------------------------	-------------------------------------------------------------------------------------------------------------------------------------	------------------------------------------------------------------------------------------------------------------------------------------



## Product Selection

### 2-Wire AC/DC

Barrel Diameter	Nominal Sensing Distance [mm (in.)]	Shielded	Output Configuration	Switching Frequency [Hz]	Housing Length [mm (in.)]	Threaded Length [mm (in.)]	Cat. No.
12 mm	3 (0.12)	Yes	N.O.	35	83.4 (3.28)	38.4 (1.51)	871TM-B3N12-R3
	4 (0.16)	No		20		31.5 (1.24)	871TM-B4N12-R3
18 mm	5 (0.20)	Yes		20	84.3 (3.32)	60 (2.36)	871TM-B5N18-R3
	8 (0.31)	No		15		48.2 (1.90)	871TM-B8N18-R3
30 mm	10 (0.39)	Yes		15	85.7 (3.37)	61.3 (2.41)	871TM-B10N30-R3
	15 (0.59)	No		12		46.1 (1.81)	871TM-B15N30-R3

### PLC Interfacer Models

Barrel Diameter [mm]	Nominal Sensing Distance [mm (in.)]	Shielded	Output Configuration	Switching Frequency [Hz]	Housing Length [mm (in.)]	Threaded Length [mm (in.)]	Cat. No.
12 mm	2 (0.08)	Yes	N.O.	75	61 (2.40)	26.4 (1.04)	871TM-BH2N12-R3
	4 (0.16)	No		35		19.6 (0.77)	871TM-BH4N12-R3
18 mm	5 (0.20)	Yes		65	65 (2.56)	41.7 (1.64)	871TM-BH5N18-R3
	8 (0.31)	No		30		41.7 (1.64)	871TM-BH8N18-R3
30 mm	10 (0.39)	Yes		45	66.3 (2.61)	41.9 (1.65)	871TM-BH10N30-R3
	15 (0.59)	No		20	66.3 (2.61)	39.4 (1.55)	871TM-BH15N30-R3

**Note:** PLC Interfacer Models feature low leakage current for improved compatibility with PLC inputs.

## Specifications

<b>Certifications</b>	UL Listed, CSA Certified, and CE Marked for all applicable directives
<b>Enclosure Type Rating</b>	NEMA 1, 2, 3, 3R, 4, 4X, 6, 6P, 12, 13; IP67 (IEC 529) all models; 1200 psi (8270 kPa) washdown; ToughLink and Micro connector versions are also rated IP69K (IEC 529)
<b>Operating Temperature [C (F)]</b>	-25...+70 ° (-13...+158 °)
<b>Operating Voltage</b>	20...250V AC/DC
<b>Protection Type</b>	False pulse, transient noise, short-circuit, overload
<b>Load Current</b>	12 mm models: 5...200 mA; 18 & 30 mm models: 5...250 mA; PLC Interfacer models: 2...25 mA
<b>Leakage Current, Max.</b>	≤1.9 mA @ 120V AC (PLC Interfacer models: ≤0.9 mA @ 24V DC, ≤1.7 mA @ 20...120V AC, ≤2.5 mA @ 121...250V AC)
<b>Housing Material</b>	Stainless steel face and barrel

## Required Cordsets and Accessories

Description	Cat. No.
AC Micro (M12) QD cordset, straight, 3-pin, 2 m (6.5 ft)	889R-F3ECA-2
Right angle mounting bracket	871A-BRN <sup>1</sup>
Snap clamp mounting bracket	871A-SCPB <sup>2</sup>

<sup>1</sup> Add **12**, **18**, or **30** to the end of the catalog number for sensor barrel diameter in mm.

<sup>2</sup> Add **12** or **18** to the end of the catalog number for sensor barrel diameter in mm.





# Proximity Sensors

SENSORS

## Food and Beverage 871TS

- Corrosion-resistant stainless steel housing with FDA Certified PPS sensing face
- IP67, IP68, and IP69K enclosure ratings
- Extended sensing range
- Extended temperature rating
- ECOLAB and Johnson Diversey Certified
- Smooth barrel models for sanitary applications (18 mm models)
- Laser etched product markings



## Sensors for the Food & Beverage Industry

The Allen-Bradley 871TS food and beverage inductive proximity sensors are designed to address the most demanding applications in the food and beverage industry. These sensors withstand high pressure and high temperature washdown, while offering superior resistance to corrosion and damage caused by harsh cleansing agents.

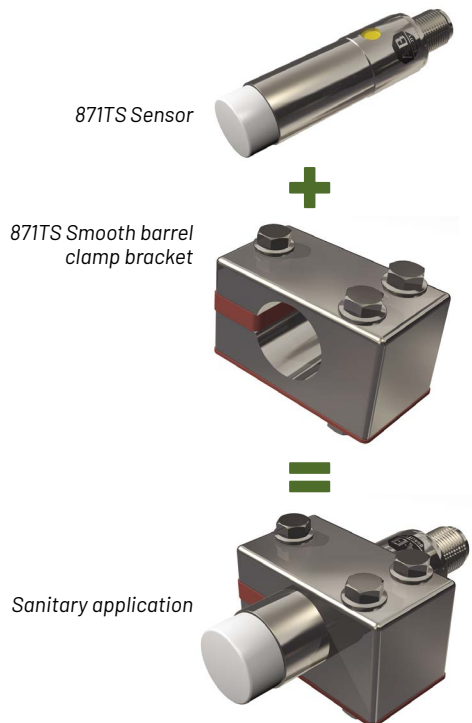

*Bottling application - An 871TS ensures a bottle cap is in place prior to a cartoning process.*

7-64

Photoelectric  
Sensors



7-2...7-49

**Proximity  
Sensors**



**7-50...7-79**

Ultrasonic  
Sensors



7-80...7-83

Limit  
Switches



7-84...7-95

Encoders



7-96...7-103

Condition  
Sensing



7-104...7-113

Identification  
Devices



7-114...7-121



## Product Selection

### 4-Wire DC

Barrel Diameter	Barrel Type	Nominal Sensing Distance [mm (in.)]	Shielded	Output Configuration	Switching Frequency (Hz)	Housing Length [mm (in.)]	Thread Length [mm (in.)]	Connection Type	Cat. No.
12 mm	Threaded	4 (0.16)	Y	N.O. and N.C., PNP	2000	65.0 (2.56)	38.1 (1.50)	Micro QD	871TS-M4BP12-D4
		8 (0.31)	N				32.5 (1.28)		871TS-N8BP12-D4
18 mm	Threaded	8 (0.31)	Y		1500	63.0 (2.48)	34.5 (1.36)		871TS-M8BP18-D4
		12 (0.47)	N				26.5 (1.04)		871TS-N12BP18-D4
	Smooth	8 (0.31)	Y		63.0 (2.48)	-	871TS-MM8BP18-D4		
		12 (0.47)	N				871TS-NM12BP18-D4		

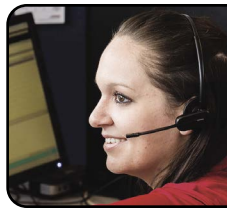

#### Need Help?

The Rockwell Automation Support Center is your 24/7 support for the answers you need now.

[rok.auto/support](http://rok.auto/support)

## Specifications

<b>Certifications</b>	cULus Listed and CE Marked for all applicable directives; ECOLAB and Johnson and Diversey Certified
<b>Enclosure Type Rating</b>	IP67, IP68, and IP69K (IEC 529)
<b>Operating Temperature [C (F)]</b>	-40...+80 ° (-40...+176 °)
<b>Operating Voltage</b>	10...30V DC
<b>Protection Type</b>	False pulse on power, transient noise, reverse polarity, short-circuit, overload
<b>Load Current</b>	≤200 mA
<b>Housing Material</b>	Stainless steel 316L barrel and PPS sensing face (FDA Certified)

## Required Cordsets and Accessories

Description	Cat. No.
DC Micro (M12) QD cordset, straight, 4-pin, 2 m (6.5 ft)	889D-F4AC-2
Right angle mounting bracket	871A-BRN <sup>1</sup>
Snap clamp mounting bracket	871A-SCPB <sup>2</sup>
Smooth barrel clamp bracket, stainless steel, 18 mm	60-BCS-18B

<sup>1</sup> Add **12** or **18** to the end of the catalog number for sensor barrel diameter in mm.

<sup>2</sup> Add **12** or **18** to the end of the catalog number for sensor barrel diameter in mm.



# Proximity Sensors

SENSORS

## Weld Field Immune with Equal Sensing 871ZT

- Equal sensing distance for all metals
- Weld-field immune
- Weld-slag resistant PTFE-coated brass barrel and face
- Extended sensing range
- IP67, IP69K, and 1200 psi washdown rated
- 360° visible LED status indicator



## The Full-featured Line for Welding Applications

The 871ZT inductive proximity sensors are equal sensing models – they sense all metals at nearly the same distance. Plus, these special weld-field immune models are ideal for welding environments and other applications where large magnetic fields are present.

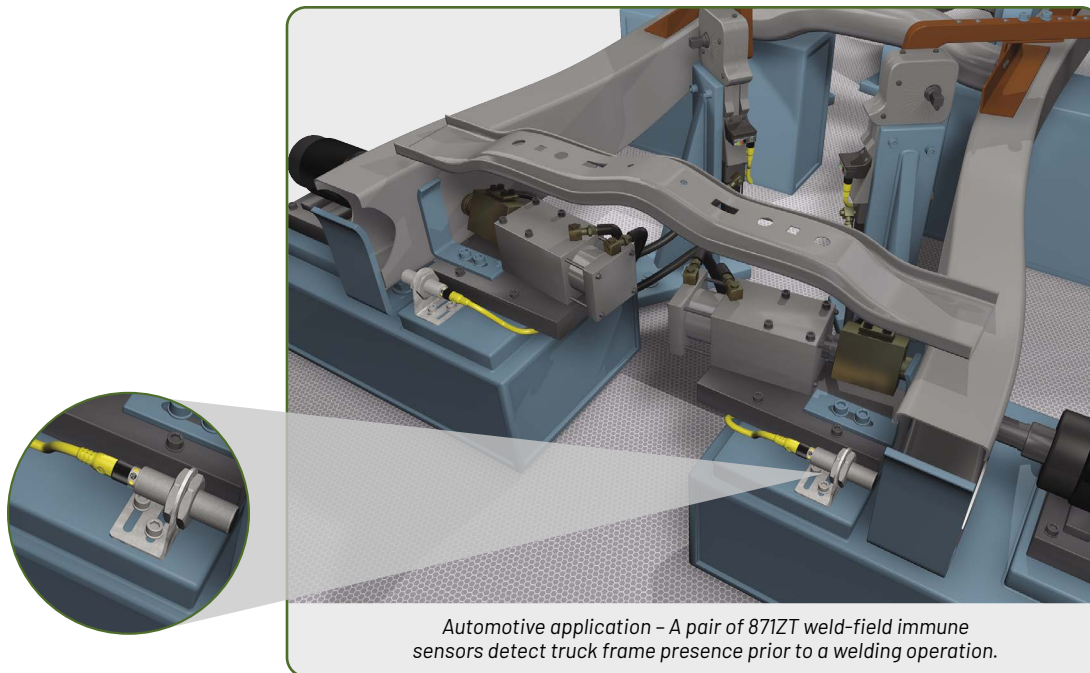

7-66

Photoelectric  
Sensors



7-2...7-49

**Proximity  
Sensors**



**7-50...7-79**

Ultrasonic  
Sensors



7-80...7-83

Limit  
Switches



7-84...7-95

Encoders



7-96...7-103

Condition  
Sensing



7-104...7-113

Identification  
Devices



7-114...7-121



## Product Selection

### 3-Wire DC

Barrel Diameter	Nominal Sensing Distance [mm (in.)]	Shielded	Output Configuration	Switching Frequency [Hz]	Housing Length [mm (in.)]	Thread Length [mm (in.)]	Connection Type	Cat. No.
12 mm	3 (0.12)	Yes	N.O., PNP	2000	65.0 (2.56)	50.0 (1.97)	Micro QD	871ZT-MB3NP12-D4
	8 (0.31)	No				40.0 (1.58)		871ZT-NB8NP12-D4
18 mm	5 (0.20)	Yes		2500		50.0 (1.97)		871ZT-MB5NP18-D4
	12 (0.47)	No				40.0 (1.58)		871ZT-NB12NP18-D4
30 mm	10 (0.39)	Yes		600		50.5 (1.99)		871ZT-MB10NP30-D4
	20 (0.79)	No				1000		37.5 (1.48)



#### Sales Offices and Distributors

Our network of sales offices and distributors offers exceptional knowledge and service to help you design, implement and support your automation investment.

[rok.auto/buy](http://rok.auto/buy)

## Specifications

<b>Certifications</b>	cULus Listed and CE Marked for all applicable directives
<b>Enclosure Type Rating</b>	NEMA 1, 2, 3, 3R, 4, 4X, 6, 6P, 12, 13; IP67 (IEC 529)
<b>Operating Temperature [C (F)]</b>	-25...+70 ° (-13...+158 °)
<b>Operating Voltage</b>	10...30V DC
<b>Protection Type</b>	False pulse, transient noise, reverse polarity, short-circuit (trigger at 340 mA typical), overload
<b>Load Current</b>	≤200 mA
<b>Leakage Current, Max.</b>	≤0.08 mA
<b>Housing Material</b>	PTFE-coated brass barrel and PTFE face

## Required Cordsets and Accessories

Description	Cat. No.
DC Micro (M12) ToughWeld™ QD cordset, straight, 4-pin, 2 m (6.5 ft)	889D-F4WE-2
Right angle mounting bracket	871A-BRN <sup>1</sup>
Snap clamp mounting bracket	871A-SCP B <sup>2</sup>

<sup>1</sup> Add **12**, **18**, or **30** to the end of the catalog number for sensor barrel diameter in mm.

<sup>2</sup> Add **12** or **18** to the end of the catalog number for sensor barrel diameter in mm.



# Proximity Sensors

SENSORS

## Weld Field Immune 871Z

- Weld-field immune
- PTFE-coated brass barrel
- High-heat and weld slag resistant face
- Three-wire DC or two-wire AC/DC models



## Tough Sensors for Automotive Applications

The 871Z inductive proximity sensors are special weld-field immune models ideal for welding environments and other applications where large magnetic fields are present.

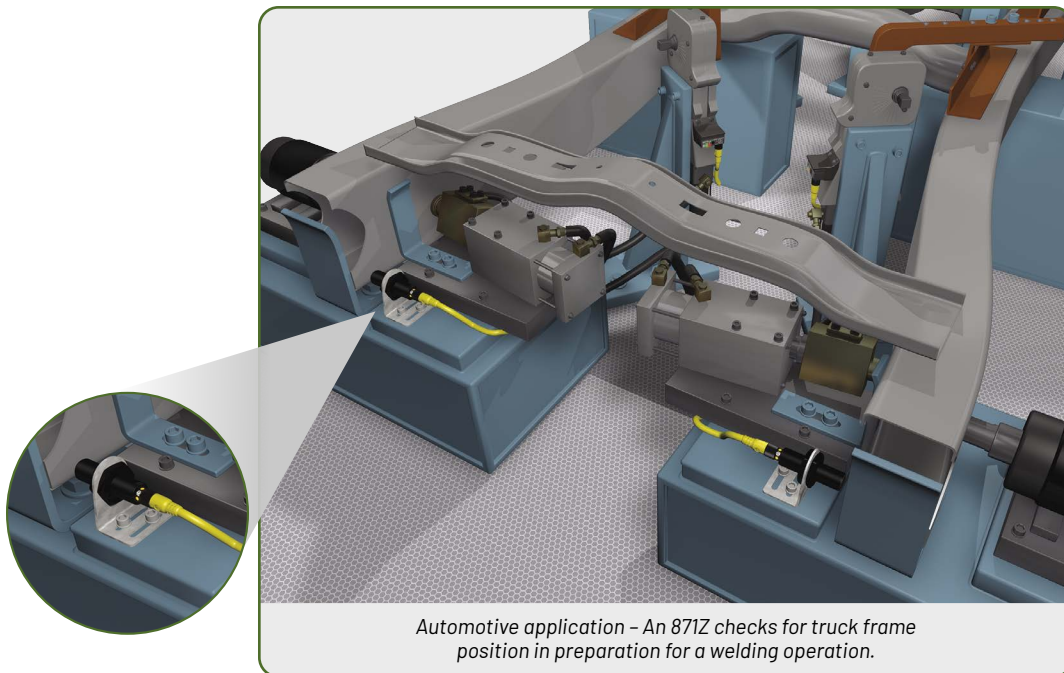

Automotive application - An 871Z checks for truck frame position in preparation for a welding operation.

Photoelectric  
Sensors



7-2...7-49

Proximity  
Sensors



7-50...7-79

Ultrasonic  
Sensors



7-80...7-83

Limit  
Switches



7-84...7-95

Encoders



7-96...7-103

Condition  
Sensing



7-104...7-113

Identification  
Devices



7-114...7-121

7-68





## Product Selection

### 3-Wire DC

Barrel Diameter	Nominal Sensing Distance [mm (in.)]	Shielded	Output Configuration	Switching Frequency [Hz]	Housing Length [mm (in.)]	Thread Length [mm (in.)]	Connection Type	Cat. No.
12 mm	2 (0.08)	Yes	N.O., PNP	15	70.0 (2.76)	50.0 (1.97)	Micro QD	871Z-DW2NP12-D4
18 mm	5 (0.20)				80.0 (3.15)	60.0 (2.36)		871Z-DW5NP18-D4
30 mm	10 (0.39)				80.0 (3.15)	60.0 (2.36)		871Z-DW10NP30-D4

### 2-Wire AC/DC

Barrel Diameter	Nominal Sensing Distance [mm (in.)]	Shielded	Output Configuration	Switching Frequency (Hz)	Housing Length [mm (in.)]	Thread Length [mm (in.)]	Connection Type	Cat. No.
12 mm	2 (0.07)	Y	N.O.	30	90.1 (3.55)	46.7 (1.85)	Micro QD (1/2-20 UNF-2 A)	871Z-BW2N12-R3
	4 (0.15)	N				39.7 (1.56)		871Z-BW4N12-R3
18 mm	5 (0.19)	Y			83.5 (3.29)	61.6 (2.43)		871Z-BW5N18-R3
30 mm	10 (0.39)	Y			86.0 (3.38)	64.3 (2.53)		871Z-BW10N30-R3

## Specifications

<b>Certifications</b>	UL Listed, CSA Certified, and CE Marked for all applicable directives
<b>Enclosure Type Rating</b>	NEMA 1, 2, 3, 4, 12, 13; IP67 (IEC 529)
<b>Operating Temperature [C (F)]</b>	-25...+70 ° (-13...+158 °)
<b>Operating Voltage</b>	10...30V DC, 20...250V AC/DC
<b>Protection Type</b>	False pulse on power, transient noise, short-circuit, overload
<b>Load Current</b>	200 mA DC, 5...200 mA for 12 mm AC/DC, 5...250 mA for 18 and 30 mm AC/DC
<b>Housing Material</b>	PTFE-coated brass

## Required Cordsets and Accessories

Description	Cat. No.
DC Micro (M12) ToughWeld QD cordset, straight, 4-pin, 2 m (6.5 ft)	889D-F4WE-2
AC Micro (M12) ToughWeld QD cordset, straight, 3-pin, 2 m (6.5 ft)	889R-F3WEA-2
Right angle mounting bracket	871A-BRN <sup>1</sup>
Snap clamp mounting bracket	871A-SCPB <sup>2</sup>

<sup>1</sup> Add **12**, **18**, or **30** to the end of the catalog number for sensor barrel diameter in mm.

<sup>2</sup> Add **12** or **18** to the end of the catalog number for sensor barrel diameter in mm.





# Proximity Sensors

SENSORS

## Miniature Rectangular 871FM

- Space-critical applications
- Equal sensing distance for all metals (select models)
- Cable, Micro QD, Pico QD, and Pico QD on 6-inch pigtail
- Stainless steel, chrome-plated brass and plastic housings
- IP67 or IP69K rated
- Factor-1/equal sensing auto detect NPN or PNP on power-up for 871FM Metal Flat Pack

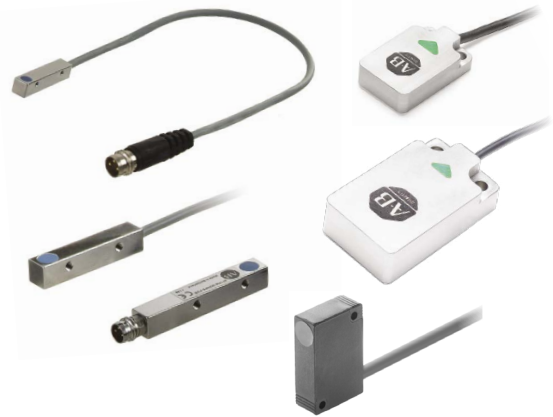

## Smaller Sensors for Your Hard-to-reach Applications

There are some applications that can't be solved with an industry standard-sized proximity sensor. Whether the application you're trying to solve is part of the semiconductor industry, or you're an OEM who manufactures machines which generate miniature parts, these sensors are able to go where traditional proximity sensor sizes cannot. These IO-Link enabled miniature inductive proximity sensors are ideal for applications where limited space - not sensing distance - is the driving factor.

5 mm x 22 mm x 5 mm (W x L x H)  
(actual size)



20 mm x 32 mm x 8 mm (W x L x H)  
(actual size)



30 mm x 52 mm x 14 mm  
(W x L x H)(actual size)



Weld Slag Resistance



871FM Miniature Rectangular sensors can be applied where traditional tubular proximity sensors cannot, whether you're trying to sense small parts, space is at a premium, or both.

7-70

Photoelectric Sensors



7-2...7-49

Proximity Sensors



7-50...7-79

Ultrasonic Sensors



7-80...7-83

Limit Switches



7-84...7-95

Encoders



7-96...7-103

Condition Sensing



7-104...7-113

Identification Devices



7-114...7-121



## Product Selection

### 3-Wire DC

Dimensions w x h x d [mm (in.)]	Nominal Sensing Distance [mm (in.)]	Shielded	Output Configuration	Switching Frequency (Hz)	Weld Immune	Connector Type	Cat. No.	
5 x 22 x 5 (0.19 x 0.86 x 0.19)	0.8 (0.03)	Y	N.O., PNP	5,000	—	2 m cable	871FM-M1NP5-E2	
	1.5 (0.05)	Y		3,000	—		871FM-M2NP5-E2	
5 x 25 x 5 (0.20 x 0.98 x 0.20)	0.8 (0.03)	Y		5,000	—	Pico QD with 6" pigtail	871FM-M1NP5-AP3	
	1.5 (0.05)	Y		3,000	—	Pico QD with 6" pigtail	871FM-M2NP5-AP3	
8 x 35 x 8 (0.31 x 1.37 x 0.31)	2 (0.07)	Y		3,000	—	2 m cable	871FM-M2NP8-E2	
	3 (0.11)	N			1,000		—	871FM-N3NP8-E2
8 x 50 x 8 (0.31 x 1.97 x 0.31)	2 (0.07)	Y		3,000	—	Pico QD	871FM-M2NP8-P3	
28 x 16 x 11 (1.10 x 0.62 x 0.43)	2 (0.07)	Y		600	—	Pico QD	871FM-D2NP11-P3	
20 x 8 x 32 (0.78 x 0.31 x 1.25)	7 (0.27)	Y		Complementary N.O./N.C., auto detect NPN or PNP on power-up	≤200	No	PVC Pigtail, DC Micro QD, 4-pin	871FM-M7BA20-FD02
					≤200	No	PVC Cable, 2m	871FM-M7BA20-E2
			≤50		Yes - ToughCoat Finish™ weld slag coating	PVC Pigtail, DC Micro QD, 4-pin, Weld tube cable protection	871FM-MV7BA20-FD02X	
≤200	No	PVC Pigtail, DC Micro QD, 4-pin	871FM-M10BA30-FD02					
≤200	No	PVC Cable, 2m	871FM-M10BA30-E2					
≤50	Yes - ToughCoat Finish weld slag coating	PVC Pigtail, DC Micro QD, 4-pin, Weld tube cable protection	871FM-MV10BA30-FD02X					
20 x 8 x 32 (0.78 x 0.31 x 1.25)	7	Y	≤200		No	PVC Pigtail, DC Pico QD, 4-Pin	871FM-M7BA20-FP02	
20 x 8 x 32 (0.78 x 0.31 x 1.25)	7	Y	≤50		Yes - ToughCoat Finish weld slag coating	PVC Pigtail, DC Pico QD, 4-Pin	871FM-MV7BA20-FP02X	
30 x 14 x 52 (1.18 x 0.55 x 2.04)	10	Y	≤200		No	PVC Pigtail, DC Pico QD, 4-Pin	871FM-M10BA30-FP02	
30 x 14 x 52 (1.18 x 0.55 x 2.04)	10	Y	≤50		Yes - ToughCoat Finish weld slag coating	PVC Pigtail, DC Pico QD, 4-Pin	871FM-MV10BA30-FP02X	

IO-Link enabled.

## Specifications

<b>Certifications</b>	CE Marked for all applicable directives
<b>Enclosure Type Rating</b>	IP67 (IEC 529)
<b>Operating Temperature [C (F)]</b>	-25...+70 °C (-13...+158 °F)
<b>Operating Voltage</b>	10...30V DC
<b>Protection Type</b>	False pulse on power, transient noise, reverse polarity, short circuit, overload
<b>Load Current</b>	≤50mA at 12V, ≤100mA for 20 x 8 x 32, 30 x 14 x 52 and ≤200 mA for all others
<b>Housing Material</b>	5 x 22 x 5 and 8 x 35 x 8 chrome-plated brass with plastic face; 20 x 8 x 32 and 30 x 14 x 52 all stainless steel; plastic for all other products

## Required Cordsets and Accessories

Description	Cat. No.
DC Pico (M8) QD cordset, straight, 3-pin, 2 m (6.5 ft), PVC	889P-F3AB-2
DC Pico (M8) QD cordset, straight, 4-pin, 2 m (6.5 ft), PVC	889P-F4AB-2
Point I/O IO-Link Master Module	1734-4IOL
ArmorBlock IO-Link Master	1732E-8IOLM12R
DC Micro (M12) QD cordset, straight, 4-pin, 2 m (6.5 ft), PVC	889D-F4AB-2
DC Micro (M12) QD cordset, straight, 4-pin, 2 m (6.5 ft), CPE	889D-F4WE-2
DC Pico (M8) QD cordset, straight, 4-pin, 2 m (6.5 ft), TPE	889P-F4HB-2

For more information on our complete family of inductive proximity products, please visit:  
[rok.auto/presence-sensing](http://rok.auto/presence-sensing)



# Proximity Sensors

SENSORS

## VersaCube Equal Sensing 871P

- Weld-field immune with optional ToughCoat Finish™
- Factor-1/equal sensing for all metals
- Five-position sensing face
- Enhanced-visibility status LEDs
- Optional heavy duty model with metal base
- Unique jam nut and L-bracket mounting option



## Equal Sensing, Versatility, and Durability

These 4-wire DC sensors integrate standard and specialty features into a 40 mm rectangular housing suited for general purpose and welding applications. For the most demanding welding applications, the 871P VersaCube™ can be ordered with ToughCoat Finish (our patented weld-slag resistant coating).

### Changing the Sensing Head Position

To switch the sensing head between top and side sensing positions, follow these steps:

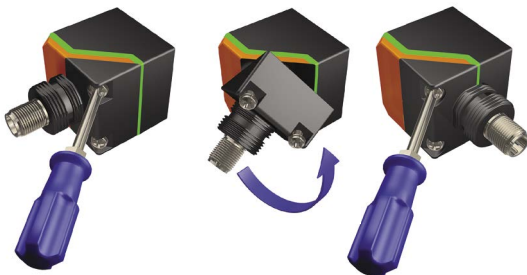

### Mounting



Standard Zinc Mounting Bracket

Optional Stainless Steel Mounting L-Bracket

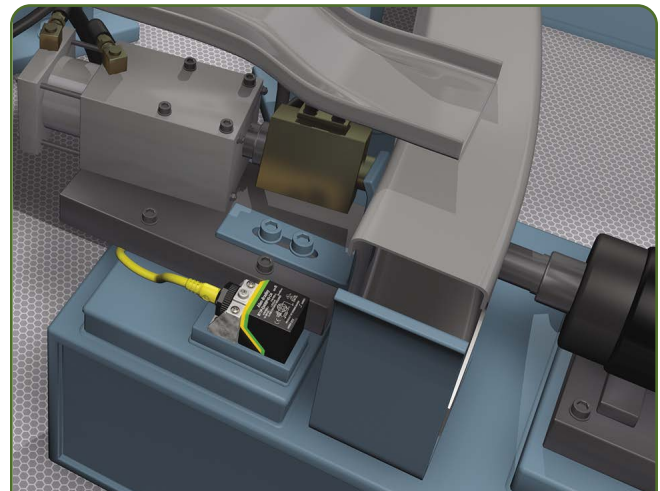

Automotive application - A VersaCube detecting the presence of a truck frame prior to initiating a weld.

7-72

Photoelectric Sensors



7-2...7-49

Proximity Sensors



7-50...7-79

Ultrasonic Sensors



7-80...7-83

Limit Switches



7-84...7-95

Encoders



7-96...7-103

Condition Sensing



7-104...7-113

Identification Devices



7-114...7-121



## Product Selection

### 4-Wire DC <sup>1</sup>

Dimensions w x h x d [mm (in.)]	Nominal Sensing Distance [mm (in.)]	Shielded	Output Configuration	Switching Frequency (Hz)	Weld Field Immune	Connector Type	Cat. No.	
40 x 68.2 x 40 (1.57 x 2.68 x 1.57)	20 (0.79)	Y	N.O. and N.C., PNP	40	Y	Micro QD	871P-D20BP40-D4	
	40 (1.57)	N					871P-D40BP40-D4	
	20 (0.79)	Y			Yes - ToughCoat Finish™ weld slag coating		871P-DV20BP40-D4	
	40 (1.57)	N					871P-DV40BP40-D4	
40 x 68.2 x 40 (1.57 x 2.68 x 1.57)	20 (0.79)	Y					Y	871P-D20BP40-D4
	40 (1.57)	N						871P-D40BP40-D4
	20 (0.79)	Y			Yes - ToughCoat Finish™ weld slag coating			871P-DV20BP40-D4
	40 (1.57)	N						871P-DV40BP40-D4
40 x 68.2 x 40 (1.57 x 2.68 x 1.57)	20 (0.79)	Y					Y	871P-DP20BP40-D4
	40 (1.57)	N					Y	871P-DP40BP40-D4
	20 (0.79)	Y			Yes - ToughCoat Finish™ weld slag coating			871P-DPV20BP40-D4
	40 (1.57)	N			Yes - ToughCoat Finish™ weld slag coating			871P-DPV40BP40-D4

<sup>1</sup> All units ship with a standard zinc mounting bracket.

## Specifications

<b>Certifications</b>	cULus Listed and CE Marked for all applicable directives
<b>Enclosure Type Rating</b>	NEMA 1, 2, 3, 4, 6, 12, 13; IP67, IP68, and IP69K (IEC 529)
<b>Operating Temperature [C (F)]</b>	-25...+70 ° (-13...+158 °)
<b>Operating Voltage</b>	10...30V DC
<b>Protection Type</b>	False pulse on power, transient noise, short-circuit, overload, reverse polarity
<b>Load Current</b>	≤200 mA from 25...50 °C (77...122 °F) ≤100 mA from 50...70 °C (122...158 °F)
<b>Housing Material</b>	PBT housing, acrylic lens covers and zinc base

## Required Cordsets and Accessories

Description	Cat. No.
DC Micro (M12) QD ToughWeld cordset, straight, 4-pin, 2 m (6.5 ft)	889D-F4WE-2
Standard zinc mounting bracket	871A-PBR
Stainless steel L-bracket (with 22 mm plastic mounting nut)	871A-BRS59
22 mm plastic mounting nut	871T-N9



# Proximity Sensors

SENSORS

## VersaCube General Purpose 871P

- General purpose and weld-field immune versions
- Weld-slag resistant PEEK housing (WFI models)
- One-piece housing and mounting bracket
- Five-position sensing face



General Purpose Model

## Long Range General-purpose Sensing

The VersaCube package is ideal for applications that require long-range sensing in a compact sensor. Their size is approximately half that of a NEMA style limit switch. In fact, the mounting holes on the VersaCube base align with the standard NEMA limit switch mounting holes allowing for an easy and convenient retrofit.

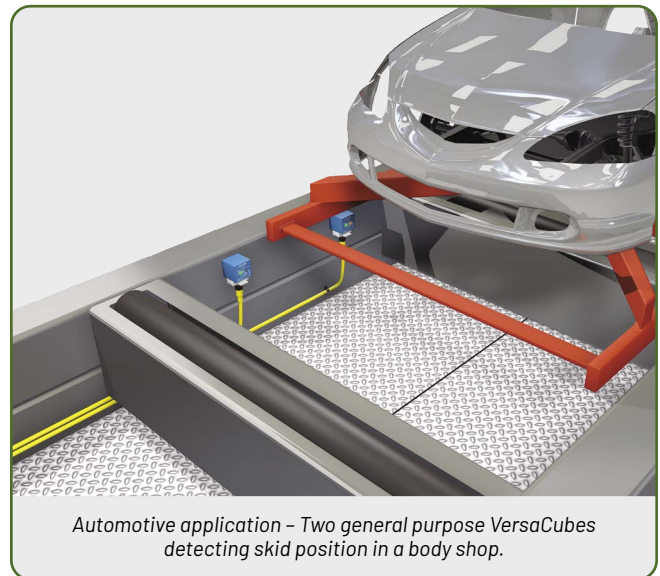
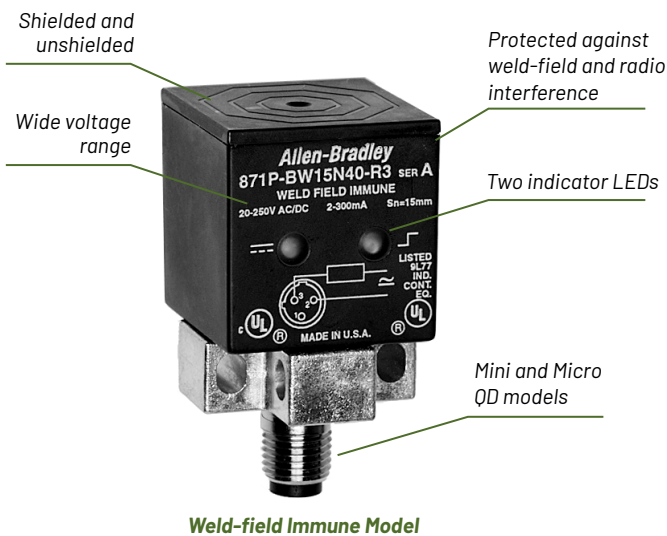

7-74

Photoelectric Sensors



7-2...7-49

Proximity Sensors



7-50...7-79

Ultrasonic Sensors



7-80...7-83

Limit Switches



7-84...7-95

Encoders



7-96...7-103

Condition Sensing



7-104...7-113

Identification Devices



7-114...7-121





## Product Selection

### 2-Wire AC/DC

Dimensions w x h x d [mm (in.)]	Weld Field Immune	Nominal Sensing Distance [mm (in.)]	Shielded	Output Configuration	Switching Frequency (Hz)	Connector Type	Cat. No.
40 x 68.7 x 40 (1.57 x 2.70 x 1.57)	N	20 (0.79)	Y	N.O.	30	Micro QD (1/2-20 UNF-2A)	871P-B20N40-R3
		40 (1.57)	N		20		871P-B40N40-R3
	Y	15 (0.59)	Y		30		871P-BW15N40-R3
		25 (0.98)	N		20		871P-BW25N40-R3



**Looking for More?**  
This catalog highlights only our most essential components; for a complete product selection, visit us at: [rok.auto/directory](http://rok.auto/directory)

## Specifications

<b>Certifications</b>	cULus Listed and CE Marked for all applicable directives
<b>Enclosure Type Rating</b>	NEMA 1, 2, 3, 4, 6, 6P, 12, 13; IP67 and IP69K (IEC 529)
<b>Operating Temperature [C (F)]</b>	-25...+70 ° (-13...+158 °)
<b>Operating Voltage</b>	20...250V AC/DC
<b>Protection Type</b>	False pulse on power, transient noise, short-circuit, overload
<b>Load Current</b>	100 mA for standard versions and 300 mA for WFI versions
<b>Housing Material</b>	Plastic body and zinc base

## Required Cordsets and Accessories

Description	Cat. No.
AC Micro (M12) QD cordset, straight, 3-pin, 2 m (6.5 ft)	889R-F3ECA-2
Mounting kit <sup>1</sup>	871A-PKIT
Limit Switch style mounting kit (w/22 mm plastic mounting nut)	871A-PKITLS
PTFE cover - short	871A-KCT40-F
PTFE cover - long	871A-KCT40-T

<sup>1</sup> Each mounting kit includes a ground lug, a ground screw, and an optional adaptor for competitive retrofits.





# Proximity Sensors

SENSORS

## Flat Pack 871F

- General purpose and weld-field immune versions
- Sensing ranges up to 65 mm (2.55 in.)
- Through-hole or DIN Rail mounting
- Complementary N.O. and N.C. outputs



## Maximum Sensing Range

The 871F is ideal for applications that require long sensing range - up to 65 mm (2.56 in.). This sensor is often used in material handling and welding applications.

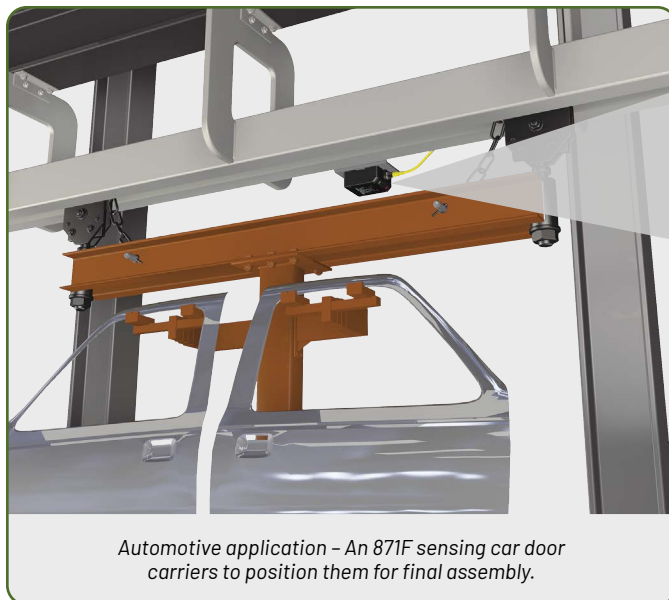

Automotive application - An 871F sensing car door carriers to position them for final assembly.

## Mounting Requirements

Shielded units must be fully embedded in mild steel to achieve maximum sensing distance.



Photoelectric  
Sensors



7-2...7-49

**Proximity  
Sensors**



**7-50...7-79**

Ultrasonic  
Sensors



7-80...7-83

Limit  
Switches



7-84...7-95

Encoders



7-96...7-103

Condition  
Sensing



7-104...7-113

Identification  
Devices



7-114...7-121



## Product Selection

### 4-Wire DC

Dimensions w x h x d [mm (in.)]	Weld Field Immune	Nominal Sensing Distance [mm (in.)]	Shielded	Output Configuration	Switching Frequency (Hz)	Connector Type	Cat. No.
83 x 94 x 40 (3.26 x 3.70 x 1.57)	N	50 (1.96)	Y	N.O. and N.C., PNP	100	Micro QD	871F-P50BP80-D4
		65 (2.55)	N				871F-N65BP80-D4
	Y	40 (1.57)	Y		15		871F-PW40BP80-D4
		50 (1.96)	N				871F-NW50BP80-D4

### 2-Wire AC/DC

Dimensions w x h x d [mm (in.)]	Weld Field Immune	Nominal Sensing Distance [mm (in.)]	Shielded	Output Configuration	Switching Frequency (Hz)	Connector Type	Cat. No.
83 x 94 x 40 (3.26 x 3.70 x 1.57)	N	50 (1.96)	Y	N.O.	10	Micro QD (1/2-20 UNF-2A)	871F-R50N80-R3
		65 (2.55)	N				871F-K65N80-R3
	Y	40 (1.57)	Y				871F-JW40N80-R3
		50 (1.96)	N				871F-KW50N80-R3

## Specifications

<b>Certifications</b>	UL Listed, cUL Certified, and CE Marked for all applicable directives
<b>Enclosure Type Rating</b>	NEMA 1, 2, 3, 4, 6, 6P, 12, 13; IP67 and IP69K (IEC 529)
<b>Operating Temperature [C (F)]</b>	-25...+70 °C (-13...+158 °F)
<b>Operating Voltage</b>	10...30V DC or 20...250V AC/DC
<b>Protection Type</b>	False pulse on power, transient noise, short circuit, overload, reverse polarity
<b>Load Current</b>	DC models: ≤200 mA AC models: ≤100 mA
<b>Housing Material</b>	PBT

## Required Cordsets

Description	Cat. No.
DC Micro (M12) QD cordset, straight, 4-pin, 2 m (6.5 ft)	889D-F4AC-2
AC Micro (M12) QD cordset, straight, 3-pin, 2 m (6.5 ft)	889R-F3ECA-2

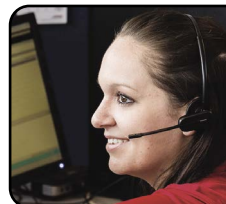

### Need Help?

The Rockwell Automation Support Center is your 24/7 support for the answers you need now.

[rok.auto/support](http://rok.auto/support)



# Proximity Sensors

SENSORS

## Capacitive 875F, 875L

- Metal, nonmetal solid, and liquid sensing
- Adjustable sensing distance (875L)
- Cylindrical (875L) and flat housing types (875F)
- IP67 and IP69K enclosures
- Cable or quick-disconnect styles



## Reliably Detect a Variety of Materials

Unlike inductive proximity sensors, the 875F and 875L capacitive sensors can detect non-metal solids and liquids in addition to standard metal targets. They can even sense the presence of some targets through certain other materials, making them an ideal choice in those applications where the inductive proximity and photoelectric sensors cannot be used.



7-78

Photoelectric  
Sensors



7-2...7-49

Proximity  
Sensors



7-50...7-79

Ultrasonic  
Sensors



7-80...7-83

Limit  
Switches



7-84...7-95

Encoders



7-96...7-103

Condition  
Sensing



7-104...7-113

Identification  
Devices



7-114...7-121



## Product Selection

### 3-Wire DC

Barrel Diameter	Product Type	Sensing Distance	Output Configuration	Connection	Rockwell Cat #
30	Flush	16	Normally Open PNP	DC Micro Quick Disconnect	875L-M16NP30-D4
			Normally Open NPN		875L-M16NN30-D4
			Normally Closed PNP		875L-M16CP30-D4
			Normally Closed NPN		875L-M16CN30-D4
	Non-Flush	25	Normally Open PNP	DC Micro Quick Disconnect	875L-N25NP30-D4
			Normally Open NPN		875L-N25NN30-D4
			Normally Closed PNP		875L-N25CP30-D4
			Normally Closed NPN		875L-N25CN30-D4
18	Flush	8	Normally Open PNP	DC Micro Quick Disconnect	875L-M8NP18-D4
			Normally Open NPN		875L-M8NN18-D4
			Normally Closed PNP		875L-M8CP18-D4
			Normally Closed NPN		875L-M8CN18-D4
	Non-Flush	12	Normally Open PNP	DC Micro Quick Disconnect	875L-N12NP18-D4
			Normally Open NPN		875L-N12NN18-D4
			Normally Closed PNP		875L-N12CP18-D4
			Normally Closed NPN		875L-N12CN18-D4
Flat	Flush	10	Normally Open PNP	0.2 m PVC Cable 4-Pin DC Pico	875F-M10NP34-FP02
			Normally Open NPN		875F-M10NN34-FP02
			Normally Closed PNP		875F-M10CP34-FP02
			Normally Closed NPN		875F-M10CN34-FP02

IO-Link enabled.

## Specifications

<b>Certifications</b>	CE Marked for all applicable directives
<b>Enclosure Type Rating</b>	IP65, IP66, IP67, IP68 @ 1.3 m and 24 h; IP69K (NEMA 1, 2, 4, 4x, 5, 12)
<b>Operating Temperature [C (F)]</b>	-25...+80 °C (-13...+176 °F)
<b>Operating Voltage</b>	10...30V DC
<b>Protection Type</b>	False pulse on power, transient noise, reverse polarity, short circuit, overload, temperature fault, quality of run
<b>Load Current</b>	13 mA
<b>Housing Material</b>	PBT housing

## Accessories

Description	Cat. No.
DC Pico (M8) QD cordset, straight, 3-pin, 2 m (6.5 ft), PVC	889P-F3AB-2
DC Pico (M8) QD cordset, straight, 4-pin, 2 m (6.5 ft), PVC	889P-F4AB-2
Point I/O IO-Link Master Module	1734-4I0L
ArmorBlock IO-Link Master	1732E-8I0LM12R
DC Micro (M12) QD cordset, straight, 4-pin, 2 m (6.5 ft), PVC	889D-F4AB-2
DC Micro (M12) QD cordset, straight, 4-pin, 2 m (6.5 ft), CPE	889D-F4WE-2
DC Pico (M8) QD cordset, straight, 4-pin, 2 m (6.5 ft), TPE	889P-F4HB-2



# Ultrasonic Sensors

SENSORS

## 18, 30 and 38.8 mm Plastic Discrete and Analog 873P

- Detect clear, shiny or non-reflective objects
- Sensing range up to 6 m (19.6 ft)
- Push button programming
- Discrete output models (single set-point or window mode)
- Scalable analog output models
- Wide range of operating voltages
- Synchronization on select models to prevent crosstalk
- Four output modes

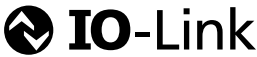

### A Sound Solution

The 873P ultrasonic sensors use reflected sound waves to detect targets – such as clear, shiny, or non-reflective objects – that can be challenging for other sensing technologies. The 873P sensors offer a wide range of operating voltages, simple push-button setup and a synchronization feature to reduce cross-talk between adjacent sensors.

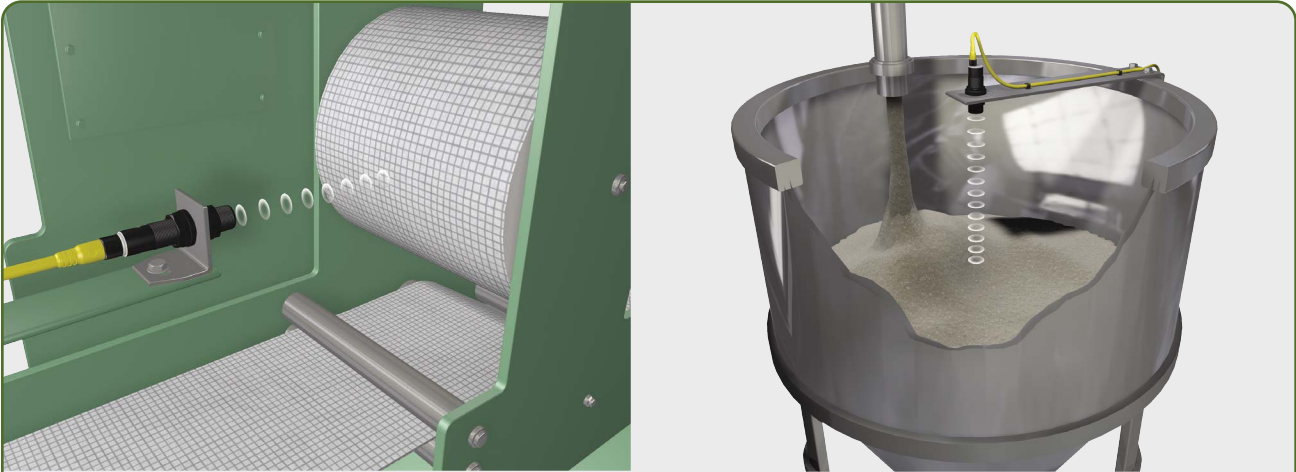

Roll diameter and tank level – An 873P analog ultrasonic continuously measures roll diameter or tank level and provides a proportional 4...20 mA or 0...10V DC output. If a dual discrete output sensor is used, one switch point is set for low level indication and the other set for a full condition.

7-80

Photoelectric Sensors



7-2...7-49

Proximity Sensors



7-50...7-79

**Ultrasonic Sensors**



**7-80...7-83**

Limit Switches



7-84...7-95

Encoders



7-96...7-103

Condition Sensing



7-104...7-113

Identification Devices



7-114...7-121



## Product Selection

### 18 and 30 mm Plastic Discrete and Analog

Sensing Distance [mm (in.)] <sup>1</sup>	Beam Angle	Operating Voltage	Switching Frequency [Hz]	Output Type	Resolution	Response Time	Transducer Frequency	Operating Temperature [C (F)]	Cat. No. <sup>2,3</sup>
<b>Single or Dual Discrete</b>									
50...400 (1.97...15.75)	±8 °	15...30V DC	10 Hz	(1) PNP or (2) PNP	1 mm (0.04 in.)	50 ms	300 kHz	-20...+60 ° (-4...+140 °)	873P-D18PØ-400-D4 ☉
100...900 (3.93...35.43)	±7 °		4 Hz		2 mm (0.08 in.)	125 ms			873P-D18PØ-900-D4 ☉
200...2200 (7.87...86.61)			1 Hz		3 mm (0.12 in.)	500 ms	200 kHz		873P-D18PØ-2200-D4 ☉
200...2500 (7.87...98.42)	14 ° ±1 °		2 Hz		2 mm (0.08 in.)	250 ms	150 kHz		873P-D18PØ-2500-D4 ☉
250...3500 mm (9.84...137.80)	15 ° ±2 °	12...30V DC	4 mm (0.16 in.)	112 kHz	-20...+70 ° (-4...+158 °)		873P-D30PØ-3500-D4 ☉		
350...6000 mm (13.8...236.2 in.)			1 Hz	6 mm (0.24 in.)	500 ms	75 kHz	873P-D30PØ-6000-D4 ☉		
<b>Analog</b>									
100...900 (3.93...35.43)	±7 °	15...30V DC	N/A	4...20 mA or 0...10V DC	2 mm	500 ms	300 kHz	-20...+60 ° (-4...140 °)	873P-D18⊗-900-D4 ☉
200...2500 (7.87...98.42)	14 ±1 °	12...30V DC				600 ms	150 kHz	-20...+70 ° (-4...158 °)	873P-D30⊗-2500-D4 ☉
350...6000 mm (13.8...236.2 in.)	15 ° ±2 °	12...30V DC				6 mm	600 ms	75 kHz	-20...+70 ° (-4...158 °)
100...900 (3.93...35.43)	±7 °	15...30V DC			3 mm	500 ms	300 kHz	-20...+60 ° (-4...140 °)	873P-D18⊗-900-D4 ☉
200...2200 (7.87...86.61)							200 kHz	-20...+60 ° (-4...140 °)	873P-D18⊗-2200-D4 ☉
350...6000 mm (13.8...236.2 in.)	15 ° ±2 °				6 mm	600 ms	75 kHz	-20...+70 ° (-4...158 °)	873P-D30⊗-6000-D4 ☉

<sup>1</sup> Blind Zone = 0 mm to minimum sensing distance<sup>2</sup> The barrel diameter is indicated after the first **D** in the catalog number. For example, catalog number 873P-D18P1-400-D4 is an 18 mm barrel diameter and 873P-D30P1-2500-D4 is a 30 mm barrel diameter.<sup>3</sup> The **-D4** suffix indicates a 4-pin DC Micro (M12) **-QD** and the **-D5** suffix indicates a 5-pin DC Micro (M12) **QD**.

☉ IO-Link enabled.

⊗ Insert 1 for (1) PNP and 2 for (2) PNP.

⊗ Insert 1 for 4...20 mA current output or V for 0...10V output. For Analog Current with (2) PNP, insert AIP2. For Analog Voltage with (2) PNP, insert AVP2.

## Specifications

<b>Certifications</b>	cULus Listed and CE Marked for all applicable directives
<b>Enclosure Type Rating</b>	IP67
<b>Current Consumption</b>	<50 mA
<b>Protection Type</b>	Short circuit, reverse polarity, transient noise, overload
<b>Housing Material</b>	PBT
<b>Repeatability</b>	0.1% up to 3.5 m, 0.2% from 3.5 m to 6 m
<b>Absolute Accuracy</b>	0.1% of sensing range (analog only)
<b>Sensor Voltage Drop</b>	<2.2V DC (discrete only)
<b>Hysteresis</b>	1% of full scale value

## Required Cordsets and Accessories

Description	Cat. No.
DC Micro (M12) QD cordset, straight, 4-pin, 2 m (6.5 ft)	889D-F4AC-2
DC Micro (M12) QD cordset, straight, 5-pin, 2 m (6.5 ft)	889D-F5AC-2
Swivel/tilt style mounting bracket (M18)	60-2649
Swivel/tilt style mounting bracket (M30)	60-2439
Zinc-plated steel right angle bracket (M18)	871A-BRN18
Stainless steel right angle bracket (M18)	871A-BRS18
Zinc-plated steel right angle bracket (M30)	871A-BRN30
Stainless steel right angle bracket (M30)	871A-BRS30
Point I/O IO-Link Master	1734-4I0L
ArmorBlock IO-Link Master	1732E-8I0LM12R





# Ultrasonic Sensors

SENSORS

## 18 mm Metal General Purpose 873M

- Detect clear, shiny, or non-reflective objects
- Sensing range up to 800 mm (31.5 in.)
- Compact 18 mm (0.71 in.) housing
- Scalable analog output models
- Teachable discrete output models (single set-point or window mode)
- Remote teach or optional programming cable



## Compact Clear Object Detection

The 873M general purpose ultrasonic sensors detect solid or liquid targets by using sound waves. These compact sensors are a great solution for areas with limited space and are excellent for standard packaging and assembly applications. They are ideal for sensing targets that are challenging for photoelectric sensors to detect, including clear, shiny, or non-reflective objects.



Film position detection - An 873M ultrasonic checks for continual feed of a clear wrap while monitoring tension.



Part counting - A right angle 873M counts bottles that, due to color, luster and clarity, might be difficult to sense with photoelectric sensors.

7-82

Photoelectric Sensors



7-2...7-49

Proximity Sensors



7-50...7-79

**Ultrasonic Sensors**



**7-80...7-83**

Limit Switches



7-84...7-95

Encoders



7-96...7-103

Condition Sensing



7-104...7-113

Identification Devices



7-114...7-121



## Product Selection

### 18 mm Metal General Purpose

Sensing Distance [mm (in.)] <sup>1</sup>	Sensing Direction	Operating Voltage	Switching Frequency [Hz]	Output Type	Repeatability	Transducer Frequency	Response Time	Cat. No.
30...300 (1.18...11.8)	Straight	10...30V DC	13	PNP, Selectable N.O./N.C.	<1%	390 kHz	30 ms	873M-D18P0300-D4
								873M-D18RP0300-D4
	Right angle	15...30V DC	N/A	4...20 mA	±0.5% of full-scale value			873M-D18RAI300-D4
				0...10V DC				873M-D18RAV300-D4
	Straight	10...30V DC	4...20 mA	873M-D18AI300-D4				
		15...30V DC	0...10V DC	873M-D18AV300-D4				
50...800 (1.97...31.5)	Straight	10...30V DC	4	PNP, Selectable N.O./N.C.	<1%	255 kHz	100 ms	873M-D18P0800-D4
								873M-D18RP0800-D4
	Right angle	10...30V DC	N/A	4...20 mA	±0.5% of full-scale value			873M-D18RAI800-D4
				0...10V DC				873M-D18RAV800-D4
	Straight	10...30V DC	4...20 mA	873M-D18AI800-D4				
		15...30V DC	0...10V DC	873M-D18AV800-D4				

<sup>1</sup> Blind Zone = 0 mm to minimum sensing distance

## Specifications

<b>Certifications</b>	cULus Listed and CE Marked for all applicable directives
<b>Barrel Size</b>	M18
<b>Enclosure Type Rating</b>	IP67
<b>Operating Temperature [C (F)]</b>	-25...+70 ° (-13...+158 °)
<b>Protection Type</b>	Short circuit, overload, reverse polarity
<b>Load Current</b>	200 mA
<b>Current Consumption</b>	<20 mA
<b>Housing Material</b>	Nickel-plated brass
<b>Resolution</b>	0.4 mm at max. sensing range
<b>Voltage Drop</b>	<3V
<b>Hysteresis</b>	1% set operating distance

## Required Cordsets and Accessories

Description	Cat. No.
DC Micro (M12) QD cordset, straight, 4-pin, 2 m (6.5 ft)	889D-F4AC-2
Zinc-plated steel right angle bracket	871A-BRN18
Programming cable	873M-ProgCable
Snap clamp mounting bracket (18 mm)	871A-SCBP18
Swivel/tilt style bracket (18 mm)	60-2649



### Sales Offices and Distributors

Our network of sales offices and distributors offers exceptional knowledge and service to help you design, implement and support your automation investment.

[rok.auto/buy](http://rok.auto/buy)



# Limit Switches

SENSORS

## Oiltight Plug-in 802T

- Heavy duty
- Plug-in style
- Front mount
- Side rotary or side push styles
- Quick mode change (CW/CCW)
- Castle-lock head design



## The Benchmark for Toughness and Reliability

The 802T limit switches are ideal for applications in which heavy-duty pilot ratings, small size, a high degree of versatility and a rugged NEMA Type 4, 13, and 6P construction are desirable. These limit switches are extensively applied in rugged and heavy-duty production environments.

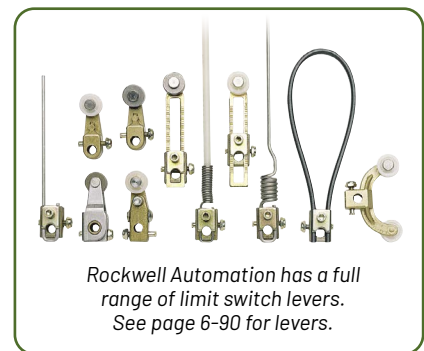

7-84

Photoelectric Sensors



7-2...7-49

Proximity Sensors



7-50...7-79

Ultrasonic Sensors



7-80...7-83

Limit Switches



7-84...7-95

Encoders



7-96...7-103

Condition Sensing



7-104...7-113

Identification Devices



7-114...7-121



## Product Selection – Oiltight Plug-in

### Lever Type, Spring Return Standard and Low Operating Torque Models – Switch without Lever

No. of Circuits	Lever Movement	Torque to Operate [N·m (lb·in.)]	Travel to Operate Contacts	Maximum Travel	Travel to Reset Contacts	Cat. No.
2	CW or CCW	0.29 (2.6) max.	13° max.	90°	7°	802T-AP
2	CW or CCW	0.29 (2.6) max.	18° max.	90°	7°	802T-A5P
2	CW or CCW	0.56 (5) max.	9° max.	90°	4°	802T-HP
2	CW	0.29 (2.6) max.	13° max.	90°	7°	802T-A1P
2	CW or CCW	0.106 (0.94) max.	13° max.	90°	7°	802T-ALP
4	CW or CCW	0.45 (4) max.	13° max.	90°	7°	802T-ATP
4	CW or CCW	0.79 (7) max.	9° max.	90°	4°	802T-HTP

## Specifications

<b>Certifications</b>	UL Listed, CSA Certified, and CE Marked for all applicable directives
<b>Enclosure Type Rating</b>	NEMA 4, 6P, and IP67
<b>Ambient Temperature [C (F)]</b>	-18...+110 ° (0...230 °) Wobble stick & cat whisker models: -18...+54 ° (0...130 °)



### Product Selection Tools

Available online or for download, our tools help you access info while in the office or on the go.

[rok.auto/selection](http://rok.auto/selection)



# Limit Switches

## Product Selection – Oiltight Plug-in

### Lever Type, Maintained Contact Models – Switch without Lever

No. of Circuits	Lever Movement	Torque to Operate	Travel to Operate Contacts	Maximum Travel	Travel to Reset Contacts	Cat. No.
2	CW or CCW	0.31 N•m (2.75 lb•in.) max.	70° max.	88°	32° max.	802T-AMP

### Lever Type, Spring Return Neutral Position Models – Switch without Lever

No. of Circuits	Torque to Operate, Max.	Travel to Operate Contacts	Maximum Travel	Travel to Reset Contacts	Cat. No.
4	CW: 0.28 N•m (2.5 lb•in.), CCW: 0.47 N•m (4.2 lb•in.)	13° max.	75°	7° max.	802T-NPTP

### Wobble Stick and Cat Whisker, Spring Return – Complete Switch

No. of Circuits	Operator Type	Torque to Operate	Travel to Operate Contacts	Maximum Travel	Travel to Reset Contacts	Cat. No.
2	Nylon wobble stick	0.51 N•m (4.5 lb•in.) max.	9° max.	10°	5° max.	802T-WSP
	Wire cat whisker	0.06 N•m (8 oz•in.) max.	21° max.	28°	14° max.	802T-CWP





**Product Selection Tools**

Available online or for download, our tools help you access info while in the office or on the go.

[rok.auto/selection](http://rok.auto/selection)

<p>Photoelectric Sensors</p>  <p>7-2...7-49</p>	<p>Proximity Sensors</p>  <p>7-50...7-79</p>	<p>Ultrasonic Sensors</p>  <p>7-80...7-83</p>	<p><b>Limit Switches</b></p>  <p><b>7-84...7-95</b></p>	<p>Encoders</p>  <p>7-96...7-103</p>	<p>Condition Sensing</p>  <p>7-104...7-113</p>	<p>Identification Devices</p>  <p>7-114...7-121</p>
------------------------------------------------------------------------------------------------------------------------------------	---------------------------------------------------------------------------------------------------------------------------------	----------------------------------------------------------------------------------------------------------------------------------	--------------------------------------------------------------------------------------------------------------------------------------------	--------------------------------------------------------------------------------------------------------------------------	-------------------------------------------------------------------------------------------------------------------------------------	------------------------------------------------------------------------------------------------------------------------------------------



## Product Selection – Oiltight Plug-in

### Push Type, Spring Return – Complete Switch

No. of Circuits	Operator Type	Force to Operate [N (lb)]	Travel to Operate Contacts [mm (in.)]	Maximum Travel [mm (in.)]	Travel to Reset Contacts [mm (in.)]	Cat. No.
2	Top push rod	13.8 (3.1)	1.4 (0.057) max.	6.0 (0.236)	0.9 (0.034) max.	802T-BP
	Adjustable top push rod					802T-BAP
	Side push rod	16.4 (3.7)	3.3 (0.131) max.	5.7 (0.226)	1.9 (0.074) max.	802T-CP
					1.3 (0.052) max.	802T-CGP <sup>1</sup>
	Top push rod	13.8 (3.1)	1.4 (0.057) max.	6.0 (0.236)	0.9 (0.034) max.	802T-DP
					0.7 mm (0.028 in.)	802T-DGP <sup>1</sup>
	Side push vertical roller	16.4 (3.7)	3.3 (0.131) max.	5.7 (0.226)	1.9 (0.074) max.	802T-KP
					1.3 (0.052) max.	802T-KGP <sup>1</sup>
4	Top push rod	22.2 (5.0)	1.4 (0.057) max.	6.0 (0.236)	0.9 (0.034) max.	802T-BTP
						802T-DTP

<sup>1</sup> Low energy models.

## Specifications

<b>Certifications</b>	UL Listed, CSA Certified, and CE Marked for all applicable directives
<b>Enclosure Type Rating</b>	NEMA 4, 6P, and IP67
<b>Ambient Temperature [C (F)]</b>	-18...+110 ° (0...230 °) Wobble stick & cat whisker models: -18...+54 ° (0...130 °)

For more information on our complete family of limit switch products, please visit:  
[rok.auto/limit-switches](http://rok.auto/limit-switches)





# Limit Switches

SENSORS

## Pre-wired, Factory Sealed 802M and 802MC

- Harsh environment applications
- NEMA 4, 4X, 6P, and IP69K enclosure ratings
- Resistant to moisture and cleaning agents
- Submersible (802MC)
- Sealed, corrosion resistant versions with stainless steel shaft and hardware (802MC)
- Two- and four-circuit versions (only two-circuit for 802MC)
- Oil resistant cable on pre-wired models



## For the Most Demanding Environments

The 802M and 802MC compact pre-wired limit switches are factory-sealed to meet the demanding requirements for NEMA Type 4, 4X, 6P, and IP67 enclosures. A large variety of operating heads and levers are available to suit a wide range of applications, especially where the switch may be subject to washdowns, steams of coolant, or occasionally submerged in fluids commonly found on machines or in industrial processes.

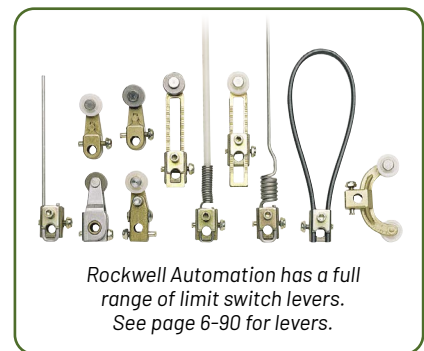
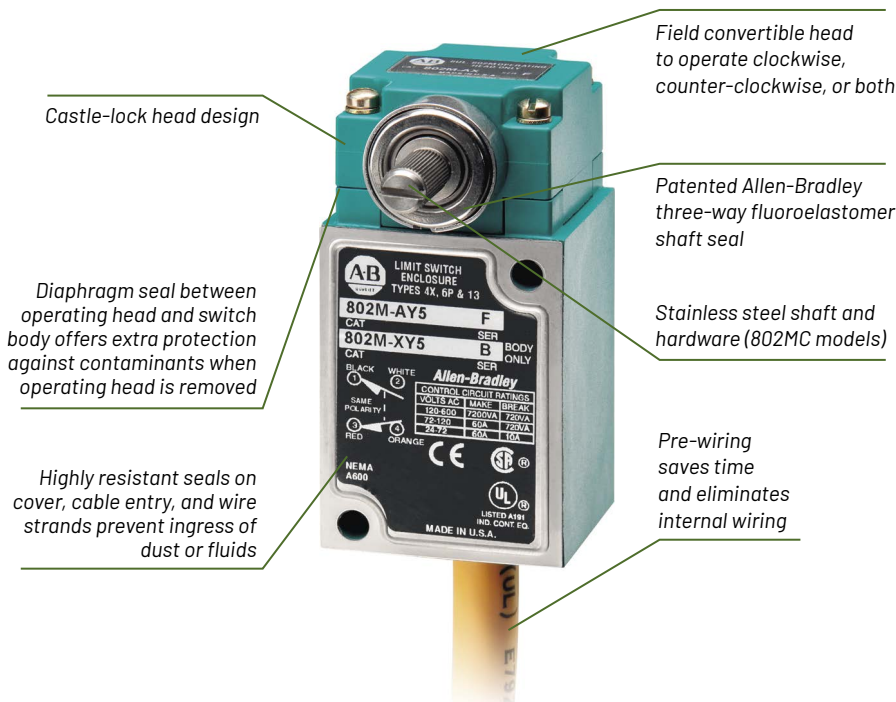

7-88

Photoelectric Sensors



7-2...7-49

Proximity Sensors



7-50...7-79

Ultrasonic Sensors



7-80...7-83

Limit Switches



7-84...7-95

Encoders



7-96...7-103

Condition Sensing



7-104...7-113

Identification Devices



7-114...7-121



## Product Selection

### Pre-wired, Factory Sealed

Description	Torque/Force to Operate, Max.	Travel to Operate Contacts, Max.	Maximum Travel	Travel to Reset Contacts, Max.	Connection Type	Cat. No.
Lever type - spring return	0.34 N•m (3 lb•in.)	15°	86°	6°	1.5 m (5 ft) cable	802M-AY5
Lever type - spring return corrosion resistant					5-pin mini QD	802M-AJ1
Lever type neutral position - spring return (4 circuit)	CW: 0.79 N•m (7 lb•in.), CCW: 0.85 N•m (7.5 lb•in.)	16°	75°	7°	1.5 m (5 ft) cable	802M-NPY5
Push type - spring return top push rod	13.3 N (3 lb)	1.45 mm (0.057 in.)	5.26 mm (0.207 in.)	0.56 mm (0.022 in.)	1.5 m (5 ft) cable	802M-BY5
Push type - spring return top push roller	14.7 N (3.3 lb)					802M-DY5
Push type - spring return side push vertical roller	20 N (4.5 lb)	2.59 mm (0.102 in.)	5.1 mm (0.203 in.)	1.14 mm (0.045 in.)	1.5 m (5 ft) cable	802M-KY5



**Looking for More?**  
This catalog highlights only our most essential components; for a complete product selection, visit us at: [rok.auto/directory](http://rok.auto/directory)

## Specifications

<b>Certifications</b>	UL Listed, CSA Certified, and CE Marked for all applicable directives
<b>Enclosure Type Rating</b>	NEMA 1, 4, 6P, 13 and IP67 (802MC also NEMA 4X)
<b>Ambient Temperature [C (F)]</b>	0...80 ° (32...180 °)

## Required Cordsets and Accessories

Description	Cat. No.
Mini plus QD cordset, straight, 5-pin, 1.8 m (6 ft)	889N-F5AFC-6F



# Limit Switches

SENSORS

## IEC 30 mm Metal 802K

- Rugged die-cast 30 mm housing
- Large selection of actuator heads
- Positive operation, forced disconnection of contacts
- Snap-acting, slow make before break, or slow break before make contact blocks
- Two- or four-contact configurations
- IP66 enclosure



## Our Rugged, IEC-style Offering

The 802K limit switches have a range of options including snap action or slow break/make with two or four contact configurations and a choice of actuator heads. You can rotate the head in 90° increments before installation for easy mounting. Operation of these limit switches is achieved by the moving objects deflecting the plunger or lever.

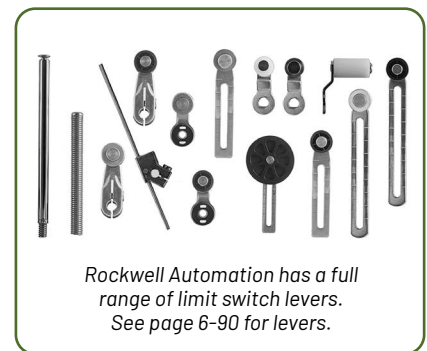
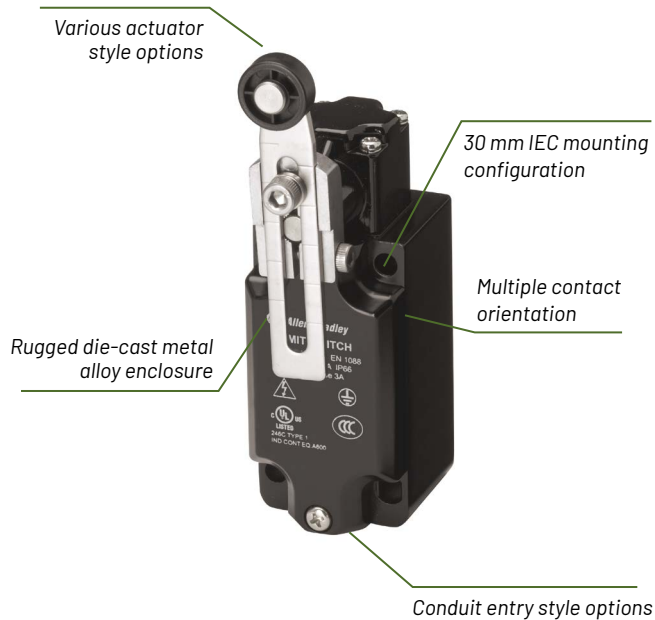

7-90

Photoelectric Sensors



7-2...7-49

Proximity Sensors



7-50...7-79

Ultrasonic Sensors



7-80...7-83

Limit Switches



7-84...7-95

Encoders



7-96...7-103

Condition Sensing



7-104...7-113

Identification Devices



7-114...7-121



## Product Selection

### IEC 30 mm Metal

Operator Type	Force/Torque to Operate, Max.	Contacts	Aux Contacts	Contact Action	Connection Type	Cat. No.
Metal roller plunger	11 N (2.5 lb)	2 N.C.	2 N.O.	BBM	1/2 in. NPT conduit	802K-MRPB22E
	13 N (2.9 lb)	1 N.C.	1 N.O.	Snap acting		802K-MRPS11E
						802K-MDPST1E
	11 N (2.5 lb)	2 N.C.	2 N.O.	BBM	1/2 in. NPT conduit	802K-MDPB22E
					M20 conduit	802K-MDPB22B
Metal short lever	0.34 N•m (3.01 lb•in.)	1 N.C.	1 N.O.	Snap acting	1/2 in. NPT conduit	802K-MSLS11E
					M20 conduit	802K-MSLS11B
	0.20 N•m (1.77 lb•in.)	4 N.C.	—	—	1/2 in. NPT conduit	802K-MSLB04E
	0.34 N•m (3.01 lb•in.)	2 N.C.	2 N.O.	BBM	1/2 in. NPT conduit	802K-MSLB22E
					M20 conduit	802K-MSLB22B
Metal short lever, metal roller	0.34 N•m (3.01 lb•in.)	1 N.C.	1 N.O.	Snap acting	1/2 in. NPT conduit	802K-MMHS11E
					M20 conduit	802K-MMHS11B
		2 N.C.	2 N.O.	BBM	1/2 in. NPT conduit	802K-MMHB22E
Metal adjustable lever	0.34 N•m (3.01 lb•in.)	1 N.C.	1 N.O.	Snap acting	1/2 in. NPT conduit	802K-MALS11E
					M20 conduit	802K-MALS11B
		2 N.C.	2 N.O.	BBM	1/2 in. NPT conduit	802K-MALB22E
					M20 conduit	802K-MALB22B
Metal rod lever	0.34 N•m (3.01 lb•in.)	1 N.C.	1 N.O.	Snap acting	1/2 in. NPT conduit	802K-MARS11E
Metal spring rod	0.20 N•m (1.77 lb•in.)	1 N.C.	1 N.O.	Snap acting	1/2 in. NPT conduit	802K-MSRS11E
					M20 conduit	802K-MSRS11B

## Specifications

<b>Certifications</b>	cULus Listed and CE Marked for all applicable directives
<b>Enclosure Type Rating</b>	IP66
<b>Ambient Temperature [C (F)]</b>	-25...+80 ° (-18...+176 °)

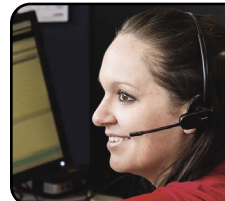

### Need Help?

The Rockwell Automation Support Center is your 24/7 support for the answers you need now.

[rok.auto/support](http://rok.auto/support)



# Limit Switches

SENSORS

## Operating Levers 802T and 802M

- Use with 802T, 802M, and 802MC limit switches
- Adjustable and non-adjustable levers
- Fork levers
- Offset levers
- Rod levers

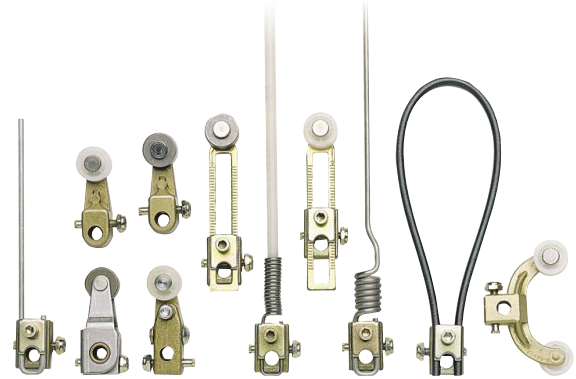

## Roller Levers

For use with the 802T, 802M, & 802X switches

Description	Roller Material	Roller Diameter	Roller Width	Cat. No.
Non-adjustable cast-lever 1.5 in. radius roller on front	Nylon	19 (0.748)	7.11 (0.28)	802T-W1
	Nylon	19 (0.748)	25.4 (1.0)	802T-W1H
	Steel	19 (0.748)	6.35 (0.25)	802T-W1A
	Ball bearing	19 (0.748)	5.84 (0.229)	802T-W1B
Non-adjustable cast-lever 1.5 in. radius roller on rear	Nylon	19.05 (0.749)	25.4 (1)	802T-W1D
	Steel	19.05 (0.749)	6.35 (0.25)	802T-W1F
	Steel	19.05 (0.749)	19.05 (0.749)	802T-W1C
Adjustable lever 1.19...3 in. radius	Nylon	19.05 (0.749)	7.11 (0.28)	802T-W2
	Nylon	19.05 (0.749)	25.4 (1.0)	802T-W2D
	Nylon	38.1 (1.5)	7.11 (0.28)	802T-W2A
	Steel	19.05 (0.749)	6.35 (0.25)	802T-W2B
	Ball bearing	19.05 (0.749)	5.8 (0.228)	802T-W2C
Fork lever 1.5 in. radius	Steel; both rollers on front	19.05 (0.749)	6.35 (0.25)	802T-W4C
Micrometer adjustment lever 1.5 in. radius <sup>1</sup>	Nylon R.H. adjustable	19.05 (0.749)	7.11 (0.28)	802T-W6
	Steel R.H. adjustable	19.05 (0.749)	6.35 (0.25)	802T-W6A
Non-adjustable offset lever 1.44 in. radius roller on front	Steel	19.05 (0.749)	6.35 (0.25)	802T-W12A <sup>2</sup>

## Roller Levers

For use with the 802T, 802M, & 802X switches

Material	Rod Diameter [mm (in.)]	Cat. No.
Stainless steel rod, 5 in. long	3.3 (0.13)	802T-W3 <sup>3</sup>
Stainless steel rod, 8.5 in. long	3.3 (0.13)	802T-W3B <sup>3</sup>
Stainless steel rod, 11.5 in. long	3.3 (0.13)	802T-W3A
Stainless steel rod, 11.5 in. long	2.03 (0.08)	802T-W3F <sup>4</sup>
Nylon rod, 12 in. long	6.35 (0.25)	802T-W3C
Stainless steel, 5 in. long	1.52 (0.06)	802T-W5 <sup>3</sup>
Nylatron looped rod, 6 in. long, 2 in. wide loop	4.57 (0.18)	802T-W14

<sup>1</sup> The micrometer adjustment roller lever is designed especially for installations where the position of the roller is a critical factor. This lever has a pivoted roller which can be turned laterally. After clamping the lever to the switch shaft, the position of the roller can be precisely adjusted through an arc of 7.5° on either side of the center or straight-line position.

<sup>2</sup> When mounted on Plug-In devices, the offset lever provides equivalent cam tracking to the Non-Plug-In devices using catalog number 802T-W1 levers.

<sup>3</sup> Recommended for use with low-operating-torque switches.

<sup>4</sup> Not for use with catalog number 802M-NPY5 type switches.

Photoelectric Sensors



7-2...7-49

Proximity Sensors



7-50...7-79

Ultrasonic Sensors



7-80...7-83

Limit Switches



7-84...7-95

Encoders



7-96...7-103

Condition Sensing



7-104...7-113

Identification Devices



7-114...7-121



## Replacement Operating Levers 802K and 440P

- Use with all 440P safety and 802K non-safety lever type limit switches
- Adjustable and non-adjustable levers
- Rod levers
- Spring rod levers
  - Short levers with wide roller
  - Telescopic arm levers

SENSORS

## Operating Levers, Rods, Spring Rods and Telescopic Arms

For use with 802K and 440P limit switches

Description	Cat. No.
<b>Levers</b>	
Short lever with nylon roller for 440P-ASL <sup>1</sup> or -AWL <sup>1</sup>	440P-WA1
Short lever with metal roller for 440P-ASL <sup>1</sup> or -AWL <sup>1</sup>	440P-WA1A
Short lever with wide roller for 440P-ASL <sup>1</sup> or -AWL <sup>1</sup>	440P-WA1B
Short lever with nylon roller for 440P-CSL <sup>1</sup> or -CHM <sup>1</sup>	440P-WC1
Short lever with metal roller for 440P-CSL <sup>1</sup> or -CHM <sup>1</sup>	440P-WC1A
Short lever with nylon roller for 802K-/440P-MSL <sup>1</sup> or -MMH <sup>1</sup>	440P-WM1
Short lever with metal roller for 802K-/440P-MSL <sup>1</sup> or -MMH <sup>1</sup>	440P-WM1A
Adjustable lever arm with nylon roller for 440P-AAL <sup>1</sup> or -AA1L <sup>1</sup>	440P-WA2A
Adjustable lever arm with steel roller for 440P-AAL <sup>1</sup> or -AA1L <sup>1</sup>	440P-WA2B
Adjustable lever with nylon roller for 440P-CAL <sup>1</sup> , -CRR <sup>1</sup> , -MRR <sup>1</sup>	440P-WC2
Adjustable lever with large rubber roller for 440P-CAL <sup>1</sup> , -CRR <sup>1</sup> , -MRR <sup>1</sup>	440P-WC2A
Adjustable lever with metal roller for 440P-CAL <sup>1</sup> or -CRR <sup>1</sup>	440P-WC2B
Adjustable lever with nylon roller for 802K-/440P-MAL <sup>1</sup> or -MRR <sup>1</sup>	440P-WM2
Adjustable lever with metal roller for 802K-/440P-MAL <sup>1</sup> or -MRR <sup>1</sup>	440P-WM2A
<b>Rods</b>	
Adjustable metal rod for 802K-/440P-MAR <sup>1</sup>	440P-WM3
<b>Spring Rods</b>	
Metal spring rod for 802K-/440P-MSR <sup>1</sup>	440P-WM4
<b>Telescopic Arms</b>	
Telescopic arm for 802K-/440P-MTA <sup>1</sup>	440P-WM5

<sup>1</sup> Use these levers only with this catalog number.





# Limit Switches

SENSORS

## Compact, Precision and Small Precision 802B

- Rugged die-cast housings
- Industry standard dimensions
- Low trip and reset points (precision and small precision models)
- Wide range of options and operators



## For When Bigger Switches Won't Fit

The 802B product line consists of different body styles: compact, precision, and small precision. Each style has been designed to withstand the rugged environments that industrial applications demand. The 802B family of limit switches can be mounted in areas that traditional NEMA limit switches can not, due to their size and mounting options.

## Specifications

	802B Compact	Precision	Small Precision
<b>Certifications</b>	UL Listed, CSA Certified, and CE Marked for all applicable directives	UL Listed, CSA Certified, and CE Marked for all applicable directives	UL Listed, CSA Certified, and CE Marked for all applicable directives
<b>Enclosure Type Rating</b>	NEMA 1, 3, 4, 6, 12, 13 and IP67	Non-booted models: NEMA 1 and IP60 Booted models: NEMA 1, 3, 4, and IP65	NEMA 1, 3, 4, 6, 13 and IP67
<b>Operating Temperature [C (F)]</b>	-10...+70 ° (14...158 °)	-10...+80 ° (14...176 °)	-10...+80 ° (14...176 °)
<b>Contact Type</b>	SPDT form C	SPDT form C	SPDT form C
<b>Mechanical Life</b>	10 million operations		

7-94

Photoelectric Sensors



7-2...7-49

Proximity Sensors



7-50...7-79

Ultrasonic Sensors



7-80...7-83

Limit Switches



7-84...7-95

Encoders



7-96...7-103

Condition Sensing



7-104...7-113

Identification Devices



7-114...7-121



## Product Selection

### 802B Compact



Head Type	Torque to Operate, Max. [N·m (lb·in.)]	Force to Operate [N (lb)]	Travel to Operate Contacts, Max.	Maximum Travel	Travel to Reset Contacts	Cat. No.
Rotary arm	0.216 (2)	–	25°	70°	3°	802B-CSAAXSXC3
Center rotary arm	0.216 (2)	–	10 ±3°	65°	4°	802B-CSAA2XSXC3
Wobble stick	0.118 (1.04)	–	15°	18° (Nominal Value)	11° (Nominal Value)	802B-CSACXSXC3
Top push booted head	–	17.65 (3.97)	1.8 mm (0.071 in.)	5 mm (0.197 in.)	0.2 mm (0.008 in.)	802B-CSABBSXC3
Top push roller booted head	–	17.65 (3.97)	1.8 mm (0.071 in.)	5 mm (0.197 in.)	0.2 mm (0.008 in.)	802B-CSADBSXC3
Top push cross roller booted head	–	17.65 (3.97)	1.8 mm (0.071 in.)	5 mm (0.197 in.)	0.2 mm (0.008 in.)	802B-CSAD1BSXC3
Top push panel mount	–	11.77 (2.65)	1.8 mm (0.071 in.)	5 mm (0.197 in.)	0.2 mm (0.008 in.)	802B-CPABXSXC3
Top push roller panel mount	–	11.77 (2.65)	1.8 mm (0.071 in.)	5 mm (0.197 in.)	0.2 mm (0.008 in.)	802B-CPADXSXC3
Top push cross roller panel mount	–	11.77 (2.65)	1.8 mm (0.071 in.)	5 mm (0.197 in.)	0.2 mm (0.008 in.)	802B-CPAD1XSXC3

### Precision

Head Type	Force to Operate [N (lb)]	Travel to Operate Contacts, Max. [mm (in.)]	Maximum Travel [mm (in.)]	Travel to Reset Contacts [mm (in.)]	Mounting	Cat. No.
Top push	2.45...3.43 (0.55...0.77)	0.4 (0.016)	5.9 (0.232)	0.05 (0.002)	Side	802B-PSABXSX
Top push roller	2.45...3.43 (0.55...0.77)	0.5 (0.020)	4.1 (0.161)	0.05 (0.002)	Side	802B-PSADXSX
Roller lever	5.59 (1.28)	4 (0.157)	10 (0.394)	0.4 (0.016)	Side	802B-PSARXSX
Top push booted	7.85 (1.76)	2 (0.079)	7 (0.276)	0.1 (0.004)	Side	802B-PSABBSX
Top push roller booted	4.9 (1.09)	1 (0.039)	4.5 (0.177)	0.12 (0.005)	Side	802B-PSADBSX
Top push cross roller booted	4.9 (1.09)	1 (0.039)	4.5 (0.177)	0.12 (0.005)	Side	802B-PSAD1BSX
Roller lever booted	6.28 (1.40)	5 (0.197)	11 (0.433)	0.4 (0.016)	Side	802B-PSARBSX

### Small Precision

Head Type	Force to Operate [N (lb)]	Travel to Operate Contacts, Max. [mm (in.)]	Maximum Travel [mm (in.)]	Travel to Reset Contacts [mm (in.)]	Mounting	Cat. No.
Top push	11.8 (2.65)	1.5 (0.059)	3.9 (0.154)	0.2 (0.008)	Side	802B-SSABXSX
Top push panel mount	11.8 (2.65)	1.5 (0.059)	4.5 (0.177)	0.2 (0.008)	Side	802B-SPABXSX
Top push roller panel mount	11.8 (2.65)	1.5 (0.059)	4.5 (0.177)	0.2 (0.008)	Side	802B-SPADXSX
Top push roller booted	6.86 (1.54)	1.5 (0.059)	4 (0.157)	0.2 (0.008)	Side	802B-SSADBSX
Short hinge lever	3.92 (0.88)	6.2 (0.244) ± 1.2	12.2 (0.480)	1 (0.04)	Side	802B-SSAH1XSX
Hinge lever	2.75 (0.62)	8.2 (0.323) ± 1.2	16.6 (0.645)	1.4 (0.055)	Side	802B-SSAHXSX
Short roller lever	3.92 (0.88)	6.2 (0.244) ± 1.2	12.2 (0.480)	1 (0.04)	Side	802B-SSAR1XSX
Roller lever	2.75 (0.62)	8.3 (0.327) ± 1.2	16.7 (0.657)	1.4 (0.055)	Side	802B-SSARXSX



# Encoders

SENSORS

## EtherNet/IP 842E

- EtherNet/IP Interface
- Single- and multi-turn
- Status indication LEDs
- Easy integration and setup in Studio 5000 Logix Designer®
- Fully compliant CIP sync and CIP motion support (842E-CM)
- Endless shaft
- Flash upgradable



## Integrated Motion on EtherNet/IP

EtherNet/IP uses CIP Sync and CIP Motion technologies to provide real-time, closed loop motion on standard Ethernet. This topology-independent network provides a simplified integration of the entire control solution on one network, including HMI, PAC, IO, and Motion Control.



Which version meets your application?

Velocity or Position Control  
842E-<sup>1</sup>



- Use the EtherNet/IP Encoder
- Provides position and velocity back to the Logix controller on EtherNet/IP
- Ideal applications: standard VFD drives

Position/Servo Control  
842E-CM-<sup>1</sup>



- Use the Integrated Motion on EtherNet/IP Encoder for servo applications
- Ideal applications: Kinetix® 5500 Servo drive applications that require auxiliary feedback or master half axis for gearing/camming applications

<sup>1</sup> Please see Product Selection on page 7-97 for complete catalog numbers.

7-96

Photoelectric Sensors



7-2...7-49

Proximity Sensors



7-50...7-79

Ultrasonic Sensors



7-80...7-83

Limit Switches



7-84...7-95

Encoders



7-96...7-103

Condition Sensing



7-104...7-113

Identification Devices



7-114...7-121



## Product Selection

### 842E EtherNet/IP

Description	Single-/Multi-turn	Shaft Size/Type	Power Supply	Resolution	Connector Type	Cat. No.
EtherNet/IP Encoder	Single-turn	Solid shaft 10 mm with flat	10...30V DC	18 bit	M12	842E-SIP4BA
		Solid shaft 3/8 in. with flat				842E-SIP2BA
		Hollow shaft 15 mm				842E-SIP12BA
	Multi-turn	Solid shaft 10 mm with flat		30 bit		842E-MIP4BA
		Solid shaft 3/8 in. with flat				842E-MIP2BA
		Hollow shaft 1/2 in.				842E-MIP10BA
CIP Motion Encoder EIP	Single-turn	Solid shaft 3/8 in. with flat	10...30V DC	18 bit	M12	842E-CM-SIP2BA
		Solid shaft 3/8 in. with flat				842E-CM-SIP1BA
		Hollow shaft 1/2 in.				842E-CM-SIP10BA
	Multi-turn	Solid shaft 10 mm with flat		30 bit		842E-CM-MIP4BA
		Solid shaft 3/8 in. with flat				842E-CM-MIP2BA
		Hollow shaft 1/2 in.				842E-CM-MIP10BA

## Specifications

<b>Transmission Rate</b>	10/100 MBit/s
<b>Code Type</b>	Binary
<b>Operating Voltage Range</b>	10...30V
<b>No. of Revolutions, Max.</b>	4,096 (12 Bit)
<b>Operating Speed</b>	9,000 RPM (solid shaft), max. 6,000 RPM (blind hollow shaft), max.
<b>Shaft Loading</b>	Radial: 80 N max. (solid shaft) Axial: 40 N max. (solid shaft)
<b>Housing Material</b>	Aluminum
<b>Shaft Material</b>	Stainless steel
<b>Operating Temperature [C (F)]</b>	-30...+85 ° (-22...+185 °)
<b>Enclosure Type Rating <sup>1</sup></b>	IP65 (shaft); IP67 (housing)
<b>Certifications</b>	CE Marked for all applicable directives

<sup>1</sup> With mating connector inserted.

## Required Cordsets and Accessories

Description	Cat. No.
Flexible coupling	845-CA-C-25
Flexible coupling	845-FC-B-B
842E Hollow shaft encoder clamp ring	845-MB-10
842E Hollow shaft encoder 2-point stator coupling	845-MB-11
842E square face mount flange, 63 mm	845-MB-12
DC Micro QD cordset (flying leads), straight, 4-pin, 2 m (6.5 ft)	889D-F4AC-2
M12 D-code patchcord, straight, male/male, 2 m (6.5 ft)	1585D-M4TBDM-2
M12 to RJ45 patchcord, male/male, 2 m (6.5 ft)	1585D-M4TBJM-2
M12 D-code patchcord, straight, male/male (shielded), 2 m (6.5 ft)	1585D-M4UBDM-2
M12 to RJ45 patchcord (shielded), male/male, 2 m (6.5 ft)	1585D-M4UBJM-2



# Encoders

SENSORS

## Sine Cosine/Serial 842HR

- Absolute feedback for position control
- High resolution incremental feedback for speed control
- Sine/Cosine differential interface
- Digital bi-directional RS-485 interface
- Compatible with Hiperface interface
- Internal diagnostic functions

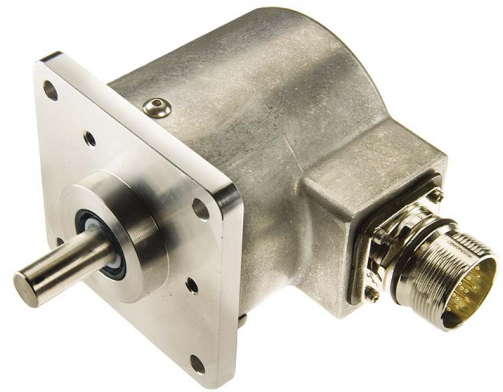

## Replace Multiple Encoders with a Single 842HR Encoder

Today's high performance digital servo drive systems require absolute feedback for position control and high resolution incremental feedback for speed control. Conventional systems use multiple incremental and absolute encoders to achieve this. The Allen-Bradley® 842HR Sine/Cosine encoder combines the advantages of incremental and absolute encoder technologies in a single, standalone unit targeted for high performance digital servo drive systems.



## Ideal Applications

Compatible with a variety of motor control products including Kinetix drives and the Allen-Bradley Guardmaster® MSR57 safe speed monitoring relay, the 842HR is a flexible solution for wide range of industrial applications.

## Single- Versus Multi-turn

In a single-turn encoder, absolute position retention on one full rotation of the encoder is provided. Multi-turn encoders provide absolute position on multiple turns of the encoder shaft (better for linear applications).

7-98

Photoelectric Sensors



7-2...7-49

Proximity Sensors



7-50...7-79

Ultrasonic Sensors



7-80...7-83

Limit Switches



7-84...7-95

**Encoders**



**7-96...7-103**

Condition Sensing



7-104...7-113

Identification Devices



7-114...7-121



## Product Selection

### Sine Cosine/Serial

Single-/Multi-turn	Shaft Size/Type	Power Supply	Resolution	Connector Type and Pinout	Cat. No.
Single-turn	Solid shaft 3/8 in. with flat	5...12V DC	15 bit	MS & 10-pin	842HR-SJDN115FWY2
					842HR-SJDZ115FWY2
Multi-turn	Solid shaft 3/8 in. with flat			M23 & 17-pin	842HR-SJDZ115FWYD
					842HR-MJDZ115FWYD
	Hub shaft 15 mm			MS & 10-pin	842HR-MJA115FWY2
	Solid shaft 3/8 in. with flat			M23 & 17-pin	842HR-MJDN115FWYD



**Looking for More?**  
 This catalog highlights only our most essential components; for a complete product selection, visit us at:  
[rok.auto/directory](http://rok.auto/directory)

## Specifications

<b>Sine/Cosine</b>	1024 cycles per revolution
<b>Code Type</b>	Binary
<b>No. of Revolutions</b>	4,096 (12 Bit), max.
<b>Operating Speed</b>	6,000 RPM, max.
<b>Shaft Loading</b>	Radial: 35 lb, max. Axial: 40 lb, max.
<b>Housing Material</b>	Aluminum
<b>Shaft Material</b>	Stainless steel
<b>Operating Temperature [C (F)]</b>	-20...+85 ° (-4...+185 °)
<b>Enclosure Type Rating <sup>1</sup></b>	IP66
<b>Certifications</b>	CE Marked for all applicable directives

<sup>1</sup> With mating connector inserted.

## Required Cordsets and Accessories

Description	Cat. No.
Pre-wired cable for 17-pin connector	2090-XXNFMF-S⊗
10-pin encoder cable assembly	845-CA-C-10
3/8 in. bore flex coupling	845-FC-B-B
Tether	842HR
Mounting Bracket	845-MB-15

⊗ The catalog number as listed is incomplete. Replace ⊗ with **1, 2, 3, 4, 5, 7, 9, 12, 15, 20, 25,** or **30** for available lengths in meters.





# Encoders

SENSORS

## CIP Safety with EtherNet/IP Encoder 843ES

- Rated up to and including
  - SIL 3 according to IEC 61800-5-2, IEC 620261, and IEC 61508-1
  - PLe, Cat. 3, according to ISO 13849-1
- Solid and hollow shafts available
- Dual Ethernet ports with embedded EtherNet/IP switch for linear networks and Device Level Ring topologies
- IP67 washdown rating
- 15-bit safety resolution, 18-bit standard resolution
- 12-bit multi-turn resolution



EtherNet/IP

## The first and only encoder on the market featuring CIP Safety over EtherNet/IP up to – and including – SIL 3/PLe safety applications

Networked safety solutions provide the ability to simplify your machine design and minimize equipment redundancies. Fewer components mean smaller panel enclosures which helps reduce machine footprint.

### Benefits of Controller-based Safety/Integrated Safety

- A single GuardLogix® controller manages both safety and standard control
- Complete safety function integration within one software environment – Studio 5000 Logix Designer®
- Improved visibility to all machine events – including safety events
- Reduced complexity and rich diagnostic data
- Simplified zoning and reduced changeover time
- Integrated or hardwired safety – Safe Torque-Off – SIL3 PLe
- Advanced safety with five safe stop functions and three safe monitoring functions
- Safety and standard control share the same EtherNet/IP network

### Integrated Safety Solutions for AC and servo drives

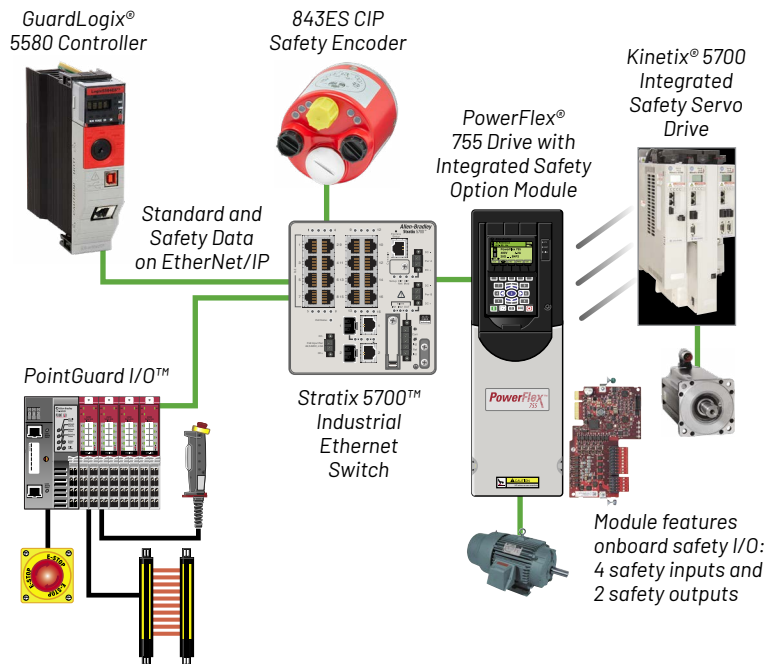

7-100

Photoelectric Sensors



7-2...7-49

Proximity Sensors



7-50...7-79

Ultrasonic Sensors



7-80...7-83

Limit Switches



7-84...7-95

Encoders



7-96...7-103

Condition Sensing



7-104...7-113

Identification Devices



7-114...7-121



# Encoders

SENSORS

## General Purpose and Compact Incremental 847H and 847T

- 847H: General purpose, 2.5 in. diameter
- 847T: Compact, 2 in. diameter
- Resolution up to 65536 ppr
- Various output configurations, mounting options, and shaft sizes
- Cable, M12, and military-style connections
- Zero set input option



## The General Purpose Encoder Family

Use the 847 incremental encoder for general purpose auxiliary feedback for a variety of configurable options. Ideal for machine tools, packaging machinery, motion control, and robotics.

**847T**



*Square Flange*

**847H**



*Easy servo flange mount*

**847T-PY**



*2.5 in. with Bell housing and coupler, to protect encoder from damage and contamination*

7-102

Photoelectric Sensors



7-2...7-49

Proximity Sensors



7-50...7-79

Ultrasonic Sensors



7-80...7-83

Limit Switches



7-84...7-95

**Encoders**



**7-96...7-103**

Condition Sensing



7-104...7-113

Identification Devices



7-114...7-121



# Product Selection

## General Purpose and Compact Incremental

Mounting Configuration	Shaft Size	Power Supply	Output Configuration	Connector/ Cable Exit	Connector Type & Pinout	Cat. No. <sup>1</sup>
Standard square flange	3/8 in. diameter shaft with flat	4.5...5.5V DC	4.5...5.5V DC Line Driver Outputs (TTL)	Radial Exit	MS & 10-pin	847H-DN1A-RH01024
Standard servo mount		8...30V DC			M12 & 8-pin with mating connector <sup>2</sup>	847H-HN2A-RA01024
Standard square flange	10 mm diameter shaft with flat	4.5...5.5V DC	8...30V Line Driver Outputs (HTL)		MS & 6-pin with mating connector	847T-DL2C-RC01024
	3/8 in. diameter shaft with flat	4.5...5.5V DC	4.5...5.5V DC Line Driver Outputs (TTL)		MS & 10-pin with mating connector	847T-DN1A-RG01024
		8...30V DC	4.5...5.5V DC Line Driver Outputs (TTL)		MS & 10-pin	847T-DN2A-RH01024
			8...30V Line Driver Outputs (HTL)		MS & 6-pin	847T-DN2C-RD01024
5PY mounting	5/8 in. diameter extended shaft with flat	8...30V DC	8...30V Line Driver Outputs (HTL)		M12 & 8-pin with mating connector <sup>2</sup>	847T-DN2C-RA01024
					M12 & 8-pin with mating connector <sup>2</sup>	847T-PY2C-RA01024

<sup>1</sup> Replace **01024** (revolution) with **1...65536** for optional revolutions.

<sup>2</sup> 8-pin M12 connector is now available for all models.

## Specifications

Revolutions	1...65536 CPR (16 bit)
Code Type	Incremental, 2 channels with zero index
Angular Acceleration	500,000 radians/sec <sup>2</sup>
Operating Speed	9,000 RPM, max.
Shaft Loading	80 N radial
Housing Material	Aluminum
Shaft Material	Stainless steel
Operating Temperature [C (F)]	-30...+80 ° (-22...+176 °)
Enclosure Type Rating 3	IP67 housing, shaft seal IP65
Certifications	CE Marked for all applicable directives

<sup>3</sup> With mating connector inserted.

## Required Cordsets and Accessories

Description	Cat. No.
DC Micro M12 QD cordset, straight, 8-pin, 2 m (6.5 ft)	889D-F8FB-2 <sup>4</sup>
6-pin encoder cable assembly	845-CA-A-10
7-pin encoder cable assembly	845-CA-B-10
10-pin encoder cable assembly	845-CA-C-10 <sup>5</sup>
Flexible coupling	845-FC-B-B
Flexible coupling	845-CA-C-2 <sup>5</sup>

<sup>4</sup> Replace **2** with **5** or **10** for other standard cable lengths in meters.

<sup>5</sup> Replace **10** with **25**, **50**, **100**, **200**, or **330** for standard cable lengths in feet.



### Sales Offices and Distributors

Our network of sales offices and distributors offers exceptional knowledge and service to help you design, implement and support your automation investment.

[rok.auto/buy](http://rok.auto/buy)



# Condition Sensing

SENSORS

## Integrated Condition Monitoring System Dynamix 1444

- Machinery protection and condition monitoring of rotating and reciprocating assets
- Distributed I/O on Ethernet/IP
- Easy integration and setup in Studio 5000 Logix Designer®
- Rugged, conformally coated and approved for electrical safety and hazardous areas
- Expansion modules available for additional capabilities



## Enable Smart Machine strategy with the Dynamix 1444 series

Don't let unplanned downtime impact your manufacturing objectives. The Dynamix™ 1444 series provides a distributed solution for protecting or monitoring the condition of your critical machinery. The dynamic measurement module can support dynamic and static measurements to realize the benefits of a condition based maintenance or a predictive maintenance program. As a part of the Rockwell Automation's Integrated Architecture, other system components such as controllers, visualization products, other input/output products, and more can be easily applied to meet the specific needs of the application.

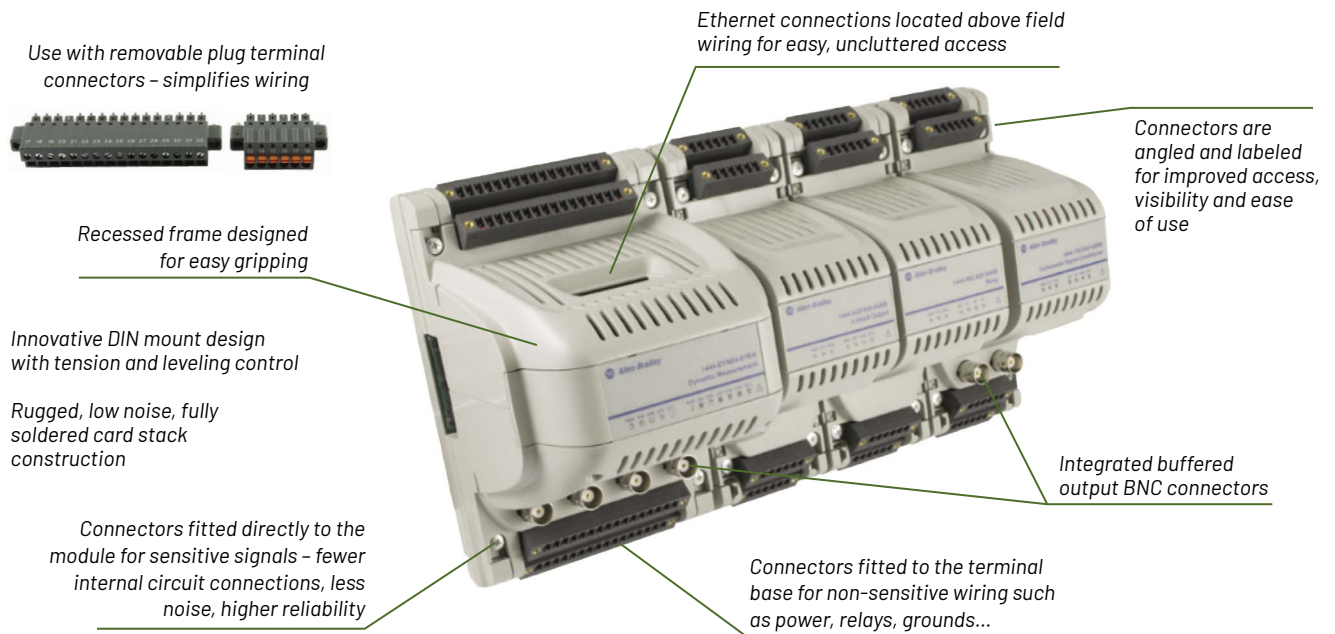

7-104

Photoelectric Sensors



7-2...7-49

Proximity Sensors



7-50...7-79

Ultrasonic Sensors



7-80...7-83

Limit Switches



7-84...7-95

Encoders



7-96...7-103

Condition Sensing



7-104...7-113

Identification Devices



7-114...7-121



## Product Selection

### Integrated Condition Monitoring

Type	Module	Cat. No.
Measurement modules	Dynamic measurement module	1444-DYN04-01RA
Speed modules	Tachometer signal conditioner expansion module	1444-TSCX02-02RB
Relay modules	Relay expansion module	1444-RELX00-04RB
Analog output modules	4...20 mA expansion module	1444-AOFX00-04RB
Terminal bases	Dynamic measurement module terminal base	1444-TB-A
	Expansion module terminal base	1444-TB-B

### Removable Plug Connector Sets

Module	Spring Connector	Screw Connector
1444-DYN04-01RA	1444-DYN-RPC-SPR-01	1444-DYN-RPC-SCW-01
1444-TSCX02-02RB	1444-TSC-RPC-SPR-01	1444-TSC-RPC-SCW-01
1444-RELX00-04RB	1444-REL-RPC-SPR-01	1444-REL-RPC-SCW-01
1444-AOFX00-04RB	1444-AOF-RPC-SPR-01	1444-AOF-RPC-SCW-01
<b>Terminal Base</b>		
1444-TB-A	1444-TBA-RPC-SPR-01	1444-TBA-RPC-SCW-01
1444-TB-B	1444-TBB-RPC-SPR-01	1444-TBB-RPC-SCW-01 21

## Specifications

<b>Certifications</b>	c-UL-us and CE marked for all applicable directives			
	<table border="1"> <tr> <td>Ex</td> <td>           European Union 94/9/EC ATEX Directive, compliant with:           <ul style="list-style-type: none"> <li>EN 60079-15; Potentially Explosive Atmospheres, Protection "n"</li> <li>EN 60079-0; General Requirements</li> <li>II 3 G Ex N/A IIC T4 Gc</li> <li>II 3 G Ex N/A nC IIC T4 Gc (only 1444-DYN04-01RA and 1444-RELX00-04RB)</li> <li>DEMKO14ATEX1365X</li> </ul> </td> </tr> <tr> <td>IECEx</td> <td>           IECEx System, compliant with:           <ul style="list-style-type: none"> <li>IEC 60079-15; Potentially Explosive Atmospheres, Protection "n"</li> <li>IEC 60079-0; General Requirements</li> <li>II 3 G Ex N/A IIC T4 Gc</li> <li>II 3 G Ex N/A nC IIC T4 Gc (only 1444-DYN04-01RA and 1444-RELX00-04RB)</li> <li>IECEx UL 14.0082X</li> </ul> </td> </tr> </table>	Ex	European Union 94/9/EC ATEX Directive, compliant with: <ul style="list-style-type: none"> <li>EN 60079-15; Potentially Explosive Atmospheres, Protection "n"</li> <li>EN 60079-0; General Requirements</li> <li>II 3 G Ex N/A IIC T4 Gc</li> <li>II 3 G Ex N/A nC IIC T4 Gc (only 1444-DYN04-01RA and 1444-RELX00-04RB)</li> <li>DEMKO14ATEX1365X</li> </ul>	IECEx
Ex	European Union 94/9/EC ATEX Directive, compliant with: <ul style="list-style-type: none"> <li>EN 60079-15; Potentially Explosive Atmospheres, Protection "n"</li> <li>EN 60079-0; General Requirements</li> <li>II 3 G Ex N/A IIC T4 Gc</li> <li>II 3 G Ex N/A nC IIC T4 Gc (only 1444-DYN04-01RA and 1444-RELX00-04RB)</li> <li>DEMKO14ATEX1365X</li> </ul>			
IECEx	IECEx System, compliant with: <ul style="list-style-type: none"> <li>IEC 60079-15; Potentially Explosive Atmospheres, Protection "n"</li> <li>IEC 60079-0; General Requirements</li> <li>II 3 G Ex N/A IIC T4 Gc</li> <li>II 3 G Ex N/A nC IIC T4 Gc (only 1444-DYN04-01RA and 1444-RELX00-04RB)</li> <li>IECEx UL 14.0082X</li> </ul>			
<b>Operating temperature</b>	-25...70 °C (-13...158 °F)			
<b>Relative humidity</b>	5...95% noncondensing			
<b>Vibration</b>	2 g @ 10...500 Hz			
<b>Enclosure type rating</b>	None (open style)			
<b>Voltage</b>	Limited Voltage Source ATEX/IECEx: 18...32V, max 8 A SELV/PELV Source			
<b>Operating shock</b>	15 g			





# Condition Sensing

SENSORS

## Solid-State Pressure Sensors 836P

### Display

- -1...551 bar (-14.5 psi to 8,000 psi)
- Rotatable housing (320°) and head(330°)
- IO-Link enabled

### Non-Display

- -1...689 bar (-30 in. Hg to 10,000 psi)
- Multiple process connections available
- IP67 enclosure rating



## Accurate and Reliable with Quick Response Time

High-accuracy, new technology, and rigid standards have combined to manufacture the Solid-State 836P Pressure Sensors, available in display and non-display models in rugged, compact housings with corrosion-resistant 316L solid-state sensor elements.

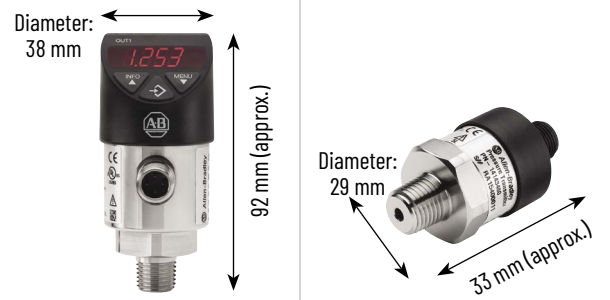

Sensor Model	Standard	•	•
	Flush Mount	•	
	Hygienic	•	
Pressure Range Bar (psi)	-1 to 20 (-14.5 to 300)	•	•
	0 to 550 (0 to 8,000)	•	
	0 to 689 (0 to 10,000)		•
Process Connection	NPT (male/female)	•	•
	G BSPP (male/female)	•	•
	SAE (male)	•	•
	Sanitary	•	
Pressure Type	Vacuum	•	•
	Absolute	•	•
	Gauge	•	•
Output Type	2 x PNP, IO -Link	•	
	1 x PNP + 1 x Analog (4...20 mA), IO-Link	•	
	Analog (4...20 mA)		•
Connection Style	4 Pin DC Micro (M12) Integral QD	•	•

7-106

Photoelectric Sensors



7-2...7-49

Proximity Sensors



7-50...7-79

Ultrasonic Sensors



7-80...7-83

Limit Switches



7-84...7-95

Encoders



7-96...7-103

Condition Sensing



7-104...7-113

Identification Devices





7-114...7-121



### Product Selection



Flush Mount and Hygienic options are also available

	Lower Pressure Range Bar (psi) <sup>1</sup>	Pressure Type	Process Connection <sup>1</sup>	Output Type	Catalog No.
	-1...1 (-14.5...14.5)	Gauge <sup>2</sup>	1/4" NPT female	2 x PNP	836P-D1NFGA14PP-D4
				1 x PNP + 1 analog (4...20 mA)	836P-D1NFGA14PA-D4
	-1...10 (-14.5...145)		1/4" NPT female	1 x PNP + 1 analog (4...20 mA)	836P-D1NFGB14PA-D4
			1/4" NPT male	1 x PNP + 1 analog (4...20 mA)	836P-D1NMG14PA-D4
			G 1/4" BSPP male	1 x PNP + 1 analog (4...20 mA)	836P-D1GM14PA-D4
	0...1 (0...14.5)		1/4" NPT female	2 x PNP	836P-D2NFGA14PP-D4
				1 x PNP + 1 analog (4...20 mA)	836P-D2NFGA14PA-D4
	0...2.5 (0...36.2)		1/4" NPT female	2 x PNP	836P-D2NFGA36PP-D4
				1 x PNP + 1 analog (4...20 mA)	836P-D2NFGA36PA-D4
	0...25 (0...362)		1/4" NPT female	2 x PNP	836P-D2NFGB36PP-D4
				1 x PNP + 1 analog (4...20 mA)	836P-D2NFGB36PA-D4
			1/4" NPT male	1 x PNP + 1 analog (4...20 mA)	836P-D2NMG36PA-D4
G 1/4" BSPP female		1 x PNP + 1 analog (4...20 mA)	836P-D2GFG36PA-D4		
		2 x PNP	836P-D2GFG36PP-D4		
0...100 (0...1450)	1/4" NPT female	2 x PNP	836P-D2NFGC14PP-D4		
		1 x PNP + 1 analog (4...20 mA)	836P-D2NFGC14PA-D4		
0...248 (0...3600)	1/4" NPT female	2 x PNP	836P-D2NFGC36PP-D4		
		1 x PNP + 1 analog (4...20 mA)	836P-D2NFGC36PA-D4		
0...400 (0...5800)	1/4" NPT female	2 x PNP	836P-D2NFGC58PP-D4		
		1 x PNP + 1 analog (4...20 mA)	836P-D2NFGC58PA-D4		
		SAE 7/16-20 UNF female	2 x PNP	836P-D2SFGC58PP-D4	
	-1.01...10 (-30 in. Hg...145)	Gauge <sup>2</sup>	1/4" NPT male	Analog (4...20mA)	836P-N3NMG14A-D4
			1/4" NPT female		836P-N3NFG14A-D4
	0...1 (0...14.5)		1/4" NPT male		836P-N2NMG14A-D4
			1/4" NPT male		836P-N2NMG30A-D4
	0...2 (0...30)		1/4" NPT female		836P-N2NFG30A-D4
			1/4" NPT male		836P-N2NMG10A-D4
	0...6.89 (0...100)		1/4" NPT female		836P-N2NFG10A-D4
			1/4" NPT male		836P-N2NMG14A-D4
	0...10 (0...145)		1/4" NPT female		836P-N2NFG14A-D4
			1/4" NPT male		836P-N2NMG50A-D4
	0...34 (0...500)		1/4" NPT male		836P-N2NMG10A-D4
	0...68 (0...1000)		1/4" NPT male		836P-N2NMG30A-D4
0...206 (0...3000)	1/4" NPT male	836P-N2NMG50A-D4			
0...344 (0...5000)	1/4" NPT male				

### 836P- Pressure Sensor Accessories

Description	Catalog No.
M12 x 1 Connector	889D-F4AC-2
M12 x 1 Right-angle connector	889D-R4AC-2
IO-Link Master Module for POINT I/O™	1734-4IOL
POINT I/O EtherNet/IP Adapter Module	1734-AENTR (dual-port Ethernet) <sup>3</sup>
POINT I/O EtherNet/IP Adapter Module	1734 AENT (single Ethernet port) <sup>3</sup>
ArmorBlock IO-Link Master	1732E-8IOLM12R

IO-Link enabled.

<sup>1</sup> For additional pressure ranges and process connections configurations, please visit <https://rok.auto/directory>.

<sup>2</sup> Absolute pressure models also available.

<sup>3</sup> Compatible only with Series B, firmware version 5.012 or later.

<sup>4</sup> Hygienic and flush mount models available.



For more information on our complete family of condition sensing products, please visit: [rok.auto/condition-sensors](http://rok.auto/condition-sensors)

# Condition Sensing

SENSORS

## Solid-State Temperature Switches 837T, 837RTD

### Display

- Temperature range: -20...80 °C (-4...176 °F)
- Large visual display rotates 180°

### Non-display

- Temperature range: -50...250 °C (-58...482 °F)
- IP67, IP69K enclosure ratings

### Resistance Temperature Detector

- Temperature range:  
-50...200 °C (-58...392 °F)
- Pt100, Pt1000 measuring elements



## A Compact, Comprehensive Solution

Built with high-accuracy and new technology, 837T and 837RTD solid-state switches provide users with a comprehensive solution for measuring temperatures in liquids, gases and vapors.

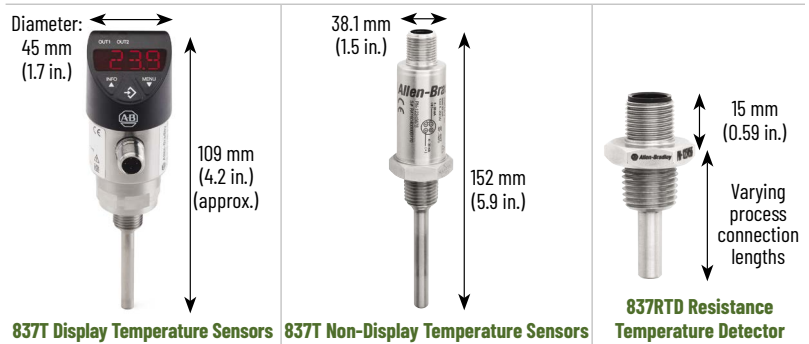

		837T Display Temperature Sensors	837T Non-Display Temperature Sensors	837RTD Resistance Temperature Detector
Sensor Model	Standard	•	•	•
	Hygienic		•	
Temperature Range °C (°F)	-20... 80 (-4 ... 176)	•		
	-50... 150 (-58...302)		•	
	-50...250 (-58...482)		•	
	-30... 130 (-22...266)			•
	-50... 200 (-58...392)			•
Process Connection	1/4 NPT Male	•	•	•
	1/2 NPT Male	•		
	G 1/4 BSPP Male	•	•	•
	G 1/2 BSPP Male	•	•	
	Sanitary		•	
Probe Length	22 mm to 250 mm			•
	25 mm to 400 mm	•	•	
Output Type	2 x PNP / 1 x PNP + 1 x Analog (4...20 mA)	•		
	Analog (4...20 mA)	•	•	
	2 x PNP, IO -Link	•		
	Pt100, Pt1000			•
Connection Style	4-Pin DC Micro (M12) QD	•	•	•

Photoelectric Sensors



7-2...7-49

Proximity Sensors



7-50...7-79

Ultrasonic Sensors



7-80...7-83

Limit Switches



7-84...7-95

Encoders



7-96...7-103

Condition Sensing



7-104...7-113

Identification Devices



7-114...7-121



# Product Selection

## 837T Display Model

	Process Connection	Probe Length mm (inch)	Temperature Range °C (°F)	Catalog No.		
				Output: 2 x PNP	Output: 1 PNP + 1 Analog 4...20...mA	
	1/4" NPT Male	25 (0.98)	-20...80 (-4...178)	837T-D3N14A25PP-D4	837T-D3N14A25PA-D4	
		50 (1.96)		837T-D3N14A50PP-D4	837T-D3N14A50PA-D4	
		100 (3.93)		837T-D3N14B10PP-D4	837T-D3N14B10PA-D4	
		150 (5.9)		837T-D3N14B15PP-D4	837T-D3N14B15PA-D4	
		250 (9.84)		837T-D3N14B25PP-D4	837T-D3N14B25PA-D4	
		350 (13.7)		837T-D3N14B35PP-D4	837T-D3N14B35PA-D4	
	1/2" NPT Male	25 (0.98)		837T-D3N12A25PP-D4	837T-D3N12A25PA-D4	
		50 (1.96)		837T-D3N12A50PP-D4	837T-D3N12A50PA-D4	
		100 (3.93)		837T-D3N12B10PP-D4	837T-D3N12B10PA-D4	
		150 (5.9)		837T-D3N12B15PP-D4	837T-D3N12B15PA-D4	
		250 (9.84)		837T-D3N12B25PP-D4	837T-D3N12B25PA-D4	
				837T-D3N14A25A-D4	837T-D3N14A25A-D4	
				837T-D3N14A50A-D4	837T-D3N14A50A-D4	
				837T-D3N14B10A-D4	837T-D3N14B10A-D4	

 Hygienic option is also available	1/4" NPT Male	25 (0.98)	Standard -50...150 (-58...302)	1 Analog 4...20 mA	837T-N1N14A25A-D4	
		50 (1.96)			837T-N1N14A50A-D4	
		100 (3.93)			837T-N1N14B10A-D4	
		150 (5.9)			837T-N1N14B15A-D4	
		250 (9.84)			837T-N1N14B25A-D4	
		300 (11.81)			837T-N1N14B30A-D4	
		350 (13.7)			837T-N1N14B35A-D4	
		400 (15.75)			837T-N1N14B40A-D4	
		25 (0.98)			Extended Range -50...250 (-58...482)	837T-N2N14A25A-D4
		50 (1.96)				837T-N2N14A50A-D4
	100 (3.93)	837T-N2N14B10A-D4				
	150 (5.9)	837T-N2N14B15A-D4				
	250 (9.84)	837T-N2N14B25A-D4				
	300 (11.81)	837T-N2N14B30A-D4				
	350 (13.7)	837T-N2N14B35A-D4				
	400 (15.75)	837T-N2N14B40A-D4				

	1/4" NPT Male	28 (1.1)	Standard -30...130 (-22...266)	Resistance Output	837RTD-N1N14A28P1-D4
		30 (1.18)			837RTD-N1N14A30P1-D4
		40 (1.57)			837RTD-N1N14A40P1-D4
		50 (1.97)			837RTD-N1N14A50P1-D4
		60 (2.36)			837RTD-N1N14A60P1-D4
		65 (2.56)			837RTD-N1N14A65P1-D4
		28 (1.1)			Extended Range -50...200 (-58...392)
		30 (1.18)	837RTD-N2N14A30P1-D4		
		40 (1.57)	837RTD-N2N14A40P1-D4		
		50 (1.97)	837RTD-N2N14A50P1-D4		
		60 (2.36)	837RTD-N2N14A60P1-D4		
		65 (2.56)	837RTD-N2N14A65P1-D4		

IO-Link enabled.

**Note:** IO-Link Master Module (Catalog No. 1734-4I01 or 1732E-8IOLM12R) is required for premier IO-Link integration experience.

### 837T Temperature Sensor Accessories

Description	Catalog No.
DC Micro (M12) QD cordset, straight, 4-pin, 2 m (6.5 ft)	889D-F4AC-2
DC Micro (M12) QD cordset, right angle, 4-pin, 2 m (6.5 ft)	889D-R4AC-2
IO-Link Master Module for POINT I/O™	1734-4I0L
ArmorBlock IP67 IO-Link Master	1732E-8IOLM12R

SENSORS

For more information on our complete family of condition sensing products, please visit: [rok.auto/condition-sensors](http://rok.auto/condition-sensors)



# Condition Sensing

SENSORS

## Solid-State Flow Switches 839E

- Flow rates from 0.03...3 m/s
- Rugged, corrosion-resistant stainless steel housing, and sensing element
- RTD sensor technology
- Calorimetric measurement principle
- Independently programmable dual N.O./N.C. PNP outputs or 4...20 mA analog output with single PNP output
- Operation and visualization via PC using ReadWin 2000 software



## Flow Sensors for the Harshest Environments

Allen-Bradley 839E solid-state flow sensors are used for process and industrial automation applications. Rockwell Automation sensors can be found in food and beverage, pharmaceuticals, water and waste water plants, and hydraulic applications.

These sensors are capable of measuring the liquid flow rate from 0.03 m/s to 3 m/s. The flow rate is displayed as a percentage of flow rate. For example at no flow the display will read 0%. The sensor probe is designed using 316L stainless steel probe and is resistant to aggressive media and capable of withstanding corrosive liquids.

## Technology

Allen-Bradley flow switches are based on the calorimetric principle. The 839E sensors incorporate a heated temperature element; as media flows passed the sensor heat is removed due to convection. The amount of heat transfer is dependent on the flow velocity of the medium and the temperature difference between the sensor and the medium.

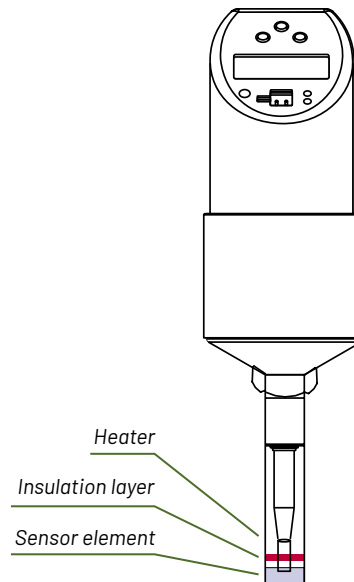

7-110

Photoelectric  
Sensors



7-2...7-49

Proximity  
Sensors



7-50...7-79

Ultrasonic  
Sensors



7-80...7-83

Limit  
Switches



7-84...7-95

Encoders



7-96...7-103

Condition  
Sensing



7-104...7-113

Identification  
Devices



7-114...7-121



## Product Selection

### 839E Solid-State Flow Switches

Process Connection	Probe Length [mm (in.)]	Display	Output	Cat. No.		
1/4 in. NPT (male)	30 (1.18)	Yes	Dual PNP N.O./N.C. programmable	839E-DA1BA1A3D4		
	100 (3.93)			839E-DA1BA1A2D4		
	30 (1.18)		4...20 mA + 1 PNP	839E-DC1BA1A3D4		
	100 (3.93)			839E-DC1BA1A2D4		
1/2 in. NPT (male)	30 (1.18)		Dual PNP N.O./N.C. programmable	Dual PNP N.O./N.C. programmable	839E-DA1BA2A3D4	
	100 (3.93)				839E-DA1BA2A2D4	
	30 (1.18)			4...20 mA + 1 PNP	839E-DC1BA2A3D4	
	100 (3.93)				839E-DC1BA2A2D4	
G 1/4 BSPP	30 (1.18)			Dual PNP N.O./N.C. programmable	Dual PNP N.O./N.C. programmable	839E-DA1BA3A3D4
	100 (3.93)					839E-DA1BA3A2D4
	30 (1.18)				4...20 mA + 1 PNP	839E-DC1BA3A3D4
	100 (3.93)					839E-DC1BA3A2D4
G 1/2 BSPP	30 (1.18)		Dual PNP N.O./N.C. programmable		Dual PNP N.O./N.C. programmable	839E-DA1BA4A3D4
	100 (3.93)					839E-DA1BA4A2D4
	30 (1.18)				4...20 mA + 1 PNP	839E-DC1BA4A3D4
	100 (3.93)					839E-DC1BA4A2D4

## Specifications

<b>Certifications</b>	cULus Listed and CE Marked for all applicable directives, and 3 A authorized only with sanitary adaptor
<b>Enclosure Type Rating</b>	IP66
<b>Operating Range</b>	Liquids from 0.03...3 m/s (0.1... 9.84 ft/s) Mass flow as a relative value between 0 and 100%
<b>Media Temperature [C (F)]</b>	-20...+85 ° (-4...+185 °)
<b>Operating Voltage</b>	18...30V DC, < 100 mA
<b>Load Current, Max.</b>	250 mA
<b>Housing Material</b>	316L stainless steel

## Required Cordsets and Accessories

Description	Cat. No.
DC Micro QD cordset, straight, 4-pin, 2 m (6.5 ft)	889D-F4AC-2





# Condition Sensing

SENSORS

## Solid-State Level Switches 840E

- Piezoelectric effect technology
- Rugged, corrosion-resistant stainless steel housing and sensing element
- DC Micro (M12) and DIN valve connection types
- Highly-visible status LED for process monitoring
- Complementary N.O./N.C. outputs
- Operation independent of the medium properties – build up, changing media, turbulence, air bubbles, foam, and vibration



## Reliable Level Detection Regardless of Media Characteristics

Allen-Bradley level sensors are a quick and easy solution for applications requiring point level detection. These sensors have been applied in applications such as liquid level monitoring in tanks, containers, and pipes.

The 840E stainless steel liquid level sensors are capable of detecting corrosive liquid media and operate independently of the media properties such as liquid build up on the forks, change of media structure, turbulence, foam or air bubbles as well as plant vibrations.

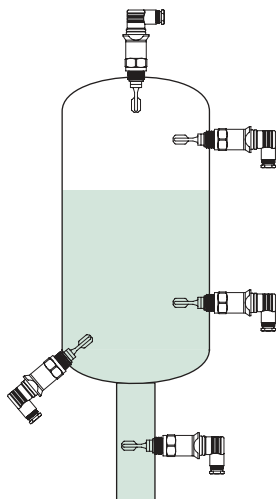

## Technology

The 840E switch uses piezoelectric effect technology to see the difference in vibration when the medium is sensed on the forks. The use of alternating voltage current causes the piezo to expand and contract. The difference in vibration oscillation detected by the medium indicates the presence of the medium.



7-112

Photoelectric  
Sensors



7-2...7-49

Proximity  
Sensors



7-50...7-79

Ultrasonic  
Sensors



7-80...7-83

Limit  
Switches



7-84...7-95

Encoders



7-96...7-103

Condition  
Sensing



7-104...7-113

Identification  
Devices



7-114...7-121



## Product Selection

### 840E Solid-State Level Switches

Connector Type	Process Connection	Power Supply	Cat. No.
DC-PNP with M12 connector	1/2 in. NPT (male)	DC-PNP	840E-TB1B1A1-D4
	3/4 in. NPT (male)	DC-PNP	840E-TB1B2A1-D4
AC with NPT 1/2 valve connector	1/2 in. NPT (male)	AC	840E-TB2B1A1-E4
	3/4 in. NPT (male)	AC	840E-TB2B2A1-E4



**Connected Components**  
Simpler, faster, cost-effective machine building.  
[rok.auto/ccw](http://rok.auto/ccw)

## Specifications

<b>Certifications</b>	cCSAus Certified and CE Marked for all applicable directives
<b>Enclosure Type Rating</b>	DC-PNP with M12 connector: NEMA 4X (IP66/67) AC with NPT 1/2 valve connector: NEMA 4 (IP65)
<b>Operating Temperature [C (F)]</b>	-40...+70 ° (-40...+158 °)
<b>Process Temperature [C (F)]</b>	-40...+100 ° (-40...+212 °)
<b>Operating Voltage</b>	DC-PNP with M12 connector: 10...35V DC, 15 mA max. AC with NPT 1/2 valve connector: 19...253V AC, 3.8 mA max.
<b>Load Current, Min.</b>	250 mA
<b>Repeatability</b>	±0.5 mm (±0.02 in.)
<b>Settling Time</b>	< 2 s
<b>Resolution [mm (in.)]</b>	< 0.5 (0.02)
<b>Hysteresis [mm (in.)]</b>	3.0 ± 0.5 (0.12 ± 0.02)
<b>Housing Material</b>	316L stainless steel

## Required Cordsets and Accessories

Description	Cat. No.
DC Micro QD cordset, straight, 4-pin, 2 m (6.5 ft)	889D-F4AC-2
AC DIN valve cordset	889V-RZ3ABE-2



# Identification Devices

SENSORS

## Code Reader 48CR

- Compact IP65/67 housing
- Two models available:
  - Standard: (WVGA, 0.34 MP resolution, fixed focus)
  - Advanced: (SXGA, 1.2 MP resolution, autofocus)
- Read ranges 102...400 mm (4.02...15.75 in.) fixed and auto focus
- Speeds up to 60 frames per second (fps) for fixed focus and 42 fps for autofocus code readers
- 16 LED-integrated illumination



EtherNet/IP

## One of the Smallest Industrial Code Reader on the Market

### Provides clear, high-speed codes on any surface

The rugged 48CR decodes 1D/2D and Direct Part Marked (DPM) codes and solves the most challenging readings under most conditions. Featuring the latest decoding algorithms technology, the 48CR can successfully read damaged and incomplete symbols despite scenarios with poor prints, scratches or various obstructions. The 48CR supports Ethernet/IP™ and can be configured through either the Studio 5000 Logix Designer® Add-On Profile (AOP) or the embedded WebConnect visual browser.

The 48CR solves difficult barcode reading challenges throughout various applications and industries:

- automotive
- packaging
- material handling
- assembly
- pharmaceutical
- food and beverage

### Able to read any barcode or QR code

- 1D/2D and Direct Part Marked (DPM) codes
- Advanced decoding algorithm allows for successful reads of damaged and/or incomplete symbols



Aztec



Data Matrix



Micro QR



QR

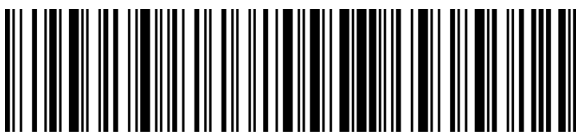

RockwellAutomation

Code 128



PDF417

**Note:** Above example codes are scannable by the 48CR and can be used for demonstration. Additionally they all will 'decode' to spell Rockwell, RockwellAutomation or RockwellAutomation.com.

7-114

Photoelectric Sensors



7-2...7-49

Proximity Sensors



7-50...7-79

Ultrasonic Sensors



7-80...7-83

Limit Switches



7-84...7-95

Encoders



7-96...7-103

Condition Sensing



7-104...7-113

Identification Devices



7-114...7-121



## Product Selection

### 48CR Code Reader

Focus	Resolution	Imager	Lens Size	Focal Distance	Cat. No.
Advanced	(Auto focus)	SXGA 1.2MP Resolution	5 mm	133 mm	48CR-CC50RAF-E8
Advanced	(Auto focus)	SXGA 1.2MP Resolution	7.7 mm	190 mm	48CR-CC77RAF-E8
Advanced	(Auto focus)	SXGA 1.2MP Resolution	16 mm	400 mm	48CR-CC16RAF-E8
Standard	(Fixed focus)	WVGA 0.3 MP Resolution	5.2 mm	102 mm	48CR-CB52R102-E8
Standard	(Fixed focus)	WVGA 0.3 MP Resolution	8 mm	133 mm	48CR-CB80R133-E8
Standard	(Fixed focus)	WVGA 0.3 MP Resolution	8 mm	190 mm	48CR-CB80R190-E8
Standard	(Fixed focus)	WVGA 0.3 MP Resolution	16 mm	400 mm	48CR-CB16R400-E8

## Specifications

	Standard	Advanced
<b>Certifications</b>	FFC, CE, RoHC	
<b>Enclosure Type Rating</b>	Aluminum IP65/67	
<b>Speed</b>	High speed (up to 60 fps)	High speed (up to 42 fps)
<b>Sensor (CMOS)</b>	WYGA (0.34 MP, 752 x 480)	SXGA (1.2 MP, 1280 x 980)
<b>Frames per second</b>	WYGA (60 FPS)	SXGA (42 FPS)
<b>Connectivity</b>	M12 8-pin power, M12 4-pin Ethernet	
<b>Digital I/O</b>	2 opto-isolator inputs, 2 opto-isolator outputs	
<b>Operating Temperature [C (F)]</b>	0...+40 ° (-32...104 °)	
<b>Dimensions</b>	25 x 45 x 45 mm (1 x 1.75 x 1.75 in.)	

## Accessories

Description	Cat. No.
Diffuser - lens cover kit	48CR-DIFFUSER
Polarizer - lens cover kit	48CR-POLARIZER
Bracket, L-shaped	48CR-LBKT
Adjustable bracket	48CR-ADJBKT
Right-angle mirror	48CR-45MIRROR
T-port	879D-F8D4M



# Identification Devices

SENSORS

## High Frequency RFID 56RF/59RF

- One- and two-channel EtherNet/IP and IO-Link interfaces available
- Production efficiency – detailed tracking of who, when, where and what was done to build product(s)
- Rugged IP67, IP68, and IP69K (depending on the specific product) enclosures for harsh industrial applications
- Pre-programmed batches – tags identify which recipe to load automatically, reducing errors



## Track and Trace Materials Through Your Process

Industrial Radio Frequency Identification (RFID) systems are a rugged and reliable way to track and document products as they move through the manufacturing process. Unlike the bar code systems used for similar, less demanding applications, industrial RFID systems are designed to withstand harsh environments. Plus, reusable read/write tags allow for flexibility in information and application

### Manufacturing Application

Each tool, person, and machine has an RFID tag for validation and usage count.

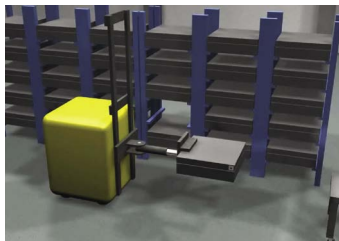

- Inventory control by tagging each tool
- Validate user checking out tool



- Validate tool with machine
- Read/write tool usage count



- Schedule tool maintenance during downtime
- Total tool usage count stored on tool RFID tag

Photoelectric  
Sensors



7-2...7-49

Proximity  
Sensors



7-50...7-79

Ultrasonic  
Sensors



7-80...7-83

Limit  
Switches



7-84...7-95

Encoders



7-96...7-103

Condition  
Sensing



7-104...7-113

Identification  
Devices



7-114...7-121



## Product Selection

### High Frequency 13.56 MHz ICODE with EtherNet/IP Interface

#### Transceivers

Dimensions [mm (in.)]	Recommended Sensing Distance [mm (in.)]	Max. Sensing Distance [mm (in.)]	Cat. No.
Rectangular 80 x 90 (3.15 x 3.54)	102 (4)	168 (6.61)	56RF-TR-8090
Square 40 x 40 (1.57 x 1.57)	50 (1.97)	85 (3.35)	56RF-TR-4040
Cylindrical M30	45 (1.77)	75 (3)	56RF-TR-M30
Cylindrical M18	30 (1.18)	55 (2.16)	56RF-TR-M18
Cylindrical M18	10 (0.39)	34 (1.34)	59RF-TR-M18
Cylindrical M30	23 (.91)	50 (1.97)	59RF-TR-M30
Square 40 x 40 (1.57 x 1.57)	41 (1.61)	78 (3.07)	59RF-TR-4040

#### Tags

Description	Type	Memory Size	Dimensions [mm (in.)]	Cat. No.
Disc	SLI	128 Bytes	16...50 (0.63...1.97)	56RF-TG-⊗
Disc - Mount on Metal	SLI	128 Bytes	50 (1.97)	56RF-TG-50MOM
Disc - FRAM	FRAM	2K Bytes	20...50 (0.79...1.97)	56RF-TG-∅-2KB
Square - Hi Temp (340 C (464 F) max.)	SLI	128 Bytes	50 x 50 (1.97 x 1.97)	56RF-TG-50HT

\* See "RFID Specifications Technical Data" to see full tag offerings in more detail

#### EtherNet/IP Interface Blocks

RFID Ports	Inputs	Outputs	Cat. No.
2	1	1	56RF-IN-IPD22
2	2	—	56RF-IN-IPD22A
1	1	1	56RF-IN-IPS12
IO LINK	Inputs	Outputs	Cat. No.
Armour Block	8	8	1732E-810LM12R
POINT IO	four channels that can be individually configured		1734-4IOL

⊗ IO-Link enabled.

⊗ Replace with diameter in millimeters (16, 30 or 50).

∅ Replace with diameter in millimeters (20, 30 or 50).

## Specifications

<b>Certifications</b>	Interfaces & rectangular transceivers: cULus Listed, C-Tick, CE Marked for all applicable directives Cylindrical transceivers: CE Marked for all applicable directives
<b>Operating Temperature [C (F)]</b>	Interfaces: -20...+60 ° (-4...+140 °) Transceivers, Disc Tags < 20mm: -25...+70 ° (-13...+158 °) Disc Tags ≥ 20mm: -25...+85 ° (-13...+185 °) Hi Temp Tags: -40...+220 ° (-40...+428 °)
<b>Operating Voltage</b>	24V DC
<b>Output Current, max.</b>	100 mA per transceiver
<b>Frequency</b>	13.56 MHz
<b>Read/write Speed</b>	625 B/s max.
<b>Tag Memory</b>	Up to 8 KB, SLI, SLIX & FRAM

\* See individual product specifications

## Required Cordsets and Accessories

Description	Cat. No.
DC Micro (M12) female straight to male straight QD patchcord, 5-pin, 2 m (6.5 ft)	889D-F5FCDM-J2
DC Micro (M12) female straight to male straight QD patchcord, 4-pin, 2 m (6.5 ft)	889D-F4ACDM-2
M12 D-code patchcords	1585D-M4TBDM-2
M12 D-code patchcords, male straight to male straight 4-pin shielded 2 m (6.5 ft)	1585D-M4UBDM-2

\* Other cord-sets lengths/connections available





# Identification Devices

SENSORS

## Ultra-High Frequency (UHF) RFID Transceivers – 58UHF

- Rugged IP66/67 enclosures for harsh industrial applications
- Global Gen2 (ISO 18000-63) standard for tags
- Built-in circular and linear antenna
- Custom AOP with embedded configuration software for easy set up
- Readability
  - up to 150 tags/sec max (58UHF long range transceiver)
  - up to 500 tags/sec max (58UHF short range transceiver)
- User Memory > up to 64KB



EtherNet/IP

## Make your Supply Chain Compliant, Secured, and Transparent

UHF RFID technology offers a large working range and enables multitagging. Because UHF systems communicate over a range of up to 5 m and can read multiple data carriers simultaneously (bulk reading). This makes UHF technology especially ideal for track-and-trace solutions in supply chain management and logistics. UHF supports the digitalization of production and intralogistics processes.

You can automatically register incoming and outgoing goods or reliably monitor the work progress and material consumption. We offer reliable solutions that we have tailored to your specific requirements. Our wide-ranging solution spectrum with many different combination possibilities of data carriers and antennas makes using our systems highly flexible. Integration via EtherNet/ IP into our Rockwell Automation Logix controller platform allows to communicate seamlessly into our higher-level IT systems.

7-118

Photoelectric Sensors



7-2...7-49

Proximity Sensors



7-50...7-79

Ultrasonic Sensors



7-80...7-83

Limit Switches



7-84...7-95

Encoders



7-96...7-103

Condition Sensing



7-104...7-113

Identification Devices



7-114...7-121



## Product Selection

### 58UHF Ultra-High Frequency (UHF) RFID Transceivers

Description	Sensing Distance [m (ft.)]	Dimensions [mm (in.)]	Cat. No.
Short-range	1.5 (4.92)	109 x 116 x 54 (4.3 x 4.6 x 2.1)	58UHF-TR-100-SR15US
Long-range	5 (16.4)	203 x 212 x 66 (8 x 8.3 x 2.6) 5	58UHF-TR-200-LR50US
Short-range	1.5 (4.92)	109 x 116 x 54 (4.3 x 4.6 x 2.1)	58UHF-TR-100-SR15EU
Long-range	5 (16.4)	203 x 212 x 66 (8x 8.3 x 2.6) 5	58UHF-TR-200-LR50EU

## Accessories

Type/Style	Connector Type	No. of Pins	Shield	Wire Size [AWG]	Cat. No. <sup>2</sup>
EtherNet/IP™ DC Micro (M12) patchcords <sup>1</sup>	Straight plug	4	—	24	1585D-M4TBJM-x
DC Micro (M12) cordset [power]	Straight socket	4	—	22	889D-F4AC-x
DC Micro (M12) cordset [power]	Right-angle socket	4	—	22	889D-R4AC-x

<sup>1</sup> The transceiver supports both shielded and unshielded Ethernet cords.

<sup>2</sup> x = 2 (2 m [6.6 ft.]), 5 (5 m [16.4]), or 10 (10 m [32.8 ft.]) for standard cable lengths.



# Identification Devices

## SENSORS

### Swift-E Reconfigurable 3D

- Fast and reliable 3D sensing
- EtherNet/IP connectivity and Studio 5000® Add-on Profile (AOP)
- Built-in applications for distance or height measurement
- Fully configurable via built in web interface (no software required)
- Storage for up to 255 different templates, each with up to 64 virtual sensing zones of user defined shape
- Integrated Near Infrared (NIR) illumination with very low sensitivity to ambient light



EtherNet/IP®

### Based on 3D Time-of-Flight (ToF) technology for fast and reliable, fully reconfigurable distance or height measurement

The Swift-E 3D reconfigurable sensor is designed for industrial applications and includes built-in application profiles for distance or height measurement. These solutions are can be customized via an easy to use, web based interface that require no additional software.

### Example Applications

#### Robotic Palletizing

- Validating that all the product has been transferred from staging to the pallet is a common challenge in palletizing systems. With Swift-E each pallet level can be validated for completeness, ensuring the integrity of the pallet stacking. With 255 templates available, up to 255 different pallet layouts can be stored.

#### Case Packing Inspection

- Many of the modern case packing systems use robots or pneumatic transfer systems to fill product boxes. Validation of box filling is crucial – and difficult. Swift-E can provide height or completeness inspection to ensure all boxes are filled as expected.

#### Completeness Checking

- In many industrial systems it is necessary to validate the completeness or presence/absence of product. Swift-E provides no-touch, wide range solutions for validating the completeness or height of objects for a range of industrial applications.

7-120

Photoelectric  
Sensors



7-2...7-49

Proximity  
Sensors



7-50...7-79

Ultrasonic  
Sensors



7-80...7-83

Limit  
Switches



7-84...7-95

Encoders



7-96...7-103

Condition  
Sensing



7-104...7-113

Identification  
Devices



7-114...7-121



## Product Selection

### Swift-E Reconfigurable 3D

Description	Voltage	Field of View	Cat. No.
Swift 3D EtherNet/IP sensor with built in applications	24V DC power	43x33 deg	0I-E1480

## Specifications

<b>Resolution</b>	640x480 pixels
<b>Response Time</b>	~50 ms
<b>Operating Range</b>	0.5 – 6 m (~1.5 to 20 ft) (typical)
<b>Measurement Precision</b>	~1 cm (typical, varies with return signal level)
<b>Field of View</b>	43°x33° (H x V, measured in center)
<b>Illumination</b>	7x LEDs @ 850 nm, built-in
<b>Output Data</b>	Height, presence or absence
<b>Interface</b>	EtherNet/IP
<b>Power</b>	24V DC / 25 W (typical), 70 W (peak)
<b>Virtual Sensing Zones</b>	Up to 64 virtual sensing zones per template
<b>Number of Templates</b>	Up to 255 different templates

## Accessories

Description	Cat. No.
Mounting plate with 1/4 in.-20 thread for standard tripod mount	0I-TMOUNT
Allen-Bradley 24-28V DC Power Supply - industrial grade (90 W)	1606-XLB*
DC Micro-Style (M12) 4-pin female cordset for use with industrial power supply (or similar)	889D-F4AC-x
Shielded M12 x-code Ethernet cable	1585D-x



# Additional Sensor Products

## 42KL MiniSight General Purpose



Bulletin 42KL Minisight™ general purpose sensors are an exact match for one of the industry’s most popular form factors, but with additional features. 871D cylinder position models for in-port end-of-stroke detection on hydraulic and pneumatic cylinders.

- Universal 18 mm and through-hole mounting
- Durable 1200 psi washdown-rated housing
- 360° visible status indicators

## 45CLR ColorSight

The 45CLR ColorSight™ is a compact color sensing solution that offers high-end performance and advanced features to address a broad range of color-based inspection challenges.

- Concurrent sensing of three different colors
- Easy-to-use teach button (3 channels) and remote teach (single channel)
- IP67 housing with 270° rotatable connector



## 45BPD/BRD Laser Measurement

The Allen-Bradley 45BPD and 45BRD are laser sensors intended for industrial applications requiring reliable small part detection, positioning and precision measurement.

- Visible red Class 2 laser for small beam spot and easy alignment
- Teach-in and fixed range models
- IP67 housing with 270° rotatable connector



Photoelectric Sensors



7-2...7-49

Proximity Sensors



7-50...7-79

Ultrasonic Sensors



7-80...7-83

Limit Switches



7-84...7-95

Encoders



7-96...7-103

Condition Sensing



7-104...7-113

Identification Devices



7-114...7-121



## Cylinder Position Sensors

Our cylinder position inductive proximity sensors are specialty models used to indicate position of pneumatic and hydraulic cylinders or power clamps and grippers.

- 871D cylinder position models for in-port end-of-stroke detection on hydraulic and pneumatic cylinders
- 871D WorldClamp™ sensors for open/closed position indication in power clamp and gripper applications
- Rugged, low-profile housings
- Weld-field immune

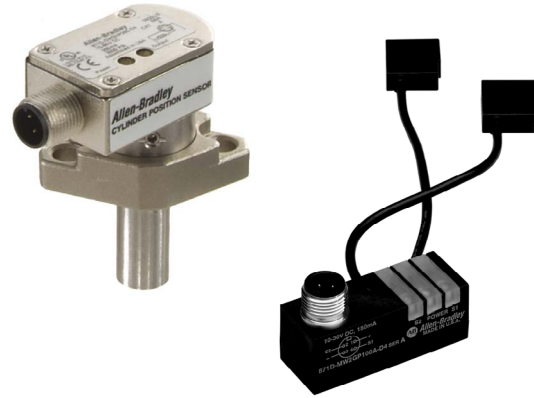

## Rectangular Inductive Proximity Sensors

Our rectangular inductive proximity sensors offer sensing ranges longer than those found in traditional cylindrical housings. Choose from our many styles of rectangular sensors for your welding applications and other environments.

- 802PR heavy duty limit switch style sensors (including hazardous location models)
- 871L/872L limit switch style sensors
- 871F aluminum block sensors
- 871P can sensors

## 871C Specialty Proximity Sensors

We offer a complete line of 871C specialty inductive proximity sensors to address your toughest industrial applications in the harshest environments. Models include:

- Extended temperature
- Analog output
- Intrinsically safe
- Miniature





# Additional Sensor Products



## 801 General Purpose Limit Switches

801 general purpose limit switches are ideal for a wide variety of applications.

- Multiple contact arrangements
- Slow and snap action contacts
- High snap-through force

## 802T Direct Action Limit Switches

802T direct action NEMA-style limit switches are used for safety applications per ISO 14119. Direct opening action assures that the normally closed contacts open when the limit switch is actuated.

- Direct opening action
- Snap acting contacts
- Rugged metal construction
- NEMA 6P/IP67 plug-in design

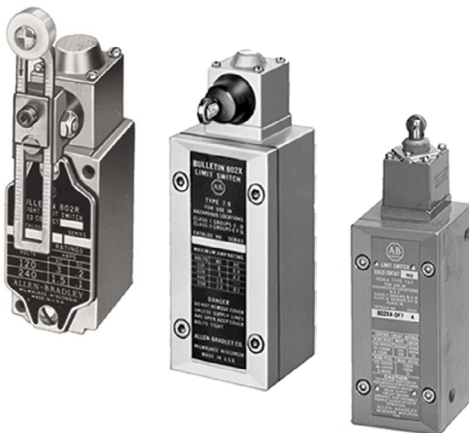

## 802R/X/XR Hazardous Location Limit Switches

Our hazardous location switches are designed for use in applications such as refineries, distilleries, grain elevators, and flour mills where dangerous gases or other materials may be present.

- 802R sealed contact (Class 1, Division 2)
- 802X NEMA Type 4 watertight (Class 1, groups B, C and D or Class 2, groups E, F and G or Class 3)
- 802XR sealed contact (Class 1, Groups B, C and D or Class 2, Groups E, F and G)

Photoelectric Sensors



7-2...7-49

Proximity Sensors



7-50...7-79

Ultrasonic Sensors



7-80...7-83

Limit Switches



7-84...7-95

Encoders



7-96...7-103

Condition Sensing



7-104...7-113

Identification Devices



7-114...7-121



# Essential Components

Get the right components, at the right price, right when you need them.

## Logic Control



RELAYS & TIMERS



PROGRAMMABLE CONTROLLERS



SIGNAL INTERFACE

## Motor Control



CIRCUIT BREAKERS



ROTARY DISCONNECT SWITCHES



VISIBLE BLADE DISCONNECT SWITCHES

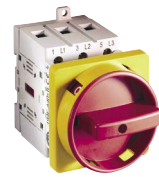

CONTROL & LOAD SWITCHES



CONTROL CIRCUIT & LOAD PROTECTION



POWER SUPPLIES



POWER QUALITY & ENERGY MANAGEMENT



SURGE & FILTER

## Power



NEMA CONTACTORS



IEC CONTACTORS



IEC STARTERS



NEMA STARTERS



MOTOR PROTECTION



SOLID-STATE MOTOR CONTROL



DRIVES

## Operator Interface



PUSH BUTTONS



SIGNALING



GRAPHIC TERMINALS

## Sensors



PHOTOELECTRIC SENSORS



PROXIMITY SENSORS



ULTRASONIC SENSORS



LIMIT SWITCHES



ENCODERS



CONDITION SENSING



IDENTIFICATION DEVICES

## Connectivity



TERMINAL BLOCKS



WIRING SYSTEMS



CONNECTION SYSTEMS



SAFETY CONNECTION SYSTEMS



NETWORK MEDIA

## Safety



PRESENCE SENSING SAFETY DEVICES



INTERLOCK SWITCHES



ACCESS CONTROL



SAFETY RELAYS



EMERGENCY STOP DEVICES



SAFETY LIMIT SWITCHES

# Index

Bulletin Number .....	Page
22F.....	2-46
25A.....	2-48
25B.....	2-50
42AF.....	7-12
42BC.....	7-30
42BT.....	7-30
42CA.....	7-22
42CM.....	7-24
42CS.....	7-28
42EF.....	7-16
42G.....	7-20
42JA.....	7-10
42JS.....	7-6
42JT.....	7-6, 7-8
42KD.....	7-4
43GR.....	7-48
43GT.....	7-48
43PR.....	7-49
43PT.....	7-49
45AST.....	7-40
45CRM.....	7-35
45DLA.....	7-38
45LMS.....	7-32
45LSP.....	7-44
45LUM.....	7-36
45MLA.....	7-38
45PLA.....	7-42
45PVA.....	7-40
46CLR.....	7-34
48CR.....	7-114
46DFA.....	7-46
59RF.....	7-16
100-C.....	2-4
100-E.....	2-8
100-K.....	2-2
100S-C.....	2-9
100S-E.....	2-9
104-C.....	2-4
104-E.....	2-8
104-K.....	2-2
104S-C.....	2-9
105-C.....	2-20
109-C.....	2-20
112.....	2-22
113.....	2-22
140G.....	1-8
140MG.....	1-8
140MP.....	1-3
140MT.....	1-3
150 SMC™ 3.....	2-40
150 SMC™ -50.....	2-44
150 SMC™ Flex.....	2-42
154.....	2-38
156-C.....	2-36
188-J.....	1-32
190E.....	2-18
191E.....	2-18
193 E100.....	2-32
193 E200/E300.....	2-34
193-K.....	2-30
193-T1.....	2-30
194E.....	1-26
194L.....	1-24
194R.....	1-16
194U.....	1-18
300.....	2-24
309.....	2-26

Bulletin Number .....	Page
312.....	2-28
313.....	2-28
440C.....	6-42
440E.....	6-48
440F.....	6-18
440G.....	6-34
440G-EZ.....	6-28
440G-LZ.....	6-30
440G-MZ.....	6-32
440K.....	6-24
440L.....	6-10
440N.....	6-20, 6-22
440P.....	6-50
440R.....	6-44
440T.....	6-38
442G.....	6-40
442L.....	6-16
445L.....	6-12
509.....	2-26
512.....	2-28
513.....	2-28
600.....	2-16
609.....	2-16
609TU.....	2-16
609U.....	2-16
700-CF.....	3-16
700-EF.....	3-16
700-FE.....	3-2
700-FS.....	3-2
700-HA.....	3-4
700-HC.....	3-6
700-HK.....	3-8
700-HL.....	3-10
700-HPS.....	3-18
700-HR.....	3-12
700-K.....	3-16
700-P.....	3-14
700S-EF.....	3-18
700S-P.....	3-18
700S-PK.....	3-18
800B.....	4-22
800F.....	4-2, 4-8
800FD.....	4-8, 4-10
800K.....	4-20
800T/H.....	4-12, 4-18
802B.....	7-94
802K.....	7-88
802M.....	7-88
802MC.....	7-88
802T.....	7-84, 7-124
836P.....	7-104
837RTD.....	7-108
837T.....	7-108
839E.....	7-110
840E.....	7-112
842E.....	7-96
842HR.....	7-98
843ES.....	7-100
847H.....	7-102
847T.....	7-102
854J.....	4-26
854K.....	4-26
855B.....	4-34
855H.....	4-32
855HM.....	4-32
855P.....	4-24
855W.....	4-30

Bulletin Number .....	Page
856T.....	4-28
871A.....	5-43
871C.....	7-52
871F.....	7-76
871FM.....	7-70
871P.....	7-72
871TM.....	7-60
871TS.....	7-64
871Z.....	7-68
871ZT.....	7-66
872C.....	7-54
873M.....	7-82
873P.....	7-80
875F.....	7-78
875L.....	7-78
888D.....	5-44
888N.....	5-45
888P.....	5-45
888R.....	5-44
889D.....	5-43
889N.....	5-40
889P.....	5-43
889R.....	5-39
898D.....	5-48
898P.....	5-42
898R.....	5-48
931N.....	3-24
931S.....	3-24
937C.....	3-26
937T.....	3-26
937Z.....	3-26
1408.....	1-49
1420.....	1-49
1426.....	1-49
1444.....	7-104
1489.....	1-28
1492.....	5-26, 5-30
1492-FB.....	1-36
1492-J.....	5-3
1492-L.....	5-3
1492-P.....	5-3
1492-PDE.....	5-32
1492-RCDA.....	1-34
1492-SPM.....	1-30
1494C.....	1-22
1494U.....	1-20
1494V.....	1-22
1585.....	5-52
1585A.....	5-52
1585D.....	5-53
1585J.....	5-54
1606.....	1-40
1606-XLB.....	1-40
1606-XLD.....	1-40
1606-XLE.....	1-40
1606-XLP.....	1-40
1606-XLS.....	1-40
1609-B.....	1-46
1609-D.....	1-46
1694.....	1-38
2080.....	3-20
2711R.....	4-36
4983-DS.....	1-52
4983-DC.....	1-54
4983-PF.....	1-54

# Join Us

Take advantage of upcoming events to learn more about how you can use technology as a competitive advantage – to get your products and services to market faster, reduce costs, better utilize power and plant-floor assets, and minimize the risks in your manufacturing environment.



**Automation Fair®**



**Process Solutions  
User Group**



**On the Move**



Rockwell Automation offers a variety of global industry events for partners and customers to learn more about our products and technologies.



Rockwell Automation offers a breadth of quality Allen-Bradley® components to fit your specific needs. In order to assist you with your component selection, we offer a variety of configuration and selection tools.

### Local Distributor

Visit <https://rok.auto/distributor> to find your local Distributor.



### Online Product Directory



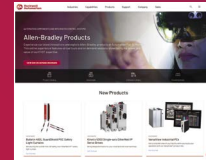

Our extensive product portfolio is designed to improve your processes through every stage of your manufacturing cycle. <https://rok.auto/directory>

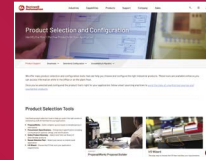

### Product Selection Toolbox

Our powerful range of product selection and system configuration tools assist you in choosing and applying our products. <https://rok.auto/selection>



Connect with us.    

[rockwellautomation.com](http://rockwellautomation.com) — expanding human possibility®

AMERICAS: Rockwell Automation, 1201 South Second Street, Milwaukee, WI 53204-2496 USA, Tel: (1) 414.382.2000, Fax: (1) 414.382.4444

EUROPE/MIDDLE EAST/AFRICA: Rockwell Automation NV, Pegasus Park, De Kleetlaan 12a, 1831 Diegem, Belgium, Tel: (32) 2663 0600, Fax: (32) 2 663 0640

ASIA PACIFIC: Rockwell Automation SEA Pte Ltd, 2 Corporation Road, #04-05, Main Lobby, Corporation Place, Singapore 618494, Tel: (65) 6510 6608, FAX: (65) 6510 6699

UNITED KINGDOM: Rockwell Automation Ltd., Pitfield, Kiln Farm, Milton Keynes, MK11 3DR, United Kingdom, Tel: (44)(1908) 838-800, Fax: (44)(1908) 261-917

Allen-Bradley, AppView, ArcShield, ArmorBlock, ArmorBlock Guard I/O, ArmorPower, ArmorStart, ArmorStratix, Atlas Guard Locking Switch, Cadet, CENTERLINE, ClearMultiPrint, ClearPlot, ClearSight, ClearTools, ColorSight, CompactBlock Guard I/O, CompactLogix, Connected Components Workbench, Control Tower, ControlLogix, CrossBoard, CustomView, DeviceLogix, DySC, E1 Plus Electronic Overload Relay, E300 Electronic Overload Relay, Elf Miniature Tongue Interlock Switch, expanding human possibility, FactoryTalk EnergyMetrix, Ferrogard, Flex I/O, Guard I/O, GuardLink, GuardLogix, Guardmaster, GuardPLC, GuardShield, i-Grid, i-Sense, Kinetix, LaserSight, Lifeline, MachineAlert, MCS, Micro800, Micro810, Micro820, Micro830, Micro850, Micro870, MicroLogix, Minisight, On-Machine, PanelView, POINT I/O, PowerFlex, PowerMonitor, ProSafe, QuadConnect, RightSight, Rockwell Automation, Rotacam, RSEnergyMetrix, Safedge, SafeZone, SensaGuard, Series 9000, SmartGuard, SMC, Stratix, Studio 5000, Studio 5000 Logix Designer, ToughCoat Finish, ToughLink, ToughWeld, Trojan Tongue Interlock Switch, VersaCube, VisiSight and WorldProx are trademarks of Rockwell Automation.

Trademarks not belonging to Rockwell Automation are property of their respective companies.

Publication EC-CA100F-EN-P - September 2024 | Supersedes Publication EC-CA100E-EN-P - August 2021

Copyright © 2024 Rockwell Automation, Inc. All Rights Reserved. Printed in USA.

