



OptixPanel Compact Operator Panel

Bulletin 2800C



Allen-Bradley

by **ROCKWELL AUTOMATION**

User Manual

Original Instructions

Important User Information

Read this document and the documents listed in the additional resources section about installation, configuration, and operation of this equipment before you install, configure, operate, or maintain this product. Users are required to familiarize themselves with installation and wiring instructions in addition to requirements of all applicable codes, laws, and standards.

Activities including installation, adjustments, putting into service, use, assembly, disassembly, and maintenance are required to be carried out by suitably trained personnel in accordance with applicable code of practice.

If this equipment is used in a manner not specified by the manufacturer, the protection provided by the equipment may be impaired.

In no event will Rockwell Automation, Inc. be responsible or liable for indirect or consequential damages resulting from the use or application of this equipment.

The examples and diagrams in this manual are included solely for illustrative purposes. Because of the many variables and requirements associated with any particular installation, Rockwell Automation, Inc. cannot assume responsibility or liability for actual use based on the examples and diagrams.

No patent liability is assumed by Rockwell Automation, Inc. with respect to use of information, circuits, equipment, or software described in this manual.

Reproduction of the contents of this manual, in whole or in part, without written permission of Rockwell Automation, Inc., is prohibited.

Throughout this manual, when necessary, we use notes to make you aware of safety considerations.



WARNING: Identifies information about practices or circumstances that can cause an explosion in a hazardous environment, which may lead to personal injury or death, property damage, or economic loss.



ATTENTION: Identifies information about practices or circumstances that can lead to personal injury or death, property damage, or economic loss. Attentions help you identify a hazard, avoid a hazard, and recognize the consequence.

IMPORTANT

Identifies information that is critical for successful application and understanding of the product.

These labels may also be on or inside the equipment to provide specific precautions.



SHOCK HAZARD: Labels may be on or inside the equipment, for example, a drive or motor, to alert people that dangerous voltage may be present.



BURN HAZARD: Labels may be on or inside the equipment, for example, a drive or motor, to alert people that surfaces may reach dangerous temperatures.



ARC FLASH HAZARD: Labels may be on or inside the equipment, for example, a motor control center, to alert people to potential Arc Flash. Arc Flash will cause severe injury or death. Wear proper Personal Protective Equipment (PPE). Follow ALL Regulatory requirements for safe work practices and for Personal Protective Equipment (PPE).

The following icon may appear in the text of this document.



Identifies information that is useful and can help to make a process easier to do or easier to understand.

	Catalog Numbers	5
	Summary of Changes	5
	Additional Resources	5
	Chapter 1	
Product Description	Highlights	7
	Bezels	7
	Side View	10
	Connectors/LEDs/Buttons	10
	Standards Compliance and Certifications	11
	Technical specifications	12
	Chapter 2	
Installation	Safety	13
	Unpack	14
	Installation Guidelines	15
	Mounting Requirements	15
	Approximate Dimensions	16
	Prepare the Panel Cutout	16
	Install the Operator Panel	17
	DC Power Supply Guidelines	18
	Connect DC Power	19
	Chapter 3	
Operation	Operating guidelines	21
	Touch Screen Precautions	21
	Touchscreen calibration	21
	Restart/Factory reset	23
	Chapter 4	
Configuration	Factory settings	25
	System Manager	25
	System Manager	27
	General	28
	FT Optix	31
	Interfaces	33
	FT Remote Access	34
	Users	36
	Diagnostic	37
	Maintenance	37
	Update the Device	38
	Restore the Device to factory defaults	39
	External storage devices	40

Clean the Operator Panel	Chapter 5	
	Clean the Integrated Display	41
	Clean the Air Openings and Heatsinks	41
	Remove Paint and Grease from the Bezel	41
Troubleshooting	Chapter 6	
	Display Troubleshooting	43
	Ship or Transport the operator panel.	43
	Dispose of the operator panel.	43
Replace Components	Chapter 7	
	Voltage precautions	45
	Electrostatic Discharge Precautions	45
	Pre-configuration	45
	Post-configuration	46
	Remove the cover.	46
	Backup battery replacement (BR1225A).	46
	Reinstall the Cover	47

This manual is a user guide for OptixPanel™ Compact Operator Panels for visualization and control. It provides procedures for the following:

- Install the operator panel.
- Make operator panel connections.
- Operate the operator panel.
- Troubleshoot the operator panel.

A general knowledge of automation technology is needed to understand and follow the instructions in this publication.

Catalog Numbers

This publication applies to these OptixPanel operator panels. For your catalog number, see the product label on the side of your operator panel.

Cat. No.	Bezel material	Touchscreen type
2800C-***AS-**	Aluminum	Resistive
2800C-***CM-**	Aluminum and glass True Flat	PCAP

Summary of Changes

This publication contains the following new or updated information. This list includes substantive updates only and is not intended to reflect all changes.

Topic	Page
Chapter 4: added new functions for firmware 4.0.4.52	throughout

Additional Resources

These documents contain additional information concerning related products from Rockwell Automation. You can view or download publications at rok.auto/literature.

Resource	Description
OptixPanel Compact Installation Instructions, publication 2800C-IN001	Provides basic installation guidelines and instructions for OptixPanel systems.
OptixPanel Technical Data, publication 2800-TD001	Provides technical specifications about the OptixPanel systems.
FactoryTalk Optix Help Center, website	FactoryTalk Optix Help Center.
EtherNet/IP Network Devices User Manual, ENET-UM006	Describes how to configure and use EtherNet/IP devices to communicate on the EtherNet/IP network.
Ethernet Reference Manual, ENET-RM002	Describes basic Ethernet concepts, infrastructure components, and infrastructure features.
System Security Design Guidelines Reference Manual, SECURE-RM001	Provides guidance on how to conduct security assessments, implement Rockwell Automation products in a secure system, harden the control system, manage user access, and dispose of equipment.
UL Standards Listing for Industrial Control Products, publication CMPNTS-SR002	Assists original equipment manufacturers (OEMs) with construction of panels, to help ensure that they conform to the requirements of Underwriters Laboratories.
Safety Guidelines for the Application, Installation, and Maintenance of Solid-state Control, publication SGI-1.1	Designed to harmonize with NEMA Standards Publication No. ICS 1.1-1987 and provides general guidelines for the application, installation, and maintenance of solid-state control in the form of individual devices or packaged assemblies incorporating solid-state components.
Industrial Automation Wiring and Grounding Guidelines, publication 1770-4.1	Provides general guidelines for installing a Rockwell Automation industrial system.
Product Certifications website, rok.auto/certifications	Provides declarations of conformity, certificates, and other certification details.

Notes:

Product Description

The Allen-Bradley® OptixPanel™ Compact is an operator panel, equipped with an NXP® i.MX 8M Mini Quad ARM Cortex A53 1.6 GHz processor, for visualization and control, ideal for applications that require a high-performance Human Machine Interface (HMI).

Highlights

- Embedded solutions based on FactoryTalk® Optix™, the new collaborative, cloud-based software platform that offers an unprecedented degree of flexibility, scalability, extensibility and openness for visualization and Edge Computing applications.
- Full industrial interoperability for M2M scenarios and interfacing to MES and ERP systems thanks to native support for the OPC UA protocol, simple two-way communication with Cloud infrastructures via MQTT protocol.
- Natively equipped with one Gigabit Ethernet port, one USB 2.0 port, and a multi-standard serial port.
- Integrated FactoryTalk® Remote Access™ software for remote assistance (UBIQUITY license compatible).

Bezels

The system is available with different kinds of bezels:

- Aluminum bezel (AF) with single touch resistive touchscreen.
- Aluminum and True Flat glass bezel (GL) with multi-touch capacitive touchscreen.

Figure 1 - OptixPanel compact bezels

Aluminum bezel with single touch resistive touchscreen (AF)



Sizes available

4.3 in. W [16:9]
7.0 in. W [5:3]

Aluminum and glass True Flat bezel with multi touch capacitive touchscreen (GL)



Sizes available

4.3 in. W [16:9]
7.0 in. W [5:3]

Widescreen (W) format is offered with analog resistive and projective capacitive (PCAP) touch screens.

Aluminum bezel with single touch resistive touchscreen (AF)

Table 1 - Aspect ratio

Panel size	Aspect ratio
4.3 in. W	16: 9
7.0 in. W	5:3

Figure 2 - Aluminum bezel with resistive touchscreen



No.	Description
1	Frame
2	Active display area
3	On/Off/Standby LED

The front panel has a STEP between the frame and the touchscreen.

Figure 3 - STEP detail

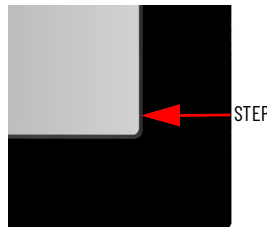

Features:

- IP rating: IP65.
- Seal Type: Polyurethane gasketing elastomer.
- Frame material: EN AW-5754, H22 EN 485-1.

Figure 4 - Construction detail

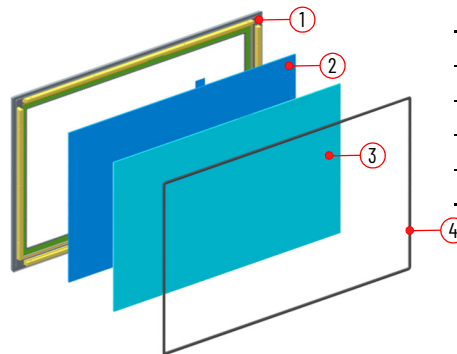

No.	Description
1	Aluminum Frame
2	5 wires resistive touchscreen
3	Glass
4	Seal

Aluminum and Glass True Flat bezel with multi touch capacitive touchscreen (GL)

Table 2 - Aspect ratio

Panel size	Aspect ratio
4.3 in. W	16: 9
7.0 in. W	5:3

Figure 5 - Aluminum bezel with resistive touchscreen



No.	Description
1	Frame
2	Active display area
3	On/Off/Standby LED

The front panel has a no STEP between the frame and the touchscreen.

Figure 6 - NO STEP detail

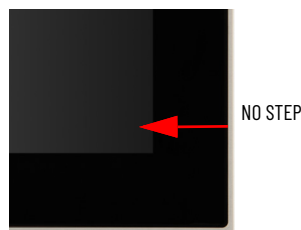

Features:

- IP rating: IP65.
- Seal Type: Polyurethane gasketing elastomer.
- Frame material: Aluminum alloy 5754.

Figure 7 - Construction detail

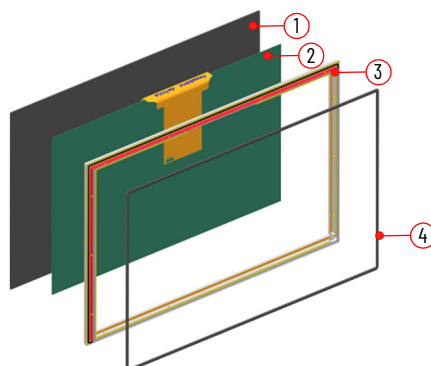

No.	Description
1	Tempered glass
2	PCAP capacitive multi-touch touchscreen
3	Aluminum frame
4	Seal

Side View

Figure 8 - 4.3 in. side view

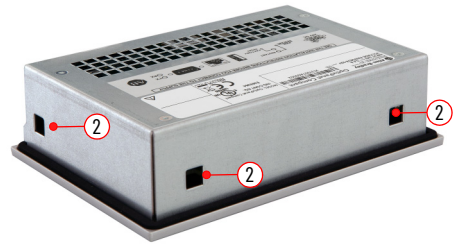
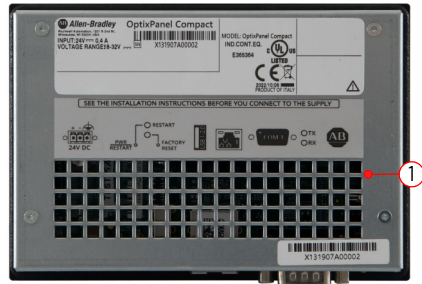

No.	Description
1	Aeration holes
2	Clip holes for mounting clips

Figure 9 - 7.0 in. side view



No.	Description
1	Aeration holes
2	Clip holes for mounting clips

Connectors/LEDs/Buttons

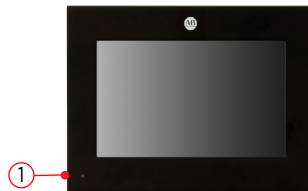

*LED 1 is present only in: OptixPanel Compact systems 7.0 in. size.

OptixPanel Compact - bottom view

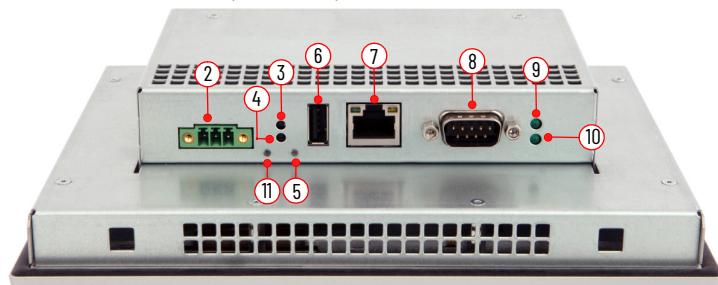

Item No.	Description	Required cable	LED Color	Function
1	Front Power On LED	—	Green	Indicates the system is powered on and boot sequence was successful.
2	DC power	Unshielded	—	Power connector.
3	Restart button	—	—	Forces an internal reset, as if power was lost temporarily and then returned. IMPORTANT: Use this button only if there are no better options, like keyboard or mouse commands, or if the resumed DC power does not restart the operator panel. System reset can cause data loss and possible corruption to the operating system.
4	Factory reset button	—	—	Allows the total restoration of the firmware and factory settings with the deletion of all application data.
5	Factory reset LED	—	Blue	Factory reset procedure in progress.
			OFF	Standard/common status.
6	USB 2.0	Shielded	—	USB 2.0 connector.
7	LAN	Shielded	—	RJ45 connector.
8	COM	Shielded	—	RS232/422/485 serial port connector.
9	LED COM1 TX	—	Green	Transmission signal for COM interface.
10	LED COM1 RX	—	Green	Receive signal for COM interface.
11	Restart / Power LED	—	Red	Power supply ON and Boot sequence FAIL.
			Red	Restart button pressed.
			Green	Power supply ON and correct BOOT sequence.

COM Pinouts

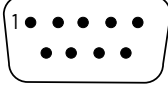
PIN	RS232	RS422	RS485	Connector layout
1	+5V DC (OUT)	+5V DC (OUT)	+5V DC (OUT)	
2	RX	RX+	N.C.	
3	TX	TX-	RTX-	
4	N.C.	N.C.	N.C.	
5	GND	GND	GND	
6	N.C.	N.C.	N.C.	
7	RTS	RTX+	TX+	
8	CTS	RX-	N.C.	
9	N.C.	N.C.	N.C.	

Standards Compliance and Certifications

UL/cUL Mark Compliance

Equipment with the UL/cUL mark complies with the requirements of UL 61010-1, UL 61010-2-201, CSA C22.2 No. 61010-1, and CSA C22.2 No. 61010-2-201.

A copy of the certificate of compliance is available at rok.auto/certifications.

European Union Directive Compliance

This computer meets the European Union Directive requirements when installed within the European Union or EEA regions and have the CE marking. A copy of the declaration of the conformity is available at rok.auto/certifications.



ATTENTION: This equipment is intended to operate in an industrial or control room environment, which uses some form of power isolation from the public low-voltage mains. Some computer configurations cannot comply with the EN 61000-3-2 Harmonic Emissions standard as specified by the EMC Directive of the European Union. Obtain permission from the local power authority before you connect any computer configuration that draws more than 75 W of AC power directly from the public mains.
All other I/O cables must be used only indoors.

Connect peripheral cables to the appropriate I/O ports on the operator panel. To comply with EN 61326-1, see [Connectors/LEDs/Buttons on page 10](#) for the required cable types.

Technical specifications

OptixPanel Compact Operator Panel			
Attribute		Aluminum bezel (AF)	Aluminum and glass true flat bezel (GL)
HMI software		FactoryTalk® Optix™ runtime - S license (Upgradeable to M)	
Remote assistance software		FactoryTalk® Remote™ Access Basic (Upgradeable to Pro)	
O.S. installed		Linux Yocto	
LED back-light TFT LCD		4.3 in. W 7.0 in. W	
Touchscreen		Resistive 4 wires	P-CAP Multitouch
Front Panel	Material	Aluminum (AT)	Aluminum and glass true flat (GL)
	Logo	Allen-Bradley or unbranded	
Protection grade IP	IP rating	IP 65 frontal - IP 20 rear	
	NEMA rating	UL type 1, 4x (indoor only)	
Case	Installation	Panel mounting	
	Material	Zinc-coated skin pass steel	
Processor (soldered on-board)		NXP® i.MX 8M Mini Quad ARM® Cortex® A53 1.6GHz, 64bit, integrated GPU	
System memory RAM		1GB (LP-DDR4 module)	
Mass storage		eMMC p-SLC (~2GB available for Optix application)	
Interfaces	LAN	1 x Gigabit Ethernet (RJ45)	
	USB	1 x USB 2.0 (Type-A / host)	
	Serial	1 x RS232/422/485 (DB9M) not isolated	
Power supply input	DC input	24V 0.4A SELV	
	Voltage Range	18...32V	
Battery		1 x BR1225A Internal access	
Operating Temperature		0° ...+50 °C (32...122 °F)	
Storage Temperature		-20° ...+60 °C (-4...+140 °F)	
Operating / Storage Relative humidity		20%...90% RH (non-condensing)	

Installation

Follow these guidelines and procedures to help you plan your installation, prepare the panel cutout, and mount and power up the operator panel.

Safety

Installation according to the instructions

Commissioning the system device is prohibited until it has been absolutely ensured that the system in which the system is to be installed complies with all the applicable EU and international regulation. The customer should follow local standards and regulations and Rockwell is not responsible for any issues resulting from not following regulations applicable where the product is used.

Qualified personnel

- OptixPanel™ may be operated only by personnel qualified for the specific task in accordance with the relevant documentation for the specific task, in particular its warning notices and safety instructions.
- Qualified personnel are those who, based on their training and experience, are able to identify risks and avoid potential hazards when working with these systems.

Hazardous locations

Do not use the system in hazardous areas.

Environment and Enclosure Information

- The enclosure must allow sufficient space around air inlets and outlets to provide the circulation necessary for cooling. Never allow air passages to become obstructed.
- Hot air rises. The temperature at the top of the enclosure is often higher than the temperature in other parts of the enclosure, especially if air is not circulating.
- Consider a user-supplied fan, heat exchanger, or air conditioner for heat generated by other devices in the enclosure.
- For installation in control cabinets and, in particular, in closed containers, make sure the ambient temperature complies with the requirements.
- The indicated environmental conditions must be observed.
- Verify the operating temperature of the equipment to ensure that the specified temperature range is not exceeded after it is installed in the end user application.



ATTENTION: This equipment is intended for use in a Pollution Degree 2 industrial environment, in overvoltage Category II applications (as defined in IEC 60664-1), at altitudes up to 2000 m (6561 ft) without derating. This equipment is considered Group 1, Class A industrial equipment according to IEC/EN 61326-1. Without appropriate precautions, there can be potential difficulties with electromagnetic compatibility in other environments due to conducted and radiated disturbance.

This equipment is UL Listed. However, to meet some regulatory requirements, the computer must be mounted in an enclosure that is suitably designed for environmental conditions that can be present.

All OptixPanel Operator Panels are shipped with a gasketed bezel to meet specified NEMA, UL Type, and IEC IP ratings only when mounted in a panel or enclosure with an equivalent rating.

In addition to this publication, see the following: Industrial Automation Wiring and Grounding Guidelines, publication [1770-4.1](#), for more installation requirements.

UL 50, CSA C22.2 No. 94.1, and IEC 60529, as applicable, for explanations of the degrees of protection provided by enclosures.

Working on the control cabinet

- The system is an open equipment. The cabinet in which the system is installed should only be accessed with a key or tool and only by trained and authorized personnel.
- Dangerous voltage Opening the cabinet may expose high voltage parts. Before opening the cabinet always disconnect the power.

Unpack

Before you unpack the operator panel, inspect the shipping carton for damage. If damage is visible, immediately contact the shipper and request assistance. Otherwise, proceed with unpacking.

Keep the original packing material in case you must return the computer for repair or transport it to another location.

This product is shipped with the following items:

Parts List

Item	Description
Hardware	OptixPanel™ Compact Operator Panel with FactoryTalk Optix and FactoryTalk Remote Access installed and activated.
	Mounting clips for panel installation.
	Hexagonal key 1.5 mm.
	Removable power terminal block pre-installed.
	Removable power terminal block cover kit.
	Eyelet terminal pre-installed.
Document	Installation instructions.

Installation Guidelines

Follow these guidelines to make sure that your operator panel provides service with excellent reliability.

- When choosing the installation site, consider the following:
 - The site must have sufficient power.
 - The site must be indoors and non-hazardous.
 - The site must not expose the computer to direct sunlight.
- The operator panel can operate in the following environmental conditions:
 - Operation temperature: 0...+50 °C (32...122 °F).
 - Storage temperature: -10° ...+60 °C (4° ...+140 °F).
 - Operation / storage relative humidity (RH) non condensing: 20...90%.

IMPORTANT The operator panel can operate at a range of extremes. However, the life span of any electronic device is shortened if you continuously operate the operator panel at its highest rated temperature, which includes the touch screen and LCD panel.

Mounting Requirements

Follow these requirements to mount the operator panel.

- Choose a suitable mounting height.
- To help prevent overheating and to provide access to the I/O ports for cable connections, mount the computer with the following minimum clearances from all four sides of the outer frame and back of the computer chassis:
 - X direction ≥ 50 mm (1.96 in.)
 - Y direction ≥ 100 mm (3.93 in.)
 - Z direction ≥ 50 mm (1.96 in.)

Installation min. clearance

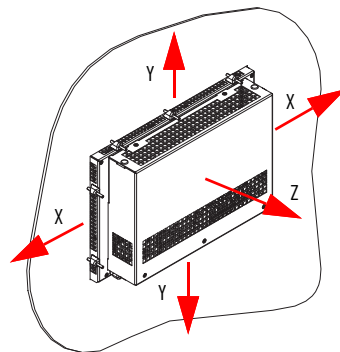

Installation max. tilt

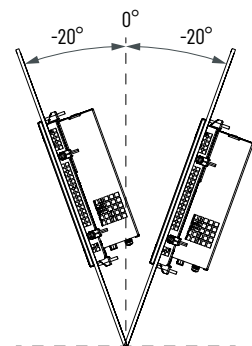

For optimal performance, mount the computer in the horizontal orientation and vertical (upright) position, so the I/O ports face down.

IMPORTANT The vertical position can be tilted up to 20° forward or backward from the upright position. In that case the maximum operating temperature will be reduced from 50°C (122 °F) to 45°C (113 °F).

Approximate Dimensions

Dimensions are in mm (inches). Dimensions are not intended to be used for manufacturing purposes.

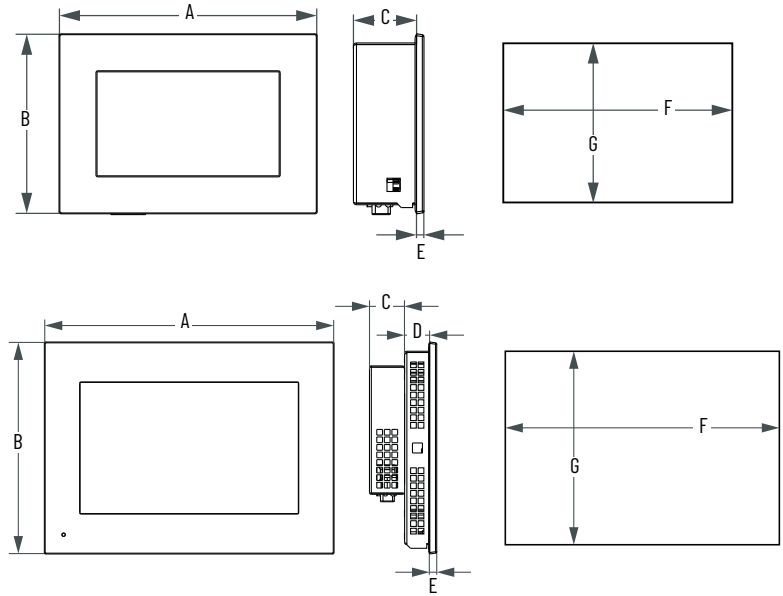

Display Size [in.]	Cat. No.	Format ⁽¹⁾	Aspect Ratio	Bezel Type	Dimensions [mm (in)]					Cutout	
					A	B	C	D	E	F ⁽²⁾	G ⁽²⁾
4.3	2800C-043AS-1S	W1	16:10	Aluminum	136.2 (5.36)	95 (3.74)	33.2 (1.30)	-	4 (0.15)	129.5 (5.09)	88.5 (3.48)
	2800C-043AS-1B										
	2800C-043CM-1S	W2		Aluminum-glass True Flat							
	2800C-043CM-1B										
7.0	2800C-070AS-1S	W1	Aluminum	203 (7.99)	148.6 (5.82)	24.6 (0.96)	17.5 (0.68)	5 (0.19)	196 (7.71)	139.5 (5.49)	
	2800C-070AS-1B										
	2800C-070CM-1S	W2	Aluminum-glass True Flat					4 (0.15)			
	2800C-070CM-1B										

(1) W = widescreen; 1 = single touch and 2 = multi-touch.

(2) Dimensions are +0/1mm (0.04 in.).

Prepare the Panel Cutout

Follow these guidelines to install the operator panel in a panel.



ATTENTION: Failure to follow these guidelines can result in personal injury or damage to the panel components. Take precautions so any metal fragments during the panel cutout do not enter components that are installed already in the panel.

Plan the panel cutout according to the following:

- Plan the panel cutout area that is needed for your Operator Panel, see Approximate dimensions paragraph.
- Verify that the area around the panel is clear of obstructions.
- Remove all electrical power from the panel before you make the cutout.
- The mounting panel material must be 2...6 mm (0.08...0.24 in.) thick with a max deformation limit on the plane of 0.5 mm (0.01 in.).
- For a uniform gasket seal, ensure the surface is clean and free of debris and that the roughness of the panel surface must be ≤ 120 microns (Rz 120).

Required Tools

- Panel cut out tools.
- 1.5 mm hex key (supplied with the mounting clips).
- Adjustable torque driver with 1.5 mm hex key bit.
- Safety glasses.
- Mounting clips (supplied), [Figure 10](#).

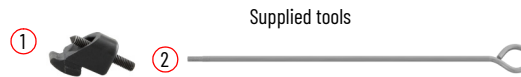

Sequence No.	Description
1	Clip
2	Hexagonal key

Install the Operator Panel

To install the computer in the panel cutout, perform the following steps.

Perform the following steps to install the computer in the panel cutout.

IMPORTANT You need two people to install the computer; one person to hold the computer in place while another person installs the mounting clips.

1. Cut an opening in the panel area to the dimensions needed for your operator panel.
2. After the cutout is completed, clean the panel area of all debris and metal fragments.
3. Make sure that the sealing gasket is positioned properly on the operator panel.

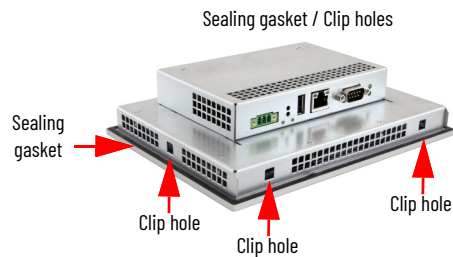

IMPORTANT The gasket is a part of the display and forms a compression-type seal. Do not use sealing compounds.

4. From the front of the panel insert the computer into the cutout (A) and rotate it (B) until it adheres completely to the panel (C).

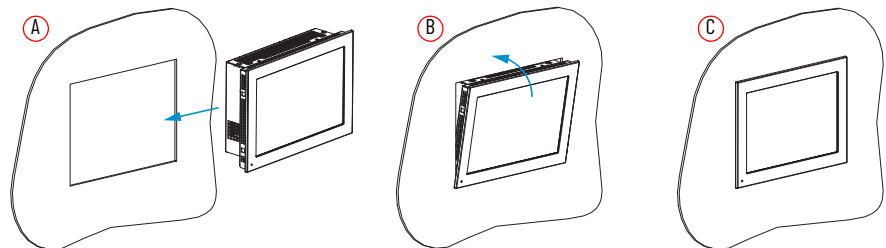

- Slide the mounting clips into the holes on all four sides of the computer and repeat the following procedure for all the clips.

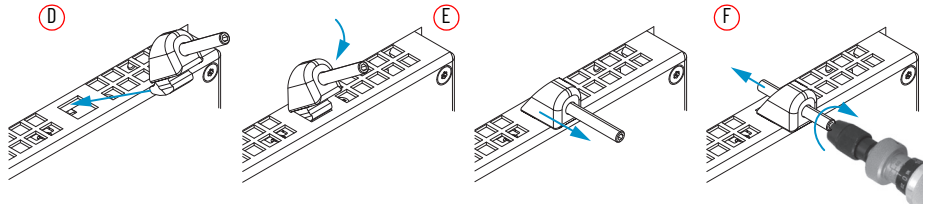

- Insert the clip into the mounting hole side (D).
- Rotate it down (E).
- Pull it outward (F).
- According to the tighten sequence in [Figure 10](#), tighten the mounting clips (F) with the supplied hexagonal key and verify the torque of 0.2 N•m (1.8 lb•in) with a limiting screwdriver (needed a 1.5 mm hex key bit).

Figure 10 - Mounting clips tighten and torque sequence by display size

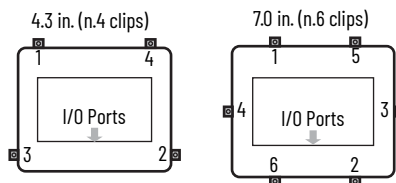

ATTENTION: tighten the mounting clips to the specified torque to provide a proper seal and to help prevent product damage. Rockwell Automation assumes no responsibility for water or chemical damage to the computer or other equipment within the enclosure because of improper installation.

DC Power Supply Guidelines

Follow these guidelines to select the DC power supply for the computer.

- These Operator Panels are intended to be connected to a “Secondary Circuit Overvoltage Category II”
- The Operator Panel must only be connected to a 24V DC () [admissible operating voltage range 18...32V DC ()] power supply which satisfies the requirements of safe extra low voltage (SELV) in accordance with IEC/EN/DIN EN/UL61010-1 and UL61010-2-201.
- The power supply has to fulfill the requirements NEC Class 2 or LPS in accordance with IEC/EN/DIN EN/UL60950-1.
- The inrush current cannot exceed a peak current of < 5 A and a pulse width time < 2 ms.
- Power consumption is rated at 11 W max @ 50 °C (122 °F) ambient temperature.

Power Consumption

[Table 3](#) shows the maximum power consumption in Watts of various components in the operator panels.

Table 3 - Maximum Power Consumption

Component	Description	Power [W]
Display size [in.]	4.3	0.5
	7.0	2.5
Motherboard and Processor	NXP® i.MX 8M Plus Quad ARM® Cortex® A53 1.6GHz	2.1
Storage	32GB eMMC	0.6
RAM	1 GB	1.3

Table 3 - Maximum Power Consumption (Continued)

Component	Description	Power [W]
USB	1x USB 2.0 (Type-A / host)	2.5
LAN	1x Gigabit Ethernet (RJ45)	0.6
Serial	1x RS232/422/485 (DB9M)	0.25



WARNING: Do not exceed 11 W for the total system configuration. Power consumption greater than 11 W can overpower the external and internal power supplies that can lead to component damage, or in extreme cases, electrical fires.

Connect DC Power

Required Tools

- Adjustable torque screwdriver with M2 and M3 flat-blade screw bits.
- Wire stripper, cutter, and crimper tool.
- Cutting pliers.

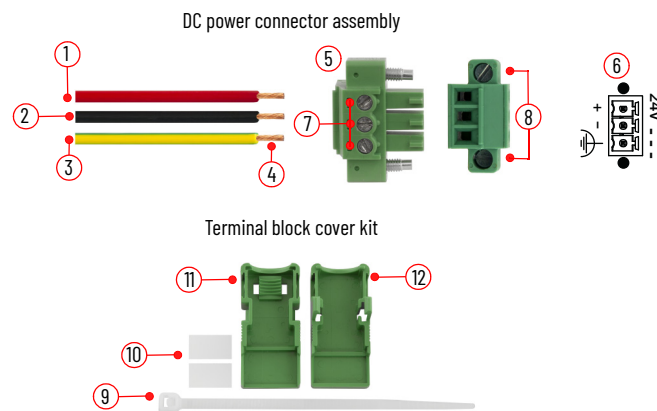

Item No.	Description	Note
1	DC+ (24V DC nominal)	1.5 mm ² (16 AWG) wire
2	DC- (0V DC nominal)	
3	Ground wire	
4	Stripped wire length	7 mm (0.275 in)
5	Terminal block	—
6	Polarity symbol	—
7	Torque range to secure DC power wires	0.22...0.25 N•m (0.16...0.18 lb•ft)
8	Torque value to reinstall DC terminal block to computer	0.3 N•m (0.22 lb•in)
9	1 cable tie	—
10	2 labels	—
11	Half cover with cable tie slot	—
12	Half closing cover	—

- Remove the DC terminal block (5) from the computer.
- Use wires not included, (1) (2) (3) with 1.5 mm² (16 AWG) cross section.



The color of wires should follow the local regulations.

- Strip 7 mm (0.275 in) the end of each power wire (4).
- Insert each stripped end into the DC terminal block and fix it with the corresponding screws (7) with 0.22...0.25 N•m (0.16...0.18 lb•ft) torque.
- Insert the cable tie (9) through the slots of the terminal block (11) connector clamp [step (A)].

6. Slide the connector half with the attached tie onto the end of the DC terminal block [step (B)].
7. Tighten the tie and remove the excess part [step (C)].
8. Install the white labels (10) supplied with the terminal block cover kit [steps (D)(E)].



The white labels (10) can be used for identification or other information.

9. Align and install the other connector (12) clamp half [step (F)] to complete the assembly [step (G)]



When installed correctly, both tabs of the clamp half lock into place.

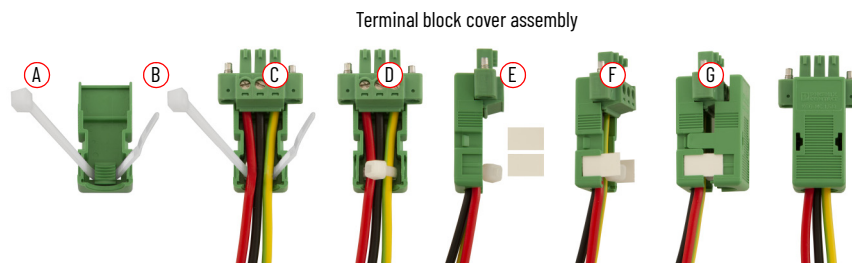

10. Connect the DC terminal block (complete with cables and cover) to the Operator Panel chassis and fix it with the corresponding screws (8) with 0.3 N•m (0.22 lb•ft) torque.



ATTENTION: The earth ground connection to ground is mandatory. This connection is required for noise immunity, reliability, and Electromagnetic Compliance (EMC) with the European Union (EU) EMC Directive for CE marking conformance. This connection is required for safety by Underwriters Laboratory (UL).

11. Apply power to the Operator Panel.
12. LED (a) and LED (b) illuminate green.
13. The operating system desktop appears after few seconds.

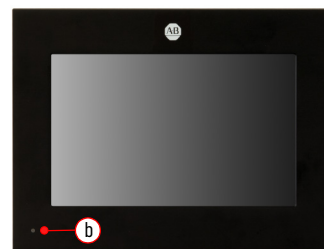
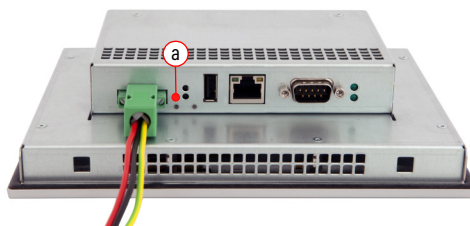

LED (b) is present only on 7.0 in. size.

Operation

Operating guidelines

Follow these operating guidelines for your operator panel.

When your operator panel is mounted in an enclosure:

- operator access is limited to the front of your operator panel, which includes the display and the touch screen.

IMPORTANT Access to components behind the panel where your operator panel is installed is restricted to authorized and properly trained personnel.

- keep the enclosure door closed during operation to minimize dust and other airborne contamination entering your operator panel. Open the door only for routine maintenance.



ATTENTION: Do **not** operate your operator panel with the covers removed. All covers are required to maintain its electromagnetic interference (EMI) shield.

- After you shut down your operator panel, do not apply power again until shutdown is complete.

IMPORTANT It is highly recommended, from cyber-security perspective, to physically protect the Operator Panel's I/O (i.e. Ethernet, Serial and USB ports, Reset and Factory Reset push buttons) from unauthorized access installing the OptixPanel in an enclosure.

Touch Screen Precautions



WARNING: Failure to follow these instructions can result in potential death, serious injury, or equipment damage.

Use of the LCD screen could result in a potentially hazardous outcome if the LCD screen darkens, is difficult to read, or the back light is not functioning properly. Do **not** use the LCD touch screen under these circumstances.

The design of the system must consider the possibility of the LCD screen or LCD touch screen to lose functionality, which can result in the inability to use, maintain, or change control of the system. The touch screen **cannot** be the single point of control of critical functions and is **not** intended to replace an E-stop. Design of the system must follow all applicable code and good engineering practice. Factors to consider include:

- the possibility of an unreadable LCD screen
- the possibility of an inoperable touch screen
- unexpected communication errors or delays
- operator error in the control of the system
- proper use of E-stops and other safety practices

You must provide means to achieve a safe state during anomalies and verify that the system has adequate redundancy for critical functions.

Touchscreen calibration

The calibration of the touchscreen is only possible via panel in the General Menu, under Display. The option does not appear on the web version of the System Manager.

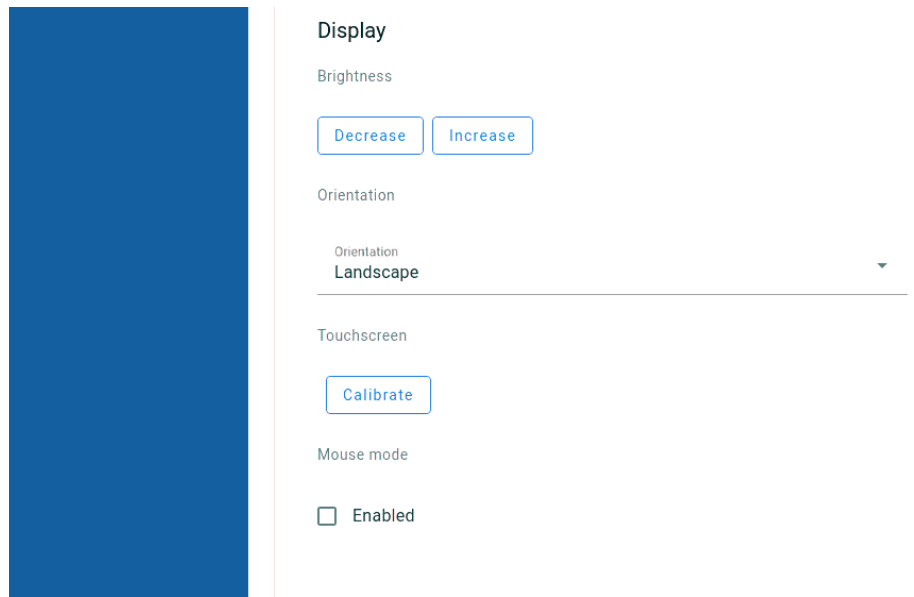

The calibration of the touchscreen is needed only for the Resistive Touchscreens. If your OptixPanel device uses a Capacitive Touchscreen, the Calibrate option is not shown.

In order to Calibrate:

- Place yourself in front of the panel and access the System Manager.
- Navigate on the Display section in the General Menu.
- Press Calibrate.

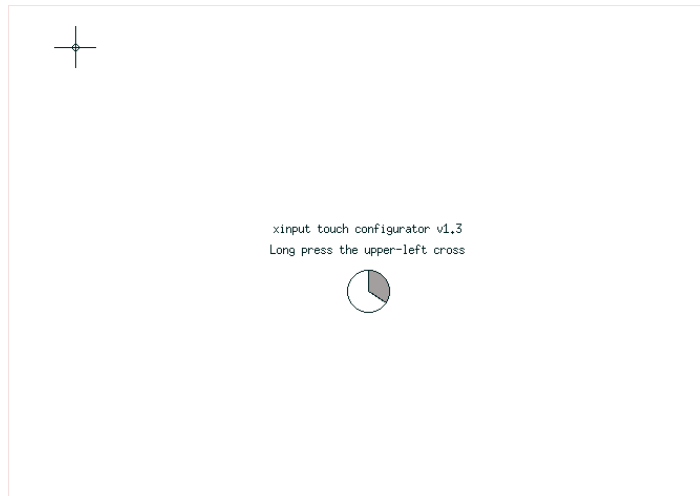

- Follow the instructions on the screen and press on the crosses on the screen as they appear.

The new calibration parameters are automatically saved as you exit the calibration procedure.

Restart/Factory reset

Table 4 - OptixPanel Compact operator panel

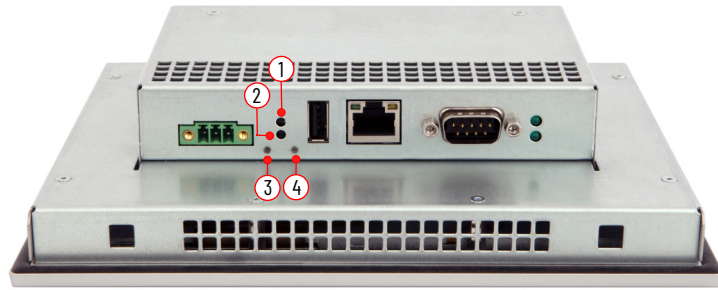

Note No.	Description
1	Restart button
2	Factory Reset button
3	Restart / Power LED
4	Factory Reset LED

Restart



This Restart button must be used when other options (use of keyboard / mouse) do not work.

Press the Restart button (1) to perform a restart of the system. The Restart / Power LED (3) illuminates red for a few seconds.

Table 5 - Power ON / Restart LED

LED	Color	Function
Power ON	Green	The system is powered on
	Red	The system is restarting

Restore to Factory Defaults

This procedure allows restoring the firmware to the original factory defaults which means also that if the firmware has been updated, given that the factory default will be restored, this will result in a downgrade.

IMPORTANT HMI software licenses are maintained.



The restore procedure will not remove:

- FactoryTalk Optix entitlements.
- The link to FactoryTalk Remote Access organization. This means that it is not possible to change the Organization/Domain doing the restore to factory defaults as a protection against unwanted Organization/Domain change.
- Contents of microSD card or USB Memory plugged on the device.

IMPORTANT Before proceeding, make sure to back up any important data stored on the device. This procedure erases all user settings, configurations, and data like the FactoryTalk Optix application and the related FactoryTalk Optix runtime.

IMPORTANT The process takes approximately 2 minutes to complete. During this time, it's important NOT to turn off the device or remove power.

To restore your device to its factory defaults, follow the steps below:

1. Power Off the device.
2. Power On the device while pressing and holding the "**Factory Reset**" pushbutton (2).

3. Keep pressing the **"Factory Reset"** pushbutton (2) while the **"Factory Reset"** LED (4) blinks in blue 4 times.
4. Stop pressing the **"Factory Reset"** button (2) when the **"Restart / Power"** LED (3) becomes steady green.
5. After a few seconds, the **"Factory Reset"** LED (4) starts rapidly blinking in blue, alternatively with **"Restart / Power"** LED (3) that blinks in green: this means the restore is in progress.
6. The restore is completed when the **"Restart / Power"** LED (3) turns off and the **"Factory Reset"** LED (4) will become steady blue, then the **"Factory Reset"** LED (4) turns off and the **"Restart / Power"** LED (3) will stay steady green.
7. At the end the system restarts.

Table 6 - Restart / Factory Reset LED

LED	Color	Function
Factory Reset	Blue	Blinking blue when factory restore procedure is in progress.
	Off	Normal state.

Configuration

Factory settings

Default Configuration

The devices can have one or two Ethernet interfaces, whose factory settings is shown in the following table.

Device type	Interface	IP address	Mask
2800S - OptixPanel Standard	Eth1: LAN	192.168.0.1	255.255.255.0
	Eth2: WAN	dynamically assigned by DHCP	
2800C - OptixPanel Compact	Eth1: LAN	192.168.0.1	255.255.255.0

Device configuration access is protected with a combination of username and password.

The default **username** is **admin**.

The default **password** is **admin**.

At the first access, you will be prompted to change the password. After the password changes a restart will be required.



The admin account allows to access the System Manager interface and is also the one to be used to transfer the Optix Application via FactoryTalk Optix Studio.

System Manager

Access the System Manager

The device can be configured through the System Manager application, accessible locally from the device or remotely via any web browser.

Access from device

1. After it is powered on, the Device starts showing the boot logo.

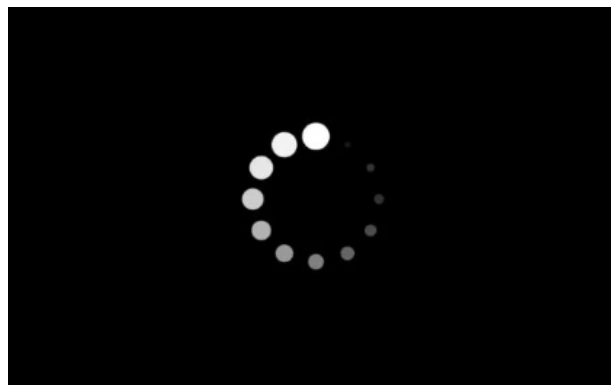

2. Click on the blue button with the caption "Touch here to open Device Configuration", that appears on the screen:

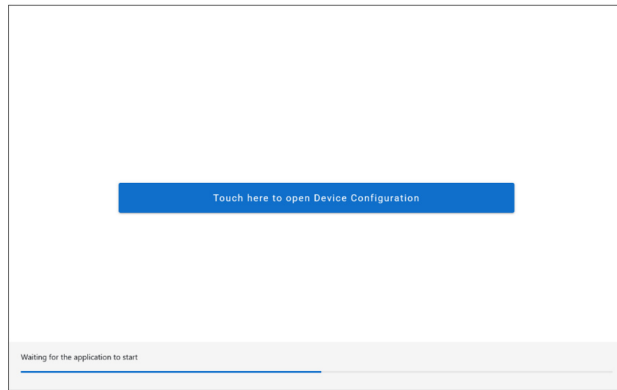

A popup for the login appears:

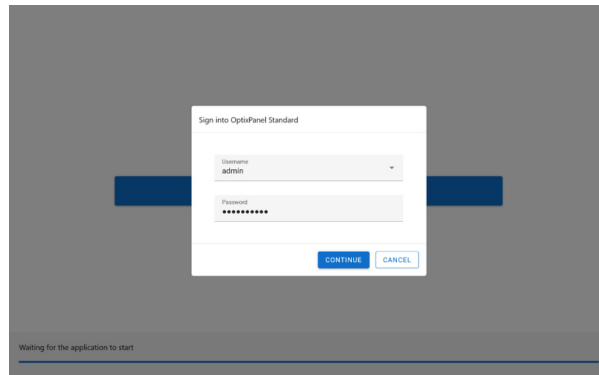

If it is the first time accessing the System Manager, you have to use the default credentials:

- username: admin
- password: admin

Then after the login, you will be required to change the password.

IMPORTANT

Creating a strong and secure password can reduce the risk of cybercriminals guessing your password and accessing sensitive data.

For this reasons, the password must meet the following criteria:

- be at least 8 characters long.
- meet at least 3 of the following requirements: at least one uppercase character, at least one lowercase character, at least one numeric character, at least a symbolic character.

Given that a strong password makes the amount of time it takes to guess it exponentially longer, it's highly recommended the use of pass phrases longer than 8 characters.

From the second time on, you can access with the "admin" username and the new password, or with the User account (if activated by the Admin).



ATTENTION: Take note of the new password! Admin account is required to transfer the Optix Application via FactoryTalk Optix Studio. If you lose the password, you must restore the device to Factory Defaults, which deletes the Optix Application and system updates.

Access from a Browser

System Manager can also be reached remotely via Ethernet connection, by typing the device's IP address into a web browser window. See [Factory settings](#) for the Ethernet interface default configuration.

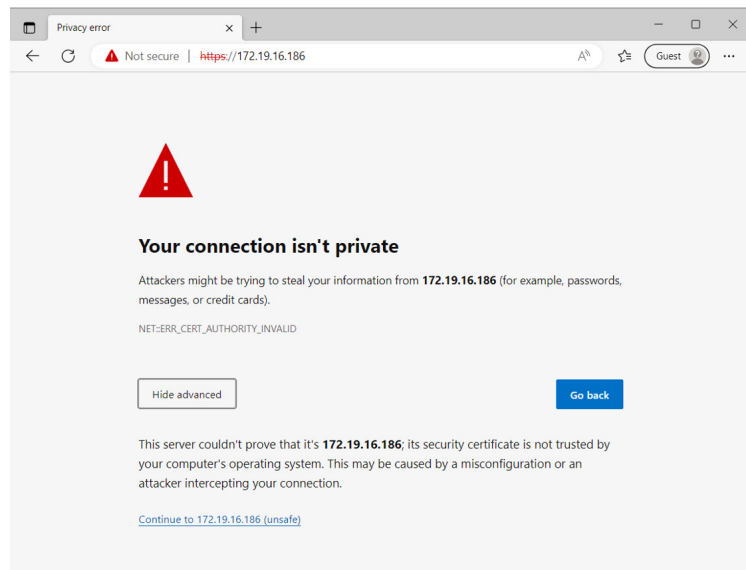

When you remotely access the system (not via Browser to System Manager), you may be warned that the connection is not private and the security certificate is not trusted. In this case, select the Advanced option and proceed.

To access the System Manager interface you are prompted to authenticate. If it is the first time accessing the System Manager, you have to use the default Admin username and password, then you will be prompted for the password change.

From the second time on, you can access with the Admin username and password, or with the User account (if activated by the Admin).



ATTENTION: Take note of the new password! Admin account is required to transfer the Optix Application via FactoryTalk Optix Studio. If you lose the password, you must restore the device to Factory Defaults, which deletes the Optix Application and system updates.

System Manager

The System Manager interface is divided into the following sections:

- General
- FT Optix
- Interfaces
- Networking.
- FT Remote Access
- Users
- Diagnostic

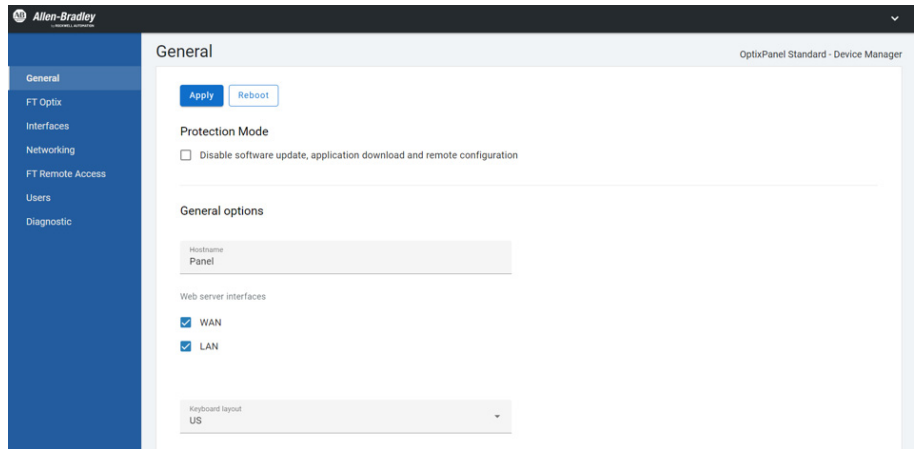

Apply the configuration to the device

To apply changes to the device it is enough to click the “Apply” button. A message will confirm the success of the operation. Depending on the options changed, the device will need to be restarted with the “Reboot” button.

General

Protection mode

Disable software update, application download and remote configuration

When this option is enabled on your device, the security of the device is enhanced by disabling software updates, application downloads, and remote configurations. In this state, the device will reject the following actions:

- Interface updates: TCP/IP configuration (configuration method, network address, hostname), Ethernet Link configuration (link enable, speed, and duplex) and remote configuration requests via CIP.
- Firmware updates via USB or remotely through FactoryTalk Remote Access.
- FactoryTalk Optix application updates.

The device will still accept settings and reboot requests through the System Manager web interface, FactoryTalk Optix System Tags, and FactoryTalk Remote Access tools, which all require user authentication. This ensures that changes are only made by authorized administrators.

IMPORTANT

Protection Mode is disabled by default for all out-of-the-box products and after a factory reset.

To reduce the surface of cyber-attacks is highly recommended to enable this option in a production environment, preventing unauthorized changes and potential security risks.

General Options

Hostname

The Hostname is a unique identifier that is assigned to the device. It is used to identify and communicate with the device over the network and can be used to configure or troubleshoot the device as needed. This name will be the device name visualized on the FactoryTalk Remote Access organization.

Web server interfaces

- WAN - Enable this option to allow access to the System Manager through the device's WAN port. This makes it easy for users to remotely manage and configure the device via the web interface.
- LAN - Enable this option to use the System Manager through the device's LAN port. This allows users to access the web interface for device management and configuration via the local network.



It is recommended to configure the options above to let the web server be only accessible from the strictly needed interfaces to reduce surface exposure to cyber-attacks. Ideally, it should be only enabled when the configuration needs to be changed.

Keyboard layout

Configuration of the device's keyboard layout. This setting allows you to choose the appropriate layout for your region or language preferences, ensuring that the device recognizes the correct characters and key positions when you type. The available options are the US (United States), DE (Germany), and IT (Italy). Changing the keyboard layout will adjust the key mapping to match the standard keyboard layout for the selected country, enhancing your typing experience and reducing the likelihood of typing errors.

Boot

Show boot menu at startup

When enabled, display the button "Touch here to open Device Configuration" to access the System Manager when the device start.



To reduce the surface of cyber-attacks is highly recommended to disable this option in a production environment, preventing users from being able to access System Manager directly from the device.

Application startup delay

The default startup time of the application is 5 seconds. This includes the time it takes to visualize the loading progress bar and the button to access the device configuration (if enabled). By default, the startup delay is set to 0, meaning the application will start up after 5 seconds. If you set a different delay, the startup time will be 5 seconds plus the value set in the Application startup delay (seconds) field.

Display

Brightness

Increase or decrease the screen brightness in 10% steps.

Orientation

Sets the orientation of the display: Landscape, Portrait, and Portrait (flipped).

This combo box allows you to change your device's screen orientation according to your viewing preferences or setup requirements. By default, the screen orientation is set to Landscape, which displays content horizontally. There are two additional alternatives available: Portrait and Portrait (flipped). Portrait mode presents content vertically, while the Portrait (flipped) option rotates the vertical orientation by 180°, which can be helpful in unique mounting situations or for accessibility purposes.

Calibrate

Turn on this option to start the display calibration process, which enhances the touchscreen's precision. When activated, a small red X will show up on the screen for you to tap. After tapping the red cross, a green check mark will appear to confirm success. Do this four times (4 red X in total). After completing all four, the screen is calibrated for better touch accuracy.



Available only on devices with resistive touchscreen, not available via browser.

Mouse mode

This check box is specifically designed for resistive touchscreen displays. When enabled, it provides users with the ability to select text by dragging, rather than scrolling.



Only available for device with resistive displays.

Date and time

Time synchronization mode

This combo box enables you to configure your device's date and time settings. Select Manual to set the date and time manually or choose Auto (Remote NTP server) to synchronize the date and time automatically using a remote Network Time Protocol (NTP) server.



The device can be configured to automatically adjust the date and time from a remote NTP server and provide the same service to connected devices (local NTP server).

Remote NTP Server

Visible only when the Time synchronization mode is Auto (Remote NTP server), allowing to set the IP address of the NTP server.

Date/Time

Enabled only when the Time synchronization mode is Manual, allowing to set the current Year/Month/Day and Hour/Minute.

Time zone

Allow to set the time zone that will affect the current time.

Local NTP server interfaces

The Local NTP server interfaces check boxes activate the local NTP server on the specified interface (WAN and/or LAN), maintaining accurate timekeeping across your network. Selecting at least one interface will enable the local NTP server to listen for connections on the standard UDP port 123. Selecting no interface will disable the local NTP Server.

External storage devices

USB Enabled

This check-box allows to activate/deactivate the mount of storage devices on USB ports. This switch doesn't impact the recognition and usage of USB devices like Keyboards, Mouse or other HID devices.

Micro SD Enabled

This check-box allows to activate/deactivate the mount of storage devices on micro SD slot.

Format Micro SD as EXT4

This button allows formatting the Micro SD card plugged into the slot with the EXT4 filesystem. This is the preferred filesystem when the Micro SD card is used to extend the content of the OptixPanel eMMC memory, for example as a storage of the Optix Application's embedded database file.

System information

This section shows useful information about your device such as the Product Name and the version of software components that are part of the Firmware:

- Firmware version.
- OS version.
- System Manager version.
- FactoryTalk Remote Access runtime version.



Please note that version of OS, System Manager and FT Remote Access runtime are dependent on the Firmware version.

Update Firmware

The Update Firmware button allows to upload a firmware image (.img file) to the OptixPanel directly from the browser. Please refer to the section "Update the device" for more information about it.

Legal notices

The Legal Notices section of the device manual has two types of licenses: Main Licenses for commercial software and Open-Source Licenses for open-source software.

Options for FactoryTalk Optix Runtime and its entitlements.

Configuration

Run FT Optix update server at system startup

When this setting is enabled, the FactoryTalk Optix update server activates at device startup, allowing the download and update of FactoryTalk Optix applications using FactoryTalk Optix Studio. If not enabled, downloading and updating FactoryTalk Optix applications on the device is not possible.

Load only password protected applications

When this setting is enabled, will be possible to load and execute on the device only password protected applications.

Enable Modbus TCP-over-USB

When this setting is enabled, the FactoryTalk Optix Application will be able to communicate using the Modbus TCP communication driver via the OptixPanel USB port. This communication mode is only available for a limited set of PLCs that are listed in the tooltip on the System Manager web interface.

FT Optix

Application

Application name

This section displays the name of the project that has been loaded onto the device.

FT Optix Runtime version

This section displays the version of the FactoryTalk Optix Studio that was used to develop the loaded project. The FactoryTalk Optix Studio provides a development environment for creating and testing HMI projects before deploying them to the device. The version number is important for ensuring compatibility between the project and the runtime environment and may be useful for troubleshooting issues related to project development and deployment.

Load application from USB

The Load button allow to transfer an FT Optix Application from a USB Memory to the OptixPanel. The procedure requires following steps:

- From FT Optix Studio, you select Save > Export > FactoryTalk Optix Application choosing OptixPanel Standard/Compact as target.
- Define a password for the package.
- Transfer the package to an USB Memory.
- Plug the USB Memory into an available USB port.
- Press the "Load" button.
- In the pop-up, type-in the previously defined password.



Note: optionally it's possible to select "Delete all application files". This is useful if you are updating an application and you want to clear up all historical data of the project (dataloggers db, persistent db...).

Delete current application

The Delete button allow to delete the current application stored on the device.

Entitlement

Installed entitlements

The Installed entitlements section shows the already present entitlement keys one by row. By pressing the row of an entitlement key, the button Details allows you to open a dialog with all the entitlement details.

The button "Rehost" instead, is meant to send back the entitlement and the entitlement key to the FT Optix dashboard (under Organization Entitlement) on FT Hub so can be used on another device.

NOTE: the default entitlement that is provided from factory cannot be rehosted.

Activate a new entitlement

OptixPanel comes out-of-the-box with a pre-activated Entitlement with a certain size in token. It's possible, going to the [Rockwell commerce portal](#), to purchase an upgrade for next size up.

The purchased Entitlement upgrade, then will be provided through the FactoryTalk Design Hub and can be assigned to your own organization. On FactoryTalk Optix section of FactoryTalk Design Hub portal, which is part of, under Entitlements you will then find the Entitlement Key to be used for the online or offline activation.

The Activate a New entitlement section provides two options for activating an entitlement upgrade on the device: Online and Offline.

Online

- If the device has internet access, by clicking the Online button, a popup appears where you are asked to type in the entitlement key.
- Then selecting "Activate" the device will contact the FactoryTalk Optix servers to validate the key and activate the entitlement on the device. Then a popup showing the result of the activation process appear

Offline

- If the device does not have internet access, it is possible to activate the entitlement by using the Offline button. The offline activation procedure consists of three steps explained below: Export the entitlement activation request, activate the entitlement on a PC with internet access and then install the entitlement on the device.
- On the device, selecting the Offline button, a popup appears where you have to select "Export an entitlement activation request for this device to a file". Then you are asked to type in the entitlement key and by pressing the button "Create", the procedure will create a .req file.
- On the Entitlement Manager, part of the FactoryTalk Optix Runtime Tools, on a PC with internet access, click the Online button and select "Activate an entitlement for a different device". A popup appears to provide the .req file and if activation succeeds an entitlement file .ent is generated in exchange.
- On the device, selecting again the Offline button, a popup appears where you have now to select "Install an already activated entitlement file into this device". Then you are asked to import the .ent file and a popup showing the result of the activation process appears.

Interfaces

Section to set the device's interfaces.

Eth1: LAN

Mac address

The MAC address section displays the unique identifier for the Eth1 port of the device. This address is essential for network communication and device identification purposes.

Obtain IP configuration automatically

The Obtain IP configuration automatically checkbox option for the Eth1 (LAN) device port enables the automatic acquisition of an IP address, subnet mask, and default gateway from a DHCP server on the local network.

IP addresses

More common for the LAN interface is to use a fixed IP and, in this case, un-mark the checkbox, specify the IP with the mask, and click the Add button. The IP will be added to the list.



Please note that the LAN interface supports also multiple IPs. To add additional IP, simply repeat the above sequence. To delete an IP address from the list, select the IP and hit the Remove button. All the classes corresponding to the added IP/ mask couples will be reachable from the VPN through FactoryTalk Remote Acces.

Enable enhanced discovery on Eth1:LAN interface

The FactoryTalk Remote Access provides a Device Discovery tool that can identify OptixPanels that are available on the network. In certain network topologies, such as when the OptixPanel and the PC running the Discovery Tool are on different subnets and without a default gateway, the device may not be detected. Activating this option allows the device to be detected on Eth1:LAN, regardless of the network configuration.

Serial Port

This section allows setting up the serial port mode for the usage from FactoryTalk Optix application or FactoryTalk Remote Access serial pass-through. Click on the combo box to access the available options. The options are the following:

- RS-232C.
- RS-422.
- RS-485.

FT Remote Access

Options for connecting the device to a FactoryTalk Remote Access organization.

Connection

The Connect/Disconnect button lets you manage the connection/disconnection of the device to/from the FactoryTalk Remote Access Network. By pressing Connect, if the device has never been registered to an FactoryTalk Remote Access domain, the ID and Password will appear to be used for the registration.



The only way to unregister a device from its FactoryTalk Remote Access organization is to delete the device from the FactoryTalk Remote Access manager. Then the ID and Password will reappear to be used for a new registration.

Status

This section displays the connection status to the FactoryTalk Remote Access services. Possible statuses include:

- Disconnected from the FactoryTalk Remote Access infrastructure.
- Connecting.
- Connected to the FactoryTalk Remote Access infrastructure.
- Disconnecting.
- Protocol error.
- A newer version of firmware is required.
- This firmware version is not supported by the Server.
- Device registration error.

Configuration

This section outlines the configuration parameters required for establishing a connection to a FactoryTalk Remote Access organization.

Availability mode

- Always on—When is checked it's not possible to disconnect the device from the FactoryTalk Remote Access network and also is not possible to manage the connection/disconnection of the device to the FT Remote Access network from the FactoryTalk Optix application.
- Reconnect to server on reboot if left connected - If turned on, this option reconnects to the server automatically after restarting the device, if it was connected before.

Connection port

Select the appropriate port for connecting to the FactoryTalk Remote Access organization's servers. The available options include Auto (automatic selection), 80, 443, or 5935.

Server

Determine whether the FactoryTalk Remote Access network to which the device should connect.

- **Public:** this is the default value and means that the device will connect to the public network infrastructure hosted by Rockwell Automation.
- **Legacy:** means that the device will connect to the legacy public network infrastructure as known as Ubiquity.
- **Private:** means that the device will connect to an on-premise/private network infrastructure (future).

Proxy configuration

Configure the connection parameters for the FactoryTalk Remote Access organization if a proxy is required. The available options for proxy types are: None (no proxy), SOCKS5, and HTTP. Choose the option that best aligns with your network requirements and security policies.

Local Connection

Enabled

Activate the Local Connection feature, allowing the connection to the device by using FT [Remote Access Tools](#) without an Internet connection and leverage similar functionality to VNC with additional capabilities.

Password

Define a local password to be used to connect to the device through the Local Connection.

Networking

VPN

In this section, it is possible to choose which networks are reachable when establishing a VPN through FactoryTalk Remote Access.



OptixPanel Compact includes by default the FactoryTalk Remote Access Basic entitlement that allows only to establish a VPN limited to the device only.

Network interfaces

- **LAN** - Select this option to be able to reach via VPN the device with the IP Address defined on Eth1 port.
- **Point-to-point virtual Ethernet adapter** - Select this option to be able to reach via VPN the device with the IP Address of the virtual Ethernet adapter (10.173.249.x).

Reserve static IP pool for VPN

Enabling this option lets you define one or more IP pools that are used to dynamically assign the IP address to the remote PC on which the FactoryTalk Remote Access tools are running.



ATTENTION: The IP addresses included in the pool are not subject to any check, it is your responsibility to ensure that there is no conflict with WAN or LAN subnets.

Users

Accounts

This section allows you to:

- Change the password for the Admin account.
- Enable the low-privileged User account.

Passwords for both Admin and User accounts must meet the following requirements:

- must be at least 8 characters long.
- must meet additionally at least 3 of the following requirements:
 - at least one uppercase character.
 - at least one lowercase character.
 - at least one numeric character.
 - at least a symbolic character.

Enable the User account

After the first configuration of the device, you can enable the low-privilege account called User by selecting it from the menu and assigning a password.

The password assigned to this account can then be replaced by the end user. If necessary, the Admin may reset the User's password at any time by disabling the User account.

The user account can be used to access the System Manager from the device or from the Browser.

The available options to the user account are as follows:

- General options, without the option Web server interfaces.
- Display brightness.
- Mouse mode.
- Date and Time, without the option Set local NTP server interfaces.
- System information and Legal notices.
- Entitlements (activate and Details).
- WAN.
- FactoryTalk Remote Access, without Connection status, Server, and Availability mode.
- Password, for changing the user's login password.
- Ping.
- Export diagnostic logs.

IMPORTANT In case of User's password loss, the Admin user can change/reset it.

Security Policies

Automatic session lock

Define how many minutes the System Manager session will be kept active.

When timed out, a popup with 30 second countdown will appear allowing the user to avoid the session being closed.

Maximum password age (days)

Determines the maximum period of time (in days) that a password can be used before it must be changed. You can set a value between 0 (that means disabled) and 365.

Enforce password history

Prevents users from reusing a certain number of previous passwords. You can set a value between 1 and 20.

Minimum password age (days)

Determines the period of time (in days) that a password must be used before the user can change it. You can set a value between 0 (that means disabled) and 365 or greater than the Maximum password age (if defined).

Diagnostic

The Diagnostic section provides tools for troubleshooting and identifying issues with the device. This section includes two options: Ping and Export Diagnostic Logs.

Ping

The ping option allows the user to run the ping command to an IP address specified in the Network address box. This tool tests network connectivity and can help identify issues with network communication. The result of the ping command will be the log file SystemManager_log_*.txt available in the Export logs section.

Logs

The Export all button, allows the user to download files containing activity logs. These logs provide valuable information for diagnosing issues and identifying the root cause of problems with the device. It is possible to download a file containing logs that can be reviewed and analyzed for troubleshooting purposes.



Logs can be exported only via Browser. This feature is not available when the System Manager is opened locally from the device.

Maintenance

The Maintenance section covers tasks like setting up a new device or replacing hardware importing an existing configuration, and exporting your settings to move them between devices.

Configuration Import

The Import can be done manually by using the button available into the System Manager interface or automatically at startup. The import of the configuration file at startup requires that the OptixPanel be in its factory default state.

Then following steps must then be taken:

1. Load the previously exported configuration file into a USB stick.
2. Plug the USB stick into the device's USB port and reboot it.
3. After rebooting, the configuration will be applied. It is important to note that the device may reboot itself.
4. In the event of an error occurring during the process, the error will be logged into the System Manager logs.

The manual import, by using the button in the System Manager interface, behaves differently depending on whether the System Manager is opened from a web browser or directly from the device.

- From a browser: the procedure opens a dialog to browse for a previously exported configuration file with the JSON format.

- From the device: the previously exported configuration file must be loaded on a USB stick and plugged into the device's USB port. The importer will look for a json file with the device's serial number into the filename. If it's not found, it will look for a generic file named "DeviceConfiguration.json".

Configuration Export

The Export allow you to export in a json file the device's configuration. The UI allow to choose which settings have to be exported then the Export button behaves differently depending on whether the System Manager is opened from a web browser or directly from the device:

- From a browser: after confirmation, the configuration file with format "{hostname}_{serial_number}.json" gets downloaded.
- From the Device: after confirmation, if a USB drive is present, the configuration file with format {hostname}_{serial_number}.json" gets saved on the USB drive as a file.

Update the Device

Firmware update

The firmware is a collection of software components whose versions are available in the System Information section, located at the bottom of the General screen. The firmware image can be updated remotely through FactoryTalk Remote Access or locally by uploading via the System Manager web interface or using a USB Memory.

Local update via System Manager

By using the Update Firmware button, available under the System Information group of the General page, is possible to upload a firmware image to the device directly from the browser.

The upload can be interrupted/resumed and at the end of the transfer, if it succeeds, you can start the firmware upgrade simply doing a reboot.

While restarting, the device detects the firmware image file and checks if it's valid, then the update procedure starts: the "POWER" led will stay steady green while the "Update in progress" message is displayed on the screen.

The update is completed when, after the device reboot, the "FACTORY RESET" led starts rapidly blinking in blue, alternatively with the "POWER" led blinking in green, then the "FACTORY RESET" led turns off and the "POWER" led will stay steady green.

IMPORTANT The process takes approximately 2 minutes to complete. During this time, it's important NOT to turn off the device or remove power.

Local update via USB memory

The firmware image is provided in the format of a single file that works as a "container" for the components to be updated. The container files are identified by the extension .img and for convenience, firmware images are available on the Product Compatibility and Download Center ([PCDC](#)) portal.



Firmware update is supported only via USB Memory with file systems FAT32 or exFAT.

MicroSD Cards are not supported.

IMPORTANT The process takes approximately 2 minutes to complete. During this time, it's important NOT to turn off the device or remove power.

To execute the update, copy the proper file to the root folder of an empty USB Memory, plug the USB Memory into the device's USB port, and reboot.

While restarting, the device detects the USB Memory with the firmware image file and checks if it's valid, then the update procedure starts: the "POWER" led will stay steady green while the "Update in progress" message is displayed on the screen.

The update is completed when, after the device reboot, the "FACTORY RESET" led starts rapidly blinking in blue, alternatively with the "POWER" led blinking in green, then the "FACTORY RESET" led turns off and the "POWER" led will stay steady green.

Remote update via FT Remote Access

Alternatively to local update via USB Memory, it is possible to update the device remotely, transferring the firmware image through the FactoryTalk Remote Access.



This procedure requires that the device has been registered within a FactoryTalk Remote Access organization. See the FactoryTalk Remote Access user manual to learn how to get access to FactoryTalk Remote Access Manager and how to register a device in an organization.

IMPORTANT The process takes approximately 2 minutes to complete. During this time, it's important NOT to turn off the device or remove power.

Using the FactoryTalk Remote Access manager web interface, select the device from the Domain view and click on the Device Access button, paying attention to selecting the Advanced mode.

When the FactoryTalk Remote Access Tools window opens, select the Explorer tab on the left menu and copy the firmware image from the local system to the folder shown in the table.

Local System folder	Remote Device folder
...\ <i><FirmwareImage></i> .img	\persistent\data\Updates\ <i><FirmwareImage></i> .img

After copying is complete, restart the device by using the Restart button available in the left menu of the FactoryTalk Remote Access Tools window.

While restarting, the device detects the Firmware image file and checks if it's valid, then the update procedure starts: the "POWER" led will stay steady green while the "Update in progress" message is displayed on the screen.

The update is completed when, after the device reboot, the "FACTORY RESET" led starts rapidly blinking in blue, alternatively with the "POWER" led blinking in green, then the "FACTORY RESET" led turns off and the "POWER" led will stay steady green.

Restore the Device to factory defaults

Restore to Factory Defaults

This procedure allows restoring the firmware to the original factory defaults which means also that if the firmware has been updated, given that the factory default will be restored, this will result in a downgrade.



The restore procedure will not remove:

- FactoryTalk Optix entitlements.
- The link to FactoryTalk Remote Access organization. This means that it is not possible to change the Organization/Domain doing the restore to factory defaults as a protection against unwanted Organization/Domain change.
- Contents of USB Memory plugged on the device.

IMPORTANT Before proceeding, make sure to back up any important data stored on the device. This procedure erases all user settings, configurations, and data like the FactoryTalk Optix application and the related FactoryTalk Optix runtime.

IMPORTANT The process takes approximately 2 minutes to complete. During this time, it's important NOT to turn off the device or remove power.

To restore your device to its factory defaults, follow the steps below:

1. Power Off the device.
2. Power On the device while pressing and holding the "FACTORY RESET" pushbutton.
3. Keep pressing the pushbutton while the "FACTORY RESET" led blink in blue 4 times.
4. Stop pressing the pushbutton when the "POWER" led become steady green.

After a few seconds, the "FACTORY RESET" led starts rapidly blinking in blue, alternatively with "POWER" led that blink in green: this means the restore is in progress.

The restore is completed when the "POWER" led turns off and the "FACTORY RESET" led will become steady blue, then the "FACTORY RESET" led turns off and the "POWER" led will stays steady green.

External storage devices

The device allows the use of USB Memory as storage devices.

USB Memory is usually used as temporary storage (i.e. file transfers, logs, system updates).

For these reasons, different file systems are supported:

Storage type	File system supported	Usage
USB Memory	FAT32	Suggested if used as temporary storage
	exFAT	

To access external storage devices through an Optix Application, use the system path shown in the following table:

Storage type	Folder
USB Memory	/storage/usb1
	/storage/usb2
	/storage/usb3
	... is accessed with progressive numbers

Clean the Operator Panel

For optimal performance, it is important to clean the operator panels periodically.

To maintain your operator panel it is important to clean the display, vent holes, and to remove grease or paint.

-
- IMPORTANT** OptixPanel® operator panels resist the following chemicals:
- Alcohol (methyl, ethyl or isopropyl).
 - Commercial glass cleaners
-

Clean the Integrated Display

Perform the following steps to clean a display.

- Disconnect power from the operator pane at the power source.
-



ATTENTION: Since the display is a touchscreen, it is possible for screen objects to activate equipment wash-downs if the operator panel is turned on.

- Clean the display with a mild soap and a clean sponge or a soft cloth.
-



ATTENTION: Use of abrasive cleansers, solvents and high-pressure washes can damage the display window. Do not scrub or use brushes.

- Dry the display with a chamois or moist cellulose sponge to avoid water spots.
-

Clean the Air Openings and Heatsinks

Perform the following steps to clean the operator panel.

- Disconnect power from the operator panel at the power source.
- Disconnect all peripheral devices from the operator panel.
- Vacuum dust and debris from all air openings on the displays, and from any heatsinks on the chassis. Remove stubborn dirt with a mild detergent and soft cloth.

Remove Paint and Grease from the Bezel

Perform the following steps to remove paint and grease from the bezel of operator panels that are properly mounted in IP65 enclosures.

- Remove paint splashes and grease by rubbing lightly with isopropyl alcohol.
-



ATTENTION: Make sure that the isopropyl alcohol does not come in contact with the equipment labels. Alcohol can cause the label printing to smear.

- Use a mild soap or detergent solution to remove residue.
- Rinse with clean water.

Notes:

Troubleshooting

Display Troubleshooting

[Table 7](#) lists typical problems that are possible with the integrated display. It contains symptoms and possible actions to correct a problem.

Table 7 - Display troubleshooting

Symptom	Action
Screen is blank	Verify that the power cord is connected.
	Replace the suspected faulty cable or power cord.
	Have the monitor serviced.
Picture is scrambled	Check the tightness of the position screws, test the machine on a table far from the electric panel
Picture is not clear	Check the tightness of the position screws, test the machine on a table far from the electric panel, check the grounding
Applications appear blurry	Be sure to have the last operating system and runtime version installed
	Check the tightness of the position screws, test the machine on a table far from the electric panel, check the grounding
Image is not stable	Check the tightness of the position screws, test the machine on a table far from the electric panel, check the grounding
Screen jitter or noisy video	Check the host computer and monitor grounding.

Ship or Transport the operator panel

If you must ship the computer via common carrier or otherwise transport it to another location for service or any other reason, you must place it in its original packing material.

IMPORTANT Do not ship or transport the operator panel when it is installed in a machine, panel, or rack. To avoid damage to the operator panel, you must uninstall the operator panel and place it in its original packing material before you ship it. Rockwell Automation is not responsible for damage to a operator panel that is shipped or transported while installed in a machine, panel, or rack.

Dispose of the operator panel



At the end of its life, collect the computer separately from any unsorted municipal waste.

You cannot dispose of operator panel equipment like other waste material. Most computers and monitors contain heavy metals that can contaminate the earth. Therefore, check with local health and sanitation agencies for ways to dispose monitor equipment safely.

When a storage drive is part of what you plan to dispose, then erase any data on it permanently or destroy the drive before it is disposed of.

Notes:

Replace Components

OptixPanel™ operator panels have replacement parts and upgrade accessories. This chapter explains how to replace or add these components.

IMPORTANT Access to internal components of the operator panel is restricted to qualified and properly trained personnel.

Voltage precautions

The operator panels contain line voltages. Disconnect all power to the operator panel before you install or remove components.

Electrostatic Discharge Precautions

Follow these ESD precautions:



ATTENTION: Electrostatic discharge (ESD) can damage static-sensitive devices or micro-circuitry:

- Disconnect all power before you work on the operator panel as detailed in Voltage Precautions
- Observe all proper packaging and grounding techniques to help prevent damage

-
- Transport the operator panel and replacement parts in static-safe containers, such as conductive tubes, bags, or boxes.
 - Keep electrostatic-sensitive parts in their containers until they arrive at the designated static-free work area.
 - Cover the designated work area with approved static-dissipating material:
 - - Use an anti-static wrist strap that is connected to the work surface.
 - - Use properly grounded tools and equipment.
 - Keep the designated work area free of nonconductive materials, such as ordinary plastic assembly aids and foam packing.
 - Avoid contact with pins, leads, or circuitry.
 - Always hold components with a printed circuit board (PCB) by its edges and place it with the assembly side down.

Pre-configuration

IMPORTANT Before you install hardware or perform maintenance procedures that require access to internal components, we recommend that you first back up all operator panel data to avoid loss.



ATTENTION: Make sure to read and understand all installation and removal procedures before you configure the operator panel hardware.

Follow these steps before you remove the operator panel cover or replace a hardware component.

1. Shut down the operator panel and all peripherals that are connected to it.
2. To avoid exposure to high energy levels, disconnect all cables from power outlets. If necessary, label each cable to expedite reassembly.
3. Disconnect all peripheral cables from the I/O ports.
4. Loosen the mounting clips and remove the operator panel from its mounting.

Post-configuration

Follow these steps after you install or replace a hardware component.

1. Reinstall the operator panel to its mounting.
2. Tighten the mounting clips.
3. Reinstall any peripherals and system cables that were previously removed.
4. Reconnect all external cables and power to the operator panel.
5. Turn on the main power switch or breaker.

Remove the cover

To install, replace or upgrade internal operator panel components, you must first remove the cover.



Tools required:

- Torx screwdriver T7 (not provided).
- Hexagonal 5mm box spanner (not provided).
- Follow the steps for [Pre-configuration](#).
- With a hexagonal 5 mm box screwdriver unscrew and remove the two columns (1) indicated in the figure below.
- With a Torx T7 screwdriver remove the four fixing screws (2) of the back cover on the side of the system.

Figure 11 - Remove the cover

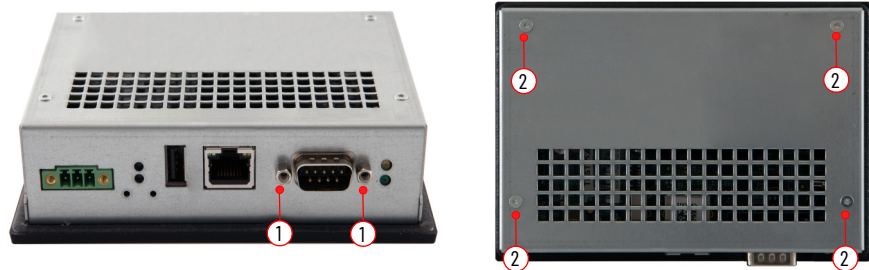

- Remove the cover.
- After you install, replace, or upgrade internal operator panel components, perform the steps in [Reinstall the Cover](#).

Backup battery replacement (BR1225A)

All OptixPanel PCs use nonvolatile memory that requires a real-time clock (RTC) lithium battery to retain system information when power is removed.

IMPORTANT Battery replacement requires work near static-sensitive equipment. Therefore, only service personnel must replace it.

This battery must be replaced during the life of the operator panel. The battery life depends on the amount of time the operator panel is on, or on-time.

Follow these steps to replace the RTC battery.

- Locate the backup battery position (1).
- Remove the battery and replace it with one of the same model (BR1225A).
- Replace the battery so the positive polarity side faces the locking tab.

Figure 12 - Battery position / replacement

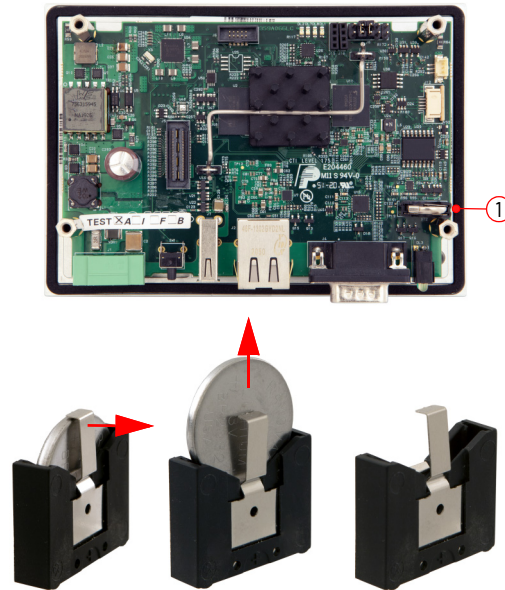

ATTENTION: Replace the battery with the same model. There is a risk of explosion if the battery is replaced with the wrong type.

ADVERTISSEMENT: Remplacer la batterie par la même modèle, sinon il y a risque d'explosion.

- Follow the steps in [Post-configuration](#).

IMPORTANT

When you replace the battery you must reconfigure the time settings. Please see [Date and time](#) paragraph.



At the end of its life, collect the battery that is contained in this operator panel separately from any unsorted municipal waste.

- After you install, replace or upgrade internal operator panel components, perform the steps in [Reinstall the Cover](#).

Reinstall the Cover

To reinstall the cover perform the following steps.



Tools required:

- Torx screwdriver T7 with torque limiting (not provided).
- Hexagonal 5mm box spanner with torque limiting (not provided).
- Reinstall the cover.
- Reinstall the two columns (1) indicated in the figure below and with an hexagonal 5mm box spanner with torque limiting verify the torque of 0.6...0.7 N•m (5.3...6.1 lb•in).
- On the side of the system reinstall the four fixing screws (2) of the back cover and with a Torx T7 screwdriver with torque limiting verify the torque of 0.6...0.7 N•m (5.3...6.1 lb•in).

Figure 13 - Reinstall the cover



- Follow the steps for [Post-configuration](#).

Notes:

Rockwell Automation Support

Use these resources to access support information.

Technical Support Center	Find help with how-to videos, FAQs, chat, user forums, Knowledgebase, and product notification updates.	rok.auto/support
Local Technical Support Phone Numbers	Locate the telephone number for your country.	rok.auto/phonesupport
Technical Documentation Center	Quickly access and download technical specifications, installation instructions, and user manuals.	rok.auto/techdocs
Literature Library	Find installation instructions, manuals, brochures, and technical data publications.	rok.auto/literature
Product Compatibility and Download Center (PCDC)	Download firmware, associated files (such as AOP, EDS, and DTM), and access product release notes.	rok.auto/pcdc

Documentation Feedback

Your comments help us serve your documentation needs better. If you have any suggestions on how to improve our content, complete the form at rok.auto/docfeedback.

Waste Electrical and Electronic Equipment (WEEE)



At the end of life, this equipment should be collected separately from any unsorted municipal waste.





Rockwell Automation maintains current product environmental compliance information on its website at rok.auto/pec.

Allen-Bradley, expanding human possibility, FactoryTalk, Optix, OptixPanel, Remote Access, and Rockwell Automation are trademarks of Rockwell Automation, Inc.

EtherNet/IP is a trademark of ODVA, Inc.

Trademarks not belonging to Rockwell Automation are property of their respective companies.

Rockwell Otomasyon Ticaret A.Ş. Kar Plaza İş Merkezi E Blok Kat:6 34752, İçerenköy, İstanbul, Tel: +90 (216) 5698400 EEE Yönetmeliğine Uygundur

Connect with us.    

rockwellautomation.com ————— **expanding human possibility®**

AMERICAS: Rockwell Automation, 1201 South Second Street, Milwaukee, WI 53204-2496 USA, Tel: (1) 414.382.2000

EUROPE/MIDDLE EAST/AFRICA: Rockwell Automation NV, Pegasus Park, De Kleetlaan 12a, 1831 Diegem, Belgium, Tel: (32) 2663 0600

ASIA PACIFIC: Rockwell Automation SEA Pte Ltd, 2 Corporation Road, #04-05, Main Lobby, Corporation Place, Singapore 618494, Tel: (65) 6510 6608

UNITED KINGDOM: Rockwell Automation Ltd., Pitfield, Kiln Farm, Milton Keynes, MK11 3DR, United Kingdom, Tel: (44)(1908) 838-800

Publication 2800C-UM001C-EN-P - June 2024

Supersedes Publication 2800C-UM001B-EN-P - May 2024

Copyright © 2024 Rockwell Automation, Inc. All rights reserved. Printed in the U.S.A.