

Series 9000 Photoelectric Sensors Specifications

Bulletin Numbers 42GLP, 42GRC, 42GRF, 42GRL, 42GRP, 42GRR, 42GRU, 42GSP, 42GTC, 42GTF, 42GTP, 42GTR, 42GTU

Topic	Page
Summary of Changes	1
Product Overview	1
Specifications	2
Sensor User Interface	5
Wiring Diagrams	6
Approximate Dimensions	7
Typical Response Curves	8

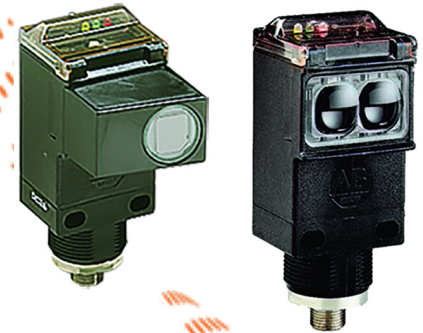

Summary of Changes

This publication contains the following new or updated information. This list includes substantive updates only and is not intended to reflect all changes.

Topic	Page
Updated Bulletin Number list.	1
Updated transmitted beam operating voltage in Table 6 .	3

Product Overview

The Series 9000™ Photoelectric Sensors include the following features:

- Extended sensing range for maximum application flexibility
- Class 1 laser models ideal for the detection of small parts
- DC (PNP and NPN) and AC/DC (relay output, solid-state) models
- Time delay models
- Dual (NPN and PNP) output models
- IP69K, IP67 with 1200 psi, NEMA, and ECOLAB rated enclosures

Available Models

The following standard models are available:

- Retroreflective
- Polarized retroreflective
- Clear object detection
- Diffuse
- Transmitted beam
- Large aperture fiber-optic
- Small aperture fiber-optic

The following laser models are available:

- Polarized retroreflective
- Standard diffuse

Specifications

Table 1 - All Models

Attribute	Value
Certifications	cULus Listed, CSA Certified, and CE Marked for all applicable directives
Shock	30 g with 1 ms pulse duration, meets or exceeds IEC 60947-5-2
Vibration	10...55 Hz, 1 mm amplitude, meets or exceeds IEC 60947-5-2
Environmental	
Enclosure type rating	IP69K, IP67 with 1200 psi; NEMA 3, 4X, 6P, 12, 13; ECOLAB rated
Relative humidity	5...95%
Ambient light immunity	Incandescent light 5000 lux
Electrical	
Operating voltage	See Table 6 on page 3 .
Mechanical	
Material	<ul style="list-style-type: none"> Housing: Valox[®] Lens: Acrylic
Connection type	See Table 6 on page 3 .

Table 2 - Standard Models

Attribute	Value
Environmental	
Operating temperature	-34...+70 °C (-29...+158 °F)
User Interface	
Status indicator	See Table 8 on page 5 .
Electrical	
Current consumption	30 mA max
Protection type	<ul style="list-style-type: none"> Short circuit Reverse polarity False pulse Overload
Outputs	
Output type	See Table 6 on page 3 .
Output function	Selectable light or dark operate
Load current	<ul style="list-style-type: none"> 250 mA at 30V DC (all models except 42GLP and 42GSP) 2 A at 132V AC and 1 A at 264V AC (SPDT relay models) 300 mA at 264V AC (MOSFET models)

Table 3 - Laser Models

Attribute	Value
Environmental	
Operating temperature	-10...+50 °C (-14...+122 °F)
Electrical	
Current consumption, max	<ul style="list-style-type: none"> DC models: 45 mA AC/DC models: 10 mA AC models: 70 mA
Protection type	<ul style="list-style-type: none"> Overload and short circuit (DC models) Reverse polarity False pulse
Outputs	
Output type	See Table 6 on page 3 .
Output function	Selectable light or dark operate
Leakage current, max	10 µA (DC models)

Optical and Response Time Characteristics

Table 4 - Optical and Response Time Characteristics—Standard and Intrinsically Safe Transmitted Beam Models

Attribute	Sensing Mode					
	Retroreflective	Polarized Retroreflective	Diffuse	Transmitted Beam	Small Aperture Fiber Optic	Large Aperture Fiber Optic
Field of view	1.5°		3.5° for 1.5 m (4.92 ft) 6.5° for 3 m (9.8 ft) and 4 m (13 ft) range	1.5°	Depends on fiber-optic cable	
Light source	Visible red 660 nm					Infrared 880 nm
Response time	2 ms (DC), SPDT EM relay (15 ms), 2 ms (MOSFET AC/DC)					

Table 5 - Optical and Response Time Characteristics—Laser Models

Attribute	Sensing Mode	
	Polarized Retroreflective	Diffuse
Spot size	20 x 25 mm (0.98 in.) at 40 m (131.23 ft)	2 x 3.5 mm (0.14 in.) at 800 nm
Response time	0.5 ms	

Product Selection

Table 6 - Product Selection

Sensing Mode	Operating Voltage	Light Source	Sensing Distance	Output Type	Sensor Type	Cat. No. (1)
 <p>Retroreflective</p>	10...30V DC	Visible red 660 nm	0.050...9.1 m (0.16...30 ft)	PNP and NPN	Standard ON/OFF	42GRU-9000-QD
	10...55V DC; 20...40V AC			NPN and PNP	Timing	42GTU-9000-QD
				70...264V AC/DC	SPDT EM relay	Standard ON/OFF
	Timing					42GTU-9001-QD
	N-MOSFET				Standard ON/OFF	42GRU-9002-QD
				Timing	42GTU-9002-QD	
 <p>Polarized Retroreflective</p>	10...30V DC	Visible red 660 nm	0.050...4.9 m (0.16...16 ft)	NPN and PNP	Standard ON/OFF	42GRU-9200-QD
	10...55V DC; 20...40V AC			SPDT EM relay	Timing	42GTU-9200-QD
					70...264V AC/DC	Standard ON/OFF
	Timing			42GTU-9201-QD		
	N-MOSFET			Standard ON/OFF		42GRU-9202-QD
				Timing	42GTU-9202-QD	
10...30V DC	Class 1 Laser	0.3...40 m (1...130 ft)	NPN and PNP (DC only), EM relay	Standard ON/OFF	42GRU-92L0-QD	
				105...132V AC	SPDT EM relay	Standard ON/OFF
 <p>Clear Object Detection</p>	10...30V DC	Visible red 660 nm	0.050...1.2 m (0.16...4 ft)	NPN and PNP	Standard ON/OFF	42GRC-9200-QD
	70...264V AC/DC			SPDT EM relay	Timing	42GTC-9200-QD
					N-MOSFET	Standard ON/OFF
	Timing			42GTC-9202-QD		
				Standard ON/OFF	42GRC-9203-QD	
	Timing				42GTC-9203-QD	
 <p>Transmitted Beam</p>	10...264V AC/DC	Infrared 880 nm	0.025...61 m (0.83...200 ft)	-(Emitter)	-	42GRL-9000-QD
	1...30V DC		0.025...152 m (0.83...500 ft)			42GRL-9040-QD
			10...55V DC; 20...40V AC	Depends on transmitted beam emitter	NPN and PNP	Standard ON/OFF
	Timing					42GTR-9000-QD
	70...264V AC/DC		SPDT EM relay	Standard ON/OFF	42GRR-9001-QD	
				Timing	42GTR-9001-QD	
Standard ON/OFF	42GRR-9002-QD					
	Timing	42GTR-9002-QD				
N-MOSFET	Standard ON/OFF	42GRR-9003-QD				
	Timing	42GTU-9203-QD				

Table 6 - Product Selection (Continued)

Sensing Mode	Operating Voltage	Light Source	Sensing Distance	Output Type	Sensor Type	Cat. No. ⁽¹⁾
 <p>Diffuse</p>	10...30V DC	Visible red 660 nm	0.050...1.5 m (0.16...5 ft)	NPN and PNP	Standard ON/OFF Linear Adjustment	42GLP-9000-QD
	10...55V DC; 20...40V AC				Standard ON/OFF Teach Push Button	42GSP-9000-QD
					Standard ON/OFF	42GRP-9000-QD
					Timing	42GTP-9000-QD
	70...264V AC/DC	SPDT EM relay	Standard ON/OFF	42GRP-9001-QD		
			Timing	42GTP-9001-QD		
			Standard ON/OFF	42GRP-9002-QD		
	70...264V AC/DC	N-MOSFET	Standard ON/OFF	42GRP-9003-QD		
			Timing	42GTP-9003-QD		
	10...30V DC	Class 1 Laser	1...800 mm (0.03...31.5 in.)	NPN and PNP	Standard ON/OFF	42GRP-92L0-QD
105...132V AC	SPDT EM relay					42GRP-92L2-QD
 <p>Small Aperture Fiber Optic</p>	10...30V DC	Visible red 660 nm	Depends on fiber-optic cable	NPN and PNP	Standard ON/OFF	42GRF-9100-QD
	10...55V DC; 20...40V AC				Timing	42GTF-9100-QD
				70...264V AC/DC	SPDT EM relay	Standard ON/OFF
	Timing					42GTF-9101-QD
	Standard ON/OFF					42GRF-9102-QD
	70...264V AC/DC			N-MOSFET	Standard ON/OFF	42GRF-9103-QD
					Timing	42GTF-9103-QD
	 <p>Large Aperture Fiber Optic</p>			10...30V DC	Infrared 880 nm	Depends on fiber-optic cable
10...55V DC; 20...40V AC		Timing	42GTF-9000-QD			
		70...264V AC/DC	SPDT EM relay	Standard ON/OFF		
Timing				42GTF-9001-QD		
Standard ON/OFF				42GRF-9002-QD		
70...264V AC/DC		N-MOSFET	Standard ON/OFF	42GRF-9003-QD		
			Timing	42GTF-9003-QD		
Recommended DC micro (M12) quick-disconnect cordset, straight, 4-pin, 2 m (6.6 ft)						
Recommended DC pico (M8) quick-disconnect cordset, straight, 4-pin, 2 m (6.6 ft)						889D-F4AB-2

(1) Connection Options: The -QD suffix describes a 4-pin DC micro (M12) integral QD for DC models, a 5-pin mini QD for SPDT EM Relay models, and a 4-pin mini (M12) integral QD for N-MOSFET models.
 For additional connection options:
 - Remove the -QD suffix for a 2 m (6.6 ft) cable without QD (Example: 42GRU-9200).
 - For NPN and PNP models replace the -QD suffix with a -QD1 for a 4-pin mini-integral QD (for example, 42GRU-9200-QD1). For N-MOSFET models, replace the -QD suffix with a -QD1 for a 4-pin AC micro (M12) integral QD (for example, 42GRU-9203-QD1).
 - See ProposalWorks™ for available connection options in 600V 2 m (6.6 ft) cables.

Cordsets and Accessories

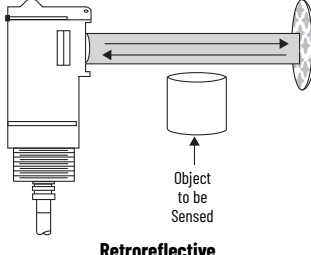
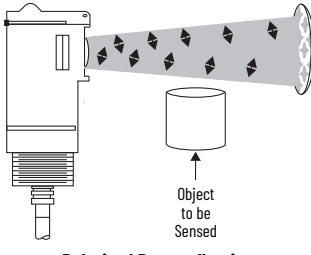
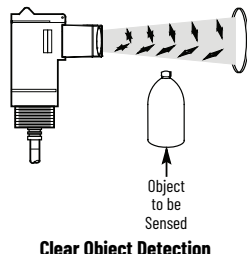
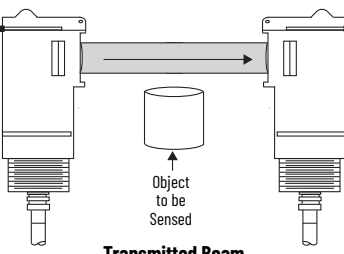
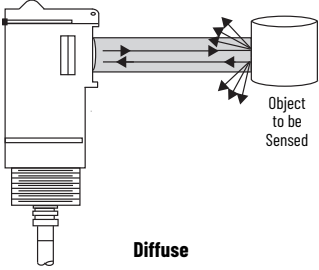
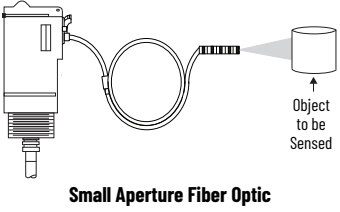
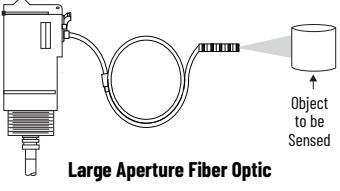
Description		Cat. No.
Cordsets	AC micro QD, straight, 4-pin, 2 m (6.5 ft)	889D-F4AEA-2
	Mini QD, 1.8 m (6 ft) 5-pin	889N-F5AF-6F
	Mini QD, 2 m (6 ft) 4-pin	889N-F4AF-6F
Mounting bracket	30 mm (1.2 in.) swivel/tilt	60-2439
	Heavy-duty impact	60-2702
Spare reflector, corner cube	76 mm (3 in.) diameter with mounting hole	92-39
	32 mm (1.25 in.) diameter with mounting hole	92-47
Extended range lens assembly [260 °C (500 °F)]		60-1844
		60-2559
Fiber-optic cable lens extender		60-2738

Sensor User Interface

Table 7 - Standard Sensors

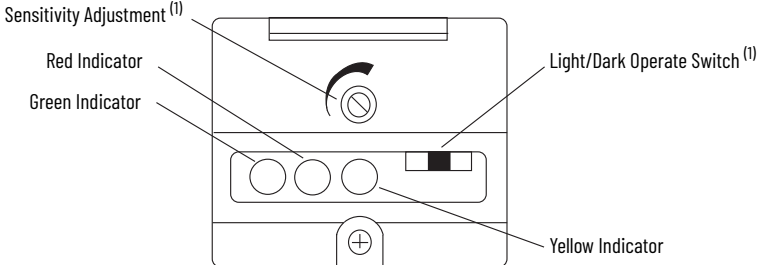
42GRx Versions – Top View Detail	Status Indicator Color	State	Status
 <p>Sensitivity Adjustment ⁽¹⁾</p> <p>Red Indicator</p> <p>Green Indicator</p> <p>Light/Dark Operate Switch ⁽¹⁾</p> <p>Yellow Indicator</p>	Red	OFF	Margin < 2.5X
		ON	Margin > 2.5X
	Green	OFF	Output is de-energized
		ON	Output is energized
	Yellow	OFF	Power is OFF
		ON	Power is ON

(1) Transmitted beam receivers do not have a flashing (low margin) state.

Table 8 - Time Delay Sensors

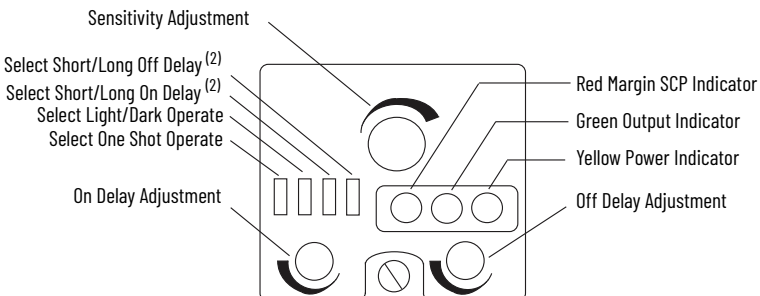
42GTx Versions – Top View Detail	Status Indicator Color	State	Status
 <p>Sensitivity Adjustment</p> <p>Select Short/Long Off Delay ⁽²⁾</p> <p>Select Short/Long On Delay ⁽²⁾</p> <p>Select Light/Dark Operate</p> <p>Select One Shot Operate</p> <p>On Delay Adjustment</p> <p>Red Margin SCP Indicator</p> <p>Green Output Indicator</p> <p>Yellow Power Indicator</p> <p>Off Delay Adjustment</p>	Red	OFF	Margin < 2.5X
		ON	Margin > 2.5X
	Green	OFF	Output is de-energized
		ON	Output is energized
	Yellow	OFF	Power is OFF
		ON	Power is ON

(2) The sensors timing can be set as short (0...1.5 s) or long (0...15 s).

Wiring Diagrams

IMPORTANT Do not connect an NPN and PNP load simultaneously.

Figure 1 - Standard and Laser Models

Cable Model: 9_ _0

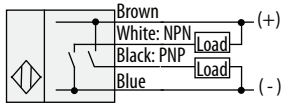

4-pin DC Micro QD Model: 9_ _0-QD

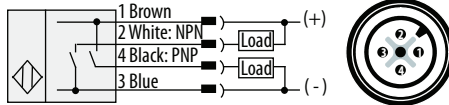

4-pin DC Mini QD Model: 9_ _0-QD1

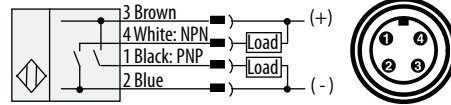

Cable Model: 9_ _1, 9_ _2

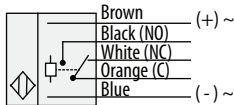

5-pin AC/DC Mini QD Model: 9_ _1-QD, 9_ _2-QD

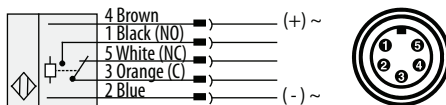

Cable Model: 9_ _3

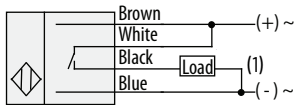

AC/DC Mini QD Model: 9_ _3-QD

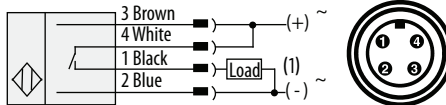

AC/DC Micro QD Model: 9_ _3-QD1

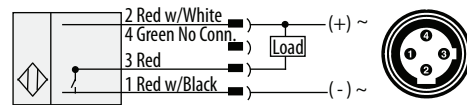

Transmitted Beam Source

Cable Model: 42GRL-90_ _

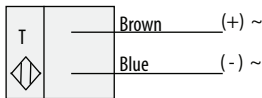

AC/DC Mini QD Model: 42GRL-9_ _2-QD

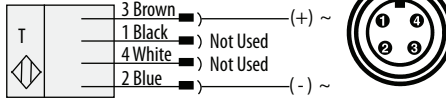

DC Micro QD Model: 42GRL-9_ _0-QD

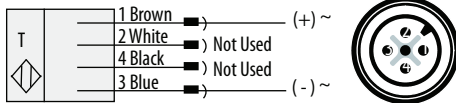

4-pin DC Micro QD Model: 42GRL-90_ _3-QD1

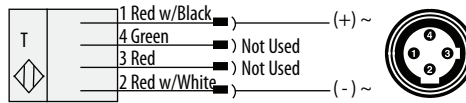

(1) Load can be placed on either black wire to create sourcing or on white wire to create sinking.

Approximate Dimensions

Dimensions are shown in mm (in.). Dimensions are not intended to be used for installation purposes.

Figure 2 - All Versions (Except Fiber Optic) – Cable Version

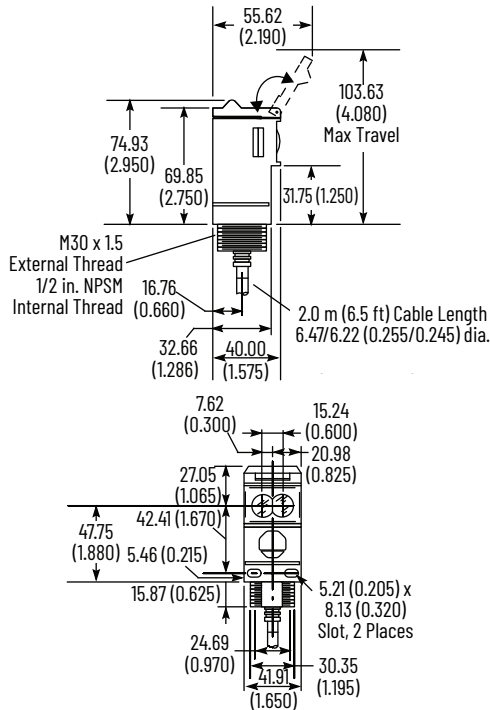

Figure 3 - Fiber-optic Versions – Cable Version

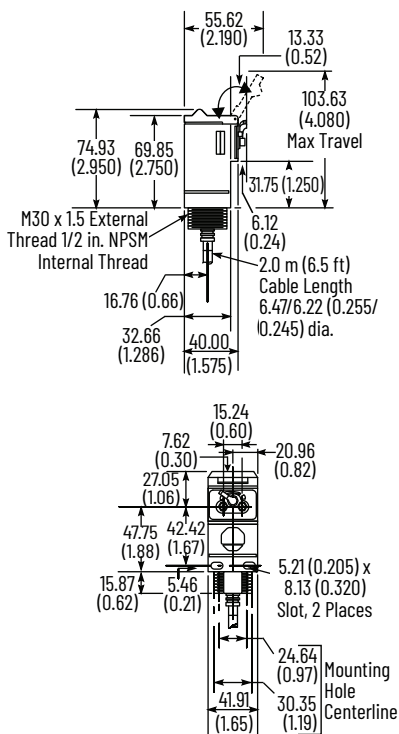

Figure 4 - ClearSight™ 9000 Sensor – Cable Version

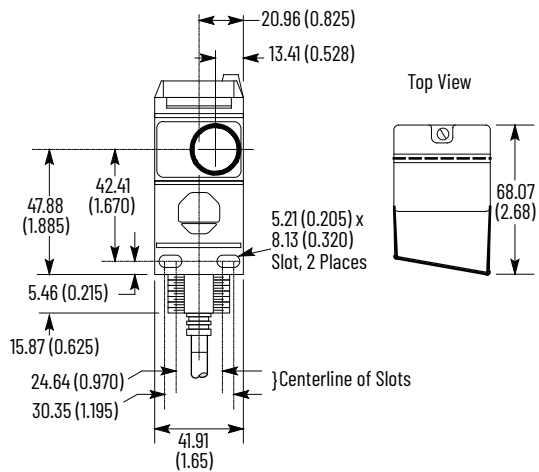
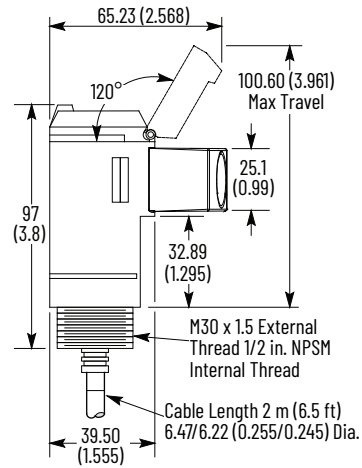

Figure 5 - Connector Version

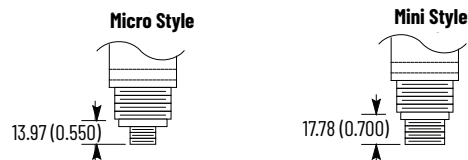

Table 9 - Thread Sizes

Style	AC	DC
Micro	1/2-20 UNF 2 keyways	M12 x 1 1 keyway
Mini	7/8-16 UN 1 keyway	

Typical Response Curves

Table 10 - Non-clear Object Detection Versions

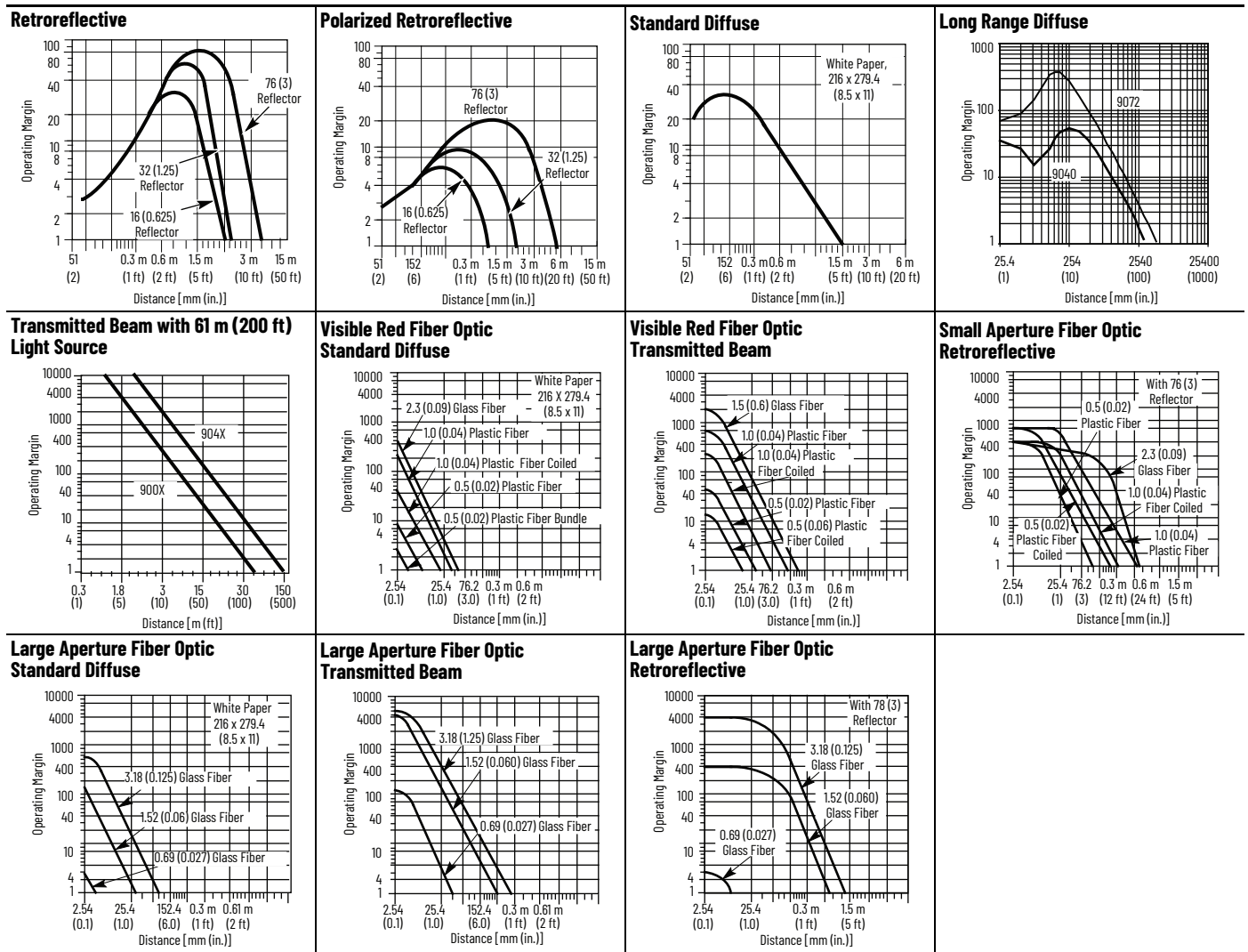
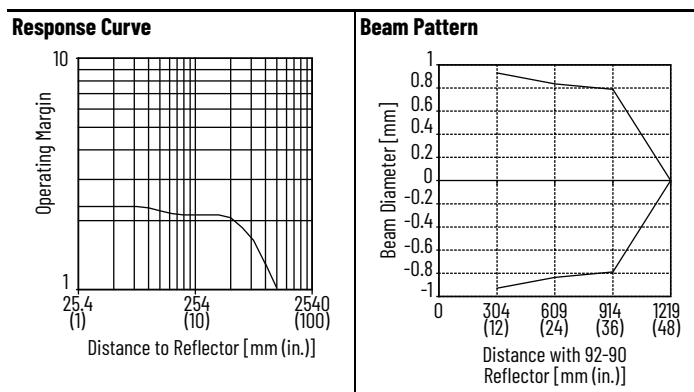

Table 11 - Clear Object Detection Versions



Notes:

Rockwell Automation Support

Use these resources to access support information.

Technical Support Center	Find help with how-to videos, FAQs, chat, user forums, and product notification updates.	rok.auto/support
Knowledgebase	Access Knowledgebase articles.	rok.auto/knowledgebase
Local Technical Support Phone Numbers	Locate the telephone number for your country.	rok.auto/phonesupport
Literature Library	Find installation instructions, manuals, brochures, and technical data publications.	rok.auto/literature
Product Compatibility and Download Center (PCDC)	Download firmware, associated files (such as AOP, EDS, and DTM), and access product release notes.	rok.auto/pcdc





Documentation Feedback

Your comments help us serve your documentation needs better. If you have any suggestions on how to improve our content, complete the form at rok.auto/docfeedback.

Allen-Bradley, ClearSight, expanding human possibility, ProposalWorks, Rockwell Automation, and Series 9000 are trademarks of Rockwell Automation, Inc. Trademarks not belonging to Rockwell Automation are property of their respective companies.

Rockwell Automation maintains current product environmental compliance information on its website at rok.auto/pec.

Rockwell Otomasyon Ticaret A.Ş. Kar Plaza İş Merkezi E Blok Kat:6 34752, İçerenköy, İstanbul, Tel: +90 (216) 5698400 EEE Yönetmeliğine Uygundur

Connect with us.    

rockwellautomation.com ————— expanding **human possibility**[®]

AMERICAS: Rockwell Automation, 1201 South Second Street, Milwaukee, WI 53204-2496 USA, Tel: (1) 414.382.2000, Fax: (1) 414.382.4444

EUROPE/MIDDLE EAST/AFRICA: Rockwell Automation NV, Pegasus Park, De Kleetlaan 12a, 1831 Diegem, Belgium, Tel: (32) 2 663 0600, Fax: (32) 2 663 0640

ASIA PACIFIC: Rockwell Automation, Level 14, Core F, Cyberport 3, 100 Cyberport Road, Hong Kong, Tel: (852) 2887 4788, Fax: (852) 2508 1846