

PowerFlex 700H Adjustable Frequency AC Drive



LISTEN.
THINK.
SOLVE.®

Table of Contents

Topic	Page
Product Overview	3
Key Features and Benefits	3
Standard Drives	6
Catalog Number Explanation	6
Standard Drives Product Selection	7
Factory Installed Options	10
User Installed Options	12
Installation Considerations	20
Cable Recommendations	21
Maximum Motor Cable Lengths	23
Drive Ratings	37
Fusing and Circuit Breakers	46
Minimum Mounting Clearances	54
Approximate Dimensions	55
Standard Drive Specifications	73
Derating Guidelines	75
Configured Drives Program	86
Program Description	86
Target Lead Times	86
Catalog Number Explanation	87
Configured Drives Product Selection	90
Factory Installed Options	91
Enclosure Options	99
Configured Drives Codes and Standards	100
Recommended Documentation	103
Additional Resources	103

Summary of Changes

This publication contains new and updated information as indicated in the following table.

Topic	Page
Added Ecodesign regulation (EU) 2019/1781, IE2 efficiency class, to Specifications table.	73
Corrected Frame 10 Carrier Derating Curve	76

Product Overview

The PowerFlex 700H AC drive offers a cost-effective, variable speed applications. It is designed to meet the demands for space, flexibility and performance. The many features allow the user to easily configure the drive for most application needs. Ratings currently available include 200...1900 HP output at 480V AC, 150...2400 HP at 600V AC and 160...2000 kW at 690V AC input.

An LCD Human Interface Module (also used with the PowerFlex® 70, 700 and 700S) provides text for startup, metering, programming, and troubleshooting.

PowerFlex 700H AC drives are configurable for Volts-per-Hertz or Sensorless Vector control modes to meet a wide variety of application needs. This control is housed in a module which is separately removable from the power structure. The control module is the same for all drive ratings, simplifying installation and maintenance for the entire product line. Optional I/O is available as 24V DC or 115V AC.

Optional internal communication modules are available as user-installed kits. These provide fast and efficient control and/or data exchange with host controllers over popular interfaces. These interfaces include; DeviceNet™, ControlNet™, Ethernet/IP™, Profibus, Interbus, Remote I/O, Serial Communications and other open control and communication networks. PC tools such as DriveExplorer™ and DriveTools™ SP assist with programming, monitoring and troubleshooting the PowerFlex 700H.

Key Features and Benefits

Excellent Speed Control Performance

- Open-loop speed control with slip compensation
- Excellent torque at low speeds for demanding speed control applications
- Configurable for Volts-per-Hertz or Sensorless Vector control modes for a wide variety of applications
- ATEX certified option for drives that operate in potentially explosive environments

Flexible Programming, Hardware, and Communication Interfaces.

- Advanced features and parameter set modeled after the PowerFlex 700 AC drive.
- Standard I/O includes either 24V or 115V digital I/O plus analog I/O.
- NetLinx communication options, including DeviceNet, ControlNet, and EtherNet/IP networks.

Easy to Use

- Full-featured LCD Human Interface Module (HIM) with multi-line and multi-lingual display simplifies programming.
 - Large and easy to read 7 line x 21 character backlit display
 - Variety of languages (English, French, German, Italian, Spanish, Portuguese, Dutch)
 - Alternate function keys for shortcuts to common tasks
 - “Calculator-like” number pad for fast and easy data entry (Full Numeric version only)
 - Control keys for local start, stop, speed, and direction
 - Remote versions for panel mount application
- S.M.A.R.T. Start and assisted startup routines in the LCD HIM allow for easy configuring and tuning of the drive.
- Pull-apart control terminal blocks allow for easy wiring and quick disconnect of I/O wiring.
- Easy-to-remove control module is common among all PowerFlex 700H power ratings.
- Optimized global voltage settings designed to worldwide standards allow quick set-up anywhere in the world.
- PC-based configuration tools include:
 - DriveExplorer and DriveExplorer Lite - A simple and flexible “On-line” tool for monitoring and configuration while connected to a drive.
 - DriveTools SP - A suite of software tools which provide an intuitive means for programming, troubleshooting and maintaining Allen-Bradley® AC & DC drives.

Premier Integration with PowerFlex Drives

For simplified AC drive start-up and reduced development time using the Allen-Bradley Logix control platform, we’ve integrated PowerFlex AC drive configuration with RSLogix™ 5000 software. This single-software approach simplifies parameter and tag programming while still allowing stand-alone drive software tool use on the factory floor.

Industry-Standard Packaging

- Modular design and high degree of power structure commonality with equivalent PowerFlex® 700S AC drive ratings for reduced spare parts stocking.
- Standard floor-standing cabinet designs (frame 10 and larger) for compact stand-alone drive applications or multi-drive lineups.
- Along with IP21/UL Type 1 (NEMA 1) package options, many PowerFlex 700H drive ratings are also available in an IP54/UL Type 12 (NEMA 12) package
- Option of internally mounted, or door-mounted NEMA 1 or NEMA 4/12 operator interface
- Line reactor on AC input for all ratings

Support

Rockwell Automation is committed to maintaining and supporting Allen-Bradley drives and installations. Included in this commitment is start-up support and consultation for drive applications.

ProtectionPlus Drive Start-Up

With ProtectionPlus Drives Start-Up Services from Rockwell Automation, users can leverage the extensive product and industry experience of Rockwell Automation technicians to quickly commission drives and reduce the time between integration and actual start-up.

ProtectionPlus Drive Start-Up Services verify drive installation to ensure proper electrical, mechanical and environmental criteria are met. This includes verification of power and I/O wiring to the drive, custom drive configuration/tuning to meet application specific requirements, and diagnosing/troubleshooting problems that occur during a standalone drive start-up. ProtectionPlus can also extend an eligible product parts warranty and add a labor warranty. For more information about onsite support services, including ProtectionPlus Drives Services, contact your local Rockwell Automation sales office or authorized distributor, or visit: <http://www.rockwellautomation.com/services/onsite/>

Standard Drives

Catalog Number Explanation

1-3			4	5-7		8	9		10	11	12	13	14	15	16
20C			D	261		A	3		A	Y	N	B	N	N	0
a			b	c		d	e		f	g	h	i	j	k	l

a

Drive	
Code	Type
20C	PowerFlex 700H

b

Voltage Rating		
Code	Voltage	Ph.
C	400V AC	3
D	480V AC	3
E	600V AC	3
F	690V AC	3

c1

Rating		
400V, 50Hz Input		
Code	Amps - ND (HD)	kW - ND (HD)
261	261 (205)	132 (110)
300	300 (245)	160 (132)
385	385 (300)	200 (160)
460	460 (385)	250 (200)
500	500 (420)	250 (250)
590	590 (520)	315 (250)
650	650 (590)	355 (315)
730	730 (650)	400 (355)
820	820 (730)	450 (400)
920	920 (820)	500 (450)
1K0	1030 (920)	560 (500)
1K1	1150 (1030)	630 (560)
1K3	1300 (1150)	710 (630)
1K4	1450 (1200)	800 (710)
1K7	1770 (1600)	1000 (900)
2K1	2150 (1940)	1200 (1100)

c2

Rating		
480V, 60Hz Input		
Code	Amps - ND (HD)	Hp - ND (HD)
261	261 (205)	200 (150)
300	300 (245)	250 (200)
385	385 (300)	300 (250)
460	460 (385)	350 (300)
500	500 (420)	450 (350)
590	590 (520)	500 (450)
650	650 (590)	500 (500)
730	730 (650)	600 (500)
820	820 (730)	700 (600)
920	920 (820)	800 (700)
1K0	1030 (920)	900 (800)
1K1	1150 (1030)	1000 (900)
1K3	1300 (1150)	1100 (1000)
1K4	1450 (1200)	1250 (1000)
1K7	1770 (1600)	1500 (1400)
2K1	2150 (1940)	1900 (1700)

c3

Rating		
600V, 60Hz Input		
Code	Amps - ND (HD)	Hp - ND (HD)
170	170 (144)	150 (150)
208	208 (170)	200 (150)
261	261 (208)	250 (200)
325	325 (261)	350 (250)
385	385 (325)	400 (350)
416	416 (325)	450 (350)
460	460 (385)	500 (400)
502	502 (460)	500 (500)
590	590 (502)	600 (500)
650	650 (590)	700 (650)
750	750 (650)	800 (700)
820	820 (750)	900 (700)
920	920 (820)	1000 (900)
1K0	1030 (920)	1100 (1000)
1K1	1180 (1030)	1300 (1100)
1K5	1500 (1300)	1600 (1400)
1K9	1900 (1500)	2000 (1600)
2K2	2250 (1900)	2400 (2000)

c4

Rating		
690V, 50Hz Input		
Code	Amps - ND (HD)	kW - ND (HD)
170	170 (144)	160 (132)
208	208 (170)	200 (160)
261	261 (208)	250 (200)
325	325 (261)	315 (250)
385	385 (325)	355 (315)
416	416 (325)	400 (315)
460	460 (385)	450 (355)
502	502 (460)	500 (450)
590	590 (502)	560 (500)
650	650 (590)	630 (560)
750	750 (650)	710 (630)
820	820 (750)	800 (630)
920	920 (820)	900 (800)
1K0	1030 (920)	1000 (900)
1K1	1180 (1030)	1100 (1000)
1K5	1500 (1300)	1500 (1300)
1K9	1900 (1500)	1900 (1500)
2K2	2250 (1900)	2300 (1900)

d

Enclosure	
Code	Enclosure
A	IP21, NEMA Type 1 (Frame 9) Rittal Enclosure (Frames 10 & Up)
B	IP20, NEMA Type 1, MCC §
H	IP54, NEMA Type 12, Rittal §
K	IP20, NEMA Type 1, MCC with Conformal Coat §
M	IP21, NEMA Type 1 (Frame 9) Rittal Enclosure (Frames 10 & Up) with Conformal Coat
W	IP54, NEMA Type 12, Rittal with Conformal Coat §

§ Frame 10 & up only.

e

HIM	
Code	Operator Interface
0	Blank Cover
3	Full Numeric LCD, Drive Mounted
C	Full Numeric LCD, Door Mount *

* IP21, NEMA Type 1 Frame 10 & up only.

Catalog Number Explanation, Continued

f

Documentation	
Code	Type
A	Manual

g

Brake	
Code	w/Brake IGBT [⊛]
Y	Yes
N	No

⊛ Brake IGBT is available on Frame 9 drives only.

h

Brake Resistor	
Code	w/Resistor
N	No

i

Emission			
Code	CE Filter	CM Choke	dv/dt Filter
B	Yes	No	No
N ‡	No	No	No
E *	Yes	No	Yes

‡ For use on ungrounded or resistive grounded distribution systems (Frame 9 drives only).
* Output dv/dt filter is only available on Frame 14 drives.

j

Comm Slot	
Code	Version
N	None

k

I/O	
Code	I/O Volts
A	24V DC
B	115V AC
G	24V DC with Safe-Off
N	None

l

Feedback	
Code	Type
0	None

Standard Drives Product Selection

IP21, NEMA Type 1 (Position d = A)

380...500V AC, Three-Phase Drives

480V AC Input					380-400V AC Input					IP21, NEMA Type 1 ⁽⁴⁾⁽⁵⁾	
Output Amps			Normal Duty HP	Heavy Duty HP	Output Amps			Normal Duty kW	Heavy Duty kW	Cat. No. 20CD ...	Frame Size
Cont. ⁽¹⁾	1 Min.	2 Sec. ⁽³⁾			Cont. ⁽¹⁾	1 Min.	2 Sec. ⁽³⁾				
261 (205)	287 (308)	410 (410)	200	150	261 (205)	287 (308)	410 (410)	132	110	261A0ANNBNN0	9
300 (245)	330 (368)	450 (490)	250	200	300 (245)	330 (368)	450 (490)	160	132	300A0ANNBNN0	9
385 (300)	424 (450)	600 (600)	300	250	385 (300)	424 (450)	600 (600)	200	160	385A0ANNBNN0	10
460 (385)	506 (578)	770 (770)	350	300	460 (385)	506 (578)	770 (770)	250	200	460A0ANNBNN0	10
500 (420)	550 (630)	750 (840)	450	350	500 (420)	550 (630)	750 (840)	250	250	500A0ANNBNN0	10
590 (520)	649 (780)	956 (956)	500	450	590 (520)	649 (780)	956 (956)	315	250	590A0ANNBNN0	11
650 (590)	715 (885)	1062 (1062)	500	500	650 (590)	715 (885)	1062 (1062)	355	315	650A0ANNBNN0	11
730 (650)	803 (975)	1095 (1170)	600	500	730 (650)	803 (975)	1095 (1170)	400	355	730A0ANNBNN0	11
820 (730)	902 (1095)	1230 (1314)	700	600	820 (730)	902 (1095)	1230 (1314)	450	400	820A0ANNBNN0	12
920 (820)	1012 (1230)	1380 (1476)	800	700	920 (820)	1012 (1230)	1380 (1476)	500	450	920A0ANNBNN0	12
1030 (920) ⁽²⁾	1133 (1370)	1555 (1600)	900	800	1030 (920) ⁽²⁾	1133 (1370)	1555 (1600)	560	500	1K0A0ANNBNN0	12
1150 (1030)	1265 (1545)	1620 (1620)	1000	900	1150 (1030)	1265 (1545)	1620 (1620)	630	560	1K1A0ANNBNN0	13
1300 (1150)	1430 (1725)	2079 (2079)	1100	1000	1300 (1150)	1430 (1725)	2079 (2079)	710	630	1K3A0ANNBNN0	13
1450 (1200)	1595 (1800)	2175 (2400)	1250	1000	1450 (1200)	1595 (1800)	2175 (2400)	800	710	1K4A0ANNBNN0	13
1770 (1600)	1947 (2400)	2655 (2880)	1500	1400	1770 (1600)	1947 (2400)	2655 (2880)	1000	900	1K7A0ANNENNO	14
2150 (1940)	2365 (2910)	3225 (3492)	1900	1700	2150 (1940)	2365 (2910)	3225 (3492)	1200	1100	2K1A0ANNENNO	14

- (1) These drives have dual current ratings; normal duty applications and heavy duty applications (in parenthesis). The drive may be operated at either rating.
- (2) Heavy duty rating is limited to 35° C surrounding air.
- (3) The 2 sec. output current is only available at initial start or drive operating at light load.
- (4) Frames 10 & up include a Rittal enclosure.
- (5) Drives listed Do Not include a Control and I/O option. Refer to page 11 for available options.

600...690V AC, Three-Phase Drives

600V AC Input					690V AC Input ⁽⁵⁾⁽⁶⁾					IP21, NEMA Type 1 ⁽⁵⁾⁽⁶⁾	
Output Amps			Normal Duty HP	Heavy Duty HP	Output Amps			Normal Duty kW	Heavy Duty kW	Cat. No. 20CE ...	Frame Size
Cont. ⁽¹⁾	1 Min.	2 Sec. ⁽⁴⁾			Cont. ⁽¹⁾	1 Min.	2 Sec. ⁽³⁾				
170 (144)	187 (216)	245 (245)	150	150	170 (144)	187 (216)	245 (245)	160	132	170A0ANNBNN0	9
208 (170)	230 (250)	289 (289)	200	150	208 (170)	230 (250)	289 (289)	200	160	208A0ANNBNN0	9
261 (208)	287 (312)	375 (375)	250	200	261 (208)	287 (312)	375 (375)	250	200	261A0ANNBNN0	10
325 (261)	358 (392)	470 (470)	350	250	325 (261)	358 (392)	470 (470)	315	250	325A0ANNBNN0	10
385 (325)	424 (488)	585 (585)	400	350	385 (325)	424 (488)	585 (585)	355	315	385A0ANNBNN0	10
416 (325) ⁽²⁾	458 (488)	585 (585)	450	350	416 (325) ⁽²⁾	458 (488)	585 (585)	400	315	416A0ANNBNN0	10
460 (385)	506 (578)	693 (693)	500	400	460 (385)	506 (578)	693 (693)	450	355	460A0ANNBNN0	11
502 (460)	552 (690)	828 (828)	500	500	502 (460)	552 (690)	828 (828)	500	450	502A0ANNBNN0	11
590 (502)	649 (753)	885 (904)	600	500	590 (502)	649 (753)	885 (904)	560	500	590A0ANNBNN0	11
650 (590)	715 (885)	1062 (1062)	700	650	650 (590)	715 (885)	1062 (1062)	630	560	650A0ANNBNN0	12
750 (650)	825 (975)	1170 (1170)	800	700	750 (650)	825 (975)	1170 (1170)	710	630	750A0ANNBNN0	12
820 (750) ⁽²⁾	902 (975)	1170 (1170)	900	700	820 (750) ⁽²⁾	902 (975)	1170 (1170)	800	630	820A0ANNBNN0	12
920 (820)	1012 (1230)	1380 (1410)	1000	900	920 (820)	1012 (1230)	1380 (1410)	900	800	920A0ANNBNN0	13
1030 (920)	1133 (1380)	1545 (1755)	1100	1000	1030 (920)	1133 (1380)	1545 (1755)	1000	900	1030A0ANNBNN0	13
1180 (1030)	1298 (1463)	1755 (1755)	1300	1100	1180 (1030)	1298 (1463)	1755 (1755)	1100	1000	1180A0ANNBNN0	13
1500 (1300)	1650 (1950)	2250 (2340)	1600	1400	1500 (1300)	1650 (1950)	2250 (2340)	1500	1300	1500A0ANNENNO	14
1900 (1500)	2090 (2250)	2700 (2700)	2000	1600	1900 (1500)	2090 (2250)	2700 (2700)	1900	1500	1900A0ANNENNO	14
2250 (1900) ⁽³⁾	2475 (2782)	3335 (3335)	2400	2000	2250 (1900) ⁽³⁾	2475 (2782)	3335 (3335)	2300	1900	2250A0ANNENNO	14

- (1) These drives have dual current ratings; normal duty applications and heavy duty applications (in parenthesis). The drive may be operated at either rating.
- (2) Normal duty rating is limited to 35° C surrounding air.
- (3) Normal and heavy duty rating is limited to 35° C surrounding air.
- (4) The 2 sec. output current is only available at initial start or drive operating at light load.
- (5) Frames 10 & up include a Rittal enclosure.
- (6) Drives listed Do Not include a Control and I/O option. Refer to page 11 for available options.

IP20, NEMA Type 1, CENTERLINE® 2100 MCC (Position d = B)

380...500V AC, Three-Phase Drives

480V AC Input					380-400V AC Input					IP20, NEMA Type 1 ⁽⁴⁾	
Output Amps			Normal Duty HP	Heavy Duty HP	Output Amps			Normal Duty kW	Heavy Duty kW	Cat. No. 20CD ...	Frame Size
Cont. ⁽¹⁾	1 Min.	2 Sec. ⁽³⁾			Cont. ⁽¹⁾	1 Min.	2 Sec. ⁽³⁾				
385 (300)	424 (450)	600 (600)	300	250	385 (300)	424 (450)	600 (600)	200	160	385B0ANNBNN0	10
460 (385)	506 (578)	770 (770)	350	300	460 (385)	506 (578)	770 (770)	250	200	460B0ANNBNN0	10
500 (420)	550 (630)	750 (840)	450	350	500 (420)	550 (630)	750 (840)	250	250	500B0ANNBNN0	10
590 (520)	649 (780)	956 (956)	500	450	590 (520)	649 (780)	956 (956)	315	250	590B0ANNBNN0	11
650 (590)	715 (885)	1062 (1062)	500	500	650 (590)	715 (885)	1062 (1062)	355	315	650B0ANNBNN0	11
730 (650)	803 (975)	1095 (1170)	600	500	730 (650)	803 (975)	1095 (1170)	400	355	730B0ANNBNN0	11
820 (730)	902 (1095)	1230 (1314)	700	600	820 (730)	902 (1095)	1230 (1314)	450	400	820B0ANNBNN0	12
920 (820)	1012 (1230)	1380 (1476)	800	700	920 (820)	1012 (1230)	1380 (1476)	500	450	920B0ANNBNN0	12
1030 (920) ⁽²⁾	1133 (1370)	1555 (1600)	900	800	1030 (920) ⁽²⁾	1133 (1370)	1555 (1600)	560	500	1030B0ANNBNN0	12

- (1) These drives have dual current ratings; normal duty applications and heavy duty applications (in parenthesis). The drive may be operated at either rating.
- (2) Heavy duty rating is limited to 35° C surrounding air.
- (3) The 2 sec. output current is only available at initial start or drive operating at light load.
- (4) Drives listed Do Not include a Control and I/O option. Refer to page 11 for available options.

600V AC, Three-Phase Drives

600V AC Input			IP20, NEMA Type 1 ⁽⁴⁾			
Output Amps			Normal Duty HP	Heavy Duty HP	Cat. No. 20CE ...	Frame Size
Cont. ⁽¹⁾	1 Sec.	2 Sec. ⁽³⁾				
261 (208)	287 (312)	375 (375)	250	200	261B0ANNBNN0	10
325 (261)	358 (392)	470 (470)	350	250	325B0ANNBNN0	10
325 (261)	358 (392)	470 (470)	350	250	325B0ANNBNN0	10
385 (325)	424 (488)	585 (585)	400	350	385B0ANNBNN0	10
416 (325) ⁽²⁾	458 (488)	585 (585)	450	350	416B0ANNBNN0	10
460 (385)	506 (578)	693 (693)	500	400	460B0ANNBNN0	11
502 (460)	552 (690)	828 (828)	500	500	502B0ANNBNN0	11
590 (502)	649 (753)	885 (904)	600	500	590B0ANNBNN0	11
650 (590)	715 (885)	1062 (1062)	700	650	650B0ANNBNN0	12
750 (650)	825 (975)	1170 (1170)	800	700	750B0ANNBNN0	12
820 (750) ⁽²⁾	902 (975)	1170 (1170)	900	700	820B0ANNBNN0	12

(1) These drives have dual current ratings; normal duty applications and heavy duty applications (in parenthesis). The drive may be operated at either rating.

(2) Normal duty rating is limited to 35° C surrounding air.

(3) The 2 sec. output current is only available at initial start or drive operating at light load.

(4) Drives listed Do Not include a Control and I/O option. Refer to page 11 for available options.

IP54, NEMA Type 12, Rittal (Position d = H)

380...500V AC, Three-Phase Drives

480V AC Input					380-400V AC Input					IP54, NEMA Type 12 ⁽⁴⁾	
Output Amps			Normal Duty HP	Heavy Duty HP	Output Amps			Normal Duty kW	Heavy Duty kW	Cat. No. 20CD ...	Frame Size
Cont. ⁽¹⁾	1 Min.	2 Sec. ⁽³⁾			Cont. ⁽¹⁾	1 Min.	2 Sec. ⁽³⁾				
385 (300)	424 (450)	600 (600)	300	250	385 (300)	424 (450)	600 (600)	200	160	385H0ANNBNN0	10
460 (385)	506 (578)	770 (770)	350	300	460 (385)	506 (578)	770 (770)	250	200	460H0ANNBNN0	10
500 (420)	550 (630)	750 (840)	450	350	500 (420)	550 (630)	750 (840)	250	250	500H0ANNBNN0	10
590 (520)	649 (780)	956 (956)	500	450	590 (520)	649 (780)	956 (956)	315	250	590H0ANNBNN0	11
650 (590)	715 (885)	1062 (1062)	500	500	650 (590)	715 (885)	1062 (1062)	355	315	650H0ANNBNN0	11
730 (650)	803 (975)	1095 (1170)	600	500	730 (650)	803 (975)	1095 (1170)	400	355	730H0ANNBNN0	11
820 (730)	902 (1095)	1230 (1314)	700	600	820 (730)	902 (1095)	1230 (1314)	450	400	820H0ANNBNN0	12
920 (820)	1012 (1230)	1380 (1476)	800	700	920 (820)	1012 (1230)	1380 (1476)	500	450	920H0ANNBNN0	12
1030 (920) ⁽²⁾	1133 (1370)	1555 (1600)	900	800	1030 (920) ⁽²⁾	1133 (1370)	1555 (1600)	560	500	1K0H0ANNBNN0	12
1150 (1030)	1265 (1545)	1620 (1620)	1000	900	1150 (1030)	1265 (1545)	1620 (1620)	630	560	1K1H0ANNBNN0	13
1300 (1150)	1430 (1725)	2079 (2079)	1200	1000	1300 (1150)	1430 (1725)	2079 (2079)	710	630	1K3H0ANNBNN0	13
1450 (1200)	1595 (1800)	2175 (2400)	1250	1000	1450 (1200)	1595 (1800)	2175 (2400)	800	710	1K4H0ANNBNN0	13
1770 (1600)	1947 (2400)	2655 (2880)	1500	1400	1770 (1600)	1947 (2400)	2655 (2880)	1000	900	1K7H0ANNENNO	14
2150 (1940)	2365 (2910)	3225 (3492)	1900	1700	2150 (1940)	2365 (2910)	3225 (3492)	1200	1100	2K1H0ANNENNO	14

(1) These drives have dual current ratings; normal duty applications and heavy duty applications (in parenthesis). The drive may be operated at either rating.

(2) Heavy duty rating is limited to 35° C surrounding air.

(3) The 2 sec. output current is only available at initial start or drive operating at light load.

(4) Drives listed Do Not include a Control and I/O option. Refer to page 11 for available options.

600...690V AC, Three-Phase Drives

600V AC Input					690V AC Input					IP54, NEMA Type 12 ⁽⁵⁾	
Output Amps			Normal Duty HP	Heavy Duty HP	Output Amps			Normal Duty kW	Heavy Duty kW	Cat. No. 20CE...	Frame Size
Cont. ⁽¹⁾	1 Min.	2 Sec. ⁽⁴⁾			Cont. ⁽¹⁾	1 Min.	2 Sec. ⁽⁴⁾				
261 (208)	287 (312)	375 (375)	250	200	261 (208)	287 (312)	375 (375)	250	200	261H0ANNBNN0	10
325 (261)	358 (392)	470 (470)	350	250	325 (261)	358 (392)	470 (470)	315	250	325H0ANNBNN0	10
385 (325)	424 (488)	585 (585)	400	350	385 (325)	424 (488)	585 (585)	355	315	385H0ANNBNN0	10
416 (325) ⁽²⁾	458 (488)	585 (585)	450	350	416 (325) ⁽²⁾	458 (488)	585 (585)	400	315	416H0ANNBNN0	10
460 (385)	506 (578)	693 (693)	500	400	460 (385)	506 (578)	693 (693)	450	355	460H0ANNBNN0	11
502 (460)	552 (690)	828 (828)	500	500	502 (460)	552 (690)	828 (828)	500	450	502H0ANNBNN0	11
590 (502)	649 (753)	885 (904)	600	500	590 (502)	649 (753)	885 (904)	560	500	590H0ANNBNN0	11
650 (590)	715 (885)	1062 (1062)	700	650	650 (590)	715 (885)	1062 (1062)	630	560	650H0ANNBNN0	12
750 (650)	825 (975)	1170 (1170)	800	700	750 (650)	825 (975)	1170 (1170)	710	630	750H0ANNBNN0	12
820 (750) ⁽²⁾	902 (975)	1170 (1170)	900	700	820 (750) ⁽²⁾	902 (975)	1170 (1170)	800	630	820H0ANNBNN0	12
920 (820)	1012 (1230)	1380 (1410)	1000	900	920 (820)	1012 (1230)	1380 (1410)	900	800	920H0ANNBNN0	13
1030 (920)	1133 (1380)	1545 (1755)	1100	1000	1030 (920)	1133 (1380)	1545 (1755)	1000	900	1030H0ANNBNN0	13
1180 (1030)	1298 (1463)	1755 (1755)	1300	1100	1180 (1030)	1298 (1463)	1755 (1755)	1100	1000	1180H0ANNBNN0	13
1500 (1300)	1650 (1950)	2250 (2340)	1600	1400	1500 (1300)	1650 (1950)	2250 (2340)	1500	1300	1500H0ANNENNO	14
1900 (1500)	2090 (2250)	2700 (2700)	2000	1600	1900 (1500)	2090 (2250)	2700 (2700)	1900	1500	1900H0ANNENNO	14
2250 (1900) ⁽³⁾	2475 (2782)	3335 (3335)	2400	2000	2250 (1900) ⁽³⁾	2475 (2782)	3335 (3335)	2300	1900	2250H0ANNENNO	14

- (1) These drives have dual current ratings; normal duty applications and heavy duty applications (in parenthesis). The drive may be operated at either rating.
- (2) Normal duty rating is limited to 35° C surrounding air.
- (3) Normal and heavy duty rating is limited to 35° C surrounding air.
- (4) The 2 sec. output current is only available at initial start or drive operating at light load.
- (5) Drives listed Do Not include a Control and I/O option. Refer to page 11 for available options.

Factory Installed Options

Conformal Coat (Position d = K, M or W)

Description	Frame
Conformal Coat Printed circuit boards are coated to provide improved resistance to dust and moisture. Consult factory for additional details.	9
	10
	11
	12
	13
	14

Human Interface and Wireless Interface Modules IP21 - NEMA/UL Type 1 (Position e)



Cat. Code: 0
No HIM
(Blank Plate)



Cat. Code: 3
LCD Display, Full
Numeric Keypad



Cat. Code: C
Door Mounted Bezel,
LCD Display,
Full Numeric Keypad
Frame 10 and up

IMPORTANT For additional factory installed options, refer to the Configured Drives Program.

Internal Brake IGBT

Brake IGBT	Frame	Cat. Code
		(Position g)
None	9...14	N
Optional	9	Y

Internal EMC Filter and Common Mode Choke

Drive Input Voltage	Frame	Description	Cat. Code
			(Position i)
380-500V AC & 600-690V AC	9-13	with CE Filter, No Choke, No dv/dt Filter	B
380-500V AC & 600-690V AC	9	No CE Filter, No Choke, No dv/dt Filter	N ⁽¹⁾
380-500V AC & 600-690V AC	14	with CE Filter, dv/dt Filter, No Choke	E

(1) For use with ungrounded or resistive grounded distribution systems.

Control and I/O Options

Description	Cat. Code
	(Position k)
24V DC Digital Inputs (6) w/Analog I/O & 115V AC Digital Outputs (3)	A
115V AC Digital Inputs (6) w/Analog I/O & 115V AC Digital Outputs (3)	B
24V DC Digital Inputs (6) w/Analog I/O, 24V DC Disable (Safe-Off) Inputs (2) & 115V AC Digital Outputs (2)	G
None	N

User Installed Options

Human Interface Modules



No HIM
(Blank Plate)
20-HIM-A0



LCD Display, Full
Numeric Keypad
20-HIM-A3



LCD Display,
Programmer
Only
20-HIM-A5



Remote Panel Mount
LCD Display,
Full Numeric Keypad
20-HIM-C3S



Remote Panel Mount
LCD Display,
Programmer Only
20-HIM-C5S

Description	Handheld/Local (Drive Mount)	Remote (Panel Mount) IP66, UL Type 4x/12 ⁽¹⁾
	Cat. No.	Cat. No.
No HIM (Blank Plate)	20-HIM-A0	—
LCD Display, Full Numeric Keypad	20-HIM-A3	20-HIM-C3S ⁽²⁾
LCD Display, Programmer Only	20-HIM-A5	20-HIM-C5S ⁽²⁾

(1) For indoor use only.

(2) Includes a 1202-C30 interface cable (3 meters) for connection to the drive.

Human Interface Module Accessories

Description	Cat. No.
Bezel Kit for LCD HIMs, NEMA/UL Type 1 ⁽¹⁾	20-HIM-B1
PowerFlex HIM Interface Cable, 1 m (39 in) ⁽²⁾	20-HIM-H10
Cable Kit (Male-Female) ⁽³⁾	
0.33 Meters (1.1 Feet)	1202-H03
1 Meter (3.3 Feet)	1202-H10
3 Meter (9.8 Feet)	1202-H30
9 Meter (29.5 Feet)	1202-H90
DPI/SCANport™ One to Two Port Splitter Cable	1203-S03

(1) Includes a 1202-C30 interface cable (3 meters) for connection to the drive.

(2) Required only when HIM is used as handheld or remote.

(3) Required in addition to 20-HIM-H10 for distances up to a total maximum of 10 Meters (32.8 Feet).

I/O Option Kit

Description	Slot ⁽¹⁾		Cat. No.
	A	B	
24V DC Digital Inputs (6) w/Analog I/O	X		20C-DA1-A
115V AC Digital Inputs (6) w/Analog I/O	X		20C-DA1-B
115V AC Digital Outputs (3)		X	20C-DO1
Safe-Off Board - 24V DC Disable Inputs (2) & 115V AC Digital Outputs (2)		X	20C-DG1

(1) Only one card allowed per slot.

Communication Option Kits

Description	Cat. No.
BACnet® MS/TP RS485 Communication Adapter	20-COMM-B
ControlNet™ Communication Adapter (Coax)	20-COMM-C
ControlNet™ Communication Adapter (Coax) Conformal Coat	20-COMM-CMX3
DeviceNet™ Communication Adapter	20-COMM-D
DeviceNet™ Communication Adapter Conformal Coat	20-COMM-DMX3
EtherNet/IP™ Communication Adapter	20-COMM-E
EtherNet/IP™ Communication Adapter Conformal Coat	20-COMM-EMX3
HVAC Communication Adapter	20-COMM-H
Interbus™ Communication Adapter	20-COMM-I
CANopen® Communication Adapter	20-COMM-K
LonWorks® Communication Adapter	20-COMM-L
Modbus/TCP Communication Adapter	20-COMM-M
PROFIBUS™ DP Communication Adapter	20-COMM-P
ControlNet™ Communication Adapter (Fiber)	20-COMM-Q
Remote I/O Communication Adapter	20-COMM-R
Remote I/O Communication Adapter Conformal Coat	20-COMM-RMX3
RS485 DF1 Communication Adapter	20-COMM-S
RS485 DF1 Communication Adapter Conformal Coat	20-COMM-SMX3
External Communications Kit Power Supply	20-XCOMM-PS1
DPI External Communications Kit	20-XCOMMDC-BASE
External DPI I/O Option Board ⁽¹⁾	20-XCOMMIO-OPT1
Serial Null Modem Adapter	1203-SNM
Smart Self-powered Serial Converter (RS232) includes 1203-SFC and 1202-C10 Cables	1203-SSS
Universal Serial Bus™ (USB) Converter includes 2m USB, 20-HIM-H10 & 22-HIM-H10 Cables	1203-USB
Compact I/O Module (3 Channel)	1769-SM1

(1) For use only with DPI External Communications Kits 20-XCOMM-DCBASE.

Protective Cover for DC Bus or Internal Brake IGBT Terminals

Description	Frame	Cat. No.
Touch Cover - Converts IP00/Open Type drive to IP20/NEMA/UL Type 1. No wiring space provided.	9	20-OPT-TC
Top Hat- Converts IP00/Open Type drive to IP20/NEMA/UL Type 1. Allows for wiring space.	9	20-OPT-TH

1492 Wiring System Modules and Cables

Wiring System Modules and Cables provide an easy means to extend drive control wiring. A pre-wired cable (available in various lengths) plugs into the appropriate drive I/O terminal block. The remaining cable end plugs into the Wiring Module which provides a terminal block for direct I/O connection. See publication 1492-TD008... for detailed information.

1492 Wiring Module and Cable Selection

700H Drive I/O	Wiring Module Description	Wiring Module Cat. No.		Use with Cable (see below...)
		Fixed Terminal Block	Removable Terminal Block	
DC Discrete Digital I/O (TB2)	Standard, 264V AC/DC	1492-IFM20F	1492-RIFM20F	1492-CABxxxA7H
	Narrow Standard, 132V AC/DC	1492-IFM20FN	1492-RIFM20FN	1492-CABxxxA7H
	Extra Terminals (2 per I/O), 264V AC/DC	1492-IFM20F-2	1492-RIFM20F-2	1492-CABxxxA7H
AC Discrete Digital I/O (20CDA1-B & 20CDO1)	Standard, 264V AC/DC	1492-IFM20F	1492-RIFM20F	1492-CABxxxA7H
	Narrow Standard, 132V AC/DC	1492-IFM20FN	1492-RIFM20FN	1492-CABxxxA7H
	Extra Terminals (2 per I/O), 264V AC/DC	1492-IFM20F-2	1492-RIFM20F-2	1492-CABxxxA7H
Analog I/O (TB1)	6 Channel Isolated - 3 Terminals/Channel	1492-AIFM6S-3	1492-RAIFM6S-3	1492-ACABxxxZ7H

Pre-Wired Cable Assemblies

Description	Cat. No.
Pre-Wired Cable for Analog I/O	
0.5 Meter (1.6 Feet)	1492-ACAB005Z7H
1.0 Meter (3.3 Feet)	1492-ACAB010Z7H
2.5 Meters (8.2 Feet)	1492-ACAB025Z7H
5.0 Meters (16.4 Feet)	1492-ACAB050Z7H
Pre-Wired Cable for Discrete DC I/O	
0.5 Meter (1.6 Feet)	1492-CAB005A7H
1.0 Meter (3.3 Feet)	1492-CAB010A7H
2.5 Meters (8.2 Feet)	1492-CAB025A7H
5.0 Meters (16.4 Feet)	1492-CAB050A7H
Pre-Wired Cable for Discrete AC I/O	
0.5 Meter (1.6 Feet)	1492-CAB005B7H
1.0 Meter (3.3 Feet)	1492-CAB010B7H
2.5 Meters (8.2 Feet)	1492-CAB025B7H
5.0 Meters (16.4 Feet)	1492-CAB050B7H

Bonitron Braking Solutions

Description	Rating	Model Number / Order Code	Replaces Cat. No.
380-480V AC	9A	M3452-H75B7-A	1336-WB009
	35A	M3452-H150B7-A	1336-WB035
	110A	M3452-H300K6-A	1336-WB110
500-600V AC	9A	M3452-C75B7-A	1336-WC009
	35A	M3452-C75B7-A	1336-WC035
	85A	M3452-C300K6-A	1336-WC085

Terminators

Description ⁽¹⁾	Cat. No.
for use with 1.5 kW (2 Hp) & up drives	1204-TFB2

(1) Refer to Appendix A of publication DRIVES-IN001 for selection information.

Reflected Wave Reduction Modules

Voltage	Drive Cat. No.	ND HP	Cat. No.
480V AC	20CD261	200	1321-RWR320-DP
	20CD300	250	1321-RWR320-DP

PC Programming Software

Description	
DriveTools™ SP Software ⁽¹⁾	See publication PFLEX-SG002 for further information.
DriveExplorer™ Software (Lite/Full) ^{(1) (2)}	
Pocket DriveExplorer™ Software	

(1) Set-up wizards are available for use with DriveTools SP and DriveExplorer (Lite/Full) only.

(2) DriveExplorer Lite is available for free download at: http://www.ab.com/drives/driveexplorer/free_download.html.

Output Reactors

For impedance matching and motor protection, reactors are available for the output sides of the drive.

480V, 60 Hz, Three-Phase, 3% Impedance

Drive Catalog Number	Duty	HP	Output Line Reactor ⁽¹⁾	
			IP 00 (Open Style)	IP 11 (NEMA/UL Type 1)
			Catalog Number	Catalog Number
20CD261	Heavy Duty	150	1321-3R200-B	1321-3RA200-B
20CD261	Normal Duty	200	1321-3RB250-B	1321-3RAB250-B
20CD300	Heavy Duty	200	1321-3RB250-B	1321-3RAB250-B
20CD300	Normal Duty	250	1321-3RB320-B	1321-3RAB320-B
20CD385	Heavy Duty	250	1321-3RB320-B	1321-3RAB320-B
20CD385	Normal Duty	300	1321-3RB400-B	1321-3RAB400-B
20CD460	Heavy Duty	300	1321-3RB400-B	1321-3RAB400-B
20CD460	Normal Duty	350	1321-3R500-B	1321-3RA500-B
20CD500	Heavy Duty	350	1321-3RB400-B	1321-3RAB400-B
20CD500	Normal Duty	450	1321-3R500-B	1321-3RA500-B
20CD590	Heavy Duty	450	1321-3R500-B	1321-3RA500-B
20CD590	Normal Duty	500	1321-3R600-B	1321-3RA600-B
20CD650	Heavy Duty	500	1321-3R600-B	1321-3RA600-B
20CD650	Normal Duty	500	1321-3R750-B	1321-3RA750-B
20CD730	Heavy Duty	500	1321-3R750-B	1321-3RA750-B
20CD730	Normal Duty	600	1321-3R750-B	1321-3RA750-B
20CD820	Heavy Duty	600	1321-3R750-B	1321-3RA750-B
20CD820	Normal Duty	700	1321-3RB400-B ⁽²⁾	1321-3RAB400-B ⁽²⁾
20CD920	Heavy Duty	700	1321-3RB400-B ⁽²⁾	1321-3RAB400-B ⁽²⁾
20CD920	Normal Duty	800	1321-3R500-B ⁽²⁾	1321-3RA500-B ⁽²⁾
20CD1K0	Heavy Duty	800	1321-3R500-B ⁽²⁾	1321-3RA500-B ⁽²⁾
20CD1K0	Normal Duty	900	1321-3R500-B ⁽²⁾	1321-3RA500-B ⁽²⁾
20CD1K1	Heavy Duty	900	1321-3R600-B ⁽²⁾	1321-3RA600-B ⁽²⁾
20CD1K1	Normal Duty	1000	1321-3R600-B ⁽²⁾	1321-3RA600-B ⁽²⁾
20CD1K3	Heavy Duty	1000	1321-3R750-B ⁽²⁾	1321-3RA750-B ⁽²⁾
20CD1K3	Normal Duty	1200	1321-3R750-B ⁽²⁾	1321-3RA750-B ⁽²⁾
20CD1K4	Heavy Duty	1000	1321-3R750-B ⁽²⁾	1321-3RA750-B ⁽²⁾
20CD1K4	Normal Duty	1250	1321-3R750-B ⁽²⁾	1321-3RA750-B ⁽²⁾

(1) PowerFlex 700H drives have integral input reactors. Output reactors were sized based on the VD rated output currents.

(2) Requires two output reactors wired in parallel.

480V, 60 Hz, Three-Phase, 5% Impedance

Drive Catalog Number	Duty	HP	Output Line Reactor ⁽¹⁾	
			IP 00 (Open Style)	IP 11 (NEMA/UL Type 1)
			Catalog Number	Catalog Number
20CD261	Heavy Duty	150	1321-3R200-C	1321-3RA200-C
20CD261	Normal Duty	200	1321-3RB250-C	1321-3RAB250-C
20CD300	Heavy Duty	200	1321-3RB250-C	1321-3RAB250-C
20CD300	Normal Duty	250	1321-3RB320-C	1321-3RAB320-C
20CD385	Heavy Duty	250	1321-3RB320-C	1321-3RAB320-C
20CD385	Normal Duty	300	1321-3RB400-C	1321-3RAB400-C
20CD460	Heavy Duty	300	1321-3RB400-C	1321-3RAB400-C
20CD460	Normal Duty	350	1321-3R500-C	1321-3RA500-C
20CD500	Heavy Duty	350	1321-3RB400-C	1321-3RAB400-C
20CD500	Normal Duty	450	1321-3R500-C	1321-3RA500-C
20CD590	Heavy Duty	450	1321-3R500-C	1321-3RA500-C
20CD590	Normal Duty	500	1321-3R600-C	1321-3RA600-C
20CD650	Heavy Duty	500	1321-3R600-C	1321-3RA600-C

Drive Catalog Number	Duty	HP	Output Line Reactor ⁽¹⁾	
			IP 00 (Open Style)	IP 11 (NEMA/UL Type 1)
			Catalog Number	Catalog Number
20CD650	Normal Duty	500	1321-3R750-C ⁽²⁾	1321-3RA750-C ⁽²⁾
20CD730	Heavy Duty	500	1321-3R750-C ⁽²⁾	1321-3RA750-C ⁽²⁾
20CD730	Normal Duty	600	1321-3R750-C ⁽²⁾	1321-3RA750-C ⁽²⁾
20CD820	Heavy Duty	600	1321-3R750-C ⁽²⁾	1321-3RA750-C ⁽²⁾
20CD820	Normal Duty	700	1321-3RB400-C ⁽³⁾	1321-3RAB400-C ⁽³⁾
20CD920	Heavy Duty	700	1321-3RB400-C ⁽³⁾	1321-3RAB400-C ⁽³⁾
20CD920	Normal Duty	800	1321-3R500-C ⁽³⁾	1321-3RA500-C ⁽³⁾
20CD1K0	Heavy Duty	800	1321-3R500-C ⁽³⁾	1321-3RA500-C ⁽³⁾
20CD1K0	Normal Duty	900	1321-3R500-C ⁽³⁾	1321-3RA500-C ⁽³⁾
20CD1K1	Heavy Duty	900	1321-3R600-C ⁽³⁾	1321-3RA600-C ⁽³⁾
20CD1K1	Normal Duty	1000	1321-3R600-C ⁽³⁾	1321-3RA600-C ⁽³⁾
20CD1K3	Heavy Duty	1000	1321-3R750-C ⁽²⁾⁽³⁾	1321-3RA750-C ⁽²⁾⁽³⁾
20CD1K3	Normal Duty	1200	1321-3R750-C ⁽²⁾⁽³⁾	1321-3RA750-C ⁽²⁾⁽³⁾
20CD1K4	Heavy Duty	1000	1321-3R750-C ⁽²⁾⁽³⁾	1321-3RA750-C ⁽²⁾⁽³⁾
20CD1K4	Normal Duty	1250	1321-3R750-C ⁽³⁾	1321-3RA750-C ⁽³⁾

(1) PowerFlex 700H drives have integral input reactors. Output reactors were sized based on the VD rated output currents.

(2) 4% impedance.

(3) Requires two output reactors wired in parallel.

600V, 60 Hz, Three-Phase, 3% Impedance

Drive Catalog Number	Duty	HP	Output Line Reactor ⁽¹⁾	
			IP 00 (Open Style)	IP 11 (NEMA/UL Type 1)
			Catalog Number	Catalog Number
20CE170	Heavy Duty	150	1321-3R200-C	1321-3RA200-C
20CE170	Normal Duty	150	1321-3R200-C	1321-3RA200-C
20CE208	Heavy Duty	150	1321-3R200-C	1321-3RA200-C
20CE208	Normal Duty	200	1321-3R200-B	1321-3RA200-B
20CE261	Heavy Duty	200	1321-3R200-B	1321-3RA200-B
20CE261	Normal Duty	250	1321-3RB250-B	1321-3RAB250-B
20CE325	Heavy Duty	250	1321-3RB250-B	1321-3RAB250-B
20CE325	Normal Duty	350	1321-3RB320-B	1321-3RAB320-B
20CE385	Heavy Duty	350	1321-3RB320-B	1321-3RAB320-B
20CE385	Normal Duty	400	1321-3RB400-B	1321-3RAB400-B
20CE416	Heavy Duty	350	1321-3RB320-B	1321-3RAB320-B
20CE416	Normal Duty	450	1321-3RB400-B	1321-3RAB400-B
20CE460	Heavy Duty	400	1321-3RB400-B	1321-3RAB400-B
20CE460	Normal Duty	450	1321-3R500-B	1321-3RA500-B
20CE502	Heavy Duty	450	1321-3RB400-B	1321-3RAB400-B
20CE502	Normal Duty	500	1321-3R500-B	1321-3RA500-B
20CE590	Heavy Duty	500	1321-3R500-B	1321-3RA500-B
20CE590	Normal Duty	600	1321-3R600-B	1321-3RA600-B
20CE650	Heavy Duty	650	1321-3RB320-B ⁽²⁾	1321-3RAB320-B ⁽²⁾
20CE650	Normal Duty	700	1321-3RB320-B ⁽²⁾	1321-3RAB320-B ⁽²⁾
20CE750	Heavy Duty	700	1321-3RB400-C ⁽²⁾	1321-3RAB400-C ⁽²⁾
20CE750	Normal Duty	800	1321-3RB400-C ⁽²⁾	1321-3RAB400-C ⁽²⁾
20CE820	Heavy Duty	700	1321-3RB400-B ⁽²⁾	1321-3RAB400-B ⁽²⁾
20CE820	Normal Duty	900	1321-3RB400-B ⁽²⁾	1321-3RAB400-B ⁽²⁾
20CE920	Heavy Duty	900	1321-3R1000-C	1321-3RA1000-C
20CE920	Normal Duty	1000	1321-3R1000-C	1321-3RA1000-C
20CE1K0	Heavy Duty	1000	1321-3R1000-B	1321-3RA1000-B
20CE1K0	Normal Duty	1100	1321-3R1000-B	1321-3RA1000-B
20CE1K1	Heavy Duty	1100	1321-3R600-B ⁽²⁾	1321-3RA600-B ⁽²⁾
20CE1K1	Normal Duty	1300	1321-3R600-B ⁽²⁾	1321-3RA600-B ⁽²⁾

(1) PowerFlex 700H drives have integral input reactors. Output reactors were sized based on the VD rated output currents.

(2) Requires two output reactors wired in parallel.

600V, 60 Hz, Three-Phase, 5% Impedance

Drive Catalog Number	Duty	HP	Output Line Reactor ⁽¹⁾	
			IP 00 (Open Style)	IP 11 (NEMA/UL Type 1)
			Catalog Number	Catalog Number
20CE170	Heavy Duty	150	1321-3R160-C ⁽²⁾	1321-3RA160-C ⁽²⁾
20CE170	Normal Duty	150	1321-3R200-C ⁽³⁾	1321-3RA200-C ⁽³⁾
20CE208	Heavy Duty	150	1321-3R200-C ⁽³⁾	1321-3RA200-C ⁽³⁾
20CE208	Normal Duty	200	1321-3R200-B ⁽²⁾	1321-3RA200-B ⁽²⁾
20CE261	Heavy Duty	200	1321-3R200-C ⁽²⁾	1321-3RA200-C ⁽²⁾
20CE261	Normal Duty	250	1321-3RB250-C ⁽²⁾	1321-3RAB250-C ⁽²⁾
20CE325	Heavy Duty	250	1321-3RB250-C ⁽²⁾	1321-3RAB250-C ⁽²⁾
20CE325	Normal Duty	350	1321-3RB320-C ⁽²⁾	1321-3RAB320-C ⁽²⁾
20CE385	Heavy Duty	350	1321-3RB320-C ⁽²⁾	1321-3RAB320-C ⁽²⁾
20CE385	Normal Duty	400	1321-3RB400-C ⁽²⁾	1321-3RAB400-C ⁽²⁾
20CE416	Heavy Duty	350	1321-3RB320-C ⁽²⁾	1321-3RAB320-C ⁽²⁾
20CE416	Normal Duty	450	1321-3RB400-C	1321-3RAB400-C
20CE460	Heavy Duty	400	1321-3RB400-C ⁽²⁾	1321-3RAB400-C ⁽²⁾
20CE460	Normal Duty	450	1321-3R500-C ⁽²⁾	1321-3RA500-C ⁽²⁾
20CE502	Heavy Duty	450	1321-3RB400-C	1321-3RAB400-C
20CE502	Normal Duty	500	1321-3R500-C	1321-3RA500-C ⁽²⁾
20CE590	Heavy Duty	500	1321-3R500-C	1321-3RA500-C
20CE590	Normal Duty	600	1321-3R600-C ⁽²⁾	1321-3RA600-C ⁽²⁾
20CE650	Heavy Duty	650	1321-3RB320-C ⁽²⁾⁽⁴⁾	1321-3RAB320-C ⁽²⁾⁽⁴⁾
20CE650	Normal Duty	700	1321-3RB320-C ⁽²⁾⁽⁴⁾	1321-3RAB320-C ⁽²⁾⁽⁴⁾
20CE750	Heavy Duty	700	1321-3RB400-C ⁽²⁾⁽⁴⁾	1321-3RAB400-C ⁽²⁾⁽⁴⁾
20CE750	Normal Duty	800	1321-3RB400-C ⁽²⁾⁽⁴⁾	1321-3RAB400-C ⁽²⁾⁽⁴⁾
20CE820	Heavy Duty	700	1321-3RB400-C ⁽²⁾⁽⁴⁾	1321-3RAB400-C ⁽²⁾⁽⁴⁾
20CE820	Normal Duty	900	1321-3RB400-C ⁽⁴⁾	1321-3RAB400-C ⁽⁴⁾
20CE920	Heavy Duty	900	1321-3R500-C ⁽²⁾⁽⁴⁾	1321-3RA500-C ⁽²⁾⁽⁴⁾
20CE920	Normal Duty	1000	1321-3R500-C ⁽²⁾⁽⁴⁾	1321-3RA500-C ⁽²⁾⁽⁴⁾
20CE1K0	Heavy Duty	1000	1321-3R1000-C ⁽²⁾	1321-3RA1000-C ⁽²⁾
20CE1K0	Normal Duty	1100	1321-3R1000-C ⁽²⁾	1321-3RA1000-C ⁽²⁾
20CE1K1	Heavy Duty	1100	1321-3R600-C ⁽²⁾⁽⁴⁾	1321-3RA600-C ⁽²⁾⁽⁴⁾
20CE1K1	Normal Duty	1300	1321-3R600-C ⁽²⁾⁽⁴⁾	1321-3RA600-C ⁽²⁾⁽⁴⁾

(1) PowerFlex 700H drives have integral input reactors. Output reactors were sized based on the VD rated output currents.

(2) 4% impedance.

(3) 3% impedance.

(4) Requires two output reactors wired in parallel.

690V, 60 Hz, Three-Phase, 3% Impedance

Drive Catalog Number	Duty	HP	Output Line Reactor ⁽¹⁾	
			IP 00 (Open Style)	IP 11 (NEMA/UL Type 1)
			Catalog Number	Catalog Number
20CF170	Heavy Duty	132	1321-3RB250-C	1321-3RAB250-C
20CF170	Normal Duty	160	1321-3RB250-C	1321-3RAB250-C
20CF208	Heavy Duty	160	1321-3RB250-C	1321-3RAB250-C
20CF208	Normal Duty	200	1321-3RB250-C	1321-3RAB250-C
20CF261	Heavy Duty	200	1321-3RB320-C	1321-3RAB320-C
20CF261	Normal Duty	250	1321-3RB320-C	1321-3RAB320-C
20CF325	Heavy Duty	250	1321-3RB400-C	1321-3RAB400-C
20CF325	Normal Duty	315	1321-3RB400-C	1321-3RAB400-C
20CF385	Heavy Duty	315	1321-3R500-C	1321-3RA500-C
20CF385	Normal Duty	355	1321-3R500-C	1321-3RA500-C
20CF416	Heavy Duty	315	1321-3R500-C	1321-3RA500-C
20CF416	Normal Duty	400	1321-3R500-C	1321-3RA500-C
20CF460	Heavy Duty	355	1321-3R600-C	1321-3RA600-C
20CF460	Normal Duty	450	1321-3R600-C	1321-3RA600-C
20CF502	Heavy Duty	450	1321-3R600-C	1321-3RA600-C
20CF502	Normal Duty	500	1321-3R600-C	1321-3RA600-C
20CF590	Heavy Duty	500	1321-3R750-C	1321-3RA750-C
20CF590	Normal Duty	560	1321-3R750-C	1321-3RA750-C
20CF650	Heavy Duty	560	1321-3RB400-C ⁽²⁾	1321-3RAB400-C ⁽²⁾
20CF650	Normal Duty	630	1321-3RB400-C ⁽²⁾	1321-3RAB400-C ⁽²⁾
20CF750	Heavy Duty	630	1321-3R500-C ⁽²⁾	1321-3RA500-C ⁽²⁾
20CF750	Normal Duty	710	1321-3R500-C ⁽²⁾	1321-3RA500-C ⁽²⁾
20CF820	Heavy Duty	630	1321-3R500-C ⁽²⁾	1321-3RA500-C ⁽²⁾
20CF820	Normal Duty	800	1321-3R500-C ⁽²⁾	1321-3RA500-C ⁽²⁾
20CF920	Heavy Duty	800	1321-3R600-C ⁽²⁾	1321-3RA600-C ⁽²⁾
20CF920	Normal Duty	900	1321-3R600-C ⁽²⁾	1321-3RA600-C ⁽²⁾
20CF1K0	Heavy Duty	900	1321-3R600-C ⁽²⁾	1321-3RA600-C ⁽²⁾
20CF1K0	Normal Duty	1000	1321-3R600-C ⁽²⁾	1321-3RA600-C ⁽²⁾
20CF1K1	Heavy Duty	1000	1321-3R750-C ⁽²⁾	1321-3RA750-C ⁽²⁾
20CF1K1	Normal Duty	1100	1321-3R750-C ⁽²⁾	1321-3RA750-C ⁽²⁾

(1) PowerFlex 700H drives have integral input reactors. Output reactors were sized based on the VD rated output currents.

(2) Requires two output reactors wired in parallel.

Installation Considerations

Power Wiring

The PowerFlex 700H has the following built in protective features to help simplify installation:

- Ground fault protection during start up and running ensures reliable operation
- Electronic motor overload protection increases motor life
- To ensure compatibility with ungrounded systems, Frame 10 - 14 drives incorporate removable MOV to ground and common mode capacitors to ground. Frame 9 drives can be specially ordered to allow compatibility with ungrounded systems.
- 6 kV transient protection provides increased robustness for 380-480V system voltages

There are many other factors that must be considered for optimal performance in any given application. The block diagram below highlights the primary installation considerations.

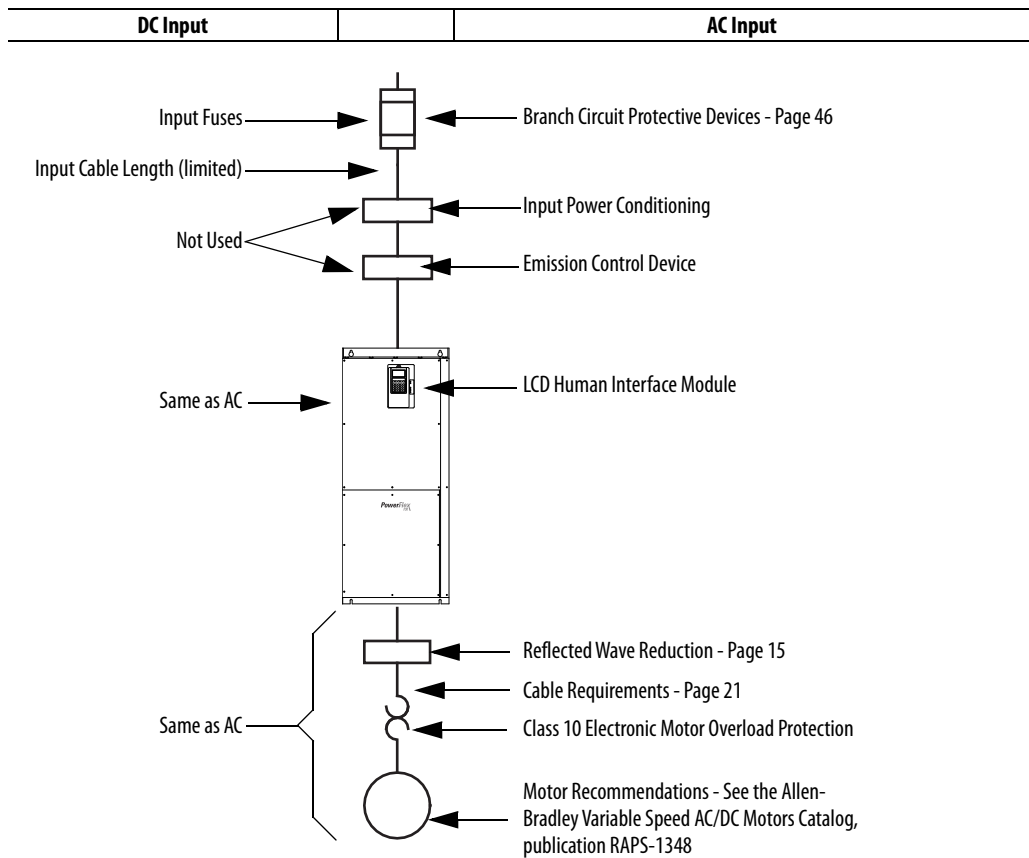

Cable Recommendations

- Important points to remember about I/O wiring:
- Always use copper wire.
- Wire with an insulation rating of 600V or greater is recommended.
- Control and signal wires should be separated from power wires by at least 0.3 meters (1 foot).

IMPORTANT I/O terminals labeled “(-)” or “Common” are not referenced to earth ground and are designed to greatly reduce common mode interference. Grounding these terminals can cause signal noise.

Signal and Control Wire Types

Recommended Signal Wire

Signal Type	Wire Type(s)	Description	Minimum Insulation Rating
Analog I/O	Belden 8760/9460 (or equiv.)	0.750 mm ² (18 AWG), twisted pair, 100% shield with drain. ⁽¹⁾	300V, 75...90 °C
	Belden 8770 (or equiv.)	0.750 mm ² (18 AWG), 3 cond., shielded for remote pot only.	(167...194 °F)
EMC Compliance	Refer to Installation Manual for details.		

(1) If the wires are short and contained within a cabinet which has no sensitive circuits, the use of shielded wire may not be necessary, but is always recommended.

Recommended Control Wire for Digital I/O

Type	Wire Type(s)	Description	Minimum Insulation Rating
Unshielded	Per US NEC or applicable national or local code	–	300V, 60 °C
Shielded	Multi-conductor shielded cable such as Belden 8770 (or equiv.)	0.750 mm ² (18 AWG), 3 conductor, shielded.	(140 °F)

Cable Types Acceptable for 200-600 Volt Installations

A variety of cable types are acceptable for drive installations. For many installations, unshielded cable is adequate, provided it can be separated from sensitive circuits. As an approximate guide, allow a spacing of 0.3 meters (1 foot) for every 10 meters (32.8 feet) of length. In all cases, long parallel runs must be avoided. Do not use cable with an insulation thickness less than or equal to 15 mils (0.4mm/0.015 in.). Use Copper wire only. Wire gauge requirements and recommendations are based on 75 °C. Do not reduce wire gauge when using higher temperature wire.

Unshielded Cable

THHN, THWN or similar wire is acceptable for drive installation in dry environments provided adequate free air space and/or conduit fill rates limits are provided. **Do not use THHN or similarly coated wire in wet areas.** Any wire chosen must have a minimum insulation thickness of 15 mils (0.4mm/0.015 in.) and should not have large variations in insulation concentricity.

Shielded Cable

Shielded cable contains all of the general benefits of multi-conductor cable with the added benefit of a copper braided shield that can contain much of the noise generated by a typical AC drive. Strong consideration for shielded cable should be given in installations with sensitive equipment such as weigh scales, capacitive proximity switches and other devices that may be affected by electrical noise in the distribution system. Applications with large numbers of drives in a similar location, imposed EMC regulations or a high degree of communications/ networking are also good candidates for shielded cable.

Shielded cable may also help reduce shaft voltage and induced bearing currents for some applications. In addition, the increased impedance of shielded cable may help extend the distance that the motor can be located from the drive without the addition of motor protective devices such as terminator networks. Refer to *Reflected Wave* in “Wiring and Grounding Guidelines for PWM AC Drives,” publication [DRIVES-IN001](#).

Consideration should be given to all of the general specifications dictated by the environment of the installation, including temperature, flexibility, moisture characteristics and chemical resistance. In addition, a braided shield should be included and be specified by the cable manufacturer as having coverage of at least 75%. An additional foil shield can greatly improve noise containment.

A good example of recommended cable is Belden® 295xx (xx determines gauge). This cable has four (4) XLPE insulated conductors with a 100% coverage foil and an 85% coverage copper braided shield (with drain wire) surrounded by a PVC jacket.

Other types of shielded cable are available, but the selection of these types may limit the allowable cable length. Particularly, some of the newer cables twist 4 conductors of THHN wire and wrap them tightly with a foil shield. This construction can greatly increase the cable charging current required and reduce the overall drive performance. Unless specified in the individual distance tables as tested with the drive, these cables are not recommended and their performance against the lead length limits supplied is not known.

Armored Cable

Cable with continuous aluminum armor is often recommended in drive system applications or specific industries. It offers most of the advantages of standard shielded cable and also combines considerable mechanical strength and resistance to moisture. It can be installed in concealed and exposed manners and removes the requirement for conduit (EMT) in the installation. It can also be directly buried or embedded in concrete.

Because noise containment can be affected by incidental grounding of the armor to building steel when the cable is mounted, it is recommended the armored cable have an overall PVC jacket. Refer to “Wire Types,” in publication [DRIVES-IN001](#), *Wiring and Grounding Guidelines for Pulse Width Modulated (PWM) AC Drives*.

Interlocked armor is acceptable for shorter cable runs, but continuous welded armor is preferred.

Best performance is achieved with 3 spaced ground conductors, but acceptable performance below 200 HP is provided via a single ground conductor.

Recommended Shielded / Armored Cable

Location	Rating/Type	Description
Standard (Option 1)	600V, 90 °C (194 °F) XHHW2/RHW-2 Anixter B209500-B209507, Belden 29501-29507, or equivalent	<ul style="list-style-type: none"> Four tinned copper conductors with XLPE insulation. Copper braid/aluminum foil combination shield and tinned copper drain wire. PVC jacket.
Standard (Option 2)	Tray rated 600V, 90 °C (194 °F) RHH/RHW-2 Anixter OLF-7xxxx or equivalent	<ul style="list-style-type: none"> Three tinned copper conductors with XLPE insulation. 5 mil single helical copper tape (25% overlap min.) with three bare copper grounds in contact with shield. PVC jacket.
Class I & II; Division I & II	Tray rated 600V, 90 °C (194 °F) RHH/RHW-2 Anixter 7V-7xxxx-3G or equivalent	<ul style="list-style-type: none"> Three bare copper conductors with XLPE insulation and impervious corrugated continuously welded aluminum armor. Black sunlight resistant PVC jacket overall. Three copper grounds on #10 AWG and smaller.

Single-Phase Input Power

The PowerFlex 700H drives are typically used with a three-phase input supply. The drives have been listed by UL to operate on single-phase input power with the requirement that the output current is derated by 80% of the three-phase ratings beginning on [page 37](#).

Maximum Motor Cable Lengths

IMPORTANT In the following tables, a “●” in the TFB2 column indicates that this drive rating can be used with an Allen-Bradley Terminator, catalog number 1204-TFB2.

- For the Terminator, the maximum cable length is 182.9 meters (600 feet) for 400/480/600V drives (not 690V). The PWM frequency must be 2 kHz. Only 1204-TFB2 terminators are compatible with PowerFlex 700H AC drives.

The 1321-RWR is a complete reflected wave reduction solution available for many of the PowerFlex drives. If available, a 1321-RWR catalog number will be indicated in the “Reactor/RWR” column. When not available, use the reactor and resistor information provided to build a solution.

For Further Information on ...	see Publication...
1321-RWR	1321-TD001
1204-RWR2	1204-5.1
1204-RWC	1204-IN001
1204-TFxx	1204-IN002

400V Shielded/Unshielded Cable – Meters (Feet)

Drive			No Solution				Reactor Only				Reactor + Damping Resistor or 1321-RWR				Reactor/RWR	Resistor		Available Options			
Frame	kW	kHz	1000V	1200V	1488V	1600V	1000V	1200V	1488V	1600V	1000V	1200V	1488V	1600V	Cat. No.	Ohms	Watts	TFB2	TFA1	RWR2	RWC
9	132	2	24.4 (80)	48.8 (160)	76.2 (250)	137.2 (450)	24.4 (80)	48.8 (160)	365.8 (1200)	365.8 (1200)	121.9 (400)	274.3 (900)	365.8 (1200)	365.8 (1200)	1321-RWR320-DP			●			
	160	2	24.4 (80)	48.8 (160)	76.2 (250)	137.2 (450)	24.4 (80)	48.8 (160)	365.8 (1200)	365.8 (1200)	121.9 (400)	274.3 (900)	365.8 (1200)	365.8 (1200)	1321-RWR320-DP			●			
10	200	2	24.4 (80)	48.8 (160)	76.2 (250)	121.9 (400)	24.4 (80)	48.8 (160)	365.8 (1200)	365.8 (1200)	121.9 (400)	274.3 (900)	365.8 (1200)	365.8 (1200)	1321-3R500-B	20	495 ⁽³⁾	●			
	250	2	24.4 (80)	48.8 (160)	61.0 (200)	121.9 (400)	24.4 (80)	48.8 (160)	365.8 (1200)	365.8 (1200)	121.9 (400)	274.3 (900)	365.8 (1200)	365.8 (1200)	1321-3R500-B	20	495 ⁽³⁾	●			
11	315	2	18.3 (60)	42.7 (140)	61.0 (200)	121.9 (400)	18.3 (60)	42.7 (140)	365.8 (1200)	365.8 (1200)	121.9 (400)	243.8 (800)	365.8 (1200)	365.8 (1200)	1321-3R600-B	20	495 ⁽³⁾	●			
	355	2	18.3 (60)	42.7 (140)	61.0 (200)	121.9 (400)	18.3 (60)	42.7 (140)	304.8 (1000)	365.8 (1200)	121.9 (400)	243.8 (800)	365.8 (1200)	365.8 (1200)	1321-3R750-B	20	495 ⁽³⁾	●			
	400	2	18.3 (60)	42.7 (140)	61.0 (200)	121.9 (400)	18.3 (60)	42.7 (140)	274.3 (900)	365.8 (1200)	121.9 (400)	243.8 (800)	365.8 (1200)	365.8 (1200)	1321-3R750-B	20	735 ⁽⁴⁾	●			
12 ⁽¹⁾	450	2	18.3 (60)	42.7 (140)	61.0 (200)	121.9 (400)	18.3 (60)	42.7 (140)	243.8 (800)	365.8 (1200)	121.9 (400)	243.8 (800)	365.8 (1200)	365.8 (1200)	2 x 1321-3RB400-B	40	375 ⁽⁴⁾	●			
	500	2	12.2 (40)	42.7 (140)	61.0 (200)	121.9 (400)	18.3 (60)	42.7 (140)	243.8 (800)	365.8 (1200)	121.9 (400)	243.8 (800)	365.8 (1200)	365.8 (1200)	2 x 1321-3R500-B	40	375 ⁽⁴⁾	●			
	560	2	12.2 (40)	42.7 (140)	61.0 (200)	121.9 (400)	18.3 (60)	42.7 (140)	243.8 (800)	365.8 (1200)	121.9 (400)	243.8 (800)	365.8 (1200)	365.8 (1200)	2 x 1321-3R500-B	20	525 ⁽⁵⁾				
13	630 ⁽²⁾	2	12.2 (40)	61.0 (200)	99.1 (325)	167.6 (550)	36.6 (120)	61.0 (200)	304.8 (1000)	365.8 (1200)	198.1 (650)	274.3 (900)	365.8 (1200)	365.8 (1200)	2 x 1321-3R600-B	20	525 ⁽⁵⁾				
	710 ⁽²⁾	2	12.2 (40)	61.0 (200)	99.1 (325)	167.6 (550)	36.6 (120)	61.0 (200)	304.8 (1000)	365.8 (1200)	198.1 (650)	274.3 (900)	365.8 (1200)	365.8 (1200)	2 x 1321-3R750-B	20	525 ⁽⁵⁾				
	800 ⁽²⁾	2	12.2 (40)	61.0 (200)	99.1 (325)	167.6 (550)	36.6 (120)	61.0 (200)	304.8 (1000)	365.8 (1200)	198.1 (650)	274.3 (900)	365.8 (1200)	365.8 (1200)	2 x 1321-3R750-B	20	525 ⁽⁵⁾				

- (1) Frame 12 drives have dual inverters and require two output reactors. The resistor ratings are per phase values for each reactor.
- (2) Some Frame 13 drives require two output reactors to match drive amp rating. The resistor ratings are per phase values for each reactor.
- (3) Resistor specification is based on two cables per phase.
- (4) Resistor specification is based on three cables per phase.
- (5) Resistor specification is based on four cables per phase.

480V Shielded/Unshielded Cable - Meters (Feet)

Drive			No Solution				Reactor Only				Reactor + Damping Resistor or 1321-RWR				Reactor/RWR	Resistor		Available Options			
Frame	HP	kHz	1000V	1200V	1488V	1600V	1000V	1200V	1488V	1600V	1000V	1200V	1488V	1600V	Cat. No.	Ohms	Watts	TFB2	TFA1	RWR2	RWC
9	200	2	12.2 (40)	24.4 (80)	42.7 (140)	76.2 (250)	12.2 (40)	24.4 (80)	106.9 (350)	152.4 (500)	61.0 (200)	167.6 (550)	304.8 (1000)	365.8 (1200)	1321-RWR320-DP			●			
	250	2	12.2 (40)	24.4 (80)	42.7 (140)	76.2 (250)	12.2 (40)	24.4 (80)	91.4 (300)	121.9 (400)	61.0 (200)	152.4 (500)	304.8 (1000)	365.8 (1200)	1321-RWR320-DP			●			
10	300	2	12.2 (40)	24.4 (80)	42.7 (140)	76.2 (250)	12.2 (40)	24.4 (80)	76.2 (250)	91.4 (300)	61.0 (200)	121.9 (400)	304.8 (1000)	365.8 (1200)	1321-3RB400-B	20	495 ⁽³⁾	●			
	350	2	12.2 (40)	24.4 (80)	42.7 (140)	76.2 (250)	12.2 (40)	24.4 (80)	76.2 (250)	91.4 (300)	61.0 (200)	121.9 (400)	304.8 (1000)	365.8 (1200)	1321-3R500-B	20	495 ⁽³⁾	●			
	450	2	12.2 (40)	24.4 (80)	36.6 (120)	61.0 (200)	12.2 (40)	24.4 (80)	61.0 (200)	91.4 (300)	61.0 (200)	121.9 (400)	274.3 (900)	365.8 (1200)	1321-3R500-B	20	495 ⁽³⁾	●			
11	500	2	12.2 (40)	24.4 (80)	36.6 (120)	61.0 (200)	12.2 (40)	24.4 (80)	61.0 (200)	91.4 (300)	61.0 (200)	121.9 (400)	243.8 (800)	365.8 (1200)	1321-3R750-B	20	495 ⁽³⁾	●			
	600	2	12.2 (40)	24.4 (80)	36.6 (120)	61.0 (200)	12.2 (40)	24.4 (80)	45.7 (150)	91.4 (300)	45.7 (150)	121.9 (400)	243.8 (800)	365.8 (1200)	1321-3R750-B	20	735 ⁽⁴⁾	●			
12 ⁽¹⁾	700	2	12.2 (40)	24.4 (80)	36.6 (120)	61.0 (200)	12.2 (40)	24.4 (80)	45.7 (150)	91.4 (300)	45.7 (150)	106.9 (350)	243.8 (800)	365.8 (1200)	2 x 1321-3RB400-B	40	375 ⁽⁴⁾	●			
	800	2	12.2 (40)	24.4 (80)	36.6 (120)	61.0 (200)	12.2 (40)	24.4 (80)	45.7 (150)	91.4 (300)	45.7 (150)	106.9 (350)	243.8 (800)	365.8 (1200)	2 x 1321-3R500-B	40	375 ⁽⁴⁾	●			
	900	2	12.2 (40)	24.4 (80)	36.6 (120)	61.0 (200)	12.2 (40)	24.4 (80)	45.7 (150)	91.4 (300)	45.7 (150)	106.9 (350)	243.8 (800)	365.8 (1200)	2 x 1321-3R500-B	20	525 ⁽⁵⁾				
13	1000 ⁽²⁾	2	12.2 (40)	30.5 (100)	61.0 (200)	121.9 (400)	12.2 (40)	45.7 (150)	61.0 (200)	121.9 (400)	45.7 (150)	152.4 (500)	304.8 (1000)	365.8 (1200)	2 x 1321-3R600-B	20	525 ⁽⁵⁾				
	1200 ⁽²⁾	2	12.2 (40)	30.5 (100)	61.0 (200)	121.9 (400)	12.2 (40)	45.7 (150)	61.0 (200)	121.9 (400)	45.7 (150)	152.4 (500)	304.8 (1000)	365.8 (1200)	2 x 1321-3R750-B	20	525 ⁽⁵⁾				
	1250 ⁽²⁾	2	12.2 (40)	30.5 (100)	61.0 (200)	121.9 (400)	12.2 (40)	45.7 (150)	61.0 (200)	121.9 (400)	45.7 (150)	152.4 (500)	304.8 (1000)	365.8 (1200)	2 x 1321-3R750-B	20	525 ⁽⁵⁾				

- (1) Frame 12 drives have dual inverters and require two output reactors. The resistor ratings are per phase values for each reactor.
(2) Some Frame 13 drives require two output reactors to match drive amp rating. The resistor ratings are per phase values for each reactor.
(3) Resistor specification is based on two cables per phase.
(4) Resistor specification is based on three cables per phase.
(5) Resistor specification is based on four cables per phase.

600V Shielded/Unshielded Cable - Meters (Feet)

Drive			No Solution		Reactor Only		Reactor + Damping Resistor or 1321-RWR		Reactor/RWR	Resistor		Available Options			
Frame	HP	kHz	1488V	1850V	1488V	1850V	1488V	1850V	Cat. No.	Ohms	Watts	TFB2	TFA1	RWR2	RWC
9	150	2	30.5 (100)	54.9 (180)	36.6 (120)	152.4 (500)	213.4 (700)	365.8 (1200)	1321-RWR200-EP			●			
	200	2	30.5 (100)	54.9 (180)	36.6 (120)	121.9 (400)	182.9 (600)	365.8 (1200)	1321-RWR250-EP			●			
10	250	2	30.5 (100)	54.9 (180)	36.6 (120)	91.4 (300)	182.9 (600)	365.8 (1200)	1321-3RB250-B	50	315	●			
	350	2	30.5 (100)	45.7 (150)	30.5 (100)	76.2 (250)	167.6 (550)	365.8 (1200)	1321-3RB320-B	20	585 ⁽³⁾	●			
	400	2	30.5 (100)	45.7 (150)	30.5 (100)	61.0 (200)	167.6 (550)	365.8 (1200)	1321-3RB400-B	20	585 ⁽³⁾	●			
	450	2	30.5 (100)	45.7 (150)	30.5 (100)	61.0 (200)	152.4 (500)	365.8 (1200)	1321-3R500-B	20	585 ⁽³⁾	●			
11	500	2	30.5 (100)	45.7 (150)	30.5 (100)	45.7 (150)	152.4 (500)	365.8 (1200)	1321-3R500-B	20	585 ⁽³⁾	●			
	600	2	30.5 (100)	45.7 (150)	30.5 (100)	45.7 (150)	152.4 (500)	365.8 (1200)	1321-3R600-B	20	585 ⁽³⁾	●			
12 ⁽¹⁾	700	2	30.5 (100)	45.7 (150)	30.5 (100)	45.7 (150)	152.4 (500)	365.8 (1200)	2 x 1321-3RB320-B	40	300 ⁽³⁾	●			
	800	2	30.5 (100)	45.7 (150)	30.5 (100)	45.7 (150)	137.2 (450)	365.8 (1200)	2 x 1321-3RB400-C	40	480 ⁽⁴⁾	●			
	900	2	30.5 (100)	45.7 (150)	30.5 (100)	45.7 (150)	121.9 (400)	365.8 (1200)	2 x 1321-3R400-B	40	480 ⁽⁴⁾				
13	1000	2	42.7 (140)	152.4 (500)	61.0 (200)	304.8 (1000)	365.8 (1200)	365.8 (1200)	1321-3R1000-C	20	960 ⁽⁴⁾				
	1100	2	42.7 (140)	152.4 (500)	61.0 (200)	304.8 (1000)	365.8 (1200)	365.8 (1200)	1321-3R1000-B	10	1440 ⁽⁵⁾				
	1300 ⁽²⁾	2	42.7 (140)	152.4 (500)	61.0 (200)	304.8 (1000)	365.8 (1200)	365.8 (1200)	2 x 1321-3R600-B	20	720 ⁽⁵⁾				

- (1) Frame 12 drives have dual inverters and require two output reactors. The resistor ratings are per phase values for each reactor.
- (2) Some Frame 13 drives require two output reactors to match drive amp rating. The resistor ratings are per phase values for each reactor.
- (3) Resistor specification is based on two cables per phase.
- (4) Resistor specification is based on three cables per phase.
- (5) Resistor specification is based on four cables per phase.

690V Shielded/Unshielded Cable – Meters (Feet)

Drive			No Solution		Reactor Only		Reactor + Damping Resistor		Reactor	Resistor		Available Options			
Frame	kW	kHz	1850V	2000V	1850V	2000V	1850V	2000V	Cat. No.	Ohms	Watts	TFB2	TFA1	RWR2	RWC
9	160	2	15.2 (50)	30.5 (100)	15.2 (50)	30.5 (100)	243.8 (800)	304.8 (1000)	1321-3RB250-C	50	480				
	200	2	15.2 (50)	30.5 (100)	15.2 (50)	30.5 (100)	243.8 (800)	304.8 (1000)	1321-3RB250-C	50	480				
10	250	2	15.2 (50)	30.5 (100)	15.2 (50)	30.5 (100)	243.8 (800)	304.8 (1000)	1321-3RB320-C	50	480				
	315	2	15.2 (50)	30.5 (100)	15.2 (50)	30.5 (100)	213.4 (700)	304.8 (1000)	1321-3RB400-C	20	945 ⁽³⁾				
	355	2	15.2 (50)	30.5 (100)	15.2 (50)	30.5 (100)	213.4 (700)	304.8 (1000)	1321-3R500-C	20	945 ⁽³⁾				
	400	2	15.2 (50)	30.5 (100)	15.2 (50)	30.5 (100)	213.4 (700)	304.8 (1000)	1321-3R500-C	20	945 ⁽³⁾				
11	450	2	15.2 (50)	30.5 (100)	15.2 (50)	30.5 (100)	213.4 (700)	304.8 (1000)	1321-3R600-C	20	945 ⁽³⁾				
	500	2	15.2 (50)	30.5 (100)	15.2 (50)	30.5 (100)	213.4 (700)	304.8 (1000)	1321-3R600-C	20	945 ⁽³⁾				
	560	2	15.2 (50)	30.5 (100)	15.2 (50)	30.5 (100)	182.9 (600)	304.8 (1000)	1321-3R750-C	20	945 ⁽³⁾				
12 ⁽¹⁾	630	2	15.2 (50)	30.5 (100)	15.2 (50)	30.5 (100)	182.9 (600)	304.8 (1000)	2 x 321-3RB400-C	40	480 ⁽³⁾				
	710	2	15.2 (50)	30.5 (100)	15.2 (50)	30.5 (100)	182.9 (600)	304.8 (1000)	2 x 1321-3R500-C	40	645 ⁽⁴⁾				
	800	2	15.2 (50)	30.5 (100)	15.2 (50)	30.5 (100)	182.9 (600)	304.8 (1000)	2 x 1321-3R500-C	40	645 ⁽⁴⁾				
13	900 ⁽²⁾	2	30.5 (100)	68.6 (225)	61.0 (200)	91.4 (300)	243.8 (800)	304.8 (1000)	2 x 1321-3R600-C	40	645 ⁽⁴⁾				
	1000 ⁽²⁾	2	30.5 (100)	68.6 (225)	48.8 (160)	91.4 (300)	243.8 (800)	304.8 (1000)	2 x 1321-3R600-C	20	840 ⁽⁵⁾				
	1100 ⁽²⁾	2	30.5 (100)	68.6 (225)	48.8 (160)	91.4 (300)	243.8 (800)	304.8 (1000)	2 x 1321-3R750-C	20	840 ⁽⁵⁾				

- (1) Frame 12 drives have dual inverters and require two output reactors. The resistor ratings are per phase values for each reactor.
- (2) Some Frame 13 drives require two output reactors to match drive amp rating. The resistor ratings are per phase values for each reactor.
- (3) Resistor specification is based on two cables per phase.
- (4) Resistor specification is based on three cables per phase.
- (5) Resistor specification is based on four cables per phase.

Power Terminal Block Specifications

Frame 9

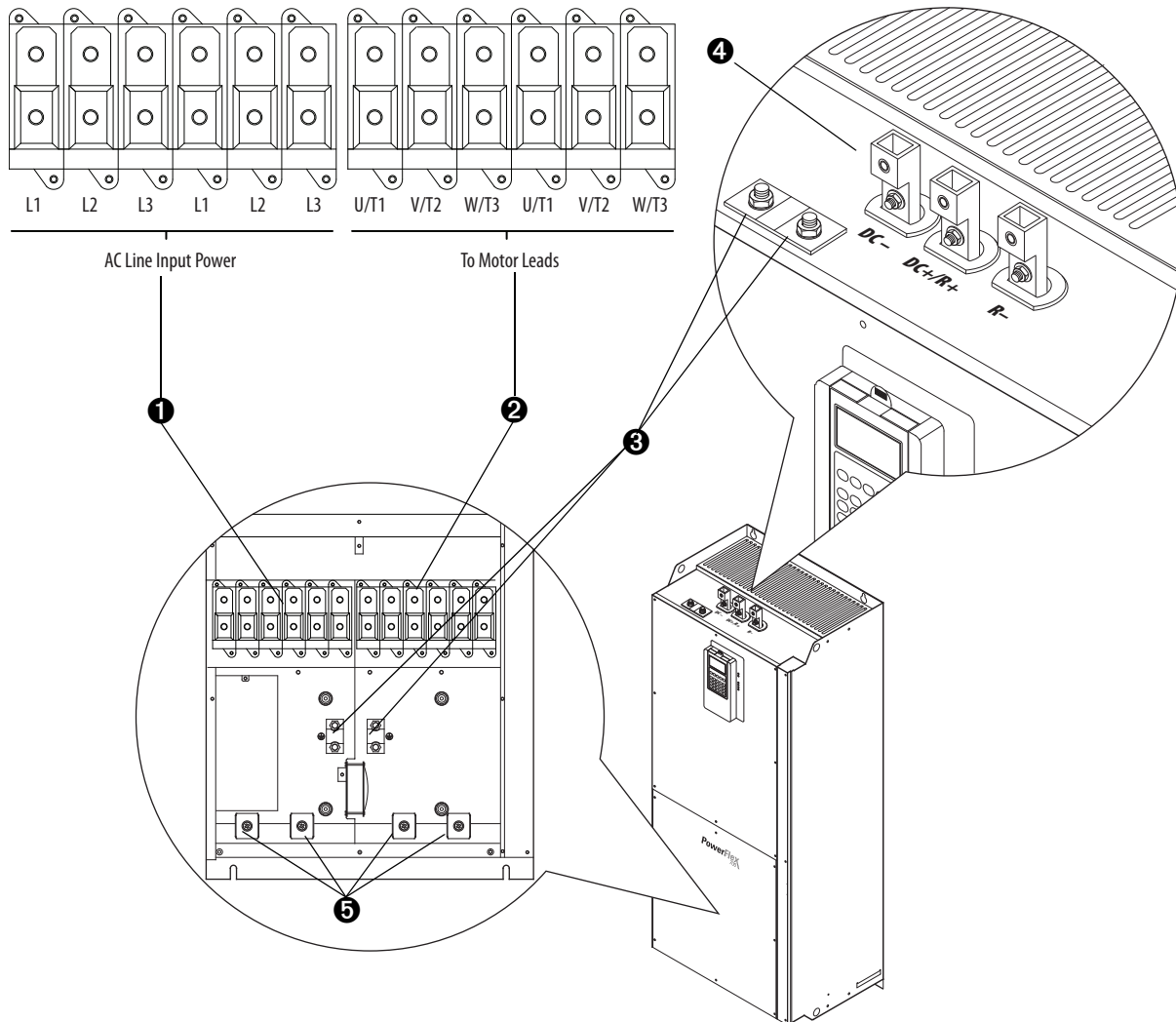

No.	Name	Description	Wire Size Range ⁽³⁾		Torque
			Maximum	Minimum	Recommended
❶	Input Power Terminal Block ⁽¹⁾ L1, L2, L3	Input power	185.0 mm ² (350 MCM)	95.0 mm ² (4/0 AWG)	40 N·m (354 lb·in)
❷	Output Power Terminal Block ⁽²⁾ U/T1, V/T2, W/T3	Motor connections	185.0 mm ² (350 MCM)	95.0 mm ² (4/0 AWG)	40 N·m (354 lb·in)
❸	SHLD Terminal, PE, Motor Ground	Terminating point for wiring shields	95.0 mm ² (4/0 AWG)	5.0 mm ² (10 AWG)	22 N·m (195 lb·in)
❹	DC Bus ⁽²⁾ (2 Terminals; DC-, DC+)	DC input or external brake resistor (Internal Brake option <u>not</u> ordered)	185.0 mm ² (350 MCM)	95.0 mm ² (4/0 AWG)	40 N·m (354 lb·in)
	DC Bus w/Brake ⁽³⁾ (3 Terminals; DC-, DC+/R+, R-)	DC input/internal brake (Internal Brake option <u>is</u> ordered)	185.0 mm ² (350 MCM)	95.0 mm ² (4/0 AWG)	40 N·m (354 lb·in)
❺	Cable Clamp for Shield				

- (1) Do Not exceed maximum wire size. Parallel connections may be required.
 (2) DC terminal and brake lugs can be removed.
 (3) Maximum/minimum sizes that the terminal block will accept - these are not recommendations.

Frame 10

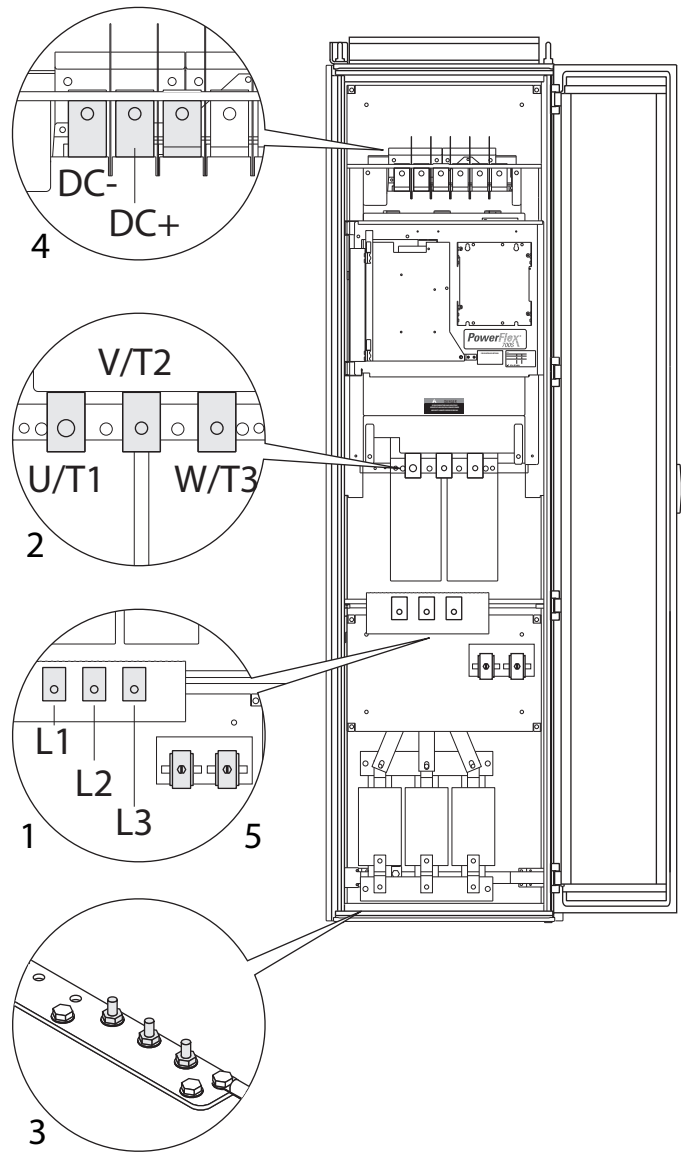

No.	Name	Description	Wire Size Range ⁽¹⁾⁽²⁾		Torque Recommended	Terminal Bolt Size ⁽³⁾⁽⁴⁾
			Maximum	Minimum		
1	Input Power Terminal Block ⁽³⁾ L1, L2, L3	Input power	300 mm ² (600 MCM)	2.1 mm ² (14 AWG)	40 N•m (354 lb•in)	M12
2	Output Power Terminal Block ⁽³⁾ U/T1, V/T2, W/T3	Motor connections	300 mm ² (600 MCM)	2.1 mm ² (14 AWG)	40 N•m (354 lb•in)	M12
3	SHLD Terminal, PE, Motor Ground ⁽³⁾	Terminating point for wiring shields	300 mm ² (600 MCM)	2.1 mm ² (14 AWG)	40 N•m (354 lb•in)	M10
4	DC Bus ⁽³⁾ (2 Terminals; DC-, DC+)	DC input or external brake	300 mm ² (600 MCM)	2.1 mm ² (14 AWG)	40 N•m (354 lb•in)	M12
5	Cable Clamp for Shield					

- (1) Maximum/minimum sizes that the terminal block will accept - these are not recommendations.
- (2) Do Not exceed maximum wire size. Parallel connections may be required.
- (3) These connections are bus bar type terminations and require the use of lug type connectors.
- (4) Apply counter torque to the nut on the other side of terminations when tightening or loosening the terminal bolt in order to avoid damage to the terminal.

Frame 11

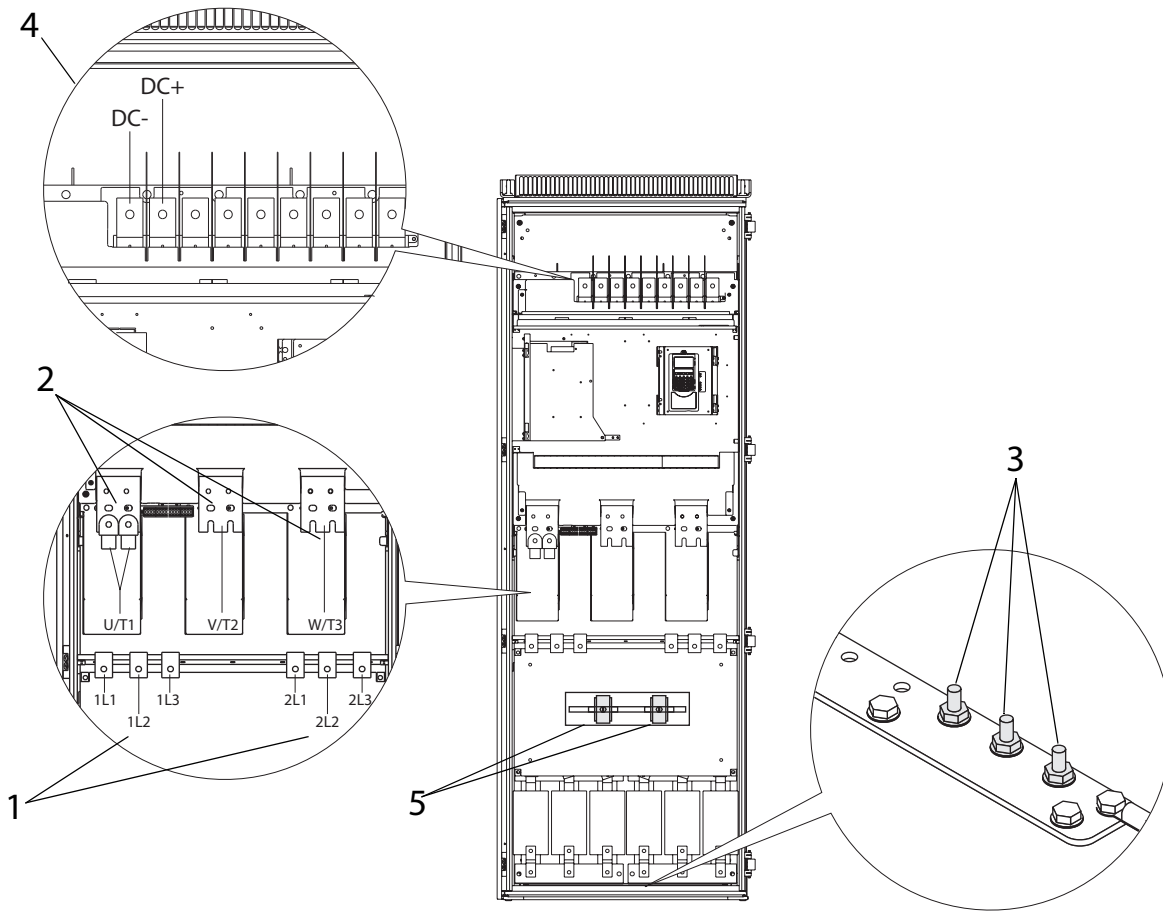

No.	Name	Description	Wire Size Range ⁽¹⁾⁽²⁾		Torque	Terminal Bolt Size ⁽³⁾⁽⁴⁾
			Maximum	Minimum	Recommended	
1	Input Power Terminal Block ⁽³⁾ 1L1, 1L2, 1L3, 2L1, 2L2, 2L3	AC Input power	300 mm ² (600 MCM)	2.1 mm ² (14 AWG)	40 N·m (354 lb·in)	M12
2	Output Power Terminal Block ⁽³⁾ U/T1, V/T2, W/T3	Motor connections	300 mm ² (600 MCM)	2.1 mm ² (14 AWG)	40 N·m (354 lb·in)	M12
3	SHLD Terminal, PE, Motor Ground ⁽³⁾	Terminating point for wiring shields	300 mm ² (600 MCM)	2.1 mm ² (14 AWG)	40 N·m (354 lb·in)	M10
4	DC Bus ⁽³⁾ (2 Terminals; DC-, DC+)	DC input or external brake	300 mm ² (600 MCM)	2.1 mm ² (14 AWG)	40 N·m (354 lb·in)	M12
5	Cable Clamp for Shield					

- (1) Maximum/minimum sizes that the terminal block will accept - these are not recommendations.
- (2) Do Not exceed maximum wire size. Parallel connections may be required.
- (3) These connections are bus bar type terminations and require the use of lug type connectors.
- (4) Apply counter torque to the nut on the other side of terminations when tightening or loosening the terminal bolt in order to avoid damage to the terminal.

Frame 12

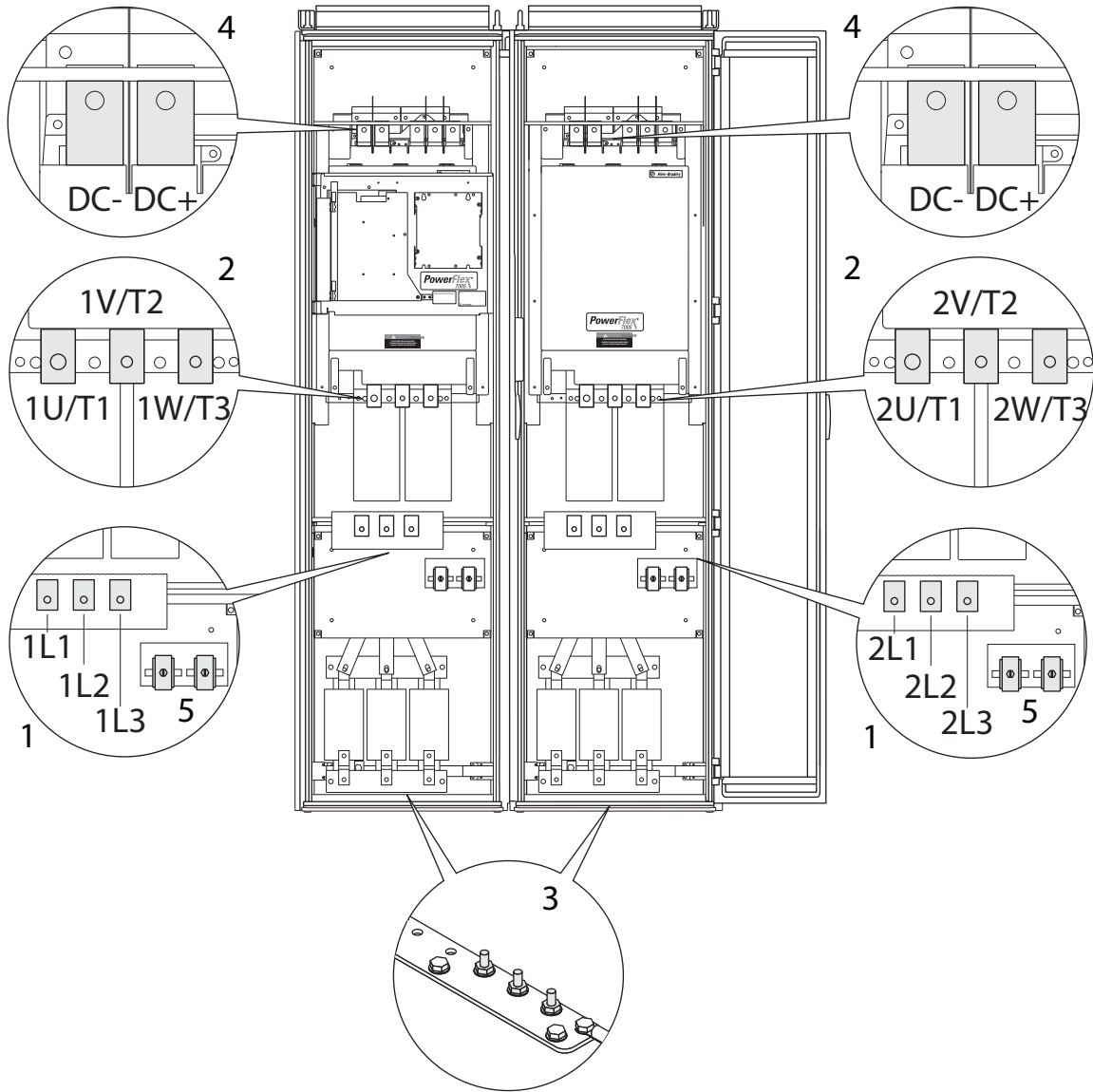

No.	Name	Description	Wire Size Range ⁽¹⁾⁽²⁾		Torque	Terminal Bolt Size ⁽³⁾⁽⁴⁾
			Maximum	Minimum	Recommended	
1	Input Power Terminal Block ⁽³⁾ 1L1, 1L2, 1L3, 2L1, 2L2, 2L3	Input power	300 mm ² (600 MCM)	2.1 mm ² (14 AWG)	40 N·m (354 lb·in)	M12
2	Output Power Terminal Block ⁽³⁾ 1U/1T1, 1V/1T2, 1W/1T3, 2U/2T1, 2V/2T2, 2W/2T3	Motor connections	300 mm ² (600 MCM)	2.1 mm ² (14 AWG)	40 N·m (354 lb·in)	M12
3	SHLD Terminal, PE, Motor Ground ⁽³⁾	Terminating point for wiring shields	300 mm ² (600 MCM)	2.1 mm ² (14 AWG)	40 N·m (354 lb·in)	M10
4	DC Bus ⁽³⁾ (2 Terminals; DC-, DC+)	DC input or external brake	300 mm ² (600 MCM)	2.1 mm ² (14 AWG)	40 N·m (354 lb·in)	M12
5	Cable Clamp for Shield					

- (1) Maximum/minimum sizes that the terminal block will accept - these are not recommendations.
- (2) Do Not exceed maximum wire size. Parallel connections may be required.
- (3) These connections are bus bar type terminations and require the use of lug type connectors.
- (4) Apply counter torque to the nut on the other side of terminations when tightening or loosening the terminal bolt in order to avoid damage to the terminal.

Frame 13

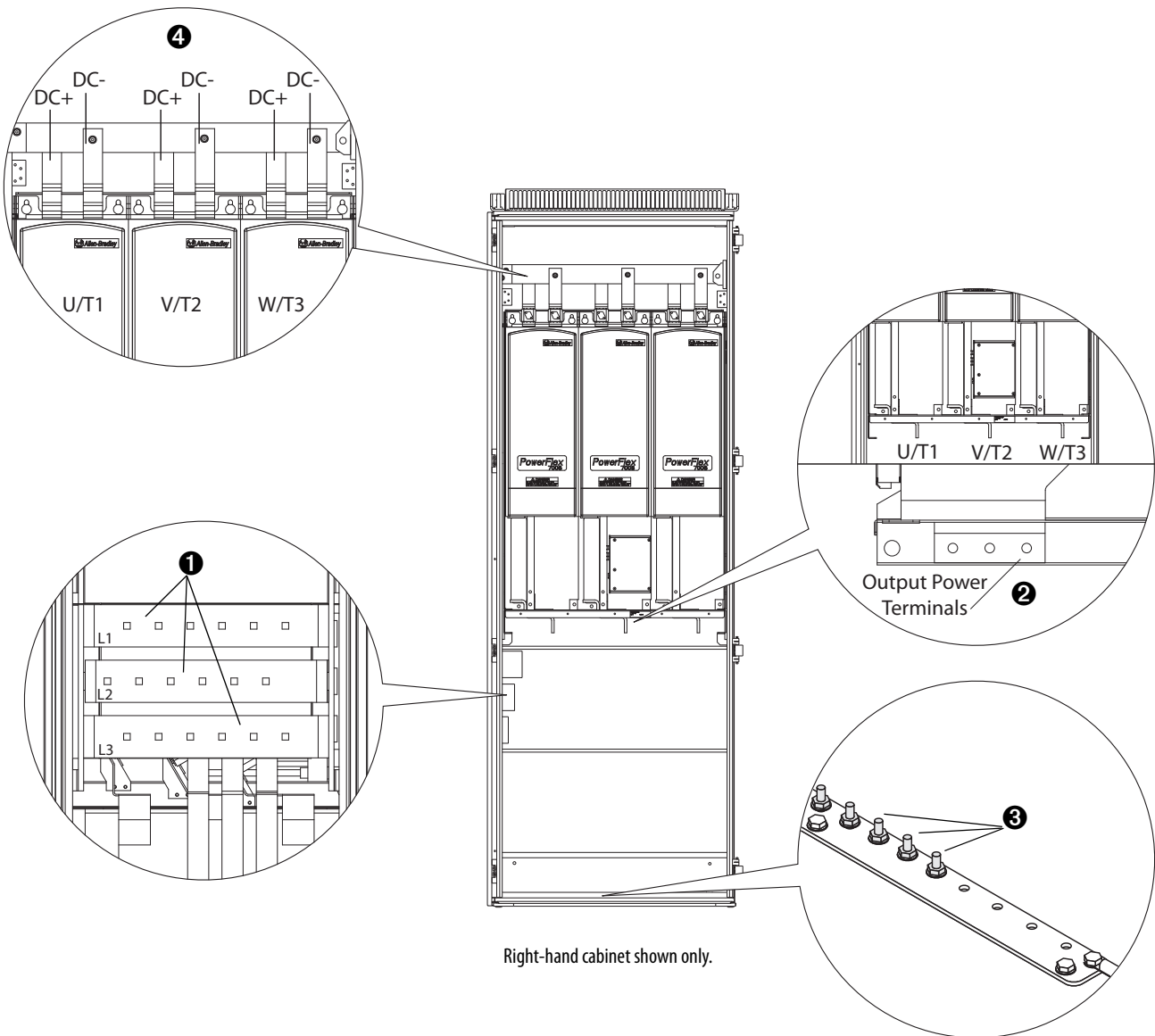

No.	Name	Description	Wire Size Range ⁽¹⁾⁽²⁾		Torque	Terminal Bolt Size ⁽³⁾⁽⁴⁾
			Maximum	Minimum	Recommended	
1	Input Power Terminal Block ⁽¹⁾ L1, L2, L3	Input power	300 mm ² (600 MCM)	2.1 mm ² (14 AWG)	40 N·m (354 lb·in)	M12
2	Output Power Terminal Block ⁽³⁾ U/T1, V/T2, W/T3	Motor connections	300 mm ² (600 MCM)	2.1 mm ² (14 AWG)	40 N·m (354 lb·in)	M12
3	SHLD Terminal, PE, Motor Ground ⁽³⁾	Terminating point for wiring shields	300 mm ² (600 MCM)	2.1 mm ² (14 AWG)	40 N·m (354 lb·in)	M10
4	DC Bus ⁽³⁾ (3 Terminals; DC-, DC+)	DC input or external brake	300 mm ² (600 MCM)	2.1 mm ² (14 AWG)	40 N·m (354 lb·in)	M12

- (1) Maximum/minimum sizes that the terminal block will accept - these are not recommendations.
- (2) Do Not exceed maximum wire size. Parallel connections may be required.
- (3) These connections are bus bar type terminations and require the use of lug type connectors.
- (4) Apply counter torque to the nut on the other side of terminations when tightening or loosening the terminal bolt in order to avoid damage to the terminal.

Frame 14 (Example of Drive Above 1500A Shown)

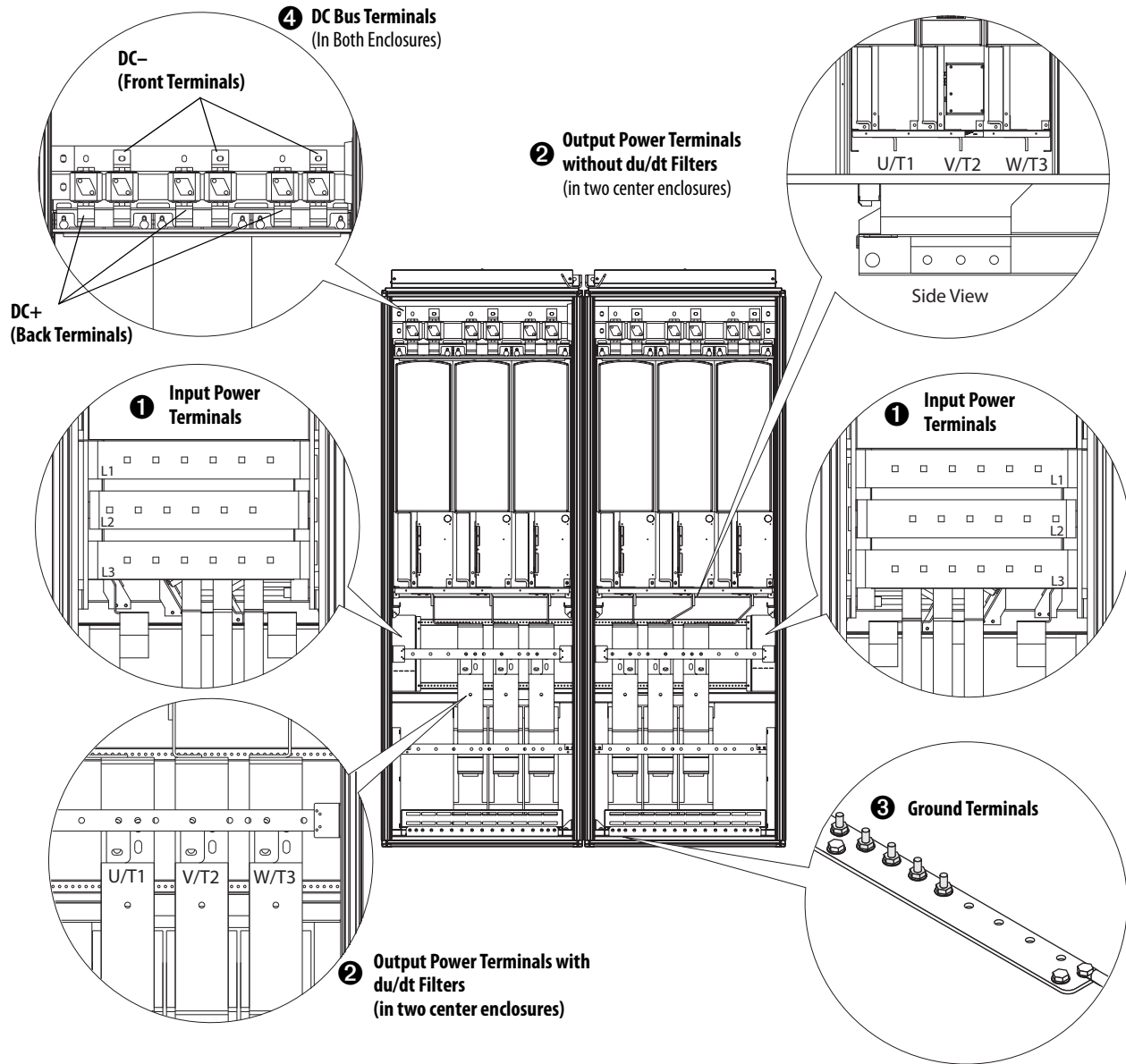

No.	Name	Description	Wire Size Range ⁽¹⁾⁽²⁾		Torque	Terminal Bolt Size ⁽³⁾⁽⁴⁾
			Maximum	Minimum	Recommended	
1	Input Power Terminal Block ⁽¹⁾ L1, L2, L3	Input power	300 mm ² (600 MCM)	2.1 mm ² (14 AWG)	40 N·m (354 lb·in)	M12
2	Output Power Terminal Block ⁽³⁾ U/T1, V/T2, W/T3	Motor connections	300 mm ² (600 MCM)	2.1 mm ² (14 AWG)	40 N·m (354 lb·in)	M12
3	SHLD Terminal, PE, Motor Ground ⁽³⁾	Terminating point for wiring shields	300 mm ² (600 MCM)	2.1 mm ² (14 AWG)	40 N·m (354 lb·in)	M10
4	DC Bus ⁽³⁾ (3 Terminals; DC-, DC+)	DC input or external brake	300 mm ² (600 MCM)	2.1 mm ² (14 AWG)	40 N·m (354 lb·in)	M12

- (1) Maximum/minimum sizes that the terminal block will accept - these are not recommendations.
- (2) Do Not exceed maximum wire size. Parallel connections may be required.
- (3) These connections are bus bar type terminations and require the use of lug type connectors.
- (4) Apply counter torque to the nut on the other side of terminations when tightening or loosening the terminal bolt in order to avoid damage to the terminal.

Control Terminals

I/O Terminal Blocks & Jumpers

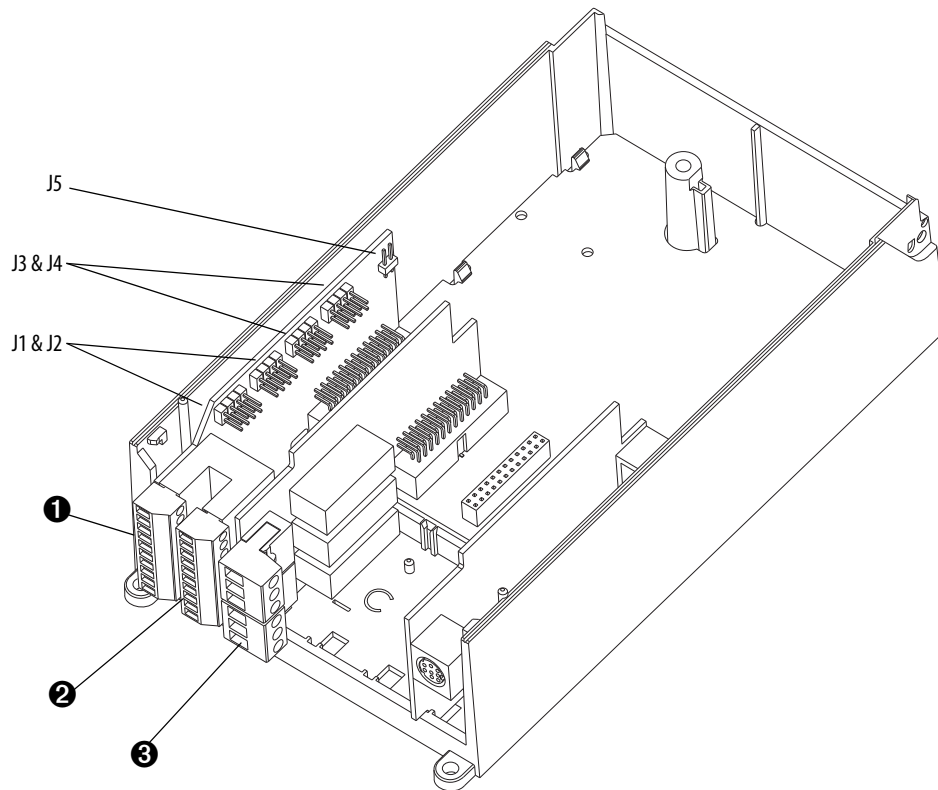

I/O Terminal Block Specifications

No.	Name	Description	Wire Size Range ⁽¹⁾		Torque	
			Maximum	Minimum	Maximum	Recommended
1	Analog I/O	Analog I/O Signals	2.5 mm ² (14 AWG)	0.5 mm ² (22 AWG)	0.2 N·m (1.8 lb·in)	0.2 N·m 1.8 (lb·in)
2	Digital Inputs	Digital Input Signals	2.5 mm ² (14 AWG)	0.5 mm ² (22 AWG)	0.2 N·m 1.8 (lb·in)	0.2 N·m 1.8 (lb·in)
3	Digital Outputs	Digital Out Relays	2.5 mm ² (14 AWG)	0.5 mm ² (22 AWG)	0.5 N·m 4.5 (lb·in)	0.5 N·m 4.5 (lb·in)

(1) Maximum/Minimum sizes that the terminal block will accept - these are not recommendations.

I/O Terminal Designations

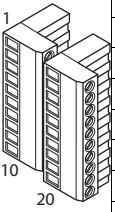
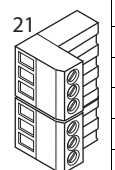
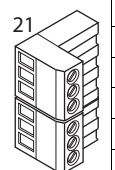
	No.	Signal	Factory Default	Description	Related Parameter(s)
	1	Analog In 1 (-) ⁽¹⁾	(4)	Isolated ⁽⁵⁾ , bipolar, differential, 9 bit & sign, 88k ohm input impedance. A jumper (page 35) selects: 0-10V, ±10V, 4-20 mA. Default: 0-10V (Ri =200k), 4-20 mA (Ri=100 ohm).	320 - 327
	2	Analog In 1 (+) ⁽¹⁾			
	3	Analog In 2 (-) ⁽¹⁾			
	4	Analog In 2 (+) ⁽¹⁾			
	5	-10V Pot Reference	-	2k ohm minimum, 10 mA maximum load, 1% accuracy.	
	6	Pot Common (GND)		For (+) and (-) 10V pot references.	
	7	+10V Pot Reference	-	2k ohm minimum, 10mA maximum load, 1% accuracy.	
	8	Analog Out 1 (+)	(4)	Bipolar (current out is not bipolar), 9 bit & sign, 2k ohm minimum load. A jumper (see page 35) selects: 0-10V, ±10V, 4-20mA.	340 - 347
	9	Analog Out Common			
	10	Analog Out 2 (+)			
	11	Digital In 1	Stop - CF	115V AC, 50/60 Hz - Opto isolated	361 - 366
	12	Digital In 2	Start	Low State: less than 30V AC	
	13	Digital In 3	Auto/Man	High State: greater than 40V AC	
	14	Digital In 4	Speed Sel 1	24V DC - Opto isolated (250V)	
	15	Digital In 5	Speed Sel 2	Low State: less than 5V DC	
	16	Digital In 6/Hardware Enable, see page 36	Speed Sel 3	High State: greater than 20V DC 11.2 mA DC Enable: Digital Input 6 is jumper selectable for HW Enable. On-Time: < 16.7 ms, Off-Time < 1 ms	
	17	Digital In Common		Allows source or sink operation. Terminals 17/18 & 19 can also be used to provide backup power to DPI and control devices.	
	18				
	19	+24VDC ⁽²⁾	-	Drive supplied logic input power.	
	20	24V Common ⁽²⁾	-	Common for internal power supply.	
	21	Digital Out 1 - N.C. ⁽³⁾	Fault	Max. Resistive Load:	380 - 391
	22	Digital Out 1 Common		240V AC/30V DC - 1200VA, 150 W	
	23	Digital Out 1 - N.O. ⁽³⁾	NOT Fault	Max. Current: 5A, Min. Load: 10 mA	
	24	Digital Out 2 - N.C. ⁽³⁾	NOT Run	Max. Inductive Load:	
	25	Digital Out 2/3 Com.		240V AC/30V DC - 840VA, 105 W	
	26	Digital Out 3 - N.O. ⁽³⁾	Run	Max. Current: 3.5A, Min. Load: 10 mA	

- (1) Important: Input must be configured with a jumper. Drive damage may occur if jumper is not installed properly. Refer to page 35.
- (2) 150mA maximum Load. Not present on 115V versions. Can be used to provide control power from an external 24V source when main power is not applied. Refer to page 36.
- (3) Contacts in unpowered state. Any relay programmed as Fault or Alarm will energize (pick up) when power is applied to drive and de-energize (drop out) when a fault or alarm exists. Relays selected for other functions will energize only when that condition exists and will deenergize when condition is removed.
- (4) These inputs/outputs are dependant on a number of parameters (see "Related Parameters").
- (5) Differential Isolation - External source must be maintained at less than 160V with respect to PE. Input provides high common mode immunity.

I/O Cable Grounding

When installing/stripping shielded multi-conductor cable for analog and digital I/O, allow sufficient distance from the terminal plug to permit attachment to the cable clamp for grounding.

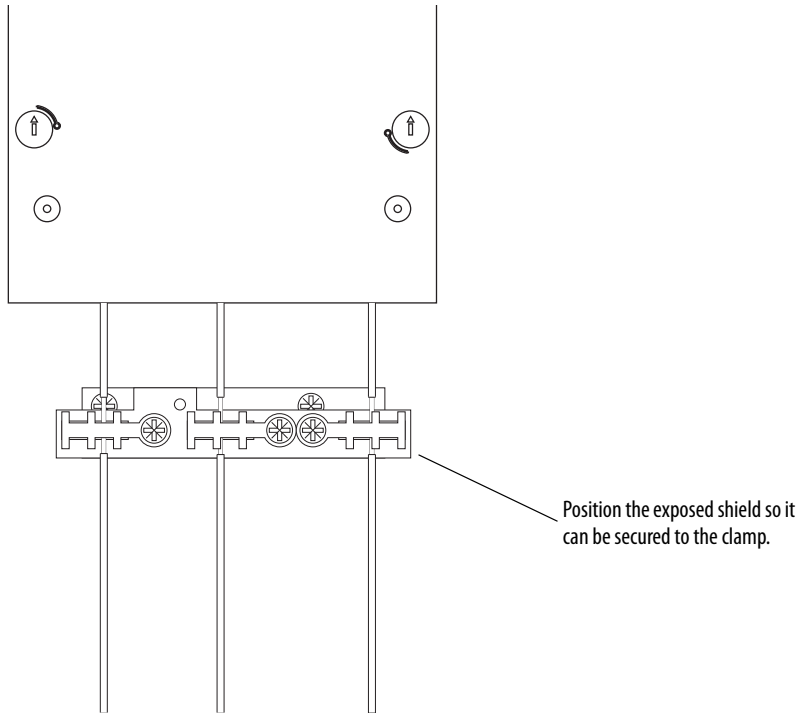

Note: This clamp is not designed for strain relief.

Analog I/O Configuration

IMPORTANT Analog I/O must be configured through programming, as well as the jumpers shown below. Refer to publication [20C-PM001](#), PowerFlex 700H Adjustable Frequency AC Drive, Programming Manual.

I/O Configuration

See [I/O Terminal Blocks & Jumpers on page 33](#) for jumper locations.

Signal	Jumper	Setting		
Analog Inputs	J1 (Analog In 1) J2 (Analog In 2)	0...20 mA	0...10V	±10V
Analog Outputs	J3 (Analog Out 1) J4 (Analog Out 2)	0...20 mA	0...10V	±10V

Hardware Enable Circuitry

By default, the user can program a digital input as an Enable input. The status of this input is *interpreted by drive software*. If the application requires the drive to be disabled *without* software interpretation, a “dedicated” hardware enable configuration can be utilized. This is done by removing jumper J5 and wiring the enable input to “Digital In 6” (see below). Verify that [Digital In6 Sel], parameter 366 is set to “1, Enable.” See [I/O Terminal Blocks & Jumpers on page 33](#) for jumper J5 location.

Hardware Enable Configuration

Signal	Jumper	Setting						
Hardware Enable	J5	Hardware Enable						
		Input Programmable (No Hardware Enable)						
		<table border="0"> <tr> <td style="text-align: center;">J5</td> <td style="text-align: center;">J5</td> </tr> <tr> <td style="text-align: center;">A B</td> <td style="text-align: center;">A B</td> </tr> <tr> <td style="text-align: center;">○ ○</td> <td style="text-align: center;">● ●</td> </tr> </table>	J5	J5	A B	A B	○ ○	● ●
J5	J5							
A B	A B							
○ ○	● ●							

Auxiliary Power Supply

You may use an auxiliary power supply to keep the PowerFlex 700H Control Unit energized, when input power is deenergized. This provides back-up power for the Control Unit and is sufficient for setting parameters. Connect 24V DC power to pin 19 and 24V DC common to pin 20 of the 24V DC version of the I/O card.

Auxiliary Power Supply Specifications

Voltage	Current (Min)	Current (Max)
24V DC ± 15%	150 mA	250 mA

If 24V terminals of several drives are connected in parallel, a diode circuit is recommended to block current flow in the opposite direction. Reverse current flow could damage the control board.

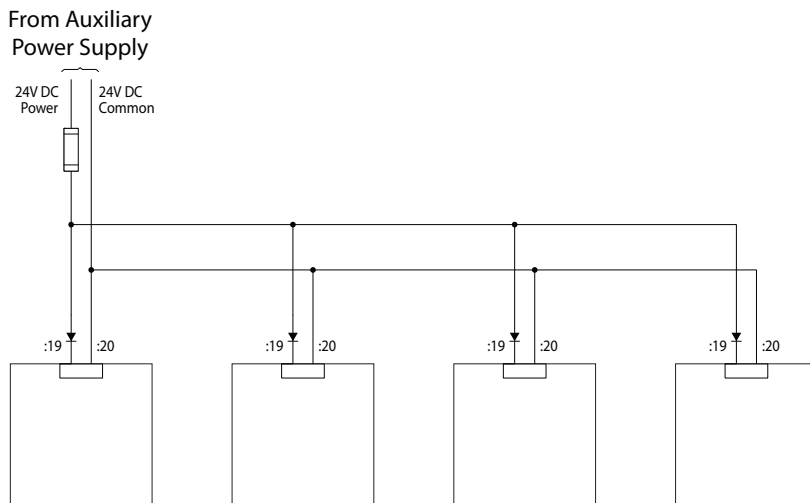

Drive Ratings

The tables on the following pages provide drive ratings (including continuous, 1 minute and 3 seconds), PWM frequency ratings, ambient operating temperatures and watts loss information.

Frame Size to AC Input Drive Rating Cross Reference

Frame	208		240		400V		480V		600V		690V	
	ND kW	HD kW	ND HP	HD HP	ND kW	HD kW	ND HP	HD HP	ND HP	HD HP	ND kW	HD kW
9	–	–	–	–	132	110	200	150	150	150	160	132
	–	–	–	–	160	132	250	200	200	150	200	160
10	–	–	–	–	200	160	300	250	250	200	250	200
	–	–	–	–	250	200	350	300	350	250	315	250
	–	–	–	–	250	250	450	350	400	350	355	315
	–	–	–	–	–	–	–	–	450	350	400	315
11	–	–	–	–	315	250	500	450	500	400	450	355
	–	–	–	–	355	315	500	500	500	500	500	400
	–	–	–	–	400	355	600	500	600	500	560	500
12	–	–	–	–	450	400	700	600	700	650	630	560
	–	–	–	–	500	450	800	700	800	700	710	630
	–	–	–	–	560	500	900	800	900	700	800	630
13	–	–	–	–	630	560	1000	900	1000	900	900	800
	–	–	–	–	710	630	1200	1000	1100	1000	1000	900
	–	–	–	–	800	710	1250	1000	1300	1100	1100	1000
14	–	–	–	–	1000	900	1500	1400	1600	1400	1500	1300
	–	–	–	–	1200	1100	1900	1700	2000	1600	1800	1500
	–	–	–	–	1600	1300	2300	2000	2400	2000	2000	1800

Frame Size to DC Input Drive Rating Cross Reference

Frame	325V		540V		650V		810V		932V	
	ND HP	HD HP	ND kW	HD kW	ND HP	HD HP	ND HP	HD HP	ND kW	HD kW
9	–	–	132	110	200	150	150	150	160	132
	–	–	160	132	250	200	200	150	200	160
10	–	–	200	160	300	250	250	200	250	200
	–	–	250	200	350	300	350	250	315	250
	–	–	250	250	450	350	400	350	355	315
	–	–	–	–	–	–	450	350	400	315
11	–	–	315	250	500	450	500	400	450	355
	–	–	355	315	500	500	500	500	500	400
	–	–	400	355	600	500	600	500	560	500
12	–	–	450	400	700	600	700	650	630	560
	–	–	500	450	800	700	800	700	710	630
	–	–	560	500	900	800	900	700	800	630
13	–	–	630	560	1000	900	1000	900	1000	900
	–	–	710	630	1200	1000	1100	1000	1100	1000
	–	–	800	710	1250	1000	1300	1100	1300	1100
14	–	–	1000	900	1500	1400	1600	1400	1500	1300
	–	–	1200	1100	1900	1700	2000	1600	1800	1500
	–	–	1600	1300	2300	2000	2400	2000	2000	1800

400 Volt AC Input Drive Ratings

Drive Catalog Number	Frame	kW Rating		PWM Freq.	Temp.	Input Ratings	Output Amps			Watts Loss
		ND	HD	kHz	°C	Amps	Cont.	1 Min.	3 Sec.	Watts
20CC261	9	132	-	2	40	263	261	287	410	2700
		-	110	2	40	207	205	308	410	2700
20CC300	9	160	-	2	40	302	300	330	450	3100
		-	132	2	40	247	245	368	490	3100
20CC385	10	200	-	2	40	388	385	424	600	4320
		-	160	2	40	302	300	450	600	4320
20CC460	10	250	-	2	40	463	460	506	770	5335
		-	200	2	40	388	385	578	770	5335
20CC500	10	250	-	2	40	504	500	550	750	5921
		-	250	2	40	423	420	630	840	5921
20CC590	11	315	-	2	40	594	590	649	956	6620
		-	250	2	40	524	520	780	956	6620
20CC650	11	355	-	2	40	655	650	715	1062	7538
		-	315	2	40	594	590	885	1062	7538
20CC730	11	400	-	2	40	735	730	803	1095	8312
		-	355	2	40	655	650	975	1170	8312
20CC820	12	450	-	2	40	826	820	902	1230	9201
		-	400	2	40	735	730	1095	1314	9201
20CC920	12	500	-	2	40	927	920	1012	1380	10670
		-	450	2	40	826	820	1230	1476	10670
20CC1K0	12	560	-	2	40	1038	1030	1133	1555	11729
		-	500	2	35	927	920	1370	1600	11729
20CC1K1	13	630	-	2	40	1158	1150	1265	1620	13801
		-	560	2	40	1038	1030	1545	1620	13801
20CC1K3	13	710	-	2	40	1310	1300	1430	2079	15077
		-	630	2	40	1158	1150	1725	2079	15077
20CC1K4	13	800	-	2	40	1461	1450	1595	2175	16511
		-	710	2	40	1209	1200	1800	2400	16511
20CC1K7	14	1000	-	2	40	1783	1770	1947	2655	24800
		-	900	2	40	1612	1600	2400	2880	24800
20CC2K1	14	1200	-	2	40	2166	2150	2365	3225	29900
		-	1100	2	40	1954	1940	2910	3492	29900
20CC2K7	14	1600	-	2	40	2720	2700	2970	3933	39680
		-	1300	2	40	2317	2300	3287	3933	39680

480 Volt AC Input Drive Ratings

Drive Catalog Number	Frame	HP Rating		PWM Freq.	Temp.	Input Ratings	Output Amps			Watts Loss
		ND	HD	kHz	°C	Amps	Cont.	1 Min.	3 Sec.	Watts
20CD261	9	200	-	2	40	252	261	287	410	2700
		-	150	2	40	207	205	308	410	2700
20CD300	9	250	-	2	40	290	300	330	450	3100
		-	200	2	40	247	245	368	490	3100
20CD385	10	300	-	2	40	372	385	424	600	4320
		-	250	2	40	302	300	450	600	4320
20CD460	10	350	-	2	40	444	460	506	770	5335
		-	300	2	40	388	385	578	770	5335
20CD500	10	450	-	2	40	483	500	550	750	5921
		-	350	2	40	423	420	630	840	5921
20CD590	11	500	-	2	40	570	590	649	956	6620
		-	450	2	40	524	520	780	956	6620
20CD650	11	500	-	2	40	628	650	715	1062	7538
		-	500	2	40	594	590	885	1062	7538
20CD730	11	600	-	2	40	705	730	803	1095	8312
		-	500	2	40	655	650	975	1170	8312
20CD820	12	700	-	2	40	792	820	902	1230	9201
		-	600	2	40	735	730	1095	1314	9201
20CD920	12	800	-	2	40	888	920	1012	1380	10670
		-	700	2	40	826	820	1230	1476	10670
20CD1K0	12	900	-	2	40	994	1030	1133	1555	11729
		-	800	2	35	927	920	1370	1600	11729
20CD1K1	13	1000	-	2	40	1110	1150	1265	1620	13801
		-	900	2	40	994	1030	1545	1620	13801
20CD1K3	13	1200	-	2	40	1255	1300	1430	2079	15077
		-	1000	2	40	1110	1150	1725	2079	15077
20CD1K4	13	1250	-	2	40	1400	1450	1595	2175	16511
		-	1000	2	40	1158	1200	1800	2400	16511
20CD1K7	14	1500	-	2	40	1709	1770	1947	2655	24800
		-	1400	2	40	1545	1600	2400	2880	24800
20CD2K1	14	1900	-	2	40	2076	2150	2365	3225	29900
		-	1700	2	40	1873	1940	2910	3492	29900
20CD2K7	14	2300	-	2	40	2607	2700	2970	3933	39680
		-	2000	2	40	2220	2300	3287	3933	39680

600 Volt AC Input Drive Ratings

Drive Catalog Number	Frame	HP Rating		PWM Freq.	Temp.	Input Ratings	Output Amps			Watts Loss
		ND	HD	kHz	°C	Amps	Cont.	1 Min.	3 Sec.	Watts
20CE170	9	150	–	1.5	40	164	170	187	245	3493
		–	150	1.5	40	139	144	216	245	3493
20CE208	9	200	–	1.5	35	201	208	230	289	3802
		–	150	1.5	40	164	170	250	289	3802
20CE261	10	250	–	1.5	40	252	261	287	375	4206
		–	200	1.5	40	201	208	312	375	4206
20CE325	10	350	–	1.5	40	314	325	358	470	4751
		–	250	1.5	40	252	261	392	470	4751
20CE385	10	400	–	1.5	40	372	385	424	585	5527
		–	350	1.5	40	314	325	488	585	5527
20CE416	10	450	–	1.5	35	402	416	458	585	5622
		–	350	1.5	40	314	325	488	585	5622
20CE460	11	500	–	1.5	40	444	460	506	693	6345
		–	400	1.5	40	372	385	578	693	6345
20CE502	11	500	–	1.5	40	485	502	552	828	6925
		–	500	1.5	40	444	460	690	828	6925
20CE590	11	600	–	1.5	35	570	590	649	885	7539
		–	500	1.5	35	485	502	753	904	7539
20CE650	12	700	–	1.5	40	628	650	715	1062	9502
		–	650	1.5	40	570	590	885	1062	9502
20CE750	12	800	–	1.5	40	724	750	825	1170	10570
		–	700	1.5	40	628	650	975	1170	10570
20CE820	12	900	–	1.5	35	792	820	902	1170	11082
		–	700	1.5	35	628	650	975	1170	11082
20CE920	13	1000	–	1.5	40	888	920	1012	1380	12690
		–	900	1.5	40	792	820	1230	1410	12690
20CE1K0	13	1100	–	1.5	40	994	1030	1133	1545	15907
		–	1000	1.5	40	888	920	1380	1755	15907
20CE1K1	13	1300	–	1.5	35	1139	1180	1298	1755	17306
		–	1100	1.5	35	994	1030	1463	1755	17306
20CE1K5	14	1600	–	1.5	40	1448	1500	1650	2250	22500
		–	1400	1.5	40	1255	1300	1950	2340	22500
20CE1K9	14	2000	–	1.5	40	1834	1900	2090	2700	28500
		–	1600	1.5	40	1448	1500	2250	2700	28500
20CE2K2	14	2400	–	1.5	30	2172	2250	2475	3335	33400
		–	2000	1.5	30	1834	1900	2782	3335	33400

690 Volt AC Input Drive Ratings

Drive Catalog Number	Frame	kW Rating		PWM Freq.	Temp.	Input Ratings	Output Amps			Watts Loss
		ND	HD	kHz	°C	Amps	Cont.	1 Min.	3 Sec.	Watts
20CF170	9	160	—	2	40	171	170	187	245	3113
		—	132	2	40	145	144	216	245	3113
20CF208	9	200	—	2	35	210	208	230	289	3594
		—	160	2	40	171	170	250	289	3594
20CF261	10	250	—	2	40	263	261	287	375	4206
		—	200	2	40	210	208	312	375	4206
20CF325	10	315	—	2	40	327	325	358	470	4751
		—	250	2	40	263	261	392	470	4751
20CF385	10	355	—	2	40	388	385	424	585	5527
		—	315	2	40	327	325	488	585	5527
20CF416	10	400	—	2	35	419	416	458	585	5622
		—	315	2	40	327	325	488	585	5622
20CF460	11	450	—	2	40	463	460	506	693	6345
		—	355	2	40	388	385	578	693	6345
20CF502	11	500	—	2	40	506	502	552	828	6925
		—	400	2	40	463	460	690	828	6925
20CF590	11	560	—	2	35	594	590	649	885	7539
		—	500	2	35	506	502	753	904	7539
20CF650	12	630	—	2	40	655	650	715	1062	9502
		—	560	2	40	594	590	885	1062	9502
20CF750	12	710	—	2	40	756	750	825	1170	10570
		—	630	2	40	655	650	975	1170	10570
20CF820	12	800	—	2	35	826	820	902	1170	11082
		—	630	2	35	655	650	975	1170	11082
20CF920	13	900	—	2	40	927	920	1012	1380	12690
		—	800	2	40	826	820	1230	1410	12690
20CF1K0	13	1000	—	2	40	1038	1030	1133	1545	15907
		—	900	2	40	927	920	1380	1755	15907
20CF1K1	13	1100	—	2	35	1189	1180	1298	1755	17306
		—	1000	2	35	1038	1030	1463	1755	17306
20CF1K5	14	1500	—	2	40	1511	1500	1650	2250	22500
		—	1300	2	40	1310	1300	1950	2340	22500
20CF1K9	14	1800	—	2	40	1914	1900	2090	2700	28500
		—	1500	2	40	1511	1500	2250	2700	28500
20CF2K2	14	2000	—	2	30	2267	2250	2475	3335	33400
		—	1800	2	30	1914	1900	2782	3335	33400

540 Volt DC Input Drive Ratings

Drive Catalog Number	Frame	kW Rating		PWM Freq.	Temp.	DC Input Ratings	Output Amps			Watts Loss
		ND	HD	kHz	°C	Amps	Cont.	1 Min.	3 Sec.	Watts
20CH261	9	132	-	2	40	307	261	287	410	1890
		-	110	2	40	241	205	308	410	1890
20CH300	9	160	-	2	40	353	300	330	450	2170
		-	132	2	40	288	245	368	490	2170
20CH385	10	200	-	2	40	453	385	424	600	3240
		-	160	2	40	353	300	450	600	3240
20CH460	10	250	-	2	40	541	460	506	770	4001
		-	200	2	40	453	385	578	770	4001
20CH500	10	250	-	2	40	589	500	550	750	4441
		-	250	2	40	494	420	630	840	4441
20CH590	11	315	-	2	40	695	590	649	956	4700
		-	250	2	40	612	520	780	956	4700
20CH650	11	355	-	2	40	765	650	715	1062	5352
		-	315	2	40	695	590	885	1062	5352
20CH730	11	400	-	2	40	859	730	803	1095	5902
		-	355	2	40	765	650	975	1170	5902
20CH820	12	450	-	2	40	965	820	902	1230	6901
		-	400	2	40	859	730	1095	1314	6901
20CH920	12	500	-	2	40	1083	920	1012	1380	8003
		-	450	2	40	965	820	1230	1476	8003
20CH1K0	12	560	-	2	40	1213	1030	1133	1555	8797
		-	500	2	35	1083	920	1370	1600	8797
20CH1K1	13	630	-	2	40	1354	1150	1265	1620	10627
		-	560	2	40	1213	1030	1545	1620	10627
20CH1K3	13	710	-	2	40	1530	1300	1430	2079	11609
		-	630	2	40	1354	1150	1725	2079	11609
20CH1K4	13	800	-	2	40	1707	1450	1595	2175	12713
		-	710	2	40	1413	1200	1800	2400	12713
20CH1K7	14	1000	-	2	40	2084	1770	1947	2655	19096
		-	900	2	40	1883	1600	2400	2880	19096
20CH2K1	14	1200	-	2	40	2531	2150	2365	3225	23023
		-	1100	2	40	2284	1940	2910	3492	23023
20CH2K7	14	1600	-	2	40	3178	2700	2970	3933	30554
		-	1300	2	40	2708	2300	3287	3933	30554

650 Volt DC Input Drive Ratings

Drive Catalog Number	Frame	HP Rating		PWM Freq.	Temp.	DC Input Ratings	Output Amps			Watts Loss
		ND	HD	kHz	°C	Amps	Cont.	1 Min.	3 Sec.	Watts
20CJ261	9	200	-	2	40	294	261	287	410	1890
		-	150	2	40	231	205	308	410	1890
20CJ300	9	250	-	2	40	338	300	330	450	2170
		-	200	2	40	294	245	368	490	2170
20CJ385	10	300	-	2	40	434	385	424	600	3240
		-	250	2	40	338	300	450	600	3240
20CJ460	10	350	-	2	40	519	460	506	770	4001
		-	300	2	40	434	385	578	770	4001
20CJ500	10	450	-	2	40	564	500	550	750	4441
		-	350	2	40	474	420	630	840	4441
20CJ590	11	500	-	2	40	666	590	649	956	4700
		-	450	2	40	587	520	780	956	4700
20CJ650	11	500	-	2	40	733	650	715	1062	5352
		-	500	2	40	666	590	885	1062	5352
20CJ730	11	600	-	2	40	824	730	803	1095	5902
		-	500	2	40	733	650	975	1170	5902
20CJ820	12	700	-	2	40	925	820	902	1230	6901
		-	600	2	40	824	730	1095	1314	6901
20CJ920	12	800	-	2	40	1038	920	1012	1380	8003
		-	700	2	40	925	820	1230	1476	8003
20CJ1K0	12	900	-	2	40	1162	1030	1133	1555	8797
		-	800	2	35	1038	920	1370	1600	8797
20CJ1K1	13	1000	-	2	40	1297	1150	1265	1620	10627
		-	900	2	40	1162	1030	1545	1620	10627
20CJ1K3	13	1200	-	2	40	1467	1300	1430	2079	11609
		-	1000	2	40	1297	1150	1725	2079	11609
20CJ1K4	13	1250	-	2	40	1636	1450	1595	2175	12713
		-	1000	2	40	1354	1200	1800	2400	12713
20CJ1K7	14	1500	-	2	40	1997	1770	1947	2655	19096
		-	1400	2	40	1805	1600	2400	2880	19096
20CJ2K1	14	1900	-	2	40	2425	2150	2365	3225	23023
		-	1700	2	40	2189	1940	2910	3492	23023
20CJ2K7	14	2300	-	2	40	3046	2700	2970	3933	30554
		-	2000	2	40	2595	2300	3287	3933	30554

810 Volt DC Input Drive Ratings

Drive Catalog Number	Frame	HP Rating		PWM Freq.	Temp.	DC Input Ratings	Output Amps			Watts Loss
		ND	HD	kHz	°C	Amps	Cont.	1 Min.	3 Sec.	Watts
20CK170	9	150	–	2	40	192	170	187	245	2741
		–	150	2	40	162	144	216	245	2741
20CK208	9	200	–	2	35	235	208	230	289	2954
		–	150	2	40	192	170	250	289	2954
20CK261	10	250	–	2	40	294	261	287	375	3155
		–	200	2	40	235	208	312	375	3155
20CK325	10	350	–	2	40	367	325	358	470	3563
		–	250	2	40	294	261	392	470	3563
20CK385	10	400	–	2	40	434	385	424	585	4145
		–	350	2	40	367	325	488	585	4145
20CK416	10	450	–	2	35	469	416	458	585	4217
		–	350	2	40	367	325	488	585	4217
20CK460	11	500	–	2	40	519	460	506	693	4505
		–	400	2	40	434	385	578	693	4505
20CK502	11	500	–	2	40	566	502	552	828	4917
		–	500	2	40	519	460	690	828	4917
20CK590	11	600	–	2	35	666	590	649	885	5353
		–	500	2	35	566	502	753	904	5353
20CK650	12	700	–	2	40	733	650	715	1062	7127
		–	650	2	40	666	590	885	1062	7127
20CK750	12	800	–	2	40	846	750	825	1170	7928
		–	700	2	40	733	650	975	1170	7928
20CK820	12	900	–	2	35	925	820	902	1170	8312
		–	700	2	35	733	650	975	1170	8312
20CK920	13	1000	–	2	40	1038	920	1012	1380	9771
		–	900	2	40	925	820	1230	1410	9771
20CK1K0	13	1100	–	2	40	1162	1030	1133	1545	12248
		–	1000	2	40	1038	920	1380	1755	12248
20CK1K1	13	1300	–	2	35	1331	1180	1298	1755	13326
		–	1100	2	35	1162	1030	1463	1755	13326
20CK1K5	14	1600	–	2	40	1692	1500	1650	2250	17325
		–	1400	2	40	1467	1300	1950	2340	17325
20CK1K9	14	2000	–	2	40	2143	1900	2090	2700	21945
		–	1600	2	40	1692	1500	2250	2700	21945
20CK2K2	14	2400	–	2	30	2538	2250	2475	3335	25718
		–	2000	2	30	2143	1900	2782	3335	25718

932 Volt DC Input Drive Ratings

Drive Catalog Number	Frame	kW Rating		PWM Freq.	Temp.	DC Input Ratings	Output Amps			Watts Loss
		ND	HD	kHz	°C	Amps	Cont.	1 Min.	3 Sec.	Watts
20CM170	9	160	–	2	40	200	170	187	245	2715
		–	132	2	40	170	144	216	245	2715
20CM208	9	200	–	2	35	245	208	230	289	2941
		–	160	2	40	200	170	250	289	2941
20CM261	10	250	–	2	40	307	261	287	375	3155
		–	200	2	40	245	208	312	375	3155
20CM325	10	315	–	2	40	383	325	358	470	3563
		–	250	2	40	307	261	392	470	3563
20CM385	10	355	–	2	40	453	385	424	585	4145
		–	315	2	40	383	325	488	585	4145
20CM416	10	400	–	2	35	490	416	458	585	4217
		–	315	2	40	383	325	488	585	4217
20CM460	11	450	–	2	40	542	460	506	693	4505
		–	355	2	40	453	385	578	693	4505
20CM502	11	500	–	2	40	591	502	552	828	4917
		–	400	2	40	542	460	690	828	4917
20CM590	11	560	–	2	35	695	590	649	885	5353
		–	500	2	35	591	502	753	904	5353
20CM650	12	630	–	2	40	765	650	715	1062	7127
		–	560	2	40	695	590	885	1062	7127
20CM750	12	710	–	2	40	883	750	825	1170	7928
		–	630	2	40	765	650	975	1170	7928
20CM820	12	800	–	2	35	965	820	902	1170	8312
		–	630	2	35	765	650	975	1170	8312
20CM920	13	900	–	2	40	1038	920	1012	1380	9771
		–	800	2	40	925	820	1230	1410	9771
20CM1K0	13	1000	–	2	40	1162	1030	1133	1545	12248
		–	900	2	40	1038	920	1380	1755	12248
20CM1K1	13	1100	–	2	35	1331	1180	1298	1755	13326
		–	1000	2	35	1162	1030	1463	1755	13326
20CM1K5	14	1500	–	2	40	1766	1500	1650	2250	17325
		–	1300	2	40	1530	1300	1950	2340	17325
20CM1K9	14	1800	–	2	40	2237	1900	2090	2700	21945
		–	1500	2	40	1766	1500	2250	2700	21945
20CM2K2	14	2000	–	2	30	2649	2250	2475	3335	25718
		–	1800	2	30	2237	1900	2782	3335	25718

Branch Circuit Short Circuit Protection

Integral solid state short circuit protection does not provide branch circuit protection. Branch circuit protection must be provided in accordance with the National Electrical Code and any additional local codes, or the equivalent.

Fusing and Circuit Breakers

The tables on the following pages provide recommended AC line input fuse and circuit breaker information. See Fusing on page 46 and Circuit Breakers on page 46 below for UL and IEC requirements. Sizes listed are the recommended sizes based on 40 °C (104 °F) and the U.S. NEC. Other country, state, or local codes can require different ratings. Tables with DC link fuse recommendations for DC input drives are also provided.

Fusing

The recommended fuse types are listed below. If available current ratings do not match those listed in the tables provided, chose the next higher fuse rating.

- IEC – BS88 (British Standard) Parts 1 & 2, EN60269-1, Parts 1 & 2 ⁽¹⁾ type gG or equivalent should be used.
- UL – UL requirements specify that UL Class CC, T, or J fuses must be used for all drives in this section.

Circuit Breakers

The ‘non-fuse’ listings in the following tables include inverse time circuit breakers and instantaneous trip circuit breakers (motor circuit protectors). If one of these is chosen as the desired protection method, the following requirements apply:

- IEC – Both types of circuit breakers are acceptable for IEC installations.
- UL – Only inverse time circuit breakers are acceptable for UL installations.

(1) Typical designations include, but may not be limited to the following; Parts 1 & 2:AC, AD, BC, BD, CD, DD, ED, EFS, EF, FF, FG, GF, GG, GH

400 Volt AC Input Drive Protection Devices

Drive Catalog Number	Frame	kW Rating		Input Ratings		Dual Element Time Delay Fuse		Non-Time Delay Fuse		Bussmann Style Semi-Conductor Fuse	Circuit Breaker ⁽⁴⁾ Max. ⁽⁵⁾	Motor Circuit Protector ⁽⁶⁾ Max.
		ND	HD	Amps	Min. ⁽¹⁾	Max. ⁽²⁾	Min. ⁽¹⁾	Max. ⁽²⁾				
20CC261	9	132	-	263	350	550	350	700	170M5813	700	400	
		-	110	207	275	450	275	600	170M5813	600	300	
20CC300	9	160	-	302	400	650	400	900	170M5813	900	400	
		-	132	247	350	500	350	700	170M5813	700	400	
20CC385	10	200	-	388	500	850	500	1100	170M5813	1100	600	
		-	160	302	400	650	400	900	170M5813	900	400	
20CC460	10	250	-	463	600	1000	600	1300	170M8547	1300	600	
		-	200	388	500	850	500	1100	170M8547	1100	600	
20CC500	10	250	-	504	650	1100	650	1500	170M8547	1500	700	
		-	250	423	550	900	550	1200	170M8547	1200	600	
20CC590	11	315	-	594	750 (1 per phs) 375 (2 per phs)	1300	750 (1 per phs) 375 (2 per phs)	1700	170M5813	1700	800	
		-	250	524	700 (1 per phs) 350 (2 per phs)	1100	700 (1 per phs) 350 (2 per phs)	1500	170M5813	1500	700	
20CC650	11	355	-	655	850 (1 per phs) 425 (2 per phs)	1400	850 (1 per phs) 425 (2 per phs)	1900	170M5813	1900	1000	
		-	315	594	750 (1 per phs) 375 (2 per phs)	1300	750 (1 per phs) 375 (2 per phs)	1700	170M5813	1700	800	
20CC730	11	400	-	735	1000 (1 per phs) 500 (2 per phs)	1600	1000 (1 per phs) 500 (2 per phs)	2100	170M5813	2100	1200	
		-	355	655	850 (1 per phs) 425 (2 per phs)	1400	850 (1 per phs) 425 (2 per phs)	1900	170M5813	1900	1000	
20CC820	12	450	-	826	1100 (1 per phs) 550 (2 per phs)	1800	1100 (1 per phs) 550 (2 per phs)	2400	170M8547	2400	1200	
		-	400	735	1000 (1 per phs) 500 (2 per phs)	1600	1000 (1 per phs) 500 (2 per phs)	2100	170M8547	2100	1200	
20CC920	12	500	-	927	1200 (1 per phs) 600 (2 per phs)	2000	1200 (1 per phs) 600 (2 per phs)	2700	170M8547	2700	1200	
		-	450	826	1100 (1 per phs) 550 (2 per phs)	1800	1100 (1 per phs) 550 (2 per phs)	2400	170M8547	2400	1200	
20CC1K0	12	560	-	1038	1350 (1 per phs) 700 (2 per phs)	2300	1350 (1 per phs) 700 (2 per phs)	3000	170M8547	3000	1400	
		-	500	927	1200 (1 per phs) 600 (2 per phs)	2000	1200 (1 per phs) 600 (2 per phs)	2700	170M8547	2700	1200	
20CC1K1	13	630	-	1158	1350 (1 per phs) 700 (2 per phs)	2300 ⁽³⁾	1350 (1 per phs) 700 (2 per phs)	3000 ⁽³⁾	170M6466 ⁽³⁾	3000	1400	
		-	560	1038	1500 (1 per phs) 750 (2 per phs)	2500 ⁽³⁾	1500 (1 per phs) 750 (2 per phs)	3400 ⁽³⁾	170M6466 ⁽³⁾	3400	1500	
20CC1K3	13	710	-	1310	1700 (1 per phs) 850 (2 per phs)	2900 ⁽³⁾	1700 (1 per phs) 850 (2 per phs)	3900 ⁽³⁾	170M6466 ⁽³⁾	3900	1700	
		-	630	1158	1500 (1 per phs) 750 (2 per phs)	2500 ⁽³⁾	1500 (1 per phs) 750 (2 per phs)	3400 ⁽³⁾	170M6466 ⁽³⁾	3400	1500	
20CC1K4	13	800	-	1461	1900 (1 per phs) 950 (2 per phs)	3000 ⁽³⁾	1900 (1 per phs) 950 (2 per phs)	4300 ⁽³⁾	170M6466 ⁽³⁾	4300	1900	
		-	710	1209	1600 (1 per phs) 800 (2 per phs)	2700 ⁽³⁾	1600 (1 per phs) 800 (2 per phs)	3600 ⁽³⁾	170M6466 ⁽³⁾	3600	1600	
20CC1K7	14	1000	-	1783	2500 (1 per phs) 825 (3 per phs)	3900	2500 (1 per phs) 825 (3 per phs)	5300	170M6466	5300	2500	
		-	900	1612	2100 (1 per phs) 700 (3 per phs)	3500	2100 (1 per phs) 700 (3 per phs)	4800	170M6466	4800	2100	
20CC2K1	14	1200	-	2166	3000 (1 per phs) 1000 (3 per phs)	4800	3000 (1 per phs) 1000 (3 per phs)	6400	170M6466	6400	3000	
		-	1100	1954	2500 (1 per phs) 825 (3 per phs)	4300	2500 (1 per phs) 825 (3 per phs)	5800	170M6466	5800	2500	
20CC2K7	14	1600	-	2720	3500 (1 per phs) 1200 (3 per phs)	6000	3500 (1 per phs) 1200 (3 per phs)	8000	170M6466	8000	3500	
		-	1300	2317	3000 (1 per phs) 1000 (3 per phs)	5000	3000 (1 per phs) 1000 (3 per phs)	6900	170M6466	6900	3000	

(1) Minimum protection device size is the lowest rated device that supplies maximum protection without nuisance tripping.

(2) Maximum protection device size is the highest rated device that supplies drive protection. For US NEC, minimum size is 125% of motor FLA. Ratings shown are maximum.

(3) These fuses and disconnect are supplied with AC input NEMA/UL Type 1 drives.

(4) Inverse time breaker. Ratings shown are maximum.

(5) Maximum allowable rating by US NEC. Exact size must be chosen for each installation.

(6) Motor Circuit Protector - instantaneous trip circuit breaker. For US NEC minimum size is 125% of motor/drive FLA. Ratings shown are suggested. Instantaneous trip settings must be set to US NEC code. Not to exceed 1300% FLA.

480 Volt AC Input Drive Protection Devices

Drive Catalog Number	Frame	HP Rating		Input Ratings		Dual Element Time Delay Fuse		Non-Time Delay Fuse		Bussmann Style Semi-Conductor Fuse	Circuit Breaker ⁽⁴⁾ Max. ⁽⁵⁾	Motor Circuit Protector ⁽⁶⁾ Max.
		ND	HD	Amps	Min. ⁽¹⁾	Max. ⁽²⁾	Min. ⁽¹⁾	Max. ⁽²⁾				
20CD261	9	200	-	252	350	550	350	700	170M5813	700	400	
		-	150	207	275	450	275	600	170M5813	600	300	
20CD300	9	250	-	290	400	650	400	900	170M5813	900	400	
		-	200	247	350	550	350	700	170M5813	700	400	
20CD385	10	300	-	372	500	850	500	1100	170M5813	1100	600	
		-	250	302	400	650	400	900	170M5813	900	400	
20CD460	10	350	-	444	600	1000	600	1300	170M8547	1300	600	
		-	300	388	500	850	500	1100	170M8547	1100	600	
20CD500	10	450	-	483	650	1000	650	1500	170M8547	1500	700	
		-	350	423	550	900	550	1200	170M8547	1200	600	
20CD590	11	500	-	570	750 (1 per phs) 375 (2 per phs)	1300	750 (1 per phs) 375 (2 per phs)	1700	170M5813	1700	800	
		-	450	524	700 (1 per phs) 350 (2 per phs)	1100	700 (1 per phs) 350 (2 per phs)	1500	170M5813	1500	700	
20CD650	11	500	-	628	800 (1 per phs) 400 (2 per phs)	1400	800 (1 per phs) 400 (2 per phs)	1900	170M5813	1900	800	
		-	500	594	750 (1 per phs) 375 (2 per phs)	1300	750 (1 per phs) 375 (2 per phs)	1700	170M5813	1700	800	
20CD730	11	600	-	705	900 (1 per phs) 450 (2 per phs)	1600	900 (1 per phs) 450 (2 per phs)	2100	170M5813	2100	900	
		-	500	655	850 (1 per phs) 425 (2 per phs)	1400	850 (1 per phs) 425 (2 per phs)	1900	170M5813	1900	900	
20CD820	12	700	-	792	1000 (1 per phs) 500 (2 per phs)	1800	1000 (1 per phs) 500 (2 per phs)	2400	170M8547	2400	1000	
		-	600	735	900 (1 per phs) 475 (2 per phs)	1600	900 (1 per phs) 475 (2 per phs)	2100	170M8547	2100	1000	
20CD920	12	800	-	888	1200 (1 per phs) 600 (2 per phs)	2000	1200 (1 per phs) 600 (2 per phs)	2700	170M8547	2700	1200	
		-	700	826	1100 (1 per phs) 550 (2 per phs)	1800	1100 (1 per phs) 550 (2 per phs)	2400	170M8547	2400	1200	
20CD1K0	12	900	-	994	1300 (1 per phs) 650 (2 per phs)	2300	1300 (1 per phs) 650 (2 per phs)	3000	170M8547	3000	1300	
		-	800	927	1200 (1 per phs) 600 (2 per phs)	2000	1200 (1 per phs) 600 (2 per phs)	2700	170M8547	2700	1200	
20CD1K1	13	1000	-	1110	1400 (1 per phs) 700 (2 per phs)	2500 ⁽³⁾	1400 (1 per phs) 700 (2 per phs)	3400 ⁽³⁾	170M6466 ⁽³⁾	3400	1400	
		-	900	994	1300 (1 per phs) 650 (2 per phs)	2300 (3)	1300 (1 per phs) 650 (2 per phs)	3000 (3)	170M6466 ⁽³⁾	3000	1300	
20CD1K3	13	1200	-	1255	1600 (1 per phs) 800 (2 per phs)	2900 (3)	1600 (1 per phs) 800 (2 per phs)	3900 (3)	170M6466 ⁽³⁾	3900	1600	
		-	1000	1110	1400 (1 per phs) 700 (2 per phs)	2500 (3)	1400 (1 per phs) 700 (2 per phs)	3400 (3)	170M6466 ⁽³⁾	3400	1400	
20CD1K4	13	1250	-	1400	1800 (1 per phs) 900 (2 per phs)	3200 (3)	1800 (1 per phs) 900 (2 per phs)	4300 (3)	170M6466 ⁽³⁾	4300	1800	
		-	1000	1158	1500 (1 per phs) 750 (2 per phs)	2700 (3)	1500 (1 per phs) 750 (2 per phs)	3600 (3)	170M6466 ⁽³⁾	3600	1500	
20CD1K7	14	1500	-	1709	2200 (1 per phs) 750 (3 per phs)	3800	2200 (1 per phs) 750 (3 per phs)	5300	170M6466	5300	2200	
		-	1400	1545	2000 (1 per phs) 675 (3 per phs)	3600	2000 (1 per phs) 675 (3 per phs)	4800	170M6466	4800	2000	
20CD2K1	14	1900	-	2076	2600 (1 per phs) 900 (3 per phs)	4800	2600 (1 per phs) 900 (3 per phs)	6400	170M6466	6400	2600	
		-	1700	1873	2400 (1 per phs) 800 (3 per phs)	4300	2400 (1 per phs) 800 (3 per phs)	5800	170M6466	5800	2400	
20CD2K7	14	2300	-	2607	3000 (1 per phs) 1100 (3 per phs)	6000	3000 (1 per phs) 1100 (3 per phs)	8000	170M6466	8000	3300	
		-	2000	2220	2800 (1 per phs) 900 (3 per phs)	5000	2800 (1 per phs) 900 (3 per phs)	6900	170M6466	6900	2800	

(1) Minimum protection device size is the lowest rated device that supplies maximum protection without nuisance tripping.

(2) Maximum protection device size is the highest rated device that supplies drive protection. For US NEC, minimum size is 125% of motor FLA. Ratings shown are maximum.

(3) These fuses and disconnect are supplied with AC input NEMA/UL Type 1 drives.

(4) Inverse time breaker. Ratings shown are maximum.

(5) Maximum allowable rating by US NEC. Exact size must be chosen for each installation.

(6) Motor Circuit Protector - instantaneous trip circuit breaker. For US NEC minimum size is 125% of motor/drive FLA. Ratings shown are suggested. Instantaneous trip settings must be set to US NEC code. Not to exceed 1300% FLA.

600 Volt AC Input Drive Protection Devices

Drive Catalog Number	Frame	HP Rating		Input Ratings	Dual Element Time Delay Fuse		Non-Time Delay Fuse		Bussmann Style Semi-Conductor Fuse	Circuit Breaker ⁽⁴⁾ Max ⁽⁵⁾	Motor Circuit Protector ⁽⁶⁾ Max.
		ND	HD	Amps	Min. ⁽¹⁾	Max. ⁽²⁾	Min. ⁽¹⁾	Max. ⁽²⁾			
20CE170	9	150	—	164	225	375	225	500	170M3819	500	250
		—	150	139	175	300	175	500	170M3819	500	200
20CE208	9	200	—	201	275	450	275	600	170M3819	600	300
		—	150	164	225	375	225	500	170M3819	500	250
20CE261	10	250	—	252	325	575	325	775	170M5813	700	350
		—	200	201	275	450	275	600	170M5813	600	300
20CE325	10	350	—	314	400	725	400	950	170M5813	900	450
		—	250	252	325	575	325	775	170M5813	750	400
20CE385	10	400	—	372	475	850	475	1100	170M5813	1100	500
		—	350	314	400	725	400	950	170M5813	900	450
20CE416	10	450	—	402	525	900	525	1200	170M5813	1200	550
		—	350	314	400	725	400	950	170M5813	900	450
20CE460	11	500	—	444	575 (1 per phs) 300 (2 per phs)	1000	575 (1 per phs) 300 (2 per phs)	1300	170M8547	1300	600
		—	400	372	475 (1 per phs) 250 (2 per phs)	850	475 (1 per phs) 250 (2 per phs)	1100	170M8547	1100	500
20CE502	11	500	—	485	625 (1 per phs) 325 (2 per phs)	1100	625 (1 per phs) 325 (2 per phs)	1500	170M8547	1500	650
		—	500	444	575 (1 per phs) 300 (2 per phs)	1000	575 (1 per phs) 300 (2 per phs)	1300	170M8547	1300	600
20CE590	11	600	—	570	725 (1 per phs) 375(2 per phs)	1300	725 (1 per phs) 375(2 per phs)	1700	170M5813	1700	800
		—	500	485	625 (1 per phs) 325 (2 per phs)	1100	625 (1 per phs) 325 (2 per phs)	1500	170M5813	1500	700
20CE650	12	700	—	628	800 (1 per phs) 400 (2 per phs)	1400	800 (1 per phs) 400 (2 per phs)	1900	170M5813	1900	900
		—	650	570	725 (1 per phs) 375 (2 per phs)	1300	725 (1 per phs) 375 (2 per phs)	1700	170M5813	1700	800
20CE750	12	800	—	724	950 (1 per phs) 475 (2 per phs)	1600	950 (1 per phs) 475 (2 per phs)	2200	170M5813	2200	1000
		—	700	628	800 (1 per phs) 400 (2 per phs)	1400	800 (1 per phs) 400 (2 per phs)	1900	170M5813	1900	900
20CE820	12	900	—	792	1000 (1 per phs) 500 (2 per phs)	1800	1000 (1 per phs) 500 (2 per phs)	2400	170M5813	2400	1100
		—	700	628	800 (1 per phs) 400 (2 per phs)	1400	800 (1 per phs) 400 (2 per phs)	1900	170M5813	1900	900
20CE920	13	1000	—	888	1200 (1 per phs) 600 (2 per phs)	2000 ⁽³⁾	1200 (1 per phs) 600 (2 per phs)	2700 ⁽³⁾	170M6466 ⁽³⁾	2700	1200
		—	900	792	1000 (1 per phs) 500 (2 per phs)	1800 (3)	1000 (1 per phs) 500 (2 per phs)	2400 (3)	170M6466 ⁽³⁾	2400	1100
20CE1K0	13	1100	—	994	1300 (1 per phs) 650 (2 per phs)	2300 (3)	1300 (1 per phs) 650 (2 per phs)	3000 (3)	170M6466 ⁽³⁾	3000	1300
		—	1000	888	1200 (1 per phs) 600 (2 per phs)	2000 (3)	1200 (1 per phs) 600 (2 per phs)	2700 (3)	170M6466 ⁽³⁾	2700	1200
20CE1K1	13	1300	—	1139	1500 (1 per phs) 750 (2 per phs)	2600 (3)	1500 (1 per phs) 750 (2 per phs)	3500 (3)	170M6466 ⁽³⁾	3500	1500
		—	1100	994	1300 (1 per phs) 650 (2 per phs)	2200 (3)	1300 (1 per phs) 650 (2 per phs)	3000 (3)	170M6466 ⁽³⁾	3000	1300
20CE1K5	14	1600	—	1448	1900 (1 per phs) 650 (3 per phs)	3300	1900 (1 per phs) 650 (3 per phs)	4500	170M6466	4500	1900
		—	1400	1255	1600 (1 per phs) 550 (3 per phs)	2900	1600 (1 per phs) 550 (3 per phs)	3900	170M6466	3900	1700
20CE1K9	14	2000	—	1834	2300 (1 per phs) 800 (3 per phs)	4200	2300 (1 per phs) 800 (3 per phs)	5700	170M6466	5700	2400
		—	1600	1448	1900 (1 per phs) 650 (3 per phs)	3200	1900 (1 per phs) 650 (3 per phs)	4500	170M6466	4500	1900
20CE2K2	14	2400	—	2172	2800 (1 per phs) 950 (3 per phs)	5000	2800 (1 per phs) 950 (3 per phs)	6700	170M6466	6700	2900
		—	2000	1834	2300 (1 per phs) 800 (3 per phs)	4200	2300 (1 per phs) 800 (3 per phs)	5700	170M6466	5700	2400

(1) Minimum protection device size is the lowest rated device that supplies maximum protection without nuisance tripping.

(2) Maximum protection device size is the highest rated device that supplies drive protection. For US NEC, minimum size is 125% of motor FLA. Ratings shown are maximum.

- (3) These fuses and disconnect are supplied with AC input NEMA/UL Type 1 drives.
- (4) Inverse time breaker. Ratings shown are maximum.
- (5) Maximum allowable rating by US NEC. Exact size must be chosen for each installation.
- (6) Motor Circuit Protector - instantaneous trip circuit breaker. For US NEC minimum size is 125% of motor/drive FLA. Ratings shown are suggested. Instantaneous trip settings must be set to US NEC code. Not to exceed 1300% FLA.

690 Volt AC Input Drive Protection Devices

Drive Catalog Number	Frame	kW Rating		Input Ratings		Dual Element Time Delay Fuse		Non-Time Delay Fuse		Bussmann Style Semi-Conductor Fuse	Circuit Breaker ⁽⁴⁾		Motor Circuit Protector ⁽⁶⁾	
		ND	HD	Amps	Min. ⁽¹⁾	Max. ⁽²⁾	Min. ⁽¹⁾	Max. ⁽²⁾	Max. ⁽⁵⁾		Max.			
20CF170	9	160	—	171	225	375	225	500	170M3819	500	250			
		—	132	145	200	300	200	500	170M3819	400	200			
20CF208	9	200	—	210	275	450	275	600	170M3819	600	300			
		—	160	171	225	375	225	500	170M3819	500	250			
20CF261	10	250	—	263	350	575	350	775	170M5813	750	350			
		—	200	210	275	450	275	600	170M5813	600	300			
20CF325	10	315	—	327	425	725	425	950	170M5813	900	450			
		—	250	263	350	575	350	775	170M5813	750	400			
20CF385	10	355	—	388	500	850	500	1100	170M5813	1100	500			
		—	315	327	425	725	425	950	170M5813	900	450			
20CF416	10	400	—	419	525	900	525	1200	170M5813	1200	550			
		—	315	327	425	700	425	950	170M5813	900	450			
20CF460	11	500	—	463	600 (1 per phs) 300 (2 per phs)	1000	600 (1 per phs) 300 (2 per phs)	1300	170M8547	1300	600			
		—	400	388	500 (1 per phs) 250 (2 per phs)	850	500 (1 per phs) 250 (2 per phs)	1100	170M8547	1100	500			
20CF502	11	560	—	506	650 (1 per phs) 325 (2 per phs)	1100	650 (1 per phs) 325 (2 per phs)	1500	170M8547	1500	650			
		—	500	463	600 (1 per phs) 300 (2 per phs)	1000	600 (1 per phs) 300 (2 per phs)	1300	170M8547	1300	600			
20CF590	11	580	—	594	750 (1 per phs) 375 (2 per phs)	1300	750 (1 per phs) 375 (2 per phs)	1700	170M5813	1700	800			
		—	500	506	650 (1 per phs) 325 (2 per phs)	1100	650 (1 per phs) 325 (2 per phs)	1500	170M5813	1500	700			
20CF650	12	630	—	655	850 (1 per phs) 425 (2 per phs)	1400	850 (1 per phs) 425 (2 per phs)	1900	170M5813	1900	900			
		—	560	594	750 (1 per phs) 375 (2 per phs)	1300	750 (1 per phs) 375 (2 per phs)	1700	170M5813	1700	800			
20CF750	12	710	—	756	950 (1 per phs) 475 (2 per phs)	1600	950 (1 per phs) 475 (2 per phs)	2200	170M5813	2200	1000			
		—	630	655	850 (1 per phs) 425 (2 per phs)	1400	850 (1 per phs) 425 (2 per phs)	1900	170M5813	1900	900			
20CF820	12	800	—	826	1100 (1 per phs) 550 (2 per phs)	1800	1100 (1 per phs) 550 (2 per phs)	2400	170M5813	2400	1100			
		—	630	655	850 (1 per phs) 425 (2 per phs)	1400	850 (1 per phs) 425 (2 per phs)	1900	170M5813	1900	900			
20CF920	13	900	—	927	1200 (1 per phs) 600 (2 per phs)	2000 ⁽³⁾	1200 (1 per phs) 600 (2 per phs)	2700 ⁽³⁾	170M6466 ⁽³⁾	2700	1200			
		—	800	826	1100 (1 per phs) 550 (2 per phs)	1800 (3)	1100 (1 per phs) 550 (2 per phs)	2400 (3)	170M6466 ⁽³⁾	2400	1100			
20CF1K0	13	1000	—	1038	1300 (1 per phs) 650 (2 per phs)	2300 (3)	1300 (1 per phs) 650 (2 per phs)	3000 (3)	170M6466 ⁽³⁾	3000	1300			
		—	900	927	1200 (1 per phs) 600 (2 per phs)	2000 (3)	1200 (1 per phs) 600 (2 per phs)	2700 (3)	170M6466 ⁽³⁾	2700	1200			
20CF1K1	13	1100	—	1189	1500 (1 per phs) 750 (2 per phs)	2600 (3)	1500 (1 per phs) 750 (2 per phs)	3500 (3)	170M6466 ⁽³⁾	3500	1500			
		—	1000	1038	1300 (1 per phs) 650 (2 per phs)	2300 (3)	1300 (1 per phs) 650 (2 per phs)	3000 (3)	170M6466 ⁽³⁾	3000	1300			
20CF1K5	14	1500	—	1511	1900 (1 per phs) 650 (3 per phs)	3300	1900 (1 per phs) 650 (3 per phs)	4500	170M6466	4500	1900			
		—	1300	1310	1700 (1 per phs) 575 (3 per phs)	2900	1700 (1 per phs) 575 (3 per phs)	3900	170M6466	3900	1700			

Drive Catalog Number	Frame	kW Rating		Input Ratings		Dual Element Time Delay Fuse		Non-Time Delay Fuse		Bussmann Style Semi-Conductor Fuse	Circuit Breaker ⁽⁴⁾ Max. ⁽⁵⁾	Motor Circuit Protector ⁽⁶⁾ Max.
		ND	HD	Amps	Min. ⁽¹⁾	Max. ⁽²⁾	Min. ⁽¹⁾	Max. ⁽²⁾				
20CF1K9	14	1800	–	1914	2400 (1 per phs) 800 (3 per phs)	4200	2400 (1 per phs) 800 (3 per phs)	5700	170M6466	5700	2400	
		–	1500	1511	1900 (1 per phs) 650 (3 per phs)	3200	1900 (1 per phs) 650 (3 per phs)	4500	170M6466	4500	1900	
20CF2K2	14	2000	–	2267	2900 (1 per phs) 950 (3 per phs)	5000	2900 (1 per phs) 950 (3 per phs)	6700	170M6466	6700	2900	
		–	1800	1914	2400 (1 per phs) 800 (3 per phs)	4200	2400 (1 per phs) 800 (3 per phs)	5700	170M6466	5700	2400	

- (1) Minimum protection device size is the lowest rated device that supplies maximum protection without nuisance tripping.
(2) Maximum protection device size is the highest rated device that supplies drive protection. For US NEC, minimum size is 125% of motor FLA. Ratings shown are maximum.
(3) These fuses and disconnect are supplied with AC input NEMA/UL Type 1 drives.
(4) Inverse time breaker. Ratings shown are maximum.
(5) Maximum allowable rating by US NEC. Exact size must be chosen for each installation.
(6) Motor Circuit Protector - instantaneous trip circuit breaker. For US NEC minimum size is 125% of motor/drive FLA. Ratings shown are suggested. Instantaneous trip settings must be set to US NEC code. Not to exceed 1300% FLA.

540 Volt DC Input Drive Protection Devices

Drive Catalog Number	Frame	kW Rating		DC Input Ratings		Fuse	Bussmann Style Fuse
		ND	HD	Amps			
20CH261	9	132	–	307		500	170M6608
		–	110	241		500	170M6608
20CH300	9	160	–	353		630	170M6610
		–	132	288		630	170M6610
20CH385	10	200	–	453		700	170M6611
		–	160	353		700	170M6611
20CH460	10	250	–	541		900	170M6613
		–	200	453		900	170M6613
20CH500	10	250	–	589		500 (2 per phs)	170M6608
		–	250	494		500 (2 per phs)	170M6608
20CH590	11	315	–	695		550 (2 per phs)	170M6609
		–	250	612		550 (2 per phs)	170M6609
20CH650	11	355	–	765		630 (2 per phs)	170M6610
		–	315	695		630 (2 per phs)	170M6610
20CH730	11	400	–	859		700 (2 per phs)	170M6611
		–	355	765		700 (2 per phs)	170M6611
20CH820	12	450	–	965		700 (2 per phs)	170M6611
		–	400	859		700 (2 per phs)	170M6611
20CH920	12	500	–	1083		550 (3 per phs)	170M6609
		–	450	965		550 (3 per phs)	170M6609
20CH1K0	12	560	–	1213		630 (3 per phs)	170M6610
		–	500	1083		630 (3 per phs)	170M6610
20CH1K1	13	630	–	1354		2400	170M7107
		–	560	1213		2400	170M7107
20CH1K3	13	710	–	1530		2400	170M7107
		–	630	1354		2400	170M7107
20CH1K4	13	800	–	1707		2400	170M7107
		–	710	1413		2400	170M7107
20CH1K7	14	1000	–	2084		–	170M8610
		–	900	1883		–	170M8610
20CH2K1	14	1200	–	2531		–	170M8610
		–	1100	2284		–	170M8610
20CH2K7	14	1600	–	3178		–	170M8610
		–	1300	2708		–	170M8610

650 Volt DC Input Drive Protection Devices

Drive Catalog Number	Frame	HP Rating		DC Input Ratings		Fuse	Bussmann Style Fuse
		ND	HD	Amps			
20CJ261	9	200	-	294		500	170M6608
		-	150	231		500	170M6608
20CJ300	9	250	-	338		630	170M6610
		-	200	294		630	170M6610
20CJ385	10	300	-	434		700	170M6611
		-	250	338		700	170M6611
20CJ460	10	350	-	519		900	170M6613
		-	300	434		900	170M6613
20CJ500	10	450	-	564		500 (2 per phs)	170M6608
		-	350	474		500 (2 per phs)	170M6608
20CJ590	11	500	-	666		550 (2 per phs)	170M6609
		-	450	587		550 (2 per phs)	170M6609
20CJ650	11	500	-	733		630 (2 per phs)	170M6610
		-	500	666		630 (2 per phs)	170M6610
20CJ730	11	600	-	824		700 (2 per phs)	170M6611
		-	500	733		700 (2 per phs)	170M6611
20CJ820	12	700	-	925		700 (2 per phs)	170M6611
		-	600	824		700 (2 per phs)	170M6611
20CJ920	12	800	-	1038		550 (3 per phs)	170M6609
		-	700	925		550 (3 per phs)	170M6609
20CJ1K0	12	900	-	1162		630 (3 per phs)	170M6610
		-	800	1038		630 (3 per phs)	170M6610
20CJ1K1	13	1000	-	1297		2400	170M7107
		-	900	1162		2400	170M7107
20CJ1K3	13	1200	-	1467		2400	170M7107
		-	1000	1297		2400	170M7107
20CJ1K4	13	1250	-	1636		2400	170M7107
		-	1000	1354		2400	170M7107
20CJ1K7	14	1500	-	1997		-	170M8610
		-	1400	1805		-	170M8610
20CJ2K1	14	1900	-	2425		-	170M8610
		-	1700	2189		-	170M8610
20CJ2K7	14	2300	-	3046		-	170M8610
		-	2000	2595		-	170M8610

810 Volt DC Input Drive Protection Devices

Drive Catalog Number	Frame	HP Rating		DC Input Ratings		Fuse	Bussmann Style Fuse
		ND	HD	Amps			
20CK170	9	150	-	192		400	170M5608
		-	150	162		400	170M5608
20CK208	9	200	-	235		450	170M5609
		-	150	192		450	170M5609
20CK261	10	250	-	294		450	170M5609
		-	200	235		450	170M5609
20CK325	10	350	-	367		550	170M6609
		-	250	294		550	170M6609
20CK385	10	400	-	434		700	170M6611
		-	350	367		700	170M6611
20CK416	10	450	-	469		800	170M6612
		-	350	367		800	170M6612
20CK460	11	500	-	519		450 (2 per phs)	170M5609
		-	400	434		450 (2 per phs)	170M5609
20CK502	11	500	-	566		500 (2 per phs)	170M6608
		-	500	519		500 (2 per phs)	170M6608

Drive Catalog Number	Frame	HP Rating		DC Input Ratings		Fuse	Bussmann Style Fuse
		ND	HD	Amps			
20CK590	11	600	—	666		500 (2 per phs)	170M6608
		—	500	566		500 (2 per phs)	170M6608
20CK650	12	700	—	733		500 (2 per phs)	170M6608
		—	650	666		500 (2 per phs)	170M6608
20CK750	12	800	—	846		630 (2 per phs)	170M6610
		—	700	733		630 (2 per phs)	170M6610
20CK820	12	900	—	925		630 (2 per phs)	170M6610
		—	700	733		630 (2 per phs)	170M6610
20CK920	13	1000	—	1038		2400	170M7107
		—	900	925		2400	170M7107
20CK1K0	13	1100	—	1162		2400	170M7107
		—	1000	1038		2400	170M7107
20CK1K1	13	1300	—	1331		2400	170M7107
		—	1100	1162		2400	170M7107
20CK1K5	14	1600	—	1692		—	170M8610
		—	1400	1467		—	170M8610
20CK1K9	14	2000	—	2143		—	170M8610
		—	1600	1692		—	170M8610
20CK2K2	14	2400	—	2538		—	170M8610
		—	2000	2143		—	170M8610

932 Volt DC Input Drive Protection Devices

Drive Catalog Number	Frame	kW Rating		DC Input Ratings		Fuse	Bussmann Style Fuse
		ND	HD	Amps			
20CM170	9	160	—	200		315	170M3746
		—	132	170		315	170M3746
20CM208	9	200	—	245		400	170M5742
		—	160	200		400	170M5742
20CM261	10	250	—	307		500	170M5744
		—	200	245		500	170M5744
20CM325	10	315	—	383		630	170M5746
		—	250	307		630	170M5746
20CM385	10	355	—	453		700	170M6745
		—	315	383		700	170M6745
20CM416	10	400	—	490		700	170M6745
		—	315	383		700	170M6745
20CM460	11	450	—	542		450 (2 per phs)	170M5743
		—	355	453		450 (2 per phs)	170M5743
20CM502	11	500	—	591		500 (2 per phs)	170M5744
		—	400	542		500 (2 per phs)	170M5744
20CM590	11	560	—	695		500 (2 per phs)	170M5744
		—	500	591		500 (2 per phs)	170M5744
20CM650	12	630	—	765		550 (2 per phs)	170M5745
		—	560	695		550 (2 per phs)	170M5745
20CM750	12	710	—	883		630 (2 per phs)	170M5746
		—	630	765		630 (2 per phs)	170M5746
20CM820	12	800	—	965		630 (2 per phs)	170M5746
		—	630	765		630 (2 per phs)	170M5746
20CM920	13	900	—	1038		2400	170M7107
		—	800	925		2400	170M7107
20CM1K0	13	1000	—	1162		2400	170M7107
		—	900	1038		2400	170M7107
20CM1K1	13	1100	—	1331		2400	170M7107
		—	1000	1162		2400	170M7107
20CM1K5	14	1500	—	1766		—	170M8610
		—	1300	1530		—	170M8610
20CM1K9	14	1800	—	2237		—	170M8610
		—	1500	1766		—	170M8610
20CM2K2	14	2000	—	2649		—	170M8610
		—	1800	2237		—	170M8610

Minimum Mounting Clearances

Frame 9

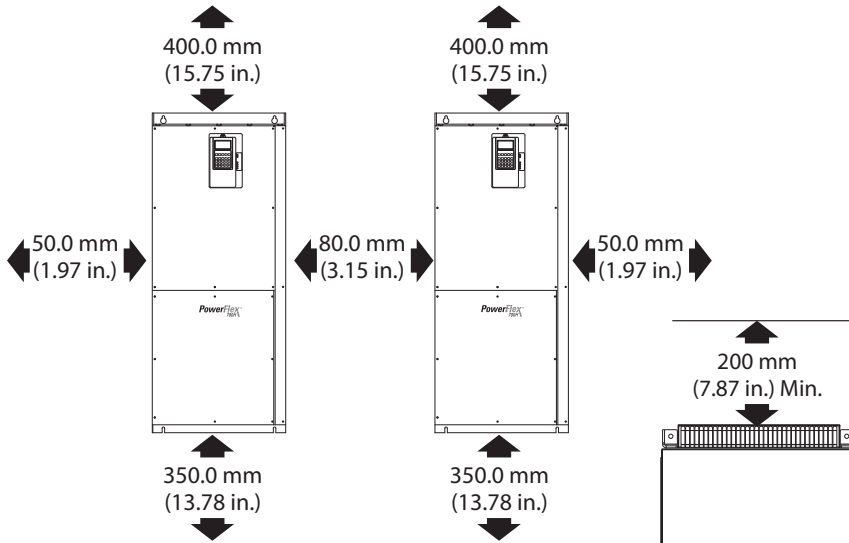

Frames 10...14 (NEMA/UL Type 1 - IP21 Enclosure (Frame 10 shown))

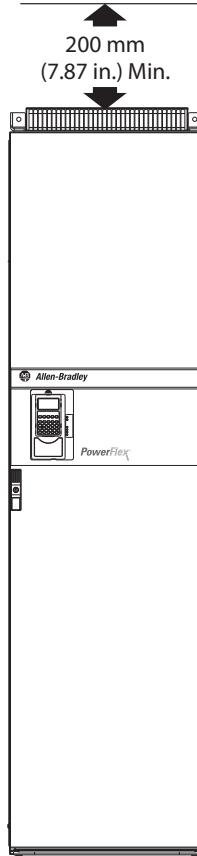

Frames 10...12 (NEMA/UL Type 1 - IP20 MCC Enclosure (Frame 10 shown))

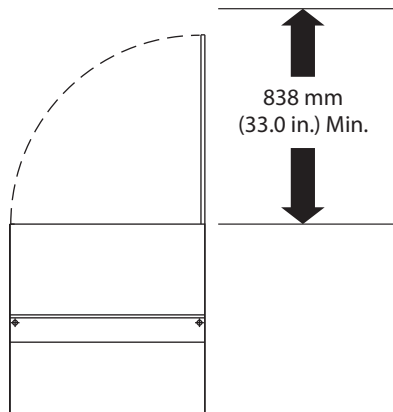
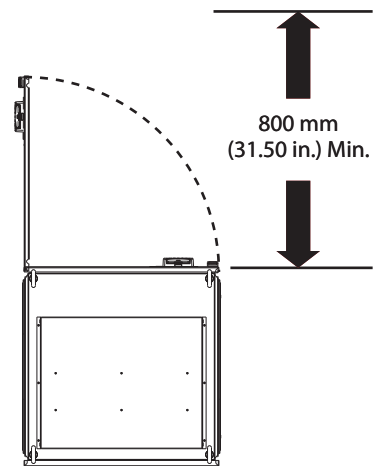
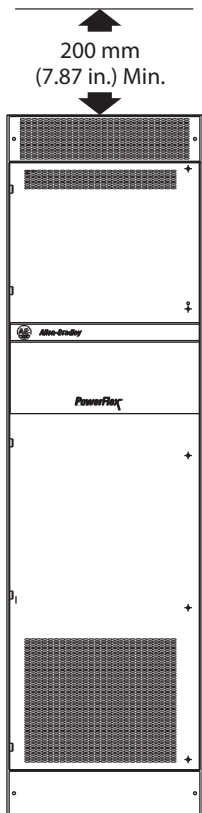

Approximate Dimensions

Frame 9

Dimensions are in millimeters and (inches).

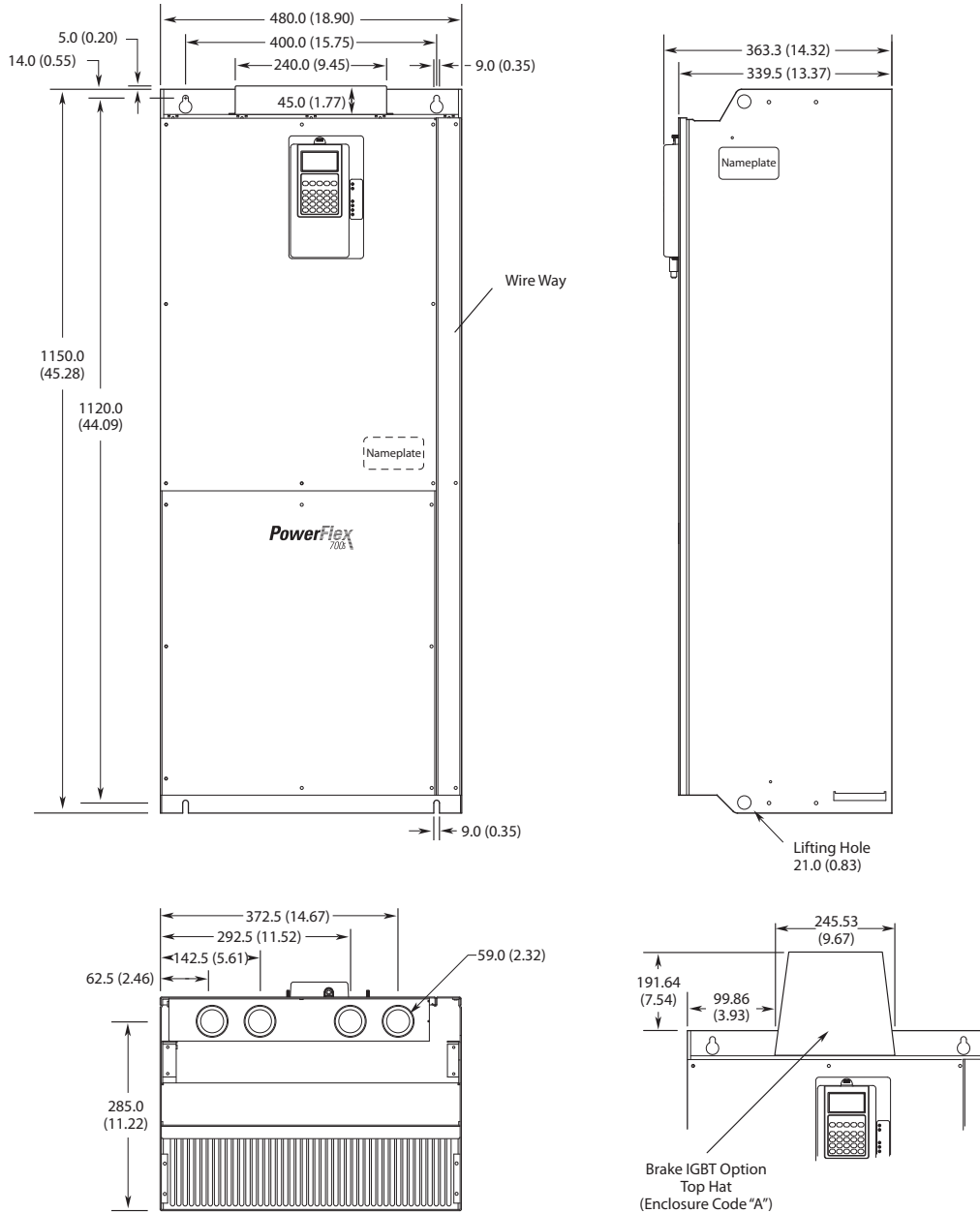

Frame 9 Drive Weights

Type	Weight kg (lb)
400V/480V AC, 261 Amp Drive & Enclosure	143 (315)
400V/480V AC, 300 Amp Drive & Enclosure	151 (333)
540/650V DC, 261 Amp Drive & Enclosure	109 (240)
540/650V DC, 300 Amp Drive & Enclosure	117 (257)
600/690V AC Drive & Enclosure	143 (315)
810/932V DC Drive & Enclosure	109 (240)

Frame 10 Enclosure Code A (NEMA/UL Type 1, IP21) and M (NEMA/UL Type 1, IP21 w/Conformal Coat)

Dimensions are in millimeters and (inches).

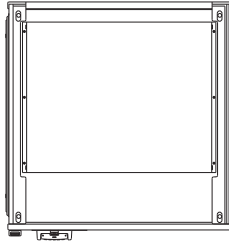

* This dimension is the depth for drives with the optional door-mounted HIM installed.

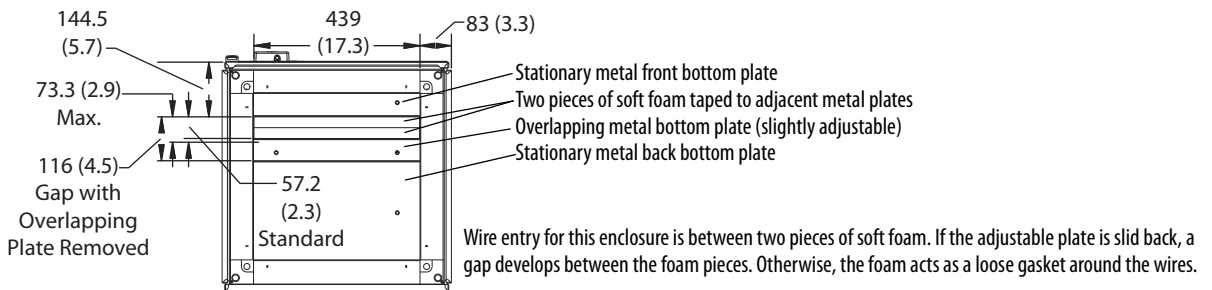
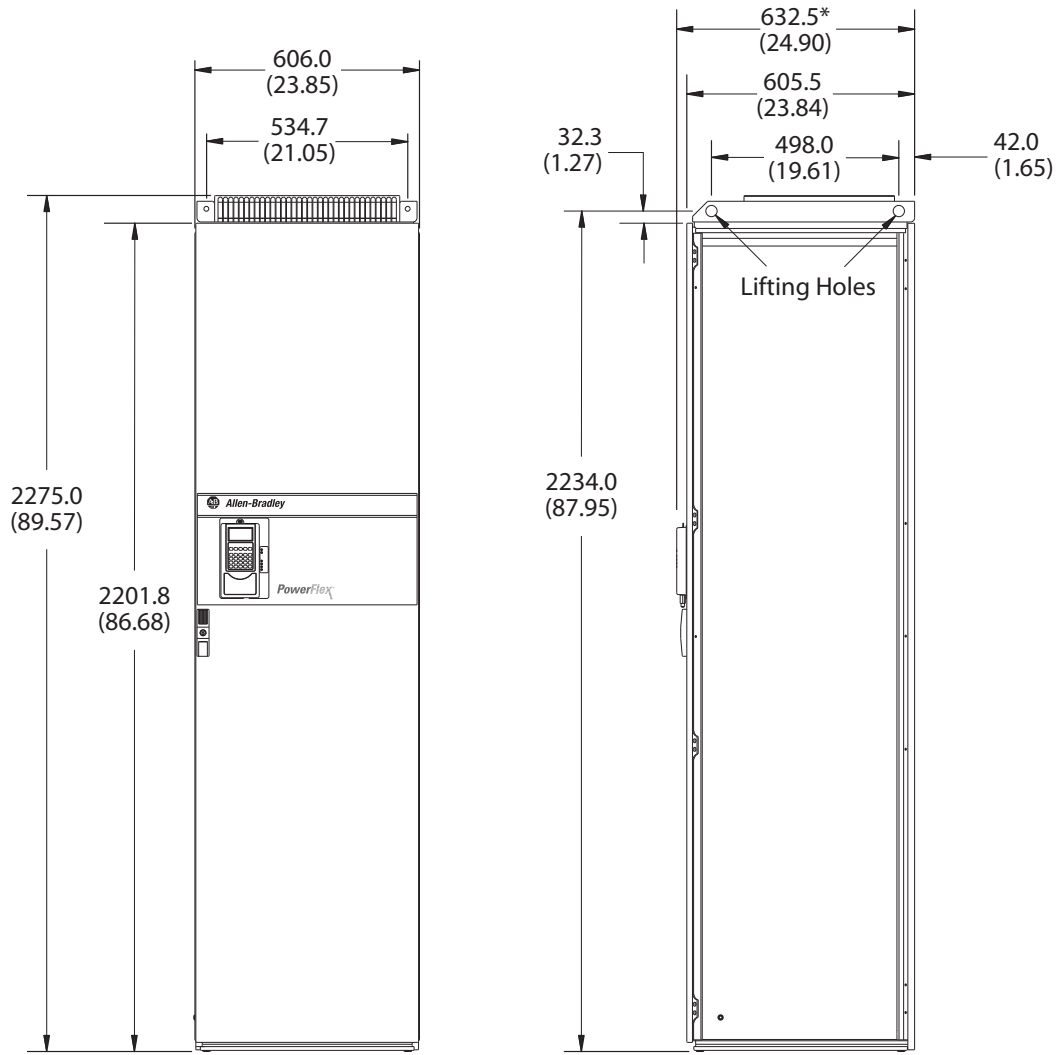

Frame 10 Enclosure Code B (NEMA/UL Type 1, IP20 MCC) and K (NEMA/UL Type 1, IP20 MCC w/Conformal Coat)

Dimensions are in millimeters and (inches).

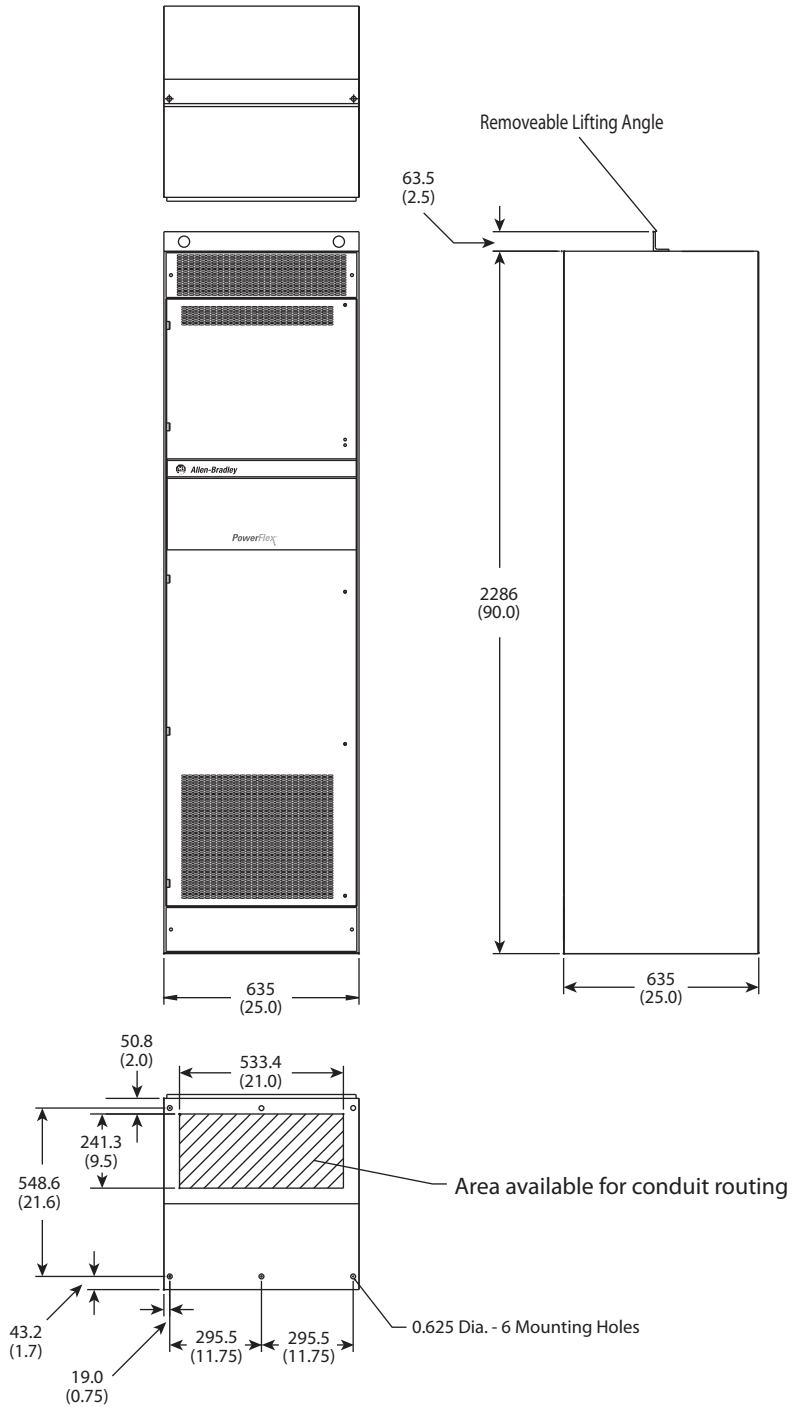

Frame 10 Enclosure Code H (NEMA/UL Type 12 - IP54) and W (NEMA/UL Type 12 - IP54 w/Conformal Coat)

Dimensions are in millimeters and (inches).

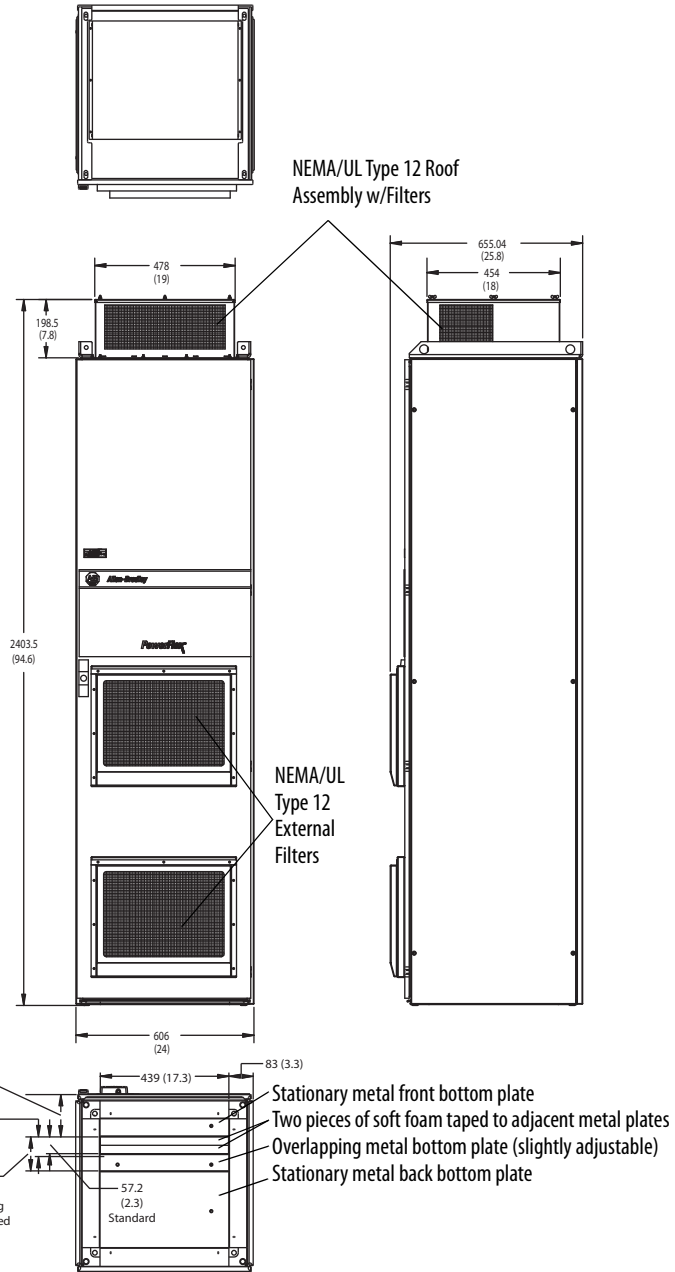

Wire entry for this enclosure is between two pieces of soft foam. If the adjustable plate is slid back, a gap develops between the foam pieces. Otherwise, the foam acts as a loose gasket around the wires.

Frame 10 Drive Weights

Voltage Class	Drive Rating Amps	Approx. Weight kg (lb) Drive & Enclosure (AC Input)	Approx. Weight kg (lb) Drive & Enclosure (DC Input)
400/480V AC (540/650V DC)	385	432 (952)	317 (699)
	460	432 (952)	317 (699)
	520	432 (952)	317 (699)
600/690V AC (810/932V DC)	261	370 (816)	317 (699)
	325	401 (884)	317 (699)
	385	401 (884)	317 (699)
	416	401 (884)	317 (699)

Frame 11 Enclosure Code A NEMA/UL Type 1 - IP21 and M (NEMA/UL Type 1, IP21 w/Conformal Coat)

Dimensions are in millimeters and (inches).

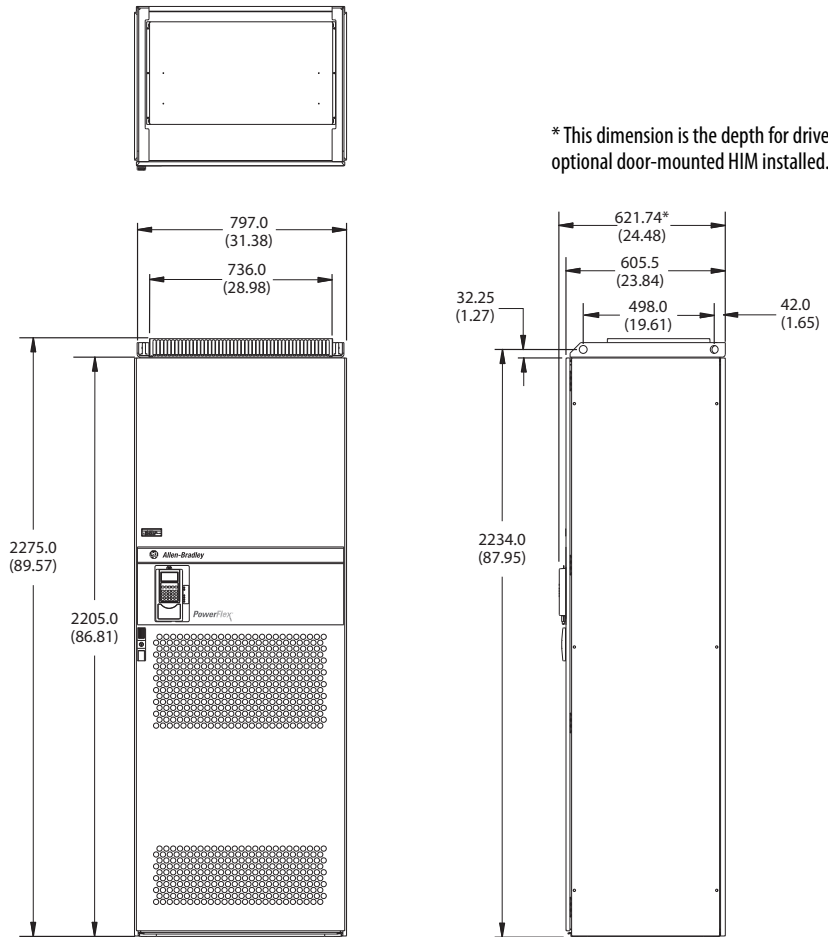

* This dimension is the depth for drives with the optional door-mounted HIM installed.

Wire entry for this enclosure is between two pieces of soft foam. If the adjustable plate is slid back, a gap develops between the foam pieces. Otherwise, the foam acts as a loose gasket around the wires.

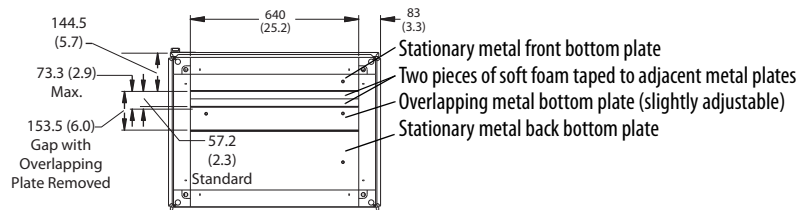

Frame 11 Enclosure Code B (NEMA/UL Type 1, IP20 MCC) and K (NEMA/UL Type 1, IP20 MCC w/Conformal Coat)

Dimensions are in millimeters and (inches).

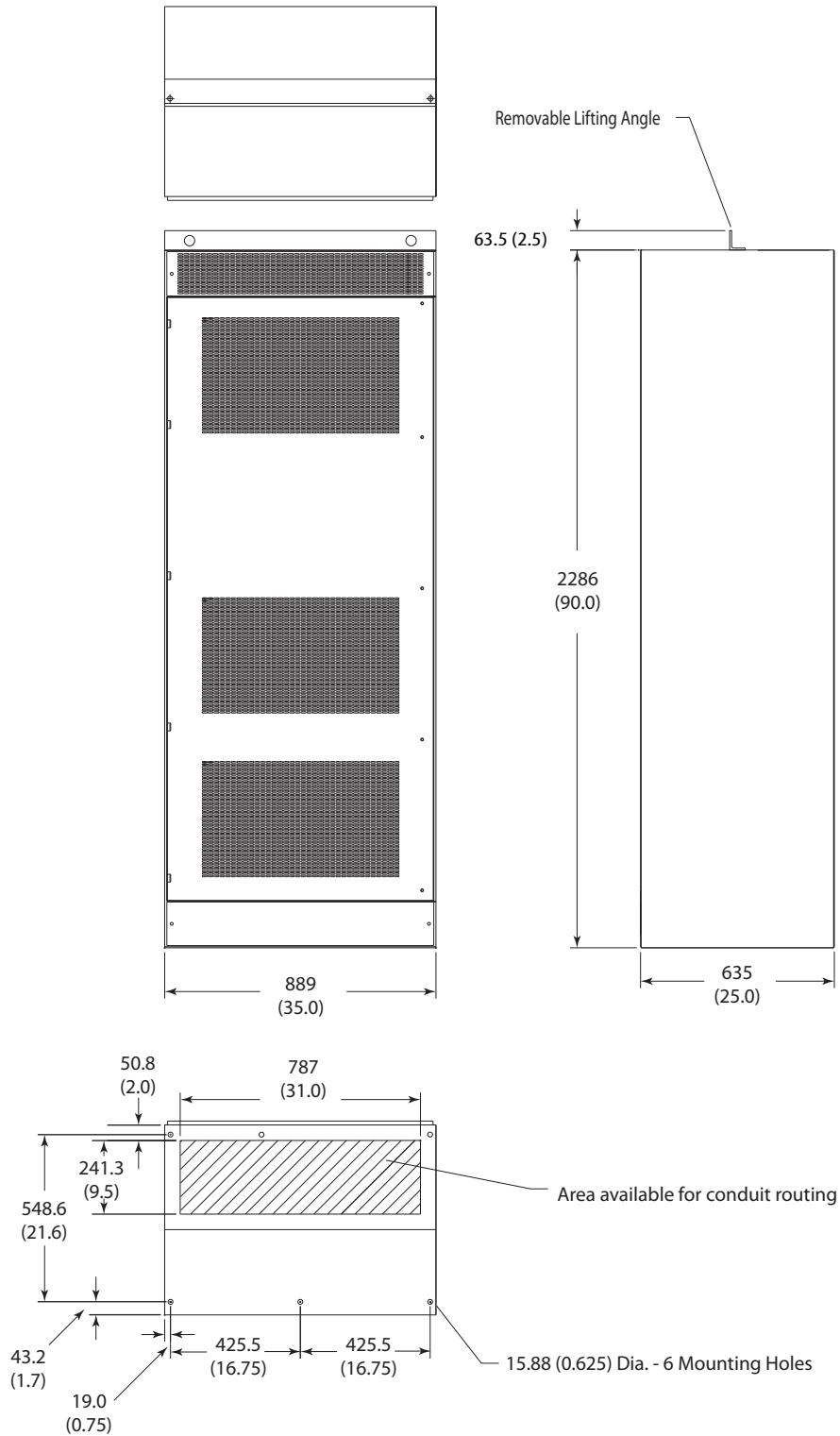

Frame 11 Enclosure Code H (NEMA/UL Type 12, IP54) and W (NEMA/UL Type 12 - IP54 w/Conformal Coat)

Dimensions are in millimeters and (inches).

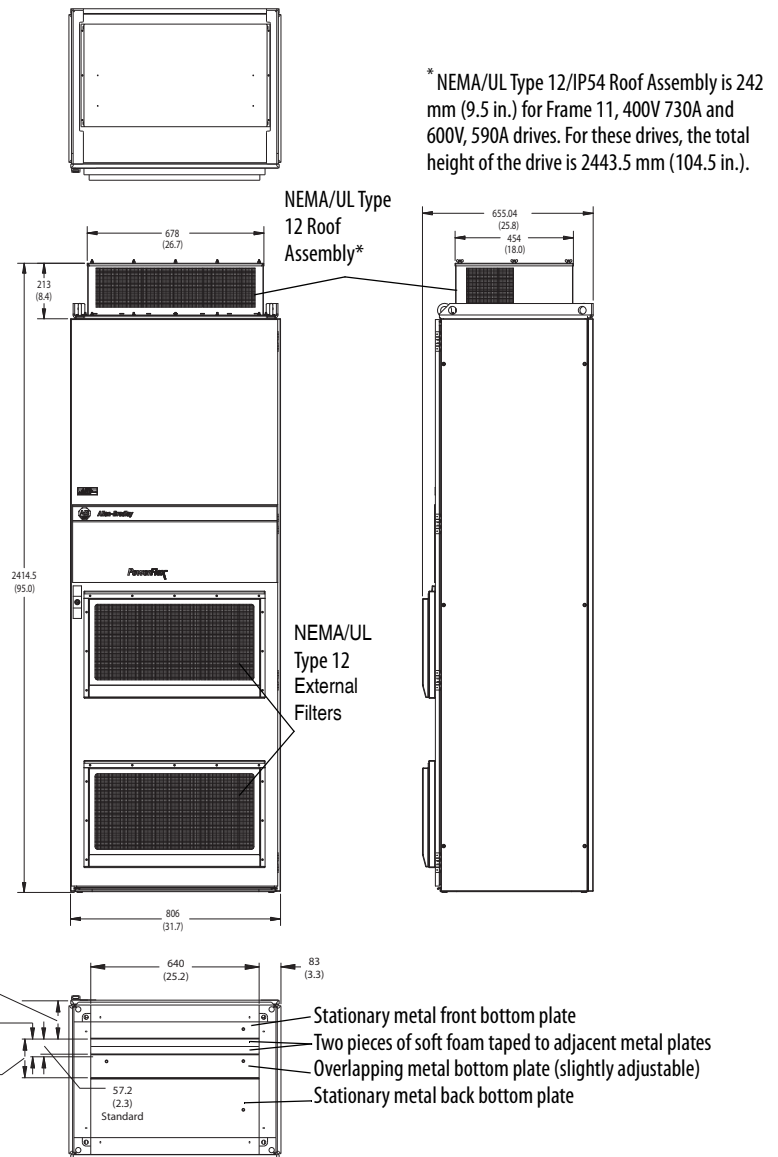

Wire entry for this enclosure is between two pieces of soft foam. If the adjustable plate is slid back, a gap develops between the foam pieces. Otherwise, the foam acts as a loose gasket around the wires.

Frame 11 Drive Weights

Voltage Class	Drive Rating Amps	Approx. Weight kg (lb)	
		Drive & Enclosure (AC Input)	Drive & Enclosure (DC Input)
400/480V AC (540/650V DC)	590	614 (1354)	446 (983)
	650	614 (1354)	446 (983)
	730	614 (1354)	446 (983)
600/690V AC (810/932V DC)	460	561 (1237)	446 (983)
	502	561 (1237)	446 (983)
	590	676 (1490)	446 (983)

Frame 12, Enclosure Code A (NEMA/UL Type 1 - IP21) and M (NEMA/UL Type 1, IP21 w/Conformal Coat)

Dimensions are in millimeters and (inches).

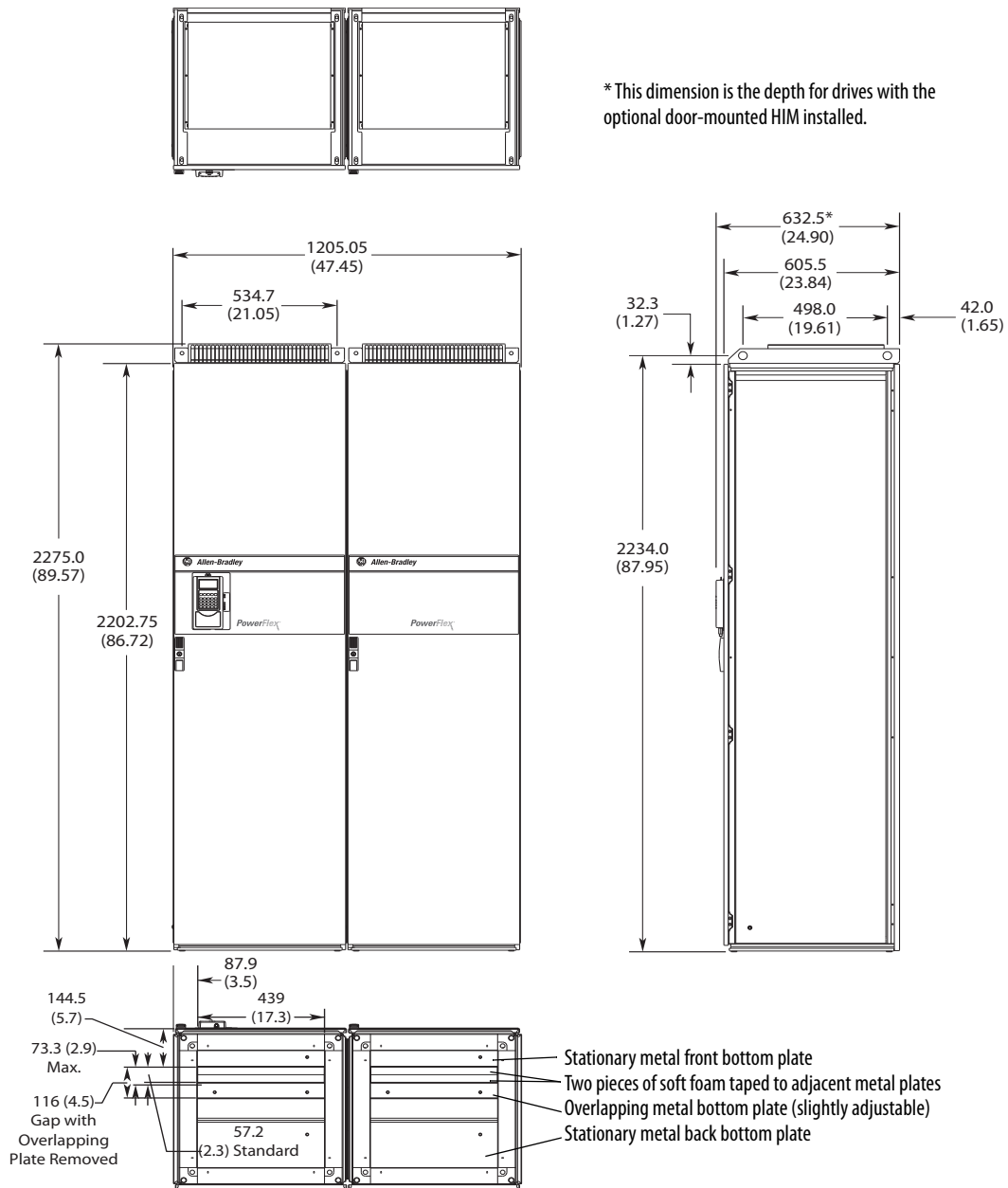

* This dimension is the depth for drives with the optional door-mounted HIM installed.

Wire entry for this enclosure is between two pieces of soft foam. If the adjustable plate is slid back, a gap develops between the foam pieces. Otherwise, the foam acts as a loose gasket around the wires.

Frame 12 Enclosure Code B (NEMA/UL Type 1, IP21) and K (NEMA/UL Type 1, IP21 w/Conformal Coat)

Dimensions are in millimeters and (inches).

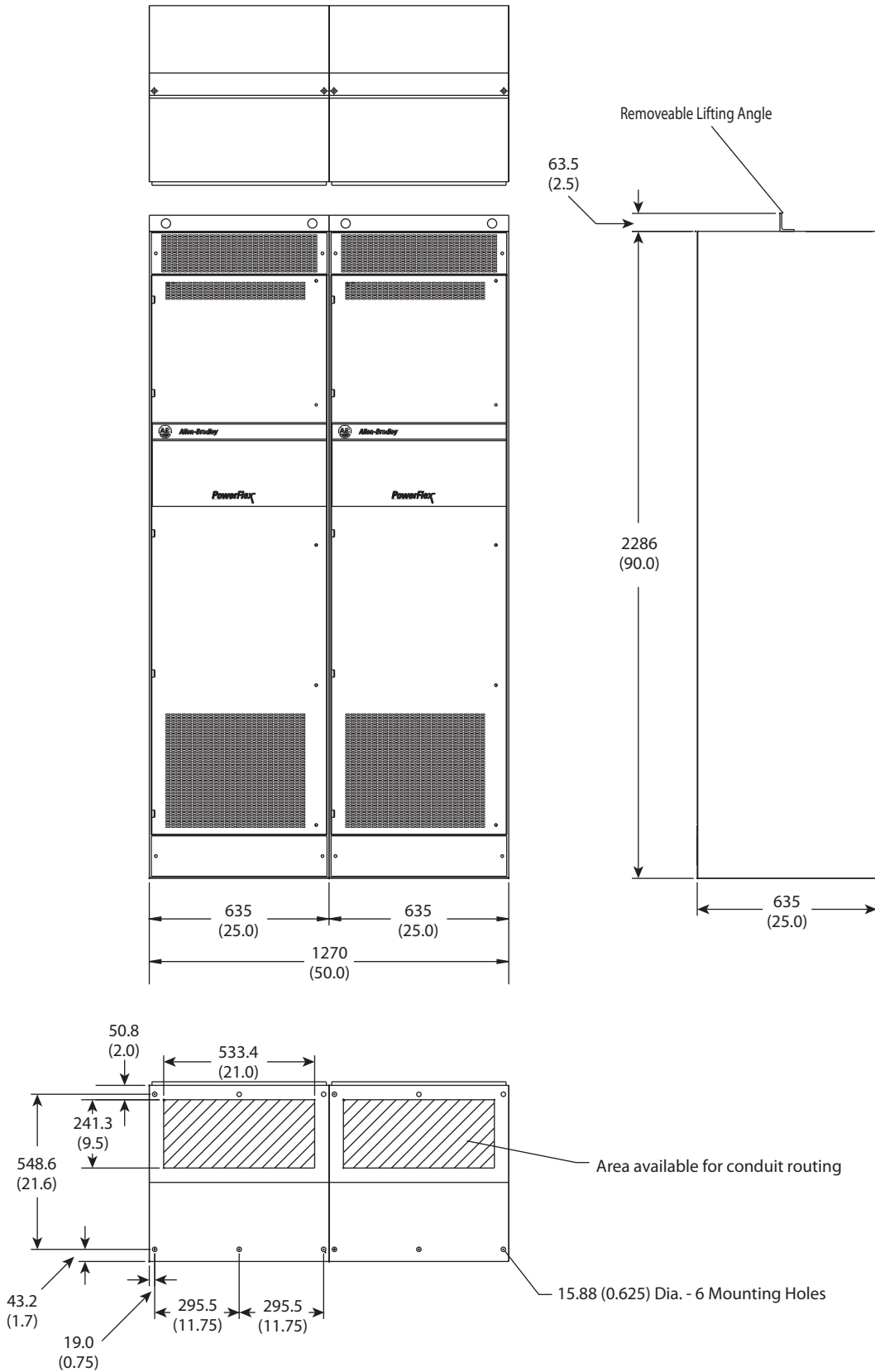

Frame 12 Enclosure Code H (NEMA/UL Type 12, IP54) and W (NEMA/UL Type 12, IP54 w/Conformal Coat)

Dimensions are in millimeters and (inches).

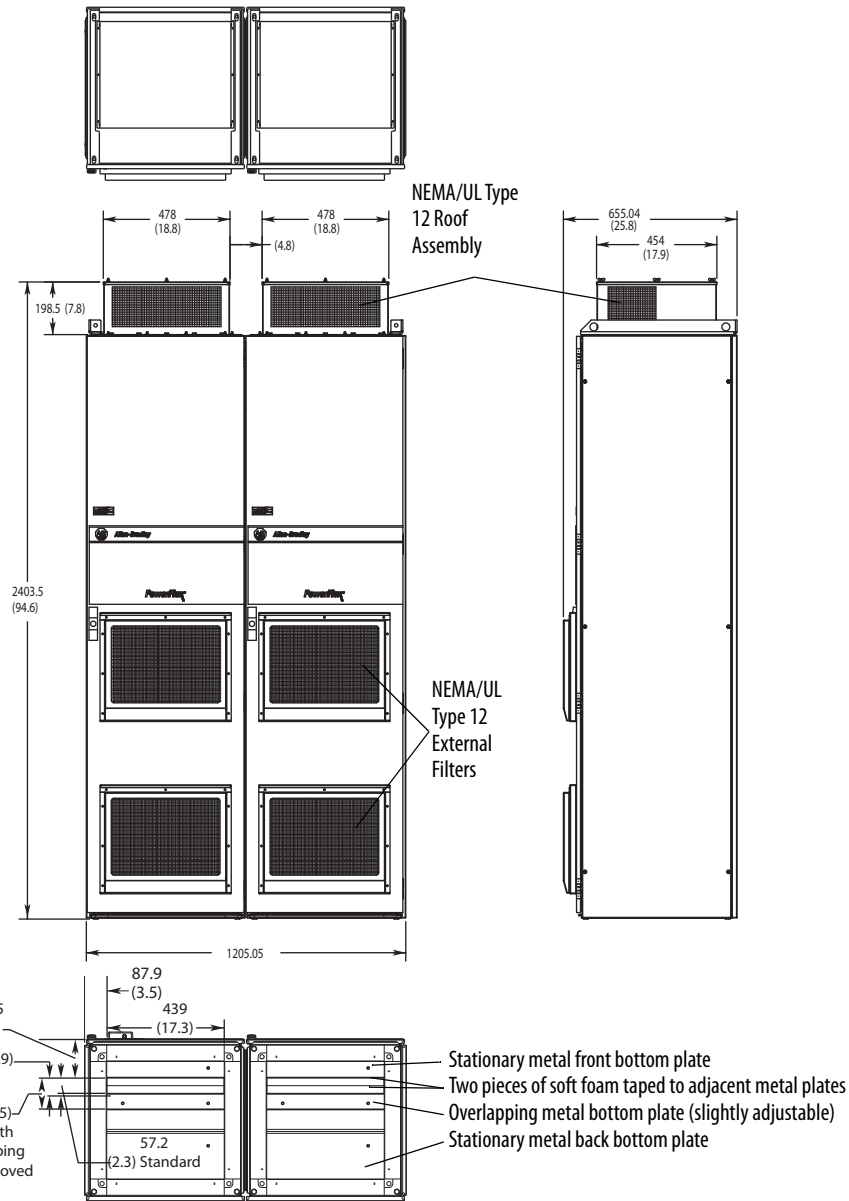

Wire entry for this enclosure is between two pieces of soft foam. If the adjustable plate is slid back, a gap develops between the foam pieces. Otherwise, the foam acts as a loose gasket around the wires.

Frame 12 Drive Weights

Voltage Class	Drive Rating Amps	Approx. Weight kg (lb)	
		Drive & Enclosure (AC Input)	Drive & Enclosure (DC Input)
400/480V AC (540/650V DC)	820	864 (1906)	634 (1398)
	920	864 (1906)	634 (1398)
	1030	864 (1906)	634 (1398)
600/690V AC (810/932V DC)	650	802 (1768)	634 (1398)
	750	802 (1768)	634 (1398)
	820	802 (1768)	634 (1398)

Frame 13 Enclosure Code A (NEMA/UL Type 1, IP21) and M (NEMA/UL Type 1, IP21 w/Conformal Coat)

Voltage Class	Amps	A	B	C	D	E	F
400/480V AC (540/650V DC)	1150	1412 (56)	1329 (52)	1264 (50)	535 (21)	735 (29)	1264 (50)
	1300	1600 (63)	1529 (60)	1464 (58)	735 (29)	735 (29)	1464 (58)
	1450						
600/690V AC (810/932V DC)	920	1412 (56)	1329 (52)	1264 (50)	535 (21)	735 (29)	1264 (50)
	1030						
	1180						

Dimensions are in mm and (in.)

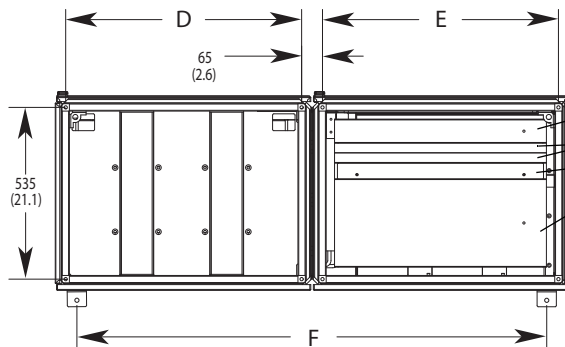
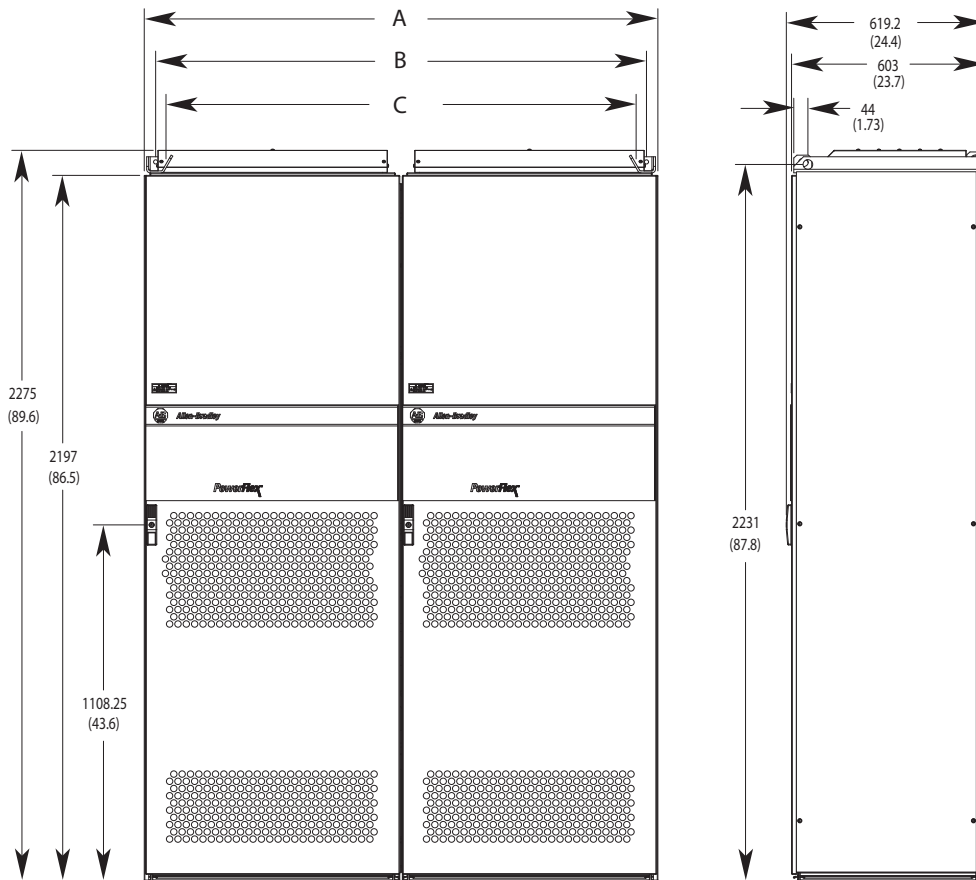

- Stationary metal front bottom plate
- Two pieces of soft foam taped to adjacent metal plates
- Overlapping metal bottom plate (slightly adjustable)
- Stationary metal back bottom plate

Wire entry for this enclosure is between two pieces of soft foam. If the adjustable plate is slid back, a gap develops between the foam pieces. otherwise, the foam acts as a loose gasket around the wires.

Frame 13 Enclosure Code H (NEMA/UL Type 12, IP54) and W (NEMA/UL Type 12, IP54 w/Conformal Coat)

Voltage Class	Amps	A	B	C	D	E	F	G	H
400/480V AC (540/650V DC)	1150	1412 (56)	478 (18.8)	678 (26.7)	1 @ 242 (9.5) 1 @ 213 (8.4)	2443.5 (104.5) max.	535 (21)	735 (29)	1264 (50)
	1300	1600 (63)	678 (26.7)	678 (26.7)	2 @ 242 (9.5)	2443.5 (104.5)	735 (29)	735 (29)	1464 (58)
	1450								
600/690V AC (810/932V DC)	920	1412 (56)	478 (18.8)	678 (26.7)	1 @ 242 (9.5) 1 @ 213 (8.4)	2443.5 (104.5) max.	535 (21)	735 (29)	1264 (50)
	1030								
	1180								

Dimensions are in mm and (in.)

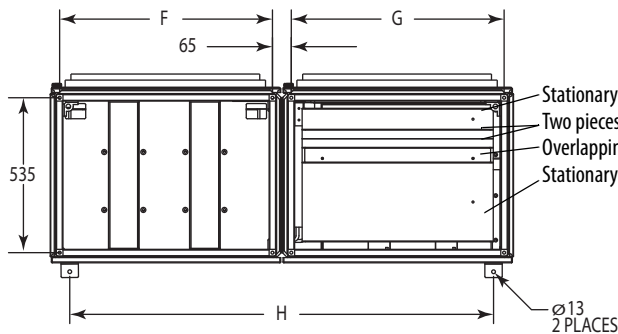
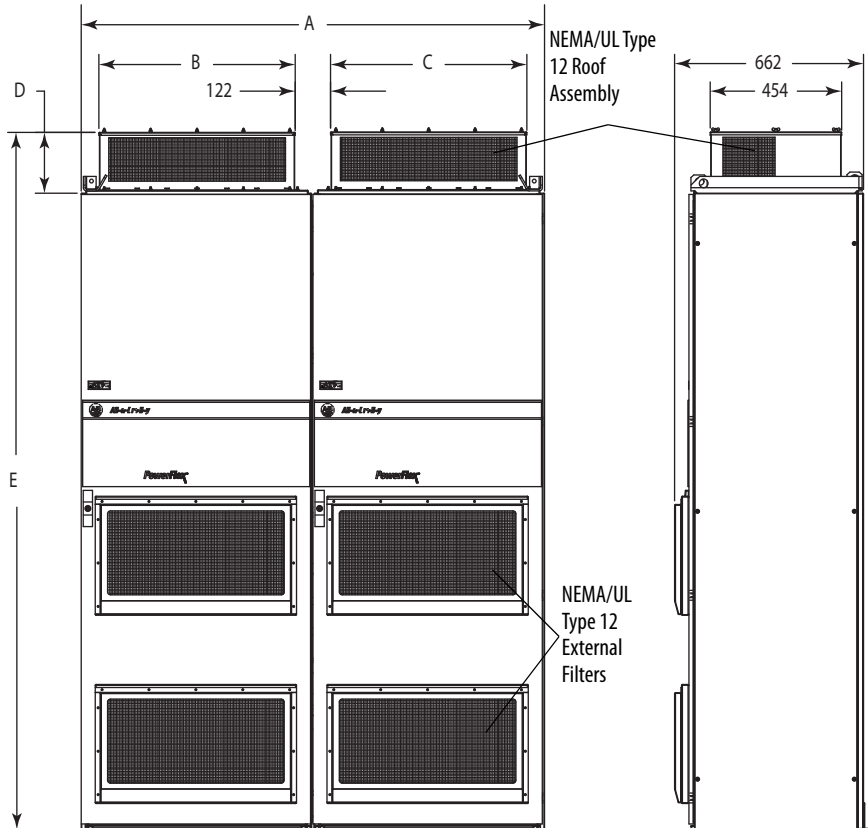

Wire entry for this enclosure is between two pieces of soft foam. If the adjustable plate is slid back, a gap develops between the foam pieces. otherwise, the foam acts as a loose gasket around the wires.

Frame 13 Weights

Voltage Class	Drive Rating Amps	Approx. Weight (kg (lb))	
		Drive & Enclosure (AC Input)	Drive & Enclosure (DC Input)
400/480V AC (540/650V DC)	1150	1248 (2751)	600 (1323)
	1300	1400 (3086)	600 (1323)
	1450	1400 (3086)	600 (1323)
600/690V AC (810/932V DC)	920	1248 (2751)	600 (1323)
	1030	1248 (2751)	600 (1323)
	1180	1248 (2751)	600 (1323)

Frame 14 1500A Drives - Enclosure Code A (NEMA/UL Type 1, IP21) and M (NEMA/UL Type 1, IP21 w/ Conformal Coat)

Dimensions are in millimeters and (inches).

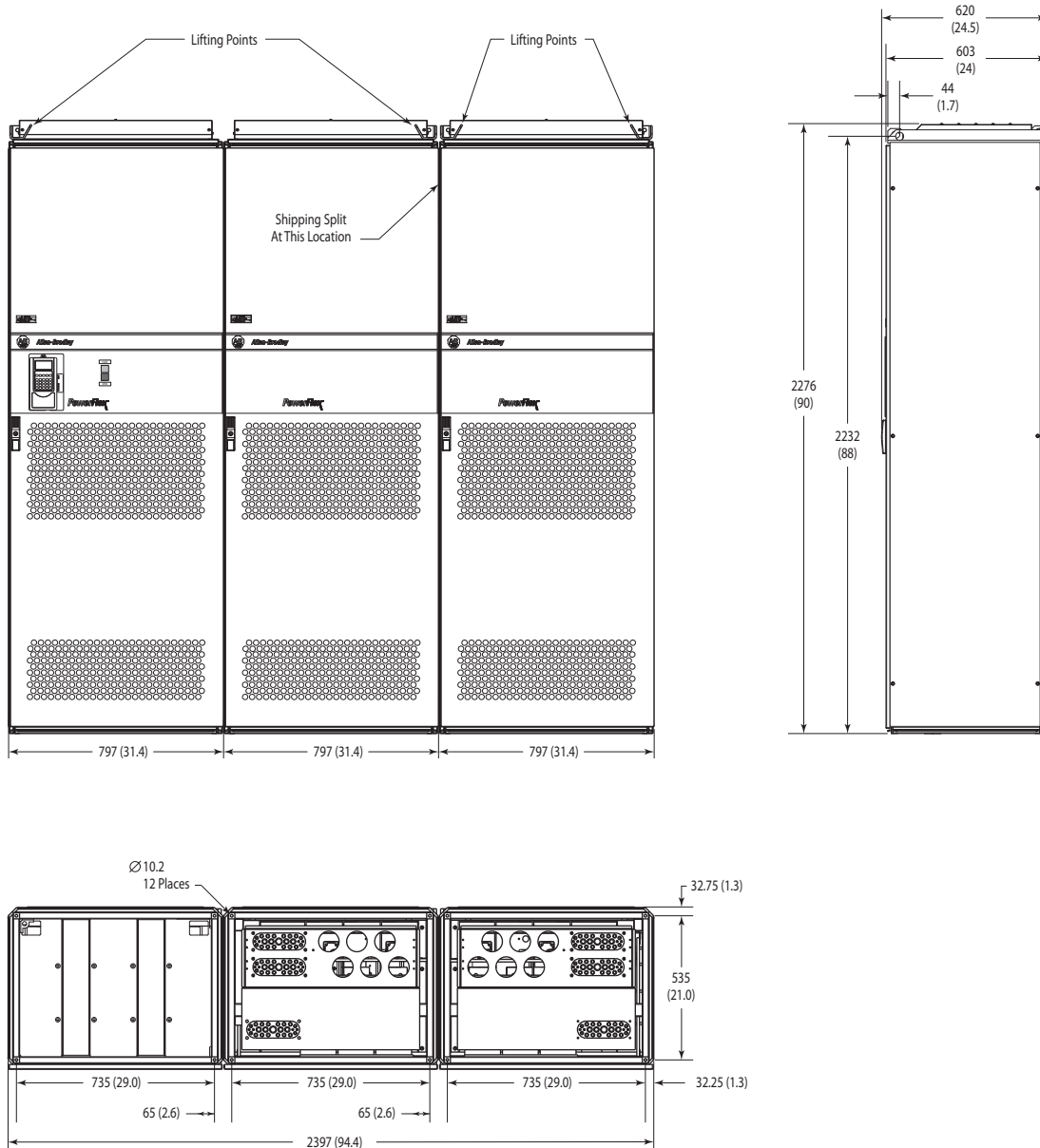

Frame 14 1500 A Drives - Enclosure Code H (NEMA/UL Type 12, IP54) and W (NEMA/UL Type 12, IP54 w/ Conformal Coat)

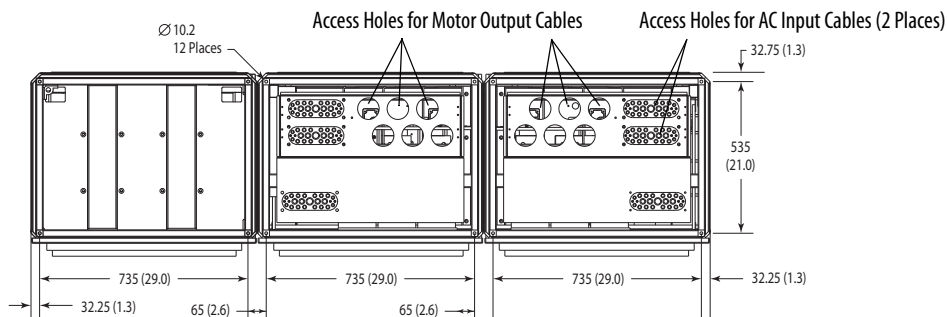
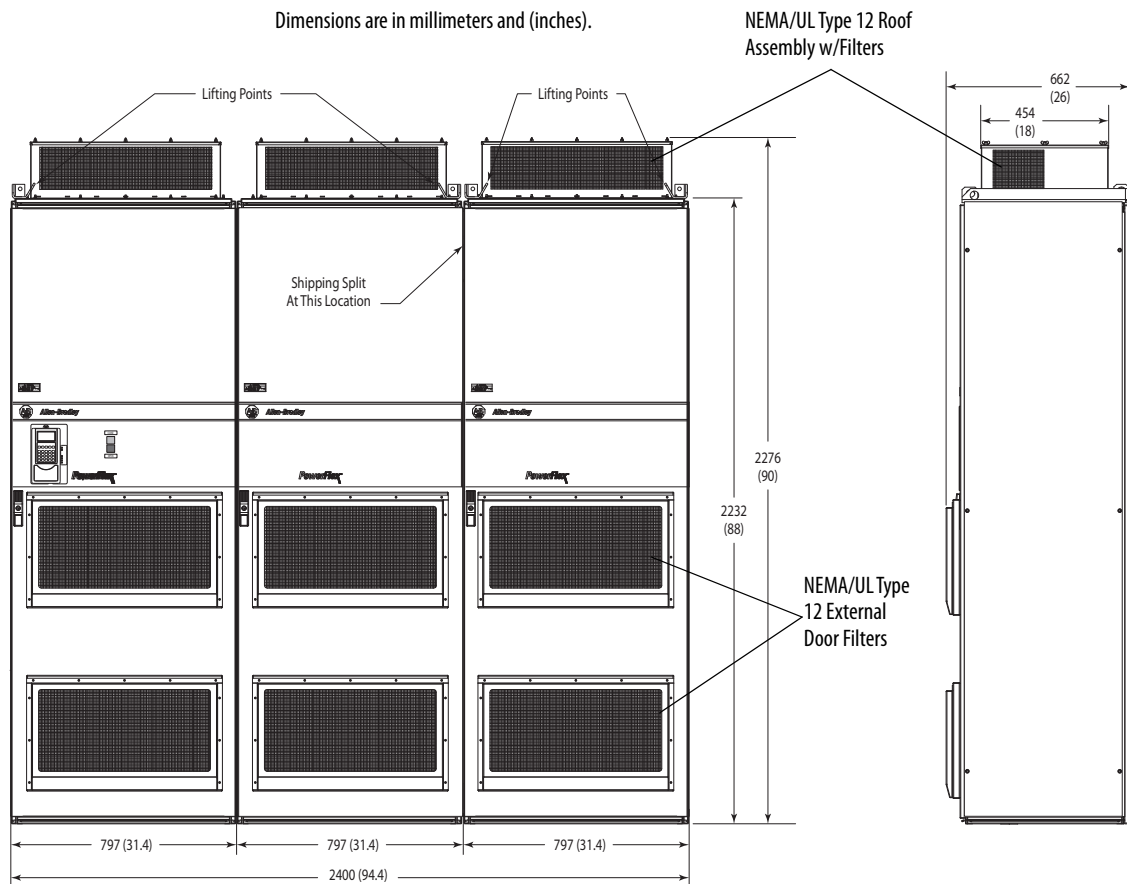

Frame 14 Drives Above 1500A - Enclosure Code A (NEMA/UL Type 1, IP21) and M (NEMA/UL Type 1, IP21 w/ Conformal Coat)

Dimensions are in millimeters and (inches).

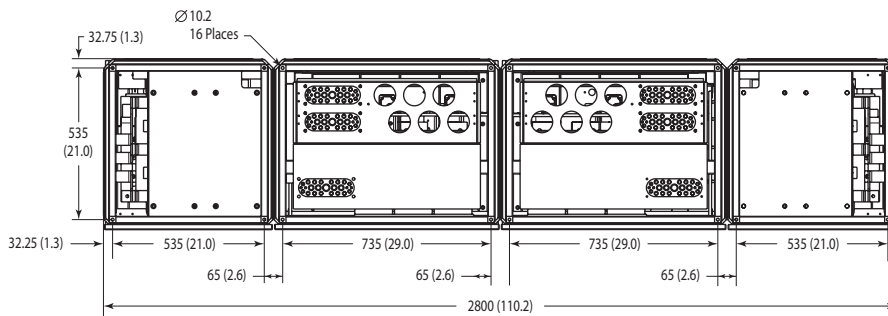
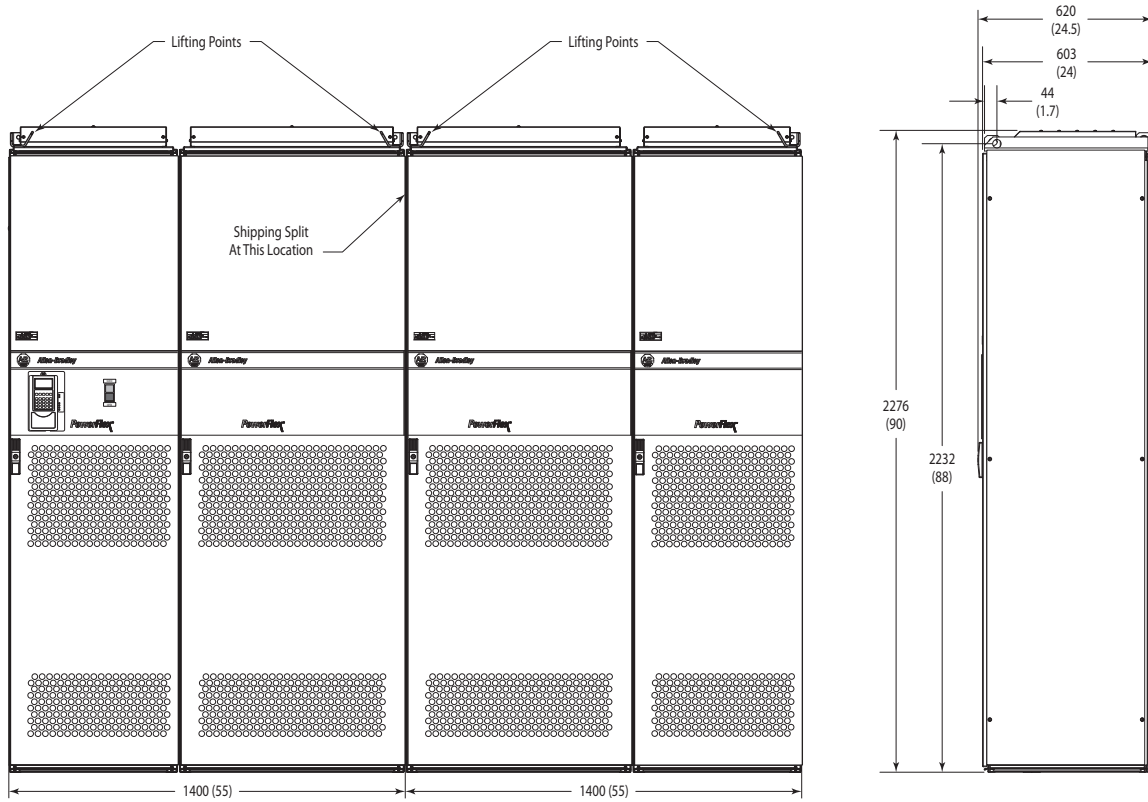

Frame 14 Drives Above 1500 A - Enclosure Code H (NEMA/UL Type 12, IP54) and W (NEMA/UL Type 12, IP54 w/Conformal Coat)

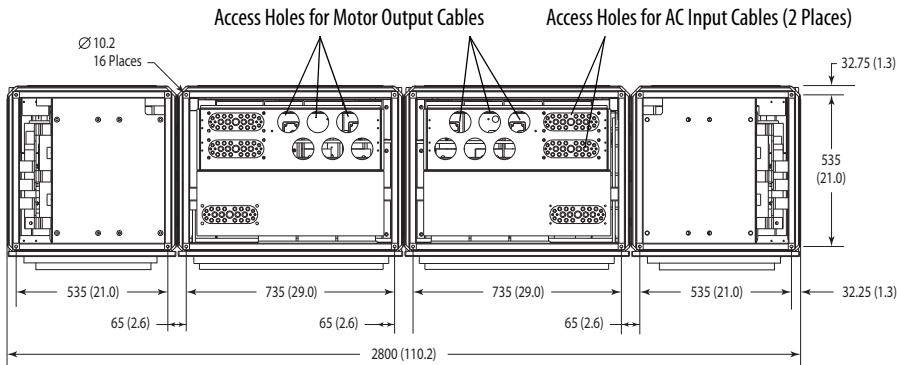
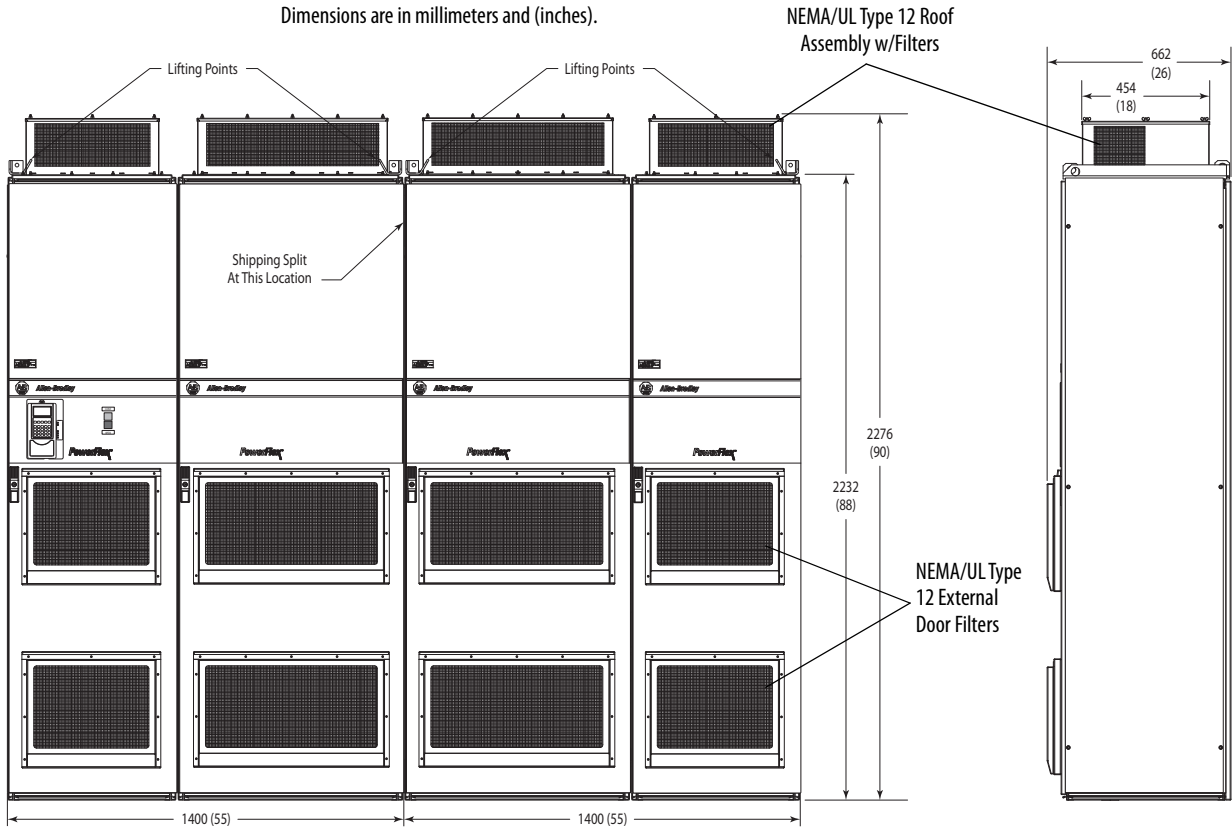

AC Input Frame 14 Drive and Standard Rittal Enclosure Weights

Voltage Class	Drive Rating Amps	Section 1 Drive & Enclosure Weight kg (lbs)	Section 1 Drive, Enclosure & Packaging Weight kg (lbs)	Section 2 Drive & Enclosure Weight kg (lbs)	Section 2 Drive, Enclosure & Packaging Weight kg (lbs)	Total Drive & Enclosure Weight (All Sections) kg (lbs)
400/480V AC (540/650V DC)	1770	1120 (2469)	1240 (2733)	1120 (2469)	1240 (2733)	2240 (4938)
	2150	1150 (2535)	1270 (2799)	1150 (2535)	1270 (2799)	2300 (5071)
	2700	1920 (4233)	2040 (4497)	1920 (4233)	2040 (4497)	3840 (8466)
600/690V AC (810/932V DC)	1500	1270 (2800)	1390 (3064)	650 (1433)	770 (1697)	1920 (4233)
	1900	1120 (2469)	1240 (2733)	1120 (2469)	1240 (2733)	2240 (4938)
	2250	1150 (2535)	1270 (2799)	1150 (2535)	1270 (2799)	2300 (5071)

Frame 14 - DC Input Enclosure Code A (NEMA/UL Type 1, IP21) and M (NEMA/UL Type 1, IP21 w/Conformal Coat)

Dimensions are in millimeters and (inches).

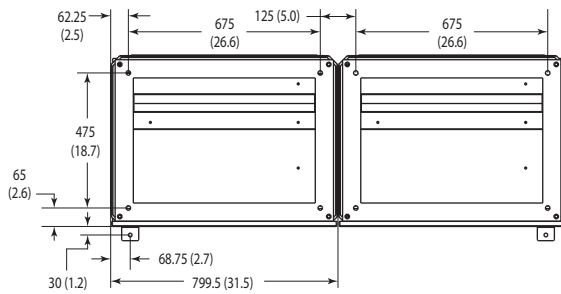
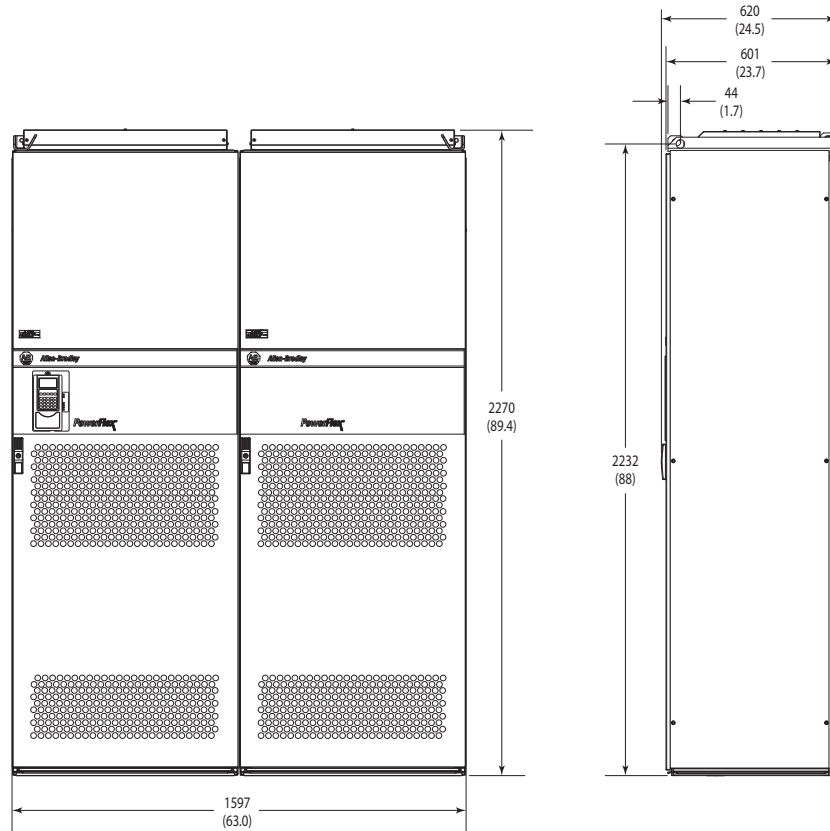

Frame 14 - DC Input Drive Enclosure Code H (NEMA/UL Type 12, IP54) and W (NEMA/UL Type 12, IP54 w/ Conformal Coat)

Dimensions are in millimeters and (inches).

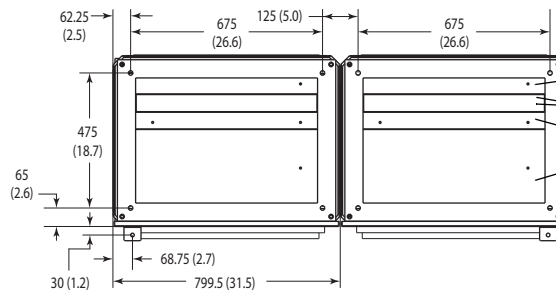
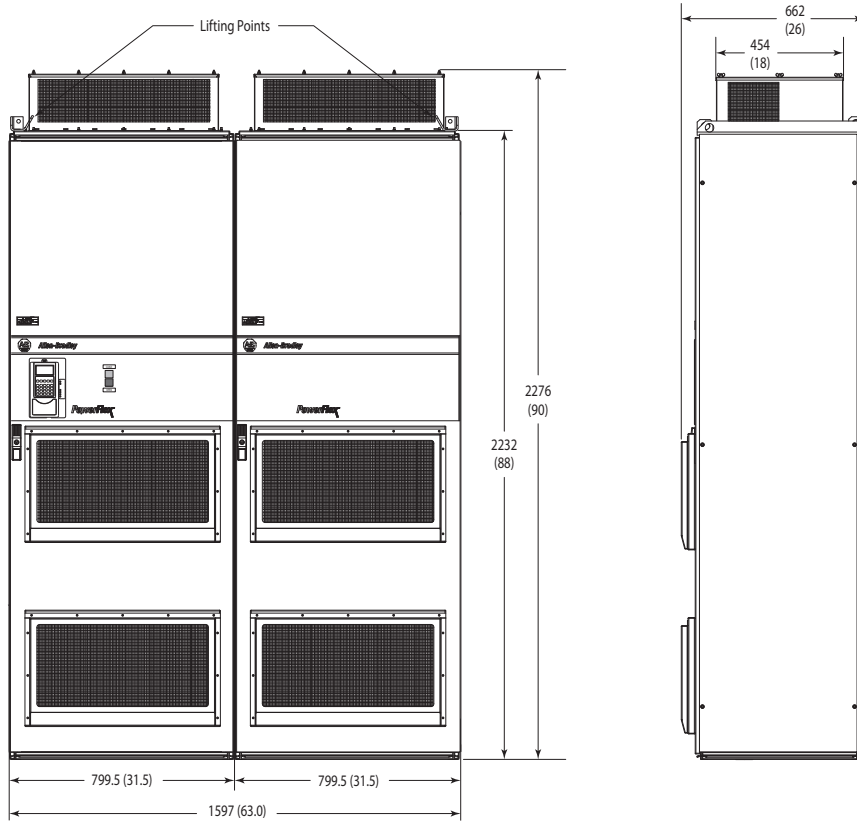

- Stationary metal front bottom plate
- Two pieces of soft foam taped to adjacent metal plates
- Overlapping metal bottom plate (slightly adjustable)
- Stationary metal back bottom plate

Wire entry for this enclosure is between two pieces of soft foam. If the adjustable plate is slid back, a gap develops between the foam pieces. Otherwise, the foam acts as a loose gasket around the wires.

DC Input Frame 14 Drive and Standard Rittal Enclosure Weights

Voltage Class	Drive Rating Amps	Drive & Enclosure Weight kg (lb)	Drive, Enclosure & Packaging Weight kg (lb)
400/480V AC (540/650V DC)	1770	1330 (2866)	1450 (3130)
	2150	1330 (2866)	1450 (3130)
	2700	1330 (2866)	1450 (3130)
600/690V AC (810/932V DC)	1500	1220 (2690)	1340 (2954)
	1900	1330 (2866)	1450 (3130)
	2250	1330 (2866)	1450 (3130)

Standard Drive Specifications

Category	Description	
Agency Certification	c-UL-us	Listed to UL508C and CAN/CSA-C2.2 No. 14-M91.
	CE	Marked for all applicable European Directives ⁽¹⁾ EMC Directive (2014/30/EU) EN 61800-3 Adjustable Speed electrical power drive systems Low Voltage Directive (2014/35/EU) EN 61800-5-1 Adjustable speed electrical power drive systems – Part 5-1: Safety requirements – Electrical, thermal and energy RoHS 2011/65/EU EN 63000 Technical documentation for the assessment of electrical and electronic products with respect to the restriction of hazardous substances
	RCM	Australian Communications and Media Authority In conformity with the following: Radiocommunications Act:1992 (including Amendments up to 2018) Radiocommunications (Electromagnetic Compatibility) Standard 2017 Radiocommunications Labeling (Electromagnetic Compatibility) Notice 2017 Standards applied: EN 61800-3
	UKCA	Compliance to EN 61800-3, EN 61800-5-1, EN 63000
	Morocco	Compliance to NM EN 61800-5-1, NM EN 61800-3
	Efficiency Class	Ecodesign regulation (EU) 2019/1781, IE2 efficiency class, refer to PowerFlex AC Drive Performance Specifications per Ecodesign Regulation (EU) 2019/1781, publication PFLEX-TD003 for additional information. Only new products manufactured after July 1, 2021 are certified under Ecodesign.
	ATEX	Certified for directive 2014/34/ EU. See Appendix E in the PowerFlex 700H Drives Programming Manual, publication 20C-PM001 , for more information
The drive is also designed to meet the following specifications:	NFPA 70 - US National Electrical Code NEMA ICS 7.1 - Safety standards for Construction and Guide for Selection, Installation and Operation of Adjustable Speed Drive Systems. IEC 146 - International Electrical Code.	

(1) Applied noise impulses may be counted in addition to the standard pulse train causing erroneously high [Pulse Freq] readings.

Category	Specification	Description				
Protection	Drive	380/400V	480V	500V	600V	690V
	AC Input Overvoltage Trip:	611VAC	611VAC	611VAC	806VAC	806VAC
	AC Input Undervoltage Trip:	235VAC	235VAC	235VAC	326VAC	326VAC
	Bus Overvoltage Trip:	911VDC	911VDC	911VDC	1200VDC	1200VDC
	Bus Undervoltage Shutoff/Fault:	333VDC	333VDC	333VDC	461VDC	461VDC
	Nominal Bus Voltage (Full Load):	517VDC	621VDC	645VDC	776VDC	890VDC
	Heat Sink Thermistor:	Monitored by microprocessor overtemp trip				
	Drive Overcurrent Trip	—				
	Software Overcurrent Trip:	—				
	Hardware Overcurrent Trip:	360% of rated Heavy Duty current (typical)				
	Instantaneous Current Limit:	—				
	Line transients:	up to 6000 volts peak per IEEE C62.41-1991				
	Control Logic Noise Immunity:	Showering arc transients up to 1500V peak				
	Power Ride-Thru:	15 milliseconds at full load				
Logic Control Ride-Thru:	0.5 seconds minimum, 2 seconds typical					
Ground Fault Trip:	Phase-to-ground on drive output					
Short Circuit Trip:	Phase-to-phase on drive output					

Category	Specification	Description			
Environment	Altitude:	Up to 1000 m (3300 ft) above sea level without derating. Derate the drive by 1% for every 100 m (328 ft) above 1000 m (3300 ft), up to the following maximum installation altitudes: <ul style="list-style-type: none"> • 380V...400V AC input - 3000 m (9842.5 ft) • 415V...500V AC input - 2000 m (6561.7 ft) • 600V...690V AC input - 2000 m (6561.7 ft) 			
	Maximum Surrounding Air Temperature without De-rating:	Based on drive rating, see Drive Ratings on page 37 .			
	Storage Temperature (all const.):	-40...60 °C (-40...140 °F)			
	Atmosphere:	Important: Drive must not be installed in an area where the ambient atmosphere contains volatile or corrosive gas, vapors or dust. If the drive is not going to be installed for a period of time, it must be stored in an area where it will not be exposed to a corrosive atmosphere.			
	Relative Humidity:	5 to 95% non-condensing			
	Shock:				
	Non-operational	15G peak for 11 ms duration (±1.0 ms)			
	Vibration:	2 mm (0.0787 in.) displacement, 1G peak EN50178 / EN60068-2-6			
	Sound:	Frame	Sound Level	Back-ground Noise Level	Note: Sound pressure level is measured at 1 meter. All devices measured are 400V IP21 and in power up mode.
		9	78 dba	49 dba	
10		77 dba	49 dba		
13		76d ba	46 dba		
Electrical	AC Input Voltage Tolerance:	±10%			
	Frequency Tolerance:	47...63 Hz			
	Input Phases:	Three-phase input provides full rating for all drives. Single-phase operation provides 50% of rated current.			
	Displacement Power Factor:	0.98 across entire speed range.			
	Efficiency:	97.5% at rated amps, nominal line volts.			
	Maximum Short Circuit Rating:	≤ 200,000 Amps symmetrical.			
	Actual Short Circuit Rating:	Determined by AIC rating of installed fuse/circuit breaker.			
	Maximum Drive to Motor Power Ratio:	Recommended not greater than 2:1 ratio.			
Control	Method:	Sine coded PWM with programmable carrier frequency. Ratings apply to all drives (refer to the <i>Derating Guidelines</i> in the PowerFlex Reference Manual). The drive can be supplied as 6 pulse or 12 pulse in a configured package.			
	Carrier Frequency:	1...6 kHz			
	Output Voltage Range:	0 to rated motor voltage			
	Output Frequency Range:	0 to 320 Hz			
	Frequency Accuracy				
	Digital Input:	Within ±0.01% of set output frequency.			
	Analog Input:	Within ±0.4% of maximum output frequency.			
	Frequency Control:	Speed regulation - with Slip Compensation 0.5% of base speed across 40:1 speed range 40:1 operating range			
	Selectable Motor Control:	Sensorless Vector with full tuning. Standard V/Hz with full custom capability.			
	Stop Modes:	Multiple programmable stop modes including - Ramp, Coast, DC-Brake, Ramp-to-Hold and S-curve.			
	Accel/Decel:	Two independently programmable accel and decel times. Each time may be programmed from 0 to 3276.7 seconds in 0.1 second increments.			
	S-Curve Time:	0...100% of accel/decel time.			
	Intermittent Overload:	110% Overload capability for up to 1 minute 150% Overload capability for up to 2 seconds			
	Current Limit Capability:	Proactive Current Limit programmable from 20 to 160% of rated output current. Programmable proportional gain.			
	Electronic Motor Overload Protection:	Class 10 motor overload protection according to NEC article 430 and motor over-temperature protection according to NEC article 430.126 (A)(2). UL 508C File E59272.			

Derating Guidelines

Carrier Derating Curves

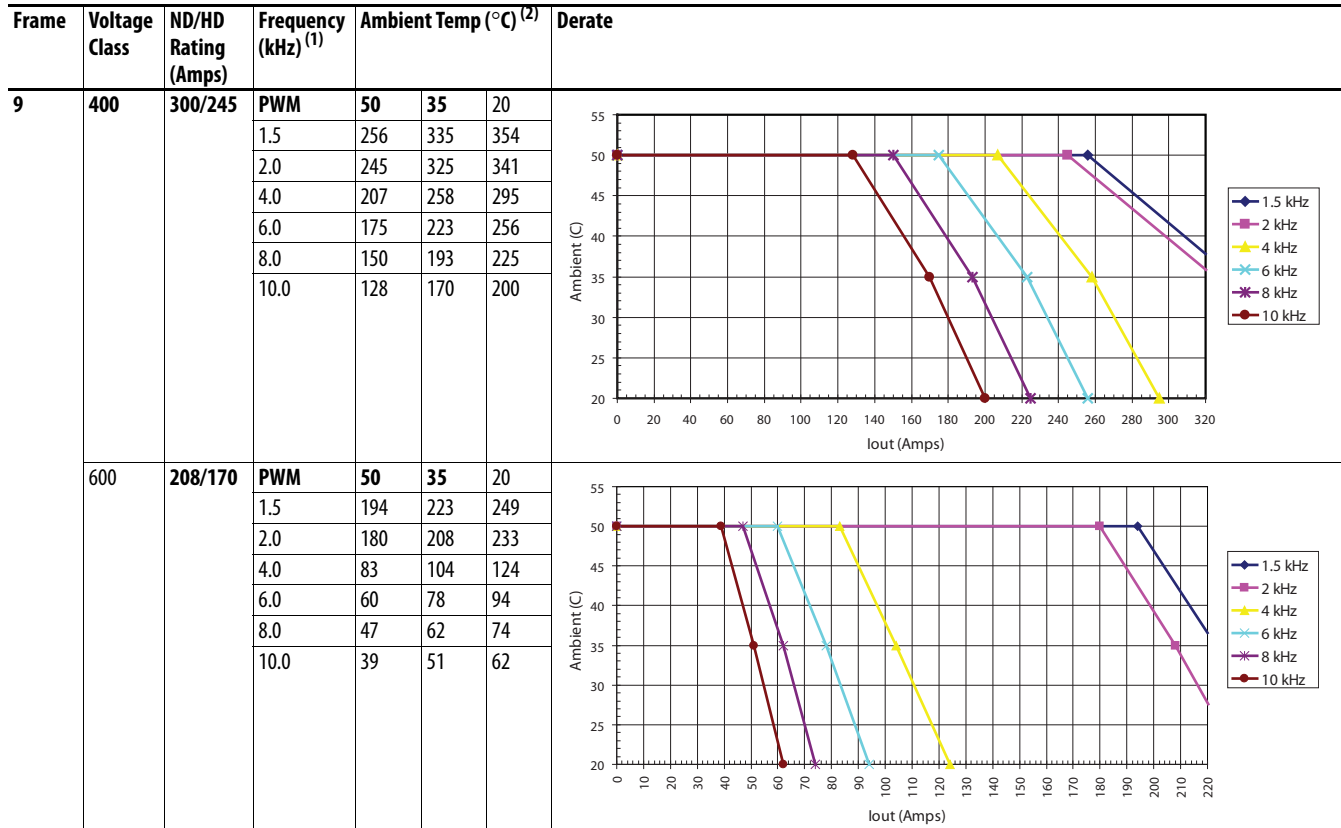

(1) Not all frequencies can be run on all drives.
 (2) Rated ambient temperature is 40/50 °C (ND/HD) for 400V and 600V class drives.

Frame	Voltage Class	ND/HD Rating (Amps)	Frequency (kHz) ⁽¹⁾	Ambient Temp (°C) ⁽²⁾			Derate
				50	35	20	
10	400	500/420	PWM	50	35	20	
			1.5	486	573	546	
			2.0	441	545	618	
			4.0	323	414	482	
			6.0	259	341	400	
			8.0	214	284	284	
			10.0	184	248	298	
600	416/325	416/325	PWM	50	35	20	
			1.5	340	424	492	
			2.0	332	416	486	
			4.0	200	264	314	
			6.0	145	195	241	
			8.0	109	155	191	
			10.0	91	127	155	

(1) Not all frequencies can be run on all drives.
 (2) Rated ambient temperature is 40/40 °C (ND/HD) for 400V class drives and 35/40 °C (ND/HD) for 600V class drives.

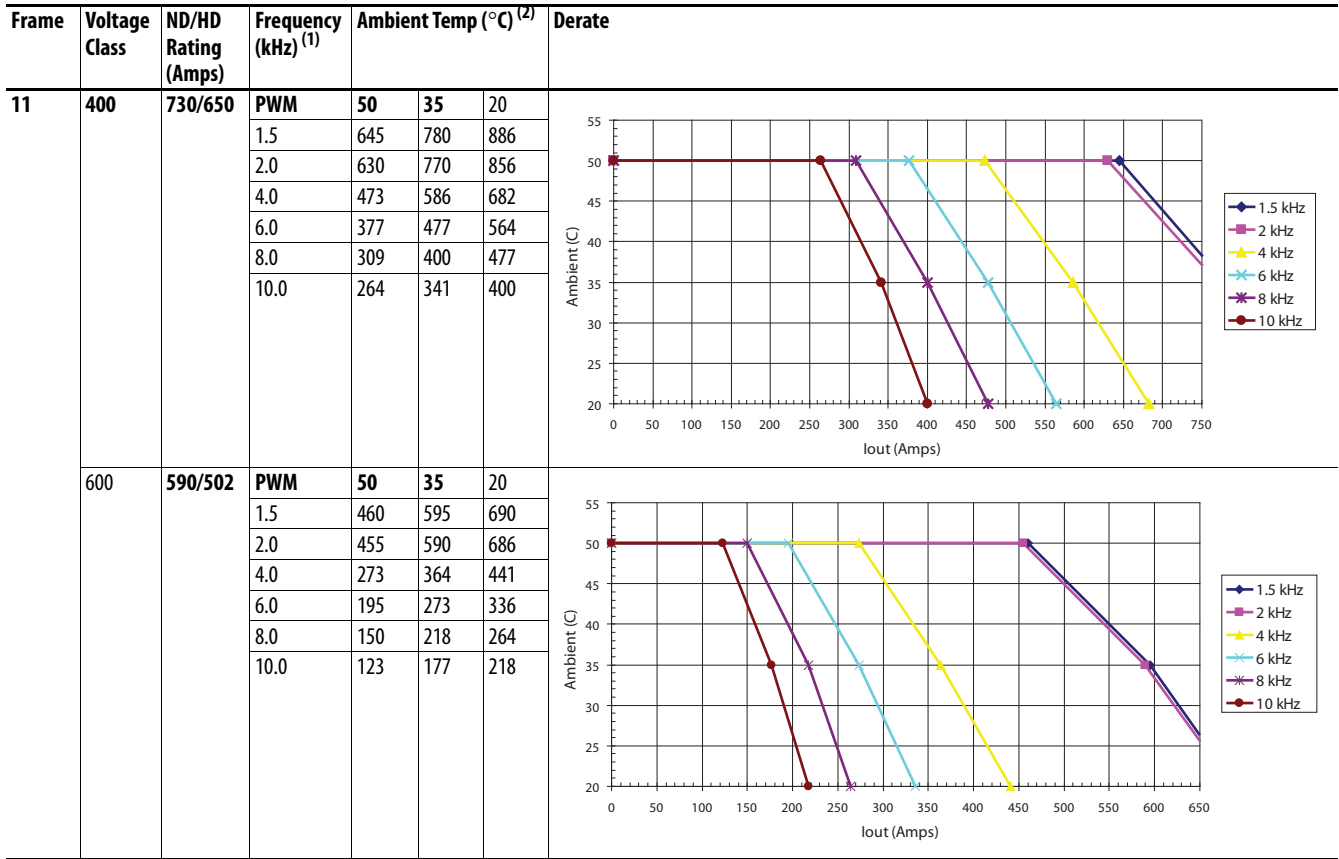

(1) Not all frequencies can be run on all drives.
 (2) Rated ambient temperature is 40/40 °C (ND/HD) for 400V and 600V class drives.

Frame	Voltage Class	ND/HD Rating (Amps)	Frequency (kHz) ⁽¹⁾	Ambient Temp (°C) ⁽²⁾			Derate
				50	35	20	
12	400	1030/920	PWM	50	35	20	
			1.5	910	1134	1278	
			2.0	873	1100	1224	
			4.0	639	819	954	
			6.0	513	675	792	
			10.0	364	492	591	
600	600	820/650	PWM	50	35	20	
			1.5	660	825	959	
			2.0	650	820	950	
			4.0	394	520	618	
			6.0	287	385	475	
			10.0	179	251	305	

(1) Not all frequencies can be run on all drives.
 (2) Rated ambient temperature is 40/35 °C (ND/HD) for 400V class drives and 35/40 °C (ND/HD) for 600V class drives.

Frame	Voltage Class	ND/HD Rating (Amps)	Frequency (kHz) ⁽¹⁾	Ambient Temp (°C) ⁽²⁾			Derate
				50	35	20	
13	400	1450/1200	PWM	50	35	20	
			1.5	1291	1591	1809	
			2.0	1236	1518	1727	
			4.0	882	1145	1327	
			6.0	709	936	1100	
			10.0	491	664	791	
	600	1180/1030	PWM	50	35	20	
			1.5	945	1241	1457	
			2.0	864	1180	1374	
			4.0	564	786	945	
			6.0	427	600	736	
			10.0	273	395	500	

(1) Not all frequencies can be run on all drives.
 (2) Rated ambient temperature is 40/40 °C (ND/HD) for 400V and 600V class drives.

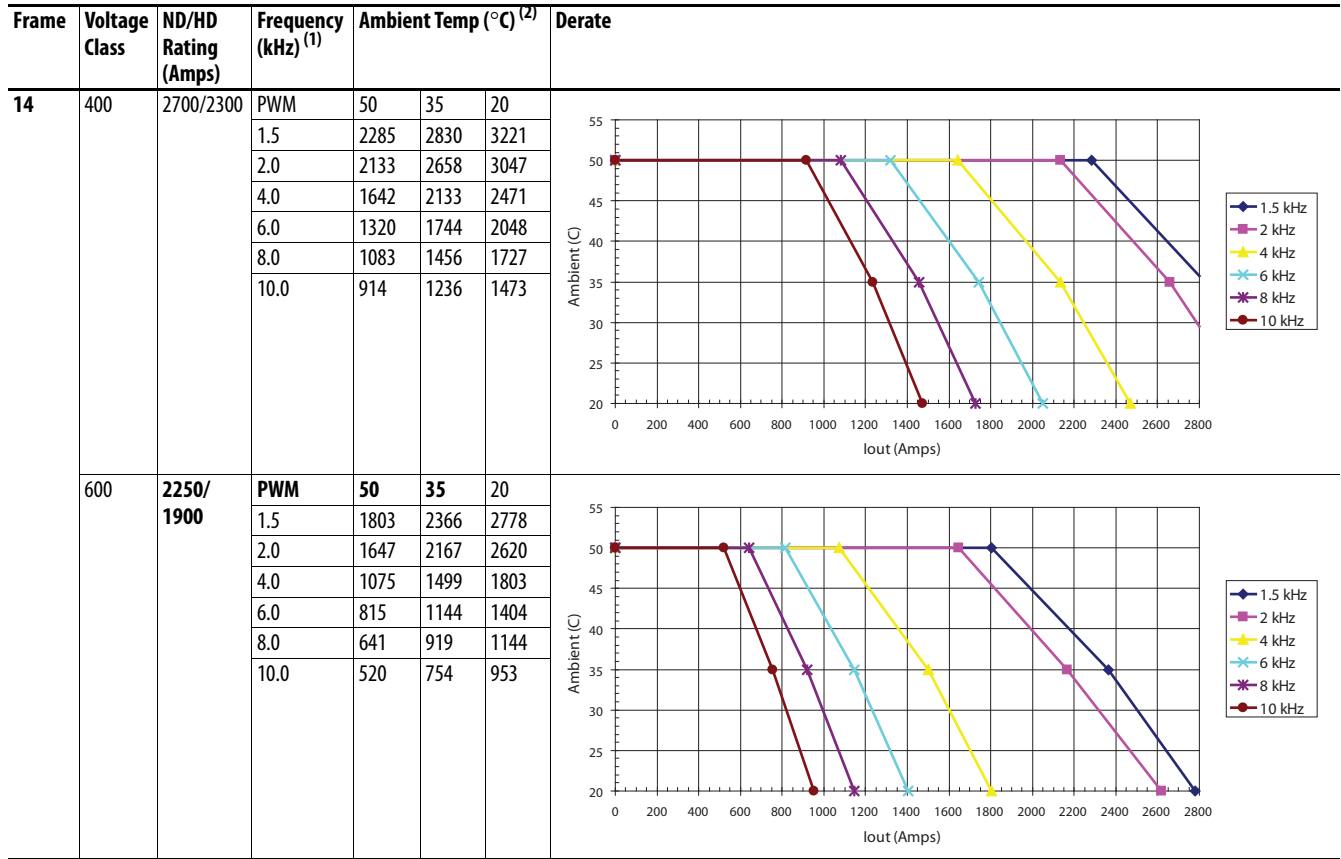

- (1) Not all frequencies can be run on all drives.
- (2) Rated ambient temperature is 40/40 °C (ND/HD) for 400V class drives and 35/35 °C (ND/HD) for 600V class drives.

Watts Loss - Frames 10...14

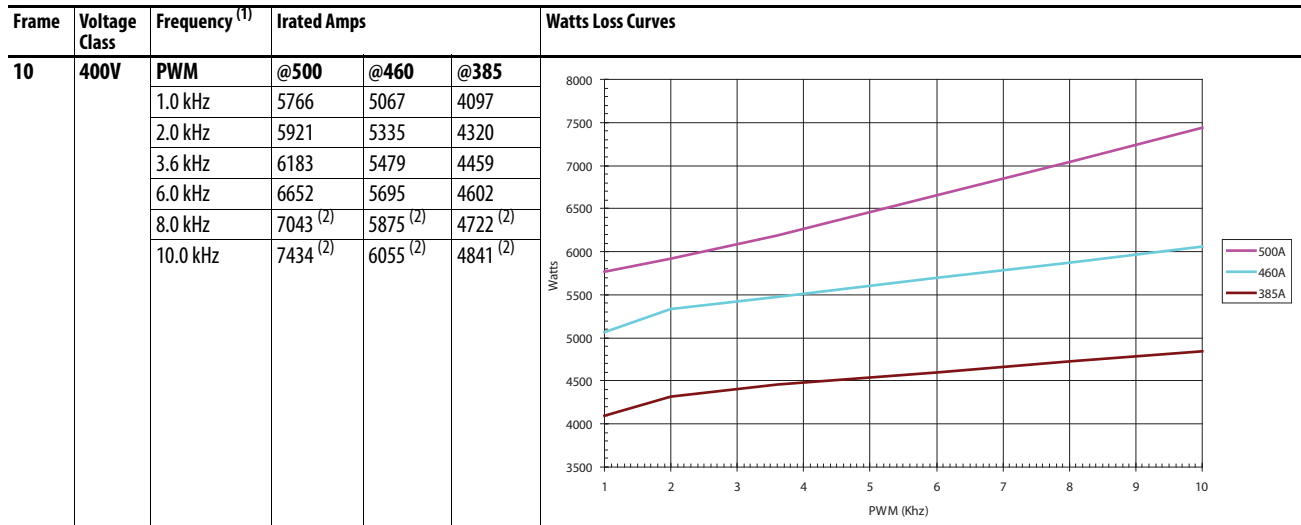

- (1) Consult the factory for further derate information at other frequencies.
- (2) Value calculated from slope.

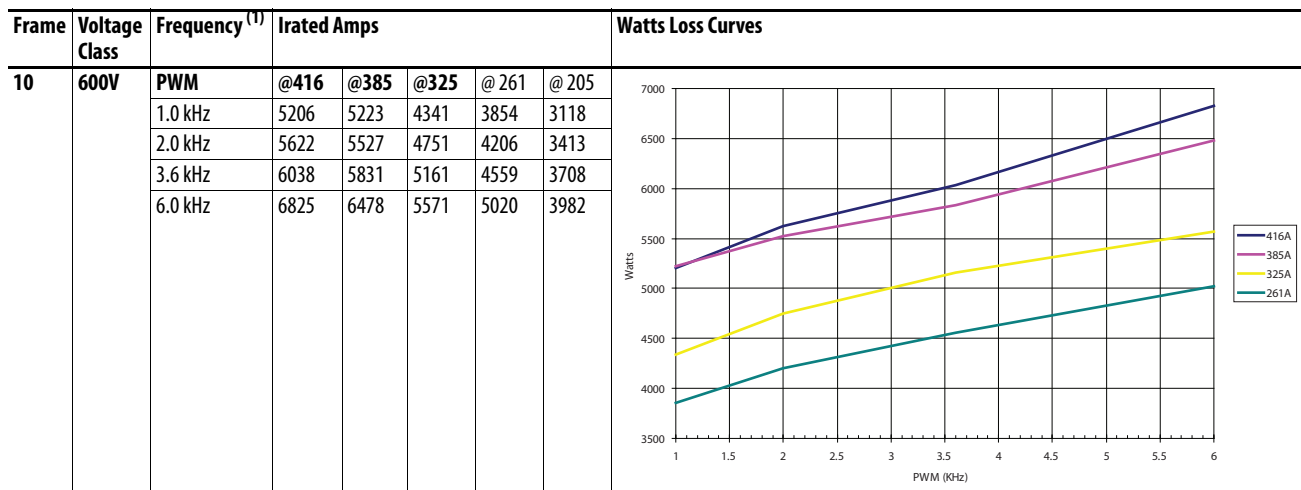

- (1) Consult the factory for further derate information at other frequencies.

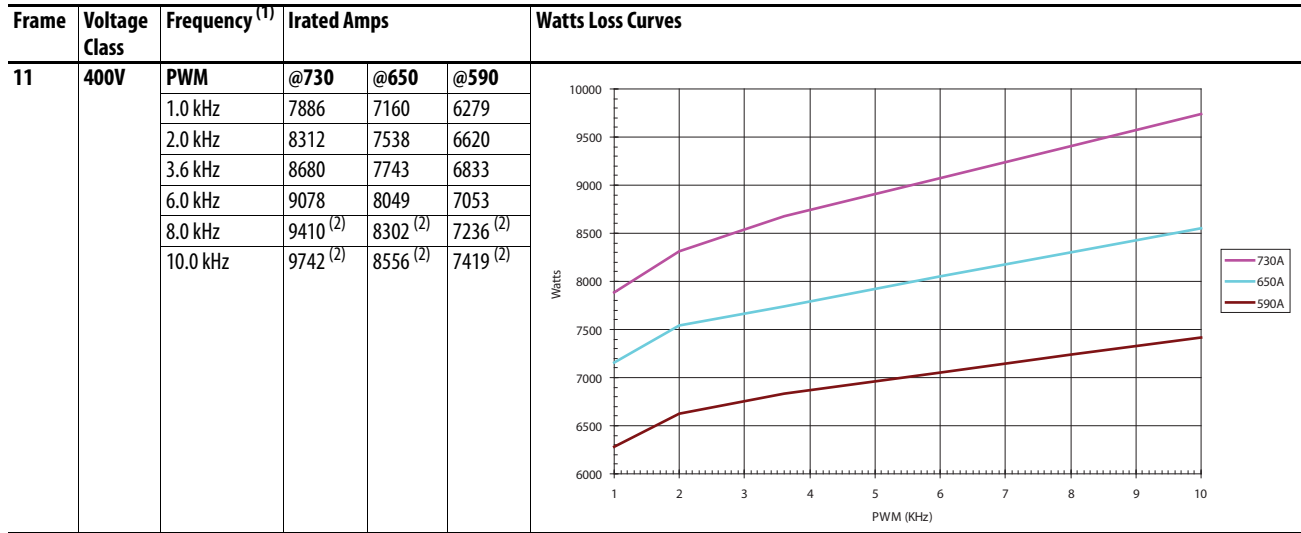

(1) Consult the factory for further derate information at other frequencies.
 (2) Value calculated from slope.

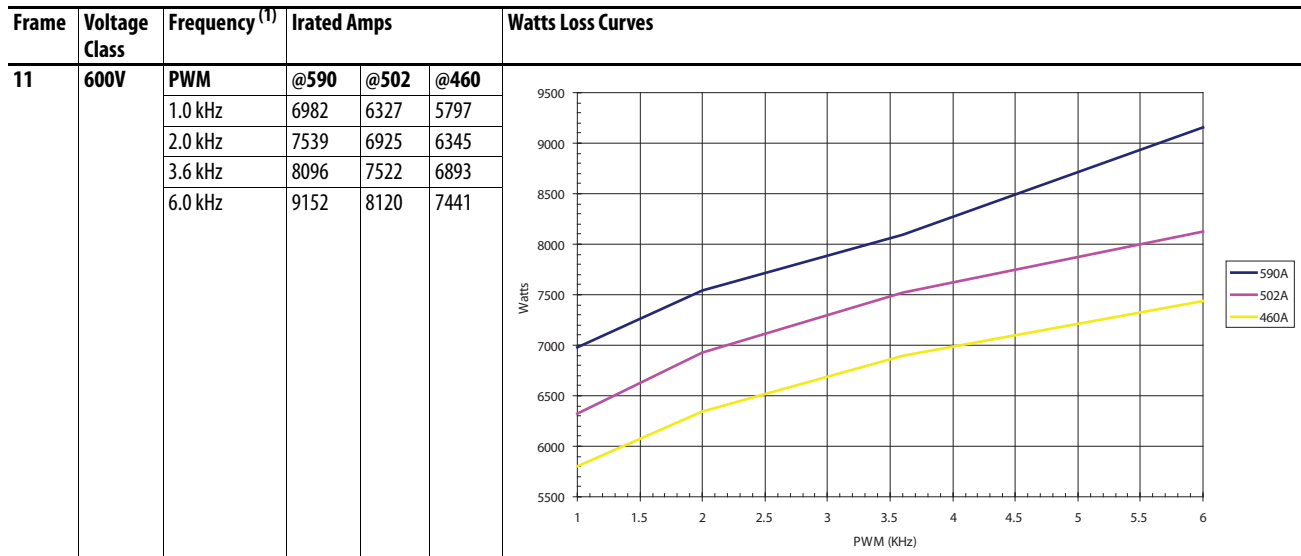

(1) Consult the factory for further derate information at other frequencies.

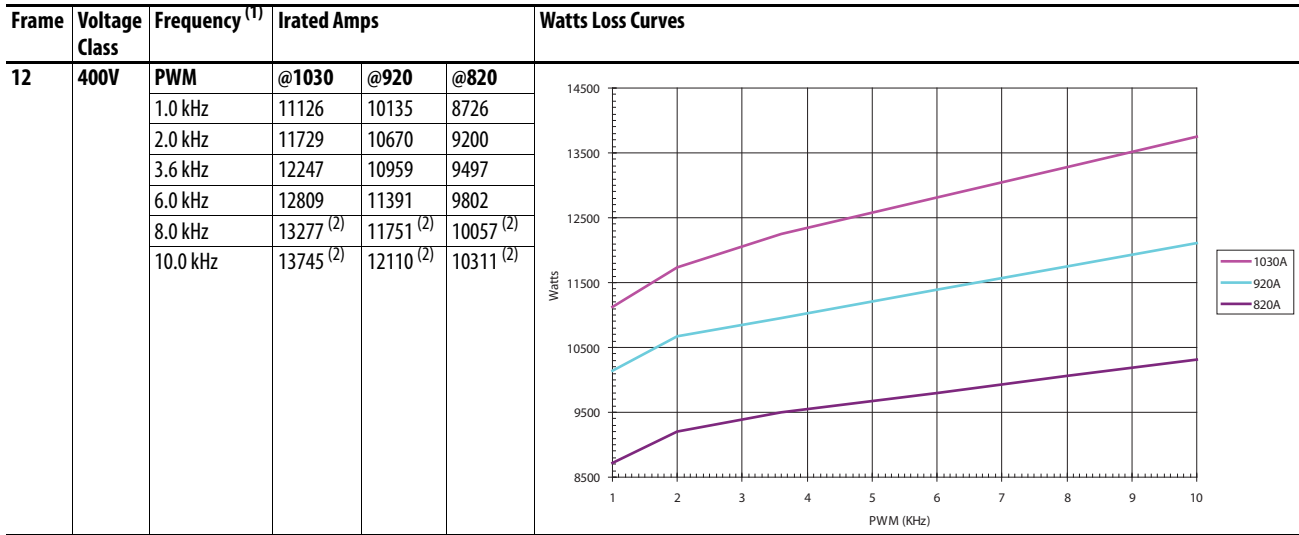

(1) Consult the factory for further derate information at other frequencies.
 (2) Value calculated from slope.

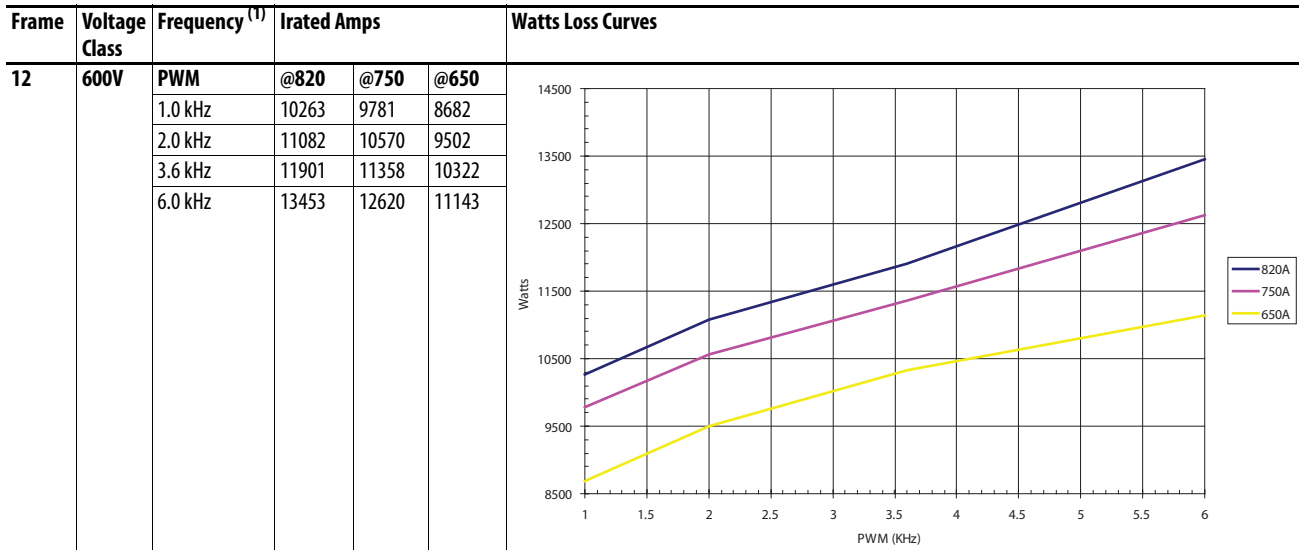

(1) Consult the factory for further derate information at other frequencies.

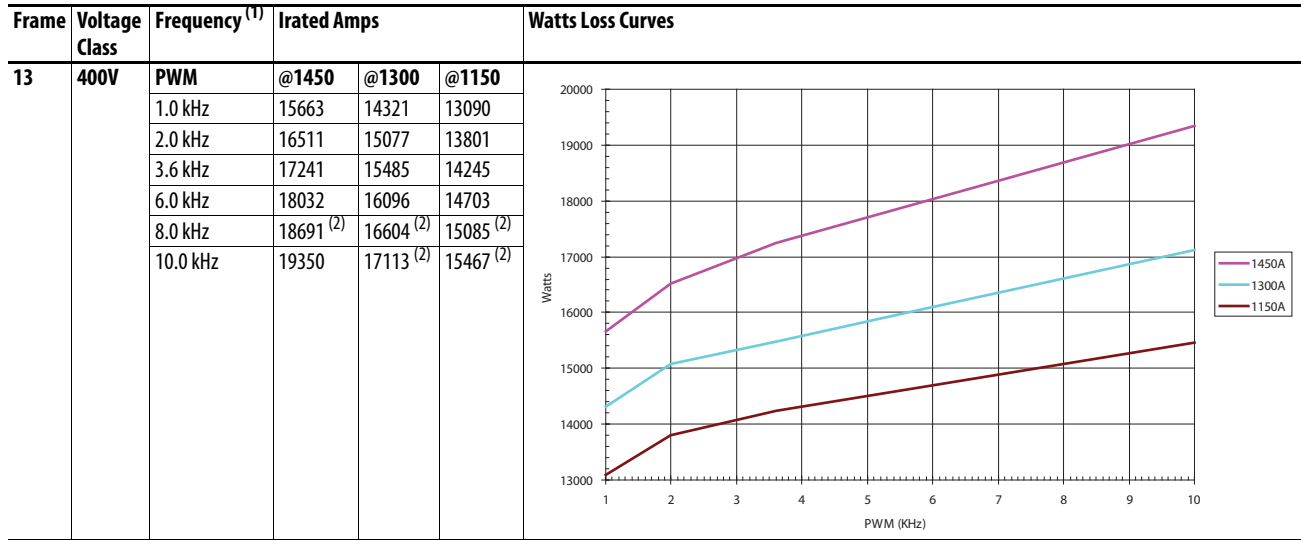

- (1) Consult the factory for further derate information at other frequencies.
- (2) Value calculated from slope.

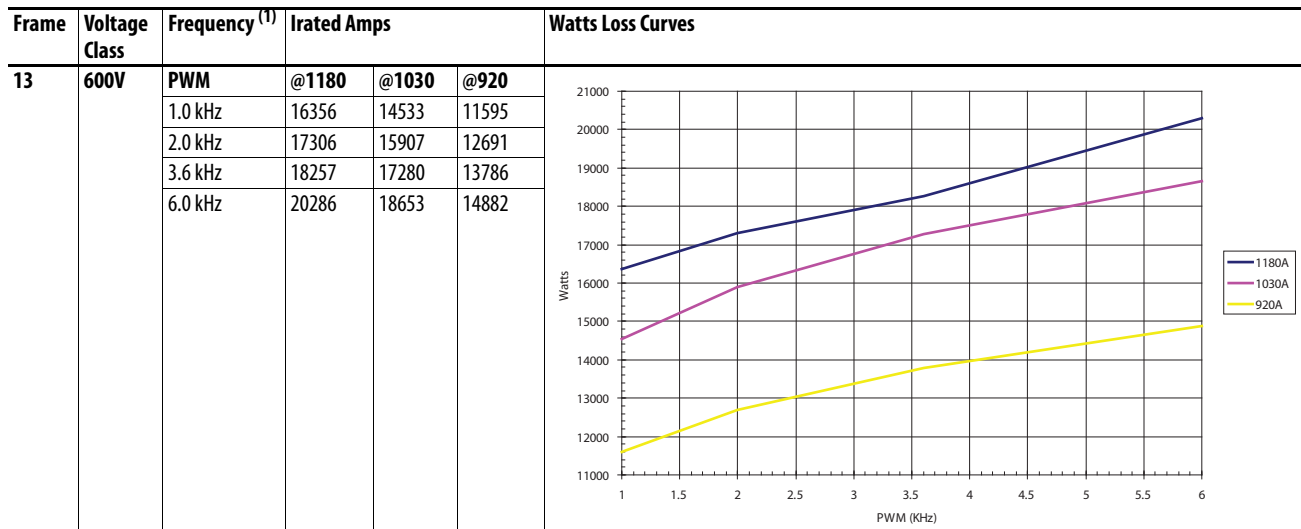

- (1) Consult the factory for further derate information at other frequencies.

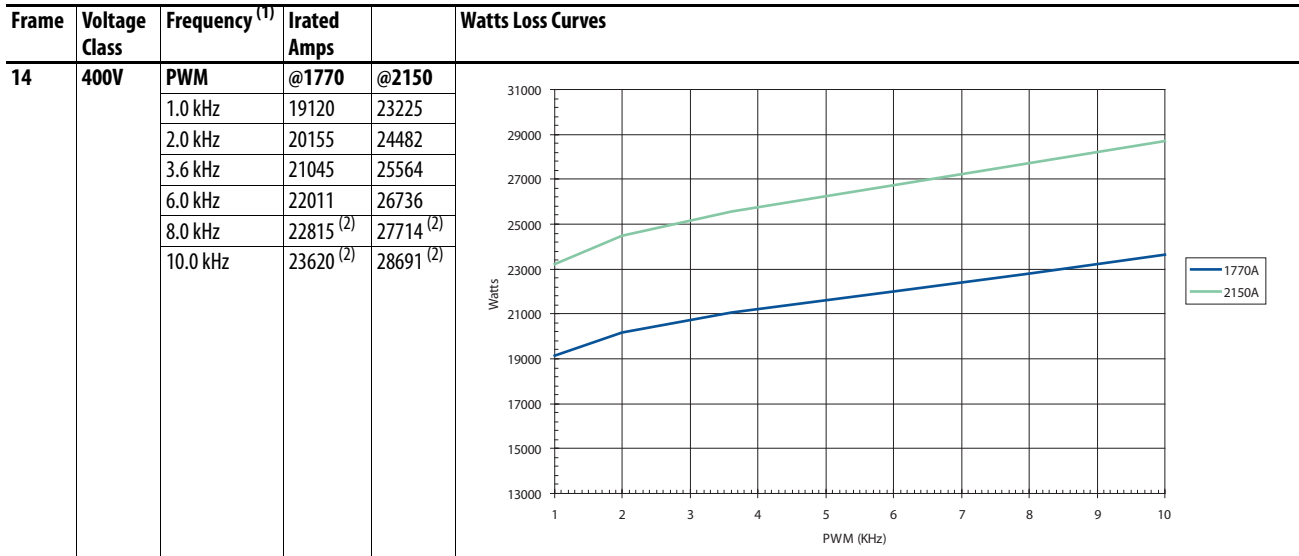

- (1) Consult the factory for further derate information at other frequencies.
- (2) Value calculated from slope.

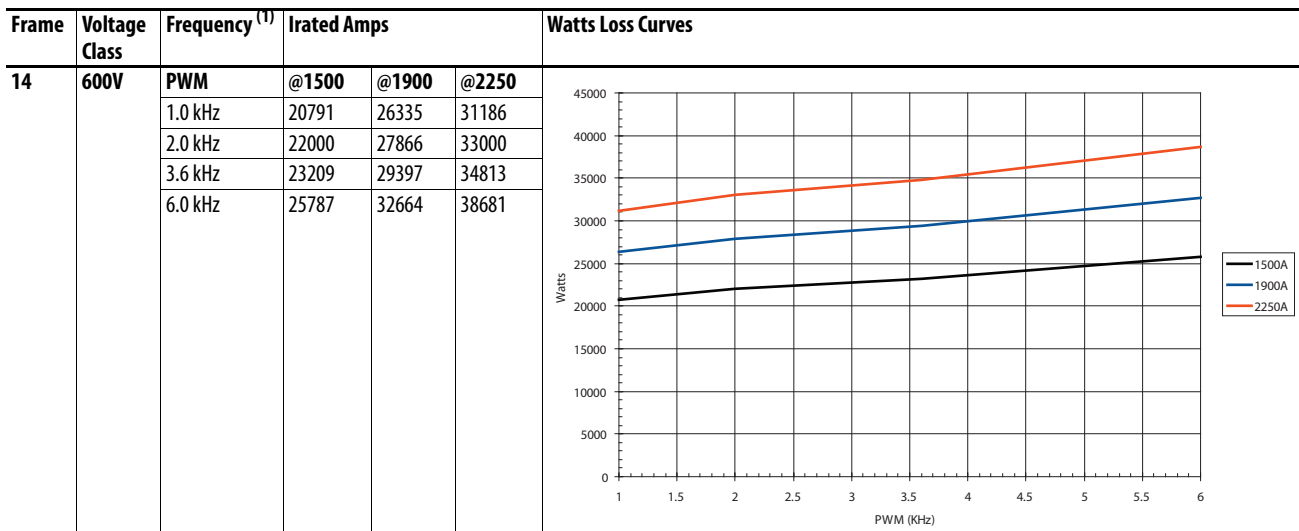

- (1) Consult the factory for further derate information at other frequencies.

Configured Drives Program

Program Description

The PowerFlex 700H Configured Drives Program allows users to create drive packages based on their specific needs. This program enhances standalone drive functionality through additional control, power and packaging options which are ideal for OEM and end users with special installation needs.

The Configured Drives Program offers users the ability to create drive packages that go beyond the standard drives offering. Catalog numbers and pricing are provided to allow quotation without requesting a custom quote from the factory.

- Assembling a catalog string and total list price for quotation purposes.
A complete Configured Drive catalog number and total list price is created by taking the applicable base drive and options entirely from the Configured Drives Program.
- Entering an order on Passport.
Enter a custom quote request on Passport using “SP-SDB-CUSTOM” as the line item part number and entering the complete catalog string and total list price in the Competitive Summary. For questions or help with a custom quote or order entry, please contact the Configured Drives Group at 262-512-8415.

Target Lead Times

Lead Times provided on the following pages are based on the codes shown below. Note that lead times may vary from those shown due to manufacturing capacity and parts availability. See Passport for current lead times.

Code	Description	Lead Time
		(Work Days)
P	Pre-Engineered (applies to Catalog Configured)	60
Q	Quick Turn	60
X	Long Lead Time	60 ⁽¹⁾
C	Custom	Consult Factory

(1) Dependent on options selected.

Catalog Number Explanation

Position																	
1-3	4	5-7	8	9	10	11	12	13	14	15	16	17-18	19-20	21	22-23	24	25 ...
21C	D	261	A	0	A	N	N	B	N	A	0	NN	NN	-	ND	-	J4...
<i>a</i>	<i>b</i>	<i>c</i>	<i>d</i>	<i>e</i>	<i>f</i>	<i>g</i>	<i>h</i>	<i>i</i>	<i>j</i>	<i>k</i>	<i>l</i>	<i>m</i>	<i>n</i>	<i>o</i>	<i>p</i>	<i>q</i>	<i>r</i>

<i>a</i>	
Drive	
Code	Type
21C	Configured PowerFlex 700H

<i>b</i>			
Voltage Rating			
Code	Voltage	Ph.	Pulse
D	480V AC	3	6
U >	480V AC	3	18

> Enter a custom quote request.

<i>d</i>	
Enclosure	
Code	Enclosure
A	IP 20, NEMA/UL Type 1
B	IP 20, NEMA/UL Type 1, MCC Style

<i>e</i>	
HIM	
Code	Operator Interface
0	Drive Mounted Blank Cover
M	Door Mounted Programmer Only (NEMA/UL Type 1)
P	Door Mounted w/LCD Full Numeric (NEMA/UL Type 1)

<i>c</i>		
Rating		
480V, 60Hz Input		
Code	Output Amps - ND (HD)	Hp - ND (HD)
261 *	240 (180)	200 (150)
300 *	300 (240)	250 (200)
385 *	361 (300)	300 (250)
460 *	414 (361)	350 (300)
500 *	500 (414)	450 (350)
590 *	590 (515)	500 (450)
650	650 (590)	500 (500)
730 *	708 (650)	600 (500)
820 *	820 (708)	700 (600)
920	920 (820)	800 (700)
1K0	1030 (920)	900 (800)
1K1	1150 (1030)	1000 (900)
1K3	1300 (1150)	1200 (1000)
1K4	1450 (1180)	1250 (1000)
1K7	1770 (1600)	1500 (1400)
2K1	2150 (1940)	1900 (1700)
2K7	2700 (2300)	2300 (2000)

700H drives include an input line reactor as standard.

* Current ratings are matched to NEC or typical motor ampere requirements. Ratings up to drive output amps are available with a custom quote.

f

Documentation	
Code	Type
A	User Manual

g

Internal Brake IGBT	
Code	w/Brake IGBT
Y *	Yes
N	No

* Available on Frame 9 drives Only.

h

Brake Resistor	
Code	w/R Resistor
N	No

i

Internal EMC Filter & Common Mode Choke		
Code	CE Filter	CM Choke
B	Yes	No
N ‡	No	No

‡ For use on ungrounded or resistive grounded distribution systems (Frame 9 drives only).

Must be selected for 18 pulse drives (Voltage code "U").

j

Internal Communication Adapters	
Code	Version
B	BACnet MS/TP
C	ControlNet (Coax)
D	DeviceNet
E	Ethernet/IP
H	HVAC
I	Interbus
L	LonWorks
N	None
P	PROFIBUS
R	Remote I/O
S	RS485

k

Control and I/O	
Code	I/O Volts
A	24V DC
B	115V AC

l

Feedback	
Code	Type
0	None

m

Special Options	
Code	Type
NN	None

n

Special Options	
Code	Type
NN	None

p

Drive Duty	
Code	Type
ND †	Normal
HD †	Heavy

† Must select either -ND or HD.

r

Engineered Options	
Code	Description
-B0 §	Bypass Not Required
-B1/B51 §‡	Manual Bypass
-B2/B52 ‡	Auto Bypass
-C1 §	Drive Only Control Power
-C5 §	115V User Supplied Control Power
-C7	Fan Control w/Thermostat
-E4	Enclosure Space Heater, Remote Power
-E9	Nameplate, Door Mounted
-G1	Johnson Controls Metasys * Interface
-J1	Aux. Contacts, Control Power On
-J2	Aux. Contacts, Drive Fault
-J3	Aux. Contacts, Alarm
-J4	Aux. Contacts, Run
-J5	Aux. Contacts, At Speed
-J8/J58 ‡	Motor Heater Control, Remote Power (180W Max.)
-L2	3% Output Load Reactor
-M3	Motor Run Meter, Drive/Bypass
-N1	Isolated Analog Input, 0-10V DC
-N2	Isolated Analog Input, 4-20 mA
-N3	Isolated Analog Output, 0-10V DC
-N5	Building Mng. Control Interface
-P1 §‡	No Input Protection
-P2 §‡	Input Fuses, Drive
-P3 §	Circuit Breaker, Drive
-P4 §	Circuit Breaker, Drive/Bypass Mode
-P6 §	Fused Disconnect Switch, Drive
-P7 §‡	Fused Disconnect Switch, Drive/Bypass Mode
-P8 ‡	Disconnect Switch (Non-Fused), Drive/Bypass Mode
-P10 ‡	Input Fuse Block (No Fuses), Drive/Bypass Mode
-P11	Contact, Drive Input
-P12	Contact, Drive Output
-S1/S51 ‡	H/O/A S.S. (Start/Stop/Spd. Ref.)
-S9/S59 ‡	Run Pilot Light
-S10/S60 ‡	Drive Fault Pilot Light
-S11/S61 ‡	At Speed Pilot Light
-S12/S62 ‡	Drive Alarm Pilot Light
-S13/S63 ‡	Control Power On Pilot Light
-S14/S64 ‡	Drive & Bypass Mode Pilot Lights
-S15/S65 ‡	Bypass Mode & Auto Bypass En. P.L.
-S16/S66 ‡	Drive Disable Mushroom P.B.
-S17/S67 ‡	Motor Fault Pilot Light
-S18/S68 ‡	Speed Potentiometer (1-Turn)

§ Must select either Bypass option -B0 or B1/B51, Power Disconnecting Means option -P1, P2, P3, P4, P6 or P7, and Control Power option -C1 or C5.

‡ Denotes 800F/800T device. When selecting multiple options, Do Not combine 800F and 800T devices (all devices must be the same type).

‡‡ 6 Pulse drives only.

‡‡‡ 18 Pulse drives only.

How to Order

- **Step 1.** Select the PowerFlex 700H Base Drive Catalog Number and required options from the Configured Drives Option section below.
- **Step 2.** Specify additional required options (starting on page XX). The listing is divided into simple categories to assist in quickly locating specific needs. Some options are horsepower and/or voltage specific, or will have special rules associated with them – Read all footnotes.
- **Step 3.** After generating a complete catalog number string, do an Option Compatibility Check by referring to the table starting on page XX.
- **Step 4.** Entering an order on Passport.
Note that a “C” lead time requires a custom quote. Enter a custom quote request on Passport using “SP-SDB-CUSTOM” as the line item part number and entering the complete catalog string and total list price in the Competitive Summary. For questions or help with a custom quote or order entry, please contact the Configured Drives Group at 262-512-8415.

Example: A refrigeration plant application requires a variable speed control for an existing 500 Hp, 480V AC, 580A conveyor motor. Both drive and motor will be located in a clean, but cold environment. Local 115V control is required for programming, start, stop, and speed. Speed reference must be selectable from a remote location as well. The motor has an internal heater requiring power. A system disconnect switch is user supplied and drive branch circuit fusing is required. Control power is required.

Configured Drives Options

Application Requirements	Description	Cat. No./Option Code	Position	Lead Time
500 Hp, 480V, 650A, Clean Environment	Basic Drive w/IP 20 (NEMA Type 1 Enclosure)	21CD650B	a...d (Base Drive)	P
Programming, Start, Stop and Speed	Human Interface Module - Door Mounted w/LCD Full Numeric	P	e (Substitution)	P
No Reference to Documentation in Example	User Manual	A	f (standard)	P
No Reference to Special Stopping in Example	No Brake IGBT	N	g (standard)	P
No Reference to Special Stopping in Example	No Brake Resistor	N	h (standard)	P
No Reference to Filtering in Example	Filtered - No Common Mode Choke	B	i (standard)	P
No Reference to Communication in Example	No Communication Module	N	j (standard)	P
Local 115V Control	115V Control	B	k (substitution)	P
No Reference to Feedback in Example	No Feedback Option	0	l (standard)	P
No Reference to Other Special in Example	Reserved for Future Options	NN	m (standard)	P
No Reference to Other Special in Example	Reserved for Future Options	NN	n (standard)	P
Conveyor - 150% Overload - HD	Heavy Duty	-HD	p (specification)	P
No Reference to Bypass in Example	Bypass Not Required	-B0	r (addition)	P
Input Fuses	Drive Input Fusing	-P2	r (addition)	P
Control Power for Drive	115V Control Power, Drive/Options Only	-C1	r (addition)	P
Internal Motor Heater	Motor Heater, Remote Power	-J8	r (addition)	P
Start/Stop/Speed Reference, Selectable	H/O/A S.S. (Start/Stop/Spd. Ref.)	-S1	r (addition)	P
21CD650BPANNBNBONNNN-HD-B0-P2-C1-J8-S1				P

IMPORTANT The final lead time for the complete drive is based on the longest option lead time.

Configured Drives Product Selection

Package includes:

- PowerFlex 700H 480V Drive
- NEMA Type 1 Freestanding Enclosure
- User Manual

IMPORTANT Customers that require drives with low harmonic front ends, generally will have an associated specification with their detailed requirements. Failure to ask for a customer specification, and the proper review of that specification, may result in significant price and/or delivery changes.

480V AC, 6 Pulse Configured Drives ⁽¹⁾

480V AC Input		IP20, NEMA Type 1	Frame Size	Lead Time
Output Amps - ND (HD) ⁽²⁾⁽³⁾	HP - ND (HD)	Cat No.		
		Positions a...d		
261 (205)	200 (150)	21CD261B	9	C
300 (245)	250 (200)	21CD300B	9	C
361 (300)	300 (250)	21CD385B	10	P
414 (361)	350 (300)	21CD460B	10	P
500 (414)	450 (350)	21CD500B	10	P
590 (515)	500 (450)	21CD590B	11	P
590 (590)	500 (500)	21CD650B	11	P
708 (590)	600 (500)	21CD730B	11	P
820 (730)	700 (600)	21CD820B	12	P
920 (820)	800 (700)	21CD920B	12	P
1030 (920)	900 (800)	21CD1K0B	12	P
1150 (1030)	1000 (900)	21CD1K1B	13	C
1300 (1150)	1200 (1000)	21CD1K3B	13	C
1450 (1200)	1250 (1000)	21CD1K4B	13	C
1770 (1600)	1500 (1400)	21CD1K7B	14	C
2150 (1940)	1900 (1700)	21CD2K1B	14	C
2700 (2300)	2300 (2000)	21CD2K7B	14	C

(1) These drives include an input line reactor as standard.

(2) These drives have dual current ratings; one for normal duty applications, and one for heavy duty applications (in parenthesis). The drive must be operated at one rating only.

(3) The overload amps are based on system output current (ND = 110%, HD = 150%).

480V AC, 18 Pulse Configured Drives (Low Harmonic) ⁽¹⁾⁽²⁾

480V AC Input	IP20, NEMA Type 1	Frame Size	Lead Time
Output Amps - ND (HD) ⁽³⁾⁽⁴⁾	HP - ND (HD) Cat No. Positions a...d		
261 (205)	200 (150) 21CU261B	9	C
300 (245)	250 (200) 21CU300B	9	C
385 (300)	300 (250) 21CU385B	10	X
460 (385)	350 (300) 21CU460B	10	X
500 (420)	450 (350) 21CU500B	10	X
590 (520)	500 (450) 21CU590B	11	X
650 (590)	500 (500) 21CU650B	11	X
730 (650)	600 (500) 21CU730B	11	X
820 (730)	700 (600) 21CU820B	12	X
920 (820)	800 (700) 21CU920B	12	X
1030 (920)	900 (800) 21CU1K0B	12	X
1150 (1030)	1000 (900) 21CU1K1B	13	C
1300 (1150)	1200 (1000) 21CU1K3B	13	C
1450 (1200)	1250 (1000) 21CU1K4B	13	C
1770 (1600)	1500 (1400) 21CU1K7B	14	C
2150 (1940)	1900 (1700) 21CU2K1B	14	C
2700 (2300)	2300 (2000) 21CU2K7B	14	C

- (1) These drives include an auto style transformer as standard. If an isolation style transformer is preferred, please submit a custom quote request.
- (2) These drives include an input line reactor as standard.
- (3) These drives have dual current ratings; one for normal duty applications, and one for heavy duty applications (in parenthesis). The drive must be operated at one rating only.
- (4) The overload amps are based on system output current (ND = 110%, HD = 150%).

Factory Installed Options

Human Interface Modules (HIM) - Position e



Cat. Code: 0
Drive Mounted
Blank Cover
No HIM



Cat. Code: M
Door Mounted LCD
Programmer Only



Cat. Code: P
Door Mounted
w/LCD Display,
Full Numeric Keypad

Note: NEMA/UL Type 12 HIMs are not available.

Documentation

Description	Cat. Code	Lead Time
	(Position f)	
Manual (Standard)	A	P

Internal Brake IGBT

Brake IGBT	Frame	Cat. Code	Lead Time
		(Position g)	
None	9...14	N	P
Optional	9	Y	C

Brake Resistor

Description	Cat. Code	Lead Time
	(Position h)	
None	N	P

Internal EMC Filter and Common Mode Choke

Drive Input Voltage	Frame	Description	Cat. Code	Lead Time
			(Position i)	
480V AC	9-13	with CE Filter, No Choke, No dv/dt Filter	B	P
480V AC	9	No CE Filter, No Choke, No dv/dt Filter	N ⁽¹⁾	C
480V AC	14	with CE Filter, dv/dt Filter, No Choke	E	C

(1) For use with ungrounded or resistive grounded distribution systems.

Internal Communication Adapters

Description	Cat. No.	Lead Time
	(Position j)	
BACnet® MS/TP RS485 Communication Adapter	20-COMM-B	P
ControlNet™ Communication Adapter (Coax)	20-COMM-C	P
DeviceNet™ Communication Adapter	20-COMM-D	P
EtherNet/IP™ Communication Adapter	20-COMM-E	P
HVAC Communication Adapter	20-COMM-H	P
Interbus™ Communication Adapter	20-COMM-I	P
LonWorks® Communication Adapter	20-COMM-L	P
None	N	P
PROFIBUS™ DP Communication Adapter	20-COMM-P	P
Remote I/O Communication Adapter	20-COMM-R	P
RS485 DF1 Communication Adapter	20-COMM-S	P

Control and I/O Options

Description	Cat. Code	Lead Time
	(Position k)	
24V DC Digital Inputs (6) w/Analog I/O & 115V AC Digital Outputs (3)	A	Q
115V AC Digital Inputs (6) w/Analog I/O & 115V AC Digital Outputs (3)	B	P

Feedback

Description (One Required)	Cat. Code	Lead Time
	(Position l)	
None	0	P

Special Options

Description (One Required)	Cat. Code	Lead Time
	(Position m)	
No Special Options	NN	P

Special Options

Description (One Required)	Cat. Code	Lead Time
	(Position n)	
No Special Options	NN	P

Drive Duty

Description (One Required)	Cat. Code	Lead Time
	(Position p)	
Normal Duty	ND	P
Heavy Duty	HD	P

Sample Power Distribution Schemes - 6 Pulse Only

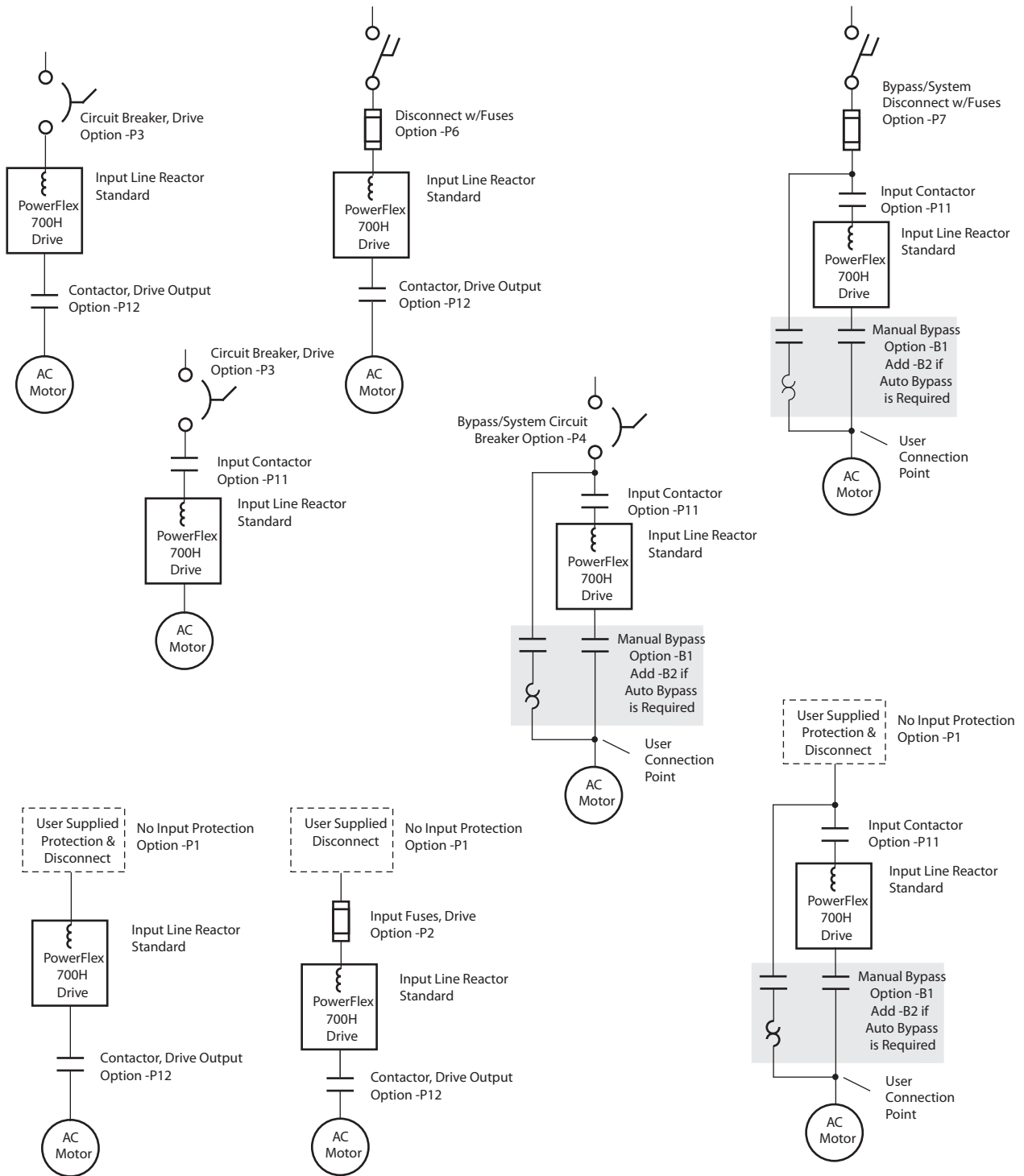

Sample Power Distribution Schemes - 18 Pulse Only

Note: Drive fusing must be specified.

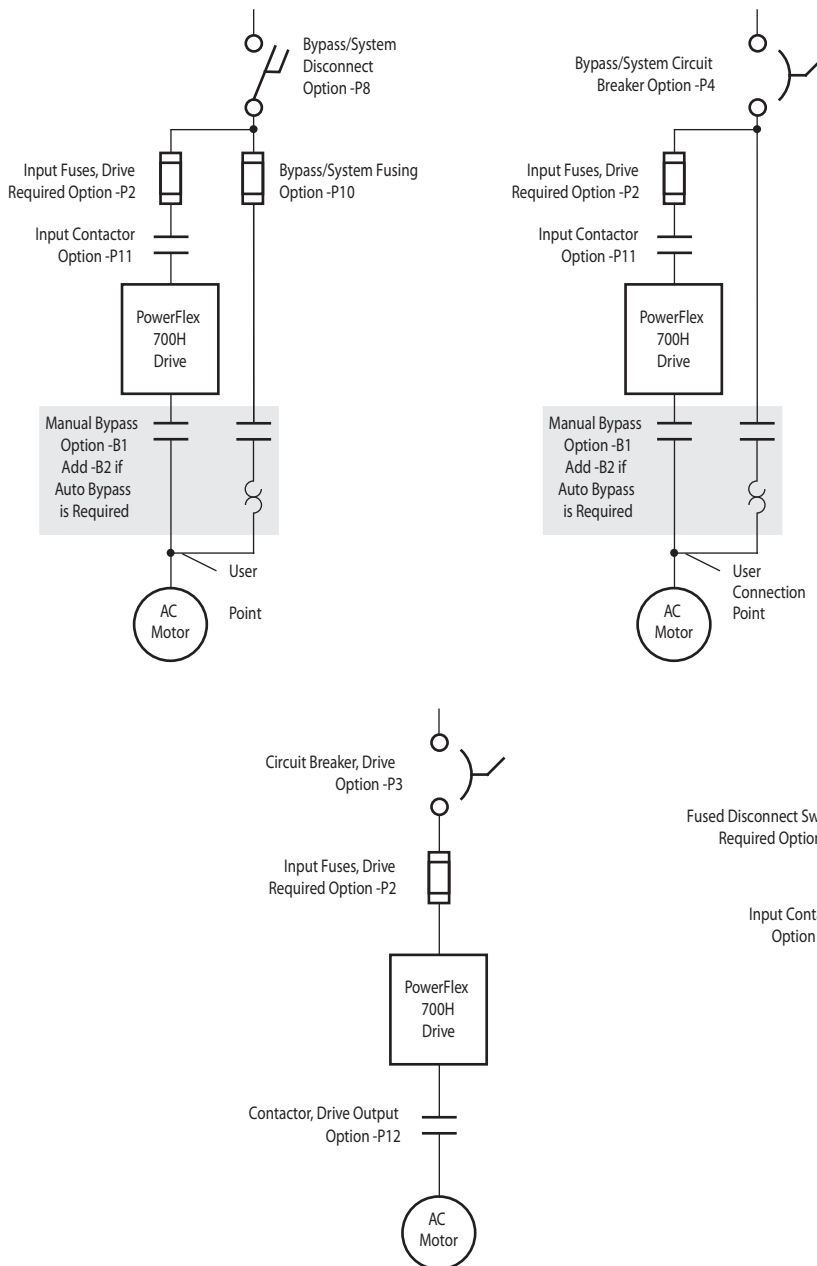

Power Disconnecting Means Options

IMPORTANT Customer must select one (and only one) of the following; -P1, P2, P3, P4, P6 or -P7 options. If option -P1 is selected, power disconnecting means and drive branch circuit protection must be supplied by user.

480V AC, Three-Phase

ND (HD) Rating HP	No Input Protection ⁽¹⁾⁽²⁾	Input Fuses, Drive	Circuit Breaker, Drive ⁽¹⁾	Circuit Breaker, Drive/Bypass Mode ⁽³⁾	Fused Disconnect Switch, Drive ⁽¹⁾	Fused Disconnect Switch, Drive Bypass Mode ⁽³⁾	Disconnect Switch, No Fusing, Drive Bypass Mode ⁽³⁾⁽⁴⁾	Input Fuse Block (No Fuses), Drive Bypass Mode ⁽³⁾⁽⁵⁾	Lead Time
200 (150)	Option Code -P1	Option Code -P2	Option Code -P3	Option Code -P4	Option Code -P6	Option Code -P7	Option Code -P8	Option Code -P10	P
250 (200)									P
300 (250)									P
350 (300)									P
450 (350)									P
500 (450)									P
500 (500)									P
600 (500)									P
700 (600)									P
800 (700)									P
900 (800)...									P

- (1) This option can not be used with Bypass.
- (2) 6 Pulse drives Only.
- (3) This option must be used in conjunction with a Bypass Option.
- (4) 18 Pulse drives only - Lead Time is "C."
- (5) Fuses must be supplied by user to match motor.

Power and Bypass Options

IMPORTANT Customer must select one (and only one) of the following; -B0 or -B1 options.

480V AC, Three-Phase

ND (HD) Rating HP	Contactor, Drive Input	Contactor, Drive Output ⁽¹⁾⁽²⁾	Bypass Not Required	Manual Bypass ⁽³⁾	Automatic Bypass Logic ⁽³⁾⁽⁴⁾	Lead Time
200 (150)	Option Code -P11	Option Code -P12	Option Code -B0	Option Code -B1/B51	Option Code -B2/B52	P
250 (200)						P
300 (250)						P
350 (300)						P
450 (350)						P
500 (450)						P
500 (500)						P
600 (500)						P
700 (600)						C
800 (700)						C
900 (800)...						C

- (1) An output contactor may not be chosen when Bypass is selected.
- (2) This option must be used in conjunction with the Auxiliary Fault Contact option -J2.
- (3) Includes a Class 10 Adjustable Overload Relay that does not require separate heater elements.
- (4) Option includes "Drive-Off-Bypass" selector switch and must be used in conjunction with the Auxiliary Fault Contact option (-J2). Also requires option -B1/B51.

Control Power Options

IMPORTANT Customer must select -C1 or -C5 (not both).

480V AC, Three-Phase

ND (HD) Rating HP	115V Control Power, Drive/Options Only	115V Control Power, User Supplied	Lead Time
200 (150)	Option Code -C1	Option Code -C5	P
250 (200)			P
300 (250)			P
350 (300)			P
450 (350)			P
500 (450)			P
500 (500)			P
600 (500)			P
700 (600)			P
800 (700)			P
900 (800)...			P

Load Reactor Options

480V AC, Three-Phase

ND (HD) Rating HP	3% Output Load Reactor Mounted in Enclosure ⁽¹⁾ ⁽²⁾	Lead Time
200 (150)	Option Code -L2	C
250 (200)		C
300 (250)		C
350 (300)		C
450 (350)		C
500 (450)		C
500 (500)		C
600 (500)		C
700 (600)		C
800 (700)		C
900 (800)...		C

(1) The standard PowerFlex 700H drive has an input line reactor as standard.

(2) A 5% output reactor is available with a custom quote.

Control and Systems Interface Options

Description	Option Code	Lead Time
Analog Inputs/Outputs		P
Isolated Analog Input, 0-10V DC	-N1	P
Isolated Analog Input, 4-20 mA	-N2	P
Isolated Analog Output, 0-10V DC	-N3	P
Control Relay Option		P
Control Power On	-J1	P
Auxiliary Contacts, (2) Form C 2-N.O., 2-N.C. ⁽¹⁾		P
Drive Fault	-J2 ⁽¹⁾	P
Alarm	-J3 ⁽¹⁾	P
Drive Run	-J4 ⁽¹⁾	P
At Speed	-J5 ⁽¹⁾	P
Building Management Control Interface	-N5	P
Communication Options Panel Mounted		P
Johnson Controls Metasys Interface	-G1	P

- (1) Maximum of two drive digital options can be selected.
 NOTE: S9 + J4 = One Digital Output
 S10 + J2 = One Digital Output
 S11 + J5 = One Digital Output
 S12 + J3 = One Digital Output
 All other combinations = One Digital Output.

Motor Interface Options

Description	Option Code	Lead Time
Motor Heater Control, Remote Power 180W Max.)	-J8/J58 ⁽¹⁾	P

- (1) Requires user supplied control power.

Operator Devices - Door Mounted

Description	Option Code	Lead Time
H/O/A Selector Switch (Start/Stop/Spd. Ref.)	-S1/S51 ⁽¹⁾	P
Run Pilot Light	-S9/S59 ⁽²⁾	P
Drive Fault Pilot Light	-S10/S60 ⁽²⁾	P
At Speed Pilot Light	-S11/S61 ⁽²⁾	P
Drive Alarm Pilot Light	-S12/S62 ⁽²⁾	P
Control Power On Pilot Light	-S13/S63	P
Drive & Bypass Mode Pilot Lights	-S14/S64 ⁽³⁾	P
Bypass Mode & Auto Bypass En. Pilot Lights	-S15/S65 ⁽⁴⁾	P
Drive Disable Mushroom Push Button	-S16/S66 ⁽¹⁾	P
Motor Fault Pilot Light	-S17/S67 ⁽³⁾	P
Speed Potentiometer (1-Turn)	-S18/S68	P

- (1) Does not require option -C1 or user supplied power (-C5) if 24V AC/DC interface is selected.
 Requires option -C1 or user supplied power (-C5), if 115V AC interface is selected.
 (2) Maximum of two drive digital options can be selected.
 NOTE: S9 + J4 = One Digital Output
 S10 + J2 = One Digital Output
 S11 + J5 = One Digital Output
 S12 + J3 = One Digital Output
 All other combinations = One Digital Output.
 (3) Option available when -B1/B51 is selected.
 (4) Option available when -B2/B52 is selected.

Meters - Door Mounted

Description	Option Code	Lead Time
Drive/Bypass Motor Run Time Meter (Elapsed Hours) Non-Resettable	-M3	P

Enclosure Options

Description	Option Code	Lead Time
Enclosure Space Heater, Remote Power	-E4	C
Nameplate, Door Mounted 158.8 x 50.8 mm (6.25 x 2 in.) white Lamacoid with black letters)	-E9 ⁽¹⁾	P
UL Type 3/4/44/12	Consult Factory	C



(1) Actual message to be defined by user at order entry, otherwise will be supplied blank.

Drawing and Test Options (For Configured Drives Only)

Description - One Set of ...	Cat. No.
Manufacturing Drawings 279 x 432 mm (11 x 17 in.) One set of schematics – “Information Only - Manufacture Proceeding” Not to be used as Approval Drawings, available after order is released from engineering.	
Electronic Drawings (Requires E-mail Address)	1301-MFDWG-E
Final Drawings (as shipped) 279 x 432 mm (11 x 17 in.) One set of schematics – “Copy of Drawings that Shipped with the Job”	
Electronic Drawings (Requires E-mail Address)	1301-FINDWG-E
Test Report, Drive Only (Requires E-mail Address)	1301-TESTR-E
Approval Drawings 279 x 432 mm (11 x 17 in.) One set of schematics – “Manufacture Held Until Approved Prints are Received”	
Electronic Drawings (Requires E-mail Address)	1301-APPDWG-E
As Commissioned Drawings 279 x 432 mm (11 x 17 in.) One set of schematics – “Provided after Field Changes are Returned to the Factory”	
Electronic Drawings (Requires E-mail Address)	1301-COMDWG-E
Analysis, Testing and Test Reports	
Basic Harmonic Analysis - Basic calculations and preliminary analysis from one line power distribution diagram.	1301-HARM1
Complete Harmonic Analysis - Detailed harmonic spectrum analysis and a written report.	1301-HARM2
Witness Test, User Viewing of Rockwell Automation Standard Test Procedures	1301-WT ⁽¹⁾

(1) Includes viewing Rockwell Automation standard test only. Any special requirements must be reviewed by Rockwell Automation for acceptance and possible price changes. Pricing is per drive.

Configured Drives Codes and Standards

Code/Standard		Action
CE ⁽¹⁾ (European Conformance Standard)		Consult the factory with requirements to meet the separate Low Voltage and/or EMC directives.
IEEE519 ⁽¹⁾ (Harmonic Distortion Levels)		Provide a one-line power distribution drawing, and the associated specification to the factory, for review. If an 18 pulse drive is being utilized, the drive will automatically meet IEEE519 at the drive input terminals (no power distribution review is required).
UL, c-UL		This program can provide UL panel recognition from the factory by adding a "-UL" to the catalog string. There is no charge for this option.

(1) Custom Drives Program Only - Request quote.

Option Selection Reference Guide - 6 Pulse

Required Options:

- Normal Duty or Heavy Duty
- Power Disconnecting Means or No Power Disconnecting Means
- Bypass or No Bypass
- Control Power or No Control Power when dependent options are selected

Base Drive (6 Pulse)

Description	Must be Used with ...	Cannot be Used with ...
Drive (position a)	21C	
Input Voltage (position b)	D Only	
Rating (position c)	One of the ratings shown	
Enclosure (position d)	One of A or B	
HIM (position e)	One of M, P or O	
Documentation (position f)	A	
Brake IGBT (position g)	One of Y or N (N standard)	
Brake Resistor (position h)	N	
Emission (position i)	One of B or N	
Comm Slot (position j)	C, D, E, H, I, L, N (Std.), P, R, S	More than One Drive Mounted Comm Option
I/O (position k)	One of A or B	
Feedback (position l)	0	
Reserved (position m)	NN	Applications Requiring Feedback
Reserved (position n)	NN	
Duty (position p)	One of ND or HD	

Required Options (6 Pulse)

Description	Must be Used with . . .	Cannot be Used with . . .
-B0	One of -B0 or B1/B51 Required	-B1/B51, B2//B52
-B1/B51	One of -B0 or B1/B51 Required	-B0, L2, L4, P2, P3, P6, P12
-C1	One of -C1 or C5 Required	-C5
-C5	One of -C1 or C5 Required	-C1
-P1	One of -P1, P2, P3, P4, P6 or P7 Required	-P2, P3, P4, P6, P7
-P2	One of -P1, P2, P3, P4, P6 or P7 Required	-P1, P3, P4, P6, P7
-P3	One of -P1, P2, P3, P4, P6 or P7 Required	-P1, P2, P4, P6, P7, B1
-P4	One of -P1, P2, P3, P4, P6 or P7 Required, -B1	-P1, P2, P3, P6, P7
-P6	One of -P1, P2, P3, P4, P6 or P7 Required	-P1, P2, P3, P4, P7, B1
-P7	One of -P1, P2, P3, P4, P6 or P7 Required, -B1	-P1, P2, P3, P4, P6

Non-Required Options (6 Pulse)

Description	Must be Used with . . .	Cannot be Used with . . .
-B2/B52	-B1/B51 & J2	-B0, P12
-E4		
-E9	Customer Supplies Message	
-G1		
-J1		
-J2		Only 2 drive digital outputs
-J3		Only 2 drive digital outputs
-J4		Only 2 drive digital outputs
-J5		Only 2 drive digital outputs
-J8/J58	-J4	
-L2		
-M3	-J4	
-M5		
-N1		
-N2		-S18/S68
-N3		
-N5	-S1/S51	
-P11		Requires Custom Quote with P12
-P12	-J2	-B1/B51, B2/B52, Requires Custom Quote with P11
-S1/S51		
-S9/S59	Only 2 drive digital outputs	Only 2 drive digital outputs
-S10/S60	Only 2 drive digital outputs	Only 2 drive digital outputs
-S11/S61	Only 2 drive digital outputs	Only 2 drive digital outputs
-S12/S62	Only 2 drive digital outputs	Only 2 drive digital outputs
-S13/S63		
-S14/S64	-B1/B51	-S15/S65
-S15/S65	-B1/B51, B2/B52	-S14/S64
-S16/S66		
-S17/S67	-B1/B51	
-S18/S68		-N2

Option Selection Reference Guide - 18 Pulse

Required Options:

- Normal Duty or Heavy Duty
- Drive Input Fusing
- Bypass or No Bypass
- Control Power or No Control Power when dependent options are selected

Base Drive (18 Pulse)

Description	Must be Used with . . .	Cannot be Used with . . .
Drive (position a)	21C	
Input Voltage (position b)	U	
Rating (position c)	One of the ratings shown	
Enclosure (position d)	B Only	
HIM (position e)	One of 0, 3, 5, A, C, E, F, G, J, K or L	
Documentation (position f)	A	
Brake IGBT (position g)	One of Y or N	
Brake Resistor (position h)	N or Y	
Emission (position i)	One of C or N	
Comm Slot (position j)	C, D, E, H, I, L, N (Std.), P, R, S	More than One Drive Mounted Comm Option
I/O (position k)	One of C or D	
Feedback (position l)	0 or 1	
Reserved (position m)	NN	Applications Requiring Feedback
Reserved (position n)	NN	
Duty (position p)	One of ND or HD	

Required Options (18 Pulse)

Description	Must be Used with . . .	Cannot be Used with . . .
-B0 (One of B0, B1/B51 Required)	One of -B0 or B1/B51 Required	-B1/B51, P4, P8, P10
-B1/B51 (One of B0, B1/B51 Required)	One of -C1 or C5 and One of -P10 or P4, P4 & P10 or P8 & P10	-B0, B1/B51, B2/B52, P12, S1/S51 . . . S18/S68, P8 Only
-C1 (One of C1 or C5 Required)		-C5
-C5 (One of C1 or C5 Required)		-C1
-P2 (Default)		-P6
-P3 (Only One Disconnect Device Allowed)	-P2	-P4, P6, P8
-P4 (Only One Disconnect Device Allowed)	-B1/B51, P2	-P3, P6, P8, B0
-P6 (Only One Disconnect Device Allowed)		-P2, P3, P4, P8
-P8 (Only One Disconnect Device Allowed)	-P10, P2	-P3, P4, P6, B0
-P10	-P2 or P6	-B0

Non-Required Options (18 Pulse)

Description	Must be Used with ...	Cannot be Used with ...
-B2/B52	-B1/B51 & J2	-B0, B1/B51, B2/B52, P12
-E9	Customer Supplies Message	
-G1		HIM Codes 3, A...G, Vector Control I/O (C or D)
-J1		
-J2		Only 2 drive digital outputs
-J3		Only 2 drive digital outputs
-J4		Only 2 drive digital outputs
-J5		Only 2 drive digital outputs
-J8/J58	-J4	-J8/58, S1/S51...S18/S68
-L2		
-M3	-J4	
-N1		
-N2		-S18/S68
-N3		
-N5	-S1/S51	
-P11		
-P12	-J2	-B1/B51
-S1/S51		-B1/B51, S1/S51...S18/S68
-S9/S59	Only 2 drive digital outputs	Only 2 drive digital outputs
-S10/S60	Only 2 drive digital outputs	Only 2 drive digital outputs
-S11/S61	Only 2 drive digital outputs	Only 2 drive digital outputs
-S12/S62	Only 2 drive digital outputs	Only 2 drive digital outputs
-S13/S63		
-S14/S64	-B1/B51	-S15/S65
-S15/S65	-B1/B51 & B2/B52	-S14/S64
-S16/S66		
-S17/S67	-B1/B51	
-S18/S68		-N2

Recommended Documentation

For additional PowerFlex 700H Drive data and information, refer to the following publications available on the Rockwell Automation Literature Library: rok.auto/literature.

Title	Publication
PowerFlex 700H Drives Programming Manual	20C-PM001...
PowerFlex 700S and 700H Installation Instructions (Frames 9 - 14)	PFLEX-IN006...
Wiring and Grounding for PWM AC Drives	DRIVES-IN001...
Safety Guidelines for the Application, Installation and Maintenance of Solid State Control	SGI-1.1...
A Global Reference Guide for Reading Schematic Diagrams	100-2.10...
Guarding Against Electrostatic Damage	8000-4.5.2...

Additional Resources

These documents contain additional information concerning related products from Rockwell Automation.

Resource	Description
Industrial Automation Wiring and Grounding Guidelines, publication 1770-4.1	Provides general guidelines for installing a Rockwell Automation industrial system.
Product Certifications website, http://www.ab.com	Provides declarations of conformity, certificates, and other certification details.

You can view or download publications at rok.auto/literature. To order paper copies of technical documentation, contact your local Allen-Bradley distributor or Rockwell Automation sales representative.

Important User Information

Solid-state equipment has operational characteristics differing from those of electromechanical equipment. Safety Guidelines for the Application, Installation and Maintenance of Solid State Controls (publication [SGL-1.1](#) available from your local Rockwell Automation sales office or online at rok.auto/literature) describes some important differences between solid-state equipment and hard-wired electromechanical devices. Because of this difference, and also because of the wide variety of uses for solid-state equipment, all persons responsible for applying this equipment must satisfy themselves that each intended application of this equipment is acceptable.

In no event will Rockwell Automation, Inc. be responsible or liable for indirect or consequential damages resulting from the use or application of this equipment.

The examples and diagrams in this publication are included solely for illustrative purposes. Because of the many variables and requirements associated with any particular installation, Rockwell Automation, Inc. cannot assume responsibility or liability for actual use based on the examples and diagrams.

No patent liability is assumed by Rockwell Automation, Inc. with respect to use of information, circuits, equipment, or software described in this manual.

Reproduction of the contents of this manual, in whole or in part, without written permission of Rockwell Automation, Inc., is prohibited.

Documentation Feedback

Your comments will help us serve your documentation needs better. If you have any suggestions on how to improve this document, complete this form, publication [RA-DU002](#), available at <http://www.rockwellautomation.com/literature/>.

Allen-Bradley, expanding human possibilities, DriveExplorer, DriveTools, PowerFlex, RSLogix, Rockwell Software, Rockwell Automation, and TechConnect are trademarks of Rockwell Automation, Inc. Trademarks not belonging to Rockwell Automation are property of their respective companies.

Rockwell Otomasyon Ticaret A.Ş., Kar Plaza İş Merkezi E Blok Kat:6 34752 İçerenköy, İstanbul, Tel: +90 (216) 5698400

www.rockwellautomation.com

Power, Control and Information Solutions Headquarters

Americas: Rockwell Automation, 1201 South Second Street, Milwaukee, WI 53204-2496 USA, Tel: (1) 414.382.2000, Fax: (1) 414.382.4444

Europe/Middle East/Africa: Rockwell Automation NV, Pegasus Park, De Kleetlaan 12a, 1831 Diegem, Belgium, Tel: (32) 2 663 0600, Fax: (32) 2 663 0640

Asia Pacific: Rockwell Automation, Level 14, Core F, Cyberport 3, 100 Cyberport Road, Hong Kong, Tel: (852) 2887 4788, Fax: (852) 2508 1846