



Installation Instructions

ControlNet Scanner Card

Catalog Number 1784-KTCS

To the Installer

This document describes how to install and use the 1784-KTCS ControlNet™ scanner card.

Topic	Page
Introducing the KTCS Card	2
Understanding the Application Software	3
Compliance to European Union Directives	3
Configuring the Card Hardware	5
Selecting the Base Memory Address Location	6
Selecting the Base I/O Space Address Location	9
Setting the Jumpers	14
Installing the Card	15
Installing IOLinx Software	16
Running the Installation Check Wizard	19
Connecting the Card	21
Connecting Another Device to ControlNet Through the NAP	23
Connecting the Card Directly to the ControlNet Network	26
Interpreting the Status Indicators	26
Removing IOLinx Software	28
CSA Hazardous Location Approval	29
Specifications	31

If you are connecting the card directly to a ControlNet network, you also need to read:

- ControlNet Tap Installation Instructions, publication 1786-5.7
- ControlNet Cable Planning and Installation Manual, publication 1786-6.2.1

Important User Information

Because of the variety of uses for the products described in this publication, those responsible for the application and use of this control equipment must satisfy themselves that all necessary steps have been taken to assure that each application and use meets all performance and safety requirements, including any applicable laws, regulations, codes and standards.

The illustrations, charts, sample programs and layout examples shown in this guide are intended solely for purposes of example. Since there are many variables and requirements associated with any particular installation, Allen-Bradley does not assume responsibility or liability (to include intellectual property liability) for actual use based upon the examples shown in this publication.

Allen-Bradley publication SGI-1.1, *Safety Guidelines for the Application, Installation, and Maintenance of Solid State Control* (available from your local Allen-Bradley office), describes some important differences between solid-state equipment and electromechanical devices that should be taken into consideration when applying products such as those described in this publication.

Reproduction of the contents of this copyrighted publication, in whole or in part, without written permission of Allen-Bradley Company, Inc., is prohibited.

Throughout this document we use notes to make you aware of safety considerations:



ATTENTION: Identifies information about practices or circumstances that can lead to personal injury or death, property damage or economic loss.

Attention statements help you to:

- identify a hazard
- avoid the hazard
- recognize the consequences

Important: Identifies information that is critical for successful application and understanding of the product.

Introducing the 1784-KTCS Communication Interface Card

The KTCS Communication Interface card lets a 16-bit ISA- or 32-bit EISA-compatible computer communicate directly with other ControlNet products.

Understanding the Application Software

The Allen-Bradley standard application programming interfaces (APIs) are INTERCHANGE™, WIntelligent LINX™, IOLinx™, and RSLinx™ software from Rockwell Software, Inc. Contact your local Rockwell Automation sales representative or distributor for further information.

Compliance to European Union Directives

If this product bears the  marking, it is approved for installation within the European Union and EEA regions. It has been designed and tested to meet the following directives.

EMC Directive

This product is tested to meet Council Directive 89/336/EEC Electromagnetic Compatibility (EMC) and the following standards, in whole or in part, documented in a technical construction file:

- EN 50081-2EMC - Generic Emission Standard, Part 2 - Industrial Environment
- EN 50082-2EMC - Generic Immunity Standard, Part 2 - Industrial Environment

This product is intended for use in an industrial environment.

Low Voltage Directive

This product is tested to meet Council Directive 73/23/EEC Low Voltage, by applying the safety requirements of EN 61131-2 Programmable Controllers, Part 2 - Equipment Requirements and Tests.

For specific information required by EN 61131-2, see the appropriate sections in the following Allen-Bradley publications:

- Industrial Automation Wiring and Grounding Guidelines for Noise Immunity, publication 1770-4.1
- Automation Systems Catalog, publication B111



ATTENTION: This digital apparatus does not exceed the Class A limits for radio noise emissions from digital apparatus set out in the Radio Interference Regulations of the Canadian Department of Communications.

Le présent appareil numérique n'émet pas de bruits radioélectriques dépassant les limites applicables aux appareils numériques de la class A prescrites dans le Règlement sur le brouillage radioélectrique édicté par le ministère des Communications du Canada.

Handling the Card



ATTENTION: The card uses CMOS technology, which is highly sensitive to electrostatic discharge (ESD). ESD may be present whenever you are handling the card. Handling a card without any ESD protection can cause internal circuit damage that may not be apparent during installation or initial use.

Take these precautions to guard against ESD damage:

- Before handling the card, be sure to touch a grounded object such as a PC's metal chassis to discharge any built-up static charge.
- Avoid touching the backplane connector or interface connector pins located on the card.
- If the card is not in use, store it in the anti-static clamshell that the card was shipped in.

Important: Remember, a computer with ac power disconnected is *not* a grounded object.

You are now ready to configure your card.

Configuring the Card Hardware

Before you install the card, you must set the card's physical addresses for the:

- ROM I/O expansion area of the host processor's system memory—enables the card and the host computer to exchange data through the dual-port interface. This is the **base memory address**.
- host processor's I/O map—enables the card's I/O devices to receive commands from the host computer. This is the **base I/O space address**.

You can have as many as four KTCS cards in one computer as long as each card has different base memory and base I/O space addresses.

To configure these addresses, you set switches on the card. The card comes factory-set with these default addresses:

Address Type	Address Setting (hex)
base memory	D000:0000
base I/O space memory	220

Important: When deciding which addresses to use, remember that each card in your computer must have a *unique* base memory address and a *unique* base I/O space memory address. If another card in the host computer is using one or both of the factory-set addresses, you must change a card's switch settings to an available address.

If you are:	go to:
changing addresses on the card	"Selecting the Base Memory Address Location" on page 6
using the factory-set addresses	"Installing the Card" on page 15

Selecting the Base Memory Address Location

The host computer and the card exchange data via a dual-port interface. The dual-port interface is 16 Kbytes long; it begins at the specified base memory address location.

The card comes set to memory address D000:0000. You may find that this selected memory address has been allocated to other interface cards or expansion memory cards you have installed in your computer system. If this occurs, change the switch settings to an available memory address.

To select a new base memory address:

1. Pick an available address from the ROM I/O adapters area of the host computer's memory.

Be sure to choose a block that is 16 Kbytes long.

2. Use Worksheet A to select a new memory address for the card.
3. Use Worksheet B to determine the proper switch settings.

Follow this guide to properly set your switches.

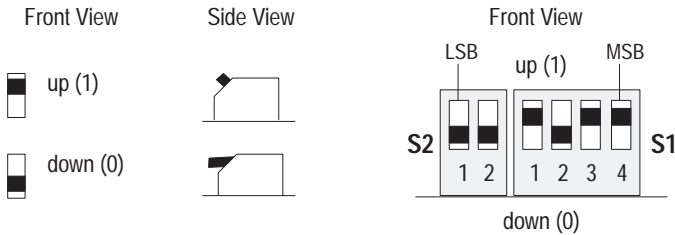

4. Fill in Worksheet C after you have determined your switch settings.
5. Follow the instructions that begin on page 11.

Worksheet A

Base memory allocation worksheet

Base Memory Address (hex)	Host Computer Assignments	Your System	
0000:0000–7000:FFFF	512K Read/Write Memory on System Board		
8000:0000–9000:FFFF	128K Read/Write Memory Expansion in I/O Channel		
A000:0000–	Video Buffer		
A400:0000–			
A800:0000–			
AC00:0000–			
B000:0000–			
B400:0000–			
B800:0000–			
BC00:0000–			
C000:0000–	Expansion Card Area (area available for KTCS memory addresses)		
C400:0000–			
C800:0000–			
CC00:0000–			
D000:0000–		Factory Default	
D400:0000–			
D800:0000–			
DC00:0000–			
E000:0000–F000:FFFF	128K ROM Reserved on System Board		

Selecting the Base I/O Space Address Location

The host addresses I/O devices on the card by using their I/O space addresses. The host addresses individual devices through registers that have addresses based on the I/O space base address. The registers are 2 bytes (1 word) long.

The card comes set to base I/O space address 220. You may find that this selected address has been allocated to other interface cards or expansion memory cards you have installed in your computer system. If this occurs, change the switch settings to an open address.

Important: When selecting configuration settings, check for conflicts with other interface cards and system memory. If there is a conflict, the system will not operate properly.

To select a new base I/O space address:

1. Pick an available address from the I/O map area of the host computer's memory.

Be sure to choose a block that is 2 bytes long.

Important: Each card requires 2 bytes of I/O space.





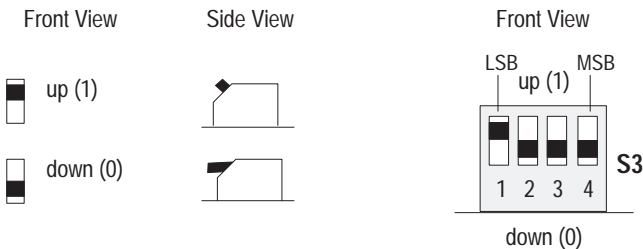







2. Use Worksheet D to select a new base I/O space address for the card (i.e., to determine the switch settings for the new address).

Follow this guide to properly set your switches:

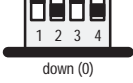

3. Fill in Worksheet E after you have determined your switch settings.
4. Follow the instructions that begin on page 11.

Worksheet D
KTCS switch settings

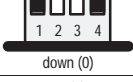
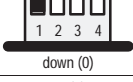
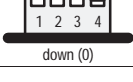
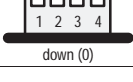
Base I/O Address (hex)	Switch Settings	Base I/O Address (hex)	Switch Settings
200 <i>potential device conflict: game port</i>	up (1)  down (0)	300 <i>potential device conflict: prototype cards</i>	up (1)  down (0)
220 factory-set default address & recommended setting	up (1)  down (0)	320 <i>potential device conflict: HDD</i>	up (1)  down (0)
240	up (1)  down (0)	340	up (1)  down (0)
260	up (1)  down (0)	360	up (1)  down (0)
280	up (1)  down (0)	380 <i>potential device conflict: SDLC</i>	up (1)  down (0)
2A0	up (1)  down (0)	3A0 <i>potential device conflict: SDLC</i>	up (1)  down (0)
2C0 <i>potential device conflict: EGA</i>	up (1)  down (0)	3C0 <i>potential device conflict: EGA</i>	up (1)  down (0)
2E0 <i>potential device conflict: GPIB</i>	up (1)  down (0)	3E0	up (1)  down (0)

Worksheet E

Your base I/O space address

Record the base I/O space address for the KTCS card:

Card: _____

Slot number: _____

Using default address: yes no

If no, new I/O space address: _____

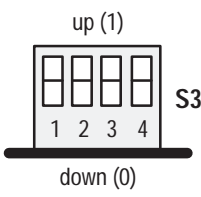

Setting the Card's Switches



ATTENTION: When setting the switches, be sure to avoid touching other components on the card.

1. Follow the card handling instructions on page 4.
2. Remove the card from the anti-static clamshell.

Important: When selecting configuration settings, check for conflicts with other interface cards and system memory. If there is a conflict, the host computer will not operate properly.

You must find a way to disable caching and shadow memory for at least the 16K of memory space occupied by each card. This can usually be accomplished through your CMOS setup program and/or memory manager, and must be done *before* running applications with the KTCS cards.

3. If you are using the card's **default memory address setting**, go to step 4.

If you are setting a **new base memory address**, set the switches to the up or down position to reflect the selected address from Worksheet C.

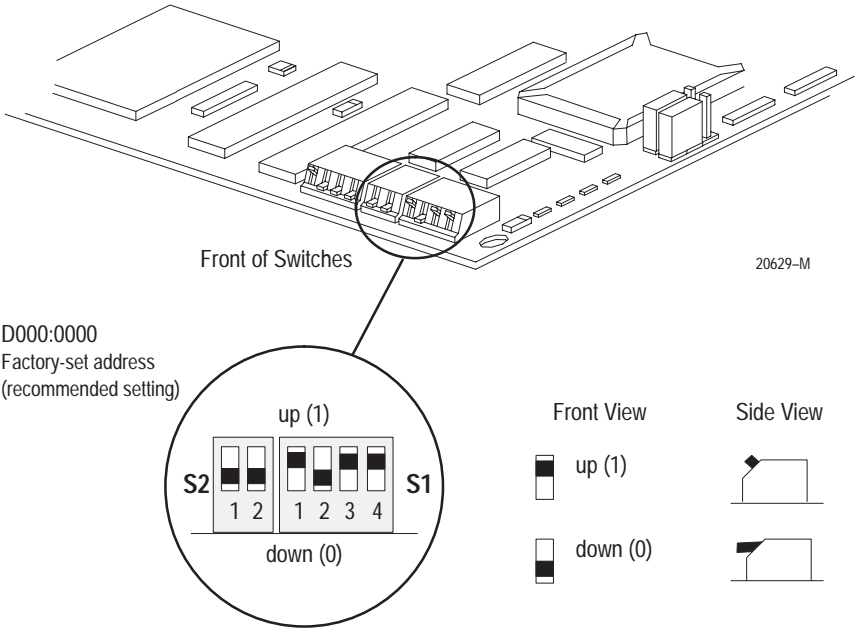

4. If you are using the card's **default base I/O space address setting**, go to the next section, Installing the Card.

If you are setting a **new base I/O space address**, set the switches to the up or down position to reflect the selected address from Worksheet E.

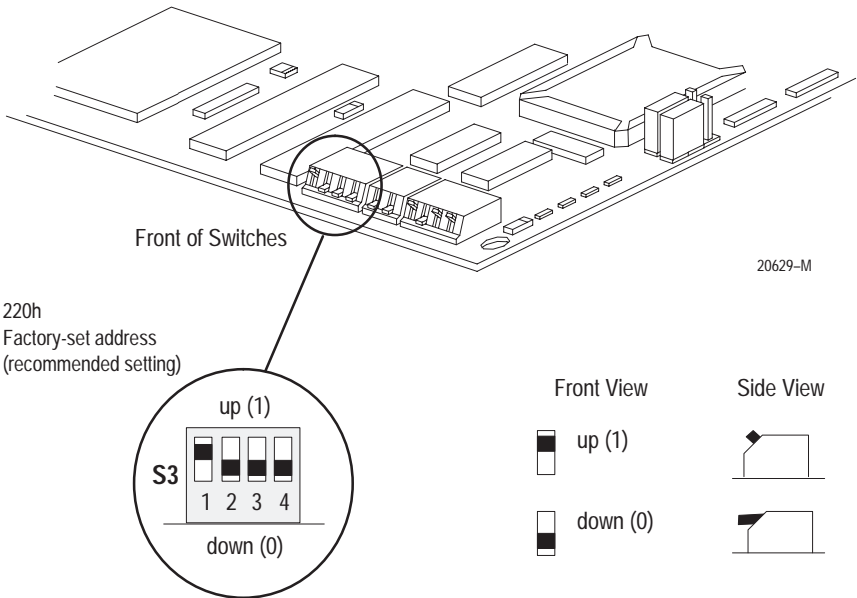

Setting the Jumpers

Important: When you receive your card, the jumpers are in the default positions, as shown in Figure 1. Do **not** alter these positions. See Figure 2 for an explanation of these jumpers.

Figure 1
KTCS jumpers

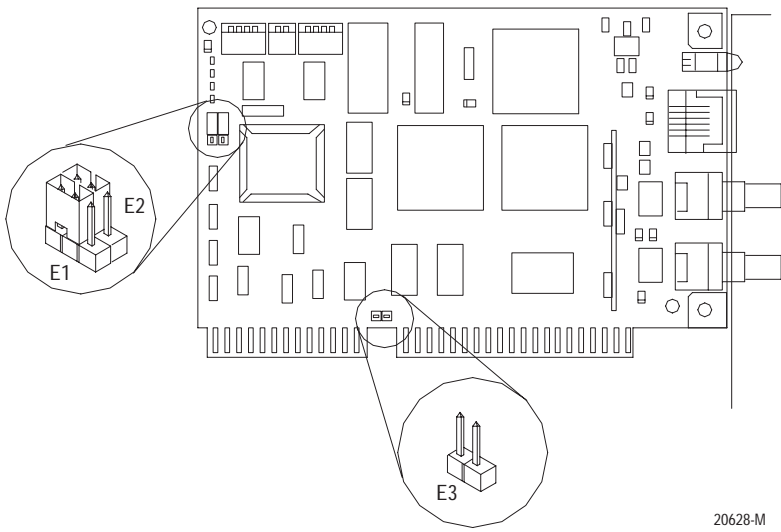

20628-M

Figure 2
Jumper Explanations

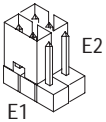

Use these jumper positions for:

- normal card operation
- field flash upgrade of the card's main code

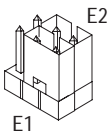

Use these jumper positions for field flash upgrade of the card's boot code.

IMPORTANT: All other E1 and E2 jumper combinations are illegal. Unknown card operation will result.

Installing the Card

Important: Before you install the card, make sure you know how to configure the computer's options, e.g., disabling cache memory, memory manager, and shadowing of memory, and that you know how to install hardware in your computer. Consult your computer's documentation for specific information.

To install the card, you need to:

- access the computer's expansion slots
You need a Phillips-head or a flat-head screwdriver, depending on your system.
- insert the card into the computer

Accessing the Computer's Expansion Slots

To install the card, you must access the computer's expansion slots. Follow these general steps, or refer to your computer's user guide for more explicit instructions.

1. Power down the host computer by turning off the power switch.
2. Remove the computer's cover.
3. Select a vacant 16- or 32-bit expansion slot.

Important: The card will function only in a 16- or 32-bit ISA/EISA expansion slot.

4. Remove the slot's expansion cover by loosening the screw on the back (rear bracket) of the computer.

Inserting the Card

To insert the card inside the computer:

1. Follow the card handling instructions on page 4.
2. Make sure you have correctly set all of the switches on the card.
3. Insert the card into the edge connector and tighten the expansion slot screw.
4. Turn on the computer to make sure it powers up correctly.

If the computer:	then:
powers up	go to step 5
does not power up correctly	<p>you probably have a memory or I/O conflict</p> <p>You should</p> <ul style="list-style-type: none"> • change switch settings and cycle power, or • remove all other cards and try again <p>If you are still unsuccessful, contact your local Rockwell Automation sales representative or distributor, or Rockwell Automation Technical Support at (440) 646-6800.</p>

5. Replace the CPU cover (when computer powers up correctly).

Installing IOLinx Software

Important: IOLinx software requires Microsoft Windows NT 4.0 or later.

Follow these steps to install the IOLinx software.

1. Insert the CD in the CD-ROM drive.

Important: We strongly recommend that you exit all Windows programs before running this Setup program.

Note: The CD-ROM will carry the Windows Autorun. Once inserted into the CD-ROM drive, if you have Autorun configured, the IOLinx software installation will automatically start at the first setup screen.

If Autorun is not configured, go to step 2.

- From the Start menu, choose Run.

You see:

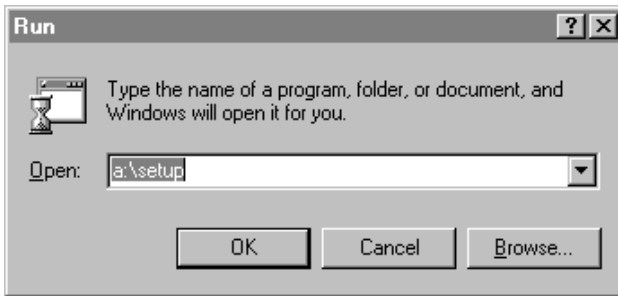

- Type `d:\setup` (if it doesn't appear automatically), where *d* is your CD-ROM drive letter.
- Click OK.

You see the progress bar, followed by the welcome screen.

- Select from this decision table.

If you want to	click on
continue with this Setup	Next You see "Enter name, company, and product serial number."
cancel Setup (because you have not exited other Windows programs)	Cancel Close those programs then run Setup again.

6. Enter your name, company, and product serial number.

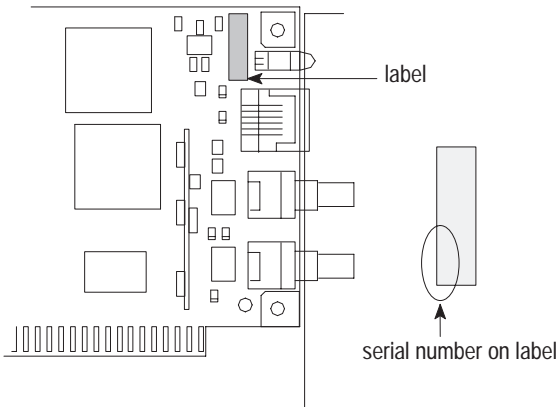

7. Click Next.

You see the “Choose Destination Location” screen.

8. Select from this decision table.

If you want to	click on
install IOLinx in this directory: C:\Program Files\Rockwell Automation\IOLinx\ControlNet	Next The IOLinx installation program launches the ControlNet Scanner Configuration Tool (SCT) installation.
install IOLinx in a different directory	Browse and select the directory
exit Setup (not install IOLinx)	Cancel

You see the Welcome screen.

9. Choose a destination location.

You see the Setup progress bar, followed by the “Setup Complete” screen.

10. Check the checkboxes on the “Setup Complete” screen to choose to view the Read Me file and/or to launch the IOLinx configuration tool.

The IOLinx configuration applet may be launched at a later time from the Control Panel (Start→Settings→Control Panel).

Important: The configuration applet **must** be run before IOLinx is started for the first time.

11. Click Finish to complete Setup.

Running the 1784-KTCS Installation Check Wizard

The installation check wizard is copied to your computer when the IOLinx software is installed, and appears in your menu (Program Files→Rockwell Automation→IOLinx for ControlNet→Check Wizard).

To make sure you have installed the card properly, run the installation check wizard. Follow these steps:

1. Launch the 1784-KTCS Installation Wizard.

You see the Welcome screen. The wizard guides you through a series of steps to be certain that your 1784-KTCS card is installed correctly.

2. Click Next to continue.

The wizard prepares to copy the necessary files to your system directory.

3. Click Next to continue.

The wizard copies the files to your system directory and brings up the Select I/O Address window.

4. Select the I/O Base Address for this card.

Refer to Worksheet E on page 11. You recorded your I/O base address there.

Important: Make sure that the card is **not** connected to a ControlNet network.

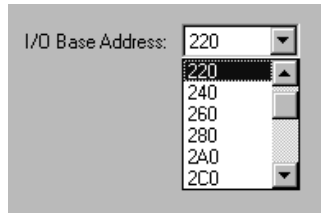

5. Click Next to continue.

The wizard prepares to locate the card at the I/O address you defined. If you have installed multiple cards, the check wizard can be run for each card by entering a different I/O address each time.

6. Click Next to continue.

The wizard attempts to locate your 1784-KTCS card at the specified I/O address.

When the wizard locates your card, it displays **Card has been found**, and:

- DualPort address where the card was found
- Bootcode version
- serial number
- main code version

7. Click Next to continue.

The wizard attempts to put the KTCS card in the online state.

Important: Make sure that the KTCS card is **not** connected to a ControlNet network.

8. Click Next to continue.

You see the message: **Going Online**.

9. Click Next to continue.

You see the message: **Online State Reached**.

10. Click Next to continue.

The wizard prepares to reset the card, and reports **Card has been reset**. LEDs should be alternating green and red. Congratulations, the check wizard has verified proper configuration of your 1784-KTCS card in your computer.

If the wizard fails, check the I/O base address on the card against the I/O base address you entered into the wizard. If the check wizard fails and the card I/O address and wizard address are identical, call Rockwell Automation Technical Support at 440-646-6800 for assistance.

Connecting the Card

After you have installed the card, you can connect it:

- to a device already connected to the ControlNet network via the 1786-CP network access port cable (page 23)
Important: This is only a temporary connection. As a permanent connection, the KTCS card should connect via a ControlNet tap.
- directly to a ControlNet network via a ControlNet tap (page 26)

Figure 3 shows the card connector.

Figure 3
KTCS card connector

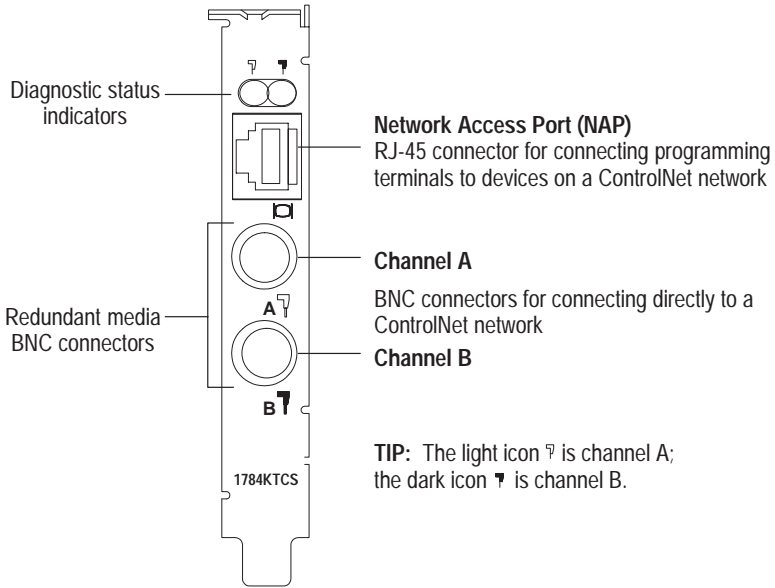

ATTENTION: Do not use the card to connect to more than one network at a time. Attempting to connect to a second network will cause your communication system to operate erratically.

See page 26 for information about status indicators. Indicators diagnose only redundant media BNC connections.

Important: If you are using a non-redundant cabling system, all ControlNet devices must be on the same channel, channel A.

Connecting Another Device to ControlNet Through the Network Access Port

By using the card's RJ-45 connector (known as the network access port or NAP), you can connect another device, e.g., programming interface such as a 1784-PCC card, to a ControlNet network, without a tap, through a programmable controller, I/O adapter, or another KTCS card.

The 1786-CP cable (Figure 4) connects a host computer, such as one with a 1784-KTCS card, to another ControlNet device (Figure 5). The 1786-CP cable has two RJ-45 8-pin connectors.

Figure 4
1786-CP cable

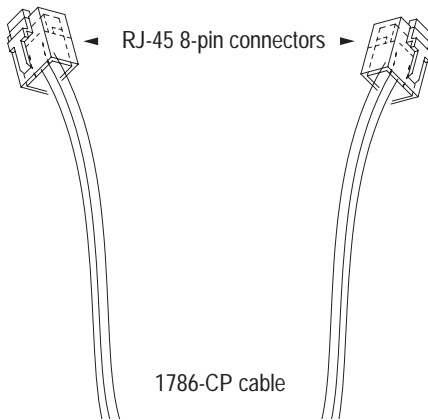

ATTENTION: Use the **1786-CP** cable when connecting a programming terminal to the network through the network access port (NAP); using another cable could result in possible network failures or product damage.

We designed the network access port as only a temporary connection. For permanent connections, a ControlNet tap, e.g., 1786-TYPR, -TYP5, should be used.

Table A shows the wiring for the cable.

Table A
Wiring for 1786-CP connector cable

Connector 1		
Wire Number	Signal Mnemonic	Signal Name
1	ISO-GND	Isolated Ground
2	N.C.	No Connection
3	PTTX-H	Transmit Data High
4	PTTX-L	Transmit Data Low
5	PTRX-L	Receive Data Low
6	PTRX-H	Receive Data High
7	N.C.	No Connection
8	ISO-GND	Isolated Ground

Connector 2		
Wire Number	Signal Mnemonic	Signal Name
1	ISO-GND	Isolated Ground
2	N.C.	No Connection
3	PTRX-H	Receive Data High
4	PTRX-L	Receive Data Low
5	PTTX-L	Transmit Data Low
6	PTTX-H	Transmit Data High
7	N.C.	No Connection
8	ISO-GND	Isolated Ground

Figure 5
Host computer connected to ControlNet device via 1786-CP cable

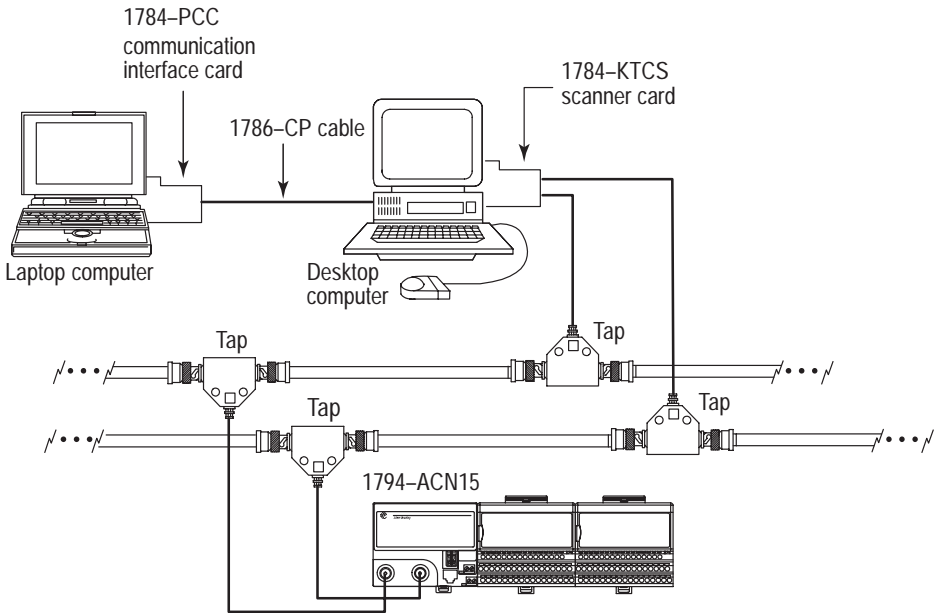

30433-M



ATTENTION: If you connect the product to a cable system that does not support or is not using redundant media, connect the tap dropline to the BNC connector labeled channel A. Channel B is left open.

If the cable system is redundant, connect the product such that all devices on the network use the same cable for the same channel. That is, all channel A connectors connect to one cable; all channel B connectors connect to the other.

Connecting the Card Directly to the ControlNet Network

To connect the card directly to a ControlNet network as shown in Figure 6, follow the instructions in these publications:

- ControlNet Tap Installation Instructions, publication 1786-5.7
- ControlNet Cable Planning and Installation Manual, publication 1786-6.2.1

Figure 6
1784-KTCS card connected directly to a ControlNet network

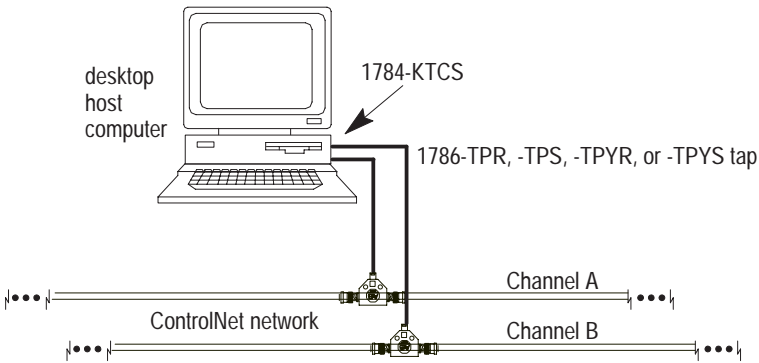





Interpreting the Status Indicators on the KTCS

The status indicators on the card give you information about the card and the network when you're connected via the BNC connectors. Table B outlines the states and explains what each state means to you and the action you should take, if any, to correct that state.

Table B
ControlNet status interpretation

- steady – indicator is on continuously in the defined state.
- alternating – the two indicators alternate between the two defined states at the same time (applies to both indicators *viewed together*). The two indicators are always in opposite states, out of phase.
- flashing – the indicator alternates between the two defined states (applies to each indicator *viewed independent* of the other). If both indicators are flashing, they must flash together, in phase.

 A and  B	Cause:	Action:
off	no power	none or power up
steady red	faulted unit	cycle power or reset unit If fault persists, contact your Rockwell Automation representative or distributor.
alternating red/green	self-test	none
alternating red/off	incorrect node configuration	check network address and other ControlNet configuration parameters

 A or  B	Cause:	Action:
off	channel disabled	program network for redundant media, if required
steady green	normal operation	none
flashing green/off	temporary errors	none; unit will self-correct
	node is not configured to go on line	make sure the configuration keeper node is present and working ^①
flashing red/off	media fault	check media for broken cables, loose connectors, missing terminators, etc.
	no other nodes present on network	add other nodes to the network
flashing red/green	incorrect network configuration	cycle power or reset unit If fault persists, contact your Rockwell Automation representative or distributor.

^① The configuration keeper node is the node responsible for distributing ControlNet configuration data to all nodes on the network.

Important: The LEDs do not apply to the network access port (NAP) connection.

Removing IOLinx Software

Use the Start menu or the Add/Remove control panel applet to uninstall the IOLinx software.

Important: Uninstall will not succeed if the IOLinx folder is active on the desktop.

You see:

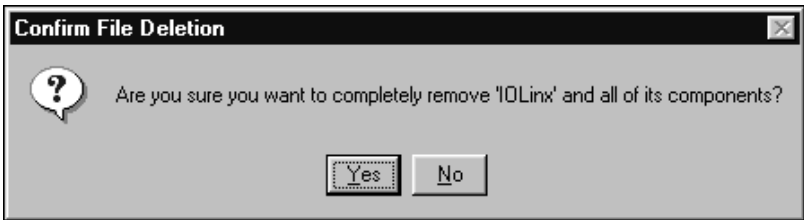

1. Select from this decision table.

If you want to	press
remove the IOLinx software	Yes You see the progress bar, which indicates the percentage of files removed from your machine.
retain the IOLinx files on your machine	No

2. Press OK.

When removal is complete, you see a confirmation message.

3. Press OK.

4. Restart your machine.

CSA Hazardous Location Approval

CSA certifies products for general use as well as for use in hazardous locations. **Actual CSA certification is indicated by the product label** as shown below, and not by statements in any user documentation.

Example of the CSA certification product label



To comply with CSA certification for use in hazardous locations, the following information becomes a part of the product literature for this CSA-certified industrial control product.

- This equipment is suitable for use in Class I, Division 2, Groups A, B, C, D, or non-hazardous locations only.
- The products having the appropriate CSA markings (that is, Class I Division 2, Groups A, B, C, D), are certified for use in other equipment where the suitability of combination (that is, application or use) is determined by the CSA or the local inspection office having jurisdiction.

Important: Due to the modular nature of a programmable control system, the product with the highest temperature rating determines the overall temperature code rating of a programmable control system in a Class I, Division 2 location. The temperature code rating is marked on the product label as shown.

Temperature code rating

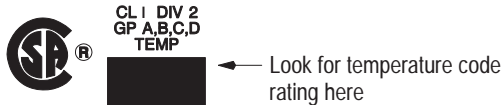

The following warnings apply to products having CSA certification for use in hazardous locations.



WARNING: Explosion hazard —

- Substitution of components may impair suitability for Class I, Division 2.
- Do not replace components unless power has been switched off or the area is known to be non-hazardous.
- Do not disconnect equipment unless power has been switched off or the area is known to be non-hazardous.
- Do not disconnect connectors unless power has been switched off or the area is known to be non-hazardous. Secure any user-supplied connectors that mate to external circuits on this equipment by using screws, sliding latches, threaded connectors, or other means such that any connection can withstand a 15 Newton (3.4 lb.) separating force applied for a minimum of one minute.
- Batteries must be changed only in an area known to be non-hazardous.

CSA logo is a registered trademark of the Canadian Standards Association.

Approbation d'utilisation dans des emplacements dangereux par la CSA

La CSA certifie les produits d'utilisation générale aussi bien que ceux qui s'utilisent dans des emplacements dangereux. **La certification CSA en vigueur est indiquée par l'étiquette du produit** et non par des affirmations dans la documentation à l'usage des utilisateurs.

Exemple d'étiquette de certification d'un produit par la CSA



Pour satisfaire à la certification de la CSA dans des endroits dangereux, les informations suivantes font partie intégrante de la documentation ce produit industriel de contrôle certifié par la CSA.

- Cet équipement convient à l'utilisation dans des emplacements de Classe 1, Division 2, Groupes A, B, C, D, ou ne convient qu'à l'utilisation dans des endroits non dangereux.
- Les produits portant le marquage approprié de la CSA (c'est à dire, Classe 1, Division 2, Groupes A, B, C, D) sont certifiés à l'utilisation pour d'autres équipements où la convenance de combinaison (application ou utilisation) est déterminée par la CSA ou le bureau local d'inspection qualifié.

Important: Par suite de la nature modulaire du système de contrôle programmable, le produit ayant le taux le plus élevé de température détermine le taux d'ensemble du code de température du système de contrôle d'un programmable dans un emplacement de Classe 1, Division 2. Le taux du code de température est indiqué sur l'étiquette du produit.

Taux du code de température



CL 1 DIV 2
GP A,B,C,D
TEMP



← Le taux du code de température est indiqué ici

Les avertissements suivants s'appliquent aux produits ayant la certification CSA pour leur utilisation dans des emplacements dangereux.



AVERTISSEMENT: Risque d'explosion —

- La substitution de composants peut rendre ce matériel inacceptable pour les emplacements de Classe 1, Division 2.
- Couper le courant ou s'assurer que l'emplacement est désigné non dangereux avant de remplacer les composants.
- Avant de débrancher l'équipement, couper le courant ou s'assurer que l'emplacement est désigné non dangereux.
- Avant de débrancher les connecteurs, couper le courant ou s'assurer que l'emplacement est reconnu non dangereux. Attacher tous connecteurs fournis par l'utilisateur et reliés aux circuits externes de cet appareil à l'aide de vis, loquets coulissants, connecteurs filetés ou autres moyens permettant aux connexions de résister à une force de séparation de 15 Newtons (3,4 lb. - 1,5 kg) appliquée pendant au moins une minute.
- Afin d'éviter tout risque d'explosion, s'assurer que l'emplacement est désigné non dangereux avant de changer la batterie.

Le sigle CSA est la marque déposée de l'Association des Standards pour le Canada.

Specifications

The operating parameters describe the environment within the KTCS slot. Refer to the documentation for your computer for environmental requirements. The card should not exceed those specifications.

General Specifications





Characteristic	Value
Power Requirements	5V dc, 640mA Maximum
Conductor	Category 2 ¹

Environmental Specifications

	Operating	Nonoperating
Slot Temperature	0 to 50° C (32 to 122° F)	-40 to 85° C (-40 to 185° F)
Humidity	5 to 95% without condensation	5 to 95% without condensation
Vibration	10 to 150 Hz, constant .012 in displacement 10 to 150 Hz, constant 2.0G acceleration	not applicable
Shock	30G peak/11 ms	50G peak/11 ms

Agency Certification

(when product or packaging is marked)

-   Class 1, Division 2 Groups A, B, C, D
-  marked for all applicable directives
-  **FM**
APPROVED

¹ Refer to the Industrial Automation Wiring and Grounding Guidelines for Noise Immunity, publication 1770-4.1

DH+, FLEX I/O, IOLinx, PanelView, and PLC-5/40C are trademarks of Rockwell Automation.
ControlNet is a trademark of ControlNet International.
WINTelligent LINX and WINTelligent LINX Gateway are trademarks of Rockwell Software Inc.
Ethernet is a registered trademark of Digital Equipment Corporation, Intel, and Xerox Corporation.
Windows NT is a trademark of Microsoft Corporation.



Allen-Bradley

Worldwide representation.



Argentina • Australia • Austria • Bahrain • Belgium • Brazil • Bulgaria • Canada • Chile • China, PRC • Colombia • Costa Rica • Croatia • Cyprus • Czech Republic • Denmark • Ecuador • Egypt • El Salvador • Finland • France • Germany • Greece • Guatemala • Honduras • Hong Kong • Hungary • Iceland • India • Indonesia • Ireland • Israel • Italy • Jamaica • Japan • Jordan • Korea • Kuwait • Lebanon • Malaysia • Mexico • Netherlands • New Zealand • Norway • Pakistan • Peru • Philippines • Poland • Portugal • Puerto Rico • Qatar • Romania • Russia-CIS • Saudi Arabia • Singapore • Slovakia • Slovenia • South Africa, Republic • Spain • Sweden • Switzerland • Taiwan • Thailand • Turkey • United Arab Emirates • United Kingdom • United States • Uruguay • Venezuela • Yugoslavia

Rockwell Automation Headquarters, 1201 South Second Street, Milwaukee, WI 53204 USA
Tel: (1) 414 382-2000 Fax: (1) 414 382-4444