



Allen-Bradley

1336 PLUS II Adjustable Frequency AC Drive

with

SENSORLESS VECTOR

0.37-448 kW (0.5 - 600 HP)
Firmware 1.xxx - 6.xxx



User Manual

**Rockwell
Automation**

Important User Information

Solid state equipment has operational characteristics differing from those of electromechanical equipment. “*Safety Guidelines for the Application, Installation and Maintenance of Solid State Controls*” (Publication SGI-1.1 available from your local Rockwell Automation Sales Office or online at www.rockwellautomation.com/literature) describes some important differences between solid state equipment and hard-wired electromechanical devices. Because of this difference, and also because of the wide variety of uses for solid state equipment, all persons responsible for applying this equipment must satisfy themselves that each intended application of this equipment is acceptable.

In no event will Rockwell Automation, Inc. be responsible or liable for indirect or consequential damages resulting from the use or application of this equipment.

The examples and diagrams in this manual are included solely for illustrative purposes. Because of the many variables and requirements associated with any particular installation, Rockwell Automation, Inc. cannot assume responsibility or liability for actual use based on the examples and diagrams.

No patent liability is assumed by Rockwell Automation, Inc. with respect to use of information, circuits, equipment, or software described in this manual.

Reproduction of the contents of this manual, in whole or in part, without written permission of Rockwell Automation, Inc. is prohibited.

Throughout this manual we use notes to make you aware of safety considerations.



ATTENTION: Identifies information about practices or circumstances that can lead to personal injury or death, property damage, or economic loss.

Attentions help you:

- identify a hazard
- avoid the hazard
- recognize the consequences

Important: Identifies information that is especially important for successful application and understanding of the product.



Shock Hazard labels may be located on or inside the drive to alert people that dangerous voltage may be present.

Summary of Changes

New/Updated Information

The information below summarizes the changes to the 1336 PLUS II User Manual since the last release.

Description of Change	Page(s)
TB1 info updated - D Frame	2-15 , B-18
Updated Parameters:	
[Load Loss Level]	6-26
[Phase Loss Level]	6-35
[Heatsink Temp]	6-39
[Drive Type]	6-42
New Parameters:	
[Motor OL Ret]	6-35
Parameter Cross References updated	A-8
Parameter Record updated	A-17

Notes

Table of Contents

Information and Precautions	Chapter 1	
	Manual Objectives	1-1
	Software Compatibility	1-1
	General Precautions	1-2
	Conventions Used in this Manual	1-2
	Catalog Number Explanation	1-2
	Nameplate Location	1-4
Installation/Wiring	Chapter 2	
	Mounting	2-1
	Installation Guidelines	2-2
	AC Supply Source	2-3
	Input Power Conditioning	2-4
	Input Fuses and Circuit Breakers	2-5
	Input Devices	2-9
	Electrical Interference - EMI/RFI	2-9
	RFI Filtering	2-10
	CE Conformity	2-10
	Grounding	2-11
	Power Cabling	2-14
	Control and Signal Wiring	2-24
	Digital Inputs	2-25
	Encoder Inputs	2-30
	Pulse Input/Output Option	2-31
	Digital Outputs	2-31
	Analog I/O	2-32
	Standard Analog I/O Setup	2-33
	Optional Analog I/O Configurations	2-34
	Output Devices	2-37
	Cable Termination	2-37
	Selecting/Verifying Fan Voltage	2-38
	Auxiliary Inputs - TB4, TB6	2-39
	Auxiliary Output - TB9	2-40
	Control Interface Board Installation and Removal	2-40
	Adapter Definitions	2-41
Human Interface Module	Chapter 3	
	HIM Description	3-1
	HIM Operation	3-4
	Handheld HIM Operation	3-13
Flash Memory	Chapter 4	
	What is Flash Memory?	4-1
	Firmware Download Requirements	4-1

	Chapter 5	
Start-Up	Start-Up Requirements	5-1
	Initial Operation	5-2
	Assisted Start-Up	5-2
	Advanced Start-Up	5-5
	Chapter 6	
Programming	Function Index	6-1
	Programming Flow Chart	6-1
	Chapter Conventions	6-4
	Chapter 7	
Troubleshooting	Fault Descriptions	7-1
	Alarms	7-9
	Appendix A	
Specifications and Supplemental Information	Specifications	A-1
	User Supplied Enclosures	A-4
	Derating Guidelines	A-5
	Parameter Cross Reference - By Number	A-8
	Parameter Cross Reference - By Name	A-9
	HIM Character Map	A-10
	Communications Data Information Format	A-11
	Typical Programmable Controller Communications Configurations	A-12
	Typical Serial Communications Configurations	A-13
	Encoder Interface Wiring	A-14
	Read/Write Parameter Record	A-17
	Appendix B	
Dimensions		
	Appendix C	
CE Conformity	Requirements for Conforming Installation	C-2
	Filter	C-2
	Electrical Configuration	C-3
	Grounding	C-4
	Mechanical Configuration	C-4

Information and Precautions

Chapter 1 provides information on the general intent of this manual, gives an overall description of the 1336 PLUS II Adjustable Frequency AC Drive and provides a listing of key drive features.

Manual Objectives

This publication provides planning, installation, wiring and diagnostic information for the 1336 PLUS II Drive. To assure successful installation and operation, the material presented must be thoroughly read and understood before proceeding. Particular attention must be directed to the Attention and Important statements contained within.

For J Frame information, refer to publication 1336F-IN014.

Software Compatibility

Three-Phase Drive Rating ¹			Compatible with Version . . .	Frame Reference
200-240V	380-480V	500-600V		
0.37-0.75 kW 0.5-1 HP	0.37-1.2 kW 0.5-1.5 HP	–	1.0 & Up	A1
1.2-1.5 kW 1.5-2 HP	1.5-2.2 kW 2-3 HP	–	1.0 & Up	A2
2.2-3.7 kW 3-5 HP	3.7 kW 5 HP	–	1.0 & Up	A3
5.5 kW 7.5 HP	5.5-15 kW 7.5-20 HP	0.75-15 kW 1-20 HP	1.0 & Up	A4
5.5-11 kW 7.5-15 HP	11-22 kW 15-30 HP	–	1.0 & Up	B1/B2
15-22 kW 20-30 HP	30-45 kW 40-60 HP	18.5-45 kW 25-60 HP	1.0 & Up	C
30-45 kW 40-60 HP	45-112 kW 60-150 HP	56-93 kW 75-125 HP	1.0 & Up	D
56-93 kW 75-125 HP	112-187 kW 150-250 HP	112-224 kW 150-300 HP	1.0 & Up	E
–	187-336 kW 250-450 HP	261-298 kW 350-400 HP	1.0 & Up	F
–	187-448 kW 250-600 HP	224-448 kW 300-600 HP	1.0 & Up	G

¹ kW and HP are constant torque.

General Precautions



ATTENTION: This drive contains ESD (Electrostatic Discharge) sensitive parts and assemblies. Static control precautions are required when installing, testing, servicing or repairing this assembly. Component damage may result if ESD control procedures are not followed. If you are not familiar with static control procedures, reference A-B publication 8000-4.5.2, “Guarding Against Electrostatic Damage” or any other applicable ESD protection handbook.



ATTENTION: An incorrectly applied or installed drive can result in component damage or a reduction in product life. Wiring or application errors, such as, undersizing the motor, incorrect or inadequate AC supply, or excessive ambient temperatures may result in malfunction of the system.



ATTENTION: Only personnel familiar with the 1336 PLUS II Adjustable Frequency AC Drive and associated machinery should plan or implement the installation, start-up and subsequent maintenance of the system. Failure to comply may result in personal injury and/or equipment damage.



ATTENTION: To avoid a hazard of electric shock, verify that the voltage on the bus capacitors has discharged before performing any work on the drive. Measure the DC bus voltage at the + & - terminals of TB1. The voltage must be 0.0V DC.

Conventions Used in this Manual

To help differentiate parameter names and display text from other text the following conventions will be used:

- Parameter Names will appear in [brackets]
- Display Text will appear in “quotes”

Catalog Number Explanation

The diagram on the following page describes the 1336 PLUS II catalog numbering scheme.

1336F – BR

F30 – AA

– EN – MODS

First Position
Bulletin Number

Second Position
Voltage

Letter	Voltages
AQ	200-240V AC or 310V DC
BR	380-480VAC or 513-620V DC
CW	500-600V AC or 775V DC
A	200-240V AC
B	380-480V AC
BP/BPR ^④	380-480V AC (F Frame)
BX	Special Rating
C	500-600V AC
CP/CPR ^④	500-600V AC (F Frame)
Q	310V DC
R	513-620V DC
RX	Special Rating
W	775V DC

Third Position
Nominal HP Rating

Refer to table below for ratings and possible voltage combinations.

Fourth Position
Enclosure Type

Code	Type
AA	IP 20 (NEMA 1)
AE	IP 20 (NEMA 1)/EMC
AF	IP 65 (NEMA 4) ^③
AJ	IP 54 (NEMA 12) ^③
AN	IP 00 (Open)

Fifth Position
Language Group^①

Code	Language
EN	English
FR	French
DE	German
IT	Italian
ES	Spanish
JP	Japanese ^⑤

Sixth Position
Options

Voltage and Nominal HP Rating Combinations

Code	Rating	AQ	BR	CW	A	B	BP/BPR	BX	C	CP/CPR	Q	R	RX	W
F05	0.37 (0.5)	●	●											
F07	0.56 (0.75)	●	●											
F10	0.75 (1)	●	●	●										
F15	1.2 (1.5)	●	●											
F20	1.5 (2)	●	●	●										
F30	2.2 (3)	●	●	●										
F50	3.7 (5)	●	●	●										
F75	5.5 (7.5)	●	●	●										
F100	7.5 (10)		●	●										
F150	11 (15)		●	●										
F200	15 (20)		●	●										
007	5.5 (7.5)				●						●			
010	7.5 (10)				●						●			
015	11 (15)				●	●					●	●		
020	15 (20)				●	●					●	●		
025	18.5 (25)				●	●			●		●	●		●
030	22 (30)				●	●			●		●	●		●
040	30 (40)				●	●		●			●	●	●	●
050	37 (50)				●	●			●		●	●	●	●
060	45 (60)				●	●		●	●		●	●	●	●
075	56 (75)				●	●			●		●	●	●	●
100	75 (100)				●	●			●		●	●	●	●
125	93 (125)				●	●			●		●	●	●	●
150	112 (150)				●	●		●	●		●	●	●	●
200	149 (200)				●	●			●		●	●	●	●
250	187 (250) ^②				●	●	●	●	●		●	●	●	●
300	224 (300) ^②				●	●		●	●		●	●	●	●
350	261 (350) ^②				●	●		●	●	●	●	●	●	●
400	298 (400) ^②				●	●		●	●	●	●	●	●	●
450	336 (450) ^②				●	●		●	●		●	●	●	●
500	373 (500) ^②				●	●		●	●		●	●	●	●
600	448 (600)				●	●		●	●		●	●	●	●

① Language must be specified to ensure shipment of appropriate User Manual.
 ② G Frame Standard Drives in enclosed construction are supplied through the *Configured Drives Program* and will have an "A" suffix after the HP rating.
 ③ D through G Frame drives in IP 65 (NEMA Type 4) and IP 54 (NEMA Type 12) configurations are supplied through the *Configured Drives Program*.
 ④ "xPR" has a "roll-in" type chassis. ⑤ Not available with v5.001 & later.

Code	Description
Human Interface Module, Snap-In, IP20 (NEMA Type 1)	
HASB	Snap-In Cradle/Blank Plate
HASP	Programmer Only
HCSP	Programmer Only & Upload/Download Capability
HAS1	Programmer/Controller w/Analog Pot
HCS1	Programmer/Controller w/Analog Pot & Upload/Download Capability
HAS2	Programmer/Controller w/Digital Pot
HCS2	Programmer/Controller w/Digital Pot & Upload/Download Capability
Human Interface Module, IP65/54 (NEMA Type 4/12)	
HJP	Programmer Only
HJ2	Programmer/Controller w/Digital Pot
Communication Options – B Frame & Up (Adapter 6)	
GM1	Single Point Remote I/O B Frame
GM2	RS-232/422/485, DF1 & DH485 B Frame
GM5	DeviceNet™
GM6	Enhanced DeviceNet™
Communication Options – All Frames (Adapter 1)	
GMS1	GM1 with Snap-In Cradle
GMS2	GM2 with Snap-In Cradle
GMS5	GM5 with Snap-In Cradle
GMS6	GM6 with Snap-In Cradle
Control Interface Options	
L4	TTL Contact
L4E	TTL Contact & Encoder Feedback
L7E	TTL Contact & Encoder Fdbck. for use with Encoder Loss Detection
L5	24V AC/DC
L5E	24V AC/DC & Encoder Feedback
L8E	24V AC/DC & Encoder Feedback for use with Encoder Loss Detection
L6	115V AC
L6E	115V AC & Encoder Feedback
L9E	115V AC & Encoder Feedback for use with Encoder Loss Detection
Analog Interface Options – Slot A	
• Choose No More than One – Configurable Inputs/Outputs are 10V or 20mA	
LA2	Two Isolated Configurable Inputs
LA6	One Isolated Bi-polar Input (±10V or ±20mA) and One Isolated Thermistor Input
LA7	One Isolated Bi-polar Input (±10V or ±20mA) and One Isolated Configurable Input
Analog Interface Options – Slot B	
• Choose No More than One – Configurable Inputs/Outputs are 10V or 20mA	
LA1	Single-ended, Non-isolated Configurable (including Pot) Input & 2 Single-ended, Non-isolated Outputs (1 - Configurable, 1 - 20mA)
LA3	Two Isolated Configurable Outputs
LA4	One Isolated Configurable Input & Output
LA5	Isolated Pulse Input, Non-isolated Pulse Output & Single-ended, Non-isolated Configurable Output
Common Mode Choke – F & G Frame (must be specified for F Frame)	
CM	Internal Common Mode Choke (factory installed)
NCM	No Common Mode Choke

Nameplate Location

Figure 1.1
1336 PLUS II Nameplate Location

¹ Refer to page 1-1 for frame reference classifications.

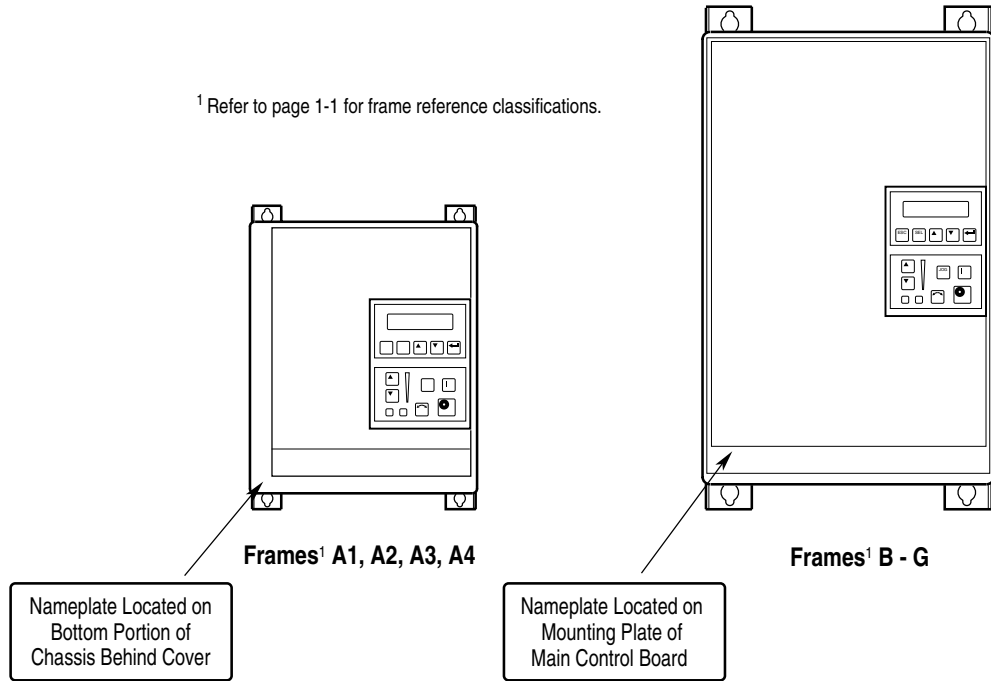

Installation/Wiring

Chapter 2 provides the information you need to properly mount and wire the 1336 PLUS II Drive. Since most start-up difficulties are the result of incorrect wiring, every precaution must be taken to assure that the wiring is done as instructed. All items must be read and understood before the actual installation begins.



ATTENTION: The following information is merely a guide for proper installation. The Allen-Bradley Company cannot assume responsibility for the compliance or the noncompliance to any code, national, local or otherwise for the proper installation of this drive or associated equipment. A hazard of personal injury and/or equipment damage exists if codes are ignored during installation.

Mounting

Minimum Mounting Requirements for Proper Heat Dissipation (Dimensions shown are between drives or other devices)

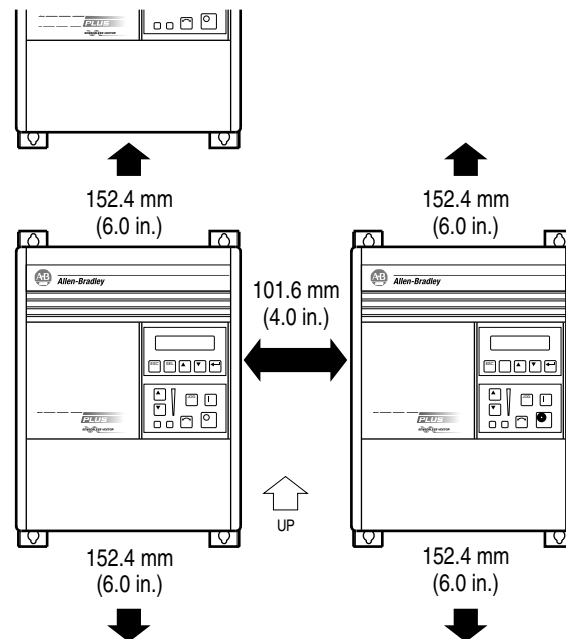

Important:

A4 Frame drives should not be mounted on a combustible surface. However, if the drive must be mounted on a combustible surface, 6.35 mm (0.25 in.) spacers must be provided under the mounting feet of the drive.

F Frame drives require a minimum of 152.4 mm (6.0 in.) between the drive back and mounting wall, if drives are mounted with sides touching another device or wall. A minimum of 76.2 mm (3.0 in.) is required on the sides if the back of the drive is mounted against a wall or other device.

Installation Guidelines

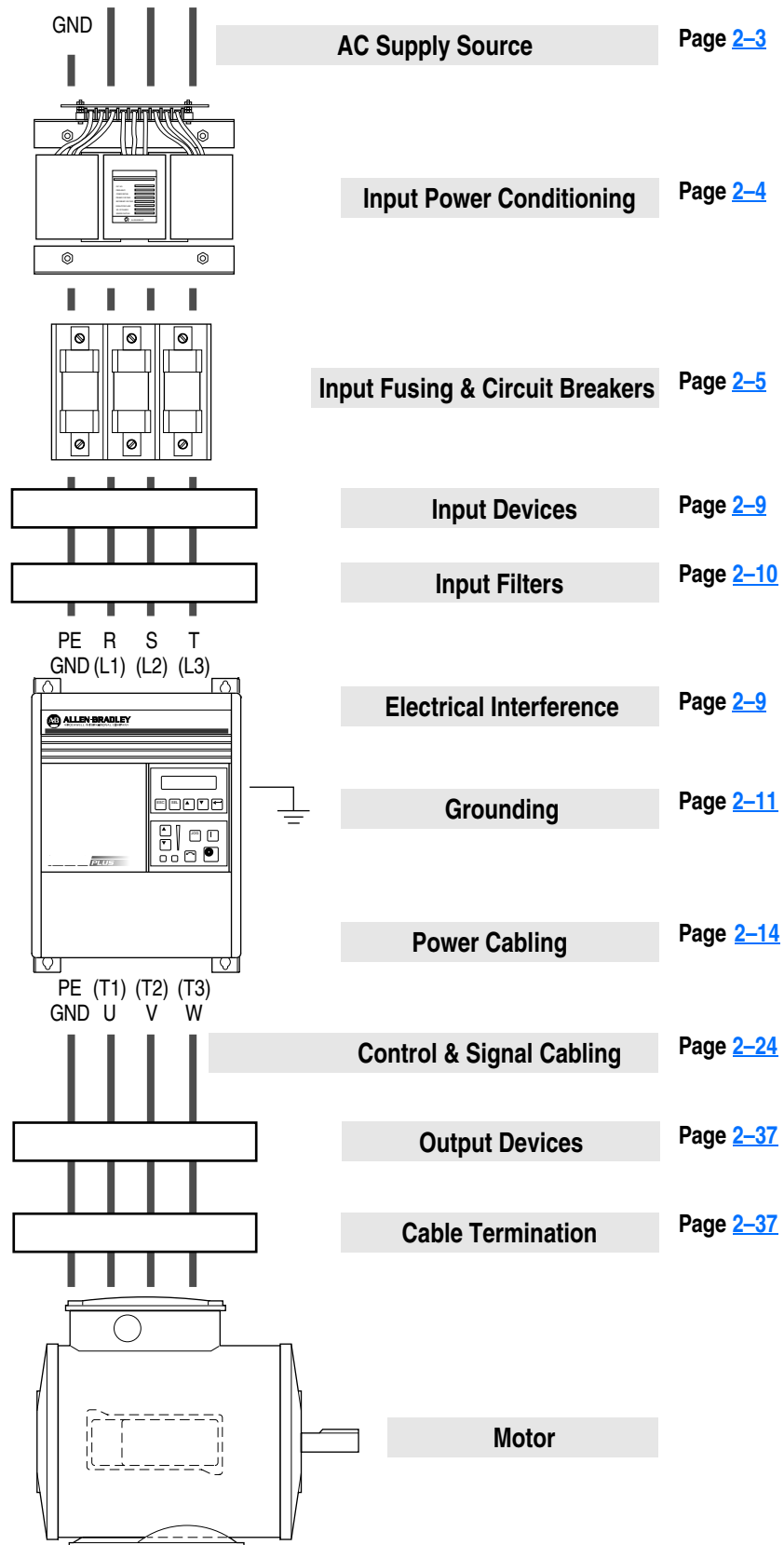

AC Supply Source

1336 PLUS II drives are suitable for use on a circuit capable of delivering up to a maximum of 200,000 rms symmetrical amperes, 600 volts. Refer to Table [2.A](#) for actual interrupt ratings based on fuse or circuit breaker choice.



ATTENTION: To guard against personal injury and/or equipment damage caused by improper fusing, use only the recommended line fuses specified in [Table 2.A](#).

Unbalanced Distribution Systems

This drive is designed to operate on three-phase supply systems whose line voltages are symmetrical. Surge suppression devices are included to protect the drive from lightning induced overvoltages between line and ground. Where the potential exists for abnormally high phase-to-ground voltages (in excess of 125% of nominal), or where the supply ground is tied to another system or equipment that could cause the ground potential to vary with operation, suitable isolation is required for the drive. Where this potential exists, an isolation transformer is strongly recommended.

Ungrounded Distribution Systems

All 1336 PLUS II drives are equipped with an MOV (Metal Oxide Varistor) that provides voltage surge protection and phase-to-phase plus phase-to-ground protection which is designed to meet IEEE 587. The MOV circuit is designed for surge suppression only (transient line protection), not continuous operation.

With ungrounded distribution systems, the phase-to-ground MOV connection could become a continuous current path to ground. Energy ratings are listed below. Exceeding the published phase-to-phase or phase-to-ground energy ratings may cause physical damage to the MOV. Refer to page A-1.

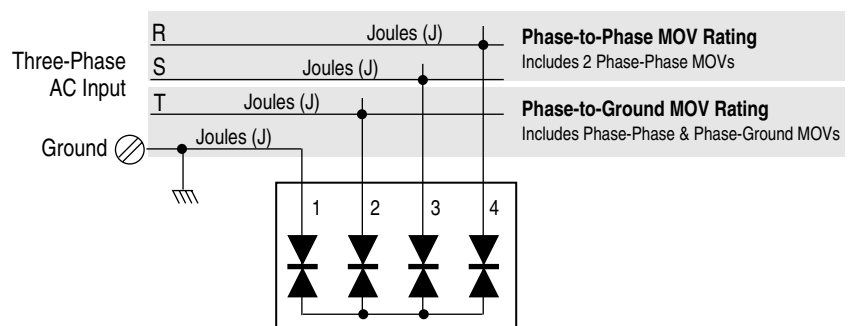

Frame Reference	A		B-C		D-G	
Device Rating (V AC)	240	480/600	240/480	600	240/480	600
Phase-Phase Total	160J	320J	280J	320J	280J	300J
Phase-Ground Total	220J	380J	360J	410J	360J	370J

Input Power Conditioning

In general, the 1336 PLUS II is suitable for direct connection to an AC line of the correct voltage. Certain conditions can exist, however, that prompt consideration of a line reactor or isolation transformer ahead of the drive.

The basic rules to aid in determining whether a line reactor or isolation transformer should be considered are as follows:

1. If the AC source experiences frequent power outages or significant voltage transients, users should calculate the VA_{max} (see formula below). If the source transformer VA exceeds the calculated VA_{max} and the drive is installed close to the source, it is an indication that there may be enough energy behind these voltage transients to cause nuisance input fuse blowing, overvoltage faults or drive power structure damage. In these cases, a line reactor or isolation transformer should be considered.

$$Z_{drive} (\Omega/\Phi) = \frac{V_{line-line}}{\sqrt{3} \times \text{Input Amps}}$$

$$VA_{max} = \frac{(V_{line-line})^2 \times \% \text{ Source Leakage (5-6\% typical)}}{Z_{drive} \times 0.01}$$

2. If the AC source does not have a neutral or one phase referenced to ground (see *Unbalanced Distribution Systems* on page [2-3](#)), an isolation transformer with the neutral of the secondary grounded is **highly recommended**. If the line-to-ground voltages on any phase can exceed 125% of the nominal line-to-line voltage, an isolation transformer with the neutral of the secondary grounded, is **highly recommended**.
3. If the AC line supplying the drive has power factor correction capacitors that are switched in and out, an isolation transformer or 5% line reactor is recommended between the drive and capacitors. If the capacitors are permanently connected and not switched, the general rules above apply.

Input Fuses and Circuit Breakers

The 1336 PLUS II can be installed with either input fuses or an input circuit breaker. Local/national electrical codes may determine additional requirements for these installations.

The tables on the following pages provide drive ratings and recommended AC line input fuse and circuit breaker information. Both types of short circuit protection are acceptable for UL and IEC requirements. Sizes listed are the recommended sizes based on 40 degree C and the U.S. N.E.C. Other country, state or local codes may require different ratings.



ATTENTION: The 1336 PLUS II does not provide input power short circuit protection. Specifications for the recommended fuse or circuit breaker to provide drive input power protection against short circuits are provided.

Fusing

If fuses are chosen as the desired protection method, refer to the recommended types listed below. If available amp ratings do not match the tables provided, the closest fuse rating that exceeds the drive rating should be chosen.

- IEC – BS88 (British Standard) Parts 1 & 2¹, EN60269-1, Parts 1 & 2, type gG or equivalent should be used.
- UL – UL Class CC, T, RK1 or J must be used.

Circuit Breakers

The “non-fuse” listings in the following tables include both circuit breakers (inverse time or instantaneous trip) and 140M Self-Protecting Motor Starters. **If one of these is chosen as the desired protection method**, the following requirements apply.

- IEC and UL – Both types of devices are acceptable for IEC and UL installations

1. Typical designations include, but may not be limited to the following; Parts 1 & 2: AC, AD, BC, BD, CD, DD, ED, EFS, EF, FF, FG, GF, GG, GH.

Table 2.A
240 Volt Input Protection Devices

Frame	Drive Catalog Number 1336F-	HP	Input Rating Amps	Output Rating Amps	Dual-Element Time Delay Fuse		Non-Time Delay Fuse		Circuit Breaker ³	Motor Circuit Protector ^{4,9}	140M Motor Starter with Adjustable Current Range ^{5, 6}			
					Min. ¹	Max. ²	Min. ¹	Max. ²			Max. ⁸	Max. ⁸	Available Catalog Numbers ⁷	
A1	F05	0.5	2.8	2.3	4	5	4	6	15	3	140M-C2E-B40	140M-D8E-B40	-	-
	F07	0.75	3.5	3.0	4	6	4	9	15	7	140M-C2E-B40	140M-D8E-B40	-	-
	F10	1	5.4	4.5	6	9	6	12	15	7	140M-C2E-B63	140M-D8E-B63	-	-
A2	F15	1.5	7.3	6.0	8	12.5	8	15	20	15	140M-C2E-C10	140M-D8E-C10	140M-F8E-C10	-
	F20	2	9.7	8.0	10	15	10	20	25	15	140M-C2E-C10	140M-D8E-C10	140M-F8E-C10	-
A3	F30	3	14.3	12.0	15	20	15	25	35	15	140M-C2E-C16	140M-D8E-C16	140M-F8E-C16	-
	F50	5	21.3	18.0	25	30	25	45	60	30	140M-C2E-C25	140M-D8E-C25	140M-F8E-C25	140M-CMN-2500
	F75	7.5	22.6	22.0	30	45	30	60	80	50	140M-C2E-C25	140M-D8E-C25	140M-F8E-C25	140M-CMN-2500
B	007	7.5	28.0	27.0	40	45	40	60	80	50	-	-	140M-F8E-C32	140M-CMN-4000
	010	10	35.0	34.0	50	60	50	80	100	50	-	-	-	140M-CMN-4000
	015	15	49.0	48.0	70	90	70	110	150	70	-	-	-	140M-CMN-6300
C	020	20	63.0	65.0	100	110	100	125	200	100	-	-	-	140M-CMN-9000
	025	25	75.0	77.0	100	150	100	200	250	100	-	-	-	140M-CMN-9000
	030	30	79.0	80.0	125	175	125	225	300	150	-	-	-	140M-CMN-9000
D	040	40	119.0	120.0	120	225	120	300	300	150	-	-	-	-
	050	50	149.0	150.0	200	250	200	350	350	250	-	-	-	-
	060	60	178.0	180.0	250	300	250	450	450	250	-	-	-	-
E	075	75	238.0	240.0	300	400	300	500	500	250	-	-	-	-
	100	100	289.0	291.0	400	500	400	700	700	400	-	-	-	-
	125	125	322.0	325.0	450	700	450	800	800	600	-	-	-	-

¹ Minimum protection device size is the lowest rated device that supplies maximum protection without nuisance tripping.

² Maximum protection device size is the highest rated device that supplies drive protection.

³ Circuit Breaker - inverse time breaker.

⁴ Motor Circuit Protector - instantaneous trip circuit breaker.

⁵ Bulletin 140M with adjustable current range should have the current trip set to the minimum range that the device will not trip.

⁶ Manual Self-Protected (Type E) Combination Motor Controller, UL listed for 208 Wye or Delta, 240 Wye or Delta, 480Y/277 or 600Y/347. Not UL listed for use on 480V or 600V Delta/Delta systems.

⁷ The AIC ratings of the Bulletin 140M Motor Protector may vary. See publication 140M-SG001B-EN-P.

⁸ Maximum rating allowed by US NEC. Exact size must be chosen for each installation.

⁹ The Maximum Short Circuit Rating of a Cutler-Hammer Series HMCP is 100,000A at 240 volts, 65,000A at 480 volts and 25,000A at 575 volts.

Table 2.A (continued)
480 Volt Input Protection Devices

Frame	Drive Catalog Number 1336F-	CT Ratings			VT Ratings			Dual Element Time Delay Fuse		Non-Time Delay Fuse		Circuit Breaker ³	Motor Circuit Protector ^{4,9}	140M Motor Starter with Adjustable Current Range ^{5,6}							
		HP	Input		Output		HP	Input		Output				Min. ¹	Max. ²	Min. ¹	Max. ²	Max. ⁸	Max. ⁸	Available Catalog Numbers - 140... ⁷	
			Amps	Amps	Amps	Amps		Amps	Amps	Min. ¹	Max. ²	Min. ¹	Max. ²							Max. ⁸	Max. ⁸
A1	F05	0.5	1.3	1.1	0.5	1.4	1.2	3	2.5	3	3	15	3	M-C2E-B16	-	-	-	-			
	F07	0.75	2.0	1.6	0.75	2.1	1.7	3	3	3	6	15	3	M-C2E-B25	-	-	-	-			
	F10	1	2.6	2.1	1	2.8	2.3	3	4.5	3	8	15	3	M-C2E-B40	M-D8E-B40	-	-	-			
	F15	1.5	3.3	2.8	1.5	3.5	3.0	4	6	4	12	15	7	M-C2E-B40	M-D8E-B40	-	-	-			
A2	F20	2	4.6	3.8	2	4.8	4.0	5	6	5	12	15	7	M-C2E-C63	M-D8E-C63	-	-	-			
	F30	3	6.4	5.3	3	7.2	6.0	8	10	8	15	25	7	M-C2E-C10	M-D8E-C10	M-F8E-C10	-				
A3	F50	5	10.0	8.4	5	10.7	9.0	12	15	12	30	35	15	M-C2E-C16	M-D8E-C16	M-F8E-C16	-				
A4	F75	7.5	13.6	13.3	10	15.7	15.4	20	30	20	50	50	30	M-C2E-C16	M-D8E-C16	M-F8E-C16	-				
	F100	10	16.4	16.1	15	22.4	22.0	30	40	30	80	80	30	M-C2E-C25	M-D8E-C25	M-F8E-C25	-CMN-2500				
	F150	15	24.5	24.0	20	24.5	24.0	35	60	35	100	100	50	M-C2E-C25	M-D8E-C25	M-F8E-C25	-CMN-2500				
	F200	20	28.0	27.0	20	28.0	27.0	35	60	35	100	100	50	-	-	M-F8E-C32	-CMN-4000				
B	O15	15	25.0	24.2	20	28.0	27.0	35	60	35	100	100	50	-	-	M-F8E-C32	-CMN-4000				
	O20	20	32.0	31.0	25	35.0	34.0	45	70	45	125	125	50	-	-	M-F8E-C45	-CMN-4000				
	O25	25	40.0	39.0	30	43.0	42.0	60	90	60	150	150	70	-	-	M-F8E-C45	-CMN-6300				
	O30	30	46.0	45.0	30	49.0	48.0	70	90	70	150	150	70	-	-	-	-CMN-6300				
C	X040	40	61.0	59.0	40	61.0	59.0	80	110	80	200	200	70	-	-	-	-CMN-6300				
	O40	40	58.0	60.0	50	63.0	65.0	80	125	80	250	250	100	-	-	-	-CMN-6300				
	O50	50	73.0	75.0	60	75.0	77.0	100	150	100	300	300	100	-	-	-	-CMN-9000				
	X060	60	75.0	77.0	60	75.0	77.0	100	150	100	300	300	100	-	-	-	-CMN-9000				
D	O60	60	82.0	85.0	75	93.0	96.0	125	200	125	350	350	150	-	-	-	-				
	O75	75	105.0	106.0	100	119.0	120.0	150	250	150	450	350	250	-	-	-	-				
	100	100	137.0	138.0	125	149.0	150.0	200	350	200	600	450	250	-	-	-	-				
	125	125	172.0	173.0	150	178.0	180.0	250	400	250	600	500	250	-	-	-	-				
	X150	150	178.0	180.0	150	178.0	180.0	250	400	250	600	500	250	-	-	-	-				
E	150	150	197.0	199.0	200	238.0	240.0	300	500	300	700	700	400	-	-	-	-				
	200	200	261.0	263.0	250	290.0	292.0	400	600	400	800	800	400	-	-	-	-				
	250	250	322.0	325.0	250	322.0	325.0	450	600	450	800	800	400	-	-	-	-				
F	P250	250	322.0	325.0	300	357.0	360.0	450	-	-	-	-	-	-	-	-	-				
	P300	300	357.0	360.0	350	421.0	425.0	500	-	-	-	-	-	-	-	-	-				
	P350	350	421.0	425.0	400	471.0	475.0	600	-	-	-	-	-	-	-	-	-				
	P400	400	471.0	475.0	450	527.0	532.0	600	-	-	-	-	-	-	-	-	-				
	P450	450	527.0	532.0	-	-	-	700	-	-	-	-	-	-	-	-	-				
G	X250	250	322.0	325.0	300	357.0	360.0	450	-	-	-	-	-	-	-	-	-				
	300	300	357.0	360.0	350	421.0	425.0	450	-	-	-	-	-	-	-	-	-				
	350	350	421.0	425.0	400	471.0	475.0	500	-	-	-	-	-	-	-	-	-				
	400	400	471.0	475.0	450	521.0	525.0	600/630	-	-	-	-	-	-	-	-	-				
	450	450	521.0	525.0	500	585.0	590.0	800	-	-	-	-	-	-	-	-	-				
	500	500	585.0	590.0	600	664.0	670.0	800	-	-	-	-	-	-	-	-	-				
	600	600	664.0	670.0	600	664.0	670.0	900	-	-	-	-	-	-	-	-	-				

Semiconductor fuse supplied with drive.
Refer to the 1336 Spare Parts list (publication 1336-6.5) for replacement information.

Bussmann Type FWP, SPP, or 170M Series
Ferraz Shawmut Type A-70Q, A-70QS or A070URD Series

- 1 Minimum protection device size is the lowest rated device that supplies maximum protection without nuisance tripping.
- 2 Maximum protection device size is the highest rated device that supplies drive protection.
- 3 Circuit Breaker - inverse time breaker.
- 4 Motor Circuit Protector - instantaneous trip circuit breaker.
- 5 Bulletin 140M with adjustable current range should have the current trip set to the minimum range that the device will not trip.
- 6 Manual Self-Protected (Type E) Combination Motor Controller, UL listed for 208 Wye or Delta, 240 Wye or Delta, 480Y/277 or 600Y/347. Not UL listed for use on 480V or 600V Delta/Delta systems.
- 7 The AIC ratings of the Bulletin 140M Motor Protector may vary. See publication 140M-SG001B-EN-P.
- 8 Maximum rating allowed by US NEC. Exact size must be chosen for each installation.
- 9 The Maximum Short Circuit Rating of a Cutler-Hammer Series HMCP is 100,000A at 240 volts, 65,000A at 480 volts and 25,000A at 575 volts.

Table 2.A (continued)
575 Volt Input Protection Devices

Frame	Drive Catalog Number 1336F-	CT Ratings			Dual Element Time Delay Fuse		Non-Time Delay Fuse		Circuit Breaker ³	Motor Circuit Protector ^{4,9}	140M Motor Starter with Adjustable Current Range ^{5,6}			
		HP	Input	Output	Min. ¹	Max. ²	Min. ¹	Max. ²			Max. ⁸	Max. ⁸	Available Catalog Numbers ⁷	
			Amps	Amps	Min. ¹	Max. ²	Min. ¹	Max. ²	Max. ⁸	Max. ⁸				
A4	F10	1	2.4	2.0	3	3	3	6	15	3	140M-C2E-B25	–	–	–
	F20	2	4.8	4.0	6	6	6	10	15	7	140M-C2E-C63	140M-D8E-C63	–	–
	F30	3	7.2	6.0	10	12	10	15	15	7	140M-C2E-C10	140M-D8E-C10	140M-F8E-C10	–
	F50	5	9.6	8.0	15	20	15	20	20	15	140M-C2E-C10	140M-D8E-C10	140M-F8E-C10	–
	F75	7.5	10.0	10.0	15	20	15	30	35	15	140M-C2E-C10	140M-D8E-C10	140M-F8E-C10	–
	F100	10	12.0	12.0	20	25	20	40	40	15	140M-C2E-C16	140M-D8E-C16	140M-F8E-C16	–
	F150	15	19.0	19.0	25	35	25	60	60	30	140M-C2E-C20	140M-D8E-C20	140M-F8E-C20	140-CMN-2500
	F200	20	25.0	24.0	30	45	30	80	80	30	140M-C2E-C25	140M-D8E-C25	140M-F8E-C25	140-CMN-2500
C	025	25	31.0	30.0	40	60	40	100	100	50	–	–	140M-F8E-C32	140-CMN-4000
	030	30	36.0	35.0	50	70	50	125	125	50	–	–	140M-F8E-C45	140-CMN-4000
	040	40	44.0	45.0	60	90	60	150	150	70	–	–	140M-F8E-C45	140-CMN-6300
	050	50	55.0	57.0	80	110	80	200	200	70	–	–	–	140M-CMN-6300
	060	60	60.0	62.0	90	125	90	225	225	100	–	–	–	140M-CMN-6300
	075	75	84.0	85.0	110	150	110	300	300	100	–	–	–	140M-CMN-9000
D	100	100	108.0	109.0	150	200	150	350	350	150	–	–	–	–
	125	125	137.0	138.0	175	250	175	500	350	250	–	–	–	–
	150	150	167.0	168.0	225	300	225	500	400	250	–	–	–	–
E	200	200	251.0	252.0	350	400	350	600	500	250	–	–	–	–
	250	250	282.0	284.0	400	500	400	700	700	400	–	–	–	–
	X300	300	295.0	298.0	400	600	400	800	800	400	–	–	–	–
	P350	350	347.0	350.0	450									
G	P400	400	397.0	400.0	500									
	300	300	297.0	300.0	400									
	350	350	347.0	350.0	450									
	400	400	397.0	400.0	500									
	450	450	446.0	450.0	600/630									
	500	500	496.0	500.0	800									
	600	600	595.0	600.0	800									

Semiconductor fuse supplied with drive.
Refer to the 1336 Spare Parts list (publication 1336-6.5) for replacement information.

Bussmann Type FWP, SPP, or 170M Series
Ferraz Shawmut Type A-70Q, A-70QS or A070URD Series

- ¹ Minimum protection device size is the lowest rated device that supplies maximum protection without nuisance tripping.
- ² Maximum protection device size is the highest rated device that supplies drive protection.
- ³ Circuit Breaker - inverse time breaker.
- ⁴ Motor Circuit Protector - instantaneous trip circuit breaker.
- ⁵ Bulletin 140M with adjustable current range should have the current trip set to the minimum range that the device will not trip.
- ⁶ Manual Self-Protected (Type E) Combination Motor Controller, UL listed for 208 Wye or Delta, 240 Wye or Delta, 480Y/277 or 600Y/347. Not UL listed for use on 480V or 600V Delta/Delta systems.
- ⁷ The AIC ratings of the Bulletin 140M Motor Protector may vary. See publication 140M-SG001B-EN-P.
- ⁸ Maximum rating allowed by US NEC. Exact size must be chosen for each installation.
- ⁹ The Maximum Short Circuit Rating of a Cutler-Hammer Series HMCP is 100,000A at 240 volts, 65,000A at 480 volts and 25,000A at 575 volts.

Input Devices

Starting and Stopping the Motor



ATTENTION: The drive start/stop control circuitry includes solid-state components. If hazards due to accidental contact with moving machinery or unintentional flow of liquid, gas or solids exist, an additional hardwired stop circuit may be required to remove AC line power to the drive. When AC power is removed, there will be a loss of inherent regenerative braking effect & the motor will coast to a stop. An auxiliary braking method may be required.

Repeated Application/Removal of Input Power



ATTENTION: The drive is intended to be controlled by control input signals that will start and stop the motor. A device that routinely disconnects then reapplies line power to the drive for the purpose of starting and stopping the motor is not recommended.

Bypass Contactors



ATTENTION: An incorrectly applied or installed bypass system can result in component damage or reduction in product life. The most common causes are:

- Wiring AC line to drive output or control terminals.
- Improper bypass or output circuits not approved by Allen-Bradley.
- Output circuits which do not connect directly to the motor.

Contact Allen-Bradley for assistance with application or wiring.

Electrical Interference - EMI/RFI

Immunity

The immunity of 1336 PLUS II drives to externally generated interference is good. Usually, no special precautions are required beyond the installation practices provided in this publication.

It is recommended that the coils of DC energized contactors associated with drives be suppressed with a diode or similar device, since they can generate severe electrical transients.

Emission

Careful attention must be given to the arrangement of power and ground connections to the drive to avoid interference with nearby sensitive equipment. The cable to the motor carries switched voltages and should be routed well away from sensitive equipment.

The ground conductor of the motor cable should be connected to the drive ground (PE) terminal directly. Connecting this ground conductor to a cabinet ground point or ground bus bar may cause high frequency current to circulate in the ground system of the enclosure. The motor end of this ground conductor must be solidly connected to the motor case ground.

Shielded or armored cable may be used to guard against radiated emissions from the motor cable. The shield or armor should be connected to the drive ground (PE) terminal and the motor ground as outlined above.

Common mode chokes at the drive output can help reduce common mode noise on installations that do not use shielded cable. Common mode chokes can also be used on analog or communication cables. Refer to page [2-37](#) for further information.

An RFI filter can be used and in most situations provides an effective reduction of RFI emissions that may be conducted into the main supply lines.

If the installation combines a drive with sensitive devices or circuits, it is recommended that the lowest possible drive PWM carrier frequency be programmed.

RFI Filtering

1336 PLUS II drives can be installed with an RFI filter, which controls radio-frequency conducted emissions into the main supply lines and ground wiring.

If the cabling and installation recommendation precautions described in this manual are adhered to, it is unlikely that interference problems will occur when the drive is used with conventional industrial electronic circuits and systems. However, a filter may be required if there is a likelihood of sensitive devices or circuits being installed on the same AC supply.

Where it is essential that very low emission levels must be achieved or if conformity with standards is required the optional RFI filter must be used. Refer to *Appendix C* and instructions included with the filter for installation and grounding information.

CE Conformity

Refer to *Appendix C*.

Grounding

Refer to the grounding diagram on page [2-13](#). The drive must be connected to system ground at the power ground (PE) terminal provided on the power terminal block (TB1). Ground impedance must conform to the requirements of national and local industrial safety regulations (NEC, VDE 0160, BSI, etc.) and should be inspected and tested at appropriate and regular intervals.

In any cabinet, a single, low-impedance ground point or ground bus bar should be used. All circuits should be grounded independently and directly. The AC supply ground conductor should also be connected directly to this ground point or bus bar.

Sensitive Circuits

It is essential to define the paths through which the high frequency ground currents flow. This will assure that sensitive circuits do not share a path with such current. Control and signal conductors should not be run near or parallel to power conductors.

Motor Cable

The ground conductor of the motor cable (drive end) must be connected directly to the drive ground (PE) terminal, not to the enclosure bus bar. Grounding directly to the drive (and filter, if installed) can provide a direct route for high frequency current returning from the motor frame and ground conductor. At the motor end, the ground conductor should also be connected to the motor case ground.

If shielded or armored cables are used, the shield/armor should also be grounded at both ends as described above.

Encoder & Communications Cabling

If encoder connections or communications cables are used, the wiring must be separated from power cabling. This can be accomplished with carefully routed, shielded cable (ground cable shield at the drive end only) or a separate steel conduit (grounded at both ends).

Discrete Control and Signal Wiring

The control and signal wiring must be grounded at a single point in the system, remote from the drive. This means the 0V or ground terminal should be grounded at the equipment end, not the drive end. If shielded control and signal wires are used, the shield must also be grounded at this point.

If the control and signal wires are short, and contained within a cabinet which has no sensitive circuits, the use of shielded control and signal wiring may not be necessary, but is always recommended.

Shield Termination - TE (True Earth)

The TE terminal block (not available on A Frame drives) is used for all cable shields at the drive. It must be connected to an earth ground by a separate continuous lead. TE connections may exist on power and/or control terminal blocks to terminate shield cables for both power and control. Refer to [Figure 2.1](#) for locations.

Safety Ground - PE (Potential Earth)

This is the safety ground required by code. This point must be connected to adjacent building steel (girder, joist) or a floor ground rod, provided grounding points comply with national or local electric code regulations. If a cabinet ground bus is used, refer to *Grounding* on page [2-11](#).

RFI Filter

Important: Using an optional RFI filter may result in relatively high ground leakage currents. Surge suppression devices are also incorporated in the filter. Therefore, the filter must be permanently installed and solidly grounded to the supply neutral. Grounding must not rely on flexible cables and should not include any form of plug or socket that would permit inadvertent disconnection. The integrity of this connection should be periodically checked.

General Grounding

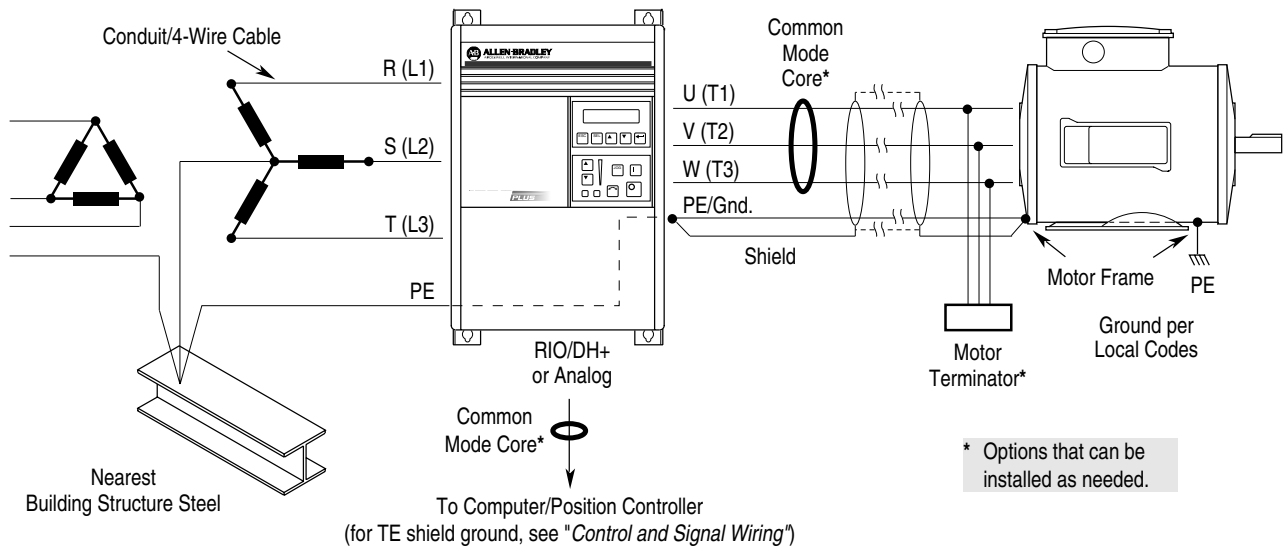

Single-Point Grounding/Panel Layout

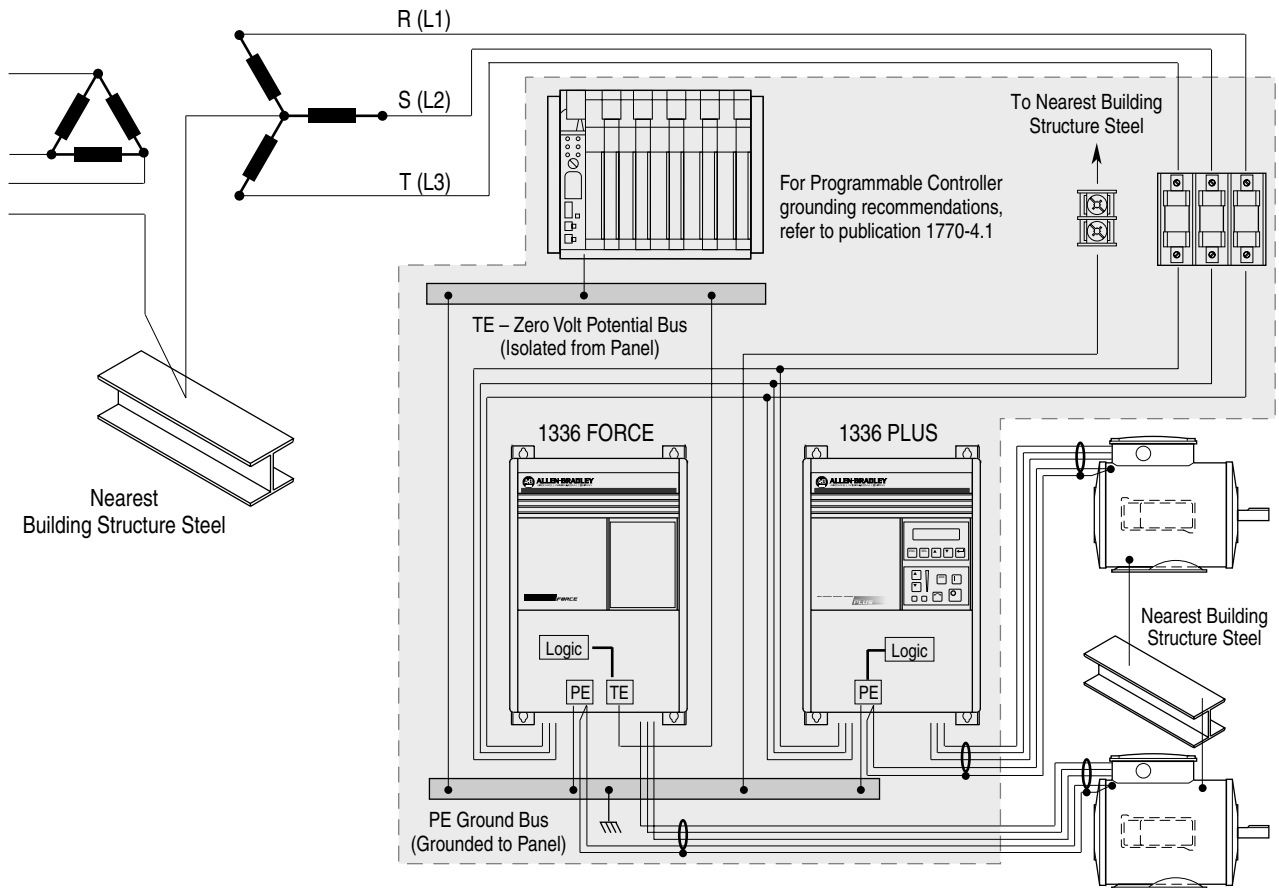

Important: Grounding requirements will vary with the drives being used. Drives with True Earth (TE) terminals must have a zero potential bus, separate from potential earth (PE) ground bus. Note that buses can be tied together at one point in the control cabinet or brought back separately to the building ground grid (tied within 3 meters (10 feet)).

Power Cabling

Input and output power connections are performed through terminal block, TB1 (see [Figure 2.1](#) for location).

Important: For maintenance and setup procedures, the drive may be operated without a motor connected.

Table 2.C
TB1 Signals

Terminal	Description
PE \perp	Potential Earth Ground
TE \perp	True Earth Ground
R (L1), S (L2), T (L3)	AC Line Input Terminals
+DC, -DC	DC Bus Terminals
U (T1), V (T2), W (T3)	Motor Connection



ATTENTION: The National Codes and standards (NEC, VDE, BSI etc.) and local codes outline provisions for safely installing electrical equipment. Installation must comply with specifications regarding wire types, conductor sizes, branch circuit protection and disconnect devices. Failure to do so may result in personal injury and/or equipment damage.

Figure 2.1
Terminal Block Locations

- TB1 Power Terminal Block
- TB2 Control & Signal Wiring
- TB3 Control Interface Option
- TB4 24V DC Auxiliary Input
- TB6 High Voltage DC Auxiliary Input
- TB9 480 or 600V Auxiliary Output (F Frame Only)
- TE Control & Signal Shield Terminals

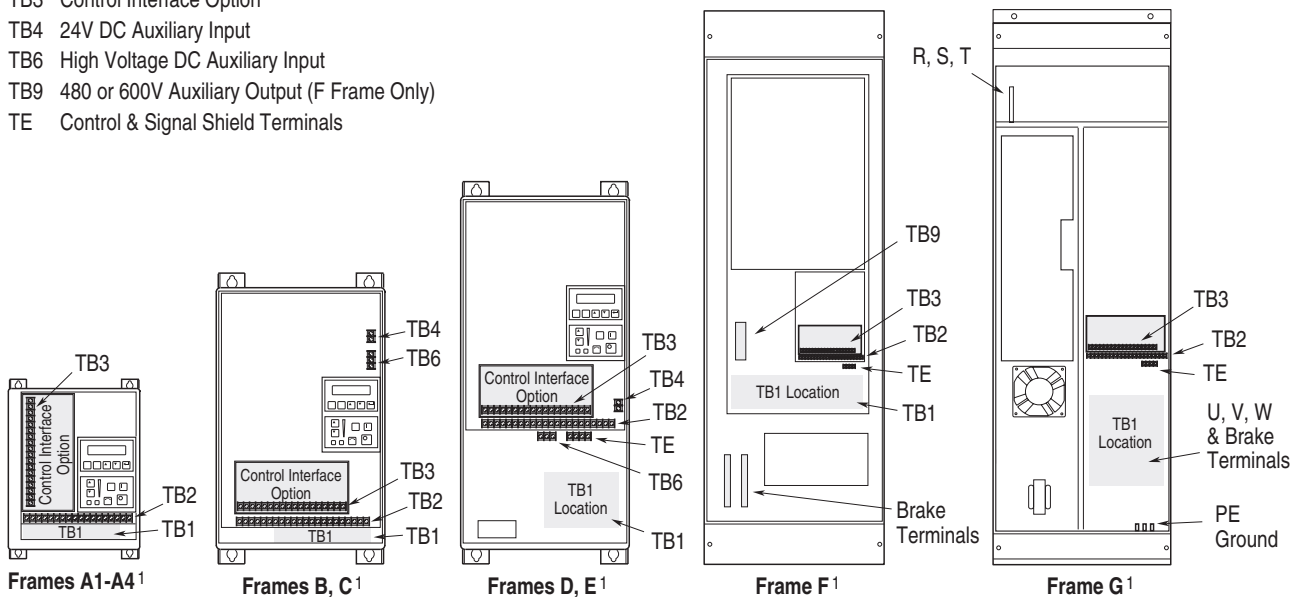

¹ Refer to page 1-1 for frame reference classifications and Figure 2.2 for TB1 details.

Table 2.D
TB1 Specifications

Drive Frame Size	Max./Min. Wire Size ¹ <i>mm² (AWG)</i>	Maximum Torque <i>N-m (lb.-in.)</i>
A1-A4 (page 2-21)	5.3/0.8 (10/18)	1.81 (16)
B1 (page 2-21)	8.4/0.8 (8/18)	1.81 (16)
B2 (page 2-21)	13.3/0.5 (6/20)	1.70 (15)
C (page 2-21)	26.7/0.8 (3/18)	5.65 (50)
D (page 2-22) ^{3,4}	120.0/2.1 (4/0 /14) 67.4/2.1 (00/14) ²	6.00 (52) 6.00 (52)
E (page 2-22) ^{3,5}	253.0/2.1 (500 MCM/14)	10.00 (87)
F (page 2-23) ³	303.6/2.1 (600 MCM/14)	23.00 (200)
G (page 2-23) ³	303.6/2.1 (600 MCM/14)	23.00 (200)

¹ Wire sizes given are maximum/minimum sizes that TB1 will accept - these are not recommendations. Use Copper wire only. Wire gauge requirements and recommendations are based on 75 degree C. Do not reduce wire gauge when using higher temperature wire.

² Applies to 30 kW (40 HP) 200-240V, 45 & 56 kW (60 & 75 HP) 380-480V, 56 kW (75 HP) 500-600V drives only.

³ These configurations of TB1 are stud type terminations and require the use of lug type connectors to terminate field installed conductors. Lug kits are available for use with these configurations. Wire size used is determined by selecting the proper lug based on the drive catalog number. Refer to [Table 2.E](#).

⁴ One TE terminal is present – Max./Min. Wire Size is the same as other terminals.

⁵ Two TE terminals are present – Max./Min. Wire Size is the same as the D Frame terminal block.

Lug Kits

D, E, F and G Frame drives have stud type terminals and/or bus bars/bolts that require standard “crimp type” connectors for cable termination. Connectors such as T & B Color-Keyed[®] connectors (or equivalent) are recommended. The following table shows the lug selection for one possible cable choice. Connectors for each installation should be chosen based on desired cable sizes, the application requirements and all applicable national, state and local codes. See the minimum/maximum values for wire size per [Table 2.D](#)

Table 2.E
Lug Selection

Drive Catalog Number	AC Input R, S, T/Output U, V, W and PE		DC+/DC- ²		TE	
	Cable (per Phase) Qty. mm ² (AWG)	T&B Part No. ³ Qty. Number	Cable (per Phase) Qty. mm ² (AWG)	T&B Part No. ³ Qty. Number	Cable (per Phase) Qty. mm ² (AWG)	T&B Part No. ³ Qty. Number
1336F-A040	(1) 53.5 (1/0)	(8) 54153 ¹	(1) 13.3 (6)	(2) 54135 ¹	(1) 13.3 (6)	(1) 54135 ¹
1336F-A050	(1) 85.0 (3/0)	(8) 54163 ¹	(1) 13.3 (6)	(2) 54135 ¹	(1) 13.3 (6)	(1) 54135 ¹
1336F-A060	(1) 107.2 (4/0)	(8) 54168 ¹	(1) 13.3 (6)	(2) 54135 ¹	(1) 21.2 (4)	(1) 54139 ¹
1336F-A075	(2) 53.5 (1/0)	(8) 54109T (8) 54109B	(1) 33.6 (2)	(2) 54109	(1) 21.2 (4)	(1) 54139 ¹
1336F-A100	(2) 85.0 (3/0)	(8) 54111T (8) 54111B	(1) 42.4 (1)	(2) 54148	(1) 33.6 (2)	(1) 54142 ¹
1336F-A125	(2) 107.2 (4/0)	(8) 54112T (8) 54112B	(1) 67.4 (2/0)	(2) 54110	(1) 33.6 (2)	(1) 54142 ¹
1336F-B060	(1) 42.4 (1)	(8) 54147 ¹	(1) 8.4 (8)	(2) 54131 ¹	(1) 13.3 (6)	(1) 54135 ¹
1336F-B075	(1) 53.5 (1/0)	(8) 54153 ¹	(1) 13.3 (6)	(2) 54135 ¹	(1) 13.3 (6)	(1) 54135 ¹
1336F-B100	(1) 85.0 (3/0)	(8) 54163 ¹	(1) 13.3 (6)	(2) 54135 ¹	(1) 13.3 (6)	(1) 54135 ¹
1336F-B125	(1) 107.2 (4/0)	(8) 54168 ¹	(1) 26.7 (3)	(2) 54147 ¹	(1) 21.2 (4)	(1) 54139 ¹
1336F-BX150	(1) 107.2 (4/0)	(8) 54168 ¹	(1) 26.7 (3)	(2) 54147 ¹	(1) 21.2 (4)	(1) 54139 ¹
1336F-B150	(2) 53.5 (1/0)	(8) 54109T (8) 54109B	(1) 33.6 (2)	(2) 54110	(1) 21.2 (4)	(1) 54139 ¹
1336F-B200	(2) 85.0 (3/0)	(8) 54111T (8) 54111B	(1) 42.4 (1)	(2) 54148	(1) 26.7 (3)	(1) 54142 ¹
1336F-B250	(2) 107.2 (4/0)	(8) 54112T (8) 54112B	(1) 67.4 (2/0)	(2) 54110	(1) 33.6 (2)	(1) 54142 ¹
1336F-BX250	(3) 53.5 (1/0)	(24) 54109	(1) 67.4 (2/0)	(2) 54110	NA	NA
1336F-BP/BPR250	(3) 53.5 (1/0)	(24) 54109	(1) 67.4 (2/0)	(2) 54110	NA	NA
1336F-B300	(3) 67.4 (2/0)	(24) 54110	(1) 42.4 (1)	(2) 54148	NA	NA
1336F-BP/BPR300	(3) 67.4 (2/0)	(24) 54110	(1) 42.4 (1)	(2) 54148	NA	NA
1336F-B350	(3) 85.0 (3/0)	(24) 54111	(1) 42.4 (1)	(2) 54148	NA	NA
1336F-BP/BPR350	(3) 85.0 (3/0)	(24) 54111	(1) 42.4 (1)	(2) 54148	NA	NA
1336F-B400	(3) 107.2 (4/0)	(24) 54112	(1) 42.4 (1)	(2) 54148	NA	NA
1336F-BP/BPR400	(3) 107.2 (4/0)	(24) 54112	(1) 42.4 (1)	(2) 54148	NA	NA
1336F-B450	(3) 127.0 (250 MCM)	(24) 54174	(1) 42.4 (1)	(2) 54148	NA	NA
1336F-BP/BPR450	(3) 127.0 (250 MCM)	(24) 54174	(1) 42.4 (1)	(2) 54148	NA	NA
1336F-B500	(3) 152.0 (300 MCM)	(24) 54179	(1) 53.5 (1/0)	(2) 54109	NA	NA
1336F-B600	(3) 152.0 (300 MCM)	(24) 54179	(1) 53.5 (1/0)	(2) 54109	NA	NA
1336F-C075	(1) 33.6 (2)	(8) 54142 ¹	(1) 13.3 (6)	(2) 54135 ¹	(1) 8.4 (8)	(1) 54131 ¹
1336F-C100	(1) 53.5 (1/0)	(8) 54153 ¹	(1) 13.3 (6)	(2) 54135 ¹	(1) 13.3 (6)	(1) 54135 ¹
1336F-C125	(1) 67.4 (2/0)	(8) 54158 ¹	(1) 26.7 (3)	(2) 54147 ¹	(1) 13.3 (6)	(1) 54135 ¹
1336F-C150	(1) 107.2 (4/0)	(8) 54111	(1) 42.4 (1)	(2) 54148	(1) 13.3 (6)	(1) 54135 ¹
1336F-C200	(2) 67.4 (2/0)	(8) 54110T (8) 54110B	(1) 42.4 (1)	(2) 54148	(1) 26.7 (3)	(1) 54142 ¹
1336F-C250	(2) 85.0 (3/0)	(8) 54111T (8) 54111B	(1) 67.4 (2/0)	(2) 54110	(1) 26.7 (3)	(1) 54142 ¹
1336F-CX300	(3) 85.0 (3/0)	(16) 54111	Consult Factory		NA	NA
1336F-C300	(3) 85.0 (3/0)	(16) 54111			NA	NA
1336F-C350	(3) 53.5 (1/0)	(24) 54109			NA	NA
1336F-C400	(3) 67.4 (2/0)	(24) 54110			NA	NA
1336F-C450	(3) 85.0 (3/0)	(24) 54111			NA	NA
1336F-C500	(3) 107.2 (4/0)	(24) 54112			NA	NA
1336F-C600	(3) 127.0 (250 MCM)	(24) 54174			NA	NA

¹ 5/16" Stud. All other studs are 3/8".

² Lugs shown for DC+/- are based on dynamic brake sizing of 50% of (motor rating X 1.25). Select proper lugs based on required braking torque. Refer to 1336-5.64 or 1336-5.65 for additional information.

³ T & B COLOR-KEYED® Connectors require T & B WT117 or TBM-6 Crimper tool or equivalent. Lugs should be crimped according to manufacturer's tool instructions. If required, Rockwell Automation can supply lug kits for lugs shown above. Kits do not include crimping tools. Consult factory for kit information.

Motor Cables

A variety of cable types are acceptable for drive installations. For many installations, unshielded cable is adequate, provided it can be separated from sensitive circuits. As an approximate guide, allow a spacing of 0.3 meters (1 ft.) for every 10 meters (32.8 ft.) of length. In all cases, long parallel runs must be avoided. Do not use cable with an insulation thickness less than or equal to 15 mils (0.4 mm/0.015 in.).

The cable should be 4-conductor with the ground lead being connected directly to the drive ground terminal (PE) and the motor frame ground terminal. See table below.

Unshielded

THHN, THWN or similar wire is acceptable for drive installation in dry environments provided adequate free air space and/or conduit fill rates limits are provided. **Do not use THHN or similarly coated wire in wet areas.** Any wire chosen must have a minimum insulation thickness of 15 mils and should not have large variations in insulation concentricity.

Shielded/Armored Cable

Shielded cable is recommended if sensitive circuits or devices are connected or mounted to the machinery driven by the motor (see table).

Recommended Shielded Wire

Location	Rating/Type	Description
Standard (Option 1)	600V, 90° C (194° F) XHHW2/RHW-2 Anixter B209500- B209507, Belden 29501- 29507, or equivalent	<ul style="list-style-type: none"> • Four tinned copper conductors with XLP insulation. • Copper braid/aluminum foil combination shield and tinned copper drain wire. • PVC jacket.
Standard (Option 2)	Tray rated 600V, 90° C (194° F) RHH/RHW-2 Anixter OLF-7xxxx or equivalent	<ul style="list-style-type: none"> • Three tinned copper conductors with XLPE insulation. • 5 mil single helical copper tape (25% overlap min.) with three bare copper grounds in contact with shield. • PVC jacket.
Class I & II; Division I & II	Tray rated 600V, 90° C (194° F) RHH/RHW-2 Anixter 7V-7xxx-3G or equivalent	<ul style="list-style-type: none"> • Three bare copper conductors with XLPE insulation and impervious corrugated continuously welded aluminum armor. • Black sunlight resistant PVC jacket overall. • Three copper grounds on #10 AWG and smaller.

Conduit

If metal conduit is preferred for cable distribution, the following guidelines must be followed.

- Drives are normally mounted in cabinets and ground connections are made at a common ground point in the cabinet. Normal installation of conduit provides grounded connections to both the motor frame ground (junction box) and drive cabinet ground. These ground connections help minimize interference. This is a noise reduction recommendation only, and does not affect the requirements for safety grounding (refer to pages [2-11](#) and [2-12](#)).

- No more than three sets of motor leads can be routed through a single conduit. This will minimize “cross talk” that could reduce the effectiveness of the noise reduction methods described. If more than three drive/motor connections per conduit are required, shielded cable as described above must be used. If practical, each conduit should contain only one set of motor leads.



ATTENTION: To avoid a possible shock hazard caused by induced voltages, unused wires in the conduit must be grounded at both ends. For the same reason, if a drive sharing a conduit is being serviced or installed, all drives using this conduit should be disabled. This will eliminate the possible shock hazard from “cross coupled” drive motor leads.

Motor Lead Lengths

Installations with long cables to the motor may require the addition of output reactors or cable terminators to limit voltage reflections at the motor. Excessive cable charging current can also reduce the amount of current available to produce rated motor torque. Refer to Tables [2.F](#) and [2.G](#) for the maximum cable length allowed for various installation techniques. Shaded distances are restricted by cable capacitance charging current. The figure below demonstrates how total cable length is calculated. Failure to follow these guidelines can result in poor motor performance and nuisance drive overcurrent or overload tripping. For installations that exceed the recommended maximum lengths listed, contact the factory.

Please note that the cable lengths shown are guidelines. Your application may be restricted to a shorter cable length due to wire type, wire placement, line reactor and type of motor.

How to Measure Motor Cable Lengths Limited by Capacitance

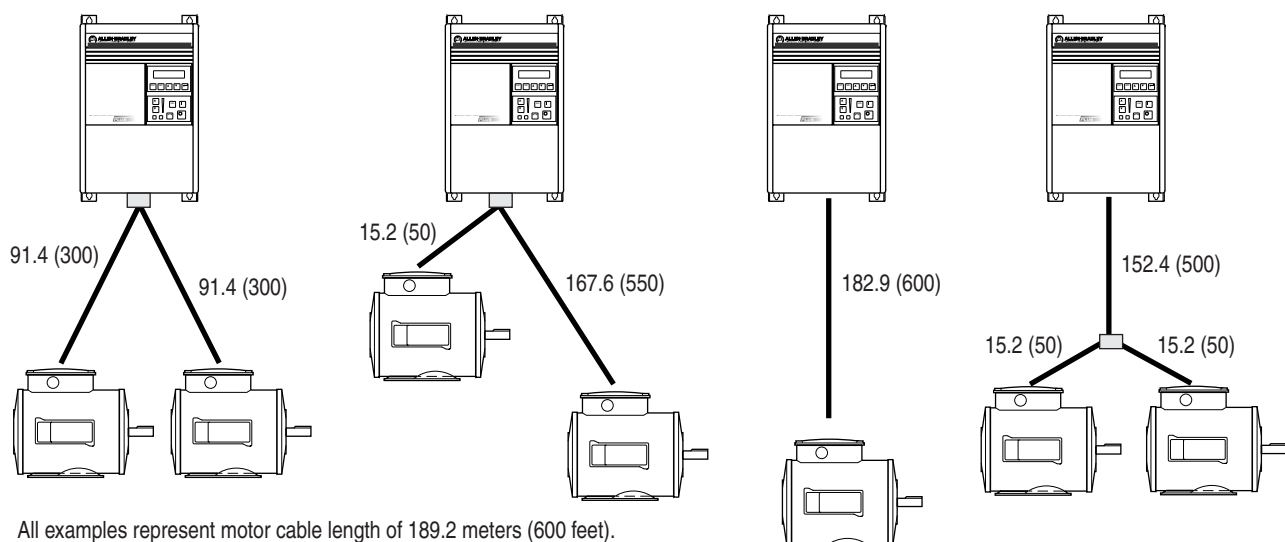

Table 2.F
Maximum Motor Cable Length Restrictions in meters (feet) - 380V-480V Drives¹

Drive Frame	Drive kW (HP)	Motor kW (HP)	No External Devices				w/1204-TFB2 Term.			w/1204-TFA1 Terminator					Reactor at Drive ²		
			Motor				Motor			Motor					Motor		
			A	B	1329	1600V or 1329R/L (1850V)	A or B		1329	A		B		1329	A	B or 1329	
			Any Cable	Any Cable	Any Cable	Any Cable ⁶	Cable Type		Any Cable	Cable Type		Cable Type		Any Cable	Any Cable	Any Cable	
				Shld. ³		Unshld.		Shld. ³		Unshld.							
A1	0.37 (0.5)	0.37 (0.5)	12.2 (40)	33.5 (110)	91.4 (300)	91.4 (300)	Use 1204-TFA1			30.5 (100)	61.0 (200)	30.5 (100)	61.0 (200)	91.4 (300)	22.9 (75)	182.9 (600)	
	0.75 (1)	0.75 (1)	12.2 (40)	33.5 (110)	91.4 (300)	91.4 (300)				30.5 (100)	30.5 (100)	30.5 (100)	30.5 (100)	91.4 (300)	22.9 (75)	182.9 (600)	
		0.37 (0.5)	0.37 (0.5)	12.2 (40)	33.5 (110)	91.4 (300)				91.4 (300)	30.5 (100)	61.0 (200)	30.5 (100)	61.0 (200)	91.4 (300)	22.9 (75)	182.9 (600)
	1.2 (1.5)	1.2 (1.5)	1.2 (1.5)	12.2 (40)	33.5 (110)	91.4 (300)				91.4 (300)	30.5 (100)	30.5 (100)	61.0 (200)	61.0 (200)	91.4 (300)	22.9 (75)	182.9 (600)
		0.75 (1)	0.75 (1)	12.2 (40)	33.5 (110)	91.4 (300)				91.4 (300)	30.5 (100)	30.5 (100)	61.0 (200)	61.0 (200)	91.4 (300)	22.9 (75)	182.9 (600)
		0.37 (0.5)	0.37 (0.5)	12.2 (40)	33.5 (110)	114.3 (375)				121.9 (400)	30.5 (100)	30.5 (100)	61.0 (200)	61.0 (200)	121.9 (400)	22.9 (75)	182.9 (600)
A2	1.5 (2)	1.5 (2)	7.6 (25)	12.2 (40)	91.4 (300)	91.4 (300)	91.4 (300)	91.4 (300)	91.4 (300)	30.5 (100)	30.5 (100)	91.4 (300)	61.0 (200)	91.4 (300)	22.9 (75)	182.9 (600)	
		1.2 (1.5)	7.6 (25)	12.2 (40)	114.3 (375)	182.9 (600)	91.4 (300)	182.9 (600)	182.9 (600)	30.5 (100)	30.5 (100)	91.4 (300)	61.0 (200)	182.9 (600)	22.9 (75)	182.9 (600)	
		0.75 (1)	7.6 (25)	12.2 (40)	114.3 (375)	182.9 (600)	182.9 (600)	182.9 (600)	182.9 (600)	30.5 (100)	30.5 (100)	91.4 (300)	61.0 (200)	182.9 (600)	22.9 (75)	182.9 (600)	
		0.37 (0.5)	0.37 (0.5)	7.6 (25)	12.2 (40)	114.3 (375)	182.9 (600)	182.9 (600)	182.9 (600)	30.5 (100)	30.5 (100)	91.4 (300)	61.0 (200)	182.9 (600)	22.9 (75)	182.9 (600)	
	2.2 (3)	2.2 (3)	2.2 (3)	7.6 (25)	12.2 (40)	91.4 (300)	91.4 (300)	182.9 (600)	182.9 (600)	182.9 (600)	Use 1204-TFB2					22.9 (75)	182.9 (600)
		1.5 (2)	1.5 (2)	7.6 (25)	12.2 (40)	114.3 (375)	182.9 (600)	182.9 (600)	182.9 (600)	22.9 (75)						182.9 (600)	
		0.75 (1)	0.75 (1)	7.6 (25)	12.2 (40)	114.3 (375)	182.9 (600)	182.9 (600)	182.9 (600)	22.9 (75)						182.9 (600)	
		0.37 (0.5)	0.37 (0.5)	7.6 (25)	12.2 (40)	114.3 (375)	182.9 (600)	182.9 (600)	182.9 (600)	22.9 (75)						182.9 (600)	
A3	3.7 (5)	3.7 (5)	7.6 (25)	12.2 (40)	114.3 (375)	182.9 (600)	182.9 (600)	182.9 (600)	182.9 (600)	Use 1204-TFB2					22.9 (75)	182.9 (600)	
		2.2 (3)	7.6 (25)	12.2 (40)	114.3 (375)	Contact factory for advice on cable lengths over 182.9 (600).	182.9 (600)	182.9 (600)	182.9 (600)						22.9 (75)	182.9 (600)	
		1.5 (2)	7.6 (25)	12.2 (40)	114.3 (375)	182.9 (600)	182.9 (600)	182.9 (600)	22.9 (75)						182.9 (600)		
		0.75 (1)	0.75 (1)	7.6 (25)	12.2 (40)	114.3 (375)	182.9 (600)	182.9 (600)	182.9 (600)						22.9 (75)	182.9 (600)	
		0.37 (0.5)	0.37 (0.5)	7.6 (25)	12.2 (40)	114.3 (375)	182.9 (600)	182.9 (600)	182.9 (600)						22.9 (75)	182.9 (600)	
A4	5.5-15 (7.5-20)	5.5-15 (7.5-20)	7.6 (25)	12.2 (40)	114.3 (375)	182.9 (600)	182.9 (600)	182.9 (600)						24.4 (80)	182.9 (600)		
B	11-22 (15-30)	11-22 (15-30)	7.6 (25)	12.2 (40)	114.3 (375)	182.9 (600)	182.9 (600)	182.9 (600)						24.4 (80)	182.9 (600)		
C	30-45 (X40-X60)	30-45 (40-60)	7.6 (25)	12.2 (40)	114.3 (375)	182.9 (600)	182.9 (600)	182.9 (600)						76.2 (250)	182.9 (600)		
D	45-112 (60-X150)	45-112 (60-150)	12.2 (40)	30.5 (100)	114.3 (375)	182.9 (600)	182.9 (600)	182.9 (600)						61.0 (200)	182.9 (600)		
E	112-187 (150-250)	112-187 (150-250)	12.2 (40)	53.3 (175)	114.3 (375)	182.9 (600)	182.9 (600)	182.9 (600)						182.9 (600)	182.9 (600)		
F	187-336 (250-450)	187-336 (250-450)	18.3 (60)	53.3 (175)	114.3 (375)	182.9 (600)	182.9 (600)	182.9 (600)						182.9 (600)	182.9 (600)		
G	187-448 (X250-600)	187-448 (250-600)	18.3 (60)	53.3 (175)	114.3 (375)	182.9 (600)	182.9 (600)	182.9 (600)						182.9 (600)	182.9 (600)		

Type A Motor Characteristics: No phase paper or misplaced phase paper, lower quality insulation systems, corona inception voltages between 850 and 1000 volts.
Type B Motor Characteristics: Properly placed phase paper, medium quality insulation systems, corona inception voltages between 1000 and 1200 volts.
1329R/L Motors: These AC variable speed motors are "Control-Matched" for use with Allen-Bradley Drives. Each motor is designed to meet or exceed the requirements of the Federal Energy Act of 1992. All 1329R/L motors are optimized for variable speed operation and include premium inverter grade insulation systems which meet or exceed NEMA MG1. Part 31.40.4.2.

Table 2.G
Maximum Motor Cable Length Restrictions in meters (feet) - 500V-600V Drives⁴

Drive Frame	Drive kW (HP)	Motor kW (HP)	No External Devices			w/1204-TFB2 Terminator			w/1204-TFA1 Terminator			Reactor at Drive ²						
			Motor			Motor			Motor			Motor						
			A	B	1329R/L Motors ⁵	A	B	1600V or 1329R/L (1850V) ⁵	A	B	1600V or 1329R/L (1850V) ⁵	A	B	1600V or 1329R/L (1850V) ⁵				
Any Cable			Any Cable			Any Cable			Any Cable			Any Cable						
A4	0.75 (1)	0.75 (1)	NR	NR	NA	NR	182.9 (600)	335.3 (1100)	NR	61.0 (200)	182.9 (600)	Not Recommended						
		0.37 (0.5)	NR	NR	NA	NR	182.9 (600)	335.3 (1100)	NR	61.0 (200)	182.9 (600)							
	1.5 (2)	1.5 (2)	NR	NR	NA	NR	182.9 (600)	335.3 (1100)	NR	61.0 (200)	182.9 (600)							
		1.2 (1.5)	NR	NR	NA	NR	182.9 (600)	335.3 (1100)	NR	61.0 (200)	182.9 (600)							
		0.75 (1)	NR	NR	182.9 (600)	NR	182.9 (600)	335.3 (1100)	NR	61.0 (200)	182.9 (600)							
		0.37 (0.5)	NR	NR	182.9 (600)	NR	182.9 (600)	335.3 (1100)	NR	61.0 (200)	182.9 (600)							
	2.2 (3)	2.2 (3)	NR	NR	NA	NR	182.9 (600)	335.3 (1100)	NR	61.0 (200)	182.9 (600)							
		1.5 (2)	NR	NR	NA	NR	182.9 (600)	335.3 (1100)	NR	61.0 (200)	182.9 (600)							
		0.75 (1)	NR	NR	182.9 (600)	NR	182.9 (600)	335.3 (1100)	NR	61.0 (200)	182.9 (600)							
		0.37 (0.5)	NR	NR	182.9 (600)	NR	182.9 (600)	335.3 (1100)	NR	61.0 (200)	182.9 (600)							
	3.7 (5)	3.7 (5)	NR	NR	NA	NR	182.9 (600)	335.3 (1100)	NR	61.0 (200)	182.9 (600)							
		2.2 (3)	NR	NR	NA	NR	182.9 (600)	335.3 (1100)	NR	61.0 (200)	182.9 (600)							
		1.5 (2)	NR	NR	182.9 (600)	NR	182.9 (600)	335.3 (1100)	NR	61.0 (200)	182.9 (600)							
		0.75 (1)	NR	NR	182.9 (600)	NR	182.9 (600)	335.3 (1100)	NR	61.0 (200)	182.9 (600)							
		0.37 (0.5)	NR	NR	182.9 (600)	NR	182.9 (600)	335.3 (1100)	NR	61.0 (200)	182.9 (600)							
	5.5-15 (7.5-20)	5.5-15 (7.5-20)	NR	9.1 (30)	182.9 (600)	91.4 (300)	182.9 (600)	182.9 (600)	NR	61.0 (200)	182.9 (600)				30.5 (100)	91.4 (300)	182.9 (600)	
	C	18.5-45 (25-60)	18.5-45 (25-60)	NR	9.1 (30)	182.9 (600)	91.4 (300)	182.9 (600)	182.9 (600)	NR	61.0 (200)				182.9 (600)	30.5 (100)	91.4 (300)	182.9 (600)
	D	56-93 (75-125)	56-93 (75-125)	NR	9.1 (30)	182.9 (600)	91.4 (300)	182.9 (600)	182.9 (600)	NR	61.0 (200)				182.9 (600)	61.0 (200)	91.4 (300)	182.9 (600)
	E	112-224 (150-X300)	112-224 (150-X300)	NR	9.1 (30)	182.9 (600)	91.4 (300)	182.9 (600)	182.9 (600)	NR	61.0 (200)				182.9 (600)	182.9 (600)	182.9 (600)	182.9 (600)
	F	261-298 (350-400)	261-298 (350-400)	NR	9.1 (30)	182.9 (600)	91.4 (300)	182.9 (600)	182.9 (600)	NR	61.0 (200)				182.9 (600)	182.9 (600)	182.9 (600)	182.9 (600)
G	224-448 (300-600)	224-448 (300-600)	NR	9.1 (30)	182.9 (600)	91.4 (300)	182.9 (600)	182.9 (600)	NR	61.0 (200)	182.9 (600)	182.9 (600)	182.9 (600)	182.9 (600)				

NR = Not Recommended
NA = Not Available at time of printing

- Values shown are for 480V nominal input voltage, drive carrier frequency of 2 kHz and ambient temperature at the motor of 40 degrees C. Consult factory regarding operation at carrier frequencies above 2 kHz. Multiply values by 0.85 for high line conditions. For input voltages of 380, 400 or 415V AC, multiply the table values by 1.25, 1.20 or 1.15, respectively.
- A 3% reactor reduces motor and cable stress but may cause a degradation of motor waveform quality. Reactors must have a turn-turn insulation rating of 2100 volts or higher.
- Includes wire in conduit.
- Values shown are for nominal input voltage and drive carrier frequency of 2 kHz. Consult factory regarding operation at carrier frequencies above 2 kHz. Multiply values by 0.85 for high line conditions.
- When used on 600V systems, 1329R/L motors have a corona inception voltage rating of approximately 1850V.
- These distance restrictions are due to charging of cable capacitance and may vary from application to application.

Figure 2.2
Terminal Block TB1

A1-A3 Frame

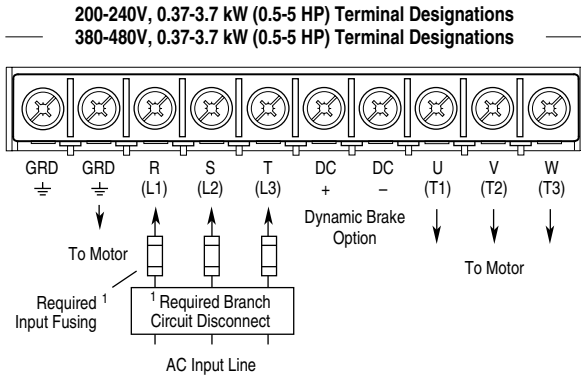

A4 Frame

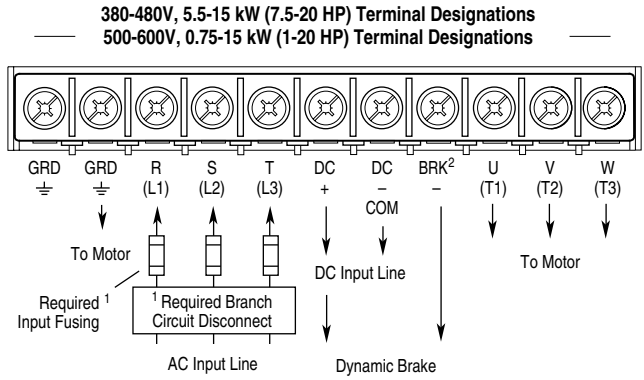

Important: A brake malfunction will occur if the Dynamic Brake is connected to "DC - COM"

B1 Frame

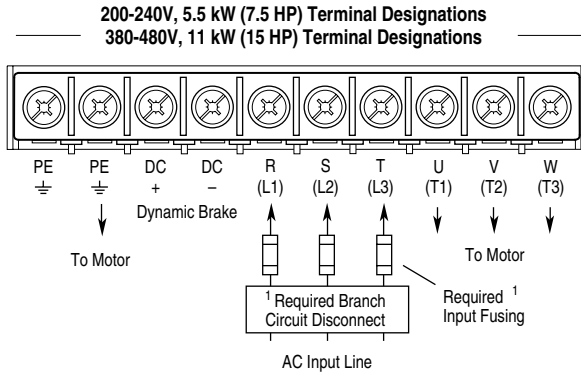

B2 Frame

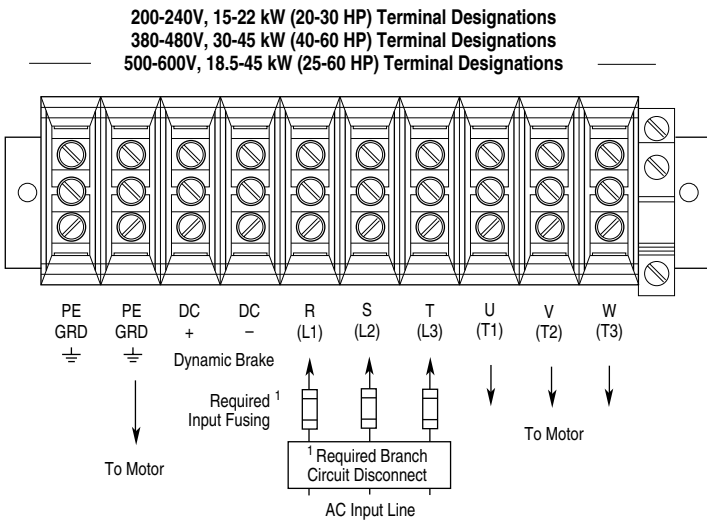
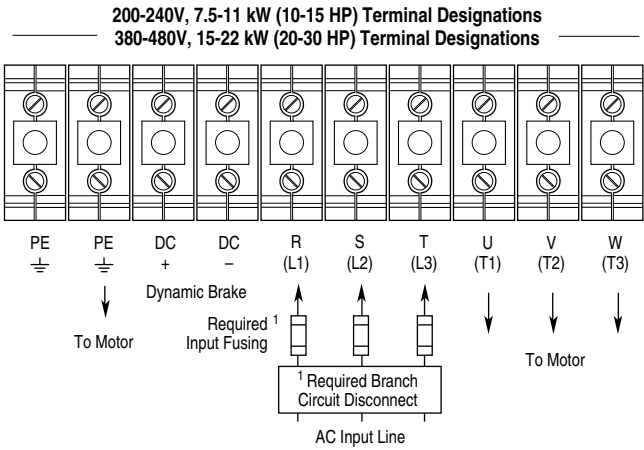

C Frame

¹ User supplied.
² Terminal located separately on Series A Drives.

D Frame

200-240V, 30-45 kW (40-60 HP) Terminal Designations
 380-480V, 45-112 kW (60-150 HP) Terminal Designations
 500-600V, 56-93 kW (75-125 HP) Terminal Designations

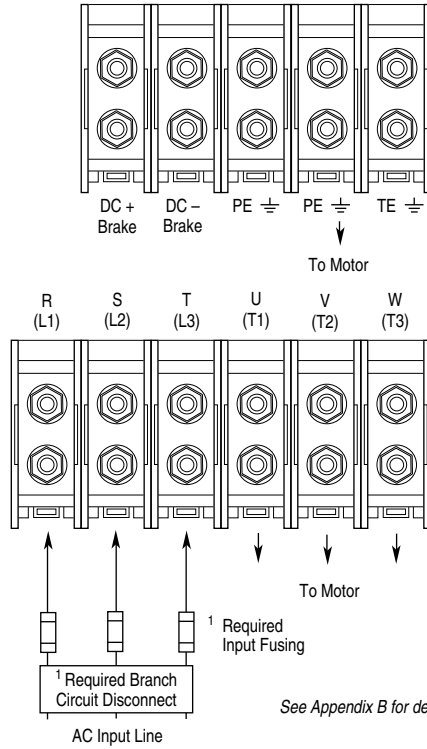

200-240V, 56-93 kW (75-125 HP) Terminal Designations
 380-480V, 112-187 kW (150-250 HP) Terminal Designations
 500-600V, 112-224 kW (150-300 HP) Terminal Designations

E Frame

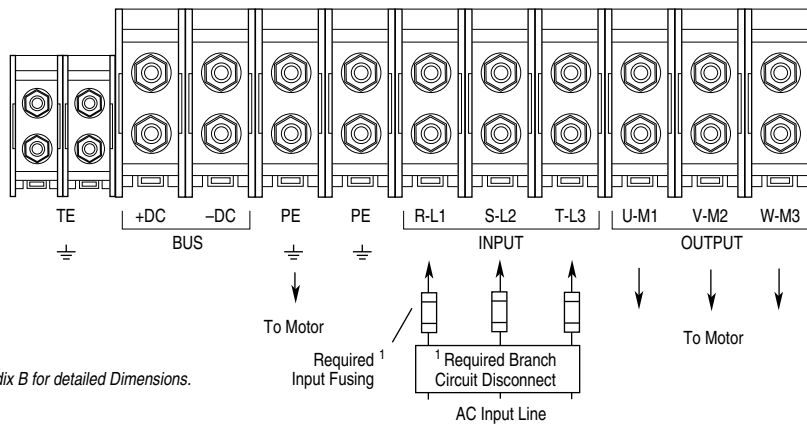

¹ User supplied.

380-480V, 187-336 kW (250-450 HP) Terminal Designations
500-600V, 261-336 kW (350-450 HP) Terminal Designations

F Frame

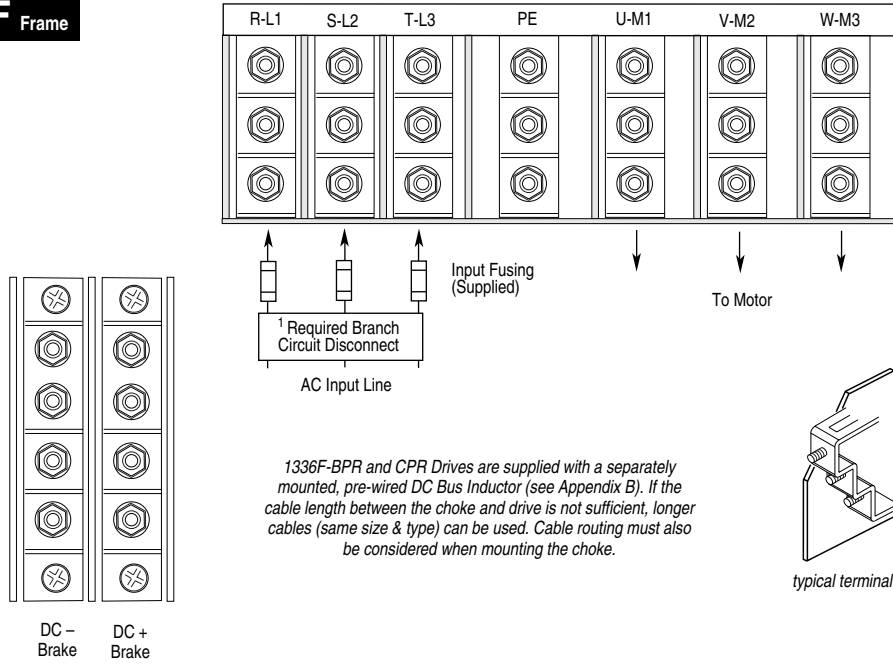

380-480V, 187-448 kW (250-600 HP) Terminal Designations
500-600V, 224-448 kW (300-600 HP) Terminal Designations

G Frame

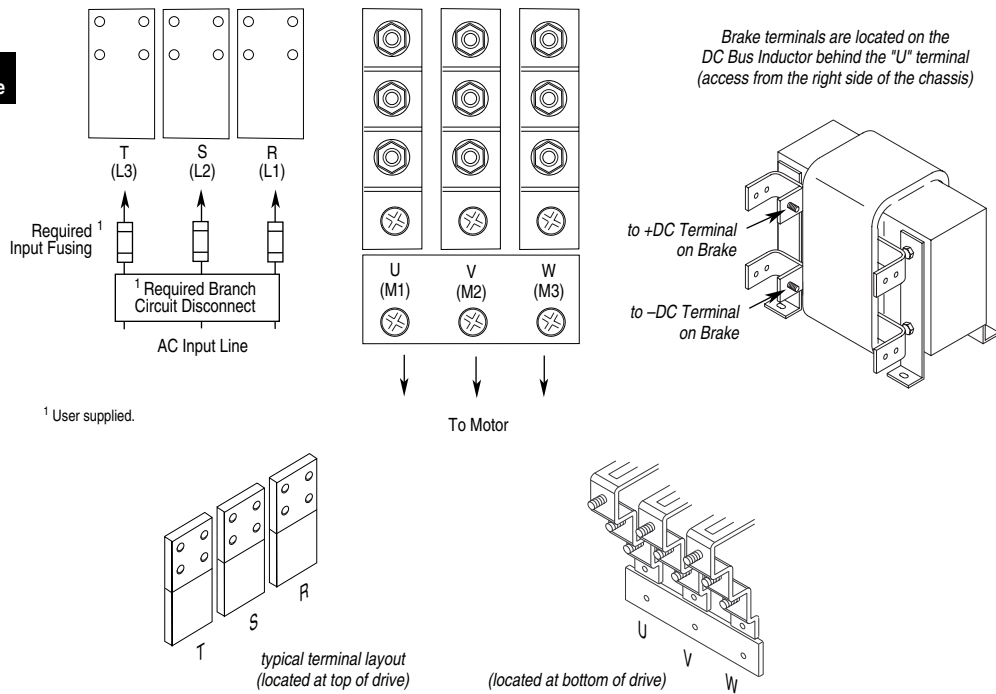

¹ User supplied.

Control and Signal Wiring

General Wiring Information

General requirements for analog signal wire include: stranded copper 0.750-0.283 mm² (18-22 AWG), twisted-pair, 100% shield with drain wire, 300V minimum insulation rating and a temperature rating suitable for the application (not less than 60 degrees C.) The recommended **signal (analog I/O)** wire is:

- Belden 8760/9460 (or equiv.) – 0.750 mm² (18 AWG), twisted pair, shielded.
- Belden 8770 (or equiv.) – 0.750 mm² (18 AWG), 3 conductor, shielded for remote pot only.

The recommended wire for **encoder or pulse inputs/outputs** is:

- Lengths less than or equal to 30 meters (98 feet)
Belden 9730 (or equiv.) – 0.196 mm² (24 AWG), individually shielded.
- Lengths greater than 30 meters (98 feet)
Belden 9773 (or equiv.) – 0.750 mm² (18 AWG), twisted pair, shielded.

Signal Connections

If the drive control connections are to be linked to an electronic circuit or device, the common or 0V line should, if possible, be grounded at the device (source) end only.

Important: Signal Common - User speed reference signals are terminated to logic common at TB2, terminal 5. This puts the negative (or common) side of these signals at earth ground potential. Control schemes must be examined for possible conflicts with this type of grounding scheme.

Shield Termination - TE (True Earth)

The TE terminal block (not available on A Frame drives) provides a terminating point for signal wiring shields. A Frame drives can use TB2, terminal 5 for signal wiring shield termination. Refer to [Figure 2.1](#) for location.

The maximum and minimum wire size accepted by this block is 2.1 and 0.30 mm² (14 and 22 AWG). Maximum torque is 1.36 N-m (12 lb.-in.). Use Copper wire Only and always separate control and power cabling.

Cable Routing

If unshielded cable is used, signal circuits should not run parallel to motor cables or unfiltered supply cables with a spacing less than 0.3 meters (1 foot). Cable tray metal dividers or separate conduit should be used.

Important: When user installed control and signal wiring with an insulation rating of less than 600V is used, this wiring must be routed inside the drive enclosure and separated from any other wiring and/or uninsulated live parts.

Terminal Block TB2

TB2 is located at the bottom of the Main Control Board. A Frame drives have 18 positions. Remaining frame sizes have 22 positions. The maximum and minimum wire size accepted by TB2 is 2.1 and 0.30 mm² (14 and 22 AWG). Maximum torque for all terminals is 1.36 N-m (12 lb.-in.). Use Copper wire only. See [Figure 2.1](#).

Terminal Block TB3

The Control Interface Option provides a means of interfacing various signals and commands to the 1336 PLUS II by using contact closures. Several different versions of the option are available:

- L4 Contact Closure Interface¹.
- L4E Contact Closure Interface¹ with Encoder Feedback Inputs.
- L7E Contact Closure Interface¹ with Encoder Feedback Inputs for use with encoder loss detection.
- L5 +24VAC/DC Interface.
- L5E +24VAC/DC Interface with Encoder Feedback Inputs.
- L8E +24VAC/DC Interface with Encoder Feedback Inputs for use with encoder loss detection.
- L6 115VAC Interface.
- L6E 115VAC Interface with Encoder Feedback Inputs.
- L9E 115VAC Interface with Encoder Feedback Inputs for use with encoder loss detection.

¹ Uses internal +5V DC supply.

The user inputs are connected to the option board through TB3 (see [Figure 2.1](#) for location). The L4, L5 and L6 options each have nine control inputs. The function of each input must be selected through programming as explained later in this section. The L4E through L9E options are similar to L4, L5 and L6 with the addition of encoder feedback inputs. In addition, the L7E, L8E and L9E options allow encoder loss detection. Refer to Appendix A for further information.

The maximum and minimum wire size accepted by TB3 is 2.1 and 0.30 mm² (14 and 22 AWG). Recommended torque for all terminals is 0.90-1.13 N-m (8-10 lb.-in.). Use Copper wire only.

Digital Inputs

Digital inputs are connected at TB3.

Input Mode Select

A number of combinations are available by first programming [Input Mode] to the desired control scheme (i.e. 2 wire, 3 wire or Status). The remaining inputs can then be configured by programming [TB3 Term 22 Sel] through [TB3 Term 28 Sel]. Refer to the *Digital I/O* parameter group in Chapter 6 for programming information.

Figure 2.3
Digital I/O Default Settings – TB3

		Input Mode (Start/Stop Functions Only)		
		Status ² (Factory Default)	2-Wire Control Single-Source Control	3-Wire Control Single-Source Reversing
Input 1	19	Status	Run Forward	Start
Input 2	20	Stop/Fault Reset ³	Stop/Fault Reset ³	Stop/Fault Reset ³
Common	21	Status Only Default Mode shown at right is not active when [Input Mode] is set to "Status"	Factory Default Inputs	
Input 3	22		Common	
Input 4	23		Rev/For ⁴	(Programmable)
Input 5	24		Jog	(Programmable)
Common	25		Auxiliary ³	(Programmable)
Input 6	26		Common	
Input 7	27		Speed Select 3 ¹	(Programmable)
Input 8	28		Speed Select 2 ¹	(Programmable)
Common	29		Speed Select 1 ¹	(Programmable)
Input 9	30	Enable ³	Enable ³	(Not Programmable)
Encoder B	31	Included on L4E through L9E Only		
Encoder NOT A	32			
Encoder NOT B	33			
Encoder A	34			
+12V (200mA max.)	35			
Encoder Common	36			

¹ See *Speed Select* Table.
² If this mode is selected, the status of all inputs can be read at the [Input Status] parameter. However, only "Stop/Fault Reset" and "Enable" will have control function.
³ These inputs must be present (reprogram if necessary) before drive will start.
⁴ Bit 0 of [Direction Mask] must = 1 to allow TB3 direction change/bipolar operation.
⁵ Requires "2 Wire" control selection for [Input Mode].
⁶ [TB3 Term 22] must be programmed to "Run Reverse."

2-Wire Control Example

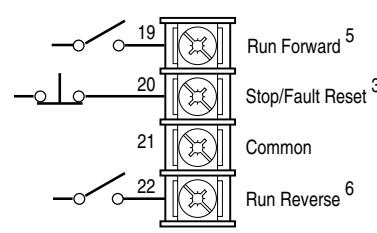

3-Wire Control Example

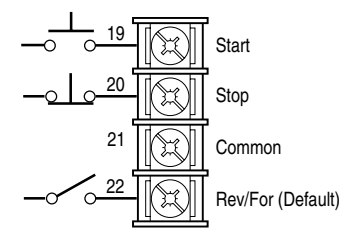

A hazard of personal injury from automatic restart exists with 2-wire control. 2-wire control uses maintained Run contacts that act as both Run (closed) and Stop (open) devices. Opening the Stop contact (terminal 20) will stop the drive. If this contact is reclosed, any fault will be reset. If a valid Start command is still present, the drive will restart. Only use 2-wire control for applications outlined in NFPA79, "Under Voltage Protection."
 If a 3-wire device (i.e. HIM) is also used, pressing the HIM Stop key will also stop the drive. Releasing the Stop key will clear any faults that are present, but the drive will not restart without cycling the Start contact.

Available Functions for Inputs 3 through 8

A variety of combinations made up of the following inputs are available.

Input	Description												
1 st and 2 nd Accel 1 st and 2 nd Decel	Closing these inputs will command the corresponding accel or decel rate. If both inputs are open or both are closed, the current rate is maintained. <table border="1"> <thead> <tr> <th>Input</th> <th>1st</th> <th>2nd</th> </tr> </thead> <tbody> <tr> <td>No Command</td> <td>0</td> <td>0</td> </tr> <tr> <td>Accel/Decel 1</td> <td>0</td> <td>1</td> </tr> <tr> <td>Accel/Decel 2</td> <td>1</td> <td>0</td> </tr> </tbody> </table>	Input	1 st	2 nd	No Command	0	0	Accel/Decel 1	0	1	Accel/Decel 2	1	0
Input	1 st	2 nd											
No Command	0	0											
Accel/Decel 1	0	1											
Accel/Decel 2	1	0											
1 st /2 nd Accel/Decel	Allows selection of the accel or decel time used by the drive. 1=2nd, 0=1st												
Auxiliary	Faults the drive via external devices (i.e. motor thermoswitch, O.L. relays, etc.). Opening this contact will fault (F02 - Aux Fault) the drive and shut the output off, ignoring the programmed stop mode.												
Clear Fault	If drive has faulted, closing this input will clear the fault.												
Digital Pot (MOP) Up/ Down	These inputs increase (up) or decrease (down) the drive commanded frequency when MOP (Motor Operated Potentiometer) is chosen as the frequency command source. The rate of increase/decrease is programmable.												
Forward	Closing these inputs (Forward or Reverse) commands the corresponding direction. If both inputs are open or both are closed, the current direction is maintained.												
Jog	Closing this input starts the drive and causes it to run at programmed jog frequency. Opening this input stops the drive using the programmed stop mode.												
Local Control	Closing this input gives exclusive control of drive logic to the inputs at terminal block TB3. No other devices may issue logic commands (excluding Stop) to the drive.												
Rev/For	Available only with three-wire control - Closing this input commands reverse direction and opening this input commands forward direction.												
Reverse	See "Forward" above.												
PI Enable	Enables the output of the process PI loop.												
PI Reset	Opening this input clamps the process PI <i>integrator</i> value at zero. Closing this input allows the integrator to continue to operate.												
Run Reverse	Available Only with two-wire control - Closing this input issues both a start command and a reverse command to the drive. Opening the input issues a stop command to the drive.												
Speed Select 1, 2, 3	These inputs choose the frequency command source for the drive. See following pages for details.												
Stop Type	Closing this input selects the stop mode in [Stop Select 2] as the method of stopping when a stop command is issued. Opening this input selects the stop mode in [Stop Select 1] as the method of stopping.												
Sync	Normally wired to multiple drives – When the Sync input is low, the drive operates normally. When the input is high, the speed of the drive will be held constant and the speed command will have no effect. During this period the speed input of the drive will normally be changed to a different source and/or value. Allows synchronized change of frequency command to multiple drives.												
Traverse	Setting this input low disables the traverse function. When the input is high, the traverse function will be active. [Speed Control] must also be set to "P Jump" for the function to be active.												

Important: If a Control Interface Option is not installed, the [Input Mode] parameter must be set to "Status" (default) and jumpers must be installed as shown in [Figure 2.7](#). If the drive was shipped from the factory without the option, these jumpers will have been installed.

Important: The [Input Mode] parameter can be changed at any time, but the change will not affect drive operation until power to the drive has been removed and bus voltage has decayed completely. When changing this parameter, it is important to note that the functions of the Start and Stop inputs will change when power is reapplied to the drive.

The programming options of the Control Interface Option allow the user to select an input combination to meet the needs of a specific installation. The firmware will verify programming, to assure an appropriate combination has been selected.

Speed Select/Frequency Reference

The drive speed command can be obtained from a number of different sources. The source is determined by drive programming and the condition of the Speed Select Inputs on TB3 (or reference select bits of command word if PLC controlled - see Appendix A).

The default source for a command reference (all speed select inputs open) is the selection programmed in [Freq Select 1]. If any of the speed select inputs are closed, the drive will use other parameters as the speed command source. See [Table 2.H](#) and the examples that follow.

Table 2.H
Speed Select Input State vs. Frequency Source

Speed Select 3	Speed Select 2	Speed Select 1	Frequency Source
Open	Open	Open	[Freq Select 1]
Open	Open	Closed	[Freq Select 2]
Accessed through [Freq Select 2] parameter			[Preset Freq 1]
Open	Closed	Open	[Preset Freq 2]
Open	Closed	Closed	[Preset Freq 3]
Closed	Open	Open	[Preset Freq 4]
Closed	Open	Closed	[Preset Freq 5]
Closed	Closed	Open	[Preset Freq 6]
Closed	Closed	Closed	[Preset Freq 7]

Important: The final speed command may be affected by the type of modulation selected with [Speed Control], parameter 77. See [Speed Control] in Chapter 6 for further information.

Important: If a bi-polar input option (LA6 or LA7) is installed, the signal is designated “Analog Input 0.” Note the following:

3 Wire Control – If [Input Mode] is set to “3 Wire” and the bi-polar input is selected as the active frequency reference [Freq Select 1 or 2], it is assumed that direction control is desired via analog polarity. If another source has control of direction, a “Bipolar Direction” fault (F16) will occur. If direction control via polarity is not required, bit 7 of [Direction Mask] should be set to “0.” This causes the input to be treated as a 0-10V frequency reference only. Negative analog signals are treated as zero and direction control must come from another source.

2 Wire Control – If [Input Mode] is set to “2 Wire,” it is assumed that direction control is provided via the 2 wire inputs (Run Forward and Run Reverse). Bit 7 of [Direction Mask] must be set to “0.” This causes the input to be treated as a 0-10V frequency reference only. Negative analog signals are treated as zero. Failure to set the Mask will generate a “Bipolar Direction” (F16) fault.

Example 1

3 Wire Control - Application calls for a local Human Interface Module (HIM) speed command or remote 4-20mA from a PLC. The drive is programmed as follows:

- [Freq Select 1] = Adapter 1
- [Freq Select 2] = Analog Input 0

With Speed Select inputs 2 & 3 open and the selector switch set to “Remote” (Speed Select 1 closed), the drive will follow [Freq Select 2] (Analog Input 0). With the switch set to “Local” (Speed Select 1 open) all speed select inputs are open and the drive will follow the local HIM (Adapter 1) as selected with [Freq Select 1].

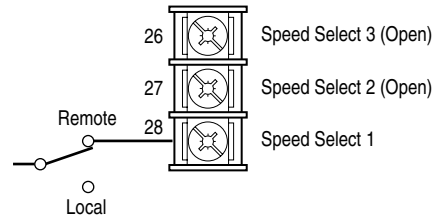

Example 2

Application is to follow a local HIM unless a preset speed is selected. The drive is programmed as follows:

- [Freq Select 1] = Adapter 1
- [Freq Select 2] = Preset Freq 1
- [Preset Freq 1] = 10 Hz.
- [Preset Freq 2] = 20 Hz.
- [Preset Freq 3] = 30 Hz.

Contact operation for the speed select switch is described in the table below. If the user does not select an input as Speed Select 3, [Preset Freq 4-7] would not be available.

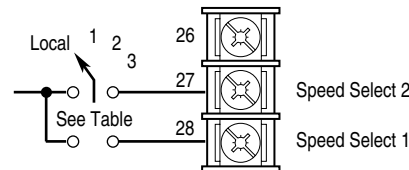

Switch Position	Speed Select Input		Parameter Used for Speed Ref.	Programmed Setting
	1 (#28)	2 (#27)		
Local	Open	Open	[Freq Select 1]	Adapter 1
1	Closed	Open	[Freq Select 2]	Preset Freq 1
2	Open	Closed	[Preset Freq 2]	20 Hz.
3	Closed	Closed	[Preset Freq 3]	30 Hz.

Encoder Inputs

Encoders must be line driver type, quadrature (dual channel) or pulse (single channel), 5VDC or 8-15VDC output, single-ended or differential and capable of supplying a minimum of 10mA per channel. Maximum input frequency is 250 kHz.

Encoder inputs are available at TB3. The interface board is jumper selectable to accept a 5V TTL or 12V DC square-wave with a minimum high state voltage of 3.0V DC (TTL) or 7.0V DC (12 volt encoder). Maximum high state voltage is 18.5V DC (board damage could result if voltage is exceeded). Maximum low state voltage is 0.4V DC. See *Encoder & Communications Cabling* on page [2-11](#).

Figure 2.4a
Encoder Signal Wiring

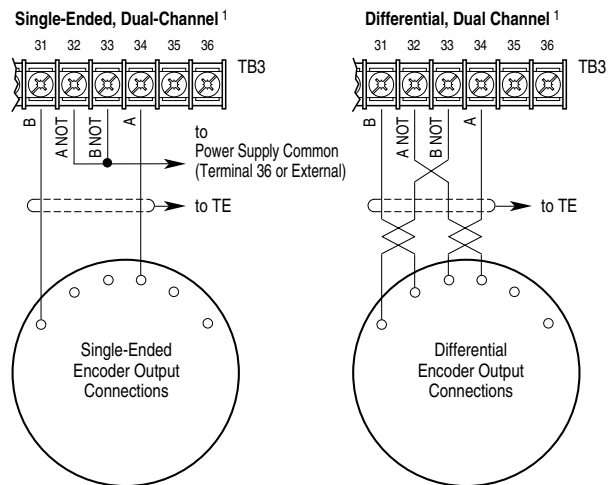

¹ For Single-Channel applications, eliminate the B and B (NOT) connections. Some encoders may label the "A" connection as "Signal." Single-channel provides speed indication Only, Not direction.

Important: Correct direction of motor rotation as determined during start-up (see Chapter 5) may require that the A or B channel wiring be reversed.

Figure 2.4b
Encoder Power Wiring

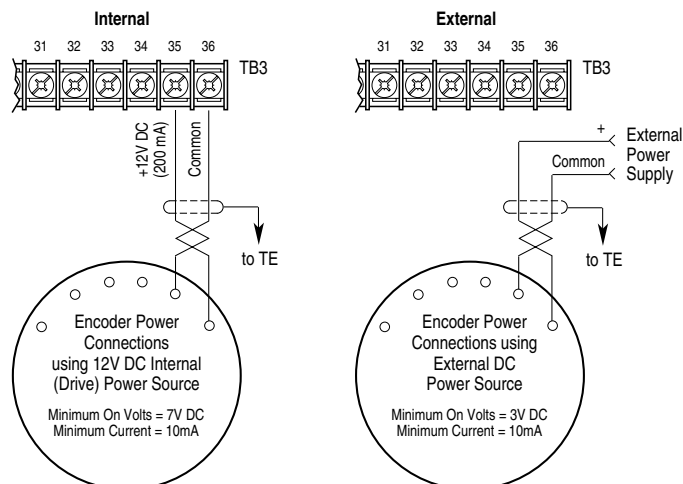

Important: Control Interface Board jumpers JP3 & JP4 must be set for the voltage level of the encoder output.

Pulse Input/Output Option

Pulse Input



ATTENTION: If input voltages are maintained at levels above $\pm 12\text{V DC}$, signals may be degraded and component damage may result.

The pulse input signal must be an externally powered square-wave pulse at a 5V TTL logic level. As measured at the terminal block, circuits in the high state must generate a voltage between 3.6 and 5.5V DC at 8 mA. Circuits in the low state must generate a voltage between 0.0 and 0.8V DC. Maximum input frequency is 250kHz. Scale factor [Pulse/Enc Scale] must be set.

Pulse Output

Provides a TTL pulse train suitable for driving up to three 1336 PLUS II pulse inputs or a separate 125 ohm load at TTL levels (4V at 32 mA source, 0.8V at 3.2 mA sink).

Digital Outputs

The digital outputs are at terminals 10 through 18 of TB2.

Figure 2.5
Digital Outputs – TB2

Any relay programmed as Fault or Alarm will energize (pick up) when power is applied to drive and deenergize (drop out) when a fault or alarm exists. Relays selected for other functions will energize only when that condition exists and will deenergize when condition is removed.

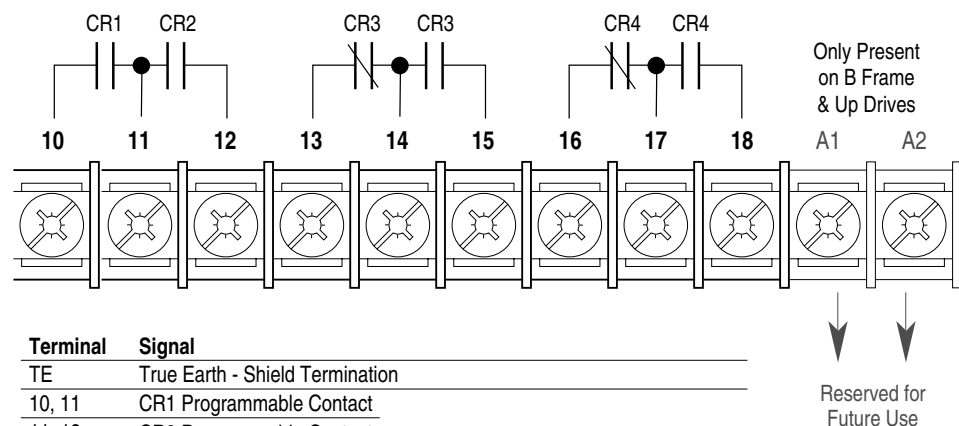

Terminal	Signal
TE	True Earth - Shield Termination
10, 11	CR1 Programmable Contact
11, 12	CR2 Programmable Contact
13, 14	CR3 Programmable Contact
14, 15	
16, 17	CR4 Programmable Contact
17, 18	
A1, A2	Reserved for Future Use

Resistive Rating = 115V AC/30V DC, 5.0A
Inductive Rating = 115V AC/30V DC, 2.0A

Important: On A Frame drives, the power supply used for relay contact outputs requires a field installation at the supply source of transient voltage surge suppression with maximum clamping voltage of 2.5 kV.

Analog I/O

The 1336 PLUS II analog I/O configuration provides a standard set of inputs and outputs with the capability to install up to 2 option boards, thus replacing the standard I/O with a variety of options. All connections are performed at TB2. Installing an option board in the slot A or B location will change the function of those terminals on TB2 from standard. Only one option board can be installed in each slot. [Figure 2.6](#) shows the standard and optional I/O configurations.

Figure 2.6
Analog I/O – TB2

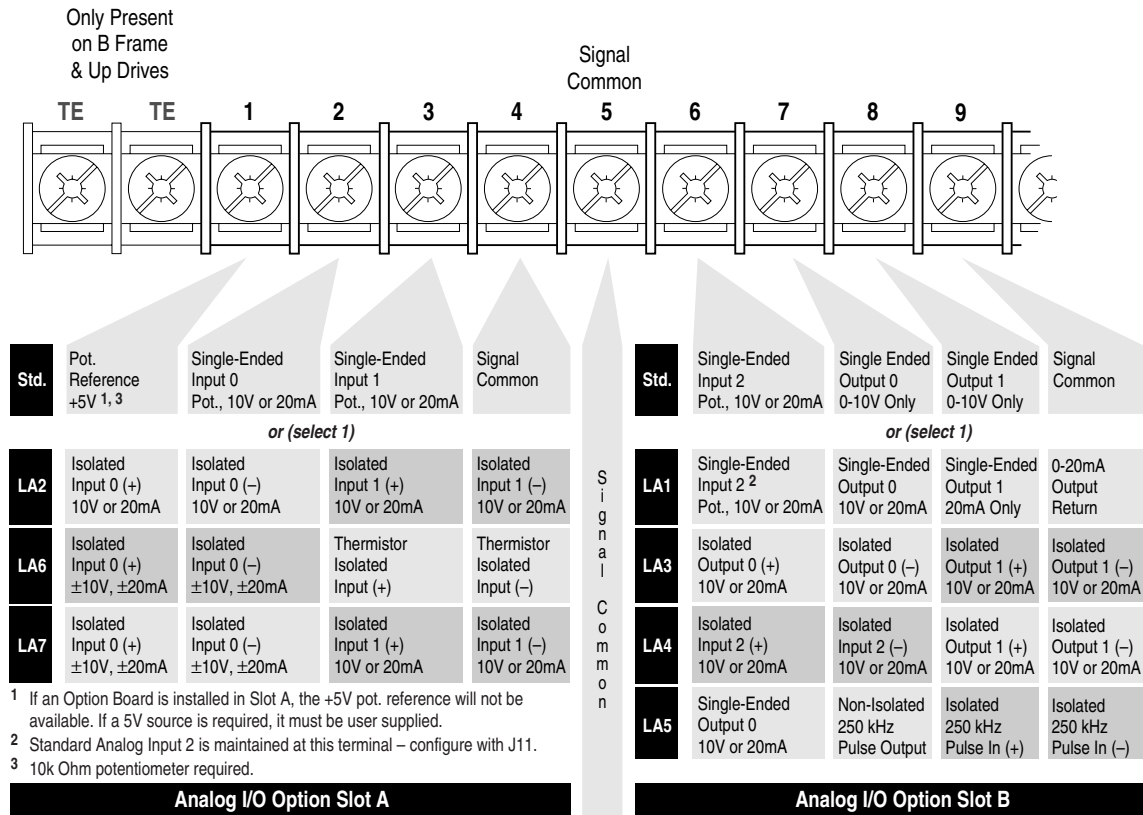

Analog 0-10V, 4-20 mA and Pulse I/O Examples

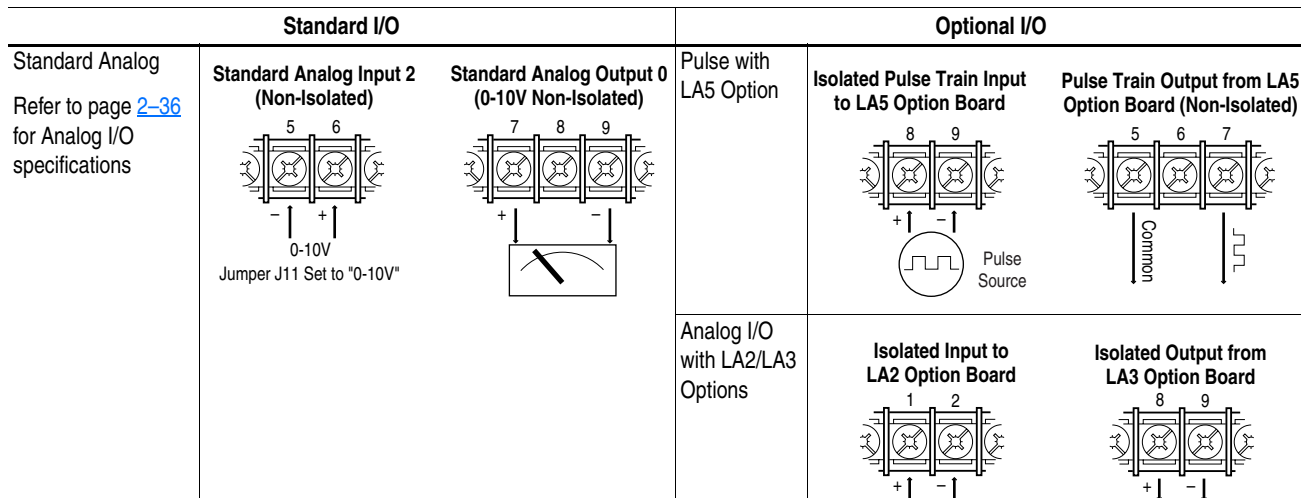

Remote Potentiometer Examples

	to Standard I/O	with Optional I/O												
<p>10k Ohm Remote Potentiometer to Standard Analog Input</p> <p>Refer to page 2-36 for Analog I/O specifications</p>	<p>Input 0 Shown - See Table below for other Inputs</p> <table border="1"> <thead> <tr> <th>TB2 Terminal</th> <th>Input</th> <th>Jumper . . . (Set to "Pot")</th> </tr> </thead> <tbody> <tr> <td>2</td> <td>0</td> <td>J8</td> </tr> <tr> <td>3</td> <td>1</td> <td>J13</td> </tr> <tr> <td>6</td> <td>2</td> <td>J11</td> </tr> </tbody> </table> <p>See table below for further jumper info.</p>	TB2 Terminal	Input	Jumper . . . (Set to "Pot")	2	0	J8	3	1	J13	6	2	J11	<p>10k Ohm Remote Potentiometer when LA2, LA6 or LA7 Option Board is Installed</p> <ol style="list-style-type: none"> If an Option Board is installed in Slot A, the +5V pot. reference will not be available at terminal 1. If a 5V source is required, it must be user supplied. Input to Terminal 6 is only valid for standard I/O or with an LA1 option installed. If an LA1 option is installed, Standard Analog Input 2 is maintained at this terminal – configure with J11. A pot cannot be connected to an isolated input.
TB2 Terminal	Input	Jumper . . . (Set to "Pot")												
2	0	J8												
3	1	J13												
6	2	J11												

Standard Analog I/O Setup

The 1336 PLUS II has a series of jumpers to connect the standard I/O to TB2 when no analog options (LA1, LA2, etc.) are present. Connectors J9 and J10 (see below) each have four jumpers connecting pins 1-2, 3-4, 5-6 and 7-8. These jumpers must be in place for the inputs and outputs to be active at TB2.

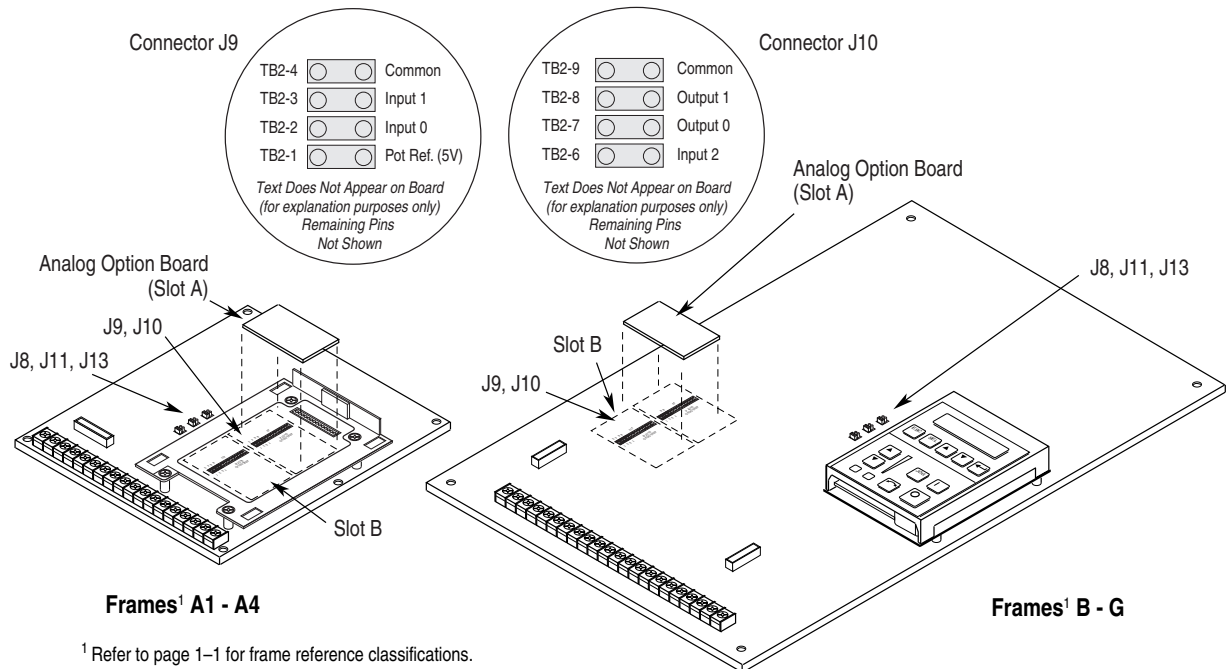

In addition, each input can be configured for 0-10V, 0-20 mA or potentiometer. Placing a jumper across the top of the connector (J8, J11, J13) configures that input for 0-10V operation. The bottom provides 0-20 mA and the right-side provides potentiometer operation. Please note that all three are factory set at 0-10V.

Important: Inputs 0, 1 & 2 are not located in logical order on the board.

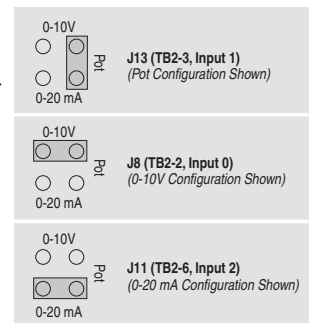

Optional Analog I/O Configurations

If your drive was received with Analog Options (LA1, LA2, etc.) factory installed, the boards must be setup before use. Proceed to “*Option Board Setup*” below.

Option Board Installation/Removal

If the drive is not factory configured with Analog Options, the desired option boards can be user installed. Prior to installation, the jumpers at J9 and/or J10 must be removed. If a board is removed at a later time, the jumpers must be reinstalled. Refer to the detailed instructions supplied with the option boards.

Important: Drive power must be removed prior to jumper installation/removal.

Option Board Setup

Before operation, each installed option board must be configured. The board will have one or two DIP switches depending on the option selected. The first function (input or output) is configured with the S1 DIP switch – the second function (if present) is configured with S51. Using the table below, set the switch(es) for correct operation.

Important: Due to different switch manufacturers, the individual switches will be designated “A or 1” and “B or 2.” In addition, switch positions will be indicated as “Off or 0” and “On or 1.”

S1 and S51 Configuration Settings

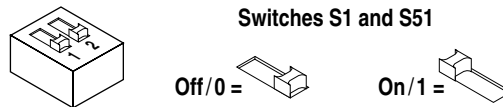

Option	DIP Switch S1				DIP Switch S51			
	Function	Mode	Switch Setting		Function	Mode	Switch Setting	
			A/1	B/2			A/1	B/2
LA1	Output 0	10V 20mA	Off/"0" On/"1"	Off/"0" On/"1"	Configure Standard Analog Input 2 with J11. See page 2-33 for further information.			
LA2	Input 0	10V 20mA	Off/"0" On/"1"	On/"1" Off/"0"	Input 1	10V 20mA	Off/"0" On/"1"	On/"1" Off/"0"
LA3	Output 0	10V 20mA	Off/"0" On/"1"	Off/"0" On/"1"	Output 1	10V 20mA	Off/"0" On/"1"	Off/"0" On/"1"
LA4	Input 2	10V 20mA	Off/"0" On/"1"	On/"1" Off/"0"	Output 1	10V 20mA	Off/"0" On/"1"	Off/"0" On/"1"
LA5	Output 0	10V 20mA	Off/"0" On/"1"	Off/"0" On/"1"				
LA6	Input 0	10V 20mA	Off/"0" On/"1"	On/"1" Off/"0"				
LA7	Input 0	10V 20mA	Off/"0" On/"1"	On/"1" Off/"0"	Input 1	10V 20mA	Off/"0" On/"1"	On/"1" Off/"0"

All isolated I/O is designed with full galvanic (greater than 10 meg ohms, less than 50 pf) isolation. This results in an insulation with-stand capability of 200VAC from each channel to True Earth (TE) ground and between channels. The Analog I/O Option Boards are summarized below.

Option	Board Type	Slot	Description
LA1	Dual Analog Output	B	This option replaces both standard analog outputs with two single-ended high resolution analog outputs. Analog Output 0 is configurable to 0-10V or 0-20 mA operation while Analog Output 1 is for 0-20 mA operation only. This option maintains access to the standard (non-isolated) Analog Input 2 through TB2-6 – Configuration remains with jumper J11.
LA2	Dual Isolated Input	A	This option replaces the two standard analog inputs with two galvanically isolated analog inputs. Both analog input channels are configurable for 0-10V or 0-20 mA operation.
LA3	Dual Isolated Output	B	Replaces Analog Input 2 and both standard analog outputs with two galvanically isolated high resolution analog outputs. Both analog output channels are configurable for 0-10V or 0-20 mA operation.
LA4	Isolated Input/ Isolated Output	B	This option replaces Analog Input 2 and both standard analog outputs with a galvanically isolated analog input and a galvanically isolated high resolution analog output. Both analog channels are configurable for 0-10V or 0-20 mA operation.
LA5	Analog Output/Pulse Output/Pulse Input	B	This option replaces Analog Input 2 and both standard analog outputs with a single-ended high resolution analog output, a single-ended 5V pulse output, and galvanically isolated 5V pulse input. The analog output channel is configurable for 0-10V or 0-20 mA operation.
LA6 ¹	Isolated Bipolar/ Isolated Thermistor Input	A	This option replaces the two standard analog inputs with a galvanically isolated analog input and a galvanically isolated thermistor input. Analog Input 0 is configurable for $\pm 10V$ or ± 20 mA operation, with polarity determining forward or reverse operation. Analog Input 1 is suitable for use with PTC sensor chains with a maximum total resistance at normal operating temperature of 1.8k ohms. An indication occurs in short circuit or over-temperature conditions. A short circuit condition is when the total resistance of the sensor chain is less than 60 ohms <u>with reset from the short circuit condition occurring when the resistance exceeds 70 ohms</u> . An over-temperature condition is when the total resistance of the sensor chain exceeds 3.3k ohms <u>with reset from the over-temperature condition occurring when the resistance is less than 2.2k ohms</u> .
LA7 ¹	Isolated Bipolar Input/Isolated Input	A	This option replaces the two standard analog inputs with two galvanically isolated analog inputs. Analog Input 0 is configurable for $\pm 10V$ or ± 20 mA operation, with polarity determining forward or reverse operation, while Analog Input 1 is configurable for 0-10V or 0-20 mA operation.

¹ Refer to the **Important** statement on page 2-28 concerning "bi-polar input option."

Specifications for the various inputs and outputs are provided below.

I/O Type	Configuration	Specification	Ref.
Standard	0-10V Input	100k ohm input impedance.	TB2-4 ¹
	0-10V Output	Can drive a 10k ohm load (60 mA short circuit current limit).	TB2-9 ¹
	0-20 mA Input	200 ohm input impedance.	TB2-4 ¹
	10k Ohm Pot. Input	760k ohm input impedance. Pot. source = 5V through 2.67k ohms to TB2-1.	TB2-4 ¹
Option Board ²	0-10V Input	100k ohm input impedance.	TB2-5
	0-10V Output	Can drive 3.3k ohms (3 - parallel 10k ohm loads).	TB2-5
	0-20 mA Input	100 ohm input impedance.	TB2-5
	0-20 mA Output	Can drive 400 ohms (3 - series 0-20 mA inputs).	TB2-5
	Pulse Input	250 ohms in series with an opto LED. Pulse high is greater than 8 mA or 3.6V, while pulse low is less than 0.8V or 0.2 mA. Absolute maximum continuous input level is 12V or 50 mA.	TB2-9
	Pulse Output	Provides a current limited 4.5V square wave. This output can drive one PLUS or three PLUS II pulse inputs.	TB2-5
Thermistor Input	5V across 3.3k ohms in series with the thermistor. This arrangement limits the measuring voltage to less than 2.5V (no self-heating).	TB2-4	

¹ Use TB2-5 for shield connection.

² Refer to Typical Isolation diagram below.

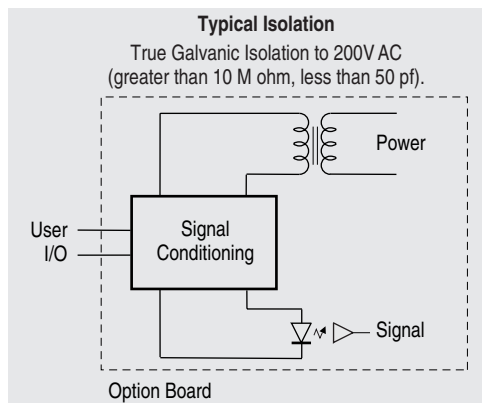

ATTENTION: Configuring an analog input for 0-20mA operation and driving it from a voltage source could cause component damage. Verify proper configuration prior to applying input signals.

Output Devices

Drive Output Disconnection



ATTENTION: Any disconnecting means wired to the drive output terminals U, V and W must be capable of disabling the drive if opened during drive operation. If opened during drive operation, the drive will continue to produce output voltage between U, V, W. An auxiliary contact must be used to simultaneously disable the drive.

Common Mode Cores

Common Mode Cores will help reduce the common mode noise at the drive output and guard against interference with other electrical equipment (programmable controllers, sensors, analog circuits, etc.). In addition, reducing the PWM carrier frequency will reduce the effects and lower the risk of common mode noise interference. Refer to the table below.

Table 2.1
1336 PLUS II Common Mode Chokes

Catalog Number	Used with . . .	Description
1321-M001	Communications Cables, Analog Signal Cables, etc.	Open Style - Signal Level
1321-M009	All 1336 PLUS II Drives Rated: 480V, 0.37-3.7 kW (0.5-5 HP)	Open Style with Terminal Block, 9A
1321-M048	All 1336 PLUS II Drives Rated: 480V, 5.5-22 kW (7.5-30 HP) 600V, 5.5-30 kW (7.5-40 HP)	Open Style, 48A
1321-M180	All 1336 PLUS II Drives Rated: 480V, 30-112 kW (40-X150 HP) 600V, 37-93 kW (50-125 HP)	Open Style, 180A
1321-M670	All 1336 PLUS II Drives Rated: 480V, 112-448 kW (150-600 HP) 600V, 149-448 kW (200-600 HP)	Open Style, 670A

Cable Termination

Optional Cable Terminator

Voltage doubling at motor terminals, known as reflected wave phenomenon, standing wave or transmission line effect, can occur when using drives with long motor cables.

Inverter duty motors with phase-to-phase insulation ratings of 1200 volts or higher should be used to minimize effects of reflected wave on motor insulation life.

Applications with non-inverter duty motors or any motor with exceptionally long leads may require an output filter or cable terminator. A filter or terminator will help limit reflection to the motor, to levels which are less than the motor insulation rating.

[Table 2.F](#) lists the maximum recommended cable length for unterminated cables, since the voltage doubling phenomenon occurs at different lengths for different drive ratings. If your installation requires longer motor cable lengths, a reactor or cable terminator is recommended. Refer to [Table 2.F](#) for frequency, cable length and voltage restrictions of 1204-TFA1 or 1204-TFB2 terminators.

Optional Output Reactor

Bulletin 1321 Reactors listed in the 1336 PLUS-3.0 Price Sheet can be used for drive input and output. These reactors are specifically constructed to accommodate IGBT inverter applications with switching frequencies up to 20 kHz. They have a UL approved dielectric strength of 4000 volts, opposed to a normal rating of 2500 volts. The first two and last two turns of each coil are triple insulated to guard against insulation breakdown resulting from high dv/dt. When using motor line reactors, it is recommended that the drive PWM frequency be set to its lowest value to minimize losses in the reactors.

Important: By using an output reactor the effective motor voltage will be lower because of the voltage drop across the reactor - this may also mean a reduction of motor torque.

Selecting/Verifying Fan Voltage

1336 PLUS II D-G Frame drives have cooling fans that utilize a transformer to match the input line voltage to the proper fan voltage. If an input voltage other than the standard 240, 480 or 600V AC is used, the transformer tap may have to be changed (see below).



ATTENTION: To avoid a shock hazard, assure that all power to the drive has been removed before proceeding.

1. Ensure that all power has been removed to the drive.
2. Locate the transformer in the lower left corner of the drive chassis. Note lead placement (tap being used).
3. Determine the correct tap from the following figure and verify.
4. If present tap is incorrect, remove the insulating sleeve from the correct tap.
5. Remove the wire lead presently connected and place on the selected tap. Replace the insulating sleeve on the unused tap.

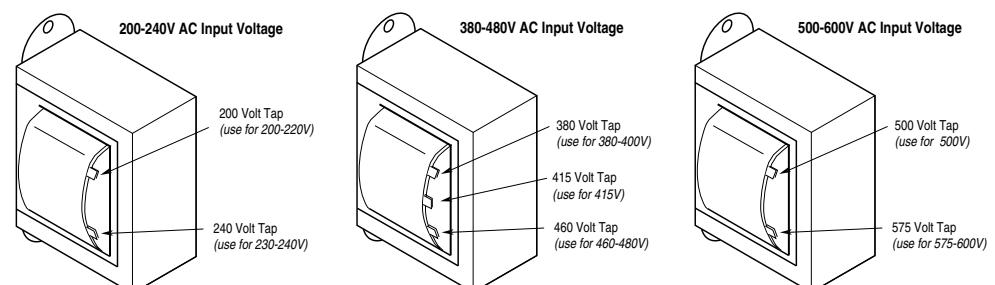

Auxiliary Inputs - TB4, TB6

Terminal blocks TB4 and TB6 (B Frame drives & up) allow the drive power supplies to be operated from an external voltage source. Both terminal blocks are located on the Base Driver Board and are accessible from the front of the drive. See [Figure 2.1](#) for locations.

TB4 can be used to externally power the low voltage power supply, allowing operation of drive control functions in the absence of bus voltage. Applying proper voltage to TB4 (see [Table 2.J](#)) provides +5V, ±15V and isolated 12V outputs for:

- Main Control Board (Control Interface Boards, RIO Board, etc.)
- SCANport™ (HIM, etc.)
- Encoder(s)
- LEMS
- Precharge
- Any DC fans in the drive

TB6 can be used to externally power the high voltage power supply which provides inverter IGBT drive voltage and the low voltage necessary to power the low voltage power supply. This allows operation of the drive in the absence of bus voltage.

The maximum and minimum wire size accepted by TB4 is 2.1 and 0.06 mm² (14 and 30 AWG). Wire sizes for TB6 are 5.3 and 0.06 mm² (10 and 30 AWG). Use Copper wire Only with a minimum temperature rating of 75 degrees C. Do not reduce wire gauge when using higher temperature wire. Maximum torque for both terminal blocks is 0.57 N-m (5 lb.-in.).

Table 2.J
Power Supply Input Requirements¹

Terminal Block	Drive Type	Input Voltage	Average Current	Peak Current
TB4-1 (+) TB4-2 (-)	All	22-28V DC ²	2.25A	5.00A
TB6	230V AC	200-375V DC ³	0.50A	1.00A
	380-480V AC	400-750V DC ³	0.25A	0.50A
	500-600V AC	400-925V DC ³	0.25A	0.50A

¹ The power source used to drive a power supply must be capable of providing the peak current at startup. A "flat" current or power limit is acceptable, but a foldback current limit may trip at startup, never allowing the supply to start.

² Must be supplied from a Class 2 Limited Power Source.

³ Must be supplied from a source that is provided with transient voltage surge suppression such that transients are suppressed to 6000V peak maximum or less.

Auxiliary Output - TB9

The 480V or 600V (depending on the input voltage to the drive) output terminal block (TB9) is only available on F Frame Drives. This terminal block provides a three-phase, high voltage connection from the load side of the AC input line fuses. Normally this connection is used to power an external control transformer (user supplied) or other auxiliary circuit. Refer to [Figure 2.1](#) for location.

Important: Depending on the circuitry connected, additional fusing may be required.



ATTENTION: The installation of auxiliary circuits must comply with the national codes and standards (NEC, VDE, BSA, etc.) and local codes regarding wire type, conductor sizes, branch circuit protection and disconnect devices. Failure to do so may result in personal injury and/or equipment damage.

The auxiliary circuit can be utilized to a maximum current capacity of 8 amperes RMS.

The maximum and minimum wire size accepted by TB9 is 4.0 and 0.8 mm² (12 and 18 AWG). Use Copper wire Only with a minimum temperature rating of 75 degrees C. Do not reduce wire gauge when using higher temperature wire. Maximum torque is 0.90-1.81 N-m (8-16 lb.-in.).

Control Interface Board Installation and Removal

Important: If the Control Interface Board is being installed, Main Control Board jumpers at pins 3 & 4 and 17 & 18 of J2 must be removed and the proper [Input Mode] selected. If this board is removed, these jumpers must be reinstalled and the [Input Mode] parameter must be programmed to “Status (1).”

Figure 2.7
Jumper Locations

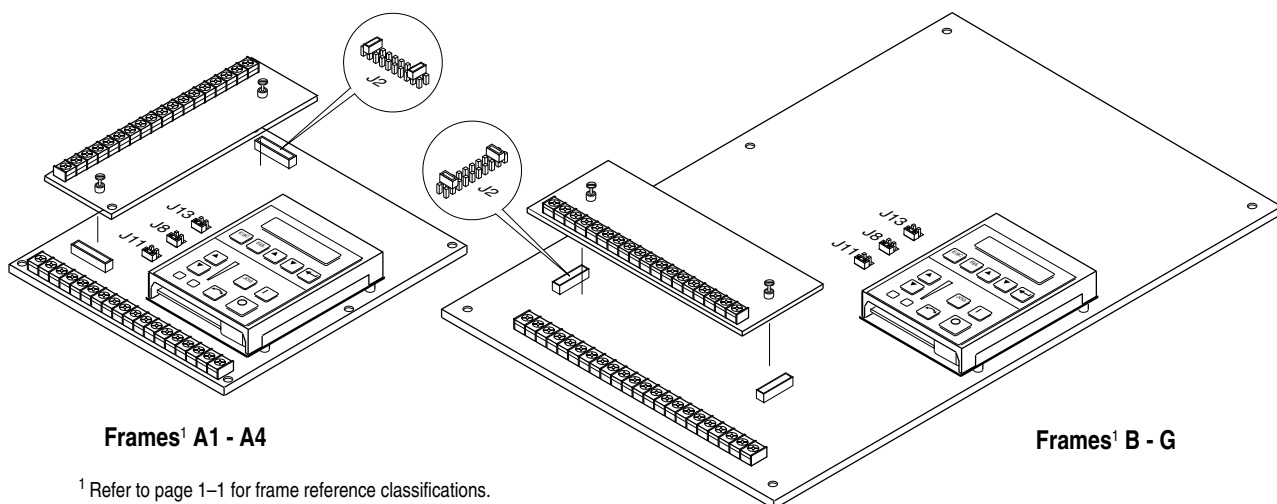

¹ Refer to page 1-1 for frame reference classifications.

Adapter Definitions

Serial communication devices such as the Human Interface Module that are connected to the drive are identified by SCANport serial communications as Adapters. Depending on the drive and options ordered, a number of different adapters are available as shown in [Figure 2.8](#). [Figure 2.9](#) shows the maximum distance allowed between devices.

Figure 2.8
Adapter Locations

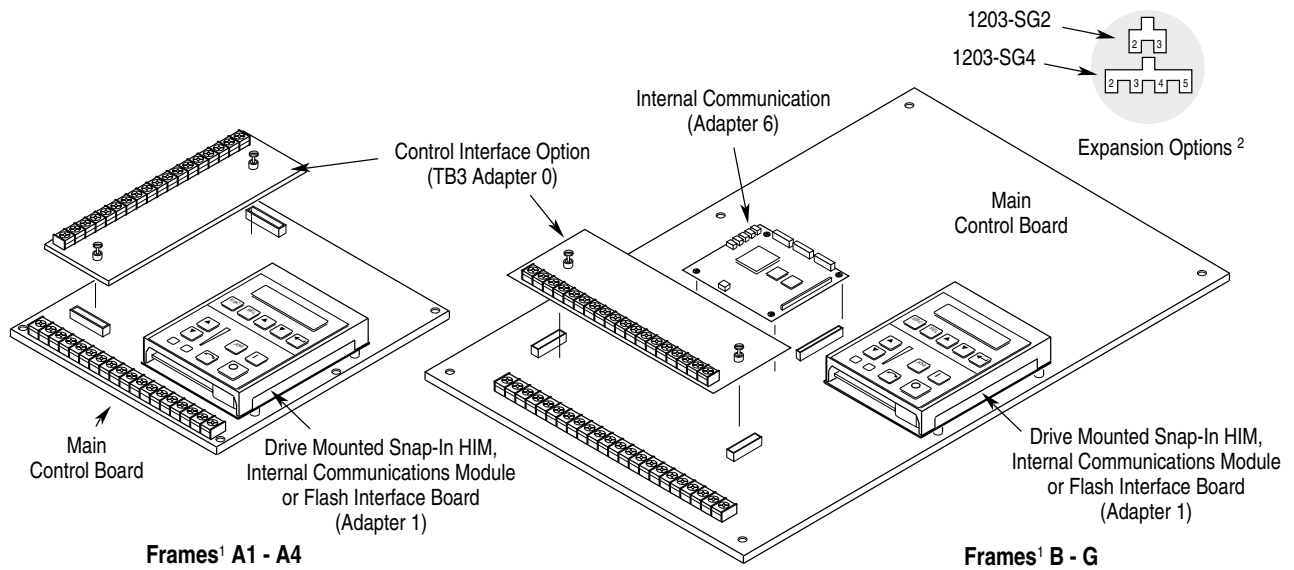

¹ Refer to page 1-1 for frame reference classifications.

² Communications Port for remote HIM/communication options (Adapter 2) or Expansion Options (Adapters 2, 3, 4, 5) is located on the bottom of the enclosure (bottom of Main Control Board Mounting Plate for frames F-G).

Figure 2.9
Remote Device Distances

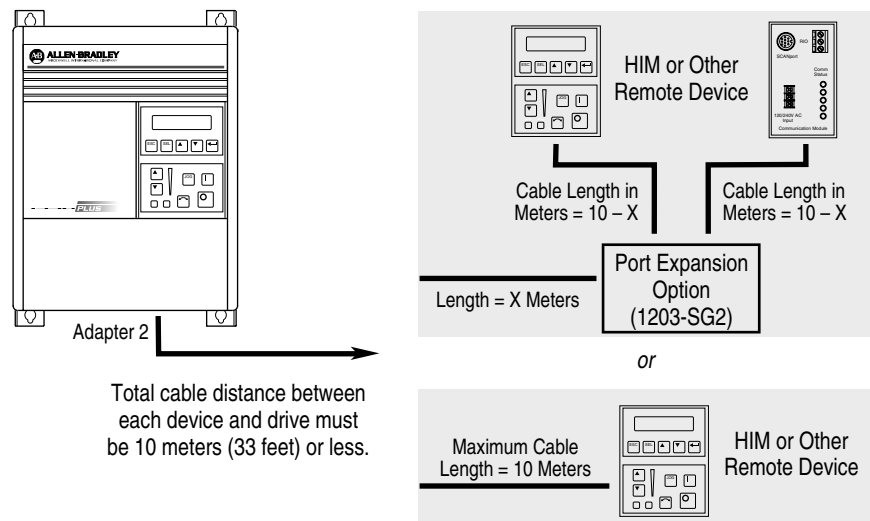

End of Chapter

Human Interface Module

Chapter 3 describes the various controls and indicators found on the optional Human Interface Modules (HIMs). The material presented in this chapter must be understood to perform the start-up procedure in Chapter 5.

HIM Description

When a **drive mounted** “snap-in” HIM is supplied, it will be connected as Adapter 1 (see *Adapter Definitions* in Chapter 2) and visible from the front of the drive. This HIM should not be removed while drive power is applied.

A **handheld** HIM can be connected to the drive (using a 1202-Cxx Option Cable) as Adapter 2, 3, 4 or 5 (see *Adapter Definitions* in Chapter 2). This type of HIM can be removed while drive power is applied. Refer to [“Control Status” on page 3–6](#) and [“Handheld HIM Operation” on page 3–13](#) for further information.

The HIM can be divided into two sections; Display Panel and Control Panel. The Display Panel provides a means of programming the drive and viewing the various operating parameters. The Control Panel allows different drive functions to be controlled. Refer to [Figure 3.1](#), [Figure 3.2](#) and the sections that follow for a description of the panels.



ATTENTION: When a drive mounted “snap-in” HIM is not supplied on enclosed NEMA Type 1 (IP 20) drives, the blank cover plate (option HASB) must be installed to close the opening in the front cover of the enclosure. Failure to install the blank cover plate allows access to electrically live parts which may result in personal injury and/or equipment damage.

When a drive mounted “snap-in” HIM is supplied with enclosed NEMA Type 1 (IP 20) drives, but has been removed, the blank cover plate must be installed in place of the HIM.

Important: The operation of some HIM functions will depend upon drive parameter settings. The default parameter values allow full HIM functionality.

Figure 3.1
HIM Display Panel



Display Panel Key Descriptions



Escape

When pressed, the ESCape key will cause the programming system to go back one level in the menu tree.



Select

Pressing the SElect key alternately causes the top or bottom line of the display to become active. The flashing first character indicates which line is active.



or



Increment/Decrement

These keys are used to increment and decrement a value or scroll through different groups or parameters. Pressing both keys simultaneously while the Process or Password Display is shown, will save that display as the startup display.



Enter

When pressed, a group or parameter will be selected or a parameter value will be entered into memory. After a parameter has been entered into memory, the top line of the display will automatically become active, allowing another parameter (or group) to be chosen.

Figure 3.2
HIM Control Panel

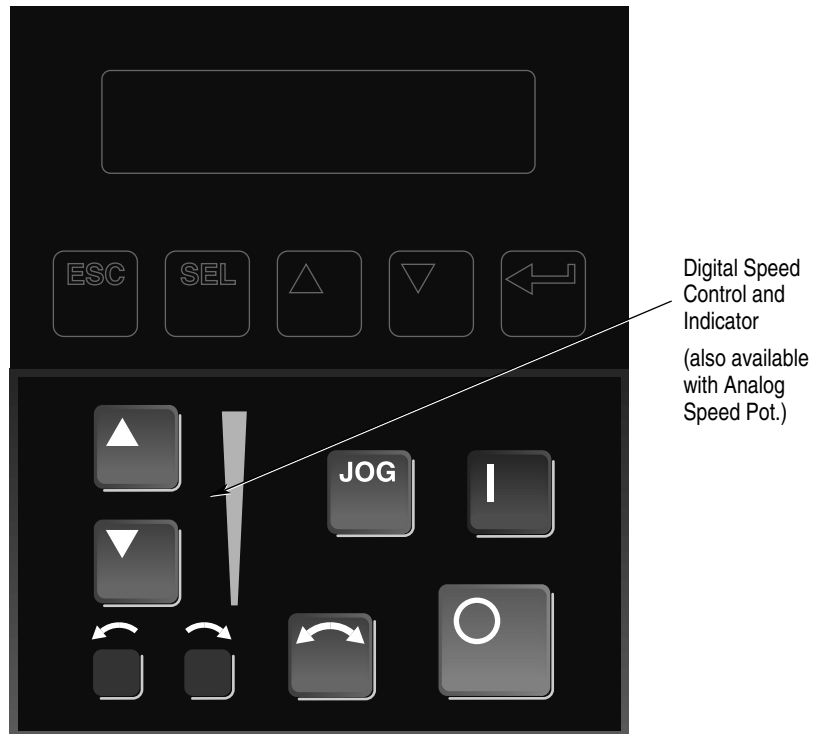

Control Panel Key Descriptions



Start

The Start key will initiate drive operation if no other control devices are sending a Stop command. This key can be disabled by the [Logic Mask] or [Start Mask].



Stop

If the drive is running, pressing the Stop key will cause the drive to stop, using the selected stop mode. Refer to the [Stop Select 1] and [Stop Select 2] parameters in Chapter 6.

If the drive has stopped due to a fault, pressing this key will clear the fault and reset the drive. Refer to the [Flt Clear Mode], [Logic Mask] and [Fault Mask] parameters.



Jog

When pressed, jog will be initiated at the frequency set by the [Jog Frequency] parameter, if no other control devices are sending a Stop command. Releasing the key will cause the drive to stop, using the selected stop mode. Refer to [Stop Select 1], [Stop Select 2], [Logic Mask] and [Jog Mask].

Control Panel Key Descriptions *(Continued)*



Change Direction

Pressing this key will cause the drive to ramp down to zero Hertz and then ramp up to set speed in the opposite direction. The appropriate Direction Indicator will illuminate to indicate the direction of motor rotation. Refer to [Logic Mask] and [Direction Mask].



Direction LEDs (Indicators)

The appropriate LED will illuminate continuously to indicate the commanded direction of rotation. If the second LED is flashing, the drive has been commanded to change direction, but is still decelerating.



Up/Down Arrows *(only available with digital speed control)*

Pressing these keys will increase or decrease the HIM frequency command. An indication of this command will be shown on the visual Speed Indicator. The drive will run at this command if the HIM is the selected frequency reference. See [Freq Select 1] and [Freq Select 2].



Pressing both keys simultaneously stores the current HIM frequency command in HIM memory. Cycling power or removing the HIM from the drive will set the frequency command to the value stored in HIM memory.

If the Analog Speed Potentiometer option has been ordered, the Up/Down keys and Speed Indicator will be replaced by the pot.



Speed Indicator *(only available with digital speed control)*

Illuminates in steps to give an approximate visual indication of the commanded speed.

If the Analog Speed Potentiometer option has been ordered, the Up/Down keys and Speed Indicator will be replaced by the pot.

HIM Operation

When power is first applied to the drive, the HIM will cycle through a series of displays. These displays will show drive name, HIM ID number and communication status. Upon completion, the Status Display (see [Figure 3.3](#)) will be shown. This display shows the current status of the drive (i.e. “Stopped,” “Running,” etc.) or any faults that may be present (refer to Chapter 7 for fault information). The Status Display can be replaced by the Process Display or Password Login menu on all HIMS, except Series A below version 3.0. See appropriate sections on the following pages for more information.

Figure 3.3
Status Display



From this display, pressing any one of the 5 Display Panel keys will cause “Choose Mode” to be displayed. Pressing the Increment or Decrement keys will allow different modes to be selected as described below and shown in [Figure 3.4](#). Refer to the pages that follow for operation examples.

Display

When selected, the Display mode allows any of the parameters to be viewed. However, parameter modifications are not allowed.

Process

The Process mode displays two user-selected parameters with text and scaling programmed by the user. Refer to Chapter 6 for further information.

Program

Program mode provides access to the complete listing of parameters available for programming. Refer to Chapter 6 for further parameter programming information.

StartUp

Performs an assisted start-up, prompting the user through major start-up steps. For further information, refer to Chapter 5.

EEProm

This mode allows all parameters to be reset to the factory default settings. In addition, certain HIMs (see table below) will allow parameter upload/download (Drive->HIM/HIM->Drive) between the HIM and drive. If your HIM does not have this capability, the option will not be displayed.

Table 3.A

HIMs with Upload/Download Capability

HIM Catalog Number	Upload/Download Capability
HAP (Series B)	●
HA1 (Series B)	●
HA2 (Series B)	●
HCSP	●
HCS1	●
HCS2	●

Search (except Series A HIMs below version 3.0)

This mode will search for parameters that are not at their default values.

Control Status (except Series A HIMs below version 3.0)

Permits the drive logic mask to be disabled/enabled allowing handheld HIM removal while drive power is applied. Disabling the logic mask with a Series A HIM below version 3.0 can be accomplished with [Logic Mask] as explained on [page 3-13](#). This menu also provides access to a fault queue which will list the last four faults that have occurred. “Trip” displayed with a fault indicates the actual fault that tripped the drive. A clear function clears the queue - it will not clear an active fault.

Password

The Password mode protects the drive parameters against programming changes by unauthorized personnel. When a password has been assigned, access to the Program/EEProm modes and the Control Logic/ Clear Fault Queue menus can only be gained when the correct password has been entered. The password can be any five digit number between 00000 and 65535. Refer to the example on [page 3-12](#).

Figure 3.4
HIM Programming Steps

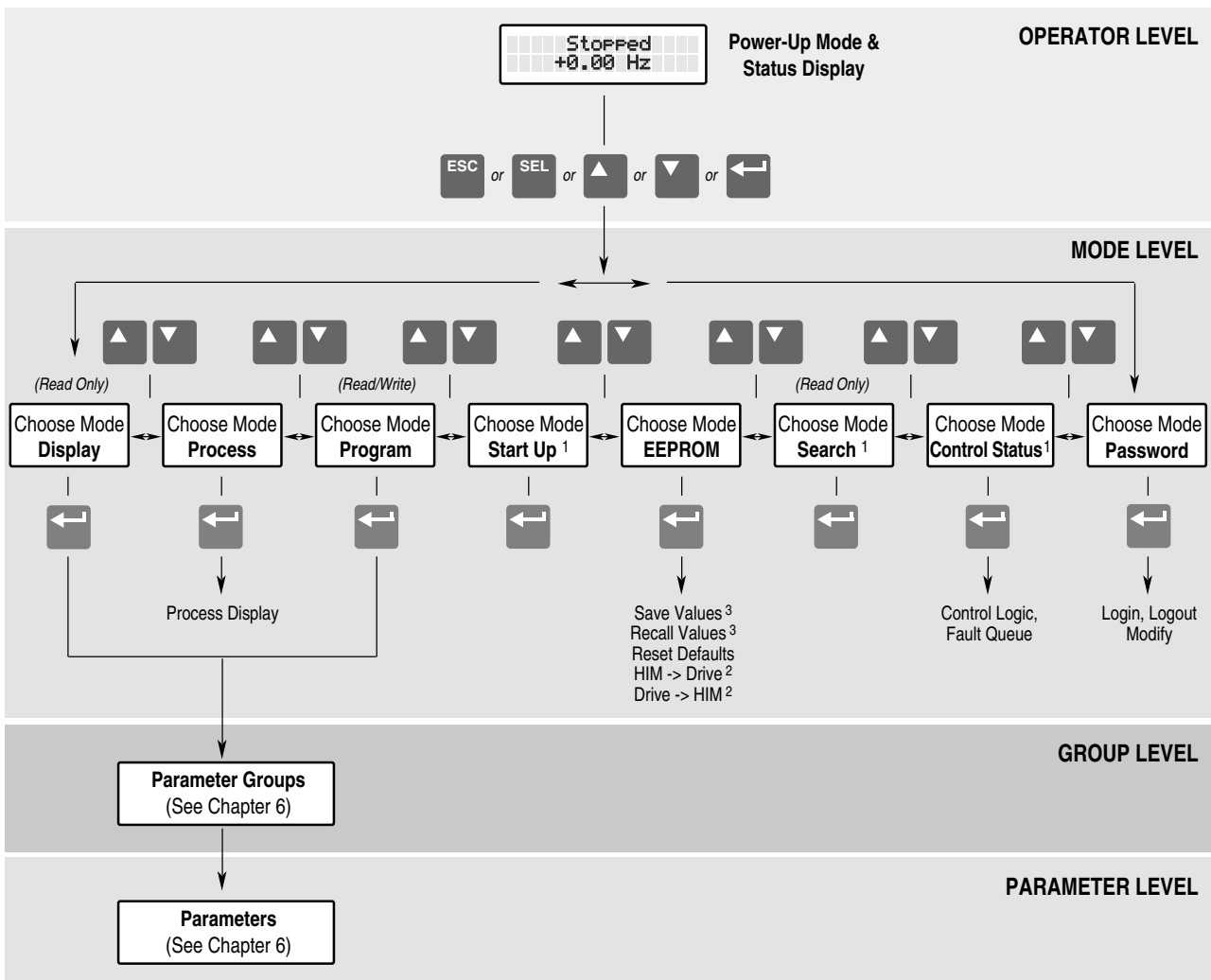

¹ Not available on Series A HIMs (below version 3.0).

² Not available on all HIMs – Refer to Table 3.A.





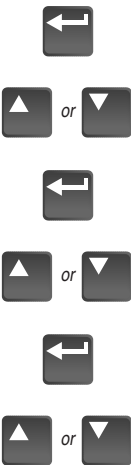
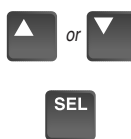

³ Reserved for future use.

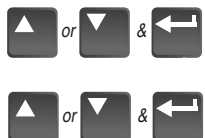





Program and Display Modes

Press these keys . . .	while following these steps . . .	The HIM Display will show . . .
	<p>1. The Display and Program modes allow access to the parameters for viewing or programming.</p> <p>A. From the Status Display, press Enter (or any key). “Choose Mode” will be shown.</p> <p>B. Press the Increment (or Decrement) key to show “Program” (or “Display”).</p> <p>C. Press Enter.</p> <p>D. Press the Increment (or Decrement) key until the desired group is displayed.</p> <p>E. Press Enter.</p> <p>F. Press the Increment (or Decrement) key to scroll to the desired parameter.</p>	<p><i>Choose Mode</i> <i>Display</i></p> <p><i>Choose Mode</i> <i>Program</i></p> <p><i>Choose Group</i> <i>Metering</i></p> <p><i>Output Current</i> <i>0.00 Amps</i></p>
	<p>Bit ENUMs (16 character text strings) will be displayed (except Series A HIMs below software version 3.0) to aid interpretation of bit parameters.</p> <p>G. Select a bit parameter with the Increment (or Decrement) keys.</p> <p>H. Press the SElect key to view the ENUM of the first bit. Pressing this key again will move the cursor to the left one bit.</p> <p>A blinking underline cursor will indicate that you are in the Display mode or that a Read Only parameter as been accessed. A flashing character will indicate that the value can be changed.</p> <p>Individual bits of a Read/Write parameter can be changed in the same manner. Pressing the SElect key will move the cursor (flashing character) one bit to the left. That bit can then be changed by pressing the Increment/Decrement keys. When the cursor is in the far right position, pressing the Increment/Decrement keys will increment or decrement the entire value.</p>	<p><i>Masks</i> <i>Logic Mask</i></p> <p><i>TB3</i> <i>X1111111</i></p>

Process Mode

Press these keys . . .	while following these steps . . .	The HIM Display will show . . .
<p>Process Mode</p> 	<p>1. When selected, the Process mode will show a custom display consisting of information programmed with the Process Display group of parameters.</p> <p>A. Follow steps A-C on the preceding page to access the Program mode.</p> <p>B. Press the Increment/Decrement key until “Process Display” is shown. Press Enter.</p> <p>C. Using the Increment/Decrement keys, select [Process 1 Par] and enter the number of the parameter you wish to monitor. Press Enter.</p>	<p><i>Choose Mode</i> <i>Program</i></p> <p><i>Choose Group</i> <i>Process Display</i></p> <p><i>Process 1 Par</i> <i>1</i></p>

Process Mode (continued)		
Press these keys . . .	while following these steps . . .	The HIM Display will show . . .
     	<p>D. Select [Process 1 Scale] using the Increment/Decrement keys. Enter the desired scaling factor. Press Enter.</p> <p>E. Select [Process 1 Txt 1] using the Increment/Decrement keys. Enter the desired text character. Press Enter and repeat for the remaining characters.</p> <p>F. If desired, a second display line can also be programmed by repeating steps A-E for [Process 2 xxx] parameters.</p> <p>G. When process programming is complete, press ESCape until “Choose Mode” is displayed. Press Increment/Decrement until “Process” is displayed.</p> <p>H. Press Enter. This selects which custom display will be on line 1 and line 2. Use the Increment/Decrement keys to select process 1 or 2 parameters for line 1.</p> <p>I. Press SElect to move to line 2. Select the desired process parameters. A zero can be entered (except Series A HIMs below version 3.0) to disable line 2. In addition, the Process Display can be set to appear when drive power is applied by simultaneously pressing the Increment and Decrement keys while the Process Display active.</p>	<p><i>Process 1 Scale</i> <i>1.00</i></p> <p><i>Process 1 Txt 1</i> <i>V</i></p> <p><i>Choose Mode</i> <i>Process</i></p> <p><i>Process Var 1=1</i> <i>Process Var 2=2</i></p> <p>Sets Process Display as Power-Up Display</p>

EEPROM Mode		
Press these keys . . .	while following these steps . . .	The HIM Display will show . . .
<p>Reset Defaults</p>       	<p>The EEPROM mode is used to restore all settings to factory default values or upload/download parameters between the HIM and drive (compatible HIMs only, see Table 3.A).</p> <p>1. To restore factory defaults:</p> <p>A. From the Status Display, press Enter (or any key). “Choose Mode” will be displayed.</p> <p>B. Press the Increment (or Decrement) key until “EEPROM” is displayed. If EEPROM is not in the menu, programming is password protected. Refer to <i>Password Mode</i> later in this section.</p> <p>C. Press Enter.</p> <p>D. Press the Increment (or Decrement) key until “Reset Defaults” is displayed.</p> <p>E. Press Enter to restore all parameters to their original factory settings.</p> <p>F. Press ESC. “Reprogram Fault” will display.</p> <p>G. Press the Stop key to reset the fault.</p> <p>Important: If [Input Mode] was previously set to a value other than “1,” cycle drive power to reset.</p>	<p><i>Choose Mode</i> <i>Display</i></p> <p><i>Choose Mode</i> <i>EEPROM</i></p> <p><i>EEPROM</i> <i>Reset Defaults</i></p> <p><i>Reprogram Fault</i> <i>F 48</i></p> <p><i>Stopped</i> <i>+0.00 Hz</i></p>



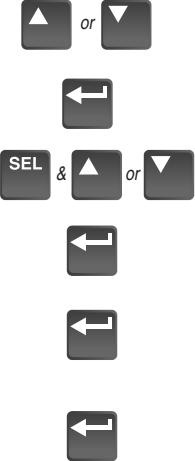
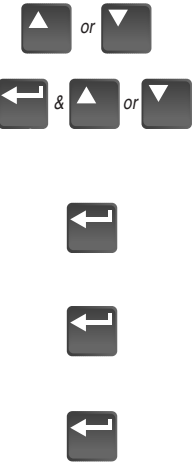

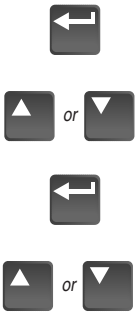

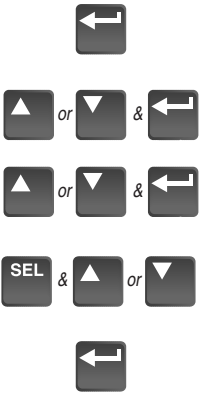





EEProm Mode (continued)











Press these keys . . .	while following these steps . . .	The HIM Display will show . . .
<p>Drive -> HIM</p> 	<p>2. To upload a parameter profile from the drive to the HIM, you must have a compatible HIM (see Table 3.A).</p> <p>A. From the EEPROM menu (see steps A-C above), press the Increment/Decrement keys until "Drive -> HIM" is displayed.</p> <p>B. Press Enter. A profile name (up to 14 characters) will be displayed on line 2 of the HIM. This name can be changed or a new name entered. Use the SEL key to move the cursor left. The Increment/Decrement keys will change the character.</p> <p>C. Press Enter. An informational display will be shown, indicating the drive type and firmware version.</p> <p>D. Press Enter to start the upload. The parameter number currently being uploaded will be displayed on line 1 of the HIM. Line 2 will indicate total progress. Press ESC to stop the upload.</p> <p>E. "COMPLETE" displayed on line 2 will indicate successful upload. Press Enter. If "ERROR" is displayed, see Chapter 7.</p>	<pre>EEProm Drive -> HIM Drive -> HIM 1 A Master Type Version 2.01 Drive -> HIM 60 Drive -> HIM 210 COMPLETE</pre>
<p>HIM -> Drive</p> 	<p>3. To download a parameter profile from the HIM to a drive, you must have a compatible HIM (see Table 3.A).</p> <p>Important: The download function will only be available when there is a valid profile stored in the HIM.</p> <p>A. From the EEPROM menu (see steps 1A-1C), press the Increment/Decrement keys until "HIM -> Drive" is displayed.</p> <p>B. Press the Enter key. A profile name will be displayed on line 2 of the HIM. Pressing the Increment/Decrement keys will scroll the display to a second profile (if available).</p> <p>C. Once the desired profile name is displayed, press the Enter key. An informational display will be shown, indicating the version numbers of the profile and drive.</p> <p>D. Press Enter to start the download. The parameter number currently being downloaded will be displayed on line 1 of the HIM. Line 2 will indicate total progress. Press ESC to stop the download.</p> <p>E. A successful download will be indicated by "COMPLETE" displayed on line 2 of the HIM. Press Enter. If "ERROR" is displayed, see Chapter 7.</p>	<pre>EEProm HIM -> Drive HIM -> Drive 1 A Master Type 2.01 -> 2.03 HIM -> Drive 60 Drive -> HIM 210 COMPLETE</pre>

Search Mode		
Press these keys . . .	while following these steps . . .	The HIM Display will show . . .
	<ol style="list-style-type: none"> The Search Mode is not available with a Series A HIM below version 3.0. This mode allows you to search through the parameter list and display all parameters that are not at the factory default values. <ol style="list-style-type: none"> From the Status Display, press Enter (or any key). "Choose Mode" will be shown. Press the Increment (or Decrement) key until "Search" is displayed. Press Enter. The HIM will search through all parameters and display any parameters that are not at their factory default values. Press the Increment (or Decrement) key to scroll through the list. 	<p><i>Choose Mode Display</i></p> <p><i>Choose Mode Search</i></p>













Control Status Mode		
Press these keys . . .	while following these steps . . .	The HIM Display will show . . .
<p>Control Logic</p> 	<ol style="list-style-type: none"> The Control Status mode is not available with a Series A HIM below version 3.0. This mode allows the drive logic mask to be disabled, thus preventing a Serial Fault when the HIM is removed while drive power is applied. The logic mask can be disabled with Series A HIMs (versions below 3.0) by using [Logic Mask] as explained on page 3-13. <ol style="list-style-type: none"> From the Status Display, press Enter (or any key). "Choose Mode" will be shown. Press the Increment (or Decrement) key until "Control Status" is displayed. Press Enter. Select "Control Logic" using the Increment/Decrement keys. Press Enter. Press the SElect key, then use the Increment (or Decrement) key to select "Disabled" (or "Enable"). Press Enter. The logic mask is now disabled (or enabled). 	<p><i>Choose Mode Display</i></p> <p><i>Choose Mode Control Status</i></p> <p><i>Control Status Control Logic</i></p> <p><i>Control Logic Disabled</i></p>

Control Status Mode (continued)

Press these keys . . .	while following these steps . . .	The HIM Display will show . . .
<p>Fault Queue/Clear Faults</p>  or    or    or   &  or  	<p>2. This menu provides a means to view the fault queue and clear it when desired.</p> <p>A. From the Control Status menu, press the Increment (or Decrement) key until "Fault Queue" is displayed.</p> <p>B. Press Enter.</p> <p>C. Press the Increment (or Decrement) key until "View Faults" is displayed.</p> <p>D. Press Enter. The fault queue will be displayed. "Trip" displayed with a fault will indicate the fault that tripped the drive.</p> <p>E. Use the Increment (or Decrement) key to scroll through the list.</p> <p>F. To clear the fault queue, press ESCape. Then use the Increment/Decrement keys to select "Clear Queue." Press Enter. Please note that "Clear Queue" will not clear active faults.</p>	<p><i>Control Status</i> <i>Fault Queue</i></p> <p><i>Fault Queue</i> <i>View Faults</i></p> <p><i>Serial Fault</i> <i>F 10 Trip 1</i></p> <p><i>Reprogram Fault</i> <i>F 48 2</i></p> <p><i>Fault Queue</i> <i>Clear Queue</i></p>

Password Mode		
Press these keys . . .	while following these steps . . .	The HIM Display will show . . .
<p>Modify Password</p>           	<ol style="list-style-type: none"> 1. The factory default password is 0 (which disables password protection). To change the password and enable password protection, perform the following steps. <ol style="list-style-type: none"> A. From the Status Display, press Enter (or any key). "Choose Mode" will be shown. B. Press the Increment (or Decrement) key until "Password" is displayed. C. Press Enter. D. Press the Increment (or Decrement) key until "Modify" is displayed. E. Press Enter. "Enter Password" will be displayed. F. Press the Increment (or Decrement) key to scroll to your desired new password. The SElect key will move the cursor (except Series A HIMs below version 3.0). G. Press Enter to save your new password. H. Press Enter again to return to the Password Mode. I. Press the Increment (or Decrement) key until "Logout" is displayed. J. Press Enter to log out of the Password mode. K. The Password mode can be programmed to appear when drive power is applied (except Series A HIMs below version 3.0). Simultaneously press the Increment and Decrement keys while the Password display is shown. 	<p><i>Choose Mode Display</i></p> <p><i>Choose Mode Password</i></p> <p><i>Password Modify</i></p> <p><i>Enter Password < 0></i></p> <p><i>Enter Password < 123></i></p> <p><i>Choose Mode Password</i></p> <p><i>Password Login</i></p> <p><i>Password Logout</i></p> <p><i>Choose Mode Password</i></p> <p>Sets Password Display as Power-Up Display</p>

Password Mode (continued)

Press these keys . . .	while following these steps . . .	The HIM Display will show . . .
<p>Login to Drive</p>  or     or  	<p>2. The Program/EEProm modes and the Control Logic/Clear Queue menus are now password protected and will not appear in the menu. To access these modes, perform the following steps.</p> <p>A. Press the Increment (or Decrement) key until "Password" is displayed.</p> <p>B. Press Enter. "Login" will be displayed.</p> <p>C. Press Enter, "Enter Password" will be displayed.</p> <p>D. Press the Increment (or Decrement) key until your correct password is displayed. The SElect key will move the cursor (except Series A HIMs below version 3.0).</p> <p>E. Press Enter.</p> <p>F. The Program and EEPROM modes will now be accessible. To prevent future access to program changes, logout as described below.</p>	<p><i>Choose Mode</i> <i>Password</i></p> <p><i>Password</i> <i>Login</i></p> <p><i>Enter Password</i> <i>< 0></i></p> <p><i>Enter Password</i> <i>< 123></i></p> <p><i>Choose Mode</i> <i>Password</i></p>
<p>Logout from Drive</p>  or    or  	<p>3. To prevent unauthorized changes to parameters, Logout must be performed as described below.</p> <p>A. Press the Increment (or Decrement) key until "Password" is displayed.</p> <p>B. Press Enter.</p> <p>C. Press the Increment (or Decrement) key until "Logout" is displayed.</p> <p>D. Press Enter to log out of the Password mode.</p>	<p><i>Choose Mode</i> <i>Password</i></p> <p><i>Password</i> <i>Login</i></p> <p><i>Password</i> <i>Logout</i></p> <p><i>Choose Mode</i> <i>Password</i></p>

Handheld HIM Operation

If remote programming is desired, a handheld HIM can be connected to the drive. Refer to *Adapter Definitions* in Chapter 2 for details.

Important: Disconnecting a handheld HIM (or other SCANport device) from a drive while power is applied will cause a "Serial Fault," unless the [Logic Mask] parameter has been set to disable this fault or Control Logic (Control Status menu) has been disabled (except Series A HIMs below version 3.0). Setting any bit of the [Logic Mask] parameter to "0" will disable "Serial Fault" from a HIM on the corresponding adapter. Note that this also disables all HIM control functions except Stop.

End of Chapter

Flash Memory

The 1336 PLUS II stores its operating firmware in state-of-the-art Flash Memory. Chapter 4 will briefly describe flash memory and the method available to upgrade the drive firmware in the event that software enhancements become available.

What is Flash Memory?

The firmware (including parameter layout and operating algorithms) resides in a form of programmable read-only memory called “Flash Memory.” Flash memory allows the user to easily upgrade the drive firmware locally using a standard computer and a Firmware Download Module (1336F-FDM). The latest firmware files are available on the Internet or from your local sales office.

Firmware Download Requirements

The necessary file can be downloaded from the Internet with a computer (IBM® compatible recommended) having the following:

- Disk drive (hard or floppy)
- Standard communications program capable of XMODEM protocol
- Standard serial “COM” port and connecting cable
- Internet access with browser software

In addition, the following is recommended:

- Windows 95® Operating System

A Firmware Download Module must be installed in the Adapter 1 location of the drive to allow access to drive memory. Detailed instructions are included with the board.

End of Chapter

Start-Up

This chapter describes how you start-up the 1336 PLUS II Drive. Included are typical adjustments and checks to assure proper operation. The information contained in previous chapters of this manual must be read and understood before proceeding.

Important: The 1336 PLUS II is designed so that start-up is simple and efficient. Two start-up methods are provided. A self prompting “assisted” procedure utilizing the 1336 PLUS II **Startup mode**. As an aid, this mode asks questions about the most used basic parameters. The second method, if required, provides a more complex start-up utilizing the “Program” mode and complete parameter access. Advanced features and adjustments are grouped separately from basic parameters for ease of use.

Start-Up Requirements

The following procedures are written for users who have a Human Interface Module (HIM) installed and who are not using a 2-wire drive control scheme. For users without a HIM, respective external commands and signals must be substituted to simulate their operation.



ATTENTION: Power must be applied to the drive to perform the following start-up procedure. Some of the voltages present are at incoming line potential. To avoid electric shock hazard or damage to equipment, only qualified service personnel should perform the following procedure. Thoroughly read and understand the procedure before beginning. If an event does not occur while performing this procedure, **Do Not Proceed. Remove Power** by opening the branch circuit disconnect device and correct the malfunction before continuing.

Important:

- Power must be applied to the drive when viewing or changing 1336 PLUS II parameters. Previous programming may affect the drive status when power is applied.
- If the Control Interface option is installed, remote start circuits may be connected to TB3 on the interface board. Confirm that all circuits are in a de-energized state before applying power. User supplied voltages may exist at TB3 even when power is not applied to the drive.
- Refer to Chapter 7 for fault code information.

Initial Operation

1. Verify that AC line power at the disconnect device is within the rated value of the drive. If a Control Interface option (L4, L5, L6, L4E through L9E) is installed, verify that the control power to this board matches the board rating.
2. Remove and lock-out all incoming power to the drive including incoming AC power to terminals R, S and T (L1, L2 and L3) plus any separate control power for remote interface devices.
3. If a Control Interface option is installed, verify that the Stop and Enable interlock inputs are present.

Important: The Stop and Enable inputs must be present before the drive will start.

If this option is not installed, verify that two jumpers are installed at pins 3 & 4 and 17 & 18 of J2. In addition, the [Input Mode] must be set to "Status."

4. Confirm that all other optional inputs are connected to the correct terminals and are secure.
5. The remainder of this procedure requires that a HIM be installed. If the HIM has a Control Panel, use the local controls to complete the start-up procedure. If a Control Panel is not present, remote devices must be used to operate the drive.
6. Proceed to ["Assisted Start-Up"](#). If a more detailed start-up is required, go to ["Advanced Start-Up" on page 5](#).

Assisted Start-Up













The following procedure provides a prompted start-up. Steps are outlined below.



ATTENTION: To guard against possible machine damage and/or personal injury caused by unintended motor rotation, Do Not press the Start key (HIM) or issue a Start command (TB3) during the Start-Up procedure until instructed to do so. Pressing the Start key or issuing a Start command will cause the drive to start.

Assisted Start-Up		
Keys	Description	The HIM Display will show . . .
Disconnect Load from Motor	1. For proper operation of the Autotune function, assure that the load is disconnected from the motor.	
Apply Power	2. Apply AC power and control voltages to the drive. The LCD Display should light and display a drive status of "Stopped" and an output frequency of "+0.00 Hz." If the drive detects a fault, a brief statement relating to the fault will be shown on the display. Record this information, remove all power and correct the fault source before proceeding. Refer to Chapter 7 for fault descriptions.	<i>Stopped</i> <i>+0.00 Hz</i>

Assisted Start-Up

Keys	Description	The HIM Display will show . . .
<p>Reset Factory Defaults</p>       	<p>3. Important: The remaining steps in this procedure are based on factory default parameter settings. If the drive has been previously operated, parameter settings may have been changed and may not be compatible with this start-up procedure or application. Drive status and fault conditions may be unpredictable when power is first applied.</p> <p>To obtain proper results, the parameters must be restored to factory default settings.</p> <p>A. From the Status Display, press Enter (or any key). “Choose Mode” will be displayed.</p> <p>B. Press the Increment (or Decrement) key until “EEPROM” is displayed. If EEPROM is not in the menu, programming is password protected. Refer to Chapter 3 for Password information.</p> <p>C. Press Enter.</p> <p>D. Press the Increment (or Decrement) key until “Reset Defaults” is displayed.</p> <p>E. Press Enter to restore all parameters to their original factory settings.</p> <p>F. Press ESC. “Reprogram Fault” will display, indicating successful reset.</p> <p>G. Press the Stop key to reset the fault. Cycle power.</p>	<p><i>Choose Mode Display</i></p> <p><i>Choose Mode EEProm</i></p> <p><i>EEProm Reset Defaults</i></p> <p><i>Choose Mode EEProm</i></p> <p><i>Reprogram Fault F48</i></p> <p><i>Stopped +0.00 Hz</i></p>
     	<p>4. From the Status Display, press the Enter key (or any key). “Choose Mode” will be displayed.</p> <p>A. Press the Increment (or Decrement) key until “Startup” is displayed.</p> <p>B. Press Enter.</p> <p>Important: All questions can be answered Yes or No. Pressing Enter will select the default (“Y” or “N”). Pressing the Increment (or Decrement) key will change the selection – press Enter to select. Choosing “Y” allows you to proceed through the step, “No” will advance you to the next step. In addition, the following should be noted:</p> <ul style="list-style-type: none"> The “Startup” mode can be exited at any time by pressing ESCape until the Status Display is shown. If you wish to re-enter the “Startup” mode, simply select “Reset Sequence” to start from the beginning. Selecting “Continue” allows you to resume from the point where you left off. Completing the last action in any step will automatically take you to the next step. Pressing SElect will activate line 2 of the display – this must be done for all values. Press the Increment (or Decrement) key to adjust a value (skip if value is correct). Press Enter to store the value or retain the existing value. Pressing Enter again will cause you to move to the next step (parameter). 	<p><i>Choose Mode Display</i></p> <p><i>Choose Mode Startup</i></p>

Assisted Start-Up



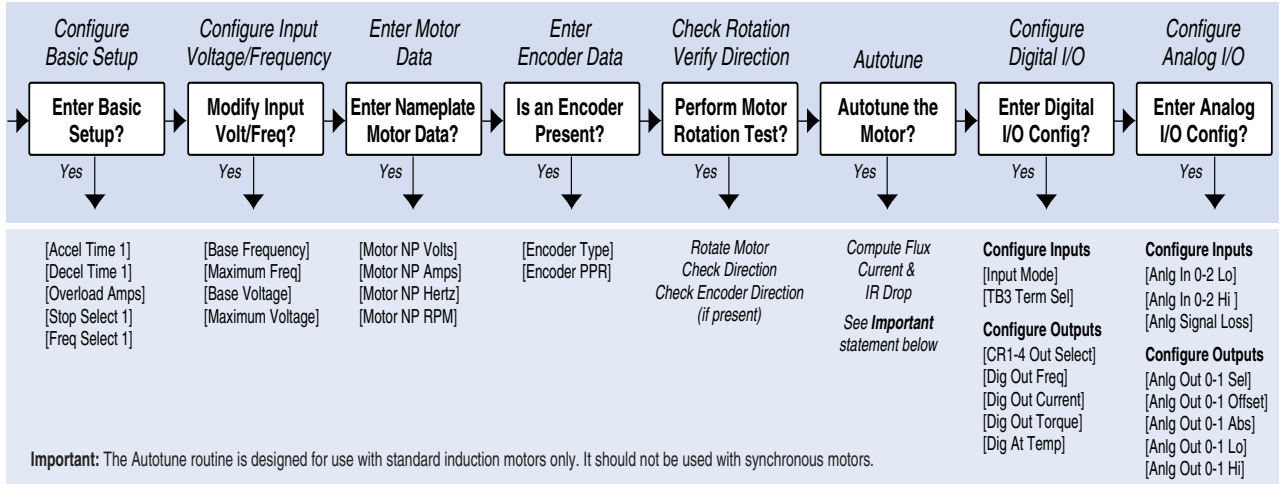





Keys	Description	The HIM Display will show . . .
	<p>5. Using the following diagram as a guide, perform the desired steps.</p> <div style="border: 1px solid black; padding: 5px; margin: 10px 0;">  <p>ATTENTION: Rotation of the motor in an undesired direction can occur during this procedure. To guard against possible injury and/or equipment damage, it is recommended that the motor be disconnected from the load before proceeding.</p> </div>	











	<p>6. Start-up is complete. Remove all power, then reconnect load to motor. Check for proper operation.</p>	
--	---	--









Advanced Start-Up

This procedure is designed for complex applications requiring a more detailed start-up.



Advanced Start-Up Procedure		
Press these keys . . .	while following these steps . . .	The HIM Display will show . . .
Disconnect Motor	1. Remove the drive cover and disconnect the motor leads from TB1, terminals U, V, W (T1, T2 and T3).	
Apply Power	2. Apply AC power and control voltages to the drive. The LCD Display should light and display a drive status of "Stopped" and an output frequency of "+0.00 Hz." If the drive detects a fault, a brief statement relating to the fault will be shown on the display. Record this information, remove all power and correct the fault source before proceeding. Refer to Chapter 7 for fault descriptions.	<i>Stopped</i> <i>+0.00 Hz</i>
Reset Factory Defaults	3. Important: The remaining steps in this procedure are based on factory default parameter settings. If the drive has been previously operated, parameter settings may have been changed and may not be compatible with this start-up procedure or application. Drive status and fault conditions may be unpredictable when power is first applied. To obtain proper results, the parameters must be restored to factory default settings.	
	A. From the Status Display, press Enter (or any key). "Choose Mode" will be displayed.	<i>Choose Mode</i> <i>Display</i>
 or 	B. Press the Increment (or Decrement) key until "EEPROM" is displayed. If EEPROM is not in the menu, programming is password protected. Refer to Chapter 3 for Password information.	<i>Choose Mode</i> <i>EEPROM</i>
	C. Press Enter.	
 or 	D. Press the Increment (or Decrement) key until "Reset Defaults" is displayed.	<i>EEPROM</i> <i>Reset Defaults</i>
	E. Press Enter to restore all parameters to their original factory settings.	<i>Choose Mode</i> <i>EEPROM</i>
	F. Press ESC. "Reprogram Fault" will display, indicating successful reset.	<i>Reprogram Fault</i> <i>F48</i>
	G. Press the Stop key to reset the fault. Cycle power.	<i>Stopped</i> <i>+0.00 Hz</i>

Advanced Start-Up Procedure		
Press these keys . . .	while following these steps . . .	The HIM Display will show . . .
<p>Program Input Mode</p>          <p>Cycle Input Power</p>	<p>4. If a Control Interface option is installed, it is important that the Input Mode selected in Chapter 2 be programmed into the drive. Since the control inputs to this option are programmable, incorrect operation can occur if an improper mode is selected. The factory default mode ("Status") disables all inputs except Stop and Enable. Verify your control scheme against the information provided in Chapter 2 and program the [Input Mode] parameter as follows:</p> <p>A. From the Status Display, press the Enter key (or any key). "Choose Mode" will be displayed.</p> <p>B. Press the Increment (or Decrement) key until "Program" is displayed. If Program is not available, programming is password protected. Refer to Chapter 3 for Password mode information.</p> <p>C. Press Enter.</p> <p>D. Press the Increment key until "Setup" is displayed.</p> <p>E. Press Enter.</p> <p>F. Press SElect. The first character of line 2 will now flash.</p> <p>G. Press the Increment or Decrement keys until the desired mode is displayed, then press Enter.</p> <p>In addition to the mode, Inputs 3-8 can also be programmed (if defaults are not desired). See Chapter 6 for parameter information. Use the steps above as a guide if input programming is desired.</p> <p>H. Press the ESCape key (3 times) to return to the Status Display.</p> <p>I. Remove power to the drive. When the HIM Display is no longer illuminated, reapply power.</p> <p>Important: Display must go blank for input mode programming changes to take effect.</p>	<p><i>Choose Mode EEProm</i></p> <p><i>Choose Mode Program</i></p> <p><i>Metering</i></p> <p><i>Setup</i></p> <p><i>Input Mode Status</i></p> <p><i>Input Mode 3 Wire</i></p> <p><i>Stopped +0.00 Hz</i></p>





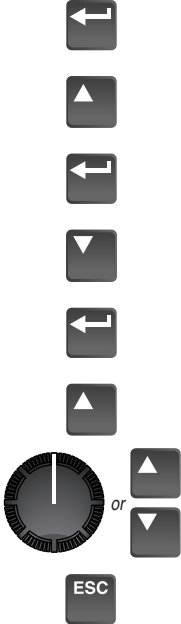
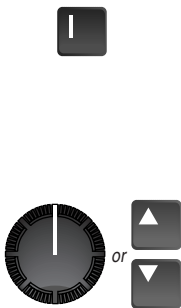

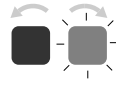
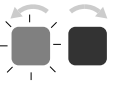
Advanced Start-Up Procedure

Press these keys . . .	while following these steps . . .	The HIM Display will show . . .
       	<p>5. Set [Maximum Freq] and [Maximum Voltage] parameters to correct values (typically line voltage/frequency). Set [Base Voltage] and [Base Frequency] parameters to the motor nameplate values.</p> <p>A. From the Status Display, press the Enter key (or any key). "Choose Mode" will be displayed.</p> <p>B. Press the Increment (or Decrement) key until "Program" is displayed.</p> <p>C. Press Enter.</p> <p>D. Press the Increment key until "Setup" is displayed.</p> <p>E. Press Enter.</p> <p>F. Press the Increment or Decrement keys until "Maximum Freq" is displayed. Press SElect. The first character of line 2 will now flash.</p> <p>G. Use the Increment/Decrement keys to display the first digit, then press Enter. Repeat for remaining digits.</p> <p>H. Repeat the above steps to program the remaining parameters located in the Motor Control group.</p> <p>I. Press the ESCape key (3 times) to return to the Status Display.</p>	<p><i>Choose Mode</i> <i>EEProm</i></p> <p><i>Choose Mode</i> <i>Program</i></p> <p><i>Metering</i></p> <p><i>Setup</i></p> <p><i>Input Mode</i> <i>3 Wire</i></p> <p><i>Maximum Freq</i> <i>60</i></p> <p><i>Stopped</i> <i>+0.00 Hz</i></p>
<p>Choose Sensorless Vector or V/Hz</p>	<p>6. Sensorless Vector or V/Hz operation. Sensorless Vector or Volts/Hertz operation is selectable via [Control Select]. Vector operation is the default. If V/Hz operation is desired, reprogram [Control Select] using the steps above as a programming guide. Refer to Chapter 6.</p>	







Advanced Start-Up Procedure

Press these keys . . .	while following these steps . . .	The HIM Display will show . . .
	<p>7. Setting Frequency Command.</p> <p>A. From the Status Display, press the Enter key (or any key). “Choose Mode” will be displayed.</p> <p>B. Press the Increment key until “Display” is shown.</p> <p>C. Press Enter.</p> <p>D. Press the Decrement key until “Metering” is displayed.</p> <p>E. Press Enter.</p> <p>F. Press the Increment key until “Freq Command” is displayed.</p> <p>G. If the frequency command is a value other than zero, use the speed source (digital, analog pot, etc.) to set the command to zero.</p> <p>H. After the command has been set to zero, press the ESCape key until the Status Display is shown.</p>	<p><i>Choose Mode</i> <i>EEProm</i></p> <p><i>Choose Mode</i> <i>Display</i></p> <p><i>Setup</i></p> <p><i>Metering</i></p> <p><i>Output Voltage</i> <i>0 Vlts</i></p> <p><i>Freq Command</i> <i>+0.00 Hz</i></p> <p><i>Stopped</i> <i>+0.00 Hz</i></p>
	<p>8. Verifying Minimum and Maximum Frequency Settings.</p> <p>A. Press the Start key. The drive should output zero Hz, which is the factory default value for the [Minimum Freq] parameter. The Status Display should indicate “At Speed” and the actual frequency (+0.00 Hz.).</p> <p>If the drive does not start, check bit 12 (Voltage Check) of the [Drive Alarm 1] parameter. If the bit is “1,” the drive terminal voltage is preventing the drive from starting. Normally this is caused by IGBT leakage current. To bypass this alarm, program [Flying Start En] to “Track Volts,” then start the drive.</p> <p>B. With the drive still running, use the speed source to command maximum speed. The drive should ramp to [Maximum Freq].</p>	<p><i>At Speed</i> <i>+0.00 Hz</i></p> <p><i>Accelerating</i> <i>+29.62 Hz</i></p> <p><i>At Speed</i> <i>+60.00 Hz</i></p>
	<p>9. Checking Direction.</p> <p>A. Initiate a Reverse command.</p> <p>Important: With [Direction Mask] set to the default value, the reverse command must be issued from the HIM or other adapter. If the reverse command is to be issued from TB3, [Direction Mask] must first be programmed to allow direction control from TB3.</p> <p>The drive will ramp to zero speed, then ramp to [Maximum Freq] in the opposite direction. The output frequency shown on the Display Panel will indicate speed with a “+” for forward or a “-” for reverse. As the drive decelerates, the Forward Direction LED will flash, indicating actual direction. During this time the Reverse Direction LED will illuminate continuously, indicating the commanded direction. Once zero Hertz is reached and the drive begins to accelerate in the reverse direction, the Forward LED will extinguish and the Reverse LED will illuminate continuously.</p>	  <p><i>At Speed</i> <i>-60.00 Hz</i></p>

Advanced Start-Up Procedure

Press these keys . . .	while following these steps . . .	The HIM Display will show . . .
<p>Open Enable Signal</p> <p>Restore Enable Signal</p> 	<p>10. If the Control Interface option is not installed, stop the drive and go to step 11. The following steps will check for correct drive when the Enable input is removed.</p> <p>A. With the drive still running, open the Enable signal. The drive should stop and indicate “Not Enabled” on the display. Restore the Enable signal.</p> <p>B. Reset the drive by pressing the Stop key.</p>	<p><i>Not Enabled</i> <i>-0.00 Hz</i></p>
<p>Press & Hold Jog Key</p>  <p>Release Jog Key</p>	<p>11. Jog Control & Stop Mode Check.</p> <p>A. With the drive reset, but not running, press and hold the Jog key on the Control Panel. The motor should accelerate to the frequency programmed by the [Jog Frequency] parameter and remain there until the Jog key is released. When released, the drive should execute a stop function using the programmed stop mode. Verify that the correct stop mode was initiated.</p>	<p><i>At Speed</i> <i>-10.00 Hz</i></p> <p><i>Stopped</i> <i>-0.00 Hz</i></p>
<p>Set to Maximum Frequency</p>   	<p>12. Checking Accel and Decel Times.</p> <p>A. Verify that the frequency command is at maximum frequency.</p> <p>B. Start the drive and observe the amount of time the drive takes to accelerate to maximum frequency. This should equal 10 seconds, which is the factory default value for the [Accel Time 1] parameter.</p> <p>C. Press the Reverse key and observe the amount of time the drive takes to decelerate from maximum frequency to zero. This time should equal the time set in the [Decel Time 1] parameter (default is 10 seconds). If these times are not correct for your application, refer to Chapter 6 for instructions on programming changes.</p> <p>Important: With [Direction Mask] set to the default value, the reverse command must be issued from the HIM or other adapter. If the reverse command is to be issued from TB3, [Direction Mask] must first be programmed to allow direction control from TB3.</p> <p>D. Stop the drive.</p>	<p><i>Stopped</i> <i>+0.00 Hz</i></p>
<p>Remove ALL Power</p> <p>Reconnect Motor</p>	<p>13. Reconnect the Motor.</p> <p>A. Remove and lock-out the input and control power to the drive. When the HIM Display is no longer illuminated, remove the drive cover.</p> <hr/>  <p>ATTENTION: To avoid a hazard of electric shock, verify that the voltage on the bus capacitors has discharged. Measure the DC bus voltage at the + & – terminals of TB1. The voltage must be zero.</p> <hr/> <p>B. Reconnect motor leads and replace cover.</p>	

Advanced Start-Up Procedure

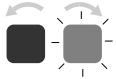
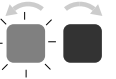
Press these keys . . .	while following these steps . . .	The HIM Display will show . . .
<p>Apply Power to Drive</p> <p>Verify Frequency Command = 0</p> <p>Verify Forward Rotation</p>  <p>Slowly Increase Speed</p>  or   <p>Verify Direction of Rotation</p> 	<p>14. Check for Correct Motor Rotation.</p> <hr/> <div style="display: flex; align-items: center;">  <p>ATTENTION: In the following steps, rotation of the motor in an undesired direction can occur. To guard against possible injury and/or equipment damage, it is recommended that the motor be disconnected from the load before proceeding.</p> </div> <hr/> <p>A. Reapply power to the drive.</p> <p>B. Verify that the frequency command is at zero Hz. For further information, refer to step 7.</p> <p>C. Using the Direction LEDs, verify that forward direction is selected.</p> <p>D. Start the drive and slowly increase the speed until the motor begins to turn. Note the direction of motor rotation. If the direction of rotation is as desired, proceed to Step E.</p> <p>If the direction of motor rotation is incorrect, stop the drive and remove all power. When the HIM Display is no longer illuminated, remove the drive cover. Verify that the bus voltage measured at “DC +” & “DC –” of TB1 is zero (see Attention on page 5-9). Interchange any two of the three motor leads at TB1 - U, V or W. Repeat Steps A through D.</p> <p>E. If encoder feedback is being used, verify that the polarity (“+” or “-”) of [Encoder Freq] equals the polarity of the actual drive output as shown on the Status Display. If the polarities are the same, go to step F. If polarities are different, stop the drive, remove all power. Reverse the “A” & “A NOT” OR “B” & “B NOT” wiring. Repeat Steps A through D.</p> <p>F. Stop the drive and replace drive cover.</p>	<div style="text-align: center;">   </div> <p style="text-align: center; margin-top: 20px;"><i>At Speed</i> +5.00 Hz</p>
	<p>15. Low Speed Operation. <i>(Speed range greater than 20:1)</i></p> <p>If Volts/Hertz operation was selected in step 6, proceed to step 20.</p> <p>Slip @ F.L.A. Adjustment.</p> <p>To increase the steady state torque performance of the motor at low speeds, the default Speed Control method is Slip Compensation. The factory default value for [Slip @ F.L.A.] is “1.0 Hz.” Optimum motor performance depends on accurate setting of [Slip @ F.L.A.].</p> <p>Estimate your motor slip value using the following:</p> $\frac{\text{Motor Sync. RPM} - \text{Motor Rated RPM}}{\text{Motor Sync. RPM}} \times \text{Motor Rated Freq. (Hz)}$ <p>Example: $\frac{1800 - 1778}{1800} \times 60 = 0.7 \text{ Hz Slip @ F.L.A.}$</p> <p style="text-align: right;"><i>Continued on next page</i></p>	

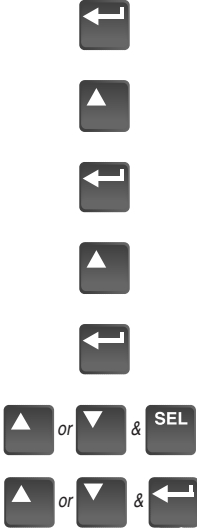

Advanced Start-Up Procedure

Press these keys . . .	while following these steps . . .	The HIM Display will show . . .
	<p>This will provide a starting point for slip compensation adjustment. If necessary, further adjustment can be made while the motor is under load.</p> <p>A. From the Status Display, press the Enter key (or any key). “Choose Mode” will be displayed.</p> <p>B. Press the Increment (or Decrement) key until “Program” is displayed.</p> <p>C. Press Enter.</p> <p>D. Press the Increment key until “Feature Select” is displayed.</p> <p>E. Press Enter.</p> <p>F. Press the Increment or Decrement keys until “Slip @ F.L.A.” is displayed. Press SElect. The first character of line 2 will now flash.</p> <p>G. Use the Increment/Decrement keys to program the value calculated above, then press Enter.</p>	<p><i>Choose Mode</i> <i>EEProm</i></p> <p><i>Choose Mode</i> <i>Program</i></p> <p><i>Metering</i></p> <p><i>Feature Select</i></p> <p><i>Dwell Frequency</i></p> <p><i>Slip @ F.L.A.</i></p> <p><i>Slip @ F.L.A.</i> <i>0.7 Hz</i></p>
<p>Program NP Data</p>	<p>16. Tuning Sensorless Vector operation.</p> <p>To further improve drive performance in Sensorless Vector mode, the actual motor nameplate data can be entered directly.</p> <p>Refer to the motor nameplate and program the following Setup group parameters:</p> <p>[Motor NP Amps] [Motor NP Volts] [Motor NP Hertz] [Motor NP RPM].</p> <p>For the typical steps involved when programming, refer to step 15.</p>	

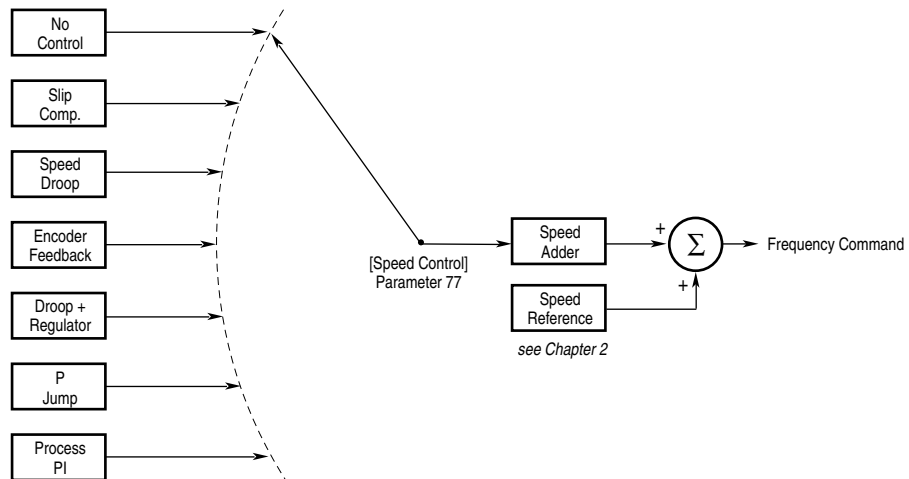
Speed Control Selection

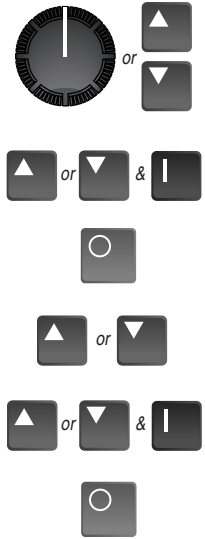

Advanced Start-Up Procedure

Press these keys . . .	while following these steps . . .	The HIM Display will show . . .
<p>Remove ALL Power Disconnect Load Apply Power to Drive</p> 	<p>17. Optimum tuning requires motor rotation and can be achieved by running the drive/motor under a “no-load” condition.</p> <p>A. Remove all power to the drive. Disconnect the load from the system by decoupling the motor shaft. Reapply drive power.</p> <p>B. While monitoring [Freq Command] in the Metering group, adjust the speed source for the drive (digital, analog pot, etc.) to 3/4 base speed.</p> <p>C. Press the Increment/Decrement keys until “Flux Current” is displayed. Start the drive and record this value.</p> <p>D. Stop the drive.</p> <p>E. Press the Increment/Decrement keys to display “Freq Command.” Adjust the speed source for the drive to zero Hz.</p> <p>F. Press the Increment (or Decrement) key to display “Output Voltage.” Start the drive and record the value.</p> <p>G. Stop the drive.</p> <p>H. Program the values recorded above into the following parameters. [Flux Amps Ref] = [Flux Current] at 45 Hz. [IR Drop Volts] = [Output Voltage] at zero Hz.</p> <p>Important: Some motors (i.e. 6 pole, special, etc.) may be particularly sensitive to the adjustment of [IR Drop Volts]. If this tuning procedure does not give the desired performance, adjust [IR Drop Volts] up/down, 1 or 2 volts until desired response is achieved.</p>	<p><i>Freq Command</i> <i>xx Hz</i></p> <p><i>Flux Current</i> <i>1 Amp</i></p> <p>Flux Current= ____ Amps</p> <p><i>Freq Command</i> <i>0 Hz</i></p> <p><i>Output Voltage</i> <i>0 Vlts</i></p> <p>Output Volts at 0 Hz = ____ V</p>
<p>Adjusting Flux Up Time</p>	<p>18. On larger motors (37 kW/50 HP, typical) additional acceleration performance can be gained by adjusting [Flux Up Time]. This parameter determines the amount of time that the drive will inject current at [Current Limit] levels before acceleration begins. This <i>pre-acceleration</i> time builds flux in the motor to allow for optimum acceleration, and may result in shorter overall acceleration. If better performance is required, adjust [Flux Up Time]. Begin with 0.2 seconds (default is zero) and increase as necessary.</p> <p>For the typical steps involved when programming, refer to step 15.</p>	
<p>Tuning Slip Comp Gain</p>	<p>19. To adjust the recovery response to load changes [Slip Comp Gain] can be increased. However, increasing the gain value too high may cause system instability. The factory default value is set to minimum. Fine adjustment will require operation with a load.</p>	<p><i>Slip Comp Gain</i> <i>1</i></p>
<p>Set Power-Up Display</p> 	<p>20. With HIM software versions 2.02 & up, the power-up display (Status, Process or Password) can be programmed to appear when drive power is applied. Simply access the desired display and simultaneously press the Increment and Decrement keys.</p>	

Advanced Start-Up Procedure

Press these keys . . .	while following these steps . . .	The HIM Display will show . . .
<p>Set Electronic Overload</p>	<p>21. Electronic overload protection is factory set to drive maximum.</p> <p>A. To properly set the electronic overload protection, program [Overload Amps] (Setup group) to the actual nameplate F.L.A.</p> <p>B. If the motor speed range is greater than 2:1, program [Overload Mode] to the proper derate.</p> <p>For the typical steps involved when programming, refer to step 15.</p>	
	<p>22. This completes the basic start-up procedure. Depending on your application, further parameter programming may be required. Refer to Chapter 6 for information.</p>	
	<p>23. If password protection is enabled, log out as described in Chapter 3.</p>	

End of Chapter

Programming

Chapter 6 describes parameter information for the 1336 PLUS II. Parameters are divided into groups for ease of programming and operator access. Grouping replaces a sequentially numbered parameter list with functional parameter groups that increases operator efficiency and helps to reduce programming time. For most applications, this means simplicity at startup with minimum drive tuning.

Function Index

The Function Index shown below provides a directory of the parameters required for each drive function. The Page Number locates within a group all parameters associated with that specific function.

<u>Function</u>	<u>Page Number</u>
Analog Input Config	6-30
At Temperature	6-28
Auto Restart	6-20
Bus Regulation	6-40
Custom Volts-per-Hertz	6-57
DC Brake-to-Stop	6-13
DC Hold Brake	6-13
Dwell	6-19
Economize	6-57
Electronic Shear Pin	6-32
Encoder Feedback	6-50
Fault Buffer History	6-32
Frequency Select	6-16
Inertia Ride-Thru	6-25
I/O Configuration	6-27
Last Speed	6-16
Line Loss Detect	6-22
Line Loss Recovery	6-22
Load Loss Detect	6-26
Minimum/Maximum Frequency	6-9
Overload Protection	6-11
Power Loss Ride-Thru	6-23
Preset Frequencies	6-16
Process Control	6-53
Process Display	6-49
Remote I/O	6-48
S-Curve Acceleration	6-21
Skip Frequencies	6-17
Slip Compensation	6-20
Step Logic	6-61
Stop Modes	6-9
Traverse Function	6-25

Programming Flow Chart

The flow chart provided on pages 6-2 and 6-3 highlight the steps required to access each group of parameters and lists all parameters for each group.

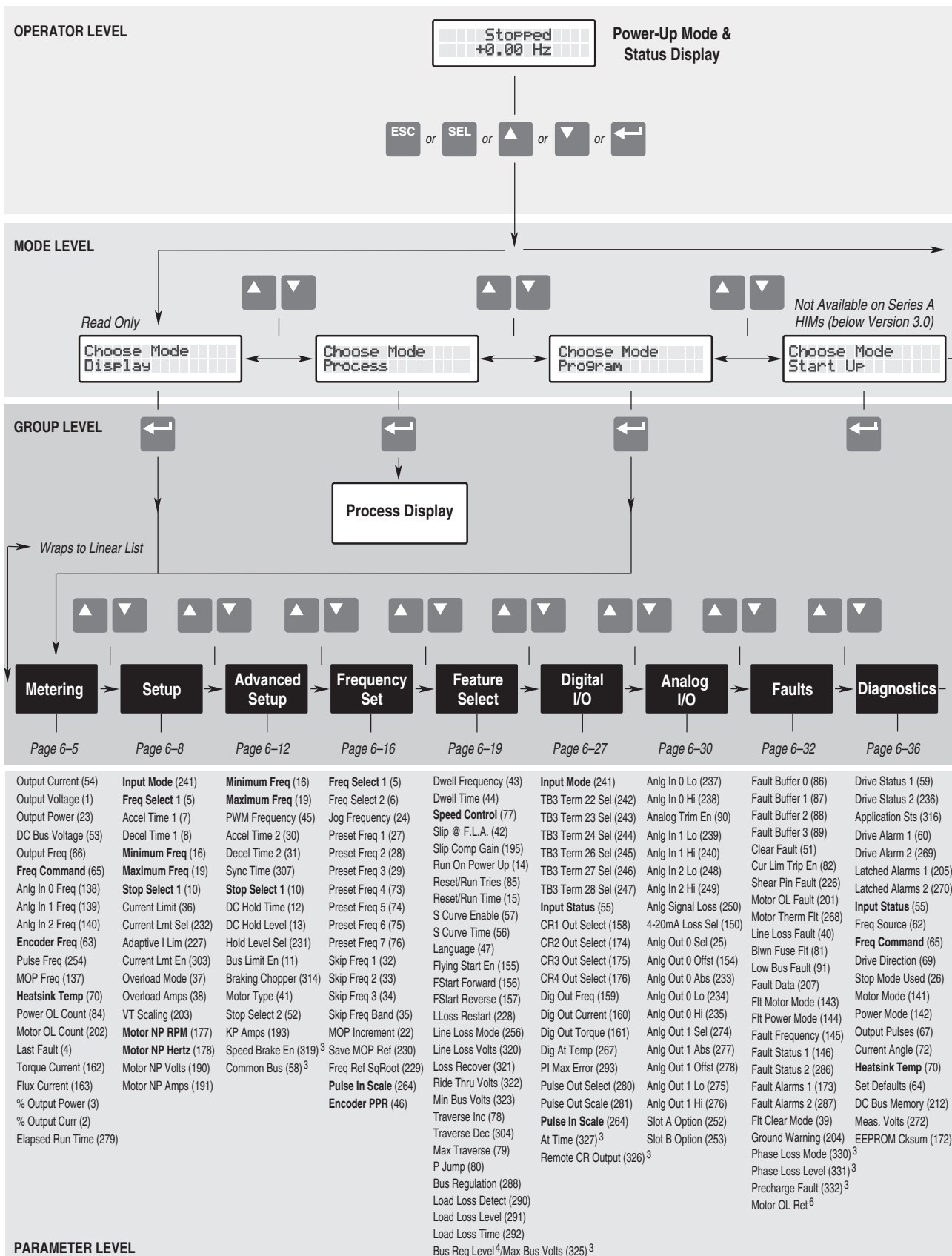

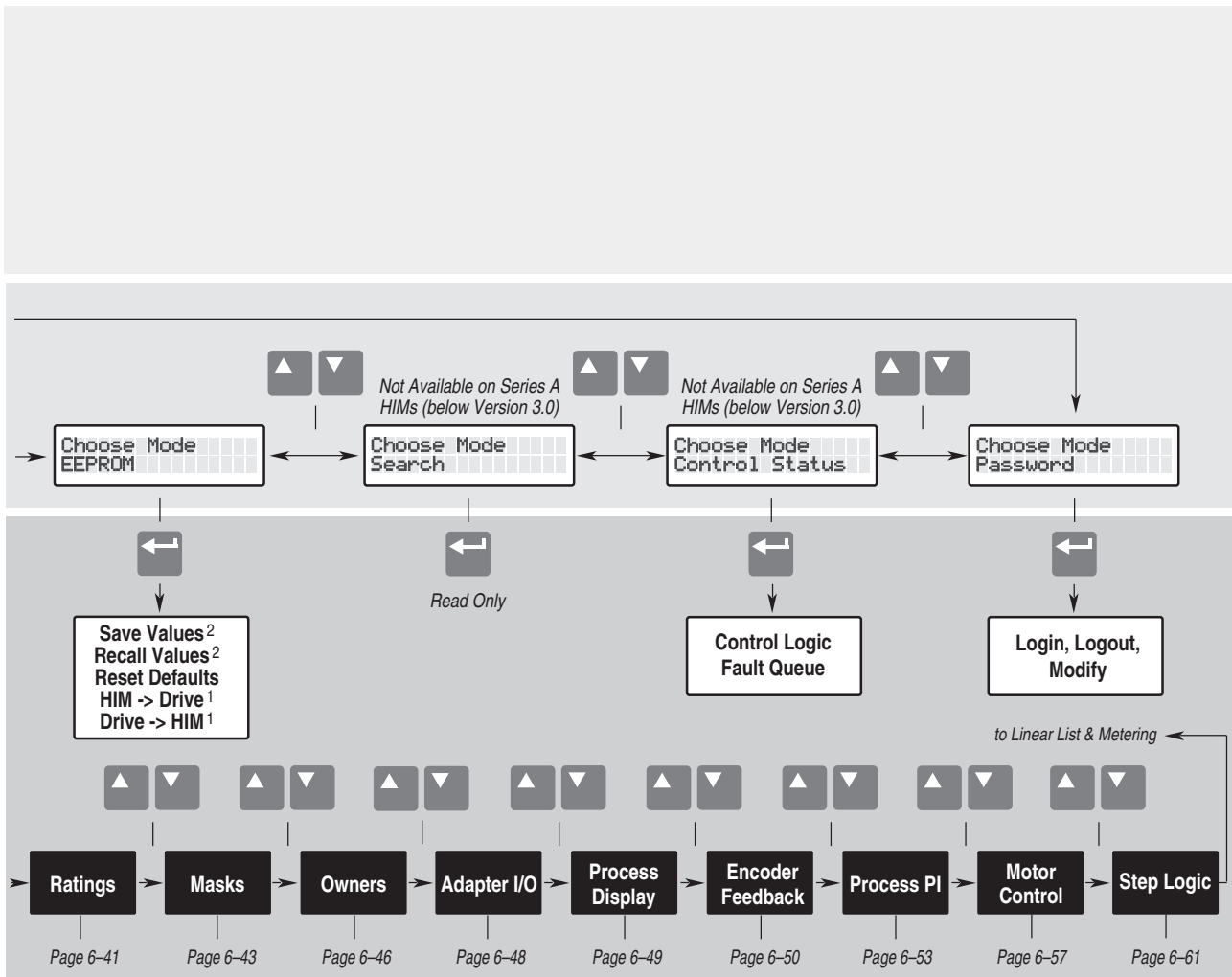

Rated Volts (147)	Direction Mask (94)	Stop Owner (102)	Data In A1 (111)	Process 1 Par (127)	Speed Control (77)	Speed Control (77)	Control Select (9)	SL0-6 Logic Step ⁵
Rated Amps (170)	Start Mask (95)	Direction Owner (103)	Data In A2 (112)	Process 1 Scale (128)	Encoder Type (152)	PI Config (213)	Flux Amps Ref (192)	SL0-6 Logic Jump ⁵
Rated kW (171)	Jog Mask (96)	Start Owner (104)	Data In B1 (113)	Process 1 Txt 1 (129)	Encoder PPR (46)	PI Status (214)	IR Drop Volts (194)	SL0-6 Step Setting ⁵
Firmware Ver. (71)	Reference Mask (97)	Jog Owner (105)	Data In B2 (114)	Process 1 Txt 2 (130)	Maximum Speed (151)	PI Ref Select (215)	Flux Up Time (200)	SL0-6 Time ⁵
Ctrl Board Rev (251)	Accel Mask (98)	Reference Owner (106)	Data In C1 (115)	Process 1 Txt 3 (131)	Motor Poles (153)	PI Fdbk Select (216)	Start Boost (48)	SL0-6 Encoder Cnts ⁵
Rated CT Amps (148)	Decel Mask (99)	Accel Owner (107)	Data In C2 (116)	Process 1 Txt 4 (132)	Speed KI (165)	PI Reference (217)	Run Boost (83)	Current Step ⁵
Rated CT kW (149)	Fault Mask (100)	Decel Owner (108)	Data In D1 (117)	Process 1 Txt 5 (133)	Speed KP* (164)	PI Feedback (218)	Boost Slope (169)	
Rated VT Amps (198)	MOP Mask (101)	Fault Owner (109)	Data In D2 (118)	Process 1 Txt 6 (134)	Speed Error (166)	PI Error (219)	Break Voltage (50)	
Rated VT kW (199)	Traverse Mask (305)	MOP Owner (110)	Data Out A1 (119)	Process 1 Txt 7 (135)	Speed Integral (167)	PI Output (220)	Break Frequency (49)	
Drive Type (61)	Sync Mask (308)	Traverse Owner (306)	Data Out A2 (120)	Process 1 Txt 8 (136)	Speed Adder (168)	KI Process (221)	Base Voltage (18)	
	Logic Mask (92)	Sync Owner (309)	Data Out B1 (121)	Process 2 Par (180)	Slip Adder (255)	KP Process (222)	Base Frequency (17)	
	Local Mask (93)	Local Owner (179)	Data Out B2 (122)	Process 2 Scale (181)	Motor NP RPM (177)	PI Neg Limit (223)	Maximum Voltage (20)	
	Alarm Mask 1 (206)		Data Out C1 (123)	Process 2 Txt 1 (182)	Motor NP Hertz (178)	PI Pos Limit (224)	Run/Accel Volts (317)	
	Alarm Mask 2 (271)		Data Out C2 (124)	Process 2 Txt 2 (183)	Encoder Counts (283)	PI Preload (225)	Sync Loss Sel (310)	
			Data Out D1 (125)	Process 2 Txt 3 (184)	Enc Count Scale (282)		Sync Loss Gain (311)	
			Data Out D2 (126)	Process 2 Txt 4 (185)	Encoder Loss Sel (284)		Sync Loss Comp (313)	
			Alt Type 2 Cmd (315)	Process 2 Txt 5 (186)	Encoder Freq (63)		Sync Loss Time (312)	
				Process 2 Txt 6 (187)	Max Enc Counts (328) ³		PWM Comp Time (333) ⁴	
				Process 2 Txt 7 (188)			Break Freq (334) ⁴	
				Process 2 Txt 8 (189)			PWM Break Freq (334) ⁵	
							Stability Gain (324) ⁴	

¹ Series B & Up Handheld HIM Only
² Reserved for Future Use
³ Firmware Version 3.001 & later
⁴ Firmware Version 4.001 & later
⁵ Firmware Version 5.001 & later
⁶ Firmware Version 6.001 & later

Note: Parameters that appear in more than one group are shown in **Bold** – Parameter Numbers are shown in (parenthesis). An asterisk (*) indicates that the parameter was not functional at time of printing.

Chapter Conventions

Parameter descriptions adhere to the following conventions.

1. All parameters required for any given drive function will be contained within a group, eliminating the need to change groups to complete a function.
2. All parameters are documented as either having ENUMS or Engineering Units.

ENUMS

[Parameter Name]	Parameter Number	①	#
Parameter description.	Parameter Type	②	Read Only or Read/Write
	Factory Default	③	Drive Factory Setting
	<u>Units</u>		<u>Display / Drive</u> ENUM Text / Internal Drive Units ④ / ⑤

Engineering Units

[Parameter Name]	Parameter Number	①	#
Parameter description.	Parameter Type	②	Read Only or Read/Write
	Display Units / Drive Units	④,⑤	User Units / Internal Drive Units
	Factory Default	③	Drive Factory Setting
	Minimum Value	⑥	Min Value Acceptable
	Maximum Value	⑦	Max Value Acceptable

- ① **Parameter Number** Each parameter is assigned a number. The number can be used for process display setup, fault buffer interpretation or serial communication.
 - ② **Parameter Type** 2 types of parameters are available:
 - Read Only* The value is changed only by the drive and is used to monitor values.
 - Read/Write* The value is changed through programming. This type can also be used to monitor a value.
 - ③ **Factory Default** This is the value assigned to each parameter at the factory.
 - ④ **Display Units** The units that appear on the HIM display. 2 types exist:
 - ENUMS* A language statement pertaining to the selection made or language description of bit function.
 - Engineering* Standard units such as; Hz, sec, volts, etc.
 - ⑤ **Drive Units** These are internal units used to communicate through the serial port, and to scale values properly when reading or writing to the drive.
 - ⑥ **Minimum Value** This is the lowest setting possible for parameters that do not use ENUMS.
 - ⑦ **Maximum Value** This is the highest setting possible for parameters that do not use ENUMS.
3. To help differentiate parameter names and display text from other text in this manual, the following conventions will be used:
 - Parameter Names will appear in [brackets]
 - Display Text will appear in “quotes”.

Metering

This group of parameters consists of commonly viewed drive operating conditions such as motor speed, drive output voltage, current and command frequency. All parameters in this group are Read Only and can only be viewed.

[Output Current]

This parameter displays the output current present at TB1, terminals T1, T2 & T3 (U, V & W).

Parameter Number	54
Parameter Type	Read Only
Display Units / Drive Units	0.1 Amp / 4096 = 100% Drive Rated Amps
Factory Default	None
Minimum Value	0.0
Maximum Value	200% Rated Drive Output Current

[Output Voltage]

This parameter displays the output voltage present at TB1, terminals T1, T2 & T3 (U, V & W).

Parameter Number	1
Parameter Type	Read Only
Display Units / Drive Units	1 Volt / 4096 = 100% Drive Rated Volts
Factory Default	None
Minimum Value	0
Maximum Value	200% Rated Drive Output Voltage

[Output Power]

This parameter displays the output power present at TB1, terminals T1, T2 & T3 (U, V & W).

Parameter Number	23
Parameter Type	Read Only
Display Units / Drive Units	1 kilowatt / 4096 = 100% Drive Rated kW
Factory Default	None
Minimum Value	-200% Rated Drive Output Power
Maximum Value	+200% Rated Drive Output Power

[DC Bus Voltage]

This parameter displays the DC bus voltage level.

Parameter Number	53
Parameter Type	Read Only
Display Units / Drive Units	1 Volt / 4096 = 100% Drive Rated Volts
Factory Default	None
Minimum Value	0
Maximum Value	200% DC Bus Voltage Max

[Output Freq]

This parameter displays the output frequency present at TB1, terminals T1, T2 & T3 (U, V & W).

Parameter Number	66
Parameter Type	Read Only
Display Units / Drive Units	0.01 Hertz / 32767 = Maximum Freq Forward
Factory Default	None
Minimum Value	-400.00 Hz
Maximum Value	+400.00 Hz

[Freq Command]

This parameter displays the frequency that the drive is commanded to output. This command may come from any one of the frequency sources selected by [Freq Select 1] or [Freq Select 2].

Parameter Number	65
Parameter Type	Read Only
Display Units / Drive Units	0.01 Hertz / 32767 = Maximum Freq Forward
Factory Default	None
Minimum Value	-400.00 Hz
Maximum Value	+400.00 Hz

[Anlg In 0 Freq]

[Anlg In 1 Freq]

[Anlg In 2 Freq]

These parameters displays the frequency command present at the specified analog input terminals. This value is displayed whether or not this is the active frequency command.

Parameter Number	138-140
Parameter Type	Read Only
Display Units / Drive Units	0.01 Hertz / 32767 = Maximum Freq
Factory Default	None
Minimum Value	0.00 Hz
Maximum Value	400.00 Hz

Metering

<p>[Encoder Freq]</p> <p>This parameter displays the frequency command present at encoder input terminals of TB3. This value is displayed whether or not this is the active frequency command.</p> $\text{Frequency Displayed} = \frac{\text{Incoming Encoder Pulse Rate}}{\text{[Encoder PPR]}}$	<p>Parameter Number Parameter Type Display Units / Drive Units Factory Default Minimum Value Maximum Value</p>	<p>63 Read Only 0.01 Hertz / 32767 = Maximum Freq None -400.00 Hz +400.00 Hz</p>
<p>[Pulse Freq]</p> <p>This parameter displays the frequency command present at pulse input terminals of TB2. This value is displayed whether or not this is the active frequency command.</p> $\text{Frequency Displayed} = \frac{\text{Incoming Pulse Rate (Hz)}}{\text{[Pulse Scale]}}$	<p>Parameter Number Parameter Type Display Units / Drive Units Factory Default Minimum Value Maximum Value</p>	<p>254 Read Only 0.01 Hertz / 32767 = Maximum Freq None -400.00 Hz +400.00 Hz</p>
<p>[MOP Freq]</p> <p>This parameter displays the frequency command from the MOP. The MOP frequency command can be adjusted by TB3 (if present) and appropriate inputs are selected (see page 2-27). Some SCANport adapters, including the RIO Adapter, can also adjust the MOP frequency command. This value is displayed whether or not this is the active frequency command.</p>	<p>Parameter Number Parameter Type Display Units / Drive Units Factory Default Minimum Value Maximum Value</p>	<p>137 Read Only 0.01 Hertz / 32767 = Maximum Freq None 0.00 Hz 400.00 Hz</p>
<p>[Heatsink Temp]</p> <p>This parameter displays the heatsink temperature of the drive.</p>	<p>Parameter Number Parameter Type Display Units / Drive Units Factory Default Minimum Value Maximum Value</p>	<p>70 Read Only 1° C / Deg. C None 0 255° C</p>
<p>[Power OL Count]</p> <p>Displays the percentage of accumulated I^2t for the <u>drive</u> thermal overload protection. Running continuously above 115% of drive rated amps will accumulate a value of 100% and generate a Power Overload Fault (F64).</p>	<p>Parameter Number Parameter Type Display Units / Drive Units Factory Default Minimum Value Maximum Value</p>	<p>84 Read Only 1 % / 4096 = 100% None 0% 200%</p>
<p>[Motor OL Count]</p> <p>This parameter displays the percentage of accumulated I^2t for the <u>motor</u> overload protection. Running continuously at programmed [Overload Amps] will accumulate approximately 70%. Reduction of load will reduce the OL count. 100% value will generate an Overload Fault (F07).</p>	<p>Parameter Number Parameter Type Display Units / Drive Units Factory Default Minimum Value Maximum Value</p>	<p>202 Read Only 1 % / 4096 = 100% None 0% 200%</p>
<p>[Last Fault]</p> <p>This parameter displays the last drive fault. It is updated whenever a new fault occurs.</p>	<p>Parameter Number Parameter Type Display Units / Drive Units Factory Default Minimum Value Maximum Value</p>	<p>4 Read Only Fault Number / Fault Number None None None</p>

Metering

[Torque Current]

This parameter displays the amount of current that is in phase with the fundamental voltage component. It is the current that is actually producing torque.

Parameter Number	162
Parameter Type	Read Only
Display Units / Drive Units	0.1 Amp / 4096 = 100% Drive Rated Amps
Factory Default	None
Minimum Value	-200% Drive Rating
Maximum Value	+200% Drive Rating

[Flux Current]

This parameter displays the amount of current that is out of phase with the fundamental voltage component. It is the current that is producing motor flux.

Parameter Number	163
Parameter Type	Read Only
Display Units / Drive Units	0.1 Amp / 4096 = 100% Drive Rated Amps
Factory Default	None
Minimum Value	-200% Drive Rating
Maximum Value	+200% Drive Rating

[% Output Power]

This parameter displays the % of drive rated output power (kw). Refer to the Ratings Group or drive data nameplate.

Parameter Number	3
Parameter Type	Read Only
Display Units / Drive Units	1 % / $\pm 4096 = \pm 100\%$
Factory Default	None
Minimum Value	200% Drive Rated Output Power
Maximum Value	+200% Drive Rated Output Power

[% Output Curr]

This parameter displays the % of drive rated output current. Refer to the Ratings Group or drive data nameplate.

Parameter Number	2
Parameter Type	Read Only
Display Units / Drive Units	1 % / 4096 = 100%
Factory Default	None
Minimum Value	0%
Maximum Value	200% Rated Drive Output Current

[Elapsed Run Time]

This parameter displays the elapsed running time of the drive. The meter is resettable to any value by reprogramming.

Parameter Number	279
Parameter Type	Read and Write
Display Units / Drive Units	0.1 Hr / Hours x 10
Factory Default	0
Minimum Value	0
Maximum Value	6553.5

Setup

This group of parameters defines basic operation and should be programmed before initial use of the drive. For advanced programming and information on specific parameters, refer to the flow chart on pages 6-2 & 6-3.

[Input Mode]

Selects the functions of inputs 1 & 2 at TB3 when an optional interface card is installed. Refer to *Input Mode Selection* in Chapter 2. This parameter cannot be changed while the drive is running. Power to the drive must be cycled before any changes will affect drive operation. "2WR-PWR DIP" provides a delay to the Start command. Drive will then start if Run & Stop commands are applied at the same time.

Parameter Number	241
Parameter Type	Read and Write
Display Units / Drive Units	Mode Number / Selection
Factory Default	"Status"
<u>Units</u>	<u>Display</u> <u>Drive</u>
	"Status" 1
	"3 Wire" 2
	"2 Wire" 3
	"2WR-PWR DIP" 4

[Freq Select 1]

This parameter controls which of the frequency sources is currently supplying the [Freq Command] to the drive unless [Freq Select 2] or [Preset Freq 1-7] is selected.

Parameter Number	5
Parameter Type	Read and Write
Factory Default	"Adapter 1"
<u>Units</u>	<u>Display</u> <u>Drive</u>
	"Use Last" 0
	"Analog In 0" 1
	"Analog In 1" 2
	"Analog In 2" 3
	"Pulse Ref" 4 Refer to [Pulse In Scale] Value
	"MOP" 5
	"Adapter 1-6" 6-11
	"Preset 1-7" 12-18
	"Encoder" 19 Refer to [Encoder PPR] Value
	"Step Logic" 20

Firmware 5.001 & later

[Accel Time 1]

This value determines the time it will take the drive to ramp from 0 Hz to [Maximum Freq]. The rate determined by this value and [Maximum Freq] is linear unless [S Curve Enable] is "Enabled." It applies to any increase in command frequency unless [Accel Time 2] is selected.

Parameter Number	7
Parameter Type	Read and Write
Display Units / Drive Units	0.1 Second / Seconds x 10
Factory Default	10.0 Sec
Minimum Value	0.0 Sec
Maximum Value	3600.0 Sec

[Decel Time 1]

This value determines the time it will take the drive to ramp from [Maximum Freq] to 0 Hz. The rate determined by this value and [Maximum Freq] is linear unless [S Curve Enable] is "Enabled." It applies to any decrease in command frequency unless [Decel Time 2] is selected.

Parameter Number	8
Parameter Type	Read and Write
Display Units / Drive Units	0.1 Second / Seconds x 10
Factory Default	10.0 Sec
Minimum Value	0.0 Sec
Maximum Value	3600.0 Sec

Accel/Decel Time

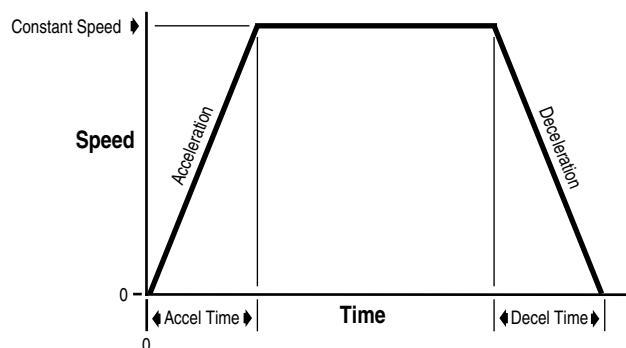

Setup

<p>[Minimum Freq]</p> <p>This parameter sets the lowest frequency the drive will output.</p>	<p>Parameter Number Parameter Type Display Units / Drive Units Factory Default Minimum Value Maximum Value</p>	<p>16 Read and Write 1 Hertz / Hertz x 10 0 Hz 0 Hz 120 Hz</p>
<p>[Maximum Freq]</p> <p>Sets the highest frequency the drive will output.</p> <p>This parameter cannot be changed while the drive is running.</p>	<p>Parameter Number Parameter Type Display Units / Drive Units Factory Default Minimum Value Maximum Value</p>	<p>19 Read and Write 1 Hertz / Hertz x 10 60 Hz 10 Hz 400 Hz</p>
<p>[Stop Select 1]</p> <p>This parameter selects the stopping mode when the drive receives a valid stop command unless [Stop Select 2] is selected.</p>	<p>Parameter Number Parameter Type Factory Default <u>Units</u></p>	<p>10 Read and Write "Coast" <u>Display</u> <u>Drive</u> "Coast" 0 Causes the drive to turn off immediately. "DC Brake" 1 Drive defluxes the motor and then injects DC braking voltage into the motor. Requires a value in both [DC Hold Time] & [DC Hold Level]. "Ramp" 2 Drive decelerates to 0 Hz., then if [DC Hold Time] & [DC Hold Level] are greater than zero the holding brake is applied. If the values equal zero, then the drive turns off. Requires a value in [Decel Time 1] or [Decel Time 2]. "S-Curve" 3 Drive causes S Curve Ramp to 0 Hz in [Decel Time 1] or [Decel Time 2] x 2. "Ramp to Hold" 4 Drive decelerates to zero Hertz then injects holding brake per [DC Hold Level] (limited to 70% of drive rated amps) until a) a Start command is issued or b) the Enable input is opened.</p>
<p>[Current Limit]</p> <p>This parameter sets the maximum drive output current that is allowed before current limiting occurs (the drive is limited to 160% internally).</p>	<p>Parameter Number Parameter Type Display Units / Drive Units Factory Default Minimum Value Maximum Value</p>	<p>36 Read and Write 1% of Max Drive Output Current / 4096 = 100% 150% 150.0% <i>Firmware 5.001 & later</i> 20% of [Rated Amps] 0.0% <i>Firmware 5.001 & later</i> 300% of [Rated Amps] 300.0% <i>Firmware 5.001 & later</i></p>
<p>[Current Lmt Sel]</p> <p>Selects the source of the [Current Limit] setting for the drive. When an external input is selected (0-10V or 4-20 mA), the minimum signal (0V or 4 mA) sets 20% current limit and the maximum signal (10V or 20mA) sets the value programmed in [Current Limit].</p> <p>This parameter cannot be changed while drive is running.</p>	<p>Parameter Number Parameter Type Factory Default <u>Units</u></p>	<p>232 Read and Write "Current Lmt" <u>Display</u> <u>Drive</u> "Current Lmt" 0 Use [Current Limit], param. 36. "Analog In 0" 1 "Analog In 1" 2</p>

Setup

[Adaptive I Lim]

When ENABLED, this parameter maintains normal current limit control to provide normal acceleration into medium to high system inertia.

When DISABLED, this parameter applies a feed forward command to acceleration, allowing quicker accel times from stopped to commanded speed with low system inertia.

Parameter Number	227
Parameter Type	Read and Write
Factory Default	"Enabled"
<u>Units</u>	<u>Display</u> <u>Drive</u>
	"Disabled" 0
	"Enabled" 1

[Current Limit En]

Enables or disables the software current limiting function (does not disable voltage limiting).

Parameter Number	303
Parameter Type	Read and Write
Factory Default	"Enabled"
<u>Units</u>	<u>Display</u> <u>Drive</u>
	"Disabled" 0
	"Enabled" 1

[Overload Mode]

This parameter selects the derating factor for the I²T electronic overload function. Motors designed to operate with wider speed ranges need less overload derating.

Parameter Number	37
Parameter Type	Read and Write
Factory Default	"No Derate"
<u>Units</u>	<u>Display</u> <u>Drive</u>
"Max Derate" 2	2:1 Speed Range Derate below 50% of Base Speed
"Min Derate" 1	4:1 Speed Range. Derate below 25% of Base Speed
"No Derate" 0	10:1 Speed Range. No Derating

Overload Patterns

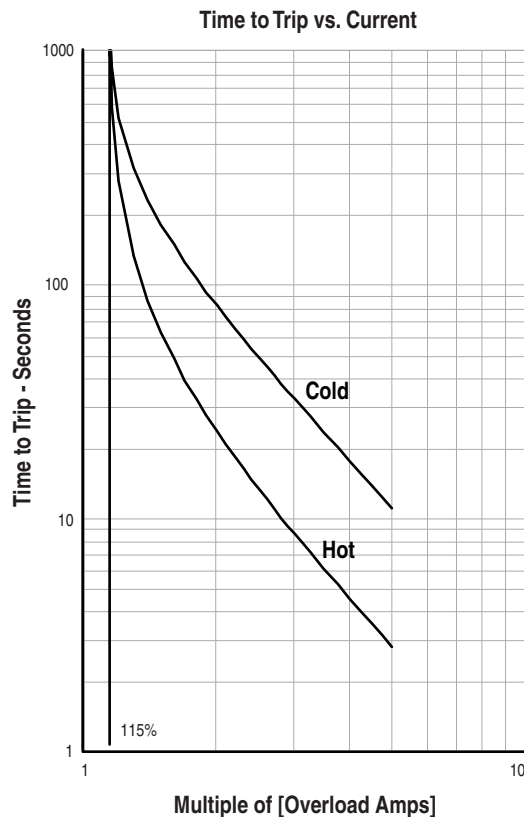
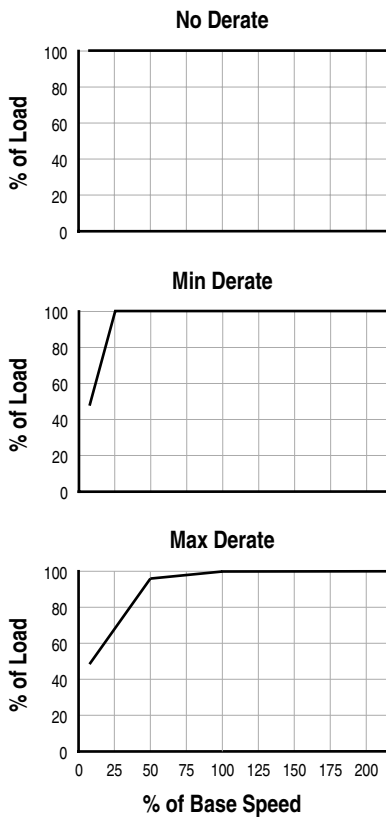

Setup

[Overload Amps]

This value should be set to the motor nameplate Full Load Amps (FLA) for 1.15 SF motors. For 1.0 SF motors the value should be set to 0.9 x nameplate FLA.

Parameter Number	38
Parameter Type	Read and Write
Display Units / Drive Units	0.1 Amps / 4096 = Rated Amps
Factory Default	115% of Drive Rating
Minimum Value	115.0% of Drive Rating <i>Firmware 5.001 & later</i>
Maximum Value	20% of Drive Rated Amps
	0.0% of Drive Rated Amps <i>Firmware 5.001 & later</i>
	115% of Drive Rated Amps
	115.0% of Drive Rated Amps <i>Firmware 5.001 & later</i>

[VT Scaling]

This parameter scales the drive for VT ampere ratings.

Important: This parameter must be set to "Disabled" when drive is used in a fibers application.

This parameter cannot be changed while the drive is running.

Parameter Number	203
Parameter Type	Read and Write
Factory Default	"Disabled"
<u>Units</u>	<u>Display</u> <u>Drive</u>
	"Disabled" 0 Disables Variable Torque Scaling
	"Enabled" 1 Enables Variable Torque Scaling

[Motor NP RPM]

This value should be set to the motor nameplate rated RPM.

This parameter cannot be changed while the drive is running.

Parameter Number	177
Parameter Type	Read and Write
Display Units / Drive Units	1 RPM / 1 RPM
Factory Default	1750 RPM
Minimum Value	60 RPM
Maximum Value	24000 RPM

[Motor NP Hertz]

This value should be set to the motor nameplate rated frequency.

This parameter cannot be changed while the drive is running.

Parameter Number	178
Parameter Type	Read and Write
Display Units / Drive Units	1 Hertz / Hertz x 10
Factory Default	60 Hz
Minimum Value	1 Hz
Maximum Value	400 Hz

[Motor NP Volts]

This value should be set to the motor nameplate rated volts.

This parameter cannot be changed while the drive is running.

Parameter Number	190
Parameter Type	Read and Write
Display Units / Drive Units	1 Volt / 4096 = Drive Rated Volts
Factory Default	Drive Rated Volts
Minimum Value	0 Volts
Maximum Value	2 x Drive Rated Volts

[Motor NP Amps]

This value should be set to the motor nameplate rated current.

This parameter cannot be changed while the drive is running.

Parameter Number	191
Parameter Type	Read and Write
Display Units / Drive Units	1 Amp / 4096 = Drive Rated Amps
Factory Default	Drive Rated Amps
Minimum Value	0 Amps
Maximum Value	2 x Drive Rated Amps

Advanced Setup

This group contains parameters that are required to setup advanced functions of the drive for complex applications.

<p>[Minimum Freq]</p> <p>This parameter sets the lowest frequency the drive will output.</p>	<p>Parameter Number 16</p> <p>Parameter Type Read and Write</p> <p>Display Units / Drive Units 1 Hertz / Hertz x 10</p> <p>Factory Default 0 Hz</p> <p>Minimum Value 0 Hz</p> <p>Maximum Value 120 Hz</p>
<p>[Maximum Freq]</p> <p>This parameter sets the highest frequency the drive will output.</p> <p>This parameter cannot be changed while the drive is running.</p>	<p>Parameter Number 19</p> <p>Parameter Type Read and Write</p> <p>Display Units / Drive Units 1 Hertz / Hertz x 10</p> <p>Factory Default 60 Hz</p> <p>Minimum Value 10 Hz</p> <p>Maximum Value 400 Hz</p>
<p>[PWM Frequency]</p> <p>This parameter sets the carrier frequency for the sine coded PWM output waveform.</p> <p>This parameter cannot be changed while the drive is running. Refer to the Derating Guidelines in Appendix A.</p>	<p>Parameter Number 45</p> <p>Parameter Type Read and Write</p> <p>Display Units / Drive Units 2 KHz / KHz/2</p> <p>Factory Default 2 KHz</p> <p>Minimum Value 2 KHz</p> <p>Maximum Value A & B Frame Drives = 8 kHz C Frame Drives & Up = 6 kHz</p>
<p>[Accel Time 2]</p> <p>This value determines the time it will take the drive to ramp from 0 Hz to [Maximum Freq]. The rate determined by this value and [Maximum Freq] is linear unless [S Curve Enable] is "Enabled." It applies to any increase in command frequency unless [Accel Time 1] is selected.</p>	<p>Parameter Number 30</p> <p>Parameter Type Read and Write</p> <p>Display Units / Drive Units 0.1 Second / Seconds x 10</p> <p>Factory Default 10.0 Sec</p> <p>Minimum Value 0.0 Sec</p> <p>Maximum Value 3600.0 Sec</p>
<p>[Decel Time 2]</p> <p>This value determines the time it will take the drive to ramp from [Maximum Freq] to 0 Hz. The rate determined by this value and [Maximum Freq] is linear unless [S Curve Enable] is "Enabled." It applies to any decrease in command frequency unless [Decel Time 1] is selected.</p>	<p>Parameter Number 31</p> <p>Parameter Type Read and Write</p> <p>Display Units / Drive Units 0.1 Second / Seconds x 10</p> <p>Factory Default 10.0 Sec</p> <p>Minimum Value 0.0 Sec</p> <p>Maximum Value 3600.0 Sec</p>

Synchronized Speed Change Function

This function is typically used in an application where multiple drives, drive different functions on one machine and the line speed must be changed.

To initiate the speed sync function:

- The drive must be running.
- [Sync Time] must be set to a non-zero value.
- [Freq Source] must be set to "Adapter 1-6" or "Preset 1-7."
- A SYNC input must be energized.

The SYNC input can come from any of the programmable input terminals.

Example: [TB3 Term 22 Sel] = "Sync"

Important: Do not select more than one input terminal as the SYNC input.

The sync input can also come through SCANport from one of the communication options,

either as a "Type 1" or "Type 2" message. For further information, refer to the instructions supplied with the option. Also, see the section titled "Communications Data Information Format" in Appendix A.

The usual sequence of events:

- Energize the SYNC input.
- The "Speed Sync" bit in [Application Sts] is set to "1".
- The drive "holds" the last frequency reference value.
- The frequency command is changed and/or a different source is selected.
- De-energize the SYNC input.
- The drive will linearly ramp from the "held" reference to the new reference in a time set by [Sync Time].
- The "Speed Sync" bit in [Application Sts] is set to "0".

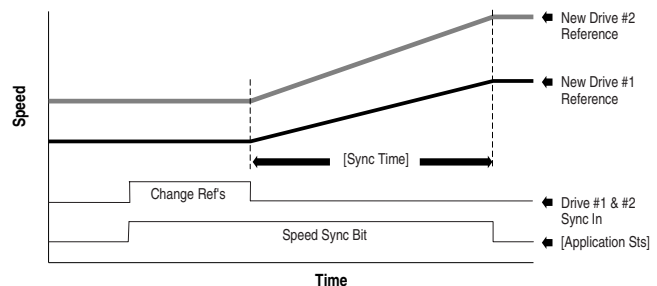

Important: The accel/decel/s-curve control is active during speed sync and will limit the rate of change of frequency if set "slower."

Advanced Setup

[Sync Time]

The time it takes for the drive to ramp from the “held frequency reference” to the “current frequency reference” after the Sync input is de-energized. Refer to [Synchronized Speed Change Function on page 6-12](#).

Parameter Number	307
Parameter Type	Read and Write
Factory Default	0.1 Second / Seconds x 10
Factory Default	0.0 Sec
Minimum Value	0.0 Sec
Maximum Value	6000.0 Sec

[Stop Select 1]

This parameter selects the stopping mode when the drive receives a valid stop command unless [Stop Select 2] is selected.

Parameter Number	10
Parameter Type	Read and Write
Factory Default	“Coast”
<u>Units</u>	<u>Display</u> <u>Drive</u>
“Coast” 0	Causes the drive to turn off immediately.
“DC Brake” 1	Drive defluxes the motor and then injects DC braking voltage into the motor. Requires a value in both [DC Hold Time] & [DC Hold Level].
“Ramp” 2	Drive decelerates to 0 Hz., then if [DC Hold Time] & [DC Hold Level] are greater than zero the holding brake is applied. If the values equal zero, then the drive turns off. Requires a value in [Decel Time 1] or [Decel Time 2].
“S-Curve” 3	Drive causes S Curve Ramp to 0 Hz in [Decel Time 1] or [Decel Time 2] x 2.
“Ramp to Hold” 4	Drive decelerates to zero Hertz then injects holding brake per [DC Hold Level] (limited to 70% of drive rated amps) until a) a Start command is issued or b) the Enable input is opened.

[DC Hold Time]

This value sets the amount of time that the [DC Hold Level] voltage will be applied to the motor when the stop mode is set to either “DC Brake” or “Ramp.” [DC Hold Time] is ignored when the stop mode ([Stop Select 1], [Stop Select 2]) is set to “Ramp to Hold.”

Parameter Number	12
Parameter Type	Read and Write
Display Units / Drive Units	1 Second / Seconds x 10
Factory Default	0.0 Sec
Minimum Value	0.0 Sec
Maximum Value	90.0 Sec

[DC Hold Level]

This value sets the DC voltage applied to the motor to produce the selected current during braking, when the stop mode is set to either “DC Brake,” “Ramp” or “Ramp to Hold.” If “Ramp to Hold” is the active stop mode, [DC Hold Level] will be clamped at 70%, even if higher values are programmed.

Parameter Number	13
Parameter Type	Read and Write
Display Units / Drive Units	1 % of [Rated Amps] / 4096 = 100%
Factory Default	0 %
Minimum Value	0 %
Maximum Value	150 %



ATTENTION: If a hazard of injury due to movement of equipment or material exists, an auxiliary mechanical braking device must be used to stop the motor.

ATTENTION: This feature should not be used with synchronous or permanent magnet motors. Motors may be demagnetized during braking.

Advanced Setup

Ramp-to-Stop

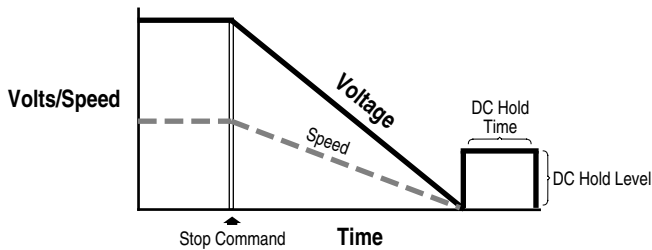

Brake-to-Stop

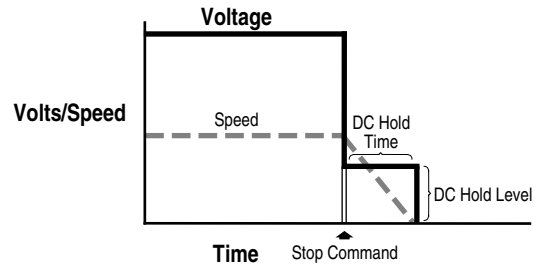

Ramp-to-Hold

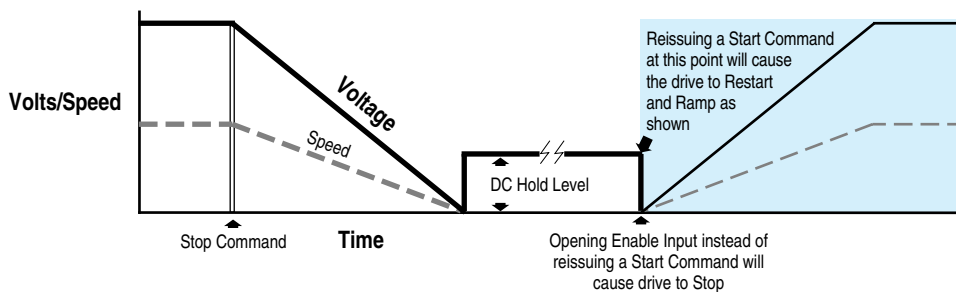

[Hold Level Sel]

This parameter selects the hold level source for [DC Hold Level]. The minimum signal level sets no DC hold, while the maximum signal sets the value programmed in [DC Hold Level].

This parameter cannot be changed while the drive is running.

Parameter Number	231
Parameter Type	Read and Write
Factory Default	"DC Hold Lvl"
Units	Display Drive
	"DC Hold Lvl" 0 Use [DC Hold Level], param. 13.
	"Analog In 0" 1
	"Analog In 1" 2

[Bus Limit En]

Enables the function that attempts to limit the drive DC bus voltage to 110% of nominal voltage during rapid decel. If bus voltage rises above the 110% level, [Bus Limit En] reduces or stops the drive decel rate until bus voltage falls below the 110% level.

Parameter Number	11
Parameter Type	Read and Write
Factory Default	"Disabled"
Units	Display Drive
	"Disabled" 0 Allow bus voltage to rise above 110%.
	"Enabled" 1 Limit bus voltage/decel ramp.

[Braking Chopper]

Not functional in the 1336 PLUS II Drive.

Parameter Number	314
Parameter Type	Read and Write
Factory Default	"Disabled"
Units	Display Drive
	"Disabled" 0
	"Enabled" 1

Advanced Setup

[Motor Type]

This parameter should be set to match the type of motor connected to the drive.

Parameter Number	41
Parameter Type	Read and Write
Factory Default	"Induction"
<u>Units</u>	<u>Display</u> <u>Drive</u>
"Induction" 0	Requires no additional setting.
"Sync Reluc" 1	[Slip @ F.L.A.] & [DC Hold Level] must be set to zero. [Stop Select 1 & 2] must be set to a selection other than "DC Brake."
"Sync PM" 2	[Slip @ F.L.A.] & [DC Hold Level] must be set to zero. [Stop Select 1 & 2] must be set to a selection other than "DC Brake."

[Stop Select 2]

This parameter selects the stopping mode when the drive receives a valid stop command unless [Stop Select 1] is selected.

Parameter Number	52
Parameter Type	Read and Write
Factory Default	"Coast"
<u>Units</u>	<u>Display</u> <u>Drive</u>
"Coast" 0	Causes the drive to turn off immediately.
"DC Brake" 1	Drive defluxes the motor and then injects DC braking voltage into the motor. Requires a value in both [DC Hold Time] & [DC Hold Level].
"Ramp" 2	Drive decelerates to 0 Hz., then if [DC Hold Time] & [DC Hold Level] are greater than zero the holding brake is applied. If the values equal zero, then the drive turns off. Requires a value in [Decel Time 1/2].
"S Curve" 3	Drive causes S Curve Ramp to 0 Hz in [Decel Time 1/2] x 2.
"Ramp to Hold" 4	Drive decelerates to zero Hertz then injects holding brake per [DC Hold Level] (limited to 70% of drive rated amps) until a) a Start command is issued or b) the Enable input is opened.

[KP Amps]

Sets the proportional gain for the current limiting function of the drive. Default values are chosen for high inertia loads. If faster accel is required, raising the gain will allow additional current to the motor. Excess gain settings may create unstable operation.

Parameter Number	193
Parameter Type	Read and Write
Display Units / Drive Units	NA / NA
Factory Default	100
Minimum Value	25
Maximum Value	400

[Speed Brake En]

Enabling this feature allows faster deceleration by raising the flux in the motor and increasing the losses. Speed change braking is used in sensorless vector mode only and is effective for motors up to 20 HP.

Parameter Number	319
Parameter Type	Read and Write
Factory Default	"Disabled"
<u>Units</u>	<u>Display</u> <u>Drive</u>
"Disabled" 0	
"Enabled" 1	DC injection braking during decel

[Common Bus]

When enabled, internal precharge is disabled, allowing common bus operation. "CB Precharge" must be selected in [TB3 Term xx Sel].

Parameter Number	58
Parameter Type	Read and Write
Factory Default	"Disabled"
<u>Units</u>	<u>Display</u> <u>Drive</u>
"Disabled" 0	
"Enabled" 1	

Frequency Set

This group of parameters contains internally stored frequency settings.

[Freq Select 1]

This parameter controls which of the frequency sources is currently supplying the [Freq Command] to the drive unless [Freq Select 2] or [Preset Freq 1-7] is selected. Refer to the Speed Select Input table in Chapter 2.

Parameter Number	5
Parameter Type	Read and Write
Factory Default	"Adapter 1"
<u>Units</u>	<u>Display</u> <u>Drive</u>
	"Use Last" 0
	"Analog In 0" 1
	"Analog In 1" 2
	"Analog In 2" 3
	"Pulse Ref" 4 Refer to [Pulse In Scale] Value
	"MOP" 5
	"Adapter 1-6" 6-11
	"Preset 1-7" 12-18
	"Encoder" 19 Refer to [Encoder PPR] Value
	"Step Logic" 20

Firmware 5.001 & later

[Freq Select 2]

This parameter controls which of the frequency sources is currently supplying the [Freq Command] to the drive unless [Freq Select 1] or [Preset Freq 1-7] is selected. Refer to the *Speed Select Input* table in Chapter 2.

Parameter Number	6
Parameter Type	Read and Write
Factory Default	"Preset 1"
<u>Units</u>	<u>Display</u> <u>Drive</u>
	"Use Last" 0
	"Analog In 0" 1
	"Analog In 1" 2
	"Analog In 2" 3
	"Pulse Ref" 4 Refer to [Pulse In Scale] Value
	"MOP" 5
	"Adapter 1-6" 6-11
	"Preset 1-7" 12-18
	"Encoder" 19 Refer to [Encoder PPR] Value
	"Step Logic" 20

Firmware 5.001 & later

[Jog Frequency]

This parameter sets the frequency the drive will output when it receives a valid jog command.

Parameter Number	24
Parameter Type	Read and Write
Display Units / Drive Units	0.1 Hertz / Hertz x 100
Factory Default	10.0 Hz
Minimum Value	0.0 Hz
Maximum Value	400.0 Hz

[Preset Freq 1]

[Preset Freq 2]

[Preset Freq 3]

[Preset Freq 4]

[Preset Freq 5]

[Preset Freq 6]

[Preset Freq 7]

Parameter Number(s)	27-29 & 73-76
Parameter Type	Read and Write
Display Units / Drive Units	0.1 Hertz / Hertz x 100
Factory Default	0.0 Hz
Minimum Value	0.0 Hz
Maximum Value	400.0 Hz

These values set the frequencies that the drive will output when selected. Refer to *Speed Select Input* table in Chapter 2.

Frequency Set

[Skip Freq 1]

[Skip Freq 2]

[Skip Freq 3]

These values, in conjunction with [Skip Freq Band], create a range of frequencies at which the drive will not continuously operate.

Parameter Number(s)	32-34
Parameter Type	Read and Write
Display Units / Drive Units	1 Hertz / Hertz
Factory Default	400 Hz
Minimum Value	0 Hz
Maximum Value	400 Hz

[Skip Freq Band]

Determines the bandwidth around a skip frequency. The actual bandwidth is 2 x [Skip Freq Band] — one band above and one band below the skip frequency.

Example:

[Skip Freq] = 20 Hz and [Skip Freq Band] = 4 Hz
Bandwidth = 8 Hz (16-24 Hz)

The output frequency will remain outside the total "band." When the actual command crosses the actual skip frequency, the output will ramp through the entire band.

Parameter Number	35
Parameter Type	Read and Write
Display Units / Drive Units	1 Hertz / Hertz
Factory Default	0 Hz
Minimum Value	0 Hz
Maximum Value	15 Hz

Skip Frequency Band

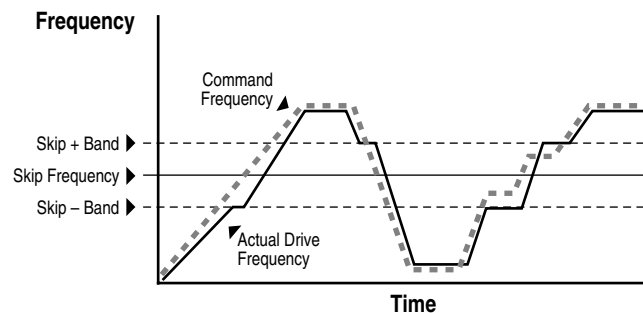

[MOP Increment]

This value sets the rate of increase or decrease to the [Freq Command] for each input at TB3 (if programmed).

Parameter Number	22
Parameter Type	Read and Write
Display Units / Drive Units	0.1 Hertz/Second / 255=(78% of [Maximum Freq])/Sec
Factory Default	1.1 Hz/Sec
Minimum Value	0 Hz/Sec
Maximum Value	(78% of [Maximum Freq]) / Sec

[Save MOP Ref]

If this parameter is enabled, the frequency command issued by the MOP inputs will be saved to EEPROM (in the event of power loss) and reused on power up. When disabled, no value is saved and the MOP reference is reset to zero on power up.

Parameter Number	230
Parameter Type	Read and Write
Factory Default	"Disabled"
<u>Units</u>	<u>Display</u> <u>Drive</u>
	"Disabled" 0
	"Enabled" 1

[Freq Ref SqRoot]

This parameter activates the square root function for 0-10V/4-20 mA inputs or signals sent through Adapters 1-6 when used as a frequency reference. If the input signal varies with the square of speed, the parameter should be set to "Enabled."

Parameter Number	229
Parameter Type	Read and Write
Factory Default	"Disabled"
<u>Units</u>	<u>Display</u> <u>Drive</u>
	"Disabled" 0
	"Enabled" 1

Frequency Set

[Pulse In Scale]

Provides a scaling factor for the pulse input.

$$\text{Scale Factor} = \frac{\text{Incoming Pulse Rate (Hz)}}{\text{Desired Command Freq.}}$$

Example:

4 Pole Motor, 60 Hz = Max. Speed.

The 1336-MOD-N1 option outputs 64 Hz/Hz. At full analog reference, the pulse input to the drive will be 60 Hz x 64 Hz/Hz = 3840 pulses/sec.

$$\text{Scale Factor} = \frac{3840 \text{ Hz}}{60 \text{ Hz}} = 64$$

Parameter Number	264
Parameter Type	Read and Write
Display Units / Drive Units	Factor / Pulses per Rev
Factory Default	64 PPR
Minimum Value	1
Maximum Value	4096

[Encoder PPR]

This parameter sets the scaling for encoder feedback speed regulation. Enter the actual encoder pulses per revolution

Parameter Number	46
Parameter Type	Read and Write
Display Units / Drive Units	Factor / Pulses per Rev
Factory Default	1024 PPR
Minimum Value	1
Maximum Value	4096

Feature Select	This group contains the necessary parameters to activate and program advanced features of the drive.
-----------------------	--

<p>[Dwell Frequency]</p> <p>This value sets the frequency that the drive will immediately output (no Accel Ramp) upon a start command. This parameter requires a programmed [Dwell Time].</p>	Parameter Number	43
	Parameter Type	Read and Write
	Display Units / Drive Units	0.1 Hertz / Hertz x 10
	Factory Default	0.0 Hz
	Minimum Value	0.0 Hz
	Maximum Value	7.0 Hz

<p>[Dwell Time]</p> <p>This value sets the time the drive will continue to output [Dwell Frequency] before ramping to [Freq Command].</p>	Parameter Number	44
	Parameter Type	Read and Write
	Display Units / Units	1 Second / Seconds
	Factory Default	0 Sec
	Minimum Value	0 Sec
	Maximum Value	10 Sec

Dwell Time

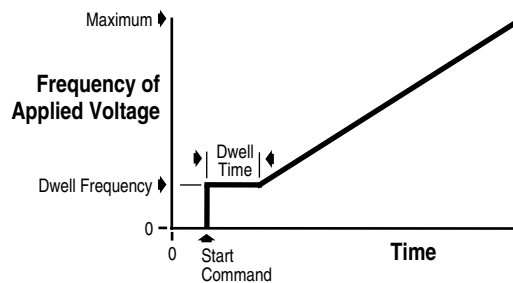

<p>[Speed Control]</p> <p>This parameter selects the type of speed modulation active in the drive.</p> <p>This parameter cannot be changed while the drive is running.</p> <p>Important: “No Control” and “Phase Lock” are the only available options for synchronous motors.</p> <p>If encoder feedback closed loop speed regulation is required, “Encoder Fdbk” must be selected.</p>	Parameter Number	77
	Parameter Type	Read and Write
	Factory Default	“Slip Comp”
	<u>Units</u>	<u>Display</u> <u>Drive</u>
		“No Control” 0 Frequency regulation
		“Slip Comp” 1 Slip compensation
		“Speed Droop” 2 Negative slip compensation
		“Phase Lock” 3 Enable phase lock to pulse input
		“Encoder Fdbk” 4 Encoder feedback-closed loop
		“Droop + Reg” 5 Enc. fdbk.-closed loop w/ active droop
	“P Jump” 6 Traverse function	
	“Process PI” 7 Closed loop PI control	

<p>[Slip @ F.L.A.]</p> <p>This value sets the amount of automatic increase or decrease to the drive output to compensate for motor slip. When [Speed Control] is set to “Slip Comp”, a percentage of this value proportional to output current is added to the drive output frequency. When [Speed Control] is set to “Droop”, a percentage of this value proportional to output current is subtracted from the drive output frequency.</p> $\frac{\text{Sync RPM} - \text{Rated RPM}}{\text{Sync RPM}} \times \text{Rated Hz.}$	Parameter Number	42
	Parameter Type	Read and Write
	Display Units / Drive Units	0.1 Hertz / Hertz x 10
	Factory Default	1.0 Hz
	Minimum Value	0.0 Hz
	Maximum Value	10.0 Hz

Feature Select

[Slip Comp Gain]

This parameter is the gain for the slip compensation and adjusts the recovery rate after a load change.

Parameter Number	195
Parameter Type	Read and Write
Display Units / Drive Units	None
Factory Default	1
Minimum Value	1
Maximum Value	40

[Run On Power Up]

This parameter enables the function that allows the drive to automatically restart on Power Up. This parameter requires that a two wire control scheme be installed at TB3 and that a valid start contact be present. Refer to *Input Mode Selection* in Chapter 2.

Parameter Number	14
Parameter Type	Read and Write
Factory Default	"Disabled"
<u>Units</u>	<u>Display</u> <u>Drive</u>
	"Disabled" 0
	"Enabled" 1



ATTENTION: This parameter may only be used as outlined in NFPA79, "Under Voltage Protection." Equipment damage and/or personal injury may result if this parameter is used in an inappropriate application.

[Reset/Run Tries]

This value sets the maximum number of times the drive attempts to reset a fault and restart before the drive issues a "Max Retries Fault". See Chapter 7 for a list of resettable faults.

Parameter Number	85
Parameter Type	Read and Write
Display Units / Drive Units	1 Try / Tries
Factory Default	0
Minimum Value	0
Maximum Value	9

[Reset/Run Time]

This value sets the time between restart attempts when [Reset/Run Tries] is set to a value other than zero.

Parameter Number	15
Parameter Type	Read and Write
Display Units / Drive Units	0.1 Second / Seconds x 100
Factory Default	1.0 Sec
Minimum Value	0.5 Sec
Maximum Value	30.0 Sec

[S Curve Enable]

This parameter enables the fixed shape S curve accel/decel ramp. Programmed accel/decel times are doubled if [S Curve Time] is set to "0". An adjustable S curve will be created if [S Curve Time] is greater than zero.

Parameter Number	57
Parameter Type	Read and Write
Factory Default	"Disabled"
<u>Units</u>	<u>Display</u> <u>Drive</u>
	"Disabled" 0
	"Enabled" 1

[S Curve Time]

This creates an adjustable s curve ramp. If S Curve Time is < the programmed accel/decel time, the actual ramp will be the sum of the two. If S Curve Time is \geq the programmed accel/decel times, a fixed S curve will be created whose time is double the programmed accel/decel time.

Parameter Number	56
Parameter Type	Read and Write
Display Units / Drive Units	0.1 Second / Seconds x 10
Factory Default	0.0 Sec
Minimum Value	0.0 Sec
Maximum Value	1800.0 Sec

Feature Select

Fixed S Curve

Accel Time = 2 x [Accel Time 1 or 2]
 Decel Time = 2 x [Decel Time 1 or 2]

Adjustable S Curve

Case 1 (see adjacent diagram)

[S Curve Time] < [Accel Time 1 or 2], and
 [S Curve Time] < [Decel Time 1 or 2],
 then

Accel Time = [Accel Time 1 or 2] + [S Curve Time], and
 Decel Time = [Decel Time 1 or 2] + [S Curve Time]

Case 2

[S Curve Time] ≥ [Accel Time 1 or 2], and
 [S Curve Time] ≥ [Decel Time 1 or 2],
 then

Accel Time = 2 x [Accel Time 1 or 2], and
 Decel Time = 2 x [Decel Time 1 or 2]

Note: If [S Curve Time] ≥ programmed accel/decel times any further increase in [S Curve Time] will have no effect on the total accel/decel times.

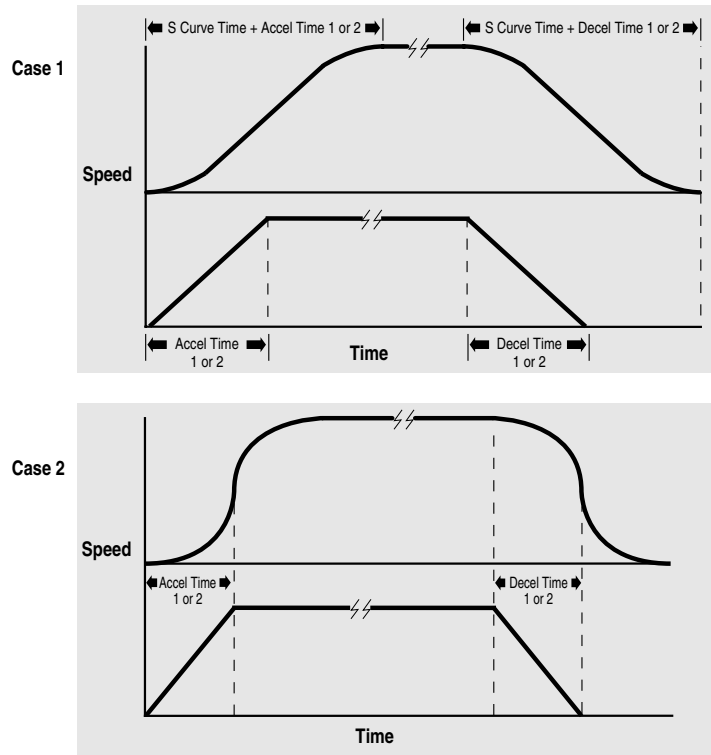

[Language]

This parameter selects the language for the HIM display.

To return to the default language (English) after an alternate language has been inadvertently selected:

- a) Cycle drive power
- b) Press the Increment key 5 times
- c) Press Enter
- d) Press the Increment key 2 times
- e) Press Enter

Parameter Number	47
Parameter Type	Read and Write
Factory Default	"English"
Units	Display Drive
	"English" 0
	"FRANCAIS" 1
	"ESPANOL" 2
	"Italiano" 3
	"Deutsch" 4
	"Japanese" 5 <i>Not available with v5.001 & later</i>
	"Portuguese" 6
	"Nederlands" 7

[Flying Start En]

This value enables the flying start function and chooses the method to be used. The drive will first search from the direction it was last running.

Firmware 5.001 & later – When restarting high inertia loads, use the longer speed searches to match load speed. This may minimize Overvoltage and Overcurrent faults.

Parameter Number	155	
Parameter Type	Read and Write	
Factory Default	"Disabled"	
Units	Display Drive	
	"Disabled" 0	
	"Speed Search" 1	Freq. sweep -see [FStart For./Rev.]
	"Use Encoder" 2	Requires feedback encoder
	"Track Volts" 3	Read back EMF from sync. pm motor
	"Speed Srch 10s" 4	Frequency sweep takes 10 seconds
	"Speed Srch 20s" 5	Frequency sweep takes 20 seconds
	"Speed Srch 40s" 6	Frequency sweep takes 40 seconds



ATTENTION: The "Speed Search" selection should not be used with synchronous or permanent magnet motors. Motors may be demagnetized during braking.

Feature Select

[FStart Forward]

This value sets the frequency at which the forward speed search begins. If this value exceeds [Maximum Freq], speed search will begin at [Maximum Freq]. Forward search ends at zero Hertz or when motor speed is found.

Parameter Number	156
Parameter Type	Read and Write
Display Units / Drive Units	1 Hertz / Hertz
Factory Default	60 Hz
Minimum Value	0 Hz
Maximum Value	400 Hz

[FStart Reverse]

This value sets the frequency at which the reverse speed search begins. If this value exceeds [Maximum Freq], speed search will begin at [Maximum Freq]. Reverse search ends at zero Hertz or when motor speed is found.

Parameter Number	157
Parameter Type	Read and Write
Display Units / Drive Units	1 Hertz / Hertz
Factory Default	0 Hz
Minimum Value	0 Hz
Maximum Value	400 Hz

[LLoss Restart]

This parameter selects the reconnect mode after recovery from a line loss condition.

Parameter Number	228
Parameter Type	Read and Write
Factory Default	"Track Volts"
<u>Units</u>	<u>Display</u> <u>Drive</u>
	"Speed Search" 1 Frequency sweep
	"Use Encoder" 2 Read feedback
	"Track Volts" 3 Read motor volts
<i>Firmware 5.001 & later</i>	"Speed Srch 10s" 4 Frequency sweep takes 10 seconds
<i>Firmware 5.001 & later</i>	"Speed Srch 20s" 5 Frequency sweep takes 20 seconds
<i>Firmware 5.001 & later</i>	"Speed Srch 40s" 6 Frequency sweep takes 40 second
<i>Drive Units="4" Firmware 4.001 & before</i>	"Last Speed" 7 Start at last output

[Line Loss Mode]

This parameter sets the drive reaction to a loss of input voltage and is often referred to as Inertia Ride Through. If the drive is used to determine loss of AC input (as opposed to an external device), it will monitor the falling DC bus voltage. When Vbus falls below 85% of nominal, a "line loss" condition is issued and an alarm bit is set.

The line loss mode selected, along with [Line Loss Fault] and [Low Bus Fault] will determine the drives response to a loss of input.

- With this parameter set to "LoBus>Off" and . . .
 - [Line Loss Fault] is . . .
 - Enabled a fault is issued 0.5 seconds after a "line loss" condition.
 - Disabled a fault will not be issued.
 - [Low Bus Fault] is . . .
 - Enabled a fault is issued at the bus undervoltage trip level.
 - Disabled a fault will not be issued.
- With this parameter set to "LoBus>Decel" and [Line Loss Fault] & [Low Bus Fault] are disabled – the drive will decelerate the output frequency following motor speed to create a regenerative condition that maintains Vbus at 85% nominal. The amount of available mechanical energy determines the length of "ride through."

If this parameter = "LoBus>Off," then [LLoss Restart] determines the reconnect scheme for the motor. If this parameter is set to "LoBus>Decel," no reconnect scheme is required.

Parameter Number	256
Parameter Type	Read/Write
Factory Default	"LoBus>Off"
<u>Units</u>	<u>Display</u> <u>Drive</u>
	"LoBus>Off" 0 Turn off output on -15% Vbus
	"Input>Off" 1 Not functional at time of printing. Turns off output on High Speed Input = True
	"LoBus>Decel" 2 Regulates Vbus using deceleration Active on -15% Vbus
	"Input>Decel" 3 Not functional at time of printing. Regulates Vbus using deceleration Active on High Speed Input = True

Feature Select

Power Loss Ride-Thru

Important: The drive has the ability to ride through short power interruptions. However, power loss ride-thru requires careful system design to guard against problems associated with rapid return of the AC line voltage after a line voltage dip. Consult the factory with your application details before attempting to program your drive to ride through an AC line voltage dip of more than 15% below the nominal voltage.

6 parameters are associated with the line loss functionality.

[Line Loss Mode] selects the method of detecting a power line loss and the response to a line loss.

[Line Loss Volts] adjusts the level at which a line loss is recognized when [Line Loss Mode] is set to “LoBus>Off” or “LoBus>Decel.”

[Loss Recover] adjusts the level at which the drive recognizes the input power has returned when [Line Loss Mode] is set to “LoBus>Off” or “LoBus>Decel.”

[Ride Thru Volts] sets the bus voltage that the inertia ride thru function will attempt to regulate. If [Line Loss Mode] is set to “LoBus>Decel,” a line loss condition activates the inertia ride thru function. The load is then decelerated such that the energy absorbed from the mechanical load balances the losses, and bus voltage is maintained.

[Min Bus Volts] sets the bus voltage below which the drive will disable firing of the output devices.

[Line Loss Restart] selects the timing and method of reconnecting the motor after power returns.

Operation when [Line Loss Mode] is set to “LoBus>Off.”

If a power interruption occurs (T1) the drive will continue to operate from stored DC bus energy until the bus voltage drops to the level set by [DC Bus Memory] – [Line Loss Volts] (T2). At this point, the drive output is turned off and a 500 ms timer is started. One of the following conditions will then occur:

1. The bus voltage will fall below the level set by [Min Bus Volts] (T5) before the timer expires. This will generate a bus Undervoltage Fault if [Low Bus Fault] is set to “enabled.”
2. The bus voltage will remain below [DC Bus Memory] – [Loss Recover], but above [Min Bus Voltage] and the timer expires (T6). If [Line Loss Fault] is set to “enabled,” a Line Loss Fault will be issued.
3. The input power is restored (T3) and the bus voltage rises above [DC Bus Memory] – [Loss Recover] (T4) before the timer expires. This allows the drive to turn its output on and resume running according to the selection programmed in [Line Loss Restart].

Operation when [Line Loss Mode] is set to “LoBus>Decel.”

Operation in this mode is similar to above, except that the drive will attempt to maintain the bus voltage at the level programmed in [Ride Thru Volts].

If a power interruption occurs (T1) the drive will continue to operate from stored DC bus energy until the bus voltage drops to the level set by [DC Bus Memory] – [Line Loss Volts] (T2). At this point, the drive will start a 500 ms timer and attempt to regulate the bus voltage at the level set by [Ride Thru Volts]. One of the following conditions will then occur:

1. The drive is unable to extract enough energy from the mechanical load, and the bus voltage will fall below the level set by [Min Bus Volts] (T5) before the timer expires. This will generate a bus Undervoltage Fault if [Low Bus Fault] is set to “enabled.”
2. The bus voltage will be maintained at the level programmed in [Ride Thru Volts] and the timer expires. If [Line Loss Fault] is set to “enabled,” a Line Loss Fault will be issued.

Important: [Ride Thru Volts] should be set below the level set by [DC Bus Memory] – [Loss Recover], below the level set by [DC Bus Memory] – [Line Loss Volts], and above the level set by [Min Bus Voltage]. If [Ride Thru Volts] is set above the recovery level, the drive will oscillate in and out of line loss. If [Ride Thru Volts] is set above the line loss level, as soon as a line loss is detected, the drive will immediately decelerate as quickly as the decel setting allows until the bus voltage increases to the ride-thru level. If [Ride Thru Volts] is set below [Min Bus Voltage], the bus voltage will be allowed to drop below the minimum required and the drive output will be turned off.

3. The input power is restored (T3) and the bus voltage rises above [DC Bus Memory] – [Loss Recover] (T4) before the timer expires. The drive will then accelerate back to the commanded speed using the programmed acceleration rate.

Operation when [Line Loss Mode] is set to “Input>Off” or “Input>Decel.”

When operating in either of these modes, the line loss condition is detected by an external source. The drive is then signaled through the Pulse input that a loss of power has occurred. Drive operation is the same as when [Line Loss Mode] is set to “LoBus>Off” or “LoBus>Decel,” except for the following: If an inertia ride-thru is initiated, the drive attempts to regulate the bus at the value in [DC Bus Memory] rather than the value in [Ride Thru Volts].

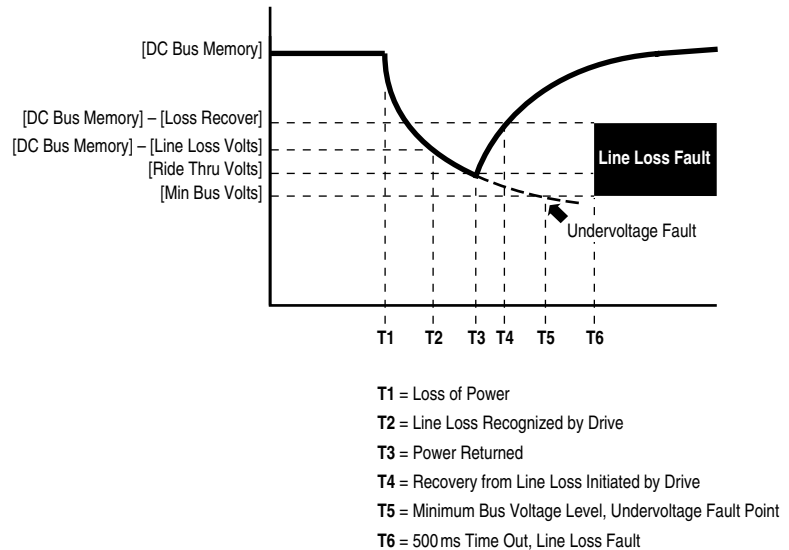

Feature Select

[Line Loss Volts]

Sets the bus voltage below which the drive recognizes a line loss. Specifically: If [DC Bus Voltage] drops below [DC Bus Memory] – [Line Loss Volts] and if [Line Loss Mode] is set to 0 or 2, the [Drive Alarm 1]. Line Loss bit will be set and the drive will take the selected line loss action.

Parameter Number	320
Parameter Type	Read and Write
Display Units / Drive Units	1 Volt / 4096 = Drive Rtd Volts
Factory Default	59/117/146 Volts
Minimum Value	40/80/100 Volts
Maximum Value	200/400/500 Volts

[Loss Recover]

Sets the bus voltage above which the drive recognizes a line loss recovery. Specifically: If [DC Bus Voltage] rises above [DC Bus Memory] – [Loss Recover] and if [Line Loss Mode] is set to 0 or 2, the “Line Loss” bit of [Drive Alarm 1] is cleared and the drive recovers from line loss. This parameter should be set lower than [Line Loss Volts] (i.e. for a higher bus voltage), otherwise the drive will cycle in and out of line loss.

Parameter Number	321
Parameter Type	Read and Write
Display Units / Drive Units	1 Volt / 4096 = Drive Rtd Volts
Factory Default	29/59/73 Volts
Minimum Value	20/40/50 Volts
Maximum Value	200/400/500 Volts

[Ride Thru Volts]

Sets the bus voltage that the inertia ride thru function will attempt to regulate. If [Line Loss Mode] = “LoBus>Decel,” a line loss condition activates the inertia ride thru function. The load is decelerated such that the energy absorbed from the mechanical load balances the losses – bus voltage is maintained.

This parameter should be set greater than [Loss Recover] (i.e. for a lower bus voltage). Otherwise the drive will cycle in and out of line loss.

NOTE: If [Line Loss Mode] = “Input>Decel,” line loss operation is similar but the inertia ride thru function regulates the bus to the value in [DC Bus Memory].

Parameter Number	322
Parameter Type	Read and Write
Display Units / Drive Units	1 Volt / 4096 = Drive Rtd Volts
Factory Default	29/59/73 Volts
Minimum Value	40/80/100 Volts
Maximum Value	200/400/500 Volts

[Min Bus Volts]

Sets the bus voltage below which the drive will disable firing. The “Line Loss” flag in [Drive Alarm 1] is always set. If [Low Bus Fault] = “Enabled” the drive faults with an F04 “Undervolt Fault.” This means that even if [Line Loss Mode] = “Input>Decel” dropping below minimum bus disables firing and signals a line loss.:

To check the minimum safe value for [Minimum Bus]:

- Set [Low Bus Fault] = “Disabled”.
- Set [Line Loss Fault] = “Disabled”.
- Select [DC Bus Voltage] on the HIM.
- With the drive stopped, disconnect power from the drive.
- Watch the HIM display for the lowest voltage reading before the HIM loses power.



ATTENTION: To guard against possible drive damage, this parameter MUST be set such that firing is disabled at a bus voltage higher than the bus voltage at which the power supply for the gate drive circuits is lost. See the procedure at left to check the minimum value for this parameter.

Parameter Number	323
Parameter Type	Read and Write
Display Units / Drive Units	1 Volt / 4096 = Drive Rtd Volts
Factory Default	194/388/485 Volts
Minimum Value	100/200/250 Volts
Maximum Value	200/400/500 Volts

[Traverse Inc]

Sets the time period of increasing frequency. Setting this parameter to zero disables the P Jump function.

Parameter Number	78
Parameter Type	Read and Write
Display Units / Drive Units	0.01 Second / Seconds x 100
Factory Default	0.00 Sec
Minimum Value	0.00 Sec
Maximum Value	30.00 Sec

Feature Select

[Traverse Dec]

Sets the time period of decreasing frequency. Setting this parameter to zero disables the traverse function.

Parameter Number	304
Parameter Type	Read and Write
Display Units / Drive Units	0.01 Second / Seconds x 100
Factory Default	0.00 Sec
Minimum Value	0.00 Sec
Maximum Value	30.00 Sec

Traverse Function

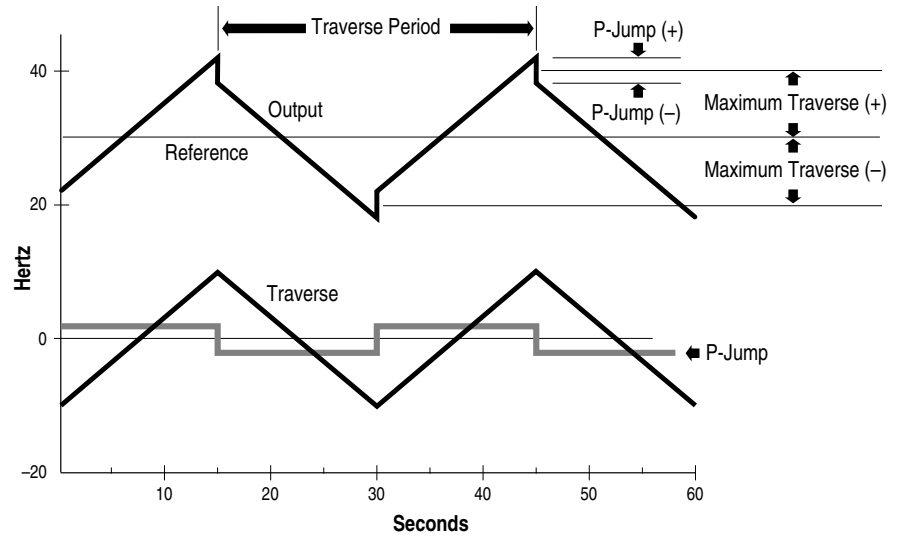

[Max Traverse]

This value sets the peak amplitude of speed modulation.

Parameter Number	79
Parameter Type	Read and Write
Display Units / Drive Units	0.01 Hertz / 32767 = [Maximum Freq]
Factory Default	0.00 Hz
Minimum Value	0.00 Hz
Maximum Value	50% of [Maximum Freq]

[P Jump]

This value sets the slip or inertia compensation amplitude of speed modulation.

Parameter Number	80
Parameter Type	Read and Write
Display Units / Drive Units	0.01 Hertz / 32767 = [Maximum Freq]
Factory Default	0.00 Hz
Minimum Value	0.00 Hz
Maximum Value	25% of [Maximum Freq]

[Bus Regulation]

Enabling this parameter causes the drive to adjust output frequency based on the DC bus voltage. If the drive senses rising bus voltage, it will increase the output frequency to reduce the regenerative energy from the motor that is causing the bus voltage to rise. This will reduce the risk of an overhauling load causing an Overvolt Fault.

Parameter Number	288
Parameter Type	Read and Write
Factory Default	"Disabled"
<u>Units</u>	<u>Display</u> <u>Drive</u>
	"Disabled" 0
	"Enabled" 1 [Bus Limit En] must also be "Enabled"

[Load Loss Detect]

This parameter enables the function that detects an indicated loss of load on the motor. A fault (F20) or alarm condition will occur if [Torque Current] falls below [Load Loss Level] for a time period greater than [Load Loss Time].

Parameter Number	290
Parameter Type	Read and Write
Factory Default	"Disabled"
<u>Units</u>	<u>Display</u> <u>Drive</u>
	"Disabled" 0
	"Alarm" 1 Requires a value in [Load Loss Time]
	"Fault" 2 Requires a value in [Load Loss Time] Generates an F20 fault

Feature Select

[Load Loss Level]	Parameter Number	291
Sets the torque current level below which a load loss fault/warning will occur. The value is expressed as a percentage of programmed [Motor NP Amps].	Parameter Type	Read and Write
	Display Units / Drive Units	1 % / 4096 = 100%
	Factory Default	50%
	Minimum Value	20%
	Maximum Value	0% <i>Firmware 6.001 & later</i>
	Maximum Value	100%
[Load Loss Time]	Parameter Number	292
Sets the amount of time the drive [Torque Current] is below [Load Loss Level], before the action set in [Load Loss Detect] is taken.	Parameter Type	Read and Write
	Display Units / Units	1 Second / Seconds
	Factory Default	0 Sec
	Minimum Value	0 Sec
	Maximum Value	30 Sec
[Bus Reg Level] – Firmware 4.001 & later [Max Bus Volts]	Parameter Number	325
When this parameter is set to the minimum value, the drive DC bus voltage is limited to 110% of nominal voltage. [Bus Limit En] must be "Enabled" for the drive to limit the bus voltage. This setting is used to move the trigger point for regulation above the turn-on point for dynamic brake or regeneration packages.	Parameter Type	Read and Write
	Display Units / Drive Units	1 Volt / 4096 = Drive Rtd Volts
	Factory Default	358/716/895 Volts
	Minimum Value	358/716/895 Volts
	Maximum Value	403/807/1009 Volts

Digital I/O

This group of parameters contains the programming options for digital drive inputs/outputs.

[Input Mode]

Selects the functions of inputs 1 & 2 at TB3 when an optional interface card is installed. Refer to *Input Mode Selection* in Chapter 2. This parameter cannot be changed while the drive is running. Power to the drive must be cycled before any changes will affect drive operation. "2WR-PWR DIP" provides a delay to the Start command. Drive will then start if Run & Stop commands are applied at the same time.

Parameter Number	241
Parameter Type	Read and Write
Display Units / Drive Units	Mode Number / Selection
Factory Default	"Status"
<u>Units</u>	<u>Display</u> <u>Drive</u>
	"Status" 1
	"3 Wire" 2
	"2 Wire" 3
	"2WR-PWR DIP" 4

[TB3 Term 22 Sel]
[TB3 Term 23 Sel]
[TB3 Term 24 Sel]
[TB3 Term 26 Sel]
[TB3 Term 27 Sel]
[TB3 Term 28 Sel]

This parameter selects the functionality of the input at TB3, terminals 22-28.

In most cases, if multiple inputs are programmed with the same function, they will be logically "OR'd."

Selections that use one input for multiple functions (A) can have only one terminal select for that option. If multiple terminals are selected with these options, a "Mult Prog Input" fault (F61) will occur.

Only one input can select "Run Reverse" and it can only be selected if [Input Mode] is set to "2 Wire." Multiple inputs will cause a "Mult Prog Input" fault (F61) and selecting "3 Wire" will cause a "Ill Prog Input" fault (F62).

If the drive has direction control from a bipolar analog input, no direction control functions (B) can be selected. An "Ill Prog Input" fault (F62) will be generated. See Chapter 7 for fault information.

Firmware 5.001 & later – "DC Bus Drop" is used to allow enabling and disabling the line loss level set in [Line Loss Volts]. If this input is set, the line loss level will be set at default (82% DC Bus Level). When the input is off, the value set in [Line Loss Volts] is used. The [Line Loss Mode] must be set at default ("LoBus>Off") to turn the drive off when low bus levels occur.

Parameter Number	242-247
Parameter Type	Read and Write
Factory Default	"Rev/For" Input 3 (terminal 22) "Jog" Input 4 (terminal 23) "Aux Fault" Input 5 (terminal 24) "Speed Sel 3" Input 6 (terminal 26) "Speed Sel 2" Input 7 (terminal 27) "Speed Sel 1" Input 8 (terminal 28)
<u>Units</u>	<u>Display</u> <u>Drive</u>
	"Unused" 0
	"Jog" 1
	"Speed Sel 1-3" 2-4
	"1st Accel" 5
	"2nd Accel" 6
(A)	"2 Acc/1 Acc" 7 2 Acc = Closed, 1 Acc = Open
	"1st Decel" 8
	"2nd Decel" 9
(A)	"2 Dec/1 Dec" 10 2 Dec = Closed, 1 Dec = Open
	"Clear Fault" 11
	"Aux Fault" 12
	"Local Ctrl" 13
	"Traverse" 14
	"Sync" 15
	"PI Enable" 16
	"PI Reset" 17
	"Dig Pot Up" 18
	"Dig Pot Dn" 19
(A)	"Stop Type" 20
(B)	"Forward" 21
(B)	"Reverse" 22
(A/B)	"Rev/For" 23 Rev = Closed, For = Open
	"Run Reverse" 24
	"CB Precharge" 25
	"DC Bus Drop" 26
	"SL Input 1" 27
	"SL Input 2" 28

Firmware 5.001 & later
Firmware 5.001 & later
Firmware 5.001 & later

[Input Status]

This parameter displays the on/off status of inputs 1-8 at TB3 if an optional interface card is installed.

A Status description (bit ENUM) is displayed on line 1 (except Series A HIMs below version 3.0).

Parameter Number	55
Parameter Type	Read Only
	Bit 7 Bit 6 Bit 5 Bit 4 Bit 3 Bit 2 Bit 1 Bit 0
	Input 1 - TB3-19
	Input 2 - TB3-20
	Input 4 - TB3-23
	Input 3 - TB3-22
	Input 5 - TB3-24
	Input 6 - TB3-26
	Input 8 - TB3-28
	Input 7 - TB3-27

Digital I/O

<p>[CR1 Out Select] [CR2 Out Select] [CR3 Out Select] [CR4 Out Select]</p> <p>This parameter sets the condition that changes the state of the output contacts at TB2 terminals 10 & 11 (CR1), 11 & 12 (CR2), 13, 14, 15 (CR3) and 16, 17, 18 (CR4).</p> <p>A change of state may mean energize or de-energize the relay, since some relays may energize on power-up and de-energize when the selected condition occurs.</p> <p>A red LED located on the Main Control Board indicates the status of the CR3 contact. The LED will illuminate when the contacts at terminals 13 & 14 of TB2 are closed and terminals 14 & 15 are open.</p>	<p>Parameter Number 158, 174-176 Parameter Type Read and Write Factory Default "At speed" CR1 "Running" CR2 "Fault" CR3 "Alarm" CR4</p> <p><u>Units</u></p> <p><u>Display</u> <u>Drive</u></p> <p>"Fault" 0 Any fault "Alarm" 1 Any unmasked alarm "Running" 2 Outputting frequency "At Speed" 3 Output = command "At Freq" 4 Requires value in [Dig Out Freq] "At Current" 5 Requires value in [Dig Out Curr] "At Torque" 6 Requires value in [Dig Out Torque] "Current Lmt" 7 In overload "Mtr Overload" 8 At present levels O.L. will occur "Line Loss" 9 Line loss in progress "Drive Power" 10 Full input volts present, bus charged "Drive Ready" 11 All necessary commands present "Forward Run" 12 Forward direction "Reverse Run" 13 Reverse direction "Braking" 14 DC brake mode (stopping or holding) "Economize" 15 Auto economizer active "Auto Reset" 16 Attempt to reset fault & restart drive "At Temp" 17 Requires value in [Dig At Temp] "PI Max Error" 18 Requires value in [PI Max Error] "Remote" 19 Set by [Remote CR Output] "Step Logic" 20 Set by [SLx Step Setting] SL Output</p> <p><i>Firmware 5.001 & later</i></p>
<p>[Dig Out Freq]</p> <p>This value sets the trip point for any digital output relay (CR1-4 – see above) that is programmed to "At Frequency". The relay will be energized when the value is exceeded.</p>	<p>Parameter Number 159 Parameter Type Read and Write Display Units / Drive Units 0.01 Hertz / 32767 = Max Freq Factory Default 0.00 Hz Minimum Value 0.00 Hz Maximum Value Programmed [Maximum Freq]</p>
<p>[Dig Out Current]</p> <p>This value sets the trip point for any digital output relay (CR1-4 – see above) that is programmed to "At Current". The relay will be energized when the value is exceeded.</p>	<p>Parameter Number 160 Parameter Type Read and Write Display Units / Drive Units 0% / 4096 = 100% of Drive Rated Amps Factory Default 0 % Minimum Value 0 % Maximum Value 200 %</p>
<p>[Dig Out Torque]</p> <p>This value sets the trip point for any digital output relay (CR1-4 – see above) that is programmed to "At Torque". The relay will be energized when the value is exceeded.</p>	<p>Parameter Number 161 Parameter Type Read and Write Display Units / Drive Units 0.1 Amps / 4096 = Rated Torque Amps Factory Default 0.0 Amps Minimum Value 0.0 Amps Maximum Value 200% of [Rated Amps]</p>
<p>[Dig At Temp]</p> <p>This parameter sets the heatsink temperature trip point for any digital output relay (CR1-4 – see above) that is programmed to "At Temp." The relay will be energized when this value is exceeded. See also [Drive Status 2], bit 13 and [Drive Alarm 1], bit 10.</p>	<p>Parameter Number 267 Parameter Type Read and Write Display Units / Drive Units 1° C / Deg. C Factory Default 120° C Minimum Value 0 Maximum Value 255° C</p>

Digital I/O

[PI Max Error] Used with the process PI loop and sets the PI error value which activates CR1-4 (if selected). The relay(s) will be activated when [PI Error] exceeds this value.	Parameter Number	293
	Parameter Type	Read and Write
	Display Units / Drive Units	0.01 Hertz / 32767 = Maximum Freq Forward
	Factory Default	Maximum Freq Forward
	Minimum Value	-400.00 Hz
	Maximum Value	400.00 Hz

[Pulse Out Select] This parameter selects the source value that drives pulse output.	Parameter Number	280
	Parameter Type	Read and Write
	Factory Default	"Output Freq"
	<u>Units</u>	<u>Display</u> <u>Drive</u> <u>Range</u>
		"Output Freq" 0 See [Output Freq]
		"Encoder Freq" 1 See [Encoder Freq]
	"Acc/Dec Freq" 2	
NOTE: Output frequency command of the drive directly at the output of the accel/decel ramp generator. It does not include any modification due to selected speed regulation mode via [Speed Control].		

[Pulse Out Scale] Provides a scaling factor for pulse output. Pulse Output Rate = Hz x [Pulse Out Scale] The pulse output will not provide a rate lower than 21 Hz. A command less than 21 Hz will generate 0 Hz output. To provide smooth operation across a wide speed range, select the maximum scale factor possible.	Parameter Number	281
	Parameter Type	Read and Write
	Display Units / Drive Units	Factor / Factor
	Factory Default	1
	Minimum Value	1
	Maximum Value	64
<u>Example:</u> [Pulse Out Select] is set to "Output Freq" and drive is programmed for [Maximum Freq] = 60 Hz. When the drive output is 60 Hz, the Pulse Output Rate is adjustable from 60 Hz (60 x 1) to 3840 Hz (60 x 64).		

[Pulse In Scale] Provides a scaling factor for the pulse input. $\text{Scale Factor} = \frac{\text{Incoming Pulse Rate (Hz)}}{\text{Desired Command Freq.}}$	Parameter Number	264
	Parameter Type	Read and Write
	Display Units / Drive Units	Factor / Pulses per Rev
	Factory Default	64 PPR
	Minimum Value	1
	Maximum Value	4096
<u>Example:</u> 4 Pole Motor, 60 Hz = Max. Speed. The 1336-MOD-N1 option outputs 64 Hz/Hz. At full analog reference, the pulse input to the drive will be 60 Hz x 64 Hz/Hz = 3840 pulses/sec. $\text{Scale Factor} = \frac{3840 \text{ Hz}}{60 \text{ Hz}} = 64$		

[At Time] Sets the delay time for the activation of the CR1-4 relays. The relay is activated at Start + [At Time] seconds. This delay affects all relays.	Parameter Number	327
	Parameter Type	Read and Write
	Display Units / Units	0.01 Second / Seconds x 100
	Factory Default	0.00 Sec
	Minimum Value	0.00 Sec
	Maximum Value	360.00 Sec

[Remote CR Output] Individual bits control relay outputs when selected with [CR1-4 Out Select]. 1 = Energize Coil. This parameter is reset to the default on power-up. <u>Example:</u> If [CR2 Out Select] is set to "Remote," bit 1 of this parameter will control CR2. A Status description (bit ENUM) is displayed on line 1 (except Series A HIMs below version 3.0).	Parameter Number	326						
	Parameter Type	Read and Write						
	Factory Default	xxxx0000						
	Bit 7	Bit 6	Bit 5	Bit 4	Bit 3	Bit 2	Bit 1	Bit 0
	CR1 Output CR2 Output CR3 Output CR4 Output Not Used							

Analog I/O

This group of parameters contains the programming options for analog drive inputs/outputs.

<p>[Anlg In 0 Lo] [Anlg In 1 Lo] [Anlg In 2 Lo]</p> <p>Sets the percentage of voltage or current from Input 0, 1 or 2 that represents [Minimum Freq].</p>	<p>Parameter Number Parameter Type Display Units / Drive Units Factory Default Minimum Value Maximum Value</p>	<p>237, 239, 248 Read and Write 0.1% / 920 = 100% 0.0% -300.0% +300.0%</p>																		
<p>[Anlg In 0 Hi] [Anlg In 1 Hi] [Anlg In 2 Hi]</p> <p>Sets the percentage of voltage or current from Input 0, 1 or 2 that represents [Maximum Freq].</p>	<p>Parameter Number Parameter Type Display Units / Drive Units Factory Default Minimum Value Maximum Value</p>	<p>238, 240, 249 Read and Write 0.1% / 920 = 100% 100.0% -300.0% +300.0%</p>																		
<p>[Analog Trim En]</p> <p>This parameter enables Analog In 0 as a trim input. Setting this parameter to "Enable" creates a trim signal to the active frequency source at Analog In 0. The trim value is $\pm 10\%$ of [Maximum Freq].</p> <p>Minimum Input = -10% Trim Mid-Point Input = No Trim Maximum Input = +10% Trim</p>	<p>Parameter Number Parameter Type Factory Default <u>Units</u></p>	<p>90 Read and Write "Disabled" <u>Display</u> <u>Drive</u> "Disabled" 0 "Enabled" 1</p>																		
<p>[Anlg Signal Loss]</p> <p>Selects the drive reaction to a loss of analog input signal. This signal could represent commanded frequency, PI feedback, or others.</p> <p>Bits 0-2 define the input as a pot with wiper loss detect and will generate an "Open Pot Fault" (F09).</p> <p>Bits 3-5 define the input as offset (4mA, 2V) with loss detect below that value (see below).</p>	<p>Parameter Number Parameter Type</p> <p>Bit 7 Bit 6 Bit 5 Bit 4 Bit 3 Bit 2 Bit 1 Bit 0</p>	<p>250 Read and Write</p> <p>Input 0 Signal Loss for Pot - 1=Yes, 0=No Input 1 Signal Loss for Pot - 1=Yes, 0=No Input 2 Signal Loss for Pot - 1=Yes, 0=No Input 0 Signal Loss for 4-20mA/2-10V - 1=Yes, 0=No Input 1 Signal Loss for 4-20mA/2-10V - 1=Yes, 0=No Input 2 Signal Loss for 4-20mA/2-10V - 1=Yes, 0=No Not Used Not Used</p>																		
<p>[4-20mA Loss Sel]</p> <p>This parameter selects the drives response to a loss of analog input signal (input below 2V or 4mA). Requires that the loss selection bits for [Anlg Signal Loss] be set to "1." This function is active only when the input is configured in [Freq Select 1/2], [PI Ref Select], [PI Fdbk Select].</p> <p>Important: Depending on the type of input configuration (i.e. Frequency or PI), the resultant action will vary (see "Action" column at right).</p> <p>When configured in [PI Ref Select] or [PI Fdbk Select], only the alarm and fault conditions will occur. The drive will not perform a speed change.</p>	<p>Parameter Number Parameter Type Factory Default <u>Units</u></p>	<p>150 Read and Write "Min/Alarm"</p> <table border="1"> <thead> <tr> <th><u>Display</u></th> <th><u>Drive</u></th> <th><u>Action</u></th> </tr> </thead> <tbody> <tr> <td>"Min/Alarm"</td> <td>0</td> <td>Freq - Drive outputs [Minimum Freq] and issues an alarm. PI - Alarm issued.</td> </tr> <tr> <td>"Stop/Fault"</td> <td>1</td> <td>Freq - Drive stops and issues "Hertz Err Fault". PI - Drive stops and issues "Hertz Err Fault".</td> </tr> <tr> <td>"Hold/Alarm"</td> <td>2</td> <td>Freq - Drive maintains last output freq & issues an alarm. PI - Alarm issued.</td> </tr> <tr> <td>"Max/Alarm"</td> <td>3</td> <td>Freq - Drive outputs [Maximum Freq] and issues an alarm. PI - Alarm issued.</td> </tr> <tr> <td>"Pre1/Alarm"</td> <td>4</td> <td>Freq - Drive outputs [Preset Freq 1] and issues an alarm. PI - Alarm issued.</td> </tr> </tbody> </table>	<u>Display</u>	<u>Drive</u>	<u>Action</u>	"Min/Alarm"	0	Freq - Drive outputs [Minimum Freq] and issues an alarm. PI - Alarm issued.	"Stop/Fault"	1	Freq - Drive stops and issues "Hertz Err Fault". PI - Drive stops and issues "Hertz Err Fault".	"Hold/Alarm"	2	Freq - Drive maintains last output freq & issues an alarm. PI - Alarm issued.	"Max/Alarm"	3	Freq - Drive outputs [Maximum Freq] and issues an alarm. PI - Alarm issued.	"Pre1/Alarm"	4	Freq - Drive outputs [Preset Freq 1] and issues an alarm. PI - Alarm issued.
<u>Display</u>	<u>Drive</u>	<u>Action</u>																		
"Min/Alarm"	0	Freq - Drive outputs [Minimum Freq] and issues an alarm. PI - Alarm issued.																		
"Stop/Fault"	1	Freq - Drive stops and issues "Hertz Err Fault". PI - Drive stops and issues "Hertz Err Fault".																		
"Hold/Alarm"	2	Freq - Drive maintains last output freq & issues an alarm. PI - Alarm issued.																		
"Max/Alarm"	3	Freq - Drive outputs [Maximum Freq] and issues an alarm. PI - Alarm issued.																		
"Pre1/Alarm"	4	Freq - Drive outputs [Preset Freq 1] and issues an alarm. PI - Alarm issued.																		

Analog I/O

<p>[Anlg Out 0 Sel] [Anlg Out 1 Sel]</p> <p>This parameter selects the source value that will drive the analog output. This output is intended for metering only and should not be used as process control feedback.</p>	<p>Parameter Number Parameter Type Factory Default</p> <p><u>Units</u></p>	<p>25, 274 Read and Write "Frequency" Out 0 "Current" Out 1</p> <p><u>Display</u> <u>Drive</u> <u>Range</u></p> <p>"Frequency" 0 Zero to programmed [Maximum Freq] "Current" 1 Zero to 200% of Drive Rated "Torque" 2 Zero to 200% of Drive Rated "Power" 3 Zero to 200% of Drive Rated "Voltage" 4 Zero to 200% of Drive Rated "% Motor OL" 5 Zero to 200% of Drive Rated "% Drive OL" 6 Zero to 200% of Drive Rated "Encoder" 7 See [Encoder Freq] "Speed Error" 8 See [Speed Error] "PI Reference" 9 See [PI Reference] "PI Feedback" 10 See [PI Feedback] "PI Error" 11 See [PI Error] "PI Output" 12 See [PI Output]</p>
<p>[Anlg Out 0 Offset] [Anlg Out 1 Offset]</p> <p>This parameter enables the voltage or current offset for the analog output. This internal value offsets 0-20mA to 4-20mA and 0-10V to 2-10V.</p>	<p>Parameter Number Parameter Type Factory Default</p> <p><u>Units</u></p>	<p>154, 278 Read and Write "Disabled"</p> <p><u>Display</u> <u>Drive</u></p> <p>"Disabled" 0 "Enabled" 1</p>
<p>[Anlg Out 0 Abs] [Anlg Out 1 Abs]</p> <p>This parameter selects whether a signed value or absolute value is used for analog out.</p>	<p>Parameter Number Parameter Type Factory Default</p> <p><u>Units</u></p>	<p>233, 277 Read and Write "Enabled"</p> <p><u>Display</u> <u>Drive</u></p> <p>"Disabled" 0 "Enabled" 1</p>
<p>[Anlg Out 0 Lo] [Anlg Out 1 Lo]</p> <p>Sets the percentage of voltage or current output that represents the low end of the "Range" listed in [Anlg Out Sel].</p>	<p>Parameter Number Parameter Type Display Units / Drive Units Factory Default Minimum Value Maximum Value</p>	<p>234, 275 Read and Write 0.1% / 4096 = 100% 0.0% -300.0% +300.0%</p>
<p>[Anlg Out 0 Hi] [Anlg Out 1 Hi]</p> <p>Sets the percentage of voltage or current output that represents the high end of the "Range" listed in [Anlg Out Sel]. Example: To get 150% of current to equal 10V/20mA, set this parameter to 150%.</p>	<p>Parameter Number Parameter Type Display Units / Drive Units Factory Default Minimum Value Maximum Value</p>	<p>235, 276 Read and Write 0.1% / 4096 = 100% 100.0% -300.0% +300.0%</p>
<p>[Slot A Option] [Slot B Option]</p> <p>Displays the catalog number of the analog I/O option board currently installed in slots A and/or B.</p>	<p>Parameter Number Parameter Type Factory Default</p> <p><u>Units</u></p>	<p>252, 253 Read Only "Standard"</p> <p><u>Display</u> <u>Drive</u></p> <p>"Standard" 0 "LA1" 1 "LA2" 2 "LA3" 3 "LA4" 4 "LA5" 5 "LA6" 6 "LA7" 7 "Undefined" 8 Board not recognized</p>

Faults

This group of parameters allows configuring, viewing and clearing drive faults.

<p>[Fault Buffer 0] [Fault Buffer 1] [Fault Buffer 2] [Fault Buffer 3]</p> <p>These parameters store the last (4) faults that occur.</p>	<p>Parameter Number 86-89 Parameter Type Read and Write Factory Default None <u>Units</u> <u>Display</u> <u>Drive</u> "0" 0 Last Fault "1" 1 Fault from Buffer 0 "2" 2 Fault from Buffer 1 "3" 3 Fault from Buffer 2</p>
<p>[Clear Fault]</p> <p>Selecting "Clear Fault" and pressing Enter will clear any faults and return the drive to ready status.</p>	<p>Parameter Number 51 Parameter Type Read and Write Factory Default "Ready" <u>Units</u> <u>Display</u> <u>Drive</u> "Ready" 0 "Clear Fault" 1</p>
<p>[Cur Lim Trip En]</p> <p>This setting determines the drive response when the hardware current limit is exceeded. The current limit is approximately 180% of [Rated VT Amps] for B Frame drives & up, and approximately 250% of [Rated VT Amps] for A Frame drives.</p>	<p>Parameter Number 82 Parameter Type Read and Write Factory Default "Disabled" <u>Units</u> <u>Display</u> <u>Drive</u> "Disabled" 0 No Fault Generated - C.L. Activated "Enabled" 1 Diag C Lim Flt Generated</p>
<p>[Shear Pin Fault]</p> <p>Enabling this parameter allows the drive to generate a Shear Pin Fault (F63) if the output amps exceed the programmed software current limit value in [Current Limit]. When set to "Not Accel" the fault will not be enabled until the drive is "at speed."</p>	<p>Parameter Number 226 Parameter Type Read and Write Factory Default "Disabled" <u>Units</u> <u>Display</u> <u>Drive</u> "Disabled" 0 No Fault Generated "Enabled" 1 Fault Generated, All Conditions "Not Accel" 2 No Fault Generated during Accel</p>
<p>[Motor OL Fault]</p> <p>This parameter enables or disables the motor overload protection feature of the drive.</p>	<p>Parameter Number 201 Parameter Type Read and Write Factory Default "Enabled" <u>Units</u> <u>Display</u> <u>Drive</u> "Disabled" 0 No Fault Generated "Enabled" 1 Fault Generated</p>
<p>[Motor Therm Flt]</p> <p>This parameter enables or disables the motor thermal protection feature of the drive. The LA6 option board <u>must</u> be installed.</p>	<p>Parameter Number 268 Parameter Type Read and Write Factory Default "Enabled" <u>Units</u> <u>Display</u> <u>Drive</u> "Disabled" 0 No Fault Generated "Enabled" 1 Fault Generated</p>
<p>[Line Loss Fault]</p> <p>This parameter enables or disables a Power Loss Fault (F03), 0.5 seconds after a Line Loss in Progress alarm.</p>	<p>Parameter Number 40 Parameter Type Read and Write Factory Default "Disabled" <u>Units</u> <u>Display</u> <u>Drive</u> "Disabled" 0 No Fault Generated "Enabled" 1 Power Loss Fault Generated</p>

Faults

<p>[Blwn Fuse Flt]</p> <p>Enabling this parameter will allow monitoring of the bus fuse (in 30 kW/40 HP and up drives) and cause a "Blwn Fuse Flt" (F58).</p>	<p>Parameter Number Parameter Type Factory Default <u>Units</u></p>	<p>81 Read and Write "Enabled" <u>Display</u> <u>Drive</u> "Disabled" 0 No Fault Generated "Enabled" 1 Blwn Fuse Flt Generated</p>
<p>[Low Bus Fault]</p> <p>This parameter enables or disables the drive fault condition for bus voltage below the Bus Undervoltage Trip value set by [Min Bus Volts].</p>	<p>Parameter Number Parameter Type Factory Default <u>Units</u></p>	<p>91 Read and Write "Enabled" <u>Display</u> <u>Drive</u> "Disabled" 0 No Fault Generated "Enabled" 1 Undervolt Fault Generated</p>
<p>[Fault Data]</p> <p>This parameter displays fault related parameter numbers or bit array information. Certain faults generate additional information to aid fault diagnosis. See Chapter 7 for further information.</p>	<p>Parameter Number Parameter Type Display Units / Drive Units Factory Default Minimum Value Maximum Value</p>	<p>207 Read and Write Parameter # / Parameter # None 1 255</p>
<p>[Flt Motor Mode]</p> <p>This parameter displays the motor mode active at the time of the last fault.</p>	<p>Parameter Number Parameter Type Factory Default <u>Units</u></p>	<p>143 Read Only None <u>Display</u> <u>Drive</u> "1" 1 Power up sequence in progress "2" 2 Motor connected, drive off "3" 3 DC boost being applied "4" 4 Motor running at [Dwell Frequency] "5" 5 Motor accelerating "6" 6 Motor at command speed "7" 7 Motor decelerating "8" 8 Motor coasting "9" 9 Motor under DC braking "10" 10 Waiting for fault reset - returns to 0 "11" 11 Start mode "12" 12 Flying start search enable "13" 13 Flying start w/encoder in process</p>
<p>[Flt Power Mode]</p> <p>This parameter displays the power mode active at the time of the last fault. These values can be helpful in troubleshooting for a condition causing a fault.</p>	<p>Parameter Number Parameter Type Factory Default <u>Units</u></p>	<p>144 Read Only None <u>Display</u> <u>Drive</u> "1" 1 Power up sequence in progress "2" 2 Precharge in progress "3" 3 Bus voltage being stored in memory "4" 4 Ready for run cmdnd. after power up "5" 5 Power stage diagnostics running "6" 6 Line loss detection occurred "7" 7 Ready for run command after stop "8" 8 Drive running "9" 9 Motor flux decay delay "10" 10 DC braking in progress "11" 11 Drive fault occurred "12" 12 Flying start search enabled "13" 13 Deceleration in progress "14" 14 SCR wake mode "15" 15 SCR check mode "16" 16 SCR wait mode</p>

Faults

[Fault Frequency]

This parameter stores and displays the last [Output Freq] prior to a fault.

Parameter Number	145
Parameter Type	Read Only
Display Units / Drive Units	0.01 Hertz / 32767 = Maximum Freq.
Factory Default	None
Minimum Value	0.00 Hz
Maximum Value	400.00 Hz

[Fault Status 1]

This parameter stores and displays the last [Drive Status 1] prior to a fault.

Bits 0-7 are displayed on lower half of line 2 on HIM display, while, bits 8-15 are displayed on the upper half of line 2.

A Status description (bit ENUM) is displayed on line 1 (except Series A HIMs below version 3.0).

Parameter Number	146															
Parameter Type	Read Only															

	Bit 15	Bit 14	Bit 13	Bit 12	Bit 11	Bit 10	Bit 9	Bit 8	Bit 7	Bit 6	Bit 5	Bit 4	Bit 3	Bit 2	Bit 1	Bit 0
	Reference ID				Local Adapter ID											Enabled
																Running Command Direction 0 = Reverse 1 = Forward
																Actual Direction 0 = Reverse 1 = Forward
																Accelerating
																Decelerating
																Alarm
																Faulted
																At Speed

Reference	15	14	13	12	Local	11	10	9
Freq Select 1	0	0	0	0	TB3	0	0	0
Preset Freq 1	0	0	0	1	1	0	0	1
Preset Freq 2	0	0	1	0	2	0	1	0
Preset Freq 3	0	0	1	1	3	0	1	1
Preset Freq 4	0	1	0	0	4	1	0	0
Preset Freq 5	0	1	0	1	5	1	0	1
Preset Freq 6	0	1	1	0	6	1	1	0
Preset Freq 7	0	1	1	1	Unused	1	1	1
Freq Select 2	1	0	0	0				
Adapter 1	1	0	0	1				
Adapter 2	1	0	1	0				
Adapter 3	1	0	1	1				
Adapter 4	1	1	0	0				
Adapter 5	1	1	0	1				
Adapter 6	1	1	1	0				
Jog Frequency	1	1	1	1				

[Fault Status 2]

This parameter stores and displays the last [Drive Status 2] prior to a fault.

Bits 0-7 are displayed on lower half of line 2 on HIM display, while, bits 8-15 are displayed on the upper half of line 2.

A Status description (bit ENUM) is displayed on line 1 (except Series A HIMs below version 3.0).

Parameter Number	286															
Parameter Type	Read Only															

	Bit 15	Bit 14	Bit 13	Bit 12	Bit 11	Bit 10	Bit 9	Bit 8	Bit 7	Bit 6	Bit 5	Bit 4	Bit 3	Bit 2	Bit 1	Bit 0
	Startup	At Temp	Auto Reset	PI Max Error	Economize	Braking	Reverse Run	Forward Run	Drive Ready	Drive Power	Line Loss	Mtr Overload	Current Lmt	At Torque	At Current	At Freq

[Fault Alarms 1]

This parameter stores and displays the last alarm conditions present prior to a fault. Refer to Chapter 7 for further alarm information.

A Status description (bit ENUM) is displayed on line 1 (except Series A HIMs below version 3.0).

Parameter Number	173															
Parameter Type	Read Only															

	Bit 15	Bit 14	Bit 13	Bit 12	Bit 11	Bit 10	Bit 9	Bit 8	Bit 7	Bit 6	Bit 5	Bit 4	Bit 3	Bit 2	Bit 1	Bit 0
	Auto Reset	Motor OL Trip	4-20 mA Loss	Phase Loss	Sync Loss	Heatsink Temp	Auxiliary Input	Ground Warning	Motor Stalled	Mtr Overload	Line Loss In Progress	Regenerating Voltage Limit	Regenerating Current Limit	Motoring Current Limit	Hardware Current Limit	Bus Charging

Faults

[Fault Alarms 2]

This parameter stores and displays the last alarm conditions present prior to a fault. Refer to Chapter 7 for further alarm information.

A Status description (bit ENUM) is displayed on line 1 (except Series A HIMs below version 3.0).

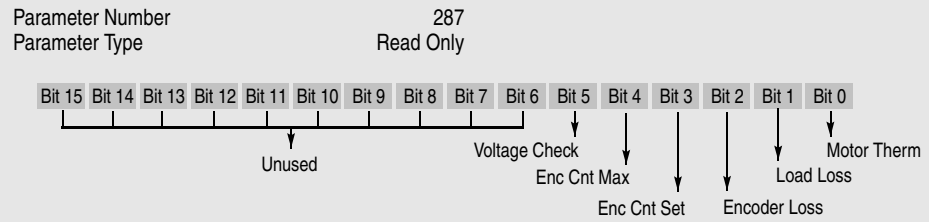

[Flt Clear Mode]

This parameter controls the method for clearing faults.

Parameter Number	39	
Parameter Type	Read and Write	
Factory Default	"Enabled"	
<u>Units</u>	<u>Display</u>	<u>Drive</u>
	"Disabled" 0	Faults cleared only by cycling power
	"Enabled" 1	Faults cleared by issuing a valid stop command (only through TB3/HIM) or cycling power - see Bit 3 of the Logic Control Structure in Appendix A.

[Ground Warning]

Enables the Ground Warning fault (F57) when the drive senses ground current in excess of 2 amperes (approximate). Refer to Chapter 7 for further information.

Parameter Number	204	
Parameter Type	Read and Write	
Factory Default	"Disabled"	
<u>Units</u>	<u>Display</u>	<u>Drive</u>
	"Disabled" 0	No Fault Generated
	"Enabled" 1	Ground Warning Generated

[Phase Loss Mode]

Enables the function that detects a phase loss or the current rating has been exceeded in the drive if powered on single-phase line. A fault (F49) or alarm condition will occur if the DC bus ripple voltage exceeds the level in [Phase Loss Level].

Parameter Number	330	
Parameter Type	Read and Write	
Factory Default	"Disabled"	
<u>Units</u>	<u>Display</u>	<u>Drive</u>
	"Disabled" 0	No Fault Generated
	"Alarm" 1	Generates a Phase Loss Alarm
	"Fault" 2	Generated F49 Input Phase Fault

[Phase Loss Level]

Sets the DC bus ripple voltage above which a phase loss fault/alarm will occur. The sensitivity for detecting a blown fuse on a three-phase system can be increased by lowering the setting for this parameter.

Parameter Number	331	
Parameter Type	Read and Write	
Display Units / Drive Units	0.1 Volts / 4096 = Drive Rtd Volts	
Factory Default	9.0/18.0/22.5 Volts	
	12.4/24.7/30.9 Volts	<i>Firmware 6.001 & later</i>
Minimum Value	5.1/10.1/12.7 Volts	
Maximum Value	22.5/45.0/56.2 Volts	
	45.0/90.0/112.5 Volts	<i>Firmware 6.001 & later</i>

[Precharge Fault]

Enables or disables the Precharge Fault, which indicates insufficient DC bus charging 20 seconds after power-up.

Parameter Number	332	
Parameter Type	Read and Write	
Factory Default	"Enabled"	
<u>Units</u>	<u>Display</u>	<u>Drive</u>
	"Disabled" 0	No Fault Generated
	"Enabled" 1	Precharge Fault Generated

[Motor OL Ret] – Firmware 6.001 & later

When enabled, the accumulated motor overload count will be stored on power-down and restored on power-up. From that point, normal overload operation continues. When the value is changed from enabled to disabled the motor overload count will be reset to 0.

Parameter Number	379	
Parameter Type	Read and Write	
Factory Default	"Disabled"	
<u>Units</u>	<u>Display</u>	<u>Drive</u>
	"Disabled" 0	Motor OL count not saved
	"Enabled" 1	Motor OL count saved on power-down and restored on power-up

Diagnostics

This group of parameters contains values that can be helpful in explaining the operation of the drive. Drive status, direction, control and alarm conditions as well as drive ratings are included.

[Drive Status 1]

This parameter displays the actual operating condition in binary format.

Bits 0-7 are displayed on lower half of line 2 on HIM display, while, bits 8-15 are displayed on the upper half of line 2.

A Status description (bit ENUM) is displayed on line 1 (except Series A HIMs below version 3.0).

Parameter Number: 59
Parameter Type: Read Only

Reference	15	14	13	12	Local	11	10	9
Freq Select 1	0	0	0	0	TB3	0	0	0
Preset Freq 1	0	0	0	1	1	0	0	1
Preset Freq 2	0	0	1	0	2	0	1	0
Preset Freq 3	0	0	1	1	3	0	1	1
Preset Freq 4	0	1	0	0	4	1	0	0
Preset Freq 5	0	1	0	1	5	1	0	1
Preset Freq 6	0	1	1	0	6	1	1	0
Preset Freq 7	0	1	1	1	Unused	1	1	1
Freq Select 2	1	0	0	0				
Adapter 1	1	0	0	1				
Adapter 2	1	0	1	0				
Adapter 3	1	0	1	1				
Adapter 4	1	1	0	0				
Adapter 5	1	1	0	1				
Adapter 6	1	1	1	0				
Jog Frequency	1	1	1	1				

[Drive Status 2]

This parameter displays the actual operating condition in binary format.

Bits 0-7 are displayed on lower half of line 2 on HIM display, while, bits 8-15 are displayed on the upper half of line 2.

A Status description (bit ENUM) is displayed on line 1 (except Series A HIMs below version 3.0).

Parameter Number: 236
Parameter Type: Read Only

[Application Sts]

Displays status of Speed Sync and Traverse functions.

Parameter Number: 316
Parameter Type: Read Only

[Drive Alarm 1]

This parameter displays which alarm condition is present when bit 6 of [Drive Status 1] is high (set to 1). Refer to Chapter 7 for further alarm information.

A Status description (bit ENUM) is displayed on line 1 (except Series A HIMs below version 3.0).

Parameter Number: 60
Parameter Type: Read Only

Diagnostics

[Drive Alarm 2]

This parameter displays which alarm condition is present when bit 6 of [Drive Status 1] is high. Refer to Chapter 7 for further alarm information.

A Status description (bit ENUM) is displayed on line 1 (except Series A HIMs below version 3.0).

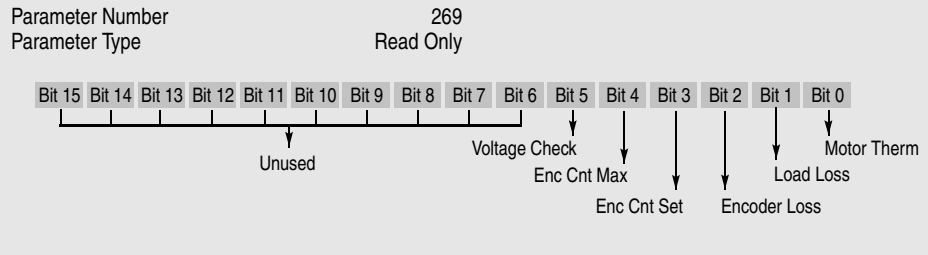

[Latched Alarms 1]

This parameter “stores” the [Drive Alarm 1] indications (see above). Bits will remain set (high/1), even if the alarm condition no longer exists. The bit(s) must be programmed to zero to release the stored indications.

A Status description (bit ENUM) is displayed on line 1 (except Series A HIMs below version 3.0).

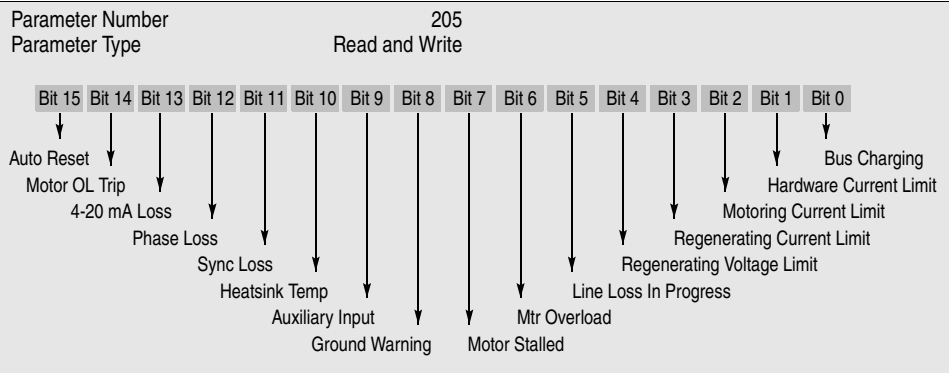

[Latched Alarms 2]

This parameter “stores” the [Drive Alarm 2] indications (see above). Bits will remain set (high/1), even if the alarm condition no longer exists. The bit(s) must be programmed to zero to release the stored indications.

A Status description (bit ENUM) is displayed on line 1 (except Series A HIMs below version 3.0).

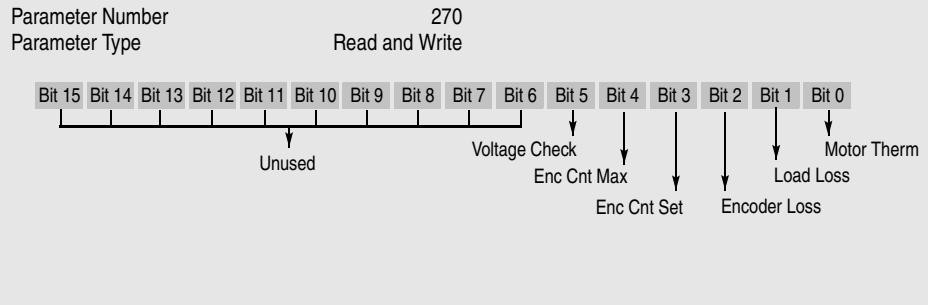

[Input Status]

This parameter displays the on/off status of inputs 1-8 at TB3 if an optional interface card is installed.

A Status description (bit ENUM) is displayed on line 1 (except Series A HIMs below version 3.0).

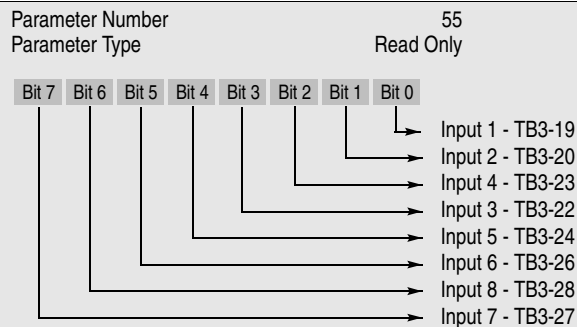

Diagnostics

<p>[Freq Source]</p> <p>This parameter displays the frequency source currently commanding the drive.</p>	<p>Parameter Number Parameter Type Factory Default <u>Units</u> <i>Firmware 5.001 & later</i></p>	<p>62 Read Only "Use Last" <u>Display</u> <u>Drive</u> "Use Last" 0 "Analog In 0" 1 "Analog In 1" 2 "Analog In 2" 3 "Pulse Ref" 4 Refer to [Pulse In Scale] Value "MOP" 5 "Adapter 1-6" 6-11 "Preset 1-7" 12-18 "Encoder" 19 Refer to [Encoder PPR] Value "Step Logic" 20 "Jog Sel" 20 "21" in Firmware 5.001 & later "AutoTune Ref" 21 "22" in Firmware 5.001 & later</p>
<p>[Freq Command]</p> <p>This parameter displays the frequency that the drive is commanded to output. This command may come from any one of the frequency sources selected by [Freq Select 1] or [Freq Select 2].</p>	<p>Parameter Number Parameter Type Display Units / Drive Units Factory Default Minimum Value Maximum Value</p>	<p>65 Read Only 0.01 Hertz / 32767 = Maximum Freq Forward None -400.00 Hz +400.00 Hz</p>
<p>[Drive Direction]</p> <p>This parameter displays the commanded running direction.</p>	<p>Parameter Number Parameter Type Factory Default <u>Units</u></p>	<p>69 Read and Write None <u>Display</u> <u>Drive</u> "Forward" 0 "Reverse" 1</p>
<p>[Stop Mode Used]</p> <p>This parameter displays the active stop mode.</p>	<p>Parameter Number Parameter Type Factory Default <u>Units</u></p>	<p>26 Read Only "Coast" <u>Display</u> <u>Drive</u> "Coast" 0 See [Stop Select 1] on page 6-9 "DC Brake" 1 See [Stop Select 1] on page 6-9 "Ramp" 2 See [Stop Select 1] on page 6-9 "S Curve" 3 See [Stop Select 1] on page 6-9 "Ramp to Hold" 4 See [Stop Select 1] on page 6-9</p>
<p>[Motor Mode]</p> <p>This parameter displays the motor mode.</p>	<p>Parameter Number Parameter Type Factory Default <u>Units</u></p>	<p>141 Read Only None <u>Display</u> <u>Drive</u> "1" 1 Power up sequence in progress "2" 2 Motor connected, drive off "3" 3 DC boost being applied "4" 4 Motor running at [Dwell Frequency] "5" 5 Motor accelerating "6" 6 Motor at command speed "7" 7 Motor decelerating "8" 8 Motor coasting "9" 9 Motor under DC braking "10" 10 Waiting for fault reset - returns to 0 "11" 11 Start mode "12" 12 Flying start search enable "13" 13 Flying start w/encoder in process</p>

Diagnostics

[Power Mode]

This parameter displays the power mode.

Parameter Number	142
Parameter Type	Read Only
Factory Default	None
<u>Units</u>	<u>Display</u> <u>Drive</u>
	"1" 1 Power up sequence in progress
	"2" 2 Precharge in progress
	"3" 3 Bus voltage being stored in memory
	"4" 4 Ready for run command after power up
	"5" 5 Power stage diagnostics running
	"6" 6 Line loss detection occurred
	"7" 7 Ready for run command after stop
	"8" 8 Drive running
	"9" 9 Motor flux decay delay
	"10" 10 DC braking in progress
	"11" 11 Drive fault occurred
	"12" 12 Flying start search enabled
	"13" 13 Deceleration in progress
	"14" 14 SCR wake mode
	"15" 15 SCR check mode
	"16" 16 SCR wait mode

[Output Pulses]

This parameter displays the number of output cycles for the PWM waveform. The count rolls over at 65535.

Parameter Number	67
Parameter Type	Read Only
Display Units / Drive Units	1 Pulse / Pulses
Factory Default	None
Minimum Value	0
Maximum Value	65535

[Current Angle]

This parameter displays the angle, in degrees, of displacement between output voltage and output current. The cosine of this number is an approximation of output power factor.

Parameter Number	72
Parameter Type	Read Only
Display Units / Drive Units	1 Deg / 255 = 360 Deg
Factory Default	None

[Heatsink Temp]

This parameter displays the heatsink temperature of the drive.

Parameter Number	70
Parameter Type	Read Only
Display Units / Drive Units	1° C / Deg. C
Factory Default	None
Minimum Value	0
Maximum Value	255° C

[Set Defaults]

Setting this parameter to "Defaults Init" resets all parameters to their factory values.

Parameter Number	64
Parameter Type	Read and Write
Factory Default	"Ready"
<u>Units</u>	<u>Display</u> <u>Drive</u>
	"Ready" 0 Display after function complete.
	"Store to EE" 1
	"Rcll frm EE" 2
	"Default Init" 3 Resets all parameters to factory settings.

Diagnostics

[DC Bus Memory]

This parameter displays the nominal DC bus voltage level. This value is used to determine line loss, overvoltage, decel frequency and other points. Additionally, the Bus Limit Enable function, as well as the Line Loss Mode alarm and recovery points are determined from this value.

Parameter Number	212
Parameter Type	Read Only
Display Units / Drive Units	1 Volt / Volts
Display	Volts

[Meas. Volts]

This parameter displays the measured output voltage present at terminals U, V & W (T1, T2 & T3).

Parameter Number	272
Parameter Type	Read Only
Display Units / Drive Units	1 Volt / 4096 = Drive Rtd Volts
Factory Default	None
Minimum Value	0
Maximum Value	200% Rated Drive Output Voltage

[EEPROM Cksum]

The value of this parameter provides a checksum value that indicates a change in drive programming has occurred.

Parameter Number	172
Parameter Type	Read Only
Display Units / Drive Units	None

Ratings

This group contains a number of "Read Only" parameters that display drive operating characteristics.

[Rated Volts]	Parameter Number Parameter Type Display Units / Drive Units Display	147 Read Only 1 Volt / Volts Drive Rated Input Voltage
This parameter displays the rated input voltage of the drive.		
[Rated Amps]	Parameter Number Parameter Type Display Units / Drive Units Display	170 Read Only 0.1 Amp / Amps x 10 Drive Rated Output Amps
This parameter displays the rated output current of the drive based on the CT/VT selection.		
[Rated kW]	Parameter Number Parameter Type Display Units / Drive Units Display	171 Read Only kW / kW x 100 Drive Rated Output kW
This parameter displays the rated kW of the drive based on the CT/VT selection.		
[Firmware Ver.]	Parameter Number Parameter Type Display Units / Drive Units Display	71 Read Only None / Version x 100 0.00
This parameter displays the version number of the drive firmware.		
[Cntrl Board Rev]	Parameter Number Parameter Type Display Units / Drive Units Display	251 Read Only None / Version x 100 0.00
This parameter displays the revision number of the drive Main Control Board.		
[Rated CT Amps]	Parameter Number Parameter Type Display Units / Drive Units Display	148 Read Only 0.1 Amp / Amps x 10 Drive Rated Output Amps
This parameter displays the rated output current of the drive.		
[Rated CT kW]	Parameter Number Parameter Type Display Units / Drive Units Display	149 Read Only kW / kW x 100 Drive Rated Output kW
This parameter displays the rated CT kW of the drive.		
[Rated VT Amps]	Parameter Number Parameter Type Display Units / Drive Units Display	198 Read Only 0.1 Amp / Amps x 10 Drive Rated Amps
This parameter displays the rated output current of the drive.		
[Rated VT kW]	Parameter Number Parameter Type Display Units / Drive Units Display	199 Read Only kW / kW x 100 Drive Rated kW
This parameter displays the rated VT kW of the drive.		

Ratings

[Drive Type]

This parameter displays a decimal number which can be translated into the drive catalog number by using the adjacent chart. Refer to Chapter 1 for an explanation of the catalog numbers.

Parameter Number		61		61		61	
Parameter Type		Read Only		Read Only		Read Only	
Display	1336F-...	Display	1336F-...	Display	1336F-...	Display	1336F-...
8449	AQF05	8710	BRF30	12841	BP400	13074	C100
8450	AQF07	8711	BRF50	12842	BP450	13075	C125
8451	AQF10	8712	BRF75	12828	BX250	13076	C150
8452	AQF15	8713	BRF100	12829	B300	13077	C200
8453	AQF20	8714	BRF150	12822	B350	13083	C250
8454	AQF30	8715	BRF200	12830	B400	13091	CX300
8455	AQF50	12810	B015	12832	B450	13085	C300
8456	AQF75	12811	B020	12834	B500	13078	C350
12552	A007	12812	B025	12823	B600	13095	CP350
12553	A010	12813	B030	12843	B700	13086	C400
12554	A015	12824	BX040	12836	B800	13096	CP400
12555	A020	12814	B040	8963	CWF10	13088	C450
12556	A025	12815	B050	8965	CWF20	13097	CP450
12557	A030	12816	BX060	8966	CWF30	13090	C500
12558	A040	12825	B060	8967	CWF50	13098	CP500
12559	A050	12817	B075	8968	CWF75	13089	C600
12560	A060	12818	B100	8969	CWF100	13079	C650
12561	A075	12819	B125	8970	CWF150	13099	C700
12562	A100	12826	BX150	8971	CWF200	13092	C800
12563	A125	12820	B150	13068	C025		
8705	BRF05	12821	B200	13069	C030		
8706	BRF07	12827	B250	13070	C040		
8707	BRF10	12838	BP250	13071	C050		
8708	BRF15	12839	BP300	13072	C060		
8709	BRF20	12840	BP350	13073	C075		

Masks

This group of parameters contains binary masks for all control functions. The masks control which adapters can issue control commands.

Each mask contains a bit for each adapter. Individual bits can be set to “Zero” to lockout control by an adapter or set to “1” to permit an adapter to have control.

A Status description (bit ENUM) is displayed on line 1 (except Series A HIMs below version 3.0).

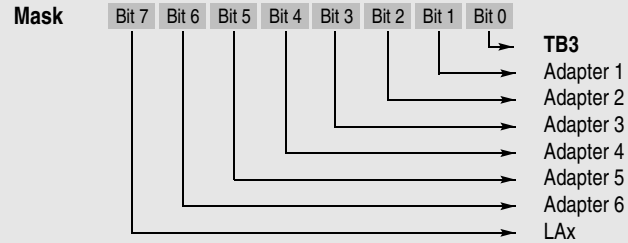

[Direction Mask]

This parameter controls which adapters can issue forward/reverse commands.

If [Freq Select 1] or [Freq Select 2] is set to “Analog In 0” and an Analog Option Board with bipolar input (LA6, LA7) is installed, that input (designated “Analog In 0”) will have exclusive ownership of direction. Bit 7 of [Direction Mask] must not be set to “0” and no other device can have claimed ownership of direction (i.e. TB3 - Run Reverse). If either condition is true, a fault will be issued.

Parameter Number	94
Parameter Type	Read and Write
Factory Default	01111110
<u>Units</u>	<u>Display</u> <u>Drive</u>
	“0” 0 Deny Control
	“1” 1 Permit Control

[Start Mask]

This parameter controls which adapters can issue start commands.

Parameter Number	95
Parameter Type	Read and Write
Factory Default	01111111
<u>Units</u>	<u>Display</u> <u>Drive</u>
	“0” 0 Deny Control
	“1” 1 Permit Control

[Jog Mask]

This parameter controls which adapters can issue jog commands.

Parameter Number	96
Parameter Type	Read and Write
Factory Default	01111111
<u>Units</u>	<u>Display</u> <u>Drive</u>
	“0” 0 Deny Control
	“1” 1 Permit Control

[Reference Mask]

This parameter controls which adapters can select an alternate reference; [Frequency Sel 1], [Frequency Sel 2] or preset speeds.

Parameter Number	97
Parameter Type	Read and Write
Factory Default	01111111
<u>Units</u>	<u>Display</u> <u>Drive</u>
	“0” 0 Deny Control
	“1” 1 Permit Control

[Accel Mask]

This parameter controls which adapters can select [Accel Time 1] and [Accel Time 2].

Parameter Number	98
Parameter Type	Read and Write
Factory Default	01111111
<u>Units</u>	<u>Display</u> <u>Drive</u>
	“0” 0 Deny Control
	“1” 1 Permit Control

Masks

<p>[Decel Mask]</p> <p>This parameter controls which adapters can select [Decel Time 1] and [Decel Time 2]</p>	<p>Parameter Number Parameter Type Factory Default <u>Units</u></p>	<p>99 Read and Write 01111111 <u>Display</u> <u>Drive</u> "0" 0 Deny Control "1" 1 Permit Control</p>
<p>[Fault Mask]</p> <p>This parameter controls which adapters can reset a fault.</p>	<p>Parameter Number Parameter Type Factory Default <u>Units</u></p>	<p>100 Read and Write 01111111 <u>Display</u> <u>Drive</u> "0" 0 Deny Control "1" 1 Permit Control</p>
<p>[MOP Mask]</p> <p>This parameter controls which adapters can issue MOP commands to the drive.</p>	<p>Parameter Number Parameter Type Factory Default <u>Units</u></p>	<p>101 Read and Write 01111111 <u>Display</u> <u>Drive</u> "0" 0 Deny Control "1" 1 Permit Control</p>
<p>[Traverse Mask]</p> <p>Controls which SCANport adapters are permitted to enable the traverse function.</p>	<p>Parameter Number Parameter Type Factory Default <u>Units</u></p>	<p>305 Read and Write 01111111 <u>Display</u> <u>Drive</u> "0" 0 Deny Control "1" 1 Permit Control</p>
<p>[Sync Mask]</p> <p>Controls which SCANport adapters are permitted to enable the sync function.</p>	<p>Parameter Number Parameter Type Factory Default <u>Units</u></p>	<p>308 Read and Write 01111111 <u>Display</u> <u>Drive</u> "0" 0 Deny Control "1" 1 Permit Control</p>
<p>[Logic Mask]</p> <p>Determines which adapters can control the drive. If the bit for an adapter is set to "0," the adapter will have no control functions except for stop. In addition, the adapter can be removed from the drive while power is applied without causing a serial fault.</p>	<p>Parameter Number Parameter Type Factory Default <u>Units</u></p>	<p>92 Read and Write 01111111 <u>Display</u> <u>Drive</u> "0" 0 Deny Control "1" 1 Permit Control</p>
<p>[Local Mask]</p> <p>This parameter controls which adapters are allowed to take exclusive control of drive logic commands (except stop). Exclusive "local" control can only be taken while the drive is stopped.</p>	<p>Parameter Number Parameter Type Factory Default <u>Units</u></p>	<p>93 Read and Write 01111111 <u>Display</u> <u>Drive</u> "0" 0 Deny Control "1" 1 Permit Control</p>

Masks

[Alarm Mask 1]

Controls which alarm conditions will activate the alarm contact (refer to Chapter 2 - TB2) and set the alarm bit (bit 6) in [Drive Status 1].

A Status description (bit ENUM) is displayed on line 1 (except Series A HIMs below version 3.0).

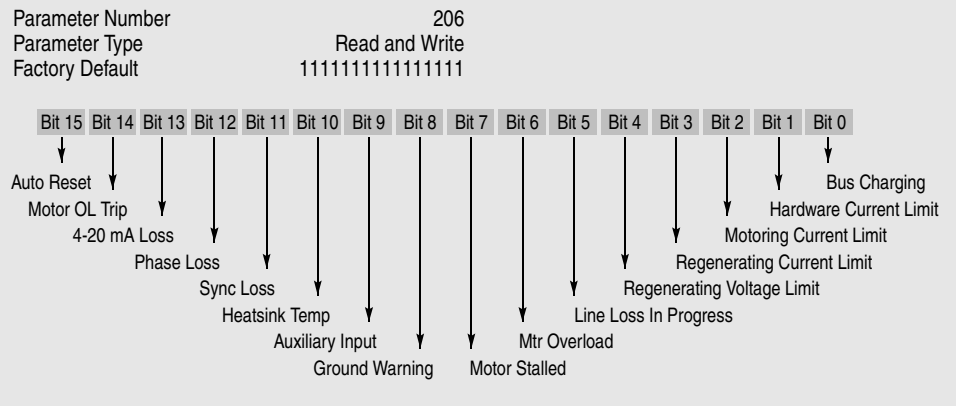

[Alarm Mask 2]

Controls which alarm conditions will activate the alarm contact (refer to Chapter 2 - TB2) and set the alarm bit (bit 6) in [Drive Status 1].

Setting the bit to "1" allows the alarm to occur. Setting the bit to "0" causes the drive to ignore that alarm.

A Status description (bit ENUM) is displayed on line 1 (except Series A HIMs below version 3.0).

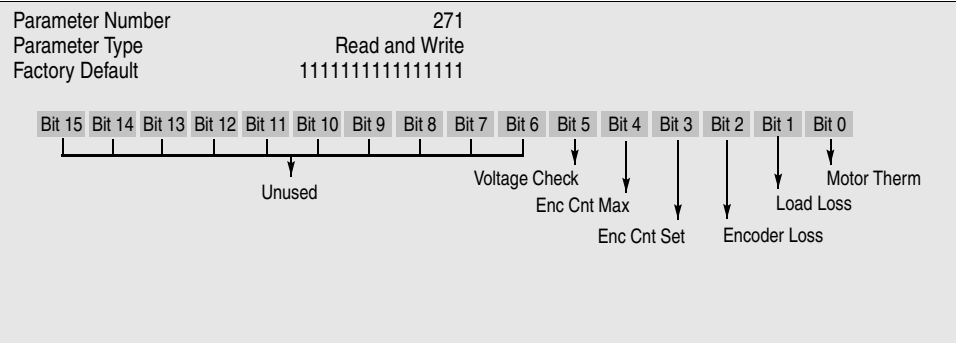

Owners

This group of parameters contains binary information to display which group of adapters are issuing control commands.

Each Owner Parameter contains a bit for each adapter. The drive will set an adapter's bit to "1" when that adapter is issuing a logic command and to "Zero" when no command is being issued.

A Status description (bit ENUM) is displayed on line 1 (except Series A HIMs below version 3.0).

Owners Display

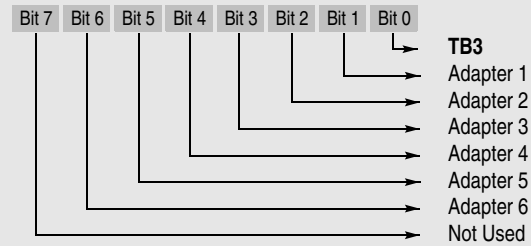

[Stop Owner]

This parameter displays which adapters are presently issuing a valid stop command.

Parameter Number	102
Parameter Type	Read Only
<u>Units</u>	<u>Display</u> <u>Drive</u>
	"0" 0 Stop Input Not Present
	"1" 1 Stop Input Present

[Direction Owner]

This parameter displays which adapter currently has exclusive control of direction changes.

If [Freq Select 1] or [Freq Select 2] is set to "Analog In 0" and an Analog Option Board with bipolar input (LA6, LA7) is installed, that input (designated "Analog In 0") will have exclusive ownership of direction. Bit 7 of [Direction Mask] must not be set to "0" and no other device can have claimed ownership of direction (i.e. TB3 - Run Reverse). If either condition is true, a fault will be issued.

Parameter Number	103
Parameter Type	Read Only
<u>Units</u>	<u>Display</u> <u>Drive</u>
	"0" 0 Non-Owner
	"1" 1 Current Owner

[Start Owner]

This parameter displays which adapters are presently issuing a valid start command.

Parameter Number	104
Parameter Type	Read Only
<u>Units</u>	<u>Display</u> <u>Drive</u>
	"0" 0 Start Input Not Present
	"1" 1 Start Input Present

[Jog Owner]

This parameter displays which adapters are presently issuing a valid jog command.

Parameter Number	105
Parameter Type	Read Only
<u>Units</u>	<u>Display</u> <u>Drive</u>
	"0" 0 Jog Input Not Present
	"1" 1 Jog Input Present

[Reference Owner]

This parameter displays which adapter currently has the exclusive control of the selection of the command frequency source.

Parameter Number	106
Parameter Type	Read Only
<u>Units</u>	<u>Display</u> <u>Drive</u>
	"0" 0 Non-Owner
	"1" 1 Current Owner

[Accel Owner]

This parameter displays which adapter has exclusive control of selecting [Accel Time 1] or [Accel Time 2].

Parameter Number	107
Parameter Type	Read Only
<u>Units</u>	<u>Display</u> <u>Drive</u>
	"0" 0 Non-Owner
	"1" 1 Current Owner

Owners

[Decel Owner]

This parameter displays which adapter has exclusive control of selecting [Decel Time 1] or [Decel Time 2].

Parameter Number	108
Parameter Type	Read Only
<u>Units</u>	<u>Display</u> <u>Drive</u>
	"0" 0 Non-Owner
	"1" 1 Current Owner

[Fault Owner]

This parameter displays which adapter is presently resetting a fault.

Parameter Number	109
Parameter Type	Read Only
<u>Units</u>	<u>Display</u> <u>Drive</u>
	"0" 0 Non-Owner
	"1" 1 Current Owner

[MOP Owner]

This parameter displays which adapters are currently issuing increases or decreases in MOP Command Frequency.

Parameter Number	110
Parameter Type	Read Only
<u>Units</u>	<u>Display</u> <u>Drive</u>
	"0" 0 Non-Owner
	"1" 1 Current Owner

[Traverse Owner]

Displays which SCANport adapter is presently enabling the traverse function.

Parameter Number	306
Parameter Type	Read Only
<u>Units</u>	<u>Display</u> <u>Drive</u>
	"0" 0 Non-Owner
	"1" 1 Current Owner

[Sync Owner]

Displays which SCANport adapter is presently enabling the sync function.

Parameter Number	309
Parameter Type	Read Only
<u>Units</u>	<u>Display</u> <u>Drive</u>
	"0" 0 Non-Owner
	"1" 1 Current Owner

[Local Owner]

This parameter displays which adapter has requested exclusive control of all drive logic functions. If an adapter is in local lockout, all other functions (except stop) on all other adapters are locked out and non-functional. Local control can only be obtained when the drive is not running.

Parameter Number	179
Parameter Type	Read Only
<u>Units</u>	<u>Display</u> <u>Drive</u>
	"0" 0 Non-Owner
	"1" 1 Current Owner

Adapter I/O

This group of parameters contains the parameters needed for an optional communications adapter to communicate with the drive.

These parameters determine the parameter number to which PLC output data table or SCANport device image information will be written. Refer to the A-B Single Point Remote I/O Adapter manuals or other SCANport device manual for data link information.

Parameter Number	111-118
Parameter Type	Read and Write
Display Units / Drive Units	Parameter # / Parameter #
1336 PLUS II	SCANport Device
[Data In A1]	
[Data In A2]	
[Data In B1]	
[Data In B2]	
[Data In C1]	
[Data In C2]	
[Data In D1]	
[Data In D2]	

These parameters determine the parameter number whose value will be read into the PLC input data table or SCANport device image. Refer to the A-B Single Point Remote I/O Adapter manuals or other SCANport device manual for data link information.

Parameter Number	119-126
Parameter Type	Read and Write
Display Units / Drive Units	Parameter # / Parameter #
1336 PLUS II	SCANport Device
[Data Out A1]	
[Data Out A2]	
[Data Out B1]	
[Data Out B2]	
[Data Out C1]	
[Data Out C2]	
[Data Out D1]	
[Data Out D2]	

[Alt Type 2 Cmd]

When ENABLED, alternate functions are assigned to some bits in the Logic Control Structure. See Appendix A for further information.

Parameter Number	315
Parameter Type	Read and Write
Factory Default	"Disabled"
Units	Display Drive
	"Disabled" 0
	"Enabled" 1

Process Display

This group of parameters contains the parameters used to scale, in "User Units", any drive parameter for display on the HIM. Two scaled parameter values can be simultaneously displayed when Process Mode is selected.

<p>[Process 1 Par]</p> <p>This parameter should be set to the number of the parameter whose scaled value will be displayed on Line 1 of the HIM Display Panel.</p> <p>The maximum process value that can be displayed is 99,999.99. If this value is exceeded, a character string of asterisks (****) will appear on the display.</p>	<table border="0"> <tr> <td>Parameter Number</td> <td>127</td> </tr> <tr> <td>Parameter Type</td> <td>Read and Write</td> </tr> <tr> <td>Display Units / Drive Units</td> <td>Parameter # / Parameter #</td> </tr> <tr> <td>Factory Default</td> <td>1</td> </tr> </table>	Parameter Number	127	Parameter Type	Read and Write	Display Units / Drive Units	Parameter # / Parameter #	Factory Default	1				
Parameter Number	127												
Parameter Type	Read and Write												
Display Units / Drive Units	Parameter # / Parameter #												
Factory Default	1												
<p>[Process 1 Scale]</p> <p>This value sets the scaling multiplier for [Process 1 Par]. The displayed value will be:</p> $\frac{[\text{Process 1 Par}] \text{ actual value}}{x [\text{Process 1 Scale}] \text{ value}} = \text{Displayed Value}$	<table border="0"> <tr> <td>Parameter Number</td> <td>128</td> </tr> <tr> <td>Parameter Type</td> <td>Read and Write</td> </tr> <tr> <td>Display Units / Drive Units</td> <td>Numeric / Scale x 100</td> </tr> <tr> <td>Factory Default</td> <td>+1.00</td> </tr> <tr> <td>Minimum Value</td> <td>-327.68</td> </tr> <tr> <td>Maximum Value</td> <td>+327.67</td> </tr> </table>	Parameter Number	128	Parameter Type	Read and Write	Display Units / Drive Units	Numeric / Scale x 100	Factory Default	+1.00	Minimum Value	-327.68	Maximum Value	+327.67
Parameter Number	128												
Parameter Type	Read and Write												
Display Units / Drive Units	Numeric / Scale x 100												
Factory Default	+1.00												
Minimum Value	-327.68												
Maximum Value	+327.67												
<p>[Process 1 Txt 1-8]</p> <p>Sets the "User Units" description for the value determined by [Process 1 Par] and [Process 1 Scale]. This 8 character description will be shown on line 1 of the display. Refer to the Character Map in Appendix A.</p>	<table border="0"> <tr> <td>Parameter Number(s)</td> <td>129-136</td> </tr> <tr> <td>Parameter Type</td> <td>Read and Write</td> </tr> <tr> <td>Display Units / Drive Units</td> <td>ASCII Code / ASCII Code</td> </tr> <tr> <td>Factory Default</td> <td>"Volts "</td> </tr> </table>	Parameter Number(s)	129-136	Parameter Type	Read and Write	Display Units / Drive Units	ASCII Code / ASCII Code	Factory Default	"Volts "				
Parameter Number(s)	129-136												
Parameter Type	Read and Write												
Display Units / Drive Units	ASCII Code / ASCII Code												
Factory Default	"Volts "												
<p>[Process 2 Par]</p> <p>This parameter should be set to the number of the parameter whose scaled value will be displayed on Line 2 of the HIM Display Panel.</p> <p>The maximum process value that can be displayed is 99,999.99. If this value is exceeded, a character string of asterisks (****) will appear on the display.</p>	<table border="0"> <tr> <td>Parameter Number</td> <td>180</td> </tr> <tr> <td>Parameter Type</td> <td>Read and Write</td> </tr> <tr> <td>Display Units / Drive Units</td> <td>Parameter # / Parameter #</td> </tr> <tr> <td>Factory Default</td> <td>54</td> </tr> </table>	Parameter Number	180	Parameter Type	Read and Write	Display Units / Drive Units	Parameter # / Parameter #	Factory Default	54				
Parameter Number	180												
Parameter Type	Read and Write												
Display Units / Drive Units	Parameter # / Parameter #												
Factory Default	54												
<p>[Process 2 Scale]</p> <p>This value sets the scaling multiplier for [Process 2 Par]. The displayed value will be:</p> $\frac{[\text{Process 2 Par}] \text{ actual value}}{x [\text{Process 2 Scale}] \text{ value}} = \text{Displayed Value}$	<table border="0"> <tr> <td>Parameter Number</td> <td>181</td> </tr> <tr> <td>Parameter Type</td> <td>Read and Write</td> </tr> <tr> <td>Display Units / Drive Units</td> <td>Numeric / Scale x 100</td> </tr> <tr> <td>Factory Default</td> <td>+1.00</td> </tr> <tr> <td>Minimum Value</td> <td>-327.68</td> </tr> <tr> <td>Maximum Value</td> <td>+327.67</td> </tr> </table>	Parameter Number	181	Parameter Type	Read and Write	Display Units / Drive Units	Numeric / Scale x 100	Factory Default	+1.00	Minimum Value	-327.68	Maximum Value	+327.67
Parameter Number	181												
Parameter Type	Read and Write												
Display Units / Drive Units	Numeric / Scale x 100												
Factory Default	+1.00												
Minimum Value	-327.68												
Maximum Value	+327.67												
<p>[Process 2 Txt 1-8]</p> <p>Sets the "User Units" description for the value determined by [Process 2 Par] and [Process 2 Scale]. This 8 character description will be shown on line 2 of the display. Refer to the Character Map in Appendix A.</p>	<table border="0"> <tr> <td>Parameter Number(s)</td> <td>182-189</td> </tr> <tr> <td>Parameter Type</td> <td>Read and Write</td> </tr> <tr> <td>Display Units / Drive Units</td> <td>ASCII Code / ASCII Code</td> </tr> <tr> <td>Factory Default</td> <td>"Amps "</td> </tr> </table>	Parameter Number(s)	182-189	Parameter Type	Read and Write	Display Units / Drive Units	ASCII Code / ASCII Code	Factory Default	"Amps "				
Parameter Number(s)	182-189												
Parameter Type	Read and Write												
Display Units / Drive Units	ASCII Code / ASCII Code												
Factory Default	"Amps "												

Encoder Feedback

This group of parameters contains all the parameters necessary to activate encoder feedback for closed loop operation.

[Speed Control]

This parameter selects the type of speed modulation active in the drive.

This parameter cannot be changed while the drive is running.

Important: “No Control” and “Phase Lock” are the only available options for synchronous motors.

If encoder feedback closed loop speed regulation is required, “Encoder Fdbk” must be selected.

Parameter Number	77
Parameter Type	Read and Write
Factory Default	“Slip Comp”
<u>Units</u>	<u>Display</u> <u>Drive</u>
	“No Control” 0 Frequency regulation
	“Slip Comp” 1 Slip compensation
	“Speed Droop” 2 Negative slip compensation
	“Phase Lock” 3 Enable phase lock to pulse input
	“Encoder Fdbk” 4 Encoder feedback-closed loop
	“Droop + Reg” 5 Enc. fdbk.-closed loop w/ active droop
	“P Jump” 6 Traverse function
	“Process PI” 7 Closed loop PI control

[Encoder Type]

This parameter selects the feedback encoder signal type. The drive can accept single channel (Pulse) or dual channel (Quadrature) signals.

This selection must match the type of encoder being used. If “Pulse” is selected and a dual channel encoder is wired (see page 2-30), the feedback indication will be incorrect by a factor of 2 and no direction indication will be offered. If “Quadrature” is selected and a single channel encoder is wired, the feedback value will always be zero.

This cannot be changed while drive is running.

Parameter Number	152
Parameter Type	Read and Write
Factory Default	“Quadrature”
<u>Units</u>	<u>Display</u> <u>Drive</u>
	“Pulse” 0 Single channel encoder
	“Quadrature” 1 Dual channel encoder

[Encoder PPR]

This parameter contains the scaling factor for encoder feedback speed regulation. Enter the actual encoder pulses per revolution

Parameter Number	46
Parameter Type	Read and Write
Display Units / Drive Units	Factor / Pulses per Rev
Factory Default	1024 PPR
Minimum Value	1
Maximum Value	4096

[Maximum Speed]

This Parameter sets the output frequency at full frequency reference for:

- 1.Encoder feedback speed regulation.
- 2.All analog inputs to TB2 (remote pot, 0-10V & 0-20 mA).

NOTE: [Maximum Freq.] must be raised to allow operation or modulation above [Maximum Speed].

Parameter Number	151
Parameter Type	Read and Write
Display Units / Drive Units	1 Hertz / Hertz x 10
Factory Default	400 Hz
Minimum Value	0 Hz
Maximum Value	400 Hz

[Motor Poles]

This parameter contains the number of motor magnetic poles. This value translates output frequency into actual motor RPM during closed loop operation. It is calculated from [Motor NP Hertz] and [Motor NP RPM].

Parameter Number	153
Parameter Type	Read Only
Display Units / Drive Units	1 Poles / Poles

Encoder Feedback

[Speed KI]	Parameter Number	165
This parameter contains the integral gain value for the velocity loop during closed loop operation.	Parameter Type	Read and Write
	Display Units / Drive Units	Numeric / Gain x 100
	Factory Default	100
	Minimum Value	0
	Maximum Value	20000
[Speed KP]	Parameter Number	164
Not functional at time of printing – will set the proportional gain for the speed loop.	Parameter Type	Read and Write
	Display Units / Drive Units	Numeric / Gain x 100
	Factory Default	0
	Minimum Value	0
	Maximum Value	20000
[Speed Error]	Parameter Number	166
This parameter displays the difference between [Freq Command] and feedback speed.	Parameter Type	Read Only
	Display Units / Drive Units	0.01 Hertz / 32767 = Maximum Freq.
	Factory Default	None
	Minimum Value	- 8.33% of [Base Frequency]
	Maximum Value	+8.33% of [Base Frequency]
[Speed Integral]	Parameter Number	167
This parameter displays the integral value from the speed loop.	Parameter Type	Read Only
	Display Units / Drive Units	0.01 Hertz / 32767 = Maximum Freq.
	Factory Default	None
	Minimum Value	-8.33% of [Base Frequency]
	Maximum Value	+8.33% of [Base Frequency]
[Speed Adder]	Parameter Number	168
This parameter displays the amount of correction applied to the [Freq Command].	Parameter Type	Read Only
	Display Units / Drive Units	0.01 Hertz / 32767 = Maximum Freq.
	Factory Default	None
	Minimum Value	- 8.33% of [Base Frequency]
	Maximum Value	+8.33% of [Base Frequency]
[Slip Adder]	Parameter Number	255
This parameter displays the amount of correction added by slip comp or phase lock loop.	Parameter Type	Read Only
	Display Units / Drive Units	0.01 Hertz / 32767 = Maximum Freq.
	Factory Default	None
	Minimum Value	-8.33% of [Base Frequency]
	Maximum Value	+8.33% of [Base Frequency]
[Motor NP RPM]	Parameter Number	177
This value should be set to the motor nameplate rated RPM. This parameter cannot be changed while the drive is running.	Parameter Type	Read and Write
	Display Units / Drive Units	1 RPM / RPM x 10
	Factory Default	1750 RPM
	Minimum Value	60 RPM
	Maximum Value	24000 RPM
[Motor NP Hertz]	Parameter Number	178
This value should be set to the motor nameplate rated frequency. This parameter cannot be changed while the drive is running.	Parameter Type	Read and Write
	Display Units / Drive Units	1 Hertz / Hertz x 10
	Factory Default	60 Hz
	Minimum Value	1 Hz
	Maximum Value	400 Hz

Encoder Feedback

[Encoder Counts]

Displays the scaled encoder count value. The value is incremented in the forward direction and decremented in the reverse direction. Requires a quadrature (dual channel) encoder and a value in [Enc Count Scale].

Parameter Number	283
Parameter Type	Read and Write
Display Units / Drive Units	1 Count / Counts
Factory Default	0
Minimum Value	-32767
Maximum Value	+32767



ATTENTION: To guard against possible machine damage and/or personal injury, be aware that the maximum encoder count value in either direction is ± 32767 . No roll-over will occur and the value will be frozen at this maximum value until manually reset or decremented below maximum (via opposite counts).

[Enc Count Scale]

Sets the scale factor for the incoming encoder pulse count.

$$[\text{Encoder Counts}] = \frac{\text{Number of Incoming Pulses}}{[\text{Enc Count Scale}]}$$

Parameter Number	282
Parameter Type	Read and Write
Display Units / Drive Units	
Factory Default	1000
Minimum Value	1
Maximum Value	4096

[Encoder Loss Sel]

Selects the drive action when a missing or incorrect encoder signal is detected.

Important: Encoder loss detection requires the use of a 1336-L7E, L8E or L9E Interface Option Board and quadrature (dual channel) encoder wired differentially (see page 2-30). In addition, selection of “Encoder” in [Freq Select 1/2], [PI Reference], [PI Feedback] or “Encoder Fdbk” in [Speed Control] must be made.

If a 1336-L4E, L5E or L6E board is used, a pulse (single channel) encoder is used or a dual channel encoder is wired single-ended, this feature will not operate.

Parameter Number	284
Parameter Type	Read and Write
Factory Default	“Disabled”
<u>Units</u>	<u>Display</u> <u>Drive</u>
“Disable” 0	After 200ms of encoder loss, a warning will be issued.
“Enable” 1	After 200ms of encoder loss, an alarm and an F60 fault will be issued.

[Encoder Freq]

This parameter displays the frequency command present at encoder input terminals of TB3. This value is displayed whether or not this is the active frequency command.

$$\text{Frequency Displayed} = \frac{\text{Incoming Encoder Pulse Rate}}{[\text{Encoder PPR}]}$$

Parameter Number	63
Parameter Type	Read Only
Display Units / Drive Units	0.01 Hertz / 32767 = Maximum Freq
Factory Default	None
Minimum Value	-400.00 Hz
Maximum Value	+400.00 Hz

[Max Enc Counts]

Sets the trip point for the “Enc Cnt Max” alarm. The alarm is high (1) when [Encoder Counts] has exceeded [Max Enc Counts].

Parameter Number	328
Parameter Type	Read and Write
Display Units / Drive Units	1 Count / Counts
Factory Default	0
Minimum Value	0
Maximum Value	32767

Process PI

This group of parameters configures the Process PI Regulator.

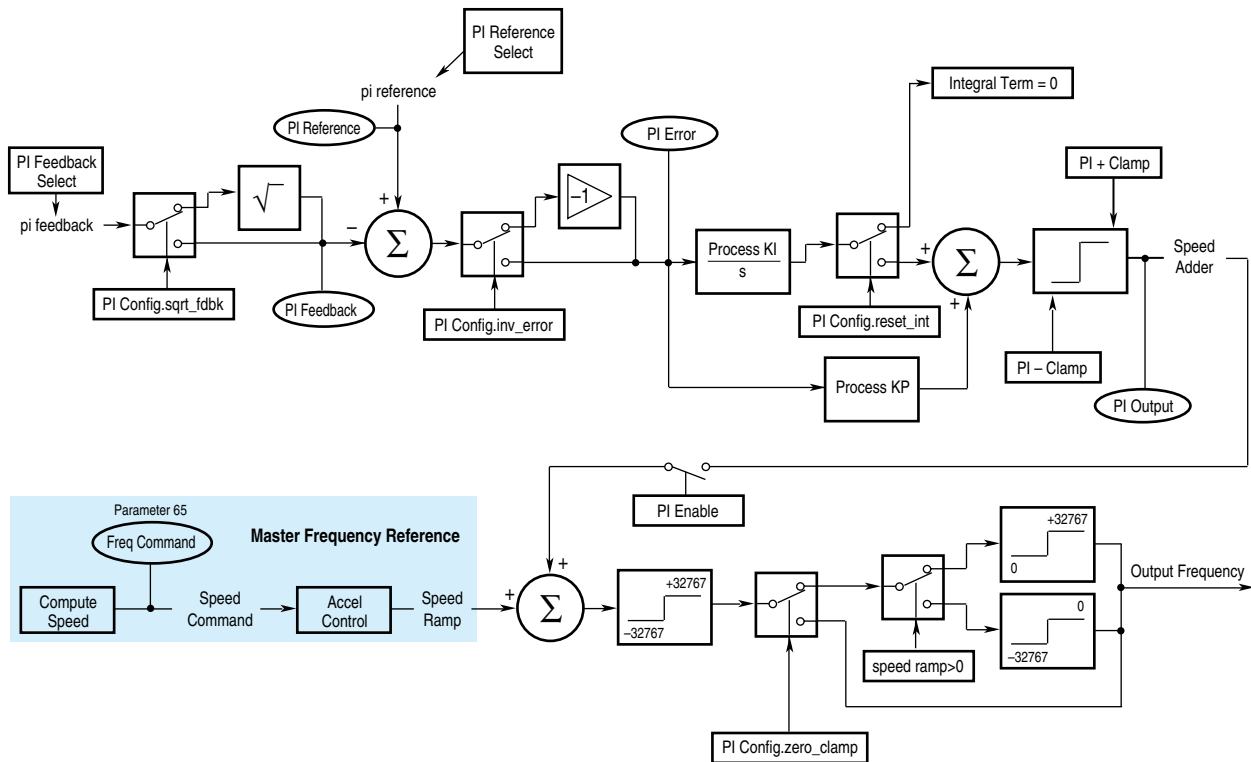

[Speed Control]

This parameter selects the type of speed modulation active in the drive.

This parameter cannot be changed while the drive is running.

Important: “No Control” and “Phase Lock” are the only available options for synchronous motors.

If encoder feedback closed loop speed regulation is required, “Encoder Fdbk” must be selected.

Parameter Number	77
Parameter Type	Read and Write
Factory Default	“Slip Comp”
Units	Display Drive
	“No Control” 0 Frequency regulation
	“Slip Comp” 1 Slip compensation
	“Speed Droop” 2 Negative slip compensation
	“Phase Lock” 3 Enable phase lock to pulse input
	“Encoder Fdbk” 4 Encoder feedback-closed loop
	“Droop + Reg” 5 Enc. fdbk.-closed loop w/ active droop
	“P Jump” 6 Traverse function
	“Process PI” 7 Closed loop PI control

[PI Config]

This parameter sets and displays the configuration for the PI regulator.

Note: Reset Integrator (Int) is also available through a digital input. See *Input Mode Selection* in Chapter 2.

Parameter Number	213			
Parameter Type	Read/Write			
Factory Default	0000000			
Bit 7	Spare			
Bit 6	PI Enable			
Bit 5	Preload Int			
Bit 4	Set Output			
Bit 3	Sqrt Fdbk - Uses sq. root of PI feedback value			
Bit 2	Zero Clamp - Prevents bidirectional operation			
Bit 1	Reset Int - Holds KI at zero			
Bit 0	Inv Error - Changes sign of PI Error			
Diagram	<table border="1"> <tr> <td>1</td> <td>2</td> <td>3</td> </tr> </table>	1	2	3
1	2	3		

(Refer to Diagrams on next page)

Process PI

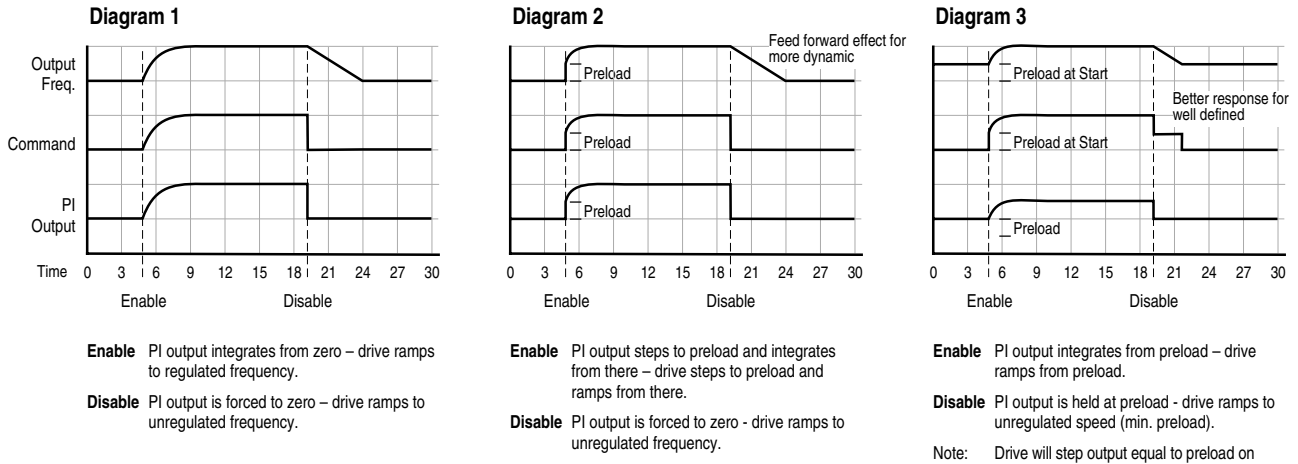

[PI Status]

This parameter displays the status of the Process PI regulator.

Parameter Number	214
Parameter Type	Read Only
Factory Default	None

Bit 7	Bit 6	Bit 5	Bit 4	Bit 3	Bit 2	Bit 1	Bit 0
							Enabled
							Spares

[PI Ref Select]

The source of the PI reference is selected with this parameter. The value from the selected reference is the “set point” for the Process PI regulator.

The drive is capable of responding to a loss of the 4-20 mA signal used as either a PI reference or PI feedback. Response to loss of 4-20 mA signal is controlled by programming and requires the following:

- a) [Speed Control] must be set to “Process PI” and
- b) Either [PI Ref Select] or [PI Fdbk Select] must be set to “4-20 mA.”

If both of the above conditions are met, the signal loss response is controlled by the setting of [4-20 mA Loss Sel]. If this parameter is set to “Stop/Fault,” loss of input will cause the drive to stop and issue a Hertz Err Fault. Loss of input while any other setting of [4-20 mA Loss Sel] is chosen will cause the drive to activate the alarm bit (bit 6 of [Drive Status] and bit 13 of [Drive Alarm]) and output programmed [Minimum Freq].

Signal loss protection is offered for the 2-10V input.

Parameter Number	215
Parameter Type	Read/Write
Factory Default	“Preset 1”
<u>Units</u>	<u>Display</u> <u>Drive</u>
	“Use Last” 0
	“Analog In 0” 1
	“Analog In 1” 2
	“Analog In 2” 3
	“Pulse Ref” 4 Refer to [Pulse In Scale] Value
	“MOP” 5
	“Adapter 1-6” 6-11
	“Preset 1-7” 12-18
	“Encoder” 19 Refer to [Encoder PPR] Value

Process PI

[PI Fdbk Select]

The source of the PI feedback is selected with this parameter. It identifies the input point for the process feedback device.

Parameter Number	216
Parameter Type	Read/Write
Factory Default	"Analog In 1"
<u>Units</u>	<u>Display</u> <u>Drive</u>
	"Use Last" 0
	"Analog In 0" 1
	"Analog In 1" 2
	"Analog In 2" 3
	"Pulse Ref" 4 Refer to [Pulse In Scale] Value
	"MOP" 5
	"Adapter 1-6" 6-11
	"Preset 1-7" 12-18
	"Encoder" 19 Refer to [Encoder PPR] Value

[PI Reference]

This parameter displays the current value of the reference selected by [PI Ref Select].

Parameter Number	217
Parameter Type	Read Only
Display Units / Drive Units	0.01 Hertz / 32767 = Maximum Freq Forward
Factory Default	None
Minimum Value	-400.00 Hz
Maximum Value	400.00 Hz

[PI Feedback]

This parameter displays the current value of the reference selected by [PI Fdbk Select].

Parameter Number	218
Parameter Type	Read Only
Display Units / Drive Units	0.01 Hertz / 32767 = Maximum Freq Forward
Factory Default	None
Minimum Value	-400.00 Hz
Maximum Value	400.00 Hz

[PI Error]

The value of the error calculated by the PI loop. This value is the difference between [PI Reference] & [PI Feedback] and determines the PI output.

Parameter Number	219
Parameter Type	Read Only
Display Units / Drive Units	0.01 Hertz / 32767 = Maximum Freq Forward
Factory Default	None
Minimum Value	-400.00 Hz
Maximum Value	400.00 Hz

[PI Output]

The current output of the PI loop is displayed with this parameter. This output is used as the speed command for process control or the speed adder for process trim.

Parameter Number	220
Parameter Type	Read Only
Display Units / Drive Units	0.01 Hertz / 32767 = Maximum Freq Forward
Factory Default	None
Minimum Value	-400.00 Hz
Maximum Value	400.00 Hz

[KI Process]

This parameter sets the integral gain of the process PI loop.

Parameter Number	221
Parameter Type	Read/Write
Display Units / Drive Units	NA / NA
Factory Default	128
Minimum Value	0
Maximum Value	1024

Process PI

[KP Process]

This parameter sets the proportional gain of the process PI loop.

Parameter Number	222
Parameter Type	Read/Write
Display Units / Drive Units	NA / NA
Factory Default	256
Minimum Value	0
Maximum Value	1024

[PI Neg Limit]

This parameter sets the lower (negative) limit of the PI output.

Parameter Number	223
Parameter Type	Read/Write
Display Units / Drive Units	0.01 Hertz / 32767 = Maximum Freq Forward
Factory Default	-8.33% of [Maximum Freq]
Minimum Value	-400.00 Hz
Maximum Value	400.00 Hz

[PI Pos Limit]

This parameter sets the upper (positive) limit of the PI output.

Parameter Number	224
Parameter Type	Read/Write
Display Units / Drive Units	0.01 Hertz / 32767 = Maximum Freq Forward
Factory Default	+8.33% of [Maximum Freq]
Minimum Value	-400.00 Hz
Maximum Value	400.00 Hz

[PI Preload]

Sets the value used to preload the PI integrator when "Set Output" or "Preload Int" bits equal "1" in [PI Config].

Parameter Number	225
Parameter Type	Read/Write
Display Units / Drive Units	0.01 Hertz / ± 32767 = Maximum Freq
Factory Default	0.00 Hz
Minimum Value	- 8.33% of [Maximum Freq]
Maximum Value	+8.33% of [Maximum Freq]

Motor Control	This group of parameters defines basic motor control.
----------------------	---

[Control Select]

Selects the motor control method for the drive. The default setting provides full stator flux control that is suitable for most applications.

Important: When using synchronous motors, [Control Select] must be set to V/Hz operation (“Fixed Boost” or “Full Custom”).

Additional selections are offered to optimally tune performance:

- Two volts/Hertz modes are available; one using simple voltage boost and one for complete configurability. These may be required for special motors or unmatched multi-motor installations.
- The Economize mode offers all the advantages of stator flux control plus the added feature of an “auto-economizer.” If a motor remains lightly loaded, the drive will reduce output voltage (and therefore output kW) in order to reduce the energy (operating) costs of the lightly loaded motor. This can result in up to 20% kW savings.

Parameter Number	9
Parameter Type	Read and Write
Factory Default	“Sens Vector”
<u>Units</u>	<u>Display</u> <u>Drive</u>
“Economize”	0 Stator Flux control with Economize
“Sens Vector”	1 Stator Flux control
“Fixed Boost”	2 V/Hz w/programmed accel/run boost
“Full Custom”	3 V/Hz with full configuration

Default

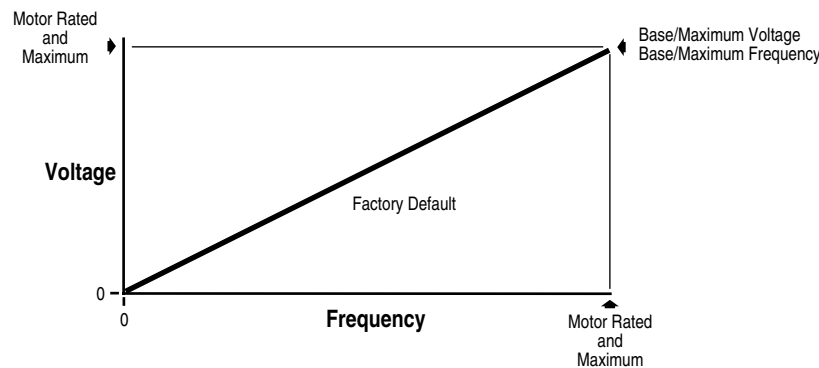

Fixed

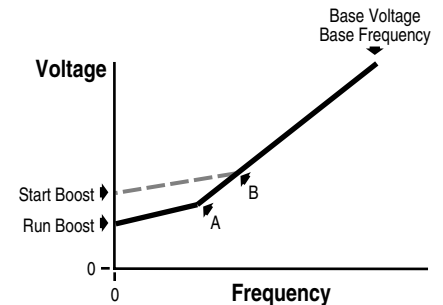

Full Custom

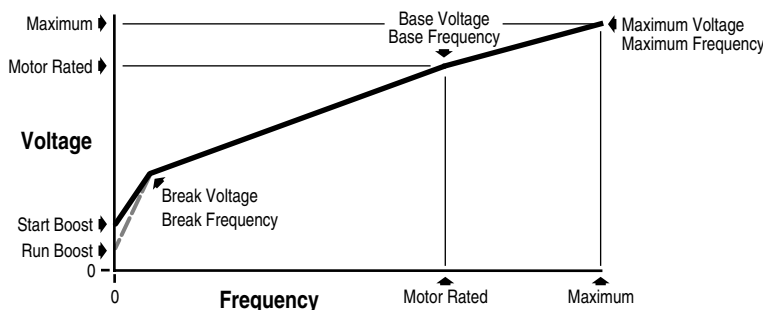

[Flux Amps Ref]

Used in “Economize” & “Sens Vector” modes - Sets the value of amps required to maintain full motor flux. If set to zero, the drive will use an internal value based on [Motor NP Amps] and drive kW (HP). Refer to Chapter 5 for setup information.

Parameter Number	192
Parameter Type	Read and Write
Display Units / Drive Units	0.1 Amp / 4096 = Drive Rated Amps
Factory Default	0.0 Amps
Minimum Value	0.0 Amps
Maximum Value	75.0% of Drive VT Rated Amps

Motor Control

<p>[IR Drop Volts]</p> <p>Used in "Economize" & "Sens Vector" modes - Sets the value of volts dropped across the resistance of the motor stator. If set to zero, the drive will use an internal value based on motor F.L.A. and rated voltage. Some motors (i.e. 6 pole, special, etc.) may be particularly sensitive to the adjustment of this parameter. Refer to the tuning procedure in Chapter 5 for further information.</p>	<p>Parameter Number 194 Parameter Type Read and Write Display Units / Drive Units 0.1 Volt / 4096 = Drive Rated Volts Factory Default Based on Drive Size & Type Minimum Value 0.0 Volts Maximum Value 25% of Drive Rated Volts</p>
<p>[Flux Up Time]</p> <p>Sets the amount of time the drive will use to try and achieve full motor stator flux. When a Start command is issued, DC current at current limit level is used to build stator flux before accelerating.</p>	<p>Parameter Number 200 Parameter Type Read and Write Display Units / Drive Units 0.1 Sec / Sec x 10 Factory Default 0.0 Sec Minimum Value 0.0 Sec Maximum Value 5.0 Sec</p>
<p>[Start Boost]</p> <p>This parameter sets the DC start boost level for acceleration when [Control Select] is set to "Fixed Boost" or "Full Custom."</p>	<p>Parameter Number 48 Parameter Type Read and Write Display Units / Drive Units 1 Volt / 4096 = Drive Rtd Volts Factory Default 0 Volts Minimum Value 0 Volts Maximum Value 9.5% of Drive Rated Voltage</p>
<p>[Run Boost]</p> <p>This parameter sets the DC boost level for constant speed level when [Control Select] is set to "Fixed Boost" or "Full Custom."</p>	<p>Parameter Number 83 Parameter Type Read and Write Display Units / Drive Units 1 Volt / 4096 = Drive Rtd Volts Factory Default 0 Volts Minimum Value 0 Volts Maximum Value 9.5% of Drive Rated Voltage</p>
<p>[Boost Slope]</p> <p>Sets the slope of the volts/Hertz curve from [Start Boost] and [Run Boost] to the intersect point (see Fixed boost diagram on previous page) when [Control Select] equals fixed boost. The intersect is determined by multiplying: Run Boost x Boost Slope = A Start Boost x Boost Slope = B.</p>	<p>Parameter Number 169 Parameter Type Read and Write Display Units / Drive Units None Factory Default 1.5 Minimum Value 1.0 Maximum Value 8.0</p>
<p>[Break Voltage]</p> <p>Sets the voltage the drive will output at [Break Frequency]. Combined with [Break Frequency], this parameter determines the volts-per-Hertz pattern between 0 and [Break Frequency].</p>	<p>Parameter Number 50 Parameter Type Read and Write Display Units / Drive Units 1 Volt / 4096 = Drive Rtd Volts Factory Default 25% of Drive Rated Voltage Minimum Value 0 Volts Maximum Value 50% of Drive Rated Voltage</p>
<p>[Break Frequency]</p> <p>This parameter sets a midpoint frequency on a custom volts-per-Hertz curve. Combined with [Break Voltage], this value determines the volts-per-Hertz ratio between 0 and [Break Frequency].</p>	<p>Parameter Number 49 Parameter Type Read and Write Display Units / Drive Units 1 Hertz / Hertz x 10 Factory Default 25% of [Maximum Freq] Minimum Value 0 Hz Maximum Value 120 Hz</p>
<p>[Base Voltage]</p> <p>This value should be set to the motor nameplate rated voltage.</p>	<p>Parameter Number 18 Parameter Type Read and Write Display Units / Drive Units 1 Volt / 4096 = Drive Rtd Volts Factory Default Drive Rated Volts Minimum Value 25% of Drive Rated Voltage Maximum Value 120% of Drive Rated Voltage</p>

Motor Control

[Base Frequency]

This value should be set to the motor nameplate rated frequency.

Parameter Number	17
Parameter Type	Read and Write
Display Units / Drive Units	1 Hertz / Hertz x 10
Factory Default	60 Hz
Minimum Value	25 Hz
Maximum Value	400 Hz

[Maximum Voltage]

This parameter sets the highest voltage the drive will output for "Fixed Boost" & "Full Custom."

Parameter Number	20
Parameter Type	Read and Write
Display Units / Drive Units	1 Volt / 4096 = Drive Rtd Volts
Factory Default	Drive Rated Volts
Minimum Value	25% of Drive Rated Voltage
Maximum Value	120% of Drive Rated Voltage

[Run/Accel Volts]

In "Fixed Boost" or "Full Custom" modes, the output voltage is reduced by the programmed amount while at frequency.

Parameter Number	317
Parameter Type	Read and Write
Display Units / Drive Units	1% / 4096 = 100%
Factory Default	100%
Minimum Value	50%
Maximum Value	100%

Motor Sync Loss Detection for Synchronous Motors

This function is enabled if [Sync Loss Sel] is set to "Alarm" or "Fault".

The motor sync loss detection attempts to sense when a synchronous motor has pulled out of sync. When this happens the motor will typically draw a high current and the power flow between the motor and the drive oscillates. Based on this, the detection algorithm looks for a large oscillation of the current (relative to voltage) angle while the current is high. When loss of sync is detected, the "Sync Loss" bit in [Drive Alarm 1] is set. Additionally, the drive will add an additional voltage set by [Sync Loss Comp] to the output voltage. This will increase the pull-in torque to allow the motor to re-synchronize.

If [Sync Loss Sel] is set to "Fault," the time the "Sync Loss" bit is set is timed. If it exceeds the time set by [Sync Loss Time], the drive faults with a F67 "Motor Sync Loss" fault indication.

[Sync Loss Sel]

This parameter allows selection of various sync loss modes.

Important: The motor must be connected to the drive when the sync loss function is enabled.

Parameter Number	310
Parameter Type	Read and Write
Factory Default	"Disabled"
<u>Units</u>	<u>Display</u> <u>Drive</u>
"Disabled" 0	sync loss detection and recovery function is disabled
"Alarm" 1	sync loss detection and recovery function is enabled
"Fault" 2	sync loss detection and recovery function is enabled. If the sync loss continues for longer than the time set by [Sync Loss Time], the drive faults with a F67 "Motor Sync Loss" fault indication.

[Sync Loss Gain]

Sets a gain that controls the sensitivity of the sync loss detection function.

Parameter Number	311
Parameter Type	Read and Write
Display Units / Drive Units	Numeric / Gain x 100
Factory Default	40
Minimum Value	0
Maximum Value	100

Motor Control

[Sync Loss Comp]

Sets the extra voltage to add when trying to get the motor to re-sync after a loss of sync is detected.

Parameter Number	313
Parameter Type	Read and Write
Display Units / Drive Units	1 Volt / 4096 = Drive Rtd. Volts
Factory Default	0 Volts
Minimum Value	0 Volts
Maximum Value	25% of Drive Rtd. Volts

[Sync Loss Time]

For [Sync Loss Sel] = "Fault," the sync loss detection and recovery function is enabled. If the sync loss continues for longer than the time set by [Sync Loss Time], the drive faults with an F67 "Motor Sync Loss" fault indication.

Parameter Number	312
Parameter Type	Read and Write
Display Units / Drive Units	1 Second / Seconds x 100
Factory Default	5 Sec
Minimum Value	1 Sec
Maximum Value	30 Sec

[PWM Comp Time] – Firmware 4.001 & later

This parameter adjusts the PWM waveform dead time compensation. This adjustment can improve the stability of lightly loaded motors at low speed. Only D Frame and larger drives will benefit from this adjustment. To tune the drive, first set [Break Freq], then lower [PWM Comp Time] until stable motor operation is achieved. [Stability Gain] can also be used to help achieve stable motor operation.

Parameter Number	333
Parameter Type	Read and Write
Display Units / Drive Units	None
Factory Default	80
Minimum Value	20
Maximum Value	90

[Break Freq] – Firmware 4.001

[PWM Break Freq] – Firmware 5.001 & later

This parameter can only be changed on D Frame & larger drives. This is the frequency where the dead time compensation returns to the default value of 80. If the motor has instability at low speeds, determine the point where the instability ends, and add 5 Hz. A good starting point is usually 10-15 Hz.

Parameter Number	334
Parameter Type	Read and Write
Display Units / Drive Units	0.01 Hertz / 32767 = Maximum Freq Forward
Factory Default	0 Hz
Minimum Value	0 Hz
Maximum Value	30 Hz

[Stability Gain]

This parameter adjusts the gain of the torque component of current to adjust for possible current instability in certain motors caused by variations in design. Increasing this value to the correct setting for a particular motor will stabilize torque pulsations in the motor.

Parameter Number	324
Parameter Type	Read and Write
Display Units / Drive Units	None
Factory Default	0
Minimum Value	0
Maximum Value	16

Important: Setting this value too high may cause additional instability. It should be set for the lowest value that eliminates the instability.

Step Logic

The Step Logic Parameters are only available with Firmware versions 5.001 and later.

StepLogic™ offers a degree of PLC functionality for simple applications. It consists of 7 frequency steps which can be stepped through based on a number of factors. The frequency steps are programmed into the [Preset Freq x] parameters (x = Current Step + 1). Each step also has a time associated with it, [SLx Time]. The logic for each step is defined by four StepLogic parameters.

- [SLx Logic Step] – if true, will move the program to the next step.
- [SLx Logic Jump] – if true, will jump to the step defined in [SL Step Jump].
- [SL Step Jump] – if both [SLx Logic Step] and [SLx Logic Jump] are true, the program will jump to the step defined in this parameter. [SLx Logic Jump] takes precedence over [SLx Logic Step].
- [SLx Step Setting] – sets 4 functions of the step. Refer to the parameter description on page [6-63](#).

A valid Start command will cause the program to run and continue to loop unless one of the steps causes the program to end, a Stop command is given or the Enable is opened. When the Enable is opened in 2-wire control, the drive will stop. When closed, the drive will restart at the last step, if the Start is still closed. Note that in order to move to a different step based on digital inputs, at least one input must change state since the last step.

See Example below and [Figure 6.1](#).

No.	Parameter	Setting
5	Freq Select 1	Step Logic
158	CR1 Out Select	Step Logic
242	TB3 Term 22 Sel	SL Input 1
243	TB3 Term 23 Sel	SL Input 2
27	Preset Freq 1	20 (SL0)
28	Preset Freq 2	10 (SL1)
29	Preset Freq 3	20 (SL2)
30	Preset Freq 4	30 (SL3)
31	Preset Freq 5	40 (SL4)
32	Preset Freq 6	50 (SL5)
33	Preset Freq 7	60 (SL6)
335	SL0 Logic Step	SL1 In True
336	SL0 Logic Jump	SL2 In True
337	SL0 Step Jump	Jump to 2
338	SL0 Step Setting	0000
339	SL0 Time	0.00
340	SL0 Encoder Cnts	0
341	SL1 Logic Step	SL1 In True
342	SL1 Logic Jump	Time and SL2
343	SL1 Step Jump	Jump to 3
344	SL1 Step Setting	0100
345	SL1 Time	10.00
346	SL1 Encoder Cnts	0
347	SL2 Logic Step	All SL True
348	SL2 Logic Jump	SL2 In True
349	SL2 Step Jump	Jump to 6
350	SL2 Step Setting	0001

No.	Parameter	Setting
351	SL2 Time	0.00
352	SL2 Encoder Cnts	0
353	SL3 Logic Step	Step on Time
354	SL3 Logic Jump	SL2 not SL1
355	SL3 Step Jump	End Fault
356	SL3 Step Setting	0111
357	SL3 Time	0.00
358	SL3 Encoder Cnts	-10
359	SL4 Logic Step	All SL True
360	SL4 Logic Jump	Do Not Step
361	SL4 Step Jump	Jump to 2
362	SL4 Step Setting	0001
363	SL4 Time	0.00
364	SL4 Encoder Cnts	0
365	SL5 Logic Step	Time and SL1
366	SL5 Logic Jump	SL2 In True
367	SL5 Step Jump	End Stop 2
368	SL5 Step Setting	1110
369	SL5 Time	0.00
370	SL5 Encoder Cnts	15
371	SL6 Logic Step	SL1 In True
372	SL6 Logic Jump	SL2 In False
373	SL6 Step Jump	End Stop 1
374	SL6 Step Setting	0000
375	SL6 Time	0.00
376	SL6 Encoder Cnts	0

Step Logic

Figure 6.1
Step Logic

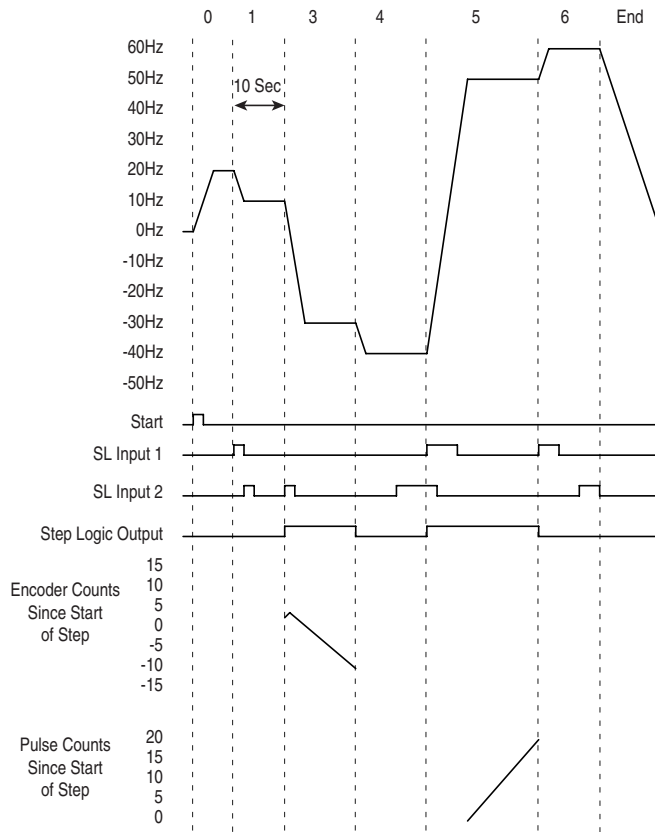

- [SL0 Logic Step]** – Firmware 5.001 & later
- [SL1 Logic Step]**
- [SL2 Logic Step]**
- [SL3 Logic Step]**
- [SL4 Logic Step]**
- [SL5 Logic Step]**
- [SL6 Logic Step]**

When the logic in this parameter is true, the program will move to the next step. The SL1 and SL2 inputs are designated in [TB3 Term xx Sel].

The logic which refers to time is also for encoder or pulse counts. Time can be replaced with counts when using the encoder and pulse inputs.

When using "Time and SLx" or "Time not SLx" the time or counts need to elapse before the logic input will be checked.

Parameter Number	335, 341, 347, 353, 359, 365, 371
Parameter Type	Read and Write
Factory Default	"Step On Time"
<u>Units</u>	<u>Display</u> <u>Drive</u>
	"Skip Step" 0
	"Step On Time" 1
	"SL1 In True" 2
	"SL2 In True" 3
	"SL1 In False" 4
	"SL2 In False" 5
	"Any SL True" 6
	"All SL True" 7
	"No SL True" 8
	"SL1 not SL2" 9
	"SL2 not SL1" 10
	"Time and SL1" 11
	"Time and SL2" 12
	"Time not SL1" 13
	"Time not SL2" 14
	"Do Not Step" 15

Step Logic

[SL0 Time] – <i>Firmware 5.001 & later</i>	Parameter Number	339, 345, 351, 357, 363, 369, 375
[SL1 Time]	Parameter Type	Read and Write
[SL2 Time]	Display Units / Units	0.01 Second / Seconds x 100
[SL3 Time]	Factory Default	0.00 Sec
[SL4 Time]	Minimum Value	0.00 Sec
[SL5 Time]	Maximum Value	600.00 Sec
[SL6 Time]		

Sets the time to remain in each step if the corresponding Logic Step or Jump is set to "Step On Time". To use the encoder or pulse counts this must be set to "0.00."

[SL0 Encoder Cnts] – <i>Firmware 5.001 & later</i>	Parameter Number	340, 346, 352, 358, 364, 370, 376
[SL1 Encoder Cnts]	Parameter Type	Read and Write
[SL2 Encoder Cnts]	Display Units / Drive Units	1 Count / Counts
[SL3 Encoder Cnts]	Factory Default	0
[SL4 Encoder Cnts]	Minimum Value	-32767
[SL5 Encoder Cnts]	Maximum Value	+32767
[SL6 Encoder Cnts]		

Sets the number of encoder or pulse counts necessary to cause a step if the corresponding Logic Step or Jump is set to "Step On Time." Current counts are stored when a step is initiated. The difference between the current and stored counts is compared to the parameter. The encoder counts are directional and stop at the Min and Max values. A F69 Step Logic fault will occur when using the encoder and [Encoder Counts] is at an end point. The pulse counts are only positive and will rollover internally.

To use the encoder counts, set the Logic Step or Jump to "Step on Time," "Time and SLx" or "Time not SLx." The [SLx Time] must be set to "0.00." Set the [SLx Step Setting] "Encoder/Puls" to "0." To use pulse counts, connect an LA5 card to the drive. Set the [SLx Step Setting] "Encoder/Puls" to "1."

[Current Step] – <i>Firmware 5.001 & later</i>	Parameter Number	377
This parameter displays the current step the Step Logic function is using. For example if [Current Step] is 2, the SL2 parameters are active. This parameter can be used to force the drive to a giving step.	Parameter Type	Read and Write
	Display Units / Drive Units	None
	Factory Default	0
	Minimum Value	0
	Maximum Value	9

Linear List

This group lists all the parameters currently installed in your drive in numerical order. Refer to the Appendix at the back of this manual for an alpha/numeric listing of all parameters.

The following parameter appears only in the Linear List and is not documented elsewhere.

[Bidir In Offset]	Parameter Number	329
Trims the offset of the bi-directional inputs on LA6 & LA7 option cards. To provide an equal response to positive and negative signals, this parameter may need to be adjusted for each board. With no voltage on input 0, monitor [Anlg In 0 Freq] and adjust [Bidir In Offset] until it is zero.	Parameter Type	Read and Write
	Display Units / Drive Units	None
	Factory Default	270
	Minimum Value	0
	Maximum Value	1024

Troubleshooting

Chapter 7 provides information to guide the user in troubleshooting the 1336 PLUS. Included is a listing and description of the various drive faults (with possible solutions, when applicable) and alarms.

Fault Descriptions

Fault Display

The LCD display is used to indicate a fault by showing a brief text statement relating to the fault (see figure below). The fault will be displayed until “Clear Faults” is initiated or drive power is cycled. A Series A (version 3.0) or Series B & up HIM will display a fault when it occurs, no matter what state the display is in. In addition, a listing of past faults can be displayed by selecting “Fault queue” from the Control Status menu (see Chapter 3 for more information). Refer to [Table 7.A](#) for a listing and description of the various faults. [Table 7.C](#) provides a listing of faults by number.



Clearing a Fault

When a fault occurs, the cause must be corrected before the fault can be cleared. After corrective action has been taken, simply cycling drive power will clear the fault. Issuing a valid Stop command from the HIM or Control Interface option (TB3) will also clear a fault if the [Flt Clear Mode] parameter is set to “Enabled.” In addition, a “Clear Faults” command can be issued anytime from a serial device (if connected).

Contact Description

Refer to [Figure 2.5](#) for a schematic representation of contacts CR1-CR4. Contacts in [Figure 2.5](#) are shown in an unpowered state. When powered, the contacts will change state. For Example: During normal operating conditions (no faults present, drive running), the CR3 contacts (default firmware setting) at TB2-13 & 14 are open, and the contacts at TB2-14 & 15 are closed. When a fault occurs, the state of these contacts will change.

Table 7.A
1336 PLUS II Fault Descriptions

Name & Fault #	Description	Action
Adptr Freq Err 65	The SCANport adapter that was the selected frequency reference sent a frequency greater than 32767 to the drive.	Correct the problem that is causing the SCANport adapter to send the illegal frequency reference to the drive.
Auxiliary Fault 02	The auxiliary input interlock is open.	If Control Interface option is installed, check TB3 connections. If not installed, set [Input Mode] to "Status."
Bgnd 10ms Over 51	Microprocessor loop fault. Occurs if the 10ms background task hasn't been run in 15 ms.	Replace Main Control Board or complete drive as required.
Bipolar Dir Flt 16	3 Wire – Bi-polar input is the active frequency reference and direction control is not possible. 2 Wire – Run Forward or Reverse commands attempt direction control, but bi-polar input is not masked from direction control.	a) Mask out direction control at bit 7 of [Direction Mask]. b) Remove or mask other direction control sources. Set bit 7 of [Direction Mask] to zero.
Blwn Fuse Flt 58	If the difference between the commanded voltage and the measured voltage is greater than 1/8 of rated voltage for 0.5 seconds, then a fault will be issued indicating that the bus fuse in 30 kW (40HP) & up drives has blown.	Locate cause, replace fuse.
C167 Watchdog 17	Internal microprocessor fault.	If there is only one occurrence, reset the fault and continue. If the fault continuously or frequently reoccurs, contact your local service representative or replace the Main Control Board.
Diag C Lim Flt 36	The drive output current has exceeded the hardware current limit and the [Cur Lim Trip En] parameter was enabled.	Check [Cur Lim Trip En]. Check for excess load, improper DC boost setting, DC brake volts set too high or other causes of excess current.
Drive -> HIM	Refer to Table 7.B .	
DSP Checksum 37	There was a breakdown in communications between the DSP and main processors.	Reset to factory defaults. Replace Main Control Board or Gate Driver Board.
DSP Comm Fault 27	Refer to the "Description" and "Action" statements for C167 Watchdog (F17) above.	
DSP Protected 46	Flash download included a new DSP Main Block and J14 was not installed when power was restored.	Remove power from the drive. Install J14 per download kit instructions and reapply power. When transfer is complete, remove power and J14.
DSP Queue Fault 31	Refer to the "Description" and "Action" statements for C167 Watchdog (F17) above.	
DSP Reset Fault 22	Power-up has been attempted with an Open Stop contact or Closed Start contact.	Check/verify wiring and contact operation.
DSP Timeout Fault 28	Refer to the "Description" and "Action" statements for C167 Watchdog (F17) above.	
EE Init Read 53	<ol style="list-style-type: none"> Gate Drive Bd. replacement (requires re-initialization). Trouble reading EEPROM during initialization. 	<ol style="list-style-type: none"> Reset to factory defaults & cycle input power. Check all connections to Power/Driver Board. Replace board or complete drive as needed.

Name & Fault #	Description	Action
EE Init Value 54	Stored parameter value out of range on initialization.	<ol style="list-style-type: none"> 1. Reset to factory defaults & cycle input power. 2. Check all connections to the Power/Driver Bd. Replace the board or complete drive as needed.
EEprom Checksum 66	The checksum read from the EEPROM does not match the checksum calculated from the EEPROM data.	<ol style="list-style-type: none"> 1. Reset to factory defaults & cycle input power. 2. Check all wire and cable connections to the Power Driver Board. Replace Power Driver Board or complete drive as required.
EEprom Fault 32	EEPROM is being programmed and will not write a new value.	Check all wire and cable connections to the Main Control Board. Replace Main Control Board or complete drive as required.
Encoder Loss 60	<p>The drive has detected an error in the encoder signals at TB3, terminals 31-36. The error could be due to a:</p> <ol style="list-style-type: none"> 1. Loss of 1 or more channels. 2. Loss of quadrature. 3. Loss of differential signal (A & A NOT or B & B NOT were high at the same time). 	Check encoder and wiring.
Fgnd 10ms Over 52	Microprocessor loop fault. Occurs if a 10ms interrupt is pending before the current interrupt is complete.	Replace Main Control Board or complete drive as required.
Ground Fault 13	A current path to earth ground in excess of 100A has been detected at one or more of the drive output terminals. NOTE: If ground current exceeds 220% of drive rated current, "Overcurrent Fit" may occur instead of Ground Fault.	Check the motor and external wiring to the drive output terminals for a grounded condition.
Ground Warning 57	A current path to earth ground in excess of 2A has been detected at one or more of the drive output terminals. See [Ground Warning].	Check the motor and external wiring to the drive output terminals for a grounded condition.
Hardware Trap 18	Refer to the "Description" and "Action" statements for C167 Watchdog (F17) on 7-2 .	
Hertz Err Fault 29	<p>This fault indicates that there is not a valid operating frequency. It can be caused by any of the following:</p> <ol style="list-style-type: none"> 1. [Maximum Freq] is less than [Minimum Freq]. 2. Skip frequencies and skip bandwidth eliminate all operating frequencies. 3. Analog input signal speed reference has been lost. See [Anlg Signal Loss] and [4-20mA Loss Sel]. 	<ol style="list-style-type: none"> 1. Check [Minimum Freq] and [Maximum Freq] parameters. 2. Check [Skip Freq 1], [Skip Freq 2], [Skip Freq 3] and [Skip Freq Band] parameters. 3. Check for broken wires, loose connections or transducer loss at analog inputs.

Name & Fault #	Description	Action
Hertz Sel Fault 30	A frequency select parameter has been programmed with an out of range value.	Reprogram [Freq Select 1] and/or [Freq Select 2] with a correct value. If problem persists, replace Main Control Board or complete drive.
HIM -> Drive	Refer to Table 7.B .	
Ill Prog Input 62	[Fault Data] = 98 – “3 Wire” is selected as the [Input Mode] and one or more digital inputs are programmed to “Run Reverse” (2 wire action).	Reprogram the digital inputs or select “2 Wire” as the [Input Mode].
Input Phase Flt 49	The DC bus ripple has exceeded the value in [Phase Loss Level].	<ol style="list-style-type: none"> 1. If the drive is operated on single-phase, the load derating level has been exceeded. 2. Check incoming power for a missing phase/blown fuse.
Load Loss Flt 20	[Load Loss Detect] is set to “Enabled” and the drive output torque current was below [Load Loss Level] for a time period greater than [Load Loss time].	<ol style="list-style-type: none"> 1. Verify connections between motor and load. 2. Verify level and time requirements or disable [Load Loss Detect].
Loop Overrn Flt 23	An overrun of the 2.5ms control loop has occurred.	Check all connections to the Main Control Board. Replace the board or complete drive as needed.
Max Retries Fault 33	Drive unsuccessfully attempted to reset a fault and resume running for the programmed number of [Reset/Run Tries].	Check fault buffer for fault code requiring reset. Correct the cause of the fault and manually clear by pressing the local Stop key or cycling the TB3 Stop input.
Motor Mode Flt 24	A fault has been detected originating from the Control Board.	Check all connections to the Control Board. Replace the board or complete drive as required.
Motor Stall Fault 06	Current remained over [Current Limit] setting (parameter 36) for more than 4 seconds.	If the motor is drawing excessive current (over [Current Limit] setting), the motor load is excessive and will not allow the drive to accelerate to set speed. A longer accel time or a reduced load may be required.
Motor Thermistor 15	An analog option board with thermistor input is installed and the value at the terminals is less than 60 ohms or greater than 3300 ohms.	<ol style="list-style-type: none"> 1. Verify that thermistor is connected. 2. Motor is overheated. Reduce load. 3. Thermistor is not present. Remove option board.
Mult Prog Input 61	A single source input function such as Reverse/Forward (open=1 st function, closed=2 nd function) has been programmed to more than one input or more than one “Run Reverse” input.	Reprogram one or more of the inputs to a different value.
Neg Slope Fault 35	Drive software detected a portion of the volts/hertz curve with a negative slope.	<p>Check drive programming.</p> <ol style="list-style-type: none"> 1. [Base Voltage] parameter must be greater than [Start Boost]. 2. If the [DC Boost Select] parameter is set to “Full Custom,” [Base Voltage] must be greater than [Break Voltage] and [Break Voltage] must be greater than [Start Boost].

Name & Fault #	Description	Action
Open Pot Fault 09	An external pot is connected and the common side of the pot is open. The drive generates this fault when the voltage between pot leads is greater than 3.9V DC.	Check the external potentiometer circuit at TB2 for an open circuit.
Op Error Fault 11	A SCANport device requests a Read or Write of a data type not supported. This will also occur if: 1. [Motor Type] is set to "Sync PM" and [Stop Mode Used] is set to "DC Brake", or 2. [Motor Type] is set to "Sync Reluc" or "Sync PM" and [Speed Control] is set to "Slip Comp".	Check programming.
Option Error 14	A slot A analog option board has been installed in slot B or A slot B board has been installed in slot A	Remove or relocate to proper slot.
Overcurrent Fit 12	Overcurrent is detected in instantaneous overcurrent trip circuit.	Check for a short circuit at the drive output or excessive load conditions at the motor.
Overload Fault 07	Internal electronic overload trip.	An excessive motor load exists. It must be reduced such that drive output current does not exceed the current set by the [Overload Amps] parameter.
Overspeed Fault 25	Not functional at time of printing.	
Overtemp Fault 08	Heat sink temperature exceeds a predefined value of 90° C (195° F).	Check for blocked or dirty heat sink fins. Check that the ambient temperature has not exceeded 40° C (104° F). Check fan.
Overvolt Fault 05	DC bus voltage exceeded maximum value.	Monitor the AC line for high line voltage or transient conditions. Bus overvoltage can also be caused by motor regeneration. Extend the decel time or install dynamic brake option.
Phase U Fault 38	A phase to ground fault has been detected between the drive and motor in this phase.	Check the wiring between the drive and motor. Check motor for grounded phase.
Phase V Fault 39	A phase to ground fault has been detected between the drive and motor in this phase.	Check the wiring between the drive and motor. Check motor for grounded phase.
Phase W Fault 40	A phase to ground fault has been detected between the drive and motor in this phase.	Check the wiring between the drive and motor. Check motor for grounded phase.
Poles Calc Fit 50	Generated if the calculated value of [Motor Poles] is less than 2 or greater than 32.	Check [Motor NP RPM] and [Motor NP Hertz] programming.
Power Loss Fault 03	DC bus voltage remained below 85% of nominal for longer than 500ms. [Line Loss Fault] parameter is set to "enabled."	Monitor the incoming AC line for low voltage or line power interruption.
Power Mode Fault 26	The internal power mode variable received an incorrect value.	Check all connections to the Control Board. Replace the board or complete drive as required.

Name & Fault #	Description	Action
Power Overload 64	The drive rating of 150% for 1 minute has been exceeded.	Reduce load.
Precharge Fault 19	The precharge device was open 20ms after the end of a line loss condition or the bus charging alarm remains on for 20 seconds (precharge did not complete).	See Chapter 1 for frame definitions. <ol style="list-style-type: none"> 1. Frames A1, A2, A3 - Check the precharge circuit. Replace the drive. 2. Frame B - Check the precharge circuit. Replace the Power Driver Bd. or complete drive as required. 3. All larger frames - Check the precharge circuit. Replace the input SCRs, SCR Firing Board, Power Driver Board or complete drive as needed.
Precharge Open 56	The precharge circuit was commanded to close, but was detected to be open.	See page 1-1 for frame definitions. <ol style="list-style-type: none"> 1. Frames A1, A2, A3 - Check the precharge circuit. Replace the drive. 2. Frame B - Check the precharge circuit. Replace the Power Driver Bd. or complete drive as required. 3. All larger frames - Check the precharge circuit. Replace the input SCRs, SCR Firing Board, Power Driver Board or complete drive as needed.
Prm Access Flt 34	A communication error occurred between the microprocessor and the serial EEPROM or the DSP.	Record the value in [Fault Data], then reset the fault. If this fault occurs repeatedly, contact factory.
Reprogram Fault 48	The drive was commanded to write default values to EEPROM.	<ol style="list-style-type: none"> 1. Clear the fault or cycle power to the drive. 2. Program the drive parameters as needed. <p>Important: If [Input Mode] has been changed from its original value, power must be cycled before the new value will take affect.</p>
ROM or RAM Flt 68	Internal power-up ROM or RAM tests have not executed properly.	Replace Control Board or complete drive as required.
Serial Fault 10	A SCANport adapter has been disconnected and the [Logic Mask] bit for that adapter is set to "1."	<ol style="list-style-type: none"> 1. If no adapter was intentionally disconnected, check wiring to the SCANport adapters. Replace wiring, SCANport expander, SCANport adapters, Main Control Board or complete drive as required. 2. If an adapter was intentionally disconnected and the [Logic Mask] bit for that adapter is set to "1", this fault will occur. To guard against this fault occurring, set the [Logic Mask] bit for the adapter to "0." 3. Check HIM connection for proper seating.
Shear Pin Fault 63	Programmed [Current Limit] amps has been exceeded and [Shear Pin Fault] is enabled.	Check load requirements and [Current Limit] setting.
Step Logic Flt 69	<ol style="list-style-type: none"> 1. [SLx Step Jump] is set to "End Fault." 2. [Encoder Counts] has reached the endpoint of ± 32767. 	<ol style="list-style-type: none"> 1. Check conditions that caused [SLx Step Jump] to occur. 2. Zero [Encoder Counts]. Change [Enc Count Scale].

Name & Fault #	Description	Action
Sync Loss Fault 67	Not functional at time of printing.	
Temp Sense Open 55	Heat sink thermistor is open or malfunctioning.	Check thermistor and connections.
Undervolt Fault 04	DC Bus voltage fell below the minimum value (388V DC at 460V AC input). [Line Loss Fault] and [Low Bus Fault] set to "enabled."	Monitor the incoming AC line for low voltage or line power interruption.
UV Short Fault 41	Excessive current has been detected between these two output terminals.	Check the motor and external wiring to the drive output terminals for a shorted condition.
UW Short Fault 42	Excessive current has been detected between these two output terminals.	Check the motor and external wiring to the drive output terminals for a shorted condition.
VW Short Fault 43	Excessive current has been detected between these two output terminals.	Check the motor and external wiring to the drive output terminals for a shorted condition.
Xsistr Desat Fit 47 <i>(Frame C & Above)</i>	One or more of the output transistors were operating in the active region instead of desaturation. This can be caused by excessive transistor current or insufficient base drive voltage.	Check for damaged output transistors. Replace output transistors, Power Driver Board or complete drive as needed.

Table 7.B
HIM Upload/Download Errors

Fault Name	Error Displayed	Probable Cause	Action
HIM -> Drive	ERROR 1	The HIM calculated a checksum for the file to be downloaded, then checked the EEPROM checksum of the download. The checksums did not match, indicating the file stored in the HIM is invalid and the download was not successful.	Upload a valid, uncorrupted file from the source drive and then repeat the download.
	ERROR 2	The number of parameters in the HIM file is different than the number of parameters in the drive file. The smaller of the two numbers is the number of parameters downloaded. The last downloaded parameter number is displayed.	Verify that the correct file is being downloaded to the correct drive, then press the Enter key. Manually reprogram parameters with numbers higher than the last number downloaded or whose values were incorrect.
	ERROR 3	The file in the HIM is for a different type of drive than the drive to which it is connected (i.e. 1336 PLUS file to 1336 IMPACT drive). Downloads can only occur between like drive types.	None - Download not allowed.
	ERROR 4	The value just transferred to the drive is an illegal value (out of range, too high or too low) for the parameter.	Record the parameter number displayed and then press Enter to continue the download. Manually reprogram all recorded parameters after the download is complete.
	ERROR 5	The download was attempted while the drive was running.	Stop the drive and repeat the download attempt.
	ERROR 6	The file in the HIM is for a different HP or voltage drive than the drive to which it is connected (i.e. 1336 PLUS 10 HP file to 1336 PLUS 15 HP drive).	If the download is desired, press the Enter key. If not desired, press the ESCape key to end the download
Drive -> HIM	ERROR 1	The HIM calculated a checksum as the file was uploaded and compared it to the HIM file checksum stored after the upload. The checksums did not match, indicating the upload was not successful and the HIM file is now corrupted.	Repeat the Upload.

Table 7.C
Fault Code Cross Reference

Fault #	Display Name	Reset/Run
02	Auxiliary Fault	Yes
03	Power Loss Fault	Yes
04	Undervolt Fault	Yes
05	Overvolt Fault	Yes
06	Motor Stall Fault	Yes
07	Overload Fault	Yes
08	Overtemp Fault	Yes
09	Open Pot Fault	No
10	Serial Fault	No
11	Op Error Fault	No
12	Overcurrent Flt	Yes
13	Ground Fault	No
14	Option Error	No
15	Motor Thermistor	No
16	Bipolar Dir Flt	No
17	C167 Watchdog	No
18	Hardware Trap	No
19	Precharge Fault	No
20	Load Loss Flt	No
22	DSP Reset Fault	Yes
23	Loop Overrn Flt	Yes
24	Motor Mode Flt	Yes
26	Power Mode Fault	Yes
27	DSP Comm Fault	No
28	DSP Timeout Fault	No
29	Hertz Err Fault	No
30	Hertz Sel Fault	No
31	DSP Queue Fault	No
32	EEprom Fault	No
33	Max Retries Fault	No
34	Prm Access Flt	No
35	Neg Slope Fault	No
36	Diag C Lim Flt	No
37	DSP Checksum	No
38	Phase U Fault	No
39	Phase V Fault	No
40	Phase W Fault	No
41	UV Short Fault	No
42	UW Short Fault	No
43	VW Short Fault	No
46	DSP Protected	No
47	Xsistr Desat Flt	No
48	Reprogram Fault	No
49	Input Phase Flt	No
50	Poles Calc Fault	No
51	Bgnd 10ms Over	Yes
52	Fgnd 10ms Over	Yes
53	EE Init Read	No
54	EE Init Value	No
55	Temp Sense Open	No

Fault #	Display Name	Reset/Run
56	Precharge Open	No
57	Ground Warning	No
58	Blwn Fuse Flt	No
60	Encoder Loss	No
61	Mult Prog Input	No
62	Ill Prog Input	No
63	Shear Pin Fault	No
64	Power Overload	No
65	Adptr Freq Err	No
66	EEprom Checksum	No
67	Sync Loss Fault	No
68	ROM or RAM Flt	No
69	Step Logic Flt	No

Note: Fault Numbers not listed are reserved for future use.

Alarms

[Table 7.D](#) presents a listing and description of the drive alarms. Alarm status can be viewed by selecting the [Drive Alarm 1/2] parameter. An active alarm will be indicated by its corresponding bit being set to high (1). Any high bit (1) can energize CR1-4 (if programmed).

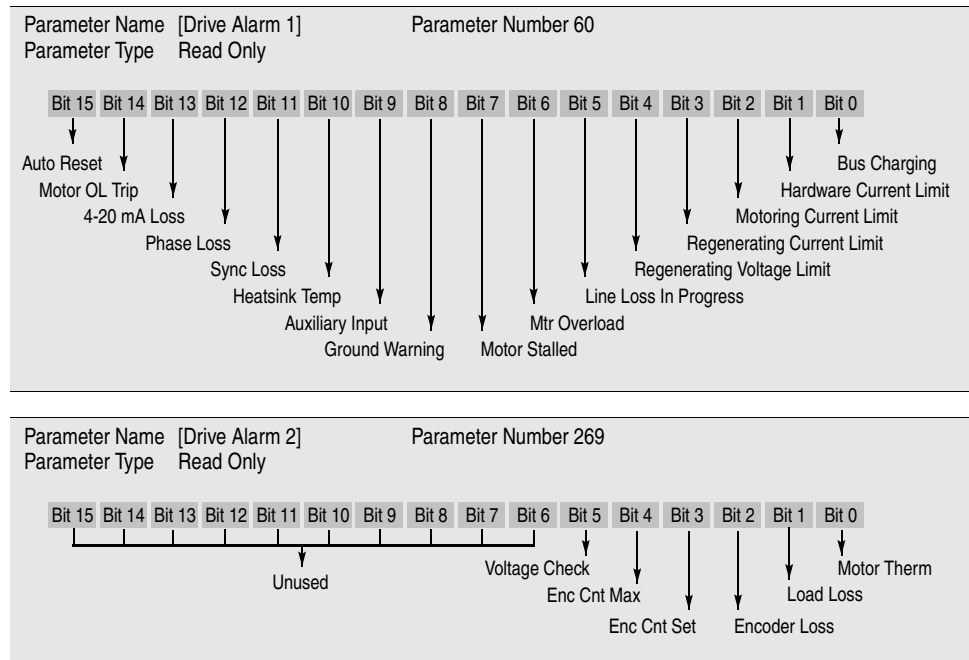

Table 7.D
Alarm Conditions

Alarm	Bit	Alarm Name	Description
[Drive Alarm 1]	0	Bus Charging	Precharge of DC bus capacitors is in progress.
	1	Hardware Current Limit	An alarm will be issued when 220% of drive rated current is reached.
	2	Motoring Current Limit	The value programmed for [Current Limit] has been exceeded while in the motoring mode.
	3	Regenerating Current Limit	An alarm will be issued when the value set for [Current Limit] has been exceeded while the motor is regenerating.
	4	Regenerating Voltage Limit	Bus limiting is active.
	5	Line Loss In Progress	An alarm will be issued when the AC incoming voltage drops below 20% of input or a 150 volt drop takes place.
	6	Mtr Overload	At the present value of output amps, a motor overload trip will eventually occur.
	7	Motor Stalled	Drive output frequency folds to 0 Hz and current limit is still active or voltage limit will not allow decel.
	8	Ground Warning	Ground current exceeds 2 amperes.
	9	Auxiliary Input	Input circuit is open.
	10	Heatsink Temp	Temperature of drive heatsink has exceeded its limit.
	11	Sync Loss	Synchronous motor not at synchronous speed.
	12	Phase Loss	The DC bus ripple has exceeded the level in [Phase Loss Level].
	13	4-20mA Loss	4-20mA signal lost.
	14	Motor OL Trip	This bit will be high when the motor overload function has integrated high enough to cause a motor overload fault. This bit is active regardless of the [Motor Overload] state (enabled/disabled).
	15	Auto Reset	Drive is attempting to reset a fault using [Reset/Run Tries] & [Reset/Run Time].

Table 7.E (continued)**Alarm Conditions**

Alarm	Bit	Alarm Name	Description
[Drive Alarm 2]	0	Motor Therm	The value at the thermistor terminals has been exceeded. This bit will be active only when [Motor Therm Flt] is enabled and an analog option board with thermistor input is installed.
	1	Load Loss	[Load Loss Detect] is set to "Enabled" and the drive output torque current was below [Load Loss Level] for a time period greater than [Load Loss time].
	2	Encoder Loss	Error has occurred in the encoder signals at TB3, terminals 31-36.
	3	Enc Cnt Set	[Encoder Counts] has reached the endpoint of ± 32767 .
	4	Enc Cnt Max	The value of [Encoder Counts] has exceeded [Max Enc Counts].
	5	Voltage Check	Voltage at drive output terminals is equal to, or greater than 10% of drive rated volts (i.e. 46V for 460V drive) when Start command is issued and flying start is disabled. Drive will not start until terminal voltage falls below 10% of drive rating or flying start is enabled.

Specifications and Supplemental Information



Specifications

Protection

	<u>200-240V Drive</u>	<u>380-480V Drive</u>	<u>500-600V Drive</u>
AC Input Overvoltage Trip:	285V AC	570V AC	690V AC
AC Input Undervoltage Trip:	138V AC	280V AC	343V AC
Bus Overvoltage Trip:	405V DC	810V DC	1013V DC
Bus Undervoltage Trip:	200V DC	400V DC	498V DC
Nominal Bus Voltage:	324V DC	648V DC	810V DC
Heat Sink Thermistor:	Monitored by microprocessor overtemp trip.		
Drive Overcurrent Trip			
Software Current Limit:	20 to 160% of VT rated current.		
Hardware Current Limit:	180 to 250% of VT rated current (dependent on drive rating).		
Instantaneous Current Limit:	220 to 300% of VT rated current (dependent on drive rating).		
Line transients:	up to 6000 volts peak per IEEE C62.41-1991.		
Control Logic Noise Immunity:	Showering arc transients up to 1500 volts peak ² .		
Power Ride-Thru:	15 milliseconds at full load.		
Logic Control Ride-Thru:	0.5 seconds minimum, 2 seconds typical.		
Ground Fault Trip:	Phase-to-ground on drive output.		
Short Circuit Trip:	Phase-to-phase on drive output.		

Environment

Altitude:	1000 m (3300 ft) max. without derating.
Ambient Operating Temperature	
IP00, Open:	0 to 50 degrees C (32 to 122 degrees F).
IP20, NEMA Type 1 Enclosed:	0 to 40 degrees C (32 to 104 degrees F).
IP54, NEMA Type 12 Enclosed:	0 to 40 degrees C (32 to 104 degrees F).
IP65, NEMA Type 4 Enclosed:	0 to 40 degrees C (32 to 104 degrees F).
Storage Temperature (all constructions):	-40 to 70 degrees C (-40 to 158 degrees F).
Atmosphere	Important: Drive must not be installed in an area where the ambient atmosphere contains volatile or corrosive gas, vapors or dust. If the drive is not going to be installed for a period of time, it must be stored in an area where it will not be exposed to a corrosive atmosphere.
Relative Humidity:	5 to 95% non-condensing.
Shock:	15G peak for 11ms duration (± 1.0 ms).
Vibration:	0.006 inches (0.152 mm) displacement, 1G peak.
Agency Certification:	

U.L. Listed CSA Certified	
Marked for all applicable directives ¹	
Emissions	EN 50081-1 EN 50081-2 EN 55011 Class A EN 55011 Class B EN 61800-3
Immunity	EN 50082-1 EN 50082-2 IEC 801-1, 2, 3, 4, 6, 8 per EN 50082-1, 2 EN 61800-3
Low Voltage	EN 60204-1 PREN 50178

¹ Note: Installation guidelines called out in *Appendix C* **must** be adhered to.

² Applied noise impulses may be counted in addition to the standard pulse train causing erroneously high [Pulse Freq] readings.

Electrical

Input Data

Voltage Tolerance:	-10% of minimum, +10% of maximum.
Frequency Tolerance:	47-63 Hz.
Input Phases:	Three-phase input provides full rating for all drives. Single-phase operation is possible for A & B Frame drives at a derating of 50%.

Displacement Power Factor

A1-A3 Frame Drives:	0.80 standard, 0.95 with optional inductor.
A4 Frame & Up Drives:	0.95 standard.

Efficiency: 97.5% at rated amps, nominal line volts.

Max. Short Circuit Current Rating: **Installations per U.S. NEC/UL/CSA**

Using Specified Fuses	200,000A
Using Specified HMCP Breakers	Per "Max. Short Circuit Amps" column in Table 2.A , specific to each rating.

Using Specified HMCP Breakers with Current Limiter Option	200,000A
---	----------

IEC Installations per IEC947

Using Specified 140 Devices	Per "Rated Service Short Circuit Capability" column in Table 2.A , specific to each rating.
-----------------------------	---

Control

Method:	Sine coded PWM with programmable carrier frequency. Ratings apply to all drives (refer to the <i>Derating Guidelines</i> on page A-5).
A & B Frame Drives	2-8 kHz. Drive rating based on 4 kHz (<i>see pg. 1-1 for frame info</i>).
C & D Frame Drives	2-6 kHz. Drive rating based on 4 kHz (<i>see pg. 1-1 for frame info</i>).
E Frame Drives & Up	2-6 kHz. Drive rating based on 2 kHz (<i>see pg. 1-1 for frame info</i>).
Output Voltage Range:	0 to rated voltage.
Output Frequency Range:	0 to 400 Hz.
Frequency Accuracy	
Digital Input:	Within $\pm 0.01\%$ of set output frequency.
Analog Input:	Within $\pm 0.4\%$ of maximum output frequency.
Selectable Motor Control:	Sensorless Vector with full tuning. Standard V/Hz with full custom capability.
Accel/Decel:	Two independently programmable accel and decel times. Each time may be programmed from 0 - 3600 seconds in 0.1 second increments ¹ .
Intermittent Overload:	Constant Torque - 150% of rated output for 1 minute. Variable Torque - 115% of rated output for 1 minute.
Current Limit Capability:	Proactive Current Limit programmable from 20 to 160% of rated output current. Independently programmable proportional and integral gain.
Inverse Time Overload Cap.	Class 10 protection with speed sensitive response. Investigated by U.L. to comply with N.E.C. Article 430. U.L. File E59272, volume 4/6.

¹ 0.1 second increments using a HIM or 0.01 with serial communications.

Input/Output Ratings

Each 1336 PLUS II Drive has constant and variable torque capabilities. The listings on the next page provide input & output current and kVA ratings.

Note: Drive ratings are at nominal values. See *Derating Guidelines* on page [A-5](#).

Cat. No.	Constant Torque				Variable Torque				Variable Torque			
	Input kVA	Input Amps	Output kVA	Output Amps	Input kVA	Input Amps	Output kVA	Output Amps	Input kVA	Input Amps	Output kVA	Output Amps
200-240V DRIVES												
AQF05	1.1	2.8	0.9	2.3	1.1	2.8	0.9	2.3				
AQF07	1.4	3.5	1.2	3.0	1.4	3.5	1.2	3.0				
AQF10	2.2	5.4	1.8	4.5	2.2	5.4	1.8	4.5				
AQF15	2.9	7.3	2.4	6.0	2.9	7.3	2.4	6.0				
AQF20	3.9	9.7	3.2	8.0	3.9	9.7	3.2	8.0				
AQF30	5.7	14.3	4.8	12	5.7	14.3	4.8	12				
AQF50	8.5	21.3	7.2	18	8.5	21.3	7.2	18				
AQF75	9.0	22.6	8.8	22	9.0	22.6	8.8	22				
A007	8-10	23	8.8	22	10	23	8.8	22				
A010	12-14	35	14	34	14	35	14	34				
A015	17-20	49	19	48	20	49	19	48				
A020	22-26	63	26	65	26	63	26	65				
A025	26-31	75	31	77	31	75	31	77				
A030	27-33	79	32	80	33	79	32	80				
A040	41-49	119	48	120	49	119	48	120				
A050	52-62	149	60	150	62	149	60	150				
A060	62-74	178	72	180	74	178	72	180				
A075	82-99	238	96	240	99	238	96	240				
A100	100-120	289	116	291	120	289	116	291				
A125	112-134	322	129	325	134	322	129	325				
380-480V DRIVES												
BRF05	0.9-1.0	1.3	0.9	1.1	1.1	1.4	1.0	1.2	0.9	1.4	1.0	1.33
BRF07	1.3-1.6	2.0	1.3	1.6	1.7	2.1	1.4	1.7	1.4	2.1	1.4	1.89
BRF10	1.7-2.1	2.6	1.7	2.1	2.2	2.8	1.8	2.3	1.8	2.8	1.8	2.55
BRF15	2.2-2.6	3.3	2.2	2.8	2.8	3.5	2.4	3.0	2.3	3.5	2.4	3.33
BRF20	3.0-3.7	4.6	3.0	3.8	3.8	4.8	3.2	4.0	3.2	4.8	3.2	4.44
BRF30	4.2-5.1	6.4	4.2	5.3	5.7	7.2	4.8	6.0	4.7	7.2	4.8	6.66
BRF50	6.6-8.0	10.0	6.7	8.4	8.5	10.7	7.2	9.0	7.0	10.7	7.2	9.99
BRF75	8.9-11.3	13.6	10.6	13.3	13.0	15.7	12.3	15.4	10.3	15.7	12.3	19.43
BRF100	10.8-13.6	16.4	12.8	16.1	18.6	22.4	17.5	22	14.7	22.4	17.5	22.00
BRF150	16.1-20.4	24.5	19.1	24	20.4	24.5	19.1	24	16.1	24.5	19.1	24.00
BRF200	18.0-23.0	28	22	27	23	28	22	27	18	28	22	27.75
B015	16-21	25	19	24.2	23	28	22	27	18	28	22	29.97
B020	21-26	32	25	31	29	35	27	34	23	35	27	37.74
B025	26-33	40	31	39	36	43	33	42	28	43	33	46.62
B030	30-38	46	36	45	41	49	38	48	32	49	38	53.28
BX040	40-50	61	47	59	50	61	47	59	40	61	47	66.60
B040	38-48	58	48	60	52	63	52	65	41	63	52	72.15
B050	48-60	73	60	75	62	75	61	77	49	75	61	83.25
BX060 ¹	62	75	61	77	62	75	61	77	62	75	61	85.47
B060	54-68	82	68	85	77	93	76	96	61	93	76	106.56
B075	69-87	105	84	106	99	119	96	120	78	119	96	133.20
B100	90-114	137	110	138	124	149	120	150	98	149	120	166.50
B125	113-143	172	138	173	148	178	143	180	117	178	143	199.80
BX150	148	178	143	180	148	178	143	180	148	178	143	199.80
B150	130-164	197	159	199	198	238	191	240	157	238	191	266.40
B200	172-217	261	210	263	241	290	233	292	191	290	233	324.12
B250	212-268	322	259	325	268	322	259	325	212	322	259	360.75
BP/BPR250	212-268	322	259	325	297	357	287	360	235	357	287	399.60
BX250	212-268	322	259	325	297	357	287	360	228	347	279	399.60
B300	235-297	357	287	360	350	421	339	425	261	397	319	471.75
BP/BPR300	235-297	357	287	360	350	421	339	425	277	421	339	471.75
B350	277-350	421	339	425	392	471	378	475	294	446	359	527.25
BP/BPR350	277-350	421	339	425	392	471	378	475	310	471	378	527.25
B400	310-392	471	387	475	433	521	418	525	326	496	398	582.75
BP/BPR400	310-392	471	378	475	438	527	424	532	347	527	424	532.05
B450	343-433	521	418	525	486	585	470	590	372	565	454	654.90
BP/BPR450	347-438	527	424	532	438	527	424	532	347	527	424	532.00
B500	385-486	585	470	590	552	664	534	670	437	664	534	743.70
B600	437-552	664	534	670	552	664	534	670	437	664	534	743.70
500-600V DRIVES												
CWF10	2.1-2.5	2.4	2.1	2.0	2.5	2.4	2.1	2.0				
CWF20	4.2-5.0	4.8	4.2	4.0	5.0	4.8	4.2	4.0				
CWF30	6.2-7.5	7.2	6.2	6.0	7.5	7.2	6.2	6.0				
CWF50	8.3-10.0	9.6	8.3	8.0	10.0	9.6	8.3	8.0				
CWF75	9.0-11.0	10.0	10.0	10.0	11.0	10.0	10.0	10.0				
CWF100	11.0-13.0	12.0	12.0	12.0	13.0	12.0	12.0	12.0				
CWF150	17.0-20.0	19.0	19.0	19.0	20.0	19.0	19.0	19.0				
CWF200	21.0-26.0	25.0	24.0	24.0	26.0	25.0	24.0	24.0				
C025	27-32	31	30	30	32	31	30	30				
C030	31-37	36	35	35	37	36	35	35				
C040	38-45	44	45	45	45	44	45	45				
C050	48-57	55	57	57	57	55	57	57				
C060	52-62	60	62	62	62	60	62	62				
C075	73-88	84	85	85	88	84	85	85				
C100	94-112	108	109	109	112	108	109	109				
C125	118-142	137	137	138	142	137	137	138				
C150	144-173	167	167	168	173	167	167	168				
C200	217-261	251	251	252	261	251	251	252				
C250	244-293	282	283	284	293	282	283	284				
CX300	256-307	295	297	298	307	295	297	298				
C300	258-309	297	299	300	309	297	299	300				
C350	301-361	347	349	350	361	347	349	350				
CP/CPR350	301-361	347	349	350	361	347	349	350				
C400	343-412	397	398	400	412	397	398	400				
CP/CPR400	343-412	397	398	400	412	397	398	400				
C450	386-464	446	448	450	464	446	448	450				
C500	429-515	496	498	500	515	496	498	500				
C600	515-618	595	598	600	618	595	598	600				

¹ 480 Volts Only.

User Supplied Enclosures

1336 PLUS II drives installed in user supplied enclosures may be mounted within an enclosure or may be mounted to allow the heat sink to extend outside the enclosure. Use the information below in combination with the enclosure manufacturer's guidelines for sizing.

Cat No.	Base Derate Amps ¹	Derate Curve ^{2, 3}	Heat Dissipation Drive Watts ^{2, 3, 4}	Heat Sink Watts ²	Total Watts ²
200-240V DRIVES					
AQF05	2.3	Figure A	13	15	28
AQF07	3.0	Figure A	15	21	36
AQF10	4.5	Figure A	17	32	49
AQF15	6.0	Figure A	21	42	63
AQF20	8.0	Figure A	25	56	81
AQF30	12	Figure A	33	72	105
AQF50	18	Figure A	42	116	158
AQF75	22	Figure A	58	186	244
A007	27	No Derate	156	486	642
A010	34	Figure B	200	721	921
A015	48	Figure D	205	819	1024
A020	65	No Derate	210	933	1143
A025	77	No Derate	215	1110	1325
A030	80	No Derate	220	1110	1330
A040	120	Figure G	361	1708	2069
A050	150	Figure H	426	1944	2370
A060	180	Figure J	522	2664	3186
A075	240	Figure L	606	2769	3375
A100	291	Figure M	755	3700	4455
A125	325	Figure N	902	4100	5002
380-480V DRIVES					
BRF05	1.2	Figure A	12	9	21
BRF07	1.7	Figure A	13	15	28
BRF10	2.3	Figure A	15	20	35
BRF15	3.0	Figure A	16	27	43
BRF20	4.0	Figure A	19	36	55
BRF30	6.0	Figure A	23	54	77
BRF50	9.0	Figure A	29	84	113
BRF75	15.4	Figure A	58	186	244
BRF100	22.0	Figure A	68	232	300
BRF150	24.0	Figure A	88	332	420
BRF200	27.0	Figure A	96	356	452
B015	27	No Derate	117	486	603
B020	34	Figure B	140	628	768
B025	42	Figure C	141	720	861
B030	48	Figure D	141	820	961
BX040	59	Figure E	175	933	1108
B040	65	Figure E	175	933	1108
B050	77	Figure F	193	1110	1303
BX060	77	Figure F	193	1110	1303
B060	96	No Derate	361	1708	2069
B075	120	Figure G	361	1708	2069
B100	150	Figure H	426	1944	2370
B125	180	Figure J	522	2664	3186
BX150	180	Figure J	606	2769	3375
B150	240	Figure L	606	2769	3375
B200	292	Figure M	755	3700	4455
B250	325	Figure N	902	4100	5002
BP/BPR250 ⁶	322	Figure O	491	4658	5149
BX250	360	No Derate	902	4100	5002
B300 ⁵	425	No Derate	1005	4805	5810
BP/BPR300 ⁶	357	Figure P	619	5342	5961
B350 ⁵	475	No Derate	1055	5455	6510
BP/BPR350 ⁶	421	Figure Q	733	6039	6772
B400 ⁵	525	No Derate	1295	6175	7470
BP/BPR400 ⁶	471	Figure R	793	6329	7122
B450 ⁵	590	No Derate	1335	6875	8210
BP/BPR450 ⁶	527	Figure S	931	7000	7931
B500 ⁵	670	Figure T	1395	7525	8920
B600 ⁵	670	Figure T	1485	8767	10252
500-600V DRIVES					
CWF10	2.4	Figure U	25	29	54
CWF20	4.8	Figure U	29	57	86
CWF30	7.2	Figure U	32	87	119
CWF50	9.6	Figure U	35	117	152
CWF75	10	Figure U	38	148	186
CWF100	12	Figure U	41	177	218
CWF150	19	Figure U	52	286	338
CWF200	24	Figure U	60	358	418
C025	30	No Derate	141	492	633
C030	35	No Derate	141	526	667
C040	45	No Derate	175	678	853
C050	57	No Derate	193	899	1092
C060	62	No Derate	193	981	1174
C075	85	Figure G	361	1533	1894
C100	109	Figure J	426	1978	2404
C125	138	Figure K	522	2162	2683
C150	168	Figure V	606	2315	2921
C200	252	Figure W	755	3065	3820
C250	284	Figure X	890	3625	4515
CX300	300	Figure Y	940	3990	4930
C300 ⁵	300	Figure AB & AC	926	5015	5941
C350 ⁵	350	Figure AB & AC	1000	5935	6935
CP/CPR350	350	Figure Z	580	6125	6705
C400 ⁵	400	Figure AB & AC	1430	7120	8550
CP/CPR400	400	Figure AA	711	7000	7711
C450 ⁵	450	Figure AB & AC	1465	8020	9485
C500 ⁵	500	Figure AB & AC	1500	8925	10425
C600 ⁵	600	Figure AB & AC	1610	10767	12377

1 Base Derate Amps are based on nominal voltage (240, 480 or 600V). If input voltage exceeds Drive Rating, Drive Output must be derated. Refer to [Figure AE](#).

2 Rating is at 4 kHz (2 kHz for 224-448 kW/300-600 HP, 500-600V). If carrier frequencies above 4 kHz are selected, drive rating must be derated. See [Figure A-AC](#).

3 Drive Ambient Temperature Rating is 40° C. If ambient exceeds 40° C, the drive must be derated. Refer to [Figure A-AC](#).

4 Drive Rating is based on altitudes of 1,000 m (3,000 ft) or less. If installed at higher altitude, drive must be derated. Refer to [Figure AD](#).

5 **Important:** Two (2) 725 CFM fans are required if an open type drive is mounted in a user supplied enclosure.

6 **Important:** 1336F-BPRxxx - two (2) 450 CFM fans are required if an open type drive is mounted in a user supplied enclosure.

Derating Guidelines

Drive ratings can be affected by a number of factors. If more than one factor exists, derating percentages must be multiplied. For example, if a 42 Amp drive (B025) running at 8 kHz is installed at a 2,000 m (6,600 ft.) altitude and has a 2% high input line voltage, the actual amp rating will be:

$$42 \times 94\% \text{ Altitude Derate} \times 96\% \text{ High Line Derate} = 37.9 \text{ Amps}$$

Ambient Temperature / Carrier Frequency

— Standard Rating for Enclosed Drive in 40°C Ambient & Open Drive in 50°C Ambient.
 — Derating Factor for Enclosed Drive in Ambient between 41°C & 50°C.

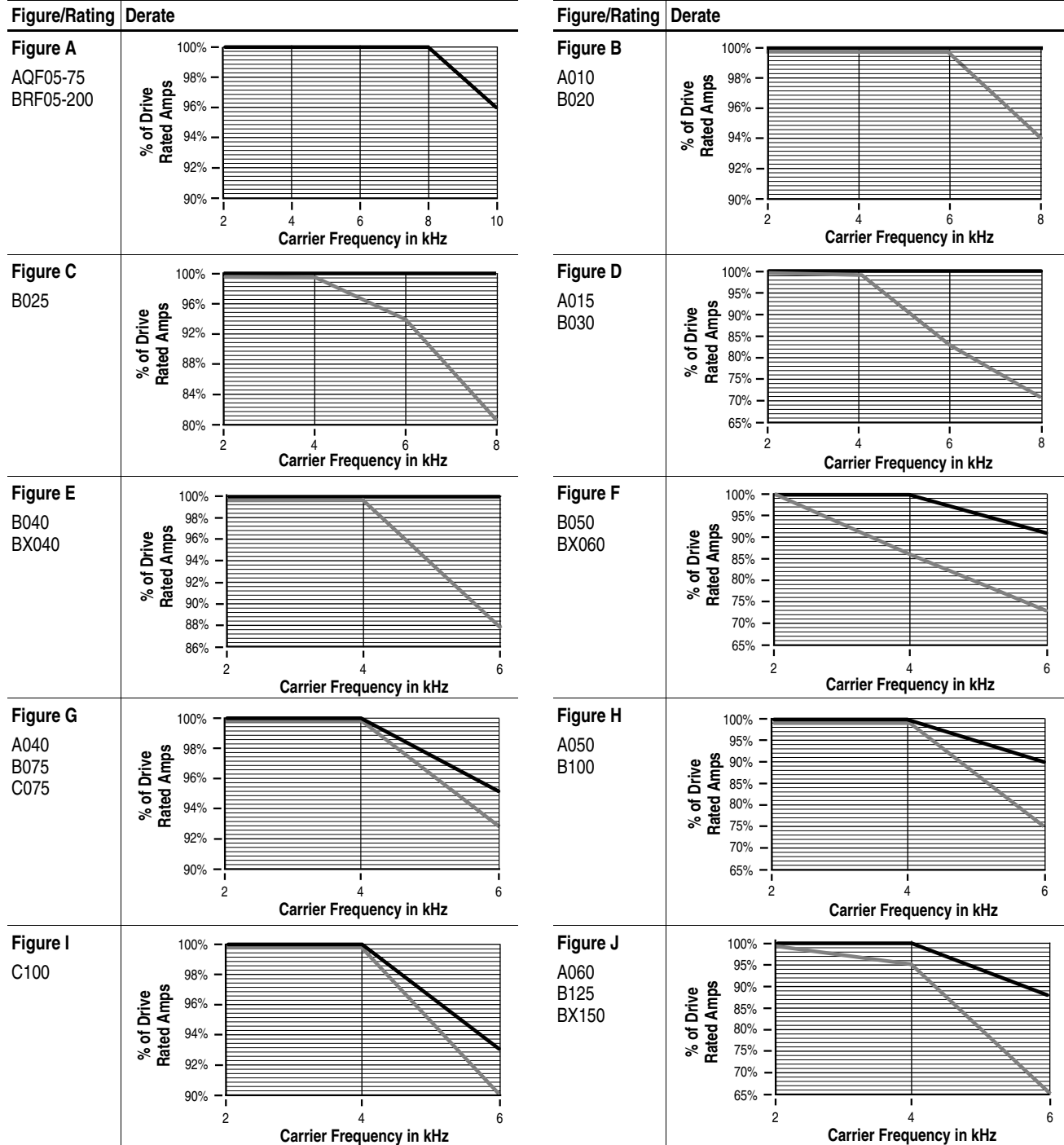

Standard Rating for Enclosed Drive in 40°C Ambient & Open Drive in 50°C Ambient.
 Derating Factor for Enclosed Drive in Ambient between 41°C & 50°C.

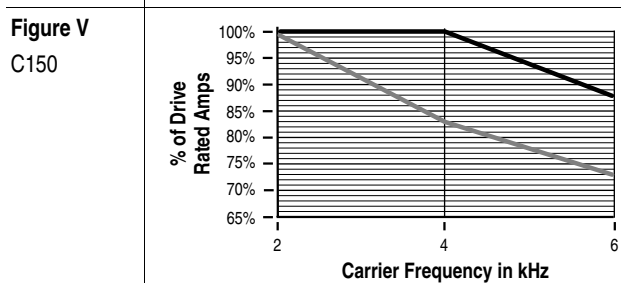
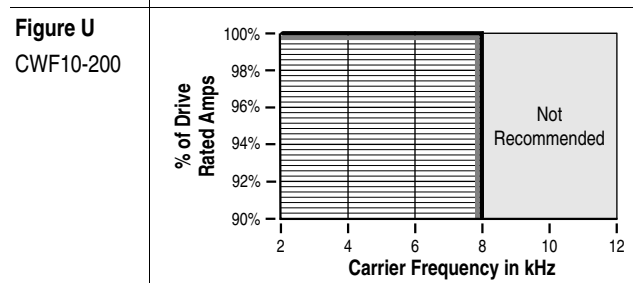
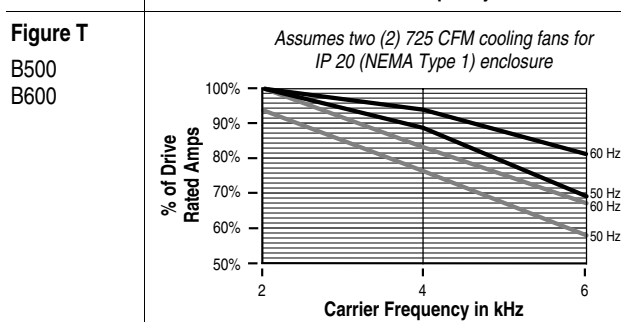
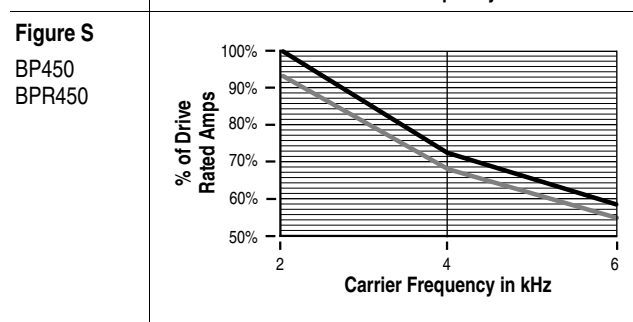
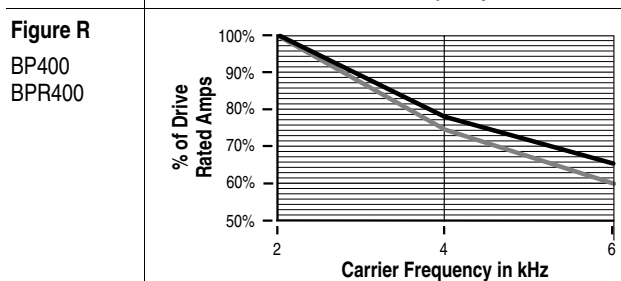
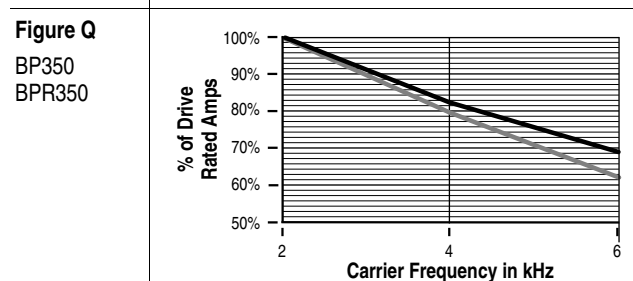
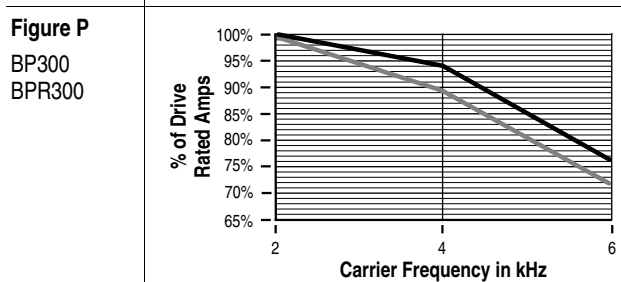
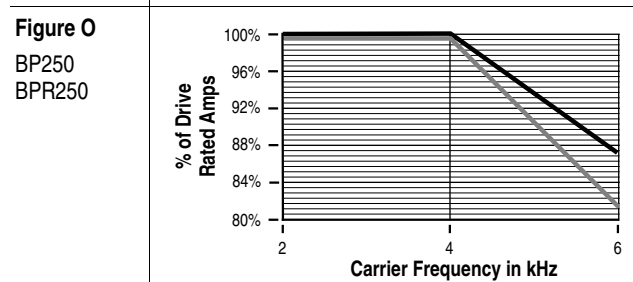
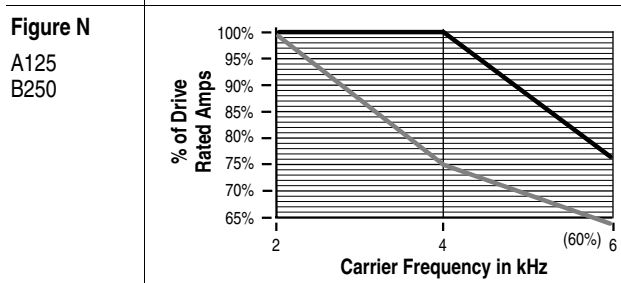
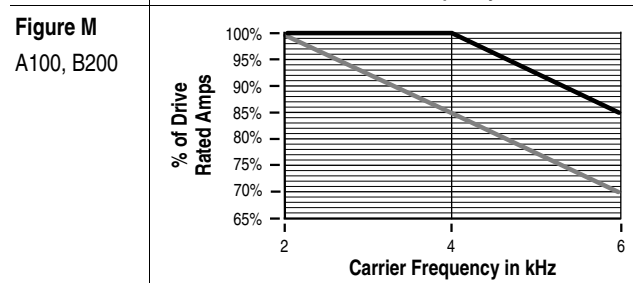
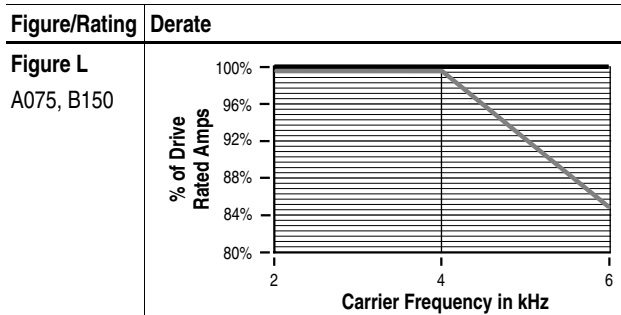
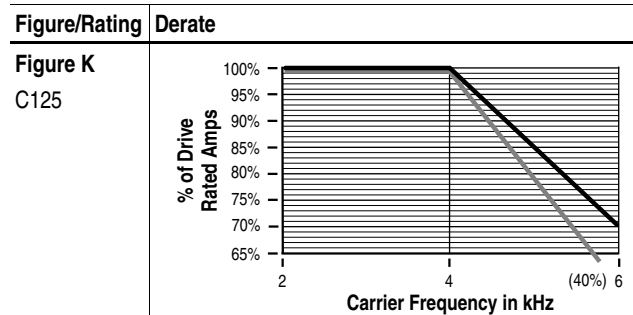

— Standard Rating for Enclosed Drive in 40°C Ambient & Open Drive in 50°C Ambient. — Derating Factor for Enclosed Drive in Ambient between 41°C & 50°C.

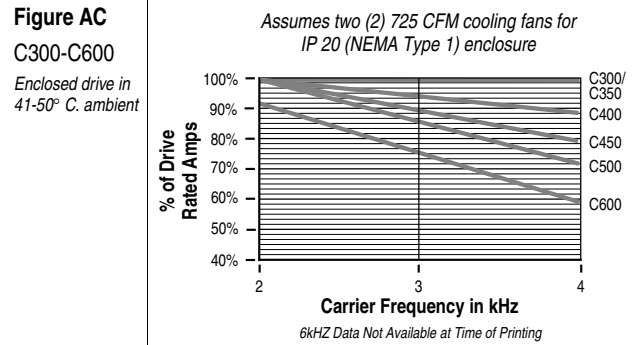
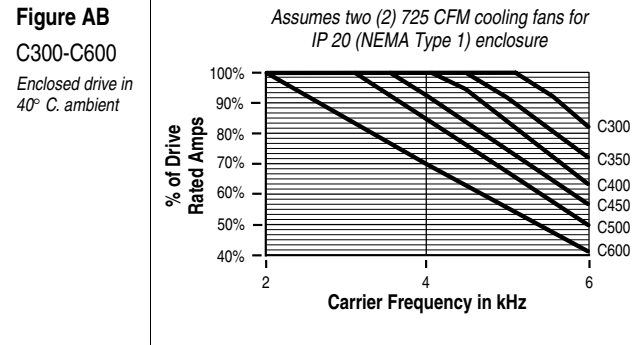
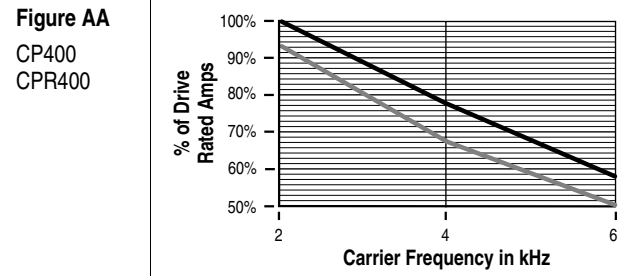
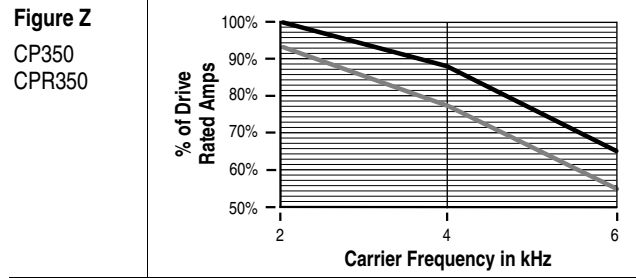
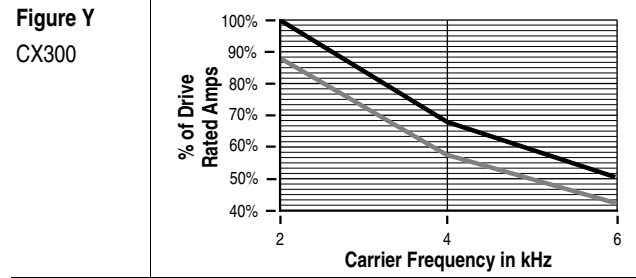
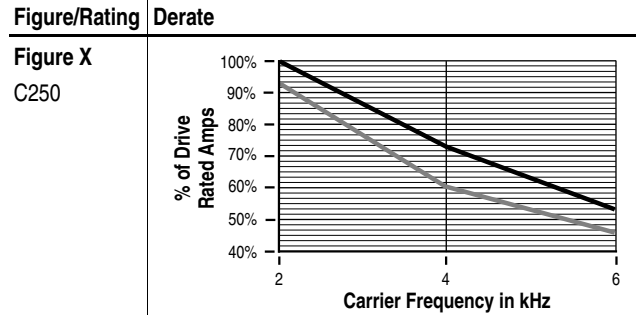
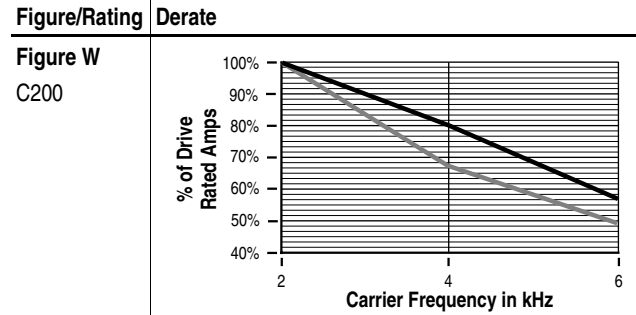

Altitude and High Input Voltage

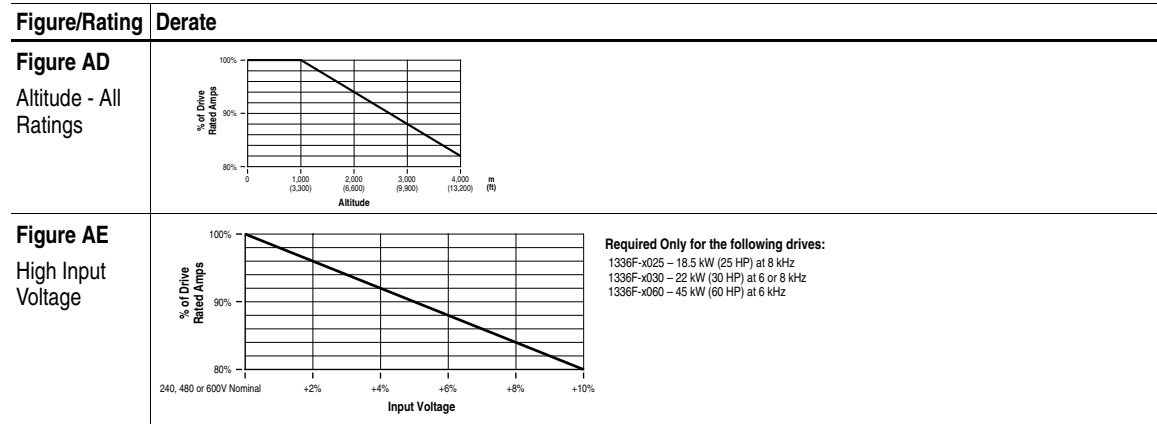

Parameter Cross Reference - By Number

No.	Name	Group	No.	Name	Group	No.	Name	Group
1	Output Voltage	Metering	100	Fault Mask	Masks	225	PI Preload	Process PI
2	% Output Curr	Metering	101	MOP Mask	Masks	226	Shear Pin Fault	Faults
3	% Output Power	Metering	102	Stop Owner	Owners	227	Adaptive I Lim	Setup
4	Last Fault	Metering	103	Direction Owner	Owners	228	L Loss Restart	Feature Select
5	Freq Select 1	Frequency Set + Setup	104	Start Owner	Owners	229	Freq Ref SqRoot	Frequency Set
6	Freq Select 2	Frequency Set	105	Jog Owner	Owners	230	Save MOP Ref	Frequency Set
7	Accel Time 1	Setup	106	Reference Owner	Owners	231	Hold Level Sel	Advanced Setup
8	Decel Time 1	Setup	107	Accel Owner	Owners	232	Current Lmt Sel	Setup
9	Control Select	Motor Control	108	Decel Owner	Owners	233	Anlg Out 0 Abs	Analog I/O
10	Stop Select 1	Advanced Setup + Setup	109	Fault Owner	Owners	234/235	Anlg Out 0 Lo/Hi	Analog I/O
11	Bus Limit En	Advanced Setup	110	MOP Owner	Owners	236	Drive Status 2	Diagnostics
12	DC Hold Time	Advanced Setup	111 -118	Data In A1-D2	Adapter I/O	237/238	Anlg In 0 Lo/Hi	Analog I/O
13	DC Hold Level	Advanced Setup	119 -126	Data Out A1-D2	Adapter I/O	239/240	Anlg In 1 Lo/Hi	Analog I/O
14	Run On Power Up	Feature Select	127	Process 1 Par	Process Display	241	Input Mode	Setup + Digital I/O
15	Reset/Run Time	Feature Select	128	Process 1 Scale	Process Display	242-247	TB3 Term Sel	Digital I/O
16	Minimum Freq	Advanced Setup + Setup	129-136	Process 1 Txt 1-8	Process Display	248/249	Anlg In 2 Lo/Hi	Analog I/O
17	Base Frequency	Motor Control	137	MOP Freq	Metering	250	Anlg Signal Loss	Analog I/O
18	Base Voltage	Motor Control	138-140	Anlg In 0-2 Freq	Metering	251	Cntrl Board Rev	Ratings
19	Maximum Freq	Advanced Setup + Setup	141	Motor Mode	Diagnostics	252/253	Slot A/B Option	Analog I/O
20	Maximum Voltage	Motor Control	142	Power Mode	Diagnostics	254	Pulse Freq	Metering
22	MOP Increment	Frequency Set	143	Flt Motor Mode	Faults	255	Slip Adder	Encoder Feedback
23	Output Power	Metering	144	Flt Power Mode	Faults	256	Line Loss Mode	Feature Select
24	Jog Frequency	Frequency Set	145	Fault Frequency	Faults	264	Pulse In Scale	Freq. Set + Digital I/O
25	Anlg Out 0 Sel	Analog I/O	146	Fault Status 1	Faults	267	Dig At Temp	Digital I/O
26	Stop Mode Used	Diagnostics	147	Rated Volts	Ratings	268	Motor Therm Fit	Faults
27-29	Preset Freq 1-3	Frequency Set	148	Rated CT Amps	Ratings	269	Drive Alarm 2	Diagnostics
30	Accel Time 2	Advanced Setup	149	Rated CT kW	Ratings	270	Latched Alarms 2	Diagnostics
31	Decel Time 2	Advanced Setup	150	4-20mA Loss Sel	Analog I/O	271	Alarm Mask 2	Masks
32-34	Skip Freq 1-3	Frequency Set	151	Maximum Speed	Encoder Feedback	272	Meas. Volts	Diagnostics
35	Skip Freq Band	Frequency Set	152	Encoder Type	Encoder Feedback	274	Anlg Out 1 Sel	Analog I/O
36	Current Limit	Setup	153	Motor Poles	Encoder Feedback	275	Anlg Out 1 Lo	Analog I/O
37	Overload Mode	Setup	154	Anlg Out 0 Offst	Analog I/O	276	Anlg Out 1 Hi	Analog I/O
38	Overload Amps	Setup	155	Flying Start En	Feature Select	277	Anlg Out 1 Abs	Analog I/O
39	Flt Clear Mode	Faults	156	FStart Forward	Feature Select	278	Anlg Out 1 Offst	Analog I/O
40	Line Loss Fault	Faults	157	FStart Reverse	Feature Select	279	Elapsed Run Time	Metering
41	Motor Type	Advanced Setup	158	CR1 Out Select	Digital I/O	280	Pulse Out Select	Digital I/O
42	Slip @ F.L.A.	Feature Select	159	Dig Out Freq	Digital I/O	281	Pulse Out Scale	Digital I/O
43	Dwell Frequency	Feature Select	160	Dig Out Current	Digital I/O	282	Enc Count Scale	Encoder Feedback
44	Dwell Time	Feature Select	161	Dig Out Torque	Digital I/O	283	Encoder Counts	Encoder Feedback
45	PWM Frequency	Advanced Setup	162	Torque Current	Metering	284	Encoder Loss Sel	Encoder Feedback
46	Encoder PPR	Freq. Set + Enc. Fdbk.	163	Flux Current	Metering	286	Fault Status 2	Faults
47	Language	Feature Select	164	Speed KP	Encoder Feedback	287	Fault Alarms 2	Faults
48	Start Boost	Motor Control	165	Speed KI	Encoder Feedback	288	Bus Regulation	Feature Select
49	Break Frequency	Motor Control	166	Speed Error	Encoder Feedback	290	Load Loss Detect	Feature Select
50	Break Voltage	Motor Control	167	Speed Integral	Encoder Feedback	291	Load Loss Level	Feature Select
51	Clear Fault	Faults	168	Speed Adder	Encoder Feedback	292	Load Loss Time	Feature Select
52	Stop Select 2	Advanced Setup	169	Boost Slope	Motor Control	293	PI Max Error	Digital I/O
53	DC Bus Voltage	Metering	170	Rated Amps	Ratings	303	Current Limit En	Setup
54	Output Current	Metering	171	Rated kW	Ratings	304	Traverse Dec	Feature Select
55	Input Status	Digital I/O + Diagnostics	172	EEPROM Cksum	Diagnostics	305	Traverse Mask	Masks
56	S Curve Time	Feature Select	173	Fault Alarms 1	Faults	306	Traverse Owner	Owners
57	S Curve Enable	Feature Select	174-176	CR2-4 Out Select	Digital I/O	307	Sync Time	Advanced Setup
58	Common Bus	Advanced Setup	177	Motor NP RPM	Setup + Enc. Fdbk.	308	Sync Mask	Masks
59	Drive Status 1	Diagnostics	178	Motor NP Hertz	Setup + Enc. Fdbk.	309	Sync Owner	Owners
60	Drive Alarm 1	Diagnostics	179	Local Owner	Owners	310	Sync Loss Sel	Motor Control
61	Drive Type	Ratings	180	Process 2 Par	Process Display	311	Sync Loss Gain	Motor Control
62	Freq Source	Diagnostics	181	Process 2 Scale	Process Display	312	Sync Loss Time	Motor Control
63	Encoder Freq	Metering + Enc. Fdbk.	182-189	Process 2 Txt 1-8	Process Display	313	Sync Loss Comp	Motor Control
64	Set Defaults	Diagnostics	190	Motor NP Volts	Setup	314	Braking Chopper	Advanced Setup
65	Freq Command	Metering + Diagnostics	191	Motor NP Amps	Setup	315	Alt Type 2 Crnd	Adapter I/O
66	Output Freq	Metering	192	Flux Amps Ref	Motor Control	316	Application Sts	Diagnostics
67	Output Pulses	Diagnostics	193	KP Amps	Advanced Setup	317	Run/Accel Volts	Motor Control
69	Drive Direction	Diagnostics	194	IR Drop Volts	Motor Control	319	Speed Brake En	Advanced Setup
70	Heatsink Temp	Metering + Diagnostics	195	Slip Comp Gain	Feature Select	320	Line Loss Volts	Feature Select
71	Firmware Ver.	Ratings	198	Rated VT Amps	Ratings	321	Loss Recover	Feature Select
72	Current Angle	Diagnostics	199	Rated VT kW	Ratings	322	Ride Thru Volts	Feature Select
73-76	Preset Freq 4-7	Frequency Set	200	Flux Up Time	Motor Control	323	Min Bus Volts	Feature Select
77	Speed Control	Feature Select + Process PI + Encoder Feedback.	201	Motor OL Fault	Faults	324	Stability Gain	Motor Control
78	Traverse Inc	Feature Select	202	Motor OL Count	Metering	325	Bus Reg Level	Feature Select
79	Max Traverse	Feature Select	203	VT Scaling	Setup		Max Bus Volts	Feature Select
80	P Jump	Feature Select	204	Ground Warning	Faults	326	Remote CR Output	Digital I/O
81	Blwn Fuse Flt	Faults	205	Latched Alarms 1	Diagnostics	327	At Time	Digital I/O
82	Cur Lim Trip En	Faults	206	Alarm Mask 1	Masks	328	Max Enc Counts	Encoder Feedback
83	Run Boost	Motor Control	207	Fault Data	Faults	329	Bidir In Offset	Linear List
84	Power OL Count	Metering	212	DC Bus Memory	Diagnostics	330	Phase Loss Mode	Faults
85	Reset/Run Tries	Feature Select	213	PI Config	Process PI	331	Phase Loss Level	Faults
86-89	Fault Buffer 0-3	Faults	214	PI Status	Process PI	332	Precharge Fault	Faults
90	Analog Trim En	Analog I/O	215	PI Ref Select	Process PI	333	PWM Comp Time	Motor Control
91	Low Bus Fault	Faults	216	PI Fdbk Select	Process PI	334	Break Freq/PWM	Motor Control
92	Logic Mask	Masks	217	PI Reference	Process PI	335-371	SLx Logic Step	Step Logic
93	Local Mask	Masks	218	PI Feedback	Process PI	336-372	SLx Logic Jump	Step Logic
94	Direction Mask	Masks	219	PI Error	Process PI	337-373	SLx Step Jump	Step Logic
95	Start Mask	Masks	220	PI Output	Process PI	338-374	SLx Step Setting	Step Logic
96	Jog Mask	Masks	221	KI Process	Process PI	339-375	SLx Time	Step Logic
97	Reference Mask	Masks	222	KP Process	Process PI	340-376	SLx Encoder Cnts	Step Logic
98	Accel Mask	Masks	223	PI Neg Limit	Process PI	377	Current Step	Step Logic
99	Decel Mask	Masks	224	PI Pos Limit	Process PI	379	Motor OL Ret	Faults

Parameter Cross Reference - By Name

Name	No.	Group	Name	No.	Group	Name	No.	Group
% Output Curr	2	Metering	Fault Alarms 2	287	Faults	PI Feedback	218	Process PI
% Output Power	3	Metering	Fault Buffer 0-3	86-89	Faults	PI Max Error	293	Digital I/O
4-20mA Loss Sel	150	Analog I/O	Fault Data	207	Faults	PI Neg Limit	223	Process PI
Accel Mask	98	Masks	Fault Frequency	145	Faults	PI Output	220	Process PI
Accel Owner	107	Owners	Fault Mask	100	Masks	PI Pos Limit	224	Process PI
Accel Time 1	7	Setup	Fault Owner	109	Owners	PI Preload	225	Process PI
Accel Time 2	30	Advanced Setup	Fault Status 1	146	Faults	PI Ref Select	215	Process PI
Adaptive I Lim	227	Setup	Fault Status 2	286	Faults	PI Reference	217	Process PI
Alarm Mask 1, 2	206, 271	Masks	Firmware Ver.	71	Ratings	PI Status	214	Process PI
Alt Type 2 Cmd	315	Adapter I/O	Flt Clear Mode	39	Faults	Power Mode	142	Diagnostics
Analog Trim En	90	Analog I/O	Flt Motor Mode	143	Faults	Power OL Count	84	Metering
Anlg In 0 Freq	138-140	Metering	Flt Power Mode	144	Faults	Precharge Fault	332	Faults
Anlg In 0 Hi	238-249	Analog I/O	Flux Amps Ref	192	Motor Control	Preset Freq 1-3	27-29	Frequency Set
Anlg In 0 Lo	237-248	Analog I/O	Flux Current	163	Metering	Preset Freq 4-7	73-76	Frequency Set
Anlg In 1 Freq	138-140	Metering	Flux Up Time	200	Motor Control	Process 1 Par	127	Process Display
Anlg In 1 Hi	238-249	Analog I/O	Flying Start En	155	Feature Select	Process 1 Scale	128	Process Display
Anlg In 1 Lo	237-248	Analog I/O	Freq Command	65	Metering + Diagnostics	Process 1 Txt 1-8	129-136	Process Display
Anlg In 2 Freq	138-140	Metering	Freq Ref SqRoot	229	Frequency Set	Process 2 Par	180	Process Display
Anlg In 2 Hi	238-249	Analog I/O	Freq Select 1	5	Frequency Set + Setup	Process 2 Scale	181	Process Display
Anlg In 2 Lo	237-248	Analog I/O	Freq Select 2	6	Frequency Set	Process 2 Txt 1-8	182-189	Process Display
Anlg Out 0 Abs	233	Analog I/O	Freq Source	62	Diagnostics	Pulse Freq	254	Metering
Anlg Out 0 Hi	235	Analog I/O	FStart Forward	156	Feature Select	Pulse In Scale	264	Freq. Set + Digital I/O
Anlg Out 0 Lo	234	Analog I/O	FStart Reverse	157	Feature Select	Pulse Out Scale	281	Digital I/O
Anlg Out 0 Offst	154	Analog I/O	Ground Warning	204	Faults	Pulse Out Select	280	Digital I/O
Anlg Out 0 Sel	25	Analog I/O	Heatsink Temp	70	Metering + Diagnostics	PWM Comp Time	333	Motor Control
Anlg Out 1 Abs	277	Analog I/O	Hold Level Sel	231	Advanced Setup	PWM Frequency Sel	45	Advanced Setup
Anlg Out 1 Hi	276	Analog I/O	Input Mode	241	Setup + Digital I/O	Rated Amps	170	Ratings
Anlg Out 1 Lo	275	Analog I/O	Input Status	55	Digital I/O + Diagnostics	Rated CT Amps	148	Ratings
Anlg Out 1 Offst	278	Analog I/O	IR Drop Volts	194	Motor Control	Rated CT kW	149	Ratings
Anlg Out 1 Sel	274	Analog I/O	Jog Frequency	24	Frequency Set	Rated kW	171	Ratings
Anlg Signal Loss	250	Analog I/O	Jog Mask	96	Masks	Rated Volts	147	Ratings
Application Sts	316	Diagnostics	Jog Owner	105	Owners	Rated VT Amps	198	Ratings
At Time	327	Digital I/O	KI Process	221	Process PI	Rated VT kW	199	Ratings
Base Frequency	17	Motor Control	KP Amps	193	Advanced Setup	Reference Mask	97	Masks
Base Voltage	18	Motor Control	KP Process	222	Process PI	Reference Owner	106	Owners
Bidir In Offset	329	Linear List	Language	47	Feature Select	Remote CR Output	326	Digital I/O
Blwn Fuse Flt	81	Faults	Last Fault	4	Metering	Reset/Run Time	15	Feature Select
Boost Slope	169	Motor Control	Latched Alarms 1	205	Diagnostics	Reset/Run Tries	85	Feature Select
Braking Chopper	314	Advanced Setup	Latched Alarms 2	270	Diagnostics	Ride Thru Volts	322	Feature Select
Break Freq	334	Motor Control	Line Loss Volts	320	Feature Select	Run/Accel Volts	317	Motor Control
Break Frequency	49	Motor Control	Line Loss Fault	40	Faults	Run Boost	83	Motor Control
Break Voltage	50	Motor Control	Line Loss Mode	256	Feature Select	Run On Power Up	14	Feature Select
Bus Limit En	11	Advanced Setup	LLoss Restart	228	Feature Select	S Curve Enable	57	Feature Select
Bus Reg Level	325	Feature Select	Load Loss Detect	290	Feature Select	S Curve Time	56	Feature Select
Bus Regulation	288	Feature Select	Load Loss Level	291	Feature Select	Save MOP Ref	230	Frequency Set
Clear Fault	51	Faults	Load Loss Time	292	Feature Select	Set Defaults	64	Diagnostics
Cntrl Board Rev	251	Ratings	Local Mask	93	Masks	Shear Pin Fault	226	Faults
Common Bus	58	Advanced Setup	Local Owner	179	Owners	Skip Freq 1-3	32-34	Frequency Set
Control Select	9	Motor Control	Logic Mask	92	Masks	Skip Freq Band	35	Frequency Set
CR1 Out Select	158	Digital I/O	Loss Recover	321	Feature Select	SLx Encoder Cnts	340-376	Step Logic
CR2-4 Out Select	174-176	Digital I/O	Low Bus Fault	91	Faults	SLx Logic Jump	336-372	Step Logic
Cur Lim Trip En	82	Faults	Max Bus Volts	325	Feature Select	SLx Logic Step	335-371	Step Logic
Current Angle	72	Diagnostics	Max Enc Counts	328	Encoder Feedback	SLx Step Jump	337-373	Step Logic
Current Limit	36	Setup	Max Traverse	79	Feature Select	SLx Step Setting	338-374	Step Logic
Current Limit En	303	Setup	Maximum Freq	19	Advanced Setup + Setup	SLx Time	339-375	Step Logic
Current Lmt Sel	232	Setup	Maximum Speed	151	Encoder Feedback	Slip Adder	255	Encoder Feedback
Current Step	377	Step Logic	Maximum Voltage	20	Motor Control	Slip @ F.L.A.	42	Feature Select
Data In A1-D2	111-118	Adapter I/O	Meas. Volts	272	Diagnostics	Slip Comp Gain	195	Feature Select
Data Out A1-D2	119126	Adapter I/O	Min Bus Volts	323	Feature Select	Slot A-B Option	252-253	Analog I/O
DC Bus Memory	212	Diagnostics	Minimum Freq	16	Advanced Setup + Setup	Speed Adder	168	Encoder Feedback
DC Bus Voltage	53	Metering	MOP Freq	137	Metering	Speed Brake En	319	Advanced Setup
DC Hold Level	13	Advanced Setup	MOP Increment	22	Frequency Set	Speed Control	77	Feature Select + Process PI + Encoder Feedback
DC Hold Time	12	Advanced Setup	MOP Mask	101	Masks	Speed Error	166	Encoder Feedback
Decel Mask	99	Masks	MOP Owner	110	Owners	Speed Integral	167	Encoder Feedback
Decel Owner	108	Owners	Motor Mode	141	Diagnostics	Speed KI	165	Encoder Feedback
Decel Time 1	8	Setup	Motor NP Amps	191	Setup	Speed KP	164	Encoder Feedback
Decel Time 2	31	Advanced Setup	Motor NP Hertz	178	Setup + Enc. Fdbk.	Stability Gain	324	Motor Control
Dig At Temp	267	Digital I/O	Motor NP RPM	177	Setup + Enc. Fdbk.	Start Boost	48	Motor Control
Dig Out Current	160	Digital I/O	Motor NP Volts	190	Setup	Start Mask	95	Masks
Dig Out Freq	159	Digital I/O	Motor OL Count	202	Metering	Start Owner	104	Owners
Dig Out Torque	161	Digital I/O	Motor OL Fault	201	Faults	Stop Mode Used	26	Diagnostics
Direction Mask	94	Masks	Motor OL Ret	379	Faults	Stop Owner	102	Owners
Direction Owner	103	Owners	Motor Poles	153	Encoder Feedback	Stop Select 1	10	Advanced Setup + Setup
Drive Alarm 1, 2	60, 269	Diagnostics	Motor Therm Flt	268	Faults	Stop Select 2	52	Advanced Setup
Drive Direction	69	Diagnostics	Motor Type	41	Advanced Setup	Sync Loss Comp	313	Motor Control
Drive Status 1, 2	59, 236	Diagnostics	Output Current	54	Metering	Sync Loss Gain	311	Motor Control
Drive Type	61	Ratings	Output Freq	66	Metering	Sync Loss Sel	310	Motor Control
Dwell Frequency	43	Feature Select	Output Power	23	Metering	Sync Loss Time	312	Motor Control
Dwell Time	44	Feature Select	Output Pulses	67	Diagnostics	Sync Mask	308	Masks
EEPROM Cksum	172	Diagnostics	Output Voltage	1	Metering	Sync Owner	309	Owners
Elapsed Run Time	279	Metering	Overload Amps	37	Setup	Sync Time	307	Advanced Setup
Enc Count Scale	282	Encoder Feedback	Overload Mode	37	Setup	TB3 Term Sel	242-247	Digital I/O
Encoder Counts	283	Encoder Feedback	P Jump	80	Feature Select	Torque Current	162	Metering
Encoder Freq	63	Metering + Enc. Fdbk.	Phase Loss Level	331	Faults	Traverse Dec	304	Feature Select
Encoder Loss Sel	284	Encoder Feedback	Phase Loss Mode	330	Faults	Traverse Inc	78	Feature Select
Encoder PPR	46	Freq. Set + Enc. Fdbk.	PI Config	213	Process PI	Traverse Mask	305	Masks
Encoder Type	152	Encoder Feedback	PI Error	219	Process PI	Traverse Owner	306	Owners
Fault Alarms 1	173	Faults	PI Fdbk Select	216	Process PI	VT Scaling	203	Setup

HIM Character Map

Character	Decimal	Hex	Character	Decimal	Hex	Character	Decimal	Hex
	032	20		096	60	#	193	C1
	033	21		097	61	!	194	C2
	034	22		098	62	"	195	C3
	035	23		099	63	£	196	C4
	036	24		100	64	¥	197	C5
	037	25		101	65	¦	198	C6
	038	26		102	66	§	199	C7
	039	27		103	67	¨	200	C8
	040	28		104	68	©	201	C9
	041	29		105	69	ª	202	CA
	042	2A		106	6A	«	203	CB
	043	2B		107	6B	»	204	CC
	044	2C		108	6C	¼	205	CD
	045	2D		109	6D	½	206	CE
	046	2E		110	6E	¾	207	CF
	047	2F		111	6F	¸	208	D0
	048	30		112	70	¹	209	D1
	049	31		113	71	º	210	D2
	050	32		114	72	»	211	D3
	051	33		115	73	¼	212	D4
	052	34		116	74	½	213	D5
	053	35		117	75	¾	214	D6
	054	36		118	76	¸	215	D7
	055	37		119	77	¹	216	D8
	056	38		120	78	º	217	D9
	057	39		121	79	»	218	DA
	058	3A		122	7A	¼	219	DB
	059	3B		123	7B	½	220	DC
	060	3C		124	7C	¾	221	DD
	061	3D		125	7D	¸	222	DE
	062	3E		126	7E	¹	223	DF
	063	3F		127	7F	º	224	E0
	064	40		161	A1	»	225	E1
	065	41		162	A2	¼	226	E2
	066	42		163	A3	½	227	E3
	067	43		164	A4	¾	228	E4
	068	44		165	A5	¸	229	E5
	069	45		166	A6	¹	230	E6
	070	46		167	A7	º	231	E7
	071	47		168	A8	»	232	E8
	072	48		169	A9	¼	233	E9
	073	49		170	AA	½	234	EA
	074	4A		171	AB	¾	235	EB
	075	4B		172	AC	¸	236	EC
	076	4C		173	AD	¹	237	ED
	077	4D		174	AE	º	238	EE
	078	4E		175	AF	»	239	EF
	079	4F		176	B0	¼	240	F0
	080	50		177	B1	½	241	F1
	081	51		178	B2	¾	242	F2
	082	52		179	B3	¸	243	F3
	083	53		180	B4	¹	244	F4
	084	54		181	B5	º	245	F5
	085	55		182	B6	»	246	F6
	086	56		183	B7	¼	247	F7
	087	57		184	B8	½	248	F8
	088	58		185	B9	¾	249	F9
	089	59		186	BA	¸	250	FA
	090	5A		187	BB	¹	251	FB
	091	5B		188	BC	º	252	FC
	092	5C		189	BD	»	253	FD
	093	5D		190	BE	¼	255	FF
	094	5E		191	BF			
	095	5F		192	C0			

Communications Data Information Format

Drive Status Structure

This provides the drive status information that will be sent to the logic controllers input image table when the Communication Module is set to control the drive.

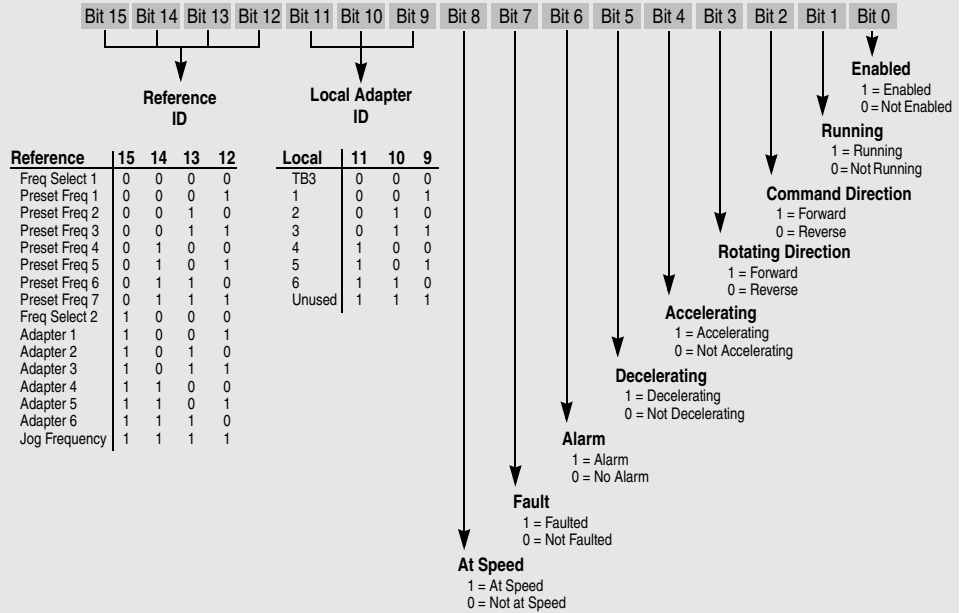

Logic Control Structure

This information provides the control logic information that is sent to the drive through the logic controllers output image table when the Communication Module is set to control the drive.

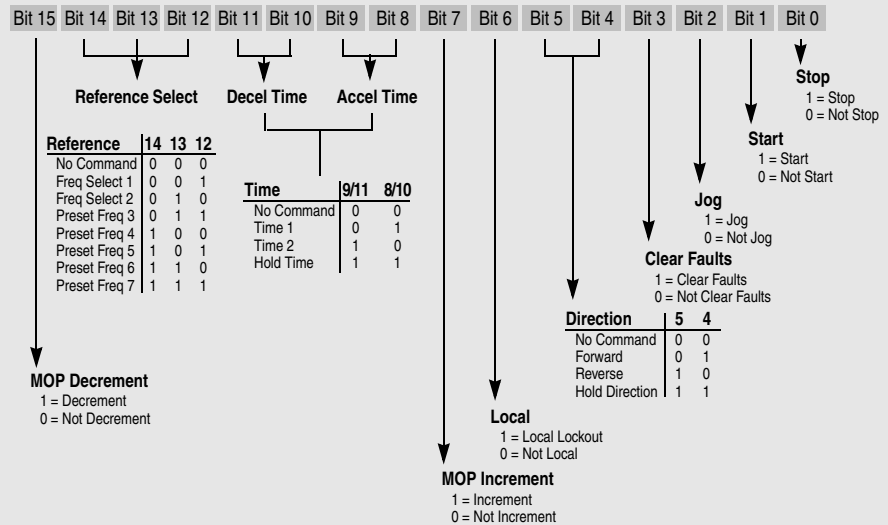

To allow convenient control of the Traverse and Sync functions through SCANport adapters, an alternate definition of the SCANport type 2 command can be selected. See also [Alt Type 2 Cmd].

Alternate Logic Control Structure

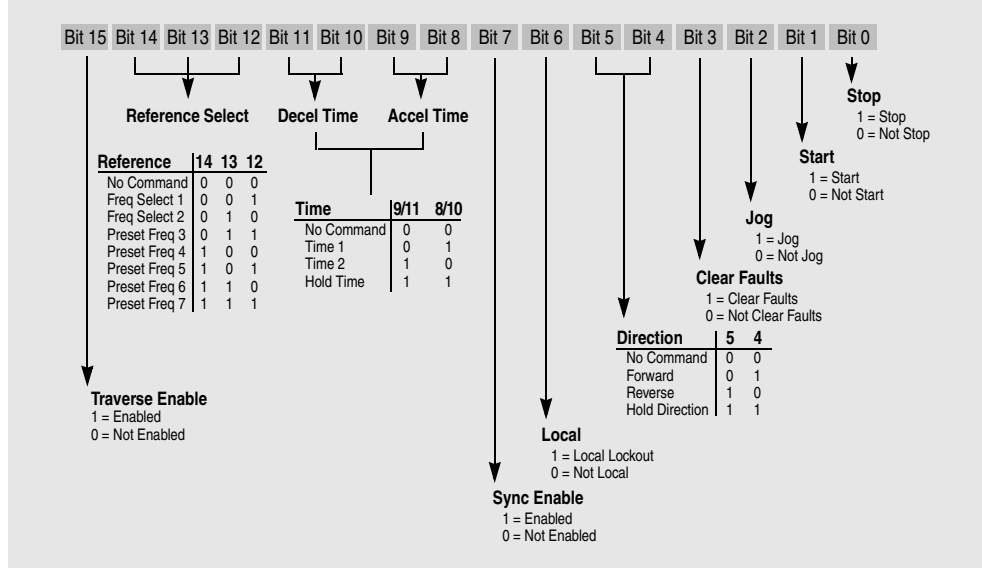

Typical Programmable Controller Communications Configurations

Important: If block transfers are programmed to continuously write data to the drive, the EEPROM will quickly exceed its life cycle and malfunction. The 1336 PLUS II does not use RAM to temporarily store parameter data, but rather stores the data immediately to the EEPROM. Since the EEPROM has a defined number of “write” cycles available, **continuous** block transfers **should not be programmed**.

Using Datalink A¹

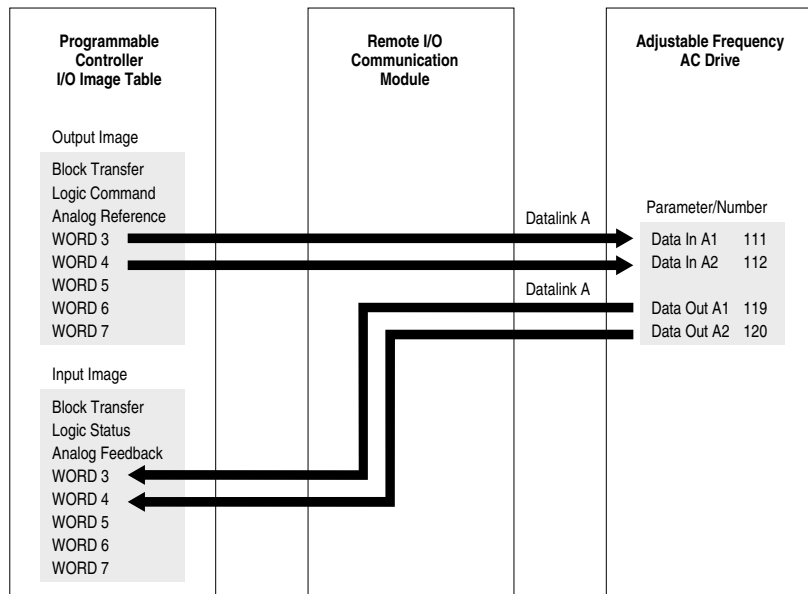

Without Block Transfer¹

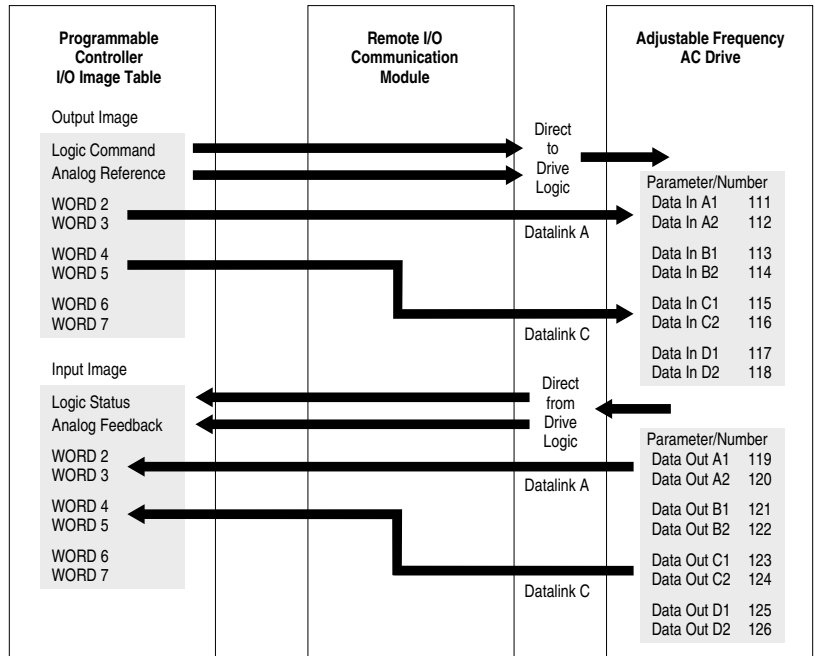

¹ Refer to the 1203 User Manual for further information.

Typical Serial Communications Configurations

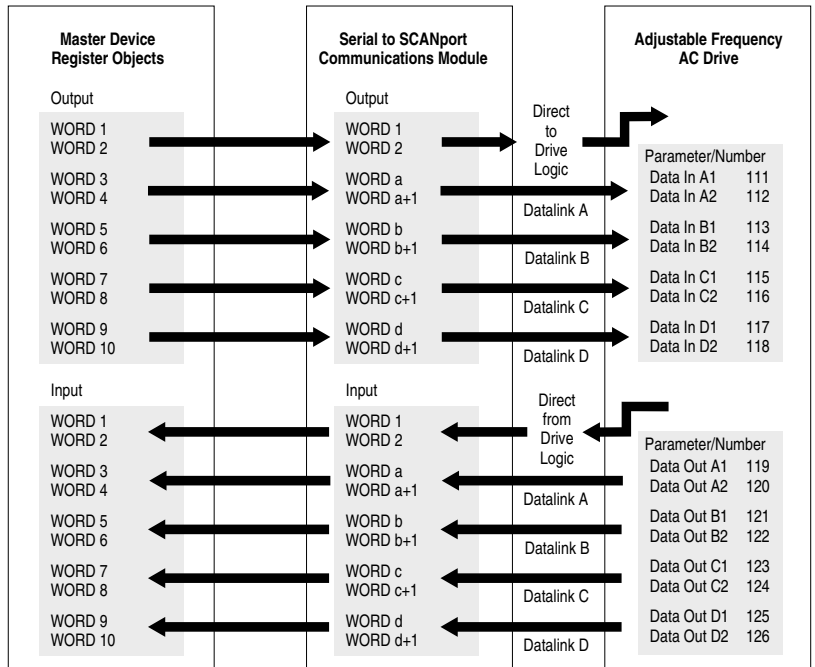

Encoder Interface Wiring

Option L4/L4E & L7E Wiring

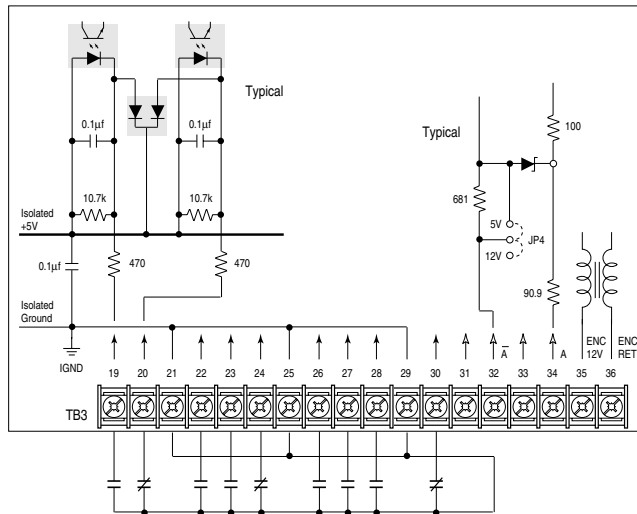

L4/L4E

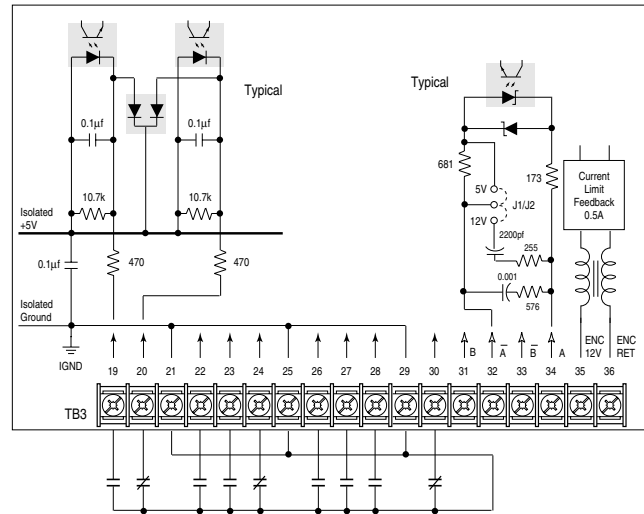

L7E

Option L4/L4E - Contact Closure Interface Board Requirements

Contacts must be capable of operating at 10 mA current levels without signal degradation. Reed type input devices are recommended.

The L4/L4E option is compatible with the following Allen-Bradley PLC® modules:

- 1771-OYL
- 1771-OZL

Option L7E - Contact Closure Interface Board Requirements

Circuits used with Option L7E must be capable of operating with low = true logic. In the low state, external circuits must be capable of a sinking current of approximately 10 mA to pull the terminal voltage low to 3.0V DC or less. In the high state, external circuits must let the terminal voltage rise to a voltage of 4.0-5.0V DC. Reed type input devices are recommended.

The L7E option is compatible with the following Allen-Bradley PLC® modules:

- 1771-OYL
- 1771-OZL

Option L5/L5E & L8E Wiring

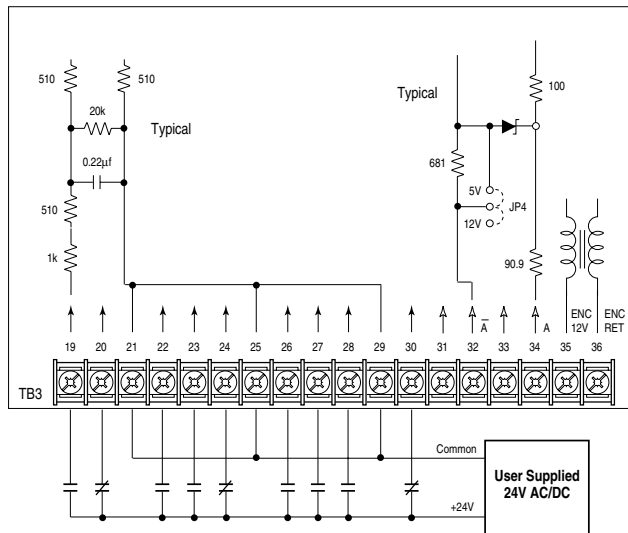

L5/L5E

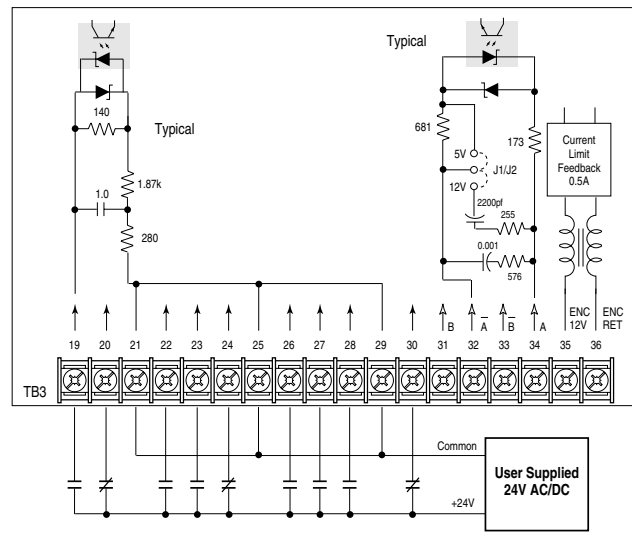

L8E

Option L5/L5E & L8E - 24V AC/DC Interface Board Requirements

Circuits used with these options must be capable of operating with high = true logic.

DC external circuits in the low state must generate a voltage of no more than 8V DC. Leakage current must be less than 1.5 mA into a 2.5k ohm load.

AC external circuits in the low state must generate a voltage of no more than 10V AC. Leakage current must be less than 2.5 mA into a 2.5k ohm load.

Both AC and DC external circuits in the high state must generate a voltage of +20 to +26 volts and source a current of approximately 10 mA for each input. These options are compatible with the following Allen-Bradley PLC modules:

- 1771-OB
- 1771-OBD
- 1771-OBN
- 1771-OQ
- 1771-OQ16
- 1771-OYL
- 1771-OZL
- 1771-OBB
- 1771-OB16

Option L6/L6E & L9E Wiring

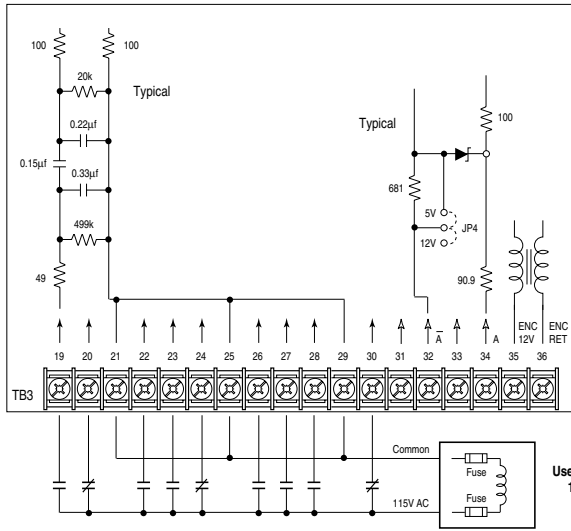

L6/L6E

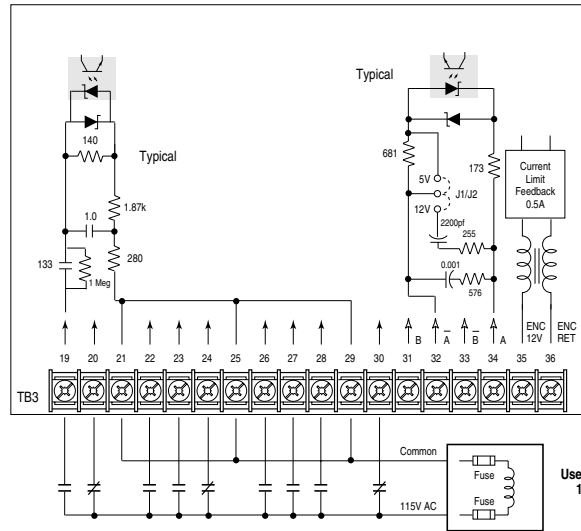

L9E

Option L6/L6E & L9E - 115V AC Interface Board Requirements

Circuits used with these options must be capable of operating with high = true logic. In the low state, circuits must generate a voltage of no more than 30V AC. Leakage current must be less than 10 mA into a 6.5k ohm load. In the high state, circuits must generate a voltage of 60 Hz, 90-115V AC $\pm 10\%$ (50 Hz, 100-115V AC $\pm 10\%$) and source a current of approximately 20 mA for each input. These options are compatible with the following Allen-Bradley PLC modules:

- 1771-OW
- 1771-OA
- 1771-OWN
- 1771-OAD

Read/Write Parameter Record

When using a compatible HIM (see [Table 3.A](#)), the parameters listed can be uploaded to the HIM for downloading to other drives.

No.	Name	Setting	No.	Name	Setting	No.	Name	Setting	No.	Name	Setting
5	Freq Select 1	_____	81	Blwn Fuse Flt	_____	169	Boost Slope	_____	243	TB3 Term 23 Sel	_____
6	Freq Select 2	_____	82	Cur Lim Trip En	_____	170	Rated Amps	_____	244	TB3 Term 24 Sel	_____
7	Accel Time 1	_____	83	Run Boost	_____	171	Rated kW	_____	245	TB3 Term 26 Sel	_____
8	Decel Time 1	_____	85	Reset/Run Tries	_____	172	EEPROM Cksum	_____	246	TB3 Term 27 Sel	_____
9	Control Select	_____	90	Analog Trim En	_____	173	Fault Alarms 1	_____	247	TB3 Term 28 Sel	_____
10	Stop Select 1	_____	91	Low Bus Fault	_____	174	CR2 Out Select	_____	248	Anlg In 2 Lo	_____
11	Bus Limit En	_____	92	Logic Mask	_____	175	CR3 Out Select	_____	249	Anlg In 2 Hi	_____
12	DC Hold Time	_____	93	Local Mask	_____	176	CR4 Out Select	_____	250	Anlg Signal Loss	_____
13	DC Hold Level	_____	94	Direction Mask	_____	177	Motor NP RPM	_____	256	Line Loss Mode	_____
14	Run On Power Up	_____	95	Start Mask	_____	178	Motor NP Hertz	_____	264	Pulse In Scale	_____
15	Reset/Run Time	_____	96	Jog Mask	_____	180	Process 2 Par	_____	267	Dig At Temp	_____
16	Minimum Freq	_____	97	Reference Mask	_____	181	Process 2 Scale	_____	268	Motor Therm Flt	_____
17	Base Frequency	_____	98	Accel Mask	_____	182	Process 2 Txt 1	_____	271	Alarm Mask 2	_____
18	Base Voltage	_____	99	Decel Mask	_____	183	Process 2 Txt 2	_____	274	Anlg Out 1 Sel	_____
19	Maximum Freq	_____	100	Fault Mask	_____	184	Process 2 Txt 3	_____	275	Anlg Out 1 Lo	_____
20	Maximum Voltage	_____	101	MOP Mask	_____	185	Process 2 Txt 4	_____	276	Anlg Out 1 Hi	_____
22	MOP Increment	_____	111	Data In A1	_____	186	Process 2 Txt 5	_____	277	Anlg Out 1 Abs	_____
24	Jog Frequency	_____	112	Data In A2	_____	187	Process 2 Txt 6	_____	278	Anlg Out 1 Offst	_____
25	Anlg Out 0 Sel	_____	113	Data In B1	_____	188	Process 2 Txt 7	_____	280	Pulse Out Select	_____
27	Preset Freq 1	_____	114	Data In B2	_____	189	Process 2 Txt 8	_____	281	Pulse Out Scale	_____
28	Preset Freq 2	_____	115	Data In C1	_____	190	Motor NP Volts	_____	282	Enc Count Scale	_____
29	Preset Freq 3	_____	116	Data In C2	_____	191	Motor NP Amps	_____	283	Encoder Counts	_____
30	Accel Time 2	_____	117	Data In D1	_____	192	Flux Amps Ref	_____	284	Encoder Loss Sel	_____
31	Decel Time 2	_____	118	Data In D2	_____	193	KP Amps	_____	288	Bus Regulation	_____
32	Skip Freq 1	_____	119	Data Out A1	_____	194	IR Drop Volts	_____	289	Phase Loss Det	_____
33	Skip Freq 2	_____	120	Data Out A2	_____	195	Slip Comp Gain	_____	290	Load Loss Detect	_____
34	Skip Freq 3	_____	121	Data Out B1	_____	200	Flux Up Time	_____	291	Load Loss Level	_____
35	Skip Freq Band	_____	122	Data Out B2	_____	201	Motor OL Fault	_____	292	Load Loss Time	_____
36	Current Limit	_____	123	Data Out C1	_____	203	VT Scaling	_____	303	Current Lmt En	_____
37	Overload Mode	_____	124	Data Out C2	_____	204	Ground Warning	_____	304	Traverse Dec	_____
38	Overload Amps	_____	125	Data Out D1	_____	206	Alarm Mask 1	_____	305	Traverse Mask	_____
39	Flt Clear Mode	_____	126	Data Out D2	_____	213	PI Config	_____	307	Sync Time	_____
40	Line Loss Fault	_____	127	Process 1 Par	_____	215	PI Ref Select	_____	308	Sync Mask	_____
41	Motor Type	_____	128	Process 1 Scale	_____	216	PI Fdbk Select	_____	310	Sync Loss Sel	_____
42	Slip @ F.L.A.	_____	129	Process 1 Txt 1	_____	221	KI Process	_____	311	Sync Loss Gain	_____
43	Dwell Frequency	_____	130	Process 1 Txt 2	_____	222	KP Process	_____	312	Sync Loss Time	_____
44	Dwell Time	_____	131	Process 1 Txt 3	_____	223	PI Neg Limit	_____	313	Sync Loss Comp	_____
45	PWM Frequency	_____	132	Process 1 Txt 4	_____	224	PI Pos Limit	_____	315	Alt Type 2 Cmd	_____
46	Encoder PPR	_____	133	Process 1 Txt 5	_____	225	PI Preload	_____	317	Run/Accel Volts	_____
47	Language	_____	134	Process 1 Txt 6	_____	226	Shear Pin Fault	_____	319	Speed Brake En	_____
48	Start Boost	_____	135	Process 1 Txt 7	_____	227	Adaptive I Lim	_____	320	Line Loss Volts	_____
49	Break Frequency	_____	136	Process 1 Txt 8	_____	228	LLoss Restart	_____	321	Loss Recover	_____
50	Break Voltage	_____	150	4-20mA Loss Sel	_____	229	Freq Ref SqRoot	_____	322	Ride Thru Volts	_____
52	Stop Select 2	_____	151	Maximum Speed	_____	230	Save MOP Ref	_____	323	Min Bus Volts	_____
56	S Curve Time	_____	152	Encoder Type	_____	231	Hold Level Sel	_____	324	Stability Gain	_____
57	S Curve Enable	_____	154	Anlg Out 0 Offst	_____	232	Current Lmt Sel	_____	325	Bus Reg/Max Bus	_____
58	Common Bus	_____	155	Flying Start En	_____	233	Anlg Out 0 Abs	_____	326	Remote CR Output	_____
73	Preset Freq 4	_____	156	FStart Forward	_____	234	Anlg Out 0 Lo	_____	327	At Time	_____
74	Preset Freq 5	_____	157	FStart Reverse	_____	235	Anlg Out 0 Hi	_____	328	Max Enc Counts	_____
75	Preset Freq 6	_____	158	CR1 Out Select	_____	237	Anlg In 0 Lo	_____	329	Bidir In Offset	_____
76	Preset Freq 7	_____	159	Dig Out Freq	_____	238	Anlg In 0 Hi	_____	330	Phase Loss Mode	_____
77	Speed Control	_____	160	Dig Out Current	_____	239	Anlg In 1 Lo	_____	331	Phase Loss Level	_____
78	Traverse Inc	_____	161	Dig Out Torque	_____	240	Anlg In 1 Hi	_____	332	Precharge Fault	_____
79	Max Traverse	_____	164	Speed KP	_____	241	Input Mode	_____	333	PWM Comp Time	_____
80	P Jump	_____	165	Speed KI	_____	242	TB3 Term 22 Sel	_____	334	Break Freq/PWM	_____

Read/Write Parameter Record (continued)

No.	Name	Setting
335	SL0 Logic Step	_____
336	SL0 Logic Jump	_____
337	SL0 Step Jump	_____
338	SL0 Step Setting	_____
339	SL0 Time	_____
340	SL0 Encoder Cnts	_____
341	SL1 Logic Step	_____
342	SL1 Logic Jump	_____
343	SL1 Step Jump	_____
344	SL1 Step Setting	_____
345	SL1 Time	_____
346	SL1 Encoder Cnts	_____
347	SL2 Logic Step	_____
348	SL2 Logic Jump	_____
349	SL2 Step Jump	_____
350	SL2 Step Setting	_____
351	SL2 Time	_____
352	SL2 Encoder Cnts	_____
353	SL3 Logic Step	_____
354	SL3 Logic Jump	_____
355	SL3 Step Jump	_____
356	SL3 Step Setting	_____
357	SL3 Time	_____
358	SL3 Encoder Cnts	_____
359	SL4 Logic Step	_____
360	SL4 Logic Jump	_____
361	SL4 Step Jump	_____
362	SL4 Step Setting	_____
363	SL4 Time	_____
364	SL4 Encoder Cnts	_____
365	SL5 Logic Step	_____
366	SL5 Logic Jump	_____
367	SL5 Step Jump	_____
368	SL5 Step Setting	_____
369	SL5 Time	_____
370	SL5 Encoder Cnts	_____
371	SL6 Logic Step	_____
372	SL6 Logic Jump	_____
373	SL6 Step Jump	_____
374	SL6 Step Setting	_____
375	SL6 Time	_____
376	SL6 Encoder Cnts	_____
377	Current Step	_____
379	Motor OL Ret	_____

Dimensions

Appendix B provides detailed dimension information for the 1336 PLUS. Included are:

- IP 20 (NEMA Type 1) Dimensions.
- IP65/54 (NEMA Type 4/12) Dimensions.
- Heat Sink-through-the-Back Cutout Dimensions.
- TB1 Terminal Block Dimensions for D, E & G Frame Drives.
- Typical Mounting of F and G Frame Open Chassis Drives in a User Supplied Enclosure.

Important: The dimensions given on the following drawings are for estimating purposes only. Contact your Allen-Bradley Sales Office if certified drawings are required.

IP 20 (NEMA Type 1) & Open Dimensions - Frames A1 through A4

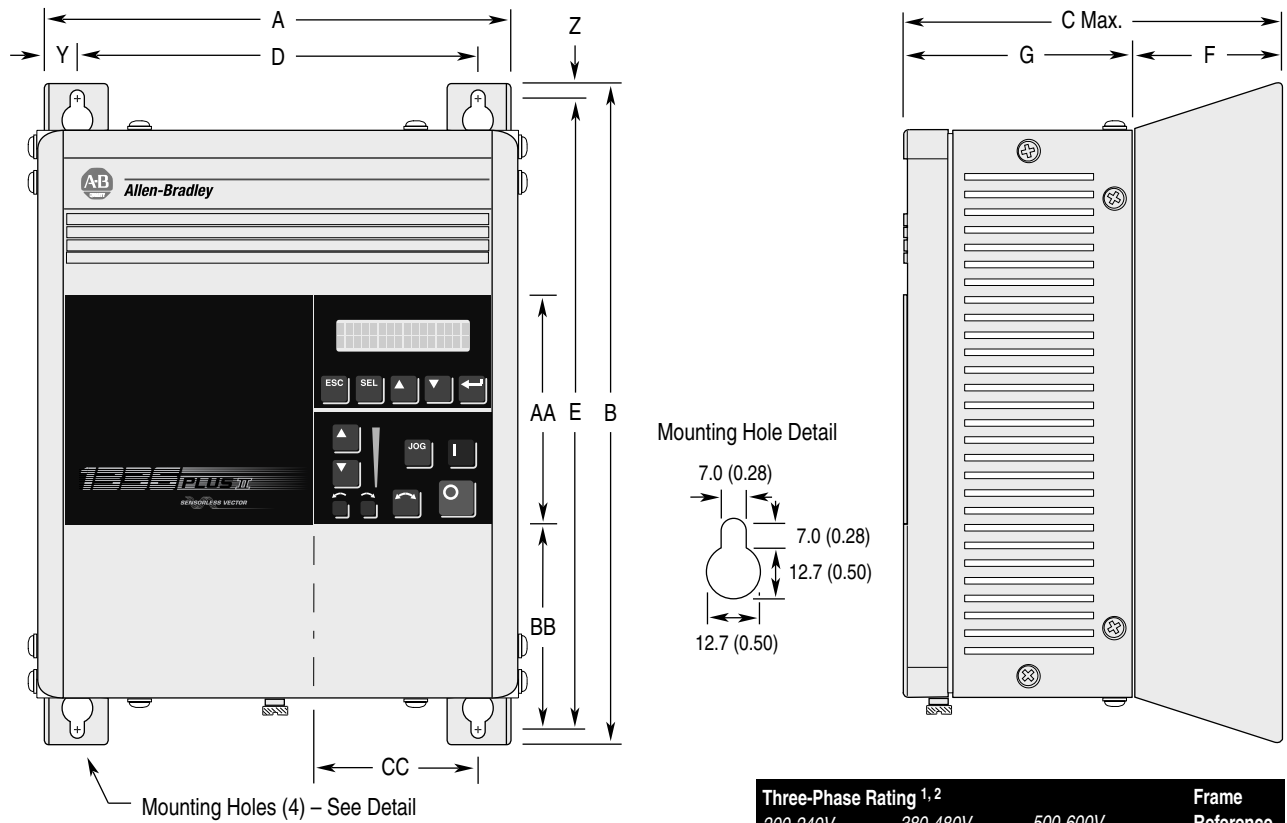

Bottom View Will Vary with HP – See Bottom View Dimensions

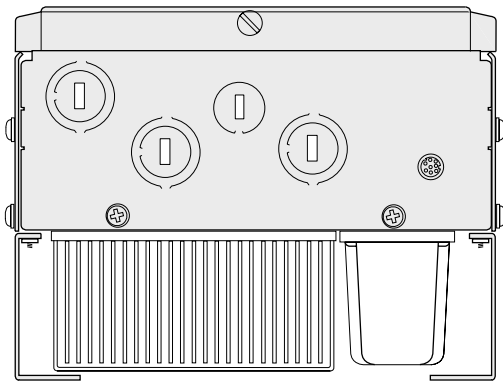

All Dimensions in Millimeters and (Inches)
All Weights in Kilograms and (Pounds)

Three-Phase Rating ^{1,2}			Frame Reference
200-240V	380-480V	500-600V	
0.37-0.75 kW	0.37-1.2 kW	-	A1
0.5-1 HP	0.5-1.5 HP	-	A2
1.2-1.5 kW	1.5-2.2 kW	-	A3
1.5-2 HP	2-3 HP	-	A4
2.2-3.7 kW	3.7 kW	-	A4
3-5 HP	5 HP	-	A4
5.5 kW	5.5-15 kW *	0.75-15 kW	A4
7.5 HP	7.5-20 HP	1-20 HP	A4
5.5-11 kW	11-22 kW *	-	B1/B2
7.5-15 HP	15-30 HP	-	B1/B2
15-22 kW	30-45 kW	18.5-45 kW	C
20-30 HP	40-60 HP	25-60 HP	C
30-45 kW	45-112 kW	56-93 kW	D
40-60 HP	60-150 HP	75-125 HP	D
56-93 kW	112-187 kW	112-224 kW	E
75-125 HP	150-250 HP	150-300 HP	E
-	187-336 kW	261-298 kW	F
-	250-450 HP	350-400 HP	F
-	187-448 kW	224-448 kW	G
-	250-600 HP	300-600 HP	G

* Use care when choosing Frame Reference - Some ratings may exist in another frame size.

Frame Reference	A	B	C Max.	D	E	F	G		Y	Z	AA	BB	CC	Shipping Weights
							Encl.	Open						
A1	215.9 (8.50)	290.0 (11.42)	160.0 (6.30)	185.2 (7.29)	275.0 (10.83)	50.8 (2.00)	105.4 (4.15)	105.4 (4.15)	15.35 (0.60)	7.5 (0.30)	130.0 (5.12)	76.2 (3.00)	85.3 (3.36)	4.31 kg (9.5 lbs.)
A2	215.9 (8.50)	290.0 (11.42)	180.5 (7.10)	185.2 (7.29)	275.0 (10.83)	71.4 (2.81)	105.4 (4.15)	105.4 (4.15)	15.35 (0.60)	7.5 (0.30)	130.0 (5.12)	76.2 (3.00)	85.3 (3.36)	5.49 kg (12.1 lbs.)
A3	215.9 (8.50)	290.0 (11.42)	207.0 (8.15)	185.2 (7.29)	275.0 (10.83)	98.8 (3.85)	105.4 (4.15)	105.4 (4.15)	15.35 (0.60)	7.5 (0.30)	130.0 (5.12)	76.2 (3.00)	85.3 (3.36)	6.71 kg (14.8 lbs.)
A4	260.0 (10.24)	350.0 (13.78)	212.0 (8.35)	230.0 (9.06)	320.0 (12.60)	90.0 (3.54)	117.0 (4.61)	117.0 (4.61)	15.35 (0.60)	15.35 (0.60)	130.0 (5.12)	133.0 (5.23)	86.0 (3.39)	15.90 kg (35.0 lbs.)

¹ Refer to Chapter 1 for catalog numbers and Appendix for derating info.

² kW/HP are constant torque (CT) ratings.

IP 20 (NEMA Type 1) & Open Dimensions - Frames B, C, D

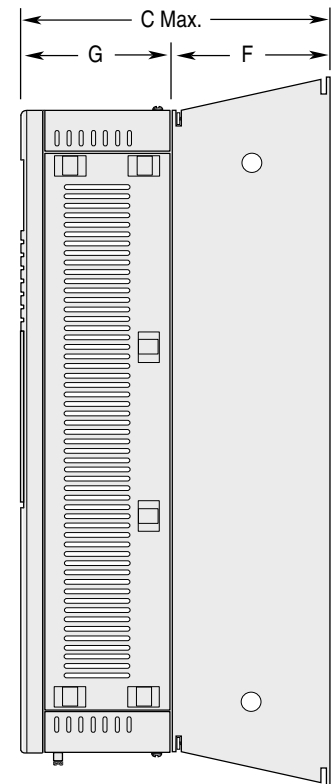
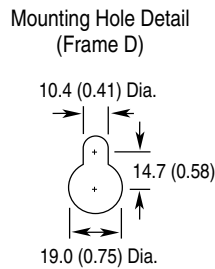
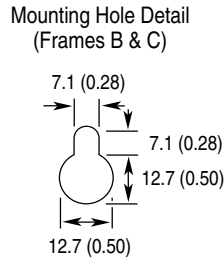
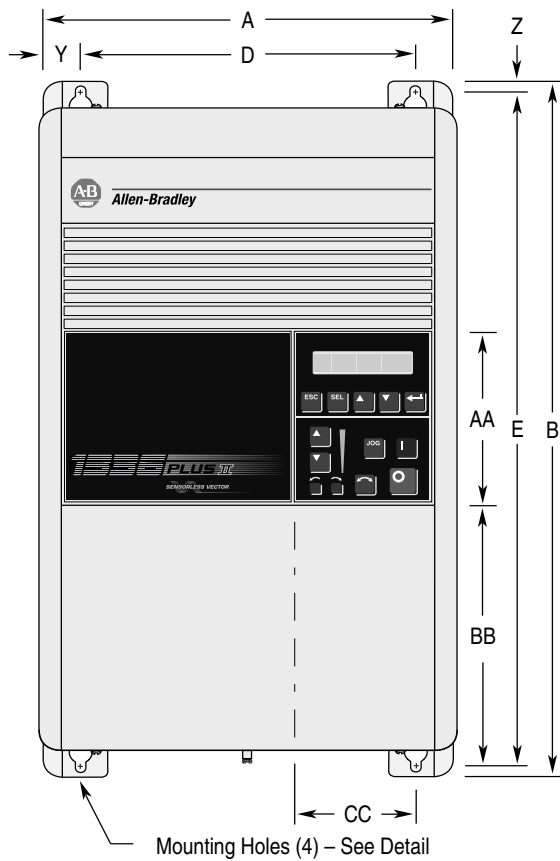

Frames B & C

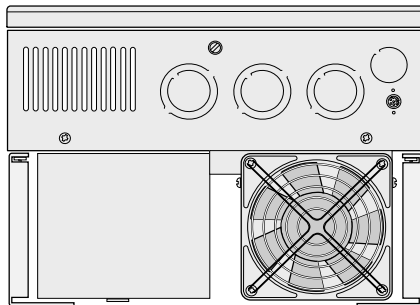

Bottom View Will Vary with HP
 See Bottom View Dimensions

Frame D

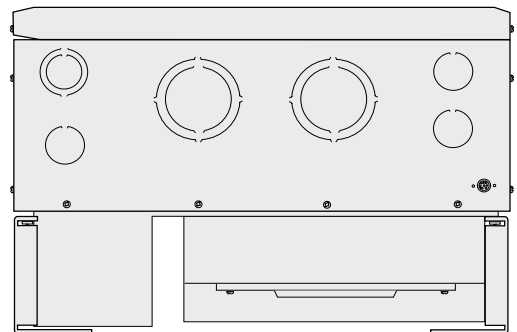

All Dimensions in Millimeters and (Inches)
 All Weights in Kilograms and (Pounds)

Frame Reference	A	B	C Max.	D	E	F	G		Y	Z	AA	BB	CC	Shipping Weight
							Encl.	Open						
B1/B2	276.4 (10.88)	476.3 (18.75)	225.0 (8.86)	212.6 (8.37)	461.0 (18.15)	131.6 (5.18)	93.5 (3.68)	88.9 (3.50)	32.00 (1.26)	7.6 (0.30)	131.1 (5.16)	180.8 (7.12)	71.9 (2.83)	22.7 kg (50 lbs.)
C	301.8 (11.88)	701.0 (27.60)	225.0 (8.86)	238.0 (9.37)	685.8 (27.00)	131.6 (5.18)	93.5 (3.68)	88.9 (3.50)	32.00 (1.26)	7.6 (0.30)	131.1 (5.16)	374.7 (14.75)	71.9 (2.83)	38.6 kg (85 lbs.)
D	381.5 (15.02)	1240.0 (48.82)	270.8 (10.66)	325.9 (12.83)	1216.2 (47.88)	81.3 (3.20)	189.5 (7.46)	184.9 (7.28)	27.94 (1.10)	11.94 (0.47)	131.1 (5.16)	688.6 (27.11)	83.6 (3.29)	108.9 kg (240 lbs.)

IP 20 (NEMA Type 1) & Open Dimensions - Frame E

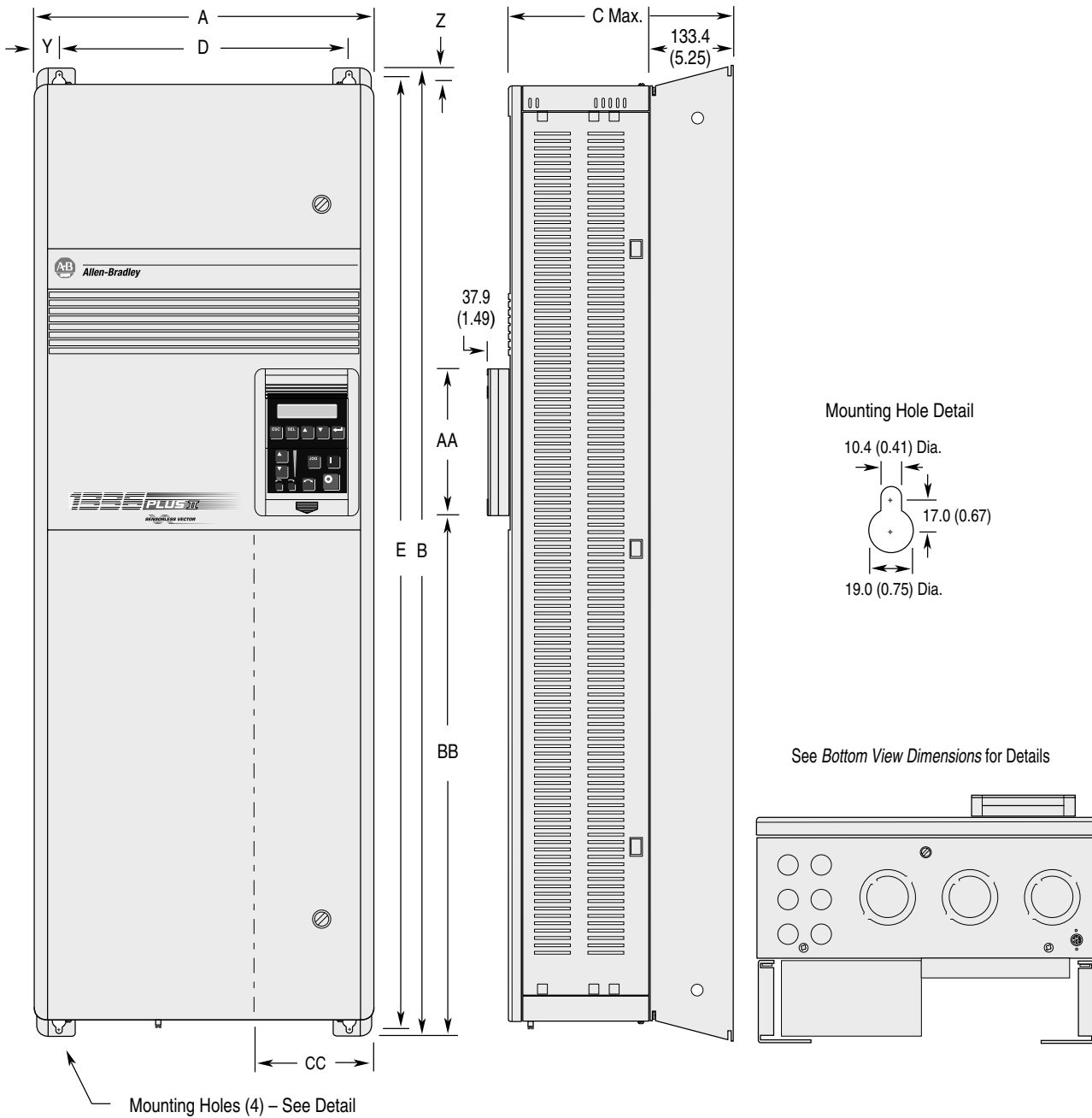

All Dimensions in Millimeters and (Inches)
 All Weights in Kilograms and (Pounds)

Frame Reference	A	B	C Max.	D	E	Y	Z	AA	BB	CC	Shipping Weight
E - Enclosed	511.0 (20.12)	1498.6 (59.00)	424.4 (16.71)	477.5 (18.80)	1447.8 (57.00)	16.8 (0.66)	40.1 (1.61)	195.0 (7.68)	901.4 (35.49)	151.9 (5.98)	186 kg (410 lbs.)
E - Open	511.0 (20.12)	1498.6 (59.00)	372.6 (14.67)	477.5 (18.80)	1447.8 (57.00)	16.8 (0.66)	40.1 (1.61)	138.4 (5.45)	680.0 (26.77)	126.3 (4.97)	163 kg (360 lbs.)

IP 20 (NEMA Type 1) & Open Dimensions - Frame F

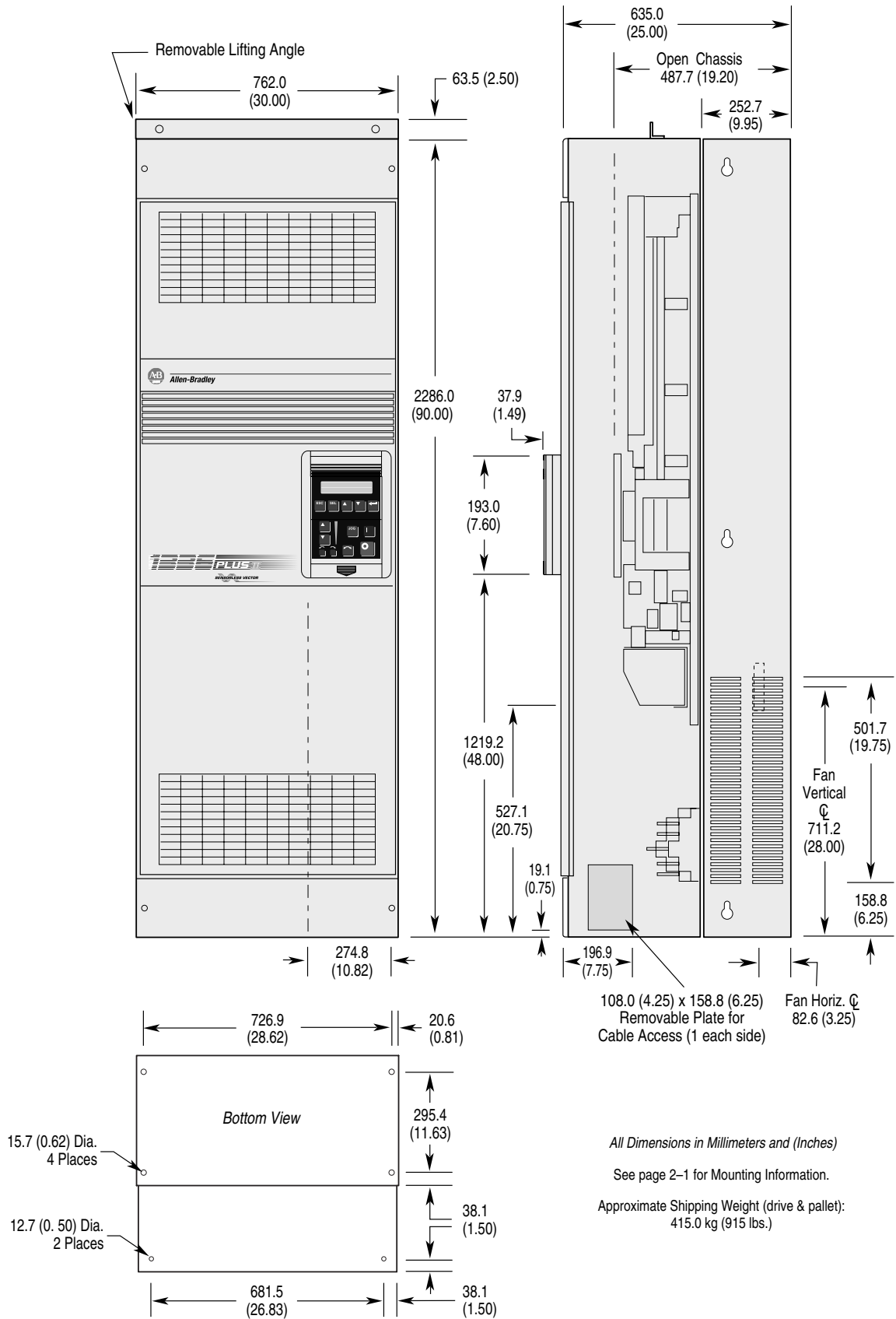

Open Dimensions - Frame F "Roll-In" Chassis

All Dimensions in Millimeters and (Inches)

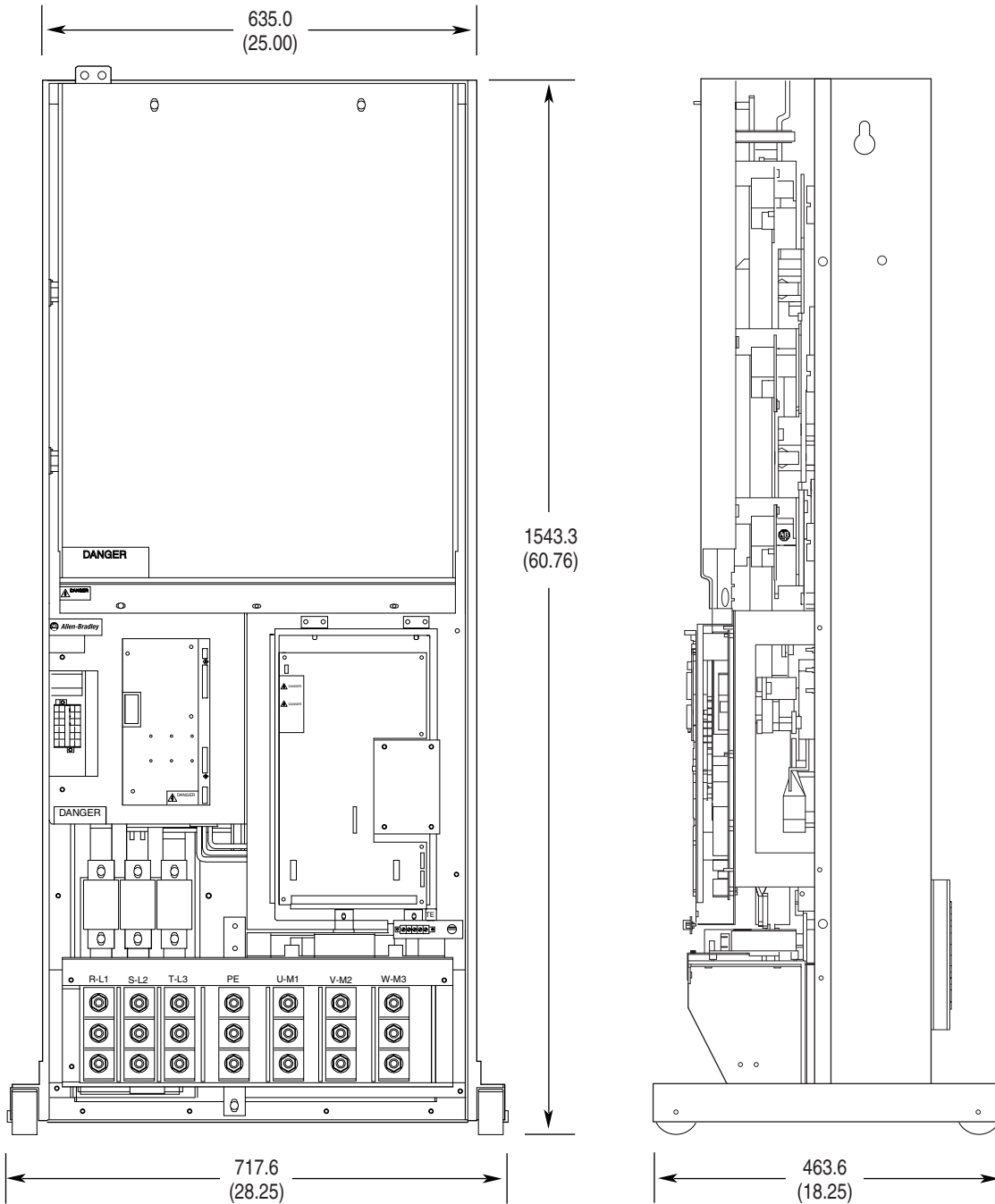

Notes:

- 1 Enclosure dimensions needed to accommodate the drive are 2286 (H) x 889 (W) x 508 (D) mm (90 x 35 x 20 in.), nominal.
- 2 A 1200 CFM (minimum) enclosure ventilating fan must be user supplied and installed.
- 3 Refer to pages [B-20](#) and [B-21](#) for drive and inductor mounting information.

IP 20 (NEMA Type 1) & Open Dimensions - Frame G

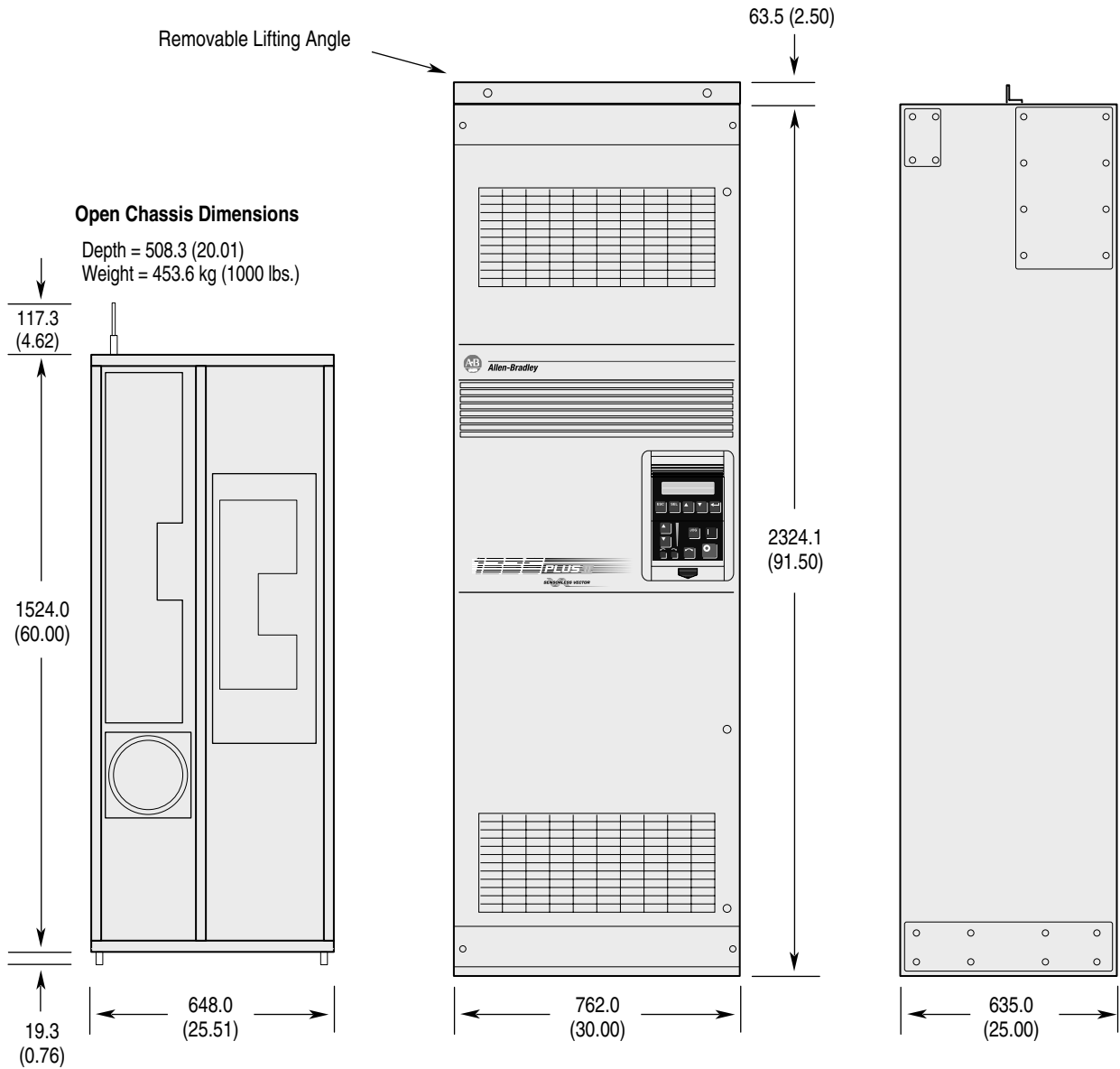

Important: Two (2) 725 CFM fans are required if an open type drive is mounted in a user supplied enclosure.

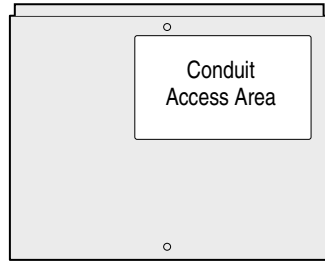

All Dimensions in Millimeters and (Inches)

See Bottom View Dimensions for Details

IP 65/54 (NEMA Type 4/12) Dimensions

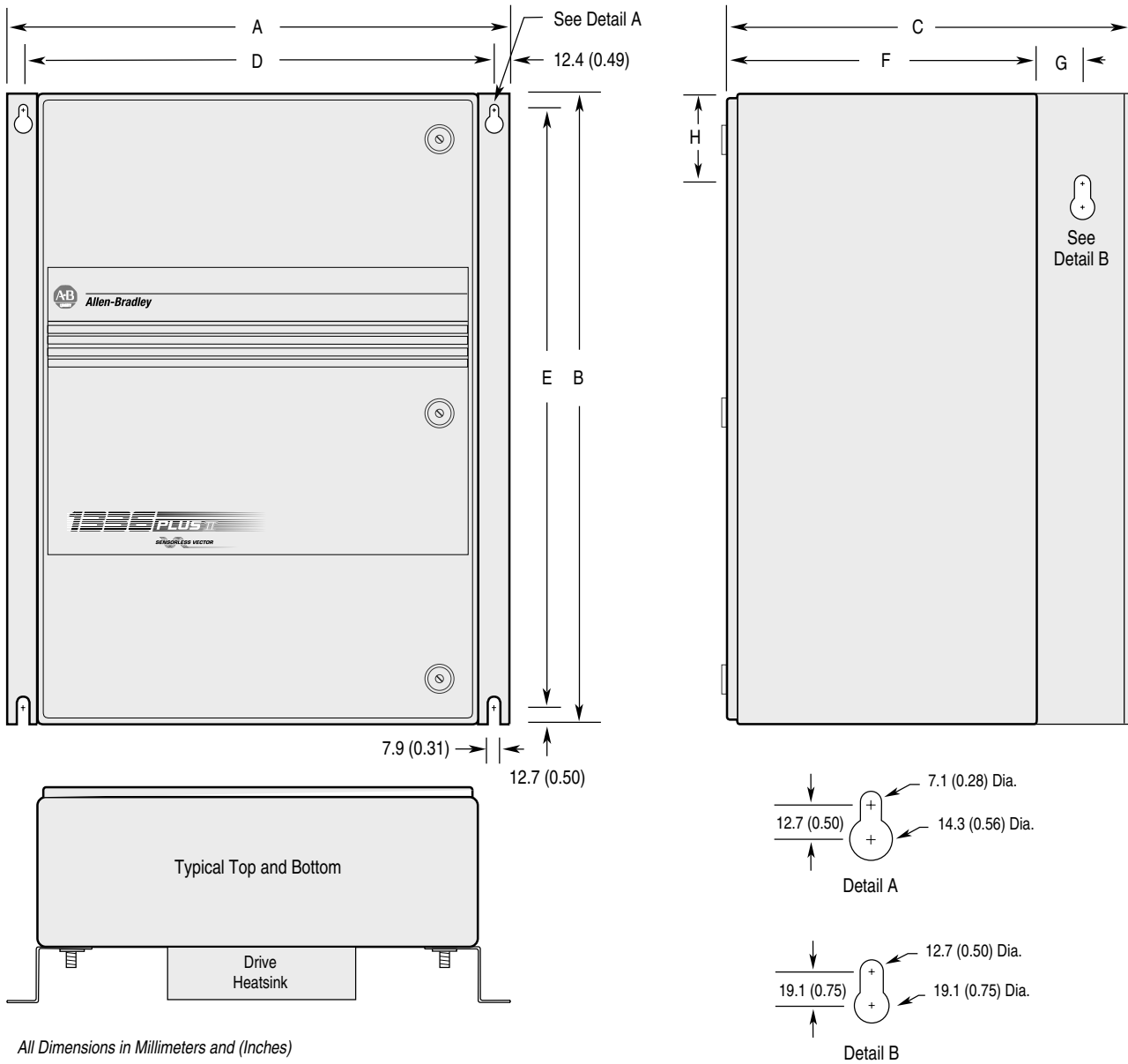

All Dimensions in Millimeters and (Inches)

Frame Reference	A	B	C	D	E	F	G	H	Approx. Ship Weight
A1	430.0 (16.93)	525.0 (20.67)	350.0 (13.78)	404.9 (15.94)	500.1 (19.69)	250.0 (9.84)	N/A	N/A	16.8 kg (37.0 lbs.)
A2	430.0 (16.93)	525.0 (20.67)	350.0 (13.78)	404.9 (15.94)	500.1 (19.69)	250.0 (9.84)	N/A	N/A	17.9 kg (39.4 lbs.)
A3	430.0 (16.93)	525.0 (20.67)	350.0 (13.78)	404.9 (15.94)	500.1 (19.69)	250.0 (9.84)	N/A	N/A	18.6 kg (41.0 lbs.)
A4	655.0 (25.79)	650.0 (25.59)	425.0 (16.74)	629.9 (24.80)	625.1 (24.61)	293.0 (11.54)	63.5 (2.50)	76.2 (3.00)	39.5 kg (87.0 lbs.)
B1 5.5 kW (7.5 HP) at 200-240V AC 11 kW (15 HP) at 380-480V AC	655.0 (25.79)	650.0 (25.59)	425.0 (16.74)	629.9 (24.80)	625.1 (24.61)	293.0 (11.54)	63.5 (2.50)	76.2 (3.00)	44.7 kg (98.5 lbs.)
B2 7.5-11 kW (10-15 HP) at 200-240V AC 15-22 kW (20-30 HP) at 380-480V AC	655.0 (25.79)	900.0 (35.43)	425.0 (16.74)	629.9 (24.80)	875.0 (34.45)	293.0 (11.54)	63.5 (2.50)	76.2 (3.00)	56.5 kg (124.5 lbs.)
C	655.0 (25.79)	1200.0 (47.24)	425.0 (16.74)	629.9 (24.80)	1174.5 (46.22)	293.0 (11.54)	63.5 (2.50)	76.2 (3.00)	80.7 kg (178.0 lbs.)

IP 20 (NEMA Type 1) Bottom View Dimensions - Frames A through C

Frames A1 through A4

Fans are present on these drives

Input Voltage	Frame	Catalog Number	kW/HP Rating
230	A4	F75	5.5 (7.5)
460	A4	F75	5.5 (7.5)
		F100	7.5 (10)
		F150	11 (15)
		F200	15 (20)
575	A4	F30	2.2 (3)
		F50	3.7 (5)
		F75	5.5 (7.5)
		F100	7.5 (10)
		F150	11 (15)
		F200	15 (20)

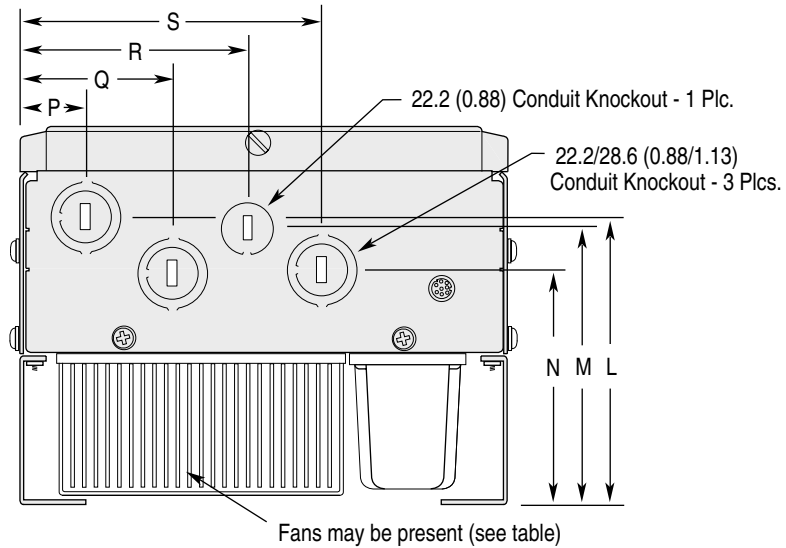

Frame Reference	L	M	N	P	Q	R	S
A1	111.8 (4.40)	105.4 (4.15)	86.3 (3.40)	31.0 (1.22)	69.1 (2.72)	102.1 (4.02)	135.4 (5.33)
A2	132.3 (5.21)	126.0 (4.96)	106.9 (4.21)	31.0 (1.22)	69.1 (2.72)	102.1 (4.02)	135.4 (5.33)
A3	158.8 (6.25)	152.4 (6.00)	133.4 (5.25)	31.0 (1.22)	69.1 (2.72)	102.1 (4.02)	135.4 (5.33)
A4	164.0 (6.45)	164.0 (6.45)	139.0 (5.47)	27.0 (1.06)	65.0 (2.56)	97.0 (3.82)	128.7 (5.07)

Frames B and C

All Dimensions in Millimeters and (Inches)

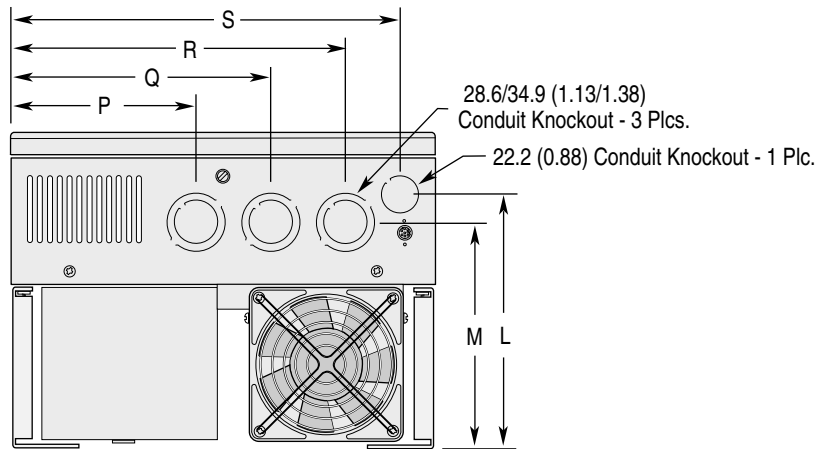

Frame Reference	L	M	P	Q	R	S
B1/B2	181.6 (7.15)	167.1 (6.58)	112.8 (4.44)	163.6 (6.44)	214.4 (8.44)	249.9 (9.84)
C	181.6 (7.15)	167.1 (6.58)	119.1 (4.69)	182.6 (7.19)	233.4 (9.19)	275.3 (10.84)

IP 20 (NEMA Type 1) Bottom View Dimensions - Frames D-G

All Dimensions in Millimeters and (Inches)

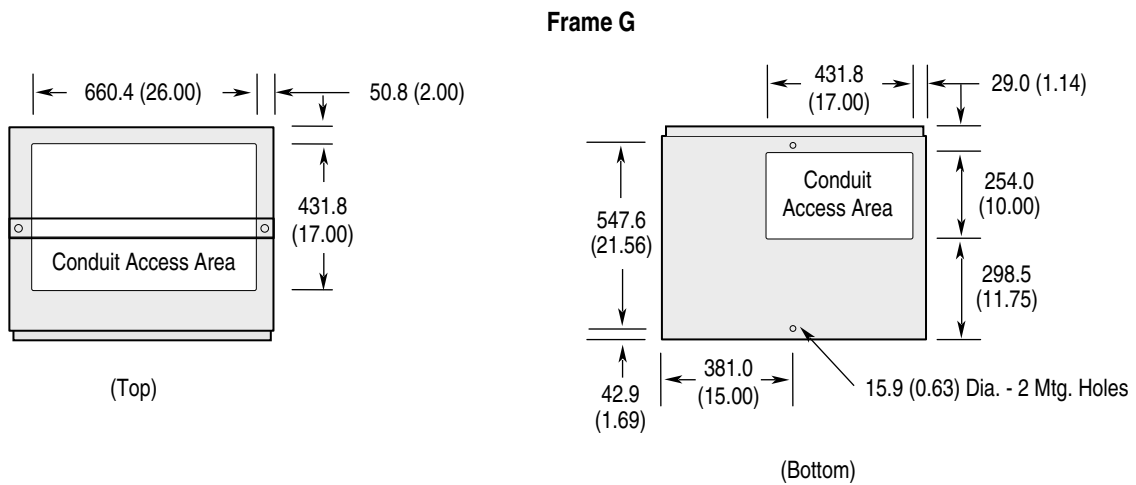
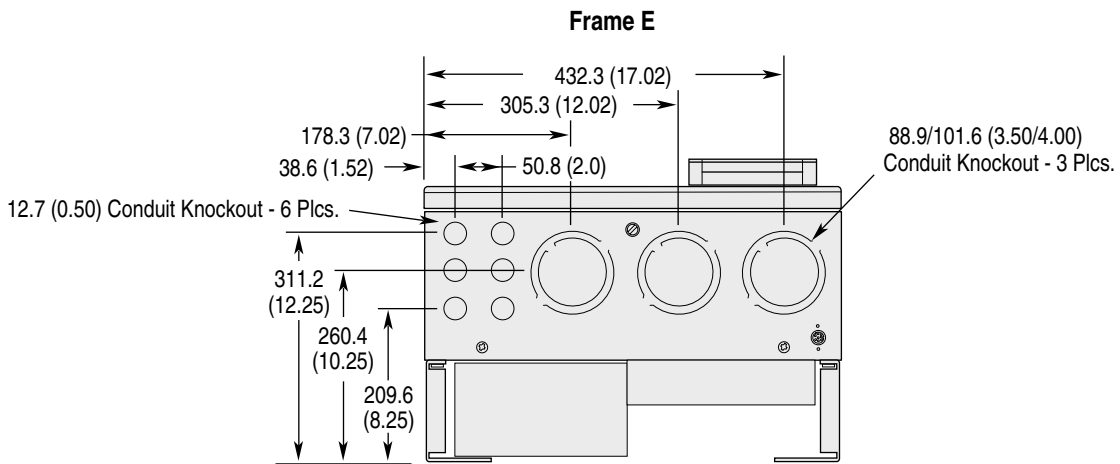
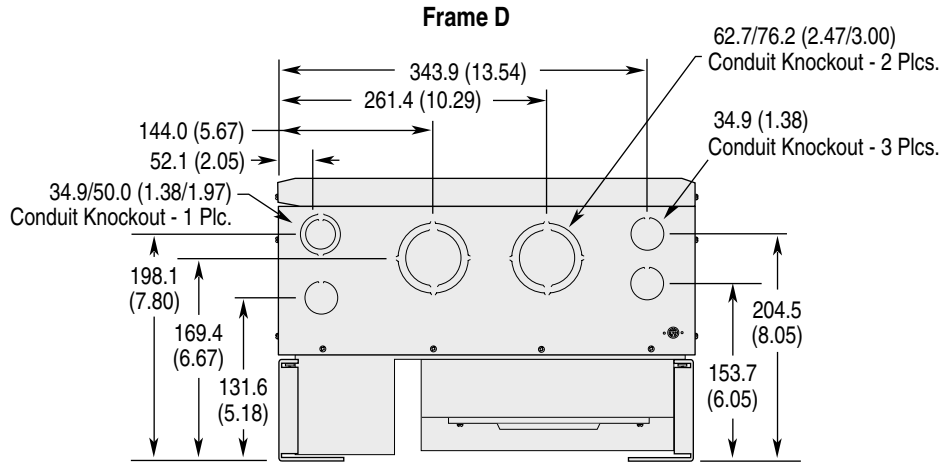

Knockout Locations for Optional Junction Boxes - Frames B & C

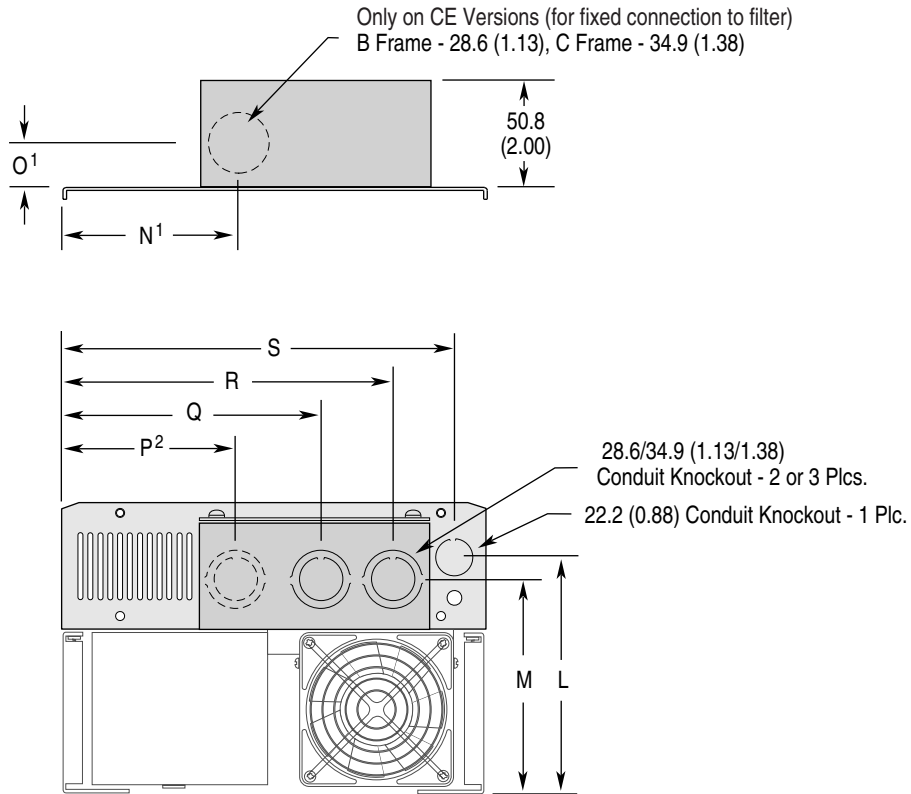

All Dimensions in Millimeters and (Inches)

Frame Reference	L	M	N ¹	O ¹	P ²	Q	R	S
B1/B2	181.6 (7.15)	167.1 (6.58)	NA	NA	106.4 (4.19)	155.2 (6.11)	206.0 (8.11)	249.9 (9.84)
B1/B2 (CE)	181.6 (7.15)	167.1 (6.58)	114.1 (4.49)	20.6 (0.81)	NA	155.2 (6.11)	206.0 (8.11)	249.9 (9.84)
C	181.6 (7.15)	167.1 (6.58)	NA	NA	112.8 (4.44)	174.5 (6.87)	227.8 (8.97)	275.3 (10.84)
C (CE)	181.6 (7.15)	167.1 (6.58)	120.7 (4.75)	25.4 (1.00)	NA	174.5 (6.87)	227.8 (8.97)	275.3 (10.84)

¹ Only present on CE version Junction Boxes.

² Not present on CE Junction Boxes.

Heat Sink Through-the-Back Mounting - Frames A1 through A3

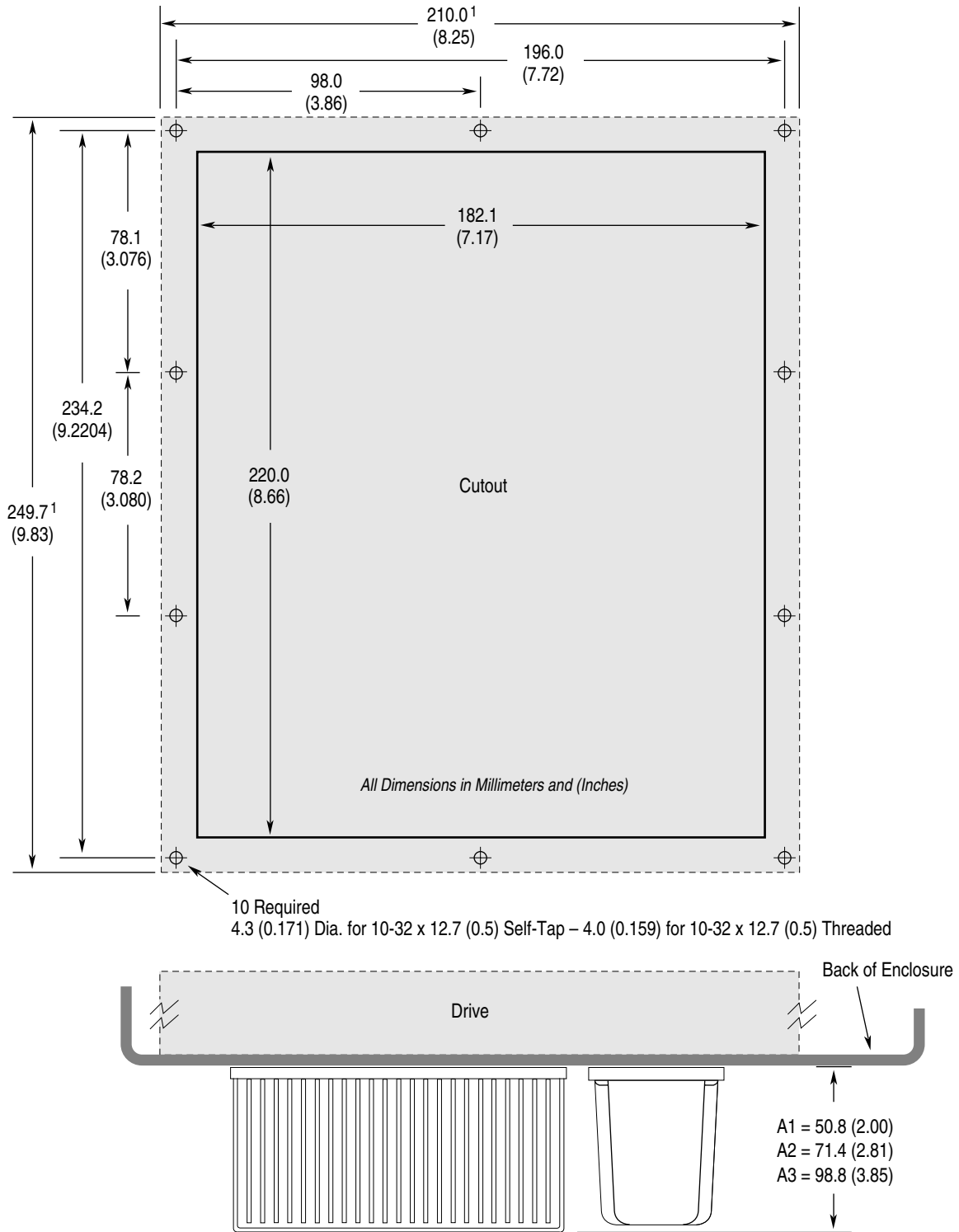

¹ Shading indicates **approximate** size of drive inside enclosure.

Heat Sink Through-the-Back Mounting - Frame A4

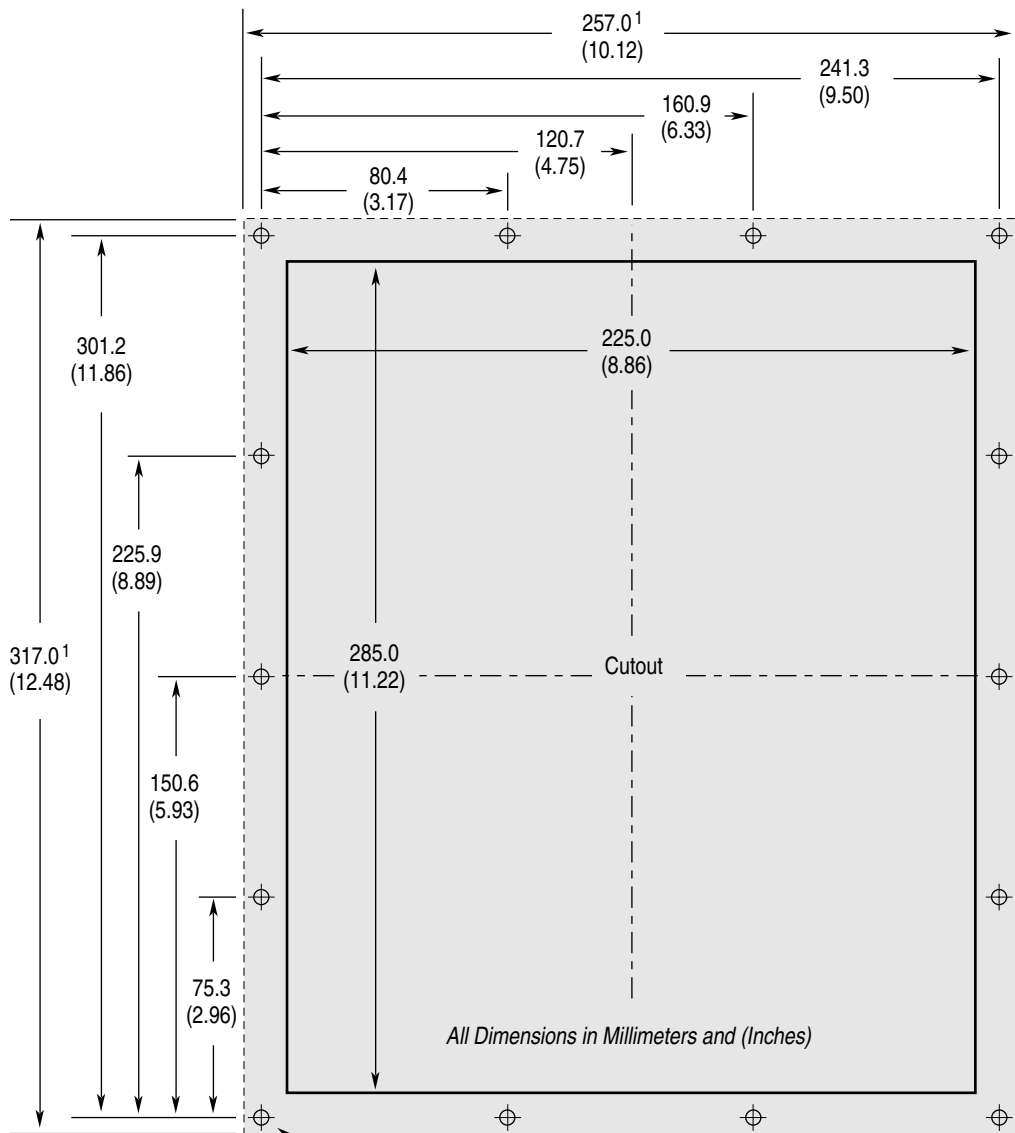

14 Required
 4.3 (0.171) Dia. for 10-32 x 12.7 (0.5) Self-Tap – 4.0 (0.159) for 10-32 x 12.7 (0.5) Threaded

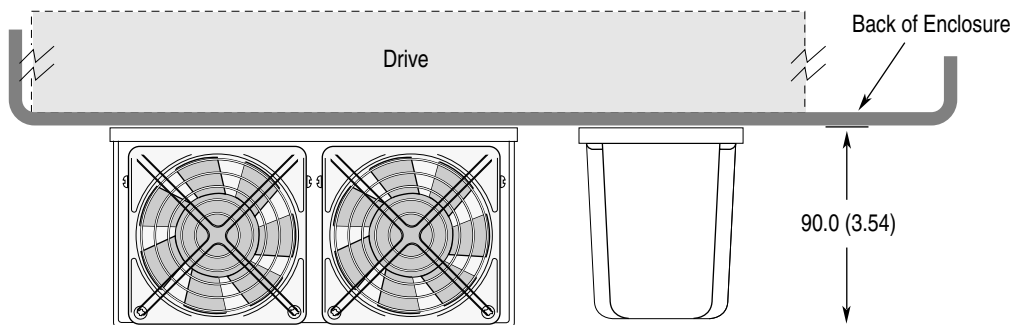

¹ Shading indicates **approximate** size of drive inside enclosure.

Heat Sink Through-the-Back Mounting - Frame B1/B2

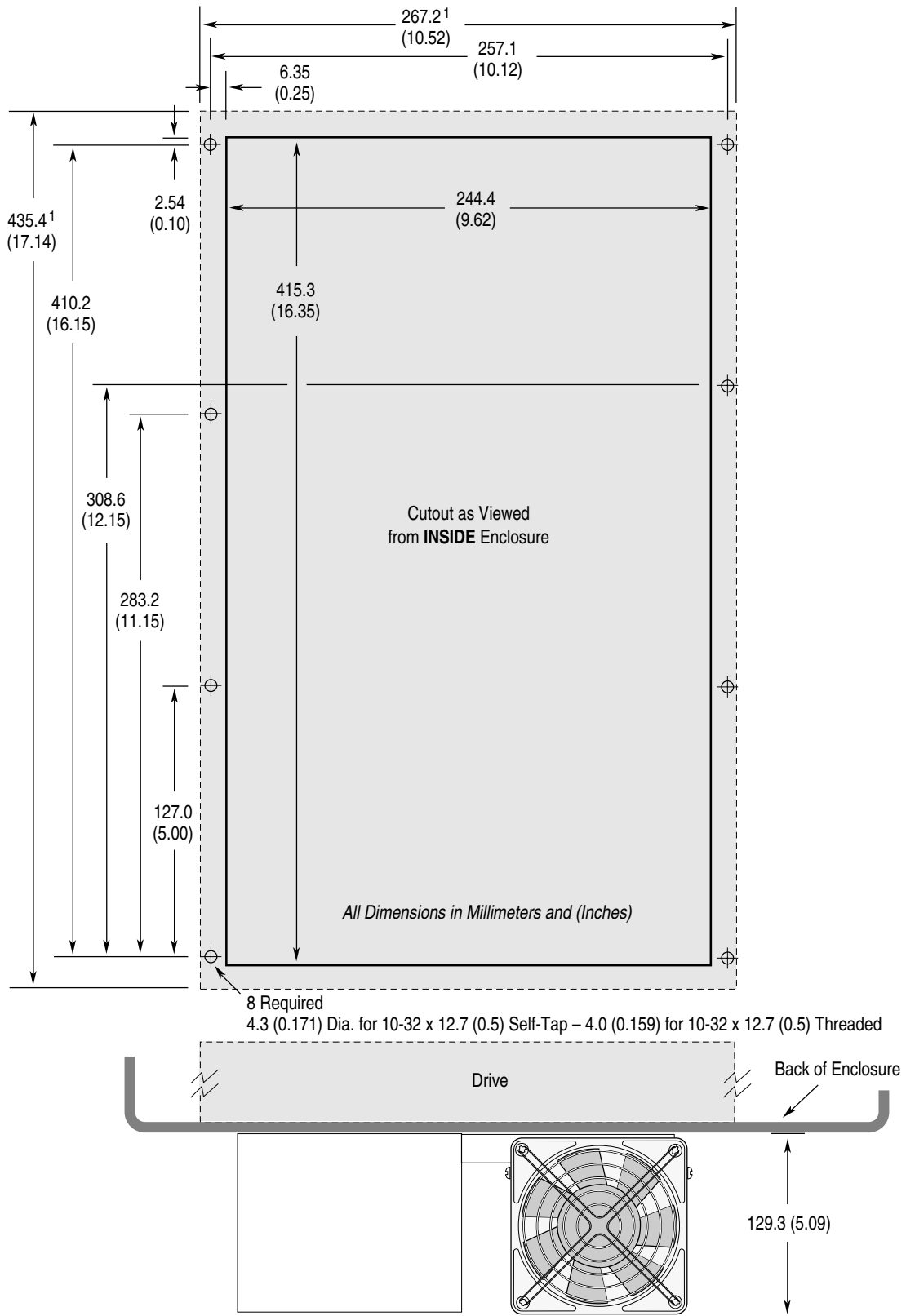

¹ Shading indicates **approximate** size of drive inside enclosure.

Heat Sink Through-the-Back Mounting - Frame C

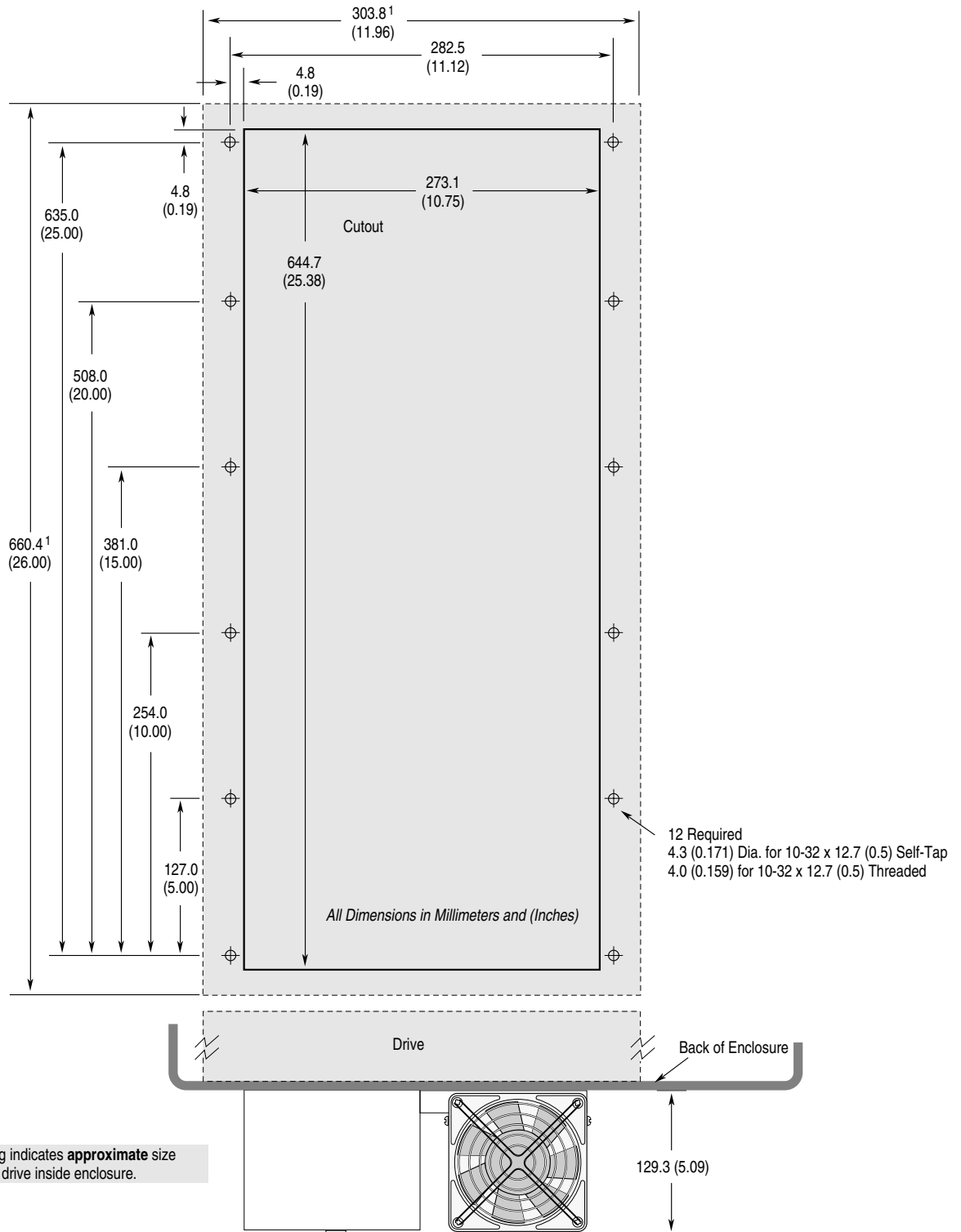

Heat Sink Through-the-Back Mounting - Frame D

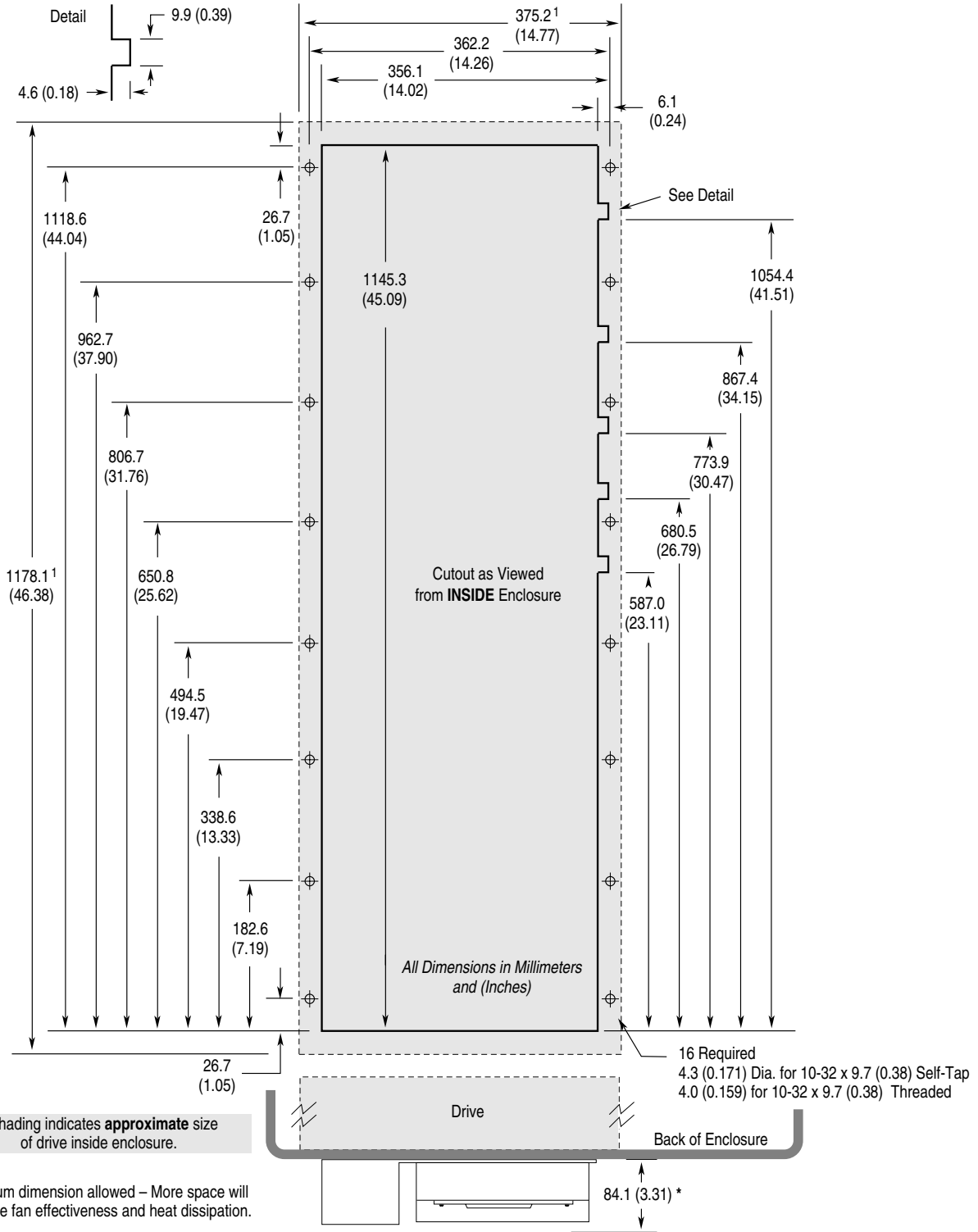

Heat Sink Through-the-Back Mounting - Frame E

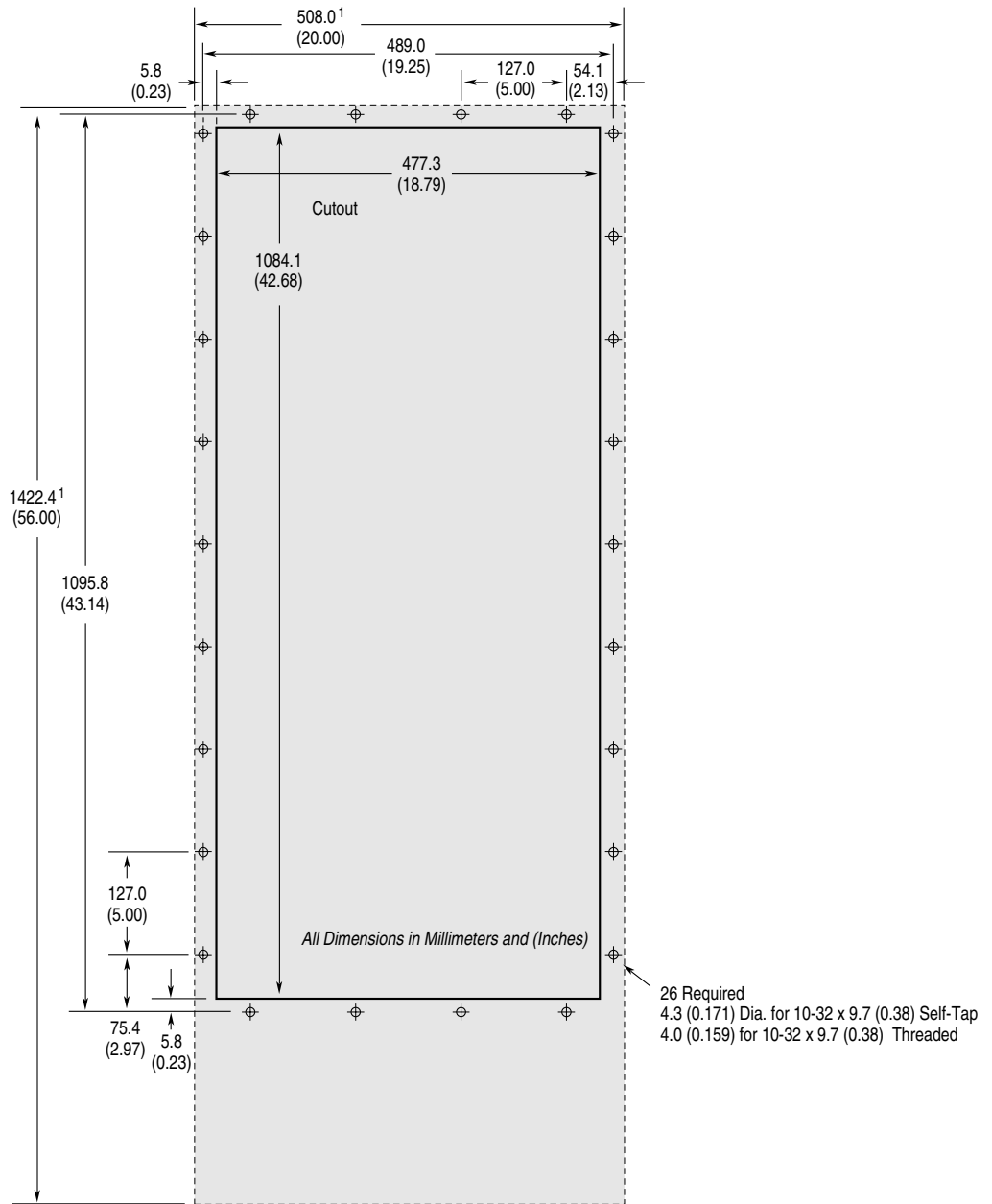

¹ Shading indicates **approximate** size of drive inside enclosure.

* Minimum dimension allowed – More space will improve fan effectiveness and heat dissipation.

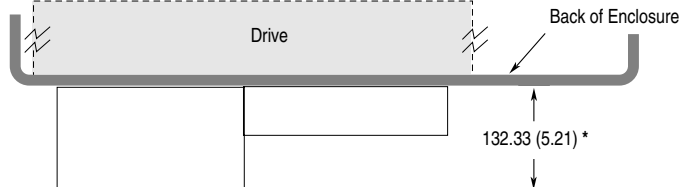

TB1 Dimensions for D & E Frame Drives

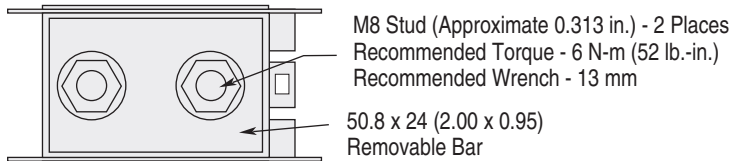
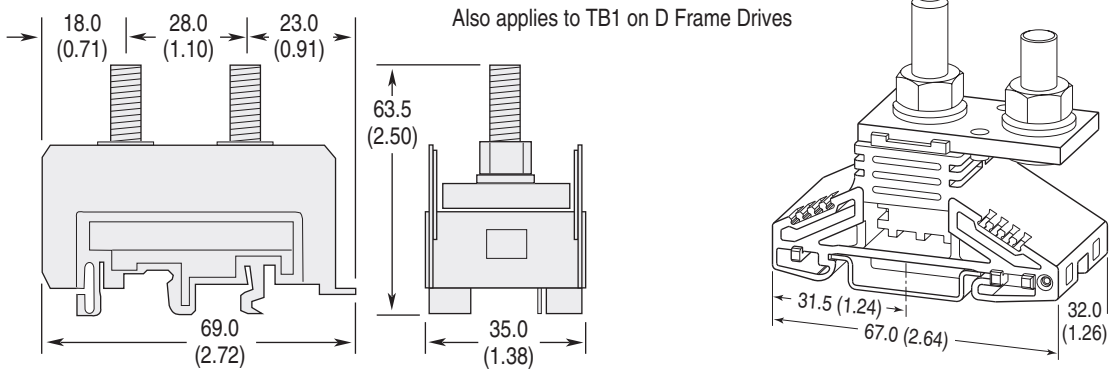
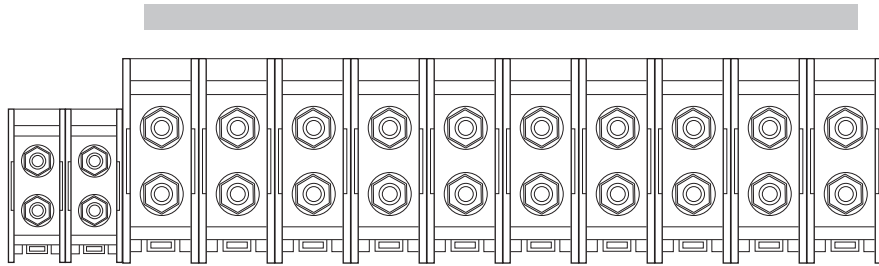
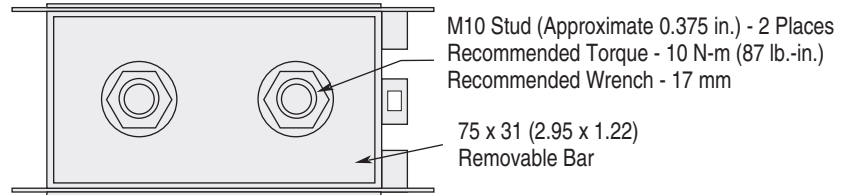
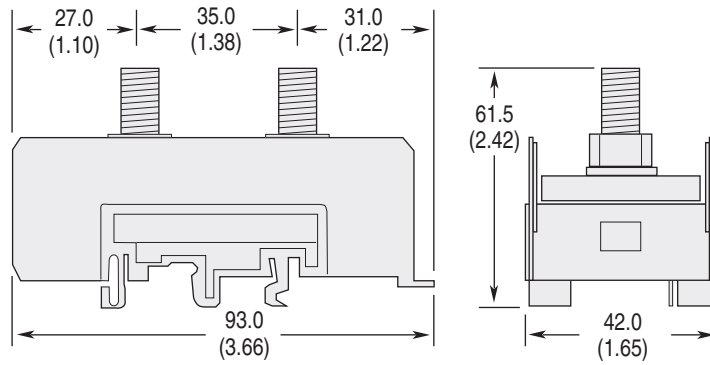

TB1 Dimensions for G Frame Drives

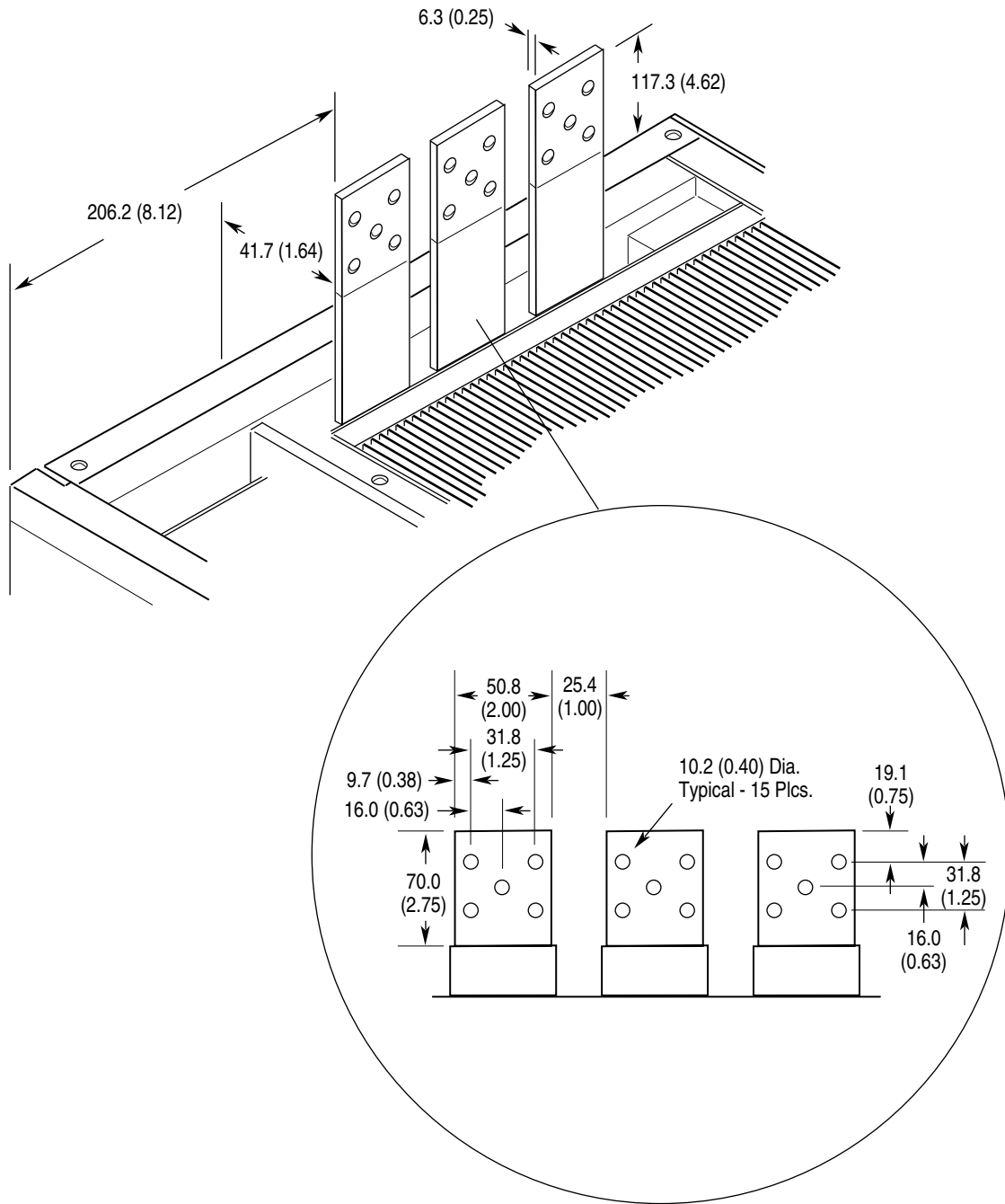

DC Bus Inductor Dimensions for F Frame “Roll-In” Drives

All Dimensions in Millimeters and (Inches)

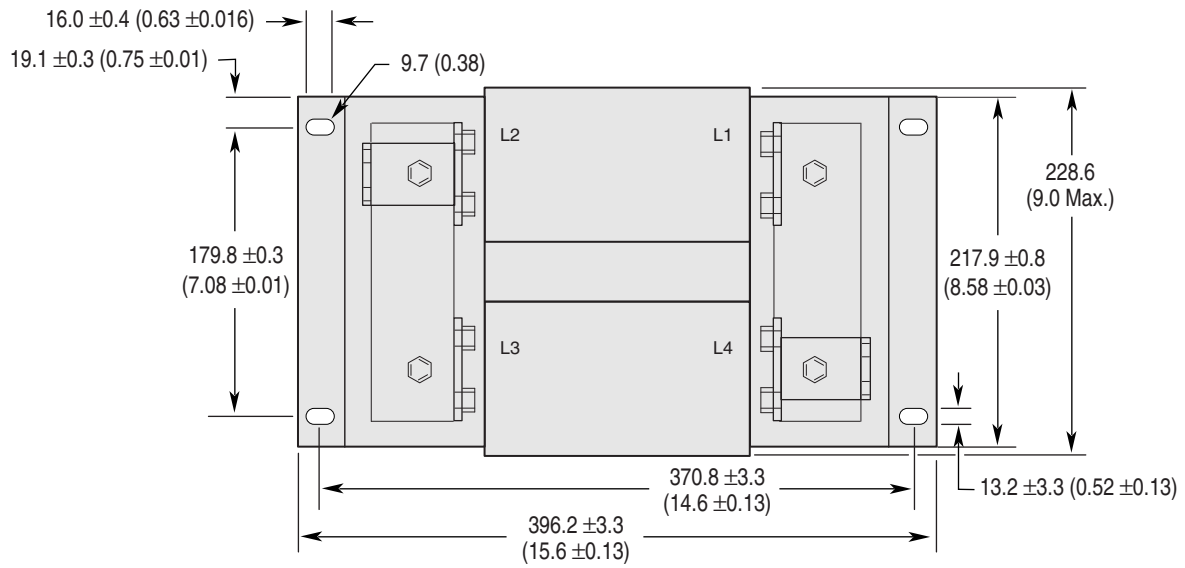

Weight = 45.36 kg (100 lbs.)

Typical F Frame “Roll-In” Mounting in User Supplied Enclosure

Important: This information represents the method used to factory mount an open (roll-in) type Frame F in an enclosure specifically designed by Allen-Bradley. Illustrations are only intended to identify structural mounting points and hardware shapes. You must design and fabricate steel components based on the actual mounting configuration, calculated loads and enclosure specifications. Minimum thickness of all parts = 4.6 (0.18).

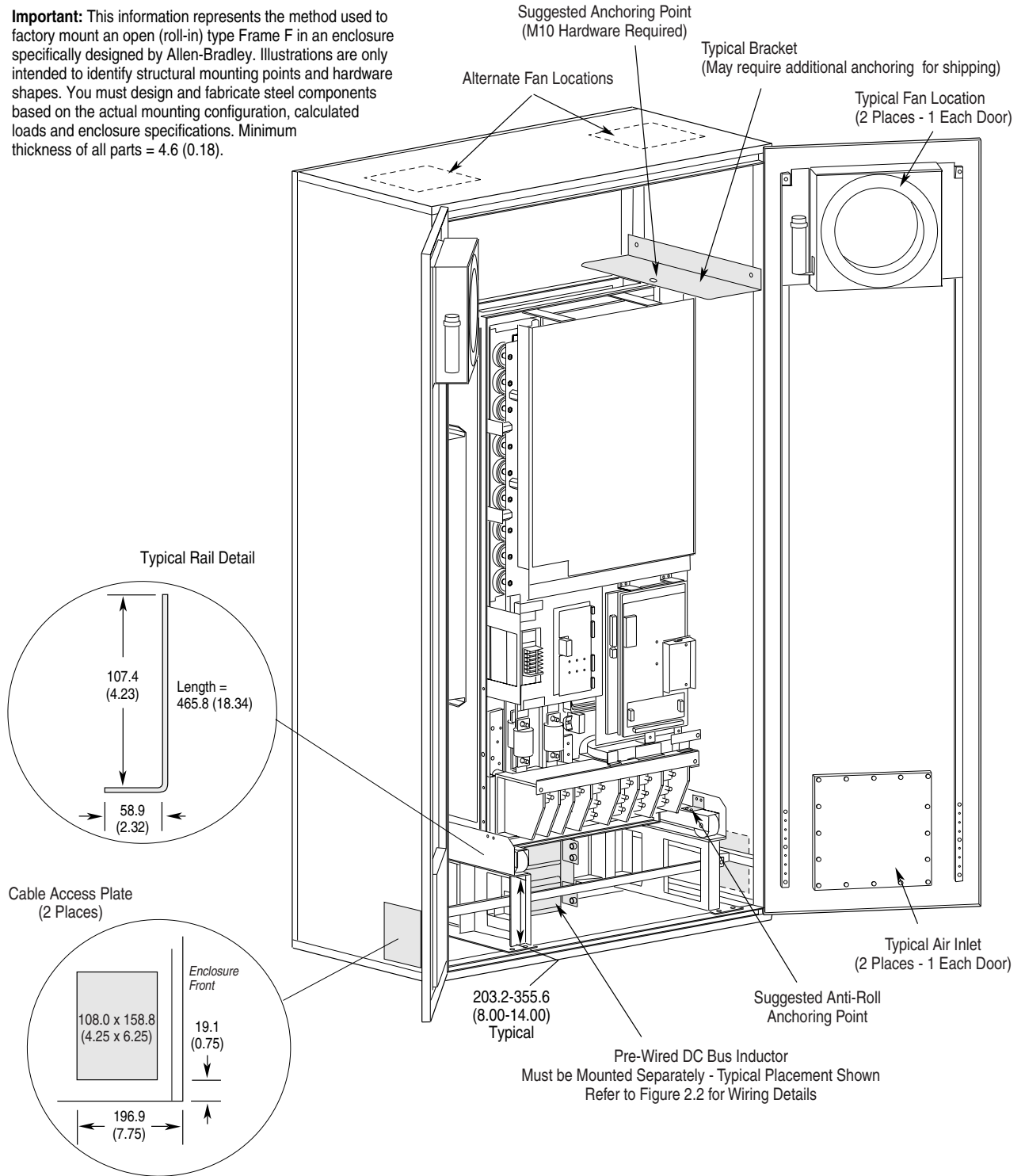

Typical G Frame Mounting in User Supplied Enclosure

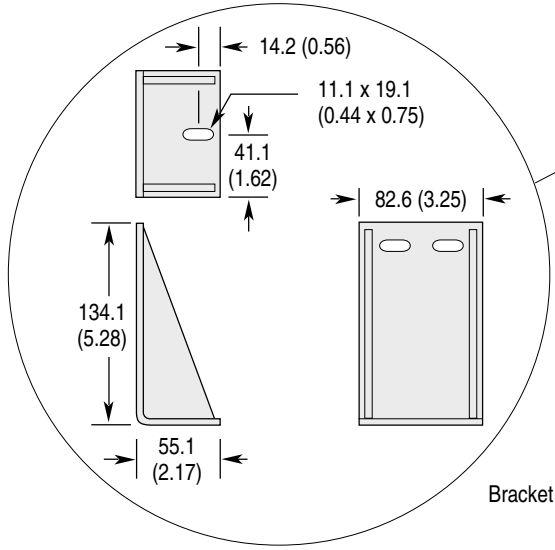

Bracket

Important: This information represents the method used to factory mount an open type Frame G in an enclosure specifically designed by Allen-Bradley. Illustrations are only intended to identify structural mounting points and hardware shapes. You must design and fabricate steel components based on the actual mounting configuration, calculated loads and enclosure specifications. Minimum thickness of all parts = 4.6 (0.18).

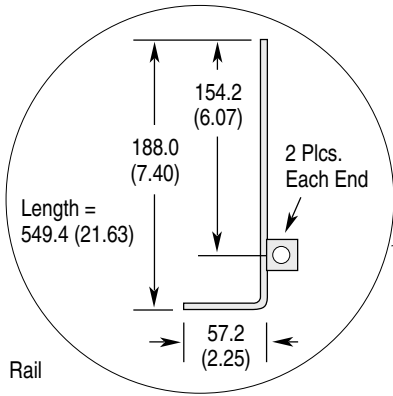

Rail

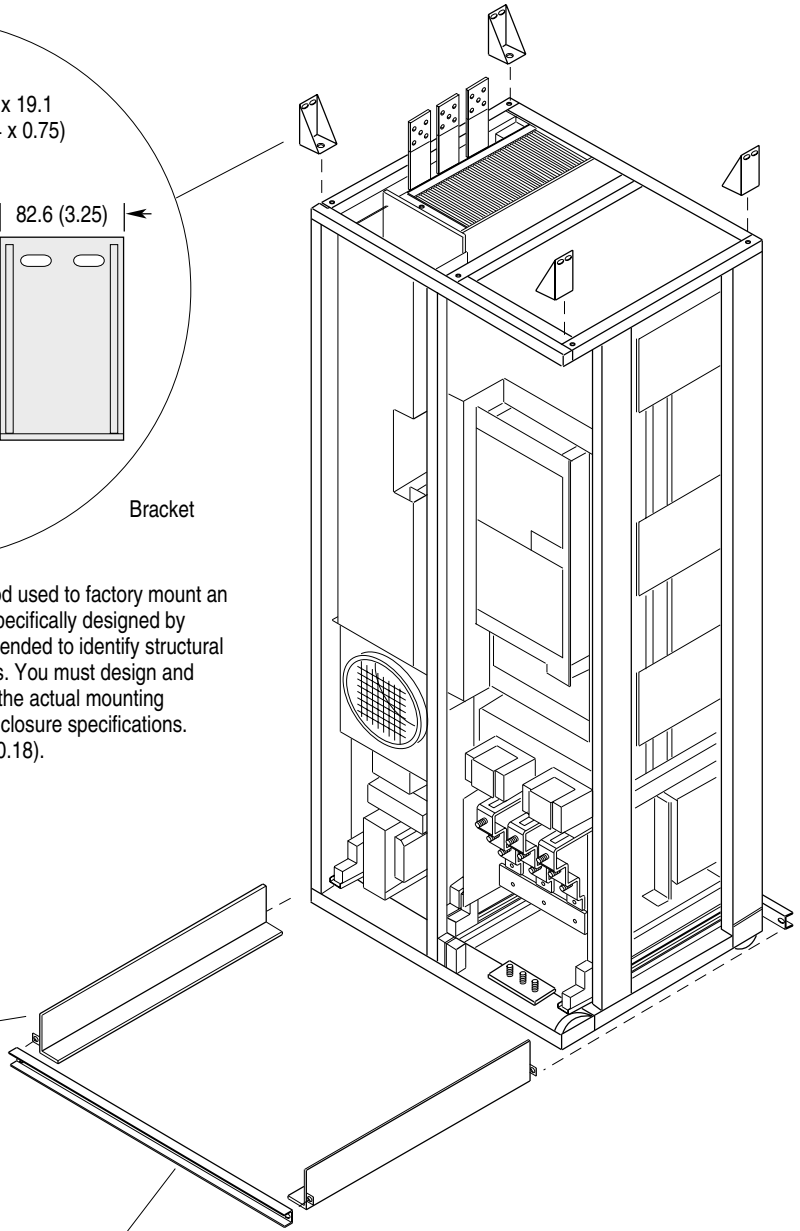

Brace

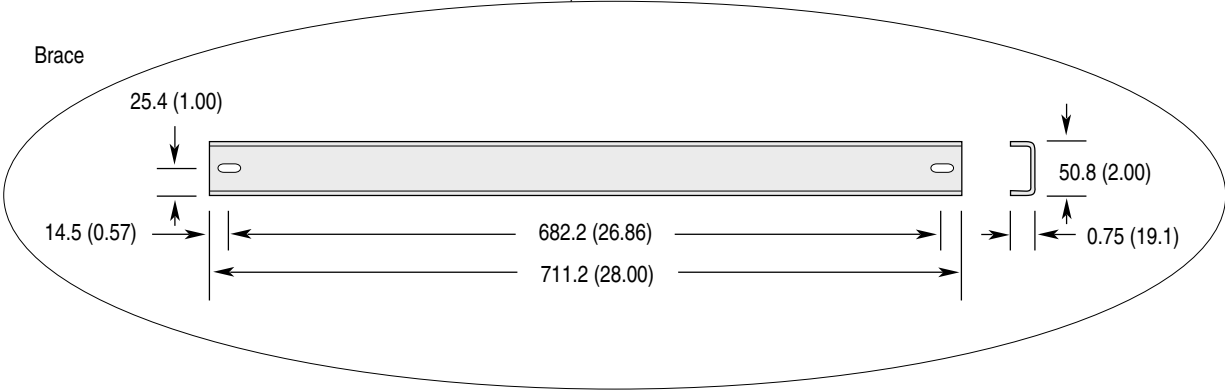

CE Conformity

Low Voltage Directive

The following low voltage directives apply:

- EN 60204-1
- PREN 50178

EMC Directive

This apparatus is tested to meet Council Directive 89/336 Electromagnetic Compatibility (EMC) using a technical construction file and the following standards:

- EN 50081-1, -2 - Generic Emission Standard
- EN 50082-1, -2 - Generic Immunity Standard

Declarations of Conformity to the European Union Directives are available. Please contact your Allen-Bradley Sales Representative.

Marked for all applicable directives ¹		
Emissions	EN 50081-1 EN 50081-2 EN 55011 Class A EN 55011 Class B EN 61800-3	
Immunity	EN 50082-1 EN 50082-2 IEC 801-1, 2, 3, 4, 6, 8 per EN 50082-1, 2 EN 61800-3	
Low Voltage	EN 60204-1 PREN 50178	

¹ Note: Installation guidelines stated below must be adhered to.

Important: The conformity of the drive and filter to any standard does not guarantee that the entire installation will conform. Many other factors can influence the total installation and only direct measurements can verify total conformity.

Requirements for Conforming Installation

The following six items **are required** for CE conformance:

1. Standard 1336 PLUS II Drive 0.37-448kW (0.5-600HP) CE compatible (Series D or higher).
2. Factory installed EMC enclosure (-AE option) or field installed EMC Enclosure Kit (1336x-AEx - see page [C-3](#)).
3. Filter as called out below.
4. Grounding as shown on page [C-4](#).
5. Input power (source to filter) and output power (filter to drive & drive to motor) wiring must be braided, shielded cable with a coverage of 75% or better, metal conduit or other with equivalent or better attenuation, mounted with appropriate connectors. For shielded cable it is recommended to use a compact strain relief connector with double saddle clamp for filter and drive input and compact strain relief connector with EMI protection for motor output.
6. Control (I/O) and signal wiring must be in conduit or have shielding with equivalent attenuation.

Filter

Filter Selection

Filter Catalog Number	Filter Series	Mounting See . . .	Power Dissipation	Three-Phase Volts	Used with . . .	Frame Reference
1336-RFB-7-AA	A	Figure C.1	4.5 Watts	200-240V	1336F-AQF05 - AQF10	A1
				380-480V	1336F-BRF05 - BRF20	A1-A2
1336-RFB-7-A	B	Figure C.1 or Figure C.2	2 Watts	200-240V	1336F-AQF05 - AQF10	A1
				380-480V	1336F-BRF05 - BRF20	A1-A2
1336-RFB-16-AA	A	Figure C.1	9 Watts	200-240V	1336F-AQF15 - AQF20	A2
				380-480V	1336F-BRF30 - BRF50	A2-A3
1336-RFB-16-A	B	Figure C.1 or Figure C.2	9.5 Watts	200-240V	1336F-AQF15 - AQF20	A2
				380-480V	1336F-BRF30 - BRF50	A2-A3
1336-RFB-30-A	A	Figure C.1	14 Watts	200-240V	1336F-AQF30 - AQF50	A3
1336-RFB-30-A4	A	Figure C.2	35 Watts	380-480V	1336F-BRF75 - BRF200	A4
1336-RFB-27-B	A	Figure C.2	30 Watts	200-240V	1336F-A007	B
				380-480V	1336F-B007 - B015	B
1336-RFB-48-B	A	Figure C.2	56 Watts	200-240V	1336F-A010 - A015	B
				380-480V	1336F-B020 - B030	B
1336-RFB-80-C	A	Figure C.2	71 Watts	200-240V	1336F-A020 - A030	C
				380-480V	1336F-BX040 - BX060	C
1336-RFB-150-D	A	Figure C.3 or Figure C.4	90 Watts	200-240V	1336F-A040 - A050	D
				380-480V	1336F-B060 - B100	D
1336-RFB-180-D	A	Figure C.3 or Figure C.4	125 Watts	200-240V	1336F-A060	D
				380-480V	1336F-B125 - BX150	D
1336-RFB-340-E	A	Figure C.3 or Figure C.4	60 Watts	200-240V	1336F-A075 - A125	E
				380-480V	1336F-B150 - B250	E
1336-RFB-475-G	A	Figure C.5	61 Watts	380-480V	1336F-BP/BPR250 - BP/BPR350	F
					1336F-BX250 - B350	G
1336-RFB-590-G	A	Figure C.5	94 Watts	380-480V	1336F-BP/BPR400 - BP/BPR450	F
					1336F-B400 - B450	G
1336-RFB-670-G	A	Figure C.5	121 Watts	380-480V	1336F-B500 - B600	G

EMC Enclosure Kit Selection

Frame Reference	Enclosure Kit Catalog Number		
	200-240V Rating	380-480V Rating	500-600V Rating
A1, A2, A3	1336F-AE3	1336F-AE3	–
A4	1336F-AE2	1336F-AE2	1336F-AE2
B	1336F-AE4	1336F-AE4	1336F-AE4
C	1336F-AE5	1336F-AE5	1336F-AE5
D	1336F-AE6	1336F-AE6	1336F-AE6
E	1336F-AE7	1336F-AE7	1336F-AE7

RFI Filter Installation

Important: Refer to the instructions supplied with the filter for details.

The RFI filter must be connected between the incoming AC supply line and the drive input terminals.

RFI Filter Leakage Current

The RFI filter may cause ground leakage currents. Therefore a solid ground connection must be provided as shown below.



ATTENTION: To guard against possible equipment damage, RFI filters can only be used with AC supplies that are nominally balanced and grounded with respect to ground. In some installations, three-phase supplies are occasionally connected in a 3-wire configuration with one phase grounded (Grounded Delta). The filter must not be used in Grounded Delta supplies.

Electrical Configuration

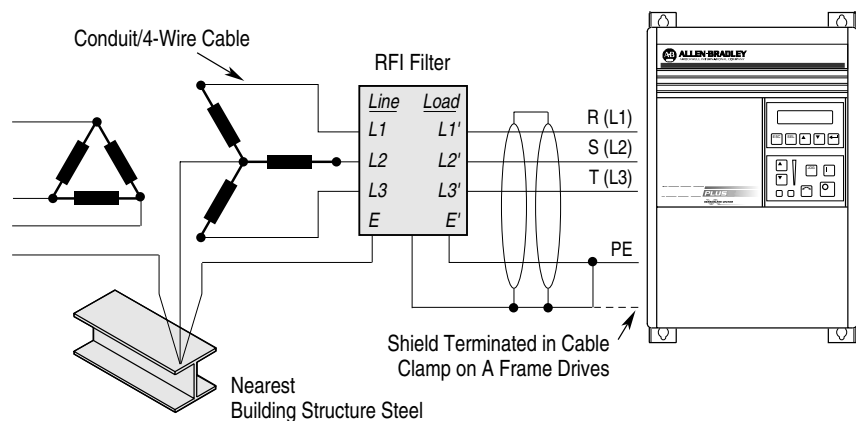

Grounding

RFI Filter Grounding

Important: Using the optional RFI filter may result in relatively high ground leakage currents. Surge suppression devices are also incorporated into the filter. Therefore, the filter must be permanently installed and solidly grounded (bonded) to the building power distribution ground. Ensure that the incoming supply neutral is solidly connected (bonded) to the same building power distribution ground.

Grounding must not rely on flexible cables and should not include any form of plug or socket that would permit inadvertent disconnection. Some local codes may require redundant ground connections. The integrity of all connections should be periodically checked.

Mechanical Configuration

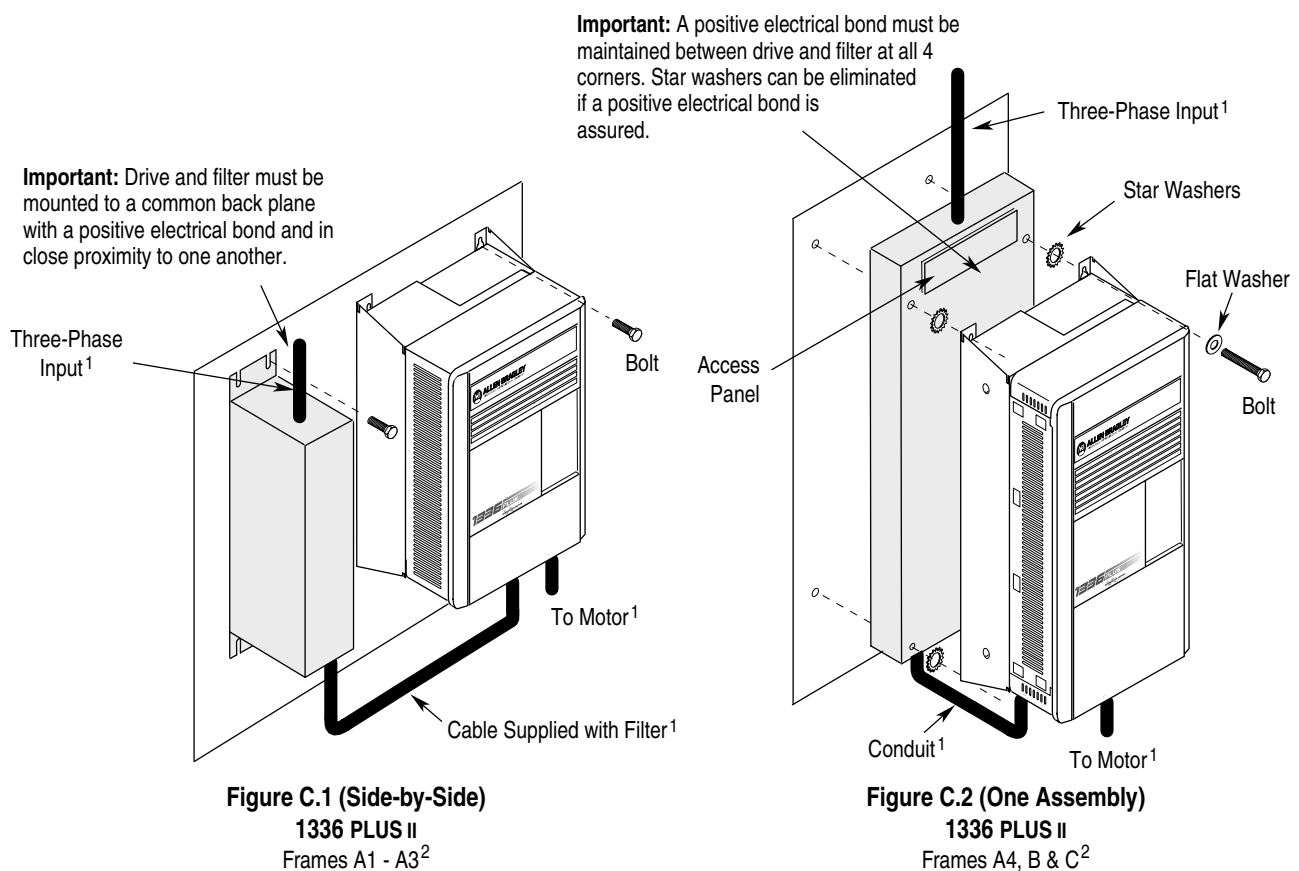

¹ Input power (source to filter) and output power (filter to drive and drive to motor) wiring must be in conduit or have shielding/armor with equivalent attenuation. Shielding/armor must be bonded to the metal bottom plate. See requirements 5 & 6 on page [C-2](#).

² Refer to the Filter Selection table on page [C-2](#) for frame references and corresponding catalog numbers.

Filter Mounting (continued)

Important: Drive and filter must be mounted to a common back plane with a positive electrical bond. Spacing is determined by Conduit Box.

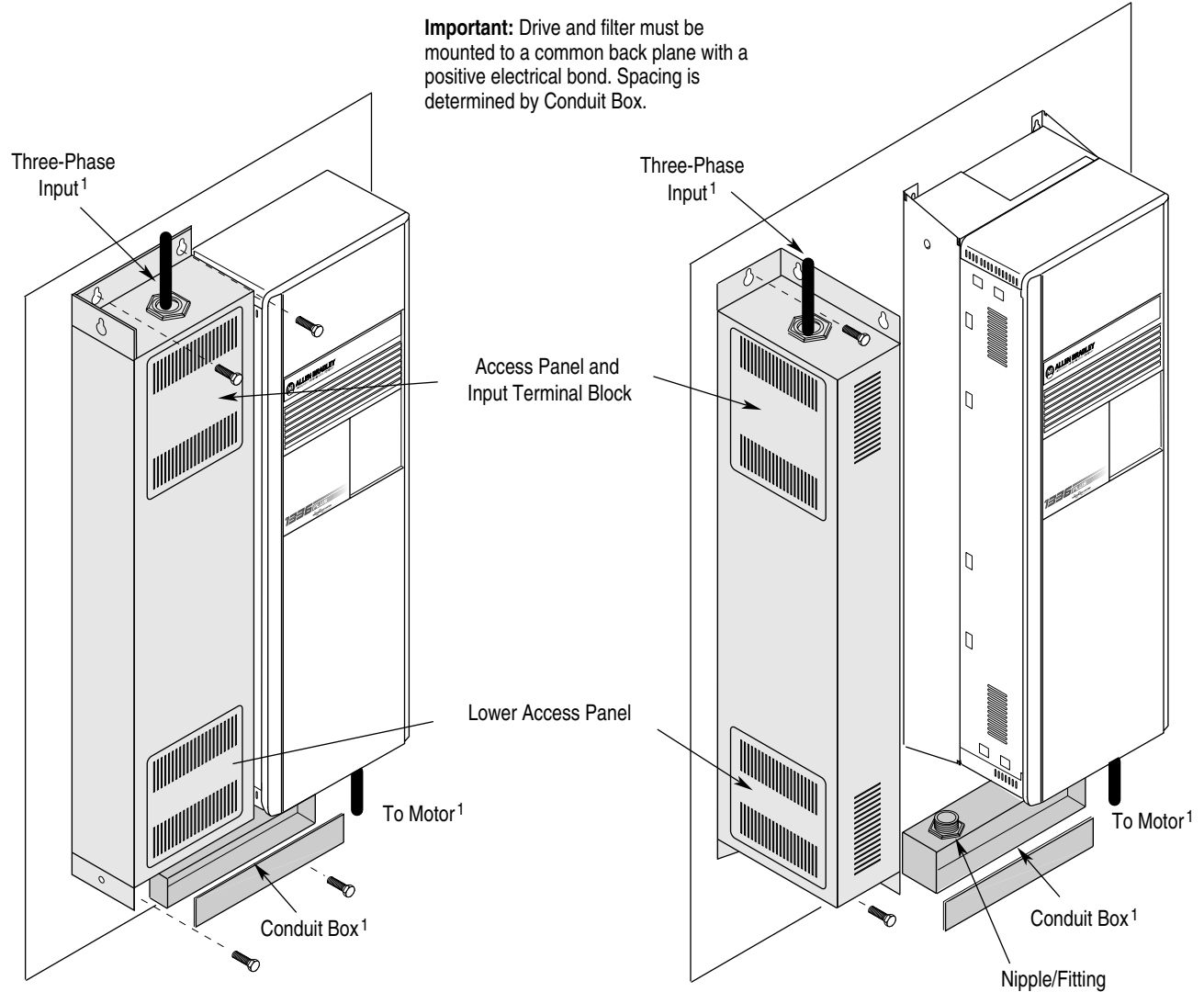

Figure C.3
1336 PLUS II
(Through-the-Wall Mounting)
Frames D & E²

Figure C.4
1336 PLUS II
(Conventional Mounting)
Frames D & E²

¹ Input power (source to filter) and output power (filter to drive and drive to motor) wiring must be in conduit or have shielding/armor with equivalent attenuation. Shielding/armor must be bonded to the metal bottom plate. See requirements 5 & 6 on page C-2.

² Refer to the Filter Selection table on page C-2 for frame references and corresponding catalog numbers.

Filter Mounting *(continued)*

Important: A positive electrical bond must be maintained between the enclosure and filter (including brackets), fans, and drive. To assure a positive electrical bond, any paint near all mounting points must be removed.

Important: Cooling fans are required for proper drive operation. Fans and air intake openings must be EMI shielded. Refer Appendix A for CFM recommendations.

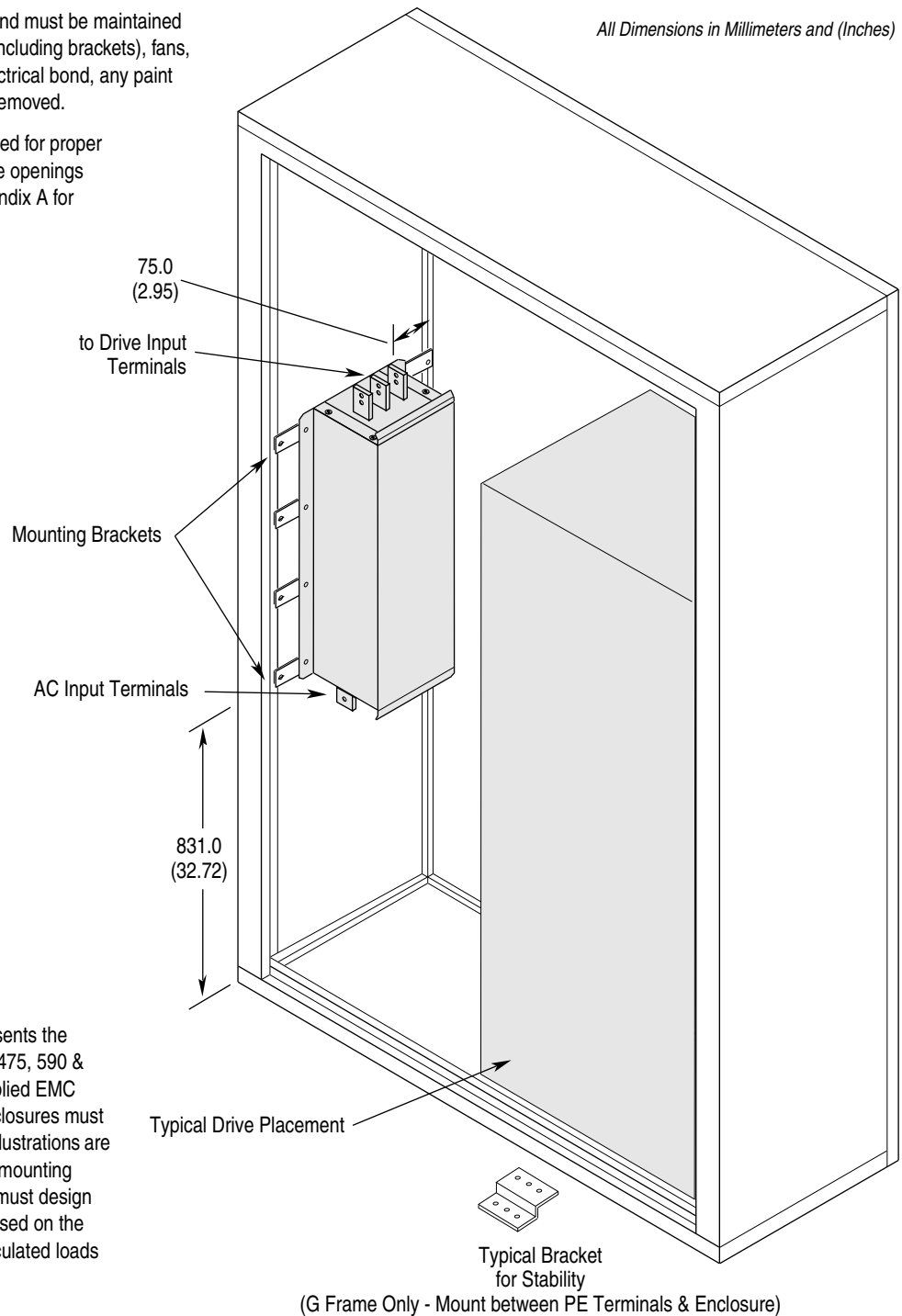

Important: This information represents the method used to mount 1336-RFB-475, 590 & 670 filters in an Allen-Bradley supplied EMC enclosure. User supplied EMC enclosures must follow all of the guidelines shown. Illustrations are only intended to identify structural mounting points and hardware shapes. You must design and fabricate steel components based on the actual mounting configuration, calculated loads and enclosure specifications.

Figure C.5
1336 PLUS II
(Typical Filter Mounting)
 Frames F & G ^{1, 2}

¹ Input power (source to filter) and output power (filter to drive and drive to motor) wiring must be in conduit or have shielding/armor with equivalent attenuation. Shielding/armor must be bonded to the metal bottom plate. See requirements 5 & 6 on page [C-2](#).

² Refer to the Filter Selection table on page [C-2](#) for frame references and corresponding catalog numbers.

Required Knockout Assignments

Dimensions are in Millimeters and (Inches)

Frames A1 through A4

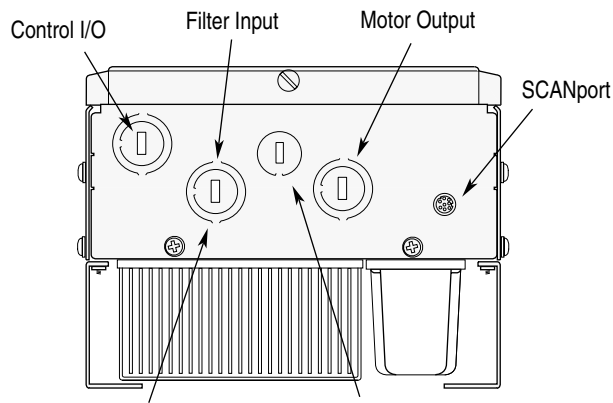

22.2/28.6 (0.88/1.13) - 3 Plcs. 22.2 (0.88) - 1 Plc.

Frames B and C

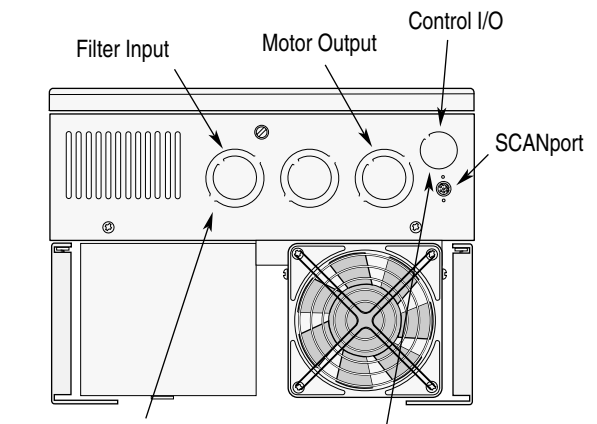

28.6/34.9 (1.13/1.38) - 3 Plcs. 22.2 (0.88) - 1 Plc.

Frame D

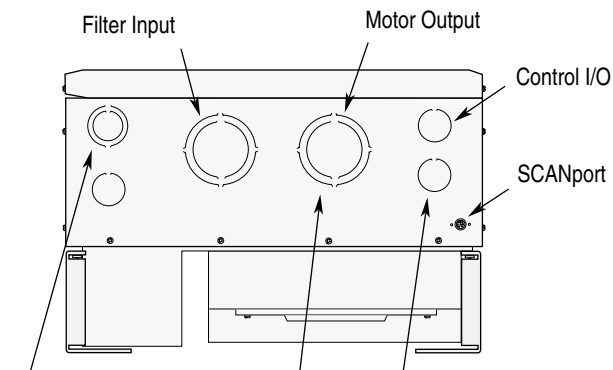

34.9/50.0 (1.38/1.97) - 1 Plc. 34.9 (1.38) - 3 Plcs.
62.7/76.2 (2.47/3.00) - 2 Plcs.

Frame E

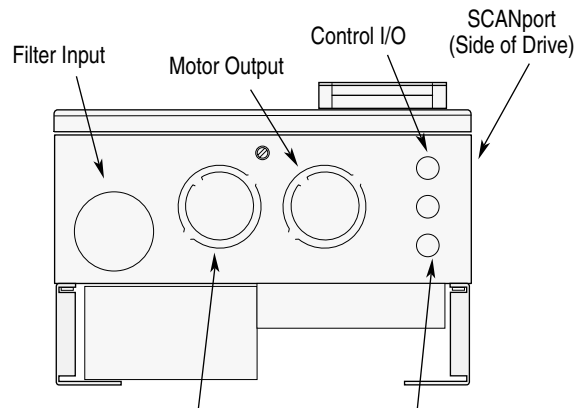

88.9/104.8 (3.50/4.13) - 2 Plcs. 12.7 (0.50) - 3 Plcs.

Filter Dimensions

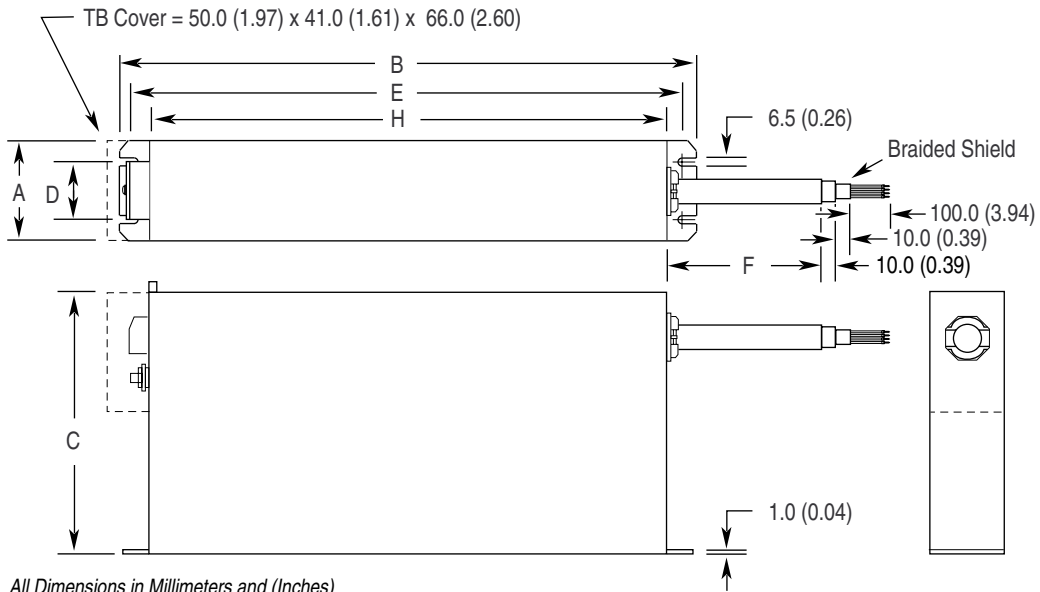

All Dimensions in Millimeters and (Inches)

Catalog Number	A	B	C	D	E	F	H	Weight kg (lbs.)
1336-RFB-7-AA	50.0 (1.97)	255.0 (10.04)	126.0 (4.96)	25.0 (0.98)	240.0 (9.45)	180.0 (7.09)	225.0 (8.86)	1.1 (2.4)
1336-RFB-16-AA	55.0 (2.17)	305.0 (12.00)	142.0 (5.59)	30.0 (1.18)	290.0 (11.42)	230.0 (9.06)	275.0 (10.83)	1.7 (3.8)
1336-RFB-30-A	60.0 (2.36)	335.0 (13.19)	160.0 (6.30)	35.0 (1.38)	320.0 (12.60)	280.0 (11.02)	305.0 (12.00)	1.8 (4.0)

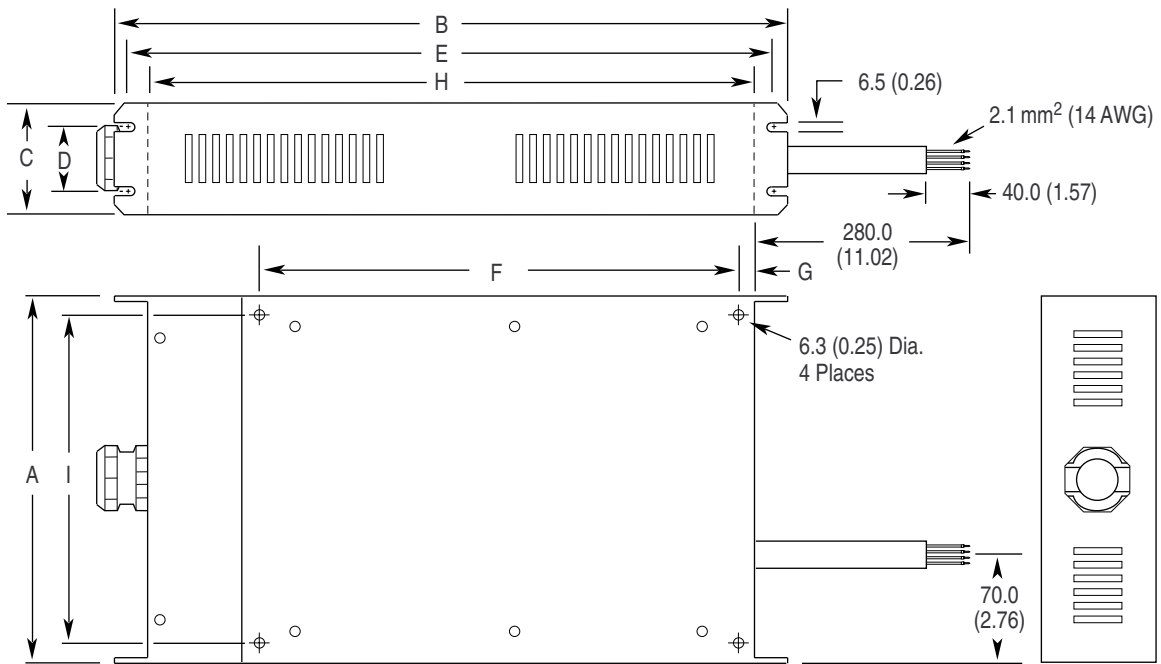

All Dimensions in Millimeters and (Inches)

Catalog Number	A	B	C	D	E	F	G	H	I
1336-RFB-7-A & 16-A Series B	215.9 (8.50)	390.0 (15.35)	58.0 (2.28)	30.0 (1.18)	375.0 (14.76)	275.0 (10.83)	7.5 (0.30)	360.0 (14.17)	185.2 (7.29)

Filter Dimensions (continued)

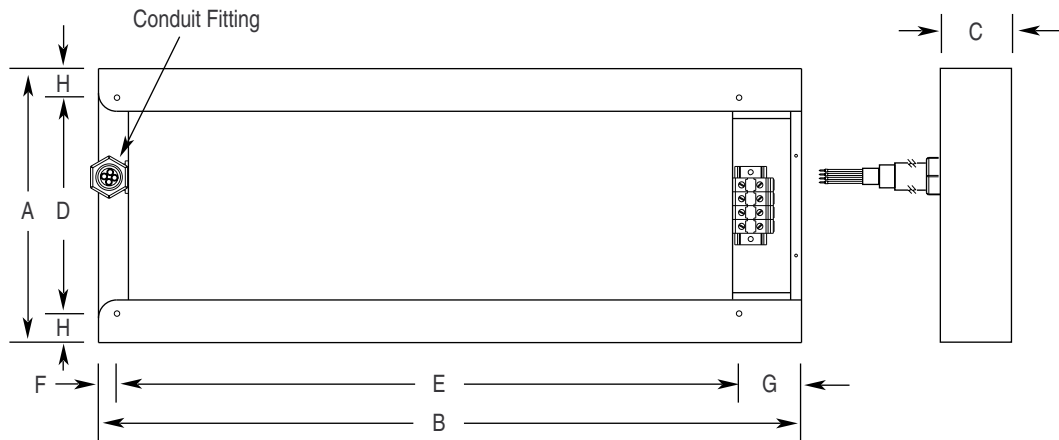

Catalog Number	A	B	C	D	E	F	G	H	Weight kg (lbs.)
1336-RFB-30-A4	260.1 (10.24)	413.7 (16.29)	58.0 (2.28)	230.1 (9.06)	320.0 (12.60)	15.0 (0.59)	70.0 (2.76)	15.0 (0.59)	4.9 (10.8)
1336-RFB-27-B	276.6 (10.89)	540.0 (21.26)	58.0 (2.28)	212.6 (8.37)	461.0 (18.15)	10.9 (0.43)	68.1 (2.68)	32.0 (1.26)	7.0 (15.4)
1336-RFB-48-B	276.6 (10.89)	540.0 (21.26)	68.1 (2.68)	212.6 (8.37)	461.0 (18.15)	10.9 (0.43)	68.1 (2.68)	32.0 (1.26)	8.5 (18.7)
1336-RFB-80-C	302.0 (11.89)	775.0 (30.50)	78.5 (3.09)	238.0 (9.37)	685.8 (27.00)	20.4 (0.80)	68.8 (2.70)	32.0 (1.26)	12.0 (26.5)

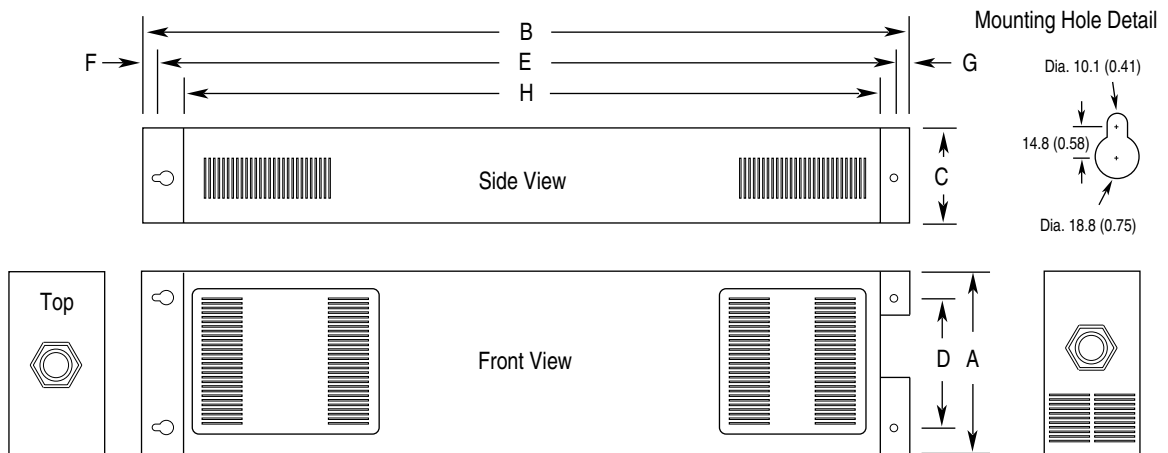

All Dimensions in Millimeters and (Inches)

Catalog Number	A	B	C	D	E	F	G	H	Weight kg (lbs.)
1336-RFB-150-D, 1336-RFB-180-D	270.0 (10.63)	1200.0 (47.20)	147.2 (5.80)	204.0 (8.03)	1159.4 (45.65)	20.3 (0.80)	20.3 (0.80)	1108.3 (43.63)	25.0 (55.1)
1336-RFB-340-E	377.0 (14.84)	1392.0 (54.80)	155.0 (6.10)	308.0 (12.13)	1346.1 (53.00)	23.0 (0.91)	23.0 (0.91)	1265 (49.80)	37.0 (81.6)

A

AC Supply Source, **2-3**
 Adapter Definitions, **2-41**
 Alarms, **7-9**
 Analog I/O Options, **2-34**
 Analog Option Board
 Installation/Removal, **2-34**
 Setup, **2-34**
 Armored Cable, **2-17**
 Auto Restart, **6-20**

B

Bypass Contactors, **2-9**

C

Cable Termination, **2-37**
 Cables, Power
 Armored, **2-17**
 Shielded, **2-17**
 Unshielded, **2-17**
 Catalog Number Explanation, **1-2**
 CE Conformity, **2-10, C-1**
 Circuit Breakers, Input, **2-5**
 Common Mode Cores, **2-37**
 Contacts, Fault, **7-1**
 Control Interface Option
 Board Removal/Installation, **2-40**
 L4/L4E, **A-14**
 L5/L5E, **A-15**
 L6/L6E, **A-16**
 L7E, **A-14**
 Control Status Mode, **3-6**
 Custom Volts/Hz, **6-57**

D

DC Brake to Stop, **6-13**
 Derate Guidelines, **A-5**
 Dimensions
 F Frame, Roll-In, **B-6**
 Filter, CE, **C-8**
 Frame F Mounting Hardware, **B-21**
 Frame G Mounting Hardware, **B-22**
 Heat Sink Through the Back, **B-12**
 Inductor, DC Bus - Frame F, **B-20**
 IP 20 (NEMA Type 1)
 Bottom Views, **B-9**
 Front Views, **B-2**
 IP 65/54 (NEMA Type 4/12)
 Enclosure, **B-8**
 Optional Junction Box, **B-11**
 TB1 - Frame G, **B-19**
 TB1 - Frames D & E, **B-18**
 Display Mode, **3-5**
 Distances Between Devices, **2-41**
 Distribution Systems
 Unbalanced, **2-3**
 Ungrounded, **2-3**
 Drive Status Structure, **A-11**
 Dwell, **6-19**

E

EEProm Mode, **3-5**
 Electrostatic Discharge (ESD), **1-2**
 Engineering Unit, **6-4**
 ENUM, **6-4**

F

Fan Voltage, Selecting/Verifying, **2-38**
 Fault Buffer History, **6-32**
 Faults
 Adptr Freq Err, **7-2**
 Auxiliary, **7-2**
 Bgnd 10ms Over, **7-2**
 Bipolar Dir Flt, **7-2**
 Blwn Fuse Flt, **7-2**
 C167 Watchdog, **7-2**
 Diag C Lim Flt, **7-2**
 Drive -> HIM, **7-2**
 DSP Checksum, **7-2**
 DSP Comm Fault, **7-2**
 DSP Protected, **7-2**
 DSP Queue Fault, **7-2**
 DSP Reset Fault, **7-2**
 DSP Timeout Fault, **7-2**
 EE Init Read, **7-2**
 EE Init Value, **7-3**
 EEProm Checksum, **7-3**
 EEProm Fault, **7-3**
 Encoder Loss, **7-3**
 Fgnd 10ms Over, **7-3**
 Ground Fault, **7-3**
 Ground Warning, **7-3**
 Hardware Trap, **7-3**
 Hertz Err Fault, **7-3**
 Hertz Sel Fault, **7-4**
 HIM -> Drive, **7-4**
 Ill Prog Input, **7-4**
 Input Phase Flt, **7-4**
 Load Loss Flt, **7-4**
 Loop Overrn Flt, **7-4**
 Max Retries Fault, **7-4**
 Motor Mode Flt, **7-4**
 Motor Stall Fault, **7-4**
 Motor Thermistor, **7-4**
 Mult Prog Input, **7-4**
 Neg Slope Fault, **7-4**
 Op Error Fault, **7-5**
 Open Pot Fault, **7-5**
 Option Error, **7-5**
 Overcurrent Flt, **7-5**
 Overload Fault, **7-5**
 Overspeed Fault, **7-5**
 Overtemp Fault, **7-5**
 Overvolt Fault, **7-5**
 Phase U Fault, **7-5**
 Phase V Fault, **7-5**
 Phase W Fault, **7-5**
 Poles Calc Flt, **7-5**
 Power Loss Fault, **7-5**
 Power Mode Fault, **7-5**
 Power Overload, **7-6**
 Precharge Fault, **7-6**

Precharge Open, 7-6
 Prm Access Flt, 7-6
 Reprogram Fault, 7-6
 ROM or RAM Fault, 7-6
 Serial Fault, 7-6
 Shear Pin Fault, 7-6
 Step Logic Flt, 7-6
 Sync Loss Fault, 7-7
 Temp Sense Open, 7-7
 Undervolt Fault, 7-7
 UV Short Fault, 7-7
 UW Short Fault, 7-7
 VW Short Fault, 7-7
 Xsistr Desat Flt, 7-7
 Filtering, RFI, 2-10, 2-12, C-4
 Flux Vector vs. V/Hz, 5-7, 5-11
 Frame References, 1-1
 Frequency Select, 6-16
 Function Index, 6-1
 Fusing, Input, 2-5

G

Grounding, 2-11

H

Human Interface Module (HIM)
 Character Map, A-10
 Description, 3-1
 Key Descriptions, 3-2
 Operation, 3-4
 Removal, 3-13

I

Input Devices, 2-9
 Input Power Conditioning, 2-4
 Input/Output Rating, A-2
 Interference, EMI/RFI, 2-9
 Isolation Transformer, 2-4

L

L4/L4E Option, A-14
 L5/L5E Option, A-15
 L6/L6E Option, A-16
 L7E Option, A-14
 Language, 6-21
 Logic Control Structure, A-11, A-12
 Low Speed Operation, 5-10
 Lug Kits, 2-15

M

Min./Max. Frequency, 6-9
 Motor Cable Length, 2-18
 Motor Starting/Stopping, 2-9
 Mounting, 2-1

N

Nameplate Location, 1-4

O

Output Configuration, 6-28
 Overload, 6-11

P

Parameter Cross Ref.
 By Name, A-9
 By Number, A-8
 Parameter Record, A-17
 Parameters
 % Output Curr, 6-7
 % Output Power, 6-7
 4-20 mA Loss Sel, 6-30
 Accel Mask, 6-43
 Accel Owner, 6-46
 Accel Time, 6-8, 6-12
 Adaptive I Lim, 6-10
 Alarm Mask, 6-45
 Alt Type 2 Cmd, 6-48
 Analog Trim En, 6-30
 Anlg In Hi, 6-30
 Anlg In Lo, 6-30
 Anlg In x Freq, 6-5
 Anlg Out Abs, 6-31
 Anlg Out Hi, 6-31
 Anlg Out Lo, 6-31
 Anlg Out Offset, 6-31
 Anlg Out Sel, 6-31
 Anlg Signal Loss, 6-30
 Application Sts, 6-36
 At Time, 6-29
 Base Frequency, 6-59
 Base Voltage, 6-58
 Bidir In Offset, 6-64
 Blwn Fuse Flt, 6-33
 Boost Slope, 6-58
 Braking Chopper, 6-14
 Break Freq, 6-60
 Break Frequency, 6-58
 Break Voltage, 6-58
 Bus Limit En, 6-14
 Bus Reg Level, 6-26
 Bus Regulation, 6-25
 Clear Fault, 6-32
 Cntrl Board Rev, 6-41
 Common Bus, 6-15
 Control Select, 6-57
 CR Out Select, 6-28
 Cur Lim Trip En, 6-32
 Current Angle, 6-39
 Current Limit, 6-9
 Current Limit En, 6-10
 Current Lmt Sel, 6-9
 Current Step, 6-64
 Data In, 6-48
 Data Out, 6-48
 DC Bus Memory, 6-40
 DC Bus Voltage, 6-5
 DC Hold Level, 6-13
 DC Hold Time, 6-13
 Decel Mask, 6-44
 Decel Owner, 6-47
 Decel Time, 6-8, 6-12
 Dig At Temp, 6-28
 Dig Out Current, 6-28
 Dig Out Freq, 6-28
 Dig Out Torque, 6-28
 Direction Mask, 6-43

- Direction Owner, 6-46
- Drive Alarm, 6-36, 6-37
- Drive Direction, 6-38
- Drive Status, 6-36
- Drive Type, 6-42
- Dwell Frequency, 6-19
- Dwell Time, 6-19
- EEPROM Cksum, 6-40
- Elapsed Run Time, 6-7
- Enc Count Scale, 6-52
- Encoder Counts, 6-52
- Encoder Freq, 6-6, 6-52
- Encoder Loss Sel, 6-52
- Encoder PPR, 6-18, 6-50
- Encoder Type, 6-50
- Fault Alarms, 6-34, 6-35
- Fault Buffer, 6-32
- Fault Data, 6-33
- Fault Frequency, 6-34
- Fault Mask, 6-44
- Fault Owner, 6-47
- Fault Status, 6-34
- Firmware Ver., 6-41
- Fit Clear Mode, 6-35
- Fit Motor Mode, 6-33
- Fit Power Mode, 6-33
- Flux Amps Ref, 6-57
- Flux Current, 6-7
- Flux Up Time, 6-58
- Flying Start En, 6-21
- Freq Command, 6-5, 6-38
- Freq Ref SqRoot, 6-17
- Freq Select, 6-8, 6-16
- Freq Source, 6-38
- FStart Forward, 6-22
- FStart Reverse, 6-22
- Ground Warning, 6-35
- Heatsink Temp, 6-6, 6-39
- Hold Level Sel, 6-14
- Input Mode, 6-8, 6-27
- Input Status, 6-27, 6-37
- IR Drop Volts, 6-58
- Jog Frequency, 6-16
- Jog Mask, 6-43
- Jog Owner, 6-46
- KI Process, 6-55
- KP Amps, 6-15
- KP Process, 6-56
- Language, 6-21
- Last Fault, 6-6
- Latched Alarms, 6-37
- Line Loss Fault, 6-32
- Line Loss Mode, 6-22
- Line Loss Volts, 6-24
- LLoss Restart, 6-22
- Load Loss Detect, 6-25
- Load Loss Level, 6-26
- Load Loss Time, 6-26
- Local Mask, 6-44
- Local Owner, 6-47
- Logic Mask, 6-44
- Loss Recover, 6-24
- Low Bus Fault, 6-33
- Max Bus Volts, 6-26
- Max Enc Counts, 6-52
- Max Traverse, 6-25
- Maximum Freq, 6-9, 6-12
- Maximum Speed, 6-50
- Maximum Voltage, 6-59
- Meas. Volts, 6-40
- Min Bus Volts, 6-24
- Minimum Freq, 6-9, 6-12
- MOP Freq, 6-6
- MOP Increment, 6-17
- MOP Mask, 6-44
- MOP Owner, 6-47
- Motor Mode, 6-38
- Motor NP Amps, 6-11
- Motor NP Hertz, 6-11, 6-51
- Motor NP RPM, 6-11, 6-51
- Motor NP Volts, 6-11
- Motor OL Count, 6-6
- Motor OL Fault, 6-32
- Motor OL Ret, 6-35
- Motor Poles, 6-50
- Motor Therm Flt, 6-32
- Motor Type, 6-15
- Output Current, 6-5
- Output Freq, 6-5
- Output Power, 6-5
- Output Pulses, 6-39
- Output Voltage, 6-5
- Overload Amps, 6-11
- Overload Mode, 6-10
- P Jump, 6-25
- Phase Loss Level, 6-35
- Phase Loss Mode, 6-35
- PI Config, 6-53
- PI Error, 6-55
- PI Fdbk Select, 6-55
- PI Feedback, 6-55
- PI Max Error, 6-29
- PI Neg Limit, 6-56
- PI Output, 6-55
- PI Pos Limit, 6-56
- PI Preload, 6-56
- PI Ref Select, 6-54
- PI Reference, 6-55
- PI Status, 6-54
- Power Mode, 6-39
- Power OL Count, 6-6
- Precharge Fault, 6-35
- Preset Freq, 6-16
- Process 1 Par, 6-49
- Process 1 Scale, 6-49
- Process 1 Txt, 6-49
- Process 2 Par, 6-49
- Process 2 Scale, 6-49
- Process 2 Txt, 6-49
- Pulse Freq, 6-6
- Pulse In Scale, 6-18, 6-29
- Pulse Out Scale, 6-29
- Pulse Out Select, 6-29
- PWM Break Freq, 6-60
- PWM Comp Time, 6-60
- PWM Frequency, 6-12
- Rated Amps, 6-41
- Rated CT Amps, 6-41
- Rated CT kW, 6-41
- Rated kW, 6-41

- Rated Volts, 6-41
 - Rated VT Amps, 6-41
 - Rated VT kW, 6-41
 - Reference Mask, 6-43
 - Reference Owner, 6-46
 - Remote CR Output, 6-29
 - Reset/Run Time, 6-20
 - Reset/Run Tries, 6-20
 - Ride Thru Volts, 6-24
 - Run Boost, 6-58
 - Run On Power Up, 6-20
 - Run/Accel Volts, 6-59
 - S Curve Enable, 6-20
 - S Curve Time, 6-20
 - Save MOP Ref, 6-17
 - Set Defaults, 6-39
 - Shear Pin Fault, 6-32
 - Skip Freq, 6-17
 - Skip Freq Band, 6-17
 - Slip Adder, 6-51
 - Slip Comp Gain, 6-20
 - Slip@F.L.A., 6-19
 - Slot A-B Option, 6-31
 - SLx Encoder Cnts, 6-64
 - SLx Logic Jump, 6-63
 - SLx Logic Step, 6-62
 - SLx Step Jump, 6-63
 - SLx Step Setting, 6-63
 - SLx Time, 6-64
 - Speed Adder, 6-51
 - Speed Brake En, 6-15
 - Speed Control, 6-19, 6-50, 6-53
 - Speed Error, 6-51
 - Speed Integral, 6-51
 - Speed KI, 6-51
 - Speed KP, 6-51
 - Stability Gain, 6-60
 - Start Boost, 6-58
 - Start Mask, 6-43
 - Start Owner, 6-46
 - Stop Mode Used, 6-38
 - Stop Owner, 6-46
 - Stop Select, 6-9, 6-13, 6-15
 - Sync Loss Comp, 6-60
 - Sync Loss Gain, 6-59
 - Sync Loss Sel, 6-59
 - Sync Loss Time, 6-60
 - Sync Mask, 6-44
 - Sync Owner, 6-47
 - Sync Time, 6-13
 - TB3 Term Sel, 6-27
 - Torque Current, 6-7
 - Traverse Dec, 6-25
 - Traverse Inc, 6-24
 - Traverse Mask, 6-44
 - Traverse Owner, 6-47
 - VT Scaling, 6-11
 - Password Mode, 3-6
 - Potentiometer, Wiring, 2-33
 - Power Loss Ride-Thru, 6-23
 - Preset Frequency, 6-16
 - Process Mode, 3-5
 - Program Mode, 3-5
 - Programmable Controller Config., A-12
 - Programming Flow Chart, 6-1
 - Pulse Input, 2-31
- ## R
- Reactors, 2-4
 - Remote I/O, 6-48
 - Reset Defaults, 5-3, 5-5
- ## S
- S Curve, 6-21
 - Search Mode, 3-5
 - Shielded Cables
 - Power, 2-17
 - Skip Frequency, 6-17
 - Software Compatibility, 1-1
 - Specification
 - Analog I/O, 2-36
 - Specifications
 - Control, A-2
 - Electrical, A-2
 - Environment, A-1
 - Input/Output Ratings, A-2
 - Protection, A-1
 - Speed Select Inputs, 2-28
 - Stability Gain, 6-60
 - Start Up Mode, 3-5
 - Status Display, 3-5
 - Step Logic, 6-61
- ## T
- TB3, Control Interface Board, 2-25
 - Terminal Blocks
 - Auxiliary Output, 2-40
 - Locations, 2-14
 - TB1, 2-15
 - TB2, Analog I/O, 2-32
 - TB2, Digital Outputs, 2-31
 - TB4/TB6, 2-39
 - Traverse Function, 6-25
 - Troubleshooting
 - Clearing a Fault, 7-1
 - Fault Code Cross Ref., 7-8
 - Fault Descriptions, 7-1
 - Fault Display, 7-1
 - HIM Upload/Download, 7-7
- ## U
- Unshielded Power Cables, 2-17
 - Upload/Download Capability, 3-5
 - User Supplied Enclosures, A-4
- ## V
- Volts/Hz Pattern, 6-57
- ## W
- Wiring
 - Control and Signal, 2-24
 - Control Interface, 2-25
 - Potentiometer, 2-33
 - Power, 2-14

www.rockwellautomation.com

Power, Control and Information Solutions Headquarters

Americas: Rockwell Automation, 1201 South Second Street, Milwaukee, WI 53204-2496 USA, Tel: (1) 414.382.2000, Fax: (1) 414.382.4444

Europe/Middle East/Africa: Rockwell Automation, Vorstlaan/Boulevard du Souverain 36, 1170 Brussels, Belgium, Tel: (32) 2 663 0600, Fax: (32) 2 663 0640

Asia Pacific: Rockwell Automation, Level 14, Core F, Cyberport 3, 100 Cyberport Road, Hong Kong, Tel: (852) 2887 4788, Fax: (852) 2508 1846