

# Linear™ Power MOSFET IXTH24N50L

## w/ Extended FBSOA

N-Channel Enhancement Mode  
Avalanche Rated

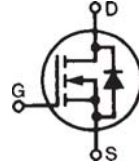

$$V_{DSS} = 500V$$

$$I_{D25} = 24A$$

$$R_{DS(on)} \leq 300m\Omega$$

Symbol	Test Conditions	Maximum Ratings	
$V_{DSS}$	$T_J = 25^\circ C$ to $150^\circ C$	500	V
$V_{DGR}$	$T_J = 25^\circ C$ to $150^\circ C$ , $R_{GS} = 1M\Omega$	500	V
$V_{GSS}$	Continuous	$\pm 30$	V
$V_{GSM}$	Transient	$\pm 40$	V
$I_{D25}$	$T_C = 25^\circ C$	24	A
$I_{DM}$	$T_C = 25^\circ C$ , Pulse Width Limited by $T_{JM}$	50	A
$I_A$	$T_C = 25^\circ C$	12	A
$E_{AS}$	$T_C = 25^\circ C$	1.5	J
$P_D$	$T_C = 25^\circ C$	400	W
$T_J$		-55 ... +150	$^\circ C$
$T_{JM}$		150	$^\circ C$
$T_{stg}$		-55 ... +150	$^\circ C$
$T_L$	1.6mm (0.062in.) from Case for 10s	300	$^\circ C$
$T_{sold}$	Plastic Body for 10 seconds	260	$^\circ C$
$M_d$	Mounting Torque	1.13 / 10	Nm/lb.in.
<b>Weight</b>		6	g

TO-247

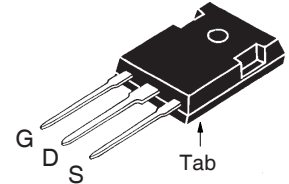

G = Gate      D = Drain  
S = Source    Tab = Drain

### Features

- Designed for Linear Operation
- International Standard Package
- Avalanche Rated
- Molding Epoxy Meets UL94 V-0 Flammability Classification

### Advantages

- Easy to Mount
- Space Savings
- High Power Density

### Applications

- Programmable Loads
- Current Regulators
- DC-DC Converters
- Battery Chargers
- DC Choppers
- Temperature and Lighting Controls

Symbol	Test Conditions ( $T_J = 25^\circ C$ , Unless Otherwise Specified)	Characteristic Values		
		Min.	Typ.	Max.
$BV_{DSS}$	$V_{GS} = 0V$ , $I_D = 250\mu A$	500		V
$V_{GS(th)}$	$V_{DS} = V_{GS}$ , $I_D = 250\mu A$	3.5		6.0 V
$I_{GSS}$	$V_{GS} = \pm 30V$ , $V_{DS} = 0V$			$\pm 100$ nA
$I_{DSS}$	$V_{DS} = V_{DSS}$ , $V_{GS} = 0V$ $T_J = 125^\circ C$			50 $\mu A$ 500 $\mu A$
$R_{DS(on)}$	$V_{GS} = 20V$ , $I_D = 0.5 \cdot I_{D25}$ , Note 1			300 m $\Omega$

Symbol	Test Conditions ( $T_J = 25^\circ\text{C}$ , Unless Otherwise Specified)	Characteristic Values			
		Min.	Typ.	Max.	
$g_{fs}$	$V_{DS} = 20\text{V}$ , $I_D = 0.5 \cdot I_{D25}$ , Note 1	3	7	11	S
$C_{iss}$	$V_{GS} = 0\text{V}$ , $V_{DS} = 25\text{V}$ , $f = 1\text{MHz}$		2500		pF
$C_{oss}$			400		pF
$C_{rss}$			100		pF
$t_{d(on)}$	<b>Resistive Switching Times</b> $V_{GS} = 15\text{V}$ , $V_{DS} = 0.5 \cdot V_{DSS}$ , $I_D = 0.5 \cdot I_{D25}$ $R_G = 4.7\Omega$ (External)		35		ns
$t_r$			85		ns
$t_{d(off)}$			110		ns
$t_f$			75		ns
$Q_{g(on)}$	$V_{GS} = 20\text{V}$ , $V_{DS} = 0.5 \cdot V_{DSS}$ , $I_D = 0.5 \cdot I_{D25}$		160		nC
$Q_{gs}$			30		nC
$Q_{gd}$			50		nC
$R_{thJC}$				0.31	$^\circ\text{C/W}$
$R_{thCS}$		0.21			$^\circ\text{C/W}$

### Safe-Operating-Area Specification

Symbol	Test Conditions	Characteristic Values			
		Min.	Typ.	Max.	
SOA	$V_{DS} = 400\text{V}$ , $I_D = 0.5\text{A}$ , $T_C = 60^\circ\text{C}$	200			W

### Source-Drain Diode

Symbol	Test Conditions ( $T_J = 25^\circ\text{C}$ , Unless Otherwise Specified)	Characteristic Values			
		Min.	Typ.	Max.	
$I_S$	$V_{GS} = 0\text{V}$			24	A
$I_{SM}$	Repetitive, Pulse Width Limited by $T_{JM}$			96	A
$V_{SD}$	$I_F = I_S$ , $V_{GS} = 0\text{V}$ , Note 1			1.5	V
$t_{rr}$	$I_F = I_S$ , $-di/dt = 100\text{A}/\mu\text{s}$ $V_R = 100\text{V}$ , $V_{GS} = 0\text{V}$		500		ns

Note 1. Pulse test,  $t \leq 300\mu\text{s}$ , duty cycle,  $d \leq 2\%$ .

### TO-247 (IXTH) Outline

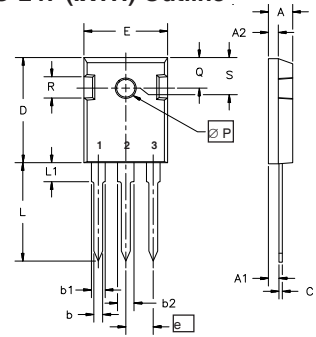

Terminals: 1 - Gate 2 - Drain  
3 - Source

Dim.	Millimeter		Inches	
	Min.	Max.	Min.	Max.
A	4.7	5.3	.185	.209
A <sub>1</sub>	2.2	2.54	.087	.102
A <sub>2</sub>	2.2	2.6	.059	.098
b	1.0	1.4	.040	.055
b <sub>1</sub>	1.65	2.13	.065	.084
b <sub>2</sub>	2.87	3.12	.113	.123
C	.4	.8	.016	.031
D	20.80	21.46	.819	.845
E	15.75	16.26	.610	.640
e	5.20	5.72	0.205	0.225
L	19.81	20.32	.780	.800
L1		4.50		.177
∅P	3.55	3.65	.140	.144
Q	5.89	6.40	0.232	0.252
R	4.32	5.49	.170	.216
S	6.15	BSC	.242	BSC

IXYS Reserves the Right to Change Limits, Test Conditions, and Dimensions.

IXYS MOSFETs and IGBTs are covered by one or more of the following U.S. patents:

4,835,592	4,931,844	5,049,961	5,237,481	6,162,665	6,404,065 B1	6,683,344	6,727,585	7,005,734 B2	7,157,338B2
4,850,072	5,017,508	5,063,307	5,381,025	6,259,123 B1	6,534,343	6,710,405 B2	6,759,692	7,063,975 B2	
4,881,106	5,034,796	5,187,117	5,486,715	6,306,728 B1	6,583,505	6,710,463	6,771,478 B2	7,071,537	

**Fig. 1. Output Characteristics**  
@  $T_J = 25^\circ\text{C}$

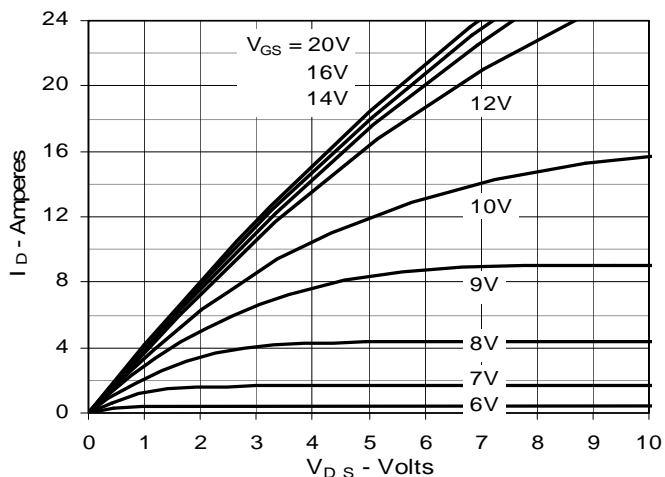

**Fig. 2. Extended Output Characteristics**  
@  $T_J = 25^\circ\text{C}$

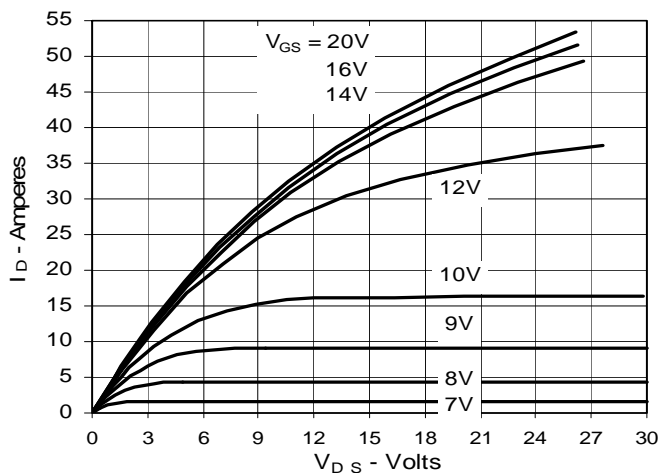

**Fig. 3. Output Characteristics**  
@  $T_J = 125^\circ\text{C}$

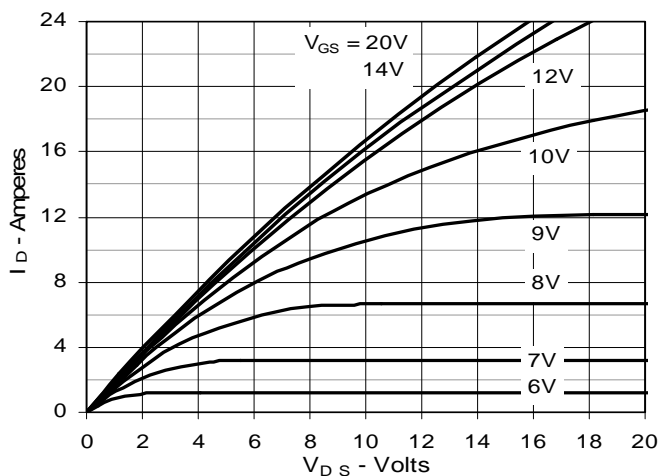

**Fig. 4.  $R_{DS(on)}$  Normalized to 0.5  $I_{D25}$  Value vs. Junction Temperature**

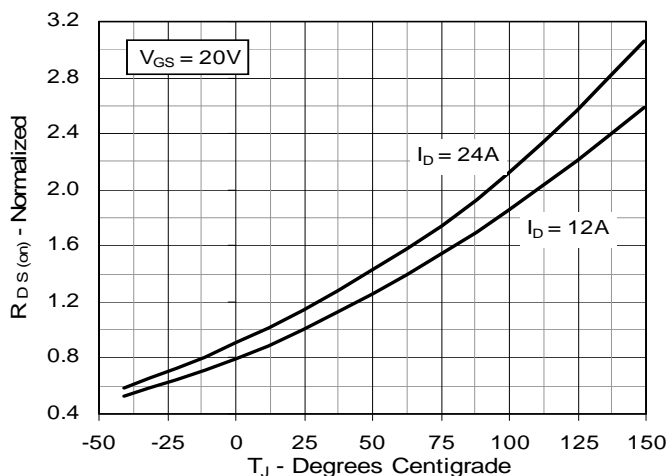

**Fig. 5.  $R_{DS(on)}$  Normalized to 0.5  $I_{D25}$  Value vs.  $I_D$**

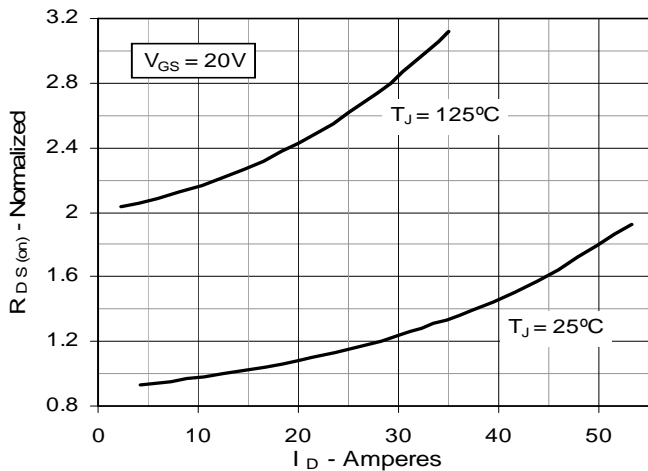

**Fig. 6. Drain Current vs. Case Temperature**

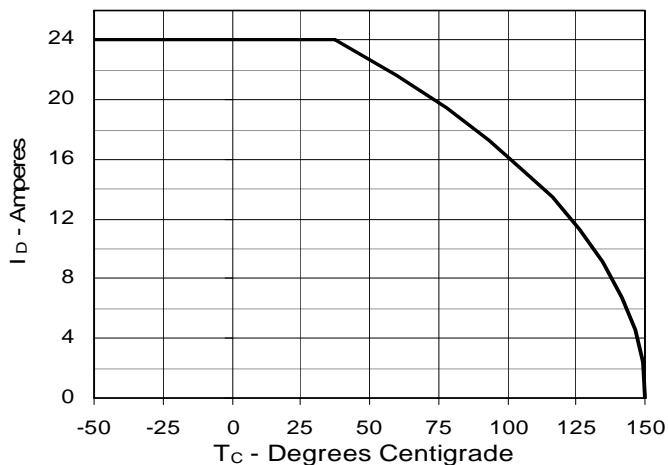

**Fig. 7. Input Admittance**

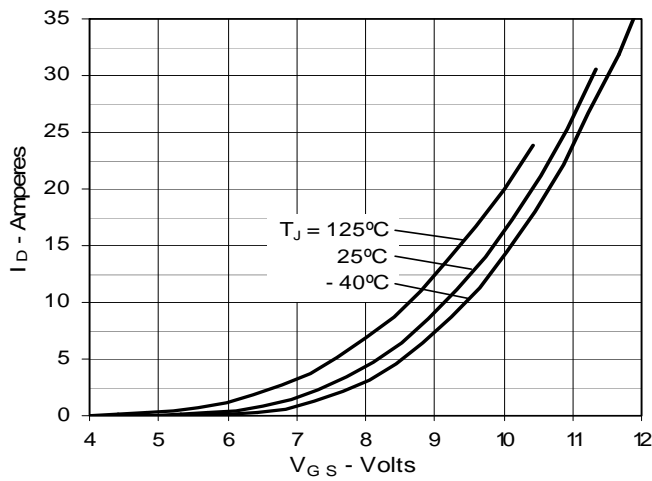

**Fig. 8. Transconductance**

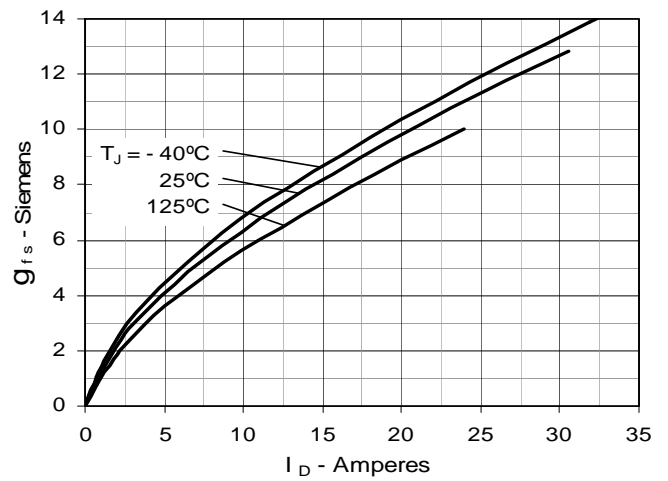

**Fig. 9. Source Current vs. Source-To-Drain Voltage**

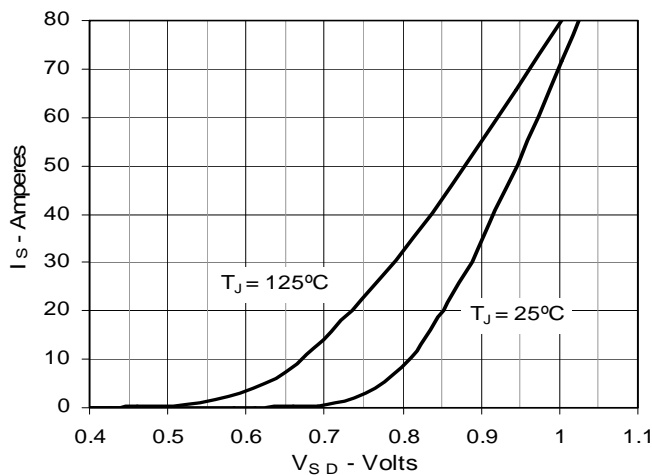

**Fig. 10. Gate Charge**

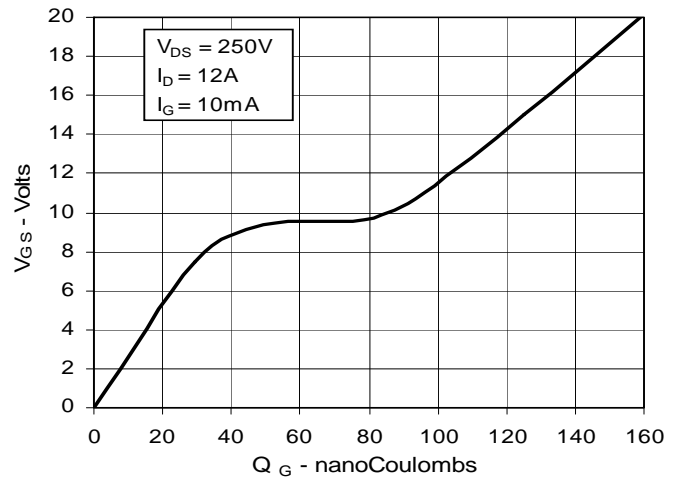

**Fig. 11. Capacitance**

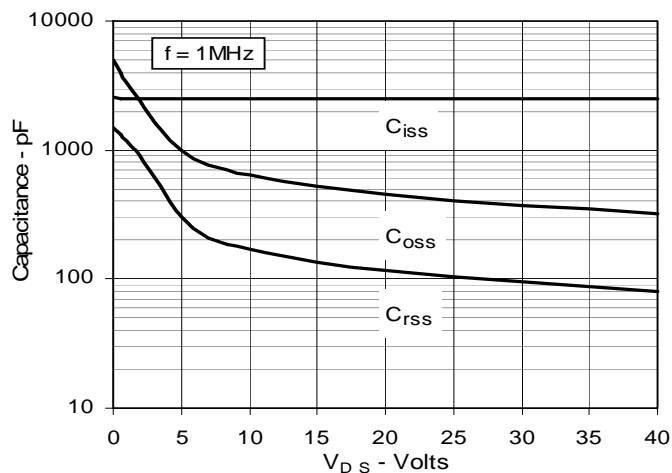

**Fig. 12. Maximum Transient Thermal Impedance**

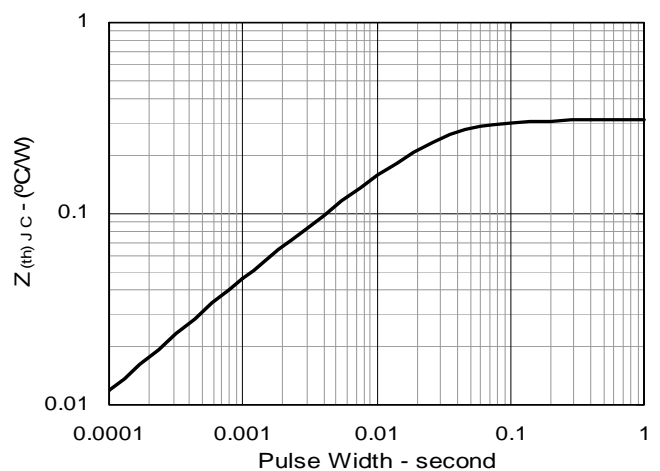

**Fig. 13. Forward-Bias Safe Operating Area @  $T_C = 25^\circ\text{C}$**

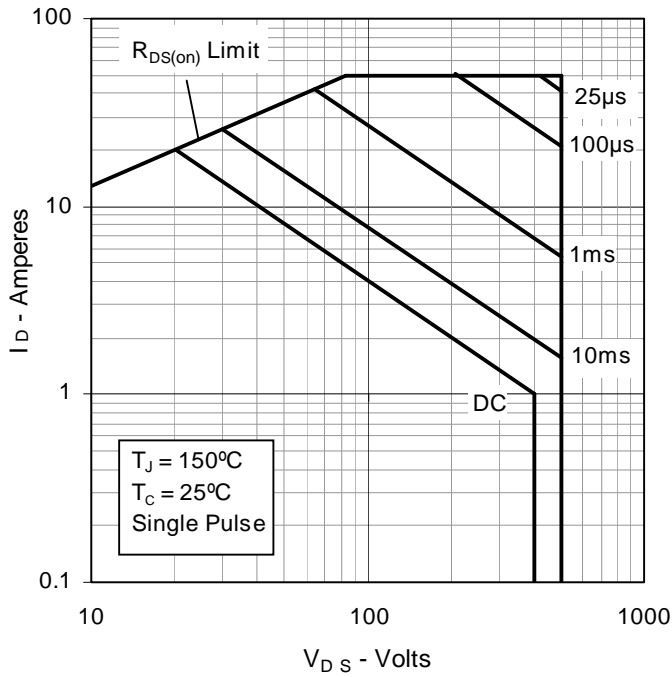

**Fig. 14. Forward-Bias Safe Operating Area @  $T_C = 60^\circ\text{C}$**

