

IGBT

Lightspeed Series

IXGA 15N120C
IXGP 15N120C

$V_{CES} = 1200$ V
 $I_{C25} = 30$ A
 $V_{CE(sat)} = 3.8$ V
 $t_{fi(typ)} = 115$ ns

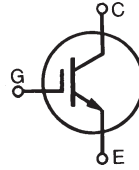

Symbol	Test Conditions	Maximum Ratings	
V_{CES}	$T_J = 25^\circ\text{C to } 150^\circ\text{C}$	1200	V
V_{CGR}	$T_J = 25^\circ\text{C to } 150^\circ\text{C}; R_{GE} = 1\text{ M}\Omega$	1200	V
V_{GES}	Continuous	± 20	V
V_{GEM}	Transient	± 30	V
I_{C25}	$T_C = 25^\circ\text{C}$	30	A
I_{C90}	$T_C = 90^\circ\text{C}$	15	A
I_{CM}	$T_C = 25^\circ\text{C}, 1\text{ ms}$	60	A
SSOA (RBSOA)	$V_{GE} = 15\text{ V}, T_{VJ} = 125^\circ\text{C}, R_G = 10\ \Omega$ Clamped inductive load	$I_{CM} = 40$ @ $0.8 V_{CES}$	A
P_C	$T_C = 25^\circ\text{C}$	200	W
T_J		-55 ... +150	$^\circ\text{C}$
T_{JM}		150	$^\circ\text{C}$
T_{stg}		-55 ... +150	$^\circ\text{C}$
Maximum lead temperature for soldering 1.6 mm (0.062 in.) from case for 10 s		300	$^\circ\text{C}$
M_d	Mounting torque with screw M3 Mounting torque with screw M3.5	0.45/4 0.55/5	Nm/lb.in.
Weight	TO-220 TO-263	4 2	g

TO-220AB (IXGP)

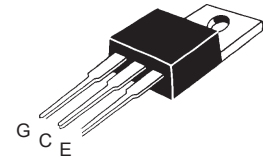

TO-263 AA (IXGA)

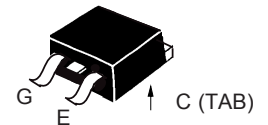

Features

- International standard packages
JEDEC TO-220AB and TO-263AA
- Low switching losses
- MOS Gate turn-on
- drive simplicity

Applications

- AC motor speed control
- DC servo and robot drives
- DC choppers
- Uninterruptible power supplies (UPS)
- Switch-mode and resonant-mode power supplies

Advantages

- Easy to mount with one screw
- Reduces assembly time and cost
- High power density

Symbol	Test Conditions ($T_J = 25^\circ\text{C}$, unless otherwise specified)	Characteristic Values		
		Min.	Typ.	Max.
BV_{CES}	$I_C = 250\ \mu\text{A}, V_{GE} = 0\text{ V}$	1200		V
$V_{GE(th)}$	$I_C = 250\ \mu\text{A}, V_{CE} = V_{GE}$	2.5		V
I_{CES}	$V_{CE} = V_{CES}$ $V_{GE} = 0\text{ V}$			100 μA 3.5 mA
	$T_J = 25^\circ\text{C}$ $T_J = 125^\circ\text{C}$			
I_{GES}	$V_{CE} = 0\text{ V}, V_{GE} = \pm 20\text{ V}$			± 100 nA
$V_{CE(sat)}$	$I_C = I_{CE90}, V_{GE} = 15$			3.8 V
	$T_J = 125^\circ\text{C}$		3.0	V

Symbol	Test Conditions ($T_J = 25^\circ\text{C}$, unless otherwise specified)	Characteristic Values			
		Min.	Typ.	Max.	
g_{fs}	$I_C = I_{C90}, V_{CE} = 10\text{ V}$ Pulse test, $t \leq 300\ \mu\text{s}$, duty cycle $\leq 2\%$	12	15	S	
C_{ies}	$V_{CE} = 25\text{ V}, V_{GE} = 0\text{ V}, f = 1\text{ MHz}$		1700	pF	
C_{oes}			95	pF	
C_{res}			38	pF	
Q_g	$I_C = I_{C90}, V_{GE} = 15\text{ V}, V_{CE} = 0.5 V_{CES}$		86	nC	
Q_{ge}			13	nC	
Q_{gc}			26	nC	
$t_{d(on)}$	Inductive load, $T_J = 25^\circ\text{C}$ $I_C = I_{C90}, V_{GE} = 15\text{ V}$ $V_{CE} = 960\text{ V}, R_G = R_{off} = 10\ \Omega$ Remarks: Switching times may increase for $V_{CE}(\text{Clamp}) > 0.8 V_{CES}$, higher T_J or increased R_G		25	ns	
t_{ri}			15	ns	
$t_{d(off)}$			150	200	ns
t_{fi}			115	190	ns
E_{off}			1.05	1.6	mJ
$t_{d(on)}$	Inductive load, $T_J = 125^\circ\text{C}$ $I_C = I_{C90}, V_{GE} = 15\text{ V}$ $V_{CE} = 960\text{ V}, R_G = R_{off} = 10\ \Omega$ Remarks: Switching times may increase for $V_{CE}(\text{Clamp}) > 0.8 V_{CES}$, higher T_J or increased R_G		25	ns	
t_{ri}			18	ns	
E_{on}			0.60	mJ	
$t_{d(off)}$			220	ns	
t_{fi}			250	ns	
E_{off}		2.1	mJ		
R_{thJC}			0.65	K/W	
R_{thCK}	TO-220	0.5		K/W	

TO-220 AB Dimensions

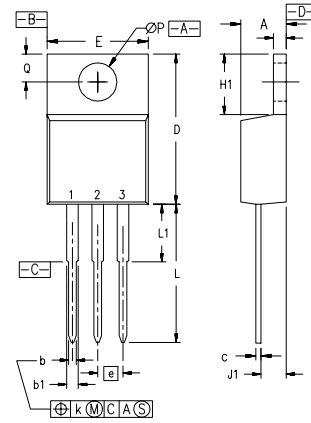

Pins: 1 - Gate
2 - Collector
3 - Emitter
4 - Collector
Bottom Side

SYM	INCHES		MILLIMETERS	
	MIN	MAX	MIN	MAX
A	.170	.190	4.32	4.83
b	.025	.040	0.64	1.02
b1	.045	.065	1.15	1.65
c	.014	.022	0.35	0.56
D	.580	.630	14.73	16.00
E	.390	.420	9.91	10.66
e	.100 BSC		2.54 BSC	
F	.045	.055	1.14	1.40
H1	.230	.270	5.85	6.85
J1	.090	.110	2.29	2.79
k	0	.015	0	0.38
L	.500	.550	12.70	13.97
L1	.110	.230	2.79	5.84
$\varnothing P$.139	.161	3.53	4.08
Q	.100	.125	2.54	3.18

NOTE: This drawing will meet all dimensions requirement of JEDEC outline TO-220 AB.

TO-263 AA Outline

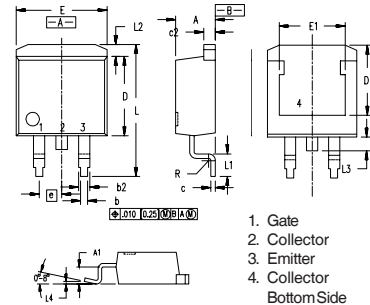

1. Gate
2. Collector
3. Emitter
4. Collector
Bottom Side

Dim.	Millimeter		Inches	
	Min.	Max.	Min.	Max.
A	4.06	4.83	.160	.190
A1	2.03	2.79	.080	.110
b	0.51	0.99	.020	.039
b2	1.14	1.40	.045	.055
c	0.46	0.74	.018	.029
c2	1.14	1.40	.045	.055
D	8.64	9.65	.340	.380
D1	7.11	8.13	.280	.320
E	9.65	10.29	.380	.405
E1	6.86	8.13	.270	.320
e	2.54	BSC	.100	BSC
L	14.61	15.88	.575	.625
L1	2.29	2.79	.090	.110
L2	1.02	1.40	.040	.055
L3	1.27	1.78	.050	.070
L4	0	0.38	0	.015
R	0.46	0.74	.018	.029

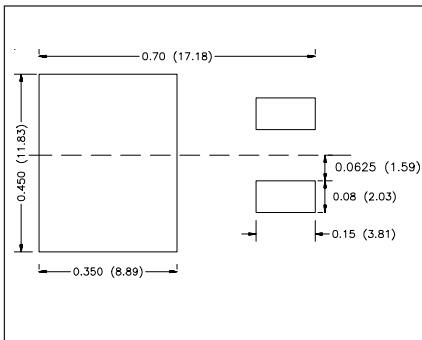

Min. Recommended Footprint
(Dimensions in inches and mm)

IXYS reserves the right to change limits, test conditions, and dimensions.

IXYS MOSFETs and IGBTs are covered by one or more of the following U.S. patents:	4,850,072	4,931,844	5,034,796	5,063,307	5,237,481	5,381,025	6,404,065B1	6,162,665	6,534,343	6,583,505
	4,835,592	4,881,106	5,017,508	5,049,961	5,187,117	5,486,715	6,306,728B1	6,259,123B1	6,306,728B1	6,683,344

Fig. 1. Output Characteristics
@ 25°C

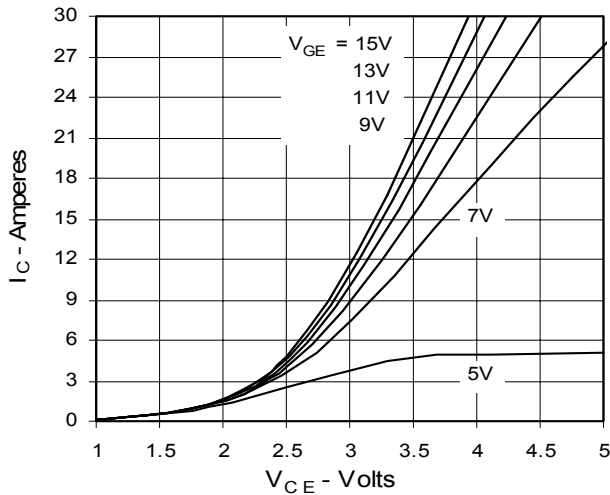

Fig. 2. Extended Output Characteristics
@ 25°C

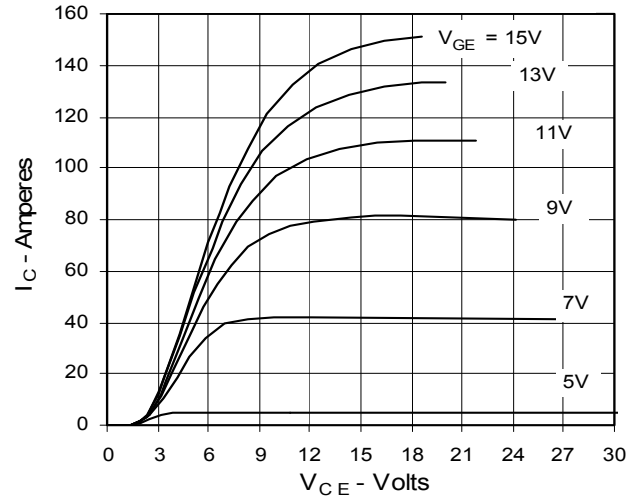

Fig. 3. Output Characteristics
@ 125°C

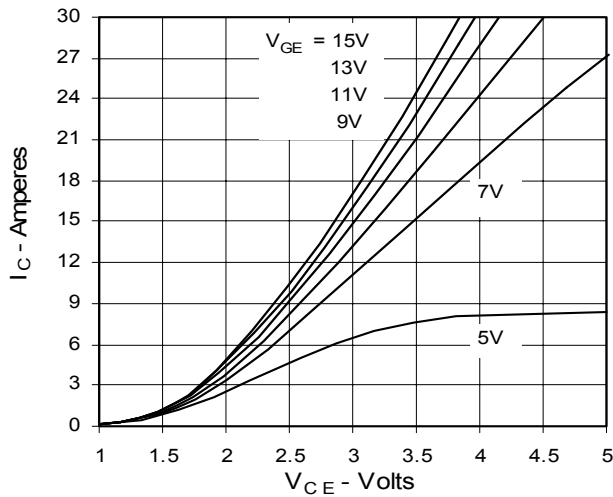

Fig. 4. Dependence of $V_{CE(sat)}$ on Temperature

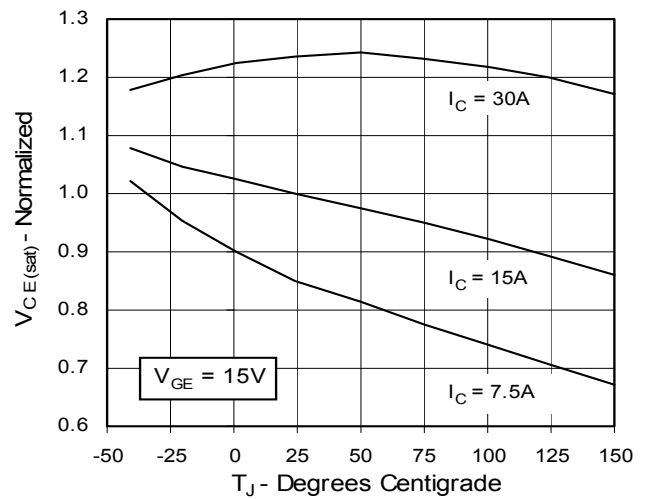

Fig. 5. Collector-to-Emitter Voltage vs. Gate-to-Emitter voltage

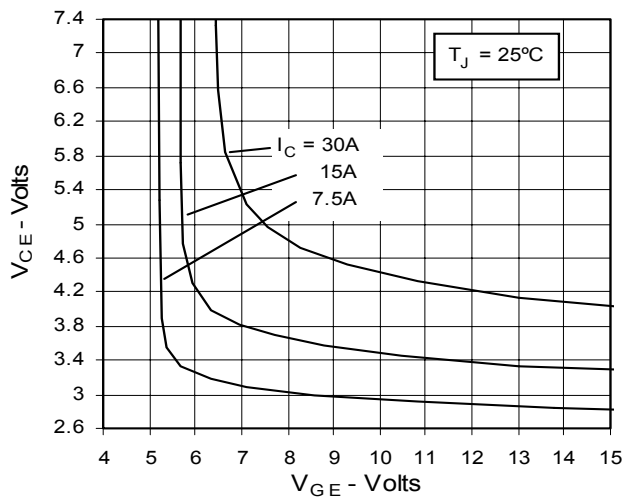

Fig. 6. Input Admittance

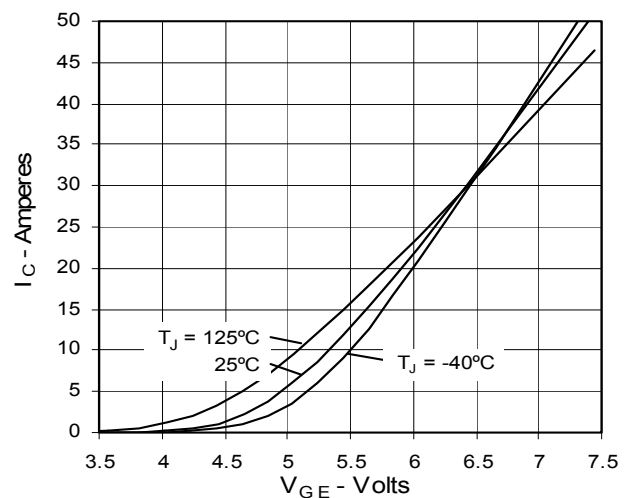

Fig. 7. Transconductance

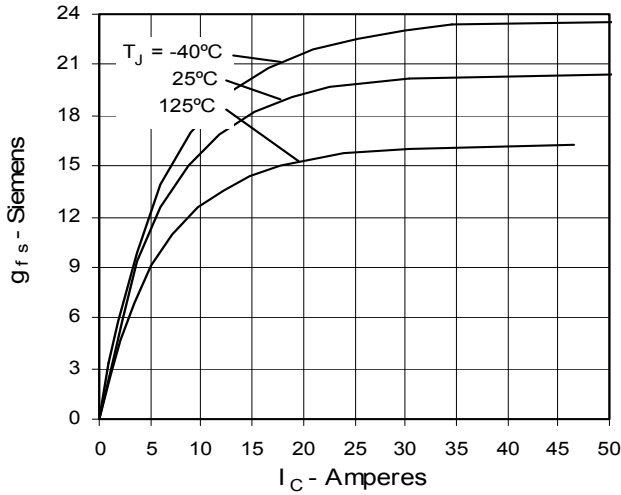

Fig. 8. Dependence of Turn-Off Energy on R_G

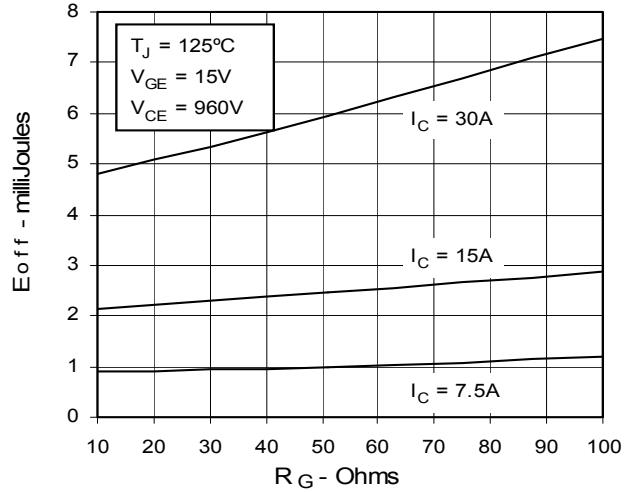

Fig. 9. Dependence of Turn-Off Energy on I_C

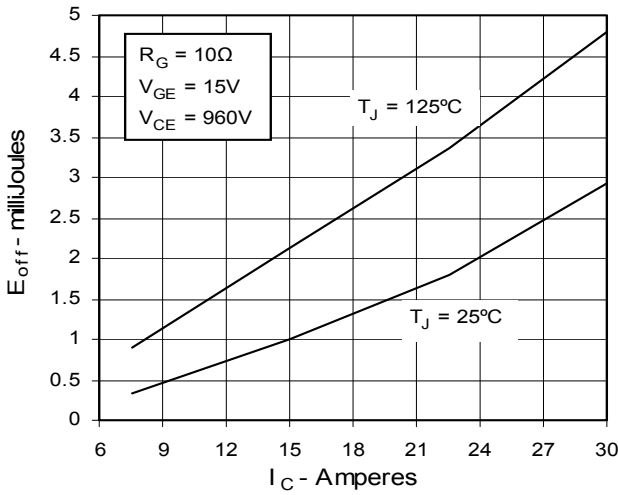

Fig. 10. Dependence of Turn-Off Energy on Temperature

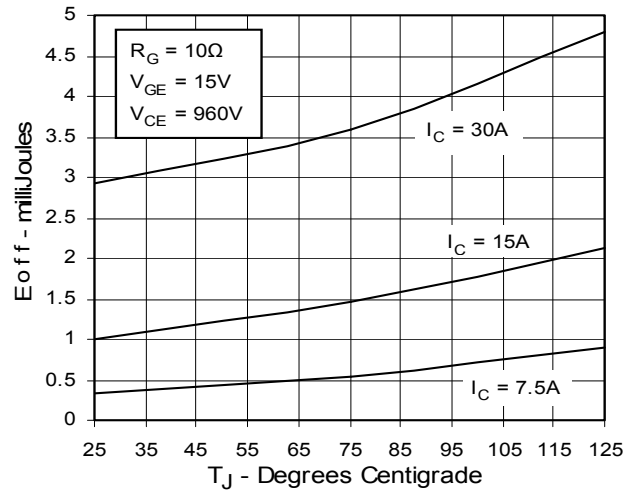

Fig. 11. Dependence of Turn-Off Switching Time on R_G

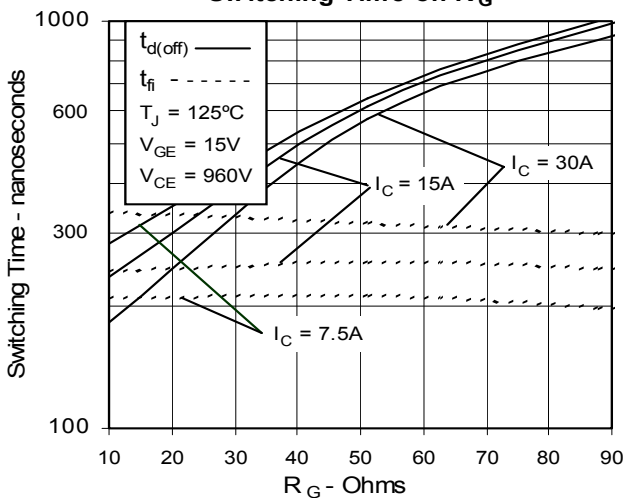
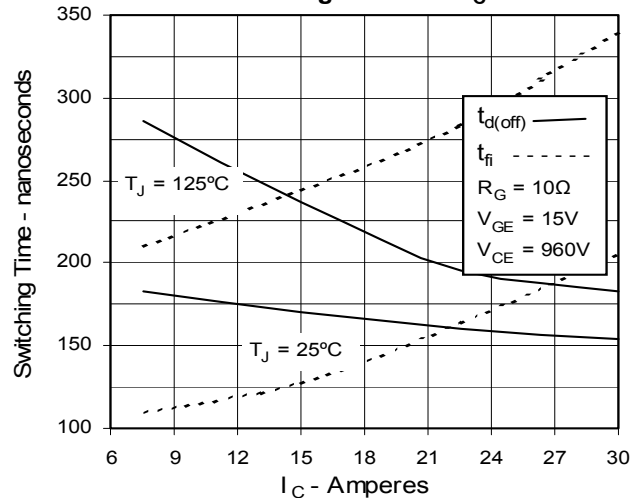

Fig. 12. Dependence of Turn-Off Switching Time on I_C



IXYS reserves the right to change limits, test conditions, and dimensions.

Fig. 13. Dependence of Turn-Off Switching Time on Temperature

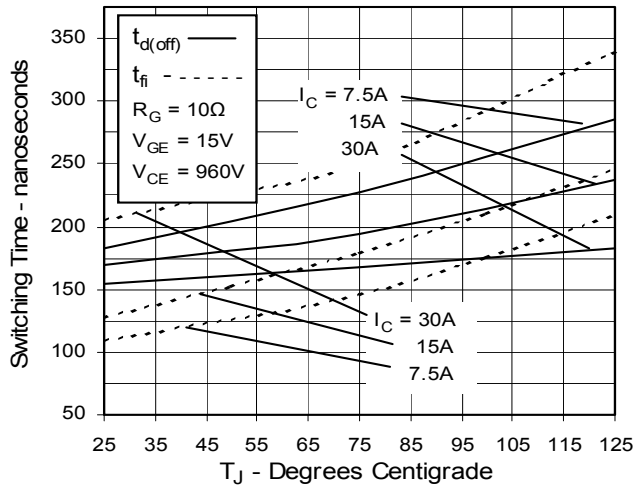

Fig. 14. Reverse-Bias Safe Operating Area

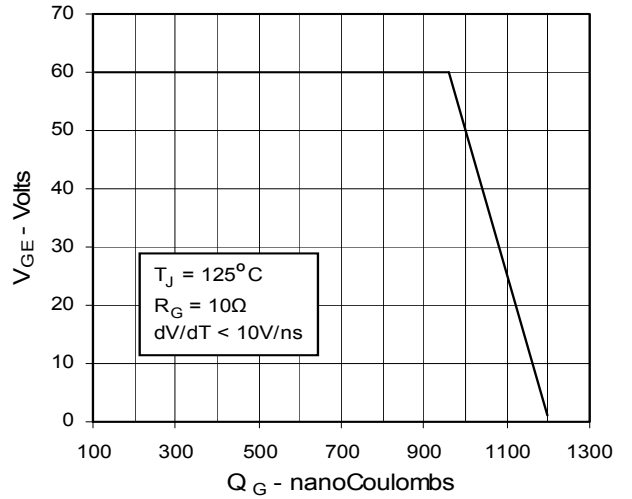

Fig. 15. Gate Charge

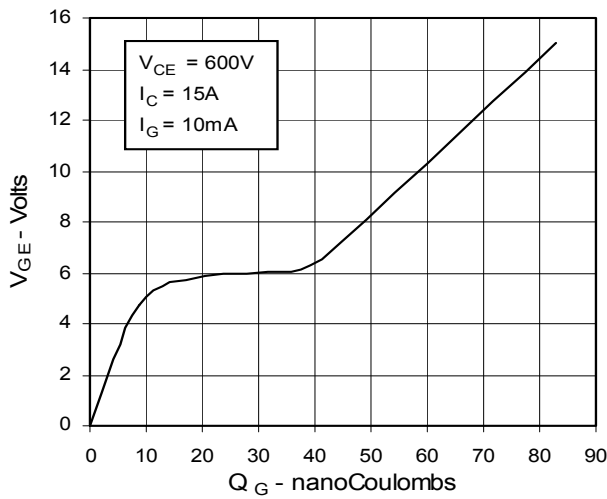

Fig. 16. Capacitance

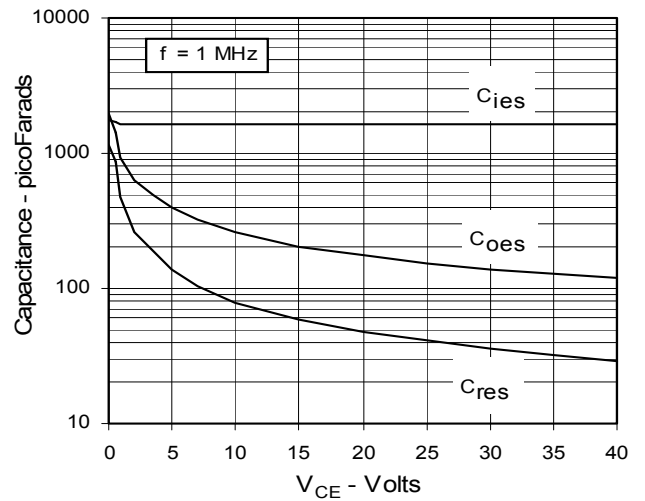

Fig. 17. Maximum Transient Thermal Resistance

