

# HiPerFET™ Power MOSFETs Q-Class

**IXFH 4N100Q**  
**IXFT 4N100Q**

**V<sub>DSS</sub> = 1000 V**  
**I<sub>D25</sub> = 4 A**  
**R<sub>DS(on)</sub> = 3.0 Ω**

**t<sub>rr</sub> ≤ 250 ns**

N-Channel Enhancement Mode  
Avalanche Rated, Low Q<sub>g</sub>, High dv/dt

Preliminary Data Sheet

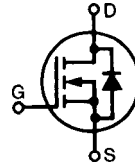

Symbol	Test Conditions	Maximum Ratings	
V <sub>DSS</sub>	T <sub>J</sub> = 25°C to 150°C	1000	V
V <sub>DGR</sub>	T <sub>J</sub> = 25°C to 150°C; R <sub>GS</sub> = 1 MΩ	1000	V
V <sub>GS</sub>	Continuous	±20	V
V <sub>GSM</sub>	Transient	±30	V
I <sub>D25</sub>	T <sub>C</sub> = 25°C	4	A
I <sub>DM</sub>	T <sub>C</sub> = 25°C, pulse width limited by T <sub>JM</sub>	16	A
I <sub>AR</sub>	T <sub>C</sub> = 25°C	4	A
E <sub>AR</sub>	T <sub>C</sub> = 25°C	20	mJ
E <sub>AS</sub>		700	mJ
dv/dt	I <sub>S</sub> ≤ I <sub>DM</sub> , di/dt ≤ 100 A/μs, V <sub>DD</sub> ≤ V <sub>DSS</sub> , T <sub>J</sub> ≤ 150°C, R <sub>G</sub> = 2 Ω	5	V/ns
P <sub>D</sub>	T <sub>C</sub> = 25°C	150	W
T <sub>J</sub>		-55 to +150	°C
T <sub>JM</sub>		150	°C
T <sub>stg</sub>		-55 to +150	°C
T <sub>L</sub>	1.6 mm (0.063 in) from case for 10 s	300	°C
M <sub>d</sub>	Mounting torque	1.13/10	Nm/lb.in.
Weight	TO-247	6	g
	TO-268	4	g

TO-247 AD (IXFH)

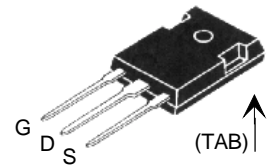

TO-268 (D3) (IXFT)

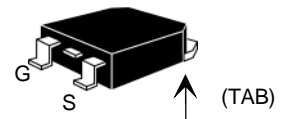

G = Gate      D = Drain  
S = Source    TAB = Drain

## Features

- IXYS advanced low Q<sub>g</sub> process
- Low gate charge and capacitances
  - easier to drive
  - faster switching
- International standard packages
- Low R<sub>DS(on)</sub>
- Unclamped Inductive Switching (UIS) rated
- Molding epoxies meet UL94 V-0 flammability classification

## Advantages

- Easy to mount
- Space savings
- High power density

Symbol	Test Conditions	Characteristic Values (T <sub>J</sub> = 25°C, unless otherwise specified)		
		min.	typ.	max.
V <sub>DSS</sub>	V <sub>GS</sub> = 0 V, I <sub>D</sub> = 1 mA	1000		V
V <sub>GS(th)</sub>	V <sub>DS</sub> = V <sub>GS</sub> , I <sub>D</sub> = 1.5 mA	3.0		V
I <sub>GSS</sub>	V <sub>GS</sub> = ±20 V <sub>DC</sub> , V <sub>DS</sub> = 0			±100 nA
I <sub>DSS</sub>	V <sub>DS</sub> = V <sub>DSS</sub> V <sub>GS</sub> = 0 V	T <sub>J</sub> = 25°C		50 μA
		T <sub>J</sub> = 125°C		1 mA
R <sub>DS(on)</sub>	V <sub>GS</sub> = 10 V, I <sub>D</sub> = 0.5 I <sub>D25</sub> Pulse test, t ≤ 300 μs, duty cycle d ≤ 2 %			3.0 Ω

Symbol	Test Conditions	Characteristic Values ( $T_j = 25^\circ\text{C}$ , unless otherwise specified)		
		min.	typ.	max.
$g_{fs}$	$V_{DS} = 20\text{ V}; I_D = 0.5 \cdot I_{D25}$ , pulse test	1.5	2.5	S
$C_{iss}$	$V_{GS} = 0\text{ V}, V_{DS} = 25\text{ V}, f = 1\text{ MHz}$		1050	pF
$C_{oss}$			120	pF
$C_{rss}$			30	pF
$t_{d(on)}$	$V_{GS} = 10\text{ V}, V_{DS} = 0.5 \cdot V_{DSS}, I_D = 0.5 \cdot I_{D25}$ $R_G = 4.7\ \Omega$ (External),		17	ns
$t_r$			15	ns
$t_{d(off)}$			32	ns
$t_f$			18	ns
$Q_{g(on)}$	$V_{GS} = 10\text{ V}, V_{DS} = 0.5 \cdot V_{DSS}, I_D = 0.5 \cdot I_{D25}$		39	nC
$Q_{gs}$			9	nC
$Q_{gd}$			22	nC
$R_{thJC}$	(TO-247)		0.8	K/W
$R_{thCK}$			0.25	K/W

TO-247 AD (IXFH) Outline

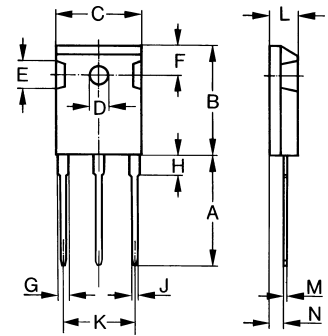

Dim.	Millimeter		Inches	
	Min.	Max.	Min.	Max.
A	19.81	20.32	0.780	0.800
B	20.80	21.46	0.819	0.845
C	15.75	16.26	0.610	0.640
D	3.55	3.65	0.140	0.144
E	4.32	5.49	0.170	0.216
F	5.4	6.2	0.212	0.244
G	1.65	2.13	0.065	0.084
H	-	4.5	-	0.177
J	1.0	1.4	0.040	0.055
K	10.8	11.0	0.426	0.433
L	4.7	5.3	0.185	0.209
M	0.4	0.8	0.016	0.031
N	1.5	2.49	0.087	0.102

Symbol	Test Conditions	Characteristic Values ( $T_j = 25^\circ\text{C}$ , unless otherwise specified)		
		min.	typ.	max.
$I_S$	$V_{GS} = 0\text{ V}$			4 A
$I_{SM}$	Repetitive; pulse width limited by $T_{JM}$			16 A
$V_{SD}$	$I_F = I_S, V_{GS} = 0\text{ V}$ , Pulse test, $t \leq 300\ \mu\text{s}$ , duty cycle $d \leq 2\%$			1.5 V
$t_{rr}$	$I_F = I_S, -di/dt = 100\text{ A}/\mu\text{s}, V_R = 100\text{ V}$		0.52	250 ns
$Q_{RM}$			1.8	$\mu\text{C}$
$I_{RM}$				A

TO-268AA (D<sup>3</sup> PAK)

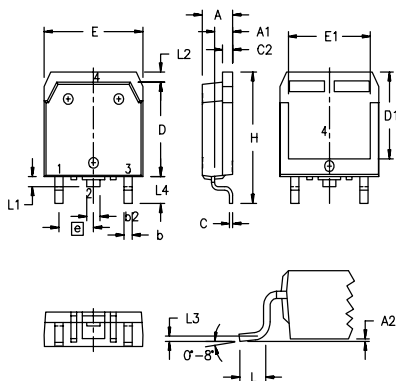

Dim.	Millimeter		Inches	
	Min.	Max.	Min.	Max.
A	4.9	5.1	.193	.201
A <sub>1</sub>	2.7	2.9	.106	.114
A <sub>2</sub>	.02	.25	.001	.010
b	1.15	1.45	.045	.057
b <sub>2</sub>	1.9	2.1	.75	.83
C	.4	.65	.016	.026
D	13.80	14.00	.543	.551
E	15.85	16.05	.624	.632
E <sub>1</sub>	13.3	13.6	.524	.535
e	5.45 BSC		.215 BSC	
H	18.70	19.10	.736	.752
L	2.40	2.70	.094	.106
L <sub>1</sub>	1.20	1.40	.047	.055
L <sub>2</sub>	1.00	1.15	.039	.045
L <sub>3</sub>	0.25 BSC		.010 BSC	
L <sub>4</sub>	3.80	4.10	.150	.161

Min. Recommended Footprint

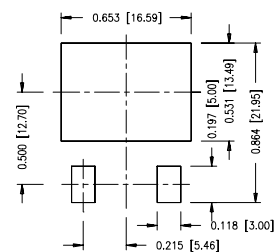

Figure 1. Output Characteristics at 25°C

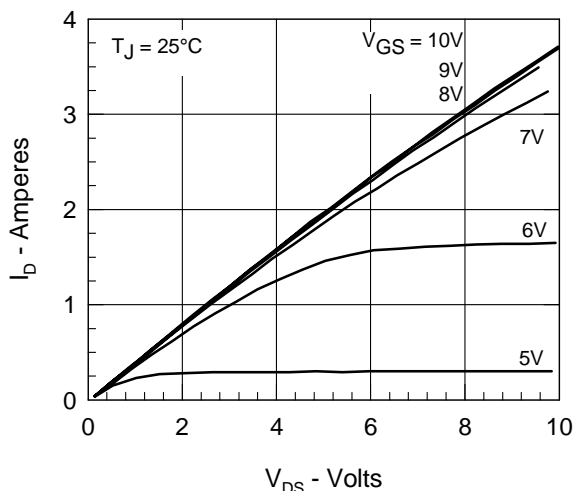

Figure 2. Extended Output Characteristics at 125°C

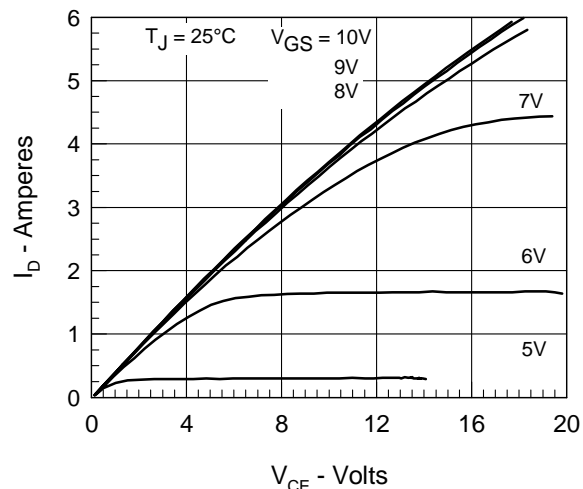

Figure 3.  $R_{DS(on)}$  normalized to 0.5  $I_{D25}$  value vs.  $I_D$

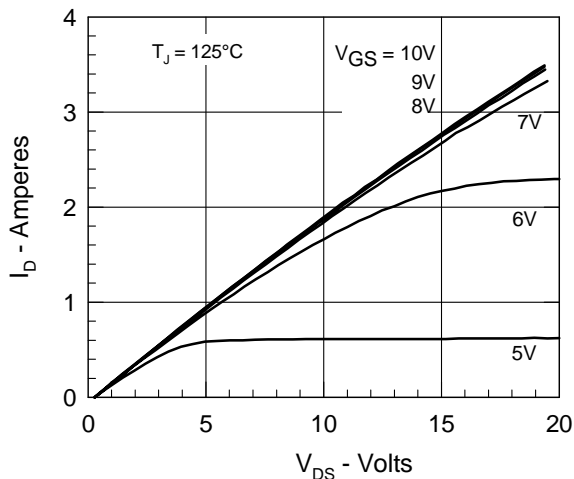

Figure 4. Admittance Curves

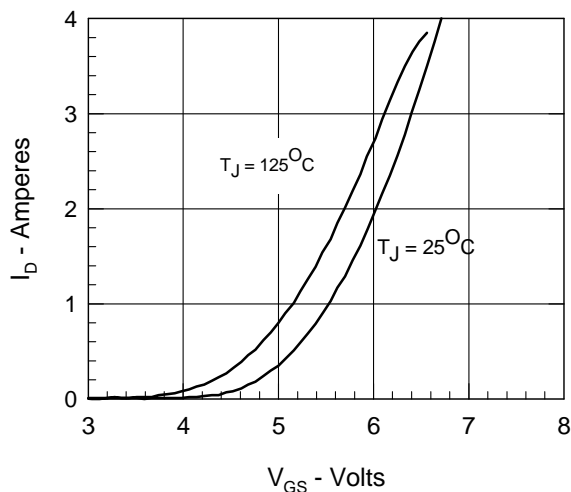

Figure 5.  $R_{DS(on)}$  normalized to 0.5  $I_{D25}$  value vs.  $I_D$

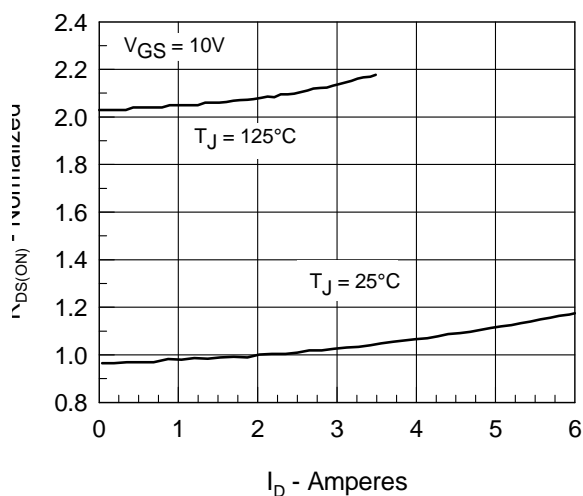

Figure 6.  $R_{DS(on)}$  normalized to 0.5  $I_{D25}$  value vs.  $T_J$

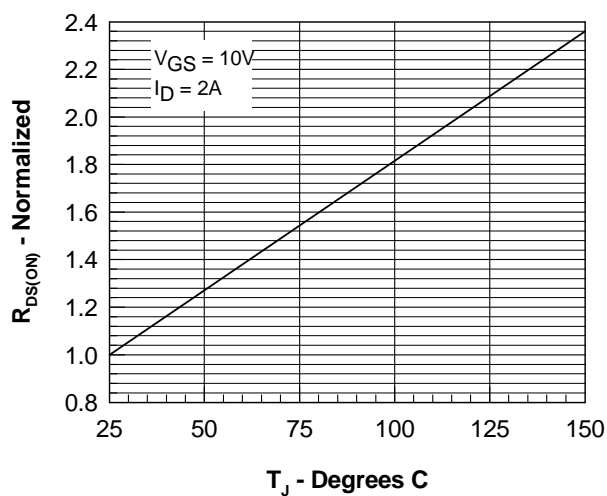

Figure 7. Gate Charge

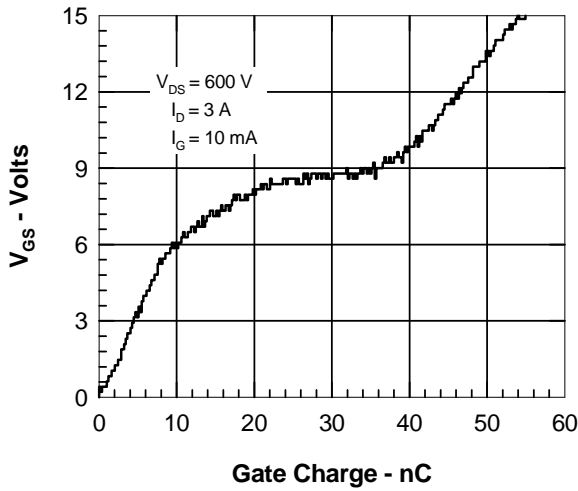

Figure 8. Capacitance Curves

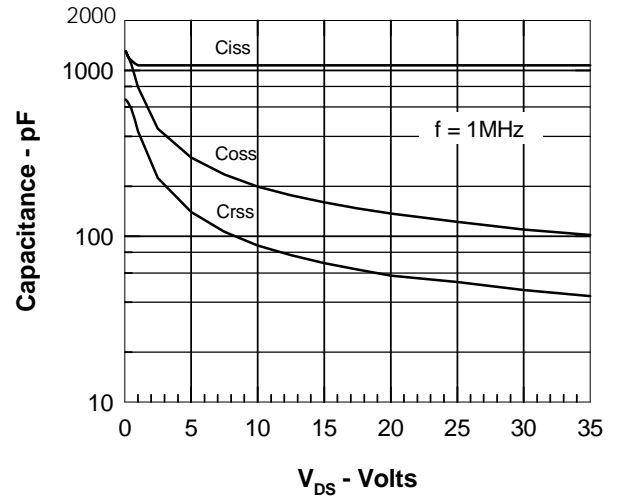

Figure 9. Forward Voltage Drop of the Intrinsic Diode

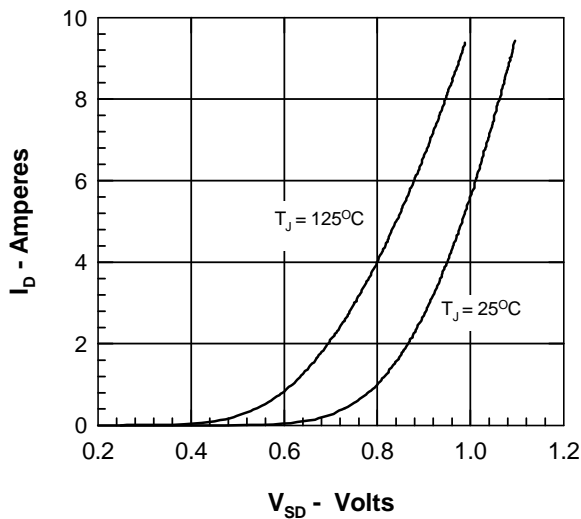

Figure 10. Drain Current vs. Case Temperature

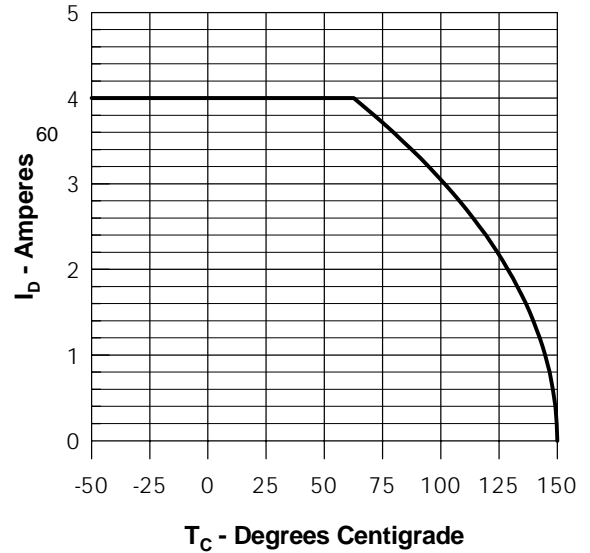

Figure 11. Transient Thermal Resistance

