

**TrenchHV™ Power  
MOSFET HiPerFET™**

**IXFH110N25T**

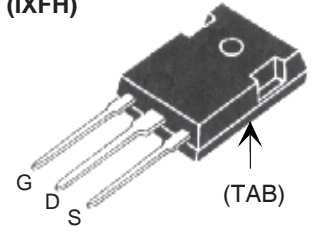
$V_{DSS} = 250V$   
 $I_{D25} = 110A$   
 $R_{DS(on)} \leq 24m\Omega$

N-Channel Enhancement Mode  
Avalanche Rated



Symbol	Test Conditions	Maximum Ratings	
$V_{DSS}$	$T_J = 25^\circ C$ to $150^\circ C$	250	V
$V_{DGR}$	$T_J = 25^\circ C$ to $150^\circ C$ , $R_{GS} = 1M\Omega$	250	V
$V_{GSS}$	Continuous	$\pm 20$	V
$V_{GSM}$	Transient	$\pm 30$	V
$I_{D25}$	$T_C = 25^\circ C$	110	A
$I_{LRMS}$	Lead Current Limit, RMS	75	A
$I_{DM}$	$T_C = 25^\circ C$ , pulse width limited by $T_{JM}$	300	A
$I_A$	$T_C = 25^\circ C$	25	A
$E_{AS}$	$T_C = 25^\circ C$	1	J
$dV/dt$	$I_S \leq I_{DM}$ , $V_{DD} \leq V_{DSS}$ , $T_J \leq 150^\circ C$	10	V/ns
$P_D$	$T_C = 25^\circ C$	694	W
$T_J$		-55 ... +150	$^\circ C$
$T_{JM}$		150	$^\circ C$
$T_{stg}$		-55 ... +150	$^\circ C$
$T_L$	1.6mm (0.062 in.) from case for 10s	300	$^\circ C$
$T_{SOLD}$	Plastic body for 10 seconds	260	$^\circ C$
$M_d$	Mounting torque	1.13 / 10	Nm/lb.in.
<b>Weight</b>		6	g

TO-247 (IXFH)



G = Gate      D = Drain  
S = Source      TAB = Drain

**Features**

- International standard package
- Avalanche rated

**Advantages**

- Easy to mount
- Space savings
- High power density

**Applications**

- DC-DC converters
- Battery chargers
- Switched-mode and resonant-mode power supplies
- DC choppers
- AC motor drives
- Uninterruptible power supplies

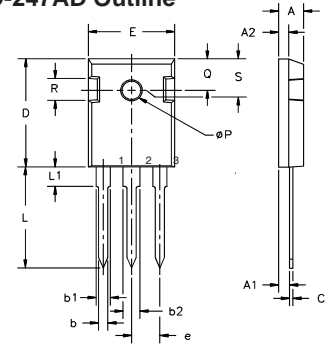
Symbol	Test Conditions ( $T_J = 25^\circ C$ unless otherwise specified)	Characteristic Values		
		Min.	Typ.	Max.
$BV_{DSS}$	$V_{GS} = 0V$ , $I_D = 250\mu A$	250		V
$V_{GS(th)}$	$V_{DS} = V_{GS}$ , $I_D = 3mA$	2.5		4.5 V
$I_{GSS}$	$V_{GS} = \pm 20V$ , $V_{DS} = 0V$			$\pm 200$ nA
$I_{DSS}$	$V_{DS} = V_{DSS}$ $V_{GS} = 0V$ $T_J = 125^\circ C$			10 $\mu A$ 1 mA
$R_{DS(on)}$	$V_{GS} = 10V$ , $I_D = 0.5 \cdot I_{D25}$ , Notes 1, 2			24 m $\Omega$

Symbol	Test Conditions	Characteristic Values		
		Min.	Typ.	Max.
$(T_J = 25^\circ\text{C}$ unless otherwise specified)				
$g_{fs}$	$V_{DS} = 10\text{V}, I_D = 0.5 \cdot I_{D25}$ , Note 1	65	110	S
$C_{iss}$	$V_{GS} = 0\text{V}, V_{DS} = 25\text{V}, f = 1\text{MHz}$		9400	pF
$C_{oss}$			850	pF
$C_{rss}$			55	pF
<b>Resistive Switching Times</b>				
$t_{d(on)}$	$V_{GS} = 15\text{V}, V_{DS} = 0.5 \cdot V_{DSS}, I_D = 0.5 \cdot I_{D25}$ $R_G = 2\Omega$ (External)		19	ns
$t_r$			27	ns
$t_{d(off)}$			60	ns
$t_f$			27	ns
$Q_{g(on)}$	$V_{GS} = 10\text{V}, V_{DS} = 0.5 \cdot V_{DSS}, I_D = 25\text{A}$		157	nC
$Q_{gs}$			40	nC
$Q_{gd}$			50	nC
$R_{thJC}$			0.18	$^\circ\text{C/W}$
$R_{thCS}$		0.21		$^\circ\text{C/W}$

### Source-Drain Diode

Symbol	Test Conditions	Characteristic Values		
		Min.	Typ.	Max.
$T_J = 25^\circ\text{C}$ unless otherwise specified)				
$I_S$	$V_{GS} = 0\text{V}$			110 A
$I_{SM}$	Pulse width limited by $T_{JM}$			350 A
$V_{SD}$	$I_F = 55\text{A}, V_{GS} = 0\text{V}$ , Note 1			1.2 V
$t_{rr}$	$I_F = 55\text{A}, -di/dt = 250\text{A}/\mu\text{s}$ $V_R = 100\text{V}, V_{GS} = 0\text{V}$			170 ns
$Q_{RM}$			946	nC
$I_{RM}$			17	A

### TO-247AD Outline



Terminals: 1 - Gate 2 - Drain  
3 - Source Tab - Drain

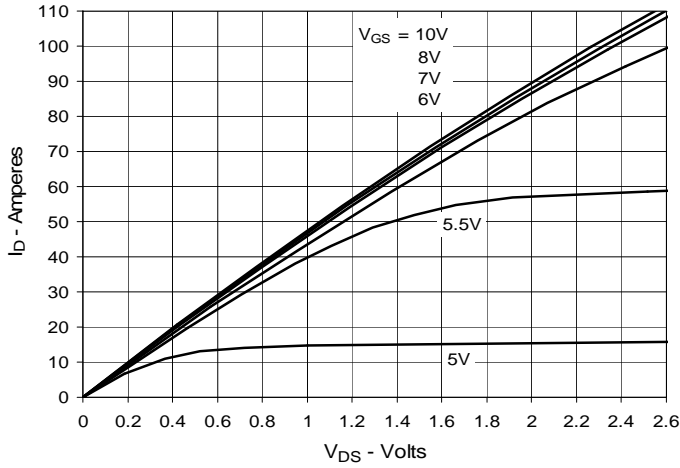
Dim.	Millimeter		Inches	
	Min.	Max.	Min.	Max.
A	4.7	5.3	.185	.209
A <sub>1</sub>	2.2	2.54	.087	.102
A <sub>2</sub>	2.2	2.6	.059	.098
b	1.0	1.4	.040	.055
b <sub>1</sub>	1.65	2.13	.065	.084
b <sub>2</sub>	2.87	3.12	.113	.123
C	.4	.8	.016	.031
D	20.80	21.46	.819	.845
E	15.75	16.26	.610	.640
e	5.20	5.72	0.205	0.225
L	19.81	20.32	.780	.800
L1		4.50		.177
ÆP	3.55	3.65	.140	.144
Q	5.89	6.40	0.232	0.252
R	4.32	5.49	.170	.216
S	6.15	BSC	242	BSC

- Notes: 1. Pulse test,  $t \leq 300\text{ms}$ ; duty cycle,  $d \leq 2\%$ .  
2. On through-hole packages,  $R_{DS(on)}$  Kelvin test contact location must be 5 mm or less from the package body.

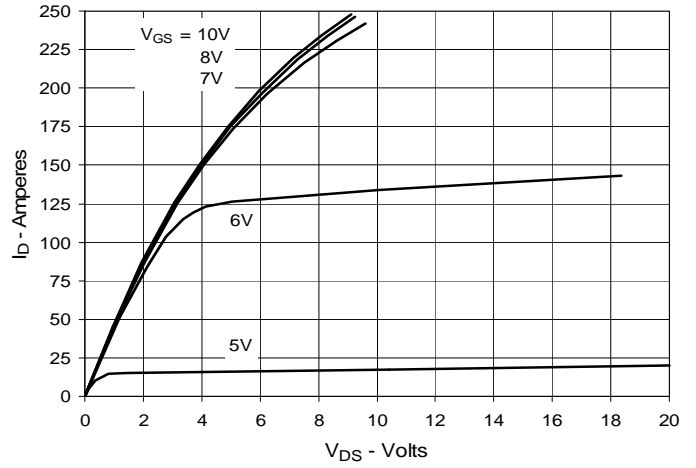
IXYS reserves the right to change limits, test conditions, and dimensions.

IXYS MOSFETs and IGBTs are covered by one or more of the following U.S. patents:	4,835,592	4,931,844	5,049,961	5,237,481	6,162,665	6,404,065 B1	6,683,344	6,727,585	7,005,734 B2	7,157,338B2
	4,850,072	5,017,508	5,063,307	5,381,025	6,259,123 B1	6,534,343	6,710,405 B2	6,759,692	7,063,975 B2	
	4,881,106	5,034,796	5,187,117	5,486,715	6,306,728 B1	6,583,505	6,710,463	6,771,478 B2	7,071,537	

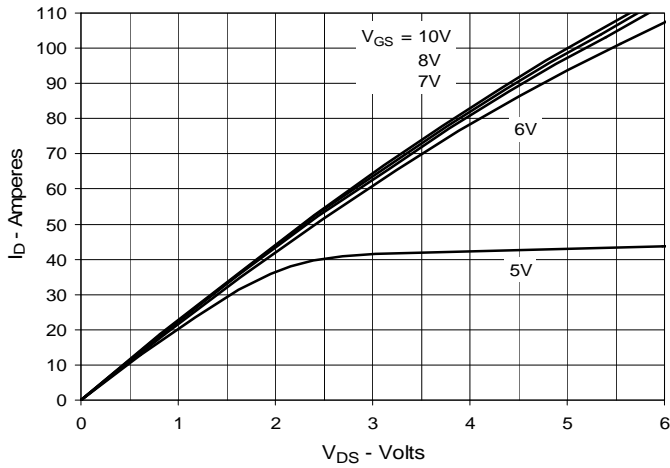
**Fig. 1. Output Characteristics @ 25°C**



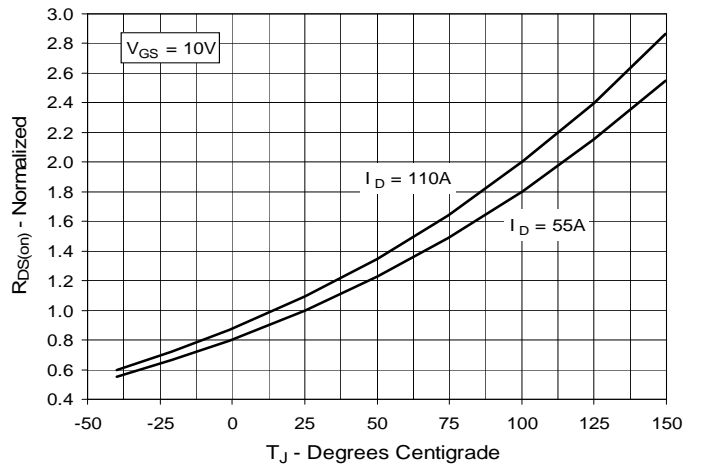
**Fig. 2. Extended Output Characteristics @ 25°C**



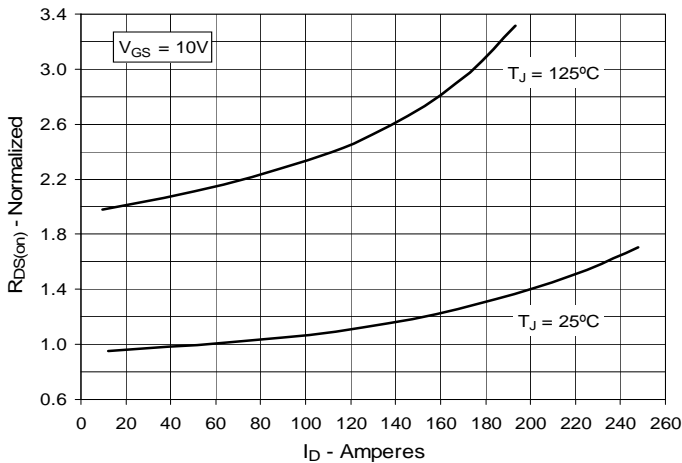
**Fig. 3. Output Characteristics @ 125°C**



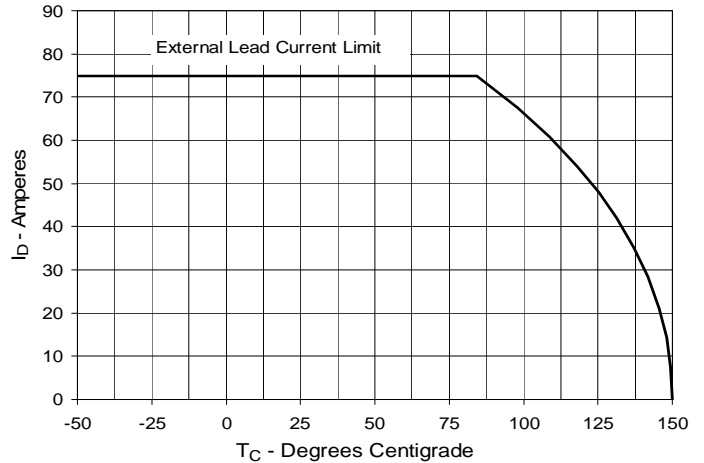
**Fig. 4.  $R_{DS(on)}$  Normalized to  $I_D = 55A$  Value vs. Junction Temperature**

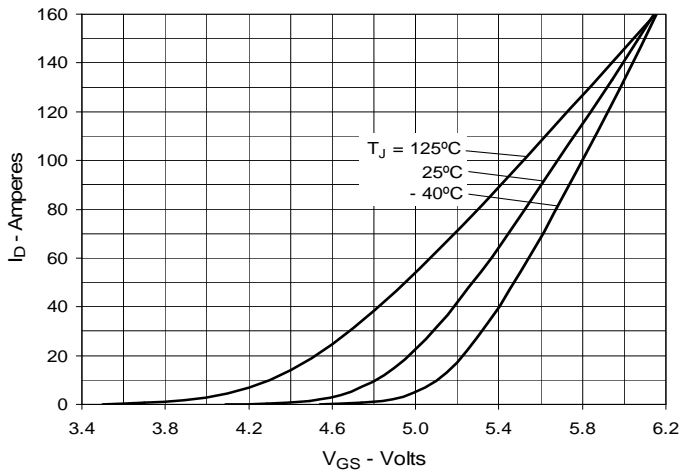
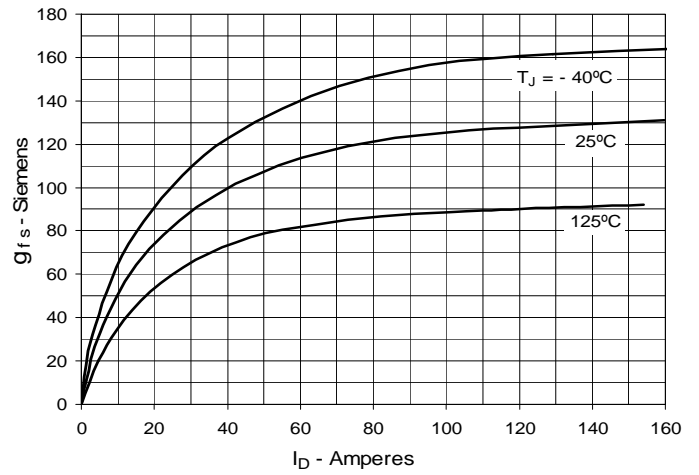
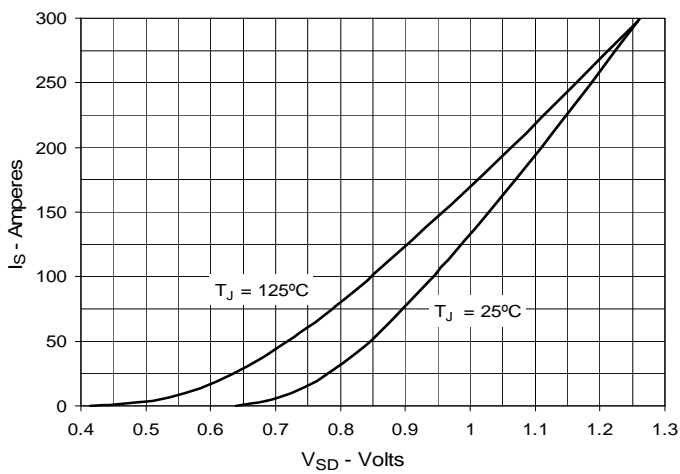
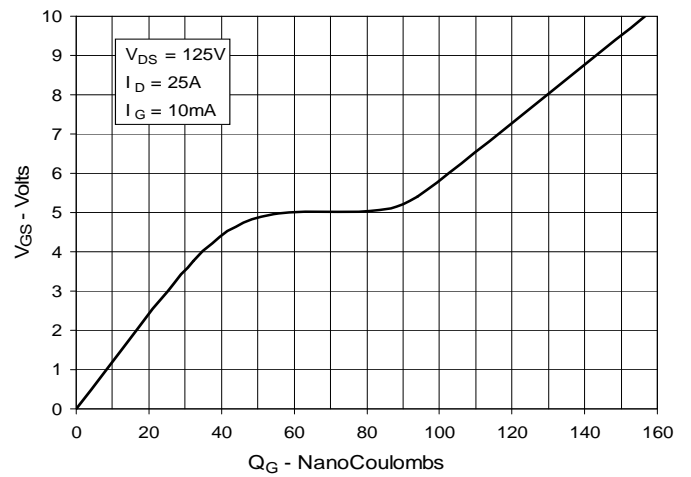
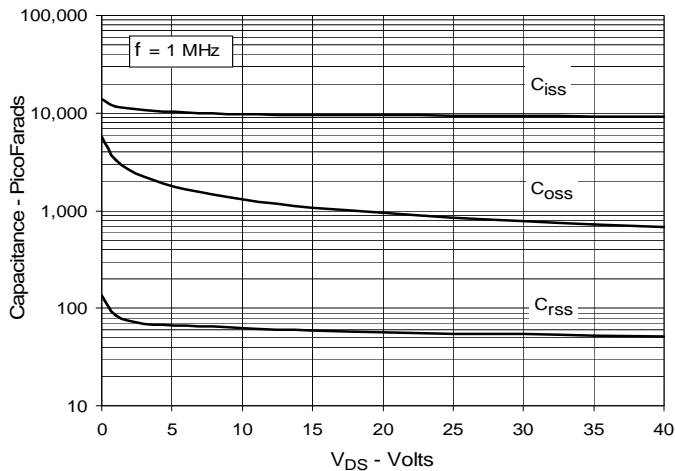
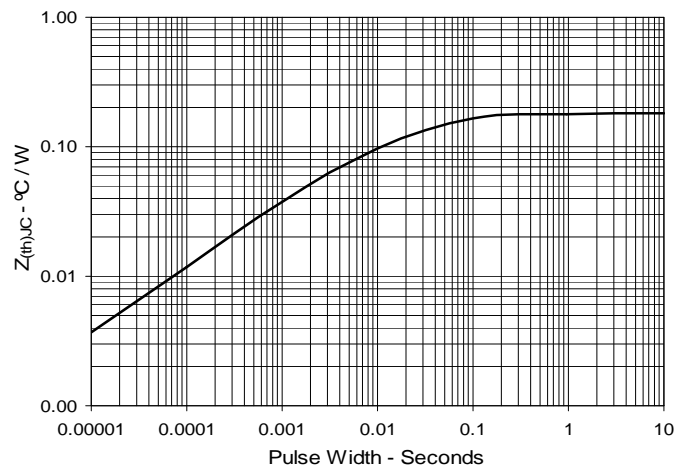


**Fig. 5.  $R_{DS(on)}$  Normalized to  $I_D = 55A$  Value vs. Drain Current**

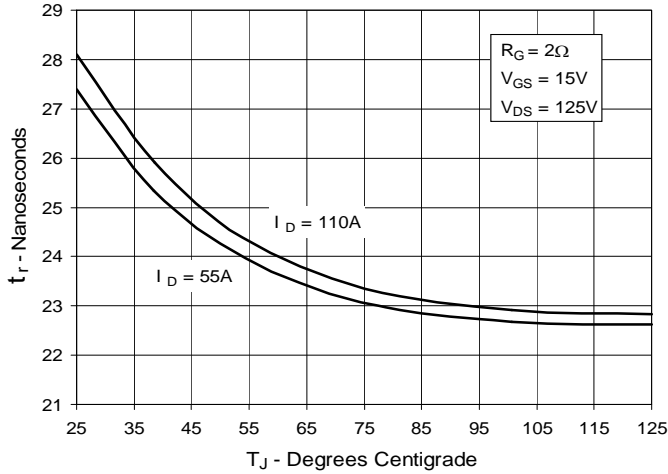


**Fig. 6. Maximum Drain Current vs. Case Temperature**

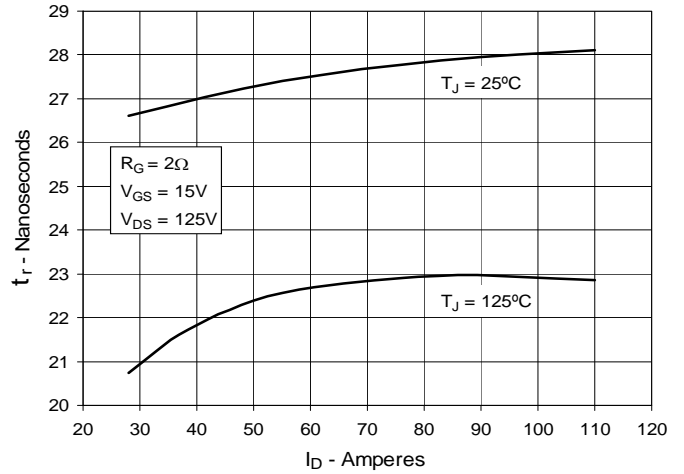


**Fig. 7. Input Admittance**

**Fig. 8. Transconductance**

**Fig. 9. Forward Voltage Drop of Intrinsic Diode**

**Fig. 10. Gate Charge**

**Fig. 11. Capacitance**

**Fig. 12. Maximum Transient Thermal Impedance**


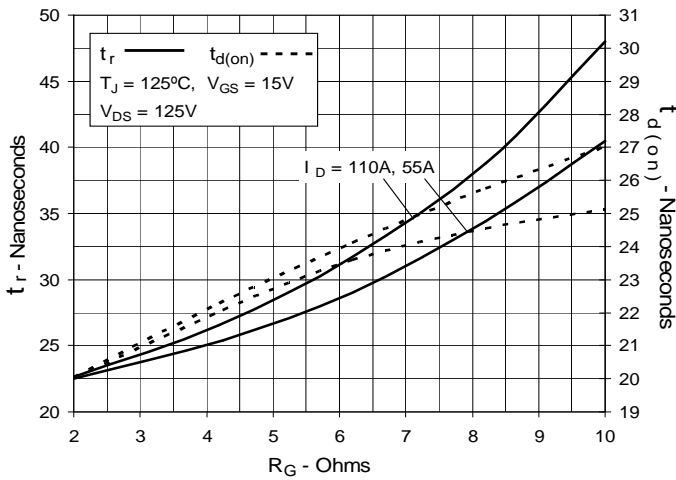
**Fig. 13. Resistive Turn-on Rise Time vs. Junction Temperature**



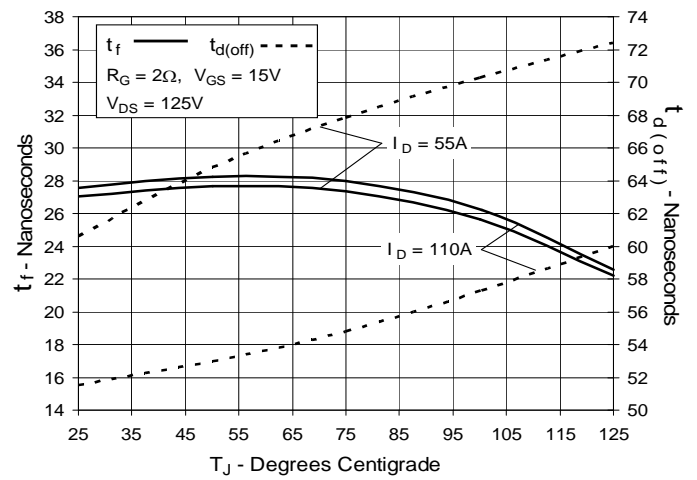
**Fig. 14. Resistive Turn-on Rise Time vs. Drain Current**



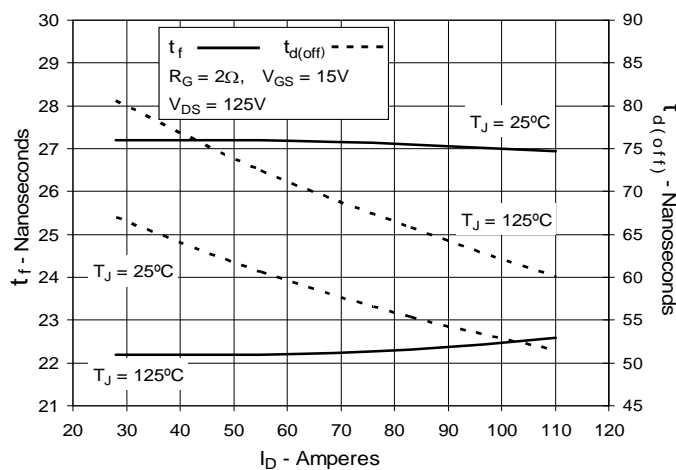
**Fig. 15. Resistive Turn-on Switching Times vs. Gate Resistance**



**Fig. 16. Resistive Turn-off Switching Times vs. Junction Temperature**



**Fig. 17. Resistive Turn-off Switching Times vs. Drain Current**



**Fig. 18. Resistive Turn-off Switching Times vs. Gate Resistance**

