

- Ultra Low On-Resistance
- P-Channel MOSFET
- Surface Mount
- Available in Tape & Reel
- Low Gate Charge

| V_{DSS} | $R_{DS(on)}$ max (m Ω) | I_D |
|-------------|--------------------------------|-------|
| -30V | 98@ $V_{GS} = -10V$ | -3.0A |
| | 165@ $V_{GS} = -4.5V$ | -2.6A |

Description

These P-channel MOSFETs from International Rectifier utilize advanced processing techniques to achieve the extremely low on-resistance per silicon area. This benefit provides the designer with an extremely efficient device for use in battery and load management applications.

A thermally enhanced large pad leadframe has been incorporated into the standard SOT-23 package to produce a HEXFET Power MOSFET with the industry's smallest footprint. This package, dubbed the Micro3™, is ideal for applications where printed circuit board space is at a premium. The low profile (<1.1mm) of the Micro3 allows it to fit easily into extremely thin application environments such as portable electronics and PCMCIA cards. The thermal resistance and power dissipation are the best available.

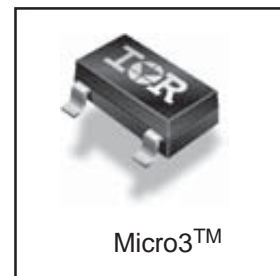
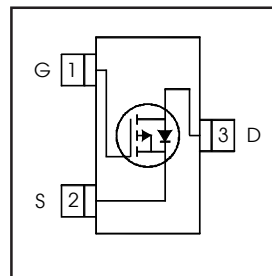

Absolute Maximum Ratings

| | Parameter | Max. | Units |
|----------------------------|---|--------------|-------|
| V_{DS} | Drain- Source Voltage | -30 | V |
| I_D @ $T_A = 25^\circ C$ | Continuous Drain Current, $V_{GS} @ -10V$ | -3.0 | A |
| I_D @ $T_A = 70^\circ C$ | Continuous Drain Current, $V_{GS} @ -10V$ | -2.4 | |
| I_{DM} | Pulsed Drain Current ① | -24 | |
| P_D @ $T_A = 25^\circ C$ | Power Dissipation | 1.25 | W |
| P_D @ $T_A = 70^\circ C$ | Power Dissipation | 0.80 | |
| | Linear Derating Factor | 10 | mW/°C |
| V_{GS} | Gate-to-Source Voltage | ± 20 | V |
| T_J, T_{STG} | Junction and Storage Temperature Range | -55 to + 150 | °C |

Thermal Resistance

| | Parameter | Max. | Units |
|-----------------|-------------------------------|------|-------|
| $R_{\theta JA}$ | Maximum Junction-to-Ambient ③ | 100 | °C/W |

Electrical Characteristics @ T_J = 25°C (unless otherwise specified)

| | Parameter | Min. | Typ. | Max. | Units | Conditions |
|--|--------------------------------------|------|-------|------|-------|---|
| V _{(BR)DSS} | Drain-to-Source Breakdown Voltage | -30 | — | — | V | V _{GS} = 0V, I _D = -250μA |
| ΔV _{(BR)DSS} /ΔT _J | Breakdown Voltage Temp. Coefficient | — | 0.019 | — | V/°C | Reference to 25°C, I _D = -1mA |
| R _{DS(on)} | Static Drain-to-Source On-Resistance | — | — | 98 | mΩ | V _{GS} = -10V, I _D = -3.0A ② |
| | | — | — | 165 | | V _{GS} = -4.5V, I _D = -2.6A ② |
| V _{GS(th)} | Gate Threshold Voltage | -1.0 | — | -2.5 | V | V _{DS} = V _{GS} , I _D = -250μA |
| g _{fs} | Forward Transconductance | 3.1 | — | — | S | V _{DS} = -10V, I _D = -3.0A |
| I _{DSS} | Drain-to-Source Leakage Current | — | — | -1.0 | μA | V _{DS} = -24V, V _{GS} = 0V |
| | | — | — | -5.0 | | V _{DS} = -24V, V _{GS} = 0V, T _J = 70°C |
| I _{GSS} | Gate-to-Source Forward Leakage | — | — | -100 | nA | V _{GS} = -20V |
| | Gate-to-Source Reverse Leakage | — | — | 100 | | V _{GS} = 20V |
| Q _g | Total Gate Charge | — | 9.5 | 14 | nC | I _D = -3.0A |
| Q _{gs} | Gate-to-Source Charge | — | 2.3 | 3.5 | | V _{DS} = -24V |
| Q _{gd} | Gate-to-Drain ("Miller") Charge | — | 1.6 | 2.4 | | V _{GS} = -10V ② |
| t _{d(on)} | Turn-On Delay Time | — | 12 | — | ns | V _{DD} = -15V ② |
| t _r | Rise Time | — | 18 | — | | I _D = -1.0A |
| t _{d(off)} | Turn-Off Delay Time | — | 88 | — | | R _G = 6.0Ω |
| t _f | Fall Time | — | 52 | — | | V _{GS} = -10V |
| C _{iss} | Input Capacitance | — | 510 | — | pF | V _{GS} = 0V |
| C _{oss} | Output Capacitance | — | 71 | — | | V _{DS} = -25V |
| C _{rss} | Reverse Transfer Capacitance | — | 43 | — | | f = 1.0MHz |

Source-Drain Ratings and Characteristics

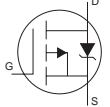
| | Parameter | Min. | Typ. | Max. | Units | Conditions |
|-----------------|--|------|------|------|-------|--|
| I _S | Continuous Source Current (Body Diode) | — | — | -1.3 | A | MOSFET symbol showing the integral reverse p-n junction diode.  |
| I _{SM} | Pulsed Source Current (Body Diode) ① | — | — | -24 | | |
| V _{SD} | Diode Forward Voltage | — | — | -1.2 | V | T _J = 25°C, I _S = -1.3A, V _{GS} = 0V ② |
| t _{rr} | Reverse Recovery Time | — | 17 | 26 | ns | T _J = 25°C, I _F = -1.3A |
| Q _{rr} | Reverse Recovery Charge | — | 12 | 18 | nC | di/dt = -100A/μs ② |

Notes:

① Repetitive rating; pulse width limited by max. junction temperature.

② Pulse width ≤ 400μs; duty cycle ≤ 2%.

③ Surface mounted on FR-4 board, t ≤ 5sec.

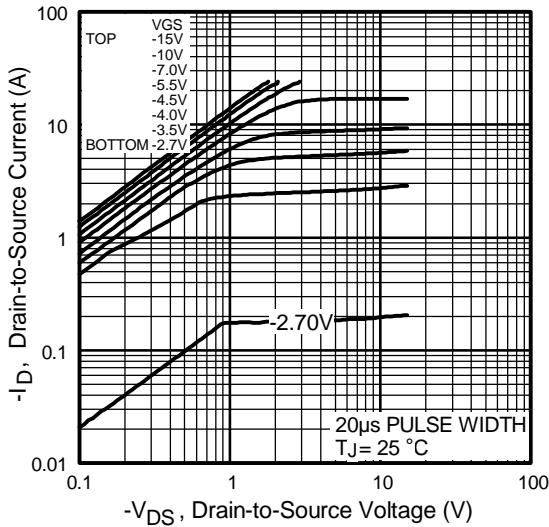

Fig 1. Typical Output Characteristics

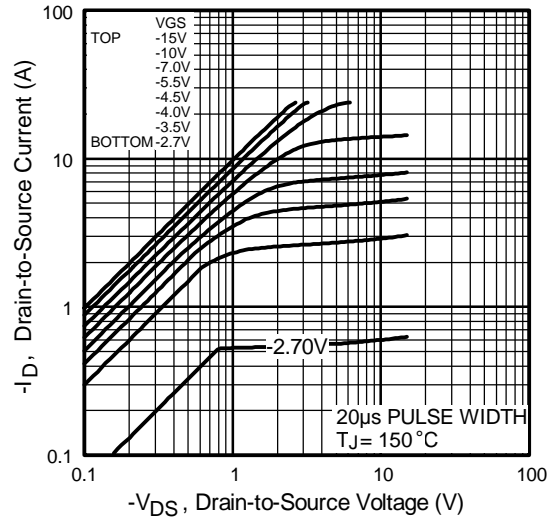

Fig 2. Typical Output Characteristics

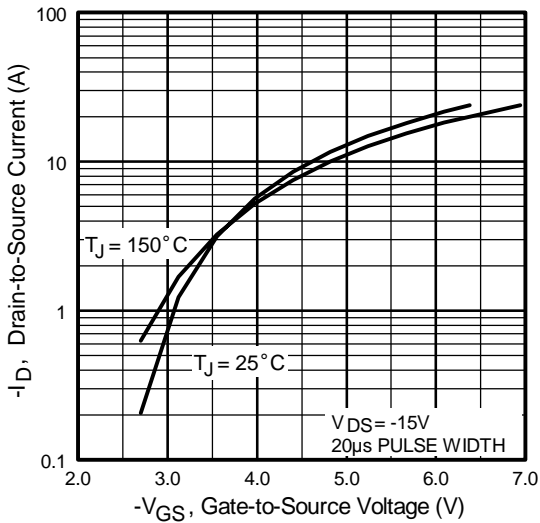

Fig 3. Typical Transfer Characteristics

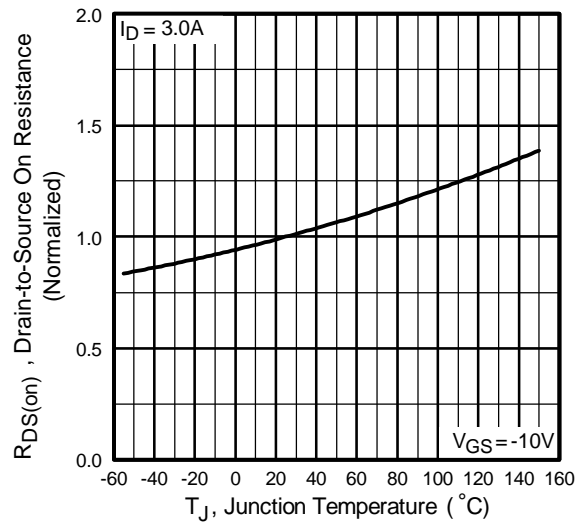

Fig 4. Normalized On-Resistance Vs. Temperature

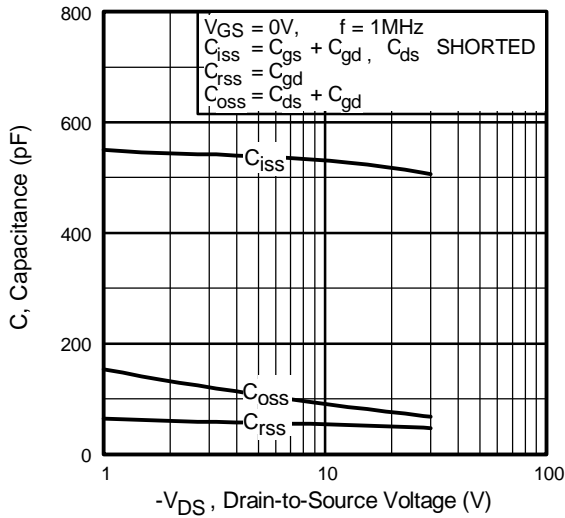

Fig 5. Typical Capacitance Vs. Drain-to-Source Voltage

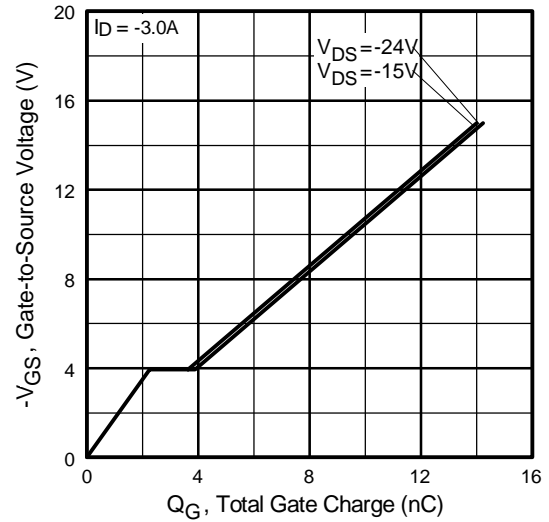

Fig 6. Typical Gate Charge Vs. Gate-to-Source Voltage

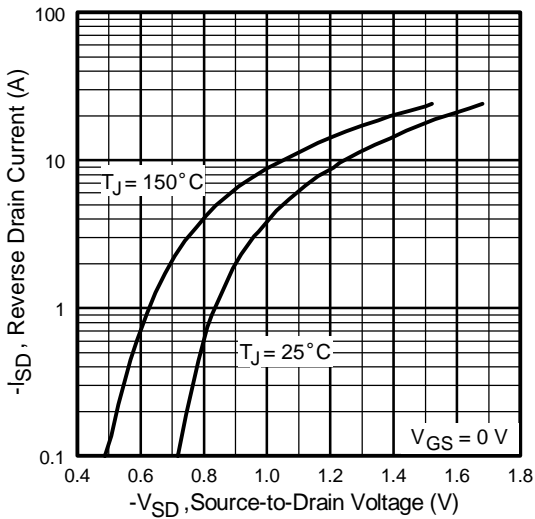

Fig 7. Typical Source-Drain Diode Forward Voltage

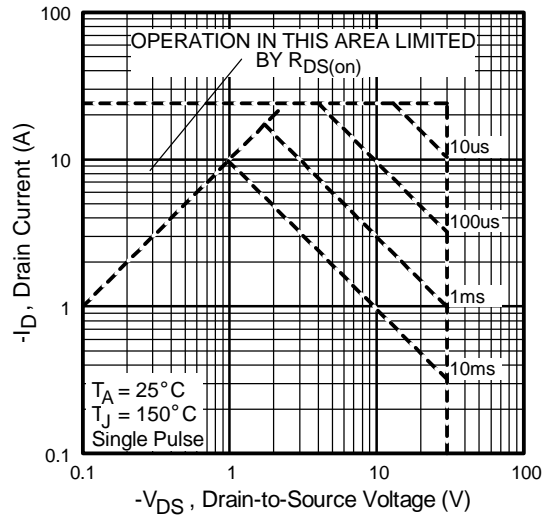

Fig 8. Maximum Safe Operating Area

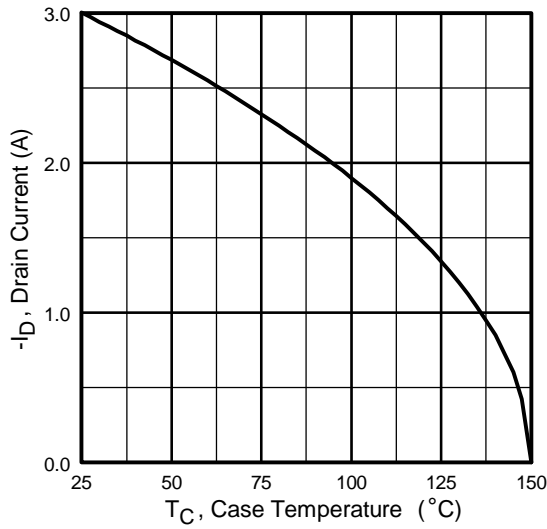

Fig 9. Maximum Drain Current Vs. Case Temperature

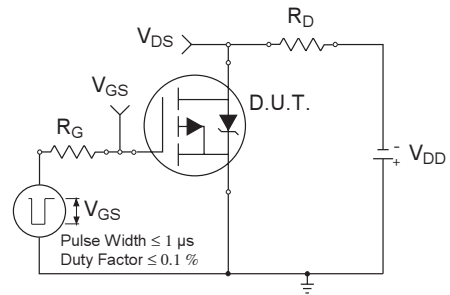

Fig 10a. Switching Time Test Circuit

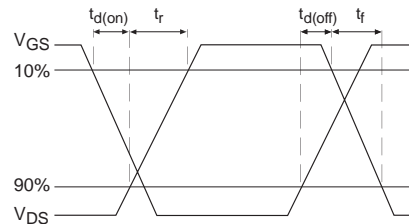

Fig 10b. Switching Time Waveforms

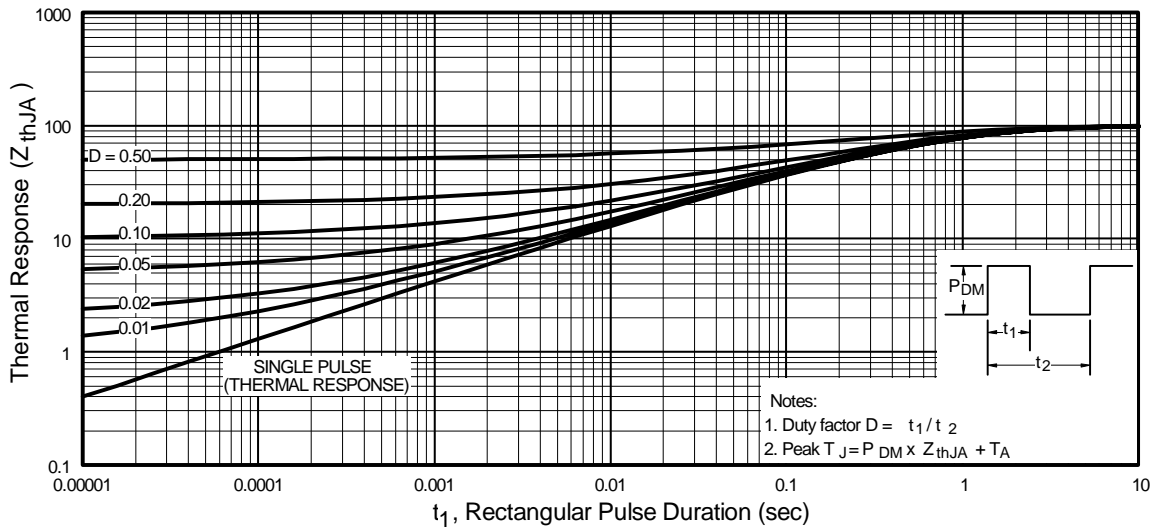

Fig 11. Maximum Effective Transient Thermal Impedance, Junction-to-Ambient

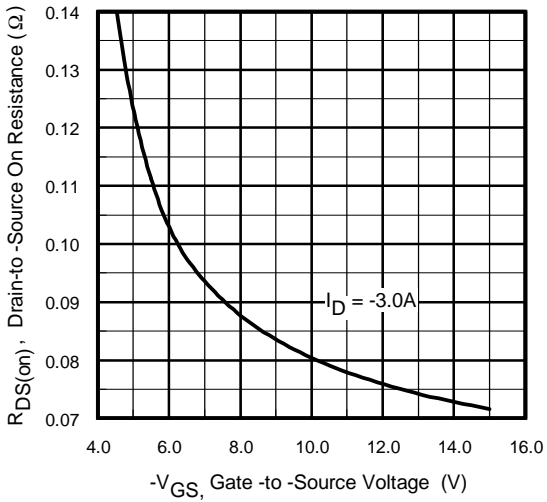

Fig 11. Typical On-Resistance Vs. Gate Voltage

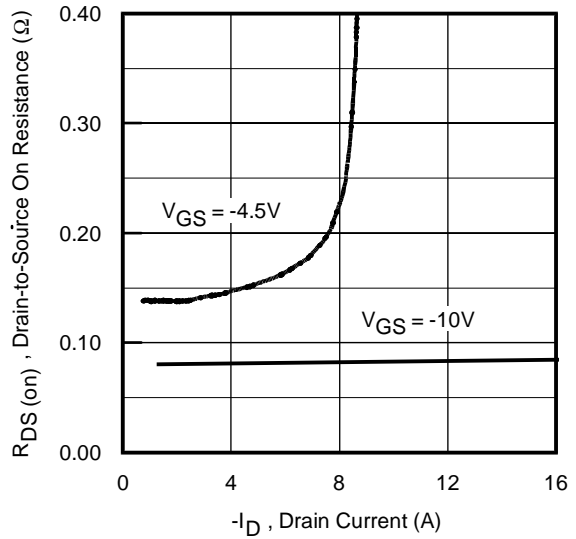

Fig 12. Typical On-Resistance Vs. Drain Current

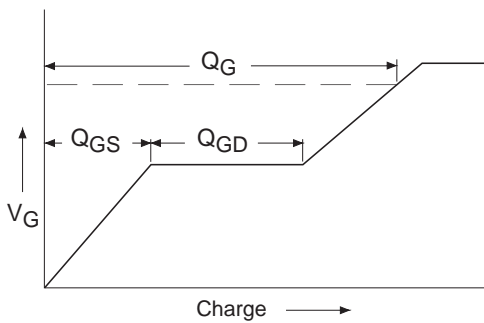

Fig 13a. Basic Gate Charge Waveform

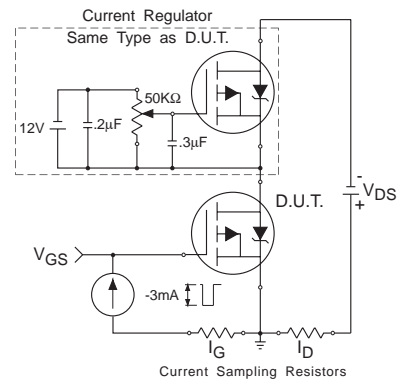

Fig 13b. Gate Charge Test Circuit

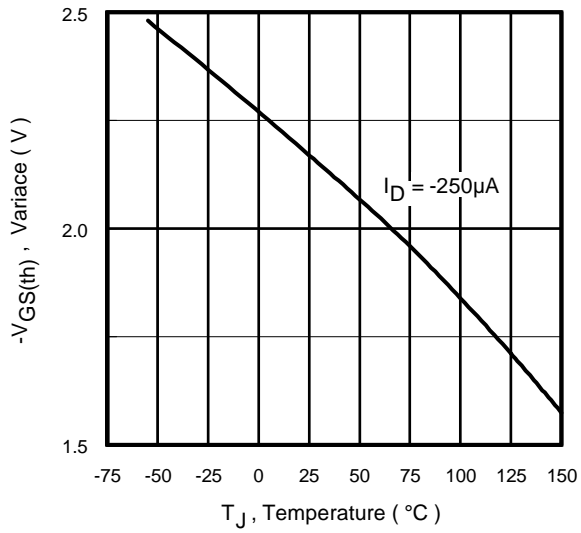

Fig 14. Threshold Voltage Vs. Temperature

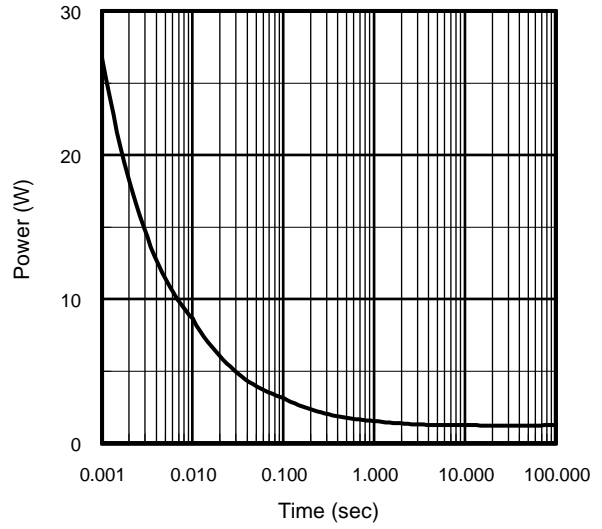
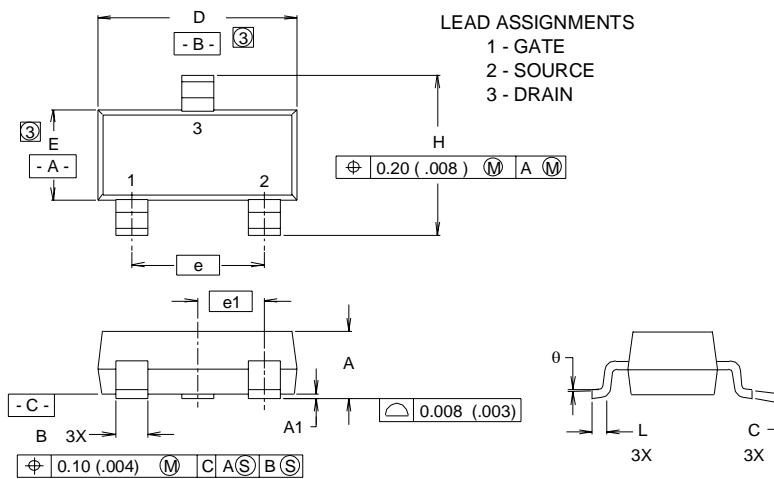

Fig 15. Typical Power Vs. Time

Micro3™ Package Outline

Dimensions are shown in millimeters (inches)



| DIM | INCHES | | MILLIMETERS | |
|-----|-------------|------|-------------|------|
| | MIN | MAX | MIN | MAX |
| A | .032 | .044 | 0.82 | 1.11 |
| A1 | .001 | .004 | 0.02 | 0.10 |
| B | .015 | .021 | 0.38 | 0.54 |
| C | .004 | .006 | 0.10 | 0.15 |
| D | .105 | .120 | 2.67 | 3.05 |
| e | .0750 BASIC | | 1.90 BASIC | |
| e1 | .0375 BASIC | | 0.95 BASIC | |
| E | .047 | .055 | 1.20 | 1.40 |
| H | .083 | .098 | 2.10 | 2.50 |
| L | .005 | .010 | 0.13 | 0.25 |
| θ | 0° | 8° | 0° | 8° |

MINIMUM RECOMMENDED FOOTPRINT

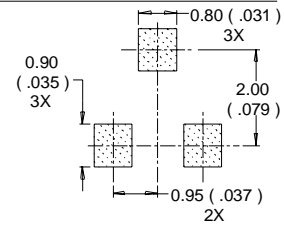

- NOTES:
 1. DIMENSIONING & TOLERANCING PER ANSI Y14.5M-1982.
 2. CONTROLLING DIMENSION : INCH.
 ③ DIMENSIONS DO NOT INCLUDE MOLD FLASH.

Notes: This part marking information applies to devices produced before 02/26/2001

EXAMPLE: THIS IS AN IRLML6302

WW = (1-26) IF PRECEDED BY LAST DIGIT OF CALENDAR YEAR

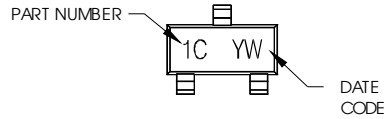

PART NUMBER CODE REFERENCE:

- 1A = IRLML2402
- 1B = IRLML2803
- 1C = IRLML6302
- 1D = IRLML5103
- 1E = IRLML6402
- 1F = IRLML6401
- 1G = IRLML2502
- 1H = IRLML5203

DATE CODE EXAMPLES:

- YWW = 9503 = 5C
- YWW = 9532 = EF

| YEAR | Y | WORK WEEK | W |
|------|---|-----------|---|
| 2001 | 1 | 01 | A |
| 2002 | 2 | 02 | B |
| 2003 | 3 | 03 | C |
| 1994 | 4 | 04 | D |
| 1995 | 5 | | |
| 1996 | 6 | | |
| 1997 | 7 | | |
| 1998 | 8 | | |
| 1999 | 9 | | |
| 2000 | 0 | 24 | X |
| | | 25 | Y |
| | | 26 | Z |

WW = (27-52) IF PRECEDED BY A LETTER

| YEAR | Y | WORK WEEK | W |
|------|---|-----------|---|
| 2001 | A | 27 | A |
| 2002 | B | 28 | B |
| 2003 | C | 29 | C |
| 1994 | D | 30 | D |
| 1995 | E | | |
| 1996 | F | | |
| 1997 | G | | |
| 1998 | H | | |
| 1999 | J | | |
| 2000 | K | 50 | X |
| | | 51 | Y |
| | | 52 | Z |

Notes: This part marking information applies to devices produced after 02/26/2001

W = (1-26) IF PRECEDED BY LAST DIGIT OF CALENDAR YEAR

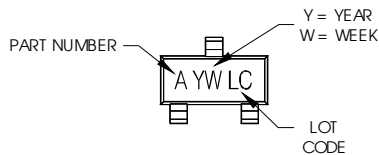

PART NUMBER CODE REFERENCE:

- A = IRLML2402
- B = IRLML2803
- C = IRLML6302
- D = IRLML5103
- E = IRLML6402
- F = IRLML6401
- G = IRLML2502
- H = IRLML5203

| YEAR | Y | WORK WEEK | W |
|------|---|-----------|---|
| 2001 | 1 | 01 | A |
| 2002 | 2 | 02 | B |
| 2003 | 3 | 03 | C |
| 1994 | 4 | 04 | D |
| 1995 | 5 | | |
| 1996 | 6 | | |
| 1997 | 7 | | |
| 1998 | 8 | | |
| 1999 | 9 | | |
| 2000 | 0 | 24 | X |
| | | 25 | Y |
| | | 26 | Z |

W = (27-52) IF PRECEDED BY A LETTER

| YEAR | Y | WORK WEEK | W |
|------|---|-----------|---|
| 2001 | A | 27 | A |
| 2002 | B | 28 | B |
| 2003 | C | 29 | C |
| 1994 | D | 30 | D |
| 1995 | E | | |
| 1996 | F | | |
| 1997 | G | | |
| 1998 | H | | |
| 1999 | J | | |
| 2000 | K | 50 | X |
| | | 51 | Y |
| | | 52 | Z |

IRLML5203

PROVISIONAL

International
IOR Rectifier

Micro3™ Tape & Reel Information

Dimensions are shown in millimeters (inches)

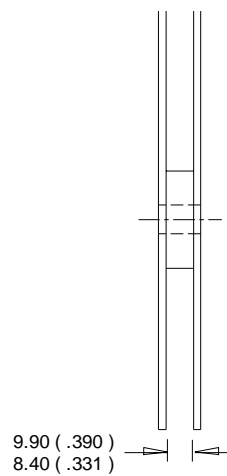
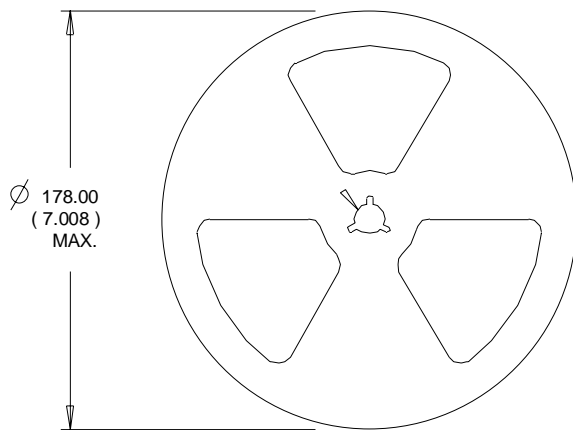
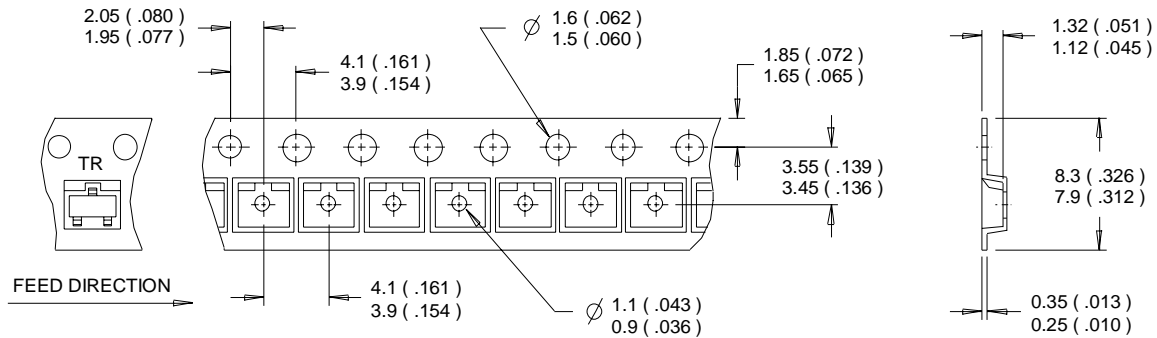

NOTES:

1. CONTROLLING DIMENSION : MILLIMETER.
2. OUTLINE CONFORMS TO EIA-481 & EIA-541.

Data and specifications subject to change without notice.

International
IOR Rectifier

IR WORLD HEADQUARTERS: 233 Kansas St., El Segundo, California 90245, USA Tel: (310) 252-7105

TAC Fax: (310) 252-7903

Visit us at www.irf.com for sales contact information. 04/03

www.irf.com