

IRF9956

HEXFET® Power MOSFET

- Generation V Technology
- Ultra Low On-Resistance
- Dual N-Channel MOSFET
- Surface Mount
- Very Low Gate Charge and Switching Losses
- Fully Avalanche Rated

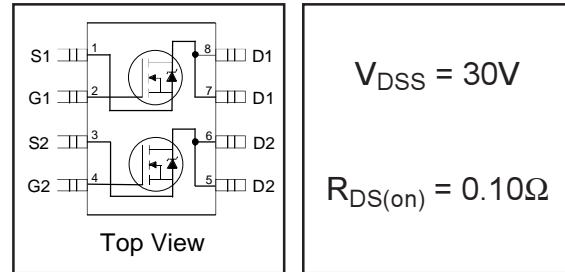

Description

Fifth Generation HEXFETs from International Rectifier utilize advanced processing techniques to achieve extremely low on-resistance per silicon area. This benefit, combined with the fast switching speed and ruggedized device design that HEXFET Power MOSFETs are well known for, provides the designer with an extremely efficient and reliable device for use in a wide variety of applications.

The SO-8 has been modified through a customized leadframe for enhanced thermal characteristics and multiple-die capability making it ideal in a variety of power applications. With these improvements, multiple devices can be used in an application with dramatically reduced board space. The package is designed for vapor phase, infra red, or wave soldering techniques.

Recommended upgrade: IRF7303 or IRF7313
Lower profile/smaller equivalent: IRF7503

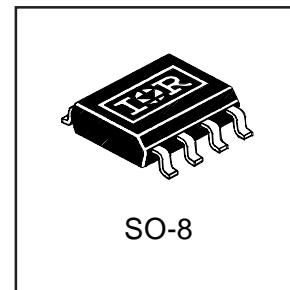

Absolute Maximum Ratings ($T_A = 25^\circ\text{C}$ Unless Otherwise Noted)

| | Symbol | Maximum | Units |
|--|----------------|--------------------------|------------------|
| Drain-Source Voltage | V_{DS} | 30 | V |
| Gate-Source Voltage | V_{GS} | ± 20 | |
| Continuous Drain Current ^① | I_D | $T_A = 25^\circ\text{C}$ | A |
| | | $T_A = 70^\circ\text{C}$ | |
| Pulsed Drain Current | I_{DM} | 16 | A |
| Continuous Source Current (Diode Conduction) | I_S | 1.7 | |
| Maximum Power Dissipation ^② | P_D | $T_A = 25^\circ\text{C}$ | W |
| | | $T_A = 70^\circ\text{C}$ | |
| Single Pulse Avalanche Energy ^② | E_{AS} | 44 | mJ |
| Avalanche Current | I_{AR} | 2.0 | A |
| Repetitive Avalanche Energy | E_{AR} | 0.20 | mJ |
| Peak Diode Recovery dv/dt ^③ | dv/dt | 5.0 | V/ ns |
| Junction and Storage Temperature Range | T_J, T_{STG} | -55 to + 150 | $^\circ\text{C}$ |

Thermal Resistance Ratings

| Parameter | Symbol | Limit | Units |
|--|-----------------|-------|--------------------|
| Maximum Junction-to-Ambient ^① | $R_{\theta JA}$ | 62.5 | $^\circ\text{C/W}$ |

Electrical Characteristics @ $T_J = 25^\circ\text{C}$ (unless otherwise specified)

| | Parameter | Min. | Typ. | Max. | Units | Conditions |
|---------------------------------|--------------------------------------|------|-------|------|----------|--|
| $V_{(BR)DSS}$ | Drain-to-Source Breakdown Voltage | 30 | — | — | V | $V_{GS} = 0V, I_D = 250\mu A$ |
| $\Delta V_{(BR)DSS}/\Delta T_J$ | Breakdown Voltage Temp. Coefficient | — | 0.015 | — | V/°C | Reference to $25^\circ\text{C}, I_D = 1\text{mA}$ |
| $R_{DS(on)}$ | Static Drain-to-Source On-Resistance | — | 0.06 | 0.10 | Ω | $V_{GS} = 10V, I_D = 2.2A$ ④ |
| | | — | 0.09 | 0.20 | | $V_{GS} = 4.5V, I_D = 1.0A$ ④ |
| $V_{GS(th)}$ | Gate Threshold Voltage | 1.0 | — | — | V | $V_{DS} = V_{GS}, I_D = 250\mu A$ |
| g_{fs} | Forward Transconductance | — | 12 | — | S | $V_{DS} = 15V, I_D = 3.5A$ |
| I_{DSS} | Drain-to-Source Leakage Current | — | — | 2.0 | μA | $V_{DS} = 24V, V_{GS} = 0V$ |
| | | — | — | 25 | | $V_{DS} = 24V, V_{GS} = 0V, T_J = 125^\circ\text{C}$ |
| I_{GSS} | Gate-to-Source Forward Leakage | — | — | 100 | nA | $V_{GS} = 24V$ |
| | Gate-to-Source Reverse Leakage | — | — | -100 | | $V_{GS} = -24V$ |
| Q_g | Total Gate Charge | — | 6.9 | 14 | nC | $I_D = 1.8A$ |
| Q_{gs} | Gate-to-Source Charge | — | 1.0 | 2.0 | | $V_{DS} = 10V$ |
| Q_{gd} | Gate-to-Drain ("Miller") Charge | — | 1.8 | 3.5 | | $V_{GS} = 10V, \text{See Fig. 10 } \textcircled{4}$ |
| $t_{d(on)}$ | Turn-On Delay Time | — | 6.2 | 12 | ns | $V_{DD} = 10V$ |
| t_r | Rise Time | — | 8.8 | 18 | | $I_D = 1.0A$ |
| $t_{d(off)}$ | Turn-Off Delay Time | — | 13 | 26 | | $R_G = 6.0\Omega$ |
| t_f | Fall Time | — | 3.0 | 6.0 | | $R_D = 10\Omega$ ④ |
| C_{iss} | Input Capacitance | — | 190 | — | pF | $V_{GS} = 0V$ |
| C_{oss} | Output Capacitance | — | 120 | — | | $V_{DS} = 15V$ |
| C_{riss} | Reverse Transfer Capacitance | — | 61 | — | | $f = 1.0\text{MHz}, \text{See Fig. 9}$ |

Source-Drain Ratings and Characteristics

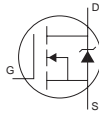
| | Parameter | Min. | Typ. | Max. | Units | Conditions |
|----------|--|------|------|------|-------|--|
| I_S | Continuous Source Current (Body Diode) | — | — | 1.7 | A | MOSFET symbol showing the integral reverse p-n junction diode.  |
| I_{SM} | Pulsed Source Current (Body Diode) ① | — | — | 16 | | |
| V_{SD} | Diode Forward Voltage | — | 0.82 | 1.2 | V | $T_J = 25^\circ\text{C}, I_S = 1.25A, V_{GS} = 0V$ ③ |
| t_{rr} | Reverse Recovery Time | — | 27 | 53 | ns | $T_J = 25^\circ\text{C}, I_F = 1.25A$ |
| Q_{rr} | Reverse Recovery Charge | — | 28 | 57 | nC | $di/dt = 100A/\mu s$ ③ |

Notes:

- ① Repetitive rating; pulse width limited by max. junction temperature. (See fig. 11)
- ② Starting $T_J = 25^\circ\text{C}, L = 22\text{mH}$
 $R_G = 25\Omega, I_{AS} = 2.0A.$
- ③ $I_{SD} \leq 2.0A, di/dt \leq 100A/\mu s, V_{DD} \leq V_{(BR)DSS}, T_J \leq 150^\circ\text{C}$
- ④ Pulse width $\leq 300\mu s$; duty cycle $\leq 2\%$.
- ⑤ Surface mounted on FR-4 board, $t \leq 10\text{sec}.$

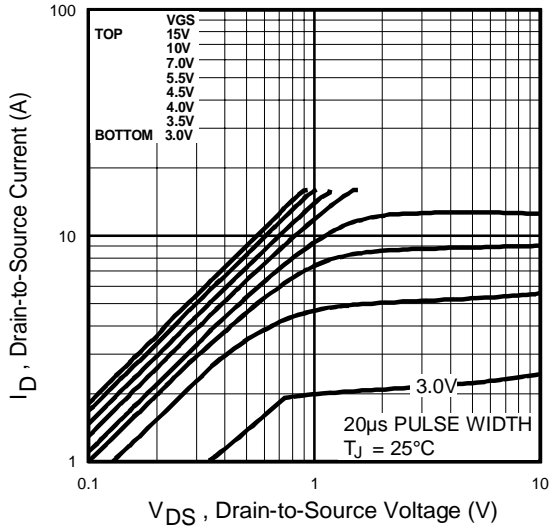

Fig 1. Typical Output Characteristics

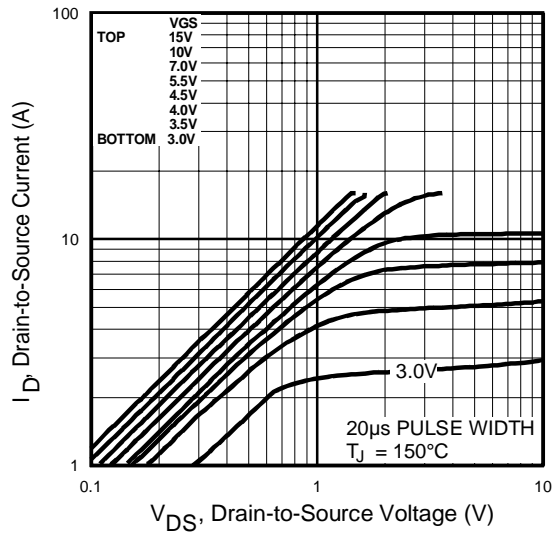

Fig 2. Typical Output Characteristics

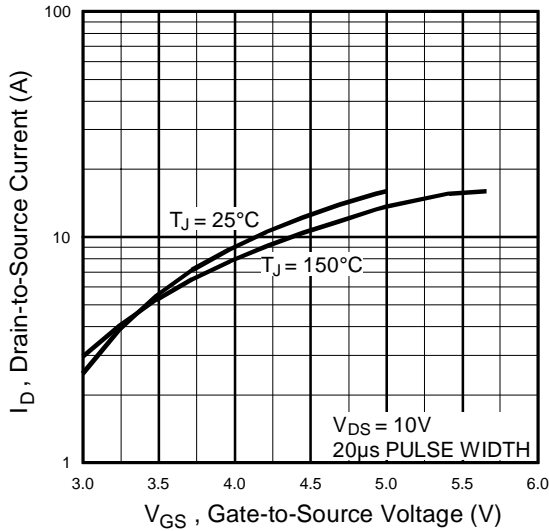

Fig 3. Typical Transfer Characteristics

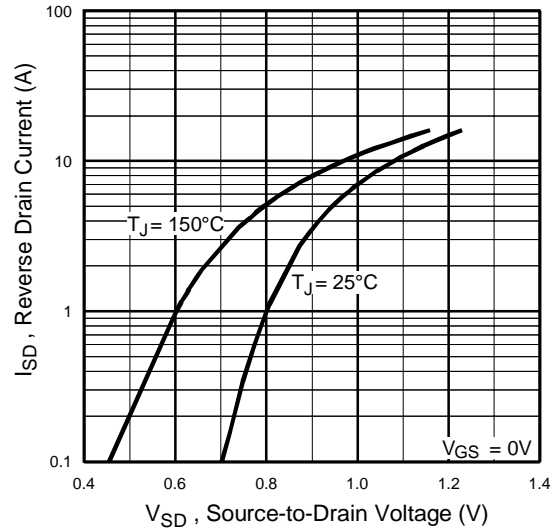

Fig 4. Typical Source-Drain Diode Forward Voltage

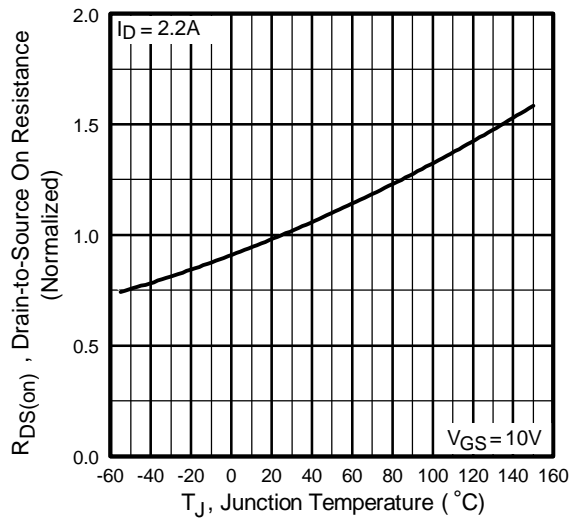

Fig 4. Normalized On-Resistance Vs. Temperature

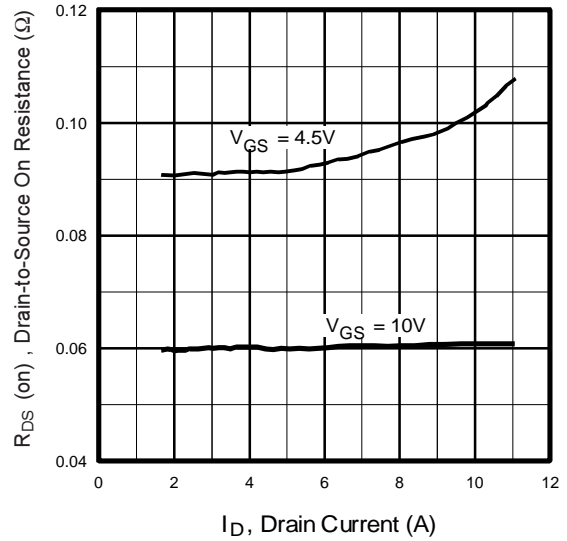

Fig 6. Typical On-Resistance Vs. Drain Current

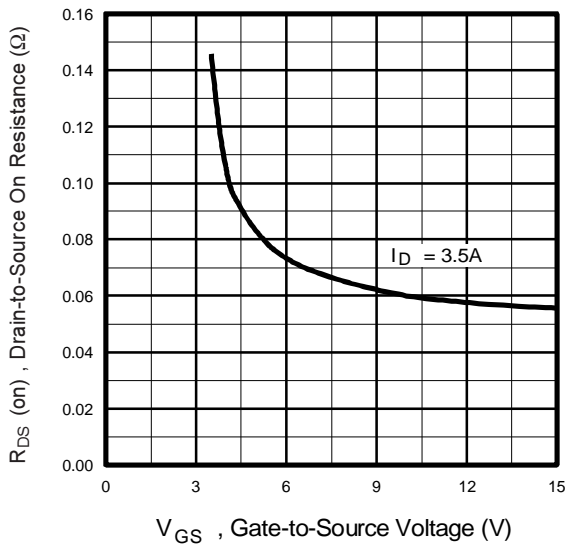

Fig 7. Typical On-Resistance Vs. Gate Voltage

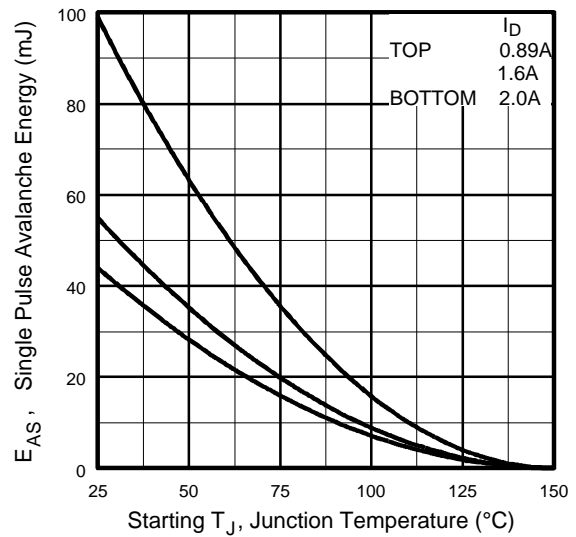

Fig 8. Maximum Avalanche Energy Vs. Drain Current

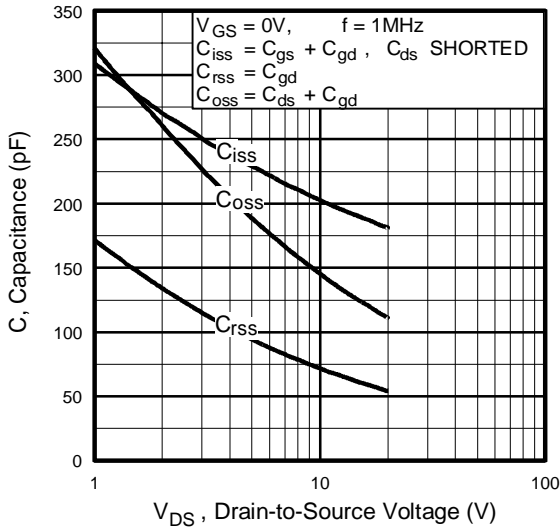

Fig 9. Typical Capacitance Vs. Drain-to-Source Voltage

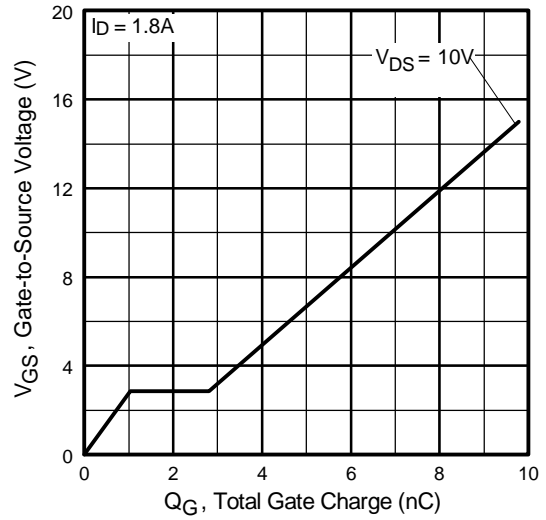

Fig 10. Typical Gate Charge Vs. Gate-to-Source Voltage

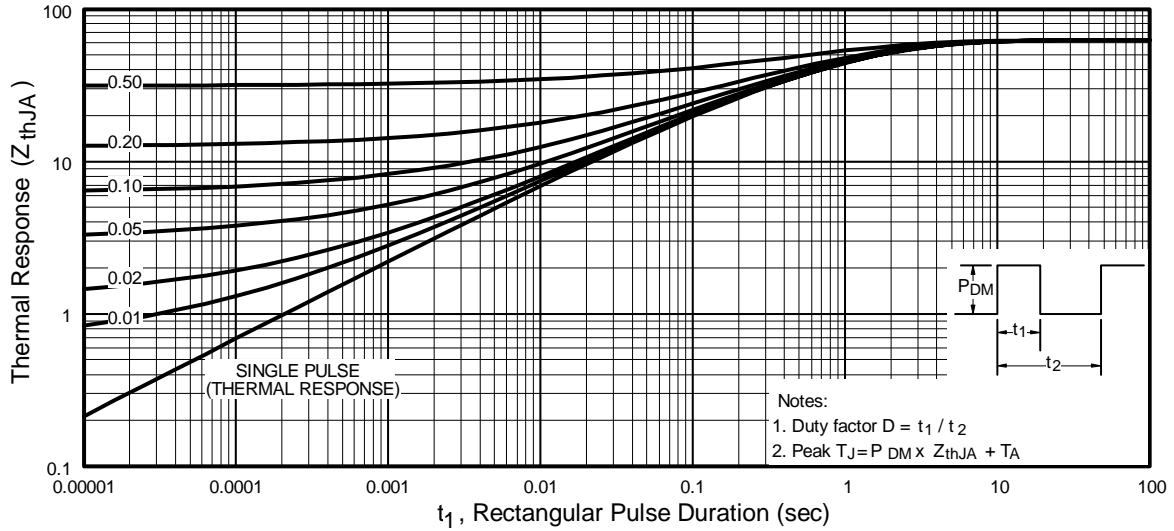

Fig 11. Maximum Effective Transient Thermal Impedance, Junction-to-Ambient

IRF9956



Package Outline

S08 Outline

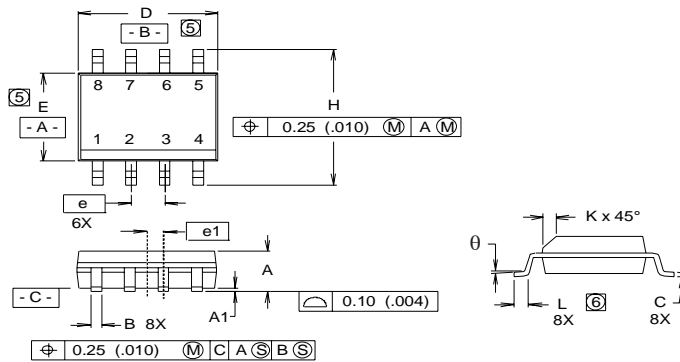

| DIM | INCHES | | MILLIMETERS | |
|-------|------------|-------|-------------|------|
| | MIN | MAX | MIN | MAX |
| A | .0532 | .0688 | 1.35 | 1.75 |
| A1 | .0040 | .0098 | 0.10 | 0.25 |
| B | .014 | .018 | 0.36 | 0.46 |
| C | .0075 | .0098 | 0.19 | 0.25 |
| D | .189 | .196 | 4.80 | 4.98 |
| E | .150 | .157 | 3.81 | 3.99 |
| e | .050 BASIC | | 1.27 BASIC | |
| e1 | .025 BASIC | | 0.635 BASIC | |
| H | .2284 | .2440 | 5.80 | 6.20 |
| K | .011 | .019 | 0.28 | 0.48 |
| L | 0.16 | .050 | 0.41 | 1.27 |
| theta | 0° | 8° | 0° | 8° |

RECOMMENDED FOOTPRINT

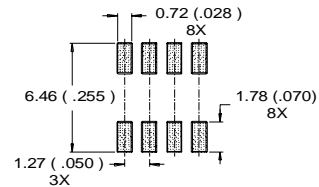

NOTES:

1. DIMENSIONING AND TOLERANCING PER ANSI Y14.5M-1982.
2. CONTROLLING DIMENSION : INCH.
3. DIMENSIONS ARE SHOWN IN MILLIMETERS (INCHES).
4. OUTLINE CONFORMS TO JEDEC OUTLINE MS-012AA.
5. DIMENSION DOES NOT INCLUDE MOLD PROTRUSIONS
MOLD PROTRUSIONS NOT TO EXCEED 0.25 (.006).
6. DIMENSIONS IS THE LENGTH OF LEAD FOR SOLDERING TO A SUBSTRATE..

Part Marking Information

S08

EXAMPLE : THIS IS AN IRF7101

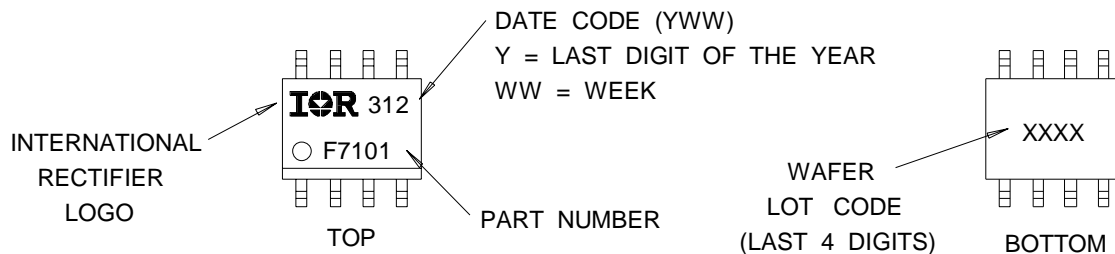

Tape & Reel Information

S08

Dimensions are shown in millimeters (inches)

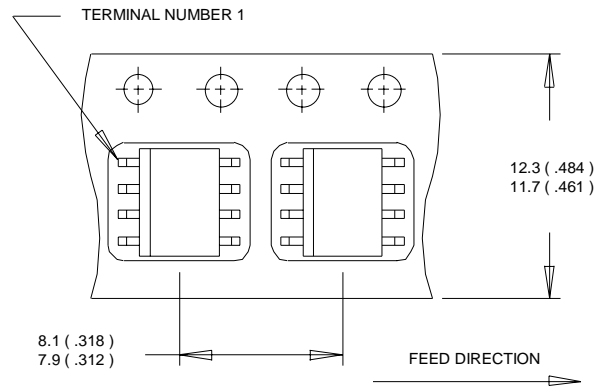

NOTES:

1. CONTROLLING DIMENSION : MILLIMETER.
2. ALL DIMENSIONS ARE SHOWN IN MILLIMETERS(INCHES).
3. OUTLINE CONFORMS TO EIA-481 & EIA-541.

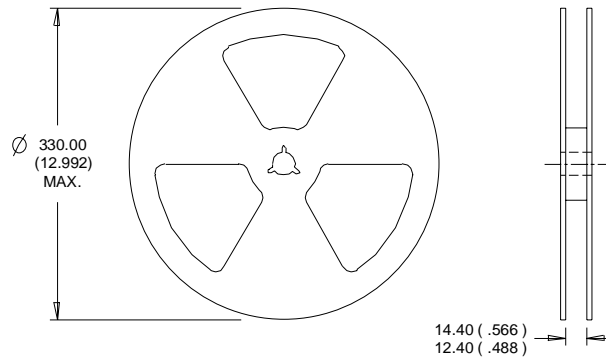

NOTES:

1. CONTROLLING DIMENSION : MILLIMETER.
2. OUTLINE CONFORMS TO EIA-481 & EIA-541.

Data and specifications subject to change without notice.

International
IR Rectifier

IR WORLD HEADQUARTERS: 233 Kansas St., El Segundo, California 90245, USA Tel: (310) 252-7105
TAC Fax: (310) 252-7903

Visit us at www.irf.com for sales contact information. 04/03