

SIEMENS







Installation Guide / User Manual

## Surge Protection Devices

TPS4 Series Products for Panelboards,  
Switchboards and other Apparatus

[usa.siemens.com/spd](http://usa.siemens.com/spd)

	 <b>Danger</b>	 <b>Peligro</b>	 <b>Danger</b>
	<b>Hazardous Voltage.</b> Will cause death or serious injury.	<b>Tensión peligrosa.</b> Puede causar la muerte o lesiones graves.	Tension dangereuse. Danger de mort ou risque de blessures graves.
	Turn off and lock out all power supplying this device before working on this device. Replace all covers before power supplying this device is turned on.	Desenergice totalmente antes de instalar o darle servicio. Reemplace todas las barreras y cubiertas antes de energizar el interruptor.	Couper l'alimentation de l'appareil et barrer avant de travailler. Remplacez tous les couverts avant que l'approvisionnement de pouvoir soit alimenté.

- **This manual shall be read in entirety prior to installing**
- Only qualified licensed electricians should install or service SPDs
- Hazardous voltages exist within SPDs
- SPDs should never be installed or serviced when energized
- Use appropriate safety precautions including Personal Protection Equipment
- Failure to follow these instructions can result in equipment damage, serious injury and/or death.

**Bonding and Grounding Hazard**

Verify that the neutral conductor in the service entrance equipment is bonded to ground in accordance with the National Electrical Code (NEC®) and all applicable codes.

Verify that the neutral terminal (XO) on the secondary side of distribution transformers are grounded to the system ground in accordance with the NEC® and all applicable codes.

During installation into an electrical system the SPD must not be energized until the electrical system is completely installed, inspected and tested. All conductors must be connected and functional including the neutral (if required). The voltage rating of the SPD and system must be verified before energizing the SPD.

Failure to follow these guidelines can lead to abnormally high voltages at the SPD. This may cause the SPD to fail. The warranty is voided if the SPD is incorrectly installed and/or if the neutral conductor in the service entrance equipment or downstream of separately derived systems is not bonded to ground in accordance with the NEC®.

**Do Not Hi-Pot Test SPDs**

The TPS4 unit needs to be fully disconnected during Hi-Pot testing. Failure to disconnect SPD and associated components during elevated voltage testing will damage the SPD and will void the warranty.

# Table of Contents

Introduction	3
Lighting Panels Installation Instructions	6
Power Panels and Distribution Switchboard Installation Instructions	11
Switchboard and Low Voltage Switchgear Installation Instructions	14
SPD Operation	16
Maintenance and Customer Support	21

---

## Siemens TPS4 SPDs have the following Type designations:

**Table 1:** Type Designations

Siemens TPS4 Series	Type Rating
TPS4 01 & L1	Type 1 & 2 Component Assembly
TPS4 05 & L5	Type 1 & 2 Component Assembly
TPS4 06 & L6	Type 1 & 2 Component Assembly

For further information, please review latest editions of NEC® Art. 285, UL 1449, contact your local Siemens sales office or contact Siemens TPS Tech Support at 800-333-7421.

## Equipment Performance

As SPDs sense overvoltage, they create a momentary internal short circuit, thereby redirecting harmful surge energy to earth ground. SPDs are capable of repeating this function repeatedly. For optimum protection, staged surge suppression should be implemented at the service entrance and all other distribution or panelboard locations feeding sensitive equipment.

## Voltage Rating

Prior to installing the TPS4 SPD, verify that the unit has the correct voltage rating for the equipment installed by checking the nameplates of both the equipment and TPS4 module. The service type should match the intended power source. See Table 2 on the following pages for voltage applications.

## Introduction

Thank you for choosing Siemens TPS4 Surge Protective Device (SPD). This is a high quality, high energy surge suppressor designed to protect sensitive equipment from damaging transient overvoltage events.

Proper installation is important to maximize performance. Please follow the steps outlined herein.

This entire user manual should be read prior to beginning installation. These instructions are not intended to replace national or local codes. Follow all applicable electrical codes to ensure compliance. Installation of this SPD should only be performed by qualified electrical personnel.

All Siemens SPDs are extensively tested in accordance with industry standards such as ANSI/IEEE C62.41.1, C62.41.2, C62.45, C62.62, C62.72, UL 1449, UL 1283, IEC 61643, etc.

## Warning & Safety Information

This equipment contains hazardous voltages. Property damage, serious injury or death can result if safety instructions are not followed. Only qualified personnel should work on or around this equipment after becoming thoroughly familiar with all warnings, safety notices, and maintenance procedures contained herein.

The successful and safe operation of this equipment is dependent upon proper handling, installation, operation, and maintenance.

## Qualified Person

For the purposes of this manual and product labels, a QUALIFIED PERSON is one who is familiar with the installation, construction, and operation of this equipment, and the hazards involved. In addition, he or she has the following qualifications:

- (a) Is trained and authorized to energize, deenergize, clear, ground and tag circuits and equipment in accordance with established safety practices.
- (b) Is trained in the proper care and use of personal protective equipment (PPE) such as rubber gloves, hard hat, safety glasses or face shields, flash clothing, etc. in accordance with established safety practices.
- (c) Is trained in rendering first aid.

## Danger

For the purposes of this manual and product labels, DANGER indicates an imminently hazardous situation, which, if not avoided, will result in serious injury or death.

## Notice

For the purposes of this manual and product labels, NOTICE indicates a potentially hazardous situation which, if not avoided, could result in damage to the equipment but does not create a potential for personal injury.

These instructions do not purport to cover all details or variations in equipment, nor to provide for every possible contingency to be met in connection with installation, operation or maintenance. Should further information

be desired or should particular problems arise which are not covered sufficiently for the purchaser's purposes, the matter should be referred to the local Siemens sales office.

## Do Not Hi-Pot Test SPDs

The TPS4 unit needs to be fully disconnected during Hi-Pot testing. Failure to disconnect SPD and associated components during elevated voltage testing will damage the SPD and will void the warranty.

## Limited Warranty

Siemens warrants its TPS4 SPDs against defective workmanship and materials for 10 years. Liability is limited to the repair or replacement of the defective product at Siemens' option. A Return Material Authorization number (RA#) must be given by the company prior to the return of any product. Returned products must be sent to the factory with the transportation charges prepaid. In addition, the company also warrants unlimited replacement of modular and component parts within the warranty period previously described.

The company specifically disclaims all other warranties, expressed or implied. Additionally, the company is not responsible for incidental or consequential damages resulting from any defect in any product or component thereof.

The sales contract contains the entire obligation of Siemens. This instruction manual shall not become part of or modify any prior existing agreement, commitment or relationship.

## Unpacking & Preliminary Inspection

Inspect the entire shipping container for damage or signs of mishandling before unpacking the unit. Remove the packing material and further inspect the unit for any obvious shipping damages. If any damage was found and is a result of shipping or handling, immediately file a claim with the shipping company and forward a copy to your local Siemens sales office.

## Storage

The unit should be stored in a clean, dry environment. Storage temperature is -55°C (-67°F) to +85°C (+185°F). Avoid exposing the unit to areas of high condensation. All of the packaging materials should be left intact until the unit is ready for installation. If the unit has been stored for an extended period of time, it may be necessary to clean the unit and make a complete inspection of the unit prior to installing and placing into service.

## General Information

This device features internal overcurrent and overtemperature protection that will disconnect affected surge suppression components at the end of their useful life, but will maintain power to the load – now unprotected. If this situation is undesirable for the application, follow these instructions for servicing or replacing the device.

Service of this unit consists of replacing the entire module and/ or display assembly.

There are no user-serviceable parts inside the replaceable module. Do not attempt to disassemble the module as it may have high voltage energy stored and can be hazardous if not handled properly.

### Precautionary Statement Regarding SPDs on Ungrounded Systems

**Caution** – Ungrounded systems are inherently unstable and can produce excessively high line-to-ground voltages during certain fault conditions. During these fault conditions, any electrical equipment including an SPD, may be subjected to voltages which exceed their designed ratings. This information is being provided to the user so that an informed decision can be made before installing any electrical equipment on an ungrounded power system.

### Overcurrent Protection

The TPS4 SPD unit draws very little current under normal operation and will only conduct current for a very brief duration upon encountering a transient surge. The TPS4 unit contains overcurrent and thermal protection to protect against abnormal overvoltage conditions.

## System Grounding

An equipment grounding conductor must be used on all electrical circuits connected to the SPD.

For the best performance, use a single point ground system where the service entrance grounding electrode system is connected to and bonded to building steel, metallic piping, driven rods, etc. (NEC® and IEEE Std 142-2007 are appropriate standards).

For sensitive electronics and computer systems, ground impedance should be as low as possible. When metallic raceway is used as an additional grounding conductor, an insulated grounding conductor should be run inside the raceway and sized per the NEC®. Adequate electrical continuity must be maintained at all raceway connections. Do not use isolating bushings to interrupt a metallic raceway run.

A separate isolated ground for the SPD is NOT recommended because it may isolate the SPD from the rest of the electrical system, thus decreasing performance. Proper equipment connections to grounding system and ground grid continuity should be verified via inspections and tested on a regular basis as part of a comprehensive electrical maintenance program.

## Environment

The TPS4 is designed to operate in an environment ranging from: -35 °C (-31 °F) to +75 °C (+167 °F) and with relative humidity of 0%-95% (non-condensing).

**Table 2:** Model Number Catalog Logic

**TPS4 01 SPD for "RP1", P2, P3 Lighting Panelboards, MCC and Busway General Suppressor Series**

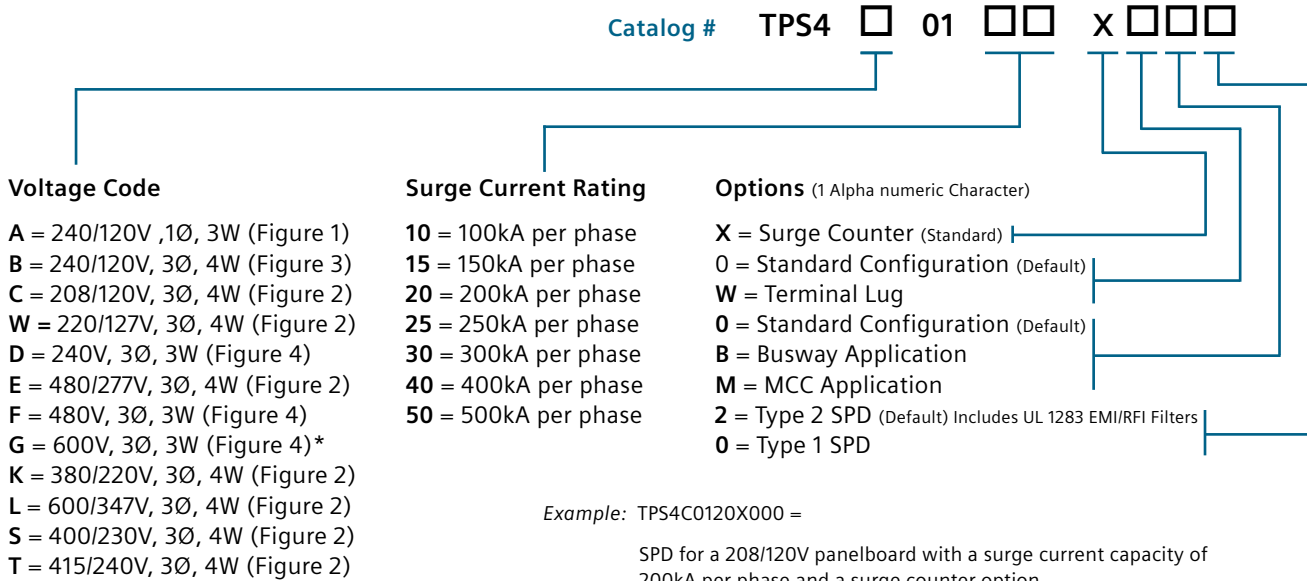

\*Not available in 300, 400 or 500kA versions

When an option is not selected, include a zero (0) in the field.

**TPS4 L1 10 Mode SPD for "RP1", P2, P3 Lighting Panelboards, MCC and Busway General Suppressor Series**

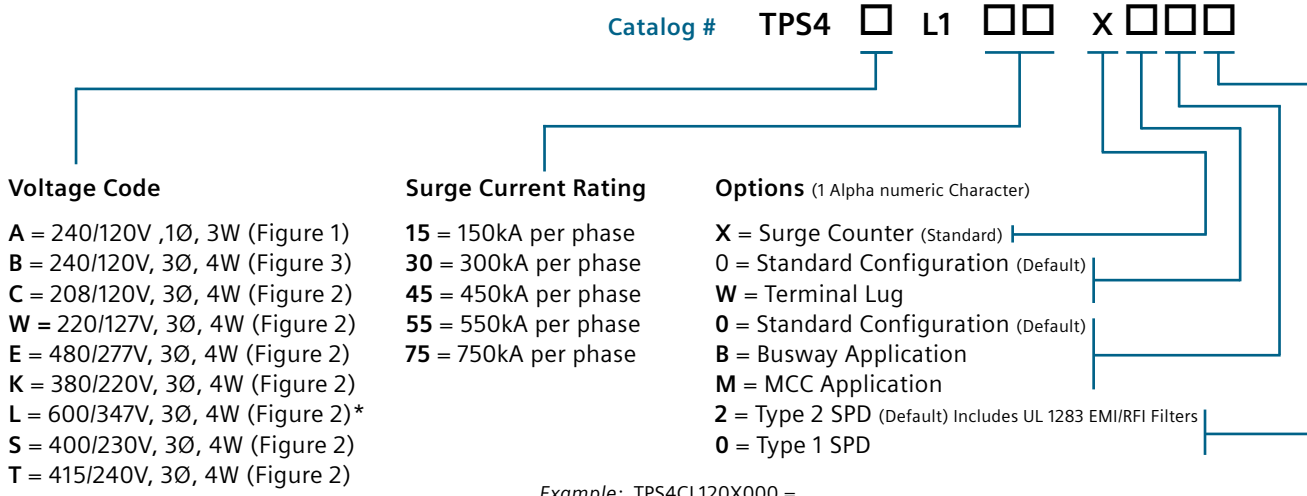

\*Not available in 450, 550 or 750kA versions

When an option is not selected, include a zero (0) in the field.

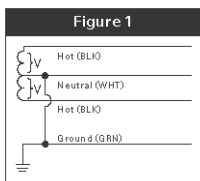

**Figure 1: SPLIT**  
2 Hots, 1 Neu, 1 Grnd

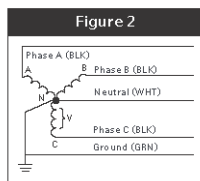

**Figure 2: WYE**  
3 Hots, 1 Neu, 1 Grnd

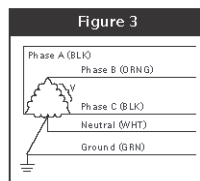

**Figure 3: HI-LEG DELTA (B High)**  
3 Hots, (B HIGH), 1 Neu, 1 Grnd

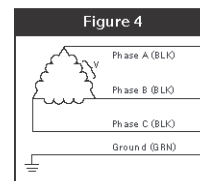

**Figure 4: DELTA & HRG WYE**  
3 Hots, 1 Grnd

## TPS4-01 Installation Instructions for: Lighting Panelboards Revise P1 (RP1)

If model number includes W option suffix, additional instructions follow:

The following instructions are for the installation of the Siemens TPS4 01 and L1 SPD modules in Siemens Revised P1 (RP1) lighting panelboards.

Be aware of differences between the Revised P1 and Original P1 panelboards. SPDs for Original P1 and Revised P1 are not interchangeable. Original P1 panelboards use TPS3 01 or L1 SPDs, whereas Revised P1 panelboards use TPS3 02 or L2 SPDs or the new TPS4 01 or L1 SPDs..

To determine if a customer has a Revised P1 panel – look at the part number of the interior. If the part number ends with “N” or “T” then it is a Revised P1. If it does not end in either “N” or “T” then it is an Original P1 panel. For example: P1E42MC250A is an Original P1 panel and P1E42MC250AT is a Revised P1 panel. If it is a Revised P1 panel ending in “N” – then there is no Subfeed space and no place for an SPD to be installed internally. A different SPD like the new Bolthshield BSPD product line can be an option for the Revised P1 panel ending in “N” because it mounts in a unit space.

Step 1) Lock off all power supplying this equipment before working on it.

Step 2) Attach TPS4 Mounting Plates (Item 2, 2 Places) to TPS4 using 10- 32 SEM screws with captive lock washers (Item 3). The mounting plates should be attached to the TPS4 with the offset oriented towards the top of the unit. Torque Screws to values listed.

Step 3) Position the TPS4 unit (item 1) on the panel base rail so that the TPS4 Phase tabs (Item 5) extend beneath the Bus Tabs on RP1 Panel. Attached TPS4 Phase Tabs to Panel Bus using #1/4-20 Hex SEM Screws (Item 6). Do not Torque at this time.

Step 4) Connect the TPS4 unit to the base rail using four (4) of the #10-24 Hex Thread Rolling screws (item 4).

Step 5) If present, connect TPS4 Neutral Connection Lug (Item 7) to Panel Neutral using 8 AWG minimum wire.

For best SPD performance, trim wire as required to provide shortest possible route between TPS4 Neutral connection and Panel Neutral Connection. Route wire as straight as possible and use gentle radius on any bends. Do not kink wire. Prevent wire from encroaching breaker locations.

**Neutral Connection is not applicable on Delta systems.**

Step 6) Torque all connections to the values as specified on the installation and maintenance instruction label affixed to the rear of the dead front.

**Table 3:** Content for Installation in Lighting Panelboards Revised P1

Item	Description	Qty.	Torque
1	TPS4	1	
2	TPS4 Mounting Plate	2	
3	#10-32 Hex Screw w/captive washer	4	30 in-lb
4	#10-24 Hex Thread Rolling Screw	4	30 in-lb
5	TPS4 Phase Tabs (part of TPS4 unit)	2* or 3	
6	#1/4-20 Hex Screw w/captive washer	2* or 3	45 in-lb
7	Neutral Lug Wire Connection	N/A	35 in-lb
8	36" #8 AWG White Neutral Conductor	1	

*\*only 2 tabs for single phase modules*

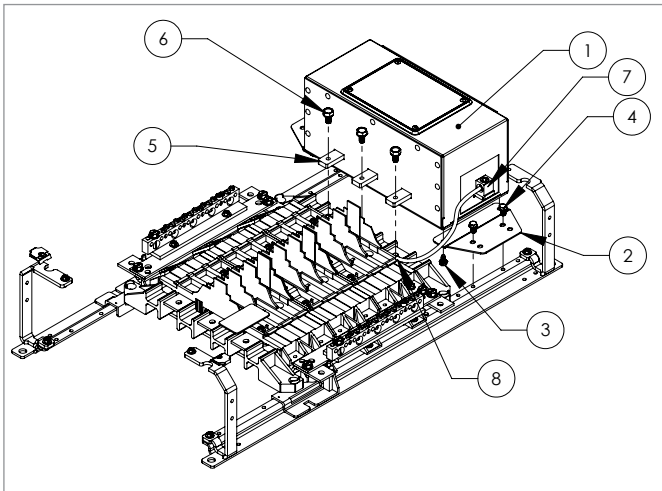

**Figure 1:** Revised P1 Panel

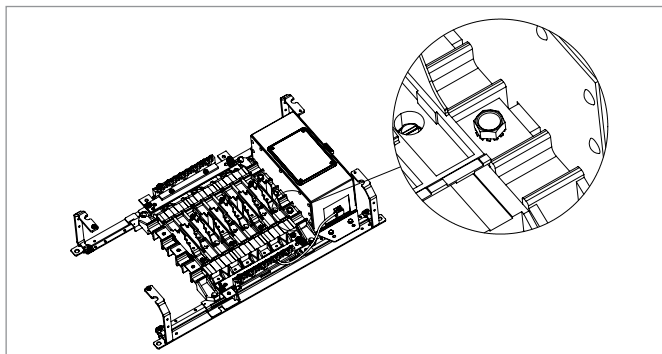

**Figure 2:** Revised P1 Panel Phase Tab Detail

### W Option Instruction:

The W option includes repositioned phase connection tabs that allow for wire connections to a circuit breaker within the panelboard. This differs from non-W models, which bolts directly to bus bars.

The circuit breaker serves as a disconnecter device and overcurrent protection to the connecting conductors. The TPS4 SPD includes internal overcurrent and overtemperature protective equipment. The breaker does not provide overcurrent protection to the SPD.

Recommended breaker size is 60A with a minimum 6 AWG conductors regardless of breaker size selected (cable should be sized to match breaker if larger breaker size is selected). Other combinations are possible. SPD Terminal lugs will accept 2-14 AWG. Breaker size should be at least 20A. All applicable codes must be followed.

It is recommended that the circuit breaker be located immediately adjacent to SPD to minimize lead lengths. Move or adjust breaker positions as appropriate. Failure to install short leads will degrade SPD performance.

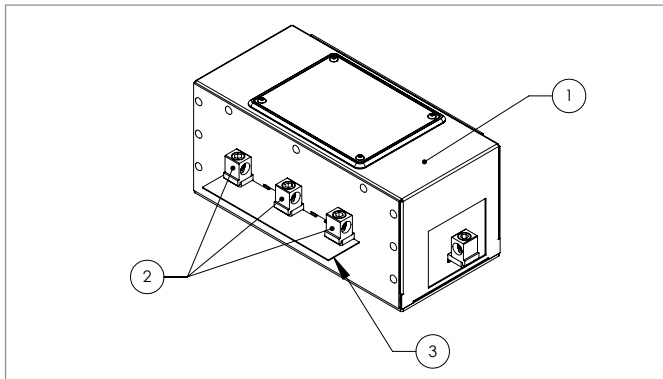

Figure 3: TPS4 -W unit configuration

Table 4: Content for -W “Wired” SPD Installation

Item	Description	Qty.	Torque
1	TPS4 -W SPD with neutral lug if needed	1	
2	Phase Connection Lugs (pre-installed) (torque value for Wire binding screws)	2 or 3	35 in-lbs
3	Phase Lug Insulation Barrier	1	

Step 1) Install appropriate circuit breaker in panelboard as directed above.

Step 2) Mount the SPD using supplied hardware, per previous instructions.

Step 3) Install phase insulation barrier into front panel of TPS4. (Insulation is needed between bottom of TPS4 -W phase tabs and tops of panel phase bus.) The “T” shaped sections on insulator provided install into wide sections of slots between phase tabs. Once in slot, press down into narrower section of slot to lock in place.

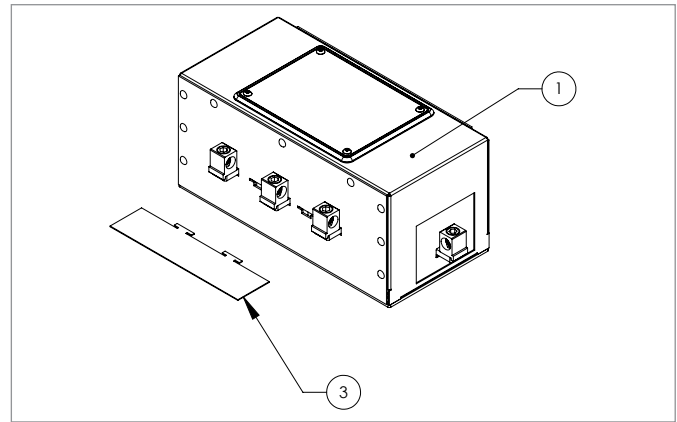

Figure 4: TPS4 -W unit insulation barrier

Step 4) Connect the neutral connection by wire as appropriate. Install conductors: Identify each panelboard bus as Phase A, B and C. When the SPD is installed, the SPD’s Phase Tabs will have near proximity above energized panelboard bus bars. The SPD’s phase connections must correspond to bus phases. Connect conductors from the SPD’s Phase Tabs to corresponding circuit breaker connections.

For example, when energized: Typical Phase bus are oriented from left to right > A-B-C

- A) The SPD Phase Tab for Phase A must be located above the panelboard bus for Phase A.
  - B) The SPD Phase Tab for Phase B must be located above the panelboard bus for Phase B.
  - C) The SPD Phase Tab for Phase C must be located above the panelboard bus for Phase C.
- Care must be taken when connecting to branch breaker to insure that A-B-C phase connection sequence is maintained.

Conductors must be routed as short and straight as possible. Use gentle radius on any bends. Do not kink wires. Prevent wires from encroaching breaker locations.

Step 5) Torque all connections to the values specified on the installation and maintenance instruction label affixed to the rear of the dead front.

Step 6) Replace dead front supports (if they were removed for ease of installation) and re-install front/trim.

Step 7) Energize breaker and confirm proper SPD operation.



## TPS4-01 Installation Instructions for: Lighting Panelboards P2 & P3

The following instructions are for the installation of the Siemens TPS4 01 and L1 SPD modules in Siemens P2 and P3 lighting panelboards (also for field replacement.)

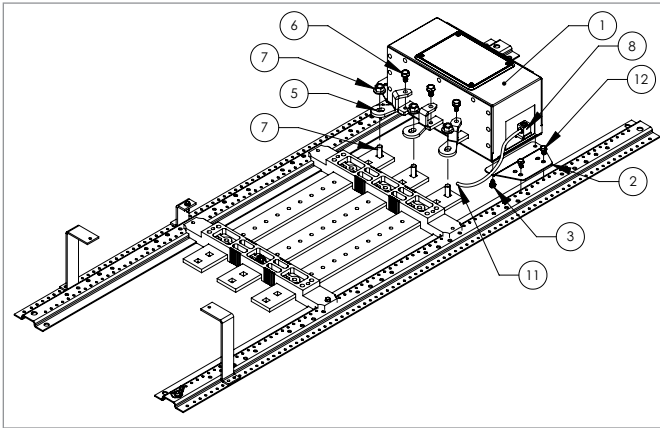

Figure 5: P2 Panel TPS4 Install

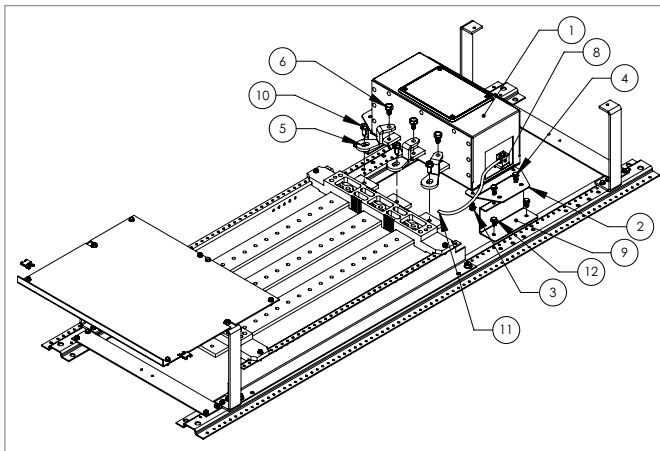

Figure 6: P3 Panel TPS4 Install

Table 5: Content for Installation in Lighting Panelboards P2, P3

Item	Description	Qty.	Torque
1	TPS4	1	
2	TPS4 Mounting Plate	2	
3	#10-32 Hex Screw with captive washer	4	30in-lb
4	#10-24 Hex Thread Rolling Screw	4	30in-lb
5	Line Bus Connector	2* or 3	
6	#1/4-20 Hex Screw w/captive washer	2* or 3	45 in-lb
7	5/16-18 x 1" Carriage Bolt 5/16-18 Belleville Combo Nut	2* or 3	125in-lb
8	Neutral Lug Wire Connection	N/A	35in-lb
9	P3 Riser Bracket	2	
10	a) P2/P3 125A-250A = 1/4-20 x 5/8" Thread forming screw b) P2 600A = 5/16-18 x 3/4" hex screw with captive washer	2* or 3	See Torque Note**
11	36" #8 AWG White Neutral Conductor	1	
12	#8-32 Hex Thread Forming Screw	4	30in-lb

\* only 2 tabs for single phase modules  
 \*\* Torque Note: For Item 10, see Bus Connection Tightening Torque values on label 15-A-1043-01 inside panel board.

Step 1) Lock off all power supplying this equipment before working on it.

Step 2) Remove the trim and dead front (and any previously installed TPS3 or TPS4 unit.)

Step 3) Attach TPS4 Mounting Plates (Item 2, 2 Places) to TPS4 using 10- 32 SEM screws with captive lock washer (Item 3). The mounting plates should be attached to the TPS4 with the offset oriented towards the top of the unit. Torque Screws to values listed.

Step 4) P3 Panel Install Only: Attach P3 Riser Brackets to TPS4 Mounting Plates using 10-24 Thread Forming Screws (Item 4). Use inside set of mounting slots on Mounting Plates.

Step 5) Install Line Bus Connectors (Item 5, 3 places) on TPS4 using 1/4-20 SEM screws with captive lock washer (Item 6). Tighten but do not torque to allow Bus Connector angle adjustment.

Step 6) Position the TPS4 unit on the panel base rail so that the TPS4 Line Bus Connectors line up with panel bus mounting toles. Slide the unit toward the interior until the four mounting holes line up with the four holes in the base rail.

Step 7) P2 Panel: Fasten unit to the main bus using the P2 Panel Carriage Bolt and Nut with captive washer (Item 7) provided w/ P2 Panel. Do not Torque at this time. Attach the Mounting Plates (item 2) to the base rail using 8-32 hex thread forming screws (item 12) provided as shown in Figure 5.

Step 8) P3 Panel: Fasten unit to the main bus using the P3 Panel Bus Bolt (Item 10) provided w/ P3 Panel. Do not Torque at this time Attach the P3 Riser Brackets (item 9) to the base rail using 8-32 hex Thread Forming screws (item 12) provided as shown in Figure #6.

Step 9) If present, connect TPS4 Neutral Connection Lug (item 8) to Panel Neutral using 8 AWG minimum wire (item 11). For best SPD performance, trim wire as required to provide shortest possible route between TPS4 Neutral connection and Panel Neutral Connection. Route wire as straight as possible and use gentle radius on any bends. Do not kink wire. Prevent wire from encroaching breaker locations.

Step 10) Torque all connections to the values as specified in Table 5 or on appropriate panel label.

Step 11) Replace dead front supports (if they had been removed for ease of placing the SPD) by installing screws, finger tight. Then tighten with tool. Replace trim and dead front.

Factory assembled TPS3 and TPS4 SPD units will use appropriate Screws or Bolt/Nut combinations depending on the panel configuration for attachment to the bus. When replacing SPD units in the field, re-use the hardware originally installed and use the table as a guide for proper torque values.

NOTE: For wired installations, see details in the previous section.

## TPS4-01 Installation Instructions for: Display Rotation

The following instructions are for rotating the display assembly in the Siemens TPS4 01 and L1 SPD modules. The display may be rotated if care is taken to not unduly crimp/ damage the ribbon cable that feeds the display. If the display is mounted in an orientation other than what is needed, care must be taken to note orientation of Phase A and Phase C buses as the TPS4's power monitoring features may report the phases as reversed.

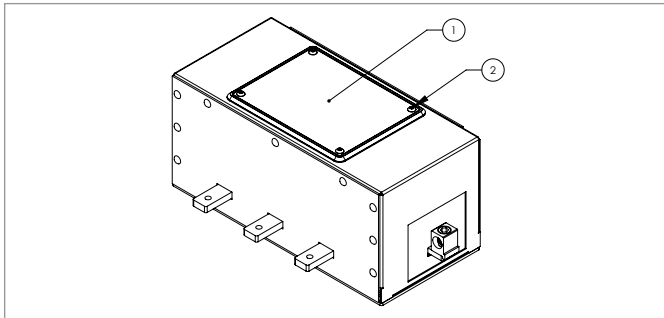

**Figure 7:** Display unit on TPS4 01 and L1

Remove the 6-32 Tamper Resistant screws in the corner of the display using a T10 Tamper Resistant Torx bit. Retain screws.





Rotate display pocket 180 degrees. Carefully fold ribbon cable below pocket and route to minimize sharp bends and double over cable directly beneath the display pocket.

Reinstall retained 6-32 tamper resistant screws and torque screws to value listed.

**Table 6:** Content for display rotation

Item	Description	Qty.	Torque
1	TPS4 Display (re-use)	1	
2	#6-32 T110 Tamper Res Screws (re-use)	4	8 in/lbs

**NOTE:** While the TPS4 SPD can be used in Busway (Busplug) and Motor Control Center (MCC) applications, installation instructions are omitted from this manual because the SPD is ONLY factory installed for these applications. Field replacement is not possible for Busway and MCC applications.

	 <b>Danger</b>	 <b>Peligro</b>	 <b>Danger</b>
	<p><b>Hazardous Voltage.</b> Will cause death or serious injury.</p> <p>Turn off and lock out all power supplying this device before working on this device. Replace all covers before power supplying this device is turned on.</p>	<p><b>Tensión peligrosa.</b> Puede causar la muerte o lesiones graves.</p> <p>Desenergice totalmente antes de instalar o darle servicio. Reemplace todas las barreras y cubiertas antes de energizar el interruptor.</p>	<p>Tension dangereuse. Danger de mort ou risque de blessures graves.</p> <p>Couper l'alimentation de l'appareil et barrer avant de travailler. Remplacez tous les couverts avant que l'alimentation de pouvoir soit alimenté.</p>

- **This manual shall be read in entirety prior to installing**
- Only qualified licensed electricians should install or service SPDs
- Hazardous voltages exist within SPDs
- SPDs should never be installed or serviced when energized
- Use appropriate safety precautions including Personal Protection Equipment
- Failure to follow these instructions can result in equipment damage, serious injury and/or death.

**Bonding and Grounding Hazard**

Verify that the neutral conductor in the service entrance equipment is bonded to ground in accordance with the National Electrical Code (NEC®) and all applicable codes.

Verify that the neutral terminal (XO) on the secondary side of distribution transformers are grounded to the system ground in accordance with the NEC® and all applicable codes.

During installation into an electrical system the SPD must not be energized until the electrical system is completely installed, inspected and tested. All conductors must be connected and functional including the neutral (if required). The voltage rating of the SPD and system must be verified before energizing the SPD.

Failure to follow these guidelines can lead to abnormally high voltages at the SPD. This may cause the SPD to fail. The warranty is voided if the SPD is incorrectly installed and/or if the neutral conductor in the service entrance equipment or downstream of separately derived systems is not bonded to ground in accordance with the NEC®.

**Do Not Hi-Pot Test SPDs**

The TPS4 unit needs to be fully disconnected during Hi-Pot testing. Failure to disconnect SPD and associated components during elevated voltage testing will damage the SPD and will void the warranty.

**Table 7:** Model Number Catalog Logic

**TPS4 05 SPD for P4, P5 Power Panelboards and Distribution Switchboards  
General Suppressor Series**

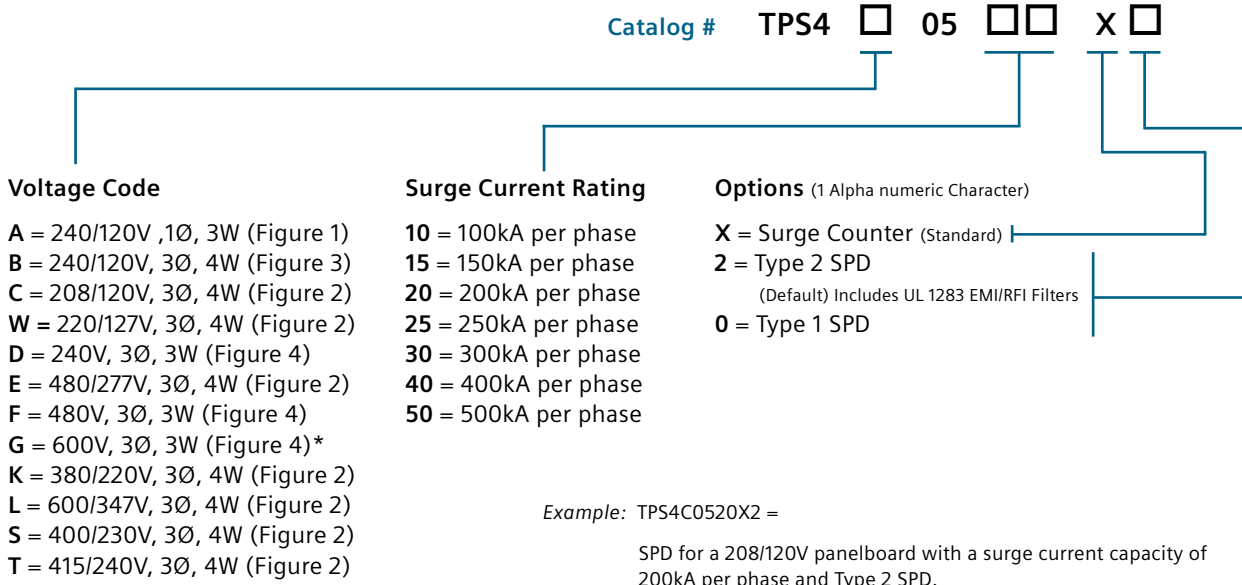

\*Not available in 300, 400 or 500kA versions

**TPS4 L5 10 Mode SPD for P4, P5 Power Panelboards and Distribution Switchboards  
General Suppressor Series**

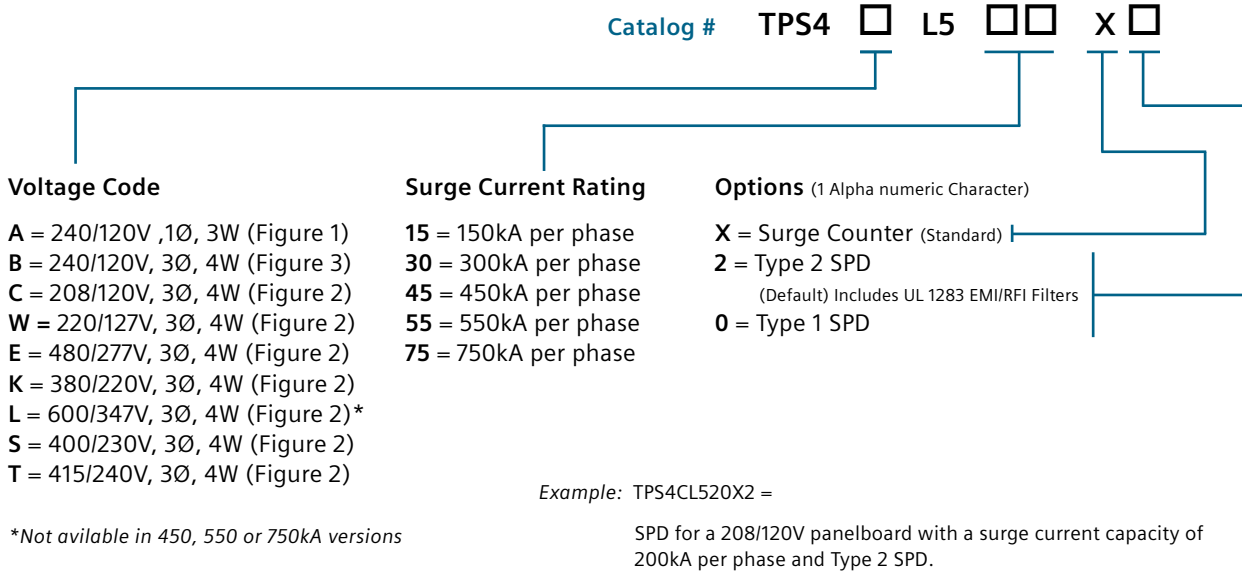

\*Not available in 450, 550 or 750kA versions

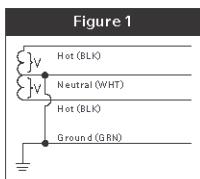

**Figure 1: SPLIT**  
2 Hots, 1 Neu, 1 Grnd

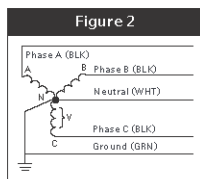

**Figure 2: WYE**  
3 Hots, 1 Neu, 1 Grnd

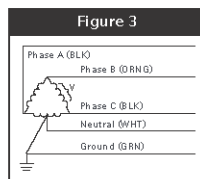

**Figure 3: HI-LEG DELTA (B High)**  
3 Hots, (B HIGH),  
1 Neu, 1 Grnd

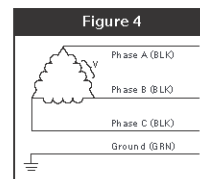

**Figure 4: DELTA & HRG WYE**  
3 Hots, 1 Grnd

## TPS4 05 Installation Instructions for: Power Panelboards (P4, P5) and Distribution Switchboards

### Full Catalog ID Replacement Instructions

The following general observations should be noted concerning field replacement of TPS3-05 assemblies with TPS4 05 assemblies.

For Panelboard (Power Panel/PP) & Distribution Switchboards, TPS3-05 may be replaced with a TPS4-05 using the following procedure:

- Step 1) Lock OFF all power supplying panel.
- Step 2) Remove gutter covers from panel.
- Step 3) Remove entire dead-front from panel.
- Step 4) Disconnect line side wires (Phase and Neutral) from TPS3-05 disconnect switch.
- Step 5) Remove TPS3-05 enclosure by removing 4 mounting screws reached via 4 access holes in back plane of enclosure.
- Step 6) Re-route phase wires to opposite side of panel.
- Step 7) Re-route neutral wire to opposite side of panel if open lug position is available.
  - If lug position is not available, leave neutral lug in its original position in panel and run a longer neutral wire.
- Step 8) Reverse steps to install TPS4-05.

## Module Only Replacement Instructions

The following instructions are for the replacement of Siemens TPS4 SPD module in Siemens TPS4 05 unit.

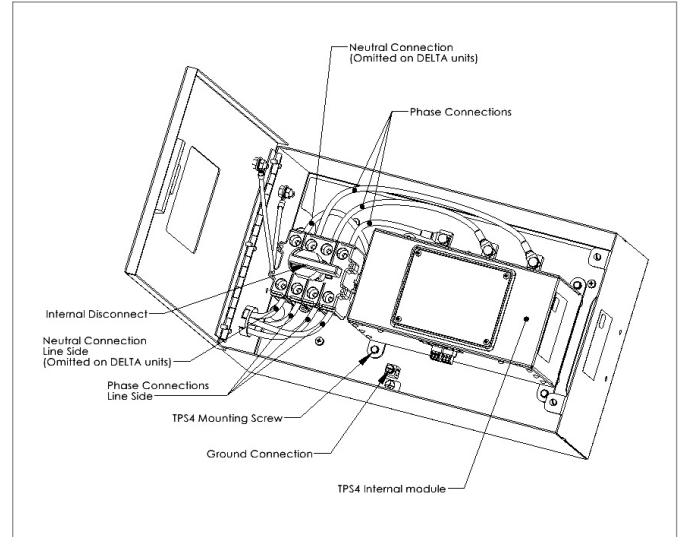

**Figure 8:** P4, P5 and Front Connected Distribution Switchboards

**NOTE:** TPS4 internal module may be replaced provided all power sources are locked out.

**NOTE:** Following replacement of a TPS4 internal module, the LCD display will now reflect the new serial number for that module.

- Step 1) Lock OFF all power supplying this equipment before working on it. Open unit door and turn the internal disconnect to the OFF position.
- Step 2) Un-bolt the phase wire compression lugs from the phase connectors on the TPS4 module.
- Step 3) If present, remove neutral wire from mechanical lug on side of TPS4 module.
- Step 4) Remove the TPS4 module from back panel by removing the (4) Hex Head mounting screws located at corners of the TPS unit.
- Step 5) Remove (2) mounting brackets from bottom of TPS4 module. Note orientation of bracket. Each mounting bracket is attached via (2) hex head screws (4 total).
- Step 6) Replace unit with the new TPS4 module.
- Step 7) Reattach mounting brackets to bottom of TPS4 module. Torque screws to 29.5 in-lbs.
- Step 8) Re-install TPS4 module onto back plate using the original (4) hex head screws. Torque to 29.5 in-lbs.
- Step 9) Reattach line wire compression lugs to phase connections on TPS4 module. Torque to 45 in-lbs.
- Step 10) If present, reattach neutral wire to mechanical lug on side of TPS4 module. Torque to 35 in-lbs.
- Step 11) Turn the internal disconnect back to the ON position.
- Step 12) Close all doors before reenergizing.

**Table 8:** Model Number Catalog Logic

**TPS4 06 for Switchboards and Low Voltage Switchgear  
General Suppressor Series**

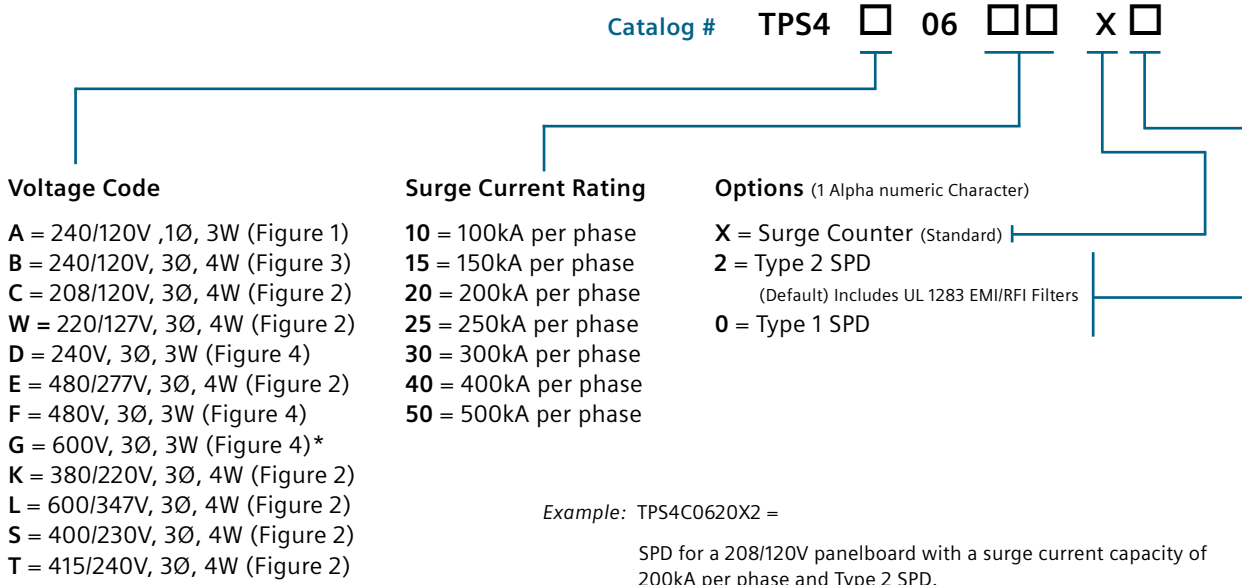

\*Not available in 300, 400 or 500kA versions

**TPS4 TPS4 L6 10 Mode for Switchboards and Low Voltage Switchgear  
General Suppressor Series**

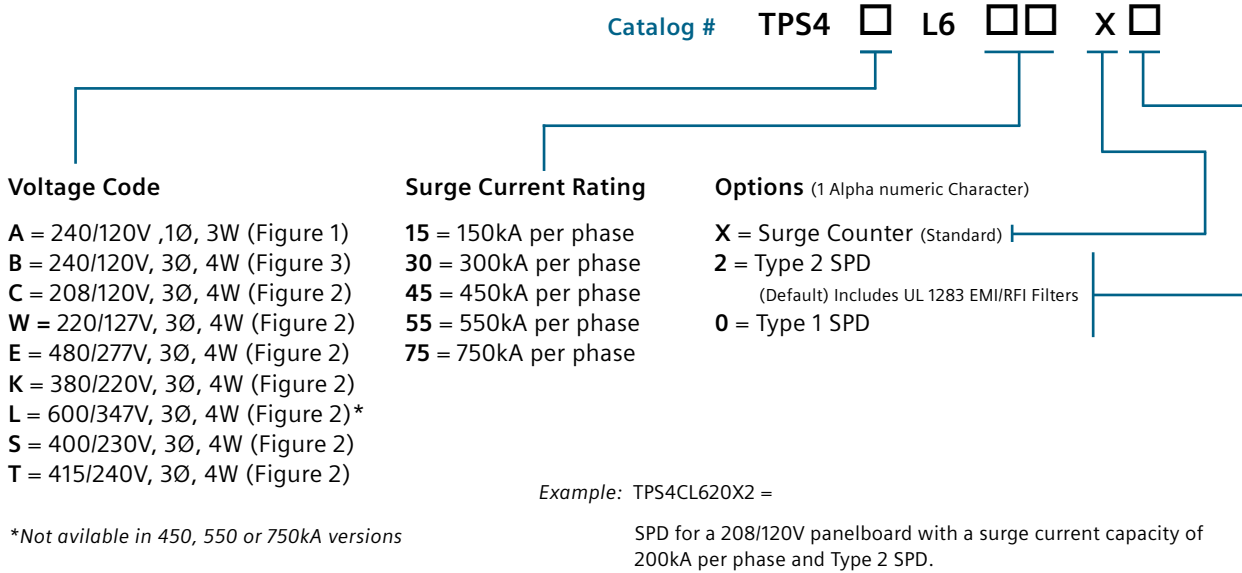

\*Not available in 450, 550 or 750kA versions

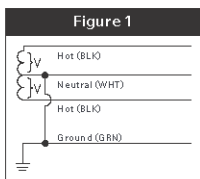

**Figure 1: SPLIT**  
2 Hots, 1 Neu, 1 Grnd

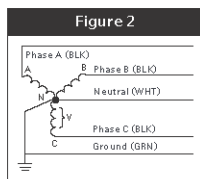

**Figure 2: WYE**  
3 Hots, 1 Neu, 1 Grnd

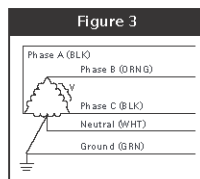

**Figure 3: HI-LEG DELTA (B High)**  
3 Hots, (B HIGH),  
1 Neu, 1 Grnd

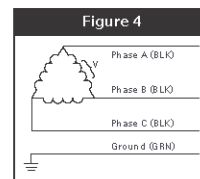

**Figure 4: DELTA & HRG WYE**  
3 Hots, 1 Grnd

## TPS4 06 Installation Instructions for: Switchboards and Low Voltage Switchgear

### Full Catalog ID Replacement Instructions

The following general observations should be noted concerning field replacement of TPS3-06 assemblies with TPS4 06 assemblies:

It is recommended that TPS3-06 installations be replaced with TPS3-06 replacements and TPS4-06 installations be replaced with TPS4-06 replacements. Otherwise, consult factory to replace TPS3-06 with a TPS4-06.

### Module Only Replacement Instructions

The following instructions are for the replacement of Siemens TPS4 SPD module in Siemens TPS4 06 unit.

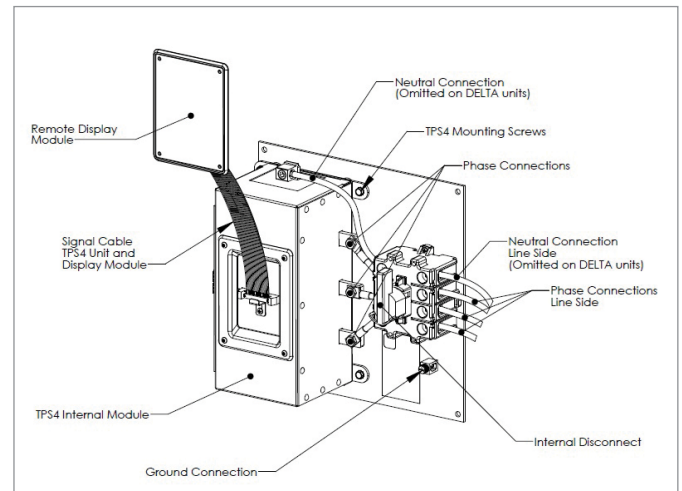

**Figure 9:** Switchboards & Low Voltage Switchgear

**NOTE:** TPS4 internal module may be replaced provided all power sources are locked out.

**NOTE:** Following replacement of a TPS4 internal module, the LCD display will continue to reflect the new serial number for the TPS4-06 unit.

Step 1) Lock OFF all power supplying this equipment before working on it. Turn the internal disconnect to the OFF position.

Step 2) Detach remote display module ribbon cable from top of TPS4 module.

Step 3) Un-bolt the phase wire compression lugs from the phase connectors on the TPS4 module.

Step 4) If present, remove neutral wire from mechanical lug on the side of TPS4 module.

Step 5) Remove the TPS4 module from back panel by removing (4) Hex Head mounting screws located at corners of unit.

Step 6) Remove (2) mounting brackets from bottom of TPS4 module. Note orientation of brackets. Each mounting bracket is attached via (2) hex head screws (4 total).

Step 7) Replace unit with the new TPS4 module.

Step 8) Reattach mounting feet to bottom of TPS4 module. Torque screws to 29.5 in-lbs.

Step 9) Re-install TPS4 module onto back plate with original (4) hex head screws. Torque to 29.5 in-lbs.

Step 10) Reattach line wire compression lugs to phase connections on TPS4 module. Torque to 45 in-lbs.

Step 11) If present, reattach neutral wire to mechanical lug on side of TPS4 module. Torque to 35 in-lbs.

Step 12) Turn the internal disconnect back to the ON position.

Step 13) Close equipment doors before reenergizing.

## Operation

TPS4 surge protective devices require minimal attention after installation. TPS4's contain diagnostic circuits which monitor the suppressor's status continuously and automatically. All phase indicators and controls are located on the display panel of the unit. Display panels are formatted for horizontal mounting orientation.

### TPS4 Control & Diagnostic Display Panel

TPS4s are equipped with a status indicating LED for each phase on the panel. When all LEDs are green, the suppressor is on-line and functioning properly. If a fault condition occurs, the audible alarm will sound, the Red Service LED will illuminate and the LED representing the affected phase will extinguish, indicating that the unit needs service. The audible alarm can be silenced by pressing ALARM SILENCE on the touchpad. The audible alarm and Dry Contact can be tested by depressing TEST. If a fault alarm occurs, see Corrective Maintenance (Testing and Repair) for further information.

### Display Panel with Surge Counter

The surge counter provides a means to display the total number of transient voltage surge events since the counter was last reset. The counter includes Eprom memory, which retains counter memory in the event of a power loss. The RESET touchpad will reset the counter to zero. The COUNT touchpad increments the counter by one (1) and tests the circuitry for proper operation. If a fault alarm does occur, see Corrective Maintenance (Testing and Repair) for further information.

Phase A, B & C: Green LED indicators—one per phase. Green is good. Extinguished green LED indicates loss of protection. Every suppression element in this SPD is monitored. N-G suppression element monitoring is logic-connected to Phase A.

- Service LED (red): LED illuminates in the event of problems. This indicator is logic-connected to the Phase LEDs. Should a Phase LED go out, the Service LED will illuminate and the Audible Alarm will sound.
- Test: Tests red Service LED and Audible Alarm, and changes state of Dry Contacts.
- Alarm Silence: Turns Audible Alarm off. (Alarm is deactivated when the Silence LED is illuminated.)
- Surge Counter Count: (if equipped) Increments optional surge counter by one (+1).
- Surge Counter Reset: (if equipped) Resets optional surge counter to zero (0).

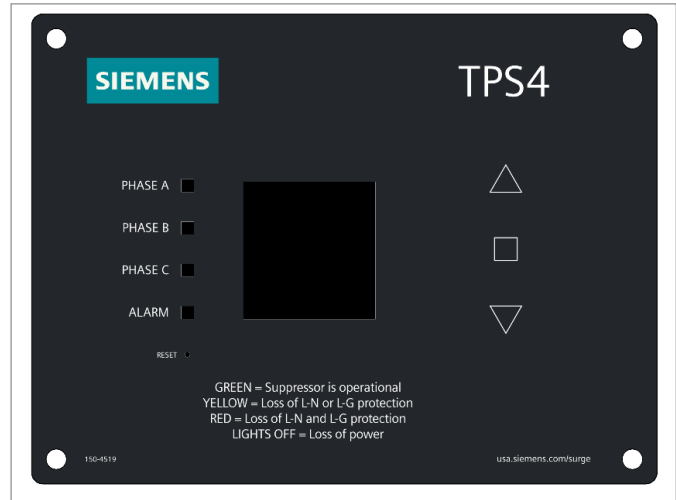

Figure 10: Display – Horizontal

### Dry Contacts Feature

TPS4 01 units are equipped with dry contacts. This feature provides Normally Open (N.O.) and Normally Closed (N.C.) circuits, which can be used for remote indication of a failed transient voltage surge suppressor. There is only one dry contact output consisting of two electrically isolated sets of NC- C-NO contacts. This dry contact output changes from “normal” to “alarm” if any problem occurs inside the SPD (i.e.: loss of power to any phase, any thermal protector inside the SPD opens, or any fuse inside the SPD opens). The dry contact terminal block is located on the back of the module, opposite side of bus tabs. This connector is designed for low voltage or control signals only. Maximum voltage should not exceed 240 volts and maximum current should not exceed 5 amperes. These contacts may be used to provide a signal to an emergency management system or computer interface board. The relay contact pin arrangement is outlined in the table below.

The Normally Closed (N.C.) configuration is recommended because it will detect a wiring defect, such as a cut wire(s), where Normally Open (N.O.) will not.

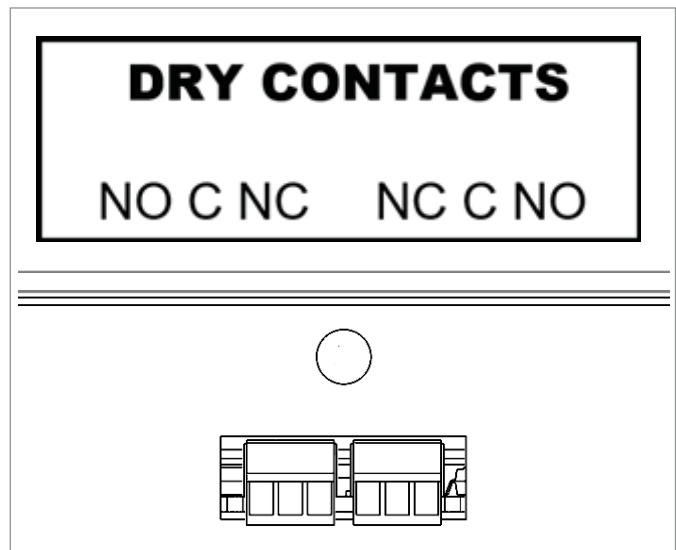

Figure 11: Dry Contact Connection Configuration



## LED Operation

- Each SPD contains 1 dual color LED per phase shown in the appropriate voltage configuration.
- The SPD also includes a Red Alarm LED. When the LEDs are green complete protection is present.
- During partial MOV stack failure the LED will change state to Amber.
- Upon full MOV stack failure the LED will change state to Red.
- During the detection of any event the Red Alarm LED will illuminate.

## Audible Alarm

Similar to the Red Alarm LED, the Audible Alarm will sound upon the detection of a power system event. The Audible Alarm may be silenced by acknowledging the event from the control panel.

## LCD Panel Operation

### Screen Saver



Immediately on power-up of the SPD the scrolling screen saver will be shown. When any of the buttons are pressed the SPD will stop showing the screen saver and advance to the Main Screen. After 5 minutes without user activity the screen saver will be displayed again. When the SPD experiences an event, the screen saver will be dismissed and will not be displayed again until the event is acknowledged by an operator.

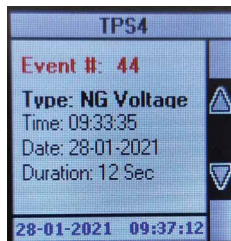

### Main Screen

The Main Screen is the starting point for navigating through the SPDs menus. The Main Screen will show the logged data for the most recent event as well as the current time and date. Pressing the UP or DOWN buttons will move to the Main Menu Screen.

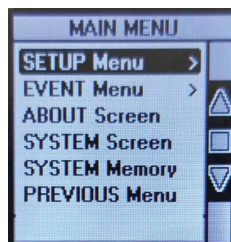

### Main Menu Screen

The Main Menu Screen will allow you to navigate to the Setup Menu, Event Menu, About Screen, System Screen, System Memory Screen, and a return to Previous Menu option. Use the UP/DOWN buttons to select the menu or screen of interest. Pressing the center button will advance you to the menu or screen you have selected.



### Setup Menu Screen

The Setup Menu Screen will allow you to set the time and date of the SPD. Accurately setting the date and time is very important for this SPD. All events are recorded with a timestamp. Use the UP/DOWN buttons to select whether to adjust the time, adjust the date or return to the previous menu. Pressing the CENTER button will move the screen to the selected menu.

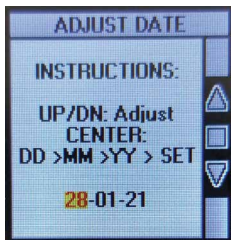

### Adjust Date Screen

The Adjust Date Screen will allow you to set the date of the SPD. Use the UP/DOWN buttons to adjust the value in the selected field until you have the correct value. Pressing the CENTER button will advance the cursor to the next date field. Once the "Year" has been set, pressing the CENTER button will finalize your changes and save them to the SPD memory. You will automatically be brought back to the Setup Menu.

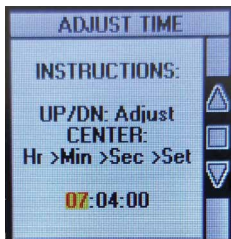

### Adjust Time Screen

The Adjust Time Screen will allow you to set the time of the SPD. Use the UP/DOWN buttons to adjust the value in the selected field until you have the correct value. Pressing the CENTER button will advance the cursor to the next time field. Once the "Seconds" have been set, pressing the CENTER button will finalize your changes and save them to the SPD memory. You will automatically be brought back to the Setup Menu.

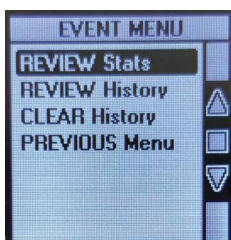

### Event Menu Screen

The Event Menu Screen will allow you to view the SPD's statistics and event history. You are also able to clear the history if need be. Use the UP/DOWN buttons to select which operation to do. Pressing the CENTER button will advance you to the screen you have selected.

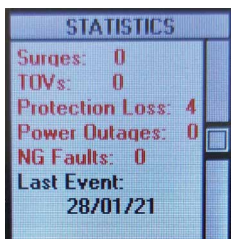

### Statistics Screen

The Statistics Screen shows the number of events that the SPD has experienced. The total number of each event type will be shown here. The date of the last recorded event will also be shown here. Unlike the Event Log, this data cannot be cleared from memory. Pressing the left button (BACK) will return you to the Main Screen.

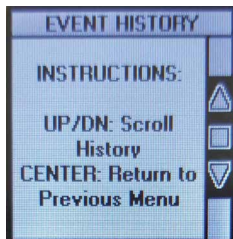

### Event History Screen

The Event History Screen will allow you to review each event the SPD has on record. Use the UP/DOWN buttons to scroll through the event log. Pressing the CENTER button will return you to the Event Menu Screen.

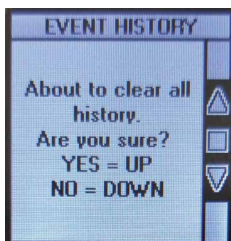

### Clear Event History Screen

The Clear Event History Screen will allow you to clear the SPD's event log. Pressing the UP button (YES) will clear the event log. Pressing the DOWN button (NO) will keep the current event log intact. Either operation will return you to the Event History Screen.

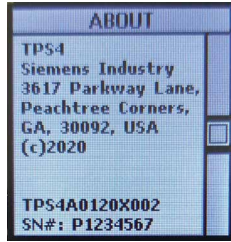

**About Screen**

The About Screen displays the manufacturer’s information, the model number and the serial number for this specific SPD. Pressing the CENTER button will return you to the Main Menu Screen.

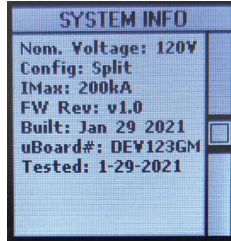

**System Info Screen**

The System Screen displays the important electrical information for this system. This includes the nominal operating voltage, System configuration (ie. Wye, Delta, Single Phase) and maximum current rating for each mode of the SPD. The processor serial number, firmware edition, build and test dates are also shown on this page. Pressing the CENTER button will return you to the Main Menu Screen.

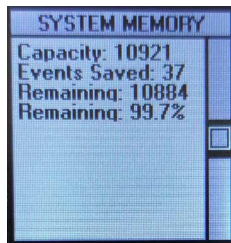

**System Memory Screen**

The System Memory Screen displays the current state of the electronic memory for this system. This includes the nominal operating voltage, System configuration (ie. Wye, Delta, Single Phase) and maximum current rating for each mode of the SPD. The processor serial number, firmware edition, build and test dates are also shown on this page. Pressing the CENTER button will return you to the Main Menu Screen.

**System Event Alarms**

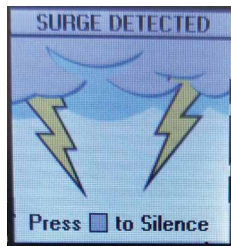

**Surge Event Screen**

When the SPD detects a surge event this animation will be shown. It will remain on screen until acknowledged by an operator. Any subsequent events that occur while the Surge event animation is on screen will be registered and queued for acknowledgment. Along with displaying the Surge animation, the Audio alarm will sound. Pressing the CENTER button will acknowledge the event and clear the alarm state. The Main Screen will be showing the details for the surge.

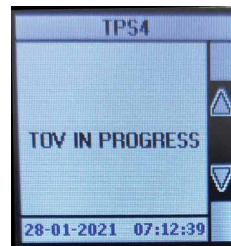
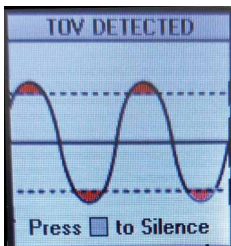

**Temporary Over Voltage Event**

When the SPD detects a Temporary Over Voltage Event (TOV) this animation will be shown. It will remain on screen until acknowledged by an operator. Any subsequent events that occur while the TOV event animation is on screen will be registered and queued for acknowledgment. Along with displaying the TOV animation, the Audio alarm will sound. Pressing the CENTER button will acknowledge the event and clear the alarm state. The Main Screen will be showing the details for the TOV.

The SPD may be exposed to a TOV for several minutes. On rare occasions a TOV can exist for hours. The TOV animation will be displayed as soon as a TOV has been detected. If an operator is able to acknowledge the event while a TOV condition still exists, the screen below will be displayed.

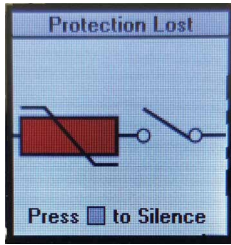

**Protection Loss**

When the SPD detects a Protection Loss this animation will be shown. It will remain on screen until acknowledged by an operator. Any subsequent events that occur while the disconnection event animation is on screen will be registered and queued for acknowledgment. Along with displaying the disconnection animation, the Audio alarm will sound, and the dry contacts will change state. A corresponding LED will also change state during a Protection Loss. A loss of protection means that either the SPD has detected the loss of a system phase or that one of the protection modes has permanently disconnected and requires attention. As long as a fault state exists the dry contacts will remain disengaged and the corresponding LEDs will be in a non-green state. If the Protection Loss event was caused by a phase loss, returning the phase will return the system to a GOOD state.

However, if the Protection Loss event was caused by a Mode disconnection, the SPD will stay in the faulted state indefinitely. Pressing the CENTER button will acknowledge the event and clear the alarm state. The Main Screen will be showing the details for the Protection Loss.

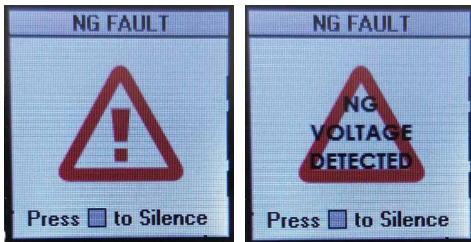

**Neutral to Ground Fault Event**

When the SPD detects a Neutral to Ground Fault Event (NGF) this animation will be shown. It will remain on screen until acknowledged by an operator. An NGF is detected when greater than 20 volts has been detected between Neutral and Ground. Any subsequent events that occur while the NGF event animation is on screen will be registered and queued for acknowledgment. Along with displaying the NGF animation, the Audio alarm will sound. Pressing the CENTER button will acknowledge the event and clear the alarm state. The Main Screen will be showing the details for the NGF.

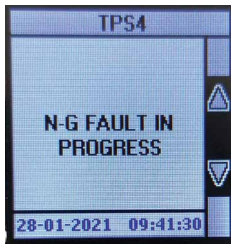

The SPD may be exposed to a NGF for several minutes. The NGF animation will be displayed as soon as a NGF has been detected. If an operator is able to acknowledge the event while a NGF condition still exists, the screen to the left will be displayed.



**Power Outage**

Should the SPD be subjected to a full power outage this animation will be shown once power is restored. It will remain on screen until acknowledged by an operator. Any subsequent events that occur while the power outage event animation is on screen will be registered and queued for acknowledgment. Along with displaying the power outage animation, the Audio alarm will sound, and the dry contacts will change state. Pressing the CENTER button will acknowledge the event and clear the alarm state. The Main Screen will be showing the details for the Power Outage.

This SPD's timekeeping is equipped to survive several days of a power outage. When power returns the SPD will record the date and time of the power loss and when power was restored. Should the SPD be exposed to an extended power outage the SPD's timekeeping may have been affected. It is highly recommended that the time and date be updated.

Due to the nature of installations, were power may be cycled several times. The Power Outage alarm is suspended. It is automatically engaged after the SPD has been continually powered for 1 hour.

## Maintenance

SPDs require minimal maintenance. Periodic inspection of diagnostic LED indicators ensures proper operation. Clean SPD as appropriate.

### Troubleshooting & Service

Please contact Siemens Technical Support at 800-333-7421 for service related issues.

Quality SPDs are designed and tested to withstand severe duty. However, there are various electrical anomalies against which SPDs cannot protect. These are generally Sustained Overvoltages also known as Temporary Overvoltages (TOVs). In this context, Sustained Overvoltages may be only a few cycles. Failed SPDs tend to be symptoms, not root causes. There may be larger issues at play. Regardless of cause, SPDs attempt to protect their load until failure.

Bonding or reference to ground problems are the root cause of many SPD problems. If the SPD shows problems on startup, there is reasonable chance of bonding/grounding/misapplication issue. Such problems permanently damage the SPD. If not corrected, SPD problems will reoccur.

*Tip:* Visually confirm N-G bonding. Be aware that a voltmeter measuring N-G can be misleading. For example, N-G voltage could read 0V because neutral and ground are at the same potential purely by happenstance, not because they are bonded. Visually confirm bonding.

*Tip:* Experience indicates that regulation-challenged generators can cause Sustained Overvoltages, as well as ungrounded generators, and/or usual load transfer systems.

### Abnormal N-G Voltage Indicators

This SPD include N-G voltage indicators. If the SPD detects excessive N-G voltage, the Red Service LED will blink and the Audible Alarm will cycle. This condition requires immediate attention as the SPD will fail.

Incorrectly bonded distribution systems damage SPDs. If the XO or N-G bonding jumper is not installed, the electrical system has no reference to ground. It becomes an ungrounded system. Please see previous section regarding SPDs on ungrounded systems. Such systems are known to eventually produce abnormally high L-G voltages. SPDs will attempt to chase this system-level overvoltage abnormality until the SPD fails. This effect is accelerated on Wye systems where SPDs are designed for grounded systems. (SPDs for ungrounded systems generally have higher MCOV to allow for L-G voltage fluctuations.) Failures of this nature are not defects in the SPDs workmanship or material. This is an installation error and is not covered by warranty.

A differential voltage circuit monitors neutral to ground voltage. When N-G voltage becomes excessive, an amplifier energizes a resistor. Eventually, that resistor will overheat and cause thermally sensitive shrink wrap to shrink around the resistor. This does not occur on transient or instantaneous N-G overvoltages. When the SPD is deenergized, the shrink wrap covered resistor can be accessed by qualified personnel under the display plate cover.

### Module Replacement & Service

The module is field replaceable. Service should only be performed by qualified persons. Deenergize SPD, confirm with appropriate measurement equipment and discharge internal capacitance to ground. Mark locations and carefully disconnect diagnostic cables, contacts, connecting conductors, etc. Remove entire TPS4 unit from the Panel. Reinstall in reverse.

There are no user serviceable parts inside the module. Disassembly is not permitted.

Modules may be returned to the factory for factory service, qualification and return. Please contact factory at 800-333-7421 for assistance.

### Display Replacement

The display is field replaceable. Service should only be performed by qualified persons. Deenergize SPD, confirm with appropriate measurement equipment and discharge internal capacitance to ground. Mark locations and carefully disconnect diagnostic cables, contacts, connecting conductors, etc. Unbolt display and replace. Reinstall in reverse.

Note that a sealing gasket between the display and the enclosure is a key component ensuring weather resistance. Replace the gasket whenever the display is removed.

### Preventive Maintenance (Inspection & Testing)

Inspection of the TPS4 SPD unit should be performed periodically, to maintain reliable system performance and continued transient voltage surge protection. The large variations in operating conditions encountered by units in the field make it difficult to set a fixed maintenance interval, but inspections utilizing the built-in diagnostics should be performed at least on a weekly or monthly basis.

### Corrective Maintenance (Repair)

The Siemens TPS4 unit is designed for years of reliable, trouble-free operation. Unfortunately, in an extreme case, you may experience an alarm condition. In this event, no attempt should be made to repair the TPS4 itself. There are no serviceable parts within the unit. Any SPD that requires service should be appropriately removed from the electrical distribution equipment, and replaced by a new SPD of the same model.

### Technical Support

800-333-7421

Prior to calling Siemens TPS4 Technical Support for assistance or ordering parts, please have the following information available:

TPS4 model number: \_\_\_\_\_  
 Manufacture date: \_\_\_\_\_  
 Date of Purchase: \_\_\_\_\_  
 Your order number: \_\_\_\_\_

### Return Shipment:

Contact Siemens Customer Support, 866-663-7324 to setup an RMA.

# Notes



**Published by  
Siemens 2021**

**Siemens Industry, Inc.**  
3617 Parkway Lane  
Peachtree Corners, GA 30092

Siemens Technical Support: 1-800-333-7421  
info.us@siemens.com

Printed in USA-CP  
Order No. RPIM-TPS41-0621  
All Rights Reserved  
© 2021, Siemens Industry, Inc.  
[usa.siemens.com/spd](http://usa.siemens.com/spd)

The technical data presented in this document is based on an actual case or on as-designed parameters, and therefore should not be relied upon for any specific application and does not constitute a performance guarantee for any projects. Actual results are dependent on variable conditions. Accordingly, Siemens does not make representations, warranties, or assurances as to the accuracy, currency or completeness of the content contained herein. If requested, we will provide specific technical data or specifications with respect to any customer's particular applications. Our company is constantly involved in engineering and development. For that reason, we reserve the right to modify, at any time, the technology and product specifications contained herein.